

PROGRAMMABLE CONTROLLERS
FX Family Catalog



High-end Model

FX3U

FX3UC

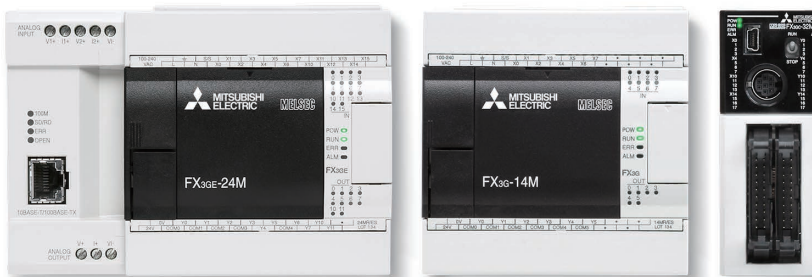

Standard Model

FX3GE

FX3G

FX3GC



Entry level Model

FX3S

FX3 series

Push the limits of control.

GLOBAL IMPACT OF MITSUBISHI ELECTRIC

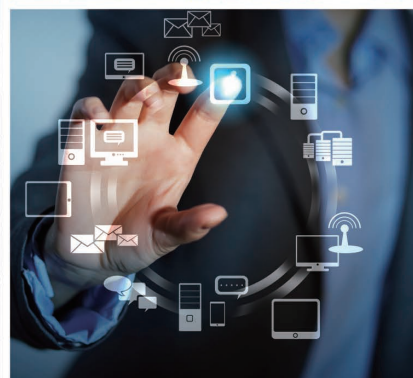

Through Mitsubishi Electric's vision, "Changes for the Better" are possible for a brighter future.

Changes for the Better

We bring together the best minds to create the best technologies. At Mitsubishi Electric, we understand that technology is the driving force of change in our lives. By bringing greater comfort to daily life, maximizing the efficiency of businesses and keeping things running across society, we integrate technology and innovation to bring changes for the better.

Mitsubishi Electric is involved in many areas including the following

Energy and Electric Systems

A wide range of power and electrical products from generators to large-scale displays.

Electronic Devices

A wide portfolio of cutting-edge semiconductor devices for systems and products.

Home Appliance

Dependable consumer products like air conditioners and home entertainment systems.

Information and Communication Systems

Commercial and consumer-centric equipment, products and systems.

Industrial Automation Systems

Maximizing productivity and efficiency with cutting-edge automation technology.

OVERVIEW

Concept	4
FX Main Units Lineup	6
FX Control Solutions	12
Analog Control	14
High-Speed Control	15
Inverter Control	15
Positioning	16
Open Field Networks	18
Serial Communication	19
Information Exchange	20
Data Management	21
Visualization	22
Software	24
Technical Information Section	25

FX3 series



Push the limits of control.

The Mitsubishi Electric FX3 PLC Family continues to be successful as a provider of customizable compact control solutions allowing customers to choose the best model to fit their applications.

Ease of use

Control systems that require minimal setup and keep program development time short.

Affordable

A high performance to cost ratio makes economical design solutions for a diverse range of applications a reality. These features combined with Mitsubishi Electric's legacy in quality and reliability ensure that the 3rd generation of micro controllers will continue to be at the forefront of the compact PLC market and provide customers with a leading edge.

Models

Entry level Model



FX3S

Simple and cost effective. Basic model that supports analog and communication expansion. Perfect for simple automation tasks.

Standard Model



FX3GE



FX3G



FX3GC

From automation to network, to more advanced control. Supports features required for basic control and a variety of applications.



Flexible

A configurable design that permits open communication, large I/O handling, as well as precise positioning and analog control, creating systems that adapt to customer requirements.

Customer Confidence

With a design philosophy spanning more than a quarter century, a customer base spread across the globe, a host of industrial certifications and almost 10 million CPUs sold, the FX3 series continues to sustain its position as the compact PLC of choice.

High-end Model



FX3U



FX3UC

Superior speed, power, and flexibility.
Realize high speed control, network support, data logging, and more.



Controllable I/O: 16 - 256 points(Max. 384 with CC-Link remote I/O)

FX Main Units Lineup



FX3U

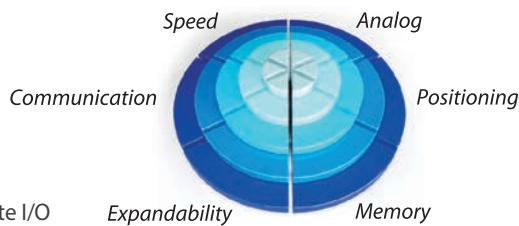

Controllable I/O: 16 - 256 points
 Max. 384 with CC-Link or AnyWireASLINK remote I/O
 (Main Unit I/O: 16/32/48/64/80/128 points)

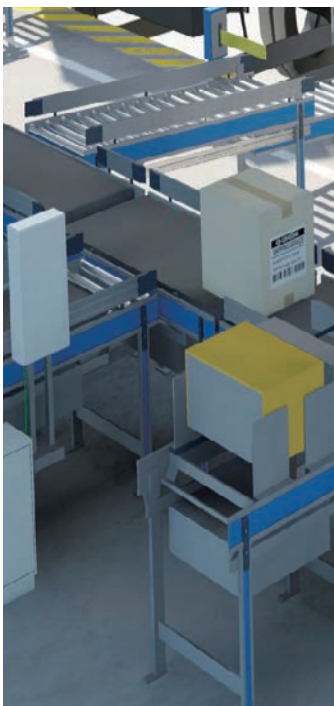

Top of the line

The FX3U is the original dual system-bus, high-speed, fully expandable compact PLC designed to seamlessly control communication, networking, analog, and positioning systems. With a maximum of 384 controllable local and networked I/O via CC-Link, the FX3U uses its power and flexibility to provide a solution for a variety of applications.

- 3rd generation compact PLC
- High efficiency with more speed, performance, memory, and new functions
- Built-in high speed processing and positioning
- The FX3U can control a maximum of 256 connected I/O, and up to 384 points with CC-Link or AnyWireASLINK remote I/O.

Product Details

All-in-one CPU, power supply and I/O includes high expandability using Expansion Boards and Special Adapters to add functionality.

Fast Instruction Times

Basic Instructions: 0.065 μ s / instruction (Contact Instruction)
 Applied Instructions: 0.642 μ s / instruction (MOV Instruction)

Large Memory

64,000 steps of built-in program memory.
 Flash Memory Cassettes with loader function are available.

Applicable Standards

All products support EN and UL/cUL standards.
 Various shipping approvals are supported as well.

Large Device Memory

Auxiliary Relays	7,680 points
Timers	512 points
Counters	235 points
Data Registers	8,000 points
Extension Registers	32,768 points
Extension File Registers	32,768 points
(with optional Memory Cassette)	

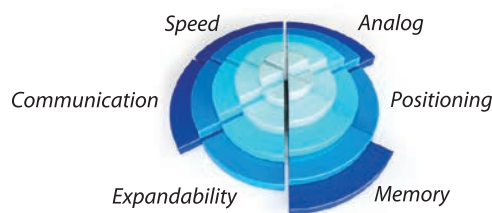

FX3UC

Controllable I/O: 16 - 256 points
 Max. 384 with CC-Link or AnyWireASLINK remote I/O
 (Main Unit I/O: 16/32/64/96 points)

Slim Fit

The FX3UC is the ultra-compact high speed, fully expandable PLC. Based on 24 V DC power and using connector-type transistor I/O, the FX3UC is designed for space conscious and modular applications. Created inline with the FX3U series, the FX3UC incorporates such attributes as built-in high speed I/O and the dual system-bus architecture, optimizing communication, networking, analog, and positioning control.

- 3rd generation super-compact PLC
- Reduced size and wiring using connector-type I/O
- Built-in high speed processing and positioning
- Even with its ultra-compact size, the FX3UC can be expanded to locally control up to 256 I/O, and up to 384 points with CC-Link or AnyWireASLINK remote I/O.

Product Details

Ultra-compact size main unit, power supply and I/O. Same programming specification as the FX3U products in an ultra compact housing with connector type wiring for fast and fault free wiring.

Fast Instruction Times

Basic Instructions: 0.065 μ s / instruction (Contact Instruction)
 Applied Instructions: 0.642 μ s / instruction (MOV Instruction)

Large Memory

64,000 steps of built-in program memory.
 Flash Memory Cassettes with loader function are available.

Applicable Standards

All products support EN and UL/cUL standards.
 Various shipping approvals are supported as well.

Large Device Memory

Auxiliary Relays	7,680 points
Timers	512 points
Counters	235 points
Data Registers	8,000 points
Extension Registers	32,768 points
Extension File Registers (with optional Memory Cassette)	32,768 points



FX Main Units Lineup



FX3G

Controllable I/O: 14 - 128 points
 Max. 256 with CC-Link or AnyWireASLINK remote I/O
 (Main Unit I/O: 14/24/40/60 points)

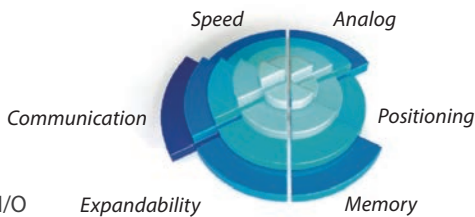

Customized Control

The FX3G is an introductory compact PLC designed for simple yet performance-critical applications. Incorporating innovative FX3 series technology the customer is presented with a suite of benefits.

- 3rd generation compact PLC
- Highly flexible
- Dual system-bus architecture
- The FX3G can control a maximum of 128 connected I/O, and up to 256 points with CC-Link or AnyWireASLINK remote I/O.

*: The standard mode is selected when the program capacity is set to 16000 steps or less using a parameter. The extension mode is selected when the program capacity is set to 16001 steps or more using a parameter.

Product Details

All-in-one CPU, power supply and I/O includes usage of the FX3 series ADP bus system and expansion boards (BD).

Instruction Times

Basic Instructions:

- Standard mode*: 0.21 μs/instruction (Contact Instruction)
- Extension mode*: 0.42 μs/instruction (Contact Instruction)

Applied Instructions:

- Standard mode*: 0.52 μs/instruction (MOV Instruction)
- Extension mode*: 1.29 μs/instruction (MOV Instruction)

Large Memory

32,000 steps of built-in program memory. EEPROM memory cassette with loader function is available.

Applicable Standards

All products support EN and UL/cUL standards. Various shipping approvals are supported as well.

Large Device Memory

Auxiliary Relays	7,680 points
Timers	320 points
Counters	235 points
Data Registers	8,000 points
Extension Registers	24,000 points
Extension File Registers	24,000 points

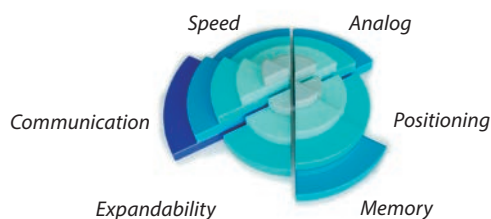

FX3GC

Controllable I/O: 32 - 128 points
 Max. 256 with CC-Link or AnyWireASLINK remote I/O
 (Main Unit I/O: 32 points)

Super Compact Control

The FX3GC expands the FX3 series line up with the connector type PLC entry model. Having the same processing capability as the highly successful FX3G, this super compact product reduces installation space, wiring time and potential wiring faults.

- 3rd generation super-compact PLC
- Reduced size and wiring using connector-type I/O
- Dual system-bus architecture
- Control of up to 128 directly connected I/O, or up to 256 I/O with CC-Link or AnyWireASLINK remote I/O.

■ Product Details

All-in-one CPU, power supply and I/O. Same programming specification as the FX3G products in an ultra compact housing with connector type wiring for fast and fault free wiring.

■ Instruction Times

Basic Instructions:
 Standard mode*: 0.21 μs/instruction (Contact Instruction)
 Extension mode*: 0.42 μs/instruction (Contact Instruction)
 Applied Instructions:
 Standard mode*: 0.52 μs/instruction (MOV Instruction)
 Extension mode*: 1.29 μs/instruction (MOV Instruction)

■ Large Memory

32,000 steps of built-in program memory.

■ Applicable Standards

All products support EN and UL/cUL standards. Various shipping approvals are supported as well.

■ Large Device Memory

Auxiliary Relays	7,680 points
Timers	320 points
Counters	235 points
Data Registers	8,000 points
Extension Registers	24,000 points
Extension File Registers	24,000 points

*: The standard mode is selected when the program capacity is set to 16000 steps or less using a parameter. The extension mode is selected when the program capacity is set to 16001 steps or more using a parameter.



FX Main Units Lineup



FX Main Units Lineup

FX Control Solutions

Visualization

Software

FX3GE

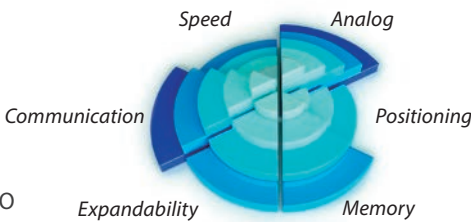

Controllable I/O: 24 - 128 points
 Max. 256 with CC-Link or AnyWireASLINK remote I/O
 (Main Unit I/O: 24/40 points)

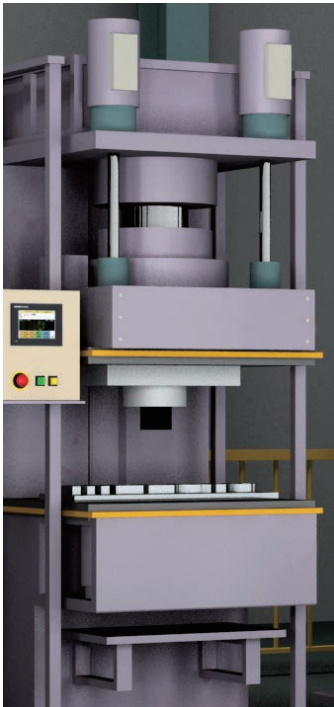

Keep it simple

FX3GE adds built-in analog input/output and Ethernet connectivity on top of FX3G performance. A great fit for many applications.

- 3rd generation, all-in-one PLC
- Highly flexible
- Dual system-bus architecture
- Control of up to 128 directly connected I/O, or up to 256 I/O with CC-Link or AnyWireASLINK remote I/O.

*: The standard mode is selected when the program capacity is set to 16000 steps or less using a parameter. The extension mode is selected when the program capacity is set to 16001 steps or more using a parameter.

Product Details

All-in-one CPU, power supply and I/O, with integrated analog I/O and Ethernet port ready to use straight out of the box.

Instruction Times

Basic Instructions:
 Standard mode*: 0.21 μs/instruction (Contact Instruction)
 Extension mode*: 0.42 μs/instruction (Contact Instruction)
 Applied Instructions:
 Standard mode*: 0.52 μs/instruction (MOV Instruction)
 Extension mode*: 1.29 μs/instruction (MOV Instruction)

Large Memory

32,000 steps of built-in program memory. EEPROM memory cassette with loader function is available.

Applicable Standards

All products support EN and UL/cUL standards.

Large Device Memory

Auxiliary Relays	7,680 points
Timers	320 points
Counters	235 points
Data Registers	8,000 points
Extension Registers	24,000 points
Extension File Registers	24,000 points

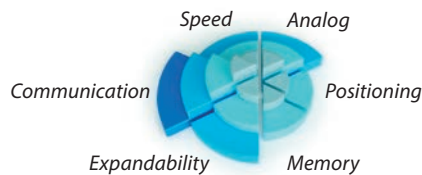

FX3S

Controllable I/O: 10 - 30 points
(Main Unit I/O: 10/14/20/30 points)

Keep it simple

The FX3S is the fit-and-forget PLC solution for space and cost conscious applications requiring up to 30 I/O. This minimum-expandability, battery-less maintenance-free controller is perfect for handling straightforward processes and can be hidden away in locations without regular maintenance activities.

- Basic controller for general applications
- High performance with minimal size

■ Product Details

All-in-one CPU, power supply and I/O. Expansion options include adapter and expansion boards for communication, analog control, or temperature input.

■ Instruction Times

Basic Instructions: 0.21 μ s/ instruction (Contact Instruction)
Applied Instructions: 0.5 μ s to several hundred μ s/ instruction

■ Large Memory

4,000 steps of built-in program memory.
No battery. No maintenance.

■ Applicable Standards

All products support EN and UL/cUL standards.
Various shipping approvals are supported as well.

■ Large Device Memory

Auxiliary Relays	1,536 points
Timers	138 points
Counters	67 points
Data Registers	3,000 points
File Registers	2,000 points



FX Control Solutions

With superior built-in functionality and straightforward usability, the FX series meets the needs of a variety of user applications. Using the factory image below as an example, key attributes that form the basis of automation control are demonstrated by the FX control system.

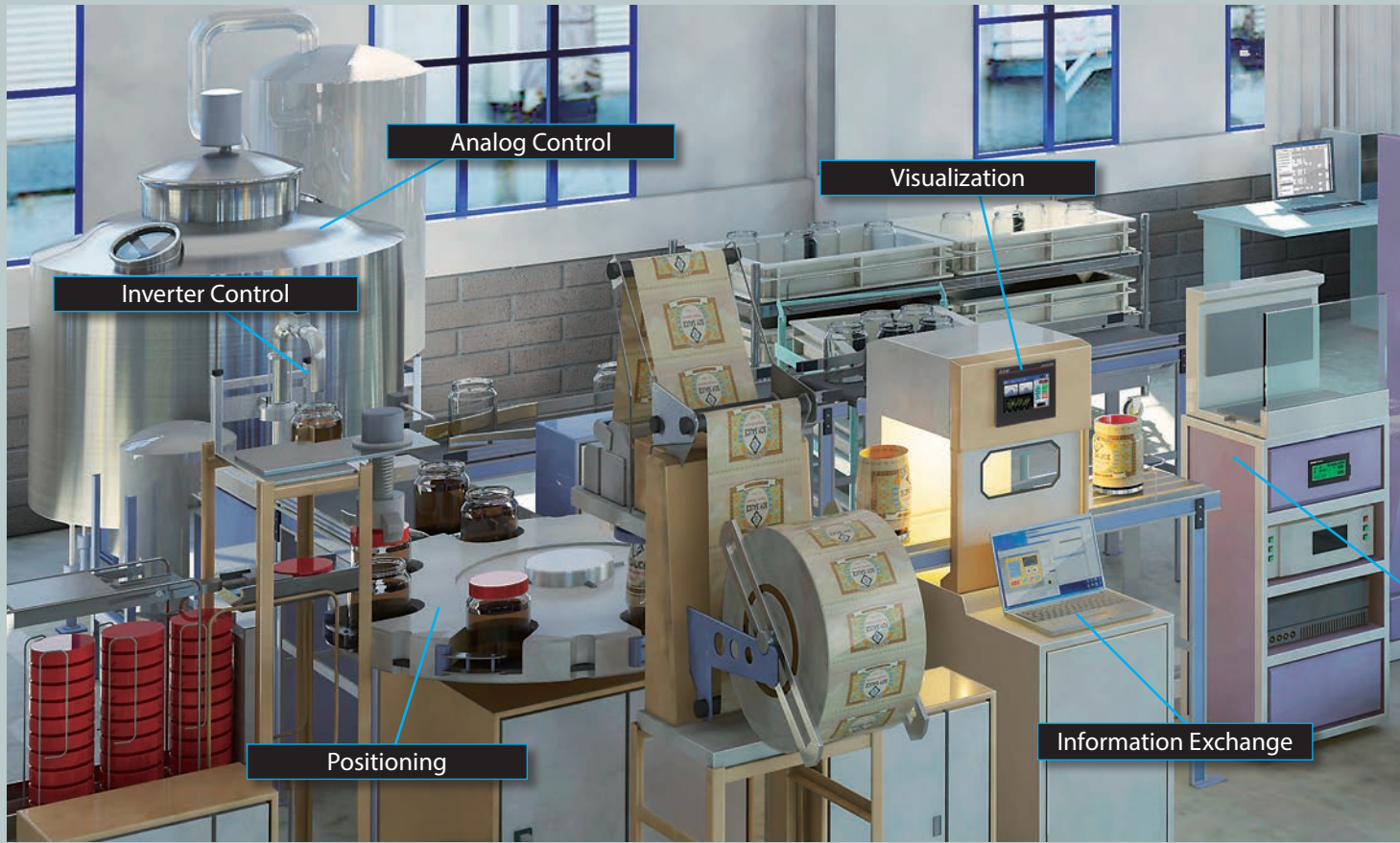

FX Main Units Lineup

FX Control Solutions

Visualization

Software

Analog Control

The FX series features easy Analog to Digital and Digital to Analog conversion for all models using Expansion Boards, Special Adapters, or Special Function Blocks. For more information, go to Page 14.

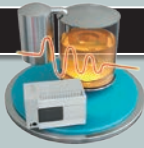

High-Speed Control

Integrated High-Speed Counters
With 6 to 8 high speed counters on each model, the FX series is perfectly suited for applications in need of pulse-catch functions, closed-loop feedback processing, or high-speed sensor use. For more information, go to Page 15.



Serial Communication

From PCs, printers, barcode readers, modems, and other PLCs, serial communication increases the flexibility of the FX series system to allow reliable data exchange over a variety of connections. For more information, go to Page 19.

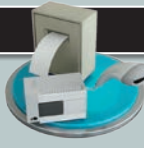

Information Exchange

Information can be sent to a higher level PC that constantly monitors production, raising the reliability and overall efficiency of the system. For more information, go to Page 20.

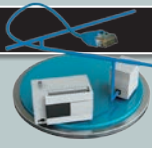

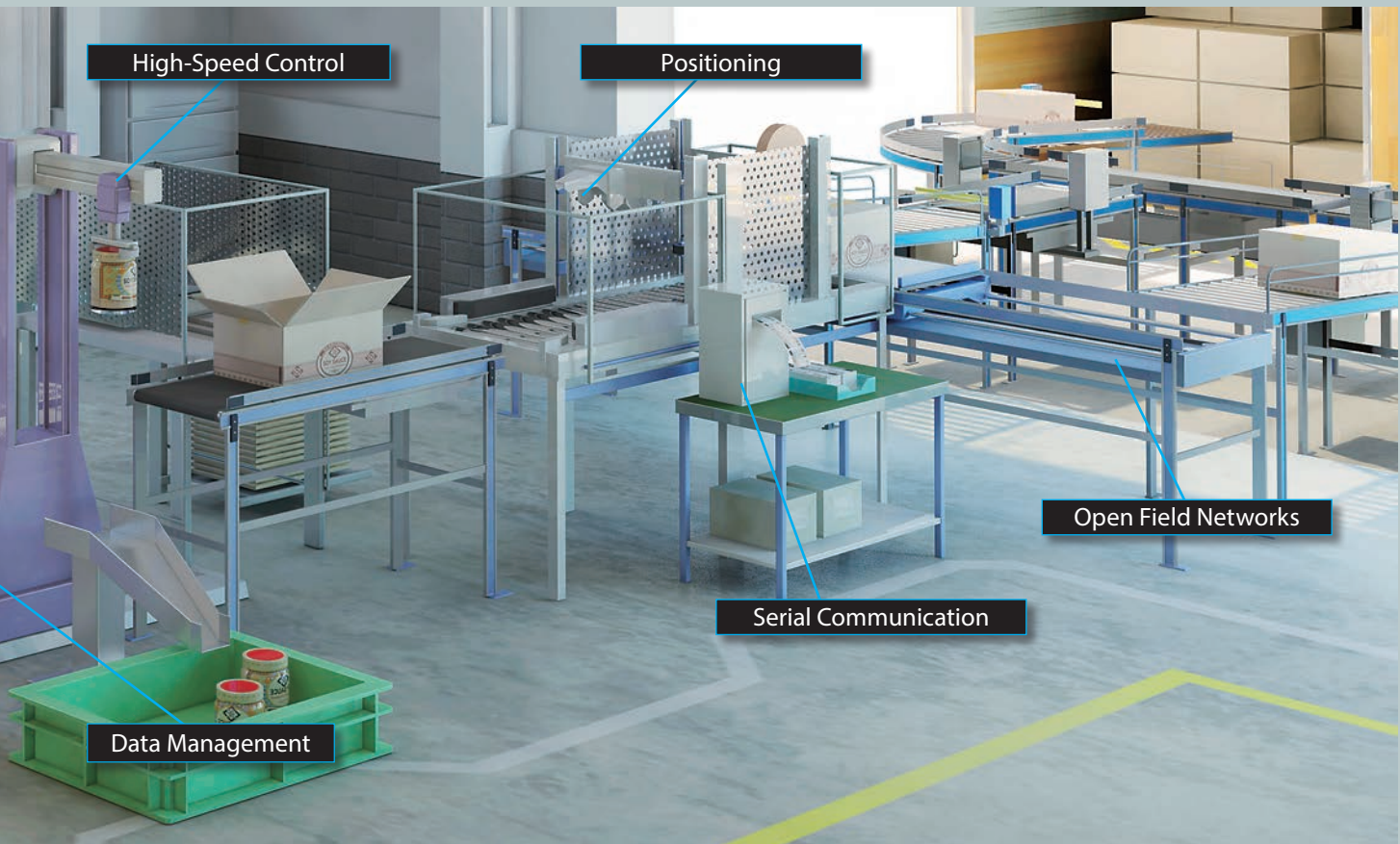

Inverter Control



Integrated FREQROL Protocol
 FX series PLCs contain the RS-485 communication protocol and special instructions that allow control of all Mitsubishi Electric FREQROL Inverters. For all other models, Analog inverter control can be used.

For more information, go to Page 15.

Positioning



Built-in high-speed pulse outputs and special instructions enable the FX series main units to control up to 3 independent axes of servo motion from the main unit itself. With special function blocks, interpolated and networked servo control solutions are also available.

For more information, go to Page 16-17.

Open Field Networks

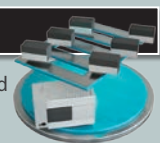

Among the networks supported by the FX series are CC-Link and Ethernet, MODBUS®, and PROFIBUS, providing both a wide selection for new solutions and an interface into existing networks.

For more information, go to Page 18.

Data Management

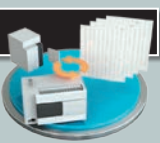

The FX3U-CF-ADP, for the FX3U and FX3UC enables data to be automatically written to a CF card at specified intervals or under certain conditions. The data is saved in universal CSV format with user-defined file names and automatic timestamps to enhance efficiency. For more information, go to Page 21.

Visualization



HMI options for the FX series range from simple text-based Display Units to advanced graphical touch-screen displays, known as the GOT2000 series Graphic Operation Terminals. GOT2000 models start at 3.8" and go up to 15". For more information, go to Page 22-23.

Analog Control

Expanding the FX PLC with analog inputs and outputs is required when the system needs to handle voltage or current inputs/outputs, temperature inputs, or temperature or PID control. The following expansion boards, special adapters, and special function blocks support different ranges and combinations of these features.



More details, please refer to the FX Analog Family.

Analog Output

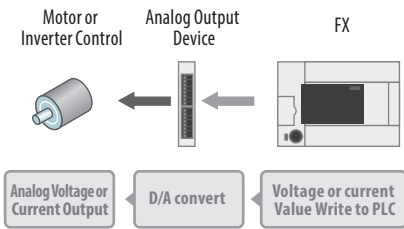

Analog Input

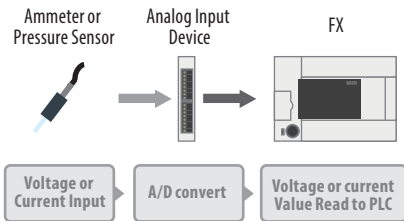

Temperature Input

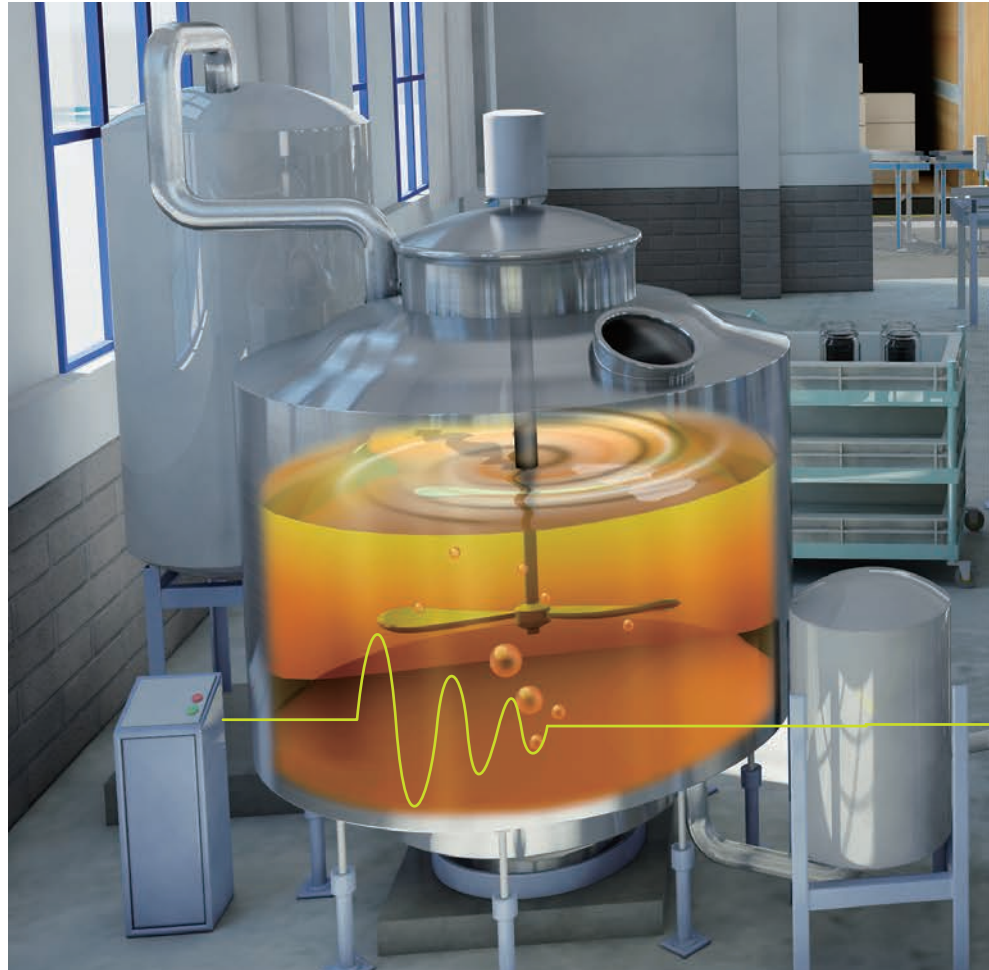
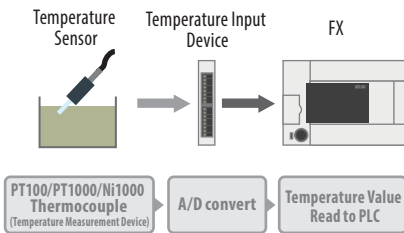

Analog Modules Lineup

	Expansion Boards	2ch	3ch	4ch	5ch	8ch
Analog Output	1ch FX3G-1DA-BD	FX2N-2DA	1ch FX3U-4DA	FX3U-4DA-ADP	1ch FX2N-5A	
Analog Input	2ch FX3G-2AD-BD	FX3S-30M□/ES□-2AD FX2N-2AD	FX3U-3A-ADP FX3GE 2ch	FX3U-4AD FX3U-4AD-ADP FX3UC-4AD	4ch	FX2N-8AD
Temperature Input		FX2N-2LC*		FX3U-4LC FX3U-4AD-TC-ADP FX3U-4AD-PTW-ADP FX3U-4AD-PT-ADP FX3U-4AD-PNK-ADP		

*: Production will be discontinued in March 2018.

High-Speed Control

All FX series PLCs are equipped with built-in open collector high-speed counters; up to 60 kHz for the FX3G/FX3GC/FX3GE/FX3S and up to 100 kHz for the FX3U/FX3UC. These high-speed inputs are connected to external devices such as encoders and ultrasound sensors for system feedback control. The FX3U main unit can be expanded with high-speed input special adapters, enabling differential line receiver inputs up to 200 kHz.

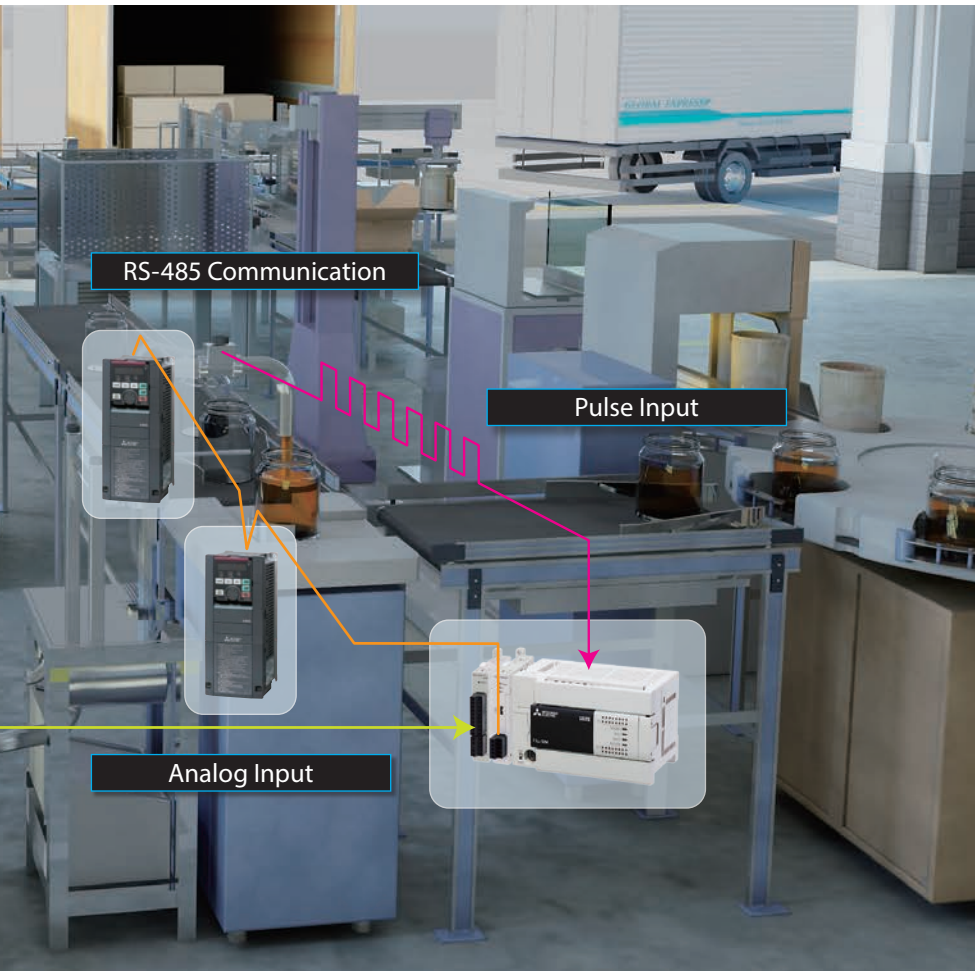
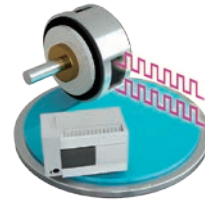

FX Integrated High-Speed Counter

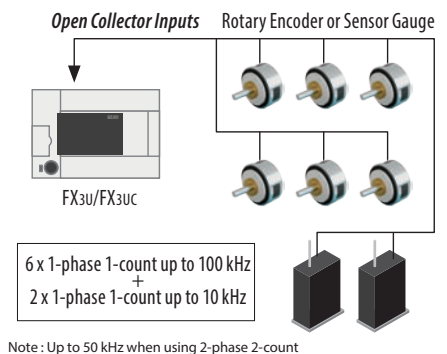

FX with High-Speed Input Adapter

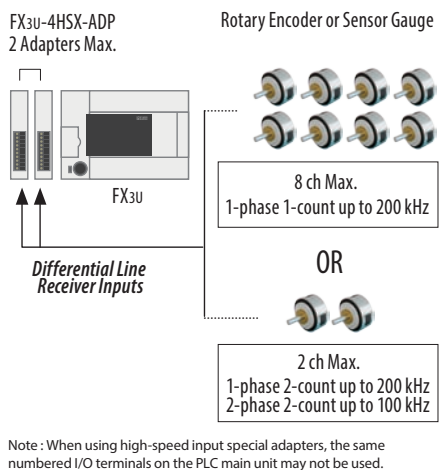

Inverter Control

Also known as Variable Frequency Drives (VFDs), Inverters play a vital role in many conveyor, pumping, and positioning systems. While the output frequency of the inverter can be varied easily using analog outputs on any of the FX series PLCs, transfer of both parameters and commands between the PLC and Mitsubishi Electric Inverters can be handled in FX series PLCs through serial communication using FREQROL protocol. Each RS-485 interface on an FX series PLC can control up to 8 Inverters with a total network extension of up to 500 m when using the FX3U-485ADP-MB.

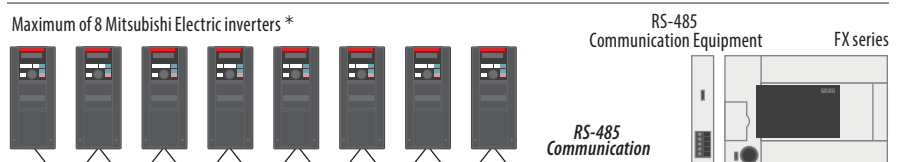

* : Applicable Inverters: A800/F800/E700/D700

Positioning

The built-in high-speed pulse outputs on all transistor-type FX series PLCs, along with special positioning operations instructions, are designed to satisfy simple independent-axis positioning applications using servo and stepping motors with speed and precision. For more advanced applications like 4-axis control and noise-free interpolation, the FX system can be expanded with special adapters and special function blocks. With high performance at a low cost, the FX series positioning possibilities provide a formidable package.



More details, please refer to the FX Positioning Family.

Upgraded Built-in Positioning Instructions for Easier Use

The FX series allows for up to 3 axes of independent positioning control at up to 100 kHz. Connecting two high-speed output special adapters to the FX3U allows for up to 4 axes of control at up to 200 kHz. *

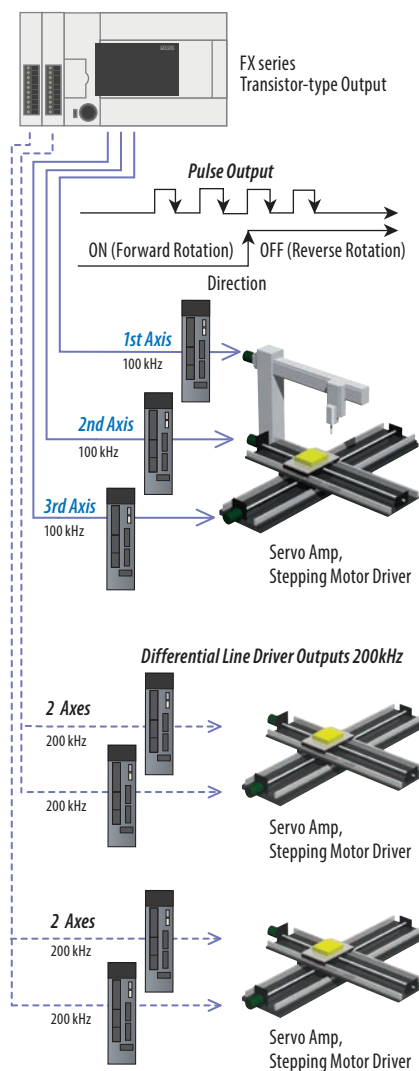

*: When using high-speed output special adapters, the same numbered I/O terminals on the PLC main unit may not be used.

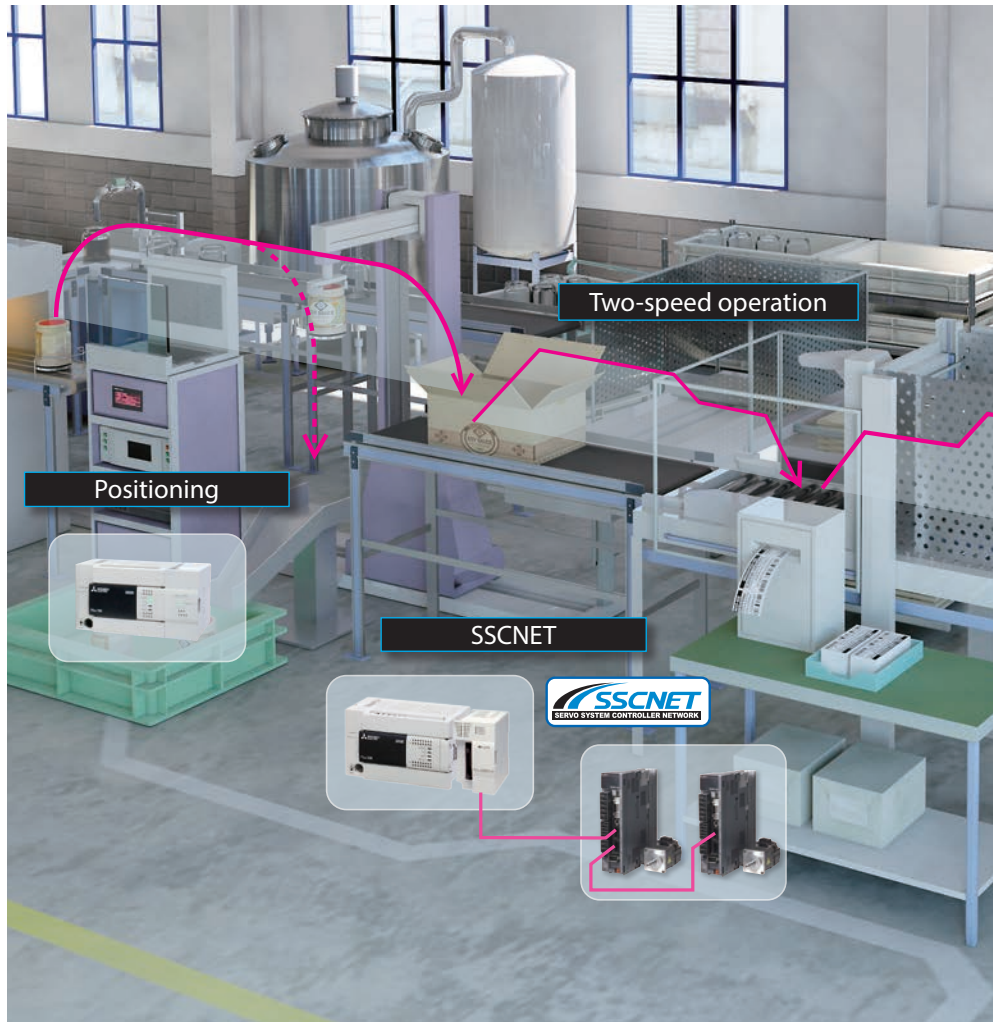

Easy Step-By-Step Positioning Programming Using the DTBL Instruction.

Only FX3U, FX3UC, FX3G, FX3GC, and FX3GE

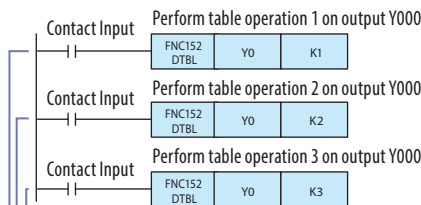

Numbered Positioning Operation Table

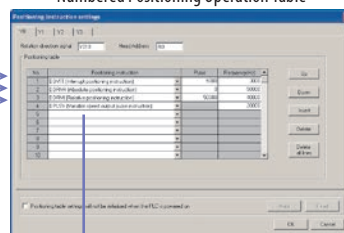

Positioning Operation Setup

Positioning Modules Lineup



*: FX3U built-in axes are not available when the High-Speed Output ADPs are attached.

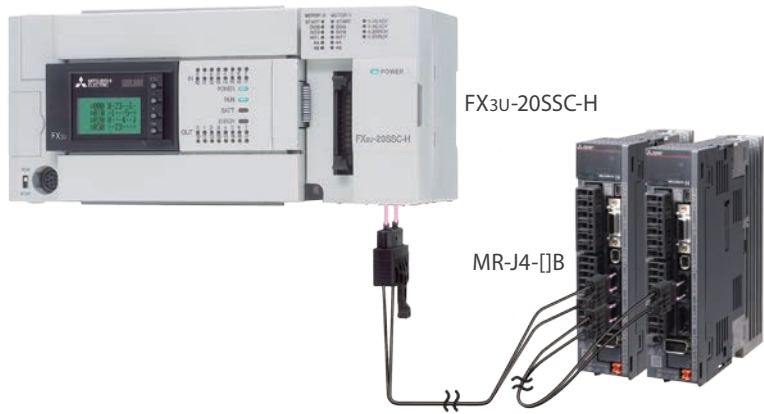

High-Speed, High-Precision Positioning Solution

For advanced positioning applications, the FX3U and FX3UC controllers can be expanded with the FX3U-20SSC-H special function block. With SSCNET III, smooth, high-speed, high-precision operations become easy to setup and execute. Use the FX PLC to set positioning and servo parameters, while monitoring the absolute axis position for program interaction.



2-Axis 50 Mbps Networked Control

Unparalleled communication speed through SSCNET III

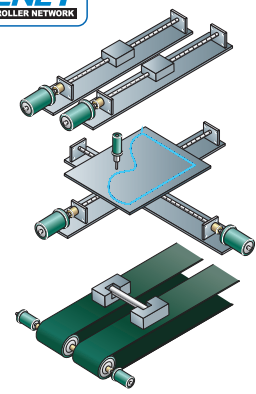

Interpolated Positioning
 - 2-Axis Linear Interpolation
 - 2-Axis Circular Interpolation
Simultaneous Start Function
 Both the X and Y axes can be controlled with a timed start, allowing for synchronous positioning operations.

Plug-and-Play fiber optic cable connectivity to servo equipment eliminates wiring errors and enhances data transfer reliability and noise resistance while supporting node-to-node distances of up to 50 m. At 50 Mbps transmission speed with highly reduced communication cycle times as low as 1.77 ms, the FX3U-20SSC-H and SSCNET III drastically improve positioning accuracy and create a high-powered solution for a variety of applications.

Inching Operation

If the forward/reverse JOG activation time is within the JOG determination time, a pulse string equivalent to ± 1 (user unit) is output at the current address.

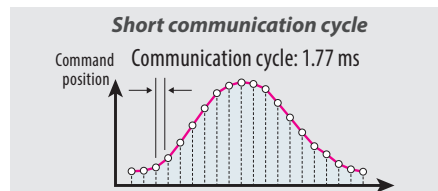

Example JOG determination time: 500 ms

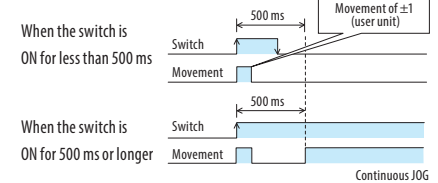

Changing the Speed and Target Address

Speed Change Function

The operation speed can be changed arbitrarily during operation.

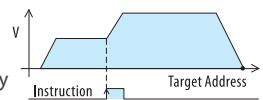

Speed Override Function

The operation speed ratio can be changed arbitrarily during operation.

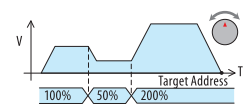

Target Address Change Function

The target address can be changed to a new address arbitrarily during operation.

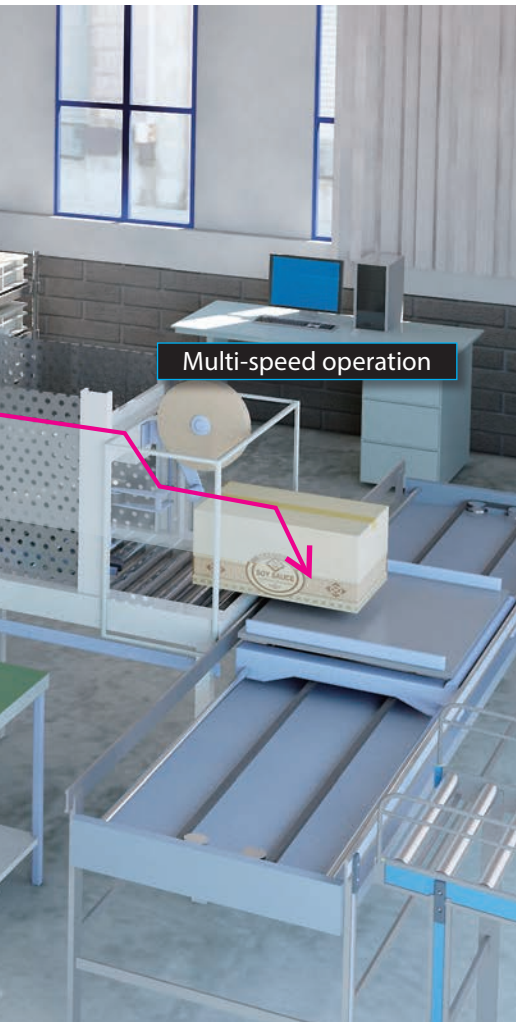
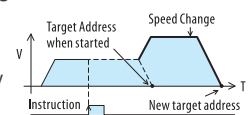

Pulse Output Blocks

FX2N-10PG
(1-axis)

FX3U-1PG
(1-axis)

Positioning Block

FX3U-20SSC-H
(2-axis)

Positioning Units

FX2N-10GM
(1-axis)

FX2N-20GM
(2-axis)

Positioning Software

FX-PCS-VPS/WIN-E

Cam Switch

FX2N-1RM

Open Field Networks

Across factory floors, though applications and databases may be made up of equipment from different manufacturers, reliable information must be passed both quickly and easily. To accomplish this, one must keep everyone speaking the same language, and therefore it is best to use open networks as a backbone to the control system. Several of the supported FX series open network extensions are shown below.

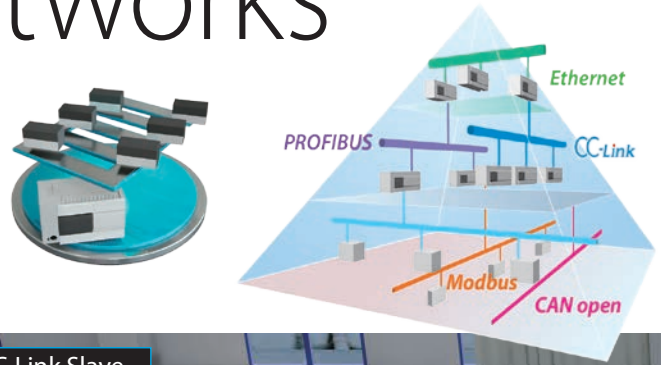

CC-Link

For inter-system data transfer and remote I/O handling, CC-Link enables the update of word and bit devices refreshed at up to 10 Mbps. With CC-Link based I/O, the 256 I/O control limit of the FX3U/FX3UC goes up to 384*, and with CC-Link Ver. 2.00, expanded cyclic transmission can also be performed, enabling more link points to be established.

Programming via CC-Link is also a new feature of the FX series. A user connected to the master FX PLC programming port can access all connected intelligent device station FX PLCs from one location, saving time and money.

*: FX3G/FX3GC/FX3GE goes up to 256.

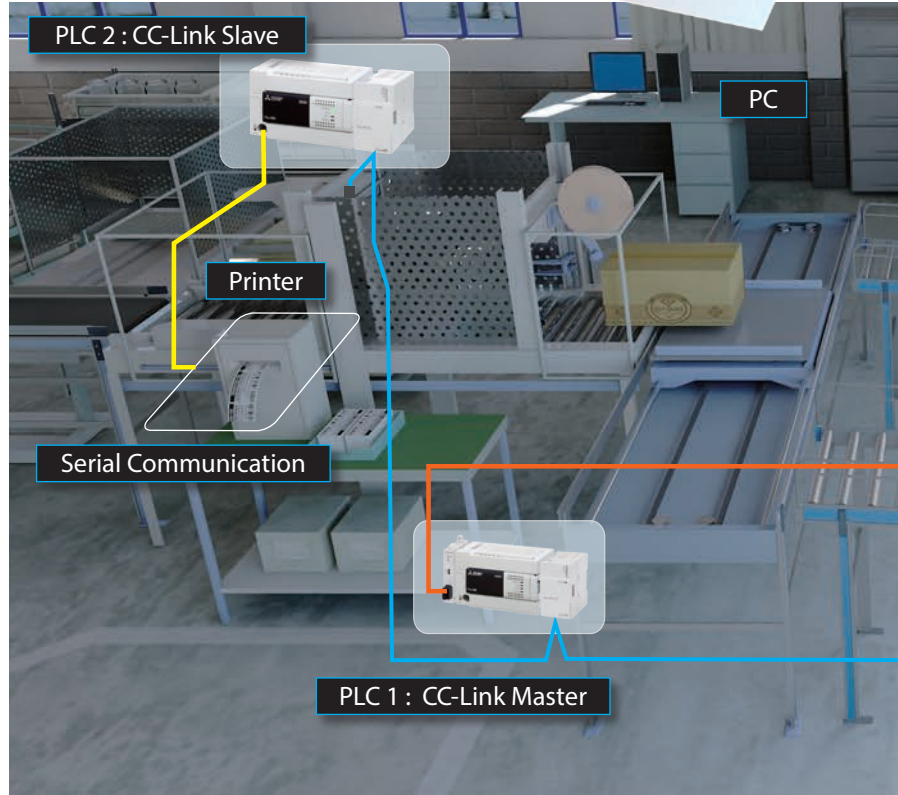

CC-Link System Configuration

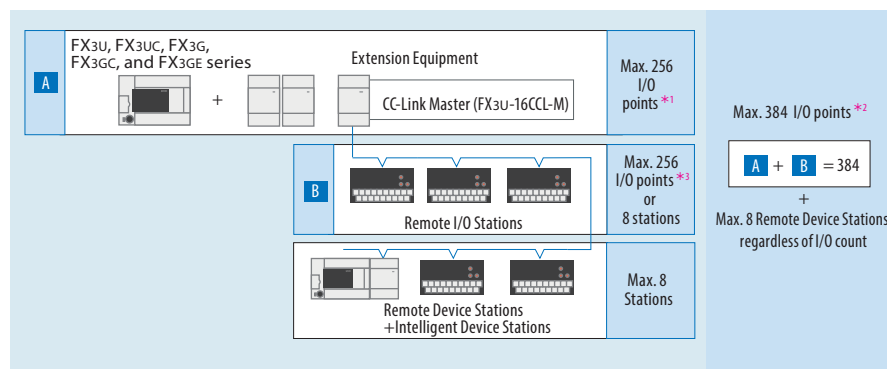
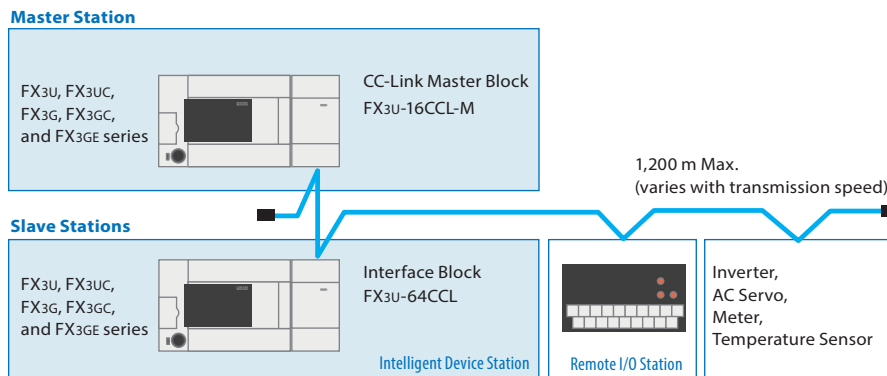

*1: FX3G/FX3GC/FX3GE up to 128 I/O points *2: FX3G/FX3GC/FX3GE goes up to 256.
*3: FX3G/FX3GC/FX3GE up to 128 I/O points or 4 stations.

Communication Modules Lineup



Serial Communication

For related systems and data transfer with external equipment and third party devices, serial communication has long been the established connection method. Serial communication allows the FX series to connect both efficiently and reliably with other PLCs, sensors, printers, and modems, etc. Multi-drop networks, non-protocol communication, and remote maintenance are just some of the many uses.

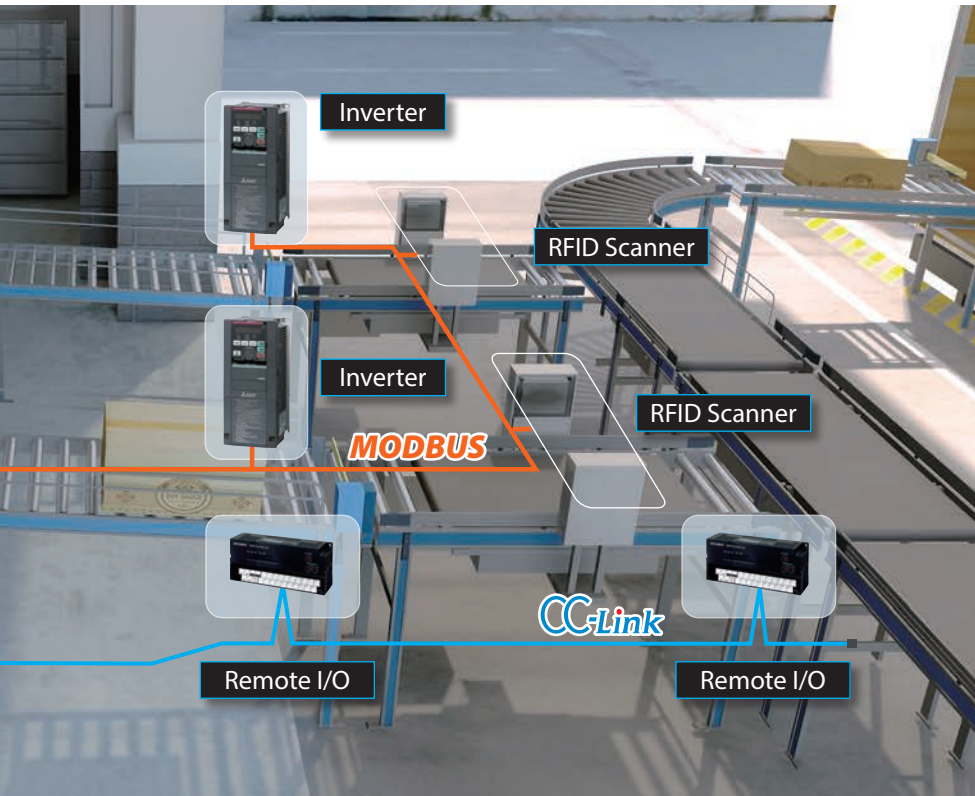

MODBUS

Both an open network and a serial communicator, MODBUS-RTU allows FX series PLCs to interface with a wide range of equipment and devices. Using RS-485 and RS-232C, the FX3U-485ADP-MB and FX3U-232ADP-MB expand the networking capabilities of the FX system while still supporting general communication with other FX systems, non-protocol devices, and serial modems. MODBUS serial communication parameters and communication execution are setup easily within the ladder program using GX Works2 or GX Developer, and the FX MODBUS Master uses the special ADPRW instruction to communicate with up to 16 Slave stations.

FX Main Units Lineup

FX Control Solutions

Visualization

Software

Communication Protocols

Serial Communication

- FX3U-232-BD
- FX3U-485-BD
- FX3G-232-BD
- FX3G-485-BD
- FX3G-485-BD-RJ

MODBUS

- FX3U-232ADP-MB
- FX3U-485ADP-MB

N:N Network

Communication between FX series PLCs

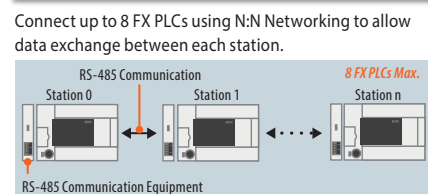

Computer Link (Dedicated Protocol)

Communication with a PC

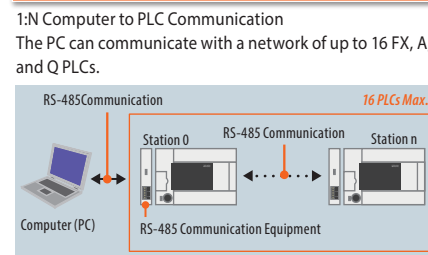

1:1 RS-232C Communication Equipment to PLC
When communicating over an RS-232C interface, the PC can communicate with one FX PLC.

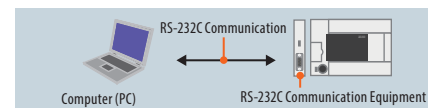

Parallel Link

Communication between 2 FX series PLCs of the same series

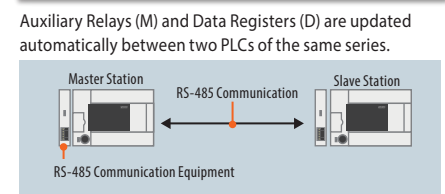

Remote Maintenance

Communication with a PC

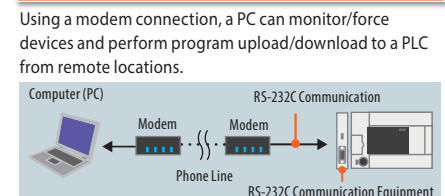

Non-Protocol Communication (RS/RS2 Instructions)

PLC communication with Printers, Barcode Readers, etc.

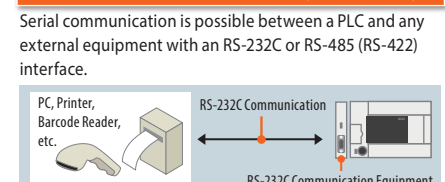

Information Exchange

Networks and remote connections go hand in hand. Get connected for remote factory control and maintenance.



Ethernet

In the information age, Ethernet has become the personal, commercial and industrial standard for easy and efficient data transfer. Whether it is between multiple PLC systems or PLC and PC servers, industrial users dictate foremost that data must always be consistent even in high-noise environments. The FX series uses industrial Ethernet on up to 8 ports, with features such as PLC-to-PLC communication, extensive e-mail send/receive options, and program upload/download.

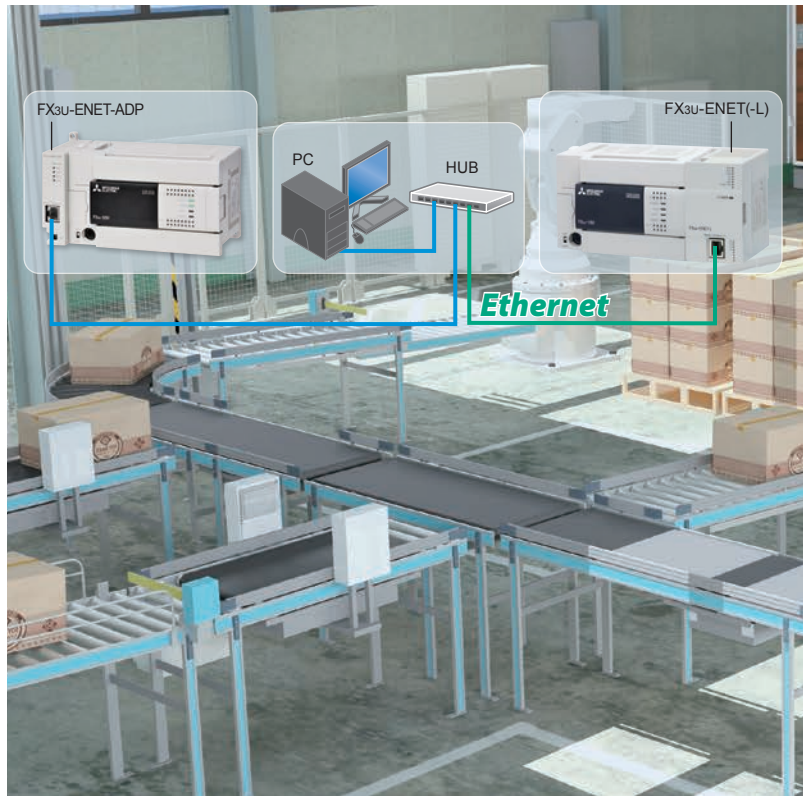

Ethernet Communication Modules Lineup

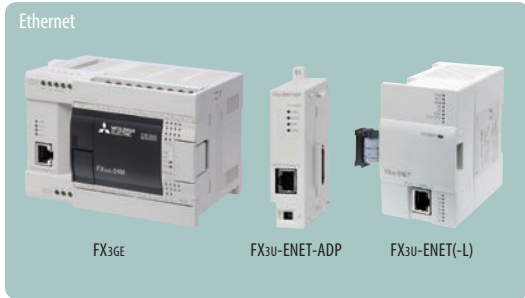

MC Protocol Communication

Device data read-out/writing to a PLC from a PC is possible.

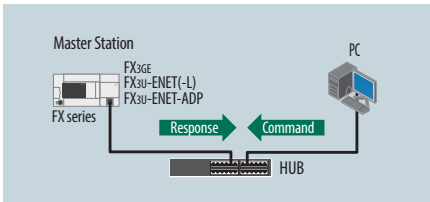

Parameter Setup

Various parameters can easily be set from the parameter setting screen of GX Works2.



Data Monitoring

PLC device values and the status of the Ethernet adapter can be monitored from a browser on a personal computer.

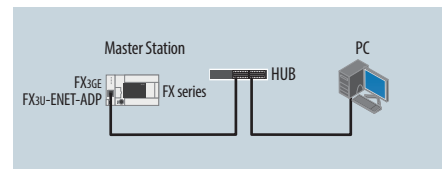

Remote Maintenance

Program read/write can be made by GX Works2 connected via VPN.*

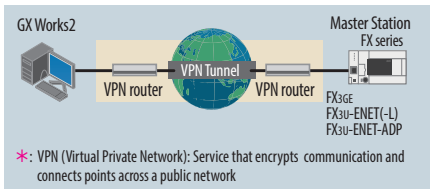

Fixed Buffer Communication

Communication with PLC and other devices possible using buffer memory (fixed buffer).

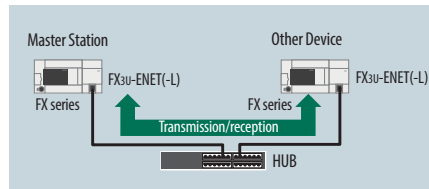

E-mail Transmission

PLC can send and receive* e-mail via mail server (SMTP).

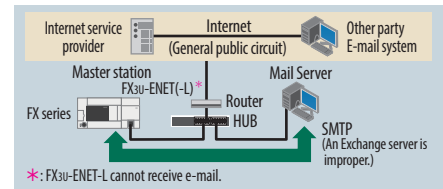

FX3GE support

FX3U-ENET(-L) support

FX3U-ENET-ADP support

Data Management

Keeping records of components, key processes, and events are crucial for maintaining a reliable system. FX PLCs offer multiple methods for saving data depending on user needs.



Data Logging

Write data to a CF card in the FX3U-CF-ADP for the FX3U and FX3UC. Logging of periodical or event-based data can be performed in 64 different files with user-defined names in universal CSV format. Time stamps can be activated to automatically tag data allowing easy analysis of trends.

Data Logging Adapter

Data Logging



FX3U-CF-ADP

Storing Data in the PLC

Utilize extension registers for data storage. 24,000 points are available in FX3G/FX3GC/FX3GE and 32,768 are available in FX3U/FX3UC.



FX3U

FX3G

Storing Data in a Memory Cassette

Utilize extension file registers for data storage on a memory cassette. 24,000 extension file registers can be used with FX3G/FX3GE and 32,768 can be used with FX3U/FX3UC.

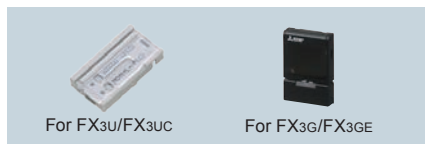

For FX3U/FX3UC

For FX3G/FX3GE

Collecting Data on a Personal Computer

A PC that is always on can log PLC data with MX Component and MX Sheet.

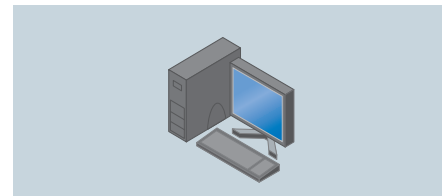

Collecting Data onto CF Card

Easily log data in CSV format with a CF card special adapter connected to FX3U/FX3UC.



FX3U-CF-ADP

Data Analysis

Data logged in CSV format on CF card can easily be read using spreadsheet software. Graph the data for easy visualization and analysis.

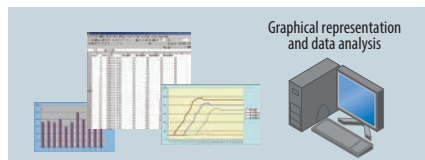

Graphical representation and data analysis

Read-Out of Data

The data logged on CF card can be read back into the PLC.

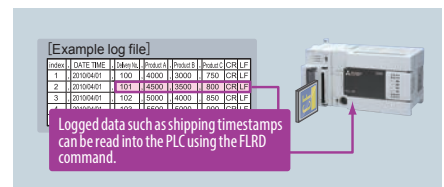

[Example log file]

Index	DATE TIME	Station	Product A	Product B	Station	CR	LF
1	20100405	100	6000	2000	750	CR	LF
2	20100405	101	6000	1000	850	CR	LF
3	20100405	102	6000	4000	850	CR	LF

Logged data such as shipping timestamps can be read into the PLC using the FLRD command.

Visualization

To provide ease of operation to a system, the overall look and feel of the interface is key. The GOT2000 series Graphical Operation Terminal HMI offers colorful and sharp touch-screen displays that make interacting with the system straight forward. If only a simple text-display is needed for simple monitoring and device setting, display modules are also available.



GOT2000

Graphic Operation Terminal

With FX series PLCs

- *Transparent Mode*
- *List Editor*
- *Multi-Connection*
- *Common Software For All GOTs*
- *Backup / Restoration function*



GT27

Advanced model with multi-touch gesture functions.

Communication interfaces such as Ethernet, RS-232, RS-422/485, USB host/ device and SD memory card are standard features. High capacity data processing ensures smooth screen operation even when multiple tasks, such as logging, script, alarm, or device data transfer, are running. In addition, image recording, image playback, video image input, and RGB output are available, thus all the functions of GOT2000 can be used on GT27 models.



- 5.7-inch**
TFT LCD 65,536 colors
GT2705-VTBD
- 8.4-inch**
TFT LCD 65,536 colors
GT2708-[]TBA
GT2510-[]TBD
- 10.4-inch**
TFT LCD 65,536 colors
GT2710-STBA
GT2710-STBD
GT2710-VT[]A
GT2710-VT[]D
- 12.1-inch**
TFT LCD 65,536 colors
GT2712-ST[]A
GT2712-ST[]D
- 15-inch**
TFT LCD 65,536 colors
GT 2715-XTBA
GT2715-XTBD

GT25

High performance, cost efficient, mid-range model.

High capacity data processing ensures smooth screen operation even when multiple tasks, such as logging, script, alarm, or device data transfer, are running.



- 8.4-inch**
TFT LCD 65,536 colors
GT2508-VT[]A
GT2508-VT[]D
- 10.4-inch**
TFT LCD 65,536 colors
GT2510-VT[]A
GT2510-VT[]D
- 12.1-inch**
TFT LCD 65,536 colors
GT2512-STBA
GT2512-STBD

Open Frame Model

Installing the GOT2000 from the back side of the control panel complements the machine-design surface. Using a stainless-look environmental protection sheet allows the touch panel to blend into the production machines for the pharmaceutical and food industries.

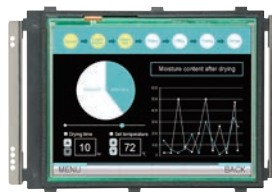

- 8.4-inch**
TFT LCD 65,536 colors
GT2508F-VTNA
GT2508F-VTND
- 10.4-inch**
TFT LCD 65,536 colors
GT2510F-VTNA
GT2510F-VTND
- 12.1-inch**
TFT LCD 65,536 colors
GT2512F-STNA
GT2512F-STND

FX3G-5DM Display Module

This backlight display module can be installed directly into the front face of the FX3G or on top of an FX3G expansion board and can be used to display the built in real-time clock, bit device statuses and word device values, and error codes with step numbers, force bit device statuses, and adjust word device values. Keywords can be added or cancelled enabling security layers that only allow authorized operators to edit devices via the display module.



FX3U-7DM Display Module & Holder

This backlight display module can be installed directly into the front face of the FX3U or mounted in a cabinet or panel using the dedicated connection cable and holder kit. The FX3U-7DM can be used to monitor and adjust devices similar to the FX3G-5DM, but with added features like device clearing and user message display.

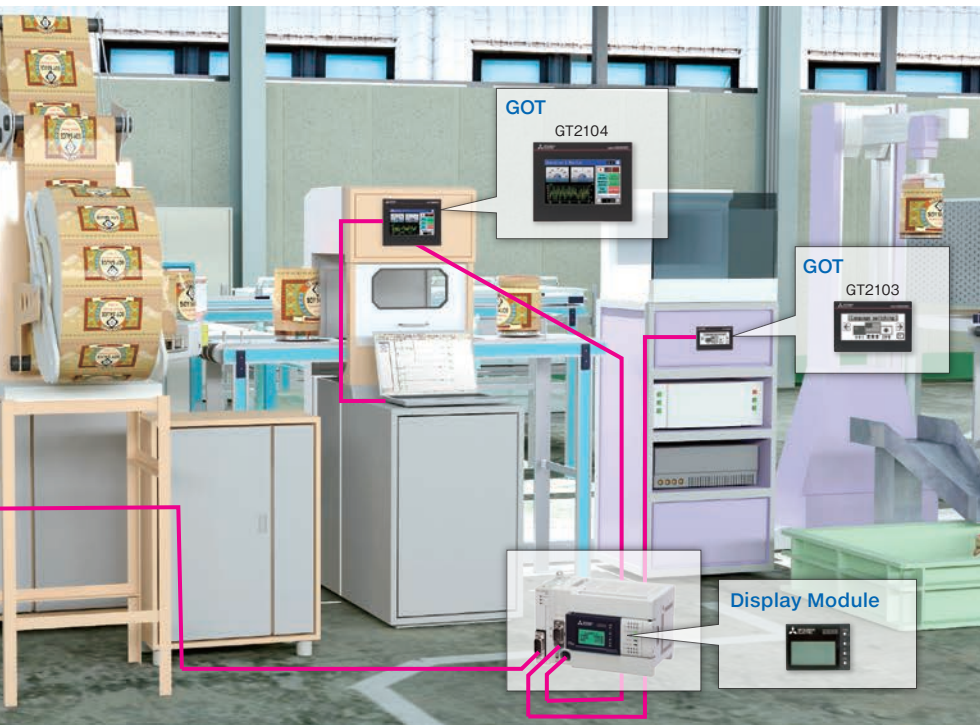

FX3S-5DM Display Module

This seven-segment and icon display module can be installed directly into the front face of the FX3S together with an expansion board. The FX3S-5DM can be used to monitor and change device states and values.



GT21

Compact model with exciting possibilities.

Introducing a compact model with high resolution LCD display. The GOT wide model satisfies your needs in various applications. Enhanced visualization in industrial environments and an excellent choice also for non-FA applications.



3.8-inch	4.3-inch wide
TFT LCD	TFT LCD 65,536 colors
GT2103-PMBD	GT2104-RTBD
GT2103-PMBDS	7-inch wide
GT2103-PMBDS2	TFT LCD 16 gray scales
GT2103-PMBLS	GT2107-WTBD
	GT2107-WTSD

GOT SIMPLE

Using Mitsubishi Electric industrial devices together with the GOT SIMPLE series provides ideal, simple solutions that enhance efficiency and reduce cost in production.



7-inch
TFTLCD
GS2107-WTBD
10-inch
TFTLCD
GS2110-WTBD

Handy GOT

Hand held terminals support mobile machine visualization and control.

The Handy GOT is used as an operation terminal in connection with the controllers such as MELSEC PLCs or third party PLCs. It is an all-in-one operation terminal that is equipped with the display unit with touch switches integrated with the mechanical keys for inputting a command to a machine.



5.7-inch
TFT LCD 65,536 colors Handy type
GT1455HS-QTBDE
TFT LCD 16 gray scales Handy type
GT1450HS-QMBDE
6.5-inch
TFT LCD 65,536 colors Handy type
GT1665HS-VTBD
Handy GOT mounting box
GT16H-CN8-42S

Software

In today's world, programming software for PLCs is a forever evolving process. Customers place more focus on reusable program code and user friendly software that helps to reduce errors and programming time, and manage the programming process.

Programming and Simulation Software

Program FX series PLCs with ease using GX Works2

Simple to program, easy to use programming environment

Improve design efficiency

Reduce debugging time

Reduce downtime

Protect important data

GX Works2 offers two styles of project development to fit different programming needs.

- Program complex operation with familiar ladder
- Easy to use version of GX Developer
- Import projects from GX Developer

- Embody frequently used code in function blocks, which can then be reused
- Use and share function blocks in a program library
- Write program code similar to C programming language

Simple Project

GX Developer

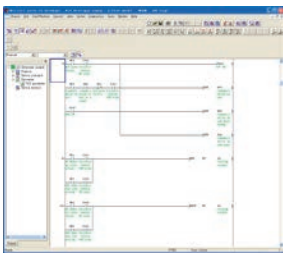

Import

GX Works2

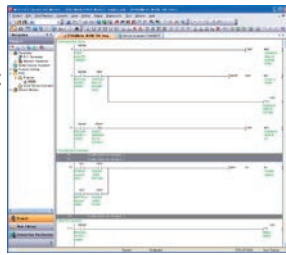

Structured Project

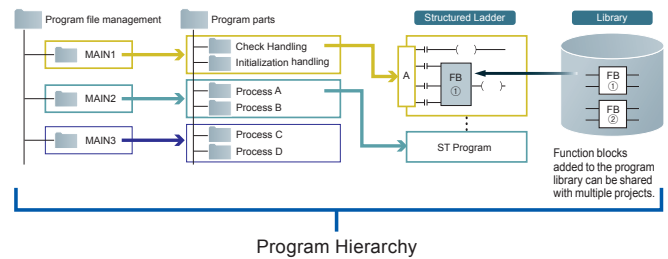

Programming Software

GX Works2

The key to good software is that it is easy to use and intuitive. The GX Works2 PLC programming package offers this in an exceptional way with different programming styles and advanced options. Other features like excellent debugging options, project documentation, and security management and more, reduce the total cost throughout a project.

FX Programming Packages

FX Configurator-FP & FX Configurator-EN(-L)

When using the FX3U-20SSC-H positioning block, or the FX3U-ENET Ethernet block, these FX programming packages simplify special function block setup and enable dedicated monitoring and testing capabilities between the PC and the module. The FX Configurator-FP configures the FX3U-20SSC-H positioning unit, including the parameter of the connected servos and features extensive monitoring and testing functions. The FX Configurator-EN(-L) provides an easy setup environment for the FX3U-ENET(-L) Ethernet block.

Screen Design Software

GT Works3

The all new GT Works3 is the most advanced screen design environment.

Experience the dawn of a new era in visualization Design. To quickly transform the front end of your machine into a more user friendly and sophisticated interface you need a design environment that is both intuitive and efficient. GT Works3 is the quintessential environment for visual design and configuration. User-oriented functions are integrated based on three main concepts - simplicity, definition and ease of use.

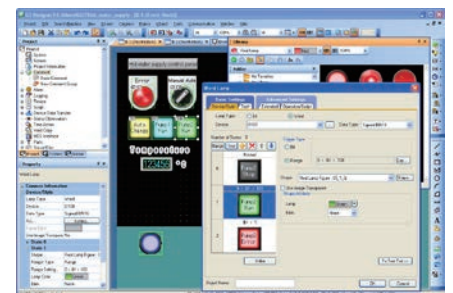
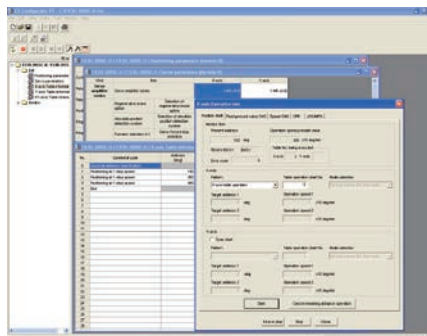
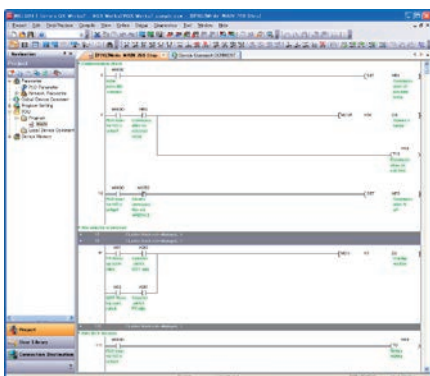

Technical Information Section

1. FX Main Units

SYSTEM DESCRIPTION & SPECIFICATIONS

◆ FX series Selection Guide	26
◆ FX PLC Extension Explanation	27
◆ FX series Configuration	28
◆ Programming Specifications	34
◆ Instruction	36
◆ Environmental & Electrical Specifications	39
◆ FX Main Units Specifications	41
◆ Description of Unit Components	46

2. FX Input/Output Extension

◆ I/O Extension	50
-----------------------	----

3. FX Analog Extension

◆ Analog Input	55
◆ Analog Output	57
◆ Combination Analog Input & Output	59
◆ Temperature Input	60

4. FX High-Speed I/O & Positioning Extension

◆ High-Speed Input & Counters	62
◆ High-Speed Output & Positioning	63

5. FX Communication & Networking Extension

◆ Serial Communication	66
◆ Networking	68

6. FX Data Management

◆ Data Management	71
-------------------------	----

7. FX Interfaces & Power Supplies

◆ Interface Options	72
◆ Power Supply Units	73

8. Accessories

◆ Memory Cassettes & Backup Batteries	74
◆ Interface Units & Terminal Blocks	75
◆ Display Modules	76
◆ Connection Cables & Connectors	77

9. α Controllers

◆ α 2 Main Units	78
◆ α series Extension Modules & Accessories	80

10. Software & Programming

◆ MELSOFT	82
◆ Software and unit for programming and configuration	83

Certifications	86
----------------------	----

Index	88
-------------	----

FX SERIES SELECTION GUIDE







		Terminal-type I/O				Connector-type I/O			
		Non-Extendable*	Extendable		Extendable				
		<i>FX3S</i>	<i>FX3G</i>	<i>FX3GE</i>	<i>FX3U</i>	<i>FX3GC</i>	<i>FX3UC</i>		
System Item	Item Specification*								
Hardware	I/O points	Up to 30 local I/O's	✓	★	★	★	★	★	
		Up to 128 local I/O's		✓	✓	★	✓	★	
		Up to 256 local I/O's				✓		✓	
		Up to 256 local and network I/O's		✓	✓	★	✓	★	
		Up to 384 local and network I/O's				✓		✓	
	Power Supply	AC Power	✓	✓	✓	✓			
		DC Power	✓	✓		✓	✓	✓	
	Input type	100 V AC				✓			
		24 V DC	✓	✓	✓	✓	✓	✓	
	Output type	Relay	✓	✓	✓	✓		✓	
		Transistor	✓	✓	✓	✓	✓	✓	
		Triac				✓			
	CPU Speed	Standard	✓	✓	✓	★	✓	★	
		Advanced				✓		✓	
	Communication ports	USB	✓	✓	✓		✓		
RS-422		✓	✓	✓	✓	✓	✓		
Ethernet				✓					
Analog I/O	Input : 2 Output : 1	✓*1		✓					
Options	Analog I/O (Current / Voltage)	Up to 4 ADP channels	✓	✓	✓	✓	✓		
		Up to 8 ADP channels		✓*2		★	✓	★	
		Up to 16 ADP channels				✓		✓	
		Up to 64 special function block channels		✓	✓	✓	✓	✓	
	Temperature Sensor Input	Up to 4 ADP input channels	✓	✓	✓	✓	✓	✓	
		Up to 8 ADP input channels		✓*2		★	✓	★	
		Up to 16 ADP input channels				✓		✓	
		Up to 64 special function block input channels		✓	✓	✓	✓	✓	
	Network	Temperature control		✓	✓	✓	✓	✓	
		CC-Link (Master/Slave)		✓	✓	✓	✓	✓	
		CANopen®		✓	✓	✓	✓	✓	
		J1939		✓	✓	✓	✓	✓	
		Ethernet	✓	✓	✓	✓	✓	✓	
	Communication	PROFIBUS-DP	Master				✓	✓	
			Slave		✓	✓	✓	✓	
N : N Network/Parallel Link		Computer Link (RS-232C/RS-485)	✓	✓	✓	✓	✓	✓	
		Non-Protocol Communication	1 Channel (RS-232C/RS-485)	✓	★	✓	★	★	★
			Multi-Channel (RS-232C)		✓		✓	✓	✓
			Multi-Channel (RS-485)		✓		✓	✓	✓
		Add-on Communication Ports	RS-485	✓	✓	✓	✓	✓	✓
			RS-232C	✓	✓	✓	✓	✓	✓
Embedded USB		✓	✓	✓		✓			
MODBUS		✓	✓	✓	✓	✓	✓		
Inverter Control	Analog	✓	✓	✓	✓	✓	✓		
	Pulse width modulation	✓	✓	✓	✓	✓	✓		
	RS-485 Communication	✓	✓	✓	✓	✓	✓		
Positioning	1 - 2 100 kHz Axis Built-in Positioning	✓	✓	✓	★	✓	★		
	Up to 3 x 100 kHz Axis Built-in Positioning		✓*3	✓*3	✓		✓		
	Up to 4 x 200 kHz Axis with High-Speed Output Adapters				✓				
	Up to 8 x 1 MHz Axis with Special Function Blocks				✓		✓		
	Up to 16 SSCNET III Axis with Special Function Blocks				✓		✓		
Cam switching				✓		✓			
High-Speed Counters	Up to 6 high speed counters, Max. 60 kHz	✓	✓	✓	★	✓	★		
	Up to 8 high speed counters, Max. 100 kHz				✓		✓		
	Up to 8 high speed counters with 200 kHz Adapter				✓				
	Additional Extension using High-Speed Counter Block				✓		✓		
Storage	Source data storage				✓		✓		
Data Logging	CF card Adapter				✓		✓		

*: Some items require additional extension modules in order to function where other connection rules and requirements may apply. For more details, refer to the respective product manuals.

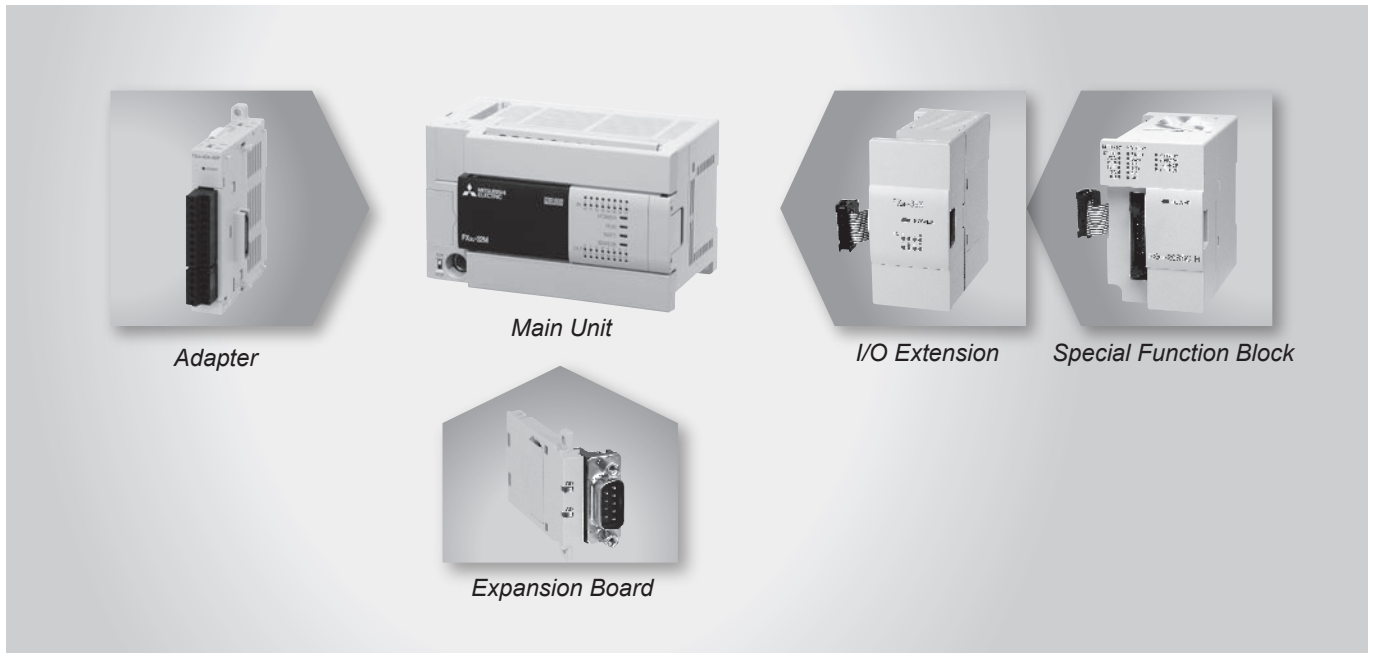
✓ : Contains required functionality
 ★ : Higher functionality or more expandability

*1: FX3S-30M□/ES□-2AD
 *2: 14 and 24 I/O points main units: Max. 4 channels
 *3: 14 and 24 I/O points main units: Max. 2 axes



<p>Expansion Boards</p> 	<p>The expansion boards, also called BDs, are a basic CPU function extension. Thanks to the compact dimensions no additional installation space is required. Programming is done directly via special commands and dedicated data register in the PLC. Available are serial communication, analog and digital I/O BDs.</p>
<p>Adapters</p> 	<p>The Special Adapters, also called ADPs, add standard high-speed functions to the PLC. Mounted on the left side, these units are extremely compact and easy to use. The programming is similar to the BDs via special commands and dedicated data registers in the PLC. Available are various serial communication, Ethernet, analog, temperature input, positioning, high-speed counting and data logging ADPs. Compared to the BDs the ADPs offer more flexibility and performance.</p>
<p>Special Function Blocks</p> 	<p>The Special Function Blocks, also called SFBs, are the most advanced function extension available for the FX PLC. Thanks to the standardized communication via memory integrated into the SFBs, programming is straightforward. The integrated CPU performs PLC scan time independent operation perfectly fitted for networking or positioning tasks, thus reducing the load on the PLC main unit. Up to 8 different units can be connected to the main unit. Available are analog, serial communication, networking, positioning, high-speed counting and temperature control. Compared to the ADPs, the SFBs offer higher functionality and more flexibility. Dedicated SFBs for the FX3GC and FX3UC are available as well.</p>
<p>I/O Extensions</p> 	<p>Digital I/O extensions are available with or without power supply. A wide range from 8 to 48 I/O points with different inputs and outputs are available. There is no limitation on the number of extension units or blocks, you can design the system to match application requirements, just make sure to check the system power supply and number of available I/O points. Dedicated I/O blocks for the FX3GC and FX3UC are available as well.</p>

FX SERIES CONFIGURATION

FX3U

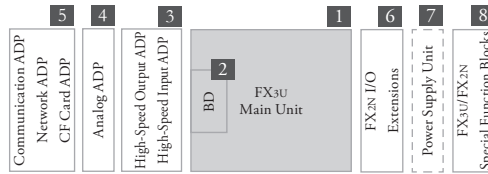

Expansion Boards

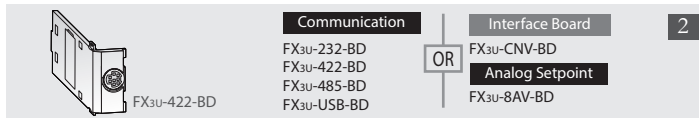

Special Adapters

5

FX3U-ENET-ADP

Communication

FX3U-232ADP-MB
FX3U-485ADP-MB

Network

FX3U-ENET-ADP*1

Data Logging

FX3U-CF-ADP*2

4

FX3U-4AD-PTW-ADP

Analog

FX3U-4AD-ADP
FX3U-4DA-ADP
FX3U-3A-ADP*2

Temperature

FX3U-4AD-PT-ADP
FX3U-4AD-PTW-ADP
FX3U-4AD-TC-ADP
FX3U-4AD-PNK-ADP

3

FX3U-4HSX-ADP

High Speed Counter

FX3U-4HSX-ADP

Positioning

FX3U-2HSY-ADP

FX3u Main Units

2

FX3U Main Unit

1

FX3U-32M

FX3u Main Units 16-128 I/O

FX3U-16MR/ES(-A)	AC D R	FX3U-48MR/ES(-A)	AC D R	FX3U-80MR/ES(-A)	AC D R
FX3U-16MT/ES(-A)	AC D T1	FX3U-48MT/ES(-A)	AC D T1	FX3U-80MT/ES(-A)	AC D T1
FX3U-16MT/ESS	AC D T2	FX3U-48MT/ESS	AC D T2	FX3U-80MT/ESS	AC D T2
FX3U-16MR/D5	DC D R	FX3U-48MR/D5	DC D R	FX3U-80MR/D5	DC D R
FX3U-16MT/D5	DC D T1	FX3U-48MT/D5	DC D T1	FX3U-80MT/D5	DC D T1
FX3U-16MT/D5S	DC D T2	FX3U-48MT/D5S	DC D T2	FX3U-80MT/D5S	DC D T2
FX3U-32MR/ES(-A)	AC D R	FX3U-64MR/ES(-A)	AC D R	FX3U-128MR/ES(-A)	AC D R
FX3U-32MT/ES(-A)	AC D T1	FX3U-64MT/ES(-A)	AC D T1	FX3U-128MT/ES(-A)	AC D T1
FX3U-32MT/ESS	AC D T2	FX3U-64MT/ESS	AC D T2	FX3U-128MT/ESS	AC D T2
FX3U-32MS/ES	AC D TR	FX3U-64MS/ES	AC D TR		
FX3U-32MR/D5	DC D R	FX3U-64MR/D5	DC D R		
FX3U-32MT/D5	DC D T1	FX3U-64MT/D5	DC D T1		
FX3U-32MT/D5S	DC D T2	FX3U-64MT/D5S	DC D T2		
FX3U-32MR/UA1	AC E R	FX3U-64MR/UA1	AC E R		

AC AC Power supply R Relay Output
 DC DC Power supply T1 Transistor (sink)
 D DC Input (sink/source) T2 Transistor (source)
 E AC Input TR Triac Output

Optional Equipment and Software

GT25

GT25

GOT

GOT2000
(GT27/GT25/GT23/GT21)
GOT SIMPLE

Interface Converters

FX-USB-AW
FX-232AWC-H

Software

GX Developer
GX Works2

*1: Firmware version 3.10 or later. *2: Firmware version 2.61 or later.

FX3UC

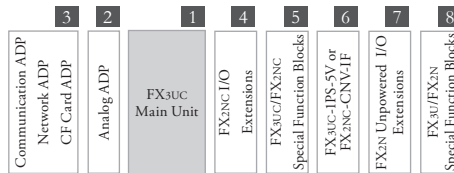

Special Adapters

3

FX3U-ENET-ADP

Network

FX3U-ENET-ADP*1

Data Logging

FX3U-CF-ADP*2

2

FX3U-4AD-ADP

Analog

FX3U-4AD-ADP
FX3U-4AD-PT-ADP
FX3U-4AD-PTW-ADP
FX3U-4AD-TC-ADP
FX3U-4AD-PNK-ADP

2

FX3U-4AD-PNK-ADP

Temperature

FX3uc Main Units

2

FX3UC Main Unit

1

FX3UC-64M

FX3uc Main Units 16-96 I/O

FX3UC-16MT/D*	DC D1 T1		
FX3UC-16MT/D5S	DC D2 T2		
FX3UC-16MR/D-T*	DC D1 R		
FX3UC-16MR/D5-T	DC D2 R		
FX3UC-32MT/D*	DC D1 T1		
FX3UC-32MT/D5S	DC D2 T2		
FX3UC-64MT/D*	DC D1 T1		
FX3UC-64MT/D5S	DC D2 T2		
FX3UC-96MT/D*	DC D1 T1		
FX3UC-96MT/D5S	DC D2 T2		

DC DC Power supply
 D1 DC Input (sink)
 D2 DC Input (sink/source)
 R Relay Output
 T1 Transistor Output (sink)
 T2 Transistor Output (source)

* Refer to the HARDWARE MANUAL for system configuration.

Optional Equipment and Software

GT25

GT25

GOT

GOT2000
(GT27/GT25/
GT23/GT21)
GOT SIMPLE

Software

GX Developer
GX Works2

Interface Converters

FX-USB-AW
FX-232AWC-H

Accessories

FX3U-FLROM-64L

FX3U-FLROM-64L

Memory Cassettes

FX3U-FLROM-16
FX3U-FLROM-64
FX3U-FLROM-64L
FX3U-FLROM-1M*3

I/O Cables

General I/O cable
FX-16E-500CAB-S (5m)

Connecting to Terminal Blocks

FX-16E-150CAB (1.5 m)
FX-16E-300CAB (3 m)
FX-16E-500CAB (5 m)

*1: Firmware version 3.10 or later. *2: The FX3uc supports the FX3U-CF-ADP and FX3U-3A-ADP from firmware version 2.61 or later. *3: Firmware version 3.00 or later.

Special Function Modules

I/O Extension Modules

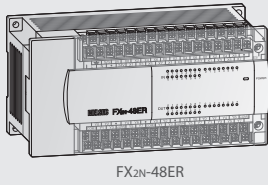

Powered Extension Units

Input/Output Extension Units

FX2N-32ER-ES/UL
FX2N-32ET-ESS/UL
FX2N-48ER-DS
FX2N-48ER-ES/UL
FX2N-48ER-UA1/UL
FX2N-48ET-DSS
FX2N-48ET-ESS/UL

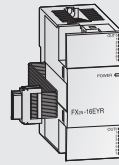
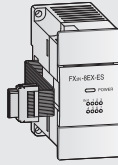

Unpowered Extension Blocks

Input Extension Blocks

FX2N-8EX-ES/UL
FX2N-8EX-UA1/UL
FX2N-16EX-ES/UL

Output Extension Blocks

FX2N-8EYR-ES/UL
FX2N-8EYT-ESS/UL
FX2N-16EYR-ES/UL
FX2N-16EYT-ESS/UL
FX2N-16EYS

Input/Output Extension Block

FX2N-8ER-ES/UL

Power Supply Unit

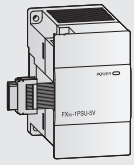

Power Supply Unit
FX3U-1PSU-5V

Special Function Blocks

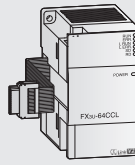
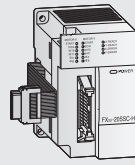

Analog	Positioning	Network	Communication
FX2N-2AD FX3U-4AD FX2N-2DA FX3U-4DA FX2N-5A FX2N-8AD	FX3U-1PG FX2N-10PG FX3U-20SSC-H FX2N-1RM-E-SET FX2N-10GM FX2N-20GM	FX2N-32CCL FX3U-16CCL-M FX3U-64CCL FX3U-ENET FX3U-ENET-L FX3U-128ASL-M	FX2N-232IF
Temperature	High Speed Counter		
FX2N-2LC*3 FX3U-4LC	FX2N-1HC FX3U-2HC		

Accessories

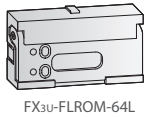

Memory Cassettes

FX3U-FLROM-16
FX3U-FLROM-64
FX3U-FLROM-64L
FX3U-FLROM-1M*4



Display Module

FX3U-7DM

Display Module Holder

FX3U-7DM-HLD



Extension Cables

FX0N-30EC (30 cm)
FX0N-65EC (65 cm)

Battery

FX3U-32BL

PLC Bus Connector

FX2N-CNV-BC

*3: Production will be discontinued in March 2018. *4: Firmware version 3.00 or later.

Special Function Modules*4

I/O Extension Blocks

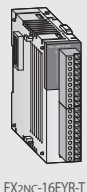

Input Extension Blocks

FX2NC-16EX-T-DS
FX2NC-16EX-DS
FX2NC-32EX-DS

Output Extension Blocks

FX2NC-16EYR-T-DS
FX2NC-16EYT-DSS
FX2NC-32EYT-DSS

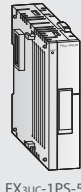

Power Supply Unit

FX3UC-1PS-5V

Interface Converter

FX2NC-CNV-IF

Unpowered Extension Blocks

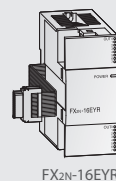
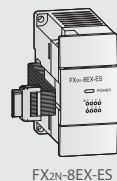

Input Extension Blocks

FX2N-8EX-ES/UL
FX2N-8EX-UA1/UL
FX2N-16EX-ES/UL

Output Extension Blocks

FX2N-8EYR-ES/UL
FX2N-8EYT-ESS/UL
FX2N-16EYR-ES/UL
FX2N-16EYT-ESS/UL
FX2N-16EYS

Input/Output Extension Block

FX2N-8ER-ES/UL

Special Function Blocks

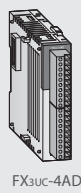

Analog
FX3UC-4AD
High Speed Counter
FX2NC-1HC

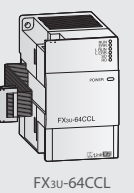
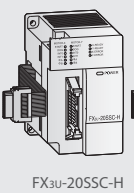
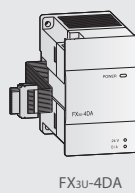

Analog	Positioning	Network	Communication
FX2N-2AD FX3U-4AD FX2N-2DA FX3U-4DA FX2N-5A FX2N-8AD	FX3U-1PG FX2N-10PG FX2N-10GM FX2N-1RM-E-SET FX3U-20SSC-H FX2N-20GM	FX2N-32CCL FX3U-16CCL-M FX3U-64CCL FX3U-ENET FX3U-ENET-L FX3U-128ASL-M	FX2N-232IF
Temperature	High Speed Counter		
FX2N-2LC*5 FX3U-4LC	FX2N-1HC FX3U-2HC		

Connector Parts

FX2c-I/O-CON
FX2c-I/O-CON-S
FX2c-I/O-CON-SA

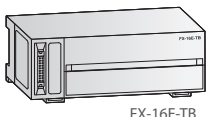

Terminal Blocks

FX-16E-TB
FX-16E-TB/UL
FX-16EYR-TB
FX-16EYR-ES-TB/UL
FX-16EYS-TB
FX-16EYT-TB
FX-16EYT-ES-TB/UL
FX-16EYT-ES-TB/UL

Input Switches

FX2c-16SW-C
FX2c-16SW-TB

Battery

FX3U-32BL



Extension Cables

FX0N-30EC (30 cm)
FX0N-65EC (65 cm)

PLC Bus Connector

FX2N-CNV-BC

Power Supply Cables
FX2NC-100PCB(1 m)
FX2NC-100BPCB(1 m)
FX2NC-108BPCB1(0.1 m)

*4: The special function Modules of FX3uc-****/DS(S)(). *5: Production will be discontinued in March 2018.

FX SERIES CONFIGURATION

FX3G

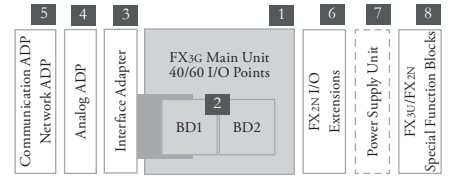
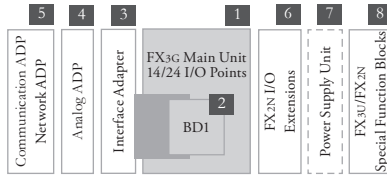

Special Adapters

5

FX3U-232ADP-MB FX3U-485ADP-MB

Communication

FX3U-232ADP-MB
FX3U-485ADP-MB

Network

FX3U-ENET-ADP*1

4

FX3U-4AD-ADP FX3U-4AD-PNK-ADP

Analog

FX3U-4AD-ADP
FX3U-4DA-ADP
FX3U-3A-ADP*2

Temperature

FX3U-4AD-PT-ADP
FX3U-4AD-TC-ADP
FX3U-4AD-PTW-ADP
FX3U-4AD-PNK-ADP

3

FX3G-CNV-ADP

Interface Adapter

FX3G-CNV-ADP

*1: Firmware version 2.00 or later. *2: Firmware version 1.20 or later.

Optional Equipment and Software

GT25

- GOT**
GOT2000 (GT27/GT25/GT23/GT21)
GOT SIMPLE
- Interface Converter**
FX-232AWC-H
- Software**
GX Developer
GX Works2

*3: Firmware version 1.10 or later. *4: Firmware version 2.20 or later.

Expansion Boards

FX3G-232-BD

Communication

FX3G-232-BD
FX3G-422-BD
FX3G-485-BD
FX3G-485-BD-RJ

Analog Setpoint

FX3G-8AV-BD*3

Analog

FX3G-2AD-BD*3
FX3G-1DA-BD*3

Input/Output

FX3G-4EX-BD*4
FX3G-2EYT-BD*4

FX3G Main Units

FX3G-24M FX3G-40M

FX3G Main Units 14-60 I/O

FX3G-14MR/ES(-A)	AC	D	R	FX3G-40MR/ES(-A)	AC	D	R
FX3G-14MT/ES(-A)	AC	D	T1	FX3G-40MT/ES(-A)	AC	D	T1
FX3G-14MT/ESS	AC	D	T2	FX3G-40MT/ESS	AC	D	T2
FX3G-14MR/DS	DC	D	R	FX3G-40MR/DS	DC	D	R
FX3G-14MT/DS	DC	D	T1	FX3G-40MT/DS	DC	D	T1
FX3G-14MT/DS	DC	D	T2	FX3G-40MT/DS	DC	D	T2
FX3G-24MR/ES(-A)	AC	D	R	FX3G-60MR/ES(-A)	AC	D	R
FX3G-24MT/ES(-A)	AC	D	T1	FX3G-60MT/ES(-A)	AC	D	T1
FX3G-24MT/ESS	AC	D	T2	FX3G-60MT/ESS	AC	D	T2
FX3G-24MR/DS	DC	D	R	FX3G-60MR/DS	DC	D	R
FX3G-24MT/DS	DC	D	T1	FX3G-60MT/DS	DC	D	T1
FX3G-24MT/DS	DC	D	T2	FX3G-60MT/DS	DC	D	T2

AC AC Power supply **R** Relay Output
DC DC Power supply **T1** Transistor Output (sink)
D DC Input (sink/source) **T2** Transistor Output (source)

FX3GE

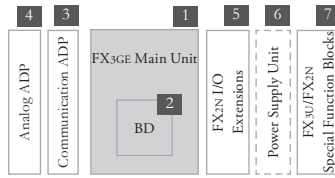

Special Adapters

4

FX3U-4AD-ADP FX3U-4AD-PNK-ADP

Analog

FX3U-4AD-ADP
FX3U-4DA-ADP
FX3U-3A-ADP

Temperature

FX3U-4AD-PT-ADP
FX3U-4AD-PTW-ADP
FX3U-4AD-TC-ADP
FX3U-4AD-PNK-ADP

3

FX3U-232ADP-MB FX3U-485ADP-MB

Communication

FX3U-232ADP-MB
FX3U-485ADP-MB

Optional Equipment and Software

GT25

- GOT**
GOT2000 (GT27/GT25/GT23/GT21)
GOT SIMPLE
- Interface Converter**
FX-232AWC-H
- Software***1
GX Developer
GX Works2

*1: To program FX3GE, select FX3G as the PLC type.

Expansion Boards

FX3G-232-BD

Communication

FX3G-232-BD
FX3G-422-BD
FX3G-485-BD
FX3G-485-BD-RJ

Analog Setpoint

FX3G-8AV-BD

Analog

FX3G-2AD-BD
FX3G-1DA-BD

Input/Output

FX3G-4EX-BD
FX3G-2EYT-BD

FX3GE Main Units



FX3GE-24M

FX3GE Main Units 24-40 I/O



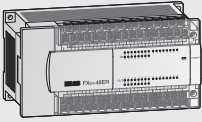

FX3GE-24MR/ES	AC	D	R	FX3GE-40MR/ES	AC	D	R
FX3GE-24MT/ES	AC	D	T1	FX3GE-40MT/ES	AC	D	T1
FX3GE-24MT/ESS	AC	D	T2	FX3GE-40MT/ESS	AC	D	T2
FX3GE-24MR/DS	DC	D	R	FX3GE-40MR/DS	DC	D	R
FX3GE-24MT/DS	DC	D	T1	FX3GE-40MT/DS	DC	D	T1
FX3GE-24MT/DS	DC	D	T2	FX3GE-40MT/DS	DC	D	T2

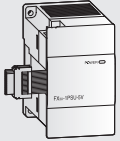
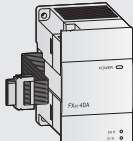
AC AC Power supply **R** Relay Output
DC DC Power supply **T1** Transistor Output (sink)
D DC Input (sink/source) **T2** Transistor Output (source)

Special Function Modules

I/O Extension Modules			Powered Extension Units			Unpowered Extension Blocks			6
 <p>FX2N-48ER</p>	Input/Output Extension Units		 <p>FX2N-8EX-ES</p>	Input Extension Blocks		Output Extension Blocks		Input/Output Extension Block	
	FX2N-32ER-ES/UL FX2N-32ET-ESS/UL FX2N-48ER-DS FX2N-48ER-ES/UL FX2N-48ER-UA1/UL FX2N-48ET-DSS FX2N-48ET-ESS/UL			FX2N-8EX-ES/UL FX2N-8EX-UA1/UL FX2N-16EX-ES/UL		FX2N-8EYR-ES/UL FX2N-8EYT-ESS/UL FX2N-16EYR-ES/UL FX2N-16EYT-ESS/UL FX2N-16EYS		FX2N-8ER-ES/UL	
Power Supply Unit			Special Function Blocks			8			
 <p>FX3U-1PSU-5V</p>	Power Supply Unit		 <p>FX3U-4DA</p>	Analog		Temperature		Network	
	FX3U-1PSU-5V			FX2N-2AD FX3U-4AD FX2N-2DA FX3U-4DA FX2N-5A FX2N-8AD		FX2N-2LC*3 FX3U-4LC		FX2N-32CCL FX3U-16CCL-M FX3U-64CCL FX3U-ENET FX3U-128ASL-M	

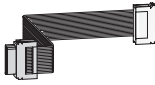
Accessories



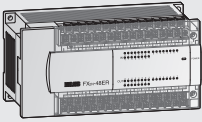
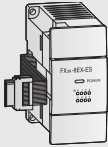
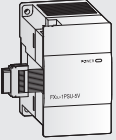
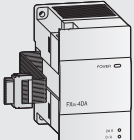

 <p>FX3G-EEPROM-32L</p>	Memory Cassette FX3G-EEPROM-32L	 <p>FX3G-5DM</p>	Display Module FX3G-5DM	 <p>FX0N-65EC</p>	Extension Cables FX0N-30EC (30 cm) FX0N-65EC (65 cm)	 <p>FX2N-CNV-BC</p>	PLC Bus Connector FX2N-CNV-BC	 <p>FX3U-32BL</p>	Battery FX3U-32BL
--	---	---	-----------------------------------	--	---	--	---	--	-----------------------------

*5: Production will be discontinued in March 2018.

Special Function Modules

I/O Extension Modules			Powered Extension Units			Unpowered Extension Blocks			5
 <p>FX2N-48ER</p>	Input/Output Extension Units		 <p>FX2N-8EX-ES</p>	Input Extension Blocks		Output Extension Blocks		Input/Output Extension Block	
	FX2N-32ER-ES/UL FX2N-32ET-ESS/UL FX2N-48ER-DS FX2N-48ER-ES/UL FX2N-48ER-UA1/UL FX2N-48ET-DSS FX2N-48ET-ESS/UL			FX2N-8EX-ES/UL FX2N-8EX-UA1/UL FX2N-16EX-ES/UL		FX2N-8EYR-ES/UL FX2N-8EYT-ESS/UL FX2N-16EYR-ES/UL FX2N-16EYT-ESS/UL FX2N-16EYS		FX2N-8ER-ES/UL	
Power Supply Unit			Special Function Blocks			7			
 <p>FX3U-1PSU-5V</p>	Power Supply Unit		 <p>FX3U-4DA</p>	Analog		Temperature		Network	
	FX3U-1PSU-5V			FX2N-2AD FX3U-4AD FX2N-2DA FX3U-4DA FX2N-5A FX2N-8AD		FX2N-2LC*2 FX3U-4LC		FX2N-32CCL FX3U-16CCL-M FX3U-64CCL FX3U-ENET FX3U-128ASL-M	

Accessories

 <p>FX3G-EEPROM-32L</p>	Memory Cassette FX3G-EEPROM-32L	 <p>FX3G-5DM</p>	Display Module FX3G-5DM	 <p>FX0N-65EC</p>	Extension Cables FX0N-30EC (30 cm) FX0N-65EC (65 cm)	 <p>FX2N-CNV-BC</p>	PLC Bus Connector FX2N-CNV-BC	 <p>FX3U-32BL</p>	Battery FX3U-32BL
--	---	---	-----------------------------------	--	---	--	---	--	-----------------------------

*2: Production will be discontinued in March 2018.

FX SERIES CONFIGURATION

FX3GC

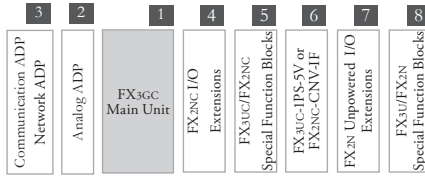

Special Adapters

3

Network
FX3U-ENET-ADP*1

Communication
FX3U-232ADP-MB
FX3U-485ADP-MB

2

Analog
FX3U-4AD-ADP
FX3U-4DA-ADP
FX3U-3A-ADP

Temperature
FX3U-4AD-PT-ADP
FX3U-4AD-TC-ADP
FX3U-4AD-PTW-ADP
FX3U-4AD-PNK-ADP

FX3GC Main Units

1

FX3GC Main Units 32 I/O
FX3GC-32MT/D* DC D1 T1
FX3GC-32MT/DSS DC D2 T2

DC DC Power supply T1 Transistor Output (sink)
D1 D1 DC input (sink) T2 Transistor Output (source)
D2 D2 DC input (sink, source)

* Refer to the HARDWARE MANUAL for system configuration.

*1: Firmware version 2.00 or later.

Optional Equipment and Software

■ GOT
GOT2000 (GT27/GT25/GT23/GT21)
GOT SIMPLE

■ Interface Converter
FX-232AWC-H

■ Software
GX Developer
GX Works2

Accessories

■ I/O Cables
General I/O cable
FX-16E-500CAB-S (5 m)

■ Connecting to Terminal Blocks
FX-16E-150CAB (1.5 m)
FX-16E-300CAB (3 m)
FX-16E-500CAB (5 m)

FX3S

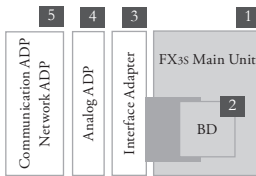

Special Adapters

5

Network
FX3U-ENET-ADP*1

Communication
FX3U-232ADP-MB
FX3U-485ADP-MB

4

Analog
FX3U-4AD-ADP
FX3U-4DA-ADP
FX3U-3A-ADP

Temperature
FX3U-4AD-PT-ADP
FX3U-4AD-TC-ADP
FX3U-4AD-PTW-ADP
FX3U-4AD-PNK-ADP

3

Interface Adapter
FX3S-CNV-ADP

*1: The FX3S is supported by FX3U-ENET-ADP Ver. 1.20 or later.

Optional Equipment and Software

■ GOT
GOT2000 (GT27/GT25/GT23/GT21)
GOT SIMPLE

■ Interface Converter
FX-232AWC-H

■ Software
GX Works2

Expansion Boards

2

Communication
FX3G-232-BD
FX3G-422-BD
FX3G-485-BD
FX3G-485-BD-RJ

Analog
FX3G-2AD-BD
FX3G-1DA-BD

Input/Output
FX3G-4EX-BD*2
FX3G-2EYT-BD*2

Analog Setpoint
FX3G-8AV-BD

*2: Firmware version 1.10 or later.

FX MAIN UNITS

Special Function Modules

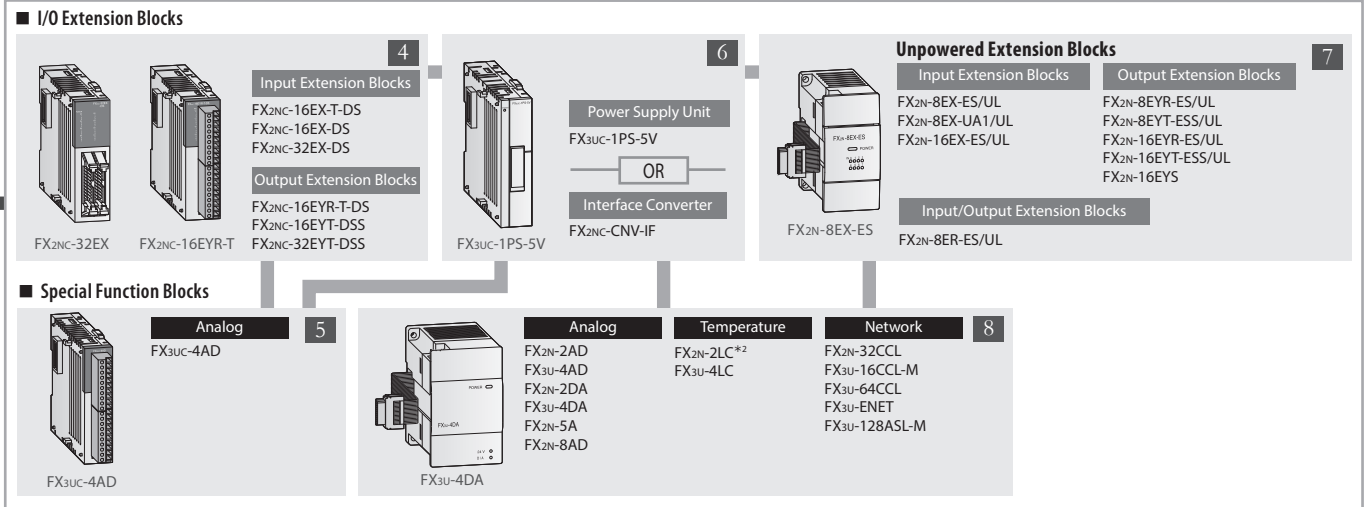

*2: Production will be discontinued in March 2018.

■ Connector Parts

FX2c-I/O-CON
FX2c-I/O-CON-S
FX2c-I/O-CON-SA

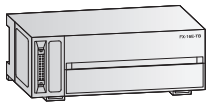

FX16E-TB

■ Terminal Blocks

FX-16E-TB FX-16EYS-TB
FX-16E-TB/UL FX-16EYS-ES-TB/UL
FX-16EYR-TB FX-16EYT-TB
FX-16EYR-ES-TB/UL FX-16EYT-ES-TB/UL

FX-16EYT-ESS-TB/UL
FX-32E-TB
FX-32E-TB/UL

■ Input Switches

FX2c-16SW-C
FX2c-16SW-TB

■ Battery
FX3U-32BL



FX0N-65EC
■ Extension Cables
FX0N-30EC (30 cm)
FX0N-65EC (65 cm)

■ PLC Bus Connector

FX2N-CNV-BC

■ Power Supply Cables

FX2NC-100MPCB (1 m)
FX2NC-100BPCB (1 m)
FX2NC-10BPCB1 (0.1 m)

FX3s Main Units

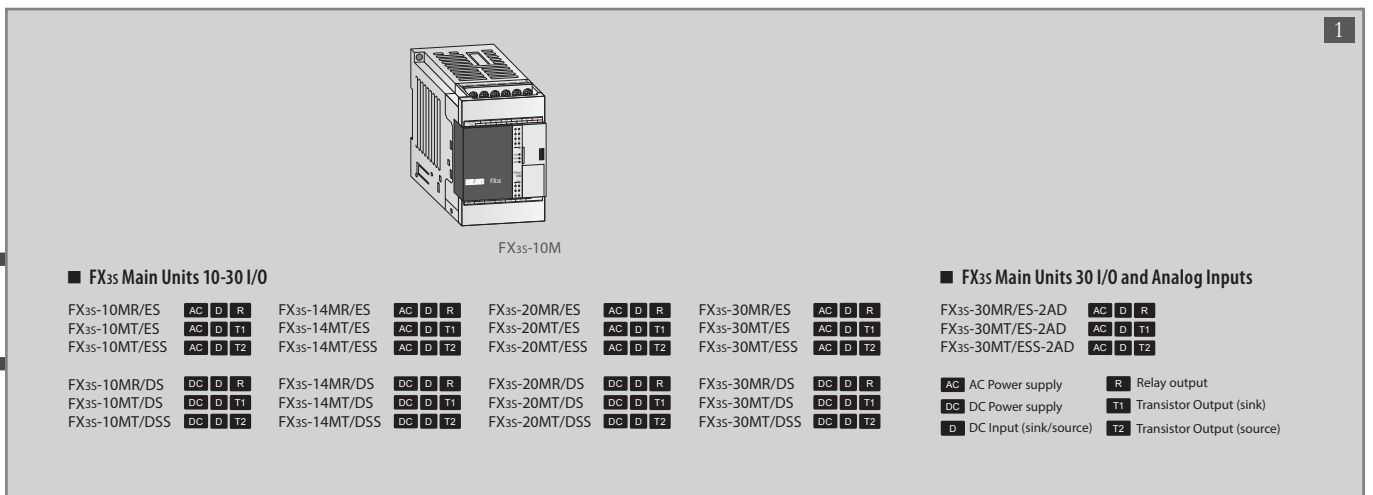

Accessories

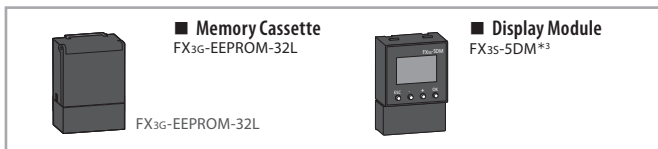

*3: Firmware version 1.20 or later.

PROGRAMMING SPECIFICATIONS

Programming Specifications

Programming

System specifications		FX3s	FX3G/FX3GC/FX3GE	FX3U/FX3UC
I/O points		30 total	256 total (combined local and CC-Link or AnyWireASLINK remote I/O)	384 total (combined local and CC-Link or AnyWireASLINK remote I/O)
Address range		Max. 30 direct addressing	Max. 128 direct addressing and Max. 128 remote I/O	Max. 256 direct addressing and Max. 256 remote I/O
Program memory		16,000 steps EEPROM (Program capacity is 4,000 steps.)	32,000 steps EEPROM (internal), exchangeable EEPROM memory cassette*	64,000 steps RAM (internal), exchangeable FLROM memory cassette
Instruction Time	Basic instructions	0.21 μs/instruction	0.21 μs/instruction (Standard mode), 0.42 μs/instruction (Extension mode)	0.21 μs/instruction
	Applied instructions	0.5 μs to several hundred μs/instruction	0.5 μs to several hundred μs/instruction (Standard mode), 1.2 μs to several hundred μs/instruction	0.5 μs to several hundred μs/instruction
Number of instructions		29 sequence instructions, 2 step ladder instructions, 116 applied instructions	29 sequence instructions, 2 step ladder instructions, 125 applied instructions	29 sequence instructions, 2 step ladder instructions, 218 applied instructions
Programming language	Simple project	Ladder, SFC, ST (Structured Text)		
	Structured project	Structured Ladder/FBD, SFC, ST		
Program execution		Cyclical execution, refresh mode processing		
Program protection		2 different keywords, Max password length 16 characters		

*: Not for FX3GC

Devices

System specifications		FX3s	FX3G/FX3GC/FX3GE	FX3U/FX3UC
Auxiliary relays		1,536 total, with 1,408 general (M0 - M383 and M512 - M1535) and 128 EEPROM latched (M384 - M511)	7,680 total, with 384 general (M0 - M383), 1,152 EEPROM latched (M384 - M1535), and 6,144 general/optional latched (M1536 - M7679)	7,680 total, with 500 general (M0 - M499), 524 optional latched (M500 - M1023), and 6,656 latched (M1024 - M7679)
Special auxiliary relays		512 (M8000 - M8511)		
State relays		256 total, with 128 EEPROM latched (S0 - S127) and 128 general (S128 - S255)	4,096 total, with 1,000 EEPROM latched (S0 - S999) and 3,096 general/optional latched (S1000 - S4095)	4,096 total, with 1,000 optional latched (S0 - S999) and 3,096 latched (S1000 - S4095)
Timers		169 total, with 69 100 ms (T0 - T62 and T132 - T137), 31 100/10 ms (T32 - T62), and 69 1 ms (T63 - T131)	320 total, with 206 100 ms (T0 - T199 and T250 - T255), 46 10 ms (T200 - T245), and 68 1 ms (T246 - T249 and T256 - T319)	512 total, with 206 100 ms (T0 - T191, T192 - T199 and T250 - T255), 46 10 ms (T200 - T245), and 260 1 ms (T246 - T249 and T256 - T511)
External setpoint entry via potentiometer		2*		
Counters		67 total (16 bit and 32 bit), with 51 general (C0 - C15 and C200 - C234) and 16 EEPROM latched (C16 - C31)	235 total (16 bit and 32 bit), with 36 general (C0 - C15 and C200 - C219) and 199 EEPROM latched (C16 - C199 and C220 - C234)	235 total (16 bit and 32 bit), with 120 general (C0 - C99 and C200 - C219) and 115 latched (C100 - C199 and C220 - C234)
High-speed counters		21 total, with 16 1-phase (C235 - C250) and 5 2-phase (C251 - C255)		
High-speed counter speed		1-phase, 6 points max: 60 kHz/2 points, 10 kHz/4 points 2-phase, 2 points max: 30 kHz/1 point, 5 kHz/1 point	1-phase, 6 points max: 60 kHz/4 points, 10 kHz/2 points 2-phase, 3 points max: 30 kHz/2 points, 5 kHz/1 point	1-phase, 8 points max: 100 kHz/6 points 10 kHz/2 points 2-phase, 2 points max: 50 kHz/2 points
Real-time clock		Year, month, day, hour, minute, second, day of the week		
Data registers		3,000 total, with 2,872 general (D0 - D127 and D256 - D2999) and 128 EEPROM latched (D128 - D255)	8,000 total, with 128 general (D0 - D127), 972 EEPROM latched (D128 - D1099), and 6,900 general/optional latched (D1100 - D7999)	8,000 total, with 200 general (D0 - D199), 312 optional latched (D200 - D511), and 7,488 latched (D512 - D7999)
Extension registers		—	24,000 (R0 - R23999)	32,768 (R0 - R32767)
Extension file registers		—	24,000 (ER0 - R23999) internal/optional memory*	32,768 (ER0 - R32767) optional memory
Index registers		16		
Special data registers		512 (D8000 - D8511)		
Pointers		256	2,048	4,096
Nestings		8		
Interrupt inputs		6		
Constants		16 bit: K: -32,768 to +32,767; H: 0 to FFFF; 32 bit: K: -2,147,483,648 to +2,147,483,647; H: 0 to FFFF FFFF; E: -1.0×2^{128} to -1.0×2^{-126} , 0, 1.0×2^{-126} to 1.0×2^{128} Decimal-point and exponential notations are possible.		

*: Not for FX3GC

MEMO

INSTRUCTION

FNC No.	Mnemonic	Function	Applicable PLC		
			FX3S	FX3G/FX3GC/FX3GE	FX3U/FX3UC
Program Flow					
0	CJ	Conditional Jump	●	●	●
1	CALL	Call Subroutine	●	●	●
2	SRET	Subroutine Return	●	●	●
3	IRET	Interrupt Return	●	●	●
4	EI	Enable Interrupt	●	●	●
5	DI	Disable Interrupt	●	●	●
6	FEND	Main Routine Program End	●	●	●
7	WDT	Watchdog Timer Refresh	●	●	●
8	FOR	Start a FOR/NEXT Loop	●	●	●
9	NEXT	End a FOR/NEXT Loop	●	●	●
Move and Compare					
10	CMP	Compare	●	●	●
11	ZCP	Zone Compare	●	●	●
12	MOV	Move	●	●	●
13	SMOV	Shift Move	●	●	●
14	CML	Complement	●	●	●
15	BMOV	Block Move	●	●	●
16	FMOV	Fill Move	●	●	●
17	XCH	Exchange	—	—	●
18	BCD	Conversion to Binary Coded Decimal	●	●	●
19	BIN	Conversion to Binary	●	●	●
Arithmetic and Logical Operation (+, -, ×, ÷)					
20	ADD	Addition	●	●	●
21	SUB	Subtraction	●	●	●
22	MUL	Multiplication	●	●	●
23	DIV	Division	●	●	●
24	INC	Increment	●	●	●
25	DEC	Decrement	●	●	●
26	WAND	Logical Word AND	●	●	●
27	WOR	Logical Word OR	●	●	●
28	WXOR	Logical Exclusive OR	●	●	●
29	NEG	Negation	—	—	●
Rotation and Shift Operation					
30	ROR	Rotation Right	●	●	●
31	ROL	Rotation Left	●	●	●
32	RCR	Rotation Right with Carry	—	—	●
33	RCL	Rotation Left with Carry	—	—	●
34	SFTR	Bit Shift Right	●	●	●
35	SFTL	Bit Shift Left	●	●	●
36	WSFR	Word Shift Right	●	●	●
37	WSFL	Word Shift Left	●	●	●
38	SFWR	Shift Write [FIFO/FILO Control]	●	●	●
39	SFRD	Shift Read [FIFO Control]	●	●	●
Data Operation					
40	ZRST	Zone Reset	●	●	●
41	DECO	Decode	●	●	●
42	ENCO	Encode	●	●	●
43	SUM	Sum of Active Bits	●	●	●
44	BON	Check Specified Bit Status	●	●	●

FNC No.	Mnemonic	Function	Applicable PLC		
			FX3S	FX3G/FX3GC/FX3GE	FX3U/FX3UC
45	MEAN	Mean	●	●	●
46	ANS	Timed Annunciator Set	—	●	●
47	ANR	Annunciator Reset	—	●	●
48	SQR	Square Root	—	—	●
49	FLT	Conversion to Floating Point	●	●	●
High-Speed Processing					
50	REF	Refresh	●	●	●
51	REFF	Refresh and Filter Adjust	—	—	●
52	MTR	Input Matrix	●	●	●
53	HSCS	High-Speed Counter Set	●	●	●
54	HSCR	High-Speed Counter Reset	●	●	●
55	HSZ	High-Speed Counter Zone Compare	●	●	●
56	SPD	Speed Detection	●	●	●
57	PLSY	Pulse Y Output	●	●	●
58	PWM	Pulse Width Modulation	●	●	●
59	PLSR	Acceleration/Deceleration Setup	●	●	●
Handy Instruction					
60	IST	Initial State	●	●	●
61	SER	Search a Data Stack	●	●	●
62	ABSD	Absolute Drum Sequencer	●	●	●
63	INCD	Incremental Drum Sequencer	●	●	●
64	TTMR	Teaching Timer	—	—	●
65	STMR	Special Timer	—	—	●
66	ALT	Alternate State	●	●	●
67	RAMP	Ramp Variable Value	●	●	●
68	ROTC	Rotary Table Control	—	—	●
69	SORT	Sort Tabulated Data	—	—	●
External FX I/O Device					
70	TKY	Ten Key Input	—	—	●
71	HKY	Hexadecimal Input	—	—	●
72	DSW	Digital Switch (Thumbwheel Input)	●	●	●
73	SEGD	Seven Segment Decoder	—	—	●
74	SEGL	Seven Segment With Latch	●	●	●
75	ARWS	Arrow Switch	—	—	●
76	ASC	ASCII Code Data Input	—	—	●
77	PR	Print (ASCII Code)	—	—	●
78	FROM	Read From a Special Function Block	—	●	●
79	TO	Write To a Special Function Block	—	●	●
External FX Device					
80	RS	Serial Communication	●	●	●
81	PRUN	Parallel Run (Octal Mode)	●	●	●
82	ASCI	Hexadecimal to ASCII Conversion	●	●	●
83	HEX	ASCII to Hexadecimal Conversion	●	●	●
84	CCD	Check Code	●	●	●
85	VRRD	Volume Read	●	●*	●
86	VRSC	Volume Scale	●	●*	●
87	RS2	Serial Communication 2	●	●	●
88	PID	PID Control Loop	●	●	●

*: Not for FX3GC

FNC No.	Mnemonic	Function	Applicable PLC		
			FX5s	FX5c/FX5cc/FX5ce	FX5u/FX5uc
Data Transfer 2					
102	ZPUSH	Batch Store of Index Register	—	—	●
103	ZPOP	Batch POP of Index Register	—	—	●
Floating Point					
110	ECMP	Floating Point Compare	●	●	●
111	EZCP	Floating Point Zone Compare	—	—	●
112	EMOV	Floating Point Move	●	●	●
116	ESTR	Floating Point to Character String Conversion	—	—	●
117	EVAL	Character String to Floating Point Conversion	—	—	●
118	EBCD	Floating Point to Scientific Notation Conversion	—	—	●
119	EBIN	Scientific Notation to Floating Point Conversion	—	—	●
120	EADD	Floating Point Addition	●	●	●
121	ESUB	Floating Point Subtraction	●	●	●
122	EMUL	Floating Point Multiplication	●	●	●
123	EDIV	Floating Point Division	●	●	●
124	EXP	Floating Point Exponent	—	—	●
125	LOGE	Floating Point Natural Logarithm	—	—	●
126	LOG10	Floating Point Common Logarithm	—	—	●
127	ESQR	Floating Point Square Root	●	●	●
128	ENEG	Floating Point Negation	—	—	●
129	INT	Floating Point to Integer Conversion	●	●	●
130	SIN	Floating Point Sine	—	—	●
131	COS	Floating Point Cosine	—	—	●
132	TAN	Floating Point Tangent	—	—	●
133	ASIN	Floating Point Arc Sine	—	—	●
134	ACOS	Floating Point Arc Cosine	—	—	●
135	ATAN	Floating Point Arc Tangent	—	—	●
136	RAD	Floating Point Degrees to Radian Conversion	—	—	●
137	DEG	Floating Point Radian to Degrees Conversion	—	—	●
Data Operation 2					
140	WSUM	Sum of Word Data	—	—	●
141	WTOB	WORD to BYTE	—	—	●
142	BTOW	BYTE to WORD	—	—	●
143	UNI	4-bit Linking of Word Data	—	—	●
144	DIS	4-bit Grouping of Word Data	—	—	●
147	SWAP	Byte Swap	—	—	●
149	SORT2	Sort Tabulated Data 2	—	—	●
Positioning Control					
150	DSZR	DOG Search Zero Return	●	●	●
151	DVIT	Interrupt Positioning	—	—	●
152	TBL	Batch Data Positioning Mode	—	●	●
155	ABS	Absolute Current Value Read	●	●	●
156	ZRN	Zero Return	●	●	●
157	PLSV	Variable Speed Pulse Output	●	●	●
158	DRVI	Drive to Increment	●	●	●
159	DRVA	Drive to Absolute	●	●	●

FNC No.	Mnemonic	Function	Applicable PLC		
			FX5s	FX5c/FX5cc/FX5ce	FX5u/FX5uc
Real Time Clock Control					
160	TCMP	RTC Data Compare	●	●	●
161	TZCP	RTC Data Zone Compare	●	●	●
162	TADD	RTC Data Addition	●	●	●
163	TSUB	RTC Data Subtraction	●	●	●
164	HTOS	Hour to Second Conversion	—	—	●
165	STOH	Second to Hour Conversion	—	—	●
166	TRD	Read RTC Data	●	●	●
167	TWR	Set RTC Data	●	●	●
169	HOUR	Hour Meter	●	●	●
External Device					
170	GRY	Decimal to Gray Code Conversion	●	●	●
171	GBIN	Gray Code to Decimal Conversion	●	●	●
176	RD3A	Read from Dedicated Analog Block	—	●	●
177	WR3A	Write to Dedicated Analog Block	—	●	●
Other					
182	COMRD	Read Device Comment Data	—	—	●
184	RND	Random Number Generation	—	—	●
186	DUTY	Timing Pulse Generation	—	—	●
188	CRC	Cyclic Redundancy Check	—	—	●
189	HCMOV	High-Speed Counter Move	—	—	●
Block Data Operation					
192	BK+	Block Data Addition	—	—	●
193	BK-	Block Data Subtraction	—	—	●
194	BKCMPE	Block Data Compare (S1) = (S2)	—	—	●
195	BKCMPE>	Block Data Compare (S1) > (S2)	—	—	●
196	BKCMPE<	Block Data Compare (S1) < (S2)	—	—	●
197	BKCMPE<>	Block Data Compare (S1) ≠ (S2)	—	—	●
198	BKCMPE≤	Block Data Compare (S1) ≤ (S2)	—	—	●
199	BKCMPE≥	Block Data Compare (S1) ≥ (S2)	—	—	●
Character String Control					
200	STR	BIN to Character String Conversion	—	—	●
201	VAL	Character String to BIN Conversion	—	—	●
202	\$+	Link Character Strings	—	—	●
203	LEN	Character String Length Detection	—	—	●
204	RIGHT	Extracting Character String Data From the Right	—	—	●
205	LEFT	Extracting Character String Data from the Left	—	—	●
206	MIDR	Random Selection of Character Strings	—	—	●
207	MIDW	Random Replacement of Character Strings	—	—	●
208	INSTR	Character String Search	—	—	●
209	\$MOV	Character String Transfer	—	—	●
Data Operation 3					
210	FDEL	Deleting Data from Tables	—	—	●
211	FINS	Inserting Data to Tables	—	—	●
212	POP	Shift Last Data Read [FILO Control]	—	—	●
213	SFR	Bit Shift Right with Carry	—	—	●
214	SFL	Bit Shift Left with Carry	—	—	●

INSTRUCTION

FNC No.	Mnemonic	Function	Applicable PLC		
			FX3S	FX3G/FX3GC/FX3GE	FX3U/FX3UC
Data Comparison					
224	LD=	Load Compare (S1)=(S2)	●	●	●
225	LD>	Load Compare (S1)>(S2)	●	●	●
226	LD<	Load Compare (S1)<(S2)	●	●	●
228	LD<>	Load Compare (S1)≠(S2)	●	●	●
229	LD<=	Load Compare (S1)≤(S2)	●	●	●
230	LD>=	Load Compare (S1)≥(S2)	●	●	●
232	AND=	AND Compare (S1)=(S2)	●	●	●
233	AND>	AND Compare (S1)>(S2)	●	●	●
234	AND<	AND Compare (S1)<(S2)	●	●	●
236	AND<>	AND Compare (S1)≠(S2)	●	●	●
237	AND<=	AND Compare (S1)≤(S2)	●	●	●
238	AND>=	AND Compare (S1)≥(S2)	●	●	●
240	OR=	OR Compare (S1)=(S2)	●	●	●
241	OR>	OR Compare (S1)>(S2)	●	●	●
242	OR<	OR Compare (S1)<(S2)	●	●	●
244	OR<>	OR Compare (S1)≠(S2)	●	●	●
245	OR<=	OR Compare (S1)≤(S2)	●	●	●
246	OR>=	OR Compare (S1)≥(S2)	●	●	●
Data Table Operation					
256	LIMIT	Limit Control	—	—	●
257	BAND	Dead Band Control	—	—	●
258	ZONE	Zone Control	—	—	●
259	SCL	Scaling (Coordinate by Point Data)	—	—	●
260	DABIN	Decimal ASCII to BIN Conversion	—	—	●
261	BINDA	BIN to Decimal ASCII Conversion	—	—	●
269	SCL2	Scaling 2 (Coordinate by X/Y Data)	—	—	●
External Device Communication (Inverter Communication)					
270	IVCK	Inverter Status Check	●	●	●
271	IVDR	Inverter Drive	●	●	●
272	IVRD	Inverter Parameter Read	●	●	●
273	IVWR	Inverter Parameter Write	●	●	●
274	IVBWR	Inverter Parameter Block Write	—	—	●
275	IVMC	Inverter Multi Command	●	●	●
Data Transfer 3					
276	ADPRW	MODBUS Read/Write	●	●	●
278	RBFM	Divided BFM Read	—	—	●
279	WBFM	Divided BFM Write	—	—	●
High-Speed Processing 2					
280	HSCT	High-Speed Counter Compare With Data Table	—	—	●
Extension File Register Control					
290	LOADR	Load From ER	—	●	●
291	SAVER	Save to ER	—	—	●
292	INITR	Initialize R and ER	—	—	●
293	LOGR	Logging R and ER	—	—	●
294	RWER	Rewrite to ER	—	●	●
295	INITER	Initialize ER	—	—	●

FNC No.	Mnemonic	Function	Applicable PLC		
			FX3S	FX3G/FX3GC/FX3GE	FX3U/FX3UC
Data Logging					
300	FLCRT	File Create/Check	—	—	●
301	FLDEL	File Delete/CF Card Format	—	—	●
302	FLWR	Data Write	—	—	●
303	FLRD	Data Read	—	—	●
304	FLCMD	FX3U-CF-ADP Command	—	—	●
305	FLSTRD	FX3U-CF-ADP Status Read	—	—	●

Environmental Specifications

General specifications	FX3s	FX3G/FX3GE	FX3GC	FX3U	FX3UC
Ambient temperature	0 – 55 °C (storage temperature: -25 – +75 °C)				
Noise durability	1000 Vpp with noise generator; 1 μs at 30 – 100 Hz				
Dielectric withstand voltage	AC PSU: 1500 V AC, 1 min. / DC PSU: 500 V AC, 1 min.		500 V AC, 1 min.	AC PSU: 1500 V AC, 1 min. / DC PSU: 500 V AC, 1 min.	
Ambient relative humidity	5 – 95% (non-condensing)				
Vibration resistance*	When installed on DIN rail	Frequency (Hz)	Acceleration (m/s ²)	Half amplitude (mm)	Sweep Count for X, Y, Z: 10 times (80 min in each direction)
		10 to 57	—	0.035	
		57 to 150	4.9	—	
		10 to 57	—	0.075	
When installed directly	57 to 150	9.8	—		
	Shock resistance* 147 m/s ² Acceleration, Action time: 11ms, 3 times by half-sine pulse in each direction X, Y, and Z				
Insulation resistance	500 V DC, 5 MΩ				
Ground	Class D: Grounding resistance 100 Ω or less				
Fuse	AC models: 250 V 1 A DC models: 250 V 1.6 A	AC models: 250 V 1 A (FX3G-14/24M) (FX3GE-24M) 250 V 3.15 A (FX3G-40/60M) (FX3GE-40M) DC models: 125 V 2.5 A (FX3G-14/24M) (FX3GE-24M) 125 V 3.15 A (FX3G-40/60M) (FX3GE-40M)	125 V 3.15 A	From FX3U-16M[] to FX3U-32M[] and FX3U-32MR/UA1: 250 V 3.15 A; From FX3U-48M[] to FX3U-128M[] and FX3U-64MR/UA1: 250 V 5 A	125 V 3.15 A
Environment	Avoid environments containing corrosive gases, install in a dust-free location.				
Certifications	Please refer to the Certifications page in this catalog.				

* The criterion is shown IEC 61131-2.

Electrical Specifications

Power Supply Specifications	FX3s	FX3G/FX3GE		
	AC Powered Models (FX3s-[]M[]/ES/ESS/E[]-2AD)	DC Powered Modules (FX3s-[]M[]/DS/DSS)	AC Powered Models (FX3G(E)-[]M[]/ES/ESS)	DC Powered Models (FX3G(E)-[]M[]/DS/DSS)
Power supply	100–240 V AC (+10 %/-15 %), 50/60 Hz (±10 %)	24 V DC (+20%/-15%)	100–240 V AC (+10 %/-15 %), 50/60 Hz	24 V DC (+20%/-15 %)
Inrush current at ON	15 A/5 ms (at 100 V AC); 28 A/5 ms (at 200 V AC)	20 A/< 1 ms (at 24 V DC)	30 A/< 5 ms (at 100 V AC); 50 A/< 5 ms (at 200 V AC)	30 A/< 1 ms (at 24 V DC)
Allowable momentary power failure time	10 ms	5 ms	10 ms	5 ms
24 V DC service power supply	400 mA	—	400 mA	—

Power Supply Specifications	FX3GC	FX3U	FX3UC	
	DC Powered Models (FX3GC-[]M[]/D/DSS)	AC Powered Models (FX3U-[]M[]/ES/ESS)	DC Powered Models (FX3U-[]M[]/DS/DSS)	DC Powered Models (FX3UC-[]M[]/D/DSS/D[]-T)
Power supply	24 V DC (+20%/-15 %)	100–240 V AC (+10%/-15%), 50/60 Hz	24 V DC (+20%/-30%)	24 V DC (+20%/-15%) Ripple Voltage (p-p)5% or less
Inrush current at ON	30 A/< 0.5 ms (at 24 V DC)	30 A/< 5 ms (at 100 V AC); 65 A/< 5 ms (at 200 V AC)	35 A/< 0.5 ms (at 24 V DC)	30 A/< 0.5 ms (at 24 V DC)
Allowable momentary power failure time	5 ms	10 ms*	5 ms	5 ms
24 V DC service power supply	—	FX3U-16/32MR/ES: 400 mA/ FX3U-48/64/80/128MR/ES: 600 mA	—	—

* When the supply voltage is 200 V AC, the time can be changed to 10 to 100 ms by editing the user program.

ENVIRONMENTAL & ELECTRICAL SPECIFICATIONS

Output Specifications	FX3S		FX3G/FX3GE		FX3GC	
	Relay Models	Transistor Models	Relay Models	Transistor Models	Transistor Models	
Switching voltage (Max.)	V	< 240 V AC, < 30 V DC	5–30 V DC	< 240 V AC, < 30 V DC	5–30 V DC	5–30 V DC
Max. output current	- per output	A 2	0.5	2	0.5	0.3 A (Y0–Y1), and 0.1 A (Y2 or higher)
	- per group*1	A 8	0.8	8	0.8	0.8
Max. switching current	- inductive load	80 VA	12 W	80 VA	12 W	38.4 W (7.2 W per point for Y0–Y1 and 2.4 W per point for Y2 or higher)
Response time	ms	10	< 0.2 (< 5 μs for Y0, Y1)	10	< 0.2 (< 5 μs for Y0, Y1)*4	< 0.2 (< 5 μs for Y0–Y1)
Life of contacts (switching times)		3,000,000 at 20 VA; 1,000,000 at 35 VA; 200,000 at 80 VA*2	—	3,000,000 at 20 VA; 1,000,000 at 35 VA; 200,000 at 80 VA*2	—	—*3

Output Specifications	FX3U			FX3UC		
	Relay Models	Transistor Models	Triac Modules	Relay Models	Transistor Models	
Switching voltage (Max.)	V	< 240 V AC, < 30 V DC	5–30 V DC	85–242 V AC	< 240 V AC, < 30 V DC	5–30 V DC
Max. output current	- per output	A 2	0.5	0.3	2	0.3 A (Y0–Y3), and 0.1 A (Y4 or higher)
	- per group*1	A 8	0.8	0.8	8	0.8
Max. switching current	- inductive load	80 VA	12 W	15 VA/100 V AC 30 VA/200 V AC	80 VA	38.4 W (7.2 W per point for Y0–Y3 and 2.4 W per point for Y4 or higher)
Response time	ms	10	< 0.2 (< 5 μs for Y0–Y2)	< 10	10	< 0.2 (< 5 μs for Y0–Y2)
Life of contacts (switching times)		3,000,000 at 20 VA; 1,000,000 at 35 VA; 200,000 at 80 VA*2	—	—	3,000,000 at 20 VA; 1,000,000 at 35 VA; 200,000 at 80 VA*2	—*3

*1 This limitation applies to the maximum output current for each reference terminal (Common), each serving 1 to 4 relay, transistor or triac outputs. Please observe the reference terminal assignments for group identification.

*2 Not guaranteed by Mitsubishi Electric.

*3 Refer to the specifications of the Terminal Block being used.

*4 The 40 and 60 I/O point main units supports 5 μs for Y2.

FX3U

Main Units with 16 I/O

Specifications	FX3U-16MR/DS	FX3U-16MR/ES(-A)	FX3U-16MT/DSS	FX3U-16MT/DS	FX3U-16MT/ESS	FX3U-16MT/ES(-A)
Integrated inputs/outputs	16	16	16	16	16	16
Input type	sink/source	sink/source	sink/source	sink/source	sink/source	sink/source
Integrated inputs	8	8	8	8	8	8
Integrated outputs	8	8	8	8	8	8
Output type	Relay	Relay	Transistor (source)	Transistor (sink)	Transistor (source)	Transistor (sink)
Power supply	24 V DC	100–240 V AC	24 V DC	24 V DC	100–240 V AC	100–240 V AC
Power consumption	W 25	30	25	25	30	30
Weight	kg 0.60	0.60	0.60	0.60	0.60	0.60
Dimensions (W x H x D)	mm 130 x 90 x 86	130 x 90 x 86	130 x 90 x 86	130 x 90 x 86	130 x 90 x 86	130 x 90 x 86

Main Units with 32 I/O

Specifications	FX3U-32MR/DS	FX3U-32MR/ES(-A)	FX3U-32MT/DSS	FX3U-32MT/DS	FX3U-32MT/ESS	FX3U-32MT/ES(-A)	FX3U-32MS/ES	FX3U-32MR/UA1
Integrated inputs/outputs	32	32	32	32	32	32	32	32
Input type	sink/source	sink/source	sink/source	sink/source	sink/source	sink/source	sink/source	AC input
Integrated inputs	16	16	16	16	16	16	16	16
Integrated outputs	16	16	16	16	16	16	16	16
Output type	Relay	Relay	Transistor (source)	Transistor (sink)	Transistor (source)	Transistor (sink)	Triac	Relay
Power supply	24 V DC	100–240 V AC	24 V DC	24 V DC	100–240 V AC	100–240 V AC	100–240 V AC	100–240 V AC
Power consumption	W 30	35	30	30	35	35	35	35
Weight	kg 0.65	0.65	0.65	0.65	0.65	0.65	0.65	0.85
Dimensions (W x H x D)	mm 150 x 90 x 86	150 x 90 x 86	150 x 90 x 86	150 x 90 x 86	150 x 90 x 86	150 x 90 x 86	150 x 90 x 86	182 x 90 x 86

Main Units with 48 I/O

Specifications	FX3U-48MR/DS	FX3U-48MR/ES(-A)	FX3U-48MT/DSS	FX3U-48MT/DS	FX3U-48MT/ESS	FX3U-48MT/ES(-A)
Integrated inputs/outputs	48	48	48	48	48	48
Input type	sink/source	sink/source	sink/source	sink/source	sink/source	sink/source
Integrated inputs	24	24	24	24	24	24
Integrated outputs	24	24	24	24	24	24
Output type	Relay	Relay	Transistor (source)	Transistor (sink)	Transistor (source)	Transistor (sink)
Power supply	24 V DC	100–240 V AC	24 V DC	24 V DC	100–240 V AC	100–240 V AC
Power consumption	W 35	40	35	35	40	40
Weight	kg 0.85	0.85	0.85	0.85	0.85	0.85
Dimensions (W x H x D)	mm 182 x 90 x 86	182 x 90 x 86	182 x 90 x 86	182 x 90 x 86	182 x 90 x 86	182 x 90 x 86

Main Units with 64 I/O

Specifications	FX3U-64MR/DS	FX3U-64MR/ES(-A)	FX3U-64MT/DSS	FX3U-64MT/DS	FX3U-64MT/ESS	FX3U-64MT/ES(-A)	FX3U-64MS/ES	FX3U-64MR/UA1
Integrated inputs/outputs	64	64	64	64	64	64	64	64
Input type	sink/source	sink/source	sink/source	sink/source	sink/source	sink/source	sink/source	AC input
Integrated inputs	32	32	32	32	32	32	32	32
Integrated outputs	32	32	32	32	32	32	32	32
Output type	Relay	Relay	Transistor (source)	Transistor (sink)	Transistor (source)	Transistor (sink)	Triac	Relay
Power supply	24 V DC	100–240 V AC	24 V DC	24 V DC	100–240 V AC	100–240 V AC	100–240 V AC	100–240 V AC
Power consumption	W 40	45	40	40	45	45	45	45
Weight	kg 1.00	1.00	1.00	1.00	1.00	1.00	1.00	1.20
Dimensions (W x H x D)	mm 220 x 90 x 86	220 x 90 x 86	220 x 90 x 86	220 x 90 x 86	220 x 90 x 86	220 x 90 x 86	220 x 90 x 86	285 x 90 x 86

FX MAIN UNITS SPECIFICATIONS

Main Units with 80 I/O

Specifications	FX3U-80MR/DS	FX3U-80MR/ES	FX3U-80MT/DSS	FX3U-80MT/DS	FX3U-80MT/ESS	FX3U-80MT/ES
Integrated inputs/outputs	80	80	80	80	80	80
Input type	sink/source	sink/source	sink/source	sink/source	sink/source	sink/source
Integrated inputs	40	40	40	40	40	40
Integrated outputs	40	40	40	40	40	40
Output type	Relay	Relay	Transistor (source)	Transistor (sink)	Transistor (source)	Transistor (sink)
Power supply	24 V DC	100–240 V AC	24 V DC	24 V DC	100–240 V AC	100–240 V AC
Power consumption	W 45	50	45	45	50	50
Weight	kg 1.20	1.20	1.20	1.20	1.20	1.20
Dimensions (W x H x D)	mm 285 x 90 x 86	285 x 90 x 86	285 x 90 x 86	285 x 90 x 86	285 x 90 x 86	285 x 90 x 86

Main Units with 128 I/O

Specifications	FX3U-128MR/ES	FX3U-128MT/ESS	FX3U-128MT/ES
Integrated inputs/outputs	128	128	128
Input type	sink/source	sink/source	sink/source
Integrated inputs	64	64	64
Integrated outputs	64	64	64
Output type	Relay	Transistor (source)	Transistor (sink)
Power supply	100–240 V AC	100–240 V AC	100–240 V AC
Power consumption	W 65	65	65
Weight	kg 1.80	1.80	1.80
Dimensions (W x H x D)	mm 350 x 90 x 86	350 x 90 x 86	350 x 90 x 86

FX3UC

Main Units with 16 – 96 I/O

Specifications	FX3UC-16MR/D-T	FX3UC-16MR/DS-T	FX3UC-16MT/D	FX3UC-16MT/DSS	FX3UC-32MT/D	FX3UC-32MT/DSS
Integrated inputs/outputs	16	16	16	16	32	32
Integrated inputs	8	8	8	8	16	16
Input type	Sink	Sink/Source	Sink	Sink/Source	Sink	Sink/Source
Integrated outputs	8	8	8	8	16	16
Output type	Relay	Relay	Transistor (sink)	Transistor (source)	Transistor (sink)	Transistor (source)
Power supply	24 V DC	24 V DC	24 V DC	24 V DC	24 V DC	24 V DC
Power consumption	W 6	6	6	6	8	8
Weight	kg 0.25	0.25	0.2	0.2	0.2	0.2
Dimensions (W x H x D)	mm 34 x 90 x 89	34 x 90 x 89	34 x 90 x 74	34 x 90 x 74	34 x 90 x 74	34 x 90 x 74

Specifications	FX3UC-64MT/D	FX3UC-64MT/DSS	FX3UC-96MT/D	FX3UC-96MT/DSS
Integrated inputs/outputs	64	64	96	96
Integrated inputs	32	32	48	48
Input type	Sink	Sink/Source	Sink	Sink/Source
Integrated outputs	32	32	48	48
Power supply	24 V DC	24 V DC	24 V DC	24 V DC
Output type	Transistor (sink)	Transistor (source)	Transistor (sink)	Transistor (source)
Power consumption	W 11	11	14	14
Weight	kg 0.3	0.3	0.35	0.35
Dimensions (W x H x D)	mm 59.7 x 90 x 74	59.7 x 90 x 74	85.4 x 90 x 74	85.4 x 90 x 74

FX3G

Main Units with 14 I/O

Specifications	FX3G-14MR/DS	FX3G-14MR/ES	FX3G-14MT/DSS	FX3G-14MT/DS	FX3G-14MT/ESS	FX3G-14MT/ES
Integrated inputs/outputs	14	14	14	14	14	14
Input type	sink/source	sink/source	sink/source	sink/source	sink/source	sink/source
Integrated inputs	8	8	8	8	8	8
Integrated outputs	6	6	6	6	6	6
Output type	Relay	Relay	Transistor (source)	Transistor (sink)	Transistor (source)	Transistor (sink)
Power supply	24 V DC	100–240 V AC	24 V DC	24 V DC	100–240 V AC	100–240 V AC
Power consumption	W 19	31	19	19	31	31
Weight	kg 0.5	0.5	0.5	0.5	0.5	0.5
Dimensions (W x H x D)	mm 90 x 90 x 86	90 x 90 x 86	90 x 90 x 86	90 x 90 x 86	90 x 90 x 86	90 x 90 x 86

Main Units with 24 I/O

Specifications	FX3G-24MR/DS	FX3G-24MR/ES	FX3G-24MT/DSS	FX3G-24MT/DS	FX3G-24MT/ESS	FX3G-24MT/ES
Integrated inputs/outputs	24	24	24	24	24	24
Input type	sink/source	sink/source	sink/source	sink/source	sink/source	sink/source
Integrated inputs	14	14	14	14	14	14
Integrated outputs	10	10	10	10	10	10
Output type	Relay	Relay	Transistor (source)	Transistor (sink)	Transistor (source)	Transistor (sink)
Power supply	24 V DC	100–240 V AC	24 V DC	24 V DC	100–240 V AC	100–240 V AC
Power consumption	W 21	32	21	21	32	32
Weight	kg 0.55	0.55	0.55	0.55	0.55	0.55
Dimensions (W x H x D)	mm 90 x 90 x 86	90 x 90 x 86	90 x 90 x 86	90 x 90 x 86	90 x 90 x 86	90 x 90 x 86

Main Units with 40 I/O

Specifications	FX3G-40MR/DS	FX3G-40MR/ES	FX3G-40MT/DSS	FX3G-40MT/DS	FX3G-40MT/ESS	FX3G-40MT/ES
Integrated inputs/outputs	40	40	40	40	40	40
Input type	sink/source	sink/source	sink/source	sink/source	sink/source	sink/source
Integrated inputs	24	24	24	24	24	24
Integrated outputs	16	16	16	16	16	16
Output type	Relay	Relay	Transistor (source)	Transistor (sink)	Transistor (source)	Transistor (sink)
Power supply	24 V DC	100–240 V AC	24 V DC	24 V DC	100–240 V AC	100–240 V AC
Power consumption	W 25	37	25	25	37	37
Weight	kg 0.7	0.7	0.7	0.7	0.7	0.7
Dimensions (W x H x D)	mm 130 x 90 x 86	130 x 90 x 86	130 x 90 x 86	130 x 90 x 86	130 x 90 x 86	130 x 90 x 86

Main Units with 60 I/O

Specifications	FX3G-60MR/DS	FX3G-60MR/ES	FX3G-60MT/DSS	FX3G-60MT/DS	FX3G-60MT/ESS	FX3G-60MT/ES
Integrated inputs/outputs	60	60	60	60	60	60
Input type	sink/source	sink/source	sink/source	sink/source	sink/source	sink/source
Integrated inputs	36	36	36	36	36	36
Integrated outputs	24	24	24	24	24	24
Output type	Relay	Relay	Transistor (source)	Transistor (sink)	Transistor (source)	Transistor (sink)
Power supply	24 V DC	100–240 V AC	24 V DC	24 V DC	100–240 V AC	100–240 V AC
Power consumption	W 29	40	29	29	40	40
Weight	kg 0.85	0.85	0.85	0.85	0.85	0.85
Dimensions (W x H x D)	mm 175 x 90 x 86	175 x 90 x 86	175 x 90 x 86	175 x 90 x 86	175 x 90 x 86	175 x 90 x 86

FX MAIN UNITS SPECIFICATIONS

FX3GE

Main Units with 24 I/O

Specifications	FX3GE-24MR/DS	FX3GE-24MR/ES	FX3GE-24MT/DSS	FX3GE-24MT/DS	FX3GE-24MT/ESS	FX3GE-24MT/ES
Integrated inputs/outputs	24	24	24	24	24	24
Input type	sink/source	sink/source	sink/source	sink/source	sink/source	sink/source
Integrated inputs	14	14	14	14	14	14
Integrated outputs	10	10	10	10	10	10
Output type	Relay	Relay	Transistor (source)	Transistor (sink)	Transistor (source)	Transistor (sink)
Power supply	24 V DC	100–240 V AC	24 V DC	24 V DC	100–240 V AC	100–240 V AC
Power consumption	W 21	32	21	21	32	32
Weight	kg 0.6	0.6	0.6	0.6	0.6	0.6
Dimensions (W x H x D)	mm 130 x 90 x 86	130 x 90 x 86	130 x 90 x 86	130 x 90 x 86	130 x 90 x 86	130 x 90 x 86

Main Units with 40 I/O

Specifications	FX3GE-40MR/DS	FX3GE-40MR/ES	FX3GE-40MT/DSS	FX3GE-40MT/DS	FX3GE-40MT/ESS	FX3GE-40MT/ES
Integrated inputs/outputs	40	40	40	40	40	40
Input type	sink/source	sink/source	sink/source	sink/source	sink/source	sink/source
Integrated inputs	24	24	24	24	24	24
Integrated outputs	16	16	16	16	16	16
Output type	Relay	Relay	Transistor (source)	Transistor (sink)	Transistor (source)	Transistor (sink)
Power supply	24 V DC	100–240 V AC	24 V DC	24 V DC	100–240 V AC	100–240 V AC
Power consumption	W 25	37	25	25	37	37
Weight	kg 0.8	0.8	0.8	0.8	0.8	0.8
Dimensions (W x H x D)	mm 175 x 90 x 86	175 x 90 x 86	175 x 90 x 86	175 x 90 x 86	175 x 90 x 86	175 x 90 x 86

FX3GC

Main Units with 32 I/O

Specifications	FX3GC-32MT/D	FX3GC-32MT/DSS
Integrated inputs/outputs	32	32
Input type	sink	sink/source
Integrated inputs	16	16
Input type	Sink	Sink/Source
Integrated outputs	16	16
Output type	Transistor(sink)	Transistor(source)
Power supply	24 V DC	24 V DC
Power consumption	W 8	8
Weight	kg 0.2	0.2
Dimensions (W x H x D)	mm 34 x 90 x 87	34 x 90 x 87

FX3S

Main Units with 10 I/O

Specifications	FX3S-10MR/DS	FX3S-10MR/ES	FX3S-10MT/DSS	FX3S-10MT/DS	FX3S-10MT/ESS	FX3S-10MT/ES
Integrated inputs/outputs	10	10	10	10	10	10
Input type	sink/source	sink/source	sink/source	sink/source	sink/source	sink/source
Integrated inputs	6	6	6	6	6	6
Integrated outputs	4	4	4	4	4	4
Output type	Relay	Relay	Transistor (source)	Transistor (sink)	Transistor (source)	Transistor (sink)
Power supply	24 V DC	100–240 V AC	24 V DC	24 V DC	100–240 V AC	100–240 V AC
Power consumption	W 6	19	6	6	19	19
Weight	kg 0.22	0.30	0.22	0.22	0.30	0.30
Dimensions (W x H x D)	mm 60 x 40 x 49	60 x 90 x 75	60 x 40 x 49	60 x 40 x 49	60 x 90 x 75	60 x 90 x 75

Main Units with 14 I/O

Specifications	FX3S-14MR/DS	FX3S-14MR/ES	FX3S-14MT/DSS	FX3S-14MT/DS	FX3S-14MT/ESS	FX3S-14MT/ES
Integrated inputs/outputs	14	14	14	14	14	14
Input type	sink/source	sink/source	sink/source	sink/source	sink/source	sink/source
Integrated inputs	8	8	8	8	8	8
Integrated outputs	6	6	6	6	6	6
Output type	Relay	Relay	Transistor (source)	Transistor (sink)	Transistor (source)	Transistor (sink)
Power supply	100–240 V AC	100–240 V AC	100–240 V AC	100–240 V AC	100–240 V AC	100–240 V AC
Power consumption	W 6.5	6	6.5	6.5	6	6
Weight	kg 0.22	0.30	0.22	0.22	0.30	0.30
Dimensions (W x H x D)	mm 60 x 90 x 49	60 x 90 x 49	60 x 90 x 49	60 x 90 x 49	60 x 90 x 49	60 x 90 x 49

Main Units with 20 – 30 I/O

Specifications	FX3S-20MR/DS	FX3S-20MR/ES	FX3S-20MT/DSS	FX3S-20MT/DS	FX3S-20MT/ESS	FX3S-20MT/ES
Integrated inputs/outputs	20	20	20	20	20	20
Input type	sink/source	sink/source	sink/source	sink/source	sink/source	sink/source
Integrated inputs	12	12	12	12	12	12
Integrated outputs	8	8	8	8	8	8
Output type	Relay	Relay	Transistor (source)	Transistor (sink)	Transistor (source)	Transistor (sink)
Power supply	24 V DC	100–240 V AC	24 V DC	24 V DC	100–240 V AC	100–240 V AC
Power consumption	W 7	20	7	7	20	20
Weight	kg 0.30	0.40	0.30	0.30	0.40	0.40
Dimensions (W x H x D)	mm 75 x 90 x 49	75 x 90 x 75	75 x 90 x 49	75 x 90 x 49	75 x 90 x 75	75 x 90 x 75

Main Units with 30 I/O

Specifications	FX3S-30MR/DS	FX3S-30MR/ES	FX3S-30MT/DSS	FX3S-30MT/DS	FX3S-30MT/ESS	FX3S-30MT/ES
Integrated inputs/outputs	30	30	30	30	30	30
Input type	sink/source	sink/source	sink/source	sink/source	sink/source	sink/source
Integrated inputs	16	16	16	16	16	16
Integrated outputs	14	14	14	14	14	14
Output type	Relay	Relay	Transistor (source)	Transistor (sink)	Transistor (source)	Transistor (sink)
Power supply	24 V DC	100–240 V AC	24 V DC	24 V DC	100–240 V AC	100–240 V AC
Power consumption	W 8.5	21	8.5	8.5	21	21
Weight	kg 0.35	0.45	0.35	0.35	0.45	0.45
Dimensions (W x H x D)	mm 100 x 90 x 49	100 x 90 x 75	100 x 90 x 49	100 x 90 x 49	100 x 90 x 75	100 x 90 x 75

Main Units with 30 I/O and analog inputs

Specifications	FX3S-30MR/ES-2AD	FX3S-30MT/ESS-2AD	FX3S-30MT/ES-2AD
Integrated inputs/outputs	30	30	30
Integrated inputs	16	16	16
Input type	sink/source	sink/source	sink/source
Integrated outputs	14	14	14
Output type	Relay	Transistor (source)	Transistor (sink)
Analog input range	0 to 10 V DC (Input resistance: 115.7 kΩ)	0 to 10 V DC (Input resistance: 115.7 kΩ)	0 to 10 V DC (Input resistance: 115.7 kΩ)
Analog channels	inputs 2	2	2
Resolution	voltage 10 mV (10 V/1000)	10 mV (10 V/1000)	10 mV (10 V/1000)
Power supply	100–240 V AC	100–240 V AC	100–240 V AC
Power consumption	W 21	21	21
Weight	kg 0.45	0.45	0.45
Dimensions (W x H x D)	mm 100 x 90 x 75	100 x 90 x 75	100 x 90 x 75

DESCRIPTION OF UNIT COMPONENTS

FX3U

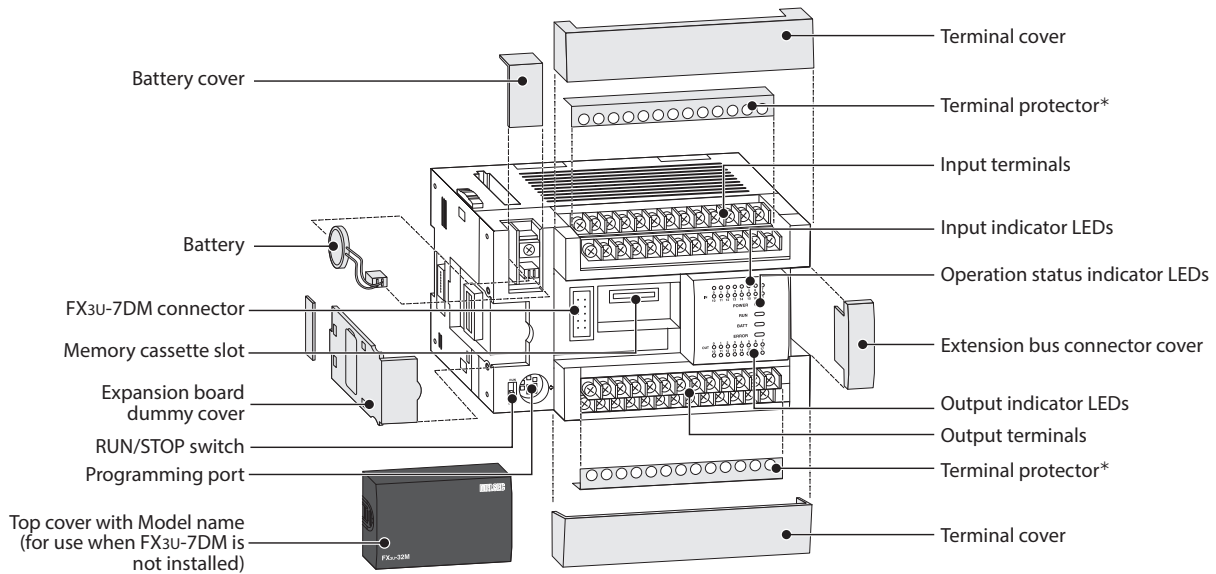

*: There is no terminal protector on "-A" product.

FX3UC

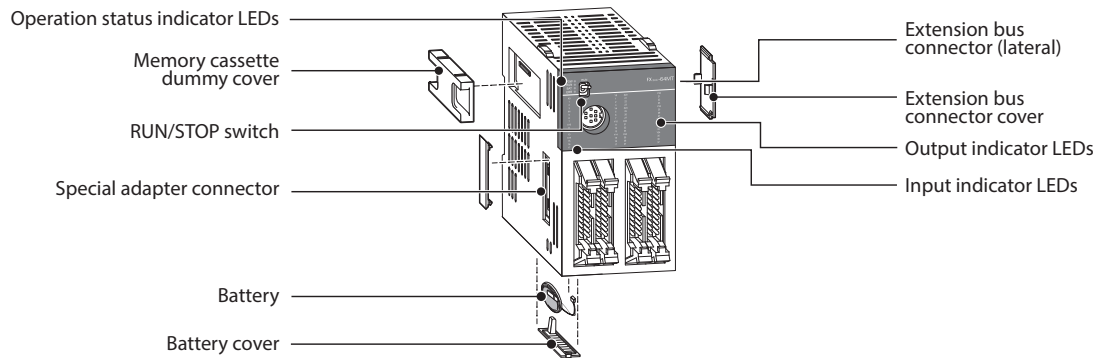

FX3G

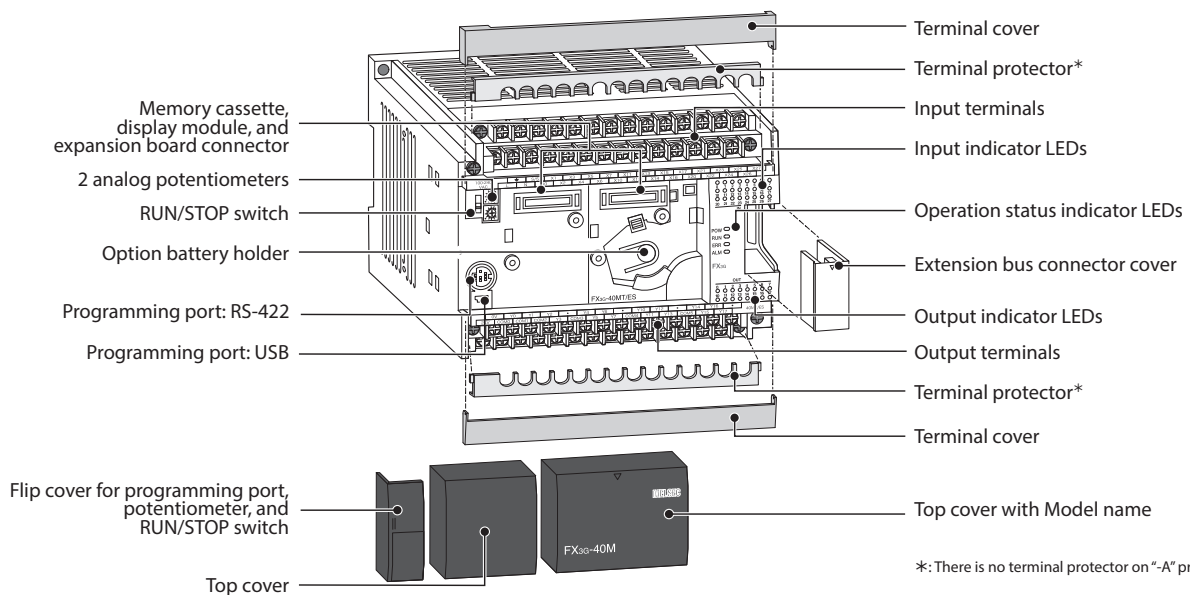

*: There is no terminal protector on "-A" product.

DESCRIPTION OF UNIT COMPONENTS

FX3GE

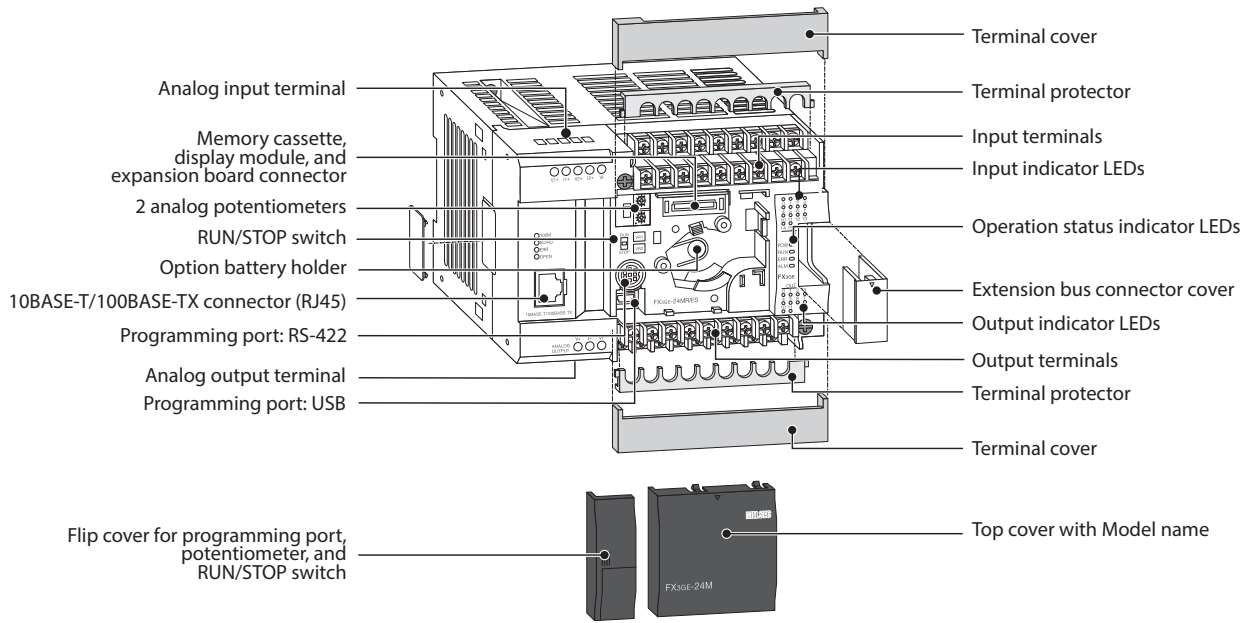

1
FX MAIN UNITS

FX3GC

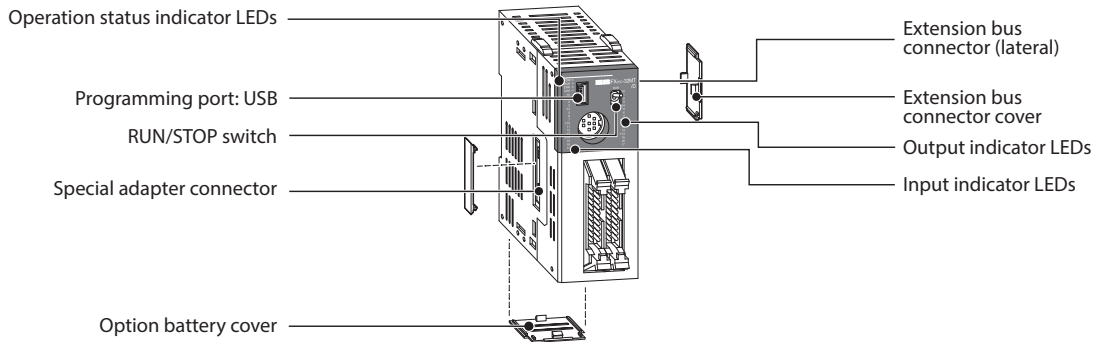

DESCRIPTION OF UNIT COMPONENTS

FX3S

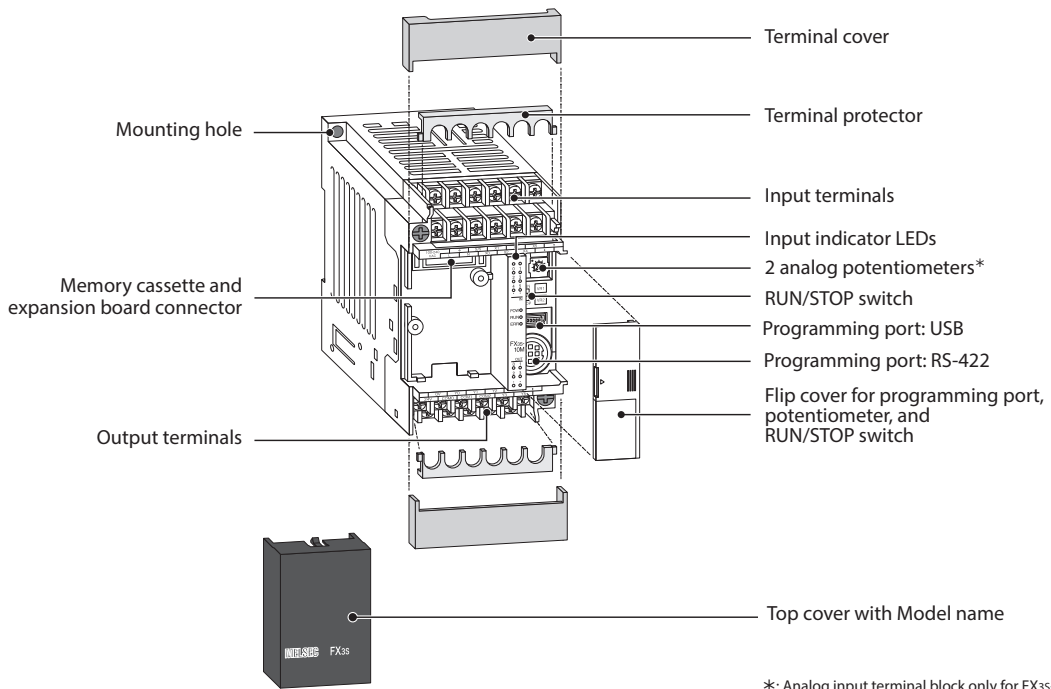

*: Analog input terminal block only for FX3s-30M[]/ES[]-2AD

MEMO

Expansion Boards

FX3S
 FX3G
 FX3GE
 FX3GC
 FX3U
 FX3UC

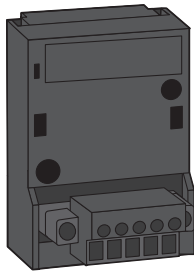

FX3G-4EX-BD

FX3G-4EX-BD and FX3G-2EYT-BD Expansion Boards

The FX3G series expansion boards are available for the FX3S, FX3G and FX3GE main unit and add 4 inputs or 2 outputs to the system. These boards are advantageous when only a few additional I/O are required without adding to the installation space.

Specifications	FX3G-4EX-BD	FX3G-2EYT-BD
Integrated inputs/outputs	4	2
Power supply	5 V DC (from main unit); 24 V DC/25 mA (S/S terminal)	5 V DC (from main unit)
Integrated inputs	4	—
Input	voltage	24 V DC (+20%/-15%)
	current	5 mA (24 V DC)
Integrated outputs	—	2
Output type	—	Transistor
Max. switching voltage	—	5 – 30 V DC
Weight	kg 0.02	0.02
Dimensions (W x H x D)	mm 35 x 51.2 x 29.2	35 x 51.2 x 29.2

■ Powered Extension Units

FX3S FX3G FX3GE FX3GC FX3U FX3UC

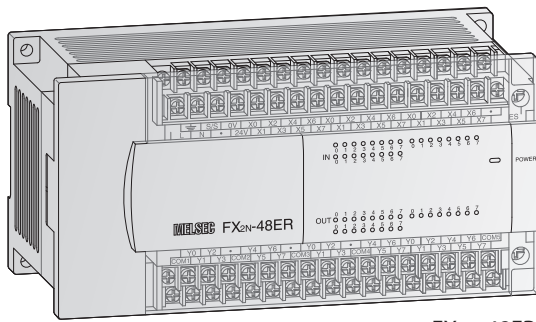

FX2N-48ER

FX2N Extension Units

The FX2N series extension units are available with 32 or 48 integrated I/O with selectable relay or transistor output models.

Features:

- Input and output indicator LEDs
- FX3G, FX3GE, and FX3U series compatible
- Removable terminal blocks
- Integrated service power supply with up to 250 mA or 460 mA capacity

Specifications		FX2N-32ER-ES/UL	FX2N-32ET-ESS/UL	FX2N-48ER-DS	FX2N-48ER-ES/UL	FX2N-48ER-UA1/UL	FX2N-48ET-DSS	FX2N-48ET-ESS/UL	
Electrical data	Integrated inputs/outputs	32	32	48	48	48	48	48	
	Power supply	AC range (+10%, -15%)	100 – 240 V	100 – 240 V	—	100 – 240 V	100 – 240 V	—	100 – 240 V
		Frequency at AC	Hz 50/60	50/60	—	50/60	50/60	—	50/60
	DC range (+20%, -30%)	—	—	24 V	—	—	24 V	—	
		Max. input apparent power	30 W	30 W	30 W	35 W	35 W	30 W	35 W
	Inrush current at ON	100 V AC	40 A < 5 ms	40 A < 5 ms	—	40 A < 5 ms	40 A < 5 ms	40 A < 5 ms	40 A < 5 ms
		200 V AC	60 A < 5 ms	—	—	60 A < 5 ms	60 A < 5 ms	60 A < 5 ms	60 A < 5 ms
	Allowable momentary power failure time	ms	10	10	5	10	—	5	10
	External service power supply (24 V DC)	mA	250	250	—	460	—	—	460
	Power supply int. bus (5 V DC)	mA	690	690	690	690	690	690	690
Inputs	Integrated inputs	16	16	24	24	24	24	24	
	Min. current for logical 1	mA	3.5	3.5	3.5	3.5	3.8	3.5	
	Max. current for logical 0	mA	1.5	1.5	1.5	1.5	1.7	1.5	
	Response time		10 ms (at time of shipment)						
	Integrated outputs		16	16	24	24	24	24	24
Outputs	Output type	Relay	Transistor (source)	Relay	Relay	Relay	Transistor (source)	Transistor (source)	
	Switching voltage (Max.)	Relay version: < 264 V AC, < 30 V DC; Transistor version: 5 – 30 V DC							
	Max. output current	- per output	A	2	0.5	2	2	0.5	0.5
		- per group*1	A	8	0.8	8	8	0.8	0.8
	Max. switching power - inductive load		80 VA	12 W	80 VA	80 VA	80 VA	12 W	12 W
	Response time	ms	10	< 0.2	10	10	10	< 0.2	< 0.2
	Life of contacts (switching times)*2		Relay version: 3,000,000 at 20 VA, 1,000,000 at 35 VA, 200,000 at 80 VA; Transistor version: -						
Mechanical data	Weight	kg	0.65	0.65	0.85	0.85	1.0	0.85	
	Dimensions (W x H x D)	mm	150 x 90 x 87	150 x 90 x 87	182 x 90 x 87	182 x 90 x 87	220 x 90 x 87	182 x 90 x 87	

*1 This limitation applies to the maximum output current for each reference terminal (Common), each serving 1 to 4 relay or transistor outputs. Please observe the reference terminal assignments for group identification.

*2 Not guaranteed by Mitsubishi Electric

I/O EXTENSION

■ Unpowered Extension Blocks

FX3S FX3G FX3GE FX3GC FX3U FX3UC

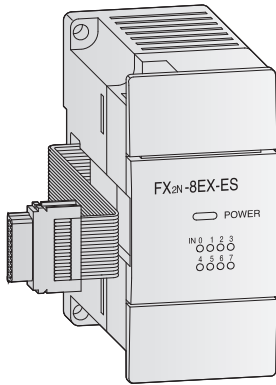

FX2N-8EX-ES

FX2N Extension Blocks

The FX2N series 8 integrated I/O extension blocks are selectable with relay or transistor outputs.

Note: When attaching an extension block to an FX3GC or FX3UC main unit, the FX2NC-CNV-IF interface converter or the FX3UC-1PS-5V power supply unit is required.

Features:

- Input and output indicator LEDs
- FX3G, FX3GE, FX3GC, FX3U, and FX3UC series compatible
- Vertically arranged terminals with upper or lower side cable placement available

Specifications	FX2N-8EX-ES/UL	FX2N-8EX-ES/UL	FX2N-8EX-UA1/UL	FX2N-8EYR-ES/UL	FX2N-8EYT-ESS/UL
Electrical data					
Integrated inputs/outputs	8	8	8	8	8
Power supply	All extension blocks are powered by the main unit or attached extension unit.				
Inputs					
Integrated inputs	4	8	8	—	—
Min. current for logical 1	mA 3.5	3.5	≥3.8	—	—
Max. current for logical 0	mA 1.5	1.5	≤1.7	—	—
Response time	10 ms				
Outputs					
Integrated outputs	4	—	—	8	8
Output type	Relay	—	—	Relay	Transistor (source)
Max. switching voltage	Relay version: < 240 V AC, < 30 V DC; Transistor version: 5 – 30 V DC				
Max. output current	A 2	—	—	2	0.5
- per group*1	A 8	—	—	8	0.8
Max. switching power	80 VA	—	—	80 VA	12 W
- inductive load					
Response time	ms 10	10	10	10	< 0.2
Life of contacts (switching times)*2	Relay version: 3,000,000 at 20 VA, 1,000,000 at 35VA, 200,000 at 80 VA; Transistor version: -				
Mechanical data					
Weight	kg 0.2	0.2	0.2	0.2	0.2
Dimensions (W x H x D)	mm 43 x 90 x 87	43 x 90 x 87	43 x 90 x 87	43 x 90 x 87	43 x 90 x 87

*1 This limitation applies to the maximum output current for each reference terminal (Common), each serving 1 to 4 relay or transistor outputs. Please observe the reference terminal assignments for group identification.

*2 Not guaranteed by Mitsubishi Electric

■ Unpowered Extension Blocks

FX3S FX3G FX3GE FX3GC FX3U FX3UC

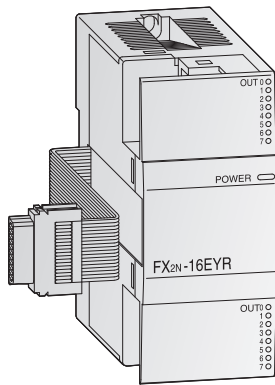

FX2N-16EYR

FX2N Extension Blocks

The FX2N series 16 integrated I/O extension blocks are selectable with relay, transistor, or triac outputs.

Note: When attaching an extension block to an FX3GC or FX3UC main unit, the FX2NC-CNV-IF interface converter or the FX3UC-1PS-5V power supply unit is required.

Features:

- Input and output indicator LEDs
- FX3G, FX3GE, FX3GC, FX3U, and, FX3UC series compatible
- Vertically arranged terminals with upper or lower side cable placement available

Specifications	FX2N-16EX-ES/UL	FX2N-16EYR-ES/UL	FX2N-16EYT-ESS/UL	FX2N-16EYS
Electrical data				
Integrated inputs/outputs	16	16	16	16
Power supply	All extension blocks are powered by the main unit or attached extension unit.			
Inputs				
Integrated inputs	16	—	—	—
Min. current for logical 1	mA 3.5	—	—	—
Max. current for logical 0	mA 1.5	—	—	—
Response time	10 ms	—	—	—
Outputs				
Integrated outputs	—	16	16	16
Output type	—	Relay	Transistor (source)	Triac
Switching voltage (Max.)	V	Relay version: < 240 V AC, < 30 V DC; Transistor version: 5 – 30 V DC; Triac version: 85–242 V AC		
Max. output current	A	2	0.5	0.3
- per group*1	A	8	1.6	0.8
Max. switching power	—	80 VA	12 W	15 VA/AC 100 V, 30 VA/AC 200 V
- inductive load	—	80 VA	12 W	15 VA/AC 100 V, 30 VA/AC 200 V
Response time	ms	10	< 0.2	OFF→ON < 1, ON→OFF < 10
Life of contacts (switching times)*2	—	Relay version: 3,000,000 at 20 VA, 1,000,000 at 35 VA, 200,000 at 80 VA; Transistor version: - ; Triac version: -		
Mechanical data				
Weight	kg 0.3	0.3	0.3	0.3
Dimensions (W x H x D)	mm 40 x 90 x 87	40 x 90 x 87	40 x 90 x 87	40 x 90 x 87

*1 This limitation applies to the maximum output current for each reference terminal (Common), each serving 1 to 4 relay, transistor, or triac outputs. Please observe the reference terminal assignments for group identification.

*2 Not guaranteed by Mitsubishi Electric

■ Unpowered Extension Blocks

□ FX3S □ FX3G □ FX3GE FX3GC □ FX3U FX3UC

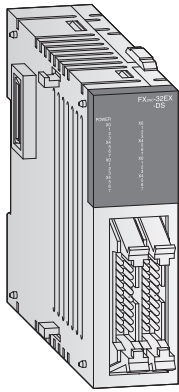

FX2NC-32EX-DS

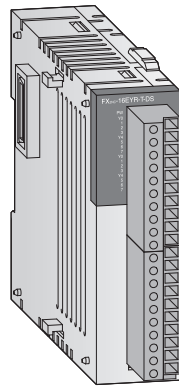

FX2NC-16EYR-T-DS

FX2NC Extension Blocks

The FX2NC series extension blocks are available with 16 or 32 integrated I/O with selectable relay or transistor 16-output models.

Features:

- Ultra-compact dimensions
- Input and output indicator LEDs
- Removable terminal blocks for FX2NC-16EYR-T-DS and FX2NC-16EX-T-DS
- Adapter modules and system cabling sets available for units with ribbon cable connectors (transistor output types)

Specifications	FX2NC-16EX-T-DS	FX2NC-16EYR-T-DS	FX2NC-16EX-DS	FX2NC-16EYT-DSS	FX2NC-32EX-DS	FX2NC-32EYT-DSS
Electrical data						
Integrated inputs/outputs	16	16	16	16	32	32
Power supply	All extension blocks are powered by the main unit.					
Inputs						
Integrated inputs	16	—	16	—	32	—
Input current	5	—	5	—	5	—
Min. current for logical 1	mA 3.5	—	3.5	—	3.5	—
Max. current for logical 0	mA 1.5	—	1.5	—	1.5	—
Isolation	Photocoupler isolation between input terminals and PC power for all base units.					
Response time	10 ms	—	10 ms	—	10 ms	—
Outputs						
Integrated outputs	—	16	—	16	—	32
Output type	—	Relay	—	Transistor (source)	—	Transistor (source)
ON voltage (Max.)	V Relay version: < 240 V AC, < 30 V DC; Transistor version: 5 – 30 V DC					
Max. output current	A —	2	—	0.1	—	0.1
- per output	A —	4	—	0.8	—	0.8
- per group*1	—	80 VA	—	2.4 W	—	2.4 W
Max. switching power	ms —	10	—	< 0.2	—	< 0.2
Response time	Life of contacts (switching times)*2 Relay version: 3,000,000 at 20 VA, 1,000,000 at 35VA, 200,000 at 80 VA; Transistor version: -					
Life of contacts (switching times)*2	—					
Mechanical data						
Connection type	Removable screw terminal blocks	Removable screw terminal blocks	Ribbon cable connector	Ribbon cable connector	Ribbon cable connector	Ribbon cable connector
Weight	kg 0.15	0.15	0.15	0.15	0.2	0.2
Dimensions (W x H x D)	mm 20.2 x 90 x 89	24.2 x 90 x 89	14.6 x 90 x 87	14.6 x 90 x 87	26.2 x 90 x 87	26.2 x 90 x 87

*1 This limitation applies to the maximum output current for each reference terminal (Common), each serving 1 to 4 relay or transistor outputs. Please observe the reference terminal assignments for group identification.

*2 Not guaranteed by Mitsubishi Electric

■ Analog Boards

FX3S
 FX3G
 FX3GE
 FX3GC
 FX3U
 FX3UC

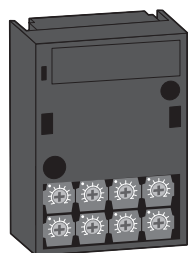

FX3G-8AV-BD

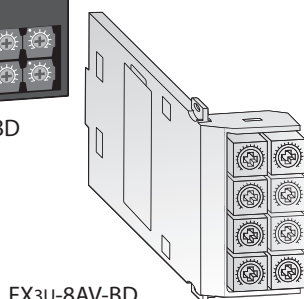

FX3U-8AV-BD

FX3G-8AV-BD and FX3U-8AV-BD Analog Setpoint boards

The FX3G-8AV-BD analog setpoint board is available for the FX3S, FX3G, and FX3GE. The FX3U-8AV-BD analog setpoint board is available for the FX3U. Both provide 8 analog setpoint potentiometers to the FX system. These setpoints can be polled by the PLC and used as default values for timers, counters, and data registers with dedicated instructions VRRD/VRSC (FNC85/86).

Specifications	FX3G-8AV-BD	FX3U-8AV-BD
Power supply	5 V DC (from main unit)	5 V DC (from main unit)
Adjustment range	8 - bit	8 - bit
Related I/O points	0	0
Potentiometer evaluation	Via PLC applied instruction (FNC 85/86)	Via PLC applied instruction (FNC 85/86)
Weight	kg 0.02	0.02
Dimensions (W x H x D)	mm 35 x 51.2 x 12	46.1 x 55.9 x 19.7

FX3G-2AD-BD Analog Expansion Board

The FX3G-2AD-BD analog input expansion board is available for the FX3S, FX3G, and FX3GE main units. It provides 2 analog inputs. The board converts analog voltage or current signals into digital values which can be used in the FX PLC.

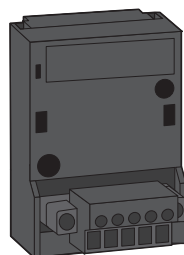

FX3G-2AD-BD

Specifications	FX3G-2AD-BD
Power supply	5 V DC (from main unit)
Analog channels	inputs 2
Analog input range	0 to 10 V DC/4 to 20 mA
Resolution	voltage 2.5 mV (12 bit)
	current 8 μ A (11 bit)
Overall accuracy for fullscale	\pm 1.0%
Related I/O points	0
Weight	kg 0.02
Dimensions (W x H x D)	mm 35 x 51.2 x 29.2

■ Analog Input Special Adapter

FX3S
 FX3G
 FX3GE
 FX3GC
 FX3U
 FX3UC

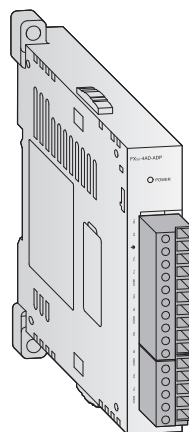

FX3U-4AD-ADP

FX3U-4AD-ADP

The FX3U-4AD-ADP analog input special adapter is available for FX3 series main units and is used for adding 4 channels of analog input to the FX PLC.

Note: When connecting to an FX3S, FX3G, or FX3U main unit, an interface adapter or interface board is required.

Specifications	FX3U-4AD-ADP
Power supply	5 V DC/15 mA (from main unit); 24 V DC/40 mA
Analog channels	inputs 4
Analog range	0 to 10 V DC/4 to 20 mA
Resolution	voltage 2.5 mV (12 bit)
	current 10 μ A (11 bit)
Overall accuracy for fullscale	\pm 0.5 % - \pm 1.0%*
Related I/O points	0
Weight	kg 0.1
Dimensions (W x H x D)	mm 17.6 x 90 x 89.5

* Dependent on the ambient temperature and signal quality

■ Analog Input Blocks

□ FX3S ✓ FX3G ✓ FX3GE ✓ FX3GC ✓ FX3U ✓ FX3UC

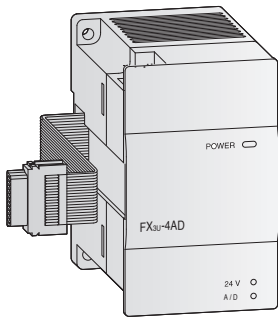

FX3U-4AD

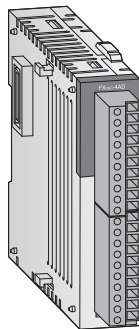

FX3UC-4AD

FX3U-4AD, FX3UC-4AD

The FX3U and FX3UC analog input blocks are available for FX3G, FX3GE, FX3GC, FX3U, and FX3UC series main units and are used to convert analog voltage or current signals into digital values which can be used in the FX PLC. These blocks provide users with 4 analog input channels with adjustable digital filters, history data, and use an integrated high-performance CPU which converts each analog input in 500µs.

Note: The FX3UC-4AD can only be used with the FX3GC or FX3UC main unit. When attaching the FX3U-4AD analog block to an FX3GC or FX3UC main unit, the FX2NC-CNV-IF interface converter or the FX3UC-1PS-5V power supply unit is required.

Specifications	FX3U-4AD	FX3UC-4AD
Power supply	5 V DC/110 mA (from main unit); 24 V DC/90 mA	5 V DC/100mA (from main unit); 24 V DC/80mA
Analog channels	inputs	4
Analog input range	-10 to +10 V DC/ -20 to +20 mA/4 to 20 mA DC	
Resolution	voltage	0.32 mV (15 bit + sign)
	current	1.25 µA (14 bit + sign)
Overall accuracy for fullscale	±0.3% – ±1.0% fullscale*	
Related I/O points	8	
Weight	kg	0.2
Dimensions (W x H x D)	mm	55 x 90 x 87

* Dependent on the ambient temperature

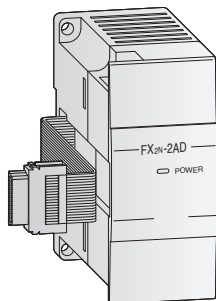

FX2N-2AD

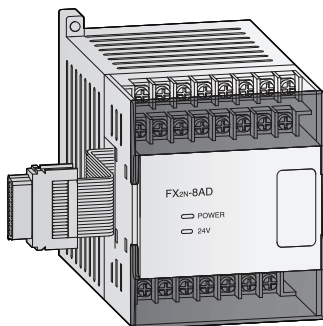

FX2N-8AD

FX2N-2AD, FX2N-8AD

The FX2N analog input blocks are used to convert analog voltage or current signals into digital values which can be used in the FX PLC. These blocks provide 2 to 8 analog inputs and use internal buffer memory to setup value sampling parameters.

Note: When attaching an FX2N analog block to an FX3GC or FX3UC main unit, the FX2NC-CNV-IF interface converter or the FX3UC-1PS-5V power supply unit is required.

Specifications	FX2N-2AD	FX2N-8AD
Power supply	5 V DC/20 mA (from main unit); 24 V DC/50 mA (from main unit)	5 V DC/50 mA (from main unit); 24 V DC/80 mA
Analog channels	inputs	2
Analog input range	0 to 10 VDC/ 0 to 5 V DC/ 4 to 20 mA DC	
Resolution	voltage	2.5 mV (12 bit)
	current	4 µA (12 bit)
Overall accuracy for fullscale	voltage	±1.0%
	current	±0.3% – ±0.5%*
Related I/O points	8	
Weight	kg	0.2
Dimensions (W x H x D)	mm	43 x 90 x 87

* Dependent on the ambient temperature

Note: The FX2N-8AD can be configured to accept standard analog inputs as well as selected temperature inputs such as K, T or J type thermocouples.

■ Analog Output Board

FX3S FX3G FX3GE FX3GC FX3U FX3UC

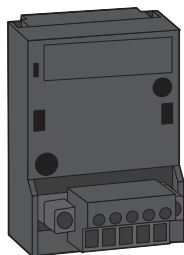

FX3G-1DA-BD

FX3G-1DA-BD Analog Expansion Board

The FX3G-1DA-BD analog output expansion board is available for the FX3S, FX3G, and FX3GE main units. It provides 1 analog output. The expansion board converts digital values from the FX3S, FX3G, or FX3GE PLC to an analog voltage or current signal.

Specifications	FX3G-1DA-BD
Power supply	5 V DC (from main unit)
Analog channels	1
outputs	
Analog output range	0 to 10 V DC/4 to 20 mA
Resolution	2.5 mV (12 bit)/8 μ A (11 bit)
Overall accuracy for fullscale	\pm 1.0%
Related I/O points	0
Weight	kg 0.02
Dimensions (W x H x D)	mm 35 x 51.2 x 29.2

■ Analog Output Special Adapter

FX3S FX3G FX3GE FX3GC FX3U FX3UC

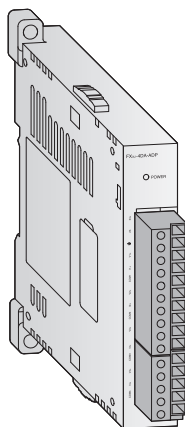

FX3U-4DA-ADP

FX3U-4DA-ADP

The FX3U-4DA-ADP analog output special adapter is available for FX series main units and is used for adding 4 channels of analog output to the FX PLC.

Note: When connecting to an FX3S, FX3G, or FX3U main unit, an interface adapter or interface board is required.

Specifications	FX3U-4DA-ADP
Power supply	5 V DC/15 mA (from main unit); 24 V DC/150 mA
Analog channels	4
outputs	
Analog range	0 to 10 V DC/4 to 20 mA DC
Resolution	voltage 2.5 mV (12 bit)
current	4 μ A (12 bit)
Overall accuracy for fullscale	\pm 0.5 % – \pm 1.0%*
Related I/O points	0
Weight	kg 0.1
Dimensions (W x H x D)	mm 17.6 x 90 x 89.5

* Dependent on the ambient temperature and signal quality

■ Analog Output Blocks

□ FX3S ✓ FX3G ✓ FX3GE ✓ FX3GC ✓ FX3U ✓ FX3UC

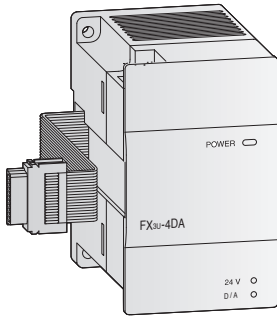

FX3U-4DA

FX3U-4DA

The FX3U-4DA is available for FX3G, FX3GE, FX3GC, FX3U, and FX3UC series main units and is used to convert digital values in the PLC to voltage or current analog output signals. This block provides users with 4 analog output channels with optional output table function and uses an integrated high-performance CPU which converts all 4 analog signals in 1ms.

Note: When attaching the FX3U-4DA analog block to an FX3GC or FX3UC main unit, the FX2NC-CNV-IF interface converter or the FX3UC-1PS-5V power supply unit is required.

Specifications		FX3U-4DA
Power supply		5 V DC/120 mA (from main unit); 24 V DC/160 mA
Analog channels	outputs	4
Analog output range		-10 to + 10 V DC/ 0 to 20 mA/4 to 20 mA DC
Resolution	voltage	0.32 mV (15 bit + sign)
	current	0.63 μ A (15 bit)
Overall accuracy for fullscale		$\pm 0.3 - \pm 0.5$ %*
Related I/O points		8
Weight	kg	0.2
Dimensions (W x H x D)	mm	55 x 90 x 87

* Dependent on the ambient temperature

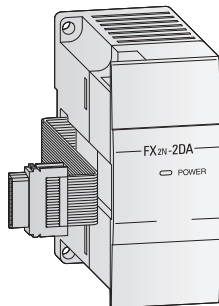

FX2N-2DA

FX2N-2DA

The FX2N-2DA analog output block is used to convert digital values in the PLC to voltage or current analog output signals. This block provides 2 analog outputs. The adjustment of the offset and gain values sets a digital equivalent to the analog data.

Specifications		FX2N-2DA
Power supply		5 V DC/30 mA (from main unit); 24 V DC/85 mA (from main unit)
Analog channels	inputs	—
	outputs	2
Analog output range		0 to 10 V DC/ 0 to 5 V DC/ 4 to 20 mA DC
Resolution	voltage	2.5 mV (12 bit)
	current	4 μ A (12 bit)
Overall accuracy for fullscale		± 1.0 %*
Related I/O points		8
Weight	kg	0.2
Dimensions (W x H x D)	mm	43 x 90 x 87

* Dependent on the ambient temperature

■ Combination Analog I/O Adapter

☑ FX3S ☑ FX3G ☑ FX3GE ☑ FX3GC ☑ FX3U ☑ FX3UC

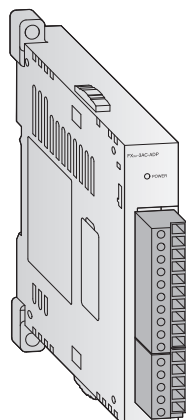

FX3U-3A-ADP

FX3U-3A-ADP

The FX3U-3A-ADP is used for both digital-to-analog and analog-to-digital conversion. This adapter provides users with 2 analog input channels and 1 analog voltage or current output channel.

Note: When connecting to an FX3S, FX3G, or FX3U main unit, an interface adapter or interface board is required.

Specifications	FX3U-3A-ADP	
Power supply	5 V DC/20 mA (from main unit); 24 V DC/90 mA	
Analog channels	inputs	2
	outputs	1
Analog Input range (resolution)	voltage	0 to 10 V DC (2.5 mV/12 bit)
	current	4 to 20 mA (5 μA/12 bit)
Analog Output range (resolution)	voltage	0 to 10 V DC (2.5 mV/12 bit)
	current	4 to 20 mA (4 μA/12 bit)
Overall accuracy for fullscale	±0.5 % – ±1.0%*	
Related I/O points	0	
Weight	kg 0.1	
Dimensions (W x H x D)	mm 17.6 x 90 x 89.5	

* Dependent on the ambient temperature

■ Combination Analog I/O Block

☐ FX3S ☑ FX3G ☑ FX3GE ☑ FX3GC ☑ FX3U ☑ FX3UC

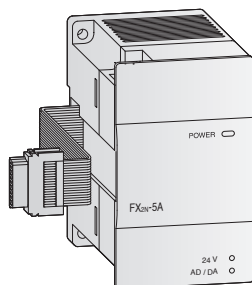

FX2N-5A

FX2N-5A

The FX2N-5A is used for both digital-to-analog and analog-to-digital conversion. This block provides users with 4 analog input channels and 1 analog voltage or current output channel.

Note: When attaching the FX2N-5A analog block to an FX3GC or FX3UC main unit, the FX2NC-CNV-IF interface converter or the FX3UC-1PS-5V power supply unit is required.

Specifications	FX2N-5A	
Power supply	5 V DC/70mA (from main unit); 24 V DC/90 mA	
Analog channels	inputs	4
	outputs	1
Analog Input range (resolution)	voltage	-10 to +10V (15 bit +sign), -100 to +100 mV (11 bit +sign)
	current	-20 to +20 mA DC (14 bit + sign), 4 to +20 mA DC (14 bit)
Analog Output range (resolution)	voltage	-10 to +10 V DC (12 bit)
	current	0/4 to 20 mA DC (10 bit)
Overall accuracy for fullscale	±0.3% – ±1.0%*	
Related I/O points	8	
Weight	kg 0.3	
Dimensions (W x H x D)	mm 55 x 90 x 87	

* Dependent on the ambient temperature

TEMPERATURE INPUT

Temperature Input Special Adapters

FX3S
 FX3G
 FX3GE
 FX3GC
 FX3U
 FX3UC

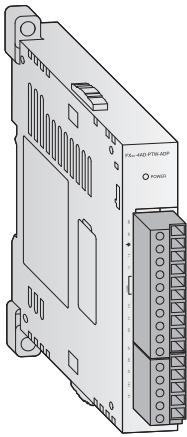

FX3U-4AD-PTW-ADP

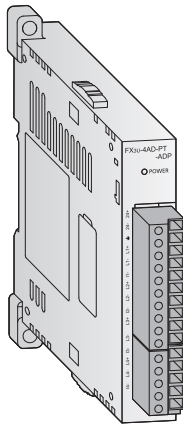

FX3U-4AD-PT-ADP

FX3U-4AD-PTW-ADP, FX3U-4AD-PT-ADP

These analog temperature input special adapters are available for FX series main units and are used for Pt100 temperature sensor input. The FX3U-4AD-PTW-ADP special adapters provide users with 4 channels of Pt100 analog input ranging from -100 to 600°C, while the FX3U-4AD-PT-ADP has a input range of -50 to 250°C.

Note: When connecting to an FX3S, FX3G, or FX3U main unit, an interface adapter or interface board is required.

Specifications	FX3U-4AD-PTW-ADP	FX3U-4AD-PT-ADP
Power supply	5 V DC/15 mA (from main unit); 24 V DC/50 mA	5 V DC/15 mA (from main unit); 24 V DC/50 mA
Analog inputs	4 (Pt100 sensors)	4 (Pt100 sensors)
Compensated temperature range	°C -100 to +600	-50 to +250
Digital outputs	-1000 to +6000	-500 to +2500
Resolution	0.2 to 0.3°C	0.1°C
Overall accuracy for fullscale	±0.5% – ±1.0%*	±0.5% – ±1.0%*
Related I/O points	0	0
Weight	kg 0.1	0.1
Dimensions (W x H x D)	mm 17.6 x 90 x 89.5	17.6 x 90 x 89.5

* Dependent on the ambient temperature

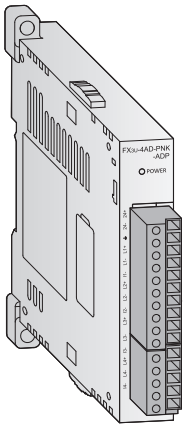

FX3U-4AD-PNK-ADP

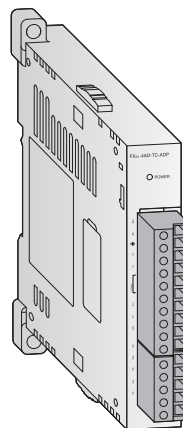

FX3U-4AD-TC-ADP

FX3U-4AD-PNK-ADP, FX3U-4AD-TC-ADP

These analog temperature input special adapters are available for FX series main units and are used for J and K type thermocouple and Pt1000/Ni1000 temperature sensor input. These special adapters provide users with 4 analog input channels with selectable input types to fit the application.

Note: When connecting to an FX3S, FX3G, or FX3U main unit, an interface adapter or interface board is required.

Specifications	FX3U-4AD-PNK-ADP	FX3U-4AD-TC-ADP
Power supply	5 V DC/15 mA (from main unit); 24 V DC/50 mA	5 V DC/15 mA (from main unit); 24 V DC/45 mA
Analog inputs	4 (Pt1000 or Ni1000)	4 (J or K type)
Compensated temperature range	°C -50 to +250 (Pt1000)/ -40 to +110 (Ni1000)	-100 to +600 (J type)/ -100 to +1000 (K type)
Digital outputs	-500 to +2500 (Pt1000)/ -400 to +1100 (Ni1000)	-1000 to +6000 (J type)/ -1000 to +10000 (K type)
Resolution	0.1°C	0.3°C (J type)/0.4°C (K type)
Overall accuracy for fullscale	±0.5% – ±1.0%*	±0.5% – ±1.0%*
Related I/O points	0	0
Weight	kg 0.1	0.1
Dimensions (W x H x D)	mm 17.6 x 90 x 89.5	17.6 x 90 x 89.5

* Dependent on the ambient temperature

Temperature Control Blocks

FX3S FX3G FX3GE FX3GC FX3U FX3UC

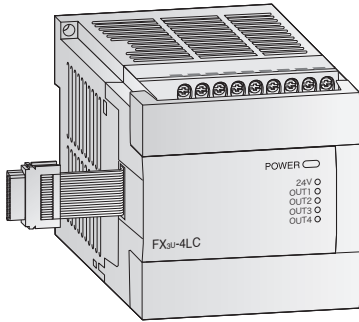

FX3U-4LC

FX2N-2LC*1, FX3U-4LC

These temperature control blocks are used when the internal PID functions are not precise or fast enough. The 4 inputs on the FX3U-4LC support Thermocouple elements, PT elements and micro voltage inputs. The two inputs on the FX2N-2LC support Thermocouple elements and PT100 elements. Each channel of the FX3U-4LC controls two outputs for heating and cooling. The FX2N-2LC is equipped with 1 output per channel for heating control. The FX3U-4LC supports cascade control as well.

Note: When attaching the FX3U-4LC or FX2N-2LC analog blocks to an FX3GC or FX3UC main unit, the FX2NC-CNV-IF interface converter or the FX3UC-1PS-5V power supply unit is required.

Specifications	FX2N-2LC	FX3U-4LC
Power supply	5 V DC/70 mA (from main unit); 24 V DC/55 mA	5 V DC/160 mA (from main unit); 24 V DC/50 mA
Analog inputs	2 points (Thermocouple and Pt100 sensor)	4 points (Thermocouple, PT and micro Voltage)
Compensated temperature range	Examples: • Type K: -100 to +1300 (°C)/ -100 to +2400 (°F) • Type J: -100.0 to +800.0 (°C)/ -100 to +2100 (°F)	Examples: • Type K: -100 to +1300 (°C)/ -100 to +2400 (°F) • Type J: -100.0 to +800.0 (°C)/ -100 to +2100 (°F) • Voltage input: 0 to 10 mV DC, 0 to 100 mV DC
Outputs	2 transistor outputs	4 transistor outputs embedded, 4 external points
Resolution	0.1 °C or 1 °C	Temperature input: 0.1°C/0.1°F or 1°C/1°F Voltage input: 0.5 μV
Overall accuracy for fullscale	±0.3% – ±0.7% (±1 digit)*2	±0.3% – ±0.7% (±1 digit)*2
Related I/O points	8	8
Weight	kg 0.3	0.4
Dimensions (W x H x D)	mm 55 x 90 x 87	90 x 90 x 87

*1 Production will be discontinued in March 2018.

*2 Dependent on the ambient temperature

HIGH-SPEED INPUT & COUNTERS

High-Speed Input Special Adapter

FX3S FX3G FX3GE FX3GC FX3U FX3UC

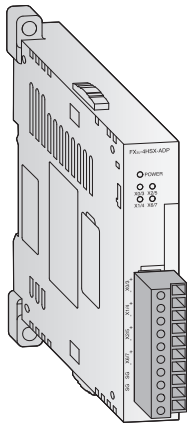

FX3U-4HSX-ADP

FX3U-4HSX-ADP

The FX3U-4HSX-ADP is available for the FX3U main unit and are used to allow direct processing of positioning applications on the FX system. The FX3U-4HSX-ADP upgrades 4 of the built-in high-speed counter inputs to 200 kHz capacity.

Specifications	FX3U-4HSX-ADP
Power supply	5 V DC/30 mA (from main unit); 24 V DC/30 mA (from main unit)
Maximum connectivity	2
Related I/O points	4
I/O type	inputs 4 outputs —
Max. frequency	inputs kHz 1-phase: 200 2-phase: 100 outputs kHz —
Input format	Differential line receiver (equivalent to AM26C32)
Output format	—
Maximum cable length	m 10
Input voltage	5 V DC
Output load	—
Weight	kg 0.08
Dimensions (W x H x D)	mm 17.6 x 90 x 89.5

High-Speed Counter Blocks

FX3S FX3G FX3GE FX3GC FX3U FX3UC

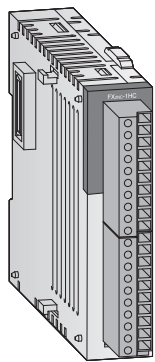

FX2NC-1HC

FX2N-1HC, FX2NC-1HC, and FX3U-2HC

FX2N-1HC, FX2NC-1HC, and FX3U-2HC provide additional high speed counter or counters to the attached FX main unit. The FX2N-1HC and FX2NC-1HC count 1- or 2-phase pulses up to a frequency of 50 kHz using 16 or 32 bits. The FX3U-2HC increases the maximum frequency to 200 kHz.

The two integrated transistor outputs per counter can be switched independently of one another by means of internal comparison functions. Hence, simple positioning tasks can also be handled economically. In addition, all three blocks can be used as a ring counter.

Note: The FX2NC-1HC may only be used in combination with an FX3UC main unit. When attaching the FX2N-1HC or FX3U-2HC high-speed counter block to an FX3UC main unit, the FX2NC-CNV-IF interface converter or the FX3UC-1PS-5V power supply unit is required.

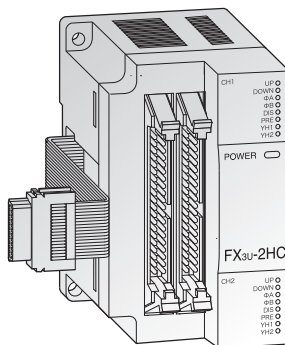

FX3U-2HC

Specifications	FX2N-1HC	FX2NC-1HC	FX3U-2HC
Signal level	5, 12, 24 V DC		5, 12, 24 V DC
Power supply	5 V DC/90 mA (from main unit)		5 V DC/245 mA (from main unit)
Counter inputs	1-phase (1 input or 2 input) 2-phase (1edge, 2edge or 4 edge count)		
Max. counting frequency	50 kHz		200 kHz
Input format	Differential line receiver/Open collector		
Input channels	1		2
Type of counter	Up/down counter, ring counter		
Counting range	16 bit 0 to +65,535 32 bit -2,147,483,648 to +2,147,483,647		
Output type	2 x transistor (5 to 24 V DC/0.5 A)		4 x transistor (5 to 24 V DC/0.5 A)
Related I/O points	8		
Weight	kg 0.3	0.13	0.2
Dimensions (W x H x D)	mm 55 x 90 x 87	20.2 x 90 x 89	55 x 90 x 87

High-Speed Output Special Adapter

FX3S FX3G FX3GE FX3GC FX3U FX3UC

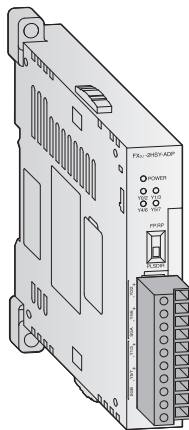

FX3U-2HSY-ADP

FX3U-2HSY-ADP

The FX3U-2HSY-ADP is available for the FX3U main unit and is used to allow direct processing of positioning applications on the FX system. The FX3U-2HSY-ADP upgrades 2 of the built-in high-speed outputs to 200 kHz capacity.

Specifications	FX3U-2HSY-ADP
Power supply	5 V DC/30 mA (from main unit); 24 V DC/60 mA (from main unit)
Max. connectivity	2
Related I/O points	4
I/O type	inputs — outputs (2 output points occupied per high-speed output)
Max. frequency	inputs kHz — outputs kHz 200
Input format	—
Output format	Differential line driver (equivalent to AM26C31) Pulse/Direction or Forward/Reverse Rotation
Max. cable length	m 10
Input voltage	—
Output load	less than 25 mA
Weight	kg 0.08
Dimensions (W x H x D)	mm 17.6 x 90 x 89.5

2-Axis Positioning Block

FX3S FX3G FX3GE FX3GC FX3U FX3UC

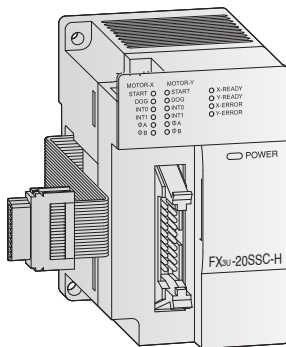

FX3U-20SSC-H

FX3U-20SSC-H

The FX3U-20SSC-H is a high-performance 2-axis positioning block for the FX3U and FX3UC main units. The module uses the SSCNET III servo system control network which implements noise-free fiber optic cabling with station-to-station spacing of up to 50 m and communication speeds up to 50 Mbps. Servo amplifier and positioning parameters are all saved within the module for easy recovery and re-installation. The block features simultaneous and interpolated 2-axis positioning control by way of operation patterns as well as pre-defined table setup. With its dedicated setup, monitor, and testing software, FX Configurator-FP, all aspects of the servo system can be centrally accessed and adjusted.

Note: When attaching FX3U-20SSC-H positioning blocks to an FX3UC main unit, the FX2NC-CNV-IF interface converter or the FX3UC-1PS-5V power supply unit is required.

Specifications	FX3U-20SSC-H	
Number of controllable axes	2 axes	
Related I/O points	8	
Connectable servo amplifier	MELSERVO MR-J4-B, MR-J3-BS, MR-J3-B, or MR-J3-W Max. 2 amplifiers can be connected Standard cord length: Station-to-station Max. 20 m Long distance cord length: Station-to-station Max. 50 m	
Servo bus	SSCNET III	
Scan cycle	1.77 ms	
Positioning	Method	Increment/Absolute
	User Units	PLS, μm , 10^{-4}inch , mdeg
	Unit magnification	1, 10, 100, and 1000-fold
	Positioning range	-2,147,483,648 to 2,147,483,647 PLS
	Speed units	Hz, cm/min, 10deg/min, inch/min
	Acceleration/deceleration process	Trapezoidal acceleration/deceleration, S-pattern acceleration/deceleration: 1 to 5000ms Only trapezoidal acceleration/deceleration is available for interpolation
	Starting time	1.6ms or less
Interpolation function	2-axis linear interpolation, 2-axis circular interpolation	
Power supply	24 V DC +20% -15% Ripple (p-p) within 5%	
Power consumption	5W	
Weight	kg 0.3	
Dimensions (W x H x D)	mm 55 x 90 x 87	

1-Axis Positioning Blocks

FX3S FX3G FX3GE FX3GC FX3U FX3UC

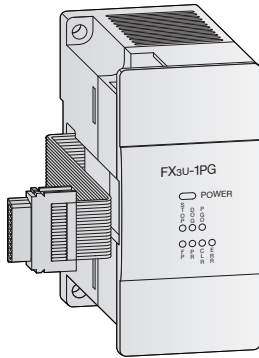

FX3U-1PG

FX3U-1PG, FX2N-10PG

The FX3U-1PG and FX2N-10PG positioning blocks are extremely efficient single-axis positioning modules for controlling either step drives or servo drives with a pulse train. The blocks are very suitable for achieving accurate positioning in combination with the FX series using a wide range of manual and automatic functions. The configuration and allocation of the positioning data are carried out directly via the PLC program.

Note: When attaching FX2N or FX3U positioning blocks to an FX3UC main unit, the FX2NC-CNV-IF interface converter or the FX3UC-1PS-5V power supply unit is required.

Specifications	FX3U-1PG	FX2N-10PG
Signal level for digital inputs	24 V DC/40 mA	5 V DC/100 mA; 24 V DC/70 mA
Power supply	5 V DC/150 mA (from main unit)	5 V DC/120 mA (from main unit)
Accessible axes	1	1
Output frequency	Max. 200 kHz	Max. 1 MHz
Related I/O points	8	8
Weight	kg 0.2	0.2
Dimensions (W x H x D)	mm 43 x 90 x 87	43 x 90 x 87

Stand-Alone Positioning Blocks

FX3S FX3G FX3GE FX3GC FX3U FX3UC

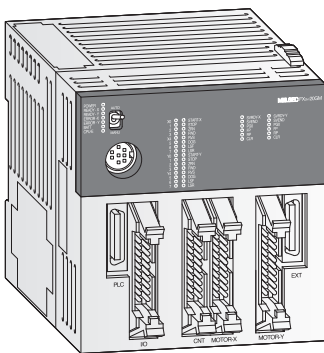

FX2N-20GM

FX2N-10GM, FX2N-20GM

The FX2N-10GM and FX2N-20GM positioning blocks are pulse train output units that enable the positioning control of stepping motors or servo motors via the drive unit. The dedicated software uses flow-chart based programming to easily complete simple to complicated positioning tasks. Furthermore, with stand-alone functionality, the FX2N-10GM and FX2N-20GM are able to control up to 48 I/O.

Note: When attaching FX2N positioning blocks to an FX3UC main unit, the FX2NC-CNV-IF interface converter or the FX3UC-1PS-5V power supply unit is required.

Specifications	FX2N-10GM	FX2N-20GM
Number of controllable axes	1 axis	2 axes (independently or simultaneously)
Program memory	3.8 K steps with EEPROM	7.8 K steps with built-in RAM (battery backup): EEPROM optionally
Positioning	method	Absolute data or incremental
	units	mm, inch, degree and pulse
	counting resolution	31 bit + sign, -2,147,483,648 to 2,147,483,647
	Max. output frequency	200 kHz
speed	1,530,000 mm/min.	1,530,000 mm/min.
Related I/O points	8	8
Power supply	24 V DC (-15 % to +10 %)	24 V DC (-15 % to +10 %)
Power consumption	5 W	10 W
Weight	kg 0.3	0.4
Dimensions (W x H x D)	mm 60 x 90 x 87	86 x 90 x 87

■ Cam-Switch Block

FX3S FX3G FX3GE FX3GC FX3U FX3UC

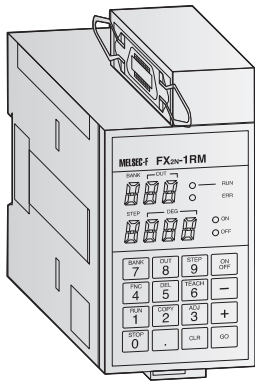

FX2N-1RM-E

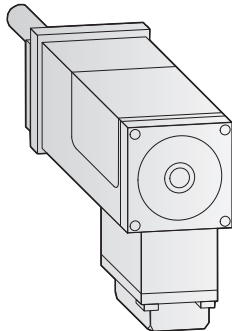

F2-720RSV

FX2N-1RM-E-SET

The FX2N-1RM-E-SET is often called an electronic cam block. It can be used to replace a mechanical cam system with a virtual electronic cam sequence using a resolver module. This makes system setup quick and easy and offers users the benefit of making simple adjustments to gain the best system performance.

Note: When attaching the FX2N-1RM-E-SET to an FX3UC main unit, the FX2NC-CNV-IF interface converter or the FX3UC-1PS-5V power supply unit is required.

Specifications	FX2N-1RM-E-SET
Number of controllable axes	1 using resolver F2-720RSV
Maximum connectivity	3
Number of cam output I/O	48 outputs (32 may be ON at one time)
Control resolution	1 revolution of 720 divisions (0.5 degrees) or 360 divisions (1 degree)
Response	415 rpm with 0.5 degrees or 830 rpm with 1 degree
ON/OFF frequency	8 times per CAM profile
Resolver	3000 rpm
Maximum cable length	up to 100 m
Power supply	24 V DC (-15 % to +10 %); 300 mA (400 mA when 32 outputs are ON)
Related I/O points	8*
Weight	kg 0.5
Dimensions (W x H x D)	mm 55 x 111 x 97

* The number of related I/O points will always be 8, regardless of how many units are attached.

Expansion Boards

FX3S
 FX3G
 FX3GE
 FX3GC
 FX3U
 FX3UC

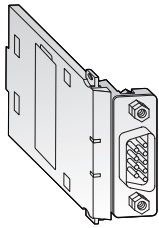

FX3U-232-BD

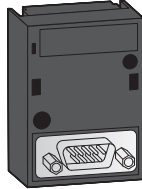

FX3G-232-BD

FX3G-232-BD and FX3U-232-BD Communication Expansion Boards

These communication expansion boards allow their respective FX main units to communicate with external devices and other FX main units over RS-232C.

Specifications	FX3G-232-BD	FX3U-232-BD
Applicable main units	FX3S, FX3G, FX3GE	FX3U
Interface	RS-232C with 9 pole D-SUB connector	
Power supply	5 V DC/20 mA (from main unit)	
Related I/O points	—	
Weight	kg 0.02	0.02
Dimensions (W x H x D)	mm 35 x 51.2 x 17.2	19.3 x 46.1 x 62.7

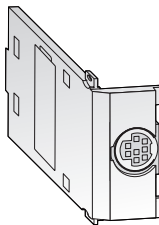

FX3U-422-BD

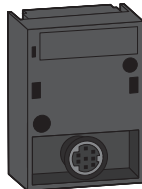

FX3G-422-BD

FX3G-422-BD and FX3U-422-BD Communication Expansion Boards

These communication expansion boards add an additional RS-422 programming port to their respective FX main units to communicate with external equipment.

Specifications	FX3G-422-BD	FX3U-422-BD
Applicable main units	FX3S, FX3G, FX3GE	FX3U
Interface	RS-422 with 8 pole mini DIN connector	
Power supply	5 V DC/20 mA (from main unit)	
Related I/O points	—	
Weight	kg 0.02	0.02
Dimensions (W x H x D)	mm 35 x 51.2 x 14.9	19.6 x 46.1 x 53.5

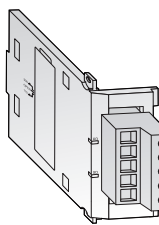

FX3U-485-BD

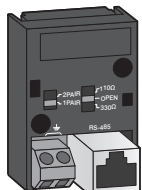

FX3G-485-BD-RJ

FX3G-485-BD, FX3G-485-BD-RJ and FX3U-485-BD Communication Expansion Boards

These communication expansion boards allow their respective FX main units to communicate with external devices and other FX main units over an RS-485 serial communication network.

Specifications	FX3G-485-BD	FX3G-485-BD-RJ	FX3U-485-BD
Applicable main units	FX3S, FX3G, FX3GE	FX3S, FX3G, FX3GE	FX3U
Interface	RS-485	RJ-45	RS-485
Power supply	5 V DC/20 mA (from main unit)	5 V DC/20 mA (from main unit)	5 V DC/40 mA (from main unit)
Related I/O points	—		
Weight	kg 0.02	0.02	0.02
Dimensions (W x H x D)	mm 35 x 51.2 x 29.2	35 x 51.2 x 22	19.6 x 46.1 x 69

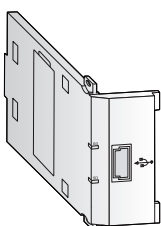

FX3U-USB-BD

FX3U-USB-BD Communication Expansion Board

The FX3U-USB-BD communication expansion board is available for the FX3U main unit and provides a direct PC-to-PLC connection port for a standard USB cable.

Specifications	FX3U-USB-BD
Applicable main units	FX3U
Power supply	5 V DC/15 mA (from main unit), 30 mA (from PC USB connector)
Weight	kg 0.02
Dimensions (W x H x D)	mm 19.6 x 46.1 x 53.5

MODBUS & Serial Communication Special Adapters

FX3S FX3G FX3GE FX3GC FX3U FX3UC

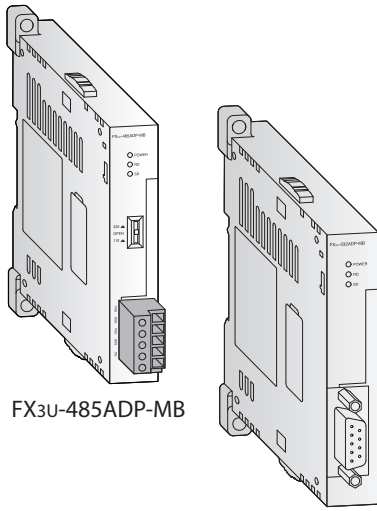

FX3U-485ADP-MB

FX3U-232ADP-MB

FX3U-485ADP-MB, FX3U-232ADP-MB

The FX3U-485ADP-MB and FX3U-232ADP-MB communication special adapters are available for FX series main units and support a wide range of serial communication standards including MODBUS. MODBUS functionality requires an FX3U or FX3UC main unit of firmware version 2.40 or later, an FX3G main unit of firmware version 1.30 or later and for MODBUS master functionality, GX Developer 8.45X or later.

Note: When attaching the FX3U-485ADP-MB or FX3U-232ADP-MB to an FX3S, FX3G, or FX3U main unit, an interface adapter or interface board is required.

Specifications	FX3U-485ADP-MB	FX3U-232ADP-MB
Power supply	5 V DC/20 mA (from main unit)	5 V DC/30 mA (from main unit)
Interface	RS-485	RS-232C
Communication speed*	Max. 115.2 kbps	Max. 115.2 kbps
Communication distance	Max. 500 m	Max. 15 m
Related I/O points	0	0
Weight	kg 0.08	0.08
Dimensions (W x H x D)	mm 17.6 x 90 x 89.5	17.6 x 90 x 89.5

* Communication speed depends on the serial communication method being used (N:N Network, Parallel Link, Computer Link, Inverter communication, Non-protocol communication, Programming communication, Remote Maintenance, or MODBUS).

Serial Communication Block

FX3S FX3G FX3GE FX3GC FX3U FX3UC

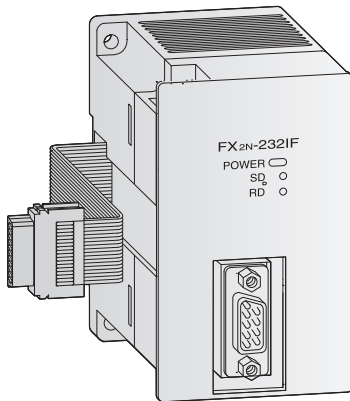

FX2N-232IF

FX2N-232IF

The FX2N-232IF serial communication block provides an RS-232C serial communication interface for use with external equipment such as PCs, printers, and barcode readers. Sent and received transmission data is stored in the internal buffer memory of the block and can be accessed by the PLC through the right-side extension bus using the FROM/TO instructions.

Note: When attaching the FX2N-232IF to an FX3UC main unit, the FX2NC-CNV-IF interface converter or the FX3UC-1PS-5V power supply unit is required.

Specifications	FX2N-232IF
Interface	RS-232C with 9 pole D-SUB connector (photocoupler isolation)
Power supply	5 V DC/40 mA (from main unit); 24 V DC/80mA
Communication speed	Max. 19.2 kbps
Communication distance	Max. 15 m
Communication cable	Shielded cable
Communication mode	Full duplex
Protocols	Non-protocol mode/start stop synchronisation
Send and receive buffer	512 bytes each
Format	7 or 8 bit, parity none/even/odd, stop bit: 1 or 2
Related I/O points	8
Weight	kg 0.3
Dimensions (W x H x D)	mm 55 x 90 x 87

■ CC-Link V2 Blocks

FX3S FX3G FX3GE FX3GC FX3U FX3UC

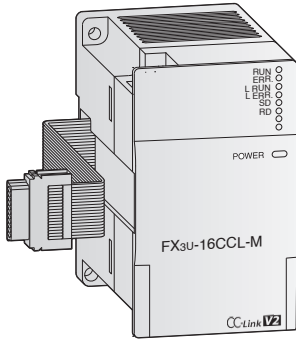

FX3U-16CCL-M

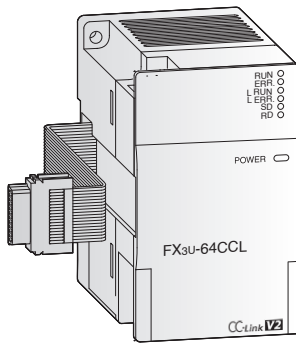

FX3U-64CCL

FX3U-16CCL-M Master Block and FX3U-64CCL Interface Block

These 2 units are available for FX3G, FX3GC, FX3GE, FX3U and FX3UC main units and enable CC-Link V2 functionality for expanded cyclic transmission and programming via CC-Link.

A large range of CC-Link devices can be found in the Mitsubishi Electric CC-Link compatible product catalog.

Note: When attaching the FX3U-16CCL-M or FX3U-64CCL to an FX3GC or FX3UC main unit, the FX2NC-CNV-IF interface converter or the FX3UC-1PS-5V power supply unit is required.

Specifications	FX3U-16CCL-M	FX3U-64CCL
Module type	Master station	Intelligent device station
Link points per station	I/O points	128 (Occupying 1 station with Octuple expanded cyclic setting)
	registers	32 (Occupying 1 station with Octuple expanded cyclic setting)
Max. number of I/O points	256 (with FX3G/FX3GC/FX3GE PLC), 384 (with FX3U/FX3UC PLC)*	
Number of connectable modules	Max. 16	—
Related I/O points	8	8
Max. transmission speed	10 Mbps	10 Mbps
Power supply	24 V DC/240 mA	24 V DC/220 mA
Weight	kg 0.3	0.3
Dimensions (W x H x D)	mm 55 x 90 x 87	55 x 90 x 87

* Including I/O points in PLC and network.

5

■ CC-Link Block

FX3S FX3G FX3GE FX3GC FX3U FX3UC

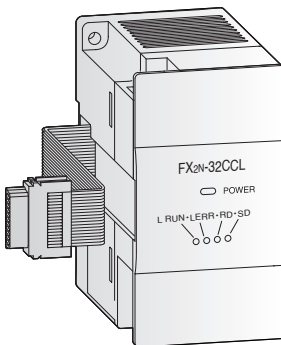

FX2N-32CCL

FX2N-32CCL Slave Block

The FX2N-32CCL block allows the attached FX3G, FX3GC, FX3GE, FX3U and FX3UC main unit to be a slave on a CC-Link V1 network.

A large range of CC-Link devices can be found in the Mitsubishi Electric CC-Link compatible product catalog.

Note: When attaching the FX2N-32CCL to an FX3GC or FX3UC main unit, the FX2NC-CNV-IF interface converter or the FX3UC-1PS-5V power supply unit is required.

Specifications	FX2N-32CCL	
Module type	Remote device station	
CC-Link Version	Ver. 1.00	
Link points per station (Occupies 1 station)	I/O points	32
	registers	4
Related I/O points	8	
Max. transmission speed	10 Mbps	
Power supply	5 V DC/130 mA (from main unit); 24 V DC/50 mA	
Weight	kg 0.3	
Dimensions (W x H x D)	mm 43 x 90 x 87	

■ Ethernet Communication Block

FX3S FX3G FX3GE FX3GC FX3U FX3UC

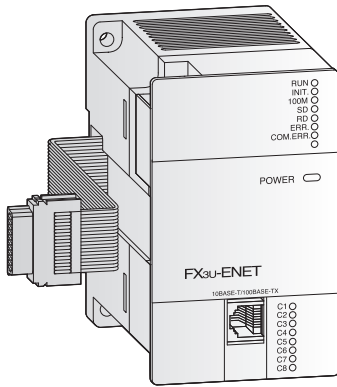

FX3U-ENET

FX3U-ENET and FX3U-ENET-L Communication Blocks

The FX3U-ENET and FX3U-ENET-L communication blocks are available for FX3 series main units and enables 4 or 8 ports of simultaneous Ethernet communication with features such as peer-to-peer communication, extensive e-mail options, and program upload/download. Easy communication parameter setup and block troubleshooting is also possible using the dedicated software, FX Configurator-EN or FX Configurator-EN-L.

Note: When attaching the FX3U-ENET or FX3U-ENET-L to an FX3GC or FX3UC main unit, the FX2NC-CNV-IF interface converter or the FX3UC-1PS-5V power supply unit is required.

Specifications	FX3U-ENET	FX3U-ENET-L
Applicable main units	FX3G, FX3GC, FX3GE, FX3U, FX3UC	FX3U, FX3UC
Applicable software	FX Configurator-EN	FX Configurator-EN-L
Protocol	MC Protocol, TCP/IP, UDP	MC Protocol, TCP/IP, UDP
Communication mode	Full-duplex/half-duplex	Full-duplex/half-duplex
Number of simultaneous open connections	8	4
Fixed buffer communication	1023 word x 8	1023 word x 2
e-mail	send/receive	send
Communication with mail server	SMTP, POP3	SMTP, POP3
Interface	IEEE802.3u (100BASE-TX), IEEE802.3 (10BASE-T)	IEEE802.3u (100BASE-TX), IEEE802.3 (10BASE-T)
Connector	RJ45	RJ45
Max. transfer rate	100 Mbps, 10 Mbps	100 Mbps, 10 Mbps
Max. segment length	100m	100m
Cable	CAT5e STP, CAT5 STP (100BASE-TX) CAT5e STP, CAT5 STP, CAT3 STP (10BASE-T)	CAT5e STP, CAT5 STP (100BASE-TX) CAT5e STP, CAT5 STP, CAT3 STP (10BASE-T)
Related I/O points	8	8
Power supply	24 V DC/240 mA	24 V DC/240 mA
Weight	kg 0.3	0.3
Dimensions (W x H x D)	mm 55 x 90 x 87	55 x 90 x 87

■ Ethernet Communication Special Adapter

FX3S FX3G FX3GE FX3GC FX3U FX3UC

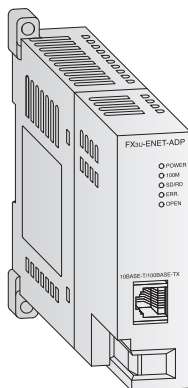

FX3U-ENET-ADP

FX3U-ENET-ADP

Easy to use FX3U-ENET-ADP for the FX series offers connectivity to GOT2000 HMI's, GX Works2 programming software and custom developed software via the open MC protocol. The PLC real time clock can be set from the network by the SNTP protocol.

Note: When connecting the FX3U-ENET-ADP to an FX3S, FX3G, or FX3U PLC, a connector conversion adapter or expansion board respectively is required.

Specifications	FX3U-ENET-ADP
Protocol	MC Protocol, TCP/IP, UDP, SNTP
Communication mode	Full-duplex/half-duplex
Number of simultaneous open connections	4
Interface	IEEE802.3u (100BASE-TX), IEEE802.3 (10BASE-T)
Connector	RJ45
Max. transfer rate	100 Mbps, 10 Mbps
Cable	CAT5e STP, CAT5 STP (100BASE-TX) CAT5e STP, CAT5 STP, CAT3 STP (10BASE-T)
Related I/O points	0
Power supply	5 V DC/30 mA (from main unit)
Weight	kg 0.1
Dimensions (W x H x D)	mm 23 x 90 x 81.5

■ AnyWireASLINK Block

FX3S FX3G FX3GE FX3GC FX3U FX3UC

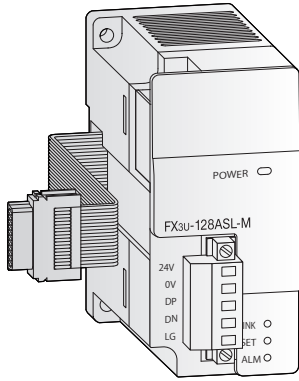

FX3U-128ASL-M

For FX3U-128ASL-M type AnyWireASLINK system master block, a unique transmission method of AnyWireASLINK is utilized in a transmission signal having a power supply (equiv. to 24 V DC, MAX. 2 A). It enables wire saving of max. 200 m using 4-core or 2-core power cables.

The FX3U-128ASL-M is jointly developed/manufactured with Anywire Corporation. Warranty details are different from other PLC products.

Note: When attaching the FX3U-128ASL-M to an FX3GC or FX3UC main unit, the FX2NC-CNV-IF interface converter or the FX3UC-1PS-5V power supply unit is required.

Specifications	FX3U-128ASL-M
Transmission clock	27.0 kHz
Max. transmission distance (total extension length)	200 m
Transmission system	DC power supply transmission total frame cyclic system
Connection type	Bus topology (multidrop system, T-branch system, tree branch system)
Transmission protocol	Dedicated protocol (AnyWireASLINK)
Communication with PLC	By FROM and TO instructions or direct specification of buffer memory via the buffer memory.
Max. number of connected I/O points	128 points (countable either by input or output)
Max. number of connected modules	128 modules
Power supply	5 V DC/130 mA
Related I/O points	8 points
No. of connectable blocks to the main unit	1 unit
Weight	kg 0.2
Dimensions (W x H x D)	mm 43 x 90 x 95.5

■ Data Logging Adapter

FX3S FX3G FX3GE FX3GC FX3U FX3UC

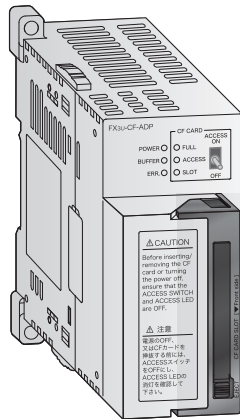

FX3U-CF-ADP

FX3U-CF-ADP

The FX3U-CF-ADP functions as a general purpose data logging adapter. Data logging is controlled by the PLC with dedicated commands for easy programming. Data transfer can be set to occur at periodical times or based on certain events. A timestamp can be automatically be added to data for tracing purposes. Data is stored on a CF card in CSV format.

Note: The FX3U-CF-ADP is available for FX3U and FX3UC main units of firmware version 2.61 or later. The FX3U-CF-ADP is handled in the same way as a communication adapter or expansion board and occupies 1 communication channel.

Specifications	FX3U-CF-ADP
Max file size (per file)	512 MB
Data format	CSV format
Max. number of files	64 (including 1 FIFO file)
Related I/O points	0
Applied instruction functions	File create/check, File delete/CF card format, Data write, Data read, FX3U-CF-ADP command, FX3U-CF-ADP status read
Power supply	5 V DC/50 mA (from main unit), 24 V DC/130 mA
Weight	kg 0.3
Dimensions (W x H x D)	mm 45 x 90 x 89.5

INTERFACE OPTIONS

Interface Board

FX3S FX3G FX3GE FX3GC FX3U FX3UC

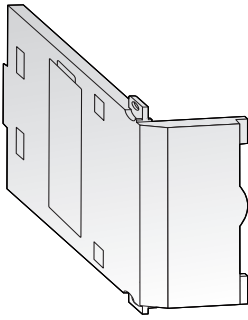

FX3U-CNV-BD

FX3U-CNV-BD

The FX series interface board enables connection of special adapters to the left-side of the associated FX3U main unit. Communication expansion boards may also be used for the FX3U main unit.

Note: The FX3U-2HSY-ADP and FX3U-4HSX-ADP do not require an FX3U-CNV-BD interface board to connect to the FX3U main unit.

Specifications	FX3U-CNV-BD
Applicable main units	FX3U
Weight	kg 0.01
Dimensions (W x H x D)	mm 19.6 x 46.1 x 53.5

Interface Adapters

FX3S FX3G FX3GE FX3GC FX3U FX3UC

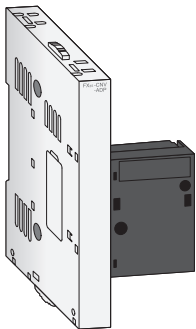

FX3S-CNV-ADP

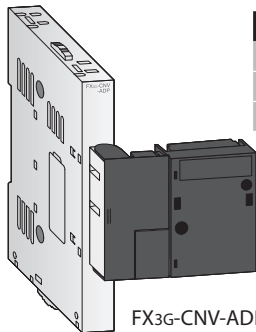

FX3G-CNV-ADP

FX3S-CNV-ADP, FX3G-CNV-ADP

The FX3S-CNV-ADP interface adapter allows FX3S main units to connect with the standard FX3S left side adapter bus.

The FX3G-CNV-ADP interface adapter allows FX3G main units to connect with the standard FX3S left side adapter bus.

Specifications	FX3S-CNV-ADP	FX3G-CNV-ADP
Applicable main units	FX3S	FX3G
Weight	kg 0.1	0.1
Dimensions (W x H x D)	mm 14.6 x 90 x 74	14.6 x 90 x 86

Interface Converter

FX3S FX3G FX3GE FX3GC FX3U FX3UC

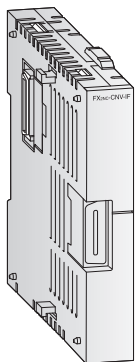

FX2NC-CNV-IF

FX2NC-CNV-IF

The FX2NC-CNV-IF interface converter allows FX3GC and FX3UC main units to connect with the standard FX3U right side extension bus.

Specifications	FX2NC-CNV-IF
Bus connection	FX3GC and FX3UC bus to FX3U bus
Weight	kg 0.06
Dimensions (W x H x D)	mm 14.6 x 90 x 74

■ Power Supply Units

FX3S FX3G FX3GE FX3GC FX3U FX3UC

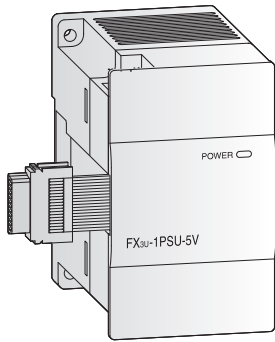

FX3U-1PSU-5V

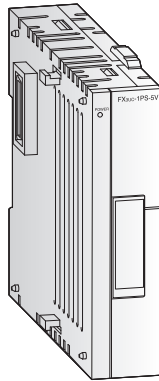

FX3UC-1PS-5V

FX3U-1PSU-5V, FX3UC-1PS-5V

The FX series power supply units are used to add power onto the 5V and 24V extension buses when the built-in service power supplies are not sufficient. The FX3U-1PSU-5V is used with the FX3G/FX3GE/FX3U and the FX3UC-1PS-5V is used with the FX3GC and FX3UC. Up to 2 modules can be added onto one system. The FX3UC-1PS-5V can also be used in place of an FX2NC-CNV-IF as a connection interface to FX3U extension and special function modules.

Note: The FX3U-1PSU-5V can not be used with 24V DC powered main units. Grounding and power cables should be adjusted to exit the unit from the top.

Specifications	FX3U-1PSU-5V	FX3UC-1PS-5V
Applicable main units	FX3G/FX3GE/FX3U (AC power supply type)	FX3GC/FX3UC
Input voltage	100 – 240 V AC	24 V DC +20% -15%
Input frequency	50/60 Hz	—
Inrush current	30 A Max. 5 ms or less/100 V AC 65 A Max. 5 ms or less/200 V AC	30 A Max. 0.5 ms/24 V DC
Power consumption	20 VA Max.	25 W Max.
Output current	24 V DC 0.3 A 5 V DC 1 A	— 1 A
Holding time	10 ms/100 V AC	5 ms
Weight	kg 0.3	0.15
Dimensions (W x H x D)	mm 55 x 90 x 87	24.2 x 90 x 74

MEMORY CASSETTES & BACKUP BATTERIES

Memory Cassettes

FX3S FX3G FX3GE FX3GC FX3U FX3UC

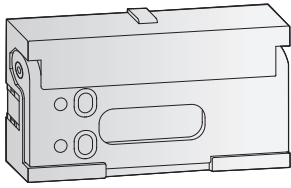

FX3U-FLROM-64L

FX3U-FLROM-16, FX3U-FLROM-64, FX3U-FLROM-64L, and FX3U-FLROM-1M

The FX3U-FLROM-16, FX3U-FLROM-64, FX3U-FLROM-64L and FX3U-FLROM-1M are Flash based memory cassette available for the FX3U and FX3UC main units. The Loader functionality in the FX3U-FLROM-64L allows the memory cassette to upload and download programs to and from the internal memory of the FX3U and FX3UC main units. When the memory cassette is attached to the FX main unit without uploading or downloading, the program on the memory cassette is executed without affecting the program within the internal PLC memory.

Specifications	FX3U-FLROM-16	FX3U-FLROM-64	FX3U-FLROM-64L	FX3U-FLROM-1M
Applicable main units	FX3U/FX3UC	FX3U/FX3UC	FX3U/FX3UC	FX3U/FX3UC
Number of steps	16,000	64,000	64,000	64,000 (source 1MB)*
Memory type	Flash memory	Flash memory	Flash memory	Flash memory
Protect switch	Provided	Provided	Provided	Provided
Data transfer buttons	Not provided	Not provided	Provided	Not Provided
Dimensions (W x H x D)	mm 37 x 20 x 6.1	37 x 20 x 6.1	37 x 20 x 6.1	37 x 20 x 6.1

* 64000 steps (program capacity) + 1300KB (symbolic information capacity)

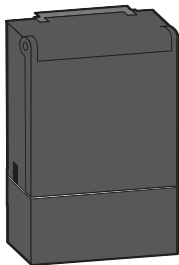

FX3G-EEPROM-32L

FX3G-EEPROM-32L

The FX3G-EEPROM-32L is an EEPROM based memory cassette available for the FX3S, FX3G, and FX3GE main units. With Loader functionality, the memory cassette can upload and download programs to and from the internal memory of the FX3S, FX3G, and FX3GE main units. When the memory cassette is attached to the main unit without uploading or downloading, the program on the memory cassette is executed without affecting the program within the internal PLC memory. The memory cassette can also be placed on top of standard FX3G BD expansion boards, FX3S-CNV-ADP, and FX3G-CNV-ADP.

Specifications	FX3G-EEPROM-32L
Applicable main units	FX3S*/FX3G/FX3GE
Memory type	EEPROM
Number of steps	2,000/4,000/8,000/16,000/32,000
Protect switch	Provided
Data transfer buttons	Provided
Weight	kg 0.02
Dimensions (W x H x D)	mm 35 x 51.2 x 9.6

* The FX3S series PLC can hold 16,000 steps of memory, but user program capacity is limited to 4000 steps.

8

ACCESSORIES

Backup Batteries

FX3S FX3G FX3GE FX3GC FX3U FX3UC

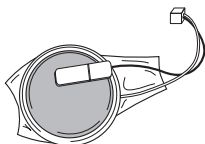

FX3U-32BL

FX2NC-32BL, FX3U-32BL

Backup batteries provide power to store relevant data within the FX main units and modules when they are not powered. For battery lifetime and battery changing procedures, refer to the relevant product manuals.

Specifications	FX2NC-32BL	FX3U-32BL
Applicable units	FX2N-20GM module/FX-30P unit	FX3G/FX3GE/FX3GC/FX3U/FX3UC main units

Interface Units

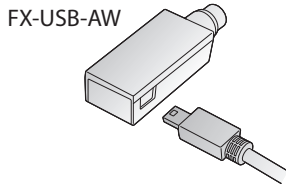

FX-USB-AW Interface converter

Specifications	FX-USB-AW	FX-232AWC-H
Applicable main units	FX3U/FX3UC	FX3S/FX3G/FX3GE/FX3GC/FX3U/FX3UC
Application	USB to RS-422 converter	RS-422 to RS-232C converter
Dimensions (W x H x D)	mm 14 x 20 x 63	25 x 80 x 60

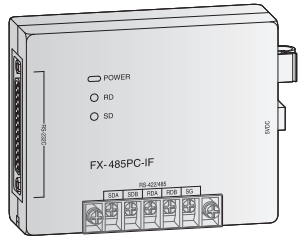

FX-485PC-IF

FX-485PC-IF PC RS-485 Interface Unit

The FX-485PC-IF interface unit is used to bridge RS-232C and RS-485 communication between a PC and several FX PLCs connected on an RS-485 1:N multidrop network.

Specifications	FX-485PC-IF
Applicable main units	FX3S/FX3G/FX3GE/FX3GC/FX3U/FX3UC
Power supply	5 V DC \pm 5%/260 mA
Interface	RS-232C/RS-485
Weight	kg 0.4
Dimensions (W x H x D)	mm 100 x 80 x 30

Terminal Blocks

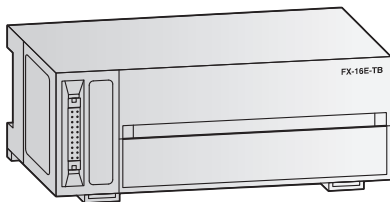

FX-16E-TB/UL

Remote Terminal Blocks

Remote terminal blocks allow I/O modules to be placed at the point of control. The blocks are connected with FX3GC or FX3UC main units and FX-GM controllers using connector-type I/O cabling.

Note: The products listed below may not comply with CE ratings.

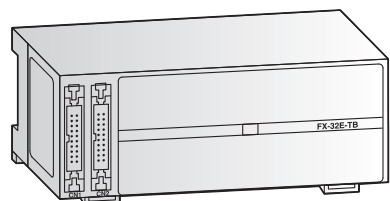

FX-32E-TB/UL

Specifications	FX-16E-TB	FX-16E-TB/UL	FX-32E-TB	FX-32E-TB/UL
Number of	inputs	up to 16 inputs or 16 outputs	up to 32 inputs or 32 outputs	up to 32 inputs or 32 outputs
	outputs			
Application		Connects directly to PLC input/output terminals.		
Weight	kg	0.3	0.3	0.3
Dimensions (W x H x D)	mm	150 x 55 x 45	150 x 55 x 45	150 x 55 x 45

Specifications	FX-16EYR-TB	FX-16EYR-TB/UL	FX-16EYS-TB	FX-16EYS-TB/UL
Number of	inputs	—	—	—
	outputs	16	16	16
Application		Relay output type	Triac output type	
Weight	kg	0.3	0.3	0.3
Dimensions (W x H x D)	mm	150 x 55 x 45	150 x 55 x 45	150 x 55 x 45

Specifications	FX-16EYT-TB	FX-16EYT-ES-TB/UL	FX-16EYT-ESS-TB/UL
Number of	inputs	—	—
	outputs	16	16
Application		Sink transistor output type	Source transistor output type
Weight	kg	0.3	0.3
Dimensions (W x H x D)	mm	150 x 55 x 45	150 x 55 x 45

■ Display Modules

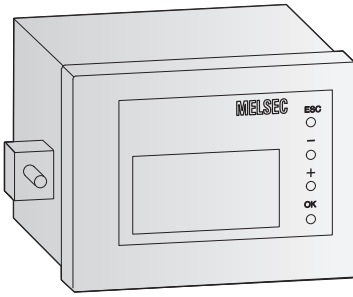

FX3U-7DM with FX3U-7DM-HLD

FX3U-7DM Display Module and FX3U-7DM-HLD Holder

The FX3U-7DM display module can be attached directly to the front face of the FX3U main unit or mounted in a panel using the FX3U-7DM-HLD display module holder. The display module enables monitoring and adjustment of PLC data devices as well as user messages.

Specifications	FX3U-7DM	FX3U-7DM-HLD
Applicable main units	FX3U	FX3U
Display	16 characters x 4 lines	—
Power supply	5 V DC/20 mA (from main unit)	—
Extension cable	—	Included
Weight	kg 0.02	0.01
Dimensions (W x H x D)	mm 48 x 35 x 11.5	66.3 x 41.8 x 13

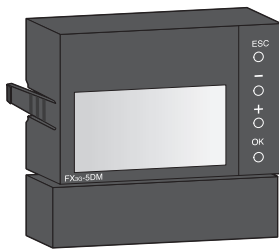

FX3G-5DM

FX3G-5DM

The FX3G-5DM display module is attached directly to the front face of the FX3G and FX3GE main units or on top of the FX3G BD expansion boards. The display module enables monitoring and adjustment of PLC data devices. When installed together with the FX3G-EEPROM-32L memory cassette (only possible with the 40 and 60 I/O point main units) the control for upload and download of the program will be done via the display module.

Specifications	FX3G-5DM
Applicable main units	FX3G/FX3GE
Display	16 characters x 4 lines
Weight	kg 0.02
Dimensions (W x H x D)	mm 49.4 x 51.2 x 12

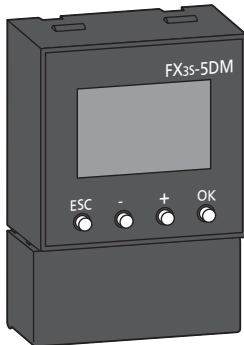

FX3s-5DM

FX3s-5DM

The FX3s-5DM display module is installed to the FX3s series main unit or expansion board to monitor/change device states and values.

Specifications	FX3s-5DM
Applicable main units	FX3s
Display	LCD (with backlight)
Weight	kg 0.02
Dimensions (W x H x D)	mm 35 x 51.2 x 12

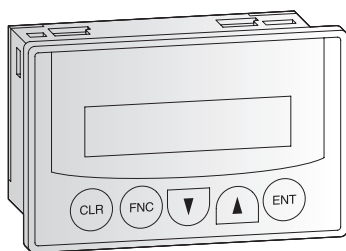

FX-10DM-E

FX-10DM-E*1

The text-based, panel-mounted FX-10DM-E control and display module provides a key-oriented user interface and enables monitoring and adjustment of PLC data devices.

Specifications	FX-10DM-E
Applicable main units	FX3U/FX3UC*2
Display	LCD (with backlight)
Resolution	2 x 16 characters (80 x 16 pixels)
Power supply	5 V DC \pm 5%/220 mA (from main unit)
Weight	kg 0.15
Dimensions (W x H x D)	mm 96 x 62 x 32

*1 Production will be discontinued in September 2017.

*2 When used with an FX3U or FX3UC main unit, the FX-10DM-E will only operate within the FX2N device range

■ Connection Cables

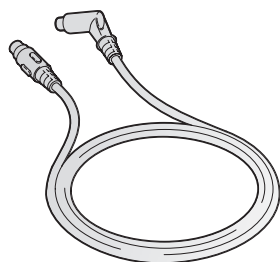

FX-20P-CAB0

FX series Connection Cables

The cables listed in the following tables are used for FX series PLC programming, positioning applications, block connections and interface conversion.

Connection cables for peripherals

Specifications	F2-RS-5CAB	F2-232CAB-1	FX-232CAB-1	FX-422CAB0
Application	FX2N-1RM to resolver	PC to FX-232AWC-H	PC to GOT	FX-232AWC-H to FX PLC
Length	m 5.0	3.0	3.0	1.5

Connection cables for programming unit

Specifications	FX-20P-CAB0
Application	FX-30P to FX PLC
Length	m 1.5

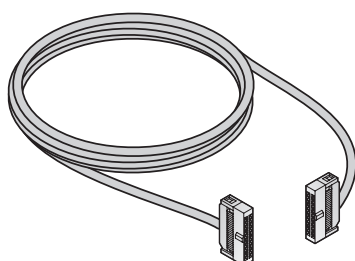

FX-16E-500CAB

Connection cables for FX3GC or FX3UC remote terminal blocks

Specifications	FX-16E-500CAB-S	FX-16E-150CAB	FX-16E-300CAB	FX-16E-500CAB	FX-16E-150CAB-R	FX-16E-300CAB-R	FX-16E-500CAB-R
Application	FX3GC/FX3UC to remote FX terminal block						
Length	m 5.0	1.5	3.0	5.0	1.5	3.0	5.0

Connection cables for remote connection

Specifications	E-GMH-200CAB	E-GMJ-200CAB	E-GMJ2-200CAB1A	E-GMC-200CAB	E-GM-200CAB
Application	FX-GM controller to servo				
Length	m 2.0	2.0	2.0	2.0	2.0

Connection cables for extension bus

Specifications	FX0N-30EC	FX0N-65EC	FX2N-GM-65EC	FX2N-GM-5EC
Application	PLC bus cable	PLC bus cable	GM bus cable	GM bus cable
Length	m 0.3	0.65	0.65	0.05

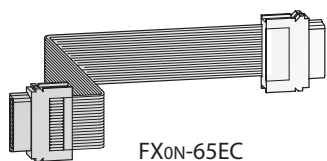

FX0N-65EC

Connection cables for FX3GC or FX3UC main units

Specifications	FX2NC-100MPCB	FX2NC-100BPCB	FX2NC-10BPCB1
Application	24 V DC power cable for main units	24 V DC power cable for extension units	Power crossover cable for input extension blocks
Length	m 1	1	0.01

■ PLC Bus Cable Connector

FX3S FX3G FX3GE FX3GC FX3U FX3UC

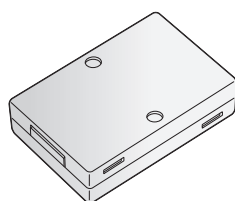

FX2N-CNV-BC

FX2N-CNV-BC

The FX2N-CNV-BC is used to connect a PLC bus extension cable (FX0N-30EC or FX0N-65EC) to the bus cable of an FX3U extension module or special function module.

Specifications	FX2N-CNV-BC
Application	PLC bus cable to FX3U extension module or special function module
Weight	kg 0.04
Dimensions (W x H x D)	mm 40 x 60.5 x 16.5

α2 series

■ Main Units

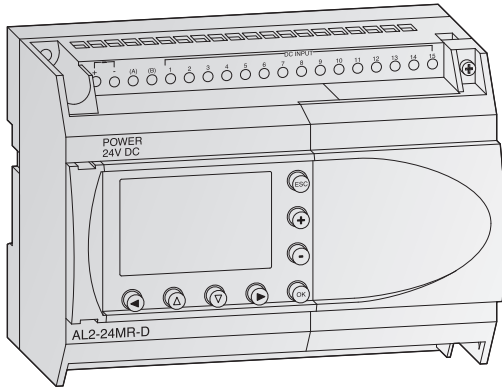

AL2-24MR-D

α2 Main Units

The α2 controllers offer simple, reliable control for a range of automation applications including lighting, air conditioning, security systems, and temperature and water control.

Features:

- Relay and Transistor output options
- Analog input and output options
- High-speed counters up to 1 kHz
- GSM modem functionality
- Language support for 7 different languages
- Display area for messages and function block data

Programming Specifications

System specifications	α2 series
Programming method	Function block
Program capacity	200 function blocks or 5000 bytes
Program processing	Cyclic processing of the stored program
Number of available instructions	38 different function blocks
Program storage	Integrated EEPROM and optional additional EEPROM cassette
Data storage	At voltage loss the current status of values, running time meters, and real-time data are stored for up to 20 days (at temperatures of 0 to 25 °C) using capacitors
Processing time	1 ms + 20 μs/logic instruction (complex commands 500 μs/instruction)
Real-time clock	Seconds, minutes, hours, day of week, month, year (4-digit); accuracy: 5 s/day; automatic daylight savings time adjustment
Program protection	3 levels using program and keys

Environmental Specifications

General Specifications	α2 series	
Ambient temperature	Display: -10 – 55 °C, Hardware: -25 – 55 °C (storage temperature: -30 – +70 °C)	
Protection rating	IP 20	
Noise immunity	1000 Vpp with noise generator; 1 μs at 30 – 100 Hz, tested by noise simulator	
Dielectric withstand voltage	3750 V AC for one minute	
Allowable relative humidity	35 – 85 % (no condensation)	
Shock resistance	Complies to IEC 68-2-27: 147 m/s ² acceleration, 11 ms 3 x 3 directions	
Vibration resistance	direct mounting	Complies to IEC-2-6: 19.6 m/s ² acceleration, 80 min. in each direction
	DIN rail mounting	Complies to IEC-2-6: 9.8 m/s ² acceleration, 80 min. in each direction
Insulation resistance	7 MΩ at 500 V DC	
Ambient conditions	No corrosive gases, no dust	
Certifications	Please refer to the Certifications page in this catalog	

Electrical Specifications

Power Supply Specifications	DC Powered Models (AL2-[]MR-D)	AC Powered Models (AL2-[]MR-A)
Power supply	24 V DC (+20 %/-15 %)	100–240 V AC (+10 %/-15 %), 50/60 Hz
Inrush current at ON	≤7.0 A (at 24 V DC)	≤6.5 A (at 240 V AC)
Allowable momentary power failure time	5 ms	10 ms
Digital Inputs		
Input voltage	24 V DC (+20 %/-15 %)	100–240 V AC (+10 %/-15 %), 50/60 Hz
Input current	The input current changes depending on Source or Sink. For Sink: (AL2-10/14/24MR-D) =5.5 mA, 24 V DC For Source: (AL2-10/14MR-D/AL2-24MR-D I01–I08) =6.0 mA, 24 V DC (AL2-24MR-D I09–I15) =5.5 mA, 24 V DC	I01–I08 0.13 mA/120 V AC* 0.25 mA/240 V AC* I09–I15 0.15 mA/120 V AC* 0.29 mA/240 V AC*
Response time	OFF→ON	10–20 ms
	ON→OFF	10–20 ms
Analog Inputs		
Analog input range	0–500	—
Resolution	9 bit, (10 V/500)	—
Conversion speed	ms 8	—
Input Voltage	0–10 V DC	—
Input Impedance	KΩ 142 ±5 %	—
Accuracy	±5 % (0.5 V DC)	—

* Current leakage from the sensors connected to the inputs might provide enough current to turn the controller ON. Do not use two-wire sensors

Output Specifications	All Models
Type	Relay
Switching voltage (Max.)	250 V AC, 30 V DC
Rated current	10M, 14M: 8 A/com 24M (001-004): 8 A/com 24M (005-009): 2 A/point
Max. switching load - inductive load	14M, 24M: 249 VA/250 V AC, 373 VA/250 V AC 24M: 93 VA/125 V AC, 93 VA/250 V AC
Min. load	10mA, 5 V DC (50 mW)
Response time	≤10 ms

Main Units with 10 – 24 I/O

Specifications	AL2-10MR-A	AL2-10MR-D	AL2-14MR-A	AL2-14MR-D	AL2-24MR-A	AL2-24MR-D
Electrical specifications						
Integrated inputs/outputs	10	10	14	14	24	24
Digital inputs	6	6	8	8	15	15
Analog inputs	—	6	—	8	—	8
Channels	—	6	—	8	—	8
Integrated outputs	4	4	6	6	9	9
Max. power consumption	W 4.9	4.0	5.5	7.5	7.0	9.0
Typical power consumption	All I/O ON/OFF	W 3.5/1.85 3.0/1.55	240 V AC 120 V AC	2.5/0.75	4.5/2.0 3.5/1.5	240 V AC 120 V AC
Weight	kg 0.2	0.2	0.3	0.3	0.35	0.3
Dimensions (W x H x D)	mm 71.2 x 90 x 52	71.2 x 90 x 52	124.6 x 90 x 52	124.6 x 90 x 52	124.6 x 90 x 52	124.6 x 90 x 52

Description of the Unit Components

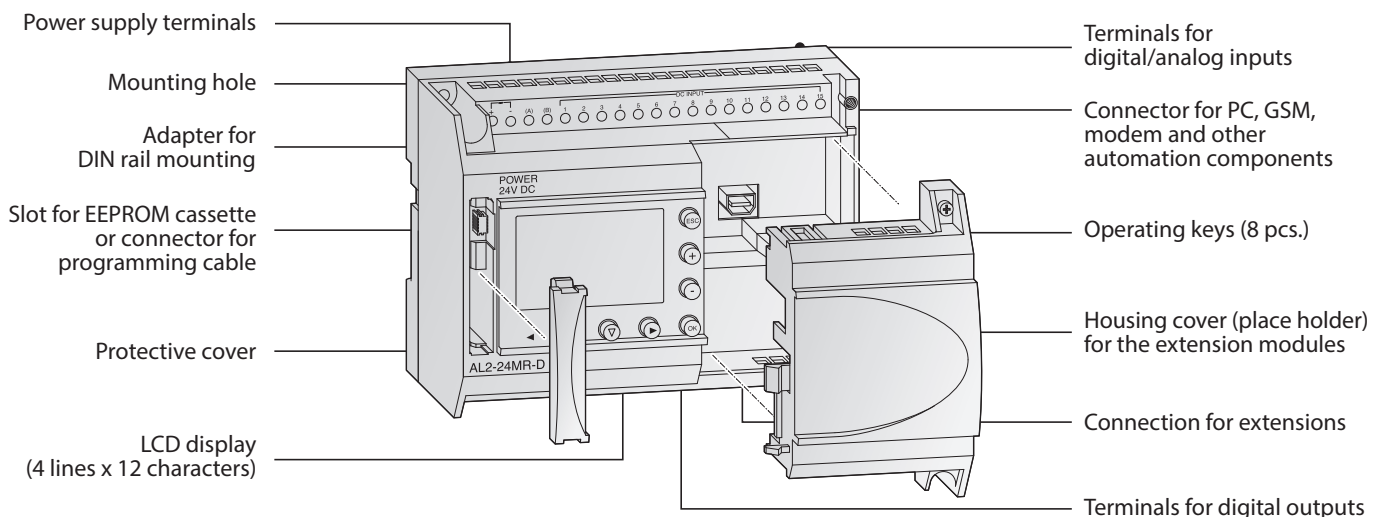

α SERIES EXTENSION MODULES & ACCESSORIES

I/O Extension Modules

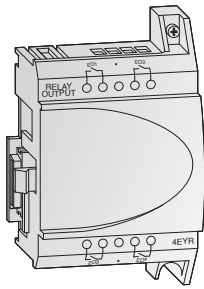

AL2-4EX-A2, AL2-4EX, AL2-4EYR, and AL2-4EYT

There are 4 different extension modules available for the α2 that extend the inputs and outputs of the controller. The modules are inserted directly into the α2 and therefore do not take up any additional space.

The AL2-4EX has an additional feature where 2 inputs may be used as high-speed counters with a counting frequency up to 1 kHz.

All modules feature photocoupler insulation for all I/O terminals.

Note: The I/O extension modules cannot be used with the AL2-10MR-series.

Digital Extension Modules Specifications		AL2-4EX-A2	AL2-4EX	AL2-4EYR	AL2-4EYT
Inputs					
Integrated inputs		4	4	—	—
Input voltage		220–240 V AC (+20%/-15%) 50/60 Hz	24 V DC (+20%/-15%)	—	—
Input current		7.5 mA at 240 V AC (50 Hz), 9.0 mA at 240 V AC (60 Hz)	5.4 mA ±1 mA at 24 V DC	—	—
Outputs					
Integrated outputs		—	—	4	4
Output type		—	—	Relay	Transistor
Switching voltage (Max.)		—	—	250 V AC, 30 V DC	5–24 V DC
Rated current		—	—	2 A/point	1 A/point
Electrical specifications					
Power Supply	AC range (+10 %, -15 %)	220–240 V AC	24 V DC	100–240 V AC	24 V DC
Mechanical specifications					
Weight	kg	0.05	0.05	0.05	0.05
Dimensions (W x H x D)	mm	53.1 x 90 x 24.5	53.1 x 90 x 24.5	53.1 x 90 x 24.5	53.1 x 90 x 24.5

Note: EI1 and EI2 of the AL2-4EX can be used as high-speed counter inputs. Each high speed counter input has an approximate response time of 0.5ms.

Analog Extension Modules

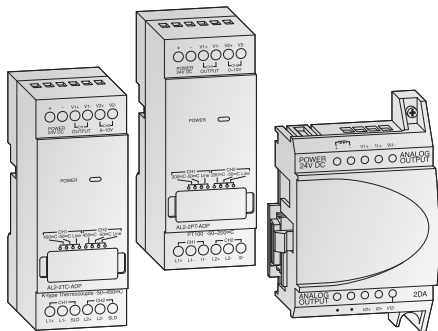

AL2-2DA, AL2-2PT-ADP, and AL2-2TC-ADP

The analog extension modules significantly increase the range of viable applications for the α2.

With these modules it is possible to measure temperature sensor inputs or output voltage or current signals.

Three different analog extension modules are available:

- The AL2-2DA offers two additional analog outputs for the α2 and allows for digital to analog voltage or current conversion. This module is inserted directly into the α2.

Note: The AL2-2DA cannot be used with the AL2-10MR-series.

- The AL2-2PT-ADP connects to external PT100 sensors and converts temperature readings into analog signals (0–10 V).
- The AL2-2TC-ADP connects to external thermocouple sensors (K type) and converts temperature readings into analog signals (0–10 V).

Analog Module Specifications		AL2-2DA	AL2-2PT-ADP	AL2-2TC-ADP
Analog inputs				
Integrated inputs		—	2	2
Connectable temperature sensors		—	PT100 sensor Temp. coefficient 3.850 ppm/°C (IEC 751)	Thermocouple (K type), isolated type (IEC 584-1 1977, IEC 584-2 1982)
Compensated range		—	-50 – +200 °C	-50 – +450 °C
Analog outputs				
Integrated outputs		2	—	—
Analog output voltage range		0 – 10 V DC (5 kΩ – 1 MΩ)	—	—
Analog output current range		4 – 20 mA (Max. 500Ω)	—	—
Electrical specifications				
Number of channels		2	2	2
Power Supply		24 V DC (-15 – +10 %), 70 mA	24 V DC (-15 – +20 %), 1 W	24 V DC (-15 – +20 %), 0.5 W
Mechanical specifications				
Weight	kg	0.05	0.07	0.07
Dimensions (W x H x D)	mm	53.1 x 90 x 24.5	35.5 x 90 x 32.5	35.5 x 90 x 32.5

■ AS-Interface Module

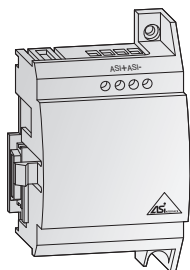

AL2-ASI-BD

The Actuator Sensor Interface (AS-i) slave module AL2-ASI-BD is inserted directly into the α2 controller and enables data communications via an AS-i system. Up to 4 inputs and 4 outputs can be exchanged with the AS-i master.

Slave device addressing can be assigned either automatically by the master, or with programming software.

The maximum communication distance is 100 m without a repeater. Up to 2 repeaters can be used, making the maximum extension distance 300m.

Since the communication signal is superimposed on the power supply bus, this module requires a designated external AS-i power supply.

Note: The AL2-ASI-BD cannot be used with the AL2-10MR-series.

Specifications	AL2-ASI-BD
Module type	Slave module
Number of I/O points	4 inputs, 4 outputs
External power supply	30.5 V DC (AS-Interface power supply)
External current consumption	Max. 40 mA
Communications protocol	AS-i standard
Weight	kg 0.05
Dimensions (W x H x D)	mm 53.1 x 90 x 24.5

■ Memory Cassette

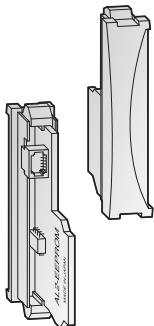

AL2-EEPROM-2

With the AL2-EEPROM-2 memory cassette, programs can be transferred to the α2 controller's internal system memory from the cassette, or the program of the internal system memory can be saved to the cassette.

When a memory cassette is plugged into the α2, the program stored in the memory cassette is run instead of the program stored in the main unit without overwriting it.

After removing the memory cassette, the program stored in the internal memory becomes active again.

The AL2-EEPROM-2 memory cassette is not a memory expansion device, but a medium for data exchange.

Specifications	AL2-EEPROM-2
Memory type	EEPROM
Application	α2
Memory capacity	5,000 bytes
Function blocks	Max. 200
Dimensions (W x H x D)	mm 10 x 45 x 25

■ Cables

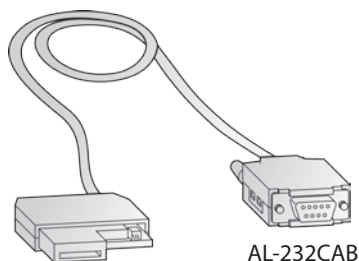

AL-232CAB

AL-232CAB Interface Cable

The AL-232CAB is an RS-232C interface cable that connects the α2 controller to a personal computer running the α2 controller programming software.

The dedicated cable ensures galvanic isolation between the α2 controller and the personal computer.

AL2-GSM-CAB GSM Cable

The GSM AL2-GSM-CAB is an RS-232C interface cable which is used to connect the α2 controller to a standard or GSM modem, a personal computer or other serial device.

It can transfer SMS data to a GSM modem for transmission to mobile telephones or e-mail addresses and also permits remote monitoring and remote maintenance.

Note: The above cables cannot be used with the AL2-10MR-series.

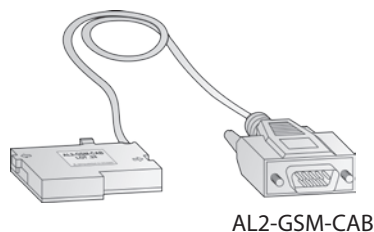

AL2-GSM-CAB

Specifications	AL-232CAB	AL2-GSM-CAB
Connector	9-pin D-SUB female connector	9-pin D-SUB male connector
Application	α2 ↔ PC	α2 ↔ PC, modem
Length	m 2.5	1.5

PROGRAMMING SOFTWARE & UNIT

MELSOFT – Integrated FA Software

The MELSOFT software family offers efficient software packages designed to reduce programming and setup time. All MELSOFT software provides instant access, direct communication, complete compatibility, and open exchange of data with MELSEC products.

MELSOFT software:

- System management software MELSOFT Navigator for all MELSOFT software
- Configuration software packages for module and network setup such as FX Configurator-FP and FX Configurator-EN
- GT Works3 for operator terminal programming (refer to the GOT2000 catalog)
- Data access and PC-to-PLC communication setup software MX Component and MX Sheet

■ System Management Software

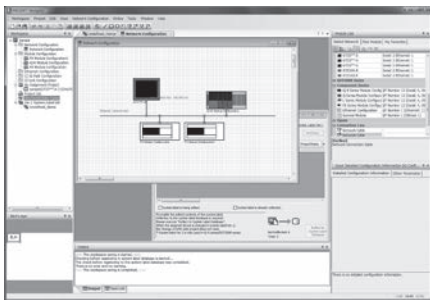

MELSOFT Navigator

MELSOFT Navigator, along with GX Works2 and other MELSOFT software, facilitates system level design and acts as the interface between each software. Useful functions include design of system configuration, parameter batch setting, system labels, and batch read.

Software	MELSOFT Navigator
Series	All FX series
Language	English
Applicable for	Microsoft® Windows® XP/Vista/7/8/8.1/10

■ PLC Programming Software



GX Works2

GX Works2 is the standard programming suite for MELSEC PLCs and incorporates the straightforward ladder programming style from GX Developer, as well as the global engineering standard IEC 61131-3.

GX Works2 supports all new functions and modules of MELSEC PLCs while remaining backward compatible to GX Developer, protecting customer assets and programs. The easy to use interface and freedom to choose programming style improves design and debugging efficiency. GX Works2 is part of the iQ Works engineering environment, promoting sharing of information such as system designs and labels between different programming environments for GOTs, motion products and robots.

Software	GX Works2
Series	All MELSEC PLCs
Language	English
Applicable for	Microsoft® Windows® XP/Vista/7/8/8.1/10

■ Data Access and Communication Setup Software

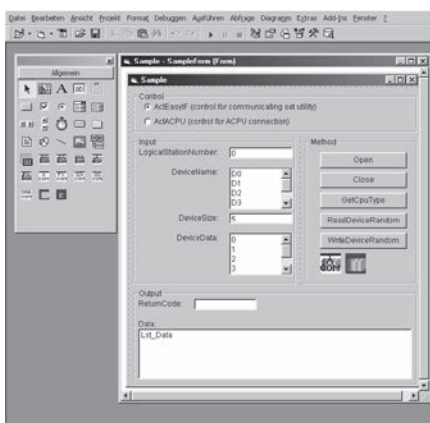

MX Component, MX Sheet

MELSOFT MX Series software provides several middleware applications for PC-to-PLC communication setup and data acquisition and adjustment through dedicated communication channels. With helpful software tools like MX Sheet, third party software packages like Microsoft® Excel® can be used for data monitoring and logging.

Software	MX Series Data Link Description	Model
MX Component	ActiveX® library for communication	SW[]DSC-ACT-E
MX Sheet	Microsoft® Excel® communication support tool	SW[]DSC-SHEET-E
Applicable for	Microsoft® Windows® XP/Vista/7/8/8.1/10	

Software and unit for programming and configuration

■ Positioning Programming Software

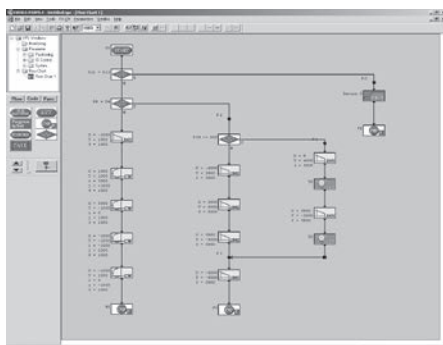

FX-PCS-VPS/WIN-E

FX-PCS-VPS/WIN-E is the standard programming software for the GM positioning units. It offers a convenient and easy to use programming environment for creating flow chart style positioning operations. With the Monitoring Window, a user can display data values, locus, and operation processes.

Software	FX-PCS-VPS/WIN-E
Series	FX2N-10GM/FX2N-20GM
Language	English
Applicable for	Microsoft® Windows® 95/98/Me/NT/2000/XP/Vista/7/8/8.1/10

■ PLC Training Software

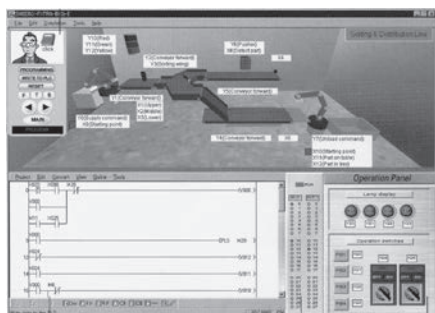

FX-TRN-BEG-E

The FX-TRN-BEG-E training software package is designed to help beginners get started with programming PLC systems. It combines a simulated PLC environment with simulated real-world applications. A software PLC simulates the operation of the PLC program and simulated machine interface items like buttons and switches are provided for user interaction while the process is running.

Software	FX-TRN-BEG-E
Series	All MELSEC PLCs
Language	English
Applicable for	Microsoft® Windows® 98/Me/NT/2000/XP

■ α Programming Software

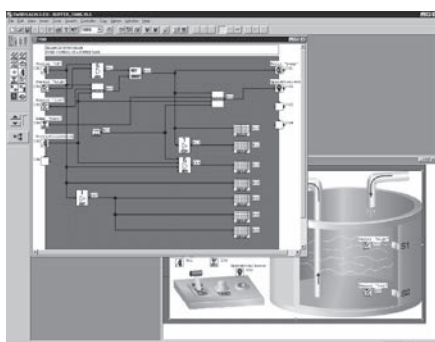

AL-PCS/WIN-E

AL-PCS/WIN is the standard programming and documentation software for all α series controllers and provides an easy to use graphical programming environment. Program elements are placed on the function block diagram with visible wires to connect them and the I/O terminals. Monitoring functions with optional pictures of the user's application in the background are also available.

Software	AL-PCS/WIN-E
Series	α series
Language	English
Applicable for	Microsoft® Windows® 95/98/Me/NT/2000/XP/Vista/7/8/8.1/10

■ Configuration Software

Software	Configuration Software Description	Model
FX Configurator-EN	FX3u-ENET configuration tool	SW1D5C-FXENET-E
FX Configurator-EN-L	FX3u-ENET-L configuration tool	SW1D5C-FXENETL-E
FX Configurator-FP	FX3u-20SSC-H configuration tool	SW1D5C-FXSSC-E
Applicable for	Microsoft® Windows® 95/98/Me/NT/2000/XP/Vista/7/8/8.1/10	

■ Hand-Held Programming Unit

FX-30P

The FX-30P is a small, industrial programming and maintenance tool for the FX series. This unit can perform program uploads/downloads and store up to 15 programs in its internal memory. Keywords can be registered, deleted or canceled in applicable PLCs. Program monitoring and data device adjustment functionality is also available. To stay up to date the latest firmware can be downloaded on a PC then installed via the USB port. PLC programs on the PC can also be transferred via USB, eliminating the need for peripheral devices.



Note: FX-30P firmware and program downloads from a PC via the embedded USB port available in firmware versions 1.10 or later.

Specifications		FX-30P
Applicable main units		FX3S/FX3G/FX3GC/FX3U/FX3UC
Ambient temperature		0 – 40 °C
Ambient relative humidity (non-condensing)		5 – 95%
Power supply		5 V DC ±5% / 155 mA (from main unit)
Display		LCD (with backlight)
Character display		21 x 8
Keys		35
Memory	Program capacity	Built-in RAM: 64 K steps for program monitoring and modification RAM retention (for about five years, ambient temperature 25 °C (77 °F)) by battery. Built-in flash memory ROM: Up to 15 programs can be stored in the built-in flash memory ROM. Allowable number of writes: 100,000 times
	HPP held data	Display language setting (Japanese, English or Chinese), contrast, buzzer sound volume, brightness adjustment, screen saver and HPP protect key (saved in the built-in flash memory)
Cable		FX-20P-CAB0
Weight		kg 0.3
Dimensions (W x H x D)		mm 87 x 170 x 30

MEMO

Model Name	CE		UL cUL	KC	Ship approvals							
	EMC	LVD			ABS	DNV GL	LR	BV	RINA	NK	KR	
FX2N Extension Units												
FX2N-32ER-ES/UL	●	●	●	●	●	●	●	●	●	●	●	
FX2N-32ET-ESS/UL	●	●	●	●	●	●	●	●	●	●	●	
FX2N-48ER-DS	●	●	●	●	●	●	—	—	—	—	●	
FX2N-48ER-ES/UL	●	●	●	●	●	●	●	●	●	—	●	
FX2N-48ER-UA1/UL	●	●	●	—	●	—	—	—	—	—	●	
FX2N-48ET-DSS	●	○	●	●	●	●	—	—	—	—	●	
FX2N-48ET-ESS/UL	●	●	●	●	●	●	●	●	●	—	●	
FX2N Extension Blocks												
FX2N-8ER-ES/UL	●	●	●	○	—	●	—	—	—	—	—	
FX2N-8EX-ES/UL	●	○	●	○	—	●	—	—	—	—	—	
FX2N-8EX-UA1/UL	—	—	●	○	—	—	—	—	—	—	—	
FX2N-8EYR-ES/UL	●	●	●	○	—	●	—	—	—	—	—	
FX2N-8EYT-ESS/UL	●	○	●	○	—	●	—	—	—	—	—	
FX2N-16EX-ES/UL	●	○	●	○	●	●	●	●	●	●	●	
FX2N-16EYR-ES/UL	●	●	●	○	●	●	●	●	●	●	●	
FX2N-16EYT-ESS/UL	●	○	●	○	●	●	●	●	●	●	●	
FX2N-16EYS	—	—	●	○	—	—	—	—	—	—	—	
FX2NC Extension Blocks												
FX2NC-16EX-DS	●	○	●	○	●	●	●	—	—	—	—	
FX2NC-16EX-T-DS	●	○	●	○	●	●	●	—	—	—	—	
FX2NC-16EYR-T-DS	●	●	●	○	●	●	●	—	—	—	—	
FX2NC-16EYT-DSS	●	○	●	○	●	●	●	—	—	—	—	
FX2NC-32EX-DS	●	○	●	○	●	●	●	—	—	—	—	
FX2NC-32EYT-DSS	●	○	●	○	●	●	●	—	—	—	—	
FX2N Special Function Blocks												
FX2N-1HC	●	○	●	●	●	●	●	●	●	—	●	
FX2N-1RM-E-SET	●	○	—	●	●	—	—	—	—	—	●	
FX2N-2AD	●	○	●	●	●	●	—	—	—	●	●	
FX2N-2DA	●	○	●	●	●	●	—	—	—	●	●	
FX2N-2LC*1	●	○	●	●	—	—	—	—	—	—	—	
FX2N-5A	●	○	●	●	—	—	—	—	—	—	—	
FX2N-8AD	●	○	●	●	—	—	—	—	—	●	●	
FX2N-10GM	●	○	●	●	—	—	—	—	—	—	—	
FX2N-10PG	●	○	●	●	—	—	—	—	—	—	—	
FX2N-20GM	●	○	●	●	—	—	—	—	—	—	—	
FX2N-32CCL	●	○	—	●	—	—	—	—	—	—	—	
FX2N-32DP-IF	●	○	●	●	—	—	—	—	—	—	—	
FX2N-64CL-M	●	○	●	●	—	—	—	—	—	—	—	
FX2N-64DNET	●	○	●	●	—	—	—	—	—	—	—	
FX2N-232IF	●	○	—	●	●	●	●	●	●	—	—	
FX2NC Special Adapters & Special Function Blocks												
FX2NC-1HC	●	○	●	●	—	—	—	—	—	—	—	
FX2NC-CNV-IF	—	—	—	—	—	—	●	—	—	—	—	
FX3U Special Function Blocks												
FX3U-1PG	●	○	●	●	—	—	—	—	—	—	—	
FX3U-1PSU-5V	●	●	●	●	—	—	—	—	—	—	—	
FX3U-2HC	●	○	●	●	—	—	—	—	—	—	—	
FX3U-4AD	●	○	●	●	—	—	—	—	—	—	—	
FX3U-4DA	●	○	●	●	—	—	—	—	—	—	—	
FX3U-4LC	●	○	●	●	—	—	—	—	—	—	—	
FX3U-20SSC-H	●	○	●	●	—	—	—	—	—	—	—	
FX3U-16CCL-M	●	○	●	●	—	—	—	—	—	—	—	
FX3U-64CCL	●	○	●	●	—	—	—	—	—	—	—	
FX3U-128ASL-M	●*2	○	●	—	—	—	—	—	—	—	—	
FX3U-ENET	●	○	●	●	—	●	●	—	—	—	—	
FX3U-ENET-L	●	○	●	●	—	—	—	—	—	—	—	

Model Name	CE		UL cUL	KC	Ship approvals							
	EMC	LVD			ABS	DNV GL	LR	BV	RINA	NK	KR	
FX3U Special Adapters												
FX3U-2HSY-ADP	●	○	●	●	●	●	●	●	●	●	●	
FX3U-3A-ADP	●	○	●	●	—	—	—	—	—	—	—	
FX3U-4AD-ADP	●	○	●	●	●	●	●	●	●	●	●	
FX3U-4AD-PNK-ADP	●	○	●	●	—	—	—	—	—	—	—	
FX3U-4AD-PT-ADP	●	○	●	●	●	●	●	●	●	●	●	
FX3U-4AD-PTW-ADP	●	○	●	●	—	—	—	—	—	—	—	
FX3U-4AD-TC-ADP	●	○	●	●	●	●	●	●	●	●	●	
FX3U-4DA-ADP	●	○	●	●	●	●	●	●	●	●	●	
FX3U-4HSX-ADP	●	○	●	●	●	●	●	●	●	●	●	
FX3U-232ADP-MB	●	○	●	●	●	●	●	●	●	●	●	
FX3U-485ADP-MB	●	○	●	●	●	●	●	●	●	●	●	
FX3U-CF-ADP	●	○	●	●	—	—	—	—	—	—	—	
FX3U-ENET-ADP	●	○	●	—	—	—	—	—	—	—	—	
FX3G Interface Adapter												
FX3G-CNV-ADP	●	○	●	○	●	●	●	●	●	●	—	
FX3S Interface Adapter												
FX3S-CNV-ADP	●	○	●	○	—	—	—	—	—	—	—	
FX3UC Special Function Blocks												
FX3UC-1PS-5V	●	○	●	●	●	●	●	●	●	—	—	
FX3UC-4AD	●	○	●	●	—	—	—	—	—	—	—	
Expansion Boards												
FX3G-1DA-BD	●	○	—	●	●	●	●	●	●	●	—	
FX3G-2AD-BD	●	○	—	●	●	●	●	●	●	●	—	
FX3G-4EX-BD	●	○	—	○	—	—	—	—	—	—	—	
FX3G-2EYT-BD	●	○	—	○	—	—	—	—	—	—	—	
FX3G-8AV-BD	●	○	—	○	●	●	●	●	●	●	—	
FX3G-232-BD	●	○	—	●	●	●	●	●	●	●	—	
FX3G-422-BD	●	○	—	○	●	●	●	●	●	●	—	
FX3G-485-BD	●	○	—	○	●	●	●	●	●	●	—	
FX3U-8AV-BD	●	○	—	○	—	—	—	—	—	—	—	
FX3U-232-BD	●	○	—	●	●	●	●	●	●	●	●	
FX3U-422-BD	●	○	—	●	●	●	●	●	●	●	●	
FX3U-485-BD	●	○	—	●	●	●	●	●	●	●	●	
FX3G-485-BD-RJ	●	○	—	●	—	—	—	—	—	—	—	
FX3U-CNV-BD	●	○	—	○	●	●	●	●	●	●	●	
FX3U-USB-BD	●	○	—	●	●	●	●	●	●	●	●	
Terminal Blocks												
FX-16E-TB	—	—	●	○	—	—	—	—	—	—	—	
FX-16E-TB/UL	—	—	●	○	—	—	—	—	—	—	—	
FX-16EYR-TB	—	—	●	○	—	—	—	—	—	—	—	
FX-16EYR-ES-TB/UL	—	—	●	○	—	—	—	—	—	—	—	
FX-16EYS-TB	—	—	○	—	—	—	—	—	—	—	—	
FX-16EYS-ES-TB/UL	—	—	●	○	—	—	—	—	—	—	—	
FX-16EYT-TB	—	—	●	○	—	—	—	—	—	—	—	
FX-16EYT-ES-TB/UL	—	—	●	○	—	—	—	—	—	—	—	
FX-32E-TB	—	—	●	○	—	—	—	—	—	—	—	
FX-32E-TB/UL	—	—	●	○	—	—	—	—	—	—	—	
Accessories												
FX-10DM-E*3	●	○	—	●	—	—	—	—	—	—	—	
FX-30P	●	○	●	●	—	—	—	—	—	—	—	
FX-232AWC-H	●	○	—	●	—	—	—	—	—	—	—	
FX-485PC-IF	●	○	—	○	—	—	—	—	—	—	—	
FX-USB-AW	●	○	—	●	—	—	—	—	—	—	—	
FX2N-CNV-BC	●	○	—	○	—	—	—	—	—	—	—	
FX3G-5DM	●	○	—	●	●	●	●	●	●	●	—	
FX3S-5DM	●	○	—	●	—	—	—	—	—	—	—	
FX3U-7DM	●	○	—	●	●	●	●	●	●	●	●	
FX3U-7DM-HLD	—	○	—	○	—	—	—	—	—	—	—	
Memory Cassettes												
FX3G-EEPROM-32L	●	○	—	○	●	●	●	●	●	●	—	
FX3U-FLROM-16	●	○	—	○	●	●	●	●	●	●	●	
FX3U-FLROM-64	●	○	—	○	●	●	●	●	●	●	●	
FX3U-FLROM-64L	●	○	—	○	●	●	●	●	●	●	●	
FX3U-FLROM-1M	●	○	—	○	—	—	—	—	—	—	—	

*1: Production will be discontinued in March 2018.
 *2: Zone A
 *3: Production will be discontinued in September 2017.
 ● = comply, ○ = no need to comply

INDEX

AL2-10MR-A.....	79, 86	FX2N-8EX-UA1/UL.....	29, 31, 33, 52, 87	FX3GE-40MT/DSS.....	30, 44, 86	FX3U-485ADP-MB	15, 19, 28, 30, 32, 67, 87
AL2-10MR-D.....	79, 86	FX2N-8EYR-ES/UL.....	29, 31, 33, 52, 87	FX3GE-40MT/ES.....	30, 44, 86	FX3U-485-BD.....	19, 28, 66, 87
AL2-14MR-A.....	79, 86	FX2N-8EYT-ESS/UL.....	29, 31, 33, 52, 87	FX3GE-40MT/ESS.....	30, 44, 86	FX3U-48MR/DS.....	28, 41, 86
AL2-14MR-D.....	79, 86	FX2N-CNV-BC.....	29, 31, 33, 77, 87			FX3U-48MR/ES.....	28, 41, 86
AL2-24MR-A.....	79, 86			FX3S-5DM.....	23, 33, 76, 87	FX3U-48MT/DS.....	28, 41, 86
AL2-24MR-D.....	78, 79, 86	FX2NC-16EX-DS.....	29, 33, 54, 87	FX3S-10MR/DS.....	33, 44, 86	FX3U-48MT/DSS.....	28, 41, 86
AL2-2DA.....	80, 86	FX2NC-16EX-T-DS.....	29, 33, 54, 87	FX3S-10MR/ES.....	33, 44, 86	FX3U-48MT/ES.....	28, 41, 86
AL2-2PT-ADP.....	80, 86	FX2NC-16EYR-T-DS.....	29, 33, 54, 87	FX3S-10MT-DS.....	33, 44, 86	FX3U-48MT/ESS.....	28, 41, 86
AL2-2TC-ADP.....	80, 86	FX2NC-16EYT-DSS.....	29, 33, 54, 87	FX3S-10MT-DSS.....	33, 44, 86	FX3U-4AD.....	14, 29, 31, 33, 56, 87
AL2-4EX.....	80, 86	FX2NC-1HC.....	29, 62, 87	FX3S-10MT/ES.....	33, 44, 86	FX3U-4AD-ADP.....	14, 28, 30, 32, 55, 87
AL2-4EX-A2.....	80, 86	FX2NC-32BL.....	74	FX3S-10MT/ESS.....	33, 44, 86	FX3U-4AD-PNK-ADP... ..	14, 28, 30, 32, 60, 87
AL2-4EYR.....	80, 86	FX2NC-32EX-DS.....	29, 33, 54, 87	FX3S-14MR/DS.....	33, 45, 86	FX3U-4AD-PT-ADP.....	14, 28, 30, 32, 60, 87
AL2-4EYT.....	80, 86	FX2NC-32EYT-DSS.....	29, 33, 54, 87	FX3S-14MR/ES.....	33, 45, 86	FX3U-4AD-PTW-ADP... ..	14, 28, 30, 32, 60, 87
AL2-ASI-BD.....	81, 86	FX2NC-CNV-IF.....	28, 29, 32, 33, 72, 87	FX3S-14MT-DS.....	33, 45, 86	FX3U-4AD-TC-ADP.....	14, 28, 30, 32, 60, 87
AL2-EEPROM-2.....	81			FX3S-14MT-DSS.....	33, 45, 86	FX3U-4DA.....	14, 29, 31, 33, 68, 87
		FX3G-14MR/DS.....	30, 43, 86	FX3S-14MT/ES.....	33, 45, 86	FX3U-4DA-ADP.....	14, 28, 30, 32, 57, 87
FX-10DM-E.....	76, 87	FX3G-14MR/ES.....	30, 43, 86	FX3S-14MT/ESS.....	33, 45, 86	FX3U-4HSX-ADP.....	28, 62, 87
FX-16E-TB.....	29, 33, 75	FX3G-14MT/DS.....	30, 43, 86	FX3S-14MR/DS.....	33, 45, 86	FX3U-4LC.....	14, 29, 31, 33, 61, 87
FX-16E-TB/UL.....	29, 33, 75, 87	FX3G-14MT/DSS.....	30, 43, 86	FX3S-20MR/DS.....	33, 45, 86	FX3U-64MCL.....	18, 29, 31, 33, 68, 87
FX-16EYR-ES-TB/UL.....	29, 33, 87	FX3G-14MT/ES.....	30, 43, 86	FX3S-20MR/ESS.....	33, 45, 86	FX3U-64MR/DS.....	28, 41, 86
FX-16EYR-TB.....	29, 33, 75	FX3G-14MT/ESS.....	30, 43, 86	FX3S-20MT-DS.....	33, 45, 86	FX3U-64MR/ES.....	28, 41, 86
FX-16EYR-TB/UL.....	75	FX3G-1DA-BD.....	14, 15, 30, 32, 57, 87	FX3S-20MT-DSS.....	33, 45, 86	FX3U-64MR/UA1.....	28, 41, 86
FX-16EYS-ES-TB/UL.....	29, 33, 87	FX3G-232-BD.....	19, 30, 32, 66, 87	FX3S-20MT/ES.....	33, 45, 86	FX3U-64MS/ES.....	28, 41, 86
FX-16EYS-TB.....	29, 33, 75	FX3G-24MR/DS.....	30, 43, 86	FX3S-20MT/ESS.....	33, 45, 86	FX3U-64MT/DS.....	28, 41, 86
FX-16EYS-TB/UL.....	75	FX3G-24MR/ES.....	30, 43, 86	FX3S-30MR/DS.....	33, 45, 86	FX3U-64MT/ESS.....	28, 41, 86
FX-16EYT-ESS-TB/UL.....	29, 33, 75, 76	FX3G-24MT/DS.....	30, 43, 86	FX3S-30MR/ES.....	33, 45, 86	FX3U-64MT/DSS.....	28, 41, 86
FX-16EYT-ES-TB/UL.....	29, 33, 75, 87	FX3G-24MT/DSS.....	30, 43, 86	FX3S-30MR/ES-2AD.....	33, 45, 86	FX3U-64MT/ES.....	28, 41, 86
FX-16EYT-TB.....	29, 33, 75	FX3G-24MT/ES.....	30, 43, 86	FX3S-30MT/DS.....	33, 45, 86	FX3U-64MT/ESS.....	28, 41, 86
FX-232AWC-H.....	30, 32, 75, 87	FX3G-24MT/ESS.....	30, 43, 86	FX3S-30MT/DSS.....	33, 45, 86	FX3U-7DM.....	23, 29, 46, 76, 87
FX-30P.....	84, 87	FX3G-2AD-BD.....	14, 30, 32, 55, 87	FX3S-30MT/ES.....	33, 45, 86	FX3U-7DM-HLD.....	29, 76
FX-32-TB.....	29, 33, 75	FX3G-2EYT-BD.....	30, 32, 50, 87	FX3S-30MT/ES-2AD.....	33, 45, 86	FX3U-80MR/DS.....	28, 41, 86
FX-32E-TB/UL.....	29, 33, 75, 87	FX3G-40MR/DS.....	30, 43, 86	FX3S-30MT/ESS.....	33, 45, 86	FX3U-80MR/ES.....	28, 41, 86
FX-485PC-IF.....	76, 87	FX3G-40MR/ES.....	30, 43, 86	FX3S-30MT/ESS-2AD.....	33, 45, 86	FX3U-80MT/DS.....	28, 41, 86
FX-USB-AW.....	28, 75, 87	FX3G-40MT/DS.....	30, 43, 86	FX3S-CNV-ADP.....	28, 69, 81	FX3U-80MT/DSS.....	28, 41, 86
		FX3G-40MT/DSS.....	30, 43, 86			FX3U-80MT/ES.....	28, 41, 86
FX2N-10GM.....	17, 29, 64, 87	FX3G-40MT/ES.....	30, 43, 86	FX3U-128ASL-M.....	29, 31, 33, 70, 87	FX3U-80MT/ESS.....	28, 41, 86
FX2N-10PG.....	17, 29, 64, 87	FX3G-40MT/ESS.....	30, 43, 86	FX3U-128MR/ES.....	28, 42, 86	FX3U-8AV-BD.....	28, 55, 87
FX2N-16EX-ES/UL.....	29, 31, 33, 53, 87	FX3G-422-BD.....	30, 32, 66, 87	FX3U-128MT/ES.....	28, 42, 86	FX3U-CF-ADP.....	21, 28, 71, 87
FX2N-16EYR-ES/UL.....	29, 31, 33, 53, 87	FX3G-485-BD.....	17, 30, 32, 66, 87	FX3U-128MT/ESS.....	28, 42, 86	FX3U-CNV-BD.....	28, 72, 87
FX2N-16EYS.....	29, 31, 33, 53, 87	FX3G-485-BD-RJ.....	17, 30, 32, 66, 87	FX3U-16CCL-LM.....	18, 29, 31, 33, 68, 87	FX3U-ENET.....	20, 21, 24, 29, 31, 33, 69, 87
FX2N-16EYT-ESS/UL.....	29, 31, 33, 53, 87	FX3G-4EX-BD.....	30, 32, 55, 87	FX3U-16MR/DS.....	28, 41, 86	FX3U-ENET-L.....	20, 21, 24, 29, 69, 87
FX2N-1HC.....	29, 62, 87	FX3G-5DM.....	23, 31, 76, 87	FX3U-16MR/ES.....	28, 41, 86	FX3U-ENET-ADP.....	20, 28, 30, 32, 69, 87
FX2N-1RM-E-SET.....	29, 65, 87	FX3G-60MR/DS.....	30, 43, 86	FX3U-16MR/DS.....	28, 41, 86	FX3U-FLROM-16.....	29, 76, 87
FX2N-20GM.....	17, 29, 64, 87	FX3G-60MR/ES.....	30, 43, 86	FX3U-16MT/DSS.....	28, 41, 86	FX3U-FLROM-1M.....	29, 76, 87
FX2N-232IF.....	29, 67, 87	FX3G-60MT/DS.....	30, 43, 86	FX3U-16MT/ES.....	28, 41, 86	FX3U-FLROM-64.....	29, 76, 87
FX2N-2AD.....	14, 29, 31, 33, 56, 87	FX3G-60MT/DSS.....	30, 43, 86	FX3U-16MT/ESS.....	28, 41, 86	FX3U-FLROM-64L.....	29, 76, 87
FX2N-2DA.....	14, 29, 31, 33, 58, 87	FX3G-60MT/ES.....	30, 43, 86	FX3U-1PG.....	17, 29, 64, 87	FX3U-USB-BD.....	28, 66, 87
FX2N-2LC.....	14, 29, 31, 33, 61, 87	FX3G-60MT/ESS.....	30, 43, 86	FX3U-1PSU-5V.....	29, 31, 73		
FX2N-32CCL.....	14, 29, 31, 33, 68, 87	FX3G-8AV-BD.....	30, 32, 55, 87	FX3U-20SSC-H.....	17, 229, 63, 87		
FX2N-32DP-IF.....	87	FX3G-CNV-ADP.....	30, 72, 87	FX3U-232ADP-MB.....	19, 28, 30, 32, 67, 87	FX3UC-16MR/DS-T.....	28, 42, 86
FX2N-32ER-ES/UL.....	29, 31, 51, 86	FX3G-EEPROM-32L.....	31, 33, 74, 76, 87	FX3U-232-BD.....	19, 28, 66, 87	FX3UC-16MR/D-T.....	28, 42, 86
FX2N-32ET-ESS/UL.....	29, 31, 51, 86			FX3U-2HC.....	29, 62, 87	FX3UC-16MT/D.....	28, 42, 86
FX2N-48ER.....	31	FX3GC-32MT/D.....	32, 44, 86	FX3U-2HSY-ADP.....	28, 63, 87	FX3UC-16MT/DSS.....	28, 42, 86
FX2N-48ER-DS.....	29, 31, 51, 86	FX3GC-32MT/DSS.....	32, 44, 86	FX3U-32BL.....	29, 31, 33, 74	FX3UC-1PS-5V.....	29, 33, 73
FX2N-48ER-ES/UL.....	29, 31, 51, 86			FX3U-32MR/DS.....	28, 41, 86	FX3UC-32MT/D.....	28, 42, 86
FX2N-48ET-UA1/UL.....	29, 31, 51, 86	FX3GE-24MR/DS.....	30, 44, 86	FX3U-32MR/ES.....	28, 41, 86	FX3UC-32MT/DSS.....	28, 42, 86
FX2N-48ET-DSS.....	29, 31, 51, 86	FX3GE-24MR/ES.....	30, 44, 86	FX3U-32MR/UA1.....	28, 41, 86	FX3UC-4AD.....	14, 29, 33, 56, 87
FX2N-48ET-ESS/UL.....	29, 31, 51, 86	FX3GE-24MT/DS.....	30, 44, 86	FX3U-32MS/ES.....	28, 41, 86	FX3UC-64MT/D.....	28, 42, 86
FX2N-5A.....	14, 29, 31, 33, 59, 87	FX3GE-24MT/DSS.....	30, 44, 86	FX3U-32MT/DS.....	28, 41, 86	FX3UC-64MT/DSS.....	28, 42, 86
FX2N-64CL-M.....	87	FX3GE-24MT/ES.....	30, 44, 86	FX3U-32MT/DSS.....	28, 41, 86	FX3UC-96MT/D.....	28, 42, 86
FX2N-64DNET.....	87	FX3GE-24MT/ESS.....	30, 44, 86	FX3U-32MT/ES.....	28, 41, 86	FX3UC-96MT/DSS.....	28, 42, 86
FX2N-8AD.....	14, 29, 31, 33, 56, 87	FX3GE-40MR/DS.....	30, 44, 86	FX3U-32MT/ESS.....	28, 41, 86		
FX2N-8ER-ES/UL.....	29, 31, 33, 52, 87	FX3GE-40MR/ES.....	30, 44, 86	FX3U-3A-ADP.....	14, 28, 30, 32, 59, 87		
FX2N-8EX-ES/UL.....	29, 31, 33, 52, 87	FX3GE-40MT/DS.....	30, 44, 86	FX3U-422-BD.....	28, 66, 87		

About this product catalog

Due to the constantly growing product range and new or changed product features, the information in this catalog may be updated without notice. Please contact your Mitsubishi Electric product provider for more details.

Texts, figures and diagrams shown in this product catalog are intended exclusively for explanation and assistance in planning and ordering the Alpha 2 controller and FX3S, FX3G, FX3GE, FX3GC, FX3U, and FX3UC series programmable logic controllers (PLCs) and the associated accessories. Only the manuals supplied with the units are relevant for installation, commissioning and handling of the units and the accessories. The information given in the manuals must be read before installation and commissioning of the units or software. If any questions arise regarding the application or use of the PLC units and accessories described in this catalog, please contact your Mitsubishi Electric product provider.

This catalog confers no industrial property rights or any rights of any other kind, nor does it confer any patent licenses. Mitsubishi Electric Corporation cannot be held responsible for any problems involving industrial property rights which may occur as a result of using the contents noted in this catalog.

©2017 MITSUBISHI ELECTRIC CORPORATION

• Microsoft®, Windows®, Windows® 95, Windows® 98, Windows Me®, Windows NT®, Windows® 2000, Windows® XP, Windows Vista®, Windows® 7, Windows® 8, Windows® 10, ActiveX®, Excel® are registered trademarks of Microsoft Corporation in the United States and other countries.

• Ethernet is a trademark of Xerox Corporation.
• MODBUS is a registered trademark of Schneider Electric SA.
• CiA and CANopen are registered Community Trademarks of CAN in Automation e.V.
• NMEA and NMEA 2000 are registered trademarks of NMEA (National Marine Electronics Association).
• All other company names and product names used in this document are trademarks or registered trademarks of their respective companies.

YOUR SOLUTION PARTNER

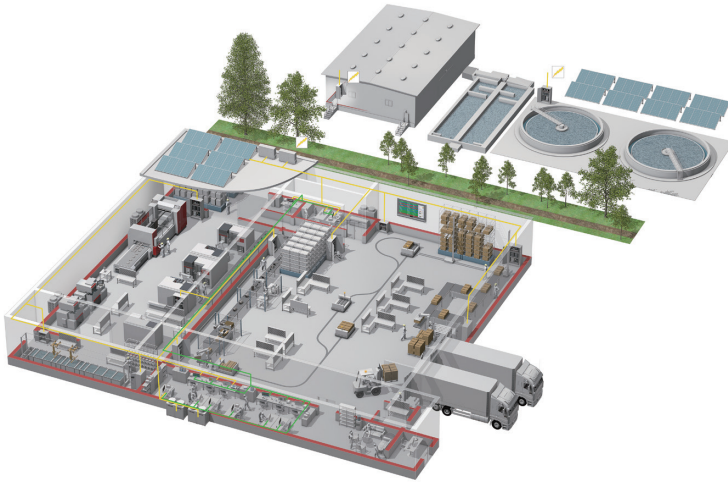

Mitsubishi Electric offers a wide range of automation equipment from PLCs and HMIs to CNC and EDM machines.

A NAME TO TRUST

Since its beginnings in 1870, some 45 companies use the Mitsubishi name, covering a spectrum of finance, commerce and industry.

The Mitsubishi brand name is recognized around the world as a symbol of premium quality.

Mitsubishi Electric Corporation is active in space development, transportation, semi-conductors, energy systems, communications and information processing, audio visual equipment and home electronics, building and energy management and automation systems, and has 237 factories and laboratories worldwide in over 121 countries.

This is why you can rely on Mitsubishi Electric automation solution - because we know first hand about the need for reliable, efficient, easy-to-use automation and control in our own factories.

As one of the world's leading companies with a global turnover of over 4 trillion Yen (over \$40 billion), employing over 100,000 people, Mitsubishi Electric has the resource and the commitment to deliver the ultimate in service and support as well as the best products.



Low voltage: MCCB, MCB, ACB



Medium voltage: VCB, VCC



Power monitoring, energy management



Compact and Modular Controllers



Inverters, Servos and Motors



Visualisation: HMIs



Numerical Control (NC)



Robots: SCARA, Articulated arm



Processing machines: EDM, Lasers, IDS



Transformers, Air conditioning, Photovoltaic systems

* Not all products are available in all countries.

Global Partner. Local Friend.

Worldwide Mitsubishi Electric Sales Offices

Australia	MITSUBISHI ELECTRIC AUSTRALIA PTY. LTD. 348 Victoria Road, P.O. Box 11, Rydalmere, N.S.W 2116, Australia Tel : +61-2-9684-7777	Indonesia	PT. Mitsubishi Electric Indonesia Gedung Jaya 8th Floor, JL. MH. Thamrin No.12, Jakarta Pusat 10340, Indonesia Tel : +62-21-3192-6461	Singapore	Mitsubishi Electric Asia Pte. Ltd. 307 Alexandra Road, Mitsubishi Electric Building, Singapore 159943 Tel : +65-6473-2486(FA), +65-6470-2482(NC), +65-6470-2462(Low-voltage Circuit Breakers)
Brazil	Mitsubishi Electric do Brasil Comercio e Servicos Ltda. Avenida Adelino Cardana, 293, 21 andar, Bethaville, Barueri SP, Brazil Tel : +55-11-4689-3000	Ireland	Mitsubishi Electric Europe B.V. Irish Branch Westgate Business Park, Ballymount, Dublin 24, Ireland Tel : +353-1-4198800	South Africa	Adroit Technologies 20 Waterford Office Park, 189 Witkoppen Road, Fourways, South Africa Tel : +27-11-658-8100
China	Mitsubishi Electric Automation (China) Ltd. Mitsubishi Electric Automation Center, No.1386 Hongqiao Road, Shanghai, China Tel : +86-21-2322-3030	Italy	Mitsubishi Electric Europe B.V. Italian Branch Via Savelli, 24, 35129 Padova (PD), Italy TEL : +39-039-60531	Spain	Mitsubishi Electric Europe B.V. Spanish Branch Carretera de Rubi, 76-80-Apdo. 420, E-08174 Sant Cugat del Valles (Barcelona), Spain Tel : +34-935-65-3131, +34-935-65-2236(CNC)
Czech	Mitsubishi Electric Europe B.V. Czech Branch Pekarska 621/7, 155 00 Praha 5, Czech Republic Tel : +420-734-402-587	Korea	Mitsubishi Electric Automation Korea Co., Ltd. 7F to 9F, Gangseo Hangang Xi-tower A, 401, Yangcheon-ro, Gangseo-Gu, Seoul Tel : +82-2-6103-9460(PLC/HMI), +82-2-6103-9474(SV), +82-2-3660-9615(Robot), +82-2-3660-9563(EDM/Laser/Laser-Drilling), +82-53-382-7400(CNC), +82-2-6103-9471(Power Monitoring Products), +82-2-6103-9459(INV)	Taiwan	SETSUYO ENTERPRISE CO., LTD. 6F, No.105, Wugong 3rd Road, Wugu District, New Taipei City 24889, Taiwan Tel : +886-2-2299-2499
France	Mitsubishi Electric Europe B.V. French Branch 2, rue de l'Union-92565 Rueil-Malmaison Cedex-France Tel : +33-1-55-68-55-68, +33-1-41-02-83-13(CNC)	Poland	Mitsubishi Electric Europe B.V. Polish Branch ul. Krakowska 48, 32-083 Balice, Poland Tel : +48-12-347-65-00, +48-12-347-65-81(Japanese)	Thailand	Mitsubishi Electric Factory Automation (Thailand) Co., Ltd. 101, True Digital Park Office, 5th Floor, Sukhumvit Road, Bang Chak, Prakanong, Bangkok, Thailand Tel : +66-2682-6522~31
Germany	Mitsubishi Electric Europe B.V. German Branch Mitsubishi-Electric-Platz 1, 40882 Ratingen, Germany Tel : +49-2102-486-0	Russia	Mitsubishi Electric (Russia) LLC 2, bld. 1, Letnikovskaya str., 115054 Moscow, Russia Tel : +7-495-721-2070	U.K.	Mitsubishi Electric Europe B.V. UK Branch Travellers Lane, Hatfield, Hertfordshire, AL10 8XB, U.K. Tel : +44-1707-27-8780
India	Mitsubishi Electric India Pvt. Ltd. Gurugram Head Office 3rd Floor, Tower A, Global gateway, MG road, Gurugram - 122002 TEL : +91-124-6739300			U.S.A.	Mitsubishi Electric Automation, Inc. 500 Corporate Woods Parkway, Vernon Hills, IL 60061, U.S.A. Tel : +1-847-478-2100(Rep), +1-847-478-2500(CNC), +1-800-950-7781 (FA Technical Consulting (English))

MITSUBISHI ELECTRIC CORPORATION

HEAD OFFICE: TOKYO BLDG., 2-7-3, MARUNOUCHI, CHIYODA-KU, TOKYO 100-8310, JAPAN
<http://Global.MitsubishiElectric.com>