

Programmable Controller

Transition from MELSEC-A0J2H Series to Q Series Handbook



Sep. 2023 Edition

● SAFETY PRECAUTIONS ●

(Read these precautions before using this product.)

Before using this product, please read this handbook and the relevant manuals introduced in this handbook carefully and pay full attention to safety to handle the product correctly.

In this manual, the safety precautions are classified into two levels: "⚠ WARNING" and "⚠ CAUTION".



Indicates that incorrect handling may cause hazardous conditions, resulting in death or severe injury.



Indicates that incorrect handling may cause hazardous conditions, resulting in minor or moderate injury or property damage.

Under some circumstances, failure to observe the precautions given under "⚠ CAUTION" may lead to serious consequences.

Observe the precautions of both levels because they are important for personal and system safety. Make sure that the end users read this handbook and then keep the handbook in a safe place for future reference.

[Design Precautions]

WARNING

- Configure safety circuits external to the programmable controller to ensure that the entire system operates safely even when a fault occurs in the external power supply or the programmable controller. Failure to do so may result in an accident due to an incorrect output or malfunction.
 - (1) Configure external safety circuits, such as an emergency stop circuit, protection circuit, and protective interlock circuit for forward/reverse operation or upper/lower limit positioning.
 - (2) When the programmable controller detects an abnormal condition, it stops the operation and all outputs are:

	Q series module	A series module
Overcurrent or overvoltage protection of the power supply module is activated.	All outputs are turned off	All outputs are turned off
The CPU module detects an error such as a watchdog timer error by the self-diagnostic function.	All outputs are held or turned off according to the parameter setting.	All outputs are turned off

All outputs may turn on when an error occurs in the part, such as I/O control part, where the CPU module cannot detect any error. To ensure safety operation in such a case, provide a safety mechanism or a fail-safe circuit external to the programmable controller. For a fail-safe circuit example, refer to the QCPU User's Manual (Hardware Design, Maintenance and Inspection).

- (3) Outputs may remain on or off due to a failure of an output module relay or transistor. Configure an external circuit for monitoring output signals that could cause a serious accident.
- In an output module, when a load current exceeding the rated current or an overcurrent caused by a load short-circuit flows for a long time, it may cause smoke and fire. To prevent this, configure an external safety circuit, such as a fuse.
 - Configure a circuit so that the programmable controller is turned on first and then the external power supply.
If the external power supply is turned on first, an accident may occur due to an incorrect output or malfunction.
 - For the operating status of each station after a communication failure, refer to relevant manuals for the network.
Incorrect output or malfunction due to a communication failure may result in an accident.

[Design Precautions]



WARNING

- When changing data of the running programmable controller from a peripheral connected to the CPU module or from a personal computer connected to an intelligent function module/special function module, configure an interlock circuit in the sequence program to ensure that the entire system will always operate safely.
For other forms of control (such as program modification or operating status change) of a running programmable controller, read the relevant manuals carefully and ensure that the operation is safe before proceeding.
Especially, in the case of a control from an external device to a remote programmable controller, immediate action cannot be taken for a problem on the programmable controller due to a communication failure.
To prevent this, configure an interlock circuit in the sequence program, and determine corrective actions to be taken between the external device and CPU module in case of a communication failure.



CAUTION

- Do not install the control lines or communication cables together with the main circuit lines or power cables.
Keep a distance of 100mm or more between them.
Failure to do so may result in malfunction due to noise.
- When a device such as a lamp, heater, or solenoid valve is controlled through an output module, a large current (approximately ten times greater than normal) may flow when the output is turned from off to on.
Take measures such as replacing the module with one having a sufficient current rating.
- After the CPU module is powered on or is reset, the time taken to enter the RUN status varies depending on the system configuration, parameter settings, and/or program size. Design circuits so that the entire system will always operate safely, regardless of the time.

[Installation Precautions]

CAUTION

- Use the programmable controller in an environment that meets the general specifications in the QCPU User's Manual (Hardware Design, Maintenance and Inspection).
Failure to do so may result in electric shock, fire, malfunction, or damage to or deterioration of the product.
- To mount the module, while pressing the module mounting lever located in the lower part of the module, fully insert the module fixing projection(s) into the hole(s) in the base unit and press the module until it snaps into place.
Incorrect mounting may cause malfunction, failure or drop of the module.
When using the programmable controller in an environment of frequent vibrations, fix the module with a screw.
Tighten the screw within the specified torque range.
Undertightening can cause drop of the screw, short circuit or malfunction.
Overtightening can damage the screw and/or module, resulting in drop, short circuit, or malfunction.
- When using an extension cable, connect it to the extension cable connector of the base unit securely.
Check the connection for looseness.
Poor contact may cause incorrect input or output.
- When using a memory card, fully insert it into the memory card slot.
Check that it is inserted completely.
Poor contact may cause malfunction.
- When using an SD memory card, fully insert it into the SD memory card slot. Check that it is inserted completely. Poor contact may cause malfunction.
- Securely insert an extended SRAM cassette into the cassette connector of a CPU module. After insertion, close the cassette cover to prevent the cassette from coming off. Poor contact may cause malfunction.
- Shut off the external power supply for the system in all phases before mounting or removing the module. Failure to do so may result in damage to the product.
A module can be replaced online (while power is on) on any MELSECNET/H remote I/O station or in the system where a CPU module supporting the online module change function is used.
Note that there are restrictions on the modules that can be replaced online, and each module has its predetermined replacement procedure.
For details, refer to the relevant sections in the QCPU User's Manual (Hardware Design, Maintenance and Inspection) and in the manual for the corresponding module.
- Do not directly touch any conductive parts and electronic components of the module, memory card, SD memory card, or extended SRAM cassette. Doing so can cause malfunction or failure of the module.
- When using a Motion CPU module and modules designed for motion control, check that the combinations of these modules are correct before applying power. The modules may be damaged if the combination is incorrect. For details, refer to the user's manual for the Motion CPU module.

[Wiring Precautions]



WARNING

- Shut off the external power supply for the system in all phases before wiring.
Failure to do so may result in electric shock or damage to the product.
- After wiring, attach the included terminal cover to the module before turning it on for operation.
Failure to do so may result in electric shock.



CAUTION

- Ground the FG and LG terminals to the protective ground conductor dedicated to the programmable controller.
Failure to do so may result in electric shock or malfunction.
- Use applicable solderless terminals and tighten them within the specified torque range. If any spade solderless terminal is used, it may be disconnected when the terminal screw comes loose, resulting in failure.
- Check the rated voltage and terminal layout before wiring to the module, and connect the cables correctly.
Connecting a power supply with a different voltage rating or incorrect wiring may cause a fire or failure.
- Connectors for external connection must be crimped or pressed with the tool specified by the manufacturer, or must be correctly soldered.
Incomplete connections could result in short circuit, fire, or malfunction.
- Securely connect the connector to the module. Poor contact may cause malfunction.
- Do not install the control lines or communication cables together with the main circuit lines or power cables. Keep a distance of 100mm or more between them. Failure to do so may result in malfunction due to noise.
- Place the cables in a duct or clamp them. If not, dangling cable may swing or inadvertently be pulled, resulting in damage to the module or cables or malfunction due to poor contact.
- Check the interface type and correctly connect the cable. Incorrect wiring (connecting the cable to an incorrect interface) may cause failure of the module and external device.
- Tighten the terminal screw within the specified torque range.
Undertightening can cause short circuit, fire, or malfunction.
Overtightening can damage the screw and/or module, resulting in drop, short circuit, or malfunction.
- Prevent foreign matter such as dust or wire chips from entering the module.
Such foreign matter can cause a fire, failure, or malfunction.
- A protective film is attached to the top of the module to prevent foreign matter, such as wire chips, from entering the module during wiring.
Do not remove the film during wiring.
Remove it for heat dissipation before system operation.
- When disconnecting the cable from the module, do not pull the cable by the cable part. For the cable with connector, hold the connector part of the cable. For the cable connected to the terminal block, loosen the terminal screw. Pulling the cable connected to the module may result in malfunction or damage to the module or cable.

[Wiring Precautions]

CAUTION

- Mitsubishi programmable controllers must be installed in control panels.
Connect the main power supply to the power supply module in the control panel through a relay terminal block.
Wiring and replacement of a power supply module must be performed by maintenance personnel who is familiar with protection against electric shock. (For wiring methods, refer to the QCPU User's Manual (Hardware Design, Maintenance and Inspection)).

[Startup and Maintenance Precautions]

WARNING

- Do not touch any terminal while power is on.
Doing so will cause electric shock or malfunction.
- Correctly connect the battery connector.
Do not charge, disassemble, heat, short-circuit, solder, or throw the battery into the fire. Also, do not expose it to liquid or strong shock. Doing so will cause the battery to produce heat, explode, ignite, or leak, resulting in injury and fire.
- Shut off the external power supply for the system in all phases before cleaning the module or retightening the terminal screws or module fixing screws.
Failure to do so may result in electric shock.

CAUTION

- Before performing online operations (especially, program modification, forced output, and operation status change) for the running CPU module from the peripheral connected, read relevant manuals carefully and ensure the safety.
Improper operation may damage machines or cause accidents.
- Do not disassemble or modify the modules.
Doing so may cause failure, malfunction, injury, or a fire.
- Use any radio communication device such as a cellular phone or PHS (Personal Handy-phone System) more than 25cm away in all directions from the programmable controller.
Failure to do so may cause malfunction.
- Shut off the external power supply for the system in all phases before mounting or removing the module. Failure to do so may cause the module to fail or malfunction.
A module can be replaced online (while power is on) on any MELSECNET/H remote I/O station or in the system where a CPU module supporting the online module change function is used.
Note that there are restrictions on the modules that can be replaced online, and each module has its predetermined replacement procedure.
For details, refer to the relevant sections in the QCPU User's Manual (Hardware Design, Maintenance and Inspection) and in the manual for the corresponding module.

[Startup and Maintenance Precautions]

CAUTION

- After the first use of the product, do not mount/remove the module to/from the base unit, and the terminal block to/from the module, and do not insert/remove the extended SRAM cassette to/from the CPU module more than 50 times (IEC 61131-2 compliant) respectively. Exceeding the limit may cause malfunction.
- After the first use of the SD memory card, do not insert/remove the memory card more than 500 times. Exceeding the limit may cause malfunction.
- Do not drop or apply shock to the battery to be installed in the module.
Doing so may damage the battery, causing the battery fluid to leak inside the battery.
If the battery is dropped or any shock is applied to it, dispose of it without using.
- Before handling the module, touch a grounded metal object to discharge the static electricity from the human body.
Failure to do so may cause the module to fail or malfunction.

[Disposal Precautions]

CAUTION

- When disposing of this product, treat it as industrial waste.
When disposing of batteries, separate them from other wastes according to the local regulations.
(For details of the battery directive in EU member states, refer to the QCPU User's Manual (Hardware Design, Maintenance and Inspection).)

[Transportation Precautions]

CAUTION

- When transporting lithium batteries, follow the transportation regulations.
For details on the regulated models, refer to the MELSEC-L CPU Module User's Manual (Hardware Design, Maintenance and Inspection).

● CONDITIONS OF USE FOR THE PRODUCT ●

- (1) Mitsubishi programmable controller ("the PRODUCT") shall be used in conditions;
- i) where any problem, fault or failure occurring in the PRODUCT, if any, shall not lead to any major or serious accident; and
 - ii) where the backup and fail-safe function are systematically or automatically provided outside of the PRODUCT for the case of any problem, fault or failure occurring in the PRODUCT.

- (2) The PRODUCT has been designed and manufactured for the purpose of being used in general industries. MITSUBISHI SHALL HAVE NO RESPONSIBILITY OR LIABILITY (INCLUDING, BUT NOT LIMITED TO ANY AND ALL RESPONSIBILITY OR LIABILITY BASED ON CONTRACT, WARRANTY, TORT, PRODUCT LIABILITY) FOR ANY INJURY OR DEATH TO PERSONS OR LOSS OR DAMAGE TO PROPERTY CAUSED BY the PRODUCT THAT ARE OPERATED OR USED IN APPLICATION NOT INTENDED OR EXCLUDED BY INSTRUCTIONS, PRECAUTIONS, OR WARNING CONTAINED IN MITSUBISHI'S USER, INSTRUCTION AND/OR SAFETY MANUALS, TECHNICAL BULLETINS AND GUIDELINES FOR the PRODUCT.

("Prohibited Application")

Prohibited Applications include, but not limited to, the use of the PRODUCT in;

- Nuclear Power Plants and any other power plants operated by Power companies, and/or any other cases in which the public could be affected if any problem or fault occurs in the PRODUCT.
- Railway companies or Public service purposes, and/or any other cases in which establishment of a special quality assurance system is required by the Purchaser or End User.
- Aircraft or Aerospace, Medical applications, Train equipment, transport equipment such as Elevator and Escalator, Incineration and Fuel devices, Vehicles, Manned transportation, Equipment for Recreation and Amusement, and Safety devices, handling of Nuclear or Hazardous Materials or Chemicals, Mining and Drilling, and/or other applications where there is a significant risk of injury to the public or property.

Notwithstanding the above restrictions, Mitsubishi may in its sole discretion, authorize use of the PRODUCT in one or more of the Prohibited Applications, provided that the usage of the PRODUCT is limited only for the specific applications agreed to by Mitsubishi and provided further that no special quality assurance or fail-safe, redundant or other safety features which exceed the general specifications of the PRODUCTS are required. For details, please contact the Mitsubishi representative in your region.

- (3) Mitsubishi shall have no responsibility or liability for any problems involving programmable controller trouble and system trouble caused by DoS attacks, unauthorized access, computer viruses, and other cyberattacks.

REVISIONS

* The handbook number is given on the bottom left of the back cover.

Print Date	* Handbook Number	Revision
Dec., 2005	L(NA)-08060ENG-A	First edition
Dec., 2007	L(NA)-08060ENG-B	<p>Addition of modules to be replaced QX41Y41P, Renewal tool for A0J2</p> <p>Addition Section 1.2, Section 1.4, Section 3.2.3 (4) (6), Section 7.7.7, Appendix 1, Appendix 2.6</p> <p>Partial correction SAFETY PRECAUTIONS, Section 1.1.3 → Section 1.3, Section 3.1, Section 3.2, Section 7.6.2, Section 7.7.1, Section 7.7.7 to 7.7.8 → Section 7.7.8 to 7.7.9, Section 8.1, Section 10.1, Section 11.1, Section 11.2, Appendix 1 → Appendix 2</p>
Jul., 2011	L(NA)-08060ENG-C	<p>Addition of modules to be replaced Universal Modul QCPU, Renewal tool for A0J2</p> <p>Addition Appendix 1</p> <p>Partial correction SAFETY PRECAUTIONS, Section 1, Section 2, Section 3.2, Section 4, Section 7, Section 8.1, Section 9.1, Section 10.1, Section 10.2.1, Section 10.2.2, Section 11.1, Appendix 2</p>
Dec., 2015	L(NA)-08060ENG-D	<p>Addition Section 7.1.4, Appendix 1</p> <p>Partial correction SAFETY PRECAUTIONS, GENERIC TERMS AND ABBREVIATIONS, Section 1.1.1, 1.1.2, 1.2.1, 1.2.2, 2.1, 2.2, 2.3.1, 2.4.1, 2.4.4, 3.1, 3.2.1, 3.2.2, 3.2.3, 4.1, 4.2, 4.3, 5.1, 5.2, 6.1, 6.2, Chapter 7, Section 7.1.1, 7.1.3, 7.2.1, 7.6.3, 7.7.3, 7.7.6, 8.1, 8.2.1, 8.2.2, 8.3, 8.4, 8.5.1, 8.5.2, 8.6, 8.47, 9.1, 10.1, 10.2.1, 10.2.2, 10.2.3, 11.2, Appendix 2.1, 2.2, 3.1, 3.4, 3.6, WARRANTY</p>
Sep., 2018	L(NA)-08060ENG-E	<p>Partial correction Cover, GENERIC TERMS AND ABBREVIATIONS, Section 1.1.1, 1.3, 1.4, Chapter 2, Section 3.1, 3.2, 3.3, 4.2, Chapter 6, 7, Section 8.4, 8.5.2, 8.6, 8.7, Chapter 9, Section 10.2.3, 10.2.4, Appendix 3.4, 3.6</p>
Sep., 2020	L(NA)-08060ENG-F	<p>Partial correction Section 10.1, 10.2.4</p>
Sep., 2020	L(NA)-08060ENG-G	<p>Partial correction Front cover, back cover</p>
Sep., 2023	L(NA)-08060ENG-H	<p>Partial correction Chapter 8</p>

Japanese Handbook Version L-08056-I

This handbook confers no industrial property rights or any rights of any other kind, nor does it confer any patent licenses. Mitsubishi Electric Corporation cannot be held responsible for any problems involving industrial property rights which may occur as a result of using the contents noted in this handbook.

CONTENTS

SAFETY PRECAUTIONS	A - 1
CONDITIONS OF USE FOR THE PRODUCT	A - 8
REVISIONS	A - 9
CONTENTS	A - 10
GENERIC TERMS AND ABBREVIATIONS	A - 14

CHAPTER 1 INTRODUCTION **1 - 1 to 1 - 13**

1.1 Proposal to Replace A0J2HCPU with QCPU	1 - 1
1.1.1 Advantages of replacement to QCPU	1 - 1
1.1.2 Proposal of replacement to QCPU (Q00UCPU)	1 - 2
1.2 Proposal of Replacement with Renewal tool for A0J2	1 - 7
1.2.1 Advantages of using renewal tool for A0J2 (manufactured by Mitsubishi Electric System & Service Co., Ltd.)	1 - 7
1.2.2 Proposal of replacement with renewal tool for A0J2	1 - 10
1.3 Precautions for Replacement	1 - 13

CHAPTER 2 REPLACING THE CPU MODULE **2 - 1 to 2 - 12**

2.1 List of Alternative CPU Module Models	2 - 1
2.2 Specifications Comparison of CPU Module	2 - 3
2.3 Functional Comparisons of CPU Module	2 - 6
2.3.1 Functional comparisons between the A0J2HCPU and QCPU	2 - 6
2.4 Precautions for Replacement of the CPU Module	2 - 8
2.4.1 Memory in the CPU module	2 - 8
2.4.2 Keyword registration and password registration	2 - 9
2.4.3 Write during RUN	2 - 10
2.4.4 I/O assignment	2 - 11

CHAPTER 3 I/O MODULES REPLACEMENT **3 - 1 to 3 - 63**

3.1 Alternative I/O Module Models List	3 - 1
3.2 I/O Module Specifications Comparison	3 - 12
3.2.1 Input module specifications comparison	3 - 12
3.2.2 Output module specifications comparison	3 - 15
3.2.3 I/O Module specifications comparison	3 - 22
3.3 Precautions for I/O Module Replacement	3 - 62

CHAPTER 4 REPLACING POWER SUPPLY MODULES **4 - 1 to 4 - 6**

4.1 List of Alternative Power Supply Module Models	4 - 1
--	-------

4.2	Specifications Comparison of Power Supply Modules	4 - 2
4.3	Precautions for Replacement of the CPU Module	4 - 6

CHAPTER 5 EXTENSION CABLE REPLACEMENT **5 - 1 to 5 - 1**

5.1	List of Alternative Extension Cable Models	5 - 1
5.2	Precautions for Extension Cable Replacement	5 - 1

CHAPTER 6 MEMORY AND BATTERY REPLACEMENT **6 - 1 to 6 - 1**

6.1	List of Alternative Memory Models	6 - 1
6.2	Precautions for Memory and Battery Replacement	6 - 1

CHAPTER 7 PROGRAMS REPLACEMENT **7 - 1 to 7 - 39**

7.1	Program Replacement Procedures	7 - 4
7.1.1	Program conversion procedure from A0J2HCPU to QCPU	7 - 4
7.1.2	Change PLC type	7 - 6
7.1.3	ACPU program conversion ratio	7 - 8
7.1.4	Reading (Reusing) other format files	7 - 10
7.1.5	How to reuse a program of a PLC type that is not supported by GX Developer	7 - 15
7.2	Instruction Conversion	7 - 18
7.2.1	List of instructions converted from A0J2HCPU to QCPU (Sequence/Basic/Application instructions)	7 - 18
7.2.2	Instruction that may need replacement from A0J2HCPU to Basic model QCPU	7 - 24
7.3	Precautions for Parameter Replacement	7 - 25
7.4	Special Relay Replacement	7 - 26
7.4.1	Replacement of A0J2HCPU with QCPU	7 - 26
7.5	Special Register Replacement	7 - 27
7.5.1	Replacement of A0J2HCPU with QCPU	7 - 27
7.6	Precautions for Replacing MELSAP-II with MELSAP3	7 - 28
7.6.1	How to start the SFC program	7 - 28
7.6.2	Block information (Information device for SFC)	7 - 28
7.6.3	Specifications comparison between MELSAP-II and MELSAP3	7 - 29
7.6.4	SFC diagram that cannot be read normally in another format	7 - 30
7.7	Precautions for Program Replacement	7 - 31
7.7.1	Applicable devices list	7 - 31
7.7.2	I/O control method	7 - 32
7.7.3	Data formats that can be used by the instructions	7 - 32
7.7.4	Timer	7 - 33
7.7.5	Counter	7 - 34
7.7.6	Display instruction	7 - 34
7.7.7	Instructions with changed specified formats	7 - 34
7.7.8	Index register	7 - 36
7.7.9	Setting method when multiple sequence programs are created	7 - 37
7.7.10	Precautions for file register replacement	7 - 39
7.7.11	Boot operation method (storing the program to ROM)	7 - 39

CHAPTER 8 REPLACING THE COMMUNICATION MODULES		8 - 1 to 8 - 11
8.1	List of Alternative Communication Module Models	8 - 1
8.2	Specifications Comparison of Communication Modules	8 - 4
8.2.1	Performance comparisons of communication module specifications	8 - 4
8.2.2	Cable specifications comparison	8 - 5
8.3	Functional Comparisons of Data Modules	8 - 6
8.4	Switch Settings Comparisons	8 - 7
8.5	Program Comparisons	8 - 8
8.5.1	I/O signal	8 - 8
8.5.2	Buffer memory	8 - 9
8.6	Program Reuse	8 - 10
8.7	Other Precautions	8 - 11
CHAPTER 9 REPLACING THE NETWORK SYSTEM		9 - 1 to 9 - 1
9.1	List of Alternative Network System Models	9 - 1
CHAPTER 10 REPLACING THE SPECIAL FUNCTION MODULE		10 - 1 to 10 - 32
10.1	List of Alternative Special Function Module Models	10 - 1
10.2	Special Function Module Comparison	10 - 3
10.2.1	Analog input module comparisons	10 - 3
10.2.2	Analog output module comparison	10 - 9
10.2.3	High-speed counter module comparison	10 - 14
10.2.4	Positioning module comparison	10 - 21
APPENDICES		App - 1 to App - 43
Appendix 1	External Dimensions	App - 1
Appendix 2	Performance Specifications Comparison between A0J2H Series and Renewal Tool for A0J2	App - 1
Appendix 2.1	Precautions for the performance specifications comparison	App - 1
Appendix 2.2	Performance specifications comparison	App - 3
Appendix 3	Related Manuals	App - 41
Appendix 3.1	Replacement handbooks	App - 41
Appendix 3.2	A0J2H Series	App - 42
Appendix 3.3	Q series	App - 42
Appendix 3.4	Programming Tool	App - 43
Appendix 3.5	Products manufactured by Mitsubishi Electric Engineering Co., Ltd.	App - 43
Appendix 3.6	Products manufactured by Mitsubishi Electric System & Service Co., Ltd.	App - 43

- For the products shown in handbooks for transition, Catalogue, and transition examples, refer to the manuals for the relevant products and check the detailed specifications, precautions for use, and restrictions before replacement.

For the products manufactured by Mitsubishi Electric Engineering Co., Ltd., Mitsubishi Electric System & Service Co., Ltd., and other companies, refer to the catalogue for each product and check the detailed specifications, precautions for use, and restrictions before use.

The manuals and catalogues for our products, products manufactured by Mitsubishi Electric Engineering Co., Ltd., and Mitsubishi Electric System & Service Co., Ltd., are shown in Appendix of each handbook for transition.

- For details on product compliance with the above standards, please contact your local Mitsubishi Electric sales office or representative.
- Products shown in this handbook are subject to change without notice.

GENERIC TERMS AND ABBREVIATIONS

Unless otherwise specified, this handbook uses the following generic terms and abbreviations.

Generic term/abbreviation	Description
■Series	
A series	An abbreviation for large types of Mitsubishi Electric MELSEC-A series programmable controllers
AnS series	An abbreviation for compact types of Mitsubishi Electric MELSEC-A series programmable controllers
A/AnS series	Generic term for A series and AnS series
A0J2(H) series	An abbreviation for Mitsubishi Electric MELSEC-A0J2(H) series programmable controllers
QnA series	An abbreviation for large types of Mitsubishi Electric MELSEC-QnA series programmable controllers
QnAS series	An abbreviation for compact types of Mitsubishi Electric MELSEC-QnA series programmable controllers
QnA/QnAS series	Generic term for QnA series and QnAS series
A/AnS/QnA/QnAS series	Generic term for A series, AnS series, QnA series, and QnAS series
Q series	An abbreviation for Mitsubishi Electric MELSEC-Q series programmable controllers
■CPU module type	
CPU module	Generic term for A series, AnS series, QnA series, QnAS series, and Q series CPU modules
Process CPU	Generic term for the Q02PHCPU, Q06PHCPU, Q12PHCPU, and Q25PHCPU
Redundant CPU	Generic term for the Q12PRHCPU and Q25PRHCPU
Universal model QCPU	Generic term for the Q00UJCPU, Q00UCPU, Q01UCPU, Q02UCPU, Q03UDCPU, Q03UDVCPU, Q03UDECPU, Q04UDHCPU, Q04UDVCPU, Q04UDEHCPU, Q06UDHCPU, Q06UDVCPU, Q06UDEHCPU, Q10UDHCPU, Q10UDEHCPU, Q13UDHCPU, Q13UDVCPU, Q13UDEHCPU, Q20UDHCPU, Q20UDEHCPU, Q26UDHCPU, Q26UDVCPU, and Q26UDEHCPU
■CPU module model	
ACPU	Generic term for MELSEC-A series programmable controller CPUs
AnSCPU	Generic term for MELSEC-AnS series programmable controller CPUs
A/AnSCPU	Generic term for MELSEC-A series and MELSEC-AnS series programmable controller CPUs
AnNCP	Generic term for the A1NCP, A1NCPUP21/R21, A1NCPUP21-S3, A2NCP, A2NCP-S1, A2NCPUP21/R21, A2NCPUP21/R21-S1, A2NCPUP21-S3(S4), A3NCP, A3NCPUP21/R21, and A3NCPUP21-S3
AnACPU	Generic term for the A2ACPU, A2ACPU-S1, A3ACPU, A2ACPUP21/R21, A2ACPUP21/R21-S1, and A3ACPUP21/R21
AnUCPU	Generic term for the A2UCPU, A2UCPU-S1, A3UCPU, A4UCPU, A2USCPU, A2USCPU-S1, and A2USHCPU-S1
AnN/AnACPU	Generic term for the AnNCP and AnACPU
AnN/AnA/AnSCPU	Generic term for the AnNCP, AnACPU, and AnSCPU
QnACPU	Generic term for MELSEC-QnA series programmable controller CPUs
QnASCPU	Generic term for MELSEC-QnAS series programmable controller CPUs
QnA/QnASCPU	Generic term for MELSEC-QnA series and MELSEC-QnAS series programmable controller CPUs
A/AnS/QnA/QnASCPU	Generic term for A series, AnS series, QnA series, and QnAS series programmable controller CPUs
QCPU	Generic term for MELSEC-Q series programmable controller CPUs

1 INTRODUCTION

1.1 Proposal to Replace A0J2HCPU with QCPU

1.1.1 Advantages of replacement to QCPU

(1) Advanced performance of equipment is possible (reduced tact time)

Increased speed of the operation processing and bus realizes several times higher performance than the A0J2HCPU and significantly improves equipment performance.

(2) Ease of module selection

The building block type allows for flexible system configurations by selecting a module from a wide range of Q series product lineups.

(3) Ease of programming by various kinds of instructions

PID control instruction, real number operating instruction, there are many convenient instructions available, i.e. and they allow complex data processing to be performed.

(4) Improved maintainability

- (a) The high speed serial port and USB port significantly reduces the read/write time of the program and, improves factory maintainability.
- (b) The flash ROM is adopted as the flash memory of the Universal model QCPU. When the CPU module is replaced with the Universal model QCPU, the ROM operation (battery-less operation) can be performed without using an option memory.

1.1.2 Proposal of replacement to QCPU (Q00UCPU)

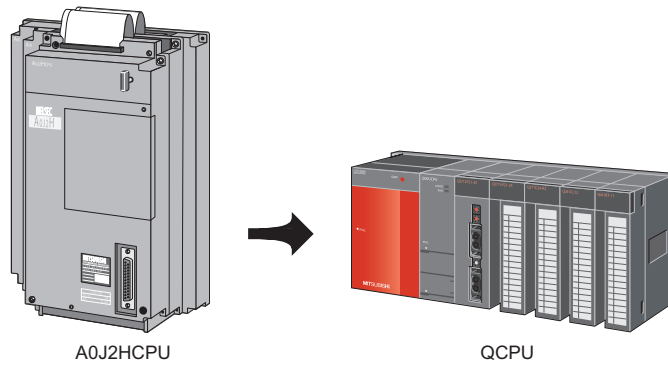

Remarks

When the A type extension base unit (A65B) is connected, refer to the following.
Transition from MELSEC-A/QnA (Large Type) Series to Q Series Handbook (Fundamentals)

(1) Comparison of the installation areas

The following shows a comparison of the installation areas when replacing the A0J2HCPU with the QCPU.

Select the optimal base unit after taking into consideration the installation space, the number of modules loaded, etc.

(a) Comparison of the A0J2-E56□ and the 3-slot main base unit Q33B

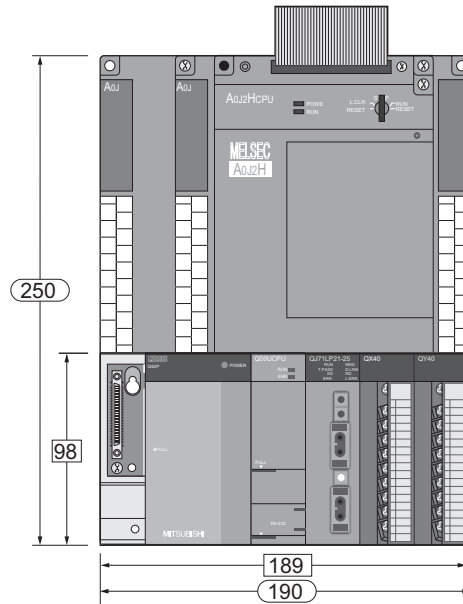

(b) Comparison of the A0J2-E56□ and the 5-slot main base unit Q35B

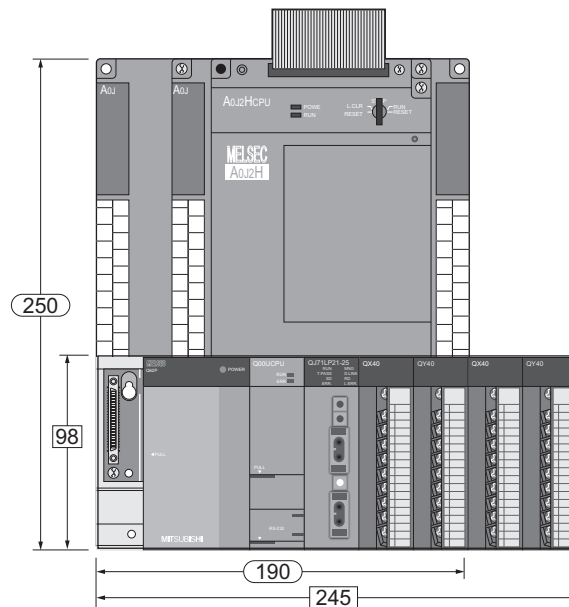

○ : A0J2H (E56□) external dimensions

□ : QCPU external dimensions

(Unit: mm)

(2) Replacement method without changing the I/O address of the A0J2HCPU

(a) Replacing the A0J2-E56□

The A0J2HCPU has I/O points consisting of 32 input points in the first half and 32 output points in the last half for each I/O module.

When replacing with the building block type, replacement with the same I/O address is possible by selecting a terminal block module to keep an equivalent wiring method and arranging in the order of two input modules and two output modules.



Replacing the A0J2-E56□

(b) Replacing the A0J2-E32□, A0J2-E24□, and special module

As the input, output, and special modules are 64 point blocks, 32 points will become vacant when replacing with Q series I/O.

When replacing with the building block type, replacement with the same I/O address is possible by arranging the modules in actual usage mode and setting the head address of each slot using the I/O assignment of the parameter.

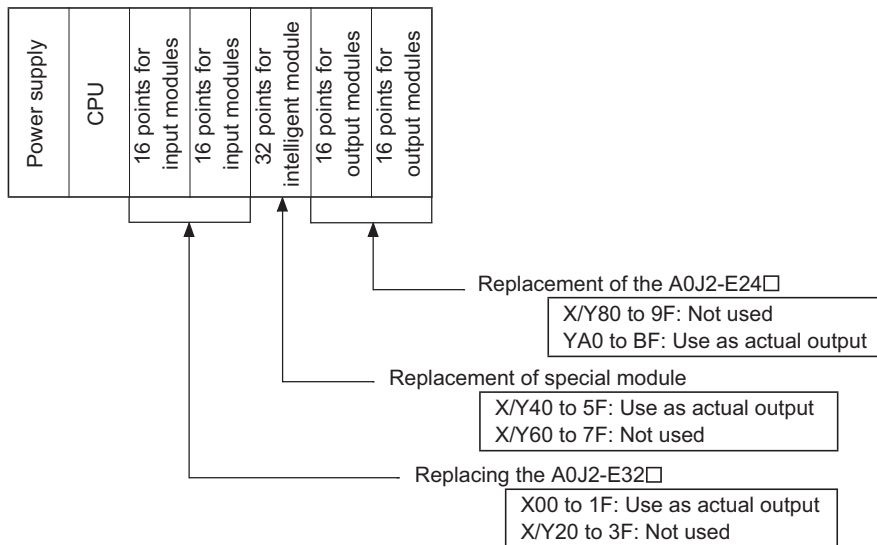

*Example of I/O assignment settings

Qn(H) Parameter

PLC name | PLC system | PLC file | PLC RAS | Device | Program | Boot file

SFC | I/O assignment | Serial

I/O Assignment(*)

Slot	Type	Model name	Points	StartXY
0	PLC			
1	0(*.0) Input		16points	0000
2	1(*.1) Input		16points	0010
3	2(*.2) Intelli.		32points	0040
4	3(*.3) Output		16points	00A0
5	4(*.4) Output		16points	00B0
6	5(*.5)			
7	6(*.6)			

Switch setting
Detailed setting

Assigning the I/O address is not necessary as the CPU does it automatically.
Leaving this setting blank will not cause an error to occur.

Base setting(*)

	Base model name	Power model name	Extension cable	Slots
Main				
Ext.Base1				
Ext.Base2				
Ext.Base3				
Ext.Base4				

Base mode
 Auto
 Detail

8 Slot Default
12 Slot Default

(*)Settings should be set as same when using multiple CPU.

Import Multiple CPU Parameter | Read PLC data

Acknowledge XY assignment | **Multiple CPU settings** | Default | Check | End | Cancel

(c) Replacement by using connector/terminal block converter module, and relay terminal module

With 32-point (or 64-point) I/O modules (connector system), this method reduces the number of slots. As to the wiring from the module, connection with external devices can be made on the terminal block by using the connector/terminal block converter module or relay terminal module externally.

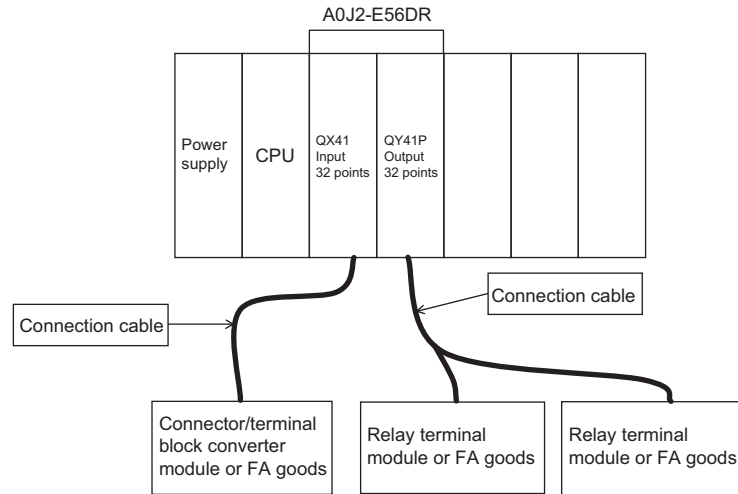

* Connector/terminal block converter module, relay terminal module

Model name	Descriptions	Applicable models
A6TBXY36	For positive common type input and sink type output modules (standard type)	QX41, QX42, QY41P, QY42P, QH42P
A6TBXY54	For positive common type input and sink type output modules (2-wire type)	
A6TBX70	For positive common type input modules (3-wire type)	QX41, QX42, QH42P, QX41Y41P

* Cables

Model name	Descriptions	Applicable models
AC05TB	For 0.5m sink type modules	A6TBXY36 A6TBXY54 A6TBX70
AC10TB	For 1m sink type modules	
AC20TB	For 2m sink type modules	
AC30TB	For 3m sink type modules	
AC50TB	For 5m sink type modules	
AC80TB	For 8m sink type modules (common current 0.5A or less)	
AC100TB	For 10m sink type modules (common current 0.5A or less)	

* Relay terminal modules

Model name	Descriptions	Applicable models
A6TE2-16SRN	For sink type output modules	QY41P, QY42P, QH42P, QX41Y41P

* Relay terminal module connecting cables

Model name	Cable length L
AC06TE	0.6m
AC10TE	1m
AC30TE	3m
AC50TE	5m
AC100TE	10m

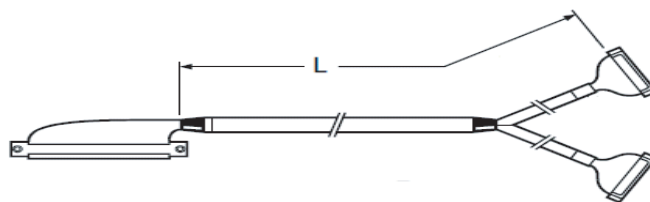

1.2 Proposal of Replacement with Renewal tool for A0J2

1.2.1 Advantages of using renewal tool for A0J2 (manufactured by Mitsubishi Electric System & Service Co., Ltd.)

(1) Renewal tool for A0J2

This tool is for replacing the A0J2(H) system with the Q series. It is composed of the interface module to which wiring terminal block of existing I/O module can be attached, components for a programmable controller, and connection cable.

Also, the interface module has the conversion function that converts AC input into DC input and DC output into relay output and triac output. The interface module can be replaced with the 40-pin connector type DC I/O module.

(a) Configuration example of Renewal tool for A0J2

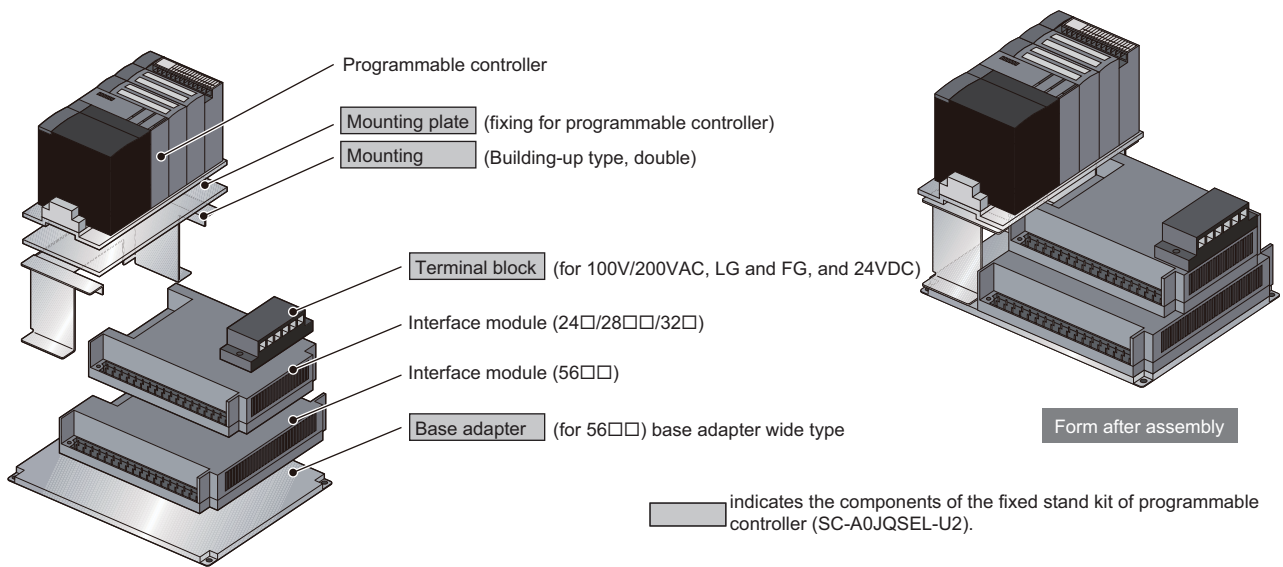

(2) Using the existing wiring

Although the CPU module, A0J2HCPU is replaced with the QCPU, the external wiring terminal block attached to the existing A0J2 I/O module can be utilized to the interface module.

It allows to replace the modules without external wiring change.

Also, new wiring is unnecessary since the Q series I/O module is connected to the interface module with the dedicated cable.

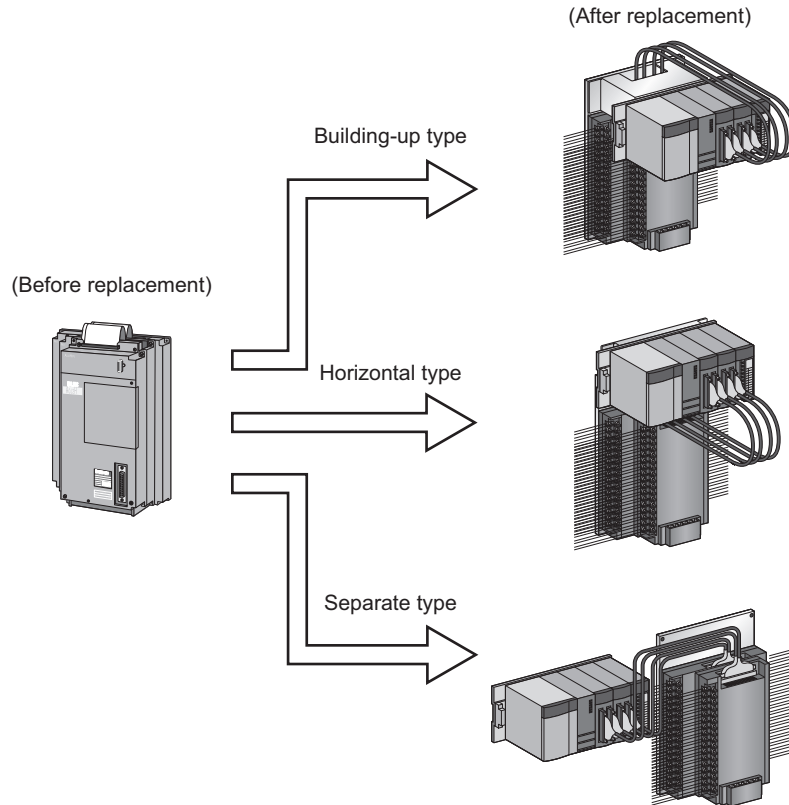

☒ Point

- 1) For specifications comparison and functional comparison between the existing A0J2HCPU and QCPU after replacement, refer to CHAPTER 2.
- 2) For specifications comparison and functional comparison between the existing A0J2 I/O module and the renewal tool for A0J2 after replacement, refer to APPENDICES.

(3) Processing the mounting holes is unnecessary.

Dimensions when renewal tool for A0J2 is mounted to base adapter is the same with existing A0J2 I/O module.

Replacement without processing the mounting holes is possible.

(4) Using the QX41Y41P eliminates I/O address change

Changing the I/O assignment for A0J2 I/O module is unnecessary by replacing the module with the QX41Y41P (combined I/O module).

It eliminates I/O address change and allows substantial reduction of program correction.

The QX41Y41P can treat 32 points for input or output per module, which leads to reduction of the number of slots required for the replaced programmable controller.

(5) List of alternative models

Model to be discontinued (A0J2 I/O module)		Alternative model (Q series/renewal tool for A0J2)		
Product	Model	Q series	Renewal tool for A0J2 ^{*1}	
			Interface module	Fixed stand kit of programmable controller ^{*2}
Input module	A0J2-E32A	QX41	SC-A0JQIF32A	SC-A0JQSES-U1 (Building-up type, single) SC-A0JQSES-F (Horizontal type, single) SC-A0JQBSS (Separate type, single)
	A0J2-E32D		SC-A0JQIF32D	
Output module	A0J2-E24R	QY41P	SC-A0JQIF24R	
	A0J2-E24S		SC-A0JQIF24S	
	A0J2-E24T		SC-A0JQIF24T	
I/O module	A0J2-E28AR	QX41Y41P	SC-A0JQIF28AR	
	A0J2-E28AS		SC-A0JQIF28AS	
	A0J2-E28DR		SC-A0JQIF28DR	
	A0J2-E28DS		SC-A0JQIF28DS	
	A0J2-E28DT		SC-A0JQIF28DT	
	A0J2-E56AR		SC-A0JQIF56AR	SC-A0JQSEL-U1 (Building-up type, single) SC-A0JQSEL-U2 (Building-up type, double) SC-A0JQSEL-F (Horizontal type, single/double) SC-A0JQBBSL (Separate type, single/double)
	A0J2-E56AS		SC-A0JQIF56AS	
	A0J2-E56DR		SC-A0JQIF56DR	
	A0J2-E56DS		SC-A0JQIF56DS	
	A0J2-E56DT		SC-A0JQIF56DT	

*1 The connection cable (SC-A0JQC□□M) is required for connecting a interface module (renewal tool for A0J2) to a Q series I/O module.

*2 The fixed stand kit of programmable controller includes the mounting plate for the Q33B as standard. When a base unit other than the Q33B is used, the mounting plate (SC-A0JQPT□) is required (sold separately).

1.2.2 Proposal of replacement with renewal tool for A0J2

(1) Building-up type

The programmable controller can be built up to the existing panel if there is room for depth in front of existing module, and can be installed on the installation surface of the existing panel.
(236mm or more is required for depth, when two interface modules are mounted.)

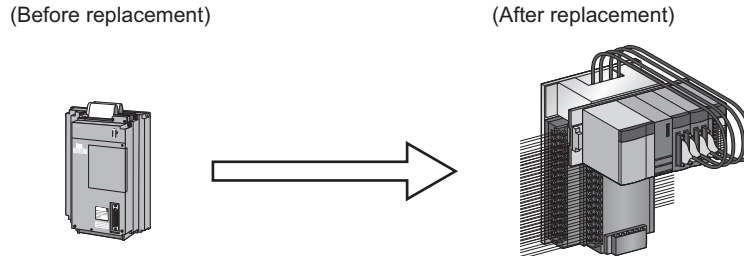

Use the Q33B as main base unit. (Up to three interface modules can be mounted to the main base unit (Q33B). (Refer to the following figure.)*¹)

Reprocess is unnecessary since the installation dimensions are the same and the mounting holes can be utilized.

It can be replaced without changing the programs by using combined I/O module, QX41Y41P.*²

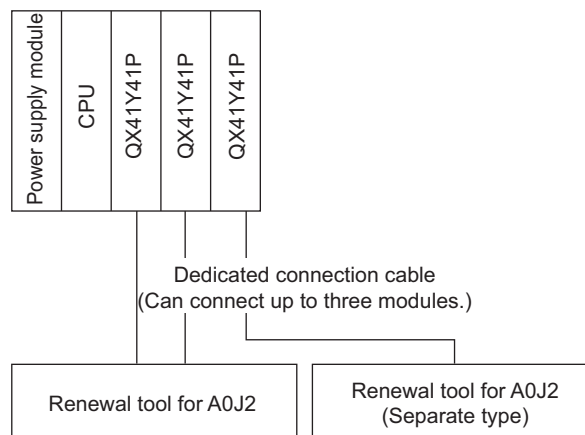

*¹ If there are many existing units, use the 5 slot mounting frame (sold separately) to mounted the main base unit(Q35B).

*² When replacing CPU module with data link function, using two QX41Y41Ps and network module allows to configure a network system.

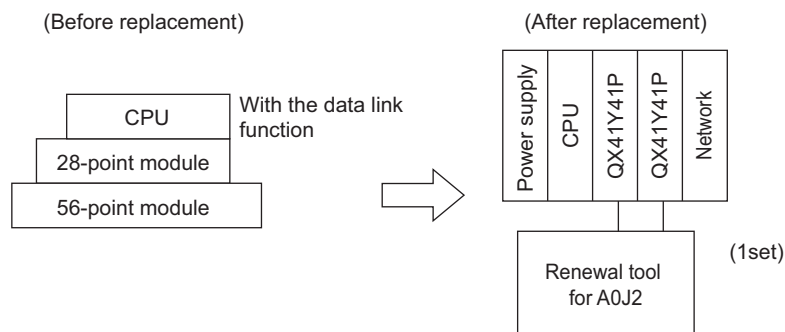

(2) Horizontal type

The programmable controller can be installed horizontally, if there is room above the existing module.

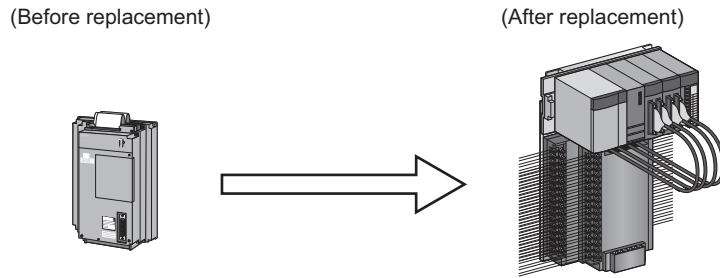

Use the Q33B as main base unit. (Up to three interface modules can be connected to the main base unit (Q33B). (Refer to the following figure.)*¹)

92mm or more room in addition to the current installation dimension is required above the existing module; however, the mounting holes can be utilized and reprocess is unnecessary.

It can be replaced without changing the programs by using combined I/O module, QX41Y41P.*²

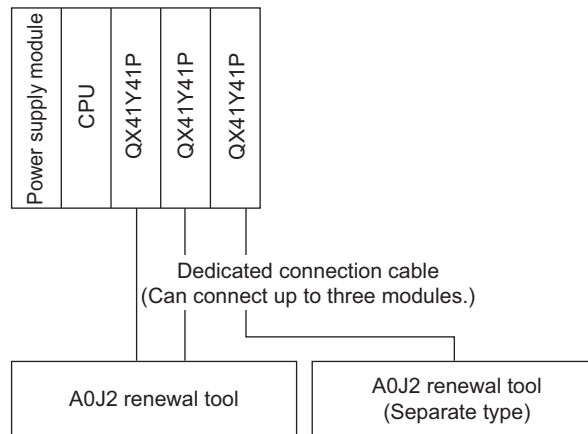

*¹ If there are many existing units, use the 5 slot mounting frame (sold separately) to mounted the main base unit(Q35B).

*² When replacing CPU module with data link function, using two QX41Y41Ps and network module allows to configure a network system.

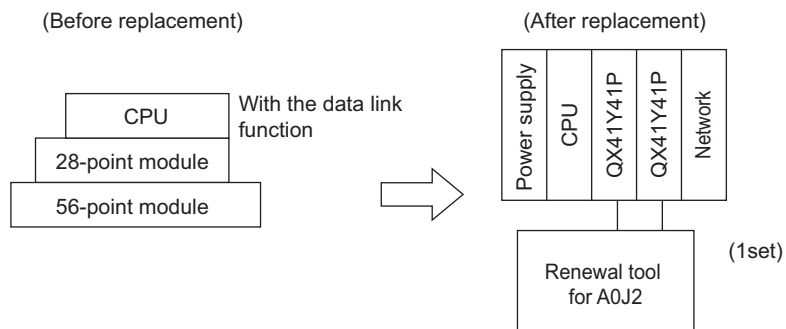

(3) Separate type

Only the programmable controller can be installed separately.

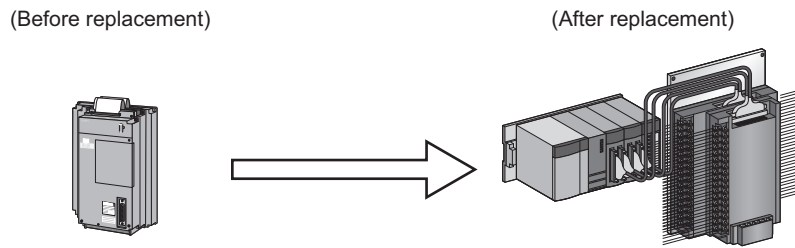

By installing CPU module separately, base unit of the arbitrary number of slots can be used according to the current system configuration.

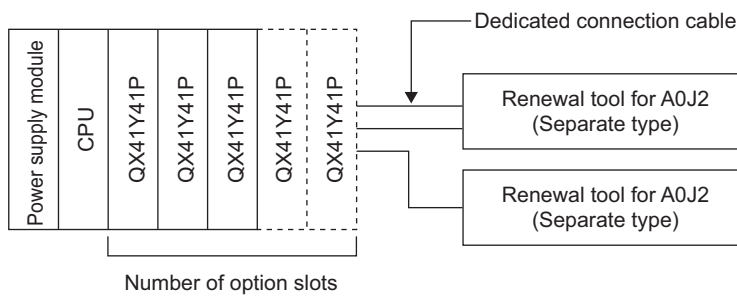

Remarks

Apart from replacement with the QCPU, the renewal tool for A0J2 can be used for replacement with the CC-Link module.

For details, contact Mitsubishi Electric System & Service Co., Ltd.

.....

1.3 Precautions for Replacement

- (a) To replace the A0J2HCPU with the QCPU or replace modules using renewal tool for A0J2, be sure to refer to the following manuals.
Select correct products after checking the functions, specifications, grounding method, and usage.
(Reference manual)
- Manual for each Q series module
 - Renewal tool for A0J2 series transition from MELSEC-A0J2(H) series to renewal system using renewal tool (Refer to Appendix 3.6.)
- (b) After replacing A0J2HCPU, be sure to check operation of the entire system before actual operation.

☒ Point

Before replacement, make sure again that the frame ground of the programmable controller system is securely grounded.

The noise tolerance of programmable controllers is secured by diverting noise to ground via the frame ground as an EMC measure.

For this reason, the system might be affected by noise if the system is reconfigured with insufficient grounding.

Also, consider the following as a provisional measure when checking grounding status is difficult.

- (1) Change the ground of the system into an exclusive ground.
- (2) Add a ferrite core between the ground wire and the module FG terminal.

For MELSEC-A/QnA (large type) Series to Q Series transition related products manufactured by Mitsubishi Electric Engineering Co., Ltd. or Mitsubishi Electric System & Service Co., Ltd., contact your local sales office or representative.

2 REPLACING THE CPU MODULE

2.1 List of Alternative CPU Module Models

The following is an example of alternative Q series CPU modules that can be chosen based on compatibility with previous A0J2H series CPU. The optimal A0J2HCPU replacement may be selected based on type of control, specifications, system scalability and cost.

Discontinued models in A0J2H series		Q series alternative models	
Product name	Model name	Model name	Remarks (restrictions)
CPU module	A0J2HCPU A0J2HCPUP21* ¹ A0J2HCPUR21* ¹ A0J2HCPUP21-S3* ¹ A0J2CPU-DC24* ²	Q00UJCPU* ³	1) I/O control: Refresh/direct switch → Refresh only 2) Processing speed (LD instruction): During refresh 1.25μs → 0.12μs 3) PC MIX value: 0.2 → 4.92 4) Number of I/O points: 480 points → 256 points 5) Number of I/O device points: 512 points → 8192 points 6) Program capacity: 8K step → 10K step 7) Number of file register points: 4096 points → 0 points 8) Microcomputer program: Usable → Not usable 9) Number of I/O slots on main base: No main base (8 units connectable using connection cable) → Max. 5 slots (including extension, Max. 16 slots available) 10) Number of extension stages: 4 modules + 1 stage (A55B, A65B) → 2 stages 11) Applicable memory: Built-in RAM/4K/8K/16K ROM → Built-in program memory(RAM)/built-in flash ROM 12) Configuration: Compact type → Building block type (including 5 slot base unit, CPU module and power supply module)
		Q00UCPU* ³	1) I/O control: Refresh/direct switch → Refresh only 2) Processing speed (LD instruction): During refresh 1.25μs → 0.08μs 3) PC MIX value: 0.2 → 7.36 4) Number of I/O points: 480 points → 1024 points 5) Number of I/O device points: 512 points → 8192 points 6) Program capacity: 8K step → 10K step 7) Number of file register points: 4096 points → 64K points 8) Microcomputer program: Usable → Not usable 9) Number of I/O slots on main base: No main base (8 units connectable using connection cable) → Max. 12 slots (including extension, Max. 24 slots available) 10) Number of extension stages: 4 modules + 1 stage (A55B, A65B) → 4 stages 11) Applicable memory: Built-in RAM/4K/8K/16K ROM → Built-in program memory (RAM)/built-in flash ROM 12) Configuration: Compact type → Building block type

*1 When replacing MELSECNET CPU module with link function, select both a CPU module and a network module from the table below.

Product name	Alternative model		Precautions
	CPU model name	Network model name	
A0J2HCPUP21	Q00UJCPU	QJ71LP21-25	Built-in link function → mount network module on the base unit (1 slot,32 points)
	Q00UCPU		
A0J2HCPUR21	Q00UJCPU	QJ71BR11	
	Q00UCPU		
A0J2HCPUP21-S3	Q00UJCPU	QJ71LP21G	
	Q00UCPU		

*2 Select "Q63P (24VDC input)" as a power supply module after the replacement.

*3 Use the SFC program and consider using the Q03UDVCPU/Q03UD(E)CPU if any of the following applies.

- Number of SFC blocks: 128 blocks or more
- Number of SFC steps: 128 steps or more/block

For details on the replacement method when using the SFC program, refer to Section 7.6.

Remarks

- When the A0J2CPU is used, read the A0J2HCPU in the above table as the A0J2CPU. Refer to the following because the performance specifications differ.
A0J2HCPU(P21/R21) User's Manual: IB-66268
- GX Developer does not support the A0J2CPU. Changing the existing CPU module type into the one which is supporting GX Developer is required using the A/QnA-Q conversion support tool when the program is used. For details, refer to Section 7.1.4.
- The modules other than CPU modules (such as I/O modules and special function modules) are common to specifications between the A0J2CPU and A0J2HCPU. For details, refer to CHAPTER 3.

2.2 Specifications Comparison of CPU Module

○ : Usable △ : Usable, however, a section of the specifications, i.e. setting methods, is different × : Not used

Function	Description	A0J2HCPU	QnUCPU		Precautions for replacement	Reference sections
			Q00UJCPU	Q00UCPU		
Control method	Cyclic operation (by the stored program)	○	○	○	–	–
I/O control method	Refresh mode/direct mode	○ ^{*1}	○ ^{*2}	○ ^{*2}	As QCPU supports only refresh mode, use the direct I/O instruction when inputting or outputting in direct mode.	Section 7.7.2
Programming language	Language dedicated to sequence control (relay symbol, logic symbol, and MELSAP languages)	○	○	○	Regarding MELSAP language, A0J2HCPU uses MELSAP II and QCPU uses MELSAP3.	Section 7.6
Processing speed	Sequence instruction (μs/step)	1.25	0.12	0.08	–	–
Watch dog timer (WDT)	Watch dog timer (WDT) (ms)	10 to 2000	10 to 2000	10 to 2000	–	–
Memory capacity	User memory capacity (Byte)	32K (Built-in RAM)	Program memory (Flash ROM) ^{*3} 40K Standard RAM:- Standard ROM: 256K	Program memory (Flash ROM) ^{*3} 40K Standard RAM: 128K Standard ROM: 512K	–	Section 2.4.1
Program capacity	Sequence program (step)	Max. 8K	Max.10K	Max.10K	–	–
	Microcomputer program (byte)	Max. 14K	×	×	QCPU does not have a microcomputer program. It is recommended to replace the microcomputer program with a sequence program.	–
Number of I/O points	Number of I/O points (points) ^{*4}	480	256	1024	–	–

*1 The direct I/O is selectable using the I/O control mode settings switch.

*2 Although QCPU supports only refresh mode, it has some instructions/devices for I/O in direct mode.

*3 This is the capacity that can store the maximum number of steps of the sequence program.

*4 This is the number of accessible points of actual I/O modules.

○ : Usable △ : Usable, however, a section of the specifications, i.e. setting methods, is different × : Not used

Function	Description	A0J2HCPU	QnUCPU		Precautions for replacement	Reference sections	
			Q00UJCPU	Q00UCPU			
Number of device points	Number of input device (X) points (points)*5	512	8192	8192	—	—	
	Number of output device (Y) points (points)*5	512	8192	8192	—	—	
	Number of internal relay (M) points (points)	Total of 2048	8192	8192	—	—	
	Number of latch relay (L) points (points)		8192	8192	—	—	
	Number of step relay (S) points (points)		8192*6	8192*6	—	—	
	Number of annunciator (F) points (points)	256	2048	2048	—	—	
	Number of edge relay (V) points (points)	×	2048	2048	—	—	
	Number of link relay (B) points (points)	1024	8192	8192	—	—	
	Number of timer (T) points (points)	256	2048	2048	—	—	
	Number of counter (C) points (points)	256	1024	1024	—	—	
	Number of data register (D) points (points)	1024	12288	12288	—	—	
	Number of link register (W) points (points)	1024	8192	8192	—	—	
	Number of file register (R) points (points)	4096	×	32768 × 2 blocks	Q00UJCPU does not have a file register. It is recommended to substitute the data register (D).	—	
	Number of accumulator (A) points (points)	2	×	×	As QCPU does not have an accumulator, it is converted to a special register (SD718, SD719) during the program conversion from A → Q.	—	
	Index register	Number of (Z) points (points)	1	20	20	—	—
		Number of (V) points (points)	1	×	×	—	—
	Number of nesting (N) points (points)	8	15	15	—	—	
	Number of pointer (P) points (points)	256	512	512	—	—	
	Number of interrupt pointer (I) points (points)	1	128	128	—	—	
	Number of special relay (M) points (points)	256	2048	2048	—	—	
	Number of special register (D) points (points)	256	2048	2048	—	—	
	Number of link special relay (SB) points (points)	—	2048	2048	—	—	
	Number of link special register (SW) points (points)	—	2048	2048	—	—	
	Number of function input (FX) points (points)	—	16	16	—	—	
	Number of function output (FY) points (points)	—	16	16	—	—	
	Number of function register (FD) points (points)	—	5	5	—	—	

○ : Usable △ : Usable, however, a section of the specifications, i.e. setting methods, is different × : Not used

Function	Description	A0J2HCPU	QnUCPU		Precautions for replacement	Reference sections
			Q00UJCPU	Q00UCPU		
Number of comments	Number of comments (points) ^{*7}	Max. 1600	Within capacity of program memory + standard ROM	Within capacity of program memory + standard RAM + standard ROM	-	-
Self-diagnostics	Watch Dog Timer (WDT), memory error detection, CPU error detection, battery error detection, etc.	○	○	○	-	-
Operation mode during error	Stop/continue selectable	○	○	○	-	-
Switching output mode during STOP → RUN	Selectable from re-output operation status before STOP and output after operation execution	○	○	○	-	-

*5 This is the number of points usable on the program.

*6 The step relay (S) of QCPU is an SFC dedicated relay.

*7 The number of comments refers to the number of points for writing to the CPU.

2.3 Functional Comparisons of CPU Module

2.3.1 Functional comparisons between the A0J2HCPU and QCPU

○ : Usable △ : Usable, however, a section of the specifications, i.e. setting methods, is different × : Not used

Function	Description	A0J2HCPU	QnUCPU	Precautions for replacement	Reference sections
Control	Constant scan	○	△	Set this function with the special register (D9020) for A0J2HCPU, and with parameters for QCPU.	-
	Latch (power backup)	○	○	-	-
	Remote RUN/STOP	○	○	-	-
	PAUSE	○	△	Set the PAUSE enable flag with the special relay (M9040) for A0J2HCPU, and with the special relay (SM206) for QCPU.*1	-
	Interrupt processing	○	○	-	-
	Microcomputer mode	○	×	It is recommended to replace the microcomputer program with a sequence program. When using utility package instructions, the corresponding QCPU instructions must be modified.	-
	Display priority of ERROR LED	○	○	Target errors vary by model, but the function is the same.	-
	ROM operation	○	△	A0J2HCPU can perform the ROM operation by using EP-ROM (sold separately). The Universal model QCPU, whose program memory is a Flash ROM, does not have to perform the ROM operation.	-
	Data protection (System protect, keyword registration/password registration)	○	△	A0J2HCPU prohibits the parameters and programs from being read/written to the user memory by keyword registration, whereas QCPU prohibits each file from being read/written by password registration.	Section 2.4.2
Output status settings during STOP → RUN	○	○	The parameter needs to be reconfigured when replacing A0J2HCPU with QCPU.	-	
Clock function	○	△	A0J2HCPU handles the last two digits of the year (western calendar), whereas QCPU handles the four digits.	-	

*1 When PLC type in GX Developer changes, the device number will change.

○ : Usable △ : Usable, however, a section of the specifications, i.e. setting methods, is different × : Not used

Function		Description	A0J2HCPU	QnUCPU	Precautions for replacement	Reference sections
Debug	Write during RUN	Changes (writes) the program while the CPU is in RUN.	○	○	Allocate memory for Write during RUN setting in advance for QCPU (default: 500 steps).	Section 2.4.3
	Status latch	Stores the contents of all the devices to the memory cassette or memory card when an error, etc. occurred and monitors the stored data using the peripheral devices.	○	×	QCPU does not have the status latch function.	–
	Sampling trace	Stores the data of the specified devices at every specified interval to the memory cassette or memory card and monitors the stored data using the peripheral devices to confirm the modified status of the device.	○	○	Q00UJCPU does not have the sampling trace function.	–
	Offline switch	Separates the devices used by the OUT instruction from the operation processing of the sequence program.	○	×	QCPU does not have the offline switch function.	–
Maintenance	Self-diagnostics function	Examines the presence of an error, detects errors, stops the CPU, etc.	○	○	The error codes differ between A0J2HCPU and QCPU.	–

2.4 Precautions for Replacement of the CPU Module

2.4.1 Memory in the CPU module

Referring to the memory configuration shown in (1), consider the memories for storage according to memory capacity/application before replacement.

(1) Memory configuration and storable data

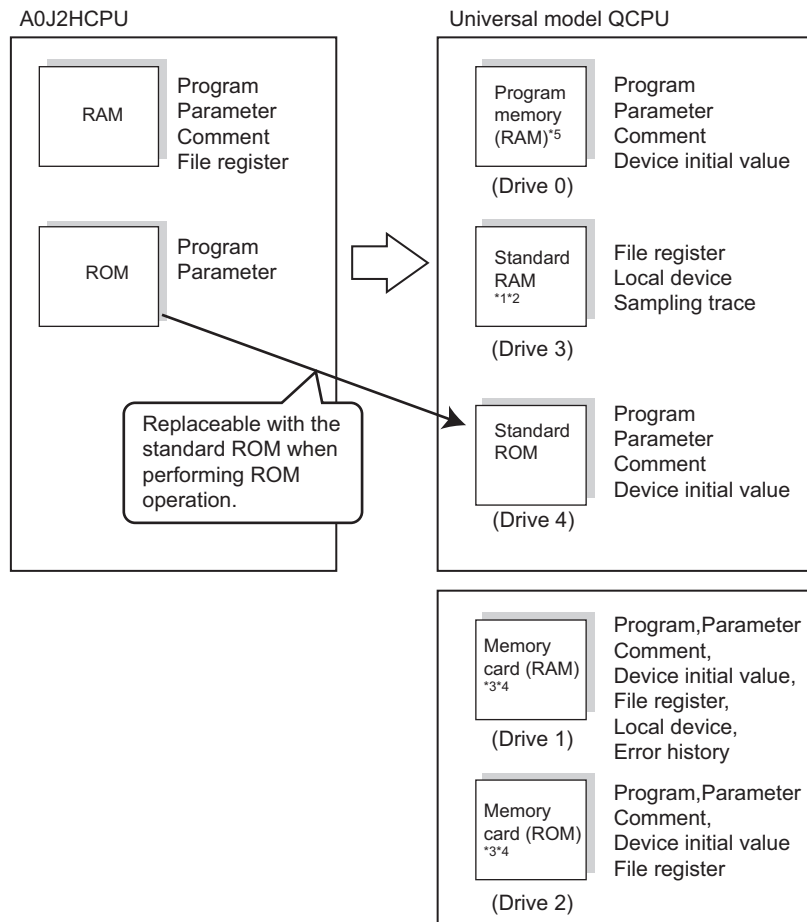

*1 The Q00UJCPU does not have the standard RAM.

*2 There are files that cannot be used in the Q00UJCPU.

*3 Only one drive, drive 1 or drive 2, can be used.

*4 Q00UJCPU, Q00UCPU, Q01UCPU does not have a memory card.

*5 The Universal model CPU, whose program memory is a Flash ROM, does not have to perform the ROM operation.

(2) Capacity of the various memories

The following shows the memory storing user programs, etc. and its capacity in each CPU module.

Item	Model name		
	A0J2HCPU	QnUCPU	
		Q00UJCPU	Q00UCPU
Program memory	32K bytes	40K bytes ^{*1}	40K bytes ^{*1}
ROM memory ^{*2}	4/8/16K bytes	–	–
Standard RAM	–	–	128K bytes
Standard ROM ^{*3}	–	256K bytes	512K bytes

*1 The program memory indicates the flash ROM.

*2 The memory is the EP-ROM (option) for the ROM operation.

*3 The memory saves data such as a device comment and PC user data.

2.4.2 Keyword registration and password registration

A0J2HCPU prohibits programs from being read/written by keyword registration, whereas QCPU uses password entries to do so. The following shows the details of executable functions.

Item	Model name	
	A0J2HCPU	QCPU
Method to prohibit writing to program, etc.	<p>The following attribute can be configured to the specified memory.</p> <ul style="list-style-type: none"> • Prohibition of read/write 	<p>The equivalent function can be implemented by collectively setting a password to all the files.</p> <p>(Supplement)</p> <p>The following attributes can be configured to each specified file of the specified memory (drive) using the password.</p> <ul style="list-style-type: none"> • Prohibition of read/write display • Prohibition of write

2.4.3 Write during RUN

The amount of program capacity increased by executing Write during RUN has to be secured before the operation.

(1) A0J2HCPU

The program capacity is determined by the parameter (memory capacity settings) and the program can be increased within the range of the memory capacity settings when executing Write during RUN.

(2) QCPU

When writing to the programmable controller, configure the program capacity increased by executing Write during RUN. (This capacity setting is called "Allocate memory for Write during RUN". As a default, 500 steps are secured.)

The following shows the setting screen of "Allocate memory for Write during RUN" as reference.

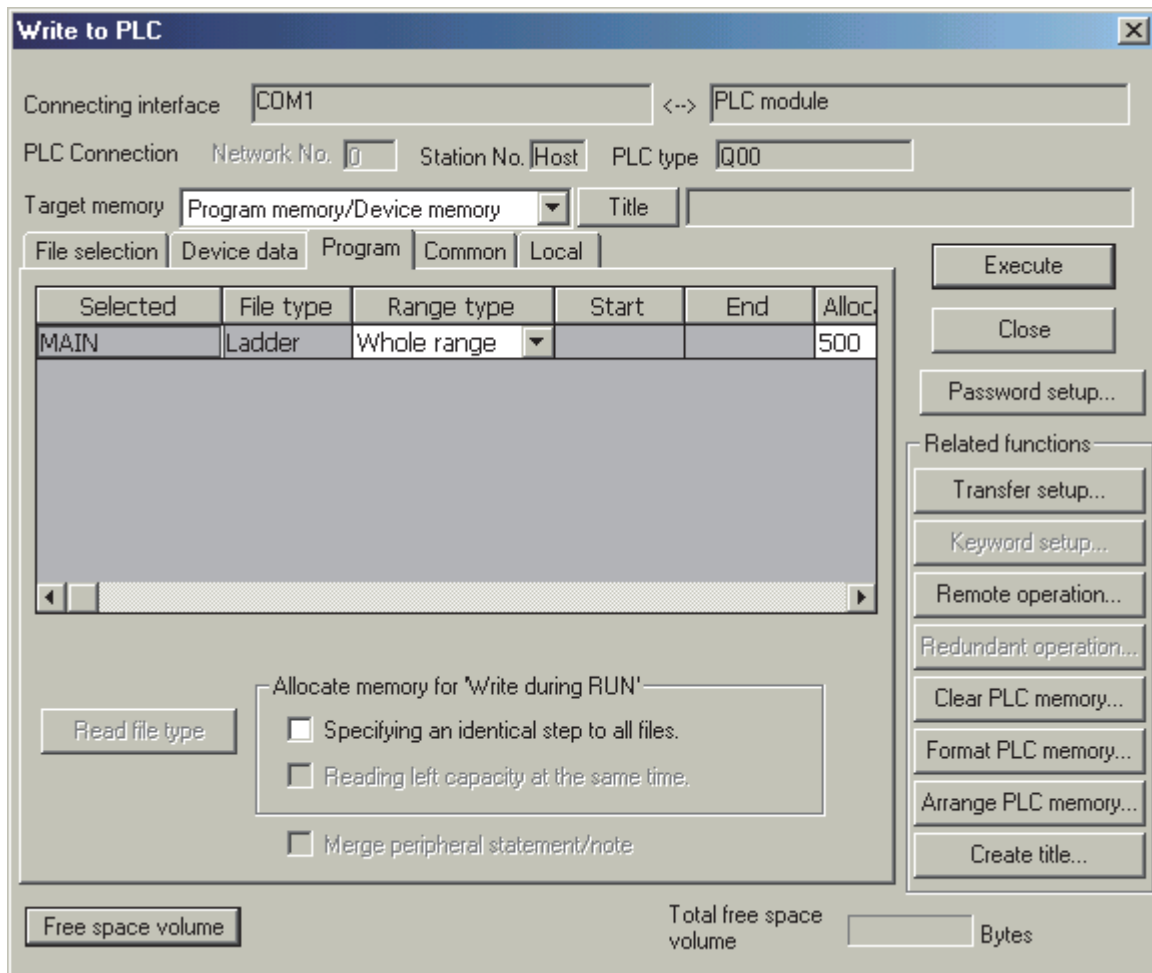

2.4.4 I/O assignment

I/O assignment is as follows.

Item	Model name	
	A0J2HCPU	QCPU
I/O assignment	Regardless of the number of I/O points on the module, the number of occupied I/O points of one module is fixed at 64 points (32 input points for the first half and 32 output points for the last half). The number of I/O points on the extension base is also fixed at 64 points and the head of the I/O numbers on the extension base starts from X/Y100.	Configure the I/O assignment using the parameters to ensure that the I/O numbers match before and after replacement.

The following shows the I/O assignment when replacing the A0J2 series I/O module with the Q series I/O module.

(1) Configuring the A0J2 series I/O module number to "0"

A0J2 series I/O module			Q series I/O module	
Number of I/O points	I/O address (64 fixed points/ module)		Number of I/O points	I/O address
A0J2-E56□□	32 input points	X00 to X1F	32 input points (16 input points × 2)	X00 to X1F (X00 to X0F, X10 to X1F)
	24 output points	Y20 to Y37 (Y38 to Y3F are not used.)	32 output points (16 output points × 2)	Y20 to Y3F (Y20 to Y2F, Y30 to Y3F)
A0J2-E28□□	16 input points	X00 to X0F (X10 to X1F are not used.)	16 input points	X00 to X0F
	12 output points	Y20 to Y2B (Y2C to Y3F are not used.)	16 output points	Y20 to Y2F
A0J2-E32□	32 input points	X00 to X1F (Y20 to Y3F are not used.)	32 input points (16 input points × 2)	X00 to X1F (X00 to X0F, X10 to X1F)
A0J2-E24□	24 output points	Y20 to Y37 (X00 to X1F are not used.) (Y38 to Y3F are not used.)	32 output points (16 output points × 2)	Y20 to Y3F (Y20 to Y2F, Y30 to Y3F)
A0J2 special function module	32 I/O points	X/Y00 to X/Y1F (X/Y20 to X/Y3F are not used.)	16/32 I/O points	X/Y00 to X/Y0F or X/Y00 to X/Y1F

(2) Replacement example

The following shows an example of I/O assignment when A0J2HCPU + system including extension base unit is replaced with the Q series.

Replace with Q00UCPU in the case that A0J2HCPU is used with a system including extension base unit. Replacement with Q00UJCPU is possible when the I/O number is X/Y00 to X/YFF (256 points) or less.

(I/O address before replacement)

I/O address of system including extension base unit

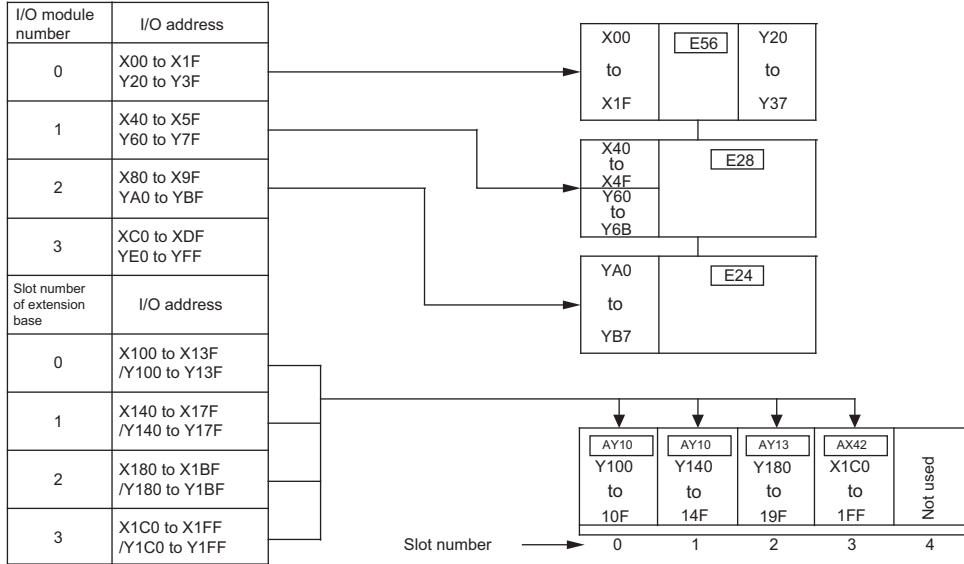

The head address of each I/O module is set with the I/O assignment of the parameter.

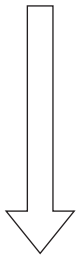

(I/O address after replacement)

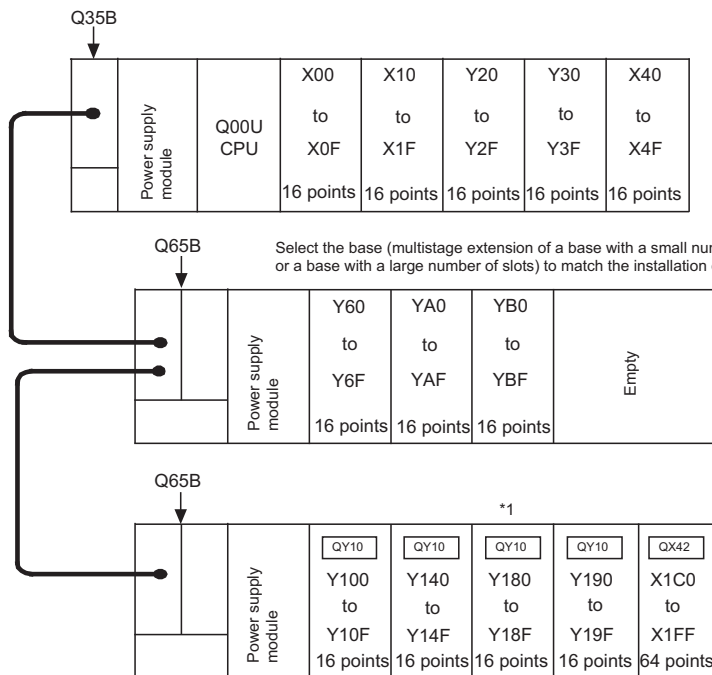
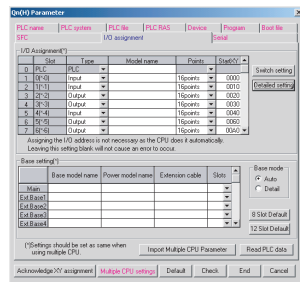

*1 Use two 16-point modules, as the Q series does not have a 32-point contact output and terminal block module.

3 I/O MODULES REPLACEMENT

3.1 Alternative I/O Module Models List

A0J2H models to be discontinued		Alternative Q series models	
Product name	Model name	Model name	Remarks (restrictions)
Input module	A0J2-E32A ^{*1}	QX10	1) Change in external wiring: Required 2) Change in the number of modules: Required (2 modules necessary) 3) Change in a program Change in the number of occupied I/O points: Required (64 points → 16 points × 2) 4) Change in specifications Change in rated input voltage: Not required Change in rated input current: Required (Approx. 10mA → Approx. 8mA) Change in ON voltage/ON current: Required Change in OFF voltage/OFF current: Required Change in input resistance: Required 5) Change in functions: Not required
	A0J2-E32D ^{*1}	QX40	1) Change in external wiring: Required 2) Change in the number of modules: Required (2 modules necessary) 3) Change in a program Change in the number of occupied I/O points: Required (64 points → 16 points × 2) 4) Change in specifications Change in rated input voltage: Required (12VDC not applicable) ^{*2} Change in rated input current: Required (Approx. 7mA → Approx. 4mA) Change in ON voltage/ON current: Required Change in OFF voltage/OFF current: Required Change in input resistance: Required 5) Change in functions: Not required

A0J2H models to be discontinued		Alternative Q series models	
Product name	Model name	Model name	Remarks (restrictions)
Input module	A0J2E-E32D	QX80	1) Change in external wiring: Required 2) Change in the number of modules: Required (2 modules necessary) 3) Change in a program Change in the number of occupied I/O points: Required (64 points → 16 points × 2) 4) Change in specifications Change in rated input voltage: Required (12VDC not applicable) ² Change in rated input current: Required (Approx. 7mA → Approx. 4mA) Change in ON voltage/ON current: Required Change in OFF voltage/OFF current: Required Change in input resistance: Required 5) Change in functions: Not required
Output module	A0J2-E24R ^{*1}	QY10	1) Change in external wiring: Required 2) Change in the number of modules: Required (2 modules necessary) 3) Change in a program Change in the number of occupied I/O points: Required (64 points → 16 points × 2) 4) Change in specifications Change in rated output voltage: Not required Change in rated output current: Not required (Note that a contact life is half.) 5) Change in functions: Not required
	A0J2E-E24R ^{*1}	QY10	1) Change in external wiring: Required 2) Change in the number of modules: Required (2 modules necessary) 3) Change in a program Change in the number of occupied I/O points: Required (64 points → 16 points × 2) 4) Change in specifications Change in rated output voltage: Not required Change in rated output current: Not required (Note that a contact life is half.) 5) Change in functions: Required (without varistor, fuse)
	A0J2-E24S ^{*1}	QY22	1) Change in external wiring: Required 2) Change in the number of modules: Required (2 modules necessary) 3) Change in a program Change in the number of occupied I/O points: Required (64 points → 16 points × 2) 4) Change in specifications Change in rated output voltage: Not required Change in rated output current: Not required 5) Change in functions: Required (without fuse)

A0J2H models to be discontinued		Alternative Q series models	
Product name	Model name	Model name	Remarks (restrictions)
Output module	A0J2E-E24T ^{*1}	QY50	1) Change in external wiring: Required 2) Change in the number of modules: Required (2 modules necessary) 3) Change in a program Change in the number of occupied I/O points: Required (64 points → 16 points × 2) 4) Change in specifications Change in rated output voltage: Not required Change in rated output current: Not required 5) Change in functions: Not required
	A0J2E-E24T	QY80	1) Change in external wiring: Required 2) Change in the number of modules: Required (2 modules necessary) 3) Change in a program Change in the number of occupied I/O points: Required (64 points → 16 points × 2) 4) Change in specifications Change in rated output voltage: Not required Change in rated output current: Required (output 0.8A → 0.5A) 5) Change in functions: Not required

A0J2H models to be discontinued		Alternative Q series models	
Product name	Model name	Model name	Remarks (restrictions)
I/O module	A0J2-E28DR* ¹	QX40 + QY10	1) Change in external wiring: Required 2) Change in the number of modules: Required (2 modules necessary: QX40 × 1 module, QY10 × 1 module) 3) Change in a program Change in the number of occupied I/O points: Required (64 points → 16 points × 2) 4) Change in specifications Change in rated input voltage: Required (12VDC not applicable)* ² Change in rated input current: Required (Approx. 7mA → Approx. 4mA) Change in ON voltage/ON current: Required Change in OFF voltage/OFF current: Required Change in input resistance: Required Change in rated output voltage: Not required Change in rated output current: Not required (Note that a contact life is half.) 5) Change in functions: Not required
	A0J2-E56DR* ¹	QX40 + QY10	1) Change in external wiring: Required 2) Change in the number of modules: Required (4 modules necessary: QX40 × 2 modules, QY10 × 2 modules) 3) Change in a program Change in the number of occupied I/O points: Not required 4) Change in specifications Change in rated input voltage: Required (12VDC not applicable)* ² Change in rated input current: Required (Approx. 7mA → Approx. 4mA) Change in ON voltage/ON current: Required Change in OFF voltage/OFF current: Required Change in input resistance: Required Change in rated output voltage: Not required Change in rated output current: Not required (Note that a contact life is half.) 5) Change in functions: Not required
	A0J2-E28DT* ¹	QX40 + QY50	1) Change in external wiring: Required 2) Change in the number of modules: Required (2 modules necessary: QX40 × 1 module, QY50 × 1 module) 3) Change in a program Change in the number of occupied I/O points: Required (64 points → 16 points × 2) 4) Change in specifications Change in rated input voltage: Required (12VDC not applicable)* ² Change in rated input current: Required (Approx. 7mA → Approx. 4mA) Change in ON voltage/ON current: Required Change in OFF voltage/OFF current: Required Change in input resistance: Required Change in rated output voltage: Not required Change in rated output current: Not required 5) Change in functions: Not required

A0J2H models to be discontinued		Alternative Q series models	
Product name	Model name	Model name	Remarks (restrictions)
I/O module	A0J2-E28DT*1	QX41Y41P	1) Change in external wiring: Required (Terminal block → connector) 2) Change in the number of modules: Not required 3) Change in a program Change in the number of occupied I/O points: Not required (Number of actual I/O points: Input 16 points, output 12 points → Input 32 points, output 32 points) 4) Change in specifications Change in rated input voltage: Required (12VDC not applicable)*2 Change in rated input current: Required (Approx. 7mA → Approx. 4mA) Change in ON voltage/ON current: Required Change in OFF voltage/OFF current: Required Change in input resistance: Required Change in rated load voltage: Not required Change in rated load current: Required (Output 0.5A → 0.1A) 5) Change in functions: Not required
	A0J2-E56DT*1	QX40 + QY50	1) Change in external wiring: Required 2) Change in the number of modules: Required (4 modules necessary: QX40 × 2 modules, QY50 × 2 modules) 3) Change in a program Change in the number of occupied I/O points: Not required 4) Change in specifications Change in rated input voltage: Required (12VDC not applicable)*2 Change in rated input current: Required (Approx. 7mA → Approx. 4mA) Change in ON voltage/ON current: Required Change in OFF voltage/OFF current: Required Change in input resistance: Required Change in rated output voltage: Not required Change in rated output current: Not required 5) Change in functions: Not required
		QX41Y41P	1) Change in external wiring: Required (Terminal block → connector) 2) Change in the number of modules: Not required 3) Change in a program Change in the number of occupied I/O points: Not required (Number of actual I/O points: Input 32 points, output 24 points → Input 32 points, output 32 points) 4) Change in specifications Change in rated input voltage: Required (12VDC not applicable)*2 Change in rated input current: Required (Approx. 7mA → Approx. 4mA) Change in ON voltage/ON current: Required Change in OFF voltage/OFF current: Required Change in input resistance: Required Change in rated load voltage: Not required Change in rated load current: Required (Output 0.5A → 0.1A) 5) Change in functions: Not required

A0J2H models to be discontinued		Alternative Q series models	
Product name	Model name	Model name	Remarks (restrictions)
I/O module	A0J2-E28AR ^{*1}	QX10 + QY10	1) Change in external wiring: Required 2) Change in the number of modules: Required (2 modules necessary: QX10 × 1 module, QY10 × 1 module) 3) Change in a program Change in the number of occupied I/O points: Required (64 points → 16 points × 2) 4) Change in specifications Change in rated input voltage: Not required Change in rated input current: Required (Approx. 10mA → Approx. 8mA) Change in ON voltage/ON current: Required Change in OFF voltage/OFF current: Required Change in input resistance: Required Change in rated output voltage: Not required Change in rated output current: Not required (Note that a contact life is half.) 5) Change in functions: Not required
	A0J2-E56AR ^{*1}	QX10 + QY10	1) Change in external wiring: Required 2) Change in the number of modules: Required (4 modules necessary: QX10 × 2 modules, QY10 × 2 modules) 3) Change in a program Change in the number of occupied I/O points: Not required 4) Change in specifications Change in rated input voltage: Not required Change in rated input current: Required (Approx. 10mA → Approx. 8mA) Change in ON voltage/ON current: Required Change in OFF voltage/OFF current: Required Change in input resistance: Required Change in rated output voltage: Not required Change in rated output current: Not required (Note that a contact life is half.) 5) Change in functions: Not required
	A0J2-E28AS ^{*1}	QX10 + QY22	1) Change in external wiring: Required 2) Change in the number of modules: Required (2 modules necessary: QX10 × 1 module, QY22 × 1 module) 3) Change in a program Change in the number of occupied I/O points: Required (64 points → 16 points × 2) 4) Change in specifications Change in rated input voltage: Not required Change in rated input current: Required (Approx. 10mA → Approx. 8mA) Change in ON voltage/ON current: Required Change in OFF voltage/OFF current: Required Change in input resistance: Required Change in rated output voltage: Not required Change in rated output current: Not required 5) Change in functions: Required (without fuse)

A0J2H models to be discontinued		Alternative Q series models	
Product name	Model name	Model name	Remarks (restrictions)
I/O module	A0J2-E56AS ^{*1}	QX10 + QY22	1) Change in external wiring: Required 2) Change in the number of modules: Required (4 modules necessary: QX10 × 2 modules, QY22 × 2 modules) 3) Change in a program Change in the number of occupied I/O points: Not required 4) Change in specifications Change in rated input voltage: Not required Change in rated input current: Required (Approx. 10mA → Approx. 8mA) Change in ON voltage/ON current: Required Change in OFF voltage/OFF current: Required Change in input resistance: Required Change in rated output voltage: Not required Change in rated output current: Not required 5) Change in functions: Required (without fuse)
	A0J2-E28DS ^{*1}	QX40 + QY22	1) Change in external wiring: Required 2) Change in the number of modules: Required (2 modules necessary: QX40 × 1 module, QY22 × 1 module) 3) Change in a program Change in the number of occupied I/O points: Required (64 points → 16 points × 2) 4) Change in specifications Change in rated input voltage: Required (12VDC not applicable) ^{*2} Change in rated input current: Required (Approx. 7mA → Approx. 4mA) Change in ON voltage/ON current: Required Change in OFF voltage/OFF current: Required Change in input resistance: Required Change in rated output voltage: Not required Change in rated output current: Not required 5) Change in functions: Required (without fuse)
	A0J2-E56DS ^{*1}	QX40 + QY22	1) Change in external wiring: Required 2) Change in the number of modules: Required (4 modules necessary: QX40 × 2 modules, QY22 × 2 modules) 3) Change in a program Change in the number of occupied I/O points: Not required 4) Change in specifications Change in rated input voltage: Required (12VDC not applicable) ^{*2} Change in rated input current: Required (Approx. 7mA → Approx. 4mA) Change in ON voltage/ON current: Required Change in OFF voltage/OFF current: Required Change in input resistance: Required Change in rated output voltage: Not required Change in rated output current: Not required 5) Change in functions: Required (without fuse)

A0J2H models to be discontinued		Alternative Q series models	
Product name	Model name	Model name	Remarks (restrictions)
I/O module	A0J2E-E28DS	QX80 + QY22	1) Change in external wiring: Required 2) Change in the number of modules: Required (2 modules necessary: QX80 × 1 module, QY22 × 1 module) 3) Change in a program Change in the number of occupied I/O points: Required (64 points → 16 points × 2) 4) Change in specifications Change in rated input voltage: Required (12VDC not applicable)*2 Change in rated input current: Required (Approx. 7mA → Approx. 4mA) Change in ON voltage/ON current: Required Change in OFF voltage/OFF current: Required Change in input resistance: Required Change in rated output voltage: Not required Change in rated output current: Not required 5) Change in functions: Required (without fuse)

A0J2H models to be discontinued		Alternative Q series models	
Product name	Model name	Model name	Remarks (restrictions)
I/O module	A0J2E-E28DR	QX80 + QY10	<ol style="list-style-type: none"> 1) Change in external wiring: Required 2) Change in the number of modules: Required (2 modules necessary: QX80 × 1 module, QY10 × 1 module) 3) Change in a program Change in the number of occupied I/O points: Required (64 points → 16 points × 2) 4) Change in specifications <ul style="list-style-type: none"> • Input module Change in rated input voltage: Required (12VDC not applicable)*2 Change in rated input current: Required (Approx. 7mA → Approx. 4mA) Change in ON voltage/ON current: Required Change in OFF voltage/OFF current: Required Change in input resistance: Required • Output module Change in rated output voltage: Not required Change in rated output current: Not required 5) Change in functions <ul style="list-style-type: none"> • Input module Response time: The QX80 does not support the high-speed mode. • Output module Surge suppressor and fuse: The QY10 does not have those.
	A0J2E-E28DT	QX80 + QY80	<ol style="list-style-type: none"> 1) Change in external wiring: Required 2) Change in the number of modules: Required (2 modules necessary: QX80 × 1 module, QY80 × 1 module) 3) Change in a program Change in the number of occupied I/O points: Required (64 points → 16 points × 2) 4) Change in specifications <ul style="list-style-type: none"> • Input module Change in rated input voltage: Required (12VDC not applicable)*2 Change in rated input current: Required (Approx. 7mA → Approx. 4mA) Change in ON voltage/ON current: Required Change in OFF voltage/OFF current: Required Change in input resistance: Required • Output module Change in rated output voltage: Not required Change in rated output current: Required (0.8A → 0.5A) 5) Change in functions <ul style="list-style-type: none"> • Input module Response time: The QX80 does not support the high-speed mode. • Output module Short circuit protection function: The QY80 does not support the function. Fuse: The QY80 has the fuse.

A0J2H models to be discontinued		Alternative Q series models	
Product name	Model name	Model name	Remarks (restrictions)
I/O module	A0J2E-E56DR	QX80 + QY10	1) Change in external wiring: Required 2) Change in the number of modules: Required (4 modules necessary: QX80 × 2 modules, QY10 × 2 modules) 3) Change in a program Change in the number of occupied I/O points: Not required (64 points → 16 points × 4) 4) Change in specifications • Input module Change in rated input voltage: Required (12VDC not applicable)*2 Change in rated input current: Required (Approx. 7mA → Approx. 4mA) Change in ON voltage/ON current: Required Change in OFF voltage/OFF current: Required Change in input resistance: Required • Output module Change in rated output voltage: Not required Change in rated output current: Not required 5) Change in functions • Input module Response time: The QX80 does not support the high-speed mode. • Output module Surge suppressor and fuse: The QY10 does not have those.
	A0J2E-E56DT	QX80 + QY80	1) Change in external wiring: Required 2) Change in the number of modules: Required (4 modules necessary: QX80 × 2 modules, QY80 × 2 modules) 3) Change in a program Change in the number of occupied I/O points: Not required (64 points → 16 points × 4) 4) Change in specifications • Input module Change in rated input voltage: Required (12VDC not applicable)*2 Change in rated input current: Required (Approx. 7mA → Approx. 4mA) Change in ON voltage/ON current: Required Change in OFF voltage/OFF current: Required Change in input resistance: Required • Output module Change in rated output voltage: Not required Change in rated output current: Required (0.8A → 0.5A) 5) Change in functions • Input module Response time: The QX80 does not support the high-speed mode. • Output module Short circuit protection function: The QY80 does not support the function. Fuse: The QY80 has the fuse.

A0J2H models to be discontinued		Alternative Q series models	
Product name	Model name	Model name	Remarks (restrictions)
I/O module	A0J2E-E56DS	QX80 + QY22	1) Change in external wiring: Required 2) Change in the number of modules: Required (4 modules necessary: QX80 × 2 modules, QY22 × 2 modules) 3) Change in a program Change in the number of occupied I/O points: Not required (64 points → 16 points × 4) 4) Change in specifications <ul style="list-style-type: none"> • Input module <ul style="list-style-type: none"> Change in rated input voltage: Required (12VDC not applicable)*2 Change in rated input current: Required (Approx. 7mA → Approx. 4mA) Change in ON voltage/ON current: Required Change in OFF voltage/OFF current: Required Change in input resistance: Required • Output module <ul style="list-style-type: none"> Change in rated output voltage: Not required Change in rated output current: Required (minimum load current: 10mA → 25mA) 5) Change in functions <ul style="list-style-type: none"> • Input module <ul style="list-style-type: none"> Response time: The QX80 does not support the high-speed mode. • Output module <ul style="list-style-type: none"> Fuse: The QY22 does not have the fuse.

*1 These modules can be replaced with the renewal tool for A0J2. For details, refer to Appendix 2.

*2 Use the QX70 when using 12VDC.

3.2 I/O Module Specifications Comparison

3.2.1 Input module specifications comparison

(1) Specifications comparison between A0J2-E32A and QX10

○ : Compatible, △ : Partially changed, × : Incompatible

Specifications		A0J2-E32A	QX10	Compatibility	Precautions for replacement
Number of input points		32 points	16 points	△	When seventeen or more points are used, use two QX10 modules.
Insulation method		Photocoupler	Photocoupler	○	
Rated input voltage		100-120VAC, 50/60Hz	100-120VAC, 50/60Hz	○	
Input voltage distortion		–	Within 5%	–	
Rated input current		10mA (100VAC, 60Hz)	Approx. 8mA (100VAC, 60Hz) Approx. 7mA (100VAC, 50Hz)	△	Rated input current is smaller.*1
Inrush current		Max. 300mA, within 0.3ms (with 132VAC)	Max. 200mA, within 1ms (with 132VAC)	○	
Operating voltage range		85 to 132VAC (50/60Hz±5%)	85 to 132VAC (50/60Hz±3Hz)	○	
Maximum number of simultaneous input points		100% (32 points) simultaneously ON	Refer to the derating chart.*2	△	Use it within the range shown in the derating chart.
ON voltage/ON current		80VAC or more/6mA or more	80VAC or more/5mA or more (50Hz, 60Hz)	○	
OFF voltage/OFF current		40VAC or less/4mA or less	30VAC or less/1.7mA or less (50Hz, 60Hz)	△	OFF current is smaller.*1
Input impedance		Approx. 10kΩ (60Hz), Approx. 12kΩ (50Hz)	Approx. 12kΩ (60Hz), Approx. 15kΩ (50Hz)	△	Input impedance is greater.*1
Response time	OFF→ON	15ms or less (6ms TYP.)	15ms or less (100VAC 50Hz, 60Hz)	○	
	ON→OFF	35ms or less (16ms TYP.)	15ms or less (100VAC 50Hz, 60Hz)	○	
Common terminal arrangement		16 points/common (Common terminal: TB17, TB34)	16 points/common (Common terminal: TB17)	○	
Operation indication		Available (Turning ON the input turns LED ON)	ON indication (LED)	○	
External connection method		36-point terminal block connector (M3 × 6 screws)	18-point terminal block (M3 × 6 screws)	×	Wiring change is required.
Applicable wire size		0.75 to 2mm ²	0.3 to 0.75mm ² core (Outside diameter: 2.8mm or less)	×	
Applicable solderless terminal		1.25-3, 1.25-YS3A, 2-S3, 2-YS3A, V1.25-3, V1.25-YS3A, V2-S3, V2-YS3A	R1.25-3 (Sleeved solderless terminals cannot be used.)	×	
Current consumption		0.105A (TYP. All points are ON.)	0.05A (TYP. All points are ON.)	○	
External dimensions		250(H) × 132(W) × 41(D) mm	98(H) × 27.4(W) × 90(D) mm	×	The dimensions are different.
Weight		0.68kg	0.17kg	△	

*1 Check the specifications of the sensor or switches to be connected to the QX10.

*2 The following shows the derating chart.

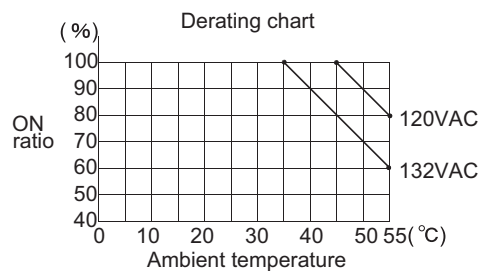

(2) Specifications comparison between A0J2-E32D and QX40

○ : Compatible, △ : Partially changed, × : Incompatible

Specifications		A0J2-E32D	QX40	Compatibility	Precautions for replacement
Number of input points		32 points	16 points	△	When seventeen or more points are used, use two QX40 modules.
Insulation method		Photocoupler	Photocoupler	○	
Rated input voltage		12VDC/24VDC	24VDC	△	12VDC cannot be used. ^{*1}
Rated input current		Approx. 3mA/Approx. 7mA	Approx. 4mA	△	Rated input current is smaller. ^{*2}
Operating voltage range		10.2 to 26.4VDC (Ripple ratio within 5%)	20.4 to 28.8VDC (Ripple ratio within 5%)	△	12VDC cannot be used. ^{*1}
Maximum number of simultaneous input points		100% (32 points) simultaneously ON	100% simultaneously ON	○	
ON voltage/ON current		9.5VDC or more/2.6mA or more	19VDC or more/3mA or more	△	12VDC cannot be used. ^{*1}
OFF voltage/OFF current		6VDC or less/1.0mA or less	11VDC or less/1.7mA or less	△	12VDC cannot be used. ^{*1}
Input resistance		Approx. 3.4kΩ	Approx. 5.6kΩ	△	Input resistance is greater. ^{*2}
Input form		Sink input (Input current flows off.)	Positive common	○	The name is different, but the specification is equal.
Response time	OFF→ON	10ms or less (6ms TYP.)	1ms/5ms/10ms/20ms/70ms or less (Set it with CPU parameter.) Initial setting is 10ms.	○	Input response time of the parameter must be used at the initial value (10ms).
	ON→OFF	10ms or less (7.5ms TYP.)	1ms/5ms/10ms/20ms/70ms or less (Set it with CPU parameter.) Initial setting is 10ms.	○	
Common terminal arrangement		16 points/common (Common terminal: TB17, TB34)	16 points/common (Common terminal: TB17)	○	
Operation indication		Available (Turning ON the input turns LED ON)	ON indication (LED)	○	
External connection method		36-point terminal block connector (M3 × 6 screws)	18-point terminal block (M3 × 6 screws)	×	Wiring change is required.
Applicable wire size		0.75 to 2mm ²	0.3 to 0.75mm ² core (Outside diameter: 2.8mm or less)	×	
Applicable solderless terminal		1.25-3, 1.25-YS3A, 2-S3, 2-YS3A, V1.25-3, V1.25-YS3A, V2-S3, V2-YS3A	R1.25-3 (Sleeved solderless terminals cannot be used.)	×	
Current consumption		0.105A (TYP. All points are ON.)	0.05A (TYP. All points are ON.)	○	
External dimensions		250(H) × 132(W) × 41(D) mm	98(H) × 27.4(W) × 90(D) mm	×	The dimensions are different.
Weight		0.63kg	0.16kg	△	

*1 Use the QX70 when using 12VDC.

*2 Check the specifications of the sensor or switches to be connected to the QX40.

(3) Specifications comparison between A0J2E-E32D and QX80

○ : Compatible, △ : Partially changed, × : Incompatible

Specifications		A0J2E-E32D	QX80	Compatibility	Precautions for replacement
Number of input points		32 points	16 points	△	When seventeen or more points are used, use two QX80 modules.
Insulation method		Photocoupler	Photocoupler	○	
Rated input voltage		12VDC/24VDC	24VDC	△	12VDC cannot be used.*1
Rated input current		Approx. 3mA/Approx. 7mA	Approx. 4mA	△	Rated input current is smaller.*2
Operating voltage range		10.2 to 26.4VDC (Ripple ratio within 5%)	20.4 to 28.8VDC (Ripple ratio within 5%)	△	12VDC cannot be used.*1
Maximum number of simultaneous input points		100% (32 points) simultaneously ON	100% simultaneously ON	○	
ON voltage/ON current		9.5VDC or more/2.6mA or more	19VDC or more/3mA or more	△	12VDC cannot be used.*1
OFF voltage/OFF current		6VDC or less/1.0mA or less	11VDC or less/1.7mA or less	△	12VDC cannot be used.*1
Input impedance		Approx. 3.4kΩ	Approx. 5.6kΩ	△	Input resistance is greater.*2
Input form		Source input (Input current flows in.)	Negative common	○	The name is different, but the specification is equal.
Response time	OFF→ON	5.5ms (TYP.)	1ms/5ms/10ms/20ms/70ms or less (Set it with CPU parameter.) Initial setting is 10ms.	○	Set the input response time of the parameter to 5ms before use.
	ON→OFF	6.0ms (TYP.)	1ms/5ms/10ms/20ms/70ms or less (Set it with CPU parameter.) Initial setting is 10ms.	○	
Response time (High speed mode) (Only upper 8 points)	OFF→ON	0.5ms or less	1ms/5ms/10ms/20ms/70ms or less (Set it with CPU parameter.) Initial setting is 10ms.	△	Set the input response time of the parameter to 1ms before use.
	ON→OFF	1.0ms or less	1ms/5ms/10ms/20ms/70ms or less (Set it with CPU parameter.) Initial setting is 10ms.	○	
Common terminal arrangement		16 points/common (Common terminal: TB17, TB34)	16 points/common (Common terminal: TB18)	○	
Operation indication		Available (Turning ON the input turns LED ON)	ON indication (LED)	○	
External connection method		36-point terminal block connector (M3 × 6 screws)	18-point terminal block (M3 × 6 screws)	×	Wiring change is required.
Applicable wire size		0.75 to 2mm ²	0.3 to 0.75mm ² core (Outside diameter: 2.8mm or less)	×	
Applicable solderless terminal		1.25-3, 1.25-YS3A, 2-S3, 2-YS3A, V1.25-3, V1.25-YS3A, V2-S3, V2-YS3A	R1.25-3 (Sleeved solderless terminals cannot be used.)	×	
Current consumption		0.105A (TYP. All points are ON.)	0.05A (TYP. All points are ON.)	○	
External dimensions		250(H) × 132(W) × 41(D) mm	98(H) × 27.4(W) × 90(D) mm	×	The dimensions are different.
Weight		0.61kg	0.16kg	△	

*1 Use the QX70 when using 12VDC.

*2 Check the specifications of the sensor or switches to be connected to the QX80.

3.2.2 Output module specifications comparison

(1) Specifications comparison between A0J2-E24R and QY10

○ : Compatible, △ : Partially changed, × : Incompatible

Specifications		A0J2-E24R	QY10	Compatibility	Precautions for replacement
Number of output points		24 points	16 points	△	When seventeen or more points are used, use two QY10 modules.
Insulation method		Photocoupler	Relay	△	Although the insulation methods differ, the performance of the Insulation is the same.
Rated switching voltage/current		24VDC 2A (Resistance load)/ point 240VAC 2A (COS ϕ =1)/ point 5A/common	24VDC 2A (Resistance load)/ point 240VAC 2A (COS ϕ = 1)/ point 8A/common	○	
Minimum switching load		5VDC 1mA	5VDC 1mA	○	
Maximum switching voltage		264VAC, 125VDC	264VAC, 125VDC	○	
Response time	OFF→ON	10ms or less	10ms or less	○	
	ON→OFF	12ms or less	12ms or less	○	
Mechanical life		20 million times or more	20 million times or more	○	
Electrical life	Rated switching voltage/current load 200,000 times or more		Rated switching voltage/current load 100,000 times or more	△	Reduce the exchange intervals of the modules as Mechanical/ Electrical Life is cut to about half.
	200 VAC 1.5A, 240 VAC 1A (COS ϕ =0.7) 200,000 times or more 200VAC 0.75A, 240VAC 0.5A (COS ϕ =0.35) 200,000 times or more 24VDC 1A, 100VDC 0.1A (L/R=7ms) 200,000 times or more		200VAC 1.5A, 240VAC 1A (COS ϕ =0.7) 100,000 times or more 200VAC 0.4A, 240VAC 0.3A (COS ϕ =0.7) 300,000 times or more 200VAC 1A, 240VAC 0.5A (COS ϕ =0.35) 100,000 times or more 200VAC 0.3A, 240VAC 0.15A (COS ϕ =0.35) 300,000 times or more 24VDC 1A, 100VDC 0.1A (L/R=7ms) 100,000 times or more 24VDC 0.3A, 100VDC 0.03A (L/R=7ms) 300,000 times or more	△	
Maximum switching frequency		3600 times/hr	3600 times/hr	○	
Common terminal arrangement		8 points/common (Common terminal: TB9, TB19, TB29)	16 points/common (Common terminal: TB17)	△	As the common changes from three commons to a common, wiring with a different voltage for each common is not possible.
Operation indication		Available (Turning ON the output turns LED ON)	ON indication (LED)	○	
External supply power (relay coil driving power)	Voltage	24VDC \pm 10% Ripple voltage 4Vp-p or less	-	○	External supply power is not required.
	Current	230mA (TYP. 24VDC All points are ON.)	-	○	

○ : Compatible, △ : Partially changed, × : Incompatible

Specifications	A0J2-E24R	QY10	Compatibility	Precautions for replacement
External connection method	36-point terminal block connector (M3 × 6 screws)	18-point terminal block (M3 × 6 screws)	×	Wiring change is required.
Applicable wire size	0.75 to 2mm ²	0.3 to 0.75mm ² core (Outside diameter: 2.8mm or less)	×	
Applicable solderless terminal	1.25-3, 1.25-YS3A, 2-S3, 2-YS3A, V1.25-3, V1.25-YS3A, V2-S3, V2-YS3A	R1.25-3 (Sleeved solderless terminals cannot be used.)	×	
Current consumption	0.145A (TYP. All points are ON.)	0.43A (TYP. All points are ON.)	△	Review current capacity since current consumption is increased.
External dimensions	250(H) × 132(W) × 41(D) mm	98(H) × 27.4(W) × 90(D) mm	×	The dimensions are different.
Weight	0.71kg	0.22kg	△	

(2) Specifications comparison between A0J2E-E24R and QY10

○ : Compatible, △ : Partially changed, × : Incompatible

Specifications		A0J2E-E24R	QY10	Compatibility	Precautions for replacement
Number of output points		24 points	16 points	△	When seventeen or more points are used, use two QY10 modules.
Insulation method		Photocoupler	Relay isolation	△	Although the insulation methods differ, the performance of the insulation is the same.
Rated switching voltage/current		24VDC 2A (Resistance load)/ point 240VAC 2A (COSφ=1)/ point 5A/common	24VDC 2A (Resistance load)/ point 240VAC 2A (COSφ = 1)/ point 8A/common	○	
Minimum switching load		5VDC 1mA	5VDC 1mA	○	
Maximum switching voltage		250VAC, 125VDC	264VAC, 125VDC	○	
Response time	OFF→ON	10ms or less	10ms or less	○	
	ON→OFF	12ms or less	12ms or less	○	
Mechanical life		20 million times or more	20 million times or more	○	
Electrical life	Rated switching voltage/current load 200,000 times or more		Rated switching voltage/current load 100,000 times or more	△	Reduce the exchange intervals of the modules as Mechanical/ Electrical Life is cut to about half.
	200VAC 1.5A, 240VAC 1A (COSφ=0.7) 200,000 times or more 200VAC 0.75A, 240VAC 0.5A (COSφ=0.35) 200,000 times or more 24VDC 1A, 100VDC 0.1A (L/R=7ms) 200,000 times or more	200VAC 1.5A, 240VAC 1A (COSφ=0.7) 100,000 times or more 200VAC 0.4A, 240VAC 0.3A (COSφ=0.7) 300,000 times or more 200VAC 1A, 240VAC 0.5A (COSφ=0.35) 100,000 times or more 200VAC 0.3A, 240VAC 0.15A (COSφ=0.35) 300,000 times or more 24VDC 1A, 100VDC 0.1A (L/R=7ms) 100,000 times or more 24VDC 0.3A, 100VDC 0.03A (L/R=7ms) 300,000 times or more		△	
Maximum switching frequency		3600 times/hr	3600 times/hr	○	
Surge suppressor		Varistor (387 to 473V)	None	×	The varistor is not built in.*1
Fuse		Available (8A)MF51NM8 or FGMA250V8A	None	×	The fuse is not built in.*2
Common terminal arrangement		8 points/common (Common terminal: TB9, TB19, TB29)	16 points/common (Common terminal: TB17)	△	As the common changes from three commons to a common, wiring with a different voltage for each common is not possible.
Operation indication		Available (Turning ON the output turns LED ON))	ON indication (LED)	○	
External supply power (relay coil driving power)	Voltage	24VDC±10% Ripple voltage 4Vp-p or less	-	○	External supply power is not required.
	Current	220mA (24VDC All points are ON.)	-	○	

○ : Compatible, △ : Partially changed, × : Incompatible

Specifications	A0J2E-E24R	QY10	Compatibility	Precautions for replacement
External connection method	36-point terminal block connector (M3 × 6 screws)	18-point terminal block (M3 × 6 screws)	×	Wiring change is required.
Applicable wire size	0.75 to 2mm ²	0.3 to 0.75mm ² core (Outside diameter: 2.8mm or less)	×	
Applicable solderless terminal	1.25-3, 1.25-YS3A, 2-S3, 2-YS3A, V1.25-3, V1.25-YS3A, V2-S3, V2-YS3A	R1.25-3 (Sleeved solderless terminals cannot be used.)	×	
Current consumption	0.145A (TYP. All points are ON.)	0.43A (TYP. All points are ON.)	△	Review current capacity since current consumption is increased.
External dimensions	250(H) × 132(W) × 41(D) mm	98(H) × 27.4(W) × 90(D) mm	×	The dimensions are different.
Weight	0.75kg	0.22kg	△	

*1 Connect the varistor exteriorly to reduce noise.

*2 Install a fuse for each external terminal point to prevent the burnout of the external devices and modules during load shorts.

(3) Specifications comparison between A0J2-E24S and QY22*1

○ : Compatible, △ : Partially changed, × : Incompatible

Specifications	A0J2-E24S	QY22	Compatibility	Precautions for replacement
Number of output points	24 points	16 points	△	When seventeen or more points are used, use two QY22 modules.
Insulation method	Photocoupler	Photocoupler	○	
Rated load voltage	100 to 240VAC, 40 to 70Hz	100 to 240VAC 50/60Hz±5%	△	The frequency will be low. Check the specifications of external devices.
Maximum load voltage	264VAC	264VAC	○	
Maximum load current	0.6A/point, 2.4A/common	0.6A/point, 4.8A/common	○	
Minimum load voltage/ current	24VAC 100mA 100VAC 10mA 240VAC 10mA	24VAC 100mA 100VAC 25mA 240VAC 25mA	△	The minimum load current is greater. Use caution on selecting the load to use.
Maximum inrush current	20A 10ms or less 8A 100ms or less	20A 1 cycle or less	○	
Leakage current at OFF	1.5mA (120VAC 60Hz) 3mA (240VAC 60Hz)	1.5mA or less (During 120V 60Hz) 3mA or less (During 240V 60Hz)	○	
Maximum voltage drop at ON	1.5V or less (100 to 600mA) 1.8V or less (100mA or less) 2V or less (10 to 50mA)	1.5V or less	○	
Response time	OFF→ON	1ms or less	○	
	ON→OFF	0.5 cycle + 1ms or less	○	
Surge suppressor	CR absorber (0.022μF + 47Ω)	CR absorber	○	
Common terminal arrangement	8 points/common (Common terminal: TB9, TB19, TB29)	16 points/common (Common terminal: TB17)	△	As the common changes from three commons to a common, wiring with a different voltage for each common is not possible.
Operation indication	Available (Turning ON the output turns LED ON)	ON indication (LED)	○	
Fuse rating	High speed type fuse 3.2A (1/common) HP-32	None	×	The fuse is not built in.*2
Fuse blown indication	Available (When a fuse blown occurs, LED is lit, and a signal is output to the CPU)	—	×	
External connection method	36-point terminal block connector (M3 × 6 screws)	18-point terminal block (M3 × 6 screws)	×	Wiring change is required.
Applicable wire size	0.75 to 2mm ²	0.3 to 0.75mm ² core (Outside diameter: 2.8mm or less)	×	
Applicable solderless terminal	1.25-3, 1.25-YS3A, 2-S3, 2-YS3A, V1.25-3, V1.25-YS3A, V2-S3, V2-YS3A	R1.25-3 (Sleeved solderless terminals cannot be used.)	×	
Current consumption	400mA (TYP. All points are ON.)	0.25A (MAX. All points are ON.)	○	
External dimensions	250(H) × 132(W) × 41(D) mm	98(H) × 27.4(W) × 112.3(D) mm	×	The dimensions are different.
Weight	0.70kg	0.40kg	△	

*1 Consider the characteristics of the triac and observe the necessary precautions by referring to Section 3.3 (3) before replacing the modules.

*2 Install a fuse for each external terminal point to prevent the burnout of the external devices and modules during load shorts. In addition, when a fuse blown indication is necessary, configure an external circuit.

(4) Specifications comparison between A0J2-E24T and QY50

○ : Compatible, △ : Partially changed, × : Incompatible

Specifications		A0J2-E24T	QY50	Compatibility	Precautions for replacement
Number of output points		24 points	16 points	△	When seventeen or more points are used, use two QY50 modules.
Insulation method		Photocoupler	Photocoupler	○	
Rated load voltage		12VDC/24VDC	12VDC/24VDC	○	
Operating load voltage range		10.2 to 30VDC	10.2 to 28.8VDC	△	Voltages exceeding 28.8VDC cannot be applied.
Maximum load current		0.5A/point, 4A/common	0.5A/point, 4A/common	△	Use caution on the used current of the entire module.
Maximum inrush current		4A, 10ms or less	4A, 10ms or less	○	
Leakage current at OFF		0.1mA or less	0.1mA or less	○	
Maximum voltage drop at ON		0.9VDC (TYP.) 0.5A 1.5VDC (MAX.) 0.5A	0.2VDC (TYP.) 0.5A 0.3VDC (MAX.) 0.5A	○	
Response time	OFF→ON	2ms or less	1ms or less	○	
	ON→OFF	2ms or less (Resistance load)	1ms or less (Rated load, resistance load)	○	
Surge suppressor		Varistor (52 to 62V)	Zener diode	○	
Common terminal arrangement		8 points/common (Common terminal: TB9, TB19, TB29)	16 points/common (Common terminal: TB18)	△	As the common changes from three commons to a common, wiring with a different voltage for each common is not possible.
Operation indication		Available (Turning ON the output turns LED ON)	ON indication (LED)	○	
Fuse		None	6.7A (Not exchangeable) (Fuse blown capacity: 50A)	○	
Fuse blown indication		None	Available (When a fuse blown occurs, LED is lit, and a signal is output to the CPU)	○	
External connection method		36-point terminal block connector (M3 × 6 screws)	18-point terminal block (M3 × 6 screws)	×	Wiring change is required.
Applicable wire size		0.75 to 2mm ²	0.3 to 0.75mm ² core (Outside diameter: 2.8mm or less)	×	
Applicable solderless terminal		1.25-3, 1.25-YS3A, 2-S3, 2-YS3A, V1.25-3, V1.25-YS3A, V2-S3, V2-YS3A	R1.25-3 (Sleeved solderless terminals cannot be used.)	×	
External supply power	Voltage	12VDC/24VDC (10.2 to 30VDC)	12VDC/24VDC (10.2VDC to 28.8VDC) (Ripple ratio within 5%)	△	Voltages exceeding 28.8 VDC cannot be applied.
	Current	23mA (TYP. 24VDC/8 points/common ON)	20mA (During 24VDC)	○	
Current consumption		0.145A (TYP. All points are ON.)	0.08A (TYP. All points are ON.)	○	
External dimensions		250(H) × 132(W) × 41(D) mm	98(H) × 27.4(W) × 90(D) mm	×	The dimensions are different.
Weight		0.68kg	0.17kg	△	

(5) Specifications comparison between A0J2E-E24T and QY80

○ : Compatible, △ : Partially changed, × : Incompatible

Specifications		A0J2E-E24T	QY80	Compatibility	Precautions for replacement
Number of output points		24 points	16 points	△	When seventeen or more points are used, use two QY80s.
Insulation method		Photocoupler	Photocoupler	○	
Rated load voltage		12VDC/24VDC	12VDC/24VDC	○	
Operating load voltage range		10.2 to 26.4VDC	10.2 to 28.8VDC	○	
Maximum load current		0.8A/ point, 0.6A/ point (60% ON, 55°C)	0.5A/ point, 4A/common	△	The maximum load current per point is smaller. Use caution on selecting the load to use.
Maximum inrush current		No restriction (Short protect)	4A 10ms or less	△	The inrush current value differs. Use caution on selecting the load to use.
Leakage current at OFF		1.0mA or less	0.1mA or less	○	
Maximum voltage drop at ON		1VDC (TYP.) 0.8A 1.5VDC (MAX.) 0.8A	0.2VDC (TYP.) 0.5A 0.3VDC (MAX.) 0.5A	○	
Response time	OFF→ON	0.5ms or less	1ms or less	△	The response times differ.
	ON→OFF	1.5ms or less	1ms or less (Rated load, resistance load)	○	
Surge suppressor		Surge absorbing diode	Zener diode	○	
Common terminal arrangement		8 points/common (Common terminal: TB9, TB19, TB29)	16 points/common (Common terminal: TB17)	△	As the common changes from three commons to a common, wiring with a different voltage for each common is not possible.
Operation indication		Available (Turning ON the output turns LED ON)	ON indication (LED)	○	
Fuse		None	6.7A (Not exchangeable) (Fuse blown capacity: 50A)	○	The QY80 has the fuse instead of overheat and short circuit protection function.
Fuse blown indication		–	Available (When a fuse blown occurs, LED is lit, and a signal is output to the CPU)	○	
Protection function		Available (overheat protection and short circuit protection)	None	×	
Protection function reset		Automatic reset (by deactivating protection function)	–	–	
External connection method		36-point terminal block connector (M3 × 6 screws)	18-point terminal block (M3 × 6 screws)	×	Wiring change is required.
Applicable wire size		0.75 to 2mm ²	0.3 to 0.75mm ² core (Outside diameter: 2.8mm or less)	×	
External supply power	Voltage	12VDC/24VDC (10.2VDC to 26.4VDC)	12VDC/24VDC (10.2VDC to 28.8VDC) (Ripple ratio within 5%)	○	
	Current	200mA (24VDC, All points are ON.)	20mA (During 24VDC)	○	
Current consumption		0.145A (TYP. All points are ON.)	0.08A (TYP. All points are ON.)	○	
External dimensions		250(H) × 132(W) × 41(D) mm	98(H) × 27.4(W) × 90(D) mm	×	The dimensions are different.
Weight		0.73kg	0.17kg	△	

3.2.3 I/O Module specifications comparison

(1) Specifications comparison between A0J2-E28DR and QX40+QY10

○ : Compatible, △ : Partially changed, × : Incompatible

Specifications		A0J2-E28DR input specifications	QX40	Compatibility	Precautions for replacement
Number of input points		16 points	16 points	○	
Insulation method		Photocoupler	Photocoupler	○	
Rated input voltage		12VDC/24VDC	24VDC	△	12VDC cannot be used. ^{*1}
Rated input current		Approx. 3mA/Approx. 7mA	Approx. 4mA	△	Rated input current is smaller. ^{*2}
Operating voltage range		10.2 to 26.4VDC (Ripple ratio within 5%)	20.4 to 28.8VDC (Ripple ratio within 5%)	△	12VDC cannot be used. ^{*1}
Maximum number of simultaneous input points		100% (16 points) simultaneously ON	100% simultaneously ON	○	
ON voltage/ON current		9.5VDC or more/2.6mA or more	19VDC or more/3mA or more	△	12VDC cannot be used. ^{*1}
OFF voltage/OFF current		6VDC or less/1.0mA or less	11VDC or less/1.7mA or less	△	12VDC cannot be used. ^{*1}
Input resistance		Approx. 3.4kΩ	Approx. 5.6kΩ	△	Input resistance is greater. ^{*2}
Input form		Sink input (Input current flows off.)	Positive common	○	The name is different, but the specification is equal.
Response time	OFF→ON	10ms or less (6ms TYP.)	1ms/5ms/10ms/20ms/70ms or less (Set it with CPU parameter.) Initial setting is 10ms.	○	Input response time of the parameter must be used at the initial value (10ms).
	ON→OFF	10ms or less (7.5ms TYP.)	1ms/5ms/10ms/20ms/70ms or less (Set it with CPU parameter.) Initial setting is 10ms.	○	
Common terminal arrangement		16 points/common (Common terminal: TB17)	16 points/common (Common terminal: TB17)	○	
Operation indication		Available (Turning ON the input turns LED ON)	ON indication (LED)	○	
Specifications		A0J2-E28DR output specifications	QY10	Compatibility	Precautions for replacement
Number of output points		12 points	16 points	○	
Insulation method		Photocoupler	Relay	△	Although the insulation methods differ, the performance of the insulation is the same.
Rated switching voltage/current		24VDC 2A (Resistance load)/ point 240VAC 2A (COSφ=1)/ point 5A/common	24VDC 2A (Resistance load)/ point 240VAC 2A (COSφ = 1)/ point 8A/common	○	
Minimum switching load		5VDC 1mA	5VDC 1mA	○	
Maximum switching voltage		264VAC, 125VDC	264VAC, 125VDC	○	
Maximum switching frequency		3600 times/hr	3600 times/hr	○	

*1 Use the QX70 when using 12VDC.

*2 Check the specifications of the sensor or switches to be connected to the QX40.

○ : Compatible, △ : Partially changed, × : Incompatible

Specifications		A0J2-E28DR output specifications	QY10	Compatibility	Precautions for replacement
Mechanical life		20 million times or more	20 million times or more	○	
Electrical life		Rated switching voltage/current load 200,000 times or more	Rated switching voltage/current load 100,000 times or more	△	Reduce the exchange intervals of the modules as Mechanical/ Electrical Life is cut to about half.
		200VAC 1.5A, 240VAC 1A (COSφ=0.7) 200,000 times or more	200VAC 1.5A, 240VAC 1A (COSφ=0.7) 100,000 times or more	△	
		200VAC 0.75A, 240VAC 0.5A (COSφ=0.35) 200,000 times or more	200VAC 0.4A, 240VAC 0.3A (COSφ=0.7) 300,000 times or more		
		24VDC 1A, 100VDC 0.1A (L/R=7ms) 200,000 times or more	200VAC 1A, 240VAC 0.5A (COSφ=0.35) 100,000 times or more 200VAC 0.3A, 240VAC 0.15A (COSφ=0.35) 300,000 times or more 24VDC 1A, 100VDC 0.1A (L/R=7ms) 100,000 times or more 24VDC 0.3A, 100VDC 0.03A (L/R=7ms) 300,000 times or more		
Response time	OFF→ON	10ms or less	10ms or less		○
	ON→OFF	12ms or less	12ms or less	○	
External supply power (Relay coil driving power)	Voltage	24VDC±10% Ripple voltage 4Vp-p or less	-	○	External supply power is not required.
	Current	125mA (24VDC TYP. All points are ON.)	-	○	
Specifications		A0J2-E28DR	QX40/QY10	Compatibility	Precautions for replacement
Common terminal arrangement		8 points/common (Common terminal: TB26) 3 points/common (Common terminal: TB31) Independent contact (Common terminal: TB33)	16 points/common (Common terminal: TB17)	△	As the common changes from three commons to a common, wiring with a different voltage for each common is not possible.
Operation indication		Available (Turning ON the output turns LED ON.)	ON indication (LED)	○	
Current consumption		0.130A (TYP. All points are ON.)	0.05 + 0.43 = 0.48A (TYP. All points are ON.)	△	Review current capacity since current consumption is increased.
External connection method		36-point terminal block connector (M3 × 6 screws)	18-point terminal block (M3 × 6 screws) 2 pieces	×	Wiring change is required.
Applicable wire size		0.75 to 2mm ²	0.3 to 0.75mm ² core (Outside diameter: 8mm or less)	×	
Applicable solderless terminal		1.25-3, 1.25-YS3A, 2-S3, 2-YS3A, V1.25-3, V1.25-YS3A, V2-S3, V2-YS3A	R1.25-3 (Sleeved solderless terminals cannot be used.)	×	
External dimensions		250(H) × 132(W) × 41(D) mm	98(H) × 27.4(W) × 90(D)mm × 2	×	The dimensions are different.
Weight		0.68kg	0.16 + 0.22 = 0.38kg	△	

(2) Specifications comparison between A0J2-E56DR and QX40+QY10

○ : Compatible, △ : Partially changed, × : Incompatible

Specifications		A0J2-E56DR input specifications	QX40	Compatibility	Precautions for replacement
Number of input points		32 points	16 points	△	When seventeen or more points are used, use two QX40 modules.
Insulation method		Photocoupler	Photocoupler	○	
Rated input voltage		12VDC/24VDC	24VDC	△	12VDC cannot be used.*1
Rated input current		Approx. 3mA/Approx. 7mA	Approx. 4mA	△	Rated input current is smaller.*2
Operating voltage range		10.2 to 26.4VDC (Ripple ratio within 5%)	20.4 to 28.8VDC (Ripple ratio within 5%)	△	12VDC cannot be used.*1
Maximum number of simultaneous input points		60% (10 points/common) simultaneously ON	100% simultaneously ON	○	
ON voltage/ON current		9.5VDC or more/2.6mA or more	19VDC or more/3mA or more	△	12VDC cannot be used.*1
OFF voltage/OFF current		6VDC or less/1.0mA or less	11VDC or less/1.7mA or less	△	12VDC cannot be used.*1
Input resistance		Approx. 3.4kΩ	Approx. 5.6kΩ	△	Input resistance is greater.*2
Input form		Sink input (Input current flows off.)	Positive common	○	The name is different, but the specification is equal.
Response time	OFF→ON	10ms or less (6ms TYP.)	1ms/5ms/10ms/20ms/70ms or less (Set it with CPU parameter.) Initial setting is 10ms.	○	Input response time of the parameter must be used at the initial value (10ms).
	ON→OFF	10ms or less (7.5ms TYP.)	1ms/5ms/10ms/20ms/70ms or less (Set it with CPU parameter.) Initial setting is 10ms.	○	
Common terminal arrangement		16 points/common (Common terminal: TB17, TB34)	16 points/common (Common terminal: TB17)	○	
Operation indication		Available (Turning ON the output turns LED ON)	ON indication (LED)	○	
Specifications		A0J2-E56DR output specifications	QY10	Compatibility	Precautions for replacement
Number of output points		24 points	16 points	△	When seventeen or more points are used, use two QY10s.
Insulation method		Photocoupler	Relay	△	Although the insulation methods differ, the performance of the insulation is same.
Rated switching voltage/current		24VDC 2A (Resistance load)/point 240VAC 2A (COSφ=1)/point 5A/common	24VDC 2A (Resistance load)/point 240VAC 2A (COSφ = 1)/point 8A/common	○	
Minimum switching load		5VDC 1mA	5VDC 1mA	○	
Maximum switching voltage		264VAC, 125VDC	264VAC, 125VDC	○	
Maximum switching frequency		3600 times/hr	3600 times/hr	○	

○ : Compatible, △ : Partially changed, × : Incompatible

Specifications		A0J2-E56DR output specifications	QY10	Compatibility	Precautions for replacement
Mechanical life		20 million times or more	20 million times or more	○	
Electrical life		Rated switching voltage/current load 200,000 times or more	Rated switching voltage/current load 100,000 times or more	△	Reduce the exchange intervals of the modules as Mechanical/ Electrical Life is cut to about half.
		200VAC 1.5A, 240VAC 1A (COSφ=0.7) 200,000 times or more 200VAC 0.75A, 240VAC 0.5A (COSφ=0.35) 200,000 times or more 24VDC 1A, 100VDC 0.1A (L/R=7ms) 200,000 times or more	200VAC 1.5A, 240VAC 1A (COSφ=0.7) 100,000 times or more 200VAC 0.4A, 240VAC 0.3A (COSφ=0.7) 300,000 times or more 200VAC 1A, 240VAC 0.5A (COSφ=0.35) 100,000 times or more 200VAC 0.3A, 240VAC 0.15A (COSφ=0.35) 300,000 times or more 24VDC 1A, 100VDC 0.1A (L/R=7ms) 100,000 times or more 24VDC 0.3A 100VDC 0.03A(L/R = 7ms) 300,000 times or more	△	
Response time	OFF→ON	10ms or less	10ms or less	○	
	ON→OFF	12ms or less	12ms or less	○	
External supply power (Relay coil driving power)	Voltage	24VDC±10% Ripple voltage 4Vp-p or less	—	○	External supply power is not required.
	Current	230mA (24VDC All points are ON.)	—	○	
Specifications	A0J2-E56DR		QX40/QY10	Compatibility	Precautions for replacement
Common terminal arrangement	8 points/common (Common terminal: TB9, TB19, TB29)		16 points/common (Common terminal: TB17)	△	As the common changes from three commons to a common, wiring with a different voltage for each common is not possible.
Operation indication	Available (Turning ON the output turns LED ON)		ON indication (LED)	○	
Current consumption	0.230A (TYP. All points are ON.)		0.05 × 2 + 0.43 × 2 = 0.96A (TYP. All points are ON.)	△	Review current capacity since current consumption is increased.
External connection method	36-point terminal block connector (M3 × 6 screws) 2 pieces		18-point terminal block (M3 × 6 screws) 4 pieces	×	Wiring change is required.
Applicable wire size	0.75 to 2mm ²		0.3 to 0.75mm ² core (Outside diameter: 2.8mm or less)	×	
Applicable solderless terminal	1.25-3, 1.25-YS3A, 2-S3, 2-YS3A, V1.25-3, V1.25-YS3A, V2-S3, V2-YS3A		R1.25-3 (Sleeved solderless terminals cannot be used.)	×	
External dimensions	250(H) × 190(W) × 41(D)mm		98(H) × 27.4(W) × 90(D)mm × 4	×	The dimensions are different.
Weight	1.08kg		0.16 × 2 + 0.22 × 2 = 0.76kg	△	

*1 Use the QX70 when using 12VDC.

*2 Check the specifications of the sensor or switches to be connected to the QX40.

(3) Specifications comparison between A0J2-E28DT and QX40+QY50

○ : Compatible, △ : Partially changed, × : Incompatible

Specifications		A0J2-E28DT input specifications	QX40	Compatibility	Precautions for replacement
Number of input points		16 points	16 points	○	
Insulation method		Photocoupler	Photocoupler	○	
Rated input voltage		12VDC/24VDC	24VDC	△	12VDC cannot be used.*1
Rated input current		Approx. 3mA/Approx. 7mA	Approx. 4mA	△	Rated input current is smaller.*2
Operating voltage range		10.2 to 26.4VDC (Ripple ratio within 5%)	20.4 to 28.8VDC (Ripple ratio within 5%)	△	12VDC cannot be used.*1
Maximum number of simultaneous input points		100% (16 points) simultaneously ON	100% simultaneously ON	○	
ON voltage/ON current		9.5VDC or more/2.6mA or more	19VDC or more/3mA or more	△	12VDC cannot be used.*1
OFF voltage/OFF current		6VDC or less/1.0mA or less	11VDC or less/1.7mA or less	△	12VDC cannot be used.*1
Input resistance		Approx. 3.4kΩ	Approx. 5.6kΩ	△	Input resistance is greater.*2
Input form		Sink input (Input current flows off.)	Positive common	○	The name is different, but the specification is equal.
Response time	OFF→ON	10ms or less (6ms TYP.)	1ms/5ms/10ms/20ms/ 70ms or less (Set it with CPU parameter.) Initial setting is 10ms.	○	Input response time of the parameter must be used at the initial value (10ms).
	ON→OFF	10ms or less (7.5ms TYP.)	1ms/5ms/10ms/20ms/ 70ms or less (Set it with CPU parameter.) Initial setting is 10ms.	○	
Common terminal arrangement		16 points/common (Common terminal: TB17)	16 points/common (Common terminal: TB17)	○	
Operation indication		Available (Turning ON the input turns LED ON)	ON indication (LED)	○	
Specifications		A0J2-E28DT output specifications	QY50	Compatibility	Precautions for replacement
Number of output points		12 points	16 points	○	
Insulation method		Photocoupler	Photocoupler	○	
Rated load voltage		12 VDC/24VDC	12VDC/24VDC	○	
Operating load voltage range		10.2 to 30 VDC	10.2 to 28.8VDC	△	Voltages exceeding 28.8 VDC cannot be applied.
Maximum load current		0.5A/point, 4A/common	0.5A/point, 4A/common	○	
Maximum inrush current		4A, 10ms or less	4A, 10ms or less	○	
Leakage current at OFF		0.1mA or less	0.1mA or less	○	
Maximum voltage drop at ON		0.9VDC (TYP.) 0.5A 1.5VDC (MAX.) 0.5A	0.2VDC (TYP.) 0.5A 0.3VDC (MAX.) 0.5A	○	
Response time	OFF→ON	2ms or less	1ms or less	○	
	ON→OFF	2ms or less (Resistance load)	1ms or less (Rated load, resistance load)	○	
External supply power	Voltage	12VDC/24VDC (10.2VDC to 30VDC)	12VDC/24VDC (10.2VDC to 28.8VDC) (Ripple ratio within 5%)	△	Voltages exceeding 28.8 VDC cannot be applied.
	Current	23mA (TYP. 24VDC/8 points/common ON)	20mA (During 24VDC)	○	
Surge suppressor		Varistor (52 to 62V)	Zener diode	○	
Common terminal arrangement		8 points/common (Common terminal: TB26) 4 points/common (Common terminal: TB33)	16 points/common (Common terminal: TB18)	△	As the common changes from two commons to a common, wiring with a different voltage for each common is not possible.
Operation indication		Available (Turning ON the output turns LED ON)	ON indication (LED)	○	
Fuse		None	6.7A (Not exchangeable) (Fuse blown capacity: 50A)	○	
Fuse blown indication		None	Available (When a fuse blown occurs, LED is lit, and a signal is output to the CPU)	○	

○ : Compatible, △ : Partially changed, × : Incompatible

Specifications	A0J2-E28DT	QX40/QY50	Compatibility	Precautions for replacement
Current consumption	0.125A (TYP. All points are ON.)	0.05 + 0.08 = 0.13A (TYP. All points are ON.)	△	Review current capacity since current consumption is increased.
External connection method	36-point terminal block connector (M3 × 6 screws)	18-point terminal block (M3 × 6 screws) 2 pieces	×	Wiring change is required.
Applicable wire size	0.75 to 2mm ²	0.3 to 0.75mm ² core (Outside diameter: 2.8mm or less)	×	
Applicable solderless terminal	1.25-3, 1.25-YS3A, 2-S3, 2-YS3A, V1.25-3, V1.25-YS3A, V2-S3, V2-YS3A	R1.25-3 (Sleeved solderless terminals cannot be used.)	×	
External dimensions	250(H) × 132(W) × 41(D) mm	98(H) × 27.4(W) × 90(D)mm × 2	×	The dimensions are different.
Weight	0.65kg	0.16 + 0.17 = 0.33kg	△	

*1 Use the QX70 when using 12VDC.

*2 Check the specifications of the sensor or switches to be connected to the QX40.

(4) Specifications comparison between A0J2-E28DT and QX41Y41P

○ : Compatible, △ : Partially changed, × : Incompatible

Specifications		A0J2-E28DT input specifications	QX41Y41P input specifications	Compatibility	Precautions for replacement
Number of input points		16 points	32 points	○	
Insulation method		Photocoupler	Photocoupler	○	
Rated input voltage		12VDC/24VDC	24VDC	△	12VDC cannot be used.*1
Rated input current		Approx. 3mA/Approx. 7mA	Approx. 4mA	△	Rated input current is smaller.
Operating voltage range		10.2 to 26.4VDC (Ripple ratio within 5%)	20.4 to 28.8VDC (Ripple ratio within 5%)	△	12VDC cannot be used.*1
Maximum number of simultaneous input points		100% (16 points) simultaneously ON	Refer to the derating chart.*3	△	Use it within the range shown in the derating chart.
ON voltage/ON current		9.5VDC or more/2.6mA or more	19VDC or more/3mA or more	△	12VDC cannot be used.*1
OFF voltage/OFF current		6VDC or less/1.0mA or less	11VDC or less/1.7mA or less	△	12VDC cannot be used.*1
Input resistance		Approx. 3.4kΩ	Approx. 5.6kΩ	△	Input resistance is greater.*2
Input form		Sink input (Input current flows off.)	Positive common type	○	The name is different, but the specification is equal.
Response time	OFF→ON	10ms or less (6ms TYP.)	1ms/5ms/10ms/20ms/70ms or less (Set it with CPU parameter.) Initial setting is 10ms.	○	Input response time of the parameter must be used at the initial value (10ms).
	ON→OFF	10ms or less (7.5ms TYP.)	1ms/5ms/10ms/20ms/70ms or less (Set it with CPU parameter.) Initial setting is 10ms.	○	
Common terminal arrangement		16 points/common (Common terminal: TB17)	32 points/common (Common terminal: 1B01, 1B02)	○	
Operation indication		Available (Turning ON the input turns LED ON)	Available (Turning ON the input turns LED ON) (32-point switching indication with SW)	○	
Specifications		A0J2-E28DT output specifications	QX41Y41P output specifications	Compatibility	Precautions for replacement
Number of output points		12 points	32 points	○	
Insulation method		Photocoupler	Photocoupler	○	
Rated load voltage		12VDC/24VDC	12VDC/24VDC	○	
Operating load voltage range		10.2 to 30VDC	10.2 to 28.8VDC	△	Voltages exceeding 28.8 VDC cannot be applied.
Maximum load current		0.5A/point, 4A/common	0.1A/point, 2A/common	△	The maximum load current per point is smaller. Pay attention to the selection of the load to be used.
Maximum inrush current		4A, 10ms or less	0.7A, 10ms or less	△	Maximum inrush current is smaller.
Leakage current at OFF		0.1mA or less	0.1mA or less	○	
Maximum voltage drop at ON		0.9VDC (TYP.) 0.5A 1.5VDC (MAX.) 0.5A	0.1VDC (TYP.) 0.1A 0.2VDC (MAX.) 0.1A	○	The maximum voltage drop at ON is smaller.
Response time	OFF→ON	2ms or less	1ms or less	○	
	ON→OFF	2ms or less (Resistance load)	1ms or less (Rated load, resistance load)	○	
External supply power	Voltage	12VDC/24VDC (10.2 to 30VDC)	12VDC/24VDC (10.2 to 28.8VDC)	△	Voltages exceeding 28.8 VDC cannot be applied.
	Current	23mA (TYP. 24VDC 8 points/common ON)	Max. 15mA/common (24VDC, When all points are ON)	○	
Surge suppressor		Varistor (52 to 62V)	Zener diode	○	
Common terminal arrangement		8 points/common (Common terminal: TB26) 4 points/common (Common terminal: TB33)	32 points/common (Common terminal: 2A01, 2A02)	△	As the common changes from two commons to a common, wiring with a different voltage for each common is not possible.
Operation indication		Available (Turning ON the output turns LED ON)	Available (Turning ON the output turns LED ON) (32-point switching indication with SW)	○	

○ : Compatible, △ : Partially changed, × : Incompatible

Specifications	A0J2-E28DT	QX41Y41P	Compatibility	Precautions for replacement
Current consumption	125mA (TYP. All points are ON.)	130mA (TYP. All points are ON.)	△	Review current capacity since current consumption is increased.
External connection method	36-point terminal block connector (M3 × 6 screws)	40-pin connector	×	Wiring change is required.
Applicable wire size	0.75 to 2mm ²	0.3mm ²	×	
Applicable solderless terminal	1.25-3, 1.25-YS3A, 2-S3, 2-YS3A, V1.25-3, V1.25-YS3A, V2-S3, V2-YS3A	-	×	
External dimensions	250(H) × 132(W) × 41(D) mm	98(H) × 27.4(W) × 90(D)mm	×	The dimensions are different. When a connector is attached: D = 135mm
Weight	0.65kg	0.20kg	△	

- *1 Use the QX70 when using 12VDC.
- *2 Check the specifications of the sensor or switches to be connected to the QX41Y41P.
- *3 The following shows the derating chart.

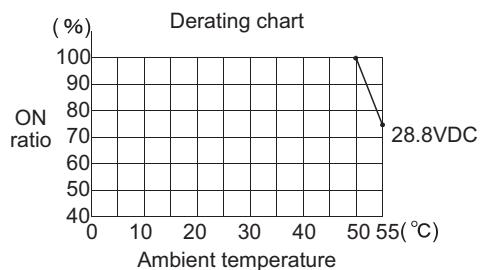

(5) Specifications comparison between A0J2-E56DT and QX40+QY50

○ : Compatible, △ : Partially changed, × : Incompatible

Specifications		A0J2-E56DT input specifications	QX40	Compatibility	Precautions for replacement
Number of input points		32 points	16 points	△	When seventeen or more points are used, use two QX40 modules.
Insulation method		Photocoupler	Photocoupler	○	
Rated input voltage		12VDC/24VDC	24VDC	△	12VDC cannot be used. ^{*1}
Rated input current		Approx. 3mA/Approx. 7mA	Approx. 4mA	△	Rated input current is smaller. ^{*2}
Operating voltage range		10.2 to 26.4VDC (Ripple ratio within 5%)	20.4 to 28.8VDC (Ripple ratio within 5%)	△	12VDC cannot be used. ^{*1}
Maximum number of simultaneous input points		60% (10 points/common) simultaneously ON	100% simultaneously ON	○	
ON voltage/ON current		9.5VDC or more/2.6mA or more	19VDC or more/3mA or more	△	12VDC cannot be used. ^{*1}
OFF voltage/OFF current		6VDC or less/1.0mA or less	11VDC or less/1.7mA or less	△	12VDC cannot be used. ^{*1}
Input resistance		Approx. 3.4kΩ	Approx. 5.6kΩ	△	Input resistance is greater. ^{*2}
Input form		Sink input (Input current flows off.)	Positive common	○	The name is different, but the specification is equal.
Response time	OFF→ON	10ms or less (6ms TYP.)	1ms/5ms/10ms/20ms/70ms or less (Set it with CPU parameter.) Initial setting is 10ms.	○	Input response time of the parameter must be used at the initial value (10ms).
	ON→OFF	10ms or less (7.5ms TYP.)	1ms/5ms/10ms/20ms/70ms or less (Set it with CPU parameter.) Initial setting is 10ms.	○	
Common terminal arrangement		16 points/common (Common terminal: TB17, TB34)	16 points/common (Common terminal: TB17)	○	
Operation indication		Available (Turning ON the input turns LED ON)	ON indication (LED)	○	
Specifications		A0J2-E56DT output specifications	QY50	Compatibility	Precautions for replacement
Number of output points		24 points	16 points	△	When seventeen or more points are used, use two QY50 modules.
Insulation method		Photocoupler	Photocoupler	○	
Rated load voltage		12VDC/24VDC	12VDC/24VDC	○	
Operating load voltage range		10.2 to 30 VDC	10.2 to 28.8VDC	△	Voltages exceeding 28.8 VDC cannot be applied.
Maximum load current		0.5A/point, 4A/common	0.5A/point, 4A/common	○	
Maximum inrush current		4A, 10ms or less	4A, 10ms or less	○	
Leakage current at OFF		0.1mA or less	0.1mA or less	○	
Maximum voltage drop at ON		0.9VDC (TYP.) 0.5A 1.5VDC (MAX.) 0.5A	0.2VDC (TYP.) 0.5A 0.3VDC (MAX.) 0.5A	○	
Response time	OFF→ON	2ms or less	1ms or less	○	
	ON→OFF	2ms or less (Resistance load)	1ms or less (Rated load, resistance load)	○	
External supply power	Voltage	12VDC/24VDC (10.2VDC to 30VDC)	12VDC/24VDC (10.2VDC to 28.8VDC) (Ripple ratio within 5%)	△	Voltages exceeding 28.8 VDC cannot be applied.
	Current	23mA (TYP. 24VDC/8 points common ON)	20mA (During 24VDC)	○	
Surge suppressor		Varistor (52 to 62V)	Zener diode	○	
Common terminal arrangement		8 points/common (Common terminal: TB9, TB19, TB29)	16 points/common (Common terminal: 2A01, 2A02)	△	As the common changes from two commons to a common, wiring with a different voltage for each common is not possible.
Operation indication		Available (Turning ON the output turns LED ON)	ON indication (LED)	○	
Fuse		None	6.7A (Not exchangeable) (Fuse blown capacity: 50A)	○	
Fuse blown indication		None	Available (When a fuse blown occurs, LED is lit, and a signal is output to the CPU)	○	

○ : Compatible, △ : Partially changed, × : Incompatible

Specifications	A0J2-E56DT	QX40/QY50	Compatibility	Precautions for replacement
Current consumption	0.225A (TYP. All points are ON.)	$0.05 \times 2 + 0.08 \times 2 = 0.26A$ (TYP. All points are ON.)	△	Review current capacity since current consumption is increased.
External connection method	36-point terminal block connector (M3 × 6 screws) 2 pieces	18-point terminal block (M3 × 6 screws) 4 pieces	×	Wiring change is required.
Applicable wire size	0.75 to 2mm ²	0.3 to 0.75mm ² core (Outside diameter: 2.8mm or less)	×	
Applicable solderless terminal	1.25-3, 1.25-YS3A, 2-S3, 2-YS3A, V1.25-3, V1.25-YS3A, V2-S3, V2-YS3A	R1.25-3 (Sleeved solderless terminals cannot be used.)	×	
External dimensions	250(H) × 190(W) × 41(D) mm	98(H) × 27.4(W) × 90(D)mm × 4	×	The dimensions are different.
Weight	1.04kg	$0.16 \times 2 + 0.17 \times 2 = 0.66kg$	△	

*1 Use the QX70 when using 12VDC.

*2 Check the specifications of the sensor or switches to be connected to the QX40.

(6) Specifications comparison between A0J2-E56DT and QX41Y41P

○ : Compatible, △ : Partially changed, × : Incompatible

Specifications		A0J2-E56DT input specifications	QX41Y41P input specifications	Compatibility	Precautions for replacement
Number of input points		32 points	32 points	○	
Insulation method		Photocoupler	Photocoupler	○	
Rated input voltage		12VDC/24VDC	24VDC	△	12VDC cannot be used.*1
Rated input current		Approx. 3mA/Approx. 7mA	Approx. 4mA	△	Rated input current is smaller.
Operating voltage range		10.2 to 26.4VDC (Ripple ratio within 5%)	20.4 to 28.8VDC (Ripple ratio within 5%)	△	12VDC cannot be used.*1
Maximum number of simultaneous input points		60% 10 points/common) simultaneously ON	Refer to the derating chart.*3	△	Use it within the range shown in the derating chart.
ON voltage/ON current		9.5VDC or more/2.6mA or more	19VDC or more/3mA or more	△	12VDC cannot be used.*1
OFF voltage/OFF current		6VDC or less/1.0mA or less	11VDC or less/1.7mA or less	△	12VDC cannot be used.*1
Input resistance		Approx. 3.4kΩ	Approx. 5.6kΩ	△	Input resistance is greater.*2
Input form		Sink input (Input current flows off.)	Positive common type	○	The name is different, but the specification is equal.
Response time	OFF→ON	10ms or less (6ms TYP.)	1ms/5ms/10ms/20ms/70ms or less (Set it with CPU parameter.) Initial setting is 10ms.	○	Input response time of the parameter must be used at the initial value (10ms).
	ON→OFF	10ms or less (7.5ms TYP.)	1ms/5ms/10ms/20ms/70ms or less (Set it with CPU parameter.) Initial setting is 10ms.	○	
Common terminal arrangement		16 points/common (Common terminal: TB17, TB34)	32 points/common (Common terminal: 1B01, 1B02)	○	As the common changes from two commons to a common, wiring with a different voltage for each common is not possible.
Operation indication		Available (Turning ON the input turns LED ON)	Available (Turning ON the input turns LED ON) (32-point switching indication with SW)	○	
Specifications		A0J2-E56DT output specifications	QX41Y41P output specifications	Compatibility	Precautions for replacement
Number of output points		24 points	32 points	○	
Insulation method		Photocoupler	Photocoupler	○	
Rated load voltage		12VDC/24VDC	12VDC/24VDC	○	
Operating load voltage range		10.2 to 30VDC	10.2 to 28.8VDC	△	Voltages exceeding 28.8 VDC cannot be applied.
Maximum load current		0.5A/point, 4A/common	0.1A/point, 2A/common	△	The maximum load current per point is smaller. Pay attention to the selection of the load to be used.
Maximum inrush current		4A, 10ms or less	0.7A, 10ms or less	△	Maximum inrush current is smaller.
Leakage current at OFF		0.1mA or less	0.1mA or less	○	
Maximum voltage drop at ON		0.9VDC (TYP.) 0.5A 1.5VDC (MAX.) 0.5A	0.1VDC (TYP.) 0.1A 0.2VDC (MAX.) 0.1A	○	The maximum voltage drop at ON is smaller.
Response time	OFF→ON	2ms or less	1ms or less	○	
	ON→OFF	2ms or less (Resistance load)	1ms or less (Rated load, resistance load)	○	
External supply power	Voltage	12VDC/24VDC (10.2 to 30VDC)	12VDC/24VDC (10.2 to 28.8VDC)	△	Voltages exceeding 28.8 VDC cannot be applied.
	Current	23mA (TYP. 24VDC 8 points/common ON)	Max. 15mA /common (24VDC, When all points are ON)	○	
Surge suppressor		Varistor (52 to 62V)	Zener diode	○	
Common terminal arrangement		8 points/common (Common terminal: TB9, TB19, TB29)	32 points/common (Common terminal: 2A01, 2A02)	△	As the common changes from three commons to a common, wiring with a different voltage for each common is not possible.
Operation indication		Available (Turning ON the output turns LED ON)	Available (Turning ON the output turns LED ON) (32-point switching indication with SW)	○	

○ : Compatible, △ : Partially changed, × : Incompatible

Specifications	A0J2-E56DT	QX41Y41P	Compatibility	Precautions for replacement
Current consumption	225mA (TYP. All points are ON.)	130mA(TYP. All points are ON.)	○	
External connection method	36-point terminal block connector (M3 × 6 screws) 2 pieces	40-pin connector	×	Wiring change is required.
Applicable wire size	0.75 to 2mm ²	0.3mm ²	×	
Applicable solderless terminal	1.25-3, 1.25-YS3A, 2-S3, 2-YS3A, V1.25-3, V1.25-YS3A, V2-S3, V2-YS3A	-	×	
External dimensions	250(H) × 190(W) × 41(D) mm	98(H) × 27.4(W) × 90(D)mm	×	The dimensions are different. When a connector is attached: D = 135mm
Weight	1.04kg	0.20kg	△	

*1 Use the QX70 when using 12VDC.

*2 Check the specifications of the sensor or switches to be connected to the QX41Y41P.

*3 The following shows the derating chart.

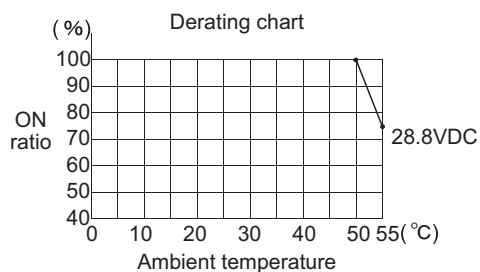

(7) Specifications comparison between A0J2-E28AR and QX10+QY10

○ : Compatible, △ : Partially changed, × : Incompatible

Specifications		A0J2-E28AR input specifications	QX10	Compatibility	Precautions for replacement
Number of input points		16 points	16 points	○	
Insulation method		Photocoupler	Photocoupler	○	
Rated input voltage		100-120VAC, 50/60Hz	100-120VAC, 50/60Hz	○	
Input voltage distortion		–	Within 5%	–	
Rated input current		10mA (100VAC, 60Hz)	Approx. 8mA (100VAC, 60Hz) Approx. 7mA (100VAC, 50Hz)	△	Rated input current is smaller.*1
Operating voltage range		85 to 132VAC (50/60Hz±5%)	85 to 132VAC (50/60Hz±3Hz)	○	
Maximum number of simultaneous input points		100% (16 points) simultaneously ON	Refer to the derating chart.*2	△	Use it within the range shown in the derating chart.
ON voltage/ON current		80VAC or more/6mA or more	80VAC or more/5mA or more (50Hz, 60Hz)	○	
OFF voltage/OFF current		40VAC or less/4mA or less	30VAC or less/1.7mA or less (50Hz, 60Hz)	△	OFF current is smaller.*1
Inrush current		Max. 300mA, within 0.3ms (132VAC)	Max. 200mA, within 1ms (with 132VAC)	○	
Input impedance		Approx. 10kΩ (60Hz), Approx. 12kΩ (50Hz)	Approx. 12kΩ (60Hz), Approx. 15kΩ (50Hz)	△	Input impedance is larger.*1
Response time	OFF→ON	15ms or less (6ms TYP.)	15ms or less (100VAC 50Hz, 60Hz)	○	
	ON→OFF	35ms or less (16ms TYP.)	20ms or less (100VAC 50Hz, 60Hz)	○	
Common terminal arrangement		16 points/common (Common terminal: TB17)	16 points/common (Common terminal: TB17)	○	
Operation indication		Available (Turning ON the input turns LED ON)	ON indication (LED)	○	
Specifications		A0J2-E28AR output specifications	QY10	Compatibility	Precautions for replacement
Number of output points		12 points	16 points	○	
Insulation method		Photocoupler	Relay	△	Although the insulation methods differ, the performance of the insulation is the same.
Rated switching voltage/current		24VDC 2A (Resistance load)/ point 240VAC 2A (COSφ=1)/point 5A/common	24VDC 2A (Resistance load)/ point 240VAC 2A (COSφ = 1)/point 8A/common	○	
Minimum switching load		5VDC 1mA	5VDC 1mA	○	
Maximum switching voltage		264VAC, 125VDC	264VAC, 125VDC	○	
Maximum switching frequency		3600 times/hr	3600 times/hr	○	

○ : Compatible, △ : Partially changed, × : Incompatible

Specifications		A0J2-E28AR output specifications	QY10	Compatibility	Precautions for replacement
Mechanical life		20 million times or more	20 million times or more	○	
Electrical life		Rated switching voltage/current load 200,000 times or more	Rated switching voltage/current load 100,000 times or more	△	Reduce the exchange intervals of the modules as Mechanical/ Electrical Life is cut to about half.
		200VAC 1.5A, 240VAC 1A (COSφ=0.7) 200,000 times or more 200VAC 0.75A, 240VAC 0.5A (COSφ=0.35) 200,000 times or more 24VDC 1A, 100VDC 0.1A (L/R=7ms) 200,000 times or more	200VAC 1.5A, 240VAC 1A (COSφ=0.7) 100,000 times or more 200VAC 0.4A, 240VAC 0.3A (COSφ=0.7) 300,000 times or more 200VAC 1A, 240VAC 0.5A (COSφ=0.35) 100,000 times or more 200VAC 0.3A, 240VAC 0.15A (COSφ=0.35) 300,000 times or more 24VDC 1A, 100VDC 0.1A (L/R=7ms) 100,000 times or more 24VDC 0.3A, 100VDC 0.03A (L/R=7ms) 300,000 times or more	△	
Response time	OFF→ON	10ms or less	10ms or less	○	
	ON→OFF	12ms or less	12ms or less	○	
External supply power (Relay coil driving power)	Voltage	24VDC±10% Ripple voltage 4Vp-p or less	—	○	External supply power is not required.
	Current	125mA (24VDC. All points are ON.)	—	○	

○ : Compatible, △ : Partially changed, × : Incompatible

Specifications	A0J2-E28AR	QX10/QY10	Compatibility	Precautions for replacement
Common terminal arrangement	8 points/common (Common terminal: TB26) 3 points/common (Common terminal: TB31) Independent contact (Common terminal: TB33)	16 points/common (Common terminal: TB17)	△	As the common changes from three commons to a common, wiring with a different voltage for each common is not possible.
Operation indication	Available (Turning ON the output turns LED ON)	ON indication (LED)	○	
Current consumption	0.140A (TYP. All points are ON.)	0.05 + 0.43 = 0.48A (TYP. All points are ON.)	△	Review current capacity since current consumption is increased.
External connection method	36-point terminal block connector (M3 × 6 screws)	18-point terminal block (M3 × 6 screws) 2 pieces	×	Wiring change is required.
Applicable wire size	0.75 to 2mm ²	0.3 to 0.75mm ² core (Outside diameter: 2.8mm or less)	×	
Applicable solderless terminal	1.25-3, 1.25-YS3A, 2-S3, 2-YS3A, V1.25-3, V1.25-YS3A, V2-S3, V2-YS3A	R1.25-3 (Sleeved solderless terminals cannot be used.)	×	
External dimensions	250(H) × 132(W) × 41(D) mm	98(H) × 27.4(W) × 90(D)mm × 2	×	The dimensions are different.
Weight	0.68kg	0.17 + 0.22 = 0.39kg	△	

*1 Check the specifications of the sensor or switches to be connected to the QX10.

*2 The following shows the derating chart.

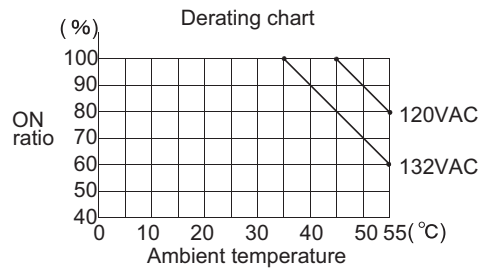

(8) Specifications comparison between A0J2-E56AR and QX10+QY10

○ : Compatible, △ : Partially changed, × : Incompatible

Specifications		A0J2-E56AR input specifications	QX10	Compatibility	Precautions for replacement
Number of input points		32 points	16 points	△	When seventeen or more points are used, use two QX10s.
Insulation method		Photocoupler	Photocoupler	○	
Rated input voltage		100-120VAC, 50/60Hz	100-120VAC, 50/60Hz	○	
Input voltage distortion		-	Within 5%	-	
Rated input current		10mA (100VAC, 60Hz)	Approx. 8mA (100VAC, 60Hz) Approx. 7mA (100VAC, 50Hz)	△	Rated input current is smaller.*1
Operating voltage range		85 to 132VAC (50/60Hz±5%)	85 to 132VAC (50/60Hz±3Hz)	○	
Maximum number of simultaneous input points		60% (10 points/common) simultaneously ON	Refer to the derating chart.*2	△	Use it within the range shown in the derating chart.
ON voltage/ON current		80VAC or more/6mA or more	80VAC or more/5mA or more (50Hz, 60Hz)	○	
OFF voltage/OFF current		40VAC or less/4mA or less	30VAC or less/1.7mA or less (50Hz, 60Hz)	△	OFF current is smaller.*1
Inrush current		Max. 300mA, within 0.3ms (132VAC)	Max. 200mA, within 1ms (with 132VAC)	○	
Input impedance		Approx. 10kΩ (60Hz), Approx. 12kΩ (50Hz)	Approx. 12kΩ (60Hz), Approx. 15kΩ (50Hz)	△	Input impedance is larger.*1
Response time	OFF→ON	15ms or less (6ms TYP.)	15ms or less (100VAC 50Hz, 60Hz)	○	
	ON→OFF	35ms or less (16ms TYP.)	20ms or less (100VAC 50Hz, 60Hz)	○	
Common terminal arrangement		16 points/common (Common Terminal: TB17, TB34)	16 points/common (Common terminal: TB17)	○	
Operation indication		Available (Turning ON the input turns LED ON)	ON indication (LED)	○	
Specifications		A0J2-E56AR output specifications	QY10	Compatibility	Precautions for replacement
Number of output points		24 points	16 points	△	When seventeen or more points are used, use two QY10 modules.
Insulation method		Photocoupler	Relay	△	Although the insulation methods differ, the performance of the insulation is the same.
Rated switching voltage/current		24VDC 2A (Resistance load)/ point 240VAC 2A (COSφ=1)/point 5A/common	24VDC 2A (Resistance load)/ point 240VAC 2A (COSφ = 1)/point 8A/common	○	
Minimum switching load		5VDC 1mA	5VDC 1mA	○	
Maximum switching voltage		264VAC, 125VDC	264VAC, 125VDC	○	
Maximum switching frequency		3600 times/hr	3600 times/hr	○	

○ : Compatible, △ : Partially changed, × : Incompatible

Specifications		A0J2-E56AR output specifications	QY10	Compatibility	Precautions for replacement
Mechanical life		20 million times or more	20 million times or more	○	
Electrical life		Rated switching voltage/current load 200,000 times or more	Rated switching voltage/current load 100,000 times or more	△	Reduce the exchange intervals of the modules as Mechanical/ Electrical Life is cut to about half.
		200VAC 1.5A, 240VAC 1A (COSφ=0.7) 200,000 times or more 200VAC 0.75A, 240VAC 0.5A (COSφ=0.35) 200,000 times or more 24VDC 1A, 100VDC 0.1A (L/R=7ms) 200,000 times or more	200VAC 1.5A, 240VAC 1A (COSφ=0.7) 100,000 times or more 200VAC 0.4A, 240VAC 0.3A (COSφ=0.7) 300,000 times or more 200VAC 1A, 240VAC 0.5A (COSφ=0.35) 100,000 times or more 200VAC 0.3A, 240VAC 0.15A (COSφ=0.35) 300,000 times or more 24VDC 1A, 100VDC 0.1A (L/R=7ms) 100,000 times or more 24VDC 0.3A, 100VDC 0.03A (L/R=7ms) 300,000 times or more	△	
Response time	OFF→ON	10ms or less	10ms or less	○	
	ON→OFF	12ms or less	12ms or less	○	
External supply power (Relay coil driving power)	Voltage	24VDC±10% Ripple voltage 4Vp-p or less	—	○	External supply power is not required.
	Current	230mA (24VDC TYP. All points are ON.)	—	○	

○ : Compatible, △ : Partially changed, × : Incompatible

Specifications	A0J2-E56AR	QX10/QY10	Compatibility	Precautions for replacement
Common terminal arrangement	8 points/common (Common terminal: TB9, TB19, TB29)	16 points/common (Common terminal: TB17)	△	As the common changes from three commons to a common, wiring with a different voltage for each common is not possible.
Operation indication	Available (Turning ON the output turns LED ON)	ON indication (LED)	○	
Current consumption	0.225A (TYP. All points are ON.)	$0.05 \times 2 + 0.43 \times 2 = 0.96A$ (TYP. All points are ON.)	△	Review current capacity since current consumption is increased.
External connection method	36-point terminal block connector (M3 × 6 screws) 2 pieces	18-point terminal block (M3 × 6 screws) 4 pieces	×	Wiring change is required.
Applicable wire size	0.75 to 2mm ²	0.3 to 0.75mm ² core (Outside diameter: 2.8mm or less)	×	
Applicable solderless terminal	1.25-3, 1.25-YS3A, 2-S3, 2-YS3A, V1.25-3, V1.25-YS3A, V2-S3, V2-YS3A	R1.25-3 (Sleeved solderless terminals cannot be used.)	×	
External dimensions	250(H) × 190(W) × 41(D) mm	98(H) × 27.4(W) × 90(D)mm × 4	×	The dimensions are different.
Weight	1.10kg	$0.17 \times 2 + 0.22 \times 2 = 0.78kg$	△	

- *1 Check the specifications of the sensor or switches to be connected to the QX10.
- *2 The following shows the derating chart.

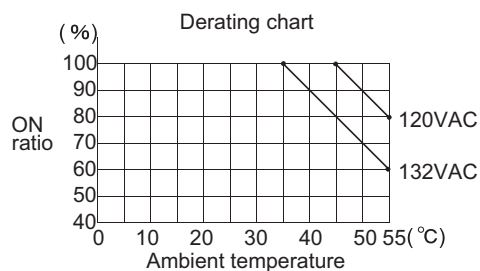

(9) Specifications comparison between A0J2-E28AS and QX10+QY22*1

○ : Compatible, △ : Partially changed, × : Incompatible

Specifications		A0J2-E28AS input specifications	QX10	Compatibility	Precautions for replacement
Number of input points		16 points	16 points	○	
Insulation method		Photocoupler	Photocoupler	○	
Rated input voltage		100-120VAC, 50/60Hz	100-120VAC, 50/60Hz	○	
Input voltage distortion		–	Within 5%	–	
Rated input current		10mA (100VAC, 60Hz)	Approx. 8mA (100VAC, 60Hz) Approx. 7mA (100VAC, 50Hz)	△	Rated input current is smaller.*2
Operating voltage range		85 to 132VAC (50/60Hz±5%)	85 to 132VAC (50/60Hz±3Hz)	○	
Maximum number of simultaneous input points		100% (16 points) simultaneously ON	Refer to the derating chart.*3	△	Use it within the range shown in the derating chart.
ON voltage/ON current		80VAC or more/6mA or more	80VAC or more/5mA or more (50Hz, 60Hz)	○	
OFF voltage/OFF current		40VAC or less/4mA or less	30VAC or less/1.7mA or less (50Hz, 60Hz)	△	OFF current is smaller. The shape configuration differs.
Inrush current		Max. 300mA, within 0.3ms (132VAC)	Max. 200mA, within 1ms (with 132VAC)	○	
Input impedance		Approx. 10kΩ (60Hz), Approx. 12kΩ (50Hz)	Approx. 12kΩ (60Hz), Approx. 15kΩ (50Hz)	△	Input impedance is larger.*2
Response time	OFF→ON	15ms or less (6ms TYP.)	15ms or less (100VAC 50Hz, 60Hz)	○	
	ON→OFF	35ms or less (16ms TYP.)	20ms or less (100VAC 50Hz, 60Hz)	○	
Common terminal arrangement		16 points/common (Common terminal: TB17)	16 points/common (Common terminal: TB17)	○	
Operation indication		Available (Turning ON the input turns LED ON)	ON indication (LED)	○	
Specifications		A0J2-E28AS output specifications	QY22	Compatibility	Precautions for replacement
Number of output points		12 points	16 points	○	
Insulation method		Photocoupler	Photocoupler	○	
Rated load voltage		100 to 240VAC, 40 to 70Hz	100 to 240VAC 50/60Hz±5%	△	The frequency will be low. Check the specifications of external devices.
Maximum load voltage		264VAC	264VAC	○	
Maximum load current		0.6A/point, 2.4A/common	0.6A/point, 4.8A/common	○	
Minimum load voltage/current		24VAC 100mA 100VAC 10mA 240VAC 10mA	24VAC 100mA 100VAC 25mA 240VAC 25mA	△	The minimum load current is greater. Use caution on selecting the load to use.
Maximum inrush current		20A, 10ms or less 8A 100ms or less	20A 1 cycle or less	○	
Leakage current at OFF		1.5mA (120VAC 60Hz) 3mA (240VAC 60Hz)	1.5mA or less (During 120V 60Hz) 3mA or less (During 240V 60Hz)	○	
Maximum voltage drop at ON		1.5V or less (100 to 600mA) 1.8V or less (100mA or less) 2.0V or less (10 to 50mA)	1.5V or less	○	
Response time	OFF→ON	1ms or less	1ms or less	○	
	ON→OFF	0.5 cycle + 1ms or less	1ms + 0.5 cycle or less (Rated load, resistance load)	○	
Fuse rating		High speed type fuse 3.2A (One/common) HP-32	None	×	
Fuse blown indication		Available (When a fuse blown occurs, LED is lit, and a signal is output to the CPU)	–	×	The fuse is not built in.*4
Surge suppressor		CR absorber (0.022μF + 47Ω)	CR absorber	○	

○ : Compatible, △ : Partially changed, × : Incompatible

Specifications	A0J2-E28AS output specifications	QY22	Compatibility	Precautions for replacement
Common terminal arrangement	8 points/common (Common terminal: TB26) 4 points/common (Common terminal: TB33)	16 points/common (Common terminal: TB17)	△	As the common changes from two commons to a common, wiring with a different voltage for each common is not possible.
Operation indication	Available (Turning ON the output turns LED ON)	ON indication (LED)	○	
Specifications	A0J2-E28AS	QX10/QY22	Compatibility	Precautions for replacement
Current consumption	0.260A (TYP. All points are ON.)	0.05 + 0.25 = 0.30A (TYP. All points are ON.)	△	Review current capacity since current consumption is increased.
External connection method	36-point terminal block connector (M3 × 6 screws)	18-point terminal block (M3 × 6 screws) 2 pieces	×	Wiring change is required.
Applicable wire size	0.75 to 2mm ²	0.3 to 0.75mm ² core (Outside diameter: 2.8mm or less)	×	
Applicable solderless terminal	1.25-3, 1.25-YS3A, 2-S3, 2-YS3A, V1.25-3, V1.25-YS3A, V2-S3, V2-YS3A	R1.25-3 (Sleeved solderless terminals cannot be used.)	×	
External dimensions	250(H) × 132(W) × 41(D) mm	98(H) × 27.4(W) × 90(D)mm + 98(H) × 27.4(W) × 112.3(D)mm	×	The dimensions are different.
Weight	0.68kg	0.17 + 0.40 = 0.57kg	△	

- *1 Consider the characteristics of the triac and observe the necessary precautions by referring to Section 3.3 (3) before replacing the modules.
- *2 Check the specifications of the sensor or switches to be connected to the QX10.
- *3 The following shows the derating chart.

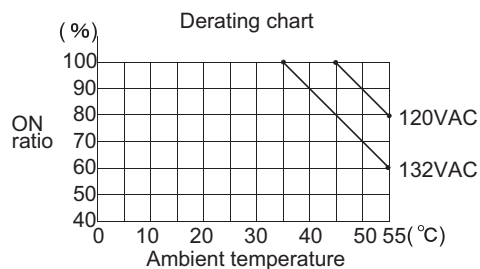

- *4 Install a fuse for each external terminal point to prevent the burnout of the external devices and modules during load shorts. In addition, when a fuse blown indication is necessary, configure an external circuit.

(10) Specifications comparison between A0J2-E56AS and QX10+QY22*1

○ : Compatible, △ : Partially changed, × : Incompatible

Specifications		A0J2-E56AS input specifications	QX10	Compatibility	Precautions for replacement
Number of input points		32 points	16 points	△	When seventeen or more points are used, use two QX10 modules.
Insulation method		Photocoupler	Photocoupler	○	
Rated input voltage		100-120VAC, 50/60Hz	100-120VAC, 50/60Hz	○	
Input voltage distortion		–	Within 5%	–	
Rated input current		10mA (100VAC, 60Hz)	Approx. 8mA (100VAC, 60Hz) Approx. 7mA (100VAC, 50Hz)	△	Rated input current is smaller.*2
Operating voltage range		85 to 132VAC (50/60Hz±5%)	85 to 132VAC (50/60Hz±3Hz)	○	
Maximum number of simultaneous input points		60% (10 points/common) simultaneously ON	Refer to the derating chart.*3	△	Use it within the range shown in the derating chart.
ON voltage/ON current		80VAC or more/6mA or more	80VAC or more/5mA or more (50Hz, 60Hz)	○	
OFF voltage/OFF current		40VAC or less/4mA or less	30VAC or less/1.7mA or less (50Hz, 60Hz)	△	OFF current is smaller.*2
Inrush current		Max. 300mA, within 0.3ms (132VAC)	Max. 200mA, within 1ms (with 132VAC)	○	
Input impedance		Approx. 10kΩ (60Hz), Approx. 12kΩ (50Hz)	Approx. 12kΩ (60Hz), Approx. 15kΩ (50Hz)	△	Input impedance is larger.*2
Response time	OFF→ON	15ms or less (6ms TYP.)	15ms or less (100VAC 50Hz, 60Hz)	○	
	ON→OFF	35ms or less (16ms TYP.)	20ms or less (100VAC 50Hz, 60Hz)	○	
Common terminal arrangement		16 points/common (Common Terminal: TB17, TB34)	16 points/common (Common terminal: TB17)	○	
Operation indication		Available (Turning ON the input turns LED ON)	ON indication (LED)	○	
Specifications		A0J2-E56AS output specifications	QY22	Compatibility	Precautions for replacement
Number of output points		24 points	16 points	△	When seventeen or more points are used, use two QY22 modules.
Insulation method		Photocoupler	Photocoupler	○	
Rated load voltage		100 - 240VAC, 40 - 70Hz	100 - 240VAC 50/60Hz±5%	△	The frequency will be low. Check the specifications of external devices.
Maximum load voltage		264VAC	264VAC	○	
Maximum load current		0.6A/point, 2.4A/common	0.6A/point, 4.8A/common	○	
Minimum load voltage/current		24VAC 100mA 100VAC 10mA 240VAC 10mA	24VAC 100mA 100VAC 25mA 240VAC 25mA	△	The minimum load current is greater. Use caution on selecting the load to use.
Maximum inrush current		20A 10ms or less 8A 100ms or less	20A 1 cycle or less	○	
Leakage current at OFF		1.5mA (120VAC 60Hz) 3mA (240VAC 60Hz)	1.5mA or less (During 120V 60Hz) 3mA or less (During 240V 60Hz)	○	
Maximum voltage drop at ON		1.5V or less (100 to 600mA) 1.8V or less (100mA or less) 2.0V or less (10 to 50mA)	1.5V or less	○	
Response time	OFF→ON	1ms or less	1ms or less	○	
	ON→OFF	0.5 cycle + 1ms or less	1ms + 0.5 cycle or less (Rated load, resistance load)	○	
Fuse rating		High speed type fuse 3.2A (One/common) HP-32	None	×	
Fuse blown indication		Available (When a fuse blown occurs, LED is lit, and a signal is output to the CPU)	–	×	The fuse is not built in.*4

○ : Compatible, △ : Partially changed, × : Incompatible

Specifications	A0J2-E56AS output specifications	QY22	Compatibility	Precautions for replacement
Surge suppressor	CR absorber (0.022μF + 47Ω)	CR absorber	○	
Common terminal arrangement	8 points/common (Common terminal: TB9, TB19, TB29)	16 points/common (Common terminal: TB17)	△	As the common changes from three commons to a common, wiring with a different voltage for each common is not possible.
Operation indication	Available (Turning ON the output turns LED ON)	ON indication (LED)	○	
Specifications	A0J2-E56AS	QX10/QY22	Compatibility	Precautions for replacement
Current consumption	0.460A (TYP. All points are ON.)	$0.05 \times 2 + 0.25 \times 2 = 0.60A$ (TYP. All points are ON.)	△	Review current capacity since current consumption is increased.
External connection method	36-point terminal block connector (M3 × 6 screws) 2 pieces	18-point terminal block (M3 × 6 screws) 4 pieces	×	Wiring change is required.
Applicable wire size	0.75 to 2mm ²	0.3 to 0.75mm ² core (Outside diameter: 2.8mm or less)	×	
Applicable solderless terminal	1.25-3, 1.25-YS3A, 2-S3, 2-YS3A, V1.25-3, V1.25-YS3A, V2-S3, V2-YS3A	R1.25-3 (Sleeved solderless terminals cannot be used.)	×	
External dimensions	250(H) × 190(W) × 41(D) mm	$98(H) \times 27.4(W) \times 90(D)mm \times 2$ $+ 98(H) \times 27.4(W) \times 112.3(D)mm \times 2$	×	The dimensions are different.
Weight	1.10kg	$0.17 \times 2 + 0.40 \times 2 = 1.14kg$	△	Be aware of that the weight increases when calculating the weight.

- *1 Consider the characteristics of the triac and observe the necessary precautions by referring to Section 3.3 (3) before replacing the modules.
- *2 Check the specifications of the sensor or switches to be connected to the QX10.
- *3 The following shows the derating chart.

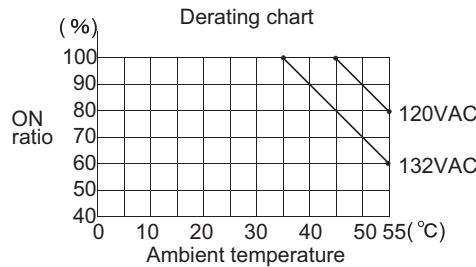

- *4 Install a fuse for each external terminal point to prevent the burnout of the external devices and modules during load shorts. In addition, when a fuse blown indication is necessary, configure an external circuit.

(11) Specifications comparison between A0J2-E28DS and QX40+QY22*1

○ : Compatible, △ : Partially changed, × : Incompatible

Specifications		A0J2-E28DS input specifications	QX40	Compatibility	Precautions for replacement
Number of input points		16 points	16 points	○	
Insulation method		Photocoupler	Photocoupler	○	
Rated input voltage		12VDC/24VDC	24VDC	△	12VDC cannot be used.*2
Rated input current		Approx. 3mA/Approx. 7mA	Approx. 4mA	△	Rated input current is smaller.*3
Operating voltage range		10.2 to 26.4VDC (Ripple ratio within 5%)	20.4 to 28.8VDC (Ripple ratio within 5%)	△	12VDC cannot be used.*2
Maximum number of simultaneous input points		100% (16 points) simultaneously ON	100% simultaneously ON	○	
ON voltage/ON current		9.5VDC or more/2.6mA or more	19VDC or more/3mA or more	△	12VDC cannot be used.*2
OFF voltage/OFF current		6VDC or less/1.0mA or less	11VDC or less/1.7mA or less	△	12VDC cannot be used.*2
Input resistance		Approx. 3.4kΩ	Approx. 5.6kΩ	△	Input resistance is greater.*3
Input form		Sink input (Input current flows off.)	Positive common	○	The name is different, but the specification is equal.
Response time	OFF→ON	10ms or less (6ms TYP.)	1ms/5ms/10ms/20ms/70ms or less (Set it with CPU parameter.) Initial setting is 10ms.	○	Input response time of the parameter must be used at the initial value (10ms).
	ON→OFF	10ms or less (7.5ms TYP.)	1ms/5ms/10ms/20ms/70ms or less (Set it with CPU parameter.) Initial setting is 10ms.	○	
Common terminal arrangement		16 points/common (Common terminal: TB17)	16 points/common (Common terminal: TB17)	○	
Operation indication		Available (Turning ON the input turns LED ON)	ON indication (LED)	○	
Specifications		A0J2-E28DS output specifications	QY22	Compatibility	Precautions for replacement
Number of output points		12 points	16 points	○	
Insulation method		Photocoupler	Photocoupler	○	
Rated load voltage		100 to 240VAC, 40 to 70Hz	100 to 240VAC 50/60Hz±5%	△	The frequency will be low. Check the specifications of external devices.
Maximum load voltage		264VAC	264VAC	○	
Maximum load current		0.6A/point, 2.4A/common	0.6A/point, 4.8A/common	○	
Minimum load voltage, current		24VAC 100mA 100VAC 10mA 240VAC 10mA	24VAC 100mA 100VAC 25mA 240VAC 25mA	△	The minimum load current is greater. Use caution on selecting the load to use.
Maximum inrush current		20A 10ms or less 8A 100ms or less	20A 1 cycle or less	○	
Leakage current at OFF		1.5mA (120VAC 60Hz) 3mA (240VAC 60Hz)	1.5mA or less (During 120V 60Hz) 3mA or less (During 240V 60Hz)	○	
Maximum voltage drop at ON		1.5V or less (100 to 600mA) 1.8V or less (100mA or less) 2.0V or less (10 to 50mA)	1.5V or less	○	
Response time	OFF→ON	1ms or less	1ms or less	○	
	ON→OFF	0.5 cycle + 1ms or less	1ms + 0.5 cycle or less (Rated load, resistance load)	○	
Fuse rating		High speed type fuse 3.2A (1/common) HP-32	None	×	The fuse is not built in.*4
Fuse blown indication		Available (When a fuse blown occurs, LED is lit, and a signal is output to the CPU)	–	×	
Surge suppressor		CR absorber (0.022μF + 47Ω)	CR absorber	○	

○ : Compatible, △ : Partially changed, × : Incompatible

Specifications	A0J2-E28DS output specifications	QY22	Compatibility	Precautions for replacement
Common terminal arrangement	8 points/common (Common terminal: TB26) 4 points/common (Common terminal: TB33)	16 points/common (Common terminal: TB17)	△	As the common changes from two commons to a common, wiring with a different voltage for each common is not possible.
Operation indication	Available (Turning ON the output turns LED ON)	ON indication (LED)	○	
Specifications	A0J2-E28DS	QX40/QY22	Compatibility	Precautions for replacement
Current consumption	0.260A (TYP. All points are ON.)	0.05 + 0.25 = 0.30A (TYP. All points are ON.)	△	Review current capacity since current consumption is increased.
External connection method	36-point terminal block connector (M3 × 6 screws)	18-point terminal block (M3 × 6 screws) 2 pieces	×	Wiring change is required.
Applicable wire size	0.75 to 2mm ²	0.3 to 0.75mm ² core (Outside diameter: 2.8mm or less)	×	
Applicable solderless terminal	1.25-3, 1.25-YS3A, 2-S3, 2-YS3A, V1.25-3, V1.25-YS3A, V2-S3, V2-YS3A	R1.25-3 (Sleeved solderless terminals cannot be used.)	×	
External dimensions	250(H) × 132(W) × 41(D) mm	98(H) × 27.4(W) × 90(D)mm + 98(H) × 27.4(W) × 112.3(D)mm	×	The dimensions are different.
Weight	0.65kg	0.16 + 0.40 = 0.56kg	△	

- *1 Consider the characteristics of the triac and observe the necessary precautions by referring to Section 3.3 (3) before replacing the modules.
- *2 Use the QX70 when using 12VDC.
- *3 Check the specifications of the sensor or switches to be connected to the QX40.
- *4 Install a fuse for each external terminal point to prevent the burnout of the external devices and modules during load shorts. In addition, when a fuse blown indication is necessary, configure an external circuit.

(12) Specifications comparison between A0J2-E56DS and QX40+QY22*1

○ : Compatible, △ : Partially changed, × : Incompatible

Specifications		A0J2-E56DS input specifications	QX40	Compatibility	Precautions for replacement
Number of input points		32 points	16 points	△	When seventeen or more points are used, use two QX40 modules.
Insulation method		Photocoupler	Photocoupler	○	
Rated input voltage		12VDC/24VDC	24VDC	△	12VDC cannot be used.*2
Rated input current		Approx. 3mA/Approx. 7mA	Approx. 4mA	△	Rated input current is smaller.*3
Operating voltage range		10.2 to 26.4VDC (Ripple ratio within 5%)	20.4 to 28.8VDC (Ripple ratio within 5%)	△	12VDC cannot be used.*2
Maximum number of simultaneous input points		60% (10 points/common) simultaneously ON	100% simultaneously ON	○	
ON voltage/ON current		9.5VDC or more/2.6mA or more	19VDC or more/3mA or more	△	12VDC cannot be used.*2
OFF voltage/OFF current		6VDC or less/1.0mA or less	11VDC or less/1.7mA or less	△	12VDC cannot be used.*2
Input resistance		Approx. 3.4kΩ	Approx. 5.6kΩ	△	Input resistance is greater.*3
Input format		Sink input (Input current flows off.)	Positive common	○	The name is different, but the specification is equal.
Response time	OFF→ON	10ms or less (6ms TYP.)	1ms/5ms/10ms/20ms/70ms or less (Set it with CPU parameter.) Initial setting is 10ms.	○	Input response time of the parameter must be used at the initial value (10ms).
	ON→OFF	10ms or less (7.5ms TYP.)	1ms/5ms/10ms/20ms/70ms or less (Set it with CPU parameter.) Initial setting is 10ms.	○	
Common terminal arrangement		16 points/common (Common terminal: TB17, TB34)	16 points/common (Common terminal: TB17)	○	
Operation indication		Available (Turning ON the input turns LED ON)	ON indication (LED)	○	
Specifications		A0J2-E56DS output specifications	QY22	Compatibility	Precautions for replacement
Number of output points		24 points	16 points	△	When seventeen or more points are used, use two QY22 modules.
Insulation method		Photocoupler	Photocoupler	○	
Rated load voltage		100 to 240VAC, 40 to 70Hz	100 to 240VAC 50/60Hz±5%	△	The frequency will be low. Check the specifications of external devices.
Maximum load voltage		264VAC	264VAC	○	
Maximum load current		0.6A/point, 2.4A/common	0.6A/point, 4.8A/common	○	
Minimum load voltage/current		24VAC 100mA 100VAC 10mA 240VAC 10mA	24VAC 100mA 100VAC 25mA 240VAC 25mA	△	The minimum load current is greater. Use caution on selecting the load to use.
Maximum inrush current		20A, 10ms or less 8A 100ms or less	20A 1 cycle or less	○	
Leakage current at OFF		1.5mA (120VAC 60Hz) 3mA (240VAC 60Hz)	1.5mA or less (During 120V 60Hz) 3mA or less (During 240V 60Hz)	○	
Maximum voltage drop at ON		1.5V or less (100 to 600mA) 1.8V or less (100mA or less) 2.0V or less (10 to 50mA)	1.5V or less	○	
Response time	OFF→ON	1ms or less	1ms or less	○	
	ON→OFF	0.5 cycle + 1ms or less	1ms + 0.5 cycle or less (Rated load, resistance load)	○	
Fuse rating		High speed type fuse 3.2A (1/common) HP-32	None	×	The fuse is not built in.*4
Fuse blown indication		Available (When a fuse blown occurs, LED is lit, and a signal is output to the CPU)	–	×	
Surge suppressor		CR absorber (0.022μF + 47Ω)	CR absorber	○	

○ : Compatible, △ : Partially changed, × : Incompatible

Specifications	A0J2-E56DS output specifications	QY22	Compatibility	Precautions for replacement
Common terminal arrangement	8 points/common (Common terminal: TB9, TB19, TB29)	16 points/common (Common terminal: TB17)	△	As the common changes from three commons to a common, wiring with a different voltage for each common is not possible.
Operation indication	Available (Turning ON the output turns LED ON)	ON indication (LED)	○	
Specifications	A0J2-E56DS	QX40/QY22	Compatibility	Precautions for replacement
Current consumption	0.460A (TYP. All points are ON.)	$0.05 \times 2 + 0.25 \times 2 = 0.60A$ (TYP. All points are ON.)	△	Review current capacity since current consumption is increased.
External connection method	36-point terminal block connector (M3 × 6 screws) 2 pieces	18-point terminal block (M3 × 6 screws) 4 pieces	×	Wiring change is required.
Applicable wire size	0.75 to 2mm ²	0.3 to 0.75mm ² core (Outside diameter: 2.8mm or less)	×	
Applicable solderless terminal	1.25-3, 1.25-YS3A, 2-S3, 2-YS3A, V1.25-3, V1.25-YS3A, V2-S3, V2-YS3A	R1.25-3 (Sleeved solderless terminals cannot be used.)	×	
External dimensions	250(H) × 190(W) × 41(D) mm	$98(H) \times 27.4(W) \times 90(D)$ mm × 2+ $98(H) \times 27.4(W) \times 112.3(D)$ mm × 2	×	The dimensions are different.
Weight	1.05kg	$0.16 \times 2 + 0.40 \times 2 = 1.12$ kg	△	Be aware of that the weight increases when calculating the weight.

- *1 Consider the characteristics of the triac and observe the necessary precautions by referring to Section 3.3 (3) before replacing the modules.
- *2 Use the QX70 when using 12VDC.
- *3 Check the specifications of the sensor or switches to be connected to the QX40.
- *4 Install a fuse for each external terminal point to prevent the burnout of the external devices and modules during load shorts. In addition, when a fuse blown indication is necessary, configure an external circuit.

(13) Specifications comparison between A0J2E-E28DS and QX80+QY22*1

○ : Compatible, △ : Partially changed, × : Incompatible

Specifications		A0J2E-E28DS input specifications	QX80	Compatibility	Precautions for replacement
Number of input points		16 points	16 points	○	
Insulation method		Photocoupler	Photocoupler	○	
Rated input voltage		12VDC/24VDC	24VDC	△	12VDC cannot be used.*2
Rated input current		Approx. 3mA/Approx. 7mA	Approx. 4mA	△	Rated input current is smaller.*3
Operating voltage range		10.2 to 26.4VDC (Ripple ratio within 5%)	20.4 to 28.8VDC (Ripple ratio within 5%)	△	12VDC cannot be used.*2
Maximum number of simultaneous input points		100% (8 points/common) simultaneously ON	100% simultaneously ON	○	
ON voltage/ON current		9.5VDC or more/2.6mA or more	19VDC or more/3mA or more	△	12VDC cannot be used.*2
OFF voltage/OFF current		6VDC or less/1.0mA or less	11VDC or less/1.7mA or less	△	12VDC cannot be used.*2
Input resistance		Approx. 3.4kΩ	Approx. 5.6kΩ	△	Input resistance is greater.*3
Input format		Source loading input (Input current flows in)	Negative common	○	The name is different, but the specification is equal.
Response time	OFF→ON	5.5ms or less (TYP.)	1ms/5ms/10ms/20ms/70ms or less (Set it with CPU parameter.) Initial setting is 10ms.	○	Input response time of the parameter must be used at the initial value (10ms).
	ON→OFF	6.0ms or less (TYP.)	1ms/5ms/10ms/20ms/70ms or less (Set it with CPU parameter.) Initial setting is 10ms.	○	
Response time high-speed mode (Only upper 8 points)	OFF→ON	0.5ms or less	1ms/5ms/10ms/20ms/70ms or less (Set it with CPU parameter.) Initial setting is 10ms.	△	Set the input response time of the parameter to 1ms before use.
	ON→OFF	1.0ms or less	1ms/5ms/10ms/20ms/70ms or less (Set it with CPU parameter.) Initial setting is 10ms.	○	
Common terminal arrangement		16 points/common (Common terminal: TB17)	16 points/common (Common terminal: TB18)	○	
Operation indication		Available (Turning ON the input turns LED ON)	ON indication (LED)	○	
Specifications		A0J2E-E28DS output specifications	QY22	Compatibility	Precautions for replacement
Number of output points		12 points	16 points	○	
Insulation method		Photocoupler	Photocoupler	○	
Rated load voltage		100 to 240VAC, 40 to 70Hz	100 to 240VAC 50/60Hz±5%	△	The frequency will be low. Check the specifications of external devices.
Maximum load voltage		264VAC	264VAC	○	
Maximum load current		0.6A/point, 0.5A/point (60% ON, 55°C)	0.6A/point, 4.8A/common	○	
Minimum load voltage/current		24VAC 100mA 100VAC 10mA 240VAC 10mA	24VAC 100mA 100VAC 25mA 240VAC 25mA	△	The minimum load current is greater. Use caution on selecting the load to use.
Maximum inrush current		20A 10ms or less 8A 100ms or less	20A 1 cycle or less	○	
Leakage current at OFF		1.5mA (120VAC 60Hz) 3mA (240VAC 60Hz)	1.5mA or less (During 120V 60Hz) 3mA or less (During 240V 60Hz)	○	
Maximum voltage drop at ON		1.5V or less (100 to 600mA) 1.8V or less (100mA or less) 2.0V or less (10 to 50mA)	1.5V or less	○	
Response time	OFF→ON	1ms or less	1ms or less	○	
	ON→OFF	0.5 cycle + 1ms or less	1ms + 0.5 cycle or less (Rated load, resistance load)	○	

○ : Compatible, △ : Partially changed, × : Incompatible

Specifications	A0J2E-E28DS output specifications	QY22	Compatibility	Precautions for replacement
Fuse rating	High speed type fuse 3.2A (1/common) HP-32	None	×	The fuse is not built in.*4
Fuse blown indication	Available (When a fuse blown occurs, LED is lit, and a signal is output to the CPU.)	–	×	
Surge suppressor	CR absorber (0.022μF + 47Ω)	CR absorber	○	
Common terminal arrangement	8 points/common (Common terminal: TB26) 4 points/common (Common terminal: TB32)	16 points/common (Common terminal: TB17)	△	As the common changes from two commons to a common, wiring with a different voltage for each common is not possible.
Operation indication	Available (Turning ON the output turns LED ON)	ON indication (LED)	○	
Specifications	A0J2E-E28DS	QX80/QY22	Compatibility	Precautions for replacement
Current consumption	0.260A (TYP. All points are ON.)	0.05 + 0.25 = 0.30A (TYP. All points are ON.)	△	Review current capacity since current consumption is increased.
External connection method	36-point terminal block connector (M3 × 6 screws)	18-point terminal block (M3 × 6 screws) 2 pieces	×	Wiring change is required.
Applicable wire size	0.75 to 2mm ²	0.3 to 0.75mm ² core (Outside diameter: 2.8mm or less)	×	
Applicable solderless terminal	1.25-3, 1.25-YS3A, 2-S3, 2-YS3A, V1.25-3, V1.25-YS3A, V2-S3, V2-YS3A	R1.25-3 (Sleeved solderless terminals cannot be used.)	×	
External dimensions	250(H) × 132(W) × 41(D)mm	98(H) × 27.4(W) × 90(D)mm + 98(H) × 27.4(W) × 112.3(D)mm	×	The dimensions are different.
Weight	0.66kg	0.16 + 0.40 = 0.56kg	○	

- *1 Consider the characteristics of the triac and observe the necessary precautions by referring to Section 3.3 (3) before replacing the modules.
- *2 Use the QX70 when using 12VDC.
- *3 Check the specifications of the sensor or switches to be connected to the QX80.
- *4 Install a fuse for each external terminal point to prevent the burnout of the external devices and modules during load shorts. In addition, when a fuse blown indication is necessary, configure an external circuit.

(14) Specifications comparison between A0J2E-E28DR and QX80+QY10

○ : Compatible, △ : Partially changed, × : Incompatible

Specifications		A0J2E-E28DR input specifications	QX80	Compatibility	Precautions for replacement
Number of input points		16 points	16 points	○	
Insulation method		Photocoupler	Photocoupler	○	
Rated input voltage		12VDC/24VDC	24VDC	△	12VDC cannot be used.*1
Rated input current		3mA/7mA	Approx. 4mA	△	Rated input current is smaller.*2
Operating voltage range		10.2 to 26.4VDC (Ripple ratio within 5%)	20.4 to 28.8VDC (Ripple ratio within 5%)	△	12VDC cannot be used.*1
Maximum number of simultaneous input points		100% simultaneously ON	100% simultaneously ON	○	
ON voltage/ON current		9.5VDC or more/2.6mA or more	19VDC or more/3mA or more	△	12VDC cannot be used.*1
OFF voltage/OFF current		6VDC or less/1.0mA or less	11VDC or less/1.7mA or less	△	12VDC cannot be used.*1
Input resistance		Approx. 3.4kΩ	Approx. 5.6kΩ	△	Input resistance is greater.*2
Input format		Source input (Input current flows in.)	Negative common	○	The name is different, but the specification is equal.
Response time	OFF→ON	5.5ms or less (TYP.)	1ms/5ms/10ms/20ms/70ms or less (Set it with CPU parameter.) Initial setting is 10ms.	○	Set the input response time of the parameter to 5ms before use.
	ON→OFF	6.0ms or less (TYP.)	1ms/5ms/10ms/20ms/70ms or less (Set it with CPU parameter.) Initial setting is 10ms.	○	
Response time high-speed mode (Only upper 8 points)	OFF→ON	0.5ms or less	1ms/5ms/10ms/20ms/70ms or less (Set it with CPU parameter.) Initial setting is 10ms.	△	Set the input response time of the parameter to 1ms before use.
	ON→OFF	1.0ms or less	1ms/5ms/10ms/20ms/70ms or less (Set it with CPU parameter.) Initial setting is 10ms.	○	
Common terminal arrangement		16 points/common (Common terminal: TB17)	16 points/common (Common terminal: TB18)	○	
Operation indication		Available (Turning ON the input turns LED ON)	ON indication (LED)	○	

○ : Compatible, △ : Partially changed, × : Incompatible

Specifications		A0J2E-E28DR output specifications	QY10	Compatibility	Precautions for replacement
Number of output points		12 points	16 points	○	
Insulation method		Photocoupler	Relay	△	Although the insulation methods differ, the performance of the Insulation is the same.
Rated switching voltage/current		24VDC 2A (Resistance load)/point 240VAC 2A (COSφ = 1)/point 5A/common	24VDC 2A (Resistance load)/point 240VAC 2A (COSφ = 1)/point 8A/common	○	
Minimum switching load		5VDC 1mA	5VDC 1mA	○	
Maximum switching voltage		250VAC, 125VDC	264VAC, 125VDC	○	
Maximum switching frequency		3600 times/hr	3600 times/hr	○	
Life	Mechanical	20 million times or more	20 million times or more	○	Reduce the exchange intervals of the modules as mechanical/ electrical life is cut to about half.
	Electrical	Rated switching voltage/current load 200,000 times or more 200VAC 1.5A, 240VAC 1A (COSφ=0.7) 200,000 times or more 200VAC 0.75A, 240VAC 0.5A (COSφ=0.35) 200,000 times or more 24VDC 1A, 100VDC 0.1A (L/R=7ms) 200,000 times or more	Rated switching voltage/current load 100,000 times or more 200VAC 1.5A, 240VAC 1A (COSφ=0.7) 100,000 times or more 200VAC 0.4A, 240VAC 0.3A (COSφ=0.7) 300,000 times or more 200VAC 1A, 240VAC 0.5A (COSφ=0.35) 100,000 times or more 200VAC 0.3A, 240VAC 0.15A (COSφ=0.35) 300,000 times or more 24VDC 1A, 100VDC 0.1A (L/R=7ms) 100,000 times or more 24VDC 0.3A, 100VDC 0.03A (L/R=7ms) 300,000 times or more	△	
Response time	OFF→ON	10ms or less	10ms or less	○	
	ON→OFF	12ms or less	12ms or less	○	
External supply power (relay coil driving power)	Voltage	24VDC±10% Ripple voltage 4Vp-p or less	—	○	External supply power is not required.
	Current	110mA (24VDC All points are ON.)	—	○	
Surge suppressor		Varistor (387 to 473V)	—	×	The varistor is not built in.*3
Fuse rating		8A MF51NM8 or FGMA250V8A	—	×	The fuse is not built in.*4
Common terminal arrangement		8 points/common (Common terminal: TB26) 4 points/common (Common terminal: TB32)	16 points/common (Common terminal: TB17)	△	As the common changes from two commons to a common, wiring with a different voltage for each common is not possible.
Operation indication		Available (Turning ON the output turns LED ON)	ON indication (LED)	○	
Specifications		A0J2E-E28DR	QX80/QY10	Compatibility	Precautions for replacement
Current consumption		0.13A (TYP. All points are ON.)	0.05 + 0.43 = 0.48A (TYP. All points are ON.)	△	Review current capacity since current consumption is increased.
External connection method		36-point terminal block connector (M3 × 6 screws)	18-point terminal block (M3 × 6 screws) 1 screw/module	×	Wiring change is required.
Applicable wire size		0.75 to 2mm ²	0.3 to 0.75mm ² core (Outside diameter: 2.8mm or less)	×	
Applicable solderless terminal		1.25-3, 1.25-YS3A, 2-S3, 2-YS3A, V1.25-3, V1.25-YS3A, V2-S3, V2-YS3A	R1.25-3 (Sleeved solderless terminals cannot be used.)	×	

○ : Compatible, △ : Partially changed, × : Incompatible

Specifications	A0J2E-E28DR	QX80/QY10	Compatibility	Precautions for replacement
External dimensions	250(H) × 132(W) × 41(D)mm	98(H) × 27.4(W) × 90(D)mm × 2	×	The dimensions are different.
Weight	0.7kg	0.16 + 0.22 = 0.38kg	△	

- *1 Use the QX70 when using 12VDC.
- *2 Check the specifications of the sensor or switches to be connected to the QX80.
- *3 Connect the varistor exteriorly to reduce noise.
- *4 Install a fuse for each external terminal point to prevent the burnout of the external devices and modules during load shorts.

(15) Specifications comparison between A0J2E-E28DT and QX80+QY80

○ : Compatible, △ : Partially changed, × : Incompatible

Specifications		A0J2E-E28DT input specifications	QX80	Compatibility	Precautions for replacement
Number of input points		16 points	16 points	○	
Insulation method		Photocoupler	Photocoupler	○	
Rated input voltage		12VDC/24VDC	24VDC	△	12VDC cannot be used. ^{*1}
Rated input current		3mA/7mA	Approx. 4mA	△	Rated input current is smaller. ^{*2}
Operating voltage range		10.2 to 26.4VDC (Ripple ratio within 5%)	20.4 to 28.8VDC (Ripple ratio within 5%)	△	12VDC cannot be used. ^{*1}
Maximum number of simultaneous input points		100% simultaneously ON	100% simultaneously ON	○	
ON voltage/ON current		9.5VDC or more/2.6mA or more	19VDC or more/3mA or more	△	12VDC cannot be used. ^{*1}
OFF voltage/OFF current		6VDC or less/1.0mA or less	11VDC or less/1.7mA or less	△	12VDC cannot be used. ^{*1}
Input resistance		Approx. 3.4kΩ	Approx. 5.6kΩ	△	Input resistance is greater. ^{*2}
Input format		Source input (Input current flows in.)	Negative common	○	The name is different, but the specification is equal.
Response time	OFF→ON	5.5ms or less (TYP.)	1ms/5ms/10ms/20ms/70ms or less (Set it with CPU parameter.) Initial setting is 10ms.	○	Set the input response time of the parameter to 5ms before use.
	ON→OFF	6.0ms or less (TYP.)	1ms/5ms/10ms/20ms/70ms or less (Set it with CPU parameter.) Initial setting is 10ms.	○	
Response time high-speed mode (Only upper 8 points)	OFF→ON	0.5ms or less	1ms/5ms/10ms/20ms/70ms or less (Set it with CPU parameter.) Initial setting is 10ms.	△	Set the input response time of the parameter to 1ms before use.
	ON→OFF	1.0ms or less	1ms/5ms/10ms/20ms/70ms or less (Set it with CPU parameter.) Initial setting is 10ms.	○	
Common terminal arrangement		16 points/common (Common terminal: TB17)	16 points/common (Common terminal: TB18)	○	
Operation indication		Available (Turning ON the input turns LED ON)	ON indication (LED)	○	
Specifications		A0J2E-E28DT output specifications	QY80	Compatibility	Precautions for replacement
Number of output points		12 points	16 points	○	
Insulation method		Photocoupler	Photocoupler	○	
Rated load voltage		12/24VDC	12 to 24VDC	○	
Operating load voltage range		10.2 to 26.4VDC	10.2 to 28.8VDC	○	
Maximum load current		0.8A/1 point, 0.7A/1 point (60% ON, 55°C)	0.5A/1 point, 4A/1 common	△	The maximum load current per point is smaller. Use caution on selecting the load to use.
Maximum inrush current		No restriction (Short protect)	4A 10ms or less	△	The inrush current value differs. Use caution on selecting the load to use.
Leakage current at OFF		1.0mA or less	0.1mA or less	○	
Maximum voltage drop at ON		1.0V (TYP.) 0.8A, 1.5V (MAX.) 0.8A	0.2VDC (TYP.) 0.5A, 0.3VDC (MAX.) 0.5A	○	
Response time	OFF→ON	0.5ms or less	1ms or less	△	The response times differ.
	ON→OFF	1.5ms or less	1ms or less (Rated load, resistance load)	○	
External supply power	Voltage	12/24VDC (10.2 to 30VDC)	12 to 24VDC (+20/-15%) (Ripple ratio within 5%)	△	Voltages exceeding 28.8VDC cannot be applied.
	Current	100mA (24VDC, All points are ON.)	20mA (During 24VDC)	○	
Surge suppressor		Surge absorbing diode	Zener diode	○	

○ : Compatible, △ : Partially changed, × : Incompatible

Specifications	A0J2E-E28DT output specifications	QY80	Compatibility	Precautions for replacement
Fuse rating	–	6.7A (Not exchangeable) (Fuse blown capacity: 50A)	△	The QY80 has the fuse instead of overheat and short circuit protection function.
Fuse blown indication	–	Available (When a fuse blown occurs, LED is lit, and a signal is output to the CPU) ^{*3}		
Protection function	Available (overheat protection and short circuit protection) Overheat protection: activated to two points	–		
Protection function reset	Automatic reset (by deactivating overheat protection function)	–		
Common terminal arrangement	8 points/common (Common terminal: TB26) 4 points/common (Common terminal: TB32)	16 points/common (Common terminal: TB17)	△	As the common changes from two commons to a common, wiring with a different voltage for each common is not possible.
Operation indication	Available (Turning ON the output turns LED ON)	ON indication (LED)	○	
Specifications	A0J2E-E56DT	QX80/QY80	Compatibility	Precautions for replacement
Current consumption	0.125A (TYP. All points are ON.)	0.05 + 0.08 = 0.13A (TYP. All points are ON.)	△	Review current capacity since current consumption is increased.
External connection method	36-point terminal block connector (M3 × 6 screws)	18-point terminal block (M3 × 6 screws) 1 piece/module	×	Wiring change is required.
Applicable wire size	0.75 to 2mm ²	0.3 to 0.75mm ² core (Outside diameter: 2.8mm or less)	×	
Applicable solderless terminal	1.25-3, 1.25-YS3A, 2-S3, 2-YS3A, V1.25-3, V1.25-YS3A, V2-S3, V2-YS3A	R1.25-3 (Sleeved solderless terminals cannot be used.)	×	
External dimensions	250(H) × 132(W) × 41(D)mm	98(H) × 27.4(W) × 90(D)mm × 2	×	The dimensions are different.
Weight	0.68kg	0.16 + 0.17 = 0.33kg	△	

*1 Use the QX70 when using 12VDC.

*2 Check the specifications of the sensor or switches to be connected to the QX80.

*3 The fuse blown is not detected when the external power supply is off.

(16) Specifications comparison between A0J2E-E56DR and QX80+QY10

○ : Compatible, △ : Partially changed, × : Incompatible

Specifications		A0J2E-E56DR input specifications	QX80	Compatibility	Precautions for replacement
Number of input points		32 points	16 points	△	When seventeen or more points are used, use two QX80s.
Insulation method		Photocoupler	Photocoupler	○	
Rated input voltage		12VDC/24VDC	24VDC	△	12VDC cannot be used.* ¹
Rated input current		3mA/7mA	Approx. 4mA	△	Rated input current is smaller.* ²
Operating voltage range		10.2 to 26.4VDC (Ripple ratio within 5%)	20.4 to 28.8VDC (Ripple ratio within 5%)	△	12VDC cannot be used.* ¹
Maximum number of simultaneous input points		60% (10 points/common) simultaneously ON	100% simultaneously ON	○	
ON voltage/ON current		9.5VDC or more/2.6mA or more	19VDC or more/3mA or more	△	12VDC cannot be used.* ¹
OFF voltage/OFF current		6VDC or less/1.0mA or less	11VDC or less/1.7mA or less	△	12VDC cannot be used.* ¹
Input resistance		Approx. 3.4kΩ	Approx. 5.6kΩ	△	Input resistance is greater.* ²
Input format		Source input (Input current flows in.)	Negative common	○	The name is different, but the specification is equal.
Response time	OFF→ON	5.5ms or less (TYP.)	1ms/5ms/10ms/20ms/70ms or less (Set it with CPU parameter.) Initial setting is 10ms.	○	Set the input response time of the parameter to 5ms before use.
	ON→OFF	6.0ms or less (TYP.)	1ms/5ms/10ms/20ms/70ms or less (Set it with CPU parameter.) Initial setting is 10ms.	○	
Response time high-speed mode (Only upper 8 points)	OFF→ON	0.5ms or less	1ms/5ms/10ms/20ms/70ms or less (Set it with CPU parameter.) Initial setting is 10ms.	△	Set the input response time of the parameter to 1ms before use.
	ON→OFF	1.0ms or less	1ms/5ms/10ms/20ms/70ms or less (Set it with CPU parameter.) Initial setting is 10ms.	○	
Common terminal arrangement		16 points/common (Common terminal: TB17, TB34)	16 points/common (Common terminal: TB18)	○	
Operation indication		Available (Turning ON the input turns LED ON)	ON indication (LED)	○	

○ : Compatible, △ : Partially changed, × : Incompatible

Specifications		A0J2E-E56DR output specifications	QY10	Compatibility	Precautions for replacement
Number of output points		24 points	16 points	△	When seventeen or more points are used, use two QY10s.
Insulation method		Photocoupler	Relay	△	Although the insulation methods differ, the performance of the Insulation is the same.
Rated switching voltage/current		24VDC 2A (Resistance load)/point 240VAC 2A (COSφ = 1)/point 5A/common	24VDC 2A (Resistance load)/point 240VAC 2A (COSφ = 1)/point 8A/common	○	
Minimum switching load		5VDC 1mA	5VDC 1mA	○	
Maximum switching voltage		250VAC, 125VDC	264VAC, 125VDC	○	
Maximum switching frequency		3600 times/hr	3600 times/hr	○	
Life	Mechanical	20 million times or more	20 million times or more	○	Reduce the exchange intervals of the modules as mechanical/ electrical life is cut to about half.
	Electrical	Rated switching voltage/current load 200,000 times or more	Rated switching voltage/current load 100,000 times or more	△	
		200VAC 1.5A, 240VAC 1A (COSφ=0.7) 200,000 times or more 200VAC 0.75A, 240VAC 0.5A (COSφ=0.35) 200,000 times or more 24VDC 1A, 100VDC 0.1A (L/R=7ms) 200,000 times or more	200VAC 1.5A, 240VAC 1A (COSφ=0.7) 100,000 times or more 200VAC 0.4A, 240VAC 0.3A (COSφ=0.7) 300,000 times or more 200VAC 1A, 240VAC 0.5A (COSφ=0.35) 100,000 times or more 200VAC 0.3A, 240VAC 0.15A (COSφ=0.35) 300,000 times or more 24VDC 1A, 100VDC 0.1A (L/R=7ms) 100,000 times or more 24VDC 0.3A, 100VDC 0.03A (L/R=7ms) 300,000 times or more	△	
Response time	OFF→ON	10ms or less	10ms or less	○	
	ON→OFF	12ms or less	12ms or less	○	
External supply power (relay coil driving power)	Voltage	24VDC±10% Ripple voltage 4Vp-p or less	—	○	External supply power is not required.
	Current	220mA (24VDC All points are ON.)	—	○	
Surge suppressor		Varistor (387 to 473V)	—	×	The varistor is not built in. ^{*3}
Fuse rating		8A MF51NM8 or FGMA250V8A	—	×	The fuse is not built in. ^{*4}
Common terminal arrangement		8 points/common (Common terminal: TB9, TB19, TB29)	16 points/common (Common terminal: TB17)	△	As the common changes from three commons to a common, wiring with a different voltage for each common is not possible.
Operation indication		Available (Turning ON the output turns LED ON)	ON indication (LED)	○	
Specifications		A0J2E-E56DR	QX80/QY10	Compatibility	Precautions for replacement
Current consumption		0.23A (TYP. All points are ON.)	0.05 × 2 + 0.43 × 2 = 0.96A (TYP. All points are ON.)	△	Review current capacity since current consumption is increased.
External connection method		36-point terminal block connector (M3 × 6 screws) 2 pieces	18-point terminal block (M3 × 6 screws) 1 screw/module	×	Wiring change is required.
Applicable wire size		0.75 to 2mm ²	0.3 to 0.75mm ² core (Outside diameter: 2.8mm or less)	×	
Applicable solderless terminal		1.25-3, 1.25-YS3A, 2-S3, 2-YS3A, V1.25-3, V1.25-YS3A, V2-S3, V2-YS3A	R1.25-3 (Sleeved solderless terminals cannot be used.)	×	

○ : Compatible, △ : Partially changed, × : Incompatible

Specifications	A0J2E-E56DR	QX80/QY10	Compatibility	Precautions for replacement
External dimensions	250(H) × 190(W) × 41(D)mm	98(H) × 27.4(W) × 90(D)mm × 4	×	The dimensions are different.
Weight	1.13kg	0.16 × 2 + 0.22 × 2 = 0.76kg	△	

- *1 Use the QX70 when using 12VDC.
- *2 Check the specifications of the sensor or switches to be connected to the QX80.
- *3 Connect the varistor exteriorly to reduce noise.
- *4 Install a fuse for each external terminal point to prevent the burnout of the external devices and modules during load shorts.

(17) Specifications comparison between A0J2E-E56DS and QX80+QY22*1

○ : Compatible, △ : Partially changed, × : Incompatible

Specifications		A0J2E-E56DS input specifications	QX80	Compatibility	Precautions for replacement
Number of input points		32 points	16 points	△	When seventeen or more points are used, use two QX80s.
Insulation method		Photocoupler	Photocoupler	○	
Rated input voltage		12VDC/24VDC	24VDC	△	12VDC cannot be used.*2
Rated input current		3mA/7mA	Approx. 4mA	△	Rated input current is smaller.*3
Operating voltage range		10.2 to 26.4VDC (Ripple ratio within 5%)	20.4 to 28.8VDC (Ripple ratio within 5%)	△	12VDC cannot be used.*2
Maximum number of simultaneous input points		60% (10 points/common) simultaneously ON	100% simultaneously ON	○	
ON voltage/ON current		9.5VDC or more/2.6mA or more	19VDC or more/3mA or more	△	12VDC cannot be used.*2
OFF voltage/OFF current		6VDC or less/1.0mA or less	11VDC or less/1.7mA or less	△	12VDC cannot be used.*2
Input resistance		Approx. 3.4kΩ	Approx. 5.6kΩ	△	Input resistance is greater.*3
Input format		Source input (Input current flows in.)	Negative common	○	The name is different, but the specification is equal.
Response time	OFF→ON	5.5ms or less (TYP.)	1ms/5ms/10ms/20ms/70ms or less (Set it with CPU parameter.) Initial setting is 10ms.	○	Set the input response time of the parameter to 5ms before use.
	ON→OFF	6.0ms or less (TYP.)	1ms/5ms/10ms/20ms/70ms or less (Set it with CPU parameter.) Initial setting is 10ms.	○	
Response time high-speed mode (Only upper 8 points)	OFF→ON	0.5ms or less	1ms/5ms/10ms/20ms/70ms or less (Set it with CPU parameter.) Initial setting is 10ms.	△	Set the input response time of the parameter to 1ms before use.
	ON→OFF	1.0ms or less	1ms/5ms/10ms/20ms/70ms or less (Set it with CPU parameter.) Initial setting is 10ms.	○	
Common terminal arrangement		16 points/common (Common terminal: TB17, TB34)	16 points/common (Common terminal: TB18)	○	
Operation indication		Available (Turning ON the input turns LED ON)	ON indication (LED)	○	
Specifications		A0J2E-E56DS output specifications	QY22	Compatibility	Precautions for replacement
Number of output points		12 points	16 points	△	When seventeen or more points are used, use two QY22s.
Insulation method		Photocoupler	Photocoupler	○	
Rated load voltage		100 to 240VAC, 40 to 70Hz	100 to 240VAC 50/60Hz±5%	△	
Maximum load voltage		264VAC	264VAC	○	
Maximum load current		0.6A/ point 0.6A/point (60% ON, 55°C)	0.6A/point, 4.8A/common	○	
Minimum load voltage, current		24VAC 100mA 100VAC 10mA 240VAC 10mA	24VAC 100mA 100VAC 25mA 240VAC 25mA	△	The minimum load current is greater. Use caution on selecting the load to use.
Maximum inrush current		20A 10ms or less 8A 100ms or less	20A 1 cycle or less	○	
Leakage current at OFF		1.5mA (120VAC 60Hz) 3mA (240VAC 60Hz)	1.5mA or less (During 120V 60Hz) 3mA or less (During 240V 60Hz)	○	
Maximum voltage drop at ON		1.5V or less (100 to 600mA) 1.8V or less (100mA or less) 2.0V or less (10 to 50mA)	1.5V or less	○	

○ : Compatible, △ : Partially changed, × : Incompatible

Specifications		A0J2E-E56DS output specifications	QY22	Compatibility	Precautions for replacement
Response time	OFF→ON	1ms or less	1ms or less	○	
	ON→OFF	0.5 cycle + 1ms or less	1ms + 0.5 cycle or less (Rated load, resistance load)	○	
Surge suppressor		CR absorber (0.022μF + 47Ω)	CR absorber	○	
Fuse rating		High speed type fuse 3.2A (1/common) HP-32	–	×	The fuse is not built in.*4
Fuse blown indication		Available (When a fuse blown occurs, LED is lit, and a signal is output to the CPU)	–	×	
Common terminal arrangement		8 points/common (Common terminal: TB9, TB19, TB29)	16 points/common (Common terminal: TB17)	△	As the common changes from three commons to a common, wiring with a different voltage for each common is not possible.
Operation indication		Available (Turning ON the output turns LED ON)	ON indication (LED)	○	
Specifications		A0J2E-E56DS	QX80/QY22	Compatibility	Precautions for replacement
Current consumption		0.46A (TYP. All points are ON.)	0.05 × 2 + 0.25 × 2 = 0.60A (TYP. All points are ON.)	△	Review current capacity since current consumption is increased.
External connection method		36-point terminal block connector (M3 × 6 screws) 2 pieces	18-point terminal block (M3 × 6 screws) 1 piece/module	×	Wiring change is required.
Applicable wire size		0.75 to 2mm ²	0.3 to 0.75mm ² core (Outside diameter: 2.8mm or less)	×	
Applicable solderless terminal		1.25-3, 1.25-YS3A, 2-S3, 2-YS3A, V1.25-3, V1.25-YS3A, V2-S3, V2-YS3A	R1.25-3 (Sleeved solderless terminals cannot be used.)	×	
External dimensions		250(H) × 190(W) × 41(D)mm	98(H) × 27.4(W) × 90(D)mm × 4	×	The dimensions are different.
Weight		1.08kg	0.16 × 2 + 0.40 × 2 = 1.12kg	△	Be aware of that the weight increases when calculating the weight.

*1 Consider the characteristics of the triac and observe the necessary precautions by referring to Section 3.3 (3) before replacing the modules.

*2 Use the QX70 when using 12VDC.

*3 Check the specifications of the sensor or switches to be connected to the QX80.

*4 Install a fuse for each external terminal point to prevent the burnout of the external devices and modules during load shorts.

(18) Specifications comparison between A0J2E-E56DT and QX80+QY80

○ : Compatible, △ : Partially changed, × : Incompatible

Specifications		A0J2E-E56DT input specifications	QX80	Compatibility	Precautions for replacement
Number of input points		32 points	16 points	△	When seventeen or more points are used, use two QX80s.
Insulation method		Photocoupler	Photocoupler	○	
Rated input voltage		12VDC/24VDC	24VDC	△	12VDC cannot be used.*1
Rated input current		3mA/7mA	Approx. 4mA	△	Rated input current is smaller.*2
Operating voltage range		10.2 to 26.4VDC (Ripple ratio within 5%)	20.4 to 28.8VDC (Ripple ratio within 5%)	△	12VDC cannot be used.*1
Maximum number of simultaneous input points		60% (10 points/common) simultaneously ON	100% simultaneously ON	○	
ON voltage/ON current		9.5VDC or more/2.6mA or more	19VDC or more/3mA or more	△	12VDC cannot be used.*1
OFF voltage/OFF current		6VDC or less/1.0mA or less	11VDC or less/1.7mA or less	△	12VDC cannot be used.*1
Input resistance		Approx. 3.4kΩ	Approx. 5.6kΩ	△	Input resistance is greater.*2
Input format		Source input (Input current flows in.)	Negative common	○	The name is different, but the specification is equal.
Response time	OFF→ON	5.5ms or less (TYP.)	1ms/5ms/10ms/20ms/70ms or less (Set it with CPU parameter.) Initial setting is 10ms.	○	Set the input response time of the parameter to 5ms before use.
	ON→OFF	6.0ms or less (TYP.)	1ms/5ms/10ms/20ms/70ms or less (Set it with CPU parameter.) Initial setting is 10ms.	○	
Response time high-speed mode (Only upper 8 points)	OFF→ON	0.5ms or less	1ms/5ms/10ms/20ms/70ms or less (Set it with CPU parameter.) Initial setting is 10ms.	△	Set the input response time of the parameter to 1ms before use.
	ON→OFF	1.0ms or less	1ms/5ms/10ms/20ms/70ms or less (Set it with CPU parameter.) Initial setting is 10ms.	○	
Common terminal arrangement		16 points/common (Common terminal: TB17, TB34)	16 points/common (Common terminal: TB18)	○	
Operation indication		Available (Turning ON the input turns LED ON)	ON indication (LED)	○	

○ : Compatible, △ : Partially changed, × : Incompatible

Specifications		A0J2E-E56DT output specifications	QY80	Compatibility	Precautions for replacement
Number of output points		24 points	16 points	△	When seventeen or more points are used, use two QY80s.
Insulation method		Photocoupler	Photocoupler	○	
Rated load voltage		12/24VDC	12 to 24VDC	○	
Operating load voltage range		10.2 to 26.4VDC	10.2 to 28.8VDC	○	
Maximum load current		0.8A/1 point, 0.8A/1 point (60% ON, 55°C)	0.5A/1 point, 4A/1 common	△	The maximum load current per point is smaller. Use caution on selecting the load to use.
Maximum inrush current		No restriction (Short protect)	4A 10ms or less	△	The inrush current value differs. Use caution on selecting the load to use.
Leakage current at OFF		1.0mA or less	0.1mA or less	○	
Maximum voltage drop at ON		1.0V (TYP.) 0.8A, 1.5V (MAX.) 0.8A	0.2VDC (TYP.) 0.5A, 0.3VDC (MAX.) 0.5A	○	
Response time	OFF→ON	0.5ms or less	1ms or less	△	The response times differ.
	ON→OFF	1.5ms or less	1ms or less (Rated load, resistance load)	○	
External supply power	Voltage	12/24VDC (10.2 to 30VDC)	12 to 24VDC (+20/-15%) (Ripple ratio within 5%)	△	Voltages exceeding 28.8VDC cannot be applied.
	Current	200mA (24VDC, All points are ON.)	20mA (During 24VDC)	○	
Surge suppressor		Surge absorbing diode	Zener diode	○	
Fuse		–	6.7A (Not exchangeable) (Fuse blown capacity: 50A)	○	
Fuse blown indication		–	Available (When a fuse blown occurs, LED is lit, and a signal is output to the CPU)*3	○	The QY80 has the fuse instead of overheat and short circuit protection function.
Protection function		Available (overheat protection and short circuit protection) Overheat protection: activated to two points	–	×	
Protection function reset		Automatic reset (by deactivating overheat protection function)	–	–	
Common terminal arrangement		8 points/common (Common terminal: TB9, TB19, TB29)	16 points/common (Common terminal: TB17)	△	As the common changes from three commons to a common, wiring with a different voltage for each common is not possible.
Operation indication		Available (Turning ON the output turns LED ON)	ON indication (LED)	○	
Specifications		A0J2E-E56DT	QX80/QY22	Compatibility	Precautions for replacement
Current consumption		0.225A (TYP. All points are ON.)	0.05 × 2 + 0.08 × 2 = 0.26A (TYP. All points are ON.)	△	Review current capacity since current consumption is increased.
External connection method		36-point terminal block connector (M3 × 6 screws) 2 pieces	18-point terminal block (M3 × 6 screws) 1 piece/module	×	Wiring change is required.
Applicable wire size		0.75 to 2mm ²	0.3 to 0.75mm ² core (Outside diameter: 2.8mm or less)	×	
Applicable solderless terminal		1.25-3, 1.25-YS3A, 2-S3, 2-YS3A, V1.25-3, V1.25-YS3A, V2-S3, V2-YS3A	R1.25-3 (Sleeved solderless terminals cannot be used.)	×	
External dimensions		250(H) × 190(W) × 41(D)mm	98(H) × 27.4(W) × 90(D)mm × 4	×	The dimensions are different.
Weight		1.08kg	0.16 × 2 + 0.17 × 2 = 0.66kg	△	

*1 Use the QX70 when using 12VDC.

*2 Check the specifications of the sensor or switches to be connected to the QX80.

*3 The fuse blown is not detected when the external power supply is off.

3.3 Precautions for I/O Module Replacement

(1) Wiring

(a) Wire gauge and size of solderless terminals

As the Q series supports compact modules and terminal blocks, the wire gauge and size of the solderless terminals that can be used on terminal blocks differ from those that can be used on the A0J2H series.

For this reason, when replacing with the Q series, use wire gauges and solderless terminals that match the specifications of the Q series I/O modules.

(2) Precautions for input module (specifications change)

(a) The rated input current

Some Q series input modules support a smaller rated input current than the A0J2H series input modules do. Confirm the specifications of the sensors or switches to be connected.

(b) The OFF current

Some Q series input modules support an OFF current than the A0J2H series input modules do. Confirm the specifications of the sensors or switches to be connected.

(c) The maximum number of simultaneous input points

Some Q series input modules have less maximum number of simultaneous input points than the A0J2H series input modules do. When replacing with the Q series, refer to the derating chart and use within the range indicated in the derating chart.

(d) The rated voltage value

The QX4□ and QX8□ model DC input modules of the Q series are dedicated to 24VDC. When using 12VDC, use the QX7□.

(e) The response time

On the DC input modules of the Q series, the input response time can be configured using the parameter.

Use the parameter to configure the input response time according to the response time of the A0J2H series input module.

(f) Common terminal arrangement

Use caution when using voltages that differ depending on each common as common terminal arrangement may differ between the A0J2H series and the Q series.

(3) Precautions for output module (specifications change)

(a) The output current values

Some Q series output modules support a smaller output current than the A0J2H series output modules do. Before using Q series output modules having a smaller output current, confirm the specifications on the load side.

(b) Common terminal arrangement

Use caution when using voltages that differ depending on each common as common terminal arrangement may differ between the A0J2H series and the Q series.

(c) The common maximum load current

The maximum load current per common may differ between A0J2H series and Q series. Check the maximum load current per common before use.

(d) Precautions when using the triac output module

Operation of the triac that is used on the triac output module may be unstable when a sudden change occurs in the voltage and current due to component characteristics.

Problems due to voltage and current fluctuation might become obvious depending on individual differences between components. For this reason, refer to the following manual and check for any corresponding items in the precautions.

MELSEC-Q I/O Module Type Building Block User's Manual

4 REPLACING POWER SUPPLY MODULES

4.1 List of Alternative Power Supply Module Models

A0J2H series to be discontinued		Alternative Q series models	
Product name	Model name	Model name	Remarks (restricted items)
CPU built-in power supply component	A0J2HCPU	Q61P	1) Change in external wiring: Required 2) Change in specifications: Does not have 24VDC output. Requires external 24VDC power supply.
		Q62P	1) Change in external wiring: Required 2) Change in specifications: Not required
	A0J2H-DC24	Q63P	1) Change in external wiring: Required 2) Change in specifications: Not required
Power supply module	A0J2PW	-	For selecting the power supply module, refer to Section 4.2.
	A0J2PW-DC24		

4.2 Specifications Comparison of Power Supply Modules

(1) Specifications comparison between A0J2HCPU power supply component and Q61P

○ : Compatible, △ : Partially changed, × : Incompatible

Specifications		A0J2HCPU power supply component	Q61P	Compatibility	Precautions for replacement
Input power supply		100 to 120VAC +10% -15% (85 to 132VAC)	100 to 240VAC +10% -15% (85 to 264VAC)	○	The Q61P is the wide range type (100 to 240VAC).
		200 to 240VAC +10% -15% (170 to 264VAC)			
Input frequency		50/60Hz±5%	50/60Hz±5%	○	
Input voltage distortion		–	Within 5%	○	
Max. input apparent power		56VA or less	130VA	△	The apparent power of Q61P is larger than the one of A0J2HCPU power supply component. When using a UPS, check the capacity by the calculation.
Inrush current		Within 40A 5ms	Within 20A 8ms	○	
Rated output current	5VDC	2A	6A	○	
	24VDC	0.5A	–	×	When 24VDC power supply is required, add it separately.
Overcurrent protection	5VDC	2.4A or more	6.6A or more	○	
	24VDC	0.6A or more	–	○	
Overvoltage protection	5VDC	–	5.5 to 6.5V	○	
	24VDC	–	–	–	
Efficiency		65% or more	70% or more	○	
Operation indicator		LED indication of power supply	LED indication (Lit at 5VDC output)	○	
Terminal screw size		M4 × 0.7 × 8	M3.5 screw	×	Wiring change is required.
Applicable wire size		0.75 to 2mm ²	0.75 to 2mm ²	○	
Applicable solderless terminal		V1.25-4, V1.25-YS4A, V2-S4, V2-YS4A	RAV1.25-3.5, RAV2-3.5	×	Wiring change is required.
Applicable tightening torque		98 to 137N•cm	66 to 89N•cm	×	Tighten within the applicable tightening torque.
External dimensions		250(H) × 112(W) × 41(D)mm	98(H) × 55.2(W) × 90(D)mm	△	The shape configuration differs.
Weight		–	0.40kg	–	
Allowable momentary power failure period		Within 20ms	Within 20ms	○	
Noise durability		Noise voltage 1500Vp-p	According to a noise simulator with noise voltage 1500Vp-p, noise width of 1μs and noise frequency of 25 to 60Hz	○	
Dielectric withstand voltage		Between AC external terminal batch and ground 1500VAC 1 minute Between DC external terminal batch and ground 500VAC 1 minute	Between input•LG batch and output•FG batch 2,830VACrms/3 cycles (Elevation 2000m)	○	
Isolation resistance		Between AC external terminal batch and ground 500VDC 10MΩ or more according to isolation resistance tester	Between input batch and output batch(LG•FG separated), Between input batch and LG•FG Between output batch and FG•LG 10MΩ or more according to 500VDC isolation resistance tester	○	
Accessory		Short bar for operating voltage switching terminal: 1	None	○	Short bars are not included as switching an operating voltage is not necessary.

(2) Specifications comparison between A0J2HCPU power supply component and Q62P

○ : Compatible, △ : Partially changed, × : Incompatible

Specifications		A0J2HCPU power supply component	Q62P	Compatibility	Precautions for replacement
Input power supply		100 to 120VAC +10% -15% (85 to 132VAC)	100 to 240VAC +10% -15% (85 to 264VAC)	○	The Q62P is the wide range type (100 to 240VAC).
		200 to 240VAC +10% -15% (170 to 264VAC)			
Input frequency		50/60Hz±5%	50/60Hz±5%	○	
Input voltage distortion		Within 5%	Within 5%	○	
Max. input apparent power		56VA or less	105VA	△	
Inrush current		Within 40A 5ms	Within 20A 8ms	○	
Rated output current	5VDC	2A	3A	○	
	24VDC	0.5A	0.6A	○	
Overcurrent protection	5VDC	2.4A or more	3.3A or more	○	
	24VDC	0.6A or more	0.66A or more	○	
Overvoltage protection	5VDC	–	5.5 to 6.5V	○	
	24VDC	–	–	–	
Efficiency		65% or more	65% or more	○	
Operation indicator		LED indication of power supply	LED indication (Lit at 5VDC output)	○	
Terminal screw size		M4 × 0.7 × 8	M3.5 screw	×	Wiring change is required.
Applicable wire size		0.75 to 2mm ²	0.75 to 2mm ²	○	
Applicable solderless terminal		V1.25-4, V1.25-YS4A, V2-S4, V2-YS4A	RAV1.25-3.5, RAV2-3.5	×	Wiring change is required.
Applicable tightening torque		98 to 137N·cm	66 to 89N·cm	×	Tighten within the applicable tightening torque.
External dimensions		250(H) × 112(W) × 41(D)mm	98(H) × 55.2(W) × 90(D)mm	△	The shape configuration differs.
Weight		–	0.39kg	–	
Allowable momentary power failure period		Within 20ms	Within 20ms	○	
Noise durability		Noise voltage 1500Vp-p	According to a noise simulator with noise voltage 1500Vp-p, noise width of 1μs and noise frequency of 25 to 60Hz	○	
Dielectric withstand voltage		Between AC external terminal batch and ground 1500VAC 1 minute Between DC external terminal batch and ground 500VAC 1 minute	Between input·LG batch and output·FG batch 2,830VACrms/3 cycles (Elevation 2000m)	○	
Isolation resistance		Between AC external terminal batch and ground 500VDC 10MΩ or more according to isolation resistance tester	Between input batch and output batch(LG·FG separated), Between input batch and LG·FG Between output batch and FG·LG 10MΩ or more according to 500VDC isolation resistance tester	○	
Accessory		Short bar for operating voltage switching terminal: 1	None	○	Short bars are not included as switching an operating voltage is not necessary.

(3) Specifications comparison between A0J2H-DC24 power supply component and Q63P

○ : Compatible, △ : Partially changed, × : Incompatible

Specifications	A0J2H-DC24 power supply component	Q63P	Compatibility	Precautions for replacement
Input power supply	24VDC +30% -35% (15.6 to 31.2VDC)	24VDC +30% -35% (15.6 to 31.2VDC)	○	
Max. input apparent power	24W	45W	△	
Inrush current	Within 50A 2ms	Within 100A 1ms (During 24VDC input)	△	
Rated output current	5VDC	2A	○	
	24VDC	—	—	
Overcurrent protection	5VDC	2.4A or more	○	
	24VDC	—	—	
Overvoltage protection	5VDC	—	○	
	24VDC	—	—	
Efficiency	65% or more	70% or more	○	
Operation indicator	LED indication of power supply	LED indication (Lit at 5VDC output)	○	
Terminal screw size	M4 × 0.7 × 8	M3.5 screw	×	Wiring change is required.
Applicable wire size	0.75 to 2mm ²	0.75 to 2mm ²	○	
Applicable solderless terminal	V1.25-4, V1.25-YS4A, V2-S4, V2-YS4A	RAV1.25-3.5, RAV2-3.5	×	Wiring change is required.
Applicable tightening torque	98 to 137N·cm	66 to 89N·cm	×	Tighten within the applicable tightening torque.
External dimensions	250(H) × 112(W) × 41(D)mm	98(H) × 55.2(W) × 90(D)mm	△	The dimensions are different.
Weight	—	0.33kg	—	
Allowable momentary power failure period	Within 1ms	Within 10ms During 24VDC input	○	
Noise durability	Noise voltage 500Vp-p	According to a noise simulator with noise voltage 500Vp-p, noise width of 1μs and noise frequency 25 to 60Hz	○	
Dielectric withstand voltage	Between DC external terminal batch and ground 500VAC 1 minute	500VAC between primary and 5VDC	○	
Isolation resistance	Between AC external terminal batch and ground 10MΩ or more according to 500VDC isolation resistance tester	10MΩ or more according to isolation resistance tester	○	
Accessory	None	None	—	

(4) A0J2PW specifications

Specifications		A0J2PW
Input power supply		100 to 120VAC +10% -15% (85 to 132VAC)
		200 to 240VAC +10% -15% (170 to 264VAC)
Input frequency		50/60Hz±5%
Input voltage distortion		Within 5%
Max. input apparent power		120VA/150VA
Inrush current		Within 40A 5ms
Rated output current	5VDC	2.3A
	24VDC	0.8A
Overcurrent protection	5VDC	2.6A or more
	24VDC	1.95A or more
Overvoltage protection	5VDC	—
	24VDC	—
Efficiency		65% or more
Power supply indicator		LED indication of power supply
Terminal screw size		M4 × 0.7 × 8
Applicable wire size		0.75 to 2mm ²
Applicable solderless terminal		V1.25-4, V1.25-YS4A, V2-S4, V2-YS4A
Applicable tightening torque		98 to 137N·cm
External dimensions		250(H) × 112(W) × 41(D)mm
Weight		0.71kg
Allowable momentary power failure period		Within 20ms
Noise durability		Noise voltage 1500Vp-p
Dielectric withstand voltage		Between AC external terminal batch and ground 1500VAC 1 minute
		Between DC external terminal batch and ground 500VAC 1 minute
Isolation resistance		Between AC external terminal batch and ground 10MΩ or more according to 500VDC isolation resistance tester
Accessory		Short bar for operating voltage switching terminal: 1

☒ Point

When the A0J2HCPU's build-in power supply is insufficient, please use the A0J2PW power supply module.

For A0J2PW replacement, the following methods are recommended:

- When A0J2PW is used to supply 5VDC
For an alternative Q series models, select a CPU module with large capacity of 5VDC output current, such as Q61P (Select the Q63P when the A0J2HCPU-DC24 is used).
- When A0J2PW is used to supply 24VDC
Purchase a commercially available 24VDC output power supply, and add it separately.

4.3 Precautions for Replacement of the CPU Module

- (1) The current consumption of the Q series and the A0J2H series differ. Calculate the current consumption of the entire system to select the power supply module.
- (2) The wires and solderless terminals that can be used on the Q series terminal block differ from those that can be used on the A0J2H series. Use wires and solderless terminals that match the specifications.
- (3) The Q61P and Q62P (input power supply) is the wide range type. The modules support the operating voltage of 100VAC and 200VAC.
- (4) When the Q62P (5VDC output current: 3A) has insufficient current capacity, it is recommended to use Q61P (5VDC output, current: 6A) or Q64PN (5VDC output, current 8.5A). However, as these power supply modules do not output 24VDC, it is necessary to separately prepare a commercially available 24VDC output power supply.

5 EXTENSION CABLE REPLACEMENT

5.1 List of Alternative Extension Cable Models

A0J2H series models to be discontinued		Q series alternative models	
Product	Model	Model	Remarks (restrictions)
Extension cable	A0J2C01	-	For the Q series, cables for connecting between each module are not required. For details, refer to Section 5.2.
	A0J2C03		
	A0J2C03F		
	A0J2C06		
	A0J2C10		
	A0J2C20		
	A0J2C04B	-	Select an extension cable only when an extension base unit such as the Q series large type extension base unit is used. For details, refer to Section 5.2.
	A0J2C10B		

5.2 Precautions for Extension Cable Replacement

Connecting each module by using an extension cable is required in the A0J2H series system while it is not required in the Q series system.

Select an extension cable, only when an extension base unit is required because the number of slots of the main base unit is not enough or the Q series large type main base unit is used due to increasing the number of modules after replacement.

Select the length of an extension cable considering the module configuration and installation position of the base unit.

* List of the Q series extension cables

Product	Model	Cable length	Overall cable distance
Extension cable	QC05B	0.45m	13.2m
	QC06B	0.6m	
	QC12B	1.2m	
	QC30B	3.0m	
	QC50B	5.0m	
	QC100B	10.0m	

6 MEMORY AND BATTERY REPLACEMENT

6.1 List of Alternative Memory Models

A0J2H series models to be discontinued		Alternative Q series models	
Product name	Model name	Model name	Remarks (restrictions)
EP-ROM Memory	4KROM	Not required	The program memory of the Universal model QCPU is the flash ROM.
	8KROM		
	16KROM		

6.2 Precautions for Memory and Battery Replacement

(1) Precautions for memory replacement

(a) Copying programs into the ROM

The ROM memory is not required for the Universal model QCPU because the program memory is the flash ROM.

(b) Using the file register

When the existing CPU module is replaced with the Q00UJCPU, the file register cannot be used because the standard RAM is not built in the Q00UJCPU.

To use the file register, select the Q00UCPU.

(2) Precautions for battery replacement

Replace the A Series battery (A6BAT*) with a Q Series battery (Q6BAT, Q7BAT).

(The Q series CPU module comes with the Q6BAT as standard.)

Refer to the user's manuals of each CPU module regarding battery life because it varies depending on the type of CPU module.

* The A6BAT is not a model to be discontinued.

7 PROGRAMS REPLACEMENT

This chapter describes the procedures and precautions when replacing (utilizing) the programs, comments, etc. from the A0J2HCPU to a Universal model QCPU.

○ : Compatible, △ : Partially changed, × : Incompatible

Item		A0J2HCPU specifications	Universal model QCPU specifications and precautions for replacement	Compatibility	Reference sections
Sequence program	Main	<ul style="list-style-type: none"> The main program is required. The SFC is dealt as the microcomputer program of the main program. 	[Specifications] <ul style="list-style-type: none"> Each of the programs is handled in one file with the data names "MAIN" and "MAIN-SFC". 	△	Section 7.7.9
	SFC		[Measures] <ul style="list-style-type: none"> The program setting of the PLC parameters is required. 		
Microcomputer program		<ul style="list-style-type: none"> The user's microcomputer program and the microcomputer program of the utility package are available. 	[Specifications] <ul style="list-style-type: none"> The microcomputer program cannot be created. [Measures] <ul style="list-style-type: none"> The user's microcomputer program of the A0J2HCPU cannot be executed. Replacing it with the sequence program, etc. is recommended. To use the instructions from the utility package, correcting it to the equivalent instructions of QCPU is required. 	×	—
Instructions		<ul style="list-style-type: none"> Instructions (LED instructions, etc.) dedicated to ACPUs are available. 	[Specifications] <ul style="list-style-type: none"> Although instructions are automatically converted by the change PLC type, some of the instructions are not converted. [Measures] <ul style="list-style-type: none"> As the unconverted instructions are converted to SM1255 and SD1255 devices, the program needs to be corrected. 	△	Section 7.2

○ : Compatible, △ : Partially changed, × : Incompatible

Item	A0J2HCPU specifications	Universal model QCPU specifications and precautions for replacement	Compatibility	Reference sections
File register	<ul style="list-style-type: none"> A storage area is secured in the program memory. The maximum setting is 4k points. 	<p>[Specifications]</p> <ul style="list-style-type: none"> Stored to the standard RAM. One block is a 32k point unit. <p>[Measures]</p> <ul style="list-style-type: none"> Writing is required by the write to PLC. The Q00UJCPU is not equipped with the standard RAM. To use the file register, select the Q00UCPU. 	△	Section 7.7.10
Timer and Counter	<ul style="list-style-type: none"> The timer and counter are processed with END. 	<p>[Specifications]</p> <ul style="list-style-type: none"> The timer and counter are processed when the instructions are executed. <p>[Measures]</p> <ul style="list-style-type: none"> The timing of the timer and counter processing are different, so the program needs to be reviewed. 	△	Section 7.7.4, Section 7.7.5
Parameter	<ul style="list-style-type: none"> Dedicated parameters are available. 	<p>[Specifications]</p> <ul style="list-style-type: none"> Dedicated parameters are available for each CPU. <p>[Measures]</p> <ul style="list-style-type: none"> As the specifications/functions differ, to replace with QCPU, confirm those differences and reconfigure the parameters. 	△	Section 7.3
Special relay	<ul style="list-style-type: none"> 256 points of M9000 to M9255 are available. 	<p>[Specifications]</p> <ul style="list-style-type: none"> 2048 points of SM0 to SM2047 are available. <p>[Measures]</p> <ul style="list-style-type: none"> Although the setting values are automatically converted during replacement with QCPU, some specifications differ and need to be reviewed. 	△	Section 7.4
Special register	<ul style="list-style-type: none"> 256 points of D9000 to D9255 are available. 	<p>[Specifications]</p> <ul style="list-style-type: none"> 2048 points of SD0 to SD2047 are available. <p>[Measures]</p> <ul style="list-style-type: none"> Although the setting values are automatically converted during replacement with QCPU, some specifications differ and need to be reviewed. 	△	Section 7.5
Comment	<ul style="list-style-type: none"> Classifies comments into common comments and local comments. 	<p>[Specifications]</p> <ul style="list-style-type: none"> Manages all comments as local comments and common comments. Comments are automatically replaced by changing the PLC type in GX Developer at QCPU conversion. QCPU comment capacity depends on the memory capacity. 	○	Section 7.1.2

○ : Compatible, △ : Partially changed, × : Incompatible

Item	A0J2HCPU specifications	Universal model QCPU specifications and precautions for replacement	Compatibility	Reference sections
Writing programs to ROM	<ul style="list-style-type: none"> Performs ROM operation using the EP-ROM. 	<ul style="list-style-type: none"> Memory selection for this replacement is not required for the Universal model QCPU since its program memory is flash ROM. 	△	-

7.1 Program Replacement Procedures

The programs, comments of the A0J2HCPU with QCPU can be replaced by "Change PLC type" of the GX Developer.

7.1.1 Program conversion procedure from A0J2HCPU to QCPU

Program conversion is performed in the order of (1) → (2) → (3) in the following diagram.

- (1) Reading processing of the source data of conversion.
- (2) Program conversion from the A0J2HCPU program to QCPU program by the Change PLC type operation.
- (3) Writing process of the data after conversion.
Refer to Section 7.1.2 for the details of the change operation.

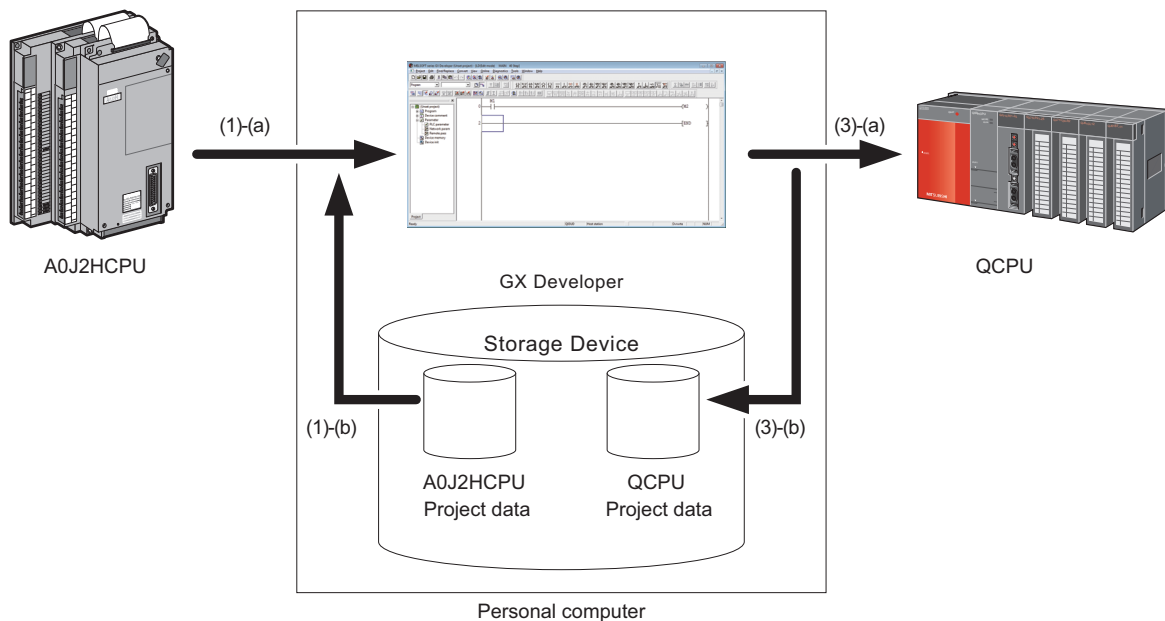
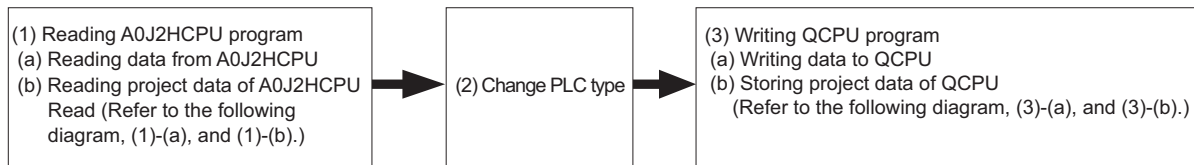

Remarks

Change of PLC type to convert it to the program of the CPU module that is supported by GX Developer is required in advance if the CPU type is "A0J2CPU", because GX Developer does not support the "A0J2CPU".

The change of PLC type can be performed with "A/QnA to Q conversion support tool". For details on the procedure, refer to Section 7.1.5.

7.1.2 Change PLC type

Change PLC type is a function for changing existing data to data for other programmable controller series for reuse.

This function changes the target programmable controller type of the data that is read to GX Developer. Some instructions that cannot be automatically converted are changed to OUT SM1255. Search for these instructions or SM1255 devices in the converted program and modify the program manually. In addition, programs and parameters need to be reviewed regarding intelligent function module and network modules.

(1) Convertible range from ACPU using GX Developer

The following list shows the convertible range from ACPU to other programmable controllers.

Product name	Change source programmable controller	Change target programmable controller		
		ACPU/AnSCPU	QnACPU/QnA-SCPU	QCPU
GX Developer	ACPU	○	○	△ ^{*1}

*1 Changing of PLC type from the existing CPU module to the High-speed Universal model QCPU is not supported in GX Developer.

(2) GX Developer operation

(a) Select "Change PLC type" in the "Project" menu.

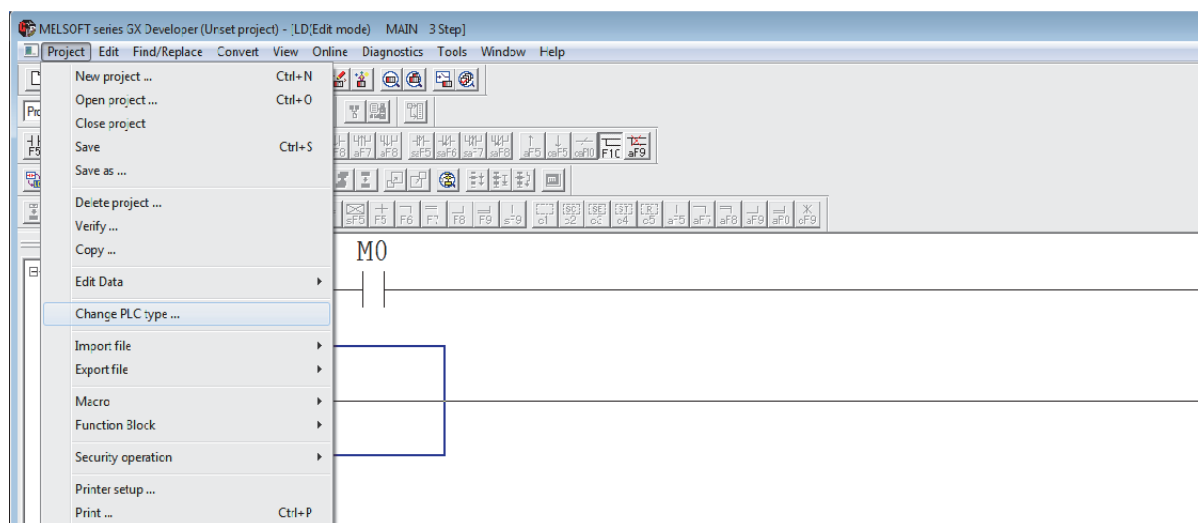

(b) Specify the target programmable controller type in the "Change PLC type" dialogue.

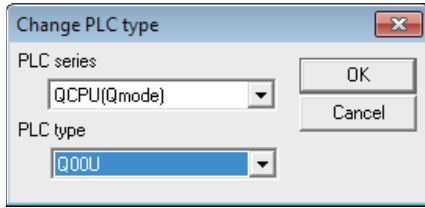

Click the [OK] button after setting the PLC type.

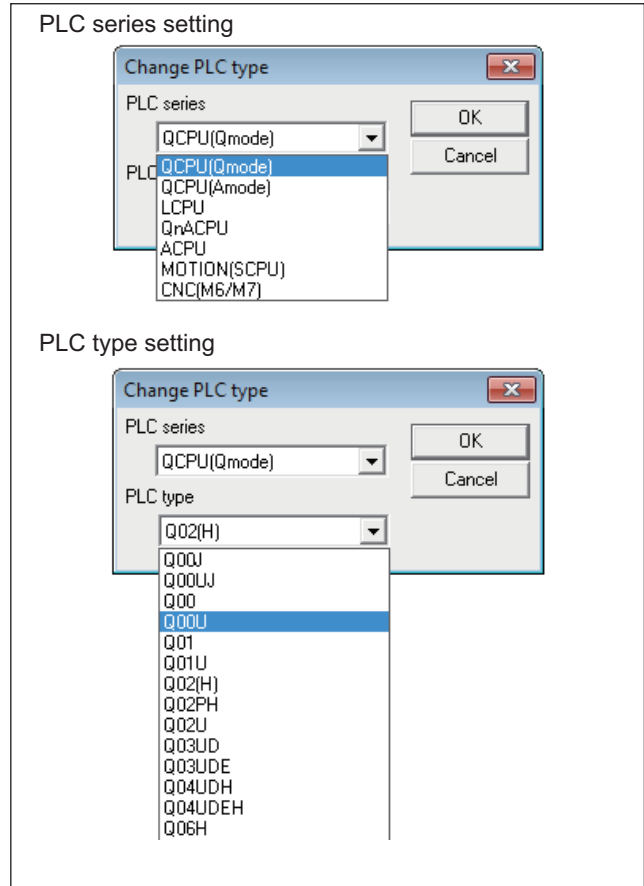

(c) Select the conversion method of the special relay/register.

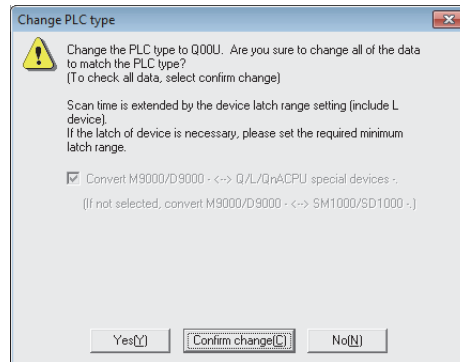

Specify the conversion destination of the special relay/register (ACPU: M9000/D9000 models) device. Please check the box next to [Convert M9000/D9000 - Q/L/QnACPU special devices].

- Checked: Converted to a device for the Basic model QCPU.
- Not checked: Converted to A compatible (SM1000/SD1000 models).

The box state is fixed to be checked when the Universal model QCPU is selected.

After specifying the destination of the device conversion, Change PLC type is executed by pressing the [Yes] or [Confirm Change] button.

- [Yes]: Executed without conducting intermediate steps and user confirmation.
- [Confirm Change]: Asks user confirmation to execute changes.

7.1.3 ACPU program conversion ratio

- **Conversion ratio of common instructions (Sequence/basic/application instructions)**

The following table shows the conversion ratio when changing the programmable controller type of the ACPU common instructions to the QCPU.

More than 90% of the common instructions are automatically converted.

Instruction type	Number of instructions	QnUCPU			
		Number of instructions applicable for automatic conversion	Number of instructions requiring manual change	Conversion ratio (rough standard)	
Sequence instruction	Contact instruction	6	6	0	100%
	Connection instruction	5	5	0	100%
	Output instruction	6	5	1	83%
	Shift instruction	2	2	0	100%
	Master control instruction	2	2	0	100%
	Termination instruction	2	2	0	100%
	Other instructions	3	3	0	100%
Total number of sequence instructions		26	25	1	96%
Basic instruction	Comparison operation instruction	36	36	0	100%
	Arithmetic operation instruction	40	40	0	100%
	BCD ↔ BIN conversion instruction	8	8	0	100%
	Data transfer instruction	16	16	0	100%
	Program branch instruction	9	9	0	100%
	Program switching instruction	1	0	1	0%
	Refresh instruction	2	2	0	100%
Total number of basic instructions		112	111	1	99%
Application instruction	Logical operation instruction	18	18	0	100%
	Rotation instruction	16	16	0	100%
	Shift instruction	12	12	0	100%
	Data processing instruction	20	19	1	95%
	FIFO instruction	4	4	0	100%
	Buffer memory access instruction	8	8	0	100%
	FOR to NEXT instruction	2	2	0	100%
	Local station, remote I/O station Access instruction	4	0	4	0%
	Display instruction	5	1	4	20%
	Other instructions	10	2	8	20%
Total number of application instructions		99	82	17	83%
Total number of sequence/basic/application instructions		237	218	19	92%

• **Conversion ratio of dedicated instructions**

The following table shows the conversion ratio when changing the programmable controller type of the ACPU dedicated instructions to the QCPU.

Instruction type	Number of instructions	QnUCPU			
		Number of instructions applicable for automatic conversion	Number of instructions requiring manual change	Conversion ratio (rough standard)	
Dedicated instruction (Functional extension)	Direct input/output instruction	3	3	0	100%
	Structured program instruction	6	2	4	33%
	Data operation instruction	6	6	0	100%
	I/O operation instruction	2	1	1	50%
	Real number processing instruction	27	27	0	100%
	Character string processing instruction	25	24	1	96%
	Data control instruction	6	6	0	100%
	Clock instruction	2	2	0	100%
	Extension file register instruction	7	0	7	0%
	Program switching instruction	4	0	4	0%
	Instruction for PID control	3	2	1	67%
	Subtotal	91	74	17	81%
	Dedicated instruction (For modules)	Instruction for data link	9	5	4
Instruction for special function modules		59	0	59	0%
Subtotal		68	5	63	7%
Total number of dedicated instructions		159	78	81	49%

Remarks

The automatic conversion is applied to the instructions when equivalent functions and instructions exist in the change destination programmable controller.

Some instructions are not converted for the following cases.

Refer to Section 7.2 Instruction Conversion to change the program manually.

- (1) The change target programmable controller does not have the equivalent functions and instructions.
- (2) Instructions to specified modules cause the change of the module and buffer memory configuration.
- (3) Multiple instructions with the same name and argument exist.
- (4) The conversion causes a mismatch in the instructions.

7.1.4 Reading (Reusing) other format files

(1) Reading (Reusing) GPPQ/GPPA files to GX Developer

This section explains the procedure to read (reuse) files in GPPQ/GPPA formats others than those of the GX Developer.

Follow this procedure to convert a file format to the GX Developer file format.

☒ Point

To read out (reuse) a program of a CPU module that is not supported by GX Developer, change PLC type to convert it to the program of the CPU module that is supported by GX Developer in advance, using "A/QnA to Q conversion support tool".

For operating procedure of the A/QnA to Q conversion support tool, refer to Section 7.1.5.

(a) GX Developer operating procedure

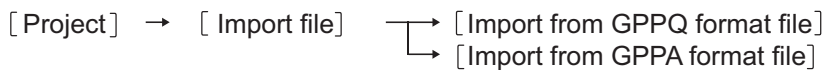

(b) Setting screen

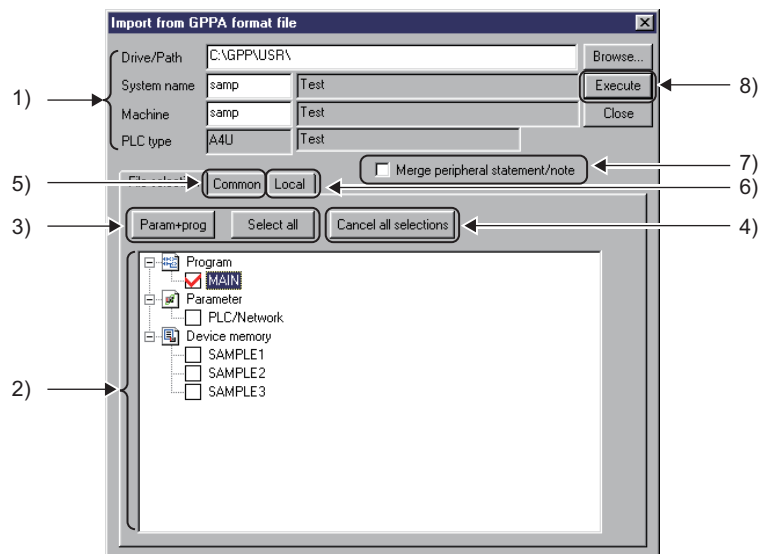

1) Drive/Path, System name, Machine name, and PLC type

Displays the location of the data created in GPPQ and GPPA.

Enter the system name and machine name of the data specified by the Drive/Path.

Click the [Browse] button to display the dialogue box asking you to select the system name and machine name. Double-click and specify the files to be read.

2) Source data list

Displays the data created in GPPQ and GPPA.

Place a ✓ mark in the checkbox of the data name to select it.

For the selected comments, use the program Common tab or Local tab to configure the range of the device comment to be read.

3) [Param+prog] button/[Select all] button

- [Param+prog] button

Selects only the parameter data and program data of the reading source.

- [Select all] button

Selects all the data in the list of source data to be read.

On the A series, Kanji character comments are selected and the device memory is displayed according to the data count.

On the Q/QnA series, the head data name is selected for the comments and file registers.

4) [Cancel all selections] button

Cancels all the selected data.

5) <<Common>>tab screen (A series)

Go to this screen to specify the range of the common comments before reading.

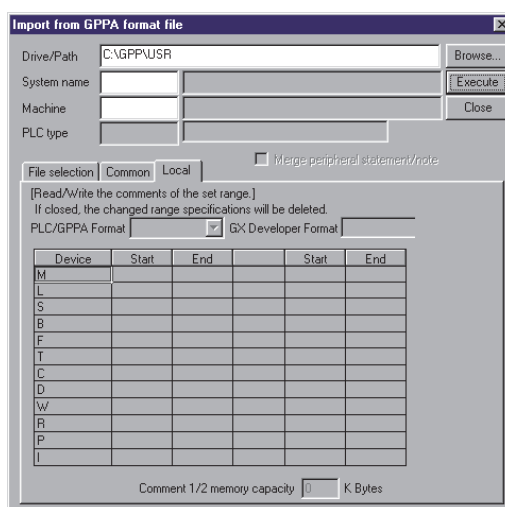

6) <<Local>>tab screen (A series)

Go to this screen to specify the range of the local comments before reading.

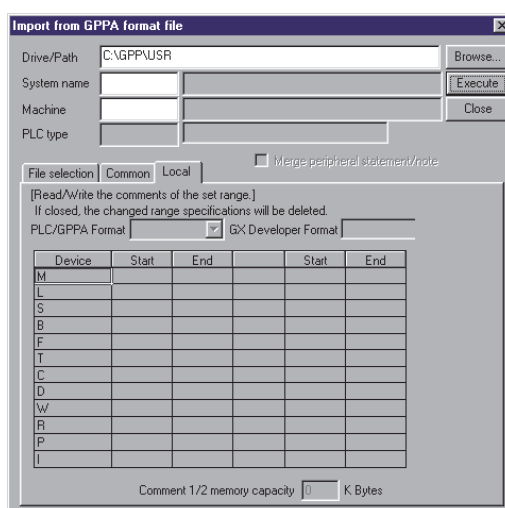

7) Merge peripheral statement/note

For detail about Merge peripheral statement/note, please refer to the GX Developer Version8 Operating manual.

8) [Execute] button

Click after completing settings.

(c) Setting procedure

1) To select

- a) Set the drive/path to read by GPPQ and GPPA.
- b) Set the system name and device name of the project to read using the [Browse] button.
- c) Select by clicking the [Param+prog] button or [Select all] button, or using a mouse to place a ✓ mark in the checkbox.
- d) Click the [Execute] button after completing settings.

2) To cancel selected data

- a) To cancel selected data arbitrarily
Remove the ✓ mark from the checkbox using the mouse or space key.
- b) To cancel all selected data
Click the [Cancel all selection] button.

(d) Precautions for reading other format files

A series	
A6GPP format, SW0S-GPPA format data	Read data with GX Developer after performing the corresponding format conversion with GPPA. For details on how to proceed, refer to the SW□SRXV/NX/IVD-GPPA GPP Function Software Package Operating Manual (Details).
Selecting data	Only either Kanji or Kana comments can be selected for the device comments.
Reading in GPPA format	Abandons the project data of the GX Developer and reads other file formats. The range exceeding the program capacity is deleted when reading. If the microcomputer program, edited by programs other than an SFC program, such as SW0SRX-FNUP is included, the program disappears.

QnA series	
Ladder return positions	Returning places are different between GPRQ and GX Developer. Because of this, if the total of return sources and return destinations exceeds 24 lines in a single ladder block, the program is not displayed properly. Corrective action: Add SM400 (normally on contact) to adjust the return positions.
For data selection	For the device memory and file register, only one data name can be selected for each item.

(2) Procedure for reading files in GX Developer format to GX Works2

The following explains how to appropriately read files in GX Developer format to GX Works2. Follow this procedure to convert the read files to the file format of GX Works2.

(a) GX Works2 operation procedure

[Project] → [Open Other Data] → [Open Other Project]

(b) Setting window

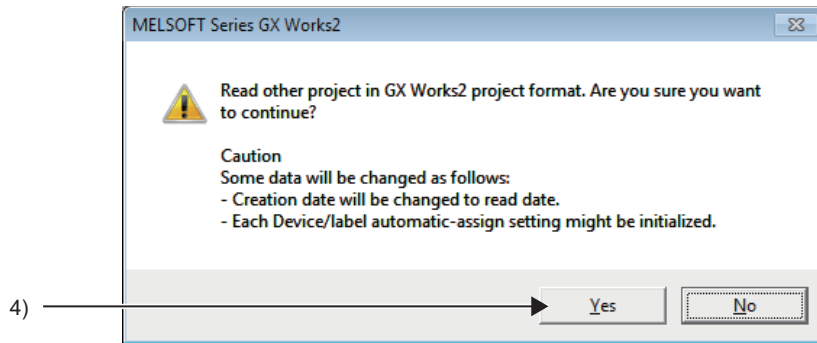
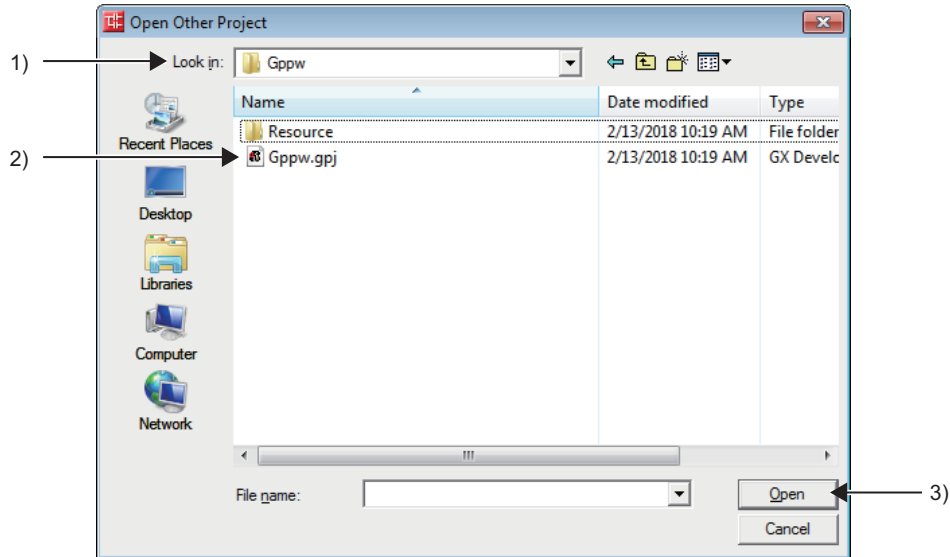

1) Look in

Display the place where the files in GX Developer format are stored and specify the file to be read.

2) Name

Select "*.gpj" for the file extension to use the file as a project file.

3) [Open] button

After selecting the file, click the [Open] button to open the execution window.

4) [Yes] button

Clicking [Yes] button executes the file read.

When the file read is completed, a completion message is displayed.

The file becomes available for GX Works2 operation.

Remarks

- (1) Performing the QCPU programming using GX Developer as a programming tool has following restrictions.
 - Model of available CPU module: QCPU excluding High-speed Universal model QCPUWhen this restriction is applied, use GX Works2 as a programming tool.
- (2) To use the existing A/QnACPU program with GX Works2, follow the procedure below.
 - (a) A/QnACPU program conversion procedure
 - 1) Read project data from the existing A/QnACPU using GX Developer and save the file.
↓
 - 2) By using "Change PLC type", convert the read A/QnACPU program to a Universal model QCPU, which can be specified with GX Developer.
↓
 - 3) Read the converted QCPU program by other format read ([Project] - [Open Other Data] - [Open Other Project]) of GX Works2.
↓
 - 4) After that, configure various settings and modify the program using GX Works2.
 - (b) Conversion procedure of the difference information embedded Q program (A/QnA-Q conversion support tool)
 - 1) Read project data from the existing A/QnACPU using GX Developer and save the file.
↓
 - 2) By using "Change PLC type", convert the read A/QnACPU program to a Universal model QCPU, which can be specified with GX Developer, and save it.
↓
 - 3) Output the difference information embedded Q program and the review information list using the A/QnA-Q conversion support tool.
↓
 - 4) Modify the difference information embedded Q program with GX Developer while referring to the review information list.
↓
 - 5) Read the difference information embedded Q program by other format read ([Project] - [Open Other Data] - [Open Other Project]) of GX Works2.
↓
 - 6) After that, configure various settings and modify the program using GX Works2.
 - (c) Conversion procedure of the MELSECNET (II) local station dedicated module link refresh program (A/QnA-Q conversion support tool)
 - 1) Using the A/QnA-Q conversion support tool, set the output type of CPU to a Universal model QCPU and output the MELSECNET (II) local station dedicated module link refresh program.
↓
 - 2) Read the MELSECNET (II) local station dedicated module link refresh program by other format read ([Project] - [Open Other Data] - [Open Other Project]) of GX Works2.
↓
 - 3) After that, configure various settings and modify the program using GX Works2.

7.1.5 How to reuse a program of a PLC type that is not supported by GX Developer

Reuse of a program of a PLC type that is not supported by GX Developer is possible using "A/QnA to Q conversion support tool". Follow the steps below.

(1) CPU modules that are not supported by GX Developer

The CPU modules listed below are not supported by GX Developer.

Change PLC type to convert it to the program of the CPU module that is supported by GX Developer in advance, by using "A/QnA to Q conversion support tool".

- A0J2CPU • A1CPU • A2CPU(-S1) • A3CPU • A73CPU
- A3HCPU • A52GCPU • A3VCPU • A3MCPUCPU

(2) Operating procedure

1) Start up "A/QnA to Q conversion support tool".

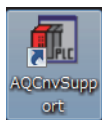

2) Select "A0J2 conversion support tool execute".

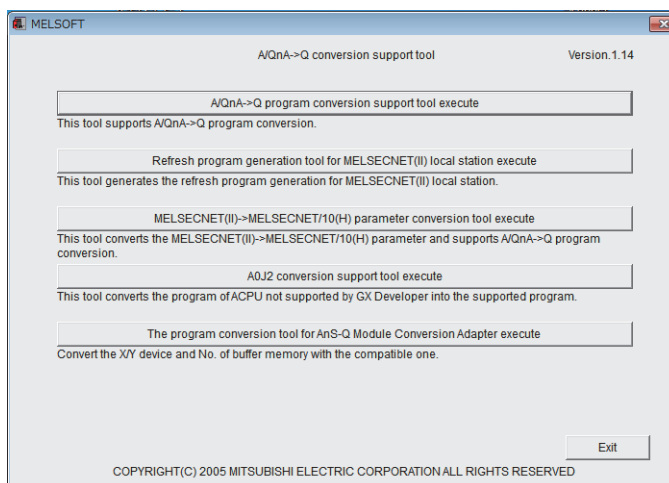

3) Go to "File" and click "New", then select the corresponding PLC type.

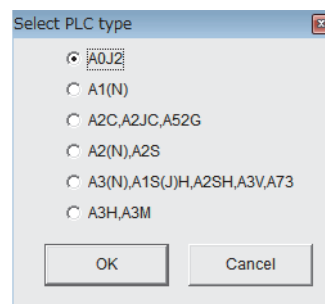
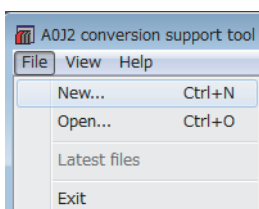

- 4) Go to "Online" and click "Read from PLC", then read the program of the corresponding CPU module.

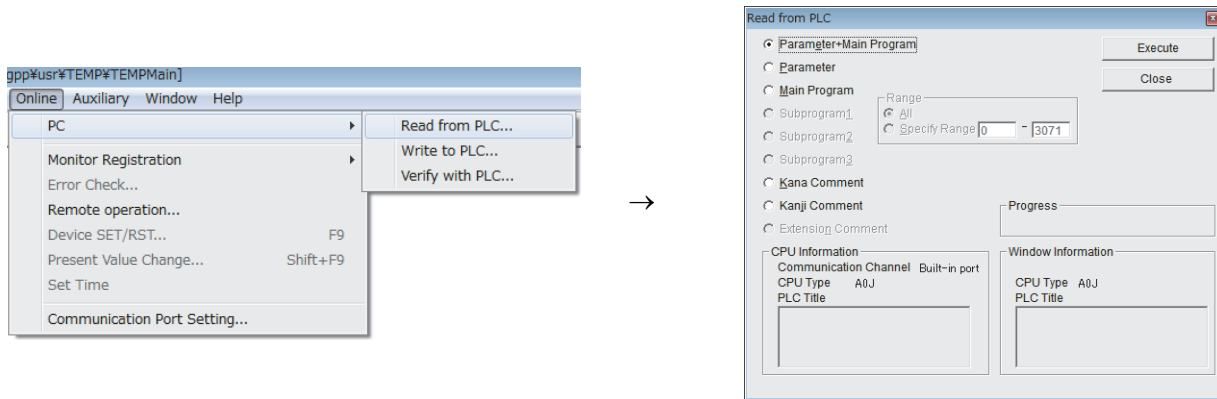

- 5) Go to "Auxiliary" and click "Change PC Type", then select a PLC type that is supported by GX Developer.

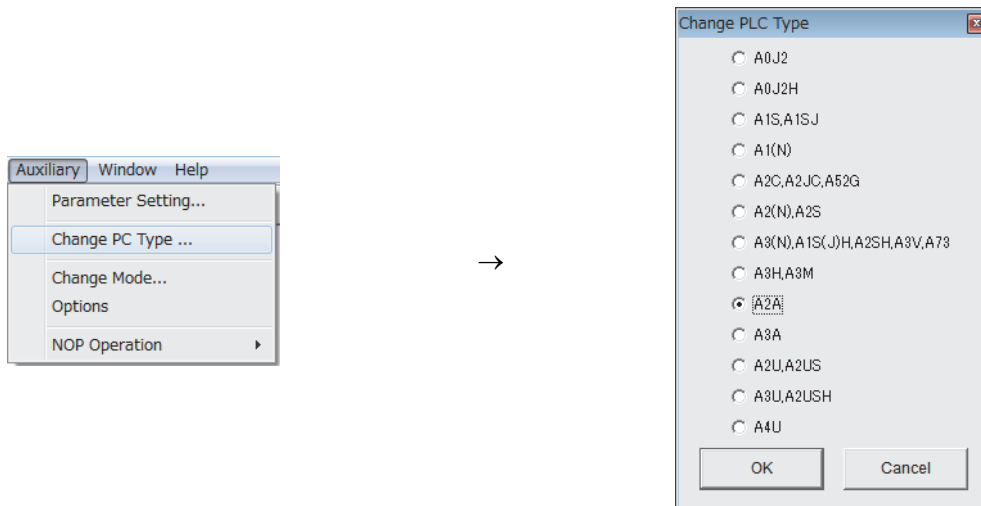

- 6) Go to "File" and select "Save as".

"System Name" and "Machine Name" defined here constitute the name of another format file, which is mentioned in Section 7.1.4.

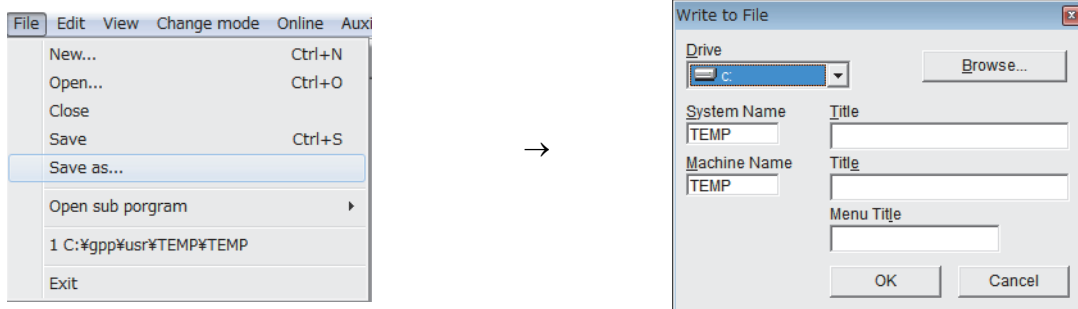

☒ Point

- For details, refer to "A/QnA to Q conversion support tool: A0J2 Conversion Support Tool Operation Guide".
 - For details on the A/QnA to Q conversion support tool, please contact your local Mitsubishi representative.
-

7.2 Instruction Conversion

Instructions are converted by Change PLC type of the GX Developer.
This section explains the corrective actions of converted and unconverted instructions.

7.2.1 List of instructions converted from A0J2HCPU to QCPU (Sequence/Basic/Application instructions)

○ : Automatic converted, × : Manual conversion required

Description	A0J2HCPU	QCPU		Reference sections
	Instruction name	Instruction name	Convertibility	
BIN 16-bit addition, subtraction	+	+	○	
	+P	+P	○	
	-	-	○	
	-P	-P	○	
BIN 16-bit multiplication, division	*	*	○	
	*P	*P	○	
	/	/	○	
	/P	/P	○	
Ladder block series connection	ANB	ANB	○	
Series connection	AND	AND	○	
BIN 16-bit data comparison	AND<	AND<	○	
	AND<=	AND<=	○	
	AND<>	AND<>	○	
	AND=	AND=	○	
	AND>	AND>	○	
	AND>=	AND>=	○	
BIN 32-bit data comparison	ANDD<	ANDD<	○	
	ANDD<=	ANDD<=	○	
	ANDD<>	ANDD<>	○	
	ANDD=	ANDD=	○	
	ANDD>	ANDD>	○	
	ANDD>=	ANDD>=	○	
Series connection	ANI	ANI	○	
Hexadecimal BIN → ASCII conversion	ASC	OUT SM1255	×	Section 7.2.2 (3)
BCD 4-digit addition, subtraction	B+	B+	○	
	B+P	B+P	○	
	B-	B-	○	
	B-P	B-P	○	
BCD 4-digit multiplication, division	B*	B*	○	
	B*P	B*P	○	
	B/	B/	○	
	B/P	B/P	○	
Conversion from BIN data to 4-digit BCD	BCD	BCD	○	
	BCDP	BCDP	○	
Conversion from 4-digit BCD to BIN data	BIN	BIN	○	
	BINP	BINP	○	
Block 16-bit data transfer	BMOV	BMOV	○	
	BMOVP	BMOVP	○	

○: Automatic converted, △: Partially changed, ×: Manual conversion required

Description	A0J2HCPU	QCPU		Reference sections
	Instruction name	Instruction name	Convertibility	
Bit reset of word device	BRST	BRST	○	
	BRSTP	BRSTP	○	
Bit set of word device	BSET	BSET	○	
	BSETP	BSETP	○	
1-bit shift to left of n-bit data	BSFL	BSFL	○	
	BSFLP	BSFLP	○	
1-bit shift to right of n-bit data	BSFR	BSFR	○	
	BSFRP	BSFRP	○	
Sub-routine program calls	CALL	CALL	○	
	CALLP	CALLP	○	
Special format failure checks	CHK	OUT SM1255	×	Section 7.2.2 (3)
Reverse of device output	CHK	OUT SM1255	×	Section 7.2.2 (1)
Pointer branch instructions	CJ	CJ	○	
Carry flag reset	CLC	OUT SM1255	×	Section 7.2.2 (3)
16-bit data negation transfer	CML	CML	○	
	CMLP	CMLP	○	
Refresh instruction	COM	COM	○	
BIN 32-bit addition, subtraction	D+	D+	○	
	D+P	D+P	○	
	D-	D-	○	
	D-P	D-P	○	
BIN 32-bit multiplication, division	D*	D*	○	
	D*P	D*P	○	
	D/	D/	○	
	D/P	D/P	○	
Logical products of 32-bit data	DAND	DAND	○	
	DANDP	DANDP	○	
BCD 8-digit addition, subtraction	DB+	DB+	○	
	DB+P	DB+P	○	
	DB-	DB-	○	
	DB-P	DB-P	○	
BCD 8-digit multiplication, division	DB*	DB*	○	
	DB*P	DB*P	○	
	DB/	DB/	○	
	DB/P	DB/P	○	
Conversion from BIN data to BCD 8-digit	DBCD	DBCD	○	
	DBCDP	DBCDP	○	
Conversion from BCD 8-digit to BIN data	DBIN	DBIN	○	
	DBINP	DBINP	○	
32-bit data negation transfer	DCML	DCML	○	
	DCMLP	DCMLP	○	
32-bit BIN data decrement	DDEC	DDEC	○	
	DDECP	DDECP	○	
16-bit BIN data decrement	DEC	DEC	○	
	DECP	DECP	○	
8 → 256-bit decode	DECO	DECO	○	
	DECOP	DECOP	○	

○ : Automatic converted, △ : Partially changed, × : Manual conversion required

Description	A0J2HCPU	QCPU		Reference sections
	Instruction name	Instruction name	Convertibility	
2-word data read from intelligent function/special function modules	DFRO	DFRO	○	
	DFROP	DFROP	○	
Interrupt disable instruction	DI	DI	○	
Link refresh disable	DI	DI	○	
32-bit BIN data increment	DINC	DINC	○	
	DINCP	DINCP	○	
4bits groupings of 16-bit data	DIS	DIS	○	
	DISP	DISP	○	
32-bit data transfer	DMOV	DMOV	○	
	DMOVP	DMOVP	○	
Logical sums of 32-bit data	DOR	DOR	○	
	DORP	DORP	○	
Left rotation of 32-bit data	DRCL	DRCL	○	Section 7.7.7
	DRCLP	DRCLP	○	Section 7.7.7
Right rotation of 32-bit data	DRCR	DRCR	○	Section 7.7.7
	DRCRP	DRCRP	○	Section 7.7.7
Left rotation of 32-bit data	DROL	DROL	○	Section 7.7.7
	DROLP	DROLP	○	Section 7.7.7
Right rotation of 32-bit data	DROR	DROR	○	Section 7.7.7
	DRORP	DRORP	○	Section 7.7.7
32-bit data search	DSER	DSER	○	Section 7.7.7
1-word shift to left n-word data	DSFL	DSFL	○	
	DSFLP	DSFLP	○	
1-word shift to right n-word data	DSFR	DSFR	○	
	DSFRP	DSFRP	○	
32-bit data checks	DSUM	DSUM	○	Section 7.7.7
	DSUMP	DSUMP	○	Section 7.7.7
2-word data write to intelligent function/special function modules	DTO	DTO	○	
	DTOP	DTOP	○	
Timing pulse generation	DUTY	DUTY	○	
32-bit data conversion	DXCH	DXCH	○	
	DXCHP	DXCHP	○	
32-bit non-exclusive logical sum operations	DXNR	DXNR	○	
	DXNRP	DXNRP	○	
32-bit exclusive logical sum operations	DXOR	DXOR	○	
	DXORP	DXORP	○	
Interrupt enable instruction	EI	EI	○	
Link refresh enable	EI	EI	○	
256 → 8-bit encode	ENCO	ENCO	○	
	ENCOP	ENCOP	○	
Sequence program completion	END	END	○	
Main routine program completion	FEND	FEND	○	
Reading oldest data from tables	FIFR	FIFR	○	
	FIFRP	FIFRP	○	
Writing data to the data table	FIFW	FIFW	○	
	FIFWP	FIFWP	○	
Identical 16-bit data block transfers	FMOV	FMOV	○	
	FMOVP	FMOVP	○	

○ : Automatic converted, △ : Partially changed, × : Manual conversion required

Description	A0J2HCPU	QCPU		Reference sections
	Instruction name	Instruction name	Convertibility	
FOR to NEXT instructions	FOR	FOR	○	
1-word data read from intelligent function/special function modules	FROM	FROM	○*1	
	FROMP	FROMP	○*1	
16-bit BIN data increment	INC	INC	○	
	INCP	INCP	○	
Return from interrupt programs	IRET	IRET	○	
Pointer branch instructions	JMP	JMP	○	
Operation start	LD	LD	○	
BIN 16-bit data comparison	LD<	LD<	○	
	LD<=	LD<=	○	
	LD<>	LD<>	○	
	LD=	LD=	○	
	LD>	LD>	○	
	LD>=	LD>=	○	
BIN 32-bit data comparison	LDD<	LDD<	○	
	LDD<=	LDD<=	○	
	LDD<>	LDD<>	○	
	LDD=	LDD=	○	
	LDD>	LDD>	○	
	LDD>=	LDD>=	○	
Operation start	LDI	LDI	○	
Error indication or annunciator reset instruction	LEDR	LEDR	○	
Local station data read	LRDP	OUT SM1255	×	Section 7.2.2 (3)
Local station data write	LWTP	OUT SM1255	×	Section 7.2.2 (3)
Master control set, reset	MC	MC	○	
	MCR	MCR	○	
16-bit data transfer	MOV	MOV	○	
	MOV _P	MOV _P	○	
Operation result pop	MPP	MPP	○	
Operation result push	MPS	MPS	○	
Operation result read	MRD	MRD	○	
BIN 16-bit data 2's complement (sign inversion)	NEG	NEG	○	
	NEGP	NEGP	○	
FOR to NEXT instruction	NEXT	NEXT	○	
No operation	NOP	NOP	○	
	NOPLF	NOPLF	○	
Parallel connection	OR	OR	○	
BIN 16-bit data comparison	OR<	OR<	○	
	OR<=	OR<=	○	
	OR<>	OR<>	○	
	OR=	OR=	○	
	OR>	OR>	○	
	OR>=	OR>=	○	
Ladder block parallel connection	ORB	ORB	○	

○ : Automatic converted, △ : Partially changed, × : Manual conversion required

Description	AQJ2HCPU	QCPU		Reference sections
	Instruction name	Instruction name	Convertibility	
BIN 32-bit data comparison	ORD<	ORD<	○	
	ORD<=	ORD<=	○	
	ORD<>	ORD<>	○	
	ORD=	ORD=	○	
	ORD>	ORD>	○	
	ORD>=	ORD>=	○	
Parallel connection	ORI	ORI	○	
Out instruction	OUT	OUT	○*2	
Training edge output	PLF	PLF	○	
Leading edge output	PLS	PLS	○	
Print ASCII code instruction	PR	OUT SM1255	×	Section 7.2.2 (3)
Print comment instruction	PRC	OUT SM1255	×	Section 7.2.2 (3)
Left rotation of 16-bit data	RCL	RCL	○	Section 7.7.7
	RCLP	RCLP	○	Section 7.7.7
Right rotation of 16-bit data	RCR	RCR	○	Section 7.7.7
	RCRP	RCRP	○	Section 7.7.7
Return from subroutine program	RET	RET	○	
Remote I/O station data read	RFRP	OUT SM1255	×	Section 7.2.2 (3)
Left rotation of 16-bit data	ROL	ROL	○	Section 7.7.7
	ROLP	ROLP	○	Section 7.7.7
Right rotation of 16-bit data	ROR	ROR	○	Section 7.7.7
	RORP	RORP	○	Section 7.7.7
Bit device reset	RST	RST	○	
Remote I/O station data write	RTOP	OUT SM1255	×	Section 7.2.2 (3)
Pointer branch instructions	SCJ	SCJ	○	
7 segments decode	SEG	SEG	○	
Partial refresh	SEG	SEG	×	Section 7.7.7
16-bit data search	SER	SER	○	Section 7.7.7
	SERP	SERP	○	Section 7.7.7
Bit device set	SET	SET	○	
n-bit shift to left of 16-bit data	SFL	SFL	○	
	SFLP	SFLP	○	
n-bit shift to right of 16-bit data	SFR	SFR	○	
	SFRP	SFRP	○	
Bit device shift	SFT	SFT	○	
	SFTP	SFTP	○	
Set and rest of status latch	SLT	OUT SM1255	×	Section 7.2.2 (3)
	SLTR	OUT SM1255	×	Section 7.2.2 (3)
Carry flag set	STC	OUT SM1255	×	Section 7.2.2 (3)
Sequence program stop	STOP	STOP	○	
Set and reset of sampling trace	STRA	OUT SM1255	×	Section 7.2.2 (3)
	STRAR	OUT SM1255	×	Section 7.2.2 (3)

*1 Note that the buffer memory address may differ between the A series and Q series.

*2 The high-speed and retentive timers are automatically converted according to the parameter settings.

○ : Automatic converted, △ : Partially changed, × : Manual conversion required

Description	A0J2HCPU	Basic Model QCPU		Reference sections
	Instruction name	Instruction name	Convertibility	
16-bit data check	SUM	SUM	○	
	SUMP	SUMP	○	
Microcomputer program call	SUB	OUT SM1255	×	Section 7.2.2 (2)
	SUBP	OUT SM1255	×	Section 7.2.2 (2)
1-word write to intelligent function/special function modules	TO	TO	○*1	
	TOP	TOP	○*1	
4-bit linking of 16-bit data	UNI	UNI	○	
	UNIP	UNIP	○	
Logical products with 16-bit data	WAND	WAND	○	
	WANDP	WANDP	○	
WDT reset	WDT	WDT	○	
	WDTP	WDTP	○	
Logical sums of 16-bit data	WOR	WOR	○	
	WORP	WORP	○	
16-bit non-exclusive logical sum operations	WXNR	WXNR	○	
	WXNRP	WXNRP	○	
16-bit exclusive logical sum operations	WXOR	WXOR	○	
	WXORP	WXORP	○	
16-bit data conversion	XCH	XCH	○	
	XCHP	XCHP	○	

*1 Note that the buffer memory address may differ between the A series and Q series.

7.2.2 Instruction that may need replacement from A0J2HCPU to Basic model QCPU

Some instructions are not automatically converted during the replacement from A0J2HCPU to QCPU. The following table lists such instructions together with the corrective actions. Reviewing the program referring to the following is recommended.

Item No.	Instruction type		A0J2HCPU instruction name	Corrective actions
(1)	Sequence instructions	Bit device output reverse	CHK	(Counter Measures) Review the program and convert manually. (Supplement) Candidate instruction to convert to: "FF" instruction
(2)	Basic instruction	Program switching instruction	SUB	(Counter Measures) Change manually to the same instructions of the Q series.
			SUBP	
(3)	Application instructions		ASC	(Counter Measures) Review the program and convert manually. (Supplement) Candidate instruction to convert to: "\$MOV" instruction
		Access instructions to local stations and remote I/O stations on MELSECNET(II),/B	LRDP	(Counter Measures) Create new programs for the network modules used by the Basic Model QCPU.
			LWTP	
			RFRP	
			RTOP	
		Special format failure checks	CHK	(Counter Measures) Replace the instruction by using an alternative program.
		Status latch instruction	SLT	(Counter Measure) There is no alternative action.
			SLTR	
		Sampling trace instructions	STRA	(Counter Measures) Review the program and convert manually. (Supplement) Candidate instructions to convert to "STRA" → "TRACE" instructions "STRAR" → "TRACER" instructions
			STRAR	
Carry flag instructions	STC	(Counter Measures) Review the program and convert manually. (Supplement) Candidate instructions to convert to: "STC" → "SET SM700" instructions "CLC" → "RST SM700" instructions		
	CLC			
Print ASCII code instruction	PR	(Counter Measures)		
Print comment instruction	PRC	Replace the instruction by using an alternative program.*1		

*1 For details, refer to the following.

FA-A-0068 Precautions for replacing A/QnA (large type) series CPU with Universal model QCPU

7.3 Precautions for Parameter Replacement

This section explains the conversion of the parameter when replacing the A0J2HCPU program with QCPU.

<Compatibility>

○: Common items of the A0J2HCPU and QCPU, and converted without any changes.

△: Items that needs resetting after conversion due to partial differences in functions/specifications.

×: Items to be deleted because there are no common items between the A0J2HCPU and QCPU.

Confirm the contents after conversions, and correct/reset if necessary.

	Name	Compatibility	Remarks
Memory capacity	Sequence program capacity	△	No attention is required to the program capacity.
	Microcomputer program capacity	×	A microcomputer program is not available.
	Comment capacity	△	No attention is required to the comment capacity.
	File register capacity	△	Resetting is necessary as the specifications differ.
PLC RAS	WDT settings	△	Becomes the default value (200ms).
	Operation mode during errors	△	Becomes default (stop all).
PLC system	RUN-PAUSE contact	△	Resetting is necessary.
	STOP → RUN output mode	△	Becomes default (output before STOP).
	Interrupt counter settings	△	Resetting is necessary.
I/O assignment		△	Resetting is necessary as the specifications differ.
Device	Number of device points		○ Becomes the number of default points. As the number of default points exceeds the number of A0J2HCPU points, program correction is unnecessary.
	Latch ranges	Latch relay (L)	○ M and L are separate devices. "L" on the program is converted just as "L".
		Data register (D)	○
		Link relay (B)	○
		Link register (W)	○
		Low speed timer (T) High-speed timer (T)	△ Converted as a single device. As the latch range is the entire range from the minimum device number to the maximum device number, it must be reviewed.
		Retentive timer (ST)	○
		Counter (C)	○
Network parameter	MELSECNET(II), /B	×	The parameter is deleted as it is not compatible with MELSECNET(II), /B.

7.4 Special Relay Replacement

The special relay is an internal relay with applications determined within the programmable controller. This section explains the replacement of the special relay when replacing the A0J2HCPU program with QCPU.

For details on AnS/QnASCPU and QCPU special relays, refer to the QCPU User's Manual (Function Explanation, Program Fundamentals) and MELSEC-Q/L Programming Manual (Common Instruction).

7.4.1 Replacement of A0J2HCPU with QCPU

A special relay different from A0J2HCPU is used with QCPU.

Automatic conversion using the Change PLC type is possible when replacing the A0J2HCPU special relay (M9000 onwards) with the Basic Model QCPU special relay (SM). (Refer to Section 7.1.2)

Point

Some A0J2HCPU special relays are not compatible with QCPU. The special relay not compatible with QCPU is converted to a dummy special relay (SM1255)^{*1} when changing the PLC type. After changing the PLC type, retrieve the dummy special relay (SM1255) and correct the program if necessary.

7.5 Special Register Replacement

The special register is an internal register with applications determined within the programmable controller.

This section explains the replacement of special registers when replacing the A0J2HCPU program with QCPU.

For details on AnS/QnASCPU and QCPU special registers, refer to the QCPU User's Manual (Function Explanation, Program Fundamentals) and MELSEC-Q/L Programming Manual (Common Instruction).

7.5.1 Replacement of A0J2HCPU with QCPU

A special register different from A0J2HCPU is used with QCPU.

Automatic conversion using the Change PLC type is possible when replacing the A0J2HCPU special register (D9000 onwards) with QCPU special register (SD). (Refer to Section 7.1.2)

Point

Some A0J2HCPU special registers are not compatible with QCPU. The special register not compatible with the Basic model QCPU is converted to a dummy special register (SD1255)^{*1} when changing the PLC type. After changing the PLC type, retrieve the dummy special register (SD1255) and correct the program if necessary.

7.6 Precautions for Replacing MELSAP-II with MELSAP3

Although the basic operations of the MELSAP3 are same as MELSAP-II, some specifications differ. This section explains items that require special cautions when replacing.

7.6.1 How to start the SFC program

The SFC program is started by using a special relay for SFC program start/stop.

The special relay (M9101) for SFC program start/stop of A0J2HCPU is replaced with the special relay (SM321) for SFC program start/stop of the Basic Model QCPU during the conversion from A0J2HCPU to QCPU.

Note that some specifications of the special relay for SFC program start/stop differ between A0J2HCPU and Basic Model QCPU.

Specifications		Precautions for replacement
MELSAP-II(M9101)	MELSAP3(SM321)	
User turns ON/OFF.	The SFC program starts as the system automatically turns ON by default.	To start or stop the SFC program according to user conditions, turning SM321 ON/OFF using the program is required.

7.6.2 Block information (Information device for SFC)

The procedure to execute "Block START/STOP" and "Reading of the number of active steps and active step numbers", which use the block information (information device for SFC), differ between the MELSAP-II and MELSAP3.

	Specifications		Precautions for replacement
	MELSAP-II	MELSAP3	
How to execute Block START/STOP methods	<p>[START] Turn the block active bit ON to execute forced start.</p> <p>[STOP] Turn the block clear bit ON to stop, and turn it OFF to execute forced termination.</p>	<p>[START] Turn the Block START/STOP bit ON to forcibly start the corresponding block.</p> <p>[STOP] Turn the Block START/STOP bit OFF to forcibly terminate the corresponding block.</p>	<p>[START] As "Block START/STOP bit" replaces "Block active bit" when the SFC program of A0J2HCPU is replaced with QCPU, the program correction is not required.</p> <p>[STOP] For the "Block clear bit", add a program that resets the "Block START/STOP bit". Delete the program that turns the block clear bit ON/OFF.</p>
Reading the number of active steps and active step numbers	The number of active steps and active step numbers of the block can be read.	Only the number of active steps of the block can be read.	Use "Active step batch readout instructions (MOV, DMOV, BMOV)" to read active step numbers.

7.6.3 Specifications comparison between MELSAP-II and MELSAP3

A part of the specifications of SFC program (MELSAP3) are different from those of SFC program (MELSAP-II).

Therefore, when utilizing the SFC program (MELSAP-II) of A0J2HCPU as the SFC program (MELSAP3) of QCPU, select the QCPU that meets the specifications of the existing SFC program (MELSAP-II).

Contents	MELSAP-II	MELSAP3	
	A0J2HCPU	QnUCPU	
		Q00UJCPU Q00UCPU	Q03UDVCPU Q03UD(E)CPU
SFC block	Max.256	Max.128	Max.320
Number of SFC steps	Max.255 steps/block	Max.128 steps/block	Max.512 steps/block
Step transition monitoring timer	Equipped (8 timers)	None	None

7.6.4 SFC diagram that cannot be read normally in another format

SFC diagram created by SW□IVD/NX-GPPA may cause an error such as incorrect reading.

Add dummy steps before replacement with SW□IVD/NX-GPPA.

(Refer to "PRECAUTIONS FOR CREATING SFC PROGRAMS" in the GX Developer Version 8 Operating Manual (SFC).)

(Example)

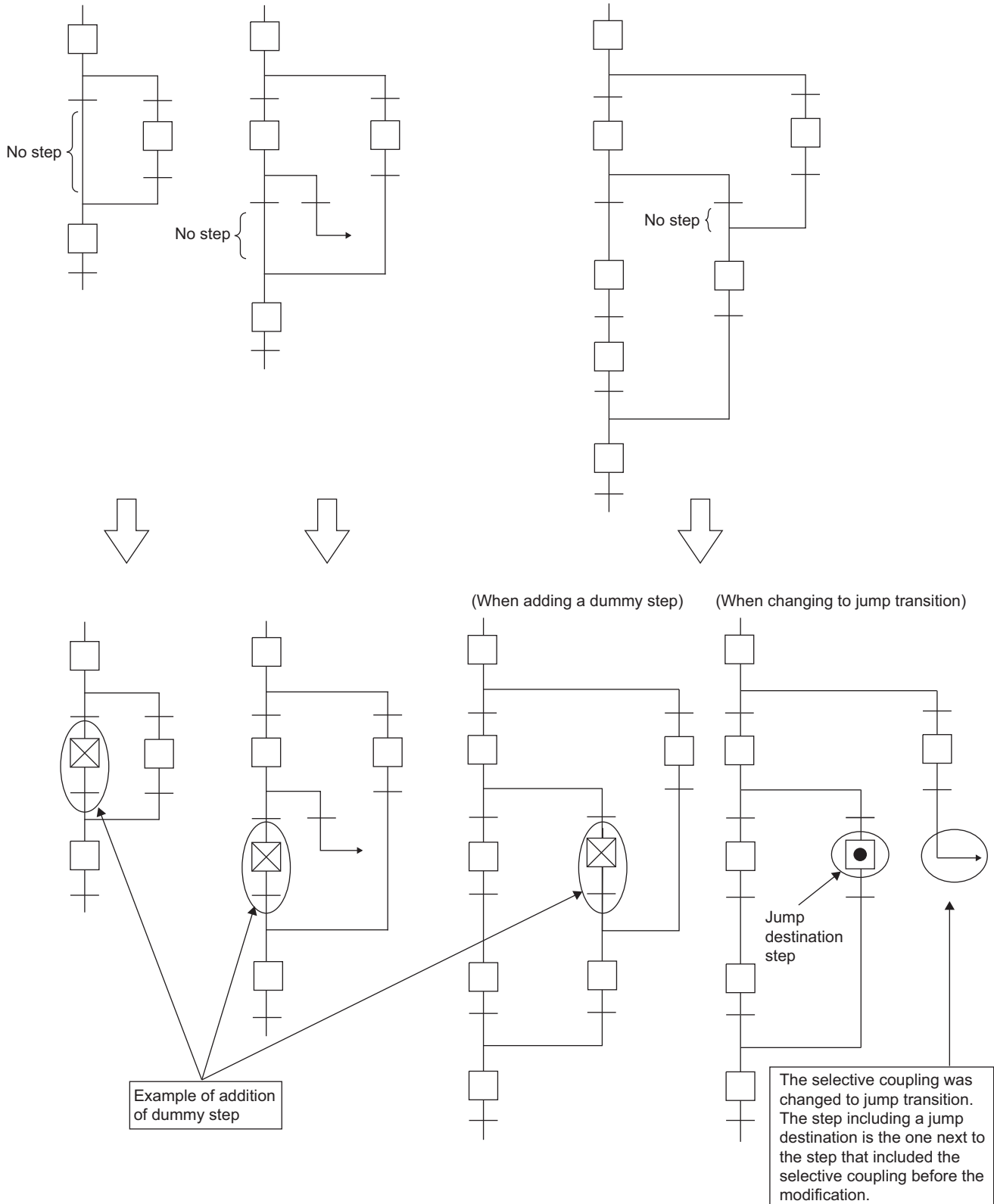

7.7 Precautions for Program Replacement

7.7.1 Applicable devices list

Device name	Q00U(J)CPU	A0J2HCPU	
Number of I/O points*8	Q00UJCPU: 256 points Q00UCPU: 1024 points	480 points	
Number of I/O device points*7	8192 points	512 points	
Internal relay	8192 points*1	Total of 2048 points	
Latch relay	8192 points		
Step relay	For sequence program		–
	For SFC		8192 points
Annunciator	2048 points*1	256 points	
Edge relay	2048 points*1	–	
Link relay	8192 points*1	1024 points	
Special link relay	2048 points	56 points	
Timer	2048 points*1	Total of 256 points	
Retentive timer	0 points*1		
Counter	1024 points*1	256 points	
Data register	12288 points*1	1024 points	
Link register	8192 points*1	1024 points	
Special link register	2048 points*1	56 points	
Function inputs	16 points (FX0 to FXF)*6	–	
Function outputs	16 points (FY0 to FYF)*6	–	
Special relay	2048 points	256 points	
Function registers	5 points (FD0 to FD4)	–	
Special register	2048 points	256 points	
Link direct device	Specified with J□\□□	–	
Special direct device	Specified with U□\G□	–	
Index register	Z	10 points (Z0 to Z9)	1 point (Z)
	V*2	–	1 point (V)
File register	32768 points/block*5 (R0 to R32,767)	4096 points (R0 to R4095)	
Accumulator*3	–	2 points	
Nesting	15 points	8 points	
Pointer	512 points	256 points	
Interrupt pointer	128 points	32 points	
SFC block	128 blocks*6	256 blocks	
Number of SFC steps	Max. 128 steps/block	–	
Dec. constant	K-2147483648 to K2147483647	K-2147483648 to K2147483647	
Hex. constant	H0 to HFFFFFFF	H0 to HFFFFFFF	
Real constant*6	E±1.17550-38 to E±3.40282+38	–	
Character string	"QnACPU", "ABCD"*4	–	

*1 The parameter can change the used points.

*2 V is used as the edge relay for QCPU.

*3 The A0J2HCPU instruction using the accumulator is changed in the instruction format on QCPU.

*4 QCPU can only be used with the \$MOV instructions.

*5 The Q00UJCPU does not have file registers.

*6 Only the five points of FX0 to FX4 and FY0 to FY4 can be used on the program.

*7 Applicable number of points on the program.

*8 Number of accessible points with actual I/O modules.

7.7.2 I/O control method

○ : Usable, - : Not used

I/O control method		QnUCPU	A0J2HCPU
Refresh method		○	○ ^{*1}
Direct I/O method	Partial refresh instruction	○	○
	Direct access input	○	-
	Direct access output	○	-
Direct mode		-	○ ^{*1}

*1 To switch between the refresh method and the direct method, use the DIP switch of the A0J2HCPU.

7.7.3 Data formats that can be used by the instructions

○ : Usable, △ : Usable with conditions, - : Not used

Set data		QnUCPU	A0J2HCPU
Bit data	Bit device	○	○
	Word device	○ (Bits need to be specified)	-
Word data	Bit device	○ (Digits need to be specified)	○ (Digits need to be specified)
	Word device	○	○
Double word data	Bit device	○ (Digits need to be specified)	○ (Digits need to be specified)
	Word device	○	○
Real number data		○	△ ^{*1}
Character string data		○	-

*1 The microcomputer package for the floating point real number type of the SW0SRXV-FN2UP package can be used during entry.

7.7.4 Timer

Function		QnUCPU	A0J2HCPU
Low-speed timer	Measurement units	<ul style="list-style-type: none"> • 100ms(Default value) Can be changed within a range of 1 to 1000ms (parameter) 	<ul style="list-style-type: none"> • Fixed at 100ms
	Specifying method		
High-speed timer	Measurement units	<ul style="list-style-type: none"> • 10ms(Default value) Can be changed within a range of 0.1 to 100ms (parameter). 	<ul style="list-style-type: none"> • Fixed at 10ms
	Specifying method		
Retentive timer	Measurement units	<ul style="list-style-type: none"> • Same measurement units as the low-speed timer. 	<ul style="list-style-type: none"> • Fixed at 100ms
	Specifying method		
High-speed retentive timer	Measurement units	<ul style="list-style-type: none"> • Same measurement units as the high-speed timer. 	<ul style="list-style-type: none"> • None
	Specifying method		
Setting range of set value		• 1 to 32767	• 1 to 32767
Processing set value 0		• Momentarily ON	• Infinite (No times out)
Updating current value		• At execution of OUT Tn instruction	• At END processing
Turning contacts ON/OFF			

(1) Precautions for using the timer

For details on precautions for using the timer, refer to the QCPU User's manual (Function Explanation, Program Fundamentals).

(a) Programming method of the timer ladder on QCPU

Specify the number of points of the timer and retentive timer in the device settings of the parameter. The appropriate uses of the low-speed timer, high-speed timer, retentive timer, and high-speed retentive timer are programmed by adding an "H" or "S" to the OUT instructions.

Example Low-speed timer : OUT T0 Kn
 High-speed timer : OUTH T0 Kn
 Low-speed retentive timer : OUT ST0 Kn
 High-speed retentive timer : OUTH ST0 Kn

(b) Programming method of the timer ladder on the A0J2HCPU

In the device settings of the parameter, specify the total number of timer points and the head device numbers of the low-speed timer, high-speed timer, and retentive timer.

The default values are; number of points: 256 points (fixed); low-speed timer head: 0 (T0 to T199); high-speed timer head: 200 (T200 to T255); and retentive timer: 0 points.

When using retentive timers, change the settings to secure the necessary number of points.

7.7.5 Counter

Function	QnUCPU	A0J2HCPU
Specifying method		
Updating current value	• At execution of OUT Cn instruction	• At END processing
Turning contacts ON/OFF		

7.7.6 Display instruction

Instruction	QnUCPU	A0J2HCPU
PR	Display instructions cannot be used for a Universal model QCPU. Consider replacing with a display unit or touch panel.	• With M9049 OFF: Outputs characters before 00H.
PRC		• With M9049 ON: Outputs 16 characters. • Outputs comment in 16 characters.

7.7.7 Instructions with changed specified formats

As QCPU does not have an accumulator (A0, A1), the A0J2HCPU instruction using the accumulator is changed in the instruction format on the Basic Model QCPU.

Accumulator A0 is changed to SD718 and accumulator A1 is changed to SD719.

Function	QCPU		A0J2HCPU	
	Instruction format	Remarks	Instruction format	Remarks
16-bit data search Rotating 32-bit data to right		• D: Rotation data		• Set rotation data to A0
		• D: Rotation data • Use SM700 for a carry flag		• Set rotation data to A0 • Use M9012 for a carry flag
16-bit data search Rotating 32-bit data to left		• D: Rotation data		• Set rotation data to A0
		• D: Rotation data • Use SM700 for a carry flag		• Set rotation data to A0 • Use M9012 for a carry flag
32-bit data search Rotating 32-bit data to right		• D: Rotation data		• Set rotation data to A0 and A1
		• D: Rotation data • Use SM700 for a carry flag		• Set rotation data to A0 and A1 • Use M9012 for a carry flag
32-bit data search Rotating 32-bit data to left		• D: Rotation data		• Set rotation data to A0 and A1
		• D: Rotation data • Use SM700 for a carry flag		• Set rotation data to A0 and A1 • Use M9012 for a carry flag

Function	QCPU		A0J2HCPU	
	Instruction format	Remarks	Instruction format	Remarks
16-bit data search	$\boxed{\text{SER}} \boxed{\text{S1}} \boxed{\text{S2}} \boxed{\text{D}} \boxed{\text{n}}$	• Stores search results to D and D+1 devices	$\boxed{\text{SER}} \boxed{\text{S1}} \boxed{\text{S2}} \boxed{\text{n}}$	• Stores search results to A0 and A1
32-bit data search	$\boxed{\text{DSER}} \boxed{\text{S1}} \boxed{\text{S2}} \boxed{\text{D}} \boxed{\text{n}}$	• Stores search results to D and D+1 devices	$\boxed{\text{DSER}} \boxed{\text{S1}} \boxed{\text{S2}} \boxed{\text{n}}$	• Stores search results to A0 and A1
Bit check on 16-bit data	$\boxed{\text{SUM}} \boxed{\text{S}} \boxed{\text{D}}$	• Stores check results to D device	$\boxed{\text{SUM}} \boxed{\text{S}}$	• Stores check results to A0
Bit check on 32-bit data	$\boxed{\text{DSUM}} \boxed{\text{S}} \boxed{\text{D}}$	• Stores check results to D device	$\boxed{\text{DSUM}} \boxed{\text{S}}$	• Stores check results to A0
Partial refresh	$\boxed{\text{RFS}} \boxed{\text{D}} \boxed{\text{n}}$	• Dedicated instruction added	$\boxed{\text{SEG}} \boxed{\text{D}} \boxed{\text{n}}$	• Only when M9052 is ON ^{*1}
ASCII conversion of 8 characters	$\boxed{\text{\$MOV}} \boxed{\text{(Charactor strings)}} \boxed{\text{D}}$		$\boxed{\text{ASC}} \boxed{\text{(Charactor strings)}} \boxed{\text{D}}$	*2
Carry flag set	$\boxed{\text{SET}} \boxed{\text{SM700}}$	• No dedicated instruction	$\boxed{\text{STC}}$	*2
Carry flag reset	$\boxed{\text{RST}} \boxed{\text{SM700}}$	• No dedicated instruction	$\boxed{\text{CLC}}$	*2
Jump to END instruction	$\boxed{\text{GOEND}}$	• Dedicated instruction added	$\boxed{\text{CJ}} \boxed{\text{P255}}$	• P255:Specified END instruction ^{*2}
			$\boxed{\text{SCJ}} \boxed{\text{P255}}$	
			$\boxed{\text{JMP}} \boxed{\text{P255}}$	

*1 As the instruction is used for different functions, being deleted or corrected is required.

*2 Converted to "SM1255" as instructions that cannot be converted.

7.7.9 Setting method when multiple sequence programs are created

For the A0J2HCPU, some programs include main program and subprogram, and main programs have SFC programs. When replacing those programs with the QCPU, they are separated into different programs.

For the separated programs in the QCPU, the Program setting of the parameter setting is required. This section provides precautions after replacement of program settings, etc.

(1) Program files at replacement

(a) When main program contains SFC program

For the A0J2HCPU, the SFC program operates as the microcomputer program of main program. Since the QCPU deals the SFC program as one program, the SFC program is converted to "MAIN-SFC". Accordingly, two separate programs are created when the ACPUCPU is converted; "MAIN", converted from main program, and "MAIN-SFC".

Register in the order of MAIN, MAIN-SFC in the Program setting of the parameter setting of GX Developer, and set all execution types to "Scan".*1

Refer to Section 7.6 for precautions of replacing from the A0J2HCPU SFC (MELSAP-II) to the QCPU (MELSAP3).

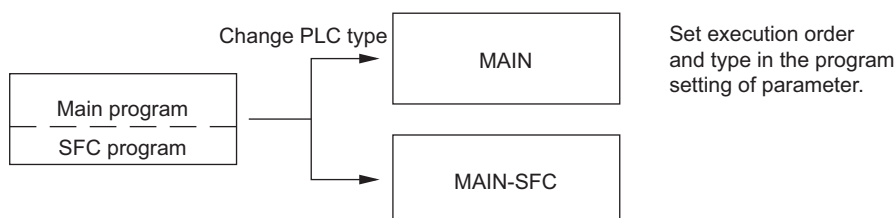

(2) Program setting of the GX Developer

The following explains required program settings for executing multiple programs.

The execution type of program is set in Program setting of the PLC parameter setting of the GX Developer.

CPU module executes the programs of the specified execution type in the setting order.

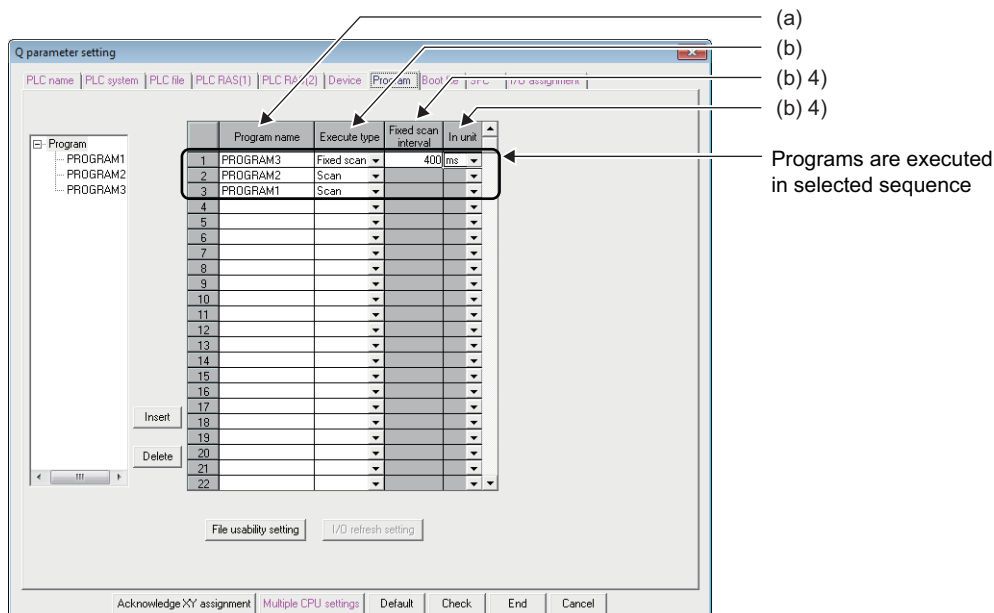

(a) Program name

Set a name for a program to be executed with a CPU module.

(b) Execution type

Select the execution type of files set in the program name.

1) Initial execution type (Initial)

This type of programs is executed only one time, when switching the power supply from off to on or STOP status to RUN status.

2) Scan execution type (Scan)

This type of programs is executed every scan, after having executed the initial execution type program.

3) Stand-by type (Wait)

This type of program is executed only when demanded.

4) Fixed scan execution type (Fixed scan)

This type of program is executed per interval set in the "Fixed scan interval" and "In unit".

- Fixed scan interval

Sets the program execution interval of fixed execution type program.

Setting range depends on the unit set in the fixed scan interval.

- For "ms": 0.5 to 999.5ms (0.5ms unit)
- For "s": 1 to 60s (1s unit)
- Unit

Selects the unit ("ms" or "s") for the fixed scan interval.

7.7.10 Precautions for file register replacement

Refer to the following notes in case where the file register is used when replacing A0J2HCPU with QCPU.

(1) Storage location and maximum number of points after replacement

	Q00(U)JCPU	Q00(U)/Q01(U)CPU	A0J2HCPU
Storage location	Not used	Standard RAM	Program memory
Maximum number of points		128k points	4K points
Number of points per block		32k points	–

(2) Operation after replacement

Create the device memory file and write the file register file to the programmable controller using GX Developer.

7.7.11 Boot operation method (storing the program to ROM)

The ROM operation of the A0J2HCPU changes to the boot operation of QCPU.

The Universal Model QCPU does not have to perform the boot operation since its program memory is a Flash ROM.

(The data written to files are not erased even if a battery error occurs.)

8 REPLACING THE COMMUNICATION MODULES

8.1 List of Alternative Communication Module Models

A0J2H models to be discontinued		Q series alternative models	
Product name	Model name	Model name	Remarks (restrictions)
Computer link module/ multidrop link (Master station)	A0J2-C214S1	QJ71C24N	<ul style="list-style-type: none"> Only the computer link function can be replaced.*1 The multidrop link function cannot be replaced.*2 Select the model compatible with the communication interface being used. The sequence program is not compatible, so a change is required.
		QJ71C24N-R2	
		QJ71C24N-R4	
Multidrop link (Remote station)	A0J2C25	None	No substitutions*2

*1 1 Select the Q series alternative model compatible with the communication interface being used.

(1) A0J2H Models to be discontinued

	CH1	CH2
A0J2-C214-S1	RS-232	RS-422

(2) Q series alternative models

	CH1	CH2
QJ71C24N	RS-232	RS-422/485
QJ71C24N-R2	RS-232	RS-232
QJ71C24N-R4	RS-422/485	RS-422/485

*2 Replacement of the multidrop link
The Q series communication modules do not have the multidrop link function. Therefore, consider the replacement methods as follows.

(1) When the remote and local stations are all replaceable with CC-Link

The following figure shows a configuration example when the remote and local stations are all replaceable with CC-Link.

*Example of existing configuration



*Example of CC-Link replacement configuration

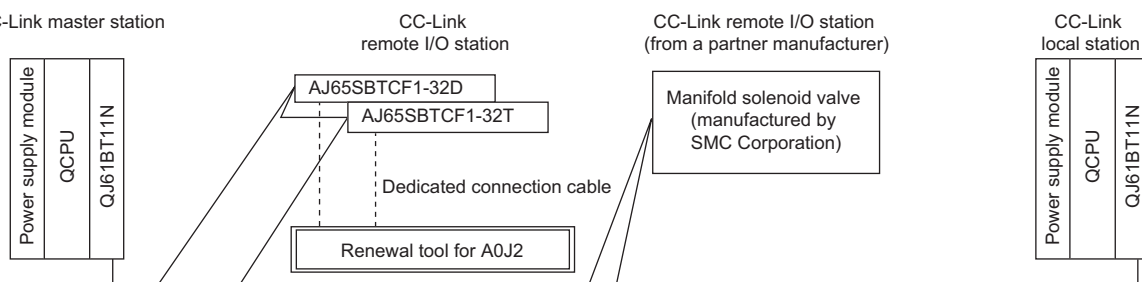

(2) When a product that cannot be replaced with CC-Link is included in the existing configuration

1) When a multidrop link module (A1SJ71UC24-R4) remains to be used as a spare

When a product from a partner manufacturer that cannot be replaced with CC-Link is included in a local station of the existing configuration, the product and the existing network can be used continuously by using the QA1S extension base unit (QA1S6□B/QA1S51B) on which the multidrop link module for the master station (A1SJ71UC24-R4) is mounted.

The following figure shows a configuration example when the product from the partner manufacturer and the existing network are continuously used.

* Example of existing configuration

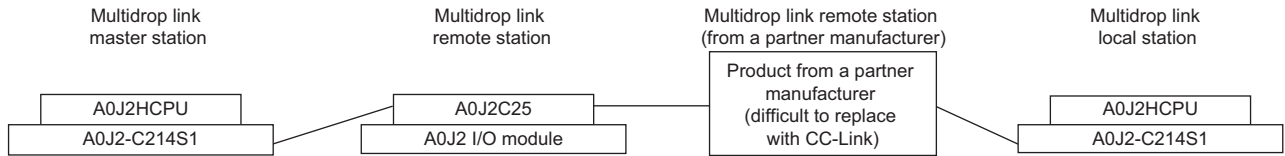

* Example of when the master station is replaced with the Q series

Station after replacement with the Q series

(by using QA(1S) extension base unit)

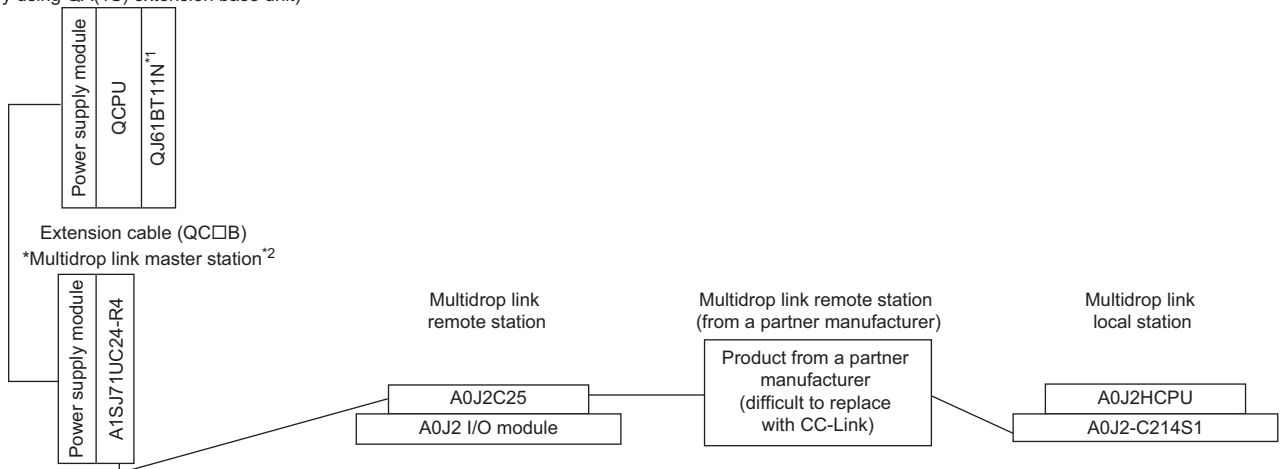

*1 This module is required only when two systems are used.

*2 • Base unit: QA1S extension base unit (QA1S6□B or QA1S51B)

• Power supply module (The QA1S51B is not required.)

• Master module: A1SJ71UC24-R4

(Note that the module was discontinued on September 30, 2014.)

2) When a multidrop link module for the master station (A1SJ71UC24-R4) does not remain to be used as a spare

When a product from a partner manufacturer that cannot be replaced with CC-Link is included in a local station of the existing configuration, replacement of the network with the one using Q series modules is difficult.

Keep using all of the existing modules in the existing configuration.

Or replace only the replaceable module(s) with CC-Link and configure two networks.

☒ Point

- (1) The I/O module of remote station A0J2C25 is an A0J2 I/O module.
Using the renewal tool for A0J2 (manufactured by Mitsubishi Electric System & Service Co., Ltd.) for replacement with CC-Link can eliminate the need for mounting hole drilling for the alternative module and enables reuse of I/O external wiring, and thus can reduce replacement man-hours. For details, refer to the Section 1.2.
 - (2) For a product from a partner manufacturer, ask the partner manufacturer whether they have an alternative product with the equivalent functions and specifications for CC-Link.
For contact information, check the website of "CC-Link Partner Association".
 - (3) When the multidrop link module does not remain to be used as a spare, the replacement of the A0J2-C214S1 is difficult.
(Note that new purchases of existing modules are not possible and the repair acceptance period cannot be extended.)
-

8.2 Specifications Comparison of Communication Modules

8.2.1 Performance comparisons of communication module specifications

○ : Compatible, △ : Partially changed, × : Incompatible

Item	Specifications		Compat- ibility	Precautions for replacement	
	A0J2-C214S1	QJ71C24N QJ71C24N-R2 QJ71C24N-R4			
Interface	RS-232 compliant (D-Sub 25P)	RS-232 compliant (D-Sub 9P)	△	Connection cable connector must be changed.	
	RS-422/485 compliant	RS-422/485 compliant (Two-piece terminal block)	○		
Communication method	Dedicated protocol communication	Half-duplex communication method	○	Called MC protocol communication in Q series.	
	Nonprocedural communication	Full-duplex communication (1:1 connection)/ half-duplex communication (1:n, m:n connection)	○		
Synchronous method	Asynchronous method		○		
Transmission speed	300 to 19200bps	50 to 230400bps	○		
Data format	Start bit	1	○		
	Data bit	7 or 8	○		
	Parity bit	1 (vertical parity)/none	○		
	Stop bit	1 or 2	○		
Error detection	Parity check	Available (odd/even)/none	○		
	Sum check	Available (MC protocol/bi-directional)/none	○		
Transmission control			○		
		RS-232			RS-422/485
	DTR /DSR (ER/DR) control	Possible			Not possible
	DC1/DC3 (Xon/Xoff) control	Possible	Possible		
	DC2/DC4 control				
Transmission distance	RS-232	Max. 15m		○	
	RS-422/485	Max. 500m (overall distance)	Max. 1200m (overall distance)	○	
Number of occupied I/O points	64 points	32 points	○		

8.2.2 Cable specifications comparison

○ : Compatible, △ : Partially changed, × : Incompatible

Item		Specifications		Compat- ibility	Precautions for replacement																
		A0J2-C214S1	QJ71C24N QJ71C24N-R2 QJ71C24N-R4																		
RS-232	Cable	Use cable that conforms to RS-232 standards*1		○																	
	Cable length	Max. 15m		○																	
	Applicable connector for external wiring (connection cable end on module side)	D-Sub 25P (male, screw clamp type)	D-Sub 9P*2 (male, screw clamp type)	△	Connector must be changed.																
RS-422/485	Cable	<table border="1"> <thead> <tr> <th>Items</th> <th>Descriptions</th> </tr> </thead> <tbody> <tr> <td>Cable type</td> <td>Shielded cable</td> </tr> <tr> <td>Logarithm</td> <td>3P</td> </tr> <tr> <td>Conductor resistance (at 20°C)</td> <td>88.0Ω/km or less</td> </tr> <tr> <td>Isolation resistance</td> <td>10000 MΩ•km or more</td> </tr> <tr> <td>Dielectric withstand voltage</td> <td>500VDC 1 minute</td> </tr> <tr> <td>Capacitance (1kHz)</td> <td>Average 60nF/km or less</td> </tr> <tr> <td>Characteristic impedance (100kHz)</td> <td>110±10Ω</td> </tr> </tbody> </table>		Items	Descriptions	Cable type	Shielded cable	Logarithm	3P	Conductor resistance (at 20°C)	88.0Ω/km or less	Isolation resistance	10000 MΩ•km or more	Dielectric withstand voltage	500VDC 1 minute	Capacitance (1kHz)	Average 60nF/km or less	Characteristic impedance (100kHz)	110±10Ω	○	
		Items	Descriptions																		
		Cable type	Shielded cable																		
		Logarithm	3P																		
		Conductor resistance (at 20°C)	88.0Ω/km or less																		
		Isolation resistance	10000 MΩ•km or more																		
		Dielectric withstand voltage	500VDC 1 minute																		
	Capacitance (1kHz)	Average 60nF/km or less																			
Characteristic impedance (100kHz)	110±10Ω																				
	*1																				
Cable length	Max. 500m (overall distance)	Max. 1200m (overall distance)	○																		
External wiring (connection cable end on module side)	Connect to terminal block		○	Refer to the manual for connection system.																	

*1 RS-232 or RS-422/485 recommended cables are described in the manual of the Q Series Serial Communication Module.

*2 Use the exclusive connector shell for the cable connected to the Q series serial communication module as described in the module's manual.

8.3 Functional Comparisons of Data Modules

○ : Compatible, △ : Partially changed, × : Incompatible

Item		Descriptions		Compat- ibility	Precautions for replacement	Reference sections
		A0J2-C214S1	QJ71C24N QJ71C24N-R2 QJ71C24N-R4			
Dedicated protocol communication	Device memory read, write	Allows the device on the other end to read and write programmable controller CPU data.		△	The usable commands, accessible device range, and access to other stations are restricted. This may require program changes of the device on the other end.	Section 8.6
Nonprocedural communication	Data transmission programmable controller→device on other end	Transmits data from device on other end to programmable controller CPU.		△	Dedicated instruction Change to a sequence program that uses (OUTPUT/INPUT).	
	Data reception programmable controller→device on other end	Receives transmitted data from device on other end.		△		
Transmission control	DTR/DSR control	Controls data transmission/reception with device on other end via RS-232 control signal.		○		
	DC code control	Transmits and receives DC code (including Xon/Xoff) and controls data transmission/reception with device on other end.		○		

8.4 Switch Settings Comparisons

○ : Compatible, △ : Partially changed, × : Incompatible

Switch name	Descriptions		Compati- bility	Precautions for replacement																																								
	A0J2-C214S1	QJ71C24N QJ71C24N-R2 QJ71C24N-R4																																										
Mode setting switch	Mode settings for each interface are made depending on the data communication function being used.		-	△																																								
		<table border="1"> <thead> <tr> <th></th> <th>RS-232</th> <th>RS-422/485</th> </tr> </thead> <tbody> <tr> <td>0</td> <td colspan="2">Not used</td> </tr> <tr> <td>1</td> <td>Dedicated protocol (format 1)</td> <td rowspan="2">Nonprocedural mode</td> </tr> <tr> <td>to</td> <td>to</td> </tr> <tr> <td>4</td> <td>Dedicated protocol (format 4)</td> <td></td> </tr> <tr> <td>5</td> <td rowspan="2">Nonprocedural mode</td> <td>Dedicated protocol (format 1)</td> </tr> <tr> <td>to</td> <td>to</td> </tr> <tr> <td>8</td> <td></td> <td>Dedicated protocol (format 4)</td> </tr> <tr> <td>9</td> <td colspan="2">Nonprocedural mode</td> </tr> <tr> <td>A</td> <td colspan="2">Dedicated protocol (format 1)</td> </tr> <tr> <td>to</td> <td colspan="2">to</td> </tr> <tr> <td>D</td> <td colspan="2">Dedicated protocol (format 4)</td> </tr> <tr> <td>E</td> <td colspan="2">Not used</td> </tr> <tr> <td>F</td> <td colspan="2">Unit loopback test</td> </tr> </tbody> </table>				RS-232	RS-422/485	0	Not used		1	Dedicated protocol (format 1)	Nonprocedural mode	to	to	4	Dedicated protocol (format 4)		5	Nonprocedural mode	Dedicated protocol (format 1)	to	to	8		Dedicated protocol (format 4)	9	Nonprocedural mode		A	Dedicated protocol (format 1)		to	to		D	Dedicated protocol (format 4)		E	Not used		F	Unit loopback test	
		RS-232			RS-422/485																																							
	0	Not used																																										
	1	Dedicated protocol (format 1)			Nonprocedural mode																																							
	to	to																																										
	4	Dedicated protocol (format 4)																																										
	5	Nonprocedural mode			Dedicated protocol (format 1)																																							
	to				to																																							
	8				Dedicated protocol (format 4)																																							
	9	Nonprocedural mode																																										
	A	Dedicated protocol (format 1)																																										
	to	to																																										
D	Dedicated protocol (format 4)																																											
E	Not used																																											
F	Unit loopback test																																											
Station number setting switch		Sets the module station number that is used for data communication with a dedicated protocol.	-	△																																								
Transmission specification setting switch	SW10	Computer link/multidrop link selection	Configures the computer link module function being used.	-	×	The Q series treats all channels equally.																																						
	SW11	Main channel settings	Specifies interface for transmission processing and reception processing.	-	×																																							
	SW12	Write during RUN enable/disable setting	Specifies whether write during RUN operation is enabled or disabled on dedicated protocol data communication.	-	△	Perform switch settings at the intelligent function module switch setting of GX Works2 or the PLC parameter settings of GX Developer.																																						
	SW13 to SW15	Transmission speed setting	Specifies the transmission speed during data transmission/reception operations.	-	△																																							
	SW16	Data bit setting	Specifies the data bit length of data to be transmitted/received.	-	△																																							
	SW17	Parity bit enable/disable setting	Specifies whether the parity bit exists in data to be transmitted/received.	-	△																																							
	SW18	Even/odd parity setting	Specifies the type of parity bit added to data to be transmitted/received.	-	△																																							
	SW19	Stop bit setting	Specifies the stop bit length of data to be transmitted/received.	-	△																																							
	SW20	Sum check enable/disable setting	Specifies whether there is a sum check code when performing data communication with a dedicated protocol.	-	△																																							

8.5 Program Comparisons

8.5.1 I/O signal

I/O signal assignment on the A0J2-C214S1 and the Q series serial communication module is not compatible. Create a new sequence program.

Signal name			
Input signal	A0J2-C214S1	Input signal	QJ71C24N(-R2/R4)
X00	Transmission complete	X00	CH1 Transmission normal completion
X01	Receive data read request	X01	CH1 Transmission abnormal completion
X02	Global signal	X02	CH1 Transmission processing
X03	Use prohibited	X03	CH1 Reception data read request
X04	C214 Transmission sequence status	X04	CH1 Reception abnormal detection
X05		X05	(For system)
X06		X06	CH1 Mode switching
X07	Use prohibited	X07	CH2 Transmission normal completion
X08		X08	CH2 Transmission abnormal completion
X09		X09	CH2 Transmission processing
X0A		X0A	CH2 Reception data read request
X0B		X0B	CH2 Reception abnormal detection
X0C		X0C	(For system)
X0D		Watchdog timer error	X0D
X0E	Use prohibited	X0E	CH1 ERR. occurrence
X0F		X0F	CH2 ERR. occurrence
X10		X10	Modem initialization completion
X11		X11	Dialing
X12		X12	Connection
X13		X13	Initialization/connection abnormal completion
X14		X14	Modem disconnection complete
X15		X15	Notification normal completion
X16		X16	Notification abnormal completion
X17		X17	Flash ROM read completion
X18		X18	Flash ROM write completion
X19		X19	Flash ROM system setting write completion
X1A		X1A	CH1 Global signal
X1B		X1B	CH2 Global signal
X1C		X1C	System setting default completion
X1D		X1D	Pre-defined protocol ready
X1E		X1E	Q series C24 ready
X1F	X1F	Watchdog timer error	

Signal name				
Output signal	A0J2-C214S1	Output signal	QJ71C24N(-R2/R4)	
Y00	Use prohibited	Y00	CH1 Transmission request	
Y01		Y01	CH1 Reception data read completion	
Y02		Y02	CH1 Mode switching request	
Y03		Use prohibited	Y03	
Y04			Y04	
Y05			Y05	
Y06		Use prohibited	Y06	
Y07			Y07	CH2 Transmission request
Y08			Y08	CH2 Reception data read completion
Y09			Y09	CH2 Mode switching request
Y0A			Use prohibited	Y0A
Y0B		Y0B		
Y0C		Y0C		
Y0D		Y0D		
Y0E		Y0E	CH1 ERR. clear request	
Y0F		Y0F	CH2 ERR. clear request	
Y10		Send request	Y10	Modem initialization request (standby request)
Y11	Receive data read complete	Y11	Connection request	

		Signal name	
Output signal	A0J2-C214S1	Output signal	QJ71C24N(-R2/R4)
Y12	Use prohibited	Y12	Modem disconnection request
Y13		Y13	Use prohibited
Y14		Y14	Notification-issued request
Y15		Y15	Use prohibited
Y16		Y16	Use prohibited
Y17		Y17	Flash ROM read request
Y18		Y18	Flash ROM write request
Y19		Y19	Flash ROM system setting write request
Y1A		Y1A	Use prohibited
Y1B		Y1B	Use prohibited
Y1C		Y1C	System setting default request
Y1D		Y1D	Use prohibited
Y1E		Y1E	Use prohibited
Y1F		Y1F	Use prohibited

8.5.2 Buffer memory

Buffer memory assignment on the A0J2-C214S1 and the Q series serial communication module is not compatible.

Initialize settings using the intelligent function module setting of GX Works2 or GX Configurator-SC and create a new sequence program.

The following table shows the main assigned areas for the initial setting and transmission/reception setting at default.

○ : Compatible, △ : Partially changed, × : Incompatible

A0J2-C214S1		Buffer memory name	Compat- ibility	Precautions for replacement
Hexadecimal	Decimal			
0H	0	Nonprocedural send data count storage area	△	Use addresses 400H, 800H (1024, 2048) as transmission data count specification areas on the Q series.
1H to 7FH	1 to 127	Send data storage area	△	Use addresses from 401H, 801H (1025, 2049) as transmission data specification areas on the Q series.
80H	128	Nonprocedural receive data count storage area	△	Use addresses 600H, A00H (1536, 2560) as receive data count storage areas on the Q series.
81H to FFH	129 to 255	Receive data storage area	△	Use addresses from 601H, A01H (1537, 2561) as receive data storage areas on the Q series.
100H	256	Nonprocedural reception end code designation area	△	Use addresses A5H, 145H (165, 325) as receive end code designation areas on the Q series.
101H	257	Error LED indication area	△	Use addresses 201H, 202H (513, 514) for LED or communication error information initialization requests on the Q series.
102H	258	Error LED off request area	△	Use addresses 0H, 1H (0,1) for LED or communication error information initialization requests on the Q series.
103H to 7FFH	259 to 2047	User free buffer memory	△	Use addresses C00H to 1AFFH (3072 to 6911) as user free buffer memory areas on the Q series.

8.6 Program Reuse

The following shows the precautions for reusing the existing programs as the Q series serial communication module program when changing modules.

Item	Target device	Precautions	Remarks
Initial settings	Programmable controller CPU side	[Initial settings] Initialize settings using the intelligent function module setting of GX Works2 or GX Configurator-SC. [Delete initial setting program] Delete the initial setting program.	Refer to the Q Corresponding Serial Communication Module User's Manual (Basic).
Dedicated protocol communication (MC protocol communication)	Device on the other end	[Access to programmable controller CPU] The usable commands, accessible device range, and access to other stations are restricted. *1*2	Refer to the Q Corresponding Serial Communication Module User's Manual (Basic). Refer to the MELSEC Communication Protocol Reference Manual.
Nonprocedural communication (Nonprocedural protocol communication)	Programmable controller CPU side	[Data transmission/reception] Change to a sequence program that uses the dedicated instruction (OUTPUT/INPUT).	Refer to the Q Corresponding Serial Communication Module User's Manual (Basic).
Others	Programmable controller CPU side	[I/O signal assignment] I/O signal (X/Y) assignment on the A0J2H series and the Q series is not compatible. Confirm the I/O signal (X/Y) being used and correct the program.	Refer to the Q Corresponding Serial Communication Module User's Manual (Basic).
	Programmable controller CPU side and device on the other end.	[Buffer memory assignment] Buffer memory assignment on the A0J2H series and the Q series is not compatible. Confirm the buffer memory and address of the read/write data, and correct the program.	

*1 Access only to the programmable controller CPU device memory is possible.
Accessible devices are those in the device range when ACPU common commands are used. Also, the following devices cannot be accessed from a device on the other end.

- Latch relay (L) and Step relay (S)
 - * For the QCPU, the latch relay (L) and step relay (S) is a separate device from the internal relay (M), but any can be specified and access the internal relay.
- File register (R)
- Special relay (M9000 or later), special register (D9000 or later)

*2 When using non-accessible devices (*1) and access functions outside device memory, use the Q series serial communication module's new commands to gain access.
(Change the program of the device on the other end.)

8.7 Other Precautions

The following shows the precautions for replacing the A0J2-C214S1 with the Q series serial communication module.

(1) Processing time

The A0J2H series and the Q series module have different data communication processing times. For this reason, the data communication timing and related factors are different. Make adjustments as needed to wait time.

Refer to each module's manual for definite processing times.

(2) Switch settings

When using the Q series serial communication module, always specify the mode, station number, and transmission specifications at the intelligent function module switch setting of GX Works2 or the switch setting of GX Developer.

(3) Data communication via the RS-422/485 interface

The precautions regarding data communication via the RS-422/485 interface are the same as with the A0J2H series computer link module.

When the device on the other end receives incorrect data, attach pull-up or pull-down resistor to the device on the other end. Refer to Section 3.3.3 of the Q Corresponding Serial Communication Module User's Manual (Basic).

9 REPLACING THE NETWORK SYSTEM

9.1 List of Alternative Network System Models

A0J2H models to be discontinued		Q series alternative models	
Product name	Model name	Model name	Remarks (restrictions)
MELSECNET data link module	A0J2HCPUP21	Q00UCPU+QJ71LP21-25	It is recommended to change to the MELSECNET/H network system.*
	A0J2HCPUR21	Q00UCPU+QJ71BR11	
	A0J2P25	QJ72LP25-25	When replacing remote I/O stations, replace the remote master station with the QCPU as well. For remote I/O stations, replace all of the corresponding modules (including I/O module) with Q series alternative models.
	A0J2R25	QJ72BR15	

* Refer to the "Transition from MELSEC-A/QnA (Large Type), AnS/QnAS (Small Type) Series to Q Series Handbook (Network Modules)" for guidance on exchanging the MELSECNET system to the MELSECNET/H system.

Additionally, use caution on the following points when configuring the MELSECNET/H network system on the Q00UCPU.

- (1) The Q00UJCPU, Q00UCPU, and Q01UCPU can only load one network module.
To load two or more network modules, use the Universal model QCPU other than the Q00UJCPU, Q00UCPU, or Q01UCPU.
- (2) The Q00UJCPU, Q00UCPU, and Q01UCPU have functions and abilities that are not compatible with the MELSECNET/H network (PLC to PLC network).
Refer to Section 2.2.3 of Q Corresponding MELSECNET/H Network System Reference Manual (PLC to PLC Network) for details.

10 REPLACING THE SPECIAL FUNCTION MODULE

10.1 List of Alternative Special Function Module Models

A0J2H series to be discontinued		Q series alternative models	
Product name	Model name	Model name	Remarks (restrictions)
Analog input module	A0J2-68AD	Q68ADV/Q68ADI	<ol style="list-style-type: none"> 1) Change in external wiring: Due to differences in terminal block 2) Change in a program: Change in I/O signal and buffer memory address 3) Change in performance specifications: Voltage or current input only(when using a mix, each module must be changed.) 4) Change in functional specifications: Change in average processing setting range
Analog output module	A0J2-62DA	Q62DAN	<ol style="list-style-type: none"> 1) Change in external wiring: Due to differences in terminal block 2) Change in a program: Change in I/O signal and buffer memory address 3) Change in performance specifications: Negative current output not allowed 4) Change in functional specifications: Upward compatible

A0J2H series to be discontinued		Q series alternative models	
Product name	Model name	Model name	Remarks (restrictions)
High-speed counter module	A0J2-D61S1	QD62	1) Change in external wiring: Wiring using the terminal block → Wiring using the connector, change in wire size 2) Change in a program: Change in the number of occupied I/O points, I/O signal, and buffer memory address 3) Change in performance specifications: Change in counting speed (2-phase, 7kPPS/1-phase, 10kPPS → 200kPPS/100kPPS/10kPPS switch setting) : Review of counting range 24-bit binary (0 to 16777215) → 32-bit signed binary (-2147483648 to 2147483647) 4) Change in functional specifications: No change (Upward compatible)
		QD62-H02*1	1) Change in external wiring: Wiring using the terminal block → Wiring using the connector, change in wire size 2) Change in a program: Change in the number of occupied I/O points, I/O signal, and buffer memory address 3) Change in performance specifications: Change in counting speed No change : Review of counting range 24-bit binary (0 to 16777215) → 32-bit signed binary (-2147483648 to 2147483647) 4) Change in functional specifications: No change (Upward compatible)
Positioning module	A0J2-D71	QD75P2N	1) Change in external wiring: Due to differences in pin arrangement 2) Change in a program: Due to differences in XY/buffer memory array 3) Change in performance specifications: Partially different, so re-examination is necessary. 4) Change in functional specifications: Partially different, so re-examination is necessary.

*1 The QD62-H02 is a dedicated module for replacing the A0J2-D61S1/AD61-S1 with Q series modules.
 The QD62-H02 and the A0J2-D61S1/AD61-S1 use the same input filter method.

Remarks

"Special function module" of the A0J2H series and A series corresponds to "intelligent function module" of the Q series.

.....

10.2 Special Function Module Comparison

10.2.1 Analog input module comparisons

(1) Specifications comparison of A0J2-68AD and Q68ADV/Q68ADI

(a) Performance specifications comparison

○ : Compatible, △ : Partially changed, × : Incompatible

Item		A0J2-68AD	Q68ADV	Q68ADI	Compat- ibility	Precautions for replacement																																																										
Analog input	Voltage	-10VDC to 0 to +10VDC (Input resistance: 30 kΩ) Select via input terminal	-10 to 10VDC (Input resistance value: 1MΩ)	-	△	At one module, voltage/current cannot be mixed.																																																										
	Current	+4 to +20mADC (Input resistance 250Ω) Select via input terminal Current input can be from -20 to 0 to +20mA	-	0 to 20mADC (Input resistance value: 250Ω)																																																												
Digital output		16bits signed binary (-2048 to +2047)	16bits signed binary (Normal resolution mode: -4096 to 4095, High resolution mode: -12288 to 12287, -16384 to 16383)		△	Since the resolution changes, the sequence program must be changed.																																																										
I/O characteristics	<table border="1"> <thead> <tr> <th>Analog input</th> <th>Digital output</th> </tr> </thead> <tbody> <tr> <td>+10V</td> <td>+2000</td> </tr> <tr> <td>+5V or +20mA</td> <td>+1000</td> </tr> <tr> <td>0V or +4mA</td> <td>±0</td> </tr> <tr> <td>-5V or -12mA</td> <td>-1000</td> </tr> <tr> <td>-10V</td> <td>-2000</td> </tr> </tbody> </table>		Analog input	Digital output	+10V	+2000	+5V or +20mA	+1000	0V or +4mA	±0	-5V or -12mA	-1000	-10V	-2000	<table border="1"> <thead> <tr> <th rowspan="2">Analog input range</th> <th colspan="2">Normal resolution mode</th> <th colspan="2">High resolution mode</th> </tr> <tr> <th>Digital</th> <th>Maximum resolution</th> <th>Digital output value</th> <th>Maximum resolution</th> </tr> </thead> <tbody> <tr> <td rowspan="3">Voltage</td> <td>0 to 10V</td> <td rowspan="3">0 to 4000</td> <td>2.5mV</td> <td rowspan="2">0 to 16000</td> <td>0.625mV</td> </tr> <tr> <td>0 to 5V</td> <td>1.25mV</td> <td>0.416mV</td> </tr> <tr> <td>1 to 5V</td> <td>1.0mV</td> <td>0 to 12000</td> <td>0.333mV</td> </tr> <tr> <td>-10 to 10V</td> <td rowspan="2">-4000 to 4000</td> <td>2.5mV</td> <td>-16000 to 16000</td> <td>0.625mV</td> </tr> <tr> <td>User range setting</td> <td>0.375mV</td> <td>-12000 to 12000</td> <td>0.333mV</td> </tr> <tr> <td rowspan="3">Current</td> <td>0 to 20mA</td> <td rowspan="3">0 to 4000</td> <td>5μA</td> <td rowspan="2">0 to 12000</td> <td>1.66μA</td> </tr> <tr> <td>4 to 20mA</td> <td>4μA</td> <td>1.33μA</td> </tr> <tr> <td>User range setting</td> <td>-4000 to 4000</td> <td>1.37μA</td> <td>-12000 to 12000</td> <td>1.33μA</td> </tr> </tbody> </table>			Analog input range	Normal resolution mode		High resolution mode		Digital	Maximum resolution	Digital output value	Maximum resolution	Voltage	0 to 10V	0 to 4000	2.5mV	0 to 16000	0.625mV	0 to 5V	1.25mV	0.416mV	1 to 5V	1.0mV	0 to 12000	0.333mV	-10 to 10V	-4000 to 4000	2.5mV	-16000 to 16000	0.625mV	User range setting	0.375mV	-12000 to 12000	0.333mV	Current	0 to 20mA	0 to 4000	5μA	0 to 12000	1.66μA	4 to 20mA	4μA	1.33μA	User range setting	-4000 to 4000	1.37μA	-12000 to 12000	1.33μA	△	Think of gain value differently.
	Analog input	Digital output																																																														
+10V	+2000																																																															
+5V or +20mA	+1000																																																															
0V or +4mA	±0																																																															
-5V or -12mA	-1000																																																															
-10V	-2000																																																															
Analog input range	Normal resolution mode		High resolution mode																																																													
	Digital	Maximum resolution	Digital output value	Maximum resolution																																																												
Voltage	0 to 10V	0 to 4000	2.5mV	0 to 16000	0.625mV																																																											
	0 to 5V		1.25mV		0.416mV																																																											
	1 to 5V		1.0mV	0 to 12000	0.333mV																																																											
-10 to 10V	-4000 to 4000	2.5mV	-16000 to 16000	0.625mV																																																												
User range setting		0.375mV	-12000 to 12000	0.333mV																																																												
Current	0 to 20mA	0 to 4000	5μA	0 to 12000	1.66μA																																																											
	4 to 20mA		4μA		1.33μA																																																											
	User range setting		-4000 to 4000	1.37μA	-12000 to 12000	1.33μA																																																										
Maximum resolution		Voltage 5mV (1/2000) Current 20μA (1/1000)				○																																																										
Overall accuracy		±1% (±20)	<table border="1"> <thead> <tr> <th rowspan="2">Analog input range</th> <th colspan="3">Normal resolution mode</th> <th colspan="3">High resolution mode</th> </tr> <tr> <th colspan="2">Ambient temperature 0 to 55°C</th> <th>Ambient temperature 25±5°C</th> <th colspan="2">Ambient temperature 0 to 55°C</th> <th>Ambient temperature 25±5°C</th> </tr> <tr> <td></td> <th>Temperature drift compensation</th> <th>Temperature drift without compensation</th> <th>Temperature drift compensation</th> <th>Temperature drift without compensation</th> <th>Temperature drift without compensation</th> <th>Temperature drift without compensation</th> </tr> </thead> <tbody> <tr> <td rowspan="3">Voltage</td> <td>0 to 10V</td> <td rowspan="3">Within ±0.3% (±12digits)</td> <td rowspan="3">Within ±0.4% (±16digits)</td> <td rowspan="3">Within ±0.1% (±48digits)</td> <td rowspan="2">Within ±0.3% (±48digits)</td> <td rowspan="2">Within ±0.4% (±64digits)</td> <td rowspan="2">Within ±0.1% (±16digits)</td> </tr> <tr> <td>-10 to 10V</td> </tr> <tr> <td>0 to 5V</td> </tr> <tr> <td>1 to 5V</td> <td rowspan="2">Within ±0.3% (±12digits)</td> <td rowspan="2">Within ±0.4% (±16digits)</td> <td rowspan="2">Within ±0.1% (±48digits)</td> <td rowspan="2">Within ±0.3% (±36digits)</td> <td rowspan="2">Within ±0.4% (±48digits)</td> <td rowspan="2">Within ±0.1% (±12digits)</td> </tr> <tr> <td>User range setting</td> </tr> <tr> <td rowspan="2">Current</td> <td>0 to 20mA</td> <td rowspan="2">Within ±0.3% (±12digits)</td> <td rowspan="2">Within ±0.4% (±16digits)</td> <td rowspan="2">Within ±0.1% (±48digits)</td> <td rowspan="2">Within ±0.3% (±36digits)</td> <td rowspan="2">Within ±0.4% (±48digits)</td> <td rowspan="2">Within ±0.1% (±12digits)</td> </tr> <tr> <td>4 to 20mA</td> </tr> <tr> <td>User range setting</td> <td></td> <td></td> <td></td> <td></td> <td></td> <td></td> <td></td> </tr> </tbody> </table>			Analog input range	Normal resolution mode			High resolution mode			Ambient temperature 0 to 55°C		Ambient temperature 25±5°C	Ambient temperature 0 to 55°C		Ambient temperature 25±5°C		Temperature drift compensation	Temperature drift without compensation	Temperature drift compensation	Temperature drift without compensation	Temperature drift without compensation	Temperature drift without compensation	Voltage	0 to 10V	Within ±0.3% (±12digits)	Within ±0.4% (±16digits)	Within ±0.1% (±48digits)	Within ±0.3% (±48digits)	Within ±0.4% (±64digits)	Within ±0.1% (±16digits)	-10 to 10V	0 to 5V	1 to 5V	Within ±0.3% (±12digits)	Within ±0.4% (±16digits)	Within ±0.1% (±48digits)	Within ±0.3% (±36digits)	Within ±0.4% (±48digits)	Within ±0.1% (±12digits)	User range setting	Current	0 to 20mA	Within ±0.3% (±12digits)	Within ±0.4% (±16digits)	Within ±0.1% (±48digits)	Within ±0.3% (±36digits)	Within ±0.4% (±48digits)	Within ±0.1% (±12digits)	4 to 20mA	User range setting								○			
Analog input range	Normal resolution mode			High resolution mode																																																												
	Ambient temperature 0 to 55°C		Ambient temperature 25±5°C	Ambient temperature 0 to 55°C		Ambient temperature 25±5°C																																																										
	Temperature drift compensation	Temperature drift without compensation	Temperature drift compensation	Temperature drift without compensation	Temperature drift without compensation	Temperature drift without compensation																																																										
Voltage	0 to 10V	Within ±0.3% (±12digits)	Within ±0.4% (±16digits)	Within ±0.1% (±48digits)	Within ±0.3% (±48digits)	Within ±0.4% (±64digits)	Within ±0.1% (±16digits)																																																									
	-10 to 10V																																																															
	0 to 5V																																																															
1 to 5V	Within ±0.3% (±12digits)	Within ±0.4% (±16digits)	Within ±0.1% (±48digits)	Within ±0.3% (±36digits)	Within ±0.4% (±48digits)	Within ±0.1% (±12digits)																																																										
User range setting																																																																
Current	0 to 20mA	Within ±0.3% (±12digits)	Within ±0.4% (±16digits)	Within ±0.1% (±48digits)	Within ±0.3% (±36digits)	Within ±0.4% (±48digits)	Within ±0.1% (±12digits)																																																									
	4 to 20mA																																																															
User range setting																																																																

○ : Compatible, △ : Partially changed, × : Incompatible

Item	A0J2-68AD	Q68ADV	Q68ADI	Compati- bility	Precautions for replacement
Maximum conversion speed	Maximum 2.5ms/channel	80μs/channel (When there is temperature drift compensation, 160μs is added to the time regardless of the number of channels used.)		○	With respect to A0J2-68AD, Q68ADV/I conversion speed increases. For this reason, for noise incorporated at A0J2-68AD, this noise can be incorporated as an analog signal at the Q68ADV/I. In this type of case, use the averaging processing specification to remove the influence
Absolute maximum input	Voltage ±15V Current ±30mA	±15V	±30mA	○	
Number of analog input points	8 channels/module			○	
E ² PROM Write count	–	Max. 100000 times		○	
Insulation method	I/O terminal and programmable controller power supply: Photocoupler Between channels: Non-isolated	Between I/O terminal and programmable controller power supply: Photocoupler Between channels: Non-isolated		○	
Dielectric withstand voltage	–	Between I/O terminal and programmable controller power supply: 500VAC 1 minute		○	
Insulation resistance	–	Between I/O terminal and programmable controller power supply: 500VDC 20MΩ or greater		○	
Number of occupied I/O points	64 points (I/O assignment: Special 64 points)	16 points (I/O assignment: Intelligent 16 points)		×	The number of I/O points changes to 16.
Connected terminal	36-point terminal block	18-point terminal block		×	Wiring change is required.
Applicable wire size	0.75 to 2mm ² (Applicable tightening torque 39 to 59 N•cm)	0.3 to 0.75mm ²		×	
Applicable solderless terminal	V1.25-3 V1.25-YS3A V2-S3 V2-YS3A	R1.25-3 (A solderless terminal with sleeve cannot be used.)		×	
5VDC internal current consumption	0.7A	0.64A		○	
Weight	0.675kg	0.19kg		△	

(b) Functional comparisons

○ : Compatible, △ : Partially changed, × : Incompatible

Item	A0J2-68AD	Q68ADV	Q68ADI	Compat- ibility	Precautions for replacement
A/D conversion possible/Prohibited setting	The number of channels where A/D conversion is possible/prohibited can be set. By making unused channels conversion prohibited, sampling time can be shortened.	A/D conversion possible/prohibited can be set. By making unused channels conversion prohibited, sampling time can be shortened.	A/D conversion possible/prohibited can be set. By making unused channels conversion prohibited, sampling time can be shortened.	○	
Sampling processing	Analog input value for each channel can have A/D conversion performed, and the digital output value can be output.	Analog input value for each channel can have A/D conversion performed, and the digital output value can be output.	Analog input value for each channel can have A/D conversion performed, and the digital output value can be output.	○	
Averaging processing	Averaging processing specified channel A/D conversion is performed according to set times or set processing time, the maximum and minimum times are removed, and the remaining total is averaged and stored in the buffer memory.	Each channel undergoes A/D conversion for an average number of times or set time, and the average value is digitally output.	Each channel undergoes A/D conversion for an average number of times or set time, and the average value is digitally output.	△	The valid range can be changed.
Maximum value/ minimum value hold function	—	The digital output maximum value and minimum value is stored in the module.	The digital output maximum value and minimum value is stored in the module.	—	
Temperature drift compensation function	—	The error depending on the module's ambient temperature conversion can be automatically compensated to increase the conversion accuracy. The temperature drift compensation function (all channel A/D conversion time) + 160μs can be implemented.	The error depending on the module's ambient temperature conversion can be automatically compensated to increase the conversion accuracy. The temperature drift compensation function (all channel A/D conversion time) + 160μs can be implemented.	—	
Resolution mode	—	Depending on the application, the resolution mode switches, and resolution of 1/4000, 1/12000, 1/16000 can be selected. Resolution mode setting can be done for all channels in batch.	Depending on the application, the resolution mode switches, and resolution of 1/4000, 1/12000, 1/16000 can be selected. Resolution mode setting can be done for all channels in batch.	—	
Online module change	—	Module can be replaced without stopping the system.	Module can be replaced without stopping the system.	—	The CPU modules that support the online module change are a Process CPU and a Redundant CPU.

(c) Programmable controller CPU I/O signal comparison

Input signal is different, so the sequence program must be changed.

Refer to the Analog-Digital converter Module User's Manual for details regarding the I/O signals and sequence program.

A0J2-68AD				Q68ADV/Q68ADI			
Device No.	Signal name	Device No.	Signal name	Device No.	Signal name	Device No.	Signal name
X0	Watchdog timer error	Y0	Use prohibited	X0	Module READY	Y0	Use prohibited
X1	A/D conversion READY	Y1		X1	Temperature drift compensation flag	Y1	
X2	Use prohibited	Y2		X2	Use prohibited	Y2	
X3		Y3		X3		Y3	
X4		Y4		X4		Y4	
X5		Y5		X5		Y5	
X6		Y6		X6		Y6	
X7		Y7		X7		Y7	
X8		Y8		X8		High resolution mode condition flag	Y8
X9		Y9		X9	Operating condition setting complete flag	Y9	Operating condition setting request
XA		YA		XA	Offset gain setting mode condition flag	YA	User range write request
XB		YB		XB	Channel change complete flag	YB	Channel change request
XC		YC		XC	Use prohibited	YC	Use prohibited
XD		YD		XD	Maximum value /Minimum value reset complete flag	YD	Maximum value/ Minimum value reset request
XE		YE		XE	A/D conversion complete flag	YE	Use prohibited
XF	YF	XF		Error occurrence flag	YF	Error clear request	
X10	Y10						
X11	Y11						
X12	Y12						
X13	Y13						
X14	Y14						
X15	Y15						
X16	Y16						
X17	Y17						
X18	Y18						
X19	Y19						
X1A	Y1A						
X1B	Y1B						
X1C	Y1C						
X1D	Y1D						
X1E	Y1E						
X1F	Y1F						

(d) Buffer memory address comparisons

Buffer memory allocation is different, so the sequence program must be changed.

Refer to the Analog-Digital Converter Module User's Manual for details regarding the buffer memory and sequence program.

A0J2-68AD			Q68ADV/Q68ADI				
Address (decimal)	Name	Read/Write	Address (decimal)	Name	Read/Write		
0	Number of channels	R/W	0	A/D conversion enabled/disabled setting	R/W		
1	Averaging processing specification		1	CH1 Average time/Average count setting			
2	CH1 Average time, count		2	CH2 Average time/Average count setting			
3	CH2 Average time, count		3	CH3 Average time/Average count setting			
4	CH3 Average time, count		4	CH4 Average time/Average count setting			
5	CH4 Average time, count		5	CH5 Average time/Average count setting			
6	CH5 Average time, count		6	CH6 Average time/Average count setting			
7	CH6 Average time, count		7	CH7 Average time/Average count setting			
8	CH7 Average time, count		8	CH8 Average time/Average count setting			
9	CH8 Average time, count	R	9	Averaging processing specification	R		
10	CH1 Digital output value		10	A/D conversion completed flag			
11	CH2 Digital output value		11	CH1 Digital output value			
12	CH3 Digital output value		12	CH2 Digital output value			
13	CH4 Digital output value		13	CH3 Digital output value			
14	CH5 Digital output value		14	CH4 Digital output value			
15	CH6 Digital output value		15	CH5 Digital output value			
16	CH7 Digital output value		16	CH6 Digital output value			
17	CH8 Digital output value		17	CH7 Digital output value			
18	Unused area	-	18	CH8 Digital output value	R/W		
19			19	Error code			
20			20	Setting range (CH1 to CH4)			
21			21	Setting range (CH5 to CH8)			
22			22	Offset gain setting mode Offset setting			
23			23	Offset gain setting mode Gain setting			
24			System area	-		24	System area
25						25	
26						26	
27						27	
28						28	
29	29						
30	Write data error code	R/W	30	CH1 Maximum value	R/W		
31			31	CH1 Minimum value			
32			32	CH2 Maximum value			
33			33	CH2 Minimum value			
34			34	CH3 Maximum value			
35			35	CH3 Minimum value			
36			36	CH4 Maximum value			
37			37	CH4 Minimum value			
38	-	-	38	CH5 Maximum value	R/W		
39			39	CH5 Minimum value			
			40	CH6 Maximum value			
			41	CH6 Minimum value			
			42	CH7 Maximum value			
			43	CH7 Minimum value			
			44	CH8 Maximum value			
			45	CH8 Minimum value			
			46	System area		-	
			to				
	157						
	158	Mode movement setting	R/W				
	159						
	160	System area	-				
	to						
	201						

Q68ADV/Q68ADI		
Address (decimal)	Name	Read/Write
202	CH1 Industrial shipment settings offset value	R/W
203	CH1 Industrial shipment settings gain value	
204	CH2 Industrial shipment settings offset value	
205	CH2 Industrial shipment settings gain value	
206	CH3 Industrial shipment settings offset value	
207	CH3 Industrial shipment settings gain value	
208	CH4 Industrial shipment settings offset value	
209	CH4 Industrial shipment settings gain value	
210	CH5 Industrial shipment settings offset value	
211	CH5 Industrial shipment settings gain value	
212	CH6 Industrial shipment settings offset value	
213	CH6 Industrial shipment settings gain value	
214	CH7 Industrial shipment settings offset value	
215	CH7 F Industrial shipment settings gain value	
216	CH8 Industrial shipment settings offset value	
217	CH8 Industrial shipment settings gain value	
218	CH1 User range setting offset value	
219	CH1 User range setting gain value	
220	CH2 User range setting offset value	
221	CH2 User range setting gain value	
222	CH3 User range setting offset value	
223	CH3 User range setting gain value	
224	CH4 User range setting offset value	
225	CH4 User range setting gain value	
226	CH5 User range setting offset value	
227	CH5 User range setting gain value	
228	CH6 User range setting offset value	
229	CH6 User range setting gain value	
230	CH7 User range setting offset value	
231	CH7 User range setting gain value	
232	CH8 User range setting offset value	
233	CH8 User range setting gain value	

R/W

10.2.2 Analog output module comparison

(1) A0J2-62DA and Q62DAN comparison

(a) Performance specifications comparison

○ : Compatible, △ : Partially changed, × : Incompatible

Item	A0J2-62DA	Q62DAN	Compat- ibility	Precautions for replacement																																																												
Digital input	Maximum setting value For voltage: ± 2000 For current: ± 1000	16bits signed binary Normal resolution mode: -4096 to 4095 High resolution mode: -12288 to 12287 -16384 to 16383	△	Match with the used I/O conversion characteristics, Q62DAN output range settings, and offset/gain settings																																																												
Analog output	Voltage: -10 to 0 to +10VDC (External load resistance 500Ω to 1MΩ) Current: +4 to +20mADC (External load resistance 0Ω to 600Ω) Current output -20 to 0 to +20mA possible Select Voltage/Current output terminal	Voltage -10 to 10VDC (External load resistance 1kΩ to 1MΩ) Current 0 to 20mADC (External load resistance 0Ω to 600Ω)	△	Negative current output is not allowed.																																																												
I/O characteristics	<table border="1"> <thead> <tr> <th>Digital input</th> <th colspan="2">Analog output</th> </tr> <tr> <th></th> <th>Voltage</th> <th>Current</th> </tr> </thead> <tbody> <tr> <td>+2000</td> <td>+10V</td> <td>-</td> </tr> <tr> <td>+1000</td> <td>+5V</td> <td>+20mA</td> </tr> <tr> <td>0</td> <td>0V</td> <td>+4mA</td> </tr> <tr> <td>-1000</td> <td>-5V</td> <td>-12mA</td> </tr> <tr> <td>-2000</td> <td>-10V</td> <td>-</td> </tr> </tbody> </table>	Digital input	Analog output			Voltage	Current	+2000	+10V	-	+1000	+5V	+20mA	0	0V	+4mA	-1000	-5V	-12mA	-2000	-10V	-	<table border="1"> <thead> <tr> <th rowspan="2">Analog output range</th> <th colspan="2">Normal resolution mode</th> <th colspan="2">High resolution mode</th> </tr> <tr> <th>Digital input value</th> <th>Maximum resolution</th> <th>Digital input value</th> <th>Maximum resolution</th> </tr> </thead> <tbody> <tr> <td>0 to 5V</td> <td rowspan="2">0 to 4000</td> <td>1.25mV</td> <td rowspan="2">0 to 12000</td> <td>0.416mV</td> </tr> <tr> <td>1 to 5V</td> <td>1.0mV</td> <td>0.333mV</td> </tr> <tr> <td>-10 to 10V</td> <td rowspan="2">-4000 to 4000</td> <td>2.5mV</td> <td>-16000 to 16000</td> <td>0.625mV</td> </tr> <tr> <td>User range setting</td> <td>0.75mV</td> <td>-12000 to 12000</td> <td>0.333mV</td> </tr> <tr> <td>0 to 20mA</td> <td rowspan="2">0 to 4000</td> <td>5 μA</td> <td rowspan="2">0 to 12000</td> <td>1.66 μA</td> </tr> <tr> <td>4 to 20mA</td> <td>4 μA</td> <td>1.33 μA</td> </tr> <tr> <td>User range setting</td> <td>-4000 to 4000</td> <td>1.5 μA</td> <td>-12000 to 12000</td> <td>0.83 μA</td> </tr> </tbody> </table>	Analog output range	Normal resolution mode		High resolution mode		Digital input value	Maximum resolution	Digital input value	Maximum resolution	0 to 5V	0 to 4000	1.25mV	0 to 12000	0.416mV	1 to 5V	1.0mV	0.333mV	-10 to 10V	-4000 to 4000	2.5mV	-16000 to 16000	0.625mV	User range setting	0.75mV	-12000 to 12000	0.333mV	0 to 20mA	0 to 4000	5 μA	0 to 12000	1.66 μA	4 to 20mA	4 μA	1.33 μA	User range setting	-4000 to 4000	1.5 μA	-12000 to 12000	0.83 μA	△	Think of gain value differently.
Digital input	Analog output																																																															
	Voltage	Current																																																														
+2000	+10V	-																																																														
+1000	+5V	+20mA																																																														
0	0V	+4mA																																																														
-1000	-5V	-12mA																																																														
-2000	-10V	-																																																														
Analog output range	Normal resolution mode		High resolution mode																																																													
	Digital input value	Maximum resolution	Digital input value	Maximum resolution																																																												
0 to 5V	0 to 4000	1.25mV	0 to 12000	0.416mV																																																												
1 to 5V		1.0mV		0.333mV																																																												
-10 to 10V	-4000 to 4000	2.5mV	-16000 to 16000	0.625mV																																																												
User range setting		0.75mV	-12000 to 12000	0.333mV																																																												
0 to 20mA	0 to 4000	5 μA	0 to 12000	1.66 μA																																																												
4 to 20mA		4 μA		1.33 μA																																																												
User range setting	-4000 to 4000	1.5 μA	-12000 to 12000	0.83 μA																																																												
Maximum resolution	Voltage: 5mV (1/2000) Current: 20μA (1/1000)		○																																																													
Overall accuracy (Accuracy relative to the maximum value of analog output value)	$\pm 1\%$ (Voltage 0.1V, Current 0.2mA)	Ambient temperature 25±5°C Within $\pm 0.1\%$ (Voltage: ± 10 mV, Current: ± 20 μA) Ambient temperature 0 to 55°C Within $\pm 0.3\%$ (Voltage: ± 30 mV, Current: ± 60 μA)	○																																																													
Maximum conversion speed	Within 16ms/2 channels (1 channel is same period of time.) Caution: After writing digital input, the time for a new analog voltage (current)	80μs/ channel	○																																																													

○ : Compatible, △ : Partially changed, × : Incompatible

Item	A0J2-62DA	Q62DAN	Compat- ibility	Precautions for replacement
Absolute maximum output	Voltage ±12V Current ±28mA Caution: With an output protection circuit, the above voltage and current output will not be exceeded.	Voltage ±12V Current 21mA	△	Negative current output is not allowed.
Number of analog output points	2 channels/ module		○	
E ² PROM write count	–	Max. 100000 times	○	
Output short protection	–	Available	○	
Insulation method	Between the output terminal and programmable controller power supply: Photocoupler Between channels: Non-isolated	Between I/O terminal and programmable controller power supply: Photocoupler Between output channels: Non-isolated Between external supply power and analog output: Non-isolated	○	
Dielectric withstand voltage	–	Between the I/O terminal and programmable controller power supply: 500VAC 1 minute Between external supply power and analog output: 500VAC 1 minute	○	
Insulation resistance	–	Between the I/O terminal and programmable controller power supply: 500VDC 20MΩ or greater Between external supply power and analog output: 500VDC 20MΩ or greater	○	
Number of occupied I/O points	64 points (I/O assignment: Special 64 points)	16 points (I/O assignment: Intelligent 16 points)	×	The number of I/O points changes to 16.
Connected terminal	36-point terminal block	18-point terminal block	×	Wiring change is required.
Applicable wire size	0.75 to 2mm ² (Applicable tightening torque 39 to 59 N•cm)	0.3 to 0.75mm ²	×	
Applicable solderless terminal	V1.25-3 V1.25-YS3A V2-S3 V2-YS3A	R1.25-3 (A solderless terminal with sleeve can not be used.)	×	
5VDC internal current consumption	0.55A	0.33A	○	
External supply power	Voltage	21.6 to 26.4VDC	○	Peak current becomes larger.
	Current consumption	0.23A	○	
	Inrush current	0.6A, 100ms (24VDC)	△	
Weight	0.75kg	0.19kg	△	

(b) Functional comparisons

○ : Compatible, △ : Partially changed, × : Incompatible

Item	A0J2-62DA	Q62DAN	Compat- ibility	Precautions for replacement
Output HOLD/CLEAR function	–	If programmable controller CPU is in stop state or an error has occurred, the output analog value is retained.	–	
D/A conversion enable/disable function	–	D/A conversion can be set to be enabled or disabled.	–	
D/A output enable/disable function	Specifies whether to output the D/A converted value or the offset value.	Output D/A conversion values can be set to be output in batch, or output an offset value.	○	
Synchronous output function	–	Synchronous analog output can be acquired at the programmable controller CPU.	–	
Programmable controller CPU Analog output test in STOP	–	If CH□ output enable/disable flag at programmable controller CPU STOP is forced ON, D/A converted analog values will be output.	–	
Resolution mode	–	Depending on the application, the resolution mode switches, and resolution of 1/4000, 1/12000, or 1/16000 can be selected.	–	
Online module change	–	Module can be replaced without stopping the system.	–	The CPU modules that support the online module change are a Process CPU and a Redundant CPU.

(c) Programmable controller CPU I/O signal comparison

I/O signal is different, so the sequence program must be changed.

Refer to the Digital-Analog Converter Module User's Manual for details regarding the I/O signals and sequence program.

A0J2-62DA				Q62DAN				
Device No.	Signal name	Device No.	Signal name	Device No.	Signal name	Device No.	Signal name	
X0	Watchdog timer error	Y0	Use prohibited	X0	Module READY	Y0	Use prohibited	
X1	D/A conversion READY	Y1		X1	Use prohibited	Y1	CH1 Output enable/disable flag	
X2	Use prohibited	Y2		X2		Y2	CH2 Output enable/disable flag	
X3		Y3		X3		Use prohibited	Y3	Use prohibited
X4		Y4		X4			Y4	
X5		Y5		X5			Y5	
X6		Y6		X6			Y6	
X7		Y7		X7			Y7	
X8		Y8		X8	High resolution mode condition flag		Y8	
X9		Y9		X9	Operating condition setting complete flag	Y9	Operating condition setting request	
XA		YA		XA	Offset gain setting mode condition flag	YA	User range write request	
XB		YB		XB	Channel change completed flag	YB	Channel change request	
XC		YC		XC	Setting change completed flag	YC	Setting change request	
XD		YD		XD	Synchronous output mode condition flag	YD	Synchronous output request	
XE		YE		XE	Use prohibited	YE	Use prohibited	
XF		YF		XF	Error occurrence flag	YF	Error clear request	
X10		Y10						
X11		Y11						
X12		Y12						
X13		Y13						
X14	Y14							
X15	Y15							
X16	Y16							
X17	Y17							
X18	Y18							
X19	Y19							
X1A	Y1A							
X1B	Y1B		Output enable					
X1C	Y1C		Use prohibited					
X1D	Y1D							
X1E	Y1E							
X1F	Y1F							

(d) Buffer memory addresses comparisons

Buffer memory allocation is different, so the sequence program must be changed.

Refer to the Digital -Analog Converter Module User's Manual for details regarding the buffer memory and sequence program.

A0J2-62DA			Q62DAN		
Address (decimal)	Name	Read/Write	Address (decimal)	Name	Read/Write
0	CH1 Digital value	R/W	0	D/A conversion enable/disable	R/W
1	CH2 Digital value		1	CH1 Digital value	
2	CH1 voltage set value check code		2	CH2 Digital value	
3	CH2 voltage set value check code		3	System area	-
4	CH1 current set value check code		4		
5	CH2 current set value check code		5		
		to			
		10	11	CH1 Set value check code	R
			12	CH2 Set value check code	
			13	System area	-
			to		
			18		
			19	Error code	R
			20	Setting range (CH1 to CH2)	
			21	System area	-
			22	Offset gain setting mode Offset setting	R/W
			23	Offset gain setting mode Gain setting	
			24	Offset/gain adjustment value	
			25	System area	-
			to		
			157		
			158	Mode movement setting	R/W
			159		
			160		
			to	System area	-
			199		
			200		
			201	System area	-
			202	CH1 Industrial shipment settings offset value	R/W
			203	CH1 Industrial shipment settings gain value	
			204	CH2 Industrial shipment settings offset value	
			205	CH2 Industrial shipment settings gain value	
			206	CH1 User range setting offset value	
			207	CH1 User range setting gain value	
			208	CH2 User range setting offset value	
			209	CH2 User range setting gain value	

10.2.3 High-speed counter module comparison

(1) A0J2-D61S1 and QD62/QD62-H02 comparison

(a) Performance specifications comparison

1) Performance specifications comparison between A0J2-D61S1 and QD62

○ : Compatible, △ : Partially changed, × : Incompatible

Item	A0J2-D61S1	QD62	Compat- ibility	Precautions for replacement						
I/O Occupied points	64 points (I/O assignment: Special 64 points)	16 points (I/O assignment: Intelligent 16 points)	×	The number of I/O points changes to 16.						
Number of channels	2 channels		○							
Performance specifications of one channel	Count input signal	Phase	1 phase -input, 2-phase input		○					
		Signal level (φ A, φ B)	5VDC 12VDC 24VDC } 2 to 5mA		○					
	Counter	Counting speed	1-phase input	10KPPS	200KPPS	100KPPS	10KPPS	○	*1 At QD62 the value is handled as a signed 32bits binary, so the sequence program must be changed.	
			2-phase input	7KPPS	200KPPS	100KPPS	10KPPS	○		
		Counting range	Binary format (binary) 24bits 0 to 16777215 (Decimal notation)		32bits signed binary (-2147483648 to 2147483647)			△		
		Type	UP/DOWN Preset counter + Ring counter function				○			
	Minimum value count pulse width (Input rise time is 5μs or less duty ratio is 50%)	 (P-phase input)		 (Min. phase differential for 2-phase input: 1.25μs)		 (Min. phase differential for 2-phase input: 2.5μs)		 (Min. phase differential for 2-phase input: 25μs)		○
	Maximum/ minimum comparison (CPU↔ A0J2-D61S1/ QD62)	Comparison range	Binary format (binary) 24bits		32bits signed binary			○		
	Comparison result	Set value< Count value Set value= Count value Set value> Count value		Set value < Count value Set value = Count value Set value > Count value			○			
	External input	Preset	12/24VDC 3/6 mA 5VDC 5mA		5/12/24VDC 2 to 5mA			△	At QD62, external input specifications are different, so confirm the external device specifications.	
Count disable		12/24VDC 3/6 mA 5VDC 5mA		-						
Function start		-		5/12/24VDC 2 to 5mA						
External output	Coincidence output	Transistor (Open collector) output 12/24VDC 0.5A		Transistor (sink type) output 2 points/channel 12/24VDC 0.5 A/point, 2 A/common			○			
5VDC internal current consumption	0.10A		0.30A			×	5VDC internal current consumption requires recalculation.			
Weight	0.65kg		0.11kg			△				

*1 The counting speed is affected by the rise/fall time of the pulse. The appropriate counting speed is as shown below.
Note that the count may be incorrect when pulses with longer rise/fall time are counted.
(For the A0J2-D61S1)

Rise/fall time	1-phase input	2-phase input
$t = 5\mu\text{s}$	10KPPS	7KPPS
$t = 500\mu\text{s}$	500PPS	250PPS

(For the QD62)

Rise/fall time	Common in 1-phase input and 2-phase input		
	200K	100K	10K
Counting speed switch setting			
$t = 1.25\mu\text{s}$ or less	200KPPS	100KPPS	10KPPS
$t = 2.5\mu\text{s}$ or less	100KPPS	100KPPS	10KPPS
$t = 25\mu\text{s}$ or less	-	10KPPS	10KPPS
$t = 500\mu\text{s}$	-	-	500KPPS

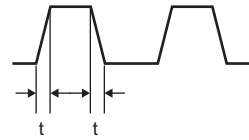
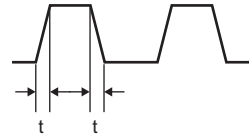

2) Performance specifications comparison between A0J2-D61S1 and QD62-H02

○ : Compatible, △ : Partially changed, × : Incompatible

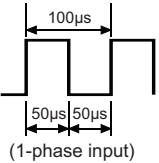
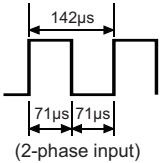
Item		A0J2-D61S1		QD62-H02		Compat- ibility	Precautions for replacement	
I/O occupied points		64 points (I/O assignment: Special 64 points)		16 points (I/O assignment: Intelligent 16 points)		△	The number of I/O points changes to 16.	
Number of channels		2 channels				○		
Counting speed switch setting		-		10KPPS		○	Set "2 (counting speed 200kPPS)" in the intelligent function module switch setting. Counting is performed using 10kPPS by setting "2 (counting speed 200kPPS)".	
Performance specifications of one channel	Count input signal	Phase		1-phase input, 2-phase input		○		
		Signal level (φ A, φ B)		5VDC 12VDC 24VDC } 2 to 5mA		○		
	Counter	Counting speed (Maximum)	1-phase input	10KPPS	1-phase input	10KPPS	○	*1
			2-phase input	7KPPS	2-phase input	7KPPS		
		Counting range	24-bit unsigned binary (0 to 16777215)		32-bit signed binary (-2147483648 to 2147483647)		△	At QD62-H02, the value is handled as a 32-bit signed binary, so the sequence program must be changed.
	Type	UP/DOWN Preset counter + Ring counter function				○		
	Minimum count pulse width (Input rise time must be 5μs or less. Duty ratio is 50%.)	 (1-phase input)		 (2-phase input)		○		
	Maximum/ minimum comparison (CPU↔ A0J2- D61S1/ QD62-H02)	Comparison range	24-bit unsigned binary		32-bit signed binary		○	
	Comparison result	Set value < Count value Set value = Count value Set value > Count value				○		
	External input	Preset	12/24VDC 3/6mA 5VDC 5mA		5/12/24VDC 2 to 5mA		△	At QD62-H02, external input specifications are different. Therefore, check the external device specifications.
Count disable		DC12/24V 3/6mA DC5V 5mA		-				
Function start		-		5/12/24VDC 2 to 5mA				
External output	Coincidence output	Transistor (open collector) output 12/24VDC 0.5A		Transistor (sink type) output 2 points/channel 12/24VDC 0.5A/point, 2A/common		○		
5VDC internal current consumption		0.10A		0.3A		△	The recalculation of 5VDC internal current consumption is required.	
Weight		0.65kg		0.11kg		△		

*1 The counting speed is affected by the rise/fall time of the pulse. The appropriate counting speed is as shown below.
Note that the count may be incorrect when pulses with longer rise/fall time are counted.
(For A0J2-D61S1 and QD62-H02)

Rise/fall time	1-phase input	2-phase input
t = 5μs	10KPPS	7KPPS
t = 500μs	500PPS	250PPS

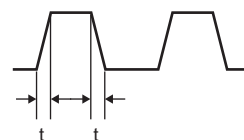

(b) Functional comparisons

○ : Compatible, △ : Partially changed, × : Incompatible

Item	A0J2-D61S1	QD62/QD62-H02	Compat- ibility	Precautions for replacement
Preset function	Preset is to overwrite counter current values to any values (initial values). The A0J2-D61S1 has no memory internal latch function, so if the power supply turns OFF or the CPU is reset, the D61S1 memory (counter values, current values, setting values, preset values) are initialized. Depending on the continuous work flow, the present counter value (present value) is stored in the CPU's data register, and when the next work is started, the stored data register values can be used as presets from which to continue counting.	Any value can be overwritten to the counter's present values.	○	
Disable function	Disable is disallowed, meaning enable is possible. If the sequencer I/O signal allocation in the count enable signal is ON, the A0J2-D61S1 count starts. If voltage is applied to the (CH1=Y14, CH2=Y1B) external input terminal's DIS (disable) terminal, the D61S1 count is stopped, so this can be used via external input to start or stop a count without relation to scan time.	Count is stopped.	○	
Ring counter function	Depending on the settings when the ring counter setting switch on the A0J2-D61S1 circuit board is ON, the counter values and similar settings are automatically preset. This function is used in cyclic controls.	Any set value is returned to perform a count.	○	
Linear counter function	–	Detects a count range overflow.	–	
Coincidence output function	It is possible for the A0J2-D61S1 to output (open collector output) counter coincidence signals (counter values and similar setting values are ON) as external output to an external terminal. To output a counter coincidence signal to an external terminal block, the coincidence signal output enable command (CH1=Y12, CH2=Y19), which is assigned to a programmable controller I/O signal, must be ON.	A signal is output when any set value coincides with the present value.	○	
Coincidence detection interrupt function	–	During coincidence detection, a programmable controller CPU interrupt request is issued.	–	
Latch counter function	–	The present value when a signal is input is latched.	–	
Sampling counter function	–	The input pulses are counted for the set sampling time.	–	
Cycle pulse counter function	–	For each specified cycle time, the present value and previous value are each stored in the present value and previous value.	–	

(c) Programmable controller CPU I/O signal comparison

Input signal is different, so the sequence program must be changed.

Refer to the High-Speed Counter Module User's Manual for details regarding the I/O signals and sequence program.

A0J2-D61S1				QD62/QD62-H02			
Device No.	Signal name	Device No.	Signal name	Device No.	Signal name	Device No.	Signal name
X0	CH1 Counter value large	Y0	Use prohibited	X0	Module READY	Y0	CH1 Coincidence signal No. 1 reset command
X1	CH1 Counter value coincidence	Y1		X1	CH1 Counter value large (Point No. 1)	Y1	CH1 Preset command
X2	CH1 Counter value small	Y2		X2	CH1 Counter value coincidence (Point No. 1)	Y2	CH1 Coincidence signal enable command
X3	CH1 External preset request detection	Y3		X3	CH1 Counter value small (Point No. 1)	Y3	CH1 Down count command
X4	CH2 Counter value large	Y4		X4	CH1 External preset request detection	Y4	CH1 Counter enable command
X5	CH2 Counter value coincidence	Y5		X5	CH1 Counter value large (Point No. 2)	Y5	CH1 External preset request detection
X6	CH2 Counter value small	Y6		X6	CH1 Counter value coincidence (Point No. 2)	Y6	CH1 Counter function selection start command
X7	CH2 External preset request detection	Y7		X7	CH1 Counter value small (Point No. 2)	Y7	CH1 Coincidence signal No. 2
X8	Use prohibited	Y8		X8	CH2 Counter value large (Point No. 1)	Y8	CH2 Coincidence signal No. 1
X9		Y9		X9	CH2 Counter value coincidence (Point No. 1)	Y9	CH2 Preset command
XA		YA		XA	CH2 Counter value small (Point No. 1)	YA	CH2 Coincidence signal enable command
XB		YB		XB	CH2 External preset request detection	YB	CH2 Down count command
XC		YC		XC	CH2 Counter value large (Point No. 2)	YC	CH2 Count enable command
XD		YD		XD	CH2 Counter value coincidence (Point No. 2)	YD	CH2 External preset request detection
XE		YE		XE	CH2 Counter value small (Point No. 2)	YE	CH2 Counter function selection start command
XF		YF		XF	Fuse blown detection flag	YF	CH2 Coincidence signal No. 2 reset command
X10		Use prohibited		Y10	CH1 Coincidence signal reset		
X11			Y11	CH1 Preset command			
X12	Y12		CH1 Coincidence signal output enable				
X13	Y13		CH1 Down count command				
X14	Y14		CH1 Count enable				
X15	Y15		CH1 Present value read request				
X16	Y16		CH1 External preset request detection				
X17	Y17		CH2 Coincidence signal reset				
X18	Y18		CH2 Preset command				
X19	Y19		CH2 Coincidence signal output enable				
X1A	Y1A		CH2 Down count command				
X1B	Y1B	CH2 count enable					
X1C	Y1C	CH2 Present value read request					
X1D	Y1D	CH2 external preset detection reset command					
X1E	Y1E	Use prohibited					
X1F	Y1F						

(d) Buffer memory address comparisons

Buffer memory allocation is different, so the sequence program must be changed.

Refer to the High-Speed Counter Module User's Manual for details regarding the buffer memory and sequence program.

A0J2-D61S1				QD62/QD62-H02				
Address		Name	Read/Write	Address		Name	Read/Write	
CH1	CH2			CH1	CH2			
0	0	–	–	0	32			
1	33	Preset value write (lower/middle)	W	1	33	Preset value setting (L) (H)	R/W	
(2)	(34)	Preset value write (upper)			2	34	Present value (L) (H)	R
3	35	Mode register	R/W	3	35			
4	36	Present value read (lower/middle)	R	4	36	Coincidence output point No. 1 (L) setting (H)	R/W	
(5)	(37)	Present value read (upper)			5			37
6	38	Set value read/write (lower/middle)	R/W	6	38	Coincidence output point No. 2 (L) setting (H)		
(7)	(39)	Set value read/write (upper)			7			39
				8	40	Overflow detection	R	
				9	41	Counter function selection setting	R/W	
				10	42	Sampling/periodic setting		
				11	43	Sampling/periodic counter flag	R	
				12	44	Latch count value (L)		
				13	45	(H)		
				14	46	Sampling count value (L)		
				15	47			(H)
				16	48	Periodic pulse count previous value (L)		
				17	49	(H)		
				18	50	Periodic pulse count present value (L)		
				19	51	(H)		
				20	52	Ring counter lower minimum value (L)	R/W	
				21	53			(H)
				22	54	Ring counter maximum value (L)		
				23	55	(H)		
				24	56	System area	–	
				to	to			
				31	63			

(e) Wiring

The external wiring method differs between A0J2-D61S1 and QD62/QD62-H02.

- A0J2-D61S1: Wiring using a terminal block
- QD62 or QD62-H02: Wiring using a connector

When reusing the I/O signal wire with a solderless terminal of the A0J2-D61S1 to replace the module, use a connector/terminal block converter module.

Rewire the I/O signal wire with a solderless terminal of the existing module to the connector/terminal block converter module and connect the converter module with the alternative module by using the dedicated cable. In this way, the module can be replaced without considering the existing wire size. How to wire when using the connector/terminal block converter module is shown below.

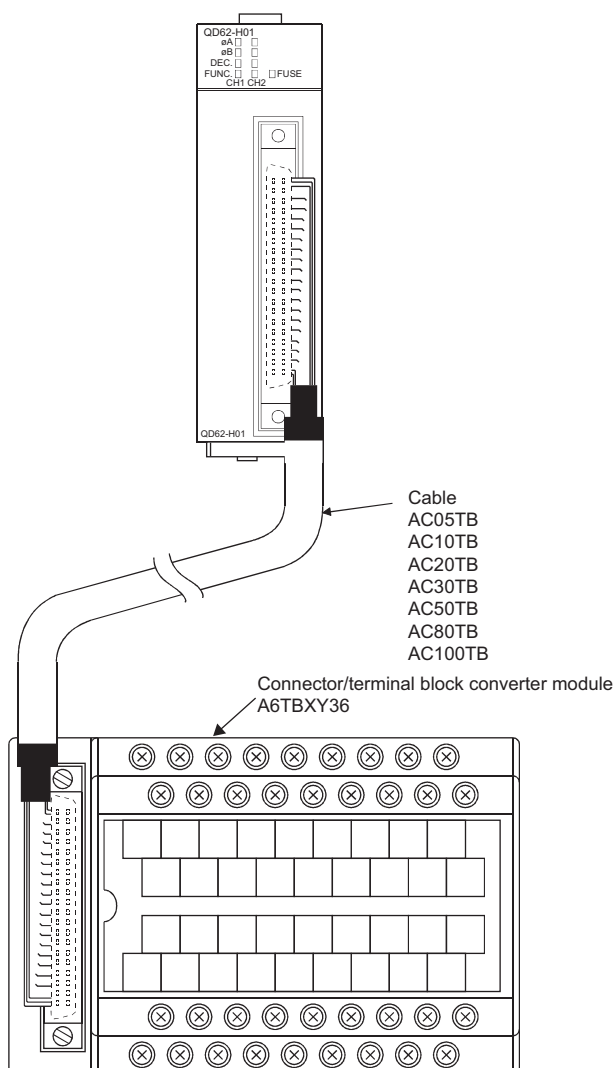

Signal name	Terminal number (connector side)	Terminal marking (terminal block side)	
CH1	Phase A pulse input 24 V	A20	10
	Phase A pulse input 12 V	B20	0
	Phase A pulse input 5 V	A19	11
	ABCOM	B19	1
	Phase B pulse input 24 V	A18	12
	Phase B pulse input 12 V	B18	2
	Phase B pulse input 5 V	A17	13
	Preset input 24 V	B17	3
	Preset input 12 V	A16	14
	Preset input 5 V	B16	4
	CTRLCOM	A15	15
	Function start 24 V	B15	5
	Function start 12 V	A14	16
	Function start 5 V	B14	6
	EQU (Coincidence output point No.1)	A06	1E
	EQU (Coincidence output point No.2)	B06	E
CH2	Phase A pulse input 24 V	A13	17
	Phase A pulse input 12 V	B13	7
	Phase A pulse input 5 V	A12	18
	ABCOM	B12	8
	Phase B pulse input 24 V	A11	19
	Phase B pulse input 12 V	B11	9
	Phase B pulse input 5 V	A10	1A
	Preset input 24 V	B10	A
	Preset input 12 V	A09	1B
	Preset input 5 V	B09	B
	CTRLCOM	A08	1C
	Function start 24 V	B08	C
	Function start 12 V	A07	1D
	Function start 5 V	B07	D
	EQU (Coincidence output point No.1)	A05	1F
	EQU (Coincidence output point No.2)	B05	F
12/24V	B02	24V	
	B01		
0V	A02	0V	
	A01		

10.2.4 Positioning module comparison

(1) A0J2-D71 and QD75P2N specifications comparison

(a) Performance specifications comparison

○ : Compatible, △ : Partially changed, × : Incompatible

Item		A0J2-D71	QD75P2N	Compat- ibility	Precautions for replacement
No. of control axes		axis 2	axis 2	○	
Number of positioning data		400/axis	600/axis	○	
Position control interpolation function	2-axis linear interpolation	Available	Available	○	
	2-axis circular interpolation	None	Available	-	
Positioning system	Positioning control	Available	Available	○	
	Speed control	None	Available	-	
	Speed-position/ position-speed switching control	None	Available	-	
Positioning range	System	Absolute Incremental system can be selected for each axis.	<Absolute system> -214748364.8 to 214748364.7 (μm) -21474.83648 to 21474.83647 (inches) 0 to 359.99999(degrees) -2147483648 to 2147483647 (pulses)		
Positioning range	Positioning command	Each axis can be selected with the 4 types of commands listed below. 1 to 16252928 (pulses) MAX. 162 (m) (command unit 0.1 to 10 μm/pulse) MAX. 16200 (inches) (Command unit 1 × 10 ⁻⁵ to 0.001inch/pulse) MAX. 16200 (degrees) (Command unit 1 × 10 ⁻⁵ to 0.001degree/pulse)	<Incremental system> -214748364.8 to 214748364.7 (μm) -21474.83648 to 21474.83647 (inches) -21474.83648 to 21474.83647(degrees) -2147483648 to 2147483647 (pulses) <During speed-position switching control> 0 to 214748364.7 (μm) 0 to 21474.83647 (inches) 0 to 21474.83647(degrees) 0 to 2147483647 (pulses)	○	
Speed command range	Speed command	Each axis can be selected with the 4 types of commands listed below. 10 to 200000 (pulse/sec) (Command unit 10pulses/sec) 10 to 120000(mm/min) (Command unit 10mm/min) 1 to 12000 (inch/min) (Command unit 1inch/min) 1 to 12000 (degree/min) (Command unit 1degree/min)	0.01 to 20000000.00 (mm/min) 0.001 to 2000000.000 (inch/min) 0.001 to 2000000.000 (degree/min) 1 to 1000000 (pulses/s) (Max. output pulse: 200kpps)	○	
Acceleration/ deceleration processing	Automatic trapezoidal acceleration/ deceleration	Available	Available	○	
	S-pattern acceleration/ deceleration	None	Available	-	
Acceleration/ deceleration time	No. of patterns	Acceleration time and deceleration time are the same period of time. (1 pattern)	Acceleration time and deceleration time can be specified. (4 patterns for each)	○	
	Setting range	64 to 4999 (ms)	1 to 8388608 (ms)	○	
Data storage destination		SRAM (battery backup)	Flash ROM (battery-less backup)	△	Flash ROM can be written 100000 times.
Connector		-	A6CON1 (soldering type, usable for straight, sold separately) A6CON4 (soldering type, usable for straight out and diagonal, sold separately)	×	Wiring change is required as the connector differs. QD75P2N connector is sold separately.

Item	A0J2-D71	QD75P2N	Compat- ibility	Precautions for replacement
Applicable wire size	0.3mm ²	A6CON1, A6CON4: 0.3mm ²	○	
Command pulse output type	Open collector	Open collector	○	
Max. output pulse	200kpps	200kpps	○	
Maximum connection distance between servos	1 to 3m	2m	△	
5VDC internal current consumption	0.65A	0.30A	○	
Flash ROM write count	–	Max. 100000 times	–	
Number of occupied I/O points	64 points (I/O assignment: Special 64 points)	32 points (I/O assignment: Intelligent function module 32 points)	△	The number of I/O points is changed to 32.
Weight	0.75kg	0.14kg	△	

○ : Compatible, △ : Partially changed, × : Incompatible

Item	A0J2-D71	QD75P2N	Compat- ibility	Precautions for replacement	
I/O signal for external devices	Upper/lower limit signals	None	Available	△	QD75P2N requires wiring.
	START signal	Available	None	×	QD75P2N does not have this signal. To use this signal, output it from the output module.
	Manual pulse generator A/B phase	On each axis	Only one pulse generator can be connected.	△	At the QD75P2N, the manual pulse generator can only be connected to one terminal. Configure the buffer memory settings to specify the controlled system axis.
	Drive module ready Stop signal Proximity signal	Operating voltage range 4.75 to 26.4VDC	Operating voltage range 19.2 to 26.4VDC	△	Input specifications are different so check the specifications of the connecting device.
	Zero point signal	Operating voltage range 4.75 to 26.4VDC Pulse width: 50µs or more	Operating voltage range 4.5 to 6.1VDC or 12 to 26.4VDC Pulse width: 1 ms or more	△	
	Forward/ reverse field pulse	Available	Available	○	
	Error value counter clear	Available	Available	○	
	Signal logic selection	None	Available	-	
Peripheral device (data setting, etc.)	Peripheral device connections	Direct connection	Programmable controller CPU, Q-compatible serial communication module, Q-compatible MELSECNET/H Connection via remote I/O module	○	Connection system is different.
	Teaching module	AD71TU	None	×	The teaching module cannot be used.
	Software package	SW0GP-AD71P (for A6GPP/A6PHP) SW1RX-AD71P (for A7PHP/A7HGP) SW1IVD-AD71P (for IBM-PC/AT-compatible personal computer)	GX Works2 GX Configurator-QP	△	The usable software package are different.

(b) Functional comparisons

○ : Compatible, △ : Partially changed, × : Incompatible

Item		A0J2-D71	QD75P2N	Compat- ibility	Precautions for replacement
Machine OPR function (OPR method)		Available (3 methods)	Available (6 methods)	○	
JOG operation		Available	Available	○	
Manual pulse generator operation		Available	Available	△	<ul style="list-style-type: none"> On the QD75P2N the manual pulse generator cannot be used independently on each axis. If the manual pulse generator must be connected to each axis, use the 1-axis module. The A0J2D71 and QD75P2N differ in the specifications of manual pulse inputs, so before connecting a manual pulse generator to the QD75P2N, confirm the specifications of the pulse generator. If not using the unit pulse on the QD75P2N, the magnification from the pulse input from the manual pulse generator will become smaller.
		Manual pulse generator connectivity is one pulse generator/axis.	Manual pulse generator connectivity is one pulse generator/module.		
		Manual pulse generator's movement per pulse 1 to 100000 ($\times 10^{-1}\mu\text{m}$) 1 to 100000 ($\times 10^{-5}\text{inches}$) 1 to 100000 ($\times 10^{-1}\text{degrees}$) 1 to 100 (pulses)	Pulse input magnification for manually generated pulse: 1 to 100 times		
Positioning data	1 time positioning (terminate)	Available	Available	○	
	n-time positioning (continue)	Available	Available	○	
	Change the speed and continue positioning (pattern change)	Available	Available	○	
Present value change		Available	Available	○	
M code output function		Available	Available	○	
M code comment		Available	None	×	QD75P2N has no M code comment function.
Speed change function		Available	Available	○	
Compensation		Backlash compensation, error compensation	Electronic gear, backlash compensation, near pass	△	The QD75P2N does not have the error compensation function. Use the electronic gear function instead.
Stroke limit function	Position control	Available	Available	○	
	JOG operation, manual pulse generator operation	None	Available (Limit check can be selected on or off.)	○	At default, the limit check is on.
Error display		None	Error LED	–	
History data (start, error, warning)		None	Available (3 types and 16 data/module)	–	

(c) Programmable controller CPU I/O signal comparisons

A0J2-D71				QD75P2N			
Device No.	Signal name		Device No.	Signal name		Device No.	Signal name
X0	Watchdog error (D71 detection)		Y0			X00	QD75 READY
X1	D71 READY		Y1			X01	Synchronization flag
X2	X-axis	Positioning complete	Y2			X02	Use prohibited
X3	Y-axis		Y3			X03	
X4	X-axis	BUSY	Y4			X04	Axis 1 M code ON
X5	Y-axis		Y5			X05	Axis 2 M code ON
X6	X-axis	OPR request	Y6			X06	Axis 3 M code ON
X7	Y-axis		Y7			X07	Axis 4 M code ON
X8	X-axis	Started	Y8			X08	Axis 1 error detection
X9	Y-axis		Y9			X09	Axis 2 error detection
XA	Battery error		YA			X0A	Axis 3 error detection
XB	Error detection		YB			X0B	Axis 4 error detection
XC	X-axis	OPR complete	YC			X0C	Axis 1 BUSY
XD	Y-axis		YD			X0D	Axis 2 BUSY
XE	X-axis	M code ON	YE			X0E	Axis 3 BUSY
XF	Y-axis		YF			X0F	Axis 4 BUSY
X10	Use prohibited		Y10	X-axis	Positioning start	X10	Axis 1 started
X11			Y11	Y-axis		Y10	Axis 1 positioning start
X12			Y12	Interpolation		Y11	Axis 2 positioning start
X13			Y13	X-axis	Y12	Axis 3 started	
X14			Y14	Y-axis	Y13	Axis 4 started	
X15			Y15	X-axis	Y14	Axis 1 positioning complete	
X16			Y16	Y-axis	Y15	Axis 2 positioning complete	
X17			Y17	X-axis forward run JOG start		Y15	Axis 2 execution prohibited flag
X18			Y18	X-axis reverse run JOG start		Y16	Axis 3 execution prohibited flag
X19			Y19	Y-axis forward run JOG start		Y17	Axis 4 execution prohibited flag
X1A			Y1A	Y-axis reverse run JOG start		X17	Axis 4 positioning complete
X1B			Y1B	X-axis	M code OFF	Y18	Use prohibited
X1C			Y1C	Y-axis		Y19	
X1D			Y1D	Programmable controller ready		Y1A	
X1E			Y1E	Use prohibited		Y1B	
X1F			Y1F			X1B	
				X1C			
				Y1D			
				Y1E			
				Y1F			

I/O signal difference

Large point differences apart from I/O number differences are described below.

A0J2-D71	QD75P2N
Watchdog error (X0)	No watchdog error signal is provided. When a watch dog error occurs on the QD75P2N, the QD75 ready (X0) turns OFF.
OPR request (X6, X7)	Check OPR request flag at <u>Md.31</u> (bit 3). If OPR request is on, it is set to '1'.
Battery error (XA)	No battery error signal is provided. QD75P2N has data stored in flash ROM, so memory backup batteries are not required.
Error detection (XB) is common with X-axis and Y-axis	Error detection is performed for each axis. Axis 1: X8, Axis 2: X9
OPR complete (XC, XD)	Check OPR complete flag at <u>Md.31</u> (bit 4). If OPR complete is on, it is set to '1'.
Positioning start interpolation (Y12)	No interpolation start signal is provided. On QD75P2N, perform interpolation movement settings to the positioning data, and interpolation movement can be performed by starting positioning.
OPR start (Y13, Y14)	No OPR start signal is provided. On QD75P2N, write "9001" to positioning start number <u>Cd.3</u> , and OPR can be performed by starting positioning.
M code OFF (Y1B, Y1C)	M code OFF request is performed at <u>Cd.7</u> . Write "1" to switch the M code signal from ON to OFF.

(d) Buffer memory addresses comparisons

A0J2-D71			QD75P2N				
Address	Name	Read/Write	Address		Name	Read/Write	
			Axis 1	Axis 2			
0 to 200	X-axis positioning start data	R/W	0	150	[Pr.1] unit setting	R/W	
201	Error reset		1	151	[Pr.2] No. of pulses per rotation (Ap)		
202 to 299	Unused area		2	152	[Pr.3] Movement amount per rotation (Al)		
300 to 500	Y-axis positioning start data	R/W	3	153	[Pr.4] Unit magnification (Am)		
501 to 511	Unused area		4	154	[Pr.5] Pulse output mode		
512 to 767	For OS		5	155	[Pr.6] Rotation direction setting		
768 to 3,871	Unused area	-	6	156	[Pr.7] Bias speed at start		-
3872 to 4271	Positioning data		7	157			
4272 to 4671	Positioning speed	R	8	158	Use prohibited		-
4672 to 5071	Dwell time		9	159			
5072 to 5871	Positioning address		10	160	[Pr.8] Speed limit value		
5872 to 6271	Positioning data		11	161			
6272 to 6671	Positioning speed		12	162	[Pr.9] Acceleration time 0		
6672 to 7071	Dwell time		13	163	[Pr.10] Deceleration time 0		
7072 to 7871	Positioning address		14	164			
7872 to 7887	X-axis parameter		15	165	Use prohibited		
7888 to 7907	Y-axis parameter		16	166	[Pr.11] Backlash compensation amount		
7908 to 7918	X-axis OPR data		17	167	[Pr.12] Software stroke limit upper limit value		
7919 to 7928	Y-axis OPR data	18	168	[Pr.13] Software stroke limit lower limit value			
		19	169	[Pr.14] Software stroke limit selection			
		20	170	[Pr.15] Software stroke limit valid invalid setting			
		21	171	[Pr.16] Command in-position width			
		22	172	[Pr.17] Torque limit setting value			
		23	173	[Pr.18] M code ON signal output timing			
		24	174	[Pr.19] Speed switching mode			
		25	175	[Pr.20] Interpolation speed designation method			
		26	176	[Pr.21] Current feed value during speed control			
		27	177	[Pr.22] Input signal logic selection			
		28	178	[Pr.23] Output signal logic selection			
		29	179	[Pr.24] Manual pulse generator input selection			
		30	180	[Pr.150] Function selection for speed-positioning			
		31	181	Use prohibited			
		32	182				
		33	-	[Pr.25] Acceleration time 1			
		34	184	[Pr.26] Acceleration time 2			
		35	185	[Pr.27] Acceleration time 3			
		36	186				
		37	187				
		38	188				
		39	189				
		40	190				
		41	191				

QD75P2N			
Address		Name	Read/Write
Axis 1	Axis 2		
42	192	[Pr.28] Deceleration time 1	R/W
43	193		
44	194	[Pr.29] Deceleration time 2	
45	195		
46	196	[Pr.30] Deceleration time 3	
47	197		
48	198	[Pr.31] JOG speed limit value	
49	199		
50	200	[Pr.32] JOG operation acceleration time selection	
51	201	[Pr.33] JOG operation deceleration time selection	
52	202	[Pr.34] Acceleration/deceleration process selection	
53	203	[Pr.35] S-pattern proportion	
54	204	[Pr.36] Sudden stop deceleration time	
55	205		
56	206	[Pr.37] Stop group 1 sudden stop selection	
57	207	[Pr.38] Stop group 2 sudden stop selection	
58	208	[Pr.39] Stop group 3 sudden stop selection	
59	209	[Pr.40] Positioning complete signal output time	
60	210	[Pr.41] Allowable circular interpolation error width	
61	211		
62	212	[Pr.42] External command function selection	
63 to 69	213 to 219	Use prohibited	-
70	220	[Pr.43] OPR method	R/W
71	221	[Pr.44] OPR direction	
72	222	[Pr.45] OP address	
73	223		
74	224	[Pr.46] OPR speed	
75	225		
76	226	[Pr.47] Creep speed	
77	227		
78	228	[Pr.48] OPR retry	
79	229	[Pr.49] OPR dwell time	
80	230	[Pr.50] Setting for the movement amount after near-point dog ON	
81	231		
82	232	[Pr.51] OPR acceleration time selection	
83	233	[Pr.52] OPR deceleration time selection	
84	234	[Pr.53] OP shift amount	
85	235		
86	236	[Pr.54] OPR torque limit value	
87	237	[Pr.55] Deviation counter clear signal output time	
88	238	[Pr.56] Speed designation during OP shift	
89	239	[Pr.57] Dwell time during OPR retry	

QD75P2N			
Address	Name	Read/Write	
1200	[Md.1] Test mode flag	R	
1201 to 1211	Use prohibited	–	
1212	[Md.3] Start information	R	
1213	[Md.4] Start number		
1214	[Md.4] Start hour		
1215	[Md.6] Start minute: second		
1216	[Md.7] Error judgment		
1217 to 1221	Start history 1		
1222 to 1226	Start history 2		
to	to		
1287 to 1291	Start history 15		
1292	[Md.8] Start history pointer		
1293	[Md.9] Error occurrence axis		R
1294	[Md.10] Axis error No.		
1295	[Md.11] Axis error occurrence (hour)		
1296	[Md.12] Axis error occurrence (minute: second)		
1297 to 1300	Error history 1		
1301 to 1304	Error history 2		
to	to		
1353 to 1356	Error history 15		
1357	[Md.13] Error history pointer		
1358	[Md.14] Warning occurrence axis	R	
1359	[Md.15] Axis warning No.		
1360	[Md.16] Axis error occurrence (Hour)		
1361	[Md.17] Axis error occurrence (minute: second)		
1362 to 1365	Warning history 1		
1366 to 1369	Warning history 2		
to	to		
1418 to 1421	Warning history 15		
1422	[Md.18] Warning history pointer		
1423	–	–	
1424	[Md.19] Flash ROM write count	R	
1425			

QD75P2N			
Address		Name	Read/Write
Axis 1	Axis 2		
800	900	Md.20 Present feed value	R
801	901		
802	902	Md.21 Machine feed value	
803	903		
804	904	Md.22 Feedrate	
805	905		
806	906	Md.23 Axis error No.	
807	907	Md.24 Axis warning No.	
808	908	Md.25 Valid M code	
809	909	Md.26 Axis operation status	
810	910	Md.27 Current speed	
811	911		
812	912	Md.28 Axis feedrate	
813	913		
814	914	Md.29 Speed-position switching control positioning amount	
815	915		
816	916	Md.30 External I/O signal	
817	917	Md.31 Status	
818	918	Md.32 Target value	
819	919		
820	920	Md.33 Target speed	
821	921		
822 to 823	922 to 923	-	-
824	924	Md.34 Movement amount after near-point dog ON	R
825	925		
826	926	Md.35 Torque limit storage value	
827	927	Md.36 Special start data instruction code setting value	
828	928	Md.37 Special start data instruction parameter setting value	
829	929	Md.38 Start position positioning data No. setting value	
830	930	Md.39 In speed control flag	
831	931	Md.40 In speed change processing flag	
832	932	Md.41 Special start repetition counter	
833	933	Md.42 Control method repetition counter	
834	934	Md.43 Executing start data pointer	
835	935	Md.44 Executing positioning data No.	
836	936	Md.45 Block No. being executed	
837	937	Md.46 Last executed positioning data No.	
838 to 847	938 to 947	Md.47 Executing positioning data	
848 to 898	948 to 998	-	
899	999	Md.48 Deceleration start flag	R

QD75P2N			
Address		Name	Read/Write
Axis 1	Axis 2		
1500	1600	[Cd.3] Positioning start No.	R/W
1501	1601	[Cd.4] Positioning start point No.	
1502	1602	[Cd.5] Axis error reset	
1503	1603	[Cd.6] Restart command	
1504	1604	[Cd.7] M code OFF request	
1505	1605	[Cd.8] External command valid	
1506	1606	[Cd.9] New current value	
1507	1607		
1508	1608	[Cd.10] New acceleration time value	
1509	1609		
1510	1610	[Cd.11] New deceleration time value	
1511	1611		
1512	1612	[Cd.12] Acceleration/deceleration time change during speed change, enable /disable selection	
1513	1613	[Cd.13] Positioning operation speed override	
1514	1614	[Cd.14] New speed value	
1515	1615		
1516	1616	[Cd.15] Speed change request	
1517	1617	[Cd.16] Inching movement amount	
1518	1618	[Cd.17] JOG speed	
1519	1619		
1520	1620	[Cd.18] Interrupt request continuous operation	
1521	1621	[Cd.19] OPR request flag OFF request	
1522	1622	[Cd.20] Manual pulse generator 1 pulse input magnification	
1523	1623		
1524	1624	[Cd.21] Manual pulse generation enable flag	
1525	1625	[Cd.22] Torque new value	
1526	1626	[Cd.23] Speed-position switching control movement amount change register	
1527	1627		
1528	1628	[Cd.24] Speed-position switching enable flag	
1529	1629	Use prohibited	-
1530	1630	[Cd.25] Speed-position switching control movement amount change register	
1531	1631		
1532	1632	[Cd.26] Speed-position switching enable flag	
1533	1633	Use prohibited	-
1534	1634	[Cd.27] New target position value (address)	
1535	1635		
1536	1636	[Cd.28] New target position value (speed)	
1537	1637		
1538	1638	[Cd.29] Target position change request flag	
1539	1639	Use prohibited	-
1540	1640	[Cd.30] Simultaneous start target axis start data No. (Axis 1 start data No.)	R/W
1541	1641	[Cd.31] Simultaneous start target axis start data No. (Axis 2 start data No.)	
1542	1642	[Cd.32] Simultaneous start target axis start data No. (Axis 3 start data No.)	
1543	1643	[Cd.33] Simultaneous start target axis start data No. (Axis 4 start data No.)	
1544	1644	[Cd.34] Step mode	
1545	1645	[Cd.35] Step valid flag	
1546	1646	[Cd.36] Step start information	
1547	1647	[Cd.37] Skip command	
1548	1648	[Cd.38] Teaching data selection	
1549	1649	[Cd.39] Teaching positioning data No.	
1550	1650	[Cd.40] ABS direction settings at degree	
1900		[Cd.1] Flash ROM write request	-
1901		[Cd.2] Parameter initialization request	
1902 to 1904		Use prohibited	
1905		[Cd.41] Deceleration start flag valid	R/W
1906		Use prohibited	-
1907		[Cd.42] Stop command processing for deceleration stop selection	R/W

QD75P2N				
Address		Name	Read/Write	
Axis 1	Axis 2			
2000	8000	[Da.1] Operation pattern [Da.2] Control method [Da.3] Acceleration time No. [Da.4] Deceleration time No. [Da.5] Interpolation target axis	No.1	
2001	8001	[Da.10] M code/condition data No./LOOP to LEND repetition count		
2002	8002	[Da.9] Dwell time/JUMP destination positioning data No.		
2003	8003	Use prohibited		
2004	8004			
2005	8005	[Da.8] Command speed		
2006	8006	[Da.6] Positioning address/movement amount		
2007	8007			
2008	8008			
2009	8009	[Da.7] Arc address		
2010 to 2019	8010 to 8019	No.2		
2020 to 2029	8020 to 8029	No.3		
to	to	to		
7990 to 7999	13990 to 13999	No.600		
26000	27000	[Da.11] Shape [Da.12] Start data No. [Da.13] Special start instruction [Da.14] Parameter	1st point R/W	
26001	27001	2nd point		
26002	27002	3rd point		
to	to	to		
26049	27049	50th point		
26100	27100	[Da.15] Condition target		No.1
26102	27102	[Da.16] Condition operator		
26103	27103	[Da.17] Address		
26104	27104	[Da.18] Parameter 1		
26105	27105			
26106	27106	[Da.19] Parameter 2		
26110 to 26119	27110 to 27119	No.2		
26120 to 26129	27120 to 27129	No.3		
to	to	to		
26190 to 26199	27190 to 27199	No.10		
26200 to 26399	27200 to 27399	Start block 1	to	
to	to	to		
26800 to 26999	27800 to 27999	Start block 4		
30000 to 30099		Programmable controller CPU memory area	Target data in condition data for condition verdicts	

APPENDICES

Appendix 1 External Dimensions

For external dimensions of modules described in this handbook, refer to the user's manual for each module.

Appendix 2 Performance Specifications Comparison between A0J2H Series and Renewal Tool for A0J2

Appendix 2.1 Precautions for the performance specifications comparison

This section describes the precautions when comparing the performance specifications between an A0J2H series I/O module and a renewal tool for A0J2.

(1) External supply power (24VDC)

The renewal tool for A0J2 requires an external supply power (24VDC). Reuse the I/O module terminal block of the existing A0J2H series and connect the external supply power (24VDC) to the renewal tool. For precautions or details when connecting the external supply power, refer to the following.

- Renewal tool for A0J2 series transition from MELSEC-A0J2(H) series to renewal system using renewal tool
(Published by Mitsubishi Electric System & Service Co., Ltd.)

When the I/O module on the programmable controller side is connected to the renewal tool for A0J2 with the dedicated cable, the external supply power (24VDC) supplies the driving power for external devices of the I/O module on the programmable controller side.

(2) Selection of I/O modules on the programmable controller side

The renewal tool for A0J2 has functions that convert AC input into DC input, and convert transistor output into relay output or triac output.

Therefore, select a DC input module and a transistor output module for the I/O modules on the programmable controller side, regardless of the type of the renewal tool for A0J2.

When the I/O module on the programmable controller side is connected to the renewal tool for A0J2 with the dedicated cable, select a module that can be wired using a connector for the I/O module on the programmable controller side.

In addition, a recommended module for the I/O module on the programmable controller side is the "QX41Y41P", which has the same I/O assignment with the A0J2H series I/O module. (Selecting the QX41Y41P enables the module replacement without the change of existing I/O addresses.)

(3) Derating chart for the maximum number of simultaneous input points

(a) Input module on the programmable controller side

Check the number of simultaneous input points by referring to the derating chart of the selected Q series input module.

Note that the maximum number of simultaneous input points is 100% (all points simultaneously ON) when the QX41/QX41Y41P is selected because the applicable voltage range of the renewal tool for A0J2 is 26.4VDC at maximum.

(b) Renewal tool for A0J2

The maximum number of simultaneous input points of the renewal tool for A0J2 (input module) has the limitation depending on the external supply power (24VDC) that supplies the power to the module. Use the module within the range shown in the derating chart in the performance specifications comparison.

(4) Temperature derating for the triac output module

The output load current of the renewal tool for A0J2 (triac output module) has the limitation depending on the ambient temperature in the environment where the module is used.

Use the module within the range shown in the temperature derating chart in the performance specifications comparison.

Appendix 2.2 Performance specifications comparison

This section shows the performance specifications comparison between A0J2 series I/O modules and interface modules of renewal tool for A0J2 described in Section 1.2.

(1) Specifications comparison between A0J2-E32A and interface module (SC-A0JQIF32A)

○ : Compatible, △ : Partially changed, × : Incompatible

Specifications	A0J2-E32A input specifications	SC-A0JQIF32A input specifications	Compatibility	Precautions for replacement
Number of input points	32 points	32 points	○	
Insulation method	Photocoupler	Photocoupler	○	
Rated input voltage	100 to 120VAC 50/60Hz	100 to 120VAC 50/60Hz	○	
Rated input current	10mA (100VAC 60Hz)	10mA (100VAC 60Hz)	○	
Operating voltage range	85 to 132VAC (50/60Hz±5%)	85 to 132VAC (50/60Hz±5%)	○	
Maximum number of simultaneous input points	100% (16 points/common) simultaneously ON	Refer to the derating chart.*1	△	Use it within the range shown in the derating chart. When the voltage of the external supply power (module power supply) is high, the rate of AC input simultaneous ON becomes small.
ON voltage/ON current	80VAC or more/6mA or more	80VAC or more/6mA or more	○	
OFF voltage/OFF current	40VAC or less/4mA or less	26VAC or less/1.7mA or less	△	OFF voltage/OFF current is smaller.*2
Inrush current	Maximum 300mA, Within 0.3ms (132VAC)	Maximum 300mA, Within 0.3ms (132VAC)	○	
Input impedance	Approx. 10kΩ (60Hz), Approx. 12kΩ (50Hz)	Approx. 10kΩ (60Hz), Approx. 12kΩ (50Hz)	○	
Response time	OFF→ON	15ms or less (6ms TYP.)	△	In combination with Q series input module: 15ms or less (12ms TYP.)*3
	ON→OFF	35ms or less (16ms TYP.)	△	In combination with Q series input module: 20ms or less (14ms TYP.)*3
Common terminal arrangement	16 points/common (Common terminal: TB17, TB34)	16 points/common (Common terminal: TB17, TB34)	○	
Operation indication	Available (Turning ON the input turns LED ON)	None	△	Operation indication can be checked with Q series input module.

○ : Compatible, △ : Partially changed, × : Incompatible.

Specifications		A0J2-E32A	SC-A0JQIF32A	Compatibility	Precautions for replacement
5VDC internal current consumption		105mA (TYP. All points are ON.)	—	—	
External supply power (Module power supply)	Voltage	None	24VDC±10% Ripple voltage 4Vp-p or less	×	To deliver a power for programmable controller operation, connecting a module power supply to the interface module, TB35 or TB36 is required.
	Current	None	210mA	×	If the voltage exceeds existing power capacity, add 24VDC power supply separately.
External connection method		36-point terminal block connector (M3 × 6 screws)	36-point terminal block connector (M3 × 6 screws)	○	
Applicable wire size		0.75 to 2mm ² (Applicable tightening torque 69N•cm)	0.75 to 2mm ² (Applicable tightening torque 69N•cm)	○	
Applicable solderless terminal		1.25-3, 1.25-YS3A, 2-S3, 2-YS3A, V1.25-3, V1.25-YS3A, V2-S3, V2-YS3A	1.25-3, 1.25-YS3A, 2-S3, 2-YS3A, V1.25-3, V1.25-YS3A, V2-S3, V2-YS3A	○	
Weight		0.68kg	0.40kg	△	Also consider the weight of fixed stand of programmable controller.*4
External dimensions		250(H) × 132(W) × 41(D)mm	182(H) × 132(W) × 41(D)mm*5	×	Check the dimensions since they depend on the installation type (building-up/horizontal/separate type).

*1 The figure below shows the derating chart.

When the voltage of the external supply power (module power supply) is high, the rate of AC input simultaneous ON becomes small.

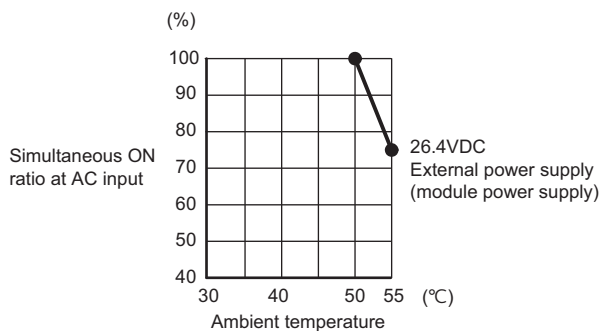

*2 Check that the specifications of leakage current of the used sensor and switches are equal to or less than the OFF current value.

If leakage current is equal to or more than the OFF current specifications, take measures against it with referring to "Input Module Troubleshooting" in the following handbook.
(Handbook for replacement)

Renewal tool for A0J2 series Transition from MELSEC-A0J2(H) series to renewal system using renewal tool.

*3 The value when using the input module QX41, etc. and 1ms is set at input response time in I/O assignment setting of PLC parameter (10ms is set at default).

*4 The weight of fixed stand of programmable controller depends on replacement type of renewal tool for A0J2.

*5 The external dimensions of the SC-A0JQIF32A do not include those of its projection.

(2) Specifications comparison between A0J2-E32D and interface module (SC-A0JQIF32D)

○ : Compatible, △ : Partially changed, × : Incompatible

Specifications	A0J2-E32D input specifications	SC-A0JQIF32D input specifications	Compatibility	Precautions for replacement	
Number of input points	32 points	32 points	○		
Insulation method	Photocoupler	Photocoupler	○		
Rated input voltage	12VDC/24VDC	12VDC/24VDC	○		
Rated input current	Approx. 3mA/Approx. 7mA	Approx. 3mA/Approx. 7mA	○		
Operating voltage range	10.2 to 26.4VDC (Ripple ratio within 5%)	10.2 to 26.4VDC (Ripple ratio within 5%)	○		
Maximum number of simultaneous input points	100% (16 points/common) simultaneously ON	Refer to the derating chart.*1	△	Use it within the range shown in the derating chart.	
ON voltage/ON current	9.5VDC or more/2.6mA or more	9.5VDC or more/2.6mA or more	○		
OFF voltage/OFF current	6VDC or less/1.0mA or less	6VDC or less/1.0mA or less	○		
Input resistance	Approx. 3.4kΩ	Approx. 3.3kΩ	○	Input resistance is smaller.	
Input form	Sink input (Input current flows off.)	Sink input (Input current flows off.)	○		
Response time	OFF→ON	10ms or less (6ms TYP.)	5ms or less (1ms TYP.)	△	In combination with Q series input module: 6ms or less (2ms TYP.) ^{*2}
	ON→OFF	10ms or less (7.5ms TYP.)	5ms or less (1ms TYP.)	△	In combination with Q series input module: 6ms or less (2ms TYP.) ^{*2}
Common terminal arrangement	16 points/common (Common terminal: TB17, TB34)	16 points/common (Common terminal: TB17, TB34)	○		
Operation indication	Available (Turning ON the input turns LED ON)	None	△	Operation indication can be checked with Q series input module.	

○ : Compatible, △ : Partially changed, × : Incompatible

Specifications	A0J2-E32D	SC-A0JQIF32D	Compatibility	Precautions for replacement
5VDC internal current consumption	105mA (TYP. All points are ON.)	—	—	
External supply power (Module power supply)	Voltage	None	×	To deliver a power for programmable controller operation, connecting a module power supply to the interface module, TB35 or TB36 is required.
	Current	None	×	If the voltage exceeds existing power capacity, add 24VDC power supply separately.
External connection method	36-point terminal block connector (M3 × 6 screws)	36-point terminal block connector (M3 × 6 screws)	○	
Applicable wire size	0.75 to 2mm ² (Applicable tightening torque 69N•cm)	0.75 to 2mm ² (Applicable tightening torque 69N•cm)	○	
Applicable solderless terminal	1.25-3, 1.25-YS3A, 2-S3, 2-YS3A, V1.25-3, V1.25-YS3A, V2-S3, V2-YS3A	1.25-3, 1.25-YS3A, 2-S3, 2-YS3A, V1.25-3, V1.25-YS3A, V2-S3, V2-YS3A	○	
Weight	0.63kg	0.34kg	△	Also consider the weight of fixed stand of programmable controller.*3
External dimensions	250(H) × 132(W) × 41(D)mm	182(H) × 132(W) × 41(D)mm*4	×	Check the dimensions since they depend on the installation type (building-up/horizontal/separate type).

- *1 The figure below shows the derating chart of the renewal tool for A0J2.
 For the derating chart of the I/O module on the programmable controller side, which is to be connected to the renewal tool for A0J2, refer to the user's manual for the module to be used.

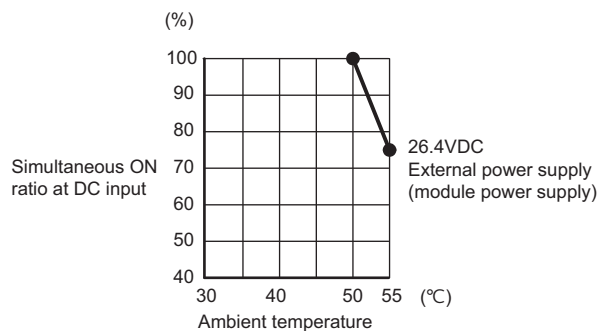

- *2 The value when using the input module QX41, etc. and 1ms is set at input response time in I/O assignment setting of PLC parameter (10ms is set at default).
- *3 The weight of fixed stand of programmable controller depends on replacement type of renewal tool for A0J2.
- *4 The external dimensions of the SC-A0JQIF32D do not include those of its projection.

(3) Specifications comparison between A0J2-E24R and interface module (SC-A0JQIF24R)

○ : Compatible, △ : Partially changed, × : Incompatible

Specifications	A0J2-E24R output specifications	SC-A0JQIF24R output specifications	Compatibility	Precautions for replacement	
Number of output points	24 points	24 points	○		
Insulation method	Photocoupler	None	△	Photocoupler is provided on Q series output module side.	
Rated switching voltage/current	24VDC 2A (Resistance load)/point 240VAC 2A (COSφ=1)/point 5A/common	24VDC 2A (Resistance load)/point 240VAC 2A (COSφ=1)/point 5A/common	○		
Minimum switching load	5VDC 1mA	5VDC 1mA	○		
Maximum switching voltage	264VAC 125VDC	264VAC 125VDC	○		
Maximum switching frequency	3600 times/hr	3600 times/hr	○		
Mechanical life	20 million times or more	20 million times or more	○		
Electrical life	Rated switching voltage/current load 200,000 times or more	Rated switching voltage/current load 200,000 times or more	○		
	200VAC 1.5A, 240VAC 1A (COSφ=0.7) 200,000 times or more 200VAC 0.75A, 240VAC 0.5A (COSφ=0.35) 200,000 times or more 24VDC 1A, 100VDC 0.1A (L/R=7ms) 200,000 times or more	200VAC 1.5A, 240VAC 1A (COSφ=0.7) 200,000 times or more 200VAC 0.75A, 240VAC 0.5A (COSφ=0.35) 200,000 times or more 24VDC 1A, 100VDC 0.1A (L/R=7ms) 200,000 times or more	○		
Response time	OFF→ON	10ms or less	9ms or less	△	In combination with Q series output module: 10ms or less (6ms TYP.)*1
	ON→OFF	12ms or less	11ms or less	△	In combination with Q series output module: 12ms or less (6ms TYP.)*1
External supply power (Relay coil driving power)	Voltage	24VDC±10% Ripple voltage 4Vp-p or less	24VDC±10% Ripple voltage 4Vp-p or less	○	
	Current	230mA (24VDC All points are ON.)	230mA (24VDC All points are ON.)	○	
Surge suppressor	None	None	○		
Fuse rating	None	None	○		
Fuse blown indication	-	-	○		
Relay socket	None	None	○		
Common terminal arrangement	8 points/common (Common terminal: TB9, TB19, TB29)	8 points/common (Common terminal: TB9, TB19, TB29)	○		
Operation indication	Available (Turning ON the output turns LED ON)	None	△	Operation indication can be checked with Q series output module.	

○ : Compatible, △ : Partially changed, × : Incompatible

Specifications	A0J2-E24R	SC-A0JQIF24R	Compatibility	Precautions for replacement
5VDC internal current consumption	145mA (TYP. All points are ON.)	—	—	
External connection method	36-point terminal block connector (M3 × 6 screws)	36-point terminal block connector (M3 × 6 screws)	○	
Applicable wire size	0.75 to 2mm ² (Applicable tightening torque 69N•cm)	0.75 to 2mm ² (Applicable tightening torque 69N•cm)	○	
Applicable solderless terminal	1.25-3, 1.25-YS3A, 2-S3, 2-YS3A, V1.25-3, V1.25-YS3A, V2-S3, V2-YS3A	1.25-3, 1.25-YS3A, 2-S3, 2-YS3A, V1.25-3, V1.25-YS3A, V2-S3, V2-YS3A	○	
Weight	0.71kg	0.47kg	△	Also consider the weight of fixed stand of programmable controller.* ²
External dimensions	250(H) × 132(W) × 41(D) mm	182(H) × 132(W) × 41(D)mm* ³	×	Check the dimensions since they depend on the installation type (building-up/horizontal/separate type).

*1 The value when using the output module, QX41Y41P, QY41P, etc.

*2 The weight of fixed stand of programmable controller depends on replacement type of renewal tool for A0J2.

*3 The external dimensions of the SC-A0JQIF24R do not include those of its projection.

(4) Specifications comparison between A0J2E-E24R and interface module (SC-A0JQIF24R)

○ : Compatible, △ : Partially changed, × : Incompatible

Specifications		A0J2E-E24R	SC-A0JQIF24R output specifications	Compatibility	Precautions for replacement
Number of output points		24 points	24 points	○	
Insulation method		Photocoupler	None	△	Photocoupler is provided on Q series output module side.
Rated switching voltage/current		24VDC 2A (Resistance load)/point 240VAC 2A (COSφ=1)/point 5A/common	24VDC 2A (Resistance load)/point 240VAC 2A (COSφ=1)/point 5A/common	○	
Minimum switching load		5VDC 1mA	5VDC 1mA	○	
Maximum switching voltage		250VAC 125VDC	250VAC 125VDC	○	
Leakage current at OFF		—	—	—	
Maximum switching frequency		3600 times/hr	3600 times/hr		
Mechanical life		20 million times or more	20 million times or more	○	
Electrical life		Rated switching voltage/current load 200,000 times or more	Rated switching voltage/current load 200,000 times or more	○	
		200VAC 1.5A, 240VAC 1A (COSφ=0.7) 200,000 times or more 200VAC 0.75A, 240VAC 0.5A (COSφ=0.35) 200,000 times or more 24VDC 1A, 100VDC 0.1A (L/R=7ms) 200,000 times or more	200VAC 1.5A, 240VAC 1A (COSφ=0.7) 200,000 times or more 200VAC 0.75A, 240VAC 0.5A (COSφ=0.35) 200,000 times or more 24VDC 1A, 100VDC 0.1A (L/R=7ms) 200,000 times or more	○	
Response time	OFF→ON	10ms or less	9ms or less	△	In combination with Q series output module: 10ms or less (6ms TYP.) ^{*1}
	ON→OFF	12ms or less	11ms or less	△	In combination with Q series output module: 12ms or less (6ms TYP.) ^{*1}
External supply power (Relay coil driving power)	Voltage	24VDC±10% Ripple voltage 4Vp-p or less	24VDC±10% Ripple voltage 4Vp-p or less	○	
	Current	220mA (24VDC All points are ON.)	230mA (24VDC All points are ON.)	○	
Surge suppressor		Varistor (387 to 473V)	None	×	The varistor is not built in. ^{*2}
Fuse		Available (8A)MF51NM8 or FGMA250V8A	None	×	The fuse is not built in. ^{*3}
Fuse blown indication		None	—	—	
Relay socket		None	None	—	
Common terminal arrangement		8 points/common (Common terminal: TB9, TB19, TB29)	8 points/common (Common terminal: TB9, TB19, TB29)	○	
Operation indication		Available (Turning ON the output turns LED ON)	None	△	Operation indication can be checked with Q series output module.
Specifications	A0J2E-E24R	SC-A0JQIF24R	Compatibility	Precautions for replacement	
5VDC internal current consumption	0.145A (TYP. All points are ON.)	—	—		
External connection method	36-point terminal block connector (M3 × 6 screws)	36-point terminal block connector (M3 × 6 screws)	○		
Applicable wire size	0.75 to 2mm ² (Applicable tightening torque 69N•cm)	0.75 to 2mm ² (Applicable tightening torque 69N•cm)	○		
Applicable solderless terminal	1.25-3, 1.25-YS3A, 2-S3, 2-YS3A, V1.25-3, V1.25-YS3A, V2-S3, V2-YS3A	1.25-3, 1.25-YS3A, 2-S3, 2-YS3A, V1.25-3, V1.25-YS3A, V2-S3, V2-YS3A	○		
Weight	0.75kg	0.47kg	△	Also consider the weight of fixed stand of programmable controller. ^{*4}	
External dimensions	250(H) × 132(W) × 41(D) mm	182(H) × 132(W) × 41(D)mm ^{*5}	×	Check the dimensions since they depend on the installation type (building-up/horizontal/separate type).	

*1 The value when using the output module, QX41Y41P, QY41P, etc.

-
- *2 Connect the varistor externally to reduce noise.
 - *3 Install a fuse for each external terminal point to prevent the burnout of the external devices and modules during load shorts.
 - *4 The weight of fixed stand of programmable controller depends on replacement type of renewal tool for A0J2.
 - *5 The external dimensions of the SC-A0JQIF24R do not include those of its projection.

(5) Specifications comparison between A0J2-E24S and interface module (SC-A0JQIF24S)

○ : Compatible, △ : Partially changed, × : Incompatible

Specifications		A0J2-E24S output specifications	SC-A0JQIF24S output specifications	Compatibility	Precautions for replacement
Number of output points		24 points	24 points	○	
Insulation method		Photocoupler	Photocoupler	○	
Rated switching voltage		100 to 240VAC, 40-70Hz	100 to 240VAC, 47-63Hz	△	The maximum frequency of SC-A0JQIF24S is smaller than the one of A0J2-E24S.
Maximum switching voltage		264AAC	264VAC	○	
Maximum switching current		0.6A/point, 2.4A/common	0.6A/point, 2.4A/common	○	
Minimum switching voltage/current		24VAC100mA, 100V/240VAC10mA	24VAC100mA, 100V/240VAC10mA	○	
Maximum inrush current		20A10ms or less 8A100ms or less	20A10ms or less 8A100ms or less	○	
Leakage current at off		1.5mA (120VAC60Hz) 3mA (240VAC60Hz)	1.5mA (120VAC60Hz) 3mA (240VAC60Hz)	○	
Maximum voltage drop at on		1.5V or less (0.1A-0.6A) 1.8V or less (0.1A or less) 2.0V or less (10-50mA)	1.5V or less (0.1A-0.6A) 1.8V or less (0.1A or less) 2.0V or less (10-50mA)	○	
Temperature derating		None	Refer to temperature derating chart ^{*1}	△	Use it within the range shown in the temperature derating chart.
Response time	OFF→ON	1ms or less (6ms TYP.)	1ms or less (1ms TYP.)	△	In combination with Q series output module: 2ms or less ^{*2}
	ON→OFF	0.5 cycle + 1ms or less	0.5 cycle + 1ms or less	△	In combination with Q series output module: 0.5 cycle + 2ms or less. ^{*2}
Fuse rating		Fast blow fuse 3.2A (1/common) HP-32	None	×	Install one fuse per common externally. (A fuse and fuse holder are included.)
Fuse blown indication		Available (LED turns on by fuse blown, and a signal is output to the CPU module.)	None	×	
Surge suppressor	CR absorber	0.022μF+47Ω	0.015μF+22Ω	△	
	Varistor	None	Varistor (400 to 540V)	△	
Common terminal arrangement		8 points/common (Common terminal: TB9, TB19, TB29)	8 points/common (Common terminal: TB9, TB19, TB29)	○	
Operation indication		Available (Turning ON the input turns LED ON)	None	△	Operation indication can be checked with Q series input module.
Specifications		A0J2-E24S	SC-A0JQIF24S	Compatibility	Precautions for replacement
5VDC internal current consumption		400mA (TYP. All points are ON.)	-	-	
External supply power (Module power supply)	Voltage	None	24VDC ±10% Ripple voltage 4Vp-p or less	×	To deliver a power for programmable controller operation, connecting a module power supply to the interface module, TB35 or TB36 is required.
	Current	None	370mA	×	If the voltage exceeds existing power capacity, add 24VDC power supply separately.
External connection method		36-point terminal block connector (M3 × 6 screws)	36-point terminal block connector (M3 × 6 screws)	○	
Applicable wire size		0.75 to 2mm ² (Applicable tightening torque 69N·cm)	0.75 to 2mm ² (Applicable tightening torque 69N·cm)	○	
Applicable solderless terminal		1.25-S3, 1.25-YS3A, 2-S3, 2-YS3A, V1.25-S3, V1.25-YS3A, V2-S3, V2-YS3A	1.25-S3, 1.25-YS3A, 2-S3, 2-YS3A, V1.25-S3, V1.25-YS3A, V2-S3, V2-YS3A	○	
Weight		0.70kg	0.46kg	△	Also consider the weight of fixed stand of programmable controller. ^{*3}
External dimensions		250(H) × 132(W) × 41(D) mm	182(H) × 132(W) × 41(D)mm ^{*4}	×	Check the dimensions since they depend on the installation type (building-up/horizontal/separate type).

*1 The figure below shows the temperature derating chart.

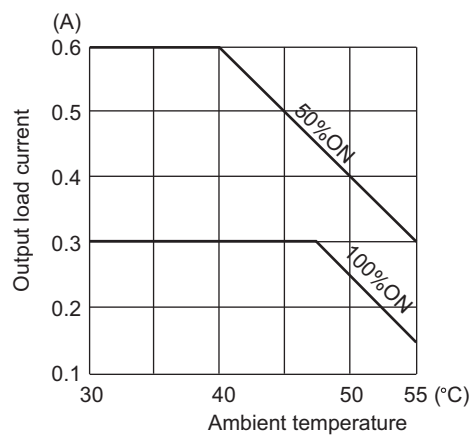

*2 The value when using the output module QY41P, etc.

*3 The weight of fixed stand of programmable controller depends on replacement type of renewal tool for A0J2.

*4 The external dimensions of the SC-A0JQIF24S do not include those of its projection.

(6) Specifications comparison between A0J2-E24T and interface module (SC-A0JQIF24T)

○ : Compatible, △ : Partially changed, × : Incompatible

Specifications	A0J2-E24T output specifications	SC-A0JQIF24T output specifications	Compatibility	Precautions for replacement
Number of output points	24 points	24 points	○	
Insulation method	Photocoupler	Photocoupler	○	
Rated input voltage	12VDC/24VDC	12VDC/24VDC	○	
Operating voltage range	10.2 to 30VDC	10.2 to 30VDC	○	
Maximum switching current	0.5A/point, 4A/common	0.5A/point, 4A/common	○	
Maximum inrush current	4A 10ms or less	4A 10ms or less	○	
Leakage current at off	0.1mA or less	0.1mA or less	○	
Maximum voltage drop at on	0.9VDC(TYP.)0.5A 1.5VDC(MAX.)0.5A	0.9VDC(TYP.)0.5A 0.8VDC(MAX.)0.5A	○	
Response time	OFF→ON	2ms or less	△	In combination with Q series output module: 2ms or less ^{*1}
	ON→OFF	2ms or less (Resistance load)	△	In combination with Q series output module: 3ms or less (Resistance load) ^{*1}
External supply power	Voltage	12VDC/24VDC (10.2VDC-30VDC)	○	
	Current	23mA (TYP.24VDC 8 points are ON/common.)	○	
Surge suppressor	Varistor (52V-62V)	Varistor (50.4V-61.6V)	○	
Common terminal arrangement	8 points/common (Common terminal: TB9, TB19, TB29)	8 points/common (Common terminal: TB9, TB19, TB29)	○	
Operation indication	Available (Turning ON the output turns LED ON)	None	△	Operation indication can be checked with Q series output module.
Fuse rating	None	6.7A (Cannot be changed.) (Fuse blown capacity: 50A)	○	
Fuse blown indication	-	-	○	

○ : Compatible, △ : Partially changed, × : Incompatible

Specifications		A0J2-E24T	SC-A0JQIF24T	Compatibility	Precautions for replacement
5VDC internal current consumption		145mA (TYP. All points are ON.)	–	–	
External supply power (Module power supply)	Voltage	None	24VDC±10% Ripple voltage 4Vp-p or less	×	To deliver a power for programmable controller operation, connecting a module power supply to the interface module, TB35 or TB36 is required.
	Current	None	70mA	×	If the voltage exceeds existing power capacity, add 24VDC power supply separately.
External connection method		36-point terminal block connector (M3 × 6 screws)	36-point terminal block connector (M3 × 6 screws)	○	
Applicable wire size		0.75 to 2mm ² (Applicable tightening torque 69N•cm)	0.75 to 2mm ² (Applicable tightening torque 69N•cm)	○	
Applicable solderless terminal		1.25-3, 1.25-YS3A, 2-S3, 2-YS3A, V1.25-3, V1.25-YS3A, V2-S3, V2-YS3A	1.25-3, 1.25-YS3A, 2-S3, 2-YS3A, V1.25-3, V1.25-YS3A, V2-S3, V2-YS3A	○	
Weight		0.68kg	0.35kg	△	Also consider the weight of fixed stand of programmable controller.*2
External dimensions		250(H) × 132(W) × 41(D)mm	182(H) × 132(W) × 41(D)mm*3	×	Check the dimensions since they depend on the installation type (building-up/horizontal/separate type).

*1 The value when using the output module QY41P, etc.

*2 The weight of fixed stand of programmable controller depends on replacement type of renewal tool for A0J2.

*3 The external dimensions of the SC-A0JQIF24T do not include those of its projection.

(7) Specifications comparison between A0J2-E28AR and interface module (SC-A0JQIF28AR)

○ : Compatible, △ : Partially changed, × : Incompatible

Specifications	A0J2-E28AR input specifications	SC-A0JQIF28AR input specifications	Compatibility	Precautions for replacement
Number of input points	16 points	16 points	○	
Insulation method	Photocoupler	Photocoupler	○	
Rated input voltage	100 to 120VAC 50/60Hz	100 to 120VAC 50/60Hz	○	
Rated input current	10mA (100VAC 60Hz)	10mA (100VAC 60Hz)	○	
Operating voltage range	85 to 132VAC (50/60Hz±5%)	85 to 132VAC (50/60Hz±5%)	○	
Maximum number of simultaneous input points	60% (16 points/common) simultaneously ON	Refer to the derating chart.*1	△	Use it within the range shown in the derating chart. When the voltage of the external supply power (module power supply) is high, the rate of AC input simultaneous ON becomes small.
ON voltage/ON current	80VAC or more/6mA or more	80VAC or more/6mA or more	○	
OFF voltage/OFF current	40VAC or less/4mA or less	26VAC or less/1.7mA or less	△	OFF voltage/OFF current is smaller.*2
Inrush current	Maximum 300mA, Within 0.3ms (132VAC)	Maximum 300mA, Within 0.3ms (132VAC)	○	
Input impedance	Approx. 10kΩ (60Hz), Approx. 12kΩ (50Hz)	Approx. 10kΩ (60Hz), Approx. 12kΩ (50Hz)	○	
Response time	OFF→ON	15ms or less (6ms TYP.)	△	In combination with Q series input module: 15ms or less (12ms TYP.)*3
	ON→OFF	35ms or less (16ms TYP.)	△	In combination with Q series input module: 20ms or less (14ms TYP.)*3
Common terminal arrangement	16 points/common (Common terminal: TB17)	16 points/common (Common terminal: TB17)	○	
Operation indication	Available (Turning ON the input turns LED ON)	None	△	Operation indication can be checked with Q series input module.

○ : Compatible, △ : Partially changed, × : Incompatible

Specifications	A0J2-E28AR output specifications	SC-A0JQIF28AR output specifications	Compatibility	Precautions for replacement	
Number of output points	12 points	12 points	○		
Insulation method	Photocoupler	Relay isolation	○		
Rated switching voltage/current	24VDC 2A (Resistance load)/point 240VAC 2A (COSφ=1)/point 5A/common	24VDC 2A (Resistance load)/point 240VAC 2A (COSφ=1)/point 5A/common	○		
Minimum switching load	5VDC 1mA	5VDC 1mA	○		
Maximum switching voltage	264VAC 125VDC	264VAC 125VDC	○		
Maximum switching frequency	3600 times/hr	3600 times/hr	○		
Mechanical life	20 million times or more	20 million times or more	○		
Electrical life	Rated switching voltage/current load 200,000 times or more	Rated switching voltage/current load 200,000 times or more	○		
	200VAC 1.5A, 240VAC 1A (COSφ=0.7) 200,000 times or more 200VAC 0.75A, 240VAC 0.5A (COSφ=0.35) 200,000 times or more 24VDC 1A, 100VDC 0.1A (L/R=7ms) 200,000 times or more	200VAC 1.5A, 240VAC 1A (COSφ=0.7) 200,000 times or more 200VAC 0.75A, 240VAC 0.5A (COSφ=0.35) 200,000 times or more 24VDC 1A, 100VDC 0.1A (L/R=7ms) 200,000 times or more	○		
Response time	OFF→ON	10ms or less	9ms or less	△	In combination with Q series output module: 10ms or less*4
	ON→OFF	12ms or less	11ms or less	△	In combination with Q series output module: 12ms or less*4
External supply power (Relay coil driving power)	Voltage	24VDC±10% Ripple voltage 4Vp-p or less	24VDC±10% Ripple voltage 4Vp-p or less	○	
	Current	125mA (24VDC All points are ON.)	125mA (24VDC All points are ON.)	○	
Surge suppressor	None	None	○		
Common terminal arrangement	8 points/common (Common terminal: TB26) 3 points/common (Common terminal: TB31) independent (Common terminal: TB31)	8 points/common (Common terminal: TB26) 3 points/common (Common terminal: TB31) independent (Common terminal: TB31)	○		
Operation indication	Available (Turning ON the output turns LED ON)	None	△	Operation indication can be checked with Q series output module.	
Fuse rating	None	None	○		
Fuse blown indication	-	-	-		
Relay socket	None	None	○		

○ : Compatible, △ : Partially changed, × : Incompatible

Specifications	A0J2-E28AR	SC-A0JQIF28AR	Compatibility	Precautions for replacement
5VDC internal current consumption	140mA (TYP. All points are ON.)	—	—	
External supply power (Module power supply)	Voltage	None	×	To deliver a power for programmable controller operation, connecting a module power supply to the interface module, TB35 or TB36 is required.
	Current	None	×	If the voltage exceeds existing power capacity, add 24VDC power supply separately.
External connection method	36-point terminal block connector (M3 × 6 screws)	36-point terminal block connector (M3 × 6 screws)	○	
Applicable wire size	0.75 to 2mm ² (Applicable tightening torque 69N•cm)	0.75 to 2mm ² (Applicable tightening torque 69N•cm)	○	
Applicable solderless terminal	1.25-3, 1.25-YS3A, 2-S3, 2-YS3A, V1.25-3, V1.25-YS3A, V2-S3, V2-YS3A	1.25-3, 1.25-YS3A, 2-S3, 2-YS3A, V1.25-3, V1.25-YS3A, V2-S3, V2-YS3A	○	
Weight	0.68kg	0.44kg	△	Also consider the weight of fixed stand of programmable controller. ^{*5}
External dimensions	250(H) × 132(W) × 41(D)mm	182(H) × 132(W) × 41(D)mm ^{*6}	×	Check the dimensions since they depend on the installation type (building-up/horizontal/separate type).

*1 The figure below shows the derating chart.

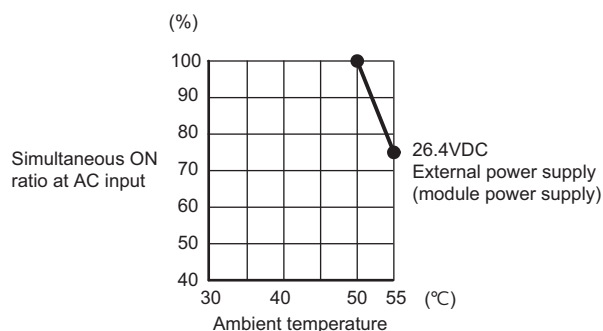

*2 Check that the specifications of leakage current of the used sensor and switches are equal to or less than the OFF current value.

If leakage current is equal to or more than the OFF current specifications, take measures against it with referring to "Input Module Troubleshooting" in the following handbook.

(Handbook for replacement)

Renewal tool for A0J2 series Transition from MELSEC-A0J2(H) series to renewal system using renewal tool.

*3 The value when using the input module, QX41Y41P, QX41, etc. and 5ms is set at input response time in I/O assignment setting of PLC parameter (10ms is set at default).

*4 The value when using the output module, QX41Y41P, QY41P, etc.

*5 The weight of fixed stand of programmable controller depends on replacement type of renewal tool for A0J2.

*6 The external dimensions of the SC-A0JQIF28AR do not include those of its projection.

(8) Specifications comparison between A0J2-E28AS and interface module (SC-A0JQIF28AS)

○ : Compatible, △ : Partially changed, × : Incompatible

Specifications		A0J2-E28AS input specifications	SC-A0JQIF28AS input specifications	Compatibility	Precautions for replacement
Number of input points		16 points	16 points	○	
Insulation method		Photocoupler	Photocoupler	○	
Rated input voltage		100 to 120VAC 50/60Hz	100 to 120VAC 50/60Hz	○	
Rated input current		10mA (100VAC 60Hz)	10mA (100VAC 60Hz)	○	
Operating voltage range		85 to 132VAC (50/60Hz±5%)	85 to 132VAC (50/60Hz±5%)	○	
Maximum number of simultaneous input points		100% (16 points/common) simultaneously ON	100% (16 points/common) simultaneously ON	○	
ON voltage/ON current		80VAC or more/6mA or more	80VAC or more/6mA or more	○	
OFF voltage/OFF current		40VAC or less/4mA or less	26VAC or less/1.7mA or less	△	OFF voltage/OFF current is smaller.*1
Inrush current		Maximum 300mA, Within 0.3ms (132VAC)	Maximum 300mA, Within 0.3ms (132VAC)	○	
Input impedance		Approx. 10kΩ (60Hz), Approx. 12kΩ (50Hz)	Approx. 10kΩ (60Hz), Approx. 12kΩ (50Hz)	○	
Response time	OFF→ON	15ms or less (6ms TYP.)	14ms or less (11ms TYP.)	△	In combination with Q series input module: 15ms or less (12ms TYP.)*2
	ON→OFF	35ms or less (16ms TYP.)	19ms or less (13ms TYP.)	△	In combination with Q series input module: 20ms or less (14ms TYP.)*2
Common terminal arrangement		16 points/common (Common terminal: TB17)	16 points/common (Common terminal: TB17)	○	
Operation indication		Available (Turning ON the input turns LED ON)	None	△	Operation indication can be checked with Q series input module.

Specifications		A0J2-E28AS output specifications	SC-A0JQIF28AS output specifications	Compatibility	Precautions for replacement
Number of output points		12 points	12 points	○	
Insulation method		Photocoupler	Photocoupler	○	
Rated switching voltage		100 to 240VAC, 40-70Hz	100 to 240VAC, 47-63Hz	○	
Maximum switching voltage		264VAC	264VAC	○	
Maximum switching current		0.6A/point, 2.4A/common	0.6A/point, 2.4A/common	○	
Minimum switching voltage/current		24VAC100mA, 100V/240VAC10mA	24VAC100mA, 100V/240VAC10mA	○	
Maximum inrush current		20A10ms or less 8A100ms or less	20A10ms or less 8A100ms or less	○	
Leakage current at off		1.5mA (120VAC60Hz) 3mA (240VAC60Hz)	1.5mA (120VAC60Hz) 3mA (240VAC60Hz)	○	
Maximum voltage drop at on		1.5V or less (0.1A-0.6A) 1.8V or less (0.1A or less) 2.0V or less (10-50mA)	1.5V or less (0.1A-0.6A) 1.8V or less (0.1A or less) 2.0V or less (10-50mA)	○	
Temperature derating		None	Refer to temperature derating chart*3	△	Use it within the range shown in the temperature derating chart.
Response time	OFF→ON	1ms or less	1ms or less	△	In combination with Q series input module: 2ms or less (6ms TYP.)*4
	ON→OFF	0.5 cycle + 1ms or less	0.5 cycle + 1ms or less	△	In combination with Q series input module: 0.5 cycle + 2ms or less.*4
Fuse rating		Fast blow fuse 3.2A (1/common) HP-32	None	×	Install one fuse per common externally. The fuse and fuse holder are included.
Fuse blown indication		Available (LED turns on by fuse blown, and a signal is output to the CPU module.)	None	×	
Surge suppressor	CR absorber	0.022μF+47Ω	0.015μF+22Ω	△	
	Varistor	None	Varistor (400 to 540V)	△	
Common terminal arrangement		8 points/common (Common terminal: TB26) 4 points/common (Common terminal: TB33)	8 points/common (Common terminal: TB26) 4 points/common (Common terminal: TB33)	○	
Operation indication		Available (Turning ON the input turns LED ON)	None	△	Operation indication can be checked with Q series input module.
Specifications		A0J2-E28AS	SC-A0JQIF28AS	Compatibility	Precautions for replacement
5VDC internal current consumption		260mA (TYP. All points are ON.)	-	-	
External supply power (Module power supply)	Voltage	None	24VDC ±10% Ripple voltage 4Vp-p or less	×	To deliver a power for programmable controller operation, connecting a module power supply to the interface module, TB35 or TB36 is required.
	Current	None	290mA	×	If the voltage exceeds existing power capacity, add 24VDC power supply separately.
External connection method		36-point terminal block connector (M3 × 6 screws)	36-point terminal block connector (M3 × 6 screws)	○	
Applicable wire size		0.75 to 2mm ² (Applicable tightening torque 69N•cm)	0.75 to 2mm ² (Applicable tightening torque 69N•cm)	○	
Applicable solderless terminal		1.25-3, 1.25-YS3A, 2-S3, 2-YS3A, V1.25-3, V1.25-YS3A, V2-S3, V2-YS3A	1.25-3, 1.25-YS3A, 2-S3, 2-YS3A, V1.25-3, V1.25-YS3A, V2-S3, V2-YS3A	○	
Weight		0.68kg	0.43kg	△	Also consider the weight of fixed stand of programmable controller.*5
External dimensions		250(H) × 132(W) × 41(D)mm	182(H) × 132(W) × 41(D)mm*6	×	Check the dimensions since they depend on the installation type (building-up/horizontal/separate type).

- *1 Check that the specifications of leakage current of the used sensor and switches are equal to or less than the OFF current value.

If leakage current is equal to or more than the OFF current specifications, take measures against it with referring to "Input Module Troubleshooting" in the following handbook.

(Handbook for replacement)

Renewal tool for A0J2 series Transition from MELSEC-A0J2(H) series to renewal system using renewal tool

- *2 The value when using the input module, QX41Y41P, QX41, etc. and 5ms is set at input response time in I/O assignment setting of PLC parameter (10ms is set at default).

- *3 The figure below shows the temperature derating chart.

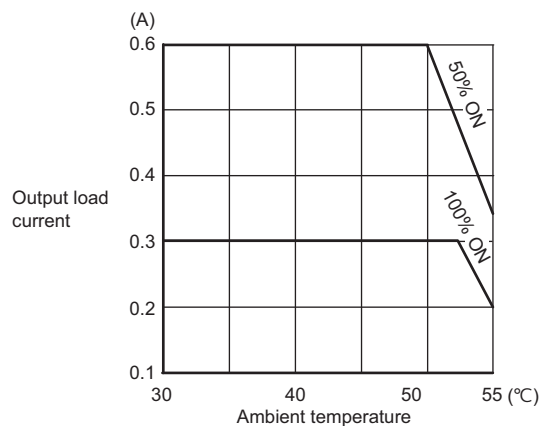

- *4 The value when using the output module, QX41Y41P, QY41P, etc.
- *5 The weight of fixed stand of programmable controller depends on replacement type of renewal tool for A0J2.
- *6 The external dimensions of the SC-A0JQIF28AS do not include those of its projection.

(9) Specifications comparison between A0J2-E28DR and interface module (SC-A0JQIF28DR)

○ : Compatible, △ : Partially changed, × : Incompatible

Specifications	A0J2-E28DR input specifications	SC-A0JQIF28DR input specifications	Compatibility	Precautions for replacement	
Number of input points	16 points	16 points	○		
Insulation method	Photocoupler	Photocoupler	○		
Rated input voltage	12VDC/24VDC	12VDC/24VDC	○		
Rated input current	Approx. 3mA/Approx. 7mA	Approx. 3mA/Approx. 7mA	○		
Operating voltage range	10.2 to 26.4VDC (Ripple ratio within 5%)	10.2 to 26.4VDC (Ripple ratio within 5%)	○		
Maximum number of simultaneous input points	100% (16 points/common) simultaneously ON	100% (16 points/common) simultaneously ON	○		
ON voltage/ON current	9.5VDC or more/2.6mA or more	9.5VDC or more/2.6mA or more	○		
OFF voltage/OFF current	6VDC or less/1.0mA or less	6VDC or less/1.0mA or less	○		
Input resistance	Approx. 3.4kΩ	Approx. 3.3kΩ	○	Input resistance is smaller.	
Input form	Sink input (Input current flows off.)	Sink input (Input current flows off.)	○		
Response time	OFF→ON	10ms or less (6ms TYP.)	5ms or less (1ms TYP.)	△	In combination with Q series input module: 10ms or less (6ms TYP.)* ¹
	ON→OFF	10ms or less (7.5ms TYP.)	5ms or less (1ms TYP.)	△	In combination with Q series input module: 10ms or less (6ms TYP.)* ¹
Common terminal arrangement	16 points/common (Common terminal: TB17)	16 points/common (Common terminal: TB17)	○		
Operation indication	Available (Turning ON the input turns LED ON)	None	△	Operation indication can be checked with Q series input module.	

○ : Compatible, △ : Partially changed, × : Incompatible

Specifications	A0J2-E28DR output specifications	SC-A0JQIF28DR output specifications	Compatibility	Precautions for replacement	
Number of output points	12 points	12 points	○		
Insulation method	Photocoupler	None	△	Photocoupler is provided on Q series output module side.	
Rated switching voltage/current	24VDC 2A (Resistance load)/point 240VAC 2A (COSφ=1)/point 5A/common	24VDC 2A (Resistance load)/point 240VAC 2A (COSφ=1)/point 5A/common	○		
Minimum switching load	5VDC 1mA	5VDC 1mA	○		
Maximum switching voltage	264VAC 125VDC	264VAC 125VDC	○		
Maximum switching frequency	3600 times/hr	3600 times/hr	○		
Mechanical life	20 million times or more	20 million times or more	○		
Electrical life	Rated switching voltage/current load 200,000 times or more	Rated switching voltage/current load 200,000 times or more	○		
	200VAC 1.5A, 240VAC 1A (COSφ=0.7) 200,000 times or more 200VAC 0.75A, 240VAC 0.5A (COSφ=0.35) 200,000 times or more 24VDC 1A, 100VDC 0.1A (L/R=7ms) 200,000 times or more	200VAC 1.5A, 240VAC 1A (COSφ=0.7) 200,000 times or more 200VAC 0.75A, 240VAC 0.5A (COSφ=0.35) 200,000 times or more 24VDC 1A, 100VDC 0.1A (L/R=7ms) 200,000 times or more	○		
Response time	OFF→ON	10ms or less	9ms or less	△	In combination with Q series output module: 10ms or less*2
	ON→OFF	12ms or less	11ms or less	△	In combination with Q series output module: 12ms or less*2
External supply power (Relay coil driving power)	Voltage	24VDC±10% Ripple voltage 4Vp-p or less	24VDC±10% Ripple voltage 4Vp-p or less	○	
	Current	125mA (24VDC All points are ON.)	125mA (24VDC All points are ON.)	○	
Surge suppressor	None	None	○		
Fuse rating	None	None	○		
Fuse blown indication	-	-	○		
Relay socket	None	None	○		
Common terminal arrangement	8 points/common (Common terminal: TB26) 3 points/common (Common terminal: TB31) Independent contact (Common terminal: TB33)	8 points/common (Common terminal: TB26) 3 points/common (Common terminal: TB31) Independent contact (Common terminal: TB33)	○		
Operation indication	Available (Turning ON the output turns LED ON)	None	△	Operation indication can be checked with Q series output module.	

○ : Compatible, △ : Partially changed, × : Incompatible

Specifications		A0J2-E28DR	SC-A0JQIF28DR	Compatibility	Precautions for replacement
5VDC internal current consumption		130mA (TYP. All points are ON.)	—	—	
External supply power (Module power supply)	Voltage	None	24VDC±10% Ripple voltage 4Vp-p or less	×	To deliver a power for programmable controller operation, connecting a module power supply to the interface module, TB27 or TB36 is required.
	Current	None	100mA	×	If the voltage exceeds existing power capacity, add 24VDC power supply separately.
External connection method		36-point terminal block connector (M3 × 6 screws)	36-point terminal block connector (M3 × 6 screws)	○	
Applicable wire size		0.75 to 2mm ² (Applicable tightening torque 69N•cm)	0.75 to 2mm ² (Applicable tightening torque 69N•cm)	○	
Applicable solderless terminal		1.25-3, 1.25-YS3A, 2-S3, 2-YS3A, V1.25-3, V1.25-YS3A, V2-S3, V2-YS3A	1.25-3, 1.25-YS3A, 2-S3, 2-YS3A, V1.25-3, V1.25-YS3A, V2-S3, V2-YS3A	○	
Weight		0.68kg	0.42kg	△	Also consider the weight of fixed stand of programmable controller.* ³
External dimensions		250(H) × 132(W) × 41(D) mm	182(H) × 132(W) × 41(D) mm* ⁴	×	Check the dimensions since they depend on the installation type (building-up/horizontal/separate type).

- *1 The value when using the input module, QX41Y41P, QX41, etc. and 5ms is set at input response time in I/O assignment setting of PLC parameter (10ms is set at default).
- *2 The value when using the output module, QX41Y41P, QY41P, etc.
- *3 The weight of fixed stand of programmable controller depends on replacement type of renewal tool for A0J2.
- *4 The external dimensions of the SC-A0JQIF28DR do not include those of its projection.

(10) Specifications comparison between A0J2-E28DS and interface module (SC-A0JQIF28DS)

○ : Compatible, △ : Partially changed, × : Incompatible

Specifications		A0J2-E28DS input specifications	SC-A0JQIF28DS input specifications	Compatibility	Precautions for replacement
Number of input points		16 points	16 points	○	
Insulation method		Photocoupler	Photocoupler	○	
Rated input voltage		12VDC/24VDC	12VDC/24VDC	○	
Rated input current		Approx.3mA /Approx. 7mA	Approx.3mA /Approx. 7mA	○	
Operating voltage range		10.2 to 26.4VDC (Ripple ratio within 5%)	10.2 to 26.4VDC (Ripple ratio within 5%)	○	
Maximum number of simultaneous input points		100% (16 points/common) simultaneously ON	100% (16 points/common) simultaneously ON	○	
ON voltage/ON current		9.5VDC or more/2.6mA or more	9.5VDC or more/2.6mA or more	○	
OFF voltage/OFF current		6VDC or less/1.0mA or less	6VDC or less/1.0mA or less	○	
Input impedance		Approx. 3.4kΩ	Approx. 3.3kΩ	○	
Input form		Sink input (Input current flows off.)	Sink input (Input current flows off.)	○	
Response time	OFF→ON	10ms or less (6ms TYP.)	5ms or less (1ms TYP.)	△	In combination with Q series input module: 6ms or less (2ms TYP.) ^{*1}
	ON→OFF	10ms or less (7.5ms TYP.)	5ms or less (1ms TYP.)	△	In combination with Q series input module: 6ms or less (2ms TYP.) ^{*1}
Common terminal arrangement		16 points/common (Common terminal: TB17)	16 points/common (Common terminal: TB17)	○	
Operation indication		Available (Turning ON the input turns LED ON)	None	△	Operation indication can be checked with Q series input module.
Specifications		A0J2-E28DS output specifications	SC-A0JQIF28DS output specifications	Compatibility	Precautions for replacement
Number of output points		12 points	12 points	○	
Insulation method		Photocoupler	Photocoupler	○	
Rated switching voltage		100 to 240VAC, 40-70Hz	100 to 240VAC, 47-63Hz	△	The maximum frequency of SC-A0JQIF28DS is smaller than the one of A0J2-E28DS.
Maximum switching voltage		264VAC	264VAC	○	
Maximum switching current		0.6A/point, 2.4A/common	0.6A/point, 2.4A/common	○	
Minimum switching voltage/current		24VAC 100mA, 100V/240VAC10mA	24VAC 100mA,100V/240VAC10mA	○	
Maximum inrush current		20A10ms or less 8A100ms or less	20A10ms or less 8A100ms or less	○	
Leakage current at off		1.5mA (120VAC60Hz) 3mA (240VAC60Hz)	1.5mA (120VAC60Hz) 3mA (240VAC60Hz)	○	
Maximum voltage drop at on		1.5V or less (0.1A-0.6A) 1.8V or less (0.1A or less) 2.0V or less (10-50mA)	1.5V or less (0.1A-0.6A) 1.8V or less (0.1A or less) 2.0V or less (10-50mA)	○	
Temperature derating		None	None	○	
Response time	OFF→ON	1ms or less	1ms or less	△	In combination with Q series output module: 2ms or less. ^{*2}
	ON→OFF	0.5 cycle + 1ms or less	0.5 cycle + 1ms or less	△	In combination with Q series output module: 0.5 cycle + 2ms or less. ^{*2}
Fuse rating		Fast blow fuse 3.2A (1/common) HP-32	None	×	Install one fuse per common externally. (A fuse and fuse holder are included.)
Fuse blown indication		Available (LED turns on by fuse blown, and a signal is output to the CPU module.)	Not available	×	

Specifications		A0J2-E28DS input specifications	SC-A0JQIF28DS input specifications	Compatibility	Precautions for replacement
Surge suppressor	CR absorber	0.022 μ F+47 Ω	0.015 μ F+22 Ω	Δ	
	Varistor	None	Varistor (400 to 540V)	Δ	
Common terminal arrangement		8 points/common (Common terminal: TB26) 4 points/common (Common terminal: TB33)	8 points/common (Common terminal: TB26) 4 points/common (Common terminal: TB33)	\circ	
Operation indication		Available (Turning ON the input turns LED ON)	None	Δ	Operation indication can be checked with Q series input module.
Specifications		A0J2-E28AS	SC-A0JQIF28AS	Compatibility	Precautions for replacement
5VDC internal current consumption		260mA (TYP. All points are ON.)	–	–	
External supply power (Module power supply)	Voltage	None	24VDC \pm 10% Ripple voltage 4Vp-p or less	\times	To deliver a power for programmable controller operation, connecting a module power supply to the interface module, TB35 or TB36 is required.
	Current	None	285mA	\times	If the voltage exceeds existing power capacity, add 24VDC power supply separately.
External connection method		36-point terminal block connector (M3 \times 6 screws)	36-point terminal block connector (M3 \times 6 screws)	\circ	
Applicable wire size		0.75 to 2mm ² (Applicable tightening torque 69N \cdot cm)	0.75 to 2mm ² (Applicable tightening torque 69N \cdot cm)	\circ	
Applicable solderless terminal		1.25-3, 1.25-YS3A, 2-S3, 2-YS3A, V1.25-3, V1.25-YS3A, V2-S3, V2-YS3A	1.25-3, 1.25-YS3A, 2-S3, 2-YS3A, V1.25-3, V1.25-YS3A, V2-S3, V2-YS3A	\circ	
Weight		0.65kg	0.41kg	Δ	Also consider the weight of fixed stand of programmable controller.* ³
External dimensions		250(H) \times 132(W) \times 41(D) mm	182(H) \times 132(W) \times 41(D)mm ⁴	\times	Check the dimensions since they depend on the installation type (building-up/horizontal/separate type).

*1 The value when using the input module, QX41Y41P, QX41, etc. and 5ms is set at input response time in I/O assignment setting of PLC parameter (10ms is set at default).

*2 The value when using the output module, QX41Y41P, QY41P, etc.

*3 The weight of fixed stand of programmable controller depends on replacement type of renewal tool for A0J2.

*4 The external dimensions of the SC-A0JQIF28DS do not include those of its projection.

(11) Specifications comparison between A0J2-E28DT and interface module (SC-A0JQIF28DT)

○ : Compatible, △ : Partially changed, × : Incompatible

Specifications		A0J2-E28DT input specifications	SC-A0JQIF28DT input specifications	Compatibility	Precautions for replacement
Number of input points		16 points	16 points	○	
Insulation method		Photocoupler	Photocoupler	○	
Rated input voltage		12VDC/24VDC	12VDC/24VDC	○	
Rated input current		Approx. 3mA/Approx. 7mA	Approx. 3mA/Approx. 7mA	○	
Operating voltage range		10.2 to 26.4VDC (Ripple ratio within 5%)	10.2 to 26.4VDC (Ripple ratio within 5%)	○	
Maximum number of simultaneous input points		100% (16 points/common) simultaneously ON	100% (16 points/common) simultaneously ON	○	
ON voltage/ON current		9.5VDC or more/2.6mA or more	9.5VDC or more/2.6mA or more	○	
OFF voltage/OFF current		6VDC or less/1.0mA or less	6VDC or less/1.0mA or less	○	
Input resistance		Approx. 3.4kΩ	Approx. 3.3kΩ	○	
Input form		Sink input (Input current flows off.)	Sink input (Input current flows off.)	○	
Response time	OFF→ON	10ms or less (6ms TYP.)	5ms or less (1ms TYP.)	△	In combination with Q series input module: 10ms or less (6ms TYP.) ^{*1}
	ON→OFF	10ms or less (7.5ms TYP.)	5ms or less (1ms TYP.)	△	In combination with Q series input module: 10ms or less (6ms TYP.) ^{*1}
Common terminal arrangement		16 points/common (Common terminal: TB17)	16 points/common (Common terminal: TB17)	○	
Operation indication		Available (Turning ON the input turns LED ON)	None	△	Operation indication can be checked with Q series input module.
Specifications		A0J2-E28DT output specifications	SC-A0JQIF28DT output specifications	Compatibility	Precautions for replacement
Number of output points		12 points	12 points	○	
Insulation method		Photocoupler	Photocoupler	○	
Rated load voltage		12VDC/24VDC	12VDC/24VDC	○	
Operating load voltage range		10.2 to 30VDC	10.2 to 30VDC	○	
Maximum load current		0.5A/point, 4A/common	0.5A/point, 4A/common	○	
Maximum inrush current		4A 10ms or less	4A 10ms or less	○	
Leakage current at OFF		0.1mA or less	0.1mA or less	○	
Maximum voltage drop at ON		0.9VDC (TYP.) 0.5A 1.5VDC (MAX.) 0.5A	0.5VDC (TYP.) 0.5A 0.8VDC (MAX.) 0.5A	○	
Response time	OFF→ON	2ms or less	1ms or less	△	In combination with Q series output module: 2ms or less ^{*2}
	ON→OFF	2ms or less (Resistance load)	1ms or less (Resistance load)	△	In combination with Q series output module: 2ms or less (Resistance load) ^{*2}
External supply power	Voltage	12VDC/24VDC (10.2 to 30VDC)	12VDC/24VDC (10.2 to 30VDC)	○	
	Current	23mA (TYP. 24VDC 8 points/common ON)	5mA (TYP. 24VDC 8 points/common ON)	○	
Surge suppressor		Varistor (52 to 62V)	Varistor (50.4 to 61.6V)	○	
Common terminal arrangement		8 points/common (Common terminal: TB26) 4 points/common (Common terminal: TB33)	8 points/common (Common terminal: TB26) 4 points/common (Common terminal: TB33)	○	
Operation indication		Available (Turning ON the output turns LED ON)	None	△	Operation indication can be checked with Q series output module.
Fuse		None	None	○	
Fuse blown indication		None	None	○	

○ : Compatible, △ : Partially changed, × : Incompatible

Specifications		A0J2-E28DT	SC-A0JQIF28DT	Compatibility	Precautions for replacement
5VDC internal current consumption		125mA (TYP. All points are ON.)	—	—	
External supply power (Module power supply)	Voltage	None	24VDC±10% Ripple voltage 4Vp-p or less	×	To deliver a power for programmable controller operation, connecting a module power supply to the interface module, TB35 or TB36 is required.
	Current	None	130mA	×	If the voltage exceeds existing power capacity, add 24VDC power supply separately.
External connection method		36-point terminal block connector (M3 × 6 screws)	36-point terminal block connector (M3 × 6 screws)	○	
Applicable wire size		0.75 to 2mm ² (Applicable tightening torque 69N•cm)	0.75 to 2mm ² (Applicable tightening torque 69N•cm)	○	
Applicable solderless terminal		1.25-3, 1.25-YS3A, 2-S3, 2-YS3A, V1.25-3, V1.25-YS3A, V2-S3, V2-YS3A	1.25-3, 1.25-YS3A, 2-S3, 2-YS3A, V1.25-3, V1.25-YS3A, V2-S3, V2-YS3A	○	
Weight		0.65kg	0.36kg	△	Also consider the weight of fixed stand of programmable controller. ^{*3}
External dimensions		250(H) × 132(W) × 41(D)mm	182(H) × 132(W) × 41(D)mm ^{*4}	×	Check the dimensions since they depend on the installation type (building-up/horizontal/separate type).

*1 The value when using the input module, QX41Y41P, QX41, etc. and 5ms is set at input response time in I/O assignment setting of PLC parameter (10ms is set at default).

*2 The value when using the output module, QX41Y41P, QY41P, etc.

*3 The weight of fixed stand of programmable controller depends on replacement type of renewal tool for A0J2.

*4 The external dimensions of the SC-A0JQIF28DT do not include those of its projection.

(12) Specifications comparison between A0J2-E56AR and interface module (SC-A0JQIF56AR)

○ : Compatible, △ : Partially changed, × : Incompatible

Specifications	A0J2-E56AR input specifications	SC-A0JQIF56AR input specifications	Compatibility	Precautions for replacement
Number of input points	32 points	32 points	○	
Insulation method	Photocoupler	Photocoupler	○	
Rated input voltage	100 to 120VAC 50/60Hz	100 to 120VAC 50/60Hz	○	
Rated input current	10mA (100VAC 60Hz)	10mA (100VAC 60Hz)	○	
Operating voltage range	85 to 132VAC (50/60Hz±5%)	85 to 132VAC (50/60Hz±5%)	○	
Maximum number of simultaneous input points	60% (10 points/common) simultaneously ON	60% (10 points/common) simultaneously ON	○	
ON voltage/ON current	80VAC or more/6mA or more	80VAC or more/6mA or more	○	
OFF voltage/OFF current	40VAC or less/4mA or less	26VAC or less/1.7mA or less	△	OFF voltage/OFF current is smaller.*1
Inrush current	Maximum 300mA, Within 0.3ms (132VAC)	Maximum 300mA, Within 0.3ms (132VAC)	○	
Input impedance	Approx. 10kΩ (60Hz), Approx. 12kΩ (50Hz)	Approx. 10kΩ (60Hz), Approx. 12kΩ (50Hz)	○	
Response time	OFF→ON	15ms or less (6ms TYP.)	△	In combination with Q series input module: 15ms or less (12ms TYP.)*2
	ON→OFF	35ms or less (16ms TYP.)	△	In combination with Q series input module: 20ms or less (14ms TYP.)*2
Common terminal arrangement	16 points/common (Common terminal: TB17, TB34)	16 points/common (Common terminal: TB17, TB34)	○	
Operation indication	Available (Turning ON the input turns LED ON)	None	△	Operation indication can be checked with Q series input module.

○ : Compatible, △ : Partially changed, × : Incompatible

Specifications		A0J2-E56AR output specifications	SC-A0JQIF56AR output specifications	Compatibility	Precautions for replacement
Number of output points		24 points	24 points	○	
Insulation method		Photocoupler	None	△	Photocoupler is provided on Q series output module side.
Rated switching voltage/current		24VDC 2A (Resistance load)/point 240VAC 2A (COSφ=1)/point 5A/common	24VDC 2A (Resistance load)/point 240VAC 2A (COSφ=1)/point 5A/common	○	
Minimum switching load		5VDC 1mA	5VDC 1mA	○	
Maximum switching voltage		264VAC 125VDC	264VAC 125VDC	○	
Maximum switching frequency		3600 times/hr	3600 times/hr	○	
Mechanical life		20 million times or more	20 million times or more	○	
Electrical life		Rated switching voltage/current load 200,000 times or more	Rated switching voltage/current load 200,000 times or more	○	
		200VAC 1.5A, 240VAC 1A (COSφ=0.7) 200,000 times or more 200VAC 0.75A, 240VAC 0.5A (COSφ=0.35) 200,000 times or more 24VDC 1A, 100VDC 0.1A (L/R=7ms) 200,000 times or more	200VAC 1.5A, 240VAC 1A (COSφ=0.7) 200,000 times or more 200VAC 0.75A, 240VAC 0.5A (COSφ=0.35) 200,000 times or more 24VDC 1A, 100VDC 0.1A (L/R=7ms) 200,000 times or more	○	
Response time	OFF→ON	10ms or less	9ms or less	△	In combination with Q series output module: 10ms or less*3
	ON→OFF	12ms or less	11ms or less	△	In combination with Q series output module: 12ms or less*3
External supply power (Relay coil driving power)	Voltage	24VDC±10% Ripple voltage 4Vp-p or less	24VDC±10% Ripple voltage 4Vp-p or less	○	
	Current	230mA (24VDC All points are ON.)	230mA (24VDC All points are ON.)	○	
Surge suppressor		None	None	○	
Fuse rating		None	None	○	
Fuse blown indication		-	-	○	
Relay socket		None	None	○	
Common terminal arrangement		8 points/common (Common terminal: TB9, TB19, TB29)	8 points/common (Common terminal: TB9, TB19, TB29)	○	
Operation indication		Available (Turning ON the output turns LED ON)	None	△	Operation indication can be checked with Q series output module.

○ : Compatible, △ : Partially changed, × : Incompatible

Specifications		A0J2-E56AR	SC-A0JQIF56AR	Compatibility	Precautions for replacement
5VDC internal current consumption		225mA (TYP. All points are ON.)	—	—	
External supply power (Module power supply)	Voltage	None	24VDC±10% Ripple voltage 4Vp-p or less	×	To deliver a power for programmable controller operation, connecting a module power supply to the interface module, TB35 or TB36 is required.
	Current	None	210mA	×	If the voltage exceeds existing power capacity, add 24VDC power supply separately.
External connection method		36-point terminal block connector (M3 × 6 screws) 2 pieces	36-point terminal block connector (M3 × 6 screws) 2 pieces	○	
Applicable wire size		0.75 to 2mm ² (Applicable tightening torque 69N•cm)	0.75 to 2mm ² (Applicable tightening torque 69N•cm)	○	
Applicable solderless terminal		1.25-3, 1.25-YS3A, 2-S3, 2-YS3A, V1.25-3, V1.25-YS3A, V2-S3, V2-YS3A	1.25-3, 1.25-YS3A, 2-S3, 2-YS3A, V1.25-3, V1.25-YS3A, V2-S3, V2-YS3A	○	
Weight		1.10kg	0.66kg	△	Also consider the weight of fixed stand of programmable controller.*4
External dimensions		250(H) × 190(W) × 41(D)mm	182(H) × 190(W) × 41(D)mm*5	×	Check the dimensions since they depend on the installation type (building-up/horizontal/separate type).

- *1 Check that the specifications of leakage current of the used sensor and switches are equal to or less than the OFF current value.
If leakage current is equal to or more than the OFF current specifications, take measures against it with referring to "Input Module Troubleshooting" in the following handbook.
(Handbook for replacement)
Renewal tool for A0J2 series Transition from MELSEC-A0J2(H) series to renewal system using renewal tool (refer to Appendix 3.5.)
- *2 The value when using the input module, QX41Y41P, QX41, etc. and 1ms is set at input response time in I/O assignment setting of PLC parameter (10ms is set at default).
- *3 The value when using the output module, QX41Y41P, QY41P, etc.
- *4 The weight of fixed stand of programmable controller depends on replacement type of renewal tool for A0J2.
- *5 The external dimensions of the SC-A0JQIF56AR do not include those of its projection.

(13) Specifications comparison between A0J2-E56AS and interface module (SC-A0JQIF56AS)

○ : Compatible, △ : Partially changed, × : Incompatible

Specifications		A0J2-E56AS input specifications	SC-A0JQIF56AS input specifications	Compatibility	Precautions for replacement
Number of input points		32 points	32 points	○	
Insulation method		Photocoupler	Photocoupler	○	
Rated input voltage		100 to 120VAC 50/60Hz	100 to 120VAC 50/60Hz	○	
Rated input current		10mA (100VAC 60Hz)	10mA (100VAC 60Hz)	○	
Operating voltage range		85 to 132VAC (50/60Hz±5%)	85 to 132VAC (50/60Hz±5%)	○	
Maximum number of simultaneous input points		60% (10 points/common) simultaneously ON	60% (10 points/common) simultaneously ON	○	
ON voltage/ON current		80VAC or more/6mA or more	80VAC or more/6mA or more	○	
OFF voltage/OFF current		40VAC or less/4mA or less	26VAC or less/1.7mA or less	△	OFF voltage/OFF current is smaller.*1
Inrush current		Maximum 300mA, Within 0.3ms (132VAC)	Maximum 300mA, Within 0.3ms (132VAC)	○	
Input impedance		Approx. 10kΩ (60Hz), Approx. 12kΩ (50Hz)	Approx. 10kΩ (60Hz), Approx. 12kΩ (50Hz)	○	
Response time	OFF→ON	15ms or less (6ms TYP.)	14ms or less (11ms TYP.)	△	In combination with Q series input module: 15ms or less (12ms TYP.)*2
	ON→OFF	35ms or less (16ms TYP.)	19ms or less (13ms TYP.)	△	In combination with Q series input module: 20ms or less (14ms TYP.)*2
Common terminal arrangement		16 points/common (Common terminal: TB17)	16 points/common (Common terminal: TB17)	○	
Operation indication		Available (Turning ON the input turns LED ON)	None	△	Operation indication can be checked with Q series input module.
Specifications		A0J2-E56AS output specifications	SC-A0JQIF56AS output specifications	Compatibility	Precautions for replacement
Number of output points		24 points	24 points	○	
Insulation method		Photocoupler	Photocoupler	○	
Rated switching voltage		100 to 240VAC, 40-70Hz	100 to 240VAC, 47-63Hz	△	The maximum frequency of SC-A0JQIF56AS is smaller than the one of A0J2-E56AS.
Maximum switching voltage		264VAC	264VAC	○	
Maximum switching current		0.6A/point, 2.4A/common	0.6A/point, 2.4A/common	○	
Minimum switching voltage/current		24V/100mAAC, 100VAC/240VAC10mA	24V/100mAAC, 100VAC/240VAC10mA	○	
Maximum inrush current		20A/10ms or less 8A/100ms or less	20A/10ms or less 8A/100ms or less	○	
Leakage current at off		1.5mA (120VAC60Hz) 3mA (240VAC60Hz)	1.5mA (120VAC60Hz) 3mA (240VAC60Hz)	○	
Maximum voltage drop at on		1.5V or less (0.1A-0.6A) 1.8V or less (0.1A or less) 2.0V or less (10-50mA)	1.5V or less (0.1A-0.6A) 1.8V or less (0.1A or less) 2.0V or less (10-50mA)	○	
Temperature derating		None	Refer to temperature derating chart*3	△	Use it within the range shown in the temperature derating chart.
Response time	OFF→ON	1ms or less	1ms or less	△	In combination with Q series input module: 2ms or less.*4
	ON→OFF	0.5 cycle + 1ms or less	0.5 cycle + 1ms or less	×	In combination with Q series input module: 0.5 cycle + 2ms or less.*4
Fuse rating		Fast blow fuse 3.2A (1/common) HP-32	None	×	Install a fuse externally (1/common). (A fuse and fuse holder are included.)
Fuse blown indication		Available (LED turns on by fuse blown, and a signal is output to the CPU module.)	Not available	×	

Specifications		A0J2-E56AS output specifications	SC-A0JQIF56AS output specifications	Compatibility	Precautions for replacement
Surge suppressor	CR absorber	0.022μF+47Ω	0.015μF+22Ω	△	
	Varistor	None	Varistor (400 to 540V)	△	
Common terminal arrangement		8 points/common (Common terminal: TB9, TB19, TB29)	8 points/common (Common terminal: TB9, TB19, TB29)	○	
Operation indication		Available (Turning ON the input turns LED ON)	None	△	Operation indication can be checked with Q series input module.
Specifications		A0J2-E56AS	SC-A0JQIF56AS	Compatibility	Precautions for replacement
5VDC internal current consumption		460mA (TYP. All points are ON.)	—	—	
External supply power (Module power supply)	Voltage	None	24VDC ±10% Ripple voltage 4Vp-p or less	×	To deliver a power for programmable controller operation, connecting a module power supply to the interface module, TB35 or TB36 is required.
	Current	None	580mA	×	If the voltage exceeds existing power capacity, add 24VDC power supply separately.
External connection method		36-point terminal block connector (M3 × 6 screws) 2 pieces	36-point terminal block connector (M3 × 6 screws) 2 pieces	○	
Applicable wire size		0.75 to 2mm ² (Applicable tightening torque 69N•cm)	0.75 to 2mm ² (Applicable tightening torque 69N•cm)	○	
Applicable solderless terminal		1.25-3, 1.25-YS3A, 2-S3, 2-YS3A, V1.25-3, V1.25-YS3A, V2-S3, V2-YS3A	1.25-3, 1.25-YS3A, 2-S3, 2-YS3A, V1.25-3, V1.25-YS3A, V2-S3, V2-YS3A	○	
Weight		1.10kg	0.66kg	△	Also consider the weight of fixed stand of programmable controller.*5
External dimensions		250(H) × 190(W) × 41(D) mm	182(H) × 190(W) × 41(D)mm*6	×	Check the dimensions since they depend on the installation type (building-up/horizontal/separate type).

- *1 Check that the specifications of leakage current of the used sensor and switches are equal to or less than the OFF current value.
If leakage current is equal to or more than the OFF current specifications, take measures against it with referring to "Input Module Troubleshooting" in the following handbook.
(Handbook for replacement)
Renewal tool for A0J2 series Transition from MELSEC-A0J2(H) series to renewal system using renewal tool (refer to Appendix 3.5.)
- *2 The value when using the input module, QX41Y41P, QX41, etc. and 5ms is set at input response time in I/O assignment setting of PLC parameter (10ms is set at default).
- *3 The figure below shows the temperature derating chart.

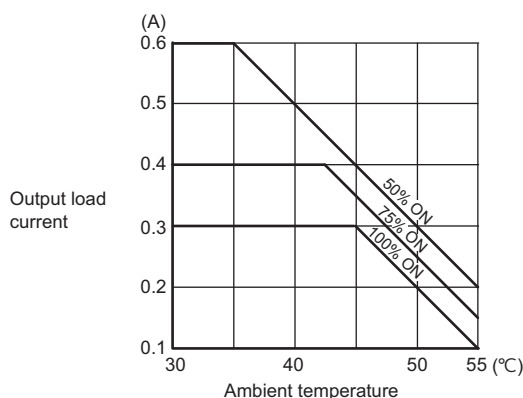

- *4 The value when using the output module, QX41Y41P, QY41P, etc.
- *5 The weight of fixed stand of programmable controller depends on replacement type of renewal tool for A0J2.
- *6 The external dimensions of the SC-A0JQIF56AS do not include those of its projection.

(14) Specifications comparison between A0J2-E56DR and interface module (SC-A0JQIF56DR)

○ : Compatible, △ : Partially changed, × : Incompatible

Specifications		A0J2-E56DR input specifications	SC-A0JQIF56DR input specifications	Compatibility	Precautions for replacement
Number of input points		32 points	32 points	○	
Insulation method		Photocoupler	Photocoupler	○	
Rated input voltage		12VDC/24VDC	12VDC/24VDC	○	
Rated input current		Approx. 3mA/Approx. 7mA	Approx. 3mA/Approx. 7mA	○	
Operating voltage range		10.2 to 26.4VDC (Ripple ratio within 5%)	10.2 to 26.4VDC (Ripple ratio within 5%)	○	
Maximum number of simultaneous input points		60% (10 points/common) simultaneously ON	60% (10 points/common) simultaneously ON	○	
ON voltage/ON current		9.5VDC or more/2.6mA or more	9.5VDC or more/2.6mA or more	○	
OFF voltage/OFF current		6VDC or less/1.0mA or less	6VDC or less/1.0mA or less	○	
Input resistance		Approx. 3.4kΩ	Approx. 3.3kΩ	○	
Input form		Sink input (Input current flows off.)	Sink input (Input current flows off.)	○	
Response time	OFF→ON	10ms or less (6ms TYP.)	5ms or less (1ms TYP.)	△	In combination with Q series input module: 10ms or less (6ms TYP.)* ¹
	ON→OFF	10ms or less (7.5ms TYP.)	5ms or less (1ms TYP.)	△	In combination with Q series input module: 10ms or less (6ms TYP.)* ¹
Common terminal arrangement		16 points/common (Common terminal: TB17, TB34)	16 points/common (Common terminal: TB17, TB34)	○	
Operation indication		Available (Turning ON the input turns LED ON)	None	△	Operation indication can be checked with Q series input module.

○ : Compatible, △ : Partially changed, × : Incompatible

Specifications	A0J2-E56DR output specifications	SC-A0JQIF56DR output specifications	Compatibility	Precautions for replacement	
Number of output points	24 points	24 points	○		
Insulation method	Photocoupler	None	△	Photocoupler is provided on Q series output module side.	
Rated switching voltage/current	24VDC 2A (Resistance load)/point 240VAC 2A (COSφ=1)/point 5A/common	24VDC 2A (Resistance load)/point 240VAC 2A (COSφ=1)/point 5A/common	○		
Minimum switching load	5VDC 1mA	5VDC 1mA	○		
Maximum switching voltage	264VAC 125VDC	264VAC 125VDC	○		
Maximum switching frequency	3600 times/hr	3600 times/hr	○		
Mechanical life	20 million times or more	20 million times or more	○		
Electrical life	Rated switching voltage/current load 200,000 times or more	Rated switching voltage/current load 200,000 times or more	○		
	200VAC 1.5A, 240VAC 1A (COSφ=0.7) 200,000 times or more 200VAC 0.75A, 240VAC 0.5A (COSφ=0.35) 200,000 times or more 24VDC 1A, 100VDC 0.1A (L/R=7ms) 200,000 times or more	200VAC 1.5A, 240VAC 1A (COSφ=0.7) 200,000 times or more 200VAC 0.75A, 240VAC 0.5A (COSφ=0.35) 200,000 times or more 24VDC 1A, 100VDC 0.1A (L/R=7ms) 200,000 times or more	○		
Response time	OFF→ON	10ms or less	9ms or less	△	In combination with Q series output module: 10ms or less*2
	ON→OFF	12ms or less	11ms or less	△	In combination with Q series output module: 12ms or less*2
External supply power (Relay coil driving power)	Voltage	24VDC±10% Ripple voltage 4Vp-p or less	24VDC±10% Ripple voltage 4Vp-p or less	○	
	Current	230mA (24VDC All points are ON.)	230mA (24VDC All points are ON.)	○	
Surge suppressor	None	None	○		
Fuse rating	None	None	○		
Fuse blown indication	-	-	○		
Relay socket	None	None	○		
Common terminal arrangement	8 points/common (Common terminal: TB9, TB19, TB29)	8 points/common (Common terminal: TB9, TB19, TB29)	○		
Operation indication	Available (Turning ON the output turns LED ON)	None	△	Operation indication can be checked with Q series output module.	

○ : Compatible, △ : Partially changed, × : Incompatible

Specifications		A0J2-E56DR	SC-A0JQIF56DR	Compatibility	Precautions for replacement
5VDC internal current consumption		230mA (TYP. All points are ON.)	–	–	
External supply power (Module power supply)	Voltage	None	24VDC±10% Ripple voltage 4Vp-p or less	×	To deliver a power for programmable controller operation, connecting a module power supply to the interface module, TB35 or TB36 is required.
	Current	None	200mA	×	If the voltage exceeds existing power capacity, add 24VDC power supply separately.
External connection method		36-point terminal block connector (M3 × 6 screws) 2 pieces	36-point terminal block connector (M3 × 6 screws) 2 pieces	○	
Applicable wire size		0.75 to 2mm ² (Applicable tightening torque 69N•cm)	0.75 to 2mm ² (Applicable tightening torque 69N•cm)	○	
Applicable solderless terminal		1.25-3, 1.25-YS3A, 2-S3, 2-YS3A, V1.25-3, V1.25-YS3A, V2-S3, V2-YS3A	1.25-3, 1.25-YS3A, 2-S3, 2-YS3A, V1.25-3, V1.25-YS3A, V2-S3, V2-YS3A	○	
Weight		1.08kg	0.62kg	△	Also consider the weight of fixed stand of programmable controller.* ³
External dimensions		250(H) × 190(W) × 41(D)mm	182(H) × 190(W) × 41(D)mm* ⁴	×	Check the dimensions since they depend on the installation type (building-up/horizontal/separate type).

- *1 The value when using the input module, QX41Y41P, QX41, etc. and 5ms is set at input response time in I/O assignment setting of PLC parameter (10ms is set at default).
- *2 The value when using the output module, QX41Y41P, QY41P, etc.
- *3 The weight of fixed stand of programmable controller depends on replacement type of renewal tool for A0J2.
- *4 The external dimensions of the SC-A0JQIF56DR do not include those of its projection.

(15) Specifications comparison between A0J2-E56DS and interface module (SC-A0JQIF56DS)

○ : Compatible, △ : Partially changed, × : Incompatible

Specifications	A0J2-E56DS input specifications	SC-A0JQIF56DS input specifications	Compatibility	Precautions for replacement	
Number of input points	32 points	32 points	○		
Insulation method	Photocoupler	Photocoupler	○		
Rated input voltage	12VDC/24VDC	12VDC/24VDC	○		
Rated input current	Approx. 3mA/Approx. 7mA	Approx. 3mA/Approx. 7mA	○		
Operating voltage range	10.2 to 26.4VDC (Ripple ratio within 5%)	10.2 to 26.4VDC (Ripple ratio within 5%)	○		
Maximum number of simultaneous input points	60% (10 points/common) simultaneously ON	60% (10 points/common) simultaneously ON	○		
ON voltage/ON current	9.5VDC or more/2.6mA or more	9.5VDC or more/2.6mA or more	○		
OFF voltage/OFF current	6VDC or less/1.0mA or less	6VDC or less/1.0mA or less	○		
Input resistance	Approx. 3.4kΩ	Approx. 3.3kΩ	○		
Input form	Sink input (Input current flows off.)	Sink input (Input current flows off.)	○		
Response time	OFF→ON	10ms or less (6ms TYP.)	5ms or less (1ms TYP.)	△	In combination with Q series input module: 6ms or less (2ms TYP.) ^{*1}
	ON→OFF	10ms or less (7.5ms TYP.)	5ms or less (1ms TYP.)	△	In combination with Q series input module: 6ms or less (2ms TYP.) ^{*1}
Common terminal arrangement	16 points/common (Common terminal: TB17,TB34)	16 points/common (Common terminal: TB17,TB34)	○		
Operation indication	Available (Turning ON the input turns LED ON)	None	△	Operation indication can be checked with Q series input module.	

○ : Compatible, △ : Partially changed, × : Incompatible

Specifications		A0J2-E56DS output specifications	SC-A0JQIF56DS output specifications	Compatibility	Precautions for replacement
Number of output points		24 points	24 points	○	
Insulation method		Photocoupler	Photocoupler	○	
Rated load voltage		100-240VAC, 40-70Hz	100-240VAC, 47-63Hz	△	The maximum frequency of SC-A0JQIF56DS is smaller than the one of A0J2-E56DS.
Maximum load voltage		264VAC	264VAC	○	
Maximum load current		0.6A/point, 2.4A/common	0.6A/point, 2.4A/common	○	
Minimum load voltage/current		24VAC100mA, AC100V/ 240VAC10mA	24VAC100mA, AC100V/ 240VAC10mA	○	
Maximum inrush current		20A10ms or less 8A100ms or less	20A10ms or less 8A100ms or less	○	
Leakage current at off		1.5mA (120VAC60Hz) 3mA (240VAC60Hz)	1.5mA (120VAC60Hz) 3mA (240VAC60Hz)	○	
Maximum voltage drop at on		1.5V or less (0.1A-0.6A) 1.8V or less (0.1A or less) 2.0V or less (10-50mA)	1.5V or less (0.1A-0.6A) 1.8V or less (0.1A or less) 2.0V or less (10-50mA)	○	
Temperature derating		None	Refer to temperature derating chart ²	△	Use it within the range shown in the temperature derating chart.
Response time	OFF→ON	1ms or less	1ms or less	△	In combination with Q series input module: 2ms or less. ^{*3}
	ON→OFF	0.5 cycle + 1ms or less	0.5 cycle + 1ms or less	×	In combination with Q series input module: 0.5 cycle + 2ms or less. ^{*3}
Fuse rating		Fast blow fuse 3.2A (1/common) HP-32	None	×	Install one fuse per common externally. (A fuse and fuse holder are included.)
Fuse blown indication		Available (LED turns on by fuse blown, and a signal is output to the CPU module.)	None	×	
Surge suppressor	CR absorber	0.022μF+47Ω	0.015μF+22Ω	△	
	Varistor	None	Varistor (400 to 540V)	△	
Common terminal arrangement		8 points/common (Common terminal: TB9, TB19, TB29)	8 points/common (Common terminal: TB9, TB19, TB29)	○	
Operation indication		Available (Turning ON the input turns LED ON)	None	△	Operation indication can be checked with Q series input module.
Specifications		A0J2-E56DS	SC-A0JQIF56DS	Compatibility	Precautions for replacement
5VDC internal current consumption		460mA (TYP. All points are ON.)	-	-	
External supply power (Module power supply)	Voltage	None	24VDC ±10% Ripple voltage 4Vp-p or less	×	To deliver a power for programmable controller operation, connecting a module power supply to the interface module, TB35 or TB36 is required.
	Current	None	570mA	×	If the voltage exceeds existing power capacity, add 24VDC power supply separately.
External connection method		36-point terminal block connector (M3 × 6 screws) 2 pieces	36-point terminal block connector (M3 × 6 screws) 2 pieces	○	
Applicable wire size		0.75 to 2mm ² (Applicable tightening torque 69N•cm)	0.75 to 2mm ² (Applicable tightening torque 69N•cm)	○	
Applicable solderless terminal		1.25-3, 1.25-YS3A, 2-S3, 2-YS3A, V1.25-3, V1.25-YS3A, V2-S3, V2-YS3A	1.25-3, 1.25-YS3A, 2-S3, 2-YS3A, V1.25-3, V1.25-YS3A, V2-S3, V2-YS3A	○	
Weight		1.05kg	0.61kg	△	Also consider the weight of fixed stand of programmable controller. ^{*4}
External dimensions		250(H) × 190(W) × 41(D) mm	182(H) × 190(W) × 41(D)mm ^{*5}	×	Check the dimensions since they depend on the installation type (building-up/horizontal/separate type).

- *1 The value when using the input module, QX41Y41P, QX41, etc. and 5ms is set at input response time in I/O assignment setting of PLC parameter (10ms is set at default).
- *2 The figure below shows the temperature derating chart.

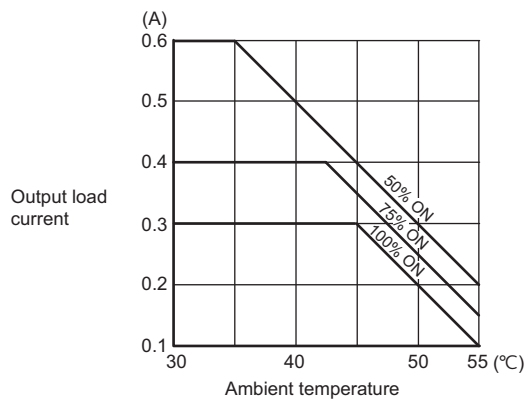

- *3 The value when using the output module, QX41Y41P, QY41P, etc.
- *4 The weight of fixed stand of programmable controller depends on replacement type of renewal tool for A0J2.
- *5 The external dimensions of the SC-A0JQIF56DS do not include those of its projection.

(16) Specifications comparison between A0J2-E56DT and interface module (SC-A0JQIF56DT)

○ : Compatible, △ : Partially changed, × : Incompatible

Specifications		A0J2-E56DT input specifications	SC-A0JQIF56DT input specifications	Compatibility	Precautions for replacement
Number of input points		32 points	32 points	○	
Insulation method		Photocoupler	Photocoupler	○	
Rated input voltage		12VDC/24VDC	12VDC/24VDC	○	
Rated input current		Approx. 3mA/Approx. 7mA	Approx. 3mA/Approx. 7mA	○	
Operating voltage range		10.2 to 26.4VDC (Ripple ratio within 5%)	10.2 to 26.4VDC (Ripple ratio within 5%)	○	
Maximum number of simultaneous input points		60% (10 points/common) simultaneously ON	60% (10 points/common) simultaneously ON	○	
ON voltage/ON current		9.5VDC or more/2.6mA or more	9.5VDC or more/2.6mA or more	○	
OFF voltage/OFF current		6VDC or less/1.0mA or less	6VDC or less/1.0mA or less	○	
Input resistance		Approx. 3.4k Ω	Approx. 3.3k Ω	○	
Input form		Sink input (Input current flows off.)	Sink input (Input current flows off.)	○	
Response time	OFF→ON	10ms or less (6ms TYP.)	5ms or less (1ms TYP.)	△	In combination with Q series input module: 10ms or less (6ms TYP.) ^{*1}
	ON→OFF	10ms or less (7.5ms TYP.)	5ms or less (1ms TYP.)	△	In combination with Q series input module: 10ms or less (6ms TYP.) ^{*1}
Common terminal arrangement		16 points/common (Common terminal: TB17, TB34)	16 points/common (Common terminal: TB17, TB34)	○	
Operation indication		Available (Turning ON the input turns LED ON)	None	△	Operation indication can be checked with Q series input module.
Specifications		A0J2-E56DT output specifications	SC-A0JQIF56DT output specifications	Compatibility	Precautions for replacement
Number of output points		24 points	24 points	○	
Insulation method		Photocoupler	Photocoupler	○	
Rated load voltage		12VDC/24VDC	12VDC/24VDC	○	
Operating load voltage range		10.2 to 30VDC	10.2 to 30VDC	○	
Maximum load current		0.5A/point, 4A/common	0.5A/point, 4A/common	○	
Maximum inrush current		4A 10ms or less	4A 10ms or less	○	
Leakage current at OFF		0.1mA or less	0.1mA or less	○	
Maximum voltage drop at ON		0.9VDC (TYP.) 0.5A 1.5VDC (MAX.) 0.5A	0.5VDC (TYP.) 0.5A 0.8VDC (MAX.) 0.5A	○	
Response time	OFF→ON	2ms or less	1ms or less	△	In combination with Q series output module: 2ms or less ^{*2}
	ON→OFF	2ms or less (Resistance load)	1ms or less (Resistance load)	△	In combination with Q series output module: 2ms or less (Resistance load) ^{*2}
External supply power	Voltage	12VDC/24VDC (10.2 to 30VDC)	12VDC/24VDC (10.2 to 30VDC)	○	
	Current	23mA (TYP. 24VDC 8 points/common ON)	5mA (TYP. 24VDC 8 points/common ON)	○	
Surge suppressor		Varistor (52 to 62V)	Varistor (50.4 to 61.6V)	○	
Common terminal arrangement		8 points/common (Common terminal: TB9, TB19, TB29)	8 points/common (Common terminal: TB9, TB19, TB29)	○	
Operation indication		Available (Turning ON the output turns LED ON)	None	△	Operation indication can be checked with Q series output module.
Fuse		None	None	○	
Fuse blown indication		None	None	○	

○ : Compatible, △ : Partially changed, × : Incompatible

Specifications	A0J2-E56DT	SC-A0JQIF56DT	Compatibility	Precautions for replacement
5VDC internal current consumption	225mA (TYP. All points are ON.)	—	—	
External supply power (Module power supply)	Voltage	None	×	To deliver a power for programmable controller operation, connecting a module power supply to the interface module, TB35 or TB36 is required.
	Current	None	×	If the voltage exceeds existing power capacity, add 24VDC power supply separately.
External connection method	36-point terminal block connector (M3 × 6 screws) 2 pieces	36-point terminal block connector (M3 × 6 screws) 2 pieces	○	
Applicable wire size	0.75 to 2mm ² (Applicable tightening torque 69N•cm)	0.75 to 2mm ² (Applicable tightening torque 69N•cm)	○	
Applicable solderless terminal	1.25-S3, 1.25-YS3A, 2-S3, 2-YS3A, V1.25-S3, V1.25-YS3A, V2-S3, V2-YS3A	1.25-S3, 1.25-YS3A, 2-S3, 2-YS3A, V1.25-S3, V1.25-YS3A, V2-S3, V2-YS3A	○	
Weight	1.04kg	0.49kg	△	Also consider the weight of fixed stand of programmable controller.*3
External dimensions	250(H) × 190(W) × 41(D)mm	182(H) × 190(W) × 41(D)mm*4	×	Check the dimensions since they depend on the installation type (building-up/horizontal/separate type).

- *1 The value when using the input module, QX41Y41P, QX41, etc. and 5ms is set at input response time in I/O assignment setting of PLC parameter (10ms is set at default).
- *2 The value when using the output module, QX41Y41P, QY41P, etc.
- *3 The weight of fixed stand of programmable controller depends on replacement type of renewal tool for A0J2.
- *4 The external dimensions of the SC-A0JQIF56DT do not include those of its projection.

Appendix 3 Related Manuals

Appendix 3.1 Replacement handbooks

(1) Renewal catalogue

No.	Manual name	Manual number	Model code
1	MELSEC-A/QnA Series Transition Guide	L08077E	–
2	MELSEC-AnS/QnAS Series Transition Guide	L08236E	–

(2) Handbook for transition

No.	Manual name	Manual number	Model code
1	Transition from MELSEC-A/QnA (Large Type) Series to Q Series Handbook (Fundamentals)	L08043ENG	–
2	Transition from MELSEC-A/QnA (Large Type) Series to Q Series Handbook (Intelligent Function Modules)	L08046ENG	–
3	Transition from MELSEC-A/QnA (Large Type), AnS/QnAS Series (Small Type) to Q Series Handbook (Network Modules)	L08048ENG	–
4	Transition from MELSEC-A/QnA (Large Type) Series, AnS/QnAS Series (Small Type) to Q Series Handbook (Communications)	L08050ENG	–
5	Transition from MELSEC-A0J2H Series to Q Series Handbook	L08060ENG	–
6	Transition from MELSECNET/MINI-S3, A2C(I/O) to CC-Link Handbook	L08061ENG	–
7	Transition from MELSEC-I/O LINK to CC-Link/LT Handbook	L08062ENG	–
8	Transition from MELSEC-I/O LINK to AnyWire DB A20 Handbook	L08263ENG	–
9	Transition of CPUs in MELSEC Redundant System Handbook (Transition from Q4ARCPU to QnPRHCPU)	L08117ENG	–

(3) Renewal examples

No.	Manual name	Manual number	Model code
1	MELSEC-A/QnA Series Transition Examples	L08121E	–

(4) Others

No.	Manual name (TECHNICAL BULLETIN)	Manual number	Model code
1	Procedures for Replacing Positioning Module AD71 with QD75	FA-A-0060	–
2	Precautions for replacing A/QnA (large type) series CPU with Universal model QCPU	FA-A-0068	–

Appendix 3.2 A0J2H Series

No.	Manual name	Manual number	Model code
1	MELSEC-A/QnA Catalog	L08033E	–
2	MELSEC-A/QnA Data Book	L08029E	–
3	A0J2HCPU(P21/R21) User's Manual	IB-66268	13J788
4	Type ACPU/QCPU-A (A Mode) (Fundamentals) Programming Manual	IB-66249	13J740
5	Type ACPU/QCPU-A (A Mode) (Common Instructions) Programming Manual	IB-66250	13J741
6	Type MELSAP-II(SFC) Programming Manual	IB-66361	13JF40
7	Type A0J2 (Input/Output unit) User's Manual	IB-66068	13J602
8	A/D converter unit for A0J2 type A0J2-68AD User's Manual	IB-66098	13J614
9	D/A converter unit for A0J2 type A0J2-62DA User's Manual	IB-66093	13J612
10	High Speed Counter Module for A0J2 Type A0J2-D61S1 User's Manual	IB-66094	13J613
11	Positioning Module for A0J2 Type A0J2-D71 User's Manual	IB-66133	13J626
12	Type A0J2-C214S1 User's Manual	IB-66266	13J659
13	Remote I/O unit type A0J2C25 User's Manual	IB-66129	13J632
14	type A0J2(Data link) User's Manual	IB-66069	13J603
15	PC fault detection module type AS91, A1SS91, A0J2-S91 User's Manual	IB-66626	13J828

Appendix 3.3 Q series

No.	Manual name	Manual number	Model code
1	MELSEC-Q Catalog	L08033E	–
2	QCPU User's Manual(Hardware Design, Maintenance and Inspection)	SH-080483ENG	13JP73
3	QCPU User's Manual(Function Explanation, Program Fundamentals)	SH-080484ENG	13JP74
4	Qn(H)/QnPH/QnPRHCPU User's Manual(Function Explanation, Program Fundamentals)	SH-080808ENG	13JZ28
5	QCPU(Q Mode)/QnACPU Programming Manual (Common Instructions)	SH-080039	13JF58
6	QCPU(Q Mode)/QnACPU Programming Manual (PID Control Instructions)	SH-080040	13JF59
7	QCPU(Q Mode)/QnACPU Programming Manual (SFC)	SH-080041	13JF60
8	QA65B/QA68B Extension Base Unit User's Manual	IB-0800158	13JR26
9	I/O Module Type Building Block User's Manual	SH-080042	13JL99
10	Insulation Displacement Connector for MELSEC-Q Series 32-Point I/O Module User's manual	IB-0800228	13JT92
11	Analog-Digital Converter Module User's Manual Q64AD/Q68ADV/Q68ADI/ GX Configurator-AD	SH-080055	13JR03
12	Digital-Analog Converter Module User's Manual	SH-080054	13JR02
13	Analog Input/Output Module Use's Manual	SH-080793	13JZ25
14	High-Speed Counter Module User's Manual	SH-080036	13JL95
15	High-Speed Counter Module User's Manual (Hardware)	IB-0800421	13JY78
16	Type QD75P/QD75D Positioning Module User's Manual	SH-080058	13JR09
17	Q Corresponding Serial Communication Module User's Manual (Basic)	SH-080006	13JL86
18	Q Corresponding Serial Communication Module User's Manual (Application)	SH-080007	13JL87
19	Q Corresponding MELSEC Communication Protocol Reference Manual	SH-080008	13JF89

Appendix 3.4 Programming Tool

No.	Manual name	Manual number	Model code
1	GX Developer Version 8 Operating Manual	SH-080373E	13JU41
2	GX Developer Version 8 Operating Manual (SFC)	SH-080374E	13JU42
3	GX Simulator Version 7 Operating Manual	SH-080468ENG	13JU51
4	GX Works2 Version 1 Operating Manual (Common)	SH-080779ENG	13JU63
5	GX Works2 Version 1 Operating Manual (Intelligent Function Module)	SH-080921ENG	13JU69
6	Type SW4IVD-GPPA (GPP) Operating Manual	IB-66855	13JL62

Appendix 3.5 Products manufactured by Mitsubishi Electric Engineering Co., Ltd.

No.	Catalog name	Catalog number
1	Programmable Controller Upgrade Tool General Catalog	SAN C044·068R

Appendix 3.6 Products manufactured by Mitsubishi Electric System & Service Co., Ltd.

No.	Data/catalog	Number
1	Renewal tool for A0J2 series Transition from MELSEC-A0J2(H) series to renewal system using renewal tool	X903071003
2	Replace A0J2(H) system with Q series using existing wiring!	X900707-115

WARRANTY

Please confirm the following product warranty details before using this product.

1. Gratis Warranty Term and Gratis Warranty Range

If any faults or defects (hereinafter "Failure") found to be the responsibility of Mitsubishi occurs during use of the product within the gratis warranty term, the product shall be repaired at no cost via the sales representative or Mitsubishi Service Company.

However, if repairs are required onsite at domestic or overseas location, expenses to send an engineer will be solely at the customer's discretion. Mitsubishi shall not be held responsible for any re-commissioning, maintenance, or testing on-site that involves replacement of the failed module.

[Gratis Warranty Term]

The gratis warranty term of the product shall be for one year after the date of purchase or delivery to a designated place. Note that after manufacture and shipment from Mitsubishi, the maximum distribution period shall be six (6) months, and the longest gratis warranty term after manufacturing shall be eighteen (18) months. The gratis warranty term of repair parts shall not exceed the gratis warranty term before repairs.

[Gratis Warranty Range]

- (1) The range shall be limited to normal use within the usage state, usage methods and usage environment, etc., which follow the conditions and precautions, etc., given in the instruction manual, user's manual and caution labels on the product.
- (2) Even within the gratis warranty term, repairs shall be charged for in the following cases.
 1. Failure occurring from inappropriate storage or handling, carelessness or negligence by the user. Failure caused by the user's hardware or software design.
 2. Failure caused by unapproved modifications, etc., to the product by the user.
 3. When the Mitsubishi product is assembled into a user's device, Failure that could have been avoided if functions or structures, judged as necessary in the legal safety measures the user's device is subject to or as necessary by industry standards, had been provided.
 4. Failure that could have been avoided if consumable parts (battery, backlight, fuse, etc.) designated in the instruction manual had been correctly serviced or replaced.
 5. Failure caused by external irresistible forces such as fires or abnormal voltages, and Failure caused by force majeure such as earthquakes, lightning, wind and water damage.
 6. Failure caused by reasons unpredictable by scientific technology standards at time of shipment from Mitsubishi.
 7. Any other failure found not to be the responsibility of Mitsubishi or that admitted not to be so by the user.

2. Onerous repair term after discontinuation of production

- (1) Mitsubishi shall accept onerous product repairs for seven (7) years after production of the product is discontinued. Discontinuation of production shall be notified with Mitsubishi Technical Bulletins, etc.
- (2) Product supply (including repair parts) is not available after production is discontinued.

3. Overseas service

Overseas, repairs shall be accepted by Mitsubishi's local overseas FA Center. Note that the repair conditions at each FA Center may differ.

4. Exclusion of loss in opportunity and secondary loss from warranty liability

Regardless of the gratis warranty term, Mitsubishi shall not be liable for compensation to:

- (1) Damages caused by any cause found not to be the responsibility of Mitsubishi.
- (2) Loss in opportunity, lost profits incurred to the user by Failures of Mitsubishi products.
- (3) Special damages and secondary damages whether foreseeable or not, compensation for accidents, and compensation for damages to products other than Mitsubishi products.
- (4) Replacement by the user, maintenance of on-site equipment, start-up test run and other tasks.

5. Changes in product specifications

The specifications given in the catalogs, manuals or technical documents are subject to change without prior notice.

The company names, system names and product names mentioned in this manual are either registered trademarks or trademarks of their respective companies.

Programmable Controller

Country/Region	Sales office	Tel/Fax
USA	MITSUBISHI ELECTRIC AUTOMATION, INC. 500 Corporate Woods Parkway, Vernon Hills, IL 60061, U.S.A.	Tel : +1-847-478-2100 Fax : +1-847-478-2253
Mexico	MITSUBISHI ELECTRIC AUTOMATION, INC. Mexico Branch Mariano Escobedo #69, Col. Zona Industrial, Tlalnepantla Edo. Mexico, C.P.54030	Tel : +52-55-3067-7500
Brazil	MITSUBISHI ELECTRIC DO BRASIL COMÉRCIO E SERVIÇOS LTDA. Avenida Adelino Cardana, 293, 21 andar, Bethaville, Barueri SP, Brazil	Tel : +55-11-4689-3000 Fax : +55-11-4689-3016
Germany	MITSUBISHI ELECTRIC EUROPE B.V. German Branch Mitsubishi-Electric-Platz 1, 40882 Ratingen, Germany	Tel : +49-2102-486-0 Fax : +49-2102-486-1120
UK	MITSUBISHI ELECTRIC EUROPE B.V. UK Branch Travellers Lane, Hatfield, Hertfordshire, AL10 8XB, U.K.	Tel : +44-1707-28-8780 Fax : +44-1707-27-8695
Ireland	MITSUBISHI ELECTRIC EUROPE B.V. Irish Branch Westgate Business Park, Ballymount, Dublin 24, Ireland	Tel : +353-1-4198800 Fax : +353-1-4198890
Italy	MITSUBISHI ELECTRIC EUROPE B.V. Italian Branch Centro Direzionale Colleoni-Palazzo Sirio Viale Colleoni 7, 20864 Agrate Brianza(Milano) Italy	Tel : +39-039-60531 Fax : +39-039-6053-312
Spain	MITSUBISHI ELECTRIC EUROPE, B.V. Spanish Branch Carretera de Rubí, 76-80-Apdo. 420, 08190 Sant Cugat del Vallés (Barcelona), Spain	Tel : +34-935-65-3131 Fax : +34-935-89-1579
France	MITSUBISHI ELECTRIC EUROPE B.V. French Branch 25, Boulevard des Bouvets, 92741 Nanterre Cedex, France	Tel : +33-1-55-68-55-68 Fax : +33-1-55-68-57-57
Czech Republic	MITSUBISHI ELECTRIC EUROPE B.V. Czech Branch Avenir Business Park, Radlicka 751/113e, 158 00 Praha5, Czech Republic	Tel : +420-251-551-470 Fax : +420-251-551-471
Poland	MITSUBISHI ELECTRIC EUROPE B.V. Polish Branch ul. Krakowska 50, 32-083 Balice, Poland	Tel : +48-12-347-65-00 Fax : +48-12-630-47-01
Sweden	MITSUBISHI ELECTRIC EUROPE B.V. (Scandinavia) Fjellievägen 8, SE-22736 Lund, Sweden	Tel : +46-8-625-10-00 Fax : +46-46-39-70-18
Russia	MITSUBISHI ELECTRIC (RUSSIA) LLC St. Petersburg Branch Piskarevsky pr. 2, bld 2, lit "Sch", BC "Benua", office 720; 195027 St. Petersburg, Russia	Tel : +7-812-633-3497 Fax : +7-812-633-3499
Turkey	MITSUBISHI ELECTRIC TURKEY A.Ş Ümraniye Branch Serifali Mah. Kale Sok. No:41 34775 Umraniye - Istanbul, Turkey	Tel : +90-216-969-2500 Fax : +90-216-526-3995
UAE	MITSUBISHI ELECTRIC EUROPE B.V. Dubai Branch Dubai Silicon Oasis, P.O.BOX 341241, Dubai, U.A.E.	Tel : +971-4-3724716 Fax : +971-4-3724721
South Africa	ADROIT TECHNOLOGIES 20 Waterford Office Park, 189 Witkoppen Road, Fourways, South Africa	Tel : +27-11-658-8100 Fax : +27-11-658-8101
China	MITSUBISHI ELECTRIC AUTOMATION (CHINA) LTD. No.1386 Hongqiao Road, Mitsubishi Electric Automation Center, Shanghai, China	Tel : +86-21-2322-3030 Fax : +86-21-2322-3000
Korea	MITSUBISHI ELECTRIC AUTOMATION KOREA CO., LTD. 7F-9F, Gangseo Hangang Xi-tower A, 401, Yangcheon-ro, Gangseo-Gu, Seoul 07528, Korea	Tel : +82-2-3660-9530 Fax : +82-2-3664-8372
Singapore	MITSUBISHI ELECTRIC ASIA PTE. LTD. 307, Alexandra Road, Mitsubishi Electric Building, Singapore 159943	Tel : +65-6473-2308 Fax : +65-6476-7439
Thailand	MITSUBISHI ELECTRIC FACTORY AUTOMATION (THAILAND) CO., LTD. 12th Floor, SV.City Building, Office Tower 1, No. 896/19 and 20 Rama 3 Road, Kwaeng Bangpongpan, Khet Yannawa, Bangkok 10120, Thailand	Tel : +66-2682-6522 Fax : +66-2682-6020
Vietnam	MITSUBISHI ELECTRIC VIETNAM COMPANY LIMITED Hanoi Branch 6th Floor, Detech Tower, 8 Ton That Thuyet Street, My Dinh 2 Ward, Nam Tu Liem District, Hanoi, Vietnam	Tel : +84-4-3937-8075 Fax : +84-4-3937-8076
Malaysia	MITSUBISHI ELECTRIC SALES MALAYSIA SDN. BHD. Lot 11, Jalan 219, 46100 Petaling Jaya, Selangor Darul Ehsan, Malaysia	Tel : +60-3-7626-5000 Fax : +60-3-7658-3544
Indonesia	PT. MITSUBISHI ELECTRIC INDONESIA Gedung Jaya 11th Floor, JL. MH. Thamrin No.12, Jakarta Pusat 10340, Indonesia	Tel : +62-21-3192-6461 Fax : +62-21-3192-3942
India	MITSUBISHI ELECTRIC INDIA PVT. LTD. Pune Branch Emerald House, EL-3, J Block, M.I.D.C., Bhosari, Pune-411026, Maharashtra, India	Tel : +91-20-2710-2000 Fax : +91-20-2710-2100
Australia	MITSUBISHI ELECTRIC AUSTRALIA PTY. LTD. 348 Victoria Road, P.O. Box 11, Rydalmere, N.S.W 2116, Australia	Tel : +61-2-9684-7777 Fax : +61-2-9684-7245

MITSUBISHI ELECTRIC CORPORATION

HEAD OFFICE: TOKYO BLDG., 2-7-3, MARUNOUCHI, CHIYODA-KU, TOKYO 100-8310, JAPAN
NAGOYA WORKS: 1-14, YADA-MINAMI 5-CHOME, HIGASHI-KU, NAGOYA 461-8670, JAPAN