

Programmable Controller

Transition from MELSEC-AnS/QnAS (Small Type) Series to L Series Handbook

(Intelligent Function Modules)



Feb. 2020 Edition

● SAFETY PRECAUTIONS ●

(Read these precautions before using this product.)

Before using this product, please read this handbook and the relevant manuals introduced in this handbook carefully and pay full attention to safety to handle the product correctly.

In this manual, the safety precautions are classified into two levels: "⚠ WARNING" and "⚠ CAUTION".



Indicates that incorrect handling may cause hazardous conditions, resulting in death or severe injury.



Indicates that incorrect handling may cause hazardous conditions, resulting in minor or moderate injury or property damage.

Under some circumstances, failure to observe the precautions given under "⚠ CAUTION" may lead to serious consequences.

Observe the precautions of both levels because they are important for personal and system safety.

[Design Precautions]

WARNING

- Configure safety circuits external to the programmable controller to ensure that the entire system operates safely even when a fault occurs in the external power supply or the programmable controller. Failure to do so may result in an accident due to an incorrect output or malfunction.
 - (1) Emergency stop circuits, protection circuits, and protective interlock circuits for conflicting operations (such as forward/reverse rotations or upper/lower limit positioning) must be configured external to the programmable controller.
 - (2) Machine OPR (Original Point Return) of the positioning function is controlled by two kinds of data: an OPR direction and an OPR speed. Deceleration starts when the near-point watchdog signal turns on. If an incorrect OPR direction is set, motion control may continue without deceleration. To prevent machine damage caused by this, configure an interlock circuit external to the programmable controller.
 - (3) When the CPU module detects an error during control by the positioning function, the motion slows down and stops.
 - (4) When the programmable controller detects an abnormal condition, it stops the operation and all outputs are:
 - Turned off if the overcurrent or overvoltage protection of the power supply module is activated.
 - Held or turned off according to the parameter setting if the self-diagnostic function of the CPU module detects an error such as a watchdog timer error.

Also, all outputs may be turned on if an error occurs in a part, such as an I/O control part, where the CPU module cannot detect any error. To ensure safety operation in such a case, provide a safety mechanism or a fail-safe circuit external to the programmable controller. For a fail-safe circuit example, refer to the MELSEC-L CPU Module User's Manual (Hardware Design, Maintenance and Inspection).
 - (5) Outputs may remain on or off due to a failure of a component such as a transistor in an output circuit. Configure an external circuit for monitoring output signals that could cause a serious accident.
- In an output circuit, when a load current exceeding the rated current or an overcurrent caused by a load short-circuit flows for a long time, it may cause smoke and fire. To prevent this, configure an external safety circuit, such as a fuse.
- Configure a circuit so that the programmable controller is turned on first and then the external power supply. If the external power supply is turned on first, an accident may occur due to an incorrect output or malfunction.
- Configure a circuit so that the external power supply is turned off first and then the programmable controller. If the programmable controller is turned off first, an accident may occur due to an incorrect output or malfunction.
- For the operating status of each station after a communication failure, refer to relevant manuals for each network. Incorrect output or malfunction due to a communication failure may result in an accident.

[Design Precautions] **WARNING**

- When changing data from a peripheral device connected to the CPU module to the running programmable controller, configure an interlock circuit in the program to ensure that the entire system will always operate safely. For other forms of control (such as program modification or operating status change) of a running programmable controller, read the relevant manuals carefully and ensure that the operation is safe before proceeding. Especially, when a remote programmable controller is controlled by an external device, immediate action cannot be taken if a problem occurs in the programmable controller due to a communication failure. To prevent this, configure an interlock circuit in the program, and determine corrective actions to be taken between the external device and CPU module in case of a communication failure.
- An absolute position restoration by the positioning function may turn off the servo-on signal (servo off) for approximately 20ms, and the motor may run unexpectedly. If this causes a problem, provide an electromagnetic brake to lock the motor during absolute position restoration.

[Design Precautions]

CAUTION

- Do not install the control lines or communication cables together with the main circuit lines or power cables. Keep a distance of 100mm or more between them. Failure to do so may result in malfunction due to noise.
- During control of an inductive load such as a lamp, heater, or solenoid valve, a large current (approximately ten times greater than normal) may flow when the output is turned from off to on. Therefore, use a module that has a sufficient current rating.
- After the CPU module is powered on or is reset, the time taken to enter the RUN status varies depending on the system configuration, parameter settings, and/or program size. Design circuits so that the entire system will always operate safely, regardless of the time.

[Installation Precautions]

WARNING

- Shut off the external power supply (all phases) used in the system before mounting or removing a module. Failure to do so may result in electric shock or cause the module to fail or malfunction.

CAUTION

- Use the programmable controller in an environment that meets the general specifications in the MELSEC-L CPU Module User's Manual (Hardware Design, Maintenance and Inspection). Failure to do so may result in electric shock, fire, malfunction, or damage to or deterioration of the product.
- To interconnect modules, engage the respective connectors and securely lock the module joint levers. Incorrect interconnection may cause malfunction, failure, or drop of the module.
- Do not directly touch any conductive parts and electronic components of the module. Doing so can cause malfunction or failure of the module.
- Securely connect an extension cable to the connectors of a branch module and an extension module. After connections, check that the cable is inserted completely. Poor contact may cause malfunction.
- When using an SD memory card, fully insert it into the SD memory card slot. Check that it is inserted completely. Poor contact may cause malfunction.
- Do not directly touch any conductive parts and electronic components of the module or SD memory card. Doing so can cause malfunction or failure of the module.

[Wiring Precautions]

WARNING

- Shut off the external power supply (all phases) used in the system before wiring. Failure to do so may result in electric shock or cause the module to fail or malfunction.
- After installation and wiring, attach the included terminal cover to the module before turning it on for operation. Failure to do so may result in electric shock.

[Wiring Precautions]

CAUTION

- Individually ground the FG and LG terminals of the programmable controller with a ground resistance of 100Ω or less. Failure to do so may result in electric shock or malfunction.
- Use applicable solderless terminals and tighten them within the specified torque range. If any spade solderless terminal is used, it may be disconnected when a terminal block screw comes loose, resulting in failure.
- Check the rated voltage and terminal layout before wiring to the module, and connect the cables correctly. Connecting a power supply with a different voltage rating or incorrect wiring may cause a fire or failure.
- Connectors for external devices must be crimped or pressed with the tool specified by the manufacturer, or must be correctly soldered. Incomplete connections may cause short circuit, fire, or malfunction.
- Securely connect the connector to the module.
- Do not install the control lines or communication cables together with the main circuit lines or power cables. Keep a distance of 100mm or more between them. Failure to do so may result in malfunction due to noise.
- Place the cables in a duct or clamp them. If not, dangling cable may swing or inadvertently be pulled, resulting in damage to the module or cables or malfunction due to poor contact.
- Check the interface type and correctly connect the cable. Incorrect wiring (connecting the cable to an incorrect interface) may cause failure of the module and external device.
- Tighten the terminal block screws within the specified torque range. Undertightening can cause short circuit, fire, or malfunction. Overtightening can damage the screw and/or module, resulting in drop, short circuit, fire, or malfunction.
- When disconnecting the cable from the module, do not pull the cable by the cable part. For the cable with connector, hold the connector part of the cable. For the cable connected to the terminal block, loosen the terminal screw. Pulling the cable connected to the module may result in malfunction or damage to the module or cable.
- Prevent foreign matter such as dust or wire chips from entering the module. Such foreign matter can cause a fire, failure, or malfunction.
- A protective film is attached to the top of the module to prevent foreign matter, such as wire chips, from entering the module during wiring. Do not remove the film during wiring. Remove it for heat dissipation before system operation.
- To use the high-speed counter function, ground the shield cable on the encoder side (relay box) with a ground resistance of 100Ω or less. Failure to do so may cause malfunction.
- Mitsubishi programmable controllers must be installed in control panels. Connect the main power supply to the power supply module in the control panel through a relay terminal block.
Wiring and replacement of a power supply module must be performed by qualified maintenance personnel with knowledge of protection against electric shock. For wiring methods, refer to the MELSEC-L CPU Module User's Manual (Hardware Design, Maintenance and Inspection).

[Startup and Maintenance Precautions]

WARNING

- Do not touch any terminal while power is on. Doing so will cause electric shock or malfunction.
- Correctly connect the battery connector. Do not charge, disassemble, heat, short-circuit, solder, or throw the battery into the fire. Also, do not expose it to liquid or strong shock.
Doing so will cause the battery to produce heat, explode, ignite, or leak, resulting in injury and fire.
- Shut off the external power supply (all phases) used in the system before cleaning the module or retightening the terminal block screws or the connector screws. Failure to do so may result in electric shock.

CAUTION

- Before performing online operations (especially, program modification, forced output, and operating status change) for the running CPU module from the peripheral device connected, read relevant manuals carefully and ensure the safety. Improper operation may damage machines or cause accidents.
- Do not disassemble or modify the modules. Doing so may cause failure, malfunction, injury, or a fire.
- Use any radio communication device such as a cellular phone or PHS (Personal Handy-phone System) more than 25cm away in all directions from the programmable controller. Failure to do so may cause malfunction.
- Shut off the external power supply (all phases) used in the system before mounting or removing a module. Failure to do so may cause the module to fail or malfunction.
- Tighten the terminal block screws and the connector screws within the specified torque range.
Undertightening can cause drop of the component or wire, short circuit, or malfunction.
Overtightening can damage the screw and/or module, resulting in drop, short circuit, or malfunction.
- After the first use of the product (module, display unit, and terminal block), the number of connections/disconnections is limited to 50 times (in accordance with IEC 61131-2). Exceeding the limit may cause malfunction.
- After the first use of the SD memory card, the number of insertions/removals is limited to 500 times. Exceeding the limit may cause malfunction.
- Do not drop or apply shock to the battery to be installed in the module. Doing so may damage the battery, causing the battery fluid to leak inside the battery. If the battery is dropped or any shock is applied to it, dispose of it without using.
- Before handling the module, touch a conducting object such as a grounded metal to discharge the static electricity from the human body. Failure to do so may cause the module to fail or malfunction.
- Before testing the operation by the positioning function, set a low speed value for the speed limit parameter so that the operation can be stopped immediately upon occurrence of a hazardous condition.

[Disposal Precautions] **CAUTION**

- When disposing of this product, treat it as industrial waste. When disposing of batteries, separate them from other wastes according to the local regulations. For details on battery regulations in EU member states, refer to the MELSEC-L CPU Module User's Manual (Hardware Design, Maintenance and Inspection).

[Transportation Precautions] **CAUTION**

- When transporting lithium batteries, follow the transportation regulations. For details on the regulated models, refer to the MELSEC-L CPU Module User's Manual (Hardware Design, Maintenance and Inspection).

● CONDITIONS OF USE FOR THE PRODUCT ●

- (1) Mitsubishi programmable controller ("the PRODUCT") shall be used in conditions;
 - i) where any problem, fault or failure occurring in the PRODUCT, if any, shall not lead to any major or serious accident; and
 - ii) where the backup and fail-safe function are systematically or automatically provided outside of the PRODUCT for the case of any problem, fault or failure occurring in the PRODUCT.

- (2) The PRODUCT has been designed and manufactured for the purpose of being used in general industries.

MITSUBISHI SHALL HAVE NO RESPONSIBILITY OR LIABILITY (INCLUDING, BUT NOT LIMITED TO ANY AND ALL RESPONSIBILITY OR LIABILITY BASED ON CONTRACT, WARRANTY, TORT, PRODUCT LIABILITY) FOR ANY INJURY OR DEATH TO PERSONS OR LOSS OR DAMAGE TO PROPERTY CAUSED BY the PRODUCT THAT ARE OPERATED OR USED IN APPLICATION NOT INTENDED OR EXCLUDED BY INSTRUCTIONS, PRECAUTIONS, OR WARNING CONTAINED IN MITSUBISHI'S USER, INSTRUCTION AND/OR SAFETY MANUALS, TECHNICAL BULLETINS AND GUIDELINES FOR the PRODUCT.

("Prohibited Application")

Prohibited Applications include, but not limited to, the use of the PRODUCT in;

- Nuclear Power Plants and any other power plants operated by Power companies, and/or any other cases in which the public could be affected if any problem or fault occurs in the PRODUCT.
- Railway companies or Public service purposes, and/or any other cases in which establishment of a special quality assurance system is required by the Purchaser or End User.
- Aircraft or Aerospace, Medical applications, Train equipment, transport equipment such as Elevator and Escalator, Incineration and Fuel devices, Vehicles, Manned transportation, Equipment for Recreation and Amusement, and Safety devices, handling of Nuclear or Hazardous Materials or Chemicals, Mining and Drilling, and/or other applications where there is a significant risk of injury to the public or property.

Notwithstanding the above restrictions, Mitsubishi may in its sole discretion, authorize use of the PRODUCT in one or more of the Prohibited Applications, provided that the usage of the PRODUCT is limited only for the specific applications agreed to by Mitsubishi and provided further that no special quality assurance or fail-safe, redundant or other safety features which exceed the general specifications of the PRODUCTS are required. For details, please contact the Mitsubishi representative in your region.

REVISIONS

* The handbook number is given on the bottom left of the back cover.

Print Date	* Handbook Number	Revision
Oct. 2012	L(NA)08259ENG-A	First edition
Dec. 2013	L(NA)08259ENG-B	Addition of LCPU models Addition of the L series analog input/output module and review of alternative models <u>Model addition</u> L02SCPU, L02SCPU-P, L06CPU, L06CPU-P, L26CPU, L26CPU-P, LH42C4NT1P, L60AD2DA2 <u>Addition</u> Insert Chapter 4 and modify the Chapter 5 or later
Sep. 2015	L(NA)08259ENG-C	<u>Model addition</u> L60ADVL8, L60ADIL8, LD75P1, LD75P2, LD75D1, LD75D2 <u>Addition</u> Section 2.4 <u>Partial correction</u> SAFETY PRECAUTIONS, Section 2.1, 3.1, 6.1, Chapter 7
Feb. 2016	L(NA)08259ENG-D	<u>Partial correction</u> Cover, WARRANTY
Apr. 2018	L(NA)08259ENG-E	<u>Model addition</u> L60DAVL8, L60DAIL8 <u>Addition</u> Section 3.4, 3.6 <u>Change</u> Chapter 9→Appendix 1, Appendix 1→Appendix 2, Appendix 2→Appendix 3, Appendix 3→Appendix 4 <u>Partial correction</u> Cover, GENERIC TERMS AND ABBREVIATIONS, Section 3.1, 3.3, 3.5, 7.2.1, Appendix 3
Feb. 2020	L(NA)08259ENG-F	<u>Partial correction</u> Cover, Section 7.2.3
Feb. 2020	L(NA)08259ENG-G	<u>Partial correction</u> Front cover, back cover

Japanese Handbook Version L08255-G

This handbook confers no industrial property rights or any rights of any other kind, nor does it confer any patent licenses. Mitsubishi Electric Corporation cannot be held responsible for any problems involving industrial property rights which may occur as a result of using the contents noted in this handbook.

CONTENTS

SAFETY PRECAUTIONS	A - 1
CONDITIONS OF USE FOR THE PRODUCT	A - 8
REVISIONS	A - 9
GENERIC TERMS AND ABBREVIATIONS	A - 14

CHAPTER 1 INTRODUCTION 1 - 1 to 1 - 2

1.1 Advantages of Transition to L Series	1 - 1
1.2 Precautions for Transition	1 - 1

CHAPTER 2 ANALOG INPUT MODULE REPLACEMENT 2 - 1 to 2 - 35

2.1 List of Analog Input Module Alternative Models for Replacement	2 - 1
2.2 A1S64AD	2 - 2
2.2.1 Performance specifications comparison	2 - 2
2.2.2 Functional comparison	2 - 6
2.2.3 I/O signal comparison	2 - 8
2.2.4 Buffer memory address comparison	2 - 9
2.3 A1S68AD (replacement with the L60AD4)	2 - 16
2.3.1 Performance specifications comparison	2 - 16
2.3.2 Functional comparison	2 - 18
2.3.3 I/O signal comparison	2 - 20
2.3.4 Buffer memory address comparison	2 - 21
2.4 A1S68AD (replacement with the L60ADVL8 or L60ADIL8)	2 - 28
2.4.1 Performance specifications comparison	2 - 28
2.4.2 Functional comparison	2 - 30
2.4.3 I/O signal comparison	2 - 31
2.4.4 Buffer memory address comparison	2 - 32

CHAPTER 3 ANALOG OUTPUT MODULE REPLACEMENT 3 - 1 to 3 - 63

3.1 List of Analog Output Module Alternative Models for Replacement	3 - 1
3.2 A1S62DA	3 - 3
3.2.1 Performance specifications comparison	3 - 3
3.2.2 Functional comparison	3 - 7
3.2.3 I/O signal comparison	3 - 8
3.2.4 Buffer memory address comparison	3 - 9
3.3 A1S68DAI (Alternative Model: L60DA4)	3 - 15
3.3.1 Performance specifications comparison	3 - 15
3.3.2 Functional comparison	3 - 19
3.3.3 I/O signal comparison	3 - 20
3.3.4 Buffer memory address comparison	3 - 21
3.4 A1S68DAI (Alternative Model: L60DAIL8)	3 - 25
3.4.1 Performance specifications comparison	3 - 25
3.4.2 Functional comparison	3 - 29

3.4.3	I/O signal comparison	3 - 30
3.4.4	Buffer memory address comparison	3 - 31
3.5	A1S68DAV (Alternative Model: L60DA4)	3 - 39
3.5.1	Performance specifications comparison	3 - 39
3.5.2	Functional comparison	3 - 43
3.5.3	I/O signal comparison	3 - 44
3.5.4	Buffer memory address comparison	3 - 45
3.6	A1S68DAV (Alternative Model: L60DAVL8)	3 - 51
3.6.1	Performance specifications comparison	3 - 51
3.6.2	Functional comparison	3 - 55
3.6.3	I/O signal comparison	3 - 56
3.6.4	Buffer memory address comparison	3 - 57

CHAPTER 4 ANALOG I/O MODULE REPLACEMENT

4 - 1 to 4 - 43

4.1	List of Analog I/O Module Alternative Models for Replacement	4 - 1
4.2	A1S63ADA	4 - 4
4.2.1	Performance specifications comparison	4 - 4
4.2.2	Functional comparison	4 - 10
4.2.3	I/O signal comparison	4 - 12
4.2.4	Buffer memory address comparison	4 - 13
4.3	A1S66ADA	4 - 24
4.3.1	Performance specifications comparison	4 - 24
4.3.2	Functional comparison	4 - 28
4.3.3	I/O signal comparison	4 - 30
4.3.4	Buffer memory address comparison	4 - 32

CHAPTER 5 HEATING-COOLING TEMPERATURE CONTROL MODULE/ TEMPERATURE CONTROL MODULE REPLACEMENT

5 - 1 to 5 - 65

5.1	List of Heating-cooling Temperature Control Module/Temperature Control Module Alternative Models for Replacement	5 - 1
5.2	Performance Specifications Comparison	5 - 3
5.2.1	A1S64TCTRT(BW) (thermocouple connection)	5 - 3
5.2.2	A1S64TCTRT(BW) (platinum resistance thermometer connection)	5 - 7
5.2.3	A1S64TCTT(BW)-S1	5 - 11
5.2.4	A1S64TCRT(BW)-S1	5 - 17
5.2.5	A1S62TCTT(BW)-S2	5 - 21
5.2.6	A1S62TCRT(BW)-S2	5 - 27
5.3	Functional Comparison	5 - 33
5.4	I/O Signal Comparison	5 - 35
5.4.1	A1S64TCTRT(BW) and L series modules (standard control)	5 - 35
5.4.2	A1S64TCTRT(BW) and L series modules (heating-cooling control)	5 - 37
5.4.3	A1S64TCTT(BW)-S1/A1S64TCRT(BW)-S1 and L series modules	5 - 39
5.4.4	A1S62TCTT(BW)-S2/A1S62TCRT(BW)-S2 and L series modules	5 - 41
5.5	Buffer Memory Address Comparison	5 - 43
5.5.1	A1S64TCTRT(BW) and L series modules (standard control)	5 - 43

5.5.2	A1S64TCTRT(BW) and L series modules (heating-cooling control)	5 - 49
5.5.3	A1S64TCTT(BW)-S1/A1S64TCRT(BW)-S1 and L series modules	5 - 55
5.5.4	A1S62TCTT(BW)-S2/A1S62TCRT(BW)-S2 and L series modules	5 - 61

CHAPTER 6 HIGH-SPEED COUNTER MODULE REPLACEMENT **6 - 1 to 6 - 24**

6.1	List of High-Speed Counter Module Alternative Models for Replacement	6 - 1
6.2	A1SD61	6 - 6
6.2.1	Performance specifications comparison	6 - 6
6.2.2	Functional comparison	6 - 10
6.2.3	I/O signal comparison	6 - 11
6.2.4	Buffer memory address comparison	6 - 12
6.3	A1SD62(E/D/D-S1)	6 - 13
6.3.1	Performance specifications comparison	6 - 13
6.3.2	Functional comparison	6 - 21
6.3.3	I/O signal comparison	6 - 22
6.3.4	Buffer memory address comparison	6 - 24

CHAPTER 7 POSITIONING MODULE REPLACEMENT **7 - 1 to 7 - 18**

7.1	List of Positioning Module Alternative Models for Replacement	7 - 1
7.2	A1SD75P1-S3/P2-S3/P3-S3	7 - 3
7.2.1	Performance specifications comparison	7 - 3
7.2.2	Functional comparison	7 - 7
7.2.3	I/O signal comparison	7 - 10
7.2.4	Buffer memory address comparison	7 - 11
7.2.5	External interface specifications comparison	7 - 18

CHAPTER 8 REPLACEMENT OF OTHER MODULES **8 - 1 to 8 - 2**

8.1	Replacement of Other Modules	8 - 1
-----	------------------------------	-------

APPENDICES **APPX - 1 to APPX - 8**

Appendix 1	External Dimensions	APPX - 1
Appendix 2	Spare Parts Storage	APPX - 1
Appendix 3	Relevant Manuals	APPX - 2
Appendix 3.1	Replacement handbooks	APPX - 2
Appendix 3.2	AnS series manuals	APPX - 3
Appendix 3.3	L series manuals	APPX - 4
Appendix 3.4	Programming tool manuals	APPX - 4
Appendix 4	How to Change Resolution After Analog I/O Module is Replaced	APPX - 5
Appendix 4.1	Resolution	APPX - 5
Appendix 4.2	Using the scaling function of an analog I/O module	APPX - 5
Appendix 4.3	Adding the scaling operation function to sequence program	APPX - 6

- For the products shown in handbooks for transition, catalogues, and transition examples, refer to the manuals for the relevant products and check the detailed specifications, precautions for use, and restrictions before replacement.

For the products manufactured by Mitsubishi Electric Engineering Co., Ltd., Mitsubishi Electric System & Service Co., Ltd., and other companies, refer to the catalogue for each product and check the detailed specifications, precautions for use, and restrictions before use.

The manuals and catalogues for our products, products manufactured by Mitsubishi Electric Engineering Co., Ltd., and Mitsubishi Electric System & Service Co., Ltd. are shown in Appendix of each handbook for transition.

- Details of models certified by each standard are available at the following Mitsubishi Electric FA site:
<http://www.mitsubishielectric.com/fa/worldwide/index.html>
- Products shown in this handbook are subject to change without notice.

GENERIC TERMS AND ABBREVIATIONS

Unless otherwise specified, this handbook uses the following generic terms and abbreviations.

Generic term/abbreviation	Description
■Series	
A series	The abbreviation for large types of Mitsubishi Electric MELSEC-A series programmable controllers
AnS series	The abbreviation for compact types of Mitsubishi Electric MELSEC-A series programmable controllers
A/AnS series	A generic term for A series and AnS series
QnA series	The abbreviation for large types of Mitsubishi Electric MELSEC-QnA series programmable controllers
QnAS series	The abbreviation for compact types of Mitsubishi Electric MELSEC-QnA series programmable controllers
QnA/QnAS series	A generic term for QnA series and QnAS series
A/AnS/QnA/QnAS series	A generic term for A series, AnS series, QnA series, and QnAS series
Q series	The abbreviation for Mitsubishi Electric MELSEC-Q series programmable controllers
L series	The abbreviation for Mitsubishi Electric MELSEC-L series programmable controllers
■CPU module type	
CPU module	A generic term for A series, AnS series, QnA series, QnAS series, Q series, and L series CPU modules
Process CPU	A generic term for the Q02PHCPU, Q06PHCPU, Q12PHCPU, and Q25PHCPU
Redundant CPU	A generic term for the Q12PRHCPU and Q25PRHCPU
Universal model QCPU	A generic term for the Q00UJCPU, Q00UCPU, Q01UCPU, Q02UCPU, Q03UDCPU, Q03UDVCPU, Q03UDECPU, Q04UDHCPU, Q04UDVCPU, Q04UDEHCPU, Q06UDHCPU, Q06UDVCPU, Q06UDEHCPU, Q10UDHCPU, Q10UDEHCPU, Q13UDHCPU, Q13UDVCPU, Q13UDEHCPU, Q20UDHCPU, Q20UDEHCPU, Q26UDHCPU, Q26UDVCPU, and Q26UDEHCPU
■CPU module model	
ACPU	A generic term for MELSEC-A series CPU modules
AnSCPU	A generic term for MELSEC-AnS series CPU modules
AnNCP	A generic term for the A1NCP, A1NCPUP21/R21, A1NCPUP21-S3, A2NCP, A2NCP-S1, A2NCPUP21/R21, A2NCPUP21/R21-S1, A2NCPUP21-S3(S4), A3NCP, A3NCPUP21/R21, and A3NCPUP21-S3
AnACPU	A generic term for the A2ACPU, A2ACPU-S1, A3ACPU, A2ACPUP21/R21, A2ACPUP21/R21-S1, and A3ACPUP21/R21
AnUCPU	A generic term for the A2UCPU, A2UCPU-S1, A3UCPU, and A4UCPU
AnUS(H)CPU	A generic term for the A2USCPU, A2USCPU-S1, A2USHCPU-S1
A/AnSCPU	A generic term for MELSEC-A series and MELSEC-AnS series CPU modules
AnN/AnACPU	A generic term for the AnNCP and AnACPU
AnN/AnA/AnSCPU	A generic term for the AnNCP, AnACPU, and AnSCPU
QnACPU	A generic term for MELSEC-QnA series CPU modules
QnASCPU	A generic term for MELSEC-QnAS series CPU modules
QnA/QnASCPU	A generic term for MELSEC-QnA series and MELSEC-QnAS series CPU modules
A/AnS/QnA/QnASCPU	A generic term for A series, AnS series, QnA series, and QnAS series CPU modules
QCPU	A generic term for MELSEC-Q series CPU modules
LCPU	A generic term for MELSEC-L series CPU modules

1 INTRODUCTION

1.1 Advantages of Transition to L Series

Advantage 1) Advanced performance of equipments (shortened takt time)

In addition to the processing performance improvement for L series CPU, the processing speed for L series intelligent function module is also increased, so that the equipment capability to improve is possible.

Advantage 2) Baseless, flexible composition

The L series does not require a main base unit and can be installed in a minimum space without restrictions of the base unit size.

Even when a module is added, the number of modules is not constrained by the number of base slots, therefore the system cost such as addition of an extension base unit can be suppressed.

Advantage 3) Improved operating efficiency for programming and monitoring

The intelligent function module operation of GX Works2 can be used on the L series intelligent function module.

Though using the intelligent function module operation of GX Works2 is not required, the use enables the following and can reduce sequence programs.

- Initial setting is possible without a program.
- The auto refresh setting allows to read/write buffer memory data of intelligent function module automatically from/to the CPU device memory.
- Checking of the setting status or operating status of intelligent function module is simplified.

1.2 Precautions for Transition

- (1) When replacing the AnS/QnAS series with the L series, be sure to read the manuals of each L series module and confirm the functions, specifications, and how to use before using the L series.
- (2) After the AnS/QnAS series is replaced with the L series, be sure to verify the operation of the entire system before the start of operations.

2 ANALOG INPUT MODULE REPLACEMENT

2.1 List of Analog Input Module Alternative Models for Replacement

AnS/QnAS series		Transition to L series	
Product	Model	Model	Remarks (Restrictions)
Analog input module	A1S64AD	L60AD4	1) External wiring: Cable size is changed. 2) Number of slots: Not changed 3) Program: The number of occupied I/O points, I/O signals, resolution, and buffer memory addresses are changed. 4) Performance specifications: Not changed 5) Functional specifications: Not changed
		L60AD4	1) External wiring: Cable size is changed. 2) Number of slots: Changed (Two modules are required.) 3) Program: The number of occupied I/O points, I/O signals, resolution, and buffer memory addresses are changed. 4) Performance specifications: Four channels per module 5) Functional specifications: Not changed
	A1S68AD	L60ADVL8 (voltage)	1) External wiring: Cable size is changed. 2) Number of slots: Not changed
		L60ADIL8 (current)	3) Program: The number of occupied I/O points, I/O signals, resolution, and buffer memory addresses are changed. 4) Performance specifications: Input signals are changed (V or I input only). 5) Functional specifications: Not changed

☒ Point

The upgrade tool (conversion adapter) manufactured by Mitsubishi Electric Engineering Co., Ltd. enables to connect the existing wiring that was connected to the A1S64AD to L series modules without change.

Product	Existing module model	Alternative module model	Conversion adapter model*1	Space module LG69*1
Analog input module	A1S64AD	L60AD4	ERNT-ASLT64AD	Available

*1 For details on the conversion adapter or LG69, refer to the Transition from MELSEC-AnS/QnAS (Small Type) Series to L Series Handbook (Fundamentals)

2.2 A1S64AD

2.2.1 Performance specifications comparison

Item		A1S64AD
Analog input	Voltage	-10 to 0 to +10VDC (Input resistance value: 1MΩ)
	Current	-20 to 0 to +20mA (Input resistance value: 250Ω)
Digital output		16-bit signed binary When 1/4000 is set: -4096 to +4095 When 1/8000 is set: -8192 to +8191 When 1/12000 is set: -12288 to +12287
I/O characteristics		*1
Resolution		
Overall accuracy (Accuracy in respect to maximum digital output value)		±1% When 1/4000 is set: ±40 When 1/8000 is set: ±80 When 1/12000 is set: ±120

*1 I/O characteristics and maximum resolutions of the A1S64AD are shown below.

Item		Specifications		
I/O characteristics	Analog input	Digital output value (when gain 5V/20mA, offset 0V/0mA)		
		1/4000	1/8000	1/12000
	+10V	+4000	+8000	+12000
	+5V or +20mA	+2000	+4000	+6000
	0V or 0mA	0	0	0
	-5V or -20mA	-2000	-4000	-6000
	-10V	-4000	-8000	-12000
Resolution		1/4000	1/8000	1/12000
	Voltage input	2.5mV	1.25mV	0.83mV
	Current input	10μA	5μA	3.33μA

○ : Compatible, △ : Partial change required, × : Incompatible

	L60AD4	Compatibility	Precautions for replacement																																		
	-10 to 10VDC (Input resistance value: 1MΩ) 0 to 20mA (Input resistance value: 250Ω)	○																																			
	16-bit signed binary (-20480 to 20479, When the scaling function is used: -32768 to 32767)	△																																			
	<table border="1"> <thead> <tr> <th></th> <th>Analog input range</th> <th>Digital output</th> <th>Resolution</th> </tr> </thead> <tbody> <tr> <td rowspan="5">Voltage</td> <td>0 to 10V</td> <td rowspan="3">0 to 20000</td> <td>500μV</td> </tr> <tr> <td>0 to 5V</td> <td>250μV</td> </tr> <tr> <td>1 to 5V</td> <td>200μV</td> </tr> <tr> <td>-10 to 10V</td> <td>-20000 to 20000</td> <td>500μV</td> </tr> <tr> <td>1 to 5V (Extended mode)</td> <td>-5000 to 22500</td> <td>200μV</td> </tr> <tr> <td></td> <td>User range setting</td> <td>-20000 to 20000</td> <td>307μV</td> </tr> <tr> <td rowspan="4">Current</td> <td>0 to 20mA</td> <td rowspan="2">0 to 20000</td> <td>1000nA</td> </tr> <tr> <td>4 to 20mA</td> <td>800nA</td> </tr> <tr> <td>4 to 20mA (Extended mode)</td> <td>-5000 to 22500</td> <td>800nA</td> </tr> <tr> <td>User range setting</td> <td>-20000 to 20000</td> <td>1230nA</td> </tr> </tbody> </table>		Analog input range	Digital output	Resolution	Voltage	0 to 10V	0 to 20000	500μV	0 to 5V	250μV	1 to 5V	200μV	-10 to 10V	-20000 to 20000	500μV	1 to 5V (Extended mode)	-5000 to 22500	200μV		User range setting	-20000 to 20000	307μV	Current	0 to 20mA	0 to 20000	1000nA	4 to 20mA	800nA	4 to 20mA (Extended mode)	-5000 to 22500	800nA	User range setting	-20000 to 20000	1230nA	△	Since the resolution differs between AnS series and L series modules, it needs to be matched using a sequence program, user range settings, or the scaling function (refer to Appendix 4).
	Analog input range	Digital output	Resolution																																		
Voltage	0 to 10V	0 to 20000	500μV																																		
	0 to 5V		250μV																																		
	1 to 5V		200μV																																		
	-10 to 10V	-20000 to 20000	500μV																																		
	1 to 5V (Extended mode)	-5000 to 22500	200μV																																		
	User range setting	-20000 to 20000	307μV																																		
Current	0 to 20mA	0 to 20000	1000nA																																		
	4 to 20mA		800nA																																		
	4 to 20mA (Extended mode)	-5000 to 22500	800nA																																		
	User range setting	-20000 to 20000	1230nA																																		
		○																																			
	Ambient temperature within 25±5°C: ±0.1% (±20 digit) Ambient temperature within 0 to 55°C: ±0.2% (±40 digit)	○																																			

Item	A1S64AD	
Maximum conversion speed	20ms/channel	
Absolute maximum input	Voltage: ±15V Current: ±30mA	
Number of analog input channels	4 channels/module	
Number of offset/gain settings	-	
Insulation method	Between the input terminal and programmable controller power supply: Photocoupler Between channels: Not insulated	
Withstand voltage	Between the input terminal and programmable controller power supply: 500VAC, for 1 minute	
Insulation resistance	Between the input terminal and programmable controller power supply: 500VDC, 5MΩ or higher	
Number of occupied I/O points	32 points (I/O assignment: special 32 points)	
External interface	20-point terminal block	
Applicable wire size	0.75 to 1.5mm ² (Applicable tightening torque: 39 to 59N•cm)	
Applicable solderless terminal	1.25-3, 1.25-YS3, V1.25-3, V1.25-YS3A	
Internal current consumption (5VDC)	0.40A	
Weight	0.25kg	

○ : Compatible, △ : Partial change required, × : Incompatible

	L60AD4	Compatibility	Precautions for replacement
	High speed: 20μs/channel (default) Medium speed: 80μs/channel Low speed: 1ms/channel	○	The conversion speed of L60AD4 is faster than A1S64AD. Therefore, noise which were not imported to A1S64AD can be imported as analog signals. In this case, use the averaging processing function to remove the effect of noise.
	Voltage: ±15V Current: ±30mA	○	
	4 channels/module	○	
	Up to 50000 times	○	
	Between the I/O terminal and programmable controller power supply: Photocoupler Between channels: Not insulated	○	
	Between the I/O terminal and programmable controller power supply: 500VACrms, for 1 minute	○	
	Between the I/O terminal and programmable controller power supply: 500VDC, 10MΩ or higher	○	
	16 points (I/O assignment: intelligent 16 points)	△	The number of occupied I/O points is changed to 16 points.
	18-point terminal block	×	Wiring needs to be changed.
	0.3 to 0.75mm ²	×	
	R1.25-3 (Solderless terminals with an insulation sleeve cannot be used.)	×	
	0.52A	△	Recalculation of internal current consumption (5VDC) is required.
	0.19kg	△	

2.2.2 Functional comparison

○ : Supported, – : Not supported

Item	Description	A1S64AD	L60AD4	Precautions for replacement
A/D conversion enable/ disable function	Sets whether to enable or disable the A/D conversion for each channel. By disabling the conversion for the channels that are not used, the sampling time can be shortened.	○	○	
Sampling processing	Performs the A/D conversion for analog input values successively for each channel, and outputs digital output values upon each conversion.	○	○	
Averaging processing	Time average	○	○	The setting range of average time and count differ. Refer to the MELSEC-L Analog-Digital Converter Module User's Manual, and check the specifications.
	Count average	○	○	
	Moving average	–	○	
Range switching function	Sets the input range to be used.	–	○	
Offset/gain setting function	Compensates for errors in digital output values.	○	○	
Conversion speed switch function	Sets the conversion speed.	–	○	
Input range extended mode function	Extends the input range. By combining this function with the input signal error detection function, simple disconnection detection can be executed.	–	○	This function can be used on GX Works2.*2
Maximum value/minimum value hold function	Stores the maximum and minimum values of the digital output values in the module.	–	○	This function can be used on GX Works2.*2
Input signal error detection function	Detects the analog input value which exceeds the setting range.	–	○	This function can be used on GX Works2.*2
Input signal error detection extension function	Extends the detection method of the input signal error detection function. Use this function to detect the input signal error only in the lower limit or upper limit, or to execute the disconnection detection.	–	○	This function can be used on GX Works2.*2
Warning output function (process alarm)	Outputs an alarm when a digital output value is within the range set in advance.	–	○	This function can be used on GX Works2.*2
Resolution mode	Sets the resolution according to the application. The resolution mode setting is applicable to all channels.*1	○	–	
Scaling function	Scale-converts the output digital value to the set range of the scaling upper limit value and scaling lower limit value. This omits the programming of the scale conversion.	–	○	By setting the same scaling upper limits and scaling lower limits as the resolution mode of A1S64AD, the same digital output values as A1S64AD can be used.*2
Shift function	Adds the set shifting amount of the conversion value to the scaling value (digital operation value) and stores the value in the buffer memory. Fine adjustment can be performed easily when the system starts.	–	○	This function can be used on GX Works2.*2
Digital clipping function	Sets the maximum value of the scaling value (digital operation value) to 20000 and the minimum value to 0 or -20000 when the input voltage or current exceeds the input range.	–	○	This function can be used on GX Works2.*2
Difference conversion function	Subtracts the difference conversion reference value from the scaling value (digital operation value) and stores the acquired value in the buffer memory.	–	○	This function can be used on GX Works2.*2
Logging function	Logs the digital output value or scaling value (digital operation value). The data of 10000 points can be logged for each channel.	–	○	This function can be used on GX Works2.*2
Flow amount integration function	Performs the A/D conversion of analog input value (voltage or current) from a source such as a flow meter and integrates the digital output value.	–	○	This function can be used on GX Works2.*2
Error log function	Stores the errors and alarms occurred in the A/D converter module to the buffer memory as a history. Up to 16 errors and alarms can be stored.	–	○	
Module error collection function	Collects the errors and alarms occurred in the A/D converter module and stores them in the CPU module.	–	○	

○ : Supported, –: Not supported

Item	Description	A1S64AD	L60AD4	Precautions for replacement
Error clear function	Clears the error from the system monitor window of the programming tool.	–	○	This function can be used on GX Works2.
Saving and restoring offset/gain values	Saves and restores the offset/gain values in the user setting range.	–	○	

- *1 For the A1S64AD, the resolution setting can be selected from 1/4000, 1/8000, and 1/12000 for both voltage and current inputs.
The L60AD4, however, does not support the resolution mode. To use the same digital value that is used for the A1S64AD, set the scaling upper and lower limit values that match the resolution of the A1S64AD using the scaling function.
- *2 Only the L60AD4 with a serial number (first five digits) 13041 or later supports this function.

2.2.3 I/O signal comparison

Sequence programs need to be changed because the I/O signal assignment differs.

For details of the I/O signals and sequence programs, refer to the MELSEC-L Analog-Digital Converter Module User's Manual.

A1S64AD				L60AD4					
Device No.	Signal name	Device No.	Signal name	Device No.	Signal name	Device No.	Signal name		
X0	Watchdog timer error flag	Y0	Use prohibited	X0	Module READY	Y0	Use prohibited		
X1	A/D conversion READY	Y1							
X2	Error flag	Y2							
X3	Use prohibited	Y3							
X4		Y4							
X5		Y5							
X6		Y6							
X7		Y7							
X8		Y8							
X9		Y9							
XA	Use prohibited	YA		Use prohibited	XA	Offset/gain setting mode flag		YA	User range write request
XB		YB		Use prohibited	XB	Channel change completed flag		YB	Channel change request
XC		YC	Use prohibited	XC	Input signal error detection signal	YC	Use prohibited		
XD		YD	Use prohibited	XD	Maximum value/minimum value reset completed flag	YD	Maximum value/minimum value reset request		
XE		YE	Use prohibited	XE	A/D conversion completed flag	YE	Use prohibited		
XF		YF	Use prohibited	XF	Error flag	YF	Error clear request		
X10			Y10						
X11			Y11						
X12			Y12	Error reset					
X13			Y13	Use prohibited					
X14		Y14							
X15		Y15							
X16		Y16							
X17		Y17							
X18		Y18							
X19		Y19							
X1A		Y1A							
X1B		Y1B							
X1C		Y1C							
X1D		Y1D							
X1E		Y1E							
X1F		Y1F							

2.2.4 Buffer memory address comparison

Sequence programs need to be changed because the buffer memory address assignment differs. For details of the buffer memory areas and sequence programs, refer to the MELSEC-L Analog-Digital Converter Module User's Manual.

A1S64AD			L60AD4		
Address (decimal)	Name	Read/write	Address (decimal)	Name	Read/write
0	A/D conversion enable/disable setting	R/W	0	A/D conversion enable/disable setting	R/W
1	Average processing specification		1	CH1 Time Average/ Count Average/Moving Average	
2	CH1 Average time, count		2	CH2 Time Average/ Count Average/Moving Average	
3	CH2 Average time, count		3	CH3 Time Average/ Count Average/Moving Average	
4	CH3 Average time, count		4	CH4 Time Average/ Count Average/Moving Average	
5	CH4 Average time, count	-	5	System area (Use prohibited)	-
6	System area (Use prohibited)		6		
7			7		
8			8		
9			9	Averaging process setting (The setting is not required when the A1S64AD is replaced.)	-
10	CH1 Digital output value	R	10	A/D conversion completed flag	R
11	CH2 Digital output value		11	CH1 Digital output value	
12	CH3 Digital output value		12	CH2 Digital output value	
13	CH4 Digital output value		13	CH3 Digital output value	
14	System area (Use prohibited)	-	14	CH4 Digital output value	-
15			15		
16			16		
17			17		
18	Write data error code	R	18		
19	A/D conversion completed flag	R/W	19	Latest error code	R
20	Resolution setting		20	Setting range	
			21	System area (Use prohibited)	-
			22	Offset/gain setting mode Offset specification	R/W
			23	Offset/gain setting mode Gain specification	
			24	Averaging process setting	R/W
			25	System area (Use prohibited)	-
			26	Conversion speed setting	R/W
			27	Input signal error detection extension setting	R/W
			28	System area (Use prohibited)	-
			29	Digital clipping enable/disable setting	R/W
			30	CH1 Maximum value	R
			31	CH1 Minimum value	
			32	CH2 Maximum value	
			33	CH2 Minimum value	
			34	CH3 Maximum value	
			35	CH3 Minimum value	
			36	CH4 Maximum value	
			37	CH4 Minimum value	
			38	System area (Use prohibited)	-
			46		
			47	Input signal error detection setting	R/W
			48	Warning output setting	R/W
			49	Input signal error detection flag	R
			50	Warning output flag (Process alarm)	R
			51	System area (Use prohibited)	-
			52		
			53	Scaling enable/disable setting	R/W
			54	CH1 Scaling value (digital operation value)	R

L60AD4		
Address (decimal)	Name	Read/write
55	CH2 Scaling value (digital operation value)	R
56	CH3 Scaling value (digital operation value)	
57	CH4 Scaling value (digital operation value)	
58	System area (Use prohibited)	-
to		
61		
62	CH1 Scaling lower limit value	R/W
63	CH1 Scaling upper limit value	
64	CH2 Scaling lower limit value	
65	CH2 Scaling upper limit value	
66	CH3 Scaling lower limit value	
67	CH3 Scaling upper limit value	
68	CH4 Scaling lower limit value	
69	CH4 Scaling upper limit value	-
70	System area (Use prohibited)	
to		
85		
86	CH1 Process alarm lower lower limit value	R/W
87	CH1 Process alarm lower upper limit value	
88	CH1 Process alarm upper lower limit value	
89	CH1 Process alarm upper upper limit value	
90	CH2 Process alarm lower lower limit value	
91	CH2 Process alarm lower upper limit value	
92	CH2 Process alarm upper lower limit value	
93	CH2 Process alarm upper upper limit value	
94	CH3 Process alarm lower lower limit value	
95	CH3 Process alarm lower upper limit value	
96	CH3 Process alarm upper lower limit value	
97	CH3 Process alarm upper upper limit value	
98	CH4 Process alarm lower lower limit value	
99	CH4 Process alarm lower upper limit value	
100	CH4 Process alarm upper lower limit value	
101	CH4 Process alarm upper upper limit value	-
102	System area (Use prohibited)	
to		
141		
142	CH1 Input signal error detection setting value	R/W
143	CH2 Input signal error detection setting value	
144	CH3 Input signal error detection setting value	
145	CH4 Input signal error detection setting value	
146	System area (Use prohibited)	-
to		
149		
150	CH1 Shifting amount to conversion value	R/W
151	CH2 Shifting amount to conversion value	
152	CH3 Shifting amount to conversion value	
153	CH4 Shifting amount to conversion value	
154	System area (Use prohibited)	-
to		
157		
158	Mode switching setting	R/W
159	System area (Use prohibited)	-
160		
to		
171	System area (Use prohibited)	-
172		
173		
174		
175	CH4 Difference conversion trigger	R/W
176	System area (Use prohibited)	
to		
179		

L60AD4		
Address (decimal)	Name	Read/write
180	CH1 Difference conversion reference value	R
181	CH2 Difference conversion reference value	
182	CH3 Difference conversion reference value	
183	CH4 Difference conversion reference value	
184	System area (Use prohibited)	-
to		
189		
190	CH1 Difference conversion status flag	R
191	CH2 Difference conversion status flag	
192	CH3 Difference conversion status flag	
193	CH4 Difference conversion status flag	
194	System area (Use prohibited)	-
to		
199		
200	Pass data classification setting	R/W
201	System area (Use prohibited)	-
202	CH1 Industrial shipment settings offset value (L)	R/W
203	CH1 Industrial shipment settings offset value (H)	
204	CH1 Industrial shipment settings gain value (L)	
205	CH1 Industrial shipment settings gain value (H)	
206	CH2 Industrial shipment settings offset value (L)	
207	CH2 Industrial shipment settings offset value (H)	
208	CH2 Industrial shipment settings gain value (L)	
209	CH2 Industrial shipment settings gain value (H)	
210	CH3 Industrial shipment settings offset value (L)	
211	CH3 Industrial shipment settings offset value (H)	
212	CH3 Industrial shipment settings gain value (L)	
213	CH3 Industrial shipment settings gain value (H)	
214	CH4 Industrial shipment settings offset value (L)	
215	CH4 Industrial shipment settings offset value (H)	
216	CH4 Industrial shipment settings gain value (L)	
217	CH4 Industrial shipment settings gain value (H)	
218	CH1 User range settings offset value (L)	
219	CH1 User range settings offset value (H)	
220	CH1 User range settings gain value (L)	
221	CH1 User range settings gain value (H)	
222	CH2 User range settings offset value (L)	
223	CH2 User range settings offset value (H)	
224	CH2 User range settings gain value (L)	
225	CH2 User range settings gain value (H)	
226	CH3 User range settings offset value (L)	
227	CH3 User range settings offset value (H)	
228	CH3 User range settings gain value (L)	
229	CH3 User range settings gain value (H)	
230	CH4 User range settings offset value (L)	
231	CH4 User range settings offset value (H)	
232	CH4 User range settings gain value (L)	
233	CH4 User range settings gain value (H)	
234	System area (Use prohibited)	-
to		
999		
1000	CH1 Logging enable/disable setting	R/W
1001	CH2 Logging enable/disable setting	
1002	CH3 Logging enable/disable setting	
1003	CH4 Logging enable/disable setting	
1004	System area (Use prohibited)	-
to		
1007		
1008	CH1 Logging hold request	R/W
1009	CH2 Logging hold request	
1010	CH3 Logging hold request	
1011	CH4 Logging hold request	

L60AD4		
Address (decimal)	Name	Read/write
1012	System area (Use prohibited)	-
to		
1015		
1016	CH1 Logging hold flag	R
1017	CH2 Logging hold flag	
1018	CH3 Logging hold flag	
1019	CH4 Logging hold flag	
1020	System area (Use prohibited)	-
to		
1023		
1024	CH1 Logging data setting	R/W
1025	CH2 Logging data setting	
1026	CH3 Logging data setting	
1027	CH4 Logging data setting	
1028	System area (Use prohibited)	-
to		
1031		
1032	CH1 Logging cycle setting value	R/W
1033	CH2 Logging cycle setting value	
1034	CH3 Logging cycle setting value	
1035	CH4 Logging cycle setting value	
1036	System area (Use prohibited)	-
to		
1039		
1040	CH1 Logging cycle unit setting	R/W
1041	CH2 Logging cycle unit setting	
1042	CH3 Logging cycle unit setting	
1043	CH4 Logging cycle unit setting	
1044	System area (Use prohibited)	-
to		
1047		
1048	CH1 Logging points after trigger	R/W
1049	CH2 Logging points after trigger	
1050	CH3 Logging points after trigger	
1051	CH4 Logging points after trigger	
1052	System area (Use prohibited)	-
to		
1055		
1056	CH1 Level trigger condition setting	R/W
1057	CH2 Level trigger condition setting	
1058	CH3 Level trigger condition setting	
1059	CH4 Level trigger condition setting	
1060	System area (Use prohibited)	-
to		
1063		
1064	CH1 Trigger data	R/W
1065	CH2 Trigger data	
1066	CH3 Trigger data	
1067	CH4 Trigger data	
1068	System area (Use prohibited)	-
to		
1071		
1072	Level data 0	R/W
1073	Level data 1	
1074	Level data 2	
1075	Level data 3	
1076	Level data 4	
1077	Level data 5	
1078	Level data 6	
1079	Level data 7	
1080	Level data 8	
1081	Level data 9	
1082	CH1 Trigger setting value	

L60AD4		
Address (decimal)	Name	Read/write
1083	CH2 Trigger setting value	R/W
1084	CH3 Trigger setting value	
1085	CH4 Trigger setting value	
1086	System area (Use prohibited)	-
to		
1089		
1090	CH1 Head pointer	R
1091	CH2 Head pointer	
1092	CH3 Head pointer	
1093	CH4 Head pointer	
1094	System area (Use prohibited)	-
to		
1097		
1098	CH1 Latest pointer	R
1099	CH2 Latest pointer	
1100	CH3 Latest pointer	
1101	CH4 Latest pointer	
1102	System area (Use prohibited)	-
to		
1105		
1106	CH1 Number of logging data	R
1107	CH2 Number of logging data	
1108	CH3 Number of logging data	
1109	CH4 Number of logging data	
1110	System area (Use prohibited)	-
to		
1113		
1114	CH1 Trigger pointer	R
1115	CH2 Trigger pointer	
1116	CH3 Trigger pointer	
1117	CH4 Trigger pointer	
1118	System area (Use prohibited)	-
to		
1121		
1122	CH1 Logging cycle monitor value (s)	R
1123	CH1 Logging cycle monitor value (ms)	
1124	CH1 Logging cycle monitor value (μs)	
1125	CH2 Logging cycle monitor value (s)	
1126	CH2 Logging cycle monitor value (ms)	
1127	CH2 Logging cycle monitor value (μs)	
1128	CH3 Logging cycle monitor value (s)	
1129	CH3 Logging cycle monitor value (ms)	
1130	CH3 Logging cycle monitor value (μs)	
1131	CH4 Logging cycle monitor value (s)	
1132	CH4 Logging cycle monitor value (ms)	
1133	CH4 Logging cycle monitor value (μs)	
1134	System area (Use prohibited)	
to		
1153		
1154	CH1 Trigger detection time (First two digits of the year/ Last two digits of the year)	R
1155	CH1 Trigger detection time (Month/ Day)	
1156	CH1 Trigger detection time (Hour/ Minute)	
1157	CH1 Trigger detection time (Second/ Day of the week)	
1158	CH2 Trigger detection time (First two digits of the year/ Last two digits of the year)	
1159	CH2 Trigger detection time (Month/ Day)	
1160	CH2 Trigger detection time (Hour/ Minute)	
1161	CH2 Trigger detection time (Second/ Day of the week)	
1162	CH3 Trigger detection time (First two digits of the year/ Last two digits of the year)	

L60AD4		
Address (decimal)	Name	Read/write
1163	CH3 Trigger detection time (Month/ Day)	R
1164	CH3 Trigger detection time (Hour/ Minute)	
1165	CH3 Trigger detection time (Second/ Day of the week)	
1166	CH4 Trigger detection time (First two digits of the year/ Last two digits of the year)	
1167	CH4 Trigger detection time (Month/ Day)	
1168	CH4 Trigger detection time (Hour/ Minute)	
1169	CH4 Trigger detection time (Second/ Day of the week)	
1170	System area (Use prohibited)	-
to		
1299		
1300	CH1 Flow amount integration enable/disable setting	R/W
1301	CH2 Flow amount integration enable/disable setting	
1302	CH3 Flow amount integration enable/disable setting	
1303	CH4 Flow amount integration enable/disable setting	
1304	System area (Use prohibited)	-
to		
1307		
1308	CH1 Integration cycle setting	R/W
1309	CH2 Integration cycle setting	
1310	CH3 Integration cycle setting	
1311	CH4 Integration cycle setting	
1312	System area (Use prohibited)	-
to		
1315		
1316	CH1 Flow amount time unit setting	R/W
1317	CH2 Flow amount time unit setting	
1318	CH3 Flow amount time unit setting	
1319	CH4 Flow amount time unit setting	
1320	System area (Use prohibited)	-
to		
1323		
1324	CH1 Unit scaling setting	R/W
1325	CH2 Unit scaling setting	
1326	CH3 Unit scaling setting	
1327	CH4 Unit scaling setting	
1328	System area (Use prohibited)	-
to		
1331		
1332	CH1 Integrated flow amount (L)	R
1333	CH1 Integrated flow amount (H)	
1334	CH2 Integrated flow amount (L)	
1335	CH2 Integrated flow amount (H)	
1336	CH3 Integrated flow amount (L)	
1337	CH3 Integrated flow amount (H)	
1338	CH4 Integrated flow amount (L)	
1339	CH4 Integrated flow amount (H)	
1340	System area (Use prohibited)	-
to		
1347		
1348	CH1 Integration cycle monitor value	R
1349	CH2 Integration cycle monitor value	
1350	CH3 Integration cycle monitor value	
1351	CH4 Integration cycle monitor value	
1352	System area (Use prohibited)	-
to		
1355		

L60AD4		
Address (decimal)	Name	Read/write
1356	CH1 Flow amount integration temporary stop request	R/W
1357	CH2 Flow amount integration temporary stop request	
1358	CH3 Flow amount integration temporary stop request	
1359	CH4 Flow amount integration temporary stop request	
1360 to 1363	System area (Use prohibited)	-
1364	CH1 Flow amount integration temporary stop flag	R
1365	CH2 Flow amount integration temporary stop flag	
1366	CH3 Flow amount integration temporary stop flag	
1367	CH4 Flow amount integration temporary stop flag	
1368 to 1371	System area (Use prohibited)	-
1372	CH1 Integrated flow amount clear request	R/W
1373	CH2 Integrated flow amount clear request	
1374	CH3 Integrated flow amount clear request	
1375	CH4 Integrated flow amount clear request	
1376 to 1379	System area (Use prohibited)	-
1380	CH1 Integrated flow amount clear flag	R
1381	CH2 Integrated flow amount clear flag	
1382	CH3 Integrated flow amount clear flag	
1383	CH4 Integrated flow amount clear flag	
1384 to 1799	System area (Use prohibited)	-

2.3 A1S68AD (replacement with the L60AD4)

2.3.1 Performance specifications comparison

Item		A1S68AD																								
Analog input	Voltage	-10 to 0 to +10VDC (Input resistance value: 1MΩ)																								
	Current	0 to +20mA (Input resistance value: 250Ω)																								
Digital output		16-bit signed binary																								
I/O characteristics and resolution		<p>I/O characteristics</p> <table border="1"> <thead> <tr> <th>Analog input</th> <th>Digital output</th> </tr> </thead> <tbody> <tr> <td>0 to +10V</td> <td>0 to +4000</td> </tr> <tr> <td>-10 to +10V</td> <td>-2000 to +2000</td> </tr> <tr> <td>0 to 5V or 0 to 20mA</td> <td>0 to +4000</td> </tr> <tr> <td>1 to 5V or 4 to 20mA</td> <td>0 to +4000</td> </tr> </tbody> </table> <p>Maximum resolution</p> <table border="1"> <thead> <tr> <th>Analog input</th> <th>Digital output</th> </tr> </thead> <tbody> <tr> <td>0 to +10V</td> <td>2.5mV</td> </tr> <tr> <td>-10 to +10V</td> <td>5mV</td> </tr> <tr> <td>0 to +5V</td> <td>1.25mV</td> </tr> <tr> <td>1 to 5V</td> <td>1mV</td> </tr> <tr> <td>0 to 20mA</td> <td>5μA</td> </tr> <tr> <td>4 to 20mA</td> <td>4μA</td> </tr> </tbody> </table>	Analog input	Digital output	0 to +10V	0 to +4000	-10 to +10V	-2000 to +2000	0 to 5V or 0 to 20mA	0 to +4000	1 to 5V or 4 to 20mA	0 to +4000	Analog input	Digital output	0 to +10V	2.5mV	-10 to +10V	5mV	0 to +5V	1.25mV	1 to 5V	1mV	0 to 20mA	5μA	4 to 20mA	4μA
Analog input	Digital output																									
0 to +10V	0 to +4000																									
-10 to +10V	-2000 to +2000																									
0 to 5V or 0 to 20mA	0 to +4000																									
1 to 5V or 4 to 20mA	0 to +4000																									
Analog input	Digital output																									
0 to +10V	2.5mV																									
-10 to +10V	5mV																									
0 to +5V	1.25mV																									
1 to 5V	1mV																									
0 to 20mA	5μA																									
4 to 20mA	4μA																									
Overall accuracy		Within ±1% at full scale (Digital output value: ±40)																								
Maximum conversion speed		0.5ms/channel (The speed is 1ms/channel on all channels if averaging processing is set even for one channel.)																								
Absolute maximum input		Voltage: ±35V Current: ±30mA																								
Number of analog input channels		8 channels/module																								
Number of offset/gain settings		—																								
Insulation method		Between the input terminal and programmable controller power supply : Photocoupler Between channels: Not insulated																								
Withstand voltage		—																								
Insulation resistance		—																								
Number of occupied I/O points		32 points (I/O assignment: special 32 points)																								
External interface		20-point terminal block																								
Applicable wire size		0.75 to 1.5mm ²																								
Applicable solderless terminal		R1.25-3, 1.25-YS3, RAV1.25-3, V1.25-YS3A																								
Internal current consumption (5VDC)		0.40A																								
Weight		0.27kg																								

○ : Compatible, △ : Partial change required, × : Incompatible

	L60AD4	Compatibility	Precautions for replacement																																		
	-10 to 10VDC (Input resistance value: 1MΩ)	○																																			
	0 to 20mA (Input resistance value: 250Ω)																																				
	16-bit signed binary (-20480 to 20479, when the scaling function is used: -32768 to 32767)	△																																			
	<table border="1"> <thead> <tr> <th colspan="2">Analog input range</th> <th>Digital output value</th> <th>Resolution</th> </tr> </thead> <tbody> <tr> <td rowspan="5">Voltage</td> <td>0 to 10V</td> <td rowspan="3">0 to 20000</td> <td>500μV</td> </tr> <tr> <td>0 to 5V</td> <td>250μV</td> </tr> <tr> <td>1 to 5V</td> <td>200μV</td> </tr> <tr> <td>-10 to 10V</td> <td>-20000 to 20000</td> <td>500μV</td> </tr> <tr> <td>1 to 5V (Extended mode)</td> <td>-5000 to 22500</td> <td>200μV</td> </tr> <tr> <td></td> <td>User range setting</td> <td>-20000 to 20000</td> <td>307μV</td> </tr> <tr> <td rowspan="4">Current</td> <td>0 to 20mA</td> <td rowspan="2">0 to 20000</td> <td>1000nA</td> </tr> <tr> <td>4 to 20mA</td> <td>800nA</td> </tr> <tr> <td>4 to 20mA (Extended mode)</td> <td>-5000 to 22500</td> <td>800nA</td> </tr> <tr> <td>User range setting</td> <td>-20000 to 20000</td> <td>1230nA</td> </tr> </tbody> </table>	Analog input range		Digital output value	Resolution	Voltage	0 to 10V	0 to 20000	500μV	0 to 5V	250μV	1 to 5V	200μV	-10 to 10V	-20000 to 20000	500μV	1 to 5V (Extended mode)	-5000 to 22500	200μV		User range setting	-20000 to 20000	307μV	Current	0 to 20mA	0 to 20000	1000nA	4 to 20mA	800nA	4 to 20mA (Extended mode)	-5000 to 22500	800nA	User range setting	-20000 to 20000	1230nA	△	Since the resolution differs between AnS series and L series modules, it needs to be matched using a sequence program, user range settings, or the scaling function (refer to Appendix 4).
Analog input range		Digital output value	Resolution																																		
Voltage	0 to 10V	0 to 20000	500μV																																		
	0 to 5V		250μV																																		
	1 to 5V		200μV																																		
	-10 to 10V	-20000 to 20000	500μV																																		
	1 to 5V (Extended mode)	-5000 to 22500	200μV																																		
	User range setting	-20000 to 20000	307μV																																		
Current	0 to 20mA	0 to 20000	1000nA																																		
	4 to 20mA		800nA																																		
	4 to 20mA (Extended mode)	-5000 to 22500	800nA																																		
	User range setting	-20000 to 20000	1230nA																																		
	Ambient temperature within 25±5°C: ±0.1% (±20 digit) Ambient temperature within 0 to 55°C: ±0.2% (±40 digit)	○																																			
	High speed: 20μs/channel (default) Medium speed: 80μs/channel Low speed: 1ms/channel	○	The conversion speed of L60AD4 is faster than A1S68AD. Therefore, noise which were not imported to A1S68AD can be imported as analog signals. In this case, use the averaging processing function to remove the effect of noise.																																		
	Voltage: ±15V Current: ±30mA	○																																			
	4 channels/module	△	Consider of replacing with several L60AD4 modules.																																		
	Up to 50000 times	○																																			
	Between the I/O terminal and programmable controller power supply: Photocoupler Between channels: Not insulated	○																																			
	Between the I/O terminal and programmable controller power supply: 500VACrms, for 1 minute	○																																			
	Between the I/O terminal and programmable controller power supply: 500VDC, 10MΩ or higher	○																																			
	16 points (I/O assignment: intelligent 16 points)	△	The number of occupied I/O points is changed to 16 points.																																		
	18-point terminal block	×	Wiring needs to be changed.																																		
	0.3 to 0.75mm ²	×																																			
	R1.25-3 (Solderless terminals with an insulation sleeve cannot be used.)	×																																			
	0.52A	△	Recalculation of internal current consumption (5VDC) is required.																																		
	0.19kg	△																																			

2.3.2 Functional comparison

○ : Supported, – : Not supported

Item	Description	A1S68AD	L60AD4	Precautions for replacement
A/D conversion enable/ disable function	Sets whether to enable or disable the A/D conversion for each channel. By disabling the conversion for the channels that are not used, the sampling time can be shortened.	○	○	
Sampling processing	Performs the A/D conversion for analog input values successively for each channel, and outputs digital output values upon each conversion.	○	○	
Averaging processing	Time average	○	○	The setting range of average time and count differ. Refer to the MELSEC-L Analog-Digital Converter Module User's Manual, and check the specifications.
	Count average	○	○	
	Moving average	–	○	
Range switching function	Sets the input range to be used.	–	○	
Offset/gain setting function	Compensates for errors in digital output values.	–	○	
Conversion speed switch function	Sets the conversion speed.	–	○	
Input range extended mode function	Extends the input range. By combining this function with the input signal error detection function, simple disconnection detection can be executed.	–	○	This function can be used on GX Works2.*2
Maximum value/minimum value hold function	Stores the maximum and minimum values of the digital output values in the module.	–	○	This function can be used on GX Works2.*2
Input signal error detection function	Detects the analog input value which exceeds the setting range.	–	○	This function can be used on GX Works2.*2
Input signal error detection extension function	Extends the detection method of the input signal error detection function. Use this function to detect the input signal error only in the lower limit or upper limit, or to execute the disconnection detection.	–	○	This function can be used on GX Works2.*2
Warning output function (process alarm)	Outputs an alarm when a digital output value is within the range set in advance.	–	○	This function can be used on GX Works2.*2
Resolution mode	Sets the resolution according to the application. The resolution mode setting is applicable to all channels.*1	–	–	
Scaling function	Scale-converts the output digital value to the set range of the scaling upper limit value and scaling lower limit value. This omits the programming of the scale conversion.	–	○	By setting the same scaling upper limits and scaling lower limits as the resolution of A1S68AD, the same digital output values as A1S68AD can be used.*2
Shift function	Adds the set shifting amount of the conversion value to the scaling value (digital operation value) and stores the value in the buffer memory. Fine adjustment can be performed easily when the system starts.	–	○	This function can be used on GX Works2.*2
Digital clipping function	Sets the maximum value of the scaling value (digital operation value) to 20000 and the minimum value to 0 or -20000 when the input voltage or current exceeds the input range.	–	○	This function can be used on GX Works2.*2
Difference conversion function	Subtracts the difference conversion reference value from the scaling value (digital operation value) and stores the acquired value in the buffer memory.	–	○	This function can be used on GX Works2.*2
Logging function	Logs the digital output value or scaling value (digital operation value). The data of 10000 points can be logged for each channel.	–	○	This function can be used on GX Works2.*2
Flow amount integration function	Performs the A/D conversion of analog input value (voltage or current) from a source such as a flow meter and integrates the digital output value.	–	○	This function can be used on GX Works2.*2
Error log function	Stores the errors and alarms occurred in the A/D converter module to the buffer memory as a history. Up to 16 errors and alarms can be stored.	–	○	
Module error collection function	Collects the errors and alarms occurred in the A/D converter module and stores them in the CPU module.	–	○	

○ : Supported, –: Not supported

Item	Description	A1S68AD	L60AD4	Precautions for replacement
Error clear function	Clears the error from the system monitor window of the programming tool.	–	○	This function can be used on GX Works2.
Saving and restoring offset/gain values	Saves and restores the offset/gain values in the user setting range.	–	○	

- *1 For the A1S68AD, the resolution is 1/4000 (fixed).
For the L60AD4, the resolution is 1/20000 (fixed). To use the same digital value that is used for the A1S68AD, set the scaling upper and lower limit values that match the resolution of the A1S68AD using the scaling function.
- *2 Only the L60AD4 with a serial number (first five digits) 13041 or later supports this function.

2.3.3 I/O signal comparison

Sequence programs need to be changed because the I/O signal assignment differs.

For details of the I/O signals and sequence programs, refer to the MELSEC-L Analog-Digital Converter Module User's Manual.

A1S68AD				L60AD4			
Device No.	Signal name	Device No.	Signal name	Device No.	Signal name	Device No.	Signal name
X0	Watchdog timer error flag	Y0	Use prohibited	X0	Module READY	Y0	Use prohibited
X1	A/D conversion READY	Y1		X1	Use prohibited	Y1	
X2	Error flag	Y2		X2		Y2	
X3	Use prohibited	Y3		X3		Y3	
X4		Y4		X4		Y4	
X5		Y5		X5		Y5	
X6		Y6		X6		Y6	
X7		Y7		X7	Y7		
X8		Y8		X8	Warming output signal	Y8	
X9	Use prohibited	Y9		X9	Operating condition setting completed flag	Y9	Operating condition setting request
XA		YA		XA	Offset/gain setting mode flag	YA	User range write request
XB		YB		XB	Channel change completed flag	YB	Channel change request
XC		YC	XC	Input signal error detection signal	YC	Use prohibited	
XD		YD	XD	Maximum value/minimum value reset completed flag	YD	Maximum value/minimum value reset request	
XE		YE	XE	A/D conversion completed flag	YE	Use prohibited	
XF		YF	XF	Error flag	YF	Error clear request	
X10		Y10					
X11		Y11					
X12		Y12	Y12	Error reset			
X13	Y13						
X14	Y14						
X15	Y15						
X16	Y16						
X17	Y17						
X18	Y18						
X19	Y19	Y19	Use prohibited				
X1A	Y1A						
X1B	Y1B						
X1C	Y1C						
X1D	Y1D						
X1E	Y1E						
X1F	Y1F						

2.3.4 Buffer memory address comparison

Sequence programs need to be changed because the buffer memory address assignment differs. For details of the buffer memory areas and sequence programs, refer to the MELSEC-L Analog-Digital Converter Module User's Manual.

A1S68AD			L60AD4		
Address (decimal)	Name	Read/write	Address (decimal)	Name	Read/write
0	A-D conversion enable/disable	R/W	0	A/D conversion enable/disable setting	
1	Write data error code	R	1	CH1 Time Average/ Count Average/Moving Average	R/W
2	Average processing specification	R/W	2	CH2 Time Average/ Count Average/Moving Average	
3	System area (Use prohibited)	-	3	CH3 Time Average/ Count Average/Moving Average	
4			4	CH4 Time Average/ Count Average/Moving Average	
5			5	System area (Use prohibited)	-
6			6		
7			7		
8			8		
9			9	Averaging process setting (The setting is not required when the A1S68AD is replaced.)	-
10			CH1 Average time, count	R/W	10
11	CH2 Average time, count	11	CH1 Digital output value		
12	CH3 Average time, count	12	CH2 Digital output value		
13	CH4 Average time, count	13	CH3 Digital output value		
14	CH5 Average time, count	14	CH4 Digital output value		-
15	CH6 Average time, count	15	System area (Use prohibited)		
16	CH7 Average time, count	16			
17	CH8 Average time, count	17			
18	System area (Use prohibited)	-	18	Latest error code	R
20	CH1 Digital output value	R	20	Setting range	-
21	CH2 Digital output value		21	System area (Use prohibited)	-
22	CH3 Digital output value		22	Offset/gain setting mode: Offset specification	R/W
23	CH4 Digital output value		23	Offset/gain setting mode: Gain specification	R/W
24	CH5 Digital output value		24	Averaging process setting	R/W
25	CH6 Digital output value		25	System area (Use prohibited)	-
26	CH7 Digital output value		26	Conversion speed setting	R/W
27	CH8 Digital output value		27	Input signal error detection extension setting	R/W
28	A/D conversion completed flag	R/W	28	System area (Use prohibited)	-
29	System area (Use prohibited)	-	29	Digital clipping enable/disable setting	R/W
			30	CH1 Maximum value	R
			31	CH1 Minimum value	
			32	CH2 Maximum value	
			33	CH2 Minimum value	
			34	CH3 Maximum value	
			35	CH3 Minimum value	
			36	CH4 Maximum value	
			37	CH4 Minimum value	
			38	System area (Use prohibited)	-
			46		
			47	Input signal error detection setting	R/W
			48	Warning output setting	R/W
			49	Input signal error detection flag	R
			50	Warning output flag (Process alarm)	R
			51	System area (Use prohibited)	-
			52		
			53	Scaling enable/disable setting	R/W

L60AD4		
Address (decimal)	Name	Read/write
54	CH1 Scaling value (digital operation value)	R
55	CH2 Scaling value (digital operation value)	
56	CH3 Scaling value (digital operation value)	
57	CH4 Scaling value (digital operation value)	
58	System area (Use prohibited)	-
to		
61		
62	CH1 Scaling lower limit value	R/W
63	CH1 Scaling upper limit value	
64	CH2 Scaling lower limit value	
65	CH2 Scaling upper limit value	
66	CH3 Scaling lower limit value	
67	CH3 Scaling upper limit value	
68	CH4 Scaling lower limit value	
69	CH4 Scaling upper limit value	
70	System area (Use prohibited)	-
to		
85		
86	CH1 Process alarm lower lower limit value	R/W
87	CH1 Process alarm lower upper limit value	
88	CH1 Process alarm upper lower limit value	
89	CH1 Process alarm upper upper limit value	
90	CH2 Process alarm lower lower limit value	
91	CH2 Process alarm lower upper limit value	
92	CH2 Process alarm upper lower limit value	
93	CH2 Process alarm upper upper limit value	
94	CH3 Process alarm lower lower limit value	
95	CH3 Process alarm lower upper limit value	
96	CH3 Process alarm upper lower limit value	
97	CH3 Process alarm upper upper limit value	
98	CH4 Process alarm lower lower limit value	
99	CH4 Process alarm lower upper limit value	
100	CH4 Process alarm upper lower limit value	
101	CH4 Process alarm upper upper limit value	
102	System area (Use prohibited)	-
to		
141		
142	CH1 Input signal error detection setting value	R/W
143	CH2 Input signal error detection setting value	
144	CH3 Input signal error detection setting value	
145	CH4 Input signal error detection setting value	
146	System area (Use prohibited)	-
to		
149		
150	CH1 Shifting amount to conversion value	R/W
151	CH2 Shifting amount to conversion value	
152	CH3 Shifting amount to conversion value	
153	CH4 Shifting amount to conversion value	
154	System area (Use prohibited)	-
to		
157		
158	Mode switching setting	R/W
159		
160	System area (Use prohibited)	-
to		
171		
172	CH1 Difference conversion trigger	R/W
173	CH2 Difference conversion trigger	
174	CH3 Difference conversion trigger	
175	CH4 Difference conversion trigger	

L60AD4		
Address (decimal)	Name	Read/write
176	System area (Use prohibited)	-
to		
179		
180	CH1 Difference conversion reference value	R
181	CH2 Difference conversion reference value	
182	CH3 Difference conversion reference value	
183	CH4 Difference conversion reference value	
184	System area (Use prohibited)	-
to		
189		
190	CH1 Difference conversion status flag	R
191	CH2 Difference conversion status flag	
192	CH3 Difference conversion status flag	
193	CH4 Difference conversion status flag	
194	System area (Use prohibited)	-
to		
199		
200	Pass data classification setting	R/W
201	System area (Use prohibited)	-
202	CH1 Industrial shipment settings offset value (L)	R/W
203	CH1 Industrial shipment settings offset value (H)	
204	CH1 Industrial shipment settings gain value (L)	
205	CH1 Industrial shipment settings gain value (H)	
206	CH2 Industrial shipment settings offset value (L)	
207	CH2 Industrial shipment settings offset value (H)	
208	CH2 Industrial shipment settings gain value (L)	
209	CH2 Industrial shipment settings gain value (H)	
210	CH3 Industrial shipment settings offset value (L)	
211	CH3 Industrial shipment settings offset value (H)	
212	CH3 Industrial shipment settings gain value (L)	
213	CH3 Industrial shipment settings gain value (H)	
214	CH4 Industrial shipment settings offset value (L)	
215	CH4 Industrial shipment settings offset value (H)	
216	CH4 Industrial shipment settings gain value (L)	
217	CH4 Industrial shipment settings gain value (H)	
218	CH1 User range settings offset value (L)	
219	CH1 User range settings offset value (H)	
220	CH1 User range settings gain value (L)	
221	CH1 User range settings gain value (H)	
222	CH2 User range settings offset value (L)	
223	CH2 User range settings offset value (H)	
224	CH2 User range settings gain value (L)	
225	CH2 User range settings gain value (H)	
226	CH3 User range settings offset value (L)	
227	CH3 User range settings offset value (H)	
228	CH3 User range settings gain value (L)	
229	CH3 User range settings gain value (H)	
230	CH4 User range settings offset value (L)	
231	CH4 User range settings offset value (H)	
232	CH4 User range settings gain value (L)	
233	CH4 User range settings gain value (H)	
234	System area (Use prohibited)	-
to		
999		
1000	CH1 Logging enable/disable setting	R/W
1001	CH2 Logging enable/disable setting	
1002	CH3 Logging enable/disable setting	
1003	CH4 Logging enable/disable setting	
1004	System area (Use prohibited)	-
to		
1007		
1008	CH1 Logging hold request	R/W
1009	CH2 Logging hold request	

L60AD4		
Address (decimal)	Name	Read/write
1010	CH3 Logging hold request	R/W
1011	CH4 Logging hold request	
1012	System area (Use prohibited)	-
to		
1015		
1016	CH1 Logging hold flag	R
1017	CH2 Logging hold flag	
1018	CH3 Logging hold flag	
1019	CH4 Logging hold flag	
1020	System area (Use prohibited)	-
to		
1023		
1024	CH1 Logging data setting	R/W
1025	CH2 Logging data setting	
1026	CH3 Logging data setting	
1027	CH4 Logging data setting	
1028	System area (Use prohibited)	-
to		
1031		
1032	CH1 Logging cycle setting value	R/W
1033	CH2 Logging cycle setting value	
1034	CH3 Logging cycle setting value	
1035	CH4 Logging cycle setting value	
1036	System area (Use prohibited)	-
to		
1039		
1040	CH1 Logging cycle unit setting	R/W
1041	CH2 Logging cycle unit setting	
1042	CH3 Logging cycle unit setting	
1043	CH4 Logging cycle unit setting	
1044	System area (Use prohibited)	-
to		
1047		
1048	CH1 Logging points after trigger	R/W
1049	CH2 Logging points after trigger	
1050	CH3 Logging points after trigger	
1051	CH4 Logging points after trigger	
1052	System area (Use prohibited)	-
to		
1055		
1056	CH1 Level trigger condition setting	R/W
1057	CH2 Level trigger condition setting	
1058	CH3 Level trigger condition setting	
1059	CH4 Level trigger condition setting	
1060	System area (Use prohibited)	-
to		
1063		
1064	CH1 Trigger data	R/W
1065	CH2 Trigger data	
1066	CH3 Trigger data	
1067	CH4 Trigger data	
1068	System area (Use prohibited)	-
to		
1071		
1072	Level data 0	R/W
1073	Level data 1	
1074	Level data 2	
1075	Level data 3	
1076	Level data 4	
1077	Level data 5	
1078	Level data 6	
1079	Level data 7	
1080	Level data 8	

L60AD4		
Address (decimal)	Name	Read/write
1081	Level data 9	
1082	CH1 Trigger setting value	R/W
1083	CH2 Trigger setting value	
1084	CH3 Trigger setting value	
1085	CH4 Trigger setting value	
1086	System area (Use prohibited)	-
to		
1089		
1090	CH1 Head pointer	R
1091	CH2 Head pointer	
1092	CH3 Head pointer	
1093	CH4 Head pointer	
1094	System area (Use prohibited)	-
to		
1097		
1098	CH1 Latest pointer	R
1099	CH2 Latest pointer	
1100	CH3 Latest pointer	
1101	CH4 Latest pointer	
1102	System area (Use prohibited)	-
to		
1105		
1106	CH1 Number of logging data	R
1107	CH2 Number of logging data	
1108	CH3 Number of logging data	
1109	CH4 Number of logging data	
1110	System area (Use prohibited)	-
to		
1113		
1114	CH1 Trigger pointer	R
1115	CH2 Trigger pointer	
1116	CH3 Trigger pointer	
1117	CH4 Trigger pointer	
1118	System area (Use prohibited)	-
to		
1121		
1122	CH1 Logging cycle monitor value (s)	R
1123	CH1 Logging cycle monitor value (ms)	
1124	CH1 Logging cycle monitor value (μs)	
1125	CH2 Logging cycle monitor value (s)	
1126	CH2 Logging cycle monitor value (ms)	
1127	CH2 Logging cycle monitor value (μs)	
1128	CH3 Logging cycle monitor value (s)	
1129	CH3 Logging cycle monitor value (ms)	
1130	CH3 Logging cycle monitor value (μs)	
1131	CH4 Logging cycle monitor value (s)	
1132	CH4 Logging cycle monitor value (ms)	
1133	CH4 Logging cycle monitor value (μs)	
1134	System area (Use prohibited)	-
to		
1153		
1154	CH1 Trigger detection time (First two digits of the year/ Last two digits of the year)	R
1155	CH1 Trigger detection time (Month/ Day)	
1156	CH1 Trigger detection time (Hour/ Minute)	
1157	CH1 Trigger detection time (Second/ Day of the week)	
1158	CH2 Trigger detection time (First two digits of the year/ Last two digits of the year)	
1159	CH2 Trigger detection time (Month/ Day)	
1160	CH2 Trigger detection time (Hour/ Minute)	
1161	CH2 Trigger detection time (Second/ Day of the week)	

L60AD4		
Address (decimal)	Name	Read/write
1162	CH3 Trigger detection time (First two digits of the year/ Last two digits of the year)	R
1163	CH3 Trigger detection time (Month/ Day)	
1164	CH3 Trigger detection time (Hour/ Minute)	
1165	CH3 Trigger detection time (Second/ Day of the week)	
1166	CH4 Trigger detection time (First two digits of the year/ Last two digits of the year)	
1167	CH4 Trigger detection time (Month/ Day)	
1168	CH4 Trigger detection time (Hour/ Minute)	
1169	CH4 Trigger detection time (Second/ Day of the week)	
1170 to 1299	System area (Use prohibited)	-
1300	CH1 Flow amount integration enable/disable setting	R/W
1301	CH2 Flow amount integration enable/disable setting	
1302	CH3 Flow amount integration enable/disable setting	
1303	CH4 Flow amount integration enable/disable setting	
1304 to 1307	System area (Use prohibited)	-
1308	CH1 Integration cycle setting	R/W
1309	CH2 Integration cycle setting	
1310	CH3 Integration cycle setting	
1311	CH4 Integration cycle setting	
1312 to 1315	System area (Use prohibited)	-
1316	CH1 Flow amount time unit setting	R/W
1317	CH2 Flow amount time unit setting	
1318	CH3 Flow amount time unit setting	
1319	CH4 Flow amount time unit setting	
1320 to 1323	System area (Use prohibited)	-
1324	CH1 Unit scaling setting	R/W
1325	CH2 Unit scaling setting	
1326	CH3 Unit scaling setting	
1327	CH4 Unit scaling setting	
1328 to 1331	System area (Use prohibited)	-
1332	CH1 Integrated flow amount (L)	R
1333	CH1 Integrated flow amount (H)	
1334	CH2 Integrated flow amount (L)	
1335	CH2 Integrated flow amount (H)	
1336	CH3 Integrated flow amount (L)	
1337	CH3 Integrated flow amount (H)	
1338	CH4 Integrated flow amount (L)	
1339	CH4 Integrated flow amount (H)	
1340 to 1347	System area (Use prohibited)	-
1348	CH1 Integration cycle monitor value	R
1349	CH2 Integration cycle monitor value	
1350	CH3 Integration cycle monitor value	
1351	CH4 Integration cycle monitor value	

L60AD4		
Address (decimal)	Name	Read/write
1352	System area (Use prohibited)	-
to		
1355		
1356	CH1 Flow amount integration temporary stop request	R/W
1357	CH2 Flow amount integration temporary stop request	
1358	CH3 Flow amount integration temporary stop request	
1359	CH4 Flow amount integration temporary stop request	
1360	System area (Use prohibited)	-
to		
1363		
1364	CH1 Flow amount integration temporary stop flag	R
1365	CH2 Flow amount integration temporary stop flag	
1366	CH3 Flow amount integration temporary stop flag	
1367	CH4 Flow amount integration temporary stop flag	
1368	System area (Use prohibited)	-
to		
1371		
1372	CH1 Integrated flow amount clear request	R/W
1373	CH2 Integrated flow amount clear request	
1374	CH3 Integrated flow amount clear request	
1375	CH4 Integrated flow amount clear request	
1376	System area (Use prohibited)	-
to		
1379		
1380	CH1 Integrated flow amount clear flag	R
1381	CH2 Integrated flow amount clear flag	
1382	CH3 Integrated flow amount clear flag	
1383	CH4 Integrated flow amount clear flag	
1384	System area (Use prohibited)	-
to		
1799		

2.4 A1S68AD (replacement with the L60ADV L8 or L60ADIL8)

2.4.1 Performance specifications comparison

Item		A1S68AD																								
Analog input	Voltage	-10 to 0 to +10VDC (Input resistance value: 1MΩ)																								
	Current	0 to +20mA (Input resistance value: 250Ω)																								
Digital output		16-bit signed binary																								
I/O characteristics and resolution		<p>I/O characteristics</p> <table border="1"> <thead> <tr> <th>Analog input</th> <th>Digital output</th> </tr> </thead> <tbody> <tr> <td>0 to +10V</td> <td>0 to +4000</td> </tr> <tr> <td>-10 to +10V</td> <td>-2000 to +2000</td> </tr> <tr> <td>0 to 5V or 0 to 20mA</td> <td>0 to +4000</td> </tr> <tr> <td>1 to 5V or 4 to 20mA</td> <td>0 to +4000</td> </tr> </tbody> </table> <p>Maximum resolution</p> <table border="1"> <thead> <tr> <th>Analog input</th> <th>Digital output</th> </tr> </thead> <tbody> <tr> <td>0 to +10V</td> <td>2.5mV</td> </tr> <tr> <td>-10 to +10V</td> <td>5mV</td> </tr> <tr> <td>0 to +5V</td> <td>1.25mV</td> </tr> <tr> <td>1 to 5V</td> <td>1mV</td> </tr> <tr> <td>0 to 20mA</td> <td>5μA</td> </tr> <tr> <td>4 to 20mA</td> <td>4μA</td> </tr> </tbody> </table>	Analog input	Digital output	0 to +10V	0 to +4000	-10 to +10V	-2000 to +2000	0 to 5V or 0 to 20mA	0 to +4000	1 to 5V or 4 to 20mA	0 to +4000	Analog input	Digital output	0 to +10V	2.5mV	-10 to +10V	5mV	0 to +5V	1.25mV	1 to 5V	1mV	0 to 20mA	5μA	4 to 20mA	4μA
Analog input	Digital output																									
0 to +10V	0 to +4000																									
-10 to +10V	-2000 to +2000																									
0 to 5V or 0 to 20mA	0 to +4000																									
1 to 5V or 4 to 20mA	0 to +4000																									
Analog input	Digital output																									
0 to +10V	2.5mV																									
-10 to +10V	5mV																									
0 to +5V	1.25mV																									
1 to 5V	1mV																									
0 to 20mA	5μA																									
4 to 20mA	4μA																									
Overall accuracy		Within ±1% at full scale (Digital output value: ±40)																								
Maximum conversion speed		0.5ms/channel (The speed is 1ms/channel on all channels if averaging processing is set even for one channel.)																								
Absolute maximum input		Voltage: ±35V Current: ±30mA																								
Number of analog input channels		8 channels/module																								
Number of offset/gain settings		–																								
Insulation method		Between the input terminal and programmable controller power supply: Photocoupler Between channels: Not insulated																								
Withstand voltage		–																								
Insulation resistance		–																								
Number of occupied I/O points		32 points (I/O assignment: special 32 points)																								
External interface		20-point terminal block																								
Applicable wire size		0.75 to 1.5mm ²																								
Applicable solderless terminal		R1.25-3, 1.25-YS3, RAV1.25-3, V1.25-YS3A																								
Internal current consumption (5VDC)		0.40A																								
Weight		0.27kg																								

○ : Compatible, △ : Partial change required, × : Incompatible

	L60ADVL8	L60ADIL8	Compatibility	Precautions for replacement																																	
	-10 to 10VDC (Input resistance value: 1.8MΩ)	-	△	The voltage and current cannot be mixed in one module.																																	
	-	0 to 20mA (Input resistance value: 250Ω)																																			
	16-bit signed binary (-16384 to 16383, when the scaling function is used: -32768 to 32767)	16-bit signed binary (-8192 to 8192, when the scaling function is used: -32768 to 32767)	△																																		
	<table border="1"> <thead> <tr> <th></th> <th>Analog input range</th> <th>Digital output value</th> <th>Resolution</th> </tr> </thead> <tbody> <tr> <td rowspan="5">Voltage</td> <td>0 to 10V</td> <td>0 to 16000</td> <td rowspan="2">625μV</td> </tr> <tr> <td>0 to 5V</td> <td rowspan="3">0 to 8000</td> </tr> <tr> <td>1 to 5V</td> <td>500μV</td> </tr> <tr> <td>-10 to 10V</td> <td>-16000 to 16000</td> <td>625μV</td> </tr> <tr> <td>1 to 5V (Extended mode)</td> <td>-2000 to 9000</td> <td>500μV</td> </tr> <tr> <td>User range setting</td> <td>-8000 to 8000</td> <td>414μV</td> </tr> <tr> <td rowspan="4">Current</td> <td>0 to 20mA</td> <td rowspan="2">0 to 8000</td> <td>2500nA</td> </tr> <tr> <td>4 to 20mA</td> <td>2000nA</td> </tr> <tr> <td>4 to 20mA (Extended mode)</td> <td>-2000 to 9000</td> <td>2500nA</td> </tr> <tr> <td>User range</td> <td>-8000 to 8000</td> <td>1660μA</td> </tr> </tbody> </table>			Analog input range	Digital output value	Resolution	Voltage	0 to 10V	0 to 16000	625μV	0 to 5V	0 to 8000	1 to 5V	500μV	-10 to 10V	-16000 to 16000	625μV	1 to 5V (Extended mode)	-2000 to 9000	500μV	User range setting	-8000 to 8000	414μV	Current	0 to 20mA	0 to 8000	2500nA	4 to 20mA	2000nA	4 to 20mA (Extended mode)	-2000 to 9000	2500nA	User range	-8000 to 8000	1660μA	△	Since the resolution differs between AnS series and L series modules, it needs to be matched using a sequence program, user range settings, or the scaling function (refer to Appendix 4).
	Analog input range	Digital output value	Resolution																																		
Voltage	0 to 10V	0 to 16000	625μV																																		
	0 to 5V	0 to 8000																																			
	1 to 5V		500μV																																		
	-10 to 10V		-16000 to 16000	625μV																																	
	1 to 5V (Extended mode)	-2000 to 9000	500μV																																		
User range setting	-8000 to 8000	414μV																																			
Current	0 to 20mA	0 to 8000	2500nA																																		
	4 to 20mA		2000nA																																		
	4 to 20mA (Extended mode)	-2000 to 9000	2500nA																																		
	User range	-8000 to 8000	1660μA																																		
	<table border="1"> <thead> <tr> <th rowspan="2">Analog input range</th> <th colspan="2">Ambient temperature</th> </tr> <tr> <th>25±5°C</th> <th>0 to 55°C</th> </tr> </thead> <tbody> <tr> <td rowspan="5">Voltage</td> <td>0 to 10V</td> <td>Within ±0.2% (±32 digit)</td> <td>Within ±1% (±160 digit)</td> </tr> <tr> <td>0 to 5V</td> <td rowspan="2">Within ±0.2% (±16 digit)</td> <td rowspan="2">Within ±1% (±80 digit)</td> </tr> <tr> <td>1 to 5V</td> </tr> <tr> <td>-10 to 10V</td> <td>Within ±0.2% (±32 digit)</td> <td>Within ±1% (±160 digit)</td> </tr> <tr> <td>1 to 5V (Extended mode)</td> <td>Within ±0.2% (±16 digit)</td> <td>Within ±1% (±80 digit)</td> </tr> <tr> <td rowspan="4">Current</td> <td>0 to 20mA</td> <td rowspan="4">Within ±0.2% (±16 digit)</td> <td rowspan="4">Within ±1% (±80 digit)</td> </tr> <tr> <td>4 to 20mA</td> </tr> <tr> <td>4 to 20mA</td> </tr> <tr> <td>4 to 20mA (Extended mode)</td> </tr> </tbody> </table>		Analog input range	Ambient temperature		25±5°C	0 to 55°C	Voltage	0 to 10V	Within ±0.2% (±32 digit)	Within ±1% (±160 digit)	0 to 5V	Within ±0.2% (±16 digit)	Within ±1% (±80 digit)	1 to 5V	-10 to 10V	Within ±0.2% (±32 digit)	Within ±1% (±160 digit)	1 to 5V (Extended mode)	Within ±0.2% (±16 digit)	Within ±1% (±80 digit)	Current	0 to 20mA	Within ±0.2% (±16 digit)	Within ±1% (±80 digit)	4 to 20mA	4 to 20mA	4 to 20mA (Extended mode)	○								
Analog input range	Ambient temperature																																				
	25±5°C	0 to 55°C																																			
Voltage	0 to 10V	Within ±0.2% (±32 digit)	Within ±1% (±160 digit)																																		
	0 to 5V	Within ±0.2% (±16 digit)	Within ±1% (±80 digit)																																		
	1 to 5V																																				
	-10 to 10V	Within ±0.2% (±32 digit)	Within ±1% (±160 digit)																																		
	1 to 5V (Extended mode)	Within ±0.2% (±16 digit)	Within ±1% (±80 digit)																																		
Current	0 to 20mA	Within ±0.2% (±16 digit)	Within ±1% (±80 digit)																																		
	4 to 20mA																																				
	4 to 20mA																																				
	4 to 20mA (Extended mode)																																				
	1ms/channel		○																																		
	Voltage: ±15V	Current: ±30mA	○																																		
	8 channels/module		○																																		
	Up to 10000 times		○																																		
	Between the I/O terminal and programmable controller power supply: Photocoupler Between input channels: Not insulated		○																																		
	Between the I/O terminal and programmable controller power supply: 500VACrms, for 1 minute		○																																		
	Between the I/O terminal and programmable controller power supply: 500VDC, 10MΩ or higher		○																																		
	16 points (I/O assignment: intelligent 16 points)		△	The number of occupied I/O points is changed to 16 points.																																	
	18-point terminal block		×	Wiring needs to be changed.																																	
	0.3 to 0.75mm ²		×																																		
	R1.25-3 (Solderless terminals with an insulation sleeve cannot be used.)		×																																		
	0.20A	0.21A	○																																		
	0.19kg		△																																		

2.4.2 Functional comparison

○: Compatible, △: Partial change required, ×: Incompatible

Item	Description	A1S68AD	L60ADVL8 L60ADIL8	Precautions for replacement
A/D conversion enable/ disable function	Sets whether to enable or disable the A/D conversion. By disabling the conversion for the channels that are not used, the sampling time can be shortened.	○	○	
Sampling processing	Performs the A/D conversion for analog input values successively for each channel, and outputs digital output values upon each conversion.	○	○	
Averaging processing	Time average	○	○	The setting range of average time and count differs. Refer to the MELSEC-L Analog-Digital Converter Module User's Manual, and check the specifications.
	Count average	○	○	
	Moving average	—	○	
Range switching function	Sets the input range to be used.	—	○	
Offset/gain setting function	Compensates for errors in digital output values.	—	○	
Input range extended mode function	Extends the input range. By combining this function with the input signal error detection function, simple disconnection detection can be executed.	—	○	This function can be used on GX Works2.
Maximum value/minimum value hold function	Stores the maximum and minimum values of the digital output values in the module.	—	○	This function can be used on GX Works2.
Input signal error detection function	Detects the analog input value which exceeds the setting range.	—	○	This function can be used on GX Works2.
Input signal error detection extension function	Extends the detection method of the input signal error detection function. Use this function to detect the input signal error only in the lower limit or upper limit, or to execute the disconnection detection.	—	○	This function can be used on GX Works2.
Warning output function (process alarm)	Outputs an alarm when a digital output value is within the range set in advance.	—	○	This function can be used on GX Works2.
Resolution mode	Sets the resolution according to the application. The resolution mode setting is applicable to all channels.*1	—	—	
Scaling function	Scale-converts the output digital value to the set range of the scaling upper limit value and scaling lower limit value. This omits the programming of the scale conversion.	—	○	By setting the same scaling upper limit value and scaling lower limit value as the resolution of A1S68AD, the same digital output values as A1S68AD can be used.
Shift function	Adds the set shifting amount of the conversion value to the scaling value (digital operation value) and stores the value in the buffer memory. Fine adjustment can be performed easily when the system starts.	—	△*2	This function can be used on GX Works2.
Digital clipping function	Sets the maximum value of the scaling value (digital operation value) to 20000 and the minimum value to 0 or -20000 when the input voltage or current exceeds the input range.	—	△*2	This function can be used on GX Works2.
Difference conversion function	Subtracts the difference conversion reference value from the scaling value (digital operation value) and stores the acquired value in the buffer memory.	—	△*2	This function can be used on GX Works2.*2
Logging function	Logs the digital output value or scaling value (digital operation value). The data of 10000 points can be logged for each channel.	—	△*3	This function can be used on GX Works2.
Error log function	Stores the errors and alarms occurred in the A/D converter module to the buffer memory as a history. Up to 16 errors and alarms can be stored.	—	○	This function can be used on GX Works2.
Module error collection function	Collects the errors and alarms occurred in the A/D converter module and stores them in the CPU module.	—	○	
Error clear function	Clears the error from the system monitor window of the programming tool.	—	○	This function can be used on GX Works2.
Saving and restoring offset/gain values	Saves and restores the offset/gain values in the user setting range.	—	○	

- *1 For the A1S68AD, the resolution is 1/4000 (fixed).
For the L60ADVL8 or L60ADIL8, the resolution is fixed by each analog input range. To use the same digital value that is used for the A1S68AD, set the scaling upper and lower limit values that match the resolution of the A1S68AD using the scaling function.
- *2 When the shift function, digital clipping function, or difference conversion function with the L60ADVL8 or L60ADIL8, use function blocks (FBs).
For function blocks, refer to the following. (SH-080899ENG)
MELSEC-L Analog-Digital Converter Module User's Manual
- *3 When the logging function is used with the L60ADVL8 or L60ADIL8, use the data logging function of a CPU module. For the function of the CPU module, refer to the following.
QnUDVCPULCPU User's Manual (Data Logging Function) (SH-080893ENG)

2.4.3 I/O signal comparison

Sequence programs need to be changed because the I/O signal assignment differs.

For details of the I/O signals and sequence programs, refer to the MELSEC-L Analog-Digital Converter Module User's Manual.

A1S68AD				L60ADVL8/L60ADIL8			
Device No.	Signal name	Device No.	Signal name	Device No.	Signal name	Device No.	Signal name
X0	Watchdog timer error flag	Y0	Use prohibited	X0	Module READY	Y0	Use prohibited
X1	A/D conversion READY	Y1		X1	Use prohibited	Y1	
X2	Error flag	Y2		X2		Y2	
X3	Use prohibited	Y3		X3		Y3	
X4		Y4		X4		Y4	
X5		Y5		X5		Y5	
X6		Y6		X6		Y6	
X7		Y7		X7		Y7	
X8		Y8		X8	Warning output signal	Y8	
X9		Y9		X9	Operating condition setting completed flag	Y9	Operating condition setting request
XA		YA		XA	Offset/gain setting mode flag	YA	User range write request
XB		YB		XB	Channel change completed flag	YB	Channel change request
XC		YC		XC	Input signal error detection signal	YC	Use prohibited
XD		YD		XD	Maximum value/minimum value reset completed flag	YD	Maximum value/minimum value reset request
XE		YE		XE	A/D conversion completed flag	YE	Use prohibited
XF		YF		XF	Error flag	YF	Error clear request
X10		Y10					
X11		Y11					
X12		Y12		Y12	Error reset		
X13	Y13						
X14	Y14						
X15	Y15						
X16	Y16						
X17	Y17						
X18	Y18						
X19	Y19	Y19	Use prohibited				
X1A	Y1A						
X1B	Y1B						
X1C	Y1C						
X1D	Y1D						
X1E	Y1E						
X1F	Y1F						

2.4.4 Buffer memory address comparison

Sequence programs need to be changed because the buffer memory address assignment differs. For details of the buffer memory areas and sequence programs, refer to the MELSEC-L Analog-Digital Converter Module User's Manual.

A1S68AD			L60ADVL8/L60ADIL8		
Address (decimal)	Name	Read/write	Address (decimal)	Name	Read/write
0	A-D conversion enable/disable	R/W	0	A/D conversion enable/disable setting	
1	Write data error code	R	1	CH1 Time Average/ Count Average/Moving Average	R/W
2	Average processing specification	R/W	2	CH2 Time Average/ Count Average/Moving Average	
3	System area (Use prohibited)	-	3	CH3 Time Average/ Count Average/Moving Average	
4			4	CH4 Time Average/ Count Average/Moving Average	
5			5	CH5 Time Average/ Count Average/Moving Average	
6			6	CH6 Time Average/ Count Average/Moving Average	
7			7	CH7 Time Average/ Count Average/Moving Average	
8			8	CH8 Time Average/ Count Average/Moving Average	
9			9	Averaging process setting (The setting is not required when the A1S68AD is replaced.)	-
10	CH1 Average time, count	R/W	10	A/D conversion completed flag	R
11	CH2 Average time, count		11	CH1 Digital output value	
12	CH3 Average time, count		12	CH2 Digital output value	
13	CH4 Average time, count		13	CH3 Digital output value	
14	CH5 Average time, count		14	CH4 Digital output value	
15	CH6 Average time, count		15	CH5 Digital output value	
16	CH7 Average time, count		16	CH6 Digital output value	
17	CH8 Average time, count		17	CH7 Digital output value	
18	System area (Use prohibited)	-	18	CH8 Digital output value	R/W
19			19	Latest error code	
20	CH1 Digital output value	R	20	Setting range (CH1 to CH4)	
21	CH2 Digital output value		21	Setting range (CH5 to CH8)	
22	CH3 Digital output value		22	Offset/gain setting mode Offset specification	
23	CH4 Digital output value		23	Offset/gain setting mode Gain specification	
24	CH5 Digital output value		24	Averaging process setting (CH1 to CH4)	
25	CH6 Digital output value		25	Averaging process setting (CH5 to CH8)	
26	CH7 Digital output value		26	System area	-
27	CH8 Digital output value			27	Input signal error detection extension setting (CH1 to CH4)
28	A/D conversion completed flag	R/W	28	Input signal error detection extension setting (CH5 to CH8)	
29	System area (Use prohibited)	-	29	System area	-
			30	CH1 Maximum value	R
			31	CH1 Minimum value	
			32	CH2 Maximum value	
			33	CH2 Minimum value	
			34	CH3 Maximum value	
			35	CH3 Minimum value	
			36	CH4 Maximum value	
			37	CH4 Minimum value	
			38	CH5 Maximum value	
			39	CH5 Minimum value	
			40	CH6 Maximum value	
			41	CH6 Minimum value	
			42	CH7 Maximum value	
			43	CH7 Minimum value	
			44	CH8 Maximum value	
			45	CH8 Minimum value	
			46	System area	-
			47	Input signal error detection setting	R/W
			48	Warning output setting	

L60ADVL8/L60ADIL8		
Address (decimal)	Name	Read/write
49	Input signal error detection flag	R
50	Warning output flag (Process alarm)	
51	System area	-
52		
53	Scaling enable/disable setting	R/W
54	CH1 Scaling value (digital operation value)	R
55	CH2 Scaling value (digital operation value)	
56	CH3 Scaling value (digital operation value)	
57	CH4 Scaling value (digital operation value)	
58	CH5 Scaling value (digital operation value)	
59	CH6 Scaling value (digital operation value)	
60	CH7 Scaling value (digital operation value)	
61	CH8 Scaling value (digital operation value)	
62	CH1 Scaling lower limit value	R/W
63	CH1 Scaling upper limit value	
64	CH2 Scaling lower limit value	
65	CH2 Scaling upper limit value	
66	CH3 Scaling lower limit value	
67	CH3 Scaling upper limit value	
68	CH4 Scaling lower limit value	
69	CH4 Scaling upper limit value	
70	CH5 Scaling lower limit value	
71	CH5 Scaling upper limit value	
72	CH6 Scaling lower limit value	
73	CH6 Scaling upper limit value	
74	CH7 Scaling lower limit value	
75	CH7 Scaling upper limit value	
76	CH8 Scaling lower limit value	
77	CH8 Scaling upper limit value	
78	System area	-
85		
86	CH1 Process alarm lower lower limit value	R/W
87	CH1 Process alarm lower upper limit value	
88	CH1 Process alarm upper lower limit value	
89	CH1 Process alarm upper upper limit value	
90	CH2 Process alarm lower lower limit value	
91	CH2 Process alarm lower upper limit value	
92	CH2 Process alarm upper lower limit value	
93	CH2 Process alarm upper upper limit value	
94	CH3 Process alarm lower lower limit value	
95	CH3 Process alarm lower upper limit value	
96	CH3 Process alarm upper lower limit value	
97	CH3 Process alarm upper upper limit value	
98	CH4 Process alarm lower lower limit value	
99	CH4 Process alarm lower upper limit value	
100	CH4 Process alarm upper lower limit value	
101	CH4 Process alarm upper upper limit value	
102	CH5 Process alarm lower lower limit value	
103	CH5 Process alarm lower upper limit value	
104	CH5 Process alarm upper lower limit value	
105	CH5 Process alarm upper upper limit value	
106	CH6 Process alarm lower lower limit value	
107	CH6 Process alarm lower upper limit value	
108	CH6 Process alarm upper lower limit value	
109	CH6 Process alarm upper upper limit value	
110	CH7 Process alarm lower lower limit value	
111	CH7 Process alarm lower upper limit value	
112	CH7 Process alarm upper lower limit value	
113	CH7 Process alarm upper upper limit value	
114	CH8 Process alarm lower lower limit value	
115	CH8 Process alarm lower upper limit value	

L60ADVL8/L60ADIL8		
Address (decimal)	Name	Read/write
116	CH8 Process alarm upper lower limit value	R/W
117	CH8 Process alarm upper upper limit value	
118	System area	-
to		
141		
142	CH1 Input signal error detection setting value	R/W
143	CH2 Input signal error detection setting value	
144	CH3 Input signal error detection setting value	
145	CH4 Input signal error detection setting value	
146	CH5 Input signal error detection setting value	
147	CH6 Input signal error detection setting value	
148	CH7 Input signal error detection setting value	
149	CH8 Input signal error detection setting value	
150	System area	-
to		
157		
158	Mode switching setting	R/W
159		
160	System area (use prohibited)	-
to		
201		
202	CH1 Industrial shipment settings offset value	R/W
203	CH1 Industrial shipment settings gain value	
204	CH2 Industrial shipment settings offset value	
205	CH2 Industrial shipment settings gain value	
206	CH3 Industrial shipment settings offset value	
207	CH3 Industrial shipment settings gain value	
208	CH4 Industrial shipment settings offset value	
209	CH4 Industrial shipment settings gain value	
210	CH5 Industrial shipment settings offset value	
211	CH5 Industrial shipment settings gain value	
212	CH6 Industrial shipment settings offset value	
213	CH6 Industrial shipment settings gain value	
214	CH7 Industrial shipment settings offset value	
215	CH7 Industrial shipment settings gain value	
216	CH8 Industrial shipment settings offset value	
217	CH8 Industrial shipment settings gain value	
218	CH1 User range settings offset value	
219	CH1 User range settings gain value	
220	CH2 User range settings offset value	
221	CH2 User range settings gain value	
222	CH3 User range settings offset value	
223	CH3 User range settings gain value	
224	CH4 User range settings offset value	
225	CH4 User range settings gain value	
226	CH5 User range settings offset value	
227	CH5 User range settings gain value	
228	CH6 User range settings offset value	
229	CH6 User range settings gain value	
230	CH7 User range settings offset value	
231	CH7 User range settings gain value	
232	CH8 User range settings offset value	
233	CH8 User range settings gain value	
234	System area	-
to		
1699		
1700	CH1 A/D conversion status	R
1701	CH2 A/D conversion status	
1702	CH3 A/D conversion status	
1703	CH4 A/D conversion status	
1704	CH5 A/D conversion status	
1705	CH6 A/D conversion status	
1706	CH7 A/D conversion status	

L60ADVL8/L60ADIL8		
Address (decimal)	Name	Read/write
1707	CH8 A/D conversion status	R
1708	System area	-
1709		
1710	CH1 Analog input monitor	R
1711	CH1 Analog input monitor unit	
1712	CH2 Analog input monitor	
1713	CH2 Analog input monitor unit	
1714	CH3 Analog input monitor	
1715	CH3 Analog input monitor unit	
1716	CH4 Analog input monitor	
1717	CH4 Analog input monitor unit	
1718	CH5 Analog input monitor	
1719	CH5 Analog input monitor unit	
1720	CH6 Analog input monitor	
1721	CH6 Analog input monitor unit	
1722	CH7 Analog input monitor	
1723	CH7 Analog input monitor unit	
1724	CH8 Analog input monitor	
1725	CH8 Analog input monitor unit	
1726	System area	-
to		
1799		

3 ANALOG OUTPUT MODULE REPLACEMENT

3.1 List of Analog Output Module Alternative Models for Replacement

AnS/QnAS series		Transition to L series	
Product	Model	Model	Remarks (Restrictions)
Analog output module	A1S62DA	L60DA4	1) External wiring: Cable size is changed. 2) Number of slots: Not changed 3) Program: The number of occupied I/O points, I/O signals, resolution, and buffer memory addresses are changed. 4) Performance specifications: Changed. Four channels per module and an external power supply (24VDC) are required. 5) Functional specifications: Not changed
		L60DA4	1) External wiring: Cable size is changed. 2) Number of slots: Changed (Two modules are required.) 3) Program: The number of occupied I/O points, I/O signals, resolution, and buffer memory addresses are changed. 4) Performance specifications: Changed. Four channels per module and an external power supply (24VDC) are required. 5) Functional specifications: Not changed
	A1S68DAI	L60DA4	1) External wiring: Cable size is changed. 2) Number of slots: Changed (1 → 2) 3) Program: The number of occupied I/O points, I/O signals, resolution, and buffer memory addresses are changed. 4) Performance specifications: An external power supply (24VDC) is required. 5) Functional specifications: Not changed
		L60DAI8	1) External wiring: Cable size is changed. 2) Number of slots: Changed (Two modules are required.) 3) Program: The number of occupied I/O points, I/O signals, and buffer memory addresses are changed. 4) Performance specifications: Changed. Four channels per module and an external power supply (24VDC) are required. 5) Functional specifications: Not changed
	A1S68DAV	L60DA4	1) External wiring: Cable size is changed. 2) Number of slots: Changed (1 → 2) 3) Program: The number of occupied I/O points, I/O signals, resolution, and buffer memory addresses are changed. 4) Performance specifications: An external power supply (24VDC) is required. 5) Functional specifications: Not changed
		L60DAVL8	1) External wiring: Cable size is changed. 2) Number of slots: Changed (1 → 2) 3) Program: The number of occupied I/O points, I/O signals, resolution, and buffer memory addresses are changed. 4) Performance specifications: An external power supply (24VDC) is required. 5) Functional specifications: Not changed

☒ Point

The upgrade tool (conversion adapter) manufactured by Mitsubishi Electric Engineering Co., Ltd. enables to connect the existing wiring that was connected to the A1S62DA to L series modules without change.

Product	Existing module model	Alternative module model	Conversion adapter model*1	Space module LG69*1
Analog output module	A1S62DA	L60DA4	ERNT-ASLT62DA	Available

*1 For details on the conversion adapter or LG69, refer to the Transition from MELSEC-AnS/QnAS (Small Type) Series to L Series Handbook (Fundamentals)

3.2 A1S62DA

3.2.1 Performance specifications comparison

Item	A1S62DA																																		
Digital input	1/4000 setting: voltage: -4000 to 4000, current: 0 to 4000 1/8000 setting: voltage: -8000 to 8000, current: 0 to 8000 1/12000 setting: voltage: -12000 to 12000, current: 0 to 12000																																		
Analog output	Voltage: -10 to 0 to +10VDC (External load resistance value: 2KΩ to 1MΩ) Current: 0 to 20mA (External load resistance value: 0 to 600Ω)																																		
I/O characteristics	<table border="1"> <thead> <tr> <th rowspan="2"></th> <th colspan="3">Resolution</th> <th rowspan="2">Voltage output value*1</th> <th rowspan="2">Current output value*2</th> </tr> <tr> <th>1/4000</th> <th>1/8000</th> <th>1/12000</th> </tr> </thead> <tbody> <tr> <td rowspan="5">Digital input value</td> <td>4000</td> <td>8000</td> <td>12000</td> <td>10V</td> <td>20mA</td> </tr> <tr> <td>2000</td> <td>4000</td> <td>6000</td> <td>5V</td> <td>12mA</td> </tr> <tr> <td>0</td> <td>0</td> <td>0</td> <td>0</td> <td>4mA</td> </tr> <tr> <td>-2000</td> <td>-4000</td> <td>-6000</td> <td>-5V</td> <td rowspan="2">-</td> </tr> <tr> <td>-4000</td> <td>-8000</td> <td>-12000</td> <td>-10V</td> </tr> </tbody> </table> <p>*1 The offset value is set to 0V and the gain value is set to 10V (factory default setting). *2 The offset value is set to 4mA and the gain value is set to 20mA.</p>		Resolution			Voltage output value*1	Current output value*2	1/4000	1/8000	1/12000	Digital input value	4000	8000	12000	10V	20mA	2000	4000	6000	5V	12mA	0	0	0	0	4mA	-2000	-4000	-6000	-5V	-	-4000	-8000	-12000	-10V
	Resolution			Voltage output value*1	Current output value*2																														
	1/4000	1/8000	1/12000																																
Digital input value	4000	8000	12000	10V	20mA																														
	2000	4000	6000	5V	12mA																														
	0	0	0	0	4mA																														
	-2000	-4000	-6000	-5V	-																														
	-4000	-8000	-12000	-10V																															
Maximum resolution	<table> <tbody> <tr> <td>1/4000</td> <td>2.5mV (10V)</td> <td>5μA (20mA)</td> </tr> <tr> <td>1/8000</td> <td>1.25mV (10V)</td> <td>2.5μA (20mA)</td> </tr> <tr> <td>1/12000</td> <td>0.83mV (10V)</td> <td>1.7μA (20mA)</td> </tr> </tbody> </table>	1/4000	2.5mV (10V)	5μA (20mA)	1/8000	1.25mV (10V)	2.5μA (20mA)	1/12000	0.83mV (10V)	1.7μA (20mA)																									
1/4000	2.5mV (10V)	5μA (20mA)																																	
1/8000	1.25mV (10V)	2.5μA (20mA)																																	
1/12000	0.83mV (10V)	1.7μA (20mA)																																	
Overall accuracy (Accuracy for the maximum analog output value)	±1% (voltage: ±100mV, current: ±200μA)																																		
Maximum conversion speed	Within 25ms/2 channels (same for 1 channel)																																		
Absolute maximum output	Voltage: ±12V Current: +28mA																																		
Number of analog output channels	2 channels/module																																		
Number of offset/gain settings	-																																		
Output short protection	Available																																		

○ : Compatible, △ : Partial change required, × : Incompatible

	L60DA4	Compatibility	Precautions for replacement																							
	16-bit signed binary (-20480 to 20479, When the scaling function is used: -32768 to 32767)	○	Since the resolution differs between AnS series and L series modules, it needs to be matched using a sequence program, user range settings, or the scaling function. (Refer to Appendix 4.)																							
	Voltage: -10 to 10VDC (External load resistance value: 1KΩ to 1MΩ) Current: 0 to 20mA (External load resistance value: 0 to 600Ω)	○																								
	<table border="1"> <thead> <tr> <th>Analog output range</th> <th>Digital value</th> <th>Maximum resolution</th> </tr> </thead> <tbody> <tr> <td rowspan="4">Voltage</td> <td rowspan="2">0 to 20000</td> <td>0 to 5V</td> <td>250μV</td> </tr> <tr> <td>1 to 5V</td> <td>200μV</td> </tr> <tr> <td rowspan="2">-20000 to 20000</td> <td>-10 to 10V</td> <td>500μV</td> </tr> <tr> <td>User range settings</td> <td>333μV</td> </tr> <tr> <td rowspan="3">Current</td> <td rowspan="2">0 to 20000</td> <td>0 to 20mA</td> <td>1000nA</td> </tr> <tr> <td>4 to 20mA</td> <td>800nA</td> </tr> <tr> <td>User range settings</td> <td>-20000 to 20000</td> <td>700nA</td> </tr> </tbody> </table>	Analog output range	Digital value	Maximum resolution	Voltage	0 to 20000	0 to 5V	250μV	1 to 5V	200μV	-20000 to 20000	-10 to 10V	500μV	User range settings	333μV	Current	0 to 20000	0 to 20mA	1000nA	4 to 20mA	800nA	User range settings	-20000 to 20000	700nA	△	Since the resolution differs between AnS series and L series modules, it needs to be matched using a sequence program, user range settings, or the scaling function. (Refer to Appendix 4.)
Analog output range	Digital value	Maximum resolution																								
Voltage	0 to 20000	0 to 5V	250μV																							
		1 to 5V	200μV																							
	-20000 to 20000	-10 to 10V	500μV																							
		User range settings	333μV																							
Current	0 to 20000	0 to 20mA	1000nA																							
		4 to 20mA	800nA																							
	User range settings	-20000 to 20000	700nA																							
	Ambient temperature 25±5°C: within ±0.1% (voltage: ±10mV, current: ±20μA) Ambient temperature 0 to 55°C: within ±0.3% (voltage: ±30mV, current: ±60μA)	○																								
	20μs/channel	○																								
	-	○																								
	4 channels/module	○																								
	Up to 50000 times	○																								
	Available	○																								

Item		A1S62DA
Insulation method		Between the output terminal and programmable controller power supply: Photocoupler Between channels: Not insulated
Dielectric withstand voltage		-
Insulation resistance		-
Number of occupied I/O points		32 points (I/O assignment: special 32 points)
External interface		20-point terminal block
Applicable wire size		0.75 to 1.5mm ²
Applicable solderless terminal		1.25-3, 1.25-YS3A, V1.25-3, V1.25-YS3A
Internal current consumption (5VDC)		0.80A
External power supply	Voltage	-
	Current consumption	
	Inrush current	
Weight		0.32kg

○ : Compatible, △ : Partial change required, × : Incompatible

	L60DA4	Compatibility	Precautions for replacement
	Between the I/O terminal and programmable controller power supply: Photocoupler Between output channels: Not insulated Between external power supply and analog output: Transformer	○	
	Between the I/O terminal and programmable controller power supply: 500VACrms, for 1 minute Between external power supply and analog output: 500VACrms, for 1 minute	○	
	Between the I/O terminal and programmable controller power supply: 500VDC, 10MΩ or higher	○	
	16 points (I/O assignment: intelligent 16 points)	△	The number of occupied I/O points is changed to 16 points.
	18-point terminal block	×	Wiring change is required.
	0.3 to 0.75mm ²	×	
	R1.25-3 (Solderless terminals with an insulation sleeve cannot be used.)	×	
	0.16A	○	
	24VDC +20%, -15% Ripple, spike 500mV _{P-P} or lower	×	An external power supply (24VDC) is required.
	0.18A	×	
	4.3A, 1000μs or less	×	
	0.20kg	△	

3.2.2 Functional comparison

○ : Available, – : Not available

Item	Description	A1S62DA	L60DA4	Precautions for replacement																
D/A conversion enable/disable function	Sets whether to enable or disable D/A conversion for each channel.	○	○	With the L60DA4, disabling the D/A conversion for an unused channel reduces the conversion cycles.																
D/A output enable/disable function	Sets whether to output the D/A conversion value or the offset value for each channel. The conversion speed is constant, regardless of the output enable/disable status.	○	○																	
Range switching function	Sets the output range to be used.	–	○																	
Offset/gain setting function	Corrects errors in analog output values.	○	○																	
Analog output HOLD/CLEAR function	Sets the status of analog output values (HOLD or CLEAR), according to the CPU module operating status (RUN, STOP, or stop error).	○	○	The A1S62DA is set the status for all channels at once using the HLD/CLR terminal on the front of the module. With the L60DA4, HOLD/CLEAR can be set for each channel.																
Analog output test when CPU module is in STOP status	Outputs the converted analog values when CH□ Output enable/disable flag is forcibly turned on while the CPU module is in the STOP status. <table border="1" style="width: 100%; border-collapse: collapse;"> <thead> <tr> <th rowspan="2">Setting combination</th> <th rowspan="2">D/A conversion enable/disable CH□ Output enable/disable flag</th> <th colspan="2">Enable</th> <th colspan="2">Disable</th> </tr> <tr> <th>Enable</th> <th>Disable</th> <th>Enable</th> <th>Disable</th> </tr> </thead> <tbody> <tr> <td colspan="2" style="text-align: center;">Analog output test</td> <td style="text-align: center;">Allowed</td> <td style="text-align: center;">Not allowed</td> <td colspan="2" style="text-align: center;">Not allowed</td> </tr> </tbody> </table>	Setting combination	D/A conversion enable/disable CH□ Output enable/disable flag	Enable		Disable		Enable	Disable	Enable	Disable	Analog output test		Allowed	Not allowed	Not allowed		–	○	
Setting combination	D/A conversion enable/disable CH□ Output enable/disable flag			Enable		Disable														
		Enable	Disable	Enable	Disable															
Analog output test		Allowed	Not allowed	Not allowed																
Resolution mode	Sets the resolution according to the application.*1	○	–	Since the resolution differs between AnS series and L series modules, it needs to be matched using a sequence program, user range settings, or the scaling function. (Refer to Appendix 4.)																
Scaling function	Scale-converts the input digital value to the set range of the scaling upper limit value and scaling lower limit value. This omits the programming of the scale conversion.	–	○	By setting the same scaling upper limits and scaling lower limits as the resolution of A1S62DA, the same digital output values as A1S62DA can be used.																
Alarm output function	Outputs an alarm when the digital value is out of the preset range.	–	○																	
Wave output function	Registers the prepared wave data (digital value) into the D/A converter module and continuously outputs the data (analog value) in the set conversion cycle.	–	○	This function can be used on the GX Works2. Only the L60DA4 with a serial number (first five digits) 14041 or later supports this function.																
External power supply READY flag	Turns on when the external power supply (24VDC) is supplied. When this flag is off, the analog output value becomes 0V/0mA regardless of other settings.	–	○																	
Error log function	Stores the errors and alarms occurred in the D/A converter module to the buffer memory as a history. Up to 16 errors and alarms can be stored.	–	○																	
Module error collection function	Collects the errors and alarms occurred in the D/A converter module and stores them in the CPU module.	–	○																	
Error clear function	Clears the error from the system monitor window of the programming tool.	–	○	This function can be used on the GX Works2.																
Saving and restoring offset/gain values	Saves and restores the offset/gain values in the user setting range.	–	○																	

*1 For the A1S62DA, the resolution setting can be selected from 1/4000, 1/8000, and 1/12000 for both voltage and current inputs.

The L60DA4, however, does not support the resolution mode. To use the same digital value that is used for the A1S62DA, set the scaling upper and lower limit values that match the resolution of the A1S62DA using the scaling function.

3.2.3 I/O signal comparison

Sequence programs need to be changed because the I/O signal assignment differs.

For details of the I/O signals and sequence programs, refer to the MELSEC-L Digital-Analog Converter Module User's Manual.

A1S62DA				L60DA4					
Device No.	Signal name	Device No.	Signal name	Device No.	Signal name	Device No.	Signal name		
X0	WDT error flag (A1S62DA detection)	Y0	Use prohibited	X0	Module ready	Y0	Use prohibited		
X1	D-A conversion READY	Y1		X1	Use prohibited	Y1	CH1 Output enable/disable flag		
X2	Error flag	Y2		X2		Y2	CH2 Output enable/disable flag		
X3	Use prohibited	Y3		X3		Y3	CH3 Output enable/disable flag		
X4		Y4		X4		Y4	CH4 Output enable/disable flag		
X5		Y5		X5	Y5	Use prohibited			
X6		Y6		X6	Y6				
X7		Y7		X7	External power supply READY flag	Y7	Use prohibited		
X8		Y8		X8	Use prohibited	Y8			
X9		Y9		X9	Operating condition setting completed flag	Y9	Operating condition setting request		
XA		YA		XA	Offset/gain setting mode flag	YA	User range writing request		
XB		YB		XB	Channel change completed flag	YB	Channel change request		
XC		YC		XC	Set value change completed flag	YC	Set value change request		
XD		YD		XD	Use prohibited	YD	Use prohibited		
XE		Use prohibited		YE	XE	Warning output signal	YE	Warning output clear request	
XF				YF	XF	Error flag	YF	Error clear request	
X10		Use prohibited		Y10	CH1 D-A conversion output enable flag				
X11				Y11	CH2 D-A conversion output enable flag				
X12				Y12	Use prohibited				
X13	Y13								
X14	Y14								
X15	Y15								
X16	Y16								
X17	Y17		Error reset						
X18	Y18								
X19	Y19		Use prohibited						
X1A	Y1A								
X1B	Y1B								
X1C	Y1C								
X1D	Y1D								
X1E	Y1E								
X1F	Y1F								

3.2.4 Buffer memory address comparison

Sequence programs need to be changed because the buffer memory address assignment differs. For details of the buffer memory areas and sequence programs, refer to the MELSEC-L Digital-Analog Converter Module User's Manual.

A1S62DA			L60DA4		
Address (decimal)	Name	Read/write	Address (decimal)	Name	Read/write
0	Analog output enable/disable channel	R/W	0	D/A conversion enable/disable setting	R/W
1	CH1 digital value		1	CH1 Digital value	
2	CH2 digital value		2	CH2 Digital value	
3	System area (Use prohibited)	-	3	CH3 Digital value	
4			4	CH4 Digital value	
5			System area (Use prohibited)	-	
6					
7					
8	R/W	9	Output mode	R	
9		Resolution of digital value	10	System area (Use prohibited)	-
10		CH1 set value check code	11	CH1 Set value check code	R
11	CH2 set value check code	12	CH2 Set value check code		
12	System area (Use prohibited)	-	13	CH3 Set value check code	
13			14	CH4 Set value check code	
14			System area (Use prohibited)	-	
15					
16					
17	R	19	Latest error code	R	
18		20	Setting range (CH1 to CH4)	-	
19		21	System area (Use prohibited)		
20	R/W	22	Offset/gain setting mode: Offset specification	R/W	
21		23	Offset/gain setting mode: Gain specification		
22		24	Offset/gain adjustment value specification		
23	-	25	System area (Use prohibited)		
24		26	HOLD/CLEAR function setting (CH1 to CH4)	R	
25		27	System area (Use prohibited)	-	
26	46				
27	R/W	47	Warning output setting	R/W	
28		48	Warning output flag	R	
29	-	49	System area (Use prohibited)	-	
30					
31					
32	R/W	53	Scaling enable/disable setting	R/W	
33		54	CH1 Scaling lower limit value		
34		55	CH1 Scaling upper limit value		
35		56	CH2 Scaling lower limit value		
36		57	CH2 Scaling upper limit value		
37		58	CH3 Scaling lower limit value		
38		59	CH3 Scaling upper limit value		
39		60	CH4 Scaling lower limit value		
40	61	CH4 Scaling upper limit value			
41	-	62	System area (Use prohibited)	-	
42					
43					
44	-	85	System area (Use prohibited)	-	
45					
46					

L60DA4		
Address (decimal)	Name	Read/write
86	CH1 Warning output upper limit value	R/W
87	CH1 Warning output lower limit value	
88	CH2 Warning output upper limit value	
89	CH2 Warning output lower limit value	
90	CH3 Warning output upper limit value	
91	CH3 Warning output lower limit value	
92	CH4 Warning output upper limit value	
93	CH4 Warning output lower limit value	
94	System area (Use prohibited)	-
to		
157		
158	Mode switching setting	R/W
159		
160	System area (Use prohibited)	-
to		
199		
200	Pass data classification setting	R/W
201	System area (Use prohibited)	-
202	CH1 Industrial shipment settings offset value	R/W
203	CH1 Industrial shipment settings gain value	
204	CH2 Industrial shipment settings offset value	
205	CH2 Industrial shipment settings gain value	
206	CH3 Industrial shipment settings offset value	
207	CH3 Industrial shipment settings gain value	
208	CH4 Industrial shipment settings offset value	
209	CH4 Industrial shipment settings gain value	
210	CH1 User range settings offset value	
211	CH1 User range settings gain value	
212	CH2 User range settings offset value	
213	CH2 User range settings gain value	
214	CH3 User range settings offset value	
215	CH3 User range settings gain value	
216	CH4 User range settings offset value	
217	CH4 User range settings gain value	
218	System area (Use prohibited)	-
to		
999		
1000	CH1 Wave output start/stop request	R/W
1001	CH2 Wave output start/stop request	
1002	CH3 Wave output start/stop request	
1003	CH4 Wave output start/stop request	
1004	System area (Use prohibited)	-
to		
1007		
1008	CH1 Output setting during wave output stop	R/W
1009	CH2 Output setting during wave output stop	
1010	CH3 Output setting during wave output stop	
1011	CH4 Output setting during wave output stop	
1012	System area (Use prohibited)	-
to		
1015		

L60DA4		
Address (decimal)	Name	Read/write
1016	CH1 Output value during wave output stop	R/W
1017	CH2 Output value during wave output stop	
1018	CH3 Output value during wave output stop	
1019	CH4 Output value during wave output stop	
1020 to 1023	System area (Use prohibited)	-
1024	CH1 Wave pattern start address setting (L)	R/W
1025	CH1 Wave pattern start address setting (H)	
1026	CH2 Wave pattern start address setting (L)	
1027	CH2 Wave pattern start address setting (H)	
1028	CH3 Wave pattern start address setting (L)	
1029	CH3 Wave pattern start address setting (H)	
1030	CH4 Wave pattern start address setting (L)	
1031	CH4 Wave pattern start address setting (H)	
1032 to 1039	System area (Use prohibited)	-
1040	CH1 Wave pattern data points setting (L)	R/W
1041	CH1 Wave pattern data points setting (H)	
1042	CH2 Wave pattern data points setting (L)	
1043	CH2 Wave pattern data points setting (H)	
1044	CH3 Wave pattern data points setting (L)	
1045	CH3 Wave pattern data points setting (H)	
1046	CH4 Wave pattern data points setting (L)	
1047	CH4 Wave pattern data points setting (H)	
1048 to 1055	System area (Use prohibited)	-
1056	CH1 Wave pattern output repetition setting	R/W
1057	CH2 Wave pattern output repetition setting	
1058	CH3 Wave pattern output repetition setting	
1059	CH4 Wave pattern output repetition setting	
1060 to 1063	System area (Use prohibited)	-
1064	CH1 Constant for wave output conversion cycle	R/W
1065	CH2 Constant for wave output conversion cycle	
1066	CH3 Constant for wave output conversion cycle	
1067	CH4 Constant for wave output conversion cycle	
1068 to 1071	System area (Use prohibited)	-
1072	Step action wave output request	R/W
1073 to 1079	System area (Use prohibited)	-

L60DA4		
Address (decimal)	Name	Read/write
1080	CH1 Wave output step action movement amount	R/W
1081	CH2 Wave output step action movement amount	
1082	CH3 Wave output step action movement amount	
1083	CH4 Wave output step action movement amount	
1084 to 1099	System area (Use prohibited)	-
1100	CH1 Wave output status monitor	R
1101	CH2 Wave output status monitor	
1102	CH3 Wave output status monitor	
1103	CH4 Wave output status monitor	
1104 to 1107	System area (Use prohibited)	-
1108	CH1 Wave output conversion cycle monitor (L)	R
1109	CH1 Wave output conversion cycle monitor (H)	
1110	CH2 Wave output conversion cycle monitor (L)	
1111	CH2 Wave output conversion cycle monitor (H)	
1112	CH3 Wave output conversion cycle monitor (L)	
1113	CH3 Wave output conversion cycle monitor (H)	
1114	CH4 Wave output conversion cycle monitor (L)	
1115	CH4 Wave output conversion cycle monitor (H)	
1116 to 1123	System area (Use prohibited)	-
1124	CH1 Wave pattern output count monitor	R
1125	CH2 Wave pattern output count monitor	
1126	CH3 Wave pattern output count monitor	
1127	CH4 Wave pattern output count monitor	
1128 to 1131	System area (Use prohibited)	-

L60DA4		
Address (decimal)	Name	Read/write
1132	CH1 Wave output current address monitor (L)	R
1133	CH1 Wave output current address monitor (H)	
1134	CH2 Wave output current address monitor (L)	
1135	CH2 Wave output current address monitor (H)	
1136	CH3 Wave output current address monitor (L)	
1137	CH3 Wave output current address monitor (H)	
1138	CH4 Wave output current address monitor (L)	
1139	CH4 Wave output current address monitor (H)	
1140	System area (Use prohibited)	-
to		
1147		
1148	CH1 Wave output current digital value monitor	R
1149	CH2 Wave output current digital value monitor	
1150	CH3 Wave output current digital value monitor	
1151	CH4 Wave output current digital value monitor	
1152	System area (Use prohibited)	-
to		
1155		
1156	CH1 Wave output digital value outside the range Address monitor (L)	R
1157	CH1 Wave output digital value outside the range Address monitor (H)	
1158	CH2 Wave output digital value outside the range Address monitor (L)	
1159	CH2 Wave output digital value outside the range Address monitor (H)	
1160	CH3 Wave output digital value outside the range Address monitor (L)	
1161	CH3 Wave output digital value outside the range Address monitor (H)	
1162	CH4 Wave output digital value outside the range Address monitor (L)	
1163	CH4 Wave output digital value outside the range Address monitor (H)	
1164	System area (Use prohibited)	-
to		
1171		

L60DA4		
Address (decimal)	Name	Read/write
1172	CH1 Wave output warning Address monitor (L)	R
1173	CH1 Wave output warning Address monitor (H)	
1174	CH2 Wave output warning Address monitor (L)	
1175	CH2 Wave output warning Address monitor (H)	
1176	CH3 Wave output warning Address monitor (L)	
1177	CH3 Wave output warning Address monitor (H)	
1178	CH4 Wave output warning Address monitor (L)	
1179	CH4 Wave output warning Address monitor (H)	
1180	System area (Use prohibited)	
to		
1799		

3.3 A1S68DAI (Alternative Model: L60DA4)

3.3.1 Performance specifications comparison

Item	A1S68DAI									
Digital input	16-bit signed binary Setting range: 0 to 4096									
Analog output	4 to 20mA (External load resistance value: 0 to 600Ω)									
I/O characteristics	<table border="1"> <thead> <tr> <th>Digital input value</th> <th>Analog output</th> </tr> </thead> <tbody> <tr> <td>4000</td> <td>20mA</td> </tr> <tr> <td>2000</td> <td>12mA</td> </tr> <tr> <td>0</td> <td>4mA</td> </tr> </tbody> </table>	Digital input value	Analog output	4000	20mA	2000	12mA	0	4mA	
Digital input value	Analog output									
4000	20mA									
2000	12mA									
0	4mA									
Maximum resolution of analog value	4μA									
Overall accuracy (accuracy at maximum analog output value)	±1.0% (±200μA)									
Maximum conversion speed	Within 4ms/8 channels If the access from the CPU module using the FROM/TO instructions is frequent, the speed may be increased for 6ms.									
Number of analog output channels	8 channels/module									
Number of offset/gain settings	-									
Output short protection	Available									

○: Compatible, △: Partial change required, ×: Incompatible

	L60DA4	Compatibility	Precautions for replacement																								
	16-bit signed binary (-20480 to 20479, When the scaling function is used: -32768 to 32767)	○	Since the resolution differs between AnS series and L series modules, it needs to be matched using a sequence program, user range settings, or the scaling function. (Refer to Appendix 4.)																								
	Voltage: -10 to 10VDC (External load resistance value: 1KΩ to 1MΩ) Current: 0 to 20mA (External load resistance value: 0 to 600Ω)	○																									
	<table border="1"> <thead> <tr> <th colspan="2">Analog output range</th> <th>Digital value</th> <th>Maximum resolution</th> </tr> </thead> <tbody> <tr> <td rowspan="4">Voltage</td> <td>0 to 5V</td> <td rowspan="2">0 to 20000</td> <td>250μV</td> </tr> <tr> <td>1 to 5V</td> <td>200μV</td> </tr> <tr> <td>-10 to 10V</td> <td rowspan="2">-20000 to 20000</td> <td>500μV</td> </tr> <tr> <td>User range settings</td> <td>333μV</td> </tr> <tr> <td rowspan="3">Current</td> <td>0 to 20mA</td> <td rowspan="2">0 to 20000</td> <td>1000nA</td> </tr> <tr> <td>4 to 20mA</td> <td>800nA</td> </tr> <tr> <td>User range settings</td> <td>-20000 to 20000</td> <td>700nA</td> </tr> </tbody> </table>	Analog output range		Digital value	Maximum resolution	Voltage	0 to 5V	0 to 20000	250μV	1 to 5V	200μV	-10 to 10V	-20000 to 20000	500μV	User range settings	333μV	Current	0 to 20mA	0 to 20000	1000nA	4 to 20mA	800nA	User range settings	-20000 to 20000	700nA	○	Since the resolution differs between AnS series and L series modules, it needs to be matched using a sequence program, user range settings, or the scaling function. (Refer to Appendix 4.)
Analog output range		Digital value	Maximum resolution																								
Voltage	0 to 5V	0 to 20000	250μV																								
	1 to 5V		200μV																								
	-10 to 10V	-20000 to 20000	500μV																								
	User range settings		333μV																								
Current	0 to 20mA	0 to 20000	1000nA																								
	4 to 20mA		800nA																								
	User range settings	-20000 to 20000	700nA																								
	Ambient temperature 25±5°C: within ±0.1% (voltage: ±10mV, current: ±20μA) Ambient temperature 0 to 55°C: within ±0.3% (voltage: ±30mV, current: ±60μA)	○																									
	20μs/channel	○																									
	4 channels/module	△	Consider replacement with several L60DA4 modules.																								
	Up to 50000 times	○																									
	Available	○																									

Item		A1S68DA1
Insulation method		Between the output terminal and programmable controller power supply: Photocoupler Between channels: Not insulated
Dielectric withstand voltage		–
Insulation resistance		–
Number of occupied I/O points		32 points (I/O assignment: special 32 points)
External interface		20-point terminal block (M3.5×7 screws)
Applicable wire size		0.75 to 1.5mm ²
Applicable solderless terminal		R1.25-3, 1.25-YS3, RAV1.25-3, V1.25-YS3A
Internal current consumption (5VDC)		0.85A
External power supply	Voltage	–
	Current consumption	
	Inrush current	
Weight		0.22kg

○ : Compatible, △ : Partial change required, × : Incompatible

	L60DA4	Compatibility	Precautions for replacement
	Between the I/O terminal and programmable controller power supply: Photocoupler Between output channels: Not insulated Between external power supply and analog output: Transformer		
	Between the I/O terminal and programmable controller power supply: 500VACrms, for 1 minute Between external power supply and analog output: 500VACrms, for 1 minute	○	
	Between the I/O terminal and programmable controller power supply: 500VDC, 10MΩ or higher	○	
	16 points (I/O assignment: intelligent 16 points)	△	The number of occupied I/O points is changed to 16 points.
	18-point terminal block	×	Wiring change is required.
	0.3 to 0.75mm ²	×	
	FG terminal: R1.25-3, 1.25-YS3, RAV1.25-3, V1.25-YS3A Terminals other than FG: R1.25-3 (Solderless terminals with an insulation sleeve cannot be used.)	×	
	0.16A	○	
	24VDC +20%, -15% Ripple, spike 500mV _{p-p} or lower	×	External power supply is required.
	0.18A		
	4.3A, 1000μs or less		
	0.20kg	△	

3.3.2 Functional comparison

○ : Available, – : Not available

Item	Description	A1S68DAI	L60DA4	Precautions for replacement																	
D/A conversion enable/disable function	Sets whether to enable or disable D/A conversion for each channel.	○	○	With the L60DA4, disabling the D/A conversion for an unused channel reduces the conversion cycles.																	
D/A output enable/disable function	Sets whether to output the D/A conversion value or the offset value for each channel. The conversion speed is constant, regardless of the output enable/disable status.	○	○																		
Range switching function	Sets the output range to be used.	–	○																		
Offset/gain setting function	Corrects errors in analog output values.	–	○																		
Analog output HOLD/CLEAR function	Sets the status of analog output values (HOLD or CLEAR), according to the CPU module operating status (RUN, STOP, or stop error).	○	○	The A1S68DAI is set the status for all channels at once using the HLD/CLR terminal on the front of the module. With L60DA4, HOLD/CLEAR is set for each channel.																	
Analog output test when CPU module is in STOP status	Outputs the converted analog values when CH□ Output enable/disable flag is forcibly turned on while the CPU module is in the STOP status. <table border="1" style="width: 100%; border-collapse: collapse;"> <thead> <tr> <th rowspan="2">Setting combination</th> <th>D/A conversion enable/disable</th> <th colspan="2">Enable</th> <th colspan="2">Disable</th> </tr> <tr> <th>CH□ Output enable/disable flag</th> <th>Enable</th> <th>Disable</th> <th>Enable</th> <th>Disable</th> </tr> </thead> <tbody> <tr> <td colspan="2">Analog output test</td> <td>Allowed</td> <td>Not allowed</td> <td colspan="2">Not allowed</td> </tr> </tbody> </table>	Setting combination	D/A conversion enable/disable	Enable		Disable		CH□ Output enable/disable flag	Enable	Disable	Enable	Disable	Analog output test		Allowed	Not allowed	Not allowed		–	○	
Setting combination	D/A conversion enable/disable		Enable		Disable																
	CH□ Output enable/disable flag	Enable	Disable	Enable	Disable																
Analog output test		Allowed	Not allowed	Not allowed																	
Resolution mode	Sets the resolution according to the application.*1	–	–	Since the resolution differs between AnS series and L series modules, it needs to be matched using a sequence program, user range settings, or the scaling function. (Refer to Appendix 4.)																	
Scaling function	Scale-converts the input digital value to the set range of the scaling upper limit value and scaling lower limit value. This omits the programming of the scale conversion.	–	○	By setting the same scaling upper limits and scaling lower limits as the resolution of A1S68DAI, the same digital output values as A1S68DAI can be used.																	
Alarm output function	Outputs an alarm when the digital value is out of the preset range.	–	○																		
Wave output function	Registers the prepared wave data (digital value) into the D/A converter module and continuously outputs the data (analog value) in the set conversion cycle.	–	○	This function can be used on the GX Works2. Only the L60DA4 with a serial number (first five digits) 14041 or later supports this function.																	
External power supply READY flag	Turns on when the external power supply (24VDC) is supplied. When this flag is off, the analog output value becomes 0V/0mA regardless of other settings.	–	○																		
Error log function	Stores the errors and alarms occurred in the D/A converter module to the buffer memory as a history. Up to 16 errors and alarms can be stored.	–	○																		
Module error collection function	Collects the errors and alarms occurred in the D/A converter module and stores them in the CPU module.	–	○																		
Error clear function	Clears the error from the system monitor window of the programming tool.	–	○	This function can be used on the GX Works2.																	
Saving and restoring offset/gain values	Saves and restores the offset/gain values in the user setting range.	–	○																		

*1 For the A1S68DAI, the resolution is 1/4000 (fixed).

For the L60DA4, the resolution is 1/20000 (fixed). To use the same digital value that is used for the A1S68DAI, set the scaling upper and lower limit values that match the resolution of the A1S68DAI using the scaling function.

3.3.3 I/O signal comparison

Sequence programs need to be changed because the I/O signal assignment differs.

For details of the I/O signals and sequence programs, refer to the MELSEC-L Digital-Analog Converter Module User's Manual.

A1S68DAI				L60DA4			
Device No.	Signal name	Device No.	Signal name	Device No.	Signal name	Device No.	Signal name
X0	WDT error flag (A1S68DAI detection)	Y0	Use prohibited	X0	Module READY	Y0	Use prohibited
X1	D/A conversion READY	Y1		X1	Use prohibited	Y1	CH1 Output enable/disable flag
X2	Error flag	Y2		X2		Y2	CH2 Output enable/disable flag
X3	Use prohibited	Y3		X3		Y3	CH3 Output enable/disable flag
X4		Y4		X4		Y4	CH4 Output enable/disable flag
X5		Y5		X5		Y5	Use prohibited
X6		Y6		X6		Y6	
X7		Y7		X7	External power supply READY flag	Y7	Use prohibited
X8		Y8		X8	Use prohibited	Y8	
X9		Y9		X9	Operating condition setting completed flag	Y9	Operating condition setting request
XA		YA		XA	Offset/gain setting mode flag	YA	User range writing request
XB		YB		XB	Channel change completed flag	YB	Channel change request
XC		YC		XC	Set value change completed flag	YC	Set value change request
XD	YD	XD		Use prohibited	YD	Use prohibited	
XE	YE	XE		Warning output signal	YE	Warning output clear request	
XF	YF	XF		Error flag	YF	Error clear request	
X10	Y10	D/A conversion output enable flag					
X11	Y11						
X12	Y12						
X13	Y13						
X14	Y14						
X15	Y15						
X16	Y16						
X17	Y17						
X18	Y18	Error reset flag					
X19	Y19	Use prohibited					
X1A	Y1A						
X1B	Y1B						
X1C	Y1C						
X1D	Y1D						
X1E	Y1E						
X1F	Y1F						

3.3.4 Buffer memory address comparison

Sequence programs need to be changed because the buffer memory address assignment differs. For details of the buffer memory areas and sequence programs, refer to the MELSEC-L Digital-Analog Converter Module User's Manual.

A1S68DAI			L60DA4			
Address (decimal)	Name	Read/write	Address (decimal)	Name	Read/write	
0	Analog output enable/disable channel	R/W	0	D/A conversion enable/disable setting	R/W	
1	CH.1 digital value					
2	CH.2 digital value					
3	CH.3 digital value					
4	CH.4 digital value		System area (Use prohibited)	4	CH4 Digital value	
5	CH.5 digital value					
6	CH.6 digital value					
7	CH.7 digital value					
8	CH.8 digital value	-	8			
9	System area (Use prohibited)		9	Output mode	R	
10	CH.1 set value check code		R	10	System area (Use prohibited)	-
11	CH.2 set value check code			11	CH1 Set value check code	R
12	CH.3 set value check code			12	CH2 Set value check code	
13	CH.4 set value check code			13	CH3 Set value check code	
14	CH.5 set value check code			14	CH4 Set value check code	
15	CH.6 set value check code			System area (Use prohibited)	15	
16	CH.7 set value check code	16				
17	CH.8 set value check code	17				
		18				
		19	Latest error code	R		
		20	Setting range (CH1 to CH4)	-		
		21	System area (Use prohibited)			
		22	Offset/gain setting mode Offset specification	R/W		
		23	Offset/gain setting mode Gain specification			
		24	Offset/gain adjustment value specification			
		25	System area (Use prohibited)	-		
		26	HOLD/CLEAR function setting (CH1 to CH4)	R		
		27	System area (Use prohibited)	-		
		to				
		46				
		47	Warning output setting	R/W		
		48	Warning output flag	R		
		49	System area (Use prohibited)	-		
		to				
		52				
		53	Scaling enable/disable setting	R/W		
		54	CH1 Scaling lower limit value			
		55	CH1 Scaling upper limit value			
		56	CH2 Scaling lower limit value			
		57	CH2 Scaling upper limit value			
		58	CH3 Scaling lower limit value			
		59	CH3 Scaling upper limit value			
		60	CH4 Scaling lower limit value			
		61	CH4 Scaling upper limit value			
		62	System area (Use prohibited)	-		
		to				
		85				
		86	CH1 Warning output upper limit value	R/W		
		87	CH1 Warning output lower limit value			
		88	CH2 Warning output upper limit value			
		89	CH2 Warning output lower limit value			
		90	CH3 Warning output upper limit value			

L60DA4		
Address (decimal)	Name	Read/write
91	CH3 Warning output lower limit value	R/W
92	CH4 Warning output upper limit value	
93	CH4 Warning output lower limit value	
94	System area (Use prohibited)	-
to		
157		
158	Mode switching setting	R/W
159	System area (Use prohibited)	-
to		
199		
200	Pass data classification setting	R/W
201	System area (Use prohibited)	-
202	CH1 Industrial shipment settings offset value	R/W
203	CH1 Industrial shipment settings gain value	
204	CH2 Industrial shipment settings offset value	
205	CH2 Industrial shipment settings gain value	
206	CH3 Industrial shipment settings offset value	
207	CH3 Industrial shipment settings gain value	
208	CH4 Industrial shipment settings offset value	
209	CH4 Industrial shipment settings gain value	
210	CH1 User range settings offset value	
211	CH1 User range settings gain value	
212	CH2 User range settings offset value	
213	CH2 User range settings gain value	
214	CH3 User range settings offset value	
215	CH3 User range settings gain value	
216	CH4 User range settings offset value	
217	CH4 User range settings gain value	
218	System area (Use prohibited)	
to		
999	System area (Use prohibited)	-
1000		
1001		
1002		
1003		
1004	System area (Use prohibited)	-
to		
1007		
1008	CH1 Output setting during wave output stop	R/W
1009	CH2 Output setting during wave output stop	
1010	CH3 Output setting during wave output stop	
1011	CH4 Output setting during wave output stop	
1012	System area (Use prohibited)	-
to		
1015		
1016	CH1 Output value during wave output stop	R/W
1017	CH2 Output value during wave output stop	
1018	CH3 Output value during wave output stop	
1019	CH4 Output value during wave output stop	
1020	System area (Use prohibited)	-
to		
1023		
1024	CH1 Wave pattern start address setting (L)	R/W
1025	CH1 Wave pattern start address setting (H)	
1026	CH2 Wave pattern start address setting (L)	
1027	CH2 Wave pattern start address setting (H)	
1028	CH3 Wave pattern start address setting (L)	
1029	CH3 Wave pattern start address setting (H)	
1030	CH4 Wave pattern start address setting (L)	
1031	CH4 Wave pattern start address setting (H)	

L60DA4		
Address (decimal)	Name	Read/write
1032	System area (Use prohibited)	-
to		
1039		
1040	CH1 Wave pattern data points setting (L)	R/W
1041	CH1 Wave pattern data points setting (H)	
1042	CH2 Wave pattern data points setting (L)	
1043	CH2 Wave pattern data points setting (H)	
1044	CH3 Wave pattern data points setting (L)	
1045	CH3 Wave pattern data points setting (H)	
1046	CH4 Wave pattern data points setting (L)	
1047	CH4 Wave pattern data points setting (H)	
1048	System area (Use prohibited)	-
to		
1055		
1056	CH1 Wave pattern output repetition setting	R/W
1057	CH2 Wave pattern output repetition setting	
1058	CH3 Wave pattern output repetition setting	
1059	CH4 Wave pattern output repetition setting	
1060	System area (Use prohibited)	-
to		
1063		
1064	CH1 Constant for wave output conversion cycle	R/W
1065	CH2 Constant for wave output conversion cycle	
1066	CH3 Constant for wave output conversion cycle	
1067	CH4 Constant for wave output conversion cycle	
1068	System area (Use prohibited)	-
to		
1071		
1072	Step action wave output request	R/W
1073	System area (Use prohibited)	-
to		
1079		
1080	CH1 Wave output step action movement amount	R/W
1081	CH2 Wave output step action movement amount	
1082	CH3 Wave output step action movement amount	
1083	CH4 Wave output step action movement amount	
1084	System area (Use prohibited)	-
to		
1099		
1100	CH1 Wave output status monitor	R
1101	CH2 Wave output status monitor	
1102	CH3 Wave output status monitor	
1103	CH4 Wave output status monitor	
1104	System area (Use prohibited)	-
to		
1107		
1108	CH1 Wave output conversion cycle monitor (L)	R
1109	CH1 Wave output conversion cycle monitor (H)	
1110	CH2 Wave output conversion cycle monitor (L)	
1111	CH2 Wave output conversion cycle monitor (H)	
1112	CH3 Wave output conversion cycle monitor (L)	
1113	CH3 Wave output conversion cycle monitor (H)	
1114	CH4 Wave output conversion cycle monitor (L)	
1115	CH4 Wave output conversion cycle monitor (H)	
1116	System area (Use prohibited)	-
to		
1123		
1124	CH1 Wave pattern output count monitor	R
1125	CH2 Wave pattern output count monitor	
1126	CH3 Wave pattern output count monitor	
1127	CH4 Wave pattern output count monitor	

L60DA4		
Address (decimal)	Name	Read/write
1128	System area (Use prohibited)	-
to		
1131		
1132	CH1 Wave output current address monitor (L)	R
1133	CH1 Wave output current address monitor (H)	
1134	CH2 Wave output current address monitor (L)	
1135	CH2 Wave output current address monitor (H)	
1136	CH3 Wave output current address monitor (L)	
1137	CH3 Wave output current address monitor (H)	
1138	CH4 Wave output current address monitor (L)	
1139	CH4 Wave output current address monitor (H)	
1140	System area (Use prohibited)	-
to		
1147		
1148	CH1 Wave output current digital value monitor	R
1149	CH2 Wave output current digital value monitor	
1150	CH3 Wave output current digital value monitor	
1151	CH4 Wave output current digital value monitor	
1152	System area (Use prohibited)	-
to		
1155		
1156	CH1 Wave output digital value outside the range Address monitor (L)	R
1157	CH1 Wave output digital value outside the range Address monitor (H)	
1158	CH2 Wave output digital value outside the range Address monitor (L)	
1159	CH2 Wave output digital value outside the range Address monitor (H)	
1160	CH3 Wave output digital value outside the range Address monitor (L)	
1161	CH3 Wave output digital value outside the range Address monitor (H)	
1162	CH4 Wave output digital value outside the range Address monitor (L)	
1163	CH4 Wave output digital value outside the range Address monitor (H)	
1164	System area (Use prohibited)	-
to		
1171		
1172	CH1 Wave output warning Address monitor (L)	R
1173	CH1 Wave output warning Address monitor (H)	
1174	CH2 Wave output warning Address monitor (L)	
1175	CH2 Wave output warning Address monitor (H)	
1176	CH3 Wave output warning Address monitor (L)	
1177	CH3 Wave output warning Address monitor (H)	
1178	CH4 Wave output warning Address monitor (L)	
1179	CH4 Wave output warning Address monitor (H)	
1180	System area (Use prohibited)	-
to		
1799		

3.4 A1S68DAI (Alternative Model: L60DAIL8)

3.4.1 Performance specifications comparison

Item	A1S68DAI									
Digital input	16-bit signed binary Setting range: 0 to 4096									
Analog output	4 to 20mAADC (External load resistance value: 0 to 600Ω)									
I/O characteristics	<table border="1"> <thead> <tr> <th>Digital input value</th> <th>Analog output</th> </tr> </thead> <tbody> <tr> <td>4000</td> <td>20mA</td> </tr> <tr> <td>2000</td> <td>12mA</td> </tr> <tr> <td>0</td> <td>4mA</td> </tr> </tbody> </table>	Digital input value	Analog output	4000	20mA	2000	12mA	0	4mA	
Digital input value	Analog output									
4000	20mA									
2000	12mA									
0	4mA									
Maximum resolution of analog value	4μA									
Overall accuracy (accuracy at maximum analog output value)	±1.0% (±200μA)									
Maximum conversion speed	Within 4ms/8 channels If the access from the CPU module using the FROM/TO instructions is frequent, the speed may be increased for 6ms.									
Number of analog output channels	8 channels/module									
Number of offset/gain settings	-									
Output short protection	Available									

○ : Compatible, △ : Partial change required, × : Incompatible

	L60DAIL8	Compatibility	Precautions for replacement													
	16-bit signed binary (-8192 to 8191, When the scaling function is used: -32768 to 32767)	○	Since the resolution differs between AnS series and L series modules, it needs to be matched using a sequence program, user range settings, or the scaling function. (Refer to Appendix 4.)													
	Current: 0 to 20mA (External load resistance value: 0 to 600Ω)	○														
	<table border="1"> <thead> <tr> <th></th> <th>Analog output range</th> <th>Digital value</th> <th>Maximum resolution</th> </tr> </thead> <tbody> <tr> <td rowspan="3">Current</td> <td>0 to 20mA</td> <td rowspan="2">0 to 8000</td> <td>2500nA</td> </tr> <tr> <td>4 to 20mA</td> <td>2000nA</td> </tr> <tr> <td>User range settings</td> <td>-8000 to 8000</td> <td>707nA</td> </tr> </tbody> </table>		Analog output range	Digital value	Maximum resolution	Current	0 to 20mA	0 to 8000	2500nA	4 to 20mA	2000nA	User range settings	-8000 to 8000	707nA	○	Since the resolution differs between AnS series and L series modules, it needs to be matched using a sequence program, user range settings, or the scaling function. (Refer to Appendix 4.)
	Analog output range	Digital value	Maximum resolution													
Current	0 to 20mA	0 to 8000	2500nA													
	4 to 20mA		2000nA													
	User range settings	-8000 to 8000	707nA													
	Ambient temperature 25±5°C: within ±0.3% (±60μA) Ambient temperature 0 to 55°C: within ±1.0% (±200μA)	○														
	200μs/channel	○														
	8 channels/module	○														
	Up to 10000 times	○														
	Available	○														

Item		A1S68DAI
Insulation method		Between the output terminal and programmable controller power supply: Photocoupler Between channels: Not insulated
Dielectric withstand voltage		–
Insulation resistance		–
Number of occupied I/O points		32 points (I/O assignment: special 32 points)
External interface		20-point terminal block (M3.5×7 screws)
Applicable wire size		0.75 to 1.5mm ²
Applicable solderless terminal		R1.25-3, 1.25-YS3, RAV1.25-3, V1.25-YS3A
Internal current consumption (5VDC)		0.85A
External power supply	Voltage	–
	Current consumption	
	Inrush current	
Weight		0.22kg

○ : Compatible, △ : Partial change required, × : Incompatible

	L60DAI18	Compatibility	Precautions for replacement
	Between the I/O terminal and programmable controller power supply: Photocoupler Between output channels: Not insulated Between external power supply and analog output: Transformer		
	Between the I/O terminal and programmable controller power supply: 500VACrms, for 1 minute Between external power supply and analog output: 500VACrms, for 1 minute	○	
	Between the I/O terminal and programmable controller power supply: 500VDC, 10MΩ or higher	○	
	16 points (I/O assignment: intelligent 16 points) (Number of occupied modules: 2)	△	The number of occupied I/O points is changed to 16 points and the number of occupied modules is changed to 2.
	18-point terminal block	×	Wiring change is required.
	0.3 to 0.75mm ²	×	
	R1.25-3 (solderless terminals with sleeve are not usable)	×	
	0.15A	○	
	24VDC +20%, -15% Ripple, spike 500mV _{p-p} or lower	×	External power supply is required.
	0.25A		
	3.9A, 2.0ms or less		
	0.22kg	△	

3.4.2 Functional comparison

○ : Available, – : Not available

Item	Description	A1S68DAI	L60DAI8	Precautions for replacement																	
D/A conversion enable/disable function	Sets whether to enable or disable D/A conversion for each channel.	○	○	With the L60DAI8, disabling the D/A conversion for an unused channel reduces the conversion cycles.																	
D/A output enable/disable function	Sets whether to output the D/A conversion value or the offset value for each channel. The conversion speed is constant, regardless of the output enable/disable status.	○	○																		
Range switching function	Sets the output range to be used.	–	○																		
Offset/gain setting function	Corrects errors in analog output values.	–	○																		
Analog output HOLD/CLEAR function	Sets the status of analog output values (HOLD or CLEAR), according to the CPU module operating status (RUN, STOP, or stop error).	○	○	The A1S68DAI is set the status for all channels at once using the HLD/CLR terminal on the front of the module. With L60DAI8, HOLD/CLEAR is set for each channel.																	
Analog output test when CPU module is in STOP status	Outputs the converted analog values when CH□ Output enable/disable flag is forcibly turned on while the CPU module is in the STOP status. <table border="1" style="width: 100%; border-collapse: collapse;"> <thead> <tr> <th rowspan="2">Setting combination</th> <th>D/A conversion enable/disable</th> <th colspan="2">Enable</th> <th colspan="2">Disable</th> </tr> <tr> <th>CH□ Output enable/disable flag</th> <th>Enable</th> <th>Disable</th> <th>Enable</th> <th>Disable</th> </tr> </thead> <tbody> <tr> <td colspan="2">Analog output test</td> <td>Allowed</td> <td>Not allowed</td> <td colspan="2">Not allowed</td> </tr> </tbody> </table>	Setting combination	D/A conversion enable/disable	Enable		Disable		CH□ Output enable/disable flag	Enable	Disable	Enable	Disable	Analog output test		Allowed	Not allowed	Not allowed		–	○	
Setting combination	D/A conversion enable/disable		Enable		Disable																
	CH□ Output enable/disable flag	Enable	Disable	Enable	Disable																
Analog output test		Allowed	Not allowed	Not allowed																	
Resolution mode	Sets the resolution according to the application. *1	–	–	Since the resolution differs between AnS series and L series modules, it needs to be matched using a sequence program, user range settings, or the scaling function. (Refer to Appendix 4.)																	
Scaling function	Scale-converts the input digital value to the set range of the scaling upper limit value and scaling lower limit value. This omits the programming of the scale conversion.	–	○	By setting the same scaling upper limits and scaling lower limits as the resolution of A1S68DAI, the same digital output values as A1S68DAI can be used.																	
Alarm output function	Outputs an alarm when the digital value is out of the preset range.	–	○																		
Wave output function	Registers the prepared wave data (digital value) into the D/A converter module and continuously outputs the data (analog value) in the set conversion cycle.	–	○	This function can be used on the GX Works2.																	
External power supply READY flag	Turns on when the external power supply (24VDC) is supplied. When this flag is off, the analog output value becomes 0V/0mA regardless of other settings.	–	○																		
Error log function	Stores the errors and alarms occurred in the D/A converter module to the buffer memory as a history. Up to 16 errors and alarms can be stored.	–	○																		
Module error collection function	Collects the errors and alarms occurred in the D/A converter module and stores them in the CPU module.	–	○																		
Error clear function	Clears the error from the system monitor window of the programming tool.	–	○	This function can be used on the GX Works2.																	
Saving and restoring offset/gain values	Saves and restores the offset/gain values in the user setting range.	–	○																		

*1 For the A1S68DAI, the resolution is 1/4000 (fixed).

For the L60DAI8, the resolution is 1/8000 (fixed). To use the same digital value that is used for the A1S68DAI, set the scaling upper and lower limit values that match the resolution of the A1S68DAI using the scaling function.

3.4.3 I/O signal comparison

Sequence programs need to be changed because the I/O signal assignment differs.

For details of the I/O signals and sequence programs, refer to the MELSEC-L Digital-Analog Converter Module User's Manual.

A1S68DAI				L60DAI8			
Device No.	Signal name	Device No.	Signal name	Device No.	Signal name	Device No.	Signal name
X0	WDT error flag (A1S68DAI detection)	Y0	Use prohibited	X0	Module READY	Y0	Use prohibited
X1	D/A conversion READY	Y1		X1	Use prohibited	Y1	CH1 Output enable/disable flag
X2	Error flag	Y2		X2		Y2	CH2 Output enable/disable flag
X3	Use prohibited	Y3		X3		Y3	CH3 Output enable/disable flag
X4		Y4		X4		Y4	CH4 Output enable/disable flag
X5		Y5		X5		Y5	CH5 Output enable/disable flag
X6		Y6		X6		Y6	CH6 Output enable/disable flag
X7		Y7		X7	External power supply READY flag	Y7	CH7 Output enable/disable flag
X8		Y8		X8	Use prohibited	Y8	CH8 Output enable/disable flag
X9		Y9		X9	Operating condition setting completed flag	Y9	Operating condition setting request
XA		YA		XA	Offset/gain setting mode flag	YA	User range writing request
XB		YB		XB	Channel change completed flag	YB	Channel change request
XC		YC		XC	Set value change completed flag	YC	Set value change request
XD	Use prohibited	YD		XD	Use prohibited	YD	Use prohibited
XE	YE	XE		Warning output signal	YE	Warning output clear request	
XF	YF	XF		Error flag	YF	Error clear request	
X10	Y10	D/A conversion output enable flag					
X11	Y11						
X12	Y12						
X13	Y13						
X14	Y14						
X15	Y15						
X16	Y16						
X17	Y17						
X18	Y18	Error reset flag					
X19	Y19	Use prohibited					
X1A	Y1A						
X1B	Y1B						
X1C	Y1C						
X1D	Y1D						
X1E	Y1E						
X1F	Y1F						

3.4.4 Buffer memory address comparison

Sequence programs need to be changed because the buffer memory address assignment differs. For details of the buffer memory areas and sequence programs, refer to the MELSEC-L Digital-Analog Converter Module User's Manual.

A1S68DAI			L60DAI8		
Address (decimal)	Name	Read/write	Address (decimal)	Name	Read/write
0	Analog output enable/disable channel	R/W	0	D/A conversion enable/disable setting	R/W
1	CH.1 digital value				
2	CH.2 digital value				
3	CH.3 digital value				
4	CH.4 digital value				
5	CH.5 digital value				
6	CH.6 digital value				
7	CH.7 digital value				
8	CH.8 digital value	R	8	CH8 Digital value	
9	System area (Use prohibited)		9	Output mode	R
10	CH.1 set value check code		10	System area (Use prohibited)	-
11	CH.2 set value check code		11	CH1 Set value check code	R
12	CH.3 set value check code		12	CH2 Set value check code	
13	CH.4 set value check code		13	CH3 Set value check code	
14	CH.5 set value check code		14	CH4 Set value check code	
15	CH.6 set value check code		15	CH5 Set value check code	
16	CH.7 set value check code	16	CH6 Set value check code		
17	CH.8 set value check code	17	CH7 Set value check code		
			18	CH8 Set value check code	
			19	Latest error code	R
			20	Setting range (CH1 to CH4)	
			21	Setting range (CH5 to CH8)	
			22	Offset/gain setting mode Offset specification	R/W
			23	Offset/gain setting mode Gain specification	
			24	Offset/gain adjustment value specification	
			25	System area (Use prohibited)	-
			26	HOLD/CLEAR function setting (CH1 to CH4)	R
			27	HOLD/CLEAR function setting (CH5 to CH8)	
			28	System area (Use prohibited)	-
			46		
			47		
			48	Warning output flag	R
			49	System area (Use prohibited)	-
			to		
			52		

L60DAIL8		
Address (decimal)	Name	Read/write
53	Scaling enable/disable setting	R/W
54	CH1 Scaling lower limit value	
55	CH1 Scaling upper limit value	
56	CH2 Scaling lower limit value	
57	CH2 Scaling upper limit value	
58	CH3 Scaling lower limit value	
59	CH3 Scaling upper limit value	
60	CH4 Scaling lower limit value	
61	CH4 Scaling upper limit value	
62	CH5 Scaling lower limit value	
63	CH5 Scaling upper limit value	
64	CH6 Scaling lower limit value	
65	CH6 Scaling upper limit value	
66	CH7 Scaling lower limit value	
67	CH7 Scaling upper limit value	
68	CH8 Scaling lower limit value	
69	CH8 Scaling upper limit value	
70	System area (Use prohibited)	-
to		
85		
86	CH1 Warning output upper limit value	R/W
87	CH1 Warning output lower limit value	
88	CH2 Warning output upper limit value	
89	CH2 Warning output lower limit value	
90	CH3 Warning output upper limit value	
91	CH3 Warning output lower limit value	
92	CH4 Warning output upper limit value	
93	CH4 Warning output lower limit value	
94	CH5 Warning output upper limit value	
95	CH5 Warning output lower limit value	
96	CH6 Warning output upper limit value	
97	CH6 Warning output lower limit value	
98	CH7 Warning output upper limit value	
99	CH7 Warning output lower limit value	
100	CH8 Warning output upper limit value	
101	CH8 Warning output lower limit value	
102	System area (Use prohibited)	-
to		
157		
158	Mode switching setting	R/W
159		R/W
160	System area (Use prohibited)	-
to		
201		
202	CH1 Industrial shipment settings offset value	R/W
203	CH1 Industrial shipment settings gain value	
204	CH2 Industrial shipment settings offset value	
205	CH2 Industrial shipment settings gain value	
206	CH3 Industrial shipment settings offset value	
207	CH3 Industrial shipment settings gain value	
208	CH4 Industrial shipment settings offset value	
209	CH4 Industrial shipment settings gain value	
210	CH5 Industrial shipment settings offset value	
211	CH5 Industrial shipment settings gain value	
212	CH6 Industrial shipment settings offset value	
213	CH6 Industrial shipment settings gain value	
214	CH7 Industrial shipment settings offset value	
215	CH7 Industrial shipment settings gain value	
216	CH8 Industrial shipment settings offset value	
217	CH8 Industrial shipment settings gain value	

L60DAI18		
Address (decimal)	Name	Read/write
218	CH1 User range settings offset value	R/W
219	CH1 User range settings gain value	
220	CH2 User range settings offset value	
221	CH2 User range settings gain value	
222	CH3 User range settings offset value	
223	CH3 User range settings gain value	
224	CH4 User range settings offset value	
225	CH4 User range settings gain value	
226	CH5 User range settings offset value	
227	CH5 User range settings gain value	
228	CH6 User range settings offset value	
229	CH6 User range settings gain value	
230	CH7 User range settings offset value	
231	CH7 User range settings gain value	
232	CH8 User range settings offset value	
233	CH8 User range settings gain value	
234	System area (Use prohibited)	-
to		
999		
1000	CH1 Wave output start/stop request	R/W
1001	CH2 Wave output start/stop request	
1002	CH3 Wave output start/stop request	
1003	CH4 Wave output start/stop request	
1004	CH5 Wave output start/stop request	
1005	CH6 Wave output start/stop request	
1006	CH7 Wave output start/stop request	
1007	CH8 Wave output start/stop request	
1008	CH1 Output setting during wave output stop	R/W
1009	CH2 Output setting during wave output stop	
1010	CH3 Output setting during wave output stop	
1011	CH4 Output setting during wave output stop	
1012	CH5 Output setting during wave output stop	
1013	CH6 Output setting during wave output stop	
1014	CH7 Output setting during wave output stop	
1015	CH8 Output setting during wave output stop	
1016	CH1 Output value during wave output stop	R/W
1017	CH2 Output value during wave output stop	
1018	CH3 Output value during wave output stop	
1019	CH4 Output value during wave output stop	
1020	CH5 Output value during wave output stop	
1021	CH6 Output value during wave output stop	
1022	CH7 Output value during wave output stop	
1023	CH8 Output value during wave output stop	
1024	CH1 Wave pattern start address setting (L)	R/W
1025	CH1 Wave pattern start address setting (H)	
1026	CH2 Wave pattern start address setting (L)	
1027	CH2 Wave pattern start address setting (H)	
1028	CH3 Wave pattern start address setting (L)	
1029	CH3 Wave pattern start address setting (H)	
1030	CH4 Wave pattern start address setting (L)	
1031	CH4 Wave pattern start address setting (H)	
1032	CH5 Wave pattern start address setting (L)	
1033	CH5 Wave pattern start address setting (H)	
1034	CH6 Wave pattern start address setting (L)	
1035	CH6 Wave pattern start address setting (H)	
1036	CH7 Wave pattern start address setting (L)	
1037	CH7 Wave pattern start address setting (H)	
1038	CH8 Wave pattern start address setting (L)	
1039	CH8 Wave pattern start address setting (H)	

L60DAIL8		
Address (decimal)	Name	Read/write
1040	CH1 Wave pattern data points setting (L)	R/W
1041	CH1 Wave pattern data points setting (H)	
1042	CH2 Wave pattern data points setting (L)	
1043	CH2 Wave pattern data points setting (H)	
1044	CH3 Wave pattern data points setting (L)	
1045	CH3 Wave pattern data points setting (H)	
1046	CH4 Wave pattern data points setting (L)	
1047	CH4 Wave pattern data points setting (H)	
1048	CH5 Wave pattern data points setting (L)	
1049	CH5 Wave pattern data points setting (H)	
1050	CH6 Wave pattern data points setting (L)	
1051	CH6 Wave pattern data points setting (H)	
1052	CH7 Wave pattern data points setting (L)	
1053	CH7 Wave pattern data points setting (H)	
1054	CH8 Wave pattern data points setting (L)	
1055	CH8 Wave pattern data points setting (H)	
1056	CH1 Wave pattern output repetition setting	R/W
1057	CH2 Wave pattern output repetition setting	
1058	CH3 Wave pattern output repetition setting	
1059	CH4 Wave pattern output repetition setting	
1060	CH5 Wave pattern output repetition setting	
1061	CH6 Wave pattern output repetition setting	
1062	CH7 Wave pattern output repetition setting	
1063	CH8 Wave pattern output repetition setting	
1064	CH1 Constant for wave output conversion cycle	R/W
1065	CH2 Constant for wave output conversion cycle	
1066	CH3 Constant for wave output conversion cycle	
1067	CH4 Constant for wave output conversion cycle	
1068	CH5 Constant for wave output conversion cycle	
1069	CH6 Constant for wave output conversion cycle	
1070	CH7 Constant for wave output conversion cycle	
1071	CH8 Constant for wave output conversion cycle	
1072	Step action wave output request	R/W
1073	System area (Use prohibited)	-
to		
1079		
1080	CH1 Wave output step action movement amount	R/W
1081	CH2 Wave output step action movement amount	
1082	CH3 Wave output step action movement amount	
1083	CH4 Wave output step action movement amount	
1084	CH5 Wave output step action movement amount	
1085	CH6 Wave output step action movement amount	
1086	CH7 Wave output step action movement amount	
1087	CH8 Wave output step action movement amount	
1088	System area (Use prohibited)	-
to		
1099		
1100	CH1 Wave output status monitor	R
1101	CH2 Wave output status monitor	
1102	CH3 Wave output status monitor	
1103	CH4 Wave output status monitor	
1104	CH5 Wave output status monitor	
1105	CH6 Wave output status monitor	
1106	CH7 Wave output status monitor	
1107	CH8 Wave output status monitor	

L60DAI18		
Address (decimal)	Name	Read/write
1108	CH1 Wave output conversion cycle monitor (L)	R
1109	CH1 Wave output conversion cycle monitor (H)	
1110	CH2 Wave output conversion cycle monitor (L)	
1111	CH2 Wave output conversion cycle monitor (H)	
1112	CH3 Wave output conversion cycle monitor (L)	
1113	CH3 Wave output conversion cycle monitor (H)	
1114	CH4 Wave output conversion cycle monitor (L)	
1115	CH4 Wave output conversion cycle monitor (H)	
1116	CH5 Wave output conversion cycle monitor (L)	
1117	CH5 Wave output conversion cycle monitor (H)	
1118	CH6 Wave output conversion cycle monitor (L)	
1119	CH6 Wave output conversion cycle monitor (H)	
1120	CH7 Wave output conversion cycle monitor (L)	
1121	CH7 Wave output conversion cycle monitor (H)	
1122	CH8 Wave output conversion cycle monitor (L)	
1123	CH8 Wave output conversion cycle monitor (H)	
1124	CH1 Wave pattern output count monitor	R
1125	CH2 Wave pattern output count monitor	
1126	CH3 Wave pattern output count monitor	
1127	CH4 Wave pattern output count monitor	
1128	CH5 Wave pattern output count monitor	
1129	CH6 Wave pattern output count monitor	
1130	CH7 Wave pattern output count monitor	
1131	CH8 Wave pattern output count monitor	
1132	CH1 Wave output current address monitor (L)	R
1133	CH1 Wave output current address monitor (H)	
1134	CH2 Wave output current address monitor (L)	
1135	CH2 Wave output current address monitor (H)	
1136	CH3 Wave output current address monitor (L)	
1137	CH3 Wave output current address monitor (H)	
1138	CH4 Wave output current address monitor (L)	
1139	CH4 Wave output current address monitor (H)	
1140	CH5 Wave output current address monitor (L)	
1141	CH5 Wave output current address monitor (H)	
1142	CH6 Wave output current address monitor (L)	
1143	CH6 Wave output current address monitor (H)	
1144	CH7 Wave output current address monitor (L)	
1145	CH7 Wave output current address monitor (H)	
1146	CH8 Wave output current address monitor (L)	
1147	CH8 Wave output current address monitor (H)	
1148	CH1 Wave output current digital value monitor	R
1149	CH2 Wave output current digital value monitor	
1150	CH3 Wave output current digital value monitor	
1151	CH4 Wave output current digital value monitor	
1152	CH5 Wave output current digital value monitor	
1153	CH6 Wave output current digital value monitor	
1154	CH7 Wave output current digital value monitor	
1155	CH8 Wave output current digital value monitor	

L60DAIL8		
Address (decimal)	Name	Read/write
1156	CH1 Wave output digital value outside the range Address monitor (L)	R
1157	CH1 Wave output digital value outside the range Address monitor (H)	
1158	CH2 Wave output digital value outside the range Address monitor (L)	
1159	CH2 Wave output digital value outside the range Address monitor (H)	
1160	CH3 Wave output digital value outside the range Address monitor (L)	
1161	CH3 Wave output digital value outside the range Address monitor (H)	
1162	CH4 Wave output digital value outside the range Address monitor (L)	
1163	CH4 Wave output digital value outside the range Address monitor (H)	
1164	CH5 Wave output digital value outside the range Address monitor (L)	
1165	CH5 Wave output digital value outside the range Address monitor (H)	
1166	CH6 Wave output digital value outside the range Address monitor (L)	
1167	CH6 Wave output digital value outside the range Address monitor (H)	
1168	CH7 Wave output digital value outside the range Address monitor (L)	
1169	CH7 Wave output digital value outside the range Address monitor (H)	
1170	CH8 Wave output digital value outside the range Address monitor (L)	
1171	CH8 Wave output digital value outside the range Address monitor (H)	
1172	CH1 Wave output warning Address monitor (L)	R
1173	CH1 Wave output warning Address monitor (H)	
1174	CH2 Wave output warning Address monitor (L)	
1175	CH2 Wave output warning Address monitor (H)	
1176	CH3 Wave output warning Address monitor (L)	
1177	CH3 Wave output warning Address monitor (H)	
1178	CH4 Wave output warning Address monitor (L)	
1179	CH4 Wave output warning Address monitor (H)	
1180	CH5 Wave output warning Address monitor (L)	
1181	CH5 Wave output warning Address monitor (H)	
1182	CH6 Wave output warning Address monitor (L)	
1183	CH6 Wave output warning Address monitor (H)	
1184	CH7 Wave output warning Address monitor (L)	
1185	CH7 Wave output warning Address monitor (H)	
1186	CH8 Wave output warning Address monitor (L)	
1187	CH8 Wave output warning Address monitor (H)	
1188	System area (Use prohibited)	-
to		
1699		
1700	CH1 D/A conversion status	R
1701	CH2 D/A conversion status	
1702	CH3 D/A conversion status	
1703	CH4 D/A conversion status	
1704	CH5 D/A conversion status	
1705	CH6 D/A conversion status	
1706	CH7 D/A conversion status	
1707	CH8 D/A conversion status	
1708	System area (Use prohibited)	-
1709		

L60DAI18		
Address (decimal)	Name	Read/write
1710	CH1 Analog output command value	R
1711	CH1 Analog output command value unit	
1712	CH2 Analog output command value	
1713	CH2 Analog output command value unit	
1714	CH3 Analog output command value	
1715	CH3 Analog output command value unit	
1716	CH4 Analog output command value	
1717	CH4 Analog output command value unit	
1718	CH5 Analog output command value	
1719	CH5 Analog output command value unit	
1720	CH6 Analog output command value	
1721	CH6 Analog output command value unit	
1722	CH7 Analog output command value	
1723	CH7 Analog output command value unit	
1724	CH8 Analog output command value	
1725	CH8 Analog output command value unit	
1726	System area (Use prohibited)	-
to		
1729		
1730	RUN LED status monitor	R
1731	ERR LED status monitor	
1732	ALM LED status monitor	
1733	System area (Use prohibited)	-
to		
1799		

3.5 A1S68DAV (Alternative Model: L60DA4)

3.5.1 Performance specifications comparison

Item	A1S68DAV												
Digital input	16-bit signed binary Setting range: -2048 to 2047												
Analog output	-10 to 0 to 10VDC (External load resistance value: 2KΩ to 1MΩ)												
I/O characteristics	<table border="1"> <thead> <tr> <th>Digital input value</th> <th>Analog output value</th> </tr> </thead> <tbody> <tr> <td>2000</td> <td>10V</td> </tr> <tr> <td>1000</td> <td>5V</td> </tr> <tr> <td>0</td> <td>0V</td> </tr> <tr> <td>-1000</td> <td>-5V</td> </tr> <tr> <td>-2000</td> <td>-10V</td> </tr> </tbody> </table>	Digital input value	Analog output value	2000	10V	1000	5V	0	0V	-1000	-5V	-2000	-10V
Digital input value	Analog output value												
2000	10V												
1000	5V												
0	0V												
-1000	-5V												
-2000	-10V												
Maximum resolution of analog value	5mV												
Overall accuracy (accuracy at maximum analog output value)	±1.0% (±100mV)												
Maximum conversion speed	Within 4ms/8 channels If the access from the CPU module using the FROM/TO instructions is frequent, the speed may be increased for 6ms.												
Number of analog output channels	8 channels/module												
Number of offset/gain settings	-												
Output short protection	Available												

○ : Compatible, △ : Partial change required, × : Incompatible

	L60DA4	Compatibility	Precautions for replacement																								
	16-bit signed binary (-20480 to 20479, When the scaling function is used: -32768 to 32767)	○	Since the resolution differs between AnS series and L series modules, it needs to be matched using a sequence program, user range settings, or the scaling function. (Refer to Appendix 4.)																								
	Voltage: -10 to 10VDC (External load resistance value: 1KΩ to 1MΩ) Current: 0 to 20mA (External load resistance value: 0 to 600Ω)	○																									
	<table border="1"> <thead> <tr> <th colspan="2">Analog output range</th> <th>Digital value</th> <th>Maximum resolution</th> </tr> </thead> <tbody> <tr> <td rowspan="4">Voltage</td> <td>0 to 5V</td> <td rowspan="2">0 to 20000</td> <td>250μV</td> </tr> <tr> <td>1 to 5V</td> <td>200μV</td> </tr> <tr> <td>-10 to 10V</td> <td rowspan="2">-20000 to 20000</td> <td>500μV</td> </tr> <tr> <td>User range settings</td> <td>333μV</td> </tr> <tr> <td rowspan="3">Current</td> <td>0 to 20mA</td> <td rowspan="2">0 to 20000</td> <td>1000nA</td> </tr> <tr> <td>4 to 20mA</td> <td>800nA</td> </tr> <tr> <td>User range settings</td> <td>-20000 to 20000</td> <td>700nA</td> </tr> </tbody> </table>	Analog output range		Digital value	Maximum resolution	Voltage	0 to 5V	0 to 20000	250μV	1 to 5V	200μV	-10 to 10V	-20000 to 20000	500μV	User range settings	333μV	Current	0 to 20mA	0 to 20000	1000nA	4 to 20mA	800nA	User range settings	-20000 to 20000	700nA	○	Since the resolution differs between AnS series and L series modules, it needs to be matched using a sequence program, user range settings, or the scaling function. (Refer to Appendix 4.)
Analog output range		Digital value	Maximum resolution																								
Voltage	0 to 5V	0 to 20000	250μV																								
	1 to 5V		200μV																								
	-10 to 10V	-20000 to 20000	500μV																								
	User range settings		333μV																								
Current	0 to 20mA	0 to 20000	1000nA																								
	4 to 20mA		800nA																								
	User range settings	-20000 to 20000	700nA																								
	Ambient temperature 25±5°C: within ±0.1% (voltage: ±10mV, current: ±20μA) Ambient temperature 0 to 55°C: within ±0.3% (voltage: ±30mV, current: ±60μA)	○																									
	20μs/channel	○																									
	4 channels/module	○																									
	Up to 50000 times	○																									
	Available	○																									

Item		A1S68DAV
Insulation method		Between the output terminal and programmable controller power supply: Photocoupler Between output channels: Not insulated
Dielectric withstand voltage		–
Insulation resistance		–
Number of occupied I/O points		32 points (I/O assignment: special 32 points)
External interface		20-point terminal block (M3.5×7 screws)
Applicable wire size		0.75 to 1.5mm ²
Applicable solderless terminal		R1.25-3, 1.25-YS3, RAV1.25-3, V1.25-YS3A
Internal current consumption (5VDC)		0.65A
External power supply	Voltage	–
	Current consumption	
	Inrush current	
Weight		0.22kg

○ : Compatible, △ : Partial change required, × : Incompatible

	L60DA4	Compatibility	Precautions for replacement
	Between the I/O terminal and programmable controller power supply: Photocoupler Between output channels: Not insulated Between external power supply and analog output: Transformer	○	
	Between the I/O terminal and programmable controller power supply: 500VACrms, for 1 minute Between external power supply and analog output: 500VACrms, for 1 minute	○	
	Between the I/O terminal and programmable controller power supply: 500VDC, 10MΩ or higher	○	
	16 points (I/O assignment: intelligent 16 points)	△	The number of occupied I/O points is changed to 16 points.
	18-point terminal block	×	Wiring change is required.
	0.3 to 0.75mm ²	×	
	FG terminal: R1.25-3, 1.25-YS3, RAV1.25-3, V1.25-YS3A Terminals other than FG: R1.25-3 (Solderless terminals with an insulation sleeve cannot be used.)	×	
	0.16A	○	
	24VDC +20%, -15% Ripple, spike 500mV _{p-p} or lower	×	External power supply is required.
	0.18A		
	4.3A, 1000μs or less		
	0.20kg		

3.5.2 Functional comparison

○ : Available, – : Not available

Item	Description	A1S68DAV	L60DA4	Precautions for replacement																	
D/A conversion enable/disable function	Sets whether to enable or disable D/A conversion for each channel.	○	○	With the L60DA4, disabling the D/A conversion for an unused channel reduces the conversion cycles.																	
D/A output enable/disable function	Sets whether to output the D/A conversion value or the offset value for each channel. The conversion speed is constant, regardless of the output enable/disable status.	○	○																		
Range switching function	Sets the output range to be used.	–	○																		
Offset/gain setting function	Corrects errors in analog output values.	–	○																		
Analog output HOLD/CLEAR function	Sets the status of analog output values (HOLD or CLEAR), according to the CPU module operating status (RUN, STOP, or stop error).	○	○	The A1S68DAV is set the status for all channels at once using the HLD/CLR terminal on the front of the module. With L60DA4, HOLD/CLEAR is set for each channel.																	
Analog output test when CPU module is in STOP status	Outputs the converted analog values when CH□ Output enable/disable flag is forcibly turned on while the CPU module is in the STOP status. <table border="1" style="width: 100%; border-collapse: collapse;"> <thead> <tr> <th rowspan="2">Setting combination</th> <th>D/A conversion enable/disable</th> <th colspan="2">Enable</th> <th colspan="2">Disable</th> </tr> <tr> <th>CH□ Output enable/disable flag</th> <th>Enable</th> <th>Disable</th> <th>Enable</th> <th>Disable</th> </tr> </thead> <tbody> <tr> <td colspan="2">Analog output test</td> <td>Allowed</td> <td>Not allowed</td> <td colspan="2">Not allowed</td> </tr> </tbody> </table>	Setting combination	D/A conversion enable/disable	Enable		Disable		CH□ Output enable/disable flag	Enable	Disable	Enable	Disable	Analog output test		Allowed	Not allowed	Not allowed		–	○	
Setting combination	D/A conversion enable/disable		Enable		Disable																
	CH□ Output enable/disable flag	Enable	Disable	Enable	Disable																
Analog output test		Allowed	Not allowed	Not allowed																	
Resolution mode	Sets the resolution according to the application. *1	–	–	Since the resolution differs between AnS series and L series modules, it needs to be matched using a sequence program, user range settings, or the scaling function. (Refer to Appendix 4.)																	
Scaling function	Scale-converts the input digital value to the set range of the scaling upper limit value and scaling lower limit value. This omits the programming of the scale conversion.	–	○	By setting the same scaling upper limits and scaling lower limits as the resolution of A1S68DAV, the same digital output values as A1S68DAV can be used.																	
Alarm output function	Outputs an alarm when the digital value is out of the preset range.	–	○																		
Wave output function	Registers the prepared wave data (digital value) into the D/A converter module and continuously outputs the data (analog value) in the set conversion cycle.	–	○	This function can be used on the GX Works2. Only the L60DA4 with a serial number (first five digits) 14041 or later supports this function.																	
External power supply READY flag	Turns on when the external power supply (24VDC) is supplied. When this flag is off, the analog output value becomes 0V/0mA regardless of other settings.	–	○																		
Error log function	Stores the errors and alarms occurred in the D/A converter module to the buffer memory as a history. Up to 16 errors and alarms can be stored.	–	○																		
Module error collection function	Collects the errors and alarms occurred in the D/A converter module and stores them in the CPU module.	–	○																		
Error clear function	Clears the error from the system monitor window of the programming tool.	–	○	This function can be used on the GX Works2.																	
Saving and restoring offset/gain values	Saves and restores the offset/gain values in the user setting range.	–	○																		

*1 For the A1S68DAV, the mode is fixed at 1/4000 (-2000 to 2000).
For the L60DA4, the resolution is 1/20000 (fixed). To use the same digital value that is used for the A1S68DAV, set the scaling upper and lower limit values that match the resolution of the A1S68DAV using the scaling function.

3.5.3 I/O signal comparison

Sequence programs need to be changed because the I/O signal assignment differs.

For details of the I/O signals and sequence programs, refer to the MELSEC-L Digital-Analog Converter Module User's Manual.

A1S68DAV				L60DA4			
Device No.	Signal name	Device No.	Signal name	Device No.	Signal name	Device No.	Signal name
X0	WDT error flag (A1S68DAV detection)	Y0	Use prohibited	X0	Module READY	Y0	Use prohibited
X1	D/A conversion READY	Y1		X1	Use prohibited	Y1	CH1 Output enable/disable flag
X2	Error flag	Y2		X2		Y2	CH2 Output enable/disable flag
X3	Use prohibited	Y3		X3		Y3	CH3 Output enable/disable flag
X4		Y4		X4		Y4	CH4 Output enable/disable flag
X5		Y5		X5		Y5	Use prohibited
X6		Y6		X6		Y6	
X7		Y7		X7	External power supply READY flag	Y7	Use prohibited
X8		Y8		X8	Use prohibited	Y8	
X9		Y9		X9	Operating condition setting completed flag	Y9	Operating condition setting request
XA		YA		XA	Offset/gain setting mode flag	YA	User range writing request
XB		YB		XB	Channel change completed flag	YB	Channel change request
XC		YC		XC	Set value change completed flag	YC	Set value change request
XD	YD	XD		Use prohibited	YD	Use prohibited	
XE	YE	XE		Warning output signal	YE	Warning output clear request	
XF	YF	XF		Error flag	YF	Error clear request	
X10	Y10	D/A conversion output enable flag					
X11	Y11						
X12	Y12						
X13	Y13						
X14	Y14						
X15	Y15						
X16	Y16						
X17	Y17						
X18	Y18	Error reset flag					
X19	Y19	Use prohibited					
X1A	Y1A						
X1B	Y1B						
X1C	Y1C						
X1D	Y1D						
X1E	Y1E						
X1F	Y1F						

3.5.4 Buffer memory address comparison

Sequence programs need to be changed because the buffer memory address assignment differs. For details of the buffer memory areas and sequence programs, refer to the MELSEC-L Digital-Analog Converter Module User's Manual.

A1S68DAV			L60DA4				
Address (decimal)	Name	Read/write	Address (decimal)	Name	Read/write		
0	Analog output enable/disable channel	R/W	0	D/A conversion enable/disable setting	R/W		
1	CH.1 digital value		1	CH1 digital value			
2	CH.2 digital value		2	CH2 digital value			
3	CH.3 digital value		3	CH3 Digital value			
4	CH.4 digital value		4	CH4 Digital value	-		
5	CH.5 digital value		5	System area (Use prohibited)			
6	CH.6 digital value		6				
7	CH.7 digital value		7				
8	CH.8 digital value	8					
9	System area (Use prohibited)	-	9	Output mode	R		
10	CH.1 set value check code	R	10	System area (Use prohibited)	-		
11	CH.2 set value check code		11	CH1 Set value check code	R		
12	CH.3 set value check code		12	CH2 Set value check code			
13	CH.4 set value check code		13	CH3 Set value check code			
14	CH.5 set value check code		14	CH4 Set value check code		-	
15	CH.6 set value check code		15	System area (Use prohibited)			
16	CH.7 set value check code		16				
17	CH.8 set value check code		17				
			18				
			19	Latest error code	R		
			20	Setting range (CH1 to CH4)			
			21	System area (Use prohibited)	-		
			22	Offset/gain setting mode Offset specification	R/W		
			23	Offset/gain setting mode Gain specification			
			24	Offset/gain adjustment value specification			
			25	System area (Use prohibited)	-		
			26	HOLD/CLEAR function setting (CH1 to CH4)	R		
			27	System area (Use prohibited)	-		
			46				
			47			Warning output setting	R/W
			48	Warning output flag	R		
			49	System area (Use prohibited)	-		
			52				
			53			Scaling enable/disable setting	R/W
			54			CH1 Scaling lower limit value	
			55	CH1 Scaling upper limit value			
			56	CH2 Scaling lower limit value			
			57	CH2 Scaling upper limit value			
			58	CH3 Scaling lower limit value			
			59	CH3 Scaling upper limit value			
			60	CH4 Scaling lower limit value			
			61	CH4 Scaling upper limit value	-		
			62	System area (Use prohibited)			
			85				
			86			CH1 Warning output upper limit value	R/W
			87		CH1 Warning output lower limit value		
			88	CH2 Warning output upper limit value			
			89	CH2 Warning output lower limit value			

L60DA4		
Address (decimal)	Name	Read/write
90	CH3 Warning output upper limit value	R/W
91	CH3 Warning output lower limit value	
92	CH4 Warning output upper limit value	
93	CH4 Warning output lower limit value	
94	System area (Use prohibited)	-
to		
157		
158	Mode switching setting	R/W
159		
160	System area (Use prohibited)	-
to		
199		
200	Pass data classification setting	R/W
201	System area (Use prohibited)	-
202	CH1 Industrial shipment settings offset value	R/W
203	CH1 Industrial shipment settings gain value	
204	CH2 Industrial shipment settings offset value	
205	CH2 Industrial shipment settings gain value	
206	CH3 Industrial shipment settings offset value	
207	CH3 Industrial shipment settings gain value	
208	CH4 Industrial shipment settings offset value	
209	CH4 Industrial shipment settings gain value	
210	CH1 User range settings offset value	
211	CH1 User range settings gain value	
212	CH2 User range settings offset value	
213	CH2 User range settings gain value	
214	CH3 User range settings offset value	
215	CH3 User range settings gain value	
216	CH4 User range settings offset value	
217	CH4 User range settings gain value	
218	System area (Use prohibited)	-
to		
999		
1000	CH1 Wave output start/stop request	R/W
1001	CH2 Wave output start/stop request	
1002	CH3 Wave output start/stop request	
1003	CH4 Wave output start/stop request	
1004	System area (Use prohibited)	-
to		
1007		
1008	CH1 Output setting during wave output stop	R/W
1009	CH2 Output setting during wave output stop	
1010	CH3 Output setting during wave output stop	
1011	CH4 Output setting during wave output stop	
1012	System area (Use prohibited)	-
to		
1015		
1016	CH1 Output value during wave output stop	R/W
1017	CH2 Output value during wave output stop	
1018	CH3 Output value during wave output stop	
1019	CH4 Output value during wave output stop	

L60DA4		
Address (decimal)	Name	Read/write
1020	System area (Use prohibited)	-
to		
1023		
1024	CH1 Wave pattern start address setting (L)	R/W
1025	CH1 Wave pattern start address setting (H)	
1026	CH2 Wave pattern start address setting (L)	
1027	CH2 Wave pattern start address setting (H)	
1028	CH3 Wave pattern start address setting (L)	
1029	CH3 Wave pattern start address setting (H)	
1030	CH4 Wave pattern start address setting (L)	
1031	CH4 Wave pattern start address setting (H)	
1032	System area (Use prohibited)	-
to		
1039		
1040	CH1 Wave pattern data points setting (L)	R/W
1041	CH1 Wave pattern data points setting (H)	
1042	CH2 Wave pattern data points setting (L)	
1043	CH2 Wave pattern data points setting (H)	
1044	CH3 Wave pattern data points setting (L)	
1045	CH3 Wave pattern data points setting (H)	
1046	CH4 Wave pattern data points setting (L)	
1047	CH4 Wave pattern data points setting (H)	
1048	System area (Use prohibited)	-
to		
1055		
1056	CH1 Wave pattern output repetition setting	R/W
1057	CH2 Wave pattern output repetition setting	
1058	CH3 Wave pattern output repetition setting	
1059	CH4 Wave pattern output repetition setting	
1060	System area (Use prohibited)	-
to		
1063		
1064	CH1 Constant for wave output conversion cycle	R/W
1065	CH2 Constant for wave output conversion cycle	
1066	CH3 Constant for wave output conversion cycle	
1067	CH4 Constant for wave output conversion cycle	
1068	System area (Use prohibited)	-
to		
1071		
1072	Step action wave output request	R/W
1073	System area (Use prohibited)	-
to		
1079		
1080	CH1 Wave output step action movement amount	R/W
1081	CH2 Wave output step action movement amount	
1082	CH3 Wave output step action movement amount	
1083	CH4 Wave output step action movement amount	
1084	System area (Use prohibited)	-
to		
1099		

L60DA4		
Address (decimal)	Name	Read/write
1100	CH1 Wave output status monitor	R
1101	CH2 Wave output status monitor	
1102	CH3 Wave output status monitor	
1103	CH4 Wave output status monitor	
1104	System area (Use prohibited)	-
to		
1107		
1108	CH1 Wave output conversion cycle monitor (L)	R
1109	CH1 Wave output conversion cycle monitor (H)	
1110	CH2 Wave output conversion cycle monitor (L)	
1111	CH2 Wave output conversion cycle monitor (H)	
1112	CH3 Wave output conversion cycle monitor (L)	
1113	CH3 Wave output conversion cycle monitor (H)	
1114	CH4 Wave output conversion cycle monitor (L)	
1115	CH4 Wave output conversion cycle monitor (H)	
1116	System area (Use prohibited)	-
to		
1123		
1124	CH1 Wave pattern output count monitor	R
1125	CH2 Wave pattern output count monitor	
1126	CH3 Wave pattern output count monitor	
1127	CH4 Wave pattern output count monitor	
1128	System area (Use prohibited)	-
to		
1131		
1132	CH1 Wave output current address monitor (L)	R
1133	CH1 Wave output current address monitor (H)	
1134	CH2 Wave output current address monitor (L)	
1135	CH2 Wave output current address monitor (H)	
1136	CH3 Wave output current address monitor (L)	
1137	CH3 Wave output current address monitor (H)	
1138	CH4 Wave output current address monitor (L)	
1139	CH4 Wave output current address monitor (H)	
1140	System area (Use prohibited)	-
to		
1147		
1148	CH1 Wave output current digital value monitor	R
1149	CH2 Wave output current digital value monitor	
1150	CH3 Wave output current digital value monitor	
1151	CH4 Wave output current digital value monitor	
1152	System area (Use prohibited)	-
to		
1155		

L60DA4		
Address (decimal)	Name	Read/write
1156	CH1 Wave output digital value outside the range Address monitor (L)	R
1157	CH1 Wave output digital value outside the range Address monitor (H)	
1158	CH2 Wave output digital value outside the range Address monitor (L)	
1159	CH2 Wave output digital value outside the range Address monitor (H)	
1160	CH3 Wave output digital value outside the range Address monitor (L)	
1161	CH3 Wave output digital value outside the range Address monitor (H)	
1162	CH4 Wave output digital value outside the range Address monitor (L)	
1163	CH4 Wave output digital value outside the range Address monitor (H)	
1164 to 1171	System area (Use prohibited)	
1172	CH1 Wave output warning Address monitor (L)	R
1173	CH1 Wave output warning Address monitor (H)	
1174	CH2 Wave output warning Address monitor (L)	
1175	CH2 Wave output warning Address monitor (H)	
1176	CH3 Wave output warning Address monitor (L)	
1177	CH3 Wave output warning Address monitor (H)	
1178	CH4 Wave output warning Address monitor (L)	
1179	CH4 Wave output warning Address monitor (H)	
1180 to 1799	System area (Use prohibited)	-

3.6 A1S68DAV (Alternative Model: L60DAVL8)

3.6.1 Performance specifications comparison

Item	A1S68DAV												
Digital input	16-bit signed binary Setting range: -2048 to 2047												
Analog output	-10 to 0 to 10VDC (External load resistance value: 2KΩ to 1MΩ)												
I/O characteristics	<table border="1"> <thead> <tr> <th>Digital input value</th> <th>Analog output value</th> </tr> </thead> <tbody> <tr> <td>2000</td> <td>10V</td> </tr> <tr> <td>1000</td> <td>5V</td> </tr> <tr> <td>0</td> <td>0V</td> </tr> <tr> <td>-1000</td> <td>-5V</td> </tr> <tr> <td>-2000</td> <td>-10V</td> </tr> </tbody> </table>	Digital input value	Analog output value	2000	10V	1000	5V	0	0V	-1000	-5V	-2000	-10V
Digital input value	Analog output value												
2000	10V												
1000	5V												
0	0V												
-1000	-5V												
-2000	-10V												
Maximum resolution of analog value	5mV												
Overall accuracy (accuracy at maximum analog output value)	±1.0% (±100mV)												
Maximum conversion speed	Within 4ms/8 channels If the access from the CPU module using the FROM/TO instructions is frequent, the speed may be increased for 6ms.												
Number of analog output channels	8 channels/module												
Number of offset/gain settings	–												
Output short protection	Available												

○ : Compatible, △ : Partial change required, × : Incompatible

		L60DAVL8	Compatibility	Precautions for replacement														
		16-bit signed binary (-16384 to 16383, When the scaling function is used: -32768 to 32767)	○	Since the resolution differs between AnS series and L series modules, it needs to be matched using a sequence program, user range settings, or the scaling function. (Refer to Appendix 4.)														
		Voltage: -10 to 10VDC (External load resistance value: 1KΩ to 1MΩ)	○															
		<table border="1"> <thead> <tr> <th>Analog output range</th> <th>Digital value</th> <th>Maximum resolution</th> </tr> </thead> <tbody> <tr> <td>0 to 5V</td> <td rowspan="2">0 to 8000</td> <td>625μV</td> </tr> <tr> <td>1 to 5V</td> <td>500μV</td> </tr> <tr> <td>-10 to 10V</td> <td>-16000 to 16000</td> <td>625μV</td> </tr> <tr> <td>User range settings</td> <td>-8000 to 8000</td> <td>320μV</td> </tr> </tbody> </table>	Analog output range	Digital value	Maximum resolution	0 to 5V	0 to 8000	625μV	1 to 5V	500μV	-10 to 10V	-16000 to 16000	625μV	User range settings	-8000 to 8000	320μV	○	Since the resolution differs between AnS series and L series modules, it needs to be matched using a sequence program, user range settings, or the scaling function. (Refer to Appendix 4.)
Analog output range	Digital value	Maximum resolution																
0 to 5V	0 to 8000	625μV																
1 to 5V		500μV																
-10 to 10V	-16000 to 16000	625μV																
User range settings	-8000 to 8000	320μV																
		Ambient temperature 25±5°C: within ±0.3% (±30mV) Ambient temperature 0 to 55°C: within ±0.5% (±50mV)	○															
		200μs/channel	○															
		8 channels/module	○															
		Up to 10000 times	○															
		Available	○															

Item		A1S68DAV
Insulation method		Between the output terminal and programmable controller power supply: Photocoupler Between output channels: Not insulated
Dielectric withstand voltage		–
Insulation resistance		–
Number of occupied I/O points		32 points (I/O assignment: special 32 points)
External interface		20-point terminal block (M3.5×7 screws)
Applicable wire size		0.75 to 1.5mm ²
Applicable solderless terminal		R1.25-3, 1.25-YS3, RAV1.25-3, V1.25-YS3A
Internal current consumption (5VDC)		0.65A
External power supply	Voltage	–
	Current consumption	
	Inrush current	
Weight		0.22kg

○ : Compatible, △ : Partial change required, × : Incompatible

	L60DAVL8	Compatibility	Precautions for replacement
	Between the I/O terminal and programmable controller power supply: Photocoupler Between output channels: Not insulated Between external power supply and analog output: Transformer	○	
	Between the I/O terminal and programmable controller power supply: 500VACrms, for 1 minute Between external power supply and analog output: 500VACrms, for 1 minute	○	
	Between the I/O terminal and programmable controller power supply: 500VDC, 10MΩ or higher	○	
	16 points (I/O assignment: intelligent 16 points) (Number of occupied modules: 2)	△	The number of occupied I/O points is changed to 16 points and the number of occupied modules is changed to 2.
	18-point terminal block	×	Wiring change is required.
	0.3 to 0.75mm ²	×	
	R1.25-3 (solderless terminals with sleeve are not usable)	×	
	0.15A	○	
	24VDC +20%, -15% Ripple, spike 500mV _{p-p} or lower	×	External power supply is required.
	0.13A		
	3.9A, 2.0ms or less		
	0.22kg	△	

3.6.2 Functional comparison

○ : Available, – : Not available

Item	Description	A1S68DAV	L60DAVL8	Precautions for replacement																	
D/A conversion enable/disable function	Sets whether to enable or disable D/A conversion for each channel.	○	○	With the L60DAVL8, disabling the D/A conversion for an unused channel reduces the conversion cycles.																	
D/A output enable/disable function	Sets whether to output the D/A conversion value or the offset value for each channel. The conversion speed is constant, regardless of the output enable/disable status.	○	○																		
Range switching function	Sets the output range to be used.	–	○																		
Offset/gain setting function	Corrects errors in analog output values.	–	○																		
Analog output HOLD/CLEAR function	Sets the status of analog output values (HOLD or CLEAR), according to the CPU module operating status (RUN, STOP, or stop error).	○	○	The A1S68DAV is set the status for all channels at once using the HLD/CLR terminal on the front of the module. With L60DAVL8, HOLD/CLEAR is set for each channel.																	
Analog output test when CPU module is in STOP status	Outputs the converted analog values when CH□ Output enable/disable flag is forcibly turned on while the CPU module is in the STOP status. <table border="1" style="width: 100%; border-collapse: collapse;"> <thead> <tr> <th rowspan="2">Setting combination</th> <th>D/A conversion enable/disable</th> <th colspan="2">Enable</th> <th colspan="2">Disable</th> </tr> <tr> <th>CH□ Output enable/disable flag</th> <th>Enable</th> <th>Disable</th> <th>Enable</th> <th>Disable</th> </tr> </thead> <tbody> <tr> <td colspan="2">Analog output test</td> <td>Allowed</td> <td>Not allowed</td> <td colspan="2">Not allowed</td> </tr> </tbody> </table>	Setting combination	D/A conversion enable/disable	Enable		Disable		CH□ Output enable/disable flag	Enable	Disable	Enable	Disable	Analog output test		Allowed	Not allowed	Not allowed		–	○	
Setting combination	D/A conversion enable/disable		Enable		Disable																
	CH□ Output enable/disable flag	Enable	Disable	Enable	Disable																
Analog output test		Allowed	Not allowed	Not allowed																	
Resolution mode	Sets the resolution according to the application.*1	–	–	Since the resolution differs between AnS series and L series modules, it needs to be matched using a sequence program, user range settings, or the scaling function. (Refer to Appendix 4.)																	
Scaling function	Scale-converts the input digital value to the set range of the scaling upper limit value and scaling lower limit value. This omits the programming of the scale conversion.	–	○	By setting the same scaling upper limits and scaling lower limits as the resolution of A1S68DAV, the same digital output values as A1S68DAV can be used.																	
Alarm output function	Outputs an alarm when the digital value is out of the preset range.	–	○																		
Wave output function	Registers the prepared wave data (digital value) into the D/A converter module and continuously outputs the data (analog value) in the set conversion cycle.	–	○	This function can be used on the GX Works2.																	
External power supply READY flag	Turns on when the external power supply (24VDC) is supplied. When this flag is off, the analog output value becomes 0V/0mA regardless of other settings.	–	○																		
Error log function	Stores the errors and alarms occurred in the D/A converter module to the buffer memory as a history. Up to 16 errors and alarms can be stored.	–	○																		
Module error collection function	Collects the errors and alarms occurred in the D/A converter module and stores them in the CPU module.	–	○																		
Error clear function	Clears the error from the system monitor window of the programming tool.	–	○	This function can be used on the GX Works2.																	
Saving and restoring offset/gain values	Saves and restores the offset/gain values in the user setting range.	–	○																		

*1 For the A1S68DAV, the mode is fixed at 1/4000 (-2000 to 2000).
 For the L60DAVL8, the resolution is 1/16000 (-10 to 10V) or 1/8000 (1 to 5V, 0 to 5V, user range setting). To use the same digital value that is used for the A1S68DAV, set the scaling upper and lower limit values that match the resolution of the A1S68DAV using the scaling function.

3.6.3 I/O signal comparison

Sequence programs need to be changed because the I/O signal assignment differs.

For details of the I/O signals and sequence programs, refer to the MELSEC-L Digital-Analog Converter Module User's Manual.

A1S68DAV				L60DAVL8			
Device No.	Signal name	Device No.	Signal name	Device No.	Signal name	Device No.	Signal name
X0	WDT error flag (A1S68DAV detection)	Y0	Use prohibited	X0	Module READY	Y0	Use prohibited
X1	D/A conversion READY	Y1		X1	Use prohibited	Y1	CH1 Output enable/disable flag
X2	Error flag	Y2		X2		Y2	CH2 Output enable/disable flag
X3	Use prohibited	Y3		X3		Y3	CH3 Output enable/disable flag
X4		Y4		X4		Y4	CH4 Output enable/disable flag
X5		Y5		X5		Y5	CH5 Output enable/disable flag
X6		Y6		X6		Y6	CH6 Output enable/disable flag
X7		Y7		X7	External power supply READY flag	Y7	CH7 Output enable/disable flag
X8		Y8		X8	Use prohibited	Y8	CH8 Output enable/disable flag
X9		Y9		X9	Operating condition setting completed flag	Y9	Operating condition setting request
XA		YA		XA	Offset/gain setting mode flag	YA	User range writing request
XB		YB		XB	Channel change completed flag	YB	Channel change request
XC		YC		XC	Set value change completed flag	YC	Set value change request
XD	YD	XD		Use prohibited	YD	Use prohibited	
XE	YE	XE		Warning output signal	YE	Warning output clear request	
XF	YF	XF		Error flag	YF	Error clear request	
X10	Y10	D/A conversion output enable flag					
X11	Y11						
X12	Y12						
X13	Y13						
X14	Y14						
X15	Y15						
X16	Y16						
X17	Y17						
X18	Y18	Error reset flag					
X19	Y19	Use prohibited					
X1A	Y1A						
X1B	Y1B						
X1C	Y1C						
X1D	Y1D						
X1E	Y1E						
X1F	Y1F						

3.6.4 Buffer memory address comparison

Sequence programs need to be changed because the buffer memory address assignment differs. For details of the buffer memory areas and sequence programs, refer to the MELSEC-L Digital-Analog Converter Module User's Manual.

A1S68DAV			L60DAVL8		
Address (decimal)	Name	Read/write	Address (decimal)	Name	Read/write
0	Analog output enable/disable channel	R/W	0	D/A conversion enable/disable setting	R/W
1	CH.1 digital value				
2	CH.2 digital value				
3	CH.3 digital value				
4	CH.4 digital value				
5	CH.5 digital value				
6	CH.6 digital value				
7	CH.7 digital value				
8	CH.8 digital value	-	8	CH8 Digital value	R
9	System area (Use prohibited)				
10	CH.1 set value check code				
11	CH.2 set value check code				
12	CH.3 set value check code				
13	CH.4 set value check code				
14	CH.5 set value check code				
15	CH.6 set value check code				
16	CH.7 set value check code	R	16	CH6 Set value check code	
17	CH.8 set value check code				
		-	17	CH7 Set value check code	
		R	18	CH8 Set value check code	
		R	19	Latest error code	
		-	20	Setting range (CH1 to CH4)	
		R/W	21	Setting range (CH5 to CH8)	
		-	22	Offset/gain setting mode Offset specification	
		R	23	Offset/gain setting mode Gain specification	
		-	24	Offset/gain adjustment value specification	
		-	25	System area (Use prohibited)	
		R	26	HOLD/CLEAR function setting (CH1 to CH4)	
		-	27	HOLD/CLEAR function setting (CH5 to CH8)	
		-	28	System area (Use prohibited)	
		R/W	46	Warning output setting	
		R	47	Warning output flag	
		-	48	System area (Use prohibited)	
		-	49	System area (Use prohibited)	
		-	52	System area (Use prohibited)	

L60DAVL8		
Address (decimal)	Name	Read/write
53	Scaling enable/disable setting	R/W
54	CH1 Scaling lower limit value	
55	CH1 Scaling upper limit value	
56	CH2 Scaling lower limit value	
57	CH2 Scaling upper limit value	
58	CH3 Scaling lower limit value	
59	CH3 Scaling upper limit value	
60	CH4 Scaling lower limit value	
61	CH4 Scaling upper limit value	
62	CH5 Scaling lower limit value	
63	CH5 Scaling upper limit value	
64	CH6 Scaling lower limit value	
65	CH6 Scaling upper limit value	
66	CH7 Scaling lower limit value	
67	CH7 Scaling upper limit value	
68	CH8 Scaling lower limit value	
69	CH8 Scaling upper limit value	
70	System area (Use prohibited)	-
to		
85		
86	CH1 Warning output upper limit value	R/W
87	CH1 Warning output lower limit value	
88	CH2 Warning output upper limit value	
89	CH2 Warning output lower limit value	
90	CH3 Warning output upper limit value	
91	CH3 Warning output lower limit value	
92	CH4 Warning output upper limit value	
93	CH4 Warning output lower limit value	
94	CH5 Warning output upper limit value	
95	CH5 Warning output lower limit value	
96	CH6 Warning output upper limit value	
97	CH6 Warning output lower limit value	
98	CH7 Warning output upper limit value	
99	CH7 Warning output lower limit value	
100	CH8 Warning output upper limit value	
101	CH8 Warning output lower limit value	
102	System area (Use prohibited)	-
to		
157		
158	Mode switching setting	R/W
159		R/W
160	System area (Use prohibited)	-
to		
201		

L60DAVL8		
Address (decimal)	Name	Read/write
202	CH1 Industrial shipment settings offset value	R/W
203	CH1 Industrial shipment settings gain value	
204	CH2 Industrial shipment settings offset value	
205	CH2 Industrial shipment settings gain value	
206	CH3 Industrial shipment settings offset value	
207	CH3 Industrial shipment settings gain value	
208	CH4 Industrial shipment settings offset value	
209	CH4 Industrial shipment settings gain value	
210	CH5 Industrial shipment settings offset value	
211	CH5 Industrial shipment settings gain value	
212	CH6 Industrial shipment settings offset value	
213	CH6 Industrial shipment settings gain value	
214	CH7 Industrial shipment settings offset value	
215	CH7 Industrial shipment settings gain value	
216	CH8 Industrial shipment settings offset value	
217	CH8 Industrial shipment settings gain value	
218	CH1 User range settings offset value	
219	CH1 User range settings gain value	
220	CH2 User range settings offset value	
221	CH2 User range settings gain value	
222	CH3 User range settings offset value	
223	CH3 User range settings gain value	
224	CH4 User range settings offset value	
225	CH4 User range settings gain value	
226	CH5 User range settings offset value	
227	CH5 User range settings gain value	
228	CH6 User range settings offset value	
229	CH6 User range settings gain value	
230	CH7 User range settings offset value	
231	CH7 User range settings gain value	
232	CH8 User range settings offset value	
233	CH8 User range settings gain value	
234		-
to	System area (Use prohibited)	
999		
1000	CH1 Wave output start/stop request	R/W
1001	CH2 Wave output start/stop request	
1002	CH3 Wave output start/stop request	
1003	CH4 Wave output start/stop request	
1004	CH5 Wave output start/stop request	
1005	CH6 Wave output start/stop request	
1006	CH7 Wave output start/stop request	
1007	CH8 Wave output start/stop request	
1008	CH1 Output setting during wave output stop	R/W
1009	CH2 Output setting during wave output stop	
1010	CH3 Output setting during wave output stop	
1011	CH4 Output setting during wave output stop	
1012	CH5 Output setting during wave output stop	
1013	CH6 Output setting during wave output stop	
1014	CH7 Output setting during wave output stop	
1015	CH8 Output setting during wave output stop	
1016	CH1 Output value during wave output stop	R/W
1017	CH2 Output value during wave output stop	
1018	CH3 Output value during wave output stop	
1019	CH4 Output value during wave output stop	
1020	CH5 Output value during wave output stop	
1021	CH6 Output value during wave output stop	
1022	CH7 Output value during wave output stop	
1023	CH8 Output value during wave output stop	

L60DAVL8		
Address (decimal)	Name	Read/write
1024	CH1 Wave pattern start address setting (L)	R/W
1025	CH1 Wave pattern start address setting (H)	
1026	CH2 Wave pattern start address setting (L)	
1027	CH2 Wave pattern start address setting (H)	
1028	CH3 Wave pattern start address setting (L)	
1029	CH3 Wave pattern start address setting (H)	
1030	CH4 Wave pattern start address setting (L)	
1031	CH4 Wave pattern start address setting (H)	
1032	CH5 Wave pattern start address setting (L)	
1033	CH5 Wave pattern start address setting (H)	
1034	CH6 Wave pattern start address setting (L)	
1035	CH6 Wave pattern start address setting (H)	
1036	CH7 Wave pattern start address setting (L)	
1037	CH7 Wave pattern start address setting (H)	
1038	CH8 Wave pattern start address setting (L)	
1039	CH8 Wave pattern start address setting (H)	
1040	CH1 Wave pattern data points setting (L)	R/W
1041	CH1 Wave pattern data points setting (H)	
1042	CH2 Wave pattern data points setting (L)	
1043	CH2 Wave pattern data points setting (H)	
1044	CH3 Wave pattern data points setting (L)	
1045	CH3 Wave pattern data points setting (H)	
1046	CH4 Wave pattern data points setting (L)	
1047	CH4 Wave pattern data points setting (H)	
1048	CH5 Wave pattern data points setting (L)	
1049	CH5 Wave pattern data points setting (H)	
1050	CH6 Wave pattern data points setting (L)	
1051	CH6 Wave pattern data points setting (H)	
1052	CH7 Wave pattern data points setting (L)	
1053	CH7 Wave pattern data points setting (H)	
1054	CH8 Wave pattern data points setting (L)	
1055	CH8 Wave pattern data points setting (H)	
1056	CH1 Wave pattern output repetition setting	R/W
1057	CH2 Wave pattern output repetition setting	
1058	CH3 Wave pattern output repetition setting	
1059	CH4 Wave pattern output repetition setting	
1060	CH5 Wave pattern output repetition setting	
1061	CH6 Wave pattern output repetition setting	
1062	CH7 Wave pattern output repetition setting	
1063	CH8 Wave pattern output repetition setting	
1064	CH1 Constant for wave output conversion cycle	R/W
1065	CH2 Constant for wave output conversion cycle	
1066	CH3 Constant for wave output conversion cycle	
1067	CH4 Constant for wave output conversion cycle	
1068	CH5 Constant for wave output conversion cycle	
1069	CH6 Constant for wave output conversion cycle	
1070	CH7 Constant for wave output conversion cycle	
1071	CH8 Constant for wave output conversion cycle	
1072	Step action wave output request	R/W
1073	System area (Use prohibited)	-
to		
1079		
1080	CH1 Wave output step action movement amount	R/W
1081	CH2 Wave output step action movement amount	
1082	CH3 Wave output step action movement amount	
1083	CH4 Wave output step action movement amount	
1084	CH5 Wave output step action movement amount	
1085	CH6 Wave output step action movement amount	
1086	CH7 Wave output step action movement amount	
1087	CH8 Wave output step action movement amount	
1088	System area (Use prohibited)	-
to		
1099		

L60DAVL8		
Address (decimal)	Name	Read/write
1100	CH1 Wave output status monitor	R
1101	CH2 Wave output status monitor	
1102	CH3 Wave output status monitor	
1103	CH4 Wave output status monitor	
1104	CH5 Wave output status monitor	
1105	CH6 Wave output status monitor	
1106	CH7 Wave output status monitor	
1107	CH8 Wave output status monitor	
1108	CH1 Wave output conversion cycle monitor (L)	R
1109	CH1 Wave output conversion cycle monitor (H)	
1110	CH2 Wave output conversion cycle monitor (L)	
1111	CH2 Wave output conversion cycle monitor (H)	
1112	CH3 Wave output conversion cycle monitor (L)	
1113	CH3 Wave output conversion cycle monitor (H)	
1114	CH4 Wave output conversion cycle monitor (L)	
1115	CH4 Wave output conversion cycle monitor (H)	
1116	CH5 Wave output conversion cycle monitor (L)	
1117	CH5 Wave output conversion cycle monitor (H)	
1118	CH6 Wave output conversion cycle monitor (L)	
1119	CH6 Wave output conversion cycle monitor (H)	
1120	CH7 Wave output conversion cycle monitor (L)	
1121	CH7 Wave output conversion cycle monitor (H)	
1122	CH8 Wave output conversion cycle monitor (L)	
1123	CH8 Wave output conversion cycle monitor (H)	
1124	CH1 Wave pattern output count monitor	R
1125	CH2 Wave pattern output count monitor	
1126	CH3 Wave pattern output count monitor	
1127	CH4 Wave pattern output count monitor	
1128	CH5 Wave pattern output count monitor	
1129	CH6 Wave pattern output count monitor	
1130	CH7 Wave pattern output count monitor	
1131	CH8 Wave pattern output count monitor	
1132	CH1 Wave output current address monitor (L)	R
1133	CH1 Wave output current address monitor (H)	
1134	CH2 Wave output current address monitor (L)	
1135	CH2 Wave output current address monitor (H)	
1136	CH3 Wave output current address monitor (L)	
1137	CH3 Wave output current address monitor (H)	
1138	CH4 Wave output current address monitor (L)	
1139	CH4 Wave output current address monitor (H)	
1140	CH5 Wave output current address monitor (L)	
1141	CH5 Wave output current address monitor (H)	
1142	CH6 Wave output current address monitor (L)	
1143	CH6 Wave output current address monitor (H)	
1144	CH7 Wave output current address monitor (L)	
1145	CH7 Wave output current address monitor (H)	
1146	CH8 Wave output current address monitor (L)	
1147	CH8 Wave output current address monitor (H)	
1148	CH1 Wave output current digital value monitor	R
1149	CH2 Wave output current digital value monitor	
1150	CH3 Wave output current digital value monitor	
1151	CH4 Wave output current digital value monitor	
1152	CH5 Wave output current digital value monitor	
1153	CH6 Wave output current digital value monitor	
1154	CH7 Wave output current digital value monitor	
1155	CH8 Wave output current digital value monitor	

L60DAVL8		
Address (decimal)	Name	Read/write
1156	CH1 Wave output digital value outside the range Address monitor (L)	R
1157	CH1 Wave output digital value outside the range Address monitor (H)	
1158	CH2 Wave output digital value outside the range Address monitor (L)	
1159	CH2 Wave output digital value outside the range Address monitor (H)	
1160	CH3 Wave output digital value outside the range Address monitor (L)	
1161	CH3 Wave output digital value outside the range Address monitor (H)	
1162	CH4 Wave output digital value outside the range Address monitor (L)	
1163	CH4 Wave output digital value outside the range Address monitor (H)	
1164	CH5 Wave output digital value outside the range Address monitor (L)	
1165	CH5 Wave output digital value outside the range Address monitor (H)	
1166	CH6 Wave output digital value outside the range Address monitor (L)	
1167	CH6 Wave output digital value outside the range Address monitor (H)	
1168	CH7 Wave output digital value outside the range Address monitor (L)	
1169	CH7 Wave output digital value outside the range Address monitor (H)	
1170	CH8 Wave output digital value outside the range Address monitor (L)	
1171	CH8 Wave output digital value outside the range Address monitor (H)	
1172	CH1 Wave output warning Address monitor (L)	R
1173	CH1 Wave output warning Address monitor (H)	
1174	CH2 Wave output warning Address monitor (L)	
1175	CH2 Wave output warning Address monitor (H)	
1176	CH3 Wave output warning Address monitor (L)	
1177	CH3 Wave output warning Address monitor (H)	
1178	CH4 Wave output warning Address monitor (L)	
1179	CH4 Wave output warning Address monitor (H)	
1180	CH5 Wave output warning Address monitor (L)	
1181	CH5 Wave output warning Address monitor (H)	
1182	CH6 Wave output warning Address monitor (L)	
1183	CH6 Wave output warning Address monitor (H)	
1184	CH7 Wave output warning Address monitor (L)	
1185	CH7 Wave output warning Address monitor (H)	
1186	CH8 Wave output warning Address monitor (L)	
1187	CH8 Wave output warning Address monitor (H)	
1188	System area (Use prohibited)	-
to		
1699		
1700	CH1 D/A conversion status	R
1701	CH2 D/A conversion status	
1702	CH3 D/A conversion status	
1703	CH4 D/A conversion status	
1704	CH5 D/A conversion status	
1705	CH6 D/A conversion status	
1706	CH7 D/A conversion status	
1707	CH8 D/A conversion status	
1708	System area (Use prohibited)	-
1709		

L60DAVL8		
Address (decimal)	Name	Read/write
1710	CH1 Analog output command value	R
1711	CH1 Analog output command value unit	
1712	CH2 Analog output command value	
1713	CH2 Analog output command value unit	
1714	CH3 Analog output command value	
1715	CH3 Analog output command value unit	
1716	CH4 Analog output command value	
1717	CH4 Analog output command value unit	
1718	CH5 Analog output command value	
1719	CH5 Analog output command value unit	
1720	CH6 Analog output command value	
1721	CH6 Analog output command value unit	
1722	CH7 Analog output command value	
1723	CH7 Analog output command value unit	
1724	CH8 Analog output command value	
1725	CH8 Analog output command value unit	
1726	System area (Use prohibited)	-
to		
1729		
1730	RUN LED status monitor	R
1731	ERR LED status monitor	
1732	ALM LED status monitor	
1733	System area (Use prohibited)	-
to		
1799		

4 ANALOG I/O MODULE REPLACEMENT

4.1 List of Analog I/O Module Alternative Models for Replacement

AnS/QnAS series		Transition to L series	
Product	Model	Model	Remarks (Restrictions)
Analog I/O module	A1S63ADA	L60AD2DA2	1) External wiring: Cable size is changed. 2) Number of slots: Not changed 3) Program: The number of occupied I/O points, I/O signals, and buffer memory addresses are changed. 4) Performance specifications: An external power supply (24VDC) is required. 5) Functional specifications: Simple loop control (function expression) function available → Variable arithmetic function or variable conversion characteristics function can be used.*1
	A1S66ADA	L60AD2DA2	1) External wiring: Cable size is changed. 2) Number of slots: Not changed 3) Program: The number of occupied I/O points, I/O signals, and buffer memory addresses are changed. 4) Performance specifications: Analog input 4CH → 2CH 5) Functional specifications: Not changed

*1 Only the L60AD2DA2 with a serial number (first five digits) 17042 or later supports these functions.

Point

The following shows the replacement method for the simple loop control (function expression) function with the A1S63ADA.

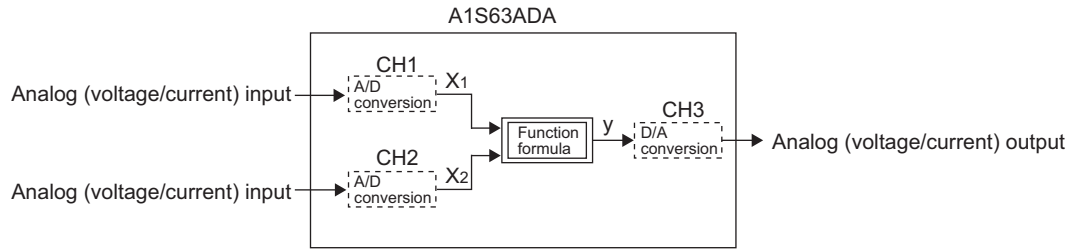

Examples of function formula

1) $y = AX_1 + BX_2 + C$

A, B, C: constant
 X1: CH1 Analog input value
 X2: CH2 Analog input value
 y: CH3 Analog output value

2) $y = A \frac{X_1}{X_2} + C$

3) Coordinate specification: CH1 Analog input/CH3 Analog output

Function expression used with the A1S63ADA	Function of the L60AD2DA2
(1) $y = AX_1 + BX_2 + C$	Variable arithmetic function
(2) $y = A \frac{X_1}{X_2} + C$	
(3) Coordinate specification	Variable conversion characteristics function

4.2 A1S63ADA

4.2.1 Performance specifications comparison

Item		A1S63ADA																																								
Number of analog input points		2 channels/module																																								
Analog input	Voltage	-10 to 0 to 10VDC (Input resistance value: 1MΩ)																																								
	Current	-20 to 0 to 20mA (Input resistance value: 250Ω)																																								
Digital output		16-bit signed binary 1/4000 setting: -4096 to 4095 1/8000 setting: -8192 to 8191 1/12000 setting: -12288 to 12287																																								
I/O characteristics		<table border="1"> <thead> <tr> <th rowspan="2"></th> <th rowspan="2">Analog input</th> <th colspan="3">Digital output value (when gain 5V/20mA, offset 0V/0mA)</th> </tr> <tr> <th>1/4000</th> <th>1/8000</th> <th>1/12000</th> </tr> </thead> <tbody> <tr> <td rowspan="5">I/O characteristics</td> <td>10V</td> <td>4000</td> <td>8000</td> <td>12000</td> </tr> <tr> <td>5V 20mA</td> <td>2000</td> <td>4000</td> <td>6000</td> </tr> <tr> <td>0V 4mA</td> <td>0</td> <td>0</td> <td>0</td> </tr> <tr> <td>-5V -12mA</td> <td>-2000</td> <td>-4000</td> <td>-6000</td> </tr> <tr> <td>-10V</td> <td>-4000</td> <td>-8000</td> <td>-12000</td> </tr> <tr> <td rowspan="2">Resolution</td> <td>Voltage input</td> <td>2.5mV</td> <td>1.25mV</td> <td>0.83mV</td> </tr> <tr> <td>Current input</td> <td>10μA</td> <td>5μA</td> <td>3.33μA</td> </tr> </tbody> </table>				Analog input	Digital output value (when gain 5V/20mA, offset 0V/0mA)			1/4000	1/8000	1/12000	I/O characteristics	10V	4000	8000	12000	5V 20mA	2000	4000	6000	0V 4mA	0	0	0	-5V -12mA	-2000	-4000	-6000	-10V	-4000	-8000	-12000	Resolution	Voltage input	2.5mV	1.25mV	0.83mV	Current input	10μA	5μA	3.33μA
	Analog input	Digital output value (when gain 5V/20mA, offset 0V/0mA)																																								
		1/4000	1/8000	1/12000																																						
I/O characteristics	10V	4000	8000	12000																																						
	5V 20mA	2000	4000	6000																																						
	0V 4mA	0	0	0																																						
	-5V -12mA	-2000	-4000	-6000																																						
	-10V	-4000	-8000	-12000																																						
Resolution	Voltage input	2.5mV	1.25mV	0.83mV																																						
	Current input	10μA	5μA	3.33μA																																						
Resolution																																										
Overall accuracy (Accuracy for the maximum digital output value)		±1% 1/4000 setting: ±40 1/8000 setting: ±80 1/12000 setting: ±120																																								
Maximum conversion speed		1/4000 setting: 1ms/channel 1/8000 setting: 2ms/channel 1/12000 setting: 3ms/channel																																								
Absolute maximum input		Voltage: ±15V Current: ±28mA																																								

○ : Compatible, △ : Partial change required, × : Incompatible

L60AD2DA2		Compatibility	Precautions for replacement																							
2 channels/module		○																								
-10 to 10VDC (Input resistance value: 1MΩ)		○																								
0 to 20mA (Input resistance value: 250Ω)		△																								
16-bit signed binary (-16384 to 16383, When the scaling function is used: -32768 to 32767)		△																								
<table border="1"> <thead> <tr> <th>Analog input range</th> <th>Digital output value</th> <th>Resolution</th> </tr> </thead> <tbody> <tr> <td rowspan="6">Voltage</td> <td>0 to 10V</td> <td>0 to 16000</td> </tr> <tr> <td>0 to 5V</td> <td rowspan="2">0 to 12000</td> </tr> <tr> <td>1 to 5V</td> </tr> <tr> <td>-10 to 10V</td> <td>-16000 to 16000</td> </tr> <tr> <td>1 to 5V (Extended mode)</td> <td>-3000 to 13500</td> </tr> <tr> <td>User range settings (voltage)</td> <td>-12000 to 12000</td> </tr> <tr> <td rowspan="4">Current</td> <td>0 to 20mA</td> <td>0 to 12000</td> </tr> <tr> <td>4 to 20mA</td> <td rowspan="2">-3000 to 13500</td> </tr> <tr> <td>4 to 20mA (Extended mode)</td> </tr> <tr> <td>User range settings (current)</td> <td>-12000 to 12000</td> </tr> </tbody> </table>		Analog input range	Digital output value	Resolution	Voltage	0 to 10V	0 to 16000	0 to 5V	0 to 12000	1 to 5V	-10 to 10V	-16000 to 16000	1 to 5V (Extended mode)	-3000 to 13500	User range settings (voltage)	-12000 to 12000	Current	0 to 20mA	0 to 12000	4 to 20mA	-3000 to 13500	4 to 20mA (Extended mode)	User range settings (current)	-12000 to 12000	△	Since the resolution differs between AnS series and L series modules, it needs to be matched using a sequence program, user range settings, or the scaling function. (Refer to Appendix 4.)
Analog input range	Digital output value	Resolution																								
Voltage	0 to 10V	0 to 16000																								
	0 to 5V	0 to 12000																								
	1 to 5V																									
	-10 to 10V	-16000 to 16000																								
	1 to 5V (Extended mode)	-3000 to 13500																								
	User range settings (voltage)	-12000 to 12000																								
Current	0 to 20mA	0 to 12000																								
	4 to 20mA	-3000 to 13500																								
	4 to 20mA (Extended mode)																									
	User range settings (current)	-12000 to 12000																								
<table border="1"> <thead> <tr> <th rowspan="2">Analog input range</th> <th colspan="2">Ambient temperature</th> </tr> <tr> <th>25±5°C</th> <th>0 to 55°C</th> </tr> </thead> <tbody> <tr> <td rowspan="5">Voltage</td> <td>0 to 10V</td> <td rowspan="2">Within ±0.2% (±32 digit)</td> <td rowspan="2">Within ±0.3% (±48 digit)</td> </tr> <tr> <td>-10 to 10V</td> </tr> <tr> <td>0 to 5V</td> <td rowspan="3">Within ±0.2% (±24 digit)</td> <td rowspan="3">Within ±0.3% (±36 digit)</td> </tr> <tr> <td>1 to 5V</td> </tr> <tr> <td>1 to 5V (Extended mode)</td> </tr> <tr> <td rowspan="3">Current</td> <td>0 to 20mA</td> <td rowspan="3">Within ±0.2% (±24 digit)</td> <td rowspan="3">Within ±0.3% (±36 digit)</td> </tr> <tr> <td>4 to 20mA</td> </tr> <tr> <td>4 to 20mA (Extended mode)</td> </tr> </tbody> </table>		Analog input range	Ambient temperature		25±5°C	0 to 55°C	Voltage	0 to 10V	Within ±0.2% (±32 digit)	Within ±0.3% (±48 digit)	-10 to 10V	0 to 5V	Within ±0.2% (±24 digit)	Within ±0.3% (±36 digit)	1 to 5V	1 to 5V (Extended mode)	Current	0 to 20mA	Within ±0.2% (±24 digit)	Within ±0.3% (±36 digit)	4 to 20mA	4 to 20mA (Extended mode)	○			
Analog input range	Ambient temperature																									
	25±5°C	0 to 55°C																								
Voltage	0 to 10V	Within ±0.2% (±32 digit)	Within ±0.3% (±48 digit)																							
	-10 to 10V																									
	0 to 5V	Within ±0.2% (±24 digit)	Within ±0.3% (±36 digit)																							
	1 to 5V																									
	1 to 5V (Extended mode)																									
Current	0 to 20mA	Within ±0.2% (±24 digit)	Within ±0.3% (±36 digit)																							
	4 to 20mA																									
	4 to 20mA (Extended mode)																									
80μs/channel		○	The conversion speed of L60AD2DA2 is faster than A1S63ADA. Therefore, noise which were not imported to A1S63ADA can be imported as analog signals. In this case, use the averaging processing function to remove the effect of noise.																							
Voltage: ±15V Current: 30mA		○																								

Item		A1S63ADA																																			
Number of analog output points		1 channels/module																																			
Digital input		1/4000 setting: voltage: -4000 to 4000, current: 0 to 4000 1/8000 setting: voltage: -8000 to 8000, current: 0 to 8000 1/12000 setting: voltage: -12000 to 12000, current: 0 to 12000																																			
Analog output	Voltage	-10 to 0 to 10VDC (External load resistance value: 2KΩ to 1MΩ)																																			
	Current	0 to 20mA (External load resistance value: 0 to 600Ω)																																			
I/O characteristics		<table border="1" style="width: 100%; border-collapse: collapse; text-align: center;"> <thead> <tr> <th colspan="3">Digital input value</th> <th colspan="2">Analog output</th> </tr> <tr> <th>1/4000</th> <th>1/8000</th> <th>1/12000</th> <th>Voltage output value *1</th> <th>Current output value *2</th> </tr> </thead> <tbody> <tr> <td>4000</td> <td>8000</td> <td>12000</td> <td>10V</td> <td>20mA</td> </tr> <tr> <td>2000</td> <td>4000</td> <td>6000</td> <td>5V</td> <td>12mA</td> </tr> <tr> <td>0</td> <td>0</td> <td>0</td> <td>0</td> <td>4mA</td> </tr> <tr> <td>-2000</td> <td>-4000</td> <td>-6000</td> <td>-5V</td> <td rowspan="2">-</td> </tr> <tr> <td>-4000</td> <td>-8000</td> <td>-12000</td> <td>-10V</td> </tr> </tbody> </table> <p>*1 The offset value is set to 0V and the gain value is set to 10V (factory default setting). *2 The offset value is set to 4mA and the gain value is set to 20mA (factory default setting).</p>		Digital input value			Analog output		1/4000	1/8000	1/12000	Voltage output value *1	Current output value *2	4000	8000	12000	10V	20mA	2000	4000	6000	5V	12mA	0	0	0	0	4mA	-2000	-4000	-6000	-5V	-	-4000	-8000	-12000	-10V
Digital input value			Analog output																																		
1/4000	1/8000	1/12000	Voltage output value *1	Current output value *2																																	
4000	8000	12000	10V	20mA																																	
2000	4000	6000	5V	12mA																																	
0	0	0	0	4mA																																	
-2000	-4000	-6000	-5V	-																																	
-4000	-8000	-12000	-10V																																		
Maximum resolution		<table style="width: 100%; border-collapse: collapse;"> <tr> <td style="width: 33%;">1/4000</td> <td style="width: 33%;">2.5mV (10V)</td> <td style="width: 33%;">5μA (20mA)</td> </tr> <tr> <td>1/8000</td> <td>1.25mV (10V)</td> <td>2.5μA (20mA)</td> </tr> <tr> <td>1/12000</td> <td>0.83mV (10V)</td> <td>1.7μA (20mA)</td> </tr> </table>		1/4000	2.5mV (10V)	5μA (20mA)	1/8000	1.25mV (10V)	2.5μA (20mA)	1/12000	0.83mV (10V)	1.7μA (20mA)																									
1/4000	2.5mV (10V)	5μA (20mA)																																			
1/8000	1.25mV (10V)	2.5μA (20mA)																																			
1/12000	0.83mV (10V)	1.7μA (20mA)																																			
Overall accuracy (Accuracy for the maximum analog output value)		±1% (voltage: ±100mV, current: ±200μA)																																			
Absolute maximum output		Voltage: ±12V Current: 28mA																																			
Conversion speed		1/4000 setting: 1ms/channel 1/8000 setting: 2ms/channel 1/12000 setting: 3ms/channel																																			
Output short protection		Available																																			
Insulation method		Between the input terminal and programmable controller power supply: Photocoupler Between channels: Not insulated																																			
Dielectric withstand voltage		Between the input terminal and programmable controller power supply: 500VACrms, for 1 minute																																			
Insulation resistance		Between the input terminal and programmable controller power supply: 500VDC, 5MΩ or higher																																			
Conversion speed during simple loop control		1/4000 setting: 4ms 1/8000 setting: 7ms 1/12000 setting: 9ms																																			
Number of occupied I/O points		32 points (I/O assignment: special 32 points)																																			
Connection terminal		20-point terminal block																																			
Applicable wire size		0.75 to 1.5mm ² (Applicable tightening torque: 39 to 59N•cm)																																			
Applicable solderless terminal		1.25-3, 1.25-YS3A, 2-3.5, 2-YS3A, V1.25-M3, V1.25-YS3A, V2-S3, V2-YS3A																																			

○ : Compatible, △ : Partial change required, × : Incompatible

L60AD2DA2		Compatibility	Precautions for replacement																									
2 channels/module		○																										
-16384 to 16383, When the scaling function is used: -32768 to 32767		○																										
-10 to 10VDC (External load resistance value: 1KΩ to 1MΩ)		○																										
0 to 20mA (External load resistance value: 0 to 600Ω)																												
<table border="1"> <thead> <tr> <th colspan="2">Analog output range</th> <th>Digital input value</th> <th>Resolution</th> </tr> </thead> <tbody> <tr> <td rowspan="4">Voltage</td> <td>0 to 5V</td> <td rowspan="2">0 to 12000</td> <td>416μV</td> </tr> <tr> <td>1 to 5V</td> <td>333μV</td> </tr> <tr> <td>-10 to 10V</td> <td>-16000 to 16000</td> <td>625μV</td> </tr> <tr> <td>User range settings (voltage)</td> <td>-12000 to 12000</td> <td>319μV</td> </tr> <tr> <td rowspan="3">Current</td> <td>0 to 20mA</td> <td rowspan="2">0 to 12000</td> <td>1666nA</td> </tr> <tr> <td>4 to 20mA</td> <td>1333nA</td> </tr> <tr> <td>User range settings (current)</td> <td>-12000 to 12000</td> <td>696nA</td> </tr> </tbody> </table>		Analog output range		Digital input value	Resolution	Voltage	0 to 5V	0 to 12000	416μV	1 to 5V	333μV	-10 to 10V	-16000 to 16000	625μV	User range settings (voltage)	-12000 to 12000	319μV	Current	0 to 20mA	0 to 12000	1666nA	4 to 20mA	1333nA	User range settings (current)	-12000 to 12000	696nA	△	Since the resolution differs between AnS series and L series modules, it needs to be matched using a sequence program, user range settings, or the scaling function. (Refer to Appendix 4.)
Analog output range		Digital input value	Resolution																									
Voltage	0 to 5V	0 to 12000	416μV																									
	1 to 5V		333μV																									
	-10 to 10V	-16000 to 16000	625μV																									
	User range settings (voltage)	-12000 to 12000	319μV																									
Current	0 to 20mA	0 to 12000	1666nA																									
	4 to 20mA		1333nA																									
	User range settings (current)	-12000 to 12000	696nA																									
		○																										
<table border="1"> <thead> <tr> <th colspan="2" rowspan="2">Analog output range</th> <th colspan="2">Ambient temperature</th> </tr> <tr> <th>25±5°C</th> <th>0 to 55°C</th> </tr> </thead> <tbody> <tr> <td rowspan="3">Voltage</td> <td>0 to 5V</td> <td rowspan="2">Within ±0.2% (±10mV)</td> <td>Within ±0.4% (±20mV)</td> </tr> <tr> <td>1 to 5V</td> <td>Within ±0.4% (±20mV)</td> </tr> <tr> <td>-10 to 10V</td> <td>Within ±0.2% (±20mV)</td> <td>Within ±0.4% (±40mV)</td> </tr> <tr> <td rowspan="2">Current</td> <td>0 to 20mA</td> <td rowspan="2">Within ±0.2% (±40μA)</td> <td>Within ±0.4% (±80μA)</td> </tr> <tr> <td>4 to 20mA</td> <td>Within ±0.4% (±80μA)</td> </tr> </tbody> </table>		Analog output range		Ambient temperature		25±5°C	0 to 55°C	Voltage	0 to 5V	Within ±0.2% (±10mV)	Within ±0.4% (±20mV)	1 to 5V	Within ±0.4% (±20mV)	-10 to 10V	Within ±0.2% (±20mV)	Within ±0.4% (±40mV)	Current	0 to 20mA	Within ±0.2% (±40μA)	Within ±0.4% (±80μA)	4 to 20mA	Within ±0.4% (±80μA)	○					
Analog output range				Ambient temperature																								
		25±5°C	0 to 55°C																									
Voltage	0 to 5V	Within ±0.2% (±10mV)	Within ±0.4% (±20mV)																									
	1 to 5V		Within ±0.4% (±20mV)																									
	-10 to 10V	Within ±0.2% (±20mV)	Within ±0.4% (±40mV)																									
Current	0 to 20mA	Within ±0.2% (±40μA)	Within ±0.4% (±80μA)																									
	4 to 20mA		Within ±0.4% (±80μA)																									
-		○																										
80μs/channel		○																										
Available		○																										
Between the I/O terminal and programmable controller power supply: Photocoupler Between I/O channels: Not insulated Between external power supply and analog I/O channel: Transformer		○																										
Between the I/O terminal and programmable controller power supply: 500VACrms, for 1 minute Between external power supply and analog I/O: 500VACrms, for 1 minute		○																										
Between the I/O terminal and programmable controller power supply: 500VDC, 10MΩ or higher		○																										
-		×																										
16 points (I/O assignment: intelligent 16 points)		△	The number of occupied I/O points is changed to 16 points.																									
18-point terminal block		×	Wiring change is required.																									
0.3 to 0.75mm ²		×																										
R1.25-3 (Solderless terminals with an insulation sleeve cannot be used.)		×																										

Item		A1S63ADA	
External power supply	Voltage		
	Current consumption	-	
	Inrush current		
Internal current consumption (5VDC)		0.8A	
Weight		0.3kg	

○ : Compatible, △ : Partial change required, × : Incompatible

	L60AD2DA2	Compatibility	Precautions for replacement
	24VDC +20%, -15% Ripple, spike 500mVp-p or lower	×	An external power supply (24VDC) is required.
	0.12A	×	
	3.5A, 1000μs or less	×	
	0.17A	○	
	0.22kg	△	

4.2.2 Functional comparison

(1) A/D conversion functions

○ : Available, - : Not available

Item		Description	A1S63ADA	L60AD2DA2	Precautions for replacement
A/D conversion enable/disable function		Sets whether to enable or disable A/D conversion for each channel. By disabling the conversion for the channels that are not used, the sampling time can be shortened.	○	○	
Sampling processing		Performs the A/D conversion for analog input values successively for each channel, and outputs digital output values upon each conversion.	○	○	
Averaging processing	Time average	For each channel, averages A/D conversion values by the amount of time, and outputs the average value as a digital value.	○	○	The setting range of average time and count differ. Refer to the MELSEC-L Analog I/O Module User's Manual, and check the specifications.
	Count average	For each channel, averages A/D conversion values by the number of times, and outputs the average value as a digital value.	○	○	
	Moving average	For each channel, averages A/D conversion values by the number of times on a moving of each sampling processing, and outputs the average value as a digital value.	-	○	
Range switching function		Sets the input range to be used.	○	○	
Input range extended function		Extends the input range. By combining this function with the input signal error detection function, simple disconnection detection can be executed.	-	○	
Maximum value/minimum value hold function		Stores the maximum and minimum values of the digital output values in the module.	-	○	
Input signal error detection function		Detects the analog input value which exceeds the setting range.	-	○	
Scaling function		Scale-converts the digital output value to the set range of the A/D conversion scaling upper limit value and A/D conversion scaling lower limit value. This omits the programming of the scale conversion.	-	○	To use the same digital output value that is used for the A1S63ADA, set the scaling upper and lower limit values that match the resolution of the A1S63ADA using the scaling function.
Logging function		Logs the digital output value or scaling value (digital operation value). The data of 10000 points can be logged for each channel.	-	○	

(2) D/A conversion functions

○ : Available, - : Not available

Item		Description	A1S63ADA	L60AD2DA2	Precautions for replacement
D/A conversion enable/disable function		Sets whether to enable or disable D/A conversion for each channel.	○	○	With the L60AD2DA2, disabling the D/A conversion for an unused channel reduces the conversion cycles.
D/A output enable/disable function		Sets whether to output the D/A conversion value or the offset value for each channel. The conversion speed is constant, regardless of the output enable/disable status.	○	○	
Range switching function		Sets the output range to be used.	○	○	
Analog output HOLD/CLEAR function		Sets the status of analog output values (HOLD or CLEAR), according to the CPU module operating status (RUN, STOP, or stop error).	○	○	The A1S63ADA is set the status for all channels at once using the HLD/CLR terminal on the front of the module. With the L60AD2DA2, the status can be set for each channel on the Switch Setting window of GX Works2.
Analog output test when CPU module is in STOP status		Outputs the D/A converted analog values when CH□ Output enable/disable flag is forcibly turned on while the CPU module is in the STOP status.	-	○	

○ : Available, – : Not available

Item	Description	A1S63ADA	L60AD2DA2	Precautions for replacement
Scaling function	Scale-converts the digital input value to the set range of the D/A conversion scaling upper limit value and D/A conversion scaling lower limit value. This omits the programming of the scale conversion.	–	○	The A1S63ADA is set the status for all channels at once using the HLD/CLR terminal on the front of the module. With the L60AD2DA2, HOLD/CLEAR can be set for each channel.
Alarm output function	Outputs an alarm when the digital value is out of the preset range.	–	○	
Wave output function	Reads the wave data (digital input values) prepared in advance and outputs analog data at the preset conversion cycle.	–	○	This function can be used on GX Works2.

(3) Common functions

○ : Available, – : Not available

Item	Description	A1S63ADA	L60AD2DA2	Precautions for replacement
Resolution mode	Sets the resolution according to the application. The resolution mode setting is applicable to all channels. *1	○	–	
Simple loop control (function expression)	Converts the analog values input through CH1 and CH2 to digital values and calculates the converted values with the function expression. The calculation result is converted to the analog value and output through CH3.	○	–	
External power supply READY flag	Turns on when the external power supply (24VDC) is supplied. When the external power supply READY flag (X7) is off, A/D and D/A conversion processing is not performed.	–	○	
Error log function	Stores the errors and alarms occurred in the L60AD2DA2 to the buffer memory as a history. Up to 16 errors and alarms can be stored.	–	○	
Module error collection function	Collects the errors and alarms occurred in the L60AD2DA2 and stores them in the CPU module.	–	○	
Error clear function	Clears the error from the system monitor window of the programming tool.	–	○	This function can be used on GX Works2.
Saving and restoring offset/gain values	Saves and restores the offset/gain values in the user setting range.	–	○	
Offset/gain setting function	Corrects errors in the analog and digital output values.	○	○	
Variable arithmetic function	Executes polynomial operations in the analog I/O module. For the polynomial expressions, any combination of parentheses, operators, constants set by users, and data stored in the buffer memory can be used. When conversion is enabled for a D/A conversion channel, operation results are output in analog.	–	○	This function can be used on GX Works2.*2
Variable conversion characteristics function	Conventionally, the I/O conversion characteristic of the analog I/O module (A/D conversion and D/A conversion) is indicated with a straight line connecting the offset value and the gain value. However, with this function, the conversion characteristic can be set by users.	–	○	This function can be used on GX Works2.*2
Variable conversion characteristics function + variable arithmetic function	Executes the operation for digital values converted according to variable conversion characteristics with polynomial expressions registered by users.	–	○	This function can be used on GX Works2.*2
PID control function	An analog input signal from a sensor (such as pressure and flow rate) is input to the module as the process value (PV) (16-bit signed binary) and the PID operation is performed in the module so that the input value reaches the set value (SV). The manipulated value (MV) calculated in the PID operation is output to an external operation device as an analog value of current or voltage.	–	○	*3

*1 For the A1S63ADA, the resolution setting can be selected from 1/4000, 1/8000, and 1/12000 for both voltage and current inputs.

The L60AD2DA2, however, does not support the resolution mode. To use the same digital value that is used for the A1S63ADA, set the scaling upper and lower limit values that match the resolution of the A1S63ADA using the scaling function.

*2 Only the L60AD2DA2 with a serial number (first five digits) 17042 or later supports this function.

*3 Only the L60AD2DA2 with a serial number (first five digits) 17112 or later supports this function.

4.2.3 I/O signal comparison

Sequence programs need to be changed because the I/O signal assignment differs.

For details of the I/O signals and sequence programs, refer to the MELSEC-L Analog I/O Module User's Manual.

A1S63ADA				L60AD2DA2			
Device No.	Signal name	Device No.	Signal name	Device No.	Signal name	Device No.	Signal name
X0	WDT error	Y0	Use prohibited	X0	Module READY	Y0	Use prohibited
X1	Conversion READY	Y1		X1	Use prohibited	Y1	
X2	Error detection	Y2		X2		Y2	
X3	CH3 output upper limit value hold	Y3		X3		Y3	CH3 Output enable/disable flag
X4	CH3 output lower limit value hold	Y4		X4		Y4	CH4 Output enable/disable flag
X5	Simple loop control in execution	Y5		X5		Y5	Use prohibited
X6	Use prohibited	Y6		X6	Set value change completed flag	Y6	Set value change request
X7		Y7		X7	External power supply READY flag	Y7	Use prohibited
X8	Offset/gain selection	Y8		X8	Warning output signal	Y8	Warning output clear request
X9		Y9		X9	Operating condition setting completed flag	Y9	Operation condition setting request
XA		YA		XA	Offset/gain setting mode flag	YA	User range write request
XB		YB		XB	Channel change completed flag	YB	Channel change request
XC		YC		XC	Input signal error detection signal	YC	Use prohibited
XD		YD		XD	Maximum value/minimum value reset completed flag	YD	Maximum value/minimum value reset request
XE	YE	XE		A/D conversion completion flag	YE	Use prohibited	
XF	YF	XF		Error flag	YF	Error clear request	
X10	Use prohibited	Y10		CH3 D-A conversion value output enable			
X11		Y11		Simple loop control execution enable			
X12		Y12	Error reset				
X13		Y13	CH3 upper/lower limits cancel				
X14		Y14	Use prohibited				
X15		Y15					
X16		Y16					
X17		Y17	Offset/gain selection				
X18		Y18					
X19		Y19					
X1A		Y1A					
X1B	Y1B	Offset/gain setting					
X1C	Y1C						
X1D	Y1D	Use prohibited					
X1E	Y1E						
X1F	Y1F						

4.2.4 Buffer memory address comparison

Sequence programs need to be changed because the buffer memory address assignment differs. For details of the buffer memory areas and sequence programs, refer to the MELSEC-L Analog I/O Module User's Manual.

A1S63ADA			L60AD2DA2			
Address (decimal)	Name	Read/write	Address (decimal)	Name	Read/write	
0	A-D/D-A conversion enable/disable setting	R/W	0	A/D conversion enable/disable setting	R/W	
1	A-D conversion averaging setting		1	CH1 Time Average/Count Average/Moving Average		
2	CH1 averaging time/count setting		2	CH2 Time Average/Count Average/Moving Average		
3	CH2 averaging time/count setting		3	System area (Use prohibited)		
4	CH3 output upper limit value setting		4			
5	CH3 output lower limit value setting		5			
6	Simple loop control type setting		6			
7	Constant A setting		7			
8	Constant B setting		8	R		
9	Constant C setting		9			
10	CH3 digital value setting	10	A/D conversion completed flag			
11	CH1 A-D conversion digital value	11	CH1 Digital output value			
12	CH2 A-D conversion digital value	12	CH2 Digital output value			
13	Simple loop control output calculation value	13	System area (Use prohibited)			
14	Resolution setting	14				
15	A-D conversion completion flag	15				
16	Error code	16				
17	Coordinate points setting	17				
18	Point 0	CH1 coordinates	18	Latest error code		
19		CH3 coordinates	19			
20	Point 1	CH1 coordinates	20	Setting range		
21		CH3 coordinates	21	Function selection monitor		
22	Point 2	CH1 coordinates	22	Offset/gain setting mode Offset specification		
23		CH3 coordinates	23	Offset/gain setting mode Gain specification		
24	Point 3	CH1 coordinates	24	Averaging process setting		
25		CH3 coordinates	25	System area (Use prohibited)		
26	Point 4	CH1 coordinates	26	Input signal error detection setting		
27		CH3 coordinates	27	System area (Use prohibited)		
28	Point 5	CH1 coordinates	28	System area (Use prohibited)		
29		CH3 coordinates	29			
30	Point 6	CH1 coordinates	30	CH1 Maximum value		
31		CH3 coordinates	31	CH1 Minimum value		
32	Point 7	CH1 coordinates	32	CH2 Maximum value		
33		CH3 coordinates	33	CH2 Minimum value		
34	Point 8	CH1 coordinates	34	System area (Use prohibited)		
35		CH3 coordinates	35			
36	Point 9	CH1 coordinates	36			
37		CH3 coordinates	37			
			38		R	
			to			
			48			
			49			Input signal error detection flag
			50			System area (Use prohibited)
			to			
			52			
			53	A/D conversion scaling enable/disable setting		
			54	CH1 Scaling value		
			55	CH2 Scaling value		
			56	System area (Use prohibited)		
			to			
			to			
			61			

L60AD2DA2		
Address (decimal)	Name	Read/write
62	CH1 A/D conversion scaling lower limit value	R/W
63	CH1 A/D conversion scaling upper limit value	
64	CH2 A/D conversion scaling lower limit value	
65	CH2 A/D conversion scaling upper limit value	
66 to 141	System area (Use prohibited)	-
142	CH1 Input signal error detection setting value	R/W
143	CH2 Input signal error detection setting value	
144 to 157	System area (Use prohibited)	-
158 159	Mode switching setting	R/W
160 to 199	System area (Use prohibited)	-
200	Pass data classification setting	R/W
201	System area (Use prohibited)	-
202	CH1 Industrial shipment settings offset value	R/W
203	CH1 Industrial shipment settings gain value	
204	CH2 Industrial shipment settings offset value	
205	CH2 Industrial shipment settings gain value	
206	CH3 Industrial shipment settings offset value	
207	CH3 Industrial shipment settings gain value	
208	CH4 Industrial shipment settings offset value	
209	CH4 Industrial shipment settings gain value	
210	CH1 User range settings offset value	
211	CH1 User range settings gain value	
212	CH2 User range settings offset value	
213	CH2 User range settings gain value	
214	CH3 User range settings offset value	
215	CH3 User range settings gain value	
216	CH4 User range settings offset value	
217	CH4 User range settings gain value	
218 to 999	System area (Use prohibited)	-
1000	CH1 Logging enable/disable setting	R/W
1001	CH2 Logging enable/disable setting	
1002 to 1007	System area (Use prohibited)	-
1008	CH1 Logging hold request	R/W
1009	CH2 Logging hold request	
1010 to 1015	System area (Use prohibited)	-
1016	CH1 Logging hold flag	R
1017	CH2 Logging hold flag	
1018 to 1023	System area (Use prohibited)	-
1024	CH1 Logging data setting	R/W
1025	CH2 Logging data setting	
1026 to 1031	System area (Use prohibited)	-
1032	CH1 Logging cycle setting value	R/W
1033	CH2 Logging cycle setting value	

L60AD2DA2		
Address (decimal)	Name	Read/write
1034	System area (Use prohibited)	-
to		
1039		
1040	CH1 Logging cycle unit setting	R/W
1041	CH2 Logging cycle unit setting	
1042	System area (Use prohibited)	-
to		
1047		
1048	CH1 Logging points after trigger	R/W
1049	CH2 Logging points after trigger	
1050	System area (Use prohibited)	-
to		
1055		
1056	CH1 Level trigger condition setting	R/W
1057	CH2 Level trigger condition setting	
1058	System area (Use prohibited)	-
to		
1063		
1064	CH1 Trigger data	R/W
1065	CH2 Trigger data	
1066	System area (Use prohibited)	-
to		
1071		
1072	Level data 0	R/W
1073	Level data 1	
1074	Level data 2	
1075	Level data 3	
1076	Level data 4	
1077	Level data 5	
1078	Level data 6	
1079	Level data 7	
1080	Level data 8	
1081	Level data 9	
1082	CH1 Trigger setting value	
1083	CH2 Trigger setting value	
1084	System area (Use prohibited)	-
to		
1089		
1090	CH1 Head pointer	R
1091	CH2 Head pointer	
1092	System area (Use prohibited)	-
to		
1097		
1098	CH1 Latest pointer	R
1099	CH2 Latest pointer	
1100	System area (Use prohibited)	-
to		
1105		
1106	CH1 Number of logging data	R
1107	CH2 Number of logging data	
1108	System area (Use prohibited)	-
to		
1113		
1114	CH1 Trigger pointer	R
1115	CH2 Trigger pointer	
1116	System area (Use prohibited)	-
to		
1121		
1122	CH1 Logging cycle monitor value (s)	R
1123	CH1 Logging cycle monitor value (ms)	
1124	CH1 Logging cycle monitor value (μs)	
1125	CH2 Logging cycle monitor value (s)	
1126	CH2 Logging cycle monitor value (ms)	

L60AD2DA2		
Address (decimal)	Name	Read/write
1127	CH2 Logging cycle monitor value (μs)	R
1128	System area (Use prohibited)	-
to		
1145		
1146	CH1 Logging status monitor value	R
1147	CH2 Logging status monitor value	
1148	System area (Use prohibited)	-
to		
1153		
1154	CH1 Trigger detection time (First two digits of the year/Last two digits of the year)	R
1155	CH1 Trigger detection time (Month/Day)	
1156	CH1 Trigger detection time (Hour/Minute)	
1157	CH1 Trigger detection time (Second/Day of the week)	
1158	CH2 Trigger detection time (First two digits of the year/Last two digits of the year)	
1159	CH2 Trigger detection time (Month/Day)	
1160	CH2 Trigger detection time (Hour/Minute)	
1161	CH2 Trigger detection time (Second/Day of the week)	
1162	System area (Use prohibited)	-
to		
1999		
2000	D/A conversion enable/disable setting	R/W
2001	System area (Use prohibited)	-
2002		
2003	CH3 Digital input value	R/W
2004	CH4 Digital input value	
2005	System area (Use prohibited)	-
to		
2012		
2013	CH3 Set value check code	R
2014	CH4 Set value check code	
2015	System area (Use prohibited)	-
to		
2023		
2024	Offset/gain adjustment value specification	R/W
2025	System area (Use prohibited)	-
2026	HOLD/CLEAR function setting	R
2027	System area (Use prohibited)	-
to		
2046		
2047	Warning output setting	R/W
2048	Warning output flag	R
2049	System area (Use prohibited)	-
to		
2052		
2053	D/A conversion scaling enable/disable setting	R/W
2054	System area (Use prohibited)	-
to		
2057		
2058	CH3 D/A conversion scaling lower limit value	R/W
2059	CH3 D/A conversion scaling upper limit value	
2060	CH4 D/A conversion scaling lower limit value	
2061	CH4 D/A conversion scaling upper limit value	
2062	System area (Use prohibited)	-
to		
2089		
2090	CH3 Warning output upper limit value	R/W
2091	CH3 Warning output lower limit value	
2092	CH4 Warning output upper limit value	
2093	CH4 Warning output lower limit value	

L60AD2DA2		
Address (decimal)	Name	Read/write
2094	System area (Use prohibited)	-
to		
3001		
3002	CH3 Wave output start/stop request	R/W
3003	CH4 Wave output start/stop request	R/W
3004	System area (Use prohibited)	-
to		
3009		
3010	CH3 Output setting during wave output stop	R/W
3011	CH4 Output setting during wave output stop	
3012	System area (Use prohibited)	-
to		
3017		
3018	CH3 Output value during wave output stop	R/W
3019	CH4 Output value during wave output stop	
3020	System area (Use prohibited)	-
to		
3027		
3028	CH3 Wave pattern start address setting (L)	R/W
3029	CH3 Wave pattern start address setting (H)	
3030	CH4 Wave pattern start address setting (L)	
3031	CH4 Wave pattern start address setting (H)	
3032	System area (Use prohibited)	-
to		
3043		
3044	CH3 Wave pattern data points setting (L)	R/W
3045	CH3 Wave pattern data points setting (H)	
3046	CH4 Wave pattern data points setting (L)	
3047	CH4 Wave pattern data points setting (H)	
3048	System area (Use prohibited)	-
to		
3057		
3058	CH3 Wave pattern output repetition setting	R/W
3059	CH4 Wave pattern output repetition setting	
3060	System area (Use prohibited)	-
to		
3065		
3066	CH3 Constant for wave output conversion cycle	R/W
3067	CH4 Constant for wave output conversion cycle	
3068	System area (Use prohibited)	-
to		
3071		
3072	Step action wave output request	R/W
3073	System area (Use prohibited)	-
to		
3081		
3082	CH3 Wave output step action movement amount	R/W
3083	CH4 Wave output step action movement amount	
3084	System area (Use prohibited)	-
to		
3101		
3102	CH3 Wave output status monitor	R
3103	CH4 Wave output status monitor	
3104	System area (Use prohibited)	-
to		
3111		
3112	CH3 Wave output conversion cycle monitor (L)	R
3113	CH3 Wave output conversion cycle monitor (H)	
3114	CH4 Wave output conversion cycle monitor (L)	
3115	CH4 Wave output conversion cycle monitor (H)	
3116	System area (Use prohibited)	-
to		
3125		

L60AD2DA2		
Address (decimal)	Name	Read/write
3126	CH3 Wave output count monitor	R
3127	CH4 Wave output count monitor	
3128	System area (Use prohibited)	-
to		
3135		
3136	CH3 Wave output current address monitor (L)	R
3137	CH3 Wave output current address monitor (H)	
3138	CH4 Wave output current address monitor (L)	
3139	CH4 Wave output current address monitor (H)	
3140	System area (Use prohibited)	-
to		
3149		
3150	CH3 Wave output current digital value monitor	R
3151	CH4 Wave output current digital value monitor	
3152	System area (Use prohibited)	-
to		
3159		
3160	CH3 Wave output digital value outside the range Address monitor (L)	R
3161	CH3 Wave output digital value outside the range Address monitor (H)	
3162	CH4 Wave output digital value outside the range Address monitor (L)	
3163	CH4 Wave output digital value outside the range Address monitor (H)	
3164	System area (Use prohibited)	-
to		
3175		
3176	CH3 Wave output warning Address monitor (L)	R
3177	CH3 Wave output warning Address monitor (H)	
3178	CH4 Wave output warning Address monitor (L)	
3179	CH4 Wave output warning Address monitor (H)	
3180	System area (Use prohibited)	-
to		
3999		
4000	Arithmetic expression1 Variable arithmetic value (L)	R
4001	Arithmetic expression1 Variable arithmetic value (H)	
4002	Arithmetic expression1 Variable arithmetic decimal point monitor	
4003	Arithmetic expression1 Variable arithmetic value for analog output	
4004	Arithmetic expression2 Variable arithmetic value (L)	
4005	Arithmetic expression2 Variable arithmetic value (H)	
4006	Arithmetic expression2 Variable arithmetic decimal point monitor	
4007	Arithmetic expression2 Variable arithmetic value for analog output	
4008	System area (Use prohibited)	-
to		
4097		
4098	Arithmetic expression data write setting	R/W
to		
4099	Variable conversion characteristics table selection	
4100	Variable conversion characteristics range setting	
4101	Arithmetic expression data write setting	-
4102	System area (Use prohibited)	
to		
4109		

L60AD2DA2		
Address (decimal)	Name	Read/write
4110	Route1 Variable conversion characteristics conversion value monitor	R
4111	Route1 Variable conversion characteristics digital value monitor	
4112	Route1 Variable conversion characteristics digital value outside the range address monitor (L)	
4113	Route1 Variable conversion characteristics digital value outside the range address monitor (H)	
4114	Route1 Variable conversion characteristics warning address monitor (L)	
4115	Route1 Variable conversion characteristics warning address monitor (H)	
4116 to 4119	System area (Use prohibited)	-
4120	Route2 Variable conversion characteristics conversion value monitor	R
4121	Route2 Variable conversion characteristics digital value monitor	
4122	Route2 Variable conversion characteristics digital value outside the range address monitor (L)	
4123	Route2 Variable conversion characteristics digital value outside the range address monitor (H)	
4124	Route2 Variable conversion characteristics warning address monitor (L)	
4125	Route2 Variable conversion characteristics warning address monitor (H)	
4126 to 4299	System area (Use prohibited)	-
4300	Loop1 Control mode monitor	R
4301	Loop1 Manipulated value (MV)	
4302	Loop1 Output conversion value	
4303	Loop1 Auto-tuning status	
4304 to 4319	System area (Use prohibited)	-
4320	Loop1 Control mode switching	R/W
4321	Loop1 Control cycle setting	
4322	Loop1 Set value (SV) setting	
4323	Loop1 Proportional gain (P) setting	
4324 to 4325	Loop1 Integral time (I) setting	
4326	Loop1 Derivative time (D) setting	
4327	Loop1 Gap width setting	
4328	Loop1 Gap gain setting	
4329	Loop1 Two-degree-of-freedom parameter alpha setting	
4330	Loop1 Two-degree-of-freedom parameter beta setting	
4331	Loop1 Derivative gain setting	
4332	Loop1 Variable speed integral judgment value A setting	
4333	Loop1 Variable speed integral judgment value B setting	
4334	Loop1 Forward/reverse action setting	
4335	Loop1 Filter coefficient	
4336	Loop1 Upper limit output limiter setting	
4337	Loop1 Lower limit output limiter setting	
4338	Loop1 Output variation limiter setting	
4339	Loop1 MAN output setting	
4340	Loop1 Output shifting amount to conversion value	
4341	Loop1 PID continuation flag on HOLD	

L60AD2DA2		
Address (decimal)	Name	Read/write
4342	System area (Use prohibited)	-
to		
4359		
4360	Loop1 Auto-tuning execution command	R/W
4361	Loop1 Auto-tuning timeout time	
4362	Loop1 Auto-tuning hysteresis	
4363	Loop1 Auto-tuning output upper limit value	
4364	Loop1 Auto-tuning output lower limit value	
4365	Loop1 Auto-tuning control type setting	
4366	System area (Use prohibited)	
to		
4379		
4380	Loop2 Control mode monitor	R
4381	Loop2 Manipulated value (MV)	
4382	Loop2 Output conversion value	
4383	Loop2 Auto-tuning status	
4384	System area (Use prohibited)	-
to		
4399		
4400	Loop2 Control mode switching	R/W
4401	Loop2 Control cycle setting	
4402	Loop2 Set value (SV) setting	
4403	Loop2 Proportional gain (P) setting	
4404	Loop2 Integral time (I) setting	
to		
4405		
4406	Loop2 Derivative time (D) setting	
4407	Loop2 Gap width setting	
4408	Loop2 Gap gain setting	
4409	Loop2 Two-degree-of-freedom parameter alpha setting	
4410	Loop2 Two-degree-of-freedom parameter beta setting	
4411	Loop2 Derivative gain setting	
4412	Loop2 Variable speed integral judgment value A setting	
4413	Loop2 Variable speed integral judgment value B setting	
4414	Loop2 Forward/reverse action setting	
4415	Loop2 Filter coefficient	
4416	Loop2 Upper limit output limiter setting	
4417	Loop2 Lower limit output limiter setting	
4418	Loop2 Output variation limiter setting	
4419	Loop2 MAN output setting	
4420	Loop2 Output shifting amount to conversion value	
4421	Loop2 PID continuation flag on HOLD	
4422	System area (Use prohibited)	-
to		
4439		
4440	Loop2 Auto-tuning execution command	R/W
4441	Loop2 Auto-tuning timeout time	
4442	Loop2 Auto-tuning hysteresis	
4443	Loop2 Auto-tuning output upper limit value	
4444	Loop2 Auto-tuning output lower limit value	
4445	Loop2 Auto-tuning control type setting	
4446	System area (Use prohibited)	
to		
4459		
4460	PID operation expression selection monitor	R
4461	System area (Use prohibited)	-
to		
4699		

L60AD2DA2		
Address (decimal)	Name	Read/write
4700	CH1 A/D conversion status	R
4701	CH2 A/D conversion status	
4702	System area (Use prohibited)	-
to		
4709		
4710	CH1 Analog input monitor	R
4711	CH1 Analog input monitor unit	
4712	CH2 Analog input monitor	
4713	CH2 Analog input monitor unit	
4714	System area (Use prohibited)	-
to		
4749		
4750	CH3 D/A conversion status	R
4751	CH4 D/A conversion status	
4752	System area (Use prohibited)	-
to		
4759		
4760	CH3 Analog output command value	R
4761	CH3 Analog output command value unit	
4762	CH4 Analog output command value	
4763	CH4 Analog output command value unit	
4764	System area (Use prohibited)	-
to		
4799		
4800	Latest address of error history	R
4801	System area (Use prohibited)	-
to		
4809		
4810	No.1 Error code	R
4811	No.1 Error time (First two digits of the year/Last two digits of the year)	
4812	No.1 Error time (Month/Day)	
4813	No.1 Error time (Hour/Minute)	
4814	No.1 Error time (Second/Day of the week)	
4815	No.1 System area (Use prohibited)	-
to		
4819		
4820	No.2 (Same as No.1)	
to		
4829		
4830	No.3 (Same as No.1)	
to		
4839		
4840	No.4 (Same as No.1)	
to		
4849		
4850	No.5 (Same as No.1)	
to		
4859		
4860	No.6 (Same as No.1)	
to		
4869		
4870	No.7 (Same as No.1)	
to		
4879		
4880	No.8 (Same as No.1)	
to		
4889		
4890	No.9 (Same as No.1)	
to		
4899		

L60AD2DA2		
Address (decimal)	Name	Read/write
4900	No.10 (Same as No.1)	
to 4909		
4910	No.11 (Same as No.1)	
to 4919		
4920	No.12 (Same as No.1)	
to 4929		
4930	No.13 (Same as No.1)	
to 4939		
4940	No.14 (Same as No.1)	
to 4949		
4950	No.15 (Same as No.1)	
to 4959		
4960	No.16 (Same as No.1)	
to 4969		
4970	System area (Use prohibited)	-
to 4999		

L60AD2DA2			
Function	Address (decimal)	Name	Read/write
Logging function	5000 to 14999	CH1 Logging data	R
	15000 to 24999	CH2 Logging data	
	25000 to 64139	System area (Use prohibited)	-
Wave output function	5000 to 54999	Wave data registry area	R/W
	55000 to 64139	System area (Use prohibited)	-
Variable arithmetic function	5000 to 64139	System area (Use prohibited)	-
Variable conversion characteristics function	5000 to 37000	Conversion characteristics table	R/W
	37001 to 64139	System area (Use prohibited)	-

4.3 A1S66ADA

4.3.1 Performance specifications comparison

Item		A1S66ADA		
Number of analog input points		4 channels/module		
Analog input	Voltage	-10 to 0 to 10VDC (Input resistance value: 1MΩ)		
	Current	0 to 20mA (Input resistance value: 250Ω)		
Digital output		12-bit binary value 0 to 4095		
I/O characteristics	Analog input range		Digital output value	Resolution
	Voltage	0 to 10V	0 to 4000	2.5mV
		0 to 5V		1.25mV
		1 to 5V		1.0mV
		-10 to 10V		5.0mV
	Current	0 to 20mA		5μA
		4 to 20mA		4μA
Resolution				
Overall accuracy (Accuracy for the maximum digital output value)		Within ±1% (±40)		
Maximum conversion speed		400μs or less/4 channels (Sampling period: 80μs/channel)		
Absolute maximum input		Voltage: ±15V Current: 30mA		

○ : Compatible, △ : Partial change required, × : Incompatible

	L60AD2DA2	Compatibility	Precautions for replacement																																		
	2 channels/module	△																																			
	-10 to 10VDC (Input resistance value: 1MΩ)	○																																			
	0 to 20mA (Input resistance value: 250Ω)	○																																			
	16-bit signed binary (-16384 to 16383, When the scaling function is used: -32768 to 32767)	△																																			
	<table border="1"> <thead> <tr> <th colspan="2">Analog input range</th> <th>Digital output value</th> <th>Resolution</th> </tr> </thead> <tbody> <tr> <td rowspan="6">Voltage</td> <td>0 to 10V</td> <td>0 to 16000</td> <td>625μV</td> </tr> <tr> <td>0 to 5V</td> <td rowspan="2">0 to 12000</td> <td>416μV</td> </tr> <tr> <td>1 to 5V</td> <td>333μV</td> </tr> <tr> <td>-10 to 10V</td> <td>-16000 to 16000</td> <td>625μV</td> </tr> <tr> <td>1 to 5V (Extended mode)</td> <td>-3000 to 13500</td> <td>333μV</td> </tr> <tr> <td>User range settings</td> <td>-12000 to 12000</td> <td>321μV</td> </tr> <tr> <td rowspan="5">Current</td> <td>0 to 20mA</td> <td rowspan="2">0 to 12000</td> <td>1666nA</td> </tr> <tr> <td>4 to 20mA</td> <td>1333nA</td> </tr> <tr> <td>4 to 20mA (Extended mode)</td> <td>-3000 to 13500</td> <td>1333nA</td> </tr> <tr> <td>User range settings</td> <td>-12000 to 12000</td> <td>1287nA</td> </tr> </tbody> </table>	Analog input range		Digital output value	Resolution	Voltage	0 to 10V	0 to 16000	625μV	0 to 5V	0 to 12000	416μV	1 to 5V	333μV	-10 to 10V	-16000 to 16000	625μV	1 to 5V (Extended mode)	-3000 to 13500	333μV	User range settings	-12000 to 12000	321μV	Current	0 to 20mA	0 to 12000	1666nA	4 to 20mA	1333nA	4 to 20mA (Extended mode)	-3000 to 13500	1333nA	User range settings	-12000 to 12000	1287nA	△	Since the resolution differs between AnS series and L series modules, it needs to be matched using a sequence program, user range settings, or the scaling function. (Refer to Appendix 4.)
Analog input range		Digital output value	Resolution																																		
Voltage	0 to 10V	0 to 16000	625μV																																		
	0 to 5V	0 to 12000	416μV																																		
	1 to 5V		333μV																																		
	-10 to 10V	-16000 to 16000	625μV																																		
	1 to 5V (Extended mode)	-3000 to 13500	333μV																																		
	User range settings	-12000 to 12000	321μV																																		
Current	0 to 20mA	0 to 12000	1666nA																																		
	4 to 20mA		1333nA																																		
	4 to 20mA (Extended mode)	-3000 to 13500	1333nA																																		
	User range settings	-12000 to 12000	1287nA																																		
			○																																		
	<table border="1"> <thead> <tr> <th colspan="2" rowspan="2">Analog input range</th> <th colspan="2">Ambient temperature</th> </tr> <tr> <th>25±5°C</th> <th>0±55°C</th> </tr> </thead> <tbody> <tr> <td rowspan="5">Voltage</td> <td>0 to 10V</td> <td rowspan="2">Within ±0.2% (±32 digit)</td> <td rowspan="2">Within ±0.3% (±48 digit)</td> </tr> <tr> <td>-10 to 10V</td> </tr> <tr> <td>0 to 5V</td> <td rowspan="3">Within ±0.2% (±24 digit)</td> <td rowspan="3">Within ±0.3% (±36 digit)</td> </tr> <tr> <td>1 to 5V</td> </tr> <tr> <td>1 to 5V (Extended mode)</td> </tr> <tr> <td rowspan="3">Current</td> <td>0 to 20mA</td> <td rowspan="3">Within ±0.2% (±24 digit)</td> <td rowspan="3">Within ±0.3% (±36 digit)</td> </tr> <tr> <td>4 to 20mA</td> </tr> <tr> <td>4 to 20mA (Extended mode)</td> </tr> </tbody> </table>	Analog input range		Ambient temperature		25±5°C	0±55°C	Voltage	0 to 10V	Within ±0.2% (±32 digit)	Within ±0.3% (±48 digit)	-10 to 10V	0 to 5V	Within ±0.2% (±24 digit)	Within ±0.3% (±36 digit)	1 to 5V	1 to 5V (Extended mode)	Current	0 to 20mA	Within ±0.2% (±24 digit)	Within ±0.3% (±36 digit)	4 to 20mA	4 to 20mA (Extended mode)	○													
Analog input range				Ambient temperature																																	
		25±5°C	0±55°C																																		
Voltage	0 to 10V	Within ±0.2% (±32 digit)	Within ±0.3% (±48 digit)																																		
	-10 to 10V																																				
	0 to 5V	Within ±0.2% (±24 digit)	Within ±0.3% (±36 digit)																																		
	1 to 5V																																				
	1 to 5V (Extended mode)																																				
Current	0 to 20mA	Within ±0.2% (±24 digit)	Within ±0.3% (±36 digit)																																		
	4 to 20mA																																				
	4 to 20mA (Extended mode)																																				
	80μs/channel	○																																			
	Voltage: ±15V Current: 30mA	○																																			

Item		A1S66ADA		
Number of analog output points		2 channels/module		
Digital input		12-bit binary value 0 to 4000		
Analog output	Voltage	-10 to 10VDC (External load resistance value: 2KΩ to 1MΩ)		
	Current	0 to 20mA (External load resistance value: 0 to 600Ω)		
I/O characteristics				
Maximum resolution	Analog output range		Resolution	
	Voltage	0 to 10V	0 to 4000	2.5mV
		0 to 5V		1.25mV
		1 to 5V		1.0mV
		-10 to 10V		5.0mV
	Current	0 to 20mA		5μA
		4 to 20mA		4μA
	Overall accuracy (Accuracy for the maximum analog output value)			±1% (voltage: ±100mV, current: ±200μA)
Conversion speed		240μs or less/2 channels (Sampling period: 80μs/channel)		
Absolute maximum output		Voltage: ±12V Current: 28mA		
Output short protection		Available		
Insulation method		Between the input terminal and programmable controller power supply: Photocoupler Between channels: Not insulated		
Dielectric withstand voltage		Between the input terminal and programmable controller power supply: 500VACrms, for 1 minute		
Insulation resistance		Between the input terminal and programmable controller power supply: 500VDC, 5MΩ or higher		
Number of occupied I/O points		64 points (Input 64 points, output 64 points) (I/O assignment: output 64 points)		
Connection terminal		20-point terminal block		
Applicable wire size		0.75 to 1.25mm ² (Applicable tightening torque: 39 to 59N•cm)		
Applicable solderless terminal		1.25-3, 1.25-YS3, 2-3.5, 2-YS3A, V1.25-M3, V1.25-YS3A, V2-S3, V2-YS3A		
External power supply	Voltage	21.6 to 26.4VDC		
	Current consumption	0.16A		
	Inrush current	-		
Internal current consumption (5VDC)		0.21A		
Weight		0.33kg		

○ : Compatible, △ : Partial change required, × : Incompatible

L60AD2DA2		Compatibility	Precautions for replacement																									
2 channels/module		○																										
-16384 to 16383 When the scaling function is used: -32768 to 32767		○																										
-10 to 10VDC (External load resistance value: 1KΩ to 1MΩ)		○																										
0 to 20mA (External load resistance value: 0 to 600Ω)																												
<table border="1"> <thead> <tr> <th colspan="2">Analog output range</th> <th>Digital input value</th> <th>Resolution</th> </tr> </thead> <tbody> <tr> <td rowspan="4">Voltage</td> <td>0 to 5V</td> <td rowspan="2">0 to 12000</td> <td>416μV</td> </tr> <tr> <td>1 to 5V</td> <td>333μV</td> </tr> <tr> <td>-10 to 10V</td> <td>-16000 to 16000</td> <td>625μV</td> </tr> <tr> <td>User range settings</td> <td>-12000 to 12000</td> <td>319μV</td> </tr> <tr> <td rowspan="3">Current</td> <td>0 to 20mA</td> <td rowspan="2">0 to 12000</td> <td>1666nA</td> </tr> <tr> <td>4 to 20mA</td> <td>1333nA</td> </tr> <tr> <td>User range settings</td> <td>-12000 to 12000</td> <td>696nA</td> </tr> </tbody> </table>		Analog output range		Digital input value	Resolution	Voltage	0 to 5V	0 to 12000	416μV	1 to 5V	333μV	-10 to 10V	-16000 to 16000	625μV	User range settings	-12000 to 12000	319μV	Current	0 to 20mA	0 to 12000	1666nA	4 to 20mA	1333nA	User range settings	-12000 to 12000	696nA	○	Since the resolution differs between AnS series and L series modules, it needs to be matched using a sequence program, user range settings, or the scaling function. (Refer to Appendix 4.)
Analog output range		Digital input value	Resolution																									
Voltage	0 to 5V	0 to 12000	416μV																									
	1 to 5V		333μV																									
	-10 to 10V	-16000 to 16000	625μV																									
	User range settings	-12000 to 12000	319μV																									
Current	0 to 20mA	0 to 12000	1666nA																									
	4 to 20mA		1333nA																									
	User range settings	-12000 to 12000	696nA																									
<table border="1"> <thead> <tr> <th colspan="2" rowspan="2">Analog output range</th> <th colspan="2">Ambient temperature</th> </tr> <tr> <th>25±5°C</th> <th>0 to 55°C</th> </tr> </thead> <tbody> <tr> <td rowspan="3">Voltage</td> <td>0 to 5V</td> <td rowspan="2">Within ±0.2% (±10mV)</td> <td>Within ±0.4% (±20mV)</td> </tr> <tr> <td>1 to 5V</td> <td>Within ±0.4% (±40mV)</td> </tr> <tr> <td>-10 to 10V</td> <td>Within ±0.2% (±20mV)</td> <td>Within ±0.4% (±40mV)</td> </tr> <tr> <td rowspan="2">Current</td> <td>0 to 20mA</td> <td rowspan="2">Within ±0.2% (±40μA)</td> <td>Within ±0.4% (±80μA)</td> </tr> <tr> <td>4 to 20mA</td> <td>Within ±0.4% (±80μA)</td> </tr> </tbody> </table>		Analog output range		Ambient temperature		25±5°C	0 to 55°C	Voltage	0 to 5V	Within ±0.2% (±10mV)	Within ±0.4% (±20mV)	1 to 5V	Within ±0.4% (±40mV)	-10 to 10V	Within ±0.2% (±20mV)	Within ±0.4% (±40mV)	Current	0 to 20mA	Within ±0.2% (±40μA)	Within ±0.4% (±80μA)	4 to 20mA	Within ±0.4% (±80μA)	○					
Analog output range				Ambient temperature																								
		25±5°C	0 to 55°C																									
Voltage	0 to 5V	Within ±0.2% (±10mV)	Within ±0.4% (±20mV)																									
	1 to 5V		Within ±0.4% (±40mV)																									
	-10 to 10V	Within ±0.2% (±20mV)	Within ±0.4% (±40mV)																									
Current	0 to 20mA	Within ±0.2% (±40μA)	Within ±0.4% (±80μA)																									
	4 to 20mA		Within ±0.4% (±80μA)																									
80μs/channel		○																										
-		○																										
Available		○																										
Between the I/O terminal and programmable controller power supply: Photocoupler Between I/O channels: Not insulated Between external power supply and analog I/O channel: Transformer		○																										
Between the I/O terminal and programmable controller power supply: 500VACrms, for 1 minute Between external power supply and analog I/O: 500VACrms, for 1 minute		○																										
Between the I/O terminal and programmable controller power supply: 500VDC, 10MΩ or higher		○																										
16 points (I/O assignment: intelligent 16 points)		△	The number of occupied I/O points is changed to 16 points.																									
18-point terminal block		×	Wiring change is required.																									
0.3 to 0.75mm ²		×																										
R1.25-3 (Solderless terminals with an insulation sleeve cannot be used.)		×																										
24VDC +20%, -15% Ripple, spike 500mVp-p or lower		○																										
0.12A		○																										
3.5A, 1000μs or less		△	Inrush current is greater.																									
0.17A		○																										
0.22kg		△																										

4.3.2 Functional comparison

(1) A/D conversion functions

○ : Available, -: Not available

Item		Description	A1S66ADA	L60AD2DA2	Precautions for replacement
A/D conversion enable/disable function		Sets whether to enable or disable A/D conversion for each channel. By disabling the conversion for the channels that are not used, the sampling time can be shortened.	-	○	
Sampling processing		Performs the A/D conversion for analog input values successively for each channel, and outputs digital output values upon each conversion.	-	○	
Averaging processing	Time average	For each channel, averages A/D conversion values by the amount of time, and outputs the average value as a digital value.	-	○	
	Count average	For each channel, averages A/D conversion values by the number of times, and outputs the average value as a digital value.	-	○	
	Moving average	For each channel, averages A/D conversion values by the number of times on a moving of each sampling processing, and outputs the average value as a digital value.	-	○	
Range switching function		Sets the input range to be used.	○	○	
Input range extended function		Extends the input range. By combining this function with the input signal error detection function, simple disconnection detection can be executed.	-	○	
Maximum value/minimum value hold function		Stores the maximum and minimum values of the digital output values in the module.	-	○	
Input signal error detection function		Detects the analog input value which exceeds the setting range.	-	○	
Scaling function		Scale-converts the digital output value to the set range of the A/D conversion scaling upper limit value and A/D conversion scaling lower limit value. This omits the programming of the scale conversion.	-	○	To use the same digital output value that is used for the A1S66ADA, set the scaling upper and lower limit values that match the resolution of the A1S66ADA using the scaling function.
Logging function		Logs the digital output value or scaling value (digital operation value). The data of 10000 points can be logged for each channel.	-	○	

(2) D/A conversion functions

○ : Available, -: Not available

Item		Description	A1S66ADA	L60AD2DA2	Precautions for replacement
D/A conversion enable/disable function		Sets whether to enable or disable D/A conversion for each channel. With the L60AD2DA2, disabling the D/A conversion for an unused channel reduces the conversion cycles.	-	○	
D/A output enable/disable function		Sets whether to output the D/A conversion value or 0V/0mA for each channel. The conversion speed is constant, regardless of the output enable/disable status.	○	-	Output varies when D/A output is disabled.
		Sets whether to output the D/A conversion value or the offset value for each channel. The conversion speed is constant, regardless of the output enable/disable status.	-	○	
Range switching function		Sets the output range to be used.	○	○	
Analog output HOLD/CLEAR function		Sets the status of analog output values (HOLD or CLEAR), according to the CPU module operating status (RUN, STOP, or stop error).	-	○	
Analog output test when CPU module is in STOP status		Outputs the D/A converted analog values when CH. Output enable/disable flag is forcibly turned on while the CPU module is in the STOP status.	-	○	

○ : Available, – : Not available

Item	Description	A1S66ADA	L60AD2DA2	Precautions for replacement
Scaling function	Scale-converts the digital input value to the set range of the D/A conversion scaling upper limit value and D/A conversion scaling lower limit value. This omits the programming of the scale conversion.	–	○	To use the same digital input value that is used for the A1S66ADA, set the scaling upper and lower limit values that match the resolution of the A1S66ADA using the scaling function.
Alarm output function	Outputs an alarm when the digital value is out of the preset range.	–	○	
Wave output function	Reads the wave data (digital input values) prepared in advance and outputs analog data at the preset conversion cycle.	–	○	This function can be used on the GX Works2.

(3) Common functions

○ : Available, – : Not available

Item	Description	A1S66ADA	L60AD2DA2	Precautions for replacement
External power supply READY flag	Turns on when the external power supply (24VDC) is supplied. When the external power supply READY flag (X7) is off, A/D and D/A conversion processing is not performed.	–	○	
Error log function	Stores the errors and alarms occurred in the L60AD2DA2 to the buffer memory as a history. Up to 16 errors and alarms can be stored.	–	○	
Module error collection function	Collects the errors and alarms occurred in the L60AD2DA2 and stores them in the CPU module.	–	○	
Error clear function	Clears the error from the system monitor window of the programming tool.	–	○	This function can be used on the GX Works2.
Saving and restoring offset/gain values	Saves and restores the offset/gain values in the user setting range.	–	○	
Offset/gain setting	Corrects errors in the analog and digital output values.	○	○	
Variable arithmetic function	Executes polynomial operations in the analog I/O module. For the polynomial expressions, any combination of parentheses, operators, constants set by users, and data stored in the buffer memory can be used. When conversion is enabled for a D/A conversion channel, operation results are output in analog.	–	○	This function can be used on GX Works2.*1
Variable conversion characteristics function	Conventionally, the I/O conversion characteristic of the analog I/O module (A/D conversion and D/A conversion) is indicated with a straight line connecting the offset value and the gain value. However, with this function, the conversion characteristic can be set by users.	–	○	This function can be used on GX Works2.*1
Variable conversion characteristics function + variable arithmetic function	Executes the operation for digital values converted according to variable conversion characteristics with polynomial expressions registered by users.	–	○	This function can be used on GX Works2.*1
PID control function	An analog input signal from a sensor (such as pressure and flow rate) is input to the module as the process value (PV) (16-bit signed binary) and the PID operation is performed in the module so that the input value reaches the set value (SV). The manipulated value (MV) calculated in the PID operation is output to an external operation device as an analog value of current or voltage.	–	○	*2

*1 Only the L60AD2DA2 with a serial number (first five digits) 17042 or later supports this function.

*2 Only the L60AD2DA2 with a serial number (first five digits) 17112 or later supports this function.

4.3.3 I/O signal comparison

Sequence programs need to be changed because the I/O signal assignment differs.

For details of the I/O signals and sequence programs, refer to the MELSEC-L Analog I/O Module User's Manual.

A1S66ADA				L60AD2DA2			
Device No.	Signal name	Device No.	Signal name	Device No.	Signal name	Device No.	Signal name
X0	CH3 Digital output value	Y0	CH1 Digital value setting	X0	Module ready	Y0	Use prohibited
X1		Y1		X1	Use prohibited	Y1	
X2		Y2		X2		Y2	
X3		Y3		X3		Y3	CH3 Output enable/disable flag
X4		Y4		X4		Y4	CH4 Output enable/disable flag
X5		Y5		X5		Y5	Use prohibited
X6		Y6		X6	Set value change completed flag	Y6	Set value change request
X7		Y7		X7	External power supply READY flag	Y7	Use prohibited
X8		Y8		X8	Warning output signal	Y8	Warning output clear request
X9		Y9		X9	Operating condition setting completed flag	Y9	Operation condition setting request
XA		YA		XA	Offset/gain setting mode flag	YA	User range write request
XB		YB		XB	Channel change completed flag	YB	Channel change request
XC	Use prohibited	YC	Use prohibited	XC	Input signal error detection signal	YC	Use prohibited
XD		YD		XD	Maximum value/minimum value reset completed flag	YD	Maximum value/minimum value reset request
XE		YE		XE	A/D conversion completion flag	YE	Use prohibited
XF		YF		XF	Error flag	YF	Error clear request
X10	CH4 Digital output value	Y10	CH2 Digital value setting				
X11		Y11					
X12		Y12					
X13		Y13					
X14		Y14					
X15		Y15					
X16		Y16					
X17		Y17					
X18		Y18					
X19		Y19					
X1A	Y1A						
X1B	Y1B						
X1C	Use prohibited	Y1C	Use prohibited				
X1D		Y1D					
X1E		Y1E					
X1F		Y1F		CH2 D/A conversion value output enable flag			

A1S66ADA			
Device No.	Signal name	Device No.	Signal name
X20	CH5 Digital output value	Y20	
X21		Y21	
X22		Y22	
X23		Y23	
X24		Y24	
X25		Y25	
X26		Y26	
X27		Y27	
X28		Y28	
X29		Y29	
X2A		Y2A	
X2B		Y2B	
X2C		Y2C	
X2D		Use prohibited	
X2E	Y2E		
X2F	Y2F		
X30	CH6 Digital output value	Y30	Use prohibited
X31		Y31	
X32		Y32	
X33		Y33	
X34		Y34	
X35		Y35	
X36		Y36	
X37		Y37	
X38		Y38	
X39		Y39	
X3A		Y3A	
X3B		Y3B	
X3C		Y3C	
X3D		Use prohibited	
X3E	Y3E		
X3F	Y3F		

4.3.4 Buffer memory address comparison

A1S66ADA uses I/O signals to exchange data with the CPU module. L60AD2DA2 uses the buffer memory to exchange data with the CPU module. The sequence program to exchange data needs to be modified.

For details of the buffer memory areas and sequence programs, refer to the MELSEC-L Analog I/O Module User's Manual.

L60AD2DA2		
Address (decimal)	Name	Read/write
0	A/D conversion enable/disable setting	R/W
1	CH1 Time Average/Count Average/Moving Average	
2	CH2 Time Average/Count Average/Moving Average	
3	System area (Use prohibited)	-
4		
5		
6		
7		
8	A/D conversion completed flag	R
9		
10		
11	CH1 Digital output value	R
12	CH2 Digital output value	
13	System area (Use prohibited)	-
14		
15		
16		
17		
18	Latest Error code	R
19	Setting range	
20	Function selection monitor	
21	Offset/gain setting mode Offset specification	R/W
22	Offset/gain setting mode Gain specification	
23	Averaging process setting	-
24	System area (Use prohibited)	
25	System area (Use prohibited)	
26	Input signal error detection setting	R/W
27	System area (Use prohibited)	R
28	System area (Use prohibited)	
29	System area (Use prohibited)	
30	CH1 Maximum value	
31	CH1 Minimum value	
32	CH2 Maximum value	R
33	CH2 Minimum value	
34	System area (Use prohibited)	-
35		
36		
37		
38		
39	to	R
40	to	
41	to	
42	48	-
43	48	
44	48	
45	Input signal error detection flag	R
46	System area (Use prohibited)	-
47	System area (Use prohibited)	
48	System area (Use prohibited)	
49	A/D conversion scaling enable/disable setting	R/W
50	CH1 scaling value	R
51	CH2 scaling value	

L60AD2DA2		
Address (decimal)	Name	Read/write
56	System area (Use prohibited)	-
to		
61		
62	CH1 A/D conversion scaling lower limit value	R/W
63	CH1 A/D conversion scaling upper limit value	
64	CH2 A/D conversion scaling lower limit value	
65	CH2 A/D conversion scaling upper limit value	
66	System area (Use prohibited)	-
to		
141		
142	CH1 Input signal error detection setting value	R/W
143	CH2 Input signal error detection setting value	
144	System area (Use prohibited)	-
to		
157		
158	Mode switching setting	R/W
159		
160		
to	System area (Use prohibited)	-
199		
200	Pass data classification setting	R/W
201	System area (Use prohibited)	-
202	CH1 Industrial shipment settings offset value	R/W
203	CH1 Industrial shipment settings gain value	
204	CH2 Industrial shipment settings offset value	
205	CH2 Industrial shipment settings gain value	
206	CH3 Industrial shipment settings offset value	
207	CH3 Industrial shipment settings gain value	
208	CH4 Industrial shipment settings offset value	
209	CH4 Industrial shipment settings gain value	
210	CH1 User range settings offset value	
211	CH1 User range settings gain value	
212	CH2 User range settings offset value	
213	CH2 User range settings gain value	
214	CH3 User range settings offset value	
215	CH3 User range settings gain value	
216	CH4 User range settings offset value	
217	CH4 User range settings gain value	
218	System area (Use prohibited)	-
to		
999		
1000	CH1 Logging enable/disable setting	R/W
1001	CH2 Logging enable/disable setting	
1002	System area (Use prohibited)	-
to		
1007		
1008	CH1 Logging hold request	R/W
1009	CH2 Logging hold request	
1010	System area (Use prohibited)	-
to		
1015		
1016	CH1 Logging hold flag	R
1017	CH2 Logging hold flag	
1018	System area (Use prohibited)	-
to		
1023		
1024	CH1 Logging data setting	R/W
1025	CH2 Logging data setting	
1026	System area (Use prohibited)	-
to		
1031		

L60AD2DA2		
Address (decimal)	Name	Read/write
1032	CH1 Logging cycle setting value	R/W
1033	CH2 Logging cycle setting value	
1034	System area (Use prohibited)	-
to		
1039		
1040	CH1 Logging cycle unit setting	R/W
1041	CH2 Logging cycle unit setting	
1042	System area (Use prohibited)	-
to		
1047		
1048	CH1 Logging points after trigger	R/W
1049	CH2 Logging points after trigger	
1050	System area (Use prohibited)	-
to		
1055		
1056	CH1 Level trigger condition setting	R/W
1057	CH2 Level trigger condition setting	
1058	System area (Use prohibited)	-
to		
1063		
1064	CH1 Trigger data	R/W
1065	CH2 Trigger data	
1066	System area (Use prohibited)	-
to		
1071		
1072	Level data 0	R/W
1073	Level data 1	
1074	Level data 2	
1075	Level data 3	
1076	Level data 4	
1077	Level data 5	
1078	Level data 6	
1079	Level data 7	
1080	Level data 8	
1081	Level data 9	
1082	CH1 Trigger setting value	
1083	CH2 Trigger setting value	
1084	System area (Use prohibited)	-
to		
1089		
1090	CH1 Head pointer	R
1091	CH2 Head pointer	
1092	System area (Use prohibited)	-
to		
1097		
1098	CH1 Latest pointer	R
1099	CH2 Latest pointer	
1100	System area (Use prohibited)	-
to		
1105		
1106	CH1 Number of logging data	R
1107	CH2 Number of logging data	
1108	System area (Use prohibited)	-
to		
1113		
1114	CH1 Trigger pointer	R
1115	CH2 Trigger pointer	
1116	System area (Use prohibited)	-
to		
1121		

L60AD2DA2		
Address (decimal)	Name	Read/write
1122	CH1 Logging cycle monitor value (s)	R
1123	CH1 Logging cycle monitor value (ms)	
1124	CH1 Logging cycle monitor value (μs)	
1125	CH2 Logging cycle monitor value (s)	
1126	CH2 Logging cycle monitor value (ms)	
1127	CH2 Logging cycle monitor value (μs)	
1128	System area (Use prohibited)	-
to		
1145		
1146	CH1 Logging status monitor value	R
1147	CH2 Logging status monitor value	
1148	System area (Use prohibited)	-
to		
1153		
1154	CH1 Trigger detection time (First two digits of the year/Last two digits of the year)	R
1155	CH1 Trigger detection time (Month/Day)	
1156	CH1 Trigger detection time (Hour/Minute)	
1157	CH1 Trigger detection time (Second/Day of the week)	
1158	CH2 Trigger detection time (First two digits of the year/Last two digits of the year)	
1159	CH2 Trigger detection time (Month/Day)	
1160	CH2 Trigger detection time (Hour/Minute)	
1161	CH2 Trigger detection time (Second/Day of the week)	
1162	System area (Use prohibited)	-
to		
1999		
2000	D/A conversion enable/disable setting	R/W
2001	System area (Use prohibited)	-
2002		
2003		
2004	CH3 Digital input value	R/W
2005	CH4 Digital input value	
2006	System area (Use prohibited)	-
to		
2012		
2013	CH3 Set value check code	R
2014	CH4 Set value check code	
2015	System area (Use prohibited)	-
to		
2023		
2024	Offset/gain adjustment value specification	R/W
2025	System area (Use prohibited)	-
2026	HOLD/CLEAR function setting	R
2027	System area (Use prohibited)	-
to		
2046		
2047	Warning output setting	R/W
2048	Warning output flag	R
2049	System area (Use prohibited)	-
to		
2052		
2053	D/A conversion scaling enable/disable setting	R/W
2054	System area (Use prohibited)	-
to		
2057		
2058	CH3 D/A conversion scaling lower limit value	R/W
2059	CH3 D/A conversion scaling upper limit value	
2060	CH4 D/A conversion scaling lower limit value	
2061	CH4 D/A conversion scaling upper limit value	

L60AD2DA2		
Address (decimal)	Name	Read/write
2062	System area (Use prohibited)	-
to		
2089		
2090	CH3 Warning output upper limit value	R/W
2091	CH3 Warning output lower limit value	
2092	CH4 Warning output upper limit value	
2093	CH4 Warning output lower limit value	
2094	System area (Use prohibited)	-
to		
3001		
3002	CH3 Wave output start/stop request	R/W
3003	CH4 Wave output start/stop request	R/W
3004	System area (Use prohibited)	-
to		
3009		
3010	CH3 Output setting during wave output stop	R/W
3011	CH4 Output setting during wave output stop	
3012	System area (Use prohibited)	-
to		
3017		
3018	CH3 Output value during wave output stop	R/W
3019	CH4 Output value during wave output stop	
3020	System area (Use prohibited)	-
to		
3027		
3028	CH3 Wave pattern start address setting (L)	R/W
3029	CH3 Wave pattern start address setting (H)	
3030	CH4 Wave pattern start address setting (L)	
3031	CH4 Wave pattern start address setting (H)	
3032	System area (Use prohibited)	-
to		
3043		
3044	CH3 Wave pattern data points setting (L)	R/W
3045	CH3 Wave pattern data points setting (H)	
3046	CH4 Wave pattern data points setting (L)	
3047	CH4 Wave pattern data points setting (H)	
3048	System area (Use prohibited)	-
to		
3057		
3058	CH3 Wave pattern output repetition setting	R/W
3059	CH4 Wave pattern output repetition setting	
3060	System area (Use prohibited)	-
to		
3065		
3066	CH3 Constant for wave output conversion cycle	R/W
3067	CH4 Constant for wave output conversion cycle	
3068	System area (Use prohibited)	-
to		
3071		
3072	Step action wave output request	R/W
3073	System area (Use prohibited)	-
to		
3081		
3082	CH3 Wave output step action movement amount	R/W
3083	CH4 Wave output step action movement amount	
3084	System area (Use prohibited)	-
to		
3101		
3102	CH3 Wave output status monitor	R
3103	CH4 Wave output status monitor	
3104	System area (Use prohibited)	-
to		
3111		

L60AD2DA2		
Address (decimal)	Name	Read/write
3112	CH3 Wave output conversion cycle monitor (L)	R
3113	CH3 Wave output conversion cycle monitor (H)	
3114	CH4 Wave output conversion cycle monitor (L)	
3115	CH4 Wave output conversion cycle monitor (H)	
3116	System area (Use prohibited)	-
to		
3125		
3126	CH3 Wave output count monitor	R
3127	CH4 Wave output count monitor	
3128	System area (Use prohibited)	-
to		
3135		
3136	CH3 Wave output current address monitor (L)	R
3137	CH3 Wave output current address monitor (H)	
3138	CH4 Wave output current address monitor (L)	
3139	CH4 Wave output current address monitor (H)	
3140	System area (Use prohibited)	-
to		
3149		
3150	CH3 Wave output current digital value monitor	R
3151	CH4 Wave output current digital value monitor	
3152	System area (Use prohibited)	-
to		
3159		
3160	CH3 Wave output digital value outside the range Address monitor (L)	R
3161	CH3 Wave output digital value outside the range Address monitor (H)	
3162	CH4 Wave output digital value outside the range Address monitor (L)	
3163	CH4 Wave output digital value outside the range Address monitor (H)	
3164	System area (Use prohibited)	-
to		
3175		
3176	CH3 Wave output warning Address monitor (L)	R
3177	CH3 Wave output warning Address monitor (H)	
3178	CH4 Wave output warning Address monitor (L)	
3179	CH4 Wave output warning Address monitor (H)	
3180	System area (Use prohibited)	-
to		
3999		
4000	Arithmetic expression1 Variable arithmetic value (L)	R
4001	Arithmetic expression1 Variable arithmetic value (H)	
4002	Arithmetic expression1 Variable arithmetic decimal point monitor	
4003	Arithmetic expression1 Variable arithmetic value for analog output	
4004	Arithmetic expression2 Variable arithmetic value (L)	
4005	Arithmetic expression2 Variable arithmetic value (H)	
4006	Arithmetic expression2 Variable arithmetic decimal point monitor	
4007	Arithmetic expression2 Variable arithmetic value for analog output	
4008	System area (Use prohibited)	-
to		
4097		

L60AD2DA2		
Address (decimal)	Name	Read/write
4098	Arithmetic expression data write setting	R/W
to		
4099	Variable conversion characteristics table selection	
4100	Variable conversion characteristics range setting	
4101	Arithmetic expression data write setting	-
4102	System area (Use prohibited)	
to		
4109		
4110	Route1 Variable conversion characteristics conversion value monitor	R
4111	Route1 Variable conversion characteristics digital value monitor	
4112	Route1 Variable conversion characteristics digital value outside the range address monitor (L)	
4113	Route1 Variable conversion characteristics digital value outside the range address monitor (H)	
4114	Route1 Variable conversion characteristics warning address monitor (L)	
4115	Route1 Variable conversion characteristics warning address monitor (H)	
4116	System area (Use prohibited)	-
to		
4119		
4120	Route2 Variable conversion characteristics conversion value monitor	R
4121	Route2 Variable conversion characteristics digital value monitor	
4122	Route2 Variable conversion characteristics digital value outside the range address monitor (L)	
4123	Route2 Variable conversion characteristics digital value outside the range address monitor (H)	
4124	Route2 Variable conversion characteristics warning address monitor (L)	
4125	Route2 Variable conversion characteristics warning address monitor (H)	
4126	System area (Use prohibited)	-
to		
4299		
4300	Loop1 Control mode monitor	R
4301	Loop1 Manipulated value (MV)	
4302	Loop1 Output conversion value	
4303	Loop1 Auto-tuning status	
4304	System area (Use prohibited)	-
to		
4319		

L60AD2DA2		
Address (decimal)	Name	Read/write
4320	Loop1 Control mode switching	R/W
4321	Loop1 Control cycle setting	
4322	Loop1 Set value (SV) setting	
4323	Loop1 Proportional gain (P) setting	
4324	Loop1 Integral time (I) setting	
to		
4325		
4326	Loop1 Derivative time (D) setting	
4327	Loop1 Gap width setting	
4328	Loop1 Gap gain setting	
4329	Loop1 Two-degree-of-freedom parameter alpha setting	
4330	Loop1 Two-degree-of-freedom parameter beta setting	
4331	Loop1 Derivative gain setting	
4332	Loop1 Variable speed integral judgment value A setting	
4333	Loop1 Variable speed integral judgment value B setting	
4334	Loop1 Forward/reverse action setting	
4335	Loop1 Filter coefficient	
4336	Loop1 Upper limit output limiter setting	
4337	Loop1 Lower limit output limiter setting	
4338	Loop1 Output variation limiter setting	
4339	Loop1 MAN output setting	
4340	Loop1 Output shifting amount to conversion value	
4341	Loop1 PID continuation flag on HOLD	
4342	System area (Use prohibited)	
to		
4359		
4360	Loop1 Auto-tuning execution command	R/W
4361	Loop1 Auto-tuning timeout time	
4362	Loop1 Auto-tuning hysteresis	
4363	Loop1 Auto-tuning output upper limit value	
4364	Loop1 Auto-tuning output lower limit value	
4365	Loop1 Auto-tuning control type setting	
4366	System area (Use prohibited)	-
to		
4379		
4380	Loop2 Control mode monitor	R
4381	Loop2 Manipulated value (MV)	
4382	Loop2 Output conversion value	
4383	Loop2 Auto-tuning status	
4384	System area (Use prohibited)	-
to		
4399		

L60AD2DA2		
Address (decimal)	Name	Read/write
4400	Loop2 Control mode switching	R/W
4401	Loop2 Control cycle setting	
4402	Loop2 Set value (SV) setting	
4403	Loop2 Proportional gain (P) setting	
4404	Loop2 Integral time (I) setting	
to		
4405		
4406	Loop2 Derivative time (D) setting	
4407	Loop2 Gap width setting	
4408	Loop2 Gap gain setting	
4409	Loop2 Two-degree-of-freedom parameter alpha setting	
4410	Loop2 Two-degree-of-freedom parameter beta setting	
4411	Loop2 Derivative gain setting	
4412	Loop2 Variable speed integral judgment value A setting	
4413	Loop2 Variable speed integral judgment value B setting	
4414	Loop2 Forward/reverse action setting	
4415	Loop2 Filter coefficient	
4416	Loop2 Upper limit output limiter setting	
4417	Loop2 Lower limit output limiter setting	
4418	Loop2 Output variation limiter setting	
4419	Loop2 MAN output setting	
4420	Loop2 Output shifting amount to conversion value	
4421	Loop2 PID continuation flag on HOLD	
4422	System area (Use prohibited)	-
to		
4439		
4440	Loop2 Auto-tuning execution command	R/W
4441	Loop2 Auto-tuning timeout time	
4442	Loop2 Auto-tuning hysteresis	
4443	Loop2 Auto-tuning output upper limit value	
4444	Loop2 Auto-tuning output lower limit value	
4445	Loop2 Auto-tuning control type setting	
4446	System area (Use prohibited)	-
to		
4459		
4460	PID operation expression selection monitor	R
4461	System area (Use prohibited)	-
to		
4699		
4700	CH1 A/D conversion status	R
4701	CH2 A/D conversion status	
4702	System area (Use prohibited)	-
to		
4709		
4710	CH1 Analog input monitor	R
4711	CH1 Analog input monitor unit	
4712	CH2 Analog input monitor	
4713	CH2 Analog input monitor unit	
4714	System area (Use prohibited)	
to		
4749		
4750	CH3 D/A conversion status	R
4751	CH4 D/A conversion status	
4752	System area (Use prohibited)	-
to		
4759		

L60AD2DA2		
Address (decimal)	Name	Read/write
4760	CH3 Analog output command value	R
4761	CH3 Analog output command value unit	
4762	CH4 Analog output command value	
4763	CH4 Analog output command value unit	
4764	System area (Use prohibited)	-
to		
4799		
4800	Latest address of error history	R
4801	System area (Use prohibited)	-
to		
4809		
4810	No.1 Error code	R
4811	No.1 Error time (First two digits of the year/Last two digits of the year)	
4812	No.1 Error time (Month/Day)	
4813	No.1 Error time (Time/Minute)	
4814	No.1 Error time (Second/Day of the week)	
4815	No.1 System area (Use prohibited)	-
to		
4819		
4820	No.2 (Same as No.1)	
to		
4829		
4830	No.3 (Same as No.1)	
to		
4839		
4840	No.4 (Same as No.1)	
to		
4849		
4850	No.5 (Same as No.1)	
to		
4859		
4860	No.6 (Same as No.1)	
to		
4869		
4870	No.7 (Same as No.1)	
to		
4879		
4880	No.8 (Same as No.1)	
to		
4889		
4890	No.9 (Same as No.1)	
to		
4899		
4900	No.10 (Same as No.1)	
to		
4909		
4910	No.11 (Same as No.1)	
to		
4919		
4920	No.12 (Same as No.1)	
to		
4929		
4930	No.13 (Same as No.1)	
to		
4939		
4940	No.14 (Same as No.1)	
to		
4949		
4950	No.15 (Same as No.1)	
to		
4959		

L60AD2DA2		
Address (decimal)	Name	Read/write
4960	No.16 (Same as No.1)	
to		
4969		
4970	System area (Use prohibited)	-
to		
4999		
5000	CH1 Logging data (When the logging function is used)	R
to		
14999		
15000	CH2 Logging data (When the logging function is used)	
to		
24999		
25000	System area (Use prohibited) (When the logging function is used)	-
to		
54999		
5000	Wave data registry area (When the wave output function is used)	R/W
to		
54999		
55000	System area (Use prohibited)	-
to		
61439		

(1) When the logging function is used

L60AD2DA2		
Address (decimal)	Name	Read/write
5000 to 14999	CH1 Logging data	R
15000 to 24999	CH2 Logging data	
25000 to 64139	System area (Use prohibited)	-

(2) When the wave output function is used

L60AD2DA2		
Address (decimal)	Name	Read/write
5000 to 54999	Wave data registry area	R/W
55000 to 64139	System area (Use prohibited)	-

(3) When the variable arithmetic function is used

L60AD2DA2		
Address (decimal)	Name	Read/write
5000 to 64139	System area (Use prohibited)	-

(4) When the variable conversion characteristics function is used

L60AD2DA2		
Address (decimal)	Name	Read/write
5000 to 37000	Conversion characteristics table	R/W
37001 to 64139	System area (Use prohibited)	-

5 HEATING-COOLING TEMPERATURE CONTROL MODULE/TEMPERATURE CONTROL MODULE REPLACEMENT

5.1 List of Heating-cooling Temperature Control Module/Temperature Control Module Alternative Models for Replacement

AnS/QnAS series		Transition to L series	
Product	Model	Model	Remarks (Restrictions)
Heating-cooling temperature control module Temperature control module	A1S64TCTRT Thermocouple connection	L60TCTT4	1) External wiring: Cable size is changed. 2) Number of slots: Not changed 3) Program: The number of occupied I/O points, I/O signals, and buffer memory addresses are changed. 4) Performance specifications: Not changed 5) Functional specifications: Changed (Refer to Section 5.3.)
	A1S64TCTRT Platinum resistance thermometer connection	L60TCRT4	1) External wiring: Cable size is changed. 2) Number of slots: Not changed 3) Program: The number of occupied I/O points, I/O signals, and buffer memory addresses are changed. 4) Performance specifications: Not changed 5) Functional specifications: Changed (Refer to Section 5.3.)
	A1S64TCTRTBW Thermocouple connection	L60TCTT4BW	1) External wiring: Cable size is changed. 2) Number of slots: Changed (2 modules occupied, 16 intelligent points) 3) Program: The number of occupied I/O points, I/O signals, and buffer memory addresses are changed. 4) Performance specifications: Not changed 5) Functional specifications: Changed (Refer to Section 5.3.)
	A1S64TCTRTBW Platinum resistance thermometer connection	L60TCRT4BW	1) External wiring: Cable size is changed. 2) Number of slots: Changed (2 modules occupied, 16 intelligent points) 3) Program: The number of occupied I/O points, I/O signals, and buffer memory addresses are changed. 4) Performance specifications: Not changed 5) Functional specifications: Changed (Refer to Section 5.3.)

AnS/QnAS series		Transition to L series	
Product	Model	Model	Remarks (Restrictions)
Heating-cooling temperature control module Temperature control module	A1S64TCTT-S1	L60TCTT4	<ol style="list-style-type: none"> 1) External wiring: Cable size is changed. 2) Number of slots: Not changed 3) Program: The number of occupied I/O points, I/O signals, and buffer memory addresses are changed. 4) Performance specifications: Not changed 5) Functional specifications: Changed (Refer to Section 5.3.)
	A1S64TCTTBW-S1	L60TCTT4BW	<ol style="list-style-type: none"> 1) External wiring: Cable size is changed. 2) Number of slots: Changed (2 modules occupied, 16 intelligent points) 3) Program: The number of occupied I/O points, I/O signals, and buffer memory addresses are changed. 4) Performance specifications: Not changed 5) Functional specifications: Changed (Refer to Section 5.3.)
	A1S64TCRT-S1	L60TCRT4	<ol style="list-style-type: none"> 1) External wiring: Cable size is changed. 2) Number of slots: Not changed 3) Program: The number of occupied I/O points, I/O signals, and buffer memory addresses are changed. 4) Performance specifications: Not changed 5) Functional specifications: Changed (Refer to Section 5.3.)
	A1S64TCRTBW-S1	L60TCRT4BW	<ol style="list-style-type: none"> 1) External wiring: Cable size is changed. 2) Number of slots: Changed (2 modules occupied, 16 intelligent points) 3) Program: The number of occupied I/O points, I/O signals, and buffer memory addresses are changed. 4) Performance specifications: Not changed 5) Functional specifications: Changed (Refer to Section 5.3.)
	A1S62TCTT-S2	L60TCTT4	<ol style="list-style-type: none"> 1) External wiring: Cable size is changed. 2) Number of slots: Not changed 3) Program: The number of occupied I/O points, I/O signals, and buffer memory addresses are changed. 4) Performance specifications: Changed (2 channels/module → 4 channels/ module) 5) Functional specifications: Changed (Refer to Section 5.3.)
	A1S62TCTTBW-S2	L60TCTT4BW	<ol style="list-style-type: none"> 1) External wiring: Cable size is changed. 2) Number of slots: Changed (2 modules occupied, 16 intelligent points) 3) Program: The number of occupied I/O points, I/O signals, and buffer memory addresses are changed. 4) Performance specifications: Changed (2 channels/module → 4 channels/ module) 5) Functional specifications: Changed (Refer to Section 5.3.)
	A1S62TCRT-S2	L60TCRT4	<ol style="list-style-type: none"> 1) External wiring: Cable size is changed. 2) Number of slots: Not changed 3) Program: The number of occupied I/O points, I/O signals, and buffer memory addresses are changed. 4) Performance specifications: Changed (2 channels/module → 4 channels/ module) 5) Functional specifications: Changed (Refer to Section 5.3.)
	A1S62TCRTBW-S2	L60TCRT4BW	<ol style="list-style-type: none"> 1) External wiring: Cable size is changed. 2) Number of slots: Changed (2 modules occupied, 16 intelligent points) 3) Program: The number of occupied I/O points, I/O signals, and buffer memory addresses are changed. 4) Performance specifications: Changed (2 channels/module → 4 channels/ module) 5) Functional specifications: Changed (Refer to Section 5.3.)

5.2 Performance Specifications Comparison

5.2.1 A1S64TCTRT(BW) (thermocouple connection)

Item		Specifications		
		A1S64TCTRT	A1S64TCTRTBW	
Control output		Transistor output		
Number of temperature input points		Standard control: 4 channels/module Heating-cooling control: 2 channels/module		
Applicable temperature sensor		(Refer to Section 5.2.1 (1).)		
Accuracy	Indication accuracy		(Ambient temperature: 25°C±5°C) Full scale × (±0.3%)±1 digit	
			(Ambient temperature: 0°C to 55°C) Full scale × (±0.7%)±1 digit	
	Cold junction temperature compensation accuracy (ambient temperature: 0°C to 55°C)	Temperature process value (PV): -100°C or more	Within ±1.0°C	
		Temperature process value (PV): -150°C to -100°C	Within ±2.0°C	
Temperature process value (PV): -200°C to -150°C		Within ±3.0°C		
Sampling cycle		0.5s (Constant regardless of the number of channels used)		
Control output cycle		1 to 100s		
Input impedance		1MΩ		
Input filter		0 to 100s		
Sensor correction value setting		-50.00 to 50.00%		
Operation at sensor input disconnection		Upscale processing		
Temperature control method		Standard control: PID ON/OFF pulse or two-position control Heating-cooling control: PID ON/OFF pulse		
PID constants range	PID constants setting		Standard control: Can be set by auto tuning or self-tuning. Heating-cooling control: Can be set by auto tuning.	
	Proportional band (P)		Standard control: 0.0 to 1000.0% Heating-cooling control: 0.1 to 1000.0%	
	Integral time (I)		1 to 3600s	
	Derivative time (D)		0 to 3600s	
Set value (SV) setting range		Within the temperature range set for the temperature sensor to be used		
Transistor output	Output signal		ON/OFF pulse	
	Rated load voltage		10.2 to 30VDC (peak voltage 30.0V)	
	Maximum load current		0.1A/point, 0.4A/common	
	Maximum inrush current		0.4A, 10ms	
	Leakage current at OFF		0.1mA or lower	
	Maximum voltage drop at ON		1.0VDC (TYP) at 0.1A 2.5VDC (MAX) at 0.1A	
	Response time		OFF→ON: 2ms or less, ON→OFF: 2ms or less	
Number of writes to E ² PROM		Maximum 10 ¹² times (number of read/write from/to the FeRAM)		

○: Compatible, △: Partial change required, ×: Incompatible

	Specifications		Compatibility	Precautions for replacement
	L60TCTT4	L60TCTT4BW		
	Transistor output		○	
	Standard control: 4 channels/module Heating-cooling control: 2 channels/module		○	The standard control and heating-cooling control can be combined in the L series module.
	(Refer to Section 5.2.1 (1).)		○	
	(Ambient temperature: 25°C±5°C) Full scale × (±0.3%)* ¹		○	
	(Ambient temperature: 0°C to 55°C) Full scale × (±0.7%)* ¹			
	Within ±1.0°C* ¹		○	
	Within ±2.0°C* ¹			
	Within ±3.0°C* ¹			
	250ms/4 channels, 500ms/4 channels (Constant regardless of the number of channels used)		○	The sampling cycle can be selected in the L series module.
	0.5s to 100.0s		○	
	1MΩ		○	
	0 to 100s		○	
	-50.00 to 50.00%		○	
	Upscale processing		○	
	PID ON/OFF pulse or two-position control		○	
	Standard control: Can be set by auto tuning or self-tuning. Heating-cooling control: Can be set by auto tuning.		○	
	0.0 to 1000.0%		○	
	0 to 3600s		○	
	0 to 3600s		○	
	Within the temperature range set for the temperature sensor to be used		○	
	ON/OFF pulse		○	
	10 to 30VDC		○	
	0.1A/point, 0.4A/common		○	
	0.4A, 10ms		○	
	0.1mA or lower		○	
	1.0VDC (TYP) at 0.1A 2.5VDC (MAX) at 0.1A		○	
	OFF→ON: 2ms or less, ON→OFF: 2ms or less		○	
	Maximum 10 ¹² times (number of read/write from/to a non-volatile memory)		○	

*1 Calculate the accuracy in the following method.

(Accuracy) = (Indication accuracy) + (Cold junction temperature compensation accuracy)

(Example) Accuracy at the input range of 38, the operating ambient temperature of 35°C, and the temperature process value (PV) of 300°C

{400.0-(-200.0)} [Full scale] × (±0.007) [±0.7%] + (±1.0°C) [Cold junction temperature compensation accuracy] = ±5.2°C

Item	Specifications	
	A1S64TCTRT	A1S64TCTRTBW
Insulation method	Between the input terminal and programmable controller power supply: Transformer Between input channels: Transformer	
Dielectric withstand voltage	Between the input terminal and programmable controller power supply: 500VAC, for 1 minute Between input channels: 500VAC, for 1 minute	
Insulation resistance	Between the input terminal and programmable controller power supply: 500VDC, 10MΩ or more Between input channels: 500VDC, 10MΩ or more	
Heater disconnection detection specifications	Current sensor	U.R.D. Co., LTD. CTL-12-S36-8 CTL-6-P(-H)
	Input accuracy	Full scale × (±1.0%)
	Number of alert delay	3 to 255
Number of occupied I/O points	32 points (I/O assignment: special 32 points)	
Connection terminal	20-point terminal block	
Applicable wire size	0.75 to 1.5mm ²	
Applicable solderless terminal	R1.25-3, 1.25-YS3, RAV1.25-3, V1.25-YS3A	
Internal current consumption	0.33A (0.19A)* ²	0.39A (0.25A)* ²
Weight	0.26kg	0.28kg
External dimensions	34.5(W) × 130(H) × 93.6(D)mm	

*2 A current value when the temperature conversion function is not used in an unused channel under heating-cooling control.

(1) List of thermocouple type, temperature measurement range, and resolution

Thermocouple type	°C		°F	
	Temperature measurement range	Resolution	Temperature measurement range	Resolution
R	0 to 1700	1	0 to 3000	1
K	0 to 500	1	0 to 1000	1
	0 to 800		0 to 2400	
	0 to 1300			
	-200.0 to 400.0	0.1	0.0 to 1000.0	0.1
J	0.0 to 400.0	0.1	0.0 to 1000.0	0.1
	0.0 to 500.0			
	0.0 to 800.0			
	0 to 500	1	0 to 1000	1
	0 to 800		0 to 1600	
0 to 1200	0 to 2100			
T	-200 to 400	1	0 to 700	1
	-200 to 200		-300 to 400	
	0 to 200			
	0 to 400			
	-200.0 to 400.0	0.1	0.0 to 700.0	0.1
	0.0 to 400.0			

(To the next page)

○: Compatible, △: Partial change required, ×: Incompatible

Specifications		Compatibility	Precautions for replacement
L60TCTT4	L60TCTT4BW		
Between the input terminal and programmable controller power supply: Transformer Between input channels: Transformer		○	
Between the input terminal and programmable controller power supply: 500VAC, for 1 minute Between input channels: 500VAC, for 1 minute		○	
Between the input terminal and programmable controller power supply: 500VDC, 20MΩ or more Between input channels: 500VDC, 20MΩ or more		○	
-	U.R.D. Co., LTD. CTL-12-S36-8 CTL-12-S36-10 CTL-12-S56-10 CTL-6-P(-H)	○	
	Full scale × (±1.0%)		
	3 to 255		
16 points/slot (I/O assignment: intelligent 16 points)	16 points/2 slots (I/O assignment: intelligent 16 points)	△	The number of occupied I/O points and slots are different.
18-point terminal block	Two 18-point terminal blocks	×	Wiring change is required.
22 to 18 AWG			
R1.25-3			
0.30A	0.33A	△	Recalculation of internal current consumption (5VDC) is required.
0.18kg	0.33kg	△	
28.5(W) × 90(H) × 117(D)mm	57.0(W) × 90(H) × 117(D)mm	-	

(From the previous page)

Thermocouple type	°C		°F	
	Temperature measurement range	Resolution	Temperature measurement range	Resolution
S	0 to 1700	1	0 to 3000	1
B	400 to 1800	1	800 to 3000	1
E	0 to 400	1	0 to 1800	1
	0 to 1000			
N	0.0 to 700.0	0.1	-	-
	0 to 1300			
U	0 to 400	1	0 to 700	1
	-200 to 200			
	0.0 to 600.0			
L	0 to 400	1	0 to 800	1
	0 to 900			
	0.0 to 400.0	0.1	-	-
	0.0 to 900.0			
PL II	0 to 1200	1	0 to 2300	1
W5Re/W26Re	0 to 2300	1	0 to 3000	1

5.2.2 A1S64TCTRT(BW) (platinum resistance thermometer connection)

Item		Specifications	
		A1S64TCTRT	A1S64TCTRTBW
Control output		Transistor output	
Number of temperature input points		Standard control: 4 channels/module Heating-cooling control: 2 channels/module	
Applicable temperature sensor		(Refer to Section 5.2.2 (1).)	
Indication accuracy		(Ambient temperature: 25°C±5°C) Full scale × (±0.3%)±1 digit	
		(Ambient temperature: 0°C to 55°C) Full scale × (±0.7%)±1 digit	
Sampling cycle		0.5s (Constant regardless of the number of channels used)	
Control output cycle		1 to 100s	
Input impedance		1MΩ	
Input filter		0 to 100s	
Sensor correction value setting		-50.00 to 50.00%	
Operation at sensor input disconnection		Upscale processing	
Temperature control method		Standard control: PID ON/OFF pulse or two-position control Heating-cooling control: PID ON/OFF pulse	
PID constants range	PID constants setting	Standard control: Can be set by auto tuning or self-tuning. Heating-cooling control: Can be set by auto tuning.	
	Proportional band (P)	Standard control: 0.0 to 1000.0% Heating-cooling control: 0.1 to 1000.0%	
	Integral time (I)	1 to 3600s	
	Derivative time (D)	0 to 3600s	
Set value (SV) setting range		Within the temperature range set for the temperature sensor to be used	
Transistor output	Output signal	ON/OFF pulse	
	Rated load voltage	10.2 to 30VDC (peak voltage 30.0V)	
	Maximum load current	0.1A/point, 0.4A/common	
	Maximum inrush current	0.4A, 10ms	
	Leakage current at OFF	0.1mA or lower	
	Maximum voltage drop at ON	1.0VDC (TYP) at 0.1A 2.5VDC (MAX) at 0.1A	
	Response time	OFF→ON: 2ms or less, ON→OFF: 2ms or less	
Number of writes to E ² PROM		Maximum 10 ¹² times (number of read/write from/to the FeRAM)	

○: Compatible, △: Partial change required, ×: Incompatible

	Specifications		Compatibility	Precautions for replacement
	L60TCRT4	L60TCRT4BW		
	Transistor output		○	
	Standard control: 4 channels/module Heating-cooling control: 2 channels/module		○	The standard control and heating-cooling control can be combined in the L series module.
	(Refer to Section 5.2.2 (1).)		○	
	(Ambient temperature: 25°C±5°C) Full scale × (±0.3%)* ¹		○	
	(Ambient temperature: 0°C to 55°C) Full scale × (±0.7%)* ¹		○	
	250ms/4 channels, 500ms/4 channels (Constant regardless of the number of channels used)		○	The sampling cycle can be selected in the L series module.
	0.5s to 100.0s		○	
	1MΩ		○	
	0 to 100s		○	
	-50.00 to 50.00%		○	
	Upscale processing		○	
	PID ON/OFF pulse or two-position control		○	
	Standard control: Can be set by auto tuning or self-tuning. Heating-cooling control: Can be set by auto tuning.		○	
	0.0 to 1000.0%		○	
	0 to 3600s		○	
	0 to 3600s		○	
	Within the temperature range set for the temperature sensor to be used		○	
	ON/OFF pulse		○	
	10 to 30VDC		○	
	0.1A/point, 0.4A/common		○	
	0.4A, 10ms		○	
	0.1mA or lower		○	
	1.0VDC (TYP) at 0.1A 2.5VDC (MAX) at 0.1A		○	
	OFF→ON: 2ms or less, ON→OFF: 2ms or less		○	
	Maximum 10 ¹² times (number of read/write from/to a non-volatile memory)		○	

*1 Calculate the accuracy in the following method.

(Accuracy) = (Indication accuracy) + (Cold junction temperature compensation accuracy)

(Example) Accuracy at the input range of 38, the operating ambient temperature of 35°C, and the temperature process value (PV) of 300°C

{400.0-(-200.0)} [Full scale] × (±0.007) [±0.7%] + (±1.0°C) [Cold junction temperature compensation accuracy] = ±5.2°C

Item		Specifications	
		A1S64TCTRT	A1S64TCTRTBW
Insulation method		Between the input terminal and programmable controller power supply: Transformer Between input channels: Transformer	
Dielectric withstand voltage		Between the input terminal and programmable controller power supply: 500VAC, for 1 minute Between input channels: 500VAC, for 1 minute	
Insulation resistance		Between the input terminal and programmable controller power supply: 500VDC, 10MΩ or more Between input channels: 500VDC, 10MΩ or more	
Heater disconnection detection specifications	Current sensor	-	U.R.D. Co., LTD. CTL-12-S36-8 CTL-6-P(-H)
	Input accuracy		Full scale × (±1.0%)
	Number of alert delay		3 to 255
Number of occupied I/O points		32 points (I/O assignment: special 32 points)	
Connection terminal		20-point terminal block	
Applicable wire size		0.75 to 1.5mm ²	
Applicable solderless terminal		R1.25-3, 1.25-YS3, RAV1.25-3, V1.25-YS3A	
Internal current consumption		0.33A (0.19A) ^{*2}	0.39A (0.25A) ^{*2}
Weight		0.26kg	0.28kg
External dimensions		34.5(W)×130(H)×93.6(D)mm	

*2 A current value when the temperature conversion function is not used in an unused channel under heating-cooling control.

(1) List of usable platinum resistance thermometer, temperature measurement range, and resolution

Platinum resistance thermometer type	°C		°F	
	Temperature measurement range	Resolution	Temperature measurement range	Resolution
Pt100	-200.0 to 600.0	0.1	-300 to 1100	1
	-200.0 to 200.0		-300.0 to 300.0	0.1
JPt100	-200.0 to 500.0	0.1	-300 to 900	1
	-200.0 to 200.0		-300.0 to 300.0	0.1

○: Compatible, △: Partial change required, ×: Incompatible

	Specifications		Compatibility	Precautions for replacement
	L60TGRT4	L60TCRT4BW		
	Between the input terminal and programmable controller power supply: Transformer Between input channels: Transformer		○	
	Between the input terminal and programmable controller power supply: 500VAC, for 1 minute Between input channels: 500VAC, for 1 minute		○	
	Between the input terminal and programmable controller power supply: 500VDC, 20MΩ or more Between input channels: 500VDC, 20MΩ or more		○	
	-	U.R.D. Co., LTD. CTL-12-S36-8 CTL-12-S36-10 CTL-12-S56-10 CTL-6-P(-H)	○	
		Full scale × (±1.0%)		
		3 to 255		
	16 points/slot (I/O assignment: intelligent 16 points)	16 points/2 slots (I/O assignment: intelligent 16 points)	△	The number of occupied I/O points and slots are different.
	18-point terminal block	Two 18-point terminal blocks	×	Wiring change is required.
	22 to 18 AWG			
	R1.25-3			
	0.31A	0.35A	△	Recalculation of internal current consumption (5VDC) is required.
	0.18kg	0.33kg	△	
	28.5(W) × 90(H) × 117(D)mm	57.0(W) × 90(H) × 117(D)mm	-	

5.2.3 A1S64TCTT(BW)-S1

Item		Specifications		
		A1S64TCTT-S1	A1S64TCTTBW-S1	
Control output		Transistor output		
Number of temperature input points		4 channels/module		
Applicable temperature sensor		(Refer to Section 5.2.3 (1).)		
Accuracy	Indication accuracy		(Ambient temperature: 25°C±5°C) Full scale × (±0.3%)±1 digit	
			(Ambient temperature: 0°C to 55°C) Full scale × (±0.7%)±1 digit	
	Cold junction temperature compensation accuracy (ambient temperature: 0°C to 55°C)	Temperature process value (PV):	Within ±1.0°C	
		Temperature process value (PV):	Within ±2.0°C	
Temperature process value (PV):		Within ±3.0°C		
Sampling cycle		0.5s (Constant regardless of the number of channels used)		
Control output cycle		1 to 100s		
Input impedance		1MΩ		
Input filter		0 to 100s		
Sensor correction value setting		-50.00 to 50.00%		
Operation at sensor input disconnection		Upscale processing		
Temperature control method		PID ON/OFF pulse or two-position control		
PID constants range	PID constants setting		Can be set by auto tuning or self-tuning.	
	Proportional band (P)		0.0 to 1000.0%	
	Integral time (I)		1 to 3600s	
	Derivative time (D)		0 to 3600s	
Set value (SV) setting range		Within the temperature range set for the temperature sensor to be used		
Transistor output	Output signal		ON/OFF pulse	
	Rated load voltage		10.2 to 30.0VDC	
	Maximum load current		0.1A/point, 0.4A/common	
	Maximum inrush current		0.4A, 10ms	
	Leakage current at OFF		0.1mA or lower	
	Maximum voltage drop at ON		1.0VDC (TYP) at 0.1A 2.5VDC (MAX) at 0.1A	
	Response time		OFF→ON: 2ms or less, ON→OFF: 2ms or less	
Number of writes to E ² PROM		Maximum 100000 times		
Insulation method		Between the input terminal and programmable controller power supply: Transformer Between input channels: Transformer		
Dielectric withstand voltage		Between the input terminal and programmable controller power supply: 500VAC, for 1 minute Between input channels: 500VAC, for 1 minute		
Insulation resistance		Between the input terminal and programmable controller power supply: 500VDC, 10MΩ or more Between input channels: 500VDC, 10MΩ or more		

○: Compatible, △: Partial change required, ×: Incompatible

	Specifications		Compatibility	Precautions for replacement
	L60TCTT4	L60TCTT4BW		
	Transistor output		○	
	Standard control: 4 channels/module Heating-cooling control: 2 channels/module		○	The standard control and heating-cooling control can be combined in the L series module.
	(Refer to Section 5.2.3 (1).)		○	
	(Ambient temperature: 25°C±5°C) Full scale × (±0.3%)* ¹		○	
	(Ambient temperature: 0°C to 55°C) Full scale × (±0.7%)* ¹			
	Within ±1.0°C* ¹		○	
	Within ±2.0°C* ¹			
	Within ±3.0°C* ¹			
	250ms/4 channels, 500ms/4 channels (Constant regardless of the number of channels used)		○	The sampling cycle can be selected in the L series module.
	0.5s to 100.0s		○	
	1MΩ		○	
	0 to 100s		○	
	-50.00 to 50.00%		○	
	Upscale processing		○	
	PID ON/OFF pulse or two-position control		○	
	Can be set by auto tuning or self-tuning.		○	
	0.0 to 1000.0%		○	
	0 to 3600s		○	
	0 to 3600s		○	
	Within the temperature range set for the temperature sensor to be used		○	
	ON/OFF pulse		○	
	10 to 30VDC		○	
	0.1A/point, 0.4A/common		○	
	0.4A, 10ms		○	
	0.1mA or lowers		○	
	1.0VDC (TYP) at 0.1A 2.5VDC (MAX) at 0.1A		○	
	OFF→ON: 2ms or less, ON→OFF: 2ms or less		○	
	Maximum 10 ¹² times (number of read/write from/to a non-volatile memory)		○	
	Between the input terminal and programmable controller power supply: Transformer insulation Between input channels: Transformer insulation		○	
	Between the input terminal and programmable controller power supply: 500VAC, for 1 minute Between input channels: 500VAC, for 1 minute		○	
	Between the input terminal and programmable controller power supply: 500VDC, 20MΩ or more Between input channels: 500VDC, 20MΩ or more		○	

*1 Calculate the accuracy in the following method.

(Accuracy) = (Indication accuracy) + (Cold junction temperature compensation accuracy)

(Example) Accuracy at the input range of 38, the operating ambient temperature of 35°C, and the temperature process value (PV) of 300°C

{400.0-(-200.0)} [Full scale] × (±0.007)[±0.7%] + (±1.0°C) [Cold junction temperature compensation accuracy] = ±5.2°C

Item		Specifications	
		A1S64TCTT-S1	A1S64TCTTBW-S1
Heater disconnection detection specifications	Current sensor	-	U.R.D. Co., LTD. CTL-12-S36-8 CTL-6-P(-H)
	Input accuracy		Full scale × (±1.0%)
	Number of alert delay		3 to 255
Number of occupied I/O points		32 points (I/O assignment: special 32 points)	
Connection terminal		20-point terminal block	
Applicable wire size		0.75 to 1.5mm ²	
Applicable solderless terminal		R1.25-3, 1.25-YS3, RAV1.25-3, V1.25-YS3A	
Internal current consumption		0.33A	0.42A
Weight		0.27kg	0.30kg
External dimensions		34.5(W) × 130(H) × 93.6(D)mm	

(1) List of thermocouple type, temperature measurement range, and resolution

Thermocouple type	°C		°F			
	Temperature measurement range	Resolution	Temperature measurement range	Resolution		
R	0 to 1700	1	0 to 3000	1		
K	0 to 500	1	0 to 1000	1		
	0 to 800		0 to 2400			
	0 to 1300					
	-200.0 to 400.0		0.0 to 1000.0		0.1	
J	0.0 to 400.0	0.1	0.0 to 1000.0	0.1		
	0.0 to 500.0					
	0.0 to 800.0					
	0 to 500		1		0 to 1000	1
	0 to 800				0 to 1600	
	0 to 1200				0 to 2100	
T	-200 to 400	1	0 to 700	1		
	-200 to 200		-300 to 400			
	0 to 200					
	0 to 400					
	-200.0 to 400.0		0.1		0.0 to 700.0	0.1
	0.0 to 400.0					

(To the next page)

○: Compatible, △: Partial change required, ×: Incompatible

Specifications		Compatibility	Precautions for replacement
L60TCTT4	L60TCTT4BW		
-	U.R.D. Co., LTD. CTL-12-S36-8 CTL-12-S36-10 CTL-12-S56-10 CTL-6-P(-H)	○	
	Full scale × (±1.0%)		
	3 to 255		
16 points/slot (I/O assignment: intelligent 16 points)	16 points/2 slots (I/O assignment: intelligent 16 points)	△	The number of occupied I/O points and slots are different.
18-point terminal block	Two 18-point terminal blocks	×	Wiring change is required.
22 to 18 AWG			
R1.25-3			
0.29A	0.33A	△	Recalculation of internal current consumption (5VDC) is required.
0.17kg	0.28kg	△	
28.5(W) × 90(H) × 117(D)mm	57.0(W) × 90(H) × 117(D)mm	-	

(From the previous page)

Thermocouple type	°C		°F	
	Temperature measurement range	Resolution	Temperature measurement range	Resolution
S	0 to 1700	1	0 to 3000	1
B	400 to 1800	1	800 to 3000	1
E	0 to 400	1	0 to 1800	1
	0 to 1000			
N	0.0 to 700.0	0.1	-	-
	0 to 1300			
U	0 to 400	1	0 to 700	1
	-200 to 200			
L	0.0 to 600.0	0.1	-	-
	0 to 400			
	0 to 900			
PL II	0.0 to 400.0	0.1	-	-
	0.0 to 900.0			
PL II	0 to 1200	1	0 to 2300	1
W5Re/W26Re	0 to 2300	1	0 to 3000	1

5.2.4 A1S64TCRT(BW)-S1

Item		Specifications	
		A1S64TCRT-S1	A1S64TCRTBW-S1
Control output		Transistor output	
Number of temperature input points		4 channels/module	
Applicable temperature sensor		(Refer to Section 5.2.4 (1).)	
Indication accuracy		(Ambient temperature: 25°C±5°C) Full scale × (±0.3%)±1 digit	
		(Ambient temperature: 0°C to 55°C) Full scale × (±0.7%)±1 digit	
Sampling cycle		0.5s (Constant regardless of the number of channels used)	
Control output cycle		1 to 100s	
Input impedance		1MΩ	
Input filter		0 to 100s	
Sensor correction value setting		-50.00 to 50.00%	
Operation at sensor input disconnection		Upscale processing	
Temperature control method		PID ON/OFF pulse or two-position control	
PID constants range	PID constants setting	Can be set by auto tuning or self-tuning.	
	Proportional band (P)	0.0 to 1000.0%	
	Integral time (I)	1 to 3600s	
	Derivative time (D)	0 to 3600s	
Set value (SV) setting range		Within the temperature range set for the temperature sensor to be used	
Transistor output	Output signal	ON/OFF pulse	
	Rated load voltage	10.2 to 30.0VDC	
	Maximum load current	0.1A/point, 0.4A/common	
	Maximum inrush current	0.4A, 10ms	
	Leakage current at OFF	0.1mA or lower	
	Maximum voltage drop at ON	1.0VDC (TYP) at 0.1A 2.5VDC (MAX) at 0.1A	
	Response time	OFF→ON: 2ms or less, ON→OFF: 2ms or less	
Number of writes to E ² PROM		Maximum 100000 times	
Insulation method		Between the input terminal and programmable controller power supply: Transformer Between input channels: Transformer	
Dielectric withstand voltage		Between the input terminal and programmable controller power supply: 500VAC, for 1 minute Between input channels: 500VAC, for 1 minute	
Insulation resistance		Between the input terminal and programmable controller power supply: 500VDC, 10MΩ or more Between input channels: 500VDC, 10MΩ or more	
Heater disconnection detection specifications	Current sensor	-	U.R.D. Co., LTD. CTL-12-S36-8 CTL-6-P(-H)
	Input accuracy		Full scale × (±1.0%)
	Number of alert delay		3 to 255

○: Compatible, △: Partial change required, ×: Incompatible

	Specifications		Compatibility	Precautions for replacement
	L60TCRT4	L60TCRT4BW		
	Transistor output		○	
	Standard control: 4 channels/module Heating-cooling control: 2 channels/module		○	The standard control and heating-cooling control can be combined in the L series module.
	(Refer to Section 5.2.4 (1).)		○	
	(Ambient temperature: 25°C±5°C) Full scale × (±0.3%)* ¹		○	
	(Ambient temperature: 0°C to 55°C) Full scale × (±0.7%)* ¹			
	250ms/4 channels, 500ms/4 channels (Constant regardless of the number of channels used)		○	The sampling cycle can be selected in the L series module.
	0.5s to 100.0s		○	
	1MΩ		○	
	0 to 100s		○	
	-50.00 to 50.00%		○	
	Upscale processing		○	
	PID ON/OFF pulse or two-position control		○	
	Can be set by auto tuning or self-tuning.		○	
	0.0 to 1000.0%		○	
	0 to 3600s		○	
	0 to 3600s		○	
	Within the temperature range set for the temperature sensor to be used		○	
	ON/OFF pulse		○	
	10 to 30VDC		○	
	0.1A/point, 0.4A/common		○	
	0.4A, 10ms		○	
	0.1mA or lower		○	
	1.0VDC (TYP) at 0.1A 2.5VDC (MAX) at 0.1A		○	
	OFF→ON: 2ms or less, ON→OFF: 2ms or less		○	
	Maximum 10 ¹² times (number of read/write from/to a non-volatile memory)		○	
	Between the input terminal and programmable controller power supply: Transformer Between input channels: Transformer		○	
	Between the input terminal and programmable controller power supply: 500VAC, for 1 minute Between input channels: 500VAC, for 1 minute		○	
	Between the input terminal and programmable controller power supply: 500VDC, 20MΩ or more Between input channels: 500VDC, 20MΩ or more		○	
	-	U.R.D. Co., LTD. CTL-12-S36-8 CTL-12-S36-10 CTL-12-S56-10 CTL-6-P(-H)	○	
		Full scale × (±1.0%)		
		3 to 255		

*1 Calculate the accuracy in the following method.

(Accuracy) = (Indication accuracy) + (Cold junction temperature compensation accuracy)

(Example) Accuracy at the input range of 38, the operating ambient temperature of 35°C, and the temperature process value (PV) of 300°C

{400.0-(-200.0)} [Full scale] × (±0.007)[±0.7%] + (±1.0°C) [Cold junction temperature compensation accuracy] = ±5.2°C

Item	Specifications	
	A1S64TCRT-S1	A1S64TCRTBW-S1
Number of occupied I/O points	32 points (I/O assignment: special 32 points)	
Connection terminal	20-point terminal block	
Applicable wire size	0.75 to 1.5mm ²	
Applicable solderless terminal	R1.25-3, 1.25-YS3, RAV1.25-3, V1.25-YS3A	
Internal current consumption	0.33A	0.42A
Weight	0.27kg	0.30kg
External dimensions	34.5(W) × 130(H) × 93.6(D)mm	

(1) List of usable platinum resistance thermometer, temperature measurement range, and resolution

Platinum resistance thermometer type	°C		°F	
	Temperature measurement range	Resolution	Temperature measurement range	Resolution
Pt100	-200.0 to 600.0	0.1	-300 to 1100	1
	-200.0 to 200.0		-300.0 to 300.0	0.1
JPt100	-200.0 to 500.0	0.1	-300 to 900	1
	-200.0 to 200.0		-300.0 to 300.0	0.1

○: Compatible, △: Partial change required, ×: Incompatible

Specifications		Compatibility	Precautions for replacement
L60TCRT4	L60TCRT4BW		
16 points/slot (I/O assignment: intelligent 16 points)	16 points/2 slots (I/O assignment: intelligent 16 points)	△	The number of occupied I/O points and slots are different.
18-point terminal block	Two 18-point terminal blocks	×	Wiring change is required.
22 to 18 AWG			
R1.25-3			
0.31A	0.35A	△	Recalculation of internal current consumption (5VDC) is required.
0.18kg	0.33kg	△	
28.5(W) × 90(H) × 117(D)mm	57.0(W) × 90(H) × 117(D)mm	–	

5.2.5 A1S62TCTT(BW)-S2

Item		Specifications	
		A1S62TCTT-S2	A1S62TCTTBW-S2
Control output		Transistor output	
Number of temperature input points		2 channels/module	
Applicable temperature sensor		(Refer to Section 5.2.5 (1).)	
Accuracy	Indication accuracy		(Ambient temperature: 25°C±5°C) Full scale × (±0.3%)±1 digit
			(Ambient temperature: 0°C to 55°C) Full scale × (±0.7%)±1 digit
	Cold junction temperature compensation accuracy (ambient temperature: 0°C to 55°C)	Temperature process value: -100°C or more	Within ±1.0°C
		Temperature process value: -150°C to -100°C	Within ±2.0°C
	Temperature process value: -200°C to -150°C	Within ±3.0°C	
Sampling cycle		0.5s (Constant regardless of the number of channels used)	
Control output cycle		1 to 100s	
Input impedance		1MΩ	
Input filter		0 to 100s	
Sensor correction value setting		-50.00 to 50.00%	
Operation at sensor input disconnection		Upscale processing	
Temperature control method		PID ON/OFF pulse or two-position control	
PID constants range	PID constants setting		Can be set by auto tuning or self-tuning.
	Proportional band (P)		0.0 to 1000.0%
	Integral time (I)		1 to 3600s
	Derivative time (D)		0 to 3600s
Set value (SV) setting range		Within the temperature range set for the temperature sensor to be used	
Transistor output	Output signal		ON/OFF pulse
	Rated load voltage		10.2 to 30.0VDC
	Maximum load current		0.1A/point, 0.4A/common
	Maximum inrush current		0.4A, 10ms
	Leakage current at OFF		0.1mA or lower
	Maximum voltage drop at ON		1.0VDC (TYP) at 0.1A 2.5VDC (MAX) at 0.1A
	Response time		OFF→ON: 2ms or less, ON→OFF: 2ms or less
Number of writes to E ² PROM		Maximum 100000 times	
Insulation method		Between the input terminal and programmable controller power supply: Transformer Between input channels: Transformer	
Dielectric withstand voltage		Between the input terminal and programmable controller power supply: 500VAC, for 1 minute Between input channels: 500VAC, for 1 minute	
Insulation resistance		Between the input terminal and programmable controller power supply: 500VDC, 10MΩ or more Between input channels: 500VDC, 10MΩ or more	

○: Compatible, △: Partial change required, ×: Incompatible

	Specifications		Compatibility	Precautions for replacement
	L60TCTT4	L60TCTT4BW		
	Transistor output		○	
	Standard control: 4 channels/module Heating-cooling control: 2 channels/module		○	The standard control and heating-cooling control can be combined in the L series module.
	(Refer to Section 5.2.5 (1).)		○	
	(Ambient temperature: 25°C±5°C) Full scale × (±0.3%)* ¹		○	
	(Ambient temperature: 0°C to 55°C) Full scale × (±0.7%)* ¹			
	Within ±1.0°C* ¹		○	
	Within ±2.0°C* ¹		○	
	Within ±3.0°C* ¹		○	
	(Refer to Section 5.2.5 (1).)		○	
	1 to 100s		○	
	1MΩ		○	
	0 to 100s		○	
	-50.00 to 50.00%		○	
	Upscale processing		○	
	PID ON/OFF pulse or two-position control		○	
	Can be set by auto tuning or self-tuning.		○	
	0.0 to 1000.0%		○	
	0 to 3600s		○	
	0 to 3600s		○	
	Within the temperature range set for the temperature sensor to be used		○	
	ON/OFF pulse		○	
	10 to 30VDC		○	
	0.1A/point, 0.4A/common		○	
	0.4A 10ms		○	
	0.1mA or lower		○	
	1.0VDC (TYP) at 0.1A 2.5VDC (MAX) at 0.1A		○	
	OFF→ON: 2ms or less, ON→OFF: 2ms or less		○	
	Maximum 10 ¹² times (number of read/write from/to a non-volatile memory)		○	
	Between the input terminal and programmable controller power supply: Transformer Between input channels: Transformer		○	
	Between the input terminal and programmable controller power supply: 500VAC, for 1 minute Between input channels: 500VAC, for 1 minute		○	
	Between the input terminal and programmable controller power supply: 500VDC, 20MΩ or more Between input channels: 500VDC, 20MΩ or more		○	

Item		Specifications	
		A1S62TCTT-S2	A1S62TCTTBW-S2
Heater disconnection detection specifications	Current sensor	-	U.R.D. Co., LTD. CTL-12-S36-8 CTL-6-P(-H)
	Input accuracy		Full scale × (±1.0%)
	Number of alert delay		3 to 255

○: Compatible, △: Partial change required, ×: Incompatible

Specifications		Compatibility	Precautions for replacement
L60TCTT4	L60TCTT4BW		
-	U.R.D. Co., LTD. CTL-12-S36-8 CTL-12-S36-10 CTL-12-S56-10 CTL-6-P(-H)	○	
	Full scale × (±1.0%)		
	3 to 255		

- *1 Calculate the accuracy in the following method.
 (Accuracy) = (Indication accuracy) + (Cold junction temperature compensation accuracy)
 (Example) Accuracy at the input range of 38, the operating ambient temperature of 35°C, and the temperature process value (PV) of 300°C
 $\{400.0 - (-200.0)\} [\text{Full scale}] \times (\pm 0.007) [\pm 0.7\%] + (\pm 1.0^\circ\text{C}) [\text{Cold junction temperature compensation accuracy}] = \pm 5.2^\circ\text{C}$

Item	Specifications	
	A1S62TCTT-S2	A1S62TCTTBW-S2
Number of occupied I/O points	32 points (I/O assignment: special 32 points)	
Connection terminal	20-point terminal block	
Applicable wire size	0.75 to 1.5mm ²	
Applicable solderless terminal	R1.25-3, 1.25-YS3, RAV1.25-3, V1.25-YS3A	
Internal current consumption	0.19A	0.28A
Weight	0.25kg	0.28kg
External dimensions	34.5(W) × 130(H) × 93.6(D)mm	

(1) List of thermocouple type, temperature measurement range, and resolution

Thermocouple type	°C		°F	
	Temperature measurement range	Resolution	Temperature measurement range	Resolution
R	0 to 1700	1	0 to 3000	1
K	0 to 500	1	0 to 1000	1
	0 to 800		0 to 2400	
	0 to 1300			
	-200.0 to 400.0			
J	0.0 to 400.0	0.1	0.0 to 1000.0	0.1
	0.0 to 500.0			
	0.0 to 800.0			
	0.0 to 1200			
T	0 to 500	1	0 to 1000	1
	0 to 800		0 to 1600	
	0 to 1200		0 to 2100	
	-200 to 400			
S	-200 to 200	1	0 to 700	1
	0 to 200		-300 to 400	
	0 to 400			
	-200.0 to 400.0			
B	0.0 to 400.0	0.1	0.0 to 700.0	0.1
	0.0 to 400.0			
E	0 to 1700	1	0 to 3000	1
	400 to 1800		800 to 3000	
N	0 to 400	1	0 to 1800	1
	0 to 1000		0 to 700	
U	0.0 to 700.0	0.1	–	–
	0 to 1300		0 to 2300	
L	0 to 400	1	0 to 700	1
	-200 to 200		-300 to 400	
PL II	0.0 to 600.0	0.1	–	–
	0 to 400		0 to 800	
W5Re/W26Re	0 to 900	1	0 to 1600	1
	0.0 to 400.0		–	
W5Re/W26Re	0.0 to 900.0	0.1	–	–
	0 to 1200		0 to 2300	
	0 to 2300	1	0 to 3000	1

○: Compatible, △: Partial change required, ×: Incompatible

Specifications		Compatibility	Precautions for replacement
L60TCTT4	L60TCTT4BW		
16 points/slot (I/O assignment: intelligent 16 points)	16 points/2 slots (I/O assignment: intelligent 16 points)	△	The number of occupied I/O points and slots are different.
18-point terminal block	Two 18-point terminal blocks	×	Wiring change is required.
22 to 18 AWG			
R1.25-3			
0.31A	0.35A	△	Recalculation of internal current consumption (5VDC) is required.
0.18kg	0.33kg	△	
28.5(W) × 90(H) × 117(D)mm	57.0(W) × 90(H) × 117(D)mm	–	

5.2.6 A1S62TCRT(BW)-S2

Item	Specifications	
	A1S62TCRT-S2	A1S62TCRTBW-S2
Control output	Transistor output	
Number of temperature input points	2 channels/module	
Applicable temperature sensor	(Refer to Section 5.2.6 (1).)	
Indication accuracy	(Ambient temperature: 25°C±5°C) Full scale × (±0.3%)±1 digit	
	(Ambient temperature: 0°C to 55°C) Full scale × (±0.7%)±1 digit	
Sampling cycle	0.5s (Constant regardless of the number of channels used)	
Control output cycle	1 to 100s	
Input impedance	1MΩ	
Input filter	0 to 100s	
Sensor correction value setting	-50.00 to 50.00%	
Operation at sensor input disconnection	Upscale processing	
Temperature control method	PID ON/OFF pulse or two-position control	
PID constants range	PID constants setting	Can be set by auto tuning or self-tuning.
	Proportional band (P)	0.0 to 1000.0%
	Integral time (I)	1 to 3600s
	Derivative time (D)	0 to 3600s
Set value (SV) setting range	Within the temperature range set for the temperature sensor to be used	
Transistor output	Output signal	ON/OFF pulse
	Rated load voltage	10.2 to 30.0VDC
	Maximum load current	0.1A/point, 0.4A/common
	Maximum inrush current	0.4A, 10ms
	Leakage current at OFF	0.1mA or lower
	Maximum voltage drop at ON	1.0VDC (TYP) at 0.1A 2.5VDC (MAX) at 0.1A
	Response time	OFF→ON: 2ms or less, ON→OFF: 2ms or less
Number of writes to E ² PROM	Maximum 100000 times	
Insulation method	Between the input terminal and programmable controller power supply: Transformer Between input channels: Transformer	
Dielectric withstand voltage	Between the input terminal and programmable controller power supply: 500VAC, for 1 minute Between input channels: 500VAC, for 1 minute	
Insulation resistance	Between the input terminal and programmable controller power supply: 500VDC, 10MΩ or more Between input channels: 500VDC, 10MΩ or more	
Heater disconnection detection specifications	Current sensor	U.R.D. Co., LTD. CTL-12-S36-8 CTL-6-P(-H)
	Input accuracy	Full scale × (±1.0%)
	Number of alert delay	3 to 255

○: Compatible, △: Partial change required, ×: Incompatible

	Specifications		Compatibility	Precautions for replacement
	L60TCRT4	L60TCRT4BW		
	Transistor output		○	
	Standard control: 4 channels/module Heating-cooling control: 2 channels/module		○	The standard control and heating-cooling control can be combined in the L series module.
	(Refer to Section 5.2.6 (1).)		○	
	(Ambient temperature: 25°C±5°C) Full scale × (±0.3%)* ¹		○	
	(Ambient temperature: 0°C to 55°C) Full scale × (±0.7%)* ¹			
	250ms/4 channels, 500ms/4 channels (Constant regardless of the number of channels used)		○	The sampling cycle can be selected in the L series module.
	0.5s to 100.0s		○	
	1MΩ		○	
	0 to 100s		○	
	-50.00 to 50.00%		○	
	Upscale processing		○	
	PID ON/OFF pulse or two-position control		○	
	Can be set by auto tuning or self-tuning.		○	
	0.0 to 1000.0%		○	
	0 to 3600s		○	
	0 to 3600s		○	
	Within the temperature range set for the temperature sensor to be used		○	
	ON/OFF pulse		○	
	10 to 30VDC		○	
	0.1A/point, 0.4A/common		○	
	0.4A, 10ms		○	
	0.1mA or lower		○	
	1.0VDC (TYP) at 0.1A 2.5VDC (MAX) at 0.1A		○	
	OFF→ON: 2ms or less, ON→OFF: 2ms or less		○	
	Maximum 10 ¹² times (number of read/write from/to a non-volatile memory)		○	
	Between the input terminal and programmable controller power supply: Transformer Between input channels: Transformer		○	
	Between the input terminal and programmable controller power supply: 500VAC, for 1 minute Between input channels: 500VAC, for 1 minute		○	
	Between the input terminal and programmable controller power supply: 500VDC, 20MΩ or more Between input channels: 500VDC, 20MΩ or more		○	
	-	U.R.D. Co., LTD. CTL-12-S36-8 CTL-12-S36-10 CTL-12-S56-10 CTL-6-P(-H)	○	
		Full scale × (±1.0%)		
		3 to 255		

*1 Calculate the accuracy in the following method.

(Accuracy) = (Indication accuracy) + (Cold junction temperature compensation accuracy)

(Example) Accuracy at the input range of 38, the operating ambient temperature of 35°C, and the temperature process value (PV) of 300°C

{400.0-(-200.0)} [Full scale] × (±0.007)[±0.7%] + (±1.0°C) [Cold junction temperature compensation accuracy] = ±5.2°C

Item	Specifications	
	A1S62TCRT-S2	A1S62TCRTBW-S2
Number of occupied I/O points	32 points (I/O assignment: special 32 points)	
Connection terminal	20-point terminal block	
Applicable wire size	0.75 to 1.5mm ²	
Applicable solderless terminal	R1.25-3, 1.25-YS3, RAV1.25-3, V1.25-YS3A	
Internal current consumption	0.19A	0.28A
Weight	0.25kg	0.28kg
External dimensions	34.5(W) × 130(H) × 93.6(D)mm	

(1) List of usable platinum resistance thermometer, temperature measurement range, and resolution

Platinum resistance thermometer type	°C		°F	
	Temperature measurement range	Resolution	Temperature measurement range	Resolution
Pt100	-200.0 to 600.0	0.1	-300 to 1100	1
	-200.0 to 200.0		-300.0 to 300.0	0.1
JPt100	-200.0 to 500.0	0.1	-300 to 900	1
	-200.0 to 200.0		-300.0 to 300.0	0.1

○: Compatible, △: Partial change required, ×: Incompatible

Specifications		Compatibility	Precautions for replacement
L60TCRT4	L60TCRT4BW		
16 points/slot (I/O assignment: intelligent 16 points)	16 points/2 slots (I/O assignment: intelligent 16 points)	△	The number of occupied I/O points and slots are different.
18-point terminal block	Two 18-point terminal blocks	×	Wiring change is required.
22 to 18 AWG			
R1.25-3			
0.31A	0.35A	△	Recalculation of internal current consumption (5VDC) is required.
0.18kg	0.33kg	△	
28.5(W) × 90(H) × 117(D)mm	57.0(W) × 90(H) × 117(D)mm	–	

5.3 Functional Comparison

Item	Description	
Auto tuning function	The temperature control module automatically sets the optimal PID constants.	
Self-tuning function	The temperature control module constantly monitors the control status. If the control is affected by disturbance, the module automatically changes or sets PID constants for the optimum control.	
Forward action/reverse action selection function	Selects and controls the heating control (reverse action) or cooling control (forward action).	
RFB limiter function	Suppresses the manipulated value overshoot which frequently occurs when the set value (SV) or the control target is changed.	
Sensor correction function	Corrects the difference between the temperature process value (PV) and actual temperature caused due to the measurement status.	
Unused channel setting	Specifies to not execute the PID operation in a channel that do not perform temperature control.	
PID control forced stop	Forcibly stops the PID operation in a channel that temperature control is in process.	
Heater disconnection detection function	Measures the current that flows in the heater main circuit and detects the disconnection.	
Output off-time current error detection function	Measures the current that is flowing in the heater main circuit when the transistor output is off, and detects the output off-time current error	
Loop disconnection detection function	Detects errors in the control system (control loop) caused by a load (heater) disconnection, external operation devices (such as magnet relay) error, or sensor disconnection.	
Data storage in E ² PROM	By backing up data in the buffer memory to E ² PROM, the load of sequence program can be reduced.	
Alert function	Monitors the process value (PV) and issues a warning.	
Output setting at CPU stop error	Whether to hold or stop the temperature control output when a CPU stop error occurs can be selected.	
Control function	Specifies a control status by setting output signals and buffer memory areas.	
Simultaneous temperature rise function	Coordinates the time when several loops reach the set value (SV) at the same time.	
Peak current suppression function	Suppresses the peak current by changing automatically the upper limit output limiter value of each channel and dividing the timing of transistor output.	
Temperature conversion function (using unused channels)	Performs only the temperature measurement using unused temperature input terminals in the heating-cooling control (normal mode) and mix control (normal mode).	
Temperature process value (PV) scaling function	Converts the temperature process value (PV) to the set width and stores this value into the buffer memory areas.	
Error history function	Stores the errors and alarms occurred in the module to the buffer memory as a history. Up to 16 errors and alarms can be stored.	
Module error history collection function	Notifies the CPU module of the error detail when errors and alarms occur on the module. Error information is stored to the memory in the CPU module as the module error history.	
Error clear function ^{*2}	Clears the error from the system monitor window of the programming tool.	
Heating-cooling control	Cooling method setting function	Specifies a auto tuning operation formula according to the selected cooling system (water-cooling or air-cooling).
	Overlap/dead band function	Specifies a temperature area near the temperature where heating output and cooling output is switched from the following: <ul style="list-style-type: none"> • Overlap area where both are output • Dead band area where neither is output
	Temperature conversion function (using unused channels)	Performs the temperature conversion in input channels that are not used for the control (monitor channel 1, 2)

○: Available, -: Not available

	Temperature control module/Heating-cooling temperature control module*1					
	A1S64TCRT A1S64TCRTBW	A1S64TCTT-S1 A1S64TCTTBW-S1	A1S64TCRT-S1 A1S64TCRTBW-S1	A1S62TCTT-S2 A1S62TCTTBW-S2	A1S62TCRT-S2 A1S62TCRTBW-S2	L60TCTT4 L60TCTT4BW L60TCRT4 L60TCRT4BW
	○	○	○	○	○	○
	○	-	-	-	-	○
	○	○	○	-	-	○
	○	○	○	○	○	○
	○	○	○	○	○	○
	○	○	○	○	○	○
	○	○	○	○	○	○
	○(BW only)	○(BW only)	○(BW only)	○(BW only)	○(BW only)	○(BW only)
	○(BW only)	○(BW only)	○(BW only)	○(BW only)	○(BW only)	○(BW only)
	○	○	○	-	-	○
	○(FeRAM)	○	○	○	○	○
	○	○	○	○	○	○
	-	-	-	-	-	○
	○	○	○	○	○	○
	-	-	-	-	-	○
	-	-	-	-	-	○
	-	-	-	-	-	○
	-	-	-	-	-	○
	-	-	-	-	-	○
	-	-	-	-	-	○
	-	-	-	-	-	○
	-	-	-	-	-	○
	○	-	-	○	○	○
	○	-	-	○	○	○
	○	-	-	-	-	○

*1 When an L series module is used for the temperature control/heating-cooling temperature control, the control mode setting (standard control mode or heating-cooling control mode) using the switch setting is required.

*2 This function can be used on GX Works2.

5.4 I/O Signal Comparison

Sequence programs need to be changed because the I/O signal assignment differs.
For details of the I/O signals and sequence programs, refer to the user' manual for each module.

5.4.1 A1S64TCTRT(BW) and L series modules (standard control)

A1S64TCTRT(BW)				L60TCTT4, L60TCRT4*1 L60TCTT4BW, L60TCRT4BW			
Device No.	Signal name	Device No.	Signal name	Device No.	Signal name	Device No.	Signal name
X0	Watchdog timer error flag	Y0	Use prohibited	X0	Module READY flag	Y0	N/A
X1	Temperature control module READY flag	Y1		X1	Setting/operation mode status	Y1	Setting/operation mode instruction
X2	Write error flag	Y2		X2	Error occurrence flag	Y2	Error reset instruction
X3	Hardware error flag	Y3		X3	Hardware error flag	Y3	N/A
X4	CH1 tuning status flag	Y4		X4	CH1 Auto tuning status	Y4	CH1 Auto tuning instruction
X5	CH2 tuning status flag	Y5		X5	CH2 Auto tuning status	Y5	CH2 Auto tuning instruction
X6	CH3 tuning status flag	Y6		X6	CH3 Auto tuning status	Y6	CH3 Auto tuning instruction
X7	CH4 tuning status flag	Y7		X7	CH4 Auto tuning status	Y7	CH4 Auto tuning instruction
X8	FeRAM write complete flag	Y8		X8	Back-up of the set value completion flag	Y8	Set value backup instruction
X9	Default value write complete flag	Y9		X9	Default value write completion flag	Y9	Default setting registration instruction
XA	FeRAM write incomplete flag	YA		XA	Back-up of the set value fail flag	YA	N/A
XB	Use prohibited	YB		XB	Setting change completion flag	YB	Setting change instruction
XC	CH1 Alert occurrence flag	YC		XC	CH1 Alert occurrence flag	YC	CH1 PID control forced stop instruction
XD	CH2 Alert occurrence flag	YD		XD	CH2 Alert occurrence flag	YD	CH2 PID control forced stop instruction
XE	CH3 Alert occurrence flag	YE		XE	CH3 Alert occurrence flag	YE	CH3 PID control forced stop instruction
XF	CH4 Alert occurrence flag	YF		XF	CH4 Alert occurrence flag	YF	CH4 PID control forced stop instruction
X10	Use prohibited	Y10					
X11		Y11	Setting/operation mode command				
X12		Y12	Error reset command				
X13		Y13	Use prohibited				
X14		Y14	CH1 Auto tuning command				
X15		Y15	CH2 Auto tuning command				
X16		Y16	CH3 Auto tuning command				

A1S64TCTRT(BW)			
Device No.	Signal name	Device No.	Signal name
X17	Use prohibited	Y17	CH4 Auto tuning command
X18		Y18	FeRAM backup command
X19		Y19	Default setting registration command
X1A		Y1A	CH1 Forced PID control stop command
X1B		Y1B	CH2 Forced PID control stop command
X1C		Y1C	CH3 Forced PID control stop command
X1D		Y1D	CH4 Forced PID control stop command
X1E		Y1E	Use prohibited
X1F		Y1F	

*1 Depending on the control mode of the L series module, some of the input/output signals listed in the above table become "use prohibited" signals. For details, refer to the MELSEC-L Temperature Control Module User's Manual.

5.4.2 A1S64TCTRT(BW) and L series modules (heating-cooling control)

A1S64TCTRT(BW)				L60TCTT4, L60TCRT4*1 L60TCTT4BW, L60TCRT4BW				
Device No.	Signal name	Device No.	Signal name	Device No.	Signal name	Device No.	Signal name	
X0	Watchdog timer error flag	Y0	Use prohibited	X0	Module READY flag	Y0	N/A	
X1	Temperature control module READY flag	Y1		X1	Setting/operation mode status	Y1	Setting/operation mode instruction	
X2	Write error flag	Y2		X2	Error occurrence flag	Y2	Error reset instruction	
X3	Hardware error flag	Y3		X3	Hardware error flag	Y3	N/A	
X4	CH1 tuning status flag	Y4		X4	CH1 Auto tuning status	Y4	CH1 Auto tuning instruction	
X5	CH2 tuning status flag	Y5		X5	CH2 Auto tuning status	Y5	CH2 Auto tuning instruction	
X6	Use prohibited	Y6		X6	CH3 Auto tuning status*2	Y6	CH3 Auto tuning instruction*2	
X7		Y7		X7	CH4 Auto tuning status*2	Y7	CH4 Auto tuning instruction*2	
X8	FeRAM write complete flag	Y8		X8	Back-up of the set value completion flag	Y8	Set value backup instruction	
X9	Default value write complete flag	Y9		X9	Default value write completion flag	Y9	Default setting registration instruction	
XA	FeRAM write incomplete flag	YA		XA	Back-up of the set value fail flag	YA	N/A	
XB	Use prohibited	YB		XB	Setting change completion flag	YB	Setting change instruction	
XC	CH1 Alert occurrence flag	YC		XC	CH1 Alert occurrence flag	YC	CH1 PID control forced stop instruction	
XD	CH2 Alert occurrence flag	YD		XD	CH2 Alert occurrence flag	YD	CH2 PID control forced stop instruction	
XE		YE		XE	CH3 Alert occurrence flag	YE	CH3 PID control forced stop instruction*2	
XF		YF		XF	CH4 Alert occurrence flag	YF	CH4 PID control forced stop instruction*2	
X10		Y10						
X11	Use prohibited	Y11		Setting/operation mode command				
X12		Y12		Error reset command				
X13		Y13		Use prohibited				
X14		Y14	CH1 Auto tuning command					
X15		Y15	CH2 Auto tuning command					
X16		Y16	Use prohibited					
X17		Y17						
X18		Y18	FeRAM backup command					
X19		Y19	Default setting registration command					

A1S64TCRT(BW)			
Device No.	Signal name	Device No.	Signal name
X1A	Use prohibited	Y1A	CH1 Forced PID control stop command
X1B		Y1B	CH2 Forced PID control stop command
X1C		Y1C	Use prohibited
X1D		Y1D	
X1E		Y1E	
X1F		Y1F	

- *1 Depending on the control mode of the L series module, some of the input/output signals listed in the above table become "use prohibited" signals. For details, refer to the MELSEC-L Temperature Control Module User's Manual.
- *2 These signals are enabled only when heating-cooling control (extended mode) is selected. For details, refer to the user's manual for the module used.

5.4.3 A1S64TCTT(BW)-S1/A1S64TCRT(BW)-S1 and L series modules

A1S64TCTT(BW)-S1, A1S64TCRT(BW)-S1				L60TCTT4, L60TCRT4*1 L60TCTT4BW, L60TCRT4BW				
Device No.	Signal name	Device No.	Signal name	Device No.	Signal name	Device No.	Signal name	
X0	Watchdog timer error flag	Y0	Use prohibited	X0	Module READY flag	Y0	N/A	
X1	Temperature control module READY flag	Y1		X1	Setting/operation mode status	Y1	Setting/operation mode instruction	
X2	Write error flag	Y2		X2	Error occurrence flag	Y2	Error reset instruction	
X3	Hardware error flag	Y3		X3	Hardware error flag	Y3	N/A	
X4	CH1 Auto tuning status	Y4		X4	CH1 Auto tuning status	Y4	CH1 Auto tuning instruction	
X5	CH2 Auto tuning status	Y5		X5	CH2 Auto tuning status	Y5	CH2 Auto tuning instruction	
X6	CH3 Auto tuning status	Y6		X6	CH3 Auto tuning status	Y6	CH3 Auto tuning instruction	
X7	CH4 Auto tuning status	Y7		X7	CH4 Auto tuning status	Y7	CH4 Auto tuning instruction	
X8	E ² PROM write completion flag	Y8		X8	Back-up of the set value completion flag	Y8	Set value backup instruction	
X9	Default value write complete flag	Y9		X9	Default value write completion flag	Y9	Default setting registration instruction	
XA	E ² PROM write incomplete flag	YA		XA	Back-up of the set value fail flag	YA	N/A	
XB	Use prohibited	YB		XB	Setting change completion flag	YB	Setting change instruction	
XC	CH1 Alert occurrence flag	YC		XC	CH1 Alert occurrence flag	YC	CH1 PID control forced stop instruction	
XD	CH2 Alert occurrence flag	YD		XD	CH2 Alert occurrence flag	YD	CH2 PID control forced stop instruction	
XE	CH3 Alert occurrence flag	YE		XE	CH3 Alert occurrence flag	YE	CH3 PID control forced stop instruction*2	
XF	CH4 Alert occurrence flag	YF		XF	CH4 Alert occurrence flag	YF	CH4 PID control forced stop instruction*2	
X10	Use prohibited	Y10						
X11		Y11		Setting/operation mode command				
X12		Y12		Error reset command				
X13		Y13		Use prohibited				
X14		Y14	CH1 Auto tuning command					
X15		Y15	CH2 Auto tuning command					
X16		Y16	CH3 Auto tuning command					
X17		Y17	CH4 Auto tuning command					
X18		Y18	E ² PROM backup command					
X19		Y19	Default setting registration command					
X1A	Y1A	CH1 Forced PID control stop command						

A1S64TCTT(BW)-S1, A1S64TCRT(BW)-S1			
Device No.	Signal name	Device No.	Signal name
X1B	Use prohibited	Y1B	CH2 Forced PID control stop command
X1C		Y1C	CH3 PID control forced stop command
X1D		Y1D	CH4 Forced PID control stop command
X1E		Y1E	Use prohibited
X1F		Y1F	

- *1 Depending on the control mode of the L series module, some of the input/output signals listed in the above table become "use prohibited" signals. For details, refer to the MELSEC-L Temperature Control Module User's Manual.
- *2 These signals are enabled only when heating-cooling control (extended mode) is selected. For details, refer to the user's manual for the module used.

5.4.4 A1S62TCTT(BW)-S2/A1S62TCRT(BW)-S2 and L series modules

A1S62TCTT(BW)-S2, A1S62TCRT(BW)-S2				L60TCTT4, L60TCRT4*1 L60TCTT4BW, L60TCRT4BW			
Device No.	Signal name	Device No.	Signal name	Device No.	Signal name	Device No.	Signal name
X0	Watchdog timer error flag	Y0	Use prohibited	X0	Module READY flag	Y0	N/A
X1	Temperature control module READY flag	Y1		X1	Setting/operation mode status	Y1	Setting/operation mode instruction
X2	Write error flag	Y2		X2	Error occurrence flag	Y2	Error reset instruction
X3	Hardware error flag	Y3		X3	Hardware error flag	Y3	N/A
X4	CH1 Auto tuning status	Y4		X4	CH1 Auto tuning status	Y4	CH1 Auto tuning instruction
X5	CH2 Auto tuning status	Y5		X5	CH2 Auto tuning status	Y5	CH2 Auto tuning instruction
X6	Use prohibited	Y6		X6	CH3 Auto tuning status*2	Y6	CH3 Auto tuning instruction*2
X7		Y7		X7	CH4 Auto tuning status*2	Y7	CH4 Auto tuning instruction*2
X8	E ² PROM write completion flag	Y8		X8	Back-up of the set value completion flag	Y8	Set value backup instruction
X9	Default value write complete flag	Y9		X9	Default value write completion flag	Y9	Default setting registration instruction
XA	E ² PROM write incomplete flag	YA		XA	Back-up of the set value fail flag	YA	N/A
XB	Use prohibited	YB		XB	Setting change completion flag	YB	Setting change instruction
XC	CH1 Alert occurrence flag	YC		XC	CH1 Alert occurrence flag	YC	CH1 PID control forced stop instruction
XD	CH2 Alert occurrence flag	YD		XD	CH2 Alert occurrence flag	YD	CH2 PID control forced stop instruction
XE	Use prohibited	YE		XE	CH3 Alert occurrence flag	YE	CH3 PID control forced stop instruction*2
XF		YF		XF	CH4 Alert occurrence flag	YF	CH4 PID control forced stop instruction*2
X10	Use prohibited	Y10					
X11		Y11		Setting/operation mode command			
X12		Y12		Error reset command			
X13		Y13		Use prohibited			
X14		Y14	CH1 Auto tuning command				
X15		Y15	CH2 Auto tuning command				
X16		Y16	Use prohibited				
X17		Y17					
X18		Y18	E ² PROM backup command				
X19		Y19	Default setting registration command				
X1A	Y1A	CH1 Forced PID control stop command					

A1S62TCTT(BW)-S2, A1S62TCRT(BW)-S2			
Device No.	Signal name	Device No.	Signal name
X1B	Use prohibited	Y1B	CH2 Forced PID control stop command
X1C		Y1C	Use prohibited
X1D		Y1D	
X1E		Y1E	
X1F		Y1F	

- *1 Depending on the control mode of the L series module, some of the input/output signals listed in the above table become "use prohibited" signals. For details, refer to the MELSEC-L Temperature Control Module User's Manual.
- *2 These signals are enabled only when heating-cooling control (extended mode) is selected. For details, refer to the user's manual for the module used.

5.5 Buffer Memory Address Comparison

Sequence programs need to be changed because the buffer memory address assignment differs. For details of the buffer memory areas and sequence programs, refer to the user's manual for each module.

5.5.1 A1S64TCTRT(BW) and L series modules (standard control)

A1S64TCTRT(BW)							
Address (hexadecimal)				Name	Read/write		
CH1	CH2	CH3	CH4				
0				Error code	R		
1	2	3	4	Decimal point position			
5	6	7	8	Alert detail			
9	A	B	C	Temperature process value (PV)			
D	E	F	10	Manipulated value (MV)			
11	12	13	14	Temperature rise judgment flag			
15	16	17	18	Transistor output flag			
19	1A	1B	1C	Measured heater current value			
1D				Cold junction temperature process value			
1E				MAN mode shift completion flag			
1F				System area (Use prohibited)		-	
20	40	60	80	Input range		RW	
21	41	61	81	Stop mode setting			
22	42	62	82	Set value (SV) setting			
23	43	63	83	Proportional band (P) setting			
24	44	64	84	Integral time (I) setting			
25	45	65	85	Derivative time (D) setting			
26	46	66	86	Setting of Alert alarm 1			
27	47	67	87	Setting of Alert alarm 2			
28	48	68	88	Setting of Alert alarm 3			
29	49	69	89	Setting of Alert alarm 4			
2A	4A	6A	8A	upper limit output limiter			
2B	4B	6B	8B	Lower limit output limiter			
2C	4C	6C	8C	Output variation limiter			
2D	4D	6D	8D	Sensor correction value setting			
2E	4E	6E	8E	Adjustment sensitivity (dead band) setting			
2F	4F	6F	8F	Control output period setting			
30	50	70	90	Primary delay digital filter setting			
31	51	71	91	Control response parameter			
32	52	72	92	AUTO/MAN mode switching			
33	53	73	93	MAN output setting			
34	54	74	94	Setting change rate limiter			
35	55	75	95	AT bias			
36	56	76	96	Forward/reverse action setting			
37	57	77	97	Upper limit setting limiter			
38	58	78	98	Lower limit setting limiter			
39	59	79	99	CT selection			
3A	5A	7A	9A	Heater disconnection alert setting			
3B	5B	7B	9B	Loop disconnection detection judgment time			
3C	5C	7C	9C	Loop disconnection detection dead band			
3D	5D	7D	9D	Unused channel setting			

L60TCTT4, L60TCRT4, L60TCTT4BW, L60TCRT4BW						
Address (hexadecimal)				Name	Read/write	
CH1	CH2	CH3	CH4			
0				Error code	R	
1	2	3	4	Decimal point position		
5	6	7	8	Alert definition		
9	A	B	C	Temperature process value (PV)		
D	E	F	10	Manipulated value (MV)		
11	12	13	14	Temperature rise judgment flag		
15	16	17	18	Transistor output flag		
19	1A	1B	1C	Set value (SV) monitor		
1D				Cold junction temperature process value*1		
1E				MAN mode shift completion flag		
1F				Memory of PID constants read/Write completion flag	R	
20	40	60	80	Input range	R/W	
21	41	61	81	Stop mode setting		
22	42	62	82	Set value (SV) setting		
23	43	63	83	Proportional band (P) setting		
24	44	64	84	Integral time (I) setting		
25	45	65	85	Derivative time (D) setting		
26	46	66	86	Alert set value 1		
27	47	67	87	Alert set value 2		
28	48	68	88	Alert set value 3		
29	49	69	89	Alert set value 4		
2A	4A	6A	8A	Upper limit output limiter		
2B	4B	6B	8B	Lower limit output limiter		
2C	4C	6C	8C	Output variation limiter setting		
2D	4D	6D	8D	Sensor correction value setting		
2E	4E	6E	8E	Adjustment sensitivity (dead band) setting		
2F	4F	6F	8F	Control output cycle setting		
30	50	70	90	Primary delay digital filter setting		
31	51	71	91	Control response parameters		
32	52	72	92	AUTO/MAN mode shift		
33	53	73	93	MAN output setting		
34	54	74	94	Setting change rate limiter/Setting change rate limiter (temperature rise)		
35	55	75	95	AT bias		
36	56	76	96	Forward/reverse action setting		
37	57	77	97	Upper limit setting limiter		
38	58	78	98	Lower limit setting limiter		
39	59	79	99	System area (Use prohibited)		-
3A	5A	7A	9A	Heater disconnection alert setting		R/W
3B	5B	7B	9B	Loop disconnection detection judgment time		
3C	5C	7C	9C	Loop disconnection detection dead band		
3D	5D	7D	9D	Unused channel setting		

*1 For the L60TCRT4(BW), this area is prohibited to use.

A1S64TCTRT(BW)						
Address (hexadecimal)				Name	Read/write	
CH1	CH2	CH3	CH4			
3E	5E	7E	9E	Self-tuning setting	R/W	
3F	5F	7F	9F	Self-tuning flag	R	
A0				Mode setting for Alert alarm 1	R/W	
A1				Mode setting for Alert alarm 2		
A2				Mode setting for Alert alarm 3		
A3				Mode setting for Alert alarm 4		
A4				Alert dead band setting		
A5				Number of alert delay		
A6				Heater disconnection/output off-time current error detection delay count		
A7				Temperature rise completion range setting		
A8				Temperature rise completion soak time setting		
A9				PID continuation flag		
AA				Heater voltage correction setting		
AB	AC	AD	AE	Reference heater current value		
AF				Transistor output monitor ON delay time setting		
B0				CT monitor method switching		
B1	B2	B3	B4	Control output monitor	R	
B5				System area (Use prohibited)	-	
B6				Cold junction temperature correction selection	R/W	
B7				Control switching monitor	R	

☒ Point

Default values for the A series modules and L series modules may be different.

To apply an A series program using a default value to an L series module, review the program.

For details, refer to the user's manual for the L series module used.

L60TCTT4, L60TCRT4, L60TCTT4BW, L60TCRT4BW					
Address (hexadecimal)				Name	Read/write
CH1	CH2	CH3	CH4		
3E	5E	7E	9E	Memory of PID constants read instruction	R/W
3F	5F	7F	9F	Automatic backup setting after auto tuning of PID constants	
A0				System area (Use prohibited)	-
A1					
A2					
A3					
A4				Alert dead band setting	R/W
A5				Number of alert delay	
A6				Heater disconnection/output off-time current error detection delay count	
A7				Temperature rise completion range setting	
A8				Temperature rise completion soak time setting	
A9				PID continuation flag	
AA				Heater disconnection correction function selection	
AB	AC	AD	AE	System area (Use prohibited)	
AF				Transistor output monitor ON delay time setting	R/W
B0				CT monitor method switching	
B1	B2	B3	B4	Manipulated value (MV) for output with another analog module	R
B5				Resolution of the manipulated value for output with another analog module	R/W
B6				Cold junction temperature compensation selection	R/W
B7				Control switching monitor	-
B8	B9	BA	BB	Auto tuning mode selection	R/W
BC to BF				System area (Use prohibited)	-
C0	D0	E0	F0	Alert 1 mode setting	R/W
C1	D1	E1	F1	Alert 2 mode setting	
C2	D2	E2	F2	Alert 3 mode setting	
C3	D3	E3	F3	Alert 4 mode setting	
C4	D4	E4	F4	System area (Use prohibited)	-
⋮	⋮	⋮	⋮		
CF	DF	EF	FF		
100 to 107				Heater current measurement value	R
108 to 10F				CT input channel assignment setting	R/W
110 to 117					
118 to 11F					
120 to 127					
128 to 21F				Reference heater current value	R/W
128 to 21F				System area (Use prohibited)	-
220	240	260	280	2-point sensor compensation offset value (measured value)	R/W
221	241	261	281	2-point sensor compensation offset value (compensation value)	R/W
222	242	262	282	2-point sensor compensation gain value (measured value)	R/W
223	243	263	283	2-point sensor compensation gain value (compensation value)	R/W
224	244	264	284	2-point sensor compensation offset latch request	R/W
225	245	265	285	2-point sensor compensation offset latch completion	R
226	246	266	286	2-point sensor compensation gain latch request	R/W
227	247	267	287	2-point sensor compensation gain latch completion	R
228	248	268	288	System area (Use prohibited)	-
⋮	⋮	⋮	⋮		
233	253	273	293		
234	254	274	294	Setting change rate limiter (temperature drop)	R/W
235	255	275	295	System area (Use prohibited)	-
⋮	⋮	⋮	⋮		
23C	25C	27C	29C	System area (Use prohibited)	-
⋮	⋮	⋮	⋮		
23D	25D	27D	29D	AT simultaneous temperature rise parameter calculation flag	R

L60TCTT4, L60TCRT4, L60TCTT4BW, L60TCRT4BW					
Address (hexadecimal)				Name	Read/write
CH1	CH2	CH3	CH4		
23E	25E	27E	29E	Self-tuning setting	R/W
23F	25F	27F	29F	Self-tuning flag	R
2A0				System area (Use prohibited)	-
⋮					
2B0					
2B1	2B2	2B3	2B4	Temperature process value (PV) for input with another analog module	R/W
2B5				System area (Use prohibited)	-
⋮					
2CF					
2D0	2E0	2F0	300		
⋮	⋮	⋮	⋮		
2D3	2E3	2F3	303	Manual reset amount setting	R/W
2D4	2E4	2F4	304	Process value (PV) scaling function enable/disable setting	R/W
2D5	2E5	2F5	305	Process value (PV) scaling lower limit value	R/W
2D6	2E6	2F6	306	Process value (PV) scaling upper limit value	R/W
2D7	2E7	2F7	307	Process value (PV) scaling value	R
2D8	2E8	2F8	308	Derivative action selection	R/W
2D9	2E9	2F9	309	Simultaneous temperature rise group setting	R/W
2DA	2EA	2FA	30A	Simultaneous temperature rise gradient data	R/W
2DB	2EB	2FB	30B	Simultaneous temperature rise dead time	R/W
2DC	2EC	2FC	30C	Simultaneous temperature rise AT mode selection	R/W
2DD	2ED	2FD	30D	Simultaneous temperature rise status	R
2DE	2EE	2FE	30E	Setting change rate limiter unit time setting	R/W
310				Peak current suppression control group setting	R/W
311				Sensor compensation function selection	R/W
312				Temperature conversion completion flag	R
313				Function extension bit monitor	R
314				Sampling cycle monitor	R
315				System area (Use prohibited)	-
⋮					
4FE					
4FF				Buffer memory for error history	R
⋮					
FFF					
1000				System area (Use prohibited)	-
⋮					
CFFF					

5.5.2 A1S64TCTRT(BW) and L series modules (heating-cooling control)

A1S64TCTRT(BW)			
Address (hexadecimal)		Name	Read/write
CH1	CH2		
0		Error code	R
1	2	Decimal point position	
5	6	Alert detail	
9	A	Temperature process value (PV)	
D	E	Manipulated value for heating (MVh)	
11	12	Temperature rise judgment flag	
15	16	Heating transistor output flag	
19	1A	Measured heater current value	
1D		Cold junction temperature process value	
1E		System area (Use prohibited)	-
1F			
20	40	Input range	R/W
21	41	Stop mode setting	
22	42	Set value (SV) setting	
23	43	Heating proportional band (Ph) setting	
24	44	Integral time (I) setting	
25	45	Derivative time (D) setting	
26	46	Setting of Alert alarm 1	
27	47	Setting of Alert alarm 2	
28	48	Setting of Alert alarm 3	
29	49	Setting of Alert alarm 4	
2A	4A	Heating upper limit output limiter	-
2B	4B	System area (Use prohibited)	
2C	4C		
2D	4D		
2E	4E	Sensor correction value setting	R/W
2F	4F	Adjustment sensitivity (dead band) setting	
30	50	Heating control output period setting	
31	51	Primary delay digital filter setting	
32	52	Control response parameter	
33	53	System area (Use prohibited)	-
34	54	Setting change rate limiter	R/W
35	55	System area (Use prohibited)	-
36	56		
37	57		
38	58	Upper limit setting limiter	R/W
39	59	Lower limit setting limiter	
3A	5A	CT selection	
3B	5B	Heater disconnection alert setting	
3C	5C	System area (Use prohibited)	-
3D	5D	Unused channel setting	R/W

L60TCTT4, L60TCRT4, L60TCTT4BW, L60TCRT4BW			
Address (hexadecimal)		Name	Read/write
CH1	CH2		
0		Error code	R
1	2	Decimal point position	
5	6	Alert definition	
9	A	Temperature process value (PV)	
D	E	Manipulated value for heating (MVh)	
11	12	Temperature rise judgment flag	
15	16	Heating transistor output flag	
19	1A	Set value (SV) monitor	
1D		Cold junction temperature process value	R
1E		MAN mode shift completion flag	
1F		Memory of PID constants read/Write completion flag	
20	40	Input range	R/W
21	41	Stop mode setting	
22	42	Set value (SV) setting	
23	43	Heating proportional band (Ph) setting	
24	44	Integral time (I) setting	
25	45	Derivative time (D) setting	
26	46	Alert set value 1	
27	47	Alert set value 2	
28	48	Alert set value 3	
29	49	Alert set value 4	
2A	4A	Heating upper limit output limiter	-
2B	4B	System area (Use prohibited)	
2C	4C	Output variation limiter setting	R/W
2D	4D	Sensor correction value setting	
2E	4E	Adjustment sensitivity (dead band) setting	-
2F	4F	Heating control output cycle setting	R/W
30	50	Primary delay digital filter setting	
31	51	Control response parameters	R/W
32	52	AUTO/MAN mode shift	
33	53	MAN output setting	
34	54	Setting change rate limiter/Setting change rate limiter (temperature rise)	R/W
35	55	AT bias	R/W
36	56	System area (Use prohibited)	-
37	57	Upper limit setting limiter	R/W
38	58	Lower limit setting limiter	
39	59	System area (Use prohibited)	-
3A	5A	Heater disconnection alert setting	R/W
3B	5B	System area (Use prohibited)	-
3C	5C	System area (Use prohibited)	-
3D	5D	Unused channel setting	R/W

A1S64TCTRT(BW)			
Address (hexadecimal)		Name	Read/write
CH1	CH2		
3E	5E	System area (Use prohibited)	-
3F	5F		
A0		Mode setting for Alert alarm 1	R/W
A1		Mode setting for Alert alarm 2	
A2		Mode setting for Alert alarm 3	
A3		Mode setting for Alert alarm 4	
A4		Alert dead band setting	
A5		Number of alert delay	
A6		Heater disconnection/output off-time current error detection delay count	
A7		Temperature rise completion range setting	
A8		Temperature rise completion soak time setting	
A9		PID continuation flag	
AA		Heater voltage correction setting	
AB	AC	Reference heater current value	
AF		Transistor output monitor ON delay time setting	
B0		CT monitor method switching	
B1	B2	Heating control output monitor	R
⋮			
B6		Cold junction temperature correction selection	R/W
B7		Control switching monitor	R
B8	B9	Temperature conversion setting	R/W
⋮			
C0		Manipulated value for cooling (MV)	R
C1			
C2		Cooling control output monitor	
C3			
C4	C5	Cooling transistor output flag	
⋮			
CF		Cooling type setting	R/W
D0	E0	Cooling proportional band (Pc) setting	
D1	E1	Cooling upper limit output limiter	
D2	E2	Cooling control output period setting	
D3	E3	Overlap/dead band	

☒ Point

Default values for the A series modules and L series modules may be different. To apply an A series program using a default value to an L series module, review the program. For details, refer to the user's manual for the L series module used.

L60TCTT4, L60TCRT4, L60TCTT4BW, L60TCRT4BW			
Address (hexadecimal)		Name	Read/write
CH1	CH2		
3E	5E	Memory of PID constants read instruction	R/W
3F	5F	Automatic backup setting after auto tuning of PID constants	R/W
	A0	System area (Use prohibited)	-
	A1		
	A2		
	A3		
	A4		
	A5	Alert dead band setting	R/W
	A6	Number of alert delay	
	A7	Heater disconnection/output off-time current error detection delay count	
	A8	Temperature rise completion range setting	
	A9	Temperature rise completion soak time setting	
	AA	PID continuation flag	
	AB	Heater disconnection correction function selection	
	AC	System area (Use prohibited)	-
	AF	Transistor output monitor ON delay time setting	R/W
	B0	CT monitor method switching	
B1	B2	Manipulated value of heating (MVh) for output with another analog module	R
	B5	Resolution of the manipulated value for output with another analog module	R/W
	B6	Cold junction temperature compensation selection	R/W
	B7	Control switching monitor	R
B8	B9	Auto tuning mode selection	R/W
	⋮		
	C0	Alert 1 mode setting	R/W
	C1	Alert 2 mode setting	
	C2	Alert 3 mode setting	
	C3	Alert 4 mode setting	
	⋮		
	D0	Alert 1 mode setting	R/W
	D1	Alert 2 mode setting	
	D2	Alert 3 mode setting	
	D3	Alert 4 mode setting	
	⋮		
	100 to 107	Heater current measurement value	R
	108 to 10F	CT input channel assignment setting	R/W
	110 to 117	CT selection	
	118 to 11F	Reference heater current value	
	⋮		
220	240	2-point sensor compensation offset value (measured value)	R/W
221	241	2-point sensor compensation offset value (compensation value)	R/W
222	242	2-point sensor compensation gain value (measured value)	R/W
223	243	2-point sensor compensation gain value (compensation value)	R/W
224	244	2-point sensor compensation offset latch request	R/W
225	245	2-point sensor compensation offset latch completion	R
226	246	2-point sensor compensation gain latch request	R/W
227	247	2-point sensor compensation gain latch completion	R
	⋮		
234	254	Setting change rate limiter (temperature drop)	R/W
	⋮		
2B8	2B9	Temperature conversion setting	R/W
	⋮		

L60TCTT4, L60TCRT4, L60TCTT4BW, L60TCRT4BW			
Address (hexadecimal)		Name	Read/write
CH1	CH2		
2C0	2C1	Manipulated value for cooling (MVc)	R
⋮			
2C4	2C5	Manipulated value of cooling (MVc) for output with another analog module	R
⋮			
2C8	2C9	Cooling transistor output flag	R
⋮			
2CF		Cooling method setting	R/W
2D0	2E0	Cooling proportional band (Pc) setting	
2D1	2E1	Cooling upper limit output limiter	
2D2	2E2	Cooling control output cycle setting	
2D3	2E3	Overlap/dead band setting	
2D4	2E4	Manual reset amount setting	R/W
2D5	2E5	Process value (PV) scaling function enable/disable setting	R/W
2D6	2E6	Process value (PV) scaling lower limit value	R/W
2D7	2E7	Process value (PV) scaling upper limit value	R/W
2D8	2E8	Process value (PV) scaling value	R
2D9	2E9	Derivative action selection	R/W
⋮			
2DF	2EF	Setting change rate limiter unit time setting	R/W
⋮			
311		Sensor compensation function selection	R/W
312		Temperature conversion completion flag	R
313		Function extension bit monitor	R
314		Sampling cycle monitor	R
315		System area (Use prohibited)	-
⋮			
4FE			
4FF		Buffer memory for error history	R
⋮			
FFF			
1000		System area (Use prohibited)	-
⋮			
CFFF			

5.5.3 A1S64TCTT(BW)-S1/A1S64TCRT(BW)-S1 and L series modules

A1S64TCTT(BW)-S1, A1S64TCRT(BW)-S1					
Address (hexadecimal)				Name	Read/write
CH1	CH2	CH3	CH4		
0				Write data error code	R/W
1	2	3	4	Decimal point position	R
5	6	7	8	Alert detail	
9	A	B	C	Temperature process value (PV)	
D	E	F	10	Manipulated value (MV)	
11	12	13	14	Temperature rise judgment flag	
15	16	17	18	Transistor output flag	
19	1A	1B	1C	Measured heater current value	
1D				Cooling contact temperature process value ^{*1}	
1E				MAN mode shift completion flag	
1F				System area (Use prohibited)	
20	40	60	80	Input range	R/W
21	41	61	81	Stop mode setting	
22	42	62	82	Set value (SV) setting	
23	43	63	83	Proportional band (P) setting	
24	44	64	84	Integral time (I) setting	
25	45	65	85	Derivative time (D) setting	
26	46	66	86	Alert alarm 1 set value	
27	47	67	87	Alert alarm 2 set value	
28	48	68	88	Alert alarm 3 set value	
29	49	69	89	Alert alarm 4 set value	
2A	4A	6A	8A	Upper limit output limiter	
2B	4B	6B	8B	Lower limit output limiter	
2C	4C	6C	8C	Output variation limiter	
2D	4D	6D	8D	Sensor correction value setting	
2E	4E	6E	8E	Adjustment sensitivity (dead band) setting	
2F	4F	6F	8F	Control output period setting	
30	50	70	90	Primary delay digital filter setting	
31	51	71	91	Control response parameter	
32	52	72	92	AUTO/MAN mode switch	
33	53	73	93	Manual output setting	
34	54	74	94	Setting change rate limiter	
35	55	75	95	AT bias	
36	56	76	96	Forward/reverse action setting	
37	57	77	97	Upper setting limiter	
38	58	78	98	Lower setting limiter	
39	59	79	99	CT selection	
3A	5A	7A	9A	Heater disconnection alert setting	
3B	5B	7B	9B	Open-loop detection time	
3C	5C	7C	9C	Open-loop detection dead band	
3D	5D	7D	9D	Unused channel setting	

*1 For the A1S64TCRT(BW)-S1, this area is prohibited to use.

*2 For the L60TCRT4 and L60TCRT4(BW), this area is prohibited to use.

L60TCTT4, L60TCRT4, L60TCTT4BW, L60TCRT4BW					Name	Read/write
Address (hexadecimal)						
CH1	CH2	CH3	CH4			
0				Error code	R	
1	2	3	4	Decimal point position		
5	6	7	8	Alert definition		
9	A	B	C	Temperature process value (PV)		
D	E	F	10	Manipulated value (MV)		
11	12	13	14	Temperature rise judgment flag		
15	16	17	18	Transistor output flag		
19	1A	1B	1C	Set value (SV) monitor		
1D				Cold junction temperature process value ^{*2}		
1E				MAN mode shift completion flag		
1F				Memory of PID constants read/Write completion flag	R	
20	40	60	80	Input range	R/W	
21	41	61	81	Stop mode setting		
22	42	62	82	Set value (SV) setting		
23	43	63	83	Proportional band (P) setting		
24	44	64	84	Integral time (I) setting		
25	45	65	85	Derivative time (D) setting		
26	46	66	86	Alert set value 1		
27	47	67	87	Alert set value 2		
28	48	68	88	Alert set value 3		
29	49	69	89	Alert set value 4		
2A	4A	6A	8A	Upper limit output limiter		
2B	4B	6B	8B	Lower limit output limiter		
2C	4C	6C	8C	Output variation limiter setting		
2D	4D	6D	8D	Sensor correction value setting		
2E	4E	6E	8E	Adjustment sensitivity (dead band) setting		
2F	4F	6F	8F	Control output cycle setting		
30	50	70	90	Primary delay digital filter setting		
31	51	71	91	Control response parameters		
32	52	72	92	AUTO/MAN mode shift		
33	53	73	93	MAN output setting		
34	54	74	94	Setting change rate limiter/Setting change rate limiter (temperature rise)		
35	55	75	95	AT bias		
36	56	76	96	Forward/reverse action setting		
37	57	77	97	Upper limit setting limiter		
38	58	78	98	Lower limit setting limiter		
39	59	79	99	System area (Use prohibited)		-
3A	5A	7A	9A	Heater disconnection alert setting		R/W
3B	5B	7B	9B	Loop disconnection detection judgment time		
3C	5C	7C	9C	Loop disconnection detection dead band		
3D	5D	7D	9D	Unused channel setting		

A1S64TCTT(BW)-S1, A1S64TCRT(BW)-S1						
Address (hexadecimal)				Name	Read/write	
CH1	CH2	CH3	CH4			
3E	5E	7E	9E	System area (Use prohibited)	-	
3F	5F	7F	9F			
A0				Alert alarm 1 mode setting	R/W	
A1				Alert alarm 2 mode setting		
A2				Alert alarm 3 mode setting		
A3				Alert alarm 4 mode setting		
A4				Alert dead band setting		
A5				Number of alert delays		
A6				Number of delays for heater disconnection/current error detection when output is turned off		
A7				Temperature increase complete range setting		
A8				Temperature increase complete soak time setting		
A9				PID continue flag		
AA				Heater voltage correction function setting		
AB	AC	AD	AE	Standard heater current value		
AF				Transistor output monitor ON delay time setting		
B0				CT monitor method switch		
B1	B2	B3	B4	Manipulation value (MV) (0 to 4000)	R	
B5				System area (Use prohibited)	-	
B6				Cold junction temperature correction selection ^{*1} (This area can be used with the software version F or later.)	R/W	

*1 For the A1S64TCRT(BW)-S1, this area is prohibited to use.

☒ Point

Default values for the A series modules and L series modules may be different.

To apply an A series program using a default value to an L series module, review the program.

For details, refer to the user's manual for the L series module used.

L60TCTT4, L60TCRT4, L60TCTT4BW, L60TCRT4BW					
Address (hexadecimal)				Name	Read/write
CH1	CH2	CH3	CH4		
3E	5E	7E	9E	Memory of PID constants read instruction	R/W
3F	5F	7F	9F	Automatic backup setting after auto tuning of PID constants	
A0				System area (Use prohibited)	-
A1					
A2					
A3					
A4				Alert dead band setting	R/W
A5				Number of alert delay	
A6				Heater disconnection/output off-time current error detection delay count	
A7				Temperature rise completion range setting	
A8				Temperature rise completion soak time setting	
A9				PID continuation flag	
AA				Heater disconnection correction function selection	
AB	AC	AD	AE	System area (Use prohibited)	-
AF				Transistor output monitor ON delay time setting	R/W
B0				CT monitor method switching	
B1	B2	B3	B4	Manipulated value (MV) for output with another analog module	R
B5				Resolution of the manipulated value for output with another analog module	-
B6				Cold junction temperature compensation selection	R/W
B7				Control switching monitor	R
⋮					
C0	D0	E0	F0	Alert 1 mode setting	R/W
C1	D1	E1	F1	Alert 2 mode setting	
C2	D2	E2	F2	Alert 3 mode setting	
C3	D3	E3	F3	Alert 4 mode setting	
⋮					
100 to 107				Heater current measurement value	R
108 to 10F				CT input channel assignment setting	R/W
110 to 117				CT selection	
118 to 11F				Reference heater current value	
120 to 127				CT ratio setting	R/W
128 to 21F				System area (Use prohibited)	-
220	240	260	280	2-point sensor compensation offset value (measured value)	R/W
221	241	261	281	2-point sensor compensation offset value (compensation value)	R/W
222	242	262	282	2-point sensor compensation gain value (measured value)	R/W
223	243	263	283	2-point sensor compensation gain value (compensation value)	R/W
224	244	264	284	2-point sensor compensation offset latch request	R/W
225	245	265	285	2-point sensor compensation offset latch completion	R
226	246	266	286	2-point sensor compensation gain latch request	R/W
227	247	267	287	2-point sensor compensation gain latch completion	R
228	248	268	288		
⋮	⋮	⋮	⋮	System area (Use prohibited)	-
233	253	273	293		
234	254	274	294	Setting change rate limiter (temperature drop)	R/W
235	255	275	295		
⋮	⋮	⋮	⋮	System area (Use prohibited)	-
23C	25C	27C	29C		
23D	25D	27D	29D	AT simultaneous temperature rise parameter calculation flag	R
23E	25E	27E	29E	Self-tuning setting	R/W
23F	25F	27F	29F	Self-tuning flag	R

L60TCTT4, L60TCRT4, L60TCTT4BW, L60TCRT4BW					
Address (hexadecimal)				Name	Read/write
CH1	CH2	CH3	CH4		
2A0				System area (Use prohibited)	-
⋮					
2B0					
2B1	2B2	2B3	2B4	Temperature process value (PV) for input with another analog module	R/W
2B5				System area (Use prohibited)	-
⋮					
2CF					
2D0	2E0	2F0	300		
⋮	⋮	⋮	⋮		
2D3	2E3	2F3	303	Manual reset amount setting	R/W
2D4	2E4	2F4	304	Process value (PV) scaling function enable/disable setting	R/W
2D5	2E5	2F5	305	Process value (PV) scaling lower limit value	R/W
2D6	2E6	2F6	306	Process value (PV) scaling upper limit value	R/W
2D7	2E7	2F7	307	Process value (PV) scaling value	R
2D8	2E8	2F8	308	Derivative action selection	R/W
2D9	2E9	2F9	309	Simultaneous temperature rise group setting	R/W
2DA	2EA	2FA	30A	Simultaneous temperature rise gradient data	R/W
2DB	2EB	2FB	30B	Simultaneous temperature rise dead time	R/W
2DC	2EC	2FC	30C	Simultaneous temperature rise AT mode selection	R/W
2DD	2ED	2FD	30D	Simultaneous temperature rise status	R
2DE	2EE	2FE	30E	Setting change rate limiter unit time setting	R/W
2DF	2EF	2FF	30F	Peak current suppression control group setting	R/W
310				Sensor compensation function selection	R/W
311				Temperature conversion completion flag	R
312				Function extension bit monitor	R
313				Sampling cycle monitor	R
314				System area (Use prohibited)	-
⋮					
4FE					
4FF				Buffer memory for error history	R
⋮					
FFF					
1000				System area (Use prohibited)	-
⋮					
CFFF					

5.5.4 A1S62TCTT(BW)-S2/A1S62TCRT(BW)-S2 and L series modules

A1S62TCTT(BW)-S2, A1S62TCRT(BW)-S2			
Address (hexadecimal)		Name	Read/write
CH1	CH2		
0		Write data error code	R/W
1	2	Decimal point position	R
5	6	Alert occurrence details	
9	A	Temperature process value (PV)	
D	E	Heating manipulation value (MV)	
11	12	Increased temperature determination flag	
15	16	Heating transistor output flag	
19	1A	Heater current process value	
1D		Cooling contact temperature process value ^{*1}	
1E		System area (Use prohibited)	-
1F			
20	40	Input range	R/W
21	41	Stop mode setting	
22	42	Set value (SV) setting	
23	43	Heating proportional band (Ph) setting	
24	44	Integral time (I) setting	
25	45	Derivative time (D) setting	
26	46	Alert set value 1	
27	47	Alert set value 2	
28	48	Alert set value 3	
29	49	Alert set value 4	
2A	4A	Heating-cooling upper limit output limiter	
2B	4B	System area (Use prohibited)	
2C	4C		
2D	4D	Sensor correction value setting	
2E	4E	System area (Use prohibited)	
2F	4F	Heating control output period setting	
30	50	Primary delay digital filter setting	
31	51	Control response parameter	
32	52	System area (Use prohibited)	
33	53		
34	54	Setting change rate limiter	
35	55	System area (Use prohibited)	
36	56		
37	57	Upper limit setting limiter	
38	58	Lower limit setting limiter	
39	59	CT selection	
3A	5A	Heater wire breakage alert setting	
3B	5B	System area (Use prohibited)	
3C	5C		
3D	5D	Not used channel setting	

*1 For the A1S62TCRT(BW), this area is prohibited to use.

*2 For the L60TCRT(BW), this area is prohibited to use.

L60TCTT4, L60TCRT4, L60TCTT4BW, L60TCRT4BW			
Address (hexadecimal)		Name	Read/write
CH1	CH2		
0		Error code	
1	2	Decimal point position	
5	6	Alert definition	
9	A	Temperature process value (PV)	
D	E	Manipulated value for heating (MVh)	R
11	12	Temperature rise judgment flag	
15	16	Heating transistor output flag	
19	1A	Set value (SV) monitor	
1D		Cold junction temperature process value ^{*2}	
1E		MAN mode shift completion flag	R
1F		Memory of PID constants read/Write completion flag	R
20	40	Input range	
21	41	Stop mode setting	
22	42	Set value (SV) setting	
23	43	Heating proportional band (Ph) setting	
24	44	Integral time (I) setting	
25	45	Derivative time (D) setting	R/W
26	46	Alert set value 1	
27	47	Alert set value 2	
28	48	Alert set value 3	
29	49	Alert set value 4	
2A	4A	Heating upper limit output limiter	
2B	4B	System area (Use prohibited)	-
2C	4C	Output variation limiter setting	
2D	4D	Sensor correction value setting	R/W
2E	4E	Adjustment sensitivity (dead band) setting	-
2F	4F	Heating control output cycle setting	
30	50	Primary delay digital filter setting	R/W
31	51	Control response parameters	
32	52	AUTO/MAN mode shift	R/W
33	53	MAN output setting	R/W
34	54	Setting change rate limiter/Setting change rate limiter (temperature rise)	R/W
35	55	AT bias	R/W
36	56	System area (Use prohibited)	R/W
37	57	Upper limit setting limiter	
38	58	Lower limit setting limiter	R/W
39	59	System area (Use prohibited)	-
3A	5A	Heater disconnection alert setting	R/W
3B	5B		
3C	5C	System area (Use prohibited)	-
3D	5D	Unused channel setting	R/W

A1S62TCTT(BW)-S2, A1S62TCRT(BW)-S2			
Address (hexadecimal)		Name	Read/write
CH1	CH2		
3E	5E	System area (Use prohibited)	-
3F	5F		
A0			
A1		Setting of Alert alarm 1	R/W
A2		Setting of Alert alarm 2	
A3		Setting of Alert alarm 3	
A4		Setting of Alert alarm 4	
A5		Alert dead band setting	
A6		Number of alert delay	
A7		Heater disconnection/output off-time current error detection delay count	
A8		Temperature rise completion range setting	
A9		Temperature rise completion soak time setting	
AA		PID continuation flag	
AB	AC	Heater voltage correction setting	
AF		Heater current reference value	
B0		Transistor output monitor ON delay time setting	
B1	B2	CT monitor method switching	
B5		Heating manipulation value (MV) (0 to 4000)	R
B6			
B7			
B8	B9		
⋮			
C0	C1	System area (Use prohibited)	-
C2	C3	Cooling manipulated value (MV)	
C4	C5	Cooling manipulated value (MV) (0 to 4000)	
CF		Cooling transistor output flag	R
D0	E0	Cooling type setting	
D1	E1	Cooling proportional band (Pc) setting	R/W
D2	E2	Cooling upper limit output limiter	
D3	E3	Cooling control output period setting	
		Overlap/dead band	

☒ Point

Default values for the A series modules and L series modules may be different.
 To apply an A series program using a default value to an L series module, review the program.
 For details, refer to the user's manual for the L series module used.

L60TCTT4, L60TCRT4, L60TCTT4BW, L60TCRT4BW			
Address (hexadecimal)		Name	Read/write
CH1	CH2		
3E	5E	Memory of PID constants read instruction	R/W
3F	5F	Automatic backup setting after auto tuning of PID constants	R/W
	A0	System area (Use prohibited)	-
	A1		
	A2		
	A3		
	A4	Alert dead band setting	R/W
	A5	Number of alert delay	
	A6	Heater disconnection/output off-time current error detection delay count	
	A7	Temperature rise completion range setting	
	A8	Temperature rise completion soak time setting	
	A9	PID continuation flag	
	AA	Heater disconnection correction function selection	
AB	AC	System area (Use prohibited)	-
	AF	Transistor output monitor ON delay time setting	R/W
	B0	CT monitor method switching	
B1	B2	Manipulated value of heating (MVh) for output with another analog module	R
	B5	Resolution of the manipulated value for output with another analog module	R/W
	B6	Cold junction temperature compensation selection	R/W
	B7	Control switching monitor	R
B8	B9	Auto tuning mode selection	R/W
	⋮		
	C0	Alert 1 mode setting	R/W
	C1	Alert 2 mode setting	
	C2	Alert 3 mode setting	
	C3	Alert 4 mode setting	
	⋮		
D0	E0	Alert 1 mode setting	R/W
D1	E1	Alert 2 mode setting	
D2	E2	Alert 3 mode setting	
D3	E3	Alert 4 mode setting	
	⋮		
	100 to 107	Heater current measurement value	R
	108 to 10F	CT input channel assignment setting	R/W
	110 to 117	CT selection	
	118 to 11F	Reference heater current value	
	⋮		
220	240	2-point sensor compensation offset value (measured value)	R/W
221	241	2-point sensor compensation offset value (compensation value)	R/W
222	242	2-point sensor compensation gain value (measured value)	R/W
223	243	2-point sensor compensation gain value (compensation value)	R/W
224	244	2-point sensor compensation offset latch request	R/W
225	245	2-point sensor compensation offset latch completion	R
226	246	2-point sensor compensation gain latch request	R/W
227	247	2-point sensor compensation gain latch completion	R
	⋮		
234	254	Setting change rate limiter (temperature drop)	R/W
	⋮		

L60TCTT4, L60TCRT4, L60TCTT4BW, L60TCRT4BW			
Address (hexadecimal)		Name	Read/write
CH1	CH2		
2B8	2B9	Temperature conversion setting	R/W
	⋮		
2C0	2C1	Manipulated value for cooling (MVc)	R
	⋮		
2C4	2C5	Manipulated value of cooling (MVc) for output with another analog module	R
	⋮		
2C8	2C9	Cooling transistor output flag	R
	⋮		
	2CF	Cooling method setting	R/W
2D0	2E0	Cooling proportional band (Pc) setting	
2D1	2E1	Cooling upper limit output limiter	
2D2	2E2	Cooling control output cycle setting	
2D3	2E3	Overlap/dead band setting	
2D4	2E4	Manual reset amount setting	R/W
2D5	2E5	Process value (PV) scaling function enable/disable setting	R/W
2D6	2E6	Process value (PV) scaling lower limit value	R/W
2D7	2E7	Process value (PV) scaling upper limit value	R/W
2D8	2E8	Process value (PV) scaling value	R
2D9	2E9	Derivative action selection	R/W
	⋮		
2DF	2EF	Setting change rate limiter unit time setting	R/W
	⋮		
	311	Sensor compensation function selection	R/W
	312	Temperature conversion completion flag	R
	313	Function extension bit monitor	R
	314	Sampling cycle monitor	R
	315		
	⋮	System area (Use prohibited)	-
	4FE		
	4FF		
	⋮	Buffer memory for error history	R
	FFF		
	1000		
	⋮	System area (Use prohibited)	-
	CFFF		

6 HIGH-SPEED COUNTER MODULE REPLACEMENT

6.1 List of High-Speed Counter Module Alternative Models for Replacement

AnS/QnAS series		Transition to L series	
Product	Model	Model	Remarks (Restrictions)
High-speed counter module	A1SD61	LD62	<ol style="list-style-type: none"> 1) External wiring: Terminal block wiring → Connector wiring Cable size is changed. 2) Number of slots: Not changed 3) Counting speed: 200K, 100K, or 10KPPS 4) Counting range: 32-bit signed binary (-2147483648 to 2147483647) Program does not need to be reviewed. 5) Program: The number of occupied I/O points, I/O signals, and buffer memory addresses are changed. 6) Performance specifications: Number of channels is 2. The input terminal filter characteristics are different. 7) Function specifications: Limit switch output function → Coincidence output function (Two coincidence detection output points can be set.)
		L02SCPU L02CPU L06CPU L26CPU L26CPU-BT	<ol style="list-style-type: none"> 1) External wiring: Terminal block wiring → Connector wiring Cable size is changed. 2) Number of slots: Changed. 0 module (I/O function built in CPU) 3) Counting speed: 200K, 100K, 50K, or 10KPPS 4) Counting range: 32-bit signed binary (-2147483648 to 2147483647) Program does not need to be reviewed. 5) Program: Incompatible, Need to be created. 6) Performance specifications: Number of channels is 2. External input voltage 24V only The input terminal filter characteristics are different. 7) Function specifications: Limit switch output function → Coincidence output function (Two coincidence detection output points can be set.) No periodic pulse counter function

AnS/QnAS series		Transition to L series	
Product	Model	Model	Remarks (Restrictions)
High-speed counter module	A1SD62	LD62	1) External wiring: Terminal block wiring → Connector wiring Cable size is changed. 2) Number of slots: Not changed 3) Counting speed: 200K, 100K, or 10KPPS 4) Counting range: 32-bit signed binary (-2147483648 to 2147483647) Program does not need to be reviewed. 5) Program: The number of occupied I/O points, I/O signals, and buffer memory addresses are changed. 6) Performance specifications: The input terminal filter characteristics are different. 7) Function specifications: Limit switch output function → Coincidence output function (Two coincidence detection output points can be set.)
		L02SCPU L02CPU L06CPU L26CPU L26CPU-BT	1) External wiring: Terminal block wiring → Connector wiring Cable size is changed. 2) Number of slots: Changed. 0 module (I/O function built in CPU) 3) Counting speed: 200K, 100K, 50K, or 10KPPS 4) Counting range: 32-bit signed binary (-2147483648 to 2147483647) Program does not need to be reviewed. 5) Program: Incompatible, Need to be created. 6) Performance specifications: External input voltage 24V only The input terminal filter characteristics are different. 7) Function specifications: Limit switch output function → Coincidence output function (Two coincidence detection output points can be set.) No periodic pulse counter function
	A1SD62E	LD62	1) External wiring: Terminal block wiring → Connector wiring Cable size is changed. 2) Number of slots: Not changed 3) Counting speed: 200K, 100K, or 10KPPS 4) Counting range: 32-bit signed binary (-2147483648 to 2147483647) Program does not need to be reviewed. 5) Program: The number of occupied I/O points, I/O signals, and buffer memory addresses are changed. 6) Performance specifications: Output terminal type: sink output The input terminal filter characteristics are different. 7) Functional specifications: Not changed
		L02SCPU-P L02CPU-P L06CPU-P L26CPU-P L26CPU-PBT	1) External wiring: Terminal block wiring → Connector wiring Cable size is changed. 2) Number of slots: Changed. 0 module (I/O function built in CPU) 3) Counting speed: 200K, 100K, 50K, or 10KPPS 4) Counting range: 32-bit signed binary (-2147483648 to 2147483647) Program does not need to be reviewed. 5) Program: Incompatible, Need to be created. 6) Performance specifications: The input terminal filter characteristics are different. 7) Function specifications: Limit switch output function → Coincidence output function (Two coincidence detection output points can be set.) No periodic pulse counter function

AnS/QnAS series		Transition to L series	
Product	Model	Model	Remarks (Restrictions)
High-speed counter module	A1SD62D A1SD62D-S1	LD62D	<ol style="list-style-type: none"> 1) External wiring: Terminal block wiring → Connector wiring Cable size is changed. 2) Number of slots: Not changed 3) Counting speed: 500K, 200K, or 100KPPS 4) Counting range: 32-bit signed binary (-2147483648 to 2147483647) Program does not need to be reviewed. 5) Program: The number of occupied I/O points, I/O signals, and buffer memory addresses are changed. 6) Performance specifications: Number of channels is 2. 7) Functional specifications: Not changed
		L02SCPU L02CPU L06CPU L26CPU L26CPU-BT	<ol style="list-style-type: none"> 1) External wiring: Terminal block wiring → Connector wiring Cable size is changed. 2) Number of slots: Changed. 0 module (I/O function built in CPU) 3) Counting speed: 200K, 100K, 50K, or 10KPPS 4) Counting range: 32-bit signed binary (-2147483648 to 2147483647) Program does not need to be reviewed. 5) Program: Incompatible, Need to be created. 6) Performance specifications: External input voltage 24V only The input terminal filter characteristics are different. 7) Function specifications: Limit switch output function → Coincidence output function (Two coincidence detection output points can be set.) No periodic pulse counter function

☒ Point

1) Module replacement

A pulse generator, such as an encoder, that is connected to an AnS series module can be connected to a L series module.

Check the operation of the device before actually used in the system because the operating environment (the external wiring method) differs.

2) Counting range of the counter

Counting range differs between AnS series modules and L series modules.

To change the counting range so that the ranges will be the same in the modules before and after the replacement, program needs to be reviewed.

A1SD62(E/D/D-S1): 0 to 16777215 (24-bit unsigned binary)

A1SD61, LCPU (built-in I/O function), LD62(D): -2147483648 to 2147483647 (32-bit signed binary)

3) Wiring

An external wiring method differs between AnS series modules and L series modules.

A1SD61, A1SD62 (E/D/D-S1): Wiring using a terminal block

LD62(D), LCPU (built-in I/O function): Wiring using a connector

When using an I/O signal wire with a solderless terminal of the A1SD61 or A1SD62 for the purpose of module replacement, change the external wiring method according to (a) or (b).

(a) Using the upgrade tool (conversion adapter)

The upgrade tool (conversion adapter) manufactured by Mitsubishi Electric Engineering Co., Ltd. enables to connect the existing wiring that was connected to the A1SD61 or A1SD62 to L series modules without change.

Product	Existing module model	Alternative module model	Conversion adapter model*1	Space module LG69**1
High-speed counter module	A1SD61	LD62	ERNT-ASLTD61	Available
	A1SD62		ERNT-ASLTD62	

*1 For details on the conversion adapter or LG69, refer to the Transition from MELSEC-AnS/QnAS (Small Type) Series to L Series Handbook (Fundamentals)

(b) Using the connector/terminal block converter module

Adopt this method if the upgrade tool (conversion adapter) manufactured by Mitsubishi Electric Engineering Co., Ltd. cannot be used because of restrictions such as a system configuration and installation location when the module is replaced to use the built-in I/O function.

By rewiring an I/O signal cable with a solderless terminal connected to the existing module to the connector/terminal block converter module and connecting it with the dedicated cable, the I/O signal cables can be used for the new module without regard to the existing wire size.

Therefore, this method can be adopted even if the space is not enough.

The following figure shows the wiring method when the connector/terminal block converter module is used.

(When replacing A1SD61 with LD62)

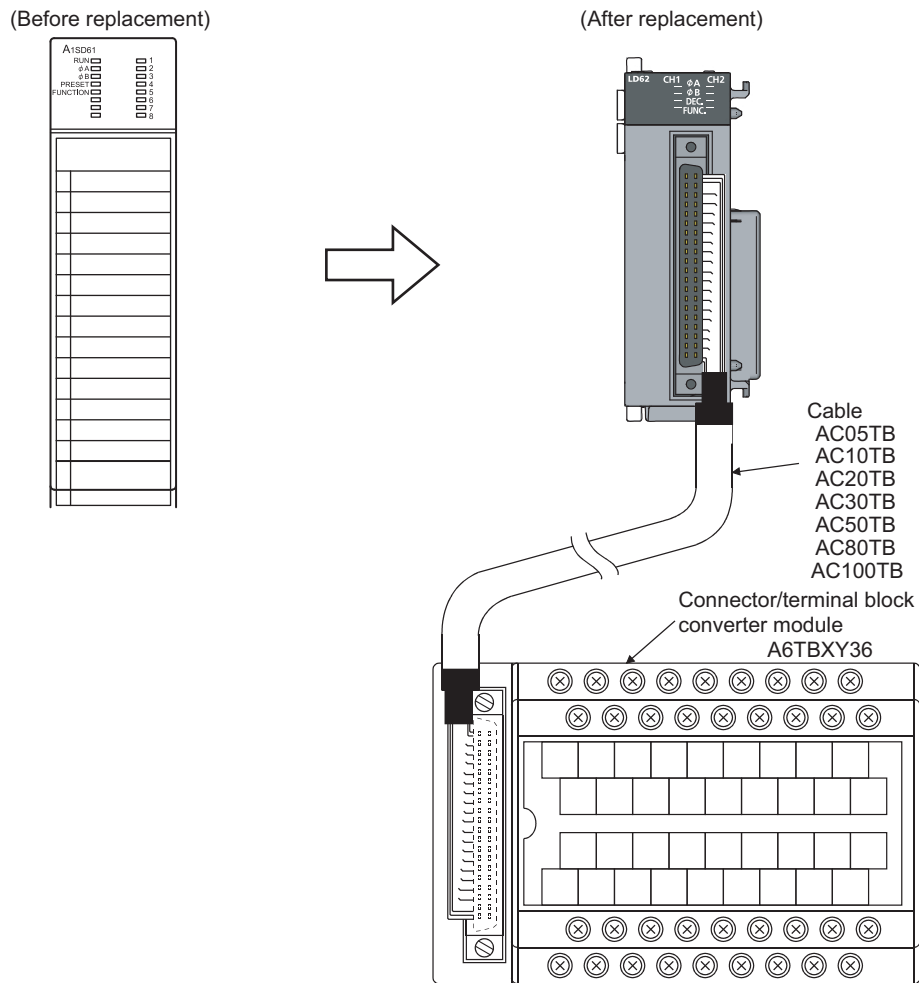

For wiring to the connector/terminal block converter module, refer to the following.

- LD62
 MELSEC-L High-speed Counter Module User's Manual: SH-080920ENG
- Built-in I/O function
 MELSEC-L CPU Module User's Manual (Built-In I/O Function): SH-080892ENG
- Connector/terminal block converter module
 MELSEC-L I/O Module User's Manual: SH-080888ENG

6.2 A1SD61

6.2.1 Performance specifications comparison

(1) Comparison between A1SD61 and LD62

○ : Compatible, △ : Partial change required, × : Incompatible

Item		A1SD61		LD62			Compati- bility	Precautions for replacement	
Number of occupied I/O points		32 points (I/O assignment: special 32 points)		16 points (I/O assignment: intelligent 16 points)			△	*1	
Number of channels		1 channel		2 channels			○		
Counting speed switch setting		50K	10K	200K (100K to 200KPPS)	100K (10K to 100KPPS)	10K (10KPPS or less)	○	Set the counting speed of the LD62 with the switch setting	
Count input signal	Phase	1-phase input, 2-phase input					○		
	Signal level (φA, φB)	5VDC 12VDC 24VDC } 2 to 5mA					○	*2	
Performance specifications of 1 channel Counter	Counting speed (maximum)	1-phase input	50KPPS	10KPPS	200KPPS	100KPPS	10KPPS	○	
		2-phase input	50KPPS	7KPPS	200KPPS	100KPPS	10KPPS		
	Counting range	32-bit signed binary (-2147483648 to 2147483647)					○		
	Type	UP/DOWN preset counter + ring counter function					○		
	Minimum count pulse width, duty ratio: 50%							-	
	(200KPPS)	-		 (Unit : μs) (Minimum phase difference in 2-phase input 1.25μs)			○		
	(100KPPS)	-		 (Unit : μs) (Minimum phase difference in 2-phase input 2.5μs)			○		
	(50KPPS)	 (Unit : μs) (1- and 2-phase input)		-			△	Set the counting speed of the LD62 to "100K".	

* 1 A program used before replacement can be utilized by setting the start I/O signal numbers of the modules connected to the right of the LD62 so that they can be the same as that of the module before replacement. (Set the start number at "Start XY" of the I/O assignment tab. The number of occupied points of the LD62 cannot be changed.)

* 2 The rise/fall time of a pulse affects the counting speed. Countable counting speeds are as follows.
Counting a pulse greater than $t = 50\mu\text{s}$ may result in a miscount.
(For the LD62)

Rise/fall time	Common to 1-phase input and 2-phase input		
	200K	100K	10K
Counter speed switch setting			
$t = 1.25\mu\text{s}$ or less	200KPPS	100KPPS	10KPPS
$t = 2.5\mu\text{s}$ or less	100KPPS	100KPPS	10KPPS
$t = 25\mu\text{s}$ or less	—	10KPPS	10KPPS
$t = 500\mu\text{s}$	—	—	500KPPS

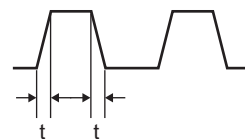

○ : Compatible, △ : Partial change required, × : Incompatible

Item		A1SD61		LD62		Compati- bility	Precautions for replacement	
(Counter speed switch setting)		50K	10K	200K	100K	10K	—	
Performance specifications of 1 channel	Counter	Minimum count pulse width, duty ratio: 50%						
		(10KPPS) 1-phase input	<p>(1-phase input) (Unit : μs)</p>		<p>(Unit : μs)</p>		○	
		(10KPPS) 2-phase input	<p>(2-phase input) (Unit : μs)</p>		<p>(Minimum phase difference in 2-phase input 25μs)</p>			
	Magnitude comparison between CPU module and high-speed counter module	Comparison range	32-bit signed binary					
		Comparison result	a contact: Dog ON address ≤ Count value ≤ Dog OFF address b contact: Dog OFF address ≤ Count value ≤ Dog ON address	Set value < count value Set value = count value Set value > count value		△	Two points need to be set.	
	External input	Preset	5/12/24VDC, 2 to 5mA				△	Confirm the specifications of an external device because the guaranteed input voltage and guaranteed operating current of the external input are different.
		Function start						
	External output	Coincidence output	—	Transistor (sink type) output 2 points/channel 12/24VDC, 0.5A/point, 2A/common		△	Output currents differ.	
		Limit switch output	Transistor (open collector) output 12/24VDC, 0.1A/point, 0.8A/common		—			
	Internal current consumption(5VDC)		0.35A		0.31A		○	
Weight		0.27kg		0.13kg		△		

(2) Comparison between A1SD61 and LCPU (built-in I/O function)

○ : Compatible, △ : Partial change required, × : Incompatible

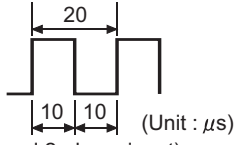
Item		A1SD61				LCPU (built-in I/O function)		Compati- bility	Precautions for replacement	
Number of occupied I/O points		32 points (I/O assignment: special 32 points)				16 points (I/O assignment: intelligent 16 points)		△	*1	
Number of channels		2 channels						○		
Counter speed switch setting		50KPPS	10KPPS	200K/100K/50K/10KPPS				○	Set the counter speed in parameter.	
Performance specifications of 1 channel	Count input signal	Phase 1-phase input, 2-phase input						○		
		Signal level (φA, φB) 5VDC 12VDC 24VDC } 2 to 5mA						○		
	Counting speed (maximum)	1-phase input	50KPPS	10KPPS	1-phase input	200K/100K/50K/10KPPS		○		
		2-phase input	50KPPS	7KPPS	2-phase input	200K/100K/50K/10KPPS				
	Counting range		32-bit signed binary (-2147483648 to 2147483647)						○	
	Type		UP/DOWN preset counter + ring counter function						○	
	Minimum count pulse width, duty ratio: 50%								—	
	Minimum count pulse width		 <p>(Unit : μs) (1- and 2-phase input) Set input rise time to 5μs or less.</p>				1-phase: 5μs 2-phase: 10μs		○	
	Magnitude comparison between CPU module and A1SD61/LCPU (built-in I/O function)		Comparison range		32-bit signed binary				○	
			Comparison result		a contact: Dog ON address ≤ Count value ≤ Dog OFF address b contact: Dog OFF address ≤ Count value ≤ Dog ON address		Set value < count value Set value = count value Set value > count value		○	
External input	Preset	5/12/24VDC, 2 to 5mA				—		△	Since the external input specifications differ, check the specifications of an external device.	
	Function start									
		External command signal		—				24VDC, 4.1mA		
External output	Coincidence output		—				Transistor (open collector) output output 2 points/channel 5 to 24VDC, 0.1A/point		△	Output currents differ.
	Limit switch output		Transistor (open collector) output 12/24VDC, 0.1A/point, 0.8A/common				—			
Internal current consumption (5VDC)		0.35A						—		
Weight		0.27kg						—		

* 1 Programs are incompatible and need to be created.

6.2.2 Functional comparison

○: Supported, –: Not supported

Item	Description	A1SD61	LCPU (built-in I/O function)	LD62	Precautions for replacement
Preset function	Changes the counter present value to a specified value.	○	○	○	
Disable function	Terminates counting.	○	○	○	
Ring counter function	Repeatedly executes counting between user's setting values.	○	○	○	For the L series modules, values are set with the intelligent function module switch setting.
Linear counter function	Detects an overflow if the count exceeds the range.	–	○	○	
Coincidence output function	Outputs a signal when the counter present value matches the preset value.	–	○	○	No.1 and No.2 coincidence output points can be set for each channel.
Limit switch output function	Outputs the ON/OFF signal when the present value of the limit switch output command counter matches the output status preset to a channel.	○	–	–	Use the coincidence output function instead. Note that the specifications (such as set point) are different.
Coincidence detection interrupt function	Generates an interrupt signal to the CPU module when coincidence is detected.	–	○	○	
Latch counter function	Latches the present value at the time a signal is input.	○	○	○	
Sampling counter function	Counts the pulse that was input during the sampling time set.	○	○	○	
Periodic pulse counter function	Stores the present value to Periodic pulse count present value and the previous value to Periodic pulse count previous value for each set cycle.	○	–	○	

6.2.3 I/O signal comparison

Sequence programs need to be changed because the I/O signal assignment differs.

For details of the I/O signals and sequence programs, refer to the MELSEC-L High-Speed Counter Module User's Manual.

When the built-in I/O functions of the LCPU are used, the special relay is used. For details, refer to the MELSEC-L CPU Module User's Manual (Built-in I/O Function).

A1SD61				L62D				
Device No.	Signal name	Device No.	Signal name	Device No.	Signal name	Device No.	Signal name	
X0	Watchdog timer error flag	Y0	Use prohibited	X0	Module READY	Y0	CH1 Coincidence signal No.1 reset command	
X1	CH1 limit switch output status flag	Y1		X1	CH1 Counter value large (point No.1)	Y1	CH1 Preset command	
X2	CH2 limit switch output status flag	Y2		X2	CH1 Counter value coincidence (point No.1)	Y2	CH1 Coincidence signal enable command	
X3	CH3 limit switch output status flag	Y3		X3	CH1 Counter value small (point No.1)	Y3	CH1 Down count command	
X4	CH4 limit switch output status flag	Y4		X4	CH1 External preset request detection	Y4	CH1 Count enable command	
X5	CH5 limit switch output status flag	Y5		X5	CH1 Counter value large (point No.2)	Y5	CH1 External preset detection reset command	
X6	CH6 limit switch output status flag	Y6		X6	CH1 Counter value coincidence (point No.2)	Y6	CH1 Counter function selection start command	
X7	CH7 limit switch output status flag	Y7		X7	CH1 Counter value small (point No.2)	Y7	CH1 Coincidence signal No.2 reset command	
X8	CH8 limit switch output status flag	Y8		X8	CH2 Counter value large (point No.1)	Y8	CH2 Coincidence signal No.1 reset command	
X9	Limit switch output enable flag	Y9		X9	CH2 Counter value coincidence (point No.1)	Y9	CH2 Preset command	
XA	External preset command detection flag	YA		XA	CH2 Counter value small (point No.1)	YA	CH2 Coincidence signal enable command	
XB	Error flag	YB		XB	CH2 External preset request detection	YB	CH2 Down count command	
XC	Fuse/external power cutoff detection flag	YC		XC	CH2 Counter value large (point No.2)	YC	CH2 Count enable command	
XD	Sampling/periodic counter flag	YD		XD	CH2 Counter value coincidence (point No.2)	YD	CH2 External preset detection reset command	
XE	Use prohibited	YE		XE	CH2 Counter value small (point No.2)	YE	CH2 Counter function selection start command	
XF		YF		XF	Use prohibited	YF	CH2 Coincidence signal No.2 reset command	
X10	Use prohibited	Y10		Count enable command				
X11		Y11		Decrement count command				
X12		Y12		Preset command				
X13		Y13		Ring counter command				
X14		Y14	Counter function selection start command					
X15		Y15	Limit switch output command					
X16		Y16	External preset command detection reset command					
X17		Y17	Error reset command					
X18		Y18	Use prohibited					
X19		Y19						
X1A		Y1A						
X1B		Y1B						
X1C		Y1C						
X1D		Y1D						
X1E		Y1E						
X1F		Y1F						

6.2.4 Buffer memory address comparison

Sequence programs need to be changed because the buffer memory address assignment differs. For details of the buffer memory areas and sequence programs, refer to the MELSEC-L High-Speed Counter Module User's Manual.

When the built-in I/O functions of the LCPU are used, the special register is used. For details, refer to the MELSEC-L CPU Module User's Manual (Built-in I/O Function).

A1SD61				LD62				
Address (decimal)	Name		Read/write	Address (decimal)		Name	Read/write	
				CH1	CH2			
0	Present value	(L)	R	0	32	Preset value	(L)	R/W
1		(H)		1	33		(H)	
2	Counter function selection count value	(L)	R	2	34	Present value	(L)	R
3		(H)		3	35		(H)	
4	Pulse input mode setting		R/W	4	36	Coincidence output point No.1	(L)	R/W
5	Counter function selection setting			5	37		(H)	
6	Preset value setting	(L)	R/W	6	38	Coincidence output point No.2	(L)	R/W
7		(H)		7	39		(H)	
8	Ring counter value setting	(L)	R	8	40	Overflow detection		R
9		(H)		9	41		Counter function selection	
10	Sampling/periodic time setting		R/W	10	42	Sampling/periodic time setting		R/W
11	Write data error code			11	43	Sampling/periodic counter flag		
12	CH1 limit switch output data setting		R	12	44	Latch count value	(L)	R
⋮				13	45		(H)	
28	CH2 limit switch output data setting		R	14	46	Sampling count value	(L)	R
29				15	47		(H)	
⋮	CH3 limit switch output data setting		R	16	48	Periodic pulse count, previous value	(L)	R
45				17	49		(H)	
46	CH4 limit switch output data setting		R	18	50	Periodic pulse count, present value	(L)	R/W
⋮				19	51		(H)	
62	CH5 limit switch output data setting		R/W	20	52	Ring counter lower limit	(L)	R/W
63				21	53		(H)	
⋮	CH6 limit switch output data setting		R/W	22	54	Ring counter upper limit	(L)	R/W
79				23	55		(H)	
80	CH7 limit switch output data setting		R/W	24	56	System area (Use prohibited)		-
⋮				⋮	⋮			
96	CH8 limit switch output data setting		R/W	31	63			-
97								
⋮	CH9 limit switch output data setting		R/W					-
113								
114	CH10 limit switch output data setting		R/W					-
⋮								
130	CH11 limit switch output data setting		R/W					-
131								
⋮	CH12 limit switch output data setting		R/W					-
147								

6.3 A1SD62(E/D/D-S1)

6.3.1 Performance specifications comparison

(1) Comparison between A1SD62(E) and LD62

○ : Compatible, △ : Partial change required, × : Incompatible

Item		A1SD62(E)		LD62	Compati- bility	Precautions for replacement	
Number of occupied I/O points		32 points (I/O assignment: special 32 points)		16 points (I/O assignment: intelligent 16 points)	△	The number of occupied I/O points is changed to 16 points.	
Number of channels		2 channels			○		
Counting speed switch setting		100K	10K	200K/100K/50K/10KPPS	○	Set the counter speed in parameter.	
Performance specifications of 1 channel Counter	Count input signal	Phase 1-phase input, 2-phase input			○		
		Signal level (φA, φB) 5VDC 12VDC 24VDC } 2 to 5mA			○		
	Counting speed (maximum)	1-phase input	100KPPS	10KPPS	200K/100K/50K/10KPPS	○	
		2-phase input	100KPPS	7KPPS	200K/100K/50K/10KPPS		
	Counting range	24-bit unsigned binary (0 to 16777215)		32-bit signed binary (-2147483648 to 2147483647)	△	Since the LD62 uses 32-bit signed binary values, sequence program needs to be changed.	
	Type	UP/DOWN preset counter + ring counter function			○		
	Minimum count pulse width, duty ratio: 50%					-	
		(200KPPS)	-		<p>(Unit : μs) (Minimum phase difference in 2-phase input 1.25μs)</p>	○	
		(100KPPS)	<p>(Unit : μs) (Minimum phase difference in 2-phase input 2.5μs)</p>				
		(10KPPS) 1-phase input	<p>(Unit : μs) (1-phase input)</p>		<p>(Unit : μs) (Minimum phase difference in 2-phase input 25μs)</p>		
	(10KPPS) 2-phase input	<p>(Unit : μs) (2-phase input)</p>					

○ : Compatible, △ : Partial change required, × : Incompatible

Item		A1SD62(E)	LD62	Compati- bility	Precautions for replacement	
Performance specifications of 1 channel	Magnitude comparison between the CPU module and high-speed counter module	Comparison range	24-bit unsigned binary	32-bit signed binary	○	
		Comparison result	Set value < count value Set value = count value Set value > count value		○	
	External input	Preset	5/12/24VDC, 2 to 5mA		○	
		Function start			○	
	External output	Coincidence output	Transistor output A1SD62: sink type 12/24VDC, 0.5A/point, 2A/common A1SD62E: source type 12/24VDC, 0.1A/point, 0.4A/common	Transistor (sink type) output 12/24VDC, 0.5A/point, 2A/common	△	Since the external output specifications differ, check the specifications of an external device. When the A1SD62E is replaced, the output type differs. Therefore, consider changing external devices and wiring as well.
			1 point/channel	2 points/channel		
Internal current consumption (5VDC)		0.1A	0.31A	△	Recalculation of internal current consumption (5VDC) is required.	
Weight		0.25kg	0.13kg	△		

(2) Comparison between A1SD62(E) and LCPU (built-in I/O function)

○ : Compatible, △ : Partial change required, × : Incompatible

Item		A1SD62(E)			LCPU (built-in I/O function)			Compati- bility	Precautions for replacement		
Number of occupied I/O points		32 points (I/O assignment: special 32 points)			16 points (I/O assignment: intelligent 16 points)			△	The number of occupied I/O points is changed to 16 points.		
Number of channels		2 channels							○		
Counting speed switch setting		100K	10K		200K (100K to 200KPPS)	100K (10K to 100KPPS)	10K (10KPPS or less)	○			
Performance specifications of 1 channel	Count input signal	Phase	1-phase input, 2-phase input					○			
		Signal level (φA, φB)	5VDC } 12VDC } 2 to 5mA 24VDC }			DC input: 24V, 6.0mA Differential input: The EIA Standard RS-422-A differential line driver can be connected.			△	Since the external input specifications differ, check the specifications of an external device.	
	Counting speed (maximum)	1-phase input	100KPPS	10KPPS		200KPPS	100KPPS	10KPPS	○	200KPPS (1-phase multiple of 2, 2-phase multiple of 4)	
		2-phase input	100KPPS	7KPPS		200KPPS	100KPPS	10KPPS			
	Counting range	24-bit unsigned binary (0 to 16777215)			32-bit signed binary (-2147483648 to 2147483647)			△	Since the LCPU (built-in I/O function) uses 32-bit signed binary values, sequence program needs to be changed.		
	Type	UP/DOWN preset counter + ring counter function							○		
	Minimum count pulse width, duty ratio: 50%		-							-	
	Counter	(200KPPS)	-								
		(100KPPS)	<p>(Unit : µs) (Minimum phase difference in 2-phase input 2.5µs)</p>					1-phase: 5µs 2-phase: 10µs		○	
		(10KPPS) 1-phase input	<p>(Unit : µs) (1-phase input)</p>								
(10KPPS) 2-phase input		<p>(Unit : µs) (2-phase input)</p>									

○ : Compatible, △ : Partial change required, × : Incompatible

Item		A1SD62(E)	LCPU (built-in I/O function)	Compati- bility	Precautions for replace- ment	
Performance specifications of 1 channel	Magnitude comparison between the CPU module and high-speed counter module	Comparison range	24-bit unsigned binary	32-bit signed binary	○	
		Comparison result	Set value < count value Set value = count value Set value > count value		○	
	External input	Preset	5/12/24VDC, 2 to 5mA	-	△	Since the external input specifications differ, check the specifications of an external device.
		Function start				
		External command signal	-	24VDC, 4.1mA		
	External output	Coincidence output	Transistor output A1S62: sink type 12/24VDC, 0.5A/point, 2A/common A1S62E: source type 12/24VDC, 0.1A/point, 0.4A/common	Transistor output (L02SCPU, L02CPU, L06CPU, L26CPU, L26CPU-BT: sink type) L02SCPU-P, L02CPU-P, L06CPU-P, L26CPU-P, L26CPU-PBT: source type) 5 to 24VDC, 0.1 A/point, 8 points/common	△	Since the external output specifications differ, check the specifications of an external device.
			1 point/channel	2 points/channel		
	Internal current consumption (5VDC)		0.10A	-	-	
	Weight		0.25kg	-	-	

(3) Comparison between A1SD62D(-S1) and LD62D

○ : Compatible, △ : Partial change required, × : Incompatible

Item		A1SD62D(-S1)			LD62D				Compati- bility	Precautions for replacement	
Number of occupied I/O points		32 points (I/O assignment: special 32 points)			16 points (I/O assignment: intelligent 16 points)				△	The number of occupied I/O points is changed to 16 points.	
Number of channels					2 channels				○		
Counting speed switch setting		200K	10K	500K (200K to 500KPPS)	200K (100K to 200KPPS)	100K (10K to 100KPPS)	10K (10KPPS or less)	○	Set the counting speed of the LD62D with the switch setting.		
Performance specifications of 1 channel	Count input signal	Phase		1-phase input, 2-phase input				○			
		Signal level (φA, φB)		EIA Standard RS-422-A differential line driver level (AM26LS31 [manufactured by Texas Instruments] or equivalent)				○			
	Counting speed (maximum)	1-phase input	200KPPS	10KPPS	500KPPS	200KPPS	100KPPS	10KPPS	○		
		2-phase input	200KPPS	7KPPS							
	Counting range	24-bit unsigned binary (0 to 16777215)			32-bit signed binary (-2147483648 to 2147483647)				△	Since the LD62D uses 32-bit signed binary values, sequence program needs to be changed.	
	Type	UP/DOWN preset counter + ring counter function							○		
	Minimum count pulse width, duty ratio: 50%										
	Counter	(500KPPS)	-			<p>(Unit : μs) (Minimum phase difference in 2-phase input 0.5μs)</p>				○	
		(200KPPS)	-			<p>(Unit : μs) (Minimum phase difference in 2-phase input 1.25μs)</p>					
		(100KPPS)	-			<p>(Unit : μs) (Minimum phase difference in 2-phase input 2.5μs)</p>					
(10KPPS) 1-phase input		<p>(Unit : μs) (1-phase input)</p>			<p>(Unit : μs) (Minimum phase difference in 2-phase input 25μs)</p>						
(10KPPS) 2-phase input		<p>(Unit : μs) (2-phase input)</p>									

○ : Compatible, △ : Partial change required, × : Incompatible

Item		A1SD62D(-S1)	LD62D	Compati- bility	Precautions for replacement	
Performance specifications of 1 channel	Magnitude comparison between CPU module and high-speed counter module	Comparison range	24-bit unsigned binary	32-bit signed binary	○	
		Comparison result	Set value < count value Set value = count value Set value > count value		○	
	External input	Preset	A1SD62D: 5/12/24VDC, 2 to 5mA A1SD62D-S1: Differential input (The EIA Standard RS-422-A differential line driver can be connected.)	DC input: 5/12/24VDC, 2 to 5mA Differential input: The EIA Standard RS-422-A differential line driver can be connected.	○	The LD62D supports both DC input and differential input.
		Function start	5/12/24VDC, 2 to 5mA			
	External output	Coincidence output	1 point/channel	2 points/channel	○	
Internal current consumption (5VDC)		0.25A	0.36A	△	Recalculation of internal current consumption (5VDC) is required.	
Weight		0.25kg	0.13kg	△		

(4) Comparison between A1SD62D(-S1) and LCPU(Built-in I/O function)

○ : Compatible, △ : Partial change required, × : Incompatible

Item		A1SD62D(-S1)			LCPU (built-in I/O function)			Compati- bility	Precautions for replacement	
Number of occupied I/O points		32 points (I/O assignment: special 32 points)			16 points (I/O assignment: intelligent 16 points)			△	The number of occupied I/O points is changed to 16 points.	
Number of channels		2 channels							○	
Counting speed switch setting		200K	10K		200K (100K to 200KPPS)	100K (10K to 100KPPS)	10K (10KPPS or less)	○		
Performance specifications of 1 channel	Count input signal	Phase	1-phase input, 2-phase input					○		
		Signal level (φA, φB)	EIA Standard RS-422-A differential line driver level (AM26LS31 [manufactured by Texas Instruments] or equivalent)			DC input: 24V, 6.0mA Differential input: The EIA Standard RS-422-A differential line driver can be connected.			○	
	Counting speed (maximum)	1-phase input	200KPPS	10KPPS		200KPPS	100KPPS	10KPPS	○	200KPPS (1-phase multiple of 2, 2-phase multiple of 4)
		2-phase input	200KPPS	7KPPS		200KPPS	100KPPS	10KPPS		
	Counting range	24-bit unsigned binary (0 to 16777215)			32-bit signed binary (-2147483648 to 2147483647)			△	Since the LCPU (built-in I/O function) uses 32-bit signed binary values, sequence program needs to be changed.	
	Type	UP/DOWN preset counter + ring counter function					○			
	Minimum count pulse width, duty ratio: 50%		-							
	Counter	(200KPPS)	<p>(Unit : μs) (Minimum phase difference in 2-phase input 1.25μs)</p>			<p>1-phase: 5μs 2-phase: 10μs</p>			○	
		(10KPPS) 1-phase input	<p>(Unit : μs) (1-phase input)</p>							
		(10KPPS) 2-phase input	<p>(Unit : μs) (2-phase input)</p>							

○ : Compatible, △ : Partial change required, × : Incompatible

Item		A1SD62D(-S1)	LCPU (built-in I/O function)	Compati- bility	Precautions for replacement		
Performance specifications of 1 channel	Magnitude comparison between the CPU module and high-speed counter module	Comparison range	24-bit unsigned binary	32-bit signed binary	○		
		Comparison result	Set value < count value Set value = count value Set value > count value		○		
	External input	Preset	A1SD62D: 5/12/24VDC, 2 to 5mA A1SD62D-S1: Differential input: The EIA Standard RS-422-A differential line driver can be connected.	-		△	Since the external input specifications differ, check the specifications of an external device.
		Function start	5/12/24VDC, 2 to 5mA				
		External command signal	-	24VDC, 4.1mA			
	External output	Coincidence output	Transistor (sink type) output 12/24VDC, 0.5A/point, 2A/common	Transistor (sink type) output 5 to 24VDC, 0.1A/point, 8 points/common		△	Since the external output specifications differ, check the specifications of an external device.
			1 point/channel	2 points/channel			
Internal current consumption (5VDC)		0.25A	-		-		
Weight		0.25kg	-		-		

6.3.2 Functional comparison

○: Supported, -: Not supported

Item	Description	A1SD62 (E/D/D-S1)	LCPU (built-in I/O function)	LD62(D)	Precautions for replacement
Preset function	Changes the counter present value to a specified value.	○	○	○	
Disable function	Terminates counting.	○	○	○	
Ring counter function	Repeatedly executes counting between user's setting values.	○	○	○	For the LD62 (D), values are set with the switch setting.
Linear counter function	Detects an overflow if the count exceeds the range.	-	○	○	
Coincidence output function	Outputs a signal when the counter present value matches the preset value.	○	○	○	No.1 and No.2 coincidence output points can be set for each channel.
Coincidence detection interrupt function	Generates an interrupt signal to the CPU module when coincidence is detected.	-	○	○	
Latch counter function	Latches the present value at the time a signal is input.	○	○	○	
Sampling counter function	Counts the pulse that was input during the sampling time set.	○	○	○	
Periodic pulse counter function	Stores the present value to Periodic pulse count present value and the previous value to Periodic pulse count previous value for each set cycle.	○	-	○	

6.3.3 I/O signal comparison

Sequence programs need to be changed because the I/O signal assignment differs.

For details of the I/O signals and sequence programs, refer to the MELSEC-L High-Speed Counter Module User's Manual.

When the built-in I/O functions of the LCPU are used, the special relay is used. For details, refer to the MELSEC-L CPU Module User's Manual (Built-in I/O Function)

A1SD62(E/D/D-S1)				LD62(D)				
Device No.	Signal name	Device No.	Signal name	Device No.	Signal name	Device No.	Signal name	
X0	CH1 Counter value large (point No.1)	Y0	Use prohibited	X0	Module READY	Y0	CH1 Coincidence signal No.1 reset command	
X1	CH1 Counter value coincidence (point No.1)	Y1		X1	CH1 Counter value large (point No.1)	Y1	CH1 Preset command	
X2	CH1 Counter value small (point No.1)	Y2		X2	CH1 Counter value coincidence (point No.1)	Y2	CH1 Coincidence signal enable command	
X3	CH1 External preset request detection	Y3		X3	CH1 Counter value small (point No.1)	Y3	CH1 Down count command	
X4	CH2 Counter value large (point No.1)	Y4		X4	CH1 External preset request detection	Y4	CH1 Count enable command	
X5	CH2 Counter value coincidence (point No.1)	Y5		X5	CH1 Counter value large (point No.2)	Y5	CH1 External preset detection reset command	
X6	CH2 Counter value small (point No.1)	Y6		X6	CH1 Counter value coincidence (point No.2)	Y6	CH1 Counter function selection start command	
X7	CH2 External preset request detection	Y7		X7	CH1 Counter value small (point No.2)	Y7	CH1 Coincidence signal No.2 reset command	
X8 *1	CH1 Counter value large (point No.2)	Y8		X8	CH2 Counter value large (point No.1)	Y8	CH2 Coincidence signal No.1 reset command	
X9 *1	CH1 Counter value coincidence (point No.2)	Y9		X9	CH2 Counter value coincidence (point No.1)	Y9	CH2 Preset command	
XA *1	CH1 Counter value small (point No.2)	YA		XA	CH2 Counter value small (point No.1)	YA	CH2 Coincidence signal enable command	
XB *1	CH2 Counter value large (point No.2)	YB		XB	CH2 External preset request detection	YB	CH2 Down count command	
XC *1	CH2 Counter value coincidence (point No.2)	YC		XC	CH2 Counter value large (point No.2)	YC	CH2 Count enable command	
XD *1	CH2 Counter value small (point No.2)	YD		XD	CH2 Counter value coincidence (point No.2)	YD	CH2 External preset detection reset command	
XE	Fuse/external power cutoff detection flag	YE		XE	CH2 Counter value small (point No.2)	YE	CH2 Counter function selection start command	
XF		YF		XF	Use prohibited	YF	CH2 Coincidence signal No.2 reset command	
X10	Use prohibited	Y10		CH1 Coincidence signal reset command				
X11		Y11		CH1 Preset command				
X12		Y12		CH1 Coincidence signal enable command				
X13		Y13		CH1 Down count command				
X14		Y14	CH1 Count enable command					
X15		Y15	CH1 Count value read request					
X16		Y16	CH1 Counter function selection start command					
X17		Y17	CH2 Coincidence signal reset command					
X18		Y18	CH2 Preset command					
X19		Y19	CH2 Coincidence signal enable command					
X1A		Y1A	CH2 Down count command					
X1B		Y1B	CH2 Count enable command					
X1C		Y1C	CH2 Count value read request					
X1D		Y1D	CH2 Counter function selection start command					
X1E		Y1E	Use prohibited					
X1F		Y1F	Use prohibited					

*1 These signals are use-prohibited in the A1SD62D-S1.

6.3.4 Buffer memory address comparison

Sequence programs need to be changed because the buffer memory address assignment differs. For details of the buffer memory areas and sequence programs, refer to the MELSEC-L High-Speed Counter Module User's Manual.

When the built-in I/O functions of the LCPU are used, the special register is used. For details, refer to the MELSEC-L CPU Module User's Manual (Built-in I/O Function).

A1SD62(E/D/D-S1)				LD62(D)				
Address (decimal)		Name	Read/write	Address (decimal)		Name	Read/write	
CH1	CH2			CH1	CH2			
0	32	Unused-	-	0	32			
1	33	Preset value setting	R/W	1	33	Preset value	(L)	
2	34			(H)	(H)			
3	35	Pulse input mode setting		2	34	Present value	(L)	
4	36	Present value	R	3	35		(H)	
5	37			(L)	4	36	Coincidence output point No.1	(L)
6	38	(H)	5	37	(H)			
7	39	Coincidence output point setting No.1	R/W	6	38	Coincidence output point No.2	(L)	
8	40			(L)	7		39	(H)
9	41	Counter function selection setting		8	40	Overflow detection	R	
10	42	Sampling/periodic time setting		9	41	Counter function selection	R/W	
11	43	External preset detection reset command	W	10	42	Sampling/periodic time setting		
11*	43*	Point No.2 coincidence signal reset command		11	43	Sampling/periodic counter flag	R	
12*	44*	Coincidence output point set No.2	R/W	12	44	Latch count value		(L)
13*	45*			(L)	13			45
14	46	Latch count value	R	14	46	Sampling count value		(L)
15	47			(L)	15			47
16	48	Sampling count value	R	16	48	Periodic pulse count, previous value		(L)
17	49			(L)	17			49
18	50	Periodic pulse count previous value	R	18	50	Periodic pulse count, present value		(L)
19	51			(L)	19			51
20	52	Periodic pulse count present value	R	20	52	Ring counter lower limit		(L)
21	53			(L)	21		53	(H)
22	54	Sampling/periodic counter flag	R/W	22	54	Ring counter upper limit	(L)	
				(H)	23		55	(H)
				24	56	System area (Use prohibited)	-	
				to	to			
				31	63			

*1 These addresses are use-prohibited in the A1SD62D-S1.

7 POSITIONING MODULE REPLACEMENT

7.1 List of Positioning Module Alternative Models for Replacement

AnS series		Transition to L series	
Product	Model	Model	Remarks (Restrictions)
Positioning module	A1SD70	None	There are no alternative models. Consider replacing with the LCPU (built-in I/O function), LD75□, or LD77MH system including external devices.
	A1SD75P1-S3	LCPU (built-in I/O function) (when an open collector is connected)	<ol style="list-style-type: none"> External wiring: Connector and wiring are changed. Number of slots: Changed. 0 module (built-in function of the CPU module) Program: Need to be created (Incompatible) Performance specifications: Changed, such as 2 axes, locus control disabled, and 200KPPS Function specifications: Changed. Positioning pattern: 10 data/axis No Manual pulse generator input, no backlash compensation function, no electronic gear function, no torque limit function, and position unit: pulse, only
		LD75P1 (when an open collector is connected)	<ol style="list-style-type: none"> External wiring: Connector and wiring are changed. Number of slots: Changed. 1 slot → 2 slots (Number of occupied points does not change (32 points).) Program: I/O signals and buffer memory assignment are changed. The entire program is reviewed according to the specifications change. Performance specifications: Not changed Function specifications: Partly changed
		LD75D1 (when a differential driver is connected)	<ol style="list-style-type: none"> Performance specifications: Not changed Function specifications: Partly changed (Example: Manual pulse generator 1/axis → 1/module)

AnS series		Transition to L series	
Positioning module	A1SD75P2-S3	LCPU (built-in I/O function) (when an open collector is connected)	<ol style="list-style-type: none"> External wiring: Connector and wiring are changed. Number of slots: Changed. 0 module (built-in function of the CPU module) Program: Need to be created (Incompatible) Performance specifications: Changed, such as locus control disabled and 200KPPS Function specifications: Changed. Positioning pattern: 10 data/axis No Manual pulse generator input, no backlash compensation function, no electronic gear function, no torque limit function, and position unit: pulse, only
		LD75P2 (when an open collector is connected)	<ol style="list-style-type: none"> External wiring: Connector and wiring are changed. Number of slots: Changed. 1 slot → 2 slots (Number of occupied points does not change (32 points).) Program: I/O signals and buffer memory assignment are changed. The entire program is reviewed according to the specifications change. Performance specifications: Not changed Function specifications: Partly changed (Example: Manual pulse generator 1/axis → 1/module)
	LD75D2 (when a differential driver is connected)		
	A1SD75P3-S3	LCPU (built-in I/O function) (when an open collector is connected)	<ol style="list-style-type: none"> External wiring: Connector and wiring are changed. Number of slots: Changed. 0 module (built-in function of the CPU module) Program: Need to be created (Incompatible) Performance specifications: Changed, such as 2 axes, locus control disabled, and 200KPPS Function specifications: Changed. Positioning pattern: 10 data/axis No Manual pulse generator input, no backlash compensation function, no electronic gear function, no torque limit function, and position unit: pulse, only
		LD75P4 (when an open collector is connected)	<ol style="list-style-type: none"> External wiring: Connector and wiring are changed. Number of slots: Changed. 1 slot → 2 slots (Number of occupied points does not change (32 points).) Program: I/O signals and buffer memory assignment are changed. The entire program is reviewed according to the specifications change. Performance specifications: 3 axes → 4 axes Function specifications: Partly changed (Example: Manual pulse generator 1/axis → 1/module)
	LD75D4 (when a differential driver is connected)		
	A1SD75M1 A1SD75M2 A1SD75M3	None	<p>There are no alternative models.</p> <p>Consider replacement to simple motion module LD77MH4.</p> <p>Note that the entire system needs to be replaced because the existing servo amplifier, servomotor, and SSCNET cable cannot be used.</p>

7.2 A1SD75P1-S3/P2-S3/P3-S3

7.2.1 Performance specifications comparison

Model		A1SD75P1-S3	A1SD75P2-S3	A1SD75P3-S3	LCPU (built-in I/O function)	LD75P1 LD75D1	LD75P2 LD75D2	LD75P4 LD75D4	Compat-ibility	Precautions for replacement		
Number of control axes		1	2	3	2	1	2	4	○			
Number of positioning data items		600/axis*1			10/axis	600/axis			○			
Position control interpolation function	2-axis linear interpolation	–	Available	Available	Available	–	Available	Available (3- or 4-axis linear interpolation)	○	Interpolation control of the built-in I/O function is pseudo interpolation control. For details, refer to the MELSEC-L CPU Module User's Manual (Built-in I/O Function).		
	2-axis circular interpolation	–	Available	Available	Not available	–	Available	Available				
Positioning system	Position control	Available			Available	Available			○			
	Speed control	Available			Available	Available						
	Speed-position switching control	Available			Available	Available						
Positioning range*2		<Absolute system> -214748364.8 to 214748364.7 (μm) /-13421772.8 to 13421772.7 (μm) -21474.83648 to 21474.83647 (inch) /-1342.17728 to 1342.17727 (inch) 0 to 359.99999 (degree) /0 to 359.99999 (degree) -2147483648 to 2147483647 (pulse) /-134217728 to 134217727 (pulse)			<Incremental system> -214748364.8 to 214748364.7 (μm) /-13421772.8 to 13421772.7 (μm) -21474.83648 to 21474.83647 (inch) /-1342.17728 to 1342.17727 (inch) -21474.83648 to 21474.83647 (degree) /-1342.17728 to 1342.17727 (degree) -2147483648 to 2147483647 (pulse) /-134217728 to 134217727 (pulse)		<Absolute system> -214748364.8 to 214748364.7 (μm) -21474.83648 to 21474.83647 (inch) 0 to 359.99999 (degree) -2147483648 to 2147483647 (pulse)		<Incremental system> -2147483648 to 2147483647 (pulse)		○	
		<In speed/position switching control> 0 to 214748364.7 (μm) /0 to 13421772.7 (μm) 0 to 21474.83647 (inch) /0 to 1342.17727 (inch) 0 to 21474.83647 (degree) /0 to 1342.17727 (degree) 0 to 2147483647 (pulse) /0 to 134217727 (pulse)					<In speed/position switching control> 0 to 214748364.7 (μm) 0 to 21474.83647 (inch) 0 to 21474.83647 (degree) 0 to 2147483647 (pulse)					
Speed command range*2		0.01 to 6000000.00 (mm/min) /0.01 to 375000.00 (mm/min) 0.001 to 600000.000 (inch/min) /0.001 to 37500.000 (inch/min) 0.001 to 600000.000 (degree/min) /0.001 to 37500.000 (degree/min) 1 to 1000000 (pulse/s) /1 to 62500 (pulse/s)			0 to 200000 (pulse/s)		0.01 to 20000000.00 (mm/min) 0.001 to 2000000.000 (inch/min) 0.001 to 2000000.000 (degree/min) 1 to 4000000 (pulse/s)			○		
Machine OPR function (OPR method)		Available (6 OPR methods)			Available (6 OPR methods)	Available (6 OPR methods)			○			
JOG operation		Available			Available	Available			○			

Model		A1SD75P1-S3	A1SD75P2-S3	A1SD75P3-S3	LCPU (built-in I/O function)	LD75P1 LD75D1	LD75P2 LD75D2	LD75P4 LD75D4	Compat-ibility	Precautions for replacement
Manual pulse generator function			1/axis		Not available		1/module		△	<ul style="list-style-type: none"> The LD75P□/D□ does not support the manual pulse generator with each axis which is independent. When connecting the manual pulse generator for each axis is required, use the module which has one axis. The manual pulse generator itself can use the same one. The operation for inputting one pulse differs. Set the parameter so that movement amount will be same.
Acceleration/ deceleration process	Automatic trapezoidal acceleration/ deceleration		Available		Available		Available		○	
	S-curve acceleration/ deceleration		Available		Available		Available			
Acceleration/ deceleration time	Number of patterns		Acceleration time and deceleration time can be set independently. (4 patterns each)		Acceleration/ deceleration time and deceleration stop time (1 pattern each)		Acceleration time and deceleration time can be set independently. (4 patterns each)		○	
	Setting range		1 to 65535ms or 1 to 8388608ms can be switched.		0 to 32767ms		1 to 8388608ms			
Compensation			Electronic gears, backlash compensation, near pass ^{*3}		Not available		Electronic gears, backlash compensation, near pass ^{*3}		△	Refer to *3.
Error display			17-segment LED		Not available		Error LED		×	To check the details of diagnostic result, use the programming tool or a display unit.
History data storage (Start, error, warning)			Provided (4 types, 16 items/module)		Not provided		Provided (3 types, 16 items/axis)		○	The start history at error is integrated into the start history.
Data storage destination			Flash ROM (battery-less backup)		Flash ROM in the CPU module (battery-less backup)		Flash ROM (battery-less backup)		○	

Item	Model			LCPU (built-in I/O function)	LD75P1 LD75D1	LD75P2 LD75D2	LD75P4 LD75D4	Compat- ibility	Precautions for replacement
	A1SD75P1- S3	A1SD75P2 -S3	A1SD75P3 -S3						
Connector	10136-3000VE (Soldering type, accessory)			A6CON1 (Soldering type, straight-out type, sold separately)	A6CON1 (Soldering type, straight-out type, sold separately)			x	Since the connectors differ, wiring needs to be changed. Connectors are sold separately. Two connectors are required for the LD75P4/D4.
	10136-6000EL (IDC type, sold separately)			A6CON2 (Crimping type, straight-out type, sold separately)	A6CON2 (Crimping type, straight-out type, sold separately)				
				A6CON4 (Soldering type, both for straight out and 45- degree types, sold separately)	A6CON4 (Soldering type, both for straight out and 45-degree types, sold separately)				
Applicable wire size	10136-3000VE: 24 to 30 AWG (approx. 0.05 to 0.2SQ)			A6CON1, A6CON4: 0.3mm ² (22 AWG) or less	A6CON1, A6CON4: 0.3mm ² (22 AWG) or less			△	
	10136-6000EL: 28 AWG (approx. 0.08SQ)			A6CON2: 24 AWG	A6CON2: 24 AWG				
Command pulse output type	Differential driver/open collector			Open collector	LD75P□: Open collector LD75D□: Differential driver			△	A differential driver and an open collector are separate module. In the default configuration, A1SD75P□-S3 outputs the pulse with positive logic, and the LD75P□/D□ outputs with negative logic.
Maximum output pulse	When an open collector is connected: 200KPPS When a differential driver is connected: 400KPPS			200KPPS	When an open collector is connected: 200KPPS When a differential driver is connected: 4MPPS			○	
Maximum connection distance between servos	When an open collector is connected: 2m When a differential driver is connected: 10m			2m	When an open collector is connected: 2m When a differential driver is connected: 10m			○	
Internal current consumption (A) (5VDC)	0.7A or lower (When a differential driver is connected: 0.78A)* ⁴			– (Included in the internal current consumption in the CPU module)	LD75P1: 0.44A	LD75P2: 0.48A	LD75P4: 0.55A	△	After the module is replaced with the LD75D4, recalculation of 5VDC current is required.
				LD75D1: 0.51A	LD75D2: 0.62A	LD75D4: 0.76A			
Flash ROM write count	Maximum 100000 times			Maximum 100000 times	Maximum 100000 times			○	When the LD75P□/ D□ executes the flash write 26 times from the sequence program, an error occurs. Reset the error to enable the flash write.
Number of occupied I/O points	32 points (I/O assignment: special 32 points)			–	32 points (I/O assignment: intelligent 32 points)			○	For the assignment of the built-in I/O functions of the LCPU, refer to the MELSEC- L CPU Module User's Manual (Built-in I/O Function).

Model		A1SD75P1-S3	A1SD75P2-S3	A1SD75P3-S3	LCPU (built-in I/O function)	LD75P1 LD75D1	LD75P2 LD75D2	LD75P4 LD75D4	Compat-ibility	Precautions for replacement
Number of module occupied slots		1			-	2 (modules)			△	The number of module occupied slots increases. Check the restriction for the number of connectable modules of a block.
Weight		0.35kg			-	0.18kg			△	
I/O signal for external devices	STRT signal	Available (External start signal)			Not available	Not available (integrated into CHG signal)			△	When both the speed/position switching control and the external start are used, input the external start signal to an interrupt module, and start then using the direct output.
	CHG signal	Speed/position switching signal			External command signal	External command signal (Can be selected in parameter, external start signal or speed/position switching signal.)			○	
	In-position (INP)	Available (for monitoring)			Not available	Not available			△	No INP signal. When the signal is required for monitor, monitor using an input module.
	Signal logic switching	Available (Command pulse output signal only)			Available (External command signal only)	Available			○	The default logic of the pulse output differs.
Peripheral (for data setting)	Connection with peripherals	Direct connection			CPU module	Via a CPU module, serial communication module, or network module			○	The connection type differs.
	Teaching unit	AD75TU			Not connectable	Not connectable			×	The teaching unit cannot be used.
	Software package	GX Configurator-AP			GX Works2	GX Works2			△	The software that can be used differs.

- *1 With the A1SD75P□-S3, No.1 to 100 data/axis of positioning data can be set using the buffer memory. No.1 to 600 data/axis can be set with the LD75P□/D□.
The positioning data in the buffer memory areas are not backed up.
- *2 This range indicates the standard mode/stepping motor mode for the A1SD75P□-S3.
- *3 The near pass function is enabled only during the continuous path control. (A1SD75P□-S3: Selected with parameters, LD75P□/D□: Standard function)
The LD75P□/D□ does not support the address pass mode. When passing the positioning address is required, connect the LD75P□/D□ with continuous running.
(However, it will stop once.)
- *4 This is the internal current consumption when the A1SD75P3-S3 is connected to a differential driver.

7.2.2 Functional comparison

(1) Functions deleted from the A1SD75P□-S3

When the following functions are used with the A1SD75P□-S3, change the program.

When the built-in I/O functions of the LCPU are used, refer to the MELSEC-L CPU Module User's Manual (Built-in I/O Function).

Deleted function	Precautions for replacement
Stepping motor mode	Requires no setting of when the stepping motor is used to improve its performance.
Fast machine OPR	With the LD75P□/D□, there is no possible function for replacement.
Special start (stop)	Execute it separately for the start two times.
Indirect designation	In the LD75P□/D□, the start block area in the buffer memory is expanded to five blocks (0 to 4). Each start block can be directly specified with Positioning start No. 7000 to 7004.
Block transfer	With the A1SD75P□-S3, this interface is used to set Positioning data No. 101 to 600 that do not exist in the buffer memory.
Positioning data I/F	Since all positioning data can be set in the buffer memory with the LD75P□/D□, this function is deleted.
Start history during errors	The contents are the same as the start history. Therefore, the LD75P□/D□ stores only the start history.
System monitor data (Module name, OS type, OS version)	These data were deleted because they can be displayed in system monitor "Module's detailed information" of GX Works2.

(2) Functions changed from the A1SD75P□-S3

When the following functions are used with the A1SD75P□-S3, check that there is no problem after the module is replaced with the LD75P□/D□.

When the built-in I/O functions of the LCPU are used, refer to the MELSEC-L CPU Module User's Manual (Built-in I/O Function).

Changed function	Description		
Software stroke limit function	<ol style="list-style-type: none"> The software stroke limit check of arc address is carried out only when a sub point is specified. The check is not carried out when a center point is specified. The software stroke limit check during the speed control is carried out in the following: <ul style="list-style-type: none"> - When the software stroke limit is applied to the current feed value with Pr.14 and the current feed value is updated with Pr.21 - When the software stroke limit is applied to the machine feed value When the current value is changed, an error occurs if the specified address is out of the software stroke limit range. Therefore, the current value is not changed. Error code change A1SD75P□-S3: There are 3 types of errors for each software stroke upper limit and lower limit. (error code: 509 to 512) LD75P□/D□: Errors for the software stroke upper limit are integrated into one (error code: 507). Errors for the software stroke lower limit are integrated into one (error code: 508). Error codes 509 to 512 are deleted. 		
Current value changing M code function	<ol style="list-style-type: none"> An error occurs when the specified new current value is out of the software stroke limit range. The M code set value is enabled during the positioning data current value changing instruction. 		
Acceleration/deceleration speed control	<ol style="list-style-type: none"> An error occurs when the command frequency value converted from the speed limit value exceeds the maximum command frequency of the positioning module being used. Only two-word type (1 to 8388608ms) can be used as the setting value for the acceleration/deceleration time. (Switching between one-word type and two-word type has been stopped.) 		
Stop process and restart after stop positioning operation stop	<ol style="list-style-type: none"> "Peripheral side (emergency) stop" is deleted from the stop causes of Stop group 2 "sudden stop selection". "Test mode fault" in the stop causes of Stop group 3 "sudden stop selection" is changed into the stop causes of Stop group 2 "sudden stop selection". "Stop (LD75 peripheral)" is added to the stop causes of Stop group 3 "sudden stop selection". Error code 100 (Peripheral device stop during operation) is deleted. "CPU module error occurrence" is added to the stop causes of Stop group 2 "Sudden stop selection". 		
READY signal (X0)	A1SD75P□-S3	LD75P□/D□	
	OFF	Normal (READY)	Not READY/WDT error
	ON	Not READY/WDT error	Normal (READY)
Manual pulse generator operation	The number of connected manual pulse generators is changed from 1/axis to 1/module.		
Axis operation status	"Step stopped" is changed to "Stopped" and "Step error occurring" is changed to "Error occurring".		
Continuous path control	<ul style="list-style-type: none"> A1SD75P□-S3: If the reference axis operates in reverse direction, the control is internally changed into the continuous positioning control (restart after deceleration stop). LD75P□/D□: Even if the reference axis operates in reverse direction with interpolation, the control remains as the continuous path control. (In single-axis operation, the operation is the same as that of the A1SD75P□-S3.) 		
Near pass	For the continuous path control, only the near pass function is available. Positioning address pass is not available.		
2-axis interpolation • 2-axis linear interpolation • 2-axis fixed-feed • Circular interpolation	The interpolation target axis can be voluntarily set with a positioning identifier.		
Step function	<ol style="list-style-type: none"> "Step stopped" is changed to "Stopped" and "Step error occurring" is changed to "Error occurring" in the axis operations status. The restart command (02H) of step start information is deleted. The step operation is restarted with the restart command. 		

Changed function	Description		
Command in-position function	The command in-position width is expanded. <ul style="list-style-type: none"> • A1SD75P□-S3: 1 to 32767000 • LD75P□/D□: 1 to 2147483647 		
Positioning start No.	7004 to 7010 (block start designation) and 8000 to 8049 (indirect designation) are deleted.		
block start data	With the LD75P□/D□, the number of blocks has been changed to 5 (7000 to 7004). (With the A1SD75P□-S3, this data is called "Positioning start information".)		
Start history	The configuration of "start information" and "start No." is changed so that the start No. can be directly checked.		
Basic parameter1 "Pr.5 Pulse output mode"	When the CPU module is powered on or reset, the valid value is only the first value after PLC READY (Y0) turns off to on.		
Detailed parameters "Pr.15 Software stroke limit valid/invalid setting"		A1SD75P□-S3	LD75P□/D□
	0 (Factory default setting)	Software stroke limit is disabled at the manual operation.	Software stroke limit is enabled at the manual operation.
	1	Software stroke limit is enabled at the manual operation.	Software stroke limit is enabled at the manual operation.

7.2.3 I/O signal comparison

Sequence programs need to be changed because the I/O signal assignment differs.

For details of the I/O signals and sequence programs, refer to the MELSEC-L LD75P/LD75D Positioning Module User's Manual.

When the built-in I/O functions of the LCPU are used, the special relay is used. For details, refer to the MELSEC-L CPU Module User's Manual (Built-in I/O Function).

Input (X)			Output (Y)		
Signal name	A1SD75P□-S3	LD75P□/D□	Signal name	A1SD75P□-S3	LD75P□/D□
Module READY	X00 ^{*1}	X00 ^{*1}	Axis 1 Positioning start	Y10	Y10
Axis 1 Start complete	X01	X10	Axis 2 Positioning start	Y11	Y11
Axis 2 Start complete	X02	X11	Axis 3 Positioning start	Y12	Y12
Axis 3 Start complete	X03	X12	Axis 4 Positioning start	-	Y13
Axis 4 Start complete	-	X13	Axis 1 Stop	Y13	Y04
Axis 1 BUSY	X04 ^{*2}	X0C	Axis 2 Stop	Y14	Y05
Axis 2 BUSY	X05 ^{*2}	X0D	Axis 3 Stop	Y1C	Y06
Axis 3 BUSY	X06 ^{*2}	X0E	Axis 4 Stop	-	Y07
Axis 4 BUSY	-	X0F	Axis 1 Forward run JOG start	Y16	Y08
Axis 1 Positioning complete	X07	X14	Axis 1 Reverse run JOG start	Y17	Y09
Axis 2 Positioning complete	X08	X15	Axis 2 Forward run JOG start	Y18	Y0A
Axis 3 Positioning complete	X09	X16	Axis 2 Reverse run JOG start	Y19	Y0B
Axis 4 Positioning complete	-	X17	Axis 3 Forward run JOG start	Y1A	Y0C
Axis 1 Error detection	X0A	X08	Axis 3 Reverse run JOG start	Y1B	Y0D
Axis 2 Error detection	X0B	X09	Axis 4 Forward run JOG start	-	Y0E
Axis 3 Error detection	X0C	X0A	Axis 4 Reverse run JOG start	-	Y0F
Axis 4 Error detection	-	X0B	PLC READY	Y1D	Y00
Axis 1 M code ON	X0D	X04	Axis 1 Execution prohibition flag	-	Y14
Axis 2 M code ON	X0E	X05	Axis 2 Execution prohibition flag	-	Y15
Axis 3 M code ON	X0F	X06	Axis 3 Execution prohibition flag	-	Y16
Axis 4 M code ON	-	X07	Axis 4 Execution prohibition flag	-	Y17
Synchronization flag	-	X01	Use prohibited	Y00 to Y0F Y1E to Y1F	Y01 to Y03 Y18 to Y1F
Use prohibited	X10 to X1F	X02, X03 X18 to X1F			

*1 The on/off status of Module READY differs between the LD75P□/D□ and A1SD75P□-S3.

	Not READY/WDT error	READY
LD75P□/D□	OFF	ON
A1SD75P□-S3	ON	OFF

*2 When using a program example of No.10 Reset program described in Section 6.4 Positioning program examples of the "A1SD75P1-S3/P2-S3/P3-S3, AD75P1-S3/P2-S3/P3-S3 Positioning Module User's Manual" for the LD75P□/D□, replace "X4 (BUSY signal for Axis 1)" with "DXC (Direct access input of BUSY signal for Axis 1)". Do the same thing for programs for Axis 2 and Axis 3.

7.2.4 Buffer memory address comparison

Sequence programs need to be changed because the buffer memory address assignment differs.

For details of the buffer memory areas and sequence programs, refer to the MELSEC-L LD75P/LD75D Positioning Module User's Manual.

■ area shows the differences between the A1SD75P□-S3 and LD75P□/D□.

When the built-in I/O functions of the LCPU are used, the special register is used. For details, refer to the MELSEC-L CPU Module User's Manual (Built-in I/O Function).

Item of A1SD75P□-S3	Buffer memory address					
	A1SD75P□-S3			LD75P□/D□		
	Axis 1	Axis 2	Axis 3	Axis 1	Axis 2	Axis 3
Pr.1 Unit setting	0	150	300	0	150	300
Pr.2 1 No. of pulses per rotation (Ap)	1	151	301	1	151	301
Pr.3 1 Movement amount per rotation (Al)	2	152	302	2	152	302
Pr.4 Unit magnification (Am)	3	153	303	3	153	303
Pr.5 Pulse output mode	4	154	304	4	154	304
Pr.6 Rotation direction setting	5	155	305	5	155	305
Pr.7 Speed limit value	6	156	306	10	160	310
	7	157	307	11	161	311
Pr.8 Acceleration time 0	8	158	308	12	162	312
	9	159	309	13	163	313
Pr.9 Deceleration time 0	10	160	310	14	164	314
	11	161	311	15	165	315
Pr.10 Bias speed at start	12	162	312	6	156	306
	13	163	313	7	157	307
Pr.11 Stepping motor mode selection	14	164	314	–	–	–
Pr.12 Backlash compensation amount	15	165	315	17	167	317
Pr.13 Software stroke limit upper limit value	16	166	316	18	168	318
	17	167	317	19	169	319
Pr.14 Software stroke limit lower limit value	18	168	318	20	170	320
	19	169	319	21	171	321
Pr.15 Software stroke limit selection	20	170	320	22	172	322
Pr.16 Software stroke limit valid/invalid setting	21	171	321	23	173	323
	22	172	322	24	174	324
Pr.17 Command in-position width	23	173	323	25	175	325
	24	174	324	26	176	326
Pr.18 Torque limit setting value	24	174	324	26	176	326
Pr.19 M code ON signal output timing	25	175	325	27	177	327
Pr.20 Speed switching mode	26	176	326	28	178	328
Pr.21 Interpolation speed designation method	27	177	327	29	179	329
Pr.22 Current feed value during speed control	28	178	328	30	180	330
Pr.23 Manual pulse generator selection	29	179	329	–	–	–
Pr.24 Logic selection for pulse output to the drive unit	30	180	330	–	–	–
Pr.25 Size selection for acceleration/deceleration time	31	181	331	–	–	–
Pr.26 Acceleration time 1	36	186	336	36	186	336
	37	187	337	37	187	337
Pr.27 Acceleration time 2	38	188	338	38	188	338
	39	189	339	39	189	339
Pr.28 Acceleration time 3	40	190	340	40	190	340
	41	191	341	41	191	341

Item of A1SD75P□-S3	Buffer memory address					
	A1SD75P□-S3			LD75P□/D□		
	Axis 1	Axis 2	Axis 3	Axis 1	Axis 2	Axis 3
Pr.29 Deceleration time 1	42	192	342	42	192	342
	43	193	343	43	193	343
Pr.30 Deceleration time 2	44	194	344	44	194	344
	45	195	345	45	195	345
Pr.31 Deceleration time 3	46	196	346	46	196	346
	47	197	347	47	197	347
Pr.32 JOG Speed limit value	48	198	348	48	198	348
	49	199	349	49	199	349
Pr.33 JOG operation acceleration time selection	50	200	350	50	200	350
Pr.34 JOG operation deceleration time selection	51	201	351	51	201	351
Pr.35 Acceleration/deceleration process selection	52	202	352	52	202	352
Pr.36 S-curve ratio	53	203	353	53	203	353
Pr.37 Sudden stop deceleration time	54	204	354	54	204	354
	55	205	355	55	205	355
Pr.38 Stop group 1 sudden stop selection	56	206	356	56	206	356
Pr.39 Stop group 2 sudden stop selection	57	207	357	57	207	357
Pr.40 Stop group 3 sudden stop selection	58	208	358	58	208	358
Pr.41 Positioning complete signal output time	59	209	359	59	209	359
Pr.42 Allowable circular interpolation error width	60	210	360	60	210	360
	61	211	361	61	211	361
Pr.43 External start function selection	62	212	362	62	212	362
(LD75P□/D□: Pr.42 External command function selection)						
Pr.44 Near pass mode selection for path control	66	216	366	–	–	–
Pr.45 OPR method	70	220	370	70	220	370
Pr.46 OPR direction	71	221	371	71	221	371
Pr.47 OP address	72	222	372	72	222	372
	73	223	373	73	223	373
Pr.48 OPR speed	74	224	374	74	224	374
	75	225	375	75	225	375
Pr.49 Creep speed	76	226	376	76	226	376
	77	227	377	77	227	377
Pr.50 OPR retry	78	228	378	78	228	378
Pr.51 OPR dwell time	79	229	379	79	229	379
Pr.52 Setting for the movement amount after near-point dog ON	80	230	380	80	230	380
	81	231	381	81	231	381
Pr.53 OPR acceleration time selection	82	232	382	82	232	382
Pr.54 OPR deceleration time selection	83	233	383	83	233	383
Pr.55 OP shift amount	84	234	384	84	234	384
	85	235	385	85	235	385
Pr.56 OPR torque limit value	86	236	386	86	236	386
Pr.57 Speed designation during OP shift	88	238	388	88	238	388
Pr.58 Dwell time during OPR retry	89	239	389	89	239	389

Item of A1SD75P□-S3	Buffer memory address	
	A1SD75P□-S3	LD75P□/D□
	Common for axis 1, 2, 3	Common for axis 1, 2, 3, 4
[Md.1] In test mode flag	450	1200
[Md.2] Module name	451	–
[Md.3] OS type	452 453 454 455	–
[Md.4] OS version	456 457	–
[Md.5] Clock data (Hour: minute)	460	–
[Md.6] Clock data (Second: 100ms)	461	–
(Pointer number)	(0) to (15)	
[Md.7] Start axis (LD75P□/D□: [Md.3] Start information)	462 to 537	1212 to 1287
[Md.8] Operation type (LD75P□/D□: [Md.4] Start No.)	463 to 538	1213 to 1288
[Md.9] Start time (Hour: minute) (LD75P□/D□: [Md.5] Start (Day: hour))	464 to 539	1214 to 1289
[Md.10] Start time (Second: 100ms) (LD75P□/D□: [Md.6] Start (Minute: second))	465 to 540	1215 to 1290
[Md.11] Error judgment	466 to 541	1216 to 1291
[Md.12] Start history pointer	542	1292
(Pointer number)	(0) to (15)	
[Md.13] Start axis	543 to 618	–
[Md.14] Operation type	544 to 619	–
[Md.15] Start time (Hour: minute)	545 to 620	–
[Md.16] Start time (Second: 100ms)	546 to 621	–
[Md.17] Error judgment	547 to 622	–
[Md.18] Start history pointer at error	623	–
(Pointer number)	(0) to (15)	
[Md.19] Axis in which the error occurred	624 to 684	1293 to 1353
[Md.20] Axis error No.	625 to 685	1294 to 1354
[Md.21] Axis error occurrence time (Hour: minute) (LD75P□/D□: [Md.11] Axis error occurrence (Day: hour))	626 to 686	1295 to 1355
[Md.22] Axis error occurrence time (Second: 100ms) (LD75P□/D□: [Md.12] Axis error occurrence (Minute: second))	627 to 687	1296 to 1356
[Md.23] Error history pointer	688	1357
(Pointer number)	(0) to (15)	
[Md.24] Axis in which the warning occurred	689 to 749	1358 to 1418
[Md.25] Axis warning No.	690 to 750	1359 to 1419
[Md.26] Axis warning occurrence time (Hour: minute) (LD75P□/D□: [Md.16] Axis warning occurrence (Day: hour))	691 to 751	1360 to 1420
[Md.27] Axis warning occurrence time (Second: 100ms) (LD75P□/D□: [Md.17] Axis warning occurrence (Minute: second))	692 to 752	1361 to 1421
[Md.28] Warning history pointer	753	1422

Item of A1SD75P□-S3	Buffer memory address					
	A1SD75P□-S3			LD75P□/D□		
	Axis 1	Axis 2	Axis 3	Axis 1	Axis 2	Axis 3
Md.29 Current feed value	800	900	1000	800	900	1000
	801	901	1001	801	901	1001
Md.30 Machine feed value	802	902	1002	802	902	1002
	803	903	1003	803	903	1003
Md.31 Feedrate	804	904	1004	804	904	1004
	805	905	1005	805	905	1005
Md.32 Valid M code	806	906	1006	808	908	1008
Md.33 Axis error No.	807	907	1007	806	906	1006
Md.34 Axis warning No.	808	908	1008	807	907	1007
Md.35 Axis operation status	809	909	1009	809	909	1009
Md.36 Current speed	810	910	1010	810	910	1010
	811	911	1010	811	911	1011
Md.37 Axis feedrate	812	912	1012	812	912	1012
	813	913	1013	813	913	1013
Md.38 Speed-position switching control positioning amount	814	914	1014	814	914	1014
	815	915	1015	815	915	1015
Md.39 External input/output signal	816	916	1016	816	916	1016
Md.40 Status	817	917	1017	817	917	1017
Md.41 Target value	818	918	1018	818	918	1018
	819	919	1019	819	919	1019
Md.42 Target speed	820	920	1020	820	920	1020
	821	921	1021	821	921	1021
Md.43 OP absolute position	822	922	1022	—	—	—
	823	923	1023	—	—	—
Md.44 Movement amount after near-point dog ON	824	924	1024	824	924	1024
	825	925	1025	825	925	1025
Md.45 Torque limit stored value	826	926	1026	826	926	1026
Md.46 Special start data instruction code setting value	827	927	1027	827	927	1027
Md.47 Special start data instruction parameter setting value	828	928	1028	828	928	1028
Md.48 Start positioning data No. setting value	829	929	1029	829	929	1029
Md.49 In speed limit flag	830	930	1030	830	930	1030
Md.50 In speed change processing flag	831	931	1031	831	931	1031
Md.51 Start data pointer being executed	832	932	1032	834	934	1034
Md.52 Last executed positioning data No.	833	933	1033	837	937	1037
Md.53 Repeat counter	834	934	1034	832	932	1032
(LD75P□/D□: Md.41 Special start repetition counter)				832	932	1032
Md.54 Positioning data No. being executed	835	935	1035	835	935	1035
Md.55 Block No. being executed	836	936	1036	836	936	1036
Md.56 Positioning data being executed	838 to 847	938 to 947	1038 to 1047	838 to 847	938 to 947	1038 to 1047
Deceleration start flag	—	—	—	899	999	1099

Item of A1SD75P□-S3	Buffer memory address					
	A1SD75P□-S3			LD75P□/D□		
	Axis 1	Axis 2	Axis 3	Axis 1	Axis 2	Axis 3
Cd.1 Clock data setting (hour)	1100			-		
Cd.2 Clock data setting (minute, second)	1101			-		
Cd.3 Clock data writing	1102			-		
Cd.4 Target axis	1103			-		
Cd.5 Positioning data No.	1104			-		
Cd.6 Write pattern	1105			-		
Cd.7 Read/write request	1106			-		
Cd.8 Read/write positioning data I/F	1108 to 1137			-		
Cd.9 Flash ROM write request	1138			1900		
Cd.10 Parameter initialization request	1139			1901		
Cd.11 Positioning start No.	1150	1200	1250	1500	1600	1700
Cd.12 Axis error reset	1151	1201	1251	1502	1602	1702
Cd.13 Restart command	1152	1202	1252	1503	1603	1703
Cd.14 M code OFF request	1153	1203	1253	1504	1604	1704
Cd.15 New current value	1154	1204	1254	1506	1606	1706
	1155	1205	1255	1507	1607	1707
Cd.16 New speed value	1156	1206	1256	1514	1614	1714
	1157	1207	1257	1515	1615	1715
Cd.17 Speed change request	1158	1208	1258	1516	1616	1716
Cd.18 Positioning operation speed override	1159	1209	1259	1513	1613	1713
Cd.19 JOG speed	1160	1210	1260	1518	1618	1718
	1161	1211	1261	1519	1619	1719
Cd.20 Speed-position switching enable flag	1163	1213	1263	1528	1628	1728
Cd.21 Speed-position switching control movement amount change register	1164	1214	1264	1526	1626	1726
	1165	1215	1265	1527	1627	1727
Cd.22 Manual pulse generator enable flag	1167	1217	1267	1524	1624	1724
Cd.23 Manual pulse generator 1 pulse input magnification	1168	1218	1268	1522	1622	1722
	1169	1219	1269	1523	1623	1723
Cd.24 OPR request flag OFF request	1170	1220	1270	1521	1621	1721
Cd.25 External start valid	1171	1221	1271	1505	1605	1705
(LD75P□/D□: Cd.8 External command valid)						
Cd.26 Step valid flag	1172	1222	1272	1545	1645	1745
Cd.27 Step mode	1173	1223	1273	1544	1644	1744
Cd.28 Step start information	1174	1224	1274	1546	1646	1746
Cd.29 Skip command	1175	1225	1275	1547	1647	1747
Cd.30 New torque value	1176	1226	1276	1525	1625	1725
Cd.31 Positioning starting point No.	1178	1228	1278	1501	1601	1701
Cd.32 Continuous operation interrupt request	1181	1231	1281	1520	1620	1720
Cd.33 New acceleration time value	1184	1234	1284	1508	1608	1708
	1185	1235	1285	1509	1609	1709
Cd.34 New deceleration time value	1186	1236	1286	1510	1610	1710
	1187	1237	1287	1511	1611	1711
Cd.35 Acceleration/deceleration time change during speed change, enable/disable selection	1188	1238	1288	1512	1612	1712

Item of A1SD75P□-S3		Buffer memory address																									
		A1SD75P□-S3						LD75P□/D□																			
		Axis 1		Axis 2		Axis 3		Axis 1		Axis 2		Axis 3															
Positioning data*1	Da.1 Operation pattern	No.1	1300		2300		3300		2000		8000		14000														
	Da.2 Control system																										
	Da.3 Acceleration time No.																										
	Da.4 Deceleration time No.																										
	Da.9 M code/condition data No.																										
	Da.8 Dwell time/JUMP destination positioning data No.																										
	Not used																										
	Da.7 Command speed																										
	Da.5 Positioning address/movement amount																										
	Da.6 Arc address																										
No.2	1310 to 1319		2310 to 2319		3310 to 3319		2010 to 2019		8010 to 8019		14010 to 14019																
No.3	1320 to 1329		2320 to 2329		3320 to 3329		2020 to 2029		8020 to 8029		14020 to 14029																
⋮	⋮		⋮		⋮		⋮		⋮		⋮																
No.100	2290 to 2299		3290 to 3299		4290 to 4299		2990 to 2999		8990 to 8999		14990 to 14999																
Positioning start information*2	Start block data*2	1st point	Da.10 Shape	4300		4350		4550		4600		4800		4850		26000		26050		27000		27050		28000		28050	
			Da.11 Start data No.																								
			Da.12 Special start instruction																								
			Da.13 Parameter																								
			2nd point	4301		4351		4551		4601		4801		4851		26001		26051		27001		27051		28001		28051	
	3rd point	4302		4352		4552		4602		4802		4852		26002		26052		27002		27052		28002		28052			
	⋮	⋮		⋮		⋮		⋮		⋮		⋮		⋮		⋮		⋮		⋮		⋮		⋮			
	50th point	4349		4399		4599		4649		4849		4899		26049		26099		27049		27099		28049		28099			
	Condition data	No.1	Da.14 Condition target	4400		4650		4900		26100		27100		28100													
			Da.15 Condition operator																								
			Da.16 Address	4402		4652		4902		26102		27102		28102													
			Da.17 Parameter 1	4403		4653		4903		26103		27103		28103													
			Da.18 Parameter 2	4404		4654		4904		26104		27104		28104													
			4405	4655		4905		26105		27105		28105															
			4406	4656		4906		26106		27106		28106															
			4407	4657		4907		26107		27107		28107															
			No.2	4410 to 4419		4660 to 4669		4910 to 4919		26110 to 26119		27110 to 27119		28110 to 28119													
			No.3	4420 to 4429		4670 to 4679		4920 to 4929		26120 to 26129		27120 to 27129		28120 to 28129													
⋮	⋮		⋮		⋮		⋮		⋮		⋮																
No.10	4490 to 4499		4740 to 4749		4990 to 4999		26190 to 26199		27190 to 27199		28190 to 28199																

*1 With the LD75P□/D□, the positioning data buffer memory addresses are No. 1 to 600.

*2 With the LD75P□/D□, it is called "block start data".

*3 With the LD75P□/D□, the "block start data" and "condition data" in are called "start block 0". There are five start blocks: 0 to 4.

Item of A1SD75P□-S3			Buffer memory address					
			A1SD75P□-S3			LD75P□/D□		
			Axis 1	Axis 2	Axis 3	Axis 1	Axis 2	Axis 3
Positioning start information	Indirect designation	Start No.8001	4500	4750	5000	-	-	-
		Start No.8002	4501	4751	5001	-	-	-
		⋮	⋮	⋮	⋮	⋮	⋮	⋮
		Start No.8050	4549	4799	5049	-	-	-
CPU module memory area	Condition judgment target data of the condition data		5050			30000		
			⋮			⋮		
			5099			30049		
Target axis			5100			-		
Head positioning block No.			5101			-		
No. of read/write data items			5102			-		
Read/write request			5103			-		
Read/write block			5110 to 6109			-		

7.2.5 External interface specifications comparison

The following table lists the differences of the external interface specifications between the A1SD75P□-S3 and LD75P□/D□.

○: Compatible, △: Partial change required

Item ^{*1}		Difference ^{*2}	Compati- bility	Precautions for replacement
Input	Drive unit READY	—	○	
	Upper/lower limit signal	—	○	
	Stop signal	—	○	
	Near-point dog signal	Input resistance: 4.7kΩ → 4.3kΩ	○	
	Speed/position switching signal	Input resistance: 4.7kΩ → 7.7kΩ	○	
	Zero signal	Input resistance: 3.5kΩ → 4.7kΩ (at input of 24V) 0.5kΩ → 0.62kΩ (at input of 5V) Response time: 0.8ms → 1ms ^{*3} ON voltage: 2.5V → 2.0V (at 5V input) Rated input current: 7mA → 5mA (at 24V input)	△	Including the response time differences, reconfirming the specifications is required.
	Manual pulse generator	ON current: 3.5mA → 2mA	○	
Output	Pulse	—	○	
	Deviation counter clear	—	○	

*1 The external start and in-position signals are not listed because the LD75P□/D□ does not have these signals.

*2 The "Difference" is described as the form, [Specifications of A1SD75P□-S3] → [Specifications of LD75P□/D□].

*3 The response time difference (0.2ms) between the A1SD75P□-S3 and LD75P□/D□ is the time difference of 1pls as the creep speed of 5000pps.

If accuracy is required, the creep speed needs to be as low as possible.

8 REPLACEMENT OF OTHER MODULES

8.1 Replacement of Other Modules

This section lists AnS series modules not introduced in previous chapters and describes their alternative methods. The AnS series modules listed in this section require some special alternative methods because there are no L series alternative models, or their functions and specifications differ from those of L series modules.

Product	Model	Alternative method
Pulse catch module	A1SP60	Consider using the pulse catch function of the built-in I/O function of the LCPU.
Temperature input module	A1S68TD	Consider using the CC-Link compatible temperature input module or temperature control module as the temperature input module.
	A1S62RD3N	
	A1S62RD4N	Or, consider using an analog input module by converting signals outside.
Position detection module	A1S62LS	Consider using CC-Link compatible ABSOCODER® VE-2CC manufactured by NSD Corporation.
Analog timer module	A1ST60	Consider using programming by indirect specification of the internal timer.
ID interface module	A1SD35ID1	There are no alternative models. Consider using our partner manufacturer's products (ID system "BIS M series" manufactured by Balluff GmbH or ID system "Z series" manufactured by B&PLUS KK), which can be connected to Mitsubishi programmable controllers. (System migration) For details, refer to the technical bulletin (FA-A-0062).
	A1SD35ID2	
Memory card interface module	A1SD59J-S2	Create a file register in a memory card or the standard RAM, and use the file register as a substitute.

APPENDICES

Appendix 1 External Dimensions

For the external dimensions of each module described in this handbook, refer to the user's manual of each module.

Appendix 2 Spare Parts Storage

- (1) **The general specifications of programmable controllers are as follows. Please do not store spare parts under a high temperature or high humidity condition, even within the range guaranteed by the specifications.**

Storage ambient temperature	-20 to 75°C
Storage ambient humidity	10 to 90%, no condensation

- (2) **Store in a place avoiding direct sunlight.**
- (3) **Store under condition with less dust or no corrosive gas.**
- (4) **The battery capacity of a A6BAT battery or a lithium-coin battery (commercially available) for memory card will be decreased by its self-discharging even when not used. Replace it with new one in 5 years as a guideline.**
- (5) **For a power supply module, CPU module with built-in power supply, or analog module that use any aluminum electrolytic capacitor, which is indicated in the table below, take the following measures since the characteristics will be deteriorated when the aluminum electrolytic capacitor is left un-energized for a long time.**

Product	Model (AnS series)
CPU module (Power supply built-in type)	A1SJHCPU
Power supply module	A1S61PN, A1S62PN, A1S63P
Analog module	A1S64AD, A1S68AD, A1S62DA, A1S68DAI, A1S68DAV, A1S63ADA, A1S66ADA

[Countermeasures for preventing aluminum electrolytic capacitor characteristics deterioration]

Apply the rated voltage to the aluminum electrolytic capacitor for several hours once a year to activate it. Or, rotate products at the periodic inspection (in every 1 year or two).

[Reference]

The life of an aluminum electrolytic capacitor, even if not used, under a normal temperature decreases approximately at 1/4 speed of the case when it is energized.

Appendix 3 Relevant Manuals

Appendix 3.1 Replacement handbooks

(1) Transition guides

No.	Manual name	Manual number	Model code
1	MELSEC-A/QnA Series Transition Guide	L08077E	-
2	MELSEC-AnS/QnAS (Small Type) Series Transition Guide	L08236E	-

(2) Transition handbooks

No.	Manual name	Manual number	Model code
1	Transition from MELSEC-AnS/QnAS (Small Type) Series to L Series Handbook (Fundamentals)	L08258ENG	-
2	Transition from MELSEC-AnS/QnAS (Small Type) Series to L Series Handbook (Intelligent Function Modules)	L08259ENG	-
3	Transition from MELSEC-AnS/QnAS (Small Type) Series to L Series Handbook (Network Modules)	L08260ENG	-
4	Transition from MELSEC-AnS/QnAS (Small Type) Series to L Series Handbook (Communications)	L08261ENG	-
5	Transition from MELSEC-A0J2H Series to Q Series Handbook	L08060ENG	-
6	Transition from MELSECNET/MINI-S3, A2C(I/O) to CC-Link Handbook	L08061ENG	-
7	Transition from MELSEC-I/OLINK to CC-Link/LT Handbook	L08062ENG	-
8	Transition from MELSEC-I/OLINK to AnyWire DB A20 Handbook	L08263ENG	-
9	Transition of CPUs in MELSEC Redundant System Handbook (Transition from Q4ARCPU to QnPRHCPU)	L08117ENG	-

(3) Transition examples manual

No.	Manual name	Manual number	Model code
1	MELSEC-A/QnA (Large), AnS/QnAS (Small) Transition Examples	L08121E	-

(4) Others

No.	Manual name	Manual number	Model code
1	Procedures for Replacing Positioning Module AD71 with QD75	FA-A-0060	-
2	Product discontinuation of ID system D-2N series	FA-A-0062	-

Appendix 3.2 AnS series manuals

No.	Manual name	Manual number	Model code
1	A/D Converter Module Type A1S64AD User's Manual	IB-66336	13J676
2	Analog-Digital Converter Module Type A1S68AD User's Manual	IB-66576	13J757
3	D/A Converter Module Type A1S62DA User's Manual	IB-66335	13J673
4	Digital-Analog Converter Module Type A1S68DAV/DAI User's Manual	IB-66587	13J810
5	Thermocouple Input Module Type A1S68TD User's Manual	IB-66571	13J781
6	Type A68RD3N/4N, A1S62RD3N/4N Pt100 Input Module User's Manual	SH-080193	13JR46
7	A1S62TCTT-S2 Heating-Cooling Temperature Control Module A1S62TCTTBW-S2 Heating-Cooling Temperature Control Module with Wire Breakage Detection Function User's Manual	SH-3643	13JL35
8	A1S62TCRT-S2 Heating-Cooling Temperature Control Module A1S62TCRTBW-S2 Heating-Cooling Temperature Control Module with Wire Breakage Detection Function User's Manual	SH-3644	13JL36
9	Temperature Control Module Type A1S64TCTRT/Temperature Control Module with Disconnection Detection Function Type A1S64TCTRTBW User's Manual	SH-080549ENG	13JR79
10	A1S64TCRT-S1 Temperature Control Module/A1S64TCRTBW-S1 Temperature Control Module with Disconnection Detection Function User's Manual	IB-66756	13JL03
11	A1S64TCTT-S1 Temperature Control Module/A1S64TCTTBW-S1 Temperature Control Module with Disconnection Detection Function User's Manual	IB-66747	13J891
12	Positioning Module Type A1SD70 User's Manual	IB-66367	13JE04
13	A1SD75M1/M2/M3, AD75M1/M2/M3 Positioning Module User's Manual	IB-66715	13J870
14	A1SD75P1-S3/P2-S3/P3-S3, AD75P1-S3/P2-S3/P3-S3 Positioning Module User's Manual	IB-66716	13J871
15	Type A1S62LS User's Manual	IB-66647	13J837
16	High Speed Counter Module Type A1SD61 User's Manual	IB-66337	13J674
17	High Speed Counter Module Type A1SD62, A1SD62E, A1SD62D(S1) User's Manual	IB-66593	13J816
18	Pulse catch module type A1SP60 (Hardware) User's Manual	IB-66477	13JE61
19	Analog timer module type A1ST60 (Hardware) User's Manual	IB-66479	13JE57
20	AJ71B62-S3/A1SJ71B62-S3 B/NET Interface Module User's Manual	IB-68930	13JM67
21	Analog input/output module type A1S63ADA User's Manual	IB-66435	13JE30
22	Analog Input/Output Module Type A1S66ADA User's Manual	IB-66819	13JL41
23	MELSECNET/MINI-S3 Master Module Type AJ71PT32-S3, AJ71T32-S3, A1SJ71PT32-S3, A1SJ71T32-S3 User's Manual	IB-66565	13JE64
24	AS-i Master module type A1SJ71AS92 User's Manual	SH-080085	13JR15
25	A1SD59J-S2/MIF Memory Card Interface Module User's Manual	SH-080056	13JR05

Appendix 3.3 L series manuals

No.	Manual name	Manual number	Model code
1	Programmable Controllers MELSEC-L Series	L-08159E	–
2	MELSEC-L Analog-Digital Converter Module User's Manual L60AD4, L60ADVL8, L60ADIL8	SH-080899ENG	13JZ42
3	MELSEC-L Digital-Analog Converter Module User's Manual L60DA4	SH-080900ENG	13JZ43
4	MELSEC-L Analog I/O Module User's Manual L60AD2DA2	SH-081167ENG	13JZ87
5	MELSEC-L Temperature Control Module User's Manual L60TCTT4, L60TCTT4BW, L60TCRT4, L60TCRT4BW	SH-081000ENG	13JZ64
6	MELSEC-L CPU Module User's Manual (Built-In I/O Function) L02SCPU, L02SCPU-P, L02CPU, L02CPU-P, L06CPU, L06CPU-P, L26CPU, L26CPU-P, L26CPU-BT, L26CPU-PBT	SH-080892ENG	13JZ38
7	MELSEC-L High-Speed Counter Module User's Manual LD62, LD62D	SH-080920ENG	13JZ49
8	MELSEC-L LD75P/LD75D Positioning Module User's Manual LD75P1, LD75P2, LD75P4, LD75D1, LD75D2, LD75D4	SH-080911ENG	13JZ46
9	MELSEC-L LD77MH Simple Motion Module User's Manual (Positioning Control) LD77MH4, LD77MH16	IB-0300172	1XB942
10	MELSEC-L LD77MS Simple Motion Module User's Manual (Positioning Control) LD77MS2, LD77MS4, LD77MS16	IB-0300211	1XB961
11	MELSEC-Q/L QD77MS/QD77GF/LD77MS/LD77MH Simple Motion Module User's Manual (Synchronous Control) QD77MS2, QD77MS4, QD77MS16, QD77GF16, LD77MS2, LD77MS4, LD77MS16, LD77MH4, LD77MH16	IB-0300174	1XB943

Appendix 3.4 Programming tool manuals

No.	Manual name	Manual number	Model code
1	GX Works2 Version 1 Operating Manual (Common)	SH-080779ENG	13JU63
2	GX Works2 Version 1 Operating Manual (Intelligent Function Module)	SH-080921ENG	13JU69
3	GX Developer Version 8 Operating Manual	SH-080373E	13JU41

Appendix 4 How to Change Resolution After Analog I/O Module is Replaced

This section describes how to change the resolution of an analog I/O module after the module is replaced from AnS series to L series.

Appendix 4.1 Resolution

The following table lists an example of the resolutions for the AnS series and L series analog I/O modules.

Each AnS series analog I/O module has different resolution. Please check the resolution of the module in this handbook or user's manual.

If the resolution differs between AnS series and L series modules, it needs to be matched by a user (by creating a sequence program or changing user range settings).

O: Measure required by user, Δ: Measure not required by user

Resolution of AnS series analog I/O module		Resolution of L series analog I/O module	
A1S64AD	1/4000	Selectable	When analog input range is 0 to 10V
A1S62DA	1/8000		L60AD4: 1/20000
A1S63ADA	1/12000		L60ADVL8: 1/16000
			(The resolution differs depending on analog input range.)
			Δ ^{*1*2}
			Δ ^{*1*2}
			Δ ^{*1*2}

*1 Adjust the resolution using the scaling function. (Refer to Appendix 4.2.)

*2 Change the resolution in a sequence program. (Refer to Appendix 4.2.)

Appendix 4.2 Using the scaling function of an analog I/O module

By using the scaling function of the L series analog I/O module, a resolution can be changed.

(1) Example of setting intelligent function module parameters

Parameters can easily be set by using the intelligent function module parameters of GX Works2 without a program. For details of the setting procedure, refer to the manual for each module.

(Setting conditions)

(a) Resolution of the AnS series module: 1/8000 (Only one channel is used.)

(b) L series module: L60AD4

(Example of scaling setting window)

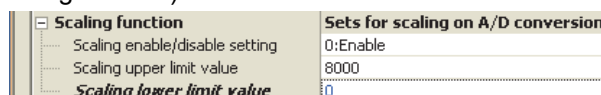

☒ Point

The scaling value (digital operation value) and digital output value of the analog input module are stored in different buffer memory addresses, therefore, the scaling value of each channel needs to be read from the buffer memory.

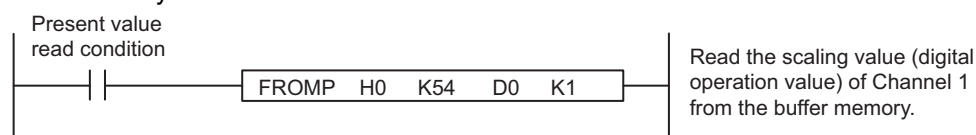

(2) Example of sequence program settings

(Setting conditions)

(a) Resolution of the AnS series module: 1/8000 (Only one channel is used.)

(b) L series module: L60AD4

(Example of scaling settings and scaling values (digital operation values) read program)

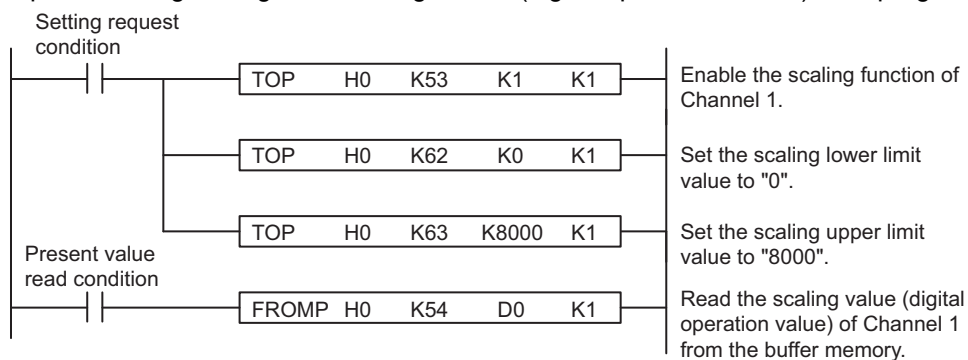

(Buffer memory areas of L60AD4 used by the scaling function ^{*1)})

Address		Description	Default	Read/write
Hexadecimal	Decimal			
35 _H	53	Scaling enable/disable setting	00FF _H	R/W
36 _H	54	CH1 Scaling value (digital operation value)	0	R
37 _H	55	CH2 Scaling value (digital operation value)	0	
38 _H	56	CH3 Scaling value (digital operation value)	0	
39 _H	57	CH4 Scaling value (digital operation value)	0	
to	to	System area (Use prohibited)		-
3E _H	62	CH1 Scaling lower limit value	0	R/W
3F _H	63	CH1 Scaling upper limit value	0	
40 _H	64	CH2 Scaling lower limit value	0	
41 _H	65	CH2 Scaling upper limit value	0	
42 _H	66	CH3 Scaling lower limit value	0	
43 _H	67	CH3 Scaling upper limit value	0	
44 _H	68	CH4 Scaling lower limit value	0	
45 _H	69	CH4 Scaling upper limit value	0	

*1 For details of the scaling function, refer to the user's manual for the module used.

Appendix 4.3 Adding the scaling operation function to sequence program

Adding a scaling operation program to the L series sequence program can change a resolution.

(1) Example of scaling operation sequence program

(Sample program conditions)

(a) Resolution of the AnS series module: 1/4000

(b) Device that stores the present value read from the analog I/O module: D0

(c) Devices used for resolution change operation*: D100 and D101

* Two-/four-word data is used in the four arithmetic operations instruction. Use unused device areas so that existing device data are not affected by this operation.

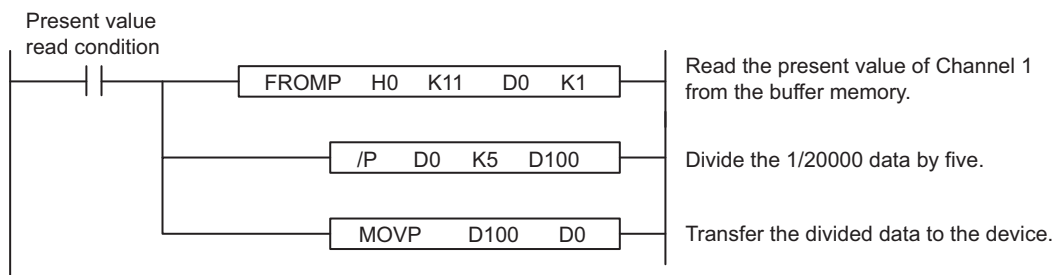

☒ Point

The scan time is longer by the addition to the sequence program.

When the scaling function described in Appendix 4.2 is used, however, because the scaling operation is performed in the analog module, the scan time is not affected.

WARRANTY

Please confirm the following product warranty details before using this product.

1. Gratis Warranty Term and Gratis Warranty Range

If any faults or defects (hereinafter "Failure") found to be the responsibility of Mitsubishi occurs during use of the product within the gratis warranty term, the product shall be repaired at no cost via the sales representative or Mitsubishi Service Company.

However, if repairs are required onsite at domestic or overseas location, expenses to send an engineer will be solely at the customer's discretion. Mitsubishi shall not be held responsible for any re-commissioning, maintenance, or testing on-site that involves replacement of the failed module.

[Gratis Warranty Term]

The gratis warranty term of the product shall be for one year after the date of purchase or delivery to a designated place. Note that after manufacture and shipment from Mitsubishi, the maximum distribution period shall be six (6) months, and the longest gratis warranty term after manufacturing shall be eighteen (18) months. The gratis warranty term of repair parts shall not exceed the gratis warranty term before repairs.

[Gratis Warranty Range]

- (1) The range shall be limited to normal use within the usage state, usage methods and usage environment, etc., which follow the conditions and precautions, etc., given in the instruction manual, user's manual and caution labels on the product.
- (2) Even within the gratis warranty term, repairs shall be charged for in the following cases.
 1. Failure occurring from inappropriate storage or handling, carelessness or negligence by the user. Failure caused by the user's hardware or software design.
 2. Failure caused by unapproved modifications, etc., to the product by the user.
 3. When the Mitsubishi product is assembled into a user's device, Failure that could have been avoided if functions or structures, judged as necessary in the legal safety measures the user's device is subject to or as necessary by industry standards, had been provided.
 4. Failure that could have been avoided if consumable parts (battery, backlight, fuse, etc.) designated in the instruction manual had been correctly serviced or replaced.
 5. Failure caused by external irresistible forces such as fires or abnormal voltages, and Failure caused by force majeure such as earthquakes, lightning, wind and water damage.
 6. Failure caused by reasons unpredictable by scientific technology standards at time of shipment from Mitsubishi.
 7. Any other failure found not to be the responsibility of Mitsubishi or that admitted not to be so by the user.

2. Onerous repair term after discontinuation of production

- (1) Mitsubishi shall accept onerous product repairs for seven (7) years after production of the product is discontinued. Discontinuation of production shall be notified with Mitsubishi Technical Bulletins, etc.
- (2) Product supply (including repair parts) is not available after production is discontinued.

3. Overseas service

Overseas, repairs shall be accepted by Mitsubishi's local overseas FA Center. Note that the repair conditions at each FA Center may differ.

4. Exclusion of loss in opportunity and secondary loss from warranty liability

Regardless of the gratis warranty term, Mitsubishi shall not be liable for compensation to:

- (1) Damages caused by any cause found not to be the responsibility of Mitsubishi.
- (2) Loss in opportunity, lost profits incurred to the user by Failures of Mitsubishi products.
- (3) Special damages and secondary damages whether foreseeable or not, compensation for accidents, and compensation for damages to products other than Mitsubishi products.
- (4) Replacement by the user, maintenance of on-site equipment, start-up test run and other tasks.

5. Changes in product specifications

The specifications given in the catalogs, manuals or technical documents are subject to change without prior notice.

Microsoft and Windows are either registered trademarks or trademarks of Microsoft Corporation in the United States and/or other countries.

Unicode is either a registered trademark or a trademark of Unicode, Inc. in the United States and other countries.

The company names, system names and product names mentioned in this manual are either registered trademarks or trademarks of their respective companies.

In some cases, trademark symbols such as [™] or [®] are not specified in this manual.

Programmable Controller

Country/Region	Sales office	Tel/Fax
USA	MITSUBISHI ELECTRIC AUTOMATION, INC. 500 Corporate Woods Parkway, Vernon Hills, IL 60061, U.S.A.	Tel : +1-847-478-2100 Fax : +1-847-478-2253
Mexico	MITSUBISHI ELECTRIC AUTOMATION, INC. Mexico Branch Mariano Escobedo #69, Col. Zona Industrial, Tlalnepantla Edo. Mexico, C.P.54030	Tel : +52-55-3067-7500
Brazil	MITSUBISHI ELECTRIC DO BRASIL COMÉRCIO E SERVIÇOS LTDA. Avenida Adelino Cardana, 293, 21 andar, Bethaville, Barueri SP, Brazil	Tel : +55-11-4689-3000 Fax : +55-11-4689-3016
Germany	MITSUBISHI ELECTRIC EUROPE B.V. German Branch Mitsubishi-Electric-Platz 1, 40882 Ratingen, Germany	Tel : +49-2102-486-0 Fax : +49-2102-486-1120
UK	MITSUBISHI ELECTRIC EUROPE B.V. UK Branch Travellers Lane, Hatfield, Hertfordshire, AL10 8XB, U.K.	Tel : +44-1707-28-8780 Fax : +44-1707-27-8695
Ireland	MITSUBISHI ELECTRIC EUROPE B.V. Irish Branch Westgate Business Park, Ballymount, Dublin 24, Ireland	Tel : +353-1-4198800 Fax : +353-1-4198890
Italy	MITSUBISHI ELECTRIC EUROPE B.V. Italian Branch Centro Direzionale Colleoni-Palazzo Sirio Viale Colleoni 7, 20864 Agrate Brianza(Milano) Italy	Tel : +39-039-60531 Fax : +39-039-6053-312
Spain	MITSUBISHI ELECTRIC EUROPE, B.V. Spanish Branch Carretera de Rubí, 76-80-Apdo. 420, 08190 Sant Cugat del Vallés (Barcelona), Spain	Tel : +34-935-65-3131 Fax : +34-935-89-1579
France	MITSUBISHI ELECTRIC EUROPE B.V. French Branch 25, Boulevard des Bouvets, 92741 Nanterre Cedex, France	Tel : +33-1-55-68-55-68 Fax : +33-1-55-68-57-57
Czech Republic	MITSUBISHI ELECTRIC EUROPE B.V. Czech Branch Avenir Business Park, Radlicka 751/113e, 158 00 Praha5, Czech Republic	Tel : +420-251-551-470 Fax : +420-251-551-471
Poland	MITSUBISHI ELECTRIC EUROPE B.V. Polish Branch ul. Krakowska 50, 32-083 Balice, Poland	Tel : +48-12-347-65-00 Fax : +48-12-630-47-01
Sweden	MITSUBISHI ELECTRIC EUROPE B.V. (Scandinavia) Fjellievägen 8, SE-22736 Lund, Sweden	Tel : +46-8-625-10-00 Fax : +46-46-39-70-18
Russia	MITSUBISHI ELECTRIC (RUSSIA) LLC St. Petersburg Branch Piskarevsky pr. 2, bld 2, lit "Sch", BC "Benuea", office 720; 195027 St. Petersburg, Russia	Tel : +7-812-633-3497 Fax : +7-812-633-3499
Turkey	MITSUBISHI ELECTRIC TURKEY A.Ş Ümraniye Branch Serifali Mah. Kale Sok. No:41 34775 Umraniye - Istanbul, Turkey	Tel : +90-216-969-2500 Fax : +90-216-526-3995
UAE	MITSUBISHI ELECTRIC EUROPE B.V. Dubai Branch Dubai Silicon Oasis, P.O.BOX 341241, Dubai, U.A.E.	Tel : +971-4-3724716 Fax : +971-4-3724721
South Africa	ADROIT TECHNOLOGIES 20 Waterford Office Park, 189 Witkoppen Road, Fourways, South Africa	Tel : +27-11-658-8100 Fax : +27-11-658-8101
China	MITSUBISHI ELECTRIC AUTOMATION (CHINA) LTD. No.1386 Hongqiao Road, Mitsubishi Electric Automation Center, Shanghai, China	Tel : +86-21-2322-3030 Fax : +86-21-2322-3000
Taiwan	SETSUYO ENTERPRISE CO., LTD. 6F, No.105, Wugong 3rd Road, Wugu District, New Taipei City 24889, Taiwan	Tel : +886-2-2299-2499 Fax : +886-2-2299-2509
Korea	MITSUBISHI ELECTRIC AUTOMATION KOREA CO., LTD. 7F-9F, Gangseo Hangang Xi-tower A, 401, Yangcheon-ro, Gangseo-Gu, Seoul 07528, Korea	Tel : +82-2-3660-9530 Fax : +82-2-3664-8372
Singapore	MITSUBISHI ELECTRIC ASIA PTE. LTD. 307, Alexandra Road, Mitsubishi Electric Building, Singapore 159943	Tel : +65-6473-2308 Fax : +65-6476-7439
Thailand	MITSUBISHI ELECTRIC FACTORY AUTOMATION (THAILAND) CO., LTD. 12th Floor, SV.City Building, Office Tower 1, No. 896/19 and 20 Rama 3 Road, Kwaeng Bangpongpan, Khet Yannawa, Bangkok 10120, Thailand	Tel : +66-2682-6522 Fax : +66-2682-6020
Vietnam	MITSUBISHI ELECTRIC VIETNAM COMPANY LIMITED Hanoi Branch 6th Floor, Detech Tower, 8 Ton That Thuyet Street, My Dinh 2 Ward, Nam Tu Liem District, Hanoi, Vietnam	Tel : +84-4-3937-8075 Fax : +84-4-3937-8076
Malaysia	MITSUBISHI ELECTRIC SALES MALAYSIA SDN. BHD. Lot 11, Jalan 219, 46100 Petaling Jaya, Selangor Darul Ehsan, Malaysia	Tel : +60-3-7626-5000 Fax : +60-3-7658-3544
Indonesia	PT. MITSUBISHI ELECTRIC INDONESIA Gedung Jaya 11th Floor, JL. MH. Thamrin No.12, Jakarta Pusat 10340, Indonesia	Tel : +62-21-3192-6461 Fax : +62-21-3192-3942
India	MITSUBISHI ELECTRIC INDIA PVT. LTD. Pune Branch Emerald House, EL-3, J Block, M.I.D.C., Bhosari, Pune-411026, Maharashtra, India	Tel : +91-20-2710-2000 Fax : +91-20-2710-2100
Australia	MITSUBISHI ELECTRIC AUSTRALIA PTY. LTD. 348 Victoria Road, P.O. Box 11, Rydalmere, N.S.W 2116, Australia	Tel : +61-2-9684-7777 Fax : +61-2-9684-7245

MITSUBISHI ELECTRIC CORPORATION

HEAD OFFICE: TOKYO BUILDING, 2-7-3, MARUNOUCHI, CHIYODA-KU, TOKYO 100-8310, JAPAN
NAGOYA WORKS: 1-14, YADA-MINAMI 5, HIGASHI-KU, NAGOYA, JAPAN