

Open Field Network  
CC-Link Troubleshooting Guidance



CC-Link

# Table of Contents

<b>Introduction</b> .....	<b>3</b>
<b>1. Preliminary confirmation items</b> .....	<b>5</b>
<b>2. Confirming the symptoms</b> .....	<b>9</b>
2.1. Confirming with GX Works2 CC-Link Diagnostics .....	10
2.1.1. CC-Link Diagnostics screen.....	10
2.1.2. Symptom Confirmation Flow Chart.....	12
2.2. Confirming with GX Developer CC-Link Diagnostics .....	15
2.2.1. CC-Link Diagnostics screen.....	15
2.2.2. Symptom Confirmation Flow Chart.....	17
2.3. Confirming with Link Special Register (SW) and Buffer Memory .....	21
2.3.1. Link special register (SW) and buffer memory .....	21
2.3.2. Symptom Confirmation Flow Chart.....	22
2.4. Confirming with Master Station and Slave Station LEDs.....	25
2.4.1. LED displays.....	25
2.4.2. Symptom Confirmation Flow Chart.....	27
<b>3. Troubleshooting when slave station is disconnected</b> .....	<b>28</b>
3.1. When CC-Link System is newly constructed or modified .....	28
3.2. When operation results are available.....	32
<b>4. Troubleshooting when Cyclic Data is Abnormal</b> .....	<b>33</b>
4.1. Remote I/O station cyclic data error .....	33
4.2. Remote device station cyclic data error .....	34
4.3. Intelligent device station (local station) cyclic data error .....	35
<b>5. Troubleshooting when Transient Data is Abnormal</b> .....	<b>36</b>
5.1. Intelligent device station (local station) transient data error.....	36
<b>6. Troubleshooting when Master Station Operation is Faulty</b> .....	<b>37</b>
6.1. Master station operation fault.....	37
<b>7. Troubleshooting when Indistinct Error Occurs</b> .....	<b>38</b>
7.1. Cause of faults .....	38
7.2. Pinpointing the detailed cause of the fault.....	39
7.3. Checking methods .....	40
7.3.1. Visual check .....	40
7.3.2. Checking with a tester .....	41
7.3.3. Checking with a data link.....	43
<b>Appendix</b> .....	<b>45</b>
Appendix 1 Restrictions According to CC-Link Version.....	45
Appendix 1.1 Maximum Overall Cable Length.....	45
Appendix 1.2 Possibilities of Cyclic Transmission .....	49
Appendix 2 Related Link Special Relays and Registers.....	51
Appendix 3 Preventive Maintenance and Quick Solutions .....	53
Appendix 3.1 Separation of CC-Link System using AJ65SBT-RPT CC-Link System .....	53
Appendix 3.2 Remote Controls with AJ65BT-G4-S3 .....	57
Appendix 4 Confirmation Sheet .....	58

## Introduction

Use of CC-Link has increased in FA fields with its outstanding high-speed and stable performance. The release of products compatible with “CC-Link Ver. 2”, having increased data volume, has made it possible to support various needs.

We have prepared this Troubleshooting Guidance as reference for CC-Link users.

Follow the procedures below when troubleshooting.

This guide includes the preliminary confirmation items, such as the system configuration, and the methods for confirming the trouble symptoms, to further clarify the troubleshooting procedures.

CC-Link diagnosis using GX Works2/GX Developer is an easy way to confirm the symptoms.

The methods for confirming with the link special register (SW) and buffer memory, and simple confirmation methods based on the LED status are also explained for situations when CC-Link diagnosis cannot be used.

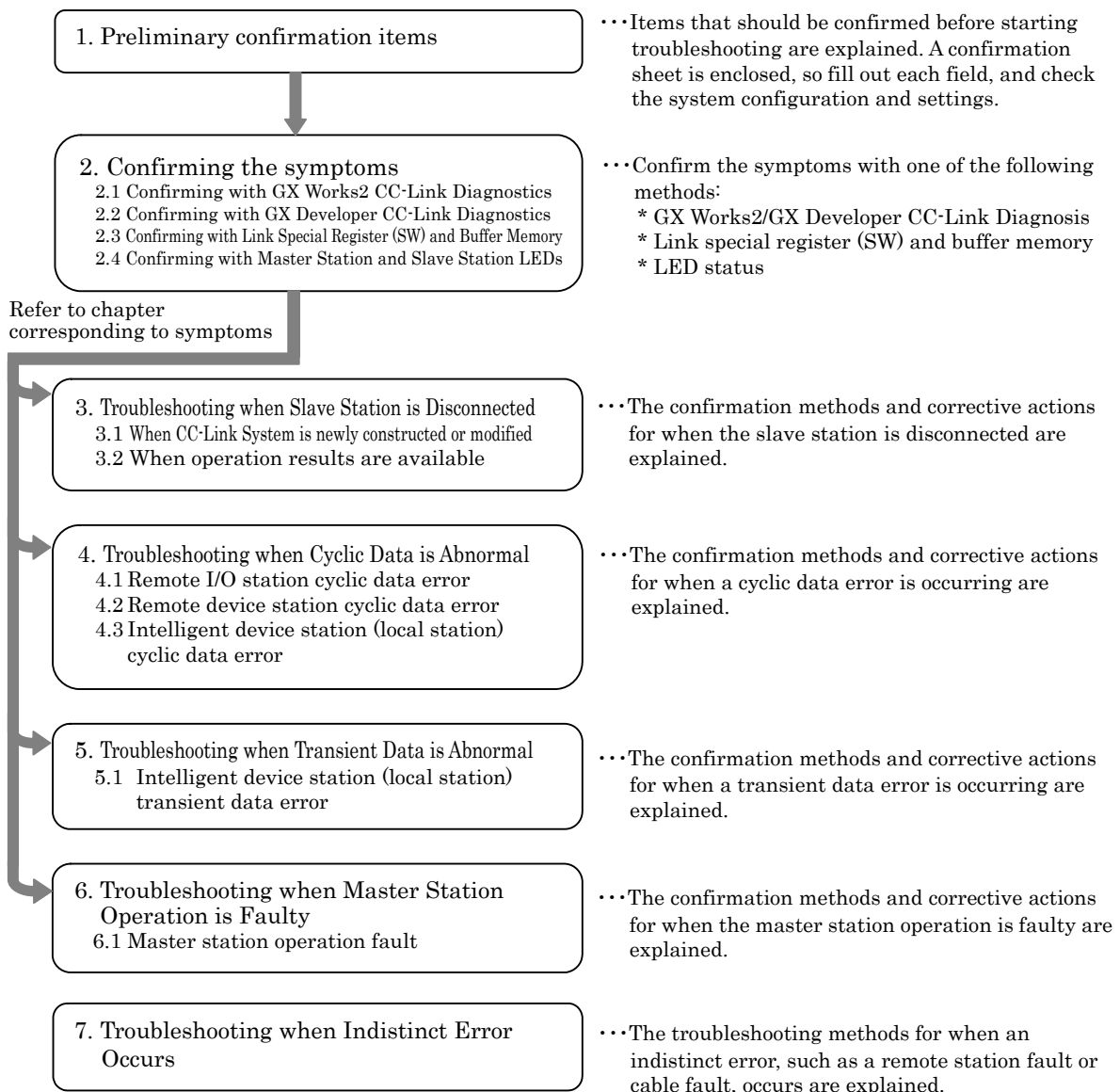

## Related Manuals

Always prepare the manual for the applicable master module when troubleshooting so that the CC-Link specifications, error codes, and link special relay and register contents can be confirmed.

The master module manuals are listed below.

PLC CPU	Manual name	Manual number (Type code)
Q Series	CC-Link System Master/Local Module User's Manual QJ61BT11	SH-080016-E (13JL91)
	MELSEC-Q CC-Link System Master/Local Module User's Manual	SH-080394E-N (13JR64)
L Series	MELSEC-L CC-Link System Master/Local Module User's Manual	SH-080895ENG-E (13JZ41)
QnA Series	CC-Link System Master/Local Module Type AJ61QBT11/A1SJ61QBT11 User's Manual	IB-66722-M (13J873)
A Series	CC-Link System Master/Local Module Type AJ61BT11/A1SJ61BT11 User's Manual	IB-66721-O (13J872)
FX Series	FX2N-16CCL-M USER'S MANUAL	JY992D93101 (09R710)
	FX3U-16CCL-M USER'S MANUAL	JY992D43601 (09R724)
Personal computer board	Type A80BDE-J61BT11 Control & Communication Link System Master/Local Interface Board User's Manual (For SW4DNF-CCLINK-B)	IB-0800175-H (13JR28)
	Type Q80BD-J61BT11N/Q81BD-J61BT11 CC-Link System Master/Local Interface Board User's Manual(For SW1DNC-CCBD2-B)	SH-080527ENG-X (13JR77)

Refer to the respective slave station manuals as necessary.

# 1. Preliminary confirmation items

This section explains the items that should be confirmed with the designs before starting troubleshooting.

Fill in each item following the confirmation items given in Appendix 4. Confirmation sheet. GX Works2 has a Wizard function for preparing the confirmation sheet.

Refer to section 2.1 GX Works2 CC-Link diagnosis for details.

An example of filling in the confirmation sheet is shown below.

Confirmation Sheet

Confirmation item	Details														
1. Master station	[1] Master type	<table border="1" style="width: 100%; border-collapse: collapse;"> <tr> <td>PLC CPU</td> <td>Q02HCPU</td> </tr> <tr> <td>Master module</td> <td>QJ81BT11N</td> </tr> </table>	PLC CPU	Q02HCPU	Master module	QJ81BT11N									
	PLC CPU	Q02HCPU													
	Master module	QJ81BT11N													
	[2] Master version	<table border="1" style="width: 100%; border-collapse: collapse;"> <tr> <td>PLC CPU</td> <td>050320000 000000C</td> </tr> <tr> <td>Master module</td> <td>050320000 000000-B</td> </tr> </table>	PLC CPU	050320000 000000C	Master module	050320000 000000-B									
	PLC CPU	050320000 000000C													
	Master module	050320000 000000-B													
	[3] Module mounting state	I/O address: 0000													
	[4] Other network module	Other network module: None													
	[5] Mode	[a] Mode setting: Remote net mode (Ver. 1 / Additional <u>Ver.2</u> Remote I/O net mode) [b] Scan mode: Synchronous mode <u>Asynchronous mode</u> [c] Module mode: I/O mode / Intelligent mode (SW8: A Series only)													
	[6] Parameters	Confirm that parameters in the designs and actual machine match <table border="1" style="width: 100%; border-collapse: collapse;"> <thead> <tr> <th>Parameter</th> <th>Setting</th> </tr> </thead> <tbody> <tr> <td>Number of modules</td> <td>Five modules</td> </tr> <tr> <td>Standby master station setting</td> <td>None</td> </tr> <tr> <td>Operation designation at CPU down</td> <td>Stop / <u>Continue</u></td> </tr> <tr> <td>Reserved station</td> <td>Station number 8</td> </tr> <tr> <td>Error invalid station</td> <td>None</td> </tr> <tr> <td>Station information</td> <td>Indicated in system configuration</td> </tr> </tbody> </table>	Parameter	Setting	Number of modules	Five modules	Standby master station setting	None	Operation designation at CPU down	Stop / <u>Continue</u>	Reserved station	Station number 8	Error invalid station	None	Station information
Parameter	Setting														
Number of modules	Five modules														
Standby master station setting	None														
Operation designation at CPU down	Stop / <u>Continue</u>														
Reserved station	Station number 8														
Error invalid station	None														
Station information	Indicated in system configuration														
[7] Parameter setting	<u>GX Developer</u> Dedicated instructions / FROM/TO instructions														
[8] Link startup method	Start up with buffer memory: Y6 / Start up with EEPROM: Y8 (QnA, A, FX Series only)														
[9] Link data access	<u>Auto refresh</u> / Dedicated instructions / FROM/TO instructions														
[10] Transmission speed	<u>10M</u> / 5M / 2.5M / 625k / 156kbps														
2. Slave station <small>* Indicate the details in 6. System configuration</small>	[11] Number of connected modules	5 modules													
	[12] Station type*	Remote I/O station: 2 stations, Remote device station: 1 station, Intelligent device station: 2 stations													
	[13] Occupied station number	<input checked="" type="checkbox"/> Station number occupied by each station (Check after confirming)													
	[14] CC-Link version	<u>Ver.1</u> / <u>Ver.2</u> (Expanded cyclic setting 1-fold <u>2-fold</u> <u>4-fold</u> 8-fold setting) Confirm setting													
	[15] Transmission speed	<u>10M</u> / 5M / 2.5M / 625k / 156kbps													
3. Transmission cable	[16] Cable type	Cable type: FANC-110SBH													
	[17] Transmission distance	Overall length: 50m													
	[18] Station-to-station distance	Shortest station-to-station distance: 0.2m													
4. Terminator	[19] Resistance value	<u>110Ω</u> / 130Ω													
	[20] Connection terminal	<input checked="" type="checkbox"/> Connection between terminator DA-DB (Check after confirming)													
5. Grounding	[21] FG terminal	<input checked="" type="checkbox"/> Grounding of each station's FG terminal (Check after confirming) If not grounded at each station, indicate the grounding state in 6. System Configuration.													
6. System configuration <small>Station number, station type, occupied station number, cable length</small>	[22]	<p>The diagram illustrates a CC-Link network topology. It starts with a Master station (Station 1) on the left, which is a Q02H CPU with a QJ81BT11N module. The bus extends to the right through several slave stations. Station 2 is a Ver.2 corresponding Remote device station (2 stations occupied, 4-fold setting). Station 4 is a Ver.2 corresponding Local station (4 stations occupied, 2-fold setting). Station 8 is a Reserved station (Remote I/O station, 1 station occupied). Station 9 is a Ver.1 corresponding Intelligent device station (4 stations occupied). The cable lengths between stations are 49m, 0.3m, 0.3m, 0.2m, and 0.2m. Terminators are connected at both ends of the bus.</p>													

MITSUBISHI ELECTRIC CORPORATION

## Explanation of each Confirmation Sheet Item

**[1] Master type:** Confirm the PLC CPU and master module types.  
The number of connectable master modules is restricted by the PLC CPU.

**[2] Master version:** Confirm the PLC CPU and master module version

Master module	Confirming the version
QJ61BT11/QJ61BT11N	<ul style="list-style-type: none"> <li>Function version, serial number: "SERIAL field on rating nameplate" on side of module or front of module (bottom) (Used when the first six digits of the Serial No. is "100325" or higher)</li> <li>Using GX Developer, select "Diagnostics" → "System Monitor", and select the module by clicking [Module Details Information] button. Display the product information in Module field by clicking [H/W information] button. (When using QJ61BT11 (N) with function version B or higher and SW6D5C-GPPW or higher)</li> <li>Using GX Works2, select "Diagnostics" → "System Monitor", and select the module by clicking [Module Details Information] button. Display the product information in Module field by clicking [H/W information] button.</li> </ul>
LJ61BT11/L26CPU-BT/ L26CPU-PBT	<ul style="list-style-type: none"> <li>Function version, serial number: "SERIAL field on rating nameplate" on side of module or front of module (bottom)</li> <li>Using GX Works2, select "Diagnostics" → "System Monitor", and select the module by clicking [Module Details Information] button. Display the product information in Module field by clicking [H/W information] button.</li> </ul>
AJ61BT11/A1SJ61BT11 AJ61QBT11/A1SJ61QBT11	<ul style="list-style-type: none"> <li>Hardware, software version: Indicated with sticker on front of module (Left side is hardware, right side is software) Function version: Date and symbol in DATE field on rating nameplate</li> </ul>
FX2N-16CCL-M	<ul style="list-style-type: none"> <li>"SERIAL field on rating nameplate" on side of module</li> </ul>
FX3U-16CCL-M	<ul style="list-style-type: none"> <li>Number indicated at "VERSION" on side of module</li> </ul>
A80BD-J61BT11	<ul style="list-style-type: none"> <li>Software version: ROM version indicated in CC-Link Utility "Card List"</li> </ul>
Q80BD-J61BT11N/ Q81BD-J61BT11	<ul style="list-style-type: none"> <li>ROM Version in Board Details Information" that appears when the [Details] button on the CC-Link Ver. 2 Utility "Board Information" is clicked.</li> </ul>

The functions may not be compatible depending on the master module version.

**[3] Module mounting state:** Confirm the layout (I/O address) of the master modules on the PLC base.  
This is required when setting the parameters or designating the master module in the program.

**[4] Other modules:** Confirm the mounting state of other special modules.  
The number of mountable special modules is restricted.

**[5] Mode:**

- [a] Mode setting:** Confirm the network parameter or switch settings. (RemoteNet mode (Ver. 1. mode / Additional mode / Ver. 2 mode) / Remote I/O net mode)  
The Ver. 1 master station cannot be linked with the Ver. 2 slave station. Slave stations other than the remote I/O station cannot be linked to with the remote I/O net mode.
- [b] Scan mode:** Confirm the parameters.  
When using the synchronous mode, make sure that the link scan time does not exceed the allowable range.
- [c] Module mode:** Confirm the SW8 switch settings (I/O mode / intelligent mode) (A PLC)  
When using an intelligent device station such as GOT, the mode must be set to the intelligent mode.

**[6] Parameters:** Confirm that the parameters in the designs and actual machine match, and record the setting values.

Master	Parameter confirmation method	
Q, QnA	When setting with GX Developer	GX Developer's "Network Parameter" → [CC-Link] button
Q,L	When setting with GX Works2	GX Works2's "Network Parameter" → [CC-Link] button
Q, QnA, A, FX	When setting with dedicated instructions or TO instructions	Monitor 01 to 5Fh with GX Developer's "Online" → "Monitor" → "Buffer Memory Batch"
Q, FX, L	When setting with dedicated instructions or TO instructions	Monitor 01 to 5Fh with GX Work2's "Online" → "Monitor" → "Buffer Memory Batch"
Personal computer board	A80BD-J61BT11	CC-Link Utility CC-Link Utility's "Card Information" → [Parameter Setting] button
	Q80BD-J61BT11N/ Q81BD-J61BT11	CC-Link Ver. 2 Utility CC-Link Ver. 2 Utility's "Parameter Setting"

Correct operation will not take place if the parameters are inconsistent.

**[7] Parameter settings:** Confirm whether the parameters are set with the GX Works2/GX Developer network parameters, dedicated instructions, or FROM/TO instructions.  
Various restrictions apply according to the setting method.

**[8] Link startup method:** Confirm the link start program (QnA, A, FX PLC)  
For Y6 and Y8, the CC-Link Diagnostics screen will not open properly unless the station information is in order of station numbers.

**[9] Link data access:** Confirm which link data access method, auto refresh, dedicated instruction or FROM/TO instruction, is in use.  
The auto refresh area must not overlap the area for other processes in the program.

**[10] Communication speed:** Check the master station's communication speed switch setting.  
Set all stations to the same communication speed.

**[11] Number of connected modules:** Confirm the number of mounted modules  
The number of connectable modules is restricted by the station type, number of occupied stations, and version (Ver. 2 expanded cyclic setting).

**[12] Station type:** Confirm the number of remote I/O station, remote device station and intelligent device station (local station) modules. (Record each station's type in 6. System configuration.)  
This item includes the reserved stations.

**[13] Number of occupied stations:** Confirm the occupied station number listed in the instruction manual for each station. (Record the number of station occupation by each station in 6. System configuration.)

- [14] **CC-Link Version:** Confirm that the parameter settings match with the "CC-Link" when using the Ver. 1.10 compatible product, and with the "V2" logo when using the Ver. 2. compatible product. (Record the version of each station in 6. System configuration.)
- [15] **Transmission speed:** Confirm the transmission speed set for each slave station
- [16] **Cable type:** Record the cable type. Confirm the cable's compatible version (Ver. 1.00/1.10), and whether the cable is a dedicated, high-performance or movable section type.  
The station-to-station distance and cable integration (Ver. 1.00 compatible products cannot be used as a rule) are restricted according to the cable type.
- [17] **Transmission distance:** Confirm the transmission distance (overall length)  
The distance may be restricted according to the transmission speed, etc.
- [18] **Station-to-station distance:** Confirm the shortest cable length within the station-to-station distances.  
The length may be restricted according to the CC-Link version, etc.
- [19] **Resistance value:** Confirm the terminal resistance value (110Ω, 130Ω).
- [20] **Connection terminal:** Confirm that the terminator is connected between the DA-DB connectors at both ends of the CC-Link system.
- [21] **Grounding:** Confirm that each station's FG is grounded. (Record in 6. System configuration if each station is not grounded).  
Connect the CC-Link dedicated cable's shield wire to "SLD" on each module, and ground both ends with Class D grounding (Class 3 grounding) via "FG".
- [22] **System configuration:** Illustrate the system configuration.  
Indicate the station number, station type, occupied station number and cable length.

### Points for setting the parameters

There are various items that must be set for the parameters. The head I/O number, number of connected modules, and station information settings are mandatory. A setting error will not occur if these mandatory items are set correctly.

The parameter settings for the Q Series PLC are shown in the following setting example. The setting methods differ for the other PLC CPUs, but the corresponding items must be set in the same manner.

The parameters enclosed with a bold line below are the mandatory items.

### (Example) Network Parameters Setting the CC-Link list screen

#### Items set on Network Parameters Setting the CC-Link list screen

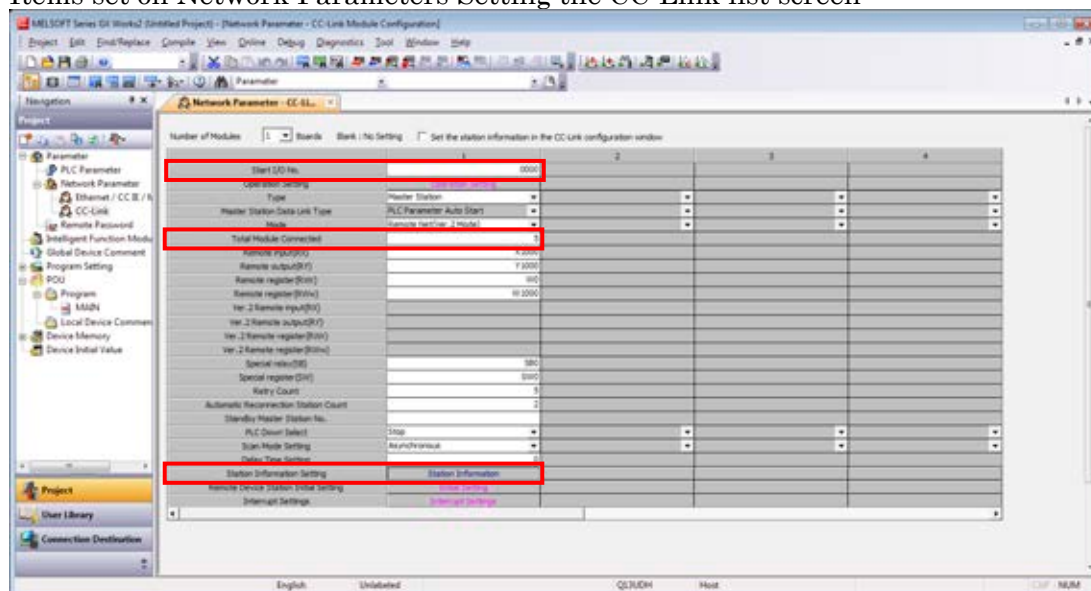

#### Items set on Station information setting screen

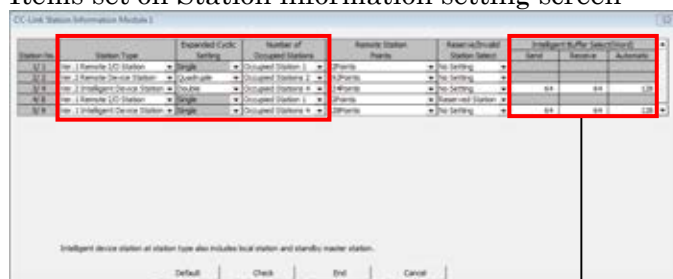

When using transient transmission with the intelligent device station (local station), set these fields according to the transmission amount.



## 2. Confirming the symptoms

GX Works2/GX Developer's CC-Link Diagnostics function is a convenient method to confirm the symptoms when trouble occurs.

When using a PLC CPU, such as the FX PLC, which is incompatible with the GX Works2/GX Developer CC-Link Diagnostics function, or when using GPPA or GPPQ for the peripheral device, use the method that monitors with the link special register and buffer memory. If a peripheral device cannot be prepared, confirm the symptoms with a simple method by checking the LED ON state. These following three methods are explained below.

### Confirmation method 1. GX Works2/GX Developer CC-Link Diagnostics

Start up GX Works2/GX Developer (SW3D5C/F-GPPW or above) with the personal computer connected to the master station, and execute CC-Link Diagnostics.

In addition to CC-Link diagnostics, check the symptom with the LED ON status and the link data communication status.

### Confirmation method 2. Monitoring with the link special register (SW) and buffer memory

Connect a peripheral device compatible with the buffer memory's monitor function to the master station, and monitor the master module's link special register and buffer memory.

A confirmation, equivalent to CC-Link Diagnostics, can be made by monitoring the link special register and buffer memory corresponding to CC-Link Diagnostics.

In addition to link special register and buffer memory, check the symptom with the LED ON status and link data communication status.

### Confirmation method 3. LED status

Check the link status by the ON state of the master station and slave station LEDs.

A simple confirmation can be made with the LED status when a peripheral device is not available.

The peripheral devices and master modules corresponding to the confirmation methods are shown below.

Confirmation method		Peripheral device	Master module	Reference section
CC-Link Diagnostics	When compatible with GX Works2/GX Developer's CC-Link Diagnostics	GX Works2/GX Developer	Q, L, QnA, A PLC	Section 2.1 Section 2.2
Monitoring the SW and buffer memory	When incompatible with GX Works2/GX Developer CC-Link Diagnostics, or When GX Works2/GX Developer is not available	Peripheral device capable of monitoring SW and buffer memory (GPPA, GPPQ, etc.)	FX PLC QnA, A PLC	Section 2.3
		Utility	Personal computer board	
LED status	When peripheral device is not available	—	All master modules	Section 2.4

## 2.1. Confirming with GX Works2 CC-Link Diagnostics

This section explains the GX Works2 CC-Link Diagnostics screen (section 2.1.1) and the Symptom Confirmation Flow Chart (section 2.1.2).

Users familiar with the CC-Link Diagnostics screen should proceed to section 2.1.2 Symptom Confirmation Flow Chart.

### 2.1.1. CC-Link Diagnostics screen

This section explains the CC-Link Diagnostics screen used to confirm the symptoms.

#### (1) CC-Link Diagnostics

GX Works2 operating procedure

[Diagnostics] → [CC-Link / CC-Link/LT Diagnostics]

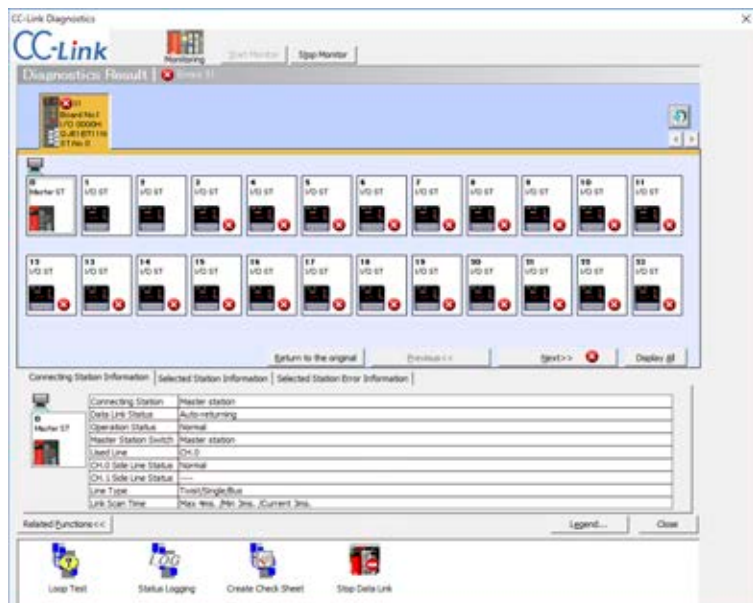

#### Explanation of items

##### 【1】 Diagnosis results

The number of all errors and warnings occurring in the master and local modules is displayed.

##### 【2】 Module List/Diagnosis Target selection

A list of master and local modules is displayed. The number of errors occurring (errors, warnings) is also displayed.

The diagnosis target can be changed by clicking on a module.

: Updates the list.

: Switches the displayed modules in lots of 8.

##### 【3】 List of stations

The stations that configure the CC-Link system are listed with icons.

When displaying the details, use to display the 24th and following stations.

Switch the displays with / . When all stations are displayed, the information for all stations can be confirmed on one screen.

The icons can be moved and freely arranged with drag & drop.

Use to return the icon layout to the station order.



Move icons with  
drag & drop.

**[4] Connected station information**

The station number, etc., of the station (other station) selected from the list of stations is displayed.

With this troubleshooting, the symptoms are confirmed with the shaded items. The other items are not used.

	Item	Details	Remarks (SB/SW)
①	Connected Station	The type of station (master station, local station, standby master station) being monitored and the CC-Link mode are displayed.	SW0061
②	Data Link Status	The data link status is displayed.	—
③	Action Status	The local station's operation status is displayed.	—
④	Master Station Switch	Whether the master station or standby master station is being used to control the data link is displayed.	SB0070
⑤	Using Line	The line "CH0" being used is displayed.	SW00B0 to B3
⑥	CH0 side line status	The status of line CH0 is displayed.	SB0091
⑥	CH1 side line status	The status of line CH1 (not used) is displayed.	SB0092
⑦	Line Type	The line type is displayed.	—
⑧	Link Scan Time	The maximum, minimum and current values for the link scan time are displayed.	SW006D (Maximum) SW006F (Minimum) SW006E (Current)

**[5] Selected station information**

The station number, etc., of the station (other station) selected from the list of stations is displayed.

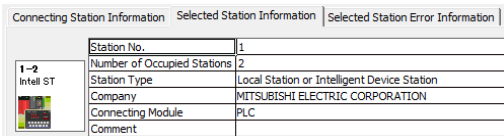

**[6] Selected station error information**

The error information of the station selected from the list of stations is displayed.

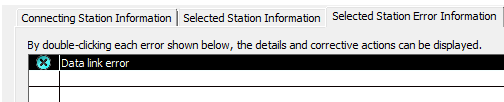

**[7] Related functions**

Select whether to show or hide the icons for related functions.

With this troubleshooting, the symptoms are confirmed with the shaded items. The other items are not used.

Item	Details
Line test	Checks that the CC-Link dedicated cable is correctly connected, and that a data link is established with the slave station. The line test is performed with the master station.
Status logging	The data link status for all stations is logged.
Make confirmation sheet	The confirmation sheet used during troubleshooting is prepared with the Wizard.
Data link start/stop	The master/local module data link is started and stopped.

**[8] Legend...**

Explanations on the icons displayed on the Diagnostics screen are displayed.

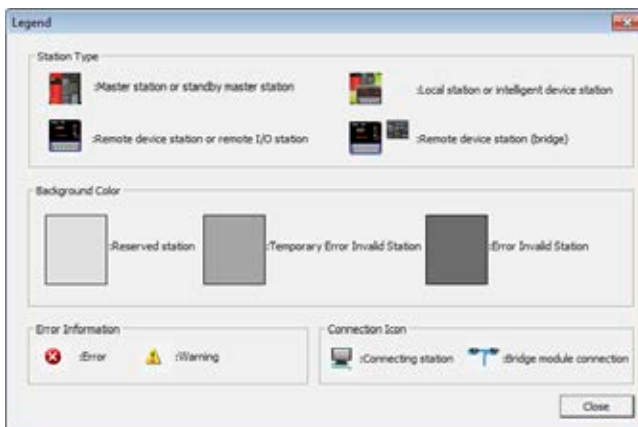

**Point**

\* Updating the number of errors/warnings in the "Diagnosis Results"

When monitoring, only the number of errors and warnings occurring in the system of the module selected with "List of Modules/Diagnostics Target Selection" are updated.

To update the number of errors and warnings in the other module, press to update the list of modules.

### 2.1.2. Symptom Confirmation Flow Chart

This section explains the procedures for confirming the symptoms when the GX Works2 CC-Link Diagnostics screen is executed using a peripheral device connected to the master station.

Confirming the symptoms with the following flow chart will lead to the number of a confirmation item in Chapters 3 to 5. Check the cause of the trouble with the confirmation method indicated with the corresponding confirmation item number, and take appropriate actions.

The flow chart is divided according to the details displayed in the shaded section of the screen.

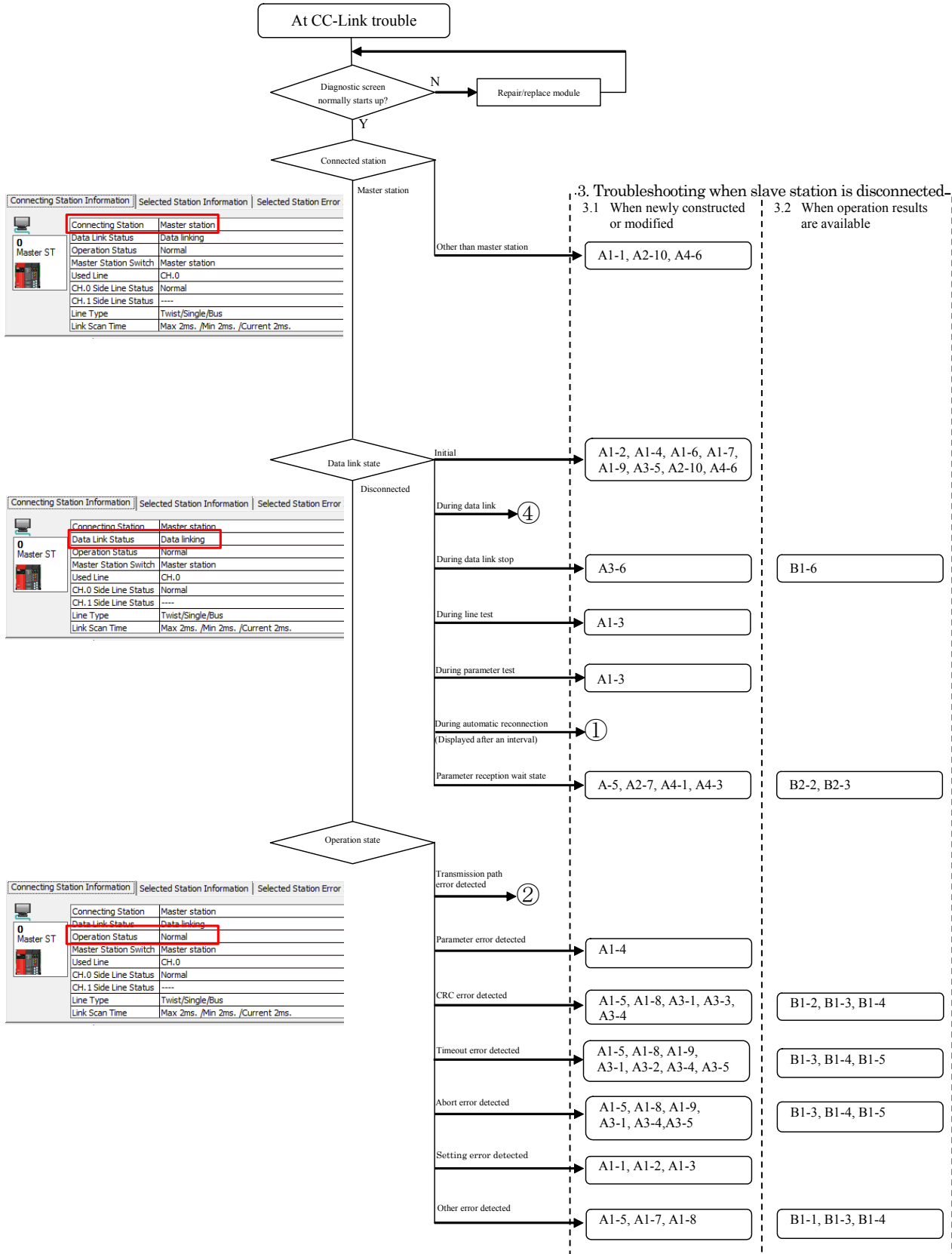

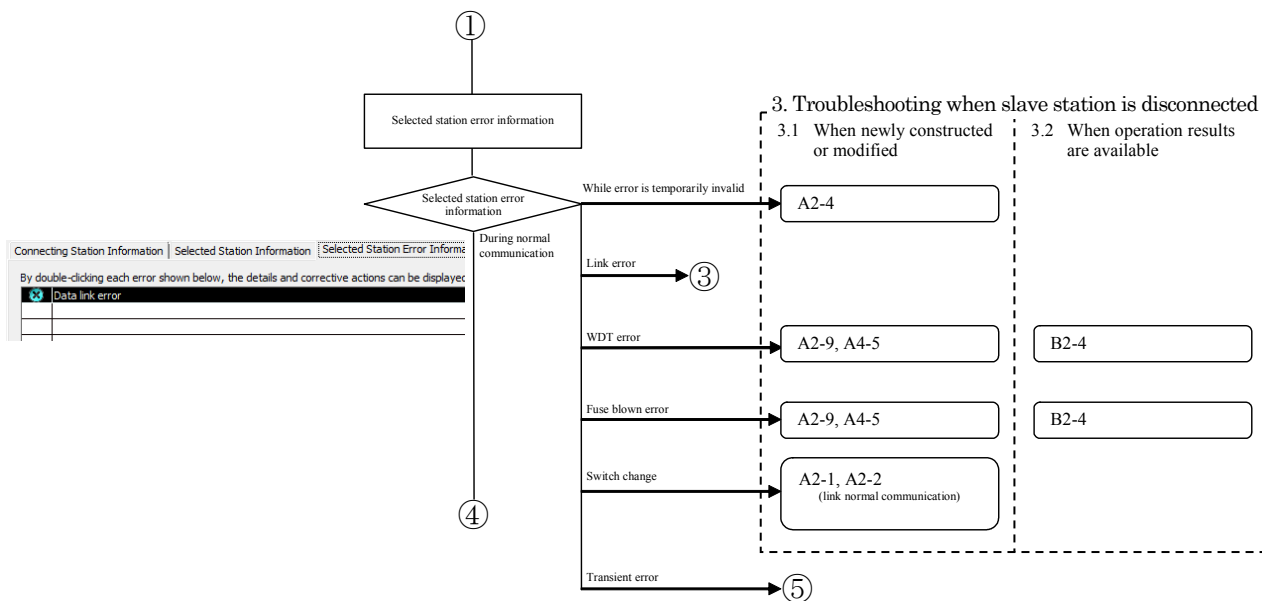

Judge the following states with the LED ON status.

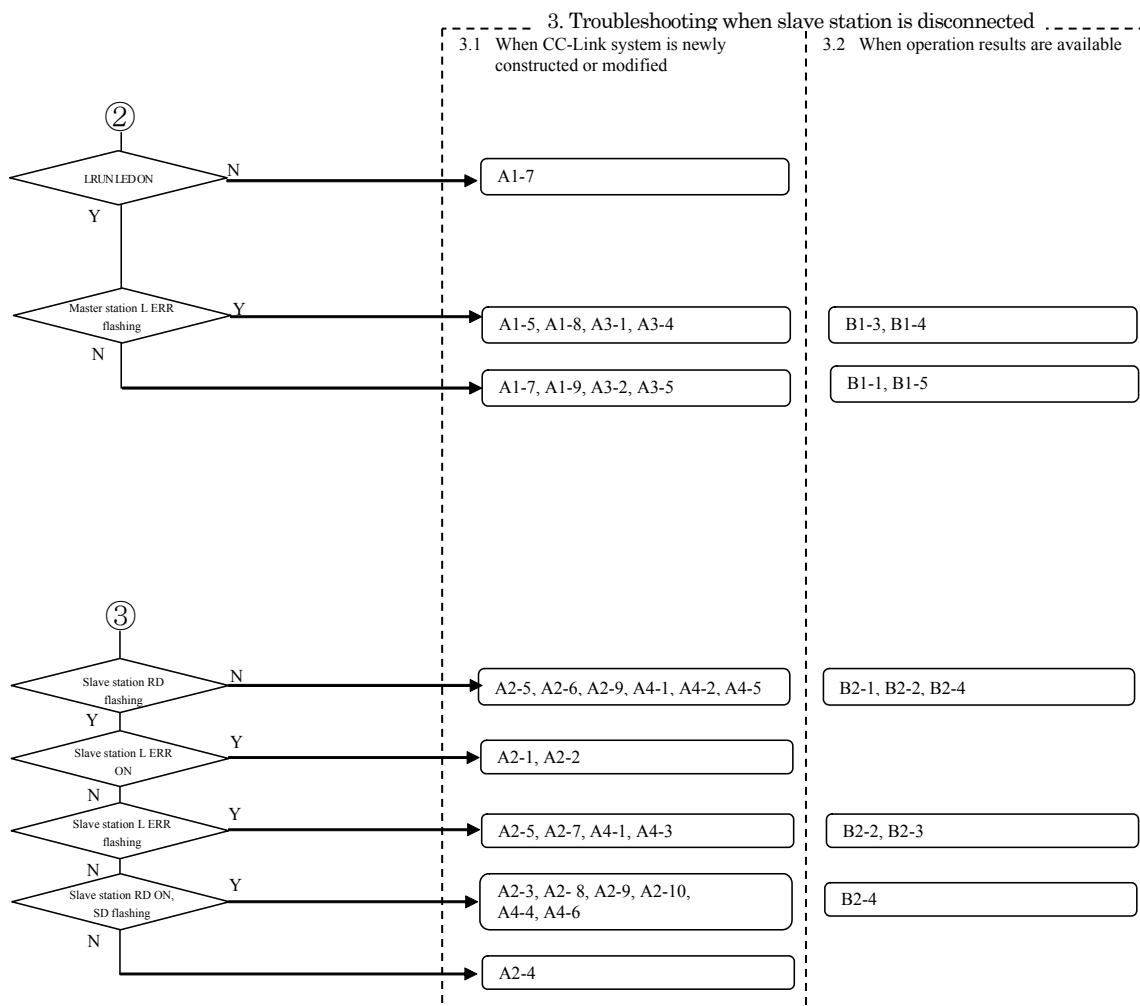

Judge the following states with the link data communication state.

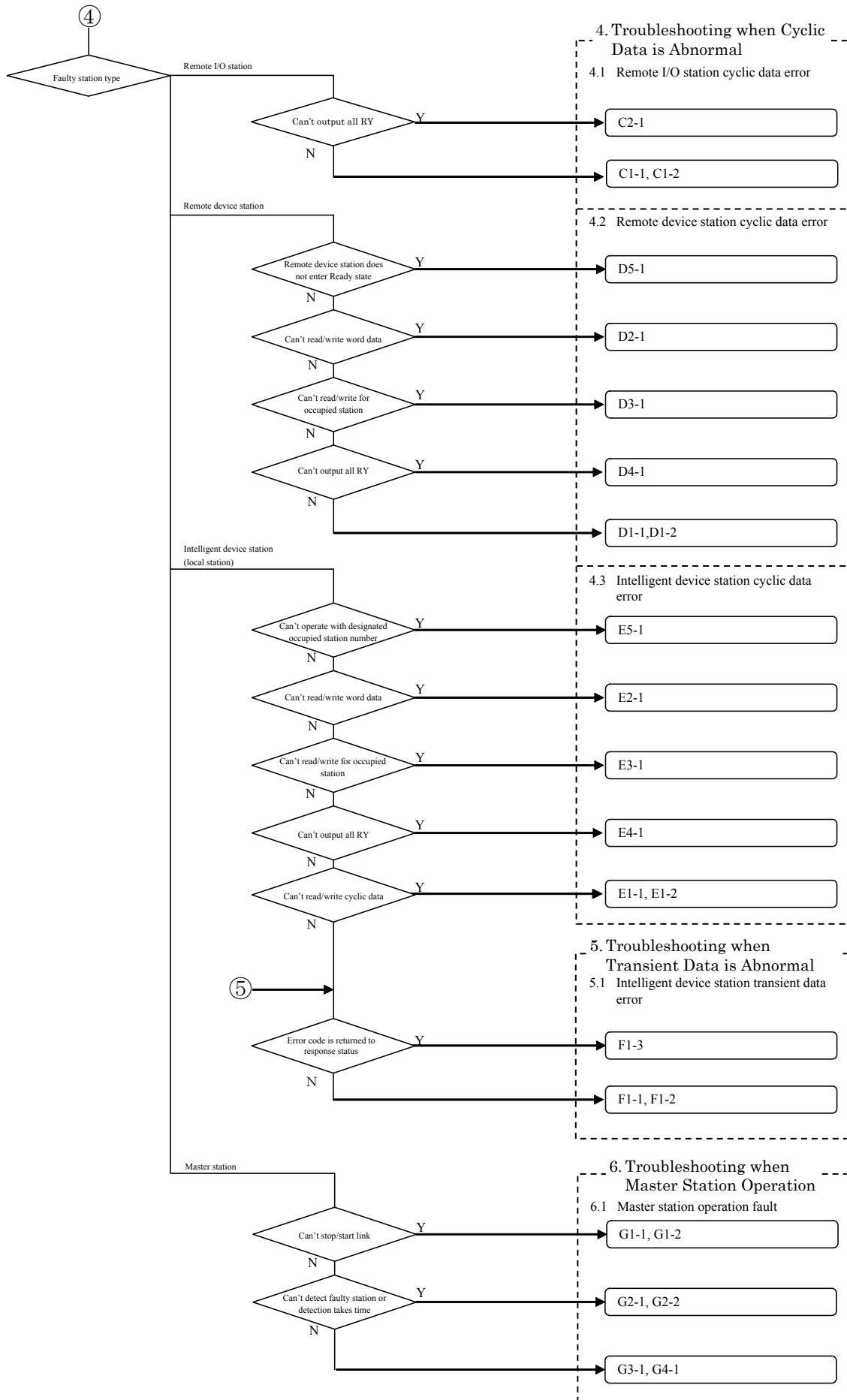

## 2.2. Confirming with GX Developer CC-Link Diagnostics

This section explains the GX Developer CC-Link Diagnostics screen (section 2.1.1) and the Symptom Confirmation Flow Chart (section 2.1.2).

Users familiar with the CC-Link Diagnostics screen should proceed to section 2.1.2 Symptom Confirmation Flow Chart.

### 2.2.1. CC-Link Diagnostics screen

This section explains the CC-Link Diagnostics screen used to confirm the symptoms.

#### (1) CC-Link Diagnostics

GX Developer operation procedures

[Diagnostics]→[CC-Link / CC-Link/LT Diagnostics]

1. Select "CC-Link" for "Module Setting".
2. Designate the module to be monitored by the host station using "Module No." or "I/O Address".
3. Click the Start Monitoring button.

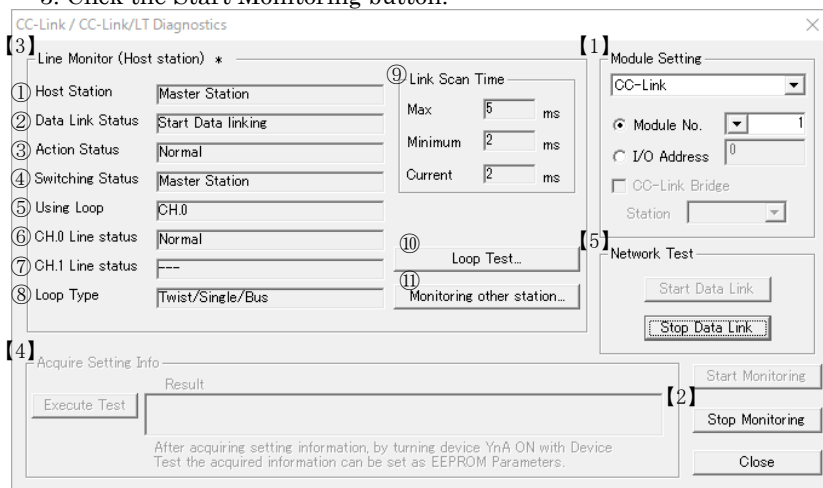

#### Explanation of each item

##### [1] Module Setting

Select the "CC-Link" to be monitored.

Module No.

Designate the CC-Link master module to be monitored.

I/O Address No.

Designate the I/O address of the CC-Link master module to be monitored.

##### [2] Start/Stop monitoring buttons

Use these buttons to start or stop the host station monitoring.

##### [3] Host Station Monitor

This indicates the status of the Host station.

With this troubleshooting, the symptoms are confirmed with the shaded items. The other items are not used.

	Items	Details	Remarks (SB/SW)
①	Host station	The type of host station and mode are displayed. Note that the mode is not displayed for the RemoteNet Ver. 1 mode.	SW0061
②	Host station Data Link Status	The data link status of the host station is displayed.	—
③	Host station Action Status	The operation status of the host station is displayed.	—
④	Master station Switching Status	Whether the master station or standby master station is being used to control the data link is displayed.	SB0070
⑤	Using Loop	The master/local module line being used is displayed.	SW00B0 to B3
⑥	CH.0 Line status	The line status is displayed.	SB0091
⑦	CH.1 Line status		SB0092
⑧	Loop Type	The CC-Link line type is displayed.	—
⑨	Link Scan Time	The maximum, minimum and current values for the link scan time are displayed.	SW006D (Maximum) SW006F (Minimum) SW006E (Current)
⑩	Loop Test	This tests all stations or the designated station. This is valid only when the master station is designated for the connection destination.	—
⑪	Monitoring other station	The other CC-Link station lines connected to the PLC CPU are monitored. This can be executed only during data link.	Refer to the next page for details.

[4] Acquire Setting Info (A/QnA Series only): Not used with this troubleshooting.

When this item is executed, the CC-Link mounting state will be set to the CC-Link module work area.

[5] Network Test: Not used with this troubleshooting.

The data link is started and stopped for the CC-Link module set with Module Setting.

## (2) Monitoring other station

GX Developer operation procedures

[Diagnostics] → [CC-Link / CC-Link/LT Diagnostics]

1. Select "CC-Link" for "Module Setting".
2. Designate the master module to be monitored by the other station using "Module No." or "I/O Address".
3. Click the Start Monitoring button.
4. Click on the Monitoring other station button.

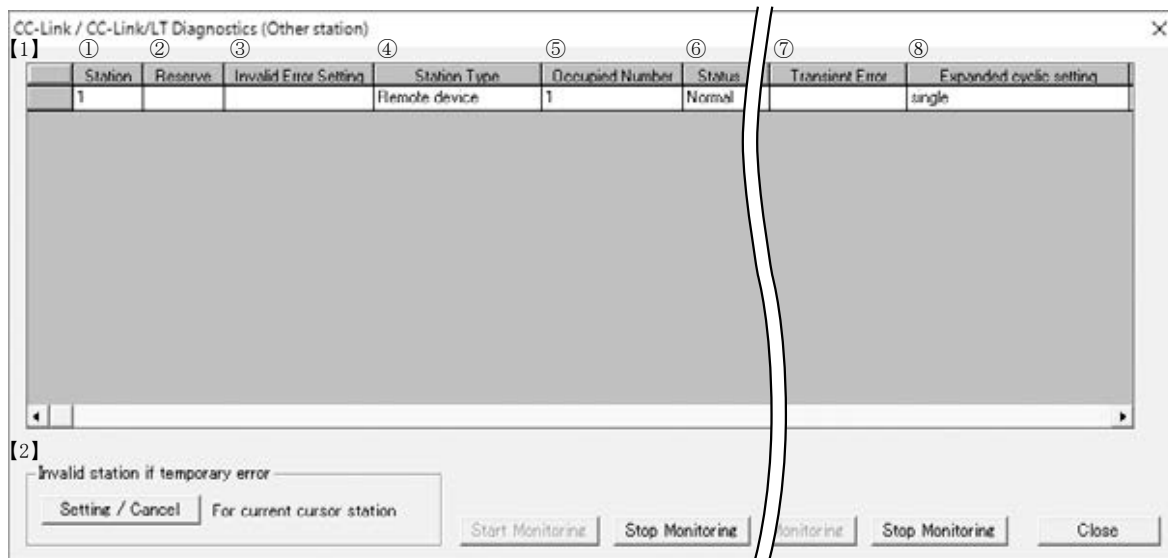

### Explanation of each item

#### [1] List of other station information

Information on the other station is displayed.

With this troubleshooting, the symptoms are confirmed with the shaded items. The other items are not used.

	Item	Details	Remarks (SW, buffer memory)
①	Station	The head number of each station is displayed.	—
②	Reserve Setting	The presence of reserved station settings is displayed.	SW0074 to 77
③	Invalid Error	The presence of stations with invalid errors is displayed.	SW0078 to 7B
④	Station Type	The station type is displayed.	Buffer memory 20H to 5FH
⑤	Occupied Number	The number of occupied stations is displayed.	Buffer memory 20H to 5FH
⑥	Station	The module link status is displayed: Error temporarily invalid Link error WDT error Fuse blown error Switch changed	SW007C to 7F SW0080 to 83 SW0084 to 87 SW0088 to 8B SW008C to 8F The higher the item is displayed, the higher the priority is.
⑦	Transient error	The presence of an error during transient transmission is displayed.	SW0094 to 97
⑧	Expanded cyclic setting	The expanded cyclic setting is displayed.	Buffer memory 20H to 5FH
	Number of Input/Output Points	This is calculated from the Occupied Number and Expanded Cyclic setting.	—
	Company name	The device's company name is displayed.	—

#### [2] Temporary error invalid station: Not used with this troubleshooting.

To set a temporary error invalid station, select the station number with the cursor.



## 2.2.2. Symptom Confirmation Flow Chart

This section explains the procedures for confirming the symptoms when the GX Developer CC-Link Diagnostics screen is executed using a peripheral device connected to the master station.

Confirming the symptoms with the following flow chart will lead to the number of a confirmation item in Chapters 3 to 5. Check the cause of the trouble with the confirmation method indicated with the corresponding confirmation item number, and take appropriate actions.

The flow chart is divided according to the details displayed in the shaded section of the screen.

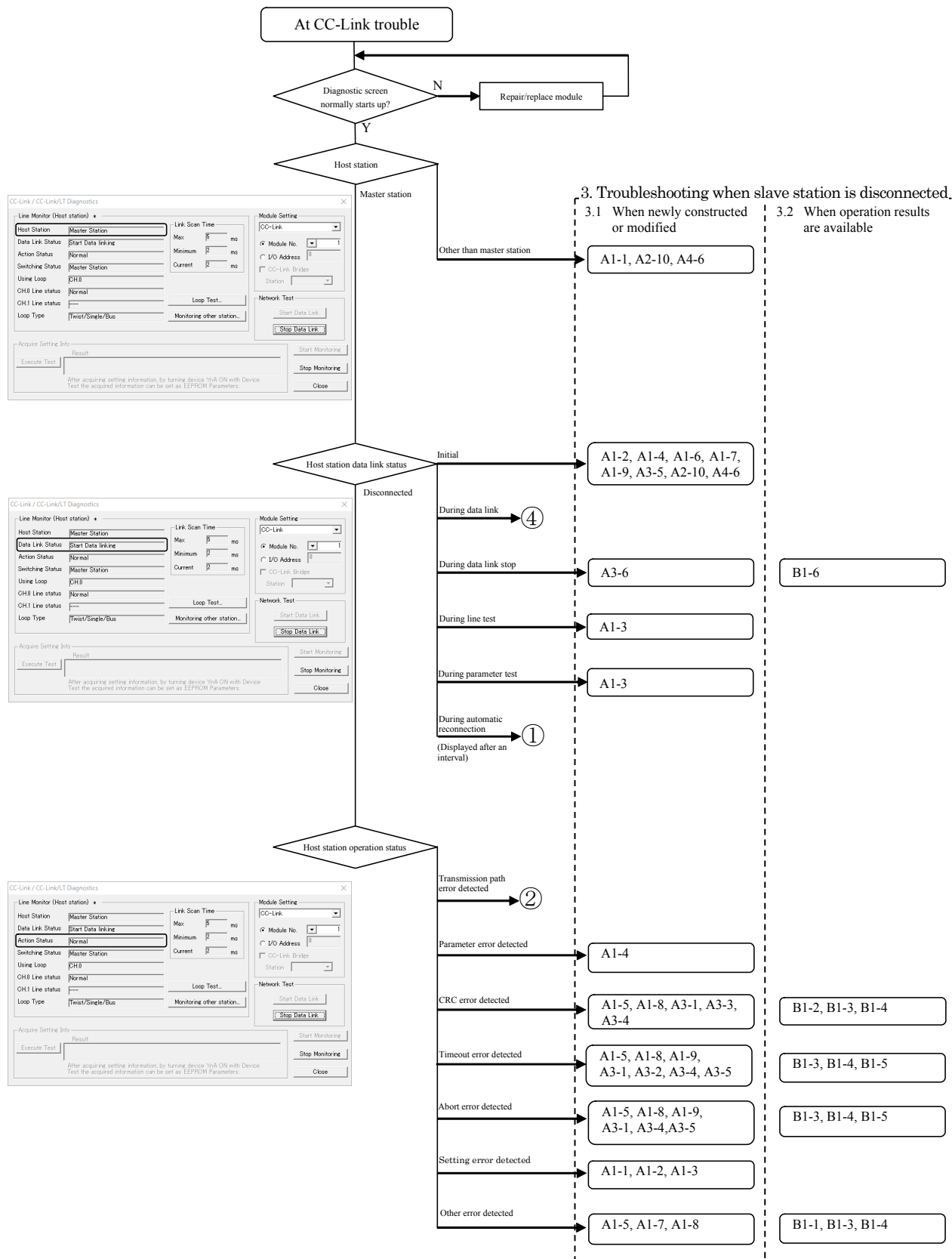

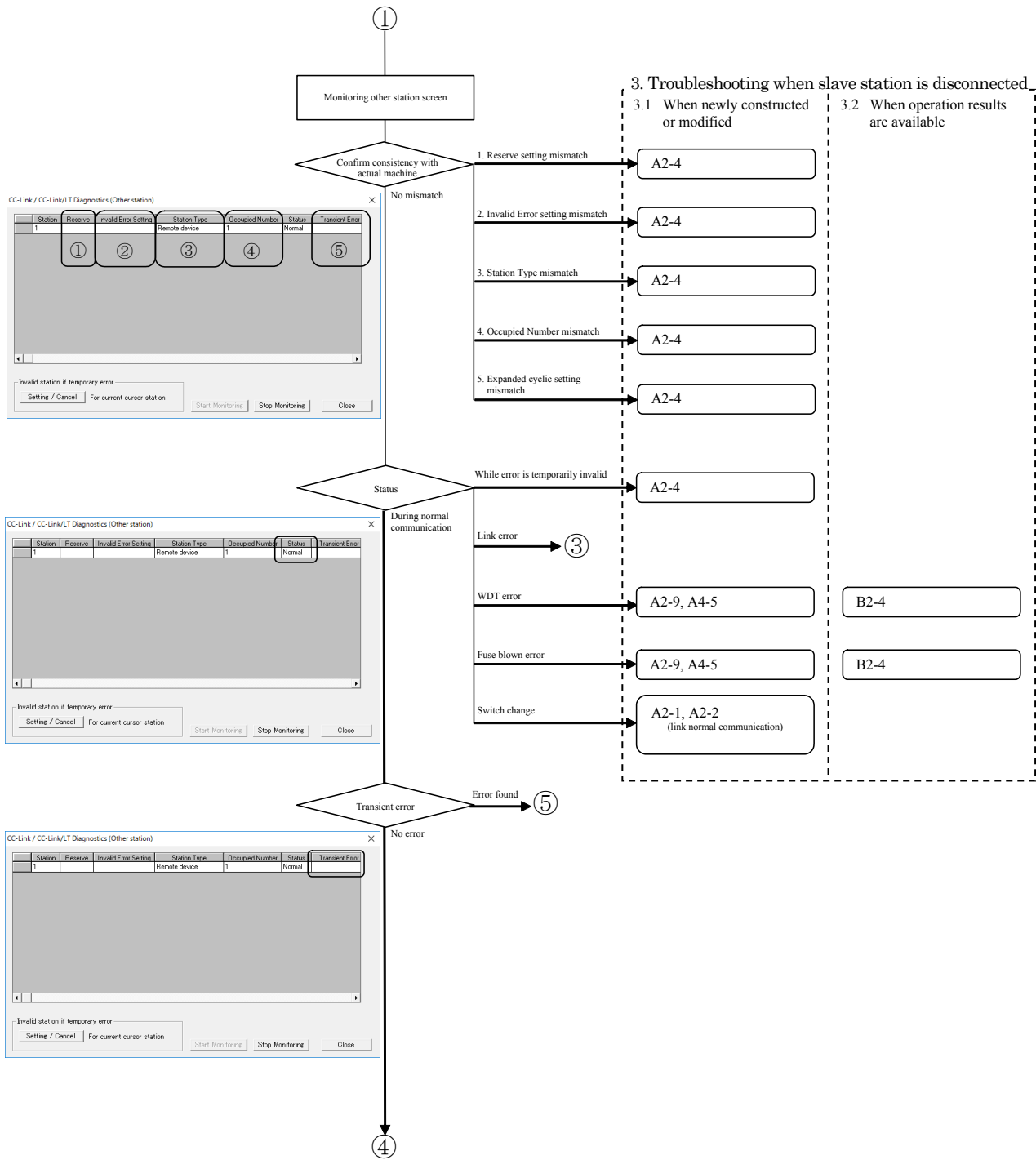

Judge the following states with the LED ON status.

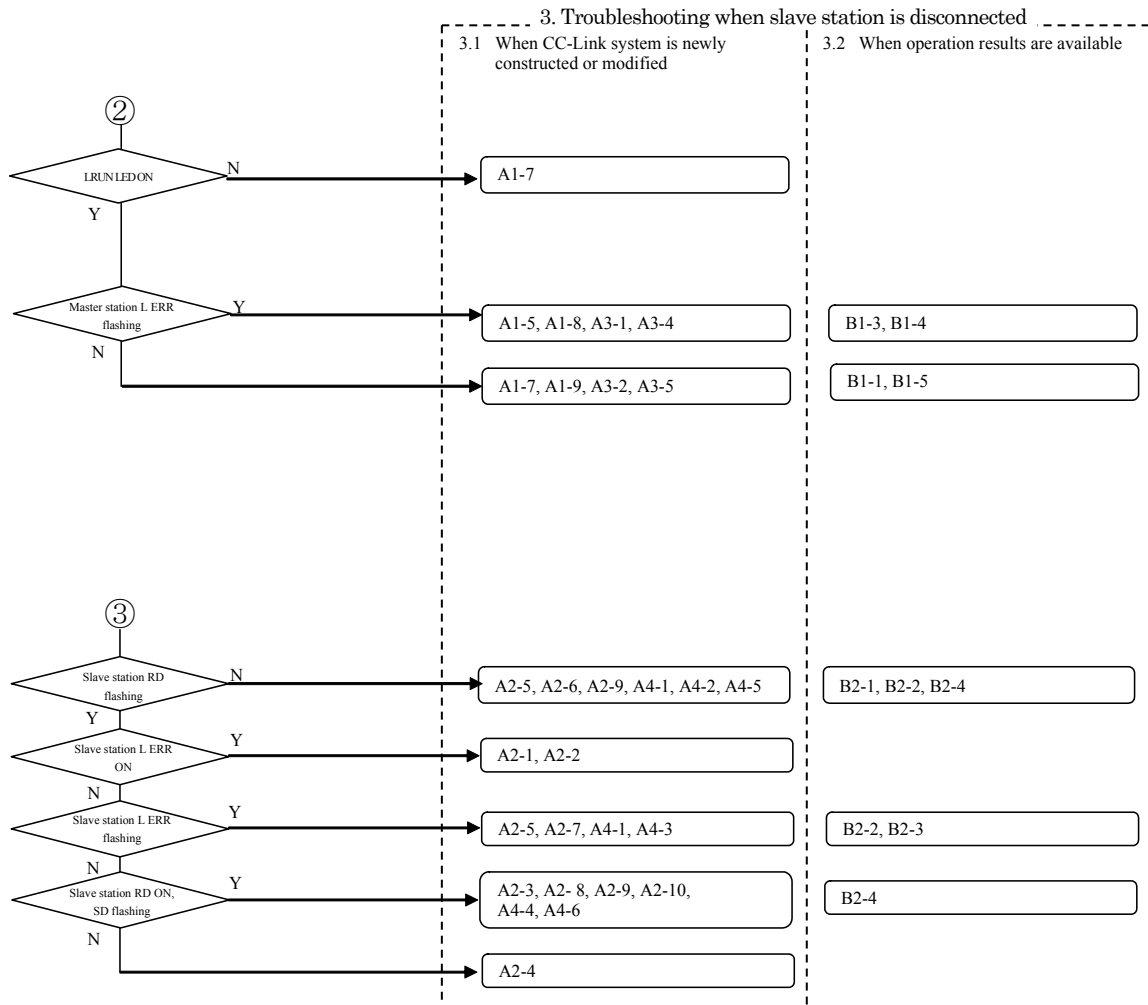

Judge the following states with the link data communication state.

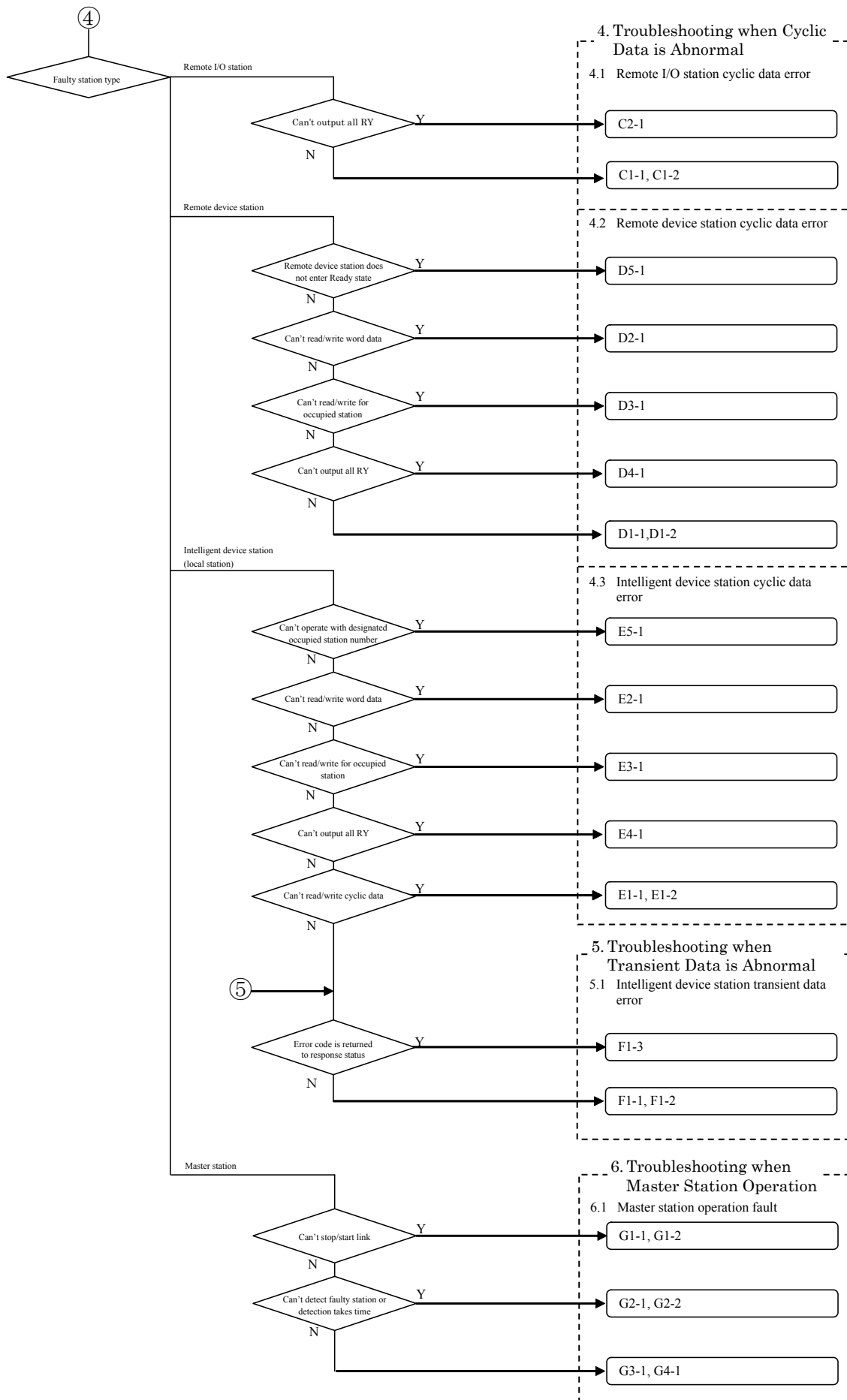

## 2.3. Confirming with Link Special Register (SW) and Buffer Memory

Use this confirmation method when the GX Developer CC-Link Diagnostics function cannot be used. Confirmation, equivalent to CC-Link Diagnostics, can be made by monitoring the link special register and buffer memory corresponding to each item of the CC-Link Diagnostics function.

### 2.3.1. Link special register (SW) and buffer memory

The link special register (SW) and buffer memory used to confirm the symptoms are explained below. Refer to the master module's manual for details on the link special register (SW) and buffer memory.

#### (1) Host monitor

		SW	Details
Host station	The type of station (master station, local station, standby master station) being monitored is displayed.	SW0061 (buffer memory: 0661H)	Station type
		0	Master station
		1 to 64	Local station
		128	Standby master station

#### (2) Other station monitor

		SW, buffer memory	Details	
Reserve setting	The presence of reserved station settings is displayed.	SW		Setting
		SW0074 to 77 (Buffer memory: 0674H to 0677H)	Corresponding bit ON	Station set
Invalid Error	The presence of stations with invalid errors is displayed.	SW		Setting
		SW0078 to 7B (Buffer memory: 0678H to 067BH)	Corresponding bit ON	Station set
Station number, occupied station number, station type, expanded cyclic setting	The setting status of the connected remote I/O station, remote device station and intelligent device station (local station) type is displayed.	buffer memory	Details	
		20H (station No. 1) to 5FH (station No. 64)	<p>0H: Ver. 1 compatible remote I/O station            1H: Ver. 1 compatible remote device station            2H: Ver. 1 compatible intelligent device station            5H: Ver. 2 compatible 1-fold setting remote device station            6H: Ver. 2 compatible 1-fold setting intelligent device station            8H: Ver. 2 compatible 2-fold setting remote device station            9H: Ver. 2 compatible 2-fold setting intelligent device station            BH: Ver. 2 compatible 4-fold setting remote device station            CH: Ver. 2 compatible 4-fold setting intelligent device station            EH: Ver. 2 compatible 8-fold setting remote device station            FH: Ver. 2 compatible 8-fold setting intelligent device station</p>	
Status	The module link status is displayed.	SW (buffer memory)		Status
		SW007C to 7F (067CH to 067FH)	Corresponding bit ON	During temporary error invalid
		SW0080 to 83 (0680H to 0683H)	Corresponding bit ON	Link error
		SW0084 to 87 (0684H to 0687H)	Corresponding bit ON	WDT error
		SW0088 to 8B (0688H to 068BH)	Corresponding bit ON	Fuse blown error
Transient error	The status of the transient transmission error is displayed.	Above SW	All OFF	During normal communication
		SW (buffer memory)		Status
		SW0094 to 97 (0694H to 0697H)	Corresponding bit ON	Error detected
			Corresponding bit OFF	No error detected

The link special register switch assigns one bit per station.

### 2.3.2. Symptom Confirmation Flow Chart

This section explains the procedures for confirming the symptoms when the link special register (SW) and buffer memory are monitored using a peripheral device connected to the master station. Confirming the symptoms with the following flow chart will lead to the number of a confirmation item in Chapters 3 to 5. Check the cause of the trouble with the confirmation method indicated with the corresponding confirmation item number, and process the state.

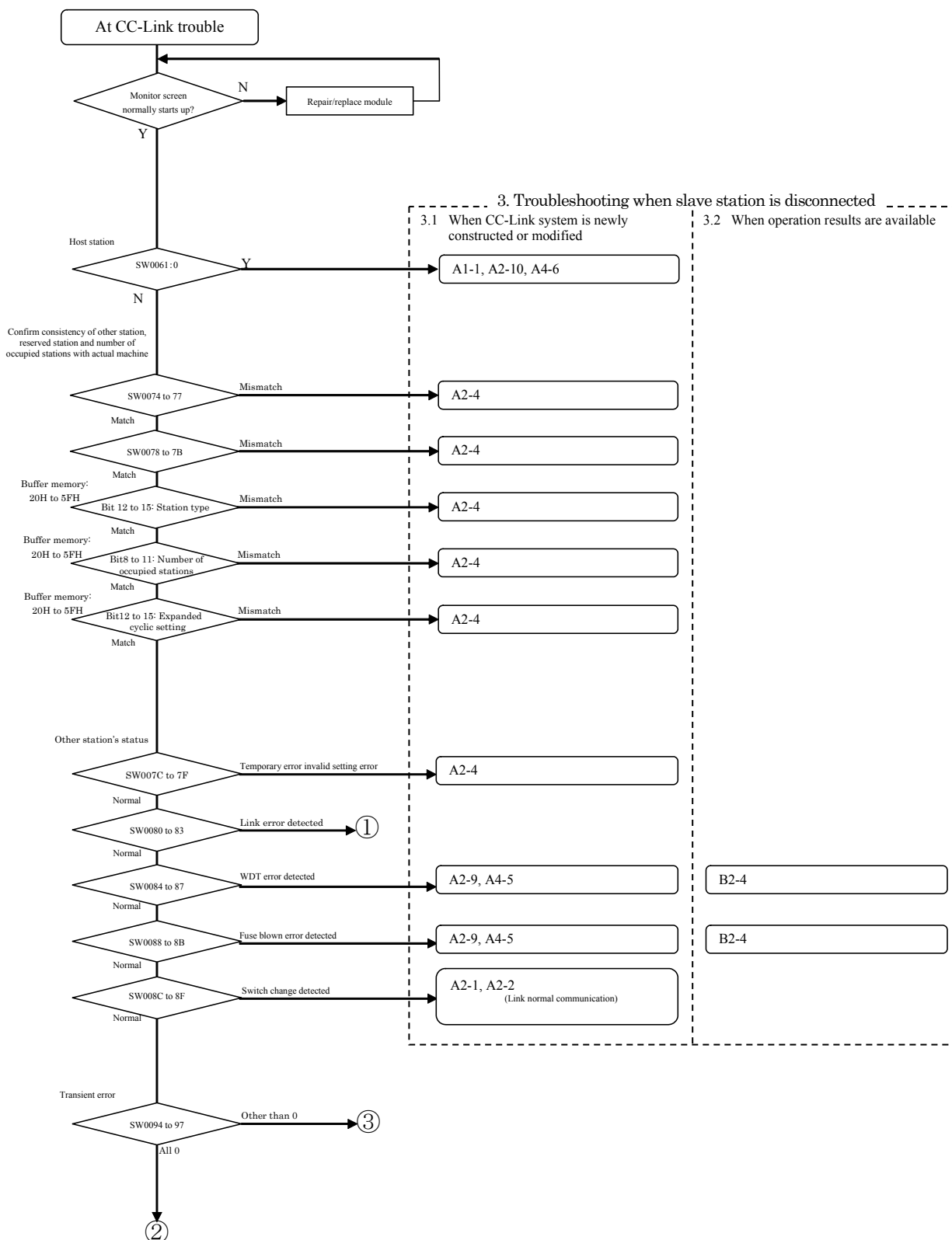

Judge the following states with the LED ON status.

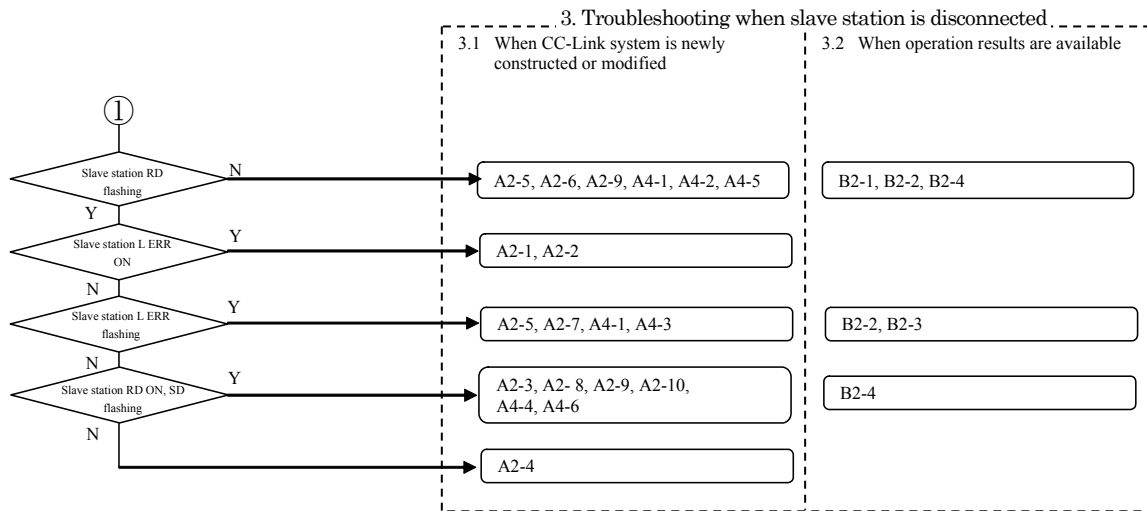

Judge the following states with the link data communication state.

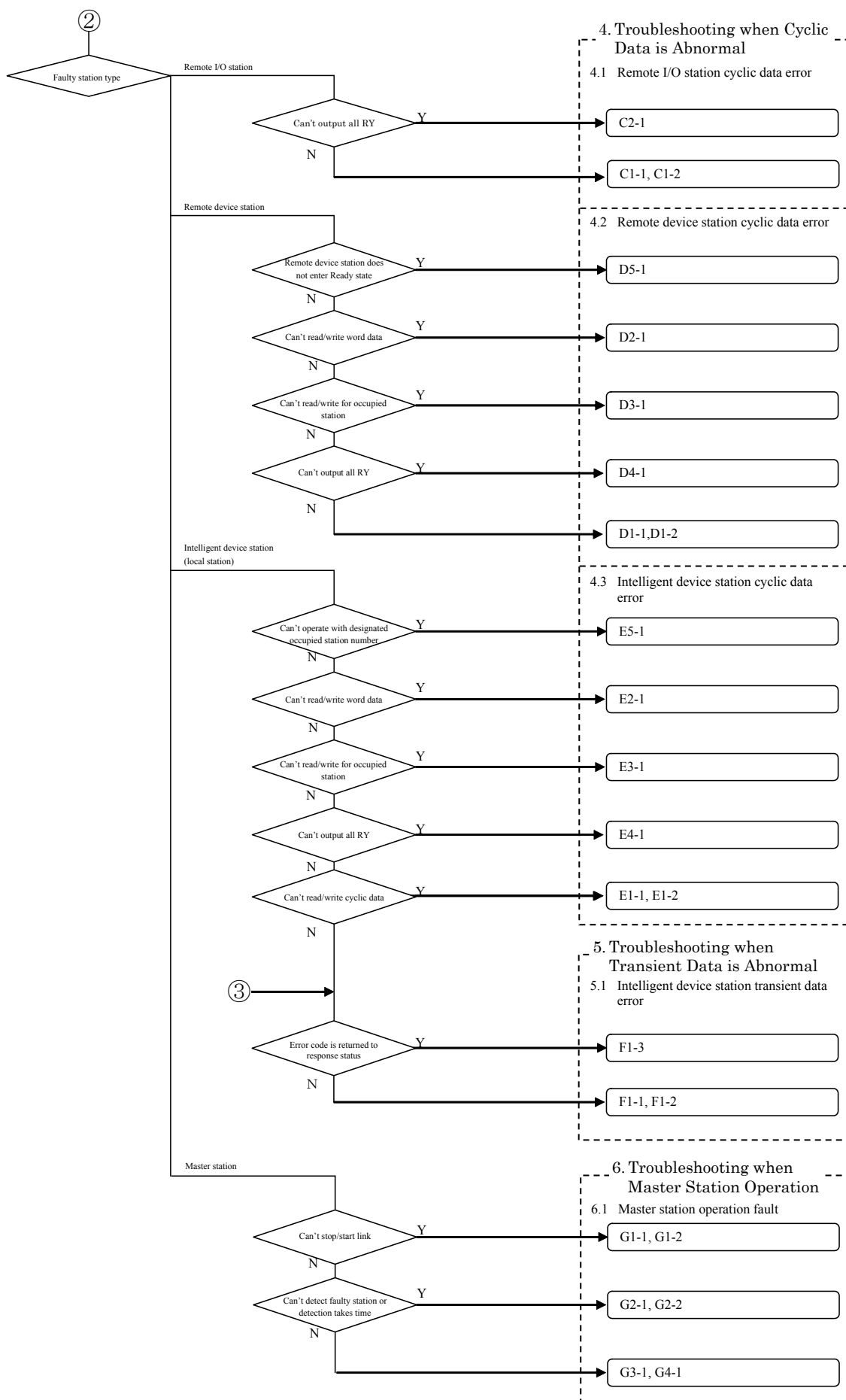



## 2.4. Confirming with Master Station and Slave Station LEDs

A peripheral device such as GX Developer is required to complete troubleshooting when the parameter setting or communication data is faulty. When the cable, etc., is faulty, the symptoms can be easily confirmed with the LED ON status even if a peripheral device cannot be prepared. The procedures are explained below.

### 2.4.1. LED displays

An LED is mounted on the master module and slave station. Basic examples of the LED mounted on each master module and slave station are shown below.

Refer to the manual of each device for details.

Master module LED

Q PLC

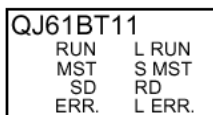
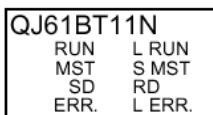

L PLC

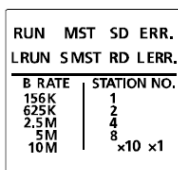

QnA PLC

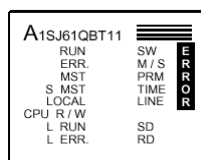
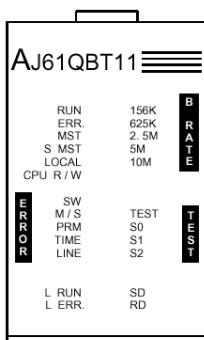

A PLC

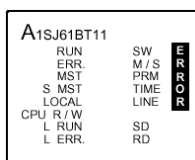
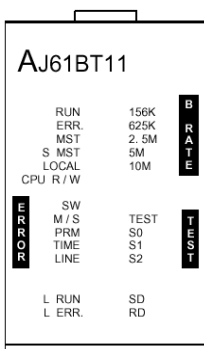

FX PLC

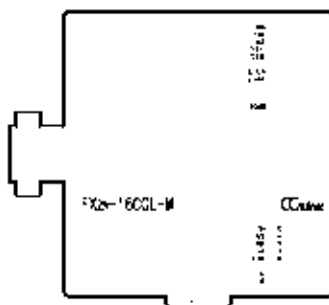
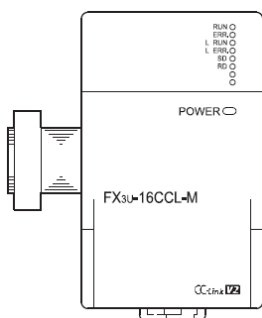

## Slave station LED

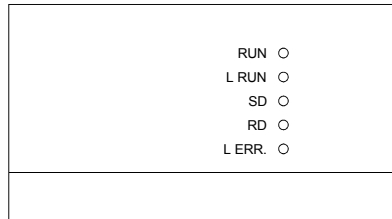

In this section, the symptoms are confirmed with the shaded LEDs mounted commonly for each station. The other LEDs are not used.

LED name	Details	Remarks
RUN	ON: When module is normal OFF: At watch dog timer error	
ERR.	ON: Communication fault in all stations Flashing: Communication fault in one station	QJ61BT11(N) also turns ON when the following types of error occur: <ul style="list-style-type: none"> <li>• Incorrect switch setting</li> <li>• Duplicate master station in same line</li> <li>• Incorrect parameter setting</li> <li>• Activation of data link monitor timer</li> <li>• Broken cable</li> </ul> The transmission path is affected by noise, etc.
MST	ON: Operating as master station (in data link control)	
S MST	ON: Operating as standby master station (standing by)	
LOCAL	ON: Set as local station	
CPU R/W	ON: Communicating with PLC CPU	Mounted on AJ61QBT11, A1SJ61QBT11, AJ61BT11, A1SJ61BT11, and FX2N-16CCL-M.
SW	ON: Switch setting is incorrect	
M/S	ON: Master station already exists on same line Flashing: Occupied station number duplicated (Excluding duplication of head station No.)	
PRM	ON: Parameter setting is incorrect	
TIME	ON: No response from any station because cable is disconnected or transmission path is affected by noise.	
LINE	ON: Cable is disconnected, or transmission path is affected by noise.	
L RUN	ON: Executing data link	
L ERR.	ON: Communication error (host station) Flashing at set interval: Switch setting was changed during power ON Flashing at irregular interval: Terminator is not attached, or module or CC-Link dedicated cable is affected by noise.	
156K	ON: When transmission speed is set to "156kbps"	Mounted only on LJ61QBT11, AJ61QBT11, and AJ61BT11.
625K	ON: When transmission speed is set to "625kbps"	
2.5M	ON: When transmission speed is set to "2.5Mbps"	
5M	ON: When transmission speed is set to "5Mbps"	
10M	ON: When transmission speed is set to "10Mbps"	
TEST	ON: Executing offline test	Mounted only on AJ61QBT11 and AJ61BT11.
TEST1,2	Display of test results	Mounted only on FX2N-16CCL-M.
S0 to 2	(Not used)	
SD	ON: Sending data	
RD	ON: Receiving data	

### 2.4.2. Symptom Confirmation Flow Chart

This section explains the procedures for confirming the symptoms with the master station and slave station LEDs. Confirming the symptoms with the following flow chart will lead to the number of a confirmation item in Chapters 3 to 5. Check the cause of the trouble with the confirmation method indicated with the corresponding confirmation item number, and process the state. Confirmation item numbers in parentheses in the flow chart require a peripheral device such as GX Works2/GX Developer to confirm the trouble.

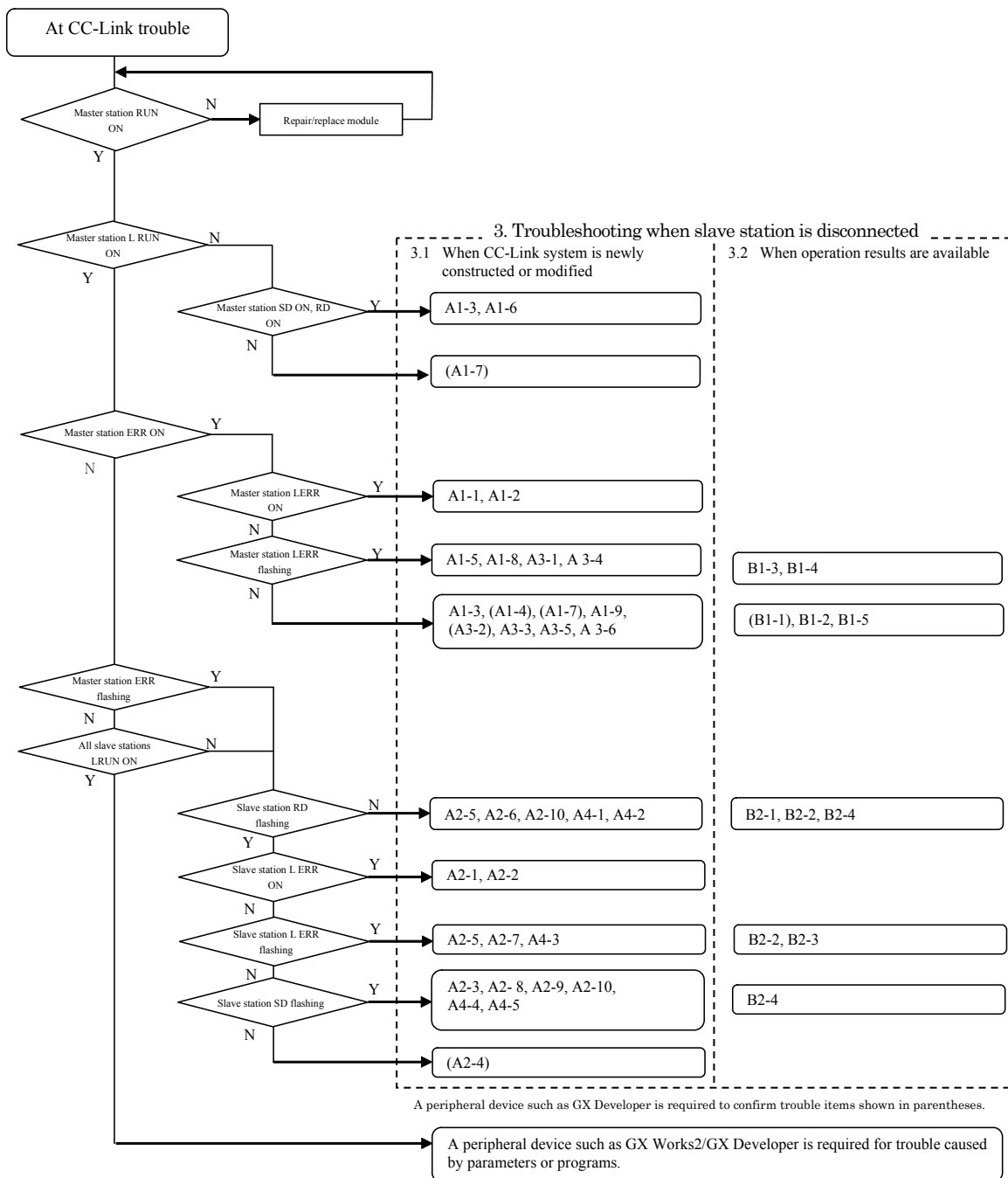

### 3. Troubleshooting when slave station is disconnected

This section explains the troubleshooting methods for when the slave station is disconnected. The Details to Check, Confirmation Method, and Actions correspond to the confirmation item number found with the Symptom Confirmation Flow Chart in Chapter 2.

The methods are divided into section 3.1 When CC-Link system is newly constructed or modified, and section 3.2 When operation results are available.

#### 3.1. When CC-Link System is newly constructed or modified

	Trouble	Confirmation item	Details to Check	Confirmation Method	Action	
A1	The entire system cannot be linked	A1-1	Station number Is the master station number set to a number other than 0? (Excluding when using QnA or A PLC remote I/O net mode.)	Check the station number switch for the master station. Check that the MST LED is ON.	Set the master station number to 0.	
		A1-2	Transmission speed Is the transmission speed outside of the setting range or different for the master station and slave station?	Check the transmission speed set for each station.	Correctly set the transmission speed.	
		A1-3	Mode, switch Is the master station in a mode other than the online mode? Is the master station switch setting correct? Is there an error at the master station?	Check the master station mode setting.	Set to the online mode.	
				Check the master station setting state (SW006A).	Set to switch correctly.	
		A1-4	Parameter setting Is the parameter information area being used correct? Are the network parameters (number of modules, station information, etc.) correct? Is there an error at the master station? • GX Works2/GX Developer network parameters (Q, L PLC) • Dedicated instructions (Q, QnA, A PLC) • Buffer memory/E <sup>2</sup> PROM (QnA, A, FX PLC) • Utility (Personal computer board)	Is the parameter information area being used correct?	Check the parameter information (SW0067).	Use the correct parameter information area.
				Are the network parameters (number of modules, station information, etc.) correct? Is there an error at the master station? • GX Works2/GX Developer network parameters (Q, L PLC) • Dedicated instructions (Q, QnA, A PLC) • Buffer memory/E <sup>2</sup> PROM (QnA, A, FX PLC) • Utility (Personal computer board)	• Check the master station's PLC CPU network parameters with GX Works2/GX Developer. (Q, L PLC) (Cannot be set for Q4ARCPU) • Check the values set in the parameter area on the buffer memory. (QnA, A PLC) • Check the parameter setting with the Utility. (Personal computer board.)	Correctly set the network parameters. Format the PLC memory once, and then write the parameters.
					Check the host station parameter status (SW0068). Check the mounting state (SW0069). Check the total number of stations (SW0070). Check the maximum number of communicating stations (SW0071). Check the number of connected modules (SW0072). Check whether the station numbers are duplicated. (SW0098 to 9B). Check the mounting and parameter consistency state (SW009C to 9F). Check the CC-Link Ver. mounting/parameter consistency state (SW0144 to 147). Check the reserved station state (SW0074 to 77).	
				Are the settings correct? (Q, L PLC: Automatic CC-Link start)	Is a value set for the intelligent function module switch?	Invalidate the GX Works2/GX Developer's intelligent function module switch setting.
				Are the settings correct? (Q, L PLC: When executing dedicated instruction RLPASET)	Is the intelligent function module switch 4 setting correct?	Set the GX Works2/GX Developer intelligent function module switch 4 to 0100H.
Are the various settings for the RLPASET instruction correct? Was the parameter setting method changed without turning the PLC system power OFF and ON or resetting the CPU?	Correctly set the network parameters. Turn the PLC system power OFF and ON or reset the PLC CPU.					
Do the connections or settings exceed the master station's specifications? (FX PLC)	Check the contents of the buffer memory (BFM#1DH). "1": The settings exceed the connectable specifications range.			Set within the specified range.		
Registering parameters to E <sup>2</sup> PROM	Is the parameter registration request (YnA) to the E <sup>2</sup> PROM ON? Has an error occurred? (QnA, A, FX PLC)	Check the PLC program. Check the E <sup>2</sup> PROM registration status (SW0090).	Correctly set the network parameters, and turn the parameter registration request (YnA) to the E <sup>2</sup> PROM ON.			

	Trouble	Confirmation item	Details to Check	Confirmation Method	Action	
A1	The entire system cannot be linked	A1-5	Cables, etc.	Check the cables for disconnections, short-circuits, incorrect wiring, connection faults, noncompliance with specifications (transmission distance, station-to-station distance, transmission cable, use of different cable types, FG connection).	Check whether the cable between the master station and slave station is disconnected.*	Correctly connect the cable.
				Terminator	Check that the terminator is connected to both ends of the CC-Link system.	Connect to both ends of the CC-Link system.
				Check that the terminator matching the applicable cable type is correctly connected.*	Connect a terminator that matches the applicable cable type.	
		A1-6	Starting the link	Is the PLC in the RESET state? (When setting GX Works2/GX Developer network parameters)	Check whether the PLC's RESET switch is set to RESET.	Set the RESET switch position to the middle.
				Is CC-Link started up automatically?	Is a value set for the intelligent function module switch?	Invalidate the GX Works/GX Developer's intelligent function module switch setting.
				Is a program running (dedicated instruction, buffer memory: Yn6, E <sup>2</sup> PROM: Yn8)?	Check the PLC stop, error, and program operation (dedicated instruction, Yn6/Yn8 startup).	Set the PLC to RUN and correctly start up.
		A1-7	PLC CPU/controller confirmation	Is there an error in the master station's PLC CPU?	Check the PLC CPU error code.	Process the PLC CPU error. Refer to the PLC Manual.
					Is the module recognized?	Make sure that the CC-Link module is correctly recognized. Refer to the PLC Manual.
				Is the personal computer (personal computer board) faulty?	Is the board recognized?	Make sure that the CC-Link board is recognized. Refer to the Personal Computer Manual.
					Remove the other option boards, and check whether operation starts up normally with just the CC-Link personal computer board.	Review the settings for the other operation board's I/O, IRQ, and memory address.
					Is there a driver message in the control tool's event viewer?	Process the error event message. Refer to the Personal Computer Board Manual.
				Is the sequence scan long? (Synchronous mode)	Does the sequence scan time exceed the allowable value? 10Mbps : 50ms 5Mbps : 50ms 2.5Mbps : 100ms 625kbps : 400ms 156kbps : 800ms	Set to the asynchronous mode, or delay the transmission speed.
		A1-8	Noise	Is noise imposed on the transmission cable?	Is the power cable laid near the transmission cable?	Separate the transmission cable and power cable as far as possible when wiring. (Recommendation: Separate by 10cm or more)
					Is the FG separated from the power system GND?	Separate the FG and power system GND.
					Lower the transmission speed and confirm the frequency of occurrence.	Provide measures against noise. Lower the transmission speed.
A1-9	Master station fault	Is the master module faulty?	Are normal operations restored when master module is replaced?	Repair or replace the master station.		

\*If the cause cannot be pinpointed with a visual check, refer to Chapter 7 Troubleshooting when Indistinct Error Occurs.

	Trouble	Confirmation item	Details to Check	Confirmation Method	Action	
A2	There is a station that cannot be linked	A2-1	Station number	Is the faulty station's station number setting correct?	Check the station number setting for the corresponding station.	Correctly set the station number.
		A2-2	Transmission speed	Is the transmission speed setting for the faulty station correct?	Check the corresponding station's transmission speed.	Set the transmission speed correctly.
		A2-3	Online status (slave station)	Is the faulty station's CC-Link interface set to the online status?	Check the status of the faulty station.	Set to the online status.
		A2-4	Parameter setting	Is the parameter information area being used correct?	Check the parameter information (SW0067).	Use the correct parameter information area.
				Are the network parameters (number of modules, station information, etc.) correct? •Are the network parameters (number of modules, station information, etc.) correct? •GX Works2/GX Developer network parameters (Q, L PLC) •Dedicated instructions (Q, QnA, A PLC) •Buffer memory/E <sup>2</sup> PROM (QnA, A, FX PLC) •Utility (Personal computer board)	<ul style="list-style-type: none"> <li>• Check the master station's PLC CPU network parameters with GX Works2/GX Developer. (Q, L PLC) (Cannot be set for Q4ARCPU)</li> <li>• Check the values set in the parameter area on the buffer memory. (QnA, A PLC)</li> <li>• Check the parameter setting with the Utility. (Personal computer board.)</li> </ul>	<ul style="list-style-type: none"> <li>Correctly set the network parameters.</li> <li>Format the PLC memory once, and then write the parameters.</li> </ul>
				Are the settings correct? (Q, L PLC: Automatic CC-Link start)	Is a value set for the intelligent function module switch?	Invalidate the GX Works2/GX Developer's intelligent function module switch setting.
				Are the settings correct? (Q, L PLC: When executing dedicated instruction RLPASET)	Is the intelligent function module switch 4 setting correct?	Set the GX Works2/GX Developer intelligent function module switch 4 to 0100H.
					Are the various settings for the RLPASET instruction correct?	Correctly set the network parameters.
					Was the parameter setting method changed without turning the PLC system power OFF and ON or resetting the CPU?	Turn the PLC system power OFF and ON or reset the PLC CPU.
				Do the connections or settings exceed the master station's specifications? (FX PLC)	Check the contents of the buffer memory (BFM#1DH).	Set within the specified range.
				Registering parameters to E <sup>2</sup> PROM	Is the parameter registration request (YnA) to the E <sup>2</sup> PROM ON? Has an error occurred? (QnA, A, FX PLC)	Check the PLC program. Check the E <sup>2</sup> PROM registration status (SW0090).
		A2-5	Cables, etc.	Check the cables for disconnections, short-circuits, incorrect wiring, connection faults, noncompliance with specifications (transmission distance, station-to-station distance, transmission cable, use of different cable types, terminator, FG connection).	Check the cable for the faulty station.* Check whether the faulty station's SD and RD LEDs are flashing.	Correctly connect the cable.
					If there are several faulty stations up to the end of the transmission path, check the cable of the station closest to the master station. (Several stations) *	Correctly connect the cable.
		A2-6	Supply power (for communication)	Power OFF, outside of voltage working range	Is the power for the faulty station ON?	Turn the power ON.
Is the supplied voltage within the specified range?	Set the supplied voltage within the specified range.					

\*If the cause cannot be pinpointed with a visual check, refer to Chapter 7 Troubleshooting when Indistinct Error Occurs.

	Trouble	Confirmation item	Details to Check	Confirmation Method	Action	
A2	There is a station that cannot be linked	A2-7	Noise	Is noise imposed on the transmission cable?	Is the power cable laid near the transmission cable?	Separate the transmission cable and power cable as far as possible when wiring. (Recommendation: Separate by 10cm or more)
				Is the FG separated from the power system GND?	Separate the FG and power system GND.	
				Lower the transmission speed and confirm the frequency of occurrence.	Provide measures against noise. Lower the transmission speed.	
		A2-8	Start up	Is the startup order correct?	Change the start up order of the faulty station, and check.	Start up following the procedures given in the manual for the corresponding station.
		A2-9	Slave station fault	Is the slave station faulty?	Is normal operation possible when faulty slave station is replaced?*	Repair or replace the faulty slave station.
A2-10	Standby master station	Is the standby master station controlling the data link?	Use the master station's CC-Link Diagnostics to check whether the master station switching station is set to the standby master station.	Startup the system again and control with the master station.		
A3	The entire system cannot be linked sometimes.	A3-1	Cables, etc.	Is there a cable/connector contact fault? Is the specified range exceeded?	Check the cable between the master station and slave station.*	Correctly connect the corresponding cable.
		A3-2	Parameter setting	Is the sequence scan long? (Synchronous mode)	Does the sequence scan time exceed the allowable value? 10Mbps : 50ms 5Mbps : 50ms 2.5Mbps : 100ms 625kbps : 400ms 156kbps : 800ms	Set to the asynchronous mode, or delay the transmission speed.
		A3-3	Supply power (for communication)	Is the power OFF or outside of the voltage working range?	Check the power of the master station and all slave stations.	Set the supplied voltage within the specified range.
		A3-4	Noise	Is noise imposed on the transmission cable?	Is the power cable laid near the transmission cable?	Separate the transmission cable and power cable as far as possible when wiring. (Recommendation: Separate by 10cm or more)
					Is the FG separated from the power system GND?	Separate the FG and power system GND.
					Lower the transmission speed and confirm the frequency of occurrence.	Provide measures against noise. Lower the transmission speed.
A3-5	Master station fault	Is the master module faulty?	Are normal operations restored when master module is replaced?	Repair or replace the master station.		
A3-6	Link stop	Was the data link stop instruction inadvertently executed?	Is data link stop (SB0002) ON?	Do not turn data link stop (SB0002) ON. Make sure that multiple devices do not read out SB0002.		
A4	There is a station that cannot be linked sometimes.	A4-1	Cables, etc.	Check the cables for disconnections, short-circuits, incorrect wiring, connection faults, noncompliance with specifications (transmission distance, station-to-station distance, transmission cable, use of different cable types, terminator, FG connection).	Check the cable for the faulty station.*	Correctly connect the corresponding cable.
					If there are several faulty stations up to the end of the transmission path, check the cable of the station closest to the master station.*	Correctly connect the corresponding cable.
					Is the correct terminator connected?*	Connect terminators that match the applicable cable type to both ends of the CC-Link system.
		A4-2	Supply power (for communication)	Power OFF, outside of voltage working range	Check the power for the faulty station.	Set the supplied voltage within the specified range.
		A4-3	Noise	Is noise imposed on the transmission cable?	Is the power cable laid near the transmission cable?	Separate the transmission cable and power cable as far as possible when wiring. (Recommendation: Separate by 10cm or more)
					Is the FG separated from the power system GND?	Separate the FG and power system GND.
					Lower the transmission speed and confirm the frequency of occurrence.	Provide measures against noise. Lower the transmission speed.
A4-4	Start up	Is the startup order correct?	Change the start up order of the faulty station, and check.	Start up following the procedures given in the manual for the corresponding station.		
A4-5	Slave station fault	Is the slave station faulty?	Is normal operation possible when faulty slave station is replaced?*	Repair or replace the faulty slave station.		
A4-6	Standby master station	Is the standby master station controlling the data link?	Use the master station's CC-Link Diagnostics to check whether the master station switching station is set to the standby master station.	Startup the system again and control with the master station.		

\*If the cause cannot be pinpointed with a visual check, refer to Chapter 7 Troubleshooting when Indistinct Error Occurs.

### 3.2. When operation results are available.

	Trouble	Confirmation item	Details to Check	Confirmation Method	Action	
B1	The entire system cannot be linked	B1-1	PLC CPU/ controller	Is there an error in the master station's PLC CPU?	Check the PLC CPU error code.	Take actions according to the PLC CPU error code. Refer to the PLC manual.
				Is the module recognized?		Make sure that the CC-Link module is correctly recognized. Refer to the PLC Manual.
				Is the personal computer (personal computer board) faulty?	Is the board recognized?	Make sure that the CC-Link board is recognized. Refer to the Personal Computer Manual.
				Remove the other option boards, and check whether operation starts up normally with just the CC-Link personal computer board.	Review the settings for the other operation board's I/O, IRQ, and memory address.	
				Is there a driver message in the control tool's event viewer?	Process the error event message. Refer to the Personal Computer Board Manual.	
		B1-2	Supply power (for communication)	Has the voltage dropped?	Check the power of the master station and all slave stations.	Set the supplied voltage within the specified range.
		B1-3	Cables, etc.	Is there a disconnection, short-circuit, or connection fault?	Check the cable connected between the master station and slave, and the cable connected between the slave stations for disconnections.*	Correctly connect the cable.
		B1-4	Noise	Is noise imposed on the transmission cable?	Is the power cable laid near the transmission cable?	Separate the transmission cable and power cable as far as possible when wiring. (Recommendation: Separate by 10cm or more)
					Is the FG separated from the power system GND?	Separate the FG and power system GND.
					Lower the transmission speed and confirm the frequency of occurrence.	Provide measures against noise. Lower the transmission speed.
B1-5	Master station fault	Is the master module faulty?	Are normal operations restored when master module is replaced?	Repair or replace the master station.		
B1-6	Link stop	Was the data link stop instruction inadvertently executed?	Is data link stop (SB0002) ON?	Do not turn data link stop (SB0002) ON. Using the sequence program, make sure that multiple devices do not read out SB0002.		
B2	There is a station that cannot be linked sometimes.	B2-1	Supply power (for communication)	Has the voltage dropped?	Check the power for the faulty station.	Set the supplied voltage within the specified range.
		If there are several faulty stations up to the end of the transmission path, check the cable of the station closest to the master station. (Several stations)	Correctly connect the corresponding cable.			
		B2-3	Noise	Is noise imposed on the transmission cable?	Is the power cable laid near the transmission cable?	Separate the transmission cable and power cable as far as possible when wiring. (Recommendation: Separate by 10cm or more)
					Is the FG separated from the power system GND?	Separate the FG and power system GND.
					Lower the transmission speed and confirm the frequency of occurrence.	Provide measures against noise. Lower the transmission speed.
		B2-4	Slave station fault	Is the slave station faulty?	Is normal operation possible when faulty slave station is replaced?*	Repair or replace the faulty slave station.

\*If the cause cannot be pinpointed with a visual check, refer to Chapter 7 Troubleshooting when Indistinct Error Occurs.



## 4. Troubleshooting when Cyclic Data is Abnormal

This section explains the troubleshooting methods for when a cyclic data error occurs. The Details to Check, Confirmation Method, and Actions correspond to the confirmation item number found with the Symptom Confirmation Flow Chart in Chapter 2.

### 4.1. Remote I/O station cyclic data error

	Trouble	Confirmation item	Details to Check	Confirmation Method	Action	
C1	The cyclic data cannot be read/written	C1-1	Refresh data area	Is auto refresh correctly set? (RX, RY, SB, SW)	Is the auto refresh setting range correct?	Correctly set the auto refresh parameter.
				Are the devices duplicated with those devices used in the sequence programs or other networks? (The 8-point or 16-point I/O module is also 32 points (fixed) per station: Excluding when QJ61BT11N remote I/O station is set.)	Are the devices duplicated with those devices used in the sequence programs or other networks? (The 8-point or 16-point I/O module is also 32 points (fixed) per station: Excluding when QJ61BT11N remote I/O station is set.)	Set the refresh device so that it is not duplicated with devices used in the sequence program or other networks.
				Are refresh using the auto refresh parameter setting and refresh using the FROM/TO instruction executed simultaneously?	Check the sequence program. Check the auto refresh parameter setting.	Execute refresh only with the auto refresh parameter setting or FROM/TO instruction.
				Is the correct address in the buffer memory read/written? (RX, RY, SB, SW)	Check the sequence program. (The 8-point or 16-point I/O module is also 32 points (fixed) per station: Excluding when the QJ61BT11N remote I/O station's number of points is set.)	Access the address for the corresponding master station. Set the refresh device so that it is not duplicated with devices used in the sequence program or other networks.
		C1-2	Parameter setting	Is the reserved station setting correct?	Is the bit set to "1" for the corresponding station which cannot read/write the reserved station designation status? (SW0074 to 77).	Cancel the reserved station setting.
				Do the connections or settings exceed the master station's specifications? (FX PLC)	Check the contents of the buffer memory (BFM#1DH).	Set within the specified range.
C2	RY is not output	C2-1	Refresh instruction	Is a refresh instruction (Yn0) issued? (When setting parameters with QnA, A PLC FROM/TO instruction)	Check whether the refresh instruction Yn0 is "ON".	Turn the refresh instruction Yn0 "ON".
				Is a refresh instruction (SB0003) issued? (Q, L PLC)	Check whether the refresh instruction SB0003 is "ON".	Turn the refresh instruction SB0003 "ON".

## 4.2. Remote device station cyclic data error

	Trouble	Confirmation item	Details to Check	Confirmation Method	Action	
D1	The cyclic data cannot be read/written	D1-1	Refresh data area	Is auto refresh correctly set? (RX, RY, RWw, RWr, SB, SW)	Is the device duplicated with devices used in the sequence program or other networks?	Set so that the device is not duplicated with the devices used in the sequence program or other networks.
				Is the buffer memory correctly accessed? (RX, RY, RWw, RWr, SB, SW)	Is the device duplicated with devices used in the sequence program or other networks?	Access the address for the corresponding station. Set so that the device is not duplicated with the devices used in the sequence program.
		D1-2	Parameter setting	Is the reserved station setting correct?	Check whether the reserved station is not set, or whether the bit is set to "1" for the station corresponding to SW0074 to 77.	Cancel the reserved station setting.
				Do the connections or settings exceed the master station's specifications? (FX PLC)	Check the contents of the buffer memory (BFM#1DH).	Set within the specified range.
D2	The word data cannot be read/written	D2-1	Parameter setting	Is the consistency with the parameters correct?	Is remote I/O station is mounted in the corresponding station number?	Match the parameters with the actually mounted model.
D3	Cannot read/write the lower area of the cyclic data	D3-1	Parameter setting	Is the consistency with the parameters correct?	Is a device with a small occupied station number mounted in the corresponding station number?	Match the parameters with the actually mounted occupied station number.
D4	RY is not output	D4-1	Refresh instruction	Is a refresh instruction (Yn0) issued? (When setting parameters with QnA, A PLC FROM/TO instruction)	Check whether the refresh instruction Yn0 is "ON".	Turn the refresh instruction Yn0 "ON".
				Is a refresh instruction (SB0003) issued? (Q, L PLC)	Check whether the refresh instruction SB0003 is "ON".	Turn the refresh instruction SB0003 "ON".
D5	Remote device station does not enter Ready (Xn1B: ON) state	D5-1	Initial setting	Are the initial settings (Xn18) completed?	Is the initial data request process request (Xn18) OFF?	Execute the initial data process.
				Is the remote device station's initialization procedure registration correctly completed? (Q, L PLC)	Check whether the remote device station initialization procedure registration is being executed (SB000D is ON). Check the remote device station initialization procedure registration instruction results (SW005F).	Review the remote device station initialization procedure registration.
				Are the remote device station's initial settings correct?	Check the parameters. Check the sequence program.	Correctly set the initial settings for the remote device station.

### 4.3. Intelligent device station (local station) cyclic data error

	Trouble	Confirmation item	Details to Check	Confirmation Method	Action	
E1	The cyclic data cannot be read/written	E1-1	Refresh data area	Is auto refresh correctly set? (RX, RY, RWw, RWr, SB, SW)	Is the device duplicated with devices used in the sequence program or other networks?	Set so that the device is not duplicated with the devices used in the sequence program or other networks.
				Is the buffer memory correctly accessed? (RX, RY, RWw, RWr, SB, SW)	Are the devices on the master station side duplicated with those used in the sequence programs or other networks?	Access with the correct address on the master station side. Set so that the device is not duplicated with the devices used in the sequence program.
				Are the devices on the local station side duplicated with those used in the sequence programs or other networks?	Access with the correct address on the local station side. Set so that the device is not duplicated with the devices used in the sequence program.	
		E1-2	Parameter setting	Is the reserved station setting correct?	Check whether the reserved station is not set, or whether the bit is set to "1" for the station corresponding to SW0074 to 77.	Cancel the reserved station setting.
E2	The word data cannot be read/written	E2-1	Parameter setting	Is the consistency with the parameters correct?	Is remote I/O station is mounted in the corresponding station number?	Match the parameters with the actually mounted model.
E3	Cannot read/write the lower area of the cyclic data	E3-1	Parameter setting	Is the consistency with the parameters correct?	Is a device with a small occupied station number mounted in the corresponding station number?	Match the parameters with the actually mounted occupied station number.
E4	RY is not output (A/QnA PLC)	E4-1	Refresh instruction	Is a refresh instruction (Yn0) issued? (When setting parameters with QnA, A PLC FROM/TO instruction)	Check whether the refresh instruction Yn0 is "ON".	Turn the refresh instruction Yn0 "ON".
E5	The local station is not running with the designated occupied station number	E5-1	Function version	Is the module version compatible with a 2 or 3 station occupation setting?	Is a master module other than the following being used? <ul style="list-style-type: none"> <li>• QJ61BT11 (Function version A)</li> <li>• AJ61BT11, AJ61QBT11 (Hardware version E and earlier)</li> <li>• A1SJ61BT11, A1SJ61QBT11 (Hardware version F and earlier)</li> </ul>	Use a master module with a compatible version. Set to 1 station occupation or 4 station occupation.

## 5. Troubleshooting when Transient Data is Abnormal

This section explains the troubleshooting methods for when a transient data error occurs. The Details to Check, Confirmation Method, and Actions correspond to the confirmation item number found with the Symptom Confirmation Flow Chart in Chapter 2.

### 5.1. Intelligent device station (local station) transient data error

Trouble		Confirmation item	Details to Check	Confirmation Method	Action	
F1	Transient error	F1-1	Refresh data area	Is there an error in the transient transmission (dedicated instruction)?	Is the correct address accessed?	Access the address for the corresponding station.
		F1-2	Parameter setting	Is the consistency with the parameters correct?	Is a remote I/O station or remote device station mounted?	Match the parameters with the actually mounted model.
				Is the mode (condition setting switch SW8) correct? (A PLC)	Is the mode set to the intelligent mode?	Set the condition setting switch (SW8) to the intelligent mode.
		F1-3	Response status	Error code 4B00H (handshake error)	Where the last two bits of RY accessed while executing the dedicated instruction?	Do not use the last two bits of RY.
				Error code B404H (response time up)	Check whether the response was returned from the request destination station within the monitor time.	Lengthen the monitor time setting value. If the error still occurs, check the request destination station, and check the cable.
				Are the transient transmission (dedicated instruction) contents correct?	Check the completion status error code when the dedicated instruction is executed.	Take actions according to the error code in the completion status.
				Is the automatic refresh parameter set? (QnA, A PLC)	Is the auto refresh parameter set with the RLPA instruction (A PLC) or GX Developer (QnA)?	Set the auto refresh parameter with the RLPA instruction (A PLC) or GX Developer (QnA).
Is there an error in the master station or intelligent device station?	Check the PLC CPU error code. Check the master station error code. Check the operation status of the master station and target intelligent device station.			Take actions according to the error code.		

## 6. Troubleshooting when Master Station Operation is Faulty

This section explains the troubleshooting methods for when the master station operation is faulty. The Details to Check, Confirmation Method, and Actions correspond to the confirmation item number found with the Symptom confirmation Flow Chart in Chapter 2.

### 6.1. Master station operation fault

	Trouble	Confirmation item	Details to Check	Confirmation Method	Action	
G1	The data link cannot be stopped or started.	G1-1	Data link stop	Is data link stop (SB0002) ON?	Check the sequence program. Check the auto refresh parameter.	Correctly set the SB area. Turn data link stop (SB0002) ON.
				Is an error occurring?	Check the data link stop results (SW0045).	Take actions according to the error code.
		G1-2	Data link restart	Is data link restart (SB0000) ON?	Check the sequence program. Check the auto refresh parameter.	Correctly set the SB area. Turn data link restart (SB0000) ON.
				Is an error occurring?	Check the data link restart results (SW0041).	Take actions according to the error code.
				Is the corresponding station disconnected?	Check the cable state visually or with a line test. Check the parameters. (For local station) Check the operation status of the PLC CPU for the corresponding station.	Review the corresponding station's cable and settings, and correctly start up.
G2	The faulty station cannot be detected.	G2-1	Faulty station detection	Is an error invalid station set?	Check the error invalid station status (SW0078 to 7B).	Disable the error invalid station setting.
				Check the temporary error invalid station status (SW007C to 7F).	Disable the temporary error invalid station setting.	
				Are the station numbers duplicated?	Check the station number setting.	Correctly set the station number.
	It takes time to detect the fault. Xn1 (local station data link status) does not turn ON, or the link special relay (SB)/link special register (SW) are not updated correctly (A PLC).	G2-2	Sequence program	Was the FROM/TO instruction executed in succession?	Does the program execute the FROM/TO instruction multiple times in one sequence scan? When the program contains the FROM/TO instruction, is the sequence scan time much shorter than the link scan time?	Access the buffer memory as a batch, and reduce the number of FROM/TO instructions. Add XnC as the b contact to the start contact of the FROM/TO instruction.
G3	A faulty station occurs because of the transmission speed	G3-1	Transmission speed, cable, etc.	Can the faulty station be pinpointed with the other station communication status (SW0080 to SW0083)?	Check the switch settings of the faulty station.	Match the transmission speed setting to the master station.
				Is correct communication possible when speed is set to a slow transmission speed such as 156kbps?	Check whether the cable is correctly wired.	Correctly wire the cable.
					Check whether the cable shield is grounded.	Ground the shield.
					Are terminators compatible with the applicable cable type connected to the last station at both ends of the CC-Link system?	Connect terminators compatible with the applicable cable type to both ends of the CC-Link system.
G4	When the power for multiple remote stations is turned OFF at 156kbps, the "L RUN" LED turns OFF temporarily.	G4-1	Transmission speed, parameter setting	Retry count setting	What is the set retry count?	Increase the transmission speed. Reduce the retry count.

## 7. Troubleshooting when Indistinct Error Occurs

This section explains the troubleshooting methods for when the trouble cannot be pinpointed with the previous sections, such as when communication fails for all stations while the system is operating, or the communication fails for a specific station.

### 7.1. Cause of faults

The following errors can cause a communication failure in all slave stations or in a specific station during system operation.

#### [Causes of faults when communication fails in all slave stations]

Faulty symptom	Possible cause of fault	Others
Communication fails in all slave stations	Communication fails when slave station is active *1	<ul style="list-style-type: none"> <li>• Master station reset→M/S error occurs.</li> <li>• Reset faulty slave station→Data link resumes.</li> </ul>
	Slave station hardware fault	<ul style="list-style-type: none"> <li>• Master station reset→M/S error occurs.</li> <li>• Remove communication terminal block from faulty slave station→Data link resumes.</li> </ul>
	Short-circuit between communication terminals (DA-DB)	A fault in the communication terminal section causes a communication path error, so the network status will not change even if the master station or slave station is reset.
	Terminator is disconnected	

\*1: An active state refers to the state in which the slave station is sending data. If the slave station fails in the active state, junk data will constantly flow to the line.

#### [Causes of faults when communication fails in specific stations]

Faulty symptom	Possible cause of fault	Others
Communication fails in specific station.	Slave station hardware fault	Remove communication terminal block from faulty slave station→Data link resumes.
	Short-circuit between communication terminal and ground terminal (DA-DG)	A fault in the communication terminal section causes a communication path error, so the network status will not change even if the master station or slave station is reset.
	Short-circuit between communication terminals (DA-DB)	
	Terminator is disconnected	
	Use in state exceeding cable restrictions	If a fault occurs in the communication path, the state will not change even if the master station or slave station is reset.
	Use in state exceeding T-branch restrictions	
	Reverse connection of communication terminal (DA-DB)	
	Internal disconnection of connection cable	

## 7.2. Pinpointing the detailed cause of the fault

Check the state with the following method to pinpoint the detailed cause listed in the previous section.

1. Visual check
2. Check using tester
3. Check using data link

The relation of these detailed causes and the check method for pinpointing the cause is given below.

Outline cause	Detailed cause	Check method
Slave station fault	Down in active state	Check with data link.
	Hardware fault	Check with tester. Check with data link.
Fault in communication terminal block section (wiring work fault)	Short-circuit between communication terminal and ground terminal (DA-DG, etc.).	Check with tester.
	Short-circuit between communication terminals (DA-DB)	
	Disconnected terminator	
Communication path (cable) fault	Use in state exceeding cable restrictions (use of different cable types, distance restrictions)	Check visually.
	Use in state exceeding T-branch restrictions (distance restrictions, transmission speed restrictions)	
	Reverse connection of communication terminal (DA-DB)	
	Internal disconnection of connection cable	Check with tester.

The outline procedure flow for this troubleshooting is shown below.

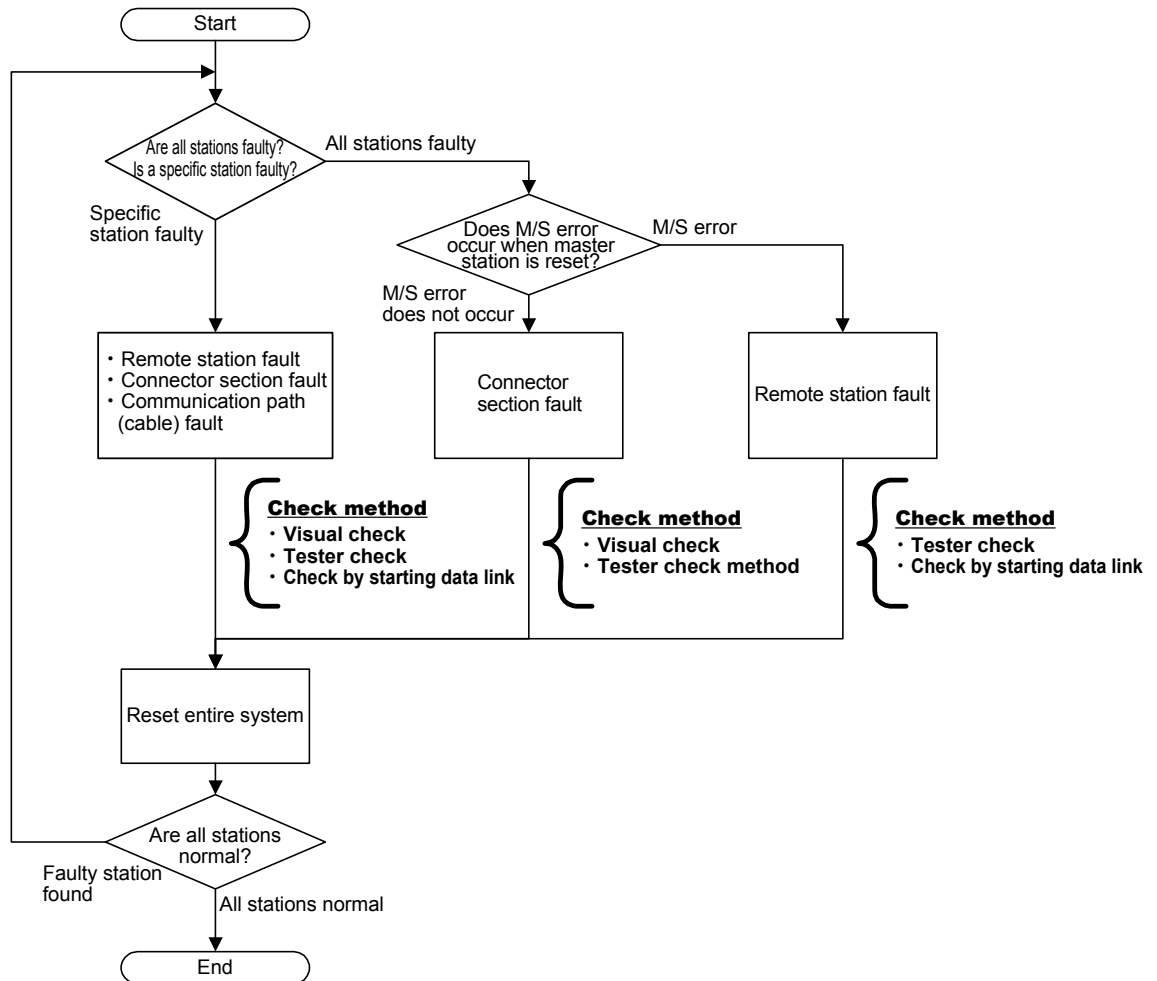

\*If a specific station is faulty, check all items. The line status must be correct to check using the data link, so check starting with (1) Visual check.

A communication error may be detected because of a fault in another station's module, or because of incorrect wiring, so if a fault is not found in a specific station, check all stations.

The checking methods given in the outline procedure are explained on the following pages.

### 7.3. Checking methods

#### 7.3.1. Visual check

This section explains the visual check methods.

<p><b>⚠ CAUTION</b></p> <p><b>Turn OFF the power for the master station and all slave stations before checking the CC-Link system.</b></p>
--

Check item	Check details	Action						
Check the cable laying state.	Is the overall length within the specified range?	Adjust the overall length according to the system configuration.						
	Is the station-to-station distance within the specified range?	Adjust the station-to-station distance according to the system configuration.						
	Are different types of cables used?	The Ver. 1.00 compatible cables used in the CC-Link 1 system must not be of different brands or types. Use only CC-Link dedicated cables, CC-Link dedicated high-performance cables, or Ver. 1.10 compatible CC-Link dedicated cables.						
	Are the T-branch connection main line/branch line distance restrictions within the specified range?	Adjust the distance as indicated in the manual.						
	Are the T-branch connection transmission speed restrictions within the specified range?	Construct the system with a speed of 625kbps or less.						
	Are DA and DB connected in reverse?	Connect the blue signal wire to DA, and the white signal wire to DB.						
Check the terminator.	Is the terminator connected between DA-DB? *2	Connect the terminator between DA-DB.						
	Is there a disconnection at the base of the terminator?	Replace with a new terminator.						
	Are terminators connected to the stations at both ends of the system?	Connect terminators to the stations at both ends of the system. If a terminator is connected to a station between the ends, remove it.						
	Does the resistance value match the cable type?	Connect a terminator that matches the cable type. <table border="1" style="width: 100%; margin-top: 5px;"> <thead> <tr> <th style="width: 60%;">Cable type</th> <th style="width: 40%;">Resistance value</th> </tr> </thead> <tbody> <tr> <td>CC-Link dedicated cable Ver. 1.10 compatible CC-Link dedicated cable</td> <td style="text-align: center;">110Ω</td> </tr> <tr> <td>CC-Link dedicated high-performance cable</td> <td style="text-align: center;">130Ω</td> </tr> </tbody> </table>	Cable type	Resistance value	CC-Link dedicated cable Ver. 1.10 compatible CC-Link dedicated cable	110Ω	CC-Link dedicated high-performance cable	130Ω
	Cable type	Resistance value						
CC-Link dedicated cable Ver. 1.10 compatible CC-Link dedicated cable	110Ω							
CC-Link dedicated high-performance cable	130Ω							
Is a terminator connected to the end of the T-branch's branch line?	Remove the terminator from the end of the T-branch's branch line.							

\*2: Connection of a terminator between DA-DB can also be confirmed with "Measurement of resistance value between communication terminals" using a tester on the next page.



### 7.3.2. Checking with a tester

This section explains the methods for checking with a tester.

**⚠ CAUTION**

**Turn OFF the power for the master station and all slave stations before checking the CC-Link system.**

Check item	Check details	Action
Measurement of resistance value between communication terminal and DG	1. Measure between DA and DG with the master station.	
	Measurement value between DA-DG	Judgment Cause
	Several ten k $\Omega$ to several hundred $\Omega$ *3	Normal -
	Several $\Omega$ *3	Faulty Short-circuit between DA-DG (including module's internal circuit)
	2. Measure between DB and DG with the master station.	
	Measurement value between DB-DG	Judgment Cause
Several ten k $\Omega$ to several hundred $\Omega$ *3	Normal -	
Several $\Omega$ *3	Faulty Short-circuit between DB-DG (including module's internal circuit)	
Measurement of resistance value between communication terminal and FG	3. Measure between DA and FG with the master station.	
	Measurement value between DA-FG	Judgment Cause
	Several k $\Omega$ or more*3	Normal -
	Several $\Omega$ *3	Faulty Short-circuit between DA-FG (including module's internal circuit)
	4. Measure between DB and FG with the master station.	
	Measurement value between DB-FG	Judgment Cause
Several k $\Omega$ or more*3	Normal -	
Several $\Omega$ *3	Faulty Short-circuit between DB-FG (including module's internal circuit)	
Measurement of resistance value between communication terminals	5. Measure between DA and DB with the master station. [When terminating resistance is 110 $\Omega$ ]	
	Measurement value between DA-DB	Judgment Cause
	0 $\Omega$ to approx. 50 $\Omega$ *3	Faulty Short-circuit between DA-DB (including module's internal circuit)
	Approx. 55 $\Omega$ *3	Normal -
	Approx. 60 $\Omega$ or more*3	Faulty Disconnected terminator Disconnected cable
	[When terminating resistance is 130 $\Omega$ ]	
	Measurement value between DA-DB	Judgment Cause
	0 $\Omega$ to approx. 60 $\Omega$ *3	Faulty Short-circuit between DA-DB (including module's internal circuit)
	Approx. 65 $\Omega$ *3	Normal -
	Approx. 70 $\Omega$ or more*3	Faulty Disconnected terminator Disconnected cable
Replace the short-circuited communication terminal block or the faulty module. Pinpoint the faulty module by <u>visually checking for incorrect wiring</u> . If incorrect wiring between the communication terminal and DG cannot be visually confirmed, the module is probably faulty. In this case, pinpoint the module <u>using the bisection check method</u> *4.		
Replace the short-circuited communication terminal block or the faulty module. <u>Use the bisection check method</u> to pinpoint the faulty module.		
Replace the short-circuited communication terminal block or the faulty module. <u>Use the bisection check method</u> to pinpoint the faulty module.		

\*3: The above resistance value will increase or decrease according to the measurement point and system scale.

\*4: Refer to the following page for details on the bisection method.

## Bisection method

The bisection method is a procedure used to pinpoint the faulty device by reducing the system configuration.

First split the entire system into half (first half, second half), and check whether there is a fault. Then, split the system in half (actually quarters) and again in half (actually eighths), and ultimately pinpoint the slave station where there is a fault.

The method of pinpointing the slave station using this bisection method in a system having 20 CC-Link slave stations is explained as an example. In this network configuration, the slave stations are connected adjacent to the master station in ascending order from station number 1 to station number 20.

- (1) Split the system in half. Disconnect the communication cable connected between station number 10 and station number 11, and connect a terminator to the station number 10 slave station. Then measure the master station's terminal block with a tester.
- (2) If the state is okay in step (1), the master station to station number 10 is normal. Disconnect the communication cable connected between station number 15 and station number 16 to split the system in half again. Connect a terminator to station number 11 and station number 15 at each end. Measure the terminal block at station number 11 with a tester.
- (3) If the state is not okay (N.G.) in step (1), there is a faulty station between the master station and station number 10. Disconnect the communication cable connected between station number 5 and station number 6, and connect the terminator to station number 5. Measure the master station's terminal block with a tester.
- (4) Repeat steps (1) to (3) to pinpoint the faulty slave station.
- (5) If the slave station cannot be pinpointed with the above procedure (if a normal data link is established with fewer stations), **pinpoint the faulty station with the check method using a data link** explained on the next page.

When this procedure is used, a measurement must be made six times for a system having 64 slave stations.

Structuring a system by separating the CC-Link network using repeater modules is recommended as a method to shorten this investigation procedure. (Refer to Appendix 3 for details.)

### 7.3.3. Checking with a data link

This section explains the method for checking with a data link. The investigation is carried out with data link running, so the user system parameters must be registered in the CPU.

**⚠ CAUTION**

**After the data link starts up, stop the PLC CPU to prevent incorrect outputs to the slave station during this investigation.**

Check item	Check details	Action																														
Turn entire system's power OFF and turn master station's power ON.	<p>Check the LED status.</p> <table border="1" style="width: 100%; border-collapse: collapse;"> <thead> <tr> <th style="width: 15%;">Station type</th> <th style="width: 25%;">LED ON status</th> <th style="width: 15%;">Status</th> <th style="width: 45%;">Cause</th> </tr> </thead> <tbody> <tr> <td rowspan="2" style="text-align: center;">Master station</td> <td>RUN ON LRUN ON ERR ON</td> <td style="text-align: center;">Normal</td> <td style="text-align: center;">—</td> </tr> <tr> <td>Other than the above</td> <td style="text-align: center;">Abnormal</td> <td style="text-align: center;">• Module fault</td> </tr> </tbody> </table>	Station type	LED ON status	Status	Cause	Master station	RUN ON LRUN ON ERR ON	Normal	—	Other than the above	Abnormal	• Module fault	The master station's module may be faulty. Replace the master station's module.																			
Station type	LED ON status	Status	Cause																													
Master station	RUN ON LRUN ON ERR ON	Normal	—																													
	Other than the above	Abnormal	• Module fault																													
Turn ON the power for all slave stations.	<p>Check the LED status.</p> <table border="1" style="width: 100%; border-collapse: collapse;"> <thead> <tr> <th style="width: 15%;">Station type</th> <th style="width: 25%;">LED ON status</th> <th style="width: 15%;">Status</th> <th style="width: 45%;">Cause</th> </tr> </thead> <tbody> <tr> <td style="text-align: center;">Master station</td> <td>RUN ON LRUN ON ERR OFF</td> <td rowspan="2" style="text-align: center;">Normal</td> <td rowspan="2" style="text-align: center;">—</td> </tr> <tr> <td style="text-align: center;">Slave station</td> <td>PW/RUN ON LRUN ON</td> </tr> </tbody> </table> <p><b>(A) When fault occurs in all stations</b></p> <table border="1" style="width: 100%; border-collapse: collapse;"> <thead> <tr> <th style="width: 15%;">Station type</th> <th style="width: 25%;">LED ON status</th> <th style="width: 15%;">Status</th> <th style="width: 45%;">Cause</th> </tr> </thead> <tbody> <tr> <td style="text-align: center;">Master station</td> <td>RUN ON LRUN ON <b>ERR ON</b></td> <td rowspan="2" style="text-align: center;">Abnormal</td> <td rowspan="2" style="text-align: center;">• Down in active state • Hardware fault</td> </tr> <tr> <td style="text-align: center;">Slave station</td> <td>PW/RUN ON <b>LRUN OFF</b></td> </tr> </tbody> </table> <p><b>(B) When fault occurs in a station</b></p> <table border="1" style="width: 100%; border-collapse: collapse;"> <thead> <tr> <th style="width: 15%;">Station type</th> <th style="width: 25%;">LED ON status</th> <th style="width: 15%;">Status</th> <th style="width: 45%;">Cause</th> </tr> </thead> <tbody> <tr> <td style="text-align: center;">Master station</td> <td>RUN ON LRUN ON <b>ERR flashing</b></td> <td rowspan="2" style="text-align: center;">Abnormal</td> <td rowspan="2" style="text-align: center;">• Hardware fault</td> </tr> <tr> <td style="text-align: center;">Slave station</td> <td>PW/RUN ON <b>LRUN ON</b></td> </tr> </tbody> </table>	Station type	LED ON status	Status	Cause	Master station	RUN ON LRUN ON ERR OFF	Normal	—	Slave station	PW/RUN ON LRUN ON	Station type	LED ON status	Status	Cause	Master station	RUN ON LRUN ON <b>ERR ON</b>	Abnormal	• Down in active state • Hardware fault	Slave station	PW/RUN ON <b>LRUN OFF</b>	Station type	LED ON status	Status	Cause	Master station	RUN ON LRUN ON <b>ERR flashing</b>	Abnormal	• Hardware fault	Slave station	PW/RUN ON <b>LRUN ON</b>	Replace the slave station that failed in the active station, or replace the slave station having the faulty hardware. <b>The methods for pinpointing the faulty station are explained on the next pages.</b>
Station type	LED ON status	Status	Cause																													
Master station	RUN ON LRUN ON ERR OFF	Normal	—																													
Slave station	PW/RUN ON LRUN ON																															
Station type	LED ON status	Status	Cause																													
Master station	RUN ON LRUN ON <b>ERR ON</b>	Abnormal	• Down in active state • Hardware fault																													
Slave station	PW/RUN ON <b>LRUN OFF</b>																															
Station type	LED ON status	Status	Cause																													
Master station	RUN ON LRUN ON <b>ERR flashing</b>	Abnormal	• Hardware fault																													
Slave station	PW/RUN ON <b>LRUN ON</b>																															

### (1) Pinpointing the faulty station when all stations are faulty

Pinpointing procedure	Details of check			
Turn OFF the power for the slave stations one station at a time.	Check the LED status.			
	Station type	LED ON status	Status	Explanation
	Master station	RUN ON LRUN ON <b><u>ERR. flashing</u></b>	Normal	The slave station for which the power was turned OFF last is faulty. Replace the slave station for which the power was turned OFF last, and then carry out <b>"Checking with a data link"</b> .
	Slave station (power ON)	PW/RUN ON <b><u>LRUN ON</u></b>		
	Slave station (power OFF)	PW/RUN OFF <b><u>LRUN OFF</u></b>		
	Master station	RUN ON LRUN ON <b><u>ERR. ON</u></b>	Abnormal	There is a faulty station among the powered slave stations. Turn OFF the power for the next slave station, and check the LED status.
	Slave station (power ON)	PW/RUN ON <b><u>LRUN OFF</u></b>		
	Slave station (power OFF)	PW/RUN OFF <b><u>LRUN OFF</u></b>		
If a normal state is not attained when the power is turned OFF one station at a time with the above procedure (when all stations are faulty even with a one-on-one connection), the slave station may be faulty because of a hardware fault. In this case, pinpoint the faulty station with method (2) <b>Pinpointing the faulty station when there is a faulty station</b> .				

### (2) Pinpointing the faulty station when there is a faulty station

When there is a faulty station, the CC-Link module's buffer memory must be monitored to pinpoint that faulty station. Connect a peripheral device, such as GX Works2/GX Developer, to the PLC CPU mounted on the master station, and carry out the following check while monitoring the buffer memory monitor.

Pinpointing procedure	Details of check			
Separate the slave station module and slave station module communication terminal block one station at a time.	Check the buffer memory			
	Buffer memory address	Value	Status	Explanation
	680H to 683H (other station data link status)	The bit corresponding to the separated station number is ON.	Normal	The slave station separated last is faulty. Replace the slave station separated last, and then check with <b>"Checking with a data link"</b> again.
	680H to 683H (other station data link status)	The bit for a station other than a separated station number is ON.	Abnormal	There is a faulty station among the powered slave stations. Remove the communication terminal block for the next slave station, and check the buffer memory value.

## Appendix

### Appendix 1 Restrictions According to CC-Link Version

#### Appendix 1.1 Maximum Overall Cable Length

(1) For Ver. 1.10

The relation of the transmission speed and maximum overall cable length when the entire system is configured of Ver. 1.10 compatible modules and cables is shown below.

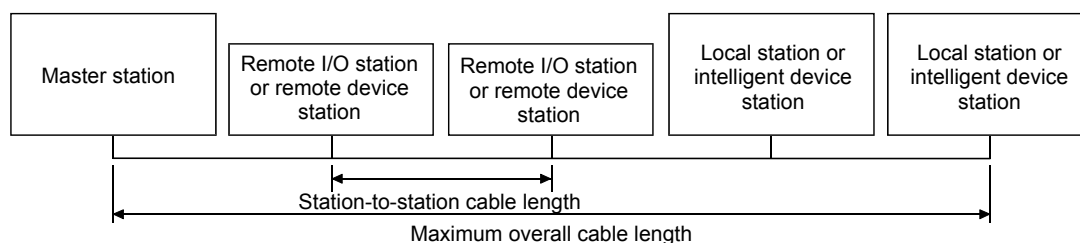

Ver. 1.10 compatible CC-Link dedicated cables (Using 110Ω terminator)

Transmission speed	Station-to-station cable length	Maximum overall cable length
156kbps	20cm or more	1200m
625kbps		900m
2.5Mbps		400m
5Mbps		160m
10Mbps		100m

(2) For Ver. 1.00

The relation of the transmission speed and maximum overall cable length is shown below.

(1) When system is configured only of remote I/O stations and remote device stations

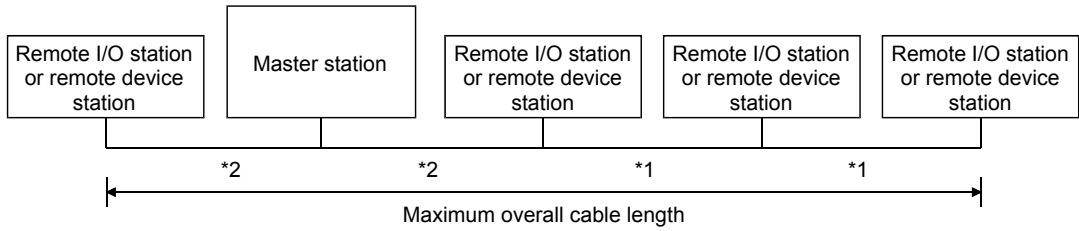

\*1 Station-to-station cable length for remote I/O station or remote device station

\*2 Station-to-station cable length between master station and previous/next stations

CC-Link dedicated cable (Using 110Ω terminator)

Transmission speed	Station-to-station cable length		Maximum overall cable length
	*1	*2	
156kbps	30cm or more	1m or more	1200m
625kbps			600m
2.5Mbps			200m
5Mbps	30cm to 59cm*		110m
	60cm or more		150m
10Mbps	30cm to 59cm*		50m
	60cm to 99cm*		80m
	1m or more	100m	

CC-Link dedicated high-performance cable (Using 130Ω terminator)

Transmission speed		Station-to-station cable length		Maximum overall cable length
		*1	*2	
156kbps		30cm or more	1m or more	1200m
625kbps				900m
2.5Mbps				400m
5Mbps				160m
10Mbps	Number of connected stations 1 to 32 stations	30cm to 39cm*	1m or more	100m
				Number of connected stations 33 to 48 stations
	40cm or more	100m		
	Number of connected stations 49 to 64 stations	30cm to 39cm*		
		40cm to 69cm*		30m
		70cm or more	100m	

\* When wiring the station-to-station cable between the remote I/O station or remote device station with this length at any one point, the length will be the maximum overall cable length given above.

**CAUTION**

Different brands and types of Ver. 1.00 compatible cables cannot be used. Contact the cable manufacturer for details on the relation of the transmission speed and maximum overall cable length for cables used at moving parts.

(Example) When 43 remote I/O stations and remote device stations are connected with a CC-Link dedicated high-performance cable at a transmission speed of 10Mbps  
The cable connecting the second and third stations is "35cm", so the maximum overall cable length is "80m".

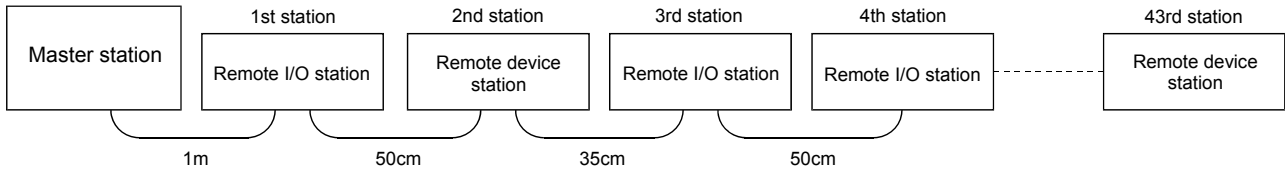

(2) When system is configured of remote I/O stations, remote device stations, local stations, and intelligent device stations

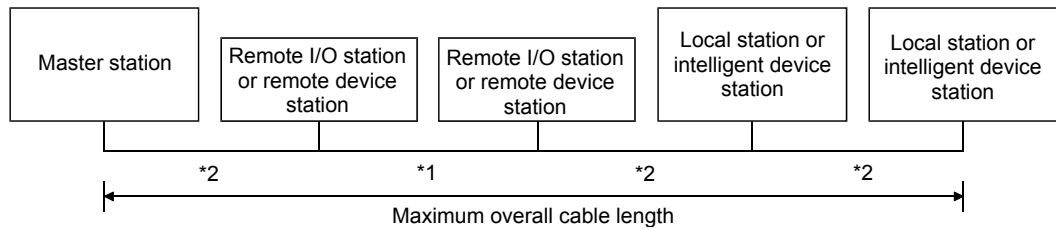

- \*1 Station-to-station cable length of remote I/O station or remote device station
- \*2 Station-to-station cable length between master/local station or intelligent device station and previous/next stations

CC-Link dedicated cable (Using 110Ω terminator)

Transmission speed	Station-to-station cable length		Maximum overall cable length
	*1	*2	
156kbps	30cm or more	2m or more	1200m
625kbps			600m
2.5Mbps			200m
5Mbps	30cm to 59cm*		110m
	60cm or more		150m
10Mbps	30cm to 59cm*		50m
	60cm to 99cm*	80m	
	1m or more	100m	

CC-Link dedicated high-performance cable (Using 130Ω terminator)

Transmission speed	Station-to-station cable length		Maximum overall cable length
	*1	*2	
156kbps	30cm or more	2m or more	1200m
625kbps			600m
2.5Mbps			200m
5Mbps	30cm to 59cm*		110m
	60cm or more		150m
10Mbps	70cm to 99cm*		50m
	1m or more	80m	

\* When wiring the station-to-station cable between the remote I/O station or remote device station with this length at any one point, the length will be the maximum overall cable length given above.

### (3) T-branch connection

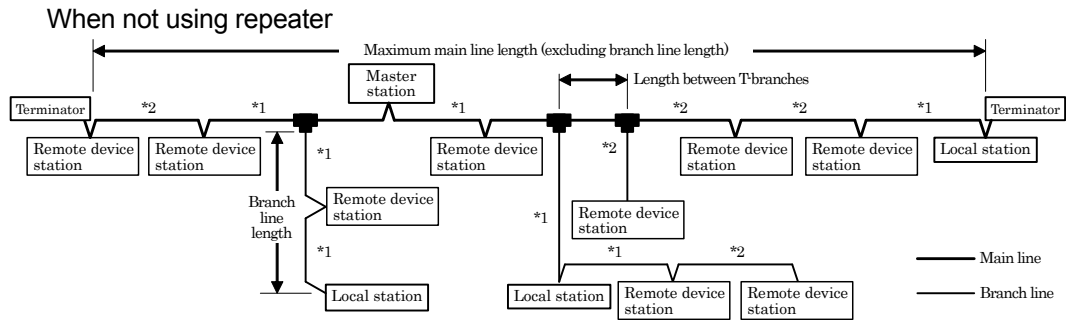

Communication speed		156kbps	625kbps	10M, 5M and 2.5Mbps cannot be used
Station-to-station cable length	Between master/local station, intelligent device station, and previous/next stations *1	1m or more		When system is configured only of remote I/O and remote device stations
	Between remote I/O station and remote device station (shortest cable)*2	2m or more		When system configuration includes local stations and intelligent device stations
	Between remote I/O station and remote device station (shortest cable)*2	30cm or more		
Maximum number of stations connected with branch line (per branch)		6		Refer to communication specifications for total number of connected stations
Maximum branch line length		500m	100m	Cable length between terminators; excludes branch line length
T-branch interval		No restrictions		
Maximum branch line length		8m		
Total branch line length		200m	50m	Total of branch line lengths

Use the CC-Link dedicated cable (110Ω terminator) for the connection cable. The CC-Link dedicated high-performance cable (130Ω terminator) cannot be used.

#### CC-Link versions

##### (1) Ver. 1.00 and Ver. 1.10

Ver. 1.10 is defined as a product for which the conventional restrictions on the station-to-station cable length have been improved. The station-to-station cable length is uniformly 20cm or longer.

Conversely, the conventional products are defined as Ver. 1.00.

The conditions for using a uniform 20cm or longer station-to-station cable are given below.

1. All modules configuring the CC-Link system must be compatible with Ver. 1.10.
2. All data link cables must be Ver. 1.10 compatible CC-Link dedicated cables.

Point
If the system contains both Ver. 1.00 and Ver. 1.10 compatible modules and cables, the maximum overall cable length and station-to-station cable length will following the Ver. 1.00 specifications.

##### (2) Ver. 2

A module compatible with the expanded number of cyclic points is defined as the Ver. 2 compatible module.

The improvements to the station-to-station cable length restrictions made with Ver. 1.10 also apply to Ver. 2. The station-to-station length is uniformly 20cm or more.



## Appendix 1.2 Possibilities of Cyclic Transmission

The restrictions for using cyclic transmission are given below.

The Ver. 2 compatible master station <sup>\*2</sup> has the following three modes.

- RemoteNet Ver. 2 mode

This mode is intended to be used when newly constructing a system.

- RemoteNet additional mode

This mode is used when adding slave stations, including Ver. 2 compatible stations, to an existing system structured with Ver. 1. The programs for the existing system can be used.

- RemoteNet Ver. 1 mode

This mode is compatible with the conventional module QJ61BT11.

Master station \ Slave station		Ver. 2 compatible master/local modules <sup>*2</sup>						QJ61BT11, etc.		Intelligent device station		Remote station		
		Local station			Standby master station			Local station	Standby master station			Remote device station		Remote I/O station
		Ver. 2 mode	Additional mode	Ver. 1 mode	Ver. 2 mode	Additional mode	Ver. 1 mode	Ver. 1 compatible	Ver. 1 compatible	Ver. 2 compatible	Ver. 1 compatible	Ver. 2 compatible	Ver. 1 compatible	Ver. 1 compatible
Ver. 2 compatible master/local module <sup>*2</sup>	Ver. 2 mode	○	×	△ <sup>*1</sup>	○	×	×	△ <sup>*1</sup>	×	○	○	○	○	○
	Additional mode	○ <sup>*3</sup>	○	△ <sup>*1</sup>	×	○	×	△ <sup>*1</sup>	×	○	○	○	○	○
	Ver. 1 mode	×	×	○	×	×	○	○	○	×	○	×	○	○
QJ61BT11, etc.	Ver. 1 compatible	×	×	○	×	×	○	○	○	×	○	×	○	○

○: Cyclic transmission possible, △: Cyclic transmission conditionally possible, ×: Cyclic transmission not possible

<sup>\*1</sup> When using the master station in the Ver. 2 mode or additional mode, and the local station is a Ver. 1 mode or Ver. 1 compatible master station, the local station can communicate with the master station, but the Ver. 2 compatible station's data cannot be confirmed.

<sup>\*2</sup> Refers to QJ61BT11N/LJ61BT11/L26CPU-BT/L26CPU-PBT.

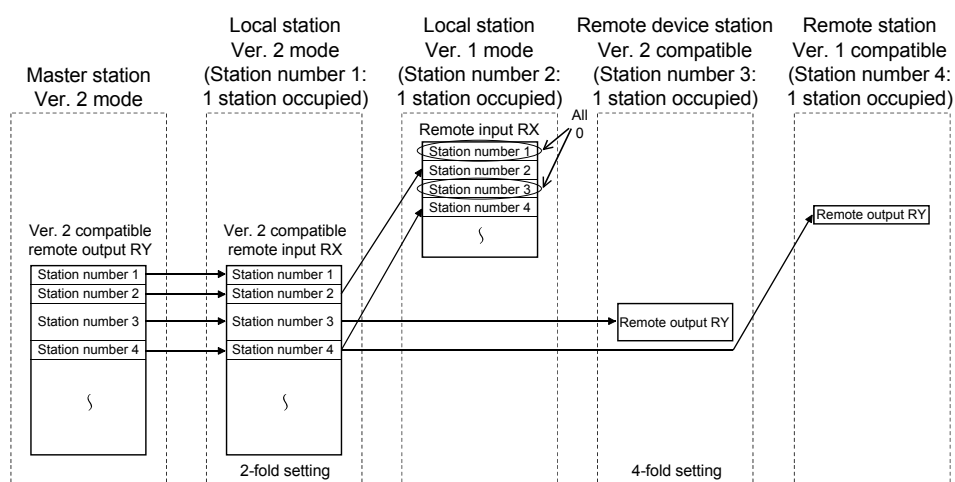

\*3 The stations are linked within the following range when the master station is the QJ61BT11N/LJ61BT11 additional mode and the local station is the QJ61BT11N Ver. 2 mode.

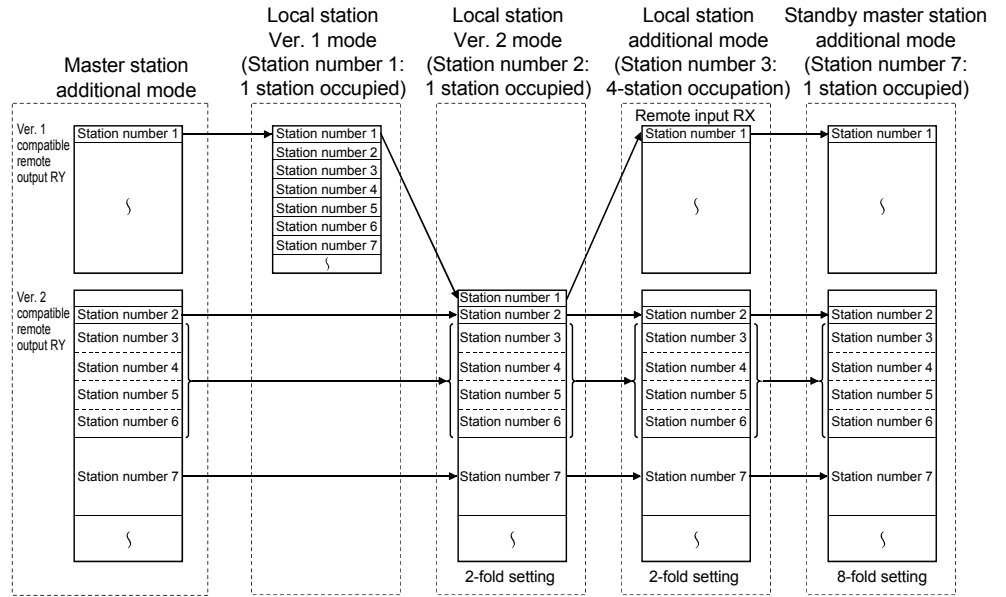

(3) Confirming the version

The Ver. 1.10 compatible module has the "CC-Link" logo on the "Rating nameplate".



The Ver. 2 compatible module has the "V2" logo on the "Rating nameplate".



## Appendix 2 Related Link Special Relays and Registers

The link special relays and registers related to troubleshooting are shown below.

### Link special relay (SB)/link special register (SW)

Name	Details	SB/SW (buffer memory)	Usability (Usable:○, Not usable:×)								
			Q	L	QnA	A	FX	A8 <sup>*3</sup>	Q8 <sup>*4</sup>		
Data link status	Host station operation status	Indicates the operation status of the host station's data link. OFF: In execution ON: Not in execution	SB006E (05E6H/bit11)	○	○	○	○	○	○	○	○
	Host station number	Stores the number of the currently running host station. 0: Master station 1 to 64: Local station	SW0061 (0661H)	○	○	○	○	○	○	○	○
	Other station data link status	Stores other station's data link status. 0: Normal 1: Data link error detected	SW0080 to 0083 (0680 to 0683H)	○	○	○	○	○	○ <sup>*1</sup>	○	○
Parameter	Parameter area (master only)		(0001 to 005FH)	○	○	○	○	○	○	○	×
	Parameter information (master only)	Stores the parameter information area used. 0H: CPU internal parameter 1H: Buffer memory (Start data link with Yn6) 2H: EPROM (Start data link with Yn8) 3H: Dedicated instruction (set parameters and start data link with dedicated instructions) DH: Default parameters (start CC-link automatically)	SW0067 (0677H)	○	○	○	○	○	○	○	○
	Total number of stations (master only)	Stores final station number set with the parameters. 1 to 64 (stations)	SW0070 (0670H)	○	○	○	○	○	○	○	○
	Maximum number of communicating stations (master only)	Stores the maximum number of stations connected with data link. 1 to 64 (stations)	SW0071 (0671H)	○	○	○	○	○	○	○	○
	Number of connected modules (master only)	Stores the number of modules connected with data link. 1 to 64 (modules)	SW0072 (0672H)	○	○	○	○	○	○	○	○
	Status of each station	Reserved station designation status	Stores designation status of reserved station. 0: Not reserved station 1: Reserved station	SW0074 to 0077 (0674 to 0677H)	○	○	○	○	○	○ <sup>*1</sup>	○
Error invalid station status		Stores designation status of error invalid station. 0: Not error invalid station 1: Error invalid station	SW0078 to 007B (0678 to 067BH)	○	○	○	○	○	○ <sup>*1</sup>	○	○
Temporary error invalid station status		Stores designation status of temporary error invalid station. 0: Not temporary error invalid station 1: Temporary error invalid station	SW007C to 007F (067C to 067FH)	○	○	○	○	○	○ <sup>*1</sup>	○	○
Station number duplication status (master only)		Stores duplication status when head station number of each module is not duplicated. 0: Normal 1: Station number duplicated (head station number only)	SW0098 to 009B (0698 to 069BH)	○	○	○	○	○	○ <sup>*1</sup>	○	○
Mounting/parameter consistency state (master only)		Stores state of parameter consistency. 0: Normal 1: Consistency error	SW009C to 009F (069C to 069FH)	○	○	○	○	○	○ <sup>*1</sup>	○	○
Transient transmission error status		Stores state of transient transmission error occurrence at each station. 0: Normal 1: Transient transmission error detected	SW0094 to 0097 (0694 to 0697H)	○	○	○	○	×	×	○	○
CC-Link Ver. mounting/parameter consistency status (Only Ver. 2 master)		Indicates slave station compatible with CC-Link Ver. 2. 0: Ver. 1 compatible slave station 1: Ver. 2 compatible slave station	SW0144 to 0147 (0744 to 0747H)	○ <sup>*2</sup>	○	×	×	×	×	×	×

\*1: The FX PLC uses only the one word at the head.

\*2: Usable only with QJ61BT11N.

\*3: A80BD-J61BT11

\*4: Q80BD-J61BT11N

Q81BD-J61BT11

Name		Details	SB/SW (buffer memory)	Usability (Usable:○, Not usable:×)							
				Q	L	QnA	A	FX	A8	QS	
Error code	Module status	Indicates the module status.	SW0020 (0620H)	○	○	○	○	○	○	○	○
	Host station parameter status (master only)	Stores the parameter setting status.	SW0068 (0668H)	○	○	○	○	○	○	○	○
	Mounting state (master only)	Stores the duplicate station numbers and parameter consistency for each module.	SW0069 (0669H)	○	○	○	○	○	○	○	○
	Switch setting status	Stores the setting status of each switch.	SW006A (066AH)	○	○	○	○	○	○	○	○
	Data link stop results	Stores the results of executing the data link stop instruction with SB0002.	SW0045 (0645H)	○	○	○	○	○	○	○	○
	Data link restart results	Stores the results of executing the data link restart instruction with SB0000.	SW0041 (0641H)	○	○	○	○	○	○	○	○
	Refresh instruction results at standby master station switching (standby master only)	Indicates the results of executing the refresh instruction when standby master is switched.	SW0043 (0643H)	○	○	○	○	×	○	○	○
	Temporary error invalid station setting (master only)	Indicates the results of setting the temporary error invalid station designation.	SW0049 (0649H)	○	○	○	○	○	○	○	○
	Temporary error invalid station cancel (master only)	Indicates the results of canceling the temporary error invalid station designation.	SW004B (064BH)	○	○	○	○	○	○	○	○
	Automatic CC-Link start execution results (master only)	Stores the results of the system configuration check when a new station is added to the system with automatic CC-Link start.	SW0052 (0652H)	○	○	×	×	×	×	○	○
	Forced master switching instruction results (master only)	Stores the results of executing the forced master switching instruction with SB000C.	SW005D (065DH)	○	○	×	×	×	×	○	○
	Remote device station initialize procedure registration instruction results (master only)	Stores the results of executing the initialize procedure registration instructions with SB000D.	SW005F (065FH)	○	○	×	×	×	×	○	○

0: Normal  
Other than 0:  
Stores  
error code

### Appendix 3 Preventive Maintenance and Quick Solutions

This section introduces effective information to consider when constructing the system so as to prevent trouble and enable quick solutions when trouble does occur.

#### Appendix 3.1 Separation of CC-Link System using AJ65SBT-RPT CC-Link System

The method for separating the CC-Link system using the AJ65SBT-RPT type CC-Link system repeater (T-branch) module (hereinafter, repeater) is explained below.

##### Separating the system with repeaters

The repeater is used to extend the CC-Link system's transmission distance and to provide T-branch wiring. When repeaters are used in the CC-Link system, the system can be separated, and faulty sections can be pinpointed easily. By separating the system, the effect onto the entire system can be reduced even if a fault occurs.

The repeater can be connected to separate the system in parallel or to separate the system serially. The effect onto the system when a fault occurs differs depending on which method is used. (The fault may extend to all stations if repeaters are not used.)

##### [Separating system in parallel by connecting repeaters]

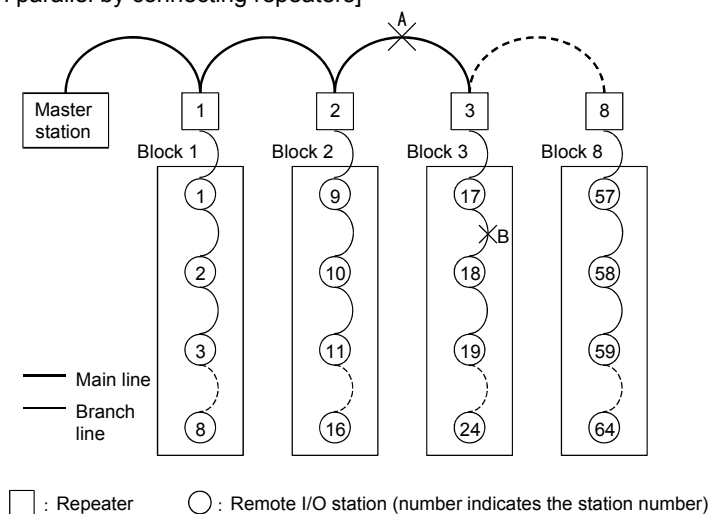

\* Prepare a drawing of the module layout and material indicating the station numbers so that the module layout is easy to see. The station numbers should be arranged in order of the wiring to make it easier to pinpoint the faulty section (faulty block) when the CC-Link Diagnostics line test or other station monitoring is executed.

##### [Separating system serially by connecting repeaters]

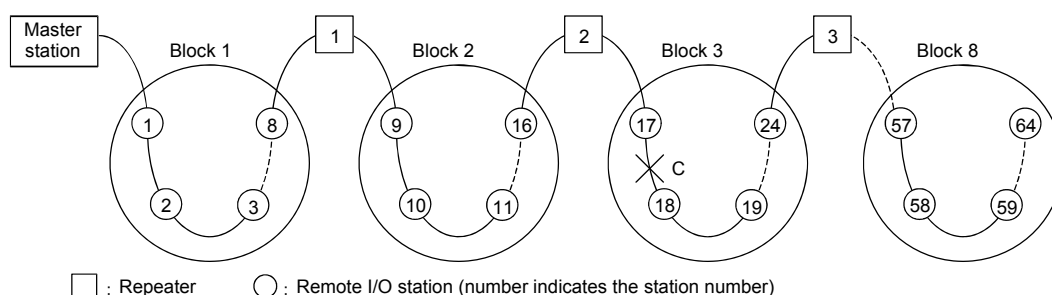

\* Prepare a drawing of the module layout and material indicating the station numbers so that the module layout is easy to see. The station numbers should be arranged in order of the wiring to make it easier to pinpoint the faulty section (faulty block) when the CC-Link Diagnostics line test or other station monitoring is executed.

System separation method	Faulty section	Remote I/O station communication status				Effect on system when fault occurs
		Station numbers 1 to 8 (Block 1)	Station numbers 9 to 16 (Block 2)	Station numbers 17 to 24 (Block 3)	Station numbers 25 to 64 (Blocks 4 to 8)	
Parallel	A (main line)	Faulty (nonspecific*)		Faulty		Affects all blocks
	B (branch line)	Normal		Station number 17: Faulty (nonspecific*) Station numbers 18 to 24: Faulty	Normal	Affects only faulty block
Serial	C	Normal		Station number 17: Faulty (nonspecific*) Station numbers 18 to 24: Faulty	Faulty	Affects all blocks following faulty block

\* May be normal or faulty depending on communication status.

### [1] Separating system in parallel by connecting repeaters

The following table shows a comparison of the troubleshooting details when the system does not have repeaters and when the system has repeaters (T-branch connection of remote I/O stations with repeater).

Number of connected repeaters	Number of connected remote I/O stations	CC-Link Diagnostics line test	Bisection method <sup>*1</sup> count
Not used	64 modules	Faulty section cannot be pinpointed	6 times
Used	8 modules <sup>*2</sup>	64 modules (8 modules/block)	Possible (pinpoint faulty block)
	11 modules	64 modules (6 modules/block)	Possible (pinpoint faulty block)
	11 modules	44 modules (4 modules/block)	Possible (pinpoint faulty block)

\*1 Refer to example (3) (b) below for details on the bisection method.

#### (Example) When eight repeaters are used

The method for pinpointing the faulty section using the system indicated with <sup>\*2</sup> above is shown below.

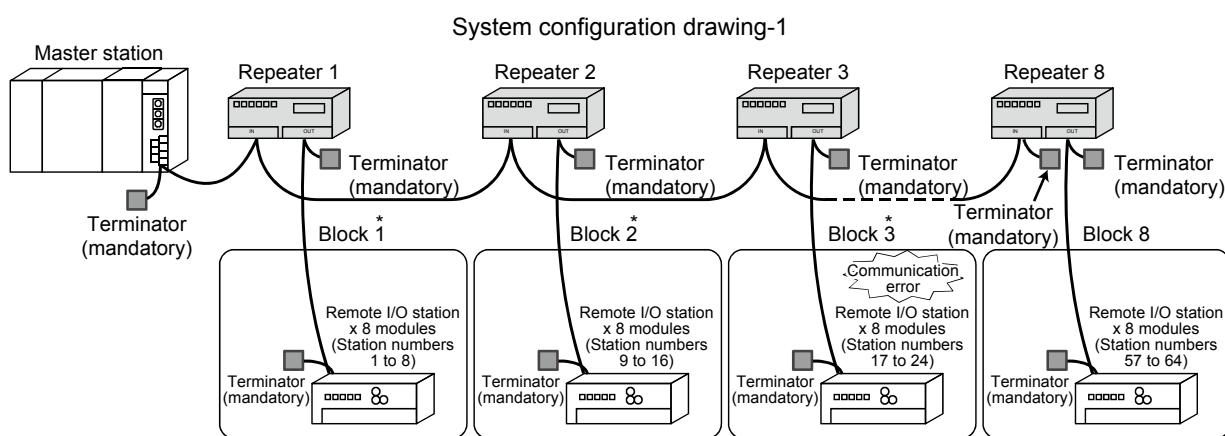

\* If a communication error is occurring in multiple blocks, check whether the main line cable is disconnected.

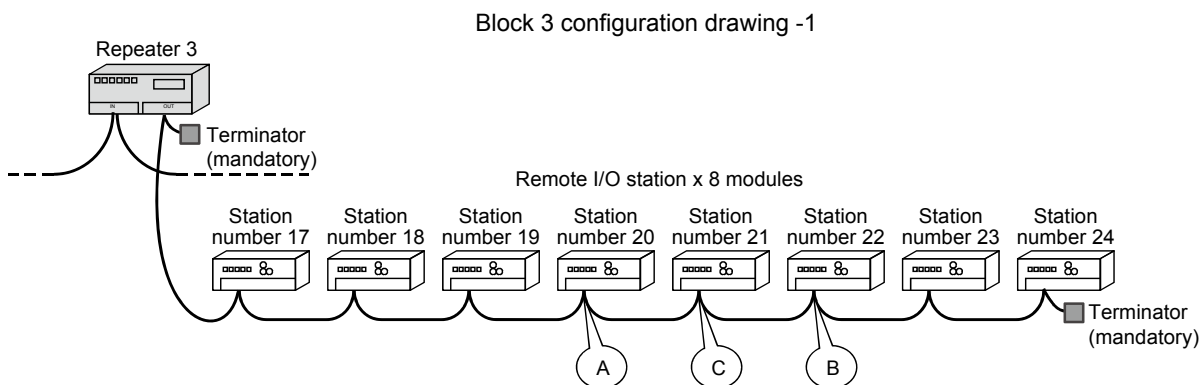

#### (1) System configuration

- Connect remote I/O stations with T-branch using repeater
- Use eight repeaters
- Connect eight remote I/O stations per block

#### (2) Faulty section

Assume that the block 3 module or cable is faulty

(3) Pinpointing the fault

(a) Pinpoint in which the block the fault is occurring using the CC-Link Diagnostics line test or other station monitor (only GX Developer).

(Refer to system configuration Fig. 1.)

For GX Developer

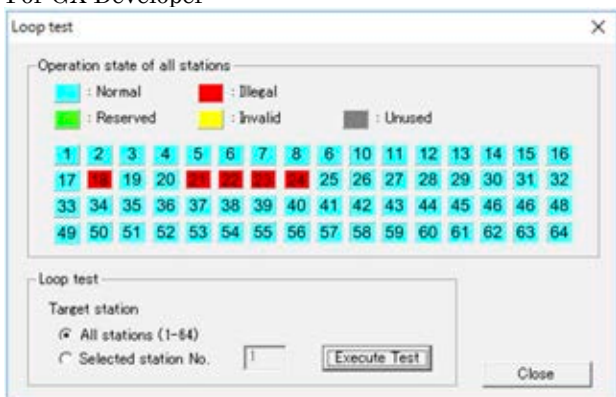

For GX Works2



A communication error is shown at the remote I/O station in block 3, indicating that there is a fault in block 3.

(b) Pinpoint the faulty section in the faulty block using the bisection method. (Refer to block 3 configuration Fig. 1) Bisection method

1. Disconnect the cable at section A (station number 20 remote I/O station), and connect a terminator.
2. If there is no fault up to section A, reconnect the section A cable, and disconnect the cable at section B (station number 22 remote I/O station). Connect a terminator.
3. If a fault is found up to section B, reconnect the section B cable, and disconnect the section C (station number 21 remote I/O station) cable. Connect a terminator.
4. If no fault is found, the section B module or the cable between C and B is faulty.
5. If a fault is found, the section C module or the cable between A and C is faulty.

**POINT**

Always connect a terminator to the end of the branch line.

## [2] Separating system serially by connecting repeaters

The following table shows a comparison of the troubleshooting details when the system does not have repeaters and when the system has repeaters (repeater is connected between remote I/O stations).

Number of connected repeaters	Number of connected remote I/O stations	CC-Link Diagnostics line test	Bisection method ** count
Not used	64 modules	Faulty section cannot be pinpointed	6 times
Used	7 modules**2	Possible (pinpoint faulty block)	3 times
	10 modules	Possible (pinpoint faulty block)	3 times
	10 modules	Possible (pinpoint faulty block)	2 times

\*1 Refer to example (3) (b) below for details on the bisection method.

(Example) When seven repeaters are used

The method for pinpointing the faulty section using the system indicated with \*\*2 above is shown below.

System configuration drawing-2

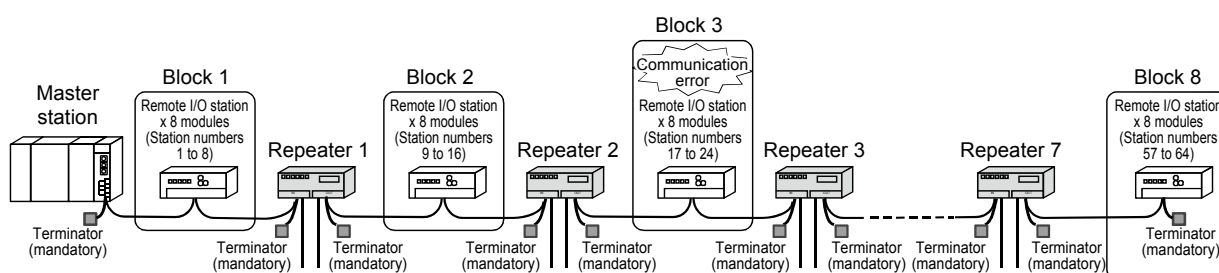

Block 3 configuration drawing -2

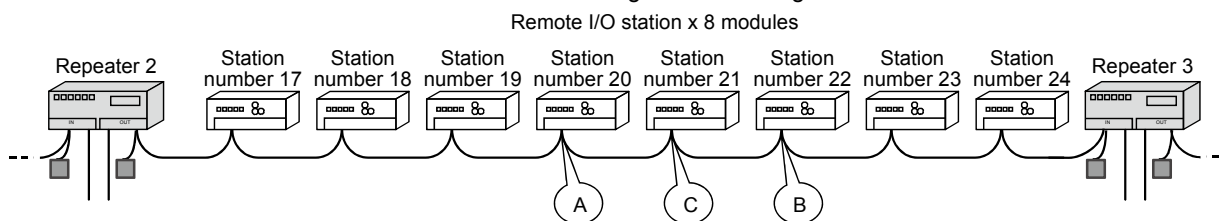

### (1) System configuration

- Connect repeater between remote I/O stations
- Use seven repeaters
- Connect eight remote I/O stations per block

### (2) Faulty section

Assume that the block 3 module or cable is faulty



(3) Pinpointing the fault

(a) Pinpoint in which the block the fault is occurring using the CC-Link Diagnostics line test or other station monitor (only GX Developer).

(Refer to system configuration Fig. 2.)

For GX Developer

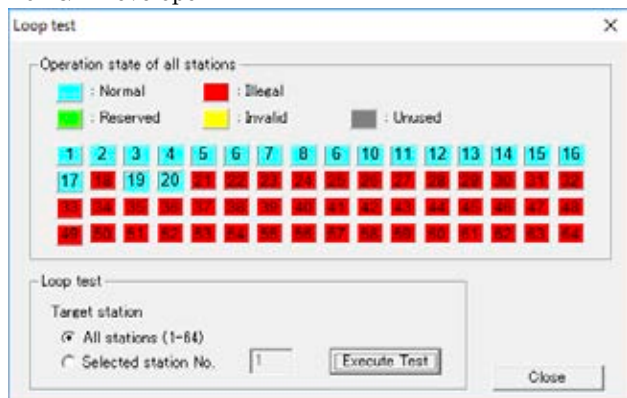

For GX Works2

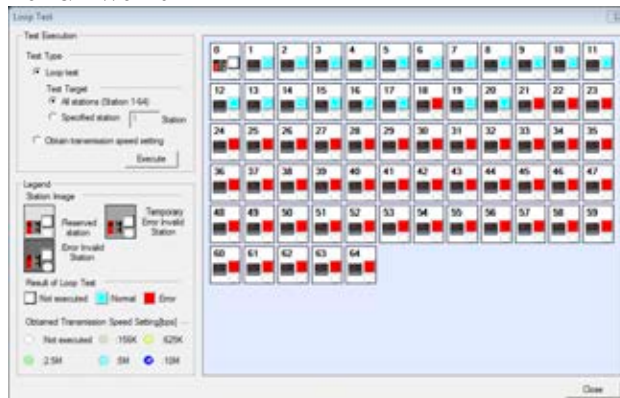

After repeater 2, a fault in all stations or multiple faults are displayed. However, block 3 and block 4 are separated with repeater 3 so it can be identified that block 3 is faulty.

(b) Pinpoint the faulty section in the faulty block using the bisection method. (Refer to block 3 configuration Fig. 2)

Bisection method

1. Disconnect the cable at section A (station number 20 remote I/O station), and connect a terminator.
2. If there is no fault up to section A, reconnect the section A cable, and disconnect the cable at section B (station number 22 remote I/O station). Connect a terminator.
3. If a fault is found up to section B, reconnect the section B cable, and disconnect the section C (station number 21 remote I/O station) cable. Connect a terminator.
4. If no fault is found, the section B module or the cable between C and B is faulty.
5. If a fault is found, the section C module or the cable between A and C is faulty.

**POINT**

Always connect a terminator to the end of the main line.

### Appendix 3.2 Remote Controls with AJ65BT-G4-S3

The various PLCs can be remotely controlled via CC-Link.

When the CC-Link data link is correctly established, the Q, QnA, and A Series PLC CPU on the CC-Link can be operated online from a peripheral device. These operations include PC write, PC read, monitor, and test, etc. The data and program can be confirmed easily even when the master station is at a remote location.

The peripheral device does not need to be moved to the PLC CPU as shown here.

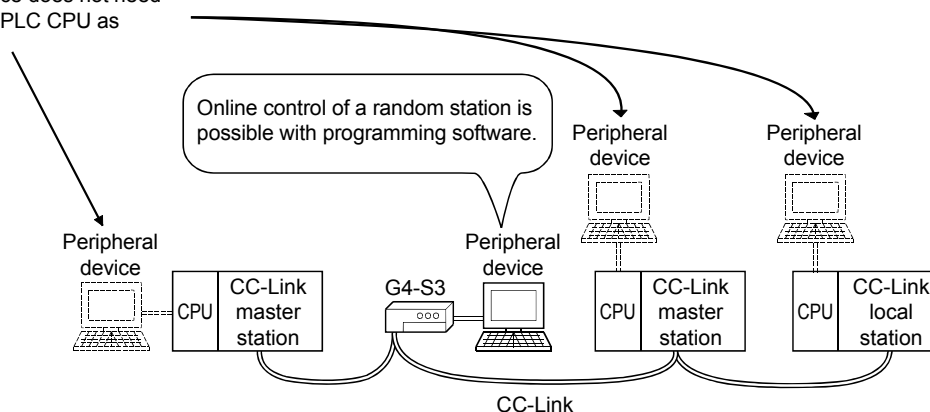

## Appendix 4 Confirmation Sheet

Confirmation item		Details	
1. Master station	[1]Master type	PLC CPU Master module	
	[2]Master version	PLC CPU Master module	
	[3]Module mounting state	I/O address:	
	[4]Other module	Other module:	
	[5]Mode	Mode setting: RemoteNet mode (Ver. 1 / Additional / Ver.2 / Remote I/O net mode) Scan mode: Synchronous mode / Asynchronous mode Module mode: I/O mode / Intelligent mode (SW8: A Series only)	
	[6]Parameters	Confirm that parameters in the designs and actual system match.	
		Parameter	Setting
		Number of modules	modules
		Standby master station setting	
		Operation designation at CPU down	Stop / Continue
	Reserved station		
	Error invalid station		
	Station information	Indicated in system configuration	
	[7]Parameter setting	GX Works2 / GX Developer / Dedicated instructions / FROM/TO instructions	
	[8]Link startup method	Start up with buffer memory: Y6 / Start up with E <sup>2</sup> PROM: Y8 (QnA, A, FX Series only)	
	[9]Link data access	Auto refresh / Dedicated instructions / FROM/TO instructions	
	[10]Transmission speed	10M / 5M / 2.5M / 625k / 156kbps	
2. Slave station	[11]Number of connected modules	modules	
	[12]Station type*	Remote I/O station: stations, Remote device station: stations, Intelligent device station: stations	
	[13]Occupied station number*	<input type="checkbox"/> Station number occupied by each station (Check box after confirming)	
	[14]CC-Link version*	Ver. 1 / Ver. 2 (Expanded cyclic setting 1-fold / 2-fold / 4-fold / 8-fold setting) Confirm setting	
	[15]Transmission speed	10M / 5M / 2.5M / 625k / 156kbps	
3. Transmission cable	[16]Cable type	Cable type:	
	[17]Transmission distance	Overall length:	
	[18]Station-to-station distance	Shortest station-to-station distance:	
4. Terminator	[19]Resistance value	110Ω / 130Ω	
	[20]Connection terminal	<input type="checkbox"/> Connection between terminator DA-DB (Check box after confirming)	
5. Grounding	[21]FG terminal	<input type="checkbox"/> Grounding of each station's FG terminal (Check box after confirming) If not grounded at each station, indicate the grounding state in 6. System Configuration.	
6. System configuration	[22]	Station number, station type, occupied station number, cable length	

#### Precautions for Choosing Products

This catalog explains the typical features and functions of the CC-Link and does not provide restrictions and other information on usage and module combinations. When choosing the products, always check the detailed specifications, restrictions, etc. of the products in the user's manuals. Mitsubishi will not be held liable for damage caused by factors found not to be the cause of Mitsubishi; machine damage or lost profits caused by faults in the Mitsubishi products; damage, secondary damage, accident compensation caused by special factors unpredictable by Mitsubishi; damages to products other than Mitsubishi products; and to other duties.

#### For Safe Use

- To use the products given in this catalog properly, always read the "manuals" before starting use.
- This product has been manufactured as a general-purpose part for general industries, and has not been designed or manufactured to be incorporated in a device or system used in purposes related to human life.
- Consult with Mitsubishi before using the product for special purposes such as nuclear power, electric power, aerospace, medicine, or manned transportation devices or system.
- This product has been manufactured under strict quality control. However, install appropriate backup or failsafe functions in the system when installing the product where major accidents or losses could occur if the product fails.

# Open Field Network

## CC-Link Troubleshooting Guidance

Country/Region	Sales office	Tel/Fax
USA	MITSUBISHI ELECTRIC AUTOMATION, INC. 500 Corporate Woods Parkway, Vernon Hills, IL 60061, U.S.A.	Tel : +1-847-478-2100 Fax : +1-847-478-2253
Mexico	MITSUBISHI ELECTRIC AUTOMATION, INC. Mexico Branch Boulevard Miguel de Cervantes Saavedra 301, Torre Norte Piso 5, Ampliacion Granada, Miguel Hidalgo, Ciudad de Mexico, Mexico, C.P.115200	Tel : +52-55-3067-7512
Brazil	MITSUBISHI ELECTRIC DO BRASIL COMERCIO E SERVICOS LTDA. Avenida Adelino Cardana, 293, 21 andar, Bethaville, Barueri SP, Brasil	Tel : +55-11-4689-3000 Fax : +55-11-4689-3016
Germany	MITSUBISHI ELECTRIC EUROPE B.V. German Branch Mitsubishi-Electric-Platz 1, 40882 Ratingen, Germany	Tel : +49-2102-486-0 Fax : +49-2102-486-7780
UK	MITSUBISHI ELECTRIC EUROPE B.V. UK Branch Travellers Lane, UK-Hatfield, Hertfordshire, AL10 8XB, U.K.	Tel : +44-1707-28-8780 Fax : +44-1707-27-8695
Ireland	MITSUBISHI ELECTRIC EUROPE B.V. Irish Branch Westgate Business Park, Ballymount, Dublin 24, Ireland	Tel : +353-1-4198800 Fax : +353-1-4198890
Italy	MITSUBISHI ELECTRIC EUROPE B.V. Italian Branch Centro Direzionale Colleoni - Palazzo Sirio, Viale Colleoni 7, 20864 Agrate Brianza (MB), Italy	Tel : +39-039-60531 Fax : +39-039-6053-312
Spain	MITSUBISHI ELECTRIC EUROPE, B.V. Spanish Branch Carretera de Rubi, 76-80-Apdo. 420, E-08190 Sant Cugat del Valles (Barcelona), Spain	Tel : +34-935-65-3131 Fax : +34-935-89-1579
France	MITSUBISHI ELECTRIC EUROPE B.V. French Branch 25, Boulevard des Bouvets, 92741 Nanterre Cedex, France	Tel : +33-1-55-68-55-68 Fax : +33-1-55-68-57-57
Czech Republic	MITSUBISHI ELECTRIC EUROPE B.V. Czech Branch, Prague Office Pekarska 621/7, 155 00 Praha 5, Czech Republic	Tel : +420-255-719-200
Poland	MITSUBISHI ELECTRIC EUROPE B.V. Polish Branch ul. Krakowska 48, 32-083 Balice, Poland	Tel : +48-12-347-65-00
Sweden	MITSUBISHI ELECTRIC EUROPE B.V. (Scandinavia) Hedvig Mollersgata 6, 223 55 Lund, Sweden	Tel : +46-8-625-10-00 Fax : +46-46-39-70-18
Russia	MITSUBISHI ELECTRIC (RUSSIA) LLC St. Petersburg Branch Piskarevsky pr. 2, bld 2, lit "Sch", BC "Benua", office 720; 195027 St. Petersburg, Russia	Tel : +7-812-633-3497 Fax : +7-812-633-3499
Turkey	MITSUBISHI ELECTRIC TURKEY A.S. Umraniye Branch Serifali Mah. Kale Sok. No:41 34775 Umraniye - Istanbul, Turkey	Tel : +90-216-969-2500 Fax : +90-216-661-4447
UAE	MITSUBISHI ELECTRIC EUROPE B.V. Dubai Branch Dubai Silicon Oasis, P.O.BOX 341241, Dubai, U.A.E.	Tel : +971-4-3724716 Fax : +971-4-3724721
South Africa	ADROIT TECHNOLOGIES 20 Waterford Office Park, 189 Witkoppen Road, Fourways, South Africa	Tel : +27-11-658-8100 Fax : +27-11-658-8101
China	MITSUBISHI ELECTRIC AUTOMATION (CHINA) LTD. Mitsubishi Electric Automation Center, No.1386 Hongqiao Road, Shanghai, China	Tel : +86-21-2322-3030 Fax : +86-21-2322-3000
Taiwan	SETSUYO ENTERPRISE CO., LTD. 6F, No.105, Wugong 3rd Road, Wugu District, New Taipei City 24889, Taiwan	Tel : +886-2-2299-2499 Fax : +886-2-2299-2509
Korea	MITSUBISHI ELECTRIC AUTOMATION KOREA CO., LTD. 7F to 9F, Gangseo Hangang Xi-tower A, 401, Yangcheon-ro, Gangseo-Gu, Seoul 07528, Korea	Tel : +82-2-3660-9569 Fax : +82-2-3664-8372
Singapore	MITSUBISHI ELECTRIC ASIA PTE. LTD. 307 Alexandra Road, Mitsubishi Electric Building, Singapore 159943	Tel : +65-6473-2308 Fax : +65-6476-7439
Thailand	MITSUBISHI ELECTRIC FACTORY AUTOMATION (THAILAND) CO., LTD. 12th Floor, SV.City Building, Office Tower 1, No. 896/19 and 20 Rama 3 Road, Kwaeng Bangpongpan, Khet Yannawa, Bangkok 10120, Thailand	Tel : +66-2682-6522-31 Fax : +66-2682-6020
Vietnam	MITSUBISHI ELECTRIC VIETNAM COMPANY LIMITED Unit 01-04, 10th Floor, Vincom Center, 72 Le Thanh Ton Street, District 1, Ho Chi Minh City, Vietnam	Tel : +84-28-3910-5945 Fax : +84-28-3910-5947
Indonesia	PT. MITSUBISHI ELECTRIC INDONESIA Gedung Jaya 8th Floor, JL. MH. Thamrin No.12, Jakarta Pusat 10340, Indonesia	Tel : +62-21-31926461 Fax : +62-21-31923942
India	MITSUBISHI ELECTRIC INDIA PVT. LTD. Pune Branch Emerald House, EL-3, J Block, M.I.D.C., Bhosari, Pune-411026, Maharashtra, India	Tel : +91-20-2710-2000 Fax : +91-20-2710-2100
Australia	MITSUBISHI ELECTRIC AUSTRALIA PTY. LTD. 348 Victoria Road, P.O. Box 11, Rydalmere, N.S.W 2116, Australia	Tel : +61-2-9684-7777 Fax : +61-2-9684-7245

**MITSUBISHI ELECTRIC CORPORATION**  
 HEAD OFFICE: TOKYO BLDG., 2-7-3, MARUNOUCHI, CHIYODA-KU, TOKYO 100-8310, JAPAN  
[www.MitsubishiElectric.com](http://www.MitsubishiElectric.com)