

FACTORY AUTOMATION

# SERVO AMPLIFIERS & MOTORS MELSERVO-JN



**One-touch Servo**  
**MELSERVO-JN**



## Automating the World



Our Factory Automation business is focused on "Automating the World" to make it a better, more sustainable environment supporting manufacturing and society, celebrating diversity and contributing towards an active and fulfilling role.

Mitsubishi Electric is involved in many areas including the following:

### **Energy and Electric Systems**

A wide range of power and electrical products from generators to large-scale displays.

### **Electronic Devices**

A wide portfolio of cutting-edge semiconductor devices for systems and products.

### **Home Appliance**

Dependable consumer products like air conditioners and home entertainment systems.

### **Information and Communication Systems**

Commercial and consumer-centric equipment, products and systems.

### **Industrial Automation Systems**

Maximizing productivity and efficiency with cutting-edge automation technology.



The Mitsubishi Electric Group is actively solving social issues, such as decarbonization and labor shortages, by providing production sites with energy-saving equipment and solutions that utilize automation systems, thereby helping towards a sustainable society.

# OVERVIEW

■ MELSERVO-JN Product Lines .....	4
■ Features .....	6
■ Application Examples .....	11
■ Servo Support Software .....	12
■ Model Designation .....	14
■ Connections with Peripheral Equipment .....	15
■ Servo Amplifiers .....	16
■ Servo Motors .....	28
■ Options/Peripheral Equipment .....	37
■ Dimensions .....	48
■ Product List .....	53
■ Precautions .....	58
■ Global FA Centers .....	61

# Easy Operation and High Performance in a Compact Shape

# One-Touch Servo MELSERVO-JN

The one-touch servo MELSERVO-JN offers high-performance operation control with much simpler process! It brings optimal drive operations to your factory line with the easiest operation ever, such as one-touch tuning.



Products shown in actual size.

**Servo amplifier**  
(MR-JN-10A)

**Servo motor**  
(HF-KN053)

Servo amplifier		Control mode			Positioning function	Power supply voltage	Compatible servo motor capacity [kW]
Model	Command interface	Position	Internal speed	Internal torque			
MR-JN-□A (1)	Pulse train	●	●*1	●*1	●*2	Main circuit: 1-phase 200VAC/ 100VAC*3 Control circuit: 24VDC	0.05 to 0.4

\*1 Analog interface is not built-in. Internal setting only.

\*2 Positioning function is supported by the servo amplifiers with software version B0 or later.

\*3 A power supply of 1-phase 100VAC is supported only by servo amplifiers of 0.2kW or smaller.

Servo motor		Rated speed (Maximum speed) [r/min]	Rated output [kW]	Electromagnetic brake (B)	Reducer		IP rating
Servo motor series	● : Supported — : Not supported				For general industrial machine (G1)	For precision application (G5, G7)	
HF-KN series	●	3000 (4500)	0.05, 0.1, 0.2, 0.4	●	—	—	IP65*4

Geared servo motor		Rated speed (Maximum speed) [r/min]	Rated output capacity [kW]	Reducer for general industrial machine (G1)	Reducer for precision application (G5, G7)	Electromagnetic brake (B)	IP rating
Servo motor series	● : Supported						
HG-KR series*7	●	3000 (4500)*5	0.05, 0.1, 0.2, 0.4	● 1/5, 1/12, 1/20*6	● 1/5, 1/9, 1/11, 1/21, 1/33, 1/45	●	Equivalent to IP44*4

\*4 The shaft-through portion is excluded.

\*5 This speed is applicable when the servo motor is used with MR-JN servo amplifier series.

\*6 This reduction ratio is nominal value. For actual reduction ratios, refer to "Geared Servo Motor Specifications" in this catalog.

\*7 HG-KR series geared servo motors are supported by servo amplifiers with software version B2 or later.

## **JN** **One-Touch Tuning**

*Servo tuning is completed just by pressing the AUTO button on the front of the servo amplifier.*

## **JN** **Tough Drive Function**

*Operation will continue even when a temporary change in load, power supply or resonance frequency occurs.*

## **JN** **Built-in Regenerative Resistor**

*The built-in regenerative resistor reduces both wiring time and installation space. Servo amplifiers of 200W or larger are standardly equipped with a regenerative resistor.*

## **JN** **Separated Power Supply for Main and Control Circuits**

*The main circuit power supply can be turned off separately to enhance your safety during maintenance!*

## **JN** **Drive Recorder Function**

*Automatic recording of the data before and after an alarm occurrence enables quick troubleshooting.*

## **JN** **Advanced Vibration Suppression Control**

*The auto tuning function enables optimal drive operations!*

## **JN** **Built-in Positioning Function**

*Built-in positioning function enables easy positioning operation without a controller!*

# From installation/wiring to setup and operation, all steps are easy!

## MELSERVO-JN

### 1 Pursuing EASY Operation and Support

#### ■ Fuss-free! One-touch quick tuning

Just turn on the one-touch tuning function to automatically complete various adjustments including estimation of load to motor inertia ratio, gain adjustment and machine resonance suppression, which maximize the servo performance. (Patented)

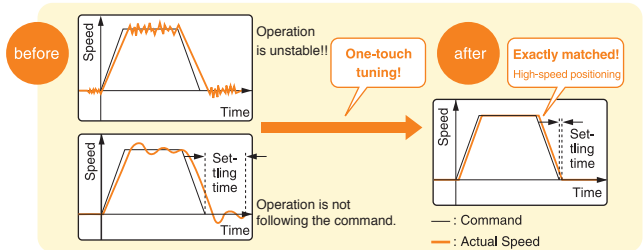
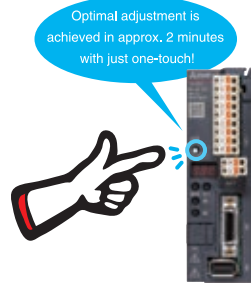

#### ■ 1-phase 100VAC and 200VAC for main circuit power supply

1-phase 200VAC and 1-phase 100VAC servo amplifiers are available.

\* 100VAC servo amplifier is available in 200W or smaller.

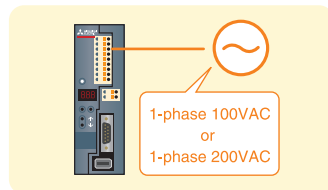

#### ■ Easy power supply wiring without a screwdriver

All wiring can be completed without a screwdriver!

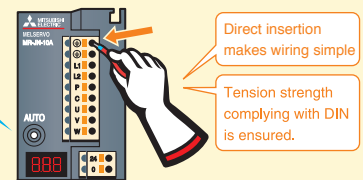

#### ■ Easy setting of electronic gear

Calculation of command pulse frequency and travel distance of the ball screw is simple since the number of command pulses per revolution of motor is set to 10000 by default. Additionally, rotation angle is controlled easily just by setting one parameter.

Example of setting

When the number of command pulses per revolution is set to 10000 (default):

10mm lead ball screw moves 1 $\mu$ m per pulse. (10mm per 10000 pulses)

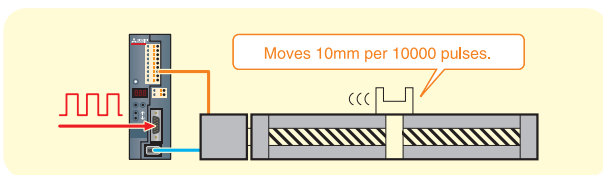

When the number of command pulses per revolution is set to 36000:

The servo motor rotates 0.01 degrees per pulse. (1 degree per 100 pulses)

\* This is when a gear reducer is not used.

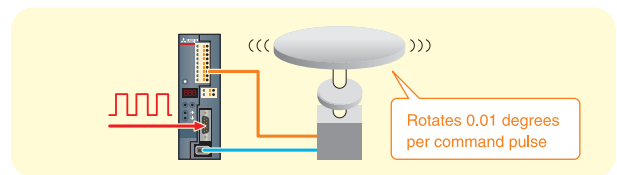

#### ■ Servo support software

##### ● Drive System Sizing Software Motorizer

Drive system sizing software Motorizer enables optimal selections of servo motors and servo amplifiers for your system. This software is available for free download. Contact your local sales office for more details.

##### ● FA Integrated Selection Tool

FA Integrated Selection Tool is now available, so you can select options such as encoder cables and power cables which are required to use with controllers, servo motors, servo amplifiers, and regenerative options of your choice.



## 2 Pursuing RELIABILITY from the Product Design Phase

### Reliable operation with "tough drive function" \*1

#### ● Overload tough drive function

Overload tough drive function automatically adjusts machine operation to prevent an alarm occurrence when load changes in the machine are detected, and thereby reduces time losses caused by machine stops. (Patented)

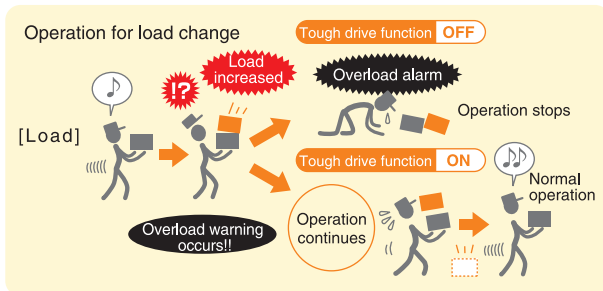

#### ● Instantaneous power failure tough drive function

When an instantaneous power failure is detected, power charged in the main circuit capacitor is supplied to keep the system running.

\* Low voltage alarm may occur depending on the load conditions.

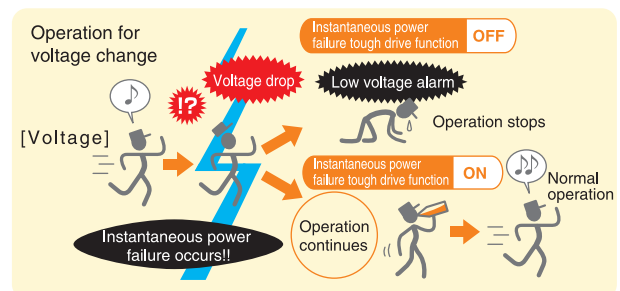

#### ● Vibration tough drive function

This function readjusts the machine resonance suppression filter automatically and prevents resonance when a machine resonance frequency is changed due to aging distortion.

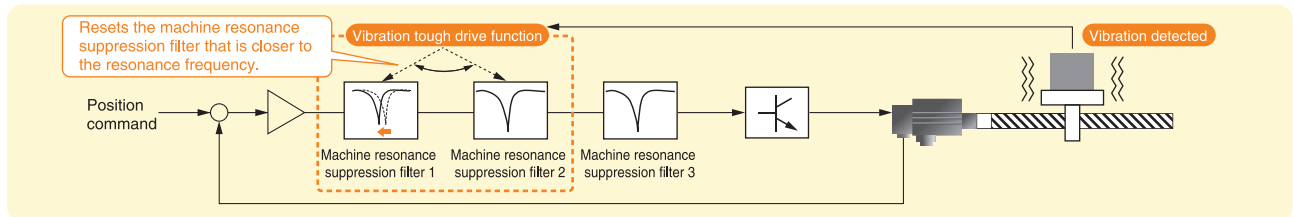

\*1 Tough drive function is activated by setting a parameter.

### Safe maintenance due to separate power supply for main and control circuits

Because both the main circuit power supply (1-phase 200VAC or 1-phase 100VAC) and the control circuit power supply (24VDC) have the respective connectors, the main circuit power supply can be turned off separately. This makes setting parameters and performing maintenance, such as checking the machine status when an error occurs, safer.

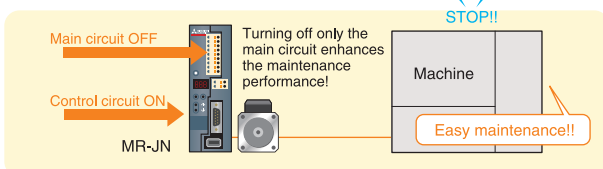

### With fanless body

The maintenance performance is improved by eliminating a cooling fan from the servo amplifier. There is no need to worry about the life of the cooling fan.

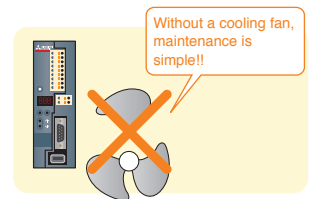

### "Drive recorder function" for quick troubleshooting

● This function automatically records data before and after the alarm occurrence. The recorded data is available in graph form even after the power is off. This enables identifying the cause of the trouble and quickly solves the issue.

● This function automatically selects data to be recorded based on alarms. Information on the causes of alarm is read and monitored easily.

The data right before the alarm occurrence is available in graph form!

\* MR Configurator2 is required to display data in the drive recorder in graph form.

#### Example: When error excessive alarm occurs.

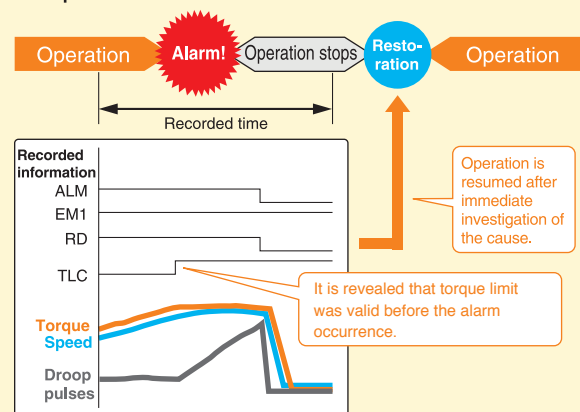

# Not just easy to use! MELSERVO-JN also has a variety of advanced functions.

## 3 "Reduced Setting Space" Makes Your Manufacturing Floor More Comfortable

### High performance while still being compact! Even high-accuracy positioning can be done easily!!

- The servo motor is equipped with high-resolution encoder (131072pulses/rev), enabling both high-accuracy positioning and speed stability in low speed. The servo amplifier supports 1Mpulse/s command pulse frequency, realizing high-accuracy positioning. MELSERVO-JN can be used for various applications.

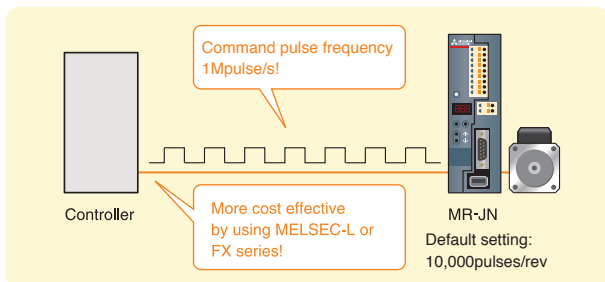

- MR-C series servo amplifiers can be replaced easily with the MR-JN since both of these servo amplifiers have the same mounting dimensions.

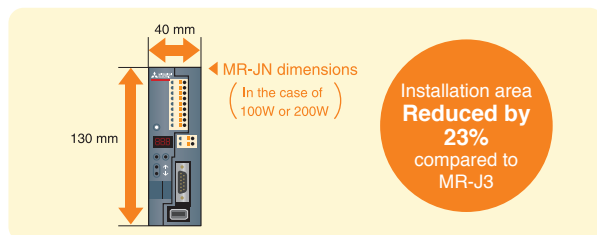

### Servo amplifiers can be installed closely to each other.

The MR-JN servo amplifiers can be installed closely to each other.

- The operation environment differs when servo amplifiers are mounted closely. For details, refer to "Servo Amplifier Specifications" and "Precautions" in this catalog.

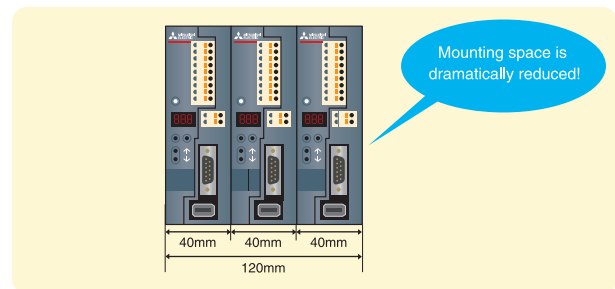

### Equipped with built-in regenerative resistor

200W or larger servo amplifiers have a built-in regenerative resistor, allowing smaller system configurations.

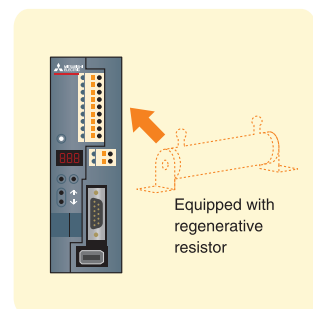

## 4 Large Selection of Servo Motors

### Compact, high-performance servo motor HF-KN series

- Capacity: 50W to 400W
- By mounting the high-resolution incremental encoder (131072pulses/rev), both "high-accuracy positioning" and "speed stability in low speed" are enabled.
- Servo motors with electromagnetic brake are also available.
- Cables can be led out either in direction or in opposite direction of the motor shaft according to the selected cables.
- The HF-KN series servo motor is rated IP65 (excluding the shaft-through portion).

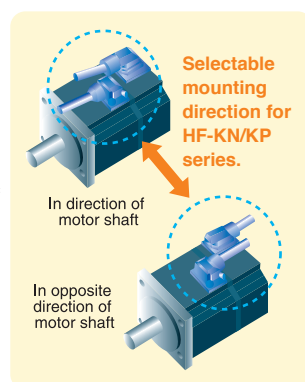

### HG-KR series geared servo motors are also available

- Capacity: 50W to 400W
- HG-KR series with gear reducer are available.
  - G1: for general industrial machines
  - G5: flange output type reducer for precision applications
  - G7: shaft output type reducer for precision applications
 These servo motors are flange mounting type.
- Servo motors with electromagnetic brake are also available.
- The HG-KR series with gear reducer is rated equivalent to IP44 (excluding the shaft-through portion).

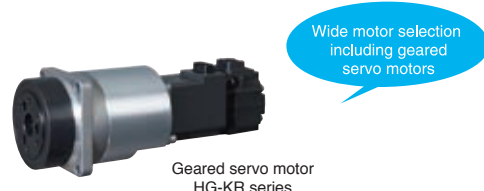





## 5 Optimal Servo Adjustment for Machines

### Extended adjustment functions by the auto tuning

- **Advanced vibration suppression control**  
The residual vibration with low frequency (up to 100Hz) is suppressed automatically.  
\* An optimal filter is set automatically by the auto tuning function.

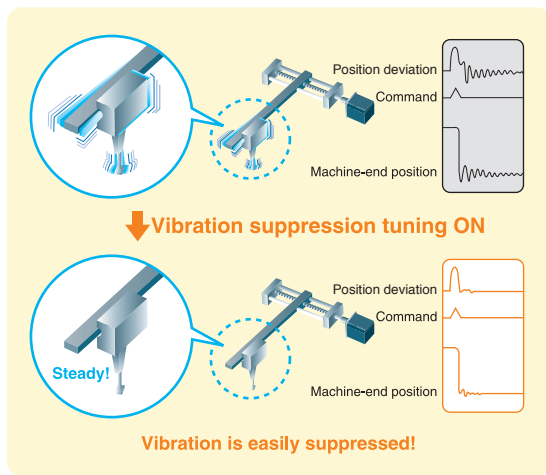

- **Adaptive filter II**  
High frequency machine resonance can be suppressed automatically by the one-touch tuning. Furthermore, by using the vibration tough drive function, the filter is readjusted automatically when a machine resonance is detected even after the tuning.

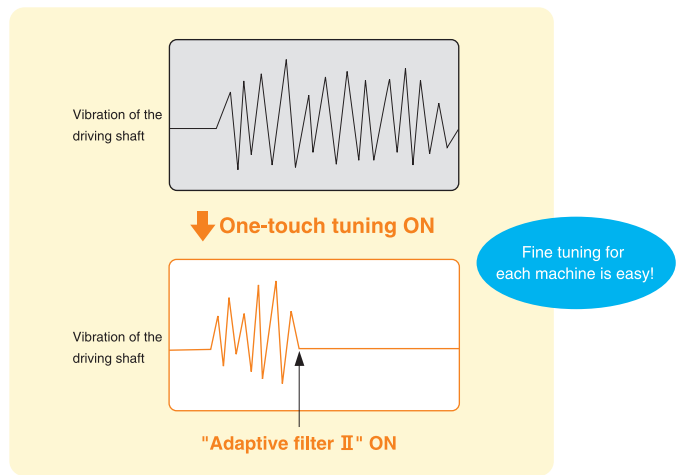

### Various control modes

- **Speed/torque control operation**  
The speed control mode and the torque control mode are supported. (The speed and the torque commands are set internally by parameters.)
- **Torque limit**  
The torque generated by the servo motor can be controlled by setting parameters.

Switchable between the position control and the torque control!

### Setup software "MR Configurator2"

MR Configurator2 enables high-speed sampling and long-time waveform measurement. This makes start up and adjustments of the servo system easier. A personal computer can be connected to the servo amplifier via USB.

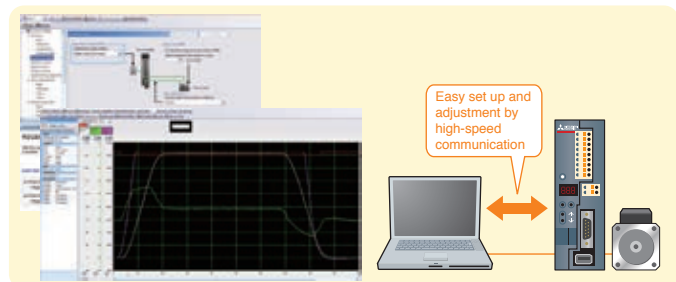

# Positioning operation with ease! MELSERVO-JN!

## 7 Built-in positioning function

### Positioning without a controller

A simple positioning system can be configured without a controller since the positioning function (point table and program methods) is built into the servo amplifier, saving both costs and space.



### Point table method

Position data (target position), servo motor speed, and acceleration/deceleration time constants can be easily set in a point table up to seven points. The positioning operation is started with an external interface signal and performed in accordance with the specified point table Nos.

#### Point table setting example

Point table No.	Position data	Servo motor speed	Acceleration time constant	Deceleration time constant	Dwell time	Auxiliary function
1	1000	2000	200	200	0	1
2	2000	1600	100	100	0	0
⋮	⋮	⋮	⋮	⋮	⋮	⋮
7	3000	3000	100	100	0	2

Incremental values can be used for position data setting.

#### Operation example

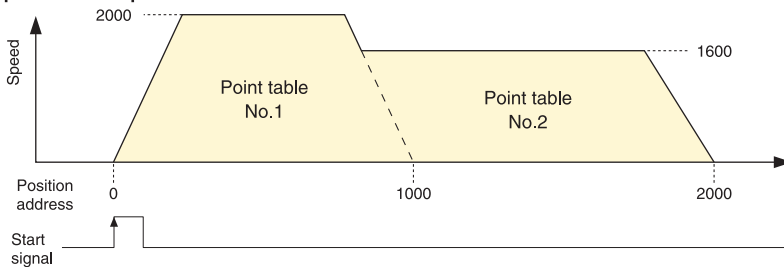

### Program method

Simple positioning programs can be created with dedicated commands. A program is executed with a start signal after selecting the program Nos. with an external interface signal. The program method enables more complex positioning operation than the point table method. Up to eight programs can be stored in the memory.

#### Program example

```

Program No. 1
SPN(3000)
STC(20)
MOV(1000)
TIM(100)
FOR(3) .....①
MOVI(100) .....②
TIM(100) .....③
NEXT
STOP
    
```

#### Operation example

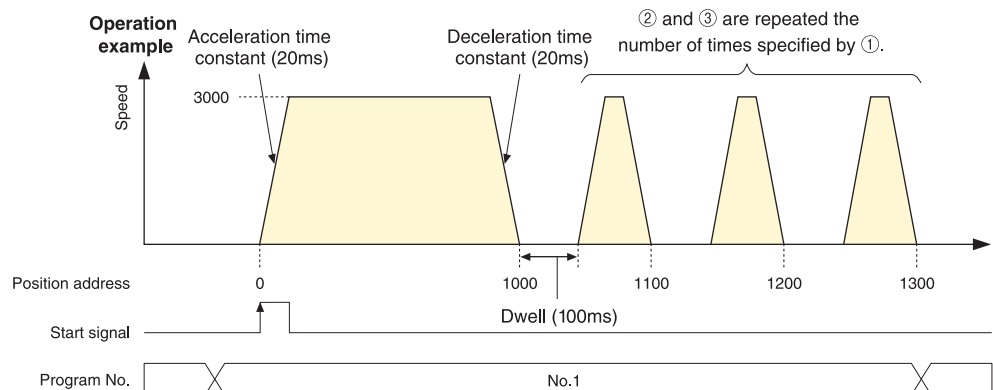

\* MR Configurator2 is required to create a program.

# Easy to use in various situations.

MELSERVO-JN, a compact servo amplifier which enables both "high-accuracy positioning" and "speed stability in low speed" satisfies control needs in various applications.

## Application examples

### ■ X-Y tables

For X-Y positioning system for machine tools, inspection machines, etc.

- The high-performance servo system enables high-speed positioning.
- 17-bit encoder enables high-accuracy positioning.
- Shorter cycle time is achieved by suppressing vibrations.

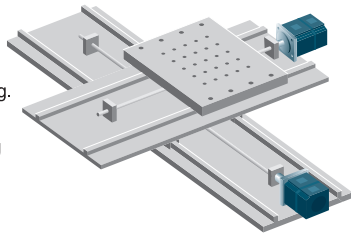

### ■ Conveyors

For conveyance between processes of each work, etc.

- High acceleration/deceleration and high-speed conveyance are enabled by the servo system.
- Constant-speed feed is available with a highly stable speed.
- Optimal gain can be set by the auto tuning function when using various works.

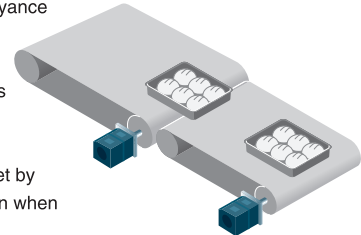

### ■ Food processing machines

For food processing, positioning of liquid filling nozzle, unwinding of wrapping material, etc.

- The high-performance servo system enables shorter cycle time.
- The tough drive function improves machine operating rate.
- The HF-KN series is rated IP65 (excluding the shaft-through portion).

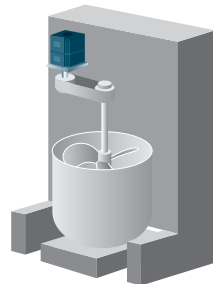

### ■ Loaders/unloaders, feeders and sliders

Work positioning and conveyance for automated warehouse, press machines, etc.

- The high speed and accurate positioning improves productivity.
- Compact machine size can be achieved by the small-size servo amplifier and servo motor.

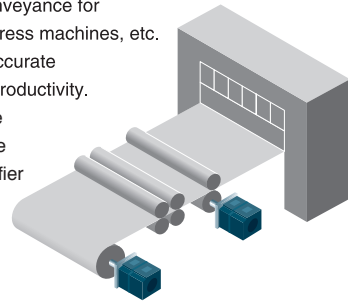

### ■ Textile machines

For string unwinding, traversing, etc.

- Compact machine size can be achieved by the small-size servo amplifier and servo motor.
- High acceleration/deceleration and high-speed conveyance are enabled by the servo system.
- The HF-KN series is rated IP65 (excluding the shaft-through portion).

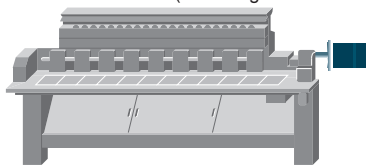

### ■ Robots

For picking up and transferring processing work

- Shorter cycle time is achieved by suppressing vibrations.
- Optimal gain can be set by the auto tuning function when using various works.
- Compact machine can be achieved by the small-size servo amplifier and servo motor.

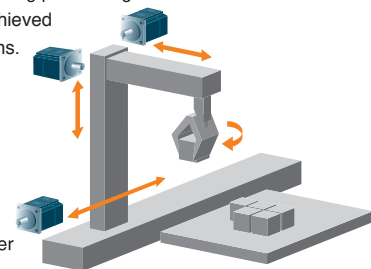

### ■ Semiconductor/liquid crystal/solar battery producing equipment

For peripheral axes of board, panel conveyance, etc.

- Easy maintenance with the separated power supply for main and control circuits.
- The tough drive function improves machine operating rate.
- Compact machine size can be achieved by the small-size servo amplifier and servo motor.

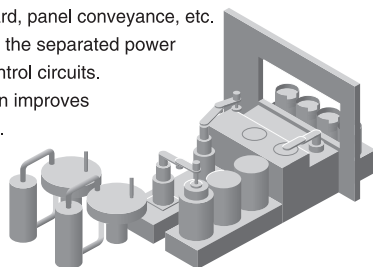

### ■ Replacement of stepping motors, DC motors, air actuator or inverters

By introducing the servo system, the driving section of the legacy products can be faster and more accurate.

- Replacement of the air actuator enables more accurate driving section.
- Step-out occurred with the stepping motor is no longer an issue.
- Replacement of the inverter improves speed and accuracy.

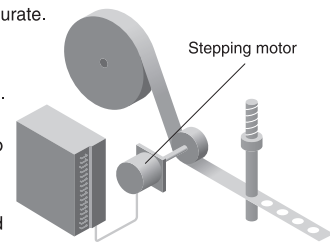

## Servo Support Software (for Easy Introduction)

### Drive System Sizing Software Motorizer

Select the most suitable servo motors, servo amplifiers, and regenerative options for your machine just by setting machine specifications and operation patterns. You can select a suitable combination from various results.

Specification input

The screenshot shows the Motorizer software interface. On the left is a navigation pane with steps: Step 1 (Load mechanism), Step 2 (Transmission mechanism), and Step 3 (Operation pattern). The main area is divided into 'Specification settings' with input fields for parameters like Mass of load, Mass of table, Counter weight mass, Load of ball screw, Ball screw inertia moment, Friction coefficient, Overall machine efficiency, Thrust load, and Option. To the right is a 3D diagram of a servo motor with force vectors labeled JOL, JOM, V, Wl, Fc, WcW, and P<sub>B</sub>. Below the settings is a 'Selection candidate list' table.

Motor	Drive	Regenerative option	Torque effective load rate(%)	Peak load rate(%)	Effective load rate at stop(%)	Motor output rate(%)	Maximum speed rate
MF-40V10	MR-20-10A	None	10.2	10.2	9.8	94	91
MF-40V10	MR-20-10A	None	24.4	24.9	9.8	94	91
MF-40V10	MR-20-10A	None	14.2	14.2	9.8	94	91

- 13 common load mechanisms
- Able to add mechanical transmissions

The selection result displays various possible options.

The selection result can be read by FA Integrated Selection Tool.

### FA Integrated Selection Tool

FA Integrated Selection Tool is available on the global website, so you can select multiple devices/entire system with one tool. Using "Select by device" or "Select by network" helps you to select devices such as programmable controllers and AC servos. Select necessary options such as encoder cables. Easily create system configuration diagrams and lists of necessary purchases to prevent mistakes when ordering.

## Selection Tool

### FA Integrated Selection Tool



Servo Support Software (Easy setup support)

MR Configurator2

MELSOFT

SW1DNC-MRC2-E

Tuning, monitor display, diagnosis, reading/writing parameters, and test operations are easily performed on a personal computer. This powerful software tool supports a stable machine system and optimum control, and moreover, shortens setup time.

[Parameter setting] window

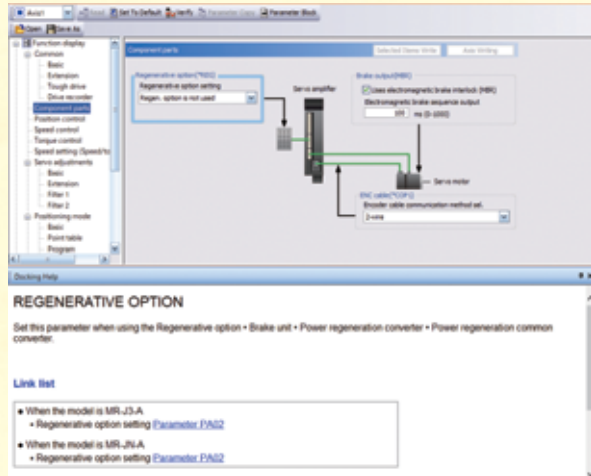

Display parameter setting in list or visual formats, and set parameters by selecting from the drop-down list.

[Display all] window

No.	Item	Unit	Axis1
1	Cumulative feedback pulses	pulse	168161
2	Servo motor speed	r/min	0
3	Droop pulse	pulse	0
4	Cumulative cmd. pulses	pulse	0
5	Command pulse frequency	kpulse/s	0
6	Regenerative load ratio	%	0
7	Effective load ratio	%	0
8	Peak load ratio	%	0
9	Instantaneous torque		
10	Within one-revolution po		
11	Load inertia moment rati		
12	Bus voltage		
13	Current position		
14	Command position		
15	Remaining command dis		
16	Point table/Program No.		
17	Step No.		
18	Settling time		
19	Oscillation detection freq		
20	Number of tough drive o		

Monitor the operation information on the [Display all] window. Assign input/output signals and monitor on/off status of the signals on the [I/O monitor] window.

Test operation:

[Positioning mode] window



The test operation suitable for the application can be selected from the multiple test mode menus such as JOG operation, positioning operation, and motor-less operation.

[Graph] window

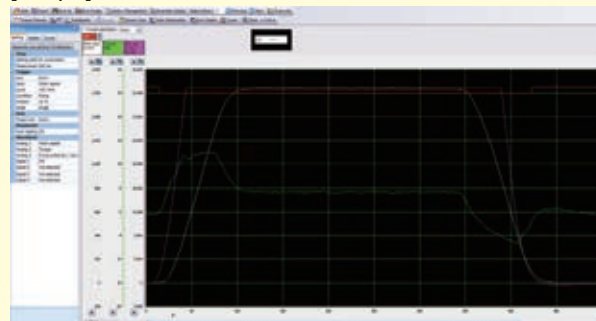

Powerful graph functions with 3 analog channels and 4 digital channels support tuning. User-friendly functions such as [Over write] and [Graph history] and a diverse waveform selection powerfully support user's work. Also, the [Gray display] function is provided for better visualization of printed data. Data can be saved either in CSV or JPEG format.

# Model Designation

## Model Designation

### ● Servo amplifiers

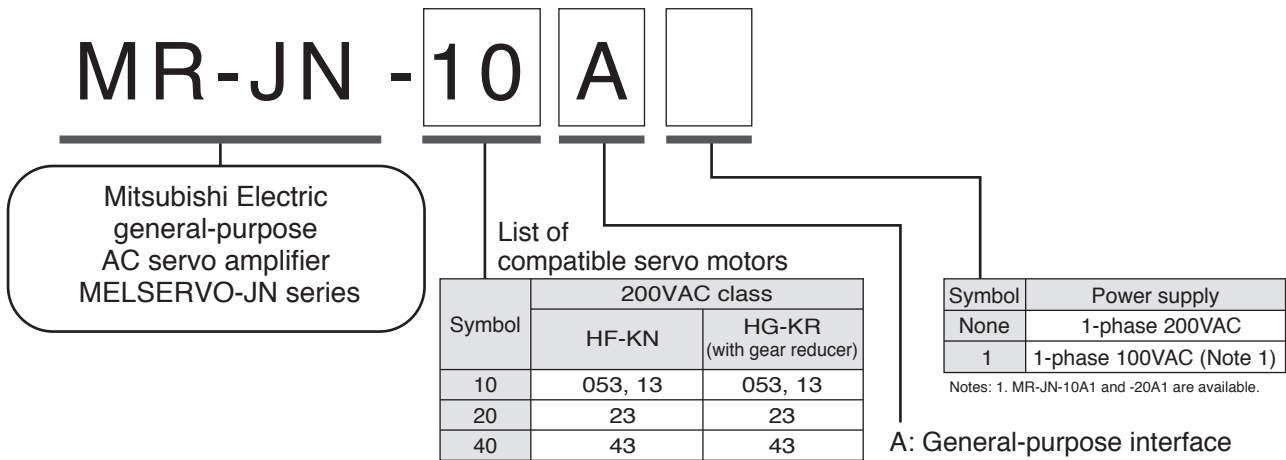

### ● HF-KN series servo motors (Note 1)

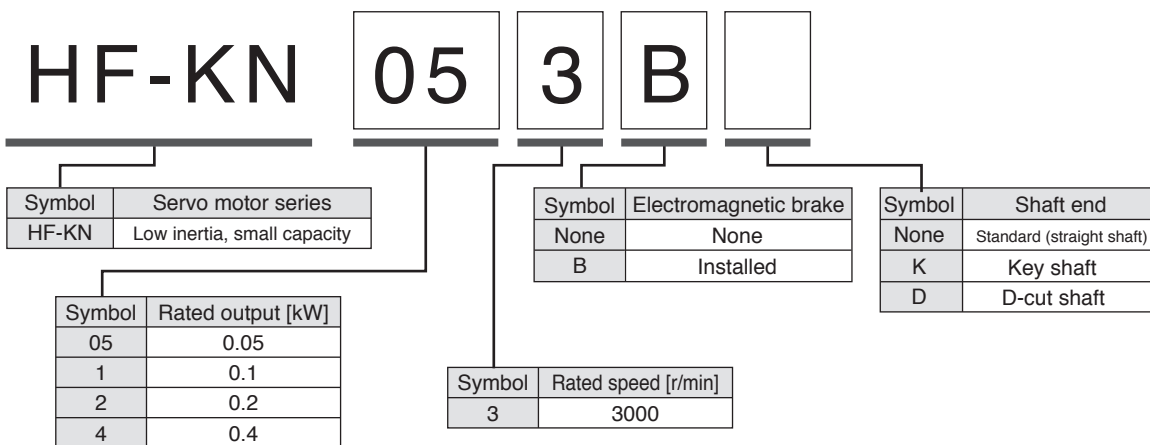

### ● HG-KR series geared servo motors

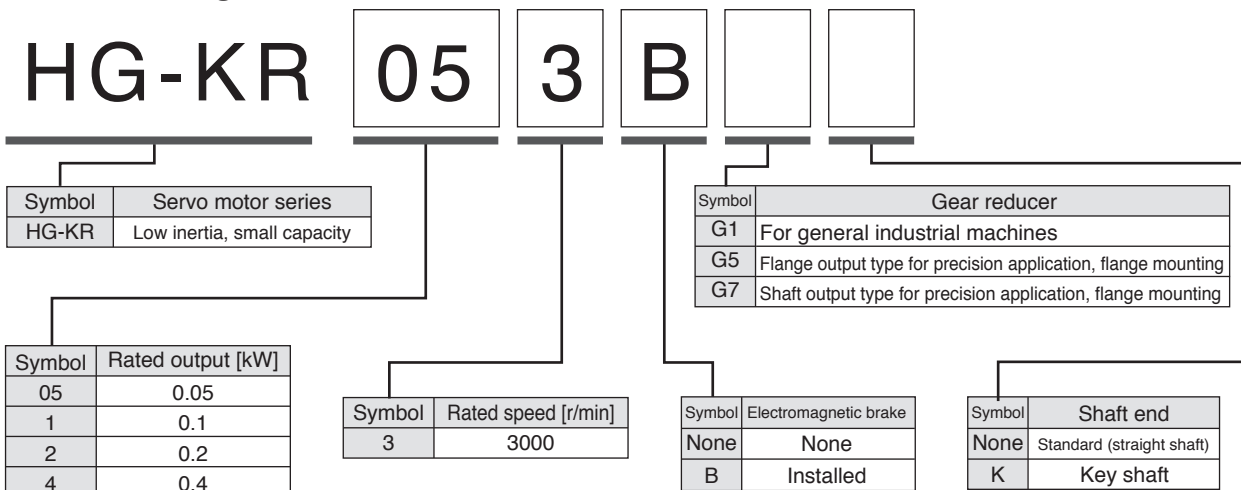

Connections with Peripheral Equipment (Note 1)

Peripheral equipment is connected to MR-JN-□A as described below. Connectors, options, and other necessary equipment are available so that users can set up MR-JN-□A easily and begin using it right away.

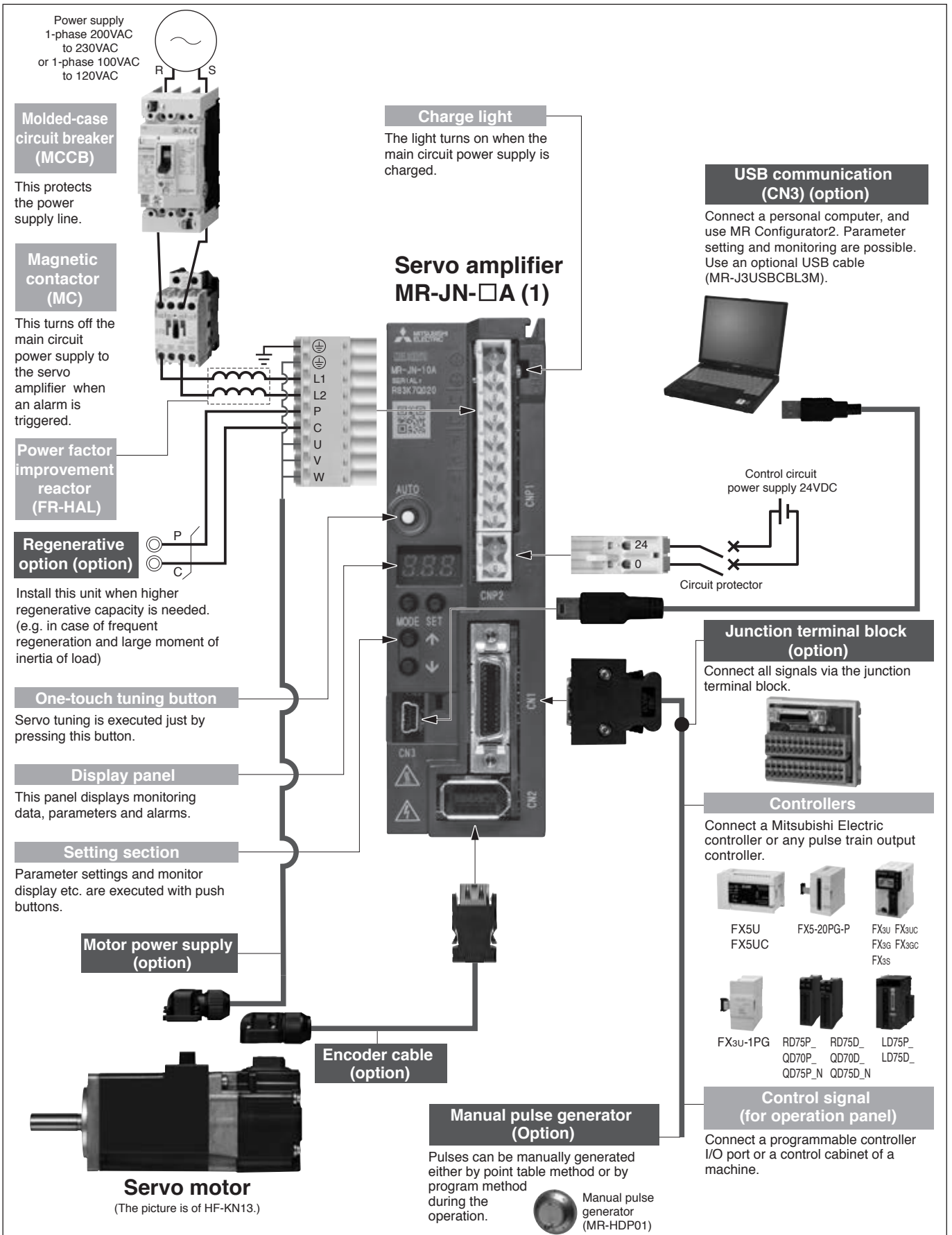

Notes: 1. Refer to "MR-JN-□A INSTRUCTION MANUAL" for the actual connections.

Servo amplifiers  
Servo motors  
Options/Peripheral Equipment  
Dimensions  
Product List  
Precautions

# Servo Amplifiers

## Servo Amplifier Specifications

Servo amplifier model		MR-JN-10A	MR-JN-20A	MR-JN-40A	MR-JN-10A1	MR-JN-20A1
Output	Rated voltage	3-phase 170VAC				
	Rated current [A]	1.1	1.6	2.8	1.1	1.6
Main circuit power supply input	Voltage/frequency (Note 1, 2)	1-phase 200VAC to 230VAC 50/60Hz			1-phase 100VAC to 120VAC 50/60Hz	
	Rated current [A]	1.5	2.4	4.5	3.0	5.0
	Permissible voltage fluctuation	1-phase 170VAC to 253VAC			1-phase 85VAC to 132VAC	
	Permissible frequency fluctuation	±5% maximum				
Control circuit power supply input	Voltage	24VDC				
	Rated current [A]	0.5				
	Permissible voltage fluctuation	±10% maximum				
	Power consumption [W]	10				
Interface power supply		24VDC ±10% (required current capacity: 0.2A (Note 5))				
Permissible regenerative power of built-in regenerative resistor (Note 3, 4) [W]		—	10	10	—	10
Control method		Sine-wave PWM control/current control method				
Dynamic brake		Built-in (Note 6, 9)				
Protective functions		Overcurrent shut-off, regeneration overvoltage shut-off, overload shut-off (electronic thermal), servo motor overheat protection, encoder error protection, regeneration error protection, undervoltage protection, instantaneous power failure protection, overspeed protection, error excessive protection				
Position control mode	Maximum input pulse frequency	1Mpulse/s (when using differential receiver), 200kpulses/s (when using open collector)				
	Positioning feedback pulse	Encoder resolution: 131072pulses/rev				
	Command pulse multiplying factor	Electronic gear A/B multiple, A: 1 to 65535, B: 1 to 65535, 1/50 < A/B < 500				
	Positioning range setting	0 to ±65535 pulses (command pulse unit)				
	Error excessive	±3 rotations				
	Torque limit	Set by parameters				
Internal speed control mode	Speed control range	Internal speed command 1:5000				
	Speed command input	Set by parameters				
	Speed fluctuation rate	±0.01% maximum (load fluctuation 0 to 100%) 0% (power fluctuation ±10%)				
	Torque limit	Set by parameters				
Internal torque control mode	Torque command input	Set by parameters				
	Speed limit	Set by parameters				
Positioning mode (Note 8)		Point table method, Program method				
Structure		Natural-cooling, open (IP rating: IP20)				
Environment	Ambient temperature (Note 7)	0°C to 55°C (non-freezing), storage: -20°C to 65°C (non-freezing)				
	Ambient humidity	Operation/storage: 5%RH to 90%RH (non-condensing)				
	Ambience	Indoors (no direct sunlight); no corrosive gas, inflammable gas, oil mist or dust				
	Altitude	1000m or less above sea level				
	Vibration resistance	5.9m/s <sup>2</sup> at 10Hz to 55Hz (directions of X, Y and Z axes)				
Mass [kg]		0.6	0.6	0.7	0.6	0.6

Notes: 1. Rated output and speed of a servo motor are applicable when the servo amplifier, combined with the servo motor, is operated within the specified power supply voltage and frequency. Torque drops when the power supply voltage is below the specified value.

2. For torque characteristics when combined with a servo motor, refer to "Servo Motor Torque Characteristics" in this catalog.

3. The optimal regenerative resistor varies for each system. Select the most suitable regenerative resistor with our drive system sizing software Motorizer.

4. Refer to "Regenerative Option" in this catalog for the permissible regenerative power [W].

5. The value 0.2A is applicable when all of the input/output points are used. The current capacity can be stepped down according to the number of input/output points in use. Refer to "MR-JN-□A INSTRUCTION MANUAL" for details.

6. When using the built-in dynamic brake, refer to "MR-JN-□A INSTRUCTION MANUAL" for the permissible load to motor inertia ratio.

7. The servo amplifiers can be mounted closely. In this case, keep the ambient temperature within 0 to 45°C, or use the servo amplifier at 75% or less of the effective load rate.

8. A servo amplifier with software version B0 or above is required for the positioning function.

9. A servo amplifier with software version B2 or above is required for the electronic dynamic brake.



Standard Wiring Diagram: Position Control Operation

• Connection example to FX5U

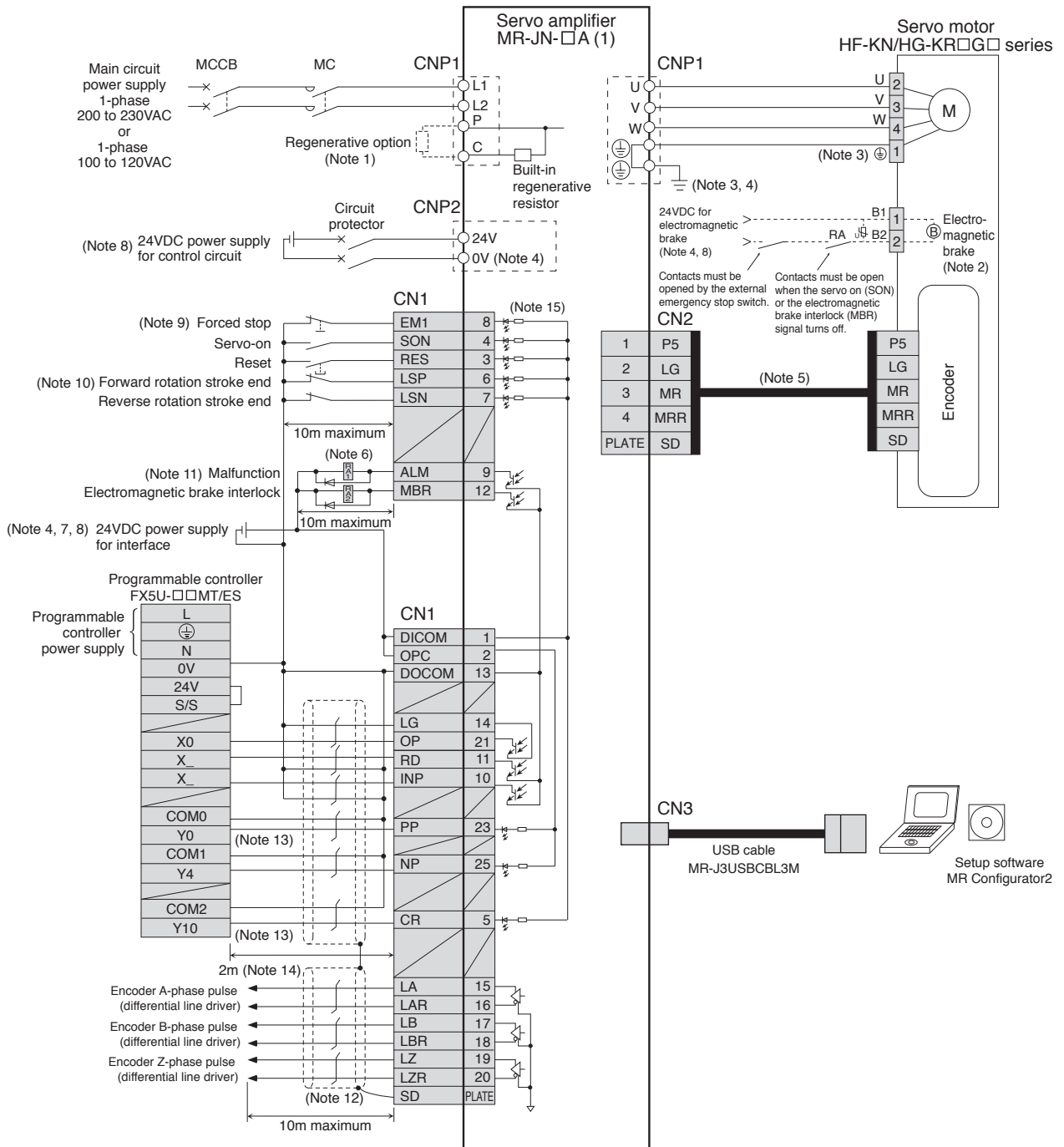

- Notes: 1. Disconnect the wires for the built-in regenerative resistor (P and C) and remove the resistor from the servo amplifier when connecting the regenerative option externally.  
 2. This is for the servo motor with electromagnetic brake. The electromagnetic brake terminals (B1, B2) do not have polarity.  
 3. Connect the ground wire to the cabinet protective earth (PE) terminal via the servo amplifier for grounding the servo motor.  
 4. Do not connect the 0V of 24VDC power supply to the servo amplifier protective earth (PE) terminal.  
 5. The signals shown are applicable when using a two-wire type encoder cable. Refer to "MR-JN-□A INSTRUCTION MANUAL" for four-wire type.  
 6. Do not reverse the diode's direction. Connecting it backwards may cause the servo amplifier to malfunction such that the signals are not output, and the forced stop and other safety circuits are inoperable.  
 7. Use the power supply 24VDC±10% (required current capacity: 0.2A). The value 0.2A is applicable when all of the input/output points are used. Note that the current capacity can be stepped down according to the number of input/output points in use. Refer to "MR-JN-□A INSTRUCTION MANUAL" for details.  
 8. Use the enhanced insulation power supply for the external power supply 24VDC. Do not use the 24VDC power supplies for the interface and control unit to power the electromagnetic brake. Provide a dedicated power supply to the electromagnetic brake.  
 9. Always turn on the forced stop (EM1) signal (normally closed contact) before starting the operation. If not, the operation will not start.  
 10. Always turn on the forward and reverse rotation stroke end (LSP/LSN) signals (normally closed contact) before starting the operation. If not, the commands will not be accepted.  
 11. The malfunction (ALM) signal (normally closed contact) is conducted to DOCOM in normal alarm-free condition.  
 12. Connect the shielded wire securely to the plate inside the connector (ground plate).  
 13. This is applicable when the setting of the programmable controller is for the first axis. For the second or third axis, the number changes.  
 14. It is recommended that the connection be 2m or shorter because an open-collector system is used.  
 15. This is for sink wiring. Source wiring is also possible. Refer to "MR-JN-□A INSTRUCTION MANUAL" for details.

Servo amplifiers  
 Servo motors  
 Options/Peripheral Equipment  
 Dimensions  
 Product List  
 Precautions

# Servo Amplifiers

## Standard Wiring Diagram: Position Control Operation

### • Connection example to QD75D/LD75D/RD75D

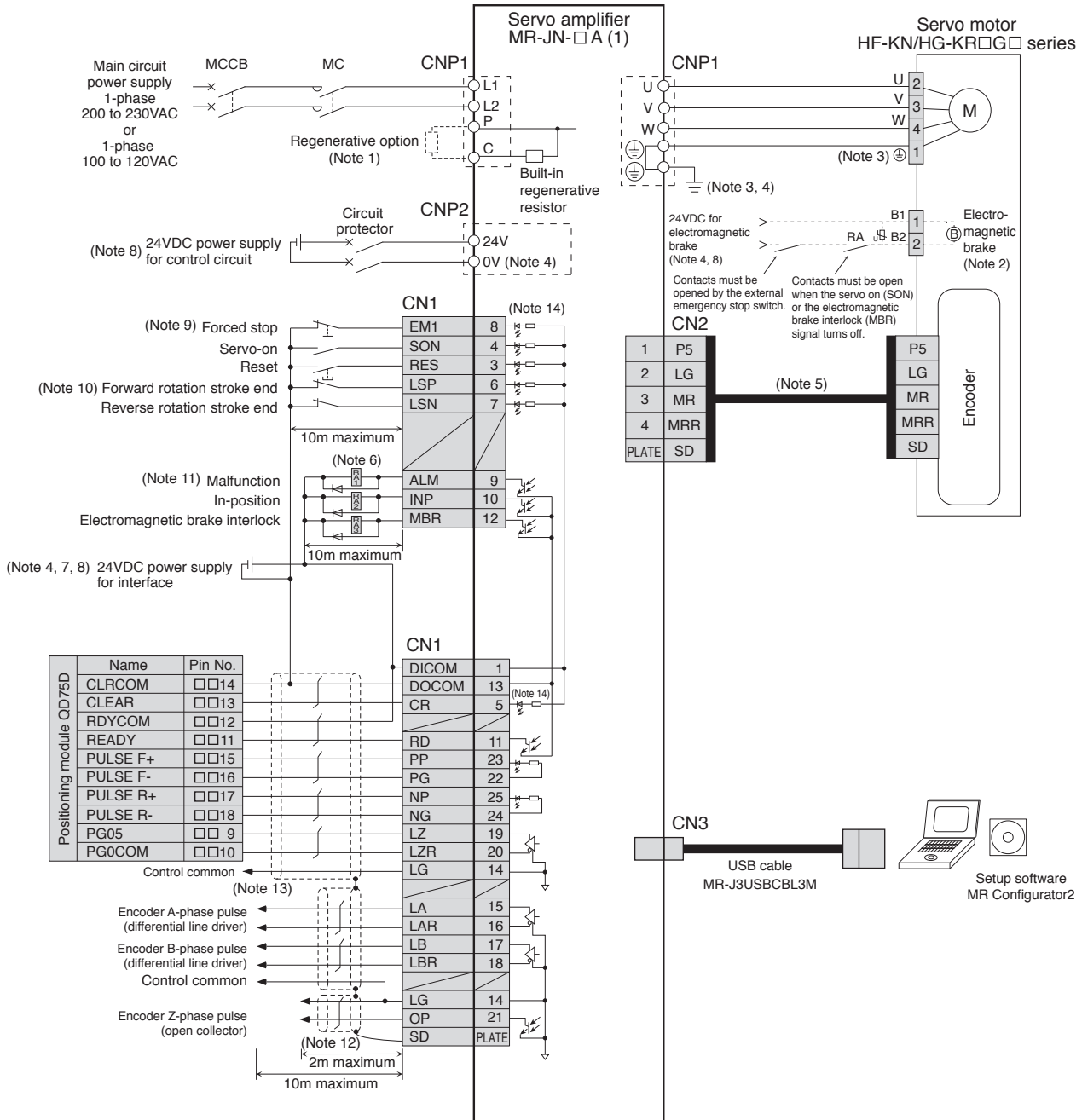

- Notes:
1. Disconnect the wires for the built-in regenerative resistor (P and C) and remove the resistor from the servo amplifier when connecting the regenerative option externally.
  2. This is for the servo motor with electromagnetic brake. The electromagnetic brake terminals (B1, B2) do not have polarity.
  3. Connect the ground wire to the cabinet protective earth (PE) terminal via the servo amplifier for grounding the servo motor.
  4. Do not connect the 0V of 24VDC power supply to the servo amplifier protective earth (PE) terminal.
  5. The signals shown are applicable when using a two-wire type encoder cable. Refer to "MR-JN-□A INSTRUCTION MANUAL" for four-wire type.
  6. Do not reverse the diode's direction. Connecting it backwards may cause the servo amplifier to malfunction such that the signals are not output, and the forced stop and other safety circuits are inoperable.
  7. Use the power supply 24VDC±10% (required current capacity: 0.2A). The value 0.2A is applicable when all of the input/output points are used. Note that the current capacity can be stepped down according to the number of input/output points in use. Refer to "MR-JN-□A INSTRUCTION MANUAL" for details.
  8. Use the enhanced insulation power supply for the external power supply 24VDC. Do not use the 24VDC power supplies for the interface and control unit to power the electromagnetic brake. Provide a dedicated power supply to the electromagnetic brake.
  9. Always turn on the forced stop (EM1) signal (normally closed contact) before starting the operation. If not, the operation will not start.
  10. Always turn on the forward and reverse rotation stroke end (LSP, LSN) signals (normally closed contact) before starting the operation. If not, the commands will not be accepted.
  11. The malfunction (ALM) signal (normally closed contact) is conducted to DOCOM in normal alarm-free condition.
  12. Connect the shielded wire securely to the plate inside the connector (ground plate).
  13. This connection is not necessary for QD75D Positioning module. Note that the connection between LG and control common terminal is recommended for some Positioning modules to improve noise tolerance.
  14. This is for sink wiring. Source wiring is also possible. Refer to "MR-JN-□A INSTRUCTION MANUAL" for details.

Standard Wiring Diagram: Speed Control Operation (Note 1)

• Connection example

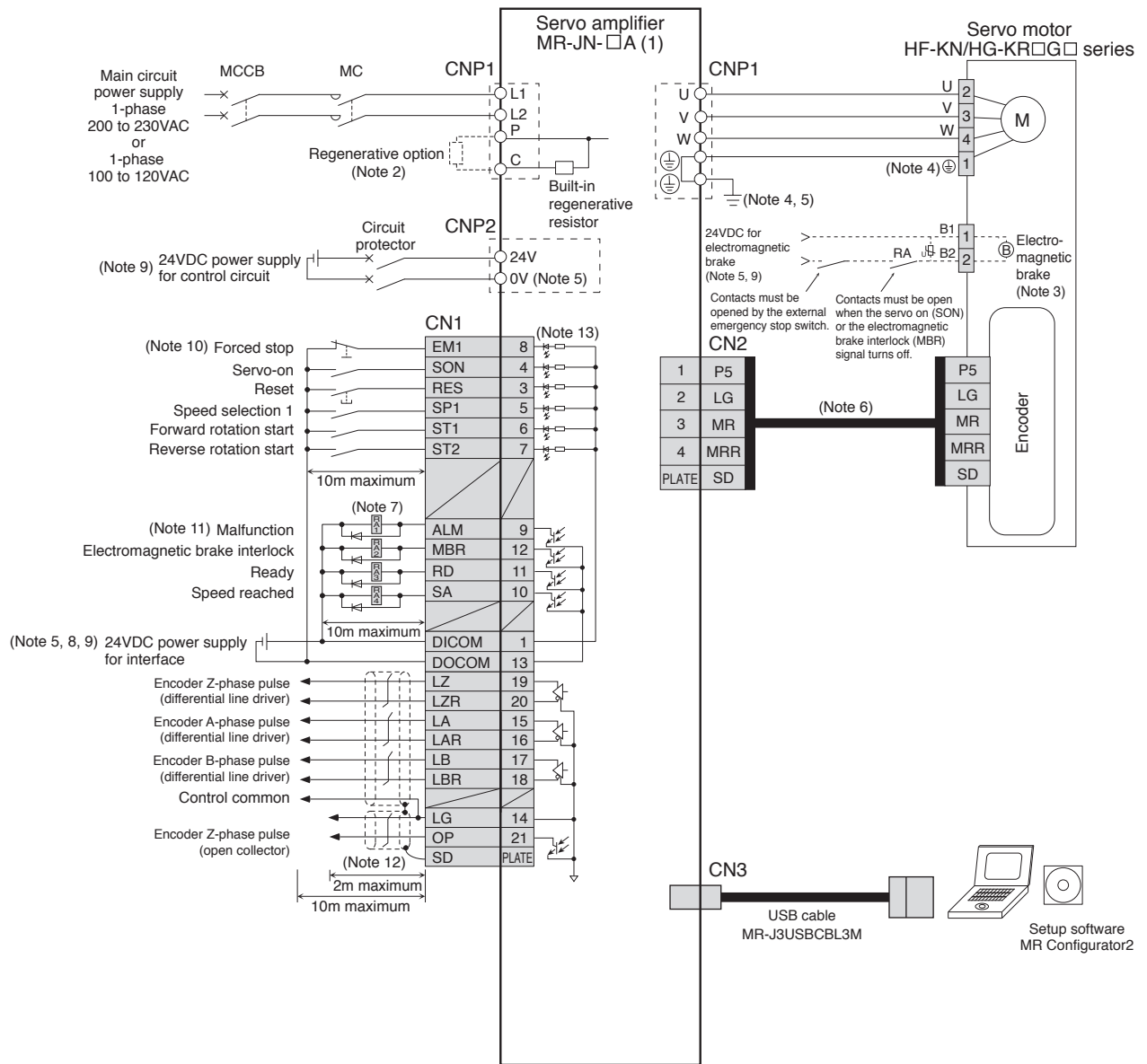

- Notes: 1. MR-JN- □A only supports operations by internal speed command.  
 2. Disconnect the wires for the built-in regenerative resistor (P and C) and remove the resistor from the servo amplifier when connecting the regenerative option externally.  
 3. This is for the servo motor with electromagnetic brake. The electromagnetic brake terminals (B1, B2) do not have polarity.  
 4. Connect the ground wire to the cabinet protective earth (PE) terminal via the servo amplifier for grounding the servo motor.  
 5. Do not connect the 0V of 24VDC power supply to the servo amplifier protective earth (PE) terminal.  
 6. The signals shown are applicable when using a two-wire type encoder cable. Refer to "MR-JN-□A INSTRUCTION MANUAL" for four-wire type.  
 7. Do not reverse the diode's direction. Connecting it backwards may cause the servo amplifier to malfunction such that the signals are not output, and the forced stop and other safety circuits are inoperable.  
 8. Use the power supply 24VDC ±10% (required current capacity: 0.2A). The value 0.2A is applicable when all of the input/output points are used.  
 Note that the current capacity can be stepped down according to the number of input/output points in use. Refer to "MR-JN-□A INSTRUCTION MANUAL" for details.  
 9. Use the enhanced insulation power supply for the external power supply 24VDC. Do not use the 24VDC power supplies for the interface and control unit to power the electromagnetic brake. Provide a dedicated power supply to the electromagnetic brake.  
 10. Always turn on the forced stop (EM1) signal (normally closed contact) before starting the operation. If not, the operation will not start.  
 11. The malfunction (ALM) signal (normally closed contact) is conducted to DOCOM in normal alarm-free condition.  
 12. Connect the shielded wire securely to the plate inside the connector (ground plate).  
 13. This is for sink wiring. Source wiring is also possible. Refer to "MR-JN-□A INSTRUCTION MANUAL" for details.

Servo amplifiers  
 Servo motors  
 Options/Peripheral Equipment  
 Dimensions  
 Product List  
 Precautions

# Servo Amplifiers

## Standard Wiring Diagram: Torque Control Operation (Note 1)

### • Connection example

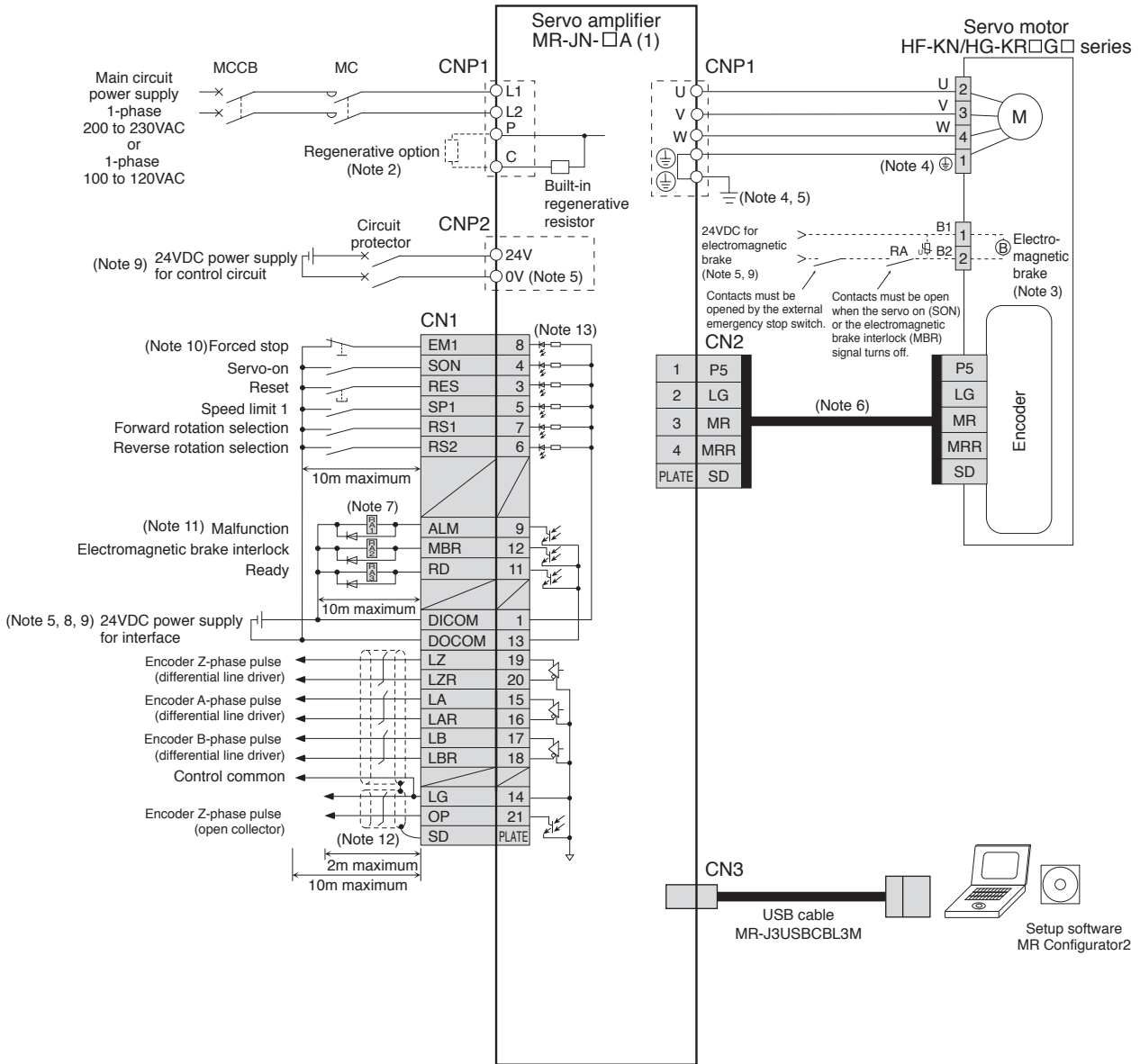

Notes: 1. MR-JN-□A only supports operations by internal torque command.

2. Disconnect the wires for the built-in regenerative resistor (P and C) and remove the resistor from the servo amplifier when connecting the regenerative option externally.

3. This is for the servo motor with electromagnetic brake. The electromagnetic brake terminals (B1, B2) do not have polarity.

4. Connect the ground wire to the cabinet protective earth (PE) terminal via the servo amplifier for grounding the servo motor.

5. Do not connect the 0V of 24VDC power supply to the servo amplifier protective earth (PE) terminal.

6. The signals shown are applicable when using a two-wire type encoder cable. Refer to "MR-JN-□A INSTRUCTION MANUAL" for four-wire type.

7. Do not reverse the diode's direction. Connecting it backwards may cause the servo amplifier to malfunction such that the signals are not output, and the forced stop and other safety circuits are inoperable.

8. Use the power supply 24VDC  $\pm 10\%$  (required current capacity: 0.2A). The value 0.2A is applicable when all of the input/output points are used.

Note that the current capacity can be stepped down according to the number of input/output points in use. Refer to "MR-JN-□A INSTRUCTION MANUAL" for details.

9. Use the enhanced insulation power supply for the external power supply 24VDC. Do not use the 24VDC power supplies for the interface and control unit to power the electromagnetic brake. Provide a dedicated power supply to the electromagnetic brake.

10. Always turn on the forced stop (EM1) signal (normally closed contact) before starting the operation. If not, the operation will not start.

11. The malfunction (ALM) signal (normally closed contact) is conducted to DCOM in normal alarm-free condition.

12. Connect the shielded wire securely to the plate inside the connector (ground plate).

13. This is for sink wiring. Source wiring is also possible. Refer to "MR-JN-□A INSTRUCTION MANUAL" for details.

## Positioning function: Point table method

Set position and speed data in the point table and select the point table number with an external interface signal to perform positioning operation.

**Point table:** The following two types of point tables are available.

### (1) Absolute value command method:

Moves to the address (absolute value) based on the home position.

Item	Setting range	Unit	Description
Position data	-999999 to 999999	$\times 10^{STM} \mu\text{m}$	<ul style="list-style-type: none"> <li>• <b>Absolute value command method</b> Sets the address. STM is the ratio for the data.</li> <li>• <b>Incremental value command method</b> Sets the movement amount. STM is the ratio for the data.</li> </ul>
Servo motor speed	0 to permissible	r/min	Sets the command speed for the servo motor used for positioning.
Acceleration time constant	0 to 20000	ms	Sets the acceleration time constant. (Note 1)
Deceleration time constant	0 to 20000	ms	Sets the deceleration time constant. (Note 1)
Dwell time	0 to 20000	ms	Runs the next point table after the set dwell time.
Auxiliary function	0 to 3	—	<ul style="list-style-type: none"> <li>• <b>Absolute value command method</b> 0: Positions and stops (waits for start signal). 1: Continues operation for the next point table without stopping.</li> <li>• <b>Incremental value command method</b> 2: Positions and stops (waits for start signal). 3: Continues operation for the next point table without stopping.</li> </ul>

(Example of setting point table data)

Point table No.	Position data	Servo motor speed	Acceleration time constant	Deceleration time constant	Dwell time	Auxiliary function
1	1000	2000	200	200	0	1
2	2000	1600	100	100	0	0
:	:	:	:	:	:	:
7	3000	3000	100	100	0	2

If the point table No.1's auxiliary function is 1 or 3, continuous positioning operation is carried out based on the point table as shown in the "●Auxiliary function 1 or 3" below.  
If the point table No.1's auxiliary function is 0 or 2, a start signal must be issued as shown in "●Auxiliary function 0 or 2" below.

● Auxiliary function 1 or 3

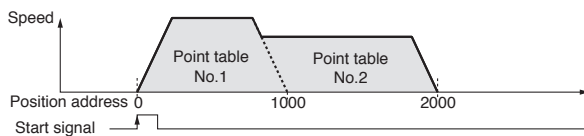

● Auxiliary function 0 or 2

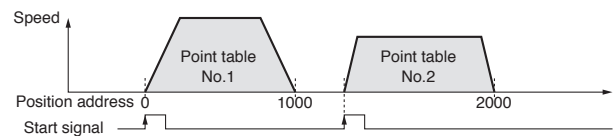

### (2) Incremental value command method:

Moves from the current value according to the set position data

Item	Setting range	Unit	Description
Position data	0 to 999999	$\times 10^{STM} \mu\text{m}$	Sets the movement amount. STM is the ratio for the data.
Servo motor speed	0 to permissible	r/min	Sets the command speed for the servo motor used for positioning.
Acceleration time constant	0 to 20000	ms	Sets the acceleration time constant. (Note 1)
Deceleration time constant	0 to 20000	ms	Sets the deceleration time constant. (Note 1)
Dwell time	0 to 20000	ms	Runs the next point table after the set dwell time.
Auxiliary function	0 and 1	—	<ul style="list-style-type: none"> <li>0: Positions and stops (waits for start signal).</li> <li>1: Continues operation for the next point table without stopping.</li> </ul>

(Example of setting point table data)

Point table No.	Position data	Servo motor speed	Acceleration time constant	Deceleration time constant	Dwell time	Auxiliary function
1	1000	2000	200	200	0	1
2	1000	1600	100	100	0	0
:	:	:	:	:	:	:
7	500	3000	100	100	0	0

If the point table No.1's auxiliary function is 1, continuous positioning operation is carried out based on the point table as shown in the "●Auxiliary function 1" below.  
If the point table No.1's auxiliary function is 0, a start signal must be issued as shown in "●Auxiliary function 0" below.

● Auxiliary function 1

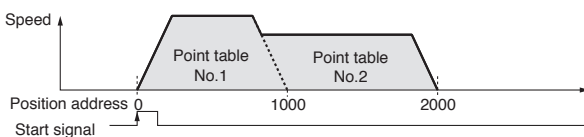

● Auxiliary function 0

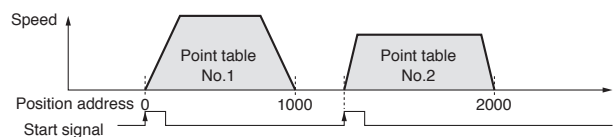

Notes: 1. S-pattern acceleration/deceleration time constant is set by the servo amplifier's parameter.

# Servo Amplifiers

## Positioning Function: Point Table Method

### • Command Method and Operation Mode

Item		Description	
Command method	Point table No. input	Command interface	DI/O (Note 1)
		Operating specification	Positions based on the specification of the point table No. (7 points)
		Input positioning command	Set in point table. One-point feed length setting range: $\pm 1\mu\text{m}$ to $\pm 999999 \times 10^{\text{STM}} \mu\text{m}$ . (Note 2)
		System	Signed absolute value command system, increment value command system
Operation mode	Automatic operation mode	Point table	Point table number input Each positioning operation based on position and speed commands.
	Manual operation mode	JOG	Inches upon input based on speed commands set by a parameter.
		Manual pulse generator	Manual feed by manual pulse generator. Command pulse multiplication: $\times 1$ , $\times 10$ or $\times 100$ is selectable by the parameter.
	Home position return mode	Dog type	Returns to home position upon Z-phase pulse count after passing through proximity dog. Home position return direction selectable. Home position shift amount and home position address settable. Automatic retreat on dog back to home position and automatic stroke retreat function.
		Count type	Returns to home position upon Z-phase pulse count after touching proximity dog. Home position return direction selectable. Home position shift amount and home position address settable. Automatic retreat on dog back to home position and automatic stroke retreat function.
		Data set type	Returns to home position without dog. Sets any position as home position using manual operation, etc. Home position address settable.
		Stopper type	Returns to home position upon hitting end of stroke. Home position return direction selectable. Home position address settable.
		Ignore home (Servo-on position as home position)	Uses position where the servo on (SON) signal turns ON as home position. Home position address settable.
		Dog type rear end reference	Returns to home position with respect to the rear end of a proximity dog. Home position return direction selectable. Home position shift amount and home position address settable. Automatic retreat on dog back to home position and automatic stroke retreat function.
		Count type front end reference	Returns to home position with respect to the front end of a proximity dog. Home position return direction selectable. Home position shift amount and home position address settable. Automatic retreat on dog back to home position and automatic stroke retreat function.
Dog cradle type		Returns to home position upon the first Z-phase pulse with respect to the front end of a proximity dog. Home position return direction selectable. Home position shift amount and home position address settable. Automatic retreat on dog back to home position and automatic stroke retreat function.	

Notes: 1. The command interface will be compatible with pulse train command by using manual pulse generator (MR-HDP01).

2. STM is the ratio for the data. It can be changed by parameter.

• Connection example

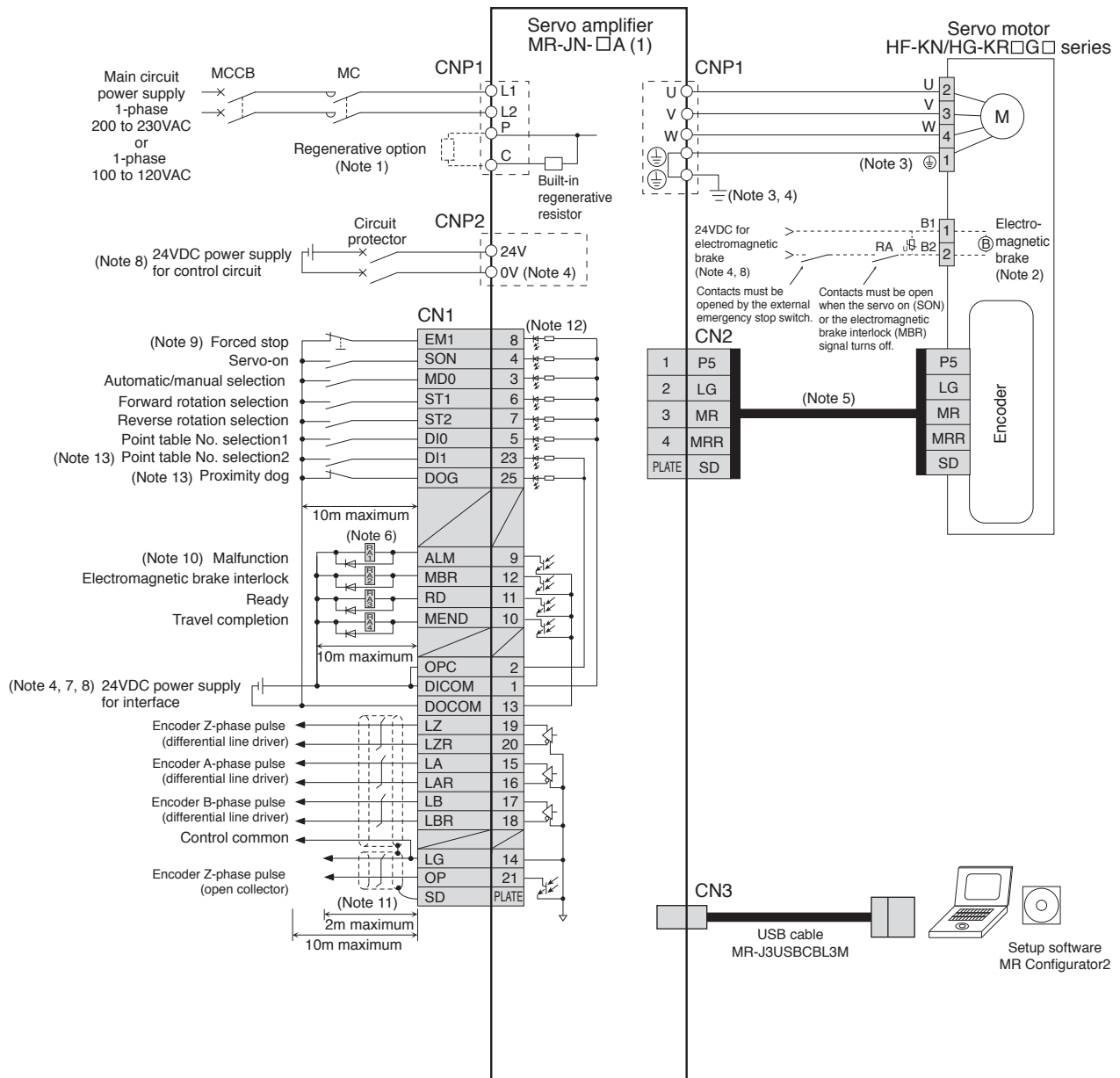

- Notes:
1. Disconnect the wires for the built-in regenerative resistor (P and C) and remove the resistor from the servo amplifier when connecting the regenerative option externally.
  2. This is for the servo motor with electromagnetic brake. The electromagnetic brake terminals (B1, B2) do not have polarity.
  3. Connect the ground wire to the cabinet protective earth (PE) terminal via the servo amplifier for grounding the servo motor.
  4. Do not connect the 0V of 24VDC power supply to the servo amplifier protective earth (PE) terminal.
  5. The signals shown are applicable when using a two-wire type encoder cable. Refer to "MR-JN-□A INSTRUCTION MANUAL" for four-wire type.
  6. Do not reverse the diode's direction. Connecting it backwards may cause the servo amplifier to malfunction such that the signals are not output, and the forced stop and other safety circuits are inoperable.
  7. Use the power supply 24VDC±10% (required current capacity: 0.2A). The value 0.2A is applicable when all of the input/output points are used.  
Note that the current capacity can be stepped down according to the number of input/output points in use. Refer to "MR-JN-□A INSTRUCTION MANUAL" for details.
  8. Use the enhanced insulation power supply for the external power supply 24VDC. Do not use the 24VDC power supplies for the interface and control unit to power the electromagnetic brake. Provide a dedicated power supply to the electromagnetic brake.
  9. Always turn on the forced stop (EM1) signal (normally closed contact) before starting the operation. If not, the operation will not start.
  10. The malfunction (ALM) signal (normally closed contact) is conducted to DOCOM in normal alarm-free condition.
  11. Connect the shielded wire securely to the plate inside the connector (ground plate).
  12. This is for sink wiring. Source wiring is also possible. However, when input signals are assigned to CN1-23 pin and CN1-25 pin, be sure to use sink wiring. Source wiring is not possible in this case. In positioning mode, input signals are assigned in the initial setting. Refer to "MR-JN-□A INSTRUCTION MANUAL" for details.
  13. Manual pulse generator can be used by setting a parameter. Refer to "MR-JN-□A INSTRUCTION MANUAL" for details.

## Positioning function: Program method

Create position data, servo motor speed, acceleration and deceleration time constants and so on as programs beforehand.

Positioning operation is performed by selecting the created Program No. with an external interface signal.

Program method enables more complex positioning operation than point table method. MR Configurator2 (Setup software) is required to create a program.

### ● Command list (Note 6)

Command	Name	Setting	Setting range	Unit	Description
SPN (Note 1)	Servo motor speed	SPN(setting)	0 to permissible speed	r/min	Set a command speed for the servo motor in positioning. Do not set a value exceeding the instantaneous permissible speed of the servo motor.
STA (Note 2)	Acceleration time constant	STA(setting)	0 to 20000	ms	Set acceleration time constant.
STB (Note 2)	Deceleration time constant	STB(setting)	0 to 20000	ms	Set deceleration time constant.
STC (Note 2)	Acceleration/ deceleration time constants	STC(setting)	0 to 20000	ms	Set acceleration and deceleration time constants.
STD (Note 2)	S-pattern acceleration/ deceleration time constants	STD(setting)	0 to 100	ms	Set S-pattern acceleration/deceleration time constants.
MOV	Absolute value travel command	MOV(setting)	-999999 to 999999	$\times 10^{\text{STM}}$ $\mu\text{m}$ (Note 5)	Travels based on the value set as an absolute value.
MOVA	Absolute value continuous travel command	MOVA(setting)	-999999 to 999999	$\times 10^{\text{STM}}$ $\mu\text{m}$ (Note 5)	Travels continuously based on the value set as an absolute value. Be sure to write this command after [MOV] command.
MOVI	Incremental value travel command	MOVI(setting)	-999999 to 999999	$\times 10^{\text{STM}}$ $\mu\text{m}$ (Note 5)	Travels based on the value set as an incremental value.
MOVIA	Incremental value continuous travel command	MOVIA(setting)	-999999 to 999999	$\times 10^{\text{STM}}$ $\mu\text{m}$ (Note 5)	Travels continuously based on the value set as an incremental value. Be sure to write this command after [MOVI] command.
SYNC (Note 3)	Waiting for external signal to switch on	SYNC(setting)	1	—	Stops the next step until PI1 (Program input 1) turns on after SOUT (SYNC synchronous output) is outputted.
OUTON (Note 3)	External signal on output	OUTON(setting)	1	—	Turns on OUT1 (Program output 1).
OUTOF (Note 3)	External signal off output	OUTOF(setting)	1	—	Turns off OUT1 (Program output 1) which was turned on with [OUTON] command.
TRIP (Note 3)	Absolute value trip point specification	TRIP(setting)	-999999 to 999999	$\times 10^{\text{STM}}$ $\mu\text{m}$ (Note 5)	Executes the next step after [MOV] or [MOVA] commands are started and then the servo motor moves for the travel amount set in [TRIP] command. Be sure to write this command after [MOV] or [MOVA] command.
TRIP1 (Note 3)	Incremental value trip point specification	TRIP1(setting)	-999999 to 999999	$\times 10^{\text{STM}}$ $\mu\text{m}$ (Note 5)	Executes the next step after [MOVI] or [MOVIA] commands are started and then the servo motor moves for the travel amount set in [TRIP1] command. Be sure to write this command after [MOVI] or [MOVIA] command.
ITP (Note 3, 4)	Interrupt positioning	ITP(setting)	0 to 999999	$\times 10^{\text{STM}}$ $\mu\text{m}$ (Note 5)	Stops the operation after the servo motor moves for the travel amount set when the interrupt signal is inputted. Be sure to write this command after [SYNC] command.
COUNT (Note 3)	External pulse count	COUNT(setting)	-999999 to 999999	pulse	Executes the next step when the value of the pulse counter exceeds the count value set in [COUNT] command. [COUNT(0)] clears the pulse counter to zero.
FOR NEXT	Step repeat command	FOR(setting) NEXT	0, and 1 to 10000	times	Repeats the steps between [FOR(setting value)] and [NEXT] commands for the number of times set. Repeats endlessly with [FOR(0) NEXT].
TIM	Dwell	TIM(setting)	1 to 20000	ms	Waits for the next step until the set time passes.
ZRT	Home position return	ZRT	—	—	Executes a manual home position return.
TIMES	Program count command	TIMES(setting)	0, and 1 to 10000	times	Set the number of program execution by writing [TIMES(setting value)] command in the first line of the program. The setting is not required for executing once. Repeats endlessly with [TIMES(0)].
STOP	Program stop	STOP	—	—	Stops the program in execution. Be sure to write this command in the final line.

Notes:1. The [SPN] command is valid while the [MOV], [MOVA], [MOVI], or [MOVIA] command is in execution.

2. The [STA], [STB], [STC], and [STD] commands are valid while the [MOV] or [MOVI] command is in execution.

3. The [SYNC], [OUTON], [OUTOF], [TRIP], [TRIP1], [ITP], and [COUNT] commands are valid while the commands are outputted.

4. [ITP] command will be skipped to the next step when the remaining distance equals to or less than the setting value, when the servo motor is not running, or when the servo motor is decelerating.

5. STM is the ratio for the data. STM can be changed with a parameter.

6. For the content of each command, refer to "MR-JN-□A INSTRUCTION MANUAL".



## Positioning Function: Program Examples

### Example 1

When executing two types of operations which have the same servo motor speed, the same acceleration and deceleration time constants and the different move commands:

Program	Description
SPN(3000)	Servo motor speed 3000 [r/min] ..... ①
STA(200)	Acceleration time constant 200 [ms] ..... ②
STB(300)	Deceleration time constant 300 [ms] ..... ③
MOV(1000)	Absolute value move command 1000 [ $\times 10^{\text{STM}} \mu\text{m}$ ] ..... ④
TIM(100)	Dwell 100 [ms] ..... ⑤
MOV(2500)	Absolute value move command 2500 [ $\times 10^{\text{STM}} \mu\text{m}$ ] ..... ⑥
STOP	Program stop

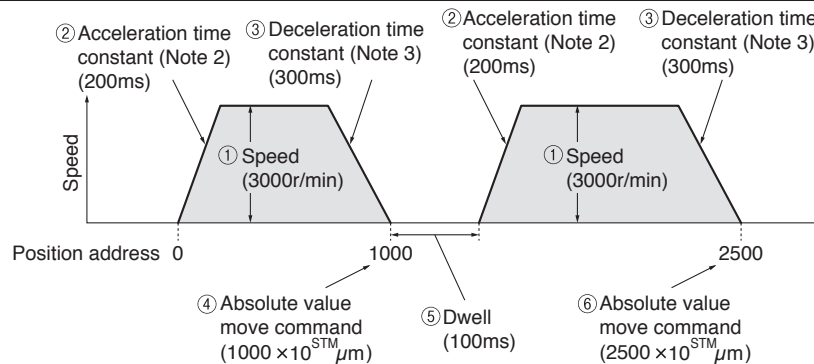

- Notes: 1. The values set as steps ①, ②, and ③ are valid as long as they are not set again.  
 2. The setting value is the time elapsing from a complete servo motor stop until reaching the rated speed.  
 3. The setting value is the time elapsing from rotating at the rated speed to the stop of the servo motor.

### Example 2

When repeating the steps between [FOR(setting value)] and [NEXT] commands for the number of times set:

Program	Description
SPN(3000)	Servo motor speed 3000 [r/min]
STC(20)	Acceleration and deceleration time constants 20 [ms]
MOV(1000)	Absolute value move command 1000 [ $\times 10^{\text{STM}} \mu\text{m}$ ]
TIM(100)	Dwell 100 [ms]
FOR(3)	Step repeat command start 3 [times] ..... ①
MOVI(100)	Incremental value move command 100 [ $\times 10^{\text{STM}} \mu\text{m}$ ] ..... ②
TIM(100)	Dwell 100 [ms] ..... ③
NEXT	Step repeat command end
STOP	Program stop

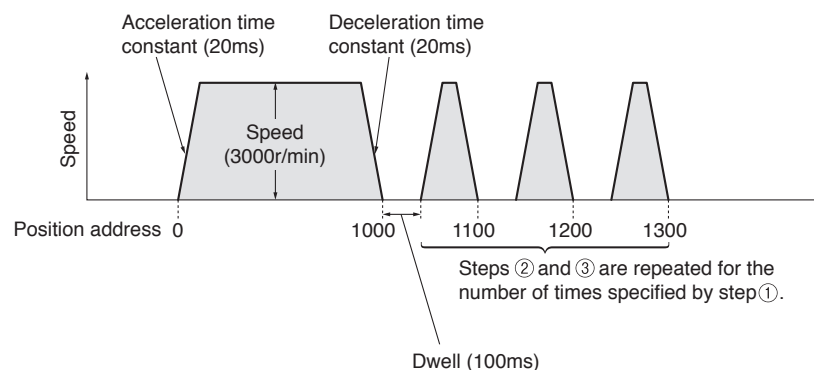

Servo amplifiers  
 Servo motors  
 Options/Peripheral Equipment  
 Dimensions  
 Product List  
 Precautions

## Positioning function: Program method

### • Command Method and Operation Mode

		Item	Description
Command method	Program	Command interface	DI/O (Note 1)
		Operating specification	Program language (programmed by MR Configurator2 (Setup software)) Program capacity: 120 steps (8 programs)
		Input positioning command	Set by the program language. One-point feed length setting range: $\pm 1\mu\text{m}$ to $\pm 999999 \times 10^{\text{STM}}\mu\text{m}$ . (Note 2)
		System	Signed absolute value command system, incremental value command system
Operation mode	Automatic operation mode	Program method	Depends on the setting of the program language
	Manual operation mode	JOG	Inches upon input based on speed commands set by a parameter.
		Manual pulse generator	Manual feed by manual pulse generator. Command pulse multiplication: $\times 1$ , $\times 10$ or $\times 100$ is selectable by the parameter.
	Home position return mode	Dog type	Returns to home position upon Z-phase pulse count after passing through proximity dog. Home position return direction selectable. Home position shift amount and home position address settable. Automatic retreat on dog back to home position and automatic stroke retreat function.
		Count type	Returns to home position upon Z-phase pulse count after touching proximity dog. Home position return direction selectable. Home position shift amount and home position address settable. Automatic retreat on dog back to home position and automatic stroke retreat function.
		Data set type	Returns to home position without dog. Sets any position as home position using manual operation, etc. Home position address settable.
		Stopper type	Returns to home position upon hitting end of stroke. Home position return direction selectable. Home position address settable.
		Ignore home (Servo-on position as home position)	Uses position where the servo on (SON) signal turns ON as home position. Home position address settable.
		Dog type rear end reference	Returns to home position with respect to the rear end of a proximity dog. Home position return direction selectable. Home position shift amount and home position address settable. Automatic retreat on dog back to home position and automatic stroke retreat function.
		Count type front end reference	Returns to home position with respect to the front end of a proximity dog. Home position return direction selectable. Home position shift amount and home position address settable. Automatic retreat on dog back to home position and automatic stroke retreat function.
Dog cradle type	Returns to home position upon the first Z-phase pulse with respect to the front end of a proximity dog. Home position return direction selectable. Home position shift amount and home position address settable. Automatic retreat on dog back to home position and automatic stroke retreat function.		

Notes: 1. The command interface will be compatible with pulse train command by using manual pulse generator (MR-HDP01).

2. STM is the ratio for the data. It can be changed by parameter.

• Connection example

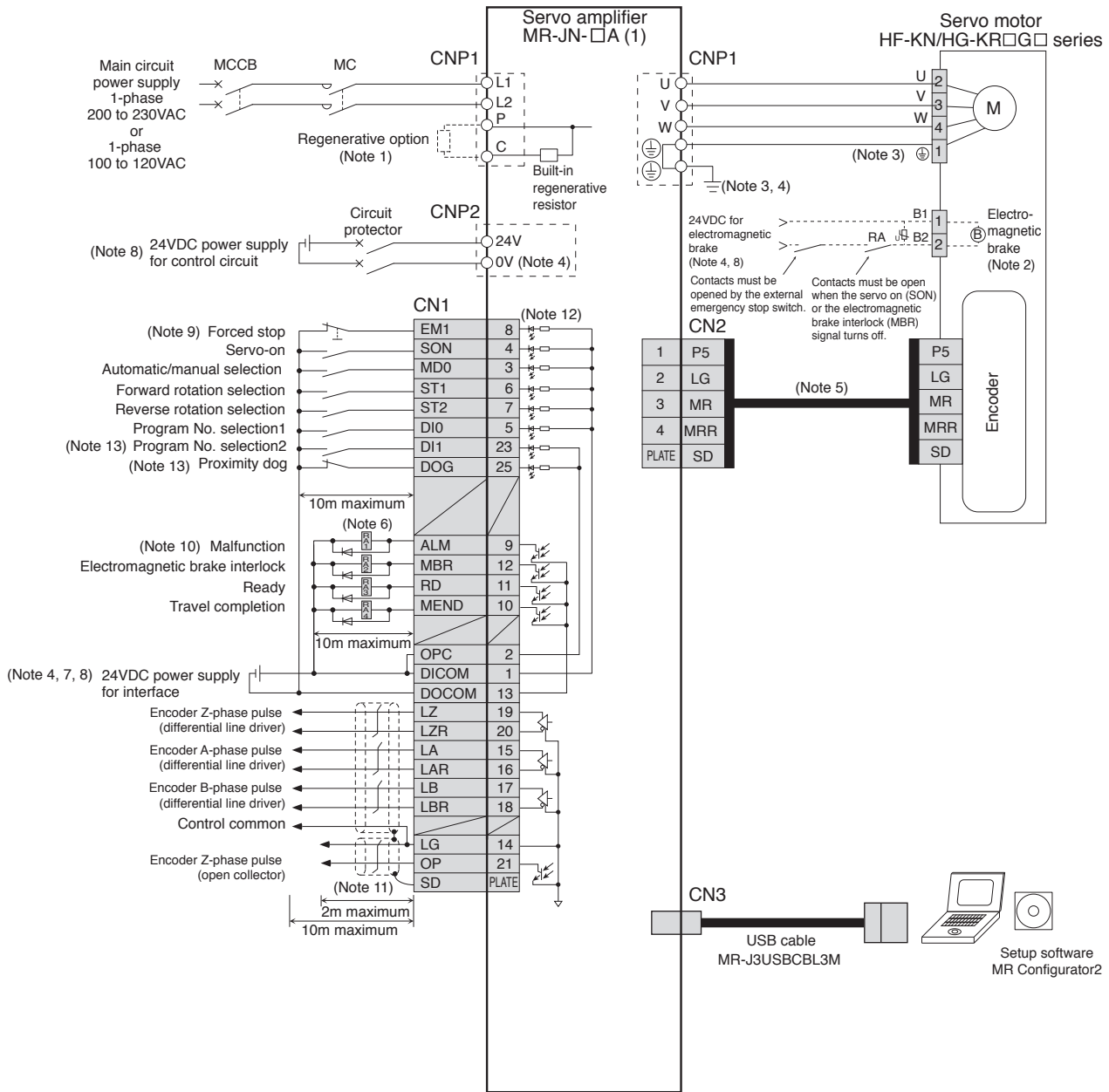

- Notes:
1. Disconnect the wires for the built-in regenerative resistor (P and C) and remove the resistor from the servo amplifier when connecting the regenerative option externally.
  2. This is for the servo motor with electromagnetic brake. The electromagnetic brake terminals (B1, B2) do not have polarity.
  3. Connect the ground wire to the cabinet protective earth (PE) terminal via the servo amplifier for grounding the servo motor.
  4. Do not connect the 0V of 24VDC power supply to the servo amplifier protective earth (PE) terminal.
  5. The signals shown are applicable when using a two-wire type encoder cable. Refer to "MR-JN-□A INSTRUCTION MANUAL" for four-wire type.
  6. Do not reverse the diode's direction. Connecting it backwards may cause the servo amplifier to malfunction such that the signals are not output, and the forced stop and other safety circuits are inoperable.
  7. Use the power supply 24VDC±10% (required current capacity: 0.2A). The value 0.2A is applicable when all of the input/output points are used.  
Note that the current capacity can be stepped down according to the number of input/output points in use. Refer to "MR-JN-□A INSTRUCTION MANUAL" for details.
  8. Use the enhanced insulation power supply for the external power supply 24VDC. Do not use the 24VDC power supplies for the interface and control unit to power the electromagnetic brake. Provide a dedicated power supply to the electromagnetic brake.
  9. Always turn on the forced stop (EM1) signal (normally closed contact) before starting the operation. If not, the operation will not start.
  10. The malfunction (ALM) signal (normally closed contact) is conducted to DOCOM in normal alarm-free condition.
  11. Connect the shielded wire securely to the plate inside the connector (ground plate).
  12. This is for sink wiring. Source wiring is also possible. However, when input signals are assigned to CN1-23 pin and CN1-25 pin, be sure to use sink wiring. Source wiring is not possible in this case. In positioning mode, input signals are assigned in the initial setting. Refer to "MR-JN-□A INSTRUCTION MANUAL" for details.
  13. Manual pulse generator can be used by setting a parameter. Refer to "MR-JN-□A INSTRUCTION MANUAL" for details.

# Servo Motors

## HF-KN Series Servo Motor Specifications

Servo motor model		HF-KN	053(B)	13(B)	23(B)	43(B)
Compatible servo amplifier model			MR-JN-10A(1)		MR-JN-20A(1)	MR-JN-40A
Power supply capacity *1		[kVA]	0.3	0.3	0.5	0.9
Continuous running duty	Rated output	[W]	50	100	200	400
	Rated torque (Note 3)	[N·m]	0.16	0.32	0.64	1.3
Maximum torque		[N·m]	0.48	0.95	1.9	3.8
Rated speed		[r/min]	3000			
Maximum speed		[r/min]	4500			
Permissible instantaneous speed		[r/min]	5175			
Power rate at continuous rated torque	Standard	[kW/s]	4.87	11.5	16.9	38.6
	With electromagnetic brake	[kW/s]	4.69	11.3	13.1	32.5
Rated current		[A]	0.9	0.8	1.4	2.7
Maximum current		[A]	2.7	2.4	4.2	8.1
Regenerative braking frequency *2		[times/min]	(Note 4)	(Note 4)	470	261
Moment of inertia J	Standard	[ $\times 10^{-4}$ kg·m <sup>2</sup> ]	0.052	0.088	0.24	0.42
	With electromagnetic brake	[ $\times 10^{-4}$ kg·m <sup>2</sup> ]	0.054	0.090	0.31	0.50
Recommended load to motor inertia ratio (Note 1)			15 times or less		24 times or less	22 times or less
Speed/position detector			Incremental 17-bit encoder (resolution: 131072pulses/rev)			
Oil seal			None	None (Servo motors with oil seal are available. (HF-KN_J))		
Thermistor			None			
Insulation class			130 (B)			
Structure			Totally enclosed, natural cooling (IP rating: IP65) (Note 2)			
Environment *3	Ambient temperature		Operation: 0°C to 40°C (non-freezing), storage: -15°C to 70°C (non-freezing)			
	Ambient humidity		Operation: 10%RH to 80%RH (non-condensing), storage: 10%RH to 90%RH (non-condensing)			
	Ambience		Indoors (no direct sunlight); no corrosive gas, inflammable gas, oil mist or dust			
	Altitude		1000m or less above sea level			
Vibration resistance *4			X: 49m/s <sup>2</sup> Y: 49m/s <sup>2</sup>			
Vibration rank			V10 *6			
Permissible load for the shaft *5	L	[mm]	25	25	30	30
	Radial	[N]	88	88	245	245
	Thrust	[N]	59	59	98	98
Mass	Standard	[kg]	0.4	0.5	1.0	1.4
	With electromagnetic brake	[kg]	0.6	0.7	1.4	1.8

Notes: 1. Contact your local sales office if the load to motor inertia ratio exceeds the value in the table.

2. The shaft-through portion is excluded. For geared servo motor, IP rating of the gear reducer portion is equivalent to IP44. Refer to the asterisk 7 of "Annotations for Servo Motor Specifications" on p. 33 in this catalog for the shaft-through portion.

3. When unbalanced torque is generated, such as in a vertical lift machine, keep the unbalanced torque of the machine under 70% of the servo motor rated torque.

4. When the servo motor decelerates to a stop from the rated speed, the regenerative frequency will not be limited if the effective torque is within the rated torque range.

When the servo motor decelerates to a stop from the maximum speed, the regenerative frequency will not be limited if the following requirements are met.

- HF-KN053(B): The load to motor inertia ratio is 8 times or less, and the effective torque is within the rated torque range.

- HF-KN13(B): The load to motor inertia ratio is 4 times or less, and the effective torque is within the rated torque range.

Refer to "Annotations for Servo Motor Specifications" on p. 33 in this catalog for the asterisks 1 to 6.

### HF-KN Series Servo Motor Electromagnetic Brake Specifications (Note 1)

Model		HF-KN	053B	13B	23B	43B
Type		Spring actuated type safety brake				
Rated voltage		24VDC <sub>-10%</sub>				
Power consumption [W] at 20°C			6.3	6.3	7.9	7.9
Electromagnetic brake static friction torque [N·m]			0.32 or higher	0.32 or higher	1.3 or higher	1.3 or higher
Permissible braking work	Per braking [J]		5.6	5.6	22	22
	Per hour [J]		56	56	220	220
Electromagnetic brake life (Note 2)	Number of braking times		20000	20000	20000	20000
	Work per braking [J]		5.6	5.6	22	22

Notes: 1. The electromagnetic brake is for holding. It cannot be used for deceleration applications.  
 2. Brake gap is not adjustable. Electromagnetic brake life is defined as the time period until readjustment is needed.

### HF-KN Series Servo Motor Torque Characteristics

● HF-KN053(B) (Note 1, 2, 3)

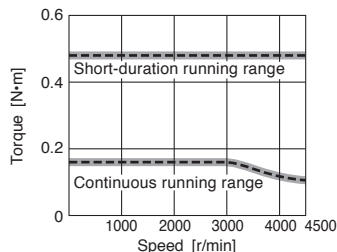

● HF-KN13(B) (Note 1, 2, 3)

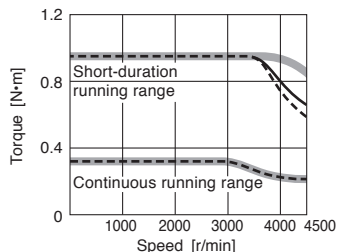

● HF-KN23(B) (Note 1, 2, 3)

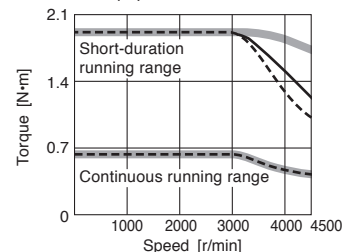

● HF-KN43(B) (Note 1, 3)

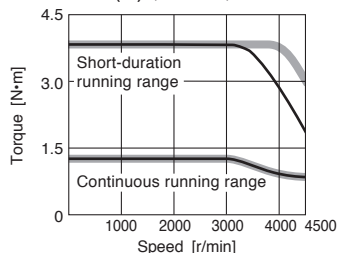

Notes: 1. ——— : For 1-phase 230VAC.  
 2. - - - : For 1-phase 100VAC.  
 3. ——— : For 1-phase 200VAC.  
 This line is only drawn where it differs from the other two lines.

### HF-KN Series Servo Motor Special Shaft End Specifications

Motors with the following specifications are also available.

**D-cut shaft (Note 1): 50W and 100W**

[Unit: mm]

---

**Key shaft (with key) (Note 1, 2): 200W and 400W**

Model	Variable dimensions								
	T	S	R	Q	W	QK	QL	U	Y
HF-KN23(B)K, 43(B)K	5	14h6	30	26	5	20	3	3	M4 screw Depth: 15

[Unit: mm]

Notes: 1. Do not use servo motors with a D-cut shaft or a key shaft for frequent start/stop applications as this may cause damage to the shaft.  
 2. A double round-ended key is attached.

## HG-KR Series Geared Servo Motor Specifications (when combined with MR-JN servo amplifiers)

Servo motor model		HG-KR	053(B)G1/G5/G7	13(B)G1/G5/G7	23(B)G1/G5/G7	43(B)G1/G5/G7
Compatible servo amplifier model			MR-JN-10A(1)		MR-JN-20A(1)	MR-JN-40A
Power supply capacity <sup>*1</sup>		[kVA]	0.3	0.3	0.5	0.9
Continuous running duty	Rated output	[W]	50	100	200	400
	Rated torque <sup>(Note 3)</sup>	[N·m]	0.16	0.32	0.64	1.3
Maximum torque		[N·m]	0.48	0.96	1.9	3.9
Rated speed		[r/min]	3000			
Maximum speed		[r/min]	4500 r/min (permissible instantaneous speed: 4500 r/min)			
Power rate at continuous rated torque	Standard	[kW/s]	5.63	13.0	18.3	43.7
	With electromagnetic brake	[kW/s]	5.37	12.1	16.7	41.3
Rated current		[A]	0.9	0.8	1.3	2.6
Maximum current		[A]	2.7	2.4	3.9	7.8
Moment of inertia J			See "Geared Servo Motor Specifications" in this catalog.			
Recommended load to motor inertia ratio <sup>(Note 1)</sup>			See "Geared Servo Motor Specifications" in this catalog.			
Speed/position detector			Incremental 18-bit encoder (resolution: 262144pulses/rev)			
Insulation class			130 (B)			
Structure			Totally enclosed, natural cooling (IP rating: equivalent to IP44) <sup>(Note 2)</sup>			
Environment <sup>*3</sup>	Ambient temperature		Operation: 0°C to 40°C (non-freezing), storage: -15°C to 70°C (non-freezing)			
	Ambient humidity		Operation: 10%RH to 80%RH (non-condensing), storage: 10%RH to 90%RH (non-condensing)			
	Ambience		Indoors (no direct sunlight); no corrosive gas, inflammable gas, oil mist or dust			
	Altitude		1000m or less above sea level			
Vibration resistance <sup>*4</sup>			X: 49m/s <sup>2</sup> Y: 49m/s <sup>2</sup>			
Vibration rank			V10 <sup>*6</sup>			
Permissible load for the shaft			Refer to "MR-JN-□A INSTRUCTION MANUAL".			
Mass		[kg]	See "Geared Servo Motor Specifications" in this catalog.			

Notes: 1. Contact your local sales office if the load to motor inertia ratio exceeds the value in the table.

2. The shaft-through portion is excluded. For geared servo motor, IP rating of the gear reducer portion is equivalent to IP44. Refer to the asterisk 7 of "Annotations for Servo Motor Specifications" on p. 33 in this catalog for the shaft-through portion.

3. When unbalanced torque is generated, such as in a vertical lift machine, keep the unbalanced torque of the machine under 70% of the servo motor rated torque.

Refer to "Annotations for Servo Motor Specifications" on p. 33 in this catalog for the asterisks 1 to 6.

### HG-KR Series Geared Servo Motor Electromagnetic Brake Specifications (Note 1)

Model	HG-KR	053BG1/G5/G7	13BG1/G5/G7	23BG1/G5/G7	43BG1/G5/G7
Type	Spring actuated type safety brake				
Rated voltage	24VDC-10%				
Power consumption [W] at 20°C		6.3	6.3	7.9	7.9
Electromagnetic brake static friction torque [N·m]		0.32 or higher	0.32 or higher	1.3 or higher	1.3 or higher
Permissible braking work	Per braking [J]	5.6	5.6	22	22
	Per hour [J]	56	56	220	220
Electromagnetic brake life (Note 2)	Number of braking times	20000	20000	20000	20000
	Work per braking [J]	5.6	5.6	22	22

Notes: 1. The electromagnetic brake is for holding. It cannot be used for deceleration applications.  
 2. Brake gap is not adjustable. Electromagnetic brake life is defined as the time period until readjustment is needed.

### HG-KR Series Geared Servo Motor Torque Characteristics (Note 1)

● HG-KR053(B)G1/G5/G7 (Note 2, 3, 4, 5)

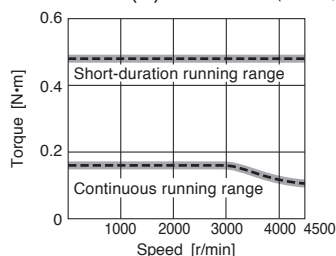

● HG-KR13(B)G1/G5/G7 (Note 2, 3, 4, 5)

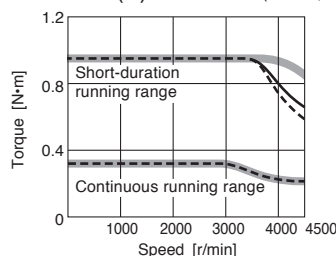

● HG-KR23(B)G1/G5/G7 (Note 2, 3, 4, 5)

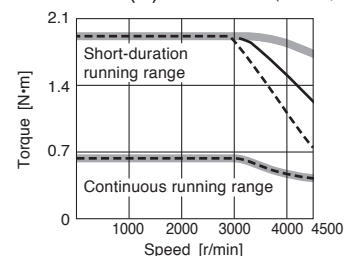

● HG-KR43(B)G1/G5/G7 (Note 2, 4, 5)

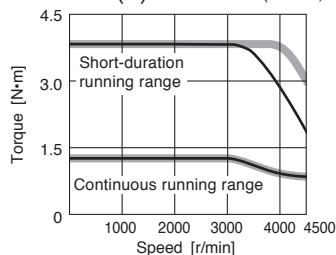

Notes: 1. For the servo motor without a gear reducer.  
 2. —: For 1-phase 230VAC.  
 3. - - -: For 1-phase 100VAC.  
 4. —: For 1-phase 200VAC.  
 This line is only drawn where it differs from the other two lines.  
 5. This value is applicable when the servo motor is combined with a MELSERVO-JN series servo amplifier.

Servo amplifiers

Servo motors

Options/Peripheral Equipment

Dimensions

Product List

Precautions

# Servo Motors

## HG-KR Series Geared Servo Motor Special Shaft End Specifications

Standard HG-KR□(B)G1 (with gear reducer for general industrial machines) has a straight shaft. Key shaft (with key) is also available as a special specification. Contact your local sales office for more details.

Standard HG-KR□(B)G7 (with shaft-output type gear reducer for high precision applications, flange mounting) has a straight shaft.

HG-KR□(B)G7K for key shaft motor (with key) is also available. Refer to the following for the shaft-end shape.

Key shaft (with key) (Note 1, 2, 3)

Model	Reduction ratio (Note 4)	Variable dimensions						
		S	Q	W	QK	U	T	Y
HG-KR053(B)G7K	1/5 (40 × 40)	10	20	4	15	2.5	4	M3 screw Depth: 6
	1/5 (60 × 60)	16	28	5	25	3	5	M4 screw Depth: 8
	1/9	10	20	4	15	2.5	4	M3 screw Depth: 6
	1/11	16	28	5	25	3	5	M4 screw Depth: 8
	1/21							
	1/33							
1/45								
HG-KR13(B)G7K	1/5 (40 × 40)	10	20	4	15	2.5	4	M3 screw Depth: 6
	1/5 (60 × 60)	16	28	5	25	3	5	M4 screw Depth: 8
	1/11	25	42	8	36	4	7	M6 screw Depth: 12
	1/21							
	1/33							
1/45								
HG-KR23(B)G7K	1/5	16	28	5	25	3	5	M4 screw Depth: 8
	1/11	25	42	8	36	4	7	M6 screw Depth: 12
	1/21							
	1/33							
1/45								
HG-KR43(B)G7K	1/5	16	28	5	25	3	5	M4 screw Depth: 8
	1/11	25	42	8	36	4	7	M6 screw Depth: 12
	1/21							
	1/33	40	82	12	70	5	8	M10 screw Depth: 20
1/45								

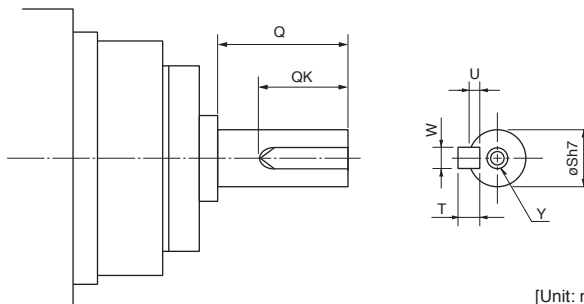

[Unit: mm]

- Notes: 1. Do not use servo motors with a key shaft for frequent start/stop applications as this may cause damage to the shaft.  
 2. A single pointed key is attached.  
 3. The dimensions not mentioned in the drawings are the same as those of the straight shaft. Refer to HG-KR□(B)G7 dimensions in this catalog.  
 4. The values in brackets represent the dimensions of the flange.



## Annotations for Servo Motor Specifications

- \* 1. The power supply capacity varies depending on the power supply impedance.
- \* 2. The regenerative braking frequency shows the permissible frequency when the servo motor, without a load and a regenerative option, decelerates from the rated speed to a stop. When a load is connected, the value will be the table value/(m+1), where m = Moment of inertia of load/Moment of inertia of the servo motor. When the operating speed exceeds the rated speed, the regenerative braking frequency is inversely proportional to the square of (operating speed/rated speed). Take measures to keep the regenerative power [W] during operation below the permissible regenerative power [W]. Use caution, especially when the operating speed changes frequently or when the regeneration is constant (as with vertical feeds). Select the most suitable regenerative option for your system with our drive system sizing software Motorizer. Refer to "Regenerative Option" in this catalog for the permissible regenerative power [W] when regenerative option is used.
- \* 3. In the environment where the servo motor is exposed to oil mist, oil and/or water, a standard specification servo motor may not be usable. Contact your local sales office for more details.
- \* 4. The vibration direction is shown in the diagram below. The numerical value indicates the maximum value of the component (commonly the bracket in the opposite direction of the servo motor shaft). Fretting tends to occur on the bearing when the servo motor stops. Thus, maintain vibration level at approximately one-half of the allowable value.

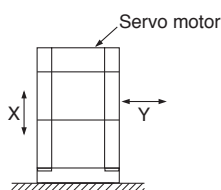

- \* 5. Refer to the diagram below for the permissible load for the shaft. Ensure that loads applied on the shaft do not exceed the values specified in the table. The values in the table are applicable when each load is applied singly.

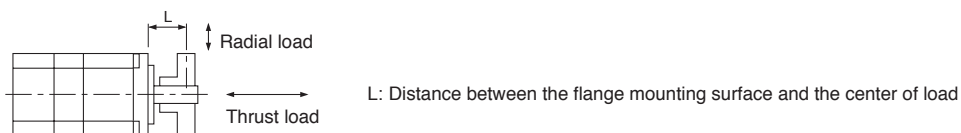

- \* 6. V10 indicates that the amplitude of the servo motor itself is 10  $\mu\text{m}$  or less. The following shows mounting orientation and measuring position of the servo motor during the measurement:

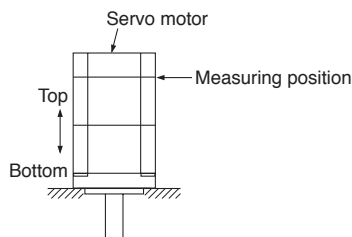

- \* 7. Refer to the diagram below for the shaft-through portion.

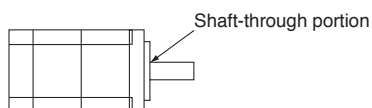

## Geared Servo Motor Specifications

With gear reducer for general industrial machines: G1

Model	Output [W]	Reduction ratio	Actual reduction ratio	Moment of inertia J [ $\times 10^{-4}$ kg·m <sup>2</sup> ] (Note 1, 6)		Permissible load to motor inertia ratio (Note 2) (when converted into the servo motor shaft)	Mass [kg]		Lubrication method	Mounting direction
				Standard	With electromagnetic brake		Standard	With electromagnetic brake		
HG-KR053(B)G1	50	1/5	9/44	0.0820	0.0840	5 times or less	1.4	1.6	Grease (filled)	Any direction
		1/12	49/576	0.104	0.106		1.8	2.0		
		1/20	25/484	0.0860	0.0880		1.8	2.0		
HG-KR13(B)G1	100	1/5	9/44	0.115	0.121	5 times or less	1.6	1.8		
		1/12	49/576	0.137	0.143		2.0	2.2		
		1/20	25/484	0.119	0.125		2.0	2.2		
HG-KR23(B)G1	200	1/5	19/96	0.375	0.397	7 times or less	3.3	3.7		
		1/12	961/11664 (Note 5)	0.418	0.440		3.9	4.3		
		1/20	513/9984 (Note 5)	0.391	0.413		3.9	4.3		
HG-KR43(B)G1	400	1/5	19/96	0.525	0.547	7 times or less	3.7	4.1		
		1/12	961/11664 (Note 5)	0.568	0.590		4.3	4.7		
		1/20	7/135 (Note 5)	0.881	0.903		5.4	5.8		

Item	Specifications
Mounting method	Flange mounting
Output shaft rotating direction	Same as the servo motor output shaft direction
Backlash (Note 4)	60 minutes or less at gear reducer output shaft
Gear reducer efficiency (Note 3)	40% to 85%

Notes: 1. The moments of inertia in the table are the values that are converted into shaft of the servo motor with gear reducer (and with electromagnetic brake).

2. Contact your local sales office if the load to motor inertia ratio exceeds the value in the table.

3. The gear reducer efficiency varies depending on the reduction ratio and also varies with the conditions of use, such as output torque, speed, and temperature.

The values in the table represent typical values at the rated torque and speed and at the normal temperature. They are not guaranteed values.

4. The backlash can be converted: 1 minute = 0.0167°

5. The actual reduction ratio of this series differs from that of HF-KP□(B)G1. When replacing HF-KP□(B)G1 with HG-KR□(B)G1, set the electronic gear.

6. The moment of inertia of this series differs from that of HF-KP□(B)G1. When replacing HF-KP□(B)G1 with HG-KR□(B)G1, adjust the servo gains.

### Geared Servo Motor Specifications

With flange-output type gear reducer for high precision applications, flange mounting: G5

Model	Output [W]	Reduction ratio (Note 3)	Moment of inertia J [ $\times 10^{-4} \text{ kg}\cdot\text{m}^2$ ] (Note 1, 6)		Permissible load to motor inertia ratio (Note 2) (when converted into the servo motor shaft)	Mass [kg]		Lubrication method	Mounting direction
			Standard	With electromagnetic brake		Standard	With electromagnetic brake		
HG-KR053(B)G5	50	1/5 (40 x 40)	0.0485	0.0507	10 times or less	0.55	0.75	Grease (filled)	Any direction
		1/5 (60 x 60)	0.113	0.115		1.1	1.3		
		1/9	0.0475	0.0497		0.56	0.76		
		1/11	0.105	0.107		1.2	1.4		
		1/21	0.0960	0.0980					
		1/33	0.0900	0.0920					
		1/45	0.0900	0.0920					
HG-KR13(B)G5	100	1/5 (40 x 40)	0.0812	0.0872	10 times or less	0.75	0.95	Grease (filled)	Any direction
		1/5 (60 x 60)	0.146	0.152		1.3	1.5		
		1/11	0.138	0.144		1.4	1.6		
		1/21	0.129	0.135					
		1/33	0.140	0.146		2.6	2.8		
		1/45	0.139	0.145					
HG-KR23(B)G5	200	1/5	0.422	0.444	14 times or less	1.8	2.2	Grease (filled)	Any direction
		1/11	0.424	0.446		1.9	2.3		
		1/21	0.719	0.741		3.4	3.8		
		1/33	0.673	0.695					
		1/45	0.672	0.694					
HG-KR43(B)G5	400	1/5	0.572	0.594	14 times or less	2.3	2.7	Grease (filled)	Any direction
		1/11	0.947	0.969		3.9	4.3		
		1/21	0.869	0.891					
		1/33	0.921	0.943		6.0	6.4		
		1/45	0.915	0.937					

Item	Specifications
Mounting method	Flange mounting
Output shaft rotating direction	Same as the servo motor output shaft direction
Backlash (Note 5)	3 minutes or less at gear reducer output shaft
Gear reducer efficiency (Note 4)	1/5 (60 x 60): 12%, 1/11, 1/21, 1/33 and 1/45 of HG-KR053(B)G5: 22% to 34% 1/5 (40 x 40) and 1/9 of HG-KR053(B)G5, and HG-KR13(B)G5 to HG-KR73(B)G5: 48% to 84%

- Notes: 1. The moments of inertia in the table are the values that are converted into shaft of the servo motor with gear reducer (and with electromagnetic brake).  
 2. Contact your local sales office if the load to motor inertia ratio exceeds the value in the table.  
 3. The values in brackets represent the dimensions of the flange.  
 4. The gear reducer efficiency varies depending on the reduction ratio and also varies with the conditions of use, such as output torque, speed, and temperature. The values in the table represent typical values at the rated torque and speed and at the normal temperature. They are not guaranteed values.  
 5. The backlash can be converted: 1 minute = 0.0167°  
 6. The moment of inertia of this series differs from that of HF-KP□(B)G5. When replacing HF-KP□(B)G5 with HG-KR□(B)G5, adjust the servo gains.

Servo amplifiers  
 Servo motors  
 Options/Peripheral Equipment  
 Dimensions  
 Product List  
 Precautions

## Geared Servo Motor Specifications

With shaft-output type gear reducer for high precision applications, flange mounting: G7

Model	Output [W]	Reduction ratio (Note 3)	Moment of inertia J [ $\times 10^{-4}$ kg·m <sup>2</sup> ] (Note 1, 6)		Permissible load to motor inertia ratio (Note 2) (when converted into the servo motor shaft)	Mass [kg]		Lubrication method	Mounting direction
			Standard	With electromagnetic brake		Standard	With electromagnetic brake		
HG-KR053(B)G7	50	1/5 (40 × 40)	0.0512	0.0534	10 times or less	0.58	0.78	Grease (filled)	Any direction
		1/5 (60 × 60)	0.119	0.121		1.2	1.4		
		1/9	0.0492	0.0514		0.58	0.78		
		1/11	0.106	0.108		1.3	1.5		
		1/21	0.0960	0.0980					
		1/33	0.0900	0.0920					
		1/45	0.0900	0.0920					
HG-KR13(B)G7	100	1/5 (40 × 40)	0.0839	0.0899	10 times or less	0.78	0.98		
		1/5 (60 × 60)	0.152	0.158		1.4	1.6		
		1/11	0.139	0.145		1.5	1.7		
		1/21	0.129	0.135					
		1/33	0.141	0.147		3.0	3.2		
		1/45	0.139	0.145					
HG-KR23(B)G7	200	1/5	0.428	0.450	14 times or less	1.9	2.3		
		1/11	0.424	0.446		2.0	2.4		
		1/21	0.721	0.743		3.8	4.2		
		1/33	0.674	0.696					
		1/45	0.672	0.694					
HG-KR43(B)G7	400	1/5	0.578	0.600	14 times or less	2.4	2.8		
		1/11	0.955	0.977		4.3	4.7		
		1/21	0.871	0.893					
		1/33	0.927	0.949		7.4	7.8		
		1/45	0.918	0.940					

Item	Specifications
Mounting method	Flange mounting
Output shaft rotating direction	Same as the servo motor output shaft direction
Backlash (Note 5)	3 minutes or less at gear reducer output shaft
Gear reducer efficiency (Note 4)	1/5 (60 × 60): 12%, 1/11, 1/21, 1/33 and 1/45 of HG-KR053(B)G7: 22% to 34% 1/5 (40 × 40) and 1/9 of HG-KR053(B)G7, and HG-KR13(B)G7 to HG-KR73(B)G7: 48% to 84%

- Notes: 1. The moments of inertia in the table are the values that are converted into shaft of the servo motor with gear reducer (and with electromagnetic brake).  
 2. Contact your local sales office if the load to motor inertia ratio exceeds the value in the table.  
 3. The values in brackets represent the dimensions of the flange.  
 4. The gear reducer efficiency varies depending on the reduction ratio and also varies with the conditions of use, such as output torque, speed, and temperature. The values in the table represent typical values at the rated torque and speed and at the normal temperature. They are not guaranteed values.  
 5. The backlash can be converted: 1 minute = 0.0167°  
 6. The moment of inertia of this series differs from that of HF-KP□(B)G7. When replacing HF-KP□(B)G7 with HG-KR□(B)G7, adjust the servo gains.

Configuration Example for Servo Motors (Note 5)

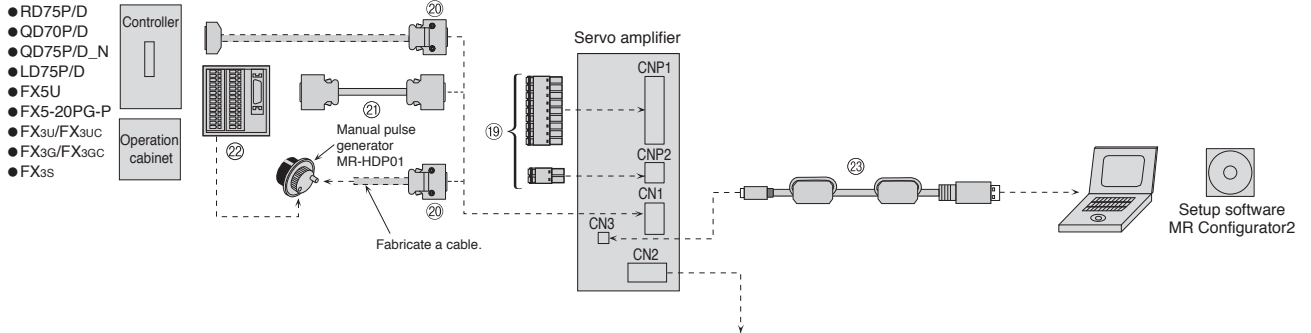

For encoder cable length 10m or shorter

- For leading the cables out in the direction of the motor shaft (Note 4)

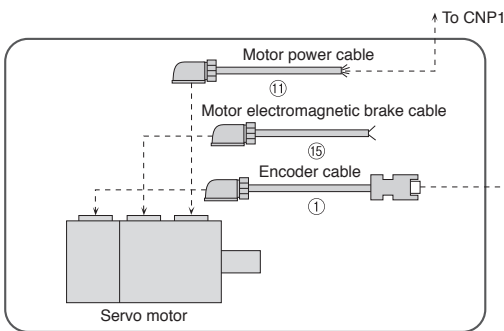

- For leading the cables out in the opposite direction of the motor shaft (Note 4)

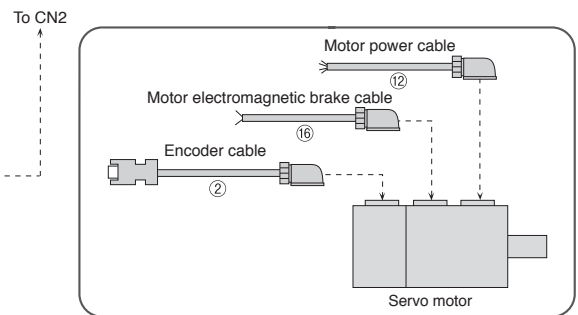

For encoder cable length exceeding 10m

- For leading the cables out in the direction of the motor shaft (Note 4)

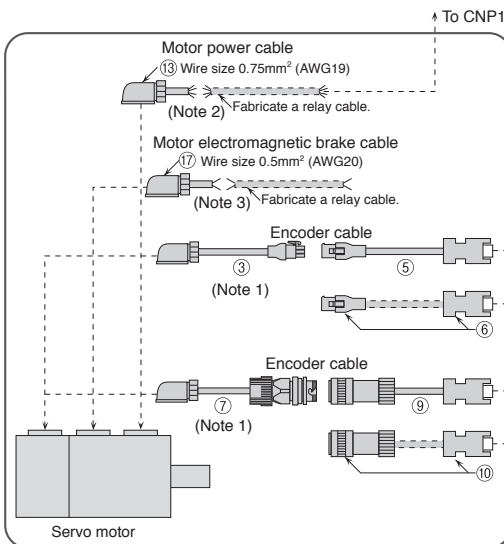

- For leading the cables out in the opposite direction of the motor shaft (Note 4)

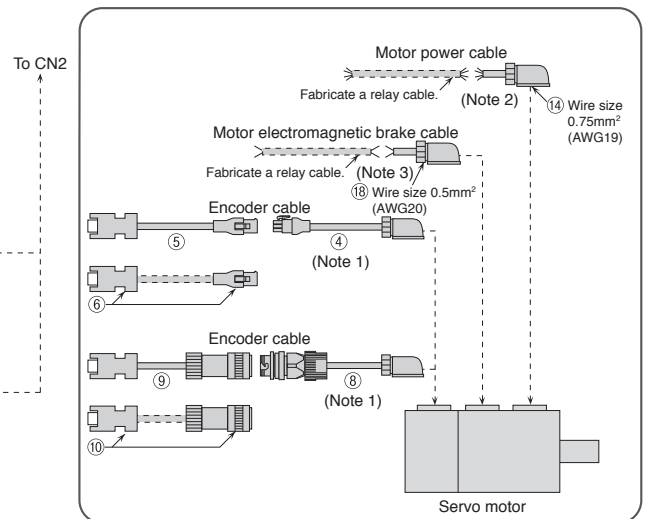





- Notes:
1. This cable does not have a long bending life, so always fix the cable before using.
  2. If the length exceeds 10m, relay a cable using MR-PWS2CBL03M-A1-L/-A2-L cable. This cable does not have a long bending life, so always fix the cable before using. Refer to "MR-JN-□A INSTRUCTION MANUAL" for details on manufacturing the relay cable.
  3. If the length exceeds 10m, relay a cable using MR-BKS2CBL03M-A1-L/-A2-L cable. This cable does not have a long bending life, so always fix the cable before using. Refer to "MR-JN-□A INSTRUCTION MANUAL" for details on manufacturing the relay cable.
  4. Cables for leading two different directions may be used for one servo motor.
  5. Cables drawn with dashed lines need to be fabricated by user. Refer to "MR-JN-□A INSTRUCTION MANUAL" for fabricating the cable.

Servo amplifiers  
 Servo motors  
 Options/Peripheral Equipment  
 Dimensions  
 Product List  
 Precautions

# Options/Peripheral Equipment

## Cables and Connectors



Encoder cables are not subject to Low Voltage Directive (50VAC to 1000VAC and 75VDC to 1500VDC).

Item		Model	Cable length (Note 2)	Description		
For encoder	①	Encoder cable (load-side lead) (Note 1, 3, 6)	MR-J3ENCBL□M-A1-H □=cable length: 2, 5, 10m	IP65	 Encoder connector 2174053-1 (TE Connectivity Ltd. Company)	Servo amplifier connector Receptacle: 36210-0100PL Shell kit: 36310-3200-008 (3M) or Connector set: 54599-1019 (Molex, LLC)
			MR-J3ENCBL□M-A1-L □=cable length: 2, 5, 10m	IP65		
	②	Encoder cable (opposite to load-side lead) (Note 1, 3, 6)	MR-J3ENCBL□M-A2-H □=cable length: 2, 5, 10m	IP65		
			MR-J3ENCBL□M-A2-L □=cable length: 2, 5, 10m	IP65		
	③	Encoder cable (load-side lead) (Note 1, 3, 6)	MR-J3JCBL03M-A1-L Cable length: 0.3m	IP20	 Junction connector Contact: 1473226-1 (with ring) Housing: 1-172169-9 Cable clamp: 316454-1 (TE Connectivity Ltd. Company)	
						④
	⑤	Encoder cable (Note 1, 5, 6)	MR-EKCBL□M-H □=cable length: 20, 30, 40, 50m	IP20	 Junction connector Housing: 1-172161-9 Connector pin: 170359-1 (TE Connectivity Ltd. Company) or an equivalent product Cable clamp: MTI-0002 (Toa Electric Industrial Co., Ltd.)	
			MR-EKCBL□M-L □=cable length: 20, 30m	IP20		Use this in combination with ③ or ④.
	⑥	Encoder connector set	MR-ECNM	IP20	 Junction connector (Note 4) Housing: 1-172161-9 Connector pin: 170359-1 (TE Connectivity Ltd. Company) or an equivalent product Cable clamp: MTI-0002 (Toa Electric Industrial Co., Ltd.)	Servo amplifier connector Receptacle: 36210-0100PL Shell kit: 36310-3200-008 (3M) or Connector set: 54599-1019 (Molex, LLC) Use this in combination with ③ or ④.

- Notes: 1. -H and -L indicate the bending life. -H indicates a long bending life, and -L indicates a standard bending life.  
 2. The IP rating indicated is for the connector's protection against ingress of dust and water when coupled to a servo amplifier/servo motor. If the IP rating of the servo amplifier/servo motor differs from that of these connectors, overall IP rating depends on the lowest of all.  
 3. The cable or the connector set may contain connectors of different shapes. However, these connectors are all usable.  
 4. The crimping tool (91529-1) manufactured by TE Connectivity Ltd. Company is required. Contact the manufacturer directly.  
 5. Encoder cables with lengths of 30m or longer are available in four-wire type. Parameter setting is required to use the four-wire type encoder cable. Refer to "MR-JN-□A INSTRUCTION MANUAL" for details.  
 6. For details, please contact Mitsubishi Electric System & Service Co., Ltd. OVERSEAS SERVICE SECTION (Email: osb.webmaster@melsc.jp)

## Cables and Connectors

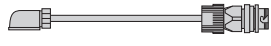
Encoder cables are not subject to Low Voltage Directive (50VAC to 1000VAC and 75VDC to 1500VDC).

		Item	Model	Cable length (Note 2)	Description
For encoder	⑦	Encoder cable (load-side lead) (Note 1, 4, 7)	MR-J3JSCBL03M-A1-L Cable length: 0.3m	IP65 (Note 6)	 Encoder connector 2174053-1 (TE Connectivity Ltd. Company)  Junction connector Cable receptacle: CMV1-CR10P-M1 (DDK Ltd.)  Use this in combination with ⑨ or ⑩.
	⑧	Encoder cable (opposite to load-side lead) (Note 1, 4, 7)	MR-J3JSCBL03M-A2-L Cable length: 0.3m	IP65 (Note 6)	
	⑨ Exceeding 10m (junction type)	Encoder cable (Note 1, 4, 7)	MR-J3ENSCL□M-H □=cable length: 2, 5, 10, 20, 30, 40, 50m	IP67	 Servo amplifier connector Receptacle: 36210-0100PL Shell kit: 36310-3200-008 (3M) or Connector set: 54599-1019 (Molex, LLC)  Junction connector (DDK Ltd.) For 10m or shorter cable Straight plug: CMV1-SP10S-M1 Socket contact: CMV1-#22ASC-C1-100  Use this in combination with ⑦ or ⑧.
			MR-J3ENSCL□M-L □=cable length: 2, 5, 10, 20, 30m	IP67	
	⑩	Encoder connector set (Note 4, 5)	MR-J3SCNS	IP67	 Junction connector Straight plug: CMV1-SP10S-M2 (Note 3) Socket contact: CMV1-#22ASC-S1-100 (DDK Ltd.)  Applicable cable Wire size: 0.5mm <sup>2</sup> (AWG20) or smaller Cable OD: 5.5 to 9.0mm  Servo amplifier connector Receptacle: 36210-0100PL Shell kit: 36310-3200-008 (3M) or Connector set: 54599-1019 (Molex, LLC)  Use this in combination with ⑦ or ⑧.

Notes: 1. -H and -L indicate the bending life. -H indicates a long bending life, and -L indicates a standard bending life.

2. The IP rating indicated is for the connector's protection against ingress of dust and water when coupled to a servo amplifier/servo motor. If the IP rating of the servo amplifier/servo motor differs from that of these connectors, overall IP rating depends on the lowest of all.

3. Cable clamps and bushings for cables with an OD of 5.5mm to 7.5mm or 7.0mm to 9.0mm are included in the set.









4. The cable or the connector set may contain connectors of different shapes. However, these connectors are all usable.

5. The connector contains a plug and contacts. Using contacts for other plugs may damage the connector. Be sure to use the enclosed contacts.

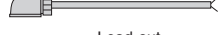
6. The encoder cable is rated IP65 while the junction connector itself is rated IP67.

7. For details, please contact Mitsubishi Electric System & Service Co., Ltd. OVERSEAS SERVICE SECTION (Email: osb.webmaster@melsc.jp)

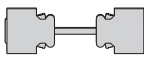
## Cables and Connectors

Item		Model	Cable length (Note 2)	Description	
For servo motor power supply	⑪ 10m or shorter (direct connection type)	Power cable (load-side lead) (Note 1, 3, 5)	MR-PWS1CBL□M-A1-H □=cable length: 2, 5, 10m	IP65	Motor power connector Plug: KN4FT04SJ1-R Socket contact: ST-TMH-S-C1B-100-(A534G) (Japan Aviation Electronics Industry, Limited)  Lead-out * The cable is not shielded.
			MR-PWS1CBL□M-A1-L □=cable length: 2, 5, 10m (Note 4)	IP65	
	⑫ Power cable (opposite to load-side lead) (Note 1, 3, 5)	MR-PWS1CBL□M-A2-H □=cable length: 2, 5, 10m	IP65		
		MR-PWS1CBL□M-A2-L □=cable length: 2, 5, 10m (Note 4)	IP65		
⑬ Exceeding 10m (junction type)	Power cable (load-side lead) (Note 1, 3)	MR-PWS2CBL03M-A1-L Cable length: 0.3m	IP55	Motor power connector Plug: KN4FT04SJ1-R Socket contact: ST-TMH-S-C1B-100-(A534G) (Japan Aviation Electronics Industry, Limited)  Lead-out * The cable is not shielded.	
	Power cable (opposite to load-side lead) (Note 1, 3)	MR-PWS2CBL03M-A2-L Cable length: 0.3m	IP55		
For servo motor electromagnetic brake	⑮ 10m or shorter (direct connection type)	Electromagnetic brake cable (load-side lead) (Note 1, 5)	MR-BKS1CBL□M-A1-H □=cable length: 2, 5, 10m	IP65	Electromagnetic brake connector Plug: JN4FT02SJ2-R Socket contact: ST-TMH-S-C1B-100-(A534G) (Japan Aviation Electronics Industry, Limited)  Lead-out * The cable is not shielded.
			MR-BKS1CBL□M-A1-L □=cable length: 2, 5, 10m	IP65	
	⑯ Electromagnetic brake cable (opposite to load-side lead) (Note 1, 5)	MR-BKS1CBL□M-A2-H □=cable length: 2, 5, 10m	IP65		
		MR-BKS1CBL□M-A2-L □=cable length: 2, 5, 10m	IP65		
⑰ Exceeding 10m (junction type)	Electromagnetic brake cable (load-side lead) (Note 1)	MR-BKS2CBL03M-A1-L Cable length: 0.3m	IP55	Electromagnetic brake connector Plug: JN4FT02SJ2-R Socket contact: ST-TMH-S-C1B-100-(A534G) (Japan Aviation Electronics Industry, Limited)  Lead-out * The cable is not shielded.	
	Electromagnetic brake cable (opposite to load-side lead) (Note 1)	MR-BKS2CBL03M-A2-L Cable length: 0.3m	IP55		
For CNP1/CNP2	⑲ Servo amplifier power connector set	(Standard accessory)	—	CNP1 connector  FKC 2,5/ 9-ST5,08 (Phoenix Contact) or an equivalent product CNP2 connector  FKCT 2,5/ 2-ST5,08 (Phoenix Contact) or an equivalent product Applicable cable Wire size: 0.2mm <sup>2</sup> (AWG24) to 2.5mm <sup>2</sup> (AWG12) Cable OD: 4.0mm or smaller	
For CN1	⑳ CN1 connector set	MR-J2CMP2	—	Servo amplifier connector Connector: 10126-3000PE Shell kit: 10326-52F0-008 (3M) or an equivalent product 	
	㉑ Junction terminal block cable	MR-TBNATBL□M □=cable length: 0.5, 1m	—	Junction terminal block connector Connector: 10126-6000EL Shell kit: 10326-3210-000 (3M) or an equivalent product 	
	㉒ Junction terminal block	MR-TB26A	—		
For CN3	㉓ Personal computer communication cable (USB cable)	MR-J3USBCBL3M Cable length: 0.3m	—	Servo amplifier connector mini-B connector (5-pin) 	

Notes: 1. -H and -L indicate the bending life. -H indicates a long bending life, and -L indicates a standard bending life.

2. The IP rating indicated is for the connector's protection against ingress of dust and water when coupled to a servo amplifier/servo motor. If the IP rating of the servo amplifier/servo motor differs from that of these connectors, overall IP rating depends on the lowest of all.

3. The cable or the connector set may contain connectors of different shapes. However, these connectors are all usable.

4. Shielded power cable MR-PWS3CBL□M-A□-L is also available. Contact your local sales office.

5. For details, please contact Mitsubishi Electric System & Service Co., Ltd. OVERSEAS SERVICE SECTION (Email: osb.webmaster@melsc.jp)



## Products on the Market for Servo Amplifiers

Contact the relevant manufacturers directly. When fabricating a cable with the following connectors, refer to the relevant manufacturers' instruction manuals for wiring and assembling procedures.

### Encoder connector (servo amplifier-side)



Application	Connector (3M)
Servo amplifier CN2 connector	Receptacle: 36210-0100PL Shell kit: 36310-3200-008
	Connector (Molex, LLC)
	54599-1019 (gray) 54599-1016 (black)

### Encoder connector (servo motor-side)



Applicable servo motor	Feature (Note 1)	Connector (TE Connectivity Ltd. Company)	Crimping tool (TE Connectivity Ltd. Company)	Applicable cable example
HF-KN/ HG-KR	IP65	2174053-1	For ground clip: 1596970-1 For receptacle contact: 1596847-1	Wire size: 0.13mm <sup>2</sup> to 0.33mm <sup>2</sup> (AWG26 to 22) Cable OD: 6.8mm to 7.4mm Wire example: Fluorine resin wire (Vinyl jacket cable TPE. SVP 70/0.08(AWG#22)-3P KB-2237-2 Bando Densen Co., Ltd. (Note 2) or an equivalent product)

### Servo motor power connector



Applicable servo motor	Feature (Note 1)	Connector (Japan Aviation Electronics Industry, Limited)	Crimping tool (Japan Aviation Electronics Industry, Limited)	Applicable cable example
HF-KN/ HG-KR	IP65	Plug: KN4FT04SJ1-R Socket contact: ST-TMH-S-C1B-100-(A534G)	For contactor: CT170-14-TMH5B	Wire size: 0.3mm <sup>2</sup> to 0.75mm <sup>2</sup> (AWG22 to 18) Cable OD: 5.3mm to 6.5mm Wire example: Fluorine resin wire (Vinyl jacket cable RMFES-A (CL3X) AWG19, 4 cores Dyden Corporation (Note 3) or an equivalent product)

### Electromagnetic brake connector



Applicable servo motor	Feature (Note 1)	Connector (Japan Aviation Electronics Industry, Limited)	Crimping tool (Japan Aviation Electronics Industry, Limited)	Applicable cable example
HF-KN/ HG-KR	IP65	Plug: JN4FT02SJ1-R Socket contact: ST-TMH-S-C1B-100-(A534G)	For contactor: CT170-14-TMH5B	Wire size: 0.3mm <sup>2</sup> to 0.5mm <sup>2</sup> (AWG22 to 20) Cable OD: 3.6mm to 4.8mm Wire example: Fluorine resin wire (Vinyl jacket cable RMFES-A (CL3X) AWG 20, 2 cores Dyden Corporation (Note 3) or an equivalent product)

Notes: 1. The IP rating indicated is for the connector's protection against ingress of dust and water when coupled to a servo amplifier/servo motor/absolute position storage unit.

If the IP rating of the servo amplifier/servo motor/absolute position storage unit differs from that of these connectors, overall IP rating depends on the lowest of all.

2. Contact Toa Electric Industrial Co., Ltd.

3. Contact Taisei Co., Ltd.

# Options/Peripheral Equipment

## Regenerative Option

Servo amplifier model	Permissible regenerative power of built-in regenerative resistor [W]	Permissible regenerative power of regenerative option [W]	
		MR-RB032 [40Ω]	MR-RB12 [40Ω]
MR-JN-10A (1)	—	30	—
MR-JN-20A (1)	10	30	100
MR-JN-40A	10	30	100

Note: The power values in this table are resistor-generated powers, not rated powers.

### \* Precautions when connecting the regenerative option

1. The regenerative option causes a temperature rise of 100°C or higher relative to the ambient temperature. Fully examine heat dissipation, installation position, and the wires used before installing the unit. Use flame-retardant wires or apply flame retardant on wires, and keep the wires clear of the unit.
2. Use twisted wires, maximum length of 5m, to connect the regenerative option with the servo amplifier.
3. Use twisted wires for a thermal sensor, and make sure that the sensor does not fail to work properly due to induced noise.

Dimensions	[Unit: mm]	Connections																											
<p>MR-RB032, MR-RB12</p> <p>LA 15, φ6 mounting hole, 156, 168, 144, 5, 12, 12, (20), LC, LD, LB</p> <p>TE1</p> <p>Mounting screw size: M5</p>	<p>[Unit: mm]</p>	<p style="text-align: center;">&lt;Terminal arrangement&gt;</p> <table border="1"> <tr><td>TE1</td></tr> <tr><td>G3</td></tr> <tr><td>G4</td></tr> <tr><td>P</td></tr> <tr><td>C</td></tr> </table> <p>Applicable wire size: 0.2mm<sup>2</sup> (AWG24) to 2.5mm<sup>2</sup> (AWG12)</p> <table border="1"> <thead> <tr> <th rowspan="2">Model</th> <th colspan="4">Variable dimensions</th> <th rowspan="2">Mass [kg]</th> </tr> <tr> <th>LA</th> <th>LB</th> <th>LC</th> <th>LD</th> </tr> </thead> <tbody> <tr> <td>MR-RB032</td> <td>30</td> <td>119</td> <td>99</td> <td>1.6</td> <td>0.5</td> </tr> <tr> <td>MR-RB12</td> <td>40</td> <td>169</td> <td>149</td> <td>2</td> <td>1.1</td> </tr> </tbody> </table> <p>Servo amplifier</p> <p>Regenerative option</p> <p>Built-in regenerative resistor</p> <p>5m maximum</p>	TE1	G3	G4	P	C	Model	Variable dimensions				Mass [kg]	LA	LB	LC	LD	MR-RB032	30	119	99	1.6	0.5	MR-RB12	40	169	149	2	1.1
TE1																													
G3																													
G4																													
P																													
C																													
Model	Variable dimensions				Mass [kg]																								
	LA	LB	LC	LD																									
MR-RB032	30	119	99	1.6	0.5																								
MR-RB12	40	169	149	2	1.1																								

- Notes:
1. Create a sequence circuit that turns off the magnetic contactor when abnormal overheating occurs.
  2. The G3 and G4 terminals are thermal sensors. G3-G4 opens when the regenerative option overheats abnormally.
  3. Disconnect the wires for the built-in regenerative resistor (P and C) and remove the resistor from the servo amplifier when using the regenerative option.

## Junction terminal block (MR-TB26A)

All signals can be connected via this junction terminal block.

Dimensions (Note 1)	[Unit: mm]	Specifications																
<p>57, 26, 55, 27, 7.5, 31.1, 26.6, 23.6</p>	<p>[Unit: mm]</p>	<table border="1"> <tr> <td>Rating</td> <td colspan="2">32VAC/DC, 0.5A</td> </tr> <tr> <td rowspan="3">Applicable wire (terminal side)</td> <td>Stranded wire</td> <td>0.08mm<sup>2</sup> (AWG28) to 1.5mm<sup>2</sup> (AWG14)</td> </tr> <tr> <td>Solid wire</td> <td>φ 0.32mm to 1.2mm</td> </tr> <tr> <td>Insulator OD</td> <td>φ 3.4mm or smaller</td> </tr> <tr> <td>Operating tool</td> <td colspan="2">210-619 (WAGO) or an equivalent</td> </tr> <tr> <td>Strip length</td> <td colspan="2">5mm to 6mm</td> </tr> </table>	Rating	32VAC/DC, 0.5A		Applicable wire (terminal side)	Stranded wire	0.08mm <sup>2</sup> (AWG28) to 1.5mm <sup>2</sup> (AWG14)	Solid wire	φ 0.32mm to 1.2mm	Insulator OD	φ 3.4mm or smaller	Operating tool	210-619 (WAGO) or an equivalent		Strip length	5mm to 6mm	
Rating	32VAC/DC, 0.5A																	
Applicable wire (terminal side)	Stranded wire	0.08mm <sup>2</sup> (AWG28) to 1.5mm <sup>2</sup> (AWG14)																
	Solid wire	φ 0.32mm to 1.2mm																
	Insulator OD	φ 3.4mm or smaller																
Operating tool	210-619 (WAGO) or an equivalent																	
Strip length	5mm to 6mm																	

Notes: 1. The length in ( ) is applicable when the junction terminal block is mounted on a 35mm wide DIN rail.

## Manual Pulse Generator (MR-HDP01): For point table method and program method

Dimensions	[Unit: mm]	Mounting	[Unit: mm]
<p>3.6 Packing 12.0, 16, 20, 27.0, 70, 60, 60, 68.0, 8.89, 7.6</p> <p>3-M4 stud L10, P.C.D 72 equally divided</p> <p>Only M3x6 can be mounted.</p>	<p>[Unit: mm]</p>	<p style="text-align: center;">Panel cutting</p> <p>3-φ4.8 equally divided</p>	<p>[Unit: mm]</p>

## Wires, Molded-Case Circuit Breakers and Magnetic Contactors

The following are examples of wire sizes when 600V grade heat-resistant polyvinyl chloride insulated wires (HIV wires) are used.

Servo amplifier	Molded-case circuit breaker (Note 5, 6, 7)	Magnetic contactor (Note 4, 6)	Wire size [mm <sup>2</sup> ] (Note 5)				
			L1, L2, ⊕ (Note 1)	24V, 0V	U, V, W, ⊕	P, C (Note 1)	B1, B2
MR-JN-10A	30A frame 5A (30A frame 5A)	S-T10	2 (AWG14) (Note 8)	2 (AWG14) (Note 8)	2 (AWG14) (Note 2, 8)	2 (AWG14)	1.25 (AWG16) (Note 3)
MR-JN-20A MR-JN-10A1	30A frame 10A (30A frame 10A)						
MR-JN-40A MR-JN-20A1	30A frame 15A (30A frame 10A)						

- Notes: 1. Connect a reactor or a regenerative option using the 5m or shorter length electrical wire.  
 2. Use a fluorine resin wire of 0.75mm<sup>2</sup> (AWG18) for wiring to the servo motor power connector.  
 3. Use a fluorine resin wire of 0.5mm<sup>2</sup> (AWG20) for wiring to the electromagnetic brake connector.  
 4. Be sure to use a magnetic contactor (MC) with an operation delay time of 80ms or less. The operation delay time is the time interval from current being applied to the coil until closure of contacts.  
 5. When complying with IEC/EN/UL/CSA standard, refer to "MELSERVO-JN Instructions and Cautions for Safe Use of AC Servos" enclosed with the servo amplifier. When using the power factor improving AC reactor, use the molded-case circuit breakers in brackets.  
 6. Install one molded-case circuit breaker and one magnetic contactor for each servo amplifier.  
 7. Use a molded-case circuit breaker having the operation characteristics equal to or higher than Mitsubishi Electric general-purpose products.  
 8. When compliance with National Electrical Code is not necessary, a wire of 1.25mm<sup>2</sup> (AWG16) can be used.

## Radio noise filter (FR-BIF)

This filter effectively suppresses noise emitted from the power supply side of the servo amplifier, and is especially effective for radio frequency bands 10MHz or lower. The FR-BIF is designed to be installed on the input side.

Dimensions [Unit: mm]	Connections
<p>Approx. 300 Red White Blue Green Leakage current: 4mA ϕ5 hole</p>	<p>This filter is not connectable to the output side of the servo amplifier. Wiring should be as short as possible. Grounding is always required. Be sure to insulate the unused wire when using the FR-BIF with a 1-phase power supply.</p> <p><b>Example 1</b></p>

## Line noise filter (FR-BSF01)

This filter is effective in suppressing noise emitted from the power supply side or the output side of the servo amplifier, and also in suppressing high-frequency leakage current (zero-phase current), especially the range of 0.5MHz to 5MHz.

Dimensions [Unit: mm]	Connections
<p>(110) 95 ± 0.5 2-ϕ5 (22.5) (65) 11.25 ± 0.5 4.5 ϕ33</p>	<p>The line noise filters can be mounted on lines of the main power supply (L1, L2, and L3) and of the servo motor power (U, V, and W). Pass each of the wires through the line noise filter an equal number of times in the same direction.</p> <p>For wires of the main power supply, the effect of the filter rises as the number of passes increases, but generally four passes would be appropriate. For the servo motor power lines, passes must be four times or less. Do not pass the grounding wire through the filter. Otherwise, the effect of the filter will drop. Wind the wires by passing through the filter to satisfy the required number of passes as shown in Example 1. If the wires are too thick to wind, use two or more filters to have the required number of passes as shown in Example 2. Place the line noise filters as close to the servo amplifier as possible for their best performance.</p> <p><b>Example 1</b></p> <p><b>Example 2</b></p>

## Data line filter

This filter is effective in preventing noise when attached to the pulse output cable of the pulse train output controller or the motor encoder cable.

- Example) ESD-SR-250 (manufactured by TOKIN Corporation)  
 ZCAT3035-1330 (manufactured by TDK)  
 GRFC-13 (manufactured by Kitagawa Industries Co., Ltd.)  
 E04SRM563218 (manufactured by Seiwa Electric Mfg. Co. Ltd.)

## Surge killer

Attach surge killers to AC relays and AC valves around the servo amplifier. Attach diodes to DC relays and DC valves.

- Example) Surge killer: CR-50500 (manufactured by Okaya Electric Industries Co., Ltd.)  
 Diode: A diode with breakdown voltage four or more times greater than the relay drive voltage, and with current capacity two or more times greater than the relay drive current.

# Options/Peripheral Equipment

## EMC filter

The following filter is recommended as a filter compliant with the EMC directive for the power supply of the servo amplifier.

Servo amplifier model	EMC filter model <sup>(Note 3)</sup>	Rated current [A]	Rated voltage [VAC]	Leakage current [mA]	Mass [kg]
MR-JN-10A (1), MR-JN-20A (1), MR-JN-40A	HF3010A-UN <sup>(Note 1, 2)</sup>	10	250	5	3.5

Dimensions	[Unit: mm]	Connections
<p>HF3010A-UN <sup>(Note 1, 2)</sup></p>		

- Notes: 1. Manufactured by Soshin Electric Co., Ltd.  
 2. A surge protector is required to use this EMC filter. Refer to "EMC Installation Guidelines".  
 3. When using the EMC filter, install one EMC filter for each servo amplifier.

## Power factor improving AC reactor (FR-HAL)

This reactor enables users to boost the servo amplifier's power factor and reduce its power supply capacity.

Servo amplifier model	Power factor improving AC reactor model <sup>(Note 1)</sup>
MR-JN-10A (1) MR-JN-20A	FR-HAL-0.75K
MR-JN-40A MR-JN-20A1	FR-HAL-1.5K

Dimensions	[Unit: mm]	Connections																									
<table border="1"> <thead> <tr> <th>Model</th> <th>W</th> <th>W1</th> <th>H</th> <th>D <sup>(Note 3)</sup></th> <th>D1</th> <th>D2</th> <th>d</th> <th>Terminal screw size</th> <th>Mass [kg]</th> </tr> </thead> <tbody> <tr> <td>FR-HAL-0.75K</td> <td rowspan="2">104±2</td> <td rowspan="2">84</td> <td rowspan="2">99</td> <td>74</td> <td>56</td> <td>44</td> <td rowspan="2">M5</td> <td rowspan="2">M4</td> <td>0.8</td> </tr> <tr> <td>FR-HAL-1.5K</td> <td>77</td> <td>61</td> <td>50</td> <td>1.1</td> </tr> </tbody> </table>		Model	W	W1	H	D <sup>(Note 3)</sup>	D1	D2	d	Terminal screw size	Mass [kg]	FR-HAL-0.75K	104±2	84	99	74	56	44	M5	M4	0.8	FR-HAL-1.5K	77	61	50	1.1	
Model	W	W1	H	D <sup>(Note 3)</sup>	D1	D2	d	Terminal screw size	Mass [kg]																		
FR-HAL-0.75K	104±2	84	99	74	56	44	M5	M4	0.8																		
FR-HAL-1.5K				77	61	50			1.1																		

- Notes: 1. When using the power factor improving AC reactor, install one reactor for each servo amplifier.  
 2. Use this mounting hole for grounding.  
 3. This indicates the maximum dimension. The dimension varies depending on the bending degree of the input/output lines.

## Servo Support Software

### Drive System Sizing Software Motorizer

#### Specifications

Item	Description
Types of motor/drive	Servo, inverter, sensorless servo
Types of load mechanism	Ball screws, rack and pinions, roll feeds, rotary tables, carts, elevators/hoists, conveyors, fans, pumps, crank, generic (rotary), generic (linear), linear servo
Types of transmission mechanism	Coupling, external gear reducer, V belt and pulley, toothed belt/roller chain
Operation pattern	Constant speed/pause, acceleration/deceleration, trapezoid, triangle, speed csv file, MELSOFT GX LogViewer file
Types of input support of moment of inertia calculation function	Solid cylinder, hollow cylinder, disk, rectangular solid, truncated cone, sphere, generic
Sizing results	Result, motor type, power supply voltage, motor, motor capacity, drive, drive capacity, effective torque, torque effective load rate, peak torque, peak load rate, effective torque at stop, effective load rate at stop, motor output, motor output rate, maximum speed, maximum speed rate, maximum load inertia moment, inertia moment ratio, regenerative power, regenerative load ratio, regenerative option, maximally increased torque, rated speed, brake, oil seal, structure specification, graph of motor side speed/motor side torque/motor output
Printing of output of results	Prints load mechanism, transmission mechanism, operation pattern, and sizing results.
Data saving	Load mechanism, transmission mechanism, operation pattern, motor selection, drive selection, and sizing results are saved with a file name.

#### Operating environment (Note 1, 2)

Item	Description	
OS	Microsoft® Windows® 11 Microsoft® Windows® 10 (64-bit/32-bit)	
.NET Framework	.NET Framework 4.6 or later	
CPU (recommended)	Windows® 11	2 or more cores on a compatible 64-bit processor or System on a Chip (SoC)
	Windows® 10	Desktop PC: Intel® Celeron® processor 2.4 GHz or more Laptop PC: Intel® Pentium® processor 1.9 GHz or more
Memory (recommended)	Windows® 11	4 GB or more (64-bit OS)
	Windows® 10	1 GB or more (32-bit OS), 2 GB or more (64-bit OS)
Required hard disk space	For installation: 1 GB or more free hard disk space For operation: 512 MB or more free virtual memory space	
Monitor	Resolution 1024 × 768 or more (XGA) Compatible with above personal computers	

- Notes: 1. This software may not run correctly on some personal computers.  
2. Surrogate pair characters and environment dependent characters are not available.

## Servo Support Software

## MR Configurator2 (SW1DNC-MRC2-E) (Note 1)

MR Configurator2 can be obtained by either of the following:

- Purchase MR Configurator2 alone.
- Purchase GX Works3 or MT Works2: MR Configurator2 is included in GX Works3 and MT Works2 with software version 1.34L or later.

## Specification (Note 2)

Item	Description
Project	New/Open/Save/Save As/Delete Project, Read Other Format, Write Other Format, System Setting, Print
Parameter	Parameter Setting, Network Parameter, Axis Name Setting, Parameter Converter
Safety	Safety parameter setting, Change password, Initialize password
Positioning-data	Point Table, Program, Indirect Addressing, Cam Data
Monitor	Display All, I/O Monitor, Graph, ABS Data Display, Object Monitor
Diagnosis	Alarm Display, Alarm Onset Data, Drive recorder, No Motor Rotation, System Configuration, Life Diagnosis, Machine Diagnosis, Linear Diagnosis, Fully Closed Loop Diagnosis, Gear Failure Diagnosis, Encoder Communication Diagnosis
Test Operation	JOG Operation, Positioning Operation, Motor-Less Operation, DO Forced Output, Program Operation, Single-Step Feed, Test Operation Information
Adjustment	One-Touch Tuning, Tuning, Multi-axis Tuning, Machine Analyzer, Advanced Gain Search
Others	Servo Assistant, Update Parameter Setting Range, Machine Unit Conversion Setting, Axis Label Name Settings, Add-ons, Switch Display Language, Help

Notes: 1. Use the latest version of this software. Contact your local sales office for updating your software.

2. Supported items vary depending on the servo amplifiers. Refer to "MR Configurator2 SW1DNC-MRC2-E Installation Guide" for details.

## Operating environment (Note 1, 3)

Components	Description	
OS	Microsoft® Windows® 11 Education Microsoft® Windows® 11 Enterprise Microsoft® Windows® 11 Pro Microsoft® Windows® 11 Home Microsoft® Windows® 10 Education Microsoft® Windows® 10 Enterprise Microsoft® Windows® 10 Pro Microsoft® Windows® 10 Home Microsoft® Windows® 10 IoT Enterprise 2016 LTSC (Note 2)	
CPU (recommended)	Windows® 11	2 or more cores on a compatible 64-bit processor or System on a Chip (SoC)
	Windows® 10	Desktop PC: Intel® Celeron® processor 2.8 GHz or more Laptop PC: Intel® Pentium® M processor 1.7 GHz or more
Memory (recommended)	Windows® 11	4 GB or more (64-bit OS)
	Windows® 10	1 GB or more (32-bit OS), 2 GB or more (64-bit OS)
Required hard disk space	1.5 GB or more	
Monitor	Resolution 1024 × 768 or more, 16-bit high color, Compatible with above personal computers	
USB cable	MR-J3USBCBL3M	
Ethernet cable	Cable type: Category 5e or higher, (double shielded/STP) straight cable Standard: IEEE802.3 (1000BASE-T) or ANSI/TIA/EIA-568-B (Category 5e) Connector: RJ-45 connector with shield	

Notes: 1. This software may not run correctly on some personal computers.

2. This software is supported by 64-bit OS only.

3. Surrogate pair characters and environment dependent characters are not available.

## Unit Conversion Table

Quantity	SI (metric) unit	U.S. customary unit
Mass	1 [kg]	2.2046 [lb]
Length	1 [mm]	0.03937 [in]
Torque	1 [N·m]	141.6 [oz·in]
Moment of inertia	1 [ $\times 10^{-4}$ kg·m <sup>2</sup> ]	5.4675 [oz·in <sup>2</sup> ]
Load (thrust load/axial load)	1 [N]	0.2248 [lbf]
Temperature	n [°C]	$n \times 9/5 + 32$ [°F]

# Dimensions

## MR-JN-A Servo Amplifier Dimensions

### ● MR-JN-10A, MR-JN-20A, MR-JN-10A1, MR-JN-20A1

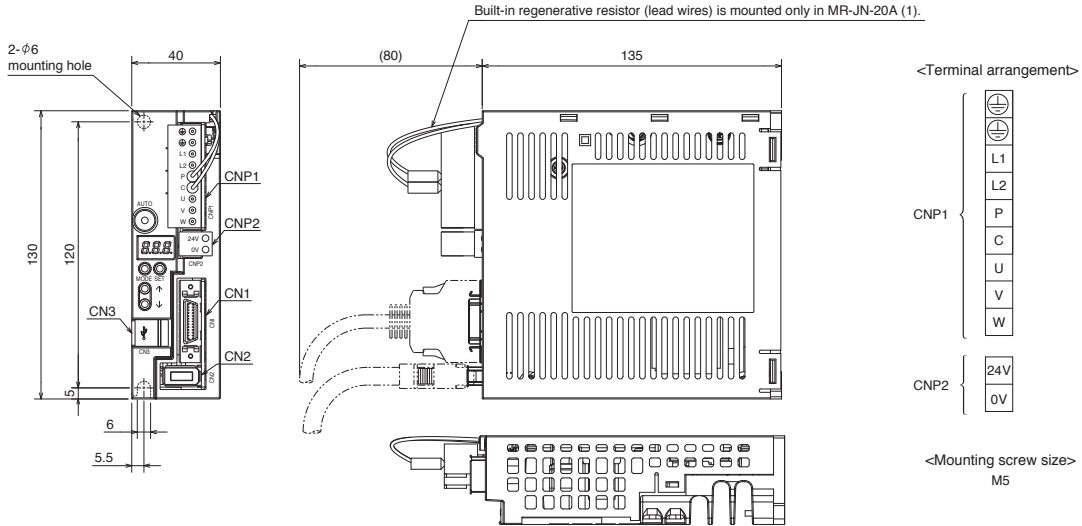

[Unit: mm]

### ● MR-JN-40A

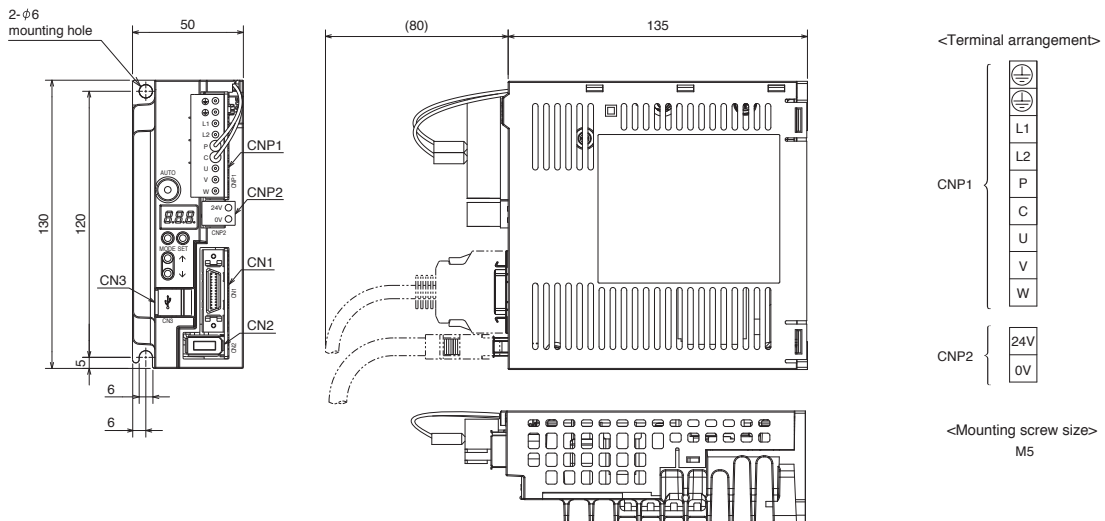

[Unit: mm]



## HF-KN Series Servo Motor Dimensions (Note 1, 4)

### ● HF-KN053(B), HF-KN13(B)

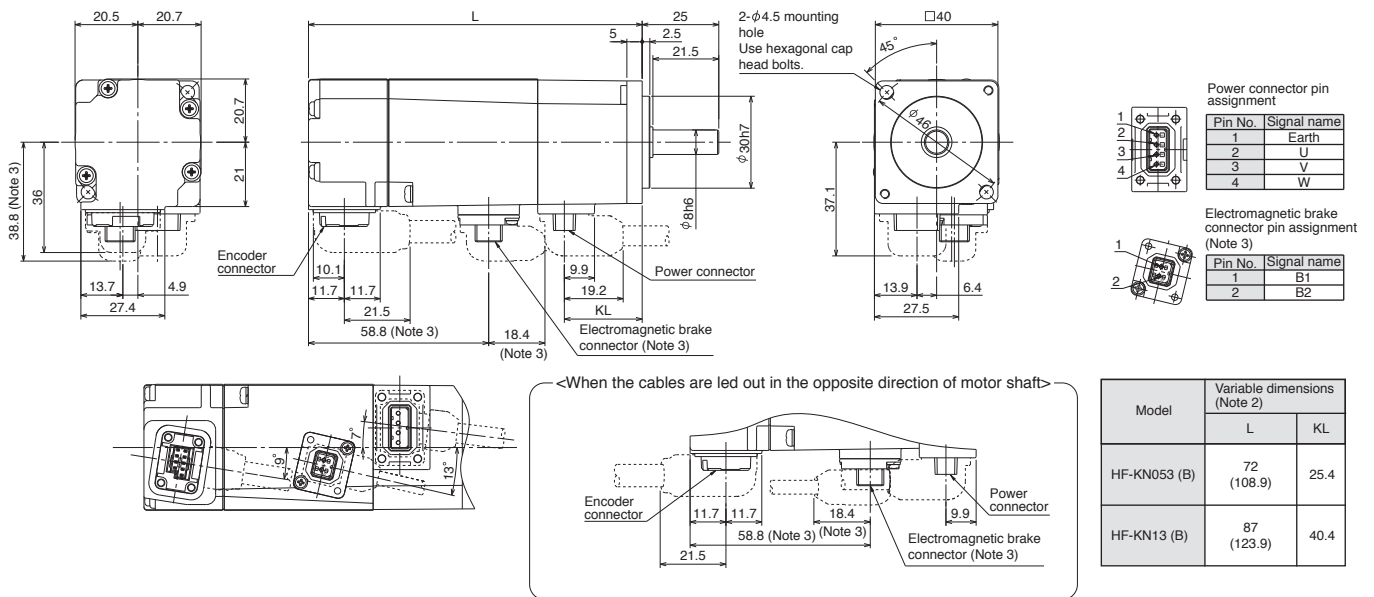

[Unit: mm]

### ● HF-KN23(B), HF-KN43(B)

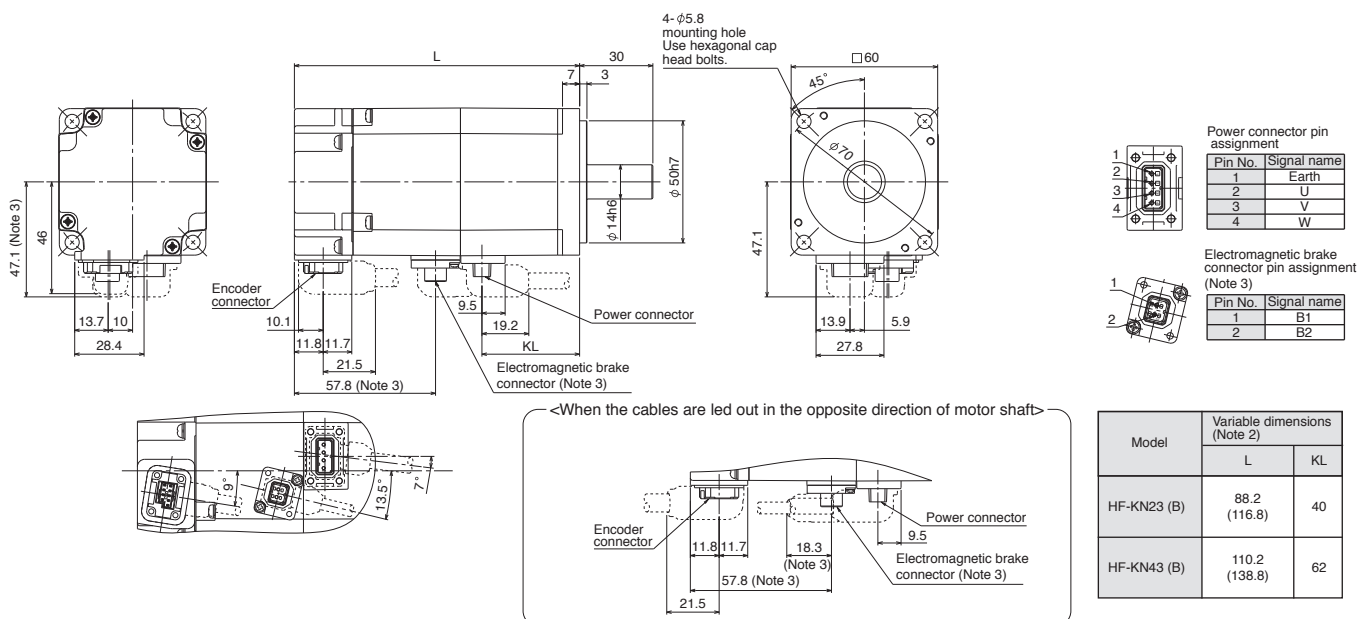

[Unit: mm]

- Notes: 1. Use a friction coupling to fasten a load.  
 2. Dimensions in brackets are for the models with electromagnetic brake.  
 3. Only for the models with electromagnetic brake. The electromagnetic brake terminals (B1, B2) do not have polarity.  
 4. For dimensions where there is no tolerance listed, use general tolerance.

# Dimensions

## HG-KR Series Geared Servo Motor Dimensions (Note 1, 5)

With gear reducer for general industrial machines

### ●HG-KR□(B)G1

The drawing below is only a schematic, and the shapes or the mounting screws may differ from those of the actual servo motor. Refer to "MR-JN-□A INSTRUCTION MANUAL" for details.

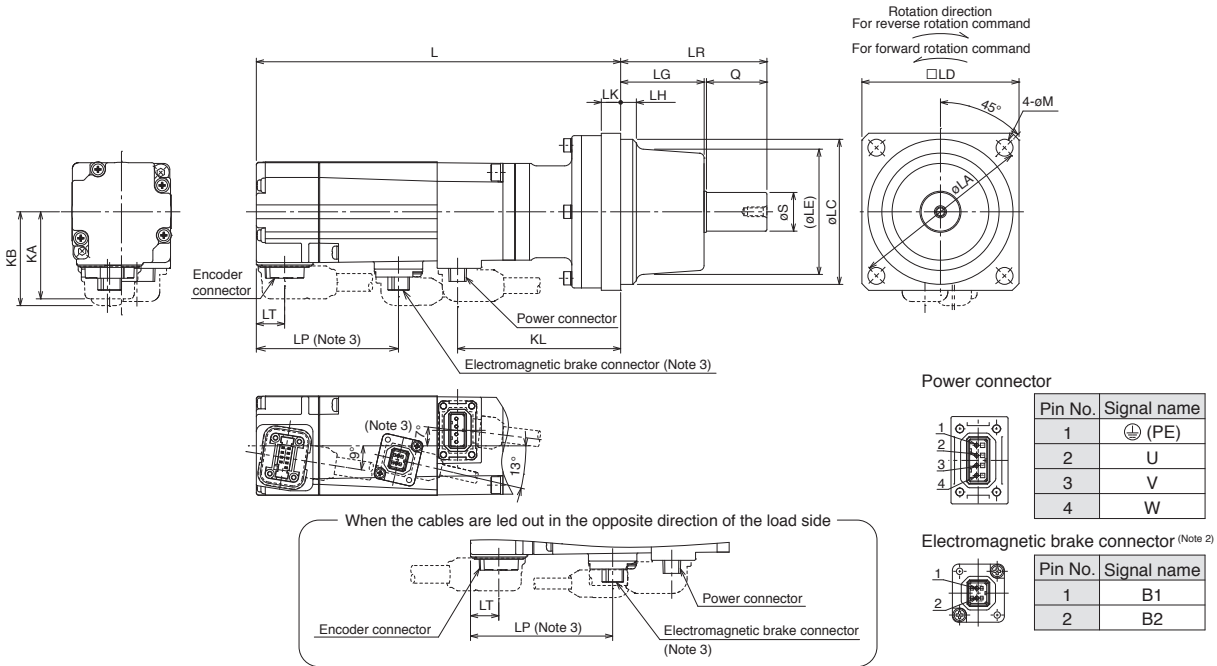

[Unit: mm]

Model	Reduction ratio (Actual reduction ratio)	Variable dimensions (Note 4)																	
		L	LA	LC	LD	LE	S	LH	LK	KL	LG	Q	LR	M	KA	KB	LT	LP	
HG-KR053(B)G1	1/5 (9/44)	110.1 (150.7)	75	60h7	65	51	16h6	6.5	8	67.5	34.5	25	60.5	7	36	37.1 (38.8)	11.7	-	(58.8)
	1/12 (49/576)	128.9 (169.5)																	
	1/20 (25/484)	126.1 (166.7)																	
	1/12 (49/576)	144.9 (185.5)																	
HG-KR13(B)G1	1/5 (9/44)	129.8 (166.6)	100	82h7	90	25h6	8	10	89.6	38	35	74	9	46	47.1 (47.1)	11.8	-	(57.8)	
	1/12 (961/11664)	149.6 (186.4)																	
	1/20 (513/9984)	151.5 (188.3)																	
	1/12 (961/11664)	171.3 (208.1)																	
HG-KR23(B)G1	1/5 (19/96)	151.5 (188.3)	115	95h7	100	83	32h6	9.5	135.1	39	50	90							
	1/12 (961/11664)	171.3 (208.1)																	
	1/20 (71/35)	175.3 (212.1)																	
	1/12 (961/11664)	151.5 (188.3)																	

- Notes: 1. General tolerances are applied to the dimensions in which tolerances are not given in the drawing. The actual dimensions may be 1 mm to 3 mm larger than those shown in the drawing because the outer frame of the gear reducer is made by casting. Design the machine to allow for sufficient space.  
2. The electromagnetic brake terminals (B1, B2) do not have polarity.  
3. Only for the models with electromagnetic brake.  
4. Dimensions in brackets are for the models with electromagnetic brake.  
5. Use a friction coupling to fasten a load.

**HG-KR Series Geared Servo Motor Dimensions (Note 1)**

With flange-output type gear reducer for high precision applications, flange mounting

● **HG-KR□(B)G5**

The drawing below is only a schematic, and the shapes or the mounting screws may differ from those of the actual servo motor. Refer to "MR-JN-□A INSTRUCTION MANUAL" for details.

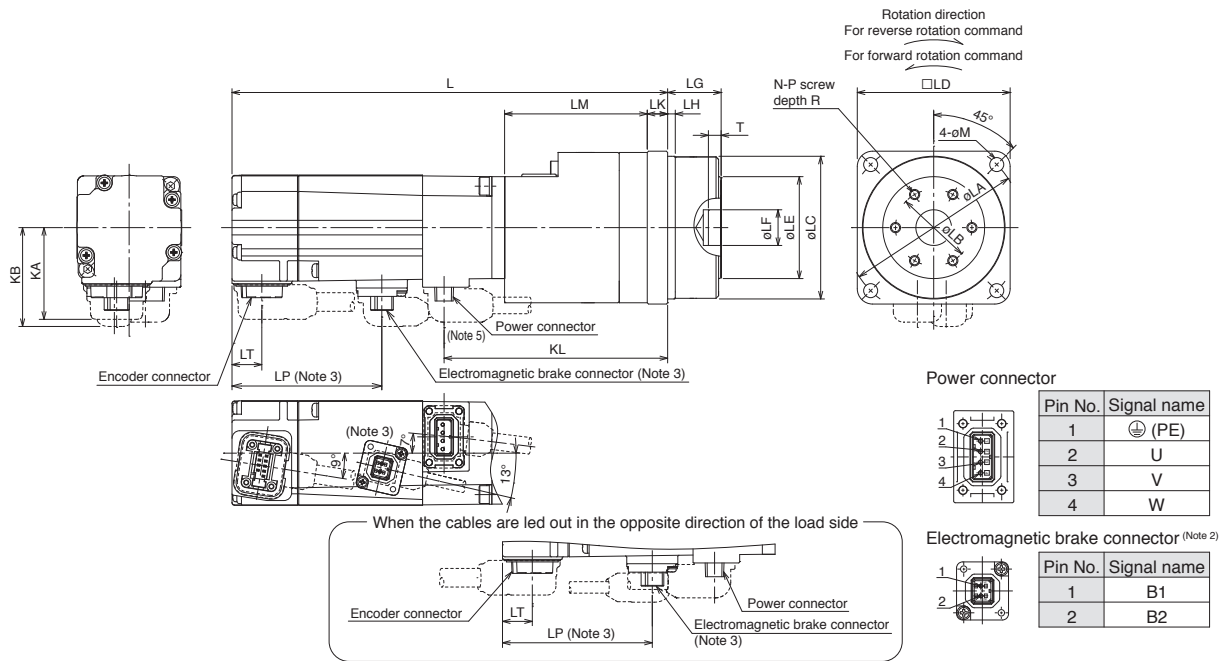

[Unit: mm]

Model	Reduction ratio (Note 6)	Variable dimensions (Note 4)																						
		L	LA	LB	LC	LD	LE	LF	LG	LH	LM	LN	M	N	P	R	M	KA	KB	LT	LP			
HG-KR053(B)G5	1/5 (40 × 40)	105.9 (146.5)	46	18	40h7	40	24	5H7	15 <sup>+0.25</sup> <sub>-0.20</sub>	2.5	5	34.5	63.3	3	3	M4	6	3.4	36	37.1 (38.8)	11.7	-	(58.8)	
	1/5 (60 × 60) (Note 5)	130.4 (171)	70	30	56h7	60	40	14H7	21 <sup>+0.4</sup> <sub>-0.5</sub>	3	8	56	87.8	5	6		7	5.5						
	1/9	105.9 (146.5)	46	18	40h7	40	24	5H7	15 <sup>+0.25</sup> <sub>-0.20</sub>	2.5	5	34.5	63.3	3	3		6	3.4						
	1/11 (Note 5)	130.4 (171)	70	30	56h7	60	40	14H7	21 <sup>+0.4</sup> <sub>-0.5</sub>	3	8	56	87.8	5	6		7	5.5						
	1/21 (Note 5)																							
1/33 (Note 5)																								
1/45 (Note 5)	105.9 (146.5)	46	18	40h7	40	24	5H7	15 <sup>+0.25</sup> <sub>-0.20</sub>	2.5	5	34.5	63.3	3	3	6	3.4								
HG-KR13(B)G5	1/5 (40 × 40)	121.9 (162.5)	46	18	40h7	40	24	5H7	15 <sup>+0.25</sup> <sub>-0.20</sub>	2.5	5	34.5	79.3	3	3	M4	6	3.4	36	37.1 (38.8)	11.7	-	(58.8)	
	1/5 (60 × 60) (Note 5)	146.4 (187)	70	30	56h7	60	40	14H7	21 <sup>+0.4</sup> <sub>-0.5</sub>	3	8	56	103.8	5	6		7	5.5						
	1/11 (Note 5)	146.4 (187)	70	30	56h7	60	40	14H7	21 <sup>+0.4</sup> <sub>-0.5</sub>	3	8	56	103.8	5	6		6	3.4						
	1/21 (Note 5)																							
	1/33 (Note 5)																							
1/45 (Note 5)	148.9 (189.5)	105	45	85h7	90	59	24H7	27 <sup>+0.4</sup> <sub>-0.5</sub>	8	10	56.5	106.3	5	6	M6	10	9							
HG-KR23(B)G5	1/5	140.6 (177.4)	70	30	56h7	60	40	14H7	21 <sup>+0.4</sup> <sub>-0.5</sub>	3	8	56	100.4	5	6	M4	7	5.5	46	47.1 (47.1)	11.8	-	(57.8)	
	1/11																							
	1/21 (Note 5)																							
HG-KR43(B)G5	1/5	162.3 (199.1)	70	30	56h7	60	40	14H7	21 <sup>+0.4</sup> <sub>-0.5</sub>	3	8	56	122.1	5	6	M4	7	5.5	46	47.1 (47.1)	11.8	-	(57.8)	
	1/11	169.3 (206.1)	105	45	85h7	90	59	24H7	27 <sup>+0.4</sup> <sub>-0.5</sub>	8	10	61	129.1				M6	10						9
	1/21 (Note 5)																							
	1/33 (Note 5)																							
1/45	181.3 (218.1)	135	60	115h7	120	84	32H7	35 <sup>+0.4</sup> <sub>-0.5</sub>	13	13	70	141.1	M8	12	11									

- Notes: 1. General tolerances are applied to the dimensions in which tolerances are not given in the drawing. The actual dimensions may be 1 mm to 3 mm larger than those shown in the drawing because the outer frame of the gear reducer is made by casting. Design the machine to allow for sufficient space.  
 2. The electromagnetic brake terminals (B1, B2) do not have polarity.  
 3. Only for the models with electromagnetic brake.  
 4. Dimensions in brackets are for the models with electromagnetic brake.  
 5. Lead out the power cable in the opposite direction of the motor shaft.  
 6. The values in brackets represent the dimensions of the flange.

# Dimensions

## HG-KR Series Geared Servo Motor Dimensions (Note 1, 5, 8)

With shaft-output type gear reducer for high precision applications, flange mounting

### ●HG-KR□(B)G7

The drawing below is only a schematic, and the shapes or the mounting screws may differ from those of the actual servo motor. Refer to "MR-JN-□A INSTRUCTION MANUAL" for details.

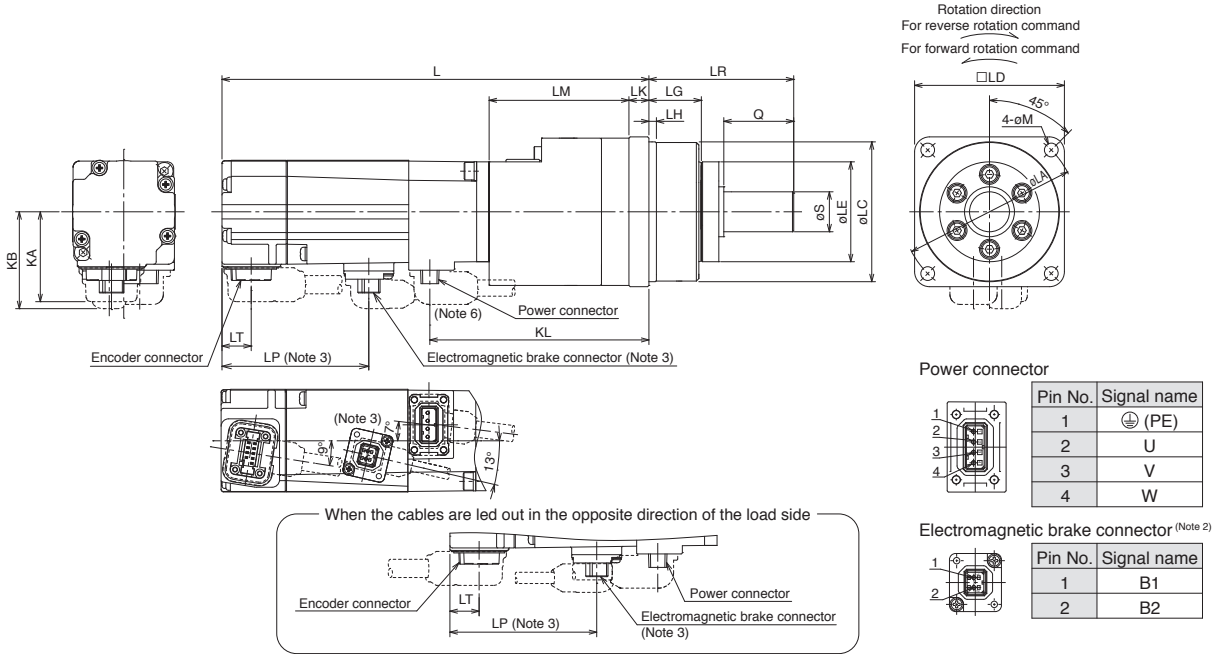

[Unit: mm]

Model	Reduction ratio (Note 7)	Variable dimensions (Note 4)																KA	KB	LT	LP
		L	LA	LC	LD	LE	S	LG	LH	Q	LR	LK	LM	KL	M						
HG-KR053(B)G7	1/5 (40 × 40)	105.9 (146.5)	46	40h7	40	29	10h7	15	2.5	20	42	5	34.5	63.3	3.4	36	37.1 (38.8)	11.7	-	(58.8)	
	1/5 (60 × 60) (Note 6)	130.4 (171)	70	56h7	60	40	16h7	21	3	28	58	8	56	87.8	5.5						
	1/9	105.9 (146.5)	46	40h7	40	29	10h7	15	2.5	20	42	5	34.5	63.3	3.4						
	1/11 (Note 6)	130.4 (171)	70	56h7	60	40	16h7	21	3	28	58	8	56	87.8	5.5						
	1/21 (Note 6)																				
1/33 (Note 6)																					
1/45 (Note 6)																					
HG-KR113(B)G7	1/5 (40 × 40)	121.9 (162.5)	46	40h7	40	29	10h7	15	2.5	20	42	5	34.5	79.3	3.4	36	37.1 (38.8)	11.7	-	(58.8)	
	1/5 (60 × 60) (Note 6)	146.4 (187)	70	56h7	60	40	16h7	21	3	28	58	8	56	103.8	5.5						
	1/11 (Note 6)	148.9 (189.5)	105	85h7	90	59	25h7	27	8	42	80	10	56.5	106.3	9						
	1/21 (Note 6)																				
	1/33 (Note 6)																				
1/45 (Note 6)																					
HG-KR23(B)G7	1/5	140.6 (177.4)	70	56h7	60	40	16h7	21	3	28	58	8	56	100.4	5.5	46	47.1 (47.1)	11.8	-	(57.8)	
	1/11 (Note 6)																				
	1/21 (Note 6)																				
	1/33 (Note 6)																				
1/45 (Note 6)																					
HG-KR43(B)G7	1/5	162.3 (199.1)	70	56h7	60	40	16h7	21	3	28	58	8	56	122.1	5.5	46	47.1 (47.1)	11.8	-	(57.8)	
	1/11 (Note 6)																				
	1/21 (Note 6)																				
	1/33 (Note 6)																				
1/45 (Note 6)																					

- Notes: 1. General tolerances are applied to the dimensions in which tolerances are not given in the drawing. The actual dimensions may be 1 mm to 3 mm larger than those shown in the drawing because the outer frame of the gear reducer is made by casting. Design the machine to allow for sufficient space.  
 2. The electromagnetic brake terminals (B1, B2) do not have polarity.  
 3. Only for the models with electromagnetic brake.  
 4. Dimensions in brackets are for the models with electromagnetic brake.  
 5. Use a friction coupling to fasten a load.  
 6. Lead out the power cable in the opposite direction of the motor shaft.  
 7. The values in brackets represent the dimensions of the flange.  
 8. HG-KR□(B)G7K is also available for key shaft motor (with key). Refer to the "HG-KR Series Geared Servo Motor Special Shaft End Specifications" for the shaft-end shape.

Servo amplifiers

Item	Model	Rated output	Main circuit power supply input
Servo amplifier	MR-JN-10A	100W	1-phase 200VAC to 230VAC
	MR-JN-10A1	100W	1-phase 100VAC to 120VAC
	MR-JN-20A	200W	1-phase 200VAC to 230VAC
	MR-JN-20A1	200W	1-phase 100VAC to 120VAC
	MR-JN-40A	400W	1-phase 200VAC to 230VAC

Servo motors

Item	Model	Rated output	Rated speed	Reduction ratio
HF-KN series B: With electromagnetic brake	HF-KN053(B)	50W	3000r/min	—
	HF-KN13(B)	100W	3000r/min	—
	HF-KN23(B)	200W	3000r/min	—
	HF-KN43(B)	400W	3000r/min	—
HG-KR series With gear reducer for general industrial machines B: With electromagnetic brake	HG-KR053(B)G1 1/5	50W	3000r/min	1/5
	HG-KR053(B)G1 1/12	50W	3000r/min	1/12
	HG-KR053(B)G1 1/20	50W	3000r/min	1/20
	HG-KR13(B)G1 1/5	100W	3000r/min	1/5
	HG-KR13(B)G1 1/12	100W	3000r/min	1/12
	HG-KR13(B)G1 1/20	100W	3000r/min	1/20
	HG-KR23(B)G1 1/5	200W	3000r/min	1/5
	HG-KR23(B)G1 1/12	200W	3000r/min	1/12
	HG-KR23(B)G1 1/20	200W	3000r/min	1/20
	HG-KR43(B)G1 1/5	400W	3000r/min	1/5
	HG-KR43(B)G1 1/12	400W	3000r/min	1/12
	HG-KR43(B)G1 1/20	400W	3000r/min	1/20
HG-KR series With flange-output type gear reducer for high precision applications, flange mounting B: With electromagnetic brake	HG-KR053(B)G5 1/5 (40 x 40)	50W	3000r/min	1/5 (flange dimensions: 40mm x 40mm)
	HG-KR053(B)G5 1/5 (60 x 60)	50W	3000r/min	1/5 (flange dimensions: 60mm x 60mm)
	HG-KR053(B)G5 1/9	50W	3000r/min	1/9
	HG-KR053(B)G5 1/11	50W	3000r/min	1/11
	HG-KR053(B)G5 1/21	50W	3000r/min	1/21
	HG-KR053(B)G5 1/33	50W	3000r/min	1/33
	HG-KR053(B)G5 1/45	50W	3000r/min	1/45
	HG-KR13(B)G5 1/5 (40 x 40)	100W	3000r/min	1/5 (flange dimensions: 40mm x 40mm)
	HG-KR13(B)G5 1/5 (60 x 60)	100W	3000r/min	1/5 (flange dimensions: 60mm x 60mm)
	HG-KR13(B)G5 1/11	100W	3000r/min	1/11
	HG-KR13(B)G5 1/21	100W	3000r/min	1/21
	HG-KR13(B)G5 1/33	100W	3000r/min	1/33
	HG-KR13(B)G5 1/45	100W	3000r/min	1/45
	HG-KR23(B)G5 1/5	200W	3000r/min	1/5
	HG-KR23(B)G5 1/11	200W	3000r/min	1/11
	HG-KR23(B)G5 1/21	200W	3000r/min	1/21
	HG-KR23(B)G5 1/33	200W	3000r/min	1/33
	HG-KR23(B)G5 1/45	200W	3000r/min	1/45
	HG-KR43(B)G5 1/5	400W	3000r/min	1/5
	HG-KR43(B)G5 1/11	400W	3000r/min	1/11
	HG-KR43(B)G5 1/21	400W	3000r/min	1/21
	HG-KR43(B)G5 1/33	400W	3000r/min	1/33
	HG-KR43(B)G5 1/45	400W	3000r/min	1/45

Servo amplifiers

Servo motors

Options/Peripheral Equipment

Dimensions

Product List

Precautions

# Product List

## Servo motors

Item	Model	Rated output	Rated speed	Reduction ratio
HG-KR series With shaft-output type gear reducer for high precision applications, flange mounting  B: With electromagnetic brake	HG-KR053(B)G7 1/5 (40 x 40)	50W	3000r/min	1/5 (flange dimensions: 40mm x 40mm)
	HG-KR053(B)G7 1/5 (60 x 60)	50W	3000r/min	1/5 (flange dimensions: 60mm x 60mm)
	HG-KR053(B)G7 1/9	50W	3000r/min	1/9
	HG-KR053(B)G7 1/11	50W	3000r/min	1/11
	HG-KR053(B)G7 1/21	50W	3000r/min	1/21
	HG-KR053(B)G7 1/33	50W	3000r/min	1/33
	HG-KR053(B)G7 1/45	50W	3000r/min	1/45
	HG-KR13(B)G7 1/5 (40 x 40)	100W	3000r/min	1/5 (flange dimensions: 40mm x 40mm)
	HG-KR13(B)G7 1/5 (60 x 60)	100W	3000r/min	1/5 (flange dimensions: 60mm x 60mm)
	HG-KR13(B)G7 1/11	100W	3000r/min	1/11
	HG-KR13(B)G7 1/21	100W	3000r/min	1/21
	HG-KR13(B)G7 1/33	100W	3000r/min	1/33
	HG-KR13(B)G7 1/45	100W	3000r/min	1/45
	HG-KR23(B)G7 1/5	200W	3000r/min	1/5
	HG-KR23(B)G7 1/11	200W	3000r/min	1/11
	HG-KR23(B)G7 1/21	200W	3000r/min	1/21
	HG-KR23(B)G7 1/33	200W	3000r/min	1/33
	HG-KR23(B)G7 1/45	200W	3000r/min	1/45
	HG-KR43(B)G7 1/5	400W	3000r/min	1/5
	HG-KR43(B)G7 1/11	400W	3000r/min	1/11
HG-KR43(B)G7 1/21	400W	3000r/min	1/21	
HG-KR43(B)G7 1/33	400W	3000r/min	1/33	
HG-KR43(B)G7 1/45	400W	3000r/min	1/45	

## Encoder cables

Item	Model	Length	Bending life	IP rating	Application
Encoder cable (load-side lead)	MR-J3ENCBL2M-A1-H	2m	Long bending life	IP65	Direct connection type
	MR-J3ENCBL5M-A1-H	5m	Long bending life	IP65	Direct connection type
	MR-J3ENCBL10M-A1-H	10m	Long bending life	IP65	Direct connection type
	MR-J3ENCBL2M-A1-L	2m	Standard	IP65	Direct connection type
	MR-J3ENCBL5M-A1-L	5m	Standard	IP65	Direct connection type
	MR-J3ENCBL10M-A1-L	10m	Standard	IP65	Direct connection type
Encoder cable (opposite to load-side lead)	MR-J3ENCBL2M-A2-H	2m	Long bending life	IP65	Direct connection type
	MR-J3ENCBL5M-A2-H	5m	Long bending life	IP65	Direct connection type
	MR-J3ENCBL10M-A2-H	10m	Long bending life	IP65	Direct connection type
	MR-J3ENCBL2M-A2-L	2m	Standard	IP65	Direct connection type
	MR-J3ENCBL5M-A2-L	5m	Standard	IP65	Direct connection type
	MR-J3ENCBL10M-A2-L	10m	Standard	IP65	Direct connection type
Encoder cable (load-side lead)	MR-J3JCBL03M-A1-L <sup>(Note 1)</sup>	0.3m	Standard	IP20	Junction type
Encoder cable (opposite to load-side lead)	MR-J3JCBL03M-A2-L <sup>(Note 1)</sup>	0.3m	Standard	IP20	Junction type
Encoder cable	MR-EKCBLL20M-H <sup>(Note 2)</sup>	20m	Long bending life	IP20	Junction type
	MR-EKCBLL30M-H <sup>(Note 2)</sup>	30m	Long bending life	IP20	Junction type
	MR-EKCBLL40M-H <sup>(Note 2)</sup>	40m	Long bending life	IP20	Junction type
	MR-EKCBLL50M-H <sup>(Note 2)</sup>	50m	Long bending life	IP20	Junction type
	MR-EKCBLL20M-L <sup>(Note 2)</sup>	20m	Standard	IP20	Junction type
	MR-EKCBLL30M-L <sup>(Note 2)</sup>	30m	Standard	IP20	Junction type
Encoder cable (load-side lead)	MR-J3JSCBL03M-A1-L <sup>(Note 3)</sup>	0.3m	Standard	IP65	Junction type
Encoder cable (opposite to load-side lead)	MR-J3JSCBL03M-A2-L <sup>(Note 3)</sup>	0.3m	Standard	IP65	Junction type
Encoder cable	MR-J3ENSCBL2M-H <sup>(Note 4)</sup>	2m	Long bending life	IP67	Junction type
	MR-J3ENSCBL5M-H <sup>(Note 4)</sup>	5m	Long bending life	IP67	Junction type
	MR-J3ENSCBL10M-H <sup>(Note 4)</sup>	10m	Long bending life	IP67	Junction type
	MR-J3ENSCBL20M-H <sup>(Note 4)</sup>	20m	Long bending life	IP67	Junction type
	MR-J3ENSCBL30M-H <sup>(Note 4)</sup>	30m	Long bending life	IP67	Junction type
	MR-J3ENSCBL40M-H <sup>(Note 4)</sup>	40m	Long bending life	IP67	Junction type
	MR-J3ENSCBL50M-H <sup>(Note 4)</sup>	50m	Long bending life	IP67	Junction type
	MR-J3ENSCBL2M-L <sup>(Note 4)</sup>	2m	Standard	IP67	Junction type
	MR-J3ENSCBL5M-L <sup>(Note 4)</sup>	5m	Standard	IP67	Junction type
	MR-J3ENSCBL10M-L <sup>(Note 4)</sup>	10m	Standard	IP67	Junction type
	MR-J3ENSCBL20M-L <sup>(Note 4)</sup>	20m	Standard	IP67	Junction type
	MR-J3ENSCBL30M-L <sup>(Note 4)</sup>	30m	Standard	IP67	Junction type

## Encoder connector sets

Item	Model	Description	IP rating	Application
Encoder connector set	MR-ECNM <sup>(Note 2)</sup>	Junction connector × 1, Servo amplifier connector × 1	IP20	Junction type
	MR-J3SCNS <sup>(Note 4)</sup>	Straight type Junction connector × 1, Servo amplifier connector × 1	IP67	Junction type

Notes: 1. Use this in combination with MR-EKCBLL\_M-H (20m to 50m), MR-EKCBLL\_M-L (20m or 30m), or MR-ECNM.

2. Use this in combination with MR-J3JCBL03M-A1-L or MR-J3JCBL03M-A2-L.

3. Use this in combination with MR-J3ENSCBL\_M-H (2m to 50m), MR-J3ENSCBL\_M-L (2m to 30m), or MR-J3SCNS.

4. Use this in combination with MR-J3JSCBL03M-A1-L or MR-J3JSCBL03M-A2-L.

## Product List

### Servo motor power cables

Item	Model	Length	Bending life	IP rating	Application
Servo motor power cable (load-side lead, lead-out)	MR-PWS1CBL2M-A1-H	2m	Long bending life	IP65	Direct connection type
	MR-PWS1CBL5M-A1-H	5m	Long bending life	IP65	Direct connection type
	MR-PWS1CBL10M-A1-H	10m	Long bending life	IP65	Direct connection type
	MR-PWS1CBL2M-A1-L	2m	Standard	IP65	Direct connection type
	MR-PWS1CBL5M-A1-L	5m	Standard	IP65	Direct connection type
	MR-PWS1CBL10M-A1-L	10m	Standard	IP65	Direct connection type
Servo motor power cable (load-side lead, lead-out)	MR-PWS1CBL2M-A2-H	2m	Long bending life	IP65	Direct connection type
	MR-PWS1CBL5M-A2-H	5m	Long bending life	IP65	Direct connection type
	MR-PWS1CBL10M-A2-H	10m	Long bending life	IP65	Direct connection type
	MR-PWS1CBL2M-A2-L	2m	Standard	IP65	Direct connection type
	MR-PWS1CBL5M-A2-L	5m	Standard	IP65	Direct connection type
	MR-PWS1CBL10M-A2-L	10m	Standard	IP65	Direct connection type
Servo motor power cable (load-side lead, lead-out)	MR-PWS2CBL03M-A1-L	0.3m	Standard	IP55	Junction type
Servo motor power cable (opposite to load-side lead, lead-out)	MR-PWS2CBL03M-A2-L	0.3m	Standard	IP55	Junction type

### Electromagnetic brake cables

Item	Model	Length	Bending life	IP rating	Application
Electromagnetic brake cable (load-side lead, lead-out)	MR-BKS1CBL2M-A1-H	2m	Long bending life	IP65	Direct connection type
	MR-BKS1CBL5M-A1-H	5m	Long bending life	IP65	Direct connection type
	MR-BKS1CBL10M-A1-H	10m	Long bending life	IP65	Direct connection type
	MR-BKS1CBL2M-A1-L	2m	Standard	IP65	Direct connection type
	MR-BKS1CBL5M-A1-L	5m	Standard	IP65	Direct connection type
	MR-BKS1CBL10M-A1-L	10m	Standard	IP65	Direct connection type
Electromagnetic brake cable (opposite to load-side lead, lead-out)	MR-BKS1CBL2M-A2-H	2m	Long bending life	IP65	Direct connection type
	MR-BKS1CBL5M-A2-H	5m	Long bending life	IP65	Direct connection type
	MR-BKS1CBL10M-A2-H	10m	Long bending life	IP65	Direct connection type
	MR-BKS1CBL2M-A2-L	2m	Standard	IP65	Direct connection type
	MR-BKS1CBL5M-A2-L	5m	Standard	IP65	Direct connection type
	MR-BKS1CBL10M-A2-L	10m	Standard	IP65	Direct connection type
Electromagnetic brake cable (load-side lead, lead-out)	MR-BKS2CBL03M-A1-L	0.3m	Standard	IP55	Junction type
Electromagnetic brake cable (opposite to load-side lead, lead-out)	MR-BKS2CBL03M-A2-L	0.3m	Standard	IP55	Junction type

### Junction terminal block/Junction terminal block cables

Item	Model	Length	Application
Junction terminal block (26 pins)	MR-TB26A	–	–
Junction terminal block cable (For MR-TB26A)	MR-TBNATBL05M	0.5m	For connecting servo amplifier and MR-TB26A
	MR-TBNATBL1M	1m	For connecting servo amplifier and MR-TB26A



## Regenerative options

Item	Model	Permissible regenerative power	Resistance value	Application
Regenerative option	MR-RB032	30W	40Ω	For MR-JN-10A(1), MR-JN-20A(1), and MR-JN-40A
	MR-RB12	100W	40Ω	For MR-JN-20A(1) and MR-JN-40A

## Peripheral cable/connector set/unit

Item	Model	Length	Application
Personal computer communication cable (USB cable)	MR-J3USBCBL3M	3m	For CN3 of servo amplifier
Connector set	MR-J2CMP2	–	For CN1 of servo amplifier
Manual pulse generator	MR-HDP01	–	For point table method and program method

## Servo Support Software

Item	Model	Application
MELSOFT MR Configurator2 <sup>(Note 1)</sup>	SW1DNC-MRC2-E	Servo setup software for AC servo

Notes: 1. MR Configurator2 is included in MELSOFT MT Works2 with software version 1.34L or later, or GX Works3.

If you have MELSOFT MT Works2 with software version earlier than 1.34L, MELSOFT iQ Works, GX Works3, GX Works2, EM Software Development Kit, or CW Configurator, MR Configurator2 is available for free download.

# Precautions

## For your safety

- To use the products given in this catalog properly, be sure to read the "Instruction Manual" and the appended document prior to use.

## Precautions for model selection

- Select a servo motor which has the rated torque equal to or higher than the continuous effective load torque.
- When unbalanced torque is generated, such as in a vertical lift machine, keep the unbalanced torque of the machine under 70% of the servo motor rated torque.
- Create operation patterns by considering the settling time (ts) to complete positioning.
- Load to motor inertia ratio or load to mass ratio must be below the recommended ratio. If the ratio is too large, the expected performance may not be achieved, and the dynamic brake may be damaged.

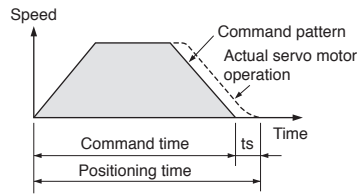

## General safety precautions

### 1. Transportation/installation

- Combinations of the servo motor and the servo amplifier are predetermined. Confirm the models of the servo motor and the servo amplifier to be used before installation.
- Do not drop or apply strong impact on the servo amplifier and the servo motor as they are precision devices. They may be damaged from such stress or shock.
- When fumigants that contain halogen materials such as fluorine, chlorine, bromine, and iodine are used for disinfecting and protecting wooden packaging from insects, they cause malfunction when entering our products. Please take necessary precautions to ensure that remaining materials from fumigant do not enter our products, or treat packaging with methods other than fumigation (heat method). Additionally, disinfect and protect wood from insects before packing products.
- Do not get on or place heavy objects on the servo amplifier or the servo motor. Doing so may result in injury or damage.
- The system must withstand high speeds and high acceleration/deceleration.
- To enable high-accuracy positioning, ensure the machine rigidity, and keep the machine resonance point at a high level.
- Mount the servo amplifier and the servo motor on nonflammable material. Mounting them directly on or near flammable material may result in fires.
- The regenerative option becomes hot (the temperature rise of 100 °C or higher) with frequent use. Do not install within flammable objects or objects subject to thermal deformation. Make sure that wires do not come into contact with the unit.
- Securely fix the servo motor onto the machine. Insufficient fixing may cause the servo motor to be dislocated during operation.
- Install electrical and mechanical stoppers at the stroke end.
- Mount the servo amplifier vertically on a wall.
- Do not block intake and exhaust areas of the servo amplifier. Doing so may cause the servo amplifier to malfunction.

- When installing multiple servo amplifiers in a row in a sealed cabinet, leave space around the servo amplifiers as described in Servo Amplifier Instruction Manual. To ensure the life and reliability of the servo amplifiers, prevent heat accumulation by keeping space as open as possible toward the top plate.

### 2. Environment

- Use the servo amplifier and the servo motor in the designated environment.
- Avoid installing the servo amplifier and the servo motor in areas with oil mist or dust. When installing in such areas, be sure to enclose the servo amplifier in a sealed cabinet, and protect the servo motor by furnishing a cover or by taking similar measures.
- Do not use in areas where the servo motor may be constantly subject to cutting fluid or lubricant oil, or where dew could condense because of oil mist, overcooling or excessive humidity. Doing so may deteriorate the insulation of the servo motor.

### 3. Grounding

- Securely ground to prevent electric shocks and to stabilize the potential in the control circuit.
- Connect the grounding wire to the cabinet protective earth (PE) terminal via the servo amplifier for the servo motor grounding.
- Faults such as a position mismatch may occur if the grounding is insufficient.

### 4. Wiring

- Do not supply power to the output terminals (U, V, and W) of the servo amplifier or the input terminals (U, V, and W) of the servo motor. Doing so damages the servo amplifier and the servo motor.
- Connect the servo motor to the output terminals (U, V, and W) of the servo amplifier.
- Match the phase of the input terminals (U, V, and W) of the servo motor to the output terminals (U, V, and W) of the servo amplifier when connecting them. If they do not match, the servo motor does not operate properly.
- Check the wiring and sequence program thoroughly before switching the power on.
- Carefully select the cable clamping method, and make sure that bending stress and the stress of the cable's own weight are not applied on the cable connection section.
- In an application where the servo motor moves, determine the cable bending radius based on the cable bending life and wire type.

### 5. Initial settings

- Select a control mode from position, speed or torque with [Pr. PA01]. Position control mode is set as default. Change the parameter setting value when using the other control modes.
- When using the regenerative option, change [Pr. PA02]. The regenerative option is disabled as default.

### 6. Operation

- Do not use a product which is damaged or has missing parts. In that case, replace the product.
- Turn on FLS and RLS (Upper/Lower stroke limit), or LSP and LSN (Forward/Reverse rotation stroke end) in position or speed control mode. The servo motor will not start if the signals are off.
- When a magnetic contactor is installed on the primary side of the servo amplifier, do not perform frequent starts and stops with the magnetic contactor. Doing so may damage the servo amplifier.

- The dynamic brake is a function for emergency stop. Do not use it to stop the servo motor in normal operations.
- As a rough guide, the dynamic brake withstands 1000 times of use when a machine which has load to motor inertia ratio equals to or lower than the recommended ratio stops from the rated speed every 10 minutes.
- When an error occurs, ensure safety by turning the power off, etc., before dealing with the error. Otherwise, it may cause an accident.
- If the protective functions of the servo amplifier activate, turn the power off immediately. Remove the cause before turning the power on again. If operation is continued without removing the cause of the error, the servo motor may malfunction, resulting in injury or damage.
- The servo amplifier, the regenerative resistor, and the servo motor can be very hot during or after operation. Take safety measures such as covering them to prevent your hand and/or parts including cables from coming in contact with them.
- Do not touch the servo amplifier, the regenerative resistor, or the servo motor while the power is on or for a while after the power is turned off. Otherwise, an electric shock may occur. Make sure that the charge light is off, and check the voltage between P+ and N- (L+ and L- for the drive unit) with a voltage tester before wiring or inspection.
- In a maintenance inspection, make sure that the emergency stop circuit operates properly such that an operation can be stopped immediately and a power can be shut off by the emergency stop switch.

#### 7. Others

- Do not touch the servo amplifier or the servo motor with wet hands.
- Do not modify the servo amplifier or the servo motor.

### Precautions for servo motors

- Do not hammer the shaft of the servo motor when installing a pulley or a coupling. Doing so may damage the encoder. When installing the pulley or the coupling to the key shaft servo motor, use the screw hole on the shaft end. Use a pulley extractor when removing the pulley.
- Do not apply a load exceeding the tolerable load onto the servo motor shaft. The shaft may break.
- When the servo motor is mounted with the shaft vertical (shaft up), take measures on the machine side so that oil from the gear box does not get into the servo motor.
- Mount the geared servo motor in a direction described in manual.
- Do not use the 24 V DC interface power supply for the electromagnetic brake. Provide a dedicated power supply to the electromagnetic brake.
- Do not apply the electromagnetic brake when the servo is on. Doing so may cause the servo amplifier overload or shorten the brake life. Apply the electromagnetic brake when the servo is off.
- Torque may drop due to temperature increase of the servo motor. Be sure to use the motor within the specified ambient temperature.

# Precautions

## Warranty

### 1. Warranty period and coverage

We will repair any failure or defect hereinafter referred to as "failure" in our FA equipment hereinafter referred to as the "Product" arisen during warranty period at no charge due to causes for which we are responsible through the distributor from which you purchased the Product or our service provider. However, we will charge the actual cost of dispatching our engineer for an on-site repair work on request by customer in Japan or overseas countries. We are not responsible for any on-site readjustment and/or trial run that may be required after a defective unit is repaired or replaced.

#### [Term]

For terms of warranty, please contact your original place of purchase.

#### [Limitations]

- (1) You are requested to conduct an initial failure diagnosis by yourself, as a general rule. It can also be carried out by us or our service company upon your request and the actual cost will be charged. However, it will not be charged if we are responsible for the cause of the failure.
- (2) This limited warranty applies only when the condition, method, environment, etc. of use are in compliance with the terms and conditions and instructions that are set forth in the instruction manual and user manual for the Product and the caution label affixed to the Product.
- (3) Even during the term of warranty, the repair cost will be charged on you in the following cases;
  - (i) a failure caused by your improper storing or handling, carelessness or negligence, etc., and a failure caused by your hardware or software problem
  - (ii) a failure caused by any alteration, etc. to the Product made on your side without our approval
  - (iii) a failure which may be regarded as avoidable, if your equipment in which the Product is incorporated is equipped with a safety device required by applicable laws and has any function or structure considered to be indispensable according to a common sense in the industry
  - (iv) a failure which may be regarded as avoidable if consumable parts designated in the instruction manual, etc. are duly maintained and replaced
  - (v) any replacement of consumable parts (battery, fan, smoothing capacitor, etc.)
  - (vi) a failure caused by external factors such as inevitable accidents, including without limitation fire and abnormal fluctuation of voltage, and acts of God, including without limitation earthquake, lightning and natural disasters
  - (vii) a failure generated by an unforeseeable cause with a scientific technology that was not available at the time of the shipment of the Product from our company
  - (viii) any other failures which we are not responsible for or which you acknowledge we are not responsible for

### 2. Term of warranty after the stop of production

- (1) We may accept the repair at charge for another seven (7) years after the production of the product is discontinued. The announcement of the stop of production for each model can be seen in our Sales and Service, etc.
- (2) Please note that the Product (including its spare parts) cannot be ordered after its stop of production.

### 3. Service in overseas countries

Our regional FA Center in overseas countries will accept the repair work of the Product. However, the terms and conditions of the repair work may differ depending on each FA Center. Please ask your local FA Center for details.

### 4. Exclusion of loss in opportunity and secondary loss from warranty liability

Regardless of the gratis warranty term, Mitsubishi shall not be liable for compensation to:

- (1) Damages caused by any cause found not to be the responsibility of Mitsubishi.
- (2) Loss in opportunity, lost profits incurred to the user by Failures of Mitsubishi products.
- (3) Special damages and secondary damages whether foreseeable or not, compensation for accidents, and compensation for damages to products other than Mitsubishi products.
- (4) Replacement by the user, maintenance of on-site equipment, start-up test run and other tasks.

### 5. Change of Product specifications

Specifications listed in our catalogs, manuals or technical documents may be changed without notice.

### 6. Application and use of the Product

- (1) For the use of our AC Servo, its applications should be those that may not result in a serious damage even if any failure or malfunction occurs in AC Servo, and a backup or fail-safe function should operate on an external system to AC Servo when any failure or malfunction occurs.
- (2) Our AC Servo is designed and manufactured as a general purpose product for use at general industries. Therefore, applications substantially influential on the public interest for such as atomic power plants and other power plants of electric power companies, and also which require a special quality assurance system, including applications for railway companies and government or public offices are not recommended, and we assume no responsibility for any failure caused by these applications when used.

In addition, applications which may be substantially influential to human lives or properties for such as airlines, medical treatments, railway service, incineration and fuel systems, man-operated material handling equipment, entertainment machines, safety machines, etc. are not recommended, and we assume no responsibility for any failure caused by these applications when used.

We will review the acceptability of the abovementioned applications, if you agree not to require a specific quality for a specific application. Please contact us for consultation.
- (3) Mitsubishi Electric shall have no responsibility or liability for any problems involving programmable controller trouble and system trouble caused by DoS attacks, unauthorized access, computer viruses, and other cyberattacks.

# Extensive global support coverage providing expert help whenever needed

## ■ Global FA centers

### ■ EMEA

#### Europe FA Center

MITSUBISHI ELECTRIC EUROPE B.V. Polish Branch  
Tel: +48-12-347-65-00

#### Germany FA Center

MITSUBISHI ELECTRIC EUROPE B.V. German Branch  
Tel: +49-2102-486-0

#### UK FA Center

MITSUBISHI ELECTRIC EUROPE B.V. UK Branch  
Tel: +44-1707-27-8780

#### Czech Republic FA Center

MITSUBISHI ELECTRIC EUROPE B.V. Czech Branch  
Tel: +420-734-402-587

#### Italy FA Center

MITSUBISHI ELECTRIC EUROPE B.V. Italian Branch  
Tel: +39-039-60531

#### Turkey FA Center

MITSUBISHI ELECTRIC TURKEY Elektrik Urunleri A.S.  
Tel: +90-216-969-2500

### ■ Asia-Pacific

#### China

##### Beijing FA Center

MITSUBISHI ELECTRIC AUTOMATION (CHINA) LTD.  
Beijing FA Center  
Tel: +86-10-6518-8830

##### Guangzhou FA Center

MITSUBISHI ELECTRIC AUTOMATION (CHINA) LTD.  
Guangzhou FA Center  
Tel: +86-20-8923-6730

##### Shanghai FA Center

MITSUBISHI ELECTRIC AUTOMATION (CHINA) LTD.  
Shanghai FA Center  
Tel: +86-21-2322-3030

##### Tianjin FA Center

MITSUBISHI ELECTRIC AUTOMATION (CHINA) LTD.  
Tianjin FA Center  
Tel: +86-22-2813-1015

#### Taiwan

##### Taipei FA Center

SETSUYO ENTERPRISE CO., LTD.  
Tel: +886-2-2299-9917

#### Korea

##### Korea FA Center

MITSUBISHI ELECTRIC AUTOMATION KOREA CO., LTD.  
Tel: +82-2-3660-9630

#### Thailand

##### Thailand FA Center

MITSUBISHI ELECTRIC FACTORY AUTOMATION  
(THAILAND) CO., LTD.  
Tel: +66-2682-6522 to 31

#### ASEAN

##### ASEAN FA Center

MITSUBISHI ELECTRIC ASIA PTE. LTD.  
Tel: +65-6470-2475

#### Malaysia

##### Malaysia FA Center

Malaysia FA Center  
Tel: +60-3-7626-5080

#### Indonesia

##### Indonesia FA Center

PT. MITSUBISHI ELECTRIC INDONESIA  
Cikarang Office  
Tel: +62-21-2961-7797

#### Vietnam

##### Hanoi FA Center

MITSUBISHI ELECTRIC VIETNAM COMPANY LIMITED  
Hanoi Branch Office  
Tel: +84-24-3937-8075

##### Ho Chi Minh FA Center

MITSUBISHI ELECTRIC VIETNAM COMPANY LIMITED  
Tel: +84-28-3910-5945

#### Philippines

##### Philippines FA Center

MELCO Factory Automation Philippines Inc.  
Tel: +63-(0)2-8256-8042

#### India

##### India Ahmedabad FA Center

MITSUBISHI ELECTRIC INDIA PVT. LTD.  
Ahmedabad Branch  
Tel: +91-7965120063

##### India Bangalore FA Center

MITSUBISHI ELECTRIC INDIA PVT. LTD.  
Bangalore Branch  
Tel: +91-80-4020-1600

##### India Chennai FA Center

MITSUBISHI ELECTRIC INDIA PVT. LTD.  
Chennai Branch  
Tel: +91-4445548772

##### India Coimbatore FA Center

MITSUBISHI ELECTRIC INDIA PVT. LTD.  
Coimbatore Branch  
Tel: +91-422-438-5606

##### India Gurgaon FA Center

MITSUBISHI ELECTRIC INDIA PVT. LTD.  
Gurgaon Head Office  
Tel: +91-124-463-0300

##### India Pune FA Center

MITSUBISHI ELECTRIC INDIA PVT. LTD.  
Pune Branch  
Tel: +91-20-2710-2000

### ■ Americas

#### USA

##### North America FA Center

MITSUBISHI ELECTRIC AUTOMATION, INC.  
Tel: +1-847-478-2100

#### Mexico

##### Mexico City FA Center

MITSUBISHI ELECTRIC AUTOMATION, INC.  
Mexico Branch  
Tel: +52-55-3067-7500

##### Mexico FA Center

MITSUBISHI ELECTRIC AUTOMATION, INC.  
Queretaro Office  
Tel: +52-442-153-6014

##### Mexico Monterrey FA Center

MITSUBISHI ELECTRIC AUTOMATION, INC.  
Monterrey Office  
Tel: +52-55-3067-7599

#### Brazil

##### Brazil FA Center

MITSUBISHI ELECTRIC DO BRASIL COMERCIO E  
SERVICOS LTDA.  
Tel: +55-11-4689-3000

Microsoft and Windows are either registered trademarks or trademarks of Microsoft Corporation in the United States and/or other countries.  
Celeron and Pentium are registered trademarks or trademarks of Intel Corporation in the U.S. and/or other countries.  
All other company names and product names used in this document are trademarks or registered trademarks of their respective companies.

 **Safety Warning**

To ensure proper use of the products listed in this catalog,  
please be sure to read the instruction manual prior to use.

## Creating Solutions Together.



Low-voltage Power Distribution Products



Transformers, Med-voltage Distribution Products



Power Monitoring and Energy Saving Products



Power (UPS) and Environmental Products



Compact and Modular Controllers



Servos, Motors and Inverters



Visualization: HMIs



Edge Computing Products



Numerical Control (NC)



Collaborative and Industrial Robots



Processing machines: EDM, Lasers



SCADA, analytics and simulation software

Mitsubishi Electric's product lineup, from various controllers and drives to energy-saving devices and processing machines, all help you to automate your world. They are underpinned by software, innovative data monitoring, and modelling systems supported by advanced industrial networking and Edgecross IT/OT connectivity. Together with a worldwide partner ecosystem, Mitsubishi Electric factory automation (FA) has everything to make IoT and Digital Manufacturing a reality.

With a complete portfolio and comprehensive capabilities that combine synergies with diverse business units, Mitsubishi Electric provides a one-stop approach to how companies can tackle the shift to clean energy and energy conservation, carbon neutrality and sustainability, which are now a universal requirement of factories, buildings, and social infrastructure.

We at Mitsubishi Electric FA are your solution partners waiting to work with you as you take a step toward the realization of sustainable manufacturing and society through the application of automation. Let's automate the world together!

# SERVO AMPLIFIERS & MOTORS MELSERVO-JN

Country/Region	Sales office	Tel
USA	Mitsubishi Electric Automation, Inc. 500 Corporate Woods Parkway, Vernon Hills, IL 60061, U.S.A.	Tel : +1-847-478-2100
Mexico	Mitsubishi Electric Automation, Inc. Mexico Branch Boulevard Miguel de Cervantes Saavedra 301, Torre Norte Piso 5, Int. 502, Ampliacion Granada, Miguel Hidalgo, Ciudad de Mexico, Mexico, C.P.11520	Tel : +52-55-3067-7500
Brazil	Mitsubishi Electric do Brasil Comercio e Servicos Ltda. Avenida Adelino Cardana, 293, 21 andar, Bethaville, Barueri SP, Brazil	Tel : +55-11-4689-3000
Germany	Mitsubishi Electric Europe B.V. German Branch Mitsubishi-Electric-Platz 1, 40882 Ratingen, Germany	Tel : +49-2102-486-0
UK	Mitsubishi Electric Europe B.V. UK Branch Travellers Lane, UK-Hatfield, Hertfordshire, AL10 8XB, U.K.	Tel : +44-1707-28-8780
Italy	Mitsubishi Electric Europe B.V. Italian Branch Campus, Energy Park Via Energy Park 14, Vimercate 20871 (MB) Italy	Tel : +39-039-60531
Spain	Mitsubishi Electric Europe B.V. Spanish Branch Carretera de Rubi, 76-80-Adpo. 420, E-08174 Sant Cugat del Valles (Barcelona), Spain	Tel : +34-935-65-3131
France	Mitsubishi Electric Europe B.V. French Branch 2, rue de l'Union-92565 Rueil-Malmaison Cedex-France	Tel : +33-1-55-68-55-68
Czech Republic	Mitsubishi Electric Europe B.V. Czech Branch, Prague Office Pekarska 621/7, 155 00 Praha 5, Czech Republic	Tel : +420-734-402-587
Poland	Mitsubishi Electric Europe B.V. Polish Branch ul. Krakowska 48, 32-083 Balice, Poland	Tel : +48-12-347-65-00
Sweden	Mitsubishi Electric Europe B.V. (Scandinavia) Hedvig Mollersgata 6, 223 55 Lund, Sweden	Tel : +46-8-625-10-00
Turkey	Mitsubishi Electric Turkey Elektrik Urunleri A.S. Serifali Mah. Kale Sok. No:41 Umraniye / Istanbul, Turkey	Tel : +90-216-969-2500
UAE	Mitsubishi Electric Europe B.V. Dubai Branch Dubai Silicon Oasis, P.O.BOX 341241, Dubai, U.A.E.	Tel : +971-4-3724716
South Africa	Adroit Technologies 20 Waterford Office Park, 189 Witkoppen Road, Fourways, South Africa	Tel : +27-11-658-8100
China	Mitsubishi Electric Automation (China) Ltd. Mitsubishi Electric Automation Center, No.1386 Hongqiao Road, Shanghai, China	Tel : +86-21-2322-3030
Taiwan	SETSUYO ENTERPRISE CO., LTD. 5F, No.105, Wugong 3rd Road, Wugu District, New Taipei City 24889, Taiwan	Tel : +886-2-2299-2499
Korea	Mitsubishi Electric Automation Korea Co., Ltd. 7F to 9F, Gangseo Hangang Xi-tower A, 401, Yangcheon-ro, Gangseo-Gu, Seoul, Korea	Tel : +82-2-6103-9474
Singapore	Mitsubishi Electric Asia Pte. Ltd. 307 Alexandra Road, Mitsubishi Electric Building, Singapore 159943	Tel : +65-6473-2486
Thailand	Mitsubishi Electric Factory Automation (Thailand) Co., Ltd. 101, True Digital Park Office, 5th Floor, Sukhumvit Road, Bang Chak, Prakanong, Bangkok, Thailand	Tel : +66-2092-8600
Indonesia	PT. Mitsubishi Electric Indonesia Gedung Jaya 8th Floor, JL. MH. Thamrin No.12, Jakarta Pusat 10340, Indonesia	Tel : +62-21-3192-6461
Vietnam	Mitsubishi Electric Vietnam Company Limited 11th & 12th Floor, Viettel Tower B, 285 Cach Mang Thang Tam Street, Ward 12, District 10, Ho Chi Minh City, Vietnam.	Tel : +84-28-3910-5945
India	Mitsubishi Electric India Pvt. Ltd. Pune Branch ICC-Devi Gaurav Technology Park, Unit no. 402, Fourth Floor, Survey no. 191-192 (P), Opp. Vallabh Nagar Bus Depot, Pune - 411018, Maharashtra, India	Tel : +91-20-4624-2100
Australia	Mitsubishi Electric Australia Pty. Ltd. 348 Victoria Road, P.O. Box 11, Rydalmere, N.S.W 2116, Australia	Tel : +61-2-9684-7777



Mitsubishi Electric's e-F@ctory concept utilizes both FA and IT technologies, to reduce the total cost of development, production and maintenance, with the aim of achieving manufacturing that is a "step ahead of the times". It is supported by the e-F@ctory Alliance Partners covering software, devices, and system integration, creating the optimal e-F@ctory architecture to meet the end users needs and investment plans.



## MITSUBISHI ELECTRIC CORPORATION

HEAD OFFICE: TOKYO BLDG., 2-7-3, MARUNOUCHI, CHIYODA-KU, TOKYO 100-8310, JAPAN  
NAGOYA WORKS: 1-14, YADA-MINAMI 5-CHOME, HIGASHI-KU, NAGOYA 461-8670, JAPAN