

**CNC  
MELDAS/MAGIC64**

**MAINTENANCE MANUAL**



MELDASMAGIC is a registered trademark of Mitsubishi Electric Corporation.  
Microsoft and MS-DOS are registered trademarks of Microsoft Corporation U.S.A.  
Windows is a registered trademark of Microsoft Corporation U.S.A.  
IBM is a registered trademark of International Business Machines Corporation U.S.A.  
Other company and product names are trademarks or registered trademarks of the respective companies.

# Introduction

This manual is the MELDASMAGIC64 maintenance manual.

Items required for the maintenance of the MELDASMAGIC64 have been summarized. Use this manual in combination with the materials below.

- MELDASMAGIC64 Setup Instruction Manual ..... (BNP-B2191)
- MELDASMAGIC64 Connection Manual ..... (BNP-B2203)
- MELDAS60/60S Series Operation Manual ..... (BNP-B2180)
- MELDAS AC Servo and Spindle MDS-A/B Series Specifications Manual ..... (BNP-B3759)
- MELDAS AC Servo and Spindle MDS-C1 Series Specifications Manual ..... (BNP-C3000)
- MELDAS AC Servo and Spindle MDS-CH Series Specifications Manual ..... (BNP-C3016)

## About MELDASMAGIC64

- (1) MELDASMAGIC64 includes the ISA NC Card compatible with the ISA bus, and the PCI NC Card compatible with the PCI bus. Either card can be selected. The user can structure a custom-made NC unit by inserting the NC Card supplied from Mitsubishi into the selected personal computer's expansion slot (ISA bus or PCI bus).

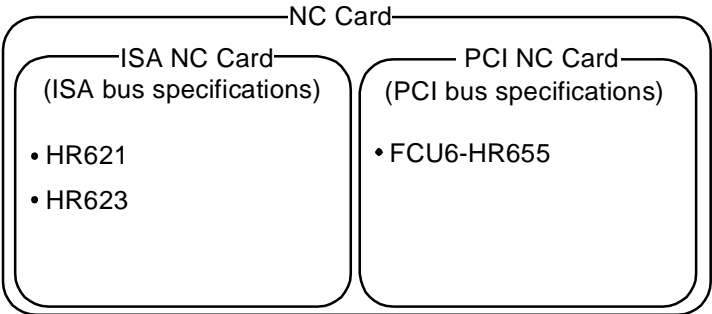

- (2) The NC Card supplied by Mitsubishi realizes the equivalent environmental resistance (ambient temperature, noise resistance and vibration resistance) as conventional NC units. However, some environmental resistance equivalent to conventional NC units is not always guaranteed regarding personal computers presumed to be normally used in an office. Therefore, when selecting a personal computer, study this manual well and select an appropriate model responding to the required uses and applications. When required, execute the appropriate countermeasures.

- (3) Take care to the working environment when using MELDASMAGIC64.

### Working environment



		PCI NC Card	ISA NC Card
Applicable personal computer		IBM PC/AT or compatible machine	
Compatible OS		<ul style="list-style-type: none"> <li>• Windows 98SE</li> <li>• Windows 2000</li> <li>• Windows XP</li> </ul>	<ul style="list-style-type: none"> <li>• Windows 95</li> <li>• Windows 98</li> <li>• Windows 98SE</li> <li>• Windows NT Workstation 4.0</li> </ul>
CPU		<ul style="list-style-type: none"> <li>• For Windows 95 Pentium 100MHz or faster (Pentium 150MHz or faster recommended)</li> <li>• For Windows 98, Windows 98SE, Windows NT Workstation 4.0 Pentium 200MHz or faster (Pentium 233MHz or faster recommended)</li> <li>• For Windows 2000, Windows XP Pentium 300MHz or faster</li> </ul>	
Memory		<ul style="list-style-type: none"> <li>• For Windows 95, Windows 98 16MB or larger (24MB or larger recommended)</li> <li>• For Windows 98SE, Windows NT Workstation 4.0 24MB or larger (32MB or larger recommended)</li> <li>• For Windows 2000 64MB or larger (128MB or larger recommended)</li> <li>• For Windows XP 128MB or larger</li> </ul>	
Hard disk		20MB or more open space recommended	
Floppy disk		One 3.5-type 1.44MB drive	
Expansion slot		PCI bus (PCI bus Standards 2.0 or higher)	ISA bus
Electric characteristics	+3.3V (*1)	0.2A or more	
	+5.0V	2.5A or more	
	+12.0V	0.7A or more	0.5A or more
Power drop characteristics		Time for +5.0V power voltage to drop from +4.5V to +4.0V when the power is turned OFF takes 1ms or more.	

(\*1) When using the PCI NC Card, always use a personal computer that supplies +3.3V power to the PCI bus.

- (4) Heat radiation-countermeasures for personal computer  
A rise in the personal computer's internal temperature could cause NC Card damage or malfunction. Select a personal computer with a fan for circulating the heat in the personal computer, or a personal computer to which a fan can be mounted.
- (5) Personal computer vibration  
If the expansion slot on the personal computer vibrates greatly, a connector connection fault could occur and result in incorrect operations. Select a personal computer with a fitting for fixing the NC Card, or a personal computer that can be fixed.

## Precautions for Safety

Always read the specifications issued by the machine maker, this manual, related manuals and attached documents before installation, operation, programming, maintenance or inspection to ensure correct use. Understand this numerical controller, safety items and cautions before using the unit.

This manual ranks the safety precautions into " Danger", " Warning" and " Caution".



When the user may be subject to imminent fatalities or major injuries if handling is mistaken.



When the user may be subject to fatalities or major injuries if handling is mistaken.



When the user may be subject to injuries or when physical damage may occur if handling is mistaken.









Note that even items ranked as " CAUTION" may lead to major results depending on the situation. In any case, important information that must always be observed is described.

### DANGER

Not applicable in this manual.





## 1. Items related to prevention of electric shocks

### WARNING

-  Do not open the front cover while the power is ON or during operation. Failure to observe this could result in electric shocks.
-  Do not operate the device with the front cover removed. The high voltage terminals and charged sections will be exposed, and could result in electric shocks.
-  Do not remove the front cover even when the power is OFF except for wiring work or periodic inspections. The controller and servo drive unit are charged internally and could result in electric shocks.
-  Always wait at least 15 minutes after turning the power OFF and check the voltage with a tester, etc., before starting wiring work or inspections. Failure to observe this could result in electric shocks.
-  Ground the 200V Series input controller, servo drive unit and servomotor with Class C or higher protective grounding, and the 400V Series input with Class D or higher protective grounding.
-  All wiring work and inspections must be carried out by a qualified electrician.
-  Wire the controller, servo drive unit and servomotor after installation. Failure to observe this could result in electric shocks.
-  Do not operate the switches with wet hands, as this may lead to electric shocks.
-  Do not damage, apply excessive stress, place heavy things on or sandwich the cables, as this may lead to electric shocks.





## 2. Items related to prevention of fires

### CAUTION

-  Install the controller, servo drive unit, servomotor and regenerative resistor on non-combustible material. Installation directly on or near combustible materials could result in fires.
-  If trouble occurs in the servo drive unit, shut off the power at the servo drive unit's input power side. Fires could result if large current continues to flow.
-  When using the regenerative resistor, shut off the power with an error signal. The regenerative resistor could abnormally overheat and cause fires due to a regenerative transistor fault, etc.
-  Incorrect wiring or connections could damage the device.

## 3. Items related to prevention of damage

### CAUTION

















-  Do not apply voltages other than those indicated in the Controller Connection Manual or Specifications Manual for Servo Drive Unit. Failure to observe this could lead to rupture, or damage, etc.
-  Do not mistake the terminal connections. Failure to observe this could lead to rupture, or damage, etc.
-  Do not mistake the polarity (+, -). Failure to observe this could lead to rupture, or damage, etc.
-  Persons wearing medical devices, such as pacemakers, must not be near this unit. The medical device could be affected by electromagnetic waves.
-  The servo drive unit fins, regenerative resistor and servomotor, etc., will be hot during operation and for a while after operation is stopped. Touching these sections could result in burns.

## 4. General Precautions

Always observe the following precautions. Incorrect handling could result in faults, injuries, or electric shocks, etc.















### (1) Transportation and installation

#### CAUTION

-  Correctly transport the product according to its weight.
-  Use servomotor's suspension bolts only to transport the servomotor.
-  Do not use suspension bolts of the servomotor on the machine to transport the machine.
-  Do not stack products above the indicated limit.
-  Do not hold cables, shaft or detector when transporting the servomotor.
-  Do not suspend or hold the controller or servo drive unit by the connected wires or cables when transporting.
-  Do not hold the front cover when transporting the controller or servo drive unit. The device could drop.
-  When installing, always observe the installation direction and install on a place which can withstand the weight.
-  Do not get on the product, or place heavy objects on it.
-  Provide the specified distance between the controller, servo drive unit and inner surface of the control panel and between other devices.
-  Do not install or operate a controller, servo drive unit or servomotor that is damaged or that has missing parts.
-  Take care not to cut hands on the heat radiating fins or metal edges.
-  Do not block the intake/outtake ports of the servomotor with cooling fan.
-  Do not allow conductive foreign matter such as screws or metal chips or combustible foreign matter such as oil enter the controller, servo drive unit or servomotor.
-  The controller, servo drive unit and servomotor are precision devices so do not drop or apply strong impacts on them.
-  Do not install the controller operation board where it may be subject to cutting oil.



## (2) Wiring

### CAUTION

-  Correctly wire this product. Failure to do so could result in servomotor runaway, etc.
-  Do not install a phase advancing capacitor, surge absorber or radio noise filter on the output side of the servo drive unit.
-  Correctly connect the output side (terminals U, V, W). The servomotor will not operate if incorrectly connected.
-  Do not directly connect a commercial power supply to the servomotor. Failure to observe this could lead to faults.
-  When using an inductive load such as relays, always connect a diode in parallel to the load as a noise measure.
-  When using a capacitive load such as a lamp, always connect a protective resistor serially to the load to suppress rush currents.
-  Do not mistake the direction of the surge absorption diode installed on the DC relay for the control output signal. The signal will not be output due to fault and the protective circuit, such as emergency stop, will be disabled.
-  Do not connect or disconnect the connection cables between each unit while the power is ON.
-  Securely tighten the cable connector fixing screw or fixing mechanism. Insufficient fixing could result in dislocation during operation.
-  Always treat the shield cables indicated in the Connection Manual with grounding measures such as cable clamps.
-  Separate the signal wire from the drive line/power line when wiring.
-  Use wires and cables having a wire diameter, heat resistance level and bending capacity that match the system.
-  Ground the device according to the requirements of the country where the device is to be used.
-  Wire the heat radiating fins and wires so that they do no contact.

## (3) Adjustments











### CAUTION

-  Check and adjust each parameter before starting operation. Unpredictable operations could occur depending on the machine.
-  Do not make marked adjustments or changes as the operation could become unstable.







#### (4) Usage methods

### CAUTION

-  Install an external emergency stop circuit so that the operation can be stopped and the power turns OFF immediately. A contactor, etc., must be used in addition to the shutoff function in the controller.
-  Turn OFF the power immediately if any smoke, abnormal noise or odor is generated from the controller, servo drive unit or servomotor.
-  Only a qualified technician may disassemble or repair this product.
-  Do not modify this product.
-  Use a noise filter, etc., to reduce the effect of electromagnetic disturbances. Electronic devices used near the servo drive unit could be affected by the electromagnetic disturbances.
-  Use the controller, servo drive unit, servomotor and regenerative resistor in the designated combination. Failure to observe this could result in fires or faults.
-  The brakes (magnetic brakes) assembled in the servomotor are used for holding, and must not be used for normal braking.
-  There may be cases when the magnetic brakes cannot hold the state because of the life or machine structure (when ball screw and servomotor are coupled via a timing belt, etc.). Install a stopping device on the machine side so that safety can be ensured.
-  After maintenance or inspection, always carry out a trial operation before starting actual operation.
-  Do not move the machine's movable range during automatic operation. Do not place hands, feet or face near the spindle during rotation.
-  Use the power (input voltage, input frequency, tolerable instantaneous power failure time) under the power specification conditions given in the Specifications.







#### (5) Measures during a fault

### CAUTION

-  If a hazardous situation could arise during a power failure or product fault, use the servomotor with magnetic brakes or provide an external brake mechanism for holding purposes.
-  Use a double circuit structure for the magnetic brake's operation circuit so that the brakes will activate even when the external emergency stop signal is issued.
-  If an alarm occurs, remove the cause, and secure surrounding safety before resetting the alarm and restarting operation.
-  The machine could suddenly restart when power is restored after an instantaneous power failure. Do not near the machine in this case. (Design the machine so that operator safety can be ensured even if the machine restarts.)



## (6) Maintenance, inspection and part replacement

### CAUTION

-  The electrolytic capacitor's capacity will drop due to deterioration. To prevent secondary damage due to capacitor's faults, Mitsubishi recommends replacing the electrolytic capacitor after approx. five years when used in a general environment. Contact the Service Center or Service Station for replacements.
-  Do not perform a megger test (insulation resistance measurement) during inspection.
-  Save the machining programs, tool data and parameters with an input/output device before replacing the battery.
-  Do not short-circuit, charge, overheat, incinerate or disassemble the battery.
-  The hard disk unit has a service life, and must be replaced when the life is reached.
-  Always back up the customer's data stored on the hard disk unit. The customer's data stored on the hard disk unit cannot be guaranteed.
-  Store the battery away from high temperature and high humidity, and prevent moisture from condensing.

## (7) Disposal

### CAUTION

-  Handle this product as general industrial waste. Note that some of the MDS Series products use alternate Freon. These corresponding models must not be handled as general industrial waste and must always be returned to the Service Center or Service Station. (Corresponding models have heat radiating fins on the back of the unit.)
-  Do not disassemble the controller, servo drive unit or servomotor parts.
-  Collect and dispose of the spent batteries according to local laws.

## (8) General precautions

### CAUTION

To explain the details, drawings given in this instruction manual, etc., may show the unit with the cover or safety partition removed. When operating the product, always install the cover or partitions at their original position, and operate as indicated in the instruction manual, etc.

# CONTENTS

<b>1. Outline</b>	
1.1 Outline.....	1
1.2 General Specifications .....	2
1.3 System Configuration.....	3
1.4 General Assembly System Diagram .....	4
<b>2. Daily Maintenance and Periodic Inspection and Maintenance</b>	
2.1 Maintenance Tools .....	5
2.2 Battery Replacement.....	6
2.2.1 ISA NC Card Battery Replacement .....	6
2.2.2 PCI NC Card Battery Replacement.....	8
<b>3. Troubleshooting</b>	
3.1 Confirmation of Trouble Status.....	10
3.1.1 General Confirmation Items.....	10
3.1.2 Symptom Confirmation .....	10
3.1.3 Possible Causes of the Trouble.....	11
3.1.4 Confirmation Items by Configuration Unit.....	12
3.1.5 MELDASMAGIC64 Confirmation Items.....	16
3.2 NC Card (HR621/HR623/FCU6-HR655) Part Names.....	17
3.3 Base I/O Unit (FCU6-DX2**) Part Names .....	21
3.4 Relay Card (HR682) Part Names.....	23
3.5 Unit Replacement.....	25
3.5.1 Precautions .....	25
3.5.2 NC Card Replacement .....	27
3.5.3 Base I/O Unit Replacement.....	29
3.5.4 Relay Card Replacement .....	30
3.5.5 Remote I/O Unit Replacement.....	31

# 1. Outline

## 1.1 Outline

This manual is the MELDASMAGIC64 maintenance manual.  
Items required for the maintenance of the MELDASMAGIC64 have been summarized. Use this manual in combination with the materials below.

MELDASMAGIC64 Setup Instruction Manual .....	(BNP-B2191)
MELDASMAGIC64 Connection Manual .....	(BNP-B2203)
MELDAS60/60S Series Operation Manual .....	(BNP-B2180)
MELDAS AC Servo and Spindle MDS-A/B Series Specifications Manual .....	(BNP-B3759)
MELDAS AC Servo and Spindle MDS-C1 Series Specifications Manual .....	(BNP-C3000)
MELDAS AC Servo and Spindle MDS-CH Series Specifications Manual .....	(BNP-C3016)

### Maintenance Points

- (1) By installing the NC Card supplied by Mitsubishi in the expansion slot of a personal computer main unit selected by the user, and connecting a base I/O unit and relay card via relay cables (F010, F011 cable), MELDASMAGIC64 configures what in conventional NC units was the control section and operation section (hereafter called a personal computer).  
By subsequently connecting with a drive section (servo drive unit, servomotor, etc.), remote I/O unit, etc., via the connectors of this personal computer base I/O unit and relay card, function begins as an NC unit.

Personal computer main unit .. (selected by the user) * NC Card ..... (supplied by Mitsubishi) (HR621/HR623/FCU6-HR655) Keyboard and mouse ..... (selected by the user) Display unit..... (selected by the user) * Relay cable ..... (supplied by Mitsubishi) (F010, F011) * Base I/O unit ..... (supplied by Mitsubishi) (DX2**/3**/4**) * Relay card ..... (supplied by Mitsubishi) (HR682) * Remote I/O unit ..... (supplied by Mitsubishi) (DX1**) Drive section ..... (supplied by Mitsubishi) (servo drive unit, servomotor, etc.)	Control section and operation section (The NC unit in the narrow sense) (Called the personal computer in this manual)	The NC unit in the broad sense (MELDASMAGIC64)
--	---	--

**(Note)** The items above indicated by an asterisk (\*) are the targets of this manual.

Thus when a failure occurs, the judgment of whether the personal computer or another unit is the cause is carried out in the same manner as conventional NC units. However, as the newly occurring judgment process, when the personal computer is the cause, it must be judged whether the user-selected personal computer main unit or the Mitsubishi-supplied NC Card is the cause. Ascertaining this is the most important point.

- (2) In MELDASMAGIC64, the part equivalent to the NC is the one NC Card (with the relay cable, base I/O unit and relay card) only.  
Thus, burdensome troubleshooting to find which PCB configuring the control section is faulty, as in conventional NC units, is unnecessary, and maintenance is simplified.
- (3) The personal computer selected by the user is not a target of this manual. However, if a business computer is to be used in a factory environment, execute sufficient environmental evaluation tests before selecting a model. When necessary, execute environmental resistance countermeasures. Furthermore, prepare spare parts when necessary.

**1. Outline**  
**1.2 General Specifications**

**1.2 General Specifications**

**NC Card peripheral environment conditions**

Type name		HR621/HR623	FCU6-HR655	HR682	
Unit name		ISA NC Card	PCI NC Card	Relay card	
General specifications	Ambient temperature	During operation	0~55°C		
		During storage	-20~60°C		
	Ambient humidity	During operation	40~75% RH (with no dew condensation)		
		During storage	40~75% RH (with no dew condensation)		
Working atmosphere		No corrosive gas or dust			
Power specifications	Power voltage		-	3.3VDC ± 5%	
			5VDC ± 2%		24VDC ± 5% Ripple ± 5% (P-P)
			12VDC ± 2%		
	Current consumption	3.3V	-	0.2A (max)	-
		5V	2.5A (max)		-
		12V	0.5A (max)	0.7A (max)	-
24V		-		0.5A (max)	
Power fall characteristics		Personal computer 5V: 4.5V → 4.0V is 1ms or more (*1)		-	
Heating value		19W	22W	12W	
Unit size		248.9×107.6×20 (mm)	174.63×106.68×21 (mm)	115×156×30 (mm) (*2)	

(\*1) If these characteristics are not satisfied, the NC Card cannot back up the absolute position information of the machine position when the power is turned OFF.

(\*2) Excluding spacers

**Environmental conditions in electric cabinet**

Type name		FCU6-DX210, FCU6-DX211	FCU6-DX220, FCU6-DX221
Unit name		Base I/O unit	
General specifications	Ambient temperature	During operation	0~55°C
		During storage	-20~60°C
	Ambient humidity	During operation	45~75% RH (with no dew condensation)
		During storage	45~80% RH (with no dew condensation)
	Vibration resistance		4.9m/s <sup>2</sup> or less (during operation)
Shock resistance		29.4m/s <sup>2</sup> or less (during operation)	
Working atmosphere		No corrosive gas or dust	
Power specifications	Power voltage		24VDC ± 5% Ripple ± 5% (P-P)
	Current consumption		5V 1A (max), 24V 3.6A (max) (*3)   5V 1A (max), 24V 4.8A (max) (*3)
Heating value		90W (*3)	110W (*3)
Mass		2.0kg	
Unit size		220×168×35 (mm)	

(\*3) During all DO points ON

# 1. Outline

## 1.3 System Configuration

### 1.3 System Configuration

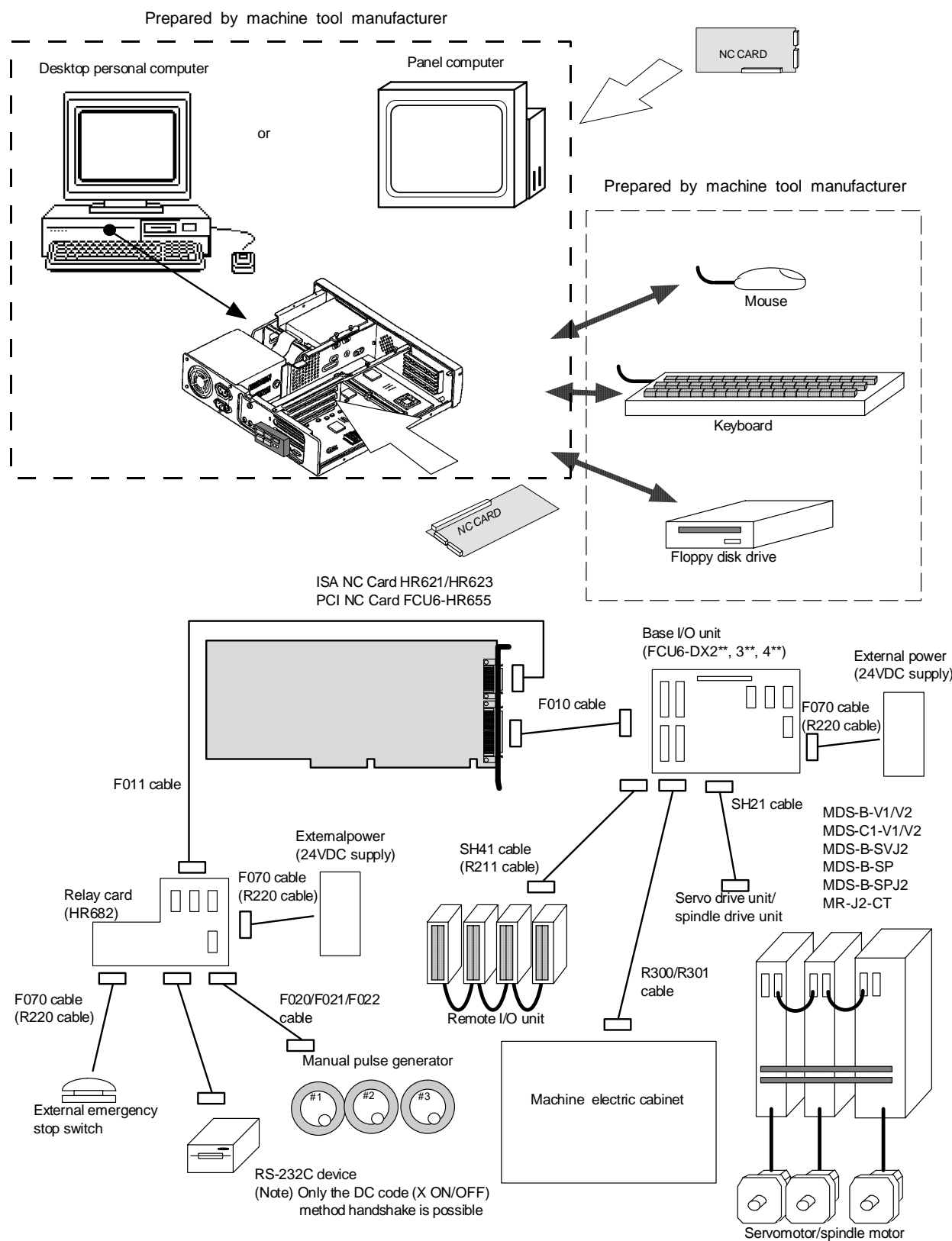

# 1. Outline

## 1.4 General Assembly System Diagram

### 1.4 General Assembly System Diagram

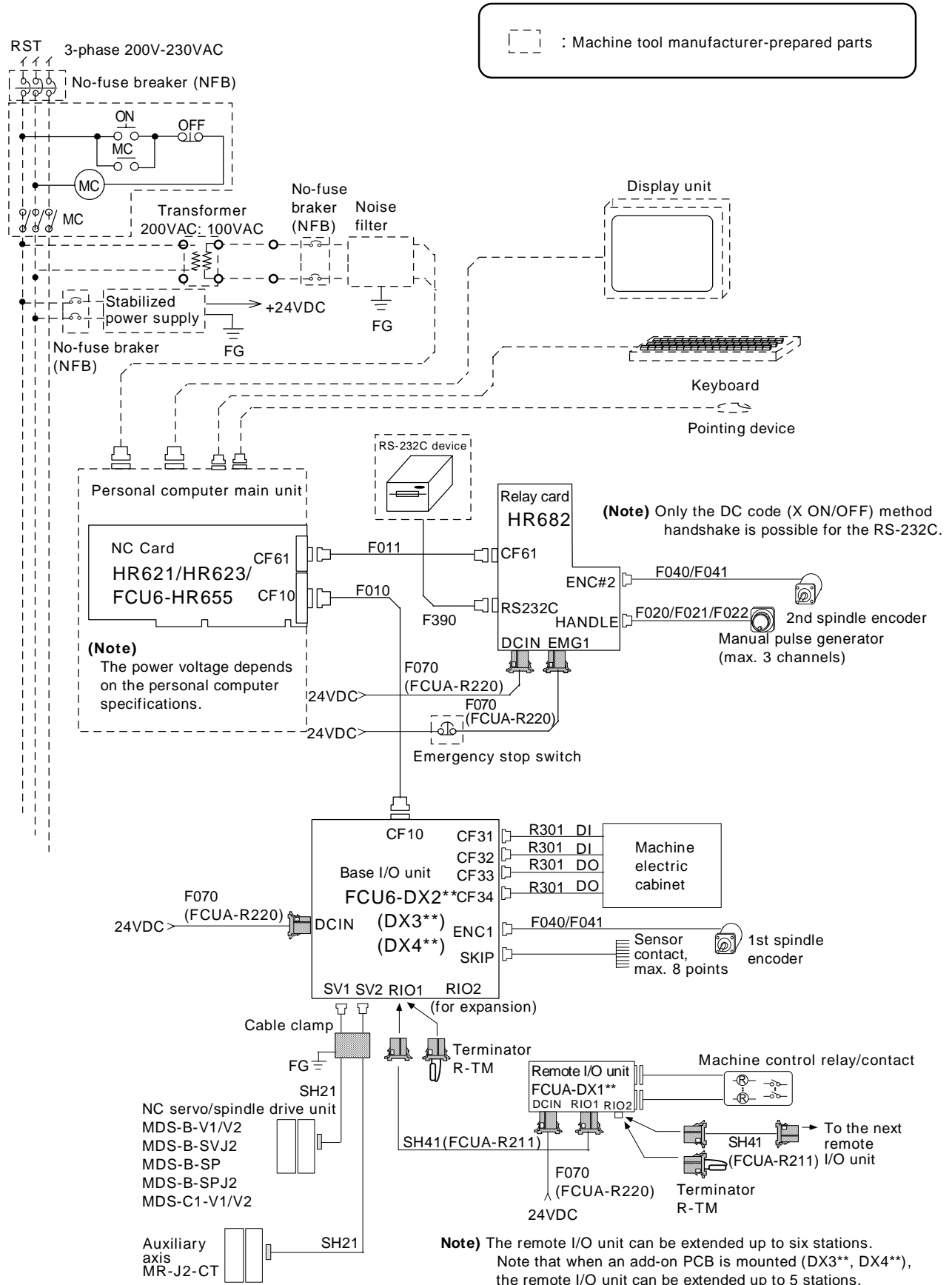

**2. Daily Maintenance and Periodic Inspection and Maintenance**  
**2.1 Maintenance Tools**

---

## 2. Daily Maintenance and Periodic Inspection and Maintenance

Because this NC unit differs from conventional NC units in that the personal computer main unit maintenance inspection is the main focus, please carry out maintenance inspections following the instruction manual of the personal computer main unit.

A battery is installed in the NC Card. Replace it when life is reached.

### 2.1 Maintenance Tools

#### (1) Measuring instruments

The following measuring instruments are used to confirm that the voltage is being supplied correctly to the NC unit, to confirm that the wiring to the NC unit is correct, and to carry out simple troubleshooting.

#### Maintenance tools

Tool	Condition	Application
Tester		To check that the wiring to the NC unit is correct before turning the power ON.
AC voltmeter	Measure the AC power voltage. The tolerable error is $\pm 2\%$ or less.	To measure the AC power voltage being supplied to the external 24VDC power supply unit.
DC voltmeter	Max. scale 30V. The tolerable error is $\pm 2\%$ or less.	To measure the DC power voltage. <ul style="list-style-type: none"> <li>• External power supply 24V (machine input/output interface)</li> <li>• Battery voltage</li> <li>• Personal computer expansion bus DC output</li> </ul>
Phase rotation meter		To check the connection order of the AC 3-phase input power supply.
Synchroscope		General measurement and simple troubleshooting

**(Note)** Currently, a high precision digital multi-meter is commonly used as a tester. This digital multi-meter can be used as both an AC voltmeter and a DC voltmeter.

#### (2) Tools

- Screwdriver (large, medium, small)
- Radio pliers



## 2. Daily Maintenance and Periodic Inspection and Maintenance

### 2.2 Battery Replacement

## 2.2 Battery Replacement

### 2.2.1 ISA NC Card Battery Replacement



Data, such as the parameters and machining programs, which must be backed up when the power is OFF is saved by the lithium battery mounted in the NC Card's battery holder.

Battery used	: One CR2450 (Toshiba battery) × 1pc.
Initial battery voltage	: 3.0V
Initial battery capacity	: 560mAh
Voltage low detection voltage	: 2.8V (Battery voltage low caution displayed on ALARM screen) 2.6V (Battery voltage low warning displayed on ALARM screen)
Battery total data hold time	: 3 years (Note that this may be shorter when using in high temperatures.)
Battery life	: Approx. 5 years (From date of battery manufacture)
Discharge current	: 20 $\mu$ A or less

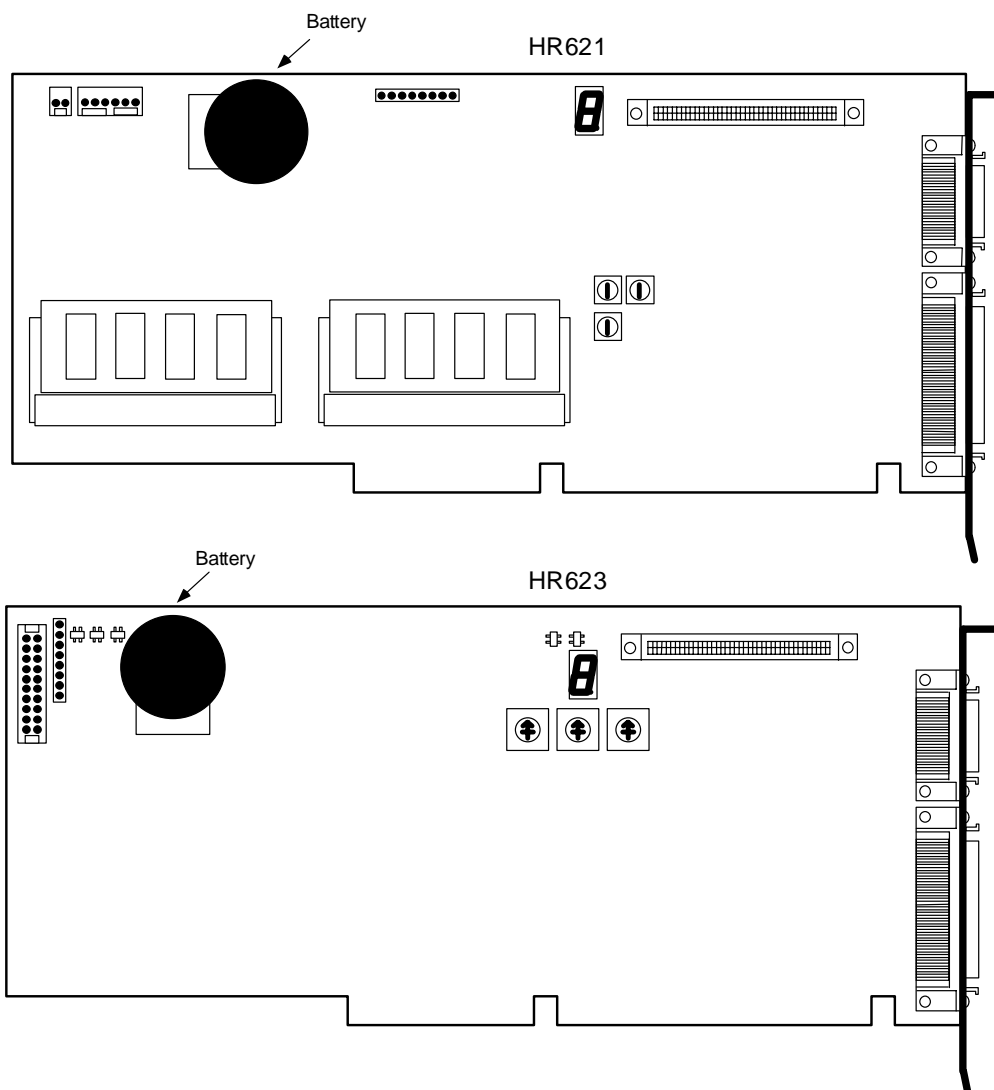
**(Note)** Replace the battery when the battery voltage low caution appears on the ALARM screen.



#### CAUTION

-  Do not short circuit, charge, overheat, incinerate or disassemble the battery.
-  Store the battery away from high temperature and high humidity, and prevent moisture from condensing.
-  Dispose of the spent battery according to local laws.

## 2. Daily Maintenance and Periodic Inspection and Maintenance

### 2.2 Battery Replacement

#### • Replacement procedure

Always back up the important data, such as the parameters and programs, before replacing the battery.

Replace the battery with the personal computer power turned OFF.

Complete the battery replacement within 30 minutes of turning the power OFF. (Note: If the battery is not connected within 30 minutes, the data being backed up will be damaged.)

- (1) Disconnect the relay cable from the personal computer.
- (2) Remove the personal computer cover, and remove the NC Card from the ISA bus.
- (3) Remove the battery from the NC Card battery holder.  
(Place the NC Card on insulated material when working.)
- (4) Fit the new battery into the battery holder.
- (5) Install the NC Card in the ISA bus, and reinstall the personal computer cover.
- (6) Connect the personal computer relay cable.

#### • Battery insertion and removal methods

##### Correct insertion method

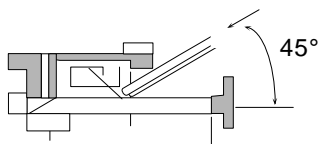

Insert at a 45° angle.  
the positive (+) polarity  
side should face up.

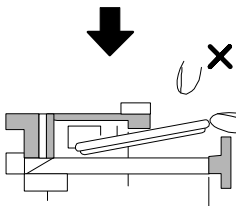

Press in horizontally.  
The insertion should complete smoothly.  
Do not press in from above.

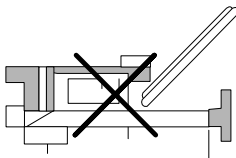

A reverse insertion prevention  
function is attached so the battery  
can only be inserted with the proper  
polarity in the holder.

##### Correct removal method

Insert a finger or small lever into the  
indentation, and lift up on the battery.  
At the same time, ...

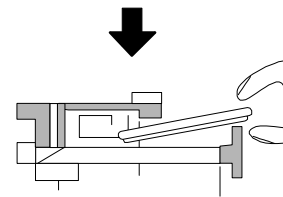
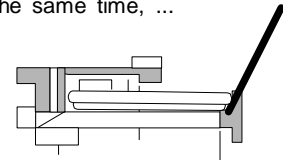

... pull the battery out while lifting it  
over the battery stopper on the side.

#### • Indication of battery's date of manufacture

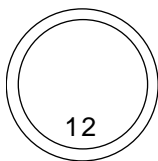

The date of manufacture is stamped as a 2-digit number on the - polarity side of the battery. The left digit is the year of manufacture, and the right digit is the month of manufacture.



**(Example)** In the example on the left, the date of manufacture is February 2001.  
Note that October is indicated as "0", November as "Y" and December as "Z".

#### • Storing the battery

Avoid storing the battery under high temperatures as the battery's discharge will increase and the capacity will diminish.

When stored at room temperature, a capacity of 90% can be maintained even after five years.

#### CAUTION

-  Do not short circuit, charge, overheat, incinerate or disassemble the battery.
-  Store the battery away from high temperature and high humidity, and prevent moisture from condensing.
-  Dispose of the spent battery according to local laws.

## 2. Daily Maintenance and Periodic Inspection and Maintenance

### 2.2 Battery Replacement

#### 2.2.2 PCI NC Card Battery Replacement



Data, such as the parameters and machining programs, which must be backed up when the power is OFF is saved by the lithium battery mounted in the NC Card's battery holder.

Battery used	: One CR2032 (Toshiba battery)
Initial battery voltage	: 3.0V
Initial battery capacity	: 220mAh
Voltage low detection voltage	: 2.8V (Battery voltage low caution displayed on ALARM screen) 2.6V (Battery voltage low warning displayed on ALARM screen)
Battery total data hold time	: 3 years (Note that this may be shorter when using in high temperatures.)
Battery life	: Approx. 5 years (From date of battery manufacture)
Discharge current	: 20 $\mu$ A or less

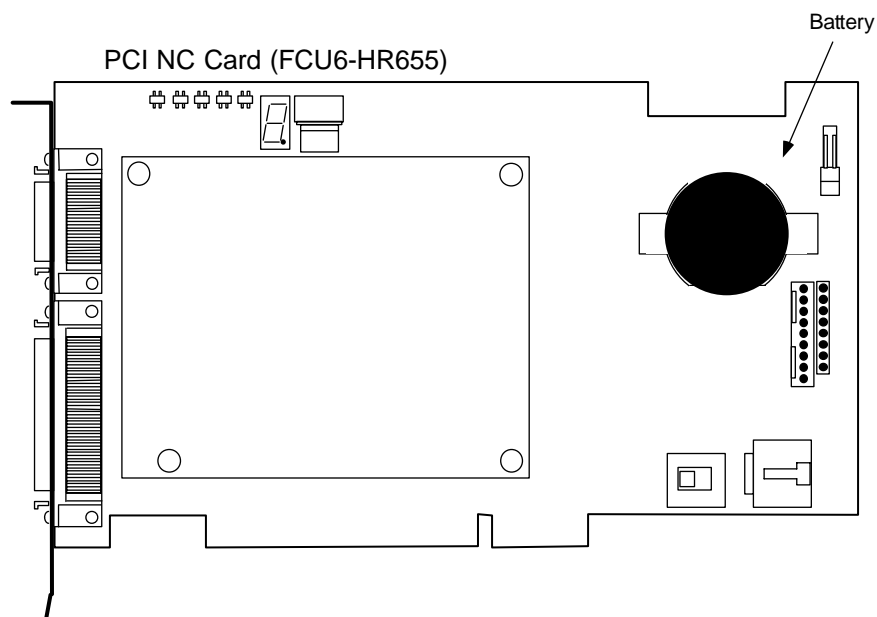
**(Note)** Replace the battery when the battery voltage low caution appears on the ALARM screen.



#### CAUTION

-  Do not short circuit, charge, overheat, incinerate or disassemble the battery.
-  Store the battery away from high temperature and high humidity, and prevent moisture from condensing.
-  Dispose of the spent battery according to local laws.

## 2. Daily Maintenance and Periodic Inspection and Maintenance

### 2.2 Battery Replacement

#### • Replacement procedure

Replace the battery with the personal computer power turned OFF.

Complete the battery replacement within 30 minutes of turning the power OFF. (Note: If the battery is not connected within 30 minutes, the data being backed up will be damaged.)

- (1) Disconnect the relay cable from the personal computer.
- (2) Remove the personal computer cover, and remove the NC Card from the PCI bus.
- (3) Remove the battery from the NC Card battery holder.  
(Place the NC Card on insulated material when working.)
- (4) Fit the new battery into the battery holder.
- (5) Install the NC Card in the PCI bus, and reinstall the personal computer cover.
- (6) Connect the personal computer relay cable.

#### • Battery insertion and removal methods

##### Correct insertion method

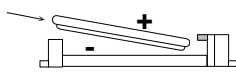

Insert with the + polarity facing upward, and catch with the hook.

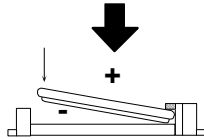

Press in vertically.

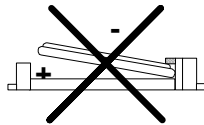

Check the battery's polarity indicated on the holder's metal section before inserting.

##### Correct removal method

Insert a finger or small lever into the indentation, and lift up on the battery. At the same time, ...

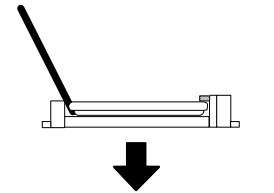

... pull the battery out while lifting it over the battery stopper on the side.

#### • Indication of battery's date of manufacture

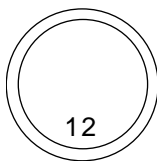

The date of manufacture is stamped as a 2-digit number on the - polarity side of the battery. The left digit is the year of manufacture, and the right digit is the month of manufacture.



**(Example)** In the example on the left, the date of manufacture is February 2001.  
Note that October is indicated as "0", November as "Y" and December as "Z".

#### • Storing the battery

Avoid storing the battery under high temperatures as the battery's discharge will increase and the capacity will diminish.

When stored at room temperature, a capacity of 90% can be maintained even after five years.

#### CAUTION

-  Do not short circuit, charge, overheat, incinerate or disassemble the battery.
-  Store the battery away from high temperature and high humidity, and prevent moisture from condensing.
-  Dispose of the spent battery according to local laws.

### 3. Troubleshooting

When a failure occurs in operation, the exact cause must be investigated to establish appropriate countermeasures. To find out the exact cause, carry out the following checks.

#### 3.1 Confirmation of Trouble Status

Find out the answers to the following when the trouble occurred. "Which personal computer was being used?", "When", "When doing what", "What kind of", "How frequently". In addition, confirm approx. how many years have elapsed since operation began, and the daily length of use.

##### 3.1.1 General Confirmation Items

- Machine manufacturer and machine type \_\_\_\_\_
- Personal computer model \_\_\_\_\_
- Is the personal computer installed in a cabinet or outside a cabinet? \_\_\_\_\_
- Is the NC Card as PCI NC Card or ISA NC Card? \_\_\_\_\_

##### 3.1.2 Symptom Confirmation

(1) "What kind of trouble occurred?" \_\_\_\_\_

- (2) "When?"
- What time did the trouble occur? \_\_\_\_\_
  - How much time had elapsed since the power was turned ON? \_\_\_\_\_

- (3) "What was being done?"
- What was the operation procedure? \_\_\_\_\_
  - What were the previous and subsequent operations? \_\_\_\_\_
  - What appeared on the screen of the personal computer main unit display unit? \_\_\_\_\_
  - What was the status of the peripheral devices? \_\_\_\_\_

- (4) "What are the trouble display details?"
- What are the details of the NC Card LED display?
    - 7-segment \_\_\_\_\_
    - SEMG \_\_\_\_\_
    - RWDG (WDER) \_\_\_\_\_
  - What are the details of the base I/O unit LED display?
    - 24IN \_\_\_\_\_
    - 5OUT \_\_\_\_\_
    - RAL 1 \_\_\_\_\_
    - RAL 2 \_\_\_\_\_
  - What are the details of the relay card LED display?
    - EMG \_\_\_\_\_
    - 5VON \_\_\_\_\_
  - What appears on the servo drive unit LED display? \_\_\_\_\_

- (5) "How frequently does the trouble occur?"
- How often does the trouble occur in a day? \_\_\_\_\_ times/day
  - Was a peripheral device operating? \_\_\_\_\_
  - Does the same trouble repeat when the same operation is carried out? (repeatability) \_\_\_\_\_
  - Does the same trouble repeat when the conditions are changed? \_\_\_\_\_

### **3.1.3 Possible Causes of the Trouble**

"The most common cause of trouble is a defective cable contact or a broken wire defect."

- Is the connection correct?
- Has the cable been bent or stepped on?
- Has the connection of the cable and connector weakened?
- Has a cable continuity inspection been carried out?
- Is there any looseness in the terminal block or connector screws?
- Has any oil or cutting oil splattered onto the cables?
- Was the cable disconnected then connected in while the power was still ON?
- Is there a cable producing heat?

"Many failures are caused by power voltage fluctuations and communication cable noise."

- Is the power voltage always correct?
- Is the power frequency always correct?
- Are there voltage fluctuations due to the time zone?
- Does the voltage momentarily drop when a peripheral device operation starts?
- Before the failure, was there a momentary power failure?
- Have noise countermeasures for each unit been carried out?
- Are the communication cables and power system cables wired separately?
- Are the communication cables sufficiently shielded?

"In rare instances, the trouble is caused by sudden temperature changes, vibration or impact."

- Are the ambient temperature and humidity appropriate?
- Is the fan rotating in the panel containing the unit?
- Is the panel fixed to a horizontal, stable floor with little vibration?

### 3.1.4 Confirmation Items by Configuration Unit

#### NC Card confirmation items

- Is the rotary switch correctly set?
- Is the connector correctly connected? Is it at an angle?

#### Base I/O unit and relay card confirmation items

- Is each unit correctly supplied with 24VDC (external power)?
- Are the connectors correctly connected to each unit? Are they at an angle?
- Are shielding clamp measures for noise countermeasures correctly carried out? (Refer to "Cable shielding clamp" described below.)

#### Remote I/O unit confirmation items

- The red lamp in the unit will light if the communication with the NC Card is not carried out correctly. The red lamp will also light if there is a broken wire in the cable. The green lamp will light when communication is carried out correctly.
- Confirm that the setting of the rotary switch on the front of the unit is correct. If more than one unit has the same setting, the system will not function properly even if the green lamps are lit. (Refer to the following description "Station settings when using more than one remote I/O unit".)
- Is each unit correctly supplied with 24VDC (external power)?
- Are the connectors correctly connected to each unit? Are they at an angle?

#### Cable shielding clamp

To prevent mis-operation due to noise, and to stabilize the system operation, connect a grounding wire to the shield of the shielded cable connected to the base I/O unit, the servo drive unit and the spindle drive unit.

There are methods of connecting the grounding wire by a lead wire, by the clamp metal fittings, etc. Treat the shielded cable using the drawing below as a reference.

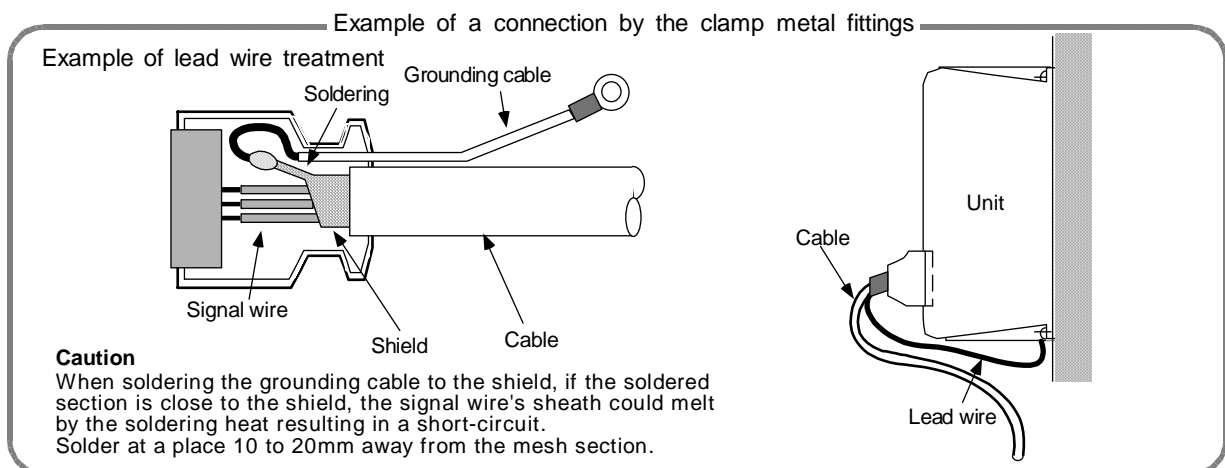

**Chapter 3 Troubleshooting**  
**3.1 Confirmation of Trouble Status**

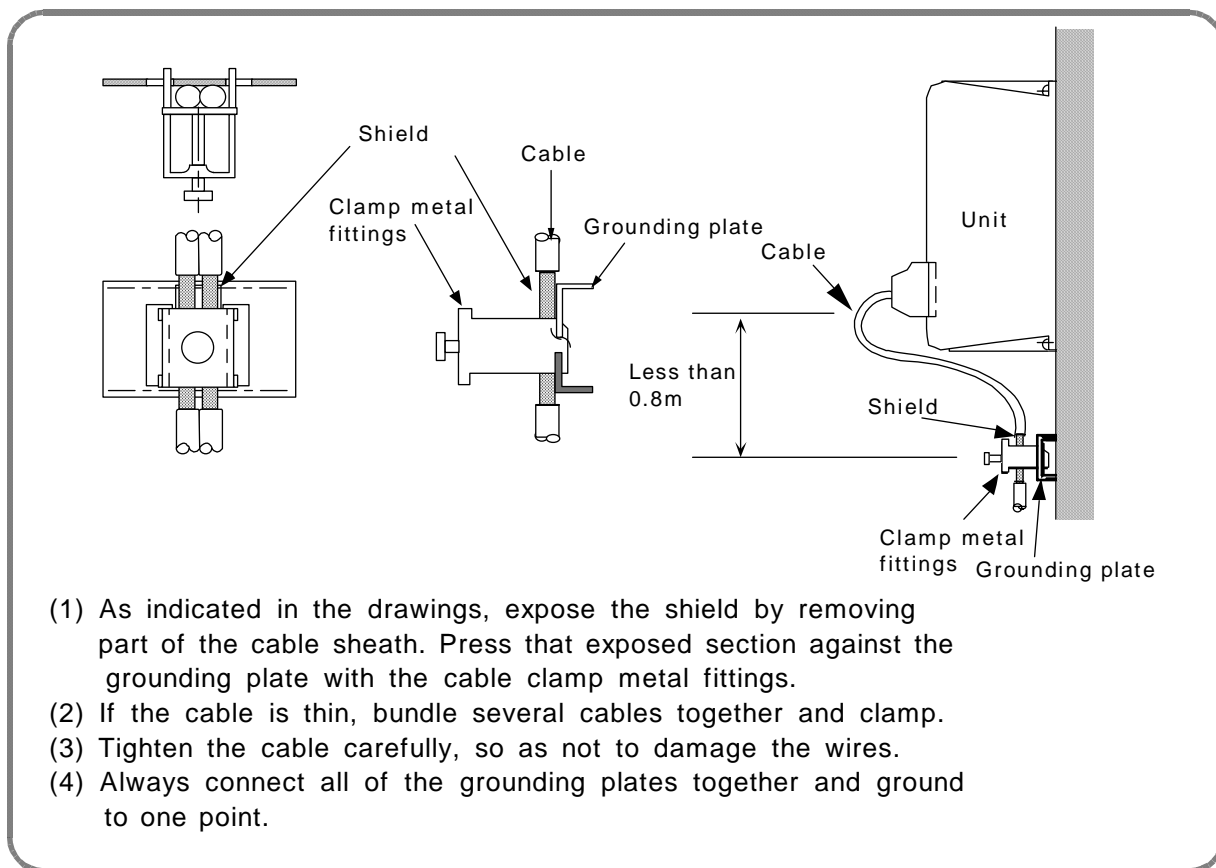

The required cables for the shield clamp according to the connector case are indicated below.

**< Shield clamp method >**

Fold back the cable shield over the sheath, and wrap over that with copper foil tape. Connect the wrapped copper foil tape to the connector grounding plate.

Unit name	Connector name	Connection destination	Treatment of cable ends	
			Connection origin	Connection destination
NC Card (HR621/HR623/ FCU6-HR655)	CF10 CF61	Base I/O unit Relay card	(NC Card) Not required (NC Card) Not required	Not required Not required
Base I/O unit (FCU6-DX2**, 3**, 4**)	CF10	NC Card	(Base I/O unit) Not required	Not required
	SV1	Servo drive unit	(Base I/O unit) Required	Not required
	SV2	Servo drive unit	(Base I/O unit) Required	Not required
	ENC1	Spindle encoder	(Base I/O unit) Required	Not required
	SKIP	Skip	(Base I/O unit) Required	Not required
	PI01 PI02	Remote I/O unit Remote I/O unit	(Base I/O unit) Required (Base I/O unit) Required	Not required Not required
Relay card (HR682)	CF61	NC Card	(Relay card) Not required	Not required
	ENC#2	Spindle encoder	(Relay card) Required	Not required
	HANDLE	Manual pulse generator	(Relay card) Required	Not required
	RS232C	RS-232C (I/O device) <b>(Note)</b>	(Relay card) Required	Not required

**(Note)** Only the DC code (X ON/OFF) method handshake is possible for the RS-232C.



**Chapter 3 Troubleshooting**  
**3.1 Confirmation of Trouble Status**

---

**Station settings when using more than one remote I/O unit**

The total No. of stations that can be occupied by remote I/O units is eight or fewer. Multiple units can be combined and used.

Remote I/O unit model	No. of occupied stations
FCUA-DX10*	1
FCUA-DX11*	2
FCUA-DX12*	2
FCUA-DX13*	2
FCUA-DX14*	2

When using more than one remote I/O unit, a characteristic station No. must be set for each unit. There is one station No. setting switch in the FCUA-DX10\* unit, and there are two in the FCUA-DX11\*, DX12\*, DX13\* and DX14\* units. Each must be set with a characteristic station No.

• **Relationship between rotary switches and device assignments**

Rotary switch setting value	Station No.	Device assignment	
		DI	DO
0	0	X00 ~ X1F	Y00 ~ Y1F
1	1	X20 ~ X3F	Y20 ~ Y3F
2	2	X40 ~ X5F	Y40 ~ Y5F
3	3	X60 ~X7F	Y60 ~ Y7F
4	4	X80 ~X9F	Y80 ~ Y9F
5	5	XA0 ~ XBF	YA0 ~ YBF
6	6	XC0 ~ XDF	YC0 ~ YDF
7	7	XE0 ~ XFF	XE0 ~ YFF
8 ~ F	Cannot be used		

< Device assignment example 1 >

Rotary switch setting value	Station No.	Device assignment	
		DI	DO
0	0	X00 ~ X1F	Y00 ~ Y1F
1	1	X20 ~ X3F	Y20 ~ Y3F
2	2	X40 ~ X5F	Y40 ~ Y5F
3	3	X60 ~X7F	Y60 ~ Y7F
4	4	X80 ~X9F	Y80 ~ Y8F

< Device assignment example 2 >

Rotary switch setting value	Station No.	Device assignment	
		DI	DO
0	0	X00 ~ X1F	Y00 ~ Y1F
1	1	X20 ~ X3F	Y20 ~ Y2F
2	2	X40 ~ X5F	Y40 ~ Y5F
3	3	X60 ~X7F	Y60 ~ Y6F
4	4	X80 ~X9F	Y80 ~ Y9F
5	5	XA0 ~ XBF	YA0 ~ YAF
6	6	XC0 ~ XDF	YC0 ~ YDF
7	7	XE0 ~ XFF	XE0 ~ YEF

### Chapter 3 Troubleshooting

#### 3.1 Confirmation of Trouble Status

I/O unit configuration for <Device assignment example 1> on the previous page.

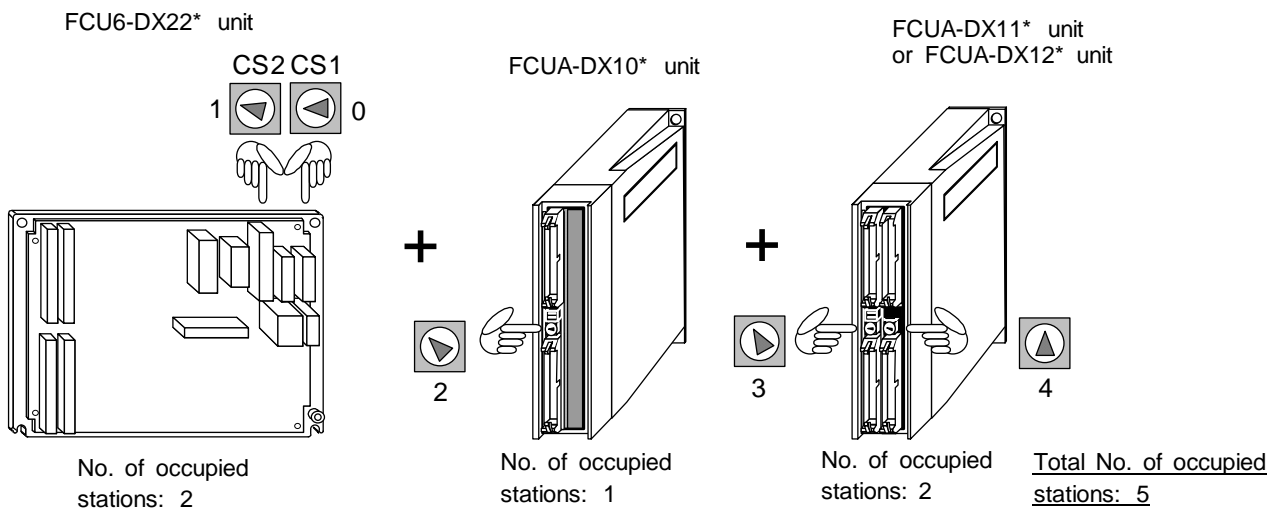

I/O unit configuration for <Device assignment example 2> on the previous page.

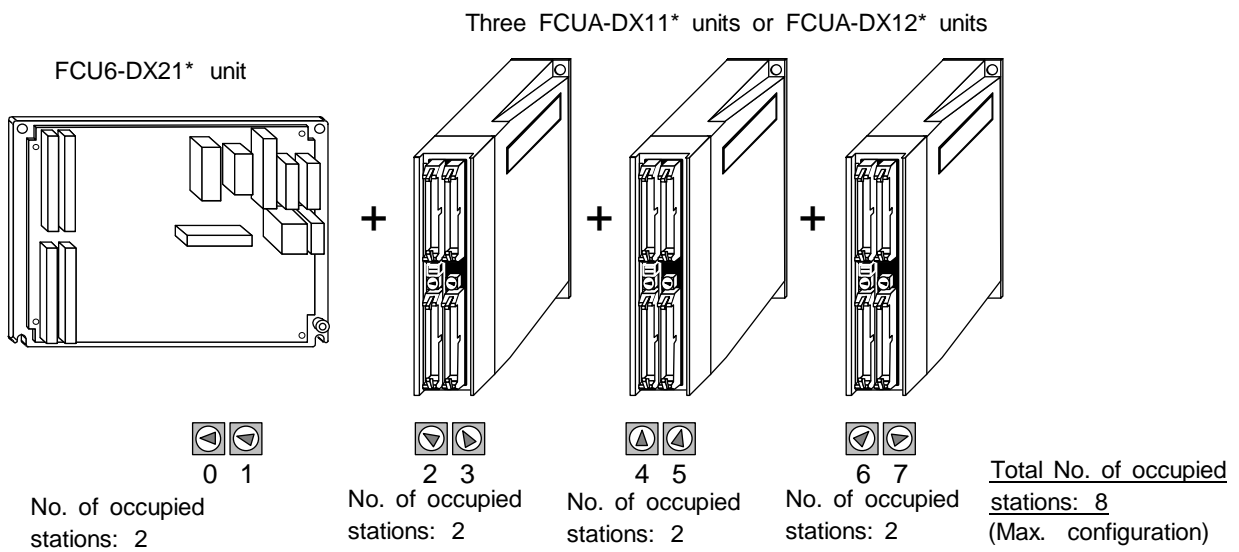

### **3.1.5 MELDASMAGIC64 Confirmation Items**

#### **Personal computer main unit confirmation items**

- Is the ambient temperature around the personal computer main unit within the range in the personal computer manufacturer's specifications?  
This will differ according to the personal computer manufacturer, or whether the personal computer is used for business or industry.  
When installed in a cabinet, install the personal computer in a cool location.
- Are noise countermeasures for the personal computer main unit carried out correctly?  
Personal computer noise resistance differs according to the model. Confirm the noise resistance with the manufacturer.  
When required, install a noise filter and shield transformer in the AC input.  
When required, install ferrite beads on the cable.
- Are vibration countermeasures for the personal computer main unit carried out correctly?  
There are devices in the personal computer, such as hard disk devices and floppy disk devices, which are sensitive to vibration. Do not install these devices in places subject to vibration.
- Is the personal computer within the tolerable instantaneous power failure time?

3.2 NC Card (HR621/HR623/FCU6-HR655) Part Names

(1) HR621

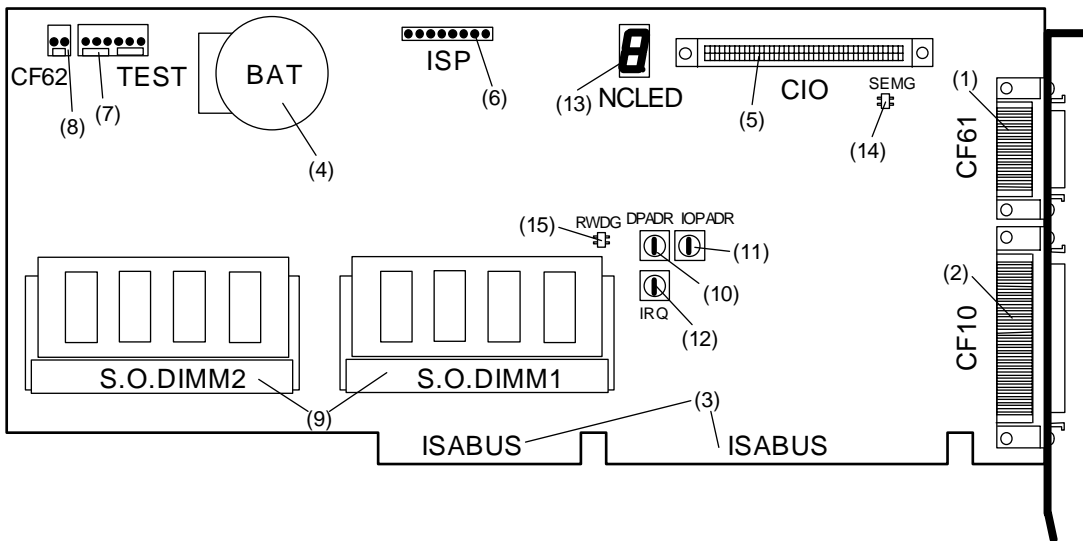

(2) HR623

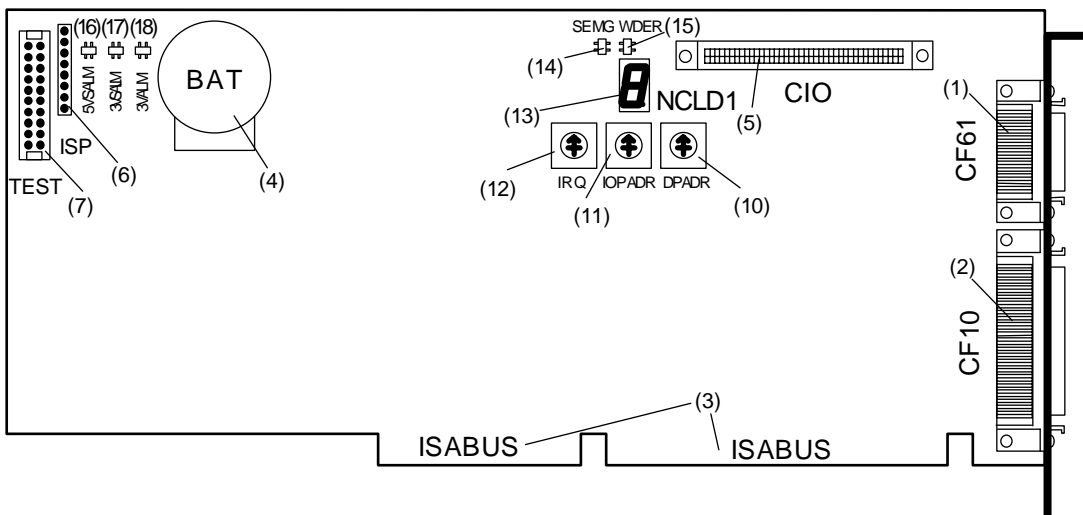

(3) FCU6-HR655

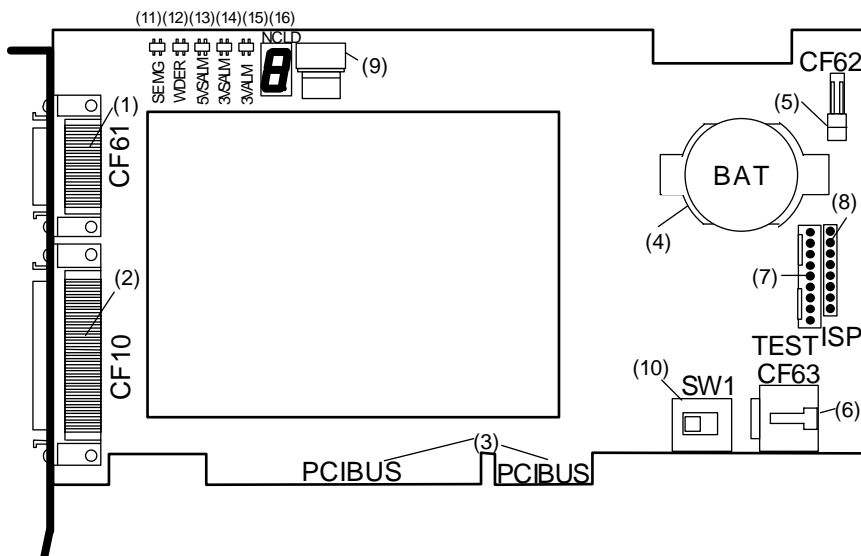

**Chapter 3 Troubleshooting**  
**3.2 NC Card (HR621/HR623/FCU6-HR655) Part Names**

**List of HR621/HR623 connectors**

No.	Name	Function details
(1)	CF61	This is used in the connection with the relay card (HR682). An F011 cable is connected.
(2)	CF10	This is used in the connection with the base I/O unit (DX2**, 3**, 4**). An F010 cable is connected.
(3)	ISABUS	This is connected to the personal computer expansion slot (ISABUS).
(4)	BAT	This is the MAGIC64 battery holder. A Toshiba battery CR2450 is installed.
(5)	CIO	This is a connector for expansion.
(6)	ISP	Cannot be used.
(7)	TEST	Cannot be used.
(8)	CF62	Cannot be used.
(9)	S.O.DIMM1, 2	This is the MAGIC64 memory module connector. Do not remove the memory module.

Items (8) and (9) do not apply to the HR623 connector.

**List of HR621/HR623 rotary switches**

No.	Name	Function details
(10)	DPADR	This is used in the address assignment setting of the personal computer expansion region. Refer to the following table for details.
(11)	IOPADR	This is used in the address assignment setting of the personal computer I/O port region. Refer to the following table for details.
(12)	IRQ	This is used in the interrupt request signal level setting to the personal computer CPU. Refer to the following table for details.

**(10) DPADR setting**

Switch	Expansion region
0	h0D_8000 ~ h0D_FFFF
1	h0D_0000 ~ h0D_7FFF
2	h0C_8000 ~ h0C_FFFF
3	h0C_0000 ~ h0C_7FFF
4	RESERVED
5	RESERVED
6	RESERVED
7	RESERVED
8	RESERVED
9	RESERVED
A	RESERVED
B	RESERVED
C	RESERVED
D	RESERVED
E	RESERVED
F	RESERVED

**(11) IOPADR setting**

Switch	I/O port region
0	h0120-h0123
1	h0140-h0143
2	h0160-h0163
3	h0180-h0183
4	h01A0-h01A3
5	h01C0-h01C3
6	h01E0-h01E3
7	h0200-h0203
8	h0220-h0223
9	h0240-h0243
A	h0260-h0263
B	h0280-h0283
C	h02A0-h02A3
D	h02C0-h02C3
E	h02E0-h02E3
F	h0300-h0303

**(12) IRQ setting**

Switch	Interrupt request signal
0	None
1	IRQ5
2	IRQ7
4	IRQ9
8	IRQ10

**HR621/HR623 LED list**

No.	HR621 Name	HR623 Name	Function details
(13)	NCLED	NCLD1	This is the 7-segment LED for the NC status display. This LED changes when at startup, during alarms, etc.
(14)	SEMG		This is the chip LED for the NC system emergency stop display. When lit (red) : System in emergency stop When not lit : Normal
(15)	RWDG	WDER	This is the chip LED for the remote communication watchdog display. When lit (red) : Watchdog alarm When not lit : Normal
(16)	None	5VSALM	This is the chip LED for the circuit power 5VDC drop alarm. When lit (red) : 5VDC drop When not lit : Normal
(17)	None	3VSALM	This is the chip LED for the circuit power 3VDC drop alarm. When lit (red) : 3VDC drop When not lit : Normal
(18)	None	3VALM	This is the chip LED for the circuit power 3VDC drop alarm. When lit (red) : 3VDC drop When not lit : Normal

**Chapter 3 Troubleshooting**  
**3.2 NC Card (HR621/HR623/FCU6-HR655) Part Names**

---

**List of FCU6-HR655 connectors**

No.	Name	Function details
(1)	CF61	This is used in the connection with the relay card (HR682). An F011 cable is connected.
(2)	CF10	This is used in the connection with the base I/O unit (DX2**, 3**, 4**). An F010 cable is connected.
(3)	PCIBUS	This is connected to the personal computer expansion slot (PCI BUS).
(4)	BAT	This is the MAGIC64 battery holder. A Toshiba battery CR2032 is installed.
(5)	CF62	This is used to input AC FAIL from an external source. (Create with dedicated external power supply or external circuit.)
(6)	CF63	This is used to supply the power from an external source.
(7)	TEST	Cannot be used.
(8)	ISP	Cannot be used.

**(Note 1)** When multiple FCU6-HR655 cards are inserted, the power supplied from the personal computer or panel computer may be insufficient. Supply the power from an external source to CF63 in this case. Input a FAIL signal to CF62 when using an external power supply.

**List of FCU6-HR655 switches**

No.	Name	Function details
(9)	CDNO	This is used to set the PCI NC Card's station No.
(10)	SW1	This sets the power supply method. Set "L" when supplying from the PCI bus, and set "M" when supplying power to CF63 from an external power supply.

**FCU6-HR655 LED list**





No.	Name	Function details	
(11)	SEMG	This is the chip LED for the NC system emergency stop display.	When lit (red) : System in emergency stop When not lit : Normal
(12)	WDER	This is the chip LED for the remote communication watchdog display.	When lit (red) : Watchdog alarm When not lit : Normal
(13)	5VSALM	This is the chip LED for the circuit power 5VDC drop alarm.	When lit (red) : 5VDC drop When not lit : Normal
(14)	3VSALM	This is the chip LED for the circuit power 3VDC drop alarm.	When lit (red) : 3VDC drop When not lit : Normal
(15)	3VALM	This is the chip LED for the circuit power 3VDC drop alarm.	When lit (red) : 3VDC drop When not lit : Normal
(16)	NCLD	This is the 7-segment LED for the NC status display. This LED changes when at startup, during alarms, etc.	

**Chapter 3 Troubleshooting**  
**3.2 NC Card (HR621/HR623/FCU6-HR655) Part Names**

Refer to the following table for correspondence to abnormalities.

The watchdog alarm LED "RWDG" (HR621) or "WDER" (HR623/FCU6-HR655) is lit.	
Cause	Remedy
The remote I/O cable is not connected, or the cable has a broken wire or the connector contact is defective.	Check the connection of the F010 cable between the NC Card and base I/O unit, or the SH41 (R211) cable between the remote I/O units.
The NC Card is defective.	Contact the Mitsubishi Service Center, and replace the card.
The system emergency stop LED "SEMG" is lit.	
Cause	Remedy
The expansion bus DC output is incorrect. <ul style="list-style-type: none"> <li>• The AC input voltage to the personal computer is incorrect.</li> <li>• There is insufficient output voltage in each DC output of the expansion bus.</li> </ul>	<ul style="list-style-type: none"> <li>• Supply the correct voltage following the personal computer instruction manual.</li> <li>• Prepare a personal computer that satisfies the power specifications described in "1.2 General Specifications" of this manual.</li> </ul>
Caused by the above watchdog alarm	Execute the above remedies.
Caused by an external emergency stop input. <ul style="list-style-type: none"> <li>• The emergency stop switch connected to the relay card (HR682) EMG1 connector is ON.</li> <li>• The relay card (HR682) EMG1 connector is disconnected.</li> </ul>	<ul style="list-style-type: none"> <li>• Put the emergency stop switch in the release status.</li> <li>• Check the connection to the EMG1 connector.</li> </ul>
Caused by a servo communication abnormality. <ul style="list-style-type: none"> <li>• The F010 cable between the NC Card and base I/O unit, or the SH21 servo communication cable is not connected.</li> <li>Or, there is a broken wire, or the connector contact is defective.</li> <li>• A terminator is not connected to the connector of unused channels, or the contact is defective.</li> </ul>	<ul style="list-style-type: none"> <li>• Check the connection of the F010 cable between the NC Card and base I/O unit, or the SH21 servo communication cable connection.</li> <li>• Check the terminator connection of unused channels.</li> </ul>
The NC Card is defective.	Contact the Mitsubishi Service Center, and replace the card.

 <b>CAUTION</b>
--

-  Do not apply voltages other than those indicated in this manual on the connector. Doing so may lead to destruction or damage.
-  Incorrect connections may damage the devices, so connect the cables to the specified connectors.
-  Do not connect or disconnect the connection cables between each unit while the power is ON.
-  Do not connect or disconnect the PCBs while the power is ON.

### 3.3 Base I/O Unit (FCU6-DX2\*\*) Part Names

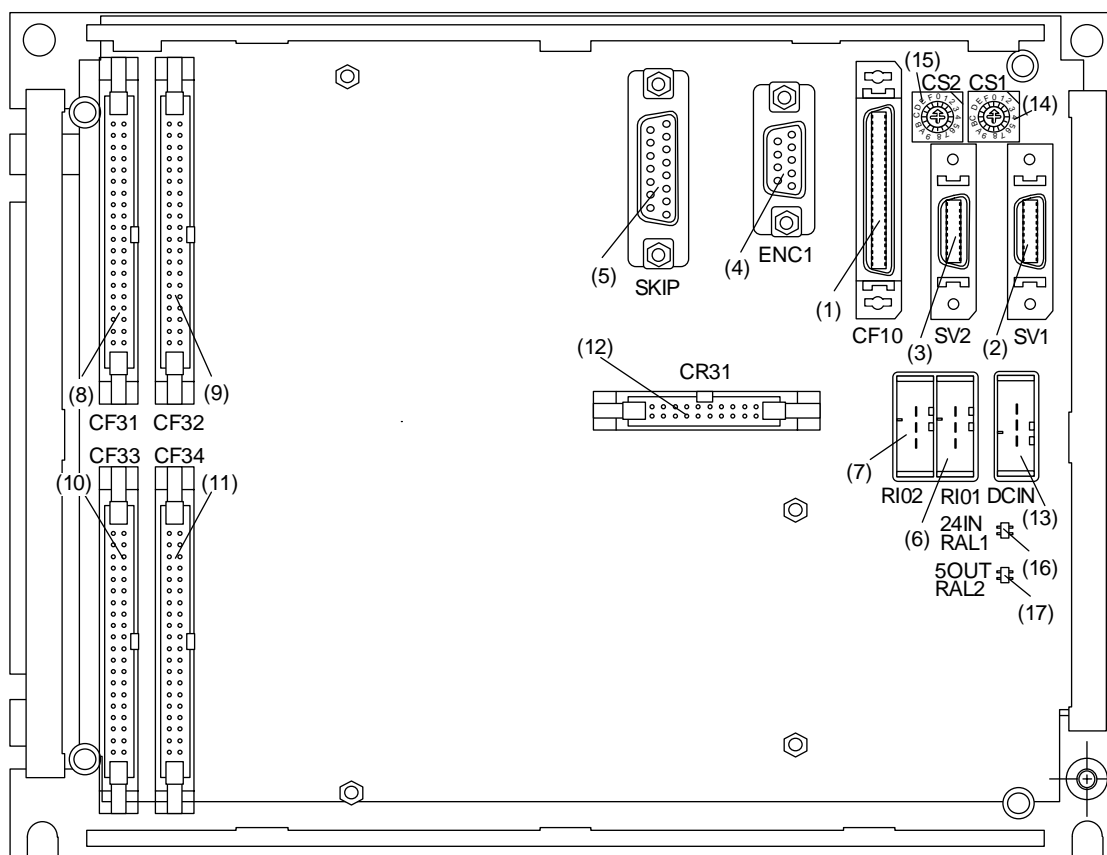

#### List of connectors

No.	Name	Function details
(1)	CF10	This is used in the connection with the NC Card (HR621/HR623/FCU6-HR655). An F010 cable is connected.
(2)	SV1	This is connected to the servo drive unit 1st part system (for spindles and NC servo axes).
(3)	SV2	This is connected to the servo drive unit 2nd part system (for auxiliary axes).
(4)	ENC1	This is connected to the encoder 1st channel (1st spindle encoder).
(5)	SKIP	This is the sensor signal (skip) input connection. Up to eight points can be used.
(6)	RI01	This is connected to the remote I/O unit 1st part system. The max. No. of occupied stations is eight. Because two stations are occupied in the base I/O unit, the remaining six occupied stations can be used. Note that when an add-on PCB is used, the remaining five occupied stations can be used.
(7)	RI02	This is connected to the remote I/O unit 2nd part system. The max. No. of occupied stations is eight. Eight occupied stations can be used. For future expansion.
(8)	CF31	This is used in the connection of the station No. machine input signal set by the CS1 rotary switch.
(9)	CF32	This is used in the connection of the station No. machine input signal set by the CS2 rotary switch.
(10)	CF33	This is used in the connection of the station No. machine output signal set by the CS1 rotary switch.
(11)	CF34	This is used in the connection of the station No. machine output signal set by the CS2 rotary switch.
(12)	CR31	This is a connector for an add-on PCB. It cannot be used unless using an add-on PCB.
(13)	DCIN	24VDC are supplied by external power. Refer to "1.2 General Specifications" for power specifications.

#### **CAUTION**

- ⚠ Do not apply voltages other than those indicated in this manual on the connector. Doing so may lead to destruction or damage.
- ⚠ Incorrect connections may damage the devices, so connect the cables to the specified connectors.
- ⊘ Do not connect or disconnect the connection cables between each unit while the power is ON.
- ⊘ Do not connect or disconnect the PCBs while the power is ON.



**Chapter 3 Troubleshooting**  
**3.3 Base I/O Unit (FCU6-DX2\*\*) Part Names**

**List of rotary switches**

No.	Name	Function details
(14)	CS1	This is used in station No. setting of the CF31 and CF33 machine input/output signal. Refer to the following table.
(15)	CS2	This is used in station No. setting of the CF32 and CF34 machine input/output signal. Refer to the following table.

Rotary switch setting value	Station No.	Device assignment	
		DI	DO
0	0	X00 ~ X1F	Y00 ~ Y1F
1	1	X20 ~ X3F	Y20 ~ Y3F
2	2	X40 ~ X5F	Y40 ~ Y5F
3	3	X60 ~ X7F	Y60 ~ Y7F
4	4	X80 ~ X9F	Y80 ~ Y9F
5	5	XA0 ~ XBF	YA0 ~ YBF
6	6	XC0 ~ XDF	YC0 ~ YDF
7	7	XE0 ~ XFF	YE0 ~ YFF
8 ~ F		Cannot be used	





**LED list**

No.	Name	Function details	
(16)	24IN	This is the LED for the 24VDC input display.	When lit (green) : 24VDC being supplied. When not lit : 24VDC supply OFF.
	RAL1	This is the LED for the onboard remote I/O 1st station (CS1 setting station No.) communication alarm display.	When lit (red) : Communication alarm. When not lit : Normal
(17)	5OUT	This is the LED for the circuit power 5VDC output display.	When lit (green) : Outputting 5VDC. When not lit : 5VDC output OFF.
	RAL2	This is the LED for the onboard remote I/O 2nd station (CS2 setting station No.) communication alarm display.	When lit (red) : Communication alarm. When not lit : Normal

Refer to the following table for correspondence to abnormalities.

The communication alarm LED "RAL" is lit.		
	<b>Cause</b>	<b>Remedy</b>
	The remote I/O connection cable is not connected, or the cable has a broken wire or the connector contact is defective.	Check the connection of the F010 cable between the NC Card and base I/O unit, or the SH41 (R211) cable between the remote I/O units.
	The base I/O unit is defective.	Contact the Mitsubishi Service Center, and replace the card.
The power system LED "24IN" and "5OUT" is not lit.		
	<b>Cause</b>	<b>Remedy</b>
	The "24IN" LED is not lit. (Input power not supplied)	Supply 24VDC $\pm$ 5% to the base I/O unit.
	The "5OUT" LED is not lit. (Outside input power tolerance range, internal power failure)	Check whether the input voltage is + 20V or less. If correctly supplied, contact the Mitsubishi Service Center.

 **CAUTION**

-  Do not apply voltages other than those indicated in this manual on the connector. Doing so may lead to destruction or damage.
-  Incorrect connections may damage the devices, so connect the cables to the specified connectors.
-  Do not connect or disconnect the connection cables between each unit while the power is ON.
-  Do not connect or disconnect the PCBs while the power is ON.

### 3.4 Relay Card (HR682) Part Names

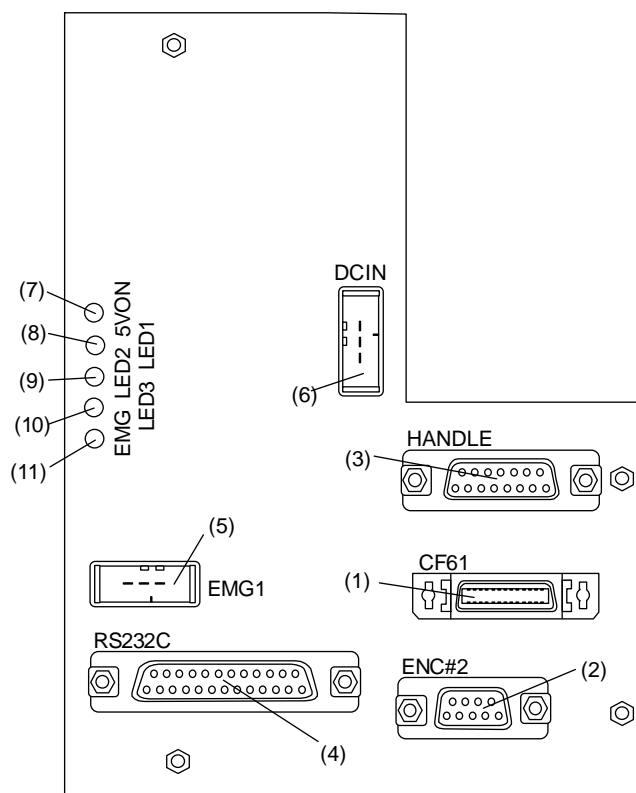

#### List of connectors

No.	Name	Function details
(1)	CF61	This is used in the connection with the NC Card (HR621/HR623/FCU6-HR655). An F011 cable is connected.
(2)	ENC#2	This is connected to the encoder 2nd channel (2nd spindle encoder).
(3)	HANDLE	This is connected to the manual pulse generator. It can be connected to a max. of three channels.
(4)	RS232C	This is connected to the RS-232C device. One channel can be connected. Note that only the DC code (X ON/OFF) method handshake is possible.
(5)	EMG1	This is connected to the external emergency stop switch.
(6)	DCIN	24VDC are supplied by external power. Refer to "1.2 General Specifications" for power specifications.

**CAUTION**

- Do not apply voltages other than those indicated in this manual on the connector. Doing so may lead to destruction or damage.
- Incorrect connections may damage the devices, so connect the cables to the specified connectors.
- Do not connect or disconnect the connection cables between each unit while the power is ON.
- Do not connect or disconnect the PCBs while the power is ON.

**Chapter 3 Troubleshooting**  
**3.4 Relay Card (HR682) Part Names**





**LED list**

No.	Name	Function details	
(7)	5VON	This is the LED for the circuit power 5VDC output display.	When lit (green) : Outputting 5VDC. When not lit : 5VDC output OFF.
(8)	LED1	Not in use.	
(9)	LED2	Not in use.	
(10)	LED3	Not in use.	
(11)	EMG	This is the LED for the NC system emergency stop display.	When lit (red) : System in emergency stop When not lit : Normal

Refer to the following table for correspondence to abnormalities.

The power system LED "5VON" is not lit.	
Cause	Remedy
The "5VON" LED is not lit. (Outside input power tolerance range, internal power failure)	Check whether the input voltage is + 20V or less. If correctly supplied, contact the Mitsubishi Service Center.
The system emergency stop LED "EMG" is lit.	
Cause	Remedy
The expansion DC output is incorrect. <ul style="list-style-type: none"> <li>The AC input voltage to the personal computer is incorrect.</li> <li>There is insufficient output voltage in each DC output of the expansion bus.</li> </ul>	<ul style="list-style-type: none"> <li>Supply the correct voltage following the personal computer instruction manual.</li> <li>Prepare a personal computer that satisfies the power specifications described in "1.2 General Specifications" of this manual.</li> </ul>
The remote I/O connection cable is not connected, or the cable has a broken wire or the connector contact is defective.	Check the connection of the F010 cable between the NC Card and base I/O unit, or the SH41 (R211) cable between the remote I/O units.
Caused by an external emergency stop input. <ul style="list-style-type: none"> <li>The emergency stop switch connected to the relay card (HR682) EMG1 connector is ON.</li> <li>The relay card (HR682) EMG1 connector is disconnected.</li> </ul>	<ul style="list-style-type: none"> <li>Put the emergency stop switch in the release status.</li> <li>Check the connection to the EMG1 connector.</li> </ul>
Caused by a servo communication abnormality. <ul style="list-style-type: none"> <li>The F010 cable between the NC Card and base I/O unit, or the SH21 servo communication cable is not connected.</li> <li>Or, there is a broken wire, or the connector contact is defective.</li> <li>A terminator is not connected to the connector of unused channels, or the contact is defective.</li> </ul>	<ul style="list-style-type: none"> <li>Check the connection of the F010 cable between the NC Card and base I/O unit, or the SH21 servo communication cable connection.</li> <li>Check the terminator connection of unused channels.</li> </ul>
The relay card is defective.	Contact the Mitsubishi Service Center, and replace the card.

 **CAUTION**

-  Do not apply voltages other than those indicated in this manual on the connector. Doing so may lead to destruction or damage.
-  Incorrect connections may damage the devices, so connect the cables to the specified connectors.
-  Do not connect or disconnect the connection cables between each unit while the power is ON.
-  Do not connect or disconnect the PCBs while the power is ON.

## 3.5 Unit Replacement

### 3.5.1 Precautions

#### When replacing the unit:

- (1) Turn OFF the power of the entire system, including peripheral devices.
- (2) All cables connected to the relevant unit must be disconnected.  
If the cable replacement work is carried out without turning OFF the power, it will cause damage to the normal units and peripheral devices, and is dangerous. Therefore, always turn the power OFF before working.  
Disconnect each cable with the following procedure.

- (a) For the following type of connector, press the tabs with a thumb and forefinger in the direction of the arrow, and pull the connector off.

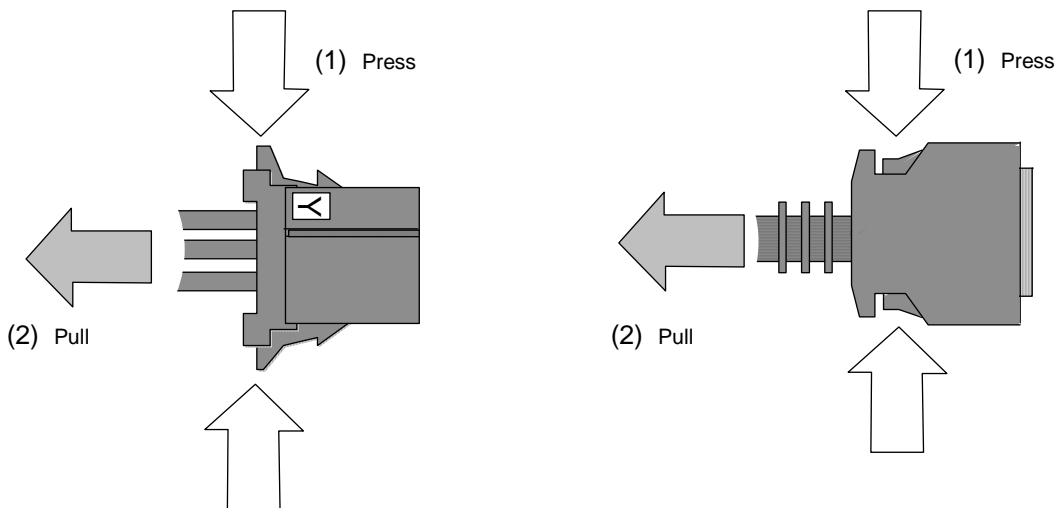

- (b) For a flat cable type connector with claws, open the claws in the direction of the arrow, and pull the connector off.

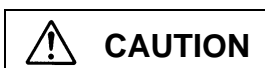
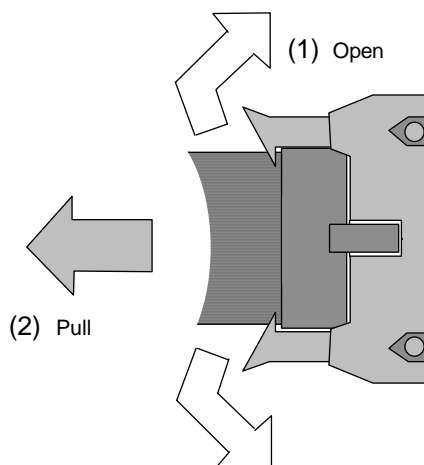

- ⊘ Do not connect or disconnect the connection cables between each unit while the power is ON.
- ⊘ Do not disconnect the connector by pulling on the cable wire.

### Chapter 3 Troubleshooting

#### 3.5 Unit Replacement

---

(c) For a screw fixed type connector, loosen the two fixing screws, and pull the connector off.

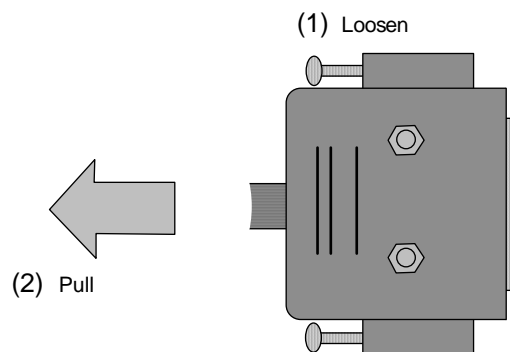
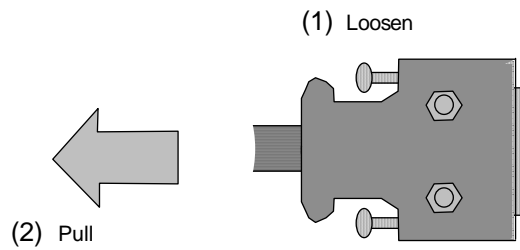

 **CAUTION**

- ⊘ Do not connect or disconnect the connection cables between each unit while the power is ON.
- ⊘ Do not disconnect the connector by pulling on the cable wire.



### 3.5.2 NC Card Replacement

Replace the NC Card with the machine and personal computer power turned OFF.

The replacement procedure is as follows. Always back up the important data, such as the parameters and programs, before replacing an NC Card. Restore the data after replacing the NC Card.

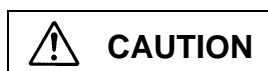
- (1) Check that the machine and personal computer power is OFF. (If the power is not OFF, turn it OFF.)
- (2) Disconnect the personal computer power cable and all cables that are connected to the NC Card.
- (3) Following the instructions in the personal computer manual, remove the personal computer cover.  
**(Note)** Follow the precautions indicated by the personal computer manufacturer. Check that the personal computer power is OFF, and that the power cable is disconnected.
- (4) Remove the fixing screw (one location) that fixes the NC Card to the personal computer. (Refer to Fig. 1)
- (5) Holding the card installation metal fittings, and the ends of the NC Card, pull the card out horizontally. (Refer to Fig. 2)  
**(Note)** Before touching the NC Card, touch an exposed metal section of the personal computer to discharge any static electricity.  
Pay attention not to touch the NC Card, personal computer chip or circuit.
- (6) Check the rotary switch setting of the removed NC Card.
- (7) Following "2.2 Battery Replacement" of this manual, remove the battery from the old NC Card, and install that battery in the new NC Card.
- (8) Set the rotary switch setting of the new NC Card to the same setting that was checked in (6).
- (9) Holding the card installation metal fittings and the ends of the NC Card, so as to push in the NC Card upper end, insert the card all the way into the personal computer expansion bus slot.  
**(Note)** Pay attention not to touch the NC Card, personal computer chip or circuit.
- (10) Fix the NC Card to the personal computer using the fixing screw removed in (4).  
**(Note)** Securely tighten the screw.
- (11) Following the instructions in the personal computer manual, install the personal computer cover.
- (12) Reconnect the personal computer power cable and all cables that were connected to the NC Card.  
**(Note)** Connect the cables to the set connectors.



-  Incorrect connections may damage the devices, so connect the cables to the specified connectors.
-  Do not replace the base I/O unit while the power is ON.
-  Do not connect or disconnect the connection cables between each unit while the power is ON.

Chapter 3 Troubleshooting  
3.5 Unit Replacement

---

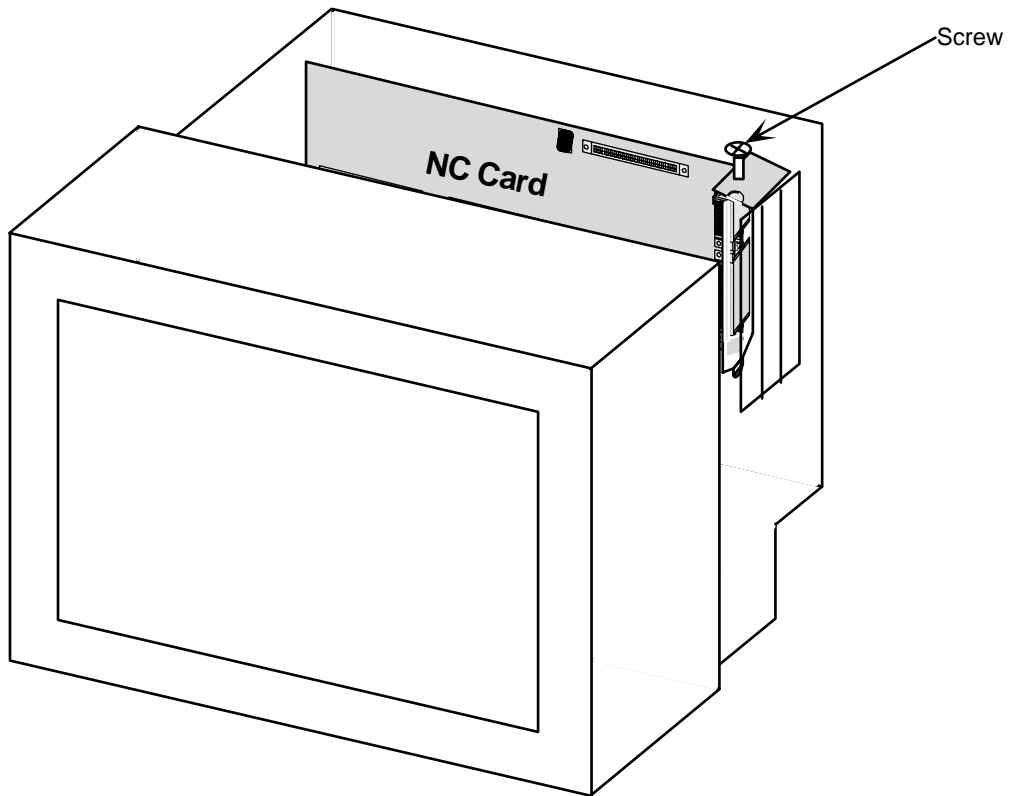

Fig. 1

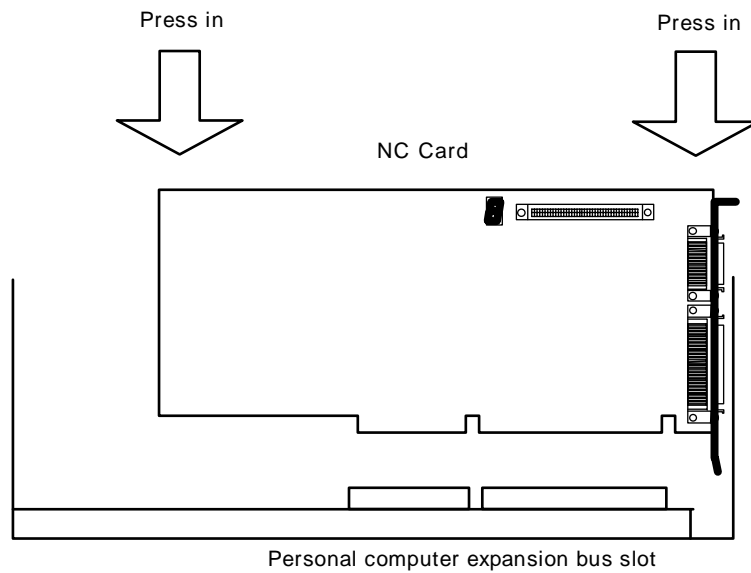
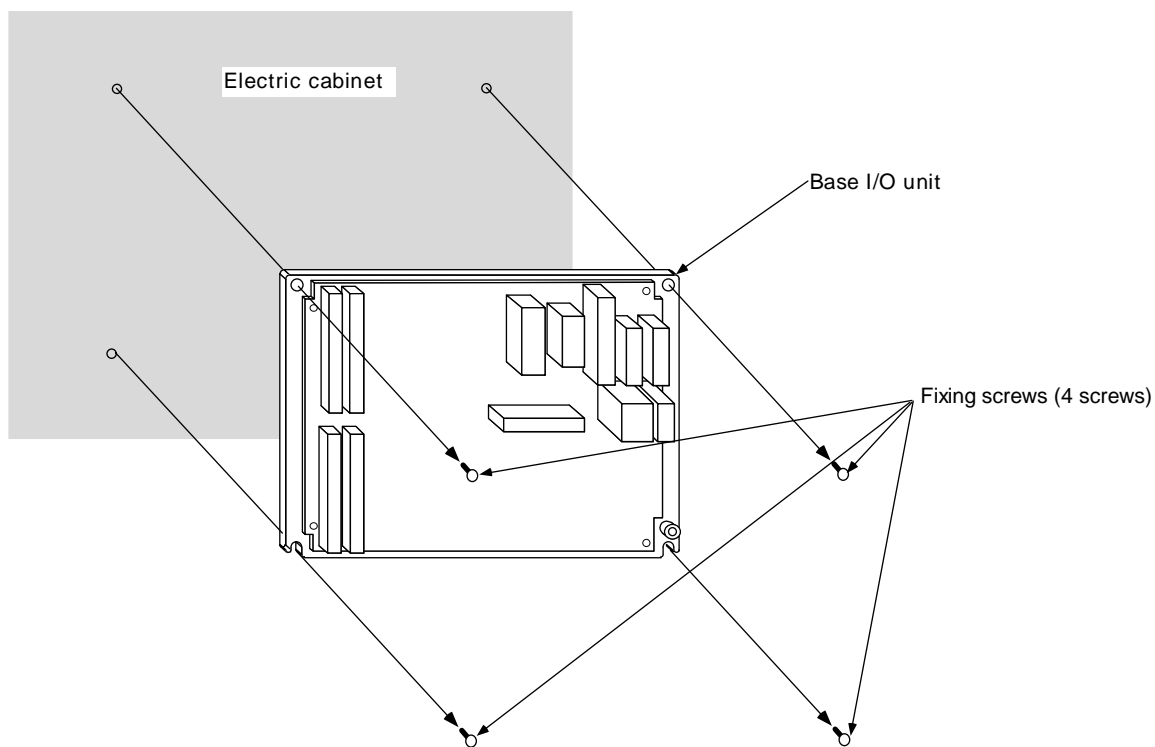



Fig. 2



### 3.5.3 Base I/O unit replacement

The base I/O unit is generally installed on the electric cabinet side.  
Replace the base I/O unit with the machine power turned OFF.  
The replacement procedure is as follows.

- (1) Check that the machine power is turned OFF. (If the power is not OFF, turn it OFF.)
- (2) Open the electric cabinet door.
- (3) Disconnect all cables connected to the base I/O unit.
- (4) Remove the fixing screws fixing the base I/O unit to the electric cabinet, and remove the base I/O unit from the electric cabinet.  
(Loosen the two lower fixing screws first, and then remove the two upper fixing screws while supporting the unit with a hand. Then lift the unit upward and off. The two lower fixing screws do not need to be removed.)
- (5) Replace with a new base I/O unit, and fix the unit onto the electric cabinet with the fixing screws.
- (6) Reconnect all cables connected to the base I/O unit. (Connect the cables to the designated connectors.)
- (7) Close the electric cabinet door.



 **CAUTION**

-  Incorrect connections may damage the devices, so connect the cables to the specified connectors.
-  Do not replace the base I/O unit while the power is ON.
-  Do not connect or disconnect the connection cables between each unit while the power is ON.



### 3.5.4 Relay Card Replacement

The relay card is generally installed on the electric cabinet side.  
Replace the relay card with the machine power turned OFF.  
The replacement procedure is as follows.

- (1) Check that the machine power is OFF. (If the power is not OFF, turn it OFF.)
- (2) Open the door of the electric cabinet.
- (3) Disconnect all cables connected to the relay card.
- (4) Remove the relay card fixing screw on the electric cabinet, and remove the relay card from the electric cabinet.  
If the relay card is added on to the base I/O unit, remove the relay card fixing screws from the base I/O unit, and then remove the relay card from the electric cabinet.  
(Remove the four fixing screws while pressing down on the relay card with a hand.)
- (5) Replace with a new relay card, install the unit on the relay card metal spacer installed on the electric cabinet, and fix with the fixing screws.
- (6) Reconnect all cables that were connected to the relay card. (Connect the cables to the designated connectors.)
- (7) Close the door of the electric cabinet.

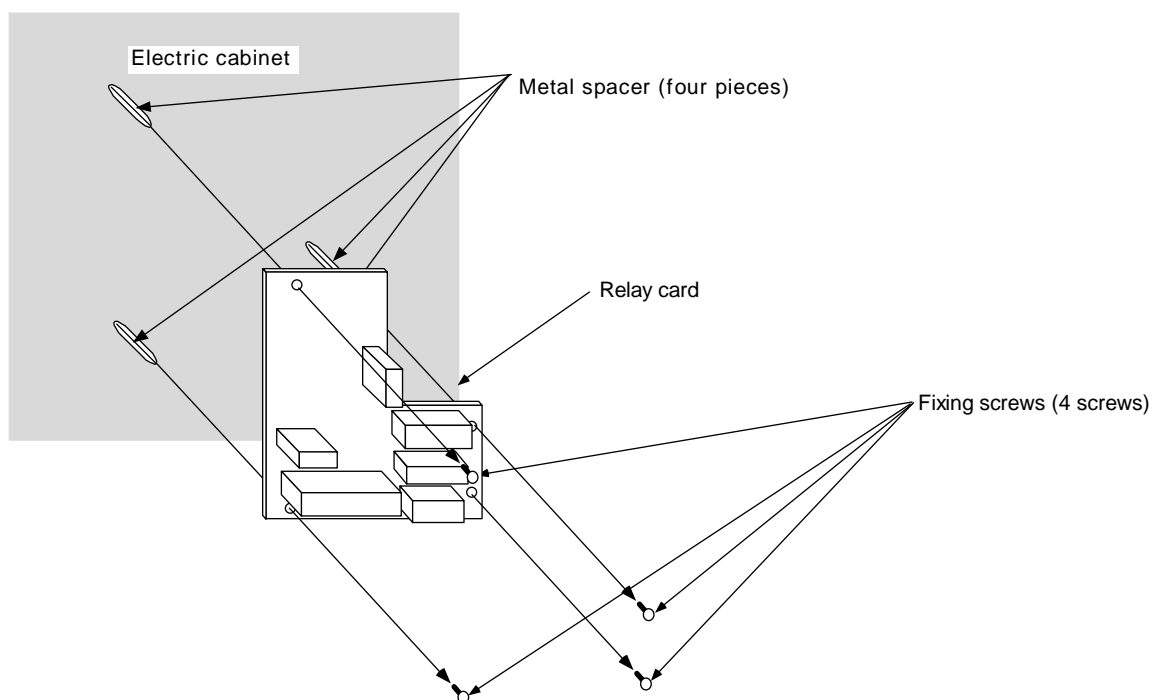

**CAUTION**

- ⚠ Incorrect connections may damage the devices, so connect the cables to the specified connectors.
- ⚠ Do not replace the relay card while the power is ON.
- ⚠ Do not connect or disconnect the connection cables between each unit while the power is ON.

### 3.5.5 Remote I/O Unit Replacement

The remote I/O unit is generally installed on the electric cabinet side.  
Replace the remote I/O unit with the machine power turned OFF.  
The replacement procedure is as follows.

- (1) Check that the machine power is turned OFF. (If the power is not OFF, turn it OFF.)
- (2) Open the electric cabinet door.
- (3) Disconnect all cables connected to the remote I/O unit.
- (4) Remove the fixing screws fixing the remote I/O unit to the electric cabinet, and remove the remote I/O unit from the electric cabinet.  
(Loosen the one lower fixing screw first, and then remove the one upper fixing screw while supporting the unit with a hand. Then lift the unit upward and off. The one lower fixing screw does not need to be removed.)
- (5) Replace with a new remote I/O unit, and fix the unit onto the electric cabinet with the fixing screws.
- (6) Reconnect all cables connected to the remote I/O unit. (Connect the cables to the designated connectors.)
- (7) Close the electric cabinet door.

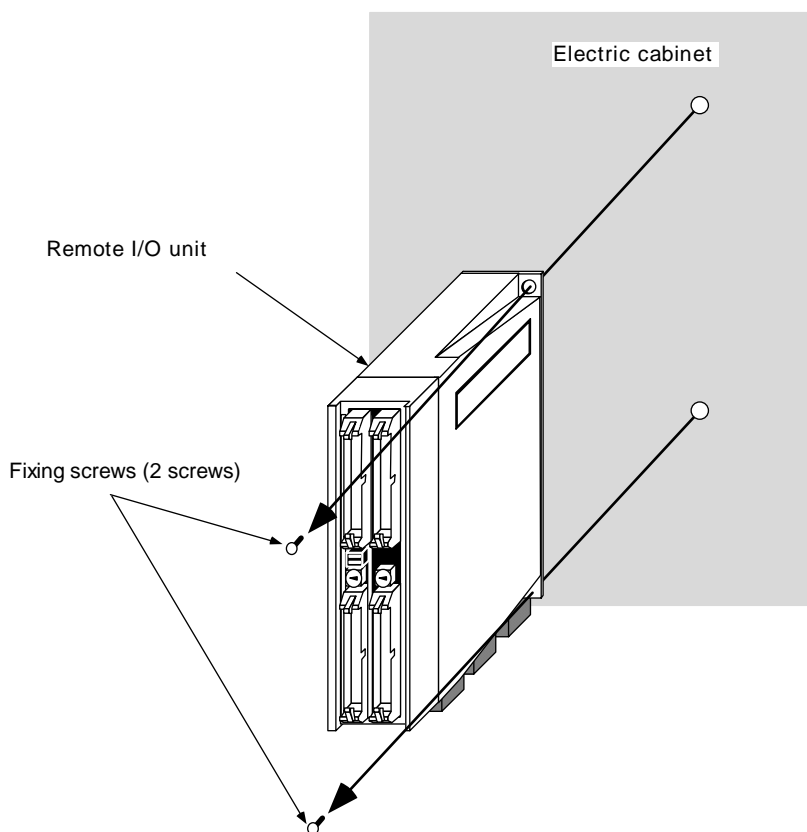

**CAUTION**

- ⚠ Incorrect connections may damage the devices, so connect the cables to the specified connectors.
- ⚠ Do not replace the remote I/O unit while the power is ON.
- ⚠ Do not connect or disconnect the connection cables between each unit while the power is ON.

## Revision History

Date of revision	Manual No.	Revision details
Dec. 1997	BNP-B2207*	First edition created.
Oct. 2003	BNP-B2207D	<ul style="list-style-type: none"><li>• Design of the cover and the back cover were changed.</li><li>• MODEL, MODEL CODE, and Manual No. were added on the back cover.</li><li>• HR623 card added.</li><li>• FCU6-HR655 unit added.</li><li>• Miswrite is corrected.</li></ul>

## **Notice**

Every effort has been made to keep up with software and hardware revisions in the contents described in this manual. However, please understand that in some unavoidable cases simultaneous revision is not possible. Please contact a Mitsubishi business office with any questions or comments regarding the use of this product.

## **Duplication Prohibited**

This instruction manual may not be reproduced in any form, in part or in whole, without written permission from Mitsubishi Electric Corporation.

© 1997-2003 MITSUBISHI ELECTRIC CORPORATION  
ALL RIGHTS RESERVED



MODEL	MAGIC64
MODEL CODE	008-097
Manual No.	BNP-B2207D(ENG)