

Numerical Control (CNC)

Instruction Manual
MDS-D2/DH2 Series

Introduction

Thank you for selecting the Mitsubishi numerical control unit. This instruction manual describes the handling and caution points for using this AC servo/spindle. Incorrect handling may lead to unforeseen accidents, so always read this instruction manual thoroughly to ensure correct usage.

Make sure that this instruction manual is delivered to the end user. Always store this manual in a safe place.

In order to confirm if all function specifications described in this manual are applicable, refer to the specifications for each CNC.

Notes on Reading This Manual

- (1) Since the description of this specification manual deals with NC in general, for the specifications of individual machine tools, refer to the manuals issued by the respective machine tool builders. The "restrictions" and "available functions" described in the manuals issued by the machine tool builders have precedence to those in this manual.
- (2) This manual describes as many special operations as possible, but it should be kept in mind that items not mentioned in this manual cannot be performed.
- (3) The characteristic values and numerical values without tolerances mentioned in this manual are representative values.

In this manual, the following abbreviations might be used.

MTB: Machine tool builder

Precautions for Safety

Please read this manual and auxiliary documents before starting installation, operation, maintenance or inspection to ensure correct usage. Thoroughly understand the device, safety information and precautions before starting operation.

The safety precautions in this instruction manual are ranked as "WARNING" and "CAUTION".

DANGER

When there is a potential risk of fatal or serious injuries if handling is mistaken.

WARNING



When a dangerous situation, or fatal or serious injuries may occur if handling is mistaken.



CAUTION

When a dangerous situation may occur if handling is mistaken leading to medium or minor injuries, or physical damage.











Note that some items described as " CAUTION" may lead to major results depending on the situation. In any case, important information that must be observed is described.

The signs indicating prohibited and mandatory matters are explained below.

	Indicates a prohibited matter. For example, "Fire Prohibited" is indicated as .
---	---

	Indicates a mandatory matter. For example, grounding is indicated as .
---	--

The meaning of each pictorial sign is as follows.

 CAUTION	 CAUTION rotated object	 CAUTION HOT	 Danger Electric shock risk	 Danger explosive
 Prohibited	 Disassembly is prohibited	 KEEP FIRE AWAY	 General instruction	 Earth ground

After reading this specifications and instructions manual, store it where the user can access it easily for reference.

The numeric control unit is configured of the control unit, operation board, servo drive unit, spindle drive unit, power supply, servo motor and spindle motor, etc.

In this section "Precautions for safety", the following items are generically called the "motor".

- Servo motor
- Linear servo motor
- Spindle motor
- Direct-drive motor

In this section "Precautions for safety", the following items are generically called the "unit".

- Servo drive unit
- Spindle drive unit
- Power supply unit
- Scale interface unit
- Magnetic pole detection unit



POINT

Important matters that should be understood for operation of this machine are indicated as a POINT in this manual.













For Safe Use

Mitsubishi CNC is designed and manufactured solely for applications to machine tools to be used for industrial purposes.

Do not use this product in any applications other than those specified above, especially those which are substantially influential on the public interest or which are expected to have significant influence on human lives or properties.





WARNING

1. Electric shock prevention

-  **Make sure the power is shut OFF before connecting a unit and a motor to the power.**
-  **Do not open the front cover while the power is ON or during operation. Failure to observe this could lead to electric shocks.**
-  **Do not operate the unit with the front cover removed. The high voltage terminals and charged sections will be exposed, and can cause electric shocks.**
-  **Do not remove the front cover and connector even when the power is OFF unless carrying out wiring work or periodic inspections. The inside of the units is charged, and can cause electric shocks.**
-  **Since the high voltage is supplied to the main circuit connector while the power is ON or during operation, do not touch the main circuit connector with an adjustment screwdriver or the pen tip. Failure to observe this could lead to electric shocks.**
-  **Wait at least 15 minutes after turning the power OFF, confirm that the CHARGE lamp has gone out, and check the voltage between P and N terminals with a tester, etc., before starting wiring, maintenance or inspections. Failure to observe this could lead to electric shocks.**
-  **Ground the unit and motor. For the motor, ground it via the drive unit.**
-  **Wiring, maintenance and inspection work must be done by a qualified technician.**
-  **Wire the servo drive unit and servo motor after installation. Failure to observe this could lead to electric shocks.**
-  **Do not touch the switches with wet hands. Failure to observe this could lead to electric shocks.**
-  **Do not damage, apply forcible stress, place heavy items on the cables or get them caught. Failure to observe this could lead to electric shocks.**
-  **Always insulate the power terminal connection section. Failure to observe this could lead to electric shocks.**
-  **After assembling the built-in IPM spindle motor, if the rotor is rotated by hand etc., voltage occurs between the terminals of lead. Take care not to get electric shocks.**







 **WARNING**

2. Injury prevention







-  **When handling a motor, perform operations in safe clothing.**
-  **In the system where the optical communication with CNC is executed, do not see directly the light generated from CN1A/CN1B connector of drive unit or the end of cable. When the light gets into eye, you may feel something is wrong for eye.**
(The light source of optical communication corresponds to class1 defined in JISC6802 or IEC60825-1.)
-  **The linear servo motor, direct-drive motor and built-in IPM spindle motor uses permanent magnets in the rotor, so observe the following precautions.**
 - (1)Handling
 - The linear servo motor, direct-drive motor and built-in IPM spindle motor could adversely affect medical electronics such as pacemakers, etc., therefore, do not approach the rotor.
 - Do not place magnetic materials as iron.
 - When a magnetic material as iron is placed, take safety measure not to pinch fingers or hands due to the magnetic attraction force.
 - Remove metal items such as watch, piercing jewelry, necklace, etc.
 - Do not place portable items that could malfunction or fail due to the influence of the magnetic force.
 - When the rotor is not securely fixed to the machine or device, do not leave it unattended but store it in the package properly.
 - When installing the motor to the machine, take it out from the package one by one, and then install it.
 - It is highly dangerous to lay out the motor or magnetic plates together on the table or pallet, therefore never do so.
 - (2)Transportation and storage
 - Correctly store the rotor in the package to transport and store.
 - During transportation and storage, draw people's attention by applying a notice saying "Strong magnet-Handle with care" to the package or storage shelf.
 - Do not use a damaged package.
 - (3)Installation
 - Take special care not to pinch fingers, etc., when installing (and unpacking) the linear servo motor.
-  **Incorrect wiring could lead to smoke or fire in the unit and the reactor, resulting in faults. Be careful when wiring.**

 **CAUTION**

1. Fire prevention

-  **Install the units, motors and regenerative resistor on non-combustible material. Direct installation on combustible material or near combustible materials could lead to fires.**
-  **Always install a circuit protector and contactor on the servo drive unit power input as explained in this manual. Refer to this manual and select the correct circuit protector and contactor. An incorrect selection could result in fire.**
-  **Shut off the power on the unit side if a fault occurs in the units. Fires could be caused if a large current continues to flow.**
-  **When using a regenerative resistor, provide a sequence that shuts off the power with the regenerative resistor's error signal. The regenerative resistor could abnormally overheat and cause a fire due to a fault in the regenerative transistor, etc.**
-  **The battery unit could heat up, ignite or rupture if submerged in water, or if the poles are incorrectly wired.**
-  **Cut off the main circuit power with the contactor when an alarm or emergency stop occurs.**

2. Injury prevention

-  **Do not apply a voltage other than that specified in this manual, on each terminal. Failure to observe this item could lead to ruptures or damage, etc.**
-  **Do not mistake the terminal connections. Failure to observe this item could lead to ruptures or damage, etc.**
-  **Do not mistake the polarity (+,-). Failure to observe this item could lead to ruptures or damage, etc.**
-  **Do not touch the radiation fin on unit back face, regenerative resistor or motor, etc., or place parts (cables, etc.) while the power is turned ON or immediately after turning the power OFF. These parts may reach high temperatures, and can cause burns or part damage.**
-  **Structure the cooling fan on the unit back face, etc., so that it cannot be touched after installation. Touching the cooling fan during operation could lead to injuries.**
-  **Take care not to suck hair, clothes, etc. into the cooling fan.**

⚠ CAUTION

3. Various precautions

Observe the following precautions. Incorrect handling of the unit could lead to faults, injuries and electric shocks, etc.

(1) Transportation and installation

- ⚠ Correctly transport the product according to its weight.
- ❗ Use the motor's hanging bolts only when transporting the motor itself. Do not use the motor's hanging bolts to transport a motor with other parts installed, or to transport a machine with a motor installed.
- ⚠ Do not stack the products above the tolerable number.
- ⚠ Follow this manual and install the unit or motor securely in a place where it can be borne and noncombustible. Insufficient fixing could lead to the unit or the motor slipping off during operation.
- ⚠ Do not get on top of or place heavy objects on the unit.

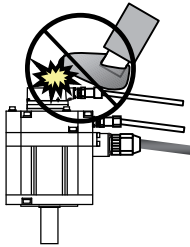

- ⚠ Do not hold the cables, axis or encoder when transporting the motor.

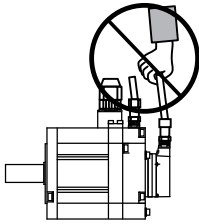

- ⚠ Do not hold the connected wires or cables when transporting the units.
- ⚠ Do not hold the front cover when transporting the unit. The unit could drop.
- ⚠ Always observe the installation directions of the units or motors.
- ⚠ Secure the specified distance between the units and control panel, or between the servo drive unit and other devices.
- ⚠ Do not install or run a unit or motor that is damaged or missing parts.
- ⚠ Do not block the intake or exhaust ports of the motor provided with a cooling fan.
- ⚠ Do not let foreign objects enter the units or motors. In particular, if conductive objects such as screws or metal chips, etc., or combustible materials such as oil enter, rupture or breakage could occur.
- ⚠ Provide adequate protection using a material such as connector for conduit to prevent screws, metallic detritus, water and other conductive matter or oil and other combustible matter from entering the motor through the power line lead-out port.
- ⚠ The units, motors and encoders are precision devices, so do not drop them or apply strong impacts to them.
- ⚠ Always operate the motor, which has a shaft with keyway, with the key attached.

⚠ CAUTION

⚠ Store and use the units under the following environment conditions.

Environment	Unit	Servo motor	Spindle motor
Ambient temperature	Operation: 0 to +55°C (with no freezing), Storage / Transportation: -15°C to +70°C (with no freezing)	Operation: 0 to +40°C (with no freezing), Storage: -15°C to +70°C (with no freezing)	Operation: 0 to +40°C (with no freezing), Storage: -20°C to +65°C (with no freezing)
Ambient humidity	Operation: 90%RH or less (with no dew condensation) Storage / Transportation: 90%RH or less (with no dew condensation)	Operation: 80%RH or less (with no dew condensation), Storage: 90%RH or less (with no dew condensation)	Operation: 90%RH or less (with no dew condensation) Storage: 90%RH or less (with no dew condensation)
Atmosphere	Indoors (no direct sunlight) With no corrosive gas, inflammable gas, oil mist, dust or conductive fine particles		
Altitude	Operation/Storage: 1000 meters or less above sea level, Transportation: 13000 meters or less above sea level	Operation/Storage: 1000 meters or less above sea level, Transportation: 10000 meters or less above sea level	
Vibration/impact	According to each unit or motor specification		

(Note) For details, confirm each unit or motor specifications in addition.

⚠ When disinfectants or insecticides must be used to treat wood packaging materials, always use methods other than fumigation (for example, apply heat treatment at the minimum wood core temperature of 56 °C for a minimum duration of 30 minutes (ISPM No. 15 (2009))).

If products such as units are directly fumigated or packed with fumigated wooden materials, halogen substances (including fluorine, chlorine, bromine and iodine) contained in fumes may contribute to the erosion of the capacitors.

When exporting the products, make sure to comply with the laws and regulations of each country.

- ⚠ Do not use the products in conjunction with any components that contain halogenated flame retardants (bromine, etc). Failure to observe this may cause the erosion of the capacitors.**
- ⚠ Securely fix the servo motor to the machine. Insufficient fixing could lead to the servo motor slipping off during operation.**
- ⚠ Always install the servo motor with reduction gear in the designated direction. Failure to do so could lead to oil leaks.**
- ⚠ Structure the rotary sections of the motor so that it can never be touched during operation. Install a cover, etc., on the shaft.**
- ⚠ When installing a coupling to a servo motor shaft end, do not apply an impact by hammering, etc. The encoder could be damaged.**
- ⚠ Do not apply a load exceeding the tolerable load onto the servo motor shaft. The shaft could break.**
- ⚠ Store the motor in the package box.**
- ⚠ When inserting the shaft into the built-in IPM spindle motor, do not heat the rotor higher than 130°C. The magnet could be demagnetized, and the specifications characteristics will not be ensured.**
- ⚠ Always use a nonmagnetic tool (explosion-proof beryllium copper alloy safety tool: NGK Insulators, etc.) when installing the built-in IPM spindle motor, direct-drive motor and linear servo motor.**
- ⚠ Always provide a mechanical stopper on the end of the linear servo motor's travel path.**
- ❗ If the unit has been stored for a long time, always check the operation before starting actual operation. Please contact the Service Center, Sales Office or dealer.**
- ⚠ Install the heavy peripheral devices to the lower part in the panel and securely fix it not to be moved due to vibration.**

⚠ CAUTION

(2) Wiring

- ⚠ Correctly and securely perform the wiring. Failure to do so could lead to abnormal operation of the motor.
- ⚠ Do not install a condensing capacitor, surge absorber or radio noise filter on the output side of the drive unit.
- ⚠ Correctly connect the output side of the drive unit (terminals U, V, W). Failure to do so could lead to abnormal operation of the motor.
- ⚠ When using a power regenerative power supply unit, always install an AC reactor for each power supply unit.
- ⚠ In the main circuit power supply side of the unit, always install an appropriate circuit protector or contactor for each unit. Circuit protector or contactor cannot be shared by several units.
- ⚠ Always connect the motor to the drive unit's output terminals (U, V, W).
- ⚠ Do not directly connect a commercial power supply to the servo motor. Failure to observe this could result in a fault.
- ⚠ When using an inductive load such as a relay, always connect a diode as a noise measure parallel to the load.
- ⚠ When using a capacitance load such as a lamp, always connect a protective resistor as a noise measure serial to the load.
- ⚠ Do not reverse the direction of a diode which connect to a DC relay for the control output signals such as contractor and motor brake output, etc. to suppress a surge. Connecting it backwards could cause the drive unit to malfunction so that signals are not output, and emergency stop and other safety circuits are inoperable.

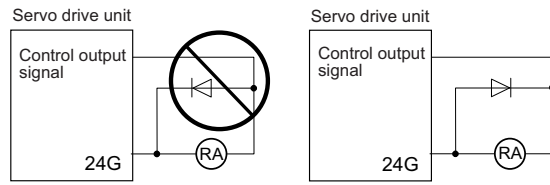

- ⚠ Do not connect/disconnect the cables connected between the units while the power is ON.
- ⚠ Securely tighten the cable connector fixing screw or fixing mechanism. An insecure fixing could cause the cable to fall off while the power is ON.
- ⚠ When using a shielded cable instructed in the instruction manual, always ground the cable with a cable clamp, etc. (Refer to "EMC Installation Guidelines")
- ⚠ Always separate the signals wires from the power line.
- ⚠ Use wires and cables that have a wire diameter, heat resistance and flexibility that conforms to the system.

(3) Trial operation and adjustment

- ⚠ Check and adjust each program and parameter before starting operation. Failure to do so could lead to unforeseen operation of the machine.
- ⚠ Do not make remarkable adjustments and changes of parameter as the operation could become unstable.
- ⚠ The usable motor and unit combination is predetermined. Always check the combinations and parameters before starting trial operation.
- ⚠ The direct-drive motor and linear servo motor do not have a stopping device such as magnetic brakes. Install a stopping device on the machine side.
- ⚠ When using the linear servo motor for an unbalance axis, adjust the unbalance weight to 0 by installing an air cylinder, etc. on the machine side. The unbalance weight disables the initial magnetic pole adjustment.

⚠ CAUTION

(4) Usage methods

- ❗ In abnormal state, install an external emergency stop circuit so that the operation can be stopped and power shut off immediately.
- ⚠ Turn the power OFF immediately if smoke, abnormal noise or odors are generated from the unit or motor.
- ⊘ Do not disassemble or repair this product.
- ⚠ Never make modifications.
- ⚠ When an alarm occurs, the machine will start suddenly if an alarm reset (RST) is carried out while an operation start signal (ST) is being input. Always confirm that the operation signal is OFF before carrying out an alarm reset. Failure to do so could lead to accidents or injuries.
- ⚠ Reduce magnetic damage by installing a noise filter. The electronic devices used near the unit could be affected by magnetic noise. Install a line noise filter, etc., if there is a risk of magnetic noise.
- ⚠ Use the unit, motor and regenerative resistor with the designated combination. Failure to do so could lead to fires or trouble.
- ⊘ The brake (magnetic brake) of the servo motor are for holding, and must not be used for normal braking.
- ⚠ There may be cases when holding is not possible due to the magnetic brake's life, the machine construction (when ball screw and servo motor are coupled via a timing belt, etc.) or the magnetic brake's failure. Install a stop device to ensure safety on the machine side.
- ⚠ After changing the programs/parameters or after maintenance and inspection, always test the operation before starting actual operation.
- ⚠ Do not enter the movable range of the machine during automatic operation. Never place body parts near or touch the spindle during rotation.
- ⚠ Follow the power supply specification conditions given in each specification for the power (input voltage, input frequency, etc.).
- ⚠ Set all bits to "0" if they are indicated as not used or empty in the explanation on the bits.
- ⚠ Do not use the dynamic brakes except during the emergency stop. Continued use of the dynamic brakes could result in brake damage.
- ⚠ If a circuit protector for the main circuit power supply is shared by several units, the circuit protector may not activate when a short-circuit fault occurs in a small capacity unit. This is dangerous, so never share the circuit protector.
- ⚠ Mitsubishi spindle motor is dedicated to machine tools. Do not use for other purposes.
- ⚠ This unit is not intended for use in low voltage public networks that supply power to households. Using this unit in such networks may cause radio frequency interference.
- ⚠ Do not use this unit in residential areas.





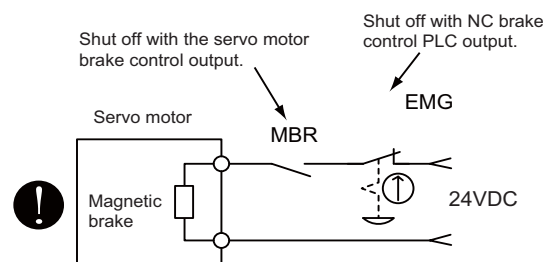

(5) Troubleshooting

- ⚠ If a hazardous situation is predicted during power failure or product trouble, use a servo motor with magnetic brakes or install an external brake mechanism.
- ⚠ Use a double circuit configuration that allows the operation circuit for the magnetic brakes to be operated even by the external emergency stop signal.
- ⚠ Always turn the main circuit power of the motor OFF when an alarm occurs.
- ⚠ If an alarm occurs, remove the cause, and secure the safety before resetting the alarm.







 **CAUTION**



(6) Maintenance, inspection and part replacement

-  Always backup the programs and parameters before starting maintenance or inspections.
-  The capacity of the electrolytic capacitor will drop over time due to self-discharging, etc. To prevent secondary disasters due to failures, replacing this part every five years when used under a normal environment is recommended. Contact the Service Center, Sales Office or dealer for repairs or part replacement.
-  Never perform a megger test (measure the insulation resistance) of the drive unit. Failure to observe this could lead to faults.
-  If the battery low warning is issued, immediately replace the battery. Replace the batteries while applying the drive unit's control power.
-  Do not short circuit, charge, overheat, incinerate or disassemble the battery.
-  For after-purchase servicing of the built-in motor, only the servicing parts for MITSUBISHI encoder can be supplied. For the motor body, prepare the spare parts at the machine tool builders.
-  For maintenance, part replacement, and services in case of failures in the built-in motor (including the encoder), take necessary actions at the machine tool builders. For drive unit, Mitsubishi can offer the after-purchase servicing as with the general drive unit.

(7) Disposal

-  Take the batteries and backlights for LCD, etc., off from the controller, drive unit and motor, and dispose of them as industrial wastes.
-  Do not disassemble the unit or motor.
-  Dispose of the battery according to local laws.
-  Dispose of the primary side of the linear servo motor as industrial waste. For the secondary side, dispose of it as industrial waste after demagnetizing it by heating it to 300°C or higher.
-  When incinerating optical communication cable, hydrogen fluoride gas or hydrogen chloride gas which is corrosive and harmful may be generated. For disposal of optical communication cable, request for specialized industrial waste disposal services that has incineration facility for disposing hydrogen fluoride gas or hydrogen chloride gas.

(8) Transportation

-  The unit and motor are precision parts and must be handled carefully.
-  According to a United Nations Advisory, the battery unit and battery must be transported according to the rules set forth by the International Civil Aviation Organization (ICAO), International Air Transportation Association (IATA), International Maritime Organization (IMO), and United States Department of Transportation (DOT), etc.

(9) General precautions

The drawings given in this manual show the covers and safety partitions, etc., removed to provide a clearer explanation. Always return the covers or partitions to their respective places before starting operation, and always follow the instructions given in this manual.

Treatment of waste

The following two laws will apply when disposing of this product. Considerations must be made to each law. The following laws are in effect in Japan. Thus, when using this product overseas, the local laws will have a priority. If necessary, indicate or notify these laws to the final user of the product.

- (1) Requirements for "Law for Promotion of Effective Utilization of Resources"
 - (a) Recycle as much of this product as possible when finished with use.
 - (b) When recycling, often parts are sorted into steel scraps and electric parts, etc., and sold to scrap contractors. Mitsubishi Electric recommends sorting the product and selling the members to appropriate contractors.
- (2) Requirements for "Law for Treatment of Waste and Cleaning"
 - (a) Mitsubishi Electric recommends recycling and selling the product when no longer needed according to item (1) above. The user should make an effort to reduce waste in this manner.
 - (b) When disposing a product that cannot be resold, it shall be treated as a waste product.
 - (c) The treatment of industrial waste must be commissioned to a licensed industrial waste treatment contractor, and appropriate measures, including a manifest control, must be taken.
 - (d) Batteries correspond to "primary batteries", and must be disposed of according to local disposal laws.

Disposal



(Note) This symbol mark is for EU countries only.
This symbol mark is according to the directive 2006/66/EC Article 20 Information for end-users and Annex II.

Your MITSUBISHI ELECTRIC product is designed and manufactured with high quality materials and components which can be recycled and/or reused.

This symbol means that batteries and accumulators, at their end-of-life, should be disposed of separately from your household waste.

If a chemical symbol is printed beneath the symbol shown above, this chemical symbol means that the battery or accumulator contains a heavy metal at a certain concentration. This will be indicated as follows:

Hg: mercury (0,0005%), Cd: cadmium (0,002%), Pb: lead (0,004%)

In the European Union there are separate collection systems for used batteries and accumulators.

Please, dispose of batteries and accumulators correctly at your local community waste collection/recycling centre.

Please, help us to conserve the environment we live in!

Trademarks

MELDAS, MELSEC, EZSocket, EZMotion, iQ Platform, MELSOFT, GOT, CC-Link, CC-Link/LT and CC-Link IE are either trademarks or registered trademarks of Mitsubishi Electric Corporation in Japan and/or other countries.

Other company and product names that appear in this manual are trademarks or registered trademarks of the respective companies.

本製品の取扱いについて

(日本語 /Japanese)

本製品は工業用(クラス A)電磁環境適合機器です。販売者あるいは使用者はこの点に注意し、住商業環境以外での使用をお願いいたします。

Handling of our product

(English)

This is a class A product. In a domestic environment this product may cause radio interference in which case the user may be required to take adequate measures.

본 제품의 취급에 대해서

(한국어 /Korean)

이 기기는 업무용(A 급) 전자파적합기기로서 판매자 또는 사용자는 이 점을 주의하시기 바라며 가정외의 지역에서 사용하는 것을 목적으로 합니다.

Contents

1 Installation	1
1.1 Installation of Servo Motor	2
1.1.1 Environmental Conditions	2
1.1.2 Quakeproof Level	3
1.1.3 Cautions for Mounting Load (Prevention of Impact on Shaft)	4
1.1.4 Installation Direction	4
1.1.5 Shaft Characteristics	5
1.1.6 Machine Accuracy	6
1.1.7 Coupling with the Load	7
1.1.8 Oil / Water Standards	8
1.1.9 Installation of Servo Motor	11
1.1.10 Cable Stress	12
1.2 Installation of Spindle Motor	13
1.2.1 Environmental Conditions	13
1.2.2 Balancing the Spindle Motor (Unit)	14
1.2.3 Shaft Characteristics	16
1.2.4 Machine Accuracy	16
1.2.5 Coupling with the Fittings	17
1.2.6 Installation of Rotary Joint and Coolant Joint (Hollow Shaft Specifications)	17
1.2.7 Ambient Environment	23
1.2.8 Installation of Spindle Motor	23
1.2.9 Connection	24
1.2.10 Cable	25
1.3 Installation of Tool Spindle Motor	26
1.3.1 Environmental Conditions	26
1.3.2 Shaft Characteristics	26
1.3.3 Installation of Tool Spindle Motor	26
1.4 Installation of the Drive Unit	27
1.4.1 Environmental Conditions	27
1.4.2 Installation Direction and Clearance	28
1.4.3 Prevention of Entering of Foreign Matter	30
1.4.4 Panel Installation Hole Work Drawings (Panel Cut Drawings)	31
1.4.5 Heating Value	33
1.4.6 Heat Radiation Countermeasures	34
1.5 Installation of the Machine End Encoder	37
1.5.1 Spindle Side ABZ Pulse Output Encoder (OSE-1024 Series)	37
1.5.2 Spindle Side PLG Serial Output Encoder (TS5690, MU1606 Series)	38
1.5.3 Twin-head Magnetic Encoder (MBA405W, MBE405W Series)	44
1.6 Noise Measures	48
2 Wiring and Connection	51
2.1 Part System Connection Diagram	53
2.2 Main Circuit Terminal Block/Control Circuit Connector	54
2.2.1 Names and Applications of Main Circuit Terminal Block Signals and Control Circuit Connectors	54
2.2.2 Connector Pin Assignment	55
2.3 NC and Drive Unit Connection	66
2.3.1 Connection of Optical Communication Cables	66
2.3.2 Drive Unit Arrangement	68
2.4 Connecting with Optical Communication Repeater Unit	70
2.5 Motor and Encoder Connection	72
2.5.1 Connection of the Servo Motor	72
2.5.2 Connection of the Full-closed Loop System	77
2.5.3 Connection of the Speed Command Synchronization Control System	79
2.5.4 Connection of the Spindle Motor	81
2.5.5 Connection of Tool Spindle Motor	83
2.6 Connection of Power Supply	86
2.6.1 Power Supply Input Connection	86

2.6.2 Connecting the Grounding Cable.....	88
2.7 Wiring of the Motor Brake	89
2.7.1 Wiring of the Motor Magnetic Brake.....	89
2.7.2 Dynamic Brake Unit Wiring	92
2.8 Peripheral Control Wiring.....	93
2.8.1 Input/Output Circuit Wiring.....	93
2.8.2 Specified Speed Output	95
2.8.3 Spindle Coil Changeover	97
2.8.4 Proximity Switch Orientation	101
3 Safety Function	105
3.1 Safety Function	106
3.1.1 Harmonized Standard	106
3.1.2 Outline of Safety Function.....	106
3.2 Emergency Stop Observation	107
3.3 SLS (Safely Limited Speed) Function	112
3.4 STO (Safe Torque Off) Function.....	116
4 Setup	123
4.1 Initial Setup	124
4.1.1 Setting the Rotary Switch.....	124
4.1.2 Setting DIP Switch	125
4.1.3 Transition of LED Display After Power Is Turned ON	126
4.2 Setting the Initial Parameters for the Servo Drive Unit	127
4.2.1 Setting of Servo Specification Parameters	128
4.2.2 Setting of Machine Side Encoder.....	130
4.2.3 Setting of Distance-coded Reference Scale	136
4.2.4 Setting of Speed Command Synchronous Control	138
4.2.5 List of Standard Parameters for Each Servo Motor	139
4.2.6 Servo Parameters	149
4.3 Setting the Initial Parameters for the Spindle Drive Unit.....	183
4.3.1 Setting of Parameters Related to the Spindle.....	183
4.3.2 List of Standard Parameters for Each Spindle Motor.....	188
4.3.3 Spindle Parameters	219
5 Servo Adjustment	255
5.1 Servo Adjustment Procedure	256
5.2 Gain Adjustment	257
5.2.1 Current Loop Gain	257
5.2.2 Speed Loop Gain.....	258
5.2.3 Position Loop Gain.....	262
5.2.4 OMR-FF Function	265
5.3 Characteristics Improvement	271
5.3.1 Optimal Adjustment of Cycle Time.....	271
5.3.2 Vibration Suppression Measures	274
5.3.3 Improving the Cutting Surface Precision.....	281
5.3.4 Improvement of Characteristics during Acceleration/Deceleration	284
5.3.5 Improvement of Protrusion at Quadrant Changeover	288
5.3.6 Improvement of Overshooting.....	292
5.3.7 Improvement of the Interpolation Control Path	295
5.4 Adjustment during Full Closed Loop Control	297
5.4.1 Outline	297
5.4.2 Speed Loop Delay Compensation	298
5.4.3 Dual Feedback Control	299
5.5 Settings for Emergency Stop	301
5.5.1 Deceleration Control	301
5.5.2 Vertical Axis Drop Prevention Control.....	304
5.5.3 Vertical Axis Pull-up Control	311
5.6 Protective Functions	312
5.6.1 Overload Detection	312
5.6.2 Excessive Error Detection.....	313
5.6.3 Collision Detection Function	314

5.7 Servo Control Signal	318
5.7.1 Servo Control Input (NC to Servo)	318
5.7.2 Servo Control Output (Servo to NC)	321
6 Spindle Adjustment	325
6.1 Adjustment Procedures for Each Control	326
6.1.1 Basic Adjustments	326
6.1.2 Gain Adjustment	327
6.1.3 Adjusting the Acceleration/Deceleration Operation	331
6.1.4 Orientation Adjustment	338
6.1.5 Synchronous Tapping Adjustment	342
6.1.6 High-speed Synchronous Tapping	345
6.1.7 Spindle C Axis Adjustment (For Lathe System)	346
6.1.8 Spindle Synchronization Adjustment (For Lathe System)	351
6.1.9 Deceleration Coil Changeover Valid Function by Emergency Stop	353
6.1.10 High-response Acceleration/Deceleration Function	354
6.1.11 Spindle Cutting Withstand Level Improvement	355
6.1.12 Spindle Motor Temperature Compensation Function	356
6.2 Settings for Emergency Stop	361
6.2.1 Deceleration Control	361
6.3 Spindle Control Signal	362
6.3.1 Spindle Control Input (NC to Spindle)	362
6.3.2 Spindle Control Output (Spindle to NC)	367
7 Troubleshooting	373
7.1 Points of Caution and Confirmation	374
7.1.1 LED Display When Alarm or Warning Occurs	375
7.2 Protective Functions List of Units	376
7.2.1 List of Alarms	376
7.2.2 List of Warnings	382
7.3 Troubleshooting	383
7.3.1 Troubleshooting at Power ON	383
7.3.2 Troubleshooting for Each Alarm No.	384
7.3.3 Troubleshooting for Each Warning No.	409
7.3.4 Parameter Numbers during Initial Parameter Error	412
7.3.5 Troubleshooting the Spindle System When There Is No Alarm or Warning	415
8 Maintenance	417
8.1 Periodic Inspections	418
8.1.1 Inspections	418
8.1.2 Cleaning of Spindle Motor	418
8.2 Service Parts	430
8.3 Adding and Replacing Units and Parts	431
8.3.1 Replacing the Drive Unit	431
8.3.2 Replacing the Unit Fan	432
8.3.3 Replacing the Battery	435
8.3.4 Replacing the Fuse	437
9 Power Backup System	439
9.1 Deceleration and Stop Function at Power Failure	440
9.1.1 Specifications of Stop Method for Deceleration and Stop Function at Power Failure System ...	440
9.1.2 Wiring of Deceleration and Stop Function at Power Failure	441
9.1.3 Setup of Deceleration and Stop Function at Power Failure	442
9.2 Retraction function at power failure	444
9.2.1 Wiring of Retraction Function at Power Failure	444
9.2.2 Setup of Retraction Function at Power Failure System	447
9.3 Explanation of Each Part of Power Backup System	449
9.3.1 How to Set Rotary Switch and Dip Switches	449
9.3.2 Transition of LED Display After Power Is Turned ON	449
9.4 Troubleshooting for Power Backup System	450
9.4.1 LED Display When Alarm or Warning Occurs	450
9.4.2 List of Power Backup Function Alarms	451

9.4.3 List of Power Backup Function Warnings	451
9.4.4 Troubleshooting for Each Alarm No.....	452
9.4.5 Troubleshooting for Each Warning No.....	455
9.4.6 Trouble Shooting at Power ON	456
Appendix 1 Cable and Connector Assembly.....	457
Appendix 1.1 CMV1-xPxxS-xx Plug Connector	458
Appendix 1.2 1747464-1 Plug Connector	464
Appendix 1.2.1 Applicable Products	464
Appendix 1.2.2 Applicable Cable	464
Appendix 1.2.3 Related Documents	464
Appendix 1.2.4 Assembly Procedure.....	464
Appendix 2 D/A Output Specifications for Drive Unit.....	467
Appendix 2.1 D/A Output Specifications	468
Appendix 2.2 Output Data Settings.....	469
Appendix 2.2.1 Servo Drive Unit Settings.....	469
Appendix 2.2.2 Spindle Drive Unit Settings	471
Appendix 2.3 Setting the Output Magnification.....	474
Appendix 2.3.1 Servo Drive Unit Settings.....	474
Appendix 2.3.2 Spindle Drive Unit Settings	475
Appendix 3 Compliance to EC Directives.....	477
Appendix 3.1 Compliance to EC Directives	478
Appendix 3.1.1 European EC Directives.....	478
Appendix 3.1.2 Cautions for EC Directive Compliance.....	478
Appendix 4 EMC Installation Guidelines	483
Appendix 4.1 Introduction	484
Appendix 4.2 EMC Directives/Electromagnetic Compatibility Regulations	484
Appendix 4.3 EMC Measures	485
Appendix 4.4 Measures for Panel Structure	485
Appendix 4.4.1 Measures for Control Panel Unit.....	485
Appendix 4.4.2 Measures for Door	486
Appendix 4.4.3 Measures for Operation Board Panel	486
Appendix 4.4.4 Shielding of the Power Supply Input Section	486
Appendix 4.5 Measures for Various Cables.....	487
Appendix 4.5.1 Measures for Wiring in Panel.....	487
Appendix 4.5.2 Measures for Shield Treatment.....	487
Appendix 4.5.3 Servo/Spindle Motor Power Cable.....	488
Appendix 4.5.4 Servo/Spindle Motor Encoder Cable.....	489
Appendix 4.6 EMC Countermeasure Parts	490
Appendix 4.6.1 Shield Clamp Fitting.....	490
Appendix 4.6.2 Ferrite Core.....	490
Appendix 4.6.3 Power Line Filter.....	492
Appendix 4.6.4 Surge Absorber.....	493
Appendix 5 Higher Harmonic Suppression Measure Guidelines	495
Appendix 5.1 Higher Harmonic Suppression Measure Guidelines	496
Appendix 5.1.1 Calculating the Equivalent Capacity of the Higher Harmonic Generator	497

Outline for MDS-D2/DH2 Series Specifications Manual (IB-1501124-E)

1 Introduction

- 1.1 Servo/Spindle Drive System Configuration
 - 1.1.1 System Configuration
- 1.2 Explanation of Type
 - 1.2.1 Servo Motor Type
 - 1.2.2 Servo Drive Unit Type
 - 1.2.3 Spindle Motor Type
 - 1.2.4 Tool Spindle Motor Type
 - 1.2.5 Spindle Drive Unit Type
 - 1.2.6 Power Supply Unit Type
 - 1.2.7 AC Reactor Type

2 Specifications

- 2.1 Servo Motor
 - 2.1.1 Specifications List
 - 2.1.2 Torque Characteristics
- 2.2 Spindle Motor
 - 2.2.1 Specifications
 - 2.2.2 Output Characteristics
- 2.3 Tool Spindle Motor
 - 2.3.1 Specifications
 - 2.3.2 Output Characteristics
- 2.4 Drive Unit
 - 2.4.1 Installation Environment Conditions
 - 2.4.2 Servo Drive Unit
 - 2.4.3 Spindle Drive Unit
 - 2.4.4 Power Supply Unit
 - 2.4.5 Unit Outline Dimension Drawing
 - 2.4.6 AC Reactor
 - 2.4.7 Explanation of Each Part

3 Function Specifications

- Function Specifications List
- 3.1 Base Control Functions
 - 3.1.1 Full Closed Loop Control
 - 3.1.2 Position Command Synchronous Control
 - 3.1.3 Speed Command Synchronous Control
 - 3.1.4 Distance-coded Reference Position Control
 - 3.1.5 Spindle's Continuous Position Loop Control
 - 3.1.6 Coil Changeover Control
 - 3.1.7 Gear Changeover Control
 - 3.1.8 Orientation Control
 - 3.1.9 Indexing Control
 - 3.1.10 Synchronous Tapping Control
 - 3.1.11 Spindle Synchronous Control
 - 3.1.12 Spindle/C Axis Control
 - 3.1.13 Proximity Switch Orientation Control
 - 3.1.14 Power Regeneration Control
 - 3.1.15 Resistor Regeneration Control
- 3.2 Servo/Spindle Control Functions
 - 3.2.1 Torque Limit Function
 - 3.2.2 Variable Speed Loop Gain Control
 - 3.2.3 Gain Changeover for Synchronous Tapping Control
 - 3.2.4 Speed Loop PID Changeover Control
 - 3.2.5 Disturbance Torque Observer
 - 3.2.6 Smooth High Gain Control (SHG Control)
 - 3.2.7 High-speed Synchronous Tapping Control (OMR-DD Control)
 - 3.2.8 Dual Feedback Control
 - 3.2.9 HAS Control
 - 3.2.10 OMR-FF Control

- 3.2.11 Control Loop Gain Changeover
- 3.2.12 Spindle Output Stabilizing Control
- 3.2.13 High-response Spindle Acceleration/Deceleration Function

3.3 Compensation Control Function

- 3.3.1 Jitter Compensation
- 3.3.2 Notch Filter
- 3.3.3 Adaptive Tracking-type Notch Filter
- 3.3.4 Overshooting Compensation
- 3.3.5 Machine End Compensation Control
- 3.3.6 Lost Motion Compensation Type 2
- 3.3.7 Lost Motion Compensation Type 3
- 3.3.8 Spindle Motor Temperature Compensation Function

3.4 Protection Function

- 3.4.1 Deceleration Control at Emergency Stop
- 3.4.2 Vertical Axis Drop Prevention/Pull-up Control
- 3.4.3 Earth Fault Detection
- 3.4.4 Collision Detection Function
- 3.4.5 SLS (Safely Limited Speed) Function
- 3.4.6 Fan Stop Detection
- 3.4.7 Open-phase Detection
- 3.4.8 Contactor Weld Detection
- 3.4.9 STO (Safe Torque Off) Function
- 3.4.10 Deceleration and Stop Function at Power Failure
- 3.4.11 Retraction Function at Power Failure

3.5 Sequence Functions

- 3.5.1 Contactor Control Function
- 3.5.2 Motor Brake Control Function
- 3.5.3 External Emergency Stop Function
- 3.5.4 Specified Speed Output
- 3.5.5 Quick READY ON Sequence

3.6 Diagnosis Function

- 3.6.1 Monitor Output Function
- 3.6.2 Machine Resonance Frequency Display Function
- 3.6.3 Machine Inertia Display Function
- 3.6.4 Motor Temperature Display Function
- 3.6.5 Load Monitor Output Function
- 3.6.6 Power Supply Diagnosis Display Function

4 Characteristics

- 4.1 Servo Motor
 - 4.1.1 Environmental Conditions
 - 4.1.2 Quakeproof Level
 - 4.1.3 Shaft Characteristics
 - 4.1.4 Machine Accuracy
 - 4.1.5 Oil / Water Standards
 - 4.1.6 Installation of Servo Motor
 - 4.1.7 Overload Protection Characteristics
 - 4.1.8 Magnetic Brake
 - 4.1.9 Dynamic Brake Characteristics
- 4.2 Spindle Motor
 - 4.2.1 Environmental Conditions
 - 4.2.2 Shaft Characteristics
 - 4.2.3 Machine Accuracy
 - 4.2.4 Installation of Spindle Motor
- 4.3 Tool Spindle Motor
 - 4.3.1 Environmental Conditions
 - 4.3.2 Shaft Characteristics
 - 4.3.3 Tool Spindle Temperature Characteristics
 - 4.3.4 Installation of Tool Spindle Motor
- 4.4 Drive Unit
 - 4.4.1 Environmental Conditions
 - 4.4.2 Heating Value

5 Dedicated Options

- 5.1 Servo Options
 - 5.1.1 Dynamic Brake Unit (MDS-D-DBU)
 - 5.1.2 Battery Option (ER6V-C119B, A6BAT, MDS-BT-BOX-36)
 - 5.1.3 Ball Screw Side Encoder (OSA105ET2A, OSA166ET2NA)
 - 5.1.4 Machine Side Encoder
 - 5.1.5 Twin-head Magnetic Encoder (MBA Series)
- 5.2 Spindle Options
 - 5.2.1 Spindle Side ABZ Pulse Output Encoder (OSE-1024 Series)
 - 5.2.2 Spindle Side PLG Serial Output Encoder (TS5690, MU1606 Series)
 - 5.2.3 Twin-head Magnetic Encoder (MBE Series)
 - 5.2.4 Spindle Side Accuracy Serial Output Encoder (ERM280, MPC1 Series)
(Other Manufacturer's Product)
- 5.3 Encoder Interface Unit
 - 5.3.1 Serial Output Interface Unit for ABZ Analog Encoder MDS-B-HR
 - 5.3.2 Serial Signal Division Unit MDS-B-SD
 - 5.3.3 Pulse Output Interface Unit for ABZ Analog Encoder IBV Series
(Other Manufacturer's Product)
 - 5.3.4 Serial Output Interface Unit for ABZ Analog Encoder EIB192M
(Other Manufacturer's Product)
 - 5.3.5 Serial Output Interface Unit for ABZ Analog Encoder EIB392M
(Other Manufacturer's Product)
 - 5.3.6 Serial Output Interface Unit for ABZ Analog Encoder ADB-20J Series
(Other Manufacturer's Product)
- 5.4 Drive Unit Option
 - 5.4.1 Optical Communication Repeater Unit (FCU7-EX022)
 - 5.4.2 DC Connection Bar
 - 5.4.3 Side Protection Cover
 - 5.4.4 Power Backup Unit (MDS-D/DH-PFU)
 - 5.4.5 Regenerative Resistors for Power Backup Unit (R-UNIT-6,7)
 - 5.4.6 Capacitor Unit for Power Backup Unit (MDS-D/DH-CU)
- 5.5 Cables and Connectors
 - 5.5.1 Cable Connection Diagram
 - 5.5.2 List of Cables and Connectors
 - 5.5.3 Optical Communication Cable Specifications

6 Specifications of Peripheral Devices

- 6.1 Selection of Wire
 - 6.1.1 Example of Wires by Unit
- 6.2 Selection of Circuit Protector and Contactor
 - 6.2.1 Selection of Circuit Protector
 - 6.2.2 Selection of Contactor
- 6.3 Selection of Earth Leakage Breaker
- 6.4 Branch-circuit Protection (for Control Power Supply)
 - 6.4.1 Circuit Protector
 - 6.4.2 Fuse Protection
- 6.5 Noise Filter
- 6.6 Surge Absorber

- 6.7 Relay
- 6.8 Selection of Link Connection
 - 6.8.1 Connection of L11 and L21 Link
 - 6.8.2 Connection of L+ and L- Link

7 Selection

- 7.1 Selection of the Servo Motor
 - 7.1.1 Outline
 - 7.1.2 Selection of Servo Motor Capacity
 - 7.1.3 Motor Shaft Conversion Load Torque
 - 7.1.4 Expressions for Load Inertia Calculation
- 7.2 Selection of the Spindle Motor
- 7.3 Selection of the Power Supply Unit
 - 7.3.1 Calculation of Spindle Output
 - 7.3.2 Calculation of Servo Motor Output
 - 7.3.3 Selection of the Power Supply Unit
 - 7.3.4 Required Capacity of Power Supply
 - 7.3.5 Example for Power Supply Unit and Power Supply Facility Capacity
 - 7.3.6 Selection of Regenerative Resistor for Power Backup Unit (R-UNIT-6,7) and Capacitor Unit for Power Backup Unit (MDS-D/DH-CU)

Appendix 1 Cable and Connector Specifications

- Appendix 1.1 Selection of Cable
 - Appendix 1.1.1 Cable Wire and Assembly
- Appendix 1.2 Cable Connection Diagram
 - Appendix 1.2.1 Battery Cable
 - Appendix 1.2.2 Power Supply Communication Cable and Connector
 - Appendix 1.2.3 Optical Communication Repeater Unit Cable
 - Appendix 1.2.4 STO Cable
 - Appendix 1.2.5 Servo / Tool Spindle Encoder Cable
 - Appendix 1.2.6 Brake Cable and Connector
 - Appendix 1.2.7 Spindle Encoder Cable
 - Appendix 1.2.8 Twin-head Magnetic Encoder Cable
- Appendix 1.3 Main Circuit Cable Connection Diagram
- Appendix 1.4 Connector Outline Dimension Drawings
 - Appendix 1.4.1 Connector for Drive Unit
 - Appendix 1.4.2 Connector for Servo and Tool Spindle
 - Appendix 1.4.3 Connector for Spindle
 - Appendix 1.4.4 Power Backup Unit Connector

Appendix 2 Restrictions for Lithium Batteries

- Appendix 2.1 Restriction for Packing
 - Appendix 2.1.1 Target Products
 - Appendix 2.1.2 Handling by User
 - Appendix 2.1.3 Reference
- Appendix 2.2 Products Information Data Sheet (ER Battery)
- Appendix 2.3 Forbiddance of Transporting Lithium Battery by Passenger Aircraft Provided in the Code of Federal Regulation
- Appendix 2.4 California Code of Regulation "Best Management Practices for Perchlorate Materials"
- Appendix 2.5 Restriction Related to EU Battery Directive
 - Appendix 2.5.1 Important Notes
 - Appendix 2.5.2 Information for End-user



For outline dimension drawings, refer to "DRIVE SYSTEM DATA BOOK" (IB-1501142(ENG)) .

Function Specifications List

< Power Supply specification >

Item		MDS-D2-CV	MDS-DH2-CV	MDS-DM2-SPV2/3,SPHV3 built-in converter	MDS-DJ-V1/V2 built-in converter	MDS-DJ-SP/SP2 built-in converter
1 Base control functions	1.14 Power regeneration control	●	●	●	-	-
	1.15 Resistor regeneration control	-	-	-	●	●
4 Protection function	4.6 Fan stop detection	●	●	●	●	●
	4.7 Open-phase detection	●	●	●	-	-
	4.8 Contactor weld detection	●	●	●	●	●
	4.10 Deceleration and stop function at power failure (Note 1)	●	●	-	-	-
	4.11 Retraction function at power failure (Note 2)	●	●	-	-	-
5 Sequence function	5.1 Contactor control function	●	●	●	●	●
	5.3 External emergency stop function	●	●	●	●	●
	5.5 High-speed READY ON sequence	●	●	●	-	-
6 Diagnosis function	6.7 Power supply diagnosis display function	●	●	●	-	-

(Note 1) The power backup unit and resistor unit option are required.

(Note 2) The power backup unit and capacitor unit option are required.

< Servo specification >

Item		MDS-D2-V1/ V2/V3	MDS-DH2-V1/ V2	MDS-DM2- SPV2/3, SPHV3	MDS-DJ-V1	MDS-DJ-V2
1 Base control functions	1.1 Full closed loop control	●	●	●	●	-
	1.2 Position command synchronous control	●	●	●	●	●
	1.3 Speed command synchronous control	● (Note 2)	●	-	-	-
	1.4 Distance-coded reference position control	●	●	●	●	-
2 Servo control function	2.1 Torque limit function (stopper function)	●	●	●	●	●
	2.2 Variable speed loop gain control	●	●	●	●	●
	2.3 Gain changeover for synchronous tapping control	●	●	●	●	●
	2.4 Speed loop PID changeover control	●	●	●	●	●
	2.5 Disturbance torque observer	●	●	●	●	●
	2.6 Smooth High Gain control (SHG control)	●	●	●	●	●
	2.7 High-speed synchronous tapping control (OMR-DD control)	●	●	●	●	●
	2.8 Dual feedback control	●	●	●	●	-
	2.9 HAS control	●	●	●	●	●
	2.10 OMR-FF control	●	●	●	●	●
3 Compensation control function	3.1 Jitter compensation	●	●	●	●	●
	3.2 Notch filter	Variable frequency: 4 Fixed frequency: 1	Variable frequency: 4 Fixed frequency: 1	Variable frequency: 4 Fixed frequency: 1	Variable frequency: 4 Fixed frequency: 1	Variable frequency: 4 Fixed frequency: 1
	3.3 Adaptive tracking-type notch filter	●	●	●	●	●
	3.4 Overshooting compensation	●	●	●	●	●
	3.5 Machine end compensation control	●	●	●	●	●
	3.6 Lost motion compensation type 2	●	●	●	●	●
	3.7 Lost motion compensation type 3	●	●	●	●	●
4 Protection function	4.1 Deceleration control at emergency stop	●	●	●	●	●
	4.2 Vertical axis drop prevention/pull-up control	●	●	●	●	●
	4.3 Earth fault detection	●	●	●	●	●
	4.4 Collision detection function	●	●	●	●	●
	4.5 SLS (Safely Limited Speed) function	●	●	●	●	●
	4.6 Fan stop detection	●	●	●	●	●
	4.9 STO (Safe Torque Off) function	●	●	●	●	●
5 Sequence function	5.2 Motor brake control function (Note 1)	●	●	●	●	●
	5.4 Specified speed output	●	●	●	-	-
	5.5 Quick READY ON sequence	●	●	●	-	-
6 Diagnosis function	6.1 Monitor output function	●	●	●	●	●
	6.2 Machine resonance frequency display function	●	●	●	●	●
	6.3 Machine inertia display function	●	●	●	●	●

(Note 1) For the multiaxis drive unit, a control by each axis is not available.

It is required to turn the servo of all axes OFF in the drive unit in order to enable a motor brake output.

(Note 2) Always set L-axis as primary axis and M-axis as secondary axis for the speed command synchronous control using MDS-D2-V3. Other settings cause the initial parameter error alarm.

< Spindle specifications >

Item		MDS-D2-SP	MDS-DH2-SP	MDS-D2-SP2	MDS-DM2-SPV2/3, SPHV3	MDS-DJ-SP	MDS-DJ-SP2
1 Base control functions	1.1 Full closed loop control	●	●	●	●	●	-
	1.5 Spindle's continuous position loop control	●	●	●	●	●	●
	1.6 Coil changeover control	●	●	-	●	-	-
	1.7 Gear changeover control	●	●	●	●	●	●
	1.8 Orientation control	●	●	●	●	●	●
	1.9 Indexing control	●	●	●	●	●	●
	1.10 Synchronous tapping control	●	●	●	●	●	●
	1.11 Spindle synchronous control	●	●	●	●	●	●
	1.12 Spindle/C axis control	●	●	●	●	●	●
1.13 Proximity switch orientation control	●	●	● (Note)	●	●	● (Note)	
2 Spindle control functions	2.1 Torque limit function	●	●	●	●	●	●
	2.2 Variable speed loop gain control	●	●	●	●	●	●
	2.5 Disturbance torque observer	●	●	●	●	●	●
	2.6 Smooth High Gain control (SHG control)	●	●	●	●	●	●
	2.7 High-speed synchronous tapping control (OMR-DD control)	●	●	●	●	●	●
	2.8 Dual feedback control	●	●	●	●	●	-
	2.11 Control loop gain changeover	●	●	●	●	●	●
	2.12 Spindle output stabilizing control	●	●	●	●	●	●
2.13 High-response spindle acceleration/deceleration function	●	●	●	●	●	●	
3 Compensation control function	3.1 Jitter compensation	●	●	●	●	●	●
	3.2 Notch filter	Variable frequency: 4 Fixed frequency: 1	Variable frequency: 4 Fixed frequency: 1	Variable frequency: 4 Fixed frequency: 1	Variable frequency: 4 Fixed frequency: 1	Variable frequency: 4 Fixed frequency: 1	Variable frequency: 4 Fixed frequency: 1
	3.3 Adaptive tracking-type notch filter	●	●	●	●	●	●
	3.4 Overshooting compensation	●	●	●	●	●	●
	3.6 Lost motion compensation type 2	●	●	●	●	●	●
3.9 Spindle motor temperature compensation function	●	●	●	●	●	●	
4 Protection function	4.1 Deceleration control at emergency stop	●	●	●	●	●	●
	4.3 Earth fault detection	●	●	●	●	●	●
	4.5 SLS (Safely Limited Speed) function	●	●	●	●	●	●
	4.6 Fan stop detection	●	●	●	●	●	●
4.9 STO (Safe Torque Off) function	●	●	●	●	●	●	
5 Sequence functions	5.4 Specified speed output	●	●	●	●	-	-
	5.5 Quick READY ON sequence	●	●	●	●	-	-
6 Diagnosis functions	6.1 Monitor output function	●	●	●	●	●	●
	6.2 Machine resonance frequency display function	●	●	●	●	●	●
	6.3 Machine inertia display function	●	●	●	●	●	●
	6.4 Motor temperature display function	●	●	●	●	●	●
	6.5 Load monitor output function	●	●	●	●	●	●

(Note) As for 2-axis spindle drive unit, setting is available only for one of the axes.



Installation

1.1 Installation of Servo Motor

CAUTION

1. Do not hold the cables, axis or encoder when transporting the motor. Failure to observe this could lead to faults or injuries.
2. Securely fix the motor to the machine. Insufficient fixing could lead to the motor deviating during operation. Failure to observe this could lead to injuries.
3. When coupling to a servo motor shaft end, do not apply an impact by hammering, etc. The encoder could be damaged.
4. Never touch the rotary sections of the motor during operations. Install a cover, etc., on the shaft.
5. Do not apply a load exceeding the tolerable load onto the servo motor shaft. The shaft could break. Failure to observe this could lead to injuries.
6. Do not connect or disconnect any of the connectors while the power is ON.

1.1.1 Environmental Conditions

Environment	Conditions
Ambient temperature	0°C to +40°C (with no freezing)
Ambient humidity	80% RH or less (with no dew condensation)
Storage temperature	-15°C to +70°C (with no freezing)
Storage humidity	90% RH or less (with no dew condensation)
Atmosphere	Indoors (no direct sunlight) No corrosive gas, inflammable gas, oil mist or dust
Altitude	Operation / storage: 1000m or less above sea level Transportation: 10000m or less above sea level

1.1.2 Quakeproof Level

Series	Motor type	Acceleration direction	
		Axis direction (X)	Direction at right angle to axis (Y)
200V series	HF75, 105	24.5m/s ² (2.5G) or less	24.5m/s ² (2.5G) or less
	HF54, 104, 154, 224, 123, 223, 142 HP54, 104, 154, 224		
	HF204, 354, 303, 453, 703, 302 HP204, 354, 454, 704	24.5m/s ² (2.5G) or less	29.4m/s ² (3G) or less
	HF903 HP903, 1103	9.8m/s ² (1G) or less	9.8m/s ² (1G) or less
	HF-KP23, 43, 73	49m/s ² (5G) or less	49m/s ² (5G) or less
400V series	HF-H75, 105	24.5m/s ² (2.5G) or less	24.5m/s ² (2.5G) or less
	HF-H54, 104, 154 HP-H54, 104, 154, 224		
	HF-H204, 354, 453, 703 HP-H204, 354, 454, 704	24.5m/s ² (2.5G) or less	29.4m/s ² (3G) or less
	HF-H903 HP-H903, 1103	9.8m/s ² (1G) or less	9.8m/s ² (1G) or less
	HC-H1502S-S10	9.8m/s ² (1G) or less	9.8m/s ² (1G) or less

The vibration conditions are as shown below.

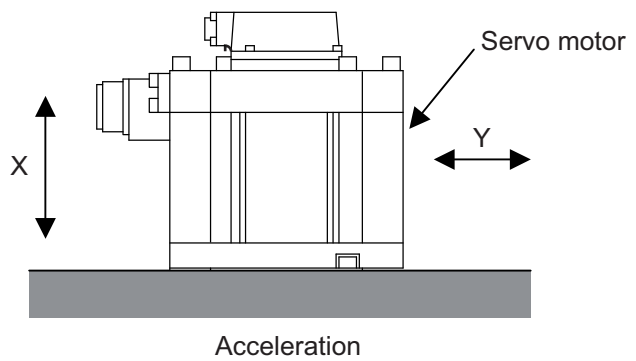
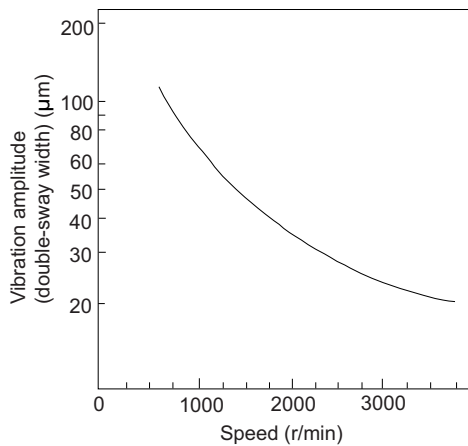

1 Installation

1.1.3 Cautions for Mounting Load (Prevention of Impact on Shaft)

- [1] When using the servo motor with key way, use the screw hole at the end of the shaft to mount the pulley onto the shaft. To install, first place the double-end stud into the shaft screw holes, contact the coupling end surface against the washer, and press in as if tightening with a nut. When the shaft does not have a key way, use a frictional coupling, etc.
- [2] When removing the pulley, use a pulley remover, and make sure not to apply an impact on the shaft.
- [3] Install a protective cover on the rotary sections such as the pulley installed on the shaft to ensure safety.
- [4] The direction of the encoder installed on the servo motor cannot be changed.

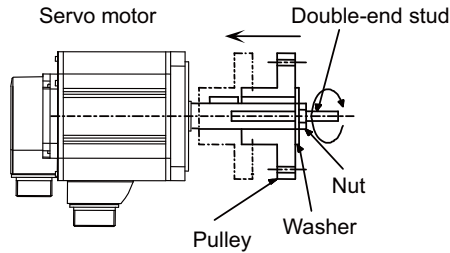

CAUTION

Never hammer the end of the shaft during assembly.

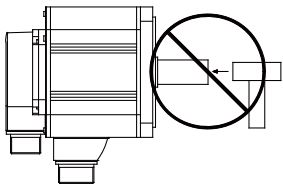

1.1.4 Installation Direction

- [1] There are no restrictions on the installation direction. Installation in any direction is possible, but as a standard the motor is installed so that the motor power line and encoder cable cannot plugs (lead-in wires) face downward. Installation in the standard direction is effective against dripping. Measure to prevent oil and water must be taken when not installing in the standard direction. When the motor is not installed in the standard direction, refer to section "Oil/Water Standards" and take the appropriate measures. The brake plates may make a sliding sound when a servo motor with magnetic brake is installed with the shaft facing upward, but this is not a fault.

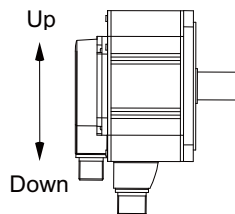

Standard installation direction

1.1.5 Shaft Characteristics

There is a limit to the load that can be applied on the motor shaft. Make sure that the load applied on the radial direction and thrust direction, when mounted on the machine, is below the tolerable values given below. These loads may affect the motor output torque, so consider them when designing the machine.

Series	Servo motor	Tolerable radial load	Tolerable thrust load
200V series	HF75T, 105T (Taper shaft)	245N (L=33)	147N
	HF75S, 105S (Straight shaft)	245N (L=33)	147N
	HF54T, 104T, 154T, 224T, 123T, 223T, 142T (Taper shaft)	392N (L=58)	490N
	HF54S, 104S, 154S, 224S, 123S, 223S, 142S (Straight shaft)	980N (L=55)	490N
	HF204S, 354S, 303S, 453S, 703S, 302S (Straight shaft)	2058N (L=79)	980N
	HF903S (Straight shaft)	2450N (L=85)	980N
	HP54T, 104T, 154T, 224T (Taper shaft)	392N (L=52.7)	490N
	HP54S, 104S, 154S, 224S (Straight shaft)	980N (L=52.7)	490N
	HP204S, 354S, 454S (Straight shaft)	1500N (L=52.7)	490N
	HP704S (Straight shaft)	1300N (L=52.7)	590N
	HP903S (Straight shaft)	2500N (L=52.7)	1100N
	HP1103S (Straight shaft)	2700N (L=52.7)	1500N
	HF-KP23, 43 (Straight shaft)	245N (L=30)	98N
	HF-KP73 (Straight shaft)	392N (L=40)	147N
400V series	HF-H75T, 105T (Taper shaft)	245N (L=33)	147N
	HF-H75S, 105S (Straight shaft)	245N (L=33)	147N
	HF-H54T, 104T, 154T (Taper shaft)	392N (L=58)	490N
	HF-H54S, 104S, 154S (Straight shaft)	980N (L=55)	490N
	HF-H204S, 354S, 453S, 703S (Straight shaft)	2058N (L=79)	980N
	HF-H903S (Straight shaft)	2450N (L=85)	980N
	HP-H54T, 104T, 154T, 224T (Taper shaft)	392N (L=52.7)	490N
	HP-H54S, 104S, 154S, 224S (Straight shaft)	980N (L=52.7)	490N
	HP-H204S, 354S, 454S (Straight shaft)	1500N (L=52.7)	490N
	HP-H704S (Straight shaft)	1300N (L=52.7)	590N
	HP-H903S (Straight shaft)	2500N (L=52.7)	1100N
	HP-H1103S (Straight shaft)	2700N (L=52.7)	1500N
	HC-H1502S-S10 (Straight shaft)	3234N (L=140)	1470N

(Note 1) The tolerable radial load and thrust load in the above table are values applied when each motor is used independently.

(Note 2) The symbol L in the table refers to the value of L below.

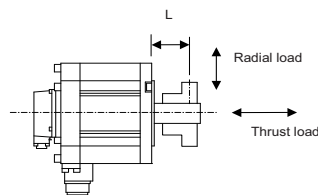

L: Length from flange installation surface to center of load mass [mm]

⚠ CAUTION

1. Use a flexible coupling when connecting with a ball screw, etc., and keep the shaft core deviation to below the tolerable radial load of the shaft.
2. When directly installing the gear on the motor shaft, the radial load increases as the diameter of the gear decreases. This should be carefully considered when designing the machine.
3. When directly installing the pulley on the motor shaft, carefully consider so that the radial load (double the tension) generated from the timing belt tension is less than the values shown in the table above.
4. In machines where thrust loads such as a worm gear are applied, carefully consider providing separate bearings, etc., on the machine side so that loads exceeding the tolerable thrust loads are not applied to the motor.
5. Do not apply the loads exceeding the tolerable level. Failure to observe this may lead to the axis or bearing damage.

1.1.6 Machine Accuracy

Machine accuracy of the servo motor's output shaft and around the installation part is as below.
(Excluding special products)

Accuracy	Measurement point	Flange size [mm]			
		Less than 100 SQ.	100 SQ., 130 SQ.	176 SQ. - 250 SQ.	280 SQ. or over
Run-out of the flange surface to the output shaft	a	0.05mm	0.06mm	0.08mm	0.08mm
Run-out of the flange surface's fitting outer diameter	b	0.04mm	0.04mm	0.06mm	0.08mm
Run-out of the output shaft end	c	0.02mm	0.02mm	0.03mm	0.03mm

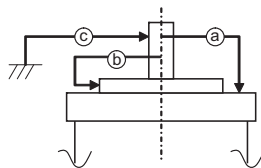

1.1.7 Coupling with the Load

There are several ways to couple the motor shaft and machine, such as direct coupling with flexible coupling or rigid coupling, gear connection, timing belt connection, etc.

Summarized comparison is as follows.

	Noise	No lubrication	Backlash	Rigidity	Reliability in coupling	Life	Torque increased at deceleration	Degree of freedom in motor installation	Cautions in motor installation
Direct coupling with flexible coupling	○	○	○	○	○ Looseness of bolt	○	×	△	Shaft core deviation (In the case of single)
Direct coupling with rigid coupling	○	○	○	○	○ Looseness of bolt	○	×	×	Shaft core deviation Angle deviation
Gear	×	×	△	△	△ Tooth chipping	△	○	○	Backlash too small Pitch diameter too small
Timing belt	△	○	○	×	×	×	○	○	Belt stretched too much Pitch diameter too small

⚠ CAUTION

If the cautions in motor installation in the above table are not observed, the motor will have a broken shaft, or the bearing will have a shorter life. Carry out design and installation adjustment so that the load on the motor shaft will be below the tolerable loads mentioned in "Shaft Characteristics".

(1) Direct coupling - Flexible coupling

When coupling the load directly, a flexible coupling is recommended. The benefits of a flexible coupling are as below.

- (a) Shaft's angle deviation and core deviation can be absorbed to some extent, so adjustment in motor installation is easier.

However, in the case of single, shaft core deviation cannot be allowed, so it is required to design and adjust so that the shaft cores of the motor and ball screw align. Check the specification of the coupling to use. If the shaft core deviation exceeds the coupling's tolerable level, the motor will have a broken shaft, or the bearing will have a shorter life. Thus, in order to simplify the installation adjustment, use a double flexible coupling.

- (b) Less looseness produces less vibration and less noise at the coupling part.

On the other hand, if assembling is loose, lower rigidity may be caused. When using a coupling with lower rigidity, the accuracy in centering the core doesn't have to be high, however, it is undesirable for servo. In order to fully utilize the servo's efficiency to ensure the maximum durability of the equipments, it is required to use a highly rigid coupling, and to fully align the shaft cores in the initial installation. It is also required to select the optimum flexible coupling according to the working conditions, and use it correctly according to the manufacturer's specification manual.

Example of direct coupling with load

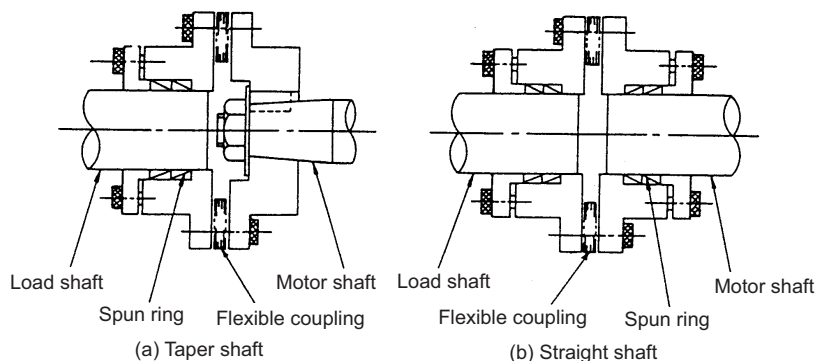

(2) Direct coupling - Rigid coupling

A rigid coupling has benefits such as high rigidity, and relatively lower price. However, shaft core deviation and angle deviation of the motor shaft and ball screw are not allowed, so full attention is required in installing the rigid coupling. Shaft core deviation is desired to be 0.01mm or less. If enough accuracy cannot be ensured, the motor will have a broken shaft, or the bearing will have a shorter life.

In addition, note that a rigid coupling is not acceptable for HF-KP Series servo motors.

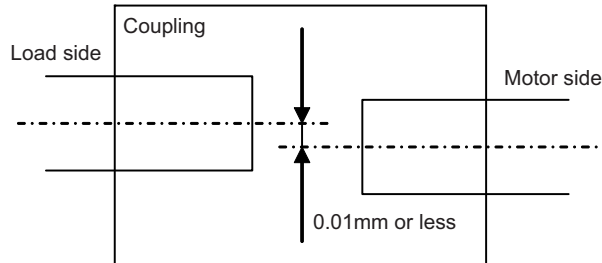

Also note that the motor side ball screw bearing must be locked so that to avoid the thrust load on the motor shaft due to expansion and contraction of the ball screw.

(3) Gear connection

Gear's accuracy and backlash amount greatly affect on the machine's positioning accuracy and noise during operation.

Thus, according to the machine's specification, appropriately select the accuracy and backlash amount.

In gear connection, it is required to take measures against oil to enter the motor.

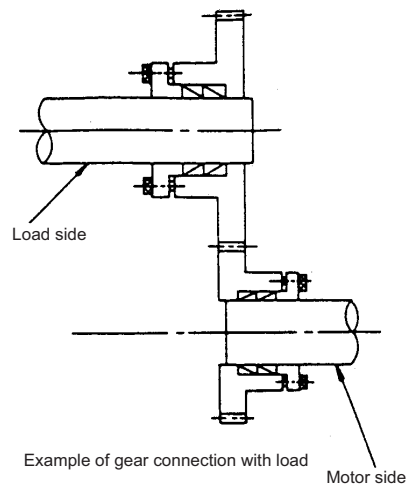

1.1.8 Oil / Water Standards

(1) The motor protective format uses the IP type, which complies with IEC Standard.

However, these Standards are short-term performance specifications. They do not guarantee continuous environmental protection characteristics. Measures such as covers, etc., must be taken if there is any possibility that oil or water will fall on the motor, and the motor will be constantly wet and permeated by water. Note that the motor's IP-type is not indicated as corrosion-resistant.

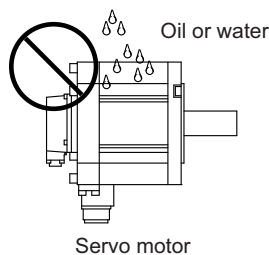

- (2) When a gear box is installed on the servo motor, make sure that the oil level height from the center of the shaft is higher than the values given below. Open a breathing hole on the gear box so that the inner pressure does not rise.

Series	Servo motor	Oil level (mm)
200V series	HF75, 105	15
	HF54, 104, 154, 224, 123, 223, 142	22.5
	HP54, 104, 154, 224	20
	HF204, 354, 303, 453, 302	30
	HP204, 354, 454, 704	25
	HF703	30
	HF903	34
	HP903, 1103	30
	HF-KP23, 43	12.5
	HF-KP73	15
400V series	HF-H75, 105	15
	HF-H54, 104, 154	22.5
	HP-H54, 104, 154, 224	20
	HF-H204, 354, 453	30
	HP-H204, 354, 454, 704	25
	HF-H703	30
	HF-H903	34
	HP-H903, 1103	30
	HC-H1502S-S10	45

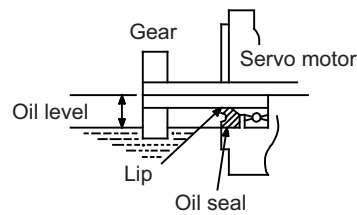

- (3) When installing the servo motor horizontally, set the connector to face downward. When installing vertically or on an inclination, provide a cable trap because the liquid such as oil or water may enter the motor from the connector by running along the cable.

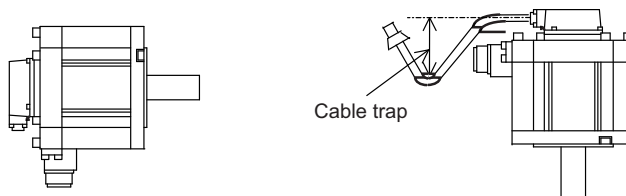

- (4) Do not use the unit with the cable submerged in oil or water.
 (Refer to following drawing.)

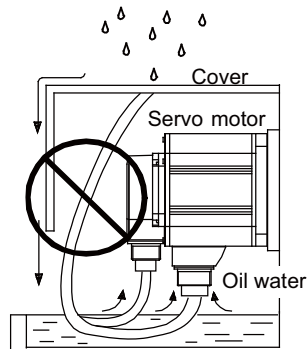

<Fault> Capillary tube phenomenon

- (5) Make sure that oil and water do not flow along the cable into the motor or encoder.
 (Refer to following drawing.)

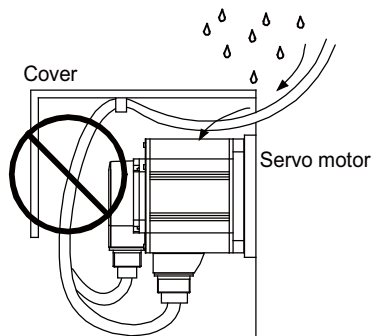

<Fault> Respiration

- (6) When installing on the top of the shaft end, make sure that oil from the gear box, etc., does not enter the servo motor.
 The servo motor does not have a waterproof structure.

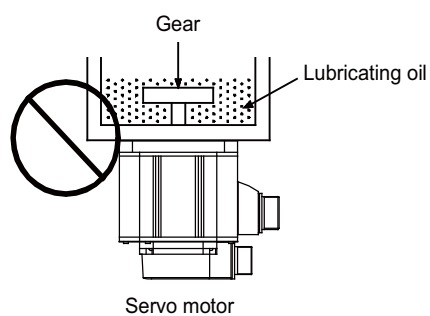

 **CAUTION**

1. The servo motors, including those having IP67 specifications, do not have a completely waterproof (oil-proof) structure. Do not allow oil or water to constantly contact the motor, enter the motor, or accumulate on the motor. Oil can also enter the motor through cutting chip accumulation, so be careful of this also.
2. Oil may enter the motor from the clearance between the cable and connector. Protect with silicon not to make the clearance.
3. When the motor is installed facing upwards, take measures on the machine side so that gear oil, etc., does not flow onto the motor shaft.

1.1.9 Installation of Servo Motor

Mount the servo motor on a flange which has the following size or produces an equivalent or higher heat dissipation effect:

Flange size (mm)	Servo motor capacity
150×150×6	100W
250×250×6	200 to 400W
250×250×12	0.5 to 1.5kW
300×300×20	2.0 to 7.0kW
800×800×35	9.0 to 11.0kW

(Note 1) These flange sizes are recommended dimensions when the flange material is an aluminum.

(Note 2) If enough flange size cannot be ensured, ensure the cooling performance by a cooling fan or operate the motor in the state that the motor overheat alarm does not occur.

1.1.10 Cable Stress

- [1] Sufficiently consider the cable clamping method so that bending stress and the stress from the cable's own weight is not applied on the cable connection part.
- [2] In applications where the servo motor moves, make sure that excessive stress is not applied on the cable. If the encoder cable and servo motor wiring are stored in a cable bear and the servo motor moves, make sure that the cable bending part is within the range of the optional encoder cable. Fix the encoder cable and power cable enclosed with the servo motor.
- [3] Make sure that the cable sheathes will not be cut by sharp cutting chips, worn or stepped on by workers or vehicles.

The bending life of the encoder cable is as shown below. Regard this with a slight allowance. If the servo motor/spindle motor is installed on a machine that moves, make the bending radius as large as possible.

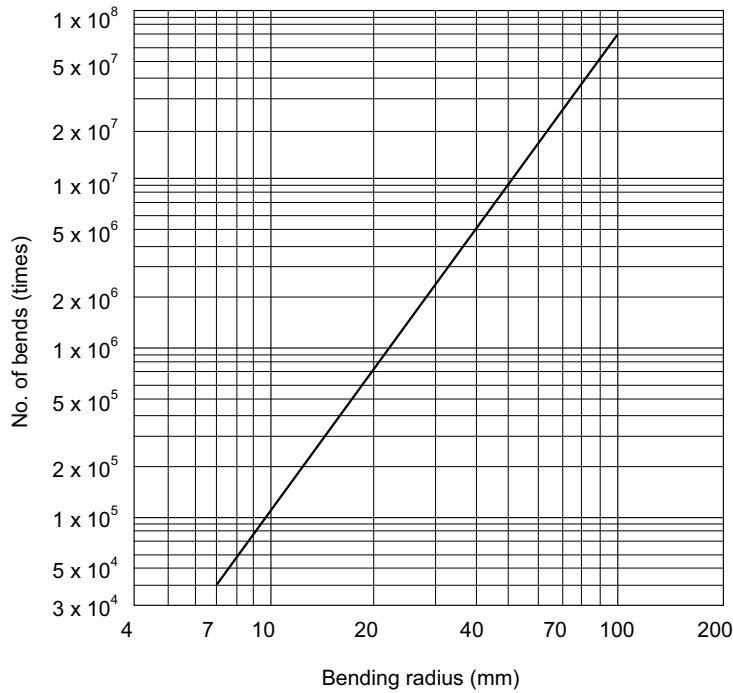

Encoder cable bending life
(Material of Mitsubishi optional encoder cable: A14B2343)

(Note) The values in this graph are calculated values and are not guaranteed.

1.2 Installation of Spindle Motor

CAUTION

1. Do not hold the cables, axis or encoder when transporting the motor. Failure to observe this could lead to faults or injuries.
2. Securely fix the motor to the machine. Insufficient fixing could lead to the motor deviating during operation. Failure to observe this could lead to injuries.
3. When coupling to a motor shaft end, do not apply an impact by hammering, etc. Failure to observe this could lead to motor failures such as the shaft distortion or bearing/encoder damage.
4. Never touch the motor during operations or right after the stop. Install a cover, etc., on the rotary sections.
5. Do not apply a load exceeding the tolerable load onto the servo motor shaft. The shaft could break. Failure to observe this could lead to injuries.
6. Do not connect or disconnect any of the connectors while the power is ON.
7. When coupling the motor directly with the spindle, perform the adequate centering and parallel correcting with the axis to be coupled. The vibration of the motor should be 4.9m/s^2 (0.5G) or less after balancing the spindle unit.
8. Perform a running-in before operating the machine.

1.2.1 Environmental Conditions

Environment	Conditions
Ambient temperature	0°C to +40°C (with no freezing)
Ambient humidity	90%RH or less (with no dew condensation)
Storage temperature	-20°C to +65°C (with no freezing)
Storage humidity	90%RH or less (with no dew condensation)
Atmosphere	Indoors (Where unit is not subject to direct sunlight) No corrosive gases, flammable gases, oil mist or dust
Altitude	Operation/storage: 1000m or less above sea level Transportation: 10000m or less above sea level
Vibration	X: 29.4m/s^2 (3G) Y: 29.4m/s^2 (3G)

1.2.2 Balancing the Spindle Motor (Unit)

When a spindle motor is driven at a high speed with unbalance generated on the rotor, the whirling load is generated and the load to the motor's internal bearings is increased. Thus abnormal vibration, and/or damages known as fretting or flaking occurs to the bearings, which may result in shorter bearing life. Therefore, it is important to balance the rotation so that great vibration does not occur during rotation at high speed.

When balancing the spindle motor, perform to the entire rotational objects including the gear, pulley, coupling, etc. that are attached directly on the motor shaft. Provide a balancing mechanism including screw holes on the fittings while measuring the vibration so that the vibration is suppressed to the specified level or lower during high speed rotation.

(1) Fittings for the motor shaft

When you select fittings for the motor shaft, such as a gear, pulley, and coupling, choose those that meet the motor specifications (shaft diameter, rotation speed and output torque).

⚠ CAUTION

1. We consider key-less shaft as standard in order to simplify balancing procedure of such as gear, pulley, and coupling. We recommend you to choose a gear, pulley and coupling that have a fully symmetric shape, and arrange screw holes on their end faces at short and equal intervals in the circumferential direction.
2. Use a fastener such as a shaft lock element to fix those fittings to the motor shaft.
3. When you attach fittings to the motor shaft, be careful not to apply excessive impact by striking with a hammer, etc. This may cause the shaft distortion and bearing damage.
4. When using screws for balancing, apply thread locker on the screws after balancing.

(2) How to measure the unbalance

After attaching the fittings such as gear, pulley, and coupling, carry out no-load operation, and use an accelerometer or vibrometer compatible with frequency analysis to confirm the vibration on the points as illustrated below (on the brackets where the bearings are stored).

Make sure to place the motor on a cushioning mat to avoid vibration to the spindle from external sources during measurement. Reaction torque is generated when accelerating/decelerating the motor, so securely fix the motor with a belt, etc. to avoid rolling during measurement.

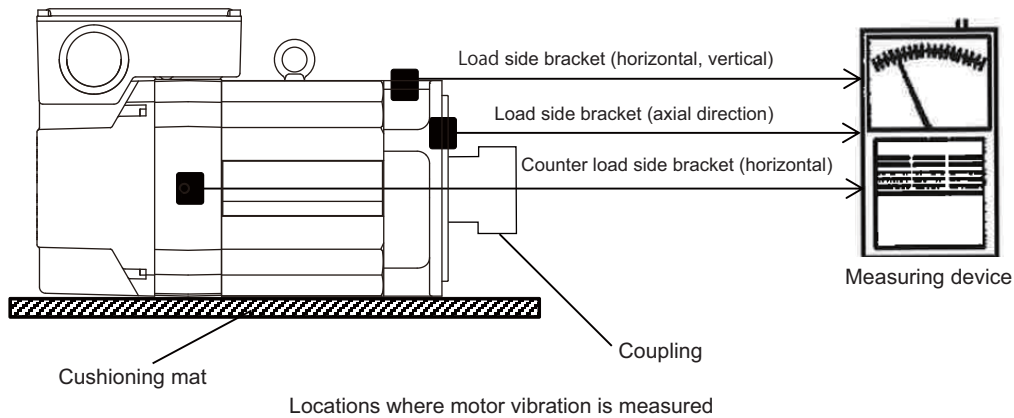

⚠ CAUTION

1. Make sure to place the motor on a cushioning mat to avoid resonance with surrounding devices during measurement.
2. Always secure the spindle motor body with a belt, etc. because it may roll due to the reaction torque generated during acceleration/deceleration operation.

(3) How to balance the rotation

Find out the rotation speed at which the vibration reaches the maximum, within the actual rotation speed range of the spindle motor. Run the motor at the speed found above and perform balancing to minimize the vibration. When balancing is decided, measure the vibration at different rotation speeds and make a further fine adjustment so that the vibration acceleration generated is always 0.5G (4.9m/s²) or less.

(The vibration acceleration of 0.5G is about 4.7 μ m when expressed in terms of the amplitude at the rotation speed of 10,000r/min. The higher the rotation speed is, the smaller the corresponding amplitude becomes.)

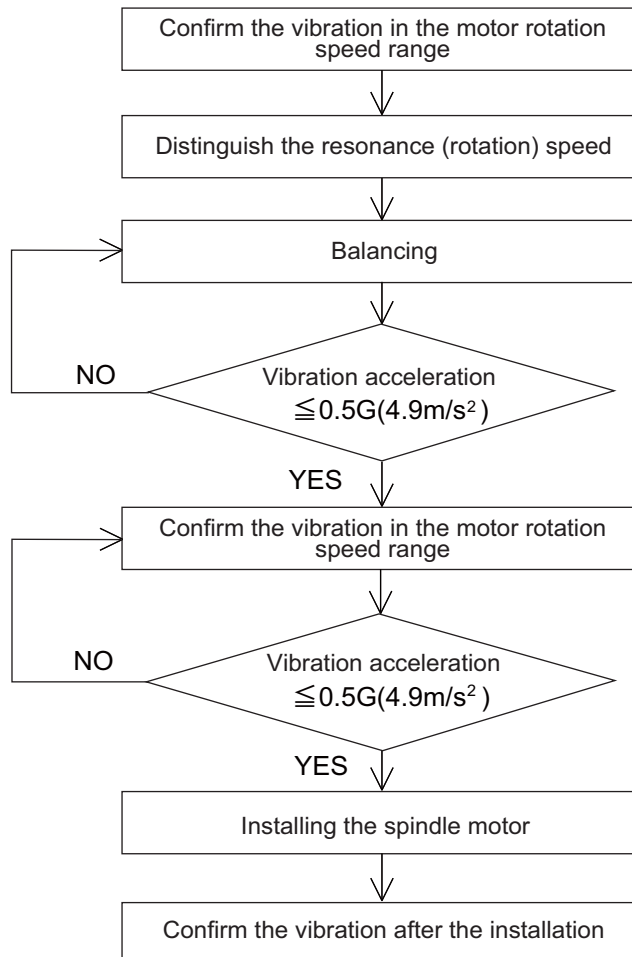

1.2.3 Shaft Characteristics

There is a limit to the load that can be applied on the motor shaft. Make sure that the load applied on the radial direction, when mounted on the machine, is below the tolerable values given below. These loads may affect the motor output torque, so consider them when designing the machine.

Series	Spindle motor	Tolerable radial load
200V series	SJ-VL11-05FZT-S01	98N
	SJ-VL2.2-02ZT	196N
	SJ-DL5.5/150-01T, SJ-DL5.5/200-01T, SJ-V3.7-02ZT, SJ-VL11-02FZT, SJ-VL18.5-05FZT	245N
	SJ-DL0.75/100-01T, SJ-DL1.5/100-01T	490N
	SJ-D3.7/100-01, SJ-D5.5/120-02, SJ-DJ5.5/100-01, SJ-DJ5.5/120-01, SJ-DL7.5/150-01T, SJ-V2.2-01T, SJ-V7.5-03ZT	980N
	SJ-D5.5/100-01, SJ-D5.5/120-01, SJ-DJ7.5/100-01, SJ-DJ7.5/120-01	1470N
	SJ-D7.5/100-01, SJ-D7.5/120-01, SJ-D11/100-01, SJ-DJ11/100-01, SJ-DJ15/80-01, SJ-V11-08ZT, SJ-V11-13ZT, SJ-V11-01T	1960N
	SJ-V22-06ZT	2450N
	SJ-V15-01ZT, SJ-V15-09ZT, SJ-V18.5-01ZT, SJ-V18.5-04ZT, SJ-V22-01ZT, SJ-V22-04ZT, SJ-V26-01ZT, SJ-V11-09T, SJ-V15-03T, SJ-V18.5-03T, SJ-V22-05T	2940N
	SJ-V37-01ZT, SJ-V45-01ZT, SJ-V22-09T, SJ-VK22-19ZT	3920N
	SJ-V55-01ZT	5880N
	400V series	SJ-4-V2.2-03T, SJ-4-V3.7-03T, SJ-4-V7.5-13ZT
SJ-4-V5.5-07T		1470N
SJ-4-V7.5-12T, SJ-4-V11-18T		1960N
SJ-4-V26-08ZT		2450N
SJ-4-V18.5-14T, SJ-4-V22-15T, SJ-4-V22-18ZT, SJ-4-V15-20T, SJ-4-V22-16T		2940N
SJ-4-V37-04ZT, SJ-4-V45-02T		3920N
SJ-4-V55-03T		5880N

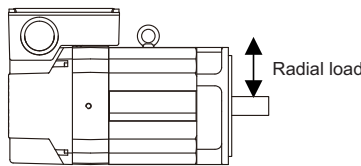

(Note) The load point is at the one-half of the shaft length.

CAUTION

Consider on the machine side so that the thrust loads are not applied to the spindle motor.

1.2.4 Machine Accuracy

Machine accuracy of the spindle motor's output shaft and around the installation part is as below.
(Excluding special products)

Accuracy	Measurement point	Frame No.	
		A71, B71, A90, B90, C90, D90, E90, A112, B112	A160, B160, C160, A180, B180, A225
Run-out of the flange surface to the output shaft	a	0.03mm	0.05mm
Run-out of the flange surface's fitting outer diameter	b	0.02mm	0.04mm
Run-out of the output shaft end	c	0.01mm	0.02mm

(Note) Refer to Specifications Manual for the frame number of each spindle motor.

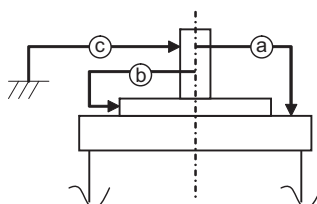

1.2.5 Coupling with the Fittings

- [1] We recommend you to adjust the dynamic balance (field balance) before fastening a belt.
- [2] The position deviation in the axial direction between the motor pulley and spindle side pulley should be as small as possible and perform parallel correcting carefully.
- [3] If the selection or tension of belt is incorrect, an excessive force is applied to the shaft end and bearings, which may result in shorter life or damages.
- [4] When the load by the belt exceeds the tolerable radial load of the motor, reselect the motor or belt/pulley.
- [5] Use an appropriate tension gauge to measure a belt tension.

1.2.6 Installation of Rotary Joint and Coolant Joint (Hollow Shaft Specifications)

Attach the fittings such as pulley, gear, coupling, and coolant joint to the motor output shaft when connecting a spindle motor to a spindle. The incorrect selection of fittings or inadequate installation accuracy can generate abnormal vibration or noise at the coupling. It can also shorten the motor or bearing life, and can damage them (fretting or flaking). Contact the manufacturer with any questions regarding the fittings mentioned above.

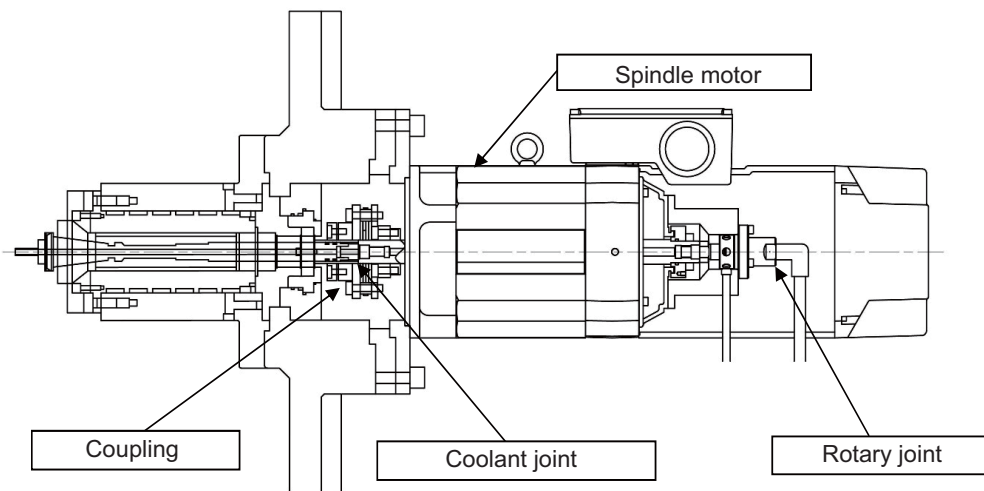

< Reference > Bearing damage

Fretting:

Fretting occurs when contact surfaces produce abrasive red-rust powders, which wear contact surfaces and make small dimples on them. If fretting occurs on the raceway surfaces, dimples are made in the rolling element pitch. Adding vibration load on the contact parts generates a small amplitude oscillation, which forces out lubrication from those parts until there is no lubrication, resulting in significant wear.

Flaking:

Flaking occurs when small pieces of bearing raceway surfaces peel off due to rotation fatigue. It may occur in an early stage due to an excessive load, handling fault, inadequate accuracy of shaft or housing, or a load application by incorrect installation.

(1) Rotary joint**(a) Installation**

Rotary joints are used to supply/exhaust high pressure fluid or liquid which is equal to or lower than the atmospheric pressure from the fixed pipe to rotary parts of each mechanical device with no leakage. When attaching a separate external-support type rotary joint to the shaft rear end, structure the rotary joint so that cutting fluid (drain), which is generated when switching ON/OFF the coolant pressure, does not enter inside of the motor.

- (i) Provide notches or drain so that the cutting fluid (drain) that has entered the rotary joint housing will not accumulate.
- (ii) A rotary joint is a consumable part. Check and replace regularly.
- (iii) Many notches must be provided on the housing as a large amount of cutting fluid may leak if the rotary joint is damaged.
- (iv) If the motor is used vertically facing down, enhance the drain using parts such as an air purge.

(b) Recommended models of rotary joint

The tables below show the recommended models manufactured by Deublin and Rix. The target models are designed to have these rotary joints attached to the shaft rear end. Contact the manufacturer for details of rotary joint.

< Deublin >

Screw size	Inner diameter of shaft end	Coolnat	
		Oil mist	
M16×1.5 (Left-handed screw)	Φ18	1121-400-345 (Note 1) (Note 2)	1124-036-301 (Note 1) (Note 3)
M12×1.25 (Left-handed screw)	Φ14	1121-400-327 (Note 1) (Note 2)	1124-400-327 (Note 1) (Note 3)

(Note 1) Housing both for straight and angle is also available.

(Note 2) Air service with dry running is not available during rotation.

(Note 3) Air service with dry running is also available during rotation.

Contact: Deublin Japan Limited

2-13-1 Minamihanayashiki Kawanishi City, Hyogo, 666-0026 Japan

TEL: 072-757-0099 / FAX: 072-757-0120

< Rix >

Screw size	Inner diameter of shaft end	Coolnat	
		Oil mist	
M16×1.5 (Left-handed screw)	Φ18	ESX20M-E016 (Note)	ESX20V-E016
M12×1.25 (Left-handed screw)	Φ14	ESX20M-E012 (Note)	ESX20V-E012

(Note) Available only during rotation and with no pressure (Available during rotation without liquid)

Contact: Rix Corporation

Production Headquarter Product Division

1321-7 Ueki, Kasuyagun Suemachi, Fukuoka 811-2112 Japan

TEL: 092-935-8773 / FAX: 029-936-2815

(2) Coolant joint

(a) Thrust load of through coolant

When spindle through coolant is used, the thrust load works between the spindle and the motor at the position A, and between the motor and the rotary joint at the position B in the figure below. Setting the diameter of the pressured area of the coolant joint attached to the end of the motor shaft appropriately makes the thrust load at the position B slightly larger than at the position A, which is effective for coolant pump pulsation.

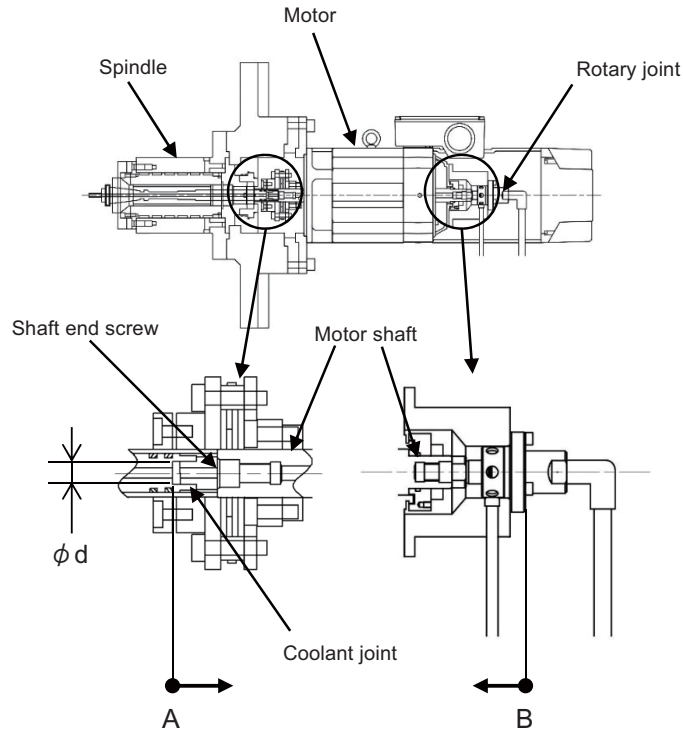

(b) d (the diameter of the pressured area of the coolant joint)

The following are the recommended diameters of the pressured area of the coolant joint installed at the end of the motor shaft.

(Note) Effective when the coolant pressure is 6.8MPa or less (Contact the manufacturer if it exceeds 6.8MPa)

Screw size of shaft head	Company	Rotary joint	Φd (diameter of the pressured area of the coolant joint) (Note)
M16	Deublin	1121-400-345	$\Phi 12.0$
		1124-036-301	$\Phi 10.0$
	Rix	ESX20M-E016 ESX20V-E016	$\Phi 11.7$
M12	Deublin	1121-400-327	$\Phi 12.5$
		1124-400-327	$\Phi 10.5$
	Rix	ESX20M-E012 ESX20V-E012	$\Phi 12.2$

(Note) Without a coolant joint, the thrust load is applied to the motor side by coolant pressure. An excessive thrust load on the spindle motor may lead to abnormal noise or vibration, or shorten the motor life. We recommend using an appropriate coolant joint.

(c) Installation of coolant joint

Install the coolant joint to the motor shaft end so that it stops at the shaft edge. Stopping the coolant joint at the edge of the inner diameter or at the screw bottom may generate an excessive radial runout, which may generate abnormal noise or vibration.

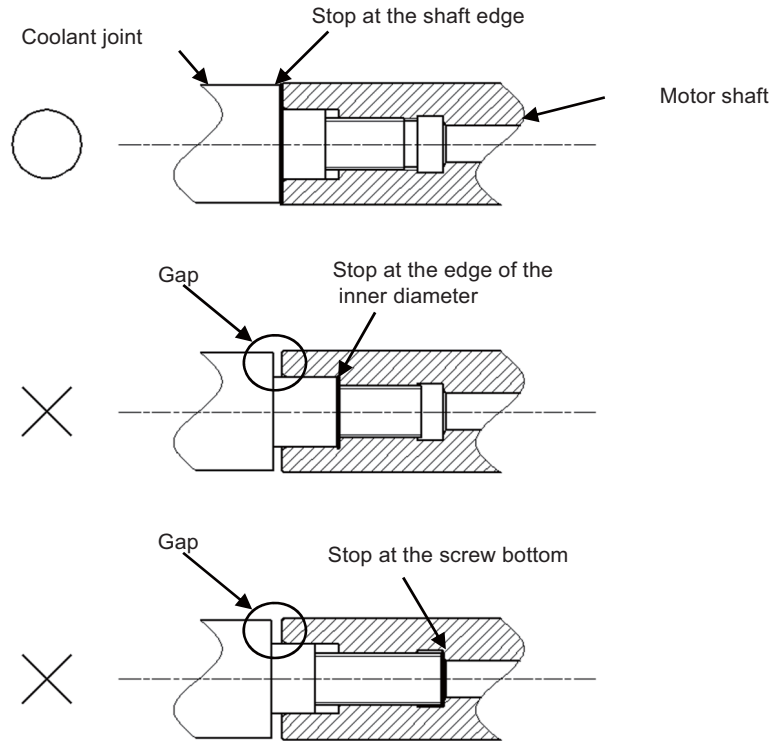

(3) Coupling

(a) Caution when selecting coupling

Always use a flexible coupling for coupling the spindle and the motor. The flexible coupling is flexible enough to absorb a certain level of radial runout and parallel offset. The flexible coupling has tolerable values for three degrees of freedom (parallel offset, angular misalignment, and axial movement), which realizes a low-vibration and low-noise coupling up to high-speed rotation.

- Tolerable values of parallel offset and angular misalignment:

Absorbs minor misalignments or declinations that were not resolved during alignment.

- Tolerable value of axial movement:

Absorbs elongation of the spindle and motor shaft due to thermal expansion.

(These tolerable values are the standard values for which the coupling does not break. They are not the standard values for which the load is not applied to the spindle or the motor bearing. Thus, in order to rotate up to high-speed with low-vibration and low-noise, the spindle and the motor shaft must be aligned.)

(b) Recommended model of coupling

The table below shows the recommended models manufactured by Miki Pulley and Eagle Industry.

Company	Product name (or Series)	Contact
Miki Pulley	SERVO FLEX	https://www.mikipulley.co.jp/EN/
Eagle Industry	Diaphragm	https://www.ekkeagle.com/en/

(Note) The diaphragm coupling in the table above absorbs the misalignment of the rotary axis with the elastic deformation of the extremely thin metal diaphragm. In addition, there are the features as light weight, no lubrication and high torsional stiffness, so it is recommended as a coupling of a high-speed motor.

(c) Installation of coupling

The following describes how to install a coupling using a product by Miki Pulley. Contact the manufacturer for details of cautions and confirmation.

- (i) Make sure that the pressure bolts of the coupling are loosened, and remove rust, dirt, and grease, etc. from the shaft and the inner diameter part of the coupling. (Grease should be wiped away with a cloth, etc., or by degreasing as required.)
- (ii) When inserting the coupling into the motor shaft, make sure that no excessive force such as compression, tension, etc. is applied to the element.
- (iii) Make sure that the insertion length of the coupling into the motor shaft is kept in the position where the target shaft is in contact with the entire length of the flange of the coupling (LF dimension) as illustrated below. (For the variation of models and the length of LF of each model, contact the manufacturer.)

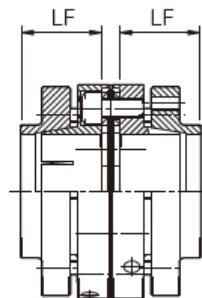

- (iv) Tighten the pressure bolts lightly diagonally by using a bore for rotation prevention.
- (v) Apply a dial gauge to the flange edge or outer diameter of the motor side. While rotating the motor shaft lightly by hand, perform hammer adjustment on the flange periphery and edge so that the radial runout will be reduced to as close as zero.

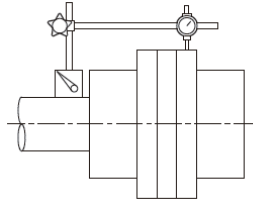

- (vi) While performing hammer adjustment, tighten the pressure bolts in sequence. Finally, use a calibrated torque wrench and tighten all the pressure bolts at the appropriate tightening torque as shown in the table below. Also, refer to the following drawing for the sequence to tighten the pressure bolts, and make sure that the bolts are tightened equally.

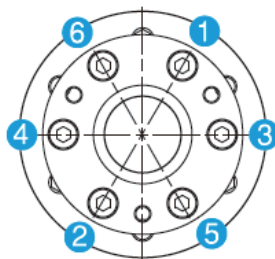

Pressure bolt size	Tightening torque (N•m)
M6	14
M8	34

- (vii) Confirm that the pressure bolts of the motor shaft side are tightened to the specified torque and the value of radial runout is small enough.
- (viii) Install the motor mounted with coupling to the machine. At this time, adjust the motor mounting position (inlay) while inserting the coupling into the spindle or feed screw. Check that there is no deformation of the plate spring. Also check that the insertion length of the mating shaft is kept in the position where the target shaft is in contact with the entire length of the flange of the coupling (LF dimension).

- (ix) The space between flange hubs (S) must be within the permissible error of the axial movement for the standard value. Note that the allowable value assumes that parallel offset and angular misalignment are 0 (zero). Adjust them to achieve values as small as possible. (For the standard value of the S dimension of each model, contact the manufacturer.)

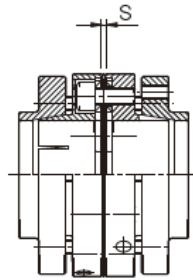

- (x) As in the sequence for the pressure bolts on the motor shaft side, sequentially tighten the pressure bolts on the spindle side or the feed screw side. Finally, tighten the bolts at the appropriate tightening torque.
- (xi) As a countermeasure against initial loosening of the pressure bolts, it is recommended to additionally tighten the bolts with the appropriate tightening torque after a certain period of operation.

CAUTION

1. Select a coupling that the thrust load will not work on the motor shaft due to a rise of temperature, during cutting, or due to the coolant pressure, etc.
2. Do not hit the coupling with a tool such as a hammer when installing it to the motor shaft so that the impact load will not be applied to the bearing.
3. Do not rely on the flexibility of the coupling only. Make sure to perform alignment also. If the motor rotates with a parallel offset, the bearing may be damaged by fretting wear etc. in a short amount of time.
4. When the motor shaft and the spindle are joined by a coupling, the motor shaft may stay pushed inside the motor. Confirm that the distance from the surface to install the housing to support the rotary joint to the rear end of the flinger is kept the same before and after inserting the coupling.

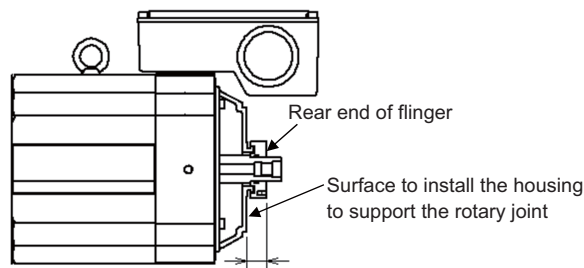

1.2.7 Ambient Environment

If you continue to use the spindle motor with dirt such as oil mist and dust adhered, its cooling performance degrades and the motor is unable to fully exercise its performance, which may cause the spindle motor overheat alarm. In some cases this may result in damage to the bearing or cooling fan. Use a filter, etc. to protect the motor from oil mist and dust.

1.2.8 Installation of Spindle Motor

Make sure that the spindle motor is installed so that the motor shaft points from downward to 90° as shown below. When installing upward more than 90°, contact your Mitsubishi Electric dealer.

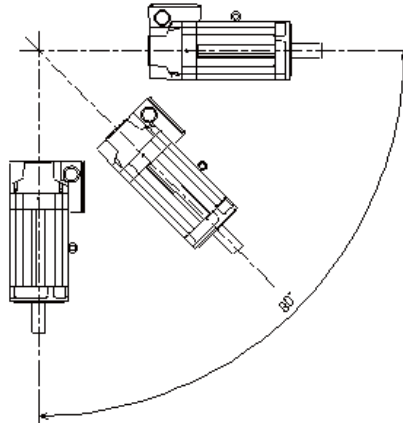

CAUTION

1. Rubber packing for waterproof is attached on the inner surface of the top cover of terminal block, and on the fan lead. After checking that the packing is installed, install the top cover so that no foreign objects are stuck in between.
2. When installing a motor on a flange, chamfer(C1) the part of flange that touches inside low part of the motor.

To yield good cooling performance, provide a space of at least 30mm between the cooling fan and wall. If the motor is covered by a structure and the air is not exchanged, its cooling performance degrades and the motor is unable to fully exercise its performance, which may cause the spindle motor overheat alarm. Do not use the spindle motor in an enclosed space with little ventilation.

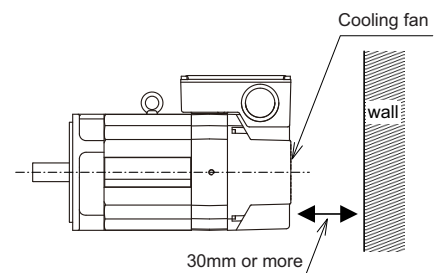

1.2.9 Connection

(1) Cable wiring

When connecting the power line to the terminal block, tighten the screws with proper torque as shown below.

Screw size	Proper torque [N·m]
M4	2.0
M5	2.5
M6	3.0
M8	10.0

CAUTION

1. When connecting the power line to the terminal block, tighten the screws with proper torque described in this section.
2. Make sure to connect the terminal to the terminal block. If running the motor with the terminal loosened, fires could be caused by motor overheat, and earth fault, short circuit and electric shocks could be caused by disconnection of the terminal.
3. To keep the insulation distance, always cover crimp terminals with insulation tubes when connecting crimp terminals at the end of the power line.

(2) Connection of conduit connector

When installing a connector to a terminal box, select a water proof connector with rubber packing and prevent conductive foreign matter and other combustible foreign matter from entering through the wiring hole on the terminal box.

Use a smaller nut than the following size to fix the connector on the terminal box.

For the wiring hole diameter, refer to "DRIVE SYSTEM DATA BOOK (IB-1501142(ENG))".

Prepare a bushing, nut, and O-ring when using a connector smaller than the wiring hole on the terminal box.

SJ-V/SJ-VL/SJ-PMF/SJ-4-V Series

Wiring hole diameter [mm]	Outer diameter [mm]
Φ35	Φ58
Φ44	Φ58
Φ51	Φ93
Φ61	Φ93
Φ63	Φ93

SJ-D/SJ-DJ Series

Wiring hole diameter [mm]	Outer diameter [mm]
Φ44	Φ56

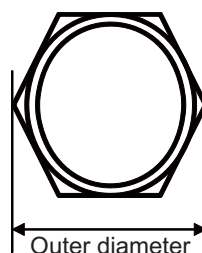

Connection method to a screwless terminal block for fan motor

- (1) Lead-out length
Strip the sheath of the cable in the range of 8 to 9mm with an appropriate tool.
Applicable cable size: 0.08mm² to 2.5mm² (28AWG to 12AWG)
- (2) Tool
Use a flat-blade screwdriver whose blade edge size is 0.6×3.5mm for connecting.
- (3) Work procedure
 - (a) Insert the edge of screwdriver into the insertion point (small square hole) in a diagonal direction. When the spring touches the blade edge, push the screwdriver down to the position that hits a conductive plate, tilting it in the inside direction of terminal block. In this state, the spring is completely opened and the screwdriver is held to the terminal block. Make sure that the screwdriver is completely held, not to create difficulties in inserting the cable for the next procedure.
 - (b) Check the stripped length of cable (8 to 9mm) and insert the cable end slowly along the outside of the insertion point (big square hole) as far as it will go, not to unravel wires. Make sure not to push thin cables too much.
 - (c) Release the screwdriver while holding one hand against the inserted cable. The spring will be closed and the cable will be connected.
 - (d) Gently pull the cable to make sure the connection. No need for a strong pull.

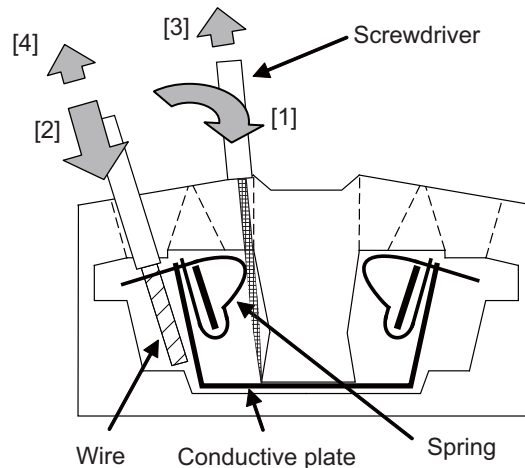
**⚠ CAUTION**

1. Connection of a cable is restricted to one to one spring.
2. For connecting a cable, both twisted wire and solid wire can be used as it is without termination after the sheath has been stripped. The cable attached with bar terminal can also be connected.

1.2.10 Cable

- [1] Do not apply the bending stress and the stress from the cable's own weight on the cable connection part.
- [2] Make sure that the cable sheathes will not be cut by sharp cutting chips, worn or stepped on by workers or vehicles.
- [3] Provide a cable trap because the liquid such as oil or water may enter the motor from the connector by running along the cable.

1.3 Installation of Tool Spindle Motor

1.3.1 Environmental Conditions

Environment	Conditions
Ambient temperature	0°C to +40°C (with no freezing)
Ambient humidity	80% RH or less (with no dew condensation)
Storage temperature	-15°C to +70°C (with no freezing)
Storage humidity	90% RH or less (with no dew condensation)
Atmosphere	Indoors (no direct sunlight) No corrosive gas, inflammable gas, oil mist or dust
Altitude	Operation/storage: 1000m or less above sea level Transportation: 10000m or less above sea level
Vibration	X:19.6m/s ² (2G) Y:19.6m/s ² (2G)

1.3.2 Shaft Characteristics

There is a limit to the load that can be applied on the motor shaft. Make sure that the load applied on the radial direction, when mounted on the machine, is below the tolerable values given below. These loads may affect the motor output torque, so consider them when designing the machine.

Tool spindle motor	Tolerable radial load	Tolerable thrust load
HF-KP46, 56	245N (L=30)	98N
HF-KP96	392N (L=40)	147N
HF-SP226, 406	980N(L=55)	490N
HF75S, 105S	245N (L=33)	147N
HF54S, 104S, 154S, 224S	980N (L=55)	490N
HF204S, 354S,453S,703S	2058N (L=79)	980N
HF903S	2450(L=85)	980N

(Note 1) The tolerable radial load and thrust load in the above table are values applied when each motor is used independently.

(Note 2) The symbol L in the table refers to the value of L below.

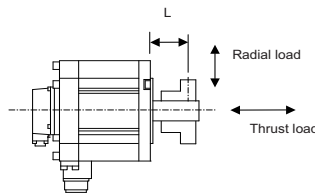

L: Length from flange installation surface to center of load mass [mm]

1.3.3 Installation of Tool Spindle Motor

Mount the servo motor on a flange which has the following size or produces an equivalent or higher heat dissipation effect:

Flange size (mm)	Tool spindle motor capacity
250×250×6	400W
250×250×12	0.5 to 1.5kW
300×300×20	2.0 to 3.0kW
800×800×35	9.0kW

1.4 Installation of the Drive Unit

CAUTION

1. Install the unit on noncombustible material. Direct installation on combustible material or near combustible materials may lead to fires.
2. Follow the instructions in this manual and install the unit while allowing for the unit mass.
3. Do not get on top of the units or motor, or place heavy objects on the unit.
Failure to observe this could lead to injuries.
4. Always use the unit within the designated environment conditions.
5. Do not let conductive objects such as screws or metal chips, etc., or combustible materials such as oil enter the units.
6. Do not block the units intake and outtake ports. Doing so could lead to failure.
7. The units and servo motor are precision devices, so do not drop them or apply strong impacts to them.
8. Do not install or run units or servo motor that is damaged or missing parts.
9. When storing for a long time, please contact your dealer.
10. Always observe the installation directions. Failure to observe this could lead to faults.
11. Secure the specified distance between the units and panel, or between the units and other devices. Failure to observe this could lead to faults.

1.4.1 Environmental Conditions

Environment	Conditions
Ambient temperature	0°C to +55°C (with no freezing)
Ambient humidity	90% RH or less (with no dew condensation)
Storage temperature	-15°C to +70°C (with no freezing)
Storage humidity	90% RH or less (with no dew condensation)
Atmosphere	Indoors (no direct sunlight); no corrosive gas, inflammable gas, oil mist, dust or conductive fine particles
Altitude	Operation/storage: 1000m or less above sea level Transportation: 13000m or less above sea level
Vibration	Operation/storage: 4.9m/s ² (0.5G) or less Transportation: 49m/s ² (5G) or less

(Note) When installing the machine at 1,000m or more above sea level, the heat dissipation characteristics will drop as the altitude increases in proportion to the air density. The ambient temperature drops 1% with every 100m increase in altitude.

When installing the machine at 1,800m altitude, the heating value of the drive unit must be reduced to 92% or less. The heating value is proportional to the square of the current, and required current decreasing rate follows the expression below.

$$\text{Required current decreasing rate} = \sqrt{0.92} = 0.95$$

Therefore, use the unit with the reduced effective load rate to 95% or less.

1.4.2 Installation Direction and Clearance

Wire each unit in consideration of the maintainability and the heat dissipation, as well as secure sufficient space for ventilation.

Installation clearance

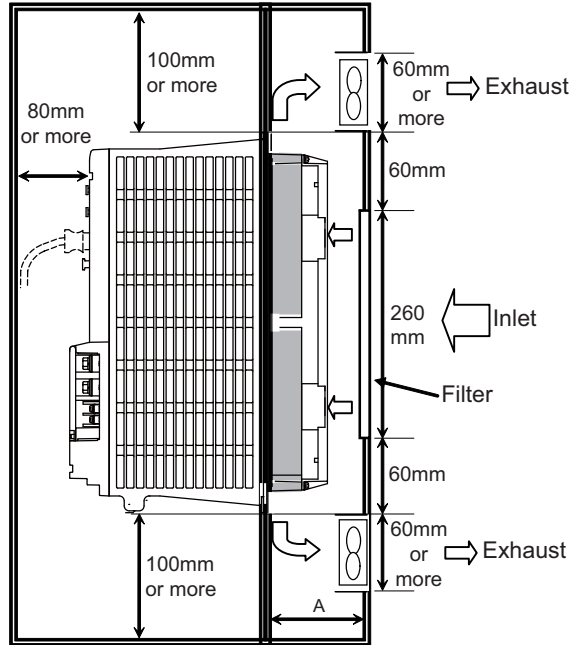
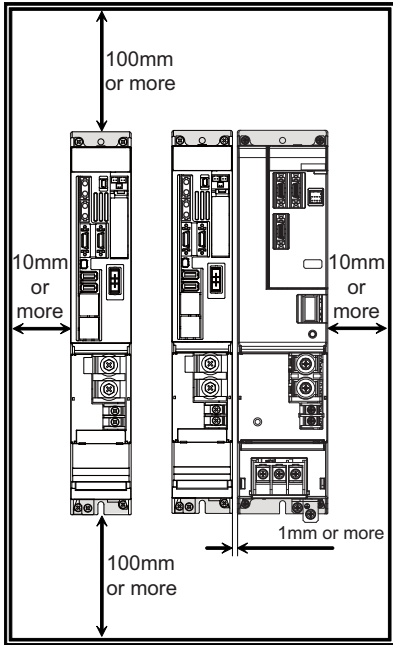

Radiation fin size	Installation clearance A
60mm/67mm	75mm or more
92mm	114mm or more

⚠ CAUTION

1. The ambient temperature condition for the power supply unit or the drive units is 55°C or less.
2. Because heat can easily accumulate in the upper portion of the units, give sufficient consideration to heat dissipation when designing the panel. If required, install a fan in the panel to agitate the heat in the upper portion of the units.

Panel structure of the unit back face

The type '(a)' that has substantial cooling effect is recommended.

(a) Back face inlet type

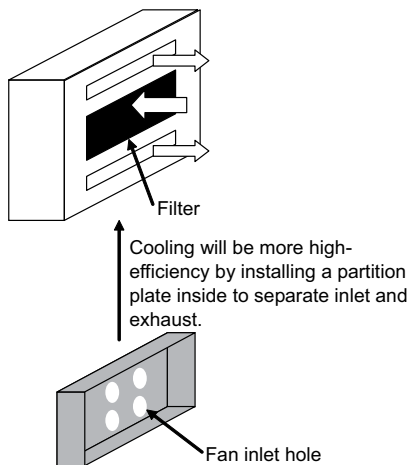

(b) Side face inlet type

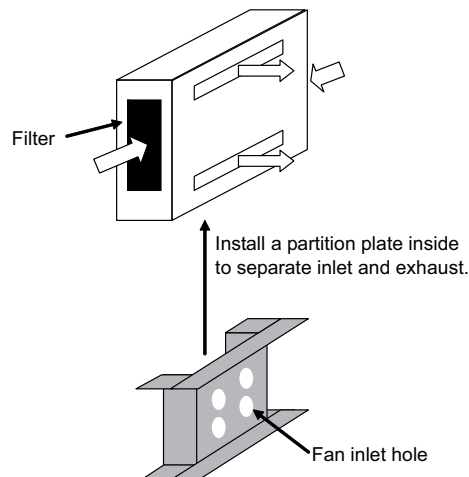

Cooling fan position

< MDS-D2/DH2-V1/V2/SP/SP2 Series >

[Unit: mm]

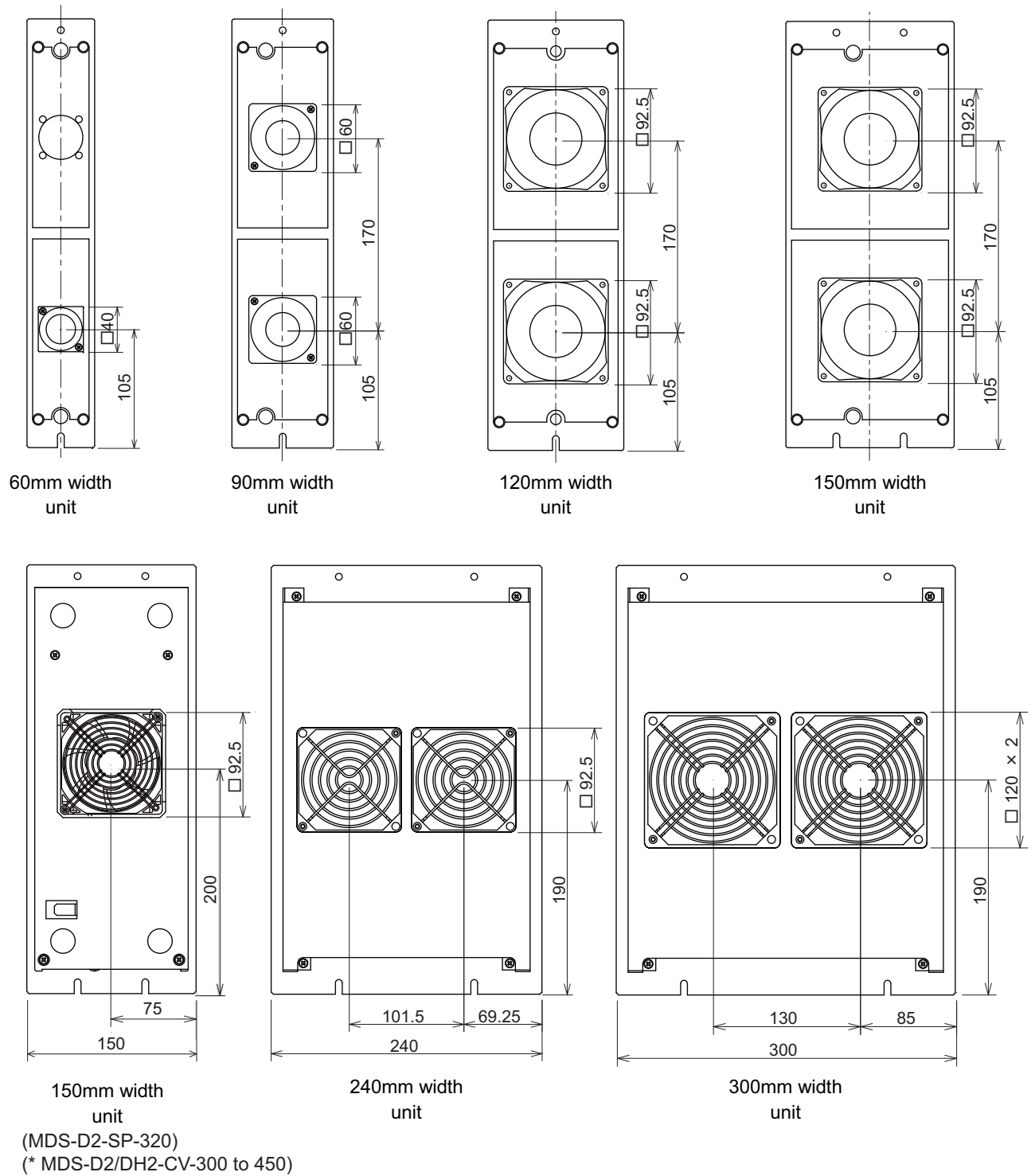

< MDS-D2-V3 Series >

The drive unit of MDS-D2-V3 Series has a cooling fan in the top.

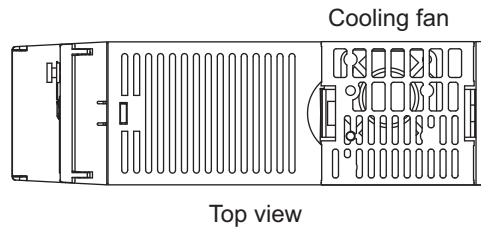

Top view

⚠ CAUTION

1. Design the inlet so that it is the position of the cooling fan.
2. Make the inlet and exhaust size more than the area that is a total of the cooling fan area.

1.4.3 Prevention of Entering of Foreign Matter

Treat the cabinet with the following items.

- (1) Make sure that the cable inlet is dust and oil proof by using packing, etc.
- (2) Make sure that the external air does not enter inside by using head radiating holes, etc.
- (3) Close all clearances of the cabinet.
- (4) Securely install door packing.
- (5) If there is a rear cover, always apply packing.
- (6) Oil will tend to accumulate on the top. Take special measures such as oil-proofing to the top so that oil does not enter the cabinet from the screw holds.
- (7) After installing each unit, avoid machining in the periphery. If cutting chips, etc., stick onto the electronic parts, trouble may occur.
- (8) When using the unit in an area with toxic gases or high levels of dust, protect the unit with air purging (system to blow clean air so that the panel's inner pressure is higher than the outer pressure).

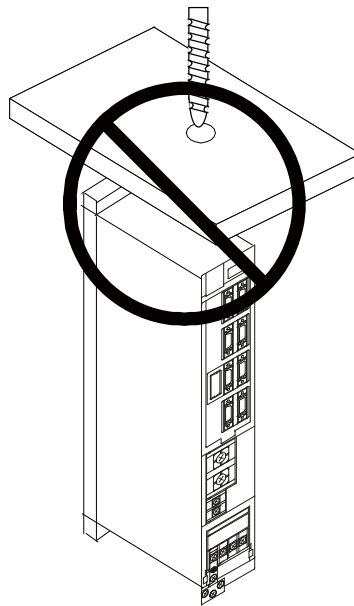

1.4.4 Panel Installation Hole Work Drawings (Panel Cut Drawings)

Prepare a square hole to match the unit width.

[Unit: mm]

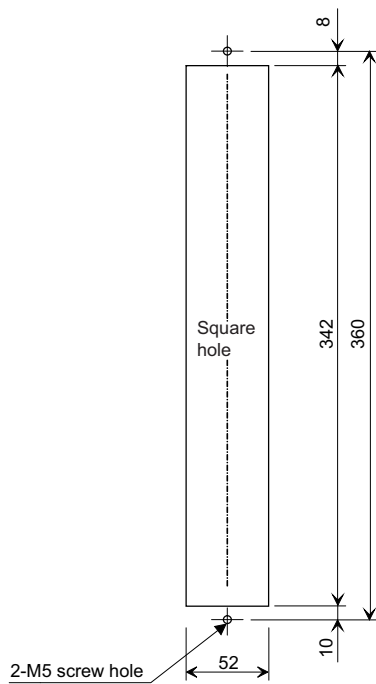

Unit width: 60mm

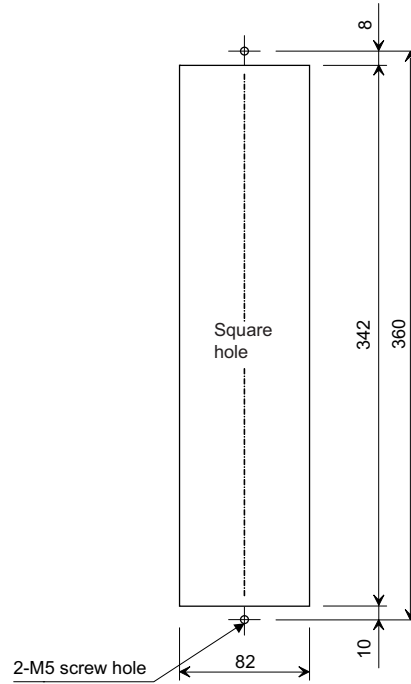

Unit width: 90mm

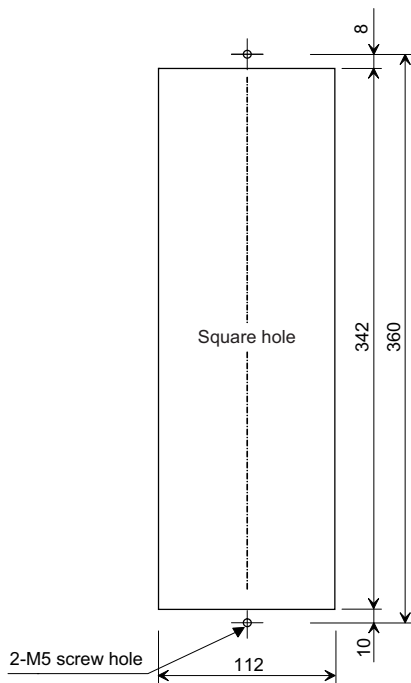

Unit width: 120mm

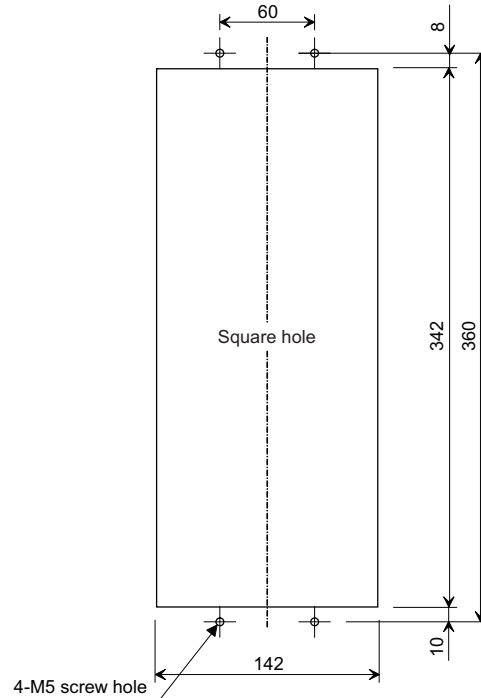

Unit width: 150mm

 **POINT**

Attach packing around the square hole to provide a seal.

[Unit: mm]

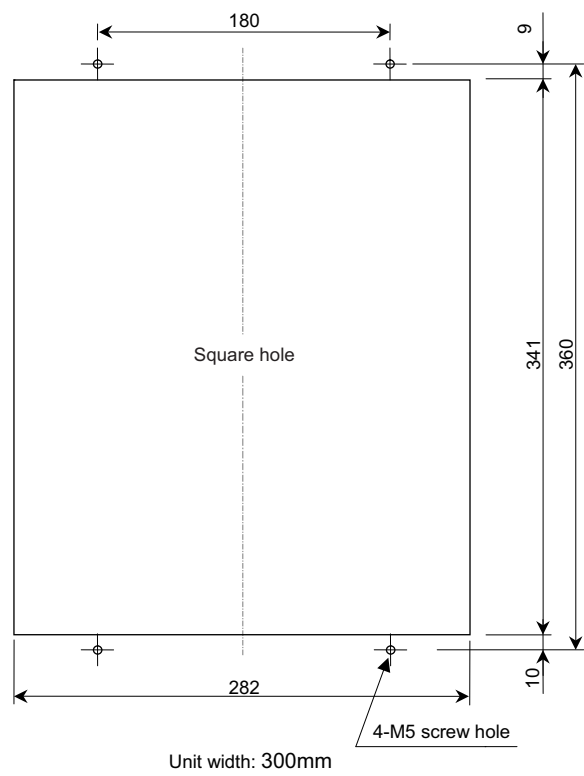
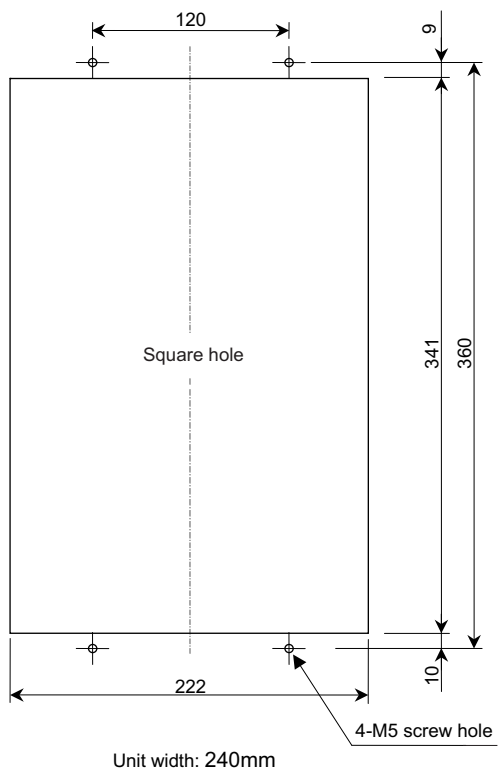

POINT

Attach packing around the square hole to provide a seal.

1.4.5 Heating Value

The values for the servo drive unit apply at the stall output. The values for the spindle drive unit apply for the continuous rated output. The values for the power supply unit include the AC reactor's heating value.

< MDS-D2 Series >

Servo drive unit					Spindle drive unit					Power supply unit			Power backup unit			
Type MDS-D2-	Heating value [W]		Type MDS-D2-	Heating value [W]		Type MDS-D2-	Heating value [W]		Type MDS-D2-	Heating value [W]		Type MDS-D2-	Heating value [W]		Type MDS-D-	Heating value [W]
	In-side panel	Out-side panel		In-side panel	Out-side panel		In-side panel	Out-side panel		In-side panel	Out-side panel		In-side panel	Out-side panel		
V1-20	18	22	V2-2020	26	44	SP-20	24	31	SP2-2020	28	62	CV-37	20	34	PFU	15
V1-40	20	38	V2-4020	28	60	SP-40	29	65	SP2-4020	33	96	CV-75	24	55		
V1-80	25	71	V2-4040	31	75	SP-80	37	121	SP2-4040S	38	130	CV-110	25	99		
V1-160	36	148	V2-8040	35	109	SP-160	54	236	SP2-4040	38	130	CV-185	32	161		
V1-160W	44	201	V2-8080	40	142	SP-200	78	404	SP2-8040	46	186	CV-300	45	272		
V1-320	59	307	V2-16080	51	219	SP-240	100	520	SP2-16080S	70	358	CV-370	53	343		
V1-320W	72	399	V2-160160	62	296	SP-320	118	688	SP2-8080	54	242	CV-450	104	392		
			V2-160160W	77	403	SP-400	148	897	SP2-16080	70	358	CV-550	164	431		
			V3-202020	89	0	SP-640	196	1231								
			V3-404040	159	0											

< MDS-DH2 Series >

Servo drive unit					Spindle drive unit				Power supply unit			Power backup unit	
Type MDS-DH2-	Heating value [W]		Type MDS-DH2-	Heating value [W]		Type MDS-DH2-	Heating value [W]		Type MDS-DH2-	Heating value [W]		Type MDS-DH-	Heating value [W]
	Inside panel	Outside panel		Inside panel	Outside panel		Inside panel	Outside panel		Inside panel	Outside panel		
V1-10	19	27	V2-1010	28	54	SP-20	32	88	CV-37	20	34	PFU	15
V1-20	22	46	V2-2010	30	74	SP-40	42	158	CV-75	24	55		
V1-40	27	87	V2-2020	33	93	SP-80	54	237	CV-110	25	99		
V1-80	40	175	V2-4020	39	133	SP-100	73	369	CV-185	32	161		
V1-80W	47	222	V2-4040	45	173	SP-160	110	639	CV-300	45	272		
V1-160	62	328	V2-8040	57	262	SP-200	126	746	CV-370	53	343		
V1-160W	81	461	V2-8080	70	350	SP-320	168	1034	CV-450	104	392		
V1-200	105	630	V2-8080W	83	445	SP-480	232	1488	CV-550	164	431		
									CV-750	228	614		

 **POINT**

1. Design the panel's heating value taking the actual axis operation (load rate) into consideration.
2. The heating values in the above tables are calculated with the following load rates.

Unit	Load rate
Servo drive unit	50%
Spindle drive unit	100%
Power supply unit	100%

1.4.6 Heat Radiation Countermeasures

(1) Heat radiation countermeasures in the control panel

In order to secure reliability and life, design the temperature in the panel so that the ambient temperature of each unit is 55°C or less.

If the heat accumulates at the top of the unit, etc., install a fan or heat exchanger so that the temperature in the panel remains constant.

Please refer to following method for heat radiation countermeasures.

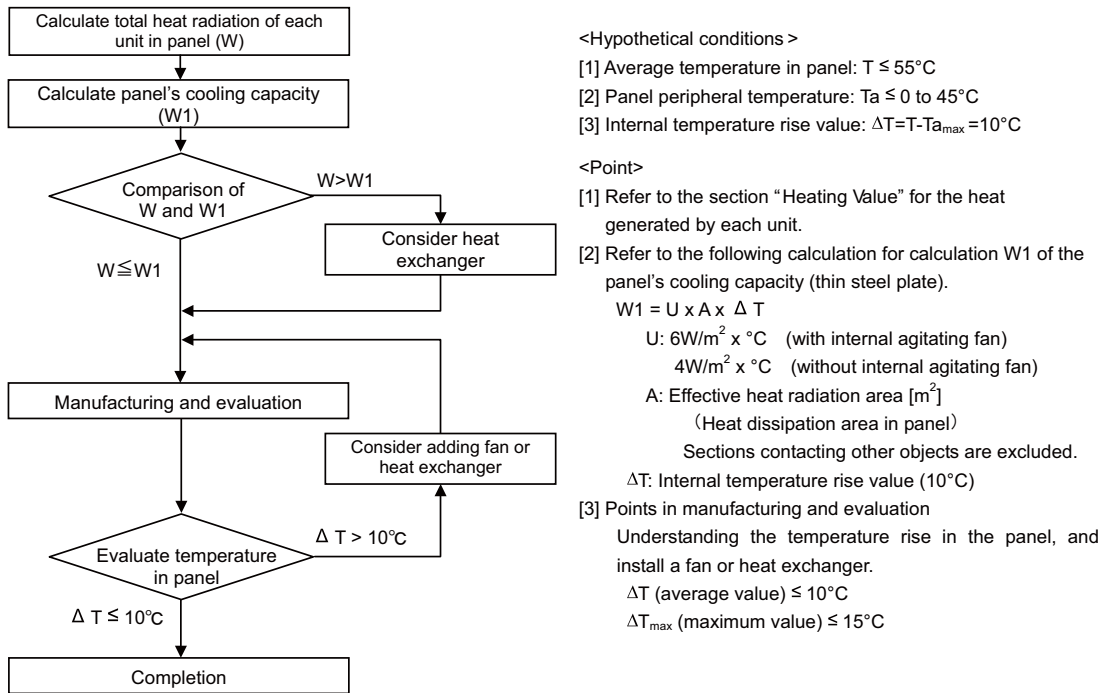

Examples of mounting heat exchanger and temperature measurement positions (reference)

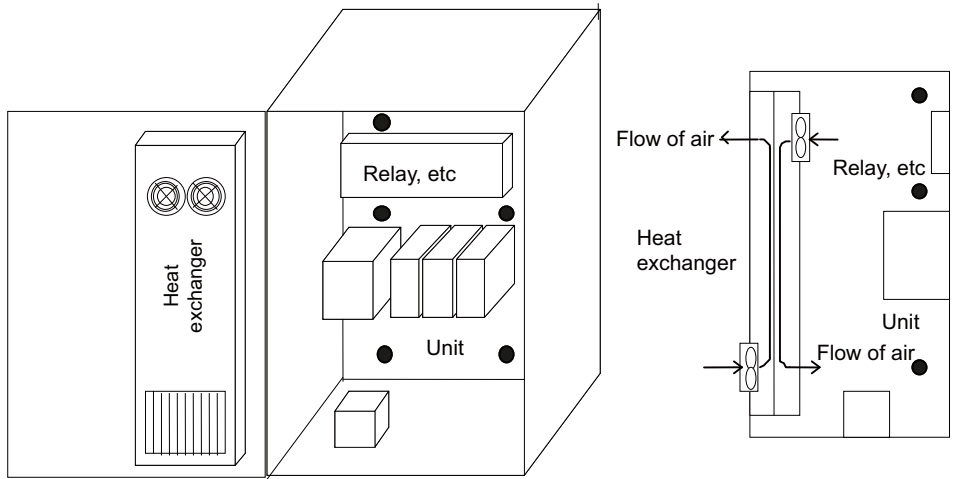

● Temperature measurement positions

The following shows a calculation example for considering heat radiation countermeasures.

< Control panel outline dimension (assumption) >

When installing four units which have the heating value in the panel of 15W

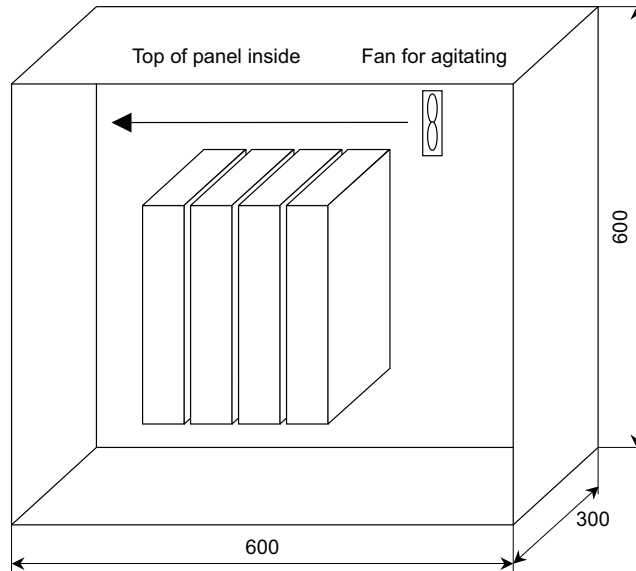

Heat radiation area (A): When a bottom section contacts with a machine

$$A = 0.6 \times 0.3 + 0.6 \times 0.6 \times 2 + 0.6 \times 0.3 \times 2 = 1.26 \text{ (m}^2\text{)}$$

(Top face)
(Front/back face)
(Side face)

(Note) Actually, sections contacting other objects are excluded.

Heating value in panel (W): when installing four units which are 15W

$$W = 15 \times 4 = 60 \text{ (W)}$$

< Considering necessity of agitating fan >

1 Temperature standard

- | | |
|---|---|
| (1) Standard of temperature in panel (around each unit) | $T \leq 55^\circ\text{C}$ |
| (2) External peripheral temperature | $T_a = 0 \text{ to } 45^\circ\text{C}$ |
| (3) Internal temperature rise value | $DT = T - T_a \text{ (MAX)} = 10^\circ\text{C}$ |

2 Cooling capacity of control panel (W1)

$$W1 = U \times A \times DT \quad DT = \text{Internal temperature rise value (=}10^\circ\text{C)}$$

$$U = 6\text{W/m}^2 \cdot ^\circ\text{C (with internal agitating fan)}$$

$$4\text{W/m}^2 \cdot ^\circ\text{C (without internal agitating fan)}$$

$$A = \text{Effective heat radiation area (m}^2\text{)}$$

- | | |
|------------------------------------|---|
| (1) With internal agitating fan | $W1 = 6 \times 1.26 \times 10 = 75.6 \text{ (W)} > 60 \text{ (W)}$ |
| (2) Without internal agitating fan | $W1 = 4 \times 1.26 \times 10 = 50.4 \text{ (W)} < 60 \text{ (W)}$ -- Internal fan is required. |



POINT

Measure an actual internal temperature, and install a fan or heat exchanger which agitates the heat at the top of the unit if the temperature rise exceeds 10°C.

(2) Heat radiation countermeasures outside the control panel

Measure the temperature at 40mm from tops of all units, and design the temperature rise so that it is 20°C or less against the ambient temperature.

If the temperature rise at the temperature measurement position exceeds 20°C, consider adding a fan.

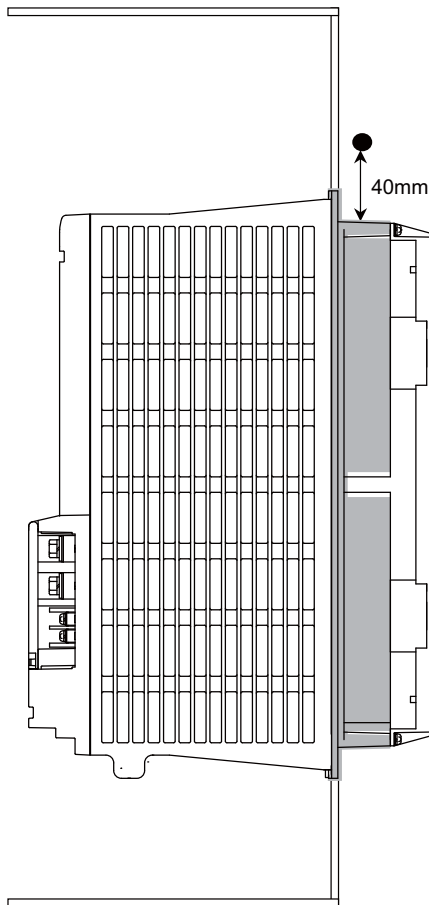

Side face

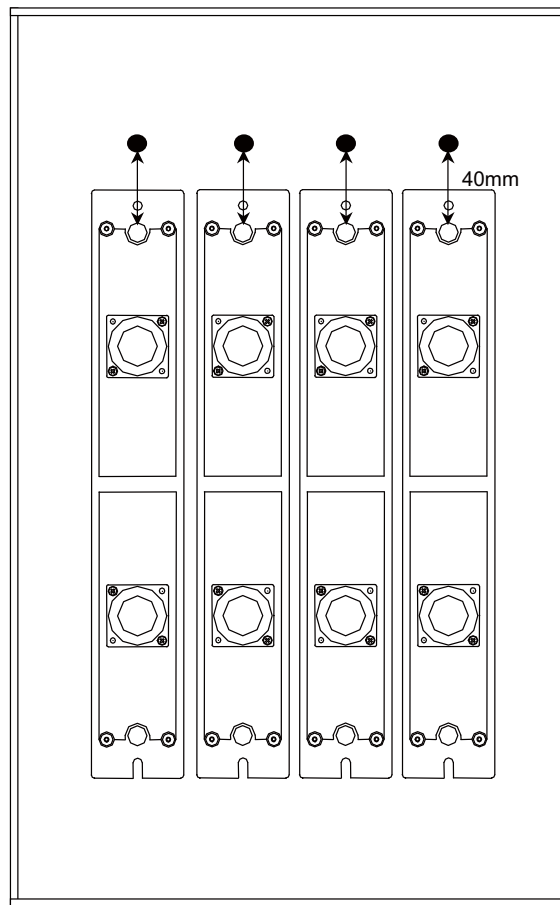

Back face

● Temperature measurement position



POINT

The temperature of some units may rise locally, because air accumulates at a particular point. Therefore, take a temperature measurement in each unit.

If a temperature at even one point exceeds 20°C in the temperature measurements, take a heat radiation countermeasure such as adding fans.

1.5 Installation of the Machine End Encoder

1.5.1 Spindle Side ABZ Pulse Output Encoder (OSE-1024 Series)

To maintain the encoder life and performance, a flexible coupling should be used to couple the spindle side encoder and C-axis encoder with the spindle.

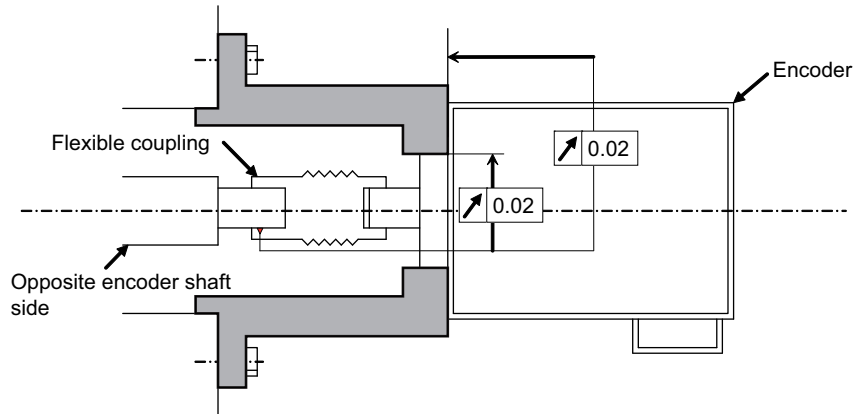

Encoder and coupling installation accuracy

Recommended coupling

		Recommendation 1	Recommendation 2
Manufacturer		Tokushu Seiko	Eagle
Model		Model M1	FCS38A
Resonance frequency		1374Hz	3515Hz
Position detection error		$0.8 \times 10^{-3} \text{ }^\circ$	$1.2 \times 10^{-3} \text{ }^\circ$
Tolerable speed		20,000r/min	10,000r/min
Mis-alignment	Core deviation	0.7mm	0.16mm
	Angle displacement	1.5°	1.5°
Outline dimensions	Max. length	74.5mm	33mm
	Max. diameter	Φ57mm	Φ38mm

CAUTION

Confirm that the gear ratio (pulley ratio) of the spindle end to the encoder is 1:1.



Refer to the coupling catalog, etc., for details on the coupling.

1.5.2 Spindle Side PLG Serial Output Encoder (TS5690, MU1606 Series)

(1) Part configuration

The encoder is configured of a sensor and detection gear. The sensor and detection gear must be used in the designated combination.

These are precision parts, and require care when handling. Do not apply an excessive force on the sensor's detection surface, as this could result in faults. Do not pull and apply a load on the lead wires. Make sure that foreign matters (iron chips, etc.) do not get on the sensor's detection surface or detection gears. If any foreign matter should get on these parts, carefully remove while taking care not to damage the parts. When handling the detection gears, take care not to damage or deform the teeth.

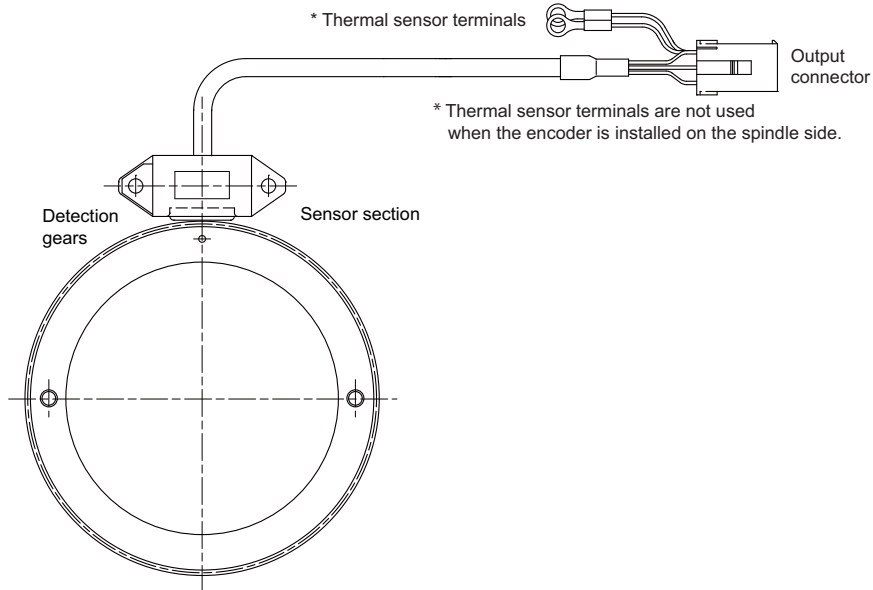

Spindle side PLG serial output encoder TS5690 Series

(2) Installing the detection gears

- [1] Install the detection gears so that the first gear's teeth side (Z phase) face the sensor's lead side.
- [2] The detection gears and shaft or sleeve should be fixed with shrink fitting. Refer to the following table for the shrink fitting values. The detection gears should be heated evenly between 120 and 150°C using an electric furnace, etc.

Guideline for detection gear shrink fitting values

Inner diameter (mm)	Shrink fitting (mm)	Inner diameter (mm)	Shrink fitting (mm)
Φ40	0.020 to 0.040	Φ140	0.050 to 0.085
Φ70	0.030 to 0.055	Φ160	0.060 to 0.090
Φ80	0.030 to 0.055	Φ215	0.080 to 0.110
Φ125	0.050 to 0.085		

- [3] Keep the run-out of the outer diameter, when the detection gears are installed on the shaft, to 0.02mm or less.
- [4] To remove a detection gear fixed with shrink fitting, use the screw holes opened in the axial direction for pulling (two M5 screw holes or two M8 screw holes), or push the end with a jig. Carry out this work carefully. Applying excessive force when pulling out the gears could cause the inner diameter of the detection gears to deform.
- [5] Before reusing detection gears which have been removed, always measure the inner diameter dimensions, and carefully check that the inner diameter is not deformed, and that the sufficient tightening amount can be secured. Do not reuse the detection gears if the inner diameter is deformed, or if any abnormality such as damage to the teeth is found.

(3) Installing the sensor section

- [1] Prepare the notched fitting section at the machine side's installation position to be of the specified dimensions in advance.
- [2] With the sensor installation seat's R section butted against the notched fitting section, fix the sensor installation seat with a mounting screw (M5 × 0.8 screws). A locking agent should be applied on the mounting screw before it is tightened.
- [3] Fix the sensor with its R section butted against the notched fitting section so that the position relation between the detection gear and sensor is kept constant. This ensures favorable accuracy of the sensor installation.
- [4] Keep the deviation of the sensor center and outer diameter center of the detection gear to ±0.25mm or less. If the center deviation cannot be directly measured, set so that the dimension from the sensor installing surface to the outer diameter edge of the detection gears is 22.5±0.25mm. (Some detection gears have thickness at the inner diameter section.)
- [5] Make sure that force is not constantly applied on the sensor's lead wires.
- [6] Check the gap between the encoder sensor and the gear (0.3±0.05mm).

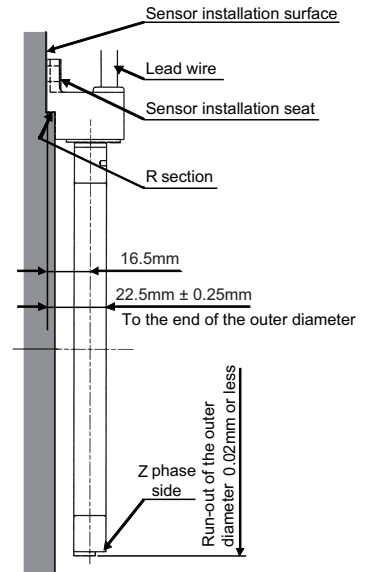

Installing the detector



POINT

To install the sensor section, the notched fitting section on the machine side must have the specified dimensions. The sensor's installation accuracy is assured by adjusting the outside dimensions of the notched fitting section.

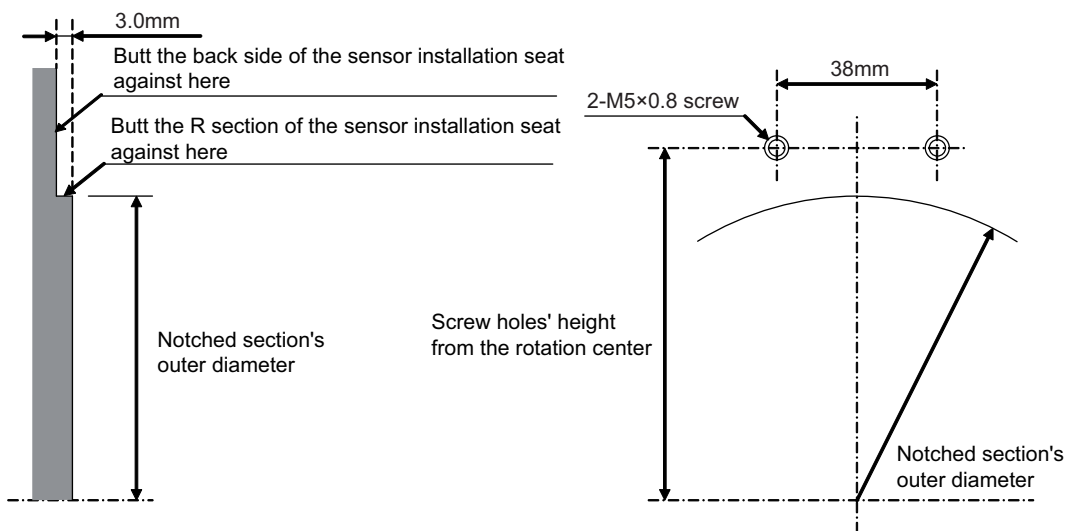

Shape of notched fitting section

Installing dimension of the sensor section

Sensor series type	Screw holes' height from the rotation center (mm)	Notched fitting section's outer diameter (mm)
TS5690N6400	51.4	Φ72.0 ^{+0.060} / _{-0.010}
TS5690N1200	77.0	Φ122.0 ^{+0.025} / _{-0.025}
TS5690N2500	128.2	Φ223.6 ^{+0.025} / _{-0.025}

(4) Installation accuracy diagnosis for spindle side PLG encoder** CAUTION**

Do not operate the spindle before performing this installation accuracy diagnosis.

If operated with an improperly installed spindle side PLG encoder, the spindle motor may rotate at high speed. Always perform this diagnosis before normal operation.

[1] Outline

In this section, check if the installation polarity of spindle side PLG encoder corresponds to the parameter setting, and the gap between the gear and the sensor is appropriate. In a full-closed loop control where the encoder is also installed on the spindle side, it is controlled based on the feedback of the spindle side encoder during the speed command operation (S command). Do not command a normal spindle operation before confirming the installation accuracy of the spindle side encoder. Spindle side PLG encoders (TS5690 Series) have the specified gap from the gear by installing the sensor section on the machine-notched fitting section. Whether a signal is detected correctly or not can be confirmed using the servo diagnosis screen on NC while rotating the spindle motor in an open loop control.

[2] Confirmation of encoder installation polarity

Open the drive monitor/spindle unit on the NC Diagnosis screen, and display "Machine position", "Motor end FB" and "FB error". Confirm that "Machine position" and "Motor end FB" are counted on the same polarity, and that "FB error" is not cumulated while rotating the spindle by hand. When the polarity of "Machine position" and "Motor end FB" is different and "FB error" is cumulated, change the setting of #13017/bit4(SP017/bit4). Set the spindle parameter so that the spindle system is in a full-closed loop control during this confirmation.

- #13019(SP019) Set the encoder resolution of spindle side PLG encoder correctly
- #13031(SP031) Set to full closed loop control (6200)

[3] Confirmation of encoder installation accuracy

Whether the gap between the sensor section and the gear is ensured correctly or not can be confirmed using the servo diagnosis screen, [PLG diagn] on NC while rotating the spindle motor in an open loop control. Confirm it according to the following procedures.

- 1) Set the spindle parameter #13018/bit1 (SP018/bit1) to 1, and set to an open loop control.
- 2) Turn the NC and drive unit power OFF and disconnect the motor side encoder cable only. After that, turn the power ON again.
- 3) Rotate the spindle by inputting 100r/min command. Although this is the same as normal S command operation, neither the spindle side encoder feed back or the motor side encoder feed back is used for the motor control on the spindle drive unit since the open loop control is set with the spindle parameter.
- 4) Switch to the [Servo diagn] menu on the NC maintenance screen and change from [Spindle unit] to [PLG diagn]. When all the diagnosis signal bits are constantly at "0", the installation of PLG encoder is normal. When the diagnosis signal bit is "1", the result of diagnosis is abnormal. Perform troubleshooting following "[4] Diagnosis and remedy" by reference to the error details and main cause.
- 5) Set the spindle parameter #13018/bit1 (SP018/bit1) to 0 again and finish the open loop control after stopping the spindle with stop command.
- 6) Turn the NC and spindle drive unit power OFF, and reconnect the motor side encoder cable as it was.

 CAUTION

The spindle PLG diagnosis is only performed during the open loop control operation. Diagnosis screen is displayed even during the normal operation, however, the error detection ("1" display) will not be performed.

<Display of spindle PLG diagnosis>

720V MEMORY / Monitr Setup Edit Diagn Mainte									
		S1		S2		S3		S4	
Alarm times	1	13	2000	13	2000	13	2000	13	2000
Alarm times	2	18	11110	18	11110	18	11110	18	11110
Alarm times	3	1F	0	1F	0	1F	0	1F	0
Alarm times	4	21	200	21	200	21	200	21	200
Alarm times	5	2F	2000	2F	2000	2F	2000	2F	2000
Alarm times	6	34	10	34	10	34	10	34	10
Alarm times	7	35	500	35	500	35	500	35	500
Alarm times	8	36	1000	36	1000	36	1000	36	1000
Alarm times	9	38	0	38	0	38	0	38	0
Alarm times	10	3A	0	3A	0	3A	0	3A	0
Encoder Diagn L			00000000		00000000		00000000		00000000
Encoder Diagn H			00000000		00000000		00000000		00000000
Sub Encoder Diagn L			00000000		00000000		00000000		00000000
Sub Encoder Diagn H			00000000		00000000		00000000		00000000

When an error is detected with spindle PLG diagnosis → "1" is displayed on the corresponding diagnosis signal bit

Information for spindle PLG diagnosis (For details of each diagnosis signal bit, refer to the next page.)

Item	Details
Encoder Diagn L	Display the motor end PLG diagnosis signal bit 7 to 0.
Encoder Diagn H	Display the motor end PLG diagnosis signal bit F to 8.
Sub Encoder Diagn L	Display the spindle side PLG diagnosis signal bit 7 to 0.
Sub Encoder Diagn H	Display the spindle side PLG diagnosis signal bit F to 8.

* Used when adjusting a built-in motor.

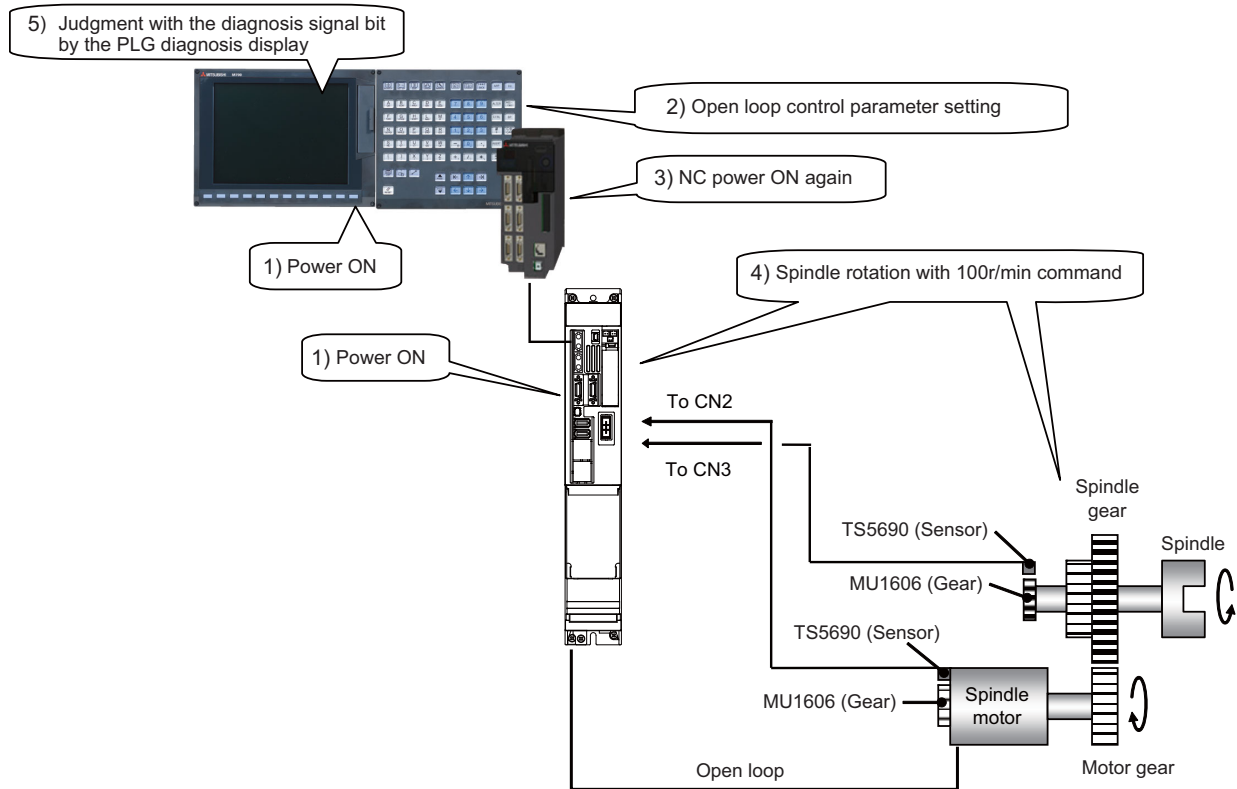

Installation diagnosis for spindle side PLG encoder

1 Installation

Details of each diagnosis signal bit which is displayed as information for spindle PLG diagnosis are shown in the following table.

Diagnosis signal bit	Error details	Description	Main factor
0	A-phase amplitude excessive	The A-phase amplitude is larger than the specified value.	Too small gap
1	A-phase amplitude too small	The A-phase amplitude is smaller than the specified value.	Excessive gap
2	A-phase offset excessive +	The A-phase offset is larger than the specified value to + side.	The deviation between the sensor and the center of the gear
3	A-phase offset excessive -	The A-phase offset is larger than the specified value to - side.	The deviation between the sensor and the center of the gear
4	B-phase amplitude excessive	The B-phase amplitude is larger than the specified value.	Too small gap
5	B-phase amplitude too small	The B-phase amplitude is smaller than the specified value.	Excessive gap
6	B-phase offset excessive +	The B-phase offset is larger than the specified value to + side.	The deviation between the sensor and the center of the gear
7	B-phase offset excessive -	The B-phase offset is larger than the specified value to - side.	The deviation between the sensor and the center of the gear
8	Z-phase width excessive	The Z-phase width is larger than the specified value. [AL2C factor]	Too small gap
9	Z-phase width too small	The Z-phase width is smaller than the specified value.	Excessive gap
A	Z-phase error incorrect output	The relation of the phases between AB and Z is abnormal. [AL2C factor]	The deviation between the sensor and the center of the gear
B	Z-phase error sliver waveform	The relation of the phases between AB and Z is abnormal. [AL2C factor]	The deviation between the sensor and the center of the gear
C	Z-phase error no signal	The Z-phase signal is not detected. [AL2C factor]	Excessive gap, detection gear error
D	-	-	-
E	Z-phase error logic reversed	The Z-phase logic (normally positive) is reversed. [AL2C factor]	Detection gear error
F	-	-	-

[4] Diagnosis and remedy

When the diagnosis signal bit on [PLG diagn] is "1", check the installation of the PLG encoder again.

<When the waveform of spindle side PLG installation gap diagnosis is abnormal>

The gap between the sensor section and the gear may deviate from the specified value. Confirm that the sensor section is installed on the notched fitting section properly. Also confirm that the notched fitting section is machined properly based on the specified dimensions for each PLG encoder.

<When the waveform of spindle side PLG installation all errors diagnosis is abnormal>

The sensor section may deviate from the center of the gear. Confirm the installation of the sensor section and the gear.

 **CAUTION**

1. When finely adjusting the sensor installation position, adjust after turning the power of the drive unit OFF.
2. "00000000" is also displayed in the following cases.
 - (1) When the spindle parameter #13018/bit1(SP018/bit1) is 0 (open loop disabled)
 - (2) When an encoder other than TS5690 Series is connected

【#13017(PR)】 SP017 SPEC1 Spindle specification 1**bit 4 : fdir Position feedback**

Set the machine side encoder's installation polarity.
0: Forward polarity 1: Reverse polarity

【#13018(PR)】 SP018 SPEC2 Spindle specification 2**bit 1 : oplp Open loop control**

This allows the operation in which no encoder feedback signals are used.
It is used when adjusting the encoder, etc.
0: Disable 1: Enable

【#13113】 SP113 OPLP Current command value for open loop

Set the current command value for when the open loop control is enabled.
When "0" is set, the state will be the same as when "50" is set.
When not using, set to "0".
The open loop control is enabled when "SP018/bit1" is set to "1".

---Setting range---

0 to 999 (Short-time rated %)

1.5.3 Twin-head Magnetic Encoder (MBA405W, MBE405W Series)

CAUTION

1. Handle with care as this is a precision component. Especially, do not apply external force on the sensor head component (thin metal film section) and the magnetized section (magnet) of the magnetic drum.
2. Pay attention not to apply excessive external force on the product by hauling the sensor head cable strongly or by hanging the installation ring with holding the cable. Applying such force will cause a fault.
3. The magnetic drum has magnets in it. Pay attention so that any magnetic dust will not adhere on the drum. If any dust adheres on it, remove it using air blow.
4. Do not make magnetic screw drivers or tools touched the magnetized section of the magnetic drum during installation.
5. Use iron screws (carbon steel, chromium molybdenum steel) for fixing the magnetic drum.
6. This product is equivalent of IP67 (IP67 is realized when cables are connected to all connectors). Note that, however, if the liquid such as oil, cutting fluid or water is constantly splashed on the product, it may cause a fault. Make sure to provide measures against splash on the machine side as much as possible.
7. Connect the preamp to the ground. Screw the preamp cabinet on the machine for grounding.
8. If the CN3 connector of the preamp is not used when using the product, leave the cap on it to prevent water from entering.
9. Accuracy of this product has been adjusted as a set of magnetic drum, installation ring (with main head and sub head) and preamp of the same serial No. So use this product as a set of those components. Note that normal accuracy cannot be achieved if this is replaced with another set having a different serial No.

[Method for checking the serial No.]
 Check the serial No. of magnetic drum, installation ring (with main head and sub head) and preamp with each nameplate sticker attached on the following part.

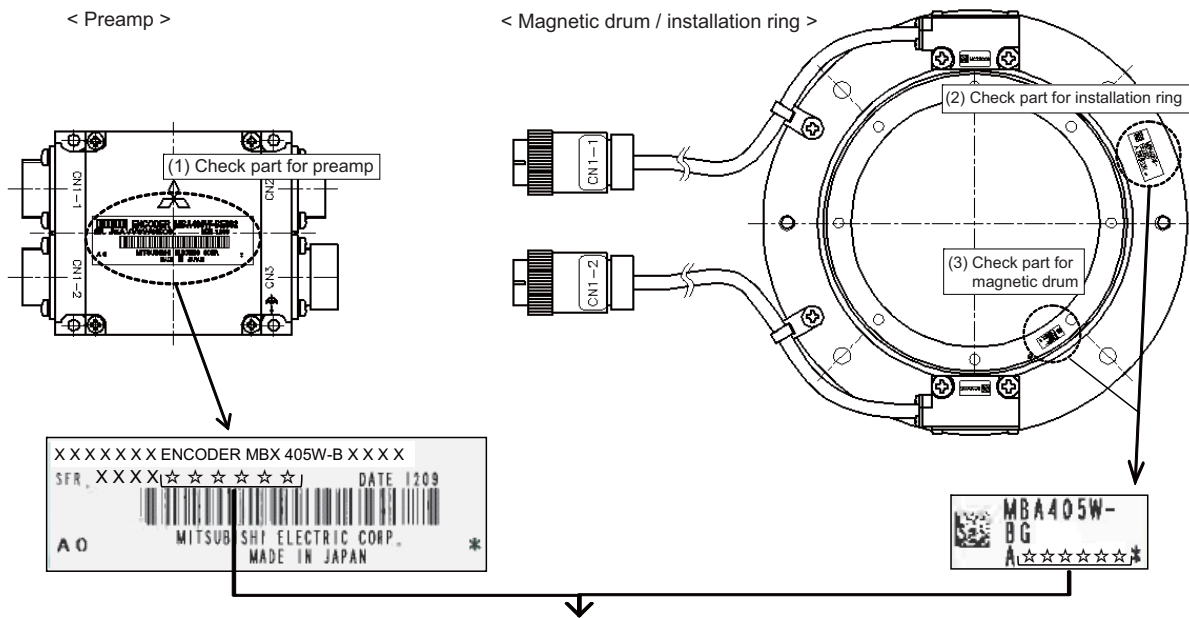

Make sure that the serial Nos. (☆ 6 digits) of the nameplate stickers attached on the above three parts are the same.

10. This product compensates an offset deviation with age in analog signals.

(1) Installing a magnetic drum

Install a flange on the shaft side and fix with screw in the axial direction by using the magnetic drum installation hole. Center the core with centering track so that the amplitude to the shaft rotation center is 15 μm or less to install the magnetic drum.

[Unit:mm]

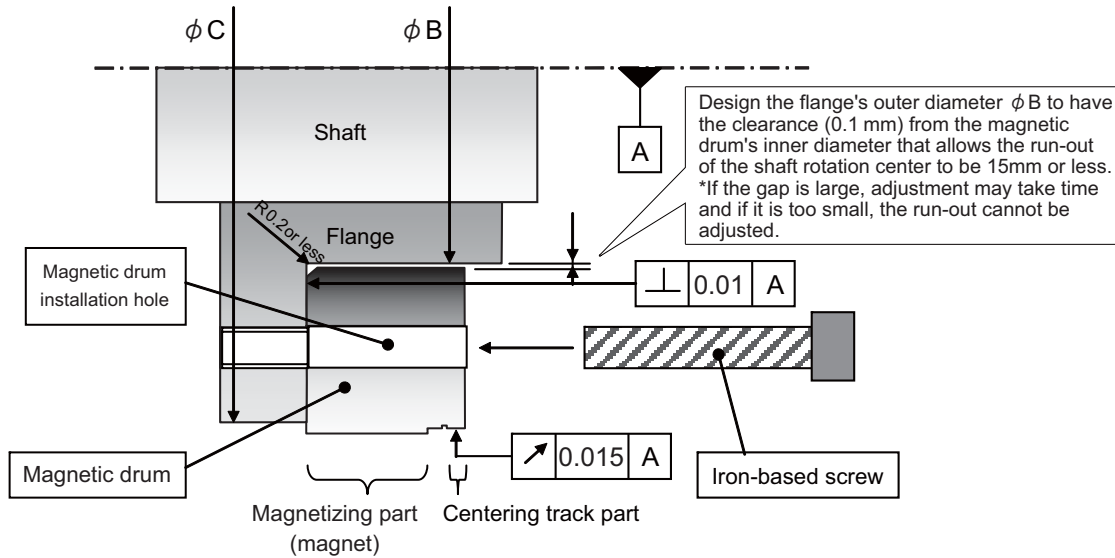

CAUTION

1. To avoid the interference with the sensor head, design the flange outer diameter ΦC so that it is equal to the magnetic drum outer diameter or less.
2. Fix the magnetic drum with screw on the shaft. (Do not fix with shrink fitting.)
3. Center the core with centering track. Do not perform by striking on the magnetizing part as it may result in damages.
4. Adherence of magnetic materials to the magnetizing part could lead to incorrect detections. Perform an air blow when the core alignment is completed.

Type	Centering track outer diameter [mm]	Magnetic drum installation hole position [mm]	Installation screw	Recommended screw torque [N·m]
MBA405W-BE082 MBE405W-BE082	Φ98	8-Φ3.4 through (evenly spaced around Φ90 circumference)	M3	0.61 to 0.83
MBA405W-BF125 MBE405W-BF125	Φ148.3	8-Φ4.5 through (evenly spaced around Φ134 circumference)	M4	1.39 to 1.89
MBA405W-BG160 MBE405W-BG160	Φ198.6	8-Φ4.5 through (evenly spaced around Φ170 circumference)	M5	2.75 to 3.63

(2) Installing a installation ring

Create a spigot-joint on machine side and fit the installation ring on the inner diameter of the spigot-joint to install the installation ring. Ensure the accuracy for the dimension of machine side spigot-joint as shown below so as not to degrade the detection accuracy.

Confirm the gap between the magnetic drum and the sensor head is secured by 0.29mm or more with clearance gauge etc. after the installation.

[Unit:mm]

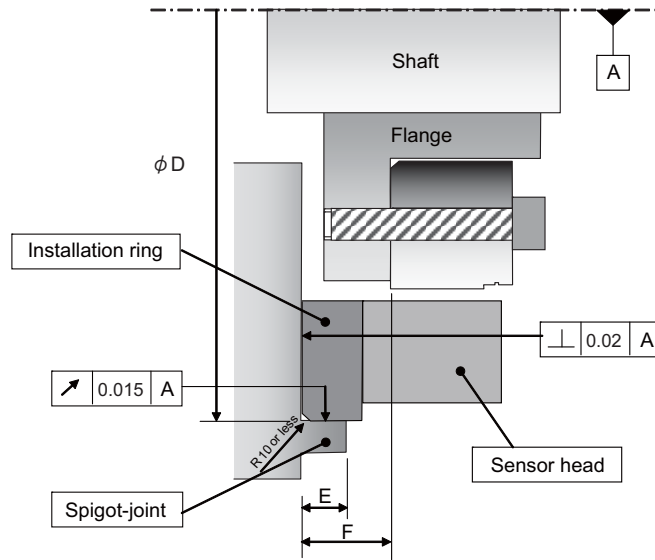

CAUTION

1. Do not contact to the magnetic drum when installing the installation ring as it may result in damages of magnetic drum or sensor head.
2. The sensor head is joined after adjusting the positional relationship with the installation ring beforehand, so do not remove the sensor head fixing screw.
3. Create a spigot-joint as close to the machine side and fit the installation ring on the spigot-joint to install. Do not center the core by striking on the installation ring outer diameter. etc.
4. Adherence of foreign materials to the element part of the sensor head (metallic thin film part) could lead to incorrect detections. Remove with an air blow when foreign materials are adhered so as not to damage them.

[Unit:mm]

Type	Installation ring outer diameter	Spigot-joint inner diameter (ΦD)	Spigot-joint height (E)	Height from installation ring bottom surface to magnetic drum bottom surface (F)
MBA405W-BE082 MBE405W-BE082	$\Phi 140 \begin{matrix} 0 \\ -0.015 \end{matrix}$	$\Phi 140 \begin{matrix} +0.015 \\ 0 \end{matrix}$	3.0 to 5.5	9.5±0.2
MBA405W-BF125 MBE405W-BF125	$\Phi 190 \begin{matrix} 0 \\ -0.015 \end{matrix}$	$\Phi 190 \begin{matrix} +0.015 \\ 0 \end{matrix}$	3.0 to 7.5	11.5±0.2
MBA405W-BG160 MBE405W-BG160	$\Phi 242 \begin{matrix} 0 \\ -0.015 \end{matrix}$	$\Phi 242 \begin{matrix} +0.015 \\ 0 \end{matrix}$	3.0 to 9.5	13.5±0.2

(3) For Z-phase signal detection

After turning the encoder power ON, Z-phase signal is required to be detected by the main head (Z-phase signal position mark is required to pass the main head). For the device configuration which the magnetic drum cannot drive more than one rotation, install the encoder so that Z-phase can pass the main head in the shaft stroke.

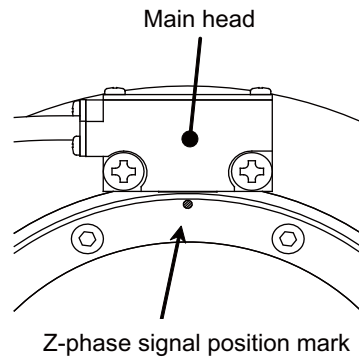
**(4) For the rotation direction of the encoder**

Seeing an encoder from the upper surface as shown below, when the magnetic drum rotates clockwise is the forward run. Confirm the rotation direction of the encoder and motor by reference to each motor specifications.

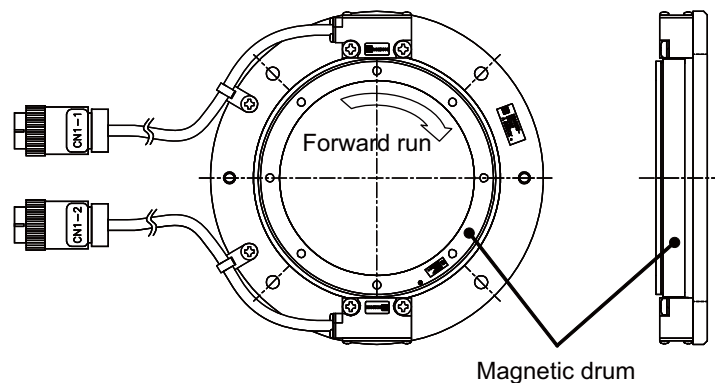
**(5) For MBA405W (absolute encoder)**

The initial setup operation is required after the operation is enabled for NC system to connect MBA405W to the servo drive unit. Refer to "4.2.2 Setting of Machine Side Encoder" for details.

The initial setup is required only for the first time after installing the encoder to the machine.

1.6 Noise Measures

Noise includes "propagation noise" generated from the power supply or relay, etc., and propagated along a cable causing the power supply unit or drive unit to malfunction, and "radiated noise" propagated through air from a peripheral device, etc., and causing the power supply unit or drive unit to malfunction.

Always implement these noise measures to prevent the peripheral devices and unit from malfunctioning. The measures differ according to the noise propagation path, so refer to the following explanation and take appropriate measures.

(1) General noise measures

- (a) Avoid laying the drive unit's power line and signal wire in a parallel or bundled state. Always separate these wires. Use a twisted pair shielded wire for the encoder cable and signal wires such as the communication cable connected with the NC unit, and accurately ground the devices.
- (d) Ground the shield of the servo encoder's cable with a cable clamp.
- (c) Accurately ground the AC reactor.

(2) Propagation noise measures

Take the following measures when noise generating devices are installed and the power supply unit or drive unit could malfunction.

- (a) Install a surge killer on devices (magnetic contacts, relays, etc.) which generate high levels of noise.
- (b) Install a power line filter in the stage before the power supply unit.
- (c) Install a ferrite core on the signal wire.
- (d) Ground the shield of the servo encoder's cable with a cable clamp.
- (e) Wire the spindle PLG encoder cable away from other wires.

(3) Measures against radiated noise

The types of propagation paths of the noise and the noise measures for each propagation path are shown below.

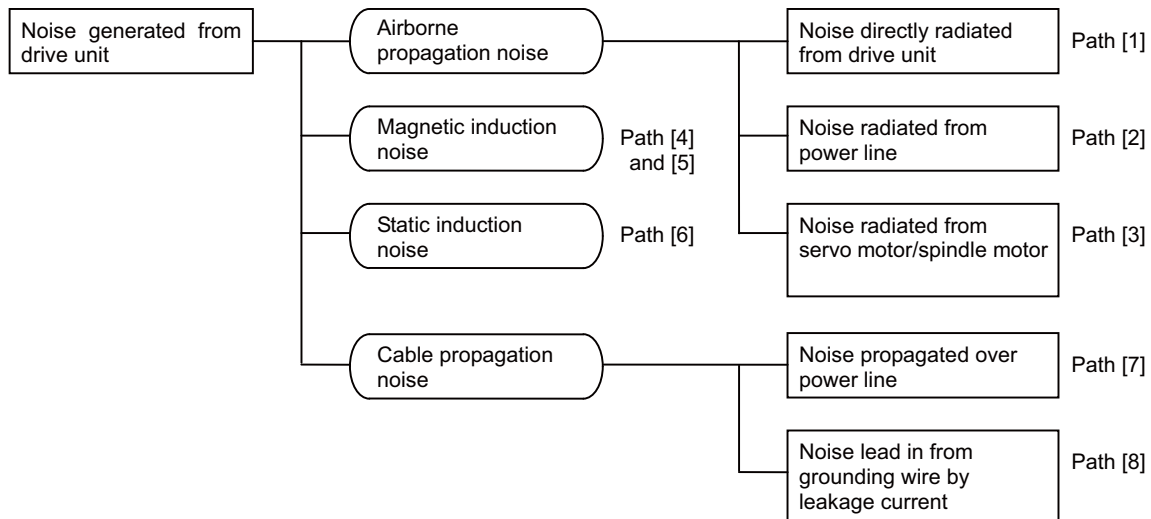

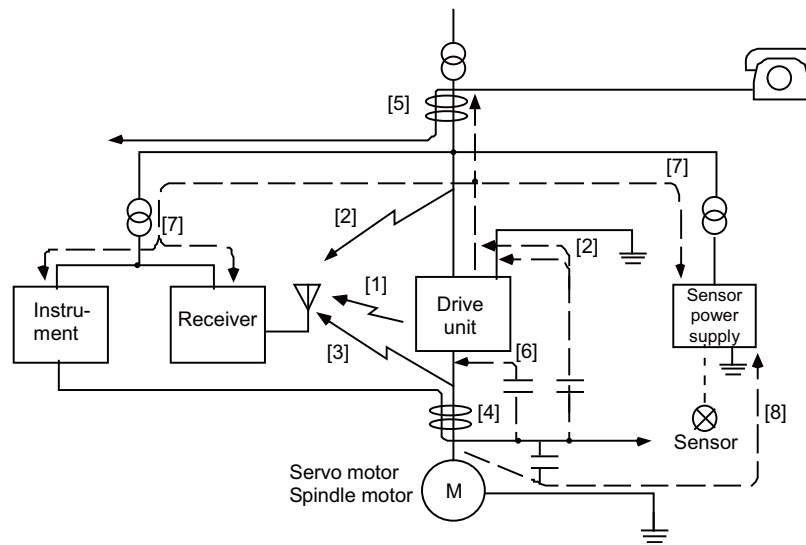

Generated noise of drive system

Noise propagation path	Measures
[1] [2] [3]	<p>When devices such as instrument, receiver or sensor, which handle minute signals and are easily affected by noise, or the signal wire of these devices, are stored in the same panel as the drive units and the wiring is close, the device could malfunction due to airborne propagation of the noise. In this case, take the following measures.</p> <p>(a) Install devices easily affected as far away from the drive units as possible.</p> <p>(b) Lay devices easily affected as far away from the signal wire of the drive unit as possible.</p> <p>(c) Avoid laying the signal wire and power line in a parallel or bundled state.</p> <p>(d) Insert a line noise filter on the input/output wire or a radio filter on the input to suppress the noise radiated from the wires.</p> <p>(e) Use a shield wire for the signal wire and power line, or place in separate metal ducts.</p>
[4] [5] [6]	<p>If the signal wire is laid in parallel to the power line, or if it is bundled with the power line, the noise could be propagated to the signal wire and cause malfunction because of the magnetic induction noise or static induction noise. In this case, take the following measures.</p> <p>(a) Install devices easily affected as far away from the drive unit as possible.</p> <p>(b) Lay devices easily affected as far away from the signal wire of the drive unit as possible.</p> <p>(c) Avoid laying the signal wire and power line in a parallel or bundled state.</p> <p>(d) Use a shield wire for the signal wire and power line, or place in separate metal ducts.</p>
[7]	<p>If the power supply for the peripheral devices is connected to the power supply in the same system as the drive units, the noise generated from the power supply unit could back flow over the power line and cause the devices to malfunction. In this case, take the following measures.</p> <p>(a) Install a radio filter on the power supply unit's power line.</p> <p>(b) Install a power filter on the power supply unit's power line.</p>
[8]	<p>If a closed loop is created by the peripheral device and drive unit's grounding wire, a leakage current could flow and cause the device to malfunction. In this case, change the device grounding methods and the grounding place.</p>

2

Wiring and Connection

⚠ WARNING

1. Wiring work must be done by a qualified technician.
2. Wait at least 15 minutes after turning the power OFF and check the voltage with a tester, etc., before starting wiring. Failure to observe this could lead to electric shocks.
3. Securely ground the drive units and servo/spindle motor.
4. Wire the drive units and servo/spindle motor after installation. Failure to observe this could lead to electric shocks.
5. Do not damage, apply forcible stress, place heavy items on the cables or get them caught. Failure to observe this could lead to electric shocks.
6. Always insulate the power terminal connection section. Failure to observe this could lead to electric shocks.

⚠ CAUTION

1. Correctly and securely perform the wiring. Failure to do so could result in runaway of the servo/spindle motor or injury.
2. Do not mistake the terminal connections.
3. Do not mistake the polarity (+ , -). Failure to observe this item could lead to ruptures or damage, etc.
4. Adjust the cable not to have an excess length. The excessive length could generate noise.
5. Do not mistake the direction of the diodes for the surge absorption installed on the DC relay for the motor brake and contactor (magnetic contactor) control. The signal might not be output when a failure occurs.

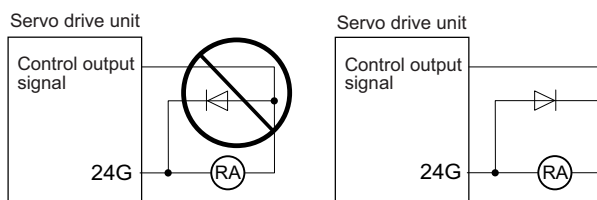

6. Electronic devices used near the drive units may receive magnetic obstruction. Reduce the effect of magnetic obstacles by installing a noise filter, etc.
7. Do not install a phase advancing capacitor, surge absorber or radio noise filter on the power line (U, V, W) of the servo/spindle motor.
8. Do not modify this unit.
9. If the connectors are connected incorrectly, faults could occur. Make sure that the connecting position and the connection are correct.
10. When grounding the motor, connect to the protective grounding terminal on the drive units, and ground from the other protective grounding terminal.(Use one-point grounding)
Do not separately ground the connected motor and drive unit as noise could be generated.
11. When the main grounding plate or the part to install a grounding cable is painted, remove the paint before grounding the cable. The electrical connection becomes insufficient and noise could be generated.

2.1 Part System Connection Diagram

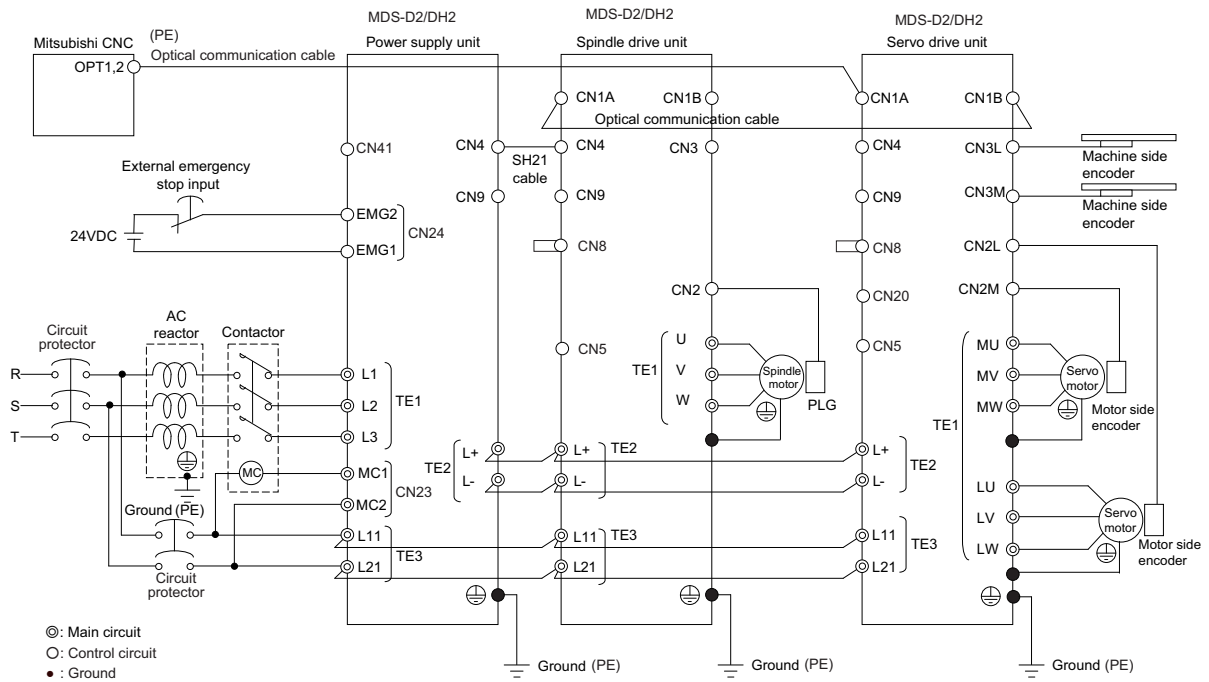

- (Note 1) The total length of the optical communication cable from the NC must be within 30m and the specified bending radius (for wiring inside panel: 25mm, and for wiring outside panel: 50mm) or more.
- (Note 2) The connection method will differ according to the used motor.
- (Note 3) Battery for the encoder back up is built-in the drive unit. (An external battery is available as an option.)
- (Note 4) The main circuit (⊙) and control circuit (○) and ground (●) are safely separated.
- (Note 5) Connect the ground of the motor to the ground of the connected drive unit.

2.2 Main Circuit Terminal Block/Control Circuit Connector

2.2.1 Names and Applications of Main Circuit Terminal Block Signals and Control Circuit Connectors

The following table shows the details for each terminal block signal.

Name	Signal name	Description
L1, L2, L3	Main circuit power supply	Main circuit power supply input terminal For MDS-D2 : Connect a 3-phase 200VAC (50Hz) or 200 to 230VAC (60Hz) power supply. For MDS-DH2 : Connect a 3-phase 380V to 440VAC (50Hz) / 380V to 480VAC (60Hz) power supply.
L11, L21	Control circuit power supply	Control circuit power supply input terminal For MDS-D2 : Connect a single-phase 200VAC (50Hz) or 200 to 230VAC (60Hz) power supply. For MDS-DH2 : Connect a single-phase 380V to 440VAC (50Hz) / 380V to 480VAC (60Hz) power supply.
MC1, MC2	Contact control	Contact control terminal
U, V, W	Motor output (Single-axis unit)	Servo/spindle motor power output terminal The servo/spindle motor power terminal (U, V, W) is connected.
LU, LV, LW MU, MV, MW	Motor output (Dual-axis unit)	Servo/spindle motor power output terminal (L-axis/M-axis) The servo/spindle motor power terminal (U, V, W) is connected.
LU, LV, LW MU, MV, MW SU, SV, SW	Motor output (Triple-axis unit)	Servo motor power output terminal (L-axis/M-axis/S-axis) The servo/spindle motor power terminal (U, V, W) is connected.
	Protective grounding (PE)	Grounding terminal The servo motor/spindle motor grounding terminal is connected and grounded.

CAUTION

1. Always use one AC reactor per power supply unit. Failure to observe this lead to unit damage.
2. When sharing a circuit protector for several power supply units, if a short-circuit fault occurs in a small capacity unit, the circuit protector could trip. This can be hazardous, so do not share the circuit protector.
3. Be sure to use the circuit protector of proper capacity for each unit.

2.2.2 Connector Pin Assignment



⚠ CAUTION

Do not apply a voltage other than that specified in Instruction Manual on each terminal. Failure to observe this item could lead to rupture or damage, etc.

(1) Main circuit terminal block and connector
Power supply unit



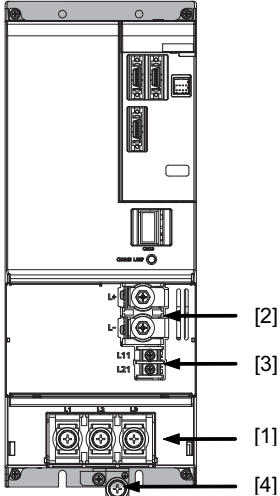
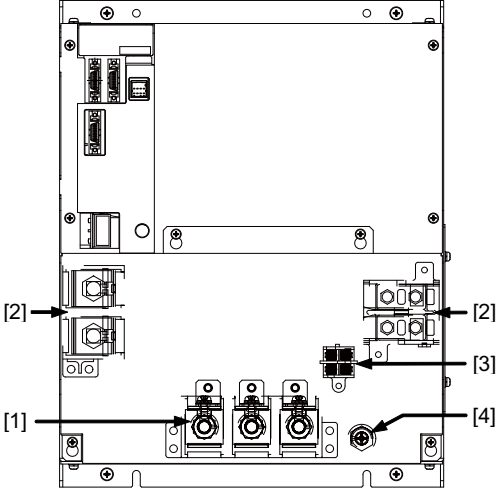
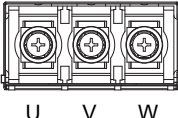
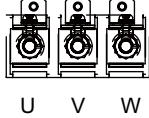
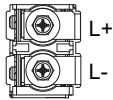

Unit		MDS-D2-CV-37 to 75	MDS-D2-CV-110 to 185 MDS-DH2-CV-37 to 185						
Terminal position									
Terminal specification/ Pin assignment	[1] TE1	<p>(Note) This is a bottom view.</p>	<table border="1"> <tr> <td>Compatible unit</td> <td>All of CV</td> </tr> <tr> <td>Screw size</td> <td>M5 x 12</td> </tr> <tr> <td>Tightening torque</td> <td>2.0Nm</td> </tr> </table>	Compatible unit	All of CV	Screw size	M5 x 12	Tightening torque	2.0Nm
	Compatible unit	All of CV							
	Screw size	M5 x 12							
	Tightening torque	2.0Nm							
[2] TE2	<table border="1"> <tr> <td>Compatible unit</td> <td>All of CV</td> </tr> <tr> <td>Screw size</td> <td>M6 x 18</td> </tr> <tr> <td>Tightening torque</td> <td>4.0Nm</td> </tr> </table>	Compatible unit	All of CV	Screw size	M6 x 18	Tightening torque	4.0Nm		
Compatible unit	All of CV								
Screw size	M6 x 18								
Tightening torque	4.0Nm								
[3] TE3	<table border="1"> <tr> <td>Compatible unit</td> <td>All of CV</td> </tr> <tr> <td>Screw size</td> <td>M4 x 10</td> </tr> <tr> <td>Tightening torque</td> <td>1.2Nm</td> </tr> </table>	Compatible unit	All of CV	Screw size	M4 x 10	Tightening torque	1.2Nm		
Compatible unit	All of CV								
Screw size	M4 x 10								
Tightening torque	1.2Nm								
[4] ⊕	<p>Screw size: M4×12 Tightening torque: 1.2Nm</p>	The PE screw size is the same as TE1.							

(Note) The illustrations of drive units are shown as an example.



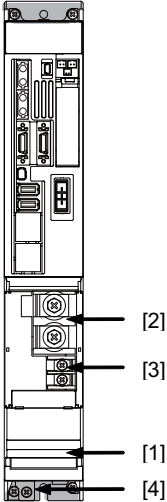
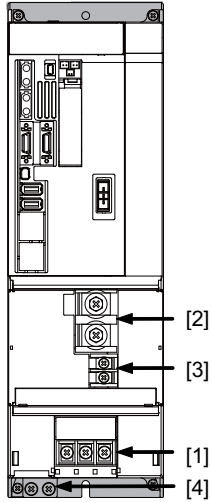
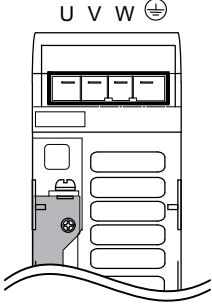

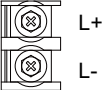

Terminal		Unit	MDS-D2-CV-300 to 450 MDS-DH2-CV-300 to 450	MDS-D2-CV-550 MDS-DH2-CV-550 to 750																						
Terminal position																										
Terminal specification/ Pin assignment	[1] TE1		 <table border="1" data-bbox="448 1072 842 1167"> <tr> <td>Compatible unit</td> <td>All of CV</td> </tr> <tr> <td>Screw size</td> <td>M8 x 16</td> </tr> <tr> <td>Tightening torque</td> <td>6.0Nm</td> </tr> </table>	Compatible unit	All of CV	Screw size	M8 x 16	Tightening torque	6.0Nm	 <table border="1" data-bbox="946 1064 1382 1182"> <tr> <td rowspan="2">Compatible unit</td> <td>D2-CV</td> <td>550</td> <td>-</td> </tr> <tr> <td>DH2-CV</td> <td>-</td> <td>550 to 750</td> </tr> <tr> <td colspan="2">Screw size</td> <td>M10 x 20</td> <td>M8 x 16</td> </tr> <tr> <td colspan="2">Tightening torque</td> <td>11.0Nm</td> <td>6.0Nm</td> </tr> </table>	Compatible unit	D2-CV	550	-	DH2-CV	-	550 to 750	Screw size		M10 x 20	M8 x 16	Tightening torque		11.0Nm	6.0Nm	
	Compatible unit	All of CV																								
	Screw size	M8 x 16																								
	Tightening torque	6.0Nm																								
Compatible unit	D2-CV	550	-																							
	DH2-CV	-	550 to 750																							
Screw size		M10 x 20	M8 x 16																							
Tightening torque		11.0Nm	6.0Nm																							
[2] TE2	 <table border="1" data-bbox="683 1272 1331 1391"> <tr> <td rowspan="2">Compatible unit</td> <td>D2-CV</td> <td>300 to 450</td> <td>-</td> <td>550 Left side</td> <td>550 Right side</td> </tr> <tr> <td>DH2-CV</td> <td>300 to 450</td> <td>550 to 750</td> <td>-</td> <td>-</td> </tr> <tr> <td colspan="2">Screw size</td> <td>M6 x 18</td> <td>M6 x 16</td> <td>M10 x 20</td> <td>M6 x 16</td> </tr> <tr> <td colspan="2">Tightening torque</td> <td>4.0Nm</td> <td>4.0Nm</td> <td>11.0Nm</td> <td>4.0Nm</td> </tr> </table>	Compatible unit	D2-CV	300 to 450	-	550 Left side	550 Right side	DH2-CV	300 to 450	550 to 750	-	-	Screw size		M6 x 18	M6 x 16	M10 x 20	M6 x 16	Tightening torque		4.0Nm	4.0Nm	11.0Nm	4.0Nm		
Compatible unit	D2-CV		300 to 450	-	550 Left side	550 Right side																				
	DH2-CV	300 to 450	550 to 750	-	-																					
Screw size		M6 x 18	M6 x 16	M10 x 20	M6 x 16																					
Tightening torque		4.0Nm	4.0Nm	11.0Nm	4.0Nm																					
[3] TE3	 <table border="1" data-bbox="783 1464 1219 1583"> <tr> <td rowspan="2">Compatible unit</td> <td>D2-CV</td> <td>300 to 450</td> <td>550</td> </tr> <tr> <td>DH2-CV</td> <td>300 to 450</td> <td>550 to 750</td> </tr> <tr> <td colspan="2">Screw size</td> <td colspan="2">M4 x 10</td> </tr> <tr> <td colspan="2">Tightening torque</td> <td>1.2Nm</td> <td>1.2Nm</td> </tr> </table>	Compatible unit	D2-CV	300 to 450	550	DH2-CV	300 to 450	550 to 750	Screw size		M4 x 10		Tightening torque		1.2Nm	1.2Nm										
Compatible unit	D2-CV		300 to 450	550																						
	DH2-CV	300 to 450	550 to 750																							
Screw size		M4 x 10																								
Tightening torque		1.2Nm	1.2Nm																							
[4] ⊖		Screw size: M8×14 Tightening torque: 6.0Nm	<table border="1" data-bbox="946 1655 1382 1774"> <tr> <td rowspan="2">Compatible unit</td> <td>D2-CV</td> <td>550</td> <td>-</td> </tr> <tr> <td>DH2-CV</td> <td>-</td> <td>550 to 750</td> </tr> <tr> <td colspan="2">Screw size</td> <td>M10 x 20</td> <td>M8 x 16</td> </tr> <tr> <td colspan="2">Tightening torque</td> <td>11.0Nm</td> <td>6.0Nm</td> </tr> </table>	Compatible unit	D2-CV	550	-	DH2-CV	-	550 to 750	Screw size		M10 x 20	M8 x 16	Tightening torque		11.0Nm	6.0Nm								
Compatible unit	D2-CV	550	-																							
	DH2-CV	-	550 to 750																							
Screw size		M10 x 20	M8 x 16																							
Tightening torque		11.0Nm	6.0Nm																							

(Note) The illustrations of drive units are shown as an example.

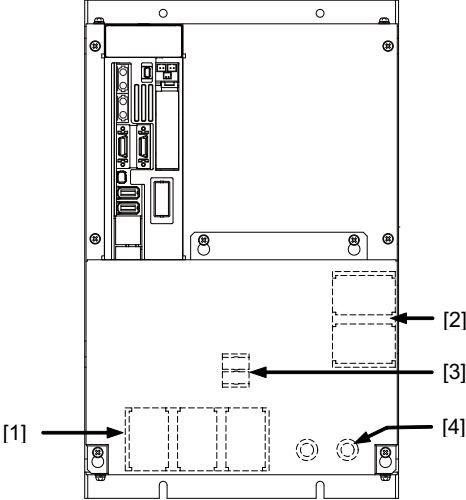
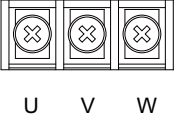
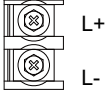
1-axis servo drive unit / 1-axis spindle drive unit

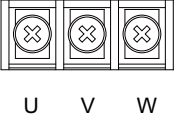
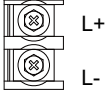
Terminal		Unit	MDS-D2-V1-160 or less MDS-D2-SP-80 or less MDS-DH2-V1-80W or less MDS-DH2-SP-80 or less	MDS-D2-V1-160W or more MDS-D2-SP-160 to 320 MDS-DH2-V1-160 to 160W MDS-DH2-SP-100 to 160																																						
Terminal position																																										
Terminal specification/ Pin assignment	[1] TE1		(Note) This is a bottom view.	 <table border="1" data-bbox="994 1061 1433 1236"> <tr> <td rowspan="4">Compatible unit</td> <td>D2-V1-</td> <td>160W to 320</td> <td>320W</td> </tr> <tr> <td>D2-SP-</td> <td>160 to 200</td> <td>240 to 320</td> </tr> <tr> <td>DH2-V1-</td> <td>160 to 160W</td> <td>-</td> </tr> <tr> <td>DH2-SP-</td> <td>100 to 160</td> <td>-</td> </tr> <tr> <td colspan="2">Screw size</td> <td>M5 x 12</td> <td>M8 x 16</td> </tr> <tr> <td colspan="2">Tightening torque</td> <td>2.0Nm</td> <td>6.0Nm</td> </tr> </table>	Compatible unit	D2-V1-	160W to 320	320W	D2-SP-	160 to 200	240 to 320	DH2-V1-	160 to 160W	-	DH2-SP-	100 to 160	-	Screw size		M5 x 12	M8 x 16	Tightening torque		2.0Nm	6.0Nm																	
	Compatible unit	D2-V1-	160W to 320	320W																																						
		D2-SP-	160 to 200	240 to 320																																						
		DH2-V1-	160 to 160W	-																																						
DH2-SP-		100 to 160	-																																							
Screw size		M5 x 12	M8 x 16																																							
Tightening torque		2.0Nm	6.0Nm																																							
[2] TE2		<table border="1" data-bbox="839 1375 1233 1469"> <tr> <td>Compatible unit</td> <td colspan="3">All of V1/V2/SP</td> </tr> <tr> <td>Screw size</td> <td colspan="3">M6 x 16</td> </tr> <tr> <td>Tightening torque</td> <td colspan="3">4.0Nm</td> </tr> </table>	Compatible unit	All of V1/V2/SP			Screw size	M6 x 16			Tightening torque	4.0Nm																														
Compatible unit	All of V1/V2/SP																																									
Screw size	M6 x 16																																									
Tightening torque	4.0Nm																																									
[3] TE3		<table border="1" data-bbox="743 1536 1305 1697"> <tr> <td rowspan="4">Compatible unit</td> <td>D2-V1-</td> <td>20 to 160</td> <td>-</td> <td>160W to 320</td> <td>-</td> <td>320W</td> </tr> <tr> <td>D2-SP-</td> <td>20 to 80</td> <td>-</td> <td>160 to 200</td> <td>-</td> <td>240 to 320</td> </tr> <tr> <td>DH2-V1-</td> <td>10 to 80W</td> <td>-</td> <td>160 to 160W</td> <td>-</td> <td>-</td> </tr> <tr> <td>DH2-SP-</td> <td>20 to 40</td> <td>80</td> <td>100</td> <td>160</td> <td>-</td> </tr> <tr> <td colspan="2">Screw size</td> <td>M4 x 10</td> <td>M4 x 12</td> <td>M4 x 10</td> <td>M4 x 12</td> <td>M4 x 10</td> </tr> <tr> <td colspan="2">Tightening torque</td> <td colspan="5">1.2Nm</td> </tr> </table>	Compatible unit	D2-V1-	20 to 160	-	160W to 320	-	320W	D2-SP-	20 to 80	-	160 to 200	-	240 to 320	DH2-V1-	10 to 80W	-	160 to 160W	-	-	DH2-SP-	20 to 40	80	100	160	-	Screw size		M4 x 10	M4 x 12	M4 x 10	M4 x 12	M4 x 10	Tightening torque		1.2Nm					
Compatible unit	D2-V1-	20 to 160		-	160W to 320	-	320W																																			
	D2-SP-	20 to 80		-	160 to 200	-	240 to 320																																			
	DH2-V1-	10 to 80W		-	160 to 160W	-	-																																			
	DH2-SP-	20 to 40	80	100	160	-																																				
Screw size		M4 x 10	M4 x 12	M4 x 10	M4 x 12	M4 x 10																																				
Tightening torque		1.2Nm																																								
[4] ⊕		<table border="1" data-bbox="743 1715 1177 1877"> <tr> <td rowspan="4">Compatible unit</td> <td>D2-V1-</td> <td>20 to 160</td> <td>160W to 320</td> <td>320W</td> </tr> <tr> <td>D2-SP-</td> <td>20 to 80</td> <td>160 to 200</td> <td>240 to 320</td> </tr> <tr> <td>DH2-V1-</td> <td>10 to 80W</td> <td>160 to 160W</td> <td>-</td> </tr> <tr> <td>DH2-SP-</td> <td>20 to 40</td> <td>80 to 160</td> <td>-</td> </tr> <tr> <td colspan="2">Screw size</td> <td>M4 x 12</td> <td>M5 x 12</td> <td>M8 x 16</td> </tr> <tr> <td colspan="2">Tightening torque</td> <td colspan="3">2.0Nm</td> </tr> </table>	Compatible unit	D2-V1-	20 to 160	160W to 320	320W	D2-SP-	20 to 80	160 to 200	240 to 320	DH2-V1-	10 to 80W	160 to 160W	-	DH2-SP-	20 to 40	80 to 160	-	Screw size		M4 x 12	M5 x 12	M8 x 16	Tightening torque		2.0Nm															
Compatible unit	D2-V1-	20 to 160		160W to 320	320W																																					
	D2-SP-	20 to 80		160 to 200	240 to 320																																					
	DH2-V1-	10 to 80W		160 to 160W	-																																					
	DH2-SP-	20 to 40	80 to 160	-																																						
Screw size		M4 x 12	M5 x 12	M8 x 16																																						
Tightening torque		2.0Nm																																								

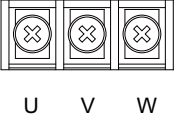
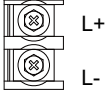
(Note) The illustrations of drive units are shown as an example.

Terminal	Unit																																																																																
Terminal position	<p style="text-align: center;">MDS-D2-SP-400 to 640 MDS-DH2-V1-200 MDS-DH2-SP-200 to 480</p> 																																																																																
	<table border="1"> <tr> <td data-bbox="113 891 288 1285" rowspan="4">Terminal specification/ Pin assignment</td> <td data-bbox="288 891 395 1285">[1] TE1</td> <td data-bbox="395 891 1444 1285">  <table border="1" data-bbox="699 1070 1139 1223"> <tr> <td rowspan="3">Compatible unit</td> <td>D2-SP-</td> <td>-</td> <td>400 to 640</td> </tr> <tr> <td>DH2-V1-</td> <td>200</td> <td>-</td> </tr> <tr> <td>DH2-SP-</td> <td>200 to 480</td> <td>-</td> </tr> <tr> <td colspan="2">Screw size</td> <td>M8 x 15</td> <td>M10 x 20</td> </tr> <tr> <td colspan="2">Tightening torque</td> <td>6.0Nm</td> <td>11.0Nm</td> </tr> </table> <p>(Note) Refer to "POINT" below.</p> </td> </tr> <tr> <td data-bbox="288 1285 395 1509">[2] TE2</td> <td data-bbox="395 1285 1444 1509">  <table border="1" data-bbox="778 1323 1214 1473"> <tr> <td rowspan="3">Compatible unit</td> <td>D2-SP-</td> <td>-</td> <td>400 to 640</td> </tr> <tr> <td>DH2-V1-</td> <td>200</td> <td>-</td> </tr> <tr> <td>DH2-SP-</td> <td>200 to 480</td> <td>-</td> </tr> <tr> <td colspan="2">Screw size</td> <td>M6 x 16</td> <td>M10 x 20</td> </tr> <tr> <td colspan="2">Tightening torque</td> <td>4.0Nm</td> <td>11.0Nm</td> </tr> </table> </td> </tr> <tr> <td data-bbox="288 1509 395 1715">[3] TE3</td> <td data-bbox="395 1509 1444 1715">  <table border="1" data-bbox="799 1518 1209 1675"> <tr> <td rowspan="3">Compatible unit</td> <td>D2-SP-</td> <td>400</td> <td>640</td> </tr> <tr> <td>DH2-V1-</td> <td>-</td> <td>200</td> </tr> <tr> <td>DH2-SP-</td> <td>-</td> <td>200 to 480</td> </tr> <tr> <td colspan="2">Screw size</td> <td>M4 x 8</td> <td>M4 x 10</td> </tr> <tr> <td colspan="2">Tightening torque</td> <td colspan="2">1.2Nm</td> </tr> </table> </td> </tr> <tr> <td data-bbox="288 1715 395 1904">[4] Ⓧ</td> <td data-bbox="395 1715 1444 1904"> <table border="1" data-bbox="711 1738 1129 1883"> <tr> <td rowspan="3">Compatible unit</td> <td>D2-SP-</td> <td>-</td> <td>400 to 640</td> </tr> <tr> <td>DH2-V1-</td> <td>200</td> <td>-</td> </tr> <tr> <td>DH2-SP-</td> <td>200 to 480</td> <td>-</td> </tr> <tr> <td colspan="2">Screw size</td> <td>M8 x 16</td> <td>M10 x 20</td> </tr> <tr> <td colspan="2">Tightening torque</td> <td>6.0Nm</td> <td>11.0Nm</td> </tr> </table> </td> </tr> </table>	Terminal specification/ Pin assignment	[1] TE1	 <table border="1" data-bbox="699 1070 1139 1223"> <tr> <td rowspan="3">Compatible unit</td> <td>D2-SP-</td> <td>-</td> <td>400 to 640</td> </tr> <tr> <td>DH2-V1-</td> <td>200</td> <td>-</td> </tr> <tr> <td>DH2-SP-</td> <td>200 to 480</td> <td>-</td> </tr> <tr> <td colspan="2">Screw size</td> <td>M8 x 15</td> <td>M10 x 20</td> </tr> <tr> <td colspan="2">Tightening torque</td> <td>6.0Nm</td> <td>11.0Nm</td> </tr> </table> <p>(Note) Refer to "POINT" below.</p>	Compatible unit	D2-SP-	-	400 to 640	DH2-V1-	200	-	DH2-SP-	200 to 480	-	Screw size		M8 x 15	M10 x 20	Tightening torque		6.0Nm	11.0Nm	[2] TE2	 <table border="1" data-bbox="778 1323 1214 1473"> <tr> <td rowspan="3">Compatible unit</td> <td>D2-SP-</td> <td>-</td> <td>400 to 640</td> </tr> <tr> <td>DH2-V1-</td> <td>200</td> <td>-</td> </tr> <tr> <td>DH2-SP-</td> <td>200 to 480</td> <td>-</td> </tr> <tr> <td colspan="2">Screw size</td> <td>M6 x 16</td> <td>M10 x 20</td> </tr> <tr> <td colspan="2">Tightening torque</td> <td>4.0Nm</td> <td>11.0Nm</td> </tr> </table>	Compatible unit	D2-SP-	-	400 to 640	DH2-V1-	200	-	DH2-SP-	200 to 480	-	Screw size		M6 x 16	M10 x 20	Tightening torque		4.0Nm	11.0Nm	[3] TE3	 <table border="1" data-bbox="799 1518 1209 1675"> <tr> <td rowspan="3">Compatible unit</td> <td>D2-SP-</td> <td>400</td> <td>640</td> </tr> <tr> <td>DH2-V1-</td> <td>-</td> <td>200</td> </tr> <tr> <td>DH2-SP-</td> <td>-</td> <td>200 to 480</td> </tr> <tr> <td colspan="2">Screw size</td> <td>M4 x 8</td> <td>M4 x 10</td> </tr> <tr> <td colspan="2">Tightening torque</td> <td colspan="2">1.2Nm</td> </tr> </table>	Compatible unit	D2-SP-	400	640	DH2-V1-	-	200	DH2-SP-	-	200 to 480	Screw size		M4 x 8	M4 x 10	Tightening torque		1.2Nm		[4] Ⓧ	<table border="1" data-bbox="711 1738 1129 1883"> <tr> <td rowspan="3">Compatible unit</td> <td>D2-SP-</td> <td>-</td> <td>400 to 640</td> </tr> <tr> <td>DH2-V1-</td> <td>200</td> <td>-</td> </tr> <tr> <td>DH2-SP-</td> <td>200 to 480</td> <td>-</td> </tr> <tr> <td colspan="2">Screw size</td> <td>M8 x 16</td> <td>M10 x 20</td> </tr> <tr> <td colspan="2">Tightening torque</td> <td>6.0Nm</td> <td>11.0Nm</td> </tr> </table>	Compatible unit	D2-SP-	-	400 to 640	DH2-V1-	200	-	DH2-SP-	200 to 480	-	Screw size		M8 x 16	M10 x 20	Tightening torque		6.0Nm
Terminal specification/ Pin assignment	[1] TE1		 <table border="1" data-bbox="699 1070 1139 1223"> <tr> <td rowspan="3">Compatible unit</td> <td>D2-SP-</td> <td>-</td> <td>400 to 640</td> </tr> <tr> <td>DH2-V1-</td> <td>200</td> <td>-</td> </tr> <tr> <td>DH2-SP-</td> <td>200 to 480</td> <td>-</td> </tr> <tr> <td colspan="2">Screw size</td> <td>M8 x 15</td> <td>M10 x 20</td> </tr> <tr> <td colspan="2">Tightening torque</td> <td>6.0Nm</td> <td>11.0Nm</td> </tr> </table> <p>(Note) Refer to "POINT" below.</p>	Compatible unit		D2-SP-	-	400 to 640	DH2-V1-	200	-	DH2-SP-	200 to 480	-	Screw size		M8 x 15	M10 x 20	Tightening torque		6.0Nm	11.0Nm																																																											
	Compatible unit		D2-SP-			-	400 to 640																																																																										
			DH2-V1-		200	-																																																																											
		DH2-SP-	200 to 480	-																																																																													
Screw size		M8 x 15	M10 x 20																																																																														
Tightening torque		6.0Nm	11.0Nm																																																																														
[2] TE2	 <table border="1" data-bbox="778 1323 1214 1473"> <tr> <td rowspan="3">Compatible unit</td> <td>D2-SP-</td> <td>-</td> <td>400 to 640</td> </tr> <tr> <td>DH2-V1-</td> <td>200</td> <td>-</td> </tr> <tr> <td>DH2-SP-</td> <td>200 to 480</td> <td>-</td> </tr> <tr> <td colspan="2">Screw size</td> <td>M6 x 16</td> <td>M10 x 20</td> </tr> <tr> <td colspan="2">Tightening torque</td> <td>4.0Nm</td> <td>11.0Nm</td> </tr> </table>	Compatible unit	D2-SP-	-	400 to 640	DH2-V1-	200	-	DH2-SP-	200 to 480	-	Screw size		M6 x 16	M10 x 20	Tightening torque		4.0Nm	11.0Nm																																																														
Compatible unit	D2-SP-		-	400 to 640																																																																													
	DH2-V1-		200	-																																																																													
	DH2-SP-	200 to 480	-																																																																														
Screw size		M6 x 16	M10 x 20																																																																														
Tightening torque		4.0Nm	11.0Nm																																																																														
[3] TE3	 <table border="1" data-bbox="799 1518 1209 1675"> <tr> <td rowspan="3">Compatible unit</td> <td>D2-SP-</td> <td>400</td> <td>640</td> </tr> <tr> <td>DH2-V1-</td> <td>-</td> <td>200</td> </tr> <tr> <td>DH2-SP-</td> <td>-</td> <td>200 to 480</td> </tr> <tr> <td colspan="2">Screw size</td> <td>M4 x 8</td> <td>M4 x 10</td> </tr> <tr> <td colspan="2">Tightening torque</td> <td colspan="2">1.2Nm</td> </tr> </table>	Compatible unit	D2-SP-	400	640	DH2-V1-	-	200	DH2-SP-	-	200 to 480	Screw size		M4 x 8	M4 x 10	Tightening torque		1.2Nm																																																															
Compatible unit	D2-SP-		400	640																																																																													
	DH2-V1-		-	200																																																																													
	DH2-SP-	-	200 to 480																																																																														
Screw size		M4 x 8	M4 x 10																																																																														
Tightening torque		1.2Nm																																																																															
[4] Ⓧ	<table border="1" data-bbox="711 1738 1129 1883"> <tr> <td rowspan="3">Compatible unit</td> <td>D2-SP-</td> <td>-</td> <td>400 to 640</td> </tr> <tr> <td>DH2-V1-</td> <td>200</td> <td>-</td> </tr> <tr> <td>DH2-SP-</td> <td>200 to 480</td> <td>-</td> </tr> <tr> <td colspan="2">Screw size</td> <td>M8 x 16</td> <td>M10 x 20</td> </tr> <tr> <td colspan="2">Tightening torque</td> <td>6.0Nm</td> <td>11.0Nm</td> </tr> </table>	Compatible unit	D2-SP-	-	400 to 640	DH2-V1-	200	-	DH2-SP-	200 to 480	-	Screw size		M8 x 16	M10 x 20	Tightening torque		6.0Nm	11.0Nm																																																														
Compatible unit	D2-SP-		-	400 to 640																																																																													
	DH2-V1-		200	-																																																																													
	DH2-SP-	200 to 480	-																																																																														
Screw size		M8 x 16	M10 x 20																																																																														
Tightening torque		6.0Nm	11.0Nm																																																																														

(Note) The illustrations of drive units are shown as an example.

 **POINT**



Always install a large capacity drive unit in the left side of power supply unit, and connect with DC connection bar.

2-axis servo/spindle drive unit

Terminal	Unit	MDS-D2-V2-160160 or less MDS-D2-SP2-8080 or less MDS-DH2-V2-8080W or less	MDS-D2-V2-160160W MDS-D2-SP2-16080S,16080																
Terminal position																			
Terminal specification/ Pin assignment	[1] TE1	<p>MU MV MW ⊕ LU LV LW ⊕</p> <p>For M axis For L axis</p> <p>(Note) This is a bottom view.</p>	<table border="1"> <tr> <td rowspan="2">Compatible unit</td> <td>D2-V2-</td> <td>160160W</td> </tr> <tr> <td>D2-SP2-</td> <td>16080</td> </tr> <tr> <td colspan="2">Screw size</td> <td>M5 x 12</td> </tr> <tr> <td colspan="2">Tightening torque</td> <td>2.0Nm</td> </tr> </table>	Compatible unit	D2-V2-	160160W	D2-SP2-	16080	Screw size		M5 x 12	Tightening torque		2.0Nm					
	Compatible unit	D2-V2-	160160W																
		D2-SP2-	16080																
	Screw size		M5 x 12																
Tightening torque		2.0Nm																	
[2] TE2	<table border="1"> <tr> <td rowspan="3">Compatible unit</td> <td>D2-V2-</td> <td>2020 to 160160W</td> </tr> <tr> <td>D2-SP2-</td> <td>2020 to 16080</td> </tr> <tr> <td>DH2-V2-</td> <td>1010 to 8080W</td> </tr> <tr> <td colspan="2">Screw size</td> <td>M6 x 16</td> </tr> <tr> <td colspan="2">Tightening torque</td> <td>4.0Nm</td> </tr> </table>	Compatible unit	D2-V2-	2020 to 160160W	D2-SP2-	2020 to 16080	DH2-V2-	1010 to 8080W	Screw size		M6 x 16	Tightening torque		4.0Nm					
Compatible unit	D2-V2-		2020 to 160160W																
	D2-SP2-		2020 to 16080																
	DH2-V2-	1010 to 8080W																	
Screw size		M6 x 16																	
Tightening torque		4.0Nm																	
[3] TE3	<table border="1"> <tr> <td rowspan="3">Compatible unit</td> <td>D2-V2-</td> <td>2020 to 160160W</td> </tr> <tr> <td>D2-SP2-</td> <td>2020 to 16080</td> </tr> <tr> <td>DH2-V2-</td> <td>1010 to 8080W</td> </tr> <tr> <td colspan="2">Screw size</td> <td>M4 x 10</td> </tr> <tr> <td colspan="2">Tightening torque</td> <td>1.2Nm</td> </tr> </table>	Compatible unit	D2-V2-	2020 to 160160W	D2-SP2-	2020 to 16080	DH2-V2-	1010 to 8080W	Screw size		M4 x 10	Tightening torque		1.2Nm					
Compatible unit	D2-V2-		2020 to 160160W																
	D2-SP2-		2020 to 16080																
	DH2-V2-	1010 to 8080W																	
Screw size		M4 x 10																	
Tightening torque		1.2Nm																	
[4] ⊕	<table border="1"> <tr> <td rowspan="3">Compatible unit</td> <td>D2-V2-</td> <td>2020 to 160160</td> <td>160160W</td> </tr> <tr> <td>D2-SP2-</td> <td>2020 to 8040</td> <td>8080, 16080</td> </tr> <tr> <td>DH2-V2-</td> <td>1010 to 8080</td> <td>8080W</td> </tr> <tr> <td colspan="2">Screw size</td> <td>M4 x 12</td> <td>M5 x 12</td> </tr> <tr> <td colspan="2">Tightening torque</td> <td>1.2Nm</td> <td>2.0Nm</td> </tr> </table>	Compatible unit	D2-V2-	2020 to 160160	160160W	D2-SP2-	2020 to 8040	8080, 16080	DH2-V2-	1010 to 8080	8080W	Screw size		M4 x 12	M5 x 12	Tightening torque		1.2Nm	2.0Nm
Compatible unit	D2-V2-		2020 to 160160	160160W															
	D2-SP2-		2020 to 8040	8080, 16080															
	DH2-V2-	1010 to 8080	8080W																
Screw size		M4 x 12	M5 x 12																
Tightening torque		1.2Nm	2.0Nm																

(Note) The illustrations of drive units are shown as an example.

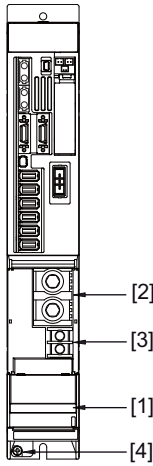
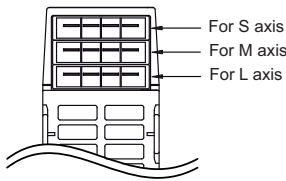
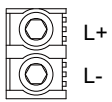
3-axis servo drive unit

Terminal		Unit	MDS-D2-V3-202020 MDS-D2-V3-404040						
Connector position									
Terminal specification/ Pin assignment	[1] TE1		<p>SU, SV, SW, ⊕ MU, MV, MW, ⊕ LU, LV, LW, ⊕</p>  <p>(Note) This is bottom view.</p>						
	[2] TE2		<table border="1"> <tr> <td>Compatible unit</td> <td>All of V3</td> </tr> <tr> <td>Screw size</td> <td>M6 x 15</td> </tr> <tr> <td>Tightening torque</td> <td>4.0Nm</td> </tr> </table>	Compatible unit	All of V3	Screw size	M6 x 15	Tightening torque	4.0Nm
	Compatible unit	All of V3							
	Screw size	M6 x 15							
Tightening torque	4.0Nm								
[3] TE3		<table border="1"> <tr> <td>Compatible unit</td> <td>All of V3</td> </tr> <tr> <td>Screw size</td> <td>M4 x 10</td> </tr> <tr> <td>Tightening torque</td> <td>1.2Nm</td> </tr> </table>	Compatible unit	All of V3	Screw size	M4 x 10	Tightening torque	1.2Nm	
Compatible unit	All of V3								
Screw size	M4 x 10								
Tightening torque	1.2Nm								
[4] ⊕		<p>Screw size: M4×12 Tightening torque: 2.0Nm</p>							

(Note) The illustrations of drive units are shown as an example.

(2) Control circuit connector
1-axis servo drive unit

Terminal		Unit	MDS-D2-V1 MDS-DH2-V1-160W or less	MDS-DH2-V1-200
Connector position				
			Optical communication connector	
Connector specification	[1] CN1A [2] CN1B			
	[3] CN5		No.1 No.5	
	[4] CN9 [5] CN4		Pin No. No.20 No.10 No.11 No.1	
	[6] CN8		No.7 No.8 No.1 No.2	
	[7] CN2L [8] CN3L		No.9 No.1 No.10 No.2	
	[9] CN20		Pin No. No.1 No.2 No.3	











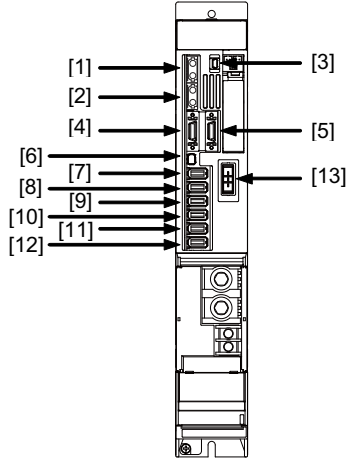



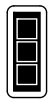

(Note) The illustrations of drive units are shown as an example.

2-axis servo drive unit

Terminal	Unit	MDS-D2/DH2-V2
Connector position		
	Connector specification	[1] CN1A [2] CN1B
[3] CN5		
[4] CN9 [5] CN4		Pin No.
[6] CN8		
[7] CN2L [8] CN3L [9] CN2M [10] CN3M		
[11] CN20		Pin No.

(Note) The illustrations of drive units are shown as an example.

3-axis servo drive unit

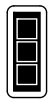
Terminal	Unit											
<p>Connector position</p>	<p>MDS-D2-V3-202020 MDS-D2-V3-404040</p> 											
	<p>Connector specification</p> <table border="1"> <tr> <td data-bbox="320 880 459 1066"> <p>[1] CN1A [2] CN1B</p> </td> <td data-bbox="459 880 1479 1066"> <p>Optical communication connector</p>  </td> </tr> <tr> <td data-bbox="320 1066 459 1211"> <p>[3] CN5</p> </td> <td data-bbox="459 1066 1479 1211"> <p>No.1 No.5</p>  </td> </tr> <tr> <td data-bbox="320 1211 459 1420"> <p>[4] CN9 [5] CN4</p> </td> <td data-bbox="459 1211 1479 1420"> <p>Pin No.</p> <p>No.20 No.10 No.11 No.1</p>  </td> </tr> <tr> <td data-bbox="320 1420 459 1541"> <p>[6] CN8</p> </td> <td data-bbox="459 1420 1479 1541"> <p>No.7 No.8 No.1 No.2</p>  </td> </tr> <tr> <td data-bbox="320 1541 459 1731"> <p>[7] CN2L [8] CN3L [9] CN2M [10] CN3M [11] CN2S [12] CN3S</p> </td> <td data-bbox="459 1541 1479 1731"> <p>No.9 No.1 No.10 No.2</p>  </td> </tr> <tr> <td data-bbox="320 1731 459 1921"> <p>[13] CN20</p> </td> <td data-bbox="459 1731 1479 1921"> <p>Pin No.</p> <p>No.1 No.2 No.3</p>  </td> </tr> </table>	<p>[1] CN1A [2] CN1B</p>	<p>Optical communication connector</p> 	<p>[3] CN5</p>	<p>No.1 No.5</p> 	<p>[4] CN9 [5] CN4</p>	<p>Pin No.</p> <p>No.20 No.10 No.11 No.1</p> 	<p>[6] CN8</p>	<p>No.7 No.8 No.1 No.2</p> 	<p>[7] CN2L [8] CN3L [9] CN2M [10] CN3M [11] CN2S [12] CN3S</p>	<p>No.9 No.1 No.10 No.2</p> 	<p>[13] CN20</p>
<p>[1] CN1A [2] CN1B</p>	<p>Optical communication connector</p> 											
<p>[3] CN5</p>	<p>No.1 No.5</p> 											
<p>[4] CN9 [5] CN4</p>	<p>Pin No.</p> <p>No.20 No.10 No.11 No.1</p> 											
<p>[6] CN8</p>	<p>No.7 No.8 No.1 No.2</p> 											
<p>[7] CN2L [8] CN3L [9] CN2M [10] CN3M [11] CN2S [12] CN3S</p>	<p>No.9 No.1 No.10 No.2</p> 											
<p>[13] CN20</p>	<p>Pin No.</p> <p>No.1 No.2 No.3</p> 											







(Note) The illustrations of drive units are shown as an example.

1-axis spindle drive unit

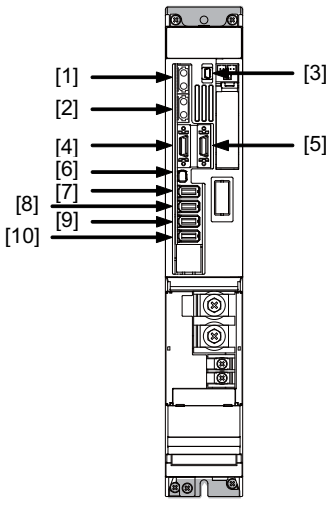
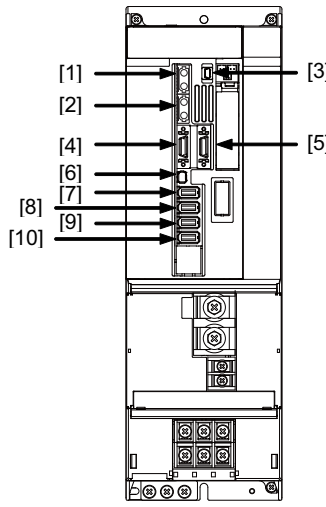
Terminal		Unit	MDS-D2-SP-320 or less MDS-DH2-SP-160 or less	MDS-D2-SP-400 or more MDS-DH2-SP-200 or more
Connector position				
Optical communication connector				
Connector specification	[1] CN1A [2] CN1B			
	[3] CN5		 No.1 No.5	
	[4] CN9 [5] CN4		Pin No. No.20 No.10 No.11 No.1	
	[6] CN8		No.7 No.8 No.1 No.2	
	[7] CN2L [8] CN3L		No.9 No.1 No.10 No.2	

(Note) The illustrations of drive units are shown as an example.

2-axis spindle drive unit

Terminal		Unit	MDS-D2-SP2-8080 or less	MDS-D2-SP2-16080S,16080
Connector position				
			Optical communication connector	
Connector specification	[1] CN1A [2] CN1B			
	[3] CN5		 No.1 No.5	
	[4] CN9 [5] CN4		Pin No.  No.20 No.10 No.11 No.1	
	[6] CN8		No.7 No.8  No.1 No.2	
	[7] CN2L [8] CN3L [9] CN2M [10] CN3M		No.9 No.1  No.10 No.2	

(Note) The illustrations of drive units are shown as an example.

2.3 NC and Drive Unit Connection

2.3.1 Connection of Optical Communication Cables

Connect the optical communication cables from the NC to the each drive unit so that they run in a straight line from the NC to the drive unit that is a final axis. And up to 16 axes can be connected per system.

Note that the number of connected axes is limited by the NC.

CAUTION

1. Connect the NC and the drive units by the optical communication cables. The distance between the NC and the final drive unit must be within 30m and the specified bending radius (for wiring inside panel: 25mm, and for wiring outside panel: 50mm) or more.
2. For the main circuit wiring of the drive unit and power supply unit, the drive unit of 200V series is to be wired with MDS-D2-CV, and the drive unit of 400V series is to be wired with MDS-DH2-CV.

POINT

Axis Nos. are determined by the rotary switch for setting the axis No. (Refer to section "Setting the rotary switch".) The axis No. has no relation to the order for connecting to the NC.

(1) When using one power supply unit

Connect the largest-capacity spindle drive unit to the final axis of the NC communication bus in order to control the power supply unit. The spindle drive unit must be installed adjacent to the power supply unit. In the system with servo only, a servo drive unit for controlling unbalance axis must be installed in the same manner in the same way.

< Connection >

CN1A : CN1B connector on NC or previous stage's drive unit

CN1B : CN1A connector on next stage's drive unit

CN4 : Connector for communication between power supply unit (primary side) and drive unit

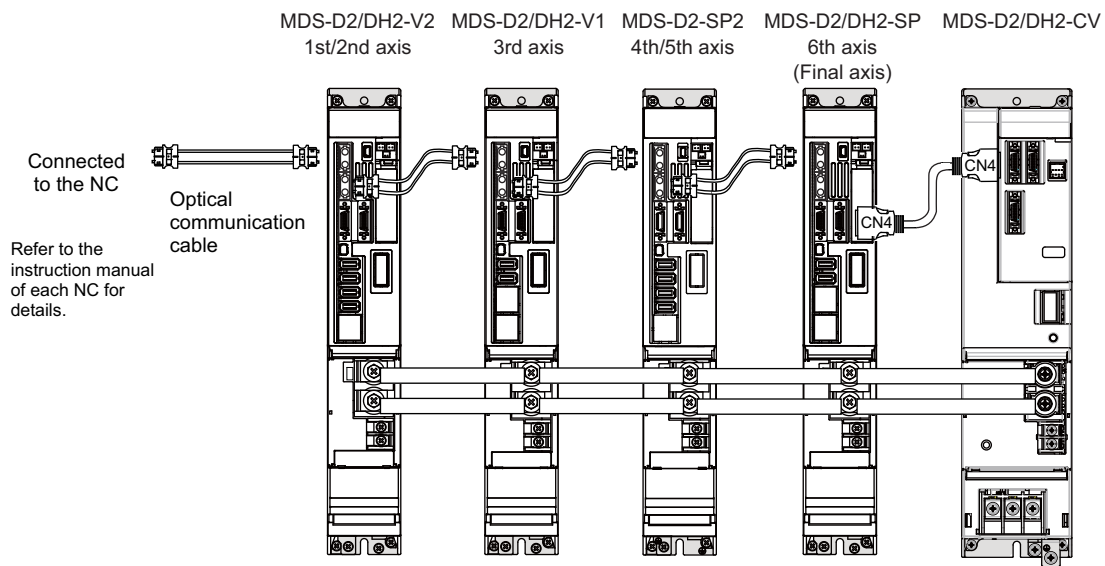

Connection when using one power supply unit

(2) When using two or more power supply units within a single NC communication bus system

Two or more power supply units may be required within a single NC communication bus system if the spindle drive unit capacity is large. The drive unit receiving power (L+, L-) from each power supply unit must always have NC communication cable connection at the NC side of each power supply unit. In the NC communication bus connection example below, power supply [1] cannot supply power (L+, L-) to the 5th axis servo drive unit. For basic connection information, refer to "(1) When using one power supply unit".

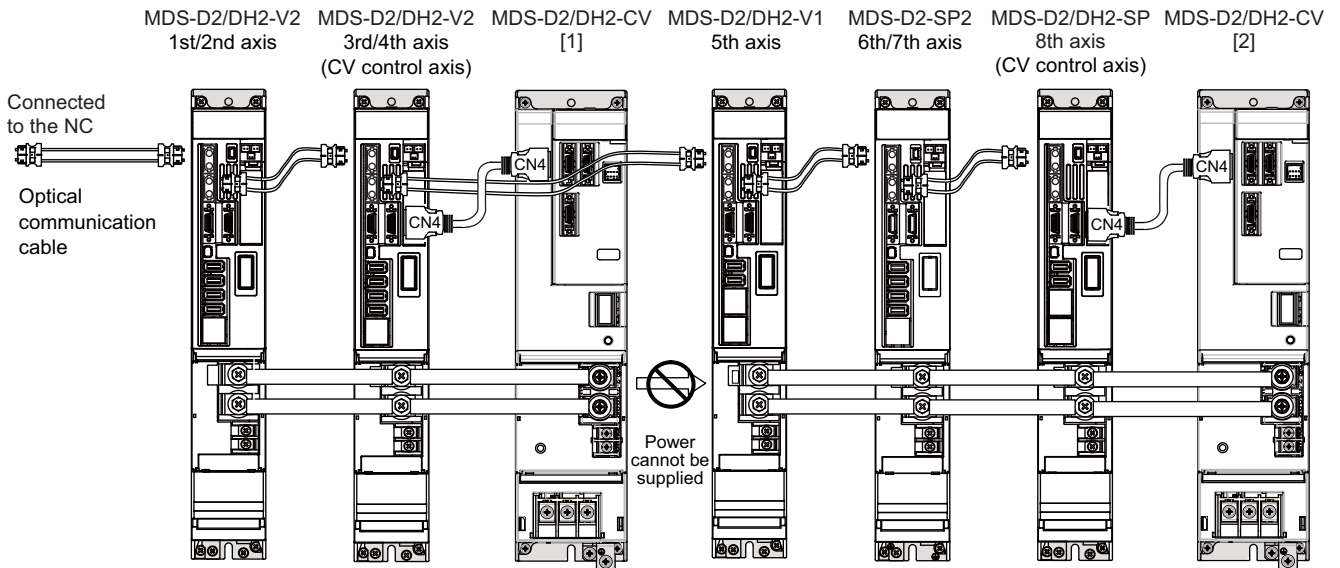

Connections when using two power supply units within a single NC communication bus system

CAUTION

1. The drive unit receiving power (L+, L-) from each power supply unit must always have NC communication bus connection at the NC side of each power supply unit.
2. If two or more power supply units are connected in the drive system, confirm that the units are not connected with each other through the L+ and L- lines before turning ON the power. Also make sure that the total capacity of the drive units connected to the same power supply unit meets the unit's selected capacity.

2.3.2 Drive Unit Arrangement

Arrange the drive units in the following procedure.

- (1) Install a power supply unit.
- (2) Arrange drive units in order of the nominal current from largest from the right.
- (3) In the arrangement, the clearance between the units is 1 mm.
- (4) Arrange the drive units with the DC connection length from the power supply unit being 800mm or less.
For the arrangement of 800mm or more, multiple power supply units are required.
- (5) Arrange large capacity drive units at the left of the power supply unit with the clearance between the drive units being 1mm.

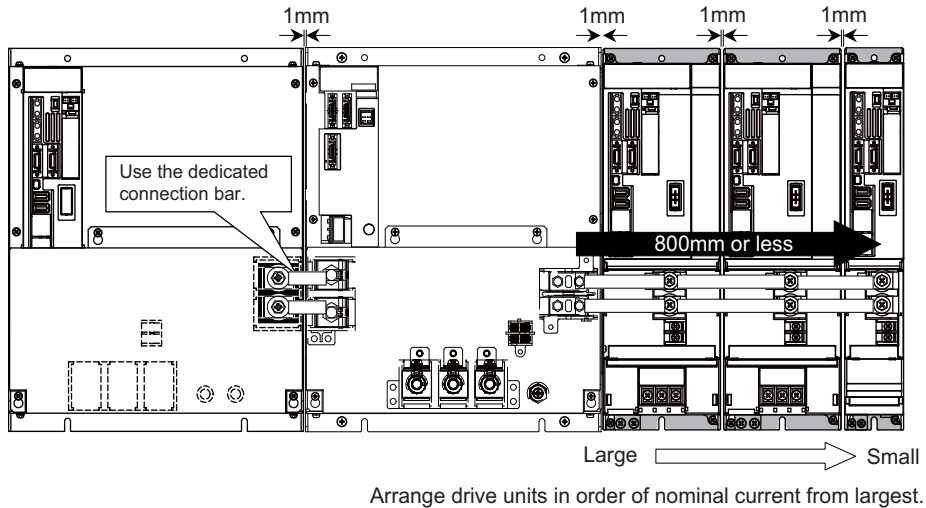

POINT

1. Arrange large capacity drive units at the left of the power supply unit with the clearance between the drive units being 1mm.
2. Power supply units equivalent to the number of large capacity drive units are required.
3. When arranging the drive unit at the right of the large capacity power supply unit, remove the side protection cover of the power supply unit.
4. MDS-D2-SP-400/640, MDS-DH2-SP-200/320/480, and MDS-DH2-V1-200 are the large capacity drive units.

< For separated arrangement of drive units >

Arranging drive units in the horizontal as much as possible is recommended. Thus, if the drive units must be arranged in the vertical, or if the drive units must be separated by more than 30mm, arrange them with the DC connection length of 500mm or less.

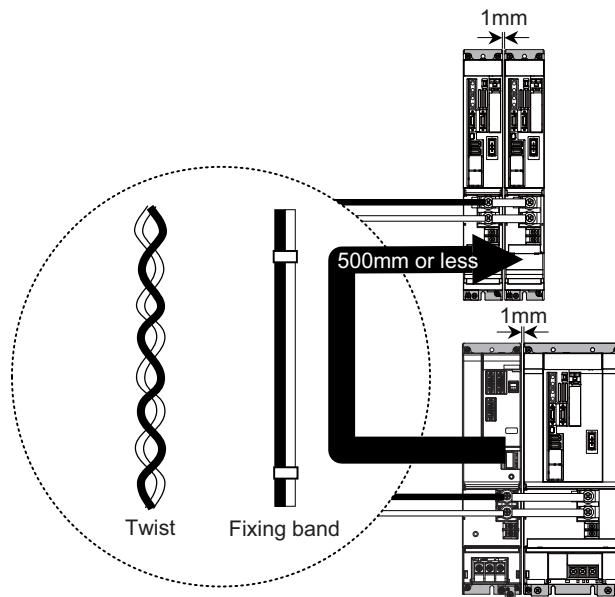
**⚠ CAUTION**

1. D2: For MDS-D2-V1-320W, MDS-D2-SP-240 to 640, the separated wiring is not available.
DH2: For MDS-DH2-V1-160W to 200, MDS-DH2-SP-160 to 480, the separated wiring is not available.
2. If the drive units are separated by more than 30mm, twist the wires used for the DC connection or bundle them with a fixing band in order to prevent two wires from being separated.
3. Failure to observe the above arrangement could damage the units.

2.4 Connecting with Optical Communication Repeater Unit

⚠ CAUTION

Optical communication repeater unit cannot be used to connect between two servo drive units.

(1) Connection example

Connect the control unit to OPT1IN and the drive unit to OPT1OUT.

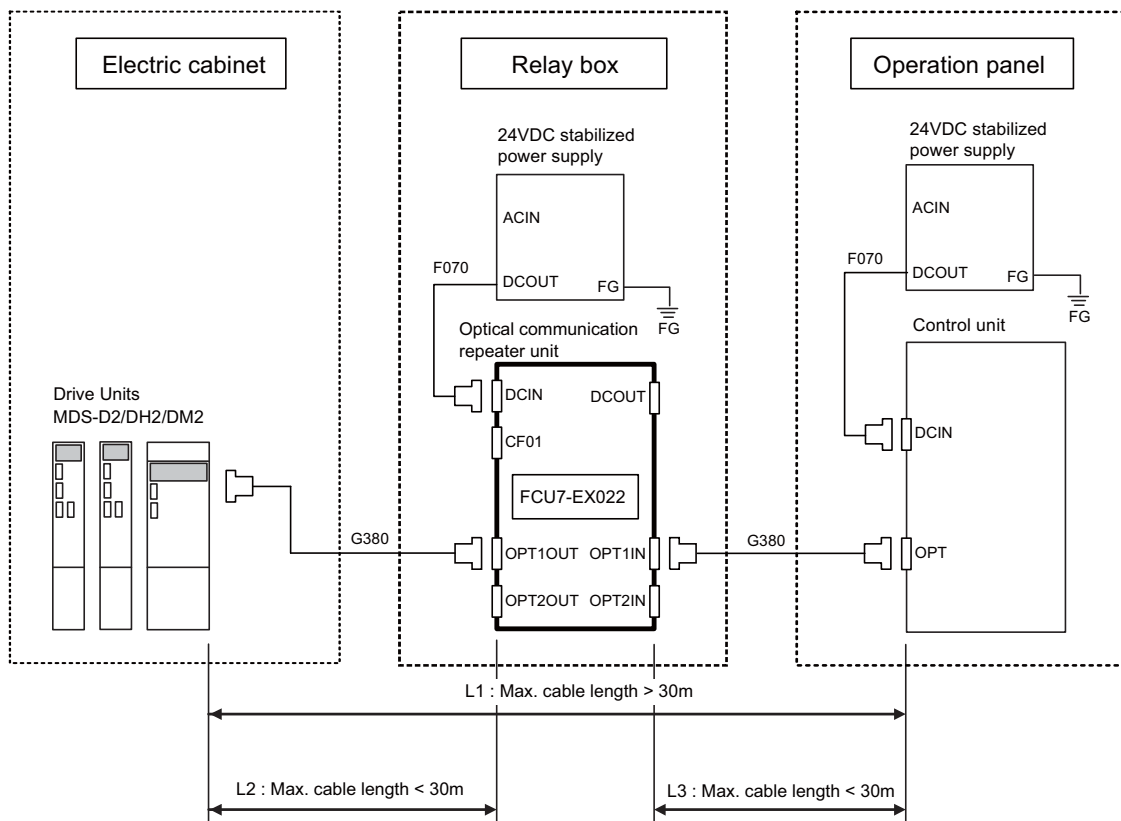

L1: Distance between the drive unit and the control unit.

L2: Distance between the drive unit and the optical communication repeater unit. (The wire length of G380 cable)

L3: Distance between the optical communication repeater unit and the control unit. (The wire length of G380 cable)

<Related items>

Cable drawing "Cable: F070 Cable", "Cable: G380 Cable"

Connector pin assignment: "General Specifications: Optical Communication Repeater Unit" (DCIN connector, OPT1IN connector, OPT1OUT connector)

(2) Power Supply Sequence

The diagram below shows the timing of power ON/OFF of the drive unit 200VAC (400VAC), the optical communication repeater unit, and the control unit.

[Power ON]

Turn the power ON in the following order; drive unit -> optical communication repeater unit -> control unit

If the control unit is powered ON before the optical communication repeater unit, the initial communication with the drive unit may fail and cause an alarm.

[Power OFF]

Turn the power OFF in the following order; control unit -> optical communication repeater unit -> drive unit.

Set aside more than 8ms the time difference between the power OFF of the control unit and the power OFF of the optical communication repeater unit.

If the optical communication repeater unit is powered OFF before the drive unit, or the time lag is less than 8ms, data acquisition from the drive unit may fail and cause an alarm.

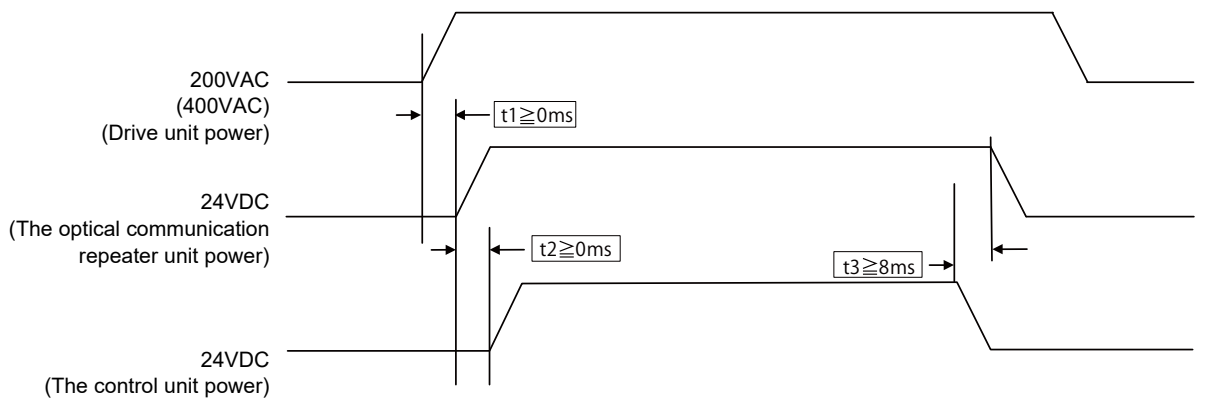

t1: Time lag between the power-ON of the drive unit and the optical communication repeater unit

t2: Time lag between the power-ON of the optical communication repeater unit and the control unit

t3: Time lag between the power-OFF of the optical communication repeater unit and the control unit

2.5 Motor and Encoder Connection

2.5.1 Connection of the Servo Motor

- (1) Connecting the HF75(B) / HF105(B) / HF54(B) / HF104(B) / HF154(B) / HF224(B) / HF123(B) / HF223(B) / HF142(B) / HP54(B) / HP104(B) / HP154(B) / HP224(B) / HF-H75(B) / HF-H105(B) / HF-H54(B) / HF-H104(B) / HF-H154(B) / HP-H54(B) / HP-H104(B) / HP-H154(B) / HP-H224(B)

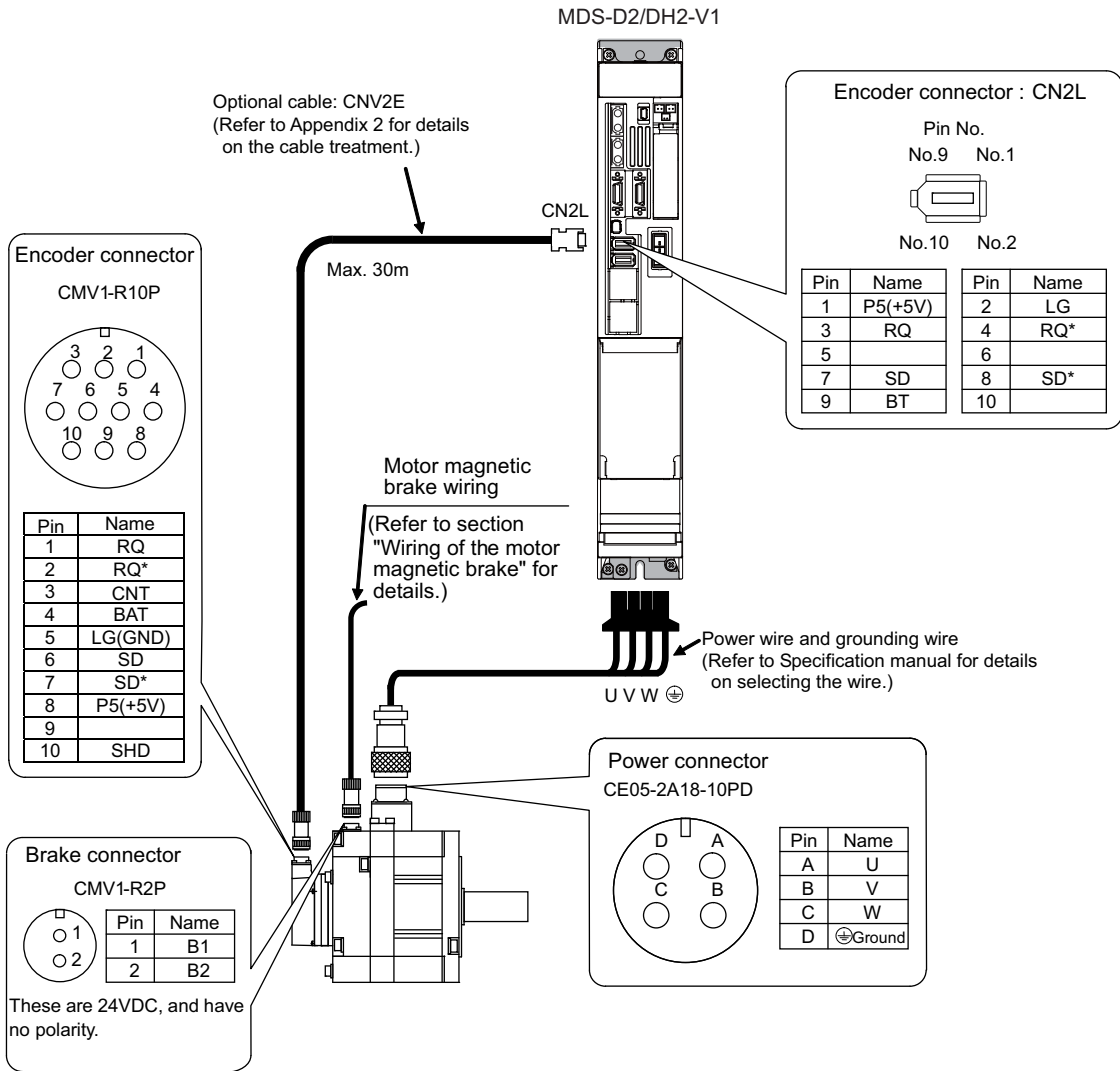

- (2) Connecting the HF204(B) / HF303(B) / HF354(B) / HF453(B) / HF302(B)
 HP204(B) / HP354(B) / HP454(B)
 HF-H204(B) / HF-H354(B) / HF-H453(B) / HF-H703(B)
 HP-H204(B) / HP-H354(B) / HP-H454(B) / HP-H704(B)

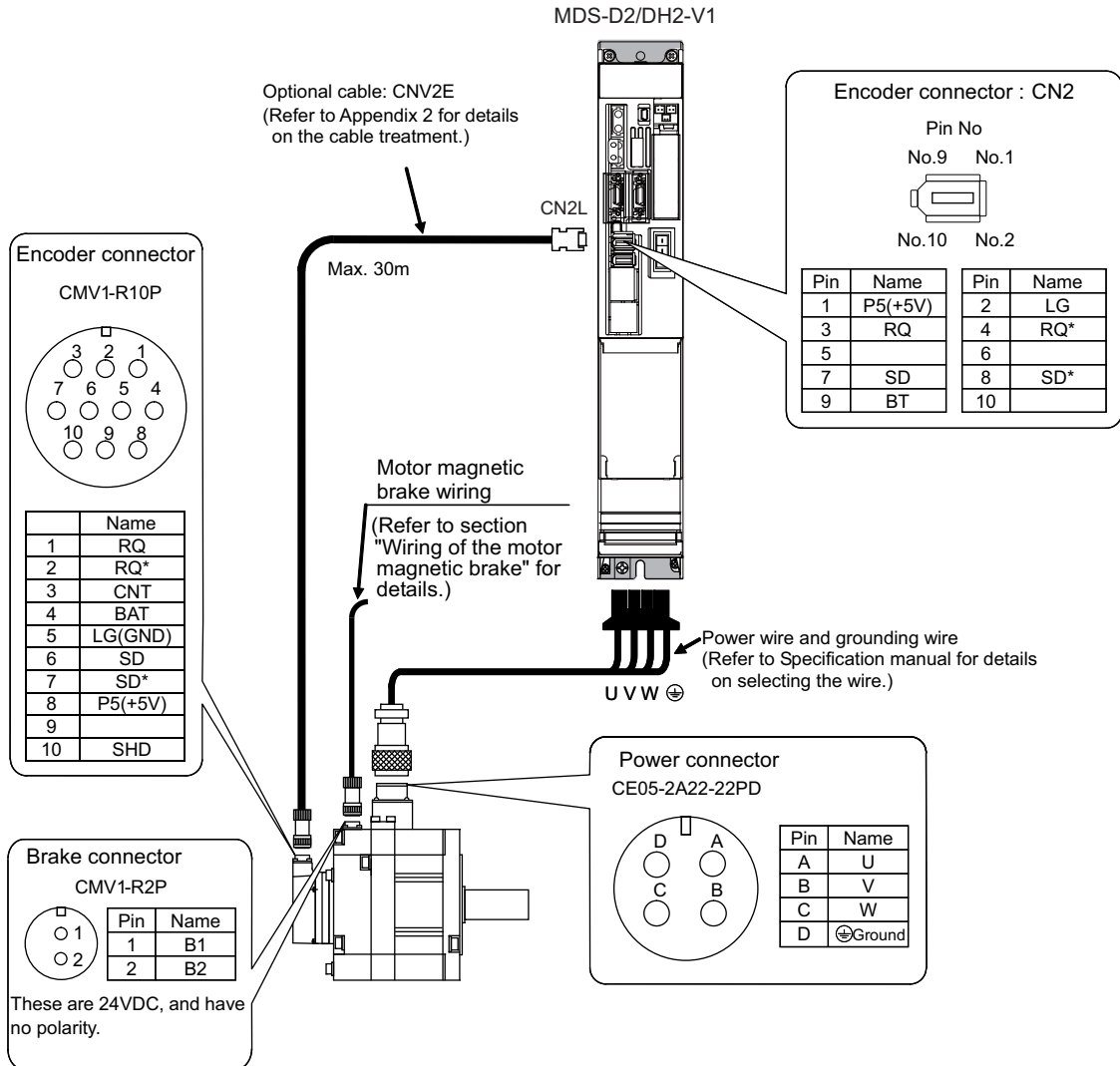

(3) Connecting the HF703(B) / HF903(B)
 HP704(B) / HP903(B) / HP1103(B)
 HF-H903(B)
 HP-H903(B) / HP-H1103(B)

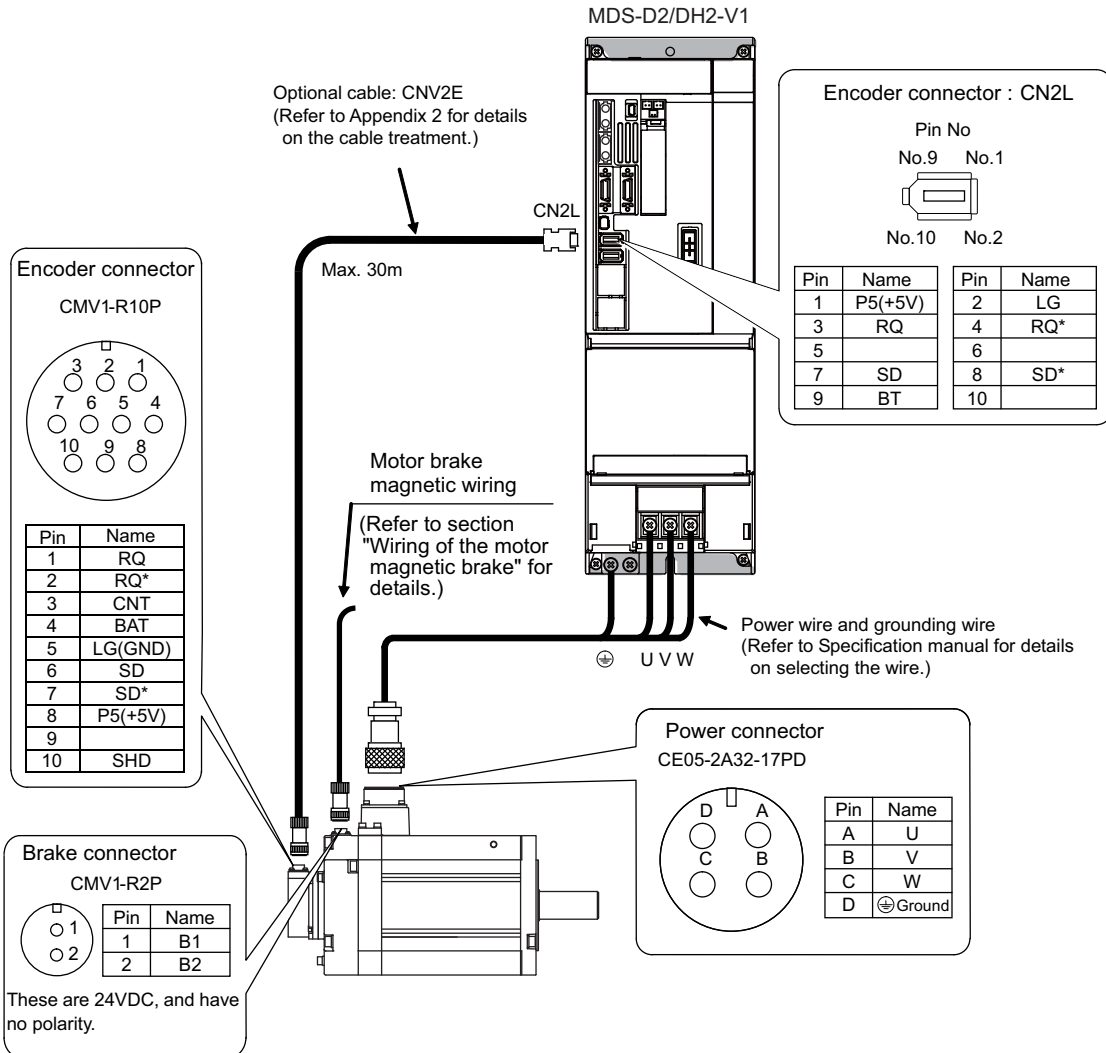

CAUTION

Dynamic brake unit is required for HP1103 and HP-H1103. Refer to section "Dynamic brake unit wiring" for details.

(4) Connecting the HF-KP23 / HF-KP43 / HF-KP73

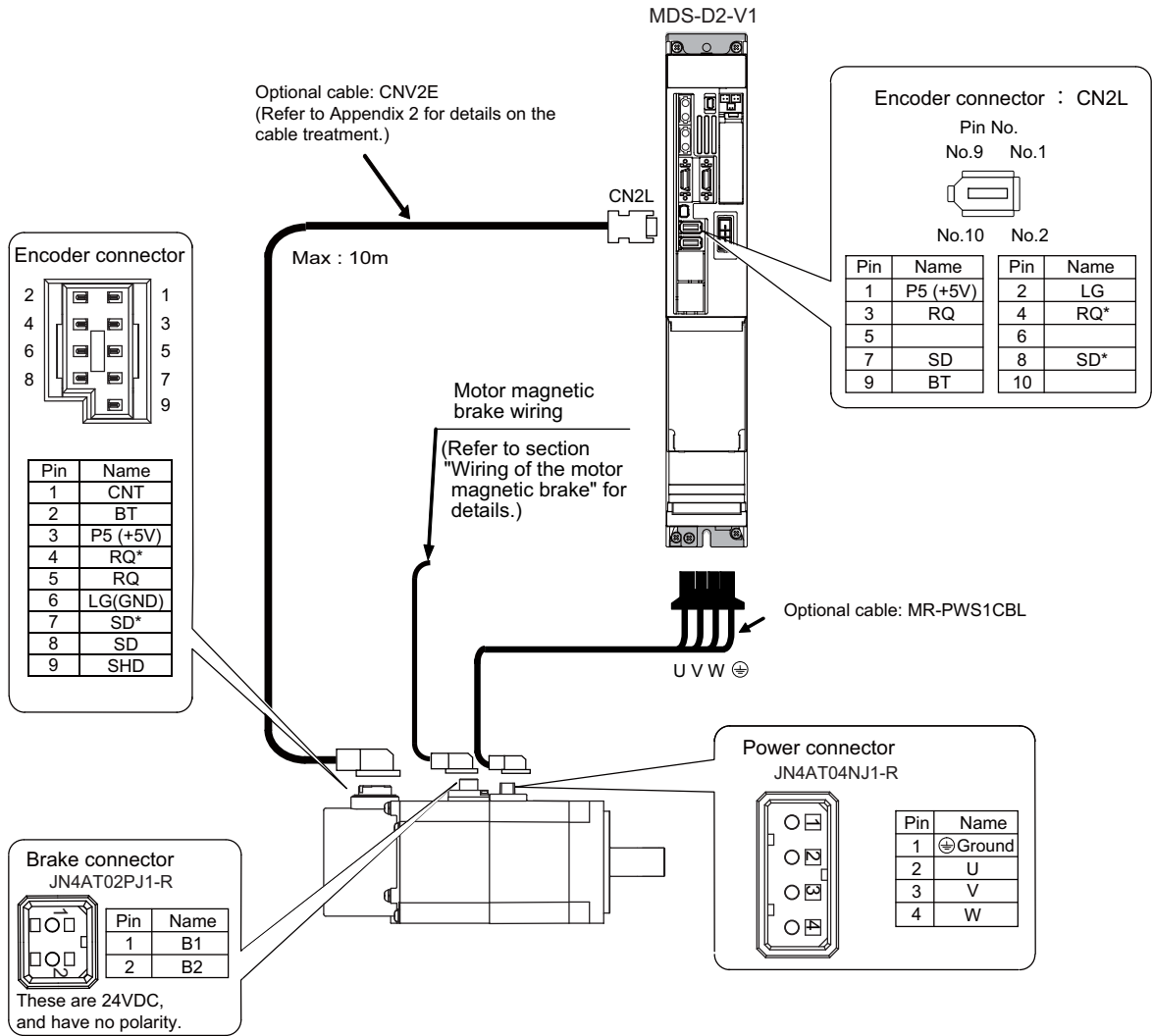

(5) Connecting the HC-H1502

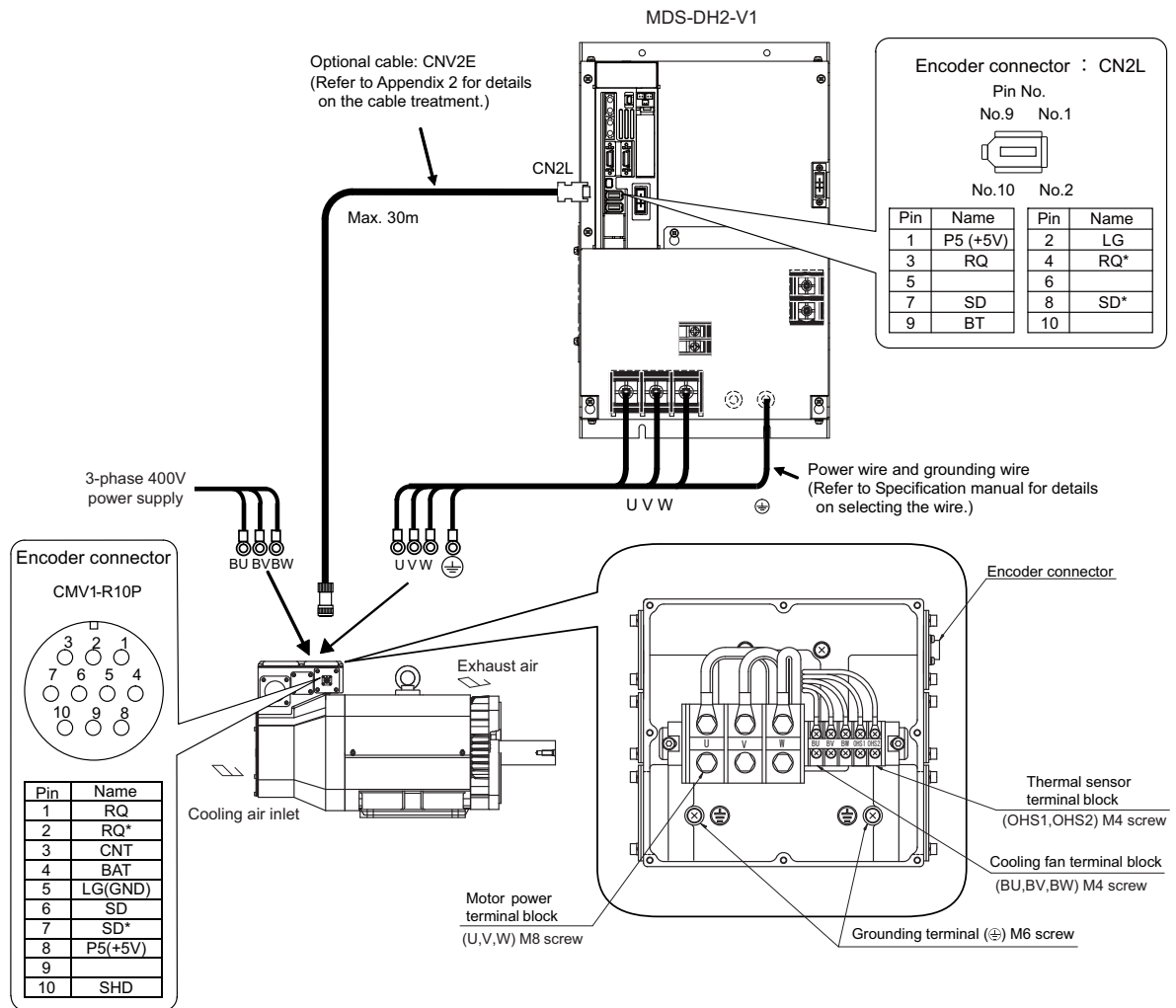

CAUTION

1. For a 3-phase cooling fan, when the phase sequence of the 3-phase power supply is connected reversely, its cooling capacity degrades due to the reversed rotation direction. Make sure the air blowoff direction.
When the fan rotates reversely, reconnect BU and BW reversely, and then check the blowoff direction.
2. The user must connect the motor thermal(OHS1 OHS2 maximum switching voltage 30V DC) with PLC and construct a sequence in which an alarm occurs in an OPEN state.
3. Dynamic brake unit is required for HC-H1502. Refer to section "Dynamic brake unit wiring" for details.

2.5.2 Connection of the Full-closed Loop System

Refer to the section "Connecting the Servo Motor" for details on connecting each motor type and wiring the power line or the motor magnetic brake.

(1) Connecting the ball screw side encoder

Connect the ball screw side encoder cable to CN3L(CN3M for M axis of dual-axis unit). Option battery is required for the absolute position system.

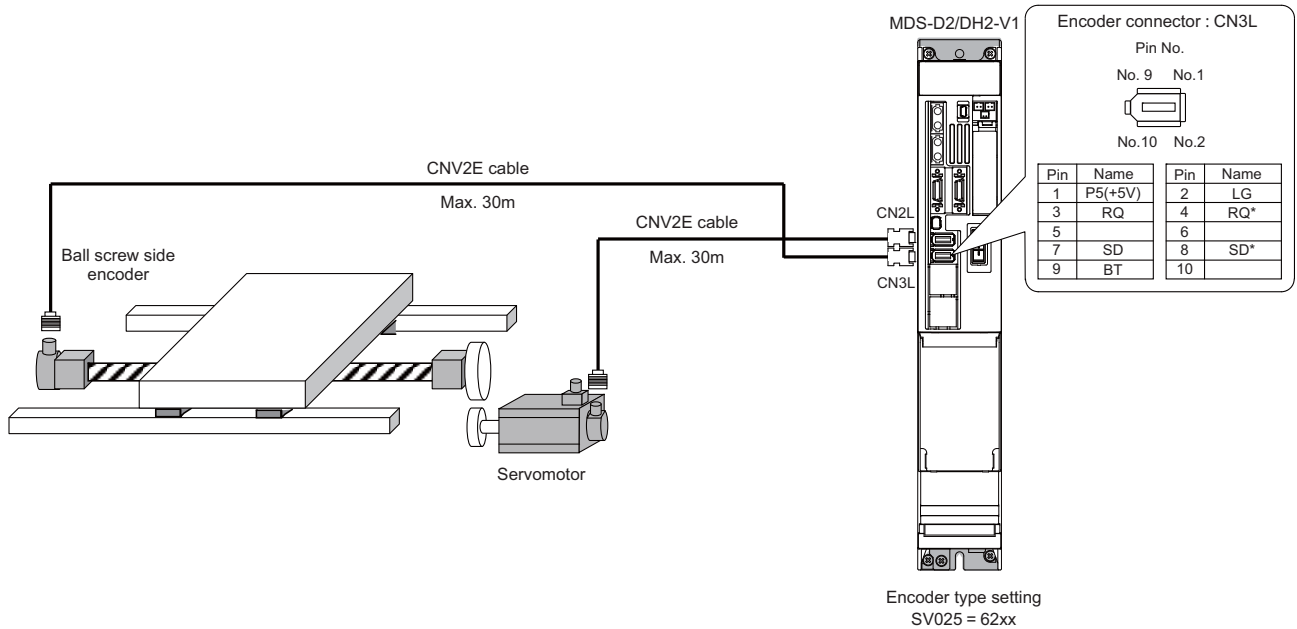

(2) Connecting the linear scale (For Mitsubishi serial signal output)

Mitsubishi serial signal output (including when SIN wave signal output is converted to Mitsubishi serial signal output with a scale manufacturer encoder interface unit) can directly connect to the drive unit.

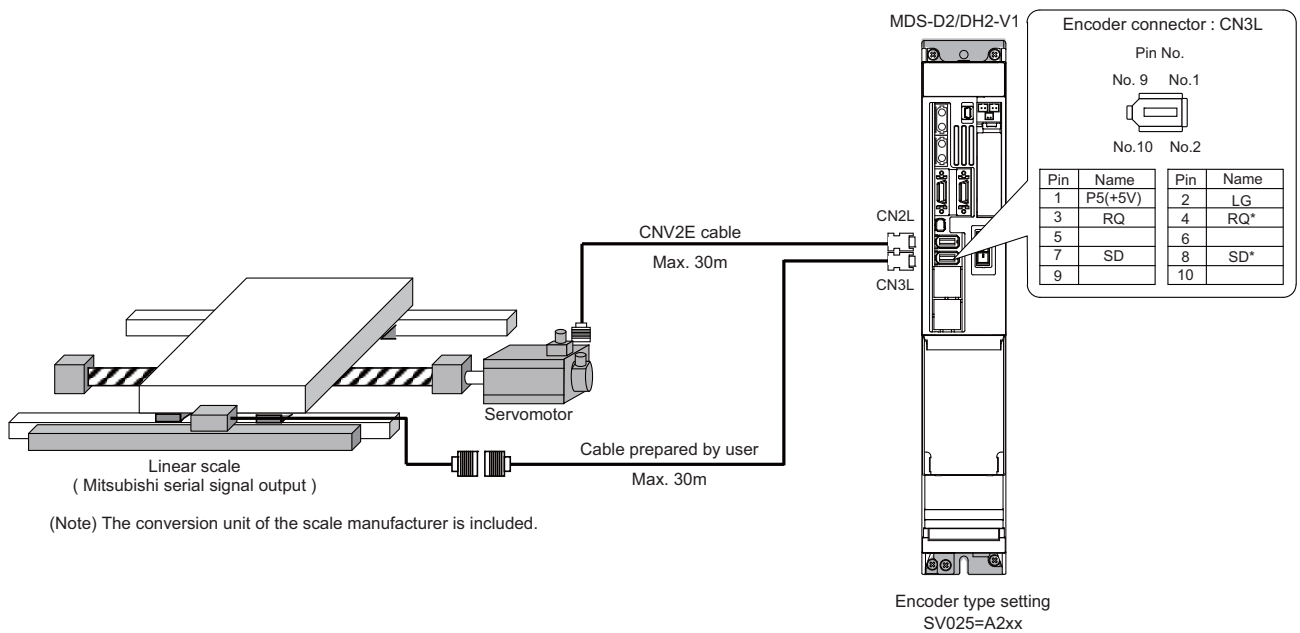

(Note) The conversion unit of the scale manufacturer is included.

(3) Connecting the linear scale (for rectangular wave signal output)

Rectangular wave signal output (including when SIN wave signal output is converted to the rectangular wave signal output with a scale manufacturer encoder interface unit) can directly input to the drive unit.

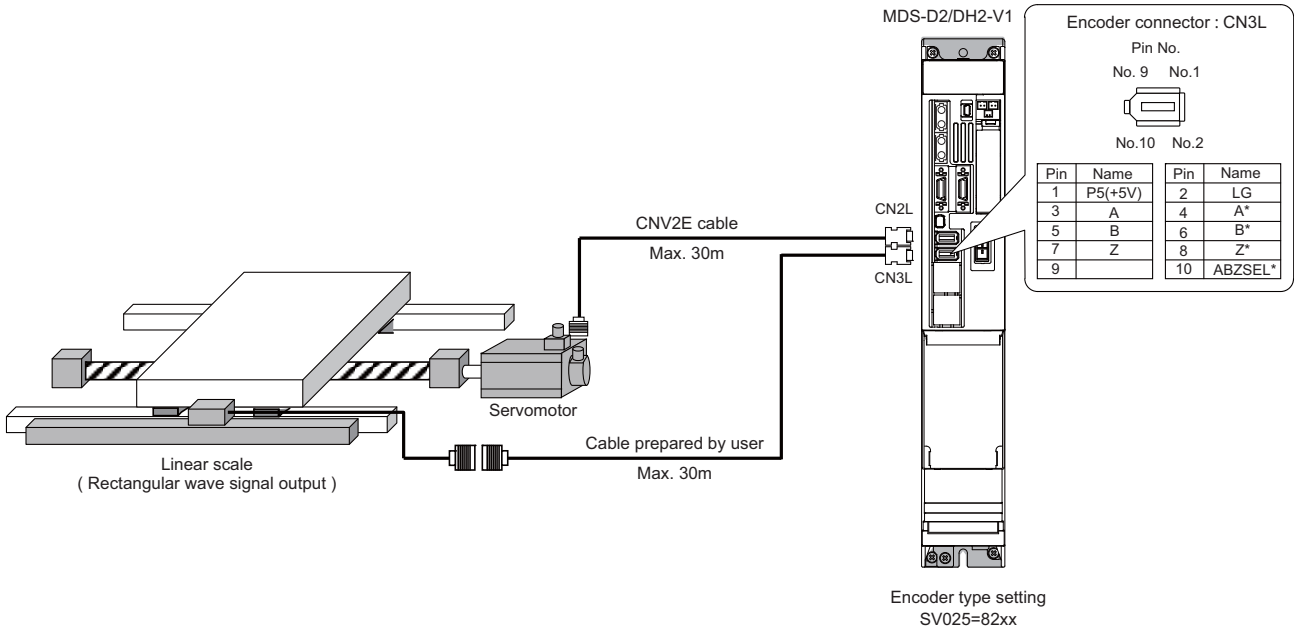

(4) Connecting the linear scale (for SIN wave signal output)

SIN wave signal output is converted to Mitsubishi serial signal output with the encoder interface unit (MDS-B-HR). The distance-coded reference scale interface is also available.

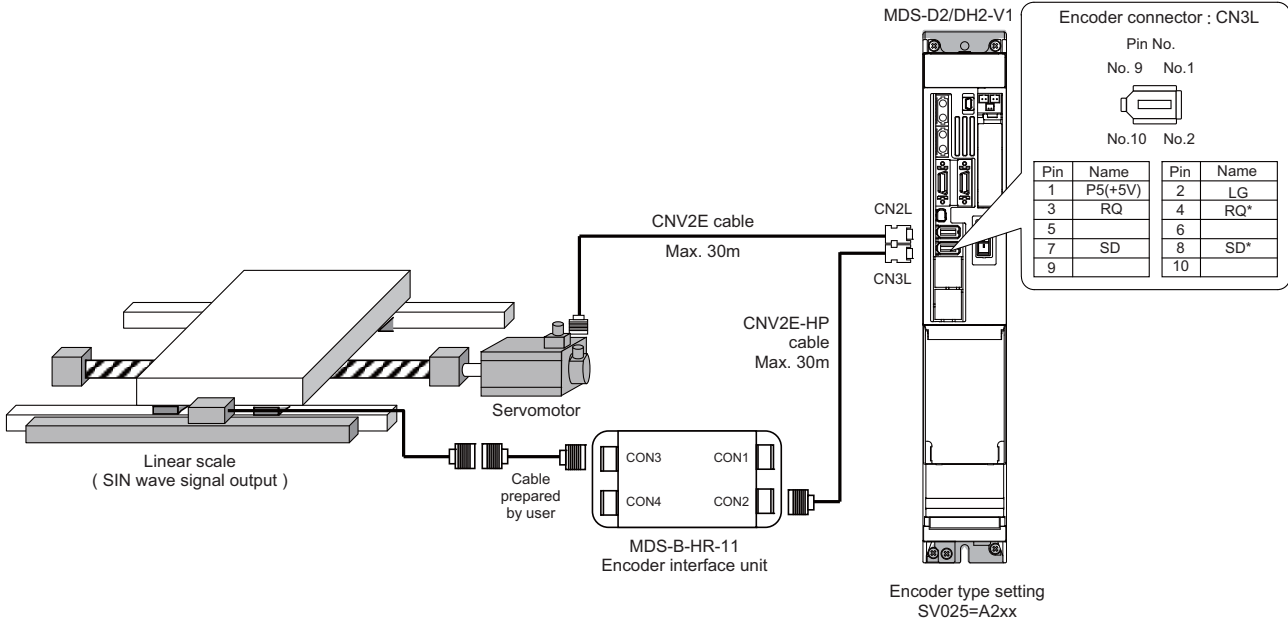

2.5.3 Connection of the Speed Command Synchronization Control System

Connecting the position command synchronous control system, connect each system as an independent axis.

(1) Connecting SIN wave signal output linear scale (when using MDS-D2/DH2-V2)

For the FB signal of the linear scale, the SIN wave signal is converted to Mitsubishi serial signal with the encoder conversion unit (MDS-B-HR-11), and that signal is divided to each axis control inside the 2-axis drive unit.

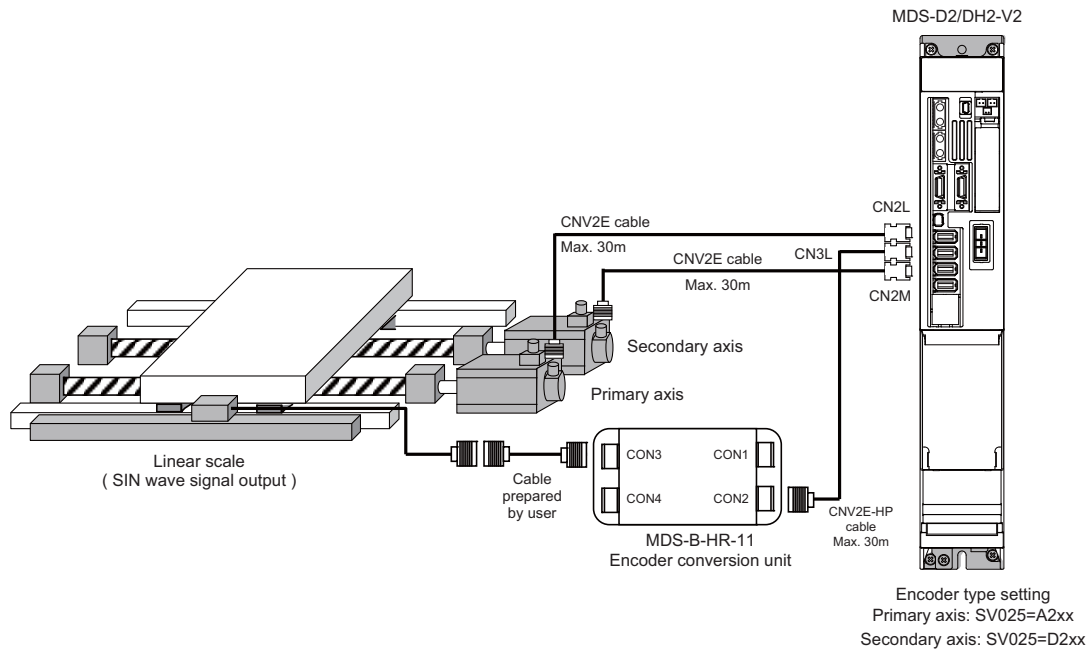

(2) Connecting SIN wave signal output linear scale (when using two units of MDS-D2/DH2-V1)

For the FB signal of the linear scale, the SIN wave signal is converted to Mitsubishi serial signal with the encoder conversion unit (MDS-B-HR-12), and that signal is divided to each drive unit.

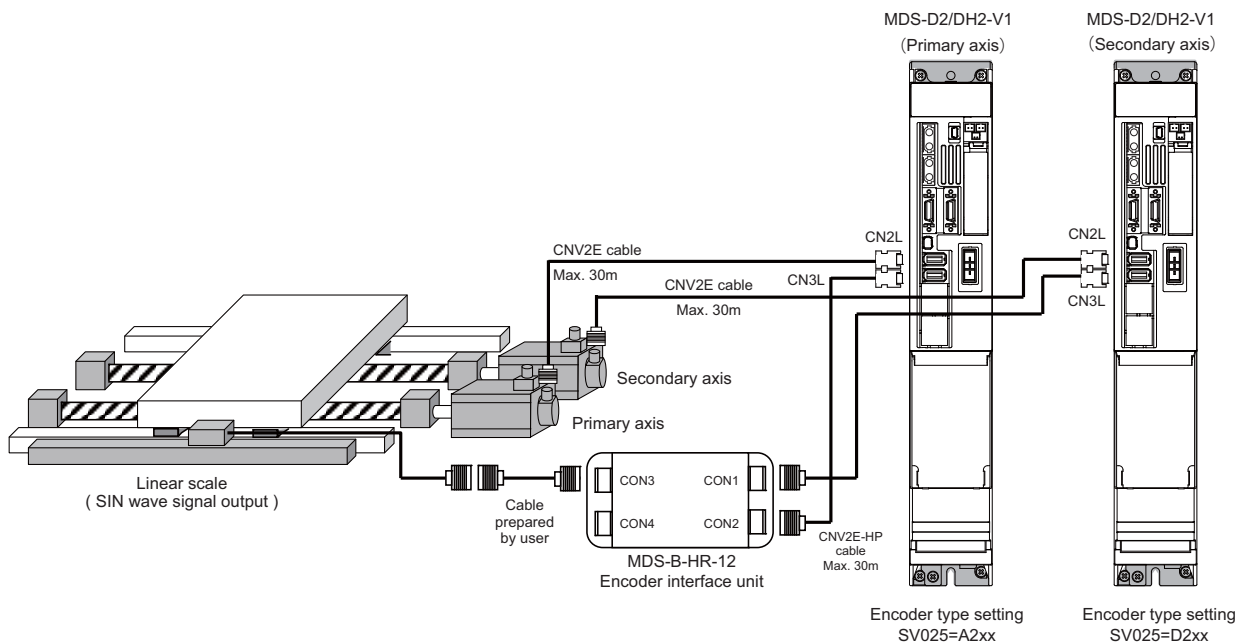

(3) Connecting Mitsubishi serial signal output linear scale (when using MDS-D2/DH2-V2)

The FB signal of the linear scale is divided to each axis control inside the 2-axis drive unit. An external option unit is not required.

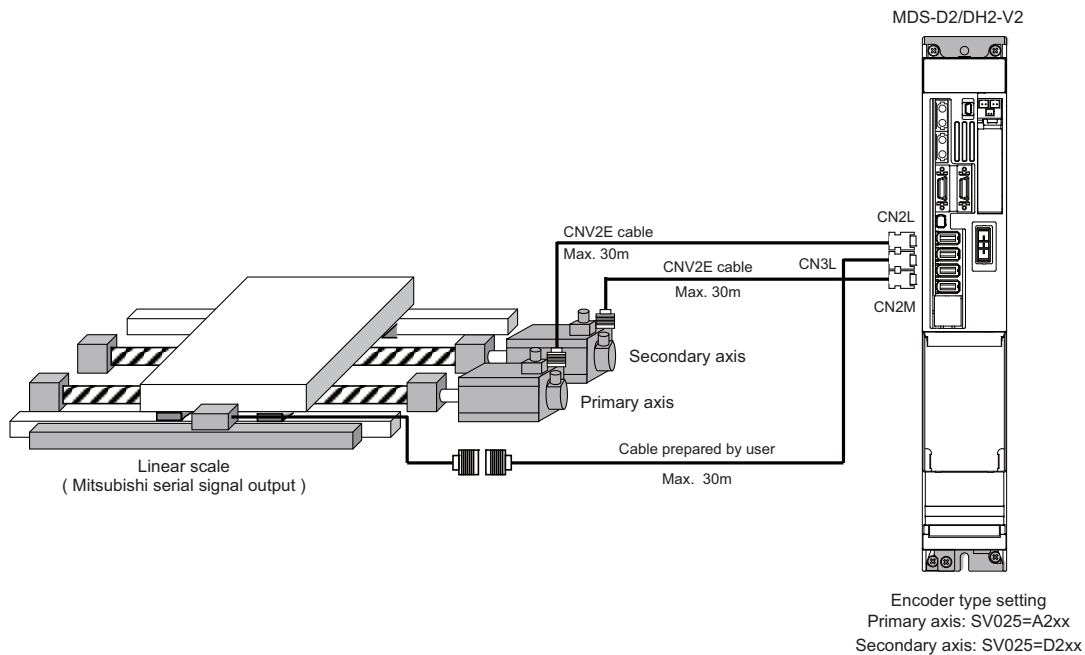

(4) Connecting Mitsubishi serial signal output linear scale (when using two units of MDS-D2/DH2-V1)

The FB signal of the linear scale is divided to each drive unit with the signal division unit (MDS-B-SD).

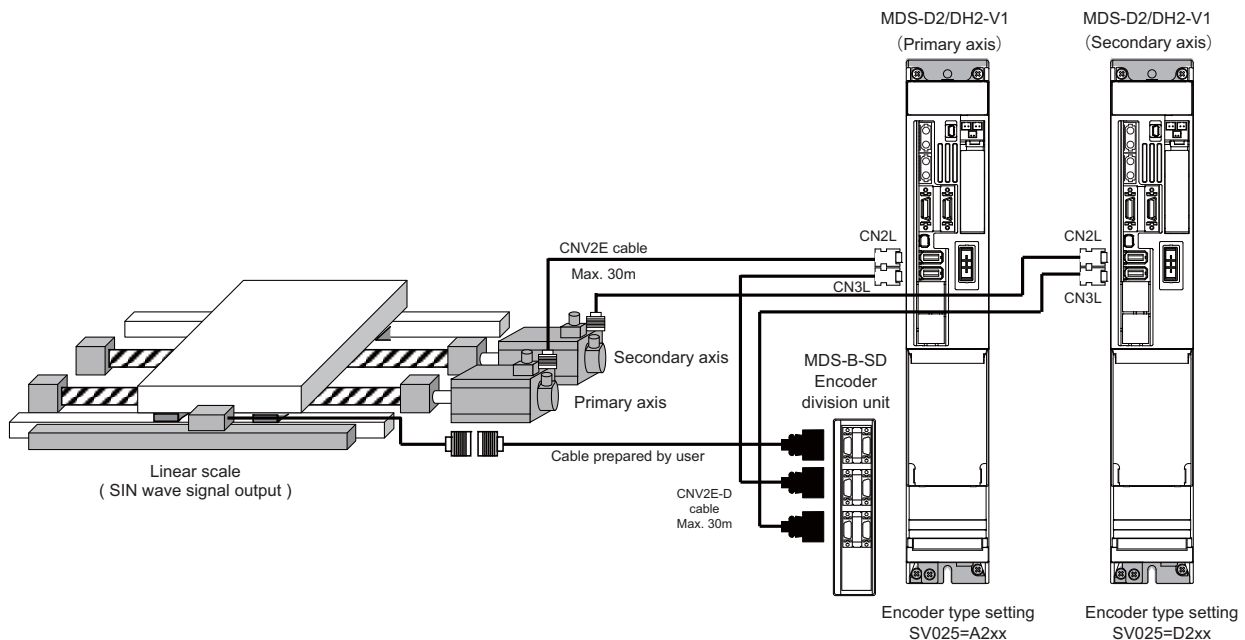

2.5.4 Connection of the Spindle Motor

Refer to each motor specifications for details on the motor side connection destination, specifications and outline, and for the spindle PLG encoder specifications.

(1) Connecting the motor built-in PLG

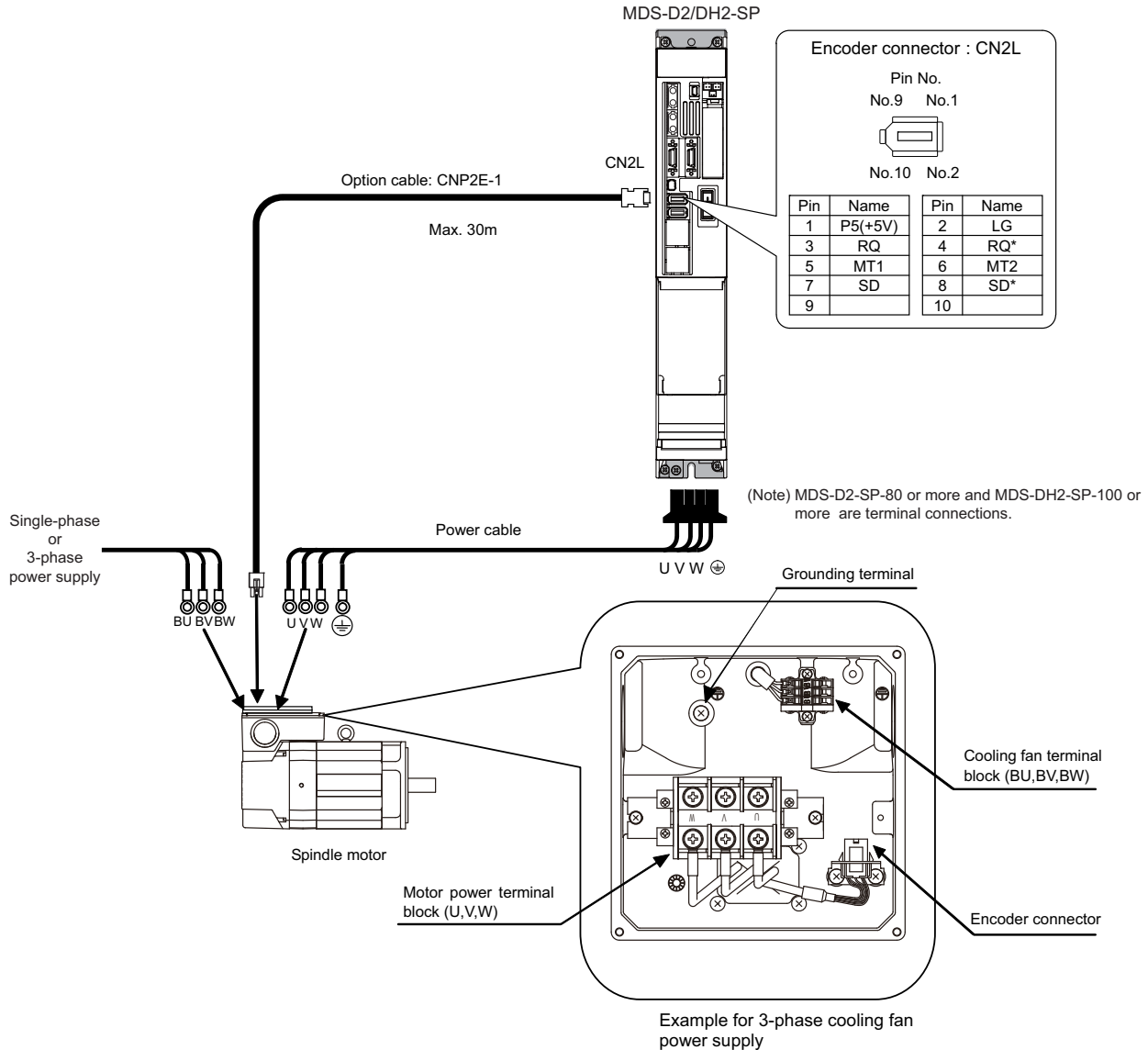

(Note) Either a single-phase or 3-phase power supply is used for the cooling fan. Refer to the Spindle Motor Specifications for details.

CAUTION

For a 3-phase cooling fan, when the phase sequence of the 3-phase power supply is connected reversely, its cooling capacity degrades due to the reversed rotation direction. Make sure the air blowoff direction.

When the fan rotates reversely, reconnect BU and BW reversely, and then check the blowoff direction.

(2) Connecting the spindle side ABZ pulse output encoder (OSE-1024-3-15-68, OSE-1024-3-15-68-8)

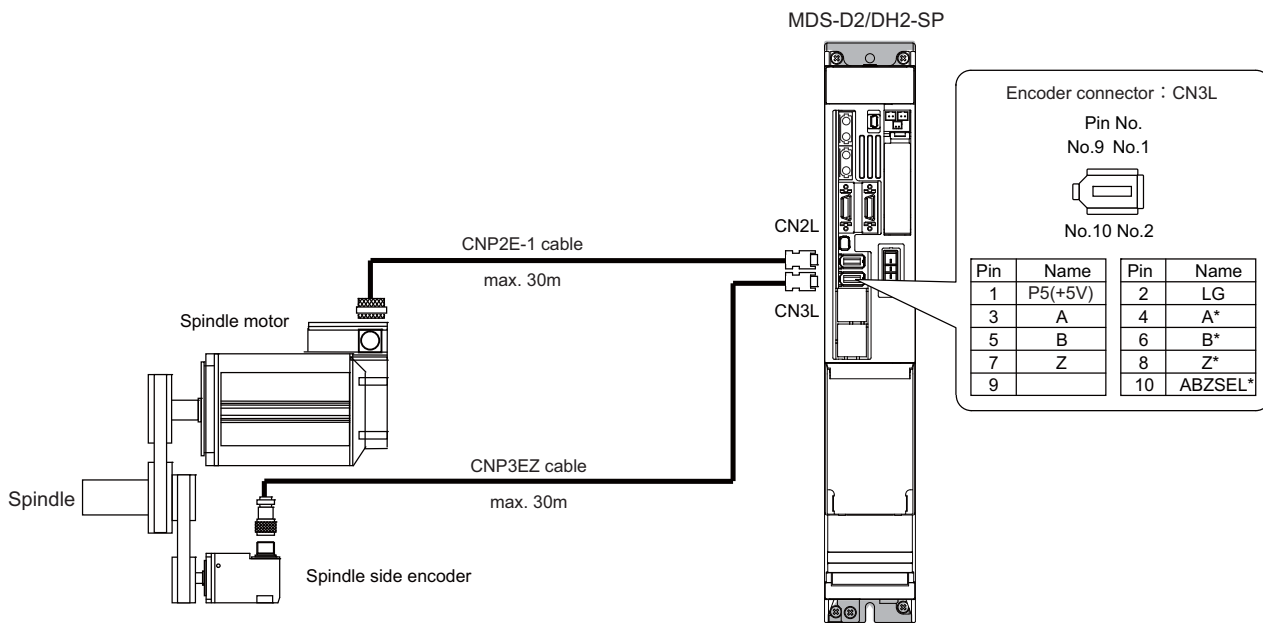

(Note) Confirm that the gear ratio (pulley ratio) of the spindle end to the encoder is 1:1. Use a timing belt for connecting.

(3) Connecting the spindle side PLG serial output encoder (TS5690, MBE405W)

< An example with TS5690 >

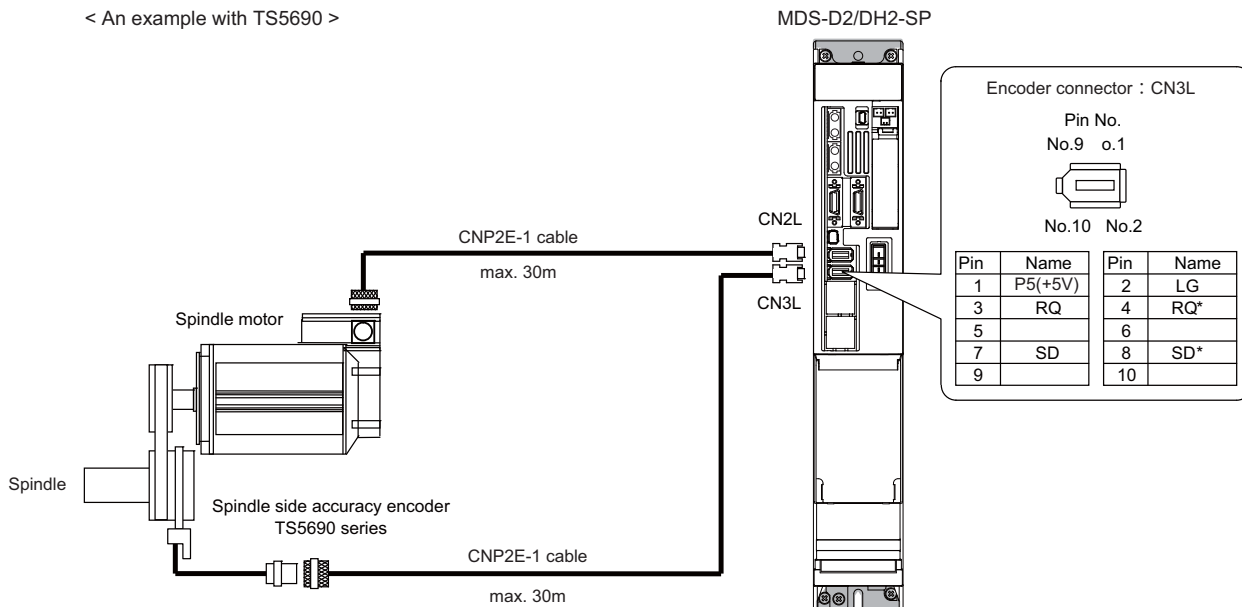

2.5.5 Connection of Tool Spindle Motor

(1) Connecting the HF-KP46 / HF-KP56 / HF-KP96

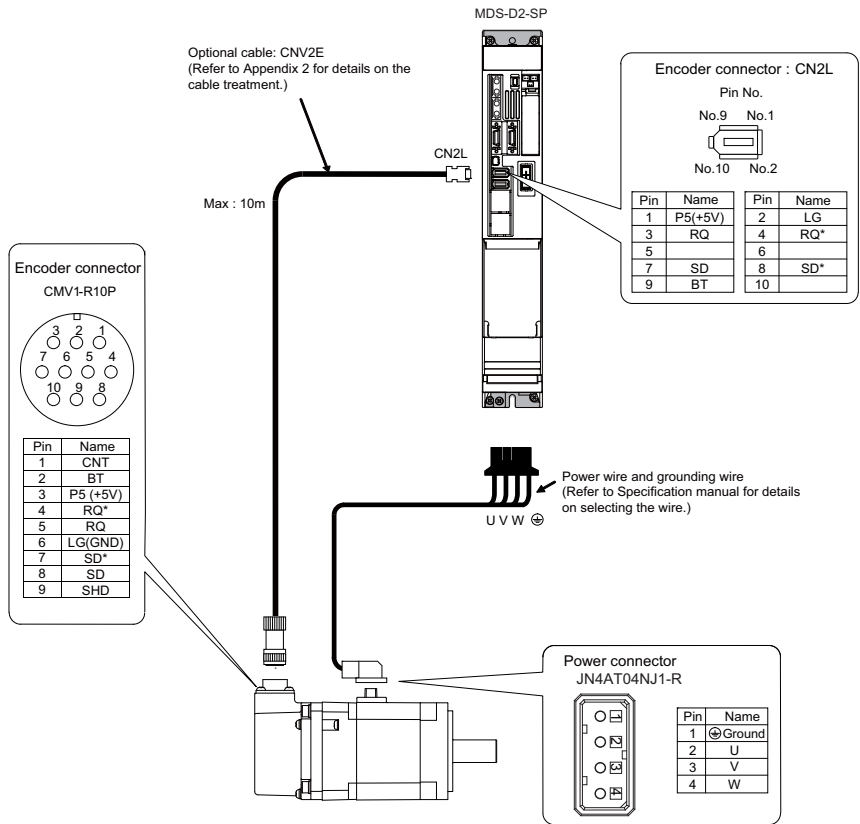

(2) Connecting the HF-SP226 / HF75 / HF105 / HF54 / HF104 / HF154 / HF224

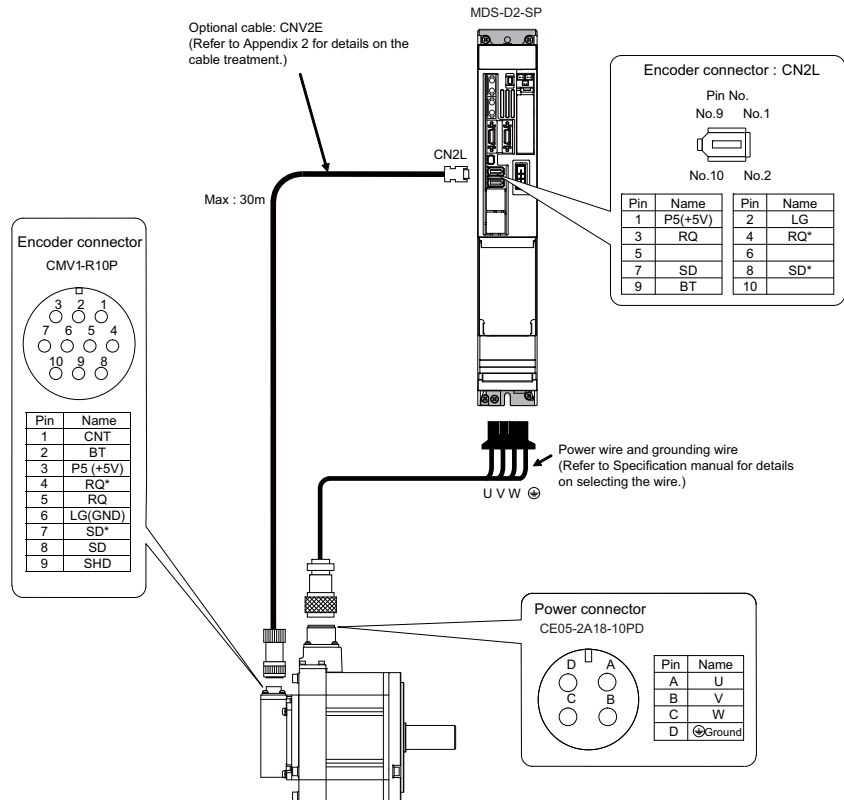

(3) Connecting the HF-SP406

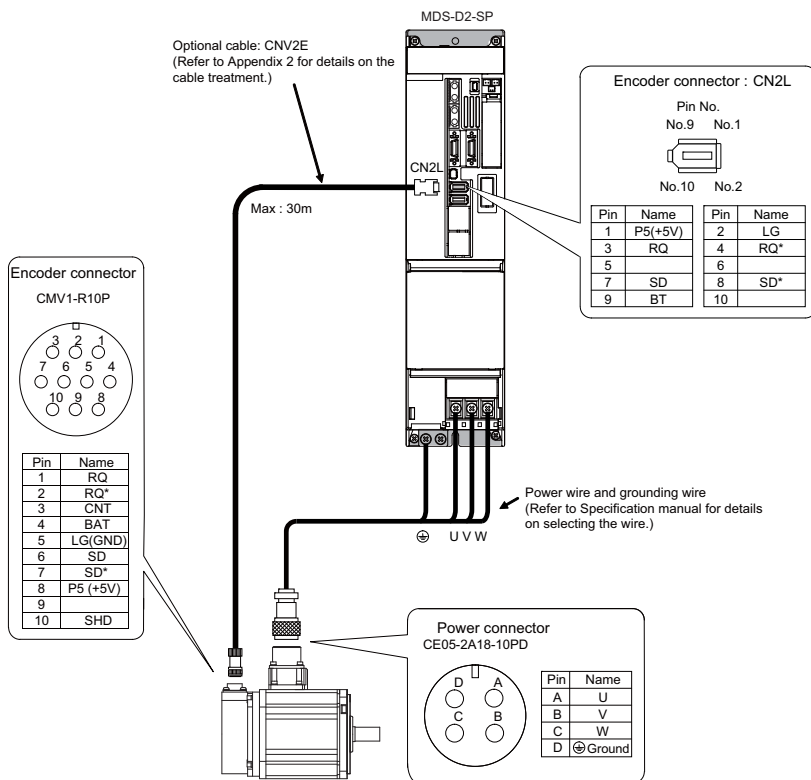

(4) Connecting the HF204

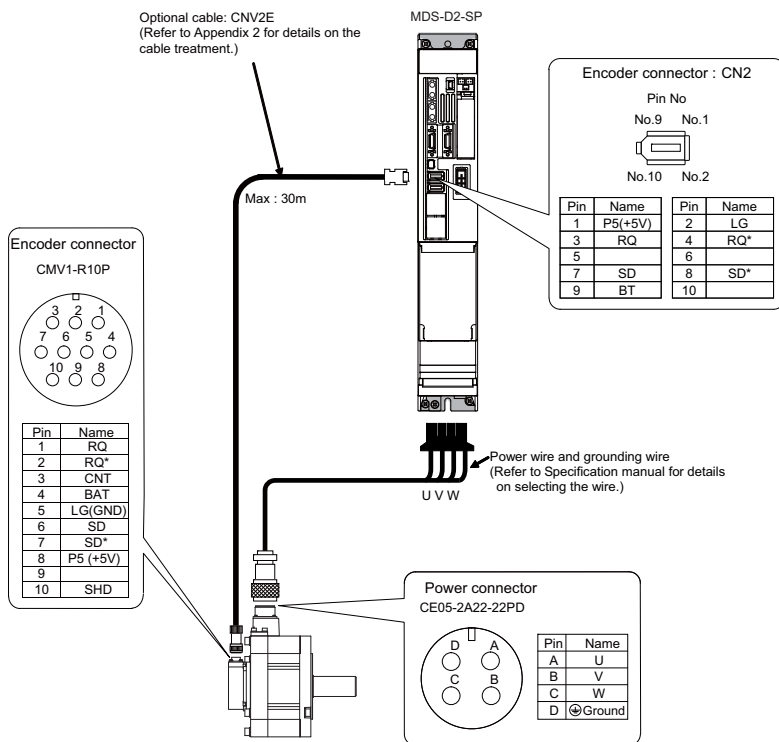

(5) Connecting the HF354 / HF453

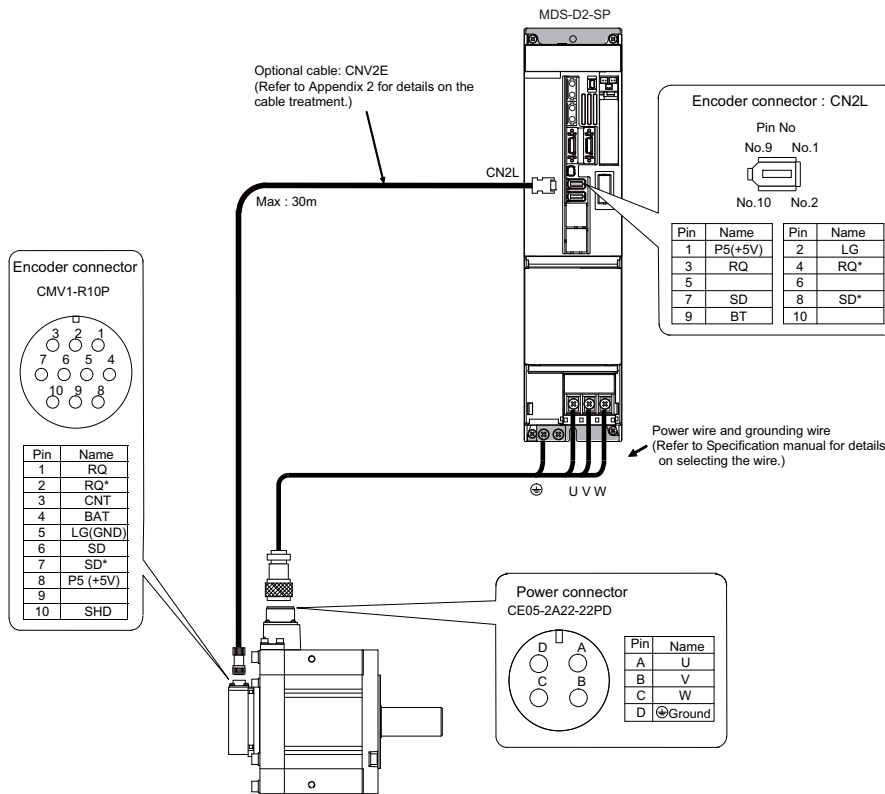

(6) Connecting the HF703 / HF903

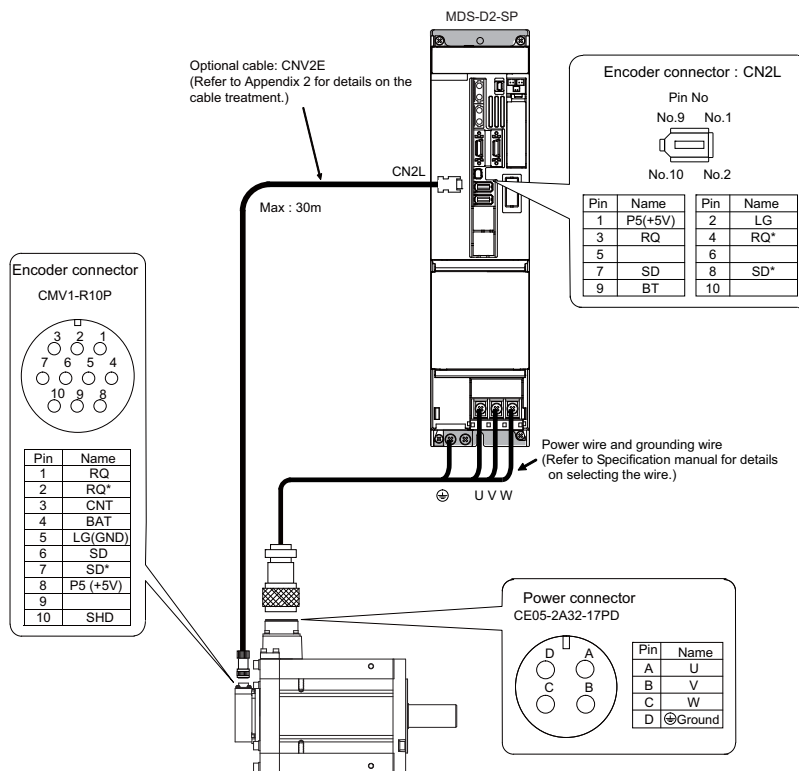

2.6 Connection of Power Supply

⚠ CAUTION

1. Make sure that the power supply voltage is within the specified range of each unit. Failure to observe this could lead to damage or faults.
2. For safety purposes, always install a circuit protector, and make sure that the circuit is cut off when an error occurs or during inspections.
3. The wire size will differ according to each drive unit capacity.
4. For safety purposes, always install a magnetic contactor (contactor) on the main circuit power supply input. Large rush currents will flow when the power is turned ON.
5. A semiconductor element is used in the power supply unit's magnetic contact drive circuit, and a surge absorber is installed to protect the element. Therefore, a leakage current of approx. 15mA is passed. Confirm that the exciting coil in the magnetic contact will not function at 15mA or less.

2.6.1 Power Supply Input Connection

(1) When using one power supply unit

Install the unit so that the total wiring length of DC power supply terminals TE2 (L+, L-) is 800mm or less. Large-capacity spindle drive units, in particular, should be installed adjacent to the power supply unit which they control.

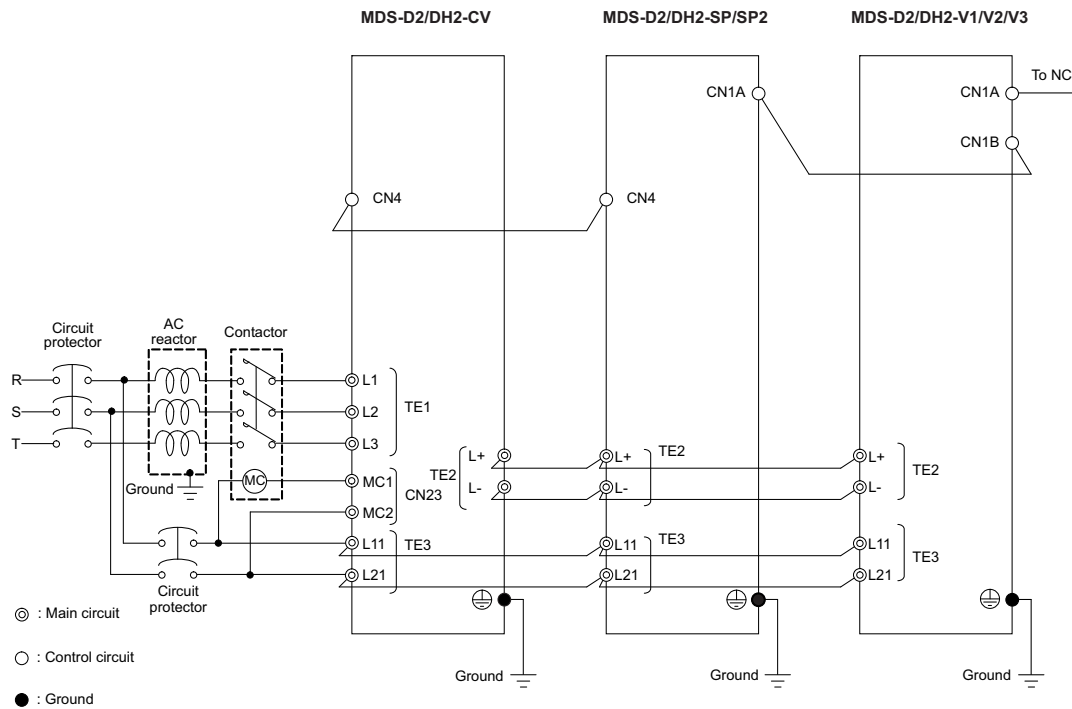

⚠ CAUTION

1. The power supply unit is equipped with a power supply regenerative type converter; an AC reactor is surely installed in the power supply line.
2. When connecting to the TE3 terminal, connect to the power supply side (primary side) of the AC reactor.
3. Connect the power supply unit's CN4 connector with the spindle drive unit of the maximum capacity. If there is no spindle drive unit, connect to the servo drive unit which is the unbalance axis.
4. When installing the units dispersed install the spindle drive unit adjacent to the power supply unit, and connections for other drive units should be such that the total TE2 wiring length is 800mm or less.

- (2) When using two or more power supply units within a single NC communication bus system
 Install a circuit protector and a contactor for each of the power supply units.

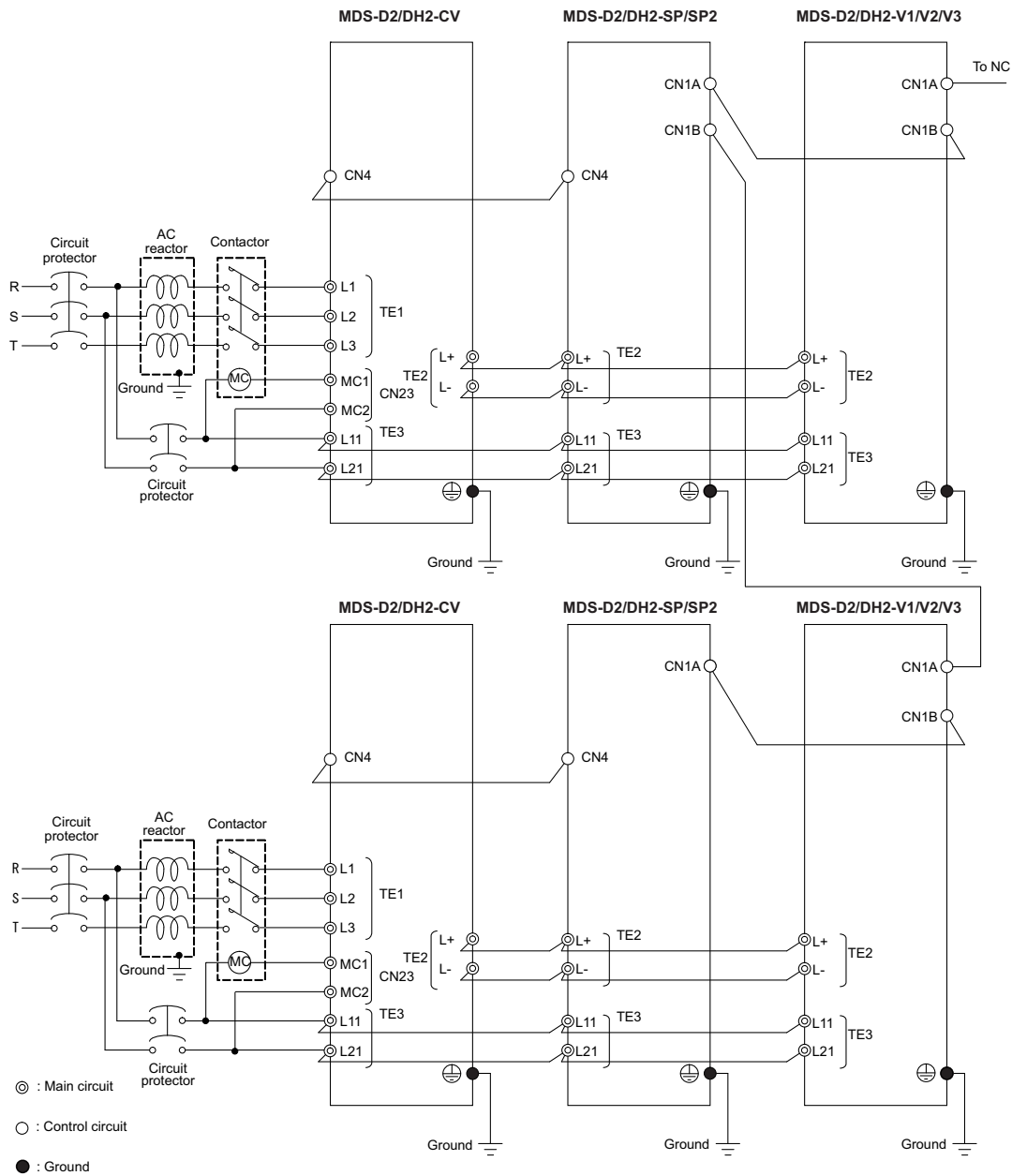

CAUTION

1. An AC reactor and circuit protector are required for each power supply unit.
2. Install the spindle drive unit of large capacity adjacent to the power supply unit, and connections for other drive units should be such that the total TE2 wiring length is 800mm or less.
3. Make sure that the total capacity of the drive units connected to the same power supply unit meets the unit's selected capacity and connect the CN4 of the drive unit, which is used as a final axis (when a spindle drive unit is included, spindle drive unit), with that of the power supply unit.
4. Confirm that the power supply units are not connected with each other through the TE2(L+,L-) wiring before turning the power ON.

2.6.2 Connecting the Grounding Cable

(1) Connecting the protective grounding (PE) and frame ground (FG)

Each unit has a terminal or mounting hole to connect PE (⊕) or FG.

Please connect an earth wire to the main ground of a cabinet or a machine frame at one point.

Ground each device according to the grounding conditions set forth by each country. (Typically, a Y-connection neutral point ground is used in Europe.)

PE: Grounding to provide protection from electric shock, etc.

FG: Grounding to stabilize the operation of the devices, etc. (Suppress noise)

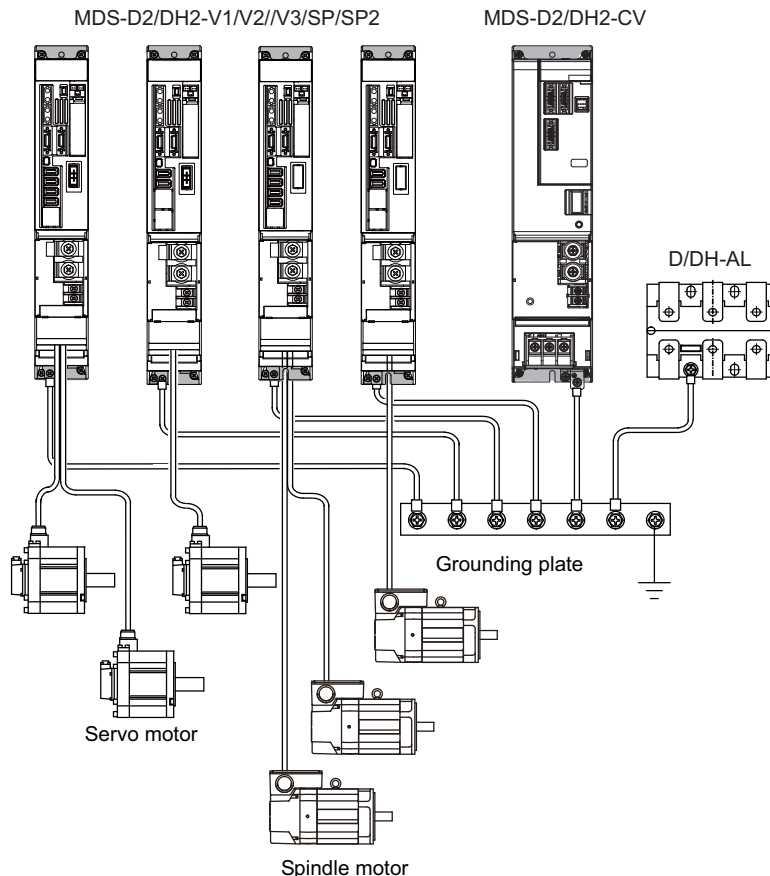

POINT

Do not connect the grounding cable from each unit directly to the grounding plate. Noise from other units could result in malfunctions.

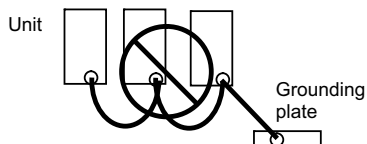

(2) Grounding cable size

Earth wire size should follow the following table.

Type	Grounding cable size (Required grounding)
MDS-D2/DH2-CV Unit	Larger than thickness of wire connected to TE1 (L1/L2/L3). (PE)
MDS-D2/DH2-V1/V2/V3/SP/SP2 Unit	Larger than thickness of wire connected to TE1 (U/V/W). (PE) (For two or three axes, the thickness of wire which the total current can be applied to.)
D/DH-AL (AC Reactor)	5.5 mm ² (AWG10) or more (FG)

2.7 Wiring of the Motor Brake

2.7.1 Wiring of the Motor Magnetic Brake

The magnetic brake of servo motors with a magnetic brake is controlled by the motor brake control connector (CN20) on the servo drive unit. The servo drive unit releases the brake when the motor is ON.

(Servo ON means when torque is generated in the motor.)

(1) Motor brake control connector output circuit

As shown in the illustration below, an external power supply circuit is controlled by the CN20 connector output. Dynamic brake unit is controlled simultaneously for the servo drive unit with the capacity of MDS-D2-V1-320W or larger and MDS-DH2-V1-160W or larger. Refer to "Dynamic brake unit wiring" for details.

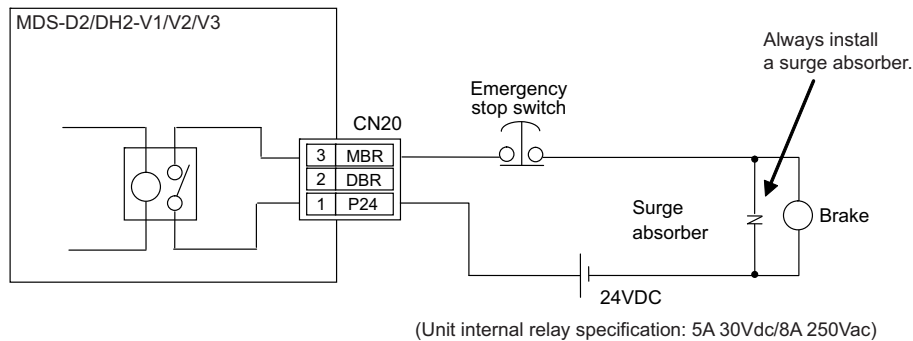

CAUTION

1. Always install a surge absorber near the motor's brake terminal to eliminate noise and protect the contacts.
2. The brakes cannot be released just by connecting the CN20 and motor brake terminal. 24VDC must be supplied.
3. For the 24V power supply used in the motor brake circuit, use the one separated from the 24V power supply for the control circuit.

(2) Motor brake release sequence

The motor brake control connector (CN20: MBR) releases the magnetic brake in the following sequences in after the start of the power ON to the servo motor when canceling the emergency stop.

If the power of the power supply unit has been charged by the servo parameter setting, the time to the Ready completion can be reduced.

【#2217(PR)】 SV017 SPEC1 Servo specification 1

bit 2 : seqh Ready on sequence

0: Normal 1: High-speed

【#13017(PR)】 SP017 SPEC1 Spindle specification 1

bit 2 : seqh READY ON sequence

0: Normal 1: High-speed

[1] When SV017 is set to bit2 = 0:

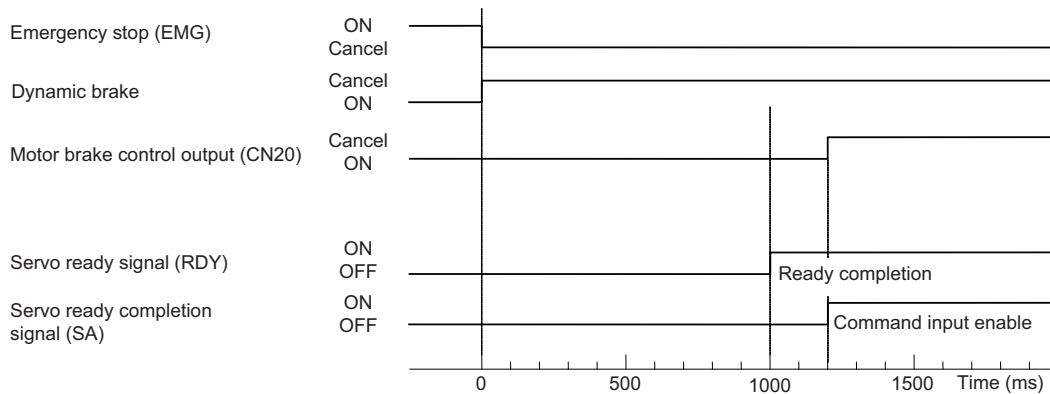

Motor brake control sequences when an emergency stop is canceled 1

[2] When SV017 is set to bit2 = 1:

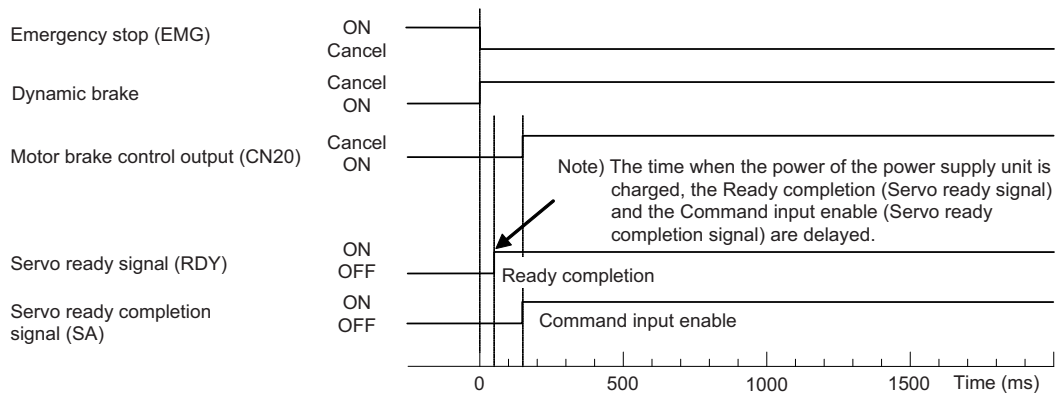

Motor brake control sequences when an emergency stop is canceled 2

POINT

Using the high-speed ready ON sequence, set the parameter for all the axes including the spindle. Especially when it is not set for the power supply control axis, power supply will not work at high-speed sequence.

CAUTION

When SV017/bit2=1, SP017/bit2=1 is set, for the model using an external dynamic brake, the Ready completion will be delayed by 10ms to ensure the external contactor operation time.

(3) Control during the servo OFF command

When a servo OFF command is input by an NC sequence input, the motor brake turns ON simultaneously when the motor ON is shut off. Note that the vertical axis drop prevention control is not validated, so a drop due to the brake operation lag occurs. When the servo OFF is canceled, a drop due to an uncontrolled state does not occur.

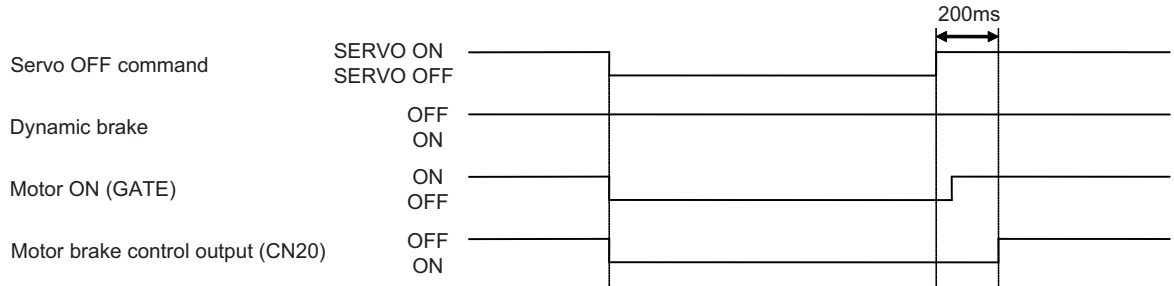

Motor brake control sequences when a servo OFF command is output

CAUTION

1. The vertical axis drop prevention control only is performed during an emergency stop (including alarms and power failures). It is not performed when a servo OFF command is input.
2. A servo OFF command is required at all axes in the same unit in order to perform a motor brake control output (MBR) at 2-axis or 3-axis drive unit.

< Caution in use of MDS-D2/DH2-V2/V3 >

It is required to input a servo OFF command to all axes in order to turn the brake ON with a motor brake control output (CN20) of drive unit. Input the servo OFF command to an axis cannot turn the brake ON. Therefore, when performing a control to fix the position with the motor brake by the servo OFF command during the motor stop for PLC axis, use 1-axis drive unit.

During emergency stop, the servo OFF is applied to all axes at same time, so a brake control is not affected.

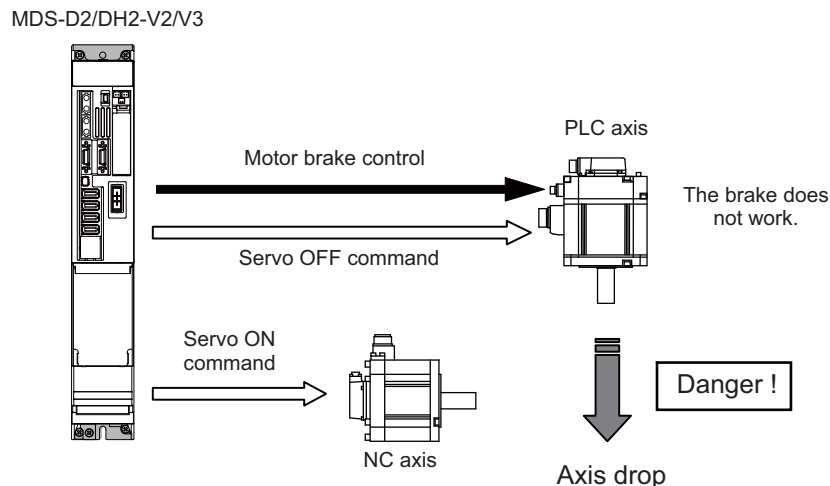

(4) Operation sequences when an emergency stop occurs

The motor brake control output operation when an emergency stop occurs differs according to the motor deceleration stop method. Refer to section "Setting for emergency stop" for details on the operation sequences for each stop method.

2.7.2 Dynamic Brake Unit Wiring

The servo drive units of MDS-D2-V1-320W or larger and MDS-DH2-V1-160W or larger do not have built-in dynamic brakes. Always install a dynamic brake unit.

The servo drive units of MDS-D2-V1-320 or smaller or MDS-DH2-V1-160 or smaller have built-in dynamic brakes.

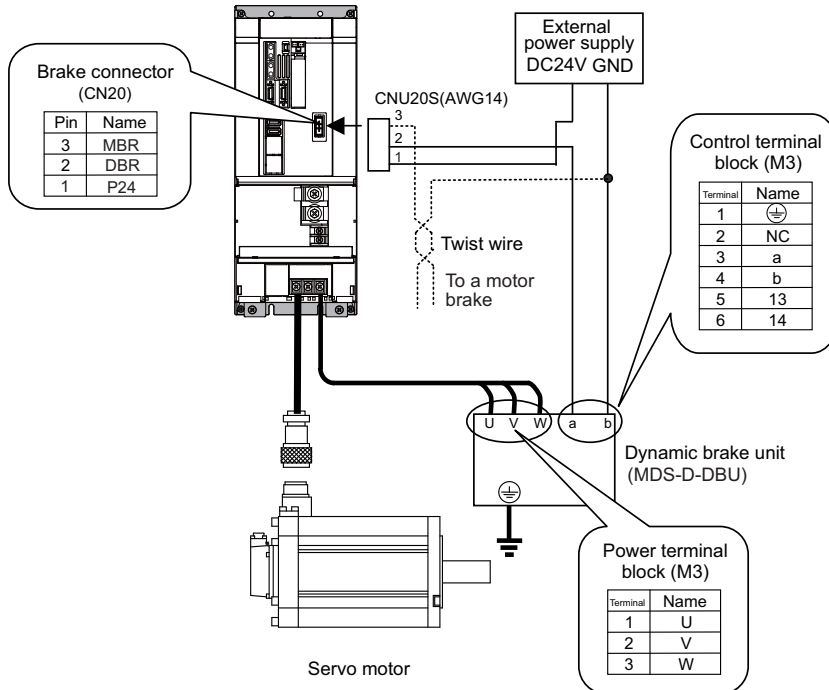

Internal circuit diagram

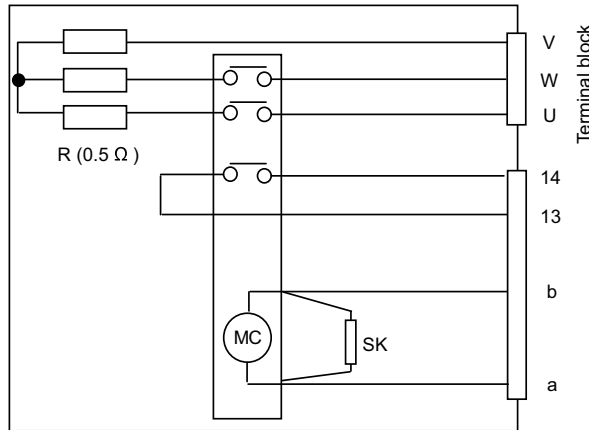

CAUTION

Correct wire the dynamic brake unit to the servo drive unit.
Do not use for applications other than emergencies (normal braking, etc.). The internal resistor could heat up, and lead to fires or faults.

POINT

When you use a servo motor with a brake, please wire (between 1pin and 3pin) of CN20 connector.

2.8 Peripheral Control Wiring

2.8.1 Input/Output Circuit Wiring

CN9 connector is equipped with 24V input/output circuit for the control of external devices and the control by an external signal.

Set the relevant parameters and use them with care for the wiring since some signals are changeover type, which can be switched over by parameters. Refer to the description of each function in relevant sections for details on the function specifications and settings.

Connector	Input condition		Connector	Output condition	
CN9	Switch ON	18VDC to 25.2VDC 4.3mA or more	CN9	Output voltage	24VDC \pm 5%
	Switch OFF	4VDC or less 2mA or less		Tolerable output current	50mA or less
CN24	Switch ON	18VDC to 25.2VDC 4.3mA or more			
	Switch OFF	4VDC or less 2mA or less			

For a switch or relay to be wired, use a switch or relay that satisfies the input/output (voltage, current) conditions.

Interface name	Selection example
For digital input signal (CN24,CN9)	Use a minute signal switch which is stably contacted and operated even with low voltage or current. < Example > OMRON: G2A, G6B type, MY type, LY type
For digital output signal (CN9)	Use a compact relay operated with rating of 24VDC, 50mA or less. < Example > OMRON: G6B type, MY type

Input circuit

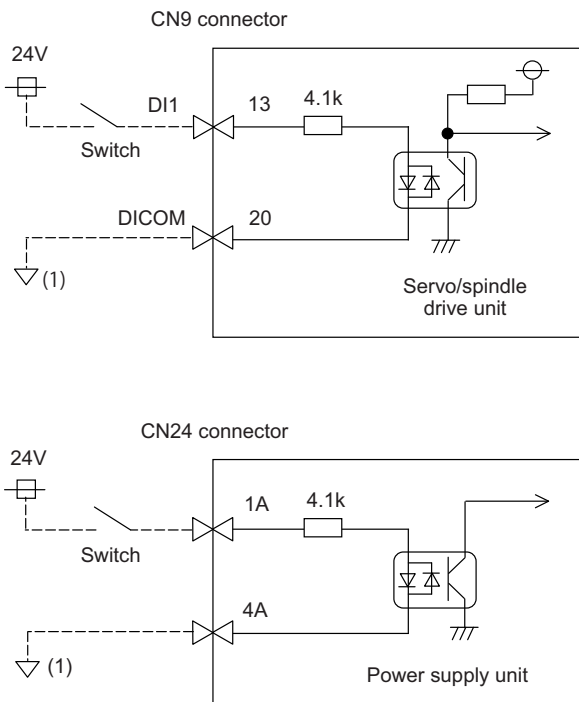

Output circuit

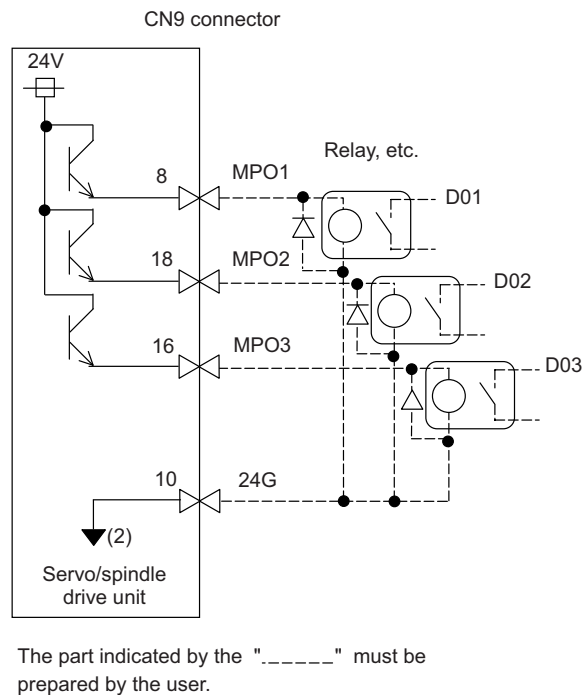

(Note) Do not connect "(1)" or "(2)".
 If a ground of the external 24V power is same as the 24V power in the drive unit, a fault or abnormal operation could occur.

Servo input/output signal (CN9 connector)

	Device name	Connector pin No.	Signal name	Signal changeover parameter
Servo input signal	MPI1	CN9-13	SLS(Safely Limited Speed) function door state signal	SV082/bitF-C=1
			Battery box voltage drop signal	SV082/bitF-C=2
	MPI2	CN9-2	(Reservation)	
	MPI3	CN9-3	(Reservation)	
Servo output signal	MPO1	CN9-8	(Reservation)	
	MPO2	CN9-18	Servo specified speed signal	SV082/bit9,8=01
	MPO3	CN9-16	(Reservation)	

Spindle input/output signal (CN9 connector)

	Device name	Connector pin No.	Signal name	Signal changeover parameter
Spindle input signal	MPI1	CN9-13	SLS(Safely Limited Speed) function door state signal	SP227/bitF-C=1
			Proximity switch signal	SP227/bitF-C=4
	MPI2	CN9-2	(Reservation)	
	MPI3	CN9-3	(Reservation)	
Spindle output signal	MPO1	CN9-8	Coil changeover signal	
	MPO2	CN9-18	Spindle specified speed signal	SP229/bitC=1
	MPO3	CN9-16	(Reservation)	

CAUTION

The different signal changeover parameter setting is not available for the same connector pin number of each axis in 2-axis or 3-axis drive unit.

2.8.2 Specified Speed Output

Specified speed output function turns the output signal ON when the machine-end speed is below the speed specified with the parameter. This function enables the safety door, etc., to be locked to secure the machine operator when the machine-end speed has exceeded the specified speed. This function can also be used for judging whether the current machine-end speed reaches the specified speed.

The specified speed output signal is output to the digital signal output 2 (MPO2). Refer to the next page for details, because the configuration of the parameters differs from the servo to spindle. For the 2-axis or 3-axis drive unit, it is required to set the parameter to the all axes. The signal output turns ON when the all axes satisfy the conditions (theoretical product output).

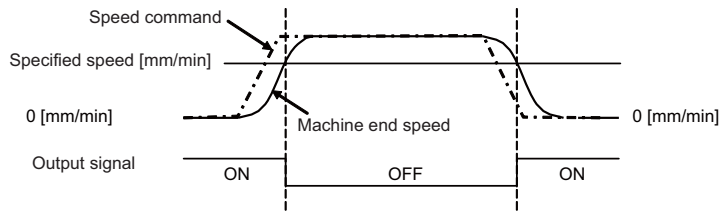

For 1-axis drive unit
(MDS-D2/DH2-V1, MDS-D2/DH2-SP)

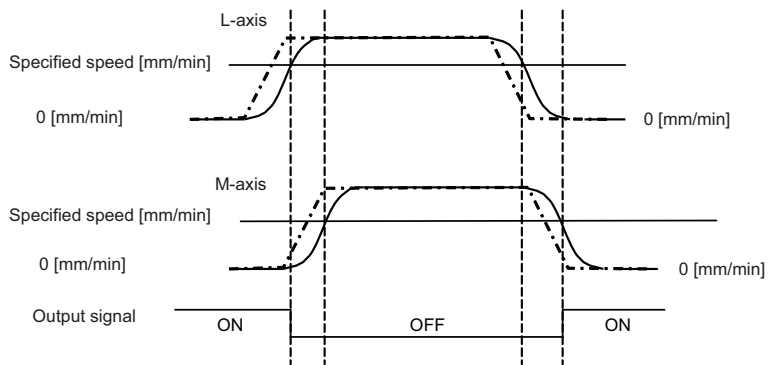

As for 2-axis drive unit, the output signal turns OFF when either axis exceeds the specified speed, and it turns ON when both axes are within the specified speed.

For 2-axis drive unit
(MDS-D2/DH2-V2, MDS-D2-SP2)

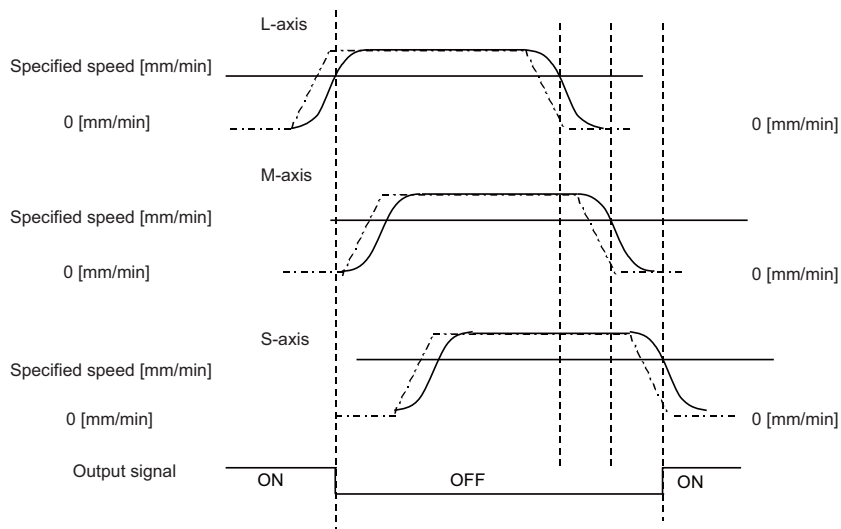

As for 3-axis drive unit, the output signal turns OFF when one of the axes exceed the specified speed, and it turns ON when all axes are within the specified speed.

For 3-axis drive unit
(MDS-D2-V3)

Specified speed signal output sequence

< Servo drive unit >

【#2233】 SV033 SSF2 Servo function 2**bit D : rps Safely limited speed setting increment**

Change the setting units of the specified speed signal output speed (SV073) and safely limited speed (SV238).

0: mm/min 1: 100mm/min

【#2273(PR)】 SV073 FEEDout Specified speed output speed

Set the specified speed.
Also set SV082/bit9,8 to output digital signal.

---Setting range---

0 to 32767 (r/min)
However, when SV033/bitD=1, the setting range is from 0 to 32767(100mm/min).

【#2282】 SV082 SSF5 Servo function 5**bit 9-8 : dos2 Digital signal output 2 selection**

00: Disable 01: Specified speed output

< Spindle drive unit >

【#13018(PR)】 SP018 SPEC2 Spindle specification 2**bit 8 : spsu Command speed limit value**

0: 33,750 r/min 1: 135,000 r/min

【#13030】 SP030 SDT2 2nd speed detection setting value

Set the specified speed of the specified speed output.
When carrying out digital output of the specified speed output, set SP229/bitC to "1".

---Setting range---

0 to 32767 (r/min)

【#13229】 SP229 SFNC9 Spindle function 9**bit C : sdt2 Specified speed output digital signal 2 output**

0: Normal 1: Enable

2.8.3 Spindle Coil Changeover

There are spindle motors capable of coil changeover control, which enables favorable characteristics to be attained from low speeds to high speeds by changing two types of coils.

(1) Coil changeover control

The speed at which to change the coils is detected by the spindle drive according to the value set with spindle parameter SP028. This is conveyed to the NC with a speed detection (SD) signal. The NC judges the other conditions (coil fixed, etc.), and issue a coil changeover command to the spindle drive with the L coil selection command (LCS).

To prevent the contactor from varying, the hysteresis set with SP029 is applied on the speed when changing from the low-speed coil to the high-speed coil and the high-speed coil to the low-speed coil.

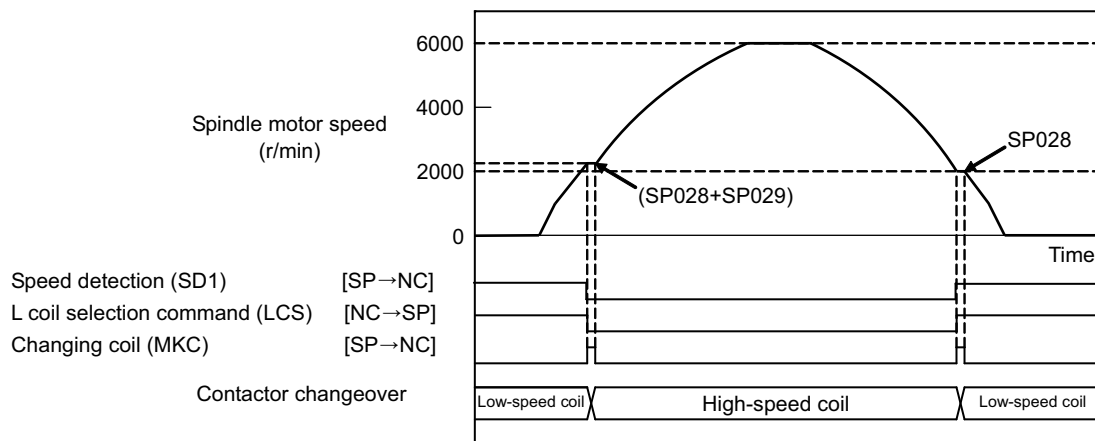

Spindle motor coil changeover control

【#13028】 SP028 SDTS Speed detection set value

Set the motor speed for detecting the speed.
 If the motor speed drops below the set speed, the speed detection signal turns ON.
 The standard setting is 10% of the maximum motor speed.

---Setting range---

10 to 32767 (r/min)

【#13029】 SP029 SDTR Speed detection reset width

Set the hysteresis width in which the speed detection changes from ON to OFF.
 If the setting value is small, the speed detection will chatter easily.
 The standard setting is "30".

---Setting range---

10 to 1000 (r/min)

(2) Protective functions**[1] Gate shutoff after a winding changeover**

When the L-coil selection command (LCS) is used to perform low-speed winding -> high-speed winding switching, or vice-versa, the gate is shut off during contactor operation time in order to protect the spindle drive unit's main circuit. The gate shutoff time is determined by the "Coil changeover gate cutoff timer" (SP114) setting. The standard time setting should be used, as a shorter time can cause contactor burn damage. (Refer to "Spindle control output 5" Coil changing (bit 6) for details.)

【#13114】 SP114 MKT Coil changeover gate cutoff timer

Set the time required to cut off the gate when turning OFF/ON the coil switch contactor.
The value should be longer than the coil switch contactor's OFF/ON time.
The standard setting is "150".

---Setting range---

0 to 3500 (ms)

[2] Current limit after coil changeover

Following a coil changeover, the current is limited (SP116) for the period specified by the current limit timer (SP115) in order to stabilize control. Because position loop control (synchronous tap, C-axis control, etc.) that occurs immediately after a coil changeover will result in unstable control, be sure that position commands specified by the sequence is input after the current limit is cancelled.

【#13115】 SP115 MKT2 Coil changeover current limit timer

Set the time required to limit the current immediately after the coil switch contactor ON/OFF is completed and the gate is turned ON.
The standard setting is "250".

---Setting range---

0 to 3500 (ms)

【#13116】 SP116 MKIL Coil changeover current limit value

Set the time required to limit the current immediately after the coil switch contactor ON/OFF is completed and the gate is turned ON.
The standard setting is "120".

---Setting range---

0 to 999 (Short-time rated %)

(3) Wiring

The illustration below shows the 2 types of changeover that occur after a coil changeover, (a) \star (star) - Δ (delta) changeover, and (b) \star (star)- \star (star) changeover. As shown in (c), one of the contactors (MC1 or MC2) is turned ON and the other is turned OFF at all of the coil changeover control circuits.

(a) \star (star) - Δ (delta) changeover circuit

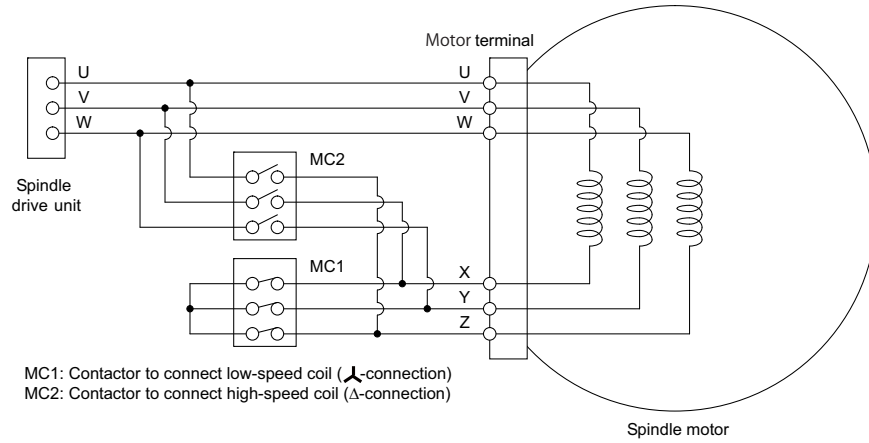

Coil changeover circuit

<Wiring of motor coil>

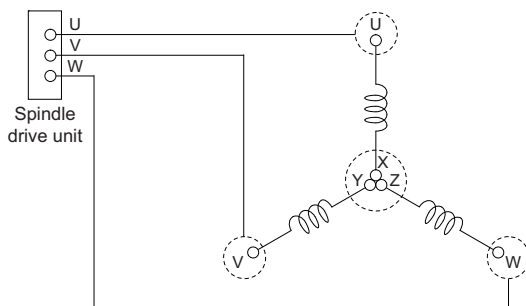

\star connection (MC1:ON MC2:OFF)

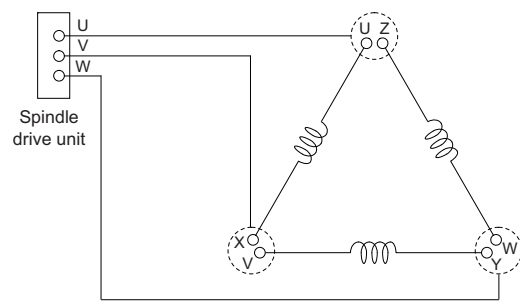

Δ connection (MC1:OFF MC2:ON)

POINT

Wire it according to each 6 terminal's sign (U, V, W, X, Y, Z) of spindle motor for the coil changeover.

(b) Δ(star) - Δ(star) changeover circuit

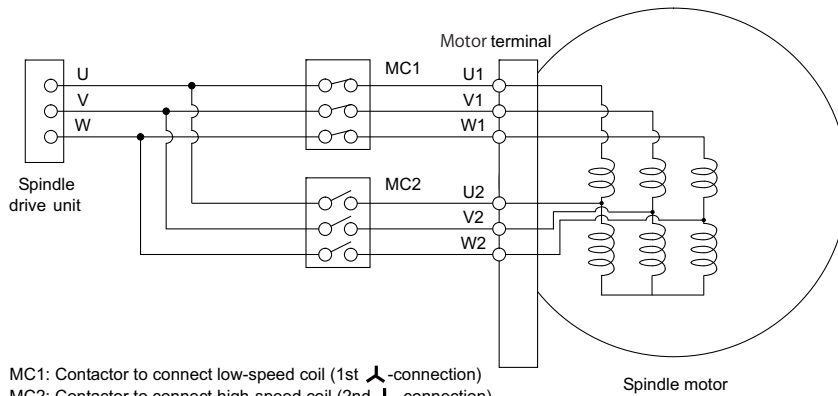

MC1: Contactor to connect low-speed coil (1st Δ-connection)
 MC2: Contactor to connect high-speed coil (2nd Δ-connection)

Coil changeover circuit

<Wiring of motor coil>

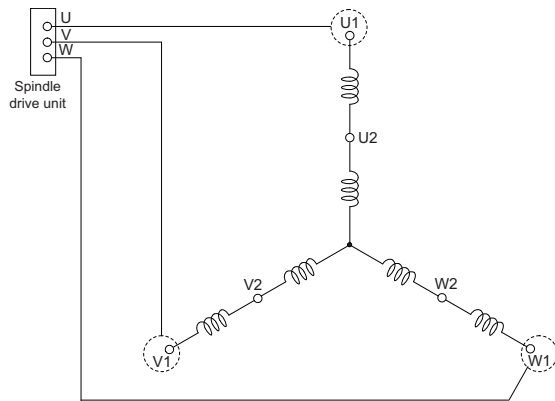

○:The terminal which is assembled at the contactor ON

Δ-connection (MC1:ON MC2:OFF)

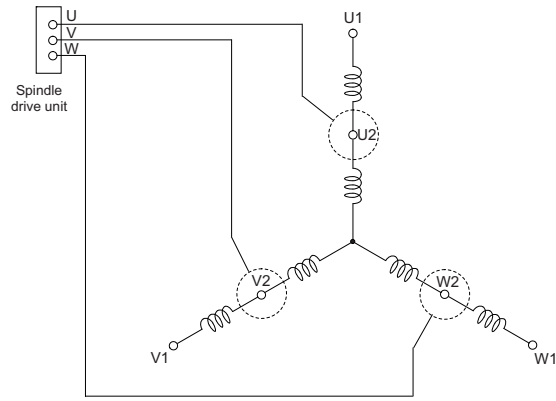

○:The terminal which is assembled at the contactor ON

Δ-connection (MC1:OFF MC2:ON)



POINT

Wire it according to each 6 terminal's sign (U1, V1, W1, U2, V2, W2) of spindle motor for the coil changeover.

(c) Coil changeover control circuit (common)

MDS-D2/DH2 Series

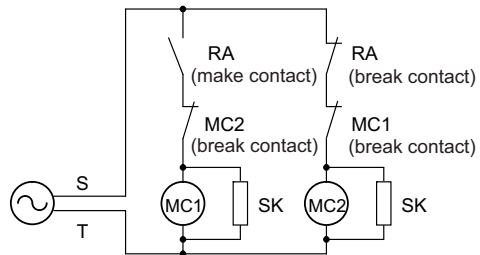
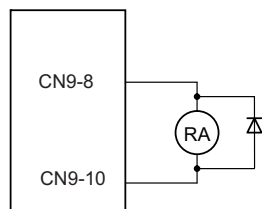

Coil changeover relay control circuit

2.8.4 Proximity Switch Orientation

(1) Electrical specifications

Use a proximity switch which satisfies the following specifications.

Item	Specification
Output method	DC double wire system /three wire system
Power supply voltage	24V DC
Response frequency	400Hz or more
Load current	14mA or more
Residual voltage	4V or less
Leakage current	1mA or less

(2) Connecting with the drive unit

(a) When DICOM is connected to 24V

< Connection details: For proximity switch of two wire system >

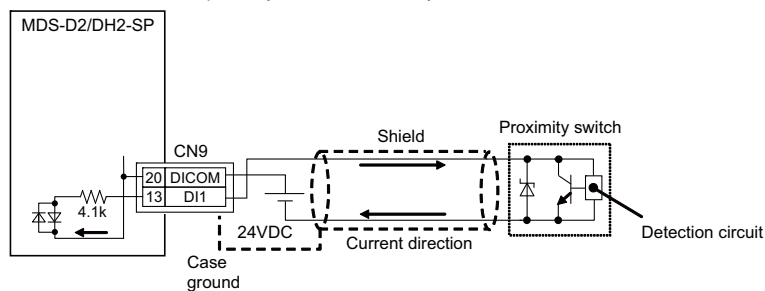

< Connection details: For proximity switch of three wire system >

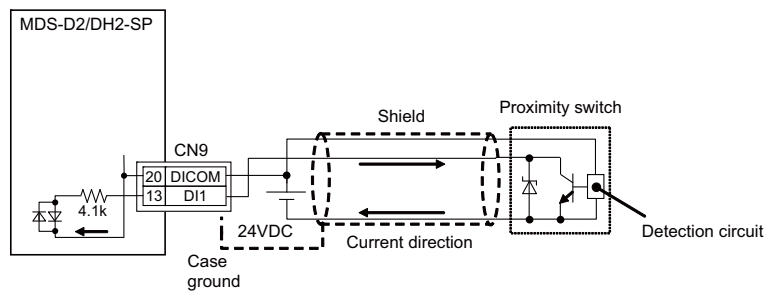

⇕ Select the polarity of DICOM

(b) When DICOM is connected to 24G

< Connection details: For proximity switch of two wire system >

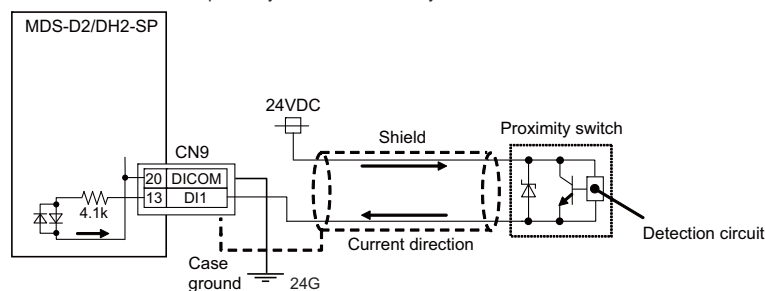

< Connection details: For proximity switch of three wire system >
Not usable.

CAUTION

1. Supply the 24VDC power externally.
2. Install a proximity switch at the spot that rotates in the ratio of 1:1 to the spindle.
3. Set the spindle parameter to the pulley ratio for belt drive or to the gear ratio for gear drive.

(3) Detection signal polarity

The table below is the polarities of the detections signals. According to the polarity, select the enable edge of the signals with the spindle parameter (SP225/bit5).

Sensor operation	Enable detection	Drive unit input signal polarity (CN9 DI1)	Enable edge selection (SP225/bit5)
Normal open (NO)	Rising part		Falling edge (0)
Normal close (NC)	Falling part		
Normal open (NO)	Rising part		Rising edge (1)
Normal close (NC)	Falling part		

(4) Parameter setting

When using the proximity switch, set the following parameters to the spindle to be used.

When the proximity switch detection is enabled, the rotation direction of the orientation follows Z-phase detection direction (#3106/bit0), and the rotation speed follows Z-phase detection speed (#3109).

【#3106】 zrn_typ Zero point return specifications

Select the zero point return specification.

bit F : Spindle zero point detection with contactless switch

- 0: Normal
- 1: Enable spindle zero point detection using proximity switch

bit E : Control mode selection in orientation

- Select non-interpolation mode when vibration occurs since the gain is high during the orientation.
- 0: Interpolation mode (Use the interpolation mode gain "SP002".)
 - 1: Non-interpolation mode (Use the non-interpolation mode gain "SP001")

bit D-B :

Not used. Set to "0".

bit A-9 : Spindle/C axis zero point return direction

- bitA,9=
- 00: Short-cut
 - 01: Forward run
 - 10: Reverse run

bit 8 : Designate zero point return

- 0: Compatible operation with our conventional series (Automatically return to zero point simultaneously with C-axis changeover)
- 1: Standard setting

bit 7 : Synchronous tapping command polarity

- 0: Forward direction
- 1: Reverse direction (The standard setting when spindle and motor are directly coupled)

bit 6-5 : Synchronous tapping zero point return direction

- bit 6,5=
- 00: Short-cut
 - 01: Forward run
 - 10: Reverse run

bit 4 : Designate zero point return

- 0: Automatically return to zero point before synchronous tapping is started (tapping phase alignment)
- 1: Not return to zero point and immediately synchronous tapping is started

bit 3 :

Not used. Set to "0".

bit 2-1 : Orientation direction

- bit 2,1=
- 00: Short-cut
- 01: Forward run
- 10: Reverse run

bit 0 : Z phase detection direction

- 0: Forward direction
- 1: Reverse direction

【#3108】 ori_sft Position shift amount for orientation

The orientation stop position can be moved with this parameter setting although normally the position is Z -phase position. During multi-point orientation control, the stop position is determined by the total value of this parameter and the position data for multi-point orientation of PLC input.

---Setting range---

-35999 to 35999 (0.01°)

【#3109】 zdetspd Z phase detection speed

For the first S command after power is turned ON, the spindle rotates at the speed of setting value for this parameter.

When "#3106/bitF = 1" (Spindle zero point proximity switch detection enabled), also proximity switch is detected.

(Note) When spindle zero point return proximity switch detection is enabled, the rotation direction of the orientation/zero point return (synchronous tapping, spindle/C axis, etc.) will follow Z phase detection direction. And the speed will follow Z phase detection speed (In order to prevent the influences of the delayed detection of the signal pulse edges).

【#13225】 SP225 SFNC5 Spindle function 5**bit 5 : ddir Proximity switch signal enable edge**

- 0: Falling edge 1: Rising edge

【#13227】 SP227 SFNC7 Spindle function 7**bit F-C : dis Digital signal input selection**

- 0: No signal
- 1: SLS (Safely Limited Speed) function door state signal
- 4: Proximity switch signal detection
- Other settings: setting prohibited

<Related control signals>**Control input 5 bitD. Zero point re-detection request (ORC)**

When ORC is changed from 0 to 1, the Z phase passed will be 0(control output2/bit0).

Control output 5 bitD. Zero point re-detection complete (ORF)

If the zero point re-detection is completed after the zero point re-detection request (control input5/bitD) is set to 1, ORF=1 is set. If the zero point re-detection request is set to 0, ORF=0 is set.

Safety Function

3.1 Safety Function

This drive unit offers the safety function which satisfies the following harmonized standard can be offered with this drive unit.

Each function can be available in the system consisting of the safety function compliant control unit and drive unit, and various communication cables, sensors, and contactors.

3.1.1 Harmonized Standard

Machinery Directive (2006/42/EC)	EN ISO13849-1:2008(Cat.3, PL d) EN61800-5-1:2007 EN61800-5-2:2007 EN61326-3-1:2008 EN50178:1997
---	---

3.1.2 Outline of Safety Function

Function	Details
Emergency stop observation	NC control unit (CNC CPU unit) and the drive unit separately observe the input of emergency stop. At the emergency stop, the motor power is shut off by controlling the contactor with each of the PLC CPU unit (only for C70), NC control unit (CNC CPU unit) and the drive unit (power supply unit).
SLS (Safely Limited Speed)	NC control unit (CNC CPU unit) and the drive unit (servo/spindle drive unit) separately observe the followings. The motor power is shut off when an error is detected during the observation. -The command speed does not exceed the speed set with the parameter. -The rotation speed of the motor does not exceed the rotation speed set with the parameter.
STO (Safe Torque Off)	The torque is shut off by shutting off the energy supply to the motor. The motor power is electronically shut off inside the drive unit.

Safety function assumes the following configuration.

- A)The machine is equipped with at least one safety door.
- B)Safety is ensured when the safety door is closed.

When an operator requests to open the safety door, enable the safety function and release the lock on the safety door. Safety is ensured by enabling the safety function while the safety door is open. When canceling the safety door open request, the safety door enters the locked state and safety function will be released.

WARNING

The sequence of enabling or disabling the safety function by opening or closing the door is required to take necessary actions at the machine tool builders.

WARNING

Precautions for the safety function described in this manual are as follows.

Read carefully all the following fundamental precautions for safety to prevent human injury or property damage.

1. Only a qualified person is authorized to perform the installation, start, repair, or adjustment of the device in which these equipment are installed.
2. The qualified person must be familiar with the laws of the country where the device into which this product is built is installed, especially the standards described in this book, and the requirements which are listed in EN ISO 13849-1, IEC/EN 61508, IEC 61,800-5-2 and IEC 60,204-1.
3. To perform the start, programming, setting and maintenance of the device in accordance with the safety standards, the staff who undertakes these work should obtain permission from the company it belongs to.

3.2 Emergency Stop Observation

The double-protection for the emergency stop signal is provided and observes whether any abnormality is found in the emergency stop signal. The whole system will be in the emergency stop state when one emergency stop signal is in open state.

(1) Input circuit of an external emergency stop

Besides the emergency stop input from the NC controller, double-protection when an emergency stop occurs can be provided by directly inputting an external emergency stop to the CN24 connector on the power supply unit. Even if the emergency stop is not input from CNC for some reason, the contactors will be shut off by the external emergency stop input from CN24 connector on the power supply unit. When the external emergency stop input and contactor are installed, compliance with "EN60204-1 category1" is basically possible.

(a) Connection

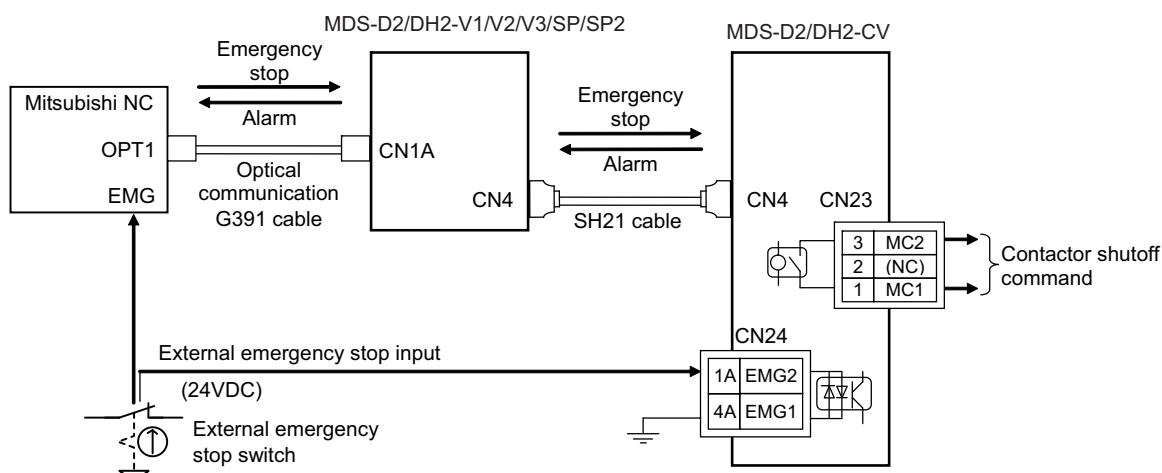

(b) Rotary switch setting

When using the external emergency stop, the rotary switch on the front of the power supply unit must be set.

- Rotary switch setting: 4

CAUTION

1. The emergency stop signal input to the CNC side cannot be used as a substitute for the external emergency stop function.
2. To provide double-protection when an emergency stop occurs, the emergency stop input of NC and the external emergency stop input of power supply unit are always wired from same emergency stop switch.
3. The external emergency stop function is a function which helps the NC emergency stop.

POINT

Stop Categories in EN60204-1

Category 0 : The power is instantly shut off using machine parts.

Category 1 : The drive section is stopped with the control (hardware/software or communication network), and then the power is instantly shut off using machine parts.

(Caution) Refer to the Standards for details.

Refer to Section 9.2.5.4.2 in EN60204-1: Safety of Machinery Electrical Equipment of Machines - Part 1.

(2) Operation sequences of emergency stop

[1] Operation sequences of normal emergency stop

If the normal NC emergency stop and the external emergency stop are simultaneously input, the operation sequence will be the same as in the case of using only the NC emergency stop.

Immediately after the emergency stop is input, deceleration control is carried out in spindle control, and dynamic brake stop in servo control in a standard case, or deceleration control when the parameter is set. The ready signal is turned OFF after the NC confirms all axes stop, and the contactor control axis turns the contactor OFF.

Even when the NC emergency stop signal and the external emergency stop signal are not simultaneously input, the operation sequence will be the same as that of the normal emergency stop provided that both signals are input before all axes stop.

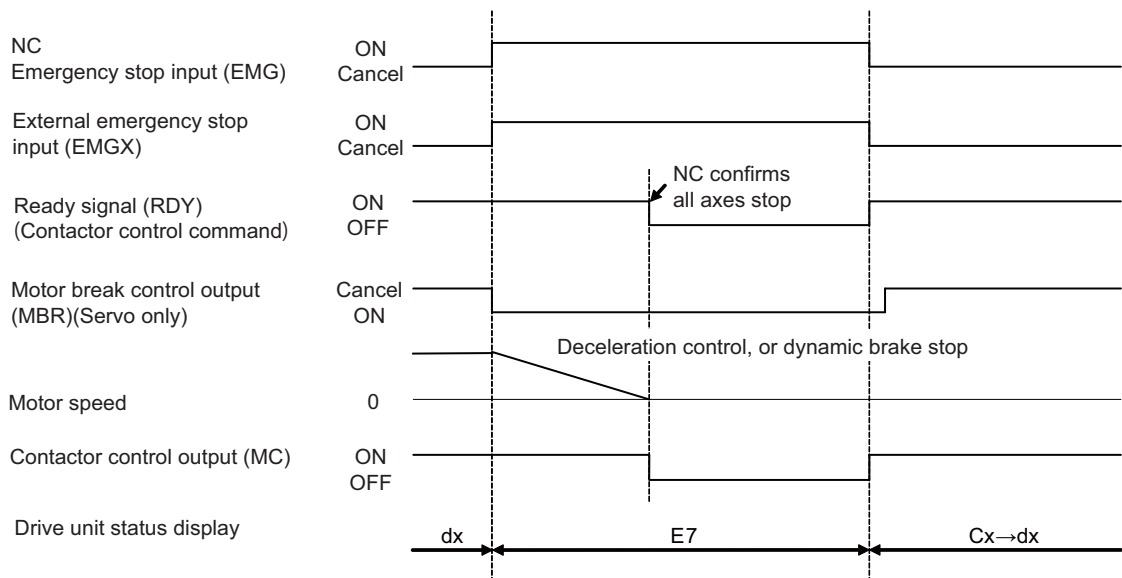

Operation sequences of normal emergency stop

[2] When only the external emergency stop is input

If only the external emergency stop is input, all the drive units that share one NC communication enter an emergency stop state and deceleration control (servo/spindle) or dynamic brake stop (servo) is executed. At this time, the axis to which the external emergency stop is input enters "in external emergency stop" (EA display). The contactor is turned OFF in accordance with the gate off delay time (SV055/SP055), as the NC emergency stop is not input and the ready signal is not turned OFF.

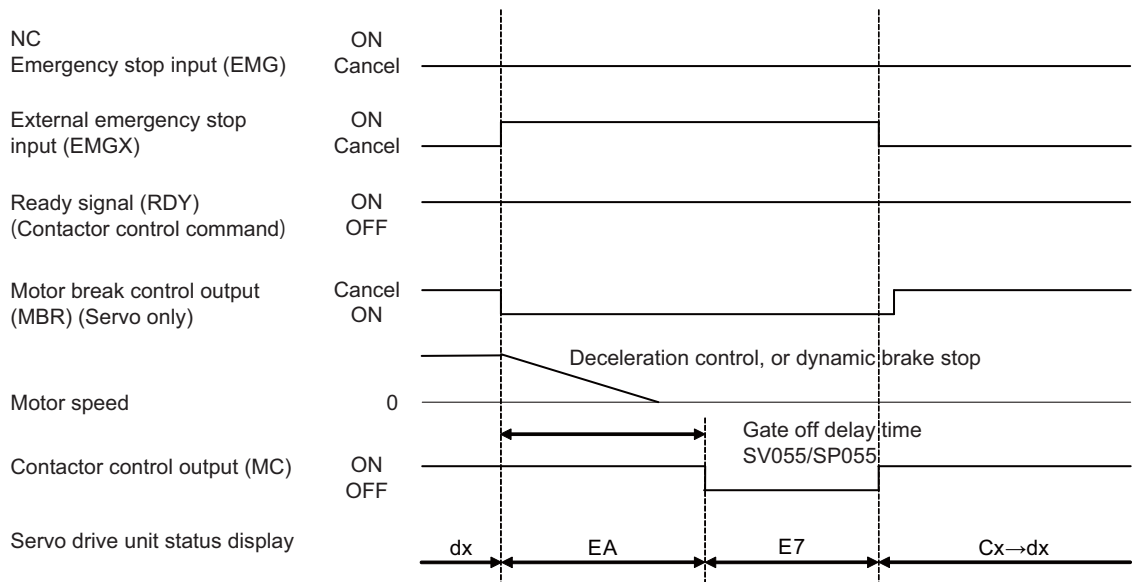

When only the external emergency stop is input

[3] When only the NC emergency stop is input

Motors of all axes enter deceleration stop in the same sequence as normal operation (when both NC and external emergency stop signals are input) and the contactor is shut off. In case that all axes stop is not confirmed and the ready signal is not turned OFF, the contactor is shut off in accordance with the max. gate off delay time (SV055/SP055) which is set to the contactor control axis.

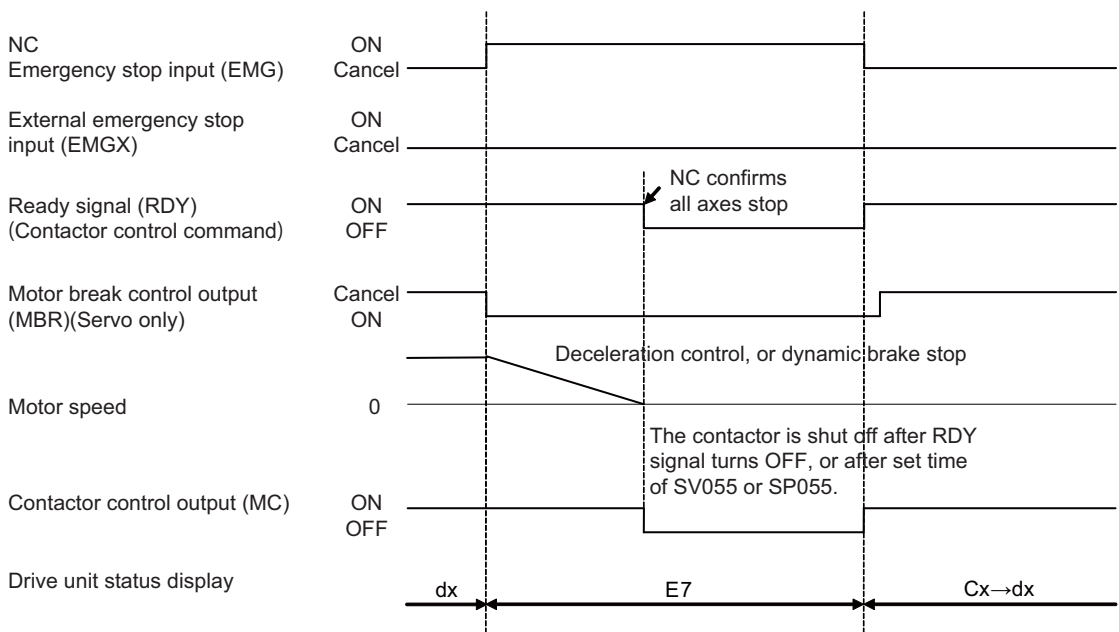

When only the emergency stop of NC is input

(3) Example of emergency stop circuit**[1] Outline of function**

The power supply unit's external emergency stop can be validated by wiring to the CN24 connector, and setting the parameters and rotary switch. If the emergency stop cannot be processed and the external contractor cannot be shut off (due to a fault) by the CNC unit, the external contractor can be shut off by the power supply unit instead of the CNC. At this time, both servo motor and spindle motor will stop with the deceleration control.

EN60204-1 Category 1 can be basically complied with by installing the external emergency stop switch and contactor.

 **CAUTION**

1. The power supply unit external emergency stop function is a function that assists the NC emergency stop.
2. The emergency stop signal input to the CNC side cannot be used as a substitute for the external emergency stop function.

The emergency stop is a signal used to stop the machine in an emergency. This is connected to the CNC unit. Wire to the power supply unit when necessary.

The servo/spindle unit will be decelerated and controlled by the software according to the deceleration stop command issued from the CNC unit.

[2] Example of emergency stop circuit

The following diagram shows an example of the emergency stop circuit (EN60204-1 Category 0) in which an off delay timer (TM1) is installed as a power shutoff method independent from the NC emergency stop input. The required safety category may be high depending on the machine and the Safety Standards may not be met. Thus, always pay special attention when selecting the parts and designing the circuit.

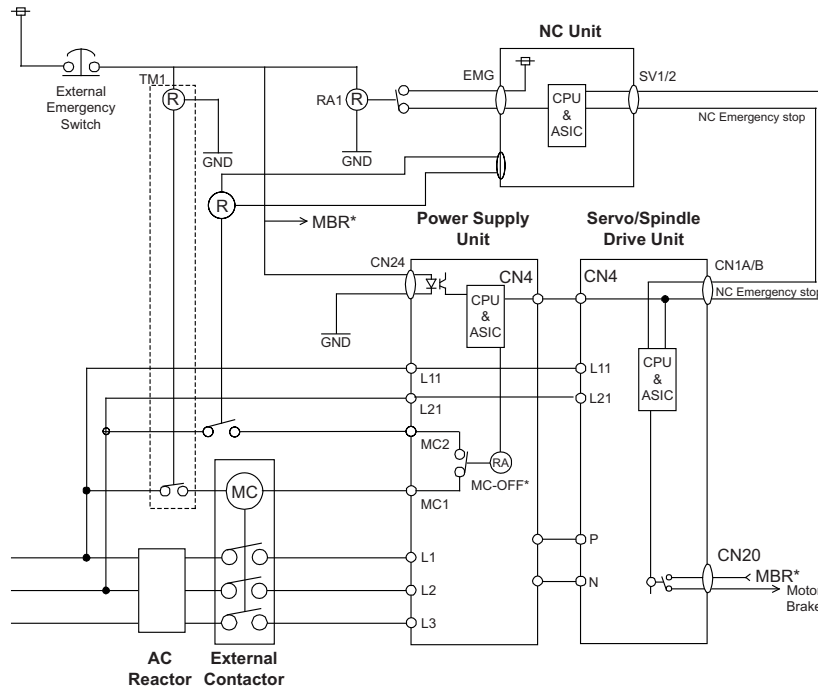

Setting the off delay timer (TM1) time
 Set the TM1 operation time so that it functions after it has been confirmed that all axes have stopped.
 If the set time is too short, a power supply alarm occurs, and the spindle motor will coast to a stop.

$t_m \geq \text{All axes stop time}$

Provide a mechanism that shuts off the power even if the CNC system fails.

POINT

Stop Categories in EN60204-1

Category 0: The power is instantly shut off using machine parts.

Category 1: The drive section is stopped with the control (hardware/software or communication network), and then the power is instantly shut off using machine parts.

(Caution) Refer to the Standards for details.

Refer to Section 9.2.5.4.2 in EN60204-1: Safety of Machinery Electrical Equipment of Machines - Part 1.

3.3 SLS (Safely Limited Speed) Function

Safely Limited Speed function observes that the motors for servo and spindle do not exceed the specified speed when the safety door of the machine is open. The setup can be performed without shutting the machine power off and this contributes to reducing preparation time and improving operation. The speed is redundantly observed by the CPU of the drive unit and the NC control unit, and an alarm is issued when either one of the CPUs detect the speed command or speed feedback exceeds the specified speed, which lead to the deceleration control in the motor. The power is shut off by the STO (Safe Torque Off) function after the motor stops.

 **POINT**

In order to set up SLS function, perform the setup in this section and the setup in "3.4 STO (Safe Torque Off) Function" additionally.

(1) Connection

The following three wirings are required for the SLS function.

- [1] The state signal for the safety door of the machine is wired to both the NC unit side (DI) and drive unit side (CN9 connector MPI1). The double-protection for the wiring must be provided by wiring the signal to each of the NC side and drive unit side as the following figure.
- [2] Add the wiring to control the contactor in the NC unit side in order to shut the power when an error occurs.
- [3] In addition to the emergency stop wiring for the NC unit, add the external emergency stop wiring for the CN24 connector of the power supply unit.

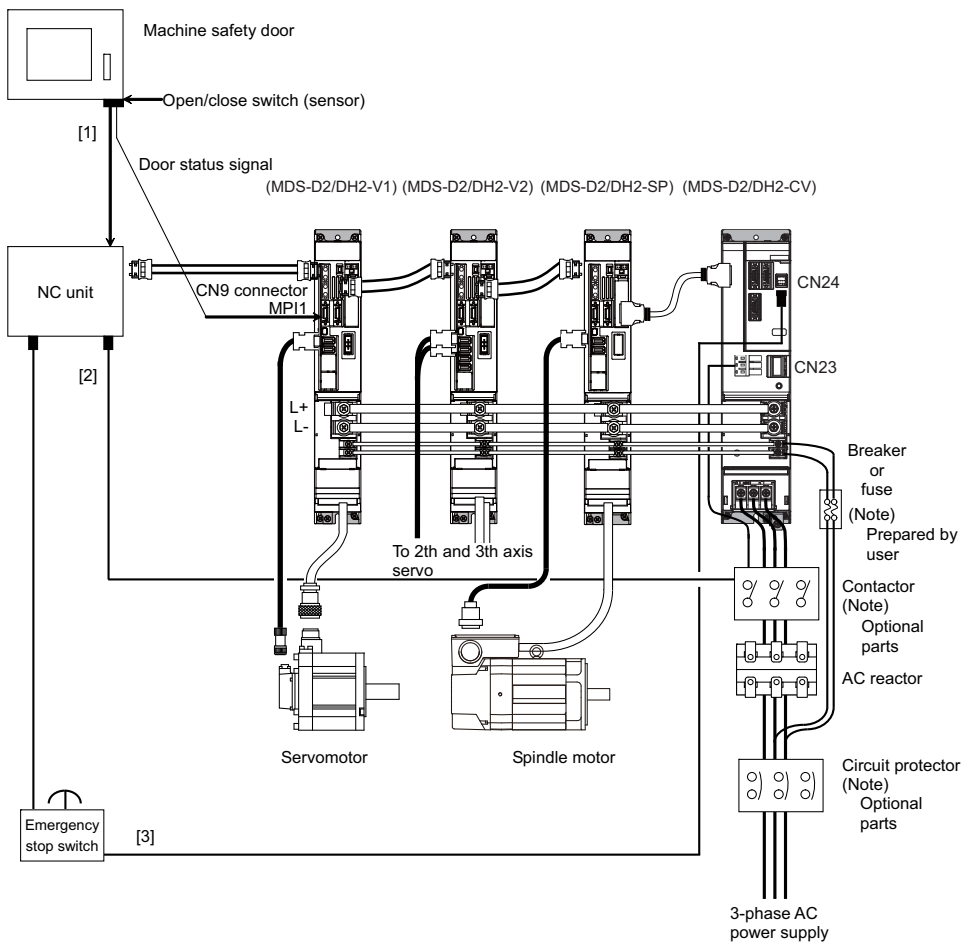

 **CAUTION**

The door state signal input port is also used for other signal input depending on the parameter setting. When the input is duplicated, consider to wire the door state signal to other drive units connecting to the same NC communication line.

⚠ CAUTION

1. The SLS (Safely Limited Speed) function is NC option. Make sure the compatibility with this function.
2. Make sure to input one of the door status signal for each control system to CN9 connector of servo or spindle drive unit. In the control system, it is conveyed to the axis which is not directly connected via the NC.
3. Using the SLS (Safely Limited Speed) function, it is required to set parameter in addition to the wiring mentioned above. To prevent a certain axis from being involved in the SLS (Safely Limited Speed) function, set SV113/bitF or SP229/bitF to 0.

(2) Parameter setting for servo drive unit

Starts the SLS (Safely Limited Speed) function.

【#2313】 SV113 SSF8 Servo function 8**bit F : ssc SLS (Safely Limited Speed) function**

0: Stop 1: Start

The digital signal input selection is set to "1" for the drive unit connected with the door state signal. The digital signal input selection is set to "0" for the other drive unit not connected with the signal.

【#2282】 SV082 SSF5 Servo function 5**bit F-C: dis Digital signal input selection**

0: No signal
1: SLS (Safely Limited Speed) function door state signal
2: Battery box voltage drop warning
3 to F: Setting prohibited

Sets the safely limited speed of the machine and motor for which the SLS (Safely Limited Speed) function is executed.

【#2233】 SV033 SSF2 Servo function 2

bit D : rps Safely limited speed setting increment

Change the setting units of the specified speed signal output speed (SV073) and safely limited speed (SV238).

0: mm/min 1: 100mm/min

【#2438】 SV238 SSCFEED Safely limited speed

Set the machine's safely limited speed for the SLS (Safely Limited Speed) function. Set this parameter within the following setting ranges.

For linear axis: 2000mm/min or less

For rotary axis: 18000°/min (50r/min) or less

When not using, set to "0".

---Setting range---

0 to 18000 (mm/min) or (°/min)

However, when SV033/bitD=1, the setting range is from -32768 to 32767 (100 mm/min) or (100°/min).

【#2439】 SV239 SSCRPM Safely limited motor speed

Set the motor's safely limited speed for the SLS (Safely Limited Speed) function.

Set a value to hold the following relationship.

Be aware when setting the parameter as the setting units for general motors and linear motors are different.

<<For general motor>>

$$SV239 = (SV238/SV018) \times (SV002/SV001)$$

Only when the product is 0, set to "1".

<<For linear motor>>

$$SV239 = SV238/60$$

Only when the product is 0, set to "1".

When not using, set to "0".

---Setting range---

For general motor: 0 to 32767 (r/min)

For linear motor: 0 to 32767 (mm/s)

(Note) The value of the safely limited speed and safely limited motor speed must satisfy the above relation. If this relation is not satisfied, the parameter error (37 or E4) will occur. (Error parameter No. is 239.) Checking this relation is executed when the drive unit is turned ON and parameter is changed and speed observation mode (states when a speed observation command is turned ON) is entered.

$$\frac{SV238 : SSCFEED}{SV018 : PIT} \times \frac{SV002 : PC2}{SV001 : PC1} = SV239 : SSCRPM$$

Note that "1 (r/min)" is applied when the calculation result is "0 (r/min)"

(3) Parameter setting for spindle drive unit

Starts the SLS (Safely Limited Speed) function.

【#13229】 SP229 SFNC9 Spindle function 9**bit F : ssc SLS (Safely Limited Speed) function**

0: Disable 1: Enable

The digital signal input selection is set to "1" for the drive unit connected with the door state signal.
The digital signal input selection is set to "0" for the other drive unit not connected with the signal.

bit D : rps Safely limited speed setting unit

0: Normal 1: 100°/min

Change the setting units of the specified speed signal output speed (SP030) and safely limited speed (SP238).

【#13227】 SP227 SFNC7 Spindle function 7**bit F-C : dis Digital signal input selection**

0: No signal
1: SLS (Safely Limited Speed) function door state signal
4: Proximity switch signal detection
Other settings: setting prohibited

Sets the safely limited speed of the machine and motor for which the SLS (Safely Limited Speed) function is executed.

【#13238】 SP238 SSCFEED Safely limited speed

Set the safely limited speed at the spindle end for the SLS (Safely Limited Speed) function.
When not using, set to "0".

---Setting range---

0 to 18000 (° /min)

However, when SP229/bitD is set to "1", the setting range is from -32768 to 32767 (100° /min).

【#13239】 SP239 SSCRPM Safely limited motor speed

Set the motor's safely limited speed for the SLS (Safely Limited Speed) function.
When not using, set to "0".

---Setting range---

0 to 32767 (r/min)

(Note) The value of the safely limited speed and safely limited motor speed must satisfy the following relation.
If this relation is not satisfied, the parameter error (37or E4) will occur. (Error parameter No. is 239.)
Checking this relation is executed when the drive unit is turned ON and parameter is changed and speed observation mode (states when a speed observation command is turned ON) is entered.

$$\frac{\text{SP238 :SSCFEED}}{360} \times \frac{\text{SP057 :GRA1}}{\text{SP061 :GRB1}} = \text{SP239 :SSCRPM}$$

Note that "1 (r/min)" is applied when the calculation result is "0 (r/min)"

3.4 STO (Safe Torque Off) Function

CAUTION

Device manufacturer accepts responsibility for all the risk assessments and related residual risks. The followings are the residual risks relevant to the STO function. Mitsubishi Electric will not accept liability for any accidents such as damage or injury caused by such residual risks.

1. STO function is a function to remove the energy of the motor electronically and not the function to shut off the input power to the drive unit or the connection between the drive unit and the motor physically. Therefore, the risk for electric shocks cannot be eliminated with the STO function. To prevent electric shocks, use the EMG function.
2. STO function is a function to disable the energy to the motor electronically. It does not guarantee the shutoff or the procedure for the deceleration control of the motor.
Read carefully the manual of each safety-related device for the correct installation, wiring, and adjustment.
For all the safety-related relay, sensor, etc., use the one which satisfies the safety standards. TUV SUD has confirmed that the safety-related parts by Mitsubishi Electric described in this manual satisfy EN ISO13849-1 Category 3, PL d.
3. Even though the STO function is enabled by the STO switch, voltage may still be residual at the servo motor for the delay specific to the device.
4. Safety is not guaranteed until the installation or adjustment for the safety-related parts in the system has been completed.
5. When replacing the drive unit, make sure that the new product is the same as the one before the replacement. After the installation, be sure to confirm the performance of the safety function before operating the system.
6. Perform all the risk assessments and safety level certifications for the whole device and system. The use of a third-party certifier such as TUV SUD is recommended as a final safety certification of the system.
7. To prevent the accumulation of failure, perform an appropriate safety confirmation check at regular intervals as required by the safety standards. The safety confirmation check must be performed at least once a day regardless of the safety level of the system.
8. When up-and-down short circuit is occurred to the power module of the drive unit, the servo motor shaft rotates for up to 0.5 revolution.
9. Be sure to supply the STO input signal (STO1, STO2) from one power supply. If the power is divided, STO shutoff state may not be realized due to a malfunction of the STO function caused by a sneak current.

DANGER

Improper installation of a safety-related device or a system could cause a operation state without safety guaranteed and may lead to a serious or fatal accident.

Preventive measure against the above danger

As described in IEC 61800-5-2, the STO (Safe Torque Off) function is a function not to supply a energy from a drive unit to a motor and does not guarantee that a motor is not moved by an external force and other influence.

Take safety measure such as brake or counter balance additionally when the external force is acted on by the motor itself.

Safe Torque Off function is a shutoff function which does not provide the energy to the motor capable of generating torque and it shuts off an energy supply electronically inside the drive unit. STO function can be used in the following two ways ((1) and (2) below).

(1) Network STO function

[1] System configuration and wiring

STO function shuts off the motor power of all axes in the system.

Warning A4(sub-number 0001) is detected while STO function is shutting off the motor power.

< A system configuration example when using network STO function >

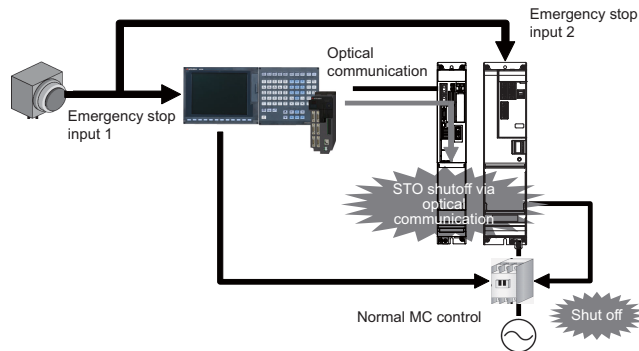

< A wiring diagram for network STO function (Dual emergency stop) >

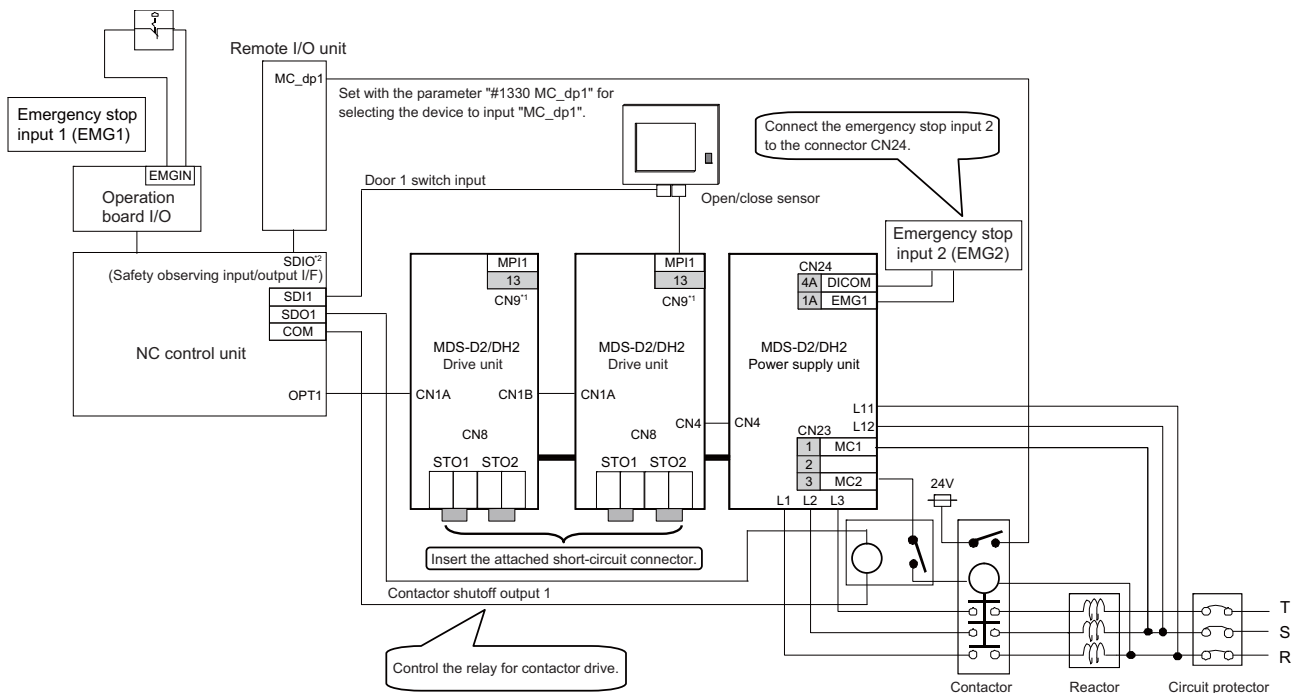

CAUTION

1. Refer to "2.8 Wiring of the peripheral control" when wiring the door input signal for CN9.
 2. The wiring diagram above is an example with M700VW. When wiring with the unit other than M700VW, connect the NC side door switch input and contactor shutoff output to the remote I/O unit. In that case, set the device of the remote I/O unit to input each signal by the following Base Specifications Parameters.
 - Door 1 switch input "#1349 DOOR_1"
 - Contactor shutoff output 1 "#1353 MC_ct1"
- For details on the setting or wiring of NC side, refer to the manual of NC system.

(2) Dedicated wiring STO function

[1] System configuration

This method is used to shut off the motor power with STO function only for the specific axis.

For example, to shut off the motor power with STO function only for the magazine rack axis, install a safety door for tool change and directly connect the door open/close signal to the STO signal input (CN8) of the drive unit. Warning A4(sub-number 0001) is detected while STO function is shutting off the motor power.

(Note) Always insert the provided short-circuit connector to CN8 for other than magazine rack axis and cause short circuit in the STO signal.

Manufacturer : Tyco Electronics < Type > Connector set: MR-D05UDL3M-B

< A system configuration example when using dedicated wiring STO function >

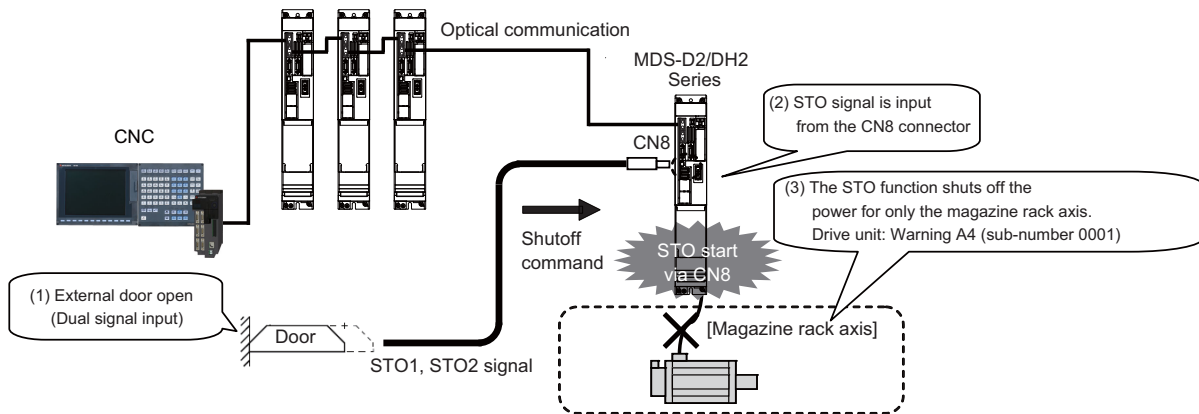

[2] Input/output signal and operation sequences

The drive unit is equipped with a connector (CN8) which provides dedicated wiring STO function. The energy supply to a motor can completely be shutoff by using this connector with external safety device. The following wiring and parameter setting (SV113,SP229/bit8) are required when using the connector (CN8).

Dedicated wiring STO function can be disabled by inserting the following connector to CN8.

Manufacturer : Tyco Electronics < Type > Connector set: MR-D05UDL3M-B

Connector for dedicated wiring STO signal (CN8) and signal array

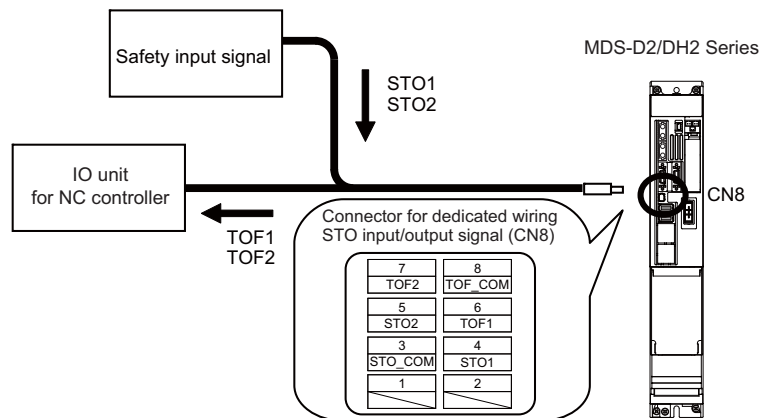

Signal name	Connector pin No.	Details	I/O class
STO_COM	CN8-3	STO input signal common	DI
STO1	CN8-4	STO input signal 1	DI
STO2	CN8-5	STO input signal 2	DI
TOF1	CN8-6	TOF output signal 1	DO
TOF2	CN8-7	TOF output signal 2	DO
TOF_COM	CN8-8	TOF output signal common	DO

< Operation sequences example for dedicated wiring STO function >

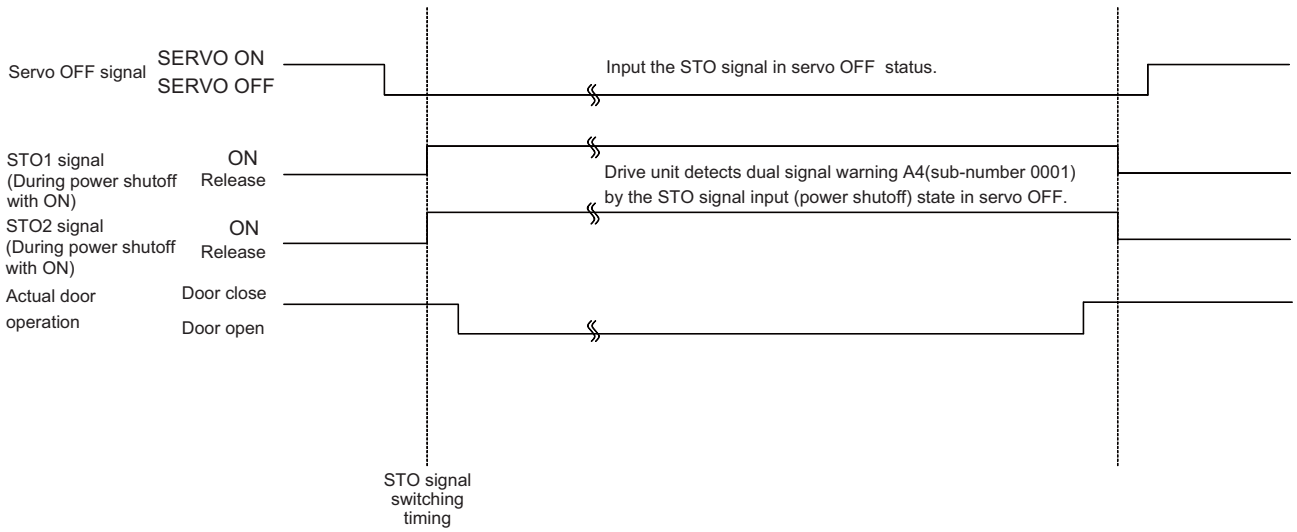

CAUTION

1. Do not connect a cable to pin 1 and 2 of CN8. A malfunction or failure may result.
2. Input the STO signal during servo OFF.

POINT

For this function which inputs the STO signal directly to the drive unit, safety is ensured by inputting synonymous STO signals redundantly to shut off the energy supply with the independent control.

External input/output signal connection example when using a NC controller

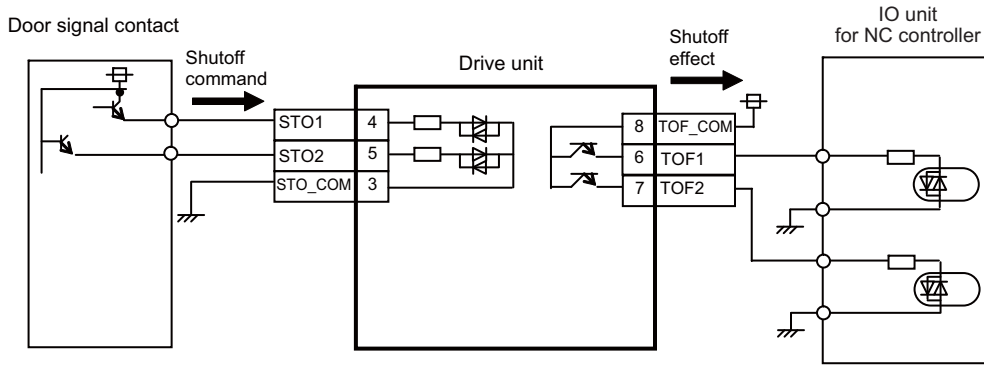

Detail description of external input/output signal connection

Details of the input/output signal as stated before (refer to "I/O class" in the table) are shown below. Connect to an external device by referring to this section.

(a) Digital input interface: DI

Provide a signal with a relay or open-collector transistor.

[1] Sink input/output interface

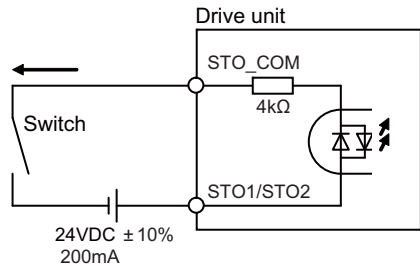

[2] Source input/output interface

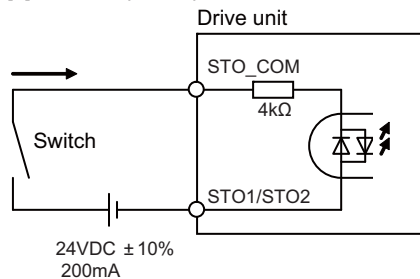

1	Input voltage at external contact ON	24VDC±10%
2	Input current at external contact ON	10mA or more
3	Input voltage at external contact OFF	4V or less
4	Input current at external contact OFF	2mA or less
5	Input resistance	4kΩ
6	Tolerable chattering time	1ms or less
7	Input signal holding time	600ms or more
8	Input circuit operation delay time	10ms typ 30ms or less

(b) Digital output interface: DO

Maximum 1.3V of voltage drop occurs inside the drive unit.

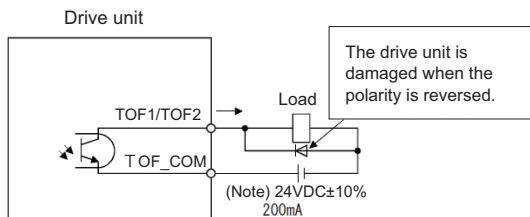

1	Insulation method	Insulation
2	Rated load voltage	24V
3	Rated current	40mA or less
4	Maximum current	50mA or less
5	Rush current	100mA or less
6	Internal voltage drop	1.3V or less

CAUTION

Maximum 1.3V of voltage drop occurs inside the drive unit. Select an external connection device operable in the output voltage after the voltage drop.

[3] Parameter setting

Input observation for dedicated wiring STO signal is set with the parameter SV113,SP229/bit8. The following parameter setting is not to enable or disable the shutoff function of STO function performed by the H/W. When using network STO function only, make sure to set to "0".

< Servo parameter >**【#2313】 SV113 SSF8 Servo function 8****bit 8 : sto Dedicated wiring STO function**

0: Dedicated wiring STO function unused 1: Dedicated wiring STO function used

< Spindle parameter >**【#13229】 SP229 SFNC9 Spindle function 9****bit 8 : sto Dedicated wiring STO function**

0: Dedicated wiring STO function unused 1: Dedicated wiring STO function used

[4] Related alarm and warning

If the dual signal error (4D) or dual signal warning (A4) occurs, the alarm, axis name and sub-number that indicates the detected factor will appear on the NC Diagnosis screen as shown below:

S05 Safety function error ○○○○ □
 ○○○○ : Alarming factor (hexadecimal)
 □ : Axis name

S53 Safety function warning ○○○○ □
 ○○○○ : Warning factor (hexadecimal)
 □ : Axis name

When dual signal error 4D occurs, eliminate the factor of illegal parameter setting or STO signal input by referring to the following.

In addition, while the power is shut off by STO signal, dual signal warning A4 is detected regardless of SV113/bit8 or SP229/bit8 setting.

< Sub-number for dual signal error (4D) >

Sub-No.	Name	Details	Reset method	Stop method
0001	Power shutoff error	- The parameter setting for dedicated wiring STO function (SV113/bit8 or SP229/bit8) is wrong. - The connector to disable STO is not installed correctly when not using dedicated wiring STO function.	NR	Servo: Dynamic stop Spindle: Coast to a stop
0002	Illegal power shutoff error	STO signal is input by dedicated wiring STO function during servo ON.		
0004	STO signal mismatch error at servo OFF	STO signal is illegally input by dedicated wiring STO function during servo OFF. (Illegal input : Signal input state for STO1 and STO2 is mismatched.)		
0006	STO signal mismatch error at servo ON	STO signal is illegally input by dedicated wiring STO function during servo ON. (Illegal input : Signal input state for STO1 and STO2 is mismatched.)		

(Note 1)Resetting methods

NR: Reset with the NC RESET button.

(Note 2)Dedicated wiring STO function is determined with the parameter (SV113:SSF8/bit8 for servo and SP229:SFNC9/bit8 for spindle) setting.

< Sub-number for dual signal warning (4D) >

Sub-No.	Name	Details	Reset method	Stop method
0001	During STO signal shutoff	STO signal is normally input and the power is shut off.	*	-

(Note 1)Resetting methods

* : Automatically reset once the cause of the warning is removed.

(Note 2)Warning A4 is detected regardless of SV113/bit8 or SP229/bit8 setting while the power is shut off by STO signal.

4

Setup

4.1 Initial Setup

4.1.1 Setting the Rotary Switch

Before turning on the power, the axis No. must be set with the rotary switch. The rotary switch settings will be validated when the drive units are turned ON.

< Drive unit >

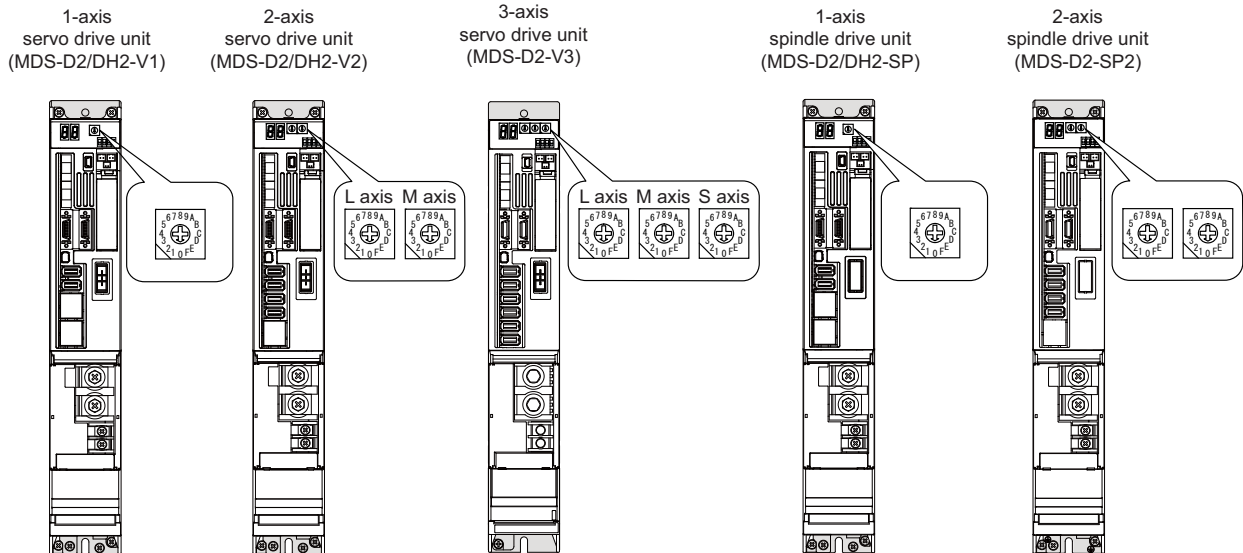

MDS-D2/DH2-V1/V2/SP, MDS-D2-V3/SP2 setting

Rotary switch setting	AXIS NO.
0	1st axis
1	2nd axis
2	3rd axis
3	4th axis
4	5th axis
5	6th axis
6	7th axis
7	8th axis
8	9th axis
9	10th axis
A	11th axis
B	12th axis
C	13th axis
D	14th axis
E	15th axis
F	16th axis

< Power supply unit >

Power supply unit
(MDS-D2/DH2-CV)

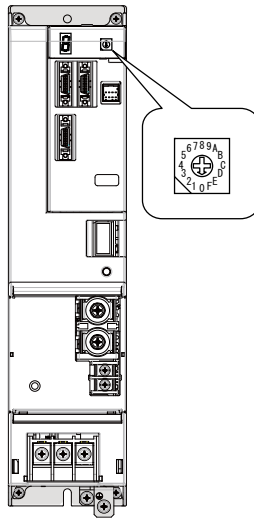

MDS-D2/DH2-CV setting

Rotary switch setting	Setting items
0	Normal setting
1 to 3	Setting prohibited
4	External emergency stop setting
5 to F	Setting prohibited

4.1.2 Setting DIP Switch

Setting the DIP switches is necessary prior to turning ON the power. Setting of the DIP switches at the time of turning ON the power is validated. The DIP switches shall be as the standard setting (all the switches OFF).

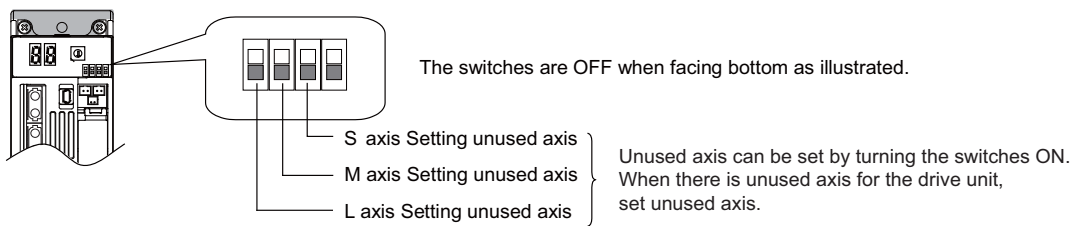

4.1.3 Transition of LED Display After Power Is Turned ON

When CNC, each drive unit and the power supply unit power have been turned ON, each unit will automatically execute self-diagnosis and initial settings for operation, etc. The LEDs on the front of the units will change as shown below according to the progression of these processes.

If an alarm occurs, the alarm No. will appear on the LEDs. Refer to section "LED display when alarm or warning occurs" for details on the alarm displays.

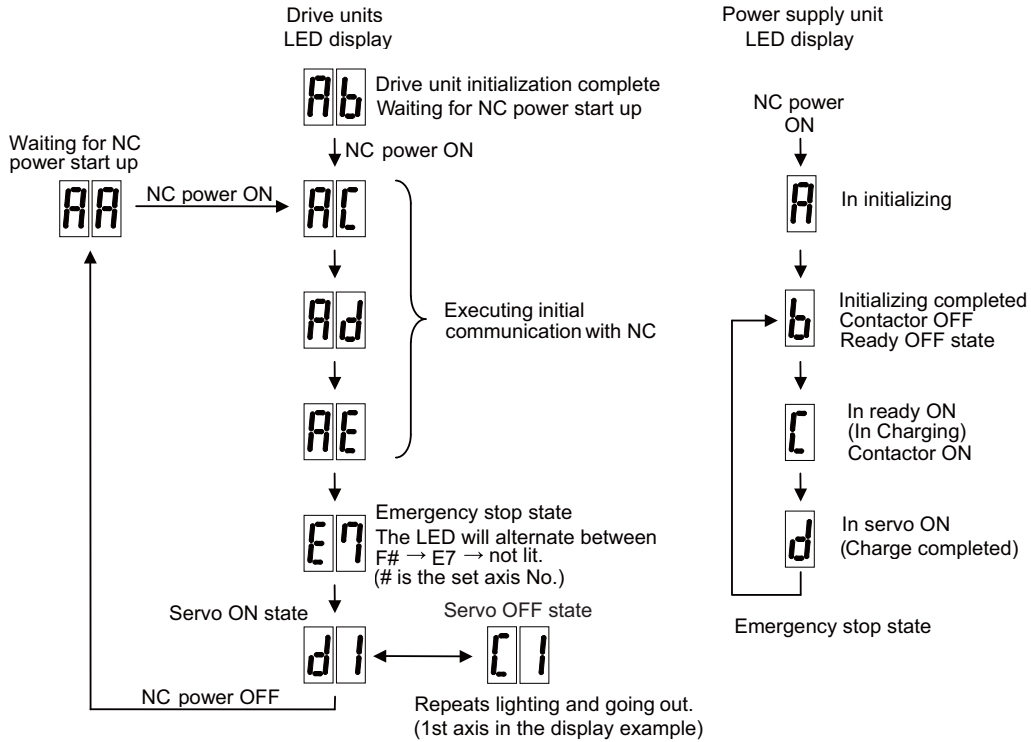

CAUTION

1. Always input emergency stop when starting the servo system.
2. Do not insert or extract the external STO input connector (CN8) after starting the servo system. Motor power will be shut off and it may cause the collision of machine.

4.2 Setting the Initial Parameters for the Servo Drive Unit

The servo parameters must be set before the servo system can be started up. The servo parameters are input from the NC. The input method differs according to the NC being used, so refer to each NC Instruction Manual.

When setting the initial setting parameters, perform the following settings in each system.

<For semi closed loop control (single-axis control)>

- (1) Set the standard parameters in the section "4.2.5 List of Standard Parameters for Each Servo Motor".
- (2) "4.2.1 Setting of Servo Specification Parameters"

< For full closed loop control (single-axis control) >

- (1) Set the standard parameters in the section "4.2.5 List of Standard Parameters for Each Servo Motor".
- (2) "4.2.1 Setting of Servo Specification Parameters"
- (3) "4.2.2 Setting of Machine Side Encoder"

<For full closed loop control with a distance-coded reference scale (single-axis control)>

- (1) Set the standard parameters in the section "4.2.5 List of Standard Parameters for Each Servo Motor".
- (2) "4.2.1 Setting of Servo Specification Parameters"
- (3) "4.2.2 Setting of Machine Side Encoder"
- (4) "4.2.3 Setting of Distance-coded Reference Scale"

< For speed command synchronous control >

- (1) Set the standard parameters in the section "4.2.5 List of Standard Parameters for Each Servo Motor".
 - (2) "4.2.1 Setting of Servo Specification Parameters"
 - (3) "4.2.2 Setting of Machine Side Encoder"
 - (4) "4.2.4 Setting of Speed Command Synchronous Control"
- (Note) For the position command synchronous control, perform the items of single-axis control for each axis.

Setting the initial parameters above enables the test operation for the servo axis (Ex. manual pulse feed, low-speed JOG feed). When machine resonance occurs, check the machine resonance frequency at AFLT frequency on the drive monitor screen and set to the following servo parameters. The display sensitivity can be adjusted in the "sensitivity of estimated resonance frequency" setting. (When the AFLT frequency displays "0", vibration at high frequency or vibration due to the machine system may be the reason.)

【#2238】 SV038 FHz1 Notch filter frequency 1

Set the vibration frequency to suppress when machine vibration occurs.
(Normally, do not set 80 or less.)

---Setting range---

0 to 2250 (Hz)

4.2.1 Setting of Servo Specification Parameters

(1) Basic specification parameters

When performing absolute position control, set the axis specification parameter #2049. When the setting value of #2049 is "1 to 4", "SV017/bit7" is automatically set to the absolute position control.

It is not possible to set SV017/bit7 directly.

【#2049(PR)】 type Absolute position detection method

Select the absolute position zero point alignment method.

- 0: Not absolute position detection (Incremental control)
- 1: Stopper method (push against mechanical stopper)
- 2: Marked point alignment method I (The grid point is the reference position.)
- 3: Dog-type (align with dog and near point detection switch)
- 4: Marked point alignment method II
(The position with which the mark was aligned is the reference position.)
- 9: Simple absolute position (Not absolute position detection, but the position when the power is turned off is registered.)

【#2217(PR)】 SV017 SPEC1 Servo specification 1

bit 7 : abs Position control

These parameters are set automatically by the NC system.

- 0: Incremental 1: Absolute position control

For C70 NC, set the following parameters. Ignore the unnecessary alarm history which occurs when the NC power is turned off.

【#2314】 SV114 SSF9 Servo function 9

bit 8 : nohis History of communication error alarm between NC and DRV (34, 36, 38, 39)

Set "1" for C70.

- 0: Enable 1: Disable

(2) Electronic gear related parameters

Servo control is performed by changing NC command unit to servo control unit with the following parameters (electric gear). Even if each parameter is within the setting range, overflow of the electric gear coefficient may occur. When the overflow of the electric gear occurs, initial parameter error (servo alarm 37) will occur.

【#2201(PR)】 SV001 PC1 Motor side gear ratio

【#2202(PR)】 SV002 PC2 Machine side gear ratio

Set the gear ratio in the machine side when there is the gear between the servo motor's shaft and machine (ball screw, etc.).

For the rotary axis, set the total deceleration (acceleration) ratio.

Even if the gear ratio is within the setting range, the electronic gears may overflow and an initial parameter error (servo alarm 37) may occur.

【#2218(PR)】 SV018 PIT Ball screw pitch/Magnetic pole pitch

Set the ball screw pitch. For the rotary axis, set to "360".

【#2219(PR)】 SV019 RNG1 Sub side encoder resolution

Set the same value as SV020.

For the full-closed loop control, refer to "Setting of Machine Side Encoder".

【#2220(PR)】 SV020 RNG2 Main side encoder resolution

Set the number of pulses per revolution of the motor side encoder.

OSA18 (-A48) (260,000 p/rev) ----- SV020 = 260
 OSA105 (-A51) (1,000,000 p/rev) ----- SV020 = 1000
 OSA166 (-A74N) (16,000,000 p/rev) ----- SV020 = 16000

(3) Setting of power supply type

Set the drive unit connected to the power supply unit with the CN4 connector. This does not need to be set if the power supply for the axis is not connected with the CN4 connector. (Set "0000".)

If the power supply unit is connected with the spindle drive unit, the parameters do not need to be set on the servo side. When connected to a multi-axis servo drive unit (MDS-D2-V2,V3/MDS-DH2-V2), set the power supply type for one of the two or three target axes.

【#2236(PR)】 SV036 PTYP Power supply type**bit F-C : amp**

Set the power backup function to be used.

No function used : 0
 Deceleration and stop function at power failure : 8
 Retraction function at power failure : C

bit 7-0 : ptyp External emergency stop setting

When the emergency stop input signal of the power supply unit is "disabled"

Power supply unit is not connected : 0000h
 MDS-D2-CV-37 / MDS-DH2-CV-37 : 0004h
 MDS-D2-CV-75 / MDS-DH2-CV-75 : 0008h
 MDS-D2-CV-110 / MDS-DH2-CV-110 : 0011h
 MDS-D2-CV-185 / MDS-DH2-CV-185 : 0019h
 MDS-D2-CV-300 / MDS-DH2-CV-300 : 0030h
 MDS-D2-CV-370 / MDS-DH2-CV-370 : 0037h
 MDS-D2-CV-450 / MDS-DH2-CV-450 : 0045h
 MDS-D2-CV-550 / MDS-DH2-CV-550 : 0055h
 MDS-DH2-CV-750 : 0075h

When the emergency stop input signal of the power supply unit is "enabled"

(Note) Set the power supply rotary switch to "4".
 Power supply unit is not connected : 0000h
 MDS-D2-CV-37 / MDS-DH2-CV-37 : 0044h
 MDS-D2-CV-75 / MDS-DH2-CV-75 : 0048h
 MDS-D2-CV-110 / MDS-DH2-CV-110 : 0051h
 MDS-D2-CV-185 / MDS-DH2-CV-185 : 0059h
 MDS-D2-CV-300 / MDS-DH2-CV-300 : 0070h
 MDS-D2-CV-370 / MDS-DH2-CV-370 : 0077h
 MDS-D2-CV-450 / MDS-DH2-CV-450 : 0085h
 MDS-D2-CV-550 / MDS-DH2-CV-550 : 0095h
 MDS-DH2-CV-750 : 00B5h

4.2.2 Setting of Machine Side Encoder

(1) Setting of the machine side encoder specification

【#2225(PR) SV025 MTYP Motor/Encoder type

Set the position encoder type, according to the machine side encoder specifications.

bit F-C: pen Position encoder

Rectangular wave signal output rotary scale : pen=4

OSA105ET2A, OSA166ET2NA : pen=6

Serial signal output rotary scale : pen=6

Rectangular wave signal output linear scale : pen=8

Serial signal output linear scale : pen=A

【#2219(PR) SV019 RNG1 Sub side encoder resolution

For a ball screw side encoder

OSA105ET2A : RNG1=1000

OSA166ET2NA : RNG1=16000

For a linear scale

Set the number of pulses per ball screw lead in one "kp" increments.

For a rotary scale

Set the number of pulses per revolution in one "kp" increments.

Note that the value must be input in increments of 10K pulses (the 1st digit of the setting value is "0").

If any restriction is imposed due to the above condition, also set SV117 in one pulse increments.

【#2317(PR) SV117 RNG1ex Expansion sub side encoder resolution

To set the resolution of the machine side encoder in one pulse increments, set the number of pulses of the encoder by 4-byte data in total to SV117 (high-order 16bit) and SV019 (low-order 16bit).

SV117= Quotient of the number of pulses divided by 65536 (If the quotient is 0, set SV117 to -1).

SV019= Remainder of the number of pulses divided by 65536

(SV019 can be set in one pulse increments).

If the NC is C70 and SV019 is greater than 32767, enter the (negative) value obtained by subtracting 65536 from the above remainder in SV019.

(2) Setting table for each encoder
Rectangular wave signal output encoder

Manufacturer	Encoder type	Interface unit type	Control resolution	SV025	SV019	SV117
MAGNESCALE	SR74 SR84	Not required	1.0 μ m	82 <input type="checkbox"/> <input type="checkbox"/>	$(SV018 \times 1000 / 1.0) / 65536 =$ remainder	quotient
			0.5 μ m	82 <input type="checkbox"/> <input type="checkbox"/>	$(SV018 \times 1000 / 0.5) / 65536 =$ remainder	quotient
			0.1 μ m	82 <input type="checkbox"/> <input type="checkbox"/>	$(SV018 \times 1000 / 0.1) / 65536 =$ remainder	quotient
			0.05 μ m	82 <input type="checkbox"/> <input type="checkbox"/>	$(SV018 \times 1000 / 0.05) / 65536 =$ remainder	quotient
HEIDENHAIN	LS187 LS487	IBV 101 (10 divisions)	0.5 μ m	82 <input type="checkbox"/> <input type="checkbox"/>	$(SV018 \times 1000 / 0.5) / 65536 =$ remainder	quotient
		IBV 102 (100 divisions)	0.05 μ m	82 <input type="checkbox"/> <input type="checkbox"/>	$(SV018 \times 1000 / 0.05) / 65536 =$ remainder	quotient
		IBV 660B (400 divisions)	0.0125 μ m	82 <input type="checkbox"/> <input type="checkbox"/>	$(SV018 \times 1000 / 0.0125) / 65536 =$ remainder	quotient
Other manufacturers	Rectangular wave output scale	Not required	Signal frequency μ m/4	82 <input type="checkbox"/> <input type="checkbox"/>	$(SV018 \times 1000 / (\text{signal cycle } \mu\text{m}/4)) / 65536 =$ remainder	quotient

(Note) When the quotient is "0", "SV117 = -1" is applied.

Mitsubishi serial signal output encoder (Incremental)

Manufacturer	Encoder type	Interface unit type	Control resolution	SV025	SV019	SV117
MAGNESCALE	SR75 SR85	Not required	0.1 μ m	A2 <input type="checkbox"/> <input type="checkbox"/>	SV018/0.1	0
			0.05 μ m	A2 <input type="checkbox"/> <input type="checkbox"/>	SV018/0.05	0
			0.01 μ m	A2 <input type="checkbox"/> <input type="checkbox"/>	SV018/0.01	0
HEIDENHAIN	LS187 LS487	EIB192M A4 20 μ m	(20/16384) μ m	A2 <input type="checkbox"/> <input type="checkbox"/>	$(SV018 \times 819200) / 65536 =$ remainder	quotient
		EIB392M A4 20 μ m				
	ERM280 1200	EIB192M C4 1200	19,660,800p/rev	62 <input type="checkbox"/> <input type="checkbox"/>	0	300
		EIB392M C4 1200				
	ERM280 2048	EIB192M C6 2048	33,554,432p/rev	62 <input type="checkbox"/> <input type="checkbox"/>	0	512
		EIB392M C6 2048				
LS187C LS487C	MDS-B-HR	Signal cycle μ m/ 512	A2 <input type="checkbox"/> <input type="checkbox"/>	$(SV018 \times 512000 / \text{signal cycle } \mu\text{m}) / 65536 =$ remainder	quotient	
	EIB192M A5 4 μ m EIB392M A5 4 μ m	Signal cycle μ m/ 16384	A2 <input type="checkbox"/> <input type="checkbox"/>	$(SV018 \times 16384000 / \text{signal cycle } \mu\text{m}) / 65536 =$ remainder	quotient	
Other manufacturers	SIN wave output linear scale	MDS-B-HR	Signal cycle μ m/ 512	A2 <input type="checkbox"/> <input type="checkbox"/>	$(SV018 \times 512000 / \text{signal cycle } \mu\text{m}) / 65536 =$ remainder	quotient
	SIN wave output rotary scale	MDS-B-HR	Signal frequency $\times 512$ p/rev	62 <input type="checkbox"/> <input type="checkbox"/>	$(\text{Signal frequency} \times 512) / 65536 =$ remainder	quotient

(Note 1) When the quotient is "0", "SV117 = -1" is applied.

(Note 2) The communication specification of EIB192M/392M is "Mitsu02-4".

Mitsubishi serial signal output encoder (Absolute position)

Manufacturer	Encoder type	Interface unit type	Control resolution	SV025	SV019	SV117
MITSUBISHI ELECTRIC	OSA105ET2A	Not required	1,000,000p/rev	62 □ □	1000	0
	OSA166ET2NA		16,000,000p/rev		16000	0
	MBA405W		4,000,000p/rev		4000	0
MAGNESCALE	SR67A	Not required	0.1μm	A2 □ □	SV018/0.1	0
	SR77		0.05μm	A2 □ □	SV018/0.05	0
	SR87		0.01μm	A2 □ □	SV018/0.01	0
	RU77	Not required	8,000,000p/rev	62 □ □	8000	0
			32,000,000p/rev	62 □ □	32000	0
HEIDENHAIN	LC193M	Not required	0.05μm	A2 □ □	SV018/0.05	0
	LC493M		0.01μm	A2 □ □	SV018/0.01	0
	LC195M	Not required	0.01μm	A2 □ □	SV018/0.01	0
	LC495M		0.001μm	A2 □ □	SV018/0.001	0
	LC291M		0.01μm	A2 □ □	SV018/0.01	0
	RCN223M	Not required	8,000,000p/rev	62 □ □	8000	0
	RCN227M	Not required	134,217,728p/rev	62 □ □	0	2048
	RCN727M	Not required	134,217,728p/rev	62 □ □	0	2048
RCN827M						
Mitutoyo	AT343	Not required	0.05μm	A2 □ □	SV018/0.05	0
	AT543	Not required	0.05μm	A2 □ □	SV018/0.05	0
	AT545	Not required	(20/4096) μm	A2 □ □	(SV018×204800)/65536 = remainder	quotient
	ST748	Not required	0.1μm	A2 □ □	SV018/0.1	0
NIDEC MACHINE TOOL	MPRZ Series	ADB-20J71	8,000,000p/rev	62 □ □	8000	0
	MPS Series	ADB-20J60	0.05μm	A2 □ □	SV018/0.05	0
	MPI Series	ADB-20J60	7,200,000p/rev	A2 □ □	7200	0
14,400,000p/rev			A2 □ □	14400	0	
FAGOR	SAM Series	Not required	0.05μm	A2 □ □	SV018/0.05	0
	SVAM Series		0.05μm	A2 □ □	SV018/0.05	0
	GAM Series		0.05μm	A2 □ □	SV018/0.05	0
	LAM Series	Not required	0.1μm	A2 □ □	SV018/0.1	0
	HAM Series	Not required	8,000,000p/rev	62 □ □	8000	0
134,217,728p/rev	62 □ □		0	2048		
Renishaw	RL40N Series	Not required	0.05μm	A2 □ □	SV018/0.05	0
			0.001μm	A2 □ □	SV018/0.001	0
	RA Series	Not required	8,000,000p/rev	62 □ □	8000	0
			134,217,728p/rev	62 □ □	0	2048
AMO	LMFA Series	Not required	1μm	A2 □ □	SV018	0
	LMBA Series		0.25μm	AA □ □	SV018/0.25	0
	WMFA Series WMBA Series WMRA Series	Not required	250,000p/rev	62 □ □	250	0
			500,000p/rev		500	0
			1,000,000p/rev		1000	0
			2,000,000p/rev		2000	0
			4,000,000p/rev		4000	0
8,000,000p/rev	8000	0				

(Note 1) When the quotient is "0", "SV117 = -1" is applied.

(Note 2) The communication specification of LC195M/LC495M/LC291M is "MITSU03-4".

For MPI scale, set the following parameters depends on the number of poles.

【#2217(PR)】 SV017 SPEC1 Servo specification 1**bit 8 : mp MPI scale pole number setting**

0: 360 poles 1: 720 poles

(3) Setting of the installation polarity of the machine side encoder

Since the installation polarity may not be judged from the encoder appearance, confirm the installation polarity of the machine side encoder with moving the axis by hand after the installation.

If "Motor end FB" or "Machine end FB" on the NC drive monitor screen changes to the opposite polarity when the axis is moved, set "SV017/bit4" to "Reverse polarity".

【#2217(PR)】 SV017 SPEC1 Servo specification 1**bit 4 : sdir Sub side encoder feedback**

0: Forward polarity 1: Reverse polarity

(4) When using MBA405W with the machine side encoder

The absolute position in a rotation is decided by detecting Z-phase signal with the main head (Z-phase signal position mark passes the main head) at initial power ON for MBA405W although it is an absolute encoder. Once this is completed, the absolute position is kept by the battery connected to the drive unit even if the power turns OFF. Therefore, unlike other absolute position encoders (such as OSA105), the following setup is required at initial power ON.

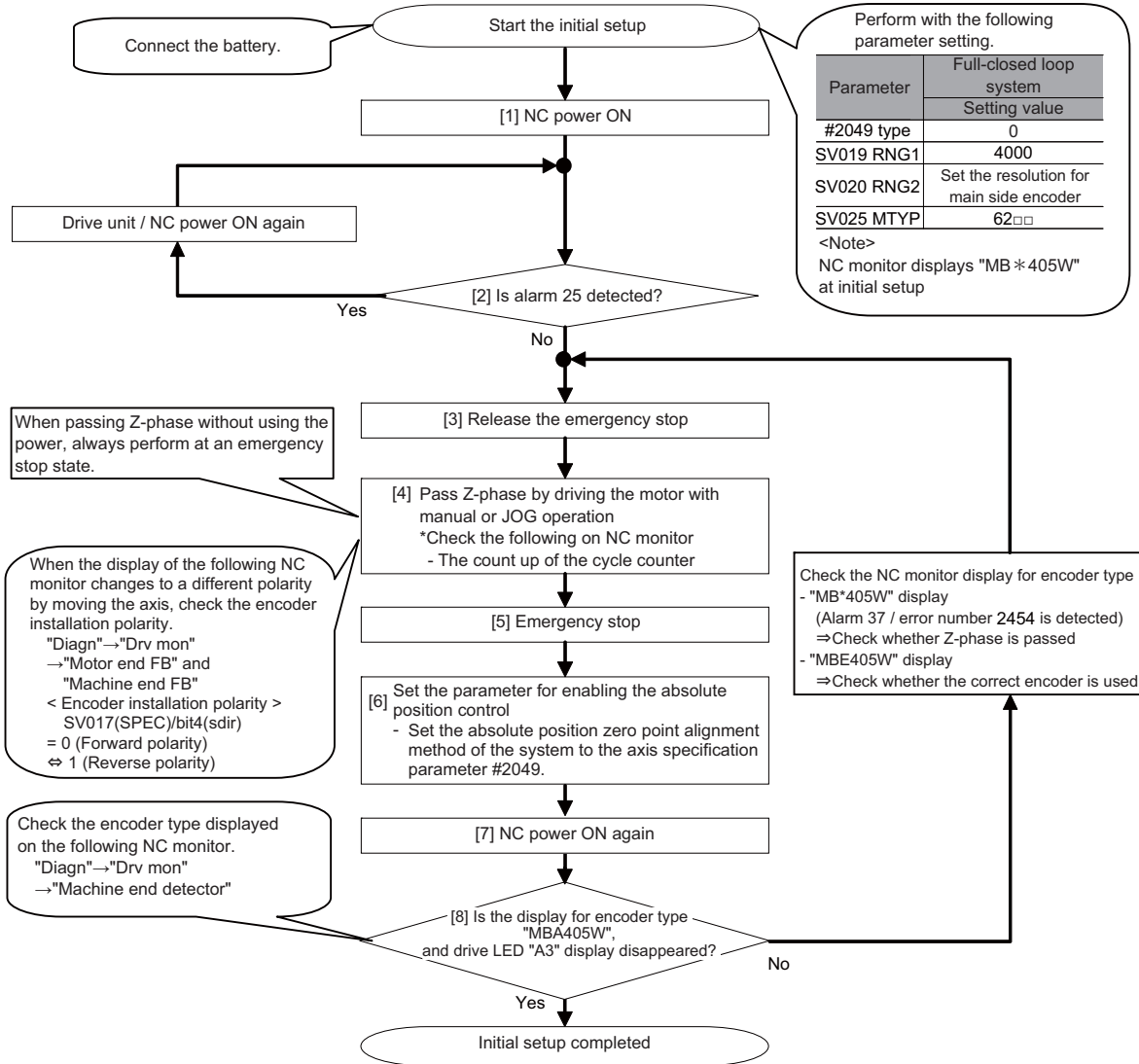

CAUTION

1. Alarm 37 / error number 2454 is detected before the initial setup operation, but this is not a fault. The alarm will be cleared after the initial setup is completed and by turning the NC power ON again.
2. The NC monitor displays "MB*405W" before the initial setup is completed. It will be correctly displayed as "MBA405W" after the initial setup is completed.

CAUTION

1. The absolute position data will immediately be lost if the cable between the drive unit and preamp of MBA405W or the battery is removed. When the cable between the drive unit and encoder is disconnected, perform the setup above again.
2. Replace the batteries with new ones immediately after the battery voltage drop alarm (9F) has been output. Replace the batteries while applying the drive unit's control power.

(5) Setting of the machine side encoder alarm detection

When using a rectangular wave linear scale, set the following parameters.

【#2235】 SV035 SSF4 Servo function 4**bit 7 : ckab No signal detection 2**

Set this to use rectangular wave output linear scale.
This enables the detection of No signal 2 (alarm 21).
0: Disable 1: Enable

【#2398】 SV198 NSE No signal 2 special detection width

Set the special detection width for the no signal 2 (alarm 21).
When "0" is set, the detection will be performed with a 15 μ m width.

---Setting range---
0 to 32767 (μ m)

4.2.3 Setting of Distance-coded Reference Scale

(1) **Setting of the base specifications**

In order to set the distance-coded reference scale, the following setting follows "Setting of Machine Side Encoder".

【#2281(PR)】 SV081 SPEC2 Servo specification 2

bit 7 : szchk Distance-coded reference scale reference mark

Set the number of reference marks to be passed during the reference position calculation. If an error occurs in passing the reference mark, the neighboring mark is checked. When an error is detected three times in total, the alarm "42" will occur.

0: Check at 4 points (standard) 1: Check at 3 points

bit 3 : absc Distance-coded reference scale

0: Disable 1: Enable

【#2330(PR)】 SV130 RPITS Base reference mark interval

Set the interval between the base reference marks arranged at regular intervals on the distance-coded reference scale. When the base reference mark interval (SV130) and the reference mark's auxiliary interval are in the specified relationship, the distance-coded reference scale is judged to be connected.

Following is the specified relationship.

$$(SV130 \times 1000) / SV131 \geq 4 \text{ (No remainder)}$$

---Setting range---

0 to 32767 (mm)

【#2331(PR)】 SV131 DPITS Auxiliary reference mark interval

Set the auxiliary interval of reference mark in the distance-coded reference scale.

---Setting range---

0 to 32767 (μ m)

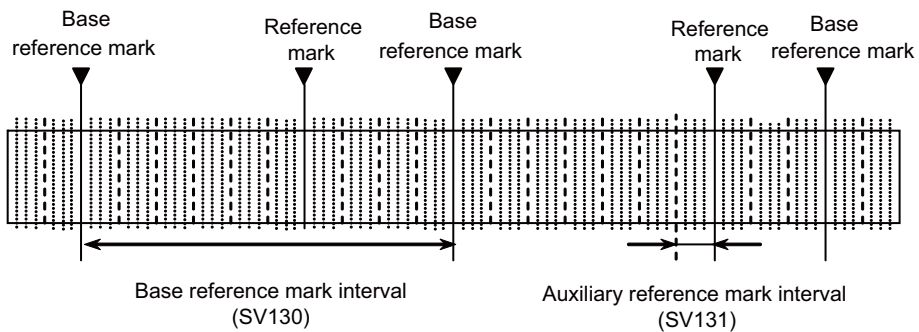

Incremental scale of distance-coded reference scale

(2) Setting of the distance-coded reference check function

If the reference marks are checked at four points by the basic point computer processing, the basic point can be recreated almost certainly. If you would like to strengthen the check further, set the distance-coded reference check function, which executes the relation check with a coordinate of the motor side encoder during the basic point calculation after the power-on.

When an error occurs, "Alarm 42" is detected. The battery option is required to use this function since the motor side encoder is under the absolute position control.

<Initial setup of the distance-coded reference check>

Performed this initial setup at the start of the system setup, linear scale exchange, or motor exchange.

- (1) Complete the setup of the distance-coded reference scale.
(Complete the base specification setting, and enable the basic point establishment.)
- (2) Turn the power ON again after setting "SV137 = -1".
(Under a state of the distance-coded reference check initial setup warning "A3".)
- (3) Perform the reference point return.
- (4) Conform that the warning "A3" turns OFF.
- (5) Set the value of "Rn", "Pn" and "MPOS" to "SV134", "SV135" and "SV136" on the drive monitor.
- (6) When SV137=32767, the distance-coded reference check function is disabled.

【#2334】 SV134 RRn0 Distance-coded reference check / revolution counter**【#2335】 SV135 RPn0H Distance-coded reference check / position within one rotation High****【#2336】 SV136 RPn0L Distance-coded reference check / position within one rotation Low**

Set this parameter to operate distance-coded reference check when using distance-coded reference scale.

During the distance-coded reference check initial setup (SV137:RAER=-1), set the following items on the NC drive monitor screen after the distance-coded reference check initial setup warning A3 turns OFF.

SV134=Rn, SV135=Pn, SV136=MPOS

【#2337】 SV137 RAER Distance-coded reference check allowable width

For the distance-coded reference check function when using distance-coded reference scale, set the allowable gap from the reference point position data calculated by the main side encoder. When the gap exceeds the allowable range, reference point created by distance-code is judged as wrong and detects alarm 42.

The standard setting value is "basic reference mark interval (SV130) / 4".

SV137=0 setting carries out the same operation as the standard setting value.

SV137=-1 setting enables the distance-coded reference initial set up mode and displays setting values of SV134 to SV136 on NC drive monitor.

To enable the distance-coded reference check function, SV081/bit3=1 setting and a battery option are needed.

---Setting range---

-1 to 32767 (mm)

4.2.4 Setting of Speed Command Synchronous Control

This section explains about the setting of the speed command synchronous control of the full closed loop control. The servo parameter setting during the position command synchronous control is same as single axis.

[#2225(PR)] SV025 MTYP Motor/Encoder type

Set the position encoder type for the secondary axis to "D". The same value is set for 2-axis drive unit, 3-axis drive unit and two 1-axis drive units.

bit F-C : pen Position encoder

Speed command synchronization control primary axis : pen=A
Speed command synchronization control secondary axis : pen=D

CAUTION

1. When performing the speed command synchronous control with 2-axis drive unit (MDS-D2/DH2-V2), make sure to set L-axis as primary axis. When performing the speed command synchronous control with 3-axis drive unit (MDS-D2-V3), make sure to set L-axis as primary axis and M-axis as secondary axis.
2. The rectangular waveform output scale is not available for the speed command synchronous control.
3. The distance-coded reference scale is not available for the speed command synchronous control.
4. When using speed command synchronization control, the following setting of NC side is required.
 - Set bit3 of #1281:ext17 to "0" and disable the synchronous error automatic correction function at servo ON.
 - Set #1064:svof of the primary axis and secondary axis to "0" and disable the error correction at servo OFF for both axes.
 - The parameter settings related to the machine error compensation such as quadrant protrusion compensation must be the same for the primary axis and secondary axis.

4.2.5 List of Standard Parameters for Each Servo Motor

(1) 200V Standard motor HF Series

Parameter			200V Standard motor HF Series															
			HF75		HF105		HF54		HF104		HF154		HF224		HF204		HF354	
No.	Abbrev.	Details	MDS-D2-V1/V2-		20		40		40		40		80		80		160	
			MDS-D2-V3-		20	40	20	40	40	40	40	80	80	80	80	160	160	160
SV001	PC1	Motor side gear ratio	-	-	-	-	-	-	-	-	-	-	-	-	-	-	-	-
SV002	PC2	Machine side gear ratio	-	-	-	-	-	-	-	-	-	-	-	-	-	-	-	-
SV003	PGN1	Position loop gain 1	33	33	33	33	33	33	33	33	33	33	33	33	33	33	33	33
SV004	PGN2	Position loop gain 2	0	0	0	0	0	0	0	0	0	0	0	0	0	0	0	0
SV005	VGN1	Speed loop gain 1	100	100	100	100	100	100	100	100	100	80	100	100	100	100	100	100
SV006	VGN2	Speed loop gain 2	0	0	0	0	0	0	0	0	0	0	0	0	0	0	0	0
SV007	VIL	Speed loop delay compensation	0	0	0	0	0	0	0	0	0	0	0	0	0	0	0	0
SV008	VIA	Speed loop lead compensation	1364	1364	1364	1364	1364	1364	1364	1364	1364	1364	1364	1364	1364	1364	1364	1364
SV009	IQA	Current loop q axis lead compensation	20480	10240	20480	10240	20480	10240	20480	10240	20480	8192	8192	8192	8192	8192	8192	8192
SV010	IDA	Current loop d axis lead compensation	20480	10240	20480	10240	20480	10240	20480	10240	20480	8192	8192	8192	8192	8192	8192	8192
SV011	IQG	Current loop q axis gain	768	512	3072	1280	1536	1280	1536	1280	1536	1280	2048	2048	2048	2048	2048	2048
SV012	IDG	Current loop d axis gain	768	512	3072	1280	1536	1280	1536	1280	1536	1280	2048	2048	2048	2048	2048	2048
SV013	ILMT	Current limit value	800	800	800	800	800	800	800	800	800	800	800	800	800	800	800	800
SV014	ILMTsp	Current limit value in special control	800	800	800	800	800	800	800	800	800	800	800	800	800	800	800	800
SV015	FFC	Acceleration rate feed forward gain	0	0	0	0	0	0	0	0	0	0	0	0	0	0	0	0
SV016	LMC1	Lost motion compensation 1	0	0	0	0	0	0	0	0	0	0	0	0	0	0	0	0
SV017	SPEC1	Servo specification 1	1000	1400	1000	1400	1000	1000	1000	1000	1000	1000	1000	1000	1000	1000	1000	1000
SV018	PIT	Ball screw pitch/Magnetic pole pitch	-	-	-	-	-	-	-	-	-	-	-	-	-	-	-	-
SV019	RNG1	Sub side encoder resolution	-	-	-	-	-	-	-	-	-	-	-	-	-	-	-	-
SV020	RNG2	Main side encoder resolution	-	-	-	-	-	-	-	-	-	-	-	-	-	-	-	-
SV021	OLT	Overload detection time constant	60	60	60	60	60	60	60	60	60	60	60	60	60	60	60	60
SV022	OLL	Overload detection level	150	150	150	150	150	150	150	150	150	150	150	150	150	150	150	150
SV023	OD1	Excessive error detection width during servo ON	6	6	6	6	6	6	6	6	6	6	6	6	6	6	6	6
SV024	INP	In-position detection width	50	50	50	50	50	50	50	50	50	50	50	50	50	50	50	50
SV025	MTYP	Motor/Encoder type	2201	2202	2203	2204	220F	2205	2206	2207	2208	2209	220A	220B	220C	220D	220E	220F
SV026	OD2	Excessive error detection width during servo OFF	6	6	6	6	6	6	6	6	6	6	6	6	6	6	6	6
SV027	SSF1	Servo function 1	4000	4000	4000	4000	4000	4000	4000	4000	4000	4000	4000	4000	4000	4000	4000	4000
SV028			0	0	0	0	0	0	0	0	0	0	0	0	0	0	0	0
:			:	:	:	:	:	:	:	:	:	:	:	:	:	:	:	:
SV032	TOF	Torque offset	0	0	0	0	0	0	0	0	0	0	0	0	0	0	0	0
SV033	SSF2	Servo function 2	0000	0000	0000	0000	0000	0000	0000	0000	0000	0000	0000	0000	0000	0000	0000	0000
SV034	SSF3	Servo function 3	0000	0000	0000	0000	0000	0000	0000	0000	0000	0000	0000	0000	0000	0000	0000	0000
SV035	SSF4	Servo function 4	0000	0000	0000	0000	0000	0000	0000	0000	0000	0000	0000	0000	0000	0000	0000	0000
SV036	PTYP	Power supply type/ Regenerative resistor type	0000	0000	0000	0000	0000	0000	0000	0000	0000	0000	0000	0000	0000	0000	0000	0000
SV037	JL	Load inertia scale	0	0	0	0	0	0	0	0	0	0	0	0	0	0	0	0
:			:	:	:	:	:	:	:	:	:	:	:	:	:	:	:	:
SV046	FHz2	Notch filter frequency 2	0	0	0	0	0	0	0	0	0	0	0	0	0	0	0	0
SV047	EC	Inductive voltage compensation gain	100	100	100	100	100	100	100	100	100	100	100	100	100	100	100	100
SV048	EMGr	Vertical axis drop prevention time	0	0	0	0	0	0	0	0	0	0	0	0	0	0	0	0
SV049	PGN1sp	Position loop gain 1 in spindle synchronous control	15	15	15	15	15	15	15	15	15	15	15	15	15	15	15	15
SV050	PGN2sp	Position loop gain 2 in spindle synchronous control	0	0	0	0	0	0	0	0	0	0	0	0	0	0	0	0
:			:	:	:	:	:	:	:	:	:	:	:	:	:	:	:	:
SV065	TLC	Machine end compensation gain	0	0	0	0	0	0	0	0	0	0	0	0	0	0	0	0
(System parameter area)																		
SV073	FEEDout	Specified speed output speed	0	0	0	0	0	0	0	0	0	0	0	0	0	0	0	0
(System parameter area)																		
SV081	SPEC2	Servo specification 2	0200	0200	0200	0200	0200	0200	0200	0200	0200	0200	0200	0200	0200	0200	0200	0200
SV082	SSF5	Servo function 5	0000	0000	0000	0000	0000	0000	0000	0000	0000	0000	0000	0000	0000	0000	0000	0000
SV083	SSF6	Servo function 6	0000	0000	0000	0000	0000	0000	0000	0000	0000	0000	0000	0000	0000	0000	0000	0000
SV084	SSF7	Servo function 7	0000	0000	0000	0000	0000	0000	0000	0000	0000	0000	0000	0000	0000	0000	0000	0000
SV085	LMCk	Lost motion compensation 3 spring constant	0	0	0	0	0	0	0	0	0	0	0	0	0	0	0	0
:			:	:	:	:	:	:	:	:	:	:	:	:	:	:	:	:
SV093			0	0	0	0	0	0	0	0	0	0	0	0	0	0	0	0
SV094	MPV	Magnetic pole position error detection speed	10	10	10	10	10	10	10	10	10	10	10	10	10	10	10	10
SV095	ZUPD	Vertical axis pull up distance	0	0	0	0	0	0	0	0	0	0	0	0	0	0	0	0
:			:	:	:	:	:	:	:	:	:	:	:	:	:	:	:	:
SV256			0	0	0	0	0	0	0	0	0	0	0	0	0	0	0	0

(Note) When driving HF354 with MDS-D2-V2-160160W, set the same parameters.

4 Setup

Parameter			Motor													
			200V Standard motor HF Series													
No.	Abbrev.	Details	MDS-D2-V1/V2-		HF123		HF223		HF303	HF453	HF703	HF903	HF142		HF302	
			20	-	20	-	40	-	80	160	160W	320	20	-	40	-
			MDS-D2-V3-		Laxis 40	MS axis 40							Laxis 40	MS axis 40		
SV001	PC1	Motor side gear ratio		-	-	-	-	-	-	-	-	-	-	-	-	
SV002	PC2	Machine side gear ratio		-	-	-	-	-	-	-	-	-	-	-	-	
SV003	PGN1	Position loop gain 1		33	33	33	33	33	33	33	33	33	33	33	33	
SV004	PGN2	Position loop gain 2		0	0	0	0	0	0	0	0	0	0	0	0	
SV005	VGN1	Speed loop gain 1		100	100	100	100	100	100	100	100	100	100	100	100	
SV006	VGN2	Speed loop gain 2		0	0	0	0	0	0	0	0	0	0	0	0	
SV007	VIL	Speed loop delay compensation		0	0	0	0	0	0	0	0	0	0	0	0	
SV008	VIA	Speed loop lead compensation		1364	1364	1364	1364	1364	1364	1364	1364	1364	1364	1364	1364	
SV009	IQA	Current loop q axis lead compensation		10240	8192	8192	10240	6144	6144	6144	4096	15360	8192	8192	8192	
SV010	IDA	Current loop d axis lead compensation		10240	8192	8192	10240	6144	6144	6144	4096	15360	8192	8192	8192	
SV011	IQG	Current loop q axis gain		1536	1280	1280	2048	2048	2048	2048	1536	2048	2048	2048	2048	
SV012	IDG	Current loop d axis gain		1536	1280	1280	2048	2048	2048	2048	1536	2048	2048	2048	2048	
SV013	ILMT	Current limit value		800	800	800	800	800	800	800	800	800	800	800	800	
SV014	ILMTsp	Current limit value in special control		800	800	800	800	800	800	800	800	800	800	800	800	
SV015	FFC	Acceleration rate feed forward gain		0	0	0	0	0	0	0	0	0	0	0	0	
SV016	LMC1	Lost motion compensation 1		0	0	0	0	0	0	0	0	0	0	0	0	
SV017	SPEC1	Servo specification 1	1000	1400	1000	1000	1000	1000	1000	1000	1000	1000	1000	1400	1000	
SV018	PIT	Ball screw pitch/Magnetic pole pitch		-	-	-	-	-	-	-	-	-	-	-	-	
SV019	RNG1	Sub side encoder resolution		-	-	-	-	-	-	-	-	-	-	-	-	
SV020	RNG2	Main side encoder resolution		-	-	-	-	-	-	-	-	-	-	-	-	
SV021	OLT	Overload detection time constant		60	60	60	60	60	60	60	60	60	60	60	60	
SV022	OLL	Overload detection level		150	150	150	150	150	150	150	150	150	150	150	150	
SV023	OD1	Excessive error detection width during servo ON		6	6	6	6	6	6	6	6	6	6	6	6	
SV024	INP	In-position detection width		50	50	50	50	50	50	50	50	50	50	50	50	
SV025	MTYP	Motor/Encoder type		2224	2226	222D	2228	2209	220A	220B	2225	2227	222E			
SV026	OD2	Excessive error detection width during servo OFF		6	6	6	6	6	6	6	6	6	6	6	6	
SV027	SSF1	Servo function 1		4000	4000	4000	4000	4000	4000	4000	4000	4000	4000	4000	4000	
SV028				0	0	0	0	0	0	0	0	0	0	0	0	
:				:	:	:	:	:	:	:	:	:	:	:	:	
SV032	TOF	Torque offset		0	0	0	0	0	0	0	0	0	0	0	0	
SV033	SSF2	Servo function 2		0000	0000	0000	0000	0000	0000	0000	0000	0000	0000	0000	0000	
SV034	SSF3	Servo function 3		0000	0000	0000	0000	0000	0000	0000	0000	0000	0000	0000	0000	
SV035	SSF4	Servo function 4		0000	0000	0000	0000	0000	0000	0000	0000	0000	0000	0000	0000	
SV036	PTYP	Power supply type/ Regenerative resistor type		0000	0000	0000	0000	0000	0000	0000	0000	0000	0000	0000	0000	
SV037	JL	Load inertia scale		0	0	0	0	0	0	0	0	0	0	0	0	
:				:	:	:	:	:	:	:	:	:	:	:	:	
SV046	FHz2	Notch filter frequency 2		0	0	0	0	0	0	0	0	0	0	0	0	
SV047	EC	Inductive voltage compensation gain		100	100	100	100	100	100	100	100	100	100	100	100	
SV048	EMGr	Vertical axis drop prevention time		0	0	0	0	0	0	0	0	0	0	0	0	
SV049	PGN1sp	Position loop gain 1 in spindle synchronous control		15	15	15	15	15	15	15	15	15	15	15	15	
SV050	PGN2sp	Position loop gain 2 in spindle synchronous control		0	0	0	0	0	0	0	0	0	0	0	0	
:				:	:	:	:	:	:	:	:	:	:	:	:	
SV065	TLC	Machine end compensation gain (System parameter area)		0	0	0	0	0	0	0	0	0	0	0	0	
SV073	FEEDout	Specified speed output speed (System parameter area)		0	0	0	0	0	0	0	0	0	0	0	0	
SV081	SPEC2	Servo specification 2		0200	0200	0200	0200	0200	0200	0200	0200	0200	0200	0200	0200	
SV082	SSF5	Servo function 5		0000	0000	0000	0000	0000	0000	0000	0000	0000	0000	0000	0000	
SV083	SSF6	Servo function 6		0000	0000	0000	0000	0000	0000	0000	0000	0000	0000	0000	0000	
SV084	SSF7	Servo function 7		0000	0000	0000	0000	0000	0000	0000	0000	0000	0000	0000	0000	
SV085	LMCK	Lost motion compensation 3 spring constant		0	0	0	0	0	0	0	0	0	0	0	0	
:				:	:	:	:	:	:	:	:	:	:	:	:	
SV093				0	0	0	0	0	0	0	0	0	0	0	0	
SV094	MPV	Magnetic pole position error detection speed		10	10	10	10	10	10	10	10	10	10	10	10	
SV095	ZUPD	Vertical axis pull up distance		0	0	0	0	0	0	0	0	0	0	0	0	
:				:	:	:	:	:	:	:	:	:	:	:	:	
SV256				0	0	0	0	0	0	0	0	0	0	0	0	

(Note) When driving HF453 with MDS-D2-V2-160160W, set the same parameters.

(2) 200V Standard motor HP Series

Parameter				200V Standard motor HP Series				
				HP54	HP104	HP154	HP224	HP204
No.	Abbrev.	Details	MDS-D2-V1/V2-40	40	80	80	80	
SV001	PC1	Motor side gear ratio	-	-	-	-	-	
SV002	PC2	Machine side gear ratio	-	-	-	-	-	
SV003	PGN1	Position loop gain 1	33	33	33	33	33	
SV004	PGN2	Position loop gain 2	0	0	0	0	0	
SV005	VGN1	Speed loop gain 1	100	100	100	60	100	
SV006	VGN2	Speed loop gain 2	0	0	0	0	0	
SV007	VIL	Speed loop delay compensation	0	0	0	0	0	
SV008	VIA	Speed loop lead compensation	1364	1364	1364	1364	1364	
SV009	IQA	Current loop q axis lead compensation	8192	4096	6144	3072	3072	
SV010	IDA	Current loop d axis lead compensation	8192	4096	6144	3072	3072	
SV011	IQG	Current loop q axis gain	1280	768	1536	1024	1024	
SV012	IDG	Current loop d axis gain	1280	768	1536	1024	1024	
SV013	ILMT	Current limit value	800	800	800	800	800	
SV014	ILMTsp	Current limit value in special control	800	800	800	800	800	
SV015	FFC	Acceleration rate feed forward gain	0	0	0	0	0	
SV016	LMC1	Lost motion compensation 1	0	0	0	0	0	
SV017	SPEC1	Servo specification 1	1000	1000	1000	1000	1000	
SV018	PIT	Ball screw pitch/Magnetic pole pitch	-	-	-	-	-	
SV019	RNG1	Sub side encoder resolution	-	-	-	-	-	
SV020	RNG2	Main side encoder resolution	-	-	-	-	-	
SV021	OLT	Overload detection time constant	60	60	60	60	60	
SV022	OLL	Overload detection level	150	150	150	150	150	
SV023	OD1	Excessive error detection width during servo ON	6	6	6	6	6	
SV024	INP	In-position detection width	50	50	50	50	50	
SV025	MTYP	Motor/Encoder type	2211	2212	2213	221B	221A	
SV026	OD2	Excessive error detection width during servo OFF	6	6	6	6	6	
SV027	SSF1	Servo function 1	4000	4000	4000	4000	4000	
:			:	:	:	:	:	
SV031	OVS1	Overshooting compensation 1	0	0	0	0	0	
SV032	TOF	Torque offset	0	0	0	0	0	
SV033	SSF2	Servo function 2	0000	0000	0000	0000	0000	
SV034	SSF3	Servo function 3	0000	0000	0000	0000	0000	
SV035	SSF4	Servo function 4	0000	0000	0000	0000	0000	
SV036	PTYP	Power supply type/ Regenerative resistor type	0000	0000	0000	0000	0000	
:			:	:	:	:	:	
SV045	TRUB	Friction torque	0	0	0	0	0	
SV046	FHz2	Notch filter frequency 2	0	0	0	0	0	
SV047	EC	Inductive voltage compensation gain	100	100	100	100	100	
SV048	EMGr	Vertical axis drop prevention time	0	0	0	0	0	
SV049	PGN1sp	Position loop gain 1 in spindle synchronous control	15	15	15	15	15	
:			:	:	:	:	:	
SV064	DA2MPY	D/A output ch2 output scale	0	0	0	0	0	
SV065	TLC	Machine end compensation gain	0	0	0	0	0	
(System parameter area)								
SV073	FEEDout	Specified speed output speed	0	0	0	0	0	
(System parameter area)								
SV081	SPEC2	Servo specification 2	0200	0200	0200	0200	0200	
SV082	SSF5	Servo function 5	0000	0000	0000	0000	0000	
SV083	SSF6	Servo function 6	0000	0000	0000	0000	0000	
SV084	SSF7	Servo function 7	0000	0000	0000	0000	0000	
SV085	LMCk	Lost motion compensation 3 spring constant	0	0	0	0	0	
:			:	:	:	:	:	
SV093			0	0	0	0	0	
SV094	MPV	Magnetic pole position error detection speed	10	10	10	10	10	
SV095	ZUPD	Vertical axis pull up distance	0	0	0	0	0	
:			:	:	:	:	:	
SV256			0	0	0	0	0	

4 Setup

Motor				200V Standard motor HP Series				
Parameter				HP354	HP454	HP704	HP903	HP1103
No.	Abbrev.	Details	MDS-D2-V1/V2-	160	160	160W	320	320W
SV001	PC1	Motor side gear ratio		-	-	-	-	-
SV002	PC2	Machine side gear ratio		-	-	-	-	-
SV003	PGN1	Position loop gain 1		33	33	33	33	33
SV004	PGN2	Position loop gain 2		0	0	0	0	0
SV005	VGN1	Speed loop gain 1		100	100	100	100	100
SV006	VGN2	Speed loop gain 2		0	0	0	0	0
SV007	VIL	Speed loop delay compensation		0	0	0	0	0
SV008	VIA	Speed loop lead compensation		1364	1364	1364	1364	1364
SV009	IQA	Current loop q axis lead compensation		4096	3072	3072	2048	2048
SV010	IDA	Current loop d axis lead compensation		4096	3072	3072	2048	2048
SV011	IQG	Current loop q axis gain		1280	1024	1024	1280	1280
SV012	IDG	Current loop d axis gain		1280	1024	1024	1280	1280
SV013	ILMT	Current limit value		800	800	800	800	800
SV014	ILMTsp	Current limit value in special control		800	800	800	800	800
SV015	FFC	Acceleration rate feed forward gain		0	0	0	0	0
SV016	LMC1	Lost motion compensation 1		0	0	0	0	0
SV017	SPEC1	Servo specification 1		1000	1000	1000	1000	1000
SV018	PIT	Ball screw pitch/Magnetic pole pitch		-	-	-	-	-
SV019	RNG1	Sub side encoder resolution		-	-	-	-	-
SV020	RNG2	Main side encoder resolution		-	-	-	-	-
SV021	OLT	Overload detection time constant		60	60	60	60	60
SV022	OLL	Overload detection level		150	150	150	150	150
SV023	OD1	Excessive error detection width during servo ON		6	6	6	6	6
SV024	INP	In-position detection width		50	50	50	50	50
SV025	MTYP	Motor/Encoder type		2215	2216	2217	2218	2219
SV026	OD2	Excessive error detection width during servo OFF		6	6	6	6	6
SV027	SSF1	Servo function 1		4000	4000	4000	4000	4000
SV028				0	0	0	0	0
:				:	:	:	:	:
SV032	TOF	Torque offset		0	0	0	0	0
SV033	SSF2	Servo function 2		0000	0000	0000	0000	0000
SV034	SSF3	Servo function 3		0000	0000	0000	0000	0000
SV035	SSF4	Servo function 4		0000	0000	0000	0000	0000
SV036	PTYP	Power supply type/ Regenerative resistor type		0000	0000	0000	0000	0000
SV037	JL	Load inertia scale		0	0	0	0	0
:				:	:	:	:	:
SV046	FHz2	Notch filter frequency 2		0	0	0	0	0
SV047	EC	Inductive voltage compensation gain		100	100	100	100	100
SV048	EMGr	Vertical axis drop prevention time		0	0	0	0	0
SV049	PGN1sp	Position loop gain 1 in spindle synchronous control		15	15	15	15	15
SV050	PGN2sp	Position loop gain 2 in spindle synchronous control		0	0	0	0	0
:				:	:	:	:	:
SV065	TLC	Machine end compensation gain		0	0	0	0	0
(System parameter area)								
SV073	FEEDout	Specified speed output speed		0	0	0	0	0
(System parameter area)								
SV081	SPEC2	Servo specification 2		0200	0200	0200	0200	0200
SV082	SSF5	Servo function 5		0000	0000	0000	0000	0000
SV083	SSF6	Servo function 6		0000	0000	0000	0000	0000
SV084	SSF7	Servo function 7		0000	0000	0000	0000	0000
SV085	LMck	Lost motion compensation 3 spring constant		0	0	0	0	0
:				:	:	:	:	:
SV093				0	0	0	0	0
SV094	MPV	Magnetic pole position error detection speed		10	10	10	10	10
SV095	ZUPD	Vertical axis pull up distance		0	0	0	0	0
:				:	:	:	:	:
SV256				0	0	0	0	0

(Note) When driving HP354 or HP454 with MDS-D2-V2-160160W, set the same parameters.

(3) 200V Standard motor HF-KP Series

Motor				200V Standard motor HF-KP Series		
Parameter				HF-KP23JW04-S6	HF-KP43JW04-S6	HF-KP73JW04-S6
No.	Abbrev.	Details	MDS-D2-V1/V2-	20	20	20
SV001	PC1	Motor side gear ratio		-	-	-
SV002	PC2	Machine side gear ratio		-	-	-
SV003	PGN1	Position loop gain 1		33	33	33
SV004	PGN2	Position loop gain 2		0	0	0
SV005	VGN1	Speed loop gain 1		5	10	30
SV006	VGN2	Speed loop gain 2		0	0	0
SV007	VIL	Speed loop delay compensation		0	0	0
SV008	VIA	Speed loop lead compensation		1364	1364	1364
SV009	IQA	Current loop q axis lead compensation		20480	15360	4096
SV010	IDA	Current loop d axis lead compensation		20480	15360	4096
SV011	IQG	Current loop q axis gain		2048	1024	768
SV012	IDG	Current loop d axis gain		2048	1024	768
SV013	ILMT	Current limit value		300	300	300
SV014	ILMTsp	Current limit value in special control		300	300	300
SV015	FFC	Acceleration rate feed forward gain		0	0	0
SV016	LMC1	Lost motion compensation 1		0	0	0
SV017	SPEC1	Servo specification 1		1000	1000	1000
SV018	PIT	Ball screw pitch/Magnetic pole pitch		-	-	-
SV019	RNG1	Sub side encoder resolution		260	260	260
SV020	RNG2	Main side encoder resolution		260	260	260
SV021	OLT	Overload detection time constant		60	60	60
SV022	OLL	Overload detection level		150	150	150
SV023	OD1	Excessive error detection width during servo ON		6	6	6
SV024	INP	In-position detection width		50	50	50
SV025	MTYP	Motor/Encoder type		22EA	22EB	22EC
SV026	OD2	Excessive error detection width during servo OFF		6	6	6
SV027	SSF1	Servo function 1		4000	4000	4000
:				:	:	:
SV031	OVS1	Overshooting compensation 1		0	0	0
SV032	TOF	Torque offset		0	0	0
SV033	SSF2	Servo function 2		0000	0000	0000
SV034	SSF3	Servo function 3		0000	0000	0000
SV035	SSF4	Servo function 4		0000	0000	0000
SV036	PTYP	Power supply type/ Regenerative resistor type		0000	0000	0000
:				:	:	:
SV045	TRUB	Friction torque		0	0	0
SV046	FHz2	Notch filter frequency 2		0	0	0
SV047	EC	Inductive voltage compensation gain		100	100	100
SV048	EMGrt	Vertical axis drop prevention time		0	0	0
SV049	PGN1sp	Position loop gain 1 in spindle synchronous control		15	15	15
:				:	:	:
SV064	DA2MPY	D/A output ch2 output scale		0	0	0
SV065	TLC	Machine end compensation gain		0	0	0
(System parameter area)						
SV073	FEEDout	Specified speed output speed		0	0	0
(System parameter area)						
SV081	SPEC2	Servo specification 2		0200	0200	0200
SV082	SSF5	Servo function 5		0000	0000	0000
SV083	SSF6	Servo function 6		0000	0000	0000
SV084	SSF7	Servo function 7		0000	0000	0000
SV085	LMCk	Lost motion compensation 3 spring constant		0	0	0
:				:	:	:
SV093				0	0	0
SV094	MPV	Magnetic pole position error detection speed		10	10	10
SV095	ZUPD	Vertical axis pull up distance		0	0	0
:				:	:	:
SV256				0	0	0

4 Setup

(4) 400V Standard motor HF-H Series

Motor				400V Standard motor HF-H Series				
Parameter				HF-H75	HF-H105	HF-H54	HF-H104	HF-H154
No.	Abbrev.	Details	MDS-DH2-V1/V2-	10	10	20	20	40
SV001	PC1	Motor side gear ratio		-	-	-	-	-
SV002	PC2	Machine side gear ratio		-	-	-	-	-
SV003	PGN1	Position loop gain 1		33	33	33	33	33
SV004	PGN2	Position loop gain 2		0	0	0	0	0
SV005	VGN1	Speed loop gain 1		100	100	100	100	100
SV006	VGN2	Speed loop gain 2		0	0	0	0	0
SV007	VIL	Speed loop delay compensation		0	0	0	0	0
SV008	VIA	Speed loop lead compensation		1364	1364	1364	1364	1364
SV009	IQA	Current loop q axis lead compensation		20480	10240	20480	10240	15360
SV010	IDA	Current loop d axis lead compensation		20480	10240	20480	10240	15360
SV011	IQG	Current loop q axis gain		768	512	3072	1280	2048
SV012	IDG	Current loop d axis gain		768	512	3072	1280	2048
SV013	ILMT	Current limit value		800	800	800	800	800
SV014	ILMTsp	Current limit value in special control		800	800	800	800	800
SV015	FFC	Acceleration rate feed forward gain		0	0	0	0	0
SV016	LMC1	Lost motion compensation 1		0	0	0	0	0
SV017	SPEC1	Servo specification 1		3000	3000	3000	3000	3000
SV018	PIT	Ball screw pitch/Magnetic pole pitch		-	-	-	-	-
SV019	RNG1	Sub side encoder resolution		-	-	-	-	-
SV020	RNG2	Main side encoder resolution		-	-	-	-	-
SV021	OLT	Overload detection time constant		60	60	60	60	60
SV022	OLL	Overload detection level		150	150	150	150	150
SV023	OD1	Excessive error detection width during servo ON		6	6	6	6	6
SV024	INP	In-position detection width		50	50	50	50	50
SV025	MTYP	Motor/Encoder type		2201	2202	2203	2204	2205
SV026	OD2	Excessive error detection width during servo OFF		6	6	6	6	6
SV027	SSF1	Servo function 1		4000	4000	4000	4000	4000
:				:	:	:	:	:
SV031	OVS1	Overshooting compensation 1		0	0	0	0	0
SV032	TOF	Torque offset		0	0	0	0	0
SV033	SSF2	Servo function 2		0000	0000	0000	0000	0000
SV034	SSF3	Servo function 3		0000	0000	0000	0000	0000
SV035	SSF4	Servo function 4		0000	0000	0000	0000	0000
SV036	PTYP	Power supply type/ Regenerative resistor type		0000	0000	0000	0000	0000
:				:	:	:	:	:
SV045	TRUB	Friction torque		0	0	0	0	0
SV046	FHz2	Notch filter frequency 2		0	0	0	0	0
SV047	EC	Inductive voltage compensation gain		100	100	100	100	100
SV048	EMGrt	Vertical axis drop prevention time		0	0	0	0	0
SV049	PGN1sp	Position loop gain 1 in spindle synchronous control		15	15	15	15	15
:				:	:	:	:	:
SV064	DA2MPY	D/A output ch2 output scale		0	0	0	0	0
SV065	TLC	Machine end compensation gain		0	0	0	0	0
(System parameter area)								
SV073	FEEDout	Specified speed output speed		0	0	0	0	0
(System parameter area)								
SV081	SPEC2	Servo specification 2		0200	0200	0200	0200	0200
SV082	SSF5	Servo function 5		0000	0000	0000	0000	0000
SV083	SSF6	Servo function 6		0000	0000	0000	0000	0000
SV084	SSF7	Servo function 7		0000	0000	0000	0000	0000
SV085	LMCk	Lost motion compensation 3 spring constant		0	0	0	0	0
:				:	:	:	:	:
SV093				0	0	0	0	0
SV094	MPV	Magnetic pole position error detection speed		10	10	10	10	10
SV095	ZUPD	Vertical axis pull up distance		0	0	0	0	0
:				:	:	:	:	:
SV256				0	0	0	0	0

4 Setup

Parameter				400V Standard motor HF-H Series				
				HF-H204	HF-H354	HF-H453	HF-H703	HF-H903
No.	Abbrev.	Details	MDS-DH2-V1/V2-	40	80	80	80W	160
SV001	PC1	Motor side gear ratio		-	-	-	-	-
SV002	PC2	Machine side gear ratio		-	-	-	-	-
SV003	PGN1	Position loop gain 1		33	33	33	33	33
SV004	PGN2	Position loop gain 2		0	0	0	0	0
SV005	VGN1	Speed loop gain 1		100	100	100	100	100
SV006	VGN2	Speed loop gain 2		0	0	0	0	0
SV007	VIL	Speed loop delay compensation		0	0	0	0	0
SV008	VIA	Speed loop lead compensation		1364	1364	1364	1364	1364
SV009	IQA	Current loop q axis lead compensation		8192	8192	6144	6144	6144
SV010	IDA	Current loop d axis lead compensation		8192	8192	6144	6144	6144
SV011	IQG	Current loop q axis gain		2048	2048	2048	2048	2048
SV012	IDG	Current loop d axis gain		2048	2048	2048	2048	2048
SV013	ILMT	Current limit value		800	800	800	800	800
SV014	ILMTsp	Current limit value in special control		800	800	800	800	800
SV015	FFC	Acceleration rate feed forward gain		0	0	0	0	0
SV016	LMC1	Lost motion compensation 1		0	0	0	0	0
SV017	SPEC1	Servo specification 1		3000	3000	3000	3000	3000
SV018	PIT	Ball screw pitch/Magnetic pole pitch		-	-	-	-	-
SV019	RNG1	Sub side encoder resolution		-	-	-	-	-
SV020	RNG2	Main side encoder resolution		-	-	-	-	-
SV021	OLT	Overload detection time constant		60	60	60	60	60
SV022	OLL	Overload detection level		150	150	150	150	150
SV023	OD1	Excessive error detection width during servo ON		6	6	6	6	6
SV024	INP	In-position detection width		50	50	50	50	50
SV025	MTYP	Motor/Encoder type		2207	2208	2209	220A	220B
SV026	OD2	Excessive error detection width during servo OFF		6	6	6	6	6
SV027	SSF1	Servo function 1		4000	4000	4000	4000	4000
:				:	:	:	:	:
SV031	OVS1	Overshooting compensation 1		0	0	0	0	0
SV032	TOF	Torque offset		0	0	0	0	0
SV033	SSF2	Servo function 2		0000	0000	0000	0000	0000
SV034	SSF3	Servo function 3		0000	0000	0000	0000	0000
SV035	SSF4	Servo function 4		0000	0000	0000	0000	0000
SV036	PTYP	Power supply type/ Regenerative resistor type		0000	0000	0000	0000	0000
:				:	:	:	:	:
SV045	TRUB	Friction torque		0	0	0	0	0
SV046	FHz2	Notch filter frequency 2		0	0	0	0	0
SV047	EC	Inductive voltage compensation gain		100	100	100	100	100
SV048	EMGr	Vertical axis drop prevention time		0	0	0	0	0
SV049	PGN1sp	Position loop gain 1 in spindle synchronous control		15	15	15	15	15
:				:	:	:	:	:
SV064	DA2MPY	D/A output ch2 output scale		0	0	0	0	0
SV065	TLC	Machine end compensation gain		0	0	0	0	0
(System parameter area)								
SV073	FEEDout	Specified speed output speed		0	0	0	0	0
(System parameter area)								
SV081	SPEC2	Servo specification 2		0200	0200	0200	0200	0200
SV082	SSF5	Servo function 5		0000	0000	0000	0000	0000
SV083	SSF6	Servo function 6		0000	0000	0000	0000	0000
SV084	SSF7	Servo function 7		0000	0000	0000	0000	0000
SV085	LMCk	Lost motion compensation 3 spring constant		0	0	0	0	0
:				:	:	:	:	:
SV093				0	0	0	0	0
SV094	MPV	Magnetic pole position error detection speed		10	10	10	10	10
SV095	ZUPD	Vertical axis pull up distance		0	0	0	0	0
:				:	:	:	:	:
SV256				0	0	0	0	0

(Note) When driving HF-H354 or HF-H453 with MDS-DH2-V2-8080W, set the same parameters.

4 Setup

(5) 400V Standard motor HP-H Series

Motor				400V Standard motor HP-H Series				
Parameter				HP-H54	HP-H104	HP-H154	HP-H224	HP-H204
No.	Abbrev.	Details	MDS-DH2-V1/V2-	20	20	40	40	40
SV001	PC1	Motor side gear ratio		-	-	-	-	-
SV002	PC2	Machine side gear ratio		-	-	-	-	-
SV003	PGN1	Position loop gain 1		33	33	33	33	33
SV004	PGN2	Position loop gain 2		0	0	0	0	0
SV005	VGN1	Speed loop gain 1		100	100	100	60	100
SV006	VGN2	Speed loop gain 2		0	0	0	0	0
SV007	VIL	Speed loop delay compensation		0	0	0	0	0
SV008	VIA	Speed loop lead compensation		1364	1364	1364	1364	1364
SV009	IQA	Current loop q axis lead compensation		8192	4096	6144	3072	3072
SV010	IDA	Current loop d axis lead compensation		8192	4096	6144	3072	3072
SV011	IQG	Current loop q axis gain		1280	768	1536	1024	1024
SV012	IDG	Current loop d axis gain		1280	768	1536	1024	1024
SV013	ILMT	Current limit value		800	800	800	800	800
SV014	ILMTsp	Current limit value in special control		800	800	800	800	800
SV015	FFC	Acceleration rate feed forward gain		0	0	0	0	0
SV016	LMC1	Lost motion compensation 1		0	0	0	0	0
SV017	SPEC1	Servo specification 1		3000	3000	3000	3000	3000
SV018	PIT	Ball screw pitch/Magnetic pole pitch		-	-	-	-	-
SV019	RNG1	Sub side encoder resolution		-	-	-	-	-
SV020	RNG2	Main side encoder resolution		-	-	-	-	-
SV021	OLT	Overload detection time constant		60	60	60	60	60
SV022	OLL	Overload detection level		150	150	150	150	150
SV023	OD1	Excessive error detection width during servo ON		6	6	6	6	6
SV024	INP	In-position detection width		50	50	50	50	50
SV025	MTYP	Motor/Encoder type		2211	2212	2213	221B	221A
SV026	OD2	Excessive error detection width during servo OFF		6	6	6	6	6
SV027	SSF1	Servo function 1		4000	4000	4000	4000	4000
SV028	:			0	0	0	0	0
SV032	TOF	Torque offset		0	0	0	0	0
SV033	SSF2	Servo function 2		0000	0000	0000	0000	0000
SV034	SSF3	Servo function 3		0000	0000	0000	0000	0000
SV035	SSF4	Servo function 4		0000	0000	0000	0000	0000
SV036	PTYP	Power supply type/ Regenerative resistor type		0000	0000	0000	0000	0000
SV037	JL	Load inertia scale		0	0	0	0	0
SV046	FHz2	Notch filter frequency 2		0	0	0	0	0
SV047	EC	Inductive voltage compensation gain		100	100	100	100	100
SV048	EMGr	Vertical axis drop prevention time		0	0	0	0	0
SV049	PGN1sp	Position loop gain 1 in spindle synchronous control		15	15	15	15	15
SV050	PGN2sp	Position loop gain 2 in spindle synchronous control		0	0	0	0	0
SV065	TLC	Machine end compensation gain		0	0	0	0	0
(System parameter area)								
SV073	FEEDout	Specified speed output speed		0	0	0	0	0
(System parameter area)								
SV081	SPEC2	Servo specification 2		0200	0200	0200	0200	0200
SV082	SSF5	Servo function 5		0000	0000	0000	0000	0000
SV083	SSF6	Servo function 6		0000	0000	0000	0000	0000
SV084	SSF7	Servo function 7		0000	0000	0000	0000	0000
SV085	LMCk	Lost motion compensation 3 spring constant		0	0	0	0	0
SV093	:			0	0	0	0	0
SV094	MPV	Magnetic pole position error detection speed		10	10	10	10	10
SV095	ZUPD	Vertical axis pull up distance		0	0	0	0	0
SV256	:			0	0	0	0	0

Motor				400V Standard motor HP-H Series				
				HP-H354	HP-H454	HP-H704	HP-H903	HP-H1103
Parameter	No.	Abbrev.	Details	MDS-DH2-V1/V2-80	80	80W	160	160W
SV001	PC1		Motor side gear ratio	-	-	-	-	-
SV002	PC2		Machine side gear ratio	-	-	-	-	-
SV003	PGN1		Position loop gain 1	33	33	33	33	33
SV004	PGN2		Position loop gain 2	0	0	0	0	0
SV005	VGN1		Speed loop gain 1	100	100	100	100	100
SV006	VGN2		Speed loop gain 2	0	0	0	0	0
SV007	VIL		Speed loop delay compensation	0	0	0	0	0
SV008	VIA		Speed loop lead compensation	1364	1364	1364	1364	1364
SV009	IQA		Current loop q axis lead compensation	4096	3072	3072	2048	2048
SV010	IDA		Current loop d axis lead compensation	4096	3072	3072	2048	2048
SV011	IQG		Current loop q axis gain	1280	1024	1024	1280	1280
SV012	IDG		Current loop d axis gain	1280	1024	1024	1280	1280
SV013	ILMT		Current limit value	800	800	800	800	800
SV014	ILMTsp		Current limit value in special control	800	800	800	800	800
SV015	FFC		Acceleration rate feed forward gain	0	0	0	0	0
SV016	LMC1		Lost motion compensation 1	0	0	0	0	0
SV017	SPEC1		Servo specification 1	3000	3000	3000	3000	3000
SV018	PIT		Ball screw pitch/Magnetic pole pitch	-	-	-	-	-
SV019	RNG1		Sub side encoder resolution	-	-	-	-	-
SV020	RNG2		Main side encoder resolution	-	-	-	-	-
SV021	OLT		Overload detection time constant	60	60	60	60	60
SV022	OLL		Overload detection level	150	150	150	150	150
SV023	OD1		Excessive error detection width during servo ON	6	6	6	6	6
SV024	INP		In-position detection width	50	50	50	50	50
SV025	MTYP		Motor/Encoder type	2215	2216	2217	2218	2219
SV026	OD2		Excessive error detection width during servo OFF	6	6	6	6	6
SV027	SSF1		Servo function 1	4000	4000	4000	4000	4000
SV028				0	0	0	0	0
:				:	:	:	:	:
SV032	TOF		Torque offset	0	0	0	0	0
SV033	SSF2		Servo function 2	0000	0000	0000	0000	0000
SV034	SSF3		Servo function 3	0000	0000	0000	0000	0000
SV035	SSF4		Servo function 4	0000	0000	0000	0000	0000
SV036	PTYP		Power supply type/ Regenerative resistor type	0000	0000	0000	0000	0000
SV037	JL		Load inertia scale	0	0	0	0	0
:				:	:	:	:	:
SV046	FHz2		Notch filter frequency 2	0	0	0	0	0
SV047	EC		Inductive voltage compensation gain	100	100	100	100	100
SV048	EMGr		Vertical axis drop prevention time	0	0	0	0	0
SV049	PGN1sp		Position loop gain 1 in spindle synchronous control	15	15	15	15	15
SV050	PGN2sp		Position loop gain 2 in spindle synchronous control	0	0	0	0	0
:				:	:	:	:	:
SV065	TLC		Machine end compensation gain	0	0	0	0	0
(System parameter area)								
SV073	FEEDout		Specified speed output speed	0	0	0	0	0
(System parameter area)								
SV081	SPEC2		Servo specification 2	0200	0200	0200	0200	0200
SV082	SSF5		Servo function 5	0000	0000	0000	0000	0000
SV083	SSF6		Servo function 6	0000	0000	0000	0000	0000
SV084	SSF7		Servo function 7	0000	0000	0000	0000	0000
SV085	LMCk		Lost motion compensation 3 spring constant	0	0	0	0	0
:				:	:	:	:	:
SV093				0	0	0	0	0
SV094	MPV		Magnetic pole position error detection speed	10	10	10	10	10
SV095	ZUPD		Vertical axis pull up distance	0	0	0	0	0
:				:	:	:	:	:
SV256				0	0	0	0	0

(Note) When driving HP-H354 or HP-H454 with MDS-DH2-V2-8080W, set the same parameters.

(6) 400V Standard motor HC-H Series

Parameter			Motor	400V Standard motor HC-H Series
No.	Abbrev.	Details	MDS-DH2-V1-	HC-H1502
SV001	PC1	Motor side gear ratio		200
SV002	PC2	Machine side gear ratio		-
SV003	PGN1	Position loop gain 1		33
SV004	PGN2	Position loop gain 2		0
SV005	VGN1	Speed loop gain 1		100
SV006	VGN2	Speed loop gain 2		0
SV007	VIL	Speed loop delay compensation		0
SV008	VIA	Speed loop lead compensation		1364
SV009	IQA	Current loop q axis lead compensation		1536
SV010	IDA	Current loop d axis lead compensation		1536
SV011	IQG	Current loop q axis gain		512
SV012	IDG	Current loop d axis gain		512
SV013	ILMT	Current limit value		800
SV014	ILMTsp	Current limit value in special control		800
SV015	FFC	Acceleration rate feed forward gain		0
SV016	LMC1	Lost motion compensation 1		0
SV017	SPEC1	Servo specification 1		F000
SV018	PIT	Ball screw pitch/Magnetic pole pitch		-
SV019	RNG1	Sub side encoder resolution		-
SV020	RNG2	Main side encoder resolution		-
SV021	OLT	Overload detection time constant		60
SV022	OLL	Overload detection level		150
SV023	OD1	Excessive error detection width during servo ON		6
SV024	INP	In-position detection width		50
SV025	MTYP	Motor/Encoder type		22B9
SV026	OD2	Excessive error detection width during servo OFF		6
SV027	SSF1	Servo function 1		4000
SV028				0
:				:
SV032	TOF	Torque offset		0
SV033	SSF2	Servo function 2		0000
SV034	SSF3	Servo function 3		0000
SV035	SSF4	Servo function 4		0000
SV036	PTYP	Power supply type/ Regenerative resistor type		0000
SV037	JL	Load inertia scale		0
:				:
SV046	FHz2	Notch filter frequency 2		0
SV047	EC	Inductive voltage compensation gain		100
SV048	EMGrt	Vertical axis drop prevention time		0
SV049	PGN1sp	Position loop gain 1 in spindle synchronous control		15
SV050	PGN2sp	Position loop gain 2 in spindle synchronous control		0
:				:
SV065	TLC	Machine end compensation gain		0
		(System parameter area)		
SV073	FEEDout	Specified speed output speed		0
		(System parameter area)		
SV081	SPEC2	Servo specification 2		0200
SV082	SSF5	Servo function 5		0000
SV083	SSF6	Servo function 6		0000
SV084	SSF7	Servo function 7		0000
SV085	LMck	Lost motion compensation 3 spring constant		0
:				:
SV093				0
SV094	MPV	Magnetic pole position error detection speed		10
SV095	ZUPD	Vertical axis pull up distance		0
:				:
SV256				0

4.2.6 Servo Parameters

The parameters with "(PR)" requires the CNC to be turned OFF after the settings. Turn the power OFF and ON to enable the parameter settings.

[#2201(PR)] SV001 PC1 Motor side gear ratio

Set the gear ratio in the motor side when there is the gear between the servo motor's shaft and machine (ball screw, etc.).
For the rotary axis, set the total deceleration (acceleration) ratio.
Even if the gear ratio is within the setting range, the electronic gears may overflow and an initial parameter error (servo alarm 37) may occur.

For linear servo system
Set to "1".

---Setting range---
1 to 32767

[#2202(PR)] SV002 PC2 Machine side gear ratio

Set the gear ratio in the machine side when there is the gear between the servo motor's shaft and machine (ball screw, etc.).
For the rotary axis, set the total deceleration (acceleration) ratio.
Even if the gear ratio is within the setting range, the electronic gears may overflow and an initial parameter error (servo alarm 37) may occur.

For linear servo system
Set to "1".

---Setting range---
1 to 32767

[#2203] SV003 PGN1 Position loop gain 1

Set the position loop gain. The standard setting is "33".
The higher the setting value is, the more accurately the command can be followed, and the shorter the settling time in positioning gets, however, note that a bigger shock will be applied to the machine during acceleration/deceleration.
When using the SHG control, also set SV004 (PGN2) and SV057 (SHGC).

When using the OMR-FF control, set the servo rigidity against quadrant projection or cutting load, etc. For the tracking ability to the command, set by SV106(PGM).

---Setting range---
1 to 200 (rad/s)

[#2204] SV004 PGN2 Position loop gain 2

When performing the SHG control, set the value of "SV003 x 8/3" to "SV004".
When not using the SHG control, set to "0".
When using the OMR-FF control, set to "0".

Related parameters: SV003, SV057

---Setting range---
0 to 999 (rad/s)

【#2205】 SV005 VGN1 Speed loop gain 1

Set the speed loop gain.

The higher the setting value is, the more accurate the control will be, however, vibration tends to occur.

If vibration occurs, adjust by lowering by 20 to 30%.

The value should be determined to the 70 to 80% of the value at which the vibration stops.

The value differs depending on servo motors.

Aim at the standard value determined by the servo motor type and load inertia ratio to adjust.

---Setting range---

1 to 30000

【#2206】 SV006 VGN2 Speed loop gain 2

Set the speed loop gain at the motor limitation speed VLMT (maximum rotation speed x 1.15) with "VCS(SV029: Speed at the change of speed loop gain)".

Use this to suppress noise at high speed rotation during rapid traverse, etc. Then, the speed loop gain decreases at faster speed than the setting value of VCS. When not using, set to "0".

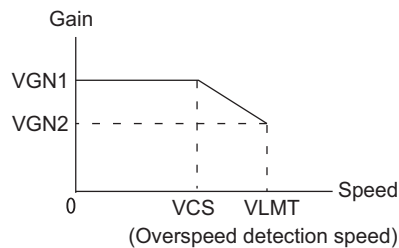
**---Setting range---**

-1000 to 30000

【#2207】 SV007 VIL Speed loop delay compensation

Set this when the limit cycle occurs in the full-closed loop, or overshooting occurs in positioning. The speed loop delay compensation method can be selected with SV027/bit1,0.

Normally, use "Changeover type 2". Changeover type 2 controls the occurrence of overshooting by lowering the speed loop lead compensation after the position droop gets 0.

When setting this parameter, make sure to set the torque offset (SV032).

---Setting range---

0 to 32767

【#2208】 SV008 VIA Speed loop lead compensation

Set the gain of the speed loop integral control.

Standard setting: 1364

Standard setting in the SHG control: 1900

Adjust the value by increasing/decreasing this by about 100 at a time.

Raise this value to improve contour tracking accuracy in high-speed cutting.

Lower this value when the position droop does not stabilize (when the vibration of 10 to 20Hz occurs).

---Setting range---

1 to 9999

【#2209】 SV009 IQA Current loop q axis lead compensation

Set the fixed value of each motor.

Set the standard value for each motor described in the standard parameter list.

---Setting range---

1 to 20480

【#2210】 SV010 IDA Current loop d axis lead compensation

Set the fixed value of each motor.
Set the standard value for each motor described in the standard parameter list.

---Setting range---
1 to 20480

【#2211】 SV011 IQG Current loop q axis gain

Set the fixed value of each motor.
Set the standard value for each motor described in the standard parameter list.

---Setting range---
1 to 8192

【#2212】 SV012 IDG Current loop d axis gain

Set the fixed value of each motor.
Set the standard value for each motor described in the standard parameter list.

---Setting range---
1 to 8192

【#2213】 SV013 ILMT Current limit value

Set the current (torque) limit value in a normal operation.
This is a limit value in forward run and reverse run (for linear motors: forward and reverse direction).
When the standard setting value is "800", the maximum torque is determined by the specification of the motor.
Set this parameter as a proportion (%) to the stall current.

---Setting range---
0 - 999 (Stall current %)

【#2214】 SV014 ILMTsp Current limit value in special control

Set the current (torque) limit value in a special operation (absolute position initial setting, stopper control and etc.).
This is a limit value in forward and reverse directions.
Set to "800" when not using.
Set this parameter as a proportion (%) to the stall current.

---Setting range---
0 - 999 (Stall current %)
However, when SV084/bitB=1, the setting range is from 0 to 32767 (Stall current 0.01%).

【#2215】 SV015 FFC Acceleration rate feed forward gain

When a relative error in synchronous control is too large, set this parameter to the axis that is delaying.
The standard setting is "0". The standard setting in the SHG control is "50".
To adjust a relative error in acceleration/deceleration, increase the value by 50 at a time.

---Setting range---
0 to 999 (%)

[#2216] SV016 LMC1 Lost motion compensation 1

Set this parameter when the protrusion (that occurs due to the non-sensitive band by friction, torsion, backlash, etc.) at quadrant change is too large. This sets the compensation torque at quadrant change (when an axis feed direction is reversed) by the proportion (%) to the stall torque. Whether to enable the lost motion compensation and the method can be set with other parameters.

Type 2: When SV027/bit9, 8=10 (Compatible with obsolete type)

Set the type 2 method compensation torque. The standard setting is double the friction torque.

Related parameters: SV027/bit9,8, SV033/bitF, SV039, SV040, SV041, SV082/bit2

Type 3: When SV082/bit1=1

Set the compensation torque equivalent of dynamic friction amount of the type 3 method compensation amount. The standard setting is double the dynamic friction torque.

Related parameters: SV041, SV082/bit2,1, SV085, SV086

To vary compensation amount according to the direction.

When SV041 (LMC2) is "0", compensate with the value of SV016 (LMC1) in both +/-directions.

If you wish to change the compensation amount depending on the command direction, set this and SV041 (LMC2).

(SV016: + direction, SV041: - direction. However, the directions may be opposite depending on other settings.)

When "-1" is set, the compensation will not be performed in the direction of the command.

---Setting range---

-1 to 200 (Stall current %)

Note that when SV082/bit2 is "1", the setting range is between -1 and 20000 (Stall current 0.01%).

【#2217(PR)】 SV017 SPEC1 Servo specification 1

Select the servo specifications.
A function is allocated to each bit.
Set this in hexadecimal format.

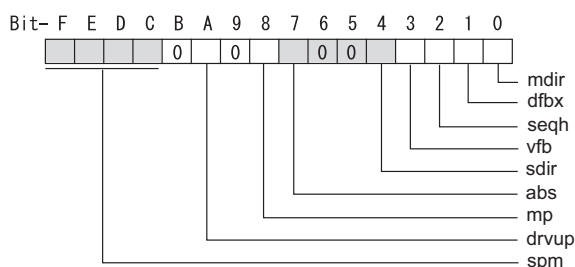
**bit F-C : spm Motor series selection**

- 0: 200V HF, HP motor
- 1: 200V HF, HP motor (Standard)
- 2: Not used
- 3: 400V HF-H, HP-H motor (Standard)
- 6: 200V LM-F linear motor
- 7: 200V direct-drive motor
- 8: 400V LM-F linear motor
- 9: 400V direct-drive motor

bit B :

Not used. Set to "0".

bit A : drvup Combined drive unit:

- For MDS-DM2/D2-V3 Series
- 0: Normal setting (Combined drive unit: normal)
- 1: Combined drive unit: one upgrade

bit 9 :

Not used. Set to "0".

bit 8 : mp MPI scale pole number setting

- 0: 360 poles 1: 720 poles

bit 7 : abs Position control

These parameters are set automatically by the NC system.
0: Incremental 1: Absolute position control

bit 6-5 :

Not used. Set to "0".

bit 4 : sdir Sub side encoder feedback

Set the machine side encoder's installation polarity.
0: Forward polarity 1: Reverse polarity

bit 3 : vfb Speed feedback filter

- 0: Stop 1: Start (2250Hz)

bit 2 : seqh Ready on sequence

0: Normal 1: High-speed
(Note) It is not available for DJ Series.

bit 1 : dfbx Dual feedback control

Control the position FB signal in full closed control by the combination of a motor side encoder and machine side encoder.
0: Stop 1: Start

Related parameters: SV051, SV052

bit 0 : mdir Machine side encoder feedback (for Linear/direct-drive motor)

Set the encoder installation polarity in the linear servo and direct-drive motor control.
0: Forward polarity 1: Reverse polarity

【#2218(PR)】 SV018 PIT Ball screw pitch/Magnetic pole pitch

For servo motor:

Set the ball screw pitch. For the rotary axis, set to "360".

For direct-drive motor

Set to "360".

For linear motor

Set the ball screw pitch. (For LM-F series, set to "48")

---Setting range---

For general motor: 1 to 32767 (mm/rev)

- For linear motor 1 to 32767 (mm)

【#2219(PR)】 SV019 RNG1 Sub side encoder resolution

For semi-closed loop control

Set the same value as SV020.

For full-closed loop control

Set the number of pulses per ball screw pitch.

For direct-drive motor

Set the same value as SV020.

For 1000 pulse unit resolution encoder, set the number of pulses in SV019 in increments of 1000 pulse (kp).

In this case, make sure to set "0" to SV117.

For high-accuracy binary resolution encoder, set the number of pulses to four bite data of SV117 (high-order) and SV019 (low-order) in pulse (p) unit.

SV117 = number of pulses / 65536 (when =0, set "-1" to SV117)

SV019 = the remainder of number of "pulses / 65536"

When the NC is C70 and "SV019 > 32767", set "the remainder of above - 65536 (negative number)" to "SV019".

---Setting range---

When SV117 = 0, the setting range is from 0 to 32767 (kp)

When SV117 ≠ 0

M700V, M70V, M70, E70: 0 to 65535 (p)

C70: -32768 to 32767 (p)

【#2220(PR)】 SV020 RNG2 Main side encoder resolution

Set the number of pulses per revolution of the motor side encoder.

OSA18 (-A48) (260,000 p/rev) ----- SV020 = 260

OSA105 (-A51) (1,000,000 p/rev) ----- SV020 = 1000

OSA166 (-A74N) (16,000,000 p/rev) ----- SV020 = 16000

For linear motor

Set the number of pulses of the encoder per magnetic pole pitch with SV118.

For direct-drive motor

Set the number of pulses per revolution of the motor side encoder.

For 1000 pulse unit resolution encoder, set the number of pulses to SV020 in increments of 1000 pulse(kp).

In this case, make sure to set SV118 to "0". For high-accuracy binary resolution encoder, set the number of pulses to four bite data of SV118 (high-order) and SV020 (low-order) in pulse(p) unit.

SV118 = number of pulses / 65536 (when =0, set "-1" to SV118)

SV019 = the remainder of "number of pulses / 65536"

When the NC is C70 and "SV020 > 32767", set "the remainder of above - 65536 (negative number)" to "SV020".

---Setting range---

When SV118 = 0, the setting range is from 0 to 32767 (kp)

When SV118 ≠ 0, -32768 to 32767 (p)

【#2221】 SV021 OLT Overload detection time constant

Normally, set to "60". (For Mitsubishi Electric adjustment.)

Related parameters: SV022

---Setting range---

1 to 999 (s)

【#2222】 SV022 OLL Overload detection level

Set the "Overload 1" (Alarm 50) current detection level as percentage to the stall current. Normally set this parameter to "150". (For Mitsubishi Electric adjustment.)

Related parameters: SV021

---Setting range---

110 to 500 (Stall current %)

【#2223】 SV023 OD1 Excessive error detection width during servo ON

Set the excessive error detection width in servo ON.

When set to "0", the excessive error alarm detection will be ignored, so do not set to "0".

<Standard setting value>

$OD1=OD2= (\text{Rapid traverse rate [mm/min]} / (60 \times \text{PGN1}) / 2 \text{ [mm]})$

Related parameters: SV026

---Setting range---

0 to 32767 (mm)

However, when SV084/bitC=1, the setting range is from 0 to 32767 (μ m).

【#2224】 SV024 INP In-position detection width

Set the in-position detection width.

Set the positioning accuracy required for the machine.

The lower the setting is, the higher the positioning accuracy will be. However the cycle time (settling time) becomes longer.

The standard setting value is "50".

---Setting range---

0 to 32767 (μ m)

【#2225(PR) SV025 MTYP Motor/Encoder type

Set the position encoder type, speed encoder type and motor type.
The setting value is a four-digit hex (HEX).

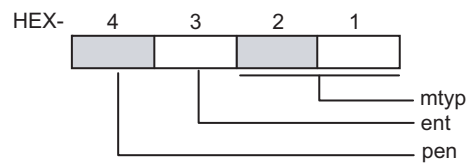
**bit F-C : pen(HEX-4) Position encoder**

Semi-closed loop control by general motor
pen=2

Full-closed loop control by general motor

- Ball screw end encoder (OSA105ET2A, OSA166ET2NA)
pen=6
- For serial signal output rotary scale (including MDS-B-HR)
pen=6
- For rectangular wave signal output scale
pen=8
- For serial signal output linear scale (including MDS-B-HR and MPI scale)
pen=A
- For speed command synchronization control
Primary axis pen=A
Secondary axis pen=D

For linear motor
pen=A

For direct-drive motor
pen=2

bit B-8 : ent(HEX-3) Speed encoder

For general motor: ent=2
For linear motor: ent=A
For direct-drive motor: ent=2

bit 7-0 : mtyp(HEX-2,1) Motor type

Set the motor type. Set this with SV017/bitF-C.

For SV017/bitF-C = 1 (200V standard motor series)

HF75 : 01h	HP54 : 11h	HF-KP13 : E9h (Note 3)
HF105 : 02h	HP104 : 12h	HF-KP23 : EAh
HF54 : 03h	HP154 : 13h	HF-KP43 : EBh
HF104 : 04h	HP224 : 1Bh	HF-KP73 : ECh
HF154 : 05h, 0Fh (Note 1)	HP204 : 14h	
HF224 : 06h	HP354 : 15h	
HF204 : 07h	HP454 : 16h	
HF354 : 08h	HP704 : 17h	
HF123 : 24h	HP903 : 18h	
HF223 : 26h, 2Dh (Note 2)	HP1103 : 19h	
HF303 : 28h		
HF453 : 09h		
HF703 : 0Ah		
HF903 : 0Bh		
HF142 : 25h		
HF302 : 27h, 2Eh (Note 2)		

(Note 1) When MDS-D2-V3 is connected

(Note 2) When MDS-D2-V3 M/S axis is connected

(Note 3) MDS-DJ-V1/V2 only

For SV017/bitF-C = 3 (400V standard motor series)

HF-H75 : 01h,	HP-H54 : 11h
HF-H105 : 02h,	HP-H104 : 12h
HF-H54 : 03h,	HP-H154 : 13h
HF-H104 : 04h,	HP-H204 : 14h
HF-H154 : 05h,	HP-H354 : 15h
	HP-H454 : 16h
HF-H204 : 07h,	HP-H704 : 17h
HF-H354 : 08h,	HP-H903 : 18h
HF-H453 : 09h,	HP-H1103: 19h
HF-H703 : 0Ah	
HF-H903 : 0Bh,	HP-H224 : 1Bh
HC-H1502: B9h	

For linear motor and direct-drive motor, follow the settings stated in respective materials.

[#2226] SV026 OD2 Excessive error detection width during servo OFF

Set the excessive error detection width during servo OFF.

When set to "0", the excessive error alarm detection will be ignored, so do not set to "0".

<Standard setting value>

$$OD1=OD2= (\text{Rapid traverse rate [mm/min]}) / (60 \times \text{PGN1}) / 2 \text{ [mm]}$$

Related parameters: SV023

---Setting range---

0 to 32767 (mm)

However, when SV084/bitC=1, the setting range is from 0 to 32767 (μ m).

【#2227】 SV027 SSF1 Servo function 1

Select the servo functions.
 A function is assigned to each bit.
 Set this in hexadecimal format.

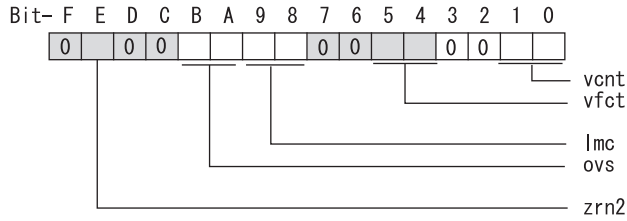

bit F :

Not used. Set to "0".

bit E : zrn2

Set to "1". (Fixed)

bit D :

Not used. Set to "0".

bit C :

Not used. Set to "0".

bit B-A : ovs Overshooting compensation

Set this if overshooting occurs during positioning.
 bitB,A=
 00: Compensation stop
 01: Setting prohibited
 10: Setting prohibited
 11: Type 3
 Set the compensation amount in SV031(OVS1) and SV042(OVS2).

Related parameters: SV031, SV042, SV034/bitF-C

bit 9-8 : lmc Lost motion compensation type

Set this parameter when the protrusion at quadrant change is too large.
 Type 2 has an obsolete type compatible control.
 bit9,8=
 00: Compensation stop
 01: Setting prohibited
 10: Type 2
 11: Setting prohibited
 Set the compensation amount in SV016(LMC1) and SV041(LMC2).
 (Note) When "SV082/bit1=1", the lost motion compensation type 3 will be selected regardless of this setting.

bit 7 :

Not used. Set to "0".

bit 6 :

Not used. Set to "0".

bit 5-4 : vfct Jitter compensation pulse number

Suppress vibration by machine backlash when axis stops.
 bit5,4=
 00: Disable
 01: 1 pulse
 10: 2 pulse
 11: 3 pulses

bit 3 :

Not used. Set to "0".

bit 2 :

Not used. Set to "0".

bit 1-0 : vcnt Speed loop delay compensation changeover type selection

Normally, use "Changeover type 2".

bit1,0=

00: Disable

01: Changeover type 1

10: Changeover type 2

11: Setting prohibited

Related parameters: SV007

[#2228(PR)] SV028 MSFT Magnetic pole shift amount (for linear/direct-drive motor)

Set this parameter to adjust the motor magnetic pole position and encoder's installation phase when using linear motors or direct-drive motors.

During the DC excitation of the initial setup (SV034/bit4=1), set the same value displayed in "AFLT gain" on the NC monitor screen.

Related parameters: SV034/bit4, SV061, SV062, SV063

For general motor:

Not used. Set to "0".

---Setting range---

-18000 to 18000 (Mechanical angle 0.01°)

[#2229] SV029 VCS Speed at the change of speed loop gain

Noise at high speed rotation including rapid traverse can be reduced by lowering the speed loop gain at high speeds.

Set the speed at which the speed loop gain changes. Use this with SV006 (VGN2).

When not using, set to "0".

---Setting range---

0 to 9999 (r/min)

[#2230] SV030 IVC Voltage non-sensitive band compensation

When 100% is set, the voltage reduction amount equivalent to the logical non-energization in the PWM control will be compensated.

When "0" is set, 100% compensation will be performed.

Adjust in increments of 10% from the default value of 100%.

If increased too much, vibration or vibration noise may be generated.

---Setting range---

0 to 255 (%)

【#2231】 SV031 OVS1 Overshooting compensation 1

This compensates the motor torque when overshooting occurs during positioning. This is valid only when the overshooting compensation (SV027/bitB,A) is selected.

Type 3 SV027/bitB,A=11

Set the compensation amount based on the motor stall current. Observing positioning droop waveform, increase in increments of 1% and find the value where overshooting does not occur.

To vary compensation amount depending on the direction.

When SV042 (OVS2) is "0", change the SV031 (OVS1) value in both of the +/- directions to compensate.

To vary the compensation amount depending on the command direction, set this and SV042 (OVS2).

(SV031: + direction, SV042: - direction. However, the directions may be opposite depending on other settings.)

When "-1" is set, the compensation will not be performed in the direction of the command.

Related parameters: SV027/bitB,A, SV034/bitF-C, SV042, SV082/bit2

---Setting range---

-1 to 100 (Stall current %)

Note that the range will be "-1 - 10000" (Stall current 0.01%) when SV082/bit2 is "1".

【#2232】 SV032 TOF Torque offset

Set the unbalance torque on vertical axis and inclined axis.

When the vertical axis pull up function is enabled, the pull up compensation direction is determined by this parameter's sign. When set to "0", the vertical axis pull up will not be executed.

This can be used for speed loop delay compensation and collision detection function.

To use load inertia estimation function (drive monitor display), set this parameter, friction torque (SV045) and load inertia display enabling flag(SV035/bitF).

Related parameters: SV007, SV033/bitE, SV059

---Setting range---

-100 to 100 (Stall current %)

[#2233] SV033 SSF2 Servo function 2

Select the servo functions.
 A function is assigned to each bit.
 Set this in hexadecimal format.

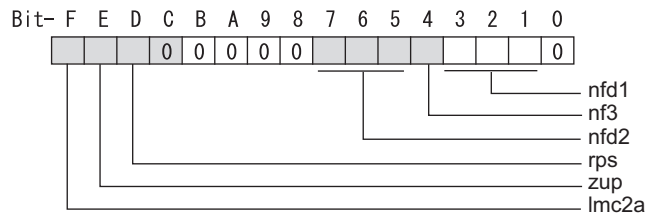

bit F : lmc2a Lost motion compensation 2 timing

0: Normal 1: Change

bit E : zup Vertical axis pull up function

0: Stop 1: Enable

Related parameters: SV032, SV095

bit D : rps Safely limited speed setting increment

Change the setting units of the specified speed signal output speed (SV073) and safely limited speed (SV238).

0: mm/min 1: 100mm/min

Related parameters: SV073, SV238

bit C-8 :

Not used. Set to "0".

bit 7-5 : nfd2 Depth of Notch filter 2

Set the depth of Notch filter 2 (SV046).

- bit7,6,5=
- 000: -∞
- 001: -18.1[dB]
- 010: -12.0[dB]
- 011: -8.5[dB]
- 100: -6.0[dB]
- 101: -4.1[dB]
- 110: -2.5[dB]
- 111: -1.2[dB]

bit 4 : fhz3 Notch filter 3

0: Stop 1: Start (1,125Hz)

bit 3-1 : nfd1 Depth of Notch filter 1

Set the depth of Notch filter 1 (SV038).

- bit3,2,1=
- 000: -∞
- 001: -18.1[dB]
- 010: -12.0[dB]
- 011: -8.5[dB]
- 100: -6.0[dB]
- 101: -4.1[dB]
- 110: -2.5[dB]
- 111: -1.2[dB]

bit 0 :

Not used. Set to "0".

[#2234] SV034 SSF3 Servo function 3

Select the servo functions.
 A function is assigned to each bit.
 Set this in hexadecimal format.

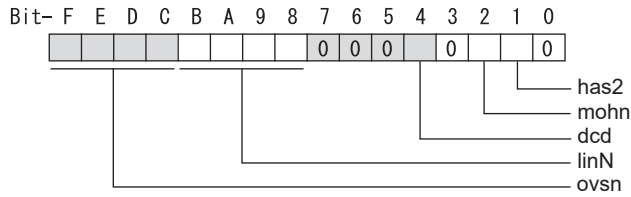

bit F-C: ovsn Overshooting compensation type 3 Non-sensitive band

Set the non-sensitive band of the model position droop overshooting amount in increments of 2 μ m. In the feed forward control, set the non-sensitive band of the model position droop and ignore the overshooting of the model.

0 : 0 μ m, 1: 2 μ m, 2: 4 μ m,---, E : 28 μ m, F: 30 μ m

bit B-8 : linN The number of parallel connections when using linear motors (for linear)

Set to "2" to perform 1 amplifier 2 motor control by linear servo.

bit 7-5 :

Not used. Set to "0".

bit 4 : dcd (linear/direct-drive motor)

0: Normal setting 1: DC excitation mode

Related parameters: SV061, SV062, SV063

bit 3 :

Not used. Set to "0".

bit 2 : mohn Thermistor temperature detection (linear/direct-drive motor)

0: Normal setting 1: Disable

bit 1 : has HAS control

This stabilizes the speed overshooting by torque saturation phenomenon.

0: Normal setting 1: Enable

Related parameters: SV084/bitF

bit 0 :

Not used. Set to "0".

[#2235] SV035 SSF4 Servo function 4

Select the servo functions.
 A function is assigned to each bit.
 Set this in hexadecimal format.

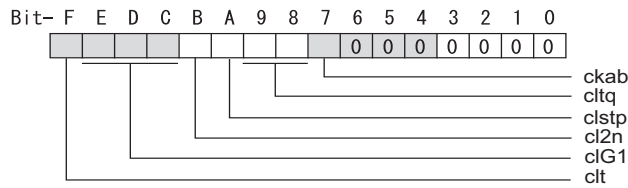

bit F : clt Inertia ratio display

0: Setting for normal use
 1: Display the total inertia ratio estimated at acceleration/deceleration at the inertia ratio on the servo monitor screen
 To display it on the screen, set an imbalance torque and friction torque to both SV032 and SV045 and repeat acceleration/deceleration operations for several times.

bit E-C: clG1 G1 Collision detection level

Set the collision detection level in the collision detection method 1 during cutting feed (G1) in multiples of that of rapid traverse (G0). When set to "0", detection of collision detection method 1 during cutting feed will be ignored.
 $G1 \text{ Collision detection level} = G0 \text{ collision detection level (SV060)} \times clG1$

bit B : cl2n Collision detection method 2

0: Enable 1: Disable

bit A : clstp Collision detection method 1 disabled during stop

0: Collision detection method 1 enabled during stop
 1: Collision detection method 1 disabled during stop

bit 9-8 : cltq Retract torque in collision detection

Set the retract torque in collision detection using the ratio of motor's maximum torque.
 bit9,8=
 00: 100%
 01: 90%
 10: 80% (Standard)
 11: 70%

bit 7 : ckab No signal detection 2

Set this to use rectangular wave output linear scale.
 This enables the detection of No signal 2 (alarm 21).
 0: Disable 1: Enable

bit 6-0 :

Not used. Set to "0".

【#2236(PR)】 SV036 PTYP Power supply type/ Regenerative resistor type**MDS-D2/DH2 Series: Power supply type**

When connecting a power supply unit, set a code for each power supply unit.

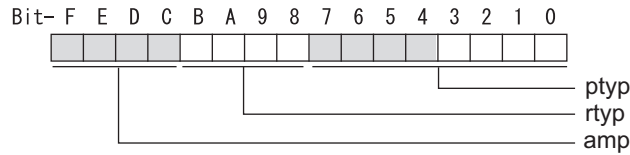
**bit F-C : amp**

Set the power backup function to be used.

No function used : 0

Deceleration and stop function at power failure : 8

bit B-8 : rtyp

Not used. Set to "0".

bit 7-0 : ptyp External emergency stop setting

When the emergency stop input signal of the power supply unit is "disabled"

Power supply unit is not connected	: 00
MDS-D2-CV-37 / MDS-DH2-CV-37	: 04
MDS-D2-CV-75 / MDS-DH2-CV-75	: 08
MDS-D2-CV-110 / MDS-DH2-CV-110	: 11
MDS-D2-CV-185 / MDS-DH2-CV-185	: 19
MDS-D2-CV-300 / MDS-DH2-CV-300	: 30
MDS-D2-CV-370 / MDS-DH2-CV-370	: 37
MDS-D2-CV-450 / MDS-DH2-CV-450	: 45
MDS-D2-CV-550 / MDS-DH2-CV-550	: 55
MDS-DH2-CV-750	: 75

When the emergency stop input signal of the power supply unit is "enabled"

(Note) Set the power supply rotary switch to "4".

Power supply unit is not connected	: 00
MDS-D2-CV-37 / MDS-DH2-CV-37	: 44
MDS-D2-CV-75 / MDS-DH2-CV-75	: 48
MDS-D2-CV-110 / MDS-DH2-CV-110	: 51
MDS-D2-CV-185 / MDS-DH2-CV-185	: 59
MDS-D2-CV-300 / MDS-DH2-CV-300	: 70
MDS-D2-CV-370 / MDS-DH2-CV-370	: 77
MDS-D2-CV-450 / MDS-DH2-CV-450	: 85
MDS-D2-CV-550 / MDS-DH2-CV-550	: 95
MDS-DH2-CV-750	: B5

MDS-DM2-SPV Series

Not used. Set to "0000".

External emergency stop power supply type is set by spindle parameter (SP032).

MDS-DJ-V1/V2 Series: Regenerative resistor type

Set the regenerative resistor type.

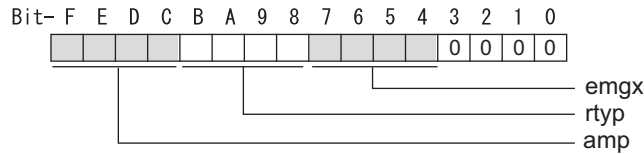

bit F-8 : amp(bit F-C) / rtyp(bit B-8)

- Resistor built-in drive unit : 10
- Setting prohibited : 11
- MR-RB032 : 12
- MR-RB12 or GZG200W39OHMK : 13
- MR-RB32 or GZG200W120OHMK 3 units connected in parallel : 14
- MR-RB30 or GZG200W39OHMK 3 units connected in parallel : 15
- MR-RB50 or GZG300W39OHMK 3 units connected in parallel : 16
- MR-RB31 or GZG200W20OHMK 3 units connected in parallel : 17
- MR-RB51 or GZG300W20OHMK 3 units connected in parallel : 18
- Setting prohibited : 19-1F

- Setting prohibited : 20-23
- FCUA-RB22 : 24
- FCUA-RB37 : 25
- FCUA-RB55 : 26
- FCUA-RB75/2 : 27
- Setting prohibited : 28
- R-UNIT2 : 29
- Setting prohibited : 2A-2C
- FCUA-RB75/2 2 units connected in parallel : 2D
- FCUA-RB55 2 units connected in parallel : 2E
- Setting prohibited : 2F

bit 7-4 : emgx External emergency stop function

Set the external emergency stop function.
0: Disable 4: Enable

bit 3-0 :

Not used. Set to "0".

[#2237] SV037 JL Load inertia scale

Set the motor axis conversion total load inertia including motor itself in proportion to the motor inertia.

$$SV037(JL) = (Jm + JI) / Jm \times 100$$

Jm: Motor inertia

JI: Motor axis conversion load inertia

For linear motor, set the gross mass of the moving sections in kg unit.

<<Drive monitor load inertia ratio display>>

Set SV035/bitF=1 and imbalance torque and friction torque to both SV032 and SV045, and then repeat acceleration/deceleration for several times.

---Setting range---

For general motor: 0 to 5000 (%)

For linear motor 0 to 5000 (kg)

【#2238】 SV038 FHz1 Notch filter frequency 1

Set the vibration frequency to suppress when machine vibration occurs.
(Normally, do not set 80 or less.)
Set to "0" when not using.

Related parameters: SV033/bit3-1, SV115

---Setting range---
0 to 2250 (Hz)

【#2239】 SV039 LMCD Lost motion compensation timing

Set this when the timing of lost motion compensation type 2 does not match.
Adjust increments of 10 at a time.

---Setting range---
0 to 2000 (ms)

【#2240】 SV040 LMCT Lost motion compensation non-sensitive band

Set the non-sensitive band of the lost motion compensation in the feed forward control.
When "0" is set, 2 μ m is the actual value to be set. Adjust increments of 1 μ m.

---Setting range---
0 to 255 (μ m)

【#2241】 SV041 LMC2 Lost motion compensation 2

Set this with SV016 (LMC1) only when you wish to vary the lost motion compensation amount depending on the command directions.
Normally, set to "0".

---Setting range---
-1 to 200 (Stall current %)
Note that when SV082/bit2 is "1", the setting range is between -1 and 20000 (Stall current 0.01%).

【#2242】 SV042 OVS2 Overshooting compensation 2

Set this with SV031 (OVS1) only when you wish to vary the overshooting compensation amount depending on the command directions.
Normally, set to "0".

---Setting range---
-1 to 100 (Stall current %)
Note that when SV082/bit2 is "1", the setting range is between -1 and 10000 (Stall current 0.01%).

【#2243】 SV043 OBS1 Disturbance observer filter frequency

Set the disturbance observer filter band.
Normally, set to "100". Setting values of 49 or less is equal to "0" setting.
To use the disturbance observer, also set SV037 (JL) and SV044 (OBS2).
When disturbance observer related parameters are changed, lost motion compensation needs to be readjusted.
Set to "0" when not using.

---Setting range---
0 to 1000 (rad/s)

[#2244] SV044 OBS2 Disturbance observer gain

Set the disturbance observer gain. The standard setting is "100 to 300".
 To use the disturbance observer, also set SV037 (JL) and SV043 (OBS1).
 When disturbance observer related parameters are changed, lost motion compensation needs to be readjusted.
 Set to "0" when not using.

---Setting range---
 0 to 500 (%)

 [#2245] SV045 TRUB Friction torque

Set the frictional torque when using the collision detection function.
 To use load inertia estimation function (drive monitor display), set this parameter, imbalance torque (SV032) and load inertia display enabling flag (SV035/bitF).

---Setting range---
 0 to 255 (Stall current %)

 [#2246] SV046 FH2z Notch filter frequency 2

Set the vibration frequency to suppress when machine vibration occurs.
 (Normally, do not set 80 or less.)
 Set to "0" when not using.

Related parameters: SV033/bit7-5, SV115

---Setting range---
 0 to 2250 (Hz)

 [#2247] SV047 EC Inductive voltage compensation gain

Set the inductive voltage compensation gain. Standard setting value is "100".
 If the current FB peak exceeds the current command peak, lower the gain.

---Setting range---
 0 to 200 (%)

 [#2248] SV048 EMGr Vertical axis drop prevention time

Input the time required to prevent the vertical axis from dropping by delaying READY OFF until the brake works at an emergency stop.
 Increase in increments of 100ms at a time, find and set the value where the axis does not drop.
 When using a motor with a brake of HF(-H) Series or HP(-H) Series, set to "200ms" as a standard.
 When the pull up function is enabled (SV033/bitE=1), the pull up is established during the drop prevention time.

Related parameters: SV033/bitE, SV055, SV056

---Setting range---
 0 to 20000 (ms)

 [#2249] SV049 PGN1sp Position loop gain 1 in spindle synchronous control

Set the position loop gain during spindle synchronization control (synchronous tapping and synchronization control with spindle C-axis).
 Set the same value as that of the position loop gain for spindle synchronous tapping control.
 When performing the SHG control, set this parameter with SV050 (PGN2sp) and SV058 (SHGCsp).
 When changing the value, change the value of "#2017 tap_g Axis servo gain".

---Setting range---
 1 to 200 (rad/s)

【#2250】 SV050 PGN2sp Position loop gain 2 in spindle synchronous control

When using SHG control during spindle synchronous control (synchronous tapping and synchronization control with spindle C-axis), set this parameter with SV049 (PGN1sp) and SV058 (SHGCsp).

Make sure to set the value 8/3 times that of SV049.

When not using the SHG control, set to "0".

---Setting range---

0 to 999 (rad/s)

【#2251】 SV051 DFBT Dual feedback control time constant

Set the control time constant in dual feed back.

When "0" is set, it operates at 1ms.

The higher the time constant is, the closer it gets to the semi-closed control, so the limit of the position loop gain will be raised.

For linear servo/direct-drive motor system

Not used. Set to "0".

Related parameters: SV017/bit1, SV052

---Setting range---

0 to 9999 (ms)

【#2252】 SV052 DFBN Dual feedback control non-sensitive band

Set the non-sensitive band in the dual feedback control.

Normally, set to "0".

For linear servo/direct-drive motor system

Not used. Set to "0".

Related parameters: SV017/bit1, SV052

---Setting range---

0 to 9999 (μ m)

【#2253】 SV053 OD3 Excessive error detection width in special control

Set the excessive error detection width when servo ON in a special control (initial absolute position setting, stopper control and etc.).

When "0" is set, excessive error detection will not be performed when servo ON during a special control.

---Setting range---

0 to 32767 (mm)

However, when SV084/bitC=1, the setting range is from 0 to 32767 (μ m).

【#2254】 SV054 ORE Overrun detection width in closed loop control

Set the overrun detection width in the full-closed loop control.

When the gap between the motor side encoder and the linear scale (machine side encoder) exceeds the value set by this parameter, it will be judged as overrun and "Alarm 43" will be detected.

When "-1" is set, if the differential velocity between the motor side encoder and the machine side encoder exceeds the 30% of the maximum motor speed, it will be judged as overrun and "Alarm 43" will be detected.

When "0" is set, overrun will be detected with a 2mm width.

For linear servo/direct-drive motor system

Not used. Set to "0".

---Setting range---

-1 to 32767 (mm)

However, when SV084/bitD=1, the setting range is from -1 to 32767 (μ m).

【#2255】 SV055 EMGx Max. gate off delay time after emergency stop

Set the time required between an emergency stop and forced READY OFF.
 Set the maximum value "+ 100ms" of the SV056 setting value of the servo drive unit electrified by the same power supply unit.
 When executing the vertical axis drop prevention, the gate off will be delayed for the length of time set at SV048 even when SV055's is smaller than that of SV048.

Related parameters: SV048, SV056

---Setting range---
 0 to 20000 (ms)

【#2256】 SV056 EMGt Deceleration time constant at emergency stop

Set the time constant used for the deceleration control at emergency stop.
 Set the time required to stop from rapid traverse rate (rapid).
 The standard setting value is $EMGt \leq G0tL \times 0.9$.
 However, note that the standard setting value differs from the above-mentioned value when the setting value of "#2003:smgst Acceleration and deceleration modes bit 3-0:Rapid traverse acceleration/deceleration type" is 8 or F. Refer to Instruction Manual of the drive unit (section "Deceleration Control") for details.

Related parameters: SV048, SV055

---Setting range---
 0 to 20000 (ms)

【#2257】 SV057 SHGC SHG control gain

When performing the SHG control, set to $SV003(PGN1) \times 6$.
 When not using the SHG control, set to "0".
 When using the OMR-FF control, set to "0".

Related parameters: SV003, SV004

---Setting range---
 0 to 1200 (rad/s)

【#2258】 SV058 SHGCsp SHG control gain in spindle synchronous control

When using SHG control during spindle synchronization control (synchronous tapping and synchronous control with spindle C-axis), set this parameter with SV049 (PGN1sp) and SV050 (PGN2sp).
 Make sure to set the value 6 times that of SV049.
 When not using the SHG control, set to "0".

---Setting range---
 0 to 1200 (rad/s)

【#2259】 SV059 TCNV Collision detection torque estimated gain

Set the torque estimated gain when using the collision detection function.
 The standard setting value is the same as the load inertia ratio (SV037 setting value) including motor inertia.
 Set to "0" when not using the collision detection function.

Related parameters: SV032, SV035/bitF-8, SV037, SV045, SV060

<<Drive monitor load inertia ratio display>>
 Set SV035/bitF=1 and imbalance torque and friction torque to both SV032 and SV045, and then repeat acceleration/deceleration for several times.

---Setting range---
 For general motor: 0 to 5000 (%)
 For linear motor: 0 to 5000 (kg)

【#2260】 SV060 TLMT Collision detection level

When using the collision detection function, set the collision detection level at the G0 feeding.
When "0" is set, none of the collision detection function will work.

Related parameters: SV032, SV035/bitF-8, SV037, SV045, SV059

---Setting range---

0 to 999 (Stall current %)

【#2261】 SV061 DA1NO D/A output ch1 data No. / Initial DC excitation level

Input the data number you wish to output to the D/A output channel 1.
When using the 2-axis drive unit, set "-1" to the axis that the data will not be output.

When the DC excitation is running (SV034/bit4=1):

Use this when the DC excitation is running (SV034/bit4=1) to adjust the initial magnetic pole position (when measuring the magnetic pole shift amount) for linear motor and direct-drive motor.
Set the initial excitation level in DC excitation control.

Set 10% as standard.

Related parameters: SV062, SV063

---Setting range---

-32768 to 32767

When the DC excitation is running (SV034/bit4=1): 0 to 100 (Stall current %)

【#2262】 SV062 DA2NO D/A output ch2 data No. / Final DC excitation level

Input the data number you wish to output to the D/A output channel 2.
When using the 2-axis drive unit, set "-1" to the axis that the data will not be output.

When the DC excitation is running (SV034/bit4=1):

Use this when the DC excitation is running (SV034/bit4=1) to adjust the initial magnetic pole position (when measuring the magnetic pole shift amount) for linear motor and direct-drive motor.
Set the final excitation level in DC excitation control.

Set 10% as standard.

When the magnetic pole shift amount measurement value is unsteady, adjust the value in increments of 5%.

Related parameters: SV061, SV063

---Setting range---

-32768 to 32767

When the DC excitation is running (SV034/bit4=1): 0 to 100 (Stall current %)

【#2263】 SV063 DA1MPY D/A output ch1 output scale / Initial DC excitation time

Set output scale of the D/A output channel 1 in increment of 1/100.
When "0" is set, the magnification is the same as when "100" is set.

When the DC excitation is running (SV034/bit4=1):

Use this when the DC excitation is running (SV034/bit4=1) to adjust the initial magnetic pole position (when measuring the magnetic pole shift amount) for linear motor and direct-drive motor.
Set the initial excitation time in DC excitation control.

Set 1000ms as standard.

When the magnetic pole shift amount measurement value is unsteady, adjust the value in increments of 500ms.

Related parameters: SV061, SV062

---Setting range---

-32768 to 32767 (1/100-fold)

When the DC excitation is running (SV034/bit4=1): 0 to 10000 (ms)

【#2264】 SV064 DA2MPY D/A output ch2 output scale

Set output scale of the D/A output channel 2 in increment of 1/100.
When "0" is set, the magnification is the same as when "100" is set.

---Setting range---

-32768 to 32767 (1/100-fold)

【#2265】 SV065 TLC Machine end compensation gain

The shape of the machine end is compensated by compensating the spring effect from the machine end to the motor end.

Set the machine end compensation gain. Measure the error amount by roundness measurement and estimate the setting value by the following formula.

$$\text{Compensation amount } (\mu\text{m}) = \text{Command speed } F(\text{mm/min})^2 * \text{SV065} / (\text{Radius } R(\text{mm}) * \text{SV003} * 16,200,000)$$

Set to "0" when not using.

---Setting range---
-30000 to 30000 (Acceleration ratio 0.1%)

【#2266-2272】 SV066 - SV072

This parameter is set automatically by the NC system.

【#2273(PR)】 SV073 FEEDout Specified speed output speed

Set the specified speed.
Also set SV082/bit9,8 to output digital signal.

---Setting range---
0 to 32767 (r/min)
However, when SV033/bitD=1, the setting range is from 0 to 32767 (100mm/min).
(Only for MDS-D2/DH2 and MDS-DM2)

【#2274-2280】 SV074 - SV080

This parameter is set automatically by the NC system.

【#2281(PR)】 SV081 SPEC2 Servo specification 2

Select the servo functions.
A function is assigned to each bit.
Set this in hexadecimal format.

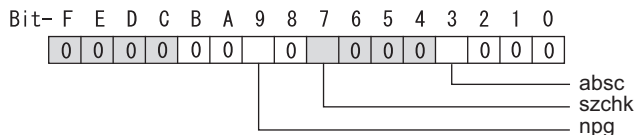

bit F-A :

Not used. Set to "0".

bit 9 : npg Earth fault detection

0: Disable 1: Enable (standard)
Set "0" and it is constantly "Enable" for MDS-DJ-V1/V2 Series.

bit 8 :

Not used. Set to "0".

bit 7 : szchk Distance-coded reference scale reference mark

0: Check at 4 points (standard) 1: Check at 3 points

bit 6-4 :

Not used. Set to "0".

bit 3 : absc Distance-coded reference scale

0: Disable 1: Enable

bit 2-0 :

Not used. Set to "0".

【#2282】 SV082 SSF5 Servo function 5

Select the servo functions.
 A function is assigned to each bit.
 Set this in hexadecimal format.

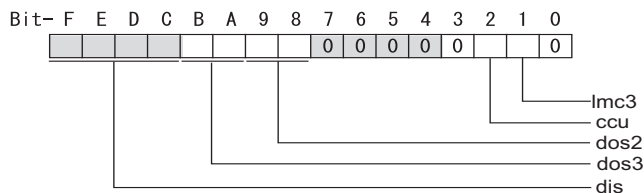

bit F-C : dis Digital signal input selection

- 0: No signal
- 1: SLS (Safely Limited Speed) function door state signal
- 2: Battery box voltage drop warning (It is not available for MDS-DJ-V1/V2 Series.)
- 3 to F: Setting prohibited

bit B-A : dos3 Digital signal output 3 selection

- bitB,A=
- 00: Disable
 - 01: Setting prohibited
 - 10: Contactor control signal output (For MDS-DJ-V1/V2)
 - 11: Setting prohibited

bit 9-8 : dos2 Digital signal output 2 selection

- bit9,8=
- 00: Disable
 - 01: Specified speed output
 - 10: Setting prohibited
 - 11: Setting prohibited

bit 7-3 :

Not used. Set to "0".

bit 2 : ccu Lost motion overshoot compensation compensation amount setting increment

- 0: Stall current % 1: Stall current 0.01%

bit 1 : lmc3 Lost motion compensation type 3

Set this when protrusion at a quadrant change is too big.
 0: Stop 1: Start

Related parameters: SV016, SV041, SV085, SV086

bit 0 :

Not used. Set to "0".

[#2283] SV083 SSF6 Servo function 6

Select the servo functions.
 A function is assigned to each bit.
 Set this in hexadecimal format.

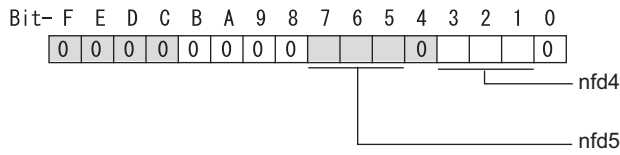

bit F-8 :

Not used. Set to "0".

bit 7-5 : nfd5 Depth of Notch filter 5

Set the depth of Notch filter 5 (SV088).
 bit7,6,5=
 000: -∞
 001: -18.1[dB]
 010: -12.0[dB]
 011: -8.5[dB]
 100: -6.0[dB]
 101: -4.1[dB]
 110: -2.5[dB]
 111: -1.2[dB]

bit 4 :

Not used. Set to "0".

bit 3-1 : nfd4 Depth of Notch filter 4

Set the depth of Notch filter 4 (SV087).
 bit3,2,1=
 000: -∞
 001: -18.1[dB]
 010: -12.0[dB]
 011: -8.5[dB]
 100: -6.0[dB]
 101: -4.1[dB]
 110: -2.5[dB]
 111: -1.2[dB]

bit 0 :

Not used. Set to "0".

【#2284】 SV084 SSF7 Servo function 7

Select the servo functions.
A function is assigned to each bit.
Set this in hexadecimal format.

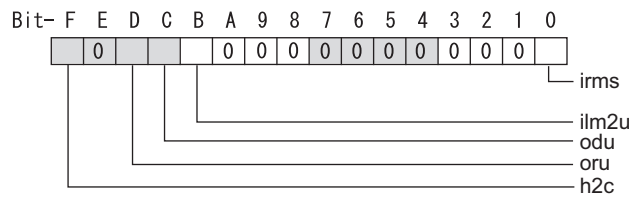
**bit F : h2c HAS control cancel amount**

0: 1/4 (standard) 1: 1/2

Related parameters: SV034/bit1

bit E :

Not used. Set to "0".

bit D : oru Overrun detection width unit

0: mm (normal setting) 1: μ m

bit C : odu Excessive error detection width unit

0: mm (normal setting) 1: μ m

bit B : ilm2u Current limit value (SV014) in special control setting unit

0: Stall current % (normal setting) 1: Stall current 0.01%

bit A-1 :

Not used. Set to "0".

bit 0 : irms Motor current display

0: Motor q axis current display (normal) 1: Motor effective current display

【#2285】 SV085 LMCK Lost motion compensation 3 spring constant

Set the machine system's spring constant when selecting lost motion compensation type 3.
When not using, set to "0".

Related parameters: SV016, SV041, SV082/bit2,1, SV086

---Setting range---

0 to 32767 (0.01%/ μ m)

【#2286】 SV086 LMCc Lost motion compensation 3 viscous coefficient

Set the machine system's viscous coefficient when selecting lost motion compensation type 3. When not using, set to "0".

Related parameters: SV016, SV041, SV082/bit2,1, SV086

---Setting range---

0 to 32767 (0.01%*s/mm)

【#2287】 SV087 FHz4 Notch filter frequency 4

Set the vibration frequency to suppress when machine vibration occurs. (Normally, do not set 80 or less.) Set to "0" when not using.

Related parameters: SV083/bit3-1, SV115

---Setting range---

0 to 2250 (Hz)

【#2288】 SV088 FHz5 Notch filter frequency 5

Set the vibration frequency to suppress when machine vibration occurs. (Normally, do not set 80 or less.) Set to "0" when not using.

Related parameters: SV083/bit7-5, SV115

---Setting range---

0 to 2250 (Hz)

【#2289】 SV089

Not used. Set to "0".

【#2290】 SV090

Not used. Set to "0".

【#2291】 SV091 LMC4G Lost motion compensation 4 gain

Use this with LMC compensation type 3. As the delay in path tracking is monitored and compensated, the delay in path tracking will be minimized even if machine friction amount changes by aging. Use the lost motion compensation amount (SV016) * 5 (10% of the dynamic friction torque) as the target. The higher the setting value is, the more accurate the quadrant change be; however, the more likely vibrations occur.

---Setting range---

0 to 20000 (Stall current 0.01%)

【#2292】 SV092

Not used. Set to "0".

【#2293】 SV093

Not used. Set to "0".

【#2294】 SV094 MPV Magnetic pole position error detection speed

The magnetic pole position detection function monitors the command speed and motor speed at the position command stop and detects the magnetic pole position error alarm (3E) if any. Set the error detection level for the command speed and motor speed at the position command stop.

Be aware when setting the parameter as the setting units for general motors and linear motors are different.

<<For general motor>>

When the command speed error detection level is set to "0", the magnetic pole position error (3E) is detected at 10r/min.

Set "10" as standard.

This detects the magnetic pole position error (3E) when the motor rotation speed is 100r/min and more.

<<For linear motor>>

When the command motor speed level is set to "0", the magnetic pole position error (3E) is detected at 1mm/s.

Set "10" as standard.

This detects the magnetic pole position error (3E) when the motor speed is 10mm/s and more.

---Setting range---

0 to 31999

<<For general motor>>

Ten-thousands digit, Thousands digit ----- Command speed error detection level (10r/min)

Hundreds digit, Tens digit, Ones digit ----- Motor speed error detection level (10r/min)

<<For linear motor>>

Ten-thousands digit, Thousands digit ----- Command speed error detection speed level

(1mm/s)

Hundreds digit, Tens digit, Ones digit ----- Motor speed error detection level (1mm/s)

【#2295】 SV095 ZUPD Vertical axis pull up distance

Set this parameter to adjust the pull up distance when the vertical axis pull up function is enabled. When the pull up function is enabled and this parameter is set to "0", for a rotary motor, 8/1000 of a rotation at the motor end is internally set as the pull up distance, and for a linear motor, 80[μ m] is set.

Related parameters:

SV032 : The pull up direction is determined. When "0" is set, pull up control is not executed.

SV033/bitE : Start-up of the pull up function

SV048 : Set the drop prevention time. When "0" is set, pull up control is not executed.

---Setting range---

-32768 to 32767 (μ m)

【#2296-2305】 SV096 - SV105

Not used. Set to "0".

【#2306】 SV106 PGM OMR-FF scale model gain

Set the scale model gain (position response) in OMR-FF control.

Set the same value as SV003(PGN1).

Increase the setting value to perform a high-speed machining such as a fine arc or to improve the path error.

Lower the value when vibration occurs during acceleration/deceleration.

Set to "0" when not using OMR-FF control.

---Setting range---

0 to 300 (rad/s)

【#2307-2311】 SV107 - SV111

Not used. Set to "0".

【#2312】 SV112 IFF OMR-FF current feed forward gain

Set the current feed forward rate in OMR-FF control.
 The standard setting is "10000".
 Setting value of "0" is equal to "10000(100%)" setting.
 Set to "0" when not using OMR-FF control.

---Setting range---
 0 to 32767 (0.01%)

【#2313】 SV113 SSF8 Servo function 8

Select the servo functions.
 A function is assigned to each bit.
 Set this in hexadecimal format.

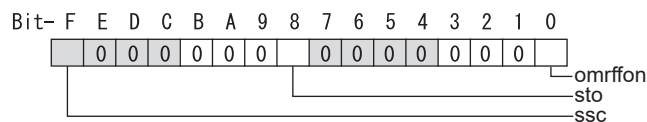

bit F : ssc SLS (Safely Limited Speed) function

0: Stop 1: Start

bit E-9 :

Not used. Set to "0".

bit 8 : sto Dedicated wiring STO function

Set this parameter to use dedicated wiring STO function.
 0: Dedicated wiring STO function unused 1: Dedicated wiring STO function used

bit 7-1 :

Not used. Set to "0".

bit 0 : omrffon OMR-FF control enabled

0: Disable 1: Enable

【#2314】 SV114 SSF9 Servo function 9

Select the servo functions.
 A function is assigned to each bit.
 Set this in hexadecimal format.

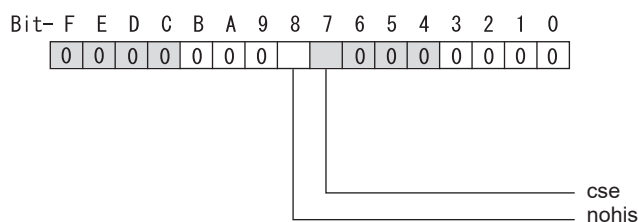

bit F-9 :

Not used. Set to "0".

bit 8 : nohis History of communication error alarm between NC and DRV (34, 36, 38, 39)

Set "1" for C70.

0: Enable 1: Disable

bit 7 : cse Command speed monitoring function

0: Normal setting 1: Enable

bit 6-0 :

Not used. Set to "0".

【#2315】 SV115 SSF10 Servo function 10

Select the servo functions.
A function is assigned to each bit.
Set this in hexadecimal format.

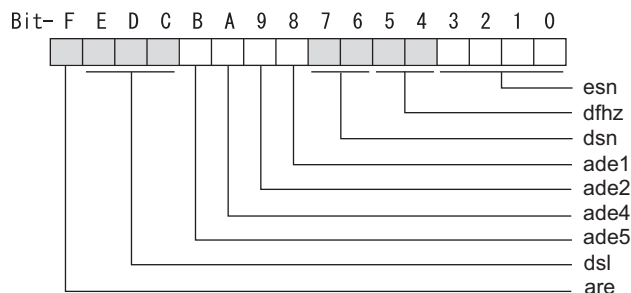
**bit F : are Notch filter5 all frequencies adapted**

When enabled, Notch filter5 all frequencies adaptive range is not limited regardless of SV115/bit4,5 setting.

0: Disable 1: Enable

bit E-C: dsl Notch filter frequency display

Switch the "AFLT frequency" display on drive monitor screen to check every notch filter frequency. When the selected notch filter is not used, "0" is displayed.

bitE,D,C=

000 : Estimated resonance frequency (Normal display)

001 : Notch filter 1 frequency

010 : Notch filter 2 frequency

011 : Notch filter 3 frequency (always displays 1125Hz)

100 : Notch filter 4 frequency

101 : Notch filter 5 frequency

Other settings: setting prohibited

bit B : ade5 Notch filter 5 / Adaptive follow-up function

0: Disable 1: Enable

bit A : ade4 Notch filter 4 / Adaptive follow-up function

0: Disable 1: Enable

bit 9 : ade2 Notch filter 2 / Adaptive follow-up function

0: Disable 1: Enable

bit 8 : ade1 Notch filter 1 / Adaptive follow-up function

0: Disable 1: Enable

bit 7-6 : dsn Estimated resonance frequency display holding time

Set the estimated resonance frequency display holding time to the "AFLT frequency" display on drive monitor screen.

bit7,6=

00: 4 [s]

01: 8 [s]

10: 12 [s]

11: 16 [s]

bit 5-4 : dfhz Notch filter frequency range

Set the adaptive range of the notch filter frequency. When the adaptive follow-up function is enabled and if the estimated resonance frequency exists in the set range, the notch filter will be adapted. Normally set this parameter to "00".

bit5,4=
 00: -10 to 10 [%]
 01: -20 to 20 [%]
 10: -30 to 30 [%]
 11: -40 to 40 [%]

bit 3-0 : esn Sensitivity of estimated resonance frequency

Set the sensitivity of the estimated resonance frequency. Smaller setting value enables to detect smaller vibration component, however, adaptive movement will be repeated frequently. Normally set this parameter to "0".

0 : Normal setting (same sensitivity as A) 1 : Sensitivity high to F : Sensitivity low

[#2316] SV116 SSF11 Servo function 11

Not used. Set to "0000".

[#2317(PR)] SV117 RNG1ex Expansion sub side encoder resolution

For high-accuracy binary resolution encoder, set the number of pulses to four bite data of SV117 (high-order) and SV019 (low-order) by pulse(p).
 When SV117=0, the setting unit of SV019 is (kp).
 Refer to SV019 for details.

Related parameters: SV019, SV020, SV118

---Setting range---
 -1 to 32767

[#2318(PR)] SV118 RNG2ex Expansion main side encoder resolution

When using high-accuracy binary resolution encoder, set the number of pulses to four bite data of SV118 (high-order) and SV020 (low-order) by pulse(p).
 When SV118=0, the setting unit of SV020 is (kp).
 Refer to SV020 for details.

Related parameters: SV019, SV020, SV117

---Setting range---
 -1 to 32767

[#2319-2328] SV119 - SV128

Not used. Set to "0".

[#2329] SV129 Kwf Synchronous control feed forward filter frequency

Set the acceleration rate feed forward filter frequency in high-speed synchronous tapping control. The standard setting is "600".

Related parameters: SV244

---Setting range---
 0 to 32767 (rad/s)

【#2330(PR) SV130 RPITS Base reference mark interval

Set the base reference mark intervals of distance-coded reference scale. When the distance-coded reference scale is not used, set to "0".

The interval of basic reference mark (SV130) and auxiliary interval (SV131) must be in the specified relationship. Other settings cause the initial parameter error (alarm 37).

Following is the specified relationship.

The quotient of $(SV130 \times 1000) / SV131$ must be 4 or more and leaves no remainder.

Related parameters: SV081/bit7,3, SV131, SV134 to SV137

---Setting range---

0 to 32767 (mm)

【#2331(PR) SV131 DPITS Auxiliary reference mark interval

Set the auxiliary interval of reference mark in the distance-coded reference scale. When the distance-coded reference scale is not used, set to "0".

The interval of basic reference mark (SV130) and auxiliary interval (SV131) must be in the specified relationship. Other settings cause the initial parameter error (alarm 37).

Following is the specified relationship.

The quotient of $(SV130 \times 1000) / SV131$ must be 4 or more and leaves no remainder.

Related parameters: SV081/bit7,3, SV130, SV134 to SV137

---Setting range---

0 to 32767 (μ m)

【#2332] SV132

Not used. Set to "0".

【#2333] SV133

Not used. Set to "0".

【#2334] SV134 RRn0 Distance-coded reference check / revolution counter

Set this parameter to operate distance-coded reference check when using distance-coded reference scale.

During the distance-coded reference check initial setup (SV137:RAER=-1), set the following items on the NC drive monitor screen after the distance-coded reference check initial setup warning A3 turns OFF.

SV134=Rn, SV135=Pn, SV136=MPOS

When reference point is set, the warning A3 turns OFF.

To enable the distance-coded reference check function, SV081/bit3=1 setting and a battery option are needed.

Related parameters: SV081/bit7,3, SV130, SV131, SV134 to SV137

---Setting range---

-32768 to 32767

【#2335】 SV135 RPN0H Distance-coded reference check / position within one rotation High

Set this parameter to operate distance-coded reference check when using distance-coded reference scale.

During the distance-coded reference check initial setup (SV137:RAER=-1), set the following items on the NC drive monitor screen after the distance-coded reference check initial setup warning A3 turns OFF.

SV134=Rn, SV135=Pn, SV136=MPOS

When reference point is set, the warning A3 turns OFF.

To enable the distance-coded reference check function, SV081/bit3=1 setting and a battery option are needed.

Related parameters: SV081/bit7,3, SV130, SV131, SV134 to SV137

---Setting range---
-32768 to 32767

【#2336】 SV136 RPN0L Distance-coded reference check / position within one rotation Low

Set this parameter to operate distance-coded reference check when using distance-coded reference scale.

During the distance-coded reference check initial setup (SV137:RAER=-1), set the following items on the NC drive monitor screen after the distance-coded reference check initial setup warning A3 turns OFF.

SV134=Rn, SV135=Pn, SV136=MPOS

When reference point is set, the warning A3 turns OFF.

To enable the distance-coded reference check function, SV081/bit3=1 setting and a battery option are needed.

Related parameters: SV081/bit7,3, SV130, SV131, SV134 to SV137

---Setting range---
-32768 to 32767

【#2337】 SV137 RAER Distance-coded reference check allowable width

For the distance-coded reference check function when using distance-coded reference scale, set the allowable gap from the reference point position data calculated by the main side encoder. When the gap exceeds the allowable range, reference point created by distance-code is judged as wrong and detects alarm 42.

The standard setting value is "basic reference mark interval (SV130) / 4".

SV137=0 setting carries out the same operation as the standard setting value.

SV137=-1 setting enables the distance-coded reference initial set up mode and displays setting values of SV134 to SV136 on NC drive monitor.

To enable the distance-coded reference check function, SV081/bit3=1 setting and a battery option are needed.

When SV137=32767, the distance-coded reference check function is disabled.

Related parameters: SV081/bit7,3, SV130, SV131, SV134 to SV136

---Setting range---
-1 to 32767 (mm)

【#2338-2397】 SV138 - SV197

Not used. Set to "0".

【#2398】 SV198 NSE No signal 2 special detection width

Set the special detection width for the no signal 2 (alarm 21).

This detects no signal 2 (alarm 21) when machine side feedback is not invoked even if the motor side encoder feedback exceeds this setting in the rectangular wave signal output linear scale.

When "0" is set, the detection will be performed with a 15 μ m width.

---Setting range---
0 to 32767 (μ m)

【#2399-2437】 SV199 - SV237

Not used. Set to "0".

【#2438】 SV238 SSCFEED Safely limited speed

Set the machine's safely limited speed for the SLS (Safely Limited Speed) function.

Set this parameter within the following setting ranges.

For linear axis: 2000mm/min or less

For rotary axis: 18000°/min (50r/min) or less

When not using, set to "0".

Related parameters: SV033/bitD, SV113/bitF, SV239

---Setting range---

0 to 18000 (mm/min) or (°/min)

However, when SV033/bitD=1, the setting range is from -32768 to 32767 (100 mm/min) or (100°/min).

【#2439】 SV239 SSCRPM Safely limited motor speed

Set the motor's safely limited speed for the SLS (Safely Limited Speed) function.

Set a value to hold the following relationship.

Be aware when setting the parameter as the setting units for general motors and linear motors are different.

<<For general motor>>

$$SV239 = (SV238/SV018) \times (SV002/SV001)$$

Only when the product is 0, set to "1".

<<For linear motor>>

$$SV239 = SV238/60$$

Only when the product is 0, set to "1".

When not using, set to "0".

---Setting range---

For general motor: 0 to 32767 (r/min)

For linear motor: 0 to 32767 (mm/s)

【#2440-2443】 SV240 - SV243

Not used. Set to "0".

【#2444(PR)】 SV244 DUNIT Communication interpolation unit for communication among drive units

Set the communication interpolation unit among drive units in high-speed synchronous tapping control.

When set to "0", it will be regarded as 20 (0.05 μ m) is set.

Related parameters: SV129

---Setting range---

0 to 2000 (1/ μ m)

【#2445-2456】 SV245 - SV256

Not used. Set to "0".

4.3 Setting the Initial Parameters for the Spindle Drive Unit

The spindle specification parameters and spindle parameters must be set before the spindle system can be started up. The spindle related parameters are input from the NC. The input method differs according to the NC being used, so refer to each NC Instruction Manual.

CAUTION

The configuration of the spindle specification parameters (#3001 to #3138) can differ depending on the NC. This Instruction Manual explains using the configuration of the parameters for M700V/M70V Series.

4.3.1 Setting of Parameters Related to the Spindle

The spindle specification parameters "#3001-#3138" and spindle parameters "#13001-#13256" must be set before the spindle is started up. Set the parameters depending on the spindle motor equipped to the machine and the machine specifications. The following parameters must be set for startup, so check the setting values.

< Common parameters set for starting >

Set the command time constant etc. up to the maximum rotation speed of the spindle end and the maximum rotation speed of the motor.

Especially the maximum rotation speed should be set not to exceed the machine specifications. In addition, acceleration/ deceleration of the spindle is executed with the constant torque control, so the time depends on the inertia size.

(1) Setting of the maximum rotation speed

Set the maximum rotation speed of S commands (synchronous tapping, etc.).

【#3001】 slimt 1 Limit rotation speed (Gear: 00)

Set the spindle rotation speed for maximum motor speed when gear 00 is selected.
Set the spindle rotation speed for the S analog output=10V during analog spindle control.

---Setting range---
0 to 99999 (r/min)

【#3002】 slimt 2 Limit rotation speed (Gear: 01)

【#3003】 slimt 3 Limit rotation speed (Gear: 10)

【#3004】 slimt 4 Limit rotation speed (Gear: 11)

【#3005】 smax 1 Maximum rotation speed (Gear: 00)

Set the maximum spindle rotation speed which is actually commanded when gear 00 is selected.
Set this as $smax1(\#3005) \leq slimit1(\#3001)$.
By comparing the S command value and the values of gear 1 - 4, a spindle gear shift command will be output automatically.

---Setting range---
0 to 99999 (r/min)

【#3006】 smax 2 Maximum rotation speed (Gear: 01)

【#3007】 smax 3 Maximum rotation speed (Gear: 10)

【#3008】 smax 4 Maximum rotation speed (Gear: 11)

(2) Time constant settings during acceleration/deceleration

Set the time constant from the stopped state to reach S commands of smax.

【#3101】 sp_t 1 Acceleration/deceleration time constant with S command (Gear: 00)

Set the acceleration/deceleration time constant with S command (speed operation mode) when gear 00 is selected. Set the linear acceleration/deceleration time up to limit rotation speed (slimit1). Set the short time constant that the motor torque at acceleration is always saturated, however, when an abnormal noise or V-belt slip occurs, increase the time constant.

---Setting range---
0 to 30000 (ms)

【#3102】 sp_t 2 Acceleration/deceleration time constant with S command (Gear: 01)**【#3103】 sp_t 3 Acceleration/deceleration time constant with S command (Gear: 10)****【#3104】 sp_t 4 Acceleration/deceleration time constant with S command (Gear: 11)****(3) Spindle speed settings for Z-phase detection when starting**

At the first spindle rotation after the power ON (including turning the power ON again only for NC), the spindle rotates at the speed of setting parameters during Z-phase detection for the encoder. Set the rotation speed.

【#3106】 zrn_typ Zero point return specifications**bit F : Spindle zero point detection with contactless switch**

0: Normal 1: Enable spindle zero point detection using proximity switch

【#3109】 zdetspd Z phase detection speed

For the first S command after power is turned ON, the spindle rotates at the speed of setting value for this parameter until Z phase is detected twice.
When "#3106/bitF = 1" (Spindle zero point proximity switch detection enabled), also proximity switch is detected.

(Note) When spindle zero point proximity switch detection is enabled, the rotation direction of the orientation/zero point return (synchronous tapping, spindle/C axis) will follow Z phase detection direction. And the speed will follow Z phase detection speed.

---Setting range---
1 to 99999 (r/min)

(4) Parameters set depending on the connected NC**【#13230】 SP230 SFNC10 Spindle function 10****bit 8 : nohis History of communication error alarm between NC and DRV(34,36,38,39)**

For C70, set "1".
0: Enable 1: Disable

< Initial parameters set depending on the machine specifications >

Set the following parameters depending on the spindle drive method (direct, gear drive, etc.) or inertia size of rotary sections for machine specifications.

(1) Adjustment parameters in orientation mode

When the inertia ratio is large for the spindle motor such as large lathes, set the following parameters so that abnormal noise or machine sway does not occur during orientation control.

【#3106】 zrn_typ Zero point return specifications**bit E : Control mode selection in orientation**

Select non-interpolation mode when vibration occurs since the gain is high during the orientation.

0: Interpolation mode (Use the interpolation mode gain "SP002".)

1: Non-interpolation mode (Use the non-interpolation mode gain "SP001")

(2) Setting of the gear ratio

Set the following parameters depending on the spindle drive method (direct, gear drive, belt drive) for the machine.

【#13057(PR)】 SP057 GRA1 Spindle side gear ratio 1

Set the number of gear teeth on the spindle side when "the gear selection command (control input 4/bit6, 5) "is set to "00".

---Setting range---

1 to 32767

【#13058(PR)】 SP058 GRA2 Spindle side gear ratio 2**【#13059(PR)】 SP059 GRA3 Spindle side gear ratio 3****【#13060(PR)】 SP060 GRA4 Spindle side gear ratio 4****【#13061(PR)】 SP061 GRB1 Motor side gear ratio 1**

Set the number of gear teeth on the spindle side when "the gear selection command (control input 4/bit6, 5) " is set to "00".

---Setting range---

1 to 32767

【#13062(PR)】 SP062 GRB2 Motor side gear ratio 2**【#13063(PR)】 SP063 GRB3 Motor side gear ratio 3****【#13064(PR)】 SP064 GRB4 Motor side gear ratio 4****< Setting parameters for the encoder with semi/full-closed loop control >**

Set parameters depending on the encoder configured in the machine. For semi-closed loop, set the same value to the main side and the sub side. For full-closed loop, set the encoder of the main side and the sub side.

【#13019(PR)】 SP019 RNG1 Sub side encoder resolution

[For semi-closed loop]

Set the same value as SP020 (RNG2). (Refer to the explanation of SP020.)

[For full-closed loop]

Set the number of pulses per revolution of the machine side encoder.

When using ABZ pulse output encoder (OSE-1024-3-15-68), set this combined with SP097(RNG1ex).

SP019 = 4096

SP097 = -1

---Setting range---

When SP097=0, the setting range is from 0 to 32767 (kp)

When SP097 ≠ 0

For M700V, M70V, M70, E70: 0 to 65535 (p)

For C70: -32768 to 32767 (p)

【#13020(PR)】 SP020 RNG2 Main side encoder resolution

Set the number of pulses per revolution of the motor side encoder.
When using the encoder interface unit MDS-B-HR, use this with SP098 (RNG2ex).

Encoder

TS5691(128 teeth): SP020 = 2000
TS5691(180 teeth): SP020 = 2880
TS5691(256 teeth): SP020 = 4000
TS5691(384 teeth): SP020 = 6000
TS5691(512 teeth): SP020 = 8000

TS5690(64 teeth): SP020 = 2000
TS5690(90 teeth): SP020 = 2880
TS5690(128 teeth): SP020 = 4000
TS5690(192 teeth): SP020 = 6000
TS5690(256 teeth): SP020 = 8000
TS5690(384 teeth): SP020 =12000

ERM280(1200 teeth): SP020 = 4800
ERM280(2048 teeth): SP020 = 8000

MPCI : SP020 = 7200
MBE205: SP020 = 2000
MBE405W: SP020 = 4000

Tool spindle motor
OSA18(-A48): SP020 = 260

---Setting range---

When SP098=0, the setting range is from 0 to 32767 (kp)
When SP098≠0
For M700V, M70V, M70, E70: 0 to 65535 (p)
For C70: -32768 to 32767 (p)

【#13097】 SP097 RNG1ex Extension sub side encoder resolution

When setting the machine side encoder resolution in pulse (p) unit, set the number of pulses to four bite data of SP097 (high-order) and SP019 (low-order) in pulse (p) unit.

When SP097=0, the setting unit of SP019 is (kp).
Refer to SP019 for details.

Related parameters: SP019, SP020, SP098

---Setting range---

-1 to 32767

【#13098】 SP098 RNG2ex Extension main side encoder resolution

When setting the motor side encoder resolution in pulse (p) unit, set the number of pulses to four bite data of SP098 (high-order) and SP020 (low-order) in pulse (p) unit.

When SP098=0, the setting unit of SP020 is (kp).
Refer to SP020 for details.

Related parameters: SP019, SP020, SP097

---Setting range---

-1 to 32767

【#13031(PR)】 SP031 MTYP Motor type

Set the control system of the spindle drive unit.

2200: Semi closed loop control
4200: Full closed loop control by using spindle side ABZ pulse output encoder
6200: Full closed loop control by using spindle side serial output encoder

[#13054] SP054 ORE Overrun detection width in closed loop control

Set the overrun detection width in the full-closed loop control.

When the gap between the motor side encoder and the machine side encoder exceeds the set value, it is judged as an overrun and "Alarm 43" is detected.

When "-1" is set, if the differential velocity between the motor side encoder and the machine side encoder exceeds the 30% of the maximum motor speed, it will be judged as overrun and "Alarm 43" will be detected.

When "0" is set, overrun will be detected with 2°.

In the full-closed loop control, normally set this parameter to "360". During V-belt drive, set to "-1".

---Setting range---

-1 to 32767 (°)

< Setting parameters of a proximity switch >

Set the following parameters when a proximity switch is equipped with the spindle end.

 [#13227] SP227 SFNC7 Spindle function 7**bit F-C : dis Digital signal input selection**

0: No signal

1: SLS (Safely Limited Speed) function door state signal

4: Proximity switch signal detection

Other settings: setting prohibited

 [#13225] SP225 SFNC5 Spindle function 5**bit 5 : ddir Proximity switch signal enable edge**

0: Falling edge 1: Rising edge

 [#3106] zrn_typ Zero point return specifications**bit F : Spindle zero point detection with contactless switch**

0: Normal 1: Enable spindle zero point detection using proximity switch

< Cautions for starting the spindle >

The test operation (acceleration/deceleration, orientation) of the spindle can be executed by setting the initial parameters, however, check the spindle operation with caution.

- Check the wiring and ensure the safety of the surroundings before starting the operation.
- Do not operate at high-speed rotation at first. After checking that there are no problems as abnormal noise, vibration, etc. from the spindle at start up with no-load and small S commands, raise the S commands gradually.
- When vibration or abnormal noise occurs during the test operation, adjust or set the speed gain or the notch filter.
- For the first check of the orientation, the orientation should be executed gradually from small S commands.

4.3.2 List of Standard Parameters for Each Spindle Motor

(1) 200V Standard motor SJ-D Series (Normal)

Parameter				200V Standard motor SJ-D Series (Normal)							
				Motor		SJ-D3.7/100-01	SJ-D5.5/100-01	SJ-D5.5/120-01	SJ-D5.5/120-02		SJ-D7.5/100-01
No.	Abbrev.	Details	MDS-D2-SP-80	80	80	80	160	200	160	160	160
			MDS-D2-SP2-8080(L) 16080S(M)	8040(L) 8080 16080S(M)	8040(L) 8080 16080S(M)	8040(L) 8080 16080S(M)	16080S(L)	-	16080S(L)	16080S(L)	16080S(L)
SP001	PGV	Position loop gain non-interpolation mode	15	15	15	15	15	15	15	15	15
SP002	PGN	Position loop gain interpolation mode	33	33	33	33	33	33	33	33	33
SP003	PGS	Position loop gain spindle synchronization	15	15	15	15	15	15	15	15	15
SP004			0	0	0	0	0	0	0	0	0
SP005	VGN1	Speed loop gain 1	150	150	150	150	150	150	150	150	150
SP006	VIA1	Speed loop lead compensation 1	1900	1900	1900	1900	1900	1900	1900	1900	1900
SP007	VIL1	Speed loop delay compensation 1	0	0	0	0	0	0	0	0	0
SP008	VGN2	Speed loop gain 2	150	150	150	150	150	150	150	150	150
SP009	VIA2	Speed loop lead compensation 2	1900	1900	1900	1900	1900	1900	1900	1900	1900
SP010	VIL2	Speed loop delay compensation 2	0	0	0	0	0	0	0	0	0
:			:	:	:	:	:	:	:	:	:
SP013			0	0	0	0	0	0	0	0	0
SP014	PY1	Minimum excitation rate 1	50	50	50	50	50	50	50	50	50
SP015	PY2	Minimum excitation rate 2	100	100	100	100	100	100	100	100	100
SP016	DDT	Phase alignment deceleration rate	20	20	20	20	20	20	20	20	20
SP017	SPEC1	Spindle specification 1	000C	000C	000C	000C	000C	000C	000C	000C	000C
SP018	SPEC2	Spindle specification 2	0000	0000	0000	0000	0000	0000	0000	0000	0000
SP019	RNG1	Sub side encoder resolution	2000	2000	2000	2000	2000	2000	2000	2000	2000
SP020	RNG2	Main side encoder resolution	2000	2000	2000	2000	2000	2000	2000	2000	2000
SP021	OLT	Overload detection time constant	60	60	60	60	60	60	60	60	60
SP022	OLL	Overload detection level	120	120	120	120	120	120	120	120	120
SP023	OD1	Excessive error detection width (interpolation mode - spindle synchronization)	120	120	120	120	120	120	120	120	120
SP024	INP	In-position width	875	875	875	875	875	875	875	875	875
SP025	INP2	2nd in-position width	875	875	875	875	875	875	875	875	875
SP026	TSP	Maximum motor speed	10000	10000	12000	12000	12000	10000	12000	10000	10000
SP027	ZSP	Motor zero speed	25	25	25	25	25	25	25	25	25
SP028	SDTS	Speed detection set value	1000	1000	1200	1200	1200	1000	1200	1000	1000
SP029	SDTR	Speed detection reset width	30	30	30	30	30	30	30	30	30
SP030	SDT2	2nd speed detection setting value	0	0	0	0	0	0	0	0	0
SP031	MTYP	Motor type	2200	2200	2200	2200	2200	2200	2200	2200	2200
SP032	PTYP	Power supply type/ Regenerative resistor type	0000	0000	0000	0000	0000	0000	0000	0000	0000
SP033	SFNC1	Spindle function 1	0000	0000	0000	0000	0000	0000	0000	0000	0000
SP034	SFNC2	Spindle function 2	0000	0000	0000	0000	0000	0000	0000	0000	0000
SP035	SFNC3	Spindle function 3	1600	1600	1600	1600	1600	1600	1600	1600	1600
SP036	SFNC4	Spindle function 4	0000	0000	0000	0000	0000	0000	0000	0000	0000
SP037	JL	Load inertia scale	100	100	100	100	100	100	100	100	100
SP038	FHz1	Notch filter frequency 1	0	0	0	0	0	0	0	0	0
:			:	:	:	:	:	:	:	:	:
SP046	FHz2	Notch filter frequency 2	0	0	0	0	0	0	0	0	0
SP047	EC	Inductive voltage compensation gain	100	100	100	100	100	100	100	100	100
SP048	LMC1	Lost motion compensation 1	0	0	0	0	0	0	0	0	0
:			:	:	:	:	:	:	:	:	:
SP052	DFBN	Dual feedback control non-sensitive band	0	0	0	0	0	0	0	0	0
SP053	ODS	Excessive error detection width (non-interpolation mode)	2000	2000	2400	2400	2400	2000	2400	2000	2400
SP054	ORE	Overrun detection width in closed loop control	0	0	0	0	0	0	0	0	0
SP055	EMGx	Max. gate off delay time after emergency stop	20000	20000	20000	20000	20000	20000	20000	20000	20000
SP056	EMGt	Deceleration time constant at emergency stop	300	300	300	300	300	300	300	300	300
SP057	GRA1	Spindle side gear ratio 1	1	1	1	1	1	1	1	1	1
SP058	GRA2	Spindle side gear ratio 2	1	1	1	1	1	1	1	1	1
SP059	GRA3	Spindle side gear ratio 3	1	1	1	1	1	1	1	1	1
SP060	GRA4	Spindle side gear ratio 4	1	1	1	1	1	1	1	1	1
SP061	GRB1	Motor side gear ratio 1	1	1	1	1	1	1	1	1	1
SP062	GRB2	Motor side gear ratio 2	1	1	1	1	1	1	1	1	1
SP063	GRB3	Motor side gear ratio 3	1	1	1	1	1	1	1	1	1
SP064	GRB4	Motor side gear ratio 4	1	1	1	1	1	1	1	1	1
SP065	TLM1	Torque limit 1	10	10	10	10	10	10	10	10	10
SP066	TLM2	Torque limit 2	10	10	10	10	10	10	10	10	10
SP067	TLM3	Torque limit 3	10	10	10	10	10	10	10	10	10
SP068	TLM4	Torque limit 4	10	10	10	10	10	10	10	10	10
SP069	PCMP	Phase alignment completion width	875	875	875	875	875	875	875	875	875
SP070	KDDT	Phase alignment deceleration rate scale	0	0	0	0	0	0	0	0	0
SP071	DIQM	Variable current limit during deceleration, lower limit value	60	60	50	30	15	50	50	50	45
SP072	DIQN	Variable current limit during deceleration, break point speed	6000	6000	6000	3700	2200	5000	6000	6000	4500
SP073	VGVN	Variable speed gain target value	0	0	0	0	0	0	0	0	0

4 Setup

Parameter				200V Standard motor SJ-D Series (Normal)							
				Motor		SJ-D3.7/100-01	SJ-D5.5/100-01	SJ-D5.5/120-01	SJ-D5.5/120-02		SJ-D7.5/100-01
No.	Abbrev.	Details	MDS-D2-SP-	8040(L) 8080 16080S (M)	8040(L) 8080 16080S (M)	8040(L) 8080 16080S (M)	16080S (L)	200	16080S (L)	16080S (L)	16080S (L)
:				:	:	:	:	:	:	:	:
SP076	DWSL	Slip compensation scale during regeneration low-speed coil		0	0	0	0	0	0	0	0
SP077	IQA	Q axis current lead compensation		4096	4096	4096	4096	4096	4096	4096	4096
SP078	IDA	D axis current lead compensation		4096	4096	4096	4096	4096	4096	4096	4096
SP079	IQG	Q axis current gain		1024	1024	1024	1024	1024	1024	1024	1024
SP080	IDG	D axis current gain		1024	1024	1024	1024	1024	1024	1024	1024
SP081	IQAL	Q axis current lead compensation low-speed coil		0	0	0	0	0	0	0	0
:				:	:	:	:	:	:	:	:
SP088	FHz5	Notch filter frequency 5		0	0	0	0	0	0	0	0
SP089	TMKQ	Spindle output stabilizing gain Q axis		100	100	100	100	100	100	100	100
SP090	TMKD	Spindle output stabilizing gain D axis		0	0	0	0	0	0	0	0
:				:	:	:	:	:	:	:	:
SP113	OPLP	Current command value for open loop		0	0	0	0	0	0	0	0
SP114	MKT	Coil changeover gate cutoff timer		150	150	150	150	150	150	150	150
SP115	MKT2	Coil changeover current limit timer		250	250	250	250	250	250	250	250
SP116	MKIL	Coil changeover current limit value		120	120	120	120	120	120	120	120
SP117	SETM	Excessive speed deviation timer		12	12	12	12	12	12	12	12
SP118	MSFT	Magnetic pole shift amount		0	0	0	0	0	0	0	0
:				:	:	:	:	:	:	:	:
SP128	DA2MPY	D/A output ch2 output scale		0	0	0	0	0	0	0	0
SP129	PM	Motor unique constants (H)		2	2	2	2	2	2	2	2
SP130	JM	Motor unique constants (H)		8	13	13	8	8	22	24	29
SP131	ATYP	Motor unique constants (H)		80	80	80	160	200	160	160	160
SP132				0	0	0	0	0	0	0	0
SP133	NR	Motor unique constants (H)		10000	10000	12000	12000	12000	10000	12000	10000
SP134	NB	Motor unique constants (H)		1800	1800	1800	2000	1700	1500	1800	1800
SP135	NF	Motor unique constants (H)		1800	1800	1800	3200	3400	1800	1800	1800
SP136	KT	Motor unique constants (H)		1155	1234	1234	722	757	1262	1262	1338
SP137	KF1	Motor unique constants (H)		59	67	67	40	36	73	73	68
SP138	KF2	Motor unique constants (H)		3222	3330	3330	3111	2975	3252	3252	3208
SP139	KF3	Motor unique constants (H)		2478	2345	2345	2550	2755	2427	2427	2468
SP140	KF4	Motor unique constants (H)		1938	1961	1961	1934	1907	1947	1947	1942
SP141	KF5	Motor unique constants (H)		86	98	98	83	77	145	145	145
SP142	KF6	Motor unique constants (H)		0	0	0	0	0	0	0	0
SP143				0	0	0	0	0	0	0	0
SP144	TMIL	Motor unique constants (H)		0	0	0	0	0	0	0	0
SP145	TMBR	Motor unique constants (H)		388	335	467	436	478	369	460	440
SP146	TMBD	Motor unique constants (H)		423	428	433	423	422	434	437	435
SP147	KE	Motor unique constants (H)		71	66	66	73	78	74	74	75
SP148	LA	Motor unique constants (H)		1869	1186	1186	691	682	969	969	811
SP149	IQSM	Motor unique constants (H)		2039	2837	2837	6083	7718	3785	3785	5233
SP150	IDSM	Motor unique constants (H)		784	1228	1228	1368	1557	1742	1742	2214
SP151	R1	Motor unique constants (H)		343	167	167	128	128	105	105	81
SP152	TMLR	Motor unique constants (H)		110	110	110	90	90	90	90	120
SP153	TMLD	Motor unique constants (H)		120	120	120	120	120	120	120	120
SP154	TMLS	Motor unique constants (H)		150	150	150	150	150	150	150	150
SP155	KI1	Motor unique constants (H)		1095	1083	1083	969	870	1051	1067	1072
SP156	PCNT	Motor unique constants (H)		0	0	0	0	0	0	0	0
SP157				0	0	0	0	0	0	0	0
SP158	DNB	Motor unique constants (H)		1500	1500	1500	0	0	0	1500	1500
SP159	SNB	Motor unique constants (H)		1500	1500	1500	1196	899	0	1500	1500
SP160	BSD	Motor unique constants (H)		0	0	0	0	0	0	0	0
:				:	:	:	:	:	:	:	:
SP224				0	0	0	0	0	0	0	0
SP225	SFNC5	Spindle function 5		0000	0000	0000	0000	0000	0000	0000	0000
SP226	SFNC6	Spindle function 6		1000	1000	1000	1000	1000	1000	1000	1000
SP227	SFNC7	Spindle function 7		0000	0000	0000	0000	0000	0000	0000	0000
:				:	:	:	:	:	:	:	:
SP232				0000	0000	0000	0000	0000	0000	0000	0000
SP233	IVC	Voltage non-sensitive band compensation		0	0	0	0	0	0	0	0
:				:	:	:	:	:	:	:	:
SP236	WIH	Temperature compensation time constant		0	0	0	0	0	0	0	0
SP237	TCF	Torque command filter		500	500	500	500	500	500	500	500
SP238	SSCFEED	Safely limited speed		0	0	0	0	0	0	0	0
SP239	SSCRPM	Safely limited motor speed		0	0	0	0	0	0	0	0
SP240				0	0	0	0	0	0	0	0
:				:	:	:	:	:	:	:	:
SP256											

(2) 200V Standard motor SJ-D Series (Hollow shaft)

Parameter		Motor	200V Standard motor SJ-D Series (Hollow shaft)		
			SJ-D5.5/120-02T-S		
No.	Abbrev.	Details	MDS-D2-SP- MDS-D2-SP2-	160 16080S(L)	200 -
SP001	PGV	Position loop gain non-interpolation mode		15	15
SP002	PGN	Position loop gain interpolation mode		33	33
SP003	PGS	Position loop gain spindle synchronization		15	15
SP004				0	0
SP005	VGN1	Speed loop gain 1		150	150
SP006	VIA1	Speed loop lead compensation 1		1900	1900
SP007	VIL1	Speed loop delay compensation 1		0	0
SP008	VGN2	Speed loop gain 2		150	150
SP009	VIA2	Speed loop lead compensation 2		1900	1900
SP010	VIL2	Speed loop delay compensation 2		0	0
SP011				0	0
SP012				0	0
SP013				0	0
SP014	PY1	Minimum excitation rate 1		50	50
SP015	PY2	Minimum excitation rate 2		100	100
SP016	DDT	Phase alignment deceleration rate		20	20
SP017	SPEC1	Spindle specification 1		000C	000C
SP018	SPEC2	Spindle specification 2		0000	0000
SP019	RNG1	Sub side encoder resolution		2000	2000
SP020	RNG2	Main side encoder resolution		2000	2000
SP021	OLT	Overload detection time constant		60	60
SP022	OLL	Overload detection level		120	120
SP023	OD1	Excessive error detection width (interpolation mode - spindle synchronization)		120	120
SP024	INP	In-position width		875	875
SP025	INP2	2nd in-position width		875	875
SP026	TSP	Maximum motor speed		12000	12000
SP027	ZSP	Motor zero speed		25	25
SP028	SDTS	Speed detection set value		1200	1200
SP029	SDTR	Speed detection reset width		30	30
SP030	SDT2	2nd speed detection setting value		0	0
SP031	MTYP	Motor type		2200	2200
SP032	PTYP	Power supply type/ Regenerative resistor type		0000	0000
SP033	SFNC1	Spindle function 1		0000	0000
SP034	SFNC2	Spindle function 2		0000	0000
SP035	SFNC3	Spindle function 3		1600	1600
SP036	SFNC4	Spindle function 4		0000	0000
SP037	JL	Load inertia scale		100	100
SP038	FHz1	Notch filter frequency 1		0	0
:				:	:
SP046	FHz2	Notch filter frequency 2		0	0
SP047	EC	Inductive voltage compensation gain		100	100
SP048	LMC1	Lost motion compensation 1		0	0
:				:	:
SP052	DFBN	Dual feedback control non-sensitive band		0	0
SP053	ODS	Excessive error detection width (non-interpolation mode)		2400	2400
SP054	ORE	Overrun detection width in closed loop control		0	0
SP055	EMGx	Max. gate off delay time after emergency stop		20000	20000
SP056	EMGt	Deceleration time constant at emergency stop		300	300
SP057	GRA1	Spindle side gear ratio 1		1	1
SP058	GRA2	Spindle side gear ratio 2		1	1
SP059	GRA3	Spindle side gear ratio 3		1	1
SP060	GRA4	Spindle side gear ratio 4		1	1
SP061	GRB1	Motor side gear ratio 1		1	1
SP062	GRB2	Motor side gear ratio 2		1	1
SP063	GRB3	Motor side gear ratio 3		1	1
SP064	GRB4	Motor side gear ratio 4		1	1
SP065	TLM1	Torque limit 1		10	10
SP066	TLM2	Torque limit 2		10	10
SP067	TLM3	Torque limit 3		10	10
SP068	TLM4	Torque limit 4		10	10
SP069	PCMP	Phase alignment completion width		875	875
SP070	KDDT	Phase alignment deceleration rate scale		0	0
SP071	DIQM	Variable current limit during deceleration, lower limit value		30	15
SP072	DIQN	Variable current limit during deceleration, break point speed		3700	2200
SP073	VGVN	Variable speed gain target value		0	0
SP074	VGVS	Variable speed gain change start speed		0	0
SP075	DWSH	Slip compensation scale during regeneration high- speed coil		0	0
SP076	DWSL	Slip compensation scale during regeneration low- speed coil		0	0

4 Setup

Parameter		Motor		200V Standard motor SJ-D Series (Hollow shaft)	
		Details		SJ-D5.5/120-02T-S	
				160	200
No.	Abbrev.	MDS-D2-SP-	MDS-D2-SP2-	16080S(L)	
SP077	IQA	Q axis current lead compensation		4096	4096
SP078	IDA	D axis current lead compensation		4096	4096
SP079	IQG	Q axis current gain		1024	1024
SP080	IDG	D axis current gain		1024	1024
SP081	IQAL	Q axis current lead compensation low-speed coil		0	0
:				:	:
SP088	FHz5	Notch filter frequency 5		0	0
SP089	TMKQ	Spindle output stabilizing gain Q axis		100	100
SP090	TMKD	Spindle output stabilizing gain D axis		0	0
:				:	:
SP112				0	0
SP113	OPLP	Current command value for open loop		0	0
SP114	MKT	Coil changeover gate cutoff timer		150	150
SP115	MKT2	Coil changeover current limit timer		250	250
SP116	MKIL	Coil changeover current limit value		120	120
SP117	SETM	Excessive speed deviation timer		12	12
SP118	MSFT	Magnetic pole shift amount		0	0
SP119				0	0
:				:	:
SP128	DA2MPY	D/A output ch2 output scale		0	0
SP129	PM	Motor unique constants (H)		2	2
SP130	JM	Motor unique constants (H)		8	8
SP131	ATYP	Motor unique constants (H)		160	200
SP132				0	0
SP133	NR	Motor unique constants (H)		12000	12000
SP134	NB	Motor unique constants (H)		2000	1700
SP135	NF	Motor unique constants (H)		3200	3400
SP136	KT	Motor unique constants (H)		722	757
SP137	KF1	Motor unique constants (H)		40	36
SP138	KF2	Motor unique constants (H)		3111	2975
SP139	KF3	Motor unique constants (H)		2550	2755
SP140	KF4	Motor unique constants (H)		1934	1907
SP141	KF5	Motor unique constants (H)		83	77
SP142	KF6	Motor unique constants (H)		0	0
SP143				0	0
SP144	TMIL	Motor unique constants (H)		0	0
SP145	TMBR	Motor unique constants (H)		436	478
SP146	TMBD	Motor unique constants (H)		423	422
SP147	KE	Motor unique constants (H)		73	78
SP148	LA	Motor unique constants (H)		691	682
SP149	IQSM	Motor unique constants (H)		6083	7718
SP150	IDSMD	Motor unique constants (H)		1368	1557
SP151	R1	Motor unique constants (H)		128	128
SP152	TMLR	Motor unique constants (H)		90	90
SP153	TMLD	Motor unique constants (H)		120	120
SP154	TMLS	Motor unique constants (H)		150	150
SP155	KI1	Motor unique constants (H)		969	870
SP156	PCNT	Motor unique constants (H)		0	0
SP157				0	0
SP158	DNB	Motor unique constants (H)		0	0
SP159	SNB	Motor unique constants (H)		1196	899
SP160	BSD	Motor unique constants (H)		0	0
SP161				0	0
:				:	:
SP224				0	0
SP225	SFNC5	Spindle function 5		0000	0000
SP226	SFNC6	Spindle function 6		1000	1000
SP227	SFNC7	Spindle function 7		0000	0000
:				:	:
SP232				0000	0000
SP233	IVC	Voltage non-sensitive band compensation		0	0
SP234				0	0
SP235	R2H	Temperature compensation gain		0	0
SP236	WIH	Temperature compensation time constant		0	0
SP237	TCF	Torque command filter		500	500
SP238	SSCFEED	Safely limited speed		0	0
SP239	SSCRPM	Safely limited motor speed		0	0
SP240				0	0
:					
SP256					

(3) 200V Standard motor SJ-DJ Series (Compact & Lightweight output)

Parameter				200V SJ-DJ Series (Compact & Lightweight output)					
				Motor		SJ-DJ5.5/ 100-01	SJ-DJ5.5/ 120-01	SJ-DJ7.5/ 100-01	SJ-DJ7.5/ 120-01
No.	Abbrev.	Details	MDS-D2-SP- 80	8040(L) 8080 16080S(M)	80 8040(L) 8080 16080S(M)	160 16080S(L)	160 16080S(L)	160 16080S(L)	200 -
SP001	PGV	Position loop gain non-interpolation mode	15	15	15	15	15	15	15
SP002	PGN	Position loop gain interpolation mode	33	33	33	33	33	33	33
SP003	PGS	Position loop gain spindle synchronization	15	15	15	15	15	15	15
SP004			0	0	0	0	0	0	0
SP005	VGN1	Speed loop gain 1	150	150	150	150	150	150	150
SP006	VIA1	Speed loop lead compensation 1	1900	1900	1900	1900	1900	1900	1900
SP007	VIL1	Speed loop delay compensation 1	0	0	0	0	0	0	0
SP008	VGN2	Speed loop gain 2	150	150	150	150	150	150	150
SP009	VIA2	Speed loop lead compensation 2	1900	1900	1900	1900	1900	1900	1900
SP010	VIL2	Speed loop delay compensation 2	0	0	0	0	0	0	0
SP011			0	0	0	0	0	0	0
SP012			0	0	0	0	0	0	0
SP013			0	0	0	0	0	0	0
SP014	PY1	Minimum excitation rate 1	50	50	50	50	50	50	50
SP015	PY2	Minimum excitation rate 2	100	100	100	100	100	100	100
SP016	DDT	Phase alignment deceleration rate	20	20	20	20	20	20	20
SP017	SPEC1	Spindle specification 1	000C	000C	000C	000C	000C	000C	000C
SP018	SPEC2	Spindle specification 2	0000	0000	0000	0000	0000	0000	0000
SP019	RNG1	Sub side encoder resolution	2000	2000	2000	2000	2000	2000	2000
SP020	RNG2	Main side encoder resolution	2000	2000	2000	2000	2000	2000	2000
SP021	OLT	Overload detection time constant	60	60	60	60	60	60	60
SP022	OLL	Overload detection level	120	120	120	120	120	120	120
SP023	OD1	Excessive error detection width (interpolation mode - spindle synchronization)	120	120	120	120	120	120	120
SP024	INP	In-position width	875	875	875	875	875	875	875
SP025	INP2	2nd in-position width	875	875	875	875	875	875	875
SP026	TSP	Maximum motor speed	10000	12000	10000	12000	10000	8000	8000
SP027	ZSP	Motor zero speed	25	25	25	25	25	25	25
SP028	SDTS	Speed detection set value	1000	1200	1000	1200	1000	800	800
SP029	SDTR	Speed detection reset width	30	30	30	30	30	30	30
SP030	SDT2	2nd speed detection setting value	0	0	0	0	0	0	0
SP031	MTYP	Motor type	2200	2200	2200	2200	2200	2200	2200
SP032	PTYP	Power supply type/ Regenerative resistor type	0000	0000	0000	0000	0000	0000	0000
SP033	SFNC1	Spindle function 1	0000	0000	0000	0000	0000	0000	0000
SP034	SFNC2	Spindle function 2	0000	0000	0000	0000	0000	0000	0000
SP035	SFNC3	Spindle function 3	1600	1600	1600	1600	1600	1600	1600
SP036	SFNC4	Spindle function 4	0000	0000	0000	0000	0000	0000	0000
SP037	JL	Load inertia scale	100	100	100	100	100	100	100
SP038	FHz1	Notch filter frequency 1	0	0	0	0	0	0	0
:			:	:	:	:	:	:	:
SP046	FHz2	Notch filter frequency 2	0	0	0	0	0	0	0
SP047	EC	Inductive voltage compensation gain	100	100	100	100	100	100	100
SP048	LMC1	Lost motion compensation 1	0	0	0	0	0	0	0
:			:	:	:	:	:	:	:
SP052	DFBN	Dual feedback control non-sensitive band	0	0	0	0	0	0	0
SP053	ODS	Excessive error detection width (non-interpolation mode)	2000	2400	2000	2400	2000	1600	1600
SP054	ORE	Overrun detection width in closed loop control	0	0	0	0	0	0	0
SP055	EMGx	Max. gate off delay time after emergency stop	20000	20000	20000	20000	20000	20000	20000
SP056	EMGt	Deceleration time constant at emergency stop	300	300	300	300	300	300	300
SP057	GRA1	Spindle side gear ratio 1	1	1	1	1	1	1	1
SP058	GRA2	Spindle side gear ratio 2	1	1	1	1	1	1	1
SP059	GRA3	Spindle side gear ratio 3	1	1	1	1	1	1	1
SP060	GRA4	Spindle side gear ratio 4	1	1	1	1	1	1	1
SP061	GRB1	Motor side gear ratio 1	1	1	1	1	1	1	1
SP062	GRB2	Motor side gear ratio 2	1	1	1	1	1	1	1
SP063	GRB3	Motor side gear ratio 3	1	1	1	1	1	1	1
SP064	GRB4	Motor side gear ratio 4	1	1	1	1	1	1	1
SP065	TLM1	Torque limit 1	10	10	10	10	10	10	10
SP066	TLM2	Torque limit 2	10	10	10	10	10	10	10
SP067	TLM3	Torque limit 3	10	10	10	10	10	10	10
SP068	TLM4	Torque limit 4	10	10	10	10	10	10	10
SP069	PCMP	Phase alignment completion width	875	875	875	875	875	875	875
SP070	KDDT	Phase alignment deceleration rate scale	0	0	0	0	0	0	0
SP071	DIQM	Variable current limit during deceleration, lower limit value	45	35	45	35	45	40	40
SP072	DIQN	Variable current limit during deceleration, break point speed	4500	4500	4500	4500	4500	3300	3300
SP073	VGVN	Variable speed gain target value	0	0	0	0	0	0	0
SP074	VGVS	Variable speed gain change start speed	0	0	0	0	0	0	0

4 Setup

Parameter			Motor	200V SJ-DJ Series (Compact & Lightweight output)					
				SJ-DJ5.5/100-01	SJ-DJ5.5/120-01	SJ-DJ7.5/100-01	SJ-DJ7.5/120-01	SJ-DJ11/100-01	SJ-DJ15/80-01
No.	Abbrev.	Details	MDS-D2-SP-80	8040(L)808016080S(M)	8040(L)808016080S(M)	16080S(L)	16080S(L)	16080S(L)	200
SP075	DWSH	Slip compensation scale during regeneration high-speed coil	0	0	0	0	0	0	0
SP076	DWSL	Slip compensation scale during regeneration low-speed coil	0	0	0	0	0	0	0
SP077	IQA	Q axis current lead compensation	4096	4096	4096	4096	4096	4096	4096
SP078	IDA	D axis current lead compensation	4096	4096	4096	4096	4096	4096	4096
SP079	IQG	Q axis current gain	1024	1024	1024	1024	1024	1024	1024
SP080	IDG	D axis current gain	1024	1024	1024	1024	1024	1024	1024
SP081	IQAL	Q axis current lead compensation low-speed coil	0	0	0	0	0	0	0
:			:	:	:	:	:	:	:
SP088	FHz5	Notch filter frequency 5	0	0	0	0	0	0	0
SP089	TMKQ	Spindle output stabilizing gain Q axis	100	100	100	100	100	100	100
SP090	TMKD	Spindle output stabilizing gain D axis	0	0	0	0	0	0	0
:			:	:	:	:	:	:	:
SP113	OPLP	Current command value for open loop	0	0	0	0	0	0	0
SP114	MKT	Coil changeover gate cutoff timer	150	150	150	150	150	150	150
SP115	MKT2	Coil changeover current limit timer	250	250	250	250	250	250	250
SP116	MKIL	Coil changeover current limit value	120	120	120	120	120	120	120
SP117	SETM	Excessive speed deviation timer	12	12	12	12	12	12	12
SP118	MSFT	Magnetic pole shift amount	0	0	0	0	0	0	0
:			:	:	:	:	:	:	:
SP128	DA2MPY	D/A output ch2 output scale	0	0	0	0	0	0	0
SP129	PM	Motor unique constants (H)	2	2	2	2	2	2	2
SP130	JM	Motor unique constants (H)	8	8	13	13	24	31	31
SP131	ATYP	Motor unique constants (H)	80	80	160	160	160	200	200
SP132			0	0	0	0	0	0	0
SP133	NR	Motor unique constants (H)	10000	12000	10000	12000	10000	8000	8000
SP134	NB	Motor unique constants (H)	1800	1800	1800	1800	1800	1500	1500
SP135	NF	Motor unique constants (H)	1800	1800	1800	1800	1800	1800	1800
SP136	KT	Motor unique constants (H)	1123	1123	1352	1352	1377	1355	1355
SP137	KF1	Motor unique constants (H)	67	67	73	73	68	73	73
SP138	KF2	Motor unique constants (H)	2880	2280	3023	3023	2963	2952	2952
SP139	KF3	Motor unique constants (H)	2939	2939	2652	2652	2796	2785	2785
SP140	KF4	Motor unique constants (H)	1884	1884	1922	1922	1900	1904	1904
SP141	KF5	Motor unique constants (H)	72	72	88	88	127	130	130
SP142	KF6	Motor unique constants (H)	0	0	0	0	0	0	0
SP143			0	0	0	0	0	0	0
SP144	TMIL	Motor unique constants (H)	0	0	0	0	0	0	0
SP145	TMBR	Motor unique constants (H)	460	473	424	468	466	404	404
SP146	TMBD	Motor unique constants (H)	423	427	429	432	434	432	432
SP147	KE	Motor unique constants (H)	82	82	73	73	83	82	82
SP148	LA	Motor unique constants (H)	1405	1405	1165	1165	940	701	701
SP149	IQSM	Motor unique constants (H)	3118	3118	3532	3532	5085	7045	7045
SP150	IDSM	Motor unique constants (H)	1189	1189	1525	1525	2197	2867	2867
SP151	R1	Motor unique constants (H)	259	259	167	167	105	68	68
SP152	TMLR	Motor unique constants (H)	90	90	90	90	90	90	90
SP153	TMLD	Motor unique constants (H)	120	120	120	120	120	120	120
SP154	TMLS	Motor unique constants (H)	150	150	150	150	150	150	150
SP155	KI1	Motor unique constants (H)	1100	1100	1065	1065	1075	1041	1041
SP156	PCNT	Motor unique constants (H)	0	0	0	0	0	0	0
SP157			0	0	0	0	0	0	0
SP158	DNB	Motor unique constants (H)	1500	1500	1500	1500	1500	0	0
SP159	SNB	Motor unique constants (H)	1500	1500	1500	1500	1500	0	0
SP160	BSD	Motor unique constants (H)	0	0	0	0	0	0	0
:			:	:	:	:	:	:	:
SP224			0	0	0	0	0	0	0
SP225	SFNC5	Spindle function 5	0000	0000	0000	0000	0000	0000	0000
SP226	SFNC6	Spindle function 6	1000	0100	1000	1000	1000	1000	1000
SP227	SFNC7	Spindle function 7	0000	0000	0000	0000	0000	0000	0000
:			:	:	:	:	:	:	:
SP232			0000	0000	0000	0000	0000	0000	0000
SP233	IVC	Voltage non-sensitive band compensation	0	0	0	0	0	0	0
:			:	:	:	:	:	:	:
SP236	WIH	Temperature compensation time constant	0	0	0	0	0	0	0
SP237	TCF	Torque command filter	500	500	500	500	500	500	500
SP238	SSCFEED	Safely limited speed	0	0	0	0	0	0	0
SP239	SSCRPM	Safely limited motor speed	0	0	0	0	0	0	0
SP240			0	0	0	0	0	0	0
:			:	:	:	:	:	:	:
SP256									

(4) 200V Standard motor SJ-DL Series (Low-inertia) / (Hollow shaft)

Parameter	Motor		200V Standard motor SJ-DL Series (Low-inertia)			200V Standard motor SJ-DL Series (Hollow shaft)	
			SJ-DL5.5/150-01T	SJ-DL5.5/200-01T	SJ-DL7.5/150-01T	SJ-DL5.5/200-01T-S	
			160 16080(L)	160 16080(L)	160 16080(L)	160 16080(L)	
No.	Abbrev.	Details	MDS-D2-SP- MDS-D2-SP2-	160 16080(L)	160 16080(L)	160 16080(L)	160 16080(L)
SP001	PGV	Position loop gain non-interpolation mode		15	15	15	15
SP002	PGN	Position loop gain interpolation mode		33	33	33	33
SP003	PGS	Position loop gain spindle synchronization		15	15	15	15
SP004				0	0	0	0
SP005	VGN1	Speed loop gain 1		150	150	150	150
SP006	VIA1	Speed loop lead compensation 1		1900	1900	1900	1900
SP007	VIL1	Speed loop delay compensation 1		0	0	0	0
SP008	VGN2	Speed loop gain 2		150	150	150	150
SP009	VIA2	Speed loop lead compensation 2		1900	1900	1900	1900
SP010	VIL2	Speed loop delay compensation 2		0	0	0	0
SP011				0	0	0	0
SP012				0	0	0	0
SP013				0	0	0	0
SP014	PY1	Minimum excitation rate 1		50	50	50	50
SP015	PY2	Minimum excitation rate 2		100	100	100	100
SP016	DDT	Phase alignment deceleration rate		20	20	20	20
SP017	SPEC1	Spindle specification 1		000C	000C	000C	000C
SP018	SPEC2	Spindle specification 2		0000	0000	0000	0000
SP019	RNG1	Sub side encoder resolution		2000	2000	2000	2000
SP020	RNG2	Main side encoder resolution		2000	2000	2000	2000
SP021	OLT	Overload detection time constant		60	60	60	60
SP022	OLL	Overload detection level		120	120	120	120
SP023	OD1	Excessive error detection width (interpolation mode - spindle synchronization)		120	120	120	120
SP024	INP	In-position width		875	875	875	875
SP025	INP2	2nd in-position width		875	875	875	875
SP026	TSP	Maximum motor speed		15000	20000	15000	20000
SP027	ZSP	Motor zero speed		50	50	25	50
SP028	SDTS	Speed detection set value		1500	2000	1500	2000
SP029	SDTR	Speed detection reset width		30	30	30	30
SP030	SDT2	2nd speed detection setting value		0	0	0	0
SP031	MTYP	Motor type		2200	2200	2200	2200
SP032	PTYP	Power supply type/ Regenerative resistor type		0000	0000	0000	0000
SP033	SFNC1	Spindle function 1		0000	0000	0000	0000
SP034	SFNC2	Spindle function 2		0000	0000	0000	0000
SP035	SFNC3	Spindle function 3		1600	1600	1600	1600
SP036	SFNC4	Spindle function 4		0000	0000	0000	0000
SP037	JL	Load inertia scale		100	100	100	100
SP038	FHz1	Notch filter frequency 1		0	0	0	0
:				:	:	:	:
SP046	FHz2	Notch filter frequency 2		0	0	0	0
SP047	EC	Inductive voltage compensation gain		100	100	100	100
SP048	LMC1	Lost motion compensation 1		0	0	0	0
:				:	:	:	:
SP052	DFBN	Dual feedback control non-sensitive band		0	0	0	0
SP053	ODS	Excessive error detection width (non-interpolation mode)		3000	4000	3000	4000
SP054	ORE	Overrun detection width in closed loop control		0	0	0	0
SP055	EMGx	Max. gate off delay time after emergency stop		20000	20000	20000	20000
SP056	EMGt	Deceleration time constant at emergency stop		300	300	300	300
SP057	GRA1	Spindle side gear ratio 1		1	1	1	1
SP058	GRA2	Spindle side gear ratio 2		1	1	1	1
SP059	GRA3	Spindle side gear ratio 3		1	1	1	1
SP060	GRA4	Spindle side gear ratio 4		1	1	1	1
SP061	GRB1	Motor side gear ratio 1		1	1	1	1
SP062	GRB2	Motor side gear ratio 2		1	1	1	1
SP063	GRB3	Motor side gear ratio 3		1	1	1	1
SP064	GRB4	Motor side gear ratio 4		1	1	1	1
SP065	TLM1	Torque limit 1		10	10	10	10
SP066	TLM2	Torque limit 2		10	10	10	10
SP067	TLM3	Torque limit 3		10	10	10	10
SP068	TLM4	Torque limit 4		10	10	10	10
SP069	PCMP	Phase alignment completion width		875	875	875	875
SP070	KDDT	Phase alignment deceleration rate scale		0	0	0	0
SP071	DIQM	Variable current limit during deceleration, lower limit value		75	55	40	55
SP072	DIQN	Variable current limit during deceleration, break point speed		11400	11400	6600	11400
SP073	VGVN	Variable speed gain target value		0	0	0	0
SP074	VGVS	Variable speed gain change start speed		0	0	0	0
SP075	DWSH	Slip compensation scale during regeneration high-speed coil		0	0	0	0

4 Setup

Parameter		Motor	200V Standard motor			200V Standard motor
			SJ-DL Series (Low-inertia)			SJ-DL Series (Hollow shaft)
			SJ-DL5.5/150-01T	SJ-DL5.5/200-01T	SJ-DL7.5/150-01T	SJ-DL5.5/200-01T-S
No.	Abbrev.	Details	160	160	160	160
		MDS-D2-SP- MDS-D2-SP2-	16080(L)	16080(L)	16080(L)	16080(L)
SP076	DWSL	Slip compensation scale during regeneration low-speed coil	0	0	0	0
SP077	IQA	Q axis current lead compensation	4096	4096	4096	4096
SP078	IDA	D axis current lead compensation	4096	4096	4096	4096
SP079	IQG	Q axis current gain	1024	1024	1024	1024
SP080	IDG	D axis current gain	1024	1024	1024	1024
SP081	IQAL	Q axis current lead compensation low-speed coil	0	0	0	0
:			:	:	:	:
SP088	FHz5	Notch filter frequency 5	0	0	0	0
SP089	TMKQ	Spindle output stabilizing gain Q axis	100	100	100	100
SP090	TMKD	Spindle output stabilizing gain D axis	0	0	0	0
:			:	:	:	:
SP112			0	0	0	0
SP113	OPLP	Current command value for open loop	0	0	0	0
SP114	MKT	Coil changeover gate cutoff timer	150	150	150	150
SP115	MKT2	Coil changeover current limit timer	250	250	250	250
SP116	MKIL	Coil changeover current limit value	120	120	120	120
SP117	SETM	Excessive speed deviation timer	12	12	12	12
SP118	MSFT	Magnetic pole shift amount	0	0	0	0
SP119			0	0	0	0
:			:	:	:	:
SP128	DA2MPY	D/A output ch2 output scale	0	0	0	0
SP129	PM	Motor unique constants (H)	2	2	2	2
SP130	JM	Motor unique constants (H)	5	5	16	5
SP131	ATYP	Motor unique constants (H)	160	160	160	160
SP132			0	0	0	0
SP133	NR	Motor unique constants (H)	15000	20000	15000	20000
SP134	NB	Motor unique constants (H)	3200	3200	1800	3200
SP135	NF	Motor unique constants (H)	4200	4200	2160	4200
SP136	KT	Motor unique constants (H)	429	429	963	429
SP137	KF1	Motor unique constants (H)	50	50	50	50
SP138	KF2	Motor unique constants (H)	2959	2959	3060	2959
SP139	KF3	Motor unique constants (H)	2642	2642	2550	2642
SP140	KF4	Motor unique constants (H)	1931	1931	1940	1931
SP141	KF5	Motor unique constants (H)	56	56	91	56
SP142	KF6	Motor unique constants (H)	0	0	0	0
SP143			0	0	0	0
SP144	TML	Motor unique constants (H)	0	0	0	0
SP145	TMBR	Motor unique constants (H)	253	345	460	345
SP146	TMBD	Motor unique constants (H)	340	436	440	436
SP147	KE	Motor unique constants (H)	84	84	80	84
SP148	LA	Motor unique constants (H)	296	296	559	296
SP149	IQSM	Motor unique constants (H)	5831	5831	6061	5831
SP150	IDSM	Motor unique constants (H)	2222	2222	2508	2222
SP151	R1	Motor unique constants (H)	56	56	58	56
SP152	TMLR	Motor unique constants (H)	90	90	90	90
SP153	TMLD	Motor unique constants (H)	120	120	120	120
SP154	TMLS	Motor unique constants (H)	150	150	150	150
SP155	KI1	Motor unique constants (H)	1050	1050	1050	1050
SP156	PCNT	Motor unique constants (H)	0	0	0	0
SP157			0	0	0	0
SP158	DNB	Motor unique constants (H)	0	0	0	0
SP159	SNB	Motor unique constants (H)	2100	2100	1227	2100
SP160	BSD	Motor unique constants (H)	0	0	0	0
SP161			0	0	0	0
:			:	:	:	:
SP224			0	0	0	0
SP225	SFNC5	Spindle function 5	0000	0000	0000	0000
SP226	SFNC6	Spindle function 6	1000	1000	1000	1000
SP227	SFNC7	Spindle function 7	0000	0000	0000	0000
:			:	:	:	:
SP232			0000	0000	0000	0000
SP233	IVC	Voltage non-sensitive band compensation	0	0	0	0
SP234			0	0	0	0
SP235	R2H	Temperature compensation gain	0	0	0	0
SP236	WIH	Temperature compensation time constant	0	0	0	0
SP237	TCF	Torque command filter	500	500	500	500
SP238	SSCFEED	Safely limited speed	0	0	0	0
SP239	SSCRPM	Safely limited motor speed	0	0	0	0
SP240			0	0	0	0
:			:	:	:	:
SP256						

(5) 200V Standard motor SJ-V Series (Normal)

Parameter			Motor	200V Standard motor SJ-V Series (Normal)					
				SJ-V2.2-01T	SJ-V7.5-03ZT	SJ-V11-08ZT	SJ-V11-13ZT	SJ-V15-01ZT	SJ-V15-09ZT
No.	Abbrev.	Details	MDS-D2-SP-	40	160	200	200	200	200
			MDS-D2-SP2-	4020(L) 4040S 8040(M)	16080S(L)	-	-	-	-
SP001	PGV	Position loop gain non-interpolation mode		15	15	15	15	15	15
SP002	PGN	Position loop gain interpolation mode		33	33	33	33	33	33
SP003	PGS	Position loop gain spindle synchronization		15	15	15	15	15	15
SP004				0	0	0	0	0	0
SP005	VGN1	Speed loop gain 1		150	150	150	150	150	150
SP006	VIA1	Speed loop lead compensation 1		1900	1900	1900	1900	1900	1900
SP007	VIL1	Speed loop delay compensation 1		0	0	0	0	0	0
SP008	VGN2	Speed loop gain 2		150	150	150	150	150	150
SP009	VIA2	Speed loop lead compensation 2		1900	1900	1900	1900	1900	1900
SP010	VIL2	Speed loop delay compensation 2		0	0	0	0	0	0
SP011				0	0	0	0	0	0
SP012				0	0	0	0	0	0
SP013				0	0	0	0	0	0
SP014	PY1	Minimum excitation rate 1		50	50	50	50	50	50
SP015	PY2	Minimum excitation rate 2		100	100	100	100	100	100
SP016	DDT	Phase alignment deceleration rate		20	20	20	20	20	20
SP017	SPEC1	Spindle specification 1		000C	000C	000C	000C	000C	000C
SP018	SPEC2	Spindle specification 2		0000	0000	0000	0000	0000	0000
SP019	RNG1	Sub side encoder resolution		4000	4000	4000	4000	4000	4000
SP020	RNG2	Main side encoder resolution		4000	4000	4000	4000	4000	4000
SP021	OLT	Overload detection time constant		60	60	60	60	60	60
SP022	OLL	Overload detection level		120	120	120	120	120	120
SP023	OD1	Excessive error detection width (interpolation mode - spindle synchronization)		120	120	120	120	120	120
SP024	INP	In-position width		875	875	875	875	875	875
SP025	INP2	2nd in-position width		875	875	875	875	875	875
SP026	TSP	Maximum motor speed		10000	12000	8000	10000	8000	8000
SP027	ZSP	Motor zero speed		25	25	25	25	25	25
SP028	SDTS	Speed detection set value		1000	1200	800	1000	800	800
SP029	SDTR	Speed detection reset width		30	30	30	30	30	30
SP030	SDT2	2nd speed detection setting value		0	0	0	0	0	0
SP031	MTYP	Motor type		2200	2200	2200	2200	2200	2200
SP032	PTYP	Power supply type/ Regenerative resistor type		0000	0000	0000	0000	0000	0000
SP033	SFNC1	Spindle function 1		0000	0000	0000	0000	0000	0000
SP034	SFNC2	Spindle function 2		0000	0000	0000	0000	0000	0000
SP035	SFNC3	Spindle function 3		1600	1600	1600	1600	1600	1600
SP036	SFNC4	Spindle function 4		0000	0000	0000	0000	0000	0000
SP037	JL	Load inertia scale		100	100	100	100	100	100
SP038	FHz1	Notch filter frequency 1		0	0	0	0	0	0
:				:	:	:	:	:	:
SP046	FHz2	Notch filter frequency 2		0	0	0	0	0	0
SP047	EC	Inductive voltage compensation gain		100	100	100	100	100	100
SP048	LMC1	Lost motion compensation 1		0	0	0	0	0	0
:				:	:	:	:	:	:
SP052	DFBN	Dual feedback control non-sensitive band		0	0	0	0	0	0
SP053	ODS	Excessive error detection width (non-interpolation mode)		2000	2400	1600	2000	1600	1600
SP054	ORE	Overrun detection width in closed loop control		0	0	0	0	0	0
SP055	EMGx	Max. gate off delay time after emergency stop		20000	20000	20000	20000	20000	20000
SP056	EMGt	Deceleration time constant at emergency stop		300	300	300	300	300	300
SP057	GRA1	Spindle side gear ratio 1		1	1	1	1	1	1
SP058	GRA2	Spindle side gear ratio 2		1	1	1	1	1	1
SP059	GRA3	Spindle side gear ratio 3		1	1	1	1	1	1
SP060	GRA4	Spindle side gear ratio 4		1	1	1	1	1	1
SP061	GRB1	Motor side gear ratio 1		1	1	1	1	1	1
SP062	GRB2	Motor side gear ratio 2		1	1	1	1	1	1
SP063	GRB3	Motor side gear ratio 3		1	1	1	1	1	1
SP064	GRB4	Motor side gear ratio 4		1	1	1	1	1	1
SP065	TLM1	Torque limit 1		10	10	10	10	10	10
SP066	TLM2	Torque limit 2		10	10	10	10	10	10
SP067	TLM3	Torque limit 3		10	10	10	10	10	10
SP068	TLM4	Torque limit 4		10	10	10	10	10	10
SP069	PCMP	Phase alignment completion width		875	875	875	875	875	875
SP070	KDDT	Phase alignment deceleration rate scale		0	0	0	0	0	0
SP071	DIQM	Variable current limit during deceleration, lower limit value		50	55	70	50	45	60
SP072	DIQN	Variable current limit during deceleration, break point speed		5000	7100	5700	5000	3700	5000

4 Setup

Parameter			Motor	200V Standard motor SJ-V Series (Normal)					
				SJ-V2.2-01T	SJ-V7.5-03ZT	SJ-V11-08ZT	SJ-V11-13ZT	SJ-V15-01ZT	SJ-V15-09ZT
No.	Abbrev.	Details	MDS-D2-SP-	40	160	200	200	200	200
			MDS-D2-SP2-	4020(L) 4040S 8040(M)	16080S(L)	-	-	-	-
SP073	VGVN	Variable speed gain target value		0	0	0	0	0	0
SP074	VGVS	Variable speed gain change start speed		0	0	0	0	0	0
SP075	DWSH	Slip compensation scale during regeneration high-speed coil		0	0	0	0	0	0
SP076	DWSL	Slip compensation scale during regeneration low-speed coil		0	0	0	0	0	0
SP077	IQA	Q axis current lead compensation		4096	4096	4096	4096	4096	4096
SP078	IDA	D axis current lead compensation		4096	4096	4096	4096	4096	4096
SP079	IQG	Q axis current gain		1024	1024	1024	1024	1024	1024
SP080	IDG	D axis current gain		1024	1024	1024	1024	1024	1024
SP081	IQAL	Q axis current lead compensation low-speed coil		0	0	0	0	0	0
:				:	:	:	:	:	:
SP113	OPLP	Current command value for open loop		0	0	0	0	0	0
SP114	MKT	Coil changeover gate cutoff timer		150	150	150	150	150	150
SP115	MKT2	Coil changeover current limit timer		250	250	250	250	250	250
SP116	MKIL	Coil changeover current limit value		120	120	120	120	120	120
SP117	SETM	Excessive speed deviation timer		12	12	12	12	12	12
SP118	MSFT	Magnetic pole shift amount		0	0	0	0	0	0
:				:	:	:	:	:	:
SP128	DA2MPY	D/A output ch2 output scale		0	0	0	0	0	0
SP129	PM	Motor unique constants (H)		2	2	2	2	2	2
SP130	JM	Motor unique constants (H)		7	25	30	30	58	58
SP131	ATYP	Motor unique constants (H)		40	160	200	200	200	200
SP132				0	0	0	0	0	0
SP133	NR	Motor unique constants (H)		10000	12000	8000	12000	8000	8000
SP134	NB	Motor unique constants (H)		1500	1500	1500	1500	1500	1500
SP135	NF	Motor unique constants (H)		1800	2100	2100	1800	1800	1800
SP136	KT	Motor unique constants (H)		1176	963	1053	1194	1517	1330
SP137	KF1	Motor unique constants (H)		68	73	68	68	73	73
SP138	KF2	Motor unique constants (H)		3035	3058	3028	3019	3005	3017
SP139	KF3	Motor unique constants (H)		2662	2683	2703	2744	2591	2601
SP140	KF4	Motor unique constants (H)		1918	1911	1911	1903	1937	1933
SP141	KF5	Motor unique constants (H)		113	170	172	170	203	203
SP142	KF6	Motor unique constants (H)		0	0	0	0	0	0
SP143				0	0	0	0	0	0
SP144	TMIL	Motor unique constants (H)		0	0	0	0	0	0
SP145	TMBR	Motor unique constants (H)		325	362	288	459	307	265
SP146	TMBD	Motor unique constants (H)		415	440	396	441	424	360
SP147	KE	Motor unique constants (H)		67	63	63	63	60	60
SP148	LA	Motor unique constants (H)		2735	607	553	696	618	473
SP149	IQSM	Motor unique constants (H)		1191	4958	6652	5865	6296	7177
SP150	IDSM	Motor unique constants (H)		517	1773	2124	1935	2614	3006
SP151	R1	Motor unique constants (H)		650	50	40	51	52	39
SP152	TMLR	Motor unique constants (H)		90	90	90	90	90	90
SP153	TMLD	Motor unique constants (H)		120	120	120	120	120	120
SP154	TMLS	Motor unique constants (H)		150	150	150	150	150	150
SP155	KI1	Motor unique constants (H)		1092	1048	1044	1046	1036	1036
SP156	PCNT	Motor unique constants (H)		0	0	0	0	0	0
SP157				0	0	0	0	0	0
SP158	DNB	Motor unique constants (H)		0	0	0	0	0	0
SP159	SNB	Motor unique constants (H)		0	0	0	0	0	0
SP160	BSD	Motor unique constants (H)		0	0	0	0	0	0
:				:	:	:	:	:	:
SP224				0	0	0	0	0	0
SP225	SFNC5	Spindle function 5		0000	0000	0000	0000	0000	0000
SP226	SFNC6	Spindle function 6		0000	0000	0000	0000	0000	0000
SP227	SFNC7	Spindle function 7		0000	0000	0000	0000	0000	0000
:				:	:	:	:	:	:
SP232				0000	0000	0000	0000	0000	0000
SP233	IVC	Voltage non-sensitive band compensation		0	0	0	0	0	0
SP234				0	0	0	0	0	0
SP235	R2H	Temperature compensation gain		0	0	0	0	0	0
SP236	WIH	Temperature compensation time constant		0	0	0	0	0	0
SP237	TCF	Torque command filter		500	500	500	500	500	500
SP238	SSCFEED	Safely limited speed		0	0	0	0	0	0
SP239	SSCRPM	Safely limited motor speed		0	0	0	0	0	0
SP240				0	0	0	0	0	0
:				:	:	:	:	:	:
SP256									

4 Setup

Parameter				200V Standard motor SJ-V Series (Normal)							
				Motor		SJ-V18.5-01ZT	SJ-V18.5-04ZT	SJ-V22-01ZT	SJ-V22-04ZT	SJ-V26-01ZT	SJ-V37-01ZT
No.	Abbrev.	Details	MDS-D2-SP-	200	240	240	320	320	400	640	640
SP001	PGV	Position loop gain non-interpolation mode		15	15	15	15	15	15	15	15
SP002	PGN	Position loop gain interpolation mode		33	33	33	33	33	33	33	33
SP003	PGS	Position loop gain spindle synchronization		15	15	15	15	15	15	15	15
SP004				0	0	0	0	0	0	0	0
SP005	VGN1	Speed loop gain 1		150	150	150	150	150	150	150	150
SP006	VIA1	Speed loop lead compensation 1		1900	1900	1900	1900	1900	1900	1900	1900
SP007	VIL1	Speed loop delay compensation 1		0	0	0	0	0	0	0	0
SP008	VGN2	Speed loop gain 2		150	150	150	150	150	150	150	150
SP009	VIA2	Speed loop lead compensation 2		1900	1900	1900	1900	1900	1900	1900	1900
SP010	VIL2	Speed loop delay compensation 2		0	0	0	0	0	0	0	0
SP011				0	0	0	0	0	0	0	0
SP012				0	0	0	0	0	0	0	0
SP013				0	0	0	0	0	0	0	0
SP014	PY1	Minimum excitation rate 1		50	50	50	50	50	50	50	50
SP015	PY2	Minimum excitation rate 2		100	100	100	100	100	100	100	100
SP016	DDT	Phase alignment deceleration rate		20	20	20	20	20	20	20	20
SP017	SPEC1	Spindle specification 1		000C	000C	000C	000C	000C	000C	000C	000C
SP018	SPEC2	Spindle specification 2		0000	0000	0000	0000	0000	0000	0000	0000
SP019	RNG1	Sub side encoder resolution		4000	4000	4000	4000	4000	4000	4000	4000
SP020	RNG2	Main side encoder resolution		4000	4000	4000	4000	4000	4000	4000	4000
SP021	OLT	Overload detection time constant		60	60	60	60	60	60	60	60
SP022	OLL	Overload detection level		120	120	120	120	120	120	120	120
SP023	OD1	Excessive error detection width (interpolation mode - spindle synchronization)		120	120	120	120	120	120	120	120
SP024	INP	In-position width		875	875	875	875	875	875	875	875
SP025	INP2	2nd in-position width		875	875	875	875	875	875	875	875
SP026	TSP	Maximum motor speed		8000	8000	8000	8000	8000	6000	6000	4500
SP027	ZSP	Motor zero speed		25	25	25	25	25	25	25	25
SP028	SDTS	Speed detection set value		800	800	800	800	800	600	600	450
SP029	SDTR	Speed detection reset width		30	30	30	30	30	30	30	30
SP030	SDT2	2nd speed detection setting value		0	0	0	0	0	0	0	0
SP031	MTYP	Motor type		2200	2200	2200	2200	2200	2200	2200	2200
SP032	PTYP	Power supply type/ Regenerative resistor type		0000	0000	0000	0000	0000	0000	0000	0000
SP033	SFNC1	Spindle function 1		0000	0000	0000	0000	0000	0000	0000	0000
SP034	SFNC2	Spindle function 2		0000	0000	0000	0000	0000	0000	0000	0000
SP035	SFNC3	Spindle function 3		1600	1600	1600	1600	1600	1600	1600	1600
SP036	SFNC4	Spindle function 4		0000	0000	0000	0000	0000	0000	0000	0000
SP037	JL	Load inertia scale		100	100	100	100	100	100	100	100
SP038	FHz1	Notch filter frequency 1		0	0	0	0	0	0	0	0
:				:	:	:	:	:	:	:	:
SP046	FHz2	Notch filter frequency 2		0	0	0	0	0	0	0	0
SP047	EC	Inductive voltage compensation gain		100	100	100	100	100	100	100	100
SP048	LMC1	Lost motion compensation 1		0	0	0	0	0	0	0	0
:				:	:	:	:	:	:	:	:
SP052	DFBN	Dual feedback control non-sensitive band		0	0	0	0	0	0	0	0
SP053	ODS	Excessive error detection width (non-interpolation mode)		1600	1600	1600	1600	1600	1200	1200	900
SP054	ORE	Overrun detection width in closed loop control		0	0	0	0	0	0	0	0
SP055	EMGx	Max. gate off delay time after emergency stop		20000	20000	20000	20000	20000	20000	20000	20000
SP056	EMGt	Deceleration time constant at emergency stop		300	300	300	300	300	300	300	300
SP057	GRA1	Spindle side gear ratio 1		1	1	1	1	1	1	1	1
SP058	GRA2	Spindle side gear ratio 2		1	1	1	1	1	1	1	1
SP059	GRA3	Spindle side gear ratio 3		1	1	1	1	1	1	1	1
SP060	GRA4	Spindle side gear ratio 4		1	1	1	1	1	1	1	1
SP061	GRB1	Motor side gear ratio 1		1	1	1	1	1	1	1	1
SP062	GRB2	Motor side gear ratio 2		1	1	1	1	1	1	1	1
SP063	GRB3	Motor side gear ratio 3		1	1	1	1	1	1	1	1
SP064	GRB4	Motor side gear ratio 4		1	1	1	1	1	1	1	1
SP065	TLM1	Torque limit 1		10	10	10	10	10	10	10	10
SP066	TLM2	Torque limit 2		10	10	10	10	10	10	10	10
SP067	TLM3	Torque limit 3		10	10	10	10	10	10	10	10
SP068	TLM4	Torque limit 4		10	10	10	10	10	10	10	10
SP069	PCMP	Phase alignment completion width		875	875	875	875	875	875	875	875
SP070	KDDT	Phase alignment deceleration rate scale		0	0	0	0	0	0	0	0
SP071	DIQM	Variable current limit during deceleration, lower limit value		45	60	45	60	80	45	80	60
SP072	DIQN	Variable current limit during deceleration, break point speed		3700	5000	3700	5000	5000	2800	3700	2800
SP073	VGVN	Variable speed gain target value		0	0	0	0	0	0	0	0
SP074	VGVS	Variable speed gain change start speed		0	0	0	0	0	0	0	0
SP075	DWSH	Slip compensation scale during regeneration high-speed coil		0	0	0	0	0	0	0	0

4 Setup

Parameter		Motor	200V Standard motor SJ-V Series (Normal)							
			SJ-V18.5-01ZT	SJ-V18.5-04ZT	SJ-V22-01ZT	SJ-V22-04ZT	SJ-V26-01ZT	SJ-V37-01ZT	SJ-V45-01ZT	SJ-V55-01ZT
No.	Abbrev.	Details	MDS-D2-SP-200	240	240	320	320	400	640	640
SP076	DWSL	Slip compensation scale during regeneration low-speed coil	0	0	0	0	0	0	0	0
SP077	IQA	Q axis current lead compensation	4096	4096	4096	4096	4096	4096	4096	4096
SP078	IDA	D axis current lead compensation	4096	4096	4096	4096	4096	4096	4096	4096
SP079	IQG	Q axis current gain	1024	1024	1024	1024	1024	1024	1024	1024
SP080	IDG	D axis current gain	1024	1024	1024	1024	1024	1024	1024	1024
SP081	IQAL	Q axis current lead compensation low-speed coil	0	0	0	0	0	0	0	0
:			:	:	:	:	:	:	:	:
SP088	FHz5	Notch filter frequency 5	0	0	0	0	0	0	0	0
SP089	TMKQ	Spindle output stabilizing gain Q axis	0	0	0	0	0	0	0	0
SP090	TMKD	Spindle output stabilizing gain D axis	0	0	0	0	0	0	0	0
:			:	:	:	:	:	:	:	:
SP112			0	0	0	0	0	0	0	0
SP113	OPLP	Current command value for open loop	0	0	0	0	0	0	0	0
SP114	MKT	Coil changeover gate cutoff timer	150	150	150	150	150	150	150	150
SP115	MKT2	Coil changeover current limit timer	250	250	250	250	250	250	250	250
SP116	MKIL	Coil changeover current limit value	120	120	120	120	120	120	120	120
SP117	SETM	Excessive speed deviation timer	12	12	12	12	12	12	12	12
SP118	MSFT	Magnetic pole shift amount	0	0	0	0	0	0	0	0
SP119			0	0	0	0	0	0	0	0
:			:	:	:	:	:	:	:	:
SP128	DA2MPY	D/A output ch2 output scale	0	0	0	0	0	0	0	0
SP129	PM	Motor unique constants (H)	2	2	2	2	2	2	2	2
SP130	JM	Motor unique constants (H)	58	58	80	80	93	340	340	853
SP131	ATYP	Motor unique constants (H)	200	240	240	320	320	400	640	640
SP132			0	0	0	0	0	0	0	0
SP133	NR	Motor unique constants (H)	8000	8000	8000	6000	8000	6000	6000	4500
SP134	NB	Motor unique constants (H)	1500	1500	1500	1500	1500	1500	1500	1150
SP135	NF	Motor unique constants (H)	1800	1800	1800	1800	1800	1380	1800	1380
SP136	KT	Motor unique constants (H)	1514	1312	1511	1365	1298	2018	1612	2179
SP137	KF1	Motor unique constants (H)	81	81	84	84	85	81	82	82
SP138	KF2	Motor unique constants (H)	2847	2847	2920	2887	2920	2951	3283	2986
SP139	KF3	Motor unique constants (H)	2847	2847	2755	2724	2755	2683	2345	2765
SP140	KF4	Motor unique constants (H)	1905	1905	1913	1923	1913	1924	1966	1903
SP141	KF5	Motor unique constants (H)	186	186	199	201	201	276	314	582
SP142	KF6	Motor unique constants (H)	0	0	0	0	0	0	0	0
SP143			0	0	0	0	0	0	0	0
SP144	TMIL	Motor unique constants (H)	0	0	0	0	0	0	0	0
SP145	TMBR	Motor unique constants (H)	333	284	244	192	240	242	225	193
SP146	TMBD	Motor unique constants (H)	434	389	331	255	325	328	304	259
SP147	KE	Motor unique constants (H)	65	65	62	61	61	74	66	49
SP148	LA	Motor unique constants (H)	538	404	392	325	243	274	219	214
SP149	IQSM	Motor unique constants (H)	7779	8979	9270	10259	12753	15226	17774	20961
SP150	IDSM	Motor unique constants (H)	3267	3768	4215	4567	5816	9830	8621	8727
SP151	R1	Motor unique constants (H)	46	34	29	24	17	14	11	11
SP152	TMLR	Motor unique constants (H)	90	90	90	90	90	90	90	90
SP153	TMLD	Motor unique constants (H)	120	120	120	120	120	120	120	120
SP154	TMLS	Motor unique constants (H)	150	150	150	150	150	150	150	150
SP155	KI1	Motor unique constants (H)	1039	1039	1036	1036	1036	1031	1025	1168
SP156	PCNT	Motor unique constants (H)	0	0	0	0	0	0	0	0
SP157			0	0	0	0	0	0	0	0
SP158	DNB	Motor unique constants (H)	0	0	0	0	0	0	0	0
SP159	SNB	Motor unique constants (H)	0	0	0	0	0	0	0	0
SP160	BSD	Motor unique constants (H)	0	0	0	0	0	0	0	0
SP161			0	0	0	0	0	0	0	0
:			:	:	:	:	:	:	:	:
SP224			0	0	0	0	0	0	0	0
SP225	SFNC5	Spindle function 5	0000	0000	0000	0000	0000	0000	0000	0000
SP226	SFNC6	Spindle function 6	0000	0000	0000	0000	0000	0000	0000	0000
SP227	SFNC7	Spindle function 7	0000	0000	0000	0000	0000	0000	0000	0000
:			:	:	:	:	:	:	:	:
SP232			0000	0000	0000	0000	0000	0000	0000	0000
SP233	IVC	Voltage non-sensitive band compensation	0	0	0	0	0	0	0	0
SP234			0	0	0	0	0	0	0	0
SP235	R2H	Temperature compensation gain	0	0	0	0	0	0	0	0
SP236	WIH	Temperature compensation time constant	0	0	0	0	0	0	0	0
SP237	TCF	Torque command filter	500	500	500	500	500	500	500	500
SP238	SSCFEED	Safely limited speed	0	0	0	0	0	0	0	0
SP239	SSCRPM	Safely limited motor speed	0	0	0	0	0	0	0	0
SP240			0	0	0	0	0	0	0	0
:			:	:	:	:	:	:	:	:
SP256										

(6) 200V Standard motor SJ-V Series (Wide range constant output)

Motor				200V Standard motor SJ-V Series (Wide range constant output)						
				SJ-V11-01T	SJ-V11-09T	SJ-V15-03T	SJ-V18.5-03T	SJ-V22-05T	SJ-V22-09T	SJ-VK22-192T
Parameter	No.	Abbrev.	Details	MDS-D2-SP-160	160	200	240	320	320	320
	SP001	PGV	Position loop gain non-interpolation mode		15	15	15	15	15	15
	SP002	PGN	Position loop gain interpolation mode		33	33	33	33	33	33
	SP003	PGS	Position loop gain spindle synchronization		15	15	15	15	15	15
	SP004				0	0	0	0	0	0
	SP005	VGN1	Speed loop gain 1		150	150	150	150	150	150
	SP006	VIA1	Speed loop lead compensation 1		1900	1900	1900	1900	1900	1900
	SP007	VIL1	Speed loop delay compensation 1		0	0	0	0	0	0
	SP008	VGN2	Speed loop gain 2		150	150	150	150	150	150
	SP009	VIA2	Speed loop lead compensation 2		1900	1900	1900	1900	1900	1900
	SP010	VIL2	Speed loop delay compensation 2		0	0	0	0	0	0
	SP011				0	0	0	0	0	0
	SP012				0	0	0	0	0	0
	SP013				0	0	0	0	0	0
	SP014	PY1	Minimum excitation rate 1		50	50	50	50	50	50
	SP015	PY2	Minimum excitation rate 2		100	100	100	100	100	100
	SP016	DDT	Phase alignment deceleration rate		20	20	20	20	20	20
	SP017	SPEC1	Spindle specification 1		000C	000C	000C	000C	000C	000C
	SP018	SPEC2	Spindle specification 2		0000	0000	0000	0000	0000	0020
	SP019	RNG1	Sub side encoder resolution		4000	4000	4000	4000	4000	4000
	SP020	RNG2	Main side encoder resolution		4000	4000	4000	4000	4000	4000
	SP021	OLT	Overload detection time constant		60	60	60	60	60	60
	SP022	OLL	Overload detection level		120	120	120	120	120	120
	SP023	OD1	Excessive error detection width (interpolation mode - spindle synchronization)		120	120	120	120	120	120
	SP024	INP	In-position width		875	875	875	875	875	875
	SP025	INP2	2nd in-position width		875	875	875	875	875	875
	SP026	TSP	Maximum motor speed		6000	6000	6000	8000	6000	4500
	SP027	ZSP	Motor zero speed		25	50	25	50	25	25
	SP028	SDTS	Speed detection set value		600	600	600	800	600	450
	SP029	SDTR	Speed detection reset width		30	30	30	30	30	30
	SP030	SDT2	2nd speed detection setting value		0	0	0	0	0	0
	SP031	MTYP	Motor type		2200	2200	2200	2200	2200	2200
	SP032	PTYP	Power supply type/ Regenerative resistor type		0000	0000	0000	0000	0000	0000
	SP033	SFNC1	Spindle function 1		0000	0000	0000	0000	0000	0000
	SP034	SFNC2	Spindle function 2		0000	0000	0000	0000	0000	0000
	SP035	SFNC3	Spindle function 3		1600	1600	1600	1600	1600	1600
	SP036	SFNC4	Spindle function 4		0000	0000	0000	0000	0000	0000
	SP037	JL	Load inertia scale		100	100	100	100	100	100
	SP038	FHz1	Notch filter frequency 1		0	0	0	0	0	0
	:				:	:	:	:	:	:
	SP046	FHz2	Notch filter frequency 2		0	0	0	0	0	0
	SP047	EC	Inductive voltage compensation gain		100	100	100	100	100	100
	SP048	LMC1	Lost motion compensation 1		0	0	0	0	0	0
	:				:	:	:	:	:	:
	SP052	DFBN	Dual feedback control non-sensitive band		0	0	0	0	0	0
	SP053	ODS	Excessive error detection width (non-interpolation mode)		1200	1200	1200	1600	1200	900
	SP054	ORE	Overrun detection width in closed loop control		0	0	0	0	0	0
	SP055	EMGx	Max. gate off delay time after emergency stop		20000	20000	20000	20000	20000	20000
	SP056	EMGt	Deceleration time constant at emergency stop		300	300	300	300	300	300
	SP057	GRA1	Spindle side gear ratio 1		1	1	1	1	1	1
	SP058	GRA2	Spindle side gear ratio 2		1	1	1	1	1	1
	SP059	GRA3	Spindle side gear ratio 3		1	1	1	1	1	1
	SP060	GRA4	Spindle side gear ratio 4		1	1	1	1	1	1
	SP061	GRB1	Motor side gear ratio 1		1	1	1	1	1	1
	SP062	GRB2	Motor side gear ratio 2		1	1	1	1	1	1
	SP063	GRB3	Motor side gear ratio 3		1	1	1	1	1	1
	SP064	GRB4	Motor side gear ratio 4		1	1	1	1	1	1
	SP065	TLM1	Torque limit 1		10	10	10	10	10	10
	SP066	TLM2	Torque limit 2		10	10	10	10	10	10
	SP067	TLM3	Torque limit 3		10	10	10	10	10	10
	SP068	TLM4	Torque limit 4		10	10	10	10	10	10
	SP069	PCMP	Phase alignment completion width		875	875	875	875	875	875
	SP070	KDDT	Phase alignment deceleration rate scale		0	0	0	0	0	0
	SP071	DIQM	Variable current limit during deceleration, lower limit value		60	100	50	35	60	65
	SP072	DIQN	Variable current limit during deceleration, break point speed		3700	3000	3100	3100	3700	2900
	SP073	VGVN	Variable speed gain target value		0	0	0	0	0	0
	SP074	VGVS	Variable speed gain change start speed		0	0	0	0	0	0
	SP075	DWSH	Slip compensation scale during regeneration high-speed coil		0	0	0	0	0	0
	SP076	DWSL	Slip compensation scale during regeneration low-speed coil		0	0	0	0	0	0

4 Setup

Parameter				200V Standard motor SJ-V Series (Wide range constant output)						
				SJ-V11-01T	SJ-V11-09T	SJ-V15-03T	SJ-V18.5-03T	SJ-V22-05T	SJ-V22-09T	SJ-VK22-192T
No.	Abbrev.	Details	MDS-D2-SP-	160	160	200	240	320	320	320
SP077	IQA	Q axis current lead compensation		4096	4096	4096	4096	4096	4096	4096
SP078	IDA	D axis current lead compensation		4096	4096	4096	4096	4096	4096	4096
SP079	IQG	Q axis current gain		1024	1024	1024	1024	1024	1024	1024
SP080	IDG	D axis current gain		1024	1024	1024	1024	1024	1024	1024
SP081	IQAL	Q axis current lead compensation low-speed coil		0	0	0	0	0	0	4096
SP082	IDAL	D axis current lead compensation low-speed coil		0	0	0	0	0	0	4096
SP083	IQGL	Q axis current gain low-speed coil		0	0	0	0	0	0	1024
SP084	IDGL	D axis current gain low-speed coil		0	0	0	0	0	0	1024
SP085				0	0	0	0	0	0	0
:				:	:	:	:	:	:	:
SP088	FHz5	Notch filter frequency 5		0	0	0	0	0	0	0
SP089	TMKQ	Spindle output stabilizing gain Q axis		0	0	0	0	0	0	0
SP090	TMKD	Spindle output stabilizing gain D axis		0	0	0	0	0	0	0
:				:	:	:	:	:	:	:
SP112				0	0	0	0	0	0	0
SP113	OPLP	Current command value for open loop		0	0	0	0	0	0	0
SP114	MKT	Coil changeover gate cutoff timer		150	150	150	150	150	150	150
SP115	MKT2	Coil changeover current limit timer		250	25	250	250	250	250	250
SP116	MKIL	Coil changeover current limit value		120	120	120	120	120	120	120
SP117	SETM	Excessive speed deviation timer		12	12	12	12	12	12	12
SP118	MSFT	Magnetic pole shift amount		0	0	0	0	0	0	0
SP119				0	0	0	0	0	0	0
:				:	:	:	:	:	:	:
SP128	DA2MPY	D/A output ch2 output scale		0	0	0	0	0	0	0
SP129	PM	Motor unique constants (L)		2	2	2	2	2	2	2
SP130	JM	Motor unique constants (L)		30	58	58	80	80	308	340
SP131	ATYP	Motor unique constants (L)		160	160	200	240	320	320	320
SP132				0	0	0	0	0	0	0
SP133	NR	Motor unique constants (L)		6000	8000	8000	8000	6000	4500	6000
SP134	NB	Motor unique constants (L)		1500	1100	1250	1250	1100	600	575
SP135	NF	Motor unique constants (L)		1800	1320	1500	1500	1320	720	690
SP136	KT	Motor unique constants (L)		1326	1893	1689	1791	1697	2897	3110
SP137	KF1	Motor unique constants (L)		68	68	73	81	84	84	84
SP138	KF2	Motor unique constants (L)		2854	3045	2886	2875	2772	2864	2970
SP139	KF3	Motor unique constants (L)		2744	2580	2775	2765	2888	3113	2652
SP140	KF4	Motor unique constants (L)		1922	1935	1913	1916	1906	1854	1928
SP141	KF5	Motor unique constants (L)		170	204	191	198	190	399	279
SP142	KF6	Motor unique constants (L)		0	0	0	0	0	0	0
SP143				0	0	0	0	0	0	0
SP144	TMIL	Motor unique constants (L)		0	0	0	0	0	0	0
SP145	TMBR	Motor unique constants (L)		266	396	322	346	310	419	463
SP146	TMBD	Motor unique constants (L)		362	435	435	436	428	436	437
SP147	KE	Motor unique constants (L)		64	60	64	62	64	61	73
SP148	LA	Motor unique constants (L)		861	966	692	549	465	751	665
SP149	IQSM	Motor unique constants (L)		5280	5044	6785	7892	11251	12087	11748
SP150	IDS	Motor unique constants (L)		1498	2083	2762	3595	4187	4156	6173
SP151	R1	Motor unique constants (L)		64	82	58	41	35	33	35
SP152	TMLR	Motor unique constants (L)		90	90	90	90	90	90	90
SP153	TMLD	Motor unique constants (L)		120	120	120	120	120	120	120
SP154	TMLS	Motor unique constants (L)		150	150	150	150	150	150	150
SP155	KI1	Motor unique constants (L)		1334	1048	1037	1037	1114	1038	1024
SP156	PCNT	Motor unique constants (L)		0	0	0	0	0	0	0
SP157				0	0	0	0	0	0	0
SP158	DNB	Motor unique constants (L)		750	750	750	750	750	500	0
SP159	SNB	Motor unique constants (L)		750	750	750	750	750	500	0
SP160	BSD	Motor unique constants (L)		0	0	0	0	0	0	0
SP161				0	0	0	0	0	0	0
:				:	:	:	:	:	:	:
SP164				0	0	0	0	0	0	0
SP165	NRL	Motor unique constants (L)		0	0	0	0	0	0	6000
SP166	NBL	Motor unique constants (L)		0	0	0	0	0	0	330
SP167	NFL	Motor unique constants (L)		0	0	0	0	0	0	396
SP168	KT	Motor unique constants (L)		0	0	0	0	0	0	5798
SP169	KF1L	Motor unique constants (L)		0	0	0	0	0	0	81
SP170	KF2L	Motor unique constants (L)		0	0	0	0	0	0	2756
SP171	KF3L	Motor unique constants (L)		0	0	0	0	0	0	3062
SP172	KF4L	Motor unique constants (L)		0	0	0	0	0	0	1879
SP173	KF5L	Motor unique constants (L)		0	0	0	0	0	0	243
SP174	KF6L	Motor unique constants (L)		0	0	0	0	0	0	0
SP175				0	0	0	0	0	0	0
SP176	TMILL	Motor unique constants (L)		0	0	0	0	0	0	0
SP177	TMBRL	Motor unique constants (L)		0	0	0	0	0	0	463
SP178	TMBDL	Motor unique constants (L)		0	0	0	0	0	0	437
SP179	KEL	Motor unique constants (L)		0	0	0	0	0	0	83
SP180	LAL	Motor unique constants (L)		0	0	0	0	0	0	1965
SP181	IQSML	Motor unique constants (L)		0	0	0	0	0	0	9234

4 Setup

Parameter				200V Standard motor SJ-V Series (Wide range constant output)						
				Motor			SJ-V11-01T	SJ-V11-09T	SJ-V15-03T	SJ-V18.5-03T
No.	Abbrev.	Details	MDS-D2-SP-	160	160	200	240	320	320	320
SP182	IDSML	Motor unique constants (L)		0	0	0	0	0	0	4453
SP183	R1L	Motor unique constants (L)		0	0	0	0	0	0	104
SP184				0	0	0	0	0	0	90
SP185	TMLRL	Motor unique constants (L)		0	0	0	0	0	0	120
SP186	TMLSL	Motor unique constants (L)		0	0	0	0	0	0	150
SP187	KI1L	Motor unique constants (L)		0	0	0	0	0	0	1078
SP188	PCNTL	Motor unique constants (L)		0	0	0	0	0	0	0
:				:	:	:	:	:	:	:
SP224				0	0	0	0		0	0
SP225	SFNC5	Spindle function 5		0000	0000	0000	0000	0000	0000	0000
SP226	SFNC6	Spindle function 6		0000	0000	0000	0000	0000	0000	0000
SP227	SFNC7	Spindle function 7		0000	0000	0000	0000	0000	0000	0000
:				:	:	:	:	:	:	:
SP232				0000	0000	0000	0000	0000	0000	0000
SP233	IVC	Voltage non-sensitive band compensation		0	0	0	0	0	0	0
SP234				0	0	0	0	0	0	0
SP235	R2H	Temperature compensation gain		0	0	0	0	0	0	0
SP236	WIH	Temperature compensation time constant		0	0	0	0	0	0	0
SP237	TCF	Torque command filter		500	500	500	500	500	500	500
SP238	SSCFEED	Safely limited speed		0	0	0	0	0	0	0
SP239	SSCRPM	Safely limited motor speed		0	0	0	0	0	0	0
SP240				0	0	0	0	0	0	0
:										
SP256										

(7) 200V Standard motor SJ-VL Series (Low-inertia)

Parameter				200V Standard motor SJ-VL Series (Low-inertia)			
				Motor		SJ-VL2.2-02ZT	SJ-VL11-02FZT
No.	Abbrev.	Details	MDS-D2-SP-40 4020(L) 4040S 8040(M)	160 16080S(L)	160 16080S(L)	240 -	
SP001	PGV	Position loop gain non-interpolation mode	15	15	15	15	
SP002	PGN	Position loop gain interpolation mode	33	33	33	33	
SP003	PGS	Position loop gain spindle synchronization	15	15	15	15	
SP004			0	0	0	0	
SP005	VGN1	Speed loop gain 1	150	150	150	150	
SP006	VIA1	Speed loop lead compensation 1	1900	1900	1900	1900	
SP007	VIL1	Speed loop delay compensation 1	0	0	0	0	
SP008	VGN2	Speed loop gain 2	150	150	150	150	
SP009	VIA2	Speed loop lead compensation 2	1900	1900	1900	1900	
SP010	VIL2	Speed loop delay compensation 2	0	0	0	0	
SP011			0	0	0	0	
SP012			0	0	0	0	
SP013			0	0	0	0	
SP014	PY1	Minimum excitation rate 1	50	50	50	50	
SP015	PY2	Minimum excitation rate 2	100	100	100	100	
SP016	DDT	Phase alignment deceleration rate	20	20	20	20	
SP017	SPEC1	Spindle specification 1	000C	000C	000C	000C	
SP018	SPEC2	Spindle specification 2	0000	0000	0000	0000	
SP019	RNG1	Sub side encoder resolution	2000	2000	2000	2000	
SP020	RNG2	Main side encoder resolution	2000	2000	2000	2000	
SP021	OLT	Overload detection time constant	60	60	60	60	
SP022	OLL	Overload detection level	120	120	120	120	
SP023	OD1	Excessive error detection width (interpolation mode - spindle synchronization)	120	120	120	120	
SP024	INP	In-position width	875	875	875	875	
SP025	INP2	2nd in-position width	875	875	875	875	
SP026	TSP	Maximum motor speed	15000	15000	20000	15000	
SP027	ZSP	Motor zero speed	25	25	25	25	
SP028	SDTS	Speed detection set value	1500	1500	2000	1500	
SP029	SDTR	Speed detection reset width	30	30	30	30	
SP030	SDT2	2nd speed detection setting value	0	0	0	0	
SP031	MTYP	Motor type	2200	2200	2200	2200	
SP032	PTYP	Power supply type/ Regenerative resistor type	0000	0000	0000	0000	
SP033	SFNC1	Spindle function 1	0000	0000	0000	0000	
SP034	SFNC2	Spindle function 2	0000	0000	0000	0000	
SP035	SFNC3	Spindle function 3	1600	1600	1600	1600	
SP036	SFNC4	Spindle function 4	0000	0000	0000	0000	
SP037	JL	Load inertia scale	100	100	100	100	
SP038	FHz1	Notch filter frequency 1	0	0	0	0	
:			:	:	:	:	
SP046	FHz2	Notch filter frequency 2	0	0	0	0	
SP047	EC	Inductive voltage compensation gain	100	100	100	100	
SP048	LMC1	Lost motion compensation 1	0	0	0	0	
:			:	:	:	:	
SP052	DFBN	Dual feedback control non-sensitive band	0	0	0	0	
SP053	ODS	Excessive error detection width (non-interpolation mode)	3000	3000	4000	3000	
SP054	ORE	Overrun detection width in closed loop control	0	0	0	0	
SP055	EMGx	Max. gate off delay time after emergency stop	20000	20000	20000	20000	
SP056	EMGt	Deceleration time constant at emergency stop	300	300	300	300	
SP057	GRA1	Spindle side gear ratio 1	1	1	1	1	
SP058	GRA2	Spindle side gear ratio 2	1	1	1	1	
SP059	GRA3	Spindle side gear ratio 3	1	1	1	1	
SP060	GRA4	Spindle side gear ratio 4	1	1	1	1	
SP061	GRB1	Motor side gear ratio 1	1	1	1	1	
SP062	GRB2	Motor side gear ratio 2	1	1	1	1	
SP063	GRB3	Motor side gear ratio 3	1	1	1	1	
SP064	GRB4	Motor side gear ratio 4	1	1	1	1	
SP065	TLM1	Torque limit 1	10	10	10	10	
SP066	TLM2	Torque limit 2	10	10	10	10	
SP067	TLM3	Torque limit 3	10	10	10	10	
SP068	TLM4	Torque limit 4	10	10	10	10	
SP069	PCMP	Phase alignment completion width	875	875	875	875	
SP070	KDDT	Phase alignment deceleration rate scale	0	0	0	0	
SP071	DIQM	Variable current limit during deceleration, lower limit value	80	55	75	80	
SP072	DIQN	Variable current limit during deceleration, break point speed	12500	8300	15000	12500	
SP073	VGVN	Variable speed gain target value	0	0	0	0	
SP074	VGVS	Variable speed gain change start speed	0	0	0	0	

4 Setup

Parameter				200V Standard motor SJ-VL Series (Low-inertia)			
				SJ-VL2.2-02ZT	SJ-VL11-02FZT	SJ-VL11-05FZT-S01	SJ-VL18.5-05FZT
No.	Abbrev.	Details	MDS-D2-SP-	40	160	160	240
			MDS-D2-SP2-	4020(L) 4040S 8040(M)	16080S(L)	16080S(L)	-
SP075	DWSH	Slip compensation scale during regeneration high-speed coil		0	0	0	0
SP076	DWSL	Slip compensation scale during regeneration low-speed coil		0	0	0	0
SP077	IQA	Q axis current lead compensation		4096	4096	4096	4096
SP078	IDA	D axis current lead compensation		4096	4096	4096	4096
SP079	IQG	Q axis current gain		1024	1024	1024	1024
SP080	IDG	D axis current gain		1024	1024	1024	1024
SP081	IQAL	Q axis current lead compensation low-speed coil		0	0	0	0
:				:	:	:	:
SP113	OPLP	Current command value for open loop		0	0	0	0
SP114	MKT	Coil changeover gate cutoff timer		150	150	150	150
SP115	MKT2	Coil changeover current limit timer		250	250	250	250
SP116	MKIL	Coil changeover current limit value		120	120	120	120
SP117	SETM	Excessive speed deviation timer		12	12	12	12
SP118	MSFT	Magnetic pole shift amount		0	0	0	0
:				:	:	:	:
SP128	DA2MPY	D/A output ch2 output scale		0	0	0	0
SP129	PM	Motor unique constants (H)		1	1	1	1
SP130	JM	Motor unique constants (H)		2	3	2	5
SP131	ATYP	Motor unique constants (H)		40	160	160	240
SP132				0	0	0	0
SP133	NR	Motor unique constants (H)		15000	15000	20000	15000
SP134	NB	Motor unique constants (H)		3000	4000	6000	5000
SP135	NF	Motor unique constants (H)		3600	4800	7200	6000
SP136	KT	Motor unique constants (H)		647	538	341	391
SP137	KF1	Motor unique constants (H)		68	34	68	81
SP138	KF2	Motor unique constants (H)		3123	2589	2897	2845
SP139	KF3	Motor unique constants (H)		2560	3082	3082	3092
SP140	KF4	Motor unique constants (H)		1930	1894	1855	1861
SP141	KF5	Motor unique constants (H)		105	90	87	176
SP142	KF6	Motor unique constants (H)		0	0	0	0
SP143				0	0	0	0
SP144	TMIL	Motor unique constants (H)		0	0	0	0
SP145	TMBR	Motor unique constants (H)		139	197	172	193
SP146	TMBD	Motor unique constants (H)		176	260	224	257
SP147	KE	Motor unique constants (H)		36	44	42	41
SP148	LA	Motor unique constants (H)		1758	557	400	296
SP149	IQSM	Motor unique constants (H)		1082	4881	5131	9042
SP150	IDSM	Motor unique constants (H)		460	1474	1260	1870
SP151	R1	Motor unique constants (H)		585	98	130	44
SP152	TMLR	Motor unique constants (H)		90	90	90	90
SP153	TMLD	Motor unique constants (H)		120	120	120	120
SP154	TMLS	Motor unique constants (H)		150	150	150	150
SP155	KI1	Motor unique constants (H)		1080	1039	1068	1043
SP156	PCNT	Motor unique constants (H)		0	0	0	0
SP157				0	0	0	0
SP158	DNB	Motor unique constants (H)		0	0	0	0
SP159	SNB	Motor unique constants (H)		0	1500	5000	1486
SP160	BSD	Motor unique constants (H)		0	0	0	0
:				:	:	:	:
SP224				0	0	0	0
SP225	SFNC5	Spindle function 5		0000	0000	0000	0000
SP226	SFNC6	Spindle function 6		0000	0000	0000	0000
SP227	SFNC7	Spindle function 7		0000	0000	0000	0000
:				:	:	:	:
SP232				0000	0000	0000	0000
SP233	IVC	Voltage non-sensitive band compensation		0	0	0	0
SP234				0	0	0	0
SP235	R2H	Temperature compensation gain		0	0	0	0
SP236	WIH	Temperature compensation time constant		0	0	0	0
SP237	TCF	Torque command filter		500	500	500	500
SP238	SSCFEED	Safely limited speed		0	0	0	0
SP239	SSCRPM	Safely limited motor speed		0	0	0	0
SP240				0	0	0	0
:				:	:	:	:
SP256							

(8) 400V Standard motor SJ-4-V Series (Normal)

Parameter				400V Standard motor SJ-4-V Series (Normal)					
				Motor		SJ-4-V2.2	SJ-4-V3.7	SJ-4-V5.5	SJ-4-V7.5
No.	Abbrev.	Details	MDS-DH2-SP-	-03T	-03T	-07T	-12T	-132T	-18T
				20	20	40	40	80	80
SP001	PGV	Position loop gain non-interpolation mode		15	15	15	15	15	15
SP002	PGN	Position loop gain interpolation mode		33	33	33	33	33	33
SP003	PGS	Position loop gain spindle synchronization		15	15	15	15	15	15
SP004				0	0	0	0	0	0
SP005	VGN1	Speed loop gain 1		150	150	150	150	150	150
SP006	VIA1	Speed loop lead compensation 1		1900	1900	1900	1900	1900	1900
SP007	VIL1	Speed loop delay compensation 1		0	0	0	0	0	0
SP008	VGN2	Speed loop gain 2		150	150	150	150	150	150
SP009	VIA2	Speed loop lead compensation 2		1900	1900	1900	1900	1900	1900
SP010	VIL2	Speed loop delay compensation 2		0	0	0	0	0	0
SP011				0	0	0	0	0	0
SP012				0	0	0	0	0	0
SP013				0	0	0	0	0	0
SP014	PY1	Minimum excitation rate 1		50	50	50	50	50	50
SP015	PY2	Minimum excitation rate 2		100	100	100	100	100	100
SP016	DDT	Phase alignment deceleration rate		20	20	20	20	20	20
SP017	SPEC1	Spindle specification 1		200C	200C	200C	200C	200C	200C
SP018	SPEC2	Spindle specification 2		0000	0000	0000	0000	0000	0000
SP019	RNG1	Sub side encoder resolution		4000	4000	4000	4000	4000	4000
SP020	RNG2	Main side encoder resolution		4000	4000	4000	4000	4000	4000
SP021	OLT	Overload detection time constant		60	60	60	60	60	60
SP022	OLL	Overload detection level		120	120	120	120	120	120
SP023	OD1	Excessive error detection width (interpolation mode - spindle synchronization)		120	120	120	120	120	120
SP024	INP	In-position width		875	875	875	875	875	875
SP025	INP2	2nd in-position width		875	875	875	875	875	875
SP026	TSP	Maximum motor speed		10000	10000	8000	8000	12000	8000
SP027	ZSP	Motor zero speed		25	25	25	25	25	25
SP028	SDTS	Speed detection set value		1000	1000	800	800	1200	800
SP029	SDTR	Speed detection reset width		30	30	30	30	30	30
SP030	SDT2	2nd speed detection setting value		0	0	0	0	0	0
SP031	MTYP	Motor type		2200	2200	2200	2200	2200	2200
SP032	PTYP	Power supply type/ Regenerative resistor type		0000	0000	0000	0000	0000	0000
SP033	SFNC1	Spindle function 1		0000	0000	0000	0000	0000	0000
SP034	SFNC2	Spindle function 2		0000	0000	0000	0000	0000	0000
SP035	SFNC3	Spindle function 3		1600	1600	1600	1600	1600	1600
SP036	SFNC4	Spindle function 4		0000	0000	0000	0000	0000	0000
SP037	JL	Load inertia scale		100	100	100	100	100	100
SP038	FHz1	Notch filter frequency 1		0	0	0	0	0	0
:				:	:	:	:	:	:
SP046	FHz2	Notch filter frequency 2		0	0	0	0	0	0
SP047	EC	Inductive voltage compensation gain		100	100	100	100	100	100
SP048	LMC1	Lost motion compensation 1		0	0	0	0	0	0
:				:	:	:	:	:	:
SP052	DFBN	Dual feedback control non-sensitive band		0	0	0	0	0	0
SP053	ODS	Excessive error detection width (non-interpolation mode)		2000	2000	1600	1600	2400	1600
SP054	ORE	Overrun detection width in closed loop control		0	0	0	0	0	0
SP055	EMGx	Max. gate off delay time after emergency stop		20000	20000	20000	20000	20000	20000
SP056	EMGt	Deceleration time constant at emergency stop		300	300	300	300	300	300
SP057	GRA1	Spindle side gear ratio 1		1	1	1	1	1	1
SP058	GRA2	Spindle side gear ratio 2		1	1	1	1	1	1
SP059	GRA3	Spindle side gear ratio 3		1	1	1	1	1	1
SP060	GRA4	Spindle side gear ratio 4		1	1	1	1	1	1
SP061	GRB1	Motor side gear ratio 1		1	1	1	1	1	1
SP062	GRB2	Motor side gear ratio 2		1	1	1	1	1	1
SP063	GRB3	Motor side gear ratio 3		1	1	1	1	1	1
SP064	GRB4	Motor side gear ratio 4		1	1	1	1	1	1
SP065	TLM1	Torque limit 1		10	10	10	10	10	10
SP066	TLM2	Torque limit 2		10	10	10	10	10	10
SP067	TLM3	Torque limit 3		10	10	10	10	10	10
SP068	TLM4	Torque limit 4		10	10	10	10	10	10
SP069	PCMP	Phase alignment completion width		875	875	875	875	875	875
SP070	KDDT	Phase alignment deceleration rate scale		0	0	0	0	0	0
SP071	DIQM	Variable current limit during deceleration, lower limit value		50	50	75	60	60	45
SP072	DIQN	Variable current limit during deceleration, break point speed		5000	5000	6000	5000	7600	3700
SP073	VGVN	Variable speed gain target value		0	0	0	0	0	0
SP074	VGVS	Variable speed gain change start speed		0	0	0	0	0	0
SP075	DWSH	Slip compensation scale during regeneration high-speed coil		0	0	0	0	0	0
SP076	DWSL	Slip compensation scale during regeneration low-speed coil		0	0	0	0	0	0

4 Setup

Parameter				400V Standard motor SJ-4-V Series (Normal)					
				SJ-4-V2.2 -03T	SJ-4-V3.7 -03T	SJ-4-V5.5 -07T	SJ-4-V7.5 -12T	SJ-4-V7.5 -13ZT	SJ-4-V11 -18T
No.	Abbrev.	Details	MDS-DH2-SP-	20	20	40	40	80	80
SP077	IQA	Q axis current lead compensation		4096	4096	4096	4096	4096	4096
SP078	IDA	D axis current lead compensation		4096	4096	4096	4096	4096	4096
SP079	IQG	Q axis current gain		1024	1024	1024	1024	1024	1024
SP080	IDG	D axis current gain		1024	1024	1024	1024	1024	1024
SP081	IQAL	Q axis current lead compensation low-speed coil		0	0	0	0	0	0
:				:	:	:	:	:	:
SP088	FHz5	Notch filter frequency 5		0	0	0	0	0	0
SP089	TMKQ	Spindle output stabilizing gain Q axis		0	0	0	0	0	100
SP090	TMKD	Spindle output stabilizing gain D axis		0	0	0	0	0	0
:				:	:	:	:	:	:
SP112				0	0	0	0	0	0
SP113	OPLP	Current command value for open loop		0	0	0	0	0	0
SP114	MKT	Coil changeover gate cutoff timer		150	150	150	150	150	150
SP115	MKT2	Coil changeover current limit timer		250	250	250	250	250	250
SP116	MKIL	Coil changeover current limit value		120	120	120	120	120	120
SP117	SETM	Excessive speed deviation timer		12	12	12	12	12	12
SP118	MSFT	Magnetic pole shift amount		0	0	0	0	0	0
SP119				0	0	0	0	0	0
:				:	:	:	:	:	:
SP128	DA2MPY	D/A output ch2 output scale		0	0	0	0	0	0
SP129	PM	Motor unique constants (H)		2	2	2	2	2	2
SP130	JM	Motor unique constants (H)		7	9	15	25	25	30
SP131	ATYP	Motor unique constants (H)		20	20	40	40	80	80
SP132				0	0	0	0	0	0
SP133	NR	Motor unique constants (H)		10000	10000	8000	8000	12000	8000
SP134	NB	Motor unique constants (H)		1500	1500	1800	1500	1500	1500
SP135	NF	Motor unique constants (H)		1800	1800	1800	1800	1950	1800
SP136	KT	Motor unique constants (H)		2354	2281	2596	2443	1926	2645
SP137	KF1	Motor unique constants (H)		68	59	67	73	73	68
SP138	KF2	Motor unique constants (H)		3053	3105	3198	3028	3058	3062
SP139	KF3	Motor unique constants (H)		2632	2632	2499	2703	2683	2734
SP140	KF4	Motor unique constants (H)		1923	1916	1936	1911	1911	1899
SP141	KF5	Motor unique constants (H)		114	122	137	168	170	171
SP142	KF6	Motor unique constants (H)		0	0	0	0	0	0
SP143				0	0	0	0	0	0
SP144	TMIL	Motor unique constants (H)		0	0	0	0	0	0
SP145	TMBR	Motor unique constants (H)		333	325	155	298	363	367
SP146	TMBD	Motor unique constants (H)		417	421	202	410	440	436
SP147	KE	Motor unique constants (H)		67	65	60	63	63	63
SP148	LA	Motor unique constants (H)		11173	7300	5175	3873	2433	3443
SP149	IQSM	Motor unique constants (H)		595	1033	1349	1955	2479	2648
SP150	IDSMS	Motor unique constants (H)		251	360	535	711	886	863
SP151	R1	Motor unique constants (H)		2559	1454	735	333	204	267
SP152	TMLR	Motor unique constants (H)		90	90	90	90	90	90
SP153	TMLD	Motor unique constants (H)		120	120	120	120	120	120
SP154	TMLS	Motor unique constants (H)		150	150	150	150	150	150
SP155	KI1	Motor unique constants (H)		1097	1061	1111	1048	1100	1045
SP156	PCNT	Motor unique constants (H)		0	0	0	0	0	0
SP157				0	0	0	0	0	0
SP158	DNB	Motor unique constants (H)		0	0	1500	0	0	0
SP159	SNB	Motor unique constants (H)		0	0	1500	0	0	0
SP160	BSD	Motor unique constants (H)		0	0	0	0	0	0
SP161				0	0	0	0	0	0
:				:	:	:	:	:	:
SP224				0	0	0	0	0	0
SP225	SFNC5	Spindle function 5		0000	0000	0000	0000	0000	0000
SP226	SFNC6	Spindle function 6		0000	0000	0000	0000	0000	1000
SP227	SFNC7	Spindle function 7		0000	0000	0000	0000	0000	0000
:				:	:	:	:	:	:
SP232				0000	0000	0000	0000	0000	0000
SP233	IVC	Voltage non-sensitive band compensation		0	0	0	0	0	0
SP234				0	0	0	0	0	0
SP235	R2H	Temperature compensation gain		0	0	0	0	0	0
SP236	WIH	Temperature compensation time constant		0	0	0	0	0	0
SP237	TCF	Torque command filter		500	500	500	500	500	500
SP238	SSCFEED	Safely limited speed		0	0	0	0	0	0
SP239	SSCRPM	Safely limited motor speed		0	0	0	0	0	0
SP240				0	0	0	0	0	0
:				:	:	:	:	:	:
SP256									

Parameter				400V Standard motor SJ-4-V Series (Normal)			
				SJ-4-V18.5-14T	SJ-4-V22-15T	SJ-4-V45-02T	SJ-4-V55-03T
No.	Abbrev.	Details	MDS-DH2-SP-100	160	320	320	
SP001	PGV	Position loop gain non-interpolation mode	15	15	15	15	
SP002	PGN	Position loop gain interpolation mode	33	33	33	33	
SP003	PGS	Position loop gain spindle synchronization	15	15	15	15	
SP004			0	0	0	0	
SP005	VGN1	Speed loop gain 1	150	150	150	150	
SP006	VIA1	Speed loop lead compensation 1	1900	1900	1900	1900	
SP007	VIL1	Speed loop delay compensation 1	0	0	0	0	
SP008	VGN2	Speed loop gain 2	150	150	150	150	
SP009	VIA2	Speed loop lead compensation 2	1900	1900	1900	1900	
SP010	VIL2	Speed loop delay compensation 2	0	0	0	0	
SP011			0	0	0	0	
SP012			0	0	0	0	
SP013			0	0	0	0	
SP014	PY1	Minimum excitation rate 1	50	50	50	50	
SP015	PY2	Minimum excitation rate 2	100	100	100	100	
SP016	DDT	Phase alignment deceleration rate	20	20	20	20	
SP017	SPEC1	Spindle specification 1	200C	200C	200C	200C	
SP018	SPEC2	Spindle specification 2	0000	0000	0000	0000	
SP019	RNG1	Sub side encoder resolution	4000	4000	4000	4000	
SP020	RNG2	Main side encoder resolution	4000	4000	4000	4000	
SP021	OLT	Overload detection time constant	60	60	60	60	
SP022	OLL	Overload detection level	120	120	120	120	
SP023	OD1	Excessive error detection width (interpolation mode - spindle synchronization)	120	120	120	120	
SP024	INP	In-position width	875	875	875	875	
SP025	INP2	2nd in-position width	875	875	875	875	
SP026	TSP	Maximum motor speed	6000	6000	3450	3450	
SP027	ZSP	Motor zero speed	25	25	25	25	
SP028	SDTS	Speed detection set value	600	600	345	345	
SP029	SDTR	Speed detection reset width	30	30	30	30	
SP030	SDT2	2nd speed detection setting value	0	0	0	0	
SP031	MTYP	Motor type	2200	2200	2200	2200	
SP032	PTYP	Power supply type/ Regenerative resistor type	0000	0000	0000	0000	
SP033	SFNC1	Spindle function 1	0000	0000	0000	0000	
SP034	SFNC2	Spindle function 2	0000	0000	0000	0000	
SP035	SFNC3	Spindle function 3	1600	1600	1600	1600	
SP036	SFNC4	Spindle function 4	0000	0000	0000	0000	
SP037	JL	Load inertia scale	100	100	100	100	
SP038	FHz1	Notch filter frequency 1	0	0	0	0	
:			:	:	:	:	
SP046	FHz2	Notch filter frequency 2	0	0	0	0	
SP047	EC	Inductive voltage compensation gain	100	100	100	100	
SP048	LMC1	Lost motion compensation 1	0	0	0	0	
:							
SP052	DFBN	Dual feedback control non-sensitive band	0	0	0	0	
SP053	ODS	Excessive error detection width (non-interpolation mode)	1200	1200	690	690	
SP054	ORE	Overrun detection width in closed loop control	0	0	0	0	
SP055	EMGx	Max. gate off delay time after emergency stop	20000	20000	20000	20000	
SP056	EMGt	Deceleration time constant at emergency stop	300	300	300	300	
SP057	GRA1	Spindle side gear ratio 1	1	1	1	1	
SP058	GRA2	Spindle side gear ratio 2	1	1	1	1	
SP059	GRA3	Spindle side gear ratio 3	1	1	1	1	
SP060	GRA4	Spindle side gear ratio 4	1	1	1	1	
SP061	GRB1	Motor side gear ratio 1	1	1	1	1	
SP062	GRB2	Motor side gear ratio 2	1	1	1	1	
SP063	GRB3	Motor side gear ratio 3	1	1	1	1	
SP064	GRB4	Motor side gear ratio 4	1	1	1	1	
SP065	TLM1	Torque limit 1	10	10	10	10	
SP066	TLM2	Torque limit 2	10	10	10	10	
SP067	TLM3	Torque limit 3	10	10	10	10	
SP068	TLM4	Torque limit 4	10	10	10	10	
SP069	PCMP	Phase alignment completion width	875	875	875	875	
SP070	KDDT	Phase alignment deceleration rate scale	0	0	0	0	
SP071	DIQM	Variable current limit during deceleration, lower limit value	60	60	80	80	
SP072	DIQN	Variable current limit during deceleration, break point speed	3700	3700	2800	2800	
SP073	VGVN	Variable speed gain target value	0	0	0	0	
SP074	VGVS	Variable speed gain change start speed	0	0	0	0	
SP075	DWSH	Slip compensation scale during regeneration high-speed coil	0	0	0	0	
SP076	DWSL	Slip compensation scale during regeneration low-speed coil	0	0	0	0	
SP077	IQA	Q axis current lead compensation	4096	4096	4096	4096	
SP078	IDA	D axis current lead compensation	4096	4096	4096	4096	

4 Setup

Parameter				Motor			
				400V Standard motor SJ-4-V Series (Normal)			
No.	Abbrev.	Details	MDS-DH2-SP-	SJ-4-V18.5-14T	SJ-4-V22-15T	SJ-4-V45-02T	SJ-4-V55-03T
				100	160	320	320
SP079	IQG	Q axis current gain		1024	1024	1024	1024
SP080	IDG	D axis current gain		1024	1024	1024	1024
SP081	IQAL	Q axis current lead compensation low-speed coil		0	0	0	0
:				:	:	:	:
SP088	FH5	Notch filter frequency 5		0	0	0	0
SP089	TMKQ	Spindle output stabilizing gain Q axis		0	0	0	0
SP090	TMKD	Spindle output stabilizing gain D axis		0	0	0	0
:				:	:	:	:
SP112				0	0	0	0
SP113	OPLP	Current command value for open loop		0	0	0	0
SP114	MKT	Coil changeover gate cutoff timer		150	150	150	150
SP115	MKT2	Coil changeover current limit timer		250	250	250	250
SP116	MKIL	Coil changeover current limit value		120	120	120	120
SP117	SETM	Excessive speed deviation timer		12	12	12	12
SP118	MSFT	Magnetic pole shift amount		0	0	0	0
SP119				0	0	0	0
:				:	:	:	:
SP128	DA2MPY	D/A output ch2 output scale		0	0	0	0
SP129	PM	Motor unique constants (H)		2	2	2	2
SP130	JM	Motor unique constants (H)		58	80	340	848
SP131	ATYP	Motor unique constants (H)		100	160	320	320
SP132				0	0	0	0
SP133	NR	Motor unique constants (H)		8000	6000	6000	4600
SP134	NB	Motor unique constants (H)		1500	1500	1500	1150
SP135	NF	Motor unique constants (H)		1800	1800	1800	1380
SP136	KT	Motor unique constants (H)		3019	3293	3227	4345
SP137	KF1	Motor unique constants (H)		81	84	82	82
SP138	KF2	Motor unique constants (H)		2826	2909	3283	2964
SP139	KF3	Motor unique constants (H)		2826	2744	2345	2744
SP140	KF4	Motor unique constants (H)		1911	1917	1966	1910
SP141	KF5	Motor unique constants (H)		186	199	315	586
SP142	KF6	Motor unique constants (H)		0	0	0	0
SP143				0	0	0	0
SP144	TMIL	Motor unique constants (H)		0	0	0	0
SP145	TMBR	Motor unique constants (H)		285	231	233	199
SP146	TMBD	Motor unique constants (H)		390	311	314	266
SP147	KE	Motor unique constants (H)		65	62	68	49
SP148	LA	Motor unique constants (H)		2150	1872	904	858
SP149	IQSM	Motor unique constants (H)		3901	4253	8878	10511
SP150	IDS	Motor unique constants (H)		1620	1928	4335	4328
SP151	R1	Motor unique constants (H)		185	141	45	46
SP152	TMLR	Motor unique constants (H)		90	90	90	90
SP153	TMLD	Motor unique constants (H)		120	120	120	120
SP154	TMLS	Motor unique constants (H)		150	150	150	150
SP155	KI1	Motor unique constants (H)		1039	1036	1024	1031
SP156	PCNT	Motor unique constants (H)		0	0	0	0
SP157				0	0	0	0
SP158	DNB	Motor unique constants (H)		0	0	0	0
SP159	SNB	Motor unique constants (H)		0	0	0	0
SP160	BSD	Motor unique constants (H)		0	0	0	0
SP161				0	0	0	0
:				:	:	:	:
SP224				0	0	0	0
SP225	SFNC5	Spindle function 5		0000	0000	0000	0000
SP226	SFNC6	Spindle function 6		0000	0000	0000	0000
SP227	SFNC7	Spindle function 7		0000	0000	0000	0000
:				:	:	:	:
SP232				0000	0000	0000	0000
SP233	IVC	Voltage non-sensitive band compensation		0	0	0	0
SP234				0	0	0	0
SP235	R2H	Temperature compensation gain		0	0	0	0
SP236	WIH	Temperature compensation time constant		0	0	0	0
SP237	TCF	Torque command filter		500	500	500	500
SP238	SSCFEED	Safely limited speed		0	0	0	0
SP239	SSCRPM	Safely limited motor speed		0	0	0	0
SP240				0	0	0	0
:				:	:	:	:
SP256							

(9) 400V Standard motor SJ-4-V Series (Wide range constant output)

Parameter		Motor		400V Standard motor SJ-4-V Series (Wide range constant output)	
				SJ-4-V15-20T	SJ-4-V22-16T
No.	Abbrev.	Details	MDS-DH2-SP-	100	160
SP001	PGV	Position loop gain non-interpolation mode		15	15
SP002	PGN	Position loop gain interpolation mode		33	33
SP003	PGS	Position loop gain spindle synchronization		15	15
SP004				0	0
SP005	VGN1	Speed loop gain 1		150	150
SP006	VIA1	Speed loop lead compensation 1		1900	1900
SP007	VIL1	Speed loop delay compensation 1		0	0
SP008	VGN2	Speed loop gain 2		150	150
SP009	VIA2	Speed loop lead compensation 2		1900	1900
SP010	VIL2	Speed loop delay compensation 2		0	0
SP011				0	0
SP012				0	0
SP013				0	0
SP014	PY1	Minimum excitation rate 1		50	50
SP015	PY2	Minimum excitation rate 2		100	100
SP016	DDT	Phase alignment deceleration rate		20	20
SP017	SPEC1	Spindle specification 1		200C	200C
SP018	SPEC2	Spindle specification 2		0000	0000
SP019	RNG1	Sub side encoder resolution		4000	4000
SP020	RNG2	Main side encoder resolution		4000	4000
SP021	OLT	Overload detection time constant		60	60
SP022	OLL	Overload detection level		120	120
SP023	OD1	Excessive error detection width (interpolation mode - spindle synchronization)		120	120
SP024	INP	In-position width		875	875
SP025	INP2	2nd in-position width		875	875
SP026	TSP	Maximum motor speed		6000	6000
SP027	ZSP	Motor zero speed		25	25
SP028	SDTS	Speed detection set value		600	600
SP029	SDTR	Speed detection reset width		30	30
SP030	SDT2	2nd speed detection setting value		0	0
SP031	MTYP	Motor type		2200	2200
SP032	PTYP	Power supply type/ Regenerative resistor type		0000	0000
SP033	SFNC1	Spindle function 1		0000	0000
SP034	SFNC2	Spindle function 2		0000	0000
SP035	SFNC3	Spindle function 3		1600	1600
SP036	SFNC4	Spindle function 4		0000	0000
SP037	JL	Load inertia scale		100	100
SP038	FHz1	Notch filter frequency 1		0	0
:				:	:
SP046	FHz2	Notch filter frequency 2		0	0
SP047	EC	Inductive voltage compensation gain		100	100
SP048	LMC1	Lost motion compensation 1		0	0
:					
SP052	DFBN	Dual feedback control non-sensitive band		0	0
SP053	ODS	Excessive error detection width (non-interpolation mode)		1200	1200
SP054	ORE	Overrun detection width in closed loop control		0	0
SP055	EMGx	Max. gate off delay time after emergency stop		20000	20000
SP056	EMGt	Deceleration time constant at emergency stop		300	300
SP057	GRA1	Spindle side gear ratio 1		1	1
SP058	GRA2	Spindle side gear ratio 2		1	1
SP059	GRA3	Spindle side gear ratio 3		1	1
SP060	GRA4	Spindle side gear ratio 4		1	1
SP061	GRB1	Motor side gear ratio 1		1	1
SP062	GRB2	Motor side gear ratio 2		1	1
SP063	GRB3	Motor side gear ratio 3		1	1
SP064	GRB4	Motor side gear ratio 4		1	1
SP065	TLM1	Torque limit 1		10	10
SP066	TLM2	Torque limit 2		10	10
SP067	TLM3	Torque limit 3		10	10
SP068	TLM4	Torque limit 4		10	10
SP069	PCMP	Phase alignment completion width		875	875
SP070	KDDT	Phase alignment deceleration rate scale		0	0
SP071	DIQM	Variable current limit during deceleration, lower limit value		60	75
SP072	DIQN	Variable current limit during deceleration, break point speed		3700	4500
SP073	VGVN	Variable speed gain target value		0	0
SP074	VGVS	Variable speed gain change start speed		0	0
SP075	DWSH	Slip compensation scale during regeneration high-speed coil		0	0
SP076	DWSL	Slip compensation scale during regeneration low-speed coil		0	0
SP077	IQA	Q axis current lead compensation		4096	4096

4 Setup

Motor				400V Standard motor SJ-4-V Series (Wide range constant output)	
Parameter		MDS-DH2-SP-		SJ-4-V15-20T	SJ-4-V22-16T
No.	Abbrev.	Details		100	160
SP078	IDA	D axis current lead compensation		4096	4096
SP079	IQG	Q axis current gain		1024	1024
SP080	IDG	D axis current gain		1024	1024
SP081	IQAL	Q axis current lead compensation low-speed coil		0	0
:				:	:
SP088	FHz5	Notch filter frequency 5		0	0
SP089	TMKQ	Spindle output stabilizing gain Q axis		0	0
SP090	TMKD	Spindle output stabilizing gain D axis		0	0
:				:	:
SP112				0	0
SP113	OPLP	Current command value for open loop		0	0
SP114	MKT	Coil changeover gate cutoff timer		150	150
SP115	MKT2	Coil changeover current limit timer		250	250
SP116	MKIL	Coil changeover current limit value		120	120
SP117	SETM	Excessive speed deviation timer		12	12
SP118	MSFT	Magnetic pole shift amount		0	0
SP119				0	0
:				:	:
SP128	DA2MPY	D/A output ch2 output scale		0	0
SP129	PM	Motor unique constants (H)		2	2
SP130	JM	Motor unique constants (H)		58	80
SP131	ATYP	Motor unique constants (H)		100	160
SP132				0	0
SP133	NR	Motor unique constants (H)		8000	8000
SP134	NB	Motor unique constants (H)		1250	1100
SP135	NF	Motor unique constants (H)		1250	1100
SP136	KT	Motor unique constants (H)		3365	3394
SP137	KF1	Motor unique constants (H)		73	68
SP138	KF2	Motor unique constants (H)		2865	2830
SP139	KF3	Motor unique constants (H)		2755	2888
SP140	KF4	Motor unique constants (H)		1919	1899
SP141	KF5	Motor unique constants (H)		191	190
SP142	KF6	Motor unique constants (H)		0	0
SP143				0	0
SP144	TMIL	Motor unique constants (H)		0	0
SP145	TMBR	Motor unique constants (H)		382	433
SP146	TMBD	Motor unique constants (H)		435	436
SP147	KE	Motor unique constants (H)		63	64
SP148	LA	Motor unique constants (H)		2771	1862
SP149	IQSM	Motor unique constants (H)		3406	5627
SP150	IDS	Motor unique constants (H)		1367	2091
SP151	R1	Motor unique constants (H)		234	141
SP152	TMLR	Motor unique constants (H)		90	90
SP153	TMLD	Motor unique constants (H)		120	120
SP154	TMLS	Motor unique constants (H)		150	150
SP155	KI1	Motor unique constants (H)		1038	1039
SP156	PCNT	Motor unique constants (H)		0	0
SP157				0	0
SP158	DNB	Motor unique constants (H)		750	750
SP159	SNB	Motor unique constants (H)		750	750
SP160	BSD	Motor unique constants (H)		0	0
SP161				0	0
:				:	:
SP224				0	0
SP225	SFNC5	Spindle function 5		0000	0000
SP226	SFNC6	Spindle function 6		0000	0000
SP227	SFNC7	Spindle function 7		0000	0000
:				:	:
SP232				0000	0000
SP233	IVC	Voltage non-sensitive band compensation		0	0
SP234				0	0
SP235	R2H	Temperature compensation gain		0	0
SP236	WIH	Temperature compensation time constant		0	0
SP237	TCF	Torque command filter		500	500
SP238	SSCFEED	Safely limited speed		0	0
SP239	SSCRPM	Safely limited motor speed		0	0
SP240				0	0
:				:	:
SP256					

(10) Tool spindle motor HF-KP Series

Parameter		Motor		Tool spindle motor HF-KP Series		
				HF-KP46	HF-KP56	HF-KP96
No.	Abbrev.	Details	MDS-D2-SP-	20	20	20
SP001	PGV	Position loop gain non-interpolation mode		15	15	15
SP002	PGN	Position loop gain interpolation mode		33	33	33
SP003	PGS	Position loop gain spindle synchronization		15	15	15
SP004				0	0	0
SP005	VGN1	Speed loop gain 1		10	10	20
SP006	VIA1	Speed loop lead compensation 1		40	70	270
SP007	VIL1	Speed loop delay compensation 1		0	0	0
SP008	VGN2	Speed loop gain 2		10	10	20
SP009	VIA2	Speed loop lead compensation 2		40	70	270
SP010	VIL2	Speed loop delay compensation 2		0	0	0
SP011				0	0	0
SP012				0	0	0
SP013				0	0	0
SP014	PY1	Minimum excitation rate 1		0	0	0
SP015	PY2	Minimum excitation rate 2		0	0	0
SP016	DDT	Phase alignment deceleration rate		20	20	20
SP017	SPEC1	Spindle specification 1		400C	400C	400C
SP018	SPEC2	Spindle specification 2		0000	0000	0000
SP019	RNG1	Sub side encoder resolution		260	260	260
SP020	RNG2	Main side encoder resolution		260	260	260
SP021	OLT	Overload detection time constant		40	40	40
SP022	OLL	Overload detection level		100	100	100
SP023	OD1	Excessive error detection width (interpolation mode - spindle synchronization)		120	120	120
SP024	INP	In-position width		875	875	875
SP025	INP2	2nd in-position width		875	875	875
SP026	TSP	Maximum motor speed		6000	6000	6000
SP027	ZSP	Motor zero speed		25	25	25
SP028	SDTS	Speed detection set value		600	600	600
SP029	SDTR	Speed detection reset width		30	30	30
SP030	SDT2	2nd speed detection setting value		0	0	0
SP031	MTYP	Motor type		2200	2200	2200
SP032	PTYP	Power supply type/ Regenerative resistor type		0000	0000	0000
SP033	SFNC1	Spindle function 1		0000	0000	0000
SP034	SFNC2	Spindle function 2		0100	0100	0100
SP035	SFNC3	Spindle function 3		1600	1600	1600
SP036	SFNC4	Spindle function 4		0000	0000	0000
SP037	JL	Load inertia scale		100	100	100
SP038	FHz1	Notch filter frequency 1		0	0	0
:				:	:	:
SP046	FHz2	Notch filter frequency 2		0	0	0
SP047	EC	Inductive voltage compensation gain		100	100	100
SP048	LMC1	Lost motion compensation 1		0	0	0
SP049	FFC	Acceleration rate feed forward gain		0	0	0
SP050	TOF	Torque offset		0	0	0
SP051	DFBT	Dual feed back control time constant		0	0	0
SP052	DFBN	Dual feedback control non-sensitive band		0	0	0
SP053	ODS	Excessive error detection width (non-interpolation mode)		1200	1200	1200
SP054	ORE	Overrun detection width in closed loop control		0	0	0
SP055	EMGx	Max. gate off delay time after emergency stop		20000	20000	20000
SP056	EMGt	Deceleration time constant at emergency stop		300	300	300
SP057	GRA1	Spindle side gear ratio 1		1	1	1
SP058	GRA2	Spindle side gear ratio 2		1	1	1
SP059	GRA3	Spindle side gear ratio 3		1	1	1
SP060	GRA4	Spindle side gear ratio 4		1	1	1
SP061	GRB1	Motor side gear ratio 1		1	1	1
SP062	GRB2	Motor side gear ratio 2		1	1	1
SP063	GRB3	Motor side gear ratio 3		1	1	1
SP064	GRB4	Motor side gear ratio 4		1	1	1
SP065	TLM1	Torque limit 1		10	10	10
SP066	TLM2	Torque limit 2		10	10	10
SP067	TLM3	Torque limit 3		10	10	10
SP068	TLM4	Torque limit 4		10	10	10
SP069	PCMP	Phase alignment completion width		875	875	875
SP070	KDDT	Phase alignment deceleration rate scale		0	0	0
SP071	DIQM	Variable current limit during deceleration, lower limit value		100	100	100
SP072	DIQN	Variable current limit during deceleration, break point speed		3000	3000	3000
SP073	VGVN	Variable speed gain target value		0	0	0
SP074	VGVS	Variable speed gain change start speed		0	0	0
SP075	DWSH	Slip compensation scale during regeneration high-speed coil		0	0	0

4 Setup

Motor				Tool spindle motor HF-KP Series		
Parameter				HF-KP46	HF-KP56	HF-KP96
No.	Abbrev.	Details	MDS-D2-SP-	20	20	20
SP076	DWSL	Slip compensation scale during regeneration low-speed coil		0	0	0
SP077	IQA	Q axis current lead compensation		1000	1950	600
SP078	IDA	D axis current lead compensation		1000	1950	600
SP079	IQG	Q axis current gain		800	1024	900
SP080	IDG	D axis current gain		800	1024	900
SP081	IQAL	Q axis current lead compensation low-speed coil		0	0	0
:				:	:	:
SP088	FHz5	Notch filter frequency 5		0	0	0
SP089	TMKQ	Spindle output stabilizing gain Q axis		100	100	100
SP090	TMKD	Spindle output stabilizing gain D axis		100	100	100
SP091				0	0	0
:				:	:	:
SP112				0	0	0
SP113	OPLP	Current command value for open loop		0	0	0
SP114	MKT	Coil changeover gate cutoff timer		0	0	0
SP115	MKT2	Coil changeover current limit timer		0	0	0
SP116	MKIL	Coil changeover current limit value		0	0	0
SP117	SETM	Excessive speed deviation timer		12	12	12
SP118	MSFT	Magnetic pole shift amount		0	0	0
SP119				0	0	0
:				:	:	:
SP128	DA2MPY	D/A output ch2 output scale		0	0	0
SP129	PM	Motor unique constants (H)		3	3	3
SP130	JM	Motor unique constants (H)		1	1	1
SP131	ATYP	Motor unique constants (H)		20	20	20
SP132				0	0	0
SP133	NR	Motor unique constants (H)		8000	8000	8000
SP134	NB	Motor unique constants (H)		6000	6000	6000
SP135	NF	Motor unique constants (H)		0	0	0
SP136	KT	Motor unique constants (H)		424	442	398
SP137	KF1	Motor unique constants (H)		4096	4096	4096
SP138	KF2	Motor unique constants (H)		1024	1024	1024
SP139	KF3	Motor unique constants (H)		25	66	74
SP140	KF4	Motor unique constants (H)		1024	1024	1024
SP141	KF5	Motor unique constants (H)		5345	2022	1806
SP142	KF6	Motor unique constants (H)		0	0	0
SP143				0	0	0
SP144	TMIL	Motor unique constants (H)		714	1609	2105
SP145	TMBR	Motor unique constants (H)		828	600	899
SP146	TMBD	Motor unique constants (H)		800	822	868
SP147	KE	Motor unique constants (H)		1000	1000	1000
SP148	LA	Motor unique constants (H)		11366	4299	3841
SP149	IQSM	Motor unique constants (H)		150	180	360
SP150	IDSM	Motor unique constants (H)		0	0	0
SP151	R1	Motor unique constants (H)		5062	1484	548
SP152	TMLR	Motor unique constants (H)		330	565	388
SP153	TMLD	Motor unique constants (H)		330	565	388
SP154	TMLS	Motor unique constants (H)		367	628	431
SP155	KI1	Motor unique constants (H)		1000	1000	1000
SP156	PCNT	Motor unique constants (H)		100	100	100
SP157				0	0	0
SP158	DNB	Motor unique constants (H)		0	0	0
SP159	SNB	Motor unique constants (H)		0	0	0
SP160	BSD	Motor unique constants (H)		0	0	0
SP161				0	0	0
:				:	:	:
SP224				0	0	0
SP225	SFNC5	Spindle function 5		0004	0004	0004
SP226	SFNC6	Spindle function 6		0000	0000	0000
SP227	SFNC7	Spindle function 7		0000	0000	0000
:				:	:	:
SP232				0000	0000	0000
SP233	IVC	Voltage non-sensitive band compensation		0	0	0
SP234				0	0	0
SP235	R2H	Temperature compensation gain		0	0	0
SP236	WIH	Temperature compensation time constant		0	0	0
SP237	TCF	Torque command filter		500	500	500
SP238	SSCFEED	Safely limited speed		0	0	0
SP239	SSCRPM	Safely limited motor speed		0	0	0
SP240				0	0	0
:				:	:	:
SP256						

(11) Tool spindle motor HF-SP Series

Parameter				Motor		Tool spindle motor HF-SP Series	
						HF-SP226	HF-SP406
No.	Abbrev.	Details	MDS-D2-SP-	80	160		
SP001	PGV	Position loop gain non-interpolation mode		15		15	
SP002	PGN	Position loop gain interpolation mode		33		33	
SP003	PGS	Position loop gain spindle synchronization		15		15	
SP004				0		0	
SP005	VGN1	Speed loop gain 1		150		150	
SP006	VIA1	Speed loop lead compensation 1		1900		1900	
SP007	VIL1	Speed loop delay compensation 1		0		0	
SP008	VGN2	Speed loop gain 2		150		150	
SP009	VIA2	Speed loop lead compensation 2		1900		1900	
SP010	VIL2	Speed loop delay compensation 2		0		0	
SP011				0		0	
SP012				0		0	
SP013				0		0	
SP014	PY1	Minimum excitation rate 1		0		0	
SP015	PY2	Minimum excitation rate 2		0		0	
SP016	DDT	Phase alignment deceleration rate		20		20	
SP017	SPEC1	Spindle specification 1		400C		400C	
SP018	SPEC2	Spindle specification 2		0000		0000	
SP019	RNG1	Sub side encoder resolution		260		260	
SP020	RNG2	Main side encoder resolution		260		260	
SP021	OLT	Overload detection time constant		300		300	
SP022	OLL	Overload detection level		100		100	
SP023	OD1	Excessive error detection width (interpolation mode - spindle synchronization)		120		120	
SP024	INP	In-position width		875		875	
SP025	INP2	2nd in-position width		875		875	
SP026	TSP	Maximum motor speed		6000		6000	
SP027	ZSP	Motor zero speed		25		25	
SP028	SDTS	Speed detection set value		600		600	
SP029	SDTR	Speed detection reset width		30		30	
SP030	SDT2	2nd speed detection setting value		0		0	
SP031	MTYP	Motor type		2200		2200	
SP032	PTYP	Power supply type/ Regenerative resistor type		0000		0000	
SP033	SFNC1	Spindle function 1		0000		0000	
SP034	SFNC2	Spindle function 2		0100		0100	
SP035	SFNC3	Spindle function 3		1600		1600	
SP036	SFNC4	Spindle function 4		0000		0000	
SP037	JL	Load inertia scale		100		100	
SP038	FHz1	Notch filter frequency 1		0		0	
:				:		:	
SP046	FHz2	Notch filter frequency 2		0		0	
SP047	EC	Inductive voltage compensation gain		100		100	
SP048	LMC1	Lost motion compensation 1		0		0	
SP049	FFC	Acceleration rate feed forward gain		0		0	
SP050	TOF	Torque offset		0		0	
SP051	DFBT	Dual feed back control time constant		0		0	
SP052	DFBN	Dual feedback control non-sensitive band		0		0	
SP053	ODS	Excessive error detection width (non-interpolation mode)		1200		1200	
SP054	ORE	Overrun detection width in closed loop control		0		0	
SP055	EMGx	Max. gate off delay time after emergency stop		20000		20000	
SP056	EMGt	Deceleration time constant at emergency stop		300		300	
SP057	GRA1	Spindle side gear ratio 1		1		1	
SP058	GRA2	Spindle side gear ratio 2		1		1	
SP059	GRA3	Spindle side gear ratio 3		1		1	
SP060	GRA4	Spindle side gear ratio 4		1		1	
SP061	GRB1	Motor side gear ratio 1		1		1	
SP062	GRB2	Motor side gear ratio 2		1		1	
SP063	GRB3	Motor side gear ratio 3		1		1	
SP064	GRB4	Motor side gear ratio 4		1		1	
SP065	TLM1	Torque limit 1		10		10	
SP066	TLM2	Torque limit 2		10		10	
SP067	TLM3	Torque limit 3		10		10	
SP068	TLM4	Torque limit 4		10		10	
SP069	PCMP	Phase alignment completion width		875		875	
SP070	KDDT	Phase alignment deceleration rate scale		0		0	
SP071	DIQM	Variable current limit during deceleration, lower limit value		100		100	
SP072	DIQN	Variable current limit during deceleration, break point speed		3000		3000	
SP073	VGVN	Variable speed gain target value		0		0	
SP074	VGVS	Variable speed gain change start speed		0		0	
SP075	DWSH	Slip compensation scale during regeneration high-speed coil		0		0	

4 Setup

Motor				Tool spindle motor HF-SP Series	
Parameter				HF-SP226	HF-SP406
No.	Abbrev.	Details	MDS-D2-SP-	80	160
SP076	DWSL	Slip compensation scale during regeneration low-speed coil		0	0
SP077	IQA	Q axis current lead compensation		640	730
SP078	IDA	D axis current lead compensation		640	730
SP079	IQG	Q axis current gain		900	1020
SP080	IDG	D axis current gain		900	1020
SP081	IQAL	Q axis current lead compensation low-speed coil		0	0
:				:	:
SP088	FHz5	Notch filter frequency 5		0	0
SP089	TMKQ	Spindle output stabilizing gain Q axis		100	100
SP090	TMKD	Spindle output stabilizing gain D axis		100	100
SP091				0	0
:				:	:
SP112				0	0
SP113	OPLP	Current command value for open loop		0	0
SP114	MKT	Coil changeover gate cutoff timer		0	0
SP115	MKT2	Coil changeover current limit timer		0	0
SP116	MKIL	Coil changeover current limit value		0	0
SP117	SETM	Excessive speed deviation timer		12	12
SP118	MSFT	Magnetic pole shift amount		0	0
SP119				0	0
:				:	:
SP128	DA2MPY	D/A output ch2 output scale		0	0
SP129	PM	Motor unique constants (H)		4	4
SP130	JM	Motor unique constants (H)		1	2
SP131	ATYP	Motor unique constants (H)		80	160
SP132				0	0
SP133	NR	Motor unique constants (H)		6000	6000
SP134	NB	Motor unique constants (H)		6000	6000
SP135	NF	Motor unique constants (H)		0	0
SP136	KT	Motor unique constants (H)		427	442
SP137	KF1	Motor unique constants (H)		4096	4096
SP138	KF2	Motor unique constants (H)		1024	1024
SP139	KF3	Motor unique constants (H)		104	231
SP140	KF4	Motor unique constants (H)		1024	1024
SP141	KF5	Motor unique constants (H)		1464	646
SP142	KF6	Motor unique constants (H)		0	0
SP143				0	0
SP144	TMIL	Motor unique constants (H)		3352	7526
SP145	TMBR	Motor unique constants (H)		899	899
SP146	TMBD	Motor unique constants (H)		875	878
SP147	KE	Motor unique constants (H)		1000	1000
SP148	LA	Motor unique constants (H)		2335	1030
SP149	IQSM	Motor unique constants (H)		820	1440
SP150	IDSM	Motor unique constants (H)		0	0
SP151	R1	Motor unique constants (H)		259	99
SP152	TMLR	Motor unique constants (H)		483	594
SP153	TMLD	Motor unique constants (H)		483	594
SP154	TMLS	Motor unique constants (H)		537	660
SP155	KI1	Motor unique constants (H)		1000	1000
SP156	PCNT	Motor unique constants (H)		100	100
SP157				0	0
SP158	DNB	Motor unique constants (H)		0	0
SP159	SNB	Motor unique constants (H)		0	0
SP160	BSD	Motor unique constants (H)		0	0
SP161				0	0
:				:	:
SP224				0	0
SP225	SFNC5	Spindle function 5		0004	0004
SP226	SFNC6	Spindle function 6		0000	0000
SP227	SFNC7	Spindle function 7		0000	0000
:				:	:
SP232				0000	0000
SP233	IVC	Voltage non-sensitive band compensation		0	0
SP234				0	0
SP235	R2H	Temperature compensation gain		0	0
SP236	WIH	Temperature compensation time constant		0	0
SP237	TCF	Torque command filter		500	500
SP238	SSCFEED	Safely limited speed		0	0
SP239	SSCRPM	Safely limited motor speed		0	0
SP240				0	0
:				:	:
SP256					

(12) Tool spindle motor HF Series

Motor				Tool spindle motor HF Series							
Parameter		Details	MDS-D2-SP-	HF75	HF105	HF54	HF104	HF154	HF224	HF204	HF354
No.	Abbrev.			20	20	40	40	80	80	80	160
SP001	PGV	Position loop gain non-interpolation mode		15	15	15	15	15	15	15	15
SP002	PGN	Position loop gain interpolation mode		33	33	33	33	33	33	33	33
SP003	PGS	Position loop gain spindle synchronization		15	15	15	15	15	15	15	15
SP004				0	0	0	0	0	0	0	0
SP005	VGN1	Speed loop gain 1		30	150	90	150	150	150	150	150
SP006	VIA1	Speed loop lead compensation 1		490	1900	1150	1900	1900	1900	1900	1900
SP007	VIL1	Speed loop delay compensation 1		0	0	0	0	0	0	0	0
SP008	VGN2	Speed loop gain 2		30	150	90	150	150	150	150	150
SP009	VIA2	Speed loop lead compensation 2		490	1900	1150	1900	1900	1900	1900	1900
SP010	VIL2	Speed loop delay compensation 2		0	0	0	0	0	0	0	0
SP011				0	0	0	0	0	0	0	0
SP012				0	0	0	0	0	0	0	0
SP013				0	0	0	0	0	0	0	0
SP014	PY1	Minimum excitation rate 1		0	0	0	0	0	0	0	0
SP015	PY2	Minimum excitation rate 2		0	0	0	0	0	0	0	0
SP016	DDT	Phase alignment deceleration rate		20	20	20	20	20	20	20	20
SP017	SPEC1	Spindle specification 1		400C	400C	400C	400C	400C	400C	400C	400C
SP018	SPEC2	Spindle specification 2		0000	0000	0000	0000	0000	0000	0000	0000
SP019	RNG1	Sub side encoder resolution		260	260	260	260	260	260	260	260
SP020	RNG2	Main side encoder resolution		260	260	260	260	260	260	260	260
SP021	OLT	Overload detection time constant		300	300	300	300	300	300	300	300
SP022	OLL	Overload detection level		100	100	100	100	100	100	100	100
SP023	OD1	Excessive error detection width (interpolation mode - spindle synchronization)		120	120	120	120	120	120	120	120
SP024	INP	In-position width		875	875	875	875	875	875	875	875
SP025	INP2	2nd in-position width		875	875	875	875	875	875	875	875
SP026	TSP	Maximum motor speed		4000	4000	3000	3000	3000	3000	3000	3000
SP027	ZSP	Motor zero speed		25	25	25	25	25	25	25	25
SP028	SDTS	Speed detection set value		400	400	300	300	300	300	300	300
SP029	SDTR	Speed detection reset width		30	30	30	30	30	30	30	30
SP030	SDT2	2nd speed detection setting value		0	0	0	0	0	0	0	0
SP031	MTYP	Motor type		2200	2200	2200	2200	2200	2200	2200	2200
SP032	PTYP	Power supply type/ Regenerative resistor type		0000	0000	0000	0000	0000	0000	0000	0000
SP033	SFNC1	Spindle function 1		0000	0000	0000	0000	0000	0000	0000	0000
SP034	SFNC2	Spindle function 2		0100	0100	0100	0100	0100	0100	0100	0100
SP035	SFNC3	Spindle function 3		1600	1600	1600	1600	1600	1600	1600	1600
SP036	SFNC4	Spindle function 4		0000	0000	0000	0000	0000	0000	0000	0000
SP037	JL	Load inertia scale		100	100	100	100	100	100	100	100
SP038	FHz1	Notch filter frequency 1		0	0	0	0	0	0	0	0
:				:	:	:	:	:	:	:	:
SP046	FHz2	Notch filter frequency 2		0	0	0	0	0	0	0	0
SP047	EC	Inductive voltage compensation gain		100	100	100	100	100	100	100	100
SP048	LMC1	Lost motion compensation 1		0	0	0	0	0	0	0	0
SP049	FFC	Acceleration rate feed forward gain		0	0	0	0	0	0	0	0
SP050	TOF	Torque offset		0	0	0	0	0	0	0	0
SP051	DFBT	Dual feed back control time constant		0	0	0	0	0	0	0	0
SP052	DFBN	Dual feedback control non-sensitive band		0	0	0	0	0	0	0	0
SP053	ODS	Excessive error detection width (non-interpolation mode)		800	800	600	600	600	600	600	600
SP054	ORE	Overrun detection width in closed loop control		0	0	0	0	0	0	0	0
SP055	EMGx	Max. gate off delay time after emergency stop		20000	20000	20000	20000	20000	20000	20000	20000
SP056	EMGt	Deceleration time constant at emergency stop		300	300	300	300	300	300	300	300
SP057	GRA1	Spindle side gear ratio 1		1	1	1	1	1	1	1	1
SP058	GRA2	Spindle side gear ratio 2		1	1	1	1	1	1	1	1
SP059	GRA3	Spindle side gear ratio 3		1	1	1	1	1	1	1	1
SP060	GRA4	Spindle side gear ratio 4		1	1	1	1	1	1	1	1
SP061	GRB1	Motor side gear ratio 1		1	1	1	1	1	1	1	1
SP062	GRB2	Motor side gear ratio 2		1	1	1	1	1	1	1	1
SP063	GRB3	Motor side gear ratio 3		1	1	1	1	1	1	1	1
SP064	GRB4	Motor side gear ratio 4		1	1	1	1	1	1	1	1
SP065	TLM1	Torque limit 1		10	10	10	10	10	10	10	10
SP066	TLM2	Torque limit 2		10	10	10	10	10	10	10	10
SP067	TLM3	Torque limit 3		10	10	10	10	10	10	10	10
SP068	TLM4	Torque limit 4		10	10	10	10	10	10	10	10
SP069	PCMP	Phase alignment completion width		875	875	875	875	875	875	875	875
SP070	KDDT	Phase alignment deceleration rate scale		0	0	0	0	0	0	0	0
SP071	DIQM	Variable current limit during deceleration, lower limit value		60	60	60	60	60	60	60	60
SP072	DIQN	Variable current limit during deceleration, break point speed		1800	1800	1800	1800	1800	1800	1800	1800
SP073	VGVN	Variable speed gain target value		0	0	0	0	0	0	0	0
SP074	VGVS	Variable speed gain change start speed		0	0	0	0	0	0	0	0
SP075	DWSH	Slip compensation scale during regeneration high-speed coil		0	0	0	0	0	0	0	0

4 Setup

Motor				Tool spindle motor HF Series							
Parameter				HF75	HF105	HF54	HF104	HF154	HF224	HF204	HF354
No.	Abbrev.	Details	MDS-D2-SP-	20	20	40	40	80	80	80	160
SP076	DWSL	Slip compensation scale during regeneration low-speed coil		0	0	0	0	0	0	0	0
SP077	IQA	Q axis current lead compensation		1700	2100	700	820	630	2700	410	370
SP078	IDA	D axis current lead compensation		1700	2100	700	820	630	2700	410	370
SP079	IQG	Q axis current gain		510	850	850	820	760	3400	830	740
SP080	IDG	D axis current gain		510	850	850	820	760	3400	830	740
SP081	IQAL	Q axis current lead compensation low-speed coil		0	0	0	0	0	0	0	0
:				:	:	:	:	:	:	:	:
SP088	FHz5	Notch filter frequency 5		0	0	0	0	0	0	0	0
SP089	TMKQ	Spindle output stabilizing gain Q axis		100	100	100	100	100	100	100	100
SP090	TMKD	Spindle output stabilizing gain D axis		100	100	100	100	100	100	100	100
SP091				0	0	0	0	0	0	0	0
:				:	:	:	:	:	:	:	:
SP112				0	0	0	0	0	0	0	0
SP113	OPLP	Current command value for open loop		0	0	0	0	0	0	0	0
SP114	MKT	Coil changeover gate cutoff timer		0	0	0	0	0	0	0	0
SP115	MKT2	Coil changeover current limit timer		0	0	0	0	0	0	0	0
SP116	MKIL	Coil changeover current limit value		0	0	0	0	0	0	0	0
SP117	SETM	Excessive speed deviation timer		12	12	12	12	12	12	12	12
SP118	MSFT	Magnetic pole shift amount		0	0	0	0	0	0	0	0
SP119				0	0	0	0	0	0	0	0
:				:	:	:	:	:	:	:	:
SP128	DA2MPY	D/A output ch2 output scale		0	0	0	0	0	0	0	0
SP129	PM	Motor unique constants (H)		4	4	4	4	4	4	4	4
SP130	JM	Motor unique constants (H)		1	1	1	1	2	2	2	8
SP131	ATYP	Motor unique constants (H)		20	20	40	40	80	80	80	160
SP132				0	0	0	0	0	0	0	0
SP133	NR	Motor unique constants (H)		5000	5000	4000	4000	4000	4000	4000	4000
SP134	NB	Motor unique constants (H)		4000	4000	3000	3000	3000	3000	3000	3000
SP135	NF	Motor unique constants (H)		0	0	0	0	0	0	0	0
SP136	KT	Motor unique constants (H)		626	652	904	1284	818	824	1022	804
SP137	KF1	Motor unique constants (H)		4096	4096	4096	4096	4096	4096	4096	4096
SP138	KF2	Motor unique constants (H)		1024	1024	1024	1024	1024	1024	1024	1024
SP139	KF3	Motor unique constants (H)		46	124	43	105	163	221	148	294
SP140	KF4	Motor unique constants (H)		1024	1024	1024	1024	1024	1024	1024	1024
SP141	KF5	Motor unique constants (H)		4139	1674	5311	2301	1480	1035	1819	1022
SP142	KF6	Motor unique constants (H)		0	0	0	0	0	0	0	0
SP143				0	0	0	0	0	0	0	0
SP144	TMIL	Motor unique constants (H)		1404	2481	1053	2384	3812	5445	3315	6812
SP145	TMBR	Motor unique constants (H)		899	331	899	899	899	899	899	899
SP146	TMBD	Motor unique constants (H)		810	485	832	842	851	855	871	875
SP147	KE	Motor unique constants (H)		1000	1000	1000	1000	1000	1000	1000	1000
SP148	LA	Motor unique constants (H)		6600	2670	8470	3670	2360	1650	2900	1630
SP149	IQSM	Motor unique constants (H)		286	366	176	248	584	850	623	1386
SP150	IDSM	Motor unique constants (H)		0	0	0	0	0	0	0	0
SP151	R1	Motor unique constants (H)		2180	1200	1690	630	340	220	250	120
SP152	TMLR	Motor unique constants (H)		392	339	764	934	712	536	731	668
SP153	TMLD	Motor unique constants (H)		392	339	764	934	712	536	731	668
SP154	TMLS	Motor unique constants (H)		490	423	955	1169	890	671	915	837
SP155	KI1	Motor unique constants (H)		1000	1000	1000	1000	1000	1000	1000	1000
SP156	PCNT	Motor unique constants (H)		100	100	100	100	100	100	100	100
SP157				0	0	0	0	0	0	0	0
SP158	DNB	Motor unique constants (H)		0	0	0	0	0	0	0	0
SP159	SNB	Motor unique constants (H)		0	0	0	0	0	0	0	0
SP160	BSD	Motor unique constants (H)		0	0	0	0	0	0	0	0
SP161				0	0	0	0	0	0	0	0
:				:	:	:	:	:	:	:	:
SP224				0	0	0	0	0	0	0	0
SP225	SFNC5	Spindle function 5		0004	0004	0004	0004	0004	0004	0004	0004
SP226	SFNC6	Spindle function 6		0000	0000	0000	0000	0000	0000	0000	0000
SP227	SFNC7	Spindle function 7		0000	0000	0000	0000	0000	0000	0000	0000
:				:	:	:	:	:	:	:	:
SP232				0000	0000	0000	0000	0000	0000	0000	0000
SP233	IVC	Voltage non-sensitive band compensation		0	0	0	0	0	0	0	0
SP234				0	0	0	0	0	0	0	0
SP235	R2H	Temperature compensation gain		0	0	0	0	0	0	0	0
SP236	WIH	Temperature compensation time constant		0	0	0	0	0	0	0	0
SP237	TCF	Torque command filter		500	500	500	500	500	500	500	500
SP238	SSCFEED	Safely limited speed		0	0	0	0	0	0	0	0
SP239	SSCRPM	Safely limited motor speed		0	0	0	0	0	0	0	0
SP240				0	0	0	0	0	0	0	0
:				:	:	:	:	:	:	:	:
SP256											

4 Setup

Parameter				Motor			Tool spindle motor HF Series		
						MDS-D2-SP-	HF453 160	HF703 160	HF903 320
No.	Abbrev.	Details							
SP001	PGV	Position loop gain non-interpolation mode		15	15	15		15	
SP002	PGN	Position loop gain interpolation mode		33	33	33		33	
SP003	PGS	Position loop gain spindle synchronization		15	15	15		15	
SP004				0	0	0		0	
SP005	VGN1	Speed loop gain 1		150	150	150		150	
SP006	VIA1	Speed loop lead compensation 1		1900	1900	1900		1900	
SP007	VIL1	Speed loop delay compensation 1		0	0	0		0	
SP008	VGN2	Speed loop gain 2		150	150	150		150	
SP009	VIA2	Speed loop lead compensation 2		1900	1900	1900		1900	
SP010	VIL2	Speed loop delay compensation 2		0	0	0		0	
SP011				0	0	0		0	
SP012				0	0	0		0	
SP013				0	0	0		0	
SP014	PY1	Minimum excitation rate 1		0	0	0		0	
SP015	PY2	Minimum excitation rate 2		0	0	0		0	
SP016	DDT	Phase alignment deceleration rate		20	20	20		20	
SP017	SPEC1	Spindle specification 1		400C	400C	400C		400C	
SP018	SPEC2	Spindle specification 2		0000	0000	0000		0000	
SP019	RNG1	Sub side encoder resolution		260	260	260		260	
SP020	RNG2	Main side encoder resolution		260	260	260		260	
SP021	OLT	Overload detection time constant		300	300	300		300	
SP022	OLL	Overload detection level		100	100	100		100	
SP023	OD1	Excessive error detection width (interpolation mode - spindle synchronization)		120	120	120		120	
SP024	INP	In-position width		875	875	875		875	
SP025	INP2	2nd in-position width		875	875	875		875	
SP026	TSP	Maximum motor speed		3000	3000	3000		3000	
SP027	ZSP	Motor zero speed		25	25	25		25	
SP028	SDTS	Speed detection set value		300	300	300		300	
SP029	SDTR	Speed detection reset width		30	30	30		30	
SP030	SDT2	2nd speed detection setting value		0	0	0		0	
SP031	MTYP	Motor type		2200	2200	2200		2200	
SP032	PTYP	Power supply type/ Regenerative resistor type		0000	0000	0000		0000	
SP033	SFNC1	Spindle function 1		0000	0000	0000		0000	
SP034	SFNC2	Spindle function 2		0000	0000	0000		0000	
SP035	SFNC3	Spindle function 3		1600	1600	1600		1600	
SP036	SFNC4	Spindle function 4		0000	0000	0000		0000	
SP037	JL	Load inertia scale		100	100	100		100	
SP038	FHz1	Notch filter frequency 1		0	0	0		0	
:				:	:	:		:	
SP046	FHz2	Notch filter frequency 2		0	0	0		0	
SP047	EC	Inductive voltage compensation gain		100	100	100		100	
SP048	LMC1	Lost motion compensation 1		0	0	0		0	
SP049	FFC	Acceleration rate feed forward gain		0	0	0		0	
SP050	TOF	Torque offset		0	0	0		0	
SP051	DFBT	Dual feed back control time constant		0	0	0		0	
SP052	DFBN	Dual feedback control non-sensitive band		0	0	0		0	
SP053	ODS	Excessive error detection width (non-interpolation mode)		600	600	600		600	
SP054	ORE	Overrun detection width in closed loop control		0	0	0		0	
SP055	EMGx	Max. gate off delay time after emergency stop		20000	20000	20000		20000	
SP056	EMGt	Deceleration time constant at emergency stop		300	300	300		300	
SP057	GRA1	Spindle side gear ratio 1		1	1	1		1	
SP058	GRA2	Spindle side gear ratio 2		1	1	1		1	
SP059	GRA3	Spindle side gear ratio 3		1	1	1		1	
SP060	GRA4	Spindle side gear ratio 4		1	1	1		1	
SP061	GRB1	Motor side gear ratio 1		1	1	1		1	
SP062	GRB2	Motor side gear ratio 2		1	1	1		1	
SP063	GRB3	Motor side gear ratio 3		1	1	1		1	
SP064	GRB4	Motor side gear ratio 4		1	1	1		1	
SP065	TLM1	Torque limit 1		10	10	10		10	
SP066	TLM2	Torque limit 2		10	10	10		10	
SP067	TLM3	Torque limit 3		10	10	10		10	
SP068	TLM4	Torque limit 4		10	10	10		10	
SP069	PCMP	Phase alignment completion width		875	875	875		875	
SP070	KDDT	Phase alignment deceleration rate scale		0	0	0		0	
SP071	DIQM	Variable current limit during deceleration, lower limit value		60	60	60		60	
SP072	DIQN	Variable current limit during deceleration, break point speed		1800	1800	1800		1800	
SP073	VGVN	Variable speed gain target value		0	0	0		0	
SP074	VGVS	Variable speed gain change start speed		0	0	0		0	
SP075	DWSH	Slip compensation scale during regeneration high-speed coil		0	0	0		0	
SP076	DWSL	Slip compensation scale during regeneration low-speed coil		0	0	0		0	

4 Setup

Motor				Tool spindle motor HF Series		
				HF453	HF703	HF903
Parameter				160	160	320
No.	Abbrev.	Details	MDS-D2-SP-			
SP077	IQA	Q axis current lead compensation		350	350	210
SP078	IDA	D axis current lead compensation		350	350	210
SP079	IQG	Q axis current gain		930	930	640
SP080	IDG	D axis current gain		930	930	640
SP081	IQAL	Q axis current lead compensation low-speed coil		0	0	0
:				:	:	:
SP088	FHz5	Notch filter frequency 5		0	0	0
SP089	TMKQ	Spindle output stabilizing gain Q axis		100	100	100
SP090	TMKD	Spindle output stabilizing gain D axis		100	100	100
SP091				0	0	0
:				:	:	:
SP112				0	0	0
SP113	OPLP	Current command value for open loop		0	0	0
SP114	MKT	Coil changeover gate cutoff timer		0	0	0
SP115	MKT2	Coil changeover current limit timer		0	0	0
SP116	MKIL	Coil changeover current limit value		0	0	0
SP117	SETM	Excessive speed deviation timer		12	12	12
SP118	MSFT	Magnetic pole shift amount		0	0	0
SP119				0	0	0
:				:	:	:
SP128	DA2MPY	D/A output ch2 output scale		0	0	0
SP129	PM	Motor unique constants (H)		4	4	4
SP130	JM	Motor unique constants (H)		11	15	20
SP131	ATYP	Motor unique constants (H)		160	160	320
SP132				0	0	0
SP133	NR	Motor unique constants (H)		3000	3000	3000
SP134	NB	Motor unique constants (H)		3000	3000	3000
SP135	NF	Motor unique constants (H)		0	0	0
SP136	KT	Motor unique constants (H)		1071	1346	1050
SP137	KF1	Motor unique constants (H)		4096	4096	4096
SP138	KF2	Motor unique constants (H)		1024	1024	1024
SP139	KF3	Motor unique constants (H)		404	472	735
SP140	KF4	Motor unique constants (H)		1024	1024	1024
SP141	KF5	Motor unique constants (H)		815	809	414
SP142	KF6	Motor unique constants (H)		0	0	0
SP143				0	0	0
SP144	TMIL	Motor unique constants (H)		8821	11483	17896
SP145	TMBR	Motor unique constants (H)		899	899	899
SP146	TMBD	Motor unique constants (H)		874	872	874
SP147	KE	Motor unique constants (H)		1000	1000	1000
SP148	LA	Motor unique constants (H)		1300	1290	660
SP149	IQSM	Motor unique constants (H)		1337	1655	2728
SP150	IDS M	Motor unique constants (H)		0	0	0
SP151	R1	Motor unique constants (H)		88	78	38
SP152	TMLR	Motor unique constants (H)		622	523	597
SP153	TMLD	Motor unique constants (H)		622	523	597
SP154	TMLS	Motor unique constants (H)		779	655	748
SP155	KI1	Motor unique constants (H)		1000	1000	1000
SP156	PCNT	Motor unique constants (H)		100	100	100
SP157				0	0	0
SP158	DNB	Motor unique constants (H)		0	0	0
SP159	SNB	Motor unique constants (H)		0	0	0
SP160	BSD	Motor unique constants (H)		0	0	0
SP161				0	0	0
:				:	:	:
SP224				0	0	0
SP225	SFNC5	Spindle function 5		0004	0004	0004
SP226	SFNC6	Spindle function 6		0000	0000	0000
SP227	SFNC7	Spindle function 7		0000	0000	0000
SP232				0000	0000	0000
SP233	IVC	Voltage non-sensitive band compensation		0	0	0
SP234				0	0	0
SP235	R2H	Temperature compensation gain		0	0	0
SP236	WIH	Temperature compensation time constant		0	0	0
SP237	TCF	Torque command filter		500	500	500
SP238	SSCFEED	Safely limited speed		0	0	0
SP239	SSCRPM	Safely limited motor speed		0	0	0
SP240				0	0	0
:				:	:	:
SP256						

4.3.3 Spindle Parameters

These parameters are sent to the spindle drive unit when the NC power is turned ON. The standard parameters are designated with the "Spindle parameter setting list" enclosed when the spindle motor is delivered. There may be cases when the machine specifications are unclear, so the parameters determined by the machine specifications should be confirmed by the user.

The parameters with "(PR)" requires the CNC to be turned OFF after the settings. Turn the power OFF and ON to enable the parameter settings.

[#13001] SP001 PGV Position loop gain non-interpolation mode

Set the position loop gain for "Non-interpolation" control mode.
When the setting value increases, the command tracking ability will enhance and the positioning settling time can be shorter. However, the impact on the machine during acceleration/deceleration will increase.
Use the selection command, the control mode "bit 2, 1, 0 = 000" in control input 4.
(Note) The control mode is commanded by NC.

---Setting range---
1 to 200 (rad/s)

[#13002] SP002 PGN Position loop gain interpolation mode

Set the position loop gain for "interpolation" control mode.
When the setting value increases, the command tracking ability will enhance and the positioning settling time can be shorter. However, the impact on the machine during acceleration/deceleration will increase.
Use the selection command, the control mode "bit 2, 1, 0 = 010 or 100" in control input 4.
(Note) The control mode is commanded by NC.
When carrying out the SHG control, set SP035/bitC to "1".

---Setting range---
1 to 200 (rad/s)

[#13003] SP003 PGS Position loop gain spindle synchronization

Set the position loop gain for "spindle synchronization" control mode.
When the setting value increases, the command tracking ability will enhance and the positioning settling time can be shorter. However, the impact on the machine during acceleration/deceleration will increase.
Use the selection command, the control mode "bit 2, 1, 0 = 001" in control input 4.
(Note) The control mode is commanded by NC.
When carrying out the SHG control, set SP036/bit4 to "1".

---Setting range---
1 to 200 (rad/s)

[#13004] SP004

Not used. Set to "0".

[#13005] SP005 VGN1 Speed loop gain 1

Set the speed loop gain.
Set this according to the load inertia size.
The higher setting value will increase the accuracy of control, however, vibration tends to occur.
If vibration occurs, adjust by lowering by 20 to 30%.
The final value should be 70 to 80% of the value at which the vibration stops.

---Setting range---
1 to 9999

【#13006】 SP006 VIA1 Speed loop lead compensation 1

Set the speed loop integral control gain.
 The standard setting is "1900". Adjust the value by increasing/decreasing the value by about 100.
 Raise this value to improve the contour tracking accuracy in high-speed cutting.
 Lower this value when the position droop does not stabilize (when the vibration of 10 to 20Hz occurs).

---Setting range---
 1 to 9999

【#13007】 SP007 VIL1 Speed loop delay compensation 1

Set this parameter when the limit cycle occurs in the full-closed loop or overshooting occurs in positioning.
 When setting this parameter, make sure to set the torque offset "SP050(TOF)".
 When not using, set to "0".

---Setting range---
 0 to 32767

【#13008】 SP008 VGN2 Speed loop gain 2

Normally SP005(VGN1) is used.
 By setting "SP035/bit1, SP035/bit9 or SP036/bit1=1", gain 2 can be used according to the application.
 Gain 2 can also be used by setting "Speed gain set 2 changeover request (control input 5/ bitC) = 1".
 Refer to SP005(VGN1) for adjustment procedures.

---Setting range---
 1 to 9999

【#13009】 SP009 VIA2 Speed loop lead compensation 2

Normally SP006(VIA1) is used.
 By setting "SP035/bit1, SP035/bit9 or SP036/bit1=1", gain 2 can be used according to the application.
 Gain 2 can also be used by setting "Speed gain set 2 changeover request (control input 5/ bitC) = 1".
 Refer to SP006(VIA1) for adjustment procedures.

---Setting range---
 1 to 9999

【#13010】 SP010 VIL2 Speed loop delay compensation 2

Normally SP007(VIL1) is used.
 By setting "SP035/bit1, SP035/bit9 or SP036/bit1=1", gain 2 can be used according to the application.
 Gain 2 can also be used by setting "Speed gain set 2 changeover request (control input 5/ bitC) = 1".
 Refer to SP007(VIL1) for adjustment procedures.

---Setting range---
 0 to 32767

【#13011】 SP011

Not used. Set to "0".

【#13012】 SP012

Not used. Set to "0".

【#13013】 SP013

Not used. Set to "0".

【#13014】 SP014 PY1 Minimum excitation rate 1

Set the minimum value for the variable excitation rate. The standard setting is "50".

Set to "0" when using an IPM spindle motor.

If noise including gear noise is loud, select a small value. However, a larger setting value is more effective for impact response.

(Note) When setting a value at "50 or more", check if there is no problem with gear noise, motor excitation noise, vibration during low-speed rotation or vibration when the servo is locked during orientation stop, etc.

When setting a value at "less than 50", check if there is no problem with the impact load response or rigidity during servo lock.

---Setting range---

0 to 100 (%)

【#13015】 SP015 PY2 Minimum excitation rate 2

Normally, SP014(PY1) is used.

By setting "SP035/bit2, SP035/bitA or SP036/bit2=1", the excitation rate 2 can be used according to the application.

The excitation rate 2 can also be used by setting "the minimum excitation rate 2 changeover request (control input 5/ bitB) = 1". Refer to SP014(PY1) for adjustment procedures.

Set to "0" when using an IPM spindle motor.

---Setting range---

0 to 100 (%)

【#13016】 SP016 DDT Phase alignment deceleration rate

Set the single-rotation position alignment deceleration rate for orientation stopping, phase alignment while rotating and switching from non-interpolation mode to spindle synchronization mode while rotating.

When the load inertia is larger, the setting value should be smaller.

When the setting value is larger, the orientation in-position and single-rotation position alignment complete faster, but the impact applied on the machine will increase.

To change the deceleration rate only during rotation command (command F Δ T ≠ 0), set this parameter together with SP070 (KDDT).

---Setting range---

1 to 32767 (0.1(r/min)/ms)

【#13017(PR) SP017 SPEC1 Spindle specification 1

Select the spindle specification.
A function is allocated to each bit.
Set this in hexadecimal format.

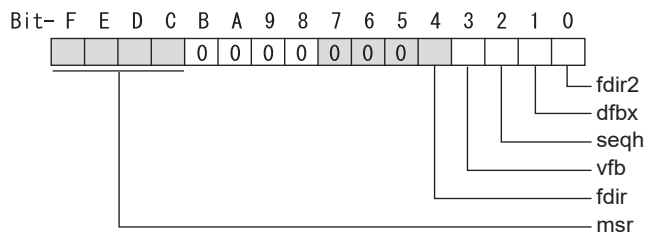
**bit F-C : msr Motor series selection**

- 0: 200V specification IM spindle motor
- 1: 200V specification IPM spindle motor
- 2: 400V specification IM spindle motor
- 3: 400V specification IPM spindle motor
- 4: 200V specification Tool spindle motor

bit B-5 :

Not used. Set to "0".

bit 4 : fdir Position feedback

Set the machine side encoder's installation polarity.
0: Forward polarity 1: Reverse polarity

bit 3 : vfb Speed feedback filter

0: Disable 1: Enable (2250Hz)

bit 2 : seqh READY ON sequence

0: Normal 1: High-speed

bit 1 : dfbx Dual feedback control

Control the position FB signal in full closed control by the combination of a motor side encoder and machine side encoder.
0: Stop 1: Start

Related parameters: SP051, SP052

bit 0 : fdir2 Speed feedback polarity

Set the motor side encoder's installation polarity by a built-in motor.
0: Forward polarity 1: Reverse polarity

【#13018(PR)】 SP018 SPEC2 Spindle specification 2

Select the spindle specification.
 A function is allocated to each bit.
 Set this in hexadecimal format.

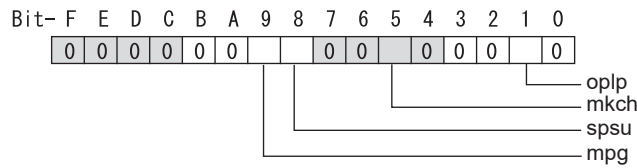

bit F-A :

Not used. Set to "0".

bit 9 : mpg Earth fault detection

0: Disable 1: Enable (standard)
 Set "0" and it is constantly "Enable" for MDS-DJ-SP Series.

bit 8 : spsu Command speed limit value

0: 33,750 r/min 1: 135,000 r/min

bit 7-6 :

Not used. Set to "0".

bit 5 : mkch Coil switch function

0: Disable 1: Enable

bit 4-2 :

Not used. Set to "0".

bit 1 : oplp Open loop control

This allows the operation in which no encoder feedback signals are used.
 It is used when adjusting the encoder, etc.
 0: Disable 1: Enable

bit 0 :

Not used. Set to "0".

【#13019(PR)】 SP019 RNG1 Sub side encoder resolution

[For semi-closed loop]
 Set the same value as SP020 (RNG2). (Refer to the explanation of SP020.)

[For full-closed loop]
 Set the number of pulses per revolution of the machine side encoder.

When using ABZ pulse output encoder (OSE-1024-3-15-68), set this combined with SP097(RNG1ex).

SP019 = 4096
 SP097 = -1

---Setting range---

When SP097=0, the setting range is from 0 to 32767 (kp)

When SP097 ≠ 0

For M700V, M70V, M70, E70: 0 to 65535 (p)

For C70: -32768 to 32767 (p)

【#13020(PR)】 SP020 RNG2 Main side encoder resolution

Set the number of pulses per revolution of the motor side encoder.
When using the encoder interface unit MDS-B-HR, use this with SP098(RNG2ex).

Encoder

TS5691(128 teeth): SP020 = 2000
TS5691(180 teeth): SP020 = 2880
TS5691(256 teeth): SP020 = 4000
TS5691(384 teeth): SP020 = 6000
TS5691(512 teeth): SP020 = 8000

TS5690(64 teeth): SP020 = 2000
TS5690(90 teeth): SP020 = 2880
TS5690(128 teeth): SP020 = 4000
TS5690(192 teeth): SP020 = 6000
TS5690(256 teeth): SP020 = 8000
TS5690(384 teeth): SP020 =12000

ERM280(1200 teeth): SP020 = 4800
ERM280(2048 teeth): SP020 = 8000

MPCI : SP020 = 7200
MBE205: SP020 = 2000
MBE405W: SP020 = 4000

Tool spindle motor
OSA18(-A48): SP020 = 260

---Setting range---

When SP098=0, the setting range is from 0 to 32767 (kp)
When SP098≠0
For M700V, M70V, M70, E70: 0 to 65535 (p)
For C70: -32768 to 32767 (p)

【#13021(PR)】 SP021 OLT Overload detection time constant

Set the detection time constant of Overload 1 (Alarm 50). (For Mitsubishi Electric adjustment)
Normally, set to "60".
Set to "300" when using an IPM spindle motor.

---Setting range---

1 to 15300 (s)

【#13022】 SP022 OLL Overload detection level

Set the current detection level of "Overload 1" (Alarm 50) as a percentage against the motor short-time rated output current. (For Mitsubishi Electric adjustment)
Normally, set to "120".
Set to "100" when using an IPM spindle motor.

---Setting range---

1 to 200 (Short-time rated %)

【#13023】 SP023 OD1 Excessive error detection width (interpolation mode - spindle synchronization)

Set the excessive error detection width for the interpolation mode and spindle synchronization.
The standard setting is "120".
When set to "0", the excessive error detection will be ignored, so do not set to "0".

---Setting range---

1 to 32767 (°)

【#13024】 SP024 INP In-position width

Set the in-position detection width.
 Set the positioning accuracy required to the machine.
 Lower setting value increases the positioning accuracy, but makes the cycle time (settling time) longer.
 The standard setting is "875".

---Setting range---
 0 to 32767 (1°/1000)

【#13025】 SP025 INP2 2nd in-position width

Use this when detecting an in-position different from normal in-position width such as advancing the in-position signal. The adjustment procedure is the same as SP024 (INP).
 The standard setting is "875".

---Setting range---
 0 to 32767 (1°/1000)

【#13026(PR)】 SP026 TSP Maximum motor speed

Set the maximum motor speed.
 If the motor speed exceeds the set maximum speed, an overspeed alarm will occur.

---Setting range---
 1 to 32767 (r/min)

【#13027】 SP027 ZSP Motor zero speed

Set the motor speed for detecting zero speed.
 If the motor speed drops below the set speed, the zero speed signal turns ON.
 The standard setting is "50".

---Setting range---
 1 to 1000 (r/min)

【#13028】 SP028 SDTS Speed detection set value

Set the motor speed for detecting the speed.
 If the motor speed drops below the set speed, the speed detection signal turns ON.
 The standard setting is 10% of the maximum motor speed.

---Setting range---
 10 to 32767 (r/min)

【#13029】 SP029 SDTR Speed detection reset width

Set the hysteresis width in which the speed detection changes from ON to OFF.
 If the setting value is small, the speed detection will chatter easily.
 The standard setting is "30".

---Setting range---
 10 to 1000 (r/min)

【#13030】 SP030 SDT2 2nd speed detection setting value

Set the specified speed of the specified speed output.
 When carrying out digital output of the specified speed output, set SP229/bitC to "1".
 It is not available for MDS-DJ-SP Series.

---Setting range---
 0 to 32767 (r/min)

【#13031(PR)】 SP031 MTYP Motor type

Set the control system of the spindle drive unit.
 2200: Semi closed loop control
 4200: Full closed loop control by using spindle side ABZ pulse output encoder
 6200: Full closed loop control by using spindle side serial output encoder

【#13032(PR)】 SP032 P TYP Power supply type/ Regenerative resistor type**MDS-D2/DH2 Series: Power supply type**

When connecting a power supply unit, set a code for each power supply unit.

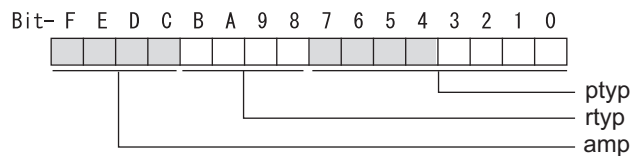
**bit F-C : amp**

Set the power backup function to be used.

No function used : 0

Deceleration and stop function at power failure : 8

bit B-8 : rtp

Not used. Set to "0".

bit 7-0 : ptyp External emergency stop setting

When the emergency stop input signal of the power supply unit is "disabled"

Power supply unit is not connected	: 00
MDS-D2-CV-37 / MDS-DH2-CV-37	: 04
MDS-D2-CV-75 / MDS-DH2-CV-75	: 08
MDS-D2-CV-110 / MDS-DH2-CV-110	: 11
MDS-D2-CV-185 / MDS-DH2-CV-185	: 19
MDS-D2-CV-300 / MDS-DH2-CV-300	: 30
MDS-D2-CV-370 / MDS-DH2-CV-370	: 37
MDS-D2-CV-450 / MDS-DH2-CV-450	: 45
MDS-D2-CV-550 / MDS-DH2-CV-550	: 55
MDS-DH2-CV-750	: 75

When the emergency stop input signal of the power supply unit is "enabled"

(Note) Set the power supply rotary switch to "4".

Power supply unit is not connected	: 00
MDS-D2-CV-37 / MDS-DH2-CV-37	: 44
MDS-D2-CV-75 / MDS-DH2-CV-75	: 48
MDS-D2-CV-110 / MDS-DH2-CV-110	: 51
MDS-D2-CV-185 / MDS-DH2-CV-185	: 59
MDS-D2-CV-300 / MDS-DH2-CV-300	: 70
MDS-D2-CV-370 / MDS-DH2-CV-370	: 77
MDS-D2-CV-450 / MDS-DH2-CV-450	: 85
MDS-D2-CV-550 / MDS-DH2-CV-550	: 95
MDS-DH2-CV-750	: B5

MDS-DM2-SPV Series: Power supply type

Set as follows for the spindle drive section of the MDS-DM2-SPV.

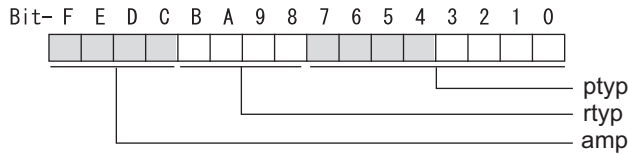

bit F-C : amp

Not used. Set to "0".

bit B-8 : rtyp

Not used. Set to "0".

bit 7-0 : ptyp External emergency stop setting

Normal : 19
 External emergency stop function: 59

MDS-DJ-SP Series: Regenerative resistor type

Set the regenerative resistor type.

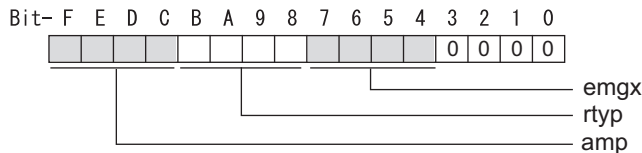

bit F-8 : amp(bit F-C) / rtyp(bit B-8)

- Setting prohibited : 10-12
- MR-RB12 or GZG200W39OHMK : 13
- MR-RB32 or GZG200W120OHMK 3 units connected in parallel : 14
- MR-RB30 or GZG200W39OHMK 3 units connected in parallel : 15
- MR-RB50 or GZG300W39OHMK 3 units connected in parallel : 16
- Setting prohibited : 17-1F
- Setting prohibited : 20-23
- FCUA-RB22 : 24
- FCUA-RB37 : 25
- FCUA-RB55 : 26
- FCUA-RB75/2 1 unit : 27
- R-UNIT1 : 28
- R-UNIT2 : 29
- R-UNIT3 : 2A
- R-UNIT4 : 2B
- R-UNIT5 : 2C
- FCUA-RB75/2 2 units connected in parallel: 2D
- FCUA-RB55/2 2 units connected in parallel: 2E
- Setting prohibited : 2F

bit 7-4 : emgx External emergency stop function

Set the external emergency stop function.
 0: Disable 4: Enable

bit 3-0 :

Not used. Set to "0".

【#13033】 SP033 SFNC1 Spindle function 1

Select the spindle specification.
A function is allocated to each bit.
Set this in hexadecimal format.

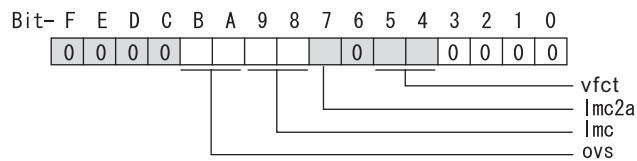
**bit F-C :**

Not used. Set to "0".

bit B-A : ovs Overshoot compensation

Set this parameter when overshooting occurs during positioning.

bitB,A=

- 00: Compensation stop
- 01: Setting prohibited
- 10: Setting prohibited
- 11: Compensation type 3

Set the compensation amount in SP043(OVS1) and SP042(OVS2).

bit 9-8 : lmc Lost motion compensation type2

Set this parameter when the protrusion at quadrant change is too large.

bit9,8=

- 00: Compensation stop
- 01: Setting prohibited
- 10: Compensation type 2
- 11: Setting prohibited

bit 7 : lmc2a Lost motion compensation 2 timing

- 0: Normal
- 1: Change

bit 6 :

Not used. Set to "0".

bit 5-4 : vfct Jitter compensation pulse number

Suppress vibration by machine backlash when axis stops.

bit5,4=

- 00: Disable
- 01: 1 pulse
- 10: 2 pulse
- 11: 3 pulses

bit 3-0 :

Not used. Set to "0".

[#13034] SP034 SFNC2 Spindle function 2

Select the spindle function.
A function is allocated to each bit.
Set this in hexadecimal format.

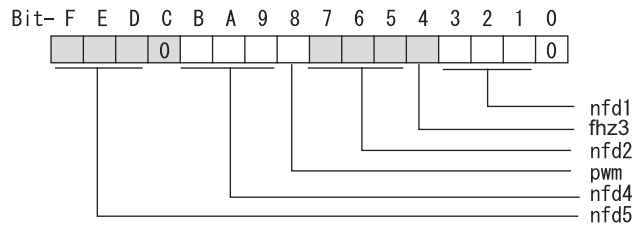
**bit F-D : nfd5 Depth of Notch filter 5**

Set the depth of Notch filter 5 (SP088).
bit F,E,D=
000: -∞
001: -18.1[dB]
010: -12.0[dB]
011: -8.5[dB]
100: -6.0[dB]
101: -4.1[dB]
110: -2.5[dB]
111: -1.2[dB]

bit C :

Not used. Set to "0".

bit B-9 : nfd4 Depth of Notch filter 4

Set the depth of Notch filter 4 (SP087).
bit B,A,9=
000: -∞
001: -18.1[dB]
010: -12.0[dB]
011: -8.5[dB]
100: -6.0[dB]
101: -4.1[dB]
110: -2.5[dB]
111: -1.2[dB]

bit 8 : pwm Current control

0: Standard current control 1: High frequency current control

bit 7-5 : nfd2 Depth of Notch filter 2

Set the depth of Notch filter 2 (SP046).
bit 7,6,5=
000: -∞
001: -18.1[dB]
010: -12.0[dB]
011: -8.5[dB]
100: -6.0[dB]
101: -4.1[dB]
110: -2.5[dB]
111: -1.2[dB]

bit 4 : fhz3 Notch filter 3

0: Stop 1: Start (1125Hz)

bit 3-1 : nfd1 Depth of Notch filter 1

Set the depth of Notch filter 1 (SP038).
 bit3,2,1=
 000: - ∞
 001: -18.1[dB]
 010: -12.0[dB]
 011: -8.5[dB]
 100: -6.0[dB]
 101: -4.1[dB]
 110: -2.5[dB]
 111: -1.2[dB]

bit 0 :

Not used. Set to "0".

【#13035(PR) SP035 SFNC3 Spindle function 3

Select the spindle function.
 A function is allocated to each bit.
 Set this in hexadecimal format.

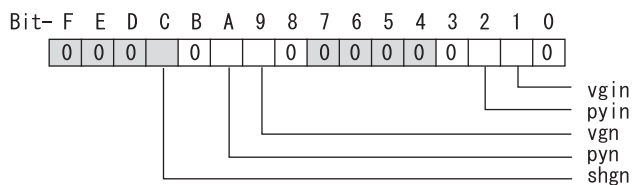

bit F-D :

Not used. Set to "0".

bit C : shgn SHG control in interpolation mode

0: Stop 1: Start
 When using the OMR-FF control, set to "0".

bit B :

Not used. Set to "0".

bit A : pyn Excitation rate selection in interpolation mode

0: Select Excitation rate 1 1: Select Excitation rate 2

bit 9 : vgn Speed loop gain set selection in interpolation mode

0: Select Set 1 1: Select Set 2

bit 8-3 :

Not used. Set to "0".

bit 2 : pyin Excitation rate selection in non-interpolation mode

The excitation rate after the in-position can be selected.
 0: Select Excitation rate 1 1: Select Excitation rate 2

bit 1 : vgin Speed loop gain set selection in non-interpolation mode

The speed loop gain set after the in-position can be selected.
 0: Select Set 1 1: Select Set 2

bit 0 :

Not used. Set to "0".

【#13036(PR)】 SP036 SFNC4 Spindle function 4

Select the spindle function.
 A function is allocated to each bit.
 Set this in hexadecimal format.

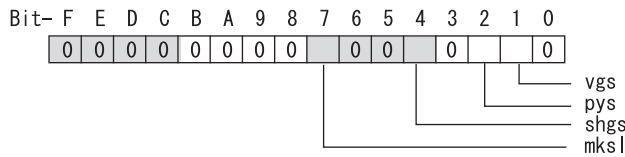

bit F-8 :

Not used. Set to "0".

bit 7 : mksl Coil selection in spindle synchronization mode

0: Select the coil commanded during synchronization 1: Select high-speed coil

bit 6-5 :

Not used. Set to "0".

bit 4 : shgs SHG control in spindle synchronization mode

0: Stop 1: Start
 When using the OMR-FF control, set to "0".

bit 3 :

Not used. Set to "0".

bit 2 : pys Excitation rate selection in spindle synchronization mode

0: Select Excitation rate 1 1: Select Excitation rate 2

bit 1 : vgs Speed loop gain set selection in spindle synchronization mode

0: Select Set 1 (SP005,SP006,SP007) 1: Select Set 2 (SP008,SP009,SP010)

bit 0 :

Not used. Set to "0".

【#13037】 SP037 JL Load inertia scale

Set the motor axis conversion total load inertia including motor itself in proportion to the motor inertia.

$$SV037(JL)=(Jm+Jl)/Jm \times 100$$

Jm: Motor inertia

Jl: Motor axis conversion load inertia

---Setting range---

0 to 5000 (%)

【#13038】 SP038 FHZ1 Notch filter frequency 1

Set the vibration frequency to suppress when machine vibration occurs.

(Enabled at 50 or more.)

When not using, set to "0".

Related parameters: SP034/bit3-1

---Setting range---

0 to 2250 (Hz)

【#13039】 SP039 LMCD Lost motion compensation timing

Set this parameter when the lost motion compensation type2 timing does not match.

Adjust by increasing the value by 10 at a time.

---Setting range---

0 to 2000 (ms)

【#13040】 SP040 LMCT Lost motion compensation non-sensitive band

Set the non-sensitive band of the lost motion compensation in the feed forward control.
When "0" is set, 2°/1000 is set. Adjust by increasing the value by 1°/1000 at a time.

---Setting range---

-32768 to 32767 (1°/1000)

【#13041】 SP041 LMC2 Lost motion compensation 2

Set this parameter with SP048(LMC1) only to vary the lost motion compensation amount depending on the command directions.
Normally, set to "0".

---Setting range---

-1 to 200 (Short-time rated %)

Note that when SP227/bit2 is "1", the range will be -1 to 20000 (Short-time rated 0.01%).

【#13042】 SP042 OVS2 Overshooting compensation 2

Set this parameter with SP043(OVS1) only to vary the lost motion compensation amount depending on the command directions.
Normally, set to "0".

---Setting range---

-1 to 100 (Short-time rated %)

Note that when SP227/bit2 is "1", the range will be -1 to 10000 (Short-time rated 0.01%).

【#13043】 SP043 OVS1 Overshooting compensation 1

Set this parameter when overshooting occurs during positioning. This compensates the motor torque during positioning.
This is valid only when the overshooting compensation SP033 (SFNC1/ovs) is selected.

[Type 3 "When SP033/ bitB,A=11"]

Use this when performing overshoot compensation in the feed forward control during arc cutting mode.

Set the compensation amount based on the motor short-time rated current.

Increase the value in increments of 1% to find the value where overshooting ceases.

[To vary compensation amount depending on the direction]

When SV042 (OVS2) is "0", change the SP043 (OVS1) value in both +/- directions to compensate.

To change the compensation amount depending on the command direction, set this with SP042 (OVS2).

(SP043: + direction, SP042: - direction, However, the directions may be opposite depending on other settings.)

When "-1" is set, the compensation will not be performed in the command direction.

---Setting range---

-1 to 100 (Short-time rated %)

Note that when SP227/bit2 is "1", the range will be -1 to 10000 (Short-time rated 0.01%).

【#13044】 SP044 OBS2 Disturbance observer gain

Set the disturbance observer gain. The standard setting is "100".

To use the disturbance observer, also set SP037(JL), SP045(OBS1) and SP226/ bitE.

When not using, set to "0".

---Setting range---

0 to 500 (%)

【#13045】 SP045 OBS1 Disturbance observer filter frequency

Set the disturbance observer filter band.

Normally, set to "100".

To use the disturbance observer, also set SP037(JL), SP044(OBS2) and SP226/ bitE.

When not using, set to "0".

---Setting range---

0 to 1000 (rad/s)

[#13046] SP046 FH2 Notch filter frequency 2

Set the vibration frequency to suppress when machine vibration occurs.
(Enabled at 50 or more.)
When not using, set to "0".

Related parameters: SP034/bit7-5

---Setting range---
0 to 2250 (Hz)

 [#13047] SP047 EC Inductive voltage compensation gain

Set the inductive voltage compensation gain. Normally, set to "100".
Lower the gain when the current FB peak exceeds the current command peak.

---Setting range---
0 to 200 (%)

 [#13048] SP048 LMC1 Lost motion compensation 1

Set this parameter when the protrusion (that occurs due to the non-sensitive band by friction, torsion, backlash, etc.) at quadrant change is too large.

This sets the compensation torque at quadrant change (when an axis feed direction is reversed) by Short-time rated %.

Whether to enable the lost motion compensation and the method can be set with other parameters.

[Type 2 "When SP033/bit9,8=10"]

Set the compensation amount based on the motor short-time rated current.

The standard setting is double of the friction torque. The compensation amount will be 0 when "0" is set.

Related parameters: SP033/bit9-8, SP039, SP040, SP041, SP227/bit2

[To vary compensation amount depending on the direction]

When SP041 (LMC2) is "0", change SP048 (LMC1) value in both of +/- directions to compensate.

To vary the compensation amount depending on the command direction, set this with SP041 (LMC2).

(SP048: + direction, SP041: - direction, However, the directions may be opposite depending on other settings.)

When "-1" is set, the compensation will not be performed in the command direction.

---Setting range---
-1 to 200 (Short-time rated %)
Note that when SP227/bit2 is "1", the range will be -1 to 20000 (Short-time rated 0.01%).

 [#13049] SP049 FFC Acceleration rate feed forward gain

When a relative error in the synchronous control is too large, set this parameter to the axis that is delaying.

The standard setting is "0". The standard setting in the SHG control is "50".

Adjust relative errors in acceleration/deceleration by increasing the value by 50.

---Setting range---
0 to 999 (%)

 [#13050] SP050 TOF Torque offset

Set the imbalance torque.

---Setting range---
-100 to 100 (Short-time rated %)

【#13051】 SP051 DFBT Dual feed back control time constant

Set the control time constant in dual feed back.

When the function is valid, the standard setting is "100". When "0" is set, the value is 1 ms.

When the time constant is increased, the operation will get closer to the semi-closed control and the limit of the position loop gain will be raised.

However, this cannot be used when the spindle slip occurs in machine configuration such as V-belt drive.

Related parameters: SP017/bit1, SP052

---Setting range---

0 to 9999 (ms)

【#13052】 SP052 DFBN Dual feedback control non-sensitive band

Set the non-sensitive band in the dual feedback control.

Normally set to "0".

Related parameters: SP017/bit1, SP051

---Setting range---

0 to 9999 (1/1000°)

【#13053】 SP053 ODS Excessive error detection width (non-interpolation mode)

Set the excessive error detection width in non-interpolation mode.

Standard setting value: ODS = Maximum motor speed [r/min] × 6/PGV/2

When set to "0", the excessive error detection will not be performed.

---Setting range---

0 to 32767 (°)

【#13054】 SP054 ORE Overrun detection width in closed loop control

Set the overrun detection width in the full-closed loop control.

When the gap between the motor side encoder and the machine side encoder exceeds the set value, it is judged as an overrun and "Alarm 43" is detected.

When "-1" is set, if the differential velocity between the motor side encoder and the machine side encoder exceeds the 30% of the maximum motor speed, it will be judged as overrun and "Alarm 43" will be detected.

When "0" is set, overrun will be detected with 2°.

In the full-closed loop control, normally set this parameter to "360". During V-belt drive, set to "-1".

---Setting range---

-1 to 32767 (°)

【#13055】 SP055 EMGx Max. gate off delay time after emergency stop

Set the time required to forcibly execute READY OFF after the emergency stop is input.

Normally set to "20000".

When "0" is set, READY OFF is forcibly executed with "7000ms".

When the set time is shorter than the time to decelerate and stop, the spindle will stop with the dynamic brake after the set time is out.

Related parameters: SP056, SP230

---Setting range---

0 to 29900 (ms)

【#13056】 SP056 EMGt Deceleration time constant at emergency stop

Set the time constant used for the deceleration control at emergency stop. Set the time required to stop from the maximum motor speed (TSP).
When "0" is set, the deceleration control is executed with "7000ms".

Related parameters: SP055, SP230

---Setting range---
0 to 29900 (ms)

【#13057(PR)】 SP057 GRA1 Spindle side gear ratio 1

Set the number of gear teeth on the spindle side when "the gear selection command (control input 4/bit6, 5) "is set to "00".

---Setting range---
1 to 32767

【#13058(PR)】 SP058 GRA2 Spindle side gear ratio 2

Set the number of gear teeth on the spindle side when "the gear selection command (control input 4/bit6, 5) " is set to "01".

---Setting range---
1 to 32767

【#13059(PR)】 SP059 GRA3 Spindle side gear ratio 3

Set the number of gear teeth on the spindle side when "the gear selection command (control input 4/bit6, 5) " is set to "10".

---Setting range---
1 to 32767

【#13060(PR)】 SP060 GRA4 Spindle side gear ratio 4

Set the number of gear teeth on the spindle side when "the gear selection command (control input 4/bit6, 5) " is set to "11".

---Setting range---
1 to 32767

【#13061(PR)】 SP061 GRB1 Motor side gear ratio 1

Set the number of gear teeth on the motor side when "the gear selection command (control input 4/bit6, 5) " is set to "00".

---Setting range---
1 to 32767

【#13062(PR)】 SP062 GRB2 Motor side gear ratio 2

Set the number of gear teeth on the motor side when "the gear selection command (control input 4/bit6, 5) " is set to "01".

---Setting range---
1 to 32767

【#13063(PR)】 SP063 GRB3 Motor side gear ratio 3

Set the number of gear teeth on the motor side when "the gear selection command (control input 4/bit6, 5) " is set to "10".

---Setting range---
1 to 32767

【#13064(PR)】 SP064 GRB4 Motor side gear ratio 4

Set the number of gear teeth on the motor side when "the gear selection command (control input 4/bit6, 5)" is set to "11".

---Setting range---
1 to 32767

【#13065】 SP065 TLM1 Torque limit 1

Set the torque limit value when "the torque limit (control input 1/bitA, 9, 8)" is set to "001".

---Setting range---
0 to 999 (Short-time rated %)

【#13066】 SP066 TLM2 Torque limit 2

Set the torque limit value when "the torque limit (control input 1/bitA, 9, 8)" is set to "010".

---Setting range---
0 to 999 (Short-time rated %)

【#13067】 SP067 TLM3 Torque limit 3

Set the torque limit value when "the torque limit (control input 1/bitA, 9, 8)" is set to "011".

---Setting range---
0 to 999 (Short-time rated %)

【#13068】 SP068 TLM4 Torque limit 4

Set the torque limit value when "the torque limit (control input 1/bitA, 9, 8)" is set to "100".

---Setting range---
0 to 999 (Short-time rated %)

【#13069】 SP069 PCMP Phase alignment completion width

Set the single-rotation position alignment completion width for phase alignment and changing from non-interpolation to spindle synchronization mode during rotation.
Set the rotation error that is required to the machine.
When the setting value decreases, the rotation error will decrease, but the cycle time (settling time) will get longer. The standard setting is "875".

---Setting range---
0 to 32767 (1°/1000)

【#13070】 SP070 KDDT Phase alignment deceleration rate scale

Set the scale for SP016 (DDT) to change the deceleration rate only during rotation command (command F $\Delta T \neq 0$).
When the setting value increases, the single-rotation position alignment will be completed faster, but the impact to the machine will also increase. When not using, set to "0".

---Setting range---
0 to 255 (1/16-fold)

【#13071】 SP071 DIQM Variable current limit during deceleration, lower limit value

Set this parameter to adjust the deceleration time by changing the current limit value during deceleration depending on the motor speed.

As shown below, set the lower limit rate of the current limit in SP071 (DIQM), and use with SP072 (DIQN).

When DIQM is set to 100%, the standard current limit value in deceleration (TMLR) is applied.

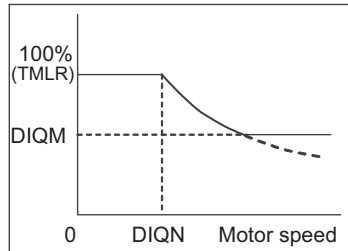
**---Setting range---**

0 to 999 (%)

【#13072】 SP072 DIQN Variable current limit during deceleration, break point speed

Set this parameter to adjust the deceleration time by changing the current limit value during deceleration depending on the motor speed.

As shown below, set the lower limit rate of the current limit in SP071 (DIQM), and use with SP072 (DIQN).

When DIQM is set to 100%, the standard current limit value in deceleration (TMLR) is applied.

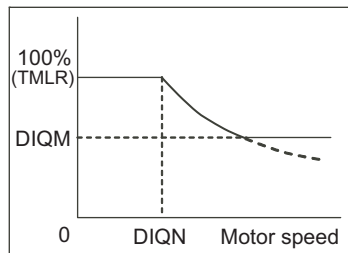
**---Setting range---**

1 to 32767 (r/min)

【#13073】 SP073 VGVN Variable speed gain target value

If noise is bothersome during high speed rotation, it may be reduced by lowering the speed loop gain at high speed.

Set this value to ensure the adequate response by suppressing noise and vibration at low speeds and increasing the speed loop gain at high speeds for a high-speed spindle of machining center, etc. As shown below, set the speed loop gain rate for the overspeed detection speed in SP073 (VGVN), and use with SP074 (VGVS).

When not using, set to "0".

The overspeed detection speed (VLMT) is 115% of the maximum motor speed (TSP).

This function can be used when either Speed loop gain set 1 or Speed loop gain set 2 is selected.

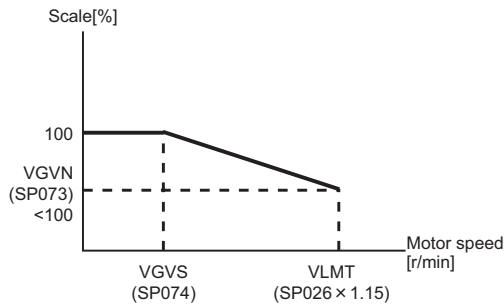

When lowering the speed loop gain at high speed

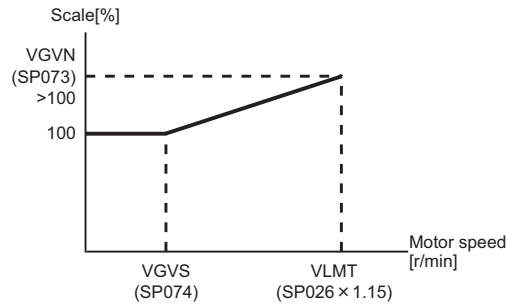

When increasing the speed loop gain at high speed

---Setting range---
0 to 999 (%)

【#13074】 SP074 VGVS Variable speed gain change start speed

If noise is bothersome during high speed rotation, it may be reduced by lowering the speed loop gain at high speed.

Set this value to ensure the adequate response by suppressing noise and vibration at low speeds and increasing the speed loop gain at high speeds for a high-speed spindle of machining center, etc. As shown below, set the speed loop gain rate for the overspeed detection speed in SP073 (VGVN), and use with SP074 (VGVS).

When not using, set to "0".

The overspeed detection speed (VLMT) is 115% of the maximum motor speed (TSP).

This function can be used when either Speed loop gain set 1 or Speed loop gain set 2 is selected.

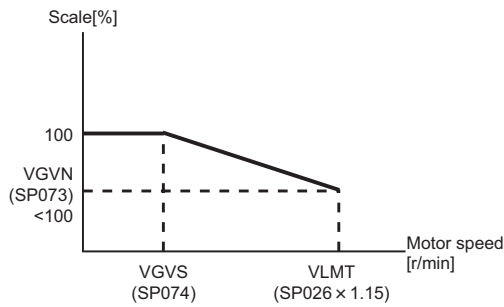

When lowering the speed loop gain at high speed

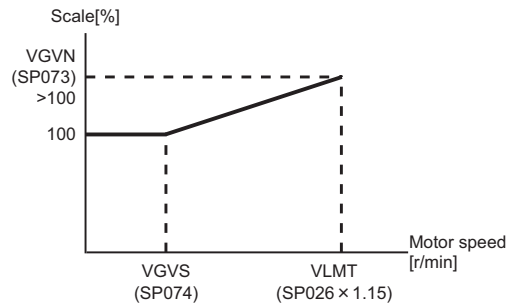

When increasing the speed loop gain at high speed

---Setting range---
0 to 32767 (r/min)

【#13075】 SP075 DWSH Slip compensation scale during regeneration high-speed coil

Set the slip frequency scale during deceleration. Normally, set to "0". (For Mitsubishi Electric adjustment)

---Setting range---
0 to 255 (1/16-fold)

【#13076】 SP076 DWSL Slip compensation scale during regeneration low-speed coil

Set the slip frequency scale at deceleration when using the low-speed coil.
Normally, set to "0". (For Mitsubishi Electric adjustment)

---Setting range---

0 to 255 (1/16-fold)

【#13077】 SP077 IQA Q axis current lead compensation

Set the current loop gain.
To use the coil switch function, set the current loop gain for when the high-speed coil is selected.
The setting value is determined by the motor's electrical characteristics so that the value is fixed to each motor used.
Set the value given in the spindle parameter list. (For Mitsubishi Electric adjustment)

---Setting range---

1 to 20480

【#13078】 SP078 IDA D axis current lead compensation

Set the current loop gain.
To use the coil switch function, set the current loop gain for when the high-speed coil is selected.
The setting value is determined by the motor's electrical characteristics so that the value is fixed to each motor used.
Set the value given in the spindle parameter list. (For Mitsubishi Electric adjustment)

---Setting range---

1 to 20480

【#13079】 SP079 IQG Q axis current gain

Set the current loop gain.
To use the coil switch function, set the current loop gain for when the high-speed coil is selected.
The setting value is determined by the motor's electrical characteristics so that the value is fixed to each motor used.
Set the value given in the spindle parameter list. (For Mitsubishi Electric adjustment)

---Setting range---

1 to 8192

【#13080】 SP080 IDG D axis current gain

Set the current loop gain.
To use the coil switch function, set the current loop gain for when the high-speed coil is selected.
The setting value is determined by the motor's electrical characteristics so that the value is fixed to each motor used.
Set the value given in the spindle parameter list. (For Mitsubishi Electric adjustment)

---Setting range---

1 to 8192

【#13081】 SP081 IQAL Q axis current lead compensation low-speed coil

When using coil switch function, set the current loop gain for when the low-speed coil is selected.
The setting value is determined by the motor's electrical characteristics so that the value is fixed to each motor used.
Set the value given in the spindle parameter list. (For Mitsubishi Electric adjustment)

---Setting range---

1 to 20480

【#13082】 SP082 IDAL D axis current lead compensation low-speed coil

When using coil switch function, set the current loop gain for when the low-speed coil is selected.
The setting value is determined by the motor's electrical characteristics so that the value is fixed to each motor used.
Set the value given in the spindle parameter list. (For Mitsubishi Electric adjustment)

---Setting range---

1 to 20480

【#13083】 SP083 IQGL Q axis current gain low-speed coil

When using coil switch function, set the current loop gain for when the low-speed coil is selected. The setting value is determined by the motor's electrical characteristics so that the value is fixed to each motor used.

Set the value given in the spindle parameter list. (For Mitsubishi Electric adjustment)

---Setting range---

1 to 8192

【#13084】 SP084 IDGL D axis current gain low-speed coil

When using coil switch function, set the current loop gain for when the low-speed coil is selected. The setting value is determined by the motor's electrical characteristics so that the value is fixed to each motor used.

Set the value given in the spindle parameter list. (For Mitsubishi Electric adjustment)

---Setting range---

1 to 8192

【#13085】 SP085

Not used. Set to "0".

【#13086】 SP086

Not used. Set to "0".

【#13087】 SP087 FHZ4 Notch filter frequency 4

Set the vibration frequency to suppress when machine vibration occurs.

(Enabled at 50 or more.)

When not using, set to "0".

Related parameters: SP034/bitB-9

---Setting range---

0 to 2250 (Hz)

【#13088】 SP088 FHZ5 Notch filter frequency 5

Set the vibration frequency to suppress when machine vibration occurs.

(Enabled at 50 or more.)

When not using, set to "0".

Related parameters: SP034/bitF-D

---Setting range---

0 to 2250 (Hz)

【#13089】 SP089 TMKQ Spindle output stabilizing gain Q axis

Set the magnification of the torque current stabilizing gain. (For Mitsubishi Electric adjustment)

When set to "0", the torque current stabilization is disabled.

When not using, set to "0".

---Setting range---

0 to 32767

【#13090】 SP090 TMKD Spindle output stabilizing gain D axis

Set the magnification of the excitation current stabilizing gain. (For Mitsubishi Electric adjustment)

When set to "0", the excitation current stabilization is disabled.

When not using, set to "0".

---Setting range---

0 to 32767

【#13091】 SP091

Not used. Set to "0".

【#13092】 SP092

Not used. Set to "0".

【#13093】 SP093

Not used. Set to "0".

【#13094】 SP094 MPV Magnetic pole error detection speed

In the magnetic pole position detection function, the command motor speed and motor speed during the position command stop are monitored.

Set the command motor speed level and motor speed level during the position command stop in "r/min" unit.

When the command motor speed level is set to "0", the magnetic pole position error is detected at 10r/min.

Set to "10" as a standard setting when the magnetic pole position error detection function is enabled. This detects the magnetic pole position error when the motor speed is "100r/min".

Ten-thousands digit, Thousands digit ----- Command motor speed level (10r/min)

Hundreds digit, Tens digit, Ones digit ----- Motor speed level (10r/min)

---Setting range---

0 to 31999

【#13095】 SP095 VIAX Lead compensation scale during high-response acceleration/ deceleration

Set the magnification against delay/lead compensation (SP006) of the high-response acceleration/ deceleration (valid when SP226/ bitD is set to "1").

Normally, set to "0". Set this parameter to suppress overshooting when the speed is reached.

---Setting range---

0 to 10000 (0.01%)

【#13096】 SP096 SDW Speed slowdown allowable width

When the spindle slows down due to multiple cutting, set the processable speed as percentage against the NC command speed.

If the speed reduces below the tolerable range, the alarm 23 (Excessive speed error) will occur. (E.g.) When set to 90 [%]

If S1000 is commanded, the speed reduced by 900r/min (=1000r/min × 90%) is the allowable lower limit.

Thus if the spindle speed reduces to 100r/min or below, the alarm will occur.

When "0" is set, the magnification is the same as when "85" is set. When set to "-1", the allowable width will be disabled.

---Setting range---

-1,0 to 100(%)

【#13097】 SP097 RNG1ex Extension sub side encoder resolution

When setting the machine side encoder resolution in pulse (p) unit, set the number of pulses to four bite data of SP097 (high-order) and SP019 (low-order) in pulse (p) unit.

When SP097=0, the setting unit of SP019 is (kp).

Refer to SP019 for details.

Related parameters: SP019, SP020, SP098

---Setting range---

-1 to 32767

【#13098】 SP098 RNG2ex Extension main side encoder resolution

When setting the motor side encoder resolution in pulse (p) unit, set the number of pulses to four bite data of SP098 (high-order) and SP020 (low-order) in pulse (p) unit.

When SP098=0, the setting unit of SP020 is (kp).
Refer to SP020 for details.

Related parameters: SP019, SP020, SP097

---Setting range---

-1 to 32767

【#13099-13105】 SP099-SP105

Not used. Set to "0".

【#13106】 SP106 PGM OMR-FF scale model gain

Set the scale model gain (position response) in OMR-FF control.

Set the same value as SV002(PGN).

Increase the setting value to perform a high-speed machining such as a fine arc or to improve the path error.

Lower the value when vibration occurs during acceleration/deceleration.

Set to "0" when not using OMR-FF control.

---Setting range---

0 to 300 (rad/s)

【#13107-13111】 SP107-SP111

Not used. Set to "0".

【#13112】 SP112 IFF OMR-FF current feed forward gain

Set the current feed forward rate in OMR-FF control.

The standard setting is "10000".

Setting value of 0 is equal to "10000(100%)" setting.

Set to "0" when not using OMR-FF control.

---Setting range---

0 to 32767 (0.01%)

【#13113】 SP113 OPLP Current command value for open loop

Set the current command value for when the open loop control is enabled.

When "0" is set, the state will be the same as when "50" is set.

When not using, set to "0".

The open loop control is enabled when "SP018/bit1" is set to "1".

---Setting range---

0 to 999 (Short-time rated %)

【#13114】 SP114 MKT Coil changeover gate cutoff timer

Set the time required to cut off the gate when turning OFF/ON the coil switch contactor.

The value should be longer than the coil switch contactor's OFF/ON time.

The standard setting is "150".

---Setting range---

0 to 3500 (ms)

【#13115】 SP115 MKT2 Coil changeover current limit timer

Set the time required to limit the current immediately after the coil switch contactor ON/OFF is completed and the gate is turned ON.
The standard setting is "250".

---Setting range---
0 to 3500 (ms)

【#13116】 SP116 MKIL Coil changeover current limit value

Set the time required to limit the current immediately after the coil switch contactor ON/OFF is completed and the gate is turned ON.
The standard setting is "120".

---Setting range---
0 to 999 (Short-time rated %)

【#13117】 SP117 SETM Excessive speed deviation timer

Set the time to detect the speed excessive error alarm.
Set the time required to the machine.
The standard setting is "12".

---Setting range---
0 to 60 (s)

【#13118(PR)】 SP118 MSFT Magnetic pole shift amount

Set the magnetic pole shift amount of IPM spindle motor.
During DC excitation of the initial setup: Set the same value displayed in the "AFLT gain" on the NC monitor screen in SP225/bit4=1.
When not using, set to "0".

---Setting range---
-18000 to 18000 (electrical angle 0.01°)

【#13119】 SP119

Not used. Set to "0".

【#13120】 SP120

Not used. Set to "0".

【#13121】 SP121 MP Kpp Magnetic pole detection position loop gain

Set the position loop gain in the magnetic polar detection loop.
This is used in the initial magnetic polar detection when the IPM spindle motor is turned ON.
Set to "0" when using an IM spindle motor.

---Setting range---
0 to 32767

【#13122】 SP122 MP Kvp Magnetic pole detection speed loop gain

Set the speed loop gain in the magnetic polar detection loop.
This is used in the initial magnetic polar detection when the IPM spindle motor is turned ON.
Set to "0" when using an IM spindle motor.

---Setting range---
0 to 32767

【#13123】 SP123 MP Kvi Magnetic pole detection speed loop lead compensation

Set the speed loop lead compensation in the magnetic polar detection loop.
This is used in the initial magnetic polar detection when the IPM spindle motor is turned ON.
Set to "0" when using an IM spindle motor.

---Setting range---
0 to 32767

【#13124】 SP124 ILMTsp Magnetic pole detection current limit value

Set the current limit value for the magnetic polar detection loop.
This is used in the initial magnetic polar detection when the IPM spindle motor is turned ON.
Set to "0" when using an IM spindle motor.

---Setting range---
0 to 999 (Short-time rated %)

【#13125】 SP125 DA1NO D/A output ch1 data No. / Initial DC excitation level

Input the desired data number to D/A output channel.
When using the 2-axis drive unit, set "-1" to the axis that the data will not be output.

When the DC excitation is running:
Use in the DC excitation function.
DC excitation: Set the initial excitation level when SP225/bit4=1.
When "0" is set, the state will be the same as when "20" is set.

---Setting range---
-32768 to 32767

【#13126】 SP126 DA2NO D/A output ch2 data No. / Final DC excitation level

Input the desired data number to D/A output channel.
When using the 2-axis drive unit, set "-1" to the axis that the data will not be output.

When the DC excitation is running:
Use in the DC excitation function.
DC excitation: Set the final excitation level when SP225/bit4=1.
When "0" is set, the state will be the same as when "50" is set.

---Setting range---
-32768 to 32767

【#13127】 SP127 DA1MPY D/A output ch1 output scale / Initial DC excitation time

Set the output scale in increments of 1/100.
When "0" is set, the scale is the same as when "100" is set.

When the DC excitation is running:
Use in the DC excitation function.
DC excitation: Set the initial excitation time when SP225/bit4=1.
When "0" is set, the state will be the same as when "10000" is set.

---Setting range---
-32768 to 32767 (1/100-fold)

【#13128】 SP128 DA2MPY D/A output ch2 output scale

Set the output scale in increments of 1/100.
When "0" is set, the scale is the same as when "100" is set.

---Setting range---
-32768 to 32767 (1/100-fold)

【#13129(PR)-13141(PR)】 SP129 - SP141

Set the unique constants for the spindle motor. (High-speed coil)
The setting value is determined by the motor's mechanical and electrical characteristics and specifications, so normally set the value given in the spindle parameter list.

【#13142(PR)】 SP142

Set the unique constants for the spindle motor. (High-speed coil)
The setting value is determined by the motor's mechanical and electrical characteristics and specifications, so normally set the value given in the spindle parameter list.
For IPM spindle motor
This parameter is used in initial magnetic pole detection of IPM spindle motor.
(1) Pulse application time: Set it in [μ s] unit. (0 < application time < 350)
(2) Pulse application coil: To select a low-speed coil, add 1000 to the pulse application time.
(3) Polarity of estimated magnetic pole: When it is set to the reverse polarity, add "-" to the total of (1) and (2).
E.g.: When performing 333 μ s pulse-applied magnetic pole estimation in a low-speed coil and selecting the reverse polarity for the estimated polarity
SP142 = -(333+1000) = -1333

【#13143(PR)-13160(PR)】 SP143 - SP160

Set the unique constants for the spindle motor. (High-speed coil)
The setting value is determined by the motor's mechanical and electrical characteristics and specifications, so normally set the value given in the spindle parameter list.

【#13161(PR)-13192(PR)】 SP161 - SP192

Set the unique constants for the spindle motor. (Low-speed coil)
The setting value is determined by the motor's mechanical and electrical characteristics and specifications, so normally set the value given in the spindle parameter list.

【#13193】 SP193 LMR Change magnification for load meter standard output (High-speed coil)

Set the standard output to be displayed as 100% in load meter using the short-time rated output ratio.
To display the continuous rated output as 100%, set as follows.
Continuous rated output/Short-time rated output \times 100
When "0" is set, the standard output to be displayed as 100% in load meter will be the short-time rated output.
(Note) When several output characteristics such as 15-minute rating and 30-minute rating are plotted on the characteristics figure, set the change magnification for the characteristic with the highest rated output.

---Setting range---
0 to 100 (%)

【#13194】 SP194 LMN Base speed for load meter standard output (High-speed coil)

Set the base speed of the standard output to be displayed as 100% in load meter.
 To display the continuous rated output as 100%, set the base speed of the continuous rated output as follows.

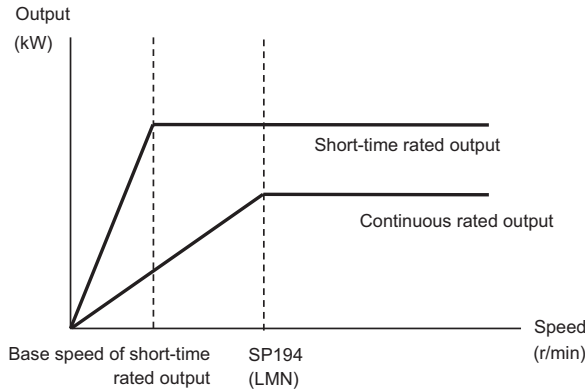

When "0" is set, the base speed of the short-time rated output will be applied.
 (Note) When the speed is less than the base speed, the standard output to be displayed as 100% in load meter changes with the motor speed.

---Setting range---
 0 to 32767 (r/min)

【#13195】 SP195 LMRL Change magnification for load meter standard output (Low-speed coil)

Set the standard output to be displayed as 100% in load meter using the short-time rated output ratio.
 To display the continuous rated output as 100%, set as follows.
 $\text{Continuous rated output} / \text{Short-time rated output} \times 100$
 When "0" is set, the standard output to be displayed as 100% in load meter will be the short-time rated output.
 (Note) When several output characteristics such as 15-minute rating and 30-minute rating are plotted on the characteristics figure, set the change magnification for the characteristic with the highest rated output.

---Setting range---
 0 to 100 (%)

【#13196】 SP196 LMNL Base speed for load meter standard output (Low-speed coil)

Set the base speed of the standard output to be displayed as 100% in load meter.
 To display the continuous rated output as 100%, set the base speed of the continuous rated output as follows.

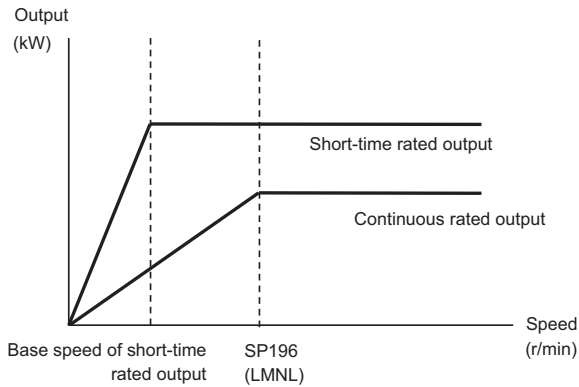

When "0" is set, the base speed of the short-time rated output will be applied.
 (Note) When the speed is less than the base speed, the standard output to be displayed as 100% in load meter changes with the motor speed.

---Setting range---
 0 to 32767 (r/min)

[#13197-13198] SP197 - SP198

Not used. Set to "0".

[#13199] SP199 RTGM Real-time tuning: maximum adaptive gain multiplier

In case that machine resonance is induced when mounting a workpiece, the speed loop gain is switched automatically in response to inertia by setting the speed loop gain and workpiece inertia multiplier in advance.

The speed loop gain SP199(RTGM) changes in response to the estimated inertia ratio SP200(RTJX) based on the speed loop gain SP005(VGN1) and the inertia multiplier SP037(JL) which were adjusted when no workpiece was mounted.

When SP199 is set to "0", the adaptation of the speed loop gain will be disabled.

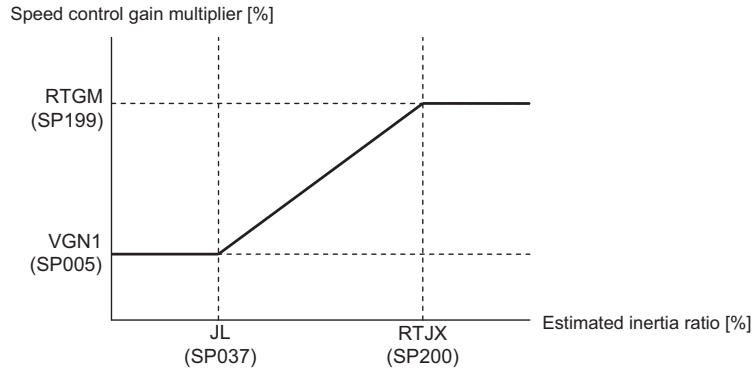

Related parameters: SP005, SP037, SP200

---Setting range---
0 to 5000 (%)

[#13200] SP200 RTJX Real-time tuning: maximum adaptive inertia ratio

In case that machine resonance is induced when mounting a workpiece, the speed loop gain is switched automatically in response to inertia by setting the speed loop gain and workpiece inertia multiplier in advance.

The speed loop gain SP199(RTGM) changes in response to the estimated inertia ratio SP200(RTJX) based on the speed loop gain SP005(VGN1) and the inertia multiplier SP037(JL) which were adjusted when no workpiece was mounted.

When SP199 is set to "0", the adaptation of the speed loop gain will be disabled.

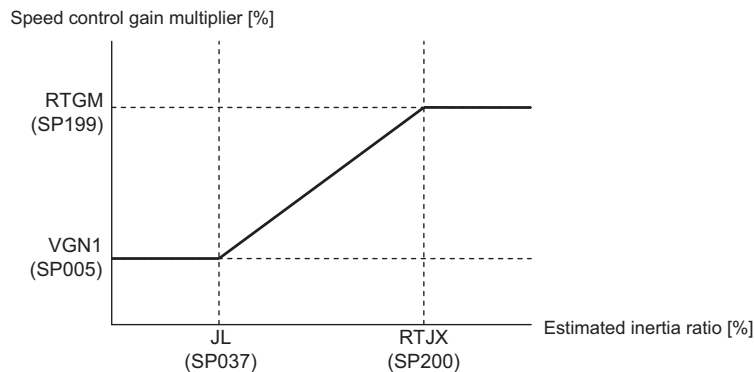

Related parameters: SP005, SP037, SP199

---Setting range---
0 to 32767 (%)

[#13201-13224] SP201 - SP224

Not used. Set to "0".

【#13225】 SP225 SFNC5 Spindle function 5

Select the spindle functions.
Functions are allocated to each bit.
Set this in hexadecimal format.

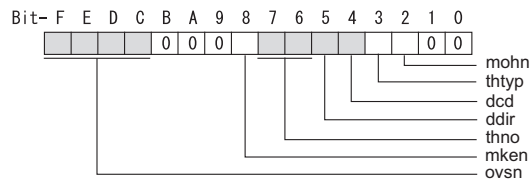
**bit F-C : ovsn Overshooting compensation type 3 non-sensitive band**

Set the non-sensitive band of the overshooting compensation type 3 in increments of $2^\circ/1000$.
In the feed forward control, set the non-sensitive band for the model position droop and ignore the model overshooting. Set to "2°/1000" as a standard.

bit B-9 :

Not used. Set to "0".

bit 8 : mken Coil switch allowance in deceleration control

This enables a coil changeover while decelerating after an emergency stop for a spindle motor with coil changeover specification. A coil changeover may enable an excessive load inertia to stop within the maximum delay time.

0: Normal (Disable) 1: Enable

bit 7-6 : thno

Select the thermistor characteristics.
When SP225/bit3=0 (N type) is selected
bit7,6=

00: For Mitsubishi spindle motor
01: Setting prohibited
10: Setting prohibited
11: Setting prohibited

When SP225/bit3=1 (P type) is selected
bit7,6=

00: KTY84-130 (Manufactured by Philips)
01: Setting prohibited
10: Setting prohibited
11: Setting prohibited

bit 5 : ddir Proximity switch signal enable edge

0: Falling edge 1: Rising edge

bit 4 : dcd DC excitation mode

0: Normal 1: Start

bit 3 : thtyp

Select the thermistor type.

0: Type N thermistor (Mitsubishi Electric standard) 1: Type P thermistor

bit 2 : mohn Thermistor temperature detection

0: Normal 1: Disable (Except for TS5690/5691)

bit 1-0 :

Not used. Set to "0".

[#13226] SP226 SFNC6 Spindle function 6

Select the spindle functions.
 Functions are allocated to each bit.
 Set this in hexadecimal format.

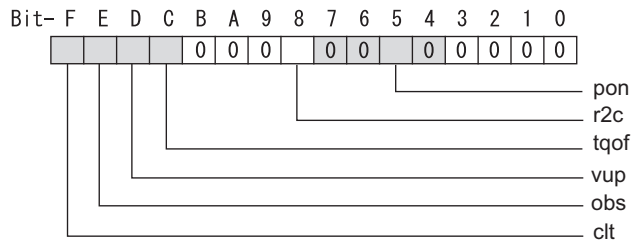

bit F : clt Spindle monitor load inertia ratio

0: Normal 1: Display

bit E : obs Disturbance observer

0: Normal 1: Enable

bit D : vup High response acceleration / deceleration

This suppresses a temporal delay which occurs when the target speed is attained from acceleration and when the spindle stops from deceleration.

0: Normal acceleration/deceleration 1: High response acceleration/deceleration Enable

bit C : tqof Spindle output stabilization during acceleration

0: Normal 1: Disable

bit B-9 :

Not used. Set to "0".

bit 8 : r2c Temperature compensation adjustment indicator

0: Normal 1: Display

bit 7-6 :

Not used. Set to "0".

bit 5 : pon IPM spindle pulse application magnetic pole estimation

0: Normal 1: Enable

bit 4-0 :

Not used. Set to "0".

【#13227】 SP227 SFNC7 Spindle function 7

Select the spindle functions.
 Functions are allocated to each bit.
 Set this in hexadecimal format.

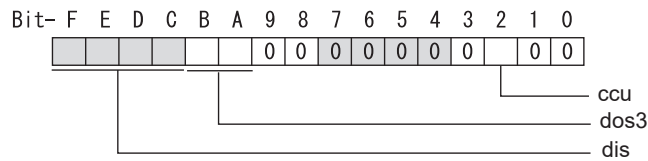

bit F-C : dis Digital signal input selection

- 0: No signal
- 1: SLS (Safely Limited Speed) function door state signal
- 4: Proximity switch signal detection
- Other settings: setting prohibited

bit B-A : dos3 Digital signal output 3 selection (MDS-DJ-SP)

- bitB,A=
- 00: Disable
 - 01: Setting prohibited
 - 10: Contactor control signal output
 - 11: Setting prohibited

bit 9-3 :

Not used. Set to "0".

bit 2 : ccu Lost motion/overshoot compensation compensation amount setting unit

- 0: Short-time rated %
- 1: Short-time rated 0.01%

bit 1-0 :

Not used. Set to "0".

【#13228】 SP228 SFNC8 Spindle function 8

Not used. Set to "0000".

[#13229] SP229 SFNC9 Spindle function 9

Select the spindle functions.
 Functions are allocated to each bit.
 Set this in hexadecimal format.

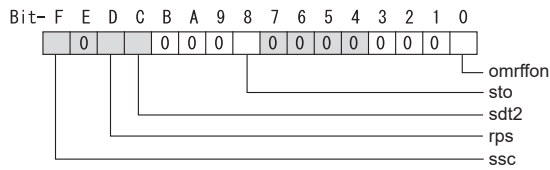

bit F : ssc SLS (Safely Limited Speed) function

0: Disable 1: Enable

bit E :

Not used. Set to "0".

bit D : rps Safely limited speed setting unit

0: Normal 1: 100°/min

bit C : sdt2 Specified speed output digital signal 2 output

0: Normal 1: Enable

bit B-9 :

Not used. Set to "0".

bit 8 : sto Dedicated wiring STO function

Set this parameter to use dedicated wiring STO function.
 0: Dedicated wiring STO function unused 1: Dedicated wiring STO function used

bit 7-1 :

Not used. Set to "0".

bit 0 : omrffon OMR-FF control enabled

0: Disable 1: Enable

【#13230】 SP230 SFNC10 Spindle function 10

Select the spindle functions.
 Functions are allocated to each bit.
 Set this in hexadecimal format.

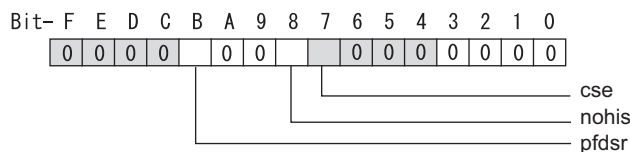

bit F-C :

Not used. Set to "0".

bit B : pfsdr

Set the spindle stop operation at a power failure when the deceleration and stop function at power failure is enabled.

Normal (Coast to a stop at power failure) : 0
 Deceleration and stop at power failure : 1

bit A-9 :

Not used. Set to "0".

bit 8 : nohis History of communication error alarm between NC and DRV(34,36,38,39)

For C70, set "1".
 0: Enable 1: Disable

bit 7 : cse Spindle C axis command speed monitoring function

0: Normal setting (function disabled) 1: Function enabled

bit 6-0 :

Not used. Set to "0".

Related parameters: SP055, SP056

【#13231】 SP231

Not used. Set to "0000".

【#13232】 SP232

Not used. Set to "0000".

【#13233】 SP233 IVC Voltage non-sensitive band compensation

When 100% is set, the voltage equivalent to the logical non-energized time will be compensated.
 When "0" is set, 100% compensation will be performed.
 Adjust in increments of 10% from the default value 100%.
 If the value is too large, vibration or vibration noise may be generated.

---Setting range---
 0 to 255 (%)

【#13234】 SP234

Not used. Set to "0".

【#13235(PR)】 SP235 R2H Temperature compensation gain

Set the magnification in converting the thermistor temperature to the control compensation amount.
 When "0" is set, the temperature compensation function is disabled.
 When not using, or when using an IPM spindle motor, set to "0".

---Setting range---
 0 to 400 (%)

【#13236(PR)】 SP236 WIH Temperature compensation time constant

Set the delay time constant from the thermistor temperature to the control compensation amount.
When "0" is set, the delay time constant is disabled.
When not using, or when using an IPM spindle motor, set to "0".

---Setting range---
0 to 150 (min)

【#13237(PR)】 SP237 TCF Torque command filter

Set the filter for the torque command.
When not using, set to "0".
The standard value is "500" when using the motor side encoder TS5690 or TS5691.

---Setting range---
0 to 4500 (Hz)

【#13238】 SP238 SSCFEED Safely limited speed

Set the safely limited speed at the spindle end for the SLS (Safely Limited Speed) function.
When not using, set to "0".

---Setting range---
0 to 18000 (°/min)
However, when SP229/bitD is set to "1", the setting range is from -32768 to 32767 (100°/min).

【#13239】 SP239 SSCRPM Safely limited motor speed

Set the motor's safely limited speed for the SLS (Safely Limited Speed) function.
Set a value to hold the following relationship.

$SP239 = (SP238/360) \times (SP057/SP061)$
Only when the product is 0, set to "1".

When not using, set to "0".

Related parameters: SP229/bitD, SP229/bitF, SP238

---Setting range---
0 to 32767 (r/min)

【#13240(PR)】 SP240

Not used. Set to "0".

【#13241(PR)-13256(PR)】 SP241 - SP256

This is automatically set by the NC system.

5

Servo Adjustment

5.1 Servo Adjustment Procedure

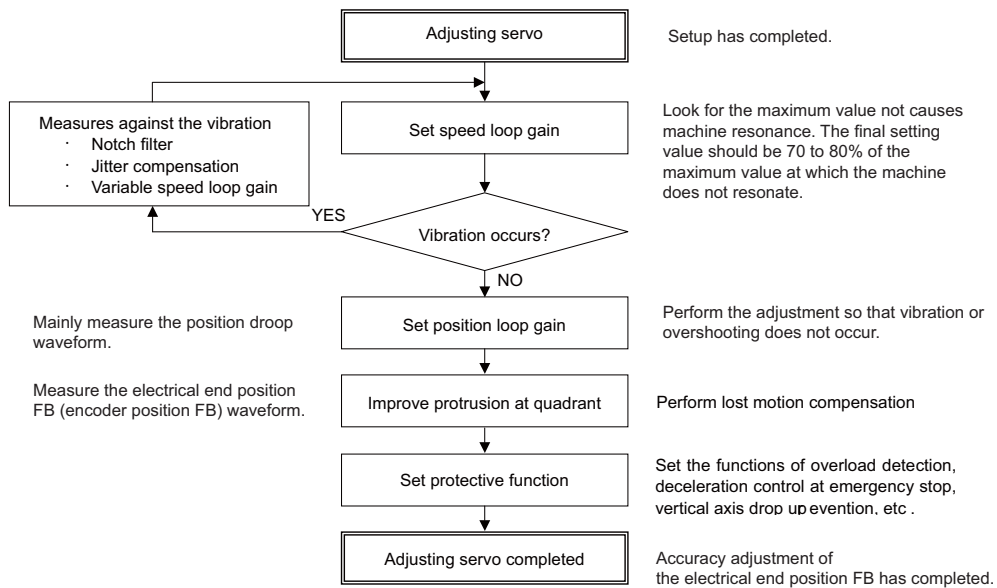

CAUTION

Perform adjusting the servo in the factory configuration of the machine. When the servo is adjusted without having an enough running-in or a cover, friction torque, machine resonance frequency or resonance gain may be different, resulting in an incorrect adjustment.

5.2 Gain Adjustment

5.2.1 Current Loop Gain

[#2209] SV009 IQA Current loop q axis lead compensation

Set the fixed value of each motor.
Set the standard value for each motor described in the standard parameter list.

---Setting range---
1 to 20480

[#2210] SV010 IDA Current loop d axis lead compensation

Set the fixed value of each motor.
Set the standard value for each motor described in the standard parameter list.

---Setting range---
1 to 20480

[#2211] SV011 IQG Current loop q axis gain

Set the fixed value of each motor.
Set the standard value for each motor described in the standard parameter list.

---Setting range---
1 to 8192

[#2212] SV012 IDG Current loop d axis gain

Set the fixed value of each motor.
Set the standard value for each motor described in the standard parameter list.

---Setting range---
1 to 8192

5.2.2 Speed Loop Gain

(1) Setting the speed loop gain

The speed loop gain 1 (SV005: VGN1) is an important parameter for determining the responsiveness of the servo control. During servo adjustment, the highest extent that this value can be set to becomes important. The setting value has a large influence on the machine cutting precision and cycle time.

- [1] Refer to the following standard VGN1 graphs and set the standard VGN1 according to the size of the entire load inertia (motor and machine load inertia).
- [2] If the standard VGN1 setting value is exceeded, the current command fluctuation will increase even if the speed feedback fluctuates by one pulse. This can cause the machine to vibrate easily, so set a lower value to increase the machine stability.

<When machine resonance does not occur at the standard VGN1>

Set the standard VGN1. Use the standard value if no problem (such as machine resonance) occurs. If sufficient cutting precision cannot be obtained at the standard VGN1, VGN1 can be raised above the standard value as long as a 70 percent margin in respect to the machine resonance occurrence limit is maintained. The cutting accuracy can also be improved by adjusting with the disturbance observer.

<When machine resonance occurs at the standard VGN1>

Machine resonance is occurring if the shaft makes abnormal sounds when operating or stopping, and a fine vibration can be felt when the machine is touched while stopped. Machine resonance occurs because the servo control responsiveness includes the machine resonance points. (Speed control resonance points occur, for example, at parts close to the motor such as ball screws.) Machine resonance can be suppressed by lowering VGN1 and the servo control responsiveness, but the cutting precision and cycle time are sacrificed. Thus, set a vibration suppression filter and suppress the machine resonance (Refer to section "Vibration Suppression Measures"), and set a value as close as possible to the standard VGN1. If the machine resonance cannot be sufficiently eliminated even by using a vibration suppression filter, then lower the VGN1.

[#2205] SV005 VGN1 Speed loop gain 1

Set the speed loop gain.

The higher the setting value is, the more accurate the control will be, however, vibration tends to occur.

If vibration occurs, adjust by lowering by 20 to 30%.

The value should be determined to the 70 to 80% of the value at which the vibration stops.

The value differs depending on servo motors.

Aim at the standard value determined by the servo motor type and load inertia ratio to adjust.

---Setting range---

1 to 30000



POINT

Suppressing the resonance with the vibration suppression function and increasing the VGN1 setting is effective for adjusting the servo later.

Load inertia ratio display

Perform the measurement in the section "Measuring unbalance torque and frictional torque", and set a torque offset (SV032) and frictional torque (SV045).

When an acceleration/deceleration operation is executed with the setting of SV035/bitF=1, an estimated load inertia ratio will be displayed in "load inertia ratio " on the drive monitor screen.

Standard VGN1 graph (servo motor HF, HF-H, HF-KP Series)

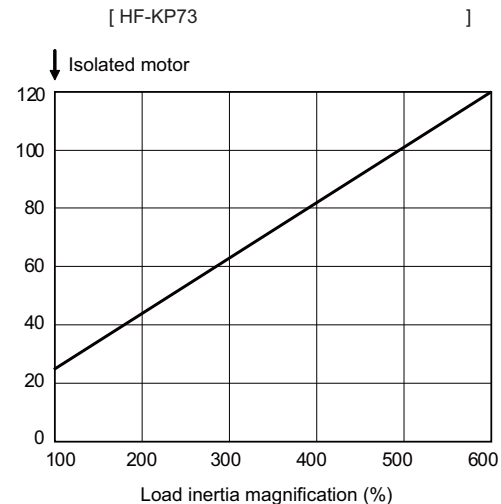
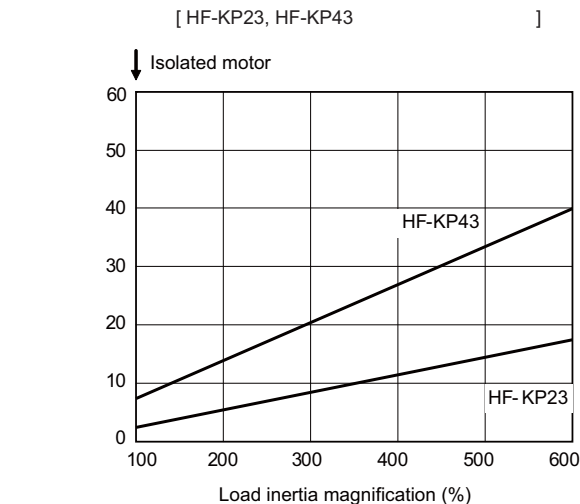
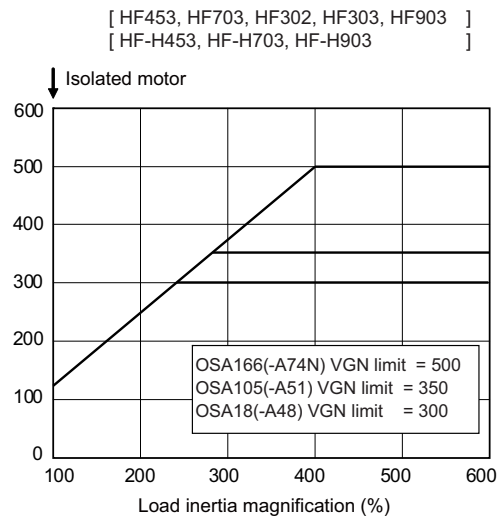
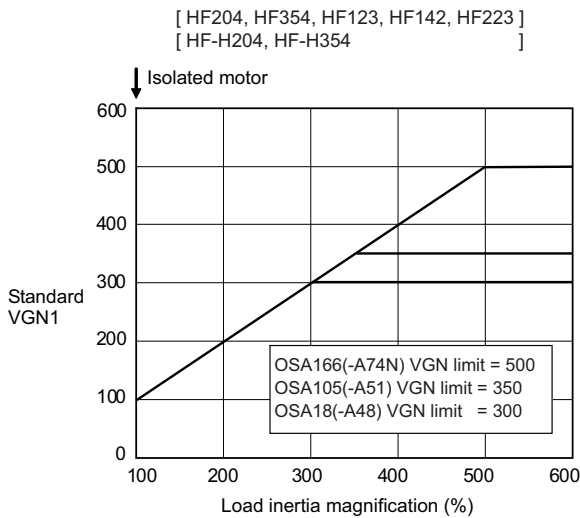
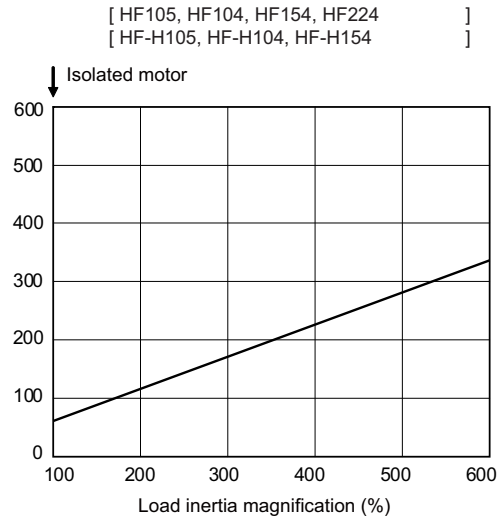
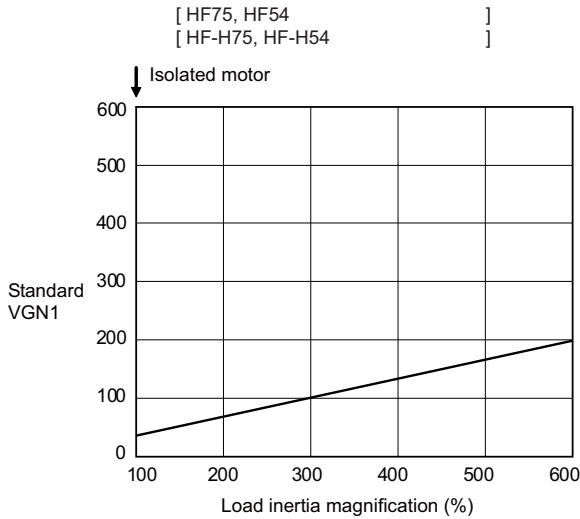

Standard VGN1 graph (servo motor HP, HP-H Series)

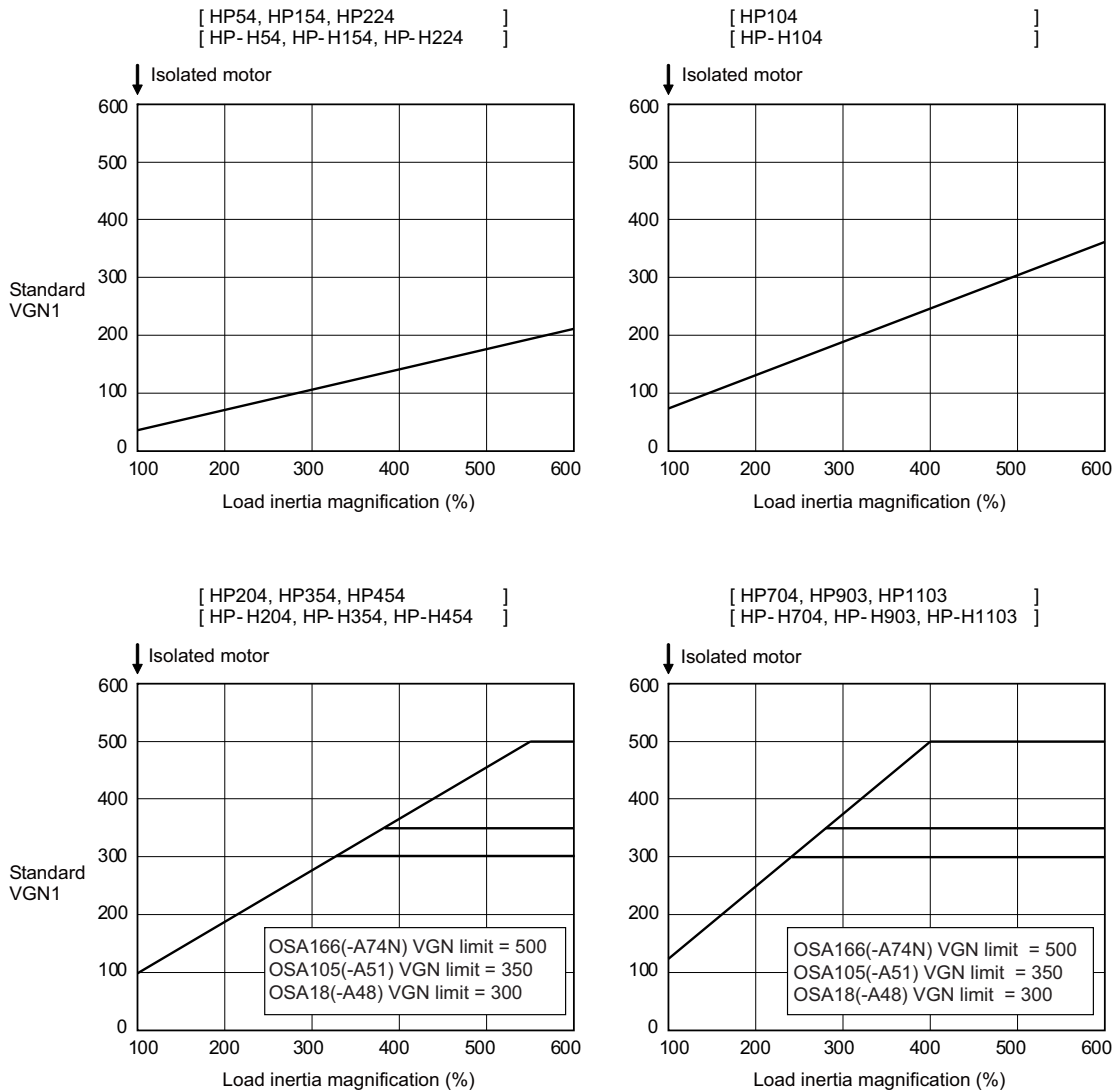

Standard VGN1 graph (servo motor HC-H Series)

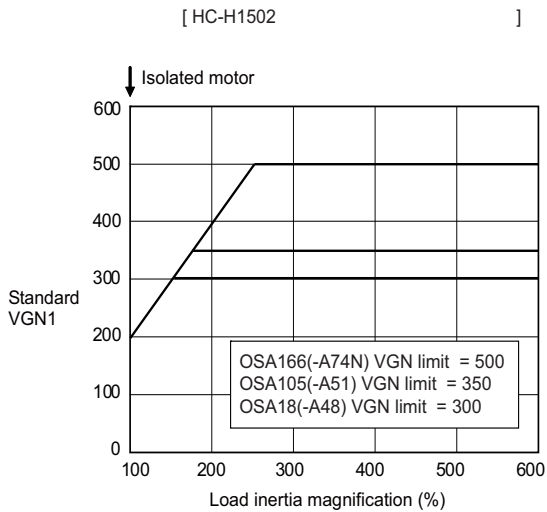

(2) Setting the speed loop lead compensation

The speed loop lead compensation (SV008: VIA) determines the characteristics of the speed loop mainly at low frequency regions. 1364 is set as a standard, and 1900 is set as a standard during SHG control. The standard value may drop in respect to loads with a large inertia.

When the VGN1 is set lower than the standard value because the load inertia is large or because machine resonance occurred, the speed loop control band is lowered. If the standard value is set in the leading compensation in this status, the leading compensation control itself will induce vibration. In concrete terms, a vibration of 10 to 20Hz could be caused during acceleration/ deceleration or stopping, and the position droop waveform could be disturbed when accelerating to a constant speed and when stopped. (Refer to lower left drawing)

This vibration cannot be suppressed by the vibration suppression functions. Lower the VIA in increments of 100 from the standard setting value. Set a value where vibration does not occur and the position droop waveform converges smoothly. Because lowering the VIA causes a drop in the position control's trackability, the vibration suppression is improved even when a disturbance observer is used without lowering the VIA. (Be careful of machine resonance occurrence at this time.)

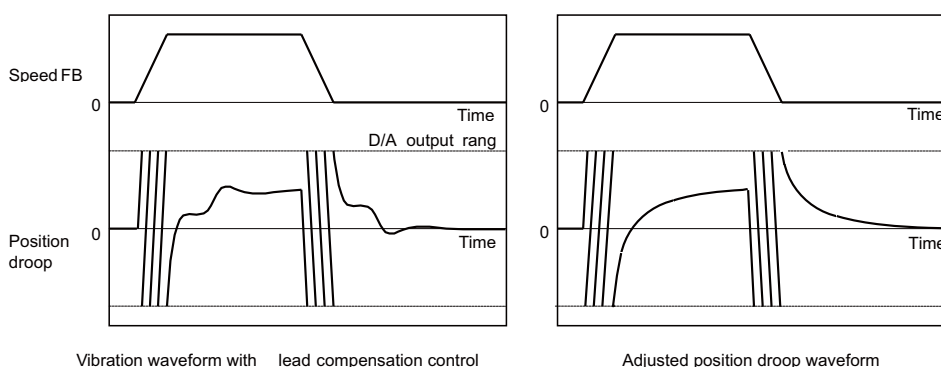

If VIA is lowered, the position droop waveform becomes smooth and overshooting does not occur.

However, because the trackability in respect to the position commands becomes worse, the positioning time and accuracy are sacrificed. VIA must be kept high (set the standard value) to guarantee precision, especially in high-speed contour cutting (generally $F = 1000$ or higher). In other words, in a machine aiming for high speed and high accuracy, a large enough value must be set in VGN1 so that VIA does not need to be lowered. When adjusting, the cutting precision will be better if adjustment is carried out to a degree where overshooting does not occur and a high VIA is maintained, without pursuing position droop smoothness.

If there are no vibration or overshooting problems, the high-speed contour cutting precision can be further improved by setting the VIA higher than the standard value. In this case, adjust by raising the VIA in increments of 100 from the standard value.

Setting a higher VIA improves the trackability regarding position commands in machines for which cycle time is important, and the time to when the position droop converges on the in-position width is shortened.

It is easier to adjust the VIA to improve precision and cycle time if a large value (a value near the standard value) can be set in VGN1, or if VGN1 can be raised equivalently using the disturbance observer.

[#2208] SV008 VIA Speed loop lead compensation

Set the gain of the speed loop integral control.

Standard setting: 1364

Standard setting in the SHG control: 1900

Adjust the value by increasing/decreasing this by about 100 at a time.

Raise this value to improve contour tracking accuracy in high-speed cutting.

Lower this value when the position droop does not stabilize (when the vibration of 10 to 20Hz occurs).

---Setting range---

1 to 9999

**POINT**

Position droop vibration of 10Hz or less is not leading compensation control vibration. The position loop gain must be adjusted.

5.2.3 Position Loop Gain

(1) Setting the position loop gain

The position loop gain 1 (SV003: PGN1) is a parameter that determines the trackability to the command position. 33 is set as a standard. Set the same position loop gain value between interpolation axes.

When PGN1 is raised, the trackability will be raised and the settling time will be shortened, but a speed loop that has a responsiveness that can track the position loop gain with increased response will be required. If the speed loop responsiveness is insufficient, several Hz of vibration or overshooting will occur during acceleration/ deceleration. Vibration or overshooting will also occur when VGN1 is smaller than the standard value during VIA adjustment, but the vibration in the position loop occurs generally 10Hz or less. (The VIA vibration occurs from 10 to 20Hz.) When the position control includes machine resonance points (Position control machine resonance points occur at the tool end parts, etc.) because of insufficient machine rigidity, the machine will vibrate during positioning, etc. In either case, lower PGN1 and adjust so that vibration does not occur.

If the machine also vibrates due to machine backlash when the motor stops, the vibration can be suppressed by lowering the PGN1 and smoothly stopping.

If SHG control is used, an equivalently high position loop gain can be maintained while suppressing these vibrations. Adjust SHG control by raising the gain gradually after setting PGN1 as 1/2 a value of PGN1 at which a vibration does not occur under the normal control. If the PGN1 setting value is more than 1/2 of the normal control PGN1 when SHG control is used, there is an improvement effect in position control. (Note that for the settling time the improvement effect is at $1/\sqrt{2}$ or more.)

【#2203】 SV003 PGN1 Position loop gain 1

Set the position loop gain. The standard setting is "33".

The higher the setting value is, the more accurately the command can be followed, and the shorter the settling time in positioning gets, however, note that a bigger shock will be applied to the machine during acceleration/deceleration.

When using the SHG control, also set SV004 (PGN2) and SV057 (SHGC).

---Setting range---

1 to 200 (rad/s)

【#2204】 SV004 PGN2 Position loop gain 2

When performing the SHG control, set the value of "SV003 x 8/3" to "SV004".

When not using the SHG control, set to "0".

---Setting range---

0 to 999 (rad/s)

【#2257】 SV057 SHGC SHG control gain

When performing the SHG control, set to SV003(PGN1)*6.

When not using the SHG control, set to "0".

---Setting range---

0 to 1200 (rad/s)



CAUTION

Always set the same value for the position loop gain between the interpolation axes.

(2) Setting the position loop gain for spindle synchronous control

During spindle synchronous control (synchronous tapping control, etc.), there are three sets of position loop gain parameters besides the normal control.

 [#2249] SV049 PGN1sp Position loop gain 1 in spindle synchronous control

Set the position loop gain during spindle synchronization control (synchronous tapping and synchronization control with spindle C-axis).

Set the same value as that of the position loop gain for spindle synchronous tapping control.

When performing the SHG control, set this parameter with SV050 (PGN2sp) and SV058 (SHGCsp).

---Setting range---

1 to 200 (rad/s)

 [#2250] SV050 PGN2sp Position loop gain 2 in spindle synchronous control

When using SHG control during spindle synchronous control (synchronous tapping and synchronization control with spindle C-axis), set this parameter with SV049 (PGN1sp) and SV058 (SHGCsp).

Make sure to set the value 8/3 times that of SV049.

When not using the SHG control, set to "0".

---Setting range---

0 to 999 (rad/s)

 [#2258] SV058 SHGCsp SHG control gain in spindle synchronous control

When using SHG control during spindle synchronization control (synchronous tapping and synchronous control with spindle C-axis), set this parameter with SV049 (PGN1sp) and SV050 (PGN2sp).

Make sure to set the value 6 times that of SV049.

When not using the SHG control, set to "0".

---Setting range---

0 to 1200 (rad/s)

 CAUTION

Always set the same value for the position loop gain between the spindle and servo synchronous axes.

(3) SHG control

If the position loop gain is increased or feed forward control (NC function) is used to shorten the settling time or increase the precision, the machine system may vibrate easily.

SHG control changes the position loop to a high-gain by stably compensating the servo system position loop through a delay. This allows the settling time to be reduced and a high precision to be achieved. (SHG: Smooth High-Gain)

(Feature 1) When the SHG control is set, even if PGN1 is set to the same value as the conventional gain, the position loop gain will be doubled.

(Feature 2) The SHG control response is smoother than conventional position control during acceleration/ deceleration, so the gain can be increased further with SHG control compared to the conventional position control.

(Feature 3) With SHG control, a high gain is achieved so a high precision can be obtained during contour control. The following drawing shows an example of the improvement in roundness characteristics with SHG control.

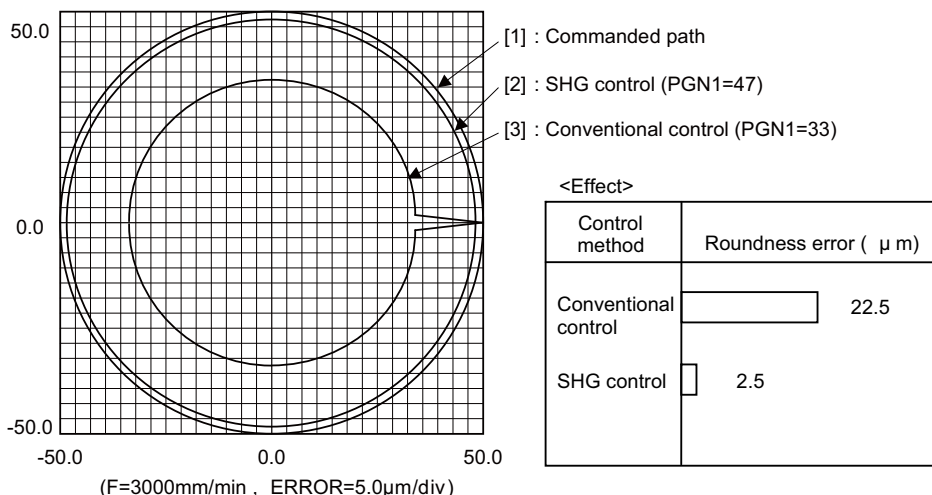

Shape error characteristics

During SHG control, PGN1, PGN2 and SHGC are set with the following ratio.

PGN1 : PGN2 : SHGC = 1 : 8/3 : 6

During SHG control even if the PGN1 setting value is the same, the actual position loop gain will be higher, so the speed loop must have a sufficient response. If the speed loop response is low, vibration or overshooting could occur during acceleration/deceleration in the same manner as conventional control. If the speed loop gain has been lowered because machine resonance occurs, lower the position loop gain and adjust.

No.	Abbrev.	Parameter name	Setting ratio	Setting example					Explanation	Setting range
SV003 (SV049)	PGN1 (PGN1sp)	Position loop gain 1	1	21	27	33	39	48	Always set with a combination of these three parameters.	1 to 200 (rad/s)
SV004 (SV050)	PGN2 (PGN2sp)	Position loop gain 2	8/3	56	72	88	104	128		0 to 999 (rad/s)
SV057 (SV058)	SHGC (SHGCsp)	SHG control gain	6	126	162	198	234	288		0 to 1200 (rad/s)

【#2208】 SV008 VIA Speed loop lead compensation

Set the gain of the speed loop integral control.
 Standard setting: 1364
 Standard setting in the SHG control: 1900
 Adjust the value by increasing/decreasing this by about 100 at a time.
 Raise this value to improve contour tracking accuracy in high-speed cutting.
 Lower this value when the position droop does not stabilize (when the vibration of 10 to 20Hz occurs).

---Setting range---
 1 to 9999

【#2215】 SV015 FFC Acceleration rate feed forward gain

When a relative error in synchronous control is too large, set this parameter to the axis that is delaying.
 The standard setting is "0". The standard setting in the SHG control is "50".
 To adjust a relative error in acceleration/deceleration, increase the value by 50 at a time.

---Setting range---
 0 to 999 (%)

5.2.4 OMR-FF Function

OMR-FF control improves the inner rounding amount of the arc, corner tracking error, or path vibration, etc. more comprehensively than conventional high-speed high-accuracy control by creating appropriate feed forward command for each of position, speed, and current depending on the vibration characteristics of the control target.

Feed forward is performed inside the drive unit according to the scale model and inertia setting in the OMR-FF generation part, and can independently set the command trackability with the scale model position loop gain (PGM) and the servo rigidity with the position control gain (PGN). This enables the higher and smoother trackability to the position command.

This function can be highly effective for linear servo, direct drive motors, or general motors in semi-closed loop control. OMR-FF control option for NC side is required when using this function.

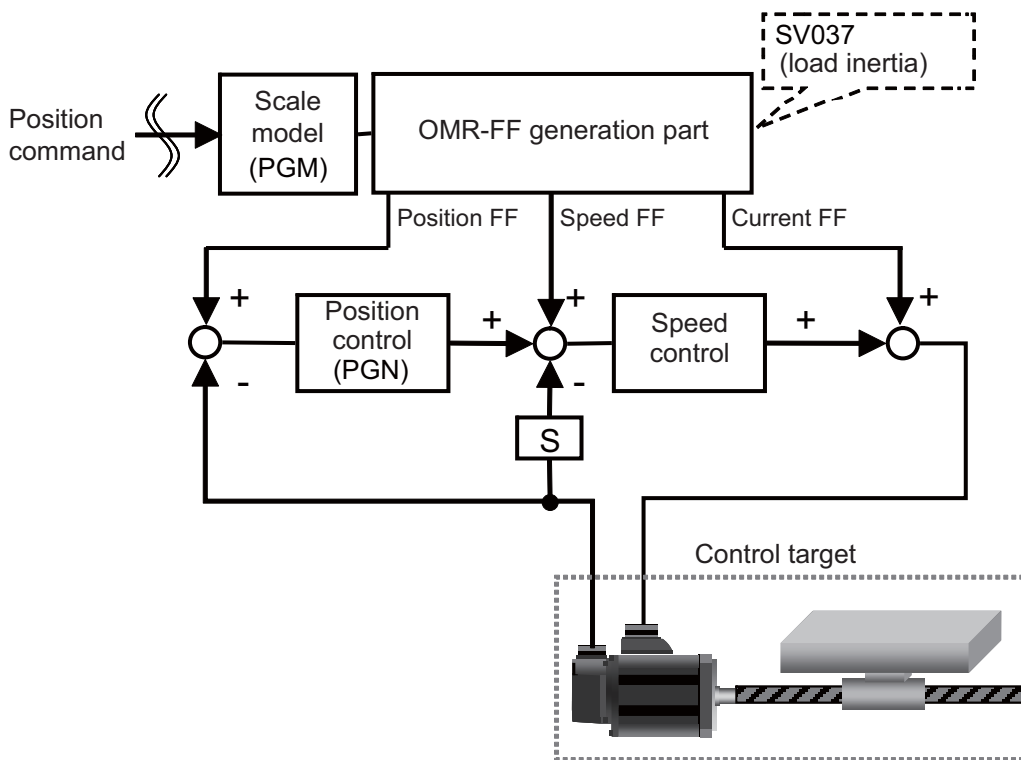

OMR-FF function adjustment parameters

No.	Abbrev.	Parameter name	Setting range (unit)
SV106	PGM	OMR-FF scale model gain	0 to 300 (rad/s)
SV112	IFF	OMR-FF current feed forward gain	0 to 32767 (0.01%)

CAUTION

1. Always set the load inertia scale when using this function because the parameter is crucial to this function.
If this function is enabled, the estimated inertia value is displayed as "0". If setting the load inertia scale, be sure to set it before the adjustment for OMR-FF function.
2. Disable SHG control when using this function.

< Initial implementation >

When using OMR-FF function, perform the following adjustment items beforehand. The adjustment for OMR-FF function does not operate correctly if the following items are not performed.

< Setting method >

- (1) Confirm that OMR-FF function is invalid.
 #2139 : omrff_off= "1"
 #2313 : SV113(SSF8)/bit0 = "0"
- (2) Set the standard parameters for the motor to be used.
- (3) Enable SHG control.
 Set #2203 : SV003(PGN1) to the standard setting, "33".
 Set #2204 : SV004(PGN2) to "88".
 Set #2257 : SV057(SHGC) to "198".
 Set #2208 : SV008(VIA) to "1900".
- (4) Adjust the speed loop gain. Adjust so that VGN1 is an appropriate value (the result of frequency response measurement on NC Analyzer is "Gain Margin > 8dB / Phase Margin > 30deg").
 -> For the adjustment method, refer to the section "6.1.2 (3) Adjusting the speed loop parameter".
- (5) Confirm that acceleration/deceleration operation can be executed with no alarm.
- (6) Set SV035(SSF4)/bitF(ctl) to "1" and repeat acceleration/deceleration several times. Check the estimated inertia value on the NC monitor screen and set the displayed value to SV037(JL).
- (7) Set SV003(PGN1) .
 Check "Cross Freq (Hz)" with frequency response measurement on NC Analyzer.

$$SV003(PGN1) = \text{"Cross Freq (Hz)}" \times 2 \pi / 4$$
 (Example 1) Measurement value Cross Freq : 100Hz
 Since $100(\text{Hz}) \times 2 \pi / 4 \doteq 157$, set SV003(PGN1) to 157.
 * The value of SV003(PGN1) must be set for each axis to be used.

【#2139】 omrff_off OMR-FF invalid

Select whether to enable or temporarily disable the OMR-FF control when OMR-FF is valid.

0 : OMR-FF function is applied if OMR-FF function is enabled.

1 : OMR-FF function is temporarily disabled and conventional feed forward control is applied if OMR-FF function is enabled.

【#2203】 SV003 PGN1 Position loop gain 1

Set the position loop gain. The standard setting is "33".
 The higher the setting value is, the more accurately the command can be followed, and the shorter the settling time in positioning gets, however, note that a bigger shock will be applied to the machine during acceleration/deceleration.
 When using the SHG control, also set SV004 (PGN2) and SV057 (SHGC).

When using the OMR-FF control, set the servo rigidity against quadrant projection or cutting load, etc. For the tracking ability to the command, set by SV106(PGM).

---Setting range---

1 to 200 (rad/s)

【#2204】 SV004 PGN2 Position loop gain 2

When performing the SHG control, set the value of "SV003 x 8/3" to "SV004".
 When not using the SHG control, set to "0".
 When using the OMR-FF control, set to "0".

Related parameters: SV003, SV057

---Setting range---

0 to 999 (rad/s)

【#2257】 SV057 SHGC SHG control gain

When performing the SHG control, set to SV003(PGN1)×6.
 When not using the SHG control, set to "0".
 When using the OMR-FF control, set to "0".

Related parameters: SV003, SV004

---Setting range---

0 to 1200 (rad/s)

【#2237】 SV037 JL Load inertia scale

Set the motor axis conversion total load inertia including motor itself in proportion to the motor inertia.

$$SV037(JL) = (Jm + JI) / Jm \times 100$$

Jm: Motor inertia

JI: Motor axis conversion load inertia

For linear motor, set the gross mass of the moving sections in kg unit.

<<Drive monitor load inertia ratio display>>

Set SV035/bitF=1 and imbalance torque and friction torque to both SV032 and SV045, and then repeat acceleration/deceleration for several times.

---Setting range---

For general motor: 0 to 5000 (%)

For linear motor 0 to 5000 (kg)

< OMR-FF function adjustment items >

Enable OMR-FF function after performing the adjustment items in < Initial implementation > and adjust the following parameters.

< Setting method >

- (1) Disable SHG control.
Set #2204 : SV004(PGN2) to "0"
Set #2257 : SV057(SHGC) to "0"
Set #2208 : SV008(VIA) to "1364"
- (2) Enable OMR-FF function.
#2139 : omrff_off = "0"
#2313 : SV113(SSF8)/bit0 = "1"
- (3) Set the OMR-FF function related parameters.
Set #2306 : SV106(PGM) to the same value as SV003.
Set #2312 : SV112(IFF) to "10000"
- (4) Set the following parameter with overshooting, machine vibration and current value in cutting feed and rapid traverse.
< Adjustment parameter >
#2306 : SV106(PGM)
- (5) Set the following parameters with the roundness measurement.
< Adjustment parameters >
#2306 : SV106(PGM)
- (6) Set the following parameters with the corner accuracy test.
< Adjustment parameters >
#2304 : SV104(FFR0)
#2305 : SV105(FFR1)
#2306 : SV106(PGM)

 CAUTION

1. After the above adjustment, set SV106 in the interpolation axes to the same value as the axis with the lowest SV106 value.
2. Perform the above confirmation of accuracy in G61.1(G8P1)(high-accuracy) mode; use the constant and filter for high-accuracy mode with OMR-FF function. Note that only #2010: fwd-g (Feed forward gain) will be disabled.
3. Feed forward gain (#2010 : fwd_g) on NC side will be disabled while this function is enabled (#2139:omrff_off = "0").
4. The following functions will be disabled when using this function.
 - Acceleration rate feed forward function
 - Overshoot compensation function

Adjustment method of OMR-FF function

Always perform < Initial implementation > before performing the following adjustment items.

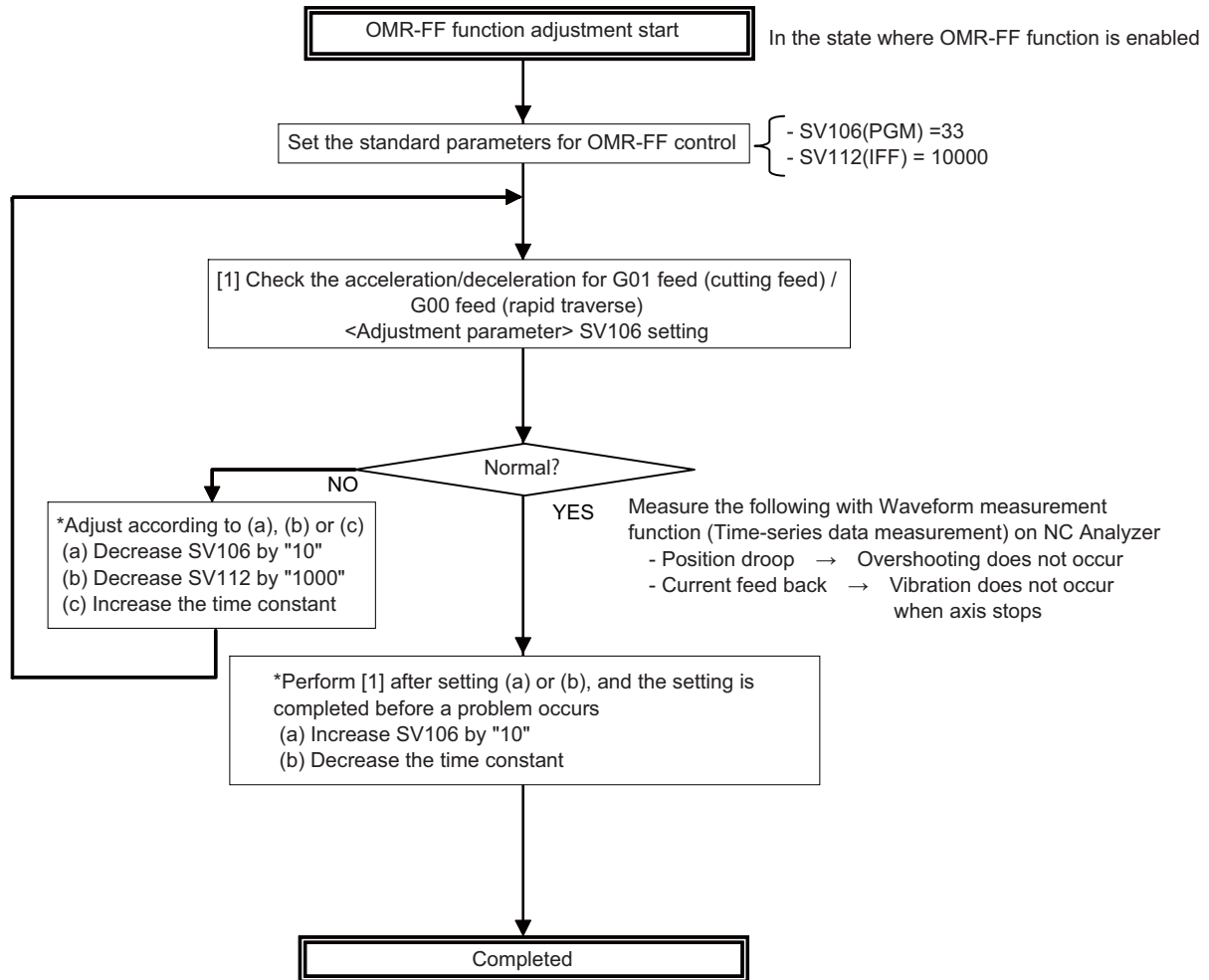

CAUTION

1. Always set the same value in the scale model gain of the interpolation axes when OMR-FF function is enabled.
2. Perform the above confirmation of accuracy in G61.1(G8P1)(high-accuracy) mode; use the constant and filter for high-accuracy mode with OMR-FF function.

Note that only #2010: fwd-g (Feed forward gain) will be disabled.

【#2306】 SV106 PGM OMR-FF scale model gain

Set the scale model gain (position response) in OMR-FF control.

Set the same value as SV003(PGN1).

Increase the setting value to perform a high-speed machining such as a fine arc or to improve the path error.

Lower the value when vibration occurs during acceleration/deceleration.

Set to "0" when not using OMR-FF control.

---Setting range---

0 to 300 (rad/s)

【#2312】 SV112 IFF OMR-FF current feed forward gain

Set the current feed forward rate in OMR-FF control.

The standard setting is "10000".

Setting value of "0" is equal to "10000(100%)" setting.

Set to "0" when not using OMR-FF control.

---Setting range---

0 to 32767 (0.01%)

【#2313】 SV113 SSF8 Servo function 8**bit 0 : omrffon OMR-FF control enabled**

0: Disable 1: Enable

5.3 Characteristics Improvement

5.3.1 Optimal Adjustment of Cycle Time

The following items must be adjusted to adjust the cycle time. Refer to the Instruction Manuals provided with each CNC for the acceleration/deceleration pattern.

- [1] Rapid traverse rate (rapid) : This will affect the maximum speed during positioning.
- [2] Clamp speed (clamp) : This will affect the maximum speed during cutting.
- [3] Acceleration/deceleration time constant (G0t*, G1t*) : Set the time to reach the feedrate.
- [4] In-position width (SV024) : This will affect each block's movement command end time.
- [5] Position loop gain (SV003) : This will affect each block's movement command settling time.

(1) Adjusting the rapid traverse

To adjust the rapid traverse, the CNC axis specification parameter rapid traverse rate (rapid) and acceleration/deceleration time constant (G0t*) are adjusted. The rapid traverse rate is set so that the motor speed matches the machine specifications in the range below the maximum speed in the motor specifications. For the acceleration/deceleration time constants, carry out rapid traverse reciprocation operation, and set so that the maximum current command value at acceleration/deceleration is within the range shown below. The output torque is limited at areas near the maximum speed, so monitor the current FB waveform during acceleration/deceleration and adjust so that the torque is within the specified range.

If the drive unit's input voltage is less than the rated voltage, the torque will easily become insufficient, and excessive errors will occur easily during acceleration/deceleration.

Maximum tolerable current command value when adjusting the rapid traverse acceleration/deceleration time constant

MDS-D2 Series (200V)				MDS-DH2 Series (400V)			
Motor model	Max. current command value	Motor model	Max. current command value	Motor model	Max. current command value	Motor model	Max. current command value
HF75	Within 350%	HP54	Within 370%	HF-H75	Within 350%	HP-H54	Within 370%
HF105	Within 270%	HP104	Within 300%	HF-H105	Within 270%	HP-H104	Within 300%
HF54	Within 420%	HP154	Within 440%	HF-H54	Within 420%	HP-H154	Within 440%
HF104	Within 350%	HP224	Within 330%	HF-H104	Within 350%	HP-H224	Within 330%
HF154	Within 380%	HP204	Within 300%	HF-H154	Within 380%	HP-H204	Within 300%
HF224	Within 310%	HP354	Within 300%	HF-H204	Within 310%	HP-H354	Within 300%
HF204	Within 310%	HP454	Within 290%	HF-H354	Within 330%	HP-H454	Within 290%
HF354	Within 420%	HP704	Within 220%	HF-H453	Within 250%	HP-H704	Within 220%
HF123	Within 190%	HP903	Within 250%	HF-H703	Within 240%	HP-H903	Within 250%
HF223	Within 230%	HP1103	Within 210%	HF-H903	Within 290%	HP-H1103	Within 210%
HF303	Within 240%						
HF453	Within 300%	HF-KP23	Within 250%	HC-H1502	Within 170%		
HF703	Within 240%	HF-KP43	Within 250%				
HF903	Within 290%	HF-KP73	Within 240%				
HF142	Within 190%						
HF302	Within 210%						

(2) Adjusting the cutting feed

To adjust the cutting rate, the NC axis specification parameter clamp speed (clamp) and acceleration/deceleration time constant (G1t*) are adjusted. The in-position width at this time must be set to the same value as actual cutting.

- Determining the clamp rate and adjusting the acceleration/deceleration time constant

(Features)The maximum cutting rate (clamp speed) can be determined freely.

(Adjustment)Carry out cutting feed reciprocation operation with dwell at the maximum cutting rate and adjust the acceleration/deceleration time constant so that the maximum current command value during acceleration/deceleration is within the range shown below.

- Setting the step acceleration/deceleration and adjusting the clamp speed

(Features)The acceleration/deceleration time constant is determined with the position loop in the servo, so the acceleration/deceleration $F \Delta T$ can be reduced.

(Adjustment)Set 1 (step) for the acceleration/deceleration time constant and carry out cutting feed reciprocation operation with dwell. Adjust the cutting feed rate so that the maximum current command value during acceleration/deceleration is within the range shown below, and then set the value in the clamp speed.

Maximum tolerable current command value when adjusting the cutting feed acceleration/deceleration time constant

MDS-D2 Series (200V)				MDS-DH2 Series (400V)			
Motor model	Max. current command value	Motor model	Max. current command value	Motor model	Max. current command value	Motor model	Max. current command value
HF75	Within 245%	HP54	Within 259%	HF-H75	Within 245%	HP-H54	Within 259%
HF105	Within 189%	HP104	Within 210%	HF-H105	Within 189%	HP-H104	Within 210%
HF54	Within 294%	HP154	Within 308%	HF-H54	Within 294%	HP-H154	Within 308%
HF104	Within 245%	HP224	Within 231%	HF-H104	Within 245%	HP-H224	Within 231%
HF154	Within 266%	HP204	Within 210%	HF-H154	Within 266%	HP-H204	Within 210%
HF224	Within 217%	HP354	Within 210%	HF-H204	Within 217%	HP-H354	Within 210%
HF204	Within 217%	HP454	Within 203%	HF-H354	Within 231%	HP-H454	Within 203%
HF354	Within 294%	HP704	Within 154%	HF-H453	Within 175%	HP-H704	Within 154%
HF123	Within 133%	HP903	Within 175%	HF-H703	Within 168%	HP-H903	Within 175%
HF223	Within 161%	HP1103	Within 147%	HF-H903	Within 203%	HP-H1103	Within 147%
HF303	Within 168%						
HF453	Within 205%	HF-KP23	Within 175%	HC-H1502	Within 119%		
HF703	Within 168%	HF-KP43	Within 175%				
HF903	Within 203%	HF-KP73	Within 168%				
HF142	Within 133%						
HF302	Within 147%						

 **CAUTION**

Always set the same value for the cutting feed time constant between the interpolation axes.

(3) Adjusting the in-position width

Because there is a response delay in the servo motor drive due to position loop control, a "settling time" is also required for the motor to actually stop after the command speed from the CNC reaches 0.

The movement command in the next block is generally started after it is confirmed that the machine has entered the "in-position width" range set for the machine.

Set the precision required for the machine as the in-position width. If a high precision is set needlessly, the cycle time will increase due to a delay in the settling time.

The in-position width is validated with the servo parameter settings, but there may be cases when it is validated with the NC parameters. Refer to each NC Instruction Manual.

[#2224] SV024 INP In-position detection width

Set the in-position detection width.

Set the positioning accuracy required for the machine.

The lower the setting is, the higher the positioning accuracy will be. However the cycle time (settling time) becomes longer.

The standard setting value is "50".

---Setting range---

0 to 32767 (μ m)

**POINT**

The in-position width setting and confirmation availability depend on the CNC parameters.

(4) Adjusting the settling time

The settling time is the time required for the position droop to enter the in-position width after the feed command ($F \Delta T$) from the CNC reaches 0.

The settling time can be shortened by raising the position loop gain or using SHG control. However, a sufficient response (sufficiently large VGN1 setting) for the speed loop is required to carry out stable control.

The settling time during normal control when the CNC is set to linear acceleration/ deceleration can be calculated using the following equation. During SHG control, estimate the settling time by multiplying PGN1 by $\sqrt{2}$.

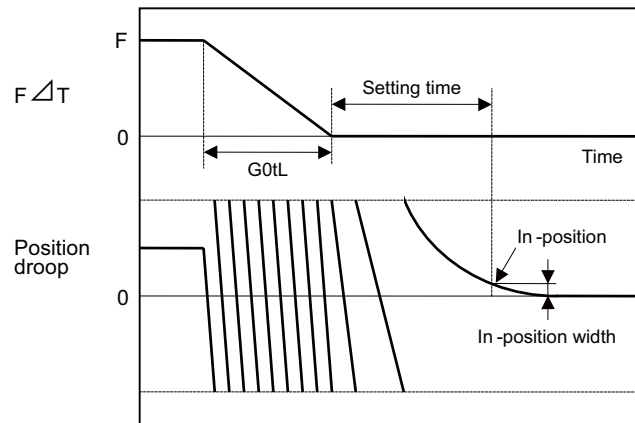

$$\text{Settling time (ms)} = \frac{10^3}{\text{PGN1}} \cdot \ln \left[\frac{F \times 10^6}{60 \times \text{G0tL} \times \text{PGN1}^2} \times \left[1 - \exp \left[-\frac{\text{PGN1} \times \text{G0tL}}{10^3} \right] \right] \right] \frac{1}{\text{INP}}$$

PGN1 : Position loop gain1 (SV003) (rad/s)
 F : Rapid traverse rate (mm/min)
 G0tL : Rapid traverse linear acceleration/
 deceleration time constant (ms)
 INP : In-position width (SV024) (μm)

5.3.2 Vibration Suppression Measures

If vibration (machine resonance) occurs, it can be suppressed by lowering the speed loop gain 1 (VGN1). However, cutting precision and cycle time will be sacrificed. (Refer to "Speed Loop Gain".) Thus, try to maintain the VGN1 as high as possible, and suppress the vibration using the vibration suppression functions.

If the VGN1 is lowered and adjusted because vibration cannot be sufficiently suppressed with the vibration suppression functions, adjust the entire gain (including the position loop gain) again.

(Examples of vibration occurrence)

- A fine vibration is felt when the machine is touched, or a groaning sound is heard.
- Vibration or noise occurs during rapid traverse.

If machine resonance occurs, the resonance frequency can be confirmed at AFLT frequency on NC drive monitor screen. Based on this frequency, the notch filter frequency can be set. The display sensitivity can be adjusted in the "sensitivity of estimated resonance frequency" setting. (When AFLT frequency "0" is displayed, vibration at high frequency or vibration due to the machine system may be the reason.)

POINT

Suppress the vibration using the vibration suppression functions, and maintain the speed loop gain (SV005) as high as possible.

<Notch filter>

This servo drive unit mounts 5 notch filters. Measure the resonance frequency with AFLT frequency display on NC drive monitor screen and the current feedback analog output function, and set that frequency in parameter.

However, if the notch filter is set to a particularly low frequency, another resonance frequency that did not vibrate initially may occur. If the notch filter's depth compensation (SV033, nfd1, nfd2) is adjusted so that the filter does not operate unless necessary, the servo control will be stabilized.

Notch filter 3 is a filter with frequency fixed to 1125Hz, and has no depth compensation.

<Setting method>

- [1] Set the resonance frequency in the notch filter frequency (1, 2, 4, 5).
- [2] If the machine starts to vibrate at another frequency, raise (make shallower) the notch filter depth compensation value, and adjust to the optimum value at which the resonance can be eliminated.
- [3] When the vibration cannot be completely eliminated, use also another notch filter for this frequency.

【#2233】 SV033 SSF2 Servo function 2**bit 7-5 : nfd2 Depth of Notch filter 2**

Set the depth of Notch filter 2 (SV046).

bit7,6,5=

000: -∞

001: -18.1[dB]

010: -12.0[dB]

011: -8.5[dB]

100: -6.0[dB]

101: -4.1[dB]

110: -2.5[dB]

111: -1.2[dB]

bit 4 : fhz3 Notch filter 3

0: Stop 1: Start (1,125Hz)

bit 3-1 : nfd1 Depth of Notch filter 1

Set the depth of Notch filter 1 (SV038).

bit3,2,1=

000: -∞

001: -18.1[dB]

010: -12.0[dB]

011: -8.5[dB]

100: -6.0[dB]

101: -4.1[dB]

110: -2.5[dB]

111: -1.2[dB]

【#2238】 SV038 FHz1 Notch filter frequency 1

Set the vibration frequency to suppress when machine vibration occurs.

(Normally, do not set 80 or less.)

Set to "0" when not using.

---Setting range---

0 to 2250 (Hz)

【#2246】 SV046 FHz2 Notch filter frequency 2

Set the vibration frequency to suppress when machine vibration occurs.

(Normally, do not set 80 or less.)

Set to "0" when not using.

---Setting range---

0 to 2250 (Hz)

【#2283】 SV083 SSF6 Servo function 6**bit 7-5 : nfd5 Depth of Notch filter 5**

Set the depth of Notch filter 5 (SV088).

bit7,6,5=

000: -∞

001: -18.1[dB]

010: -12.0[dB]

011: -8.5[dB]

100: -6.0[dB]

101: -4.1[dB]

110: -2.5[dB]

111: -1.2[dB]

bit 3-1 : nfd4 Depth of Notch filter 4

Set the depth of Notch filter 4 (SV087).

bit3,2,1=

000: -∞

001: -18.1[dB]

010: -12.0[dB]

011: -8.5[dB]

100: -6.0[dB]

101: -4.1[dB]

110: -2.5[dB]

111: -1.2[dB]

【#2287】 SV087 FH4 Notch filter frequency 4

Set the vibration frequency to suppress when machine vibration occurs.

(Normally, do not set 80 or less.)

Set to "0" when not using.

---Setting range---

0 to 2250 (Hz)

【#2288】 SV088 FH5 Notch filter frequency 5

Set the vibration frequency to suppress when machine vibration occurs.

(Normally, do not set 80 or less.)

Set to "0" when not using.

---Setting range---

0 to 2250 (Hz)

< Notch filter frequency adaptive tracking function >

Machine system resonance can vary depending on secular changes or installation conditions of machine, resonance frequency may deviate from the notch filter frequency set at the initial adjustment. The adaptive tracking function estimates minor changes in resonance frequency from current command oscillating component, automatically adjusting notch filter effective frequency. The resonance frequency is estimated while G0 is moving and effective frequency is modified while the axis is stopped.

The adaptive tracking function can be applied to notch filter 1, 2, 4, 5 (SV038, SV046, SV087, SV088). When resonance frequency is detected within the adaptive ranges which centers in the frequency set by parameter, resonance frequency from which notch filter effective frequency with the closest setting value is detected, suppressing machine resonance.

< Other specifications >

- (a) Machine resonance is detected at frequency ranges of 150Hz to 90Hz.
- (b) The depth of notch filter is not automatically adjusted. Only the effective frequency will change while the filter depth remains fixed.
- (c) When the notch filter 5 is adaptive to all frequency and also, others are not available, the effective frequency of notch filter 5 is changed.
- (d) When parameter setting value is changed; if the effective frequency remains within the adaptive ranges, it will keep operating with the original frequency; if it doesn't, changed parameter value will be applied.

Notch filter application ranges when the adaptive tracking function is available

Notch filter	Estimated adaptive frequency range	Avail. Adaptive operation	Adaptive range
Notch filter 1	150 to 900 [Hz]	SV115/bit8	Setting value(SV038) \pm Adaptive range (SV115/bit4,5) [Hz]
Notch filter 2	150 to 900 [Hz]	SV115/bit9	Setting value (SV046) \pm Adaptive range (SV115/bit4,5) [Hz]
Notch filter 3	Not included	Not included	Not included
Notch filter 4	150 to 900 [Hz]	SV115/bitA	Setting value (SV087) \pm Adaptive range (SV115/bit4,5) [Hz]
Notch filter 5	150 to 900 [Hz]	SV115/bitB	Setting value (SV088) \pm Adaptive range (SV115/bit4,5) [Hz] (Note) When adaptive to all frequency (SV115/bitF) 150 to 900 [Hz]

 CAUTION

If adaptive ranges are set too wide, frequency may fluctuate so greatly that the control can become unstable.

When the notch filter 5 is set adaptive to all frequency, the depth of the filter shall be set shallowly to enable stable operation with low frequency.

【#2315】 SV115 SSF10 Servo function 10**bit F : are Notch filter5 all frequencies adopted**

When enabled, Notch filter5 all frequencies adoptive range is not limited regardless of SV115/bit4,5 setting.

0: Disable 1: Enable

bit E-C: dsl Notch filter frequency display

Switch the "AFLT frequency" display on drive monitor screen to check every notch filter frequency. When the selected notch filter is not used, "0" is displayed.

bitE,D,C=

000 : Estimated resonance frequency (Normal display)

001 : Notch filter 1 frequency

010 : Notch filter 2 frequency

011 : Notch filter 3 frequency (always displays 1125Hz)

100 : Notch filter 4 frequency

101 : Notch filter 5 frequency

Other settings: setting prohibited

bit B : ade5 Notch filter 5 / Adoptive follow-up function

0: Disable 1: Enable

bit A : ade4 Notch filter 4 / Adoptive follow-up function

0: Disable 1: Enable

bit 9 : ade2 Notch filter 2 / Adoptive follow-up function

0: Disable 1: Enable

bit 8 : ade1 Notch filter 1 / Adoptive follow-up function

0: Disable 1: Enable

bit 7-6 : dsn Estimated resonance frequency display holding time

Set the estimated resonance frequency display holding time to the "AFLT frequency" display on drive monitor screen.

bit7,6=

00: 4 [s]

01: 8 [s]

10: 12 [s]

11: 16 [s]

bit 5-4 : dfhz Notch filter frequency range

Set the adaptive range of the notch filter frequency. When the adaptive follow-up function is enabled and if the estimated resonance frequency exists in the set range, the notch filter will be adapted. Normally set this parameter to "00".

bit5,4=

00: -10 to 10 [%]

01: -20 to 20 [%]

10: -30 to 30 [%]

11: -40 to 40 [%]

bit 3-0 : esn Sensitivity of estimated resonance frequency

Set the sensitivity of the estimated resonance frequency. When the notch filter adaptive follow-up function is enabled, smaller setting value enables to detect smaller vibration component, however, adoptive movement will be repeated frequently. Normally set this parameter to "0".

0 : Normal setting (same sensitivity as A) 1 : Sensitivity high to F : Sensitivity low

<Jitter compensation (Vibration control when motor is stopped.)>

The load inertia becomes much smaller than usual if the motor position enters the machine backlash when the motor is stopped. Because this means that an extremely large VGN1 is set for the load inertia, vibration may occur. Jitter compensation can suppress the vibration that occurs at the motor stop by ignoring the backlash amount of speed feedback pulses when the speed feedback polarity changes.

Increase the number of ignored pulses by one pulse at a time, and set a value at which the vibration can be suppressed. (Because the position feedback is controlled normally, there is no worry of positional deviation.)

When jitter compensation is set to an axis that is not vibrating is set, vibration could be induced, so take care.

【#2227】 SV027 SSF1 Servo function 1**bit 5-4 : vfct Jitter compensation pulse number**

Suppress vibration by machine backlash when axis stops.

bit5,4=

00: Disable

01: 1 pulse

10: 2 pulse

11: 3 pulses

**POINT**

Jitter compensation vibration suppression is only effective when the motor is stopped.

<Variable speed loop gain control>

If vibration occurs when the motor is rotating at a high speed, such during rapid traverse, or if disturbing noise occurs, the state can be improved by lowering the speed loop gain during high-speed rotation. The low-speed region speed loop gain used for cutting feed (G1 feed), etc., is maintained at a high level, so the vibration can be improved without dropping the machining accuracy.

【#2205】 SV005 VGN1 Speed loop gain 1

Set the speed loop gain.

The higher the setting value is, the more accurate the control will be, however, vibration tends to occur.

If vibration occurs, adjust by lowering by 20 to 30%.

The value should be determined to the 70 to 80% of the value at which the vibration stops.

The value differs depending on servo motors.

Aim at the standard value determined by the servo motor type and load inertia ratio to adjust.

---Setting range---

1 to 30000

【#2206】 SV006 VGN2 Speed loop gain 2

Set the speed loop gain at the motor limitation speed VLMT (maximum rotation speed x 1.15) with "VCS(SV029: Speed at the change of speed loop gain)".

Use this to suppress noise at high speed rotation during rapid traverse, etc. Then, the speed loop gain decreases at faster speed than the setting value of VCS.

When not using, set to "0".

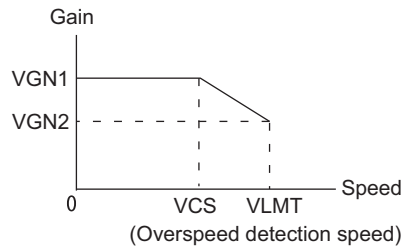
**---Setting range---**

-1000 to 30000

【#2229】 SV029 VCS Speed at the change of speed loop gain

Noise at high speed rotation including rapid traverse can be reduced by lowering the speed loop gain at high speeds.

Set the speed at which the speed loop gain changes. Use this with SV006 (VGN2).

When not using, set to "0".

---Setting range---

0 to 9999 (r/min)

5.3.3 Improving the Cutting Surface Precision

If the cutting surface precision or roundness is poor, these can be improved by increasing the speed loop gain (VGN1, VIA) or by using the disturbance observer function.

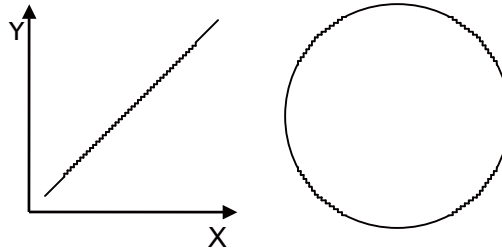

<Examples of faults>

- The surface precision in the 45° direction of a taper or arc is poor.
- The load fluctuation during cutting is large, causing vibration or surface precision defects to occur.



POINT

Adjust by raising the speed loop gain equivalently to improve cutting surface precision, even if the measures differ. In this case, it is important how much the machine resonance can be controlled, so adjust making sufficient use of vibration suppression functions.

(1) Adjusting the speed loop gain (VGN1)

If the speed loop gain is increased, the cutting surface precision will be improved but the machine will resonate easily.

The final VGN1 setting should be approx. 70 to 80% of the maximum value where resonance does not occur. (Refer to "Setting the speed loop gain")

(2) Adjusting the speed loop leading compensation (VIA)

The VIA has a large influence on the position trackability, particularly during high-speed cutting (generally F1000 or more). Raising the setting value improves the position trackability, and the contour precision during high-speed cutting can be improved. For high-speed high-precision cutting machines, adjust so that a value equal to or higher than the standard value can be set.

When VIA is set lower than the standard value and set to a value differing between interpolation axes, the roundness may worsen (the circle may distort). This is due to differences occurring in the position trackability between interpolation axes. The distortion can be improved by matching the VIA with the smaller of the values. Note that because the position trackability is not improved, the surface precision will not be improved.

(Refer to "Setting the speed loop lead compensation")

【#2205】 SV005 VGN1 Speed loop gain 1

Set the speed loop gain.
 The higher the setting value is, the more accurate the control will be, however, vibration tends to occur.
 If vibration occurs, adjust by lowering by 20 to 30%.
 The value should be determined to the 70 to 80% of the value at which the vibration stops.
 The value differs depending on servo motors.
 Aim at the standard value determined by the servo motor type and load inertia ratio to adjust.

---Setting range---
 1 to 30000

【#2208】 SV008 VIA Speed loop lead compensation

Set the gain of the speed loop integral control.
 Standard setting: 1364
 Standard setting in the SHG control: 1900
 Adjust the value by increasing/decreasing this by about 100 at a time.
 Raise this value to improve contour tracking accuracy in high-speed cutting.
 Lower this value when the position droop does not stabilize (when the vibration of 10 to 20Hz occurs).

---Setting range---
 1 to 9999

(3) Voltage non-sensitive zone (Td) compensation

With the PWM control of the inverter circuit, a dead time (non-energized time) is set to prevent short-circuits caused by simultaneous energizing of the P side and N side transistors having the same phase. The dead time has a non-sensitive zone for particularly low voltage commands. Thus, when feeding with a low speed and a low torque, the control may be unstable.

When an unbalanced axis is lowering, the frictional torque and unbalance torque, and the frictional torque and deceleration torque before the quadrant changes during circle cutting, are balanced. The motor output torque will be approximately zero, and the control accuracy may drop. In this case, the control accuracy can be improved by using the voltage non-sensitive band compensation. Note that this may cause vibration to be increased while the motor is running.

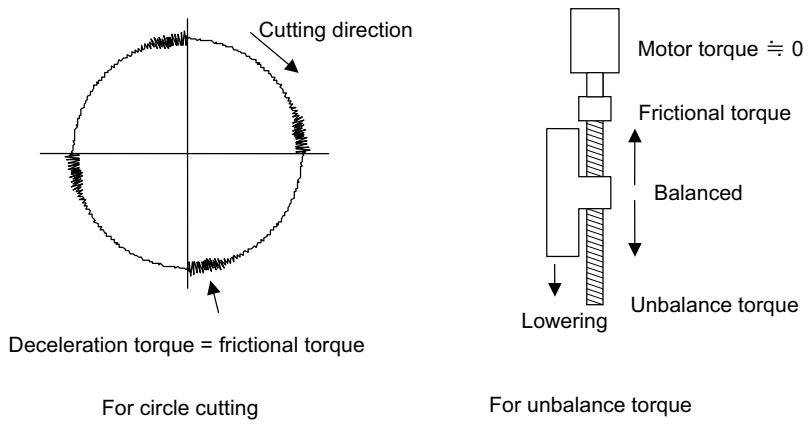

【#2230】 SV030 IVC Voltage non-sensitive band compensation

When 100% is set, the voltage reduction amount equivalent to the logical non-energization in the PWM control will be compensated.
 When "0" is set, 100% compensation will be performed.
 Adjust in increments of 10% from the default value of 100%.
 If increased too much, vibration or vibration noise may be generated.

---Setting range---
 0 to 255 (%)

(4) Disturbance observer

The disturbance observer can reduce the effect caused by disturbance, frictional resistance or torsion vibration during cutting by estimating the disturbance torque and compensating it. It also is effective in suppressing the vibration caused by speed leading compensation control.

<Setting method>

- [1] Adjust VGN1 to the value where vibration does not occur, and then lower it 10 to 20%.
- [2] Set the load inertia scale (SV037: JL) with a percentage in respect to the motor inertia of the total load inertia.
- [3] Set the observer filter band (observer pole) in the disturbance observer filter frequency (SV043: OBS1), and suppress the high frequency disturbance estimate to suppress the vibration. Set "100" as a standard.
- [4] Set the observer gain in disturbance observer gain (SV044: OBS2). The disturbance observer will function here for the first time. Set 100 first, and if vibration does not occur, increase the setting by 50 at a time to increase the observer effect.

【#2237】 SV037 JL Load inertia scale

Set the motor axis conversion total load inertia including motor itself in proportion to the motor inertia.

$$SV037(JL) = (J_m + J_l) / J_m \times 100$$

J_m : Motor inertia

J_l : Motor axis conversion load inertia

For linear motor, set the gross mass of the moving sections in kg unit.

<<Drive monitor load inertia ratio display>>

Set SV035/bitF=1 and imbalance torque and friction torque to both SV032 and SV045, and then repeat acceleration/deceleration for several times.

---Setting range---

For general motor: 0 to 5000 (%)

For linear motor 0 to 5000 (kg)

【#2243】 SV043 OBS1 Disturbance observer filter frequency

Set the disturbance observer filter band.

Normally, set to "100". Setting values of 49 or less is equal to "0" setting.

To use the disturbance observer, also set SV037 (JL) and SV044 (OBS2).

When disturbance observer related parameters are changed, lost motion compensation needs to be readjusted.

Set to "0" when not using.

---Setting range---

0 to 1000 (rad/s)

【#2244】 SV044 OBS2 Disturbance observer gain

Set the disturbance observer gain. The standard setting is "100 to 300".

To use the disturbance observer, also set SV037 (JL) and SV043 (OBS1).

When disturbance observer related parameters are changed, lost motion compensation needs to be readjusted.

Set to "0" when not using.

---Setting range---

0 to 500 (%)

**POINT**

The lost motion compensation must be readjusted when the disturbance observer is started.

5.3.4 Improvement of Characteristics during Acceleration/Deceleration

<SHG control>

Because SHG control has a smoother response during acceleration/deceleration than conventional position controls, the acceleration/deceleration torque (current FB) has more ideal output characteristics (A constant torque is output during acceleration/deceleration.) The peak torque is kept low by the same acceleration/deceleration time constant, enabling the time constant to be shortened.

Refer to item "(3) SHG control" in section "Position Loop Gain" for details on setting SHG control.

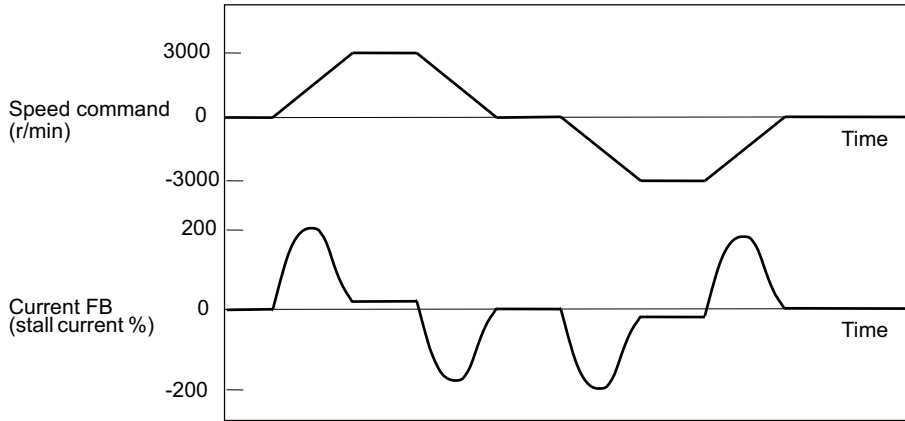

Acceleration/deceleration characteristics during conventional control

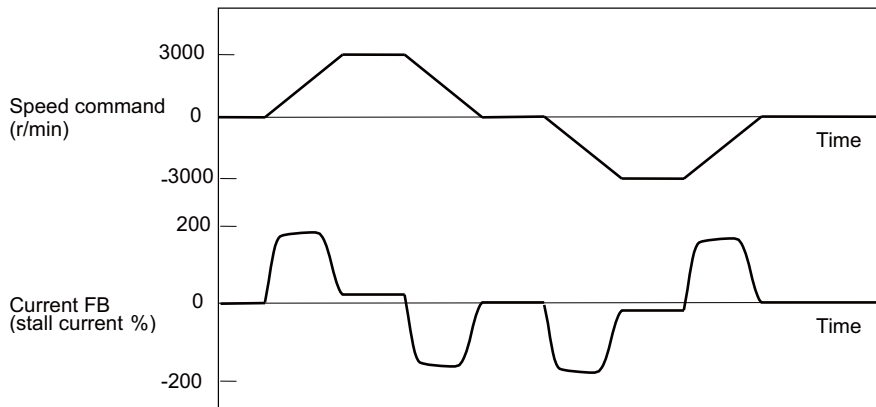

Acceleration/deceleration characteristics during SHG control

No.	Abbrev.	Parameter name	Setting ratio	Setting example					Explanation	Setting range
SV003 (SV049)	PGN1 (PGN1sp)	Position loop gain 1	1	21	27	33	39	48	Always set with a combination of these three parameters.	1 to 200 (rad/s)
SV004 (SV050)	PGN2 (PGN2sp)	Position loop gain 2	8/3	56	72	88	104	128		0 to 999 (rad/s)
SV057 (SV058)	SHGC (SHGCsp)	SHG control gain	6	126	162	198	234	288		0 to 1200 (rad/s)

<Acceleration feed forward>

Vibration may occur at 10 to 20 Hz during acceleration/deceleration when a short time constant of 30 ms or less is applied, and a position loop gain (PGN1) higher than the general standard value or SHG control is used. This is because the torque is insufficient when starting or when starting deceleration, and can be resolved by setting the acceleration rate feed forward gain (SV015: FFC). This is also effective in reducing the peak current (torque). While measuring the current command waveform, increase FFC by 50 to 100 at a time and set the value where vibration does not occur.

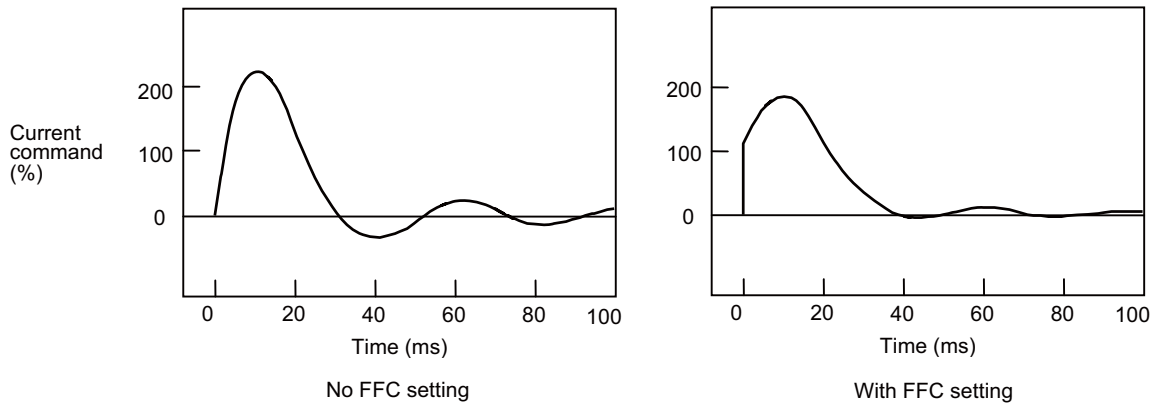

Acceleration rate feed forward gain means that the speed loop gain during acceleration/deceleration is raised equivalently. Thus, the torque (current command) required during acceleration/deceleration starts sooner. The synchronization precision will improve if the FFC of the delayed side axis is raised between axes for which high-precision synchronous control (such as synchronous tapping control and superimposition control).

【#2215】 SV015 FFC Acceleration rate feed forward gain

When a relative error in synchronous control is too large, set this parameter to the axis that is delaying.

The standard setting is "0". The standard setting in the SHG control is "50".

To adjust a relative error in acceleration/deceleration, increase the value by 50 at a time.

---Setting range---

0 to 999 (%)

**POINT**

Overshooting occurs easily when a value above the standard value is set during SHG control.

< Inductive voltage compensation >

The current loop response is improved by compensating the back electromotive force element induced by the motor rotation. This improved the current command efficiency, and allows the acceleration/deceleration time constant to be shortened.

< Adjustment method >

While accelerating/decelerating at rapid traverse, adjust the inductive voltage compensation gain (SV047: EC) so that the current FB peak (MAX current 3) is a few % smaller than the current command peak (MAX current 2).

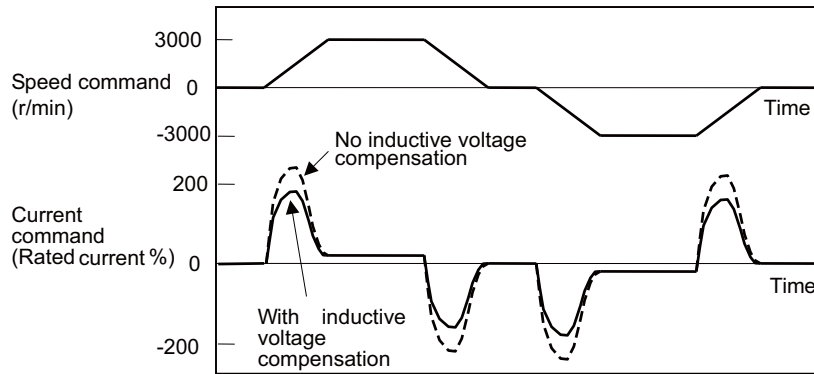

Inductive voltage compensation

【#2247】 SV047 EC Inductive voltage compensation gain

Set the inductive voltage compensation gain. Standard setting value is "100".
If the current FB peak exceeds the current command peak, lower the gain.

---Setting range---
0 to 200 (%)

**POINT**

If the current FB peak (MAX current 3) becomes larger than the current command peak (MAX current 2) (over compensation), an overcurrent (alarm 3A) will occur easily. Note that over compensation will occur easily if the load inertia is large.

< HAS control >

If an output torque during acceleration/deceleration is close to the servo motor's maximum torque, the motor cannot accelerate with a commanded time constant when the torque is saturated due to input voltage fluctuation, etc. Generally, if an acceleration command is switched to a constant speed command, speed FB overshoots to compensate a delay of position droop, making the machine operation unstable.

When the HAS control is enabled, a delay of position droop will be compensated by controlling the amount of speed FB overshoot within 1% or less than maximum speed of the motor.

The controllable amount of position droop delay with HAS control HAS can be set at 1/4 or 1/2 of the excessive error detection width.

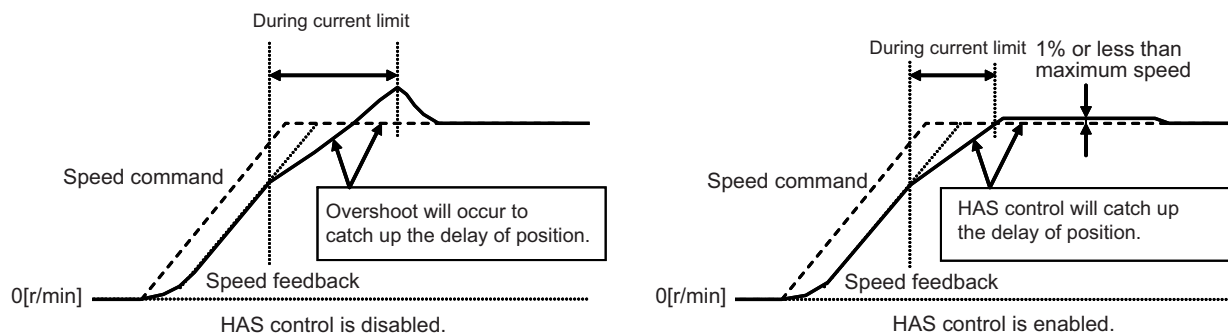
**[#2234] SV034 SSF3 Servo function 3****bit 1 : has HAS control**

This stabilizes the speed overshooting by torque saturation phenomenon.

0: Normal setting 1: Enable

[#2284] SV084 SSF7 Servo function 7**bit F : h2c HAS control cancel amount**

0: 1/4 (standard) 1: 1/2

**POINT**

1. During G1 drive, if HAS control is started, the compensation amount can not be compensated. Therefore, adjust the feed speed cramp value or acceleration/deceleration time constant so that the current limit does not occur.
2. HAS control can not be used for axes in synchronous control since machine torsion may be occur.
3. Even if HAS control is enabled, adjust the acceleration/deceleration time constant so that the current limit does not occur.
4. If setting half of error excessive encoder width to the droop compensation amount, error excessive alarm in acceleration may occur more easily than if 1/4.

5.3.5 Improvement of Protrusion at Quadrant Changeover

The response delay (caused by dead band from friction, torsion, expansion/contraction, backlash, etc.) caused when the machine advance direction reverses is compensated with the lost motion compensation (LMC compensation) function. With this, the protrusions that occur at the quadrant changeover in the DBB measurement method, or the streaks that occur when the quadrant changes during circular cutting can be improved.

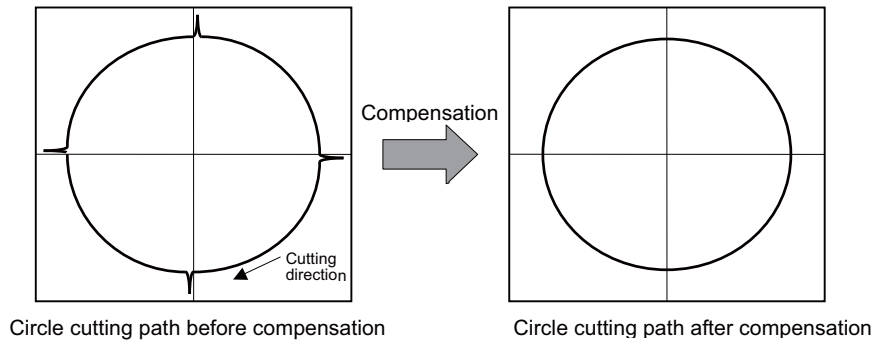

DBB: Double Ball Bar

[1] LMC compensation type 2

This is an obsolete compensation method. When performing new adjustment, use LMC compensation type 3.

[2] LMC compensation type 3

In addition to frictional torque influence, this type compensates torsion and expansion/contraction influences in the machine system in which compensation amount is changed by travel speed. A mechanical system viscosity coefficient setting further enhances the compensation accuracy even if the travel speed is changed. Adjustment requires a machine roundness measurement.

[3] LMC compensation type 4

This is used in combination with LMC compensation type 3. Compensation is performed by monitoring path tracking delay. Therefore, even if the machine friction amount has changed due to aged deterioration, the path tracking delay is controlled so that it will be minimum.



POINT

1. LMC compensation performs adjustment while measuring the electrical end roundness waveform (encoder position FB). Disable the NC side machine error compensation (pitch error compensation, relative position compensation, backlash compensation).
2. After the compensation adjustment is completed, adjust the machine error compensation while measuring the machine error compensation with DBB measurement method, etc.

(1) Measuring unbalance torque and frictional torque

Machine unbalance torque and frictional torque measurements are required before the LMC compensation can be set. However, the horizontal axis unbalance torque is necessarily "0".

Carry out the reciprocating operation (approx. F1000) with the measured axis, and the load current % value during constant-speed feed is measured at the NC servo monitor screen. The unbalance torque and frictional torque at that time are expressed by the following formulas.

$$\text{Unbalance torque (\%)} = \frac{(+ \text{ feed load current \%}) + (- \text{ feed load current \%})}{2}$$

$$\text{Frictional torque (\%)} = \frac{|(+ \text{ feed load current \%}) - (- \text{ feed load current \%})|}{2}$$

(Example)

Assume that the load current % was -55% in the + direction and -25% in the - direction when JOG feed was carried out at approx. F1000. The unbalance torque and frictional torque are as shown below.

$$\text{Unbalance torque (\%)} = \frac{(-55) + (-25)}{2} = -40\%$$

$$\text{Friction torque (\%)} = \frac{|(-55) - (-25)|}{2} = 15\%$$

The measurement values are not used for LMC compensation type 3. However, since they are used for other controls, set them to the following parameters.

【#2232】 SV032 TOF Torque offset

Set the unbalance torque on vertical axis and inclined axis.

When the vertical axis pull up function is enabled, the pull up compensation direction is determined by this parameter's sign. When set to "0", the vertical axis pull up will not be executed.

This can be used for speed loop delay compensation and collision detection function.

To use load inertia estimation function (drive monitor display), set this parameter, friction torque (SV045) and load inertia display enabling flag (SV035/bitF).

Related parameters: SV007, SV033/bitE, SV059

---Setting range---

-100 to 100 (Stall current %)

【#2245】 SV045 TRUB Friction torque

Set the frictional torque when using the collision detection function.

To use load inertia estimation function (drive monitor display), set this parameter, imbalance torque (SV032) and load inertia display enabling flag (SV035/bitF).

---Setting range---

0 to 255 (Stall current %)

(2) Setting and adjusting LMC compensation type 3

LCM compensation type 3 can be used to accommodate quadrant projection changes that accompany feed rate and circular radius changes which could not be accommodated by LCM compensation type 2. In this case, on a machine model where the travel direction is reversed, the effect caused by torsion or expansion and contraction on the machine system are also considered in addition to the friction, with compensation occurring in accordance with the changes in the cutting conditions.

Adjust Compensation parameter (SV016, SV041), a basis of compensation, while measuring roundness at low speed. Then adjust viscous coefficient (SV086) while measuring roundness at high speed.

LMC compensation type 3 parameter adjustments should be made while measuring an electrical end position FB waveform by the NC sampling function.

<Adjustment method>

- [1] Turn the NC side machine error compensation (pitch error compensation, relative position compensation or backlash compensation) OFF.
- [2] Set servo function selection 5 SV082/ bit=1. (The LMC compensation type 3 will start).
- [3] Set a value double the friction torque to the lost motion compensation 1 (SV016). The SV016 setting value will be used for compensation in the positive and negative directions when the lost motion compensation 2 (SV041) is 0.
- [4] Set the initial value, SV016 x 200 to the lost motion compensation viscous coefficient (SV086).
- [5] Perform a roundness measurement at such speed as radius R=100mm and feedrate F=1000mm/min and adjust SV016 value.
- [6] Set SV041, when changing the compensation amount in the direction for compensation. The setting of the compensation direction is shown below with the setting of CW/CCW in the NC parameter. If compensating only one direction, set -1 to the side not to be compensated.

Compensation point	CW	CCW
A	X axis: SV041	X axis: SV016
B	Y axis: SV016	Y axis: SV041
C	X axis: SV016	X axis: SV041
D	Y axis: SV041	Y axis: SV016

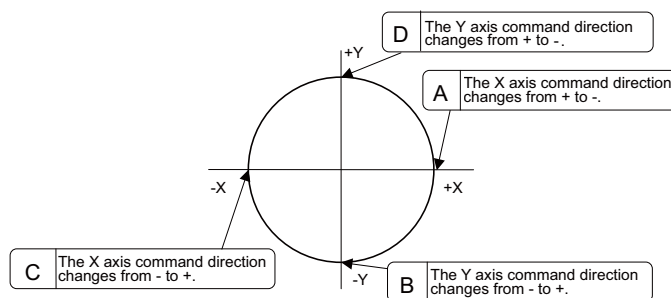

- [7] Perform a roundness measurement at such speed as radius, R=100mm and feedrate, F=5000mm/min. (Select a condition to be used for the actual cutting according to the machine's specification.) Adjust viscous coefficient (SV086) by increasing and reducing it approx. ± 500 gradually to have minimum quadrant protrusion.
- [8] After adjusting SV086, verify its accuracy by performing roundness measurement at low speed again.
- [9] At this time, if requiring to improve the accuracy further, adjust the spring constant (SV085) in increments of about 50 while performing the machine roundness measurement at low speed.

**POINT**

1. As the acceleration of circular feed increases, the quadrant protrusion tends to get larger. Therefore, the quadrant protrusion gets larger as the circular feedrate increases for the same radius and as radius gets smaller for the same feedrate.
2. Torque offset (SV032) does not work for LMC compensation type 3.
3. Always set 0 to the lost motion compensation timing (SV039:LMCD).

【#2216】 SV016 LMC1 Lost motion compensation 1

Set this parameter when the protrusion (that occurs due to the non-sensitive band by friction, torsion, backlash, etc.) at quadrant change is too large. This sets the compensation torque at quadrant change (when an axis feed direction is reversed) by the proportion (%) to the stall torque. Whether to enable the lost motion compensation and the method can be set with other parameters.

Type 2: When SV027/bit9, 8 =10 (Compatible with obsolete type)

Set the type 2 method compensation torque. The standard setting is double the friction torque.

Type 3: When SV082/bit1= 1

Set the compensation torque equivalent of dynamic friction amount of the type 3 method compensation amount. The standard setting is double the dynamic friction torque.

To vary compensation amount according to the direction.

When SV041 (LMC2) is "0", compensate with the value of SV016 (LMC1) in both +/-directions.

If you wish to change the compensation amount depending on the command direction, set this and SV041 (LMC2).

(SV016: + direction, SV041: - direction. However, the directions may be opposite depending on other settings.)

When "-1" is set, the compensation will not be performed in the direction of the command.

---Setting range---

-1 to 200 (Stall current %)

Note that when SV082/bit2 is "1", the setting range is between -1 and 20000 (Stall current 0.01%).

【#2241】 SV041 LMC2 Lost motion compensation 2

Set this with SV016 (LMC1) only when you wish to vary the lost motion compensation amount depending on the command directions.

Normally, set to "0".

---Setting range---

-1 to 200 (Stall current %)

Note that when SV082/bit2 is "1", the setting range is between -1 and 20000 (Stall current 0.01%).

【#2282】 SV082 SSF5 Servo function 5**bit 2 : ccu Lost motion overshoot compensation compensation amount setting increment**

0: Stall current % 1: Stall current 0.01%

bit 1 : lmc3 Lost motion compensation type 3

Set this when protrusion at a quadrant change is too big.

0: Stop 1: Start

【#2285】 SV085 LMCK Lost motion compensation 3 spring constant

Set the machine system's spring constant when selecting lost motion compensation type 3. When not using, set to "0".

---Setting range---

0 to 32767 (0.01%/μm)

【#2286】 SV086 LMCc Lost motion compensation 3 viscous coefficient

Set the machine system's viscous coefficient when selecting lost motion compensation type 3. When not using, set to "0".

---Setting range---

0 to 32767 (0.01%*s/mm)

(3) Setting and adjusting LMC compensation type 4

LMC compensation type 4 is enabled by being used with LMC compensation type 3. Make sure to adjust the LMC compensation type 3 before setting the LMC compensation type 4.

<Adjustment method>

- [1] Set about 5-fold SV016 setting value in SV091. (Set about 10% of machine friction.)
- [2] Increase SV0091 in increments of about 20%, and confirm the limit value where vibration does not occur. Note that the limit value is about 500.
- [3] Set 50% of the limit value.

【#2291】 SV091 LMC4G Lost motion compensation 4 gain

Use this with LMC compensation type 3. As the delay in path tracking is monitored and compensated, the delay in path tracking will be minimized even if machine friction amount changes by aging. Use the lost motion compensation amount (SV016) * 5 (10% of the dynamic friction torque) as the target. The higher the setting value is, the more accurate the quadrant change be; however, the more likely vibrations occur.

---Setting range---

0 to 20000 (Stall current 0.01%)

5.3.6 Improvement of Overshooting

The phenomenon when the machine position goes past or exceeds the command during feed stopping is called overshooting. Overshooting is compensated by overshooting compensation (OVS compensation). Overshooting occurs due to the following two causes.

- [1] Machine system torsion: Overshooting will occur mainly during rapid traverse settling.
- [2] Machine system friction: Overshooting will occur mainly during one pulse feed.

Either phenomenon can be confirmed by measuring the position droop.

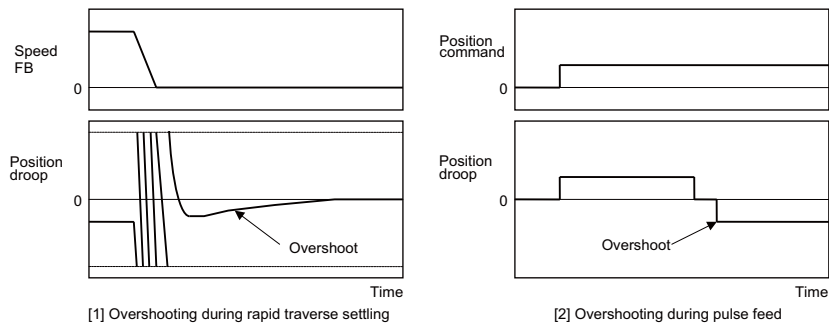

(1) Overshooting compensation (OVS compensation)

In OVS compensation, the overshooting is suppressed by subtracting the torque command set in the parameters when the motor stops.

OVS compensation type 3 has a compensation effect for the overshooting during either rapid traverse settling or pulse feed. To compensate overshooting during feed forward control, refer to the following section "(2) Adjusting for feed forward control".

<Setting and adjustment methods>

- [1] Set the servo function selection 1 (SV027: SSF1)/bit A, B. (OVS compensation type 3 will start.)
- [2] Observe the position droop waveform using the D/A output, and increase the overshooting compensation 1 (SV031: OVS1) value 1% at a time. Set the smallest value where the overshooting does not occur. If SV042 (OVS2) is 0, the overshooting will be compensated in both the forward/reverse directions with the OVS1 setting value.
- [3] If the compensation amount is to be changed in the direction to be compensated, set the + direction compensation value in OVS1 and the - direction compensation value in OVS2. If only one direction is to be compensated, set the side not to be compensated as -1. The compensation direction setting will be as reversed with the NC parameter CW/CCW setting.

**POINT**

1. When either parameter SV031: OVS1 or SV042: OVS2 is set to 0, the same amount of compensation is carried out in both the positive and negative direction, using the setting value of the other parameter (the parameter not set to 0).
2. To compensate in only one direction, set -1 in the parameter (OVS1 or OVS2) for the direction in which compensation is prohibited.
3. For contour cutting, the projection at the arc end point is compensated with OVS compensation. LMC compensation is carried out at the arc starting point.

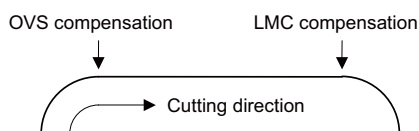
**(2) Adjusting for feed forward control**

When using feed forward control (high-speed high-accuracy control), the feed forward control must be stopped ($\text{fwd_g} = 0$) before adjusting the overshooting compensation. After adjusting the overshooting compensation with normal control, set the overshooting compensation non-sensitive zone (SV034 (SSF3)/bitC to F (ovsn) to 1 ($2\mu\text{m}$)) and start up feed forward control.

If overshooting compensation is used during feed forward control, the overshooting will increase, or protrusions could appear during arc cutting. This is because, when the NC is carrying out feed forward (fwd) control, overshooting equivalent to the operation fraction unit occurs in the position command, and the OVS compensation is recognized as a change in the command direction, resulting in compensation in the reverse direction. This can be improved by setting the overshooting compensation non-sensitive zone width.

If overshooting does not occur during normal control, and occurs only during feed forward control, adjust the feed forward gain (fwd_g).

【#2231】 SV031 OVS1 Overshooting compensation 1

This compensates the motor torque when overshooting occurs during positioning. This is valid only when the overshooting compensation (SV027/bitB,A) is selected.

Type 3 SV027/bitB,A = 11

Set the compensation amount based on the motor stall current. Observing positioning droop waveform, increase in increments of 1% and find the value where overshooting does not occur.

To vary compensation amount depending on the direction.

When SV042 (OVS2) is "0", change the SV031 (OVS1) value in both of the +/-directions to compensate.

To vary the compensation amount depending on the command direction, set this and SV042 (OVS2).

(SV031: + direction, SV042: - direction. However, the directions may be opposite depending on other settings.)

When "-1" is set, the compensation will not be performed in the direction of the command.

---Setting range---

-1 to 100 (Stall current %)

Note that the range will be "-1 - 10000" (Stall current 0.01%) when SV082/bit2 is "1".

【#2242】 SV042 OVS2 Overshooting compensation 2

Set this with SV031 (OVS1) only when you wish to vary the overshooting compensation amount depending on the command directions.

Normally, set to "0".

---Setting range---

-1 to 100 (Stall current %)

Note that when SV082/bit2 is "1", the setting range is between -1 and 10000 (Stall current 0.01%).

【#2227】 SV027 SSF1 Servo function 1**bit B-A : ovs Overshooting compensation**

Set this if overshooting occurs during positioning.

bitB,A=

00: Compensation stop

01: Setting prohibited

10: Setting prohibited

11: Type 3

Set the compensation amount in SV031(OVS1) and SV042(OVS2).

【#2234】 SV034 SSF3 Servo function 3**bit F-C: ovsn Overshooting compensation type 3 Non-sensitive band**

Set the non-sensitive band of the model position droop overshooting amount in increments of 2 μ m. In the feed forward control, set the non-sensitive band of the model position droop and ignore the overshooting of the model.

0 : 0 μ m, 1: 2 μ m, 2: 4 μ m, ---, E : 28 μ m, F: 30 μ m

【#2282】 SV082 SSF5 Servo function 5**bit 2 : ccu Lost motion overshoot compensation compensation amount setting increment**

0: Stall current % 1: Stall current 0.01%

POINT

When using feed forward control (high-speed high-accuracy control), stop the feed forward control (fwd_g=0) before adjusting the overshooting compensation. If overshooting occurs during subsequent feed forward control, adjust the feed forward gain (fwd_g).

5.3.7 Improvement of the Interpolation Control Path

(1) Machine end compensation control

The machine end compensation control compensates the shape of the tool end during high-speed and high-speed acceleration/deceleration. The spring effect from the machine (spindle) end to the motor (scale) end is compensated. If the machine has a large spring effect, the shape may be fine during low-speed operation. However, at high speeds (specially when using a small radius), the section from the machine (spindle) end to the outer sides of the motor (scale) end could swell, and cause the shape to become elliptical during measurement of the roundness. The machine end compensation control compensates the motor end position according to the acceleration size, so the tool end position is always controlled to the commanded position.

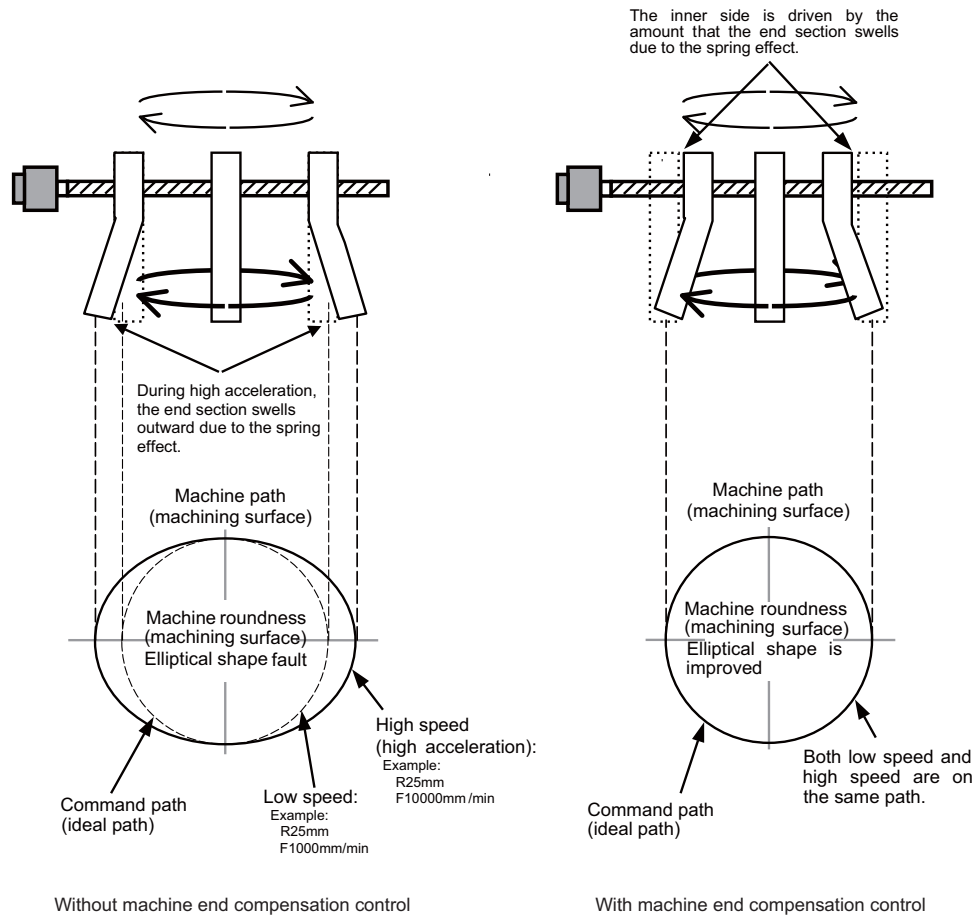

POINT

1. Always evaluate the roundness accuracy at the machine side.
2. Adjust the parameter after adjusting the electrical end roundness accuracy.

<Adjustment methods>

- [1] Confirm that the motor side circle accuracy measured with the NC sampling function is appropriate.
- [2] In this state, measure the machine side low-speed and high-speed circle path without machine end compensation control. The difference of the high-speed circle path and low-speed circle path is the amount that path has swelled due to the spring effect of the machine system. Calculate the SV065 setting value with the following expression using this amount as the compensation amount.

$$SV065 = \frac{\text{Compensation amount } [\mu\text{m}] \times \text{radius R [mm]} \times SV003 \times 16,200,000}{(\text{command speed F [mm/min]})^2}$$

- [3] Input the value calculated in step [2] into SV065. Measure the high-speed circle path. If the shape is still elliptical, adjust by increasing/decreasing the SV065 value in 1/10 units.
- [4] Confirm that there is no problem with the low-speed circle path.

Example of low-speed and high-speed roundness measurement for adjusting machine compensation

	When using grid encoder	When using DBB measurement	Acceleration
Low speed (reference circle)	R=25 [mm], F=500 [mm/min]	R=100 [mm], F=1000 [mm/min]	0.00028G
High-speed (when adjusting compensation amount)	R=25 [mm], F=10000 [mm/min]	R=100 [mm], F=20000 [mm/min]	0.11G

[#2265] SV065 TLC Machine end compensation gain

The shape of the machine end is compensated by compensating the spring effect from the machine end to the motor end.

Set the machine end compensation gain. Measure the error amount by roundness measurement and estimate the setting value by the following formula.

$$\text{Compensation amount } (\mu\text{m}) = \text{Command speed F (mm/min)}^2 \times SV065 / (\text{Radius R (mm)} \times SV003 \times 16,200,000)$$

Set to "0" when not using.

---Setting range---
 -30000 to 30000 (Acceleration ratio 0.1%)

 **POINT**

- 1. To confirm the machine's spring element, adjust the electrical end roundness, and then machine roundness while changing the cutting speed. Confirm that the error increases with the speed.
- 2. The electrical roundness will have an error on the inner side when machine end compensation control is used.

 **CAUTION**

If an excessive value is set in the machine end compensation gain (SV065), the machine could vibrate when stopping, resulting in a dangerous state.

5.4 Adjustment during Full Closed Loop Control

5.4.1 Outline

(1) Full closed loop control

The servo control is all closed loop control using the encoder's feedback. "Full closed loop control" is the system that directly detects the machine position using a linear scale, whereas the general "semi-closed loop" is the one that detects the motor position.

In a machine that drives a table with a ball screw, the following factors exist between the motor and table end:

- [1] Coupling or ball screw table bracket's backlash
- [2] Ball screw pitch error

These can adversely affect the accuracy. If the table position is directly detected with a linear scale, high-accuracy position control which is not affected by backlash or pitch error is possible. However, with the full closed loop system, the machine system is also directly included in the position loop control. Thus, if the machine's rigidity is not high, the gain cannot be increased, and the required high accuracy cannot be attained.

The procedures for adjusting the servo with the full closed loop system are the same as the semi-closed loop system. Vibration or overshooting will occur easily, so the position loop gain is generally lower than the semi-closed loop.

(2) Overrun detection

With the full closed system, the position feedback (FB) detected with the linear scale is used for the position control. However, the motor position FB is detected at the same time, and the error of both FB is observed. If this FB error exceeds the servo parameter SV054 setting value, alarm 43 will be detected and the system will stop to prevent overrunning due to a scale FB error from occurring.

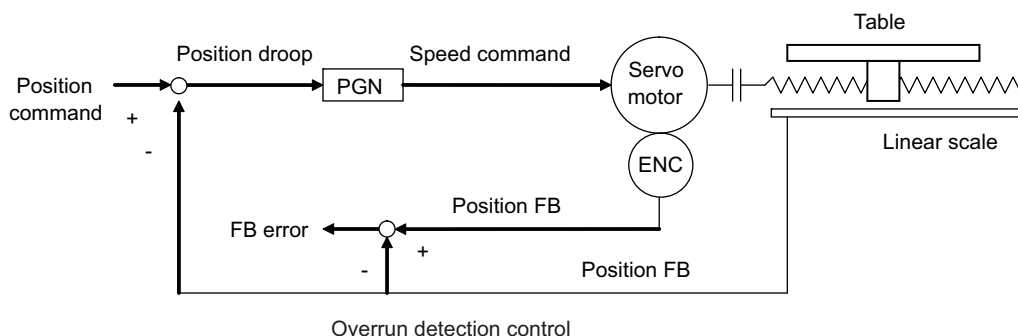

[#2254] SV054 ORE Overrun detection width in closed loop control

Set the overrun detection width in the full-closed loop control.

When the gap between the motor side encoder and the linear scale (machine side encoder) exceeds the value set by this parameter, it will be judged as overrun and "Alarm 43" will be detected.

When "-1" is set, if the differential velocity between the motor side encoder and the machine side encoder exceeds the 30% of the maximum motor speed, it will be judged as overrun and "Alarm 43" will be detected.

When "0" is set, overrun will be detected with a 2mm width.

For linear servo/direct-drive motor system

Not used. Set to "0".

---Setting range---

-1 to 32767 (mm)

However, when SV084/bitD=1, the setting range is from -1 to 32767 (μ m).

5.4.2 Speed Loop Delay Compensation

Generally, the machine position follows the operation later than the motor position. With full closed loop position loop control, the machine position is used for position feedback, so the motor position could advance too far and cause the machine position to overshoot easily. Speed loop delay compensation suppresses overshooting by weakening the speed loop PI control (weakening lead compensation = delaying). If the compensation is too large and PI control is weakened too far, the positioning time could increase, or the position droop will remain when the motor is stopped.

<Adjustment method>

- [1] Set the servo function selection 1 (SV027: SSF1)/bit1, bit0 to 10. (Select delay compensation changeover type 2)
- [2] Set the axis unbalance torque to the torque offset (SV032: TOF). (Refer to "Measuring unbalance torque and frictional torque" for details on measuring the unbalance torque.)
- [3] Observe the position droop waveform, and confirm the overshooting. Increase SV007 (VIL) in increments of 5, and adjust so that the overshooting is improved. If set too high, the position droop will remain when the axis is stopped.

【#2207】 SV007 VIL Speed loop delay compensation

Set this when the limit cycle occurs in the full-closed loop, or overshooting occurs in positioning. The speed loop delay compensation method can be selected with SV027/bit1,0. Normally, use "Changeover type 2". Changeover type 2 controls the occurrence of overshooting by lowering the speed loop lead compensation after the position droop gets 0. When setting this parameter, make sure to set the torque offset (SV032).

---Setting range---
0 to 32767

【#2232】 SV032 TOF Torque offset

Set the unbalance torque on vertical axis and inclined axis. When the vertical axis pull up function is enabled, the pull up compensation direction is determined by this parameter's sign. When set to "0", the vertical axis pull up will not be executed. This can be used for speed loop delay compensation and collision detection function. To use load inertia estimation function (drive monitor display), set this parameter, friction torque (SV045) and load inertia display enabling flag(SV035/bitF).

---Setting range---
-100 to 100 (Stall current %)

【#2227】 SV027 SSF1 Servo function 1

bit 1-0 : vcnt Speed loop delay compensation changeover type selection

Normally, use "Changeover type 2".
bit1,0=
00: Disable
01: Changeover type 1
10: Changeover type 2
11: Setting prohibited

CAUTION

The position droop will remain if SV007 is set too high.

<Adjustment method>

- [1] Set the servo specifications (SV017: SPEC)/bit1 to 1, and turn the NC power ON again.
- [2] Measure the position droop overshooting while increasing the dual feedback control time constant (SV051: DFBT) in increments of 5ms. Adjust to the time constant where overshooting does not occur.
- [3] For the final setting value, set a value 1.5 to 2-fold the value adjusted in 3.

【#2217(PR)】 SV017 SPEC1 Servo specification 1**bit 1 : dfbx Dual feedback control**

Control the position FB signal in full closed control by the combination of a motor side encoder and machine side encoder.

0: Stop 1: Start

【#2251】 SV051 DFBT Dual feedback control time constant

Set the control time constant in dual feed back.

When "0" is set, it operates at 1ms.

The higher the time constant is, the closer it gets to the semi-closed control, so the limit of the position loop gain will be raised.

For linear servo/direct-drive motor system

Not used. Set to "0".

---Setting range---

0 to 9999 (ms)

【#2252】 SV052 DFBN Dual feedback control non-sensitive band

Set the non-sensitive band in the dual feedback control.

Normally, set to "0".

For linear servo/direct-drive motor system

Not used. Set to "0".

---Setting range---

0 to 9999 (μ m)

5.5 Settings for Emergency Stop

Emergency stop in this section refers to the following states.

- [1] Emergency stop was input (including other axis alarms)
- [2] NC power down was detected
- [3] A drive unit alarm was detected

5.5.1 Deceleration Control

With the servo drive unit, if the deceleration stop function is validated, the motor will decelerate following the set time constant while maintaining the READY ON state. READY will turn OFF and the dynamic brakes will function after stopping.

If an alarm, for which dynamic brakes are designated as the stopping method, occurs, the motor will stop with the dynamic brakes.

<Features>

When the load inertia is large, deceleration stop can be executed at a shorter time than the dynamic brakes. (The stop time for the normal acceleration/deceleration time constants will be achieved.)

(1) Setting the deceleration control time constant

Set the time for stopping from the rapid traverse rate (rapid: axis specification parameter) in the deceleration time constant for emergency stop (SV056: EMGt). The operation stops with the position loop step when 0 is set.

For the standard setting value of SV056, refer to the following table.

When applying this setting to the synchronous control axes, set the same value with negative symbol to the both axes. Even if the dynamic break stop is applied to either axis, it is also applied to the other axis.

Standard setting value of SV056

#2003: smgst Acceleration and deceleration modes bit 3-0: Rapid traverse acceleration/deceleration type (hexadecimal)			SV056: EMGt Deceleration time constant at emergency stop Standard setting value
1: Linear acceleration/deceleration			$EMGt \leq G0tL \times 0.9$
8: Exponential acceleration and linear deceleration			$EMGt \leq (2 \times G0t1) \times 0.9$
F: Soft acceleration/ deceleration	#1219:aux03/bit7=0	Accelerating/decelerating time is G0tL	$EMGt \leq (G0tL - G0t1) \times 0.9$
	#1219:aux03/bit7=1	Accelerating/decelerating time is obtained by G0tL+G0t1	$EMGt \leq G0tL \times 0.9$
A value other than the above			$EMGt \leq G0tL \times 0.9$

#2004: G0tL G0 time constant (linear)

#2005: G0t1 G0 time constant (primary delay) / Second-step time constant for soft acceleration/deceleration

CAUTION

If the deceleration control time constant at emergency stop (EMGt) is set to a value longer than the above value, the soft limit point (stroke end point) may be exceeded. Take care as the axis could collide the machine.

<Operation>

When an emergency stop occurs, the motor will decelerate at the same inclination from each speed.

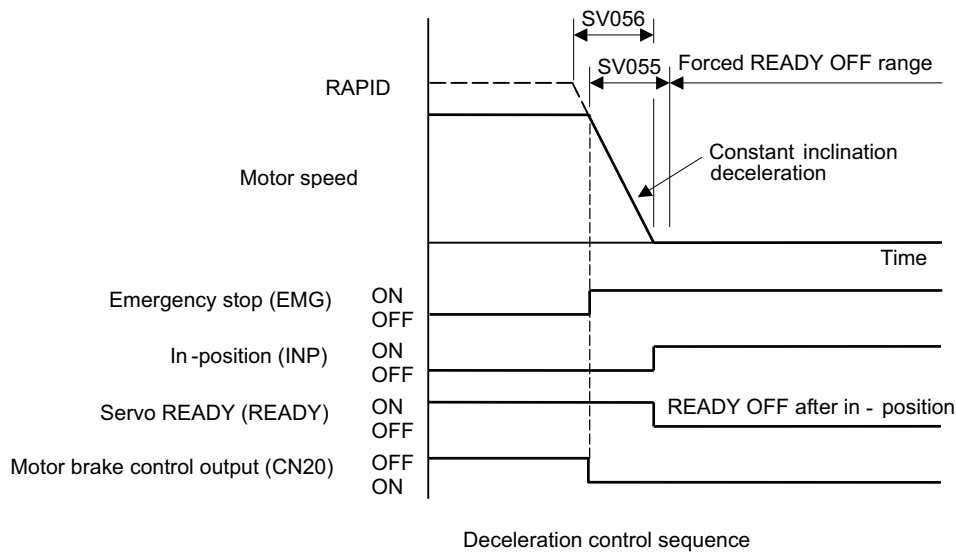

【#2255】 SV055 EMGx Max. gate off delay time after emergency stop

Set the time required between an emergency stop and forced READY OFF.
 Set the maximum value "+ 100ms" of the SV056 setting value of the servo drive unit electrified by the same power supply unit.
 When executing the vertical axis drop prevention, the gate off will be delayed for the length of time set at SV048 even when SV055's is smaller than that of SV048.

---Setting range---
 0 to 20000 (ms)

【#2256】 SV056 EMGt Deceleration time constant at emergency stop

Set the time constant used for the deceleration control at emergency stop.
 Set the time required to stop from rapid traverse rate (rapid).
 The standard setting value is $EMGt \leq G0tL \times 0.9$.
 However, note that the standard setting value differs from the above-mentioned value when the setting value of "#2003:smgst Acceleration and deceleration modes bit 3-0:Rapid traverse acceleration/deceleration type" is 8 or F. Refer to Instruction Manual of the drive unit (section "Deceleration Control") for details.

---Setting range---
 0 to 20000 (ms)

(2) Deceleration control stop distance

The stopping distance L_{emg} when the motor is stopped with deceleration control during an emergency stop can be approximated with the following expression. Note that the value will be higher than this if the current is limited during deceleration.

$$L_{emg} = \frac{F}{PGN1 \times 60} + \frac{1}{2} \times \frac{F}{60} \times \frac{F \times EMGt}{rapid \times 1000} \quad (\text{mm})$$

F :Feedrate during emergency stop (mm/min)

rapid :Rapid traverse rate (mm/min)

PGN1 :Position loop gain 1 (SV003) (rad/s)

EMGt :Deceleration time constant for emergency stop (SV056) (ms)

**POINT**

- Deceleration control will not take place when a servo alarm, for which the stopping method is dynamic, occurs.
The motor will stop with dynamic braking regardless of the parameter setting.
- If the power fails and the deceleration time constant is set to a relatively long time, the braking method may change from deceleration control to dynamic braking due to a drop in the bus voltage in the drive unit.

**CAUTION**

If the deceleration control time constant (EMGt) is set to a value longer than the acceleration/deceleration time constant, the soft limit point (stroke end point) may be exceeded.

Take care as the axis could collide the machine.

5.5.2 Vertical Axis Drop Prevention Control

The vertical axis drop prevention control is a function that prevents the vertical axis from dropping due to a delay in the brake operation when an emergency stop occurs. The no-control time until the brakes activate can be eliminated by delaying the servo READY OFF state by the time set in the parameters when an emergency stop occurs.

Always use this function together with deceleration control.

<Setting procedures>

- [1] Apply emergency stop while viewing the current position on the NC screen. Adjust the vertical axis drop prevention time (SV048), and set the 1.5-fold minimum delay time at which the axis does not drop. When using a motor with a break, confirm that the axis will not drop at the 150ms setting, and set 200ms.
- [2] Set the value of the normal acceleration/deceleration time constant plus 100ms for the max. gate off delay time at emergency stop (SV055), and set the standard setting value of the axis for the deceleration control time constant at emergency stop (SV056). Refer to "Deceleration Control" for details.
- [3] For the axis for which the vertical drop is to be controlled, set the same value as the acceleration/deceleration time constant for the deceleration control time constant at emergency stop (SV056).
- [4] If the vertical axis is MDS-D2/DH2-V2/V3 (2-axis or 3-axis drive unit), set the servo parameters for the other axis in the same unit.
 - SV048 = Same value as adjusted vertical axis SV048
 - SV055 = Same value as adjusted vertical axis SV055
 - SV056 = Standard setting value of SV055 for the axis (Refer to "Deceleration control" for details.)
- [5] If the power supply unit that supplies PN power to the vertical axis is controlled by a spindle drive unit, set the time for the spindle to stop from the maximum speed to the parameters SP055 and SP056.
- [6] If the power supply unit that supplies PN power to the vertical axis is controlled by a different servo drive unit, set the servo parameter setting for that axis as well. (Same as item [4] above).
- [7] If the CN9 connector of the power supply unit that supplies PN power is connected with the vertical axis, also set the parameter for the drive unit connected with the CN4 connector of the same power supply unit.

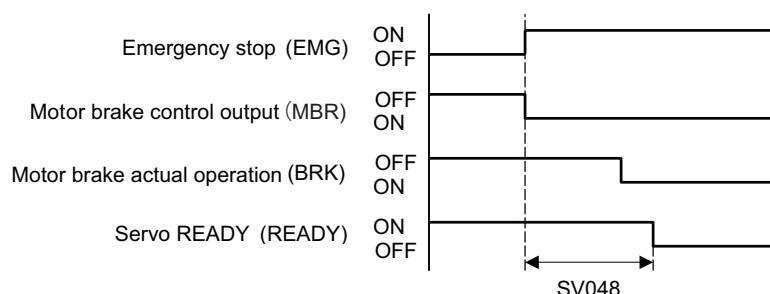

Vertical axis drop prevention control sequence

⚠ CAUTION

1. Always set deceleration control when using the vertical axis drop prevention control setting.
2. Configure so that the power supply unit is controlled directly by the servo drive unit which controls the spindle drive unit or the vertical axis drop prevention control.
3. In the 2nd part system of the power supply, if the axis for vertical axis drop prevention is connected with the CN9 connector of the power supply unit, provide the vertical axis drop prevention control setting also for the drive unit connected with CN4 connector of the same power supply unit.
4. If an alarm for which dynamic brake stopping is designated occurs, the function will not activate. To prevent axis dropping under all conditions, provide measures on the machine side by installing a balance unit, etc.
5. In consideration of the relay delay time for the break control, set the vertical axis drop prevention time.

【#2248】 SV048 EMGrt Vertical axis drop prevention time

Input the time required to prevent the vertical axis from dropping by delaying READY OFF until the brake works at an emergency stop.

Increase in increments of 100ms at a time, find and set the value where the axis does not drop. When using a motor with a break, set to "200ms" as a standard.

When the pull up function is enabled (SV033/bitE=1), the pull up is established during the drop prevention time.

---Setting range---

0 to 20000 (ms)

【#2255】 SV055 EMGx Max. gate off delay time after emergency stop

Set the time required between an emergency stop and forced READY OFF.

Set the maximum value "+ 100ms" of the SV056 setting value of the servo drive unit electrified by the same power supply unit.

When executing the vertical axis drop prevention, the gate off will be delayed for the length of time set at SV048 even when SV055's is smaller than that of SV048.

---Setting range---

0 to 20000 (ms)

【#2256】 SV056 EMGt Deceleration time constant at emergency stop

Set the time constant used for the deceleration control at emergency stop.

Set the time required to stop from rapid traverse rate (rapid).

The standard setting value is $EMGt \leq G0tL \times 0.9$.

However, note that the standard setting value differs from the above-mentioned value when the setting value of "#2003:smgst Acceleration and deceleration modes bit 3-0:Rapid traverse acceleration/deceleration type" is 8 or F. Refer to Instruction Manual of the drive unit (section "Deceleration control") for details.

Related parameters: SV048, SV055

---Setting range---

0 to 20000 (ms)

**POINT**

1. SV048 and SV055 are set for each axis, but when using MDS-D2/DH2-V2/V3 (2-axis or 3-axis drive unit), the axes are controlled with the larger setting value.
2. If an alarm for which dynamic brake stopping is designated occurs, the function will not activate.
3. A drop amount of several μm to several $10\mu\text{m}$ may be generated due to brake play.

**CAUTION**

1. Do not set the vertical axis drop prevention time longer than required. The servo control and brakes could collide, resulting in an overload alarm or drive unit damage. There is no problem if the overlapping time is within 100ms.
2. Vertical axis drop prevention control (including deceleration control) longer than 100ms will not be guaranteed during a power failure. The operation will change to dynamic brakes.
3. If only SV048 and SV055 are set, and SV056 is set to 0, the deceleration stop will be a stepped stop and could result in collision with the machine.

<Outline of system configurations and corresponding parameter settings>

[1] Spindle drive unit controls power supply unit. Vertical axis is a 1-axis unit (vertical axis: Z axis).

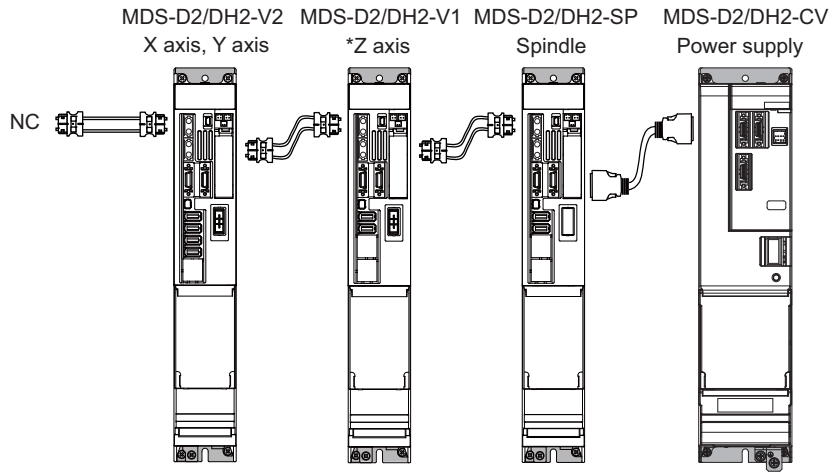

Parameter	Axis	X axis	Y axis	Z axis (Vertical axis)	Spindle
		MDS-D2/DH2-V2		MDS-D2/DH2-V1	MDS-D2/DH2-SP
SV048		0	0	200ms as a standard (Set by adjustment)	Set as follows. SP055=20000 SP056=300
SV055		X, Y, Z axis Maximum value of SV056 setting value +100ms			
SV056		Standard setting value for each axis (Note)			

(Note) For the standard setting value of SV056, refer to "Deceleration control".

[2] Spindle drive unit controls power supply unit. Vertical axis is a 2-axis unit (vertical axis: Z axis).

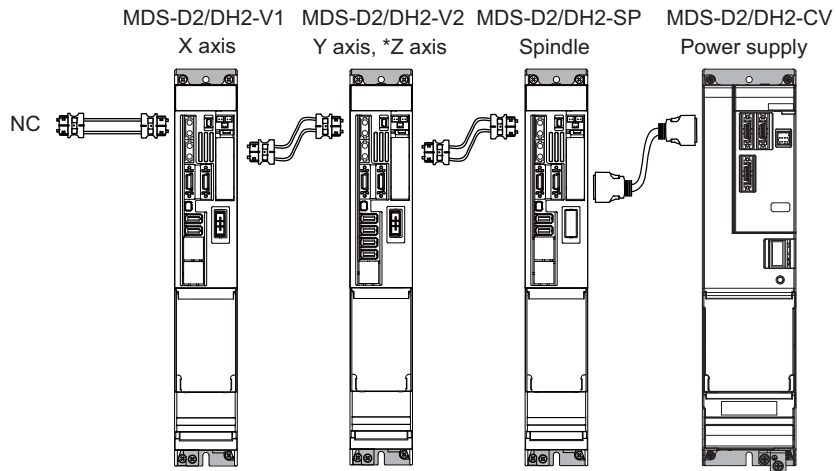

Parameter	Axis	X axis	Y axis	Z axis (Vertical axis)	Spindle
		MDS-D2/DH2-V1	MDS-D2/DH2-V2		MDS-D2/DH2-SP
SV048		0	Same value as Z axis ->	200ms as a standard (Set by adjustment)	Set as follows. SP055=20000 SP056=300
SV055		X, Y, Z axis Maximum value of SV056 setting value +100ms			
SV056		Standard setting value for each axis (Note)			

(Note) For the standard setting value of SV056, refer to "Deceleration control".

[3] Servo drive unit controls power supply unit. Vertical axis is a 1-axis unit (vertical axis: Z axis).

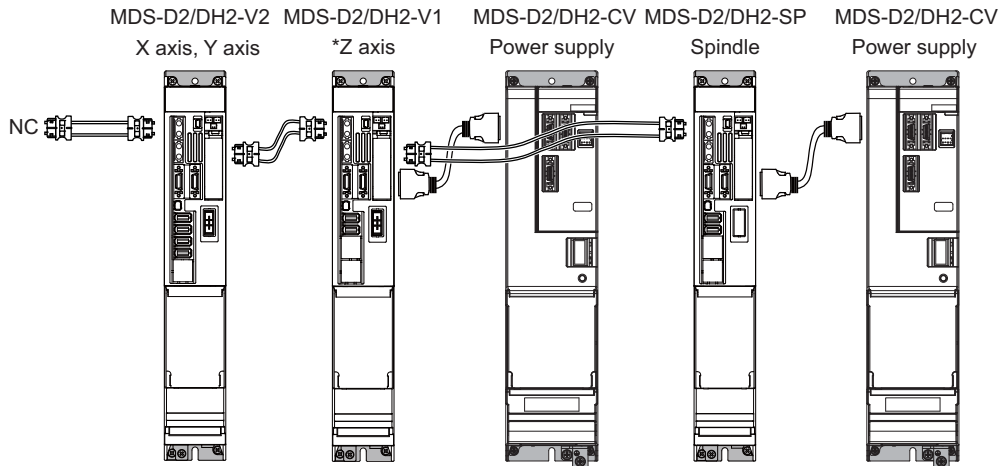

Parameter	Axis	X axis	Y axis	Z axis (Vertical axis)	Spindle
		MDS-D2/DH2-V2		MDS-D2/DH2-V1	MDS-D2/DH2-SP
SV048		0	0	200ms as a standard (Set by adjustment)	Set as follows. SP055=20000 SP056=300
SV055		X, Y, Z axis Maximum value of SV056 setting value +100ms			
SV056		Standard setting value for each axis (Note)			

(Note) For the standard setting value of SV056, refer to "Deceleration control".

[4] Servo drive unit controls power supply unit. Vertical axis is a 2-axis unit (vertical axis: Z axis).

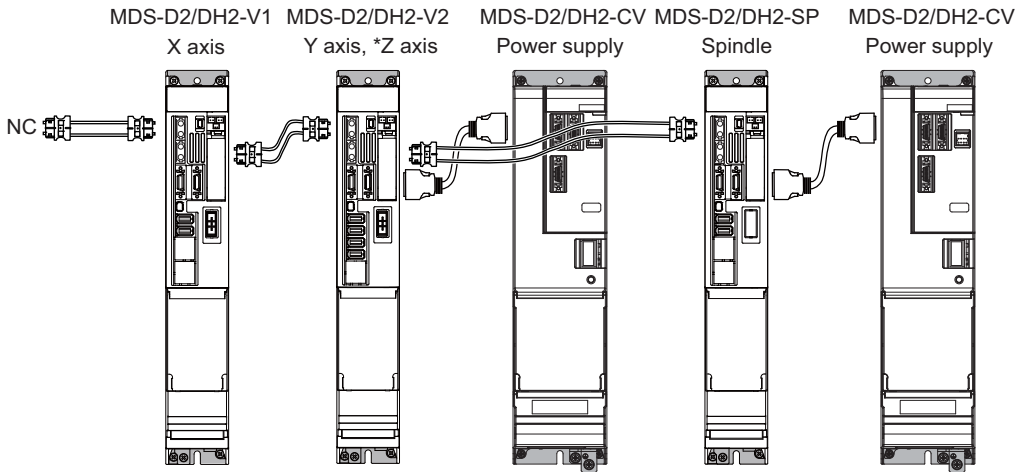

Parameter	Axis	X axis	Y axis	Z axis (Vertical axis)	Spindle
		MDS-D2/DH2-V1	MDS-D2/DH2-V2		MDS-D2/DH2-SP
SV048		0	Same value as Z axis ->	200ms as a standard (Set by adjustment)	Set as follows. SP055=20000 SP056=300
SV055		X, Y, Z axis Maximum value of SV056 setting value +100ms			
SV056		Standard setting value for each axis (Note)			

(Note) For the standard setting value of SV056, refer to "Deceleration control".

- [5] Spindle drive unit in the 2nd part system controls power supply unit.
 Vertical axis is a 1-axis unit in the 1st part system (vertical axis: Z axis).

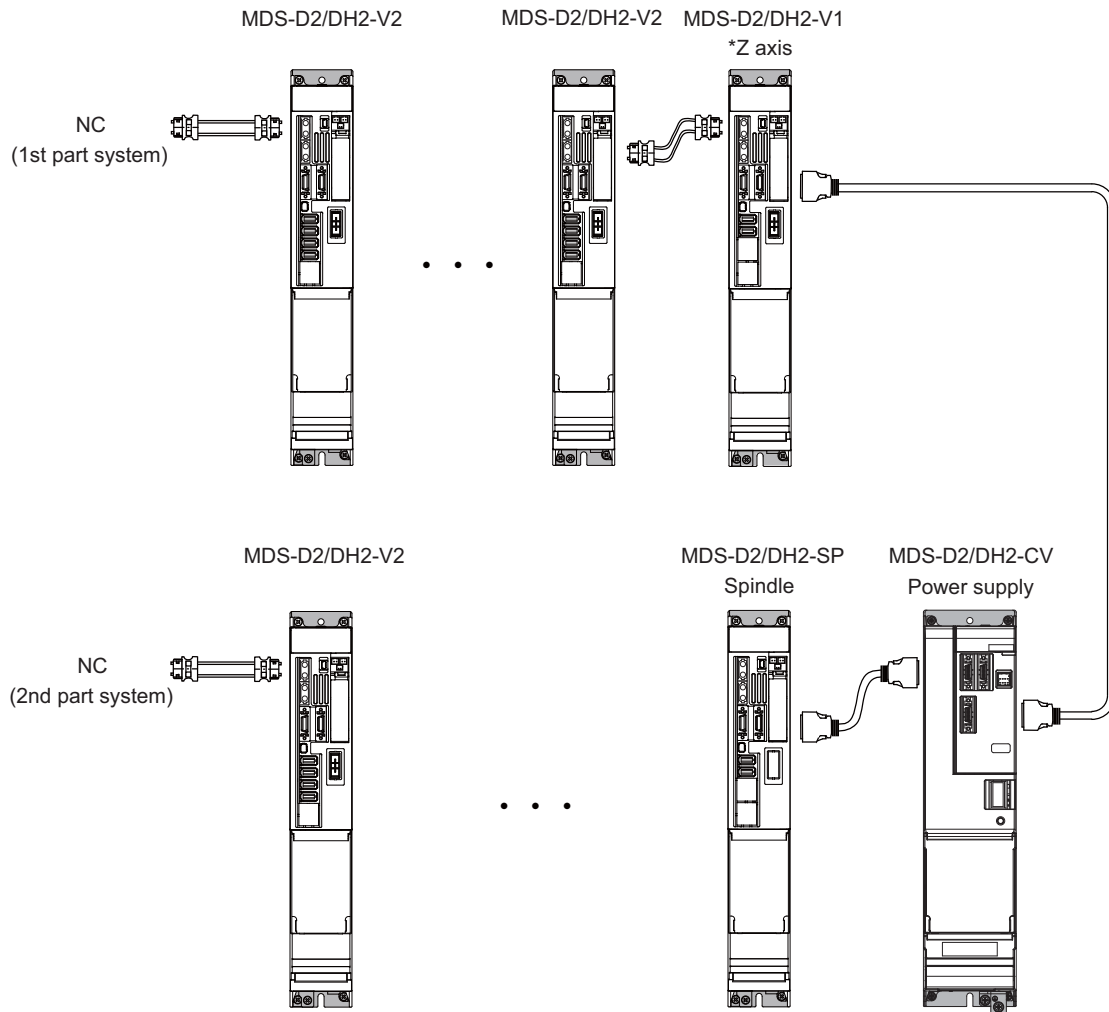

Parameter	Axis	Axis other than the right	Z axis (Vertical axis)	Spindle
		MDS-D2/DH2-V2	MDS-D2/DH2-V1	MDS-D2/DH2-SP
SV048		0	200ms as a standard (Set by adjustment)	Set as follows. SP055=20000 SP056=300
SV055		Each axis Maximum value of SV056 setting value +100ms		
SV056		Standard setting value for each axis (Note)		

(Note) For the standard setting value of SV056, refer to "Deceleration control".

CAUTION

In the 2nd part system of the power supply, if the axis for vertical axis drop prevention is connected with the CN9 connector of the power supply unit, provide the vertical axis drop prevention control setting also for the drive unit connected with CN4 connector of the same power supply unit.

[6] Spindle drive unit in the 2nd part system controls power supply unit.
 Vertical axis is a 2-axis unit in the 1st part system (vertical axis: Z axis).

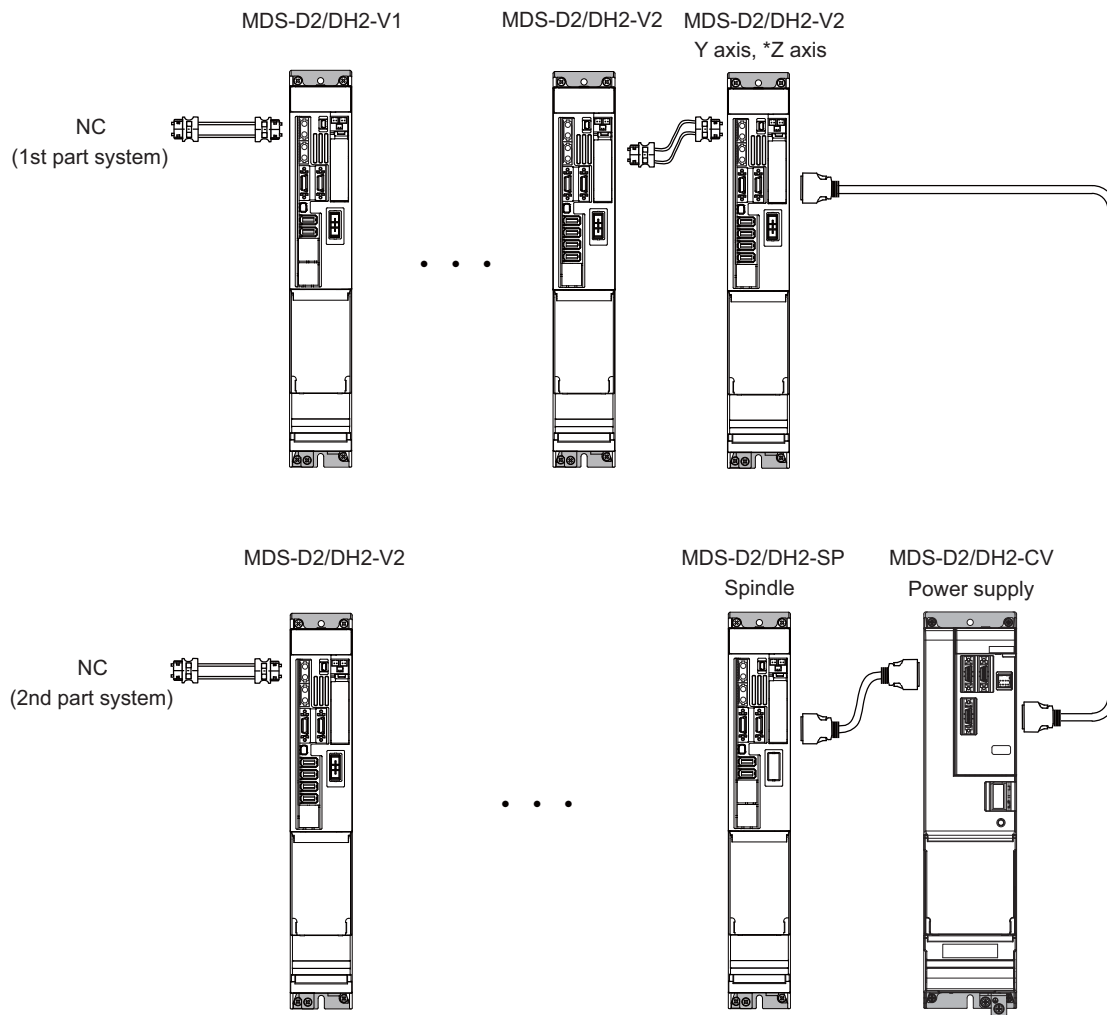

Parameter	Axis	Axis other than the right	Y axis	Z axis (Vertical axis)	Spindle
		MDS-D2/DH2-V1,V2	MDS-D2/DH2-V2		MDS-D2/DH2-SP
SV048		0	Same value as Z axis ->	200ms as a standard (Set by adjustment)	Set as follows. SP055=20000 SP056=300
SV055	Each axis Maximum value of SV056 setting value +100ms				
SV056	Standard setting value for each axis (Note)				

(Note) For the standard setting value of SV056, refer to "Deceleration control".

CAUTION

In the 2nd part system of the power supply, if the axis for vertical axis drop prevention is connected with the CN9 connector of the power supply unit, provide the vertical axis drop prevention control setting also for the drive unit connected with CN4 connector of the same power supply unit.

5.5.3 Vertical Axis Pull-up Control

Even when the vertical axis drop prevention control is applied, the axis will drop several μm due to the mechanical play of the motor brakes. Work could be damaged especially when the power fails during machining. For the vertical machining center, etc., vertical axis pull-up control protect works from collision by slightly pulling the vertical axis when an emergency stop (including the power failure) occurs.

If the pull-up control itself has possibility to cause interference during synchronous tapping machining or soft limit's stop, vertical axis pull-up control suppression command (servo control input 4/bit2) is input from NC and stops the pull-up control.

< Adjustment procedure >

- [1] Set "Vertical Axis Drop Prevention Control".
- [2] Set servo function selection 2 SV033/bitE = 1 (Vertical axis drop prevention control will start).
- [3] Set the torque offset SV032. The pull-up directions is distinguished by this setting value's sign. Refer to "Measuring unbalance torque and frictional torque measurement" for details on the setting.
- [4] Input emergency stop when axes stop and confirm the subject axis to be retracted upward.
- [5] If the pull-up range is insufficient, adjust vertical axis pull-up distance SV095.

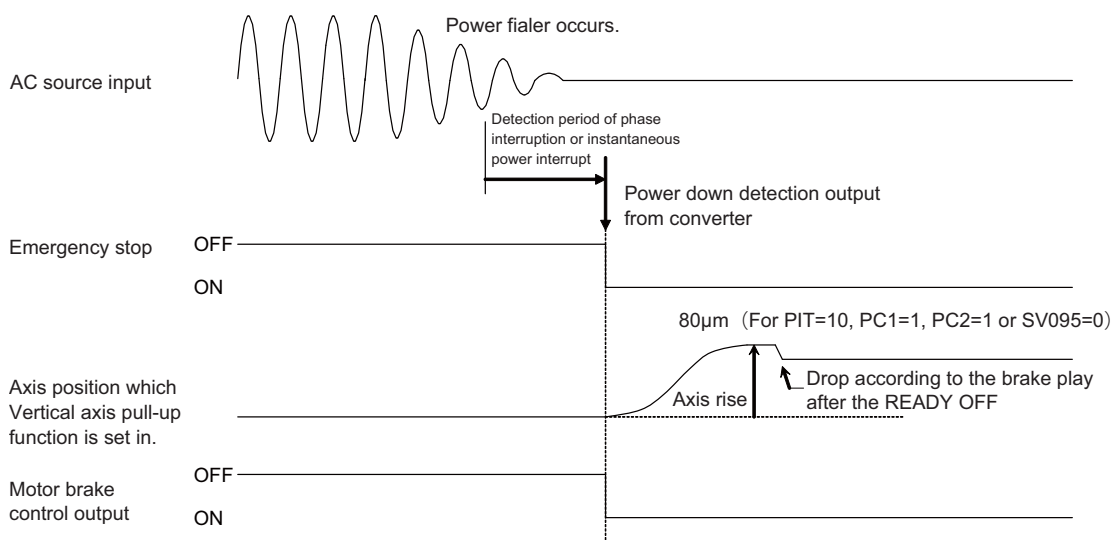

Vertical axis pull-up control operation sequences when the power fails

CAUTION

1. This function is valid for Z axis in the vertical machining center. Basically it cannot be used with the horizontal machining center's Y axis or the lathe's X axis as collisions could occur. Check the machine's working conditions carefully before using this function.
2. When the power fails, charging energy remaining in the power supply unit executes the pull-up control. Thus, pull-up range depends on charging situation of the power supply or the timing when the magnetic brake is applied.

[#2232] SV032 TOF Torque offset

Set the unbalance torque on vertical axis and inclined axis.

When the vertical axis pull up function is enabled, the pull up compensation direction is determined by this parameter's sign. When set to "0", the vertical axis pull up will not be executed.

This can be used for speed loop delay compensation and collision detection function.

To use load inertia estimation function (drive monitor display), set this parameter, friction torque (SV045) and load inertia display enabling flag(SV035/bitF).

---Setting range---

-100 to 100 (Stall current %)

【#2233】 SV033 SSF2 Servo function 2**bit E : zup Vertical axis pull up function**

0: Stop 1: Enable

【#2248】 SV048 EMGr Vertical axis drop prevention time

Input the time required to prevent the vertical axis from dropping by delaying READY OFF until the brake works at an emergency stop.

Increase in increments of 100ms at a time, find and set the value where the axis does not drop.

When using a motor with a brake, set to "200ms" as a standard.

When the pull up function is enabled (SV033/bitE=1), the pull up is established during the drop prevention time.

---Setting range---

0 to 20000 (ms)

【#2295】 SV095 ZUPD Vertical axis pull up distance

Set this parameter to adjust the pull up distance when the vertical axis pull up function is enabled.

When the pull up function is enabled and this parameter is set to "0", for a rotary motor, 8/1000 of a rotation at the motor end is internally set as the pull up distance, and for a linear motor, 80[μ m] is set.

---Setting range----32768 to 32767 (μ m)

5.6 Protective Functions

5.6.1 Overload Detection

The servo drive unit is equipped with an electronic thermal that protects the servo motor and servo drive unit from overload conditions. The overload 1 alarm (alarm 50) is detected if an overload condition occurs, and the overload 2 alarm (alarm 51) is detected if 95% or more of the maximum current is commanded continuously for 1 second or longer due to a machine collision, etc. The parameters shown below are for Mitsubishi Electric adjustment purposes only, and should be kept at their standard settings (SV021=60, SV022=150).



For details concerning the overload protection characteristics, refer to the MDS-D2/DH2 Series Specifications Manual (IB-1501124).

【#2221】 SV021 OLT Overload detection time constant

Normally, set to "60". (For Mitsubishi Electric adjustment.)

---Setting range---

1 to 999 (s)

【#2222】 SV022 OLL Overload detection level

Set the "Overload 1" (Alarm 50) current detection level as percentage to the stall current.

Normally set this parameter to "150". (For Mitsubishi Electric adjustment.)

---Setting range---

110 to 500 (Stall current %)

5.6.2 Excessive Error Detection

An excessive error (alarms 52, 53, 54) is detected when the difference between the servo's commanded position and the FB position exceeds the value set by parameter. Separate excessive error detection width can be set for servo ON (SV023) and servo OFF (SV026) statuses. When a wider excessive error detection width than that used for standard control is required in stopper control, etc., the detection width setting can be changed to the SV053 setting value by NC command.

Follow-up control (NC commanded position tracks servo FB position) is used during emergency stop and during a servo OFF command, and so there is no excessive error detection at those times, although the follow-up control during a servo OFF status can be disabled by an NC system parameter setting.

[#2223] SV023 OD1 Excessive error detection width during servo ON

Set the excessive error detection width in servo ON.

<Standard setting value>

$$OD1=OD2= (\text{Rapid traverse rate [mm/min]} / (60 \times \text{PGN1}) / 2 \text{ [mm]})$$

When set to "0", the excessive error alarm detection will be ignored, so do not set to "0".

---Setting range---

0 to 32767 (mm)

However, when SV084/bitC=1, the setting range is from 0 to 32767 (μ m).

[#2226] SV026 OD2 Excessive error detection width during servo OFF

Set the excessive error detection width during servo OFF.

<Standard setting value>

$$OD1=OD2= (\text{Rapid traverse rate [mm/min]} / (60 \times \text{PGN1}) / 2 \text{ [mm]})$$

When set to "0", the excessive error alarm detection will be ignored, so do not set to "0".

---Setting range---

0 to 32767 (mm)

However, when SV084/bitC=1, the setting range is from 0 to 32767 (μ m).

[#2253] SV053 OD3 Excessive error detection width in special control

Set the excessive error detection width when servo ON in a special control (initial absolute position setting, stopper control and etc.).

When "0" is set, excessive error detection will not be performed when servo ON during a special control.

---Setting range---

0 to 32767 (mm)

However, when SV084/bitC=1, the setting range is from 0 to 32767 (μ m).

5.6.3 Collision Detection Function

Collision detection function quickly detects a collision of the motor shaft, and decelerates and stops the motor. This suppresses the generation of an excessive torque in the machine tool, and helps to prevent an abnormal state from occurring. Impact at a collision will not be prevented by using this collision detection function, so this function does not necessarily guarantee that the machine tool will not be damaged or that the machine accuracy will be maintained after a collision. The same caution as during regular operation is required to prevent the machine from colliding.

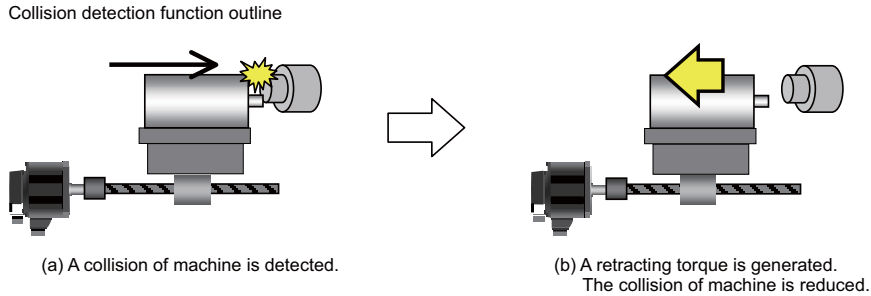

(1) Collision detection method 1

The required torque for the command is estimated from the position command issued from the NC, and the disturbance torque is obtained from the difference with the actual torque. When this disturbance torque exceeds the collision detection level set with the parameters, the motor will decelerate to a stop with a torque 80% (standard) value of the motor's maximum torque. After decelerating to a stop, alarm 58 or 59 will occur, and the system will stop.

The collision detection level for rapid traverse (G0) is set with SV060: TLMT. The collision detection level for cutting feed (G1) is set to 0 to 7-fold (SV35.cIG1) based on the collision detection level for rapid traverse. When cIG1 is set to 0, collision detection method 1 will not function during cutting feed. If SV060 is set to 0, all collision detection (including methods 1 and 2) will not function.

	Collision detection level setting parameter	Detected alarm
During rapid traverse (During G0 feed)	SV060	Alarm 58
During cutting feed (During G1 feed)	SV060 × cIG1 (SV035)	Alarm 59

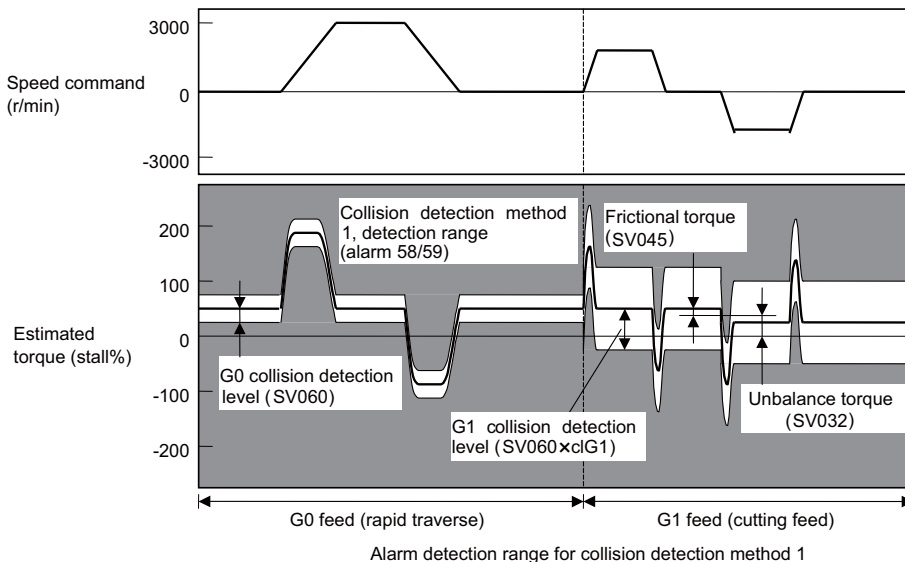

CAUTION

The collision detection function does not guarantee safety or machine accuracy when a collision occurs. Thus, the same caution as during regular operation is required to prevent the machine from colliding.

(2) Collision detection method 2

When the current command reaches the motor's maximum current, the motor will decelerate and stop at a torque 80% (standard value) of the motor's maximum torque. After decelerating to a stop, alarm 5A will occur, and the system will stop. If the acceleration/deceleration time constant is short and incorrect detections easily occur during normal operation, lengthen the acceleration/ deceleration time constant and adjust so that the current is not saturated (does not reach the maximum current) during acceleration.

If the acceleration/deceleration time constant cannot be lengthened, set parameter SV035/bitB (SSF4.c12n) to 1 to ignore collision detection method 2.

(3) Retracting torque

In each collision detection method, impact after a collision is reduced by generating the retracting torque after the collision is detected.

The retracting torque is a torque 70% to 100% which is set with SV035: SSF4/cltq (bit8, bit9) based on the current of the motor maximum ability.

**POINT**

1. Validate SHG control or OMR-FF function when using the collision detection function, or when carrying out SV059 setting value operation.
2. Provide an allowance in the detection level setting to prevent incorrect detections.
3. All collision detection functions will be disabled when SV60 is set to 0.
4. Collision detection method 2 will function if a value other than 0 is set in SV060. Note that the detection can be ignored by setting the parameter (SV035/bitB).
5. The torque estimated gain (SV059) must be readjusted when there are changes in the encoder replacement following maintenance, etc., in the encoder resolution, or in the position control system such as encoder loop gain (PGN), etc. (closed loop control and semi-closed loop has been changed).
6. The retracting torque generated when a collision is detected outputs the motor maximum torque. If the torque limitation is required in order to protect the machine, set "SV035 : SSF4/cltq (bit8, bit9)".

<Setting and adjustment methods>

- [1] Confirm that SHG control or OMR-FF function is enabled.
- [2] Set the axis unbalanced torque to the torque offset (SV032: TOF). (Refer to "Measuring unbalance torque and frictional torque" for details on measuring the unbalance torque.)
- [3] Measure the frictional torque and set in the frictional torque (SV045: TRUB). Carry out reciprocation operation (approx. F1000) with the axis to be adjusted, and measure the load current % when the axis is fed at the constant speed on the NC SERVO MONITOR screen. This frictional torque is expressed with the following expression.

$$\text{Frictional torque (\%)} = \left| \frac{(+ \text{ feed load current \%}) - (- \text{ feed load current \%})}{2} \right|$$

- [4] Set SV035: SSF4.clt (bitF) to 1 for the axis being adjusted, and move in both directions with JOG, etc., at the rapid traverse rate. When the load inertia ratio display on the NC SERVO MONITOR screen has stabilized, set that value for the torque estimated gain (SV059: TCNV). Return SV035: SSF4.clt (bitF) to 0.
- [5] If the acceleration/deceleration time is short, and the current is limited, set SV035: SSF4.c12n (bitB) to 1 to invalidate collision detection method 2.
- [6] Adjust the collision detection level (SV060: TLMT). First set 100. If operation at the rapid traverse rate results in an alarm, increase the setting value by approx. 20. If an alarm does not occur, lower the setting value by approx. 10. The estimated disturbance torque value on the servo monitor screen will indicate the estimated disturbance torque peak value for the latest two seconds. This value can be used as reference. Set the final setting value to a value approx. 1.5-fold the limit value at which an alarm does not occur.
- [7] Divide the maximum cutting load with the value set for the collision detection level (SV060: TLMT). (Round up the decimal) Set this value in SV035: SSF4.c1G1 (bitC-E).
(Example) For maximum cutting load: 200%, SV060: TLMT setting value: 80%
200/80=2.5 -> The detection level is 3 (-fold), so set SV035:SSF4 to "3xxx".
- [8] Set the retracting torque when the a collision is detected to SV035: SSF4.cltq (bit8,9).
(Example) To set the retracting torque to 70% of the motor maximum torque:
Set SV035:SSF4 to "x3xx".

【#2232】 SV032 TOF Torque offset

Set the unbalance torque on vertical axis and inclined axis.

When the vertical axis pull up function is enabled, the pull up compensation direction is determined by this parameter's sign. When set to "0", the vertical axis pull up will not be executed.

This can be used for speed loop delay compensation and collision detection function.

To use load inertia estimation function (drive monitor display), set this parameter, friction torque (SV045) and load inertia display enabling flag(SV035/bitF).

---Setting range---

-100 to 100 (Stall current %)

【#2235】 SV035 SSF4 Servo function 4**bit F : cIt Inertia ratio display**

0: Setting for normal use

1: Display the total inertia ratio estimated at acceleration/deceleration at the inertia ratio on the servo monitor screen

To display it on the screen, set an imbalance torque and friction torque to both SV032 and SV045 and repeat acceleration/deceleration operations for several times.

bit E-C: cIG1 G1 Collision detection level

Set the collision detection level in the collision detection method 1 during cutting feed (G1) in multiples of that of rapid traverse (G0). When set to "0", detection of collision detection method 1 during cutting feed will be ignored.

$G1 \text{ Collision detection level} = G0 \text{ collision detection level (SV060)} \times cIG1$

bit B : cI2n Collision detection method 2

0: Enable 1: Disable

bit 9-8 : cItq Retract torque in collision detection

Set the retract torque in collision detection using the ratio of motor's maximum torque.

bit9,8=

00: 100%

01: 90%

10: 80% (Standard)

11: 70%

【#2245】 SV045 TRUB Friction torque

Set the frictional torque when using the collision detection function.

To use load inertia estimation function (drive monitor display), set this parameter, imbalance torque (SV032) and load inertia display enabling flag (SV035/bitF).

---Setting range---

0 to 255 (Stall current %)

【#2259】 SV059 TCNV Collision detection torque estimated gain

Set the torque estimated gain when using the collision detection function.

The standard setting value is the same as the load inertia ratio (SV037 setting value) including motor inertia.

Set to "0" when not using the collision detection function.

<<Drive monitor load inertia ratio display>>

Set SV035/bitF=1 and imbalance torque and friction torque to both SV032 and SV045, and then repeat acceleration/deceleration for several times.

---Setting range---

For general motor: 0 to 5000 (%)

For linear motor: 0 to 5000 (kg)

【#2260】 SV060 TLMT Collision detection level

When using the collision detection function, set the collision detection level at the G0 feeding.

When "0" is set, none of the collision detection function will work.

---Setting range---

0 to 999 (Stall current %)

5.7 Servo Control Signal

The sequence input/output signals exchanged between the NC and servo drive unit are explained in this section. The status of each signal is displayed on the NC SERVO MONITOR screen.

5.7.1 Servo Control Input (NC to Servo)

(1) Servo control input 1

Name	Details															
Servo control input 1	F	E	D	C	B	A	9	8	7	6	5	4	3	2	1	0
								IL1	ALMR	EOM		KPM			SRV	RDY
	bit	Details														
	0	RDY	READY ON command													
	1	SRV	Servo ON command													
	2	-	(For maintenance)													
	3	-	(For maintenance)													
	4	KPM	Position loop gain changeover command													
	5	-	(For maintenance)													
	6	EOM	Excessive error detection width changeover command													
	7	ALMR	Alarm reset command													
	8	IL1	Current limit selection command													
	9	-	(For maintenance)													
	A	-	(For maintenance)													
	B	-	(For maintenance)													
	C	-	(For maintenance)													
	D	-	(For maintenance)													
E	-	(For maintenance)														
F	-	(For maintenance)														

bit0. READY ON command (RDY)
Status turns to ready ON at RDY=1.

bit1. Servo ON command (SRV)
[1] Drive unit turns ON at SRV=1 (servo ON status).
[2] Drive unit turns OFF at SRV=0 (servo OFF status).

bit4. Position loop gain changeover command (KPM)
[1] The position loop gain (SV049/SV050/SV058) for spindle synchronous (synchronoustapping, synchronous control with spindle C-axis, etc.) is selected at KPM=1.
[2] The normal position loop gain (SV003/SV004/SV057) is selected at KPM=0.

bit6. Excessive error detection width changeover command (EOM)
[1] The excessive error width (SV053) for the special control (initial absolute position setting, stopper control, etc.) is selected at EOM =1.
[2] The normal excessive error width (SV023) is selected at EOM =0.

bit7. Alarm reset command (ALMR)
NR alarm is reset at ALMR=1.

bit8. Current limit selection command (IL1)
[1] The current (torque) limit (SV014) for the special control (initial absolute position setting, stopper control, etc.) is selected at IL1 =1.
[2] The normal current (torque) limit (SV013) is selected at IL1 =0.

(Note) The bits other than those above are used for maintenance.

(2) Servo control input 2

Name	Details																
Servo control input 2	F	E	D	C	B	A	9	8	7	6	5	4	3	2	1	0	
					SRVDC	NCDC	SSW										
	bit	Details															
	0	-	(For maintenance)														
	1	-	(For maintenance)														
	2	-	(For maintenance)														
	3	-	(For maintenance)														
	4	-	(For maintenance)														
	5	-	(For maintenance)														
	6	-	(For maintenance)														
7	-	(For maintenance)															
8	-	(For maintenance)															
9	SSW	Speed monitor command valid															
A	NCDC	In door closed (controller)															
B	SRVDC	In door closed (all drive units)															
C	-	(For maintenance)															
D	-	(For maintenance)															
E	-	(For maintenance)															
F	-	(For maintenance)															

bit9. Speed monitor command valid (SSW)
When speed monitor command is valid, SSW=1 (valid) is set.

bitA. In door closed (controller) (NCDC)
When "In door closed" signal for controller is valid, NCDC =1 (valid) is set.

bitB. In door closed (all drive units) (SRVDC)
When the theoretical sum of "In door closed" signals for all drive units is valid, SRVDC =1 (valid) is set.

(Note) The bits other than those above are used for maintenance.

(3) Servo control input 3

Name	Details																
Servo control input 3	F	E	D	C	B	A	9	8	7	6	5	4	3	2	1	0	
																AXF	
	bit	Details															
	0	AXF	Control axis detachment command														
	1	-	(For maintenance)														
	2	-	(For maintenance)														
	3	-	(For maintenance)														
	4	-	(For maintenance)														
	5	-	(For maintenance)														
	6	-	(For maintenance)														
7	-	(For maintenance)															
8	-	(For maintenance)															
9	-	(For maintenance)															
A	-	(For maintenance)															
B	-	(For maintenance)															
C	-	(For maintenance)															
D	-	(For maintenance)															
E	-	(For maintenance)															
F	-	(For maintenance)															

bit0. Control axis detachment command (AXF)
The control axis is detached at AXF=1.

(Note) The bits other than those above are used for maintenance.

(4) Servo control input 4

This is used for maintenance.

(5) Servo control input 5

This is used for maintenance.

(6) Servo control input 6

Name	Details																																
Servo control input 6	<table border="1" style="width: 100%; border-collapse: collapse;"> <tr> <td style="width: 5%;">F</td><td style="width: 5%;">E</td><td style="width: 5%;">D</td><td style="width: 5%;">C</td><td style="width: 5%;">B</td><td style="width: 5%;">A</td><td style="width: 5%;">9</td><td style="width: 5%;">8</td><td style="width: 5%;">7</td><td style="width: 5%;">6</td><td style="width: 5%;">5</td><td style="width: 5%;">4</td><td style="width: 5%;">3</td><td style="width: 5%;">2</td><td style="width: 5%;">1</td><td style="width: 5%;">0</td> </tr> <tr> <td></td><td></td><td></td><td></td><td></td><td></td><td></td><td style="text-align: center;">DD1</td><td></td><td></td><td></td><td></td><td></td><td></td><td></td><td style="text-align: right;">OMRFF</td> </tr> </table>	F	E	D	C	B	A	9	8	7	6	5	4	3	2	1	0								DD1								OMRFF
	F	E	D	C	B	A	9	8	7	6	5	4	3	2	1	0																	
								DD1								OMRFF																	
	bit	Details																															
	0	OMRFF																															
	1	OMR-FF control request																															
	2	- (For maintenance)																															
	3	- (For maintenance)																															
	4	- (For maintenance)																															
	5	- (For maintenance)																															
	6	- (For maintenance)																															
	7	- (For maintenance)																															
	8	DD1																															
	9	Drivers communication control request																															
	A	- (For maintenance)																															
B	- (For maintenance)																																
C	- (For maintenance)																																
D	- (For maintenance)																																
E	- (For maintenance)																																
F	- (For maintenance)																																

bit0. OMR-FF control request (OMRFF)

- [1] The OMR-FF control which determines the tracking ability to the position command by using scale model gain is selected with OMRFF=1.
- [2] The tracking ability to the position command is determined by using conventional position loop gain with OMRFF=0.

bit8. Drivers communication control request (DD1)

- [1] The high-speed synchronous tapping control which allows data communication between drive units is selected with DD1=1.
- [2] The normal synchronous tapping is selected with DD1=0.

(Note) The bits other than those above are used for maintenance.

5.7.2 Servo Control Output (Servo to NC)

(1) Servo control output 1

Name	Details																																
Servo control output 1	<table border="1"> <tr> <td>F</td><td>E</td><td>D</td><td>C</td><td>B</td><td>A</td><td>9</td><td>8</td><td>7</td><td>6</td><td>5</td><td>4</td><td>3</td><td>2</td><td>1</td><td>0</td> </tr> <tr> <td>WRN</td><td>AER</td><td>LMT</td><td>INP</td><td></td><td></td><td></td><td>IL1</td><td>ALMR</td><td>EOM</td><td>KPM</td><td></td><td></td><td></td><td>SRV</td><td>RDY</td> </tr> </table>	F	E	D	C	B	A	9	8	7	6	5	4	3	2	1	0	WRN	AER	LMT	INP				IL1	ALMR	EOM	KPM				SRV	RDY
	F	E	D	C	B	A	9	8	7	6	5	4	3	2	1	0																	
	WRN	AER	LMT	INP				IL1	ALMR	EOM	KPM				SRV	RDY																	
	bit	Details																															
	0 RDY	In READY ON																															
	1 SRV	In servo ON																															
	2 -	(For maintenance)																															
	3 -	(For maintenance)																															
	4 KPM	In position loop gain changeover																															
	5 -	(For maintenance)																															
	6 EOM	In excessive error detection width changeover																															
	7 ALMR	In alarm																															
	8 IL1	In current limit selection																															
	9 -	(For maintenance)																															
	A -	(For maintenance)																															
	B -	(For maintenance)																															
C INP	In in-position																																
D LMT	In current limit																																
E AER	In absolute position data loss																																
F WRN	In warning																																

- bit0. In ready ON (RDY)
It indicates that the status is in ready ON at RDN=1.
- bit1. In servo ON (SRV)
It indicates that the drive unit turns ON (servo ON) at SRV=1.
- bit4. In position loop gain changeover (KPM)
 - [1] The position loop gain (SV049/SV050/SV058) for spindle synchronous (synchronoustapping, synchronous control with spindle C-axis, etc.) is being selected at KPM=1.
 - [2] The normal position loop gain (SV003/SV004/SV057) is being selected at KPM=0.
- bit6. In excessive error detection width changeover (EOM)
 - [1] The excessive error width (SV053) for the special control (initial absolute position setting, stopper control, etc.) is being selected at EOM =1.
 - [2] The normal excessive error width (SV023) is being selected at EOM =0.
- bit7. In alarm (ALMR)
It indicates that drive unit is in some alarm state at ALM=1.
- bit8. In current limit selection (IL1)
 - [1] The current (torque) limit (SV014) for the special control (initial absolute position setting, stopper control, etc.) is being selected at IL1 =1.
 - [2] The normal current (torque) limit (SV013) is being selected at IL1 =0.
- bitC. In in-position (INP)
The status changes to INP=1 when position droop exists within the in-position area set by parameter SP024 (INP) regardless of serve ON or OFF.
- bitD. In current limit (LMT)
It indicates that the drive unit is in current limit at LMT=1.

bitE. In absolute position data loss (AER)
It indicates that the drive unit is in absolute position data loss at AER=1.

bitF. In warning (WRN)
It indicates that drive unit is in some warning state at WRN=1.

(Note) The bits other than those above are used for maintenance.

(2) Servo control output 2

Name	Details															
Servo control output 2	F	E	D	C	B	A	9	8	7	6	5	4	3	2	1	0
					SRVDC	NCDC	SSW		EXEMG				ZS			ZCN
	bit	Details														
	0	ZCN	Z phase passed													
	1	-	(For maintenance)													
	2	-	(For maintenance)													
	3	ZS	In zero speed													
	4	-	(For maintenance)													
	5	-	(For maintenance)													
	6	-	(For maintenance)													
	7	EXEMG	In external emergency stop													
	8	-	(For maintenance)													
	9	SSW	In speed monitor													
	A	NCDC	In door closed (controller)													
	B	SRVDC	In door closed (self drive unit)													
	C	-	(For maintenance)													
	D	-	(For maintenance)													
	E	-	(For maintenance)													
	F	-	(For maintenance)													

bit0. Z phase passed (ZCN)
ZCN is set to "1" after passing the Z phase at ZCN=0.

bit3. In zero speed (ZS)
It indicates that the servo motor is stopping at ZS=1.

bit7. In external emergency stop
It indicates that an external stop input to the power supply is being input.

bit9. In speed monitor
It indicates that a signal in speed monitor command is being received.

bitA. In door closed (controller)
It indicates that "In door closed" signal for controller is being received.

bitB. In door closed (self drive unit)
It indicates the status of "In door closed" signal for self drive unit.

(Note) The bits other than those above are used for maintenance.

(3) Servo control output 3

Name	Details															
Servo control output 3	F	E	D	C	B	A	9	8	7	6	5	4	3	2	1	0
																AXF
	bit	Details														
	0	AXF	In control axis detachment													
	1	-	(For maintenance)													
	2	-	(For maintenance)													
	3	-	(For maintenance)													
	4	-	(For maintenance)													
	5	-	(For maintenance)													
	6	-	(For maintenance)													
	7	-	(For maintenance)													
	8	-	(For maintenance)													
	9	-	(For maintenance)													
	A	-	(For maintenance)													
	B	-	(For maintenance)													
	C	-	(For maintenance)													
	D	-	(For maintenance)													
E	-	(For maintenance)														
F	-	(For maintenance)														

bit0. In control axis detachment (AXF)
 The control axis is being detached at AXF=1.

(Note) The bits other than those above are used for maintenance.

(4) Servo control output 4

This is used for maintenance.

(5) Servo control output 5

This is used for maintenance.

(6) Servo control output 6

Name	Details															
Servo control output 6	F	E	D	C	B	A	9	8	7	6	5	4	3	2	1	0
								DD1								OMRFF
	bit	Details														
	0	OMRFF	In OMR-FF control													
	1	-	(For maintenance)													
	2	-	(For maintenance)													
	3	-	(For maintenance)													
	4	-	(For maintenance)													
	5	-	(For maintenance)													
	6	-	(For maintenance)													
	7	-	(For maintenance)													
	8	DD1	In drivers communication control													
	9	-	(For maintenance)													
	A	-	(For maintenance)													
	B	-	(For maintenance)													
	C	-	(For maintenance)													
	D	-	(For maintenance)													
E	-	(For maintenance)														
F	-	(For maintenance)														

bit0. In OMR-FF control (OMRFF)
 OMRFF=1 (enabled) if OMR-FF control is enabled.

bit8. In drivers communication control (DD1)
 DD1=1 (enabled) if high-speed synchronous tapping control is enabled.

(Note) The bits other than those above are used for maintenance.

Spindle Adjustment

6.1 Adjustment Procedures for Each Control

CAUTION

1. Do not adjust when possible risks associated with adjustment procedures are not thoroughly taken into consideration.
2. Be careful when touching rotating section, or your hand may be caught in or cut.
3. Changing of parameters has to be done carefully.

6.1.1 Basic Adjustments

(1) Items to check during trial operation

- [1] When the power is ON for the first time, check the wiring. When the machine is operated for the first time, check the set parameters again.
- [2] Confirm that the values of the NC side parameters "slimt1 to 4", "smax1 to 4", and "smini" comply with the machine specification.
- [3] When the machine running-in has not been completed, gradually raise the rotation speed (in increments of 1000r/min) for the spindle. Raise the speed at the timing when the load meter value is stabilized during rotation.
If the load meter value is higher than the normal value, stop the operation and check the spindle section of the machine.
- [4] Confirm that the command (S command) speed and actual speed match during running-in. When gear ratio is set, the spindle end speed and motor speed differ.
- [5] Confirm that there is no abnormal noise, odor or motor overheat during running-in.

(2) Adjusting the spindle rotation speed

When the spindle motor and the spindle end are coupled using a gear or pulley, the rotation speeds of the spindle motor and the spindle end may not match. Adjust the command and the rotation speed of spindle end with the following method.

Apply the following adjustment methods [1] to [3] individually to each of the gears 00 to 11. Confirm that the machine's gear changes correctly before the adjustment.

- [1] Set the spindle specification parameters, "slimt1 to 4".
Calculation expression:
$$\text{slimt1 to 4} = \text{SP026} \times (\text{deceleration rate of the gears 00 to 11 between the motor and spindle end})$$
- [2] Set the S command to half of the maximum spindle rotation speed and confirm the rotation speed of the spindle end. Adjust slimt1 to 4 until the rotation speed matches.
- [3] Set the S command to the maximum spindle end rotation speed and confirm that the S command speed and the spindle end speed match.

6.1.2 Gain Adjustment

(1) Checking the current loop gain

Check to see if the settings of following parameters, SP077 to SP084, are the standard setting.

Basically, parameters for current loop gain do not need to be changed.

【#13077】 SP077 IQA Q axis current lead compensation

Set the current loop gain.

To use the coil switch function, set the current loop gain for when the high-speed coil is selected.

The setting value is determined by the motor's electrical characteristics so that the value is fixed to each motor used.

Set the value given in the spindle parameter list. (For Mitsubishi Electric adjustment)

---Setting range---

1 to 20480

【#13078】 SP078 IDA D axis current lead compensation

Set the current loop gain.

To use the coil switch function, set the current loop gain for when the high-speed coil is selected.

The setting value is determined by the motor's electrical characteristics so that the value is fixed to each motor used.

Set the value given in the spindle parameter list. (For Mitsubishi Electric adjustment)

---Setting range---

1 to 20480

【#13079】 SP079 IQG Q axis current gain

Set the current loop gain.

To use the coil switch function, set the current loop gain for when the high-speed coil is selected.

The setting value is determined by the motor's electrical characteristics so that the value is fixed to each motor used.

Set the value given in the spindle parameter list. (For Mitsubishi Electric adjustment)

---Setting range---

1 to 8192

【#13080】 SP080 IDG D axis current gain

Set the current loop gain.

To use the coil switch function, set the current loop gain for when the high-speed coil is selected.

The setting value is determined by the motor's electrical characteristics so that the value is fixed to each motor used.

Set the value given in the spindle parameter list. (For Mitsubishi Electric adjustment)

---Setting range---

1 to 8192

【#13081】 SP081 IQAL Q axis current lead compensation low-speed coil

When using coil switch function, set the current loop gain for when the low-speed coil is selected.

The setting value is determined by the motor's electrical characteristics so that the value is fixed to each motor used.

Set the value given in the spindle parameter list. (For Mitsubishi Electric adjustment)

---Setting range---

1 to 20480

【#13082】 SP082 IDAL D axis current lead compensation low-speed coil

When using coil switch function, set the current loop gain for when the low-speed coil is selected. The setting value is determined by the motor's electrical characteristics so that the value is fixed to each motor used.

Set the value given in the spindle parameter list. (For Mitsubishi Electric adjustment)

---Setting range---

1 to 20480

【#13083】 SP083 IQGL Q axis current gain low-speed coil

When using coil switch function, set the current loop gain for when the low-speed coil is selected. The setting value is determined by the motor's electrical characteristics so that the value is fixed to each motor used.

Set the value given in the spindle parameter list. (For Mitsubishi Electric adjustment)

---Setting range---

1 to 8192

【#13084】 SP084 IDGL D axis current gain low-speed coil

When using coil switch function, set the current loop gain for when the low-speed coil is selected. The setting value is determined by the motor's electrical characteristics so that the value is fixed to each motor used.

Set the value given in the spindle parameter list. (For Mitsubishi Electric adjustment)

---Setting range---

1 to 8192

(Note) Low-speed coil setting SP081, SP082, SP083 and SP084 are set to "0" when coil changeover specification is not available.

(2) Adjusting the gain parameter

Adjust the gain parameters as usual or by application in accordance with the chart below.

Control item	S command	Orientation		Synchronous tapping/ Spindle C axis		Spindle synchronization	
		#3106/bitE=0	#3106/bitE=1	-	-		
Changeover setting	-	#3106/bitE=0	#3106/bitE=1	-	-	-	-
Position loop gain	SP001	SP002	SP001	SP002	SP003		
SHG control start parameter	No setting	No setting	No setting	SP035/bitC=1	SP036/bit4=1		
Application		Standard	Vibration suppression				

Control item	S command	Orientation				Synchronous tapping/ Spindle C axis		Spindle synchronization	
		SP035/ bit1=0	SP035/ bit1=1	SP035/ bit9=0	SP035/ bit9=1	SP036/ bit1=0	SP036/ bit1=1		
Speed loop proportional gain	-	-	SP035/ bit1=1	SP035/ bit9=0	SP035/ bit9=1	SP036/ bit1=0	SP036/ bit1=1		
Speed loop lead compensation	SP005	SP008	SP005	SP008	SP005	SP008	SP005	SP008	
Speed loop delay compensation	SP006	SP009	SP006	SP009	SP006	SP009	SP006	SP009	
Application	SP007	SP010	SP007	SP010	SP007	SP010	SP007	SP010	
Speed loop proportional gain		Standard				Standard	Double grasping control	Polygonal machining	

Control item	S command	Orientation				Synchronous tapping/ Spindle C axis		Spindle synchronization	
		SP035/ bit2=0	SP035/ bit2=1	SP035/ bitA=0	SP035/ bitA=1	SP036/ bit2=0	SP036/ bit2=1		
Changeover setting	-	-	SP035/ bit2=1	SP035/ bitA=0	SP035/ bitA=1	SP036/ bit2=0	SP036/ bit2=1		
Minimum excitation rate	SP014	SP015	SP014	SP015	SP014	SP015	SP014	SP015	
Application		Standard				Standard	Double grasping control	Polygonal machining	

(Note) Position and speed loop gain is switched depend on the control item, so set the parameter correctly.

(3) Adjusting the speed loop parameter

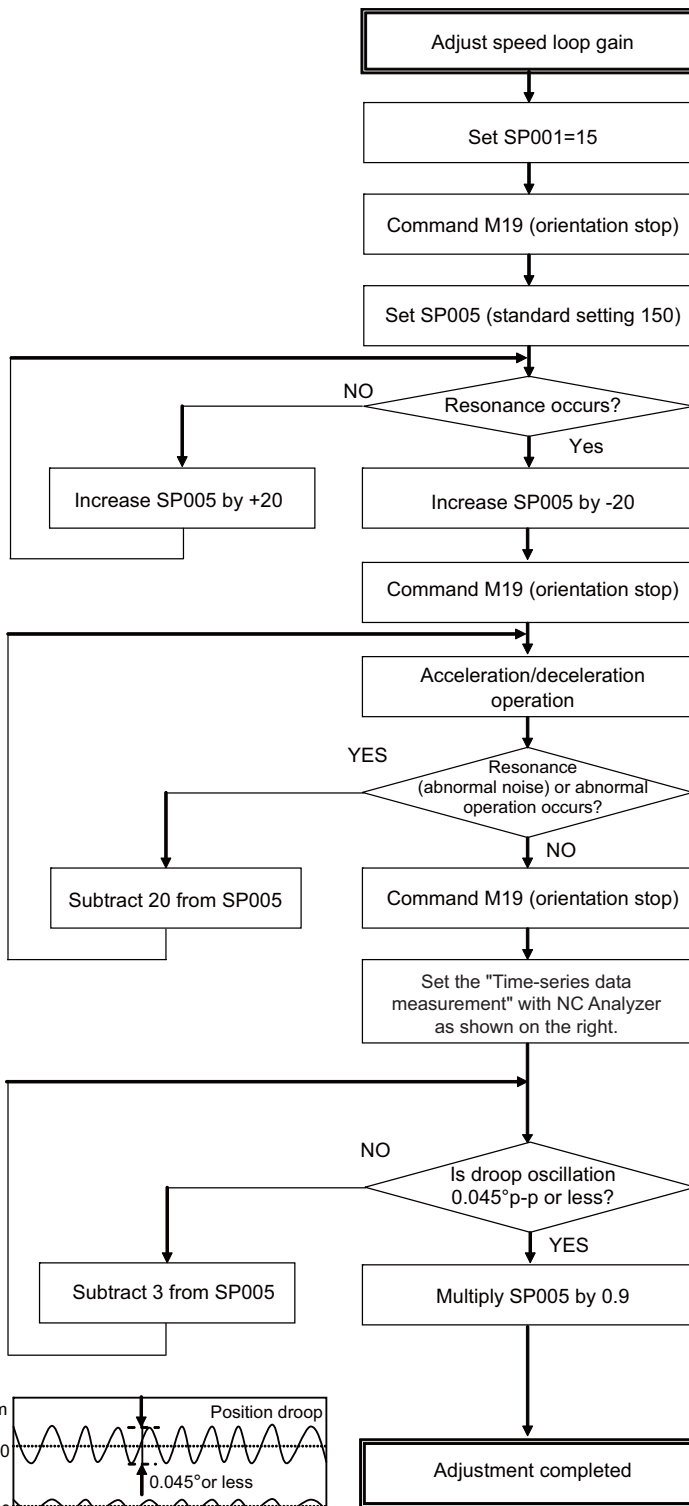

Stops at servo ON status

Increase the value up to where resonance occurs.

Executes acceleration/deceleration operation in phase up to maximum rotation speed from 0.

(Note)

When the maximum speed is 10000r/min, executes in approx. 1000r/min increments, divided by 10.

(Note)

NC analyzer cannot create a program when acquiring a spindle waveform. The program is created on the NC side.

< NC Analyzer setting (Time-series data measurement) >

Get	Waveform type
CH1	Position droop
CH2	Current feedback

Note that the maximum setting value is as follows:
 $SP005(max) \leq 150 \times \text{inertia ratio}$
 (Inertia ratio: total inertia/motor inertia)

(Example)

When inertia rate is double and the determined gain is 350, the setting value for SP005 is 315, which is 90% of the determined gain, however, the setting value for SP005 should be 300, because the maximum setting value is $150 \times 2 (\text{inertia rate}) = 300$.

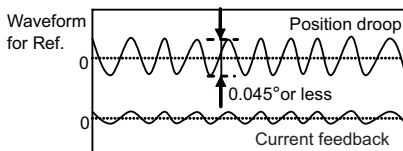

【#13005】 SP005 VGN1 Speed loop gain 1

Set the speed loop gain.
 Set this according to the load inertia size.
 The higher setting value will increase the accuracy of control, however, vibration tends to occur.
 If vibration occurs, adjust by lowering by 20 to 30%.
 The final value should be 70 to 80% of the value at which the vibration stops.

---Setting range---
 1 to 9999

(4) Adjusting the position loop gain (SP001: PGV non-interpolation mode position loop gain)

After setting the speed gain, in order to perform acceleration/deceleration operation, set the position loop gain (SP001) by increasing its setting value from 15. When overshooting occurs at the time of acceleration/deceleration completion, or when oscillation of the q axis current command gets bigger during a set rotation, the position loop gain is in limit state. Note that standard position loop gain below is set for the setting gain.

CAUTION
 Change "Excessive error detection width" (SP053) when "Position loop gain" (SP001) is changed.

Method for checking the limitation of position loop gain

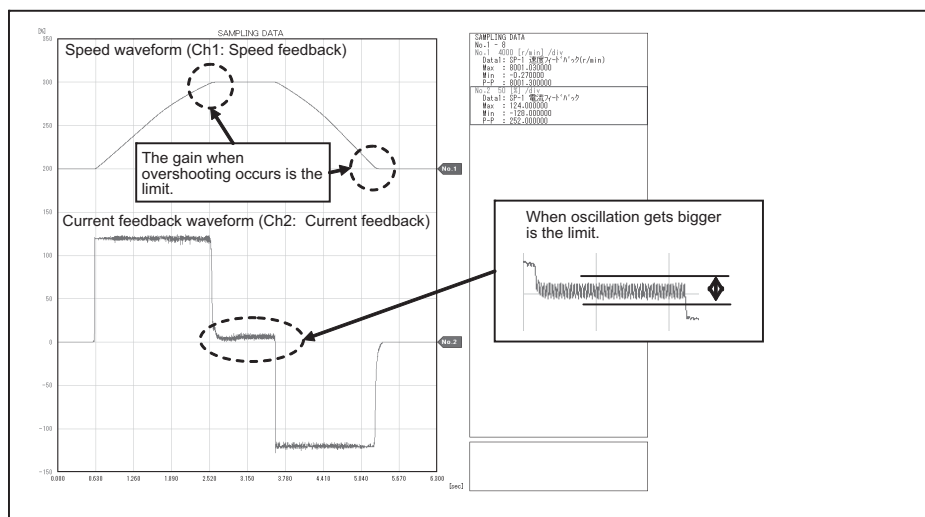

(Example)As the closest value should be selected from the standard setting range shown below, set 47 to SP001 when the limit gain is 55.

Standard position loop gain	15	18	21	23	26	33	38	47	60	70
------------------------------------	----	----	----	----	----	----	----	----	----	----

【#13001】 SP001 PGV Position loop gain non-interpolation mode

Set the position loop gain for "Non-interpolation" control mode.
 When the setting value increases, the command tracking ability will enhance and the positioning settling time can be shorter. However, the impact on the machine during acceleration/deceleration will increase.
 Use the selection command, the control mode "bit 2, 1, 0 = 000" in control input 4.
 (Note) The control mode is commanded by NC.

---Setting range---
 1 to 200 (rad/s)

6.1.3 Adjusting the Acceleration/Deceleration Operation

(1) Calculating the theoretical acceleration/deceleration time

The spindle motor output characteristics (shown on the right) have three ranges, which are constant torque, constant output, and deceleration ranges. Each range has different calculation method. The acceleration/deceleration time is calculated using the calculation expression which corresponds to each range of the rotation speed for calculation. Note that the load torque (friction torque) is not considered in the calculation expression, so the result may slightly differ from the actual acceleration/deceleration time.

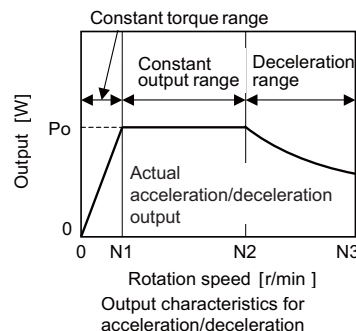

(a) Maximum motor output during acceleration/deceleration: P_o

The output during acceleration/deceleration (actual acceleration/deceleration output) P_o is 1.2-fold of "Standard output during acceleration/deceleration" or "Short time rated output".

The output P_o during acceleration/deceleration follows the expression below.

$$P_o = (\text{"Short time rated output" or "Standard output during acceleration/deceleration"}) \times 1.2$$

Substitute this value into P_o of the expression.

(b) Total load inertia: J_{all}

Total load inertia means the total inertia of the spindle motor and of the components which are rotated the motor (shaft, etc.).

$$J_{all} = (\text{Motor inertia}) + (\text{Spindle conversion inertia}) \quad [\text{kg}\cdot\text{m}^2]$$

The values obtained in (a) and (b) are substituted into the following calculation expressions.

To calculate the acceleration/deceleration time of the rotation speed N (r/min), use the expression (c), (d) or (e) which is selected depending on the range that corresponds to the speed N .

(c) Acceleration/deceleration time for constant torque range: $t_1 \cdots 0$ to N [r/min] ($0 \leq N \leq N_1$)

(For $N > N_1$, apply $N = N_1$ and also calculate t_2 or t_3 .)

$$t_1 = \frac{1.097 \times 10^{-2} \times J_{all} \times N_1 \times N}{P_o} \quad [\text{s}] \quad (\text{Caution 1})$$

(d) Acceleration/deceleration time for constant output range: $t_2 \cdots N_1$ to N [r/min] ($N_1 < N \leq N_2$)

(For $N > N_2$, apply $N = N_2$ and also calculate t_3 .)

$$t_2 = \frac{1.097 \times 10^{-2} \times J_{all} \times (N^2 - N_1^2)}{2 \times P_o} \quad [\text{s}] \quad (\text{Caution 1})$$

(e) Acceleration/deceleration time in deceleration output range: $t_3 \cdots N_2$ to N [r/min] ($N_2 < N \leq N_3$)

$$t_3 = \frac{1.097 \times 10^{-2} \times J_{all} \times (N^3 - N_2^3)}{3 \times P_o \times N_2} \quad [\text{s}] \quad (\text{Caution 1})$$

Based on the above expressions, the acceleration/deceleration time: t from 0 to N_3 [r/min] is:

$$t = t_1 + t_2 + t_3 \quad [\text{s}] \quad (\text{Caution 2})$$

⚠ CAUTION

1. Note that the inertia (J) is a quarter of "GD²".
Ex.) When "GD²" is 0.2 [kg•m²], the inertia is "0.2 / 4 = 0.05 [kg•m²]".
2. If the AC input power voltage to the power supply is low, or if the input power impedance is high, the acceleration/ deceleration time may be long. (Especially, the acceleration/deceleration time of the deceleration output range may be long.)
3. For the actual measurement in comparison with the theoretical value, perform under the same condition as the calculated load inertia of J_{all}. The acceleration/deceleration time differs according to the inertia. When performing the measurement with a workpiece or tool installed to the spindle, confirm that the acceleration/deceleration time has been calculated when the total inertia is included in the installed workpiece and tool.

[Calculation example]

Calculate the acceleration/deceleration time from 0 to 10000[r/min] for an spindle motor having the output characteristics shown on the right when the motor inertia is 0.0148 [kg•m²], and when the motor shaft conversion load inertia is 0.05 [kg•m²].

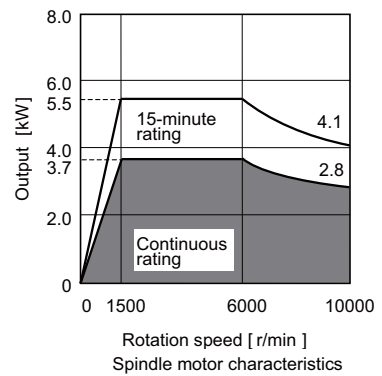

$$P_o = (\text{Short-time rated output}) \times 1.2 = 5500 \times 1.2 = 6600 \text{ [W]}$$

$$J_{all} = (\text{Motor inertia}) + (\text{load inertia}) = 0.0148 + 0.05 = 0.0648 \text{ [kg}\cdot\text{m}^2\text{]}$$

$$t_1 = \frac{1.097 \times 10^{-2} \times J_{all} \times N_1^2}{P_o} = \frac{1.097 \times 10^{-2} \times 0.0648 \times 1500^2}{6600} = 0.242 \text{ [s]}$$

$$t_2 = \frac{1.097 \times 10^{-2} \times J_{all} \times (N_2^2 - N_1^2)}{2 \times P_o} = \frac{1.097 \times 10^{-2} \times 0.0648 \times (6000^2 - 1500^2)}{2 \times 6600} = 1.818 \text{ [s]}$$

$$t_3 = \frac{1.097 \times 10^{-2} \times J_{all} \times (N_3^3 - N_2^3)}{3 \times P_o \times N_2} = \frac{1.097 \times 10^{-2} \times 0.0648 \times (10000^3 - 6000^3)}{3 \times 6600 \times 6000} = 4.691 \text{ [s]}$$

Thus,

$$t = t_1 + t_2 + t_3 = 0.242 + 1.818 + 4.691 = 6.751 \text{ [s]}$$

(2) Measuring the acceleration/deceleration waveforms

Measure the speed feedback and current feedback output by setting the monitor output data on "Time-series data measurement" with NC Analyzer, and check if theoretical acceleration/deceleration time is within $\pm 15\%$. Refer to "NC Analyzer Instruction Manual (IB-1501086)" for details on setting the monitor output data.

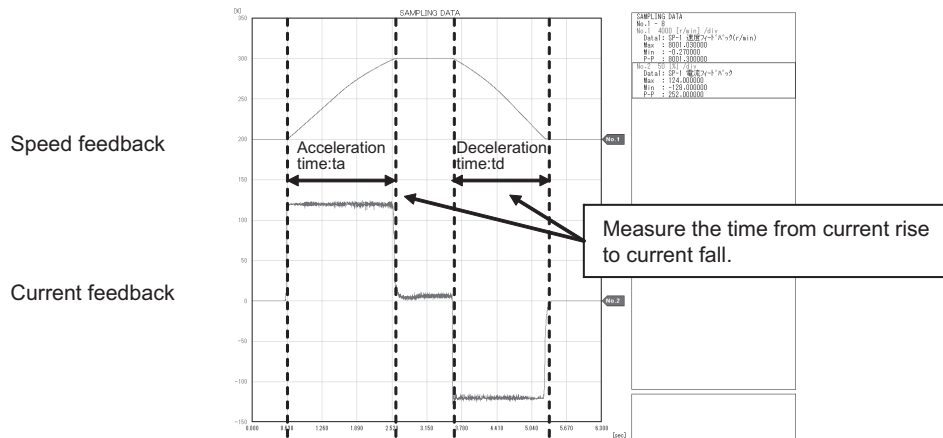

Acceleration/deceleration characteristics of spindle motor

When acceleration/deceleration time does not match the theoretical value (an error rate 15% or more), check the following items.

- [1] There may be an error in calculating load inertia for the motor axis conversion used when calculating the theoretical acceleration/deceleration time. Check the load inertia again.
- [2] When acceleration time is long and deceleration time is short, friction torque is thought to be large. Check load meter value at the maximum speed (spindle monitor screen). If the load is 10% or more, friction torque is thought to be relatively large. Mechanical friction, such as bearing friction or timing belt friction, is assumed to be large. Measure the acceleration/deceleration time again following trial run.
- [3] Even if the problems above are not found, when acceleration/deceleration time does not match, there may be a possibility of using spindle motor and spindle drive unit that are not specified, or using wrong parameters. Check the spindle motor type and spindle drive unit type again, as well as the spindle parameter settings.

**POINT**

There are cases where acceleration/deceleration waveforms change depending on the spindle temperature. Check the waveforms when the spindle temperature is high (after continuous operation) and when it is low.

**CAUTION**

Vibration or sudden acceleration/deceleration may occur during adjustment. When performing measurement with a workpiece or tool installed, pay careful attention for the safety during adjustment.

(3) Adjustment when the load inertia is large

When the load inertia is large and acceleration time is 10s or more, excessive speed deviation alarm (ALM23) may occur because the time in which deviation between speed command and speed FB, which is the actual spindle motor rotation speed, exists is prolonged. In this case, increase the time constant (3101 to 3104) during spindle rotation by S command. When the acceleration time is 10s or less, use the standard value 300 (300ms). Alarm can be avoided by adjusting excessive speed deviation timer (SP117). However, in this case, alarm detection will be delayed during constant speed operation.

【#13117】 SP117 SETM Excessive speed deviation timer

Set the time to detect the speed excessive error alarm.
Set the time required to the machine.
The standard setting is "12".

---Setting range---
0 to 60 (s)

【#3101】 sp_t 1 Acceleration/deceleration time constant with S command (Gear: 00)

Set the acceleration/deceleration time constant with S command (speed operation mode) when gear 00 is selected. Set the linear acceleration/deceleration time up to limit rotation speed (slimit1). Set the short time constant that the motor torque at acceleration is always saturated, however, when an abnormal noise or V-belt slip occurs, increase the time constant.

---Setting range---
0 to 30000 (ms)

【#3102】 sp_t 2 Acceleration/deceleration time constant with S command (Gear: 01)

Set the acceleration/deceleration time constant with S command (speed operation mode) when gear 01 is selected. Set the linear acceleration/deceleration time up to limit rotation speed (slimit2).

---Setting range---
0 to 30000 (ms)

【#3103】 sp_t 3 Acceleration/deceleration time constant with S command (Gear: 10)

Set the acceleration/deceleration time constant with S command (speed operation mode) when gear 10 is selected. Set the linear acceleration/deceleration time up to limit rotation speed (slimit3).

---Setting range---
0 to 30000 (ms)

【#3104】 sp_t 4 Acceleration/deceleration time constant with S command (Gear: 11)

Set the acceleration/deceleration time constant with S command (speed operation mode) when gear 11 is selected. Set the linear acceleration/deceleration time up to limit rotation speed (slimit4).

---Setting range---
0 to 30000 (ms)

(4) Acceleration/deceleration adjustment

Checks acceleration waveform and adjusts deceleration time.

(a) Checking acceleration waveform

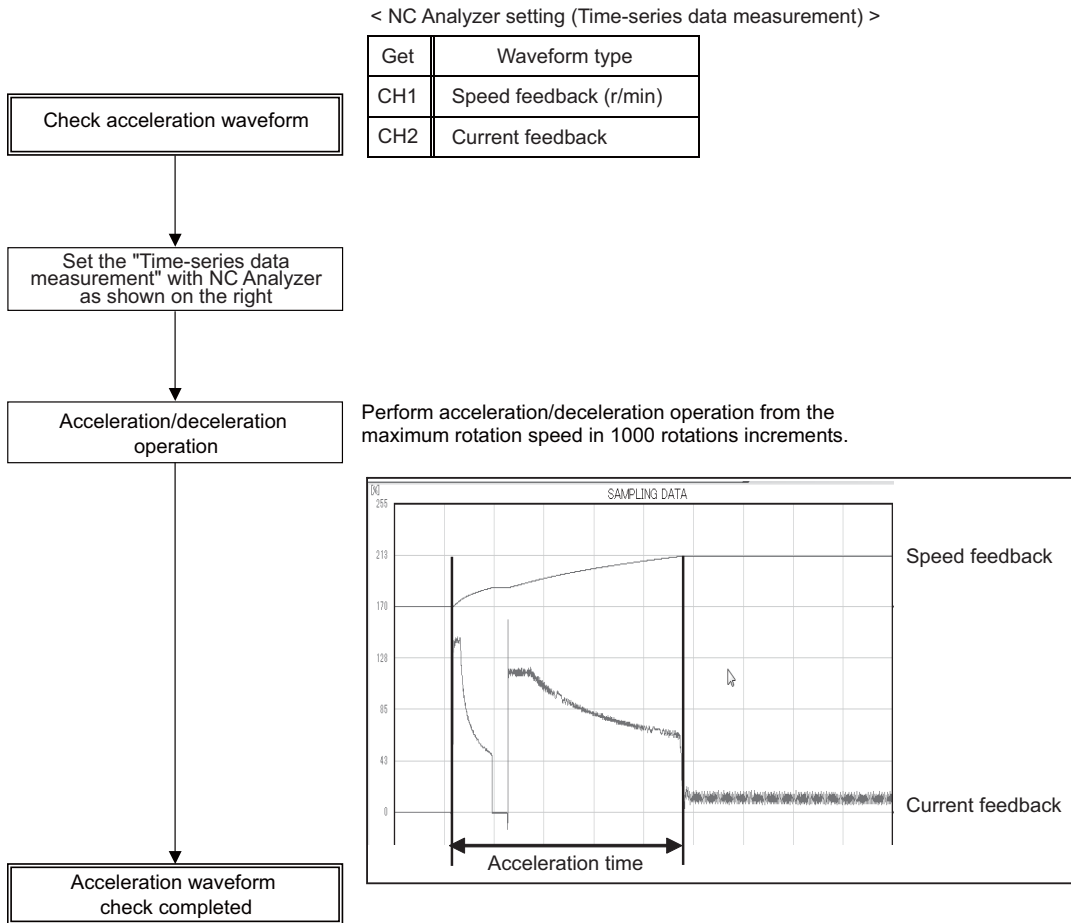

(b) Adjusting deceleration time

Adjusts deceleration time in the same manner as acceleration time by using SP071 (variable current limit during deceleration, lower limit value) and SP072 (variable current limit during deceleration, break point speed).

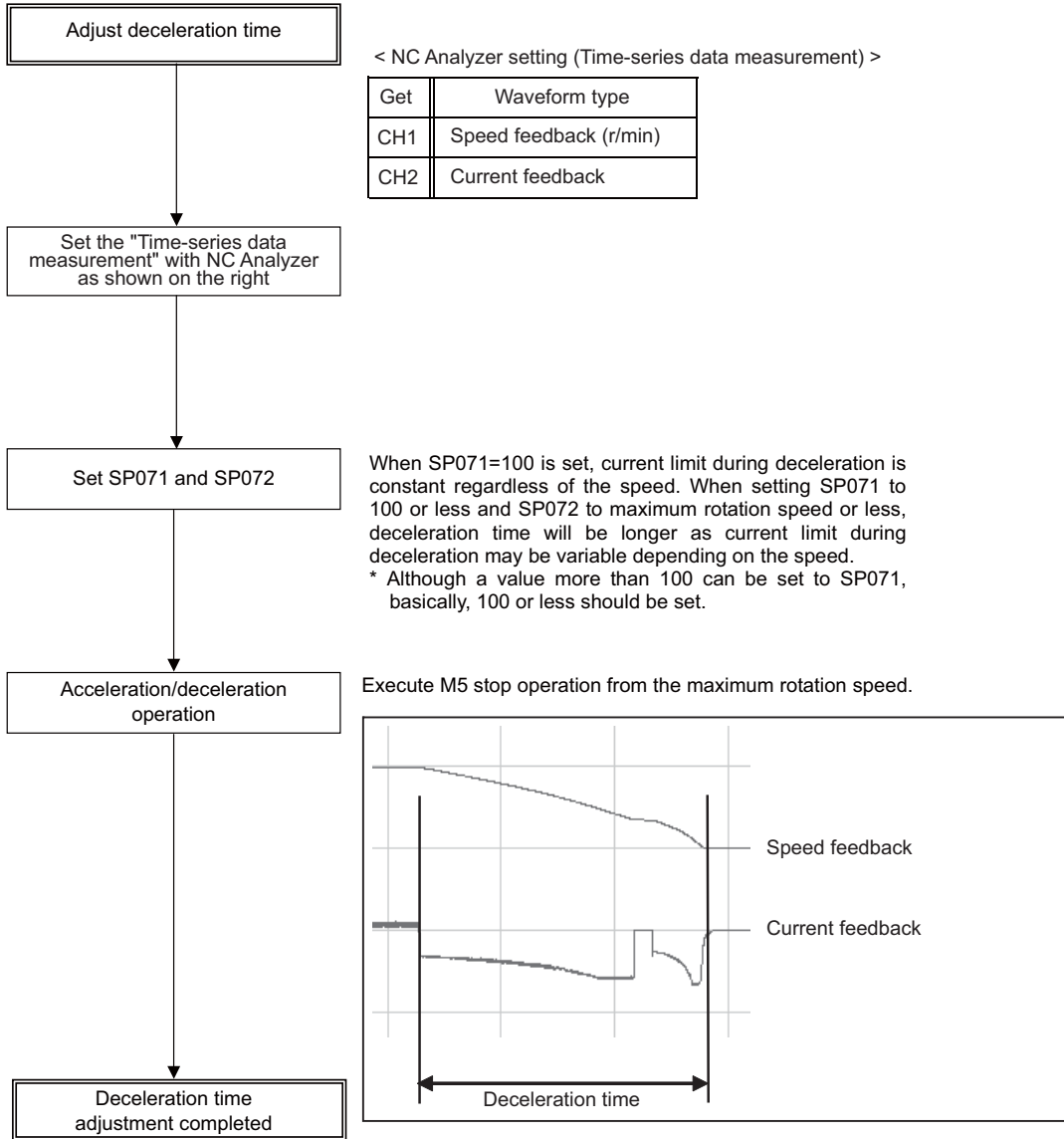

Relation between SP071 (variable current limit during deceleration, lower limit value) and SP072 (variable current limit during deceleration, break point speed)

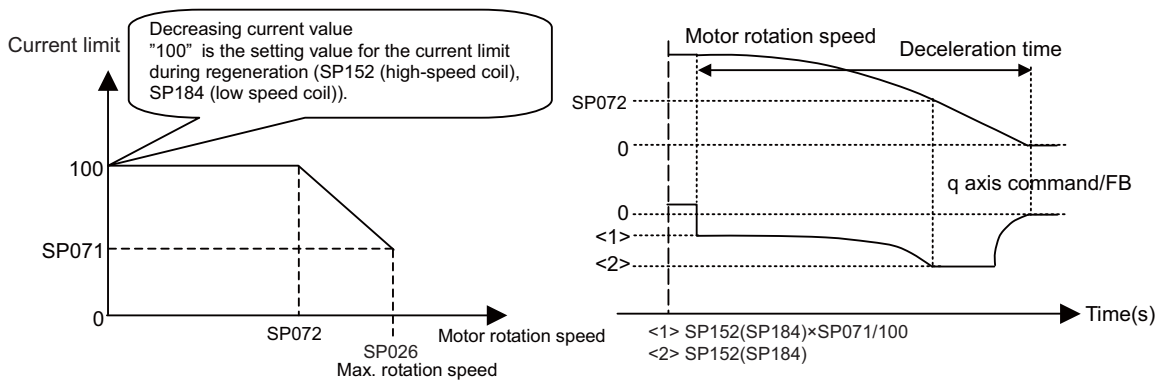

【#13071】 SP071 DIQM Variable current limit during deceleration, lower limit value

Set this parameter to adjust the deceleration time by changing the current limit value during deceleration depending on the motor speed.
 As shown below, set the lower limit rate of the current limit in SP071 (DIQM), and use with SP072 (DIQN).
 When DIQM is set to 100%, the standard current limit value in deceleration (TMLR) is applied.

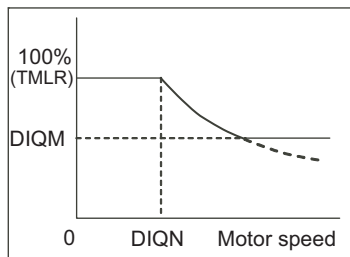

---Setting range---
 0 to 999 (%)

【#13072】 SP072 DIQN Variable current limit during deceleration, break point speed

Set this parameter to adjust the deceleration time by changing the current limit value during deceleration depending on the motor speed.
 As shown below, set the lower limit rate of the current limit in SP071 (DIQM), and use with SP072 (DIQN).
 When DIQM is set to 100%, the standard current limit value in deceleration (TMLR) is applied.

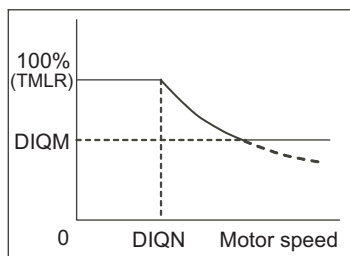

---Setting range---
 1 to 32767 (r/min)

6.1.4 Orientation Adjustment

Adjusts orientation time by adjusting SP016.

(1) Orientation characteristics

When decelerating to stop is executed with orientation, the remaining distance to the orientation stop position is compensated within one rotation. Thus, as shown in Case 1 below, when the remaining distance in deceleration is about "0", orientation time would be the shortest (time required to decelerate and stop + 0s), and as shown in Case 2 below, when the remaining distance in deceleration is about as much as one rotation amount, orientation time would be the longest.

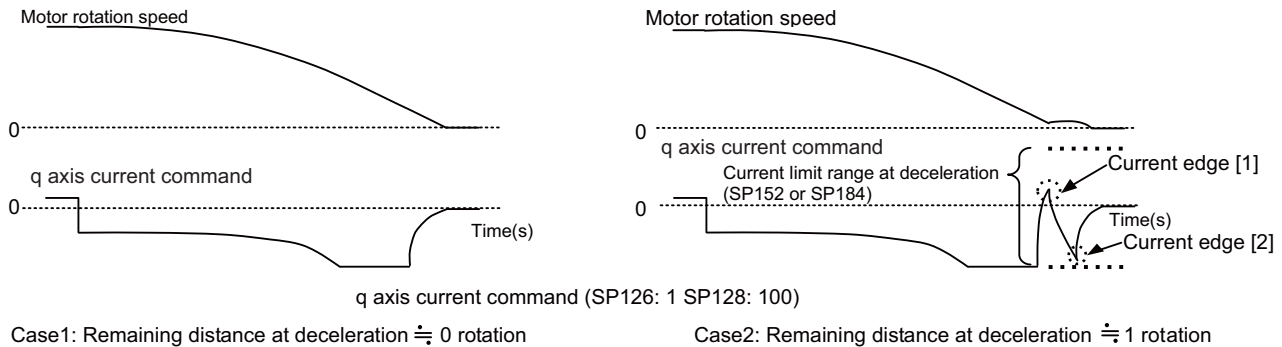

【#13016】 SP016 DDT Phase alignment deceleration rate

Set the single-rotation position alignment deceleration rate for orientation stopping, phase alignment while rotating and switching from non-interpolation mode to spindle synchronization mode while rotating.

When the load inertia is larger, the setting value should be smaller.

When the setting value is larger, the orientation in-position and single-rotation position alignment complete faster, but the impact applied on the machine will increase.

To change the deceleration rate only during rotation command (command F Δ T ≠ 0), set this parameter together with SP070 (KDDT).

---Setting range---

1 to 32767 (0.1(r/min)/ms)

【#13035(PR)】 SP035 SFNC3 Spindle function 3

bit 2 : pyin Excitation rate selection in non-interpolation mode

The excitation rate after the in-position can be selected.

0: Select Excitation rate 1 1: Select Excitation rate 2

bit 1 : vgin Speed loop gain set selection in non-interpolation mode

The speed loop gain set after the in-position can be selected.

0: Select Set 1 1: Select Set 2

(2) Confirmation in orientation stop at deceleration \approx 0 rotation according to spindle specification

If orientation stop is performed with the load inertia increased due to an excessive workpiece or tool installed to the spindle, the spindle may start vibrating by trying to reverse after overshooting the stop position and stop after converging the vibrations (refer to the waveform below).

In this case, the orientation completion time is extended by the time to converge the spindle vibrations. Thus, the adjustment to suppress the reversing and vibrations at stop is required.

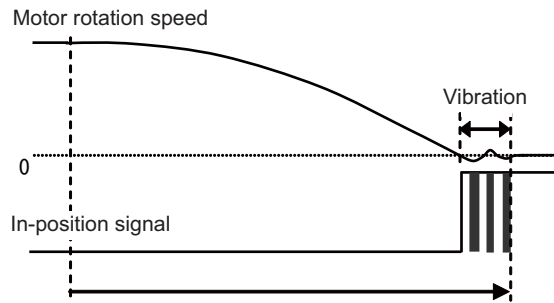
**<Adjustment method>**

- 1) Set SP016: Lower the setting value by 5. By lowering, the inclination of the speed becomes gradual. Set the optimum value while observing the speed waveform so that the speed will not vibrate.
- 2) Lower the position loop gain.
By lowering the position loop gain, a sway that exceeds the stop position is suppressed.
- 3) Adjust the speed gain (SP005, SP006).
The converging time becomes shorter if the rigidity during orientation stop is higher. However this affects the speed stability during constant feed, thus it is required to confirm the speed waveform at the constant speed and the machining surface during cutting.

(3) Orientation time adjustment method

(a) Orientation adjustment from maximum rotation speed

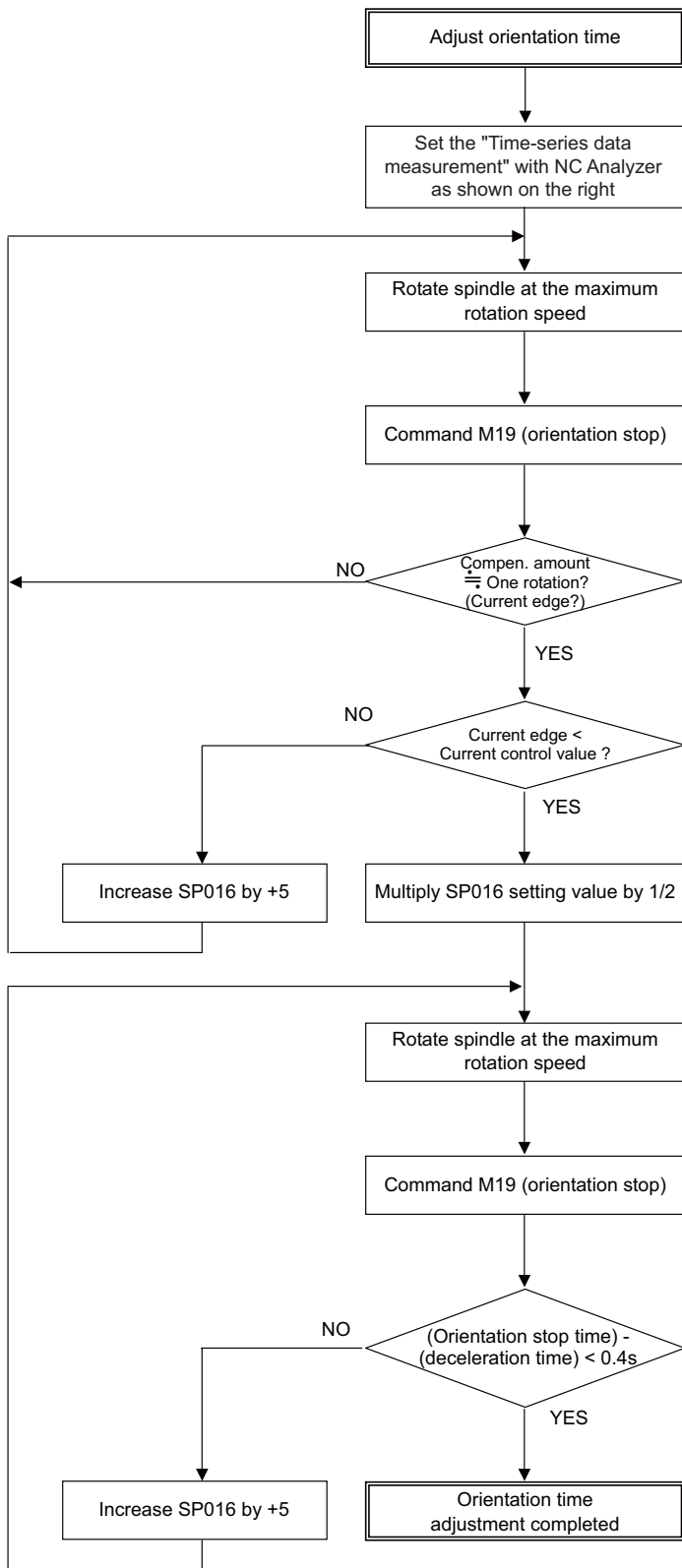

< NC Analyzer setting (Time-series data measurement) >

Get	Waveform type
CH1	Speed feedback (r/min)
CH2	Current feedback
CH3	Control output 1(bitC) *In-position signal

Orientation stop waveform example(≒ 1 rotation)

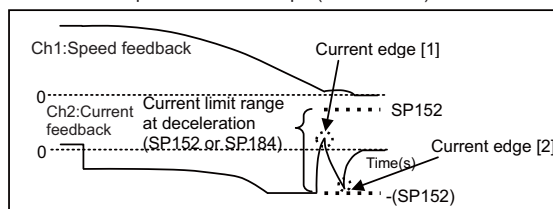

Set to SP016 as recovery time constant.

Orientation stop waveform example(≒ 1 rotation)

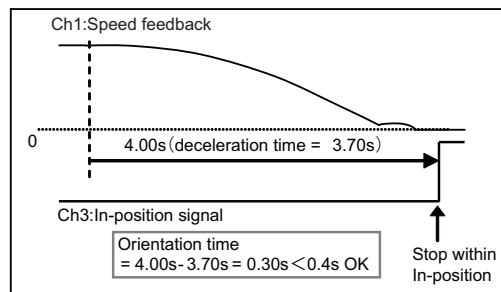

POINT

Check the orientation operation with the maximum inertia by installing a workpiece or tool to the spindle head. However, if it is dangerous to check the operation at the maximum speed, slow down to the safe speed to check.

(b) Orientation adjustment from stop mode

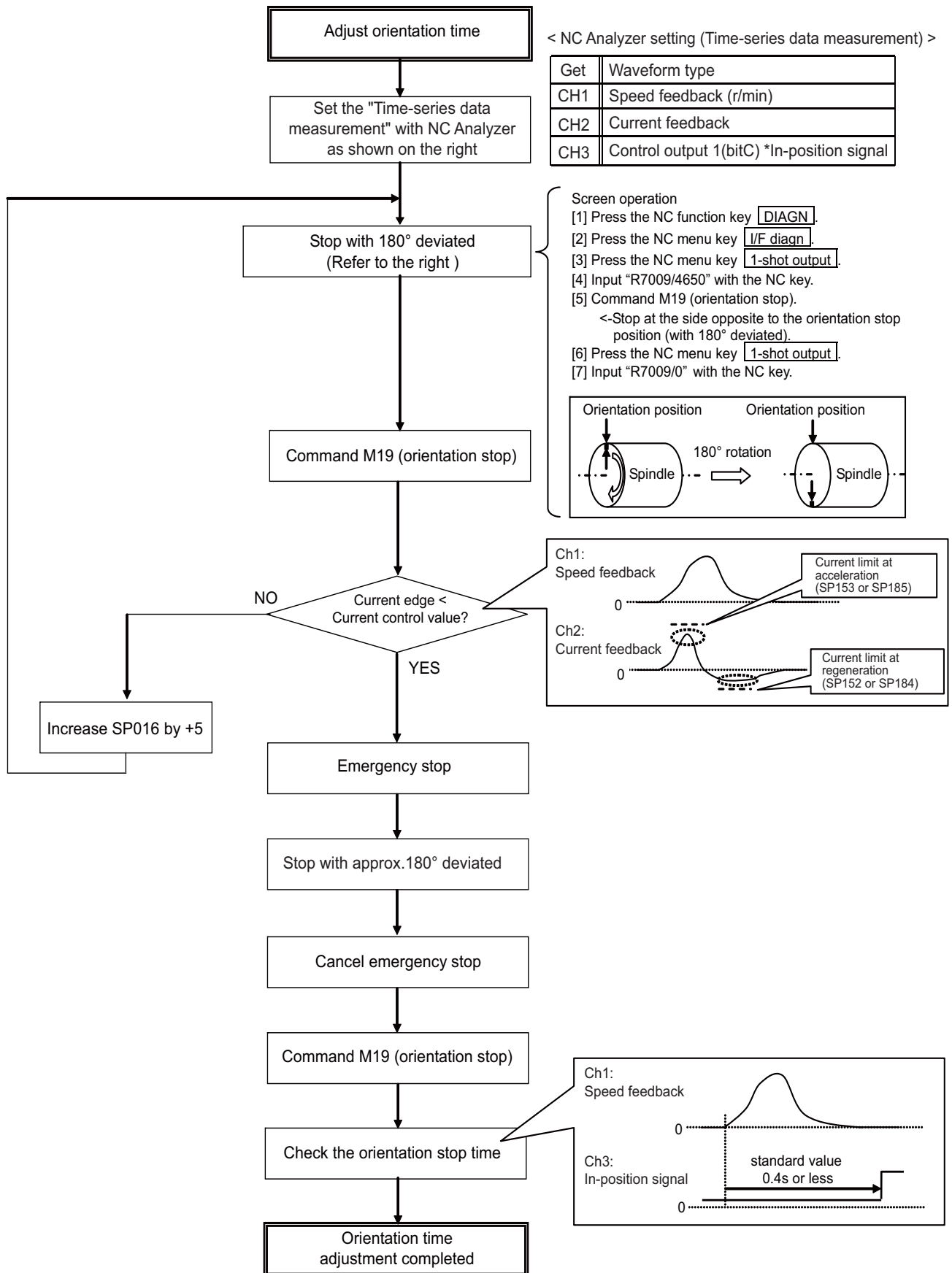

6.1.5 Synchronous Tapping Adjustment

(1) Gain setting and time constant determination

[1] For speed loop gain during synchronous tapping, speed loop gain set 2, which consists of SP008 (speed loop gain 2), SP009 (speed loop lead compensation 2), and SP010 (speed loop delay compensation 2), is used. Thus, SP035 has to be set as follows. For position loop gain, set standard 33 to SP002 (position loop gain interpolation mode).

<List of parameters used for adjustment>

Parameter	Setting value
SP002	33
SP008	Value in SP005 set at "Gain Adjustment" (Initial setting value: 150)
SP009	1900
SP010	0
SP035	0200: Speed loop gain set 2 selection (Validate bit9)

<Related servo parameters>

Set the spindle and interpolation axis by tapping.

Parameter	Setting value
SV049	Set the same value as spindle parameter "SP002"
SV050	Set it when using SHG control (when not using, set to "0")
SV058	Set it when using SHG control (when not using, set to "0")

[2] Create a NC program so that the synchronous tapping operation program has 3000r/min of spindle rotation speed, 1mm (equivalent of M6 screw) of screw pitch size, and depths at which the following two different operation patterns are generated.
(Note that the operation conditions, such as spindle rotation speed and screw pitch, may be specified by the machine tool builder.)

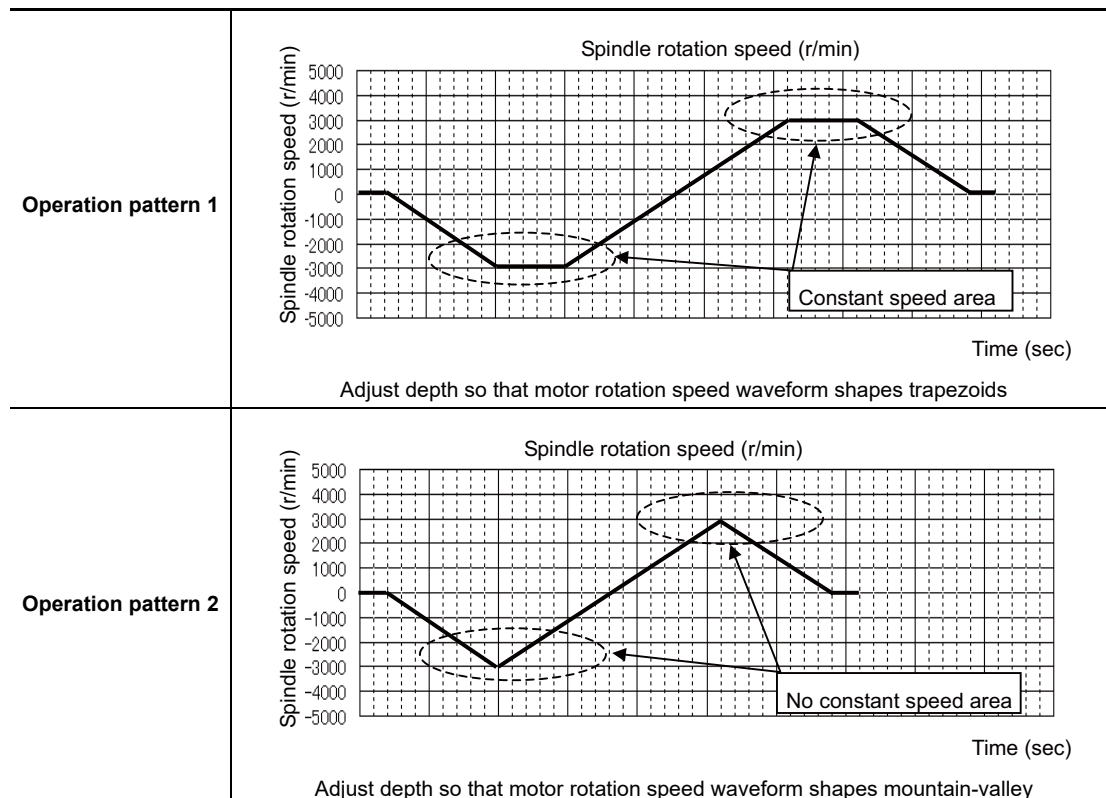

- [3] Select "Synchronous tapping error measurement" on NC Analyzer, and perform synchronous tapping operations with the operation pattern 2 above.
 *The following measurement data of servo and spindle are automatically set when "Synchronous tapping error measurement" is selected.

< NC Analyzer setting (Time-series data measurement) >

Get	Waveform type
CH1	Synchronous tapping error *Position error of spindle and servo axis
CH2	Speed feed back of servo
CH3	Speed feed back of spindle
CH4	Current feed back of servo
CH5	Current feed back of spindle

- [4] Check the waveform and adjust the synchronous tapping time constant so that the margin for current limit at acceleration/deceleration is 50% or more.

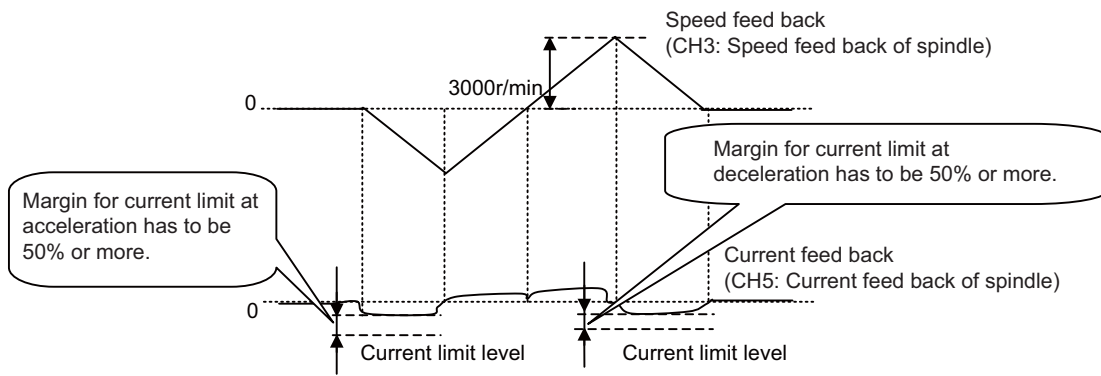

Output waveform example during synchronized tapping

(2) Accuracy test using NC Analyzer

- [1] Perform synchronous tapping operations using the time constant determined in (1) above.
- [2] Check the synchronous tapping accuracy (for both operation pattern 1 and 2) by using the synchronous tapping accuracy check tool.

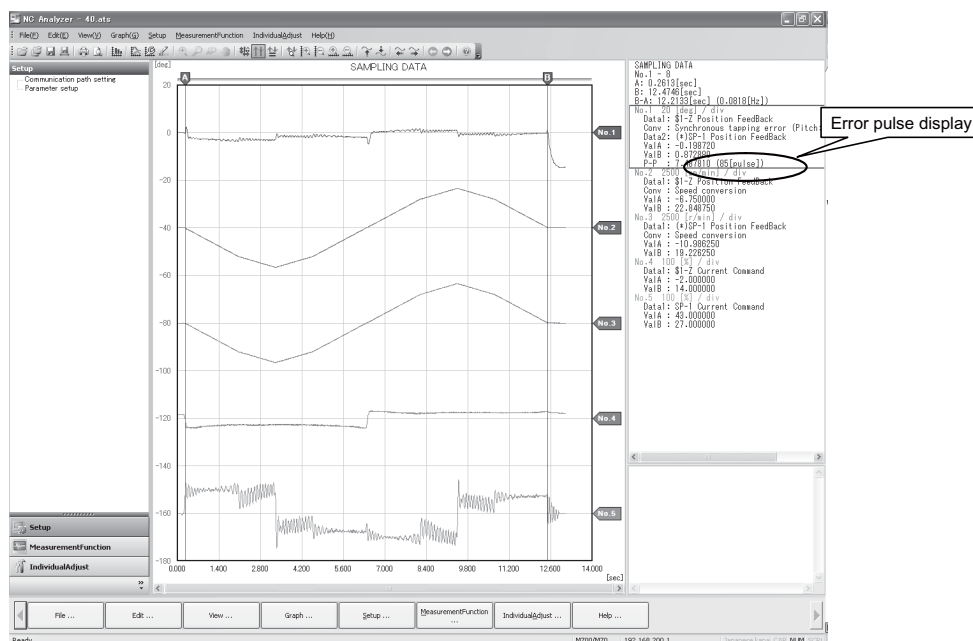

- [3] If the number of error pulse is 100 (p-p) or less, satisfactory accuracy is secured, and the check is completed.
- [4] If the number of error pulse exceeds 100, increase SP008 (VGN2) by 10 increments, and adjust so that the error pulse is 100 or less. Note that the maximum setting value is 150 × [inertia ratio].

【#13002】 SP002 PGN Position loop gain interpolation mode

Set the position loop gain for "interpolation" control mode.
When the setting value increases, the command tracking ability will enhance and the positioning settling time can be shorter. However, the impact on the machine during acceleration/deceleration will increase.

Use the selection command, the control mode "bit 2, 1, 0 = 010 or 100" in control input 4.

(Note) The control mode is commanded by NC.

When carrying out the SHG control, set SP035/bitC to "1".

---Setting range---

1 to 200 (rad/s)

【#13008】 SP008 VGN2 Speed loop gain 2

Normally SP005(VGN1) is used.

By setting "SP035/bit9=1", gain 2 can be used according to the application.

Gain 2 can also be used by setting "Speed gain set 2 changeover request (control input 5/ bitC) = 1".

Refer to SP005(VGN1) for adjustment procedures.

---Setting range---

1 to 9999

【#13009】 SP009 VIA2 Speed loop lead compensation 2

Normally SP006(VIA1) is used.

By setting "SP035/bit9=1", gain 2 can be used according to the application.

Gain 2 can also be used by setting "Speed gain set 2 changeover request (control input 5/ bitC) = 1".

Refer to SP006(VIA1) for adjustment procedures.

---Setting range---

1 to 9999

【#13010】 SP010 VIL2 Speed loop delay compensation 2

Normally SP007(VIL1) is used.

By setting "SP035/bit9=1", gain 2 can be used according to the application.

Gain 2 can also be used by setting "Speed gain set 2 changeover request (control input 5/ bitC) = 1".

Refer to SP007(VIL1) for adjustment procedures.

---Setting range---

0 to 32767

【#13035(PR)】 SP035 SFNC3 Spindle function 3**bit C : shgn SHG control in interpolation mode**

0: Stop 1: Start

bit A : pyn Excitation rate selection in interpolation mode

0: Select Excitation rate 1 1: Select Excitation rate 2

bit 9 : vgn Speed loop gain set selection in interpolation mode

0: Select Set 1 1: Select Set 2

6.1.6 High-speed Synchronous Tapping

This function enables the reduction of synchronization errors by allowing data communication between drive units.

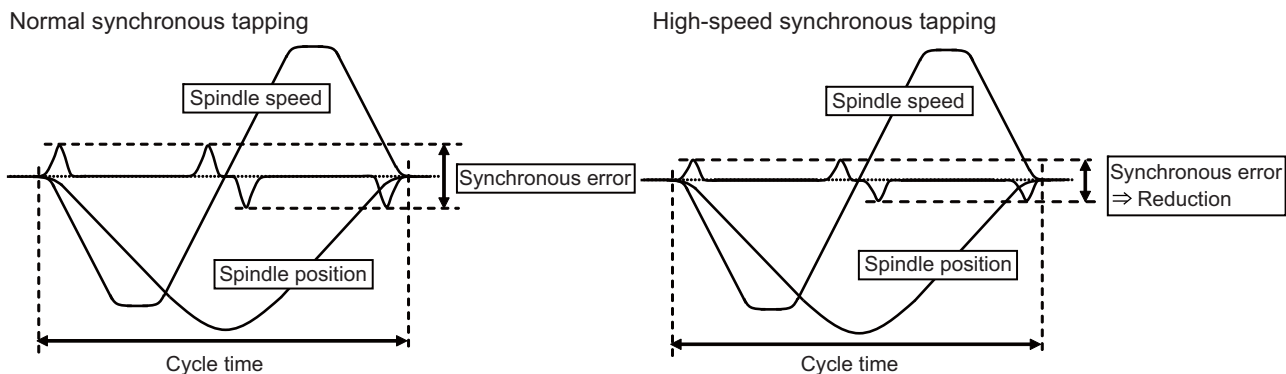

<Adjustment method>

- (1) Adjust the normal synchronous tapping.
- (2) Set the total inertia rate with respect to the motor inertia to the servo parameter "SV037". If this value has already been set for adjustment of the other functions, use the same value.
- (3) Set 600 to the servo parameter "SV129".
- (4) Set the basic specification parameter "#1281/ bit5 =1(high-speed synchronous tapping valid)".
- (5) Adjust the spindle parameter "#3120" while confirming that the current margin and the number of error pulses are within the tolerable range in the high-speed synchronous tapping operation.

High-speed synchronous tapping time constant

$$= \text{Normal synchronous tapping time constant} \times \{100 - (\text{Setting value of \#3120})\} / 100$$

【#2237】 SV037 JL Load inertia scale

Set the motor axis conversion total load inertia including motor itself in proportion to the motor inertia.

$$\text{SV037(JL)} = (\text{Jm} + \text{Jl}) / \text{Jm} \times 100$$

Jm: Motor inertia

Jl: Motor axis conversion load inertia

For linear motor, set the gross mass of the moving sections in kg unit.

<<Drive monitor load inertia ratio display>>

Set SV035/bitF=1 and imbalance torque and friction torque to both SV032 and SV045, and then repeat acceleration/deceleration for several times.

---Setting range---

For general motor: 0 to 5000 (%)

For linear motor 0 to 5000 (kg)

【#2329】 SV129 Kwf Synchronous control feed forward filter frequency

Set the acceleration rate feed forward filter frequency in high-speed synchronous tapping control. The standard setting is "600".

Related parameters: SV244

---Setting range---

0 to 32767 (rad/s)

【#1281(PR)】 ext17**bit5: High-speed synchronous tapping valid**

Select whether to enable the high-speed synchronous tapping.

0: Disable

1: Enable

【#3120】 staptr Time constant reduction rate in high-speed synchronous tapping

When performing high-speed synchronous tapping enabled (#1281/bit5), set the reduction rate of the time constant compared to the time constant in normal synchronous tapping.
(Setting "0" or "100" will be regarded as reduction rate zero, so the time constant won't be reduced.)

E.g.) When set to "10", time constant in high-speed synchronous tapping will be 90% of that in normal synchronous tapping.

---Setting range---

0 to 100(%)

6.1.7 Spindle C Axis Adjustment (For Lathe System)**(1) Setting the gain**

For spindle C axis speed loop gain, SP008 (speed loop gain 2), speed loop gain set 2, which consists of SP009 (speed loop lead compensation 2), and SP010 (speed loop delay compensation 2), is used. Thus, SP035 has to be set as follows. For position loop gain, set standard 33 to SP002 (position loop gain, interpolation mode).

Parameter	Setting value
SP002	33
SP008	SP005 setting value set in "Basic Adjustments" (Initial setting value: 150)
SP009	1900
SP010	0
SP035	0200: Speed loop gain set 2 selection (validate bit9)

<Related servo parameters>

Set the spindle and interpolation axis.

Parameter	Setting value
SV003	Set the same value as spindle parameter "SP002"
SV004	Set it when using SHG control (when not using, set to "0")
SV057	Set it when using SHG control (when not using, set to "0")

(2) Gain adjustment and accuracy test during C axis operation

- [1] Set the "Time-series data measurement" with NC Analyzer as follows during stopped in C axis mode (servo ON status) or when executing cutting feed with G01 F20. Then check the droop fluctuation is within $10^{-5}/1000$.

< NC Analyzer setting (Time-series data measurement) >

Get	Waveform type
CH1	Position droop
CH2	Current command

Offset is 2.5V.

*** Waveform during stopped in C axis (Reference)**

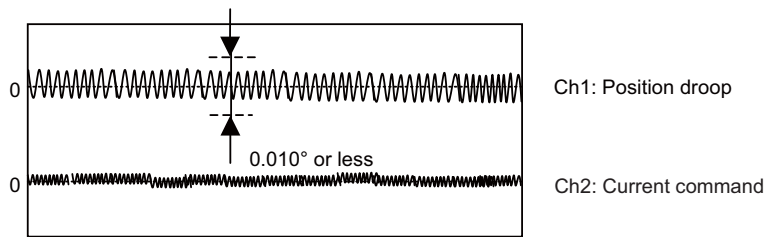

*** Waveform when executing cutting feed with G01 F20 (Reference)**

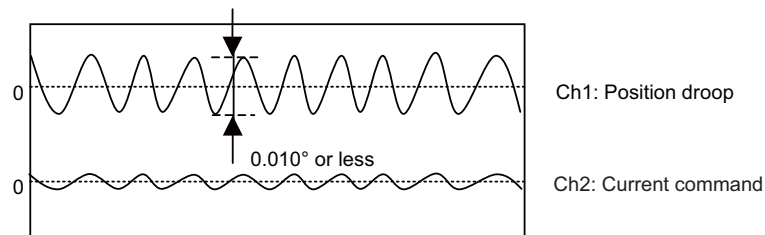

[2] When satisfactory accuracy is not secured, increase SP008 (VGN2) by 10 increments and adjust so that the accuracy level meets the standard. Note that the maximum setting value is 150 x [inertia ratio].

(3) Setting the notch filter

During spindle C axis operation, there are times where motor is rotated while brake is applied, resulting in resonance occurred. In this case, measure resonance frequency from q axis current command waveform and set the value to SP038 (notch filter 1). Also, depending on the set frequency, filter depth must be set to SP034. When notch filter is set, perform acceleration/deceleration operation at the maximum speed and confirm that no abnormal oscillation or noise is found.

Notch filter's set frequency and standard depth setting

SP034 Notch filter 1 Depth setting	bit3=0 bit2=0 bit1=0 Setting value: XXX0	bit3=0 bit2=1 bit1=0 Setting value: XXX4	bit3=1 bit2=0 bit1=0 Setting value: XXX8
SP038 Notch filter 1 Setting frequency	2000(Hz) to 400(Hz)	399(Hz) to 200(Hz)	190(Hz) or lower

Setting example: When there are 16 wavelengths within 0.02 sec.

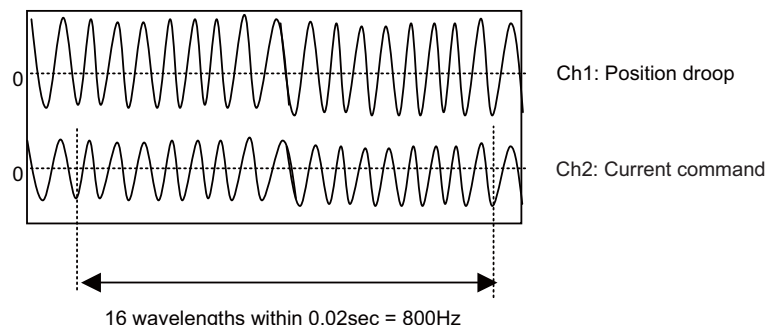

Set 800 to SP038 and XXX0 to SP034. Measure position droop and current command at this time, and adjust notch filter's frequency and depth so that the position droop is within standard range.

**POINT**

1. When incorrect frequency is set, suddenly resonance can occur and big abnormal noise can be generated. Input the appropriate value.
2. Do not set the value to low-frequency (50Hz).

【#13002】 SP002 PGN Position loop gain interpolation mode

Set the position loop gain for "interpolation" control mode.

When the setting value increases, the command tracking ability will enhance and the positioning settling time can be shorter. However, the impact on the machine during acceleration/deceleration will increase.

Use the selection command, the control mode "bit 2, 1, 0 = 010 or 100" in control input 4.

(Note) The control mode is commanded by NC.

When carrying out the SHG control, set SP035/bitC to "1".

---Setting range---

1 to 200 (1/s)

【#13008】 SP008 VGN2 Speed loop gain 2

Normally SP005(VGN1) is used.

By setting "SP035/bit9=1", gain 2 can be used according to the application.

Gain 2 can also be used by setting "Speed gain set 2 changeover request (control input 5/ bitC) = 1".

Refer to SP005(VGN1) for adjustment procedures.

---Setting range---

1 to 9999

【#13009】 SP009 VIA2 Speed loop lead compensation 2

Normally SP006(VIA1) is used.

By setting "SP035/bit9=1", gain 2 can be used according to the application.

Gain 2 can also be used by setting "Speed gain set 2 changeover request (control input 5/ bitC) = 1".

Refer to SP006(VIA1) for adjustment procedures.

---Setting range---

1 to 9999

【#13010】 SP010 VIL2 Speed loop delay compensation 2

Normally SP007(VIL1) is used.

By setting "SP035/bit9=1", gain 2 can be used according to the application.

Gain 2 can also be used by setting "Speed gain set 2 changeover request (control input 5/ bitC) = 1".

Refer to SP007(VIL1) for adjustment procedures.

---Setting range---

0 to 32767

[#13034] SP034 SFNC2 Spindle function 2 **bit F-D : nfd5 Depth of Notch filter 5**

Set the depth of Notch filter 5 (SP088).

bit F,E,D=

000: -∞

001: -18.1[dB]

010: -12.0[dB]

011: -8.5[dB]

100: -6.0[dB]

101: -4.1[dB]

110: -2.5[dB]

111: -1.2[dB]

 bit B-9 : nfd4 Depth of Notch filter 4

Set the depth of Notch filter 4 (SP087).

bit B,A,9=

000: -∞

001: -18.1[dB]

010: -12.0[dB]

011: -8.5[dB]

100: -6.0[dB]

101: -4.1[dB]

110: -2.5[dB]

111: -1.2[dB]

 bit 7-5 : nfd2 Depth of Notch filter 2

Set the depth of Notch filter 2 (SP046).

bit7,6,5=

000: -∞

001: -18.1[dB]

010: -12.0[dB]

011: -8.5[dB]

100: -6.0[dB]

101: -4.1[dB]

110: -2.5[dB]

111: -1.2[dB]

 bit 4 : fhz3 Notch filter 3

0: Stop 1: Start (1125Hz)

 bit 3-1 : nfd1 Depth of Notch filter 1

Set the depth of Notch filter 1 (SP038).

bit3,2,1=

000: -∞

001: -18.1[dB]

010: -12.0[dB]

011: -8.5[dB]

100: -6.0[dB]

101: -4.1[dB]

110: -2.5[dB]

111: -1.2[dB]

 [#13035(PR)] SP035 SFNC3 Spindle function 3 **bit C : shgn SHG control in interpolation mode**

0: Stop 1: Start

 bit A : pyn Excitation rate selection in interpolation mode

0: Select Excitation rate 1 1: Select Excitation rate 2

 bit 9 : vgn Speed loop gain set selection in interpolation mode

0: Select Set 1 1: Select Set 2

【#13038】 SP038 FHz1 Notch filter frequency 1

Set the vibration frequency to suppress when machine vibration occurs.
(Enabled at 50 or more.)
When not using, set to "0".

---Setting range---
0 to 2250 (Hz)

【#13046】 SP046 FHz2 Notch filter frequency 2

Set the vibration frequency to suppress when machine vibration occurs.
(Enabled at 50 or more.)
When not using, set to "0".

---Setting range---
0 to 2250 (Hz)

【#13087】 SP087 FHz4 Notch filter frequency 4

Set the vibration frequency to suppress when machine vibration occurs.
(Enabled at 50 or more.)
When not using, set to "0".

---Setting range---
0 to 2250 (Hz)

【#13088】 SP088 FHz5 Notch filter frequency 5

Set the vibration frequency to suppress when machine vibration occurs.
(Enabled at 50 or more.)
When not using, set to "0".

---Setting range---
0 to 2250 (Hz)

6.1.8 Spindle Synchronization Adjustment (For Lathe System)

(1) Setting the gain, changeover rotation speed and time constant

[1] For speed loop gain during spindle synchronization, SP005 (speed loop gain 1), SP006 (speed loop lead compensation 1), and SP007 (speed loop delay compensation 2) are used. For position loop gain, set standard 15 to SP003 (position loop gain spindle synchronization).

Parameter	Setting value
SP003	15
SP036	0000

(Note1) To change the setting value of SP003, set the synchronous and basic spindles to the same value.

(Note2) For the adjustment of SP005, SP006 and SP007, conduct "Adjusting the speed loop parameter" as a single unit beforehand.

[2] Set rotation speed and time constant during acceleration/deceleration figured by theoretical calculations.

[3] Set "Time-series data measurement" with NC Analyzer as follows and output speed feedback and current command.

< NC Analyzer setting (Time-series data measurement) >

Get	Waveform type
CH1	Speed feedback (r/min)
CH2	Current command

(2) Confirming the current margin

Perform acceleration/deceleration up to the maximum current speed in spindle synchronization mode. At this time, confirm that the current value for both acceleration side and deceleration side secure 30% or more of margin in respect to the current limit value. Also, confirm that no oscillation, etc. are found in the current waveforms.

(Note) If a margin is 30% or less, extend the acceleration/deceleration time constant so that the margin is adjusted to 30% or more.

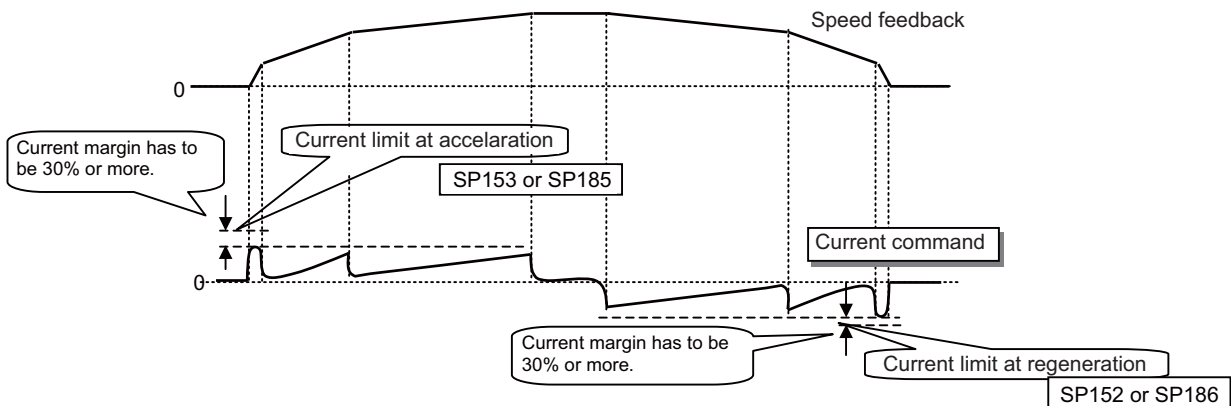

Output waveform example in spindle synchronous mode

【#13003】 SP003 PGS Position loop gain spindle synchronization

Set the position loop gain for "spindle synchronization" control mode.

When the setting value increases, the command tracking ability will enhance and the positioning settling time can be shorter. However, the impact on the machine during acceleration/deceleration will increase.

Use the selection command, the control mode "bit 2, 1, 0 = 001" in control input 4.

(Note 1) The control mode is commanded by NC.

When carrying out the SHG control, set SP036/bit4 to "1".

(Note 2) Set the same value for the basic and synchronous spindles in spindle synchronization.

---Setting range---

1 to 200 (rad/s)

【#13036(PR)】 SP036 SFNC4 Spindle function 4**bit 4 : shgs SHG control in spindle synchronization mode**

0: Stop 1: Start

bit 2 : pys Excitation rate selection in spindle synchronization mode

0: Select Excitation rate 1 1: Select Excitation rate 2

bit 1 : vgs Speed loop gain set selection in spindle synchronization mode

0: Select Set 1 (SP005,SP006,SP007) 1: Select Set 2 (SP008,SP009,SP010)

6.1.9 Deceleration Coil Changeover Valid Function by Emergency Stop

If a large workpiece is mounted on a large workpiece chuck in lathe, the acceleration/deceleration time increases because of the increase of the total inertia. When the deceleration stop time at emergency stop exceeds the upper limit value (29900ms) of the gate shutoff delay time (SP055), the spindle motor will coast.

This function enables the coil changeover motor to change to low-speed coil during emergency stop and if the deceleration time is reduced to complete within the gate shutoff time, the spindle enters an emergency stop state.

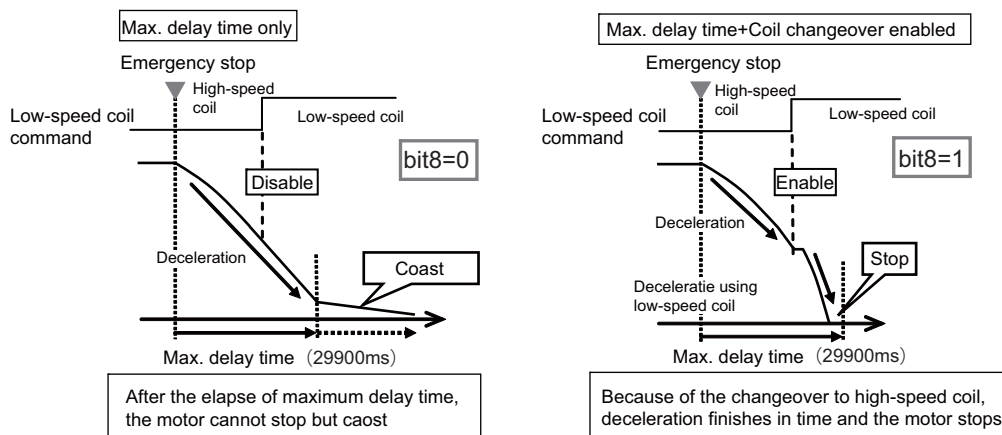

[#13225] SP225 SFNC5 Spindle function 5

bit 8 : mken Coil switch allowance in deceleration control

This enables a coil changeover while decelerating after an emergency stop for a spindle motor with coil changeover specification. A coil changeover may enable an excessive load inertia to stop within the maximum delay time.

0: Normal (Disable) 1: Enable

[#13055] SP055 EMGx Max. gate off delay time after emergency stop

Set the time required to forcibly execute READY OFF after the emergency stop is input.

Normally set to "20000".

When "0" is set, READY OFF is forcibly executed with "7000ms".

When the set time is shorter than the time to decelerate and stop, the spindle will stop with the dynamic brake after the set time is out.

---Setting range---

0 to 29900 (ms)

[#13056] SP056 EMGt Deceleration time constant at emergency stop

Set the time constant used for the deceleration control at emergency stop. Set the time required to stop from the maximum motor speed (TSP).

When "0" is set, the deceleration control is executed with "7000ms".

---Setting range---

0 to 29900 (ms)

6.1.10 High-response Acceleration/Deceleration Function

Under continuous position control method makes position droop is set with primary delay depending on the position control gain during the acceleration/deceleration by S command. If the position gain is set lower, the zero speed detection which indicates the spindle stop is more conspicuously delayed.

This function enables the position droop's primary delay to be shorter and the zero speed detection to be faster.

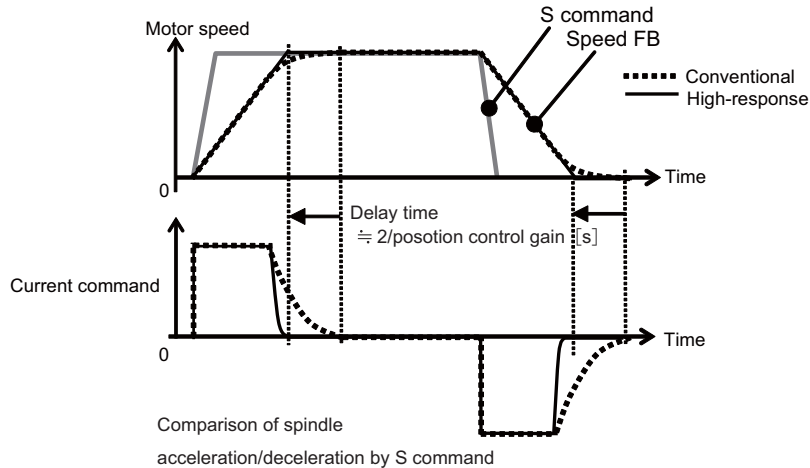

【#13095】 SP095 VIAX Lead compensation scale during high-response acceleration/deceleration

Set the magnification against delay/lead compensation (SP006) of the high-response acceleration/deceleration (valid when SP226/ bitD is set to "1"). Normally, set to "0". Set this parameter to suppress overshooting when the speed is reached.

---Setting range---

0 to 10000 (0.01%)

【#13226】 SP226 SFNC6 Spindle function 6

bit D : vup High response acceleration / deceleration

This suppresses a temporal delay which occurs when the target speed is attained from acceleration and when the spindle stops from deceleration.

0: Normal acceleration/deceleration 1: High response acceleration/deceleration Enable



POINT

This function is invalid during orientation and interpolation control (spindle synchronous/C axis/synchronous tapping control) even when it is set.

6.1.11 Spindle Cutting Withstand Level Improvement

Conventionally, the spindle rotation speed was slowed down due to heavy cutting that exceeds the spindle output characteristics, and this caused the alarm (Excessive error 52, Overload command 51) to stop the machining. This function enables setting of the dropping speed allowable value by parameter. As long as the speed is the set value or higher, machining can be executed within the output characteristics without being stopped by the alarm. Even when the parameter setting value is the normal value of 0, the standard value of 85 is applied. This can improve the efficiency of heavy cutting (feed per revolution). If excessive speed dropping occurs and the speed exceeds the allowable range, the excessive speed deviation alarm 23 is output to reduce the damage to the machine.

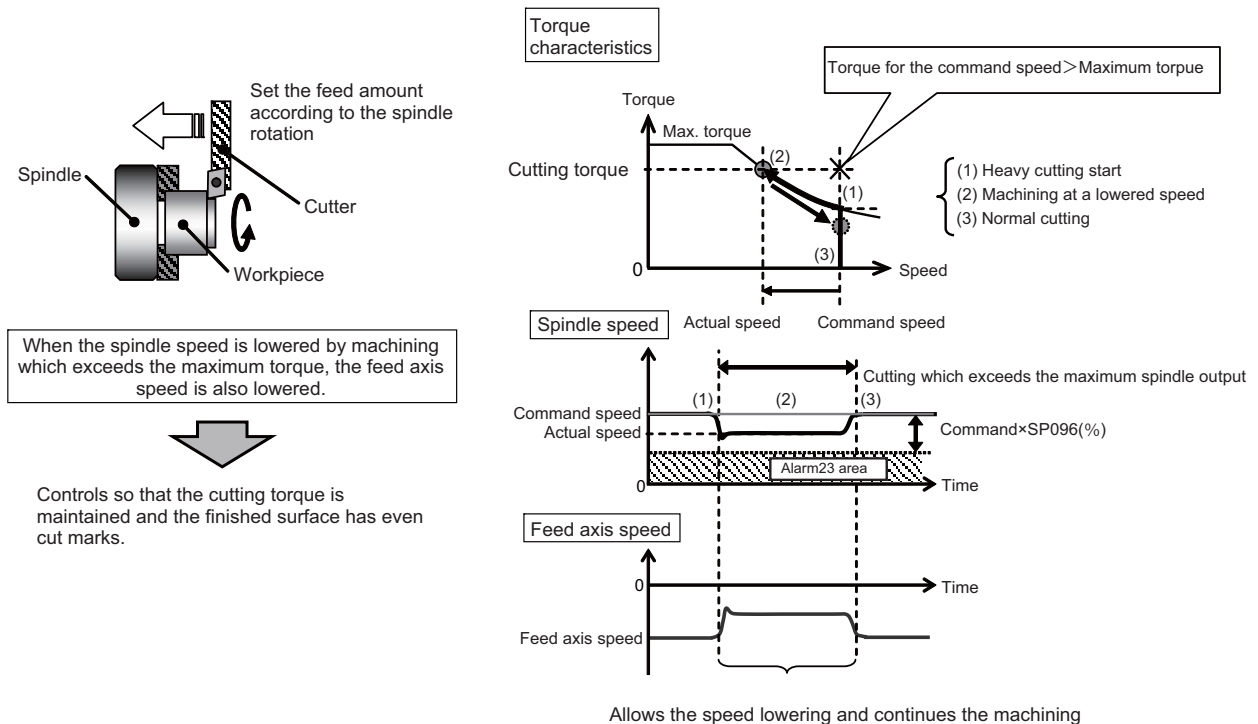

When the spindle speed is lowered by machining which exceeds the maximum torque, the feed axis speed is also lowered.

Controls so that the cutting torque is maintained and the finished surface has even cut marks.

#13096 SP096 SDW Speed slowdown allowable width

When the spindle slows down due to multiple cutting, set the processable speed as percentage against the NC command speed.

If the speed reduces below the tolerable range, the alarm 23 (Excessive speed error) will occur. E.g.] When set to 90 [%]

If S1000 is commanded, the speed reduced by 900r/min (=1000r/min × 90%) is the allowable lower limit. Thus if the spindle speed reduces to 100r/min or below, the alarm will occur.

When "0" is set, the magnification is the same as when "85" is set. When set to "-1", the allowable width will be disabled.

---Setting range---
-1,0 to 100(%)

6.1.12 Spindle Motor Temperature Compensation Function

When an IM spindle motor is in a cooled state, its maximum output characteristics tend to degrade compared to when warmed up. Eventually the spindle acceleration deceleration time may extend or the cutting load on the display may increase immediately after the start of operation.

This function is designed to reduce the motor output degradation caused by the temperature fluctuation, by applying control compensation according to the temperature detected by the motor's built-in thermistor.

For an IPM spindle motor, changes in output characteristics induced by the temperature fluctuation can be ignored in principle, so no thermal compensation function is provided for this type of motor.

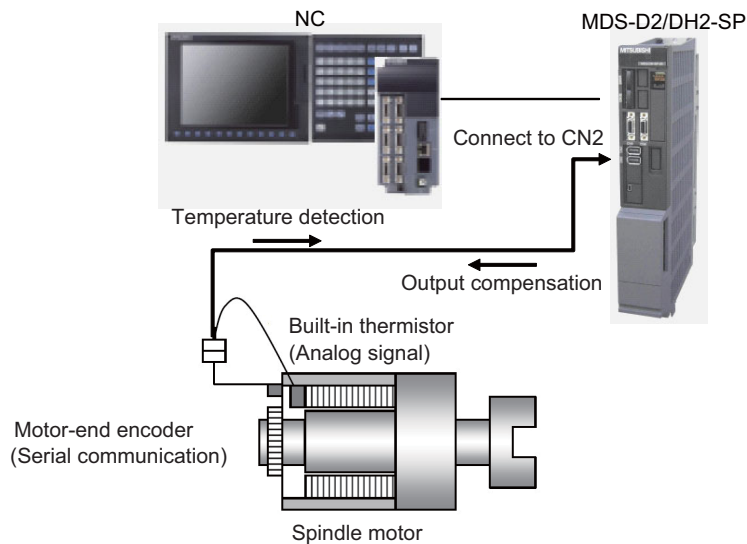

(1) Setting of the temperature compensation gain (SP235)

- [1] Set the parameters as SP235(R2H)=150 and SP236(WIH)=0.
 - * Change SP153 and SP185 to [original setting x 0.8] respectively and then turn the NC power OFF and ON.
- [2] Rotate the spindle at the command speed of 60r/min.
- [3] Make sure that [Cycle counter] on the spindle monitor screen is counting up or down.
- [4] Stop the spindle (M5 stop: servo OFF).
- [5] Create a program that repeats acceleration/deceleration up to the maximum rotation speed in constant output.
 - * If the machine's specified speed is lower than the motor's maximum speed in constant output, set the machine specification as the maximum rotation speed.

<Program example for a machining center with the maximum rotation speed in constant output of 7000r/min>

```
M3 S7000; (Accelerate to the maximum rotation speed)
G4 X2.0; (Dwell for 2.0 seconds)
M5; (Stop)
G4 X2.0; (Dwell for 2.0 seconds)
M99; (Repeat)
```
- [6] Set SP226 bit8 to 1. (Change SP226(SFNC6) from 0000 to 0100.)
- [7] Run the program (acceleration/deceleration) which you created in [5].
- [8] Make sure that [AFLT gain (dB)] on the spindle monitor is in the range of 90 to 110 during the acceleration/deceleration operation.
 - <If [AFLT gain (dB)] is out of the range of 90 to 110>
 - Adjust SP235(R2H) as follows and run the program created in [5] (acceleration/deceleration).
 - When [AFLT gain (dB)] is smaller than 90:
 - Increment SP235(R2H) by 5 at a time until the gain reaches 90 or higher during the program execution.
 - When [AFLT gain (dB)] is 111 or greater:
 - Decrement SP235(R2H) by 5 at a time until the gain reaches 110 or lower during the program execution.
- [9] Stop the spindle when [Temperature (°C)] on the spindle monitor reaches 100 (or the upper limit of temperature in practical use).
- [10] The value of SP235(R2H) you obtain at this time is the result of the final adjustment.

(2) Setting of the temperature compensation time constant (SP236)

- [1] Set SP236(WIH)=10. (Leave the setting of SP235 unchanged.)
- [2] Run the program (acceleration/deceleration) that you created in [5] of (1), and continue until [Temperature (°C)] on the spindle monitor screen reaches 100 (or the upper limit of temperature in practical use).
- [3] Stop the spindle when [Temperature (°C)] on the spindle monitor reaches 100 (or the upper limit of temperature in practical use). Then wait until [Temperature (°C)] drops to 80 (or the upper limit of temperature in practical use - 20°C).
- [4] When [Temperature (°C)] on the spindle monitor reaches 80 (or the upper limit of temperature in practical use - 20°C), run the program (acceleration/deceleration) you created in [5] of (1) by one cycle. Adjust SP236(WIH) as follows according to the value of [AFLT gain (dB)] on the spindle monitor screen during the operation.
 - When [AFLT gain (dB)] is smaller than 90:
Increment SP236(WIH) by 2 at a time and perform [2]
 - When [AFLT gain (dB)] is 111 or greater:
Decrement SP236(WIH) by 2 at a time and perform [2].
- [5] The SP236(WIH) value to be obtained while [AFLT gain (dB)] is in the range of 90 to 110 is the result of the final adjustment.
- [6] Set SP226 bit8 to 0. (Change SP226(SFNC6) from 0100 to 0000.)
*Change SP153 and SP185 back to the original settings and turn OFF and ON the NC power.

**CAUTION**

Check the monitor screen to make sure that the motor has reached the maximum rotation speed in constant output during execution of the created program.

* "Maximum rotation speed in constant output" is the maximum speed at which the short-time rated output will not drop lower than the motor's specified output. (Refer to the motor output specifications.)

If the machine's specified speed is lower than the motor's maximum speed in constant output, the machine's specified speed serves as the maximum rotation speed.

< How to adjust the spindle motor temperature compensation function >

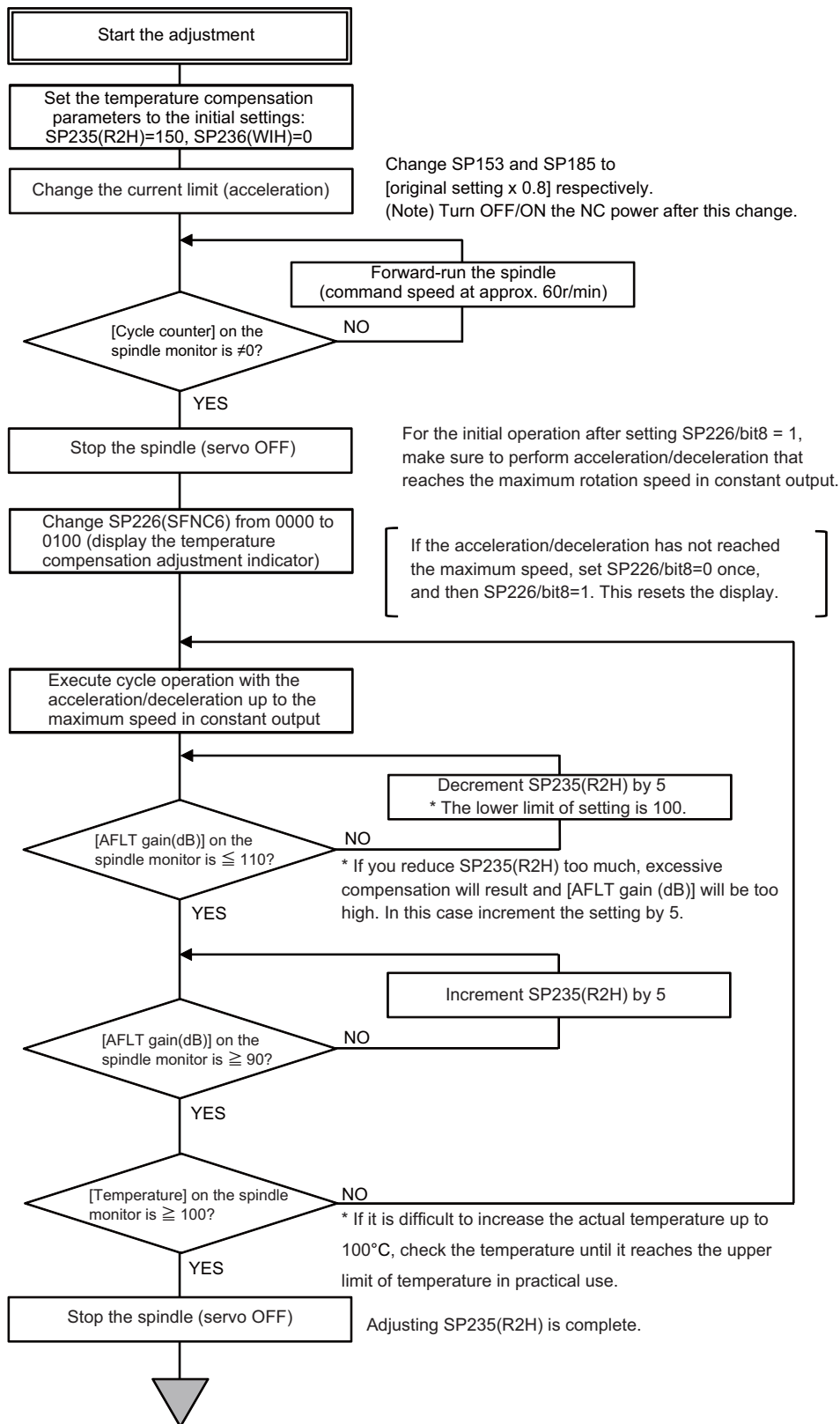

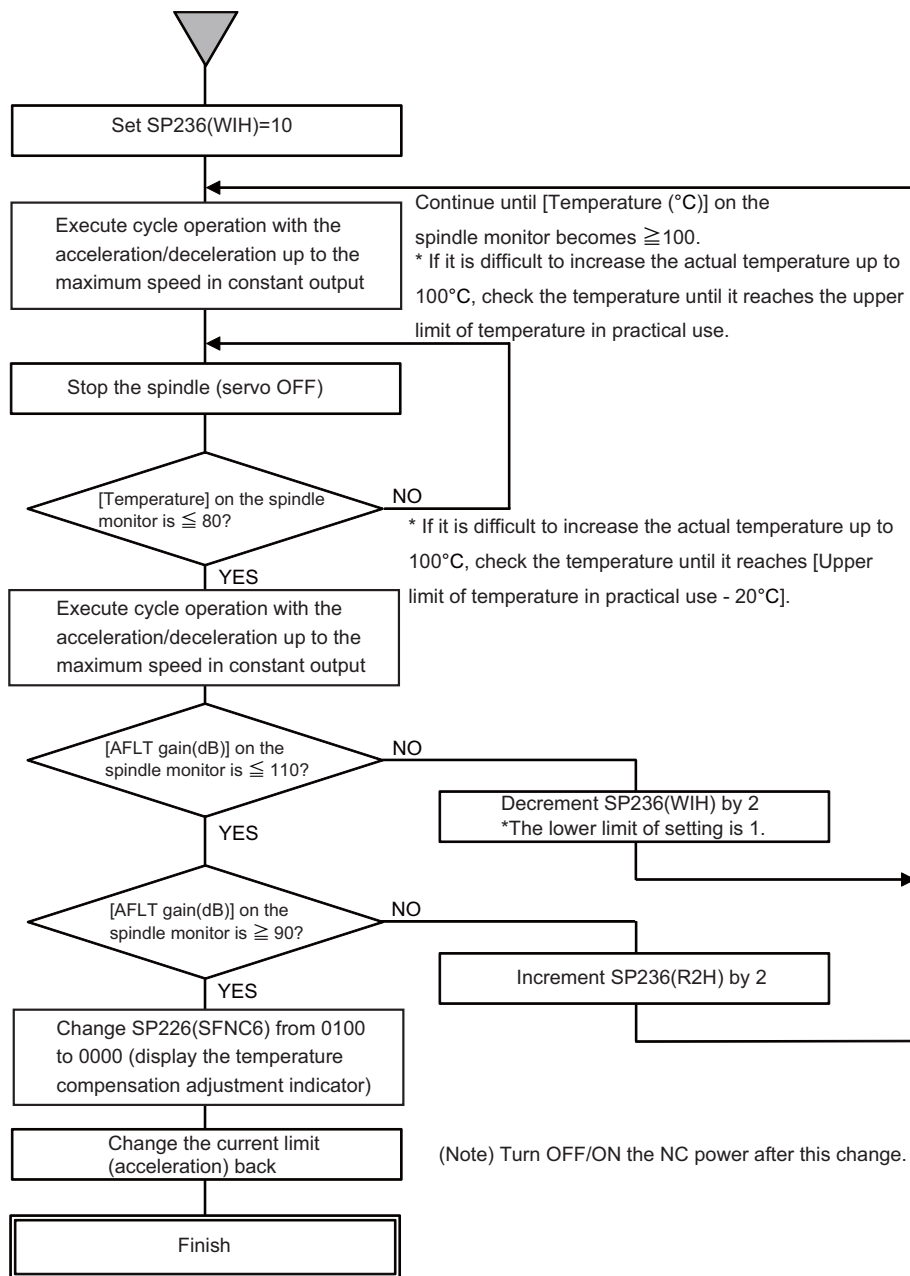

⚠ Caution

1. Carry out the adjustment within the motor's specified ambient temperature range (0 to +40°C).
2. This function is unavailable if the time taken to accelerate to the maximum speed in constant output is shorter than 0.1[s]. Make sure to perform such acceleration/deceleration that reaches the maximum rotation speed in constant output.
3. If you program a command for accelerating up to the maximum speed in constant output, insert a dwell time so that the spindle motor can reach the maximum speed.
4. Do not use this function for a spindle motor if it has a direct cooling system on the secondary side (rotor).
5. Before starting the adjustment, make sure that [Temperature (°C)] on the spindle monitor is close to the room temperature.
If [Temperature (°C)] is unchanged or any error is found during the adjustment, do not use this function.
6. Do not change the spindle motor cooling condition after the parameter adjustment for this function is complete.
Also make sure to change SP226(SFNC6)/bit8 back to 0.

【#13226】 SP226 SFNC6 Spindle function 6**bit 8 : r2c Temperature compensation adjustment indicator**

0: Normal 1: Display

【#13235(PR)】 SP235 R2H Temperature compensation gain

Set the magnification in converting the thermistor temperature to the control compensation amount.
When "0" is set, the temperature compensation function is disabled.
When not using, or when using an IPM spindle motor, set to "0".

---Setting range---

0 to 400 (%)

【#13236(PR)】 SP236 WIH Temperature compensation time constant

Set the delay time constant from the thermistor temperature to the control compensation amount.
When "0" is set, the delay time constant is disabled.
When not using, or when using an IPM spindle motor, set to "0".

---Setting range---

0 to 150 (min)

6.2 Settings for Emergency Stop

Emergency stop in this section refers to the following states.

- [1] Emergency stop was input (including other axis alarms)
- [2] NC power down was detected
- [3] A drive unit alarm was detected

6.2.1 Deceleration Control

(1) Setting the deceleration control time constant

Set the time for stopping from the maximum motor speed (TSP) in the deceleration time constant for emergency stop (SV056: EMGt). When "0" is set, the deceleration stop is executed with "7000ms".

<Operation>

When an emergency stop occurs, the motor will decelerate at the same inclination from each speed.

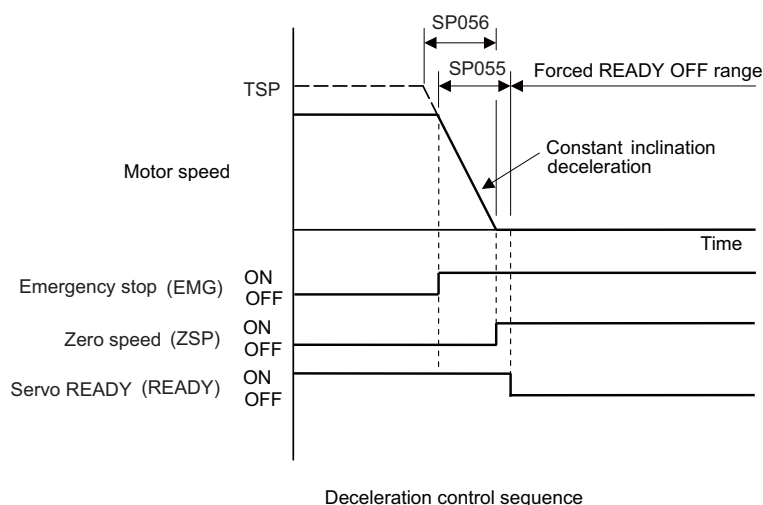

(Note) If the setting value of SP056 is longer than the value of SP055, the motor will coast.

【#13055】 SP055 EMGx Max. gate off delay time after emergency stop

Set the time required to forcibly execute READY OFF after the emergency stop is input. Normally set to "20000".

When "0" is set, READY OFF is forcibly executed with "7000ms".

When the set time is shorter than the time to decelerate and stop, the spindle will stop with the dynamic brake after the set time is out.

---Setting range---

0 to 29900 (ms)

【#13056】 SP056 EMGt Deceleration time constant at emergency stop

Set the time constant used for the deceleration control at emergency stop. Set the time required to stop from the maximum motor speed (TSP).

When "0" is set, the deceleration control is executed with "7000ms".

---Setting range---

0 to 29900 (ms)

6.3 Spindle Control Signal

The sequence input/output signals exchanged between the NC and spindle drive unit are explained in this section. The status of each signal is displayed on the NC SPINDLE MONITOR screen.

6.3.1 Spindle Control Input (NC to Spindle)

(1) Spindle control input 1

Name	Details															
Spindle control input 1	F	E	D	C	B	A	9	8	7	6	5	4	3	2	1	0
						TL3	TL2	TL1	ALMR						SRV	RDY
	bit	Details														
	0	RDY	READY ON command													
	1	SRV	Servo ON command													
	2	-	(For maintenance)													
	3	-	(For maintenance)													
	4	-	(For maintenance)													
	5	-	(For maintenance)													
	6	-	(For maintenance)													
7	ALMR	Alarm reset command														
8	TL1	Torque limit 1 selection command														
9	TL2	Torque limit 2 selection command														
A	TL3	Torque limit 3 selection command														
B	-	(For maintenance)														
C	-	(For maintenance)														
D	-	(For maintenance)														
E	-	(For maintenance)														
F	-	(For maintenance)														

bit0. READY ON command (RDY)

Status turns to ready ON at RDY=1.

bit1. Servo ON command (SRV)

- [1] Drive unit turns ON at SRV=1 (gate ON status), and rotation control starts.
Plus or minus of the rotation direction is determined depending on +/- of the NC command F Δ T.
- [2] Servo immediately turns OFF (SON=0) at SRV=0 during rotation control. Drive unit also turns OFF (gate OFF status) at this time.

bit7. Alarm reset command (ALMR)

NR alarm is reset at ALMR=1.

bit8. Torque limit 1 selection command (TL1)

bit9. Torque limit 2 selection command (TL2)

bitA. Torque limit 3 selection command (TL3)

The following 4 types of torque limit are available depending on TL1, TL2 and TL3 bit combinations.

TL3	TL2	TL1	Torque limit value
0	0	1	Torque limit value (%) set with parameter SP065
0	1	0	Torque limit value (%) set with parameter SP066
0	1	1	Torque limit value (%) set with parameter SP067
1	0	0	Torque limit value (%) set with parameter SP068

(Note) The ratio to motor short time rated torque (load meter 100%) is indicated in %.

(Note) The bits other than those above are used for maintenance.

(2) Spindle control input 2

Name	Details																
Spindle control input 2	F	E	D	C	B	A	9	8	7	6	5	4	3	2	1	0	
					SRVDC	NCDC	SSW										
	bit	Details															
	0	-	(For maintenance)														
	1	-	(For maintenance)														
	2	-	(For maintenance)														
	3	-	(For maintenance)														
	4	-	(For maintenance)														
	5	-	(For maintenance)														
	6	-	(For maintenance)														
	7	-	(For maintenance)														
	8	-	(For maintenance)														
	9	SSW	Speed monitor command valid														
	A	NCDC	In door closed (controller)														
	B	SRVDC	In door closed (all drive units)														
	C	-	(For maintenance)														
D	-	(For maintenance)															
E	-	(For maintenance)															
F	-	(For maintenance)															

bit9. Speed monitor command valid (SSW)

When speed monitor command is valid, SSW=1 (valid) is set.

bitA. In door closed (controller) (NCDC)

When "In door closed" signal for controller is valid, NCDC =1 (valid) is set.

bitB. In door closed (all drive units) (SRVDC)

When the theoretical sum of "In door closed" signals for all drive units is valid, SRVDC =1 (valid) is set.

(Note) The bits other than those above are used for maintenance.

(3) Spindle control input 3

This is used for maintenance.

(4) Spindle control input 4

Name	Details																
Spindle control input 4	F	E	D	C	B	A	9	8	7	6	5	4	3	2	1	0	
				LCS						GR2	GR1	GKC		SC3	SC2	SC1	
	bit	Details															
	0	SC1	Spindle control mode selection command 1														
	1	SC2	Spindle control mode selection command 2														
	2	SC3	Spindle control mode selection command 3														
	3	-	(For maintenance)														
	4	GKC	Gear changeover command														
	5	GR1	Gear selection command 1														
	6	GR2	Gear selection command 2														
	7	-	(For maintenance)														
	8	-	(For maintenance)														
	9	-	(For maintenance)														
	A	-	(For maintenance)														
	B	-	(For maintenance)														
	C	-	(For maintenance)														
D	LCS	L coil selection command															
E	-	(For maintenance)															
F	-	(For maintenance)															

bit0. Spindle control mode selection command 1 (SC1)

bit1. Spindle control mode selection command 2 (SC2)

bit2. Spindle control mode selection command 3 (SC3)

- [1] Drive unit operation mode can be selected with the bit correspondences below.
- [2] Mode changeover is valid during in-position (INP=1) or other than during droop cancel / phase compensation (DCSL=PCMP=0).

SC3	SC2	SC1	Operation mode	
			Conventional method	New method
0	0	0	Speed/orientation control	Non interpolation control
0	0	1	Spindle synchronization	Spindle synchronization
0	1	0	C-axis control	Interpolation control
1	0	0	Synchronous tapping control	

(Note) When selecting bits other than above, control mode error (4E) occurs.

- [3] Continuity cannot be guaranteed for the value of position FB in non-interpolation mode. (Position may be skipped for multiple rotations due to droop cancel or phase compensation.)

bit4. In gear changeover command (GKC)

By inputting GKC=1, the gear ratio is changed to the gear ratio specified with the gear selection command (GR1, GR2). This command is invalid during the interpolation mode.

bit5. Gear selection command 1 (GR1)

bit6. Gear selection command 2 (GR2)

- [1] The following 4 types of gear ratio are available depending on GR1 and GR2 2-bit input combinations.
- [2] Gear specifications in semi-closed position control do not secure a position within one rotation of the spindle.

GR2	GR1	Parameters requiring gear ratio setting
0	0	SP057 (GRA1), SP061 (GRB1)
0	1	SP058 (GRA2), SP062 (GRB2)
1	0	SP059 (GRA3), SP063 (GRB3)
1	1	SP060 (GRA4), SP064 (GRB4)

bitD. L coil selection command (LCS)

- [1] L coil is selected at LCS=1 when coil changeover is valid.
- [2] Signal change is invalid during interpolation mode, but coil changeover is valid if control mode changeover is applied together.

(Note) The bits other than those above are used for maintenance.

(5) Spindle control input 5

Name	Details																																																	
Spindle control input 5	<table border="1" style="width:100%; text-align:center;"> <tr> <td>F</td><td>E</td><td>D</td><td>C</td><td>B</td><td>A</td><td>9</td><td>8</td><td>7</td><td>6</td><td>5</td><td>4</td><td>3</td><td>2</td><td>1</td><td>0</td> </tr> <tr> <td>TLUP</td><td>ORC</td><td>VG2</td><td>PY2</td><td></td><td></td><td></td><td></td><td></td><td></td><td></td><td></td><td></td><td></td><td></td><td></td> </tr> </table>																F	E	D	C	B	A	9	8	7	6	5	4	3	2	1	0	TLUP	ORC	VG2	PY2														
	F	E	D	C	B	A	9	8	7	6	5	4	3	2	1	0																																		
TLUP	ORC	VG2	PY2																																															
	<table border="1" style="width:100%;"> <thead> <tr> <th>bit</th> <th>Details</th> </tr> </thead> <tbody> <tr><td>0</td><td>- (For maintenance)</td></tr> <tr><td>1</td><td>- (For maintenance)</td></tr> <tr><td>2</td><td>- (For maintenance)</td></tr> <tr><td>3</td><td>- (For maintenance)</td></tr> <tr><td>4</td><td>- (For maintenance)</td></tr> <tr><td>5</td><td>- (For maintenance)</td></tr> <tr><td>6</td><td>- (For maintenance)</td></tr> <tr><td>7</td><td>- (For maintenance)</td></tr> <tr><td>8</td><td>- (For maintenance)</td></tr> <tr><td>9</td><td>- (For maintenance)</td></tr> <tr><td>A</td><td>- (For maintenance)</td></tr> <tr><td>B</td><td>PY2 Minimum excitation rate 2 changeover request</td></tr> <tr><td>C</td><td>VG2 Speed gain set 2 changeover request</td></tr> <tr><td>D</td><td>ORC Zero point re-detection request</td></tr> <tr><td>E</td><td>TLUP Spindle holding force up</td></tr> <tr><td>F</td><td>- (For maintenance)</td></tr> </tbody> </table>																bit	Details	0	- (For maintenance)	1	- (For maintenance)	2	- (For maintenance)	3	- (For maintenance)	4	- (For maintenance)	5	- (For maintenance)	6	- (For maintenance)	7	- (For maintenance)	8	- (For maintenance)	9	- (For maintenance)	A	- (For maintenance)	B	PY2 Minimum excitation rate 2 changeover request	C	VG2 Speed gain set 2 changeover request	D	ORC Zero point re-detection request	E	TLUP Spindle holding force up	F	- (For maintenance)
bit	Details																																																	
0	- (For maintenance)																																																	
1	- (For maintenance)																																																	
2	- (For maintenance)																																																	
3	- (For maintenance)																																																	
4	- (For maintenance)																																																	
5	- (For maintenance)																																																	
6	- (For maintenance)																																																	
7	- (For maintenance)																																																	
8	- (For maintenance)																																																	
9	- (For maintenance)																																																	
A	- (For maintenance)																																																	
B	PY2 Minimum excitation rate 2 changeover request																																																	
C	VG2 Speed gain set 2 changeover request																																																	
D	ORC Zero point re-detection request																																																	
E	TLUP Spindle holding force up																																																	
F	- (For maintenance)																																																	

bitB. Minimum excitation rate 2 changeover request (PY2)

- [1] When PY2=1 is set, the minimum excitation rate 2 (SP015) is selected.
- [2] When PY2=0 is set, the minimum excitation rate 1 (SP014) is selected.

bitC. Speed gain set 2 changeover request (VG2)

- [1] When VG2=1 is set, the gain parameter (SP008/SP009/SP010) used in the speed loop is selected.
- [2] When VG2=0 is set, the gain parameter (SP005/SP006/SP007) used in the speed loop is selected.
- [3] The speed gain set changeover is valid during the in-position.

bitD. Zero point re-detection request (ORC)

When ORC is changed from 0 to 1, the Z phase passed will be 0 (control output2/bit0).

bitE. Spindle holding force up (TLUP)

Spindle holding force up (disturbance observer) starts at TLUP=1 and that state is retained during TLUP=1.

(Note) The bits other than those above are used for maintenance.

(6) Spindle control input 6

Name	Details																
Spindle control input 6	F	E	D	C	B	A	9	8	7	6	5	4	3	2	1	0	
								DD1									OMRFF
	bit	Details															
	0	OMRFF	OMR-FF control request														
	1	-	(For maintenance)														
	2	-	(For maintenance)														
	3	-	(For maintenance)														
	4	-	(For maintenance)														
	5	-	(For maintenance)														
	6	-	(For maintenance)														
	7	-	(For maintenance)														
	8	DD1	Drivers communication control request														
	9	-	(For maintenance)														
	A	-	(For maintenance)														
	B	-	(For maintenance)														
	C	-	(For maintenance)														
	D	-	(For maintenance)														
E	-	(For maintenance)															
F	-	(For maintenance)															

bit0. OMR-FF control request (OMRFF)

- [1] The OMR-FF control which determines the tracking ability to the position command by using scale model gain is selected with OMRFF=1.
- [2] The tracking ability to the position command is determined by using conventional position loop gain with OMRFF=0.

bit8. Drivers communication control request (DD1)

- [1] The high-speed synchronous tapping control which allows data communication between drive units is selected with DD1=1.
- [2] The normal synchronous tapping is selected with DD1=0.

(Note) The bits other than those above are used for maintenance.

6.3.2 Spindle Control Output (Spindle to NC)

(1) Spindle control output 1

Name	Details															
Spindle control output 1	F	E	D	C	B	A	9	8	7	6	5	4	3	2	1	0
	WRN	LMT	INP		TL3	TL2	TL1	ALMR							SRV	RDY
	bit	Details														
	0	RDY	In ready ON													
	1	SRV	In servo ON													
	2	-	(For maintenance)													
	3	-	(For maintenance)													
	4	-	(For maintenance)													
	5	-	(For maintenance)													
	6	-	(For maintenance)													
	7	ALMR	In alarm													
	8	TL1	In torque limit 1 selection													
	9	TL2	In torque limit 2 selection													
	A	TL3	In torque limit 3 selection													
	B	-	(For maintenance)													
	C	INP	In in-position													
D	LMT	In torque limit														
E	-	(For maintenance)														
F	WRN	In warning														

bit0. In ready ON (RDY)

It indicates that the status is in ready ON at RDY=1.

bit1. In servo ON (SRV)

- [1] It indicates that the status is in servo ON at SRV=1.
- [2] NC position command executes a followed up during SRV=0.

bit7. In alarm (ALMR)

It indicates that drive unit is in some alarm state at ALMR=1.

bit8. In torque limit 1 selection (TL1)

bit9. In torque limit 2 selection (TL2)

bitA. In torque limit 3 selection (TL3)

These are the answer outputs for torque limit 1, 2 and 3 (TL1, TL2 and TL3).

bitC. In in-position (INP)

The status changes to INP=1 when position droop exists within the in-position area set by parameter SP024 (INP) regardless of serve ON or OFF.

bitD. In torque limit (LMT)

It indicates that current command value is limited with motor maximum output current value or torque limit 1, 2 or 3 at LMT=1.

bitF. In warning (WRN)

It indicates that drive unit is in some warning state at WRN=1.

(Note) The bits other than those above are used for maintenance.

(2) Spindle control output 2

Name	Details															
Spindle control output 2	F	E	D	C	B	A	9	8	7	6	5	4	3	2	1	0
					SRVDC	NCDC	SSW		EXEMG				ZS			ZCN
	bit	Details														
	0	ZCN	Z phase passed													
	1	-	(For maintenance)													
	2	-	(For maintenance)													
	3	ZS	In zero speed													
	4	-	(For maintenance)													
	5	-	(For maintenance)													
	6	-	(For maintenance)													
	7	EXEMG	In external emergency stop													
	8	-	(For maintenance)													
	9	SSW	In speed monitor													
	A	NCDC	In door closed (controller)													
	B	SRVDC	In door closed (self drive unit)													
	C	-	(For maintenance)													
	D	-	(For maintenance)													
E	-	(For maintenance)														
F	-	(For maintenance)														

bit0. Z phase passed (ZCN)

- [1] When Z phase is passed, ZCN=0 is turned to ZCN=1.
- [2] Grid amount (within one rotation) is transmitted when ZCN =0 is changed to ZCN =1.

bit3. In zero speed (ZS)

- [1] Approximately 200ms after the motor speed reaches parameter SP027 (ZSP) + 15r/min, ZS=0 is set.
- [2] When the motor speed becomes slower than the speed set by parameter SP027 (ZSP), ZS=1 is set. ZS signal is detected by the motor speed absolute value regardless of the rotation direction.

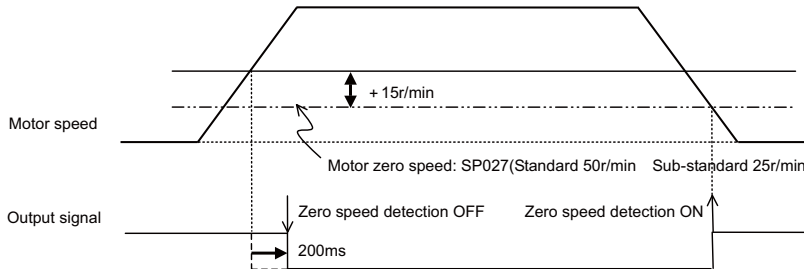

bit7. In external emergency stop

It indicates that an external stop input to the power supply is being input.

bit9. In speed monitor

It indicates that a signal in speed monitor command is being received.

bitA. In door closed (controller)

It indicates that "In door closed" signal for controller is being received.

bitB. In door closed (self drive unit)

It indicates the status of "In door closed" signal for self drive unit.

(Note) The bits other than those above are used for maintenance.

(3) Spindle control output 3

This is used for maintenance.

(4) Spindle control output 4

Name	Details																																																																																																																																																																																																																																																																																															
Spindle control output 4	<table border="1"> <tr> <td>F</td><td>E</td><td>D</td><td>C</td><td>B</td><td>A</td><td>9</td><td>8</td><td>7</td><td>6</td><td>5</td><td>4</td><td>3</td><td>2</td><td>1</td><td>0</td> </tr> <tr> <td></td><td>LCS</td><td></td><td></td><td></td><td></td><td></td><td></td><td>MPN</td><td>GR2</td><td>GR1</td><td>GKC</td><td></td><td>SC3</td><td>SC2</td><td>SC1</td> </tr> </table>																F	E	D	C	B	A	9	8	7	6	5	4	3	2	1	0		LCS							MPN	GR2	GR1	GKC		SC3	SC2	SC1																																																																																																																																																																																																																																																
	F	E	D	C	B	A	9	8	7	6	5	4	3	2	1	0																																																																																																																																																																																																																																																																																
		LCS							MPN	GR2	GR1	GKC		SC3	SC2	SC1																																																																																																																																																																																																																																																																																
	<table border="1"> <thead> <tr> <th>bit</th> <th colspan="15">Details</th> </tr> </thead> <tbody> <tr> <td>0</td> <td>SC1</td> <td colspan="14">In spindle control mode selection 1</td> </tr> <tr> <td>1</td> <td>SC2</td> <td colspan="14">In spindle control mode selection 2</td> </tr> <tr> <td>2</td> <td>SC3</td> <td colspan="14">In spindle control mode selection 3</td> </tr> <tr> <td>3</td> <td>-</td> <td colspan="14">(For maintenance)</td> </tr> <tr> <td>4</td> <td>GKC</td> <td colspan="14">In gear changeover command</td> </tr> <tr> <td>5</td> <td>GR1</td> <td colspan="14">In gear selection 1</td> </tr> <tr> <td>6</td> <td>GR2</td> <td colspan="14">In gear selection 2</td> </tr> <tr> <td>7</td> <td>MPN</td> <td colspan="14">Magnetic pole position not set</td> </tr> <tr> <td>8</td> <td>-</td> <td colspan="14">(For maintenance)</td> </tr> <tr> <td>9</td> <td>-</td> <td colspan="14">(For maintenance)</td> </tr> <tr> <td>A</td> <td>-</td> <td colspan="14">(For maintenance)</td> </tr> <tr> <td>B</td> <td>-</td> <td colspan="14">(For maintenance)</td> </tr> <tr> <td>C</td> <td>-</td> <td colspan="14">(For maintenance)</td> </tr> <tr> <td>D</td> <td>LCS</td> <td colspan="14">In L coil selection</td> </tr> <tr> <td>E</td> <td>-</td> <td colspan="14">(For maintenance)</td> </tr> <tr> <td>F</td> <td>-</td> <td colspan="14">(For maintenance)</td> </tr> </tbody> </table>																bit	Details															0	SC1	In spindle control mode selection 1														1	SC2	In spindle control mode selection 2														2	SC3	In spindle control mode selection 3														3	-	(For maintenance)														4	GKC	In gear changeover command														5	GR1	In gear selection 1														6	GR2	In gear selection 2														7	MPN	Magnetic pole position not set														8	-	(For maintenance)														9	-	(For maintenance)														A	-	(For maintenance)														B	-	(For maintenance)														C	-	(For maintenance)														D	LCS	In L coil selection														E	-	(For maintenance)														F	-	(For maintenance)													
	bit	Details																																																																																																																																																																																																																																																																																														
	0	SC1	In spindle control mode selection 1																																																																																																																																																																																																																																																																																													
	1	SC2	In spindle control mode selection 2																																																																																																																																																																																																																																																																																													
	2	SC3	In spindle control mode selection 3																																																																																																																																																																																																																																																																																													
	3	-	(For maintenance)																																																																																																																																																																																																																																																																																													
	4	GKC	In gear changeover command																																																																																																																																																																																																																																																																																													
	5	GR1	In gear selection 1																																																																																																																																																																																																																																																																																													
	6	GR2	In gear selection 2																																																																																																																																																																																																																																																																																													
	7	MPN	Magnetic pole position not set																																																																																																																																																																																																																																																																																													
	8	-	(For maintenance)																																																																																																																																																																																																																																																																																													
	9	-	(For maintenance)																																																																																																																																																																																																																																																																																													
	A	-	(For maintenance)																																																																																																																																																																																																																																																																																													
B	-	(For maintenance)																																																																																																																																																																																																																																																																																														
C	-	(For maintenance)																																																																																																																																																																																																																																																																																														
D	LCS	In L coil selection																																																																																																																																																																																																																																																																																														
E	-	(For maintenance)																																																																																																																																																																																																																																																																																														
F	-	(For maintenance)																																																																																																																																																																																																																																																																																														

bit0. In spindle control mode selection 1 (SC1)

bit1. In spindle control mode selection 2 (SC2)

bit2. In spindle control mode selection 3 (SC3)

These are the answer outputs for control mode selection command 1, 2, 3 (SC1, SC2, SC3).

bit4. In gear changeover command (GKC)

[1] This is an answerer output for the gear changeover command.

[2] The position feedback is generated from the speed encoder at GKC=1.

bit5. In gear selection 1 (GR1)

bit6. In gear selection 2 (GR2)

These are the answer outputs for gear selection command 1 and 2 (GR1 and GR2).

bit7. Magnetic pole position not set (MPN)

It indicates that the magnetic pole position of the motor is not established at MPN=1.

bitD. In L coil selection (LCS)

It indicates that L coil is being selected at LC=1.

(Note) The bits other than those above are used for maintenance.

(5) Spindle control output 5

Name	Details															
Spindle control output 5	F	E	D	C	B	A	9	8	7	6	5	4	3	2	1	0
	INP2	ORF	VG2	PY2	SD2				MKC						MD	CD
	bit	Details														
	0	CD	Current detection													
	1	MD	Speed detection													
	2	-	(For maintenance)													
	3	-	(For maintenance)													
	4	-	(For maintenance)													
	5	-	(For maintenance)													
	6	MKC	In coil changeover													
	7	-	(For maintenance)													
	8	-	(For maintenance)													
	9	SD2	2nd speed detection													
	A	-	(For maintenance)													
	B	PY2	In minimum excitation rate 2 selection													
	C	VG2	In speed gain set 2 selection													
	D	ORF	Zero point re-detection request													
E	-	(For maintenance)														
F	INP2	In 2nd in-position														

bit0. Current detection (CD)

It indicates that current command value is over 110% of the motor short time rating at CD=1.

bit1. Speed detection (MD)

- [1] When motor speed exceeds the speed set by parameter SP028 (SDTS) + SP029 (SDTR), SD=0 is set.
- [2] When motor speed becomes slower than the speed set by parameter SP028 (SDTS), SD=1 is set. SD signal is detected by the motor speed absolute value regardless of rotation direction.

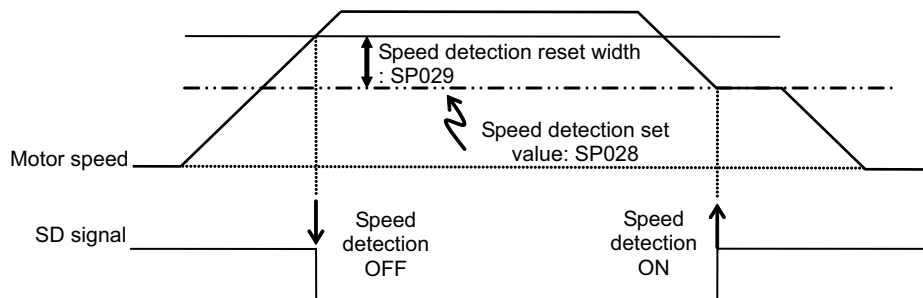

bit6. In coil changeover (MKC)

MKC=1 is set for the amount of time set by parameter SP114 (MKT) during coil changeover operation.

bit9. 2nd speed detection (SD2) (IPM spindle motor)

- [1] The status changes to SD2=0 when motor speed exceeds the speed set by parameter SP030 (SDT2) + SP029 (SDTR).
- [2] The status changes to SD2=1 when motor speed becomes slower than the speed set by parameter SP030 (SDT2).
- [3] It is used as M coil changeover speed. (IPM spindle motor only)

bitB. In minimum excitation rate 2 selection (PY2)

- [1] When PY2=1 is set, the minimum excitation rate 2 (SP015) is being selected.
- [2] When PY2=0 is set, the minimum excitation rate 1(SP014) is being selected.

bitC. In speed gain set 2 selection (VG2)

- [1] When VG2=1 is set, the gain parameter (SP008/SP009/SP010) used in the speed loop is being selected.
- [2] When VG2=0 is set, the gain parameter (SP005/SP006/SP007) used in the speed loop is being selected.

bitD. Zero point re-detection complete

If the zero point re-detection is completed after the zero point re-detection request (control input5/bitD) is set to 1, ORF=1 is set. If the zero point re-detection request is set to 0, ORF=0 is set.

bitF. In 2nd in-position (INP2)

The status changes to INP2=1 when position droop exists within the in-position area set by parameter SP025 (INP2) regardless of serve ON or OFF.

(Note) The bits other than those above are used for maintenance.

(6) Spindle control output 6

Name	Details																																																	
Spindle control output 6	<table border="1" style="width: 100%; text-align: center;"> <tr> <td>F</td><td>E</td><td>D</td><td>C</td><td>B</td><td>A</td><td>9</td><td>8</td><td>7</td><td>6</td><td>5</td><td>4</td><td>3</td><td>2</td><td>1</td><td>0</td> </tr> <tr> <td></td><td></td><td></td><td></td><td></td><td></td><td></td><td>DD1</td><td></td><td></td><td></td><td></td><td></td><td></td><td></td><td>OMRFF</td> </tr> </table>																F	E	D	C	B	A	9	8	7	6	5	4	3	2	1	0								DD1								OMRFF		
	F	E	D	C	B	A	9	8	7	6	5	4	3	2	1	0																																		
							DD1								OMRFF																																			
	<table border="1" style="width: 100%;"> <thead> <tr> <th style="text-align: left;">bit</th> <th style="text-align: left;">Details</th> </tr> </thead> <tbody> <tr> <td>0</td> <td>OMRFF In OMR-FF control</td> </tr> <tr> <td>1</td> <td>- (For maintenance)</td> </tr> <tr> <td>2</td> <td>- (For maintenance)</td> </tr> <tr> <td>3</td> <td>- (For maintenance)</td> </tr> <tr> <td>4</td> <td>- (For maintenance)</td> </tr> <tr> <td>5</td> <td>- (For maintenance)</td> </tr> <tr> <td>6</td> <td>- (For maintenance)</td> </tr> <tr> <td>7</td> <td>- (For maintenance)</td> </tr> <tr> <td>8</td> <td>DD1 In drivers communication control</td> </tr> <tr> <td>9</td> <td>- (For maintenance)</td> </tr> <tr> <td>A</td> <td>- (For maintenance)</td> </tr> <tr> <td>B</td> <td>- (For maintenance)</td> </tr> <tr> <td>C</td> <td>- (For maintenance)</td> </tr> <tr> <td>D</td> <td>- (For maintenance)</td> </tr> <tr> <td>E</td> <td>- (For maintenance)</td> </tr> <tr> <td>F</td> <td>- (For maintenance)</td> </tr> </tbody> </table>																bit	Details	0	OMRFF In OMR-FF control	1	- (For maintenance)	2	- (For maintenance)	3	- (For maintenance)	4	- (For maintenance)	5	- (For maintenance)	6	- (For maintenance)	7	- (For maintenance)	8	DD1 In drivers communication control	9	- (For maintenance)	A	- (For maintenance)	B	- (For maintenance)	C	- (For maintenance)	D	- (For maintenance)	E	- (For maintenance)	F	- (For maintenance)
bit	Details																																																	
0	OMRFF In OMR-FF control																																																	
1	- (For maintenance)																																																	
2	- (For maintenance)																																																	
3	- (For maintenance)																																																	
4	- (For maintenance)																																																	
5	- (For maintenance)																																																	
6	- (For maintenance)																																																	
7	- (For maintenance)																																																	
8	DD1 In drivers communication control																																																	
9	- (For maintenance)																																																	
A	- (For maintenance)																																																	
B	- (For maintenance)																																																	
C	- (For maintenance)																																																	
D	- (For maintenance)																																																	
E	- (For maintenance)																																																	
F	- (For maintenance)																																																	

bit0. In OMR-FF control (OMRFF)

OMRFF=1 (enabled) if OMR-FF control is enabled.

bit8. In drivers communication control (DD1)

DD1=1 (enabled) if high-speed synchronous tapping control is enabled.

(Note) The bits other than those above are used for maintenance.

7

Troubleshooting

7.1 Points of Caution and Confirmation

If an error occurs in the drive unit, the warning or alarm will occur. When a warning or alarm occurs, check the state while observing the following points, and inspect or remedy the unit according to the details given in this section.

< Points of confirmation >

- [1] What is the alarm code display?
- [2] Can the error or trouble be repeated? (Check alarm history)
- [3] Is the motor and servo drive unit temperature and ambient temperature normal?
- [4] Are the servo drive unit, control unit and motor grounded?
- [5] Was the unit accelerating, decelerating or running at a set speed? What was the speed?
- [6] Is there any difference during forward and backward run?
- [7] Was there a momentary power failure?
- [8] Did the trouble occur during a specific operation or command?
- [9] At what frequency does the trouble occur?
- [10] Is a load applied or removed?
- [11] Has the drive unit been replaced, parts replaced or emergency measures taken?
- [12] How many years has the unit been operating?
- [13] Is the power supply voltage normal? Does the state change greatly according to the time band?

CAUTION

1. This power supply unit uses a large capacity electrolytic capacitor. When the CHARGE lamp on the front of the power supply unit is lit, voltage is still present at the PN terminal (TE2). Do not touch the terminal block in this state.
2. Before replacing the unit, etc., always confirm that there is no voltage at the PN terminal (TE2) with a tester or wait at least 15 minutes after turning the main power OFF.
3. The conductivity in the unit cannot be checked.
4. Never carry out a megger test on the drive unit or power supply unit as the unit could be damaged.

POINT

When the drive unit of D2/DH2 Series which uses two cooling fans is in an emergency stop or alarm, one of fans (upper one in the case of vertical layout, or either one in the case of horizontal layout) is stopped and power-saving operation is performed. If the suspended fan is restarted by canceling the emergency stop, it is not a problem with the fan.

7.1.1 LED Display When Alarm or Warning Occurs

(1) Servo and spindle drive unit

The axis No. and alarm/warning No. alternate on the display. The display flickers when an alarm occurs.

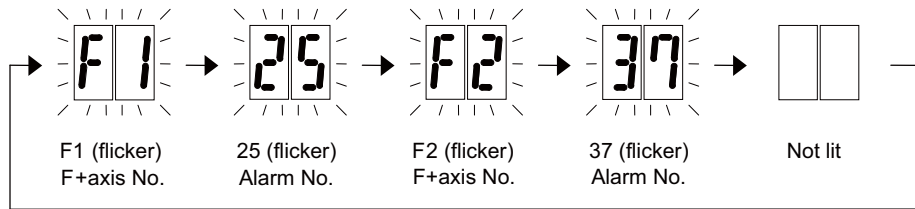

LED display during servo alarm or spindle alarm

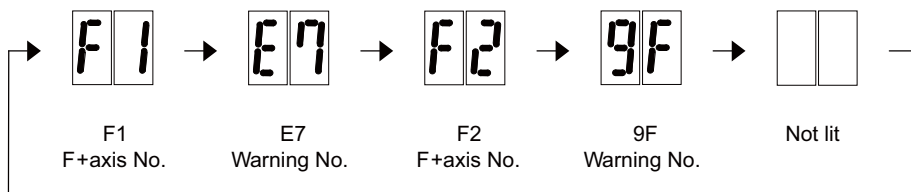

LED display during servo warning or spindle warning

Numbers displayed on LED

No.	0	1	2	3	4	5	6	7	8	9	A	B	C	D	E	F
LED display	0	1	2	3	4	5	6	7	8	9	A	b	C	d	E	F

(2) Power supply unit

The alarm/warning No. is alternately displayed by one digit. Refer to section "7.2.1 List of alarms" and "7.2.2 List of warnings" for details. The display flickers when an alarm or a warning occurs.

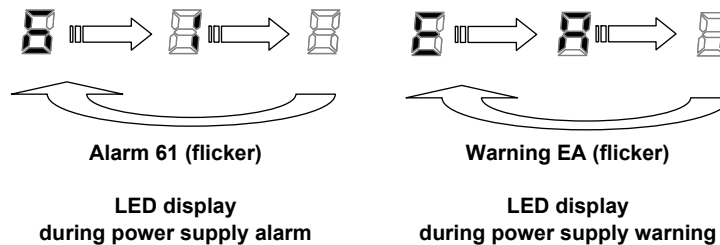

7.2 Protective Functions List of Units

7.2.1 List of Alarms

When an alarm occurs, the servo drive unit will make the motor stop by the deceleration control or dynamic brake. The spindle drive unit will coast to a stop or will decelerate to a stop. At the same time, the alarm No. will appear on the NC monitor screen and with the LEDs on the front of the drive unit. Check the alarm No., and remove the cause of the alarm by following this list.

(1) Drive unit alarm

No.	Name	Details	Reset method	Servo stop method	Spindle stop method
10	Insufficient voltage	A drop of bus voltage was detected in main circuit.	PR	Dynamic stop	Coast to a stop
11	Axis selection error	The axis selection rotary switch has been incorrectly set.	AR	Initial error	Initial error
12	Memory error 1	A hardware error was detected during the power ON self-check.	AR	Initial error	Initial error
13	Software processing error 1	An error was detected for the software execution state.	PR	Dynamic stop	Coast to a stop
14	Software processing error2	The current processor is not operating correctly.	AR	Dynamic stop	Coast to a stop
16	Initial magnetic pole position detection error	In the built-in motor which uses the absolute position encoder, the servo ON has been set before the magnetic pole shift amount is set. The magnetic pole position, detected in the initial magnetic pole position detection control, is not correctly set.	PR	Dynamic stop	Coast to a stop
17	A/D converter error	A current feedback error was detected.	PR	Dynamic stop	Coast to a stop
18	Main side encoder: Initial communication error	An error was detected in the initial communication with the motor side encoder.	PR	Initial error	Initial error
19	Encoder communication error in synchronous control	An error of the shared encoder on the machine side was detected on the secondary axis of the speed command synchronization control.	PR	Dynamic stop	-
1A	Sub side encoder: Initial communication error	An error was detected in the initial communication with the machine side encoder.	PR	Initial error	Initial error
1B	Sub side encoder: Error 1	An error was detected by the encoder connected to the machine side. The error details are different according to the encoder type. Refer to "Encoder alarm" for details.		Dynamic stop	Coast to a stop
1C	Sub side encoder: Error 2				
1D	Sub side encoder: Error 3				
1E	Sub side encoder: Error 4				
1F	Sub side encoder: Communication error	An error was detected in the communication with the machine side encoder.	PR	Dynamic stop	Coast to a stop
21	Sub side encoder no signal 2	In the machine side encoder, ABZ-phase feedback cannot be returned even when the motor moves.	PR	Dynamic stop	Coast to a stop
22	Encoder data error	An error was detected in the feedback data from the position encoder.	AR	Dynamic stop	Coast to a stop
23	Excessive speed error	The state that there is a difference between the actual speed and command speed continued for longer than the excessive speed deviation timer setting.	NR	-	Coast to a stop
24	Grounding	The motor power cable is in contact with FG (Frame Ground).	PR	Dynamic stop	Coast to a stop
25	Absolute position data lost	The absolute position data was lost in the encoder.	AR	Initial error	-
26	Unused axis error	In the multiaxis drive unit, there is an axis set to free, and the other axis detected a power module error.	PR	Dynamic stop	Coast to a stop
27	Sub side encoder: Error 5	An error was detected by the encoder connected to the machine side. The error details are different according to the encoder type. Refer to "Encoder alarm" for details.		Dynamic stop	Coast to a stop
28	Sub side encoder: Error 6				
29	Sub side encoder: Error 7				
2A	Sub side encoder: Error 8				
2B	Main side encoder: Error 1	An error was detected by the encoder connected to the motor side. The error details are different according to the encoder type. Refer to "Encoder alarm" for details.		Dynamic stop	Coast to a stop
2C	Main side encoder: Error 2				
2D	Main side encoder: Error 3				
2E	Main side encoder: Error 4				
2F	Main side encoder: Communication error	An error was detected in the communication with the motor side encoder.	PR	Dynamic stop	Coast to a stop
30	Over regeneration	Over-regeneration level exceeded 100%. The regenerative resistor is overloaded.	PR	Dynamic stop	Coast to a stop
31	Overspeed	The motor speed exceeded the allowable speed.	PR	Deceleration stop	Deceleration stop

(Note 1) Definitions of terms in the table are as follows.

Main side encoder: Encoder connected to CN2 Sub side encoder: Encoder connected to CN3

(Note 2) Resetting methods

NR: Reset with the NC RESET button. This alarm can also be reset with the PR and AR resetting conditions.

PR: Reset by turning the NC power ON again. This alarm can also be reset with the AR resetting conditions.

When the control axis is removed, this alarm can be reset with the NC RESET button. (Excluding alarms 32 and 37.)

AR: Reset by turning the NC and servo drive unit power ON again.

7 Troubleshooting

No.	Name	Details	Reset method	Servo stop method	Spindle stop method
32	Power module error (overcurrent)	The power module detected the overcurrent.	PR	Dynamic stop	Coast to a stop
33	Overvoltage	The bus voltage in main circuit exceeded the allowable value.	PR	Dynamic stop	Coast to a stop
34	NC communication: CRC error	The data received from the NC was outside the setting range.	PR	Deceleration stop	Deceleration stop
35	NC command error	The travel command data received from the NC was excessive.	PR	Deceleration stop	Deceleration stop
36	NC communication: Communication error	The communication with the NC was interrupted.	PR	Deceleration stop	Deceleration stop
37	Initial parameter error	An incorrect set value was detected among the parameters send from the NC at the power ON. In the SLS(Safely Limited Speed) function, an error was detected in the relation between the safety speed and safety rotation number in the speed observation mode.	PR	Initial error	Initial error
38	NC communication: Protocol error 1	An error was detected in the communication frames received from the NC. Or, removing an axis or changing an axis was performed in the synchronous control.	PR	Deceleration stop	Deceleration stop
39	NC communication: Protocol error 2	An error was detected in the axis data received from the NC. Or, in changing an axis, the parameter setting of the synchronous control was applied when the axis was installed.	PR	Deceleration stop	Deceleration stop
3A	Overcurrent	Excessive motor drive current was detected.	PR	Dynamic stop	Coast to a stop
3B	Power module error (overheat)	The power module detected an overheat.	PR	Dynamic stop	Coast to a stop
3C	Regeneration circuit error	An error was detected in the regenerative transistor or in the regenerative resistor.	PR	Dynamic stop	-
3D	Power supply voltage error at acceleration/deceleration	A motor control error during acceleration/deceleration, due to a power voltage failure, was detected.	PR	Dynamic stop	-
3E	Magnetic pole position detection error	The magnetic pole position, detected in the magnetic pole position detection control, is not correctly detected.	AR	Dynamic stop	Coast to a stop
41	Feedback error 3	Either a missed feedback pulse in the motor side encoder or an error in the Z-phase was detected in the full closed loop system.	PR	Dynamic stop	Coast to a stop
42	Feedback error 1	Either a missed feedback pulse in the position detection or an error in the Z-phase was detected. Or the distance-coded reference check error exceeded the allowable value when the distance-coded reference scale was used.	PR	Dynamic stop	Coast to a stop
43	Feedback error 2	An excessive difference in feedback was detected between the machine side encoder and the motor side encoder.	PR	Dynamic stop	Coast to a stop
45	Fan stop	An overheat of the power module was detected during the cooling fan stopping.	PR	Dynamic stop	Coast to a stop
46	Motor overheat / Thermal error	Either the motor or the motor side encoder detected an overheat. Or, the thermistor signal receiving circuit of the linear motor or direct-drive motor was disconnected. Or, the thermistor signal receiving circuit was short-circuited.	NR	Deceleration stop	Deceleration stop
48	Main side encoder: Error 5	An error was detected by the encoder connected to the main side. The error details are different according to the connected encoder. Refer to "Encoder alarm".		Dynamic stop	Coast to a stop
49	Main side encoder: Error 6				
4A	Main side encoder: Error 7				
4B	Main side encoder: Error 8				
4C	Current error at initial magnetic pole estimate	Current detection failed at the initial magnetic pole estimation.	NR	Dynamic stop	Coast to a stop
4D	Dual signal error	An error was detected in the signal related to the dual signal.	NR	Dynamic stop	Coast to a stop
4E	NC command mode error	An error was detected in the control mode send from the NC.	NR	Deceleration stop	Deceleration stop
4F	Instantaneous power interrupt	The control power supply has remained shut down.	NR	Deceleration stop	Deceleration stop
50	Overload 1	Overload detection level became 100% or more. The motor or the drive unit is overloaded.	NR	Deceleration stop	Deceleration stop
51	Overload 2	In a servo system, current command of 95% or more of the unit's max. current was given continuously for 1 second or longer. In a spindle system, current command of 95% or more of the motor's max. current was given continuously for 1 second or longer.	NR	Deceleration stop	Deceleration stop
52	Excessive error 1	A position tracking error during servo ON was excessive.	NR	Deceleration stop	Deceleration stop
53	Excessive error 2	A position tracking error during servo OFF was excessive.	NR	Dynamic stop	-

(Note 1) Definitions of terms in the table are as follows.

Main side encoder: Encoder connected to CN2 Sub side encoder: Encoder connected to CN3

(Note 2) Resetting methods

NR: Reset with the NC RESET button. This alarm can also be reset with the PR and AR resetting conditions.

PR: Reset by turning the NC power ON again. This alarm can also be reset with the AR resetting conditions.

When the control axis is removed, this alarm can be reset with the NC RESET button. (Excluding alarms 32 and 37.)

AR: Reset by turning the NC and servo drive unit power ON again.

7 Troubleshooting

No.	Name	Details	Reset method	Servo stop method	Spindle stop method
54	Excessive error 3	There was no motor current feedback when the alarm "Excessive error 1" was detected.	NR	Dynamic stop	Coast to a stop
56	Commanded speed error	In the C-axis control mode, excessive speed error was detected.	NR	Deceleration stop	Deceleration stop
58	Collision detection 1: G0	A disturbance torque exceeded the allowable value in rapid traverse modal (G0).	NR	Maximum capacity deceleration stop	-
59	Collision detection 1: G1	A disturbance torque exceeded the allowable value in the cutting feed modal (G1).	NR	Maximum capacity deceleration stop	-
5A	Collision detection 2	A current command with the maximum drive unit current value was detected.	NR	Maximum capacity deceleration stop	-
5B	Safely limited: Commanded speed monitoring error	A commanded speed exceeding the safely limited speed was detected in the safely limited mode.	PR	Deceleration stop	Deceleration stop
5D	Safely limited: Door state error	The door state signal input in the NC does not coincide with the door state signal input in the drive unit in the safely limited mode. Otherwise, door open state was detected in normal mode.	PR	Deceleration stop	Deceleration stop
5E	Safely limited: Speed feedback monitoring error	A motor speed exceeding the safely limited speed was detected in the safely limited mode.	PR	Deceleration stop	Deceleration stop
5F	External contactor error	A contact of the external contactor is welding.	NR	Deceleration stop	Deceleration stop
60 to 77	Power supply alarm	The power supply unit detected an error. The error details are different according to the connected power supply unit. Refer to "Power supply alarm" for details.		Dynamic stop	Coast to a stop
80	Main side encoder cable error	The cable type of the motor side encoder cable is for rectangular wave signal.	AR	Initial error	-
81	Sub side encoder cable error	The cable type of the machine side encoder cable does not coincide with the encoder type which is set by the parameter.	AR	Initial error	-
87	Drivers communication error	The communication frame between drive units was aborted.	PR	Dynamic stop	Coast to a stop
88	Watchdog	The drive unit does not operate correctly. LED display is fixed as "88".	AR	Dynamic stop	Coast to a stop
8A	Drivers communication data error 1	The communication data 1 between drivers exceeded the tolerable value in the communication between drive units.	PR	Dynamic stop	Coast to a stop
8B	Drivers communication data error 2	The communication data 2 between drivers exceeded the tolerable value in the communication between drive units.	PR	Dynamic stop	Coast to a stop

(Note 1) Definitions of terms in the table are as follows.

Main side encoder: Encoder connected to CN2 Sub side encoder: Encoder connected to CN3

(Note 2) Resetting methods

NR: Reset with the NC RESET button. This alarm can also be reset with the PR and AR resetting conditions.

PR: Reset by turning the NC power ON again. This alarm can also be reset with the AR resetting conditions.

When the control axis is removed, this alarm can be reset with the NC RESET button. (Excluding alarms 32 and 37.)

AR: Reset by turning the NC and servo drive unit power ON again.

Encoder alarm (Servo drive unit)

Alarm number when the encoder is connected to CN2 side		2B	2C	2D	2E	48	49	4A	4B
Alarm number when the encoder is connected to CN3 side		1B	1C	1D	1E	27	28	29	2A
OSA105, OSA105ET2A OSA166, OSA166ET2NA OSA18 MDS-B-HR MBA405W	Mitsubishi Electric	Memory alarm	LED alarm	Data alarm	-	-	-	-	-
		CPU alarm	-	Data alarm	-	-	-	-	-
		Memory error	-	Data error	-	Scale not connected	-	-	-
		CPU error	Waveform error	Data error	-	-	-	-	Count error
AT343 AT543 AT545 ST748	Mitsutoyo	Initialization error (bit0)	EEPROM error (bit5)	Photoelectric type, static capacity type data mismatch (bit1)	ROM/RAM error (bit6)	CPU error (bit4)	Photoelectric type overspeed (bit7)	Static capacity type error (bit3)	Photoelectric type error (bit2)
LC193M, LC493M, LC195M, LC495M, LC291M, RCN223M, RCN227M, RCN727M, RCN827M EIB Series	HEIDENHAIN	Initialization error (bit0)	EEPROM error (bit5)	Relative/absolute position data mismatch (bit1)	ROM/RAM error (bit6)	CPU error (bit4)	Overspeed (bit7)	Absolute position data error (bit3)	Relative position data error (bit2)
MPRZ scale	NIDEC MACHINE TOOL	Installation accuracy fault (bit4)	-	Detection position deviance (bit1)	Scale breaking (bit0)	Absolute position detection fault (bit5)	-	Gain fault (bit3)	Phase fault (bit2)
SR75, SR85 SR77, SR87 RU77	Magnescale	Laser diode error (bit0)	System memory error (bit5)	Encoder mismatch error (bit1)	-	-	Over speed (bit7)	Absolute position data error (bit3)	Relative position data error (bit2)
SAM/SVAM/ GAM/LAM/HAM Series	FAGOR	-	-	Absolute value detection error (bit3)	H/W error (bit1)	CPU error (bit0)	-	-	-
RL40N/RA Series	Renishaw	Initialization error (bit0)	-	Absolute position data error (bit3)	-	-	Over speed (bit7)	-	-
WMF/WMBA/ WMRA LMFA/LMBA Series	AMO	Initialization error (bit0)	-	Absolute value detection error (bit2)	-	-	Over speed (bit5)	Absolute position data error (bit6)	-

(Note 1) A drive unit processes all reset types of alarms as "PR". However, "AR" will be applied according to the encoder.

(Note 2) Bit No. in the table refers to a bit assignment for encoder side alarm management data.

Encoder alarm (Spindle drive unit)

Alarm number when the encoder is connected to CN2 side		2B	2C	2D	2E	48	49	4A	4B
Alarm number when the encoder is connected to CN3 side		1B	1C	1D	1E	27	28	29	2A
TS5690 TS5691	Mitsubishi Electric	Memory error	Waveform error	-	-	-	Overspeed	-	Relative position data error
MDS-B-HR		Initialization error	-	Data error	-	Connection error	-	-	-
OSA18		CPU error	-	Data error	-	-	-	-	-
MBE405W		CPU error	Waveform error	Data error	-	-	-	-	Count error
EIB Series	HEIDENHAIN	Initialization error (bit0)	EEPROM error (bit5)	-	-	CPU error (bit4)	Overspeed (bit7)	-	Relative position data error (bit2)
MPCI scale	NIDEC MACHINE TOOL	Installation accuracy fault (bit4)	-	Detection position deviance (bit1)	Scale breaking (bit0)	-	-	Gain fault (bit3)	Phase fault (bit2)

(Note 1) A drive unit processes all reset types of alarms as "PR". However, "AR" will be applied according to the encoder.

(Note 2) Bit No. in the table refers to a bit assignment for encoder side alarm management data.

(2) Power supply alarm

No.	Name	Details	Reset method
61	Power supply: Power module overcurrent	Overcurrent protection function in the power module has started its operation.	PR
62	Power supply: Frequency error	The input power supply frequency increased above the specification range.	PR
66	Power supply: Process error	An error occurred in the process cycle.	PR
67	Power supply: Phase interruption	An open-phase condition was detected in input power supply circuit.	PR
68	Power supply: Watchdog	The system does not operate correctly. LED display is fixed as "8".	AR
69	Power supply: Grounding	The motor power cable is in contact with FG (Frame Ground).	PR
6A	Power supply: External contactor welding	A contact of the external contactor is welding.	PR
6B	Power supply: Rush circuit error	An error was detected in the rush circuit.	PR
6C	Power supply: Main circuit error	An error was detected in charging operation of the main circuit capacitor.	PR
6D	Parameter setting error	An error was detected in the parameter sent from the drive unit.	PR
6E	Power supply: H/W error	An error was detected in the internal memory.	AR
	A/D error	An error was detected in the A/D converter.	
	Unit ID error	An error was detected in the unit identification.	
6F	Power supply error	No power supply is connected to the drive unit, or a communication error was detected.	AR (Note 4)
70	Power supply: External emergency stop error	A mismatch of the external emergency stop input and NC emergency stop input continued for 30 seconds.	PR
71	Power supply: Instantaneous power interruption	The power was momentarily interrupted.	NR
72	Power supply: Fan stop	A cooling fan built in the power supply unit stopped, and overheat occurred in the power module.	PR
73	Power supply: Over regeneration	Over-regeneration detection level became over 100%. The regenerative resistor is overloaded. This alarm cannot be reset for 15 min from the occurrence to protect the regeneration resistor. Leave the drive system energized for more than 15 min, then turn the power ON to reset the alarm.	NR
74	Power supply: Option unit error	An alarm was detected in the power backup unit (power supply option unit).	NR (Note 3)
75	Power supply: Overvoltage	L+ and L- bus voltage in main circuit exceeded the allowable value. As the voltage between L+ and L- is high immediately after this alarm, another alarm may occur if this alarm is reset in a short time. Wait more than 5 min before resetting so that the voltage drops.	NR
76	Power supply: Function setting error	The rotary switch setting of external emergency stop is not correct, or a wrong external emergency stop signal is input.	AR
	Power supply: Function selection error	Undefined area for the rotary switch is selected	
77	Power supply: Power module overheat	Thermal protection function in the power module has started its operation.	PR

(Note 1) If a power supply alarm (60 to 77) occurs, all servos will stop with the dynamic brakes, and all spindles will coast to a stop.

(Note 2) "b", "C" and "d" displayed on the power supply unit's LED as a solid light (not flickering) do not indicate an alarm.

(Note 3) Check the LED display of the power backup unit to identify what alarm is occurring to the power backup unit.

**Refer to "9.4.2 List of Power Backup Function Alarms".

(Note 4) When the power supply alarm (6F) is detected in the 2nd part system, the reset method differs depending on the detected power supply alarm.

7.2.2 List of Warnings

When a warning occurs, a warning No. will appear on the NC monitor screen and with the LEDs on the front of the drive unit. Check the warning No., and remove the cause of the warning by following this list.

(1) Drive unit warning

No.	Name	Details	Reset method	Stop method
96	Scale feedback error	An excessive difference in feedback amount was detected between the main side encoder and the MPI scale in MPI scale absolute position detection system.	*	-
97	Scale offset error	An error was detected in the offset data that is read at the NC power-ON in MPI scale absolute position detection system.	PR	-
9B	Incremental encoder/ magnetic pole shift warning	The difference between the magnetic pole position after the phase Z has been passed (magnetic pole shift amount:SV028) and the initially detected position is excessive in the built-in motor's incremental control system.The magnetic pole is controlled by the initial detection value.	*	-
9E	Absolute position encoder: Revolution counter error	An error was detected in the revolution counter data of the absolute position encoder. The accuracy of absolute position is not guaranteed.	*	-
9F	Battery voltage drop	The battery voltage to be supplied to the absolute position encoder is dropping.	NR (Note 5)	-
A3	In initial setup of ABS position	This warning is detected until the axis reaches the reference position during the initial setup of the distance-coded reference check function. This warning turns OFF after the axis has reached the position, thus set the value displayed on the drive monitor to the parameter. This warning is detected during the initial setup of MBA405W. This warning turns OFF after the initial setup is completed by having the axis pass the Z-phase of MBA405W and turning the NC power ON again.	PR	-
A4	Dual signal warning	An input was detected in the signal related to the dual signal.	*	-
A6	Fan stop warning	A cooling fan in the drive unit stopped.	*	-
E0	Overregeneration warning	Over-regeneration detection level exceeded 80%.	*	-
E1	Overload warning	A level of 80% of the Overload 1 alarm state was detected.	*	-
E4	Parameter warning	An incorrect set value was detected among the parameters send from the NC in the normal operation.	*	-
E6	Control axis detachment warning	A control axis is being detached. (State display)	*	-
E7	NC emergency stop	In NC emergency stop. (State display)	*	Deceleration stop enabled
E8 to EF	Power supply warning	The power supply unit detected a warning. The error details are different according to the connected power supply unit. Refer to "Power supply warning".	*	- *EA: Deceleration stop enabled

(Note1) Definitions of terms in the table are as follows.

Main side encoder: Encoder connected to CN2 Sub side encoder: Encoder connected to CN3

(Note 2)Resetting methods

* : Automatically reset once the cause of the warning is removed.

NR: Reset with the NC RESET button. This warning can also be reset with the PR and AR resetting conditions.

PR: Reset by turning the NC power ON again. This warning can also be reset with the AR resetting conditions.

When the control axis is removed, this warning can be reset with the NC RESET button. (Excluding warning 93.)

AR: Reset by turning the NC and servo drive unit power ON again.

(Note 3)Servo and spindle motor do not stop when the warning occurs.

(Note 4)When an emergency stop is input, servo and spindle motor decelerate to a stop.

(When SV048, SV055 or SV056 is set for servo and when SP055 or SP056 is set for spindle.)

(Note 5)When using MDS-BTBOX-36, the reset method is AR.

(2) Power supply warning

No.	Name	Details	Reset method
E9	Instantaneous power interruption warning	The power was momentarily interrupted.	NR
EA	In external emergency stop state	External emergency stop signal was input.	*
EB	Power supply: Over regeneration warning	Over-regeneration detection level exceeded 80%.	*
EE	Power supply: Fan stop warning	A cooling fan built in the power supply unit stopped.	*
EF	Power supply: Option unit warning	A warning was detected in the power backup unit (power supply option unit).	*(Note 3)

(Note 1)Resetting methods

* : Automatically reset once the cause of the warning is removed.

NR: Reset with the NC RESET button. This warning can also be reset with the PR and AR resetting conditions.

PR: Reset by turning the NC power ON again. This warning can also be reset with the AR resetting conditions.

When the control axis is removed, this warning can be reset with the NC RESET button. (Excluding warning 93.)

AR: Reset by turning the NC and servo drive unit power ON again.

(Note 2)Servo and spindle motor do not stop when the warning occurs.

(Note 3)Check the LED display of the power backup unit to identify what warning is occurring to the power backup unit.

**Refer to "9.4.3 List of Power Backup Function Warnings".

7.3 Troubleshooting

Follow this section to troubleshoot the alarms that occur during start up or while the machine is operating. If the state is not improved with the following investigations, the drive unit may be faulty. Exchange the unit with another unit of the same capacity, and check whether the state is improved.

7.3.1 Troubleshooting at Power ON

If the NC system does not start up correctly and a system error occurs when the NC power is turned ON, the drive unit may not have been started up properly. Check the LED display on the drive unit, and take measures according to this section.

LED display	Symptom	Cause of occurrence	Investigation method	Remedy
AA	Initial communication with the CNC was not completed correctly.	The drive unit axis No. setting is incorrect.	Is there any other drive unit that has the same axis No. set?	Set correctly.
		The CNC setting is incorrect.	Is the No. of CNC controlled axes correct?	Set correctly.
		Communication with CNC is incorrect.	Is the connector (CN1A, CN1B) connected? Is the cable broken?	Connect correctly. Replace the cable.
Ab	Initial communication with the CNC was not carried out.	The axis is not used, the setting is for use inhibiting.	Is the DIP switch set correctly?	Set correctly.
		Communication with CNC is incorrect.	Is the connector (CN1A, CN1B) connected?	Connect correctly.
			Is the cable broken?	Replace the cable.
12	An error was detected in the unit's memory and IC during the self-diagnosis at power ON.	The CPU peripheral circuit is abnormal.	Check the repeatability. Check whether there is any abnormality with the unit's surrounding environment, etc.	Replace the unit. Improve the surrounding environment.

The drive unit has started up normally if the following type of emergency stop (E7) is displayed on the display unit's LED display.

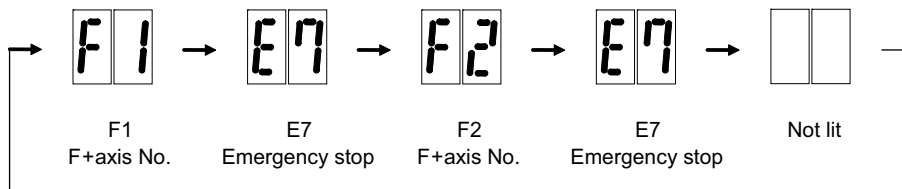

Normal drive unit LED display at NC power ON (for 1st axis)

7.3.2 Troubleshooting for Each Alarm No.

Alarm No. 10		Insufficient voltage			
		Insufficient bus voltage was detected in main circuit.			
	Investigation details	Investigation results	Remedies	SV	SP
1	Check the timing when the alarm occurs.	The moment of READY ON	Check the investigation item No. 2.	○	○
		During operation	Increase the power supply capacity (KVA).		
2	Did the external contactor turn ON at the READY ON?	The external contactor did not turn ON.	Check the investigation item No. 3.	○	○
		The external contactor turned ON, but the alarm occurred immediately.	Check the investigation item No. 4.		
3	Check the wiring of contactor excitation circuit.	The wiring is correct.	Replace the contactor.	○	○
		The wiring is not correct.	Rewire.		
4	Check the input voltage of the drive unit by a tester. (Voltage between L1 and L2, L2 and L3, L1 and L3)	The input voltage is normal.	Replace the drive unit.	○	○
		The input voltage is abnormal.	Increase the power supply capacity (KVA).		
		The measured voltage fluctuates.	Replace the power supply.		

Alarm No. 11		Axis selection error			
		The axis selection rotary switch is incorrectly set.			
	Investigation details	Investigation results	Remedies	SV	SP
1	Check the setting of the axis selection switch (rotary switch) on the top of the unit.	The same axis No. is set for the L and M axes.	Correctly set the axis No. 0 = No. 1 axis, 1 = No. 2 axis, ...	○	○
		The value is duplicated with other axis.	Correctly set the axis No. 0 = No. 1 axis, 1 = No. 2 axis, ...		
		The axis No. is correctly set.	Replace the drive unit.		

Alarm No. 12		Memory error 1			
		Hardware error (a CPU or an internal memory error was detected during the power ON self-check).			
	Investigation details	Investigation results	Remedies	SV	SP
1	Check the repeatability.	The error is always repeated.	Replace the drive unit.	○	○
		The state returns to normal once, but occurs sometimes thereafter.	Check the investigation item No. 2.		
2	Check if there is any abnormality in the unit's ambient environment. (Ex. Ambient temperature, noise, grounding)	Take remedies according to the causes of the abnormality in the ambient environment.		○	○

Alarm No. 13		Software processing error 1			
		An error was detected in the software execution state. Software processing has not finished within the specified time.			
	Investigation details	Investigation results	Remedies	SV	SP
1	Check the repeatability.	The error is always repeated.	Replace the drive unit.	○	○
		The state returns to normal once, but occurs sometimes thereafter.	Check the investigation item No. 2.		
2	Check if there is any abnormality in the unit's ambient environment. (Ex. Ambient temperature, noise, grounding)	Take remedies according to the causes of the abnormality in the ambient environment. [1] Machine grounding check		○	○

Alarm No. 14		Software processing error 2			
		The current processor is not operating correctly.			
	Investigation details	Investigation results	Remedies	SV	SP
1	Check the repeatability.	The error is always repeated.	Replace the drive unit.	○	○
		The state returns to normal once, but occurs sometimes thereafter.	Check the investigation item No. 2.		
2	Check if there is any abnormality in the unit's ambient environment. (Ex. Ambient temperature, noise, grounding)	Take remedies according to the causes of the abnormality in the ambient environment.		○	○

7 Troubleshooting

Alarm No. 16		Initial magnetic pole position detection error			
		In linear motor or IPM spindle motor using absolute position encoder, the servo ON has been set before the magnetic pole shift amount(servo:SV028,spindle:SP118) is set. In the initial magnetic pole position detection control, the pole position was not correctly set.			
	Investigation details	Investigation results	Remedies	SV	SP
1	Check the parameters, SV028 (for the servo) and SP118(for the spindle).	The parameters have not been set.	Set the magnetic shift pole amount(SP118).	○	○
		The parameters have been set, but the alarm occurs.	Carry out the magnetic pole estimation again, as the setting value is wrong.		
2	Check the repeatability.	The setting parameter value is the same even when initial magnetic pole function was executed again.	Check the investigation item No. 2.	○	○
		The error is always repeated.	Replace the drive unit.		
3	Check if there is any abnormality in the unit's ambient environment. (Ex. Ambient temperature, noise, grounding)	The state returns to normal once, but occurs sometimes thereafter.	Check the investigation item No. 3.	○	○
		Take remedies according to the causes of the abnormality in the ambient environment. [1] Machine grounding check [2] Shield connection of the cable			

Alarm No. 17		A/D converter error			
		An error was detected in the current FB.			
	Investigation details	Investigation results	Remedies	SV	SP
1	Check the repeatability.	The error is always repeated.	Replace the drive unit.	○	○
		The state returns to normal, but occurs thereafter.	Check the investigation item No. 2.		
2	Check if there is any abnormality in the unit's ambient environment. (Ex. Ambient temperature, noise, grounding)	Take remedies according to the causes of the abnormality in the ambient environment.		○	○

Alarm No. 18		Main side encoder: Initial communication error			
		An error was detected in the initial communication with the motor side encoder.			
	Investigation details	Investigation results	Remedies	SV	SP
1	Check the encoder. Check if a pulse encoder is used for serial encoder specifications.	The pulse encoder is used.	Replace the encoder to the serial.	○	○
		The serial encoder is used.	Check the investigation item No. 3.		
2	Jiggle the encoder connectors (drive unit side and encoder side) and check if they are disconnected.	The connector is disconnected (or loose).	Correctly install.	○	○
		The connector is not disconnected.	Check the investigation item No. 4.		
3	Turn the power OFF, and check the encoder cable connection with a tester.	The connection is faulty.	Replace the encoder cable.	○	○
		The connection is normal.	Check the investigation item No. 5.		
4	Replace with another unit, and check whether the fault is on the unit side or encoder side.	The alarm is on the drive unit side.	Replace the drive unit.	○	○
		The alarm is on the encoder side.	Check the investigation item No. 6.		
5	Check if there is any abnormality in the encoder's ambient environment. (Ex. Ambient temperature, noise, grounding)	Take remedies according to the causes of the abnormality in the ambient environment. [1] Machine grounding check [2] Shield connection of the cable		○	○

Alarm No. 19		Encoder communication error in synchronous control:			
		An error was detected in the machine side encoder of the secondary axis at the speed command synchronization control.			
	Investigation details	Investigation results	Remedies	SV	SP
1	Check the servo parameter value of secondary axis (SV025.pen:position encoder).	The value is not set correctly.	Correctly set.	○	
		The value is set correctly.	Check the investigation item No. 2.		
2	Check if there are no problems in the connection between the encoder (linear scale) and MDS-B-HR.	The screw connected to MDS-B-HR is winded down.	Tighten up the screw.	○	
		No problems found in the connector connection.	Check the investigation item No. 3.		
3	Jiggle the encoder connectors (drive unit side and encoder side) and check if they are disconnected.	The connector is disconnected (or loose).	Correctly install.	○	
		The connector is not disconnected.	Check the investigation item No. 3.		
4	Turn the power OFF, and check the encoder cable connection with a tester.	The connection is faulty.	Replace the encoder cable.	○	
		The connection is normal.	Check the investigation item No. 4.		
5	Replace with another unit, and check whether the fault is on the unit side or encoder side.	The alarm is on the drive unit side.	Replace the drive unit.	○	
		The alarm is on the encoder side.	Check the investigation item No. 5.		
6	Check if there is any abnormality in the encoder's ambient environment. (Ex. Ambient temperature, noise, grounding)	Take remedies according to the causes of the abnormality in the ambient environment. [1] Machine grounding check [2] Shield connection of the cable		○	

7 Troubleshooting

Alarm No. 1A		Sub side encoder: Initial communication error			
		Initial communication with the machine side encoder failed.			
	Investigation details	Investigation results	Remedies	SV	SP
1	Check the servo parameter (SV025.pen:position encoder) setting value. Check the spindle parameter(SP019) setting value. Are the serial communication type encoder parameters set for the pulse type encoder?	The value is not set correctly.	Correctly set SV025.	○	○
		The value is set correctly.	Check the investigation item No. 2.		
2	Check the encoder. Check if the pulse encoder is used for the encoder specified to be serial.	The pulse encoder is used.	Replace the encoder.	○	○
		The serial encoder is used.	Check the investigation item No. 3.		
3	Jiggle the encoder connectors (drive unit side and encoder side) and check if they are disconnected.	The connector is disconnected (or loose).	Correctly install.	○	
		The connector is not disconnected.	Check the investigation item No. 4.		
4	Turn the power OFF, and check the encoder cable connection with a tester.	The connection is faulty.	Replace the encoder cable.	○	
		The connection is normal.	Check the investigation item No. 5.		
5	Replace with another unit, and check whether the fault is on the unit side or encoder side.	The alarm is on the drive unit side.	Replace the drive unit.	○	
		The alarm is on the encoder side.	Check the investigation item No. 6.		
6	Check if there is any abnormality in the encoder's ambient environment. (Ex. Ambient temperature, noise, grounding)	Take remedies according to the causes of the abnormality in the ambient environment.		○	

Alarm No. 1B		Sub side encoder: Error 1			
		The machine side encoder (CN3 side) detected an error. As details differ for each encoder, refer to section "Encoder alarm".			
	Investigation details	Investigation results	Remedies	SV	SP
1	Check whether the servo axis has moved and the spindle has rotated when an alarm occurred.	The axis has operated.	Check the investigation item No. 3.	○	○
		The axis has not operated.	Check the investigation item No. 2.		
2	Check whether the operation at low speed is normal.	The operation is normal.	Check the investigation item No. 3.	○	○
		The operation is not normal.	Check the cautions at power ON. [1] Wiring check [2] Parameter check		
3	Jiggle the encoder connectors (drive unit side and encoder side) and check if they are disconnected.	The connector is disconnected (or loose).	Correctly install.	○	○
		The connector is not disconnected.	Check the investigation item No. 4.		
4	Turn the power OFF, and check the encoder cable connection with a tester.	The connection is faulty.	Replace the encoder cable.	○	○
		The connection is normal.	Check the investigation item No. 5.		
5	Replace with another unit, and check whether the fault is on the unit side or encoder side.	The alarm is on the drive unit side.	Replace the drive unit.	○	○
		The alarm is on the encoder side.	Check the investigation item No. 6.		
6	Check if there is any abnormality in the encoder's ambient environment. (Ex. Ambient temperature, noise, grounding)	Take remedies according to the causes of the abnormality in the ambient environment.		○	○

Alarm No. 1C		Sub side encoder: Error 2			
		The machine side encoder (CN3 side) detected an error. As details differ for each encoder, refer to section "Encoder alarm".			
	Investigation details	Investigation results	Remedies	SV	SP
1	Check the alarm No. "1B" items.			○	

Alarm No. 1D		Sub side encoder: Error 3			
		The machine side encoder (CN3 side) detected an error. As details differ for each encoder, refer to section "Encoder alarm".			
	Investigation details	Investigation results	Remedies	SV	SP
1	Check the alarm No. "1B" items.			○	

Alarm No. 1E		Sub side encoder: Error 4			
		The machine side encoder (CN3 side) detected an error. As details differ for each encoder, refer to section "Encoder alarm".			
	Investigation details	Investigation results	Remedies	SV	SP
1	Check the alarm No. "1B" items.			○	

7 Troubleshooting

Alarm No. 1F		Sub side encoder: Communication error			
		An error was detected in communication data with the linear scale or the ball screw side encoder. Or the communication was interrupted.			
	Investigation details	Investigation results	Remedies	SV	SP
1	Jiggle the encoder connectors (drive unit side and encoder side) and check if they are disconnected.	The connector is disconnected (or loose).	Correctly install.	○	
		The connector is not disconnected.	Check the investigation item No. 2.		
2	Is the encoder cable wired in the same conduit as the motor's power cable, or are the two cables laid in parallel near each other?	The cables are wired near each other. (Noise is entering from the power cable.)	Wire the encoder cable away from the power cable. Shield the power cable.	○	
		The wires are sufficiently separated.	Check the investigation item No. 3.		
3	Is the motor FG wire connected only to the drive unit which drives it? (Is the motor grounded to one point?)	The motor FG wire is grounded on the motor side.	Ground the motor to one point, connecting the wires together on the drive unit side.	○	
		The motor is grounded to one point.	Check the investigation item No. 4.		
4	Turn the power OFF, and check the encoder cable connection with a tester. (Is the cable shielded?)	The connection is faulty.	Replace the encoder cable.	○	
		The connection is normal.	Check the investigation item No. 5.		
5	Replace with another unit, and check whether the fault is on the unit side or encoder side.	The alarm is on the drive unit side.	Replace the drive unit.	○	
		The alarm is on the encoder side.	Check the investigation item No. 6.		
6	Check if there is any abnormality in the encoder's ambient environment. (Ex. Ambient temperature, noise, grounding)	Take remedies according to the causes of the abnormality in the ambient environment.		○	

Alarm No. 21		Sub side encoder: No signal2			
		When an excessive error alarm occurred, no signal from the machine side encoder was detected. An error was detected in the ABZ-phase in the full closed loop control system.			
	Investigation details	Investigation results	Remedies	SV	SP
1	Check the servo parameter (SV025: pen: machine side encoder), and spindle parameter (SP019) setting value. Are the pulse type encoder parameters set for a serial communication type encoder?	The value is not set correctly.	Correctly set SV025:pen for the servo and SP019 for the spindle (including SP097 for pulse type).	○	○
		The value is set correctly.	Check the investigation item No. 3.		
2	Jiggle the encoder connectors (drive unit side and encoder side) and check if they are disconnected.	The connector is disconnected (or loose).	Correctly install.	○	○
		The connector is not disconnected.	Check the investigation item No. 4.		
3	Turn the power OFF, and check the encoder cable connection with a tester.	The connection is faulty.	Replace the encoder cable.	○	○
		The connection is normal.	Check the investigation item No. 5.		
4	Replace with another unit, and check whether the fault is on the unit side or encoder side.	The alarm is on the drive unit side.	Replace the drive unit.	○	○
		The alarm is on the encoder side.	Replace the encoder.		
5	Check if there is any abnormality in the encoder's ambient environment. (Ex. Ambient temperature, noise, grounding)	Take remedies according to the causes of the abnormality in the ambient environment.		○	○

Alarm No. 22		Encoder data error:			
		Drive unit received a wrong feedback data (scattered data) from the encoder and position deviation occurred.			
	Investigation details	Investigation results	Remedies	SV	SP
1	Check if the installation of the encoder is loosened.	It is loosened.	Tightly install the encoder.	○	
		It is not loosened.	Check the investigation item No. 2.		
2	Check if an excessive vibration is occurring during machining.	An excessive vibration is occurring.	Check the installation of the machine.	○	
		An excessive vibration is not occurring.	Check the investigation item No. 3.		
3	Check if there is any liquid ingress inside the encoder connector.	Liquid was entered into the connector.	Replace the motor encoder.	○	○
		No liquid ingress.	Check the investigation item No. 4.		
4	Check the investigation item No.2 or subsequent items in Alarm No.21.			○	

7 Troubleshooting

Alarm No. 23		Excessive speed error			
		A difference between the speed command and speed feedback was continuously exceeding 50 r/min for longer than the setting time.			
	Investigation details	Investigation results	Remedies	SV	SP
1	Check the U, V and W wiring connected to the spindle drive unit.	The wires are not correctly connected. The wires are correctly connected.	Correctly connect. Check the investigation item No. 2.		○
2	Check the spindle parameter SP020, SP026, SP027, from SP057 to SP064 and spindle specification parameters from slimit1 to slimit4 setting value.	The correct values are not set. The correct values are set.	Correctly set. Check the investigation item No. 3.		○
3	Measure the acceleration/ deceleration time from 0 to the point where the spindle speed reaches its maximum. If the alarm occurs when forward run is changed to reverse run, measure the acceleration/ deceleration time from the forward to reverse. Also measure it from the reverse to forward.	12sec or more. (SP117 setting value or more.) Less than 12sec.	Increase the spindle acceleration/ deceleration time constant setting value(sp_t1 to sp_t4). Reduce the load inertia. Check the investigation item No. 4.		○
4	Check the load amount when the alarm occurred during cutting.	The speed deterioration due to load amount has exceeded the tolerable range which is determined by the parameter SP096. -If SP096 is set to 0, it is regarded as 85%. Thus a speed of 85% of the machining speed or faster will be the tolerable speed. The load amount is within the SP096 setting value.	Reduce the cutting load to mitigate the speed deterioration. Replace the tool. Check the investigation item No. 5.		○
5	Check the fluctuation of the input voltage into the power supply unit with a tester.	Voltage drop during acceleration is 200V or less Voltage drop during acceleration is 200V or more	Review the power supply capacity. Check the investigation item No.6.		○
6	Check the capacity of the drive unit.	The capacity does not satisfy the motor output. The capacity satisfies the motor output.	Change the capacity to the selected one. Replace the unit.		○

Alarm No. 24		Grounding			
		The motor power cable is in contact with FG (Frame Ground).			
	Investigation details	Investigation results	Remedies	SV	SP
1	Measure the insulation across the power cables (U,V,W) for connected motors and the ground. (Carry out a megger test.) (Note) When the insulation is measured, disconnect wires from the drive unit.	Less than 1MΩ. (Grounding) 1MΩ or more. (Normal)	The motor or power cable may be ground faulted. Check the investigation item No. 2.	○	○
2	Has oil come in contact with the motor or power cable?	Oil has come in contact. Oil has not come in contact.	Take measures so that oil does not come in contact. Check the motor's cannon connector and the inside of the terminal box, and clean as necessary. Check the investigation item No. 3.	○	○
3	Measure the insulation again.	Less than 1MΩ. 1MΩ or more.	Replace the motor or cable. Check the investigation item No. 4.	○	○
4	Measure the resistance across the U, V, W phase terminals of the servo/spindle drive unit and the ground with a tester. (Note) Do not measure the insulation as the unit is damaged.	Less than 100kΩ. 100kΩ or more.	Replace the drive unit. Replace the power supply unit.	○	○

Alarm No. 25		Absolute position data lost			
		The absolute position was lost, as the backup battery voltage dropped in the absolute position encoder.			
	Investigation details	Investigation results	Remedies	SV	SP
1	Is warning 9F occurring at the same time?	The warning is occurring. The warning is not occurring.	Check the investigation item No. 2. Check the investigation item No. 3.	○	
2	Measure the battery voltage with a tester at the DC range.	Less than 3V. 3V or more.	Replace the battery, and establish the zero point. Check the NC bus cable connection.	○	
3	Did alarm No.18 occur when the power was turned ON the last time?	Alarm No.18 occurred. Alarm No.18 did not occur.	Turn the drive unit control power ON again, and establish the zero point. Check the investigation item No. 4.	○	
4	Was the encoder cable or battery cable left disconnected from the unit for a long time?	The unit was left disconnected for a long time. Guide at delivery: 20 hours or more After 5 years: 10 hours or more The cables were not left disconnected.	Turn the drive unit control power ON again, and establish the zero point. Check the investigation item No. 5.	○	
5	Check the encoder cable or battery cable connection with a tester.	The connection is faulty. The connection is normal.	Replace the cable. Replace the drive unit.	○	

7 Troubleshooting

Alarm No. 26		Unused axis error			
		A power module error occurred in the axis whose axis No. selection switch was set to "F" (free axis).			
	Investigation details	Investigation results	Remedies	SV	SP
1	Check the repeatability.	The error is always repeated. The state returns to normal once, but occurs sometimes thereafter.	Replace the drive unit. Check the investigation item No. 2.	<input type="radio"/>	<input type="radio"/>
2	Check if there is any abnormality in the unit's ambient environment. (Ex. Ambient temperature, noise, grounding)	Take remedies according to the causes of the abnormality in the ambient environment.		<input type="radio"/>	<input type="radio"/>

Alarm No. 27		Sub side encoder: Error 5			
		The machine side encoder (CN3 side) detected an error. As details differ for each encoder, refer to section "Encoder alarm".			
	Investigation details	Investigation results	Remedies	SV	SP
1	Check the alarm No. "1B" items.			<input type="radio"/>	

Alarm No. 28		Sub side encoder: Error 6			
		The machine side encoder (CN3 side) detected an error. As details differ for each encoder, refer to section "Encoder alarm".			
	Investigation details	Investigation results	Remedies	SV	SP
1	Check the alarm No. "1B" items.			<input type="radio"/>	

Alarm No. 29		Sub side encoder: Error 7			
		The machine side encoder (CN3 side) detected an error. As details differ for each encoder, refer to section "Encoder alarm".			
	Investigation details	Investigation results	Remedies	SV	SP
1	Check the alarm No. "1B" items.			<input type="radio"/>	

Alarm No. 2A		Sub side encoder: Error 8			
		The machine side encoder (CN3 side) detected an error. As details differ for each encoder, refer to section "Encoder alarm".			
	Investigation details	Investigation results	Remedies	SV	SP
1	Check the alarm No. "1B" items.			<input type="radio"/>	

Alarm No. 2B		Main side encoder: Error 1			
		The motor side encoder (CN2 side) detected an error. (Note) It includes the linear scale in the case of linear motor. As details differ for each encoder, refer to section "Encoder alarm".			
	Investigation details	Investigation results	Remedies	SV	SP
1	Check the alarm No. "1B" items.			<input type="radio"/>	<input type="radio"/>

Alarm No. 2C		Main side encoder: Error 2			
		The motor side encoder (CN2 side) detected an error. (Note) It includes the linear scale in the case of linear motor. As details differ for each encoder, refer to section "Encoder alarm".			
	Investigation details	Investigation results	Remedies	SV	SP
1	Check the alarm No. "1B" items.			<input type="radio"/>	<input type="radio"/>

Alarm No. 2D		Main side encoder: Error 3			
		The motor side encoder (CN2 side) detected an error. (Note) It includes the linear scale in the case of linear motor. As details differ for each encoder, refer to section "Encoder alarm".			
	Investigation details	Investigation results	Remedies	SV	SP
1	Check the alarm No. "1B" items.			<input type="radio"/>	<input type="radio"/>

7 Troubleshooting

Alarm No. 2E		Main side encoder: Error 4			
		The motor side encoder (CN2 side) detected an error. (Note) It includes the linear scale in the case of linear motor. As details differ for each encoder, refer to section "Encoder alarm".			
Investigation details		Investigation results		Remedies	
1	Check the alarm No. "1B" items.			<input type="radio"/>	<input type="radio"/>

Alarm No. 2F		Main side encoder: Communication error			
		An error was detected in communication data with the motor side encoder or with the linear scale of a linear servo system. Or the communication was interrupted.			
Investigation details		Investigation results		Remedies	
1	Jiggle the encoder connectors (drive unit side and encoder side) and check if they are disconnected.	The connector is disconnected (or loose). The connector is not disconnected.	Correctly install. Check the investigation item No. 2.	<input type="radio"/>	<input type="radio"/>
2	Is the encoder cable wired in the same conduit as the motor's power cable, or are the two cables laid in parallel near each other?	The cables are wired near each other. (Noise is entering from the power cable.) The wires are sufficiently separated.	Improve the cable wiring. Check the investigation item No. 3.	<input type="radio"/>	<input type="radio"/>
3	Is the motor FG wire connected only to the drive unit which drives it? (Is the motor grounded to one point?)	The motor FG wire is grounded on the motor side. The motor is grounded to one point.	Ground the motor to one point, connecting the wires together on the drive unit side. Check the investigation item No. 4.	<input type="radio"/>	<input type="radio"/>
4	Turn the power OFF, and check the encoder cable connection with a tester. (Is the cable shielded?)	The connection is faulty. The connection is normal.	Replace the encoder cable. Check the investigation item No. 5.	<input type="radio"/>	<input type="radio"/>
5	Replace with another unit, and check whether the fault is on the unit side or encoder side.	The alarm is on the drive unit side. The alarm is on the encoder side.	Replace the drive unit. Check the investigation item No. 6.	<input type="radio"/>	<input type="radio"/>
6	Check if there is any abnormality in the encoder's ambient environment. (Ex. Ambient temperature, noise, grounding)	Take remedies according to the causes of the abnormality in the ambient environment.		<input type="radio"/>	<input type="radio"/>

Alarm No. 30		Over regeneration:			
		Over-regeneration detection level became over 100%. The regenerative resistor is overloaded.			
Investigation details		Investigation results		Remedies	
1	Check if the regenerative capacity exceeds the regenerative resistor tolerable capacity.	The regenerative capacity exceeds the regenerative resistor tolerable capacity. The regenerative resistor selection is appropriate.	Add the option regenerative resistor or replace it. Check the investigation item No. 2.	<input type="radio"/>	<input type="radio"/>
2	Check if the parameter is set incorrectly, and check the values of sv036 and sp032.	The parameters are set incorrectly. The parameters are correct.	Change the parameters. Check the investigation item No. 3.	<input type="radio"/>	<input type="radio"/>
3	Is an external regenerative resistor used?	An external regenerative resistor is used. A built-in regenerative resistor is used.	Check the investigation item No. 5. Check the investigation item No. 4.	<input type="radio"/>	<input type="radio"/>
4	Is the short wire connected between P and D terminal? Are there any problems with the connection condition?	The wire is not connected. The connector is disconnected. The connector has a contact fault.	Connect the wire. Reconnect the connector. Replace the connector.	<input type="radio"/>	<input type="radio"/>
5	Is the connection of the regenerative resistor or regeneration resistor cable correct?	The connection is incorrect. The connection is correct.	Rewire. Check the investigation item No. 6.	<input type="radio"/>	<input type="radio"/>
6	Is the regeneration resistor or the regeneration resistor cable broken? Disconnect the regenerative resistor terminal and check the resistance value with a tester.	The regeneration resistor is broken. Or the resistance value is large. The regeneration resistor cable is broken. The resistance value is normal.	Replace the regenerative resistor. Replace the cable. Check the investigation item No. 7.	<input type="radio"/>	<input type="radio"/>
7	Check if the power supply voltage is too high.	The power supply voltage exceeded 253V. The power supply voltage is normal.	Review the power supply. Replace the drive unit.	<input type="radio"/>	<input type="radio"/>

7 Troubleshooting

Alarm No. 31		Overspeed			
		The motor was detected to rotate at a speed exceeding the allowable speed (In the case of linear motor, it was detected to move at a speed exceeding the allowable speed).			
	Investigation details	Investigation results	Remedies	SV	SP
1	Check if the unit in which the alarm was detected is servo or spindle.	The alarm was detected in servo.	Check the investigation item No. 2.	○	○
		The alarm was detected in spindle.	Check the investigation item No. 3.		
2	Check the servo parameters SV001 (PC1), SV002 (PC2), SV018 (PIT) and SV025 (MTYP) settings.	The settings are incorrect.	Correctly set.	○	
		Correctly set.	Check the investigation item No. 5.		
3	Check the spindle parameter SP026 (TSP) setting.	The setting is incorrect.	Correctly set.		○
		The alarm is detected at 115% of SP026.	Check the investigation item No. 4.		
4	Check the PLG output waveform.	There is a problem.	Adjust the PLG output waveform.	○	○
		Normal.	Check the investigation item No. 5.		
5	Check whether the speed waveform is overshooting.	The waveform is overshooting.	Increase the acceleration/ deceleration time constant. Lower the load inertia.	○	○
		The waveform is not overshooting.	Check if there is any abnormality in the unit's ambient environment. (Ex.: Ambient temperature, noise, grounding) Check the investigation item No. 6.		
6	Check the repeatability.	[1] The alarm occurs when the motor is stopped. [2] The rotation speed displayed on the drive monitor varies when the motor is stopped.	Replace the encoder or encoder cable.	○	○
		The alarm occurs at all time.	Replace the drive unit.		

Alarm No. 32		Power module overcurrent			
		Overcurrent protection function in the power module has started its operation.			
	Investigation details	Investigation results	Remedies	SV	SP
1	Disconnect the power cable (U, V, W) from the unit's terminal block and motor, and check whether a short-circuit between the power cable or whether conduction at both end of wiring occurs with a tester.	[1] Before disconnecting the power cable, the cable connector or screw has been loosened. [2] The short-circuit condition persists even after disconnecting the cable from the unit and motor.	[1] Tighten it. [2] Check the motor wiring. [3] Replace the power cable.	○	○
		There is no problem.	Check the investigation item No. 2.		
2	Check the motor insulation with a (megger) tester. -Between motor power and ground earth Check the unit capacity. [1] The same size but smaller than the selected capacity. [2] The combination of the motor and axis is alternated in a 2-axis unit.	Less than 1MΩ. (Grounding) 1MΩ or more. (Normal)	Replace the motor. Check the investigation item No. 3.	○	○
		The capacity is small. The smaller capacity side was used in 2-axis unit.	Replace to the unit of the selected capacity or change the axis.		
3	Check the current loop gain parameters.	Different from the standard parameter settings.	Adjust the value to the standard setting.	○	○
		Equivalent to the standard parameter settings.	Check the investigation item No. 4.		
4	Jiggle the encoder connectors (drive unit side and encoder side) and check if they are disconnected.	The connector is disconnected (or loose). The connector is not disconnected.	Correctly install. Check the investigation item No. 5.	○	○
5	Turn the power OFF, and check the encoder cable connection with a tester.	Connection is faulty.	Replace the encoder cable.	○	○
		Connection is normal.	Check the investigation item No. 6.		
6	Check the repeatability.	The state returns to normal once, but occurs sometimes thereafter.	Check the investigation item No. 8.	○	○
		The error is always repeated.	Check the investigation item No. 7.		
7	Replace with another unit, and check whether the fault is on the drive unit side or encoder side.	The alarm is on the drive unit side.	Replace the drive unit.	○	○
		The alarm is on the encoder side.	Replace the encoder.		
8	Check for any abnormalities in the unit's ambient environment. (Ex.: Ambient temperature, noise, grounding)	Take remedies according to the causes of the abnormality in the ambient environment.		○	○

7 Troubleshooting

Alarm No. 33		Overvoltage: The main circuit bus voltage exceeded the tolerable value.			
	Investigation details	Investigation results	Remedies	SV	SP
1	Is an external regenerative resistor used?	An external regenerative resistor is used.	Check the investigation item No. 3.	○	
		A built-in regenerative resistor is used.	Check the investigation item No. 2.		
2	Is the short wire connected between P and D terminal? Are there any problems with the connection condition?	The wire is not connected.	Connect the wire.	○	
		The connector is disconnected.	Reconnect the connector.		
		The connector has a contact fault.	Replace the connector.		
3	Is the combination of the used regenerative resistor and drive unit appropriate?	The connection is correct.	Check the investigation item No.6.	○	○
		The combination is incorrect.	Replace the correct regenerative resistor.		
4	Is the connection of the regenerative resistor or regeneration resistor cable correct?	The combination is normal.	Check the investigation item No. 4.	○	○
		The connection is incorrect.	Rewire.		
5	Is the regeneration resistor or the regeneration resistor cable broken? Disconnect the regenerative resistor terminal and check the resistance value with a tester.	The connection is correct.	Check the investigation item No. 5.	○	○
		The regeneration resistor is broken. Or the resistance value is large.	Replace the regenerative resistor.		
		The regeneration resistor cable is broken.	Replace the cable.		
6	The acceleration/deceleration time constant is too short. At acceleration/deceleration, has the speed overshoot reached to the current limit?	The resistance value is normal.	Check the investigation item No. 6.	○	○
		Reached to the current limit.	Increase the acceleration/deceleration time constant.		
		The speed overshoot is applied.			
		The connection is normal.	Replace the drive unit.		

Alarm No. 34		NC-DRV communication: CRC error An error was detected in the data received from the CNC.			
	Investigation details	Investigation results	Remedies	SV	SP
1	Gently shake the connectors of the optical cables by hand that link between NC and drive unit or between drive units to check for loosening and disconnection. Also check if an excessive force is not applied on them.	The connector is loose or nearly disconnected. The tab of the connector is damaged.	Correctly install. Replace the cable.	○	○
		The connector is not disconnected.	Check the investigation item No. 2.		
2	Check for damages at the ends of the optical communication cable. Replace the cable.	The damage is found at the end of the cable.	Replace the communication cable.	○	○
		The connection is normal.	Check the investigation item No. 3.		
3	Check whether the NC or drive unit software version was changed recently.	The version was changed.	Change software version back to the original.	○	○
		The version was not changed.	Check the investigation item No. 4.		
4	Replace with another drive unit, and check whether the fault is on the NC side or drive unit side.	The alarm is on the drive unit side.	Replace the drive unit.	○	○
		The alarm is on the unit connections.	Check the investigation item No. 5.		
5	Check if there is any abnormality in the unit's ambient environment. (Ex. Ambient temperature, noise, grounding)	Take remedies according to the causes of the abnormality in the ambient environment.		○	○

Alarm No. 35		NC command error The travel command data that was received from the CNC was excessive.			
	Investigation details	Investigation results	Remedies	SV	SP
1	Please contact the Service Center, Service Station, Sales Office or dealer.			○	○

Alarm No. 36		NC-DRV communication: Communication error The communication with the CNC was interrupted.			
	Investigation details	Investigation results	Remedies	SV	SP
1	Check the alarm No. "34" items.			○	○

7 Troubleshooting

Alarm No. 37		Initial parameter error			
		An incorrect parameter was detected among the parameters received from the CNC at the power ON.			
	Investigation details	Investigation results	Remedies	SV	SP
1	Check if the unit in which the alarm was detected is servo axis or spindle.	The alarm was detected in servo axis. The alarm was detected in spindle.	Check the investigation item No. 2. Check the investigation item No. 3.	○	○
2	Check the error parameters displayed on the NC diagnosis screen. Servo parameters: SV001 to SV065, SV082	Wrong parameters were set. The electronic gears are overflowing. The absolute position detection parameter is valid when OSE104 and OSE105 are connected. (Absolute position control cannot be used.) SV082/bitC to F are the same setting in one unit. SV082/bitC to F are not the same setting in one unit. Correct parameters were set.	Correct the parameter setting. Set the value within the designated setting range. Set SV001, SV002 and SV018 so that they meet the machine specifications. In order to use the absolute position control function, an absolute position option is required. Correct the setting of SV082/bit0 to B. Correct to the same setting. Check the investigation item No. 4.	○	
3	Check the error parameters displayed on the NC diagnosis screen. Spindle parameters: SP001 to SP240	The setting is wrong. The set parameters are correct. The set parameter value is different from that of the machine specified encoder.	Correct the parameter setting. Set the value within the designated setting range. Check the investigation item No. 4. Change the setting to meet the machine specifications.		○
4	Check the alarm No. "34" items.			○	○

Alarm No. 38		NC-DRV communication: Protocol error 1			
		An error was detected in the communication frames received from the CNC.			
	Investigation details	Investigation results	Remedies	SV	SP
1	Check the alarm No. "34" items.			○	○

Alarm No. 39		NC-DRV communication: Protocol error 2			
		An error was detected in the axis information data received from the CNC.			
	Investigation details	Investigation results	Remedies	SV	SP
1	Check the alarm No. "34" items.			○	○

Alarm No. 3A		Overcurrent			
		Excessive current was detected in the motor drive current.			
	Investigation details	Investigation results	Remedies	SV	SP
1	[1] Check whether vibration is occurring at the table or spindle. [2] Check if the vibration caused by the load fluctuation is occurring.	Vibration is occurring. There is no vibration.	[1] Set a filter. [2] Lower the speed loop gain (SV005/SP005). Check the investigation item No. 2.	○	○
2	Check the repeatability of the alarm at the rapid traverse feed for the servo and at acceleration/ deceleration for the spindle. (Note) Check the phenomenon caused by the load fluctuation.	The alarm occurs. The alarm does not occur.	Lower the speed loop gain (SV005/SP005) to the level at which the alarm does not occur. Check the investigation item No. 3.	○	○
3	For the servo, perform the rapid traverse feed repeatedly and check if the max. current value is within the tolerable value. For the spindle, check the load meter value at the unloaded max. rotation speed.	The displayed value is high. The displayed value is appropriate.	Increase the current loop gain. Servo: SV009 to 012 Spindle: SP077 to 080 and SP081 to 084 Check the investigation item No. 4.	○	○
4	Disconnect the power cable (U,V,W) from the terminal block and the cannon plug from the motor. Check the insulation of the cable and motor with a tester.	The resistance value of the power cable for each phase is not "∞". The resistance value of the motor terminal and unit (shaft) is 1MΩ or less. The values below are met when measured with a tester. Cable: ∞ Motor terminal - unit: 1MΩ or more	Replace the motor power cable. Replace the motor. (Note) For the motors equipped with the absolute position encoder, the zero point must be established. Check the investigation item No. 5.	○	○
5	Check the insulation between the motor power cable and FG.	There is a ground fault at the power cable. There is no problem.	Replace the motor power cable. Check the investigation item No. 6.	○	○
6	Check if there is any abnormality in the motor's ambient environment. (Ex. Ambient temperature, cutting water)	Take remedies according to the causes of the abnormality in the ambient environment.		○	○

7 Troubleshooting

Alarm No. 3B		Power module overheat			
		Thermal protection function in the power module has started its operation.			
	Investigation details	Investigation results	Remedies	SV	SP
1	Check that the fan of the drive unit is rotating correctly.	Large amounts of cutting oil or cutting chips, etc., are adhered to the fan, or the rotation is slow.	Clean or replace the fan.	○	○
		The fan is rotating properly.	Check the investigation item No. 2.		
2	Check whether the heat dissipating fins are dirty.	Cutting oil or cutting chips, etc., are adhered, and the fins are clogged.	Clean the fins.	○	○
		Cutting chips etc. are not adhered to the fins.	Check the investigation item No. 3.		
3	Measure the drive unit's ambient temperature.	55°C or more.	Improve the efficiency cooling for the power distribution panel.	○	○
		Less than 55°C.	Check the investigation item No. 4.		
4	Check if there is any abnormality in the unit's ambient environment. (Ex. Ambient temperature, noise, grounding)	Take remedies according to the causes of the abnormality in the ambient environment.		○	○

Alarm No. 3C		Regeneration circuit error:			
		An error was detected in the regenerative transistor or in the regenerative resistor.			
	Investigation details	Investigation results	Remedies	SV	SP
1	Check if an external regenerative resistor is used.	An external regenerative resistor is used.	Check the investigation item No. 3.	○	
		A built-in regenerative resistor is used.	Check the investigation item No. 2.		
2	Is the short wire connected between P and D terminal? Are there any problems with the connection condition? (looseness of the screw)	The wire is not connected.	Connect the wire.	○	
		The connector is disconnected.	Reconnect the connector.		
		The connector has a contact fault.	Replace the connector.		
3	Is the connection of the regenerative resistor or regeneration resistor cable correct?	The connection is correct.	Replace the drive unit.	○	○
		The wire is not connected.	Connect the wire.		
4	Is the regeneration resistor or the regeneration resistor cable broken? Disconnect the regenerative resistor terminal and check the resistance value with a tester.	The regeneration resistor is broken. Or the resistance value is different from the specified value.	Replace the regenerative resistor.	○	○
		The regeneration resistor cable is broken.	Replace the cable.		
		The resistance value is normal.	Replace the drive unit.		

Alarm No. 3D		Power supply voltage error at acceleration/deceleration:			
		A motor control error was detected at acceleration/deceleration due to an input voltage drop.			
	Investigation details	Investigation results	Remedies	SV	SP
1	Measure the input voltage during operations with a tester.	During operations, the voltage fluctuates widely.	Increase the power capacity (KVA).	○	-
		During operations, the voltage is stable.	Check the investigation item No. 2.		
2	Check the load inertia.	The load inertia (workpiece etc.) is excessive.	[1] Lower the load inertia. [2] Extend the rapid traverse time constant for G0/G1.	○	-
		The load inertia is normal.	Check the investigation item No. 3.		
3	Check the cooling fan of the drive unit.	The fan is stopped.	Replace the fan. If the state is not improved, replace the drive unit.	○	-
		The fan is rotating correctly.	Check the investigation item No. 4.		
4	Check the ambient temperature of the drive unit during operation.	The ambient temperature exceeds the specified value.	Correct the ambient temperature within the specified value.	○	-
		There is no problem in temperature.	Replace the drive unit.		

Alarm No. 3E		Magnetic pole position detection error:			
		The magnetic pole position is not reliable in the magnetic pole position detection control. This alarm occurs at the detection level which is set in SV094.			
	Investigation details	Investigation results	Remedies	SV	SP
1	Adjust the setting value of the servo parameter SV094 and detect the magnetic pole position.	Set SV094.	Set SV094. The standard value for a rotary motor is 10. The standard value for a linear motor is 10.	○	-
		SV094 is set.	Set the optimal value allowing for the coasting distance (Increase the value).		

7 Troubleshooting

Alarm No. 41		Feedback error 3			
		Either a missed feedback pulse in the main side incremental encoder or an error in the Z-phase was detected in the full closed loop system. In the servo, Z-phase was not detected by a rotary encoder within 2 rotations.			
	Investigation details	Investigation results	Remedies	SV	SP
1	Check the connection condition of the cable and encoder. - Check if the cable is disconnected.	The cable is disconnected.	Replace the cable.	○	○
		The cable is normal.	Check for dirt on the connector terminal and reconnect it.		
		The alarm occurs even after it is reconnected.	Replace the encoder.		
Alarm No. 42		Feedback error 1			
		An error was detected in the sub side encoder (feedback signals of the position encoder in a servo system, or PLG's feedback signals in a spindle system).			
	Investigation details	Investigation results	Remedies	SV	SP
1	Check SP019 and SP020.	Parameter is set incorrectly.	Correctly set.		○
		Parameter is set correctly.	Check the investigation item No. 2.		
2	Check the alarm No. "2C" items.				○
Alarm No. 43		Feedback error 2			
		Excessive difference was detected in position data between the motor side encoder and the machine side encoder.			
	Investigation details	Investigation results	Remedies	SV	SP
1	Check if the connecting pulley ratio of the spindle end to ABZ pulse encoder meets the machine specifications.	The pulley ratio of the spindle end to encoder is 1:1.	Check the parameter setting.		○
		The spindle end and encoder are not equal in the pulley ratio.	Check the parameter setting. When the encoder is smaller than the spindle end in the pulley ratio, replace the pulley.		
		No problem.	Check the investigation item No. 2.		
2	Check the setting value of the spindle parameter from SP057 to SP064.	The correct values are not set.	Correctly set.		○
		The correct values are set.	Check the investigation item No. 3.		
3	Check the spindle parameter SP054 setting value.	V-belt is used for the spindle end driving.	Set "-1" to the spindle parameter "SP054".		○
		Other than V-belt (gears or timing belt) is used for the spindle end driving.	Set "360" to the spindle parameter "SP054".		
		SP054 is set corresponding to the machine specifications.	Check the investigation item No. 4.		
4	Jiggle the encoder connectors (drive unit side and encoder side) and check if they are disconnected.	The connector is disconnected (or loose).	Correctly install.	○	○
		The connector is not disconnected.	Check the investigation item No. 5.		
5	Is the encoder cable wired in the same conduit as the motor's power cable, or are the two cables laid in parallel near each other?	The cables are wired near each other. Noise is entering from the power cable.	Improve the cable wiring. Divide it by a FG shield.	○	○
		The wires are sufficiently separated.	Check the investigation item No. 6.		
6	Is the motor FG wire connected only to the drive unit which drives it? (Is the motor grounded to one point?)	The motor FG wire is grounded on the motor side.	Ground the motor to one point, connecting the wires together on the drive unit side.	○	○
		The motor is grounded to one point.	Check the investigation item No. 7.		
7	Turn the power OFF, and check the encoder cable connection with a tester. (Is the cable shielded?)	The connection is faulty.	Replace the encoder cable.	○	○
		The connection is normal.	Check the investigation item No. 8.		
8	Replace with another unit, and check whether the fault is on the unit side or encoder side.	The alarm is on the drive unit side.	Replace the drive unit.	○	○
		The alarm is on the encoder side.	Check the investigation item No. 9.		
9	Check if there is any abnormality in the encoder's ambient environment. (Ex. Ambient temperature, noise, grounding)		Take remedies according to the causes of the abnormality in the ambient environment.	○	○
10	Check SP019, SP020, SV019, and SV020.	Parameter is set incorrectly.	Correctly set.	○	○
		Parameter is set correctly.	Check the investigation item No. 11.		
11	Check the alarm No. "1B" items.			○	

7 Troubleshooting

Alarm No.		Fan stop			
45		A cooling fan built in the drive unit stopped, and overheat occurred in the power module.			
	Investigation details	Investigation results	Remedies	SV	SP
1	Turn the unit power ON again, and confirm the rotation of the fan. Note) Assure more than 10 seconds for the time from when the power is turned OFF till when it is turned ON. For the fan used for the drive unit, assuring more than 10 seconds for the time from when the power is turned OFF till when it is turned ON is required.	The fan is rotating, and an alarm did not occur again.	Continue to use. The power may be turned ON without assuring more than 10 seconds for the time from when the power is turned OFF till when it is turned ON. Leave for more than 10 seconds, and turn the power ON again.	○	○
		The fan did not rotate. Or, an alarm occurred again.	Check the investigation item No. 2.		
2	Check if the connector connected to a fan is loosened or disconnected in the unit.	[1]The connector is loosened. [2]The connector is disconnected.	Correctly connect the connector. Replace the fan.	○	○
		[1]The connector is not loosened. [2]The connector is not disconnected.	Check the investigation item No. 3.		
3	Check if oil or cutting chips are adhered to the fan.	Oil or cutting chips are adhered.	Improve the use environment and replace the drive unit.	○	○
		Oil or cutting chips are not adhered. The cable may be broken.	Replace the fan. Replace the drive unit.		

Alarm No.		Motor overheat / Thermal error			
46		Thermal protection function of the motor or in the encoder, has started its operation.			
	Investigation details	Investigation results	Remedies	SV	SP
1	Check the repeatability. (Note) For the spindle, check the "temperature" of the "spindle unit" displayed on the drive monitor screen.	[1] The alarm occurs before operation. [2] The "temperature" displayed on the drive monitor screen is different from ambient temperature.	Check the investigation item No. 2.	○	○
		[1] The alarm occurs after the operation continues for a while. [2] The "temperature" displayed on the drive monitor screen rises drastically during the spindle operation.	Check the investigation item No. 5.		
2	Jiggle the encoder connectors (drive unit side and encoder side) and check if they are disconnected.	The connector is disconnected (or loose).	Correctly install.	○	○
		The connector is not disconnected.	Check the investigation item No. 3.		
3	Turn the power OFF, and check the encoder cable connection with a tester.	The connection is faulty.	Replace the cable.	○	○
		The connection is normal.	Check the investigation item No. 4.		
4	When using MDS-B-HR, check if the motor is validated even if a motor thermal is not provided?	SV034/bit2 = 0	Set SP034/bit2 to 1.	○	
		SV034/bit2 = 1	Check the investigation item No. 5.		
5	Check the overload % (servo) or load meter (spindle).	The load is large.	Servo: Check the investigation item No. 6. Spindle: Check the investigation item No. 8.	○	○
		The load is not large.	Check the investigation item No. 9.		
6	Is the unbalance torque high?	The constant load torque (friction + unbalance) is 60% or more.	Select the motor so that the constant load torque is 60% or less.	○	
		The constant load torque is less than 60%.	Check the investigation item No. 7.		
7	Was the overload alarm (50) forcibly reset by turning the drive unit power OFF?	The alarm was forcibly reset.	Do not turn the drive unit's power OFF when an overload alarm occurs. (The NC power can be turned OFF.)	○	○
		The alarm was not forcibly reset.	Check the investigation item No. 9.		
8	Check the parameter settings.	The parameter is not set correctly.	Correctly set.		○
		The parameter is set correctly.	Check the investigation item No. 9.		
9	Measure the motor temperature when the alarm occurs. (Note) For the spindle motor, check the "temperature" of the "spindle unit" shown on the drive monitor screen.	The motor unit is hot.	Check the investigation item No. 10.		
		The motor is not hot.	Check the investigation item No. 12.	○	○
10	When using a motor with fan, check whether the fan is stopped, or it is clogged with dust, etc.	The motor fan was stopped.	Check the investigation item No. 11.		
		The motor fan wind flow is poor.	Clean the fan and ventilation holes inside of the motor.	○	○
		The direction of the ventilation is opposite.	Change the connected phase sequence.		
11	Check the fan wiring.	There is no problem.	Check the investigation item No. 12.		
		The cable is broken.	Replace the cable.	○	○
		The cable is not broken.	Replace the fan.		
12	Replace the drive unit or motor with another drive unit or motor, and check whether the fault is on the drive unit side or motor side	The alarm is on the drive unit side.	Replace the drive unit.	○	○
		The alarm is on the motor side.	Replace the motor.		
13	Check if there is any abnormality in the unit's ambient environment. (Ex. Ambient temperature, noise, grounding)	Take remedies according to the causes of the abnormality in the ambient environment.		○	○

7 Troubleshooting

Alarm No.		Motor side encoder: Error 5			SV	SP	
48		The motor side encoder (linear scale in the case of linear motor) detected an error. As details differ for each encoder, refer to section "Encoder alarm".					
Investigation details		Investigation results		Remedies		SV	SP
1	Check the alarm No. "1B" items.					○	○

Alarm No.		Motor side encoder: Error 6			SV	SP	
49		The motor side encoder (linear scale in the case of linear motor) detected an error. As details differ for each encoder, refer to section "Encoder alarm".					
Investigation details		Investigation results		Remedies		SV	SP
1	Check the alarm No. "1B" items.					○	

Alarm No.		Motor side encoder: Error 7			SV	SP	
4A		The motor side encoder (linear scale in the case of linear motor) detected an error. As details differ for each encoder, refer to section "Encoder alarm".					
Investigation details		Investigation results		Remedies		SV	SP
1	Check the alarm No. "1B" items.					○	○

Alarm No.		Motor side encoder: Error 8			SV	SP	
4B		The motor side encoder (linear scale in the case of linear motor) detected an error. As details differ for each encoder, refer to section "Encoder alarm".					
Investigation details		Investigation results		Remedies		SV	SP
1	Check the alarm No. "1B" items.					○	○

Alarm No.		Current error at magnetic pole estimate			SV	SP	
4C		Current detection failed at the pulse-applied magnetic pole estimation by IPM spindle motor.					
Investigation details		Investigation results		Remedies		SV	SP
1	Check the pulse-applied time.		The pulse-applied time can be short.	Set the pulse-applied time longer. Setting parameter:SP142 1) The pulse-applied time (0 to 350) 2) For low-speed coil:1)+1000 3) The polarity of magnetic pole estimate: Reverse polarity is "-" After the adjustment, perform the magnetic pole detection control again.	-	○	
			The alarm also occurs after the pulse-applied time is set.	Replace the unit.			

Alarm No.		Dual signal error			SV	SP	
4D		An error was detected in the signal related to the dual signal.					
Investigation details		Investigation results		Remedies		SV	SP
1	When not using dedicated wiring STO function	Is the connector to disable STO installed correctly?		Install the connector to disable STO correctly.		○	○
		Is the parameter setting (SV113,SP229/bit8) correct?		Set SV113,SP229/bit8. When using dedicated wiring STO function, set to "1".			
2	When using dedicated wiring STO function	The error is detected during the servo ON.		Input the STO signal after turning the servo OFF.			
		The error is detected during the servo OFF.		Remedy the wiring and signal for STO cable.			

Alarm No.		NC command mode error			SV	SP	
4E		The mode outside the specification was input in spindle control mode selection.					
Investigation details		Investigation results		Remedies		SV	SP
1	Check the wiring and setting environment. 1) Correctly grounded? 2) Any noise generating devices around the unit? 3) Are the speed/position encoder cables correctly shielded?	1) The grounding is incomplete.		Correctly ground.		-	○
		2) The alarm occurs easily when a specific device operates.		Use noise measures on the device described on the left.			
		3) The cable is not correctly shielded.		Correctly shield the cable.			
		No abnormality is found in particular.		Replace the drive unit.			

7 Troubleshooting

Alarm No.		Instantaneous power interrupt			
4F		The control power supply has remained shut down.			
Investigation details		Investigation results		Remedies	
1	Check the repeatability.	The alarm occurs occasionally.		Check the power facilities.	○ ○
				Check the wiring of the control power.	

Alarm No.		Overload 1			
50		Overload detection level became over 100%. The motor or the drive unit is overloaded.			
Investigation details		Investigation results		Remedies	
1	Check the overload parameters. Servo:SV021, SV022 Spindle:SP021,SP022	The standard values (below) are not set. Servo:SV021 = 60, SV022 = 150 Spindle:SP021=60,SP022=120 IPM:SP021=300,SP022=100		Set the standard values.	
		The standard values are set.		Investigate item 2.	
2	Check the items below displayed on the drive monitor screen during operation. <Servo> Max.current 3 (%) Overload(%) <Spindle> Load meter(%)	Perform the machining such as rapid traverse, where an alarm occurs. The examples are below. <Servo> [1] Max.current 3 constantly displays the maximum value. [2] Overload increases at a rapid speed. <Spindle> [1] The time to display 120% lasts long. [2] The value is higher than normal.		Servo [1] Mount a smaller workpiece. [2] Increase the time constant. [3] Check the investigation item No.6. Spindle [1] Lower the cutting amount. [2] Extend the cycle time.	
		The value is within the supposed level and there is no problem.		Investigate item 3.	
		Resonance is occurring when a tool or workpiece is mounted or during machining. (The load inertia changes)		Adjust the parameters. [1] Set the optimal notch filter. [2] Lower VGN1 (SV005,SP005).	
3	Check whether machine resonance is occurring. Check for vibration and abnormal noise at the spindle and table.	Resonance is not occurring.		Investigate item 4.	
		The motor is hunting.		Adjust the parameters. [1] Increase VGN1 (SV005, SP005). [2] Lower VIA (SV008, SP008).	
4	Check whether the shaft sways when the motor is stopped. "Hunting" of the spindle "Vibration" of the table	The motor is not hunting.		Servo: Investigate item 5 Spindle: Investigate item 7	
		The motor brakes are not released.		Correct the faulty section.	
5	Check the brake operation. [1] Check the brake relay. [2] Check the connector (CN20) connection.	The motor brake operation is normal.		Investigate item 6.	
		The cutting load is large.		Lower the cutting load.	
6	Check the load current with the NC Servo Monitor, and investigate the machine load.	There is interference with the positioning pin.		When using the positioning pin, turn the servo OFF when stopped.	
		An excessive force is applied from the machine.		Check whether the ball screw is bent, or whether there is a fault in the guide.	
		The machine load is not large.		Investigate item 8.	
7	Check the PLG output waveform. TS5690 cannot be checked.	There is a problem.		Adjust the PLG output waveform. For TS5690, reinstall.	
		Normal		Investigate item 8.	
8	Confirm the motor capacity selection again.	The motor performance is insufficient.		Lower the acceleration/deceleration rate or cutting load.	
		The motor performance is sufficient.		Check the tool mounted on the spindle. - The service life is reached. Increase the number of teeth (chips) of the milling cutter, etc. Investigate item 9.	
9	Try replacing the drive unit.	Improved.		Use as it is.	
		Not improved.		Replace the motor.	

(Note) NR and PR resetting are not possible when the overload level is 50% or more. Do not forcibly reset (AR) by turning the unit power OFF. If AR resetting is used at 50% or higher, the level is set to 80% when the power is turned ON next. (Servo)

7 Troubleshooting

Alarm No. 51		Overload 2 Current command of more than 95% of the unit's max. current was being continuously given for longer than 1 second in a servo system. In a spindle system, current command of more than 95% of the motor's max. current was being continuously given for longer than 1 second.			
	Investigation details	Investigation results	Remedies	SV	SP
1	Did the alarm occur immediately after READY ON?	The alarm occurred after ready ON before operation starts.	Investigate item 2.	○	
		The alarm occurred after normal operation.	Investigate item 5.		
2	Check that the PN voltage is supplied to the drive unit. MDS-DJ Series is not connected to the power supply unit, so investigate item 3 for MDS-DJ. [1] Is the CHARGE lamp ON?	The CHARGE lamp becomes dark. L+ or L- screw was loosened.	Increase the capacity of power supply. Tighten the L+ and L- screws.	○	
		Approx. 300V is correctly supplied.	Investigate item 3.		
3	Check the motor power cable (U, V, W phases). [1] The power cable is not connected. [2] Is the cable connected to the motor for another axis?	The connections are incorrect. Connected to the incorrect axis.	Connect correctly.	○	
		The connections are correct.	Investigate item 4.		
4	Check the encoder cable connection. [1] Is the cable connected to the motor for another axis?	The connections are incorrect.	Connect correctly.	○	
		The connections are correct.	Investigate item 5.		
5	Check whether the machine has collided.	The machine has collided.	Check the machining program and soft limit settings.	○	
		The machine has not collided.	Investigate item 6.		
6	Check whether the current value on the NC Servo Monitor screen is saturated during acceleration/ deceleration.	The current is saturated during acceleration/ deceleration.	Increase the acceleration/ deceleration time constant.	○	
		The current value during acceleration/ deceleration is appropriate.	Investigate item 7.		
7	Check the encoder Feedback.	The Feedback signal is abnormal. - The droop does not stabilize.	Replace the encoder. (With the absolute position system, the zero point must be established.)	○	
		The Feedback signal is normal.	Replace the drive unit.		
8	Check the load meter value.	The value is large.	Lower the load.		○
		The value is normal.	Investigate item 9.		
9	Check the PLG output waveform. For TS5690, waveform cannot be checked.	There is a problem.	Adjust the PLG output waveform.		○
		Normal	Replace the drive unit.		

Alarm No. 52		Excessive error 1 A difference between the actual and theoretical motor positions during servo ON exceeded the setting value.			
	Investigation details	Investigation results	Remedies	SV	SP
1	The load inertia is large. The unbalance torque in the Z (gravity) direction is high. An excessive workpiece or tool is mounted on the spindle.	The load inertia is excessive.	[1] Lower the machine weight applied to the servo motors (by the unbalance torque). [2] Lower the weight of the workpiece.	○	○
		The load inertia is normal.	Investigate item 2.		
2	Check the excessive error detection width. Servo SV053 Spindle SP023 (Interpolation, spindle synchronization)SP053 (Non-interpolation)	The excessive error detection width is too small. Servo standard value: $SV053 = \{RAPID / (60 * PGN1)\} / 2$ Spindle standard value: No alarm is set at SP023 = 120:0 SP053 = motor max. speed * 6 / PGV / 2	Set appropriate values.	○	○
		Appropriate values are set.	Investigate item 3.		
3	Check the position encoder polarity. SV017/bit4 (Servo) SP017/bit4 (Spindle: position FB) SP017/bit0 (Spindle: speed FB) #3106/bit7 (Synchronous tap control)	The polarity is reversed.	Correctly set the parameters.	○	○
		Normal.	Investigate item 4.		
4	Check the alarm No. "51" items.			○	○

7 Troubleshooting

Alarm No.		Excessive error 2			
53		A difference between the actual and theoretical motor positions during servo OFF exceeded the setting value.			
	Investigation details	Investigation results	Remedies	SV	SP
1	Check the follow-up function while the NC is in the servo OFF state.	The axis detachment function (NC parameter) is invalid. (Note) For the axis detachment function, refer to the NC manual.	Check the investigation item No. 2.	○	
		The axis detachment function (NC parameter) is valid. (Note) For the axis detachment function, refer to the NC manual.	Check the investigation item No. 3.		
2	Check whether the axis has moved during servo OFF (either by visual inspection or monitor the position droop waveform). [1] Check if the motor brake is released in the middle. [2] Check if the axis moves because the servo OFF is applied during the C axis mode.	[1] The axis has moved. [2] The servo OFF is applied during the mode.	[1] Adjust the brakes, etc. so that the axis does not move. [2] Avoid the servo OFF from being applied during position control.	○	
		The axis has not moved.	Check the investigation item No. 3.		
3	Check the excessive error detection width. SV026 (Servo) (Note) Set the same value to SV023.	The excessive error detection width is too small. $SV026 = \{RAPID / (60 \cdot PGN1)\} / 2$	Set an appropriate value.	○	
		An appropriate value is set.	Check for problems on the NC side, such as the position FB follow-up control.		

Alarm No.		Excessive error 3			
54		When an excessive error 1 occurred, detection of the motor current failed.			
	Investigation details	Investigation results	Remedies	SV	SP
1	Check that the PN voltage is supplied to the drive unit. [1] Is the CHARGE lamp ON?	The voltage is not supplied.	Correctly supply the PN voltage.	○	○
		It is correctly supplied (DC300V).	Investigate item 2.		
2	Check the motor power cable (U, V, W phases). [1] The power cable is not connected. [2] Is the cable connected to the motor for another axis?	The connections are incorrect.	Connect correctly.	○	○
		The connections are correct.	Replace the drive unit.		

Supplement (servo)

Depending on the ideal machine position in respect to the command position, the actual machine position could enter the actual shaded section shown below, which is separated more than the distance set in OD1.

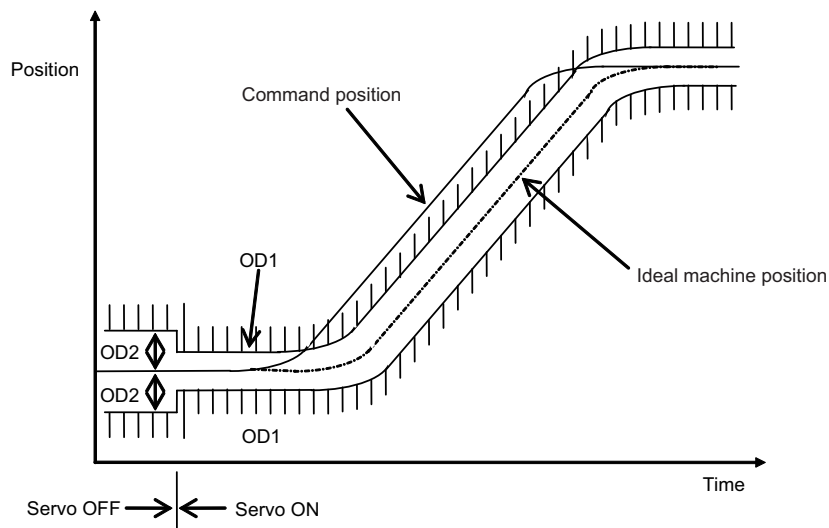

7 Troubleshooting

Alarm No. 56		Commanded speed error			
		The encoder has detected that the commanded speed exceeded 1.15 times of the rapid traverse rate (rapid), or the motor rotation speed exceeded the maximum speed.			
	Investigation details	Investigation results	Remedies	SV	SP
1	Check if the NC power is turned ON again when the rapid traverse rate (rapid) is changed.	NC power is turned OFF and ON.	Check the investigation item No. 2.	○	○ (Note)
		NC power is not turned OFF and ON	Turn the NC power OFF and ON.		
2	A value above the rapid traverse rate (rapid) is set to cutting feed clamp speed (clamp).	clamp > rapid	Review the clamp or rapid setting value.	○	○ (Note)
		clamp ≤ rapid	Check the commanded speed.		

(Note) For a spindle, the error is detected only during the spindle/C axis control.

Alarm No. 58		Collision detection 1: G0			
		When collision detection function (set to SV060) was valid, the disturbance torque in rapid traverse (G0) exceeded the collision detection level.			
	Investigation details	Investigation results	Remedies	SV	SP
1	Check whether the machine has collided during G0 operation.	A collision has occurred at the table, turret or spindle head in the machine during movement.	Check the machining program and soft limit settings.	○	
		There is no collision at the table, turret and spindle head in the machine during movement	Adjust the tolerable disturbance torque SV060. (Note) Set the detection level to be 1.5 times or more of the maximum torque.		

Alarm No. 59		Collision detection 1: G1			
		When collision detection function was valid (SV035.c1G1 was set), the disturbance torque in cutting feed (G1) exceeded the collision detection level.			
	Investigation details	Investigation results	Remedies	SV	SP
1	Check whether the machine has collided during G0 operation.	The machine has collided during movement.	Check the machining program and soft limit settings.	○	
		The machine has not collided.	Increase the detection level (SV035.c1G1). G1 collision detection level =SV060×c1G1(001 to 111) (Note) Set the detection level larger than the maximum cutting load.		

Alarm No. 5A		Collision detection 2			
		When collision detection function was valid, the command torque reached the max. motor torque.			
	Investigation details	Investigation results	Remedies	SV	SP
1	Check whether the machine has collided.	The machine has collided.	Check the machining program and soft limit settings.	○	
		The machine has not collided.	Check the investigation item No. 2.		
2	Check whether the current value on the NC Servo Monitor screen is saturated during acceleration/ deceleration.	The current is saturated during acceleration/ deceleration.	Check the investigation item No. 3.	○	
		The current value during acceleration/ deceleration is appropriate.	Investigate the cause of the load fluctuation.		
3	Can the acceleration/deceleration time constant be changed?	The constant can be changed.	Increase the acceleration/ deceleration time constant.	○	
		The constant cannot be changed.	Set to ignore collision detection method 2.		

Alarm No. 5B		Safely limited: Commanded speed error			
		In safely limited mode, the commanded speed was detected to exceed the safely limited speed.			
	Investigation details	Investigation results	Remedies	SV	SP
1	Check the commanded speed on the NC side.	The commanded speed and safely limited speed limit value are the same.	Reduce the commanded speed on the NC side or increase the safely limited speed limit value.	○	○
		The commanded speed is slower than the safely limited speed.	Replace the drive unit.		

Alarm No. 5D		Safely limited: Door state error			
		In safely limited mode, the door state signal from the NC and the same signal from the drive unit don't match. Otherwise, door open state was detected in normal mode.			
	Investigation details	Investigation results	Remedies	SV	SP
1	Check the DI input timing.	Both NC side and drive unit side input timings match one another within 500ms.	Review the DI input sequence. Check if the cable for the DI input signal is broken.	○	○
		NC side and drive unit side inputs do not match one another within 500ms.	Investigate the wiring and connection environment.		

7 Troubleshooting

Alarm No.		Safely limited: Feedback speed error			
5E		In safely limited mode, the motor speed was detected to exceed the safely limited speed.			
	Investigation details	Investigation results	Remedies	SV	SP
1	Check the DI input timing.	The feedback speed and safely limited speed limit value are the same.	Reduce the commanded speed on the NC side or increase the safely limited speed limit value.	○	○
		The feedback speed is slower than the safely limited speed.	Replace the drive unit.		
2	Check the wiring and setting environment. 1) Correctly grounded? 2) Any noise generating devices around the unit? 3) Are the speed/position encoder cables correctly shielded?	1) The grounding is incomplete.	Correctly ground.	○	○
		2) The alarm occurs easily when a specific device operates.	Use noise measures on the device described on the left.		
		3) The cable is not correctly shielded.	Correctly shield the cable.		
		No abnormality is found in particular.	Replace the drive unit.		

Alarm No.		External contactor error			
5F		A contact of the external contactor is welding.			
	Investigation details	Investigation results	Remedies	SV	SP
1	Check whether the contactor's contact has melted.	The contactor is melted.	Replace the contactor.	○	○
		The contactor is not melted.	Check the investigation item No. 2.		
2	Check whether the axis where an alarm occurred was a contactor control axis.	The alarm occurred at the axis where the contactor control is not executed.	Check the parameter. (DJ Series) With contactor control Servo:SV082, Spindle:SP227 0800h is added to the setting value. Without contactor control Change "Bit A,B" to "00" in the parameter above.	○	○
		The alarm occurred at the axis where the contactor control is executed.	Replace the drive unit.		
3	Check the connection with a regenerative resistor.	The short wire between the P and D terminals of the control circuit terminal block (CNP2) is disconnected.	Replace the control circuit terminal block (CNP2). Connect the short wire between the P and D terminals.	○	○
		The connection with an external option regenerative resistor unit is faulty.	Replace the cable.		

Alarm No.		Power supply: Power module overcurrent		
61		Overcurrent protection function in the power module of power supply has started its operation.		
	Investigation details	Investigation results	Remedies	CV
1	Check the state of the operation when the alarm occurs, and check the repeatability.	The alarm occurs immediately after 200VAC is supplied or after READY is turned ON.	Replace the unit.	○
		The alarm occurs occasionally during READY ON.	Check the investigation item No. 3.	
		The alarm occurs after continuous operation for a long time. The unit is hot.	Check the investigation item No. 2.	
2	Check the load state of all motors (during stopped).	The total load of all motors exceeds the rated capacity of the power supply unit.	Lower the motor load and operation frequency.	○
		The total does not exceed the capacity.	Check the investigation item No. 3.	
3	Check the power capacity of the facility. Check the capacity of the step-down transformer (KVA).	The power capacity of the facility is insufficient.	Increase the power capacity of the facility.	○
		The specified power capacity is secured.	Check the investigation item No. 4.	
4	Measure the voltage across wires. Is the voltage 170V or more even when the motor is accelerating?	The voltage drops to 170V or less occasionally.	Increase the power capacity of the facility.	○
		The difference of the voltage across wires is 10V or more.	Improve the power phase balance.	
		The difference of the voltage across wires is less than 10V.	Check the investigation item No. 5.	
5	Check whether there is any device (machine) causing the power distortion.	Abnormal noise is heard from an AC reactor when stopping at the servo ON.	Improve the source of the distortion. For example, when abnormal noise is heard from another machine that is in operation, move the wiring to the power which is far from the machine's power supply.	○
		Abnormal noise is not heard.	Check the investigation item No. 6.	
6	Check if there is any abnormality in the unit's ambient environment. (Ex. Noise, grounding, etc.)	Take remedies according to the causes of the abnormality in the ambient environment.		○

7 Troubleshooting

Alarm No. 62		Power supply: Frequency error		
		The input power supply frequency increased above the specification range.		
	Investigation details	Investigation results	Remedies	CV
1	Check the state of the operation when the alarm occurs, and check the repeatability.	The alarm occurs each time immediately after the power is turned ON. Or, the alarm occurs occasionally regardless of the operation state.	Check the investigation item No. 2.	○
		The alarm occurs only while the motor is accelerating/decelerating.	Check the investigation item No. 3.	
2	Measure the power voltage waveform during normal operation.	The frequency is deviated from 50Hz±3% or 60Hz±3%.	Review the power facilities.	○
		The voltage waveform dips at some sections.	Improve the source of the distortion. Install an AC reactor.	
		There is no problem.	Check the investigation item No. 4.	
3	Measure the power voltage when the motor is accelerating/decelerating.	The frequency greatly fluctuates during acceleration/deceleration.	Review the power facilities.	○
		The voltage waveform during deceleration dips in some sections.	Improve the source of the distortion. Install an AC reactor.	
		There is no problem.	Check the investigation item No. 4.	
4	Check if there is any abnormality in the unit's ambient environment. (Ex. Noise, grounding, etc.)	Take remedies according to the causes of the abnormality in the ambient environment.		○

Alarm No. 66		Power supply: Process error		
		An error occurred in the process cycle.		
	Investigation details	Investigation results	Remedies	CV
1	Check the repeatability.	The alarm occurs each time after the power is turned ON.	Replace the unit.	○
		The alarm occurs occasionally.	Check the investigation item No. 2.	
2	Check if there is any abnormality in the unit's ambient environment. (Ex. Noise, grounding, etc.)	Take remedies according to the causes of the abnormality in the ambient environment.		○

Alarm No. 67		Power supply: Phase interruption		
		An open-phase condition was detected in input power supply circuit.		
	Investigation details	Investigation results	Remedies	CV
1	Check the voltage for each input phase.	There are phases with no voltage.	Correct the power supply.	○
		There is no problem.	Check the investigation item No. 2.	
2	Check the alarm No. "71" items.			○

Alarm No. 68		Power supply: Watchdog		
		The system does not operate correctly. LED display is fixed as "8".		
	Investigation details	Investigation results	Remedies	CV
1	Check the repeatability.	The alarm occurs each time READY is turned ON.	Replace the unit.	○
		The alarm occurs occasionally.	Check the investigation item No. 2.	
2	Check if there is any abnormality in the unit's ambient environment. (Ex. Noise, grounding, etc.)	Take remedies according to the causes of the abnormality in the ambient environment.		○

Alarm No. 69		Power supply: Grounding			
		The motor power cable is in contact with FG (Frame Ground).			
	Investigation details	Investigation results	Remedies	SV	SP
1	Measure the insulation across the power cables (U,V,W) for all motors and the ground. (Carry out a megger test.)	Less than 100kΩ. (Grounding)	The motor or power cable may be ground faulted.	○	○
		100kΩ or more. (Normal)	Check the investigation item No. 2.		
2	Has oil adhered on the motor or power cable?	Oil has adhered.	Take measures so that oil does not come in contact. Check the motor's cannon connector and the inside of the terminal box, and clean as necessary.	○	○
		Oil has not adhered.	Check the investigation item No. 3.		
3	Measure the insulation again.	Less than 1MΩ. (Grounding)	Replace the motor or cable.	○	○
		1MΩ or more. (Normal)	Check the investigation item No. 2.		
4	Measure the resistance across the U, V, W phase terminals of the servo/spindle drive unit and the ground. (Note) Do not measure the insulation as the unit is damaged.	Less than 100kΩ.	Replace the drive unit.	○	○
		100kΩ or more.	Replace the power supply unit.		
5	Check whether there is any axis in which alarm 24 has occurred.	There is an axis in which alarm has occurred.	Check the alarm No. "24" items.	○	○
		There is no axis in which alarm has occurred.	Check the investigation item No. 2.		

7 Troubleshooting

Alarm No. 6A		Power supply: External contactor welding		
		A contact of the external contactor is welding.		
	Investigation details	Investigation results	Remedies	CV
1	Check whether any alarm has occurred on the drive unit side.	An alarm has occurred.	Remove the cause of the alarm on the drive side, and check the investigation item No. 2.	○
		An alarm has not occurred.	Check the investigation item No. 2.	
2	Check whether the contactor's contact has melted.	The contactor has melted.	Replace the contactor.	○
		The contactor has not melted.	Check the investigation item No. 3.	
3	Check that the contactor excitation wiring is correctly connected from the power supply unit's MC1 terminal.	The connection is correct.	Correctly connect.	○
		The connection is incorrect.	Replace the power supply unit.	

Alarm No. 6B		Power supply: Rush circuit error		
		A thyristor for rush short circuit is ON when rushing.		
	Investigation details	Investigation results	Remedies	CV
1	Check whether any alarm has occurred on the drive unit side.	An alarm has occurred.	Remove the cause of the alarm on the drive side, and then carry out the investigation details 2.	○
		An alarm has not occurred.	Check the investigation item No. 2.	
2	Check the repeatability.	The alarm occurs each time READY is turned ON.	Replace the unit.	○
		The alarm occurs occasionally.	Check the investigation item No. 3.	
3	Check if there is any ground fault in the motor.	Check the investigation item of Alarm No. 69.	Take remedies of Alarm No. 69.	○
		No ground fault.	Check the investigation item No. 4.	
4	Check if there is any abnormality in the unit's ambient environment. (Ex. Noise, grounding, etc.)	Take remedies according to the causes of the abnormality in the ambient environment.		○

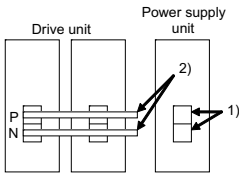
Alarm No. 6C		Power supply: Main circuit error																											
		An error was detected in charging operation of the main circuit capacitor.																											
	Investigation details	Investigation results	Remedies	CV																									
1	Check the CHARGE lamp state when the alarm occurs.	[1] The light of the lamp becomes faint. [2] An alarm occurs when ready is turned ON again.	Replace the power supply unit.	○																									
		The lamp turns ON instantly, but when the alarm occurs and the contactor turns OFF, the lamp turns OFF immediately.	Check the investigation item No. 2.																										
		The lamp never turns ON.	Check the investigation item No. 2. Then replace the unit.																										
2	Disconnect the power supply unit's PN terminal block wiring, and measure the resistance value at 1) and 2) shown below. 	1)The power supply unit side is abnormal.	Replace the power supply unit.	○																									
		2)The drive unit side is abnormal.	Disconnect the PN wiring, and then check the drive unit side.																										
	(Note) When disconnecting the PN wiring, turn OFF the power, make sure the CHARGE lamp has turned OFF at contactor OFF and then wait at least fifteen minutes before disconnecting. Do not disconnect immediately after the power OFF.	1) and 2) are both normal. <table border="1"> <thead> <tr> <th rowspan="2">Tester measurement point</th> <th colspan="2">Polarity</th> <th rowspan="2">Normal</th> <th rowspan="2">Abnormal</th> </tr> <tr> <th>+</th> <th>-</th> </tr> </thead> <tbody> <tr> <td rowspan="2">1)</td> <td>P</td> <td>N</td> <td>Several 100Ω</td> <td>Short-circuit/∞Ω</td> </tr> <tr> <td>N</td> <td>P</td> <td>∞Ω</td> <td>Several 100Ω</td> </tr> <tr> <td rowspan="2">2)</td> <td>P</td> <td>N</td> <td>Several 100Ω</td> <td>Short-circuit/∞Ω</td> </tr> <tr> <td>N</td> <td>P</td> <td>∞Ω</td> <td>Several 100Ω</td> </tr> </tbody> </table>	Tester measurement point	Polarity		Normal	Abnormal	+	-	1)	P	N	Several 100Ω	Short-circuit/∞Ω	N	P	∞Ω	Several 100Ω	2)	P	N	Several 100Ω	Short-circuit/∞Ω	N	P	∞Ω	Several 100Ω	Replace the power supply unit.	○
Tester measurement point	Polarity			Normal	Abnormal																								
	+	-																											
1)	P	N	Several 100Ω	Short-circuit/∞Ω																									
	N	P	∞Ω	Several 100Ω																									
2)	P	N	Several 100Ω	Short-circuit/∞Ω																									
	N	P	∞Ω	Several 100Ω																									

Alarm No. 6D		Parameter setting error		
		An error was detected in the parameter sent from the drive unit.		
	Investigation details	Investigation results	Remedies	CV
1	Check the repeatability.	The alarm occurs each time after the power is turned ON.	Replace the unit.	○
		The alarm occurs occasionally.	Check the investigation item No. 2.	
2	Check if there is any abnormality in the unit's ambient environment. (Ex. Noise, grounding, etc.)	Take remedies according to the causes of the abnormality in the ambient environment.		○

7 Troubleshooting

Alarm No. 6E		Power supply: H/W error/AD error		
An error was detected in the internal memory or A/D converter.				
	Investigation details	Investigation results	Remedies	CV
1	Check the repeatability.	The alarm occurs each time READY is turned ON.	Replace the unit.	○
		The alarm occurs occasionally.	Check the investigation item No. 2.	
2	Check if there is any abnormality in the unit's ambient environment. (Ex. Noise, grounding, etc.)	Take remedies according to the causes of the abnormality in the ambient environment.		○

Alarm No. 6F		Power supply error		
No power supply is connected to the drive unit, or a communication error was detected.				
	Investigation details	Investigation results	Remedies	CV
1	Check the time from when the unit power is turned OFF till when it is turned ON.	Within 3 seconds	Assure more than 3 seconds for the time from when the power is turned OFF till when it is turned ON.	○
		More than 3 seconds	Check the investigation item No. 2.	
2	Check the LED display on the power supply unit.	"F" is flickering.	An A/D converter error has occurred. Check the alarm No. "6E" items.	○
		Another alarm code is flickering.	Check items of each alarm No.	
		"0" is displayed.	Check the investigation item No. 3.	
		"F" is displayed.	Check the investigation item No. 3.	
		"8" is displayed.	Check the alarm No. "68" items.	
3	Check the rotary switch setting.	0 or 4 is set.	Check the investigation item No. 4.	○
		A value other than the above is set.	Correctly set the rotary switch.	
4	Check the communication cable (CN4) connected with the drive unit.	There is a problem with the wiring or shield.	Replace the cable.	○
		There is no problem.	Replace the unit.	

(Note) Alarm 6F is detected at the same time other power supply alarms occur.

Alarm No. 70		Power supply: External emergency stop error		
A mismatch of the external emergency stop input and CNC emergency stop input continued for 30 seconds.				
	Investigation details	Investigation results	Remedies	CV
1	Check the connection between external emergency stop and NC emergency stop.	Not wired.	Correctly wire the external emergency stop and NC emergency stop.	○
2	Check if there is any abnormality in the unit's ambient environment.	No abnormality is found in particular.	Replace the drive unit.	○
		The grounding is incomplete.	Take remedies according to the causes of the abnormality. Additionally ground and review.	

Alarm No. 71		Power supply: Instantaneous power interruption		
The power was momentarily interrupted.				
	Investigation details	Investigation results	Remedies	CV
1	Investigate the sequence to check whether the contactor has been turned OFF with an emergency stop button, etc.	The contactor has been turned OFF externally.	Review the machine sequence. When turning the contactor OFF with external means, such as an emergency stop button, this alarm can be avoided by inputting NC emergency stop at the same time.	○
		The contactor has not been turned OFF.	Check the investigation item No. 2.	
2	Check the repeatability.	The alarm occurs each time READY is turned ON.	Check the investigation item No. 3.	○
		The alarm occurs at a certain operation.	Check the investigation item No. 1. If there is no problem, check the investigation item No. 3.	
		The alarm occurs occasionally during operation.	Check the investigation item No. 4.	
3	Check whether the power input wire and contactor are correctly wired.	The wiring is incorrect.	Correctly connect.	○
		There is no problem.	Check the investigation item No. 4.	
4	Check the power voltage waveform with a synchroscope.	An instantaneous power failure or voltage drop occurs frequently.	Correct the power facility.	○
		There is no problem.	Replace the unit.	

7 Troubleshooting

Alarm No. 72		Power supply: Fan stop		
A cooling fan built in the power supply unit stopped, and overheat occurred in the power module.				
	Investigation details	Investigation results	Remedies	CV
1	Turn the unit power ON again, and confirm the rotation of the fan. Note) Assure more than 10 seconds for the time from when the power is turned OFF till when it is turned ON. For the fan used for the drive unit, assuring more than 10 seconds for the time from when the power is turned OFF till when it is turned ON is required.	The fan is rotating, and an alarm did not occur again.	Continue to use. The power may be turned ON without assuring more than 10 seconds for the time from when the power is turned OFF till when it is turned ON. Leave for more than 10 seconds, and turn the power ON again.	○
		The fan did not rotate. Or, an alarm occurred again.	Check the investigation item No. 2.	
2	Check if the connector connected to a fan is disconnected.	The connector is disconnected.	Correctly connect the connector.	○
		The connector is not disconnected.	Check the investigation item No. 3.	
3	Check if oil or cutting chips are adhered to the fan.	Oil or cutting chips are adhered.	Improve the use environment and replace the drive unit.	○
		Oil or cutting chips are not adhered. The cable may be broken.	Replace the drive unit.	

Alarm No. 73		Power supply: Over regeneration		
Over-regeneration detection level became over 100%. The regenerative resistor is overloaded. This alarm cannot be reset for 15 min from the occurrence. Leave the drive system energized for more than 15 min, then turn the power ON to reset the alarm.				
	Investigation details	Investigation results	Remedies	CV
1	Check the alarm occurrence state and regenerative load displayed on the NC Monitor screen while changing the operation mode.	The regenerative load value increases when the power is turned ON and the motor is not rotated.	Check whether the state is affected by power fluctuation, grounding or noise. If there is no problem, replace the unit.	○
		The regenerative load value increases each time the motor decelerates, and the alarm occurs.	A-CR: Check the investigation item No. 2. C1-CV: Check the investigation item No. 4.	
		The regenerative load value increases each time the motor decelerates, but the alarm does not occur when the operation mode is eased.	A-CR: Check the investigation item No. 2. C1-CV: Ease the operation mode.	
2	Check whether the parameter (regenerative resistor type) of the drive unit controlling the power supply unit is correct.	The setting is incorrect.	Correctly set. (Check the alarm No. "6D" items.)	○
		The setting is correct.	Check the investigation item No. 3.	
3	Check the regenerative resistor's state. [1] Is oil adhered? [2] Measure the resistance value.	The regenerative resistor is abnormal.	Replace the regenerative resistor.	○
		There is no problem.	Check the investigation item No. 4.	
4	Check the alarm No. "75" items.			○

Alarm No. 74		Power supply option unit error:			
An alarm was detected in the power backup unit (an option unit for the power supply).					
	Investigation details	Investigation results	Remedies	SV	SP
1	Check the LED display on the power backup unit.	Check the LED display on the power backup unit to identify what alarm is occurring to the unit.	Fix the error occurring to the power backup unit and remove the alarm. Refer to "9.5.2 List of power backup function alarms".	○	○

7 Troubleshooting

Alarm No. 75		Power supply: Overvoltage		
		L+ and L- bus voltage in main circuit exceeded the allowable value. As the voltage between L+ and L- is high immediately after this alarm, another alarm may occur if this alarm is reset in a short time. Wait more than 5 min before resetting so that the voltage drops.		
	Investigation details	Investigation results	Remedies	CV
1	Check the repeatability.	The alarm occurs each time the motor decelerates.	Check the investigation item No. 3.	○
		The alarm occurs occasionally.	Check the investigation item No. 2.	
2	Check the power supply's alarm history.	Auxiliary regeneration frequency over (E8) occurs just before the over-voltage occurs.	Limit the occurrence of the excessive instantaneous regeneration by not decelerating multiple axes at the same time.	○
		Others.	Check the investigation item No. 3.	
3	Check the power capacity.	The power capacity is insufficient.	Increase the power capacity.	○
		The specified power capacity is secured.	Check the investigation item No. 4.	
4	Measure the voltage across wires. [1] Is the voltage 170V or more even when the motor is accelerating?	The voltage drops to 170V or less occasionally.	Increase the power capacity.	○
		The difference of the voltage across wires is 10V or more.	Improve the power phase balance.	
		The difference of the voltage across wires is less than 10V.	Check the investigation item No. 5.	
5	Measure the power voltage with a synchroscope, and check whether there is any distortion. [1] Are there any other devices causing the power distortion?	The power voltage is distorted.	Improve the source of the distortion. Install an AC reactor.	○
		The power voltage waveform is not abnormal.	Check the investigation item No. 6.	
6	Check if there is any abnormality in the unit's ambient environment. (Ex. Noise, grounding, etc.)	Take remedies according to the causes of the abnormality in the ambient environment.		○

Alarm No. 76		Power supply: Function setting error		
		The rotary switch setting of external emergency stop is not correct, or a wrong external emergency stop signal is input.		
	Investigation details	Investigation results	Remedies	CV
1	Check the rotary switch setting.	When using external emergency stop, rotary switch is not set to "4".	Set the rotary switch to "4".	○
2	Check if there is any abnormality in the unit's ambient environment.	No abnormality is found in particular.	Replace the drive unit.	○
		The grounding is incomplete.	Take remedies according to the causes of the abnormality. Additionally ground and review.	

Alarm No. 77		Power supply: Power module overheat		
		Thermal protection function in the power module has started its operation.		
	Investigation details	Investigation results	Remedies	CV
1	Confirm that the fan is properly rotating.	Large amounts of cutting oil or cutting chips, etc., are adhered, or the rotation is slow.	Clean or replace the fan.	○
		The fan is properly rotating.	Check the investigation item No. 2.	
2	Check whether the heat dissipating fins are dirty.	Cutting oil or cutting chips, etc., are adhered, and the fins are clogged.	Clean the fins.	○
		The fins are normal.	Check the investigation item No. 3.	
3	Measure the power supply unit's ambient temperature.	55°C or more	Improve the ventilation and cooling for the power distribution panel.	○
		Less than 55°C.	Check the investigation item No. 4.	
4	Check if there is any abnormality in the unit's ambient environment. (Ex. Ambient temperature, noise, grounding)	Take remedies according to the causes of the abnormality in the ambient environment.		○

Alarm No. 80		Main side encoder cable error			
		A pulse type cable is used for the motor side encoder.			
	Investigation details	Investigation results	Remedies	SV	SP
1	Check the parameters. Servo:SV025 = "x200" Spindle:SP031 = "x200" And then, check the connected cable and the encoder.	The cable type is pulse.	Replace the cable to the serial type.	○	○
		There is no problem with the selection of the encoder and cable.	Replace the encoder or cable.		

7 Troubleshooting

Alarm No.		Sub side encoder cable error			
81		The cable type of machine side encoder does not match the encoder specifications set by the parameter.			
	Investigation details	Investigation results	Remedies	SV	SP
1	Check if the below parameters match the connected encoder and cable. Servo: SV025 Spindle: SP031	The encoder does not match the specifications.	Replace the encoder.	○	○
		The parameter is not correct.	Set the parameters so that they meet the machine side encoder. <Servo:SV025> - Rotary Pulse 2xxx Serial 6xxx - Scale Pulse 8xxx Serial Axxx <Spindle:SP031> Pulse 4200 Serial 6200		
		There is no problem with the selection of the encoder and cable.	Replace the encoder or cable.		

Alarm No.		Drive unit communication error			
87		The communication frame between drive units was aborted.			
	Investigation details	Investigation results	Remedies	SV	SP
1	Check the connection of the optical communication cable between drive units.	The cable and connector were loose.	Connect again so as not to be loosened.	○	○
		The cable and connector were not loose.	Replace the cable. Check the investigation item No. 2.		
2	Check the repeatability.	The error is always repeated (in high-speed synchronous tapping).	Replace the servo drive or spindle drive unit that is used for high-speed synchronous tapping.	○	○

Alarm No.		Watchdog			
88		The system does not operate correctly. LED display is fixed as "88".			
	Investigation details	Investigation results	Remedies	SV	SP
1	Check whether the servo or spindle software version was changed recently.	The version was changed.	Change software version back to the original.	○	○
		The version was not changed.	Check the investigation item No. 2.		
2	Check the repeatability.	The error is always repeated.	Replace the drive unit.	○	○
		The state returns to normal once, but occurs sometimes thereafter.	Check the investigation item No. 3.		
3	Check if there is any abnormality in the unit's ambient environment. (Ex. Ambient temperature, noise, grounding)	Take remedies according to the causes of the abnormality in the ambient environment.		○	○

(Note) For MDS-DJ Series, "888" is displayed.

Alarm No.		Drive unit communication data error 1			
8A		The communication data 1 between drive units exceeded the tolerable value in the communication between drive units.			
	Investigation details	Investigation results	Remedies	SV	SP
1	Check if the error has occurred during high-speed synchronous tapping.	The error occurs during the synchronous tapping.	[1]Check the tool. [2]Adjust the tapping.	○	○
		The error does not occur during the synchronous tapping.	Check the investigation item No. 2.		
2	Check the repeatability.	The error is always repeated.	Replace the drive unit.	○	○
		The state returns to normal once, but occurs sometimes thereafter.	Check the investigation item No. 3.		
3	Check if there is any abnormality in the unit's ambient environment. (Ex. Ambient temperature, noise, grounding)	Take remedies according to the causes of the abnormality in the ambient environment.		○	○

Alarm No.		Drive unit communication data error 2			
8B		The communication data 2 between drive units exceeded the tolerable value in the communication between drive units.			
	Investigation details	Investigation results	Remedies	SV	SP
1	Check if the error was occurred during the synchronous tapping.	The error occurs during the synchronous tapping.	[1]Check the tool. [2]Adjust the tapping.	○	○
		Check if the error has occurred during high-speed synchronous tapping.	Check the investigation item No. 2.		
2	Check the repeatability.	The error is always repeated.	Replace the drive unit.	○	○
		The state returns to normal once, but occurs sometimes thereafter.	Check the investigation item No. 3.		
3	Check if there is any abnormality in the unit's ambient environment. (Ex. Ambient temperature, noise, grounding)	Take remedies according to the causes of the abnormality in the ambient environment.		○	○

7.3.3 Troubleshooting for Each Warning No.

Warning No.	Scale feedback error				
	An excessive difference in feedback amount was detected between the main side encoder and the MPI scale in MPI scale absolute position detection system.				
	Investigation details	Investigation results	Remedies	SV	SP
1	Check if there is any abnormality in the encoder's ambient environment. (Ex. Ambient temperature, noise, grounding)	Take remedies according to the causes of the abnormality in the ambient environment.		○	
2	Check the repeatability.	Occurs frequently.	Replace the encoder.	○	○
		Is not repeated.	Check the investigation item No. 1.		

Warning No.	Scale offset error				
	An error was detected in the offset data that is read at the NC power-ON in MPI scale absolute position detection system.				
	Investigation details	Investigation results	Remedies	SV	SP
1	Check if there is any abnormality in the encoder's ambient environment. (Ex. Ambient temperature, noise, grounding)	Take remedies according to the causes of the abnormality in the ambient environment.		○	
2	Check the repeatability.	Occurs frequently.	Replace the encoder.	○	○
		Is not repeated.	Check the investigation item No. 1.		

Warning No.	Incremental encoder/magnetic pole shift warning				
	For the incremental encoder, an error was detected in the magnetic pole shift amount set in the magnetic pole shift amount parameter "SV028".				
	Investigation details	Investigation results	Remedies	SV	SP
1	Check if there is any abnormality in the encoder's ambient environment. (Ex. Ambient temperature, noise, grounding)	Take remedies according to the causes of the abnormality in the ambient environment.		○	
2	Check the repeatability.	Occurs occasionally.	Execute magnetic pole detection control again and reset SV028.	○	
		Is not repeated.	Check the investigation item No. 1.		

Warning No.	Absolute position encoder: Revolution counter error				
	An error was detected in the revolution counter of the absolute position encoder. The absolute position data cannot be compensated.				
	Investigation details	Investigation results	Remedies	SV	SP
1	Check if there is any abnormality in the encoder's ambient environment. (Ex. Ambient temperature, noise, grounding)	Take remedies according to the causes of the abnormality in the ambient environment.		○	
2	Check if there is any liquid ingress inside the encoder connector.	Liquid was entered into the connector.	Replace the motor encoder.	○	○
		No liquid ingress.	Check the investigation item No. 1.		
3	Check the repeatability.	Occurs frequently.	Replace the encoder.	○	○
		Is not repeated.	Check the investigation item No. 1.		

7 Troubleshooting

Warning No.		Battery voltage drop				
9F		The battery voltage that is supplied to the absolute position encoder dropped. The absolute position data is retained.				
	Investigation details	Investigation results		Remedies	SV	SP
1	Change the used battery and check whether the warning does not occur. (Turning the power OFF and ON is required.)	The warning does not occur.	The battery has been drained.		○	
		The warning occurs.	Check the investigation item No. 2.			
2	Check whether the battery cable is disconnected, broken, or wired incorrectly.	The connection is faulty.	Correct the connection. Replace the cable.		○	
		The connection is normal.	Check the investigation item No. 3.			
3	Measure the new battery voltage.	Less than 3.4V.	Replace the battery.		○	
		3.4V or more.	Check the investigation item No. 6. When a battery box is used, check the investigation item No. 4.			
4	Check whether the cable connecting between the battery box and CN9 is short-circuited, broken, or wired incorrectly.	The connection is faulty.	Correct the connection. Replace the cable.		○	
		The connection is normal.	Check the investigation item No. 5.			
5	Disconnect the BT-LG cable of the battery box, and then measure the voltage between DO(ALM) and DOCOM terminals at power ON.	Low voltage.	Replace the battery box.		○	
		Equivalent of 24V.	Check the investigation item No. 6.			
6	Perform a conductivity check with the encoder cable between BT and LG of the drive unit in which the warning was detected. (Note) Make sure that the encoder side connector is disconnected.	Resistance value is low.	Replace the cable.		○	
		Resistance value is 100MΩ or more.	Replace the encoder. (With the absolute position system, the zero point must be established.)			

(Note 1) When warning 9F occurs, do not turn the drive unit power OFF to ensure that the absolute position data is held.

Replace the battery with the drive unit power ON.

(Note 2) When using MDS-BTBOX-36, battery voltage drop warning (9F) is released by turning the drive unit power ON again after replacing the battery.

Warning No.		In initial setup of ABS position				
A3		When the encoder with distance-coded reference marks is used, this warning is issued until the axis reaches the reference position during the initial setup of the distance-coded reference check function. This warning disappears after the axis has reached the position. Or it is issued during the initial setup of MBA405W. This warning disappears after the axis has passed the Z-phase during the initial setup and the NC power has been turned ON again.				
	Investigation details	Investigation results		Remedies	SV	SP
1	Warning does not disappear.	Encoder with distance-coded reference marks	Stopped on the way to the reference position.	Setup again.	○	-
		MBA405W	The cycle counter is displayed.	Turn the NC power ON again.		
			The display of the cycle counter is "0".	Turn the NC power ON again after the axis has passed the Z-phase.		

Warning No.		Dual signal warning				
A4		An input was detected in the signal related to the dual signal.				
	Investigation details	Investigation results		Remedies	SV	SP
1	Warning does not disappear.	In emergency stop state?		Cancel the emergency stop.	○	○

Warning No.		Fan stop warning				
A6		A cooling fan built in the drive unit stopped.				
	Investigation details	Investigation results		Remedies	SV	SP
1	Check the alarm No. "45" items.				○	○

Warning No.		Over regeneration warning				
E0		Over-regeneration detection level exceeded 80%.				
	Investigation details	Investigation results		Remedies	SV	SP
1	Check the alarm No. "30" items.				○	○

7 Troubleshooting

Warning No. E1		Overload warning			
		Overload detection level exceeded 80%.			
	Investigation details	Investigation results	Remedies	SV	SP
1	Check the alarm No. "50" items.			<input type="radio"/>	<input type="radio"/>

Warning No. E4		Set parameter warning			
		An incorrect parameter was detected among the parameters received from the CNC.			
	Investigation details	Investigation results	Remedies	SV	SP
1	Check the error parameter No.	SV001 to SV256 SP001 to SP256	Set the value within the designated setting range.	<input type="radio"/>	<input type="radio"/>
2	Check the spindle control input 4/bit 0 to 2.	Selected other than 000, 001, 010 and 100 when the alarm occurred.	Correctly select.		<input type="radio"/>

Warning No. E6		Control axis detachment warning			
		Control axis detachment was commanded.			
	Investigation details	Investigation results	Remedies	SV	SP
1	The status in which removal of the control axis was commanded from the NC is indicated.			<input type="radio"/>	

Warning No. E7		In NC emergency stop state			
		Emergency stop was input from the CNC.			
	Investigation details	Investigation results	Remedies	SV	SP
1	Check if the emergency stop is applied on the NC side.	The emergency stop is applied.	Check the investigation item No. 2.	<input type="radio"/>	<input type="radio"/>
		The emergency stop is cancelled.	Check the investigation item No. 3.		
2	Cancel the emergency stop.	Normally starts up. "E7" remains displayed.	Normal. Check the investigation item No. 3.	<input type="radio"/>	<input type="radio"/>
3	Check whether an alarm is occurring in another drive unit.	An alarm is occurring in another drive unit.	Reset the alarm in the other drive unit.	<input type="radio"/>	<input type="radio"/>
		An alarm is not occurring.	Check the investigation item No. 4.		
4	Turn the power of NC and 200VAC (400V) ON again			<input type="radio"/>	<input type="radio"/>

Warning No. E9		Instantaneous power interruption warning		
		The power was momentarily interrupted.		
	Investigation details	Investigation results	Remedies	CV
1	Check the alarm No. "4F" or "71" items.			<input type="radio"/>

Warning No. EA		In external emergency stop state		
		External emergency stop signal was input.		
	Investigation details	Investigation results	Remedies	CV
1	Check whether the specifications allow use of the external emergency stop.	Use is not allowed.	Invalidate the external emergency stop.	<input type="radio"/>
		Use is allowed.	Check the investigation item No. 2.	
2	Measure the input voltage of the external emergency stop connector of each unit.	24V is input.	Replace the power supply unit.	<input type="radio"/>
		24V is not input.	Check whether the external emergency stop cable is broken, or check the external contact operation.	

Warning No. EB		Power supply: Over regeneration warning		
		Over-regeneration detection level exceeded 80%.		
	Investigation details	Investigation results	Remedies	CV
1	Check the alarm No. "73" items.			<input type="radio"/>

7 Troubleshooting

Warning No. EE		Power supply: Fan stop warning		
		A cooling fan built in the power supply unit stopped.		
Investigation details		Investigation results	Remedies	CV
1	Check the alarm No. "72" items.			○

Warning No. EF		Power supply option unit warning:			
		A warning was detected in the power backup unit (an option unit for the power supply).			
Investigation details		Investigation results	Remedies	SV	SP
1	Check the LED display on the power backup unit.	Check the LED display on the power backup unit to identify what warning is occurring to the unit.	Fix the error occurring to the power backup unit and remove the warning. Refer to "9.5.3 List of power backup function warnings".	○	○

7.3.4 Parameter Numbers during Initial Parameter Error

If an initial parameter error (alarm 37) or set parameter warning (warning E4) occurs, the axis name and the No. of the error parameter that exceeds the setting range will appear on the NC Diagnosis screen as shown below:

S02 Initial parameter error ○○○○□
 ○○○○ : Error parameter No.
 □ : Axis name

S52 Parameter error warning ○○○○□
 ○○○○ : Error parameter No.
 □ : Axis name

If an error No. in the following table is displayed as the error parameter No. even when the parameter is set to a value within the setting range, an error is occurring due to the hardware compatibility or specifications or in relation to several other parameters. Check the specifications of the servo and spindle system and the descriptions in the following table to correctly set the parameters.

(1) Servo parameter error No.

Error parameter No.	Details	Related parameters
2217	The motor selected is of a motor series different from the drive unit's input voltage (200V/400V). Or a motor of an incompatible motor series is selected.	SV017
2219	-In a semi-closed loop control system, the setting value of SV019 is different from that of SV020. Set them to the same value. -SV019 is set to a value outside the setting range.	SV019
2220	-The resolution of the motor side encoder actually connected is not consistent with the setting value for SV020. -SV020 is set to a value outside the setting range.	SV020
2225	Incompatible motor type is selected. The machine side encoder type or the motor side encoder type is incorrectly set.	SV017, SV025
	For the speed command synchronous control system with MDS-D2/DH2-V2/V3, -The L axis for the drive unit is set as the secondary axis. Set the M axis as the secondary axis. -The motor side encoders for the L axis and the M axis are different. Use encoders of the same specifications.	SV025
2228	For the distance-coded reference scale system, -When a HEIDENHAIN serial conversion interface unit is connected, the encoder type setting is different from the connected unit type. -When a HEIDENHAIN serial conversion interface unit with the rotary type is connected, the ball screw pitch (SV018) is set to a value other than "360". -The speed command synchronous control and the distance-coded reference scale connection are set concurrently.	SV018, SV025, SV130 SV131
	The magnetic pole shift amount (SV028) is set for a general servo motor (not a built-in motor).	SV028
2233	The vertical axis pull up function (SV033/bitE) is set in the following conditions: -when the vertical axis pull up direction is not set (SV032=0) -when the drop prevention function is not set (SV048=0) The vertical axis pull up function (SV033/bitE) is not set in the following condition: -when the vertical axis pull up distance is set (SV095 ≠ 0)	SV032, SV033, SV048 SV095
2234	Parallel connection is set when the motor is not a linear servo motor. Or the DC excitation mode (SV034/bit4) is set in the following conditions: -when the NC is powered ON -when a general servo motor (not a built-in motor) is used.	SV034

Error parameter No.	Details	Related parameters
2236	For the MDS-D2/DH2 Series: The power supply type (SV036) is set but a power supply unit is not connected. Always set the power supply type for the drive unit connected last on the NC optical communication cable.	SV036
	For the MDS-DM2 Series: Do not set the power supply type. It is set from the spindle side.	
	For the MDS-DJ Series: The selected regenerative resistor is not supported in the drive unit of this capacity.	
2261	When the DC excitation mode (SV034/bit4) is set, the initial DC excitation level (SV061) is set to a value outside the setting range.	SV034, SV061
2262	When the DC excitation mode (SV034/bit4) is set, the final DC excitation level (SV062) is set to a value outside the setting range.	SV034, SV062
2263	When the DC excitation mode (SV034/bit4) is set, the initial DC excitation time (SV063) is set to a value outside the setting range.	SV034, SV063
2281	-When the distance-coded reference scale (SV081/bit3) is set, the base reference mark interval (SV130) or the auxiliary reference mark interval (SV131) is not set. -When a HEIDENHAIN serial conversion interface unit is connected, the reference mark is set to be checked at 3 points (SV081/bit7=1).	SV025, SV081, SV130 SV131
2282	With a multiple-axis drive unit, the digital signal input selection (SV082/bitF-C) is set to a different value for each axis in the same unit.	SV082
2317	-The expansion sub side encoder resolution (SV117) is set to "0" for an encoder that requires the resolution expansion setting. If the upper 16 bits for the encoder resolution are 0, this should be set to "-1". -The expansion sub side encoder resolution (SV117) is set to a value other than "0" for an encoder that does not support the resolution expansion setting.	SV019,SV025,SV117
2318	-The expansion main side encoder resolution (SV118) is set to "0" for an encoder that requires the resolution expansion setting. If the upper 16 bits for the encoder resolution are 0, this should be set to "-1". -The expansion main side encoder resolution (SV118) is set to a value other than "0" for an encoder that does not support the resolution expansion setting.	SV020,SV025,SV118
2330	-The relation between the base reference mark interval (SV130) and the auxiliary reference mark interval (SV131) is invalid. -The base reference mark interval (SV130) is set to "0" when a distance-coded reference scale is connected. -The base reference mark interval (SV130) is set to a value other than "0" when a distance-coded reference scale is not connected. -The base reference mark interval (SV130) is set to a value other than "0" when the semi-closed loop is set .	SV018, SV025, SV130 SV131
2331	-The auxiliary reference mark interval (SV131) is not set when a distance-coded reference scale is connected. -The auxiliary reference mark interval (SV131) is set to a value other than "0" when a distance-coded reference scale is not connected.	SV130, SV131
2334	The distance-coded reference check / revolution counter (SV134) is set to a value other than "0" when the distance-coded reference scale is not set (SV081/bit3=0).	SV081, SV134
2335	- In the distance-coded reference scale system, the distance-coded reference check /position within one rotation High (SV135) is set to a value outside the motor side encoder's data range. - The distance-coded reference check /position within one rotation High (SV135) is set to a value other than "0" when the distance-coded reference scale is not set (SV081/bit3=0).	SV081, SV135, SV136
2336	The distance-coded reference check /position within one rotation Low (SV136) is set to a value other than "0" when the distance-coded reference scale is not set (SV081/bit3=0).	SV081, SV136
2337	The distance-coded reference check allowable width (SV137) is set to a value other than "0" when the distance-coded reference scale is not set (SV081/bit3=0).	SV081, SV137
2438	The safety observation safety speed (SV238) and the safety observation safety motor speed (SV239) dot not satisfy the following equation. (Round down the first decimal place. When the calculation results in "0", set SV239 to 1.) $\frac{SV238 : SSCFEED}{SV018 : PIT} \times \frac{SV002 : PC2}{SV001 : PC1} = SV239 : SSCRPM$	SV238,SV239
2439	The safety observation safety motor speed (SV239) is set to a value greater the overspeed detection motor speed.	SV239
2450	The base reference mark interval in the distance-coded reference scale is invalid.	SV019,SV117,SV130
2454	The absolute position detection is enabled when an incremental encoder is connected as an position encoder.	SV025, #2049
2455	The following settings are overflowing: -Electronic gear -Position loop gain -Conversion from the speed detection unit to position detection unit	SV001,SV002,SV003,SV018,SV019,SV020,SV049,SV117,SV118

(2) Spindle parameter error No.

Error parameter No.	Details	Related parameters
13017	The motor selected is of a motor series different from the drive unit's input voltage (200V/400V). Or a motor of an incompatible motor series is selected.	SP017
13032	For the MDS-D2/DH2 Series: The power supply type (SP032) is set, but a power supply unit is not connected. Always set the power supply type for the drive unit connected last on the NC optical communication cable.	SP032
	For the MDS-DM2 Series: Set SP032 to 0019 (normal setting), or 0059 (external emergency stop function).	
	For the MDS-DJ Series: The selected regenerative resistor is not supported in the drive unit of this capacity.	
13097	-The expansion sub side encoder resolution (SP097) is set to "0" for an encoder that requires the resolution expansion setting. If the upper 16 bits for the encoder resolution are "0", this should be set to "-1". -The expansion sub side encoder resolution (SP097) is set to a value other than "0" for an encoder that does not support the resolution expansion setting.	SP019,SP031,SP097
13098	-The expansion main side encoder resolution (SP098) is set to "0" for an encoder that requires the resolution expansion setting. If the upper 16 bits for the encoder resolution are 0, this should be set to "-1". -The expansion main side encoder resolution (SP098) is set to a value other than "0" for an encoder that does not support the resolution expansion setting.	SP020,SP031,SP098
13125	When the DC excitation mode (SP225/bit4) is set, the initial DC excitation level (SP125) is set to a value outside the setting range.	SP225, SP125
13126	When the DC excitation mode (SP225/bit4) is set, the final DC excitation level (SP126) is set to a value outside the setting range.	SP225, SP126
13127	When the DC excitation mode (SP225/bit4) is set, the initial DC time (SP127) is set to a value outside the setting range.	SP225, SP127
13142	-The pulse application time for an IPM spindle motor is excessive. Set the pulse application time (SP142) to a value lower than 350μs. -The coil switch function is disabled and the pulse application coil for an IPM spindle motor is set to the low-speed coil. Set the pulse application coil to the high-speed coil, or enable the coil switch function.	SP017,SP018,SP142, SP226
13225	The DC excitation mode (SP225/bit4) has been set before the axis passes the Z phase. Set the DC excitation mode after the axis passes the Z phase.	SP225
13238	The safety observation safety speed (SP238) and the safety observation safety motor speed (SP239) do not satisfy the following equation: (Round down the first decimal place. When the calculation results in "0", set SP239 to 1.) $\frac{SP238 : SSCFEED}{360} \times \frac{SP057 : GRA1}{SP061 : GRB1} = SP239 : SSCRPM$	SP238,SP239
13239	The safety observation safety motor speed calculated from the actual gear ratio exceeds the overspeed detection motor speed. (Note) The safety observation safety motor speed calculated from the actual gear ratio = SP238:SSCFEED / 360 × PC2 / PC1 PC2: Spindle side gear ratio (SP057 to SP060) PC1: Motor side gear ratio (SP061 to SP064)	SP239
13255	The following settings are overflowing: -Electronic gear and motor side gear -Position loop gain -Conversion from the speed detection unit to position detection unit	SP057 to SP060 SP061 to SP064 SP001 to SP003 SP019, SP020

7.3.5 Troubleshooting the Spindle System When There Is No Alarm or Warning

If an abnormality is observed in the spindle system but no alarm or warning has occurred, refer to the following table and check the state.

[1] The rotation speed command and actual rotation speed do not match.

	Investigation item	Investigation results	Remedies
1	Check the commanded speed and the spindle rotation speed displayed on the drive monitor screen.	The speed command is not input correctly.	Input the correct speed command.
		The speed command is correct.	Check the investigation item No. 2.
2	Check whether there is slipping between the motor and spindle. (When connected with a belt or clutch.)	There is slipping.	Repair the machine side.
		No particular problems found.	Check the investigation item No. 3.
3	Check the spindle parameters (SP026, SP129 and following).	The correct values are not set.	Set the correct values.
		The correct values are set.	Replace the spindle drive unit.

[2] The acceleration/deceleration time is long or has increased in length.

	Investigation item	Investigation results	Remedies
1	Check whether the friction torque or load inertia has increased.	The friction torque has increased.	Repair the machine side.
		No particular problems found.	Check the investigation item No. 2.
2	Check if there is any abnormality in the motor's rotation during coasting.	The bearings do not rotate smoothly.	Replace the spindle motor.
		The bearings rotate smoothly.	Check the investigation item No. 3.
3	Check whether the torque limit signal has been input.	The signal has been input.	Release the input signal.
		The signal is not input.	Replace the drive unit.

[3] The motor stops during cutting.

	Investigation item	Investigation results	Remedies
1	Check the load rate (load meter value) during cutting.	The load meter sways over 120% during cutting.	Reduce the cutting amount.
		No particular problems found.	Check the investigation item No. 2.
2	Carry out the same investigations and remedies as section (4).		

[4] The vibration and noise (gear noise), etc., are large.

	Investigation item	Investigation results	Remedies
1	Check the machine's dynamic balance. (Coast from the maximum speed.)	The same noise is heard during coasting.	Repair the machine side.
		No particular problems found.	Check the investigation item No. 2.
2	Check whether there is a resonance point in the machine. (Coast from the maximum speed.)	Vibration and noise increase at a set rotation speed during coasting.	Repair the machine side.
		No particular problems found.	Check the investigation item No. 3.
3	Check the machine's backlash.	The backlash is great.	Repair the machine side.
		No particular problems found.	Check the investigation item No. 4.
4	Change the setting of the speed loop parameter (SP005:VGN1).	The vibration and noise are lost when the setting value is lowered by approx.100.	Change to the setting value. (Note) The impact response will drop.
		The symptoms do not change even if the above value is set.	Return the setting values to the original values. Check the investigation item No. 5.
5	Jiggle the encoder connectors (drive unit side and encoder side) and check if they are disconnected.	The connection is loosened.	Correctly connect the connector.
		The connector fixing is normal.	Check the investigation item No. 6.
6	Turn the power OFF, and check the connection of the speed encoder cable with a tester.	The connection is faulty or disconnected.	Replace the encoder cable. Correct the connection.
		The connection is normal.	Replace the drive unit.

[5] The spindle coasts during deceleration.

	Investigation item	Investigation results	Remedies
1	When connected with a belt or clutch, check whether there is slipping between the motor and spindle.	There is slipping.	Check the machine side and repair it.
		No particular problems found.	Replace the drive unit.

[6] The rotation does not stabilize.

	Investigation item	Investigation results	Remedies
1	Check the spindle parameter SP005 (SP008) settings.	The rotation stabilizes when the settings values are both set to approx. double.	Change the setting value. Note that the gear noise may increase.
		The symptoms do not change even when the above value is set.	Return the setting values to the original values. Check the investigation item No. 2.
2	Manually shake the speed encoder connectors (spindle drive unit side and speed encoder side) to check if they are disconnected.	The connector is disconnected (or loose).	Correctly connect the connector.
		The connector is not disconnected (or loose).	Check the investigation item No. 3.
3	Turn the power OFF, and check the connection of the speed encoder cable with a tester. (Especially check the shield wiring.)	The connection is faulty.	Replace the encoder cable. Correct the connection.
		The connection is normal.	Check the investigation item No. 4.
4	Investigate the wiring and installation environment. 1) Is the ground correctly connected? 2) Are there any noise-generating devices near the drive unit?	1) The grounding is incomplete.	Correctly ground.
		2) The alarm occurs easily when a specific device operates.	Use noise measures on the device described on the left.
		No particular problems found.	Replace the spindle drive unit.

[7] The speed does not rise above the command speed sometimes.

	Investigation item	Investigation results	Remedies
1	Check the speed command. Check whether the override input is input from the machine operation panel.	The speed command is not input correctly.	Input the correct speed command.
		The speed command is input correctly.	Check the investigation item No. 2.
2	Check whether the load has suddenly become heavier.	The load has become heavier.	Repair the machine side.
		No particular problems found.	Check the investigation item No. 3.
3	Manually rotate the motor bearings and check the movement.	The bearings do not rotate smoothly.	Replace the spindle motor.
		The bearings rotate smoothly.	Check the investigation item No. 4.
4	Manually shake the speed encoder connectors (spindle drive unit side and speed encoder side) to check if they are disconnected.	The connector is disconnected (or loose).	Correctly connect the connector.
		The connector is not disconnected (or loose).	Check the investigation item No. 5.
5	Turn the power OFF, and check the connection of the speed encoder cable with a tester. (Especially check the shield wiring.)	The connection is faulty.	Replace the encoder cable. Correct the connection.
		The waveform is normal.	Replace the spindle drive unit.

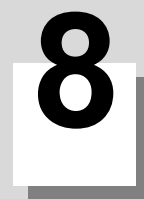

Maintenance

 **WARNING**

1. Before starting maintenance or inspections, turn the main circuit power and control power both OFF.
Wait at least fifteen minutes for the CHARGE lamp to turn OFF, and then using a tester, confirm that the input and output voltage are zero. Failure to observe this could lead to electric shocks.
2. Inspections must be carried out by a qualified technician. Failure to observe this could lead to electric shocks. Contact your nearest Mitsubishi branch or dealer for repairs and part replacement.

 **CAUTION**

1. Never perform a megger test (measure the insulation resistance) of the drive unit.
Failure to observe this could lead to faults.
2. The user must never disassemble or modify this product.

8.1 Periodic Inspections

8.1.1 Inspections

Periodic inspection of the following items is recommended.

- [1] Are any of the screws on the terminal block loose? If loose, tighten them.
- [2] Is any abnormal noise heard from the servo motor bearings or brake section?
- [3] Are any of the cables damaged or cracked? If the cables move with the machine, periodically inspect the cables according to the working conditions.
- [4] Is the core of the load coupling shaft deviated?

8.1.2 Cleaning of Spindle Motor

If you continue to use the spindle motor with dirt such as oil mist and dust adhered, its cooling performance degrades and the motor is unable to fully exercise its performance, which may cause the spindle motor overheat alarm. In some cases this may result in damage to the bearing or cooling fan. To ensure the cooling capability of the spindle motor's fan, carry out periodical cleaning of the spindle motor and its cooling fan according to the following cleaning procedure.

Note that the spindle motor SJ-D Series and the spindle motor SJ-VL Series is used as an example in this procedure. When cleaning the other spindle motors, carry it out based on this procedure.

 **CAUTION**

Do not touch the motor for some time after turning OFF the power, as the motor remains at a high temperature. This may lead to burns.

<For the spindle motor SJ-D Series>

- (1) Detaching the cooling fan unit
Remove the cooling fan unit from the spindle motor.

- [1] Remove fixing screws (hexagon socket screws at four locations) for the terminal box cover.

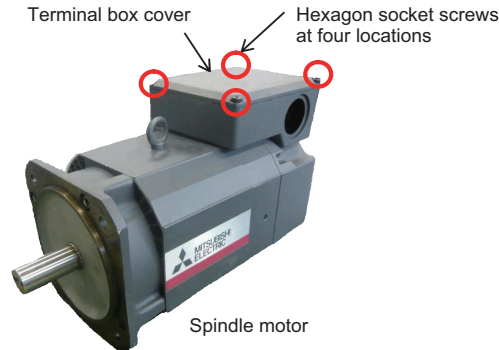

- [2] Remove the terminal box cover.

- [3] Remove the three lead wires (BU, BV, and BW) for the cooling fan from the one-touch terminal block.

[3-1] Applicable flat-blade screwdriver

Always use a flat-blade screwdriver whose blade edge size is 0.6×3.5mm for working.
(SZF1-0.6×3.5 manufactured by Phoenix Contact)

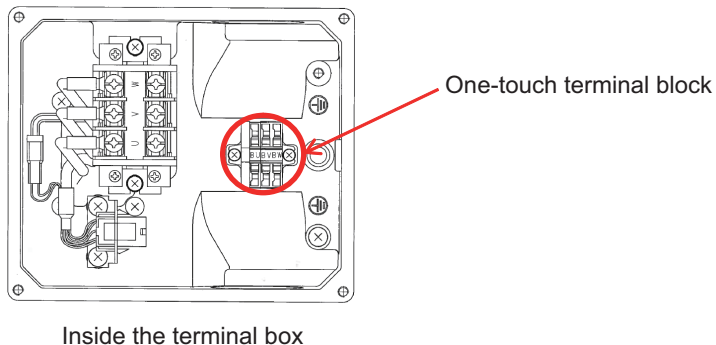

- [3-2] Insert the screwdriver into the insertion point (small square hole) of the one-touch terminal block in a diagonal direction. When the spring touches the blade edge, push the screwdriver down to the position that hits a conductive plate to the direction of arrow (a), tilting it in the inside direction of the terminal block. The screwdriver is held if it inserts appropriately.

- [3-3] After confirming that the spring is open, slowly unplug the lead wires for the cooling fan to the direction of arrow (b).

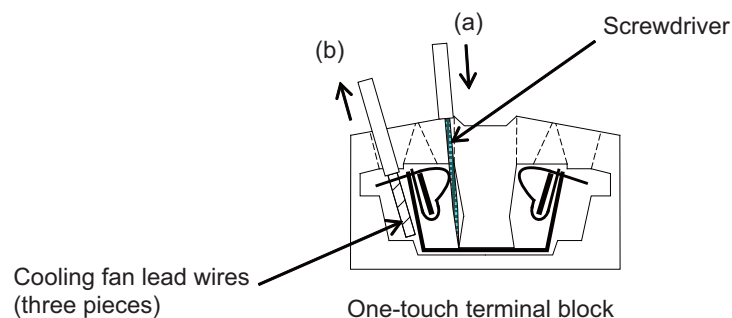

(Note 1) Do not let foreign objects enter the motor. In particular, if conductive objects such as screws or metal wires, etc., or combustible materials such as oil enter, the motor could be damaged.

- [4] Remove the fixing screws (hexagon socket screws at four locations) for the cooling fan unit.

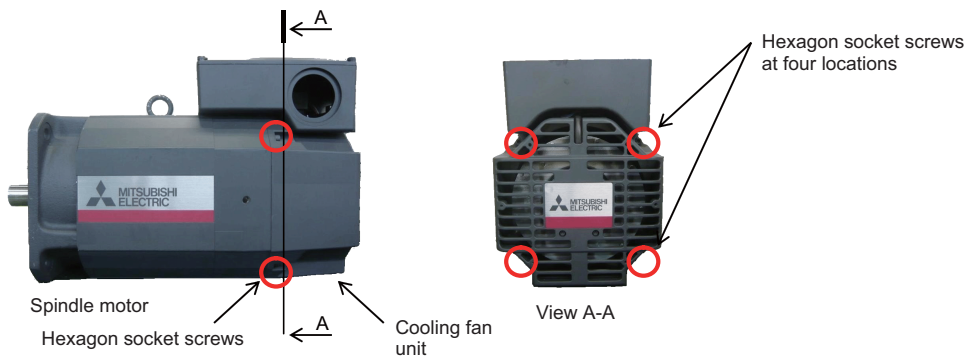

(Note 1) Some spindle motors have the fixing screws (hexagon socket screws) for the cooling fan unit at two locations.

- [5] Slowly unplug the lead wire of the cooling fan from the section where the lead wire for the cooling fan is led out. At this time, slowly unplug the protection tube which protects the lead wire for the cooling fan together. Slowly unplug the protection tube by pushing it out from inside the terminal box or pulling it from outside the terminal box not to overload the cooling fan side.

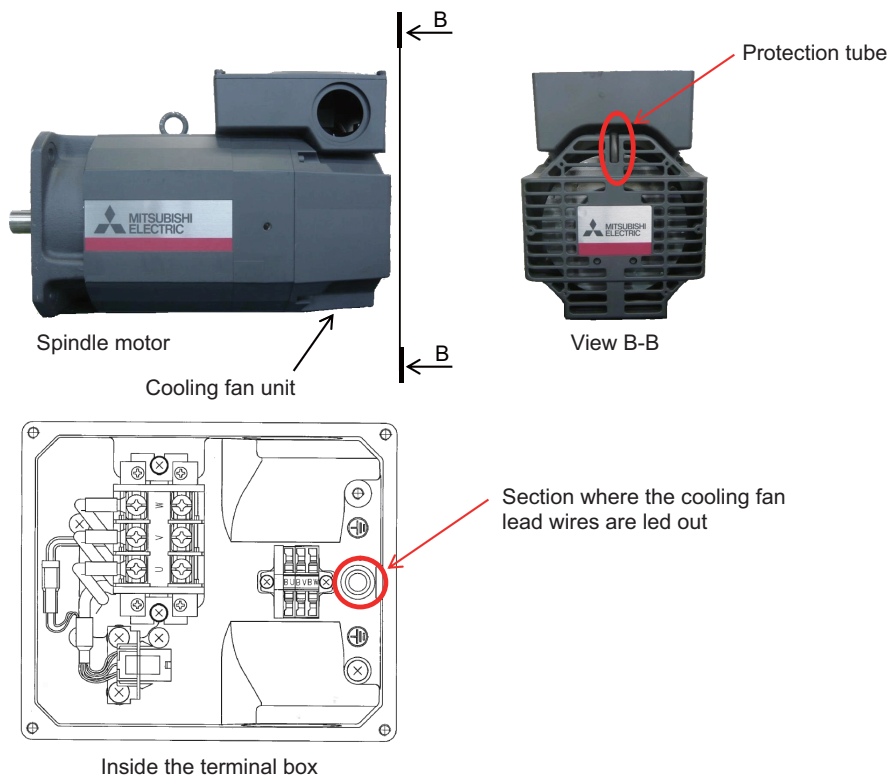

(Note 1) Take special care not to damage the lead wire for the cooling fan.

- [6] Slowly remove the cooling fan unit in the direction of arrow (c).

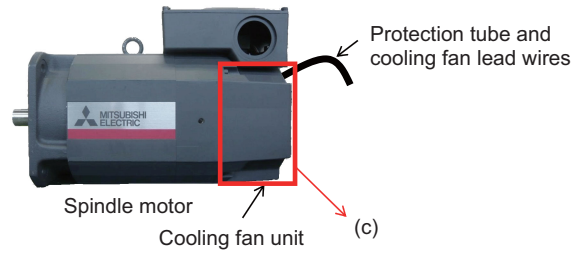

- (Note 1) Do not strike the side face of the cooling fan unit. Failure to observe this may result in damages of the fan unit.

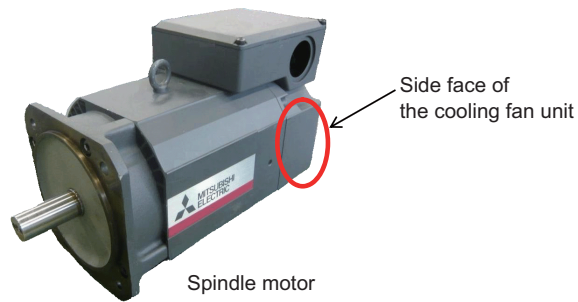

- (Note 2) Perform it so as not to touch the edge part of the cooling fan unit. Failure to observe this may result in injury.

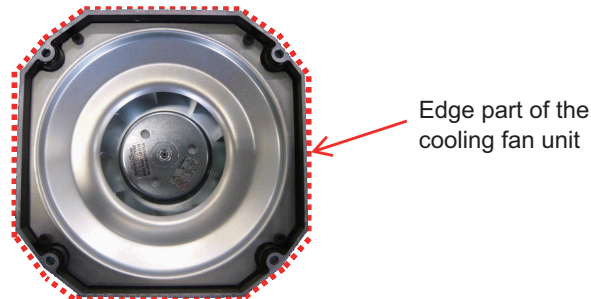

- (Note 3) Do not grip the cooling fan lead wire (including the protection tube) when carrying the cooling fan unit. Carrying with gripping them may result in damages of the fan unit.

(2) Removal of the bellmouth inside the cooling fan unit

- [1] Remove the bellmouth fixing screws (hexagon socket screws at four locations).

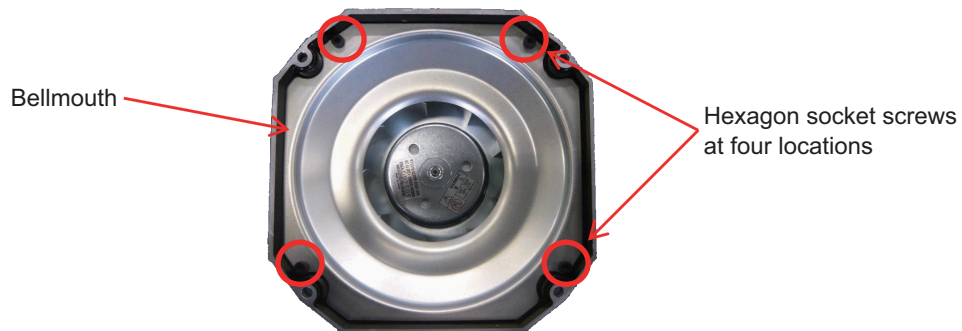

Cooling fan unit (before the bellmouth is removed)

(Note 1) Some spindle motors have the bellmouth fixing screws (hexagon socket screws) at two locations.

- [2] Remove the bellmouth.

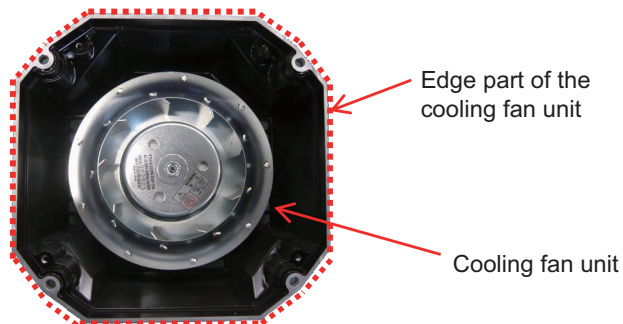

Cooling fan unit (after the bellmouth is removed)

(Note 1) Perform it so as not to touch the edge part of the cooling fan unit or the end part of the bellmouth. Failure to observe this may result in injury.

(Note 2) Do not let bellmouth fixing screws enter the cooling fan unit. Failure to observe this could lead to breakage or faults of the cooling fan.

(3) Cleaning

- [1] Check the situation of the cooling fan blade part and inside the case of the cooling fan unit by visual inspection.

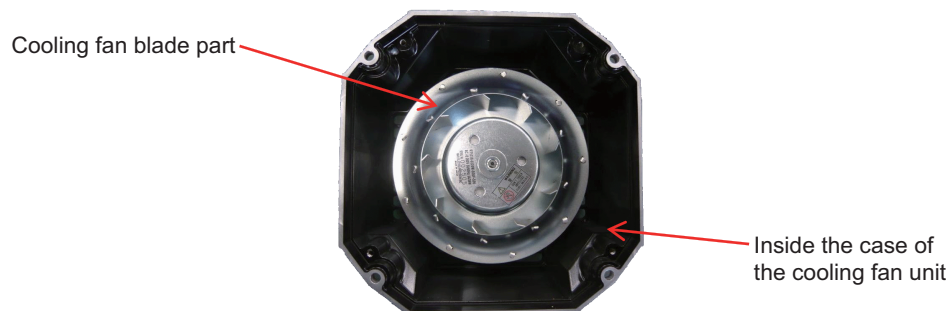

- [2] Clean up the inside of the cooling fan unit and the cooling air vent.
Wipe dirt off the inside of the cooling fan unit and the cooling air vent using wastes, etc.

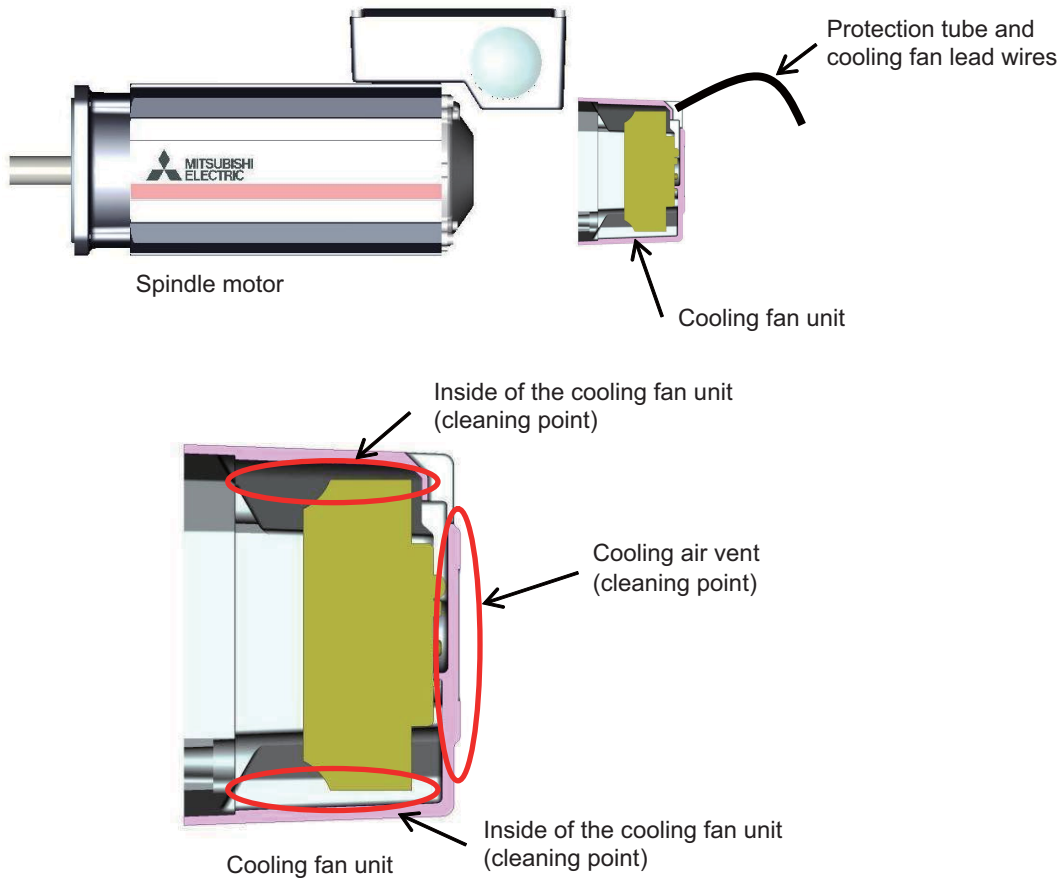

- (Note 1) Never disassemble or modify the cooling fan. Failure to observe this could lead to breakage or faults of the cooling fan.
- (Note 2) Do not drop the cooling fan or immerse it in water. Failure to observe this could lead to breakage or faults of the cooling fan.
- (Note 3) Do not use air blow as this may cause foreign matters to enter the inner part of the cooling fan motor.
- (Note 4) Do not wash with liquid detergent as the cooling fan motor is an electrical appliance.
- (Note 5) Take extra care not to damage the cooling fan during cleaning.

- [3] Clean up the air duct of the spindle motor frame
[3-1] Prepare the cleaning jigs (two types) as illustrated below.

The main body of the jigs A and B is a wire stick (approx. $\Phi 2\text{mm}$) with the length of approx. 500mm. A brush is attached at the top of the cleaning jig B. For the brush on the jig B, do not choose a hard brush such as the one made of wires.

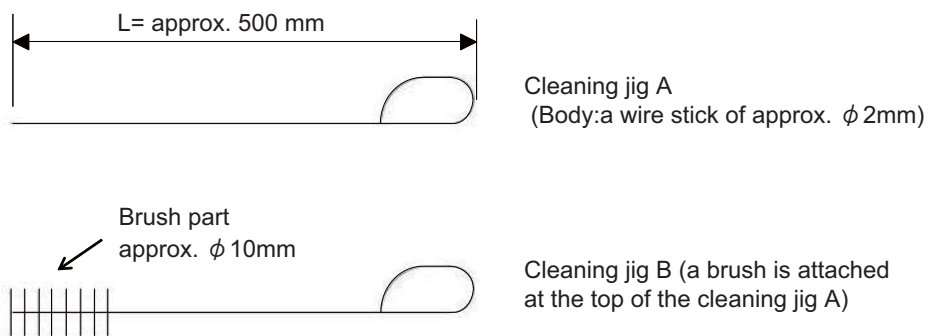

[3-2] Use the cleaning jigs to clean the air ducts of the spindle motor frame.

Insert the cleaning jigs A and B into the motor frame's air ducts from the counter-load side of the spindle motor, scrape out the dirt, and wipe it off with wastes, etc.

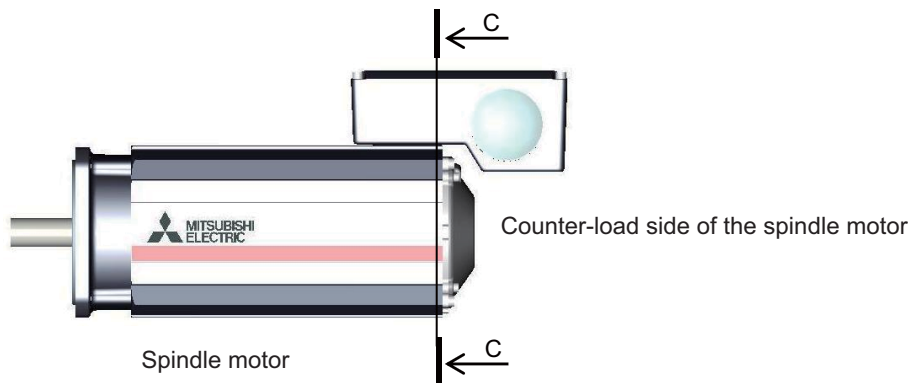

Counter-load side of the spindle motor

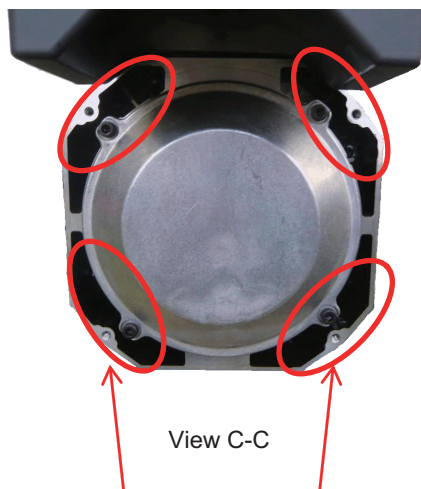

Motor frame's air ducts (cleaning points)

(4) Assembling

- [1] After all the cleaning processes have been completed, attach the cooling fan unit to the motor in the order opposite to that of the detachment process.
- [2] Precautions in installing cooling fan unit
 - (a) The section where the cooling fan lead wires are led out must be in the state without a space by inserting a protection tube for the cooling fan. A space could lead to faults of the motor by allowing foreign matters enter there.

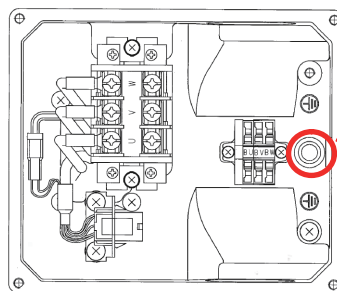

Section where the cooling fan lead wires are led out

Inside the terminal box

- (b) Draw the lead wires including the protection tube of the cooling fan unit into the terminal box not to project at the back side of the motor. Failure to observe this could lead to breakage of the lead wires.

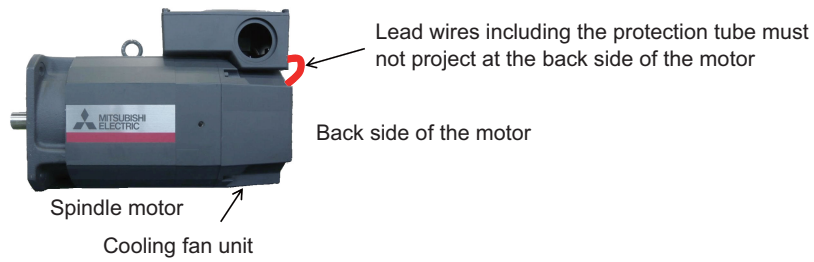

- (c) When installing the three lead wires (BU, BV, and BW) of the cooling fan to the one-touch terminal block, do not mistake the terminal connections. Improper connection could lead to breakage or malfunction.
- (d) Make sure not to pinch the cooling fan lead wire when installing the terminal box cover. Failure to observe this could lead to electric shocks.

- [3] After attaching the unit, perform a test run to check the air blow direction of the fan, etc.

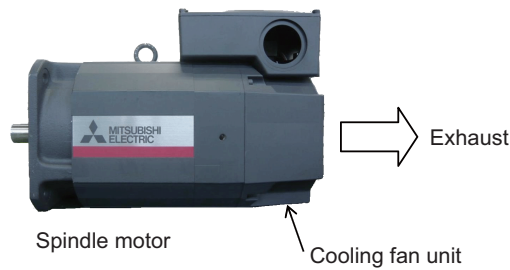

<For the spindle motor SJ-VL Series>

(1) Detaching the cooling fan unit

Remove the cooling fan unit from the spindle motor.

[1] Disconnect the cooling fan's terminals from the terminal block (See the diagram below).

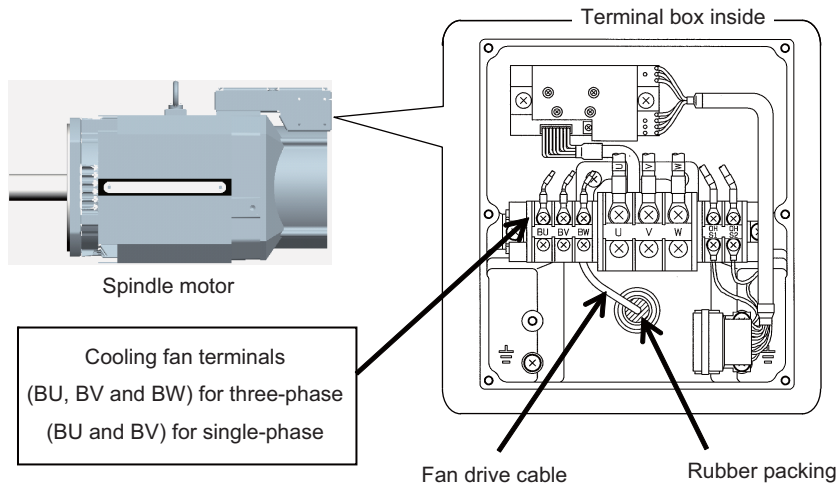

[2] Detach the cooling fan unit from the spindle motor.

Remove the four hexagon socket screws used to secure the cooling fan unit to the spindle motor.

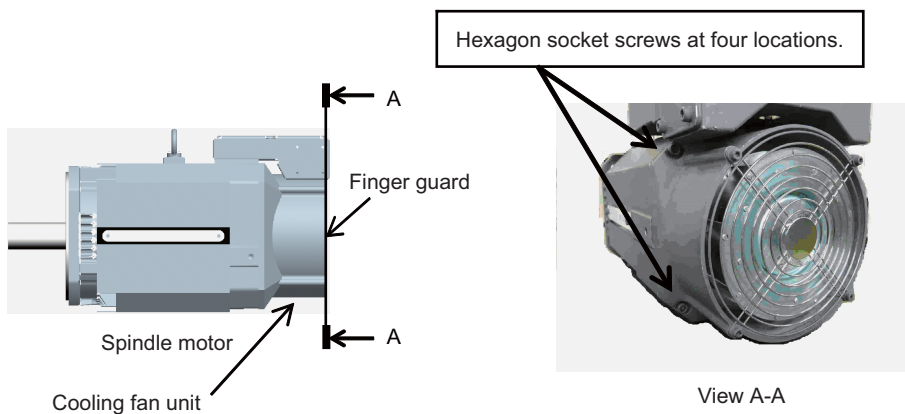

When slowly removing the cooling fan unit from the spindle motor, also unplug the fan drive cable slowly with the rubber packing left in the terminal box.

(Note 1) Pull out the solderless terminals one by one as the hole on the terminal box is small.

(Note 2) Take extra care not to damage the cable.

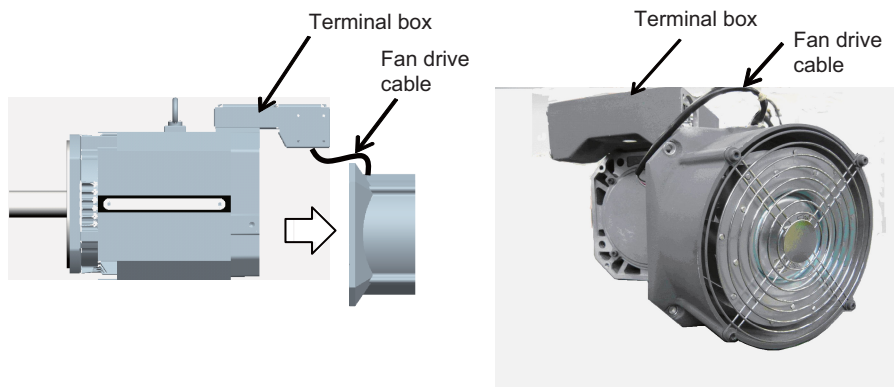

(2) Cleaning

(a) Clean up the backside of the cooling fan unit and the air duct in the counter-load side bracket of the spindle motor. Wipe dirt off the backside of the cooling fan unit and the air duct of the counter-load side bracket using wastes, etc.

(Note 1) Do not use air blow as this may cause foreign matters to enter the inner part of the cooling fan motor.

(Note 2) Do not wash with liquid detergent as the cooling fan motor is an electrical appliance.

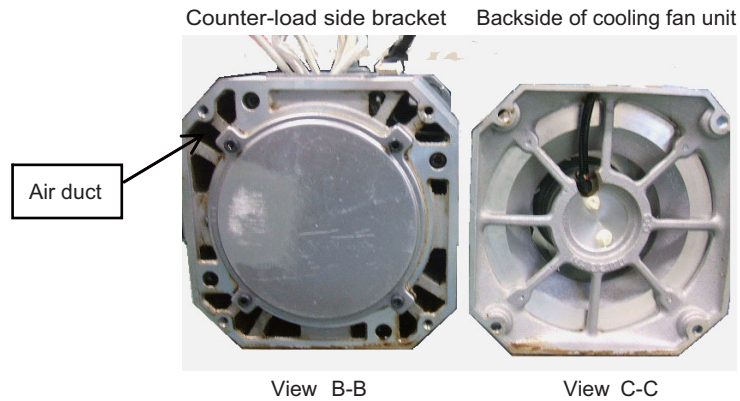
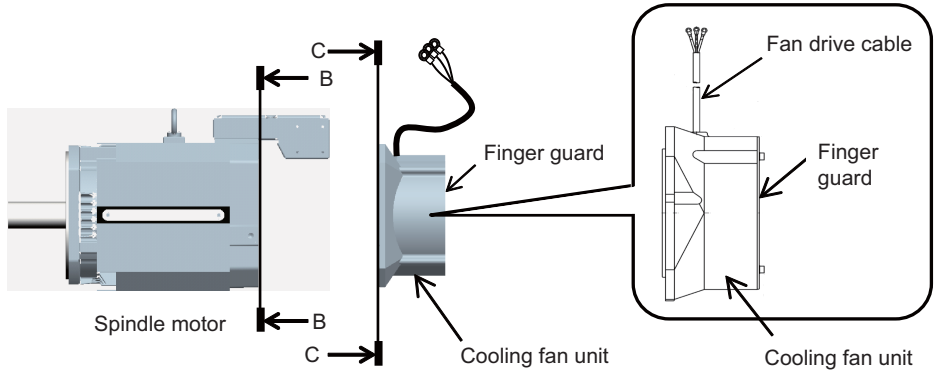

(b) Clean up the inner part of the fan case and the air duct of the spindle motor body

[1] Prepare the cleaning jigs (two types) as illustrated below.

The main body of the jigs A and B is a wire stick (approx. $\Phi 2\text{mm}$) with the length of approx. 500mm. A brush is attached at the top of the cleaning jig B. For the brush on the jig B, do not choose a hard brush such as the one made of wires.

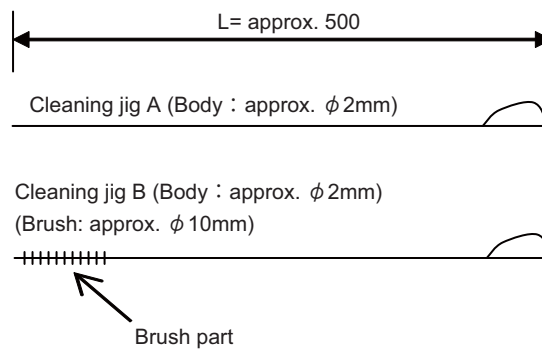

- [2] Detach the finger guard from the cooling fan unit.
Remove the four screws used for securing the finger guard.

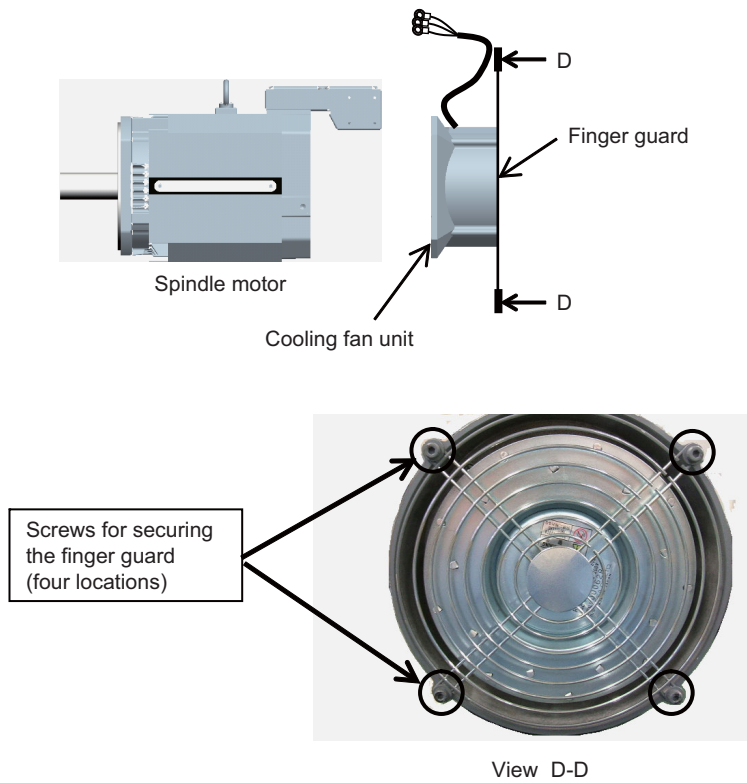

- [3] Wipe dirt off the finger guard using wastes, etc.
- [4] Use the cleaning jigs to clean the inner part of the cooling fan case.
Use the cleaning jigs A and B to scrape out dirt between the fan case and blades in the cooling fan unit, and wipe it off with wastes, etc.
(Note 1) Do not use air blow as this may cause foreign matters to enter the inner part of the cooling fan motor.
(Note 2) Do not wash with liquid detergent as the cooling fan motor is an electrical appliance.
(Note 3) Take extra care not to damage the cooling fan during cleaning.

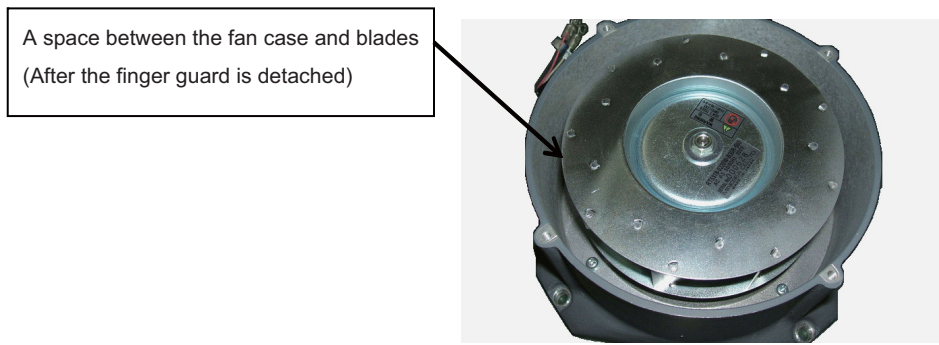

- [5] Use the cleaning jigs to clean the air ducts of the spindle motor body.
 Insert the cleaning jigs A and B into the motor's air ducts from the counter-load side bracket, scrape out the dirt, and wipe it off with wastes, etc.

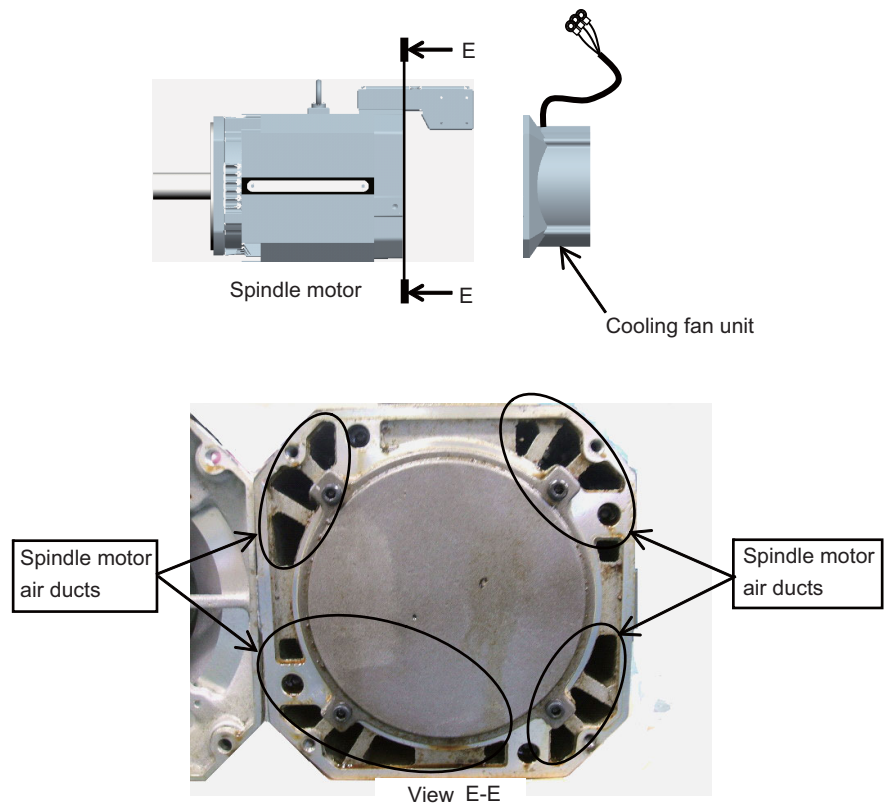

(3) Assembling

After all the cleaning processes have been completed, attach the cooling fan unit to the motor in the order opposite to that of the detachment process. After attaching the unit, perform a test run to check the air blow direction of the fan, etc. Be careful not to pinch the cable between the cooling fan unit and the terminal box.

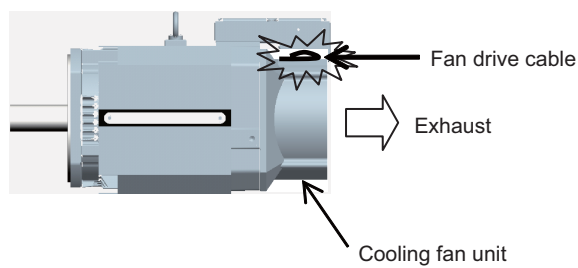

8.2 Service Parts

A guide to the part replacement cycle is shown below. Note that these will differ according to the working conditions or environmental conditions, so replace the parts if any abnormality is found. Contact Mitsubishi branch or your dealer for repairs or part replacements.

Part name		Standard replacement time	Remarks
Servo drive unit	Smoothing capacitor	10 years	The standard replacement time is a reference. Even if the standard replacement time is not reached, the part must be replaced if any abnormality is found.
	Cooling fan	10,000 to 30,000 hours (2 to 3 years)	
	Battery	10,000 hours (for ER6V-C119B / MDS-BTBOX-36)	
Servo motor	Bearings	20,000 to 30,000 hours	
	Encoder	20,000 to 30,000 hours	
	Oil seal, V-ring	5,000 hours	

[1] Power smoothing capacitor:

The characteristics of the power smoothing capacitor will deteriorate due to the effect of ripple currents, etc. The capacitor life is greatly affected by the ambient temperature and working conditions. However, when used continuously in a normal air-conditioned environment (ambient temperature is an average of 40°C or less), the service life will be ten years.

[2] Relays:

Contact faults will occur due to contact wear caused by the switching current. The service life will be reached after 100,000 cumulative switches (switching life) although this will differ according to the power capacity.

[3] Servo motor bearings:

The motor bearings should be replaced after 20,000 to 30,000 hours of rated load operation at the rated speed. This will be affected by the operation state, but the bearings must be replaced when any abnormal noise or vibration is found in the inspections.

[4] Servo motor oil seal, V-ring:

These parts should be replaced after 5,000 hours of operation at the rated speed. This will be affected by the operation state, but these parts must be replaced if oil leaks, etc., are found in the inspections.

8.3 Adding and Replacing Units and Parts

CAUTION

1. Correctly transport the product according to its weight. Failure to do so could result in injury.
2. Do not stack the product above the indicated limit.
3. Installation directly on or near combustible materials could result in fires.
4. Install the unit as indicated at a place which can withstand the weight.
5. Do not get on or place heavy objects on the unit. Failure to observe this could result in injury.
6. Always use the unit within the designated environment condition range.
7. Do not allow conductive foreign matter such as screws or metal chips, or combustible foreign matter such as oil enter the servo drive or servo motor.
8. Do not block the intake or exhaust ports of the servo drive or servo motor. Failure to observe this could result in faults.
9. The servo drive and servo motor are precision devices. Do not drop them or apply strong impacts.
10. Do not install or operate a servo drive or servo motor which is damaged or missing parts.
11. When the unit has been stored for a long time, contact the Service Center.
12. Connect the encoder (CN2/CN3) immediately after the installation of the servo drive unit. In addition, when a battery box is used, immediately connect to the BTA/BTB connector. (prevention of absolute position data lost)

8.3.1 Replacing the Drive Unit

(1) Arrangement of replacing parts

Contact Mitsubishi branch or your dealer for an order or a replacement of the drive unit.
Place an order for the same type of a drive unit as the one to be replaced.

(2) Replacement procedure

Replace the drive unit with the following procedures.

Procedures

- [1] Turn the breaker for the input power OFF. Make sure the CHARGE lamp of the power supply unit is turned OFF.
- [2] Disconnect all the connectors and the wires connected to the drive unit.
- [3] Remove the two (four) screws fixing the drive unit onto the control panel. Remove the drive unit from the control panel.
- [4] Make a same setting for the rotary switch and the dip switch of the new drive unit as those of the uninstalled drive unit.
- [5] Install a new drive unit by following the removal procedure in reverse.

(3) Restoration

Data backup and restoration is not required before replacing drive units because drive units' data such as parameters are stored in the controller. However, carry out a backup of the whole system before replacement as a precautionary measure.

The power for keeping the encoder's position data of an absolute position system is supplied from the battery connected to the drive unit. Keep the power ON once for 30 minutes or more if possible, and make sure to complete the replacement within 60 minutes after charging the encoder's capacitor.

8.3.2 Replacing the Unit Fan

(1) Replacing parts

< MDS-D2 Series >

Servo drive unit			Spindle drive unit			Power supply unit		
Type MDS-D2-	Fan type	Size [mm]	Type MDS-D2-	Fan type	Size [mm]	Type MDS-D2-	Fan type	Size [mm]
V1-20	9WF0424H6D05	40SQ.	SP-20	9WF0424H6D05	40SQ.	CV-37	-	-
V1-40			SP-40			CV-75	-	-
V1-80			SP-80			CV-110	9WF0624H4D04	60SQ.
V1-160			SP-160			CV-185		
V1-160W	9WF0624H4D04	60SQ.	SP-200	MMF-09D24TS-MM6	90SQ.	CV-300	MMF-09D24TS-MM6	90SQ.
V1-320	MMF-09D24TS-MM6	90SQ.	SP-240			CV-370		
V1-320W			SP-320	MMF-12D24DS-MM6	120SQ.	CV-450	MMF-12D24DS-MM6	120SQ.
V2-2020	9WF0424H6D05	40SQ.	SP-400	MMF-09D24TS-MMB	90SQ.	CV-550		
V2-4020			SP-640	MMF-12D24DS-MM6	120SQ.			
V2-4040			SP2-2020					
V2-8040			SP2-4020					
V2-8080	SP2-4040S							
V2-16080	9WF0624H4D04	60SQ.	SP2-4040	9WF0624H4D04	60SQ.			
V2-160160			SP2-8040					
V2-160160W	MMF-09D24TS-MM6	90SQ.	SP2-16080S					
V3-202020	109P0424H3D13	40SQ.	SP2-8080	MMF-09D24TS-MM6	90SQ.			
V3-404040			SP2-16080					

< MDS-DH2 Series >

Servo drive unit			Spindle drive unit			Power supply unit		
Type MDS-DH2-	Fan type	Size [mm]	Type MDS-DH2-	Fan type	Size [mm]	Type MDS-DH2-	Fan type	Size [mm]
V1-10	-	-	SP-20	9WF0424H6D05	40SQ.	CV-37	9WF0624H4D04	60SQ.
V1-20	9WF0424H6D05	40SQ.	SP-40			CV-75		
V1-40			SP-80	9WF0624H4D04	60SQ.	CV-110		
V1-80			SP-100	MMF-09D24TS-MM6	90SQ.	CV-185		
V1-80W			9WF0624H4D04			60SQ.	SP-160	CV-300
V1-160	MMF-09D24TS-MM6	90SQ.	SP-200	MMF-09D24TS-MMB	90SQ.	CV-370	MMF-09D24TS-MM6	90SQ.
V1-160W			SP-320			CV-450		
V1-200	MMF-09D24TS-MMB	90SQ.	SP-480	MMF-12D24DS-MM6	120SQ.	CV-550	MMF-12D24DS-MM6	120SQ.
V2-1010	-	-				CV-750		
V2-2010	9WF0424H6D05	40SQ.						
V2-2020								
V2-4020								
V2-4040								
V2-8040	9WF0624H4D04	60SQ.						
V2-8080								
V2-8080W	MMF-09D24TS-MM6	90SQ.						

**POINT**

When the drive unit of D2/DH2 Series which uses two cooling fans is in an emergency stop or alarm, one of fans (upper one in the case of vertical layout, or either one in the case of horizontal layout) is stopped and power-saving operation is performed. If the suspended fan is restarted by canceling the emergency stop, it is not a problem with the fan.

(2) Replacement procedure

Replace the unit fan with the following procedures.

< MDS-D2/DH2-V1/V2/SP/SP2 Series >

- [1] Turn the breaker for the input power OFF, and wait for the CHARGE lamp on the power supply unit to turn OFF before removing the unit.
- [2] Remove the fan guard from the back of the drive unit, and remove the two fan mounting screws.
- [3] Remove the rubber bushing for the fan power cable, and pull out the connection connector.
- [4] Disconnect the connection connector, and replace the fan.

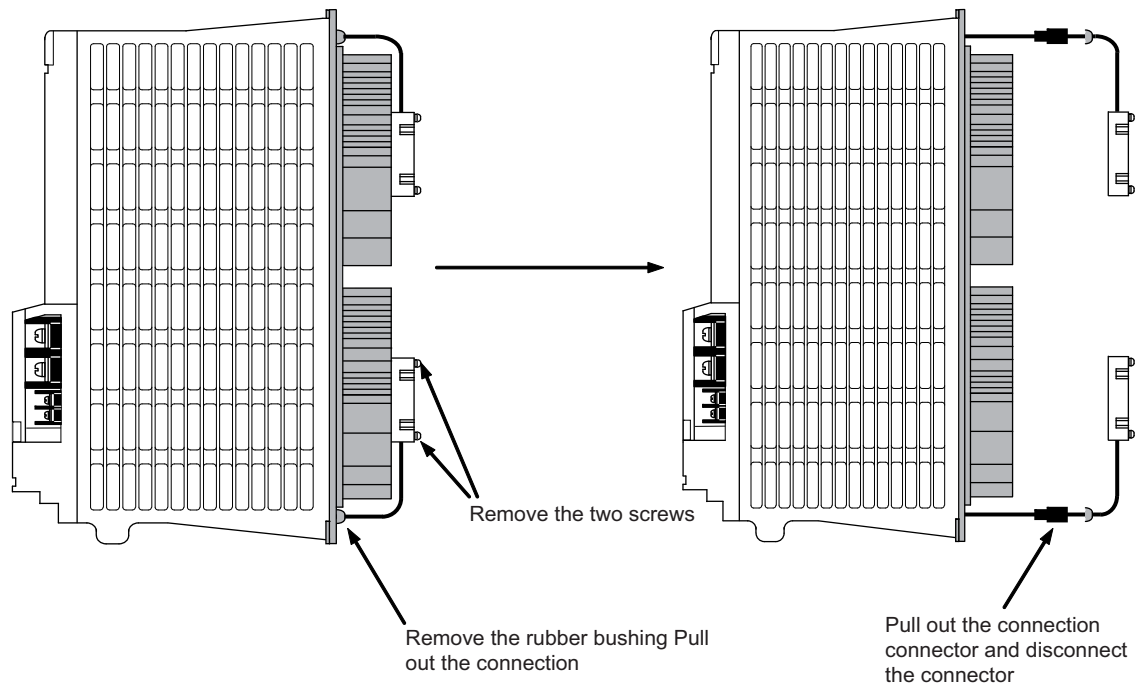

< MDS-D2-V3 Series >

[1] Remove the fan guard on the top of the drive unit.

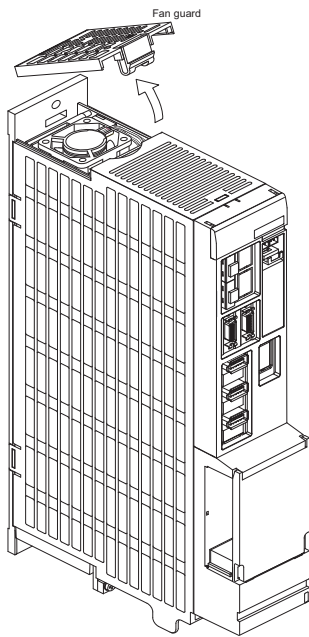

[2] Remove the fan.

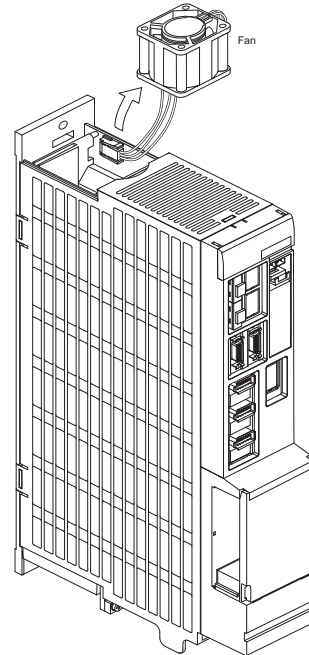

[3] Disconnect the connection connector of the fan mounted on the unit side face. Disconnect the connection connector with pressing both side of the connector.

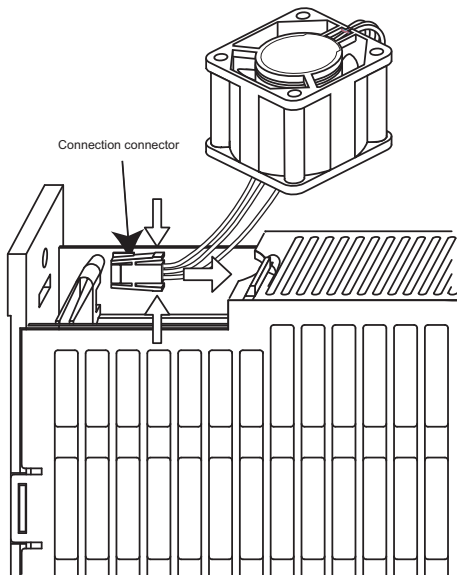

[4] Replace the fan. Install the fan so that the fan label is the top face and the fan cable is between the fan and P-plate.

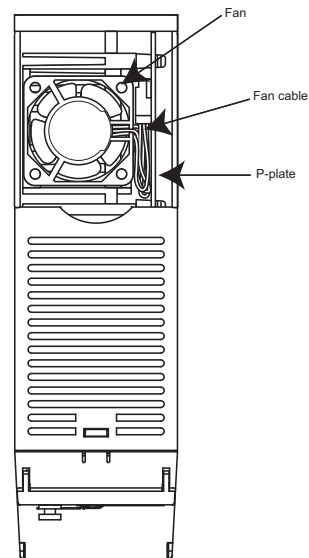

8.3.3 Replacing the Battery

(1) Replacing parts

< Replacing a battery equipped with the spindle/servo drive unit or the battery unit, MDS-BTBOX-36 >

When the battery voltage is low (warning 9F), place an order for the same type of a battery as the one currently equipped with the unit.

Battery type LR20 is commercially available as a size-D alkaline battery. The battery may be purchased and replaced by the user.

Battery type

Type	Battery equipped unit
ER6V-C119B	Spindle/servo drive unit
LR20 (size-D alkaline battery)	Battery unit, MDS-BTBOX-36

(Note) Four LR20 size-D alkaline batteries are needed for per battery unit, MDS-BTBOX-36.

⚠ CAUTION

1. When the battery voltage is low (warning 9F), do not shut OFF the power of the drive unit until replacement of the battery to protect the data.
2. Replace the MDS-BTBOX-36 battery with new batteries (LR20) that is within the recommended service period.

(2) Replacement procedure

Replace the battery with the following procedures.

⚠ CAUTION

1. Replace the batteries with new ones immediately after the battery voltage drop alarm (9F) has been output.
2. Replace the batteries while applying the drive unit's control power.

< Replacement procedure for the cell battery ER6V-C119B >

- [1] Turn the breaker for the input power OFF. Make sure the power of the replacing drive unit is turned OFF.
 - [2] Open the battery holder cover located at the front of the drive unit.
 - [3] Pull out the battery connector connected with the drive unit. Remove the battery.
 - [4] Connect a new battery connector to the connector position where the old battery connector was pulled out from in step [2].
 - [5] Cancel the warning 9F by executing an alarm reset (pushing the NC reset button).
- (Note) Replace the batteries while applying the drive unit's control power.

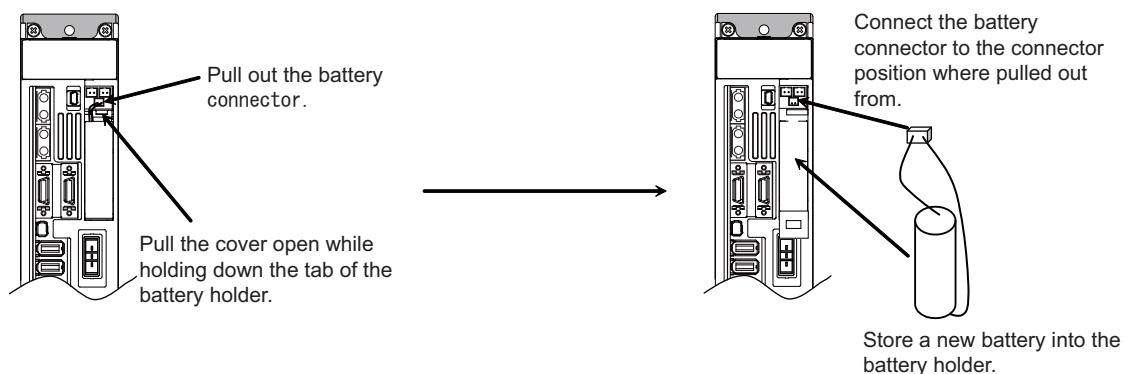

< Replacement procedure for the battery unit MDS-BTBOX-36 >**Possible backup period**

Possible backup period is at most one year. Thus, make sure to exchange the batteries in the one-year cycle.

How to replace the battery

[1] Remove the battery box cover (four screws).

[2] Replace the batteries with new ones. Be careful not to mistake the polarity.

[3] Attach the cover, and fix it with the four screws.

(Note 1) Replace the batteries while applying control power to the servo drive unit.

(Note 2) When replacing the battery, do not let foreign objects enter. If the terminal area gets dirty, clean there.

(Note 3) If the cover is ill-set, mist or foreign objects enter through the interstices and enter into the panel. Tighten the screws. (Tightening torque: 1N•m)

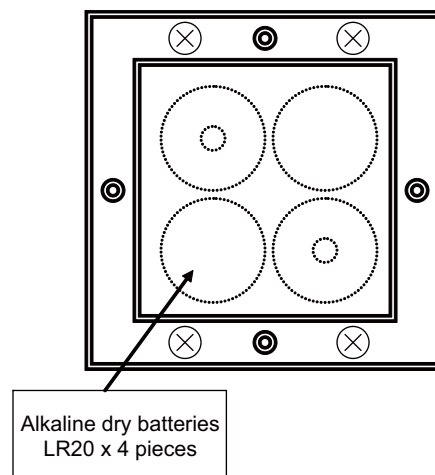
**⚠ CAUTION**

1. Use new batteries that are within the recommended service period. (Check the recommended service period written on the batteries before using them.)
2. Replace the batteries with new ones immediately after the battery voltage drop alarm (9F) has been output.
3. Replace the batteries while applying the servo drive unit's control power.
4. Wrong connection may cause liquid leakage, heat generation and/or explosion.
5. Do not mix new batteries with used ones or mix different type batteries.

8.3.4 Replacing the Fuse

(1) Replacing parts

Fuse type	
Type	Fuse equipped unit
HM32	MDS-D2 series
HM16	MDS-DH2 series

< Contact information >

Daito Communication Apparatus Co., Ltd.: <http://www.daitotusin.co.jp/english/index.htm>

(2) Replacement procedure

Replace the fuse with the following procedures.

Procedures

- [1] Turn the breaker for the input power OFF. Make sure the power of the replacing drive unit is turned OFF.
- [2] Open the terminal block cover located at the front of the drive unit.
- [3] Pull out the fuse and replace it by a new fuse.

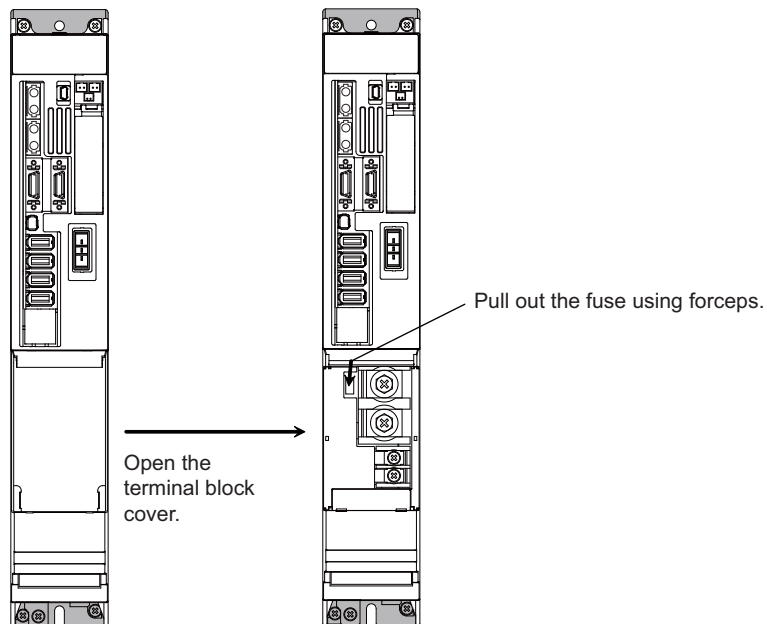

Power Backup System

9.1 Deceleration and Stop Function at Power Failure

The deceleration and stop function at power failure is a function to safely decelerate the servo axes and the spindle when a power failure occurs. This function prevents a damage on the machine due to an overrun of the servo axes, and at the same time, realizes a protection against overvoltage for high-speed IPM spindle motors and high-speed DDMs.

CAUTION

The power backup unit (MDS-D/DH-PFU) and regenerative resistor unit (R-UNIT6,7) options are required when using the deceleration and stop function at power failure.

9.1.1 Specifications of Stop Method for Deceleration and Stop Function at Power Failure

System

The power backup system is a system to protect the machine and drive units at a power failure. When it is used, stop methods during some operations are different from those of when it is not used. See below for the stop methods of <servo system> and <spindle system> when the power backup system is not used ((1) in the tables) and when it is used ((2) in the tables) depending on what is occurring.

< Servo system >

What is occurring	Power failure	NC power down	External emergency stop	MDS-D2/DH2-CV alarm	MDS-D/DH-PFU alarm	(Another axis) Drive unit alarm	(Its own axis) Drive unit deceleration and stop alarm	(Its own axis) Drive unit dynamic stop alarm
(1) No power backup system	Dynamic stop	Deceleration control + Power regeneration	Deceleration control + Power regeneration	Dynamic stop	-	Deceleration control + Power regeneration	Deceleration control + Power regeneration	Dynamic stop
(2) Deceleration and stop function at power failure	Deceleration control + PFU regeneration	Deceleration control + Power regeneration	Deceleration control + Power regeneration	Deceleration control + PFU regeneration Dynamic stop in the case of some alarms (Note 1)	Deceleration control + Power regeneration	Deceleration control + Power regeneration	Deceleration control + Power regeneration	Dynamic stop

(Note 1) A deceleration and stop operation is carried out in the case of some MDS-D2/DH2-CV alarms. (ALM66, 68 to 6E, 70, 75)

< Spindle system >

What is occurring	Power failure	NC power down	External emergency stop	MDS-D2/DH2-CV alarm	MDS-D/DH-PFU alarm	(Another axis) Drive unit alarm	(Its own axis) Drive unit deceleration and stop alarm	(Its own axis) Drive unit dynamic stop alarm
(1) No power backup system	Coast to a stop	Coast to a stop	Deceleration control + Power regeneration	Coast to a stop	-	Deceleration control + Power regeneration	Deceleration control + Power regeneration	Coast to a stop
(2)-1 Deceleration and stop function at power failure *When using IM or low-speed IPM motor	Deceleration control + PFU regeneration	Deceleration control + Power regeneration	Deceleration control + Power regeneration	Deceleration control + PFU regeneration Coast to a stop in the case of some alarms (Note 1)	Deceleration control + Power regeneration	Deceleration control + Power regeneration	Deceleration control + Power regeneration	Coast to a stop
(2)-2 Deceleration and stop function at power failure *When using high-speed IPM motor	Deceleration control + PFU regeneration	Deceleration control + Power regeneration	Deceleration control + Power regeneration	Deceleration control + PFU regeneration Coast to a stop in the case of some alarms (Note 1)	Deceleration control + Power regeneration	Deceleration control + Power regeneration	Deceleration control + Power regeneration	Overvoltage protection control (Coast to a stop from deceleration operation only during high-speed rotation)

(Note 1) A deceleration and stop operation is carried out in the case of some MDS-D2/DH2-CV alarms. (ALM66, 68 to 6E, 70, 75)

9.1.2 Wiring of Deceleration and Stop Function at Power Failure

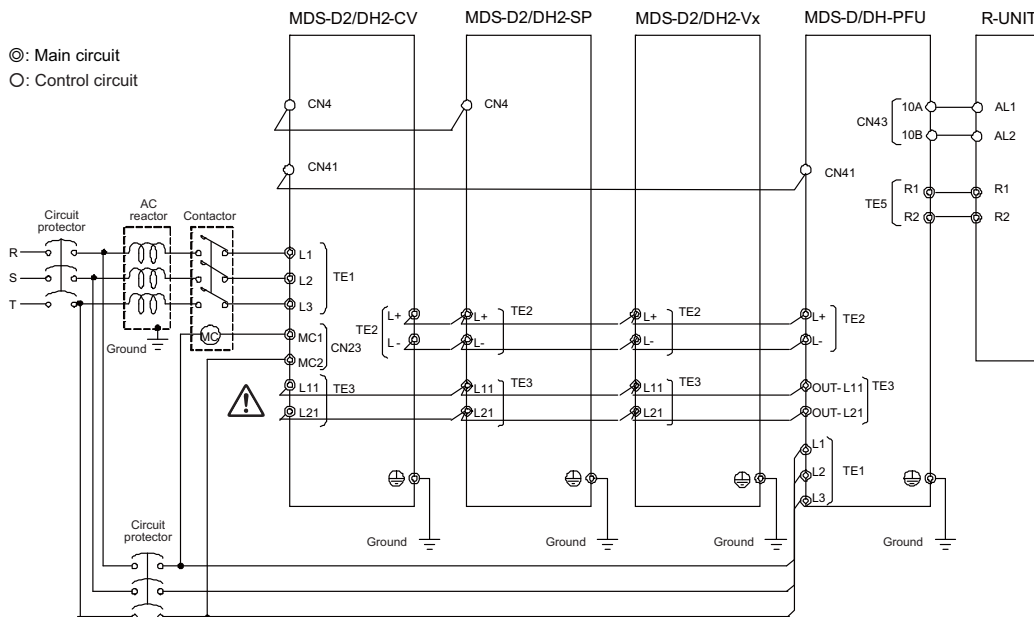

- (Note 1) When multiple power supply units are used, each power supply unit must be connected with one power backup unit. It is not possible to connect multiple power supply units to one power backup unit.
- (Note 2) Select the power supply that can be retained until the completion of deceleration stop operation for the 24V power supply of dynamic brake unit and MP scale.
- (Note 3) In the system with multiple power supply units, each power supply unit must be connected with one power backup unit.
- (Note 4) Connect the control power supply (L11,L21) of the unit where the deceleration and stop function is not used to a commercial AC power supply.

CAUTION

Connect the PFU's TE3 (OUT-L11, OUT-L21) to L11 and L21 of each unit. Do not connect them to a commercial AC power supply. The unit will be damaged if connecting the PFU's TE3 to a commercial AC power supply. When retrofitting the PFU, disconnect commercial AC power from L11, L21.

(1) Connection of Regenerative Resistor Unit

Connect the PFU connection terminal R1/R2 of the regenerative resistor for external option power backup unit between the regenerative resistor connection terminals R1 and R2 in TE5.

The regenerative resistor generates heats, so wire and install the unit while taking care to safety. When using the regenerative resistor, make sure that flammable matters, such as cables, do not contact the resistor, and provide a cover on the machine so that dust or oil does not accumulate on the resistor and ignite.

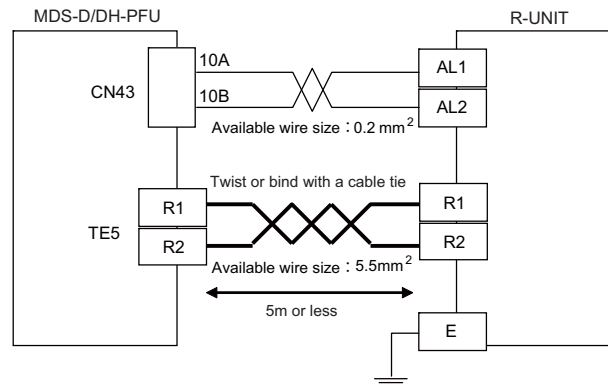
**⚠ CAUTION**

1. Make sure to install the regenerative resistor for external option power backup unit to enable the deceleration and stop function at power failure.
2. Only the designated combination can be used for the external option regenerative resistor and drive unit. There is a risk of fire, so always use the designated combination.

9.1.3 Setup of Deceleration and Stop Function at Power Failure**(1) Setting the rotary switch (SW1)**

Set the rotary switch (SW1) of MDS-D/DH-PFU depending on the regenerative resistor to be used.

- MDS-D-PFU
Rotary switch (SW1) setting : 2 R-UNIT-7 is connected
- MDS-DH-PFU
Rotary switch (SW1) setting : 1 R-UNIT-6 is connected

(2) Setting the dip switches (SW2, SW3)

Normally all OFF.

⚠ CAUTION

Refer to "9.3.1 How to Set Rotary Switch and Dip Switches" for detail specifications on the rotary switch (SW1) and dip switches (SW2, SW3) of MDS-D/DH-PFU.

(3) Parameter setting of servo drive unit

When using the deceleration and stop function at power failure, set the servo parameter of this function for the servo drive unit connected to the power supply unit.

[#2236(PR)] SV036 P TYP Power supply type/ Regenerative resistor type

MDS-D2/DH2 Series: Power supply type

When connecting a power supply unit, set a code for each power supply unit.

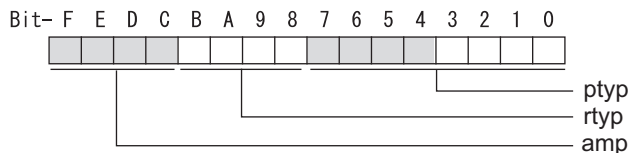

bit F-C : amp

Set the power backup function to be used.
 No function used : 0
 Deceleration and stop function at power failure : 8

(4) Parameter setting of spindle drive unit

When using the deceleration and stop function at power failure, set the spindle parameter of this function for the spindle drive unit connected to the power supply unit. To decelerate and stop the spindle at power failure, select the spindle stop method by setting the parameter of the spindle to be decelerated to a stop.

[#13032(PR)] SP032 P TYP Power supply type/ Regenerative resistor type

MDS-D2/DH2 Series: Power supply type

When connecting a power supply unit, set a code for each power supply unit.

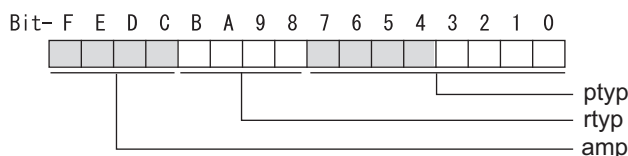

bit F-C : amp

Set the power backup function to be used.
 No function used : 0
 Deceleration and stop function at power failure : 8

[#13230] SP230 SFNC10 Spindle function 10

Select the spindle functions.
 Functions are allocated to each bit.
 Set this in hexadecimal format.

bit B : pfdsr

Set the spindle stop operation at a power failure when the deceleration and stop function at power failure is enabled.
 Normal (Coast to a stop at power failure) : 0
 Deceleration and stop at power failure : 1

9.2 Retraction function at power failure

The retraction function at power failure is a function to backup the power of the main circuit from the capacitor unit when a power failure occurs. For example, when power failure occurs during hobbing, tool escape by retraction operation can be realized using an NC command (hob retraction).

⚠ CAUTION

1. The power backup unit (MDS-D/DH-PFU) and capacitor unit (MDS-D/DH-CU) options are required when using the retraction function at power failure. Whether the regenerative resistor unit (R-UNIT6,7) is required or not is decided depending on the spindle stop operation (Deceleration and stop or Coast to a stop) at power failure.
2. Refer to the specifications manual of NC system for details on the NC settings relevant to the hob retraction function.

9.2.1 Wiring of Retraction Function at Power Failure

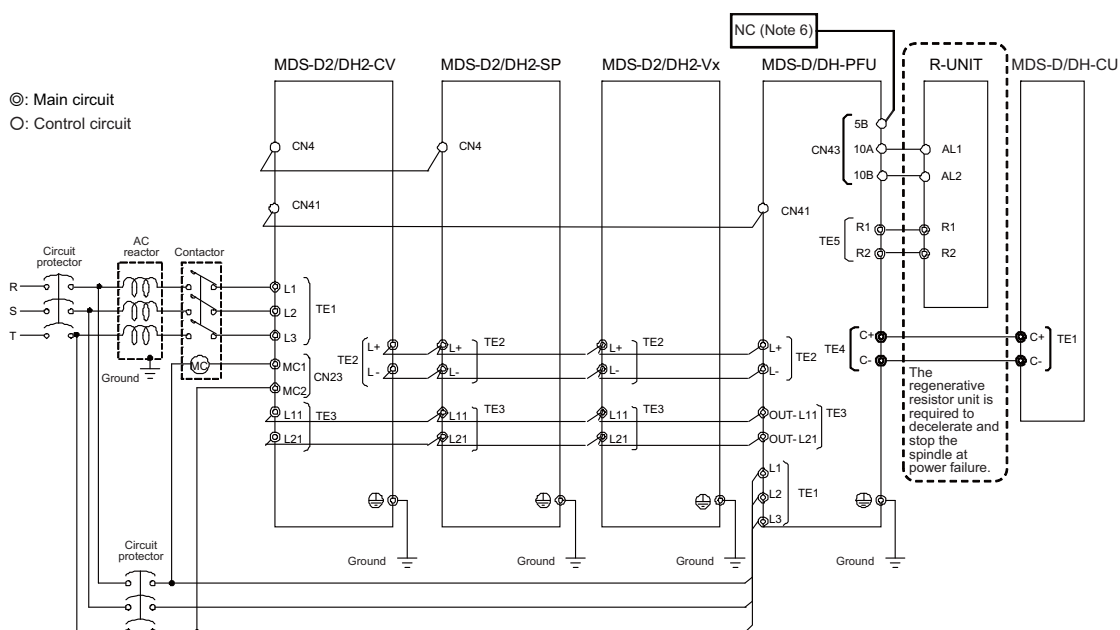

- (Note 1) When using the retraction function at power failure, uninterruptible power supply (UPS) is required for NC power.
- (Note 2) Connect the capacitor unit's TE1(C+,C-) to PFU's TE4(C+,C-).
(Do not connect them to PFU's TE2(L+,L-) or TE5(R1,R2).)
- (Note 3) Do not reverse the polarity of C+ and C- when connecting the capacitor unit.
- (Note 4) Securely perform the switch setting and control signal connection.
- (Note 5) DO2 (tool escape request) of CN43 is used for the retraction function at power failure. Input the DO2 signal to DI of the NC so that DO2 can turn ON the retraction request signal (YCDE) through the PLC sequence.
- (Note 6) In the system with multiple power supply units, each power supply unit must be connected with one power backup unit.
- (Note 7) Connect the control power supply (L11,L21) of the unit where the retraction function at power failure is not used to a commercial AC power supply.

⚠ CAUTION

Connect the PFU's TE3 (OUT-L11, OUT-L21) to L11 and L21 of each unit.
Do not connect them to a commercial AC power supply. The unit will be damaged if connecting the PFU's TE3 to a commercial AC power supply.

(1) Connection of Regenerative Resistor Unit

If the spindle motor is decelerated to a stop after servo retraction has been performed using the retraction function at power failure, the regenerative resistor unit (R-UNIT6,7) is required. When connecting the regenerative resistor unit, wire it according to "9.1.3 Connection of Regenerative Resistor Unit (1) Connection of Regenerative Resistor Unit".

(2) Connection of Capacitor Unit

Study the control panel design using the following connection methods as reference for the power backup unit and capacitor unit. Connect with the wire whose size is HIV22sq or more and wire the connection wires so that the two wires closely contact with fixing bands. The connection length between the power backup unit and capacitor unit should be 10m or less.

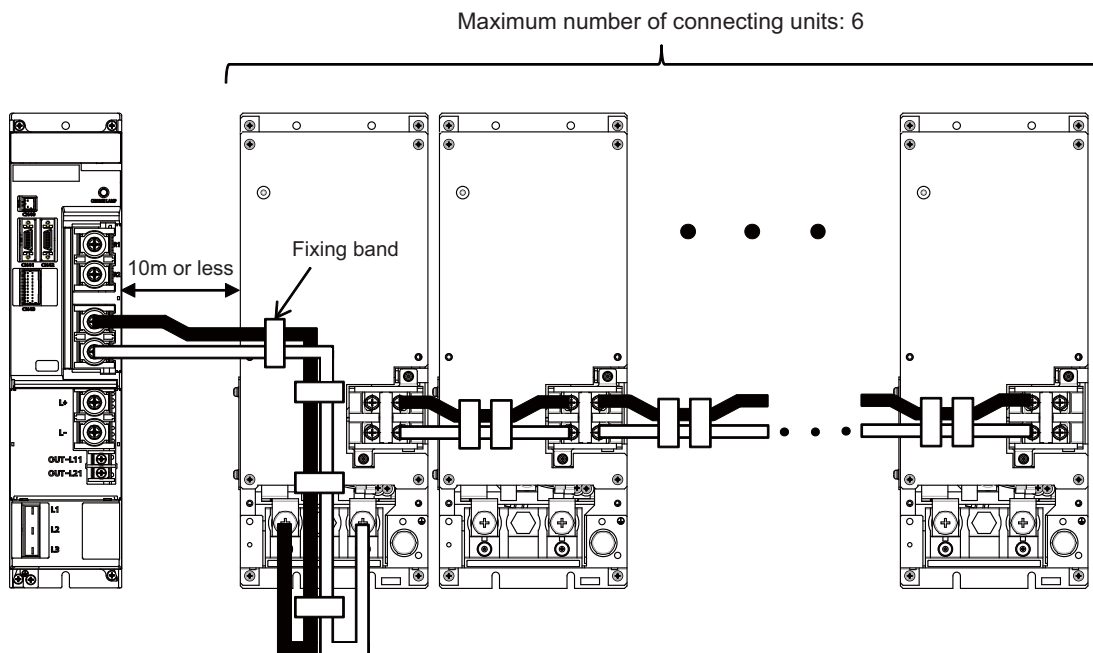
**⚠ CAUTION**

1. Only the designated combination can be used for the power backup unit and the capacitor unit.
There is a risk of fire, so always use the designated combination.
2. Connect the power backup unit's TE4(C+,C-) to the capacitor unit's TE1(C+,C-), and do not reverse the polarity.
3. When using multiple capacitor units, connect with TE2 (C+,C-) of capacitor units.

(3) Connection of tool escape request signal

When using the retraction function at power failure, input the DO2 signal of MDS-D/DH-PFU(CN43) to DI of the NC so that DO2 can turn ON the retraction request signal (YCDE) through the PLC sequence.

< Connection example for tool escape request signal >

When using external 24V power (connection to source type input DI)

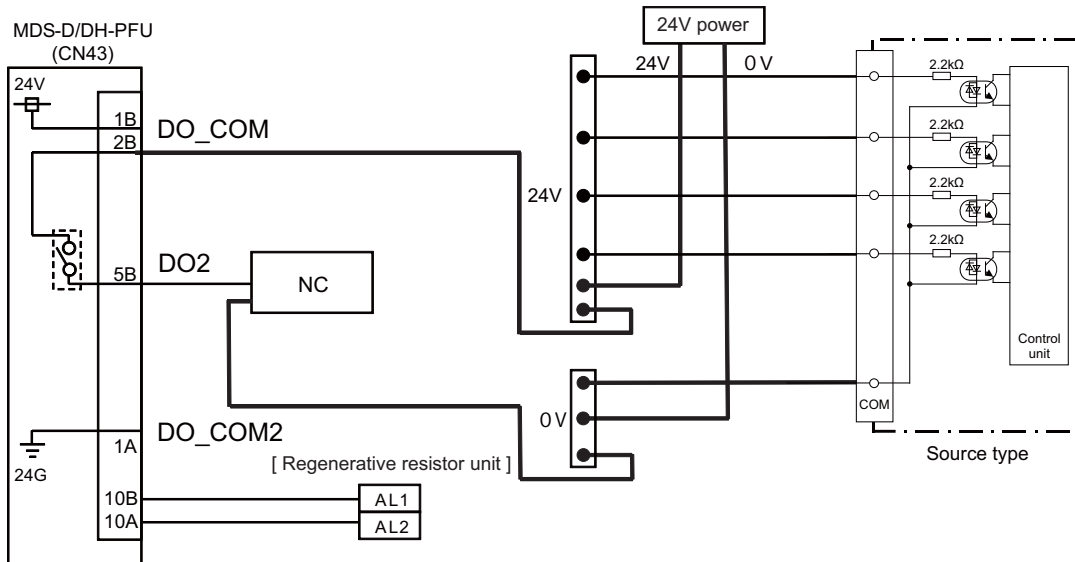

When using external 24V power (connection to sink type input DI)

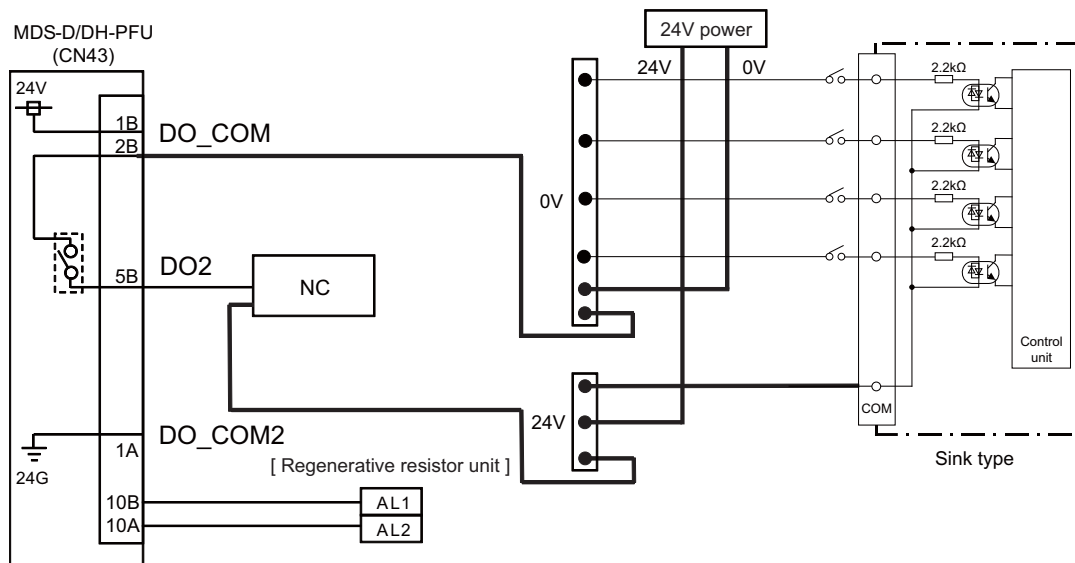

9.2.2 Setup of Retraction Function at Power Failure System

(1) Setting the rotary switch (SW1)

Set the rotary switch (SW1) of MDS-D/DH-PFU depending on the spindle motor stop operation to be made after the retraction is completed.

< Spindle stop operation after the retraction is completed : Deceleration and stop >

- MDS-D-PFU
Rotary switch (SW1) setting : 2 R-UNIT-7 is connected
- MDS-DH-PFU
Rotary switch (SW1) setting : 1 R-UNIT-6 is connected

< Spindle stop operation after the retraction is completed : Coast to a stop >

- MDS-D-PFU / MDS-DH-PFU
Rotary switch (SW1) setting : 0 Regenerative resistor unit is not connected

(2) Setting the dip switches (SW2, SW3)

Set the switch #1 (left-most) of the dip switch (SW2) to ON.

Sensitivity for detecting power failure can be changed using the dip switch (SW3).



CAUTION

Refer to "9.3.1 How to Set Rotary Switch and Dip Switches" for detail specifications on the rotary switch (SW1) and dip switches (SW2, SW3) of MDS-D/DH-PFU.

(3) Parameter setting of servo drive unit

When using the retraction function at power failure, set the servo parameter of this function for the servo drive unit connected to the power supply unit.

【#2236(PR)】 SV036 P TYP Power supply type/ Regenerative resistor type

MDS-D2/DH2 Series: Power supply type

When connecting a power supply unit, set a code for each power supply unit.

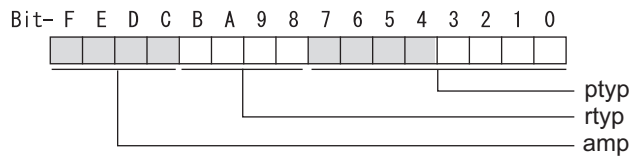

bit F-C : amp

Set the power backup function to be used.
 No function used : 0
 Retraction function at power failure : C

(4) Parameter setting of spindle drive unit

When using the retraction function at power failure, set the spindle parameter of this function for the spindle drive unit connected to the power supply unit.

【#13032(PR)】 SP032 P TYP Power supply type/ Regenerative resistor type

MDS-D2/DH2 Series: Power supply type

When connecting a power supply unit, set a code for each power supply unit.

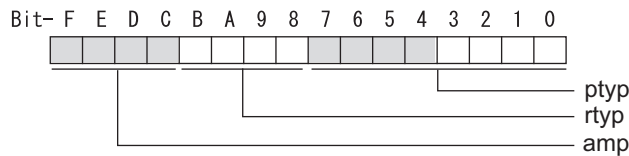

bit F-C : amp

Set the power backup function to be used.
 No function used : 0
 Retraction function at power failure : C

9.3 Explanation of Each Part of Power Backup System

9.3.1 How to Set Rotary Switch and Dip Switches

The rotary switch (SW1) of the power backup unit is for selecting the regenerative resistor for the power backup unit to be used. The dip switches (SW2, SW3) are for function selection of the power backup unit. The settings of these switches are enabled when the power backup unit power is turned ON.

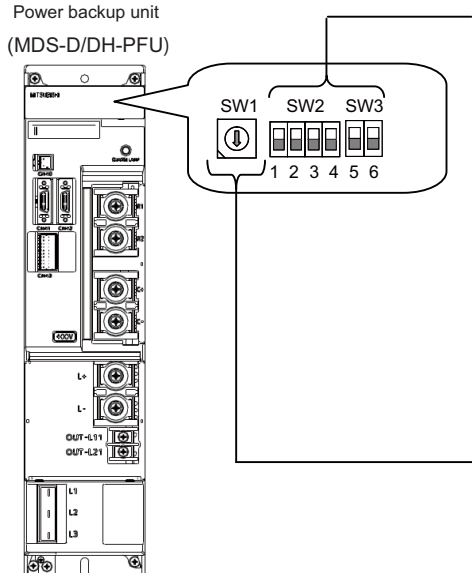

(1) Power backup unit function selection

Function selection switch (SW2/SW3)		Description	Setting	
SW2	1	Capacitor unit connection	OFF	Not connect
	2	Not used	ON	Connect
	3		Setting prohibited (All OFF) (*1)	
	4			
SW3	5	Power failure detection time for AC input voltage (including open-phase detection signal)	OFF	Standard setting (60ms)
			ON	High-speed setting (20ms)
	6	Power failure detection sensitivity for AC input voltage	OFF	Standard setting (120VAC: MDS-D-PFU) (240VAC: MDS-DH-PFU)
			ON	High-sensitivity setting (135VAC: MDS-D-PFU) (270VAC: MDS-DH-PFU)

*1: The switches are OFF when facing bottom as illustrated.

(2) Regenerative resistor selection for power backup unit

Rotary switch (SW1)	MDS-D-PFU			MDS-DH-PFU		
	Name of regenerative resistor	Resistance value [Ω]	Continuous rating [W]	Name of regenerative resistor	Resistance value [Ω]	Continuous rating [W]
0	Setting prohibited					
1	Setting prohibited			R-UNIT6	5.0	2100
2	R-UNIT-7	1.4	2100			
3 to 13	Setting prohibited (*2)					
14	Setting prohibited					
15	Setting prohibited					

*2: If you select this, the function selection error (Alarm 18) will occur in the power backup unit.

9.3.2 Transition of LED Display After Power Is Turned ON

When the power backup unit power has been turned ON, the unit will automatically execute self-diagnosis and initial settings for operation, etc. The LEDs on the front of the units will change as shown below according to the progression of these processes.

If an alarm occurs, the alarm No. will appear on the LEDs. Refer to section "9.4.1 LED display when alarm or warning occurs" for details on the alarm displays.

Power backup unit LED display

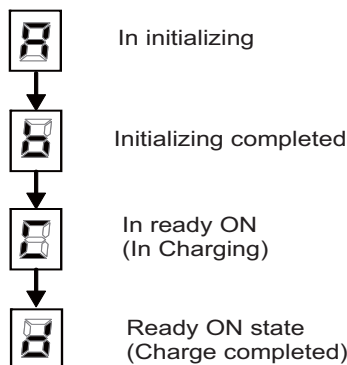

9.4 Troubleshooting for Power Backup System

9.4.1 LED Display When Alarm or Warning Occurs

An alarm/warning No. of the power backup unit is displayed with the LED of the unit. The 2nd digit number and the 1st digit number are displayed one by one.

When an alarm occurs, the LED flickers, and when a warning occurs, the LED stays lit.

< Display example of Alarm 1C >

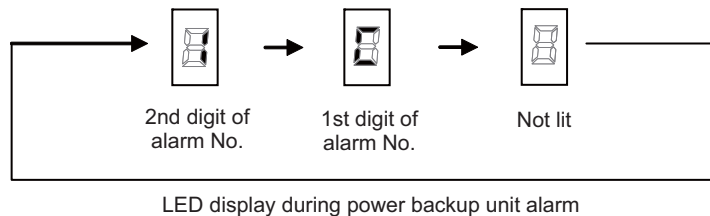

< Display example of Warning D0 >

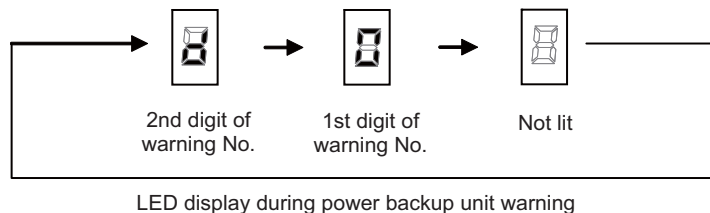

CAUTION

An alarm/warning No. of the power backup system is not displayed on the NC screen. When an alarm/warning of the power backup system occurs, the following power supply alarm/warning is displayed on the NC screen

Check the details of the alarm/warning according to the LED display of the power backup unit.

“Power supply option unit error: Alarm 74”

“Power supply option unit error: Warning EF”

9.4.2 List of Power Backup Function Alarms

When a power backup function alarm occurs, the power backup unit will notify the alarm to the power supply and will perform deceleration control. Due to this control, the servo/spindle drive units will decelerate and stop the motors. At the same time, "Power supply option unit error: Alarm 74" will appear on the NC monitor. As the details of the error status, the alarm No. is displayed with the LED on the front of the power backup unit. Check the alarm No. and remove the cause of the alarm according to this list.

No.	Name	Details	Detection period	Reset method
8	Watchdog	The system does not operate correctly.	After initialized	AR
10	Memory error 1	An internal memory error was detected during the power ON self-check.	At initializing	AR
11	Memory error 2	An error was detected in the internal clock signal.		
12	Unit ID error	An error was detected in the internal hardware ID.	At initializing	AR
13	A/D converter error	An error was detected in the A/D converter, which is used for detecting current and voltage.	After initialized	AR
18	Function selection error	An error was detected in the settings of DIP or rotary switches.	At initializing	AR
19	External emergency stop setting error	The external emergency stop cancel state was detected although the external emergency stop input is set as disabled.	After initialized	AR
1A	Resistor unit connection error	Resistor unit disconnection was detected.	After initialized	AR
1B	Capacitor connection error	Non-connection of capacitor was detected although the capacitor unit connection is set as enabled.	First ready-ON	AR
1C	Power supply unit Connect error	Communication error was detected in the connection to the power supply unit.	After initialized	PR
50	S/W processing error	Software processing has not finished within the specified time.	After initialized	PR
51	Main circuit error	An error was detected in a thyristor or charging circuit.	After initialized	PR
52	Control power output circuit error	An error was detected in the output changeover relay or power output of the control power supply.	After initialized	PR
53	Resistor unit circuit error	An error was detected in the resistor regeneration transistor or regeneration output.	After initialized	PR
54	Inrush circuit error	An error was detected in the rush circuit relay or rush resistor of the control power supply.	After initialized	PR
55	Over current in control power output circuit	An excessive current was detected in the control power supply backup output circuit.	After initialized	PR
56	Overheat in control power output circuit	An overheat was detected in the control power supply backup output circuit.	After initialized	PR
58	Resistor unit error	An abnormal resistor unit value was detected during the power ON self-check.	After initialized	PR
90	Over voltage	The voltage between L+/- of the main circuit has exceeded the tolerance.	After initialized	NR (*)

(Note 1) "b", "C" and "d" displayed on the power backup unit's LED as a solid light (not flickering) do not indicate an alarm.

(Note 2) Resetting methods

PR: Reset by turning the NC power ON again. This alarm can also be reset with the AR resetting conditions.

AR: Reset by turning the power backup unit power ON again.

NR: Reset with NC reset (Alarms with * must satisfy the resetting conditions)

9.4.3 List of Power Backup Function Warnings

When a power backup function warning occurs, "Power supply option unit error: Warning EF" will appear on the NC monitor. As the details of the error status, the warning No. is displayed with the LED on the front of the power backup unit. Check the warning No. and remove the cause of the warning according to this list.

No.	Name	Details	Detection period	Reset method
D0	Instantaneous power interruption	- AC power supply voltage decrease was detected. - Loss of phase was detected. - Bus voltage decrease was detected.	After initialized	*
D1	Over regeneration	Over-regeneration detection level exceeded 100%.	After initialized	*
D5	Resistor unit overheat	Thermal error was detected in resistor unit.	After initialized	*

(Note1) Resetting method

*: Automatically reset once the cause of the warning is removed.

9.4.4 Troubleshooting for Each Alarm No.

Alarm No. 8		Watchdog :	
		The system does not operate correctly.	
Investigation details		Investigation results	
		Remedies	
1	Check whether the PFU software version was changed recently.	Changed. Not changed.	Change the S/W version back to the original. Check the investigation item No. 2.
2	Check the reproducibility.	The error is always repeated. The state returns to normal once, but the error occurs sometimes thereafter.	Replace the power backup unit. Check the investigation item No. 3.
3	Check if there is any abnormality in the unit's ambient environment. (Ex. Ambient temperature, noise, grounding)	Take remedies according to the causes of the abnormality in the ambient environment.	

Alarm No. 10		Memory error 1 :	
		An internal memory error was detected during the power ON self-check.	
Investigation details		Investigation results	
		Remedies	
1	Check the reproducibility.	The error is always repeated. The state returns to normal once, but the error occurs sometimes thereafter.	Replace the power backup unit. Check the investigation item No. 2.
2	Check if there is any abnormality in the unit's ambient environment. (Ex. Ambient temperature, noise, grounding)	Take remedies according to the causes of the abnormality in the ambient environment.	

Alarm No. 11		Memory error 2 :	
		An error was detected in the internal clock signal.	
Investigation details		Investigation results	
		Remedies	
1	Check the investigation items of the alarm No. 10.		

Alarm No. 12		Unit ID error :	
		An error was detected in the internal hardware ID.	
Investigation details		Investigation results	
		Remedies	
1	Check the investigation items of the alarm No. 10.		

Alarm No. 13		A/D converter error:	
		An error was detected in the A/D converter, which is used for detecting current and voltage.	
Investigation details		Investigation results	
		Remedies	
1	Check the investigation items of the alarm No. 10.		

Alarm No. 18		Function selection error :	
		An error was detected in the settings of DIP or rotary switches.	
Investigation details		Investigation results	
		Remedies	
1	Check the settings of switches on the upper part of the unit.	The switch setting is wrong (disabled setting). The switch settings are correct.	Set the switches correctly. Replace the power backup unit.

Alarm No. 19		External emergency stop setting error :	
		The external emergency stop cancel state was detected although the external emergency stop input is set as disabled.	
Investigation details		Investigation results	
		Remedies	
1	Check for a wiring error in connection to the DI1 terminal of CN43.	There is an error in wiring. There is no error in wiring.	Perform wiring correctly. Check the investigation item No. 2.
2	Check the reproducibility.	The error is always repeated. The state returns to normal once, but the error occurs sometimes thereafter.	Replace the power backup unit. Check the investigation item No. 3.
3	Check if there is any abnormality in the unit's ambient environment. (Ex. Ambient temperature, noise, grounding)	Take remedies according to the causes of the abnormality in the ambient environment.	

9 Power Backup System

Alarm No. 1A		Resistor unit connection error :	
		Resistor unit disconnection was detected.	
	Investigation details	Investigation results	Remedies
1	Check the connection of resistor unit.	Resistor unit is disconnected. There is no connection failure.	Connect the resistor unit. Check the investigation item No. 2.
2	Check the setting of rotary switch (SW1).	There is setting failure. There is no setting failure.	Set correctly. Check the investigation item No. 3.
3	Check for disconnection between R1/R2 terminals of the resistor unit or check for an error in the resistance value.	Resistor unit has disconnection, or the resistance value is abnormal. No error.	Replace the resistor unit. Check the investigation item No. 4.
4	Check the reproducibility.	The error is always repeated. The state returns to normal once, but the error occurs sometimes thereafter.	Replace the power backup unit. Check the investigation item No. 5.
5	Check if there is any abnormality in the unit's ambient environment. (Ex. Ambient temperature, noise, grounding)	Take remedies according to the causes of the abnormality in the ambient environment.	

Alarm No. 1B		Capacitor connection error :	
		Non-connection of capacitor was detected although the capacitor unit connection is set as enabled.	
	Investigation details	Investigation results	Remedies
1	Check whether the capacitor unit is correctly connected.	There is connection failure. There is no connection failure.	Correctly connect the capacitor unit. Check the investigation item No. 2.
2	Check for a disconnection between C+/C- terminals of the capacitor unit.	There is disconnection between the capacitor unit's terminals No error.	Replace the capacitor unit. Check the investigation item No. 3.
3	Check the reproducibility.	The error is always repeated. The state returns to normal once, but the error occurs sometimes thereafter.	Replace the power backup unit. Check the investigation item No. 4.
4	Check if there is any abnormality in the unit's ambient environment. (Ex. Ambient temperature, noise, grounding)	Take remedies according to the causes of the abnormality in the ambient environment.	

Alarm No. 50		S/W processing error :	
		Software processing has not finished within the specified time.	
	Investigation details	Investigation results	Remedies
1	Check the investigation items of the alarm No. 8.		

Alarm No. 51		Main circuit error :	
		An error was detected in a thyristor or charging circuit.	
	Investigation details	Investigation results	Remedies
1	Check the reproducibility.	The error is always repeated. The state returns to normal once, but the error occurs sometimes thereafter.	Replace the power backup unit. Check the investigation item No. 2.
2	Check if there is any abnormality in the unit's ambient environment. (Ex. Ambient temperature, noise, grounding)	Take remedies according to the causes of the abnormality in the ambient environment.	

Alarm No. 52		Control power output circuit error :	
		An error was detected in the output changeover relay or power output of the control power supply.	
	Investigation details	Investigation results	Remedies
1	Check whether the control power OUT-L11/OUT-L21 are correctly connected.	There is connection failure. There is no connection failure.	Connect correctly. Check the investigation item No. 2.
2	Disconnect OUT-L11/OUT-L21, and check whether AC power is output between terminals.	Voltage is not output. No error in voltage output.	Set correctly. Check the investigation item No. 3.
3	Check the reproducibility.	The state returns to normal once, but the error occurs sometimes thereafter.	Check the investigation item No. 4.
4	Check if there is any abnormality in the unit's ambient environment. (Ex. Ambient temperature, noise, grounding)	Take remedies according to the causes of the abnormality in the ambient environment.	

9 Power Backup System

Alarm No. 53		Resistor unit circuit error :	
		An error was detected in the resistor regeneration transistor or regeneration output.	
Investigation details		Investigation results	Remedies
1	Check the reproducibility.	Always reproduced.	Replace the power backup unit.
		The state returns to normal once, but the error occurs sometimes thereafter.	Check the investigation item No. 2.
2	Check if there is any abnormality in the unit's ambient environment. (Ex. Ambient temperature, noise, grounding)	Take remedies according to the causes of the abnormality in the ambient environment.	

Alarm No. 54		Inrush circuit error :	
		An error was detected in the rush circuit relay or rush resistor of the control power supply.	
Investigation details		Investigation results	Remedies
1	Check the reproducibility.	The error is always repeated.	Replace the power backup unit.
		The state returns to normal once, but the error occurs sometimes thereafter.	Check the investigation item No. 2.
2	Check if there is any abnormality in the unit's ambient environment. (Ex. Ambient temperature, noise, grounding)	Take remedies according to the causes of the abnormality in the ambient environment.	

Alarm No. 55		Over-current in control power output circuit :	
		An excessive current was detected in the control power supply backup output circuit.	
Investigation details		Investigation results	Remedies
1	Check whether the control power OUT-L11/OUT-L21 are correctly connected.	There is connection failure.	Connect correctly.
		There is no connection failure.	Check the investigation item No. 2.
2	Check the reproducibility.	The state returns to normal once, but the error occurs sometimes thereafter.	Check the investigation item No. 3.
3	Check if there is any abnormality in the unit's ambient environment. (Ex. Ambient temperature, noise, grounding)	Take remedies according to the causes of the abnormality in the ambient environment.	

Alarm No. 56		Overheat in control power output circuit :	
		An overheat was detected in the control power supply backup output circuit.	
Investigation details		Investigation results	Remedies
1	Check the investigation items of the alarm No. 55.		

Alarm No. 58		Resistor unit error :	
		An abnormal resistor unit value was detected during the power ON self-check.	
Investigation details		Investigation results	Remedies
1	Check the investigation items of the alarm No. 1A.		

Alarm No. 90		Overvoltage :	
		The voltage between L+/L- of the main circuit has exceeded the tolerance. The voltage between L+/L- is relatively high immediately after the occurrence of this alarm. Therefore, wait for 5 minutes or longer until the voltage drops, and then cancel this alarm by reset.	
Investigation details		Investigation results	Remedies
1	Check the reproducibility.	This error occurs every time the motor decelerates at power failure or at power supply alarm.	Check the investigation item No. 2.
		This error occurs occasionally.	Check the investigation item No. 3.
2	Check the machine's load inertia and the maximum motor rotation speed.	Increased than before.	Decrease the machine's load inertia and the maximum motor rotation speed.
		No change.	Check the investigation item No. 4.
3	Check the power supply voltage.	Voltage is exceeding the specified maximum value.	Change the power supply voltage to be within the specified range.
		Voltage is below the specified limit.	Check the investigation item No. 4.
4	Check the capacity of the resistor unit.	Capacity is not sufficient.	Use a resistor unit with a greater capacity.
		Capacity is sufficient.	Check the investigation item No. 5.
5	Check if there is any abnormality in the unit's ambient environment. (Ex. Ambient temperature, noise, grounding)	Take remedies according to the causes of the abnormality in the ambient environment.	

9.4.5 Troubleshooting for Each Warning No.

Warning No. D0		Instantaneous power interruption :	
		Instantaneous power interruption of the input power supply or voltage drop between L+ and L- was detected. This warning also occurs at normal power OFF.	
	Investigation details	Investigation results	Remedies
1	Check whether the power voltage is properly input to L1, L2 and L3.	The voltage is not input properly.	Inputt properly.
		The voltage is input properly	Check the investigation item No. 2.
2	Check the power supply voltage.	The voltage drops under the lower limit value.	Change the power supply voltage to be within the specified range.
		The voltage frequently drops under the lower limit value.	Use a power supply voltage with a greater capacity.
		Voltage is below the specified limit.	Check the investigation item No. 3.
3	Check the reproducibility.	Always reproduced.	Replace the power backup unit.
		This error occurs occasionally.	Check the investigation item No. 4.
4	Check if there is any abnormality in the unit's ambient environment. (Ex. Ambient temperature, noise, grounding)	Take remedies according to the causes of the abnormality in the ambient environment.	

Warning No. D1		Over regeneration :	
		Over-regeneration detection level became over 100%.The regenerative resistor is overloaded.The warning is not released even if the power turns ON again. The warning is released if over-regeneration level drops to less than 80% in power ON state (usually takes 20 minutes).	
	Investigation details	Investigation results	Remedies
1	Check the reproducibility.	This error occurs every time the motor decelerates at power failure or at power supply alarm.	Check the investigation item No. 2.
		This error occurs occasionally.	Check the investigation item No. 3.
2	Check the machine's load inertia and the maximum motor rotation speed.	Increased than before.	Decrease the machine's load inertia and the maximum motor rotation speed.
		No change.	Check the investigation item No. 4.
3	Check the frequency at which power failure or power supply alarm occurs.	Occurs more than once per hour.	Reduce the frequency at which power failure or power supply alarm occurs.
		The frequency is low.	Check the investigation item No. 4.
4	Check the capacity of the resistor unit.	Capacity is not sufficient.	Use a resistor unit with a greater capacity.
		Capacity is sufficient.	Replace the power backup unit.

Warning No. D5		Resister unit overheat :	
		An overheat was detected by the thermal sensor of the resistor unit.	
	Investigation details	Investigation results	Remedies
1	Check if the regenerative resistor reaches high temperatures.	The regenerative resistor reaches high temperatures.	Wait for cooling of the regenerative resistor and wait for the overheat of the thermal to be released.
		The regenerative resistor does not reach high temperatures.	Check the investigation item No. 2.
2	Check whether the THM1/THM2 terminals of CN43 are correctly connected.	There is connection failure.	Connect correctly.
		There is no connection failure.	Check the investigation item No. 3.
3	Check for a disconnection between AL1/AL2 terminals of the regenerative resistor.	There is disconnection.	Replace the regenerative resistor.
		There is no disconnection.	Replace the power backup unit.

9.4.6 Trouble Shooting at Power ON

If the drive unit does not start up correctly and a system error occurs when the drive unit power is turned ON, the power backup unit may not have been started up properly. Check the LED display on the power backup unit, and take measures according to this list.

LED display	Symptom	Cause of occurrence	Investigation method	Remedy
None	PFU unit fails to start.	PFU's internal fuse is open.	Check whether the power voltage is properly input to L1, L2 and L3.	If voltage is properly input, replace the power backup unit.
b	Unable to cancel emergency stop. External emergency stop is occurring on the power supply unit. (The LED on power supply unit shows "q".)	Disconnection of the DO3 signal of CN43.	Check if the DO3 signal of CN43 is correctly connected to CN23A of the power supply unit.	Connect correctly.
			Check if the 24V power supply of DO3 signal is correctly connected to DO_COM terminal.	Connect correctly.
1A	Unable to cancel emergency stop. External emergency stop is occurring on the power supply unit. (The LED on power supply unit shows "q".)	Disconnection of the resistor unit or an illegal resistance value.	Check the investigation items of the alarm No. 1A.	
		PFU's internal resistor regeneration transistor is broken.	Unplug L+/L-, C+/C- and R1/R2 from the PFU unit, and measure the resistance between L+/L- terminals.	If short-circuited, replace the power backup unit.
51	Unable to cancel emergency stop. The alarm 6C (Power supply: Main circuit error) is occurring.	PFU's internal resistor regeneration transistor is broken.	Unplug L+/L-, C+/C- and R1/R2 from the PFU unit, and measure the resistance between L+/L- terminals.	If short-circuited, replace the power backup unit.
52	Power supply or drive unit fails to start.	An error in the control power output circuit.	Check the investigation items of the alarm No. 52.	
d1	Unable to cancel emergency stop. External emergency stop is occurring on the power supply unit. (The LED on power supply unit shows "q".)	Over-regeneration protection is working.	Check the investigation items of the warning No. D1.	
d5	Unable to cancel emergency stop. External emergency stop is occurring on the power supply unit. (The LED on power supply unit shows "q".)	An overheat was detected by the thermal sensor of the resistor unit.	Check the investigation items of the warning No. D5.	

Appendix 1

Cable and Connector Assembly

Appendix 1.1 CMV1-xPxxS-xx Plug Connector

This section explains how to assemble the wire to CMV1 plug connector.

(1) Cutting a cable

Cut the cable to the following dimensions:

(Note) Not to change cable length.

Cable length after cutting

connector name	Cable length after cutting [mm]
CMV1-SPxxS-xx	$40 \pm 0.5 + \text{Cable length}$
CMV1-APxxS-xx	$47 \pm 0.5 + \text{Cable length}$

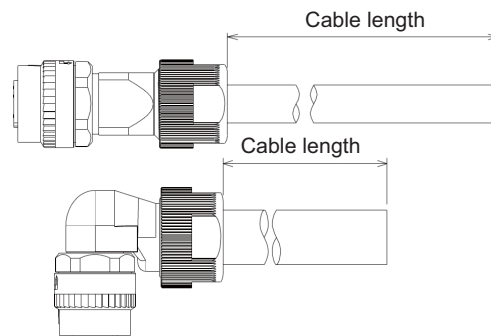

(2) Inserting parts

Insert the clamp nut, the cable clamp, the bushing and the back shell, in that order, to the cable.

(Note) Pay attention to the direction each part is inserted.

Make sure that every part is inserted.

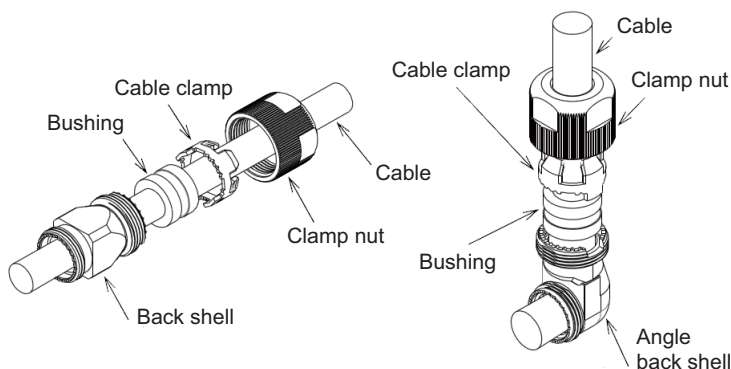

(3) Stripping a cable

Strip the cable's sheath to the A length, cut the wire set at its root and strip the core wire to the B length.

(Note) Make sure to strip the cable to the correct length.

Do not leave cutting or scratch to the cable core.

* When making CMV1-xP10S-xx, strip the cable for No. 10 terminal in a way that the A length becomes 1mm longer than that of other cores.

(This is to prevent excessive tension of the core when inserting the contact to the housing in the next process.)

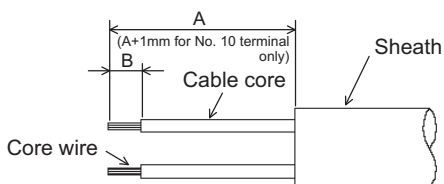

Cable length after stripping

Connector name	A [mm]	B [mm]
CMV1-SPxxS-xx	21.5 to 22.5	4.5 to 5.0
CMV1-APxxS-xx	28.5 to 29.5	

(4) Soldering a contact

Apply preliminary soldering to each contact and to the cable's core wire, then solder the core wire to the contacts.

Connector name	Applicable contact	Applicable wire
CMV1-xP2S-xx	CMV1-#22BSC-S2	AWG16 or below
CMV1-xP10S-xx	CMV1-#22ASC-S1	AWG20 or below

- (Note) Make sure that the core wire does not come out of the contact.
 When soldering, make sure that the solder does not stick to the circumference of the solder cup.
 When using a drain wire, attach a heat shrink tube to the drain cable after soldering.
- * When making CMV1-xP10S-xx, the cable for No. 10 terminal is 1mm longer than other cables. (To avoid the core tension when inserting a contact to the housing in a later process.)
 - * The difference in the total A length of the cables for other than No. 10 terminal must be 1mm or less.

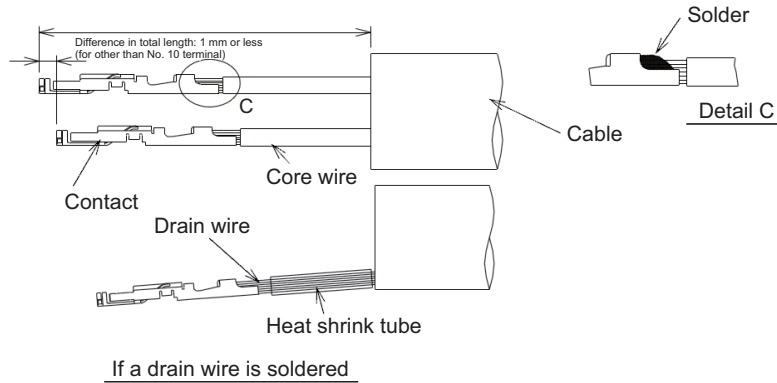

(5) Inserting the contact

Insert the contact into the specified terminal number point in the housing.

(Insert grounding wire or drain wire into terminal No. 10).

- * When the contact catches the housing, you will hear a snap.
- * Pulling the wire for confirming the correct position.

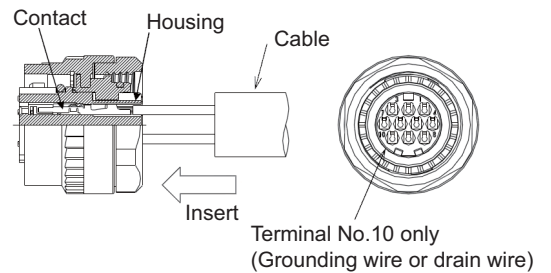

(Note) Before inserting the contact, check that the clamp nut, cable clamp, bushing and back shell is inserted.
 Take care not to insert the contact upside down as shown below.

- * Insert the contact so that the terminal number face the same direction.
- * Using a pull out tool for pulling up inserted contact.
 Tool No.: 357J-53184T
 Refer to the instruction manual in case of using pull up tool.
- * As Lance falls down easily after pulling up, set up to original position before re-insert.

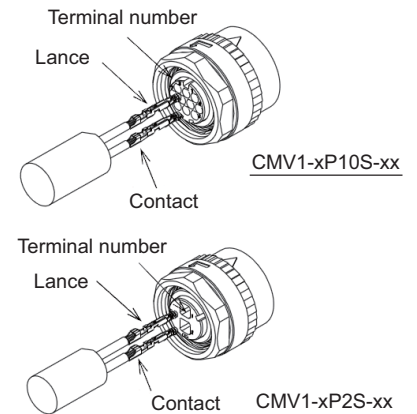

(6) Assembling a back shell

[1] To prevent the back shell from loosening, it is recommended to coat 2 threads of the circumference of the back shell with adhesive.

Recommended adhesive: 1401B (CV) (Three Bond Co., Ltd.)

[2] Rotate the back shell coupling of the connector and temporarily tighten the back shell.

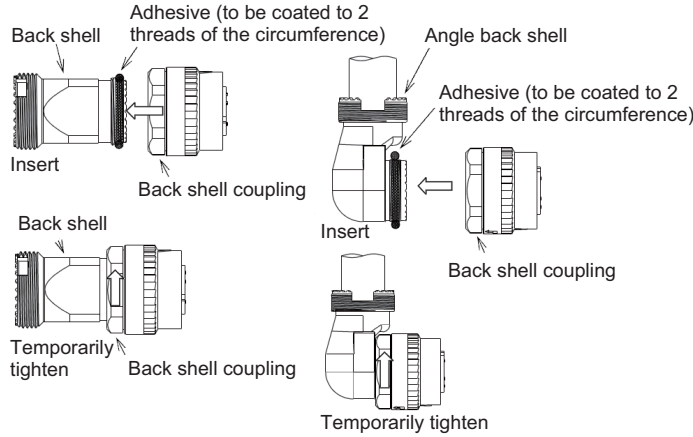

* When tightening temporarily, match the concavity and convexity of the plug shell with those of the back shell. (You can confirm the correct connection of concavity and convexity waving lightly back shell just before inserting to BS coupling.)

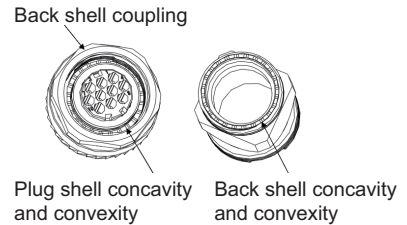

(7) Tightening a back shell

Straight back shell

- [1] Fix the 2 surface width of the straight back shell on the tightening guide.
 - [2] Set the tightening wrench adjusting to the back shell coupling.
 - [3] With the wrench, tighten the back shell coupling to the straight back shell.
- Recommended tightening torque: 4 to 5N•m
 (Note 1) When setting the work to the wrench, adjust it to the 2 surface width.
 To remove, take the reverse steps.
 (Note 2) Manufactured by DDK
 Contact: Fujikura Ltd. <http://www.fujikura.co.jp/eng/>

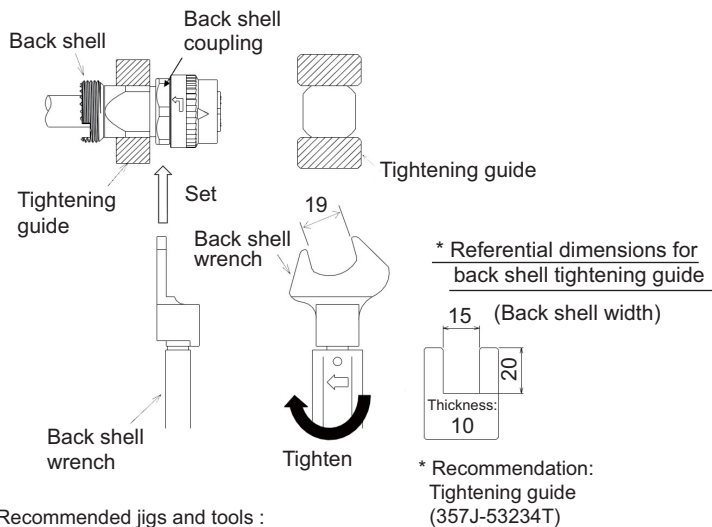

- Recommended jigs and tools :
 Back shell wrench (357J-51333T) (Note 2)
 { Bit (357J-51344T)
 Torque wrench (CL6N x 8D, Tonichi Mfg.) }
 * Recommended tightening guide: (357J-53234T) (Note 2)

Angle back shell

- [1] Fix the 2 surface width of the angle back shell on the tightening guide.
 - [2] Set the back shell wrench adjusting to the 2 surface width of the back shell coupling.
 - [3] With the wrench, tighten the back shell coupling to the angle back shell.
- Recommended tightening torque: 4 to 5N.m
- (Note 1) When setting the work to the wrench, adjust it to the 2 surface width.
 To remove, take the reverse steps.
- (Note 2) To change the back shell angle, adjust the toothing position of the plug shell and back shell.
- (Note 3) Manufactured by DDK
 Contact: Fujikura Ltd. <http://www.fujikura.co.jp/eng/>

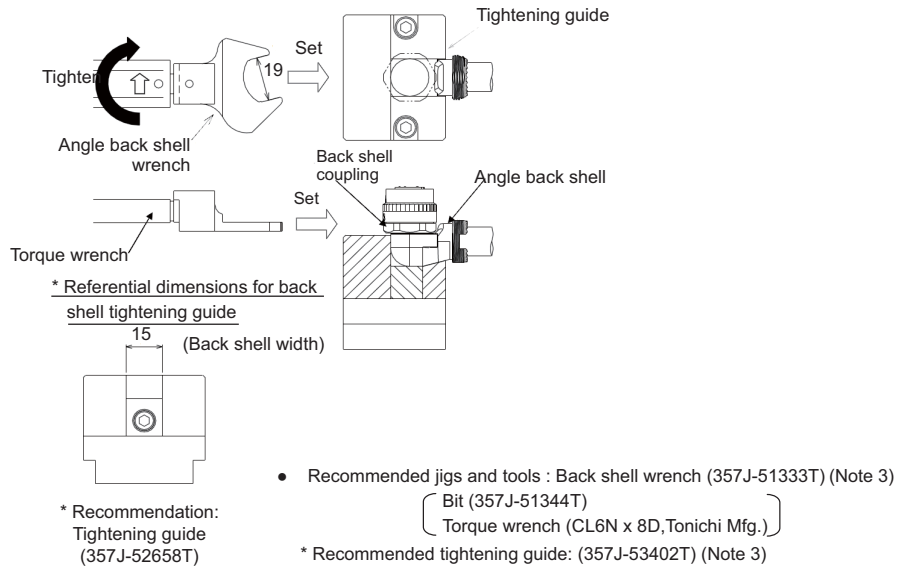

(8) Insert a bushing and a cable clamp

Insert the bushing and the cable clamp in the back shell.

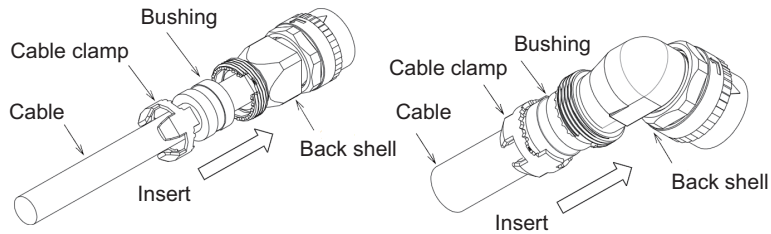

(Note) After the Bushing insert, confirm that cable position should be inside of Bushing.

(9) Tightening a clamp nut

Straight back shell

- [1] Temporarily tighten the clamp nut on the straight back shell.
 *To prevent the loosening, it is recommended to coat the straight back shell with adhesive.
Recommended adhesive: 1401B (CV) (Three Bond Co., Ltd.)
 - [2] Fix the 2 surface width of the straight back shell on the tightening guide.
 - [3] With the wrench, tighten the clamp nut on the straight back shell.
- Recommended tightening torque: 4 to 5N•m
- (Note 1) When setting the work to the wrench, adjust the 2 surface width.
 To remove, take the reverse steps.
- (Note 2) Manufactured by DDK
 Contact: Fujikura Ltd. <http://www.fujikura.co.jp/eng/>

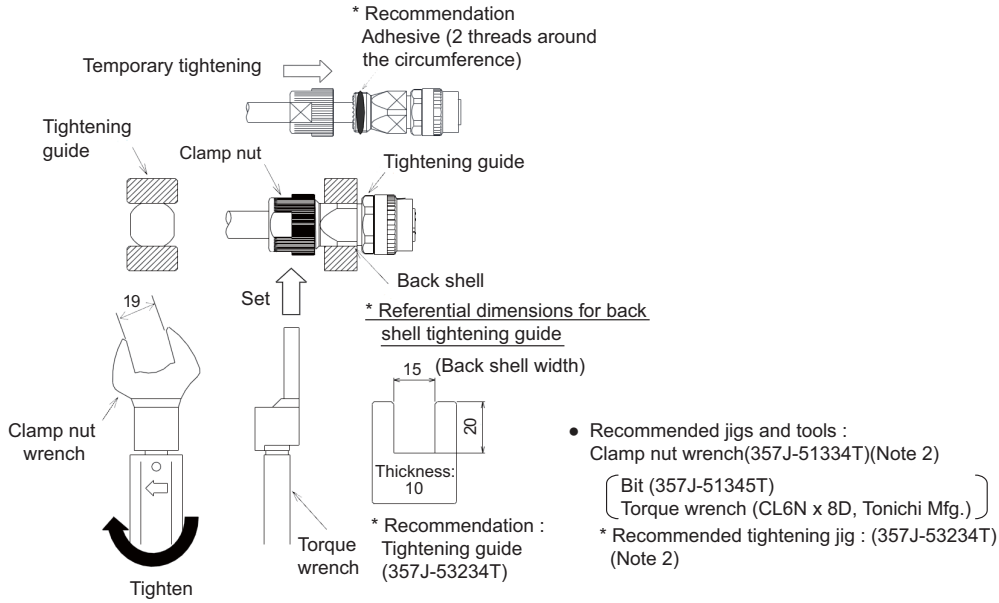

Angle back shell

- [1] Temporarily tighten the clamp nut on the angle back shell.
 * To prevent loosening, the adhesive should be applied to the angle back shell.

Recommended adhesive: 1401B (CV) (Three Bond Co., Ltd.)

- [2] Fix the 2 surface width of the angle back shell on the tightening guide.
- [3] Set the tightening wrench adjusting the 2 surface width of the clamp nut.
- [4] With the wrench, tighten the clamp nut on the angle back shell.

Recommended tightening torque: 5N•m

(Note 1) To set the work to the wrench, adjust the 2 surface width.

In case of squeezing the clamp nut with excess torque provided as above, the clamp nut may be broken. Please use the torque wrench.

To remove, take the reverse steps.

(Note 2) Manufactured by DDK

Contact: Fujikura Ltd. <http://www.fujikura.co.jp/eng/>

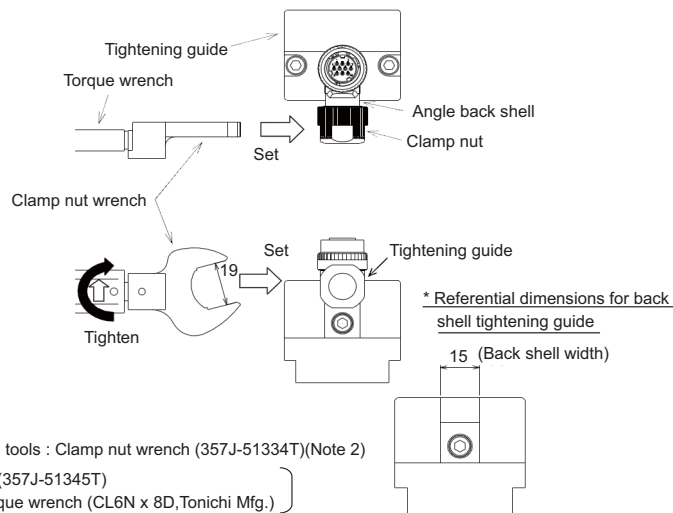
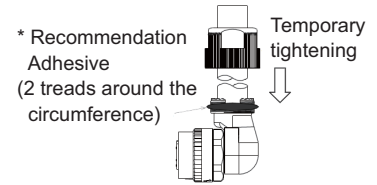

* Recommended tightening guide: (357J-52658T)(Note 2) * Recommendation:
 Tightening guide
 (357J-53402T)

<When connecting>

- [1] Set the \triangle mark of each other's connectors.

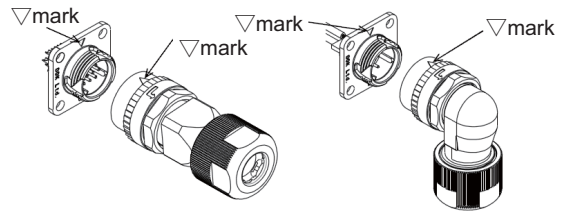

- [2] Each other's key (concavity and convexity) are fit in. Push it straight, take care not to tilt.

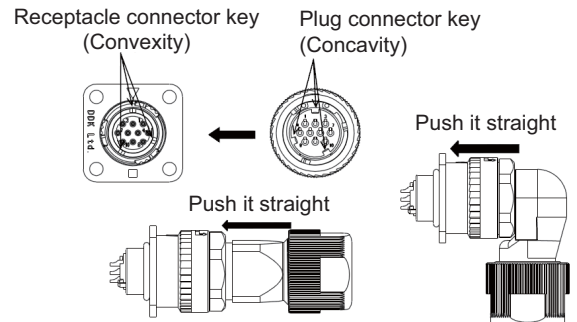

- * To remove, rotate the coupling and pull out to straight.

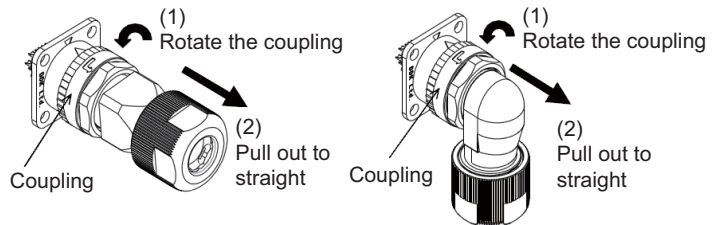

<When using a conduit>

- [1] Tighten the nipple of conduit connector on the plug connector (CMV1).
 [2] Set the conduit on the nipple of conduit connector.
 [3] Fix the conduit to the plug connector (CMV1). If the conduit is used in a moving part, fix the conduit with a saddle, etc. so that no load is applied to the plug connector (CMV1) and to the conduit connector. If the conduit is fixed with a saddle, etc., make sure that no load is applied to the fixing area. Set the protective cover (rubber etc.) on the conduit to avoid cable damage.

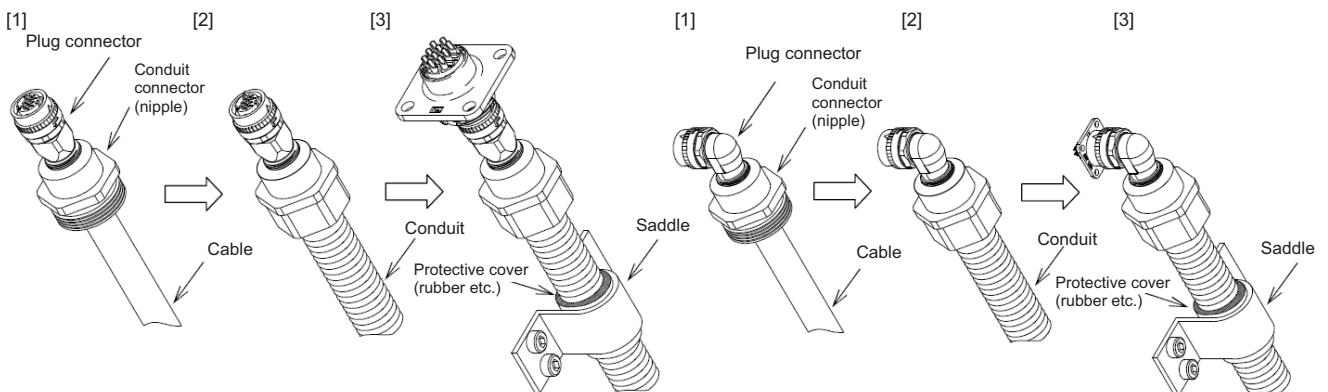

Recommended conduit

Type: VF Type: SR Type: FBN Type: EM Type: VFS Type: SRK etc. (Note)

Recommended connector

Type:RCM (Note)

(Note) Manufactured by NIPPON FLEX CO.,LTD.
 Contact: NIPPON FLEX CO.,LTD. <http://www.nipplex.co.jp/>

Appendix 1.2 1747464-1 Plug Connector

Appendix 1.2.1 Applicable Products

Part No.	Descriptions
1674320-1	Encoder cable I/O kit
1674320-2	
1674335-4	Receptacle contact

Appendix 1.2.2 Applicable Cable

Wire conductor size	Cable jacket outside diameter
#26-22AWG	6.8 - 7.4 mm

Refer to Product Specification and Application Specification for details.

Appendix 1.2.3 Related Documents

No.	Details
108-5864	Product Specification
114-5335	Rec, Contact Application Specification
114-5338	Ground Clip Application Specification

Appendix 1.2.4 Assembly Procedure

Assemble the cable in the following procedure:

- (1) Insert accessories to the cable.

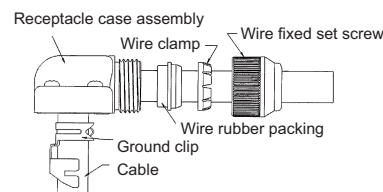

- (2) Remove the sheath of the cable jacket and core wires referring to the typical dimensions in the right figure.

Do not damage the core wires. Retry it if the core wires are partly cut off or damaged.

The length of mesh shield should be decided referring to the right figure and be turned up on the outside of a jacket.

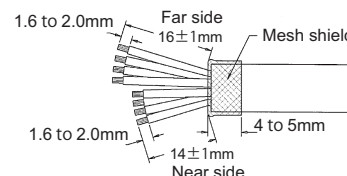

(Note) Even when the dimensions above is applied, product performance problem can occur depending on the wires which is used.

Be sure to contact with the sales department of the manufacturer below if you consider to adopt this connector.

Tyco Electronics Japan G.K. <http://www.te.com/en/home.html>

- (3) Twist a copper foil tape with conductive adhesive of width 5mm around the mesh shield.

Cable finish outside diameter: $\Phi 7.3$ to 7.7

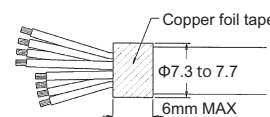

- (4) Refer to Application Specification (114-5335) and crimp the contacts. After crimping, check the state in accordance with the Specification.

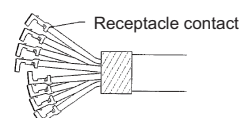

- (5) Verifying the direction, insert the crimped contact into the receptacle housing. After the insertion, pull each wire lightly to make sure that the contacts are fully inserted. (Lock feeling and sound can be confirmed when the contact is fully/ correctly inserted.)

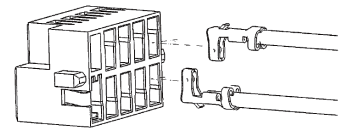

- (6) Crimp the ground clip.

As receptacle housing is settled inside a ground clip, it opts for direction according to the purpose, and positions as shown in the right figure.

(Note) Direction of receptacle housing is unchangeable after ground slip crimping.

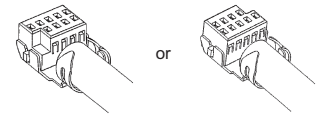

Positioning the cable jacket end as shown in the right figure. Refer to the Application Specification (114-5338) and crimp the ground clip.

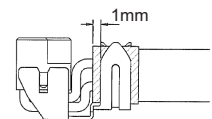

- (7) Store the receptacle housing and ground clip in the receptacle case.

Pull the cable side and draw the receptacle housing side as shown in the right figure, without pushing in it.

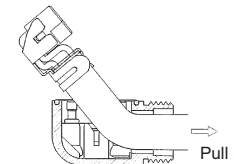

Work will become easy when the crimping part of the ground clip is pushed and the cable is bent as shown in the right figure.

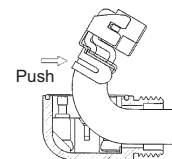

When the ground clip interferes with receptacle case at the position in the right figure and cause difficulty in continuing to draw in, push the ground clip to distort and drawing become easy.

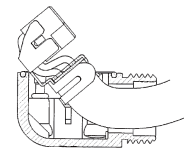

(Note) To prevent a fracture, do not use the ground clip which is bend and unbend 3 times or more.

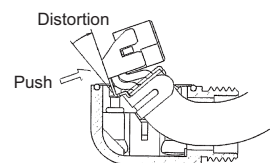

Turn the form of the ground clip back to normal and position it for the receptacle case as shown in the right figure.

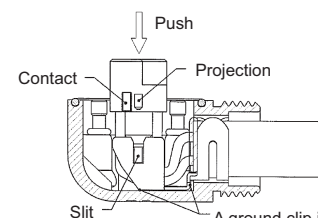

Adjust the projection of receptacle housing to the slit of the receptacle case and push in until it is fixed to the case.

(Note) See that the contact of receptacle housing goes inside a ground clip.

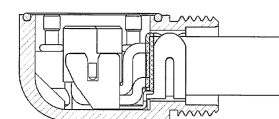

- (8) Shift the wire rubber packing and wire clamp to the position in the right figure, and tighten the wire fixed set screw to fix the cable to receptacle case.

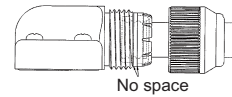

Tighten it not to create the space between the receptacle case and wire fixed set screw.

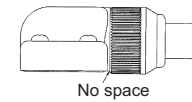

(Note) Confirm that the cable is fixed.

- (9) To ensure that there is no leaning on the receptacle housing in the receptacle case assembly, drop the POST BASE for inspection naturally as shown in the right figure.

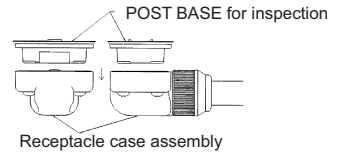

Confirm that the space between the receptacle case assembly and the POST BASE is within 1mm. Regarding POST BASE for inspection, contact with the sales department of the manufacturer below.

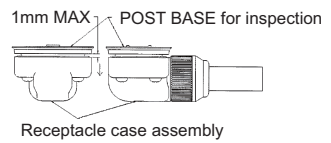

Tyco Electronics Japan G.K. <http://www.te.com/en/home.html>

- (10) Insert the assembled connector until it stick fast to the POST BASE and then, tighten the four bind screws to fix. The tightening torque of the bind screw is 5.0 to 10.0 N-cm.

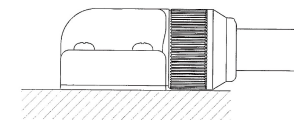

Appendix 2

D/A Output Specifications for Drive Unit

Appendix 2.1 D/A Output Specifications

Drive unit has a function to D/A output the various control data. The servo and spindle adjustment data required for setting the servo and spindle parameters to match the machine can be D/A output. Measure using a high-speed waveform recorder, oscilloscope, etc.

D/A output specifications

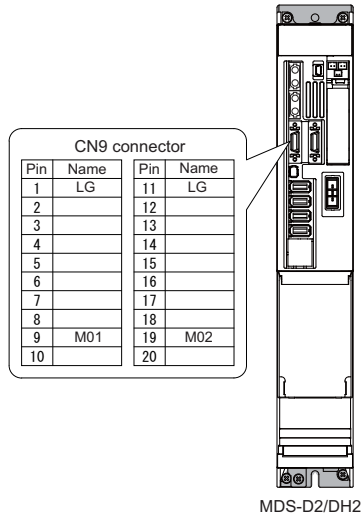

Item	Explanation
No. of channels	2ch
Output cycle	0.8ms (min. value)
Output precision	12bit
Output voltage range	0V to 2.5V (zero) to +5V
Output magnification setting	-32768 to 32767 (1/100-fold)
Output pin (CN9 connector)	MO1 = Pin 9, MO2 = Pin 19, LG = Pin 1, 11
Others	The D/A output for the 2-axis or 3-axis unit is also 2ch. When using the 2-axis or 3-axis unit, always set -1 for the output data (SV061, SV062 / SP125, SP126) of the axis that is not to be measured.

When the output data is 0, the offset voltage is 2.5V. If there is an offset voltage, adjust the zero level position in the measuring instrument side.

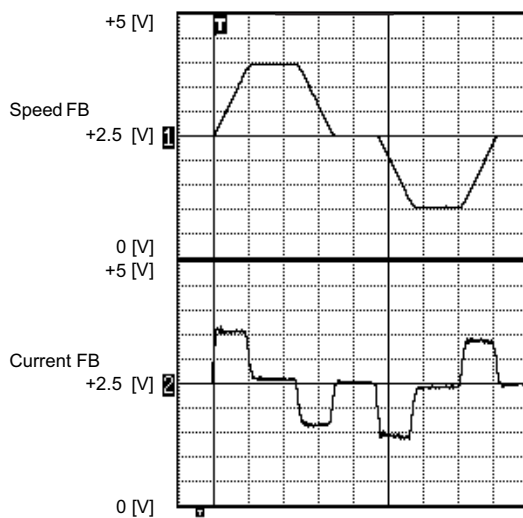

Example of D/A output waveform

Appendix 2.2 Output Data Settings

Appendix 2.2.1 Servo Drive Unit Settings

<Standard output>

[#2261] SV061 DA1NO D/A output ch1 data No.

Input the data number you wish to output to the D/A output channel 1.
When using the 2-axis drive unit, set "-1" to the axis that the data will not be output.

---Setting range---
-32768 to 32767

[#2262] SV062 DA2NO D/A output ch2 data No.

Input the data number you wish to output to the D/A output channel 2.
When using the 2-axis drive unit, set "-1" to the axis that the data will not be output.

---Setting range---
-32768 to 32767

No.	Output data	Standard output unit		Output cycle
		Linear axis	Rotary axis	
-1	D/A output not selected	For 2nd axis or 3rd axis drive unit. Set the parameters to the other axes in the drive unit that is not D/A output.		
0	Commanded rotation speed	1000(r/min)/V		0.8ms
1	Motor rotation speed	1000(r/min)/V		0.8ms
2	Torque command	Motor stall rated ratio 100%/V		0.8ms
3	Torque feedback	Motor stall rated ratio 100%/V		0.8ms
6	Effective current command	100%/V		0.8ms
7	Effective current feedback	100%/V		0.8ms
8	Machine vibration frequency	500Hz/V		0.8ms
9	HAS control droop cancel amount	1mm/V	1°/V	0.8ms
30	Collision detection estimated torque	100%/V		0.8ms
31	Collision detection disturbance estimated torque	100%/V		0.8ms
32	Estimated load inertia ratio	100%/V		0.8ms
35	Disturbance observer estimated disturbance torque	100%/V		0.8ms
50	Position droop	1μm/V	1/1000°/V	0.8ms
51	Position command	1μm/V	1/1000°/V	0.8ms
52	Position feedback	1μm/V	1/1000°/V	0.8ms
53	Position FΔT	1μm/s/V	1/1000°/s/V	0.8ms
54	Deviation from ideal position (considering servo tracking delay)	1μm/V	1/1000°/V	0.8ms
60	Position droop	1mm/V	1°/V	0.8ms
61	Position command	1mm/V	1°/V	0.8ms
62	Position feedback	1mm/V	1°/V	0.8ms
63	Position FΔT	1mm/s/V	1°/s/V	0.8ms
64	Deviation from ideal position (considering servo tracking delay)	1mm/V	1°/V	0.8ms
70	Position droop	1m/V	1000°/V	0.8ms
71	Position command	1m/V	1000°/V	0.8ms
72	Position feedback	1m/V	1000°/V	0.8ms
73	Position FΔT	1m/s/V	1000°/s/V	0.8ms
74	Deviation from ideal position (considering servo tracking delay)	1m/V	1000°/V	0.8ms
126	Saw tooth wave	1.5V to 3.5V		0.8ms
127	2.5V test data	2.5V		0.8ms

(Servo control signal)

Servo control input (NC to Servo)			Servo control output (Servo to NC)		
No.	Details		No.	Details	
16384	Servo control input 1-0	READY ON command	16480	Servo control output 1-0	In READY ON
16385	Servo control input 1-1	Servo ON command	16481	Servo control output 1-1	In servo ON
16388	Servo control input 1-4	Position loop gain changeover command	16484	Servo control output 1-4	In position loop gain changeover
16390	Servo control input 1-6	Excessive error detection width changeover command	16486	Servo control output 1-6	In excessive error detection width changeover
16391	Servo control input 1-7	Alarm reset command	16487	Servo control output 1-7	In alarm
16392	Servo control input 1-8	Current limit selection command	16488	Servo control output 1-8	In current limit selection
			16492	Servo control output 1-C	In in-position
			16493	Servo control output 1-D	In current limit
			16494	Servo control output 1-E	In absolute position data loss
			16495	Servo control output 1-F	In warning
			16496	Servo control output 2-0	Z phase passed
			16499	Servo control output 2-3	In zero speed
			16503	Servo control output 2-7	In external emergency stop
16409	Servo control input 2-9	Speed monitor command valid	16505	Servo control output 2-9	In speed monitor
16410	Servo control input 2-A	In door closed (controller)	16506	Servo control output 2-A	In door closed (controller)
16411	Servo control input 2-B	In door closed (all drive units)	16507	Servo control output 2-B	In door closed (self drive unit)
16416	Servo control input 3-0	Control axis detachment command	16512	Servo control output 3-0	In control axis detachment
16472	Servo control input 6-8	Drivers communication control request	16568	Servo control output 6-8	In drivers communication control

(Note) For details on the servo signals, refer to the section "Servo control signal".

Appendix 2.2.2 Spindle Drive Unit Settings

< Standard output >

【#13125】 SP125 DA1NO D/A output ch1 data No.

Input the desired data number to D/A output channel.

When using the 2-axis drive unit, set "-1" to the axis that the data will not be output.

---Setting range---

-32768 to 32767

【#13126】 SP126 DA2NO D/A output ch2 data No.

Input the desired data number to D/A output channel.

When using the 2-axis drive unit, set "-1" to the axis that the data will not be output.

---Setting range---

-32768 to 32767

No.	Output data	Output unit for standard setting	Output cycle
-1	D/A output stop	-	
0	Commanded motor rotation speed	1000(r/min)/V	0.8ms
1	Motor rotation speed	1000(r/min)/V	0.8ms
2	Torque current command	Short time rated ratio 100%/V	0.8ms
3	Torque current feedback	Short time rated ratio 100%/V	0.8ms
35	Disturbance observer estimated disturbance torque	Short time rated torque current value ratio 100%/V	0.8ms
50	Position droop	1/1000°/V	0.8ms
51	Position command	1/1000°/V	0.8ms
52	Position feedback	1/1000°/V	0.8ms
53	Position FΔT	1/1000°/s/V	0.8ms
54	Deviation from ideal position (considering spindle tracking delay)	1/1000°/V	0.8ms
60	Position droop	1°/V	0.8ms
61	Position command	1°/V	0.8ms
62	Position feedback	1°/V	0.8ms
63	Position FΔT	1°/s/V	0.8ms
64	Deviation from ideal position (considering spindle tracking delay)	1°/V	0.8ms
70	Position droop	1000°/V	0.8ms
71	Position command	1000°/V	0.8ms
72	Position feedback	1000°/V	0.8ms
73	Position FΔT	1000°/s/V	0.8ms
74	Deviation from ideal position (considering spindle tracking delay)	1000°/V	0.8ms
110	3.0V output load meter (Note)	40%/V, 120%/3V	0.8ms
126	Saw tooth wave	1.5V to 3.5V	0.8ms
127	2.5V test data output	2.5V	0.8ms

(Note) Load meter displays "100%(=2.5V)" when the control power turns ON and the NC is starting. After the NC has been run, it displays "0%(=0V)".

< Special output >

The result of PLG(TS5690) installation accuracy diagnosis is output to D/A output. D/A output magnification:SP127(DA1MPY) and SP128(DA2MPY) is 0.

PLG installation diagnosis function can be enabled during the rotation, when open loop control is enabled:SP018(SPEC2)/bit1=1.

D/A output No.	Details	Description
120	Motor end PLG installation Gap diagnosis	Motor end PLG installation gap is diagnosed. When the gap is good, 2.5V is output. When the gap is excessive, 2.5V+1V is output. When the gap is too small, 2.5V-1V is output.
121	Motor end PLG installation All errors diagnosis	Motor end PLG installation error (including the gap) is diagnosed. When the installation is good, 2.5V is output. When the installation is incorrect, 2.5V+1V is output.
122	Spindle end PLG installation Gap diagnosis	Spindle end PLG installation gap is diagnosed. Diagnostic procedure is the same as that of motor end PLG.
123	Spindle end PLG installation All errors diagnosis	Spindle end PLG installation error (including the gap) is diagnosed. Diagnostic procedure is the same as that of motor end PLG.

< Spindle control signal >

Spindle control input (NC to Spindle)			Spindle control output (Spindle to NC)		
No.	Details		No.	Details	
16384	Spindle control input 1-0	READY ON command	16480	Spindle control output 1-0	In ready ON
16385	Spindle control input 1-1	Servo ON command	16481	Spindle control output 1-1	In servo ON
16391	Spindle control input 1-7	Alarm reset command	16487	Spindle control output 1-7	In alarm
16392	Spindle control input 1-8	Torque limit 1 selection command	16488	Spindle control output 1-8	In torque limit 1 selection
16393	Spindle control input 1-9	Torque limit 2 selection command	16489	Spindle control output 1-9	In torque limit 2 selection
16394	Spindle control input 1-A	Torque limit 3 selection command	16490	Spindle control output 1-A	In torque limit 3 selection
			16492	Spindle control output 1-C	In in-position
			16495	Spindle control output 1-F	In warning
			16496	Spindle control output 2-0	Z phase passed
			16499	Spindle control output 2-3	In zero speed
			16503	Spindle control output 2-7	In external emergency stop
16409	Spindle control input 2-9	Speed monitor command valid	16505	Spindle control output 2-9	In speed monitor
16410	Spindle control input 2-A	In door closed (controller)	16506	Spindle control output 2-A	In door closed (controller)
16411	Spindle control input 2-B	In door closed (all drive units)	16507	Spindle control output 2-B	In door closed (self drive unit)
16432	Spindle control input 4-0	Spindle control mode selection command 1	16528	Spindle control output 4-0	In spindle control mode selection 1
16433	Spindle control input 4-1	Spindle control mode selection command 2	16529	Spindle control output 4-1	In spindle control mode selection 2
16434	Spindle control input 4-2	Spindle control mode selection command 3	16530	Spindle control output 4-2	In spindle control mode selection 3
16436	Spindle control input 4-4	Gear changeover command	16532	Spindle control output 4-4	In gear changeover command
16437	Spindle control input 4-5	Gear selection command 1	16533	Spindle control output 4-5	In gear selection 1
16438	Spindle control input 4-6	Gear selection command 2	16534	Spindle control output 4-6	In gear selection 2
			16535	Spindle control output 4-7	Magnetic pole position not set
16445	Spindle control input 4-D	L coil selection command	16541	Spindle control output 4-D	In L coil selection
			16545	Spindle control output 5-1	Speed detection
			16550	Spindle control output 5-6	In coil changeover
16458	Spindle control input 5-A	Phase synchronization suppression command	16554	Spindle control output 5-A	In phase synchronization suppression
16459	Spindle control input 5-B	Minimum excitation rate 2 changeover request	16555	Spindle control output 5-B	In minimum excitation rate 2 selection
16460	Spindle control input 5-C	Speed gain set 2 changeover request	16556	Spindle control output 5-C	In speed gain set 2 selection
16461	Spindle control input 5-D	Zero point re-detection request	16557	Spindle control output 5-D	Zero point re-detection complete
16462	Spindle control input 5-E	Spindle holding force up	16558	Spindle control output 5-E	Spindle holding force up completed
			16559	Spindle control output 5-F	In 2nd in-position
16472	Spindle control input 6-8	Drivers communication control request	16568	Spindle control output 6-8	In drivers communication control

(Note 1) Control signal is bit output. Setting the No. of the table above to the data output (SP125, SP126), and when the scale (SP127, SP128) is set to "0", the output is "0V" for bit 0, and "2.5V" for bit 1.

(Note 2) Refer to "Spindle control signal" for details on the spindle control signal.

Appendix 2.3 Setting the Output Magnification

Appendix 2.3.1 Servo Drive Unit Settings

Set when outputting other than the standard output unit. When "0" is set, the magnification will be the same as "100".

(Example 1) When SV061=1 and SV063=50

The motor rotation speed is output at 2000(r/min)/V.

(Example 2) When SV062=3 and SV064=50

The torque feedback is output to D/A output channel 2 with 200%/V unit.

【#2263】 SV063 DA1MPY D/A output ch1 output scale

Set output scale of the D/A output channel 1 in increment of 1/100.
When "0" is set, the magnification is the same as when "100" is set.

---Setting range---

-32768 to 32767 (1/100-fold)

【#2264】 SV064 DA2MPY D/A output ch 2 output scale

Set output scale of the D/A output channel 2 in accruement of 1/100.
When "0" is set, the magnification is the same as when "100" is set.

---Setting range---

-32768 to 32767 (1/100-fold)

Appendix 2.3.2 Spindle Drive Unit Settings

Set when outputting other than the standard output unit. When "0" is set, the magnification will be the same as "100".

(Example 1) When SP125=1, SP127=50

Commanded motor rotation speed is output to D/A output channel 1 in increments of 2000r/min/V.

(Example 2) When SP126=2, SP128=200

The torque axis current command is output to D/A output channel 2 in increments of 50%/V.

【#13127】 SP127 DA1MPY D/A output ch1 output scale

Set the output scale in increments of 1/100.
 When "0" is set, the scale is the same as when "100" is set.

---Setting range---
 -32768 to 32767 (1/100-fold)

【#13128】 SP128 DA2MPY D/A output ch2 output scale

Set the output scale in increments of 1/100.
 When "0" is set, the scale is the same as when "100" is set.

---Setting range---
 -32768 to 32767 (1/100-fold)

《Speed FB》

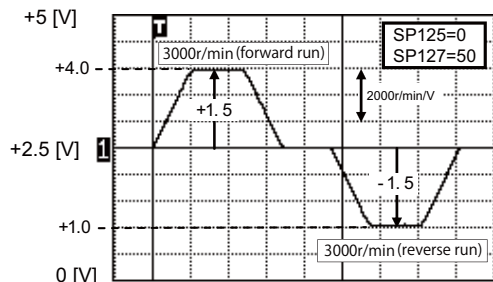

《Current FB》

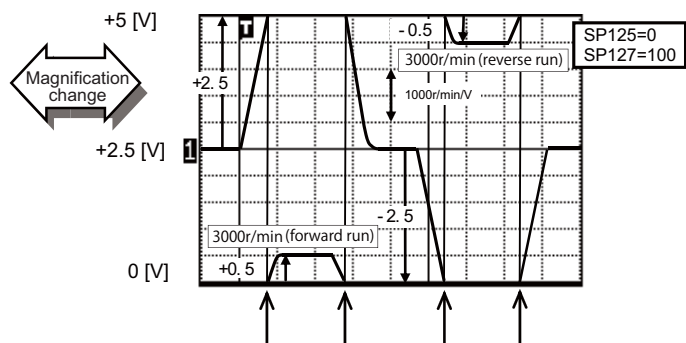
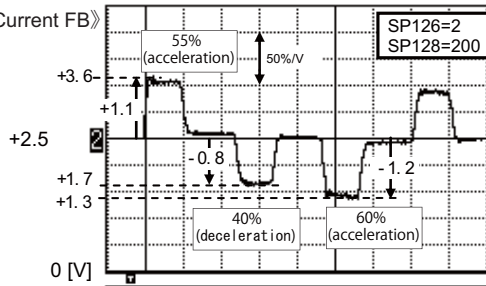

<When 3000r/min is displayed at the setting range of "1000r/min/V">
 When the speed waveform at 3000r/min is measured using a high-speed waveform recorder with SP127 set to "100", the data exceeds the D/A output range (+5.0V for forward run and 0V for reverse run) at 2500r/min, but it will be cleared immediately and then the remaining data will be output. Even if the data exceeds the D/A output range more than one time, it will be cleared and the remains will be output.

Example of D/A output waveform: 3000r/min during acceleration and deceleration

Appendix 3

Compliance to EC Directives

Appendix 3.1 Compliance to EC Directives

Appendix 3.1.1 European EC Directives

In the EU Community and UK, the attachment of a CE mark and a UKCA mark (European CE marking/UK UKCA Regulations) is mandatory to indicate that the basic safety conditions of the Machine Directives (issued Jan. 1995), EMC Directives (issued Jan. 1996), Electromagnetic Compatibility Regulations (issued Jan. 2021), the Low-voltage Directives (issued Jan. 1997), and the Electrical Equipment (Safety) Regulations (issued Jan. 2021) are satisfied. The machines and devices in which the servo and spindle drive are assembled are the targets for European CE marking and UK UKCA Regulations.

(1) Compliance to EMC Directives/Electromagnetic Compatibility Regulations

The servo and spindle drive are components designed to be used in combination with a machine or device. These are not directly targeted by the Directives, but a CE mark and a UKCA mark must be attached to machines and devices in which these components are assembled. The next section "EMC Installation Guidelines", which explains the unit installation and control panel manufacturing method, etc., has been prepared to make compliance to the EMC Directives/Electromagnetic Compatibility Regulations easier.

(2) Compliance to Low-voltage Directives/Electrical Equipment (Safety) Regulations

Each unit is targeted for the Low-voltage Directives/Electrical Equipment (Safety) Regulations. An excerpt of the precautions given in this specification is given below. Please read this section thoroughly before starting use. For the EMC Directives/Electromagnetic Compatibility Regulations and Low-voltage Directives/Electrical Equipment (Safety) Regulations, Self-Declaration Documents has been prepared. Contact Mitsubishi or your dealer when required.

Appendix 3.1.2 Cautions for EC Directive Compliance

Use the Low-voltage Directive/Electrical Equipment (Safety) Regulations compatible parts for the servo/spindle drive and servo/spindle motor. In addition to the items described in this instruction manual, observe the items described below.

(1) Configuration

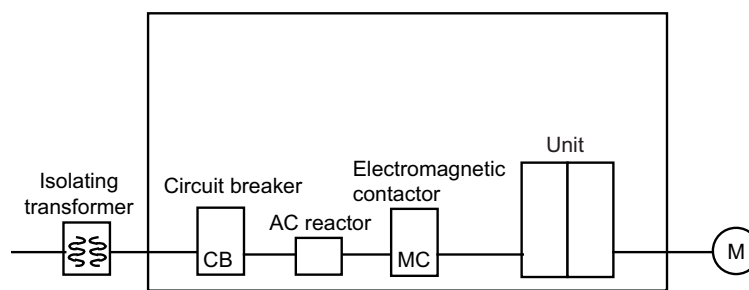

Insert a type B circuit breaker (RCD) in the power supply side of the unit.

(2) Environment

Use the units under an Overvoltage Category III (MDS-DH2)/II (MDS-D2) and Pollution Class of 2 or less environment as stipulated in IEC60664.

- (a) To adjust the units to the Overvoltage Category II, insert an isolating transformer of the star connection complying with EN or IEC standard in the input of the power supply unit.
- (b) To adjust the units to the Pollution Class of 2, install the units in a control panel having a structure (IP54 or higher) in which water, oil, carbon or dust cannot enter.

Unit

	During operation	Storage	During transportation
Ambient temperature	0°C to 55°C	-15°C to 70°C	-15°C to 70°C
Humidity	90%RH or less	90%RH or less	90%RH or less
Altitude	1000m or less	1000m or less	13000m or less

Motor

	During operation	Storage	During transportation
Ambient temperature	0°C to 40°C	-15°C to 70°C	-15°C to 70°C
Humidity	80%RH or less	90%RH or less	90%RH or less
Altitude	1000m or less	1000m or less	13000m or less

(3) Power supply

- [1] Use the power supply and servo/spindle drive unit under an Overvoltage Category III (MDS-DH2)/ II (MDS-D2) as stipulated in IEC60664.
- [2] Earth the PE terminal of the units to the neutral point of the star connection.
- [3] Do not omit the circuit breaker and electromagnetic contactor.

(4) Earthing

- [1] To prevent electric shocks, always connect the servo/spindle drive unit protective earth (PE) terminal (terminal with mark) to the protective earth (PE) on the control panel.
- [2] When connecting the earthing wire to the protective earth (PE) terminal, do not tighten the wire terminals together. Always connect one wire to one terminal.



(5) Wiring

- [1] Always use crimp terminals with insulation tubes so that the connected wire does not contact the neighboring terminals.

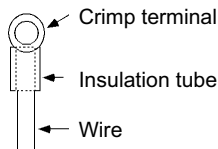

- [2] Do not connect the wires directly.

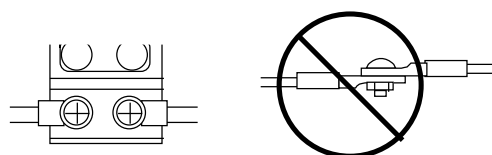

- [3] Always install the power supply unit and servo/spindle drive unit on the metal panel.

(6) Peripheral devices

- [1] Use EN/IEC Standards compliant parts for the circuit protector and contactor.
- [2] Select type B circuit protector manufactured by RCD.
 Apply Annex C of EN60204-1 for sizing of the circuit protector.

(7) Miscellaneous

- [1] Refer to the next section "EMC Installation Guidelines" for methods on complying with the EMC Directives/
 Electromagnetic Compatibility Regulations.
- [2] Ground the facility according to each country's requirements.
- [3] The control circuit connector (○) is safely separated from the main circuit (◎) and ground (●).
- [4] Inspect the appearance before installing the unit. Carry out a performance inspection of the final unit, and save the inspection records.

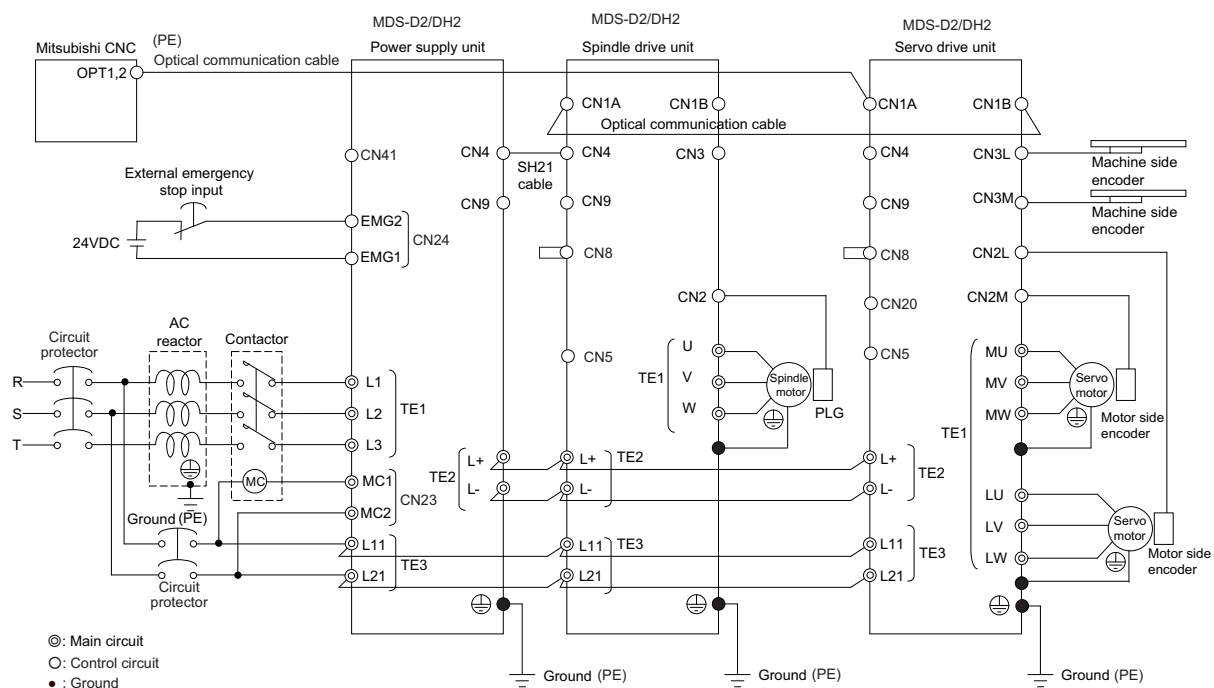

< When MDS-D/DH-PFU is connected >

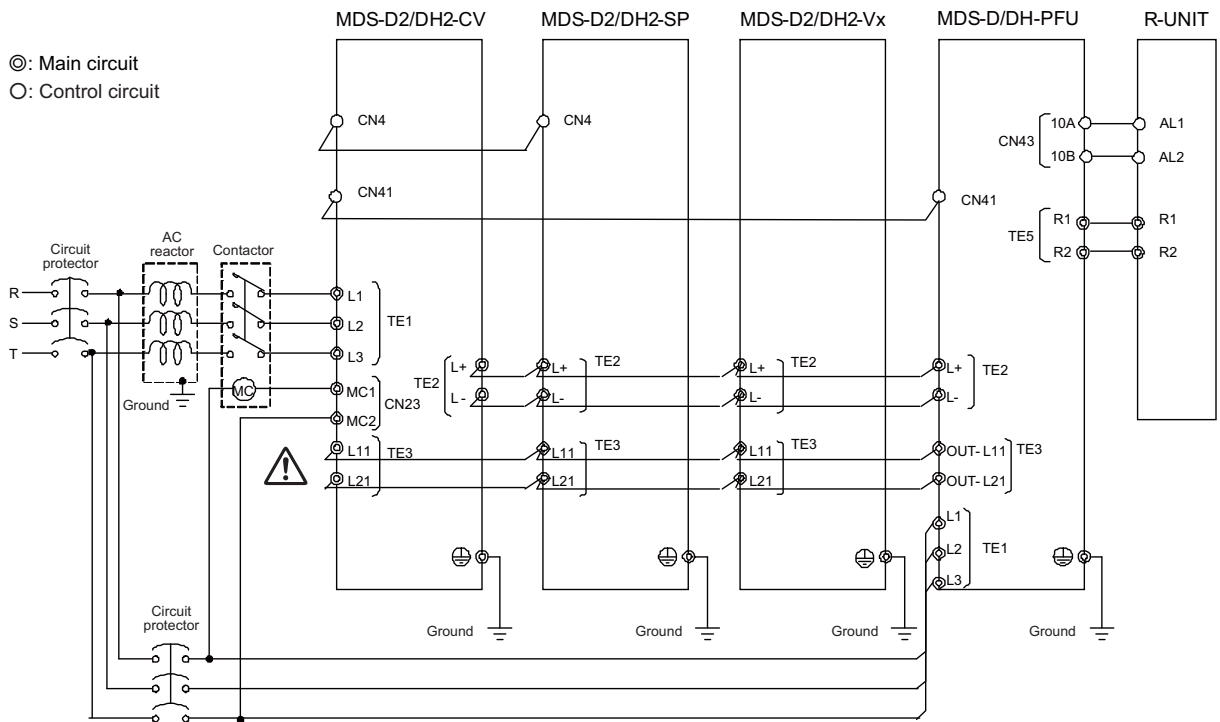

Appendix 4

EMC Installation Guidelines

Appendix 4.1 Introduction

As the NC unit is a component designed to control machine tools, it is believed to be out of the direct EMC Directives/Electromagnetic Compatibility Regulations subject. However, we would like to introduce the following measure plans to backup EMC Directives/Electromagnetic Compatibility Regulations compliance of the machine tool as the NC unit is a major component of the machine tools.

- [1] Methods for installation in control/operation panel
- [2] Methods of wiring cable outside of panel
- [3] Introduction of countermeasure parts

Mitsubishi is carrying out tests to confirm the compliance to the EMC Directives/Electromagnetic Compatibility Regulations under the environment described in this manual. However, the level of the noise will differ according to the equipment type and layout, control panel structure and wiring lead-in, etc. Thus, we ask that the final noise level be confirmed by the machine tool builder.

For measures for CNC, refer to "EMC INSTALLATION GUIDELINES" of each NC Connection Manual.

Appendix 4.2 EMC Directives/Electromagnetic Compatibility Regulations

The EMC Directives/Electromagnetic Compatibility Regulations regulate mainly the following two withstand levels.

Emission Capacity to prevent output of obstructive noise that adversely affects external sources.

Immunity Capacity not to malfunction due to obstructive noise from external sources.

The details of each level are classified in the table below. It is assumed that the Standards and test details required for a machine tool are about the same as these.

Class	Name	Details	Generic Standard	Standards for determining test and measurement
Emission	Radiated noise	Electromagnetic noise radiated through the air	EN61000-6-4 (General industrial machine) EN61800-3 (Motor control unit)	-----
	Conductive noise	Electromagnetic noise discharged from power line		
Immunity	Static electricity electrical discharge immunity test	(Example) Withstand level of discharge of electricity charged in a human body.	EN61000-6-2 (General industrial machine) EN61800-3 (Motor control unit)	EN61000-4-2
	Radiated radio-frequency magnetic field immunity test	(Example) Simulation of immunity from digital wireless transmitters		EN61000-4-3
	Electrical fast transient/burst immunity test	(Example) Withstand level of noise from relays or connecting/disconnecting live wires		EN61000-4-4
	Immunity to conducted disturbance induced by radio-frequency magnetic field	(Example) Withstand level of noise entering through power line, etc.		EN61000-4-6
	Power supply frequency field immunity test	(Example) 50/60Hz power frequency noise		EN61000-4-8
	Immunity test for voltage dip, short-time power failure and voltage fluctuation	(Example) Power voltage drop withstand level		EN61000-4-11
	Surge immunity test	(Example) Withstand level of noise caused by lightning		EN61000-4-5

Appendix 4.3 EMC Measures

The main items relating to EMC measures include the following.

- [1] Store the device in an electrically sealed metal panel.
- [2] Earth all conductors that are floating electrically. (Lower the impedance.)
- [3] Wire the power line separated from the signal wire as far as possible.
- [4] Use shielded wires for the cables wired outside of the panel.
- [5] Install a noise filter.

Ensure the following items to suppress noise radiated outside of the panel.

- [1] Accurately ground the devices.
- [2] Clamp shielded wires in the control panel.
- [3] Increase the panel's electrical seal. Reduce the gap and hole size.

Note that the electromagnetic noise radiated in the air is greatly affected by the clearance of the panel and the quality of the cable shield.

Appendix 4.4 Measures for Panel Structure

The design of the panel is a very important factor for the EMC measures, so take the following measures into consideration.

Appendix 4.4.1 Measures for Control Panel Unit

- [1] Use metal for all materials configuring the panel.
- [2] For the joining of the top plate and side plates, etc., mask the contact surface with paint, and fix with welding or screws so that the impedance is reduced. In either case, keep the joining clearance to a max. of 20cm for a better effect.

Note that if the plate warps due to the screw fixing, etc., creating a clearance, noise could leak from that place.

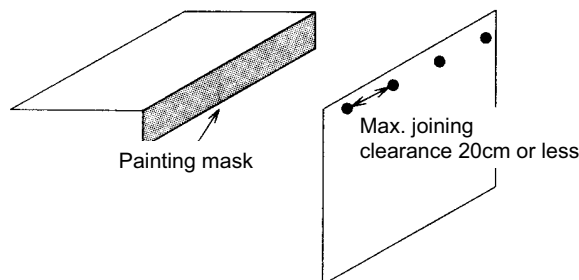

- [3] Plate the earth plate (with nickel, tin), and connect the connections with a low impedance.
- [4] If there is a opening on the panel surface, such as the ventilation holes, cover it with a metal plate or expanded metal.

Make sure not to connect using metal or a conductor without peeling off the surface, which results in an insufficient electrical connection. (ex. connection by putting painted surfaces together)

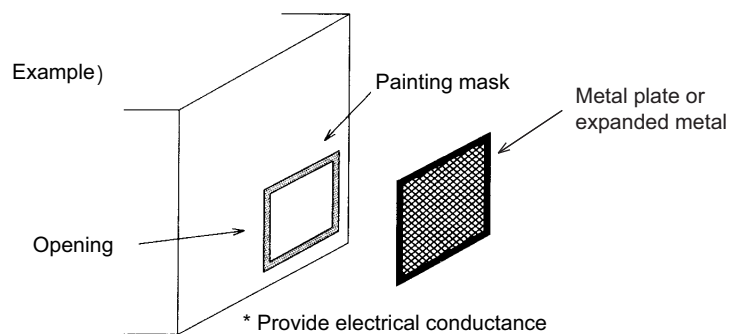

Appendix 4.4.2 Measures for Door

- [1] Use metal for all materials configuring the door.
- [2] Use an EMI gasket or conductive packing for the contact between the door and control panel unit.
- [3] The EMI gasket or conductive packing must contact at a uniform and correct position of the metal surface of the control panel unit.
- [4] The surface of the control panel unit contacted with the EMI gasket or conductive packing must have conductance treatment.
 (Example) Weld (or screw) a plate that is plated (with nickel, tin).

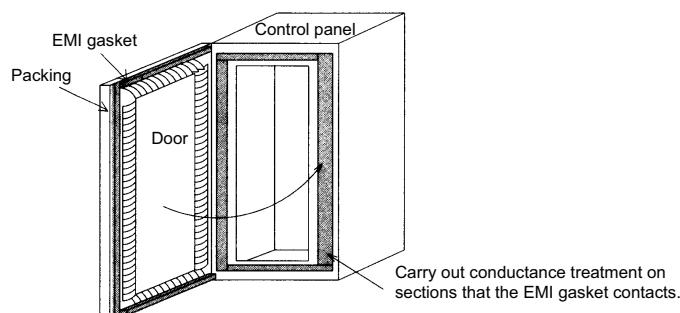

- [5] As a method other than the above, the control panel unit and door can be connected with a plain braided wire. In this case, the panel and door should be contacted at as many points as possible.

Appendix 4.4.3 Measures for Operation Board Panel

- [1] Always connect the operation board and indicator with an earthing wire.
- [2] If the operation board panel has a door, use an EMI gasket or conductive packing between the door and panel to provide electrical conductance in the same manner as the control panel.
- [3] Connect the operation board panel and control panel with a sufficiently thick and short earthing wire.

Appendix 4.4.4 Shielding of the Power Supply Input Section

- [1] Separate the input power supply section from other parts in the control panel so that the input power supply cable will not be contaminated by radiated noise.
- [2] Do not lead the power line through the panel without passing it through a filter.

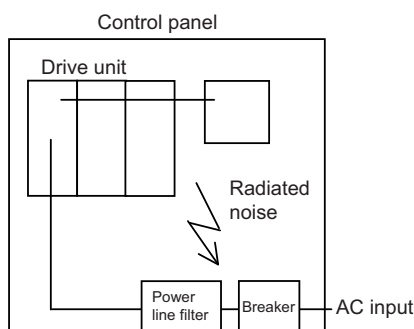

The power supply line noise is eliminated by the filter, but cable contains noise again because of the noise radiated in the control panel.

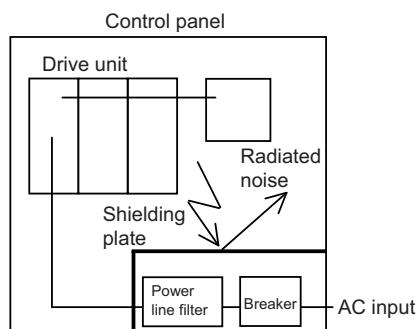

Use a metal plate, etc., for the shielding partition. Make sure not to create a clearance.

Appendix 4.5 Measures for Various Cables

The various cables act as antennas for the noise and discharge the noise externally. Thus appropriate treatment is required to avoid the noise.

The wiring between the drive unit and motor act as an extremely powerful noise source, so apply the following measures.

Appendix 4.5.1 Measures for Wiring in Panel

- [1] If the cables are led unnecessarily in the panel, they will easily pick up the radiated noise. Thus, keep the wiring length as short as possible.

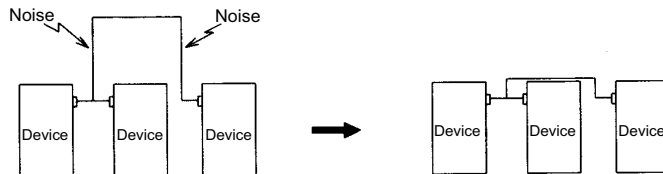

- [2] The noise from other devices will enter the cable and be discharged externally, so avoid internal wiring near the openings.

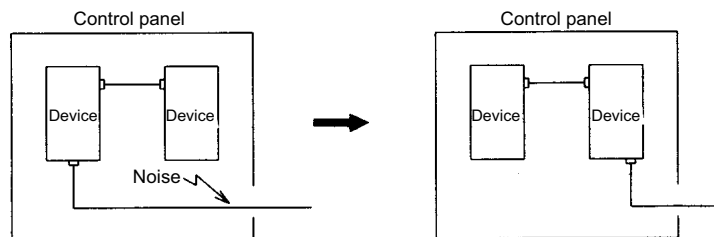

- [3] Connect the control device earthing terminal and earthing plate with a thick wire. Take care to the leading of the wire.

Appendix 4.5.2 Measures for Shield Treatment

Common items

Use of shield clamp fittings is recommended for treating the shields. The fittings are available as options, so order as required. (Refer to the section "Shield Clamp Fitting" in this chapter.)

Clamp the shield at a position within 10cm from the panel lead out port.

POINT

1. When leading the cables, including the grounding wire (FG), outside of the panel, clamp the cables near the panel outlet (recommendation: within 10cm).
2. When using a metal duct or conduit, the cables do not need to be clamped near the panel outlet.
3. When leading cables not having shields outside the panel, follow the instructions given for each cable. (Installation of a ferrite core, etc., may be required.)

Appendix 4.5.3 Servo/Spindle Motor Power Cable

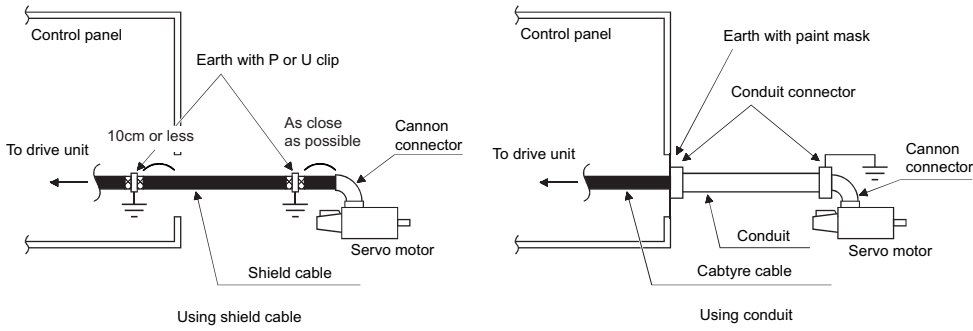

Power cable for servo motor

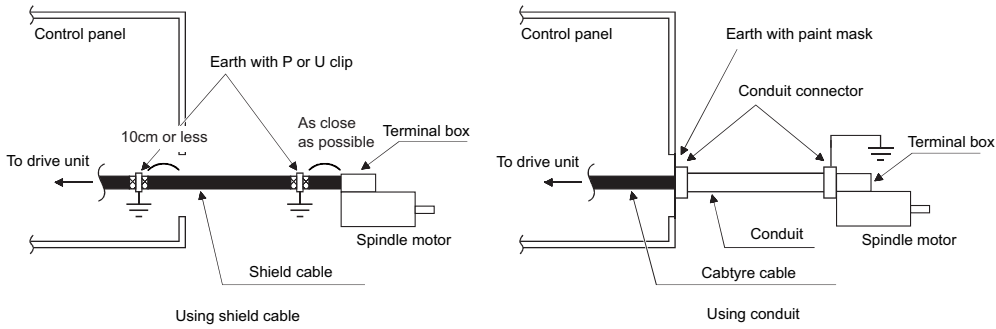

Power cable for spindle motor

- [1] Use four wires (3-phase + earthing) for the power cable that are completely shielded and free from breaks.
- [2] Earth the shield on both the control panel side and motor chassis side. The shield earth position on the drive unit side must be 10cm or less from the control panel.
- [3] Earth the shield with a metal P clip or U clip.
(A cable clamp fitting can be used depending on the wire size.)
- [4] Directly earth the shield. Do not solder the braided shield onto a wire and earth the end of the wire.

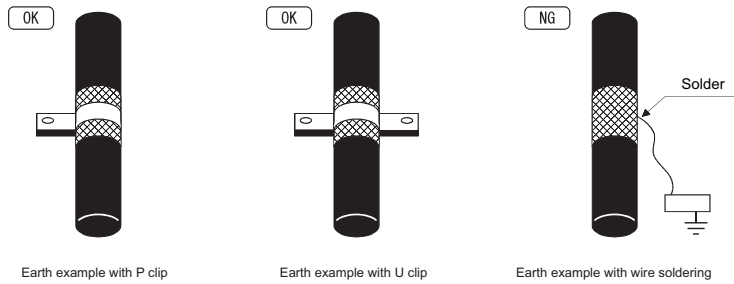

- [5] When not using a shield cable for the power cable, use a conventional cabtyre cable. Use a metal conduit outside the cable.
- [6] Earth the power cable on the control panel side at the contact surface of the conduit connector and control panel.
(Mask the side wall of the control panel with paint.)
- [7] Follow the treatment shown in the example for the conduit connector to earth the power cable on the motor side.
(Example: Use a clamp fitting, etc.)

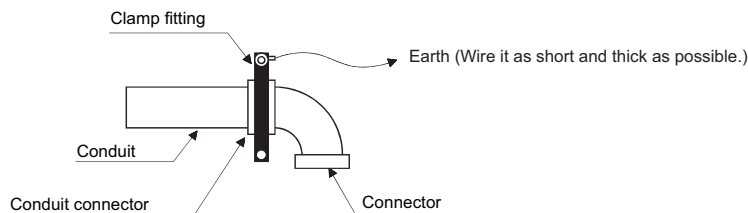

Appendix 4.5.4 Servo/Spindle Motor Encoder Cable

Use a shield pair cable for encoder cable of the servo motor to earth on NC side (inside the control panel.) Mounting a ferrite core directly behind the unit connector is also effective in suppressing noise.

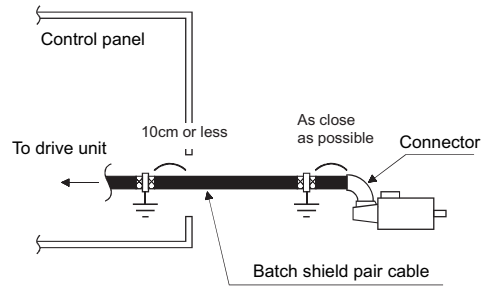

Encoder cable for servo motor

< Installation example >

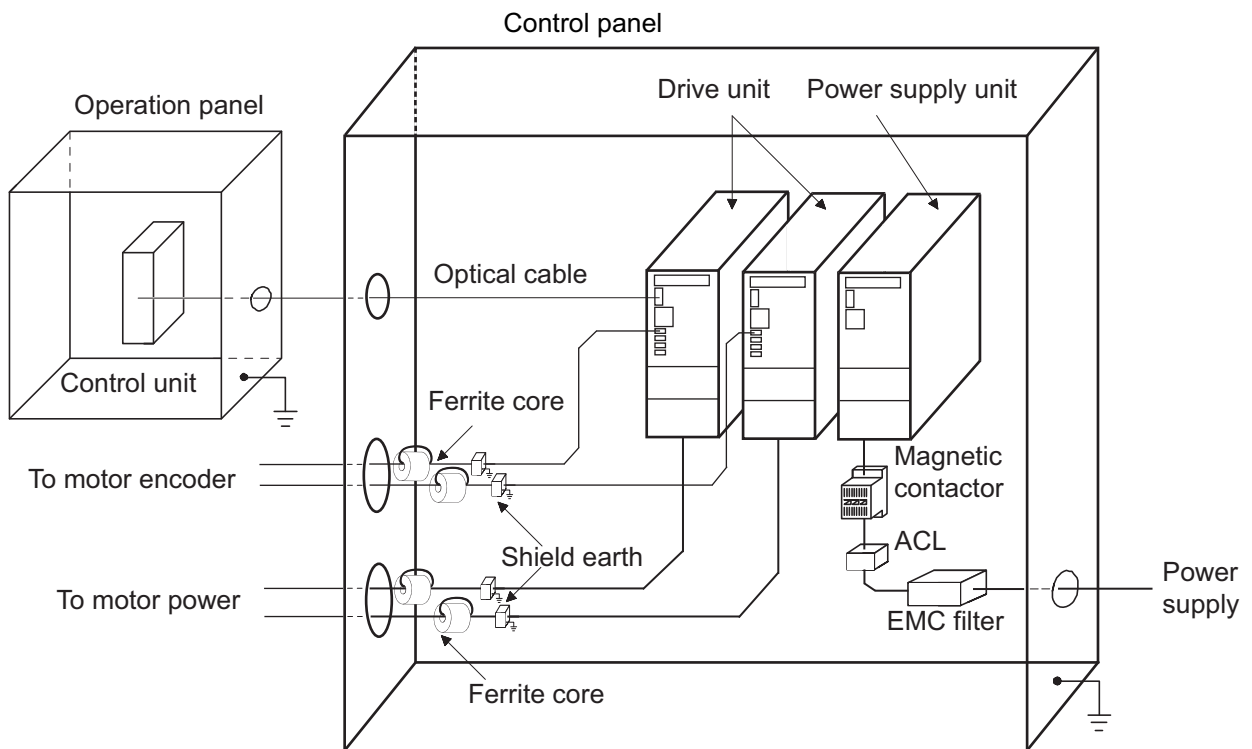

Appendix 4.6 EMC Countermeasure Parts

Appendix 4.6.1 Shield Clamp Fitting

The effect can be enhanced by connecting the cable directly to the earthing plate. Install an earthing plate near each panel's outlet (within 10cm), and press the cable against the earthing plate with the clamp fitting. If the cables are thin, several can be bundled and clamped together. Securely earth the earthing plate with the frame ground. Install directly on the cabinet or connect with an earthing wire.

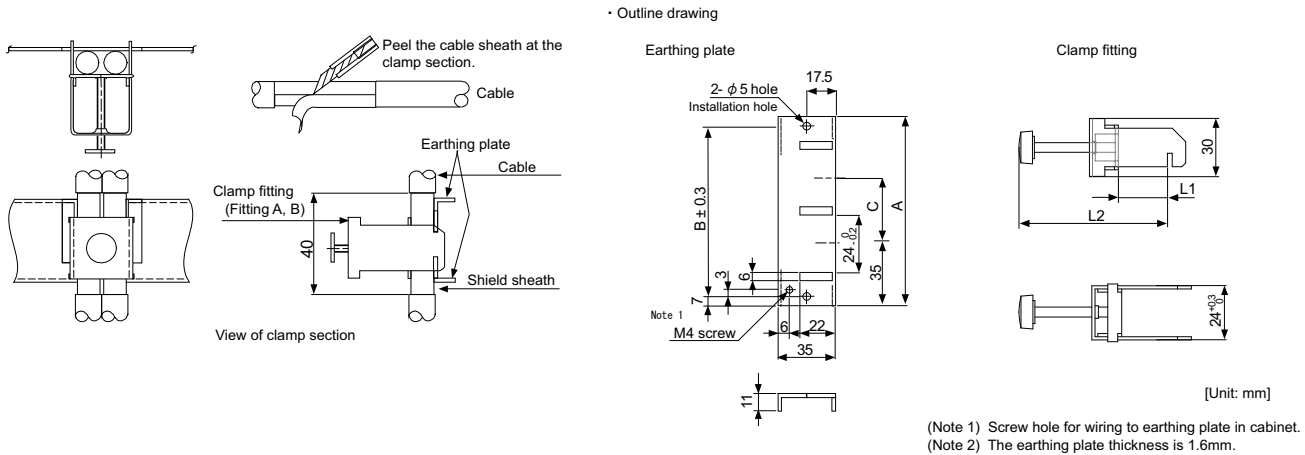

	A	B	C	Enclosed fittings
Ground Plate #D	100	86	30	Clamp fitting A x 2
Ground Plate #E	70	56	-	Clamp fitting B x 1

	L1 (maximum dimension when it is open)	L2 (reference dimension)
Clamp fitting A	25	(77)
Clamp fitting B	12	(54)

Appendix 4.6.2 Ferrite Core

Noise can be suppressed by installing a ferrite core to the cable if the power cable and encoder cable, which are led from outside of the control panel, are the noise sources. Specify the frequency of radiated noise and select the ferrite with high impedance corresponding to the frequency. By wrapping the cable around the ferrite core according to the cable diameter as shown in the example, the impedance rises, obtaining a better effect.

< Example of use >

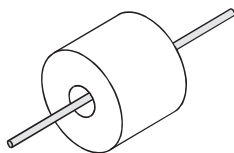

Lead through one time
(one turn)

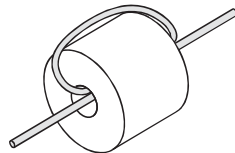

Lead through two times
(two turns)



Lead through three times
(three turns)

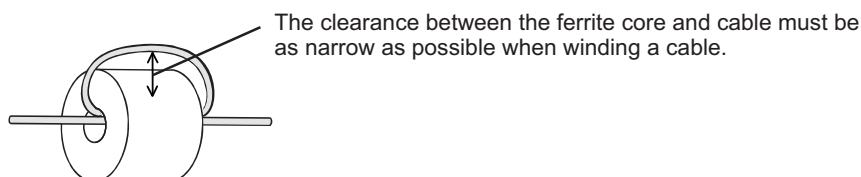

< Recommended ferrite core >

A ferrite core is integrated and mounted on the plastic case. Quick installation is possible without cutting the interface cable or power cable. This ferrite core is effective against common mode noise, allowing measures against noise to be taken without affecting the signal quality.

TDK ZCAT Series

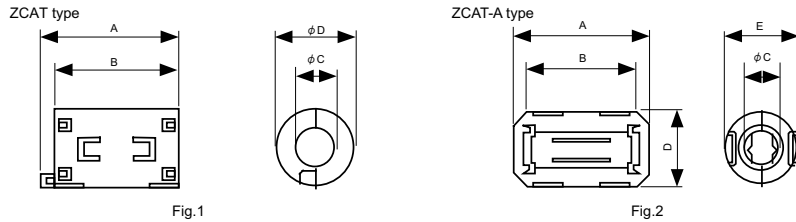

[Unit: mm]

Part name	Fig	A	B	C	D	E	Applicable cable outline	Mass
ZCAT3035-1330(-BK)*1	1	39±1	34±1	13	30	-	13max.	63
ZCAT2035-0930-M(-BK)	2	35±1	28±1	9±1	19.5±1	17.4±1	6 to 9	22

*1 A fixing band is enclosed when shipped.

Contact:
 TDK Corporation
<http://www.global.tdk.com/>

Kitagawa Industries GRFC Series

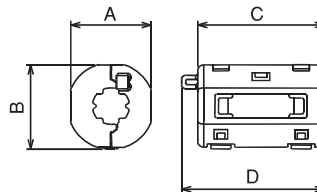

[Unit: mm]

Part number	A	B	C	D	Applicable bundle diameter	Impedance *Ω/100MHz (1 turn)
RFC-H13	31.7	29.4	41.0	-	Φ12.5 to 13.5	≥170
RFC-20	40.0	40.0	47.0	-	Max.Φ20	≥180

Contact:
 KITAGAWA INDUSTRIES CO.,LTD.
<http://www.kitagawa-ind.com/eng/>

Appendix 4.6.3 Power Line Filter

HF3000C-SZA Series for 200V/400V

■ Features

- (a) 3-phase 3-wire type (500V series)
- (b) Compatible with 200V/400V
- (c) Compliant with EU Standards EN55011 (Group 1 Class A)
- (d) Downsized for the space-saving book type

■ Application

- (a) Applications such as large machine tool, inverter, servo, etc.

■ Specifications

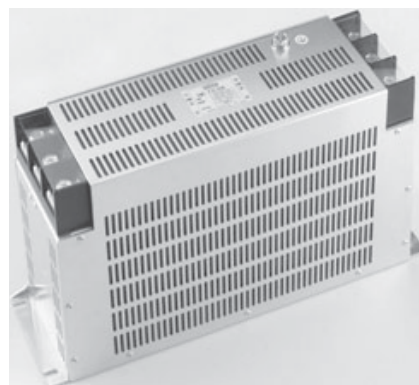

Part name	HF3000C-SZA Series											
	HF3010 C-SZA	HF3020 C-SZA	HF3030 C-SZA	HF3040 C-SZA	HF3050 C-SZA	HF3060 C-SZA	HF3080 C-SZA	HF3100 C-SZA	HF3150 C-SZA	HF3200 C-SZA	HF3250 C-SZA	HF3300 C-SZA
Rated voltage	3-phase 3-wire type 500VAC (530VAC max 50/60Hz)											
Rated current	10A	20A	30A	40A	50A	60A	80A	100A	150A	200A	250A	300A
Leakage current	7mA max 400VAC 50Hz(by UL1283)											
Ambient temp	-20 to 50°C											
Safety standards	CSA, UL1283/EN60939-2											
Vibration Resistance	Frequency: 10Hz to 55Hz Acceleration rate: 9.8m/s ²											

< Circuit diagram >

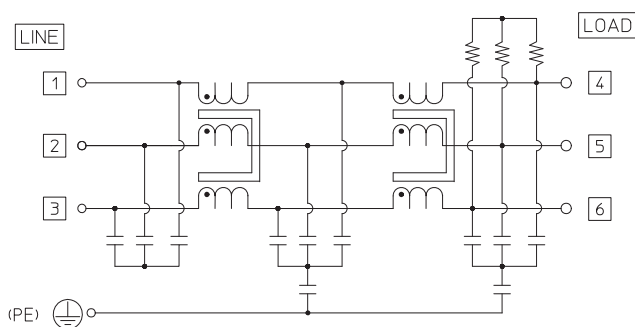

< Attenuation > Typical example: HF3150C-SZA

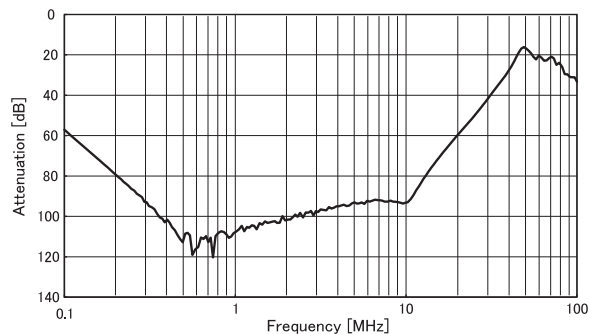

■ Outline dimensions

Model	Rated current	Mass (typ.)	Dimension [Unit:mm]		
			W	D	H
HF3010C-SZA	10A	0.9kg	220	66	78
HF3020C-SZA	20A	1.3kg			
HF3030C-SZA	30A	1.3kg			
HF3040C-SZA	40A	2.0kg	270	80	84
HF3050C-SZA	50A	2.0kg			
HF3060C-SZA	60A	2.1kg			
HF3080C-SZA	80A	5.4kg	310	100	210
HF3100C-SZA	100A	5.8kg			
HF3150C-SZA	150A	9.0kg			
HF3200C-SZA	200A	11kg	400	120	260
HF3250C-SZA	250A	12kg			
HF3300C-SZA	300A	13kg			

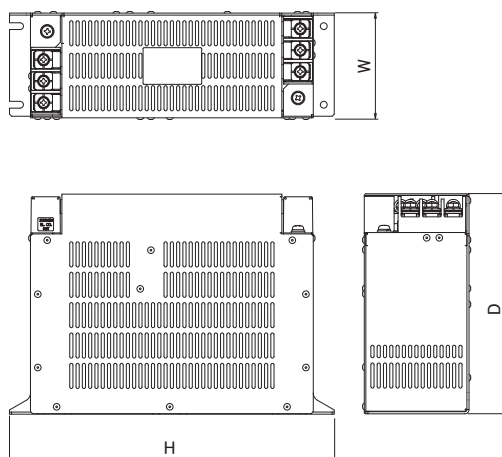

Appendix 4.6.4 Surge Absorber

Insert a surge absorber in outside the AC reactor when viewed from the power supply unit and drive unit to prevent damage to the control panel or power supply unit, etc. caused by the surge (lightning or sparks, etc.) applied on the AC power line. Do not insert the surge absorber between the AC reactor, and the power supply unit and drive unit. Harmonic components occur due to the power regeneration control.

Use a surge absorber that satisfies the following electrical specifications.

< Surge absorber for 200V >

RSPD Series for 200V (for both between phases and between phase and earth)

Part name	Rated voltage 50/60Hz	Voltage protection level	Surge withstand level 8/20 μ s	Service temperature
RSPD-250-U4	3AC 250V	1300V	2500A	-40 to 70°C

< Surge absorber for 400V >

RSPD Series for 400V (for both between phases and between phase and earth)

Part name	Rated voltage 50/60Hz	Voltage protection level	Surge withstand level 8/20 μ s	Service temperature
RSPD-500-U4	3AC 500V	2000V	2500A	-40 to 70°C

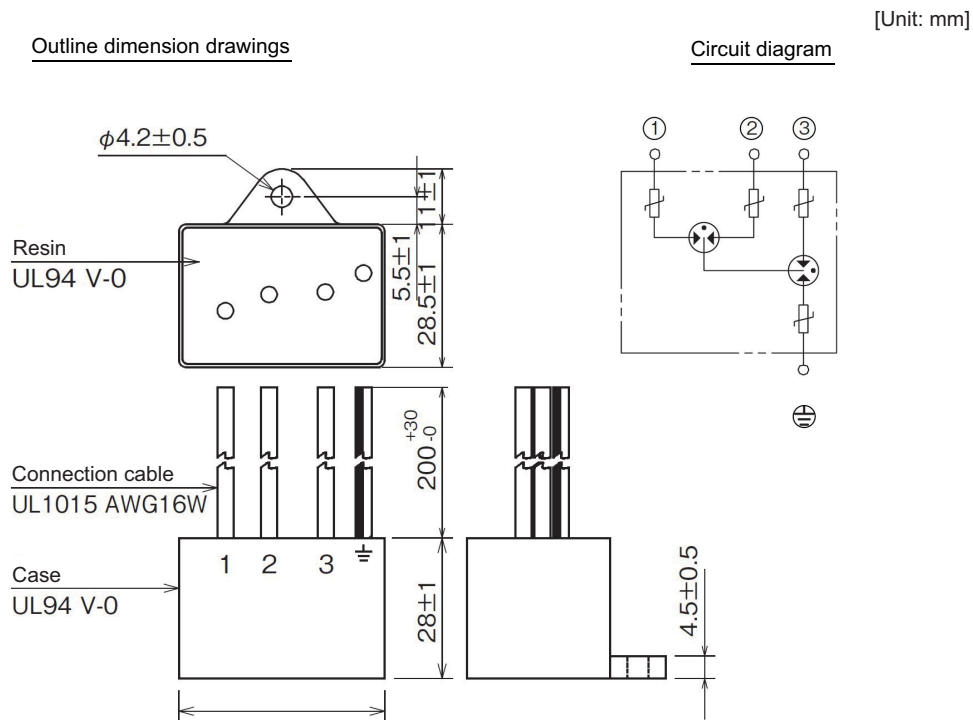

Contact: Okaya Electric Industries Co., Ltd. <http://www.okayaelec.co.jp/english/index.html>

< Example of surge absorber installation >

An example of installing the surge absorber in the machine control panel is shown below.

A short-circuit fault will occur in the surge absorber if a surge exceeding the tolerance is applied. Thus, install a circuit protector in the stage before the surge absorber. Note that almost no current flows to the surge absorber during normal use, so a circuit protector installed as the circuit protection for another device can be used for the surge absorber.

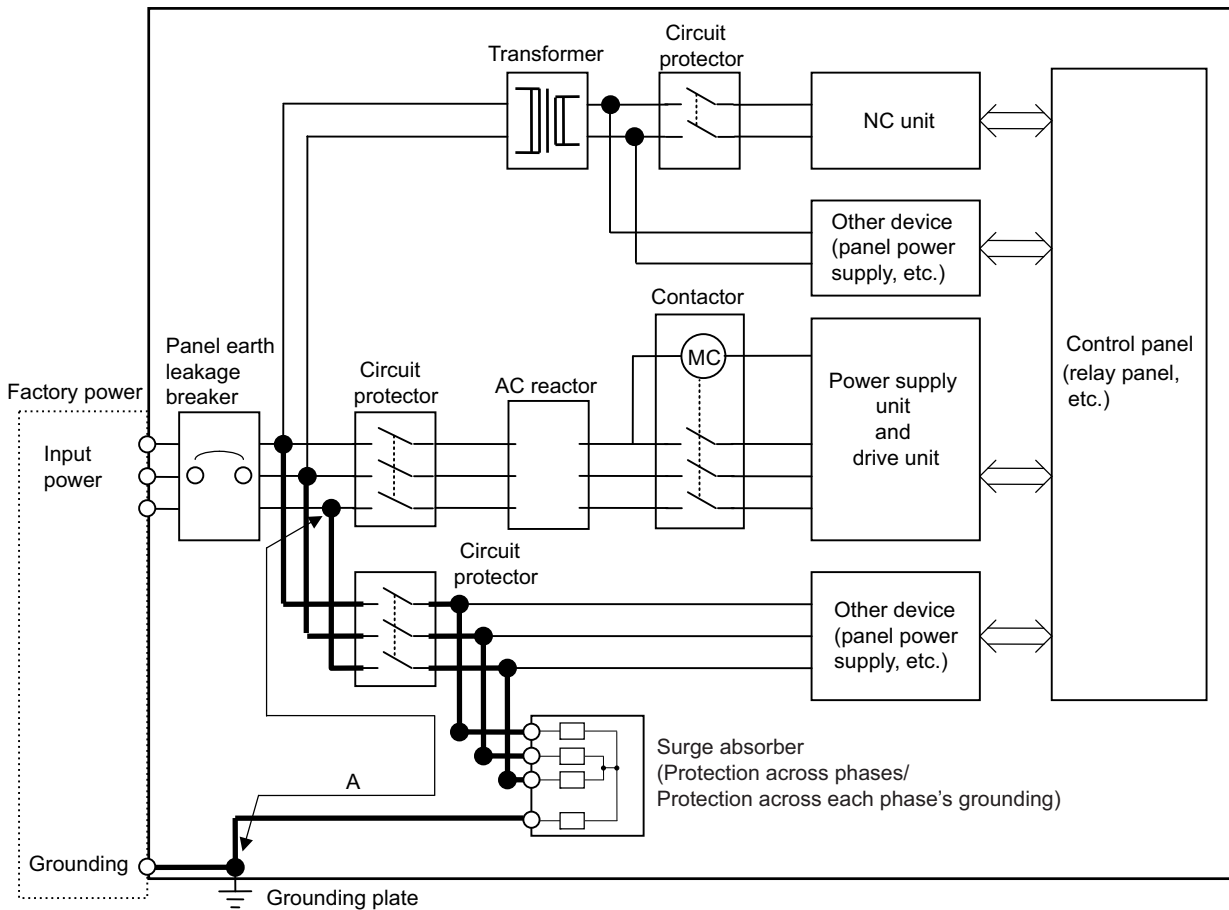

Installing the surge absorber

CAUTION

1. The wires from the surge absorber should be connected without extensions.
2. If the surge absorber cannot be installed just with the enclosed wires, keep the wiring length of A to 2m or less. If the wires are long, the surge absorber's performance may drop and inhibit protection of the devices in the panel.
3. Surge absorber to be selected varies depending on input power voltage.
4. Do not insert the surge absorber in the place with a lot of harmonic components.

Appendix 5

Higher Harmonic Suppression Measure Guidelines

Appendix 5.1 Higher Harmonic Suppression Measure Guidelines

These guidelines apply to users for which the 6-pulse equivalent capacity total of the installed higher harmonic generator exceeds the reference in the following table. (Note that household appliances and general-purpose products having a rated current of 20A/phase or less connected to a 300V or less commercial power supply are excluded from the generators.)

Use the following flow chart to confirm whether the total exceeds the reference.

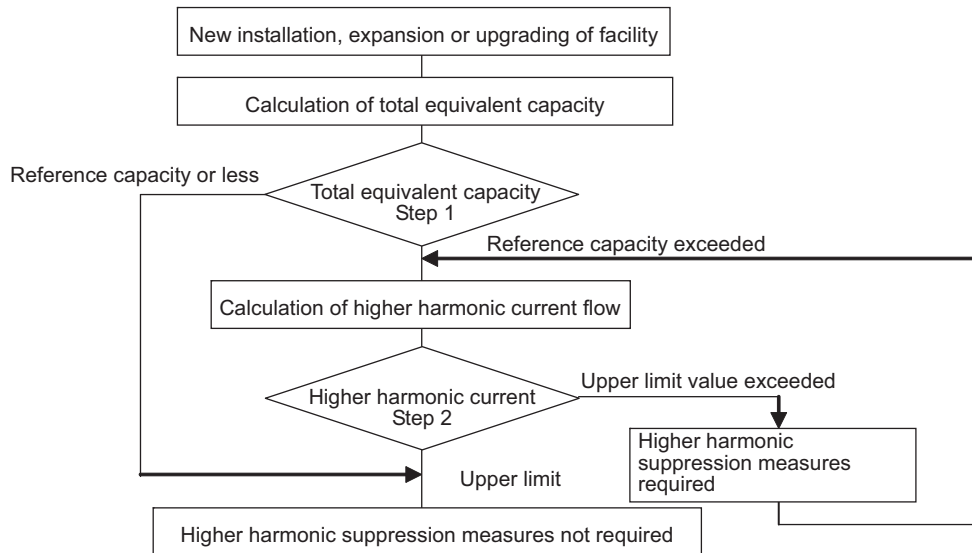

Higher Harmonic Suppression Guidelines were set in September 1994 by the Ministry of International Trade and Industry's Agency of Natural Resources and Energy.

- Higher Harmonic Suppression Measure Guidelines for Household Appliances and General-purpose Products
- Higher Harmonic Suppression Measure Guidelines for Consumers Receiving High Voltage or Special High Voltage Power

Appendix 5.1.1 Calculating the Equivalent Capacity of the Higher Harmonic Generator

As a principle, the higher harmonic suppression measure guidelines must be followed by the customer.

- (1) Calculating the total equivalent capacity (Step 1)

Calculate the total equivalent capacity with the following expression.

$$\text{Total equivalent circuit: } P_o = \sum \cdot K_i \cdot P_i$$

K_i : Conversion coefficient (Refer to following table)

P_i : Rated input capacity of each device

(Table 1) Rated capacity of each unit

Unit type MDS-		Rated input capacity pi [kVA]	Unit type MDS-		Rated input capacity pi [kVA]	Unit type MDS-		Rated input capacity pi [kVA]
D2-	DH2-		D2-	DH2-		D2-	DH2-	
SP-40	SP-20	4.61	V1-20	V1-10	1.0	V2-2020	V2-1010	2.0
SP-80	SP-40	6.77	V1-40	V1-20	1.6	V2-4020	V2-2010	2.6
SP-160	SP-80	13.1	V1-80	V1-40	2.7	V2-4040	V2-2020	3.2
SP-200	SP-100	21.8	V1-160	V1-80	5.9	V2-8040	V2-4020	4.3
SP-240	-	25.9	V1-160W	V1-80W	9	V2-8080	V2-4040	5.4
SP-320	SP-160	34.7	V1-320	V1-160	11.5	V2-16080	V2-8040	8.6
SP-400	SP-200	42.8	V1-320W	V1-160W	13.1	V2-160160	V2-8080	11.8
SP-640	SP-320	63.7		V1-200	21.7		V2-8080W	18.0
	SP-480	86.8				V3-202020		3.0
						V3-404040		4.8

(Note) The rated capacity P_i above, is the value used to calculate whether the product corresponds to the higher harmonic guidelines. Thus, the value will differ from the actual power facility's capacity.

(The power supply unit is not included.)

(Table 2) Circuit class and conversion coefficient for each unit

Name	Model	Circuit class	Circuit type	Conversion coefficient K_i
Servo drive unit	MDS-D2/DH2-V1/V2/V3 Series	3	3-phase bridge (with smoothing capacitor) With AC reactor (Note 1)	$K_{32}=1.8$
Spindle drive unit	MDS-D2/DH2-SP Series	3	3-phase bridge (with smoothing capacitor) With AC reactor (Note 1)	$K_{32}=1.8$

(Note) This applies when an AC reactor is installed on the power supply unit.

(Table 3) Limit values for total equivalent capacity

Incoming voltage	Total of 6-pulse equivalent capacity
6.6kV	50kVA
22/33kV	300kVA
66kV or more	2,000kVA

If the total equivalent capacity P_o exceeds the limit value given in (Table 3), proceed to "(2) Calculating the higher harmonic current flow".

Measures are not required if the value is not exceeded.

- (2) Calculating the higher harmonic current flow (Step 2)

To calculate the higher harmonic current flow, calculate the rated current for the incoming power voltage conversion.

$$\text{Rated current for incoming power voltage conversion (mA)} = a \cdot P_i$$

(Table 4) Incoming power voltage conversion coefficient a

Incoming power voltage	Coefficient a
6.6kV	87.5
22 kV	26.2
33 kV	17.5
66 kV	8.75
77 kV	7.5

(Table 5) Upper limit of higher harmonic current flow (mA/kW)

Conversion coefficient	5th- order	7th- order	11th- order	13th- order	17th- order	19th- order	23rd- order	25th- order
6.6kV	3.5	2.5	1.6	1.3	1.0	0.9	0.76	0.70
22kV	1.8	1.3	0.82	0.69	0.53	0.47	0.39	0.36
33kV	1.2	0.86	0.55	0.46	0.35	0.32	0.26	0.24
66kV	0.59	0.42	0.27	0.23	0.17	0.16	0.13	0.12
77kV	0.50	0.36	0.23	0.19	0.15	0.13	0.11	0.10

Obtain the upper limit of the higher harmonic current flow (judgment value) for each order.

(The contracted electricity must be known for this.)

$$\text{Upper limit of higher harmonic current flow (mA)} = \text{Contracted electricity, flow upper limit value}$$

Flow upper limit value :

Insert a value from Table 5 according to the higher harmonic order to be calculated.

Obtain the higher harmonic current flow for each order using the following expression.

$$\text{Higher harmonic current flow (mA)} = (a \cdot P_i), \text{ Device's maximum operation rate, target order}$$

Device's maximum operation rate : The user must set the operation rate.

Target order : Insert a value from Table 6 according to the higher harmonic order to be calculated.

(Table 6) Higher harmonic current generation rate %

Conversion coefficient	5th- order	7th- order	11th- order	13th- order	17th- order	19th- order	23rd- order	25th- order
K32 = 1.8	38.0	14.5	7.4	3.4	3.2	1.9	1.7	1.3
K31 = 3.4	65.0	41.0	8.5	7.7	4.3	3.1	2.6	1.8

Values when basic wave current is 100%.

Check whether the calculated results exceed the limit value.

If the limit value for the higher harmonic current flow is exceeded, consider the higher harmonic measures shown below.

Examples of higher harmonic measures

Item	Details
Power-factor improving capacitor	Higher harmonics are suppressed by adding a leading capacitor for improving the power factor.
Installation of AC line filter	A reactor and capacitor are combined to reduce the impedance for specific frequencies.

(3) Higher harmonic current flow calculation form

A higher harmonic current flow calculation form is shown below for reference.

<Form 1>

Higher harmonic generating device's higher harmonic current flow calculation form (Part 1)

User name	Industry	Incoming power voltage	kV	Contracted electricity	kV
Date of application		Application No.		Date of acceptance	

Step 1: Details of higher harmonic generating device										Step 2: Calculation of higher harmonic current flow rate										
No.	Higher harmonic generating device		Rated capacity (kVA)	Qty. of devices	Total capacity Pi (kVA)	Circuit type classification No.	6-pulse calculation coefficient Ki	6-pulse equivalent capacity [Ki x Pi] (kVA)	Rated current value for incoming power conversion [a x Pi] (mA)	Device's maximum operation rate (%)	Higher harmonic current flow per order									
	Device name	Maker									Type	5th-order	7th-order	11th-order	13th-order	17th-order	19th-order	23rd-order	25th-order	
1																				
2																				
3																				
4																				
5																				
6																				
7																				
8																				
9																				
10																				
11																				
12																				
13																				
14																				
15																				
<Instructions for completing form>										Total										
										Necessity of measures										

Step 1
 Indicate the details of the higher harmonic generating device.
 Refer to the reference and indicate the circuit type classification No., etc.
 If the device's circuit type classification No. is 10, complete the application shown in <Format 3>.
 If P_i > 50kVA (6kV incoming power), 300kVA (22, 33kV incoming power), 2000kVA (66kV or higher incoming power), proceed to Step 2. (Step 2 does not need to be completed in all other cases.)

Step 2
 If the current flow > current flow upper limit value at each order, then
 If there is a facility that lowers the higher harmonics in the factory, or when suppression measures are implemented, proceed to Calculation Form (Part 2)
 In all other cases, separate measures must be taken

Order	5th-order	7th-order	11th-order	13th-order	17th-order	19th-order	23rd-order	25th-order
Current upper limit value (mA)								

Revision History

Date of revision	Manual No.	Revision details
Nov. 2013	IB(NA)1501127-A	First edition created.
Jun. 2014	IB(NA)1501127-B	<ul style="list-style-type: none"> - The words "detector" were replaced by "encoder". - "Precautions for Safety" was revised. - Function Specifications List was revised. - "Environmental Conditions" in "Installation of Servo Motor" was revised. - "Installation of Spindle Motor" was revised. - "Installation of Tool Spindle Motor" was revised. - "Installation of the Drive Unit" was revised. - "Main Circuit Terminal Block/Control Circuit Connector" was revised. - "Connection of Tool Spindle Motor" was revised. - "Emergency Stop Observation" was revised. - "STO (Safe Torque Off) Function" was revised. - "Setting the Initial Parameters for the Servo Drive Unit" was revised. - "List of Standard Parameters for Each Spindle Motor" was revised. - "Spindle Parameters" was revised. - "OMR-FF Function" was revised. - "Servo Control Signal" was revised. - "Adjusting the Acceleration/Deceleration Operation" was revised. - "Spindle motor temperature compensation function" was added. - "Spindle Control Signal" was revised. - "Protective Functions List of Units" was revised. - "Troubleshooting" was revised. - "Replacing the Fuse" was revised. - "Power Backup System" was revised. - "Cable and Connector Specifications" was revised. - "D/A Output Specifications for Drive Unit" was revised. - "Precautions in Installing Spindle Motor" was deleted. - "Higher Harmonic Suppression Measure Guidelines" was revised. - Miswrite is corrected.
May 2016	IB(NA)1501127-C	<ul style="list-style-type: none"> - Specification descriptions of MDS-D2-CV-37 and 75 were added. - SJ-DG Series spindle motors were added. - Specifications of SJ-VL2.2-02ZT was changed to low-inertia. - SJ-4-V11-18ZT was replaced by SJ-4-V11-18T. - The following spindle motors were deleted. SJ-VS7.5-14FZT, SJ-VKS26-09FZT, SJ-VKS30-16FZT, SJ-VLS15-11FZT, SJ-4-V3.7-05ZT, SJ-4-V11-23ZT, SJ-4-V15-18T, SJ-4-V30-15ZT, SJ-4-V37-04ZT, SJ-4-V11-21T, SJ-4-V18.5-17T - "Precautions for Safety" was revised. - Function Specifications List was revised. - "Shaft Characteristics", "Oil / Water Standards" and "Installation of Servo Motor" in "Installation of Servo Motor" were revised. - "Installation of Spindle Motor" was revised. - "Balancing the Spindle Motor (Unit)", "Shaft Characteristics", "Machine Accuracy", "Coupling with the Fittings" and "Connection" in "Installation of Spindle Motor" were revised. - "Installation of the Terminal Box Cover" was added. - "Wiring and Connection" was revised.

Date of revision	Manual No.	Revision details
May 2016	IB(NA)1501127-C	<ul style="list-style-type: none"> - "Part System Connection Diagram", "Main Circuit Terminal Block/Control Circuit Connector" and "Motor and Encoder Connection" were revised. - "Input/Output Circuit Wiring" and "Spindle Coil Changeover" were revised. - "STO (Safe Torque Off) Function" was revised. - "Setting the Rotary Switch" was revised. - "Setting of Machine Side Encoder" was revised. - "List of Standard Parameters for Each Servo Motor" was revised. - "Servo Parameters" was revised. - "Setting of Parameters Related to the Spindle" was revised. - "List of Standard Parameters for Each Spindle Motor" was revised. - "Spindle Specification Parameters" and "Spindle Parameters" was revised. - "OMR-FF Function" was revised. - "Improvement of Protrusion at Quadrant Changeover" was revised. - "Vertical Axis Pull-up Control" was revised. - "Overload Detection" was revised. - "Gain Adjustment" was revised. - "List of Alarms" and "List of Warnings" were revised. - "Troubleshooting for Each Alarm No.", "Troubleshooting for Each Warning No." and "Parameter Numbers during Initial Parameter Error" were revised. - "Replacing the Unit Fan" and "Replacing the Battery" were revised. - "Setup of Deceleration and Stop Function at Power Failure" was revised. - "Wiring of Retraction Function at Power Failure" was revised. - "Cable and Connector Specifications" was deleted. - "D/A Output Specifications for Drive Unit" was revised. - "Compliance to EC Directives" was revised. - "EMC Installation Guidelines" was revised. - "EC Declaration of Conformity" was deleted. - Miswrite is corrected.
Sep. 2022	IB(NA)1501127-D	<ul style="list-style-type: none"> - "Introduction" was revised. - "Precautions for Safety" was revised. - "Function Specifications List" was revised. - "1 Installation" was revised. - "2 Wiring and Connection" was revised. - "3.3 SLS (Safely Limited Speed) Function" was revised. - "3.4 STO (Safe Torque Off) Function" was revised. - "4.2 Setting the Initial Parameters for the Servo Drive Unit" was revised. - "4.3 Setting the Initial Parameters for the Spindle Drive Unit" was revised. - "5 Servo Adjustment" was revised. - "6 Spindle Adjustment" was revised. - "7 Troubleshooting" was revised. - "8 Maintenance" was revised. - "9.1 Deceleration and Stop Function at Power Failure" was revised. - "Appendix 1.1 CMV1-xPxxS-xx Plug Connector" was revised. - "Appendix 2.3 Setting the Output Magnification" was revised. - "Appendix 3.1 Compliance to EC Directives" was revised. - "Appendix 4 EMC Installation Guidelines" was revised. - "Global Service Network" was revised. - Miswrite is corrected.

Global Service Network

AMERICA

MITSUBISHI ELECTRIC AUTOMATION INC. (AMERICA FA CENTER)

Central Region Service Center (Chicago)
500 CORPORATE WOODS PARKWAY, VERNON HILLS, ILLINOIS 60061, U.S.A.
TEL: +1-847-478-2500 / FAX: +1-847-478-2650
Minneapolis, MN Service Satellite
Detroit, MI Service Satellite
Grand Rapids, MI Service Satellite
Milwaukee, WI Service Satellite
Cleveland, OH Service Satellite
Indianapolis, IN Service Satellite
St. Louis, MO Service Satellite

South/East Region Service Center (Georgia)

1845 SATELLITE BOULEVARD STE. 450, DULUTH, GEORGIA 30097, U.S.A.
TEL: +1-678-258-4529 / FAX: +1-678-258-4519
Charleston, SC Service Satellite
Charlotte, NC Service Satellite
Raleigh, NC Service Satellite
Dallas, TX Service Satellite
Houston, TX Service Satellite
Hartford, CT Service Satellite
Knoxville, TN Service Satellite
Nashville, TN Service Satellite
Baltimore, MD Service Satellite
Pittsburg, PA Service Satellite
Tampa, FL Service Satellite
Syracuse, NY Service Satellite
Orlando, FL Service Satellite
Lafayette, LA Service Satellite
Philadelphia, PA Service Satellite

Western Region Service Center (California)

5900-B KATELLA AVE. - 5900-A KATELLA AVE. CYPRESS, CALIFORNIA 90630, U.S.A.
TEL: +1-714-699-2625 / FAX: +1-847-478-2650
San Jose, CA Service Satellite
Seattle, WA Service Satellite
Denver, CO Service Satellite

Canada Region Service Center (Toronto)

4299 14TH AVENUE MARKHAM, ONTARIO L3R 0J2, CANADA
TEL: +1-905-475-7728 / FAX: +1-905-475-7935
Edmonton, AB Service Satellite
Montreal, QC Service Satellite

Mexico Region Service Center (Querétaro)

Parque Tecnológico Innovación Querétaro, Lateral Carretera Estatal 431, Km 2+200, Lote 91 Modulos 1 y 2
Hacienda la Machorra, CP 76246, El Marqués, Querétaro, México
TEL: +52-442-153-6050
Monterrey, NL Service Satellite
Mexico City, DF Service Satellite

BRAZIL

MITSUBISHI ELECTRIC DO BRASIL COMÉRCIO E SERVIÇOS LTDA.

Votorantim Office
AV. GISELE CONSTANTINO,1578, PARQUE BELA VISTA, VOTORANTIM-SP, BRAZIL CEP:18.110-650
TEL: +55-15-3023-9000
Blumenau, Santa Catarina Office

EUROPE

MITSUBISHI ELECTRIC EUROPE B.V.

European Service Headquarters (Dusseldorf, GERMANY)
Mitsubishi-Electric-Platz 1 40882 RATINGEN, GERMANY
TEL: +49-2102-486-5000 / FAX: +49-2102-486-5910

South Germany Service Center (Stuttgart)

SCHELMENWASENSTRASSE 16-20, 70567 STUTTGART, GERMANY
TEL: +49-711-770598-0 / FAX: +49-711-770598-141

France Service Center (Paris)

2 RUE DE L'UNION, 92565 RUEIL-MALMAISON CEDEX, FRANCE
TEL: +33-1-41-02-83-13 / FAX: +33-1-49-01-07-25

France Service Satellite (Lyon)

240, ALLEE JACQUES MONOD 69800 SAINT PRIEST FRANCE
TEL: +33-1-41-02-83-13 / FAX: +33-1-49-01-07-25

Italy Service Center (Milan)

VIA ENERGY PARK 14, VIMERCATE 20871 (MB) ITALY
TEL: +39-039-6053-342 / FAX: +39-039-6053-206

Italy Service Satellite (Padova)

VIA G. SAVELLI, 24 - 35129 PADOVA, ITALY
TEL: +39-039-6053-342 / FAX: +39-039-6053-206

U.K. Service Center

TRAVELLERS LANE, HATFIELD, HERTFORDSHIRE, AL10 8XB, U.K.
TEL: +44-1707-288-780 / FAX: +44-1707-278-695

Spain Service Center

CTRA. RUBI, 76-80 8174 SAINT CUGAT DEL VALLES, BARCELONA, SPAIN
TEL: +34-935-65-2236 / FAX: +34-935-89-1579

Poland Service Center

UL.KRAKOWSKA 50, 32-083 BALICE, POLAND
TEL: +48-12-347-6500 / FAX: +48-12-630-4701

Hungary Service Center

BUDAÖRS OFFICE PARK, SZABADSÁG ÚT 117., 2040 BUDAÖRS, HUNGARY
TEL: +48-12-347-6500 / FAX: +48-12-630-4701

Turkey Service Center

MITSUBISHI ELECTRIC TURKEY ELEKTRİK ÜRÜNLERİ A.Ş
SERIFALI MAHALLESİ KALE SOKAKI NO.41 34775
UMRANIYE, ISTANBUL, TURKEY
TEL: +90-216-969-2500 / FAX: +90-216-661-44-47

Czech Republic Service Center

AutoCont Control Systems s.r.o (Service Partner)
KAFKOVA 1853/3, 702 00 OSTRAVA 2, CZECH REPUBLIC
TEL: +420-59-5691-185 / FAX: +420-59-5691-199

Russia Service Center

MITSUBISHI ELECTRIC RUSSIA LLC
LETNIKOVSKAYA STREET 2, BLD.1, 5TH 115114 MOSCOW, RUSSIA
TEL: +7-495-721-2070 / FAX: +7-495-721-2071

Sweden Service Center

HAMMARBACKEN 14, P.O.BOX 750 SE-19127, SOLLENTUNA, SWEDEN
TEL: +46-8-6251200 / FAX: +46-8-6251014

Bulgaria Service Center

AKHNATON Ltd. (Service Partner)
4 ANDREJ LJAPCHEV BLVD. POB 21, BG-1756 SOFIA, BULGARIA
TEL: +359-2-8176009 / FAX: +359-2-9744061

Ukraine Service Center (Kiev)

CSC Automation Ltd. (Service Partner)
4 B. YEVHENA SVERSTYUKA STR., 02002 KIEV, UKRAINE
TEL: +380-44-494-3344 / FAX: +380-44-494-3366

Belarus Service Center

TECHNIKON Ltd. (Service Partner)
NEZAVISIMOSTI PR.177, 220125 MINSK, BELARUS
TEL: +375-17-393-1177 / FAX: +375-17-393-0081

South Africa Service Center

Adroit Technologies (Service Partner)
20 WATERFORD OFFICE PARK, WATERFORD DRIVE, CNR OF WITKOPPEN ROAD,
FOURWAYS JOHANNESBURG SOUTH AFRICA
TEL: +27-11-658-6100 / FAX: +27-11-658-6101

ASEAN**MITSUBISHI ELECTRIC ASIA PTE. LTD. (ASEAN FA CENTER)**

Singapore Service Center
307 ALEXANDRA ROAD MITSUBISHI ELECTRIC BUILDING SINGAPORE 159943
TEL: +65-6473-2308 / FAX: +65-6476-7439

PHILIPPINES**MELCO FACTORY AUTOMATION PHILIPPINES INC.**

Head Office
128 LOPEZ RIZAL STREET, BRGY., HIGHWAY HILLS, MANDALUYONG CITY, MM PHILIPPINES 1550
TEL: +63-2-8256-8042 / FAX: +632-8637-2294

Philippines Service Center
KM.23 WEST SERVICE ROAD SSH, CUPANG, MUNTINLUPA CITY, PHILIPPINES
TEL: +63-2-8807-0420 / FAX: +63-2-8842-5202

VIETNAM**MITSUBISHI ELECTRIC VIETNAM CO., LTD.**

Vietnam Ho Chi Minh Service Center
11TH & 12TH FLOOR, VIETTEL TOWER B, 285 CACH MANG THANG 8 STREET, WARD 12, DISTRICT 10, HO CHI MINH CITY, VIETNAM
TEL: +84-28-3910-5945 / FAX: +84-28-3910-5947

Vietnam Hanoi Service Center
14TH FLOOR, CAPITAL TOWER, 109 TRAN HUNG DAO STREET, CUA NAM WARD, HOAN KIEM DISTRICT, HA NOI CITY, VIETNAM
TEL: +84-24-3937-8075 / FAX: +84-24-3937-8076

INDONESIA**PT. MITSUBISHI ELECTRIC INDONESIA**

Indonesia Service Center (Cikarang)
JL. KENARI RAYA BLOK G2-07A, DELTA SILICON 5, LIPPO CIKARANG - BEKASI 17550, INDONESIA
TEL: +62-21-2961-7797 / FAX: +62-21-2961-7794

MALAYSIA**MITSUBISHI ELECTRIC SALES MALAYSIA SDN. BHD.**

Malaysia Service Center (Kuala Lumpur Service Center)
LOT 11, JALAN 219, P.O BOX 1036, 46860 PETALING JAYA, SELANGOR DARUL EHSAN, MALAYSIA
TEL: +60-3-7626-5032
Johor Bahru Service Satellite
Pulau Pinang Service Satellite

THAILAND**MITSUBISHI ELECTRIC FACTORY AUTOMATION (THAILAND) CO., LTD.**

Thailand Service Center (Bangkok)
101, TRUE DIGITAL PARK OFFICE, 5TH FLOOR, SUKHUMVIT ROAD, BANGCHAK, PHRA KHANONG, BANGKOK, 10260 THAILAND
TEL: +66-2-092-8600 / FAX: +66-2-043-1231-33

INDIA**MITSUBISHI ELECTRIC INDIA PVT., LTD.**

CNC Technical Center (Bangalore)
PLOT NO. 56, 4TH MAIN ROAD, PEENYA PHASE 3, PEENYA INDUSTRIAL AREA, BANGALORE 560058, KARNATAKA, INDIA
TEL: +91-80-4655-2121
Chennai Service Satellite
Coimbatore Service Satellite
Hyderabad Service Satellite

North India Service Center (Gurgaon)
PLOT 517, GROUND FLOOR, UDYOG VIHAR PHASE-III, GURUGRAM 122008, HARYANA, INDIA
TEL: +91-124-463-0300
Ludhiana Service Satellite
Panthenagar Service Satellite
Delhi Service Satellite
Jamshedpur Service Satellite
Manesar Service Satellite

West India Service Center (Pune)
ICC-Devi GAURAV TECHNOLOGY PARK, UNIT NO.402, FOURTH FLOOR, NORTH WING, SURVEY NUMBER 191-192 (P), NEXT to INDIAN CARD CLOTHING COMPANY Ltd, OPP. VALLABH NAGAR, PIMPRI, PUNE- 411 018, MAHARASHTRA, INDIA
TEL: +91-20-6819-2274
Kolhapur Service Satellite
Aurangabad Service Satellite
Mumbai Service Satellite

West India Service Center (Ahmedabad)
204-209, 2ND FLOOR, 31FIVE, CORPORATE ROAD PRAHLADNAGAR, AHMEDABAD -390015, GUJARAT, INDIA
TEL: + 91-79-6777-7888
Rajkot Service Satellite

CHINA**MITSUBISHI ELECTRIC AUTOMATION (CHINA) LTD. (CHINA FA CENTER)**

CNC Call Center
TEL: +86-400-921-5130

Shanghai Service Center
NO.1386 HONG QIAO ROAD, CHANG NING QU, SHANGHAI 200336, CHINA
TEL: +86-21-2322-3030 / FAX: +86-21-2322-3000*8422
Qingdao Service Center
Suzhou Service Center
Wuhan Service Center
Ningbo Service Center
Hefei Service Center
Beijing Service Center
Tianjin Service Center
Xian Service Center
Dalian Service Center
Chengdu Service Center

Shenzhen Service Center
LEVEL8, GALAXY WORLD TOWER B, 1 YABAO ROAD, LONGGANG DISTRICT, SHENZHEN 518129, CHINA
TEL: +86-755-2399-8272 / FAX: +86-755-8229-3686
Dongguan Service Center
Xiamen Service Center

KOREA**MITSUBISHI ELECTRIC AUTOMATION KOREA CO., LTD. (KOREA FA CENTER)**

Korea Service Center
8F GANGSEO HANGANG XI-TOWER A, 401 YANGCHEON-RO, GANGSEO-GU, SEOUL 07528 KOREA
TEL: +82-2-3660-9631 / FAX: +82-2-3664-8668
Korea Daegu Service Satellite

TAIWAN**MITSUBISHI ELECTRIC TAIWAN CO., LTD. (TAIWAN FA CENTER)**

Taiwan Taichung Service Center
NO. 8-1, GONGYEQU 16th RD., XITUN DIST., TAICHUNG CITY 40768, TAIWAN
TEL: +886-4-2359-0688 / FAX: +886-4-2359-0689

Taiwan Taipei Service Center
11F, NO.88, SEC.6, ZHONGSHAN N. RD., SHILIN DIST., TAIPEI CITY 11155, TAIWAN
TEL: +886-2-2833-5430 / FAX: +886-2-2833-5433

Taiwan Tainan Service Center
11F.-1, NO.30, ZHONGZHENG S. RD., YONGKANG DIST., TAINAN CITY 71067, TAIWAN
TEL: +886-6-252-5030 / FAX: +886-6-252-5031

OCEANIA**MITSUBISHI ELECTRIC AUSTRALIA PTY. LTD.**

Oceania Service Center
348 VICTORIA ROAD, RYDALMERE, N.S.W. 2116 AUSTRALIA
TEL: +61-2-9684-7269 / FAX: +61-2-9684-7245

Notice

Every effort has been made to keep up with software and hardware revisions in the contents described in this manual. However, please understand that in some unavoidable cases simultaneous revision is not possible.

Please contact your Mitsubishi Electric dealer with any questions or comments regarding the use of this product.

Duplication Prohibited

This manual may not be reproduced in any form, in part or in whole, without written permission from Mitsubishi Electric Corporation.

© 2013-2022 Mitsubishi Electric Corporation
ALL RIGHTS RESERVED

MITSUBISHI ELECTRIC CORPORATION

HEAD OFFICE : TOKYO BLDG.,2-7-3 MARUNOUCHI,CHIYODA-KU,TOKYO 100-8310,JAPAN

MODEL	MDS-D2/DH2 Series
MODEL CODE	100-350
Manual No.	IB-1501127