

Numerical Control (CNC)

PLC Interface Manual

M800/M80/E80/C80 Series

Introduction

This manual describes the various signal interfaces and functions of the NC unit required when creating Mitsubishi Electric CNC sequence programs (built-in PLC).

Supported models are as follows:

Supported models	Abbreviations in this manual
M800W Series	M850W, M830W
M800S Series	M850S, M830S
M80W Series	M80W
M80 Series	M80 TypeA, M80 TypeB
E80 Series	E80 TypeA, E80 TypeB
C80 Series	C80

Abbreviations in this manual are as follows:







Abbreviations	Supported models
M800, M800 Series	M800W Series/M800S Series
M80, M80 Series	M80W Series/M80 Series
M800/M80, M800/M80 Series	M800W Series/M800S Series/M80W Series/M80 Series
M8, M8 Series	M800W Series/M800S Series/M80W Series/M80 Series/E80 Series

Read this manual thoroughly before programming. Thoroughly study the "Safety Precautions" on the following page to ensure safe use of this NC unit.

Be sure to keep this manual always at hand.

"Sequencer" is referred to as "PLC" in some parts of this manual.

CAUTION

-  For items described as "Restrictions" or "Usable State" in this manual, the instruction manual issued by the machine tool builder takes precedence over this manual.
-  Items that are not described in this manual must be interpreted as "not possible".
-  This manual is written on the assumption that all the applicable functions are included. Some of them, however, may not be available for your NC system. Refer to the specifications issued by the machine tool builder before use.
-  Some screens and functions may differ depending on each NC system (or version), and some functions may not be possible. Please confirm the specifications before starting to use.
-  To protect the availability, integrity and confidentiality of the NC system against cyber-attacks including unauthorized access, denial-of-service (DoS) (*1) attack, and computer virus from external sources via a network, take security measures such as firewall, VPN, and anti-virus software.
(*1) Denial-of-service (DoS) refers to a type of cyber-attack that disrupts services by overloading the system or by exploiting a vulnerability of the system.
-  Mitsubishi Electric assumes no responsibility for any problems caused to the NC system by any type of cyber-attacks including DoS attack, unauthorized access and computer virus.

In this manual, the following abbreviations might be used.

MTB: Machine tool builder.

Also refer to the manuals on "Manual List" as necessary.

Manual List

Manuals related to M800/M80/E80/C80 Series are listed as follows.

These manuals are written on the assumption that all optional functions are added to the targeted model.

Some functions or screens may not be available depending on the machine or specifications set by MTB. (Confirm the specifications before use.)

The manuals issued by MTB take precedence over these manuals.

Manual	IB No.	Purpose and Contents
M800/M80/E80 Series Instruction Manual	IB-1501274	<ul style="list-style-type: none"> ♦ Operation guide for NC ♦ Explanation for screen operation, etc.
C80 Series Instruction Manual	IB-1501453	<ul style="list-style-type: none"> ♦ Operation guide for NC ♦ Explanation for screen operation, etc.
M800/M80/E80/C80 Series Programming Manual (Lathe System) (1/2)	IB-1501275	<ul style="list-style-type: none"> ♦ G code programming for lathe system ♦ Basic functions, etc.
M800/M80/E80/C80 Series Programming Manual (Lathe System) (2/2)	IB-1501276	<ul style="list-style-type: none"> ♦ G code programming for lathe system ♦ Functions for multi-part system, high-accuracy function, etc.
M800/M80/E80/C80 Series Programming Manual (Machining Center System) (1/2)	IB-1501277	<ul style="list-style-type: none"> ♦ G code programming for machining center system ♦ Basic functions, etc.
M800/M80/E80/C80 Series Programming Manual (Machining Center System) (2/2)	IB-1501278	<ul style="list-style-type: none"> ♦ G code programming for machining center system ♦ Functions for multi-part system, high-accuracy function, etc.
M800/M80/E80 Series Alarm/Parameter Manual	IB-1501279	<ul style="list-style-type: none"> ♦ Alarms ♦ Parameters
C80 Series Alarm/Parameter Manual	IB-1501560	<ul style="list-style-type: none"> ♦ Alarms ♦ Parameters

Manuals for MTBs (NC)

Manual	IB No.	Purpose and Contents
M800/M80/E80/C80 Series Specifications Manual (Function)	IB-1501505	<ul style="list-style-type: none"> ♦ Model selection ♦ Outline of various functions
M800/M80/E80/C80 Series Specifications Manual (Hardware)	IB-1501506	<ul style="list-style-type: none"> ♦ Model selection ♦ Specifications of hardware unit
M800W/M80W Series Connection and Setup Manual	IB-1501268	<ul style="list-style-type: none"> ♦ Detailed specifications of hardware unit ♦ Installation, connection, wiring, setup (startup/adjustment)
M800S/M80/E80 Series Connection and Setup Manual	IB-1501269	<ul style="list-style-type: none"> ♦ Detailed specifications of hardware unit ♦ Installation, connection, wiring, setup (startup/adjustment)
C80 Series Connection and Setup Manual	IB-1501452	<ul style="list-style-type: none"> ♦ Detailed specifications of hardware unit ♦ Installation, connection, wiring, setup (startup/adjustment)
M800/M80/E80 Series PLC Development Manual	IB-1501270	<ul style="list-style-type: none"> ♦ Electrical design ♦ I/O relation (assignment, setting, connection), field network ♦ Development environment (PLC on-board, peripheral development environment), etc.
M800/M80/E80 Series PLC Programming Manual	IB-1501271	<ul style="list-style-type: none"> ♦ Electrical design ♦ Sequence programming ♦ PLC support functions, etc.
M800/M80/E80/C80 Series PLC Interface Manual	IB-1501272	<ul style="list-style-type: none"> ♦ Electrical design ♦ Interface signals between NC and PLC
M800/M80/E80 Series Maintenance Manual	IB-1501273	<ul style="list-style-type: none"> ♦ Cleaning and replacement for each unit ♦ Other items related to maintenance
C80 Series Maintenance Manual	IB-1501454	<ul style="list-style-type: none"> ♦ Cleaning and replacement for each unit ♦ Other items related to maintenance

Manuals for MTBs (drive section)

Manual	IB No.	Contents
MDS-E/EH Series Specifications Manual	IB-1501226	<ul style="list-style-type: none"> ♦ Specifications for power supply regeneration type
MDS-E/EH Series Instruction Manual	IB-1501229	<ul style="list-style-type: none"> ♦ Instruction for power supply regeneration type
MDS-EJ/EJH Series Specifications Manual	IB-1501232	<ul style="list-style-type: none"> ♦ Specifications for regenerative resistor type
MDS-EJ/EJH Series Instruction Manual	IB-1501235	<ul style="list-style-type: none"> ♦ Instruction for regenerative resistor type
MDS-EM/EMH Series Specifications Manual	IB-1501238	<ul style="list-style-type: none"> ♦ Specifications for multi-hybrid, power supply regeneration type
MDS-EM/EMH Series Instruction Manual	IB-1501241	<ul style="list-style-type: none"> ♦ Instruction for multi-hybrid, power supply regeneration type
DATA BOOK	IB-1501252	<ul style="list-style-type: none"> ♦ Specifications of servo drive unit, spindle drive unit, motor, etc.

Manuals for MTBs (Others)

Manual	No.	Purpose and Contents
GOT2000 Series User's Manual (Hardware)	SH-081194ENG	♦ Outline of hardware such as part names, external dimensions, installation, wiring, maintenance, etc. of GOTs
GOT2000 Series User's Manual (Utility)	SH-081195ENG	♦ Outline of utilities such as screen display setting, operation method, etc. of GOTs
GOT2000 Series User's Manual (Monitor)	SH-081196ENG	♦ Outline of each monitor function of GOTs
GOT2000 Series Connection Manual (Mitsubishi Electric Products)	SH-081197ENG	♦ Outline of connection types and connection method between GOT and Mitsubishi Electric connection devices
GT Designer3 (GOT2000) Screen Design Manual	SH-081220ENG	♦ Outline of screen design method using screen creation software GT Designer3

■ For M800/M80/E80 Series

Manual	No.	Purpose and Contents
GOT2000/GOT1000 Series CC-Link Communication Unit User's Manual	IB-0800351	♦ Explanation for handling CC-Link communication unit (for GOT2000 series/GOT1000 series)
GX Developer Version 8 Operating Manual (Startup)	SH-080372E	♦ Explanation for system configuration, installation, etc. of PLC development tool GX Developer
GX Developer Version 8 Operating Manual	SH-080373E	♦ Explanation for operations using PLC development tool GX Developer
GX Converter Version 1 Operating Manual	IB-0800004	♦ Explanation for operations using data conversion tool GX Converter
GX Works2 Installation Instructions	BCN-P5999-0944	♦ Explanation for the operating environment and installation method of GX Works2
GX Works2 Version 1 Operating Manual (Common)	SH-080779ENG	♦ Explanation for the system configuration of GX Works2 and the functions common to Simple project and Structured project such as parameter setting, operation method for the online function
GX Works2 Version 1 Operating Manual (Simple Project)	SH-080780ENG	♦ Explanation for methods for such as creating and monitoring programs in Simple project of GX Works2
GX Works2 Version 1 Operating Manual (Simple Project, Function Block)	SH-080984ENG	♦ Explanation for methods for such as creating function blocks, pasting function blocks to sequence programs, and operating FB library in Simple project of GX Works2
GX Works2 Version 1 Operating Manual (Structured Project)	SH-080781ENG	♦ Explanation for methods for such as creating and monitoring programs in Structured project of GX Works2
GX Works3 Installation Instructions	BCN-P5999-0391	♦ Explanation for the operating environment and installation method of GX Works3
MELSEC-Q CC-Link System Master/Local Module User's Manual	SH-080394E	♦ Explanation for system configuration, installation, wiring, etc. of master/local modules for CC-Link system
GOT2000 Series Connection Manual (Non-Mitsubishi Electric Products 1)	SH-081198ENG	♦ Explanation for connection types and connection method between GOT and other company's devices
GOT2000 Series Connection Manual (Non-Mitsubishi Electric Products 2)	SH-081199ENG	
GOT2000 Series Connection Manual (Microcomputers, MODBUS/Fieldbus Products, Peripherals)	SH-081200ENG	♦ Explanation for connection types and connection method between GOT and microcomputers, MODBUS/fieldbus products, peripherals
GT SoftGOT2000 Version1 Operating Manual	SH-081201ENG	♦ Explanation for system configuration, screen configuration and operation method of monitoring software GT SoftGOT2000

■ For C80 Series



Manual	No.	Purpose and Contents
MELSEC iQ-R Module Configuration Manual	SH-081262	♦ Outline of system configuration, specifications, installation, wiring, maintenance, etc.
MELSEC iQ-R CPU Module User's Manual (Startup)	SH-081263	♦ Outline of specifications, procedures before operation, troubleshooting, etc. for CPU module
MELSEC iQ-R CPU Module User's Manual (Application)	SH-081264	♦ Outline of memory, functions, devices, parameters, etc. for CPU module
MELSEC iQ-R CC-Link IE Field Network User's Manual (Application)	SH-081259	♦ Explanation for functions, parameter settings, programming, troubleshooting, etc. of the CC-Link IE Field Network function
QCPU User's Manual (Hardware Design, Maintenance and Inspection)	SH-080483	♦ Outline of specifications, necessary knowledge to configure the system and maintenance-related descriptions for Q series CPU module, etc.
GX Works3 Operating Manual	SH-081215	♦ Outline of functions, programming, etc.

Reference Manual for MTBs

Manual	No.	Purpose and Contents
M800/M80 Series Smart safety observation Specification manual	BNP-C3072-022	♦ Explanation for smart safety observation function
C80 Series Smart safety observation Specification manual	BNP-C3077-022	
M800/M80 Series CC-Link (Master/Local) Specification manual	BNP-C3072-089	♦ Explanation for CC-Link
M800/M80 Series PROFIBUS-DP Specification manual	BNP-C3072-118	♦ Explanation for PROFIBUS-DP communication function
M800/M80 Series Interactive cycle insertion (Customization) Specification manual	BNP-C3072-121-0003	♦ Explanation for interactive cycle insertion
M800/M80 Series EtherNet/IP Specifications manual	BNP-C3072-263	♦ Explanation for EtherNet/IP
M800/M80 Series CC-Link IE Field (Master/local) Specifications manual	BNP-C3072-283	♦ Explanation for CC-Link IE Field
M800/M80 Series GOT Connection Specifications manual	BNP-C3072-314	♦ Explanation for GOT connection
M800/M80 Series CC-Link IE Field Basic Specifications manual	BNP-C3072-337	♦ Explanation for CC-Link IE Field Basic
M800/M80 Series FL-net Specifications manual	BNP-C3072-368	♦ Explanation for FL-net
M800/M80 Series Synchronous Control Specifications manual	BNP-C3072-074	♦ Explanation for synchronous control
M800/M80 Series Multiple-Axis Synchronization Control Specifications manual	BNP-C3072-339	♦ Explanation for multiple-axis synchronization control





Precautions for Safety

Always read the specifications issued by the machine maker, this manual, related manuals and attached documents before installation, operation, programming, maintenance or inspection to ensure correct use. Understand this numerical controller, safety items and cautions before using the unit. This manual ranks the safety precautions into "DANGER", "WARNING" and "CAUTION".



<p> DANGER</p> <p>When the user could be subject to imminent fatalities or major injuries if handling is mistaken.</p>
<p> WARNING</p> <p>When the user could be subject to fatalities or major injuries if handling is mistaken.</p>
<p> CAUTION</p> <p>When the user could be subject to minor or moderate injuries or the property could be damaged if handling is mistaken.</p>

Note that even items ranked as "  CAUTION", may lead to major results depending on the situation. In any case, important information that must always be observed is described.

The following signs indicate prohibition and compulsory.

	<p>This sign indicates prohibited behavior (must not do). For example,  indicates "Keep fire away".</p>
	<p>This sign indicates a thing that is compulsory (must do). For example,  indicates "it must be grounded".</p>

The meaning of each pictorial sign is as follows.

 CAUTION	 CAUTION rotated object	 CAUTION HOT	 Danger Electric shock risk	 Danger explosive
 Prohibited	 Disassembly is prohibited	 KEEP FIRE AWAY	 General instruction	 Earth ground

For Safe Use



Mitsubishi Electric CNC is designed and manufactured solely for applications to machine tools to be used for industrial purposes. Do not use this product in any applications other than those specified above, especially those which are substantially influential on the public interest or which are expected to have significant influence on human lives or properties.

DANGER

There are no "Danger" items in this manual.







WARNING

1. Items related to prevention of electric shocks



-  Do not operate the switches with wet hands, as this may lead to electric shocks.
-  Do not damage, apply excessive stress, place heavy things on or sandwich the cables, as this may lead to electric shocks.

CAUTION

1. Items related to product and manual

-  For items described as "Restrictions" or "Usable State" in this manual, the instruction manual issued by the machine tool builder takes precedence over this manual.
-  Items not described in this manual must be interpreted as "not possible".
-  This manual is written on the assumption that all the applicable functions are included. Some of them, however, may not be available for your NC system. Refer to the specifications issued by the machine tool builder before use.
-  Some screens and functions may differ depending on each NC system (or version), and some functions may not be possible. Please confirm the specifications before starting to use.
-  To protect the availability, integrity and confidentiality of the NC system against cyber-attacks including unauthorized access, denial-of-service (DoS) (*1) attack, and computer virus from external sources via a network, take security measures such as firewall, VPN, and anti-virus software.
(*1) Denial-of-service (DoS) refers to a type of cyber-attack that disrupts services by overloading the system or by exploiting a vulnerability of the system.
-  Mitsubishi Electric assumes no responsibility for any problems caused to the NC system by any type of cyber-attacks including DoS attack, unauthorized access and computer virus.

2. Items related to connection

-  When using an inductive load such as relays, always contact a diode in parallel to the load as a noise measure.
-  When using a capacitive load such as a lamp, always connect a protective resistor serially to the load to suppress rush currents.
-  Since the analog output R registers are allocated in ascending order of channels and station numbers, the analog output destination may change depending on added option.

3. Items related to design

- ⚠ Always turn the spindle phase synchronization completion signal ON before chucking both ends of the workpiece to the reference spindle and synchronized spindle. If the spindle phase synchronization signal is turned ON when both ends of the workpiece are chucked to the reference spindle and synchronized spindle, the chuck or workpiece could be damaged by the torsion that occurs during phase alignment.**
- ❗ If the temperature rise detection function is invalidated with the parameters, the control could be disabled when the temperature is excessive. This could result in machine damage or personal injuries due to runaway axis, and could damage the device. Enable the detection function for normal use.**

Disposal



(Note) This symbol mark is for EU countries only.
This symbol mark is according to the directive 2006/66/EC Article 20 Information for end-users and Annex II.

Your MITSUBISHI ELECTRIC product is designed and manufactured with high quality materials and components which can be recycled and/or reused.

This symbol means that batteries and accumulators, at their end-of-life, should be disposed of separately from your household waste.

If a chemical symbol is printed beneath the symbol shown above, this chemical symbol means that the battery or accumulator contains a heavy metal at a certain concentration. This will be indicated as follows:

Hg: mercury (0.0005%), Cd: cadmium (0.002%), Pb: lead (0.004%)

In the European Union there are separate collection systems for used batteries and accumulators.

Please, dispose of batteries and accumulators correctly at your local community waste collection/recycling centre.

Please, help us to conserve the environment we live in!

Trademarks

MELDAS, MELSEC, EZSocket, EZMotion, iQ Platform, MELSEC iQ-R, MELSOFT, GOT, CC-Link, CC-Link/LT, CC-Link IE, CC-Link IE/field, EcoMonitorLight and SLMP are either trademarks or registered trademarks of Mitsubishi Electric Corporation in Japan and/or other countries.

Ethernet is a registered trademark of Xerox Corporation in the United States and/or other countries.

Microsoft®, Windows®, SQL Server® and Access® are either trademarks or registered trademarks of Microsoft Corporation in the United States and/or other countries.

SD logo and SDHC logo are either registered trademarks or trademarks of LLC.

UNIX is a registered trademark of The Open Group in the United States and/or other countries.

Intel® and Pentium® are either trademarks or registered trademarks of Intel Corporation in the United States and/or other countries.

MODBUS® is either a trademark or a registered trademark of Schneider Electric USA, Inc. or the affiliated companies in Japan and/or other countries.

EtherNet/IP is a trademark of Open DeviceNet Vendor Association, Inc.

PROFIBUS-DP and PROFINET are either trademarks or registered trademarks of PROFIBUS User Organization.

Oracle® is a registered trademark of Oracle Corporation, the subsidiaries, or the affiliated companies in the United States and /or other countries.

VNC is a registered trademark of RealVNC Ltd. in the United States and other countries.

Punchtap is licensed by EMUGE.

BiSS is a registered trademark of iC-Haus GmbH.

Other company and product names that appear in this manual are trademarks or registered trademarks of the respective companies.

本製品の取扱いについて

(日本語 /Japanese)

本製品は工業用 (クラス A) 電磁環境適合機器です。販売者あるいは使用者はこの点に注意し、住商業環境以外での使用をお願いいたします。

Handling of our product

(English)

This is a class A product. In a domestic environment this product may cause radio interference in which case the user may be required to take adequate measures.

본 제품의 취급에 대해서

(한국어 /Korean)

이 기기는 업무용 (A 급) 전자파적합기기로서 판매자 또는 사용자는 이 점을 주의하시기 바라며 가정외의 지역에서 사용하는 것을 목적으로 합니다 .

Contents

1 List of Devices	1
1.1 List of Devices	2
1.1.1 Device Range Setting at Multi-project [M8].....	4
1.2 File Register General Map.....	6
1.3 Flow of Signals [C80].....	8
1.3.1 Flow of PLC CPU and CNC CPU Data.....	8
2 Input/Output Signals with Controller	9
2.1 PLC Input Signals (Bit type: X***).....	12
2.2 PLC Input Signals (Data type: R***).....	34
2.3 PLC Output Signals (Bit type: Y***).....	67
2.4 PLC Output Signals (Data type: R***).....	92
2.5 Special Relay/Register	118
2.6 ZR Devices	120
2.7 Classified for Each Application	133
3 Other Devices	153
4 Explanation of Interface Signals	157
4.1 PLC Input Signals (Bit Type: X***).....	159
4.2 PLC Input Signals (Data Type: R***).....	275
4.3 PLC Output Signals (Bit Type: Y***).....	364
4.4 PLC Output Signals (Data Type: R***).....	537
4.5 Explanation of Special Relays (SM***).....	647
4.6 Explanation of ZR device.....	648
4.6.1 Smart Safety Observation.....	648
4.6.1.1 PLC → CNC.....	648
4.6.1.2 CNC → PLC.....	674
4.6.2 Memory Switch (PLC Switch).....	717
4.6.3 MES Interface Library [M8].....	718
4.6.4 Diagnosis Data Output.....	732
4.6.5 Spindle protection [M8].....	735
4.6.6 External encoder position output I/F [M8].....	736
4.6.7 Machine contact input/output I/F [M8].....	737
4.6.8 Common Variables [C80].....	740
4.6.9 GOT Window [C80].....	741
4.6.10 BiSS Encoder I/F [M8].....	742
5 Appx.1: PLC window [M8]/PLC window [C80]	743
5.1 Details.....	744
5.1.1 Data Flow of PLC Window Function [C80].....	746
5.1.2 Read/Write Operation [M8].....	747
5.1.3 Read/Write Operation [C80].....	750
5.2 PLC Window Interface	753
5.2.1 Parameter Interface [M8].....	753
5.2.2 Read Window Interface.....	755
5.2.3 Write Window Interface.....	757
5.2.4 Read Window Expanded Interface [M8].....	759
5.2.5 Write Window Expanded Interface [M8].....	760
5.2.6 Interface for Consecutive Writes Detection Log [M8].....	761
5.3 Data Type	762
5.4 Read/Write PLC Axis Data	762
5.5 Precautions.....	763
5.6 Usage Example [M8].....	765
5.7 Device Assignment List [C80].....	768
6 Appx.2: List of PLC Window Data[M8]/PLC Window Data [C80]	781
6.1 Section No. List.....	782
6.2 Sub-section No. List.....	784

7 Appx.3: GOT Window [C80]	815
7.1 Outline	816
7.2 Manual Setting Window	817
7.2.1 Configuration	817
7.2.2 Used Area	818
7.2.3 Operation Procedure	820
7.3 Automatic Setting Window	821
7.3.1 Configuration	821
7.3.2 Used Area	822
7.3.3 Automatic Setting Command.....	823
7.3.4 Setting Details Modification Procedure	824
7.4 Usable Command	826
7.4.1 Acquisition of Currently Running Program (0xF01).....	827
7.4.2 Modal Information Package Acquisition (0xF02).....	829
7.4.3 Coordinate Value Package Acquisition (0xF03).....	832
7.4.4 Acquisition of Alarm Message which is Occurring (0xF04)	838
7.4.5 Alarm History Acquisition (0xF05)	840
7.5 Error Code.....	842
 8 Appx.4: List of Option Status Exported to PLC [M8]	 843



List of Devices

1.1 List of Devices

The device range in the following table is the default number of device points set in the project 1 when the multi-project setting or the setting of the number of device points is not performed.

[M8]

Device	Device No.	Unit	Details
X*	X0 to X1FFF (8192 points)	1 bit	Input signal to PLC, Machine input, etc.
Y*	Y0 to Y1FFF (8192 points)	1 bit	Output signal from PLC, Machine output, etc.
M	M0 to M61439 (61440 points)	1 bit	Temporary memory
F	F0 to F2047 (2048 points)	1 bit	Temporary memory (Alarm message interface)
L	L0 to L1023 (1024 points)	1 bit	Latch relay (back up memory)
SM	SM0 to SM2047 (2048 points)	1 bit	Special relay
V	V0 to V511 (512 points)	1 bit	Edge relay
SB	SB0 to SB3FF (1024 points)	1 bit	Special relay
B	B0 to BDFFF (57344 points)	1 bit	Link relay
SW	SW0 to SW3FF (1024 points)	16 bits	Special register
SD	SD0 to SD2047 (2048 points)	16 bits	Special register
T	T0 to T2047 (2048 points)	1 bit/16 bits	Timer (The variable/fixed boundary is set with a parameter.) (Note 2)
ST	ST0 to ST127 (128 points)	1 bit/16 bits	Integrated timer (100ms unit)
C	C0 to C511 (512 points)	1 bit/16 bits	Counter (The variable/fixed boundary is set with a parameter.)
D	D0 to D4095 (4096 points)	16 bits/32 bits	Data register (Register for calculation)
R*	R0 to R32767 (32768 points)	16 bits/32 bits	File register (CNC word interface)
ZR*	ZR0 to ZR13311 (13312 points)	16 bits/32 bits	File register (Input/output signals with the PLC, Machine input/output, etc.)
W	W0 to W2FFF (12288 points)	16 bits/32 bits	Link register
Z	Z0 to Z13 (14 points)	16 bits	Address index
N	N0 to N7 (8 points)	-	Master controller nesting level
P*	P0 to P4095 (4096 points)	-	Label for conditional jump, subroutine call command
K	K-32768 to K32767	-	Decimal constant for 16-bit command
	K-2147483648 to K2147483647	-	Decimal constant for 32-bit command
H	H0 to HFFFF	-	Hexadecimal constant for 16-bit command
	H0 to HFFFFFFFF	-	Hexadecimal constant for 32-bit command

(Note 1) Devices marked with "*" in the device column have designated applications. Do not use devices other than those corresponding to the input/output signals with the machine side (input/output signals of the remote I/O unit), even if it is an undefined vacant device.

(Note 2) Distinction of 10ms timer and 100ms timer is performed by command.
(10ms timer is performed by OUTH command, 100ms timer is performed by OUT command.)

[C80]

Device	Device No.	Unit	Details
X*	X0 to X1FFF (8192 points)	1 bit	Input signal to PLC: Machine input, etc.
Y*	Y0 to Y1FFF (8192 points)	1 bit	Output signal from PLC: Machine output, etc.
M	M0 to M61439 (61440 points)	1 bit	For temporary memory
F	F0 to F2047 (2048 points)	1 bit	For temporary memory. Alarm message interface
L	L0 to L1023 (1024 points)	1 bit	Latch relay (back up memory)
SM*	SM0 to SM4095 (4096 points)	1 bit	Special relay
V	V0 to V511 (512 points)	1 bit	Edge relay
SB	SB0 to SB3FF (1024 points)	1 bit	Special relay for link
B	B0 to BDFFF (57344 points)	1 bit	Link relay
SW	SW0 to SW1023 (1024 points)	16 bit	Special register for link
SD	SD0 to SD4095 (4096 points)	16 bit	Special register
T	T0 to T2047 (2048 points)	1 bit/16 bit	Timer
ST	ST0 to ST127 (128 points)	1 bit/16 bit	Integrated timer
C	C0 to C511 (512 points)	1 bit/16 bit	Counter
D*	D0 to D8191 (8192 points)	16 bit/32 bit	Data register
R*	R0 to R32767 (32768 points)	16 bit/32 bit	File register, CNC word interface
ZR	ZR0 to ZR4184063 (4184064 points)	16 bit/32 bit	File register, CNC word interface
W	W0 to W2FFF (12288 points)	16 bit/32 bit	Link register
Z	Z0 to Z13 (14 points)	16 bit	Address index
N	N0 to N14 (15 points)		Master controller nesting level
P	P0 to P31 (32 points)		Label for conditional jump, subroutine call command
K	K-32768 to K32767		Decimal constant for 16-bit command
	K-2147483648 to K2147483647		Decimal constant for 32-bit command
H	H0 to HFFFF		Hexadecimal constant for 16-bit command
	H0 to HFFFFFFFF		Hexadecimal constant for 32-bit command

(Note 1) Devices marked with * in the device column have designated applications. Do not use undefined device No. even if the device is vacant.

1.1.1 Device Range Setting at Multi-project [M8]

Each device will be categorized to either the common device among projects (common device among projects) or the independent device for each projects (independent device among projects) when using the multi-project function.

(a) Common device among projects

Device is influenced by the access from the multiple projects.

The number of device points is fixed without being affected by the number of projects.

For example, the X/ Y/ R devices are common devices among projects.

(b) Independent device among projects

Device can be used independently in the multiple projects.

In addition, Independent device among projects are categorized into variable points or fixed points device.

- Independent device among projects (Fixed points)

The number of device points is fixed without being affected by the number of projects.

For example, the SM/ SD/ Z devices are independent devices among projects (fixed points)

- Independent device among projects (Variable points)

The maximum number of project is allocated to each project and used.

For example, the M/ L/ SB devices are independent devices among projects (variable points)

The list of device categories is as follows.

(1) Category explanation

Category	Details
Common	Common device among projects
Independent (fixed)	Independent device among projects (fixed points)
Independent (variable)	Independent device among projects (variable points)
Common/independent	Independent device among projects (variable points) However, it is possible to set as the common device among projects from the top.

(2) List of categories

Device	Category	Number of device points (Maximum number of projects)
X	Common	8192 points
Y	Common	8192 points
M	Common/Independent	61440 points (122880 points)
L	Independent(Variable)	1024 points (2048 points)
F	Common	2048 points
SB	Independent(Variable)	1024 points (2048 points)
B	Independent(Variable)	57344 points (114688 points)
SM	Independent(Fixed)	2048 points
V	Independent(Variable)	256 points (1024 points)
SW	Independent(Variable)	1024 points (2048 points)
SD	Independent(Fixed)	2048 points
T	Independent(Variable)	2048 points (4096 points)
ST	Independent(Variable)	128 points (256 points)
C	Independent(Variable)	512 points (1024 points)
D	Common/Independent	4096 points (8192 points)
R	Common	32768 points
ZR	Common	13312 points
W	Independent(Variable)	12288 points (24576 points)
Z	Independent(Fixed)	14 points
N	Independent(Fixed)	15 points
P	Independent(Fixed)	4096 points

* When the additional specification of "Number of PLC projects: 6" is valid, the number of device points in "()" (parentheses) becomes valid.

Refer to "PLC Programming Manual" for details on the independent device among projects and the common device among projects.

1.2 File Register General Map

Device	Details
R00000 to R00199	System common data (NC -> PLC)
R00200 to R00499	System common data (PLC -> NC)
R00500 to R00699	1st part system data (NC -> PLC)
R00700 to R00899	2nd part system data (NC -> PLC)
R00900 to R01099	3rd part system data (NC -> PLC)
R01100 to R01299	4th part system data (NC -> PLC)
R01300 to R01499	5th part system data (NC -> PLC)
R01500 to R01699	6th part system data (NC -> PLC)
R01700 to R01899	7th part system data (NC -> PLC)
R01900 to R02099	8th part system data (NC -> PLC)
R02100 to R02397	Pallet program data (Drive unit -> PLC) [M8]
R02398 to R02499	System reserve
R02500 to R02699	1st part system data (PLC -> NC)
R02700 to R02899	2nd part system data (PLC -> NC)
R02900 to R03099	3rd part system data (PLC -> NC)
R03100 to R03299	4th part system data (PLC -> NC)
R03300 to R03499	5th part system data (PLC -> NC)
R03500 to R03699	6th part system data (PLC -> NC)
R03700 to R03899	7th part system data (PLC -> NC)
R03900 to R04099	8th part system data (PLC -> NC)
R04100 to R04103	Pallet program data (PLC -> Drive unit) [M8]
R04104 to R04499	System reserve
R04500 to R05683	Axis data (NC -> PLC)
R05684 to R05699	System reserve
R05700 to R06371	Axis data (PLC -> NC)
R06372 to R06499	User macro (NC -> PLC: 64 point, PLC -> NC: 64 point)
R06500 to R06549	1st spindle data (NC -> PLC)
R06550 to R06599	2nd spindle data (NC -> PLC)
R06600 to R06649	3rd spindle data (NC -> PLC)
R06650 to R06699	4th spindle data (NC -> PLC)
R06700 to R06749	5th spindle data (NC -> PLC)
R06750 to R06799	6th spindle data (NC -> PLC)
R06800 to R06849	7th spindle data (NC -> PLC)
R06850 to R06899	8th spindle data (NC -> PLC)
R06900 to R06999	System reserve
R07000 to R07049	1st spindle data (PLC -> NC)
R07050 to R07099	2nd spindle data (PLC -> NC)
R07100 to R07149	3rd spindle data (PLC -> NC)
R07150 to R07199	4th spindle data (PLC -> NC)
R07200 to R07249	5th spindle data (PLC -> NC)
R07250 to R07299	6th spindle data (PLC -> NC)
R07300 to R07349	7th spindle data (PLC -> NC)
R07350 to R07399	8th spindle data (PLC -> NC)
R07400 to R07499	System reserve
R07500 to R07949	PLC constants
R07950 to R07999	System reserve
R08000 to R08099	PLC axis indexing
R08100 to R08259	System reserve
R08260 to R08289	Option status export to PLC [M8]
R08290 to R08299	Optimum acceleration/deceleration (Spindle)
R08300 to R09799	User backed up area
R09800 to R09899	User work area

Device	Details
R10000 to R10099	Remote I/O communication error information [M8]
R10181 to R10187	System reserve
R10188 to R10189	Base PLC mounting check
R10600 to R12759	ATC data, tool life management for M system / Tool life management I, II for L system
R12760 to R13999	System reserve
R14000 to R14499	EcoMonitorLight data (NC -> PLC) [M8]
R14500 to R14699	MES Interface (System common data) [M8]
R14700 to R14949	MES Interface (1st part system data) (PLC -> NC) [M8]
R14950 to R15199	MES Interface (2nd part system data) (PLC -> NC) [M8]
R15200 to R15449	MES Interface (3rd part system data) (PLC -> NC) [M8]
R15450 to R15699	MES Interface (4th part system data) (PLC -> NC) [M8]
R15700 to R15949	MES Interface (5th part system data) (PLC -> NC) [M8]
R15950 to R16199	MES Interface (6th part system data) (PLC -> NC) [M8]
R16200 to R16449	MES Interface (7th part system data) (PLC -> NC) [M8]
R16450 to R16699	MES Interface (8th part system data) (PLC -> NC) [M8]
R16700 to R17299	System reserve
R17300 to R18299	Modbus input/output device
R18300 to R19799	User backup area
R19800 to R19899	User work area
R19900 to R19999	System reserve
R20000 to R20199	System common data (NC -> PLC)
R20200 to R20499	System common data (PLC -> NC)
R20500 to R20699	1st part system data (NC -> PLC)
R20700 to R20899	2nd part system data (NC -> PLC)
R20900 to R21099	3rd part system data (NC -> PLC)
R21100 to R21299	4th part system data (NC -> PLC)
R21300 to R21499	5th part system data (NC -> PLC)
R21500 to R21699	6th part system data (NC -> PLC)
R21700 to R21899	7th part system data (NC -> PLC)
R21900 to R22099	8th part system data (NC -> PLC)
R22100 to R22499	System reserve
R22500 to R22699	1st part system data (PLC -> NC)
R22700 to R22899	2nd part system data (PLC -> NC)
R22900 to R23099	3rd part system data (PLC -> NC)
R23100 to R23299	4th part system data (PLC -> NC)
R23300 to R23499	5th part system data (PLC -> NC)
R23500 to R23699	6th part system data (PLC -> NC)
R23700 to R23899	7th part system data (PLC -> NC)
R23900 to R24099	8th part system data (PLC -> NC)
R24100 to R24499	System reserve
R24500 to R25683	Axis data (NC -> PLC)
R25684 to R26371	Axis data (PLC -> NC)
R26372 to R27499	System reserve
R27500 to R28299	PLC constants (prepared for specific machine tool builders)
R28300 to R29799	User backup area
R29800 to R29899	User work area
R29900 to R32767	System reserve

(Note) The system reserve is used for function expansion by Mitsubishi, and must not be used by the user.

1.3 Flow of Signals [C80]

1.3.1 Flow of PLC CPU and CNC CPU Data

The flow of PLC CPU and CNC CPU data is shown below.

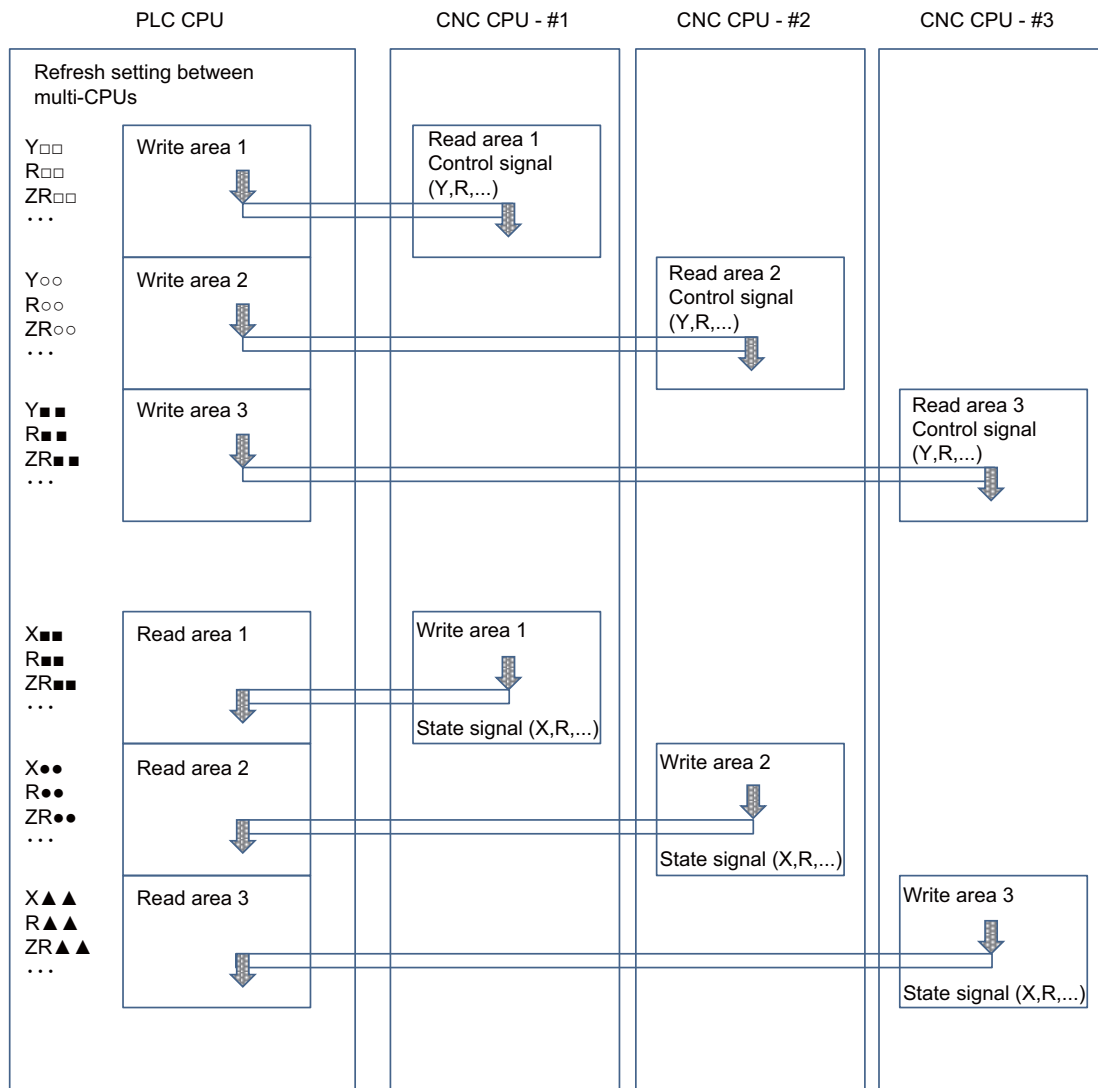

- (1) The data is sent via the high-speed bus to each CPU according to the refresh setting between multiple CPUs, that is, PLC CPU and each CNC CPU. Refer to "PLC CPU Initial Setup" in "C80 Series Connection and Setup Manual" for details of the refresh setting between multiple CPUs.
 - For PLC CPU, set arbitrary devices in the write and read areas.
 - For CNC CPU, set the device range, such as X, Y and R, which includes the control and state signals in the write and read areas.
 - The number of devices in the write and read areas of PLC CPU and CNC CPU must be the same.
- (2) The write area data of PLC CPU is sent via the high-speed bus to the read areas of each CNC CPU in the form of control signals.
- (3) The CNC data (state signal) is sent to the read area corresponding to each CNC CPU of PLC CPU by the high-speed bus.
- (4) When one CNC CPU is used, write area 1 and read area 1 are used.
- (5) When two CNC CPUs are used, write area 1 and read area 1 are used for CNC CPU#1, write area 2 and read area 2 are used for CNC CPU#2.
- (6) When three CNC CPUs are used, write area 1 and read area 1 are used for CNC CPU#1, write area 2 and read area 2 are used for CNC CPU#2, write area 3 and read area 3 are used for CNC CPU#3.

Input/Output Signals with Controller

Types of Input/Output Signals Tables

The followings are the types of input/output signals tables to be used.

For common devices used in part systems (Sample)

Device	Abbrev.	Signal name	Device	Abbrev.	Signal name
X720			X728		
X721			X729		
X722		Diagnosis data output completic	X72A		
X723		Collecting diagnosis data	X72B		
X724		In remote program input ▲	X72C		
X725		Remote program input completion▲	X72D		
X726		Remote program input error ▲	X72E		
X727		In tool ID communication ▲	X72F		Power OFF required after parameter change

For devices used in each part system (Sample)

Device No.				Abbrev.	Signal name
\$1	\$2	\$3	\$4		
Y7A0	Y7A8	Y7B0	Y7B8	*SVF1	Servo OFF 1st axis
Y7A1	Y7A9	Y7B1	Y7B9	*SVF2	2nd axis
Y7A2	Y7AA	Y7B2	Y7BA	*SVF3	3rd axis
Y7A3	Y7AB	Y7B3	Y7BB	*SVF4	4th axis
Y7A4	Y7AC	Y7B4	Y7BC	*SVF5	5th axis
Y7A5	Y7AD	Y7B5	Y7BD	*SVF6	6th axis
Y7A6	Y7AE	Y7B6	Y7BE	*SVF7	7th axis
Y7A7	Y7AF	Y7B7	Y7BF	*SVF8	8th axis

For devices used in each spindle (Sample)

Device No.						Abbrev.	Signal name
1stSP	2ndSP	3rdSP	4thSP	5thSP	6thSP		
R6500	R6550	R6600	R6650	R6700	R6750		Spindle command rotation speed input (L)
R6501	R6551	R6601	R6651	R6701	R6751		(H)
R6502	R6552	R6602	R6652	R6702	R6752		Spindle command final data (rotation speed) (L)
R6503	R6553	R6603	R6653	R6703	R6753		(H)
R6504	R6554	R6604	R6654	R6704	R6754		Spindle command final data (12-bit binary) (L)
R6505	R6555	R6605	R6655	R6705	R6755		(H)
R6506	R6556	R6606	R6656	R6706	R6756		Spindle actual speed (L)
R6507	R6557	R6607	R6657	R6707	R6757		(H)

(Note 1) Signals marked with "*" in the "Abbrev." column are handled as B contacts.

(Note 2) Signals marked with "▲" are prepared for a specific machine tool builder.

(Note 3) Unit is changed by "#1040 M_inch" for the signals marked with [M].

(Note 4) 32bit signals are shown with (L)/(H), which indicates Low/High order. Data structure and the descriptions are as follows.

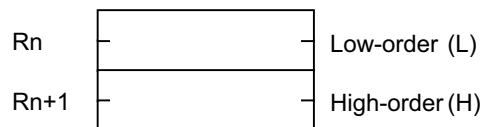

Classification of Input/Output Signals with Controller

There are 1-bit unit, and 16-bit or 32-bit unit controller input/output signals, which are classified as shown below. When designing, refer to the section indicated below and make allocations according to the table in the respective section.

"\$" and "SP" in "Device No." column stand for "part system" and "spindle" respectively.

	Signal type	Explanation	Reference
Input	DI	(1) Allocated to device X. (2) Data calculated in bit units are allocated as a principle. (3) Signals with only \$1 or 1stSP section filled are common for all part systems or all spindles.	"PLC Input Signals (Bit Type: X***)"
	Data	(1) Allocated to device R. (2) Data handled in 16-bit or 32-bit units is allocated as a principle.	"PLC Input Signals (Data Type: R***)"
Output	DO	(1) Allocated to device Y. (2) Data calculated in bit units are allocated as a principle. (3) Signals with only \$1 or 1stSP section filled are common for all part systems or all spindles.	"PLC Output Signals (Bit Type: Y***)"
	Data	(1) Allocated to device R. (2) Data handled in 16-bit or 32-bit units is allocated as a principle.	"PLC Output Signals (Data Type: R***)"
Others	Special relay/ register	(1) Allocated to device SM, SB and SW. (2) The sequence instruction calculation state, results and the signals with special operations are allocated.	"Explanation of Special Relays/Register"
	ZR	(1) Allocated to device ZR. (2) Use in the smart safety observation function.	"ZR device"
	Classified under purpose	Devices are classified under the usage purpose.	"Explanations for Each Application"

2.1 PLC Input Signals (Bit type: X***)

(Note) Signals with "▲" are prepared for specific machine tool builders.

Device	Abbrev.	Signal name	Device	Abbrev.	Signal name
X2F0	BRST	Board reset			
Device	Abbrev.	Signal name	Device	Abbrev.	Signal name
X700	IPCEI1	Power consumption computation: Consumption accumulation ON 1	X708	IPCCC1	Power consumption computation: Clearing consumption accumulation 1 complete
X701	IPCEI2	Power consumption computation: Consumption accumulation ON 2	X709	IPCCC2	Power consumption computation: Clearing consumption accumulation 2 complete
X702	IPCEI3	Power consumption computation: Consumption accumulation ON 3	X70A	IPCCC3	Power consumption computation: Clearing consumption accumulation 3 complete
X703	IPCEI4	Power consumption computation: Consumption accumulation ON 4	X70B	IPCCC4	Power consumption computation: Clearing consumption accumulation 4 complete
X704			X70C		
X705			X70D		
X706			X70E	BATWR	Battery warning
X707		Power OFF processing [M8]	X70F	BATAL	Battery alarm
Device	Abbrev.	Signal name	Device	Abbrev.	Signal name
X710	MSON	In macro single valid [C80]	X718		
X711		Optimum acceleration/deceleration switching parameter completion [spindle] ▲	X719		
X712	SMLKO	High-speed simple program check mode ON	X71A		
X713	SPSCO	High-speed simple program check: Coordinate position check ON	X71B		
X714	PNCMDO	Manual arbitrary reverse run: Actual cutting mode ON [M8]	X71C		
X715	PCHKO	Manual arbitrary reverse run mode ON	X71D		
X716	MOREV	Manual arbitrary reverse run: Reverse run ON	X71E		
X717			X71F		
Device	Abbrev.	Signal name	Device	Abbrev.	Signal name
X720		In sampling trace ▲	X728	MDBUSIF	Modbus/TCP communicating ▲
X721		Sampling trace complete ▲	X729	MDBUSE R1	Modbus time-out 1 ▲
X722		Diagnosis data output completion	X72A	MDBUSE R2	Modbus time-out 2 ▲
X723		Collecting diagnosis data	X72B	FLNETO	FL-net : Online ▲
X724		In remote program input ▲	X72C		
X725		Remote program input completion ▲	X72D		
X726		Remote program input error ▲	X72E		
X727		In tool ID communication ▲	X72F		Power OFF required after parameter change

Device	Abbrev.	Signal name	Device	Abbrev.	Signal name
X740			X748		
X741			X749		
X742			X74A		
X743			X74B		
X744			X74C		
X745			X74D	MBSTP	Thread, tap block stopping in manual arbitrary reverse run
X746			X74E	MRVNG	Thread, tap reverse run prohibition alarm in manual arbitrary reverse run
X747			X74F		MES interface library: Operation trigger status [M8]
Device	Abbrev.	Signal name	Device	Abbrev.	Signal name
X750			X758		Pallet program registration Ext. workpiece coordinate transfer completion [M8]
X751			X759		Graphic check (check method II) in progress [M8]
X752	CNOP	24 hours continuous operation	X75A		
X753	MSOE	In multi-step speed monitor [M8]	X75B		
X754			X75C		
X755			X75D	DLOAD0	FTP download in progress [C80]
X756			X75E	DLDFIN	FTP download completed [C80]
X757			X75F	DLDERR	FTP download error [C80]
Device	Abbrev.	Signal name	Device	Abbrev.	Signal name
X760		\$1 Display	X768		
X761		\$2 Display	X769		
X762		\$3 Display	X76A		
X763		\$4 Display	X76B		
X764		\$5 Display	X76C		
X765		\$6 Display	X76D		
X766		\$7 Display	X76E		
X767		\$8 Display	X76F		
Device	Abbrev.	Signal name	Device	Abbrev.	Signal name
X770			X778	GBMOD	G/B spindle synchronizing mode [M8]
X771	ITF3DTF	Interference check III: Interfering object selection data setting completed [M8]	X779	GBSYN	G/B spindle synchronization: position control synchronizing [M8]
X772	ITF3MD	Interference check III: In interference check III mode [M8]	X77A	GBPHF	G/B spindle synchronization: phase alignment complete [M8]
X773		Interference check between part systems: Mode is active [M8]	X77B	GBPCM	G/B spindle synchronization: position error compensating [M8]
X774			X77C		
X775			X77D		
X776			X77E		
X777			X77F		

Device No.					
\$1	\$2	\$3	\$4	Abbrev.	Signal name
X780	X788	X790	X798	RDY1	Servo ready 1st axis
X781	X789	X791	X799	RDY2	Servo ready 2nd axis
X782	X78A	X792	X79A	RDY3	Servo ready 3rd axis
X783	X78B	X793	X79B	RDY4	Servo ready 4th axis
X784	X78C	X794	X79C	RDY5	Servo ready 5th axis
X785	X78D	X795	X79D	RDY6	Servo ready 6th axis
X786	X78E	X796	X79E	RDY7	Servo ready 7th axis
X787	X78F	X797	X79F	RDY8	Servo ready 8th axis
Device No.					
\$1	\$2	\$3	\$4	Abbrev.	Signal name
X7A0	X7A8	X7B0	X7B8	AX1	Axis selection 1st axis
X7A1	X7A9	X7B1	X7B9	AX2	Axis selection 2nd axis
X7A2	X7AA	X7B2	X7BA	AX3	Axis selection 3rd axis
X7A3	X7AB	X7B3	X7BB	AX4	Axis selection 4th axis
X7A4	X7AC	X7B4	X7BC	AX5	Axis selection 5th axis
X7A5	X7AD	X7B5	X7BD	AX6	Axis selection 6th axis
X7A6	X7AE	X7B6	X7BE	AX7	Axis selection 7th axis
X7A7	X7AF	X7B7	X7BF	AX8	Axis selection 8th axis
Device No.					
\$1	\$2	\$3	\$4	Abbrev.	Signal name
X7C0	X7C8	X7D0	X7D8	MVP1	In axis plus motion 1st axis
X7C1	X7C9	X7D1	X7D9	MVP2	In axis plus motion 2nd axis
X7C2	X7CA	X7D2	X7DA	MVP3	In axis plus motion 3rd axis
X7C3	X7CB	X7D3	X7DB	MVP4	In axis plus motion 4th axis
X7C4	X7CC	X7D4	X7DC	MVP5	In axis plus motion 5th axis
X7C5	X7CD	X7D5	X7DD	MVP6	In axis plus motion 6th axis
X7C6	X7CE	X7D6	X7DE	MVP7	In axis plus motion 7th axis
X7C7	X7CF	X7D7	X7DF	MVP8	In axis plus motion 8th axis
Device No.					
\$1	\$2	\$3	\$4	Abbrev.	Signal name
X7E0	X7E8	X7F0	X7F8	MVM1	In axis minus motion 1st axis
X7E1	X7E9	X7F1	X7F9	MVM2	In axis minus motion 2nd axis
X7E2	X7EA	X7F2	X7FA	MVM3	In axis minus motion 3rd axis
X7E3	X7EB	X7F3	X7FB	MVM4	In axis minus motion 4th axis
X7E4	X7EC	X7F4	X7FC	MVM5	In axis minus motion 5th axis
X7E5	X7ED	X7F5	X7FD	MVM6	In axis minus motion 6th axis
X7E6	X7EE	X7F6	X7FE	MVM7	In axis minus motion 7th axis
X7E7	X7EF	X7F7	X7FF	MVM8	In axis minus motion 8th axis

(Note) The CNC control and CNC status signals are arbitrarily assigned to the device and axis numbers by the parameter "#1603 PLCdev_no" for each axis.

For details of setting, refer to the "PLC I/F axis random device assignment" in the "PLC Programming Manual".

Device No.					
\$1	\$2	\$3	\$4	Abbrev.	Signal name
X800	X808	X810	X818	ZP11	1st reference position reached 1st axis
X801	X809	X811	X819	ZP12	1st reference position reached 2nd axis
X802	X80A	X812	X81A	ZP13	1st reference position reached 3rd axis
X803	X80B	X813	X81B	ZP14	1st reference position reached 4th axis
X804	X80C	X814	X81C	ZP15	1st reference position reached 5th axis
X805	X80D	X815	X81D	ZP16	1st reference position reached 6th axis
X806	X80E	X816	X81E	ZP17	1st reference position reached 7th axis
X807	X80F	X817	X81F	ZP18	1st reference position reached 8th axis
Device No.					
\$1	\$2	\$3	\$4	Abbrev.	Signal name
X820	X828	X830	X838	ZP21	2nd reference position reached 1st axis
X821	X829	X831	X839	ZP22	2nd reference position reached 2nd axis
X822	X82A	X832	X83A	ZP23	2nd reference position reached 3rd axis
X823	X82B	X833	X83B	ZP24	2nd reference position reached 4th axis
X824	X82C	X834	X83C	ZP25	2nd reference position reached 5th axis
X825	X82D	X835	X83D	ZP26	2nd reference position reached 6th axis
X826	X82E	X836	X83E	ZP27	2nd reference position reached 7th axis
X827	X82F	X837	X83F	ZP28	2nd reference position reached 8th axis
Device No.					
\$1	\$2	\$3	\$4	Abbrev.	Signal name
X840	X848	X850	X858	ZP31	3rd reference position reached 1st axis
X841	X849	X851	X859	ZP32	3rd reference position reached 2nd axis
X842	X84A	X852	X85A	ZP33	3rd reference position reached 3rd axis
X843	X84B	X853	X85B	ZP34	3rd reference position reached 4th axis
X844	X84C	X854	X85C	ZP35	3rd reference position reached 5th axis
X845	X84D	X855	X85D	ZP36	3rd reference position reached 6th axis
X846	X84E	X856	X85E	ZP37	3rd reference position reached 7th axis
X847	X84F	X857	X85F	ZP38	3rd reference position reached 8th axis
Device No.					
\$1	\$2	\$3	\$4	Abbrev.	Signal name
X860	X868	X870	X878	ZP41	4th reference position reached 1st axis
X861	X869	X871	X879	ZP42	4th reference position reached 2nd axis
X862	X86A	X872	X87A	ZP43	4th reference position reached 3rd axis
X863	X86B	X873	X87B	ZP44	4th reference position reached 4th axis
X864	X86C	X874	X87C	ZP45	4th reference position reached 5th axis
X865	X86D	X875	X87D	ZP46	4th reference position reached 6th axis
X866	X86E	X876	X87E	ZP47	4th reference position reached 7th axis
X867	X86F	X877	X87F	ZP48	4th reference position reached 8th axis

(Note) The CNC control and CNC status signals are arbitrarily assigned to the device and axis numbers by the parameter "#1603 PLCdev_no" for each axis.

For details of setting, refer to the "PLC I/F axis random device assignment" in the "PLC Programming Manual".

Device No.					
\$1	\$2	\$3	\$4	Abbrev.	Signal name
X880	X888	X890	X898	NRF1	Near reference position 1st axis
X881	X889	X891	X899	NRF2	Near reference position 2nd axis
X882	X88A	X892	X89A	NRF3	Near reference position 3rd axis
X883	X88B	X893	X89B	NRF4	Near reference position 4th axis
X884	X88C	X894	X89C	NRF5	Near reference position 5th axis
X885	X88D	X895	X89D	NRF6	Near reference position 6th axis
X886	X88E	X896	X89E	NRF7	Near reference position 7th axis
X887	X88F	X897	X89F	NRF8	Near reference position 8th axis
Device No.					
\$1	\$2	\$3	\$4	Abbrev.	Signal name
X8A0	X8A8	X8B0	X8B8	PLFN1	Arbitrary axis superimposition complete 1st axis [M8]
X8A1	X8A9	X8B1	X8B9	PLFN2	Arbitrary axis superimposition complete 2nd axis [M8]
X8A2	X8AA	X8B2	X8BA	PLFN3	Arbitrary axis superimposition complete 3rd axis [M8]
X8A3	X8AB	X8B3	X8BB	PLFN4	Arbitrary axis superimposition complete 4th axis [M8]
X8A4	X8AC	X8B4	X8BC	PLFN5	Arbitrary axis superimposition complete 5th axis [M8]
X8A5	X8AD	X8B5	X8BD	PLFN6	Arbitrary axis superimposition complete 6th axis [M8]
X8A6	X8AE	X8B6	X8BE	PLFN7	Arbitrary axis superimposition complete 7th axis [M8]
X8A7	X8AF	X8B7	X8BF	PLFN8	Arbitrary axis superimposition complete 8th axis [M8]
Device No.					
\$1	\$2	\$3	\$4	Abbrev.	Signal name
X8C0	X8C8	X8D0	X8D8	ZSF1	Zero point initialization set completed 1st axis
X8C1	X8C9	X8D1	X8D9	ZSF2	Zero point initialization set completed 2nd axis
X8C2	X8CA	X8D2	X8DA	ZSF3	Zero point initialization set completed 3rd axis
X8C3	X8CB	X8D3	X8DB	ZSF4	Zero point initialization set completed 4th axis
X8C4	X8CC	X8D4	X8DC	ZSF5	Zero point initialization set completed 5th axis
X8C5	X8CD	X8D5	X8DD	ZSF6	Zero point initialization set completed 6th axis
X8C6	X8CE	X8D6	X8DE	ZSF7	Zero point initialization set completed 7th axis
X8C7	X8CF	X8D7	X8DF	ZSF8	Zero point initialization set completed 8th axis
Device No.					
\$1	\$2	\$3	\$4	Abbrev.	Signal name
X8E0	X8E8	X8F0	X8F8	ZSE1	Zero point initialization set error completed 1st axis
X8E1	X8E9	X8F1	X8F9	ZSE2	Zero point initialization set error completed 2nd axis
X8E2	X8EA	X8F2	X8FA	ZSE3	Zero point initialization set error completed 3rd axis
X8E3	X8EB	X8F3	X8FB	ZSE4	Zero point initialization set error completed 4th axis
X8E4	X8EC	X8F4	X8FC	ZSE5	Zero point initialization set error completed 5th axis
X8E5	X8ED	X8F5	X8FD	ZSE6	Zero point initialization set error completed 6th axis
X8E6	X8EE	X8F6	X8FE	ZSE7	Zero point initialization set error completed 7th axis
X8E7	X8EF	X8F7	X8FF	ZSE8	Zero point initialization set error completed 8th axis

(Note) The CNC control and CNC status signals are arbitrarily assigned to the device and axis numbers by the parameter "#1603 PLCdev_no" for each axis.

For details of setting, refer to the "PLC I/F axis random device assignment" in the "PLC Programming Manual".

Device No.				Abbrev.	Signal name
\$1	\$2	\$3	\$4		
X900	X908	X910	X918	ILI1	In current limit 1st axis
X901	X909	X911	X919	ILI2	In current limit 2nd axis
X902	X90A	X912	X91A	ILI3	In current limit 3rd axis
X903	X90B	X913	X91B	ILI4	In current limit 4th axis
X904	X90C	X914	X91C	ILI5	In current limit 5th axis
X905	X90D	X915	X91D	ILI6	In current limit 6th axis
X906	X90E	X916	X91E	ILI7	In current limit 7th axis
X907	X90F	X917	X91F	ILI8	In current limit 8th axis
Device No.				Abbrev.	Signal name
\$1	\$2	\$3	\$4		
X920	X928	X930	X938	ILA1	Current limit reached 1st axis
X921	X929	X931	X939	ILA2	Current limit reached 2nd axis
X922	X92A	X932	X93A	ILA3	Current limit reached 3rd axis
X923	X92B	X933	X93B	ILA4	Current limit reached 4th axis
X924	X92C	X934	X93C	ILA5	Current limit reached 5th axis
X925	X92D	X935	X93D	ILA6	Current limit reached 6th axis
X926	X92E	X936	X93E	ILA7	Current limit reached 7th axis
X927	X92F	X937	X93F	ILA8	Current limit reached 8th axis
Device No.				Abbrev.	Signal name
\$1	\$2	\$3	\$4		
X940	X948	X950	X958	ARRF1	NC axis up-to-speed 1st axis
X941	X949	X951	X959	ARRF2	NC axis up-to-speed 2nd axis
X942	X94A	X952	X95A	ARRF3	NC axis up-to-speed 3rd axis
X943	X94B	X953	X95B	ARRF4	NC axis up-to-speed 4th axis
X944	X94C	X954	X95C	ARRF5	NC axis up-to-speed 5th axis
X945	X94D	X955	X95D	ARRF6	NC axis up-to-speed 6th axis
X946	X94E	X956	X95E	ARRF7	NC axis up-to-speed 7th axis
X947	X94F	X957	X95F	ARRF8	NC axis up-to-speed 8th axis
Device No.				Abbrev.	Signal name
\$1	\$2	\$3	\$4		
X960	X968	X970	X978	UCLP1	Unclamp command 1st axis
X961	X969	X971	X979	UCLP2	Unclamp command 2nd axis
X962	X96A	X972	X97A	UCLP3	Unclamp command 3rd axis
X963	X96B	X973	X97B	UCLP4	Unclamp command 4th axis
X964	X96C	X974	X97C	UCLP5	Unclamp command 5th axis
X965	X96D	X975	X97D	UCLP6	Unclamp command 6th axis
X966	X96E	X976	X97E	UCLP7	Unclamp command 7th axis
X967	X96F	X977	X97F	UCLP8	Unclamp command 8th axis

(Note) The CNC control and CNC status signals are arbitrarily assigned to the device and axis numbers by the parameter "#1603 PLCdev_no" for each axis.

For details of setting, refer to the "PLC I/F axis random device assignment" in the "PLC Programming Manual".

Device No.				Abbrev.	Signal name
\$1	\$2	\$3	\$4		
X980	X988	X990	X998		In mixed control (cross axis control) 1st axis
X981	X989	X991	X999		In mixed control (cross axis control) 2nd axis
X982	X98A	X992	X99A		In mixed control (cross axis control) 3rd axis
X983	X98B	X993	X99B		In mixed control (cross axis control) 4th axis
X984	X98C	X994	X99C		In mixed control (cross axis control) 5th axis
X985	X98D	X995	X99D		In mixed control (cross axis control) 6th axis
X986	X98E	X996	X99E		In mixed control (cross axis control) 7th axis
X987	X98F	X997	X99F		In mixed control (cross axis control) 8th axis
Device No.				Abbrev.	Signal name
\$1	\$2	\$3	\$4		
X9A0	X9A8	X9B0	X9B8		In synchronous/superimposition control 1st axis
X9A1	X9A9	X9B1	X9B9		In synchronous/superimposition control 2nd axis
X9A2	X9AA	X9B2	X9BA		In synchronous/superimposition control 3rd axis
X9A3	X9AB	X9B3	X9BB		In synchronous/superimposition control 4th axis
X9A4	X9AC	X9B4	X9BC		In synchronous/superimposition control 5th axis
X9A5	X9AD	X9B5	X9BD		In synchronous/superimposition control 6th axis
X9A6	X9AE	X9B6	X9BE		In synchronous/superimposition control 7th axis
X9A7	X9AF	X9B7	X9BF		In synchronous/superimposition control 8th axis
Device No.				Abbrev.	Signal name
\$1	\$2	\$3	\$4		
X9C0	X9C8	X9D0	X9D8	MIR1	In mirror image 1st axis
X9C1	X9C9	X9D1	X9D9	MIR2	In mirror image 2nd axis
X9C2	X9CA	X9D2	X9DA	MIR3	In mirror image 3rd axis
X9C3	X9CB	X9D3	X9DB	MIR4	In mirror image 4th axis
X9C4	X9CC	X9D4	X9DC	MIR5	In mirror image 5th axis
X9C5	X9CD	X9D5	X9DD	MIR6	In mirror image 6th axis
X9C6	X9CE	X9D6	X9DE	MIR7	In mirror image 7th axis
X9C7	X9CF	X9D7	X9DF	MIR8	In mirror image 8th axis
Device No.				Abbrev.	Signal name
\$1	\$2	\$3	\$4		
X9E0	X9E8	X9F0	X9F8		Reference position establishment 1st axis
X9E1	X9E9	X9F1	X9F9		Reference position establishment 2nd axis
X9E2	X9EA	X9F2	X9FA		Reference position establishment 3rd axis
X9E3	X9EB	X9F3	X9FB		Reference position establishment 4th axis
X9E4	X9EC	X9F4	X9FC		Reference position establishment 5th axis
X9E5	X9ED	X9F5	X9FD		Reference position establishment 6th axis
X9E6	X9EE	X9F6	X9FE		Reference position establishment 7th axis
X9E7	X9EF	X9F7	X9FF		Reference position establishment 8th axis

(Note) The CNC control and CNC status signals are arbitrarily assigned to the device and axis numbers by the parameter "#1603 PLCdev_no" for each axis.

For details of setting, refer to the "PLC I/F axis random device assignment" in the "PLC Programming Manual".

2 Input/Output Signals with Controller

Device No.				Abbrev.	Signal name
\$1	\$2	\$3	\$4		
XA00	XA08	XA10	XA18		Reference position return direction 1st axis
XA01	XA09	XA11	XA19		Reference position return direction 2nd axis
XA02	XA0A	XA12	XA1A		Reference position return direction 3rd axis
XA03	XA0B	XA13	XA1B		Reference position return direction 4th axis
XA04	XA0C	XA14	XA1C		Reference position return direction 5th axis
XA05	XA0D	XA15	XA1D		Reference position return direction 6th axis
XA06	XA0E	XA16	XA1E		Reference position return direction 7th axis
XA07	XA0F	XA17	XA1F		Reference position return direction 8th axis
Device No.				Abbrev.	Signal name
\$1	\$2	\$3	\$4		
XA20	XA28	XA30	XA38		In NC axis control 1st axis
XA21	XA29	XA31	XA39		In NC axis control 2nd axis
XA22	XA2A	XA32	XA3A		In NC axis control 3rd axis
XA23	XA2B	XA33	XA3B		In NC axis control 4th axis
XA24	XA2C	XA34	XA3C		In NC axis control 5th axis
XA25	XA2D	XA35	XA3D		In NC axis control 6th axis
XA26	XA2E	XA36	XA3E		In NC axis control 7th axis
XA27	XA2F	XA37	XA3F		In NC axis control 8th axis
Device No.				Abbrev.	Signal name
\$1	\$2	\$3	\$4		
XA40	XA48	XA50	XA58	ECIL1	Ext. machine coordinate system offset data illegal 1st axis
XA41	XA49	XA51	XA59	ECIL2	Ext. machine coordinate system offset data illegal 2nd axis
XA42	XA4A	XA52	XA5A	ECIL3	Ext. machine coordinate system offset data illegal 3rd axis
XA43	XA4B	XA53	XA5B	ECIL4	Ext. machine coordinate system offset data illegal 4th axis
XA44	XA4C	XA54	XA5C	ECIL5	Ext. machine coordinate system offset data illegal 5th axis
XA45	XA4D	XA55	XA5D	ECIL6	Ext. machine coordinate system offset data illegal 6th axis
XA46	XA4E	XA56	XA5E	ECIL7	Ext. machine coordinate system offset data illegal 7th axis
XA47	XA4F	XA57	XA5F	ECIL8	Ext. machine coordinate system offset data illegal 8th axis
Device No.				Abbrev.	Signal name
\$1	\$2	\$3	\$4		
XA60	XA68	XA70	XA78		Vertical axis pull-up prevented 1st axis
XA61	XA69	XA71	XA79		Vertical axis pull-up prevented 2nd axis
XA62	XA6A	XA72	XA7A		Vertical axis pull-up prevented 3rd axis
XA63	XA6B	XA73	XA7B		Vertical axis pull-up prevented 4th axis
XA64	XA6C	XA74	XA7C		Vertical axis pull-up prevented 5th axis
XA65	XA6D	XA75	XA7D		Vertical axis pull-up prevented 6th axis
XA66	XA6E	XA76	XA7E		Vertical axis pull-up prevented 7th axis
XA67	XA6F	XA77	XA7F		Vertical axis pull-up prevented 8th axis

(Note) The CNC control and CNC status signals are arbitrarily assigned to the device and axis numbers by the parameter "#1603 PLCdev_no" for each axis.

For details of setting, refer to the "PLC I/F axis random device assignment" in the "PLC Programming Manual".

2 Input/Output Signals with Controller

Device No.				Abbrev.	Signal name
\$1	\$2	\$3	\$4		
XA80	XA88	XA90	XA98		Mirror image status 1st axis ▲
XA81	XA89	XA91	XA99		Mirror image status 2nd axis ▲
XA82	XA8A	XA92	XA9A		Mirror image status 3rd axis ▲
XA83	XA8B	XA93	XA9B		Mirror image status 4th axis ▲
XA84	XA8C	XA94	XA9C		Mirror image status 5th axis ▲
XA85	XA8D	XA95	XA9D		Mirror image status 6th axis ▲
XA86	XA8E	XA96	XA9E		Mirror image status 7th axis ▲
XA87	XA8F	XA97	XA9F		Mirror image status 8th axis ▲

Device No.				Abbrev.	Signal name
\$1	\$2	\$3	\$4		
XB00	XB08	XB10	XB18	CLP1	Clamp command 1st axis
XB01	XB09	XB11	XB19	CLP2	Clamp command 2nd axis
XB02	XB0A	XB12	XB1A	CLP3	Clamp command 3rd axis
XB03	XB0B	XB13	XB1B	CLP4	Clamp command 4th axis
XB04	XB0C	XB14	XB1C	CLP5	Clamp command 5th axis
XB05	XB0D	XB15	XB1D	CLP6	Clamp command 6th axis
XB06	XB0E	XB16	XB1E	CLP7	Clamp command 7th axis
XB07	XB0F	XB17	XB1F	CLP8	Clamp command 8th axis

Device No.				Abbrev.	Signal name
\$1	\$2	\$3	\$4		
XB40	XB48	XB50	XB58	ROTSPM1	Spindle-mode rotary axis control mode 1st axis [M8]
XB41	XB49	XB51	XB59	ROTSPM2	Spindle-mode rotary axis control mode 2nd axis [M8]
XB42	XB4A	XB52	XB5A	ROTSPM3	Spindle-mode rotary axis control mode 3rd axis [M8]
XB43	XB4B	XB53	XB5B	ROTSPM4	Spindle-mode rotary axis control mode 4th axis [M8]
XB44	XB4C	XB54	XB5C	ROTSPM5	Spindle-mode rotary axis control mode 5th axis [M8]
XB45	XB4D	XB55	XB5D	ROTSPM6	Spindle-mode rotary axis control mode 6th axis [M8]
XB46	XB4E	XB56	XB5E	ROTSPM7	Spindle-mode rotary axis control mode 7th axis [M8]
XB47	XB4F	XB57	XB5F	ROTSPM8	Spindle-mode rotary axis control mode 8th axis [M8]

Device No.				Abbrev.	Signal name
\$1	\$2	\$3	\$4		
XB60	XB68	XB70	XB78	AXINP1	Each axis in-position 1st axis
XB61	XB69	XB71	XB79	AXINP2	Each axis in-position 2nd axis
XB62	XB6A	XB72	XB7A	AXINP3	Each axis in-position 3rd axis
XB63	XB6B	XB73	XB7B	AXINP4	Each axis in-position 4th axis
XB64	XB6C	XB74	XB7C	AXINP5	Each axis in-position 5th axis
XB65	XB6D	XB75	XB7D	AXINP6	Each axis in-position 6th axis
XB66	XB6E	XB76	XB7E	AXINP7	Each axis in-position 7th axis
XB67	XB6F	XB77	XB7F	AXINP8	Each axis in-position 8th axis

(Note) The CNC control and CNC status signals are arbitrarily assigned to the device and axis numbers by the parameter "#1603 PLCdev_no" for each axis.

For details of setting, refer to the "PLC I/F axis random device assignment" in the "PLC Programming Manual".

2 Input/Output Signals with Controller

Device No.				Abbrev.	Signal name
\$1	\$2	\$3	\$4		
XB80	XB88	XB90	XB98	VGHLD1	Real-time tuning 1: Speed control gain changeover hold-down ON 1st axis [M8]
XB81	XB89	XB91	XB99	VGHLD2	Real-time tuning 1: Speed control gain changeover hold-down ON 2nd axis [M8]
XB82	XB8A	XB92	XB9A	VGHLD3	Real-time tuning 1: Speed control gain changeover hold-down ON 3rd axis [M8]
XB83	XB8B	XB93	XB9B	VGHLD4	Real-time tuning 1: Speed control gain changeover hold-down ON 4th axis [M8]
XB84	XB8C	XB94	XB9C	VGHLD5	Real-time tuning 1: Speed control gain changeover hold-down ON 5th axis [M8]
XB85	XB8D	XB95	XB9D	VGHLD6	Real-time tuning 1: Speed control gain changeover hold-down ON 6th axis [M8]
XB86	XB8E	XB96	XB9E	VGHLD7	Real-time tuning 1: Speed control gain changeover hold-down ON 7th axis [M8]
XB87	XB8F	XB97	XB9F	VGHLD8	Real-time tuning 1: Speed control gain changeover hold-down ON 8th axis [M8]

Device No.				Abbrev.	Signal name
\$1	\$2	\$3	\$4		
XBA0	XBA8	XBB0	XBB8	NPCHGIS1	NC axis/PLC axis switchover invalid status 1st axis
XBA1	XBA9	XBB1	XBB9	NPCHGIS2	NC axis/PLC axis switchover invalid status 2nd axis
XBA2	XBAA	XBB2	XBBA	NPCHGIS3	NC axis/PLC axis switchover invalid status 3rd axis
XBA3	XBAB	XBB3	XBBB	NPCHGIS4	NC axis/PLC axis switchover invalid status 4th axis
XBA4	XBAC	XBB4	XBBC	NPCHGIS5	NC axis/PLC axis switchover invalid status 5th axis
XBA5	XBAD	XBB5	XBBD	NPCHGIS6	NC axis/PLC axis switchover invalid status 6th axis
XBA6	XBAE	XBB6	XBBE	NPCHGIS7	NC axis/PLC axis switchover invalid status 7th axis
XBA7	XBAF	XBB7	XBBF	NPCHGIS8	NC axis/PLC axis switchover invalid status 8th axis

Device No.				Abbrev.	Signal name
\$1	\$2	\$3	\$4		
XBC0	XBC8	XBD0	XBD8	NPCHGMOD1	NC axis/PLC axis switchover 1st axis in process
XBC1	XBC9	XBD1	XBD9	NPCHGMOD2	NC axis/PLC axis switchover 2nd axis in process
XBC2	XBCA	XBD2	XBDA	NPCHGMOD3	NC axis/PLC axis switchover 3rd axis in process
XBC3	XBCB	XBD3	XBDB	NPCHGMOD4	NC axis/PLC axis switchover 4th axis in process
XBC4	XBCC	XBD4	XBDC	NPCHGMOD5	NC axis/PLC axis switchover 5th axis in process
XBC5	XBCD	XBD5	XBDD	NPCHGMOD6	NC axis/PLC axis switchover 6th axis in process
XBC6	XBCE	XBD6	XBDE	NPCHGMOD7	NC axis/PLC axis switchover 7th axis in process
XBC7	XBCF	XBD7	XBDF	NPCHGMOD8	NC axis/PLC axis switchover 8th axis in process

Device No.				Abbrev.	Signal name
\$1	\$2	\$3	\$4		
XBE0	XBE8	XBF0	XBF8	GQEMGOn	Machine group-based alarm stop: Machine group-based PLC interlock ON Group "n" (n = 1 to 32)
XBE1	XBE9	XBF1	XBF9		
XBE2	XBEA	XBF2	XBFA		
XBE3	XBEB	XBF3	XBFB		
XBE4	XBEC	XBF4	XBFC		
XBE5	XBED	XBF5	XBFD		
XBE6	XBEE	XBF6	XBFE		
XBE7	XBEF	XBF7	XBFF		

(Note) The CNC control and CNC status signals are arbitrarily assigned to the device and axis numbers by the parameter "#1603 PLCdev_no" for each axis.

For details of setting, refer to the "PLC I/F axis random device assignment" in the "PLC Programming Manual".

2 Input/Output Signals with Controller

Device No.									
\$1	\$2	\$3	\$4	\$5	\$6	\$7	\$8	Abbrev.	Signal name
XC00	XD40	XE80	XFC0	X1100	X1240	X1380	X14C0	JO	In jog mode
XC01	XD41	XE81	XFC1	X1101	X1241	X1381	X14C1	HO	In handle mode
XC02	XD42	XE82	XFC2	X1102	X1242	X1382	X14C2	SO	In incremental mode
XC03	XD43	XE83	XFC3	X1103	X1243	X1383	X14C3	PTPO	In manual arbitrary feed mode
XC04	XD44	XE84	XFC4	X1104	X1244	X1384	X14C4	ZRNO	In reference position return mode
XC05	XD45	XE85	XFC5	X1105	X1245	X1385	X14C5	ASTO	In automatic initial set mode
XC06	XD46	XE86	XFC6	X1106	X1246	X1386	X14C6		In JOG-handle simultaneous mode
XC07	XD47	XE87	XFC7	X1107	X1247	X1387	X14C7		
Device No.									
\$1	\$2	\$3	\$4	\$5	\$6	\$7	\$8	Abbrev.	Signal name
XC08	XD48	XE88	XFC8	X1108	X1248	X1388	X14C8	MEMO	In memory mode
XC09	XD49	XE89	XFC9	X1109	X1249	X1389	X14C9	TO	In tape mode
XC0A	XD4A	XE8A	XFCA	X110A	X124A	X138A	X14CA		In online operation mode
XC0B	XD4B	XE8B	XFCB	X110B	X124B	X138B	X14CB	DO	In MDI mode
XC0C	XD4C	XE8C	XFCC	X110C	X124C	X138C	X14CC		
XC0D	XD4D	XE8D	XFCD	X110D	X124D	X138D	X14CD		
XC0E	XD4E	XE8E	XFCE	X110E	X124E	X138E	X14CE	SBSMO	Sub part system control: Sub part system control I mode ON
XC0F	XD4F	XE8F	XFCF	X110F	X124F	X138F	X14CF		
Device No.									
\$1	\$2	\$3	\$4	\$5	\$6	\$7	\$8	Abbrev.	Signal name
XC10	XD50	XE90	XFD0	X1110	X1250	X1390	X14D0	MA	Controller ready completion
XC11	XD51	XE91	XFD1	X1111	X1251	X1391	X14D1	SA	Servo ready completion
XC12	XD52	XE92	XFD2	X1112	X1252	X1392	X14D2	OP	In automatic operation "run"
XC13	XD53	XE93	XFD3	X1113	X1253	X1393	X14D3	STL	In automatic operation "start"
XC14	XD54	XE94	XFD4	X1114	X1254	X1394	X14D4	SPL	In automatic operation "pause"
XC15	XD55	XE95	XFD5	X1115	X1255	X1395	X14D5	RST	In "reset"
XC16	XD56	XE96	XFD6	X1116	X1256	X1396	X14D6	CXN	In manual arbitrary feed
XC17	XD57	XE97	XFD7	X1117	X1257	X1397	X14D7	RWD	In rewind
Device No.									
\$1	\$2	\$3	\$4	\$5	\$6	\$7	\$8	Abbrev.	Signal name
XC18	XD58	XE98	XFD8	X1118	X1258	X1398	X14D8	DEN	Motion command completion
XC19	XD59	XE99	XFD9	X1119	X1259	X1399	X14D9	TIMP	All axes in-position
XC1A	XD5A	XE9A	XFDA	X111A	X125A	X139A	X14DA	TSMZ	All axes smoothing zero
XC1B	XD5B	XE9B	XFDB	X111B	X125B	X139B	X14DB		
XC1C	XD5C	XE9C	XFDC	X111C	X125C	X139C	X14DC	CXFIN	Manual arbitrary feed completion
XC1D	XD5D	XE9D	XFDD	X111D	X125D	X139D	X14DD		External search finished
XC1E	XD5E	XE9E	XFDE	X111E	X125E	X139E	X14DE		
XC1F	XD5F	XE9F	XFD F	X111F	X125F	X139F	X14DF		In high-speed machining mode (G05)
Device No.									
\$1	\$2	\$3	\$4	\$5	\$6	\$7	\$8	Abbrev.	Signal name
XC20	XD60	XEA0	XFE0	X1120	X1260	X13A0	X14E0	RPN	In rapid traverse
XC21	XD61	XEA1	XFE1	X1121	X1261	X13A1	X14E1	CUT	In cutting feed
XC22	XD62	XEA2	XFE2	X1122	X1262	X13A2	X14E2	TAP	In tapping
XC23	XD63	XEA3	XFE3	X1123	X1263	X13A3	X14E3	THRD	In thread cutting
XC24	XD64	XEA4	XFE4	X1124	X1264	X13A4	X14E4	SYN	In synchronous feed
XC25	XD65	XEA5	XFE5	X1125	X1265	X13A5	X14E5	CSS	In constant surface speed
XC26	XD66	XEA6	XFE6	X1126	X1266	X13A6	X14E6	SKIP	In skip
XC27	XD67	XEA7	XFE7	X1127	X1267	X13A7	X14E7	ZRNN	In reference position return

2 Input/Output Signals with Controller

Device No.									
\$1	\$2	\$3	\$4	\$5	\$6	\$7	\$8	Abbrev.	Signal name
XC28	XD68	XEA8	XFE8	X1128	X1268	X13A8	X14E8	INCH	In inch unit selection
XC29	XD69	XEA9	XFE9	X1129	X1269	X13A9	X14E9	DLKN	In display lock
XC2A	XD6A	XEAA	XFEA	X112A	X126A	X13AA	X14EA	F1DN	F 1-digit commanded
XC2B	XD6B	XEAB	XFEB	X112B	X126B	X13AB	X14EB	TLFO	In tool life management
XC2C	XD6C	XEAC	XFEC	X112C	X126C	X13AC	X14EC		Tool life management: Temporary cancel of tool life expiration ON
XC2D	XD6D	XEAD	XFED	X112D	X126D	X13AD	X14ED		Tool life management: Temporary cancel of tool group life expiration ON
XC2E	XD6E	XEAE	XFEE	X112E	X126E	X13AE	X14EE	TLOV	Tool life over
XC2F	XD6F	XEAF	XFEF	X112F	X126F	X13AF	X14EF		Tool group life over

Device No.									
\$1	\$2	\$3	\$4	\$5	\$6	\$7	\$8	Abbrev.	Signal name
XC30	XD70	XEB0	XFF0	X1130	X1270	X13B0	X14F0	F11	F1-digit No. code 1
XC31	XD71	XEB1	XFF1	X1131	X1271	X13B1	X14F1	F12	F1-digit No. code 2
XC32	XD72	XEB2	XFF2	X1132	X1272	X13B2	X14F2	F14	F1-digit No. code 4
XC33	XD73	XEB3	XFF3	X1133	X1273	X13B3	X14F3	F18	F1-digit No. code 8
XC34	XD74	XEB4	XFF4	X1134	X1274	X13B4	X14F4		Timing synchronization between part systems
XC35	XD75	XEB5	XFF5	X1135	X1275	X13B5	X14F5	PCINO	In PLC interrupt
XC36	XD76	XEB6	XFF6	X1136	X1276	X13B6	X14F6		
XC37	XD77	XEB7	XFF7	X1137	X1277	X13B7	X14F7	ASLE	Illegal axis selected

Device No.									
\$1	\$2	\$3	\$4	\$5	\$6	\$7	\$8	Abbrev.	Signal name
XC40	XD80	XEC0	X1000	X1140	X1280	X13C0	X1500	DM00	M code independent output M00
XC41	XD81	XEC1	X1001	X1141	X1281	X13C1	X1501	DM01	M code independent output M01
XC42	XD82	XEC2	X1002	X1142	X1282	X13C2	X1502	DM02	M code independent output M02
XC43	XD83	XEC3	X1003	X1143	X1283	X13C3	X1503	DM30	M code independent output M30
XC44	XD84	XEC4	X1004	X1144	X1284	X13C4	X1504		
XC45	XD85	XEC5	X1005	X1145	X1285	X13C5	X1505		
XC46	XD86	XEC6	X1006	X1146	X1286	X13C6	X1506		
XC47	XD87	XEC7	X1007	X1147	X1287	X13C7	X1507		

Device No.									
\$1	\$2	\$3	\$4	\$5	\$6	\$7	\$8	Abbrev.	Signal name
XC48	XD88	XEC8	X1008	X1148	X1288	X13C8	X1508		In manual speed command valid
XC49	XD89	XEC9	X1009	X1149	X1289	X13C9	X1509	MMS	Manual numerical command
XC4A	XD8A	XECA	X100A	X114A	X128A	X13CA	X150A		In tool escape and return mode [M8]
XC4B	XD8B	XECB	X100B	X114B	X128B	X13CB	X150B		
XC4C	XD8C	XECC	X100C	X114C	X128C	X13CC	X150C		
XC4D	XD8D	XECD	X100D	X114D	X128D	X13CD	X150D		
XC4E	XD8E	XECE	X100E	X114E	X128E	X13CE	X150E	SBS	Sub part system control: Sub part system processing
XC4F	XD8F	XECF	X100F	X114F	X128F	X13CF	X150F		In circular feed in manual mode [M8]

Device No.									
\$1	\$2	\$3	\$4	\$5	\$6	\$7	\$8	Abbrev.	Signal name
XC50	XD90	XED0	X1010	X1150	X1290	X13D0	X1510		
XC51	XD91	XED1	X1011	X1151	X1291	X13D1	X1511		
XC52	XD92	XED2	X1012	X1152	X1292	X13D2	X1512		
XC53	XD93	XED3	X1013	X1153	X1293	X13D3	X1513	TRTN2	In tool retract and return 2 mode ▲
XC54	XD94	XED4	X1014	X1154	X1294	X13D4	X1514		
XC55	XD95	XED5	X1015	X1155	X1295	X13D5	X1515		
XC56	XD96	XED6	X1016	X1156	X1296	X13D6	X1516		
XC57	XD97	XED7	X1017	X1157	X1297	X13D7	X1517		

2 Input/Output Signals with Controller

Device No.									
\$1	\$2	\$3	\$4	\$5	\$6	\$7	\$8	Abbrev.	Signal name
XC58	XD98	XED8	X1018	X1158	X1298	X13D8	X1518		
XC59	XD99	XED9	X1019	X1159	X1299	X13D9	X1519		
XC5A	XD9A	XEDA	X101A	X115A	X129A	X13DA	X151A		
XC5B	XD9B	XEDB	X101B	X115B	X129B	X13DB	X151B		
XC5C	XD9C	XEDC	X101C	X115C	X129C	X13DC	X151C		
XC5D	XD9D	XEDD	X101D	X115D	X129D	X13DD	X151D		
XC5E	XD9E	XEDE	X101E	X115E	X129E	X13DE	X151E		
XC5F	XD9F	XEDF	X101F	X115F	X129F	X13DF	X151F		Coordinate rotation by parameter: Manual feed coordinate system [M8]
Device No.									
\$1	\$2	\$3	\$4	\$5	\$6	\$7	\$8	Abbrev.	Signal name
XC60	XDA0	XEE0	X1020	X1160	X12A0	X13E0	X1520	MF1	M function strobe 1
XC61	XDA1	XEE1	X1021	X1161	X12A1	X13E1	X1521	MF2	M function strobe 2
XC62	XDA2	XEE2	X1022	X1162	X12A2	X13E2	X1522	MF3	M function strobe 3
XC63	XDA3	XEE3	X1023	X1163	X12A3	X13E3	X1523	MF4	M function strobe 4
XC64	XDA4	XEE4	X1024	X1164	X12A4	X13E4	X1524	SF1	S function strobe 1
XC65	XDA5	XEE5	X1025	X1165	X12A5	X13E5	X1525	SF2	S function strobe 2
XC66	XDA6	XEE6	X1026	X1166	X12A6	X13E6	X1526	SF3	S function strobe 3
XC67	XDA7	XEE7	X1027	X1167	X12A7	X13E7	X1527	SF4	S function strobe 4
Device No.									
\$1	\$2	\$3	\$4	\$5	\$6	\$7	\$8	Abbrev.	Signal name
XC68	XDA8	XEE8	X1028	X1168	X12A8	X13E8	X1528	TF1	T function strobe 1
XC69	XDA9	XEE9	X1029	X1169	X12A9	X13E9	X1529	TF2	T function strobe 2
XC6A	XDAA	XEEA	X102A	X116A	X12AA	X13EA	X152A	TF3	T function strobe 3
XC6B	XDAB	XEEB	X102B	X116B	X12AB	X13EB	X152B	TF4	T function strobe 4
XC6C	XDAC	XEEC	X102C	X116C	X12AC	X13EC	X152C	BF1	2nd M function strobe 1
XC6D	XDAD	XEED	X102D	X116D	X12AD	X13ED	X152D	BF2	2nd M function strobe 2
XC6E	XDAE	XEEE	X102E	X116E	X12AE	X13EE	X152E	BF3	2nd M function strobe 3
XC6F	XDAF	XEEF	X102F	X116F	X12AF	X13EF	X152F	BF4	2nd M function strobe 4
Device No.									
\$1	\$2	\$3	\$4	\$5	\$6	\$7	\$8	Abbrev.	Signal name
XC70	XDB0	XEF0	X1030	X1170	X12B0	X13F0	X1530	SF5	S function strobe 5
XC71	XDB1	XEF1	X1031	X1171	X12B1	X13F1	X1531	SF6	S function strobe 6
XC72	XDB2	XEF2	X1032	X1172	X12B2	X13F2	X1532	SF7	S function strobe 7
XC73	XDB3	XEF3	X1033	X1173	X12B3	X13F3	X1533	SF8	S function strobe 8
XC74	XDB4	XEF4	X1034	X1174	X12B4	X13F4	X1534		
XC75	XDB5	XEF5	X1035	X1175	X12B5	X13F5	X1535		
XC76	XDB6	XEF6	X1036	X1176	X12B6	X13F6	X1536	MF5	M function strobe 5 [C80]
XC77	XDB7	XEF7	X1037	X1177	X12B7	X13F7	X1537	MF6	M function strobe 6 [C80]
Device No.									
\$1	\$2	\$3	\$4	\$5	\$6	\$7	\$8	Abbrev.	Signal name
XC78	XDB8	XEF8	X1038	X1178	X12B8	X13F8	X1538		
XC79	XDB9	XEF9	X1039	X1179	X12B9	X13F9	X1539		
XC7A	XDBA	XEFA	X103A	X117A	X12BA	X13FA	X153A		
XC7B	XDBB	XEFB	X103B	X117B	X12BB	X13FB	X153B		
XC7C	XDBC	XEFC	X103C	X117C	X12BC	X13FC	X153C		
XC7D	XDBD	XEFD	X103D	X117D	X12BD	X13FD	X153D		
XC7E	XDBE	XEFE	X103E	X117E	X12BE	X13FE	X153E		
XC7F	XDBF	XEFF	X103F	X117F	X12BF	X13FF	X153F	CHPRCC	Chopping compensation update prevented

2 Input/Output Signals with Controller

Device No.									
\$1	\$2	\$3	\$4	\$5	\$6	\$7	\$8	Abbrev.	Signal name
XC80	XDC0	XF00	X1040	X1180	X12C0	X1400	X1540	CHOP	In chopping start
XC81	XDC1	XF01	X1041	X1181	X12C1	X1401	X1541	CHP1	Basic position -> upper dead point path flag
XC82	XDC2	XF02	X1042	X1182	X12C2	X1402	X1542	CHP2	Upper dead point -> bottom dead point path flag
XC83	XDC3	XF03	X1043	X1183	X12C3	X1403	X1543	CHP3	Bottom dead point -> upper dead point path flag
XC84	XDC4	XF04	X1044	X1184	X12C4	X1404	X1544	CHP4	Upper dead point -> basic position path flag
XC85	XDC5	XF05	X1045	X1185	X12C5	X1405	X1545	CHPMD	In chopping mode
XC86	XDC6	XF06	X1046	X1186	X12C6	X1406	X1546		Stroke compensation completion
XC87	XDC7	XF07	X1047	X1187	X12C7	X1407	X1547		Tool escape and return transit point recognition completed [M8]
Device No.									
\$1	\$2	\$3	\$4	\$5	\$6	\$7	\$8	Abbrev.	Signal name
XC88	XDC8	XF08	X1048	X1188	X12C8	X1408	X1548		
XC89	XDC9	XF09	X1049	X1189	X12C9	X1409	X1549		
XC8A	XDCA	XF0A	X104A	X118A	X12CA	X140A	X154A	SSE	Search & start Error
XC8B	XDCB	XF0B	X104B	X118B	X12CB	X140B	X154B	SSG	Search & start Search
XC8C	XDCC	XF0C	X104C	X118C	X12CC	X140C	X154C		
XC8D	XDCD	XF0D	X104D	X118D	X12CD	X140D	X154D		
XC8E	XDCE	XF0E	X104E	X118E	X12CE	X140E	X154E	PTAPn	Punchtap cycle in progress [M8]
XC8F	XDCF	XF0F	X104F	X118F	X12CF	X140F	X154F		
Device No.									
\$1	\$2	\$3	\$4	\$5	\$6	\$7	\$8	Abbrev.	Signal name
XC90	XDD0	XF10	X1050	X1190	X12D0	X1410	X1550		
XC91	XDD1	XF11	X1051	X1191	X12D1	X1411	X1551		
XC92	XDD2	XF12	X1052	X1192	X12D2	X1412	X1552		
XC93	XDD3	XF13	X1053	X1193	X12D3	X1413	X1553	TCP	Tool change position return completion
XC94	XDD4	XF14	X1054	X1194	X12D4	X1414	X1554	TCRQ	New tool change
XC95	XDD5	XF15	X1055	X1195	X12D5	X1415	X1555		All spindles simultaneous control (G47.1)
XC96	XDD6	XF16	X1056	X1196	X12D6	X1416	X1556		Tool life prediction
XC97	XDD7	XF17	X1057	X1197	X12D7	X1417	X1557	DLWAIT	FTP waiting for download [C80]
Device No.									
\$1	\$2	\$3	\$4	\$5	\$6	\$7	\$8	Abbrev.	Signal name
XC98	XDD8	XF18	X1058	X1198	X12D8	X1418	X1558	AL1	NC alarm 1
XC99	XDD9	XF19	X1059	X1199	X12D9	X1419	X1559	AL2	NC alarm 2 (Servo alarm)
XC9A	XDDA	XF1A	X105A	X119A	X12DA	X141A	X155A	AL3	NC alarm 3 (Program error)
XC9B	Xddb	XF1B	X105B	X119B	X12DB	X141B	X155B	AL4	NC alarm 4 (Operation error)
XC9C	XDDC	XF1C	X105C	X119C	X12DC	X141C	X155C	WR1	NC warning (Servo warning)
XC9D	XDDD	XF1D	X105D	X119D	X12DD	X141D	X155D		
XC9E	XDDE	XF1E	X105E	X119E	X12DE	X141E	X155E		
XC9F	XDDF	XF1F	X105F	X119F	X12DF	X141F	X155F		

Device No.									
\$1	\$2	\$3	\$4	\$5	\$6	\$7	\$8	Abbrev.	Signal name
XCA0	XDE0	XF20	X1060	X11A0	X12E0	X1420	X1560		Load monitor I : Teaching/Monitor mode in execution ▲
XCA1	XDE1	XF21	X1061	X11A1	X12E1	X1421	X1561		Load monitor I : Teaching mode valid ▲
XCA2	XDE2	XF22	X1062	X11A2	X12E2	X1422	X1562		Load monitor I : Monitor mode valid ▲
XCA3	XDE3	XF23	X1063	X11A3	X12E3	X1423	X1563		Load monitor I : Adaptive control in execution ▲
XCA4	XDE4	XF24	X1064	X11A4	X12E4	X1424	X1564	FFCO	Thread cutting: Feed-forward control ON
XCA5	XDE5	XF25	X1065	X11A5	X12E5	X1425	X1565	TRVE	Tap retract possible
XCA6	XDE6	XF26	X1066	X11A6	X12E6	X1426	X1566	PCNT	No. of work machining over
XCA7	XDE7	XF27	X1067	X11A7	X12E7	X1427	X1567	ABSW	Absolute position warning
Device No.									
\$1	\$2	\$3	\$4	\$5	\$6	\$7	\$8	Abbrev.	Signal name
XCA8	XDE8	XF28	X1068	X11A8	X12E8	X1428	X1568		
XCA9	XDE9	XF29	X1069	X11A9	X12E9	X1429	X1569		In axis name switch
XCAA	XDEA	XF2A	X106A	X11AA	X12EA	X142A	X156A		Optimum acceleration/deceleration parameter switch completion [axis] ▲
XCAB	XDEB	XF2B	X106B	X11AB	X12EB	X142B	X156B	ESTSVIN	Optimum acceleration/deceleration selection : NC axis inertia estimation in progress ▲
XCAC	XDEC	XF2C	X106C	X11AC	X12EC	X142C	X156C	GETSVAF	Optimum acceleration/deceleration selection : NC axis estimated resonance frequency acquisition in progress ▲
XCAD	XDED	XF2D	X106D	X11AD	X12ED	X142D	X156D	VFTCIS	Variable feed thread cutting invalid state ▲
XCAE	XDEE	XF2E	X106E	X11AE	X12EE	X142E	X156E	HOBRTM	Hob machining: retracting
XCAF	XDEF	XF2F	X106F	X11AF	X12EF	X142F	X156F	HOBRTF	Hob machining: retract complete
Device No.									
\$1	\$2	\$3	\$4	\$5	\$6	\$7	\$8	Abbrev.	Signal name
XCB0	XDF0	XF30	X1070	X11B0	X12F0	X1430	X1570		In spindle-NC axis polygon mode
XCB1	XDF1	XF31	X1071	X11B1	X12F1	X1431	X1571	AL5	NC alarm 5
XCB2	XDF2	XF32	X1072	X11B2	X12F2	X1432	X1572		In spindle-spindle polygon mode
XCB3	XDF3	XF33	X1073	X11B3	X12F3	X1433	X1573		Spindle-spindle polygon synchronization completion
XCB4	XDF4	XF34	X1074	X11B4	X12F4	X1434	X1574		
XCB5	XDF5	XF35	X1075	X11B5	X12F5	X1435	X1575		
XCB6	XDF6	XF36	X1076	X11B6	X12F6	X1436	X1576		
XCB7	XDF7	XF37	X1077	X11B7	X12F7	X1437	X1577		
Device No.									
\$1	\$2	\$3	\$4	\$5	\$6	\$7	\$8	Abbrev.	Signal name
XCB8	XDF8	XF38	X1078	X11B8	X12F8	X1438	X1578		
XCB9	XDF9	XF39	X1079	X11B9	X12F9	X1439	X1579		In 3-dimensional coordinate conversion
XCBA	XDFA	XF3A	X107A	X11BA	X12FA	X143A	X157A		
XCBB	XDFB	XF3B	X107B	X11BB	X12FB	X143B	X157B		
XCBC	XDFC	XF3C	X107C	X11BC	X12FC	X143C	X157C		
XCBD	XDFD	XF3D	X107D	X11BD	X12FD	X143D	X157D		
XCBE	XDFE	XF3E	X107E	X11BE	X12FE	X143E	X157E		
XCBF	XDFE	XF3F	X107F	X11BF	X12FF	X143F	X157F		

2 Input/Output Signals with Controller

Device No.									
\$1	\$2	\$3	\$4	\$5	\$6	\$7	\$8	Abbrev.	Signal name
XCC0	XE00	XF40	X1080	X11C0	X1300	X1440	X1580	RTAP	In synchronized tapping selection (M command)
XCC1	XE01	XF41	X1081	X11C1	X1301	X1441	X1581		In small diameter deep hole cycle [M8]
XCC2	XE02	XF42	X1082	X11C2	X1302	X1442	X1582		High-speed retract function valid state ▲
XCC3	XE03	XF43	X1083	X11C3	X1303	X1443	X1583		In high-speed retract function operation ▲
XCC4	XE04	XF44	X1084	X11C4	X1304	X1444	X1584		
XCC5	XE05	XF45	X1085	X11C5	X1305	X1445	X1585		
XCC6	XE06	XF46	X1086	X11C6	X1306	X1446	X1586		
XCC7	XE07	XF47	X1087	X11C7	X1307	X1447	X1587		
Device No.									
\$1	\$2	\$3	\$4	\$5	\$6	\$7	\$8	Abbrev.	Signal name
XCC8	XE08	XF48	X1088	X11C8	X1308	X1448	X1588		In barrier valid (left)
XCC9	XE09	XF49	X1089	X11C9	X1309	X1449	X1589		In barrier valid (right)
XCCA	XE0A	XF4A	X108A	X11CA	X130A	X144A	X158A	TLMSEFIN	Tool length measurement completion ▲
XCCB	XE0B	XF4B	X108B	X11CB	X130B	X144B	X158B	TLMSEERR	Tool length measurement error ▲
XCCC	XE0C	XF4C	X108C	X11CC	X130C	X144C	X158C		
XCCD	XE0D	XF4D	X108D	X11CD	X130D	X144D	X158D		
XCCE	XE0E	XF4E	X108E	X11CE	X130E	X144E	X158E	TLMSESELO	Tool length measurement sub-side selected ▲
XCCF	XE0F	XF4F	X108F	X11CF	X130F	X144F	X158F		Tool retract position reached ▲
Device No.									
\$1	\$2	\$3	\$4	\$5	\$6	\$7	\$8	Abbrev.	Signal name
XCD0	XE10	XF50	X1090	X11D0	X1310	X1450	X1590	TRME	With tool retract amount command ▲
XCD1	XE11	XF51	X1091	X11D1	X1311	X1451	X1591	TRRP	In tool repositioning ▲
XCD2	XE12	XF52	X1092	X11D2	X1312	X1452	X1592		
XCD3	XE13	XF53	X1093	X11D3	X1313	X1453	X1593		
XCD4	XE14	XF54	X1094	X11D4	X1314	X1454	X1594		
XCD5	XE15	XF55	X1095	X11D5	X1315	X1455	X1595		
XCD6	XE16	XF56	X1096	X11D6	X1316	X1456	X1596		
XCD7	XE17	XF57	X1097	X11D7	X1317	X1457	X1597		
Device No.									
\$1	\$2	\$3	\$4	\$5	\$6	\$7	\$8	Abbrev.	Signal name
XCD8	XE18	XF58	X1098	X11D8	X1318	X1458	X1598		Door open enable
XCD9	XE19	XF59	X1099	X11D9	X1319	X1459	X1599		
XCDA	XE1A	XF5A	X109A	X11DA	X131A	X145A	X159A		
XCDB	XE1B	XF5B	X109B	X11DB	X131B	X145B	X159B		
XCDC	XE1C	XF5C	X109C	X11DC	X131C	X145C	X159C		
XCDD	XE1D	XF5D	X109D	X11DD	X131D	X145D	X159D		
XCDE	XE1E	XF5E	X109E	X11DE	X131E	X145E	X159E		
XCDF	XE1F	XF5F	X109F	X11DF	X131F	X145F	X159F		

Device No.									
\$1	\$2	\$3	\$4	\$5	\$6	\$7	\$8	Abbrev.	Signal name
XD10	XE50	XF90	X10D0	X1210	X1350	X1490	X15D0		
XD11	XE51	XF91	X10D1	X1211	X1351	X1491	X15D1		
XD12	XE52	XF92	X10D2	X1212	X1352	X1492	X15D2		
XD13	XE53	XF93	X10D3	X1213	X1353	X1493	X15D3		
XD14	XE54	XF94	X10D4	X1214	X1354	X1494	X15D4		3D coordinate conversion : Manual feed valid [M8]
XD15	XE55	XF95	X10D5	X1215	X1355	X1495	X15D5	RCEI	Rotation center error compensation in progress [M8]
XD16	XE56	XF96	X10D6	X1216	X1356	X1496	X15D6		
XD17	XE57	XF97	X10D7	X1217	X1357	X1497	X15D7	SECI	Spatial error compensation in progress [M8]
Device No.									
\$1	\$2	\$3	\$4	\$5	\$6	\$7	\$8	Abbrev.	Signal name
XD18	XE58	XF98	X10D8	X1218	X1358	X1498	X15D8	MJST	Tool axis coordinate system in 3D manual feed (JOG, INC)
XD19	XE59	XF99	X10D9	X1219	X1359	X1499	X15D9	MJSB	Table coordinate system in 3D manual feed (JOG, INC)
XD1A	XE5A	XF9A	X10DA	X121A	X135A	X149A	X15DA	MJSF	Feature coordinate system in 3D manual feed (JOG, INC)
XD1B	XE5B	XF9B	X10DB	X121B	X135B	X149B	X15DB	MH1ST	Tool axis coordinate system in 3D manual feed (1st handle)
XD1C	XE5C	XF9C	X10DC	X121C	X135C	X149C	X15DC	MH1SB	Table coordinate system in 3D manual feed (1st handle)
XD1D	XE5D	XF9D	X10DD	X121D	X135D	X149D	X15DD	MH1SF	Feature coordinate system in 3D manual feed (1st handle)
XD1E	XE5E	XF9E	X10DE	X121E	X135E	X149E	X15DE	MH2ST	Tool axis coordinate system in 3D manual feed (2nd handle)
XD1F	XE5F	XF9F	X10DF	X121F	X135F	X149F	X15DF	MH2SB	Table coordinate system in 3D manual feed (2nd handle)
Device No.									
\$1	\$2	\$3	\$4	\$5	\$6	\$7	\$8	Abbrev.	Signal name
XD20	XE60	XFA0	X10E0	X1220	X1360	X14A0	X15E0	MH2SF	Feature coordinate system in 3D manual feed (2nd handle)
XD21	XE61	XFA1	X10E1	X1221	X1361	X14A1	X15E1	MH3ST	Tool axis coordinate system in 3D manual feed (3rd handle)
XD22	XE62	XFA2	X10E2	X1222	X1362	X14A2	X15E2	MH3SB	Table coordinate system in 3D manual feed (3rd handle)
XD23	XE63	XFA3	X10E3	X1223	X1363	X14A3	X15E3	MH3SF	Feature coordinate system in 3D manual feed (3rd handle)
XD24	XE64	XFA4	X10E4	X1224	X1364	X14A4	X15E4		
XD25	XE65	XFA5	X10E5	X1225	X1365	X14A5	X15E5		
XD26	XE66	XFA6	X10E6	X1226	X1366	X14A6	X15E6		
XD27	XE67	XFA7	X10E7	X1227	X1367	X14A7	X15E7	TCPRS	In tool center point rotation
Device No.									
\$1	\$2	\$3	\$4	\$5	\$6	\$7	\$8	Abbrev.	Signal name
XD28	XE68	XFA8	X10E8	X1228	X1368	X14A8	X15E8	RSSCT	R-Navi: selecting machine surface [M8]
XD29	XE69	XFA9	X10E9	X1229	X1369	X14A9	X15E9	RSIND	R-Navi: machine surface indexing [M8]
XD2A	XE6A	XFAA	X10EA	X122A	X136A	X14AA	X15EA	RSIDF	R-Navi: machine surface index complete [M8]
XD2B	XE6B	XFAB	X10EB	X122B	X136B	X14AB	X15EB		
XD2C	XE6C	XFAC	X10EC	X122C	X136C	X14AC	X15EC		
XD2D	XE6D	XFAD	X10ED	X122D	X136D	X14AD	X15ED		
XD2E	XE6E	XFAE	X10EE	X122E	X136E	X14AE	X15EE		
XD2F	XE6F	XFAF	X10EF	X122F	X136F	X14AF	X15EF	SLOP	Simple inclined surface machining/Inclined surface control command ON [M8]

2 Input/Output Signals with Controller

Device No.								Abbrev.	Signal name
\$1	\$2	\$3	\$4	\$5	\$6	\$7	\$8		
XD30	XE70	XFB0	X10F0	X1230	X1370	X14B0	X15F0		MES interface library: Sending user arbitrary information [M8]
XD31	XE71	XFB1	X10F1	X1231	X1371	X14B1	X15F1		Manual arbitrary reverse run: Reverse run invalid status [M8]
XD32	XE72	XFB2	X10F2	X1232	X1372	X14B2	X15F2		
XD33	XE73	XFB3	X10F3	X1233	X1373	X14B3	X15F3		
XD34	XE74	XFB4	X10F4	X1234	X1374	X14B4	X15F4		
XD35	XE75	XFB5	X10F5	X1235	X1375	X14B5	X15F5		
XD36	XE76	XFB6	X10F6	X1236	X1376	X14B6	X15F6		
XD37	XE77	XFB7	X10F7	X1237	X1377	X14B7	X15F7		

Device No.								Abbrev.	Signal name
\$1	\$2	\$3	\$4	\$5	\$6	\$7	\$8		
X1810	X1811	X1812	X1813	X1814	X1815	X1816	X1817	VCC	VCC: Mode in execution

Device	Abbrev.	Signal name	Device	Abbrev.	Signal name
X1870			X1878		Edit/search window displayed
X1871			X1879		
X1872			X187A		
X1873			X187B		
X1874			X187C		
X1875			X187D		
X1876			X187E		
X1877			X187F		

Device No.								Abbrev	Signal name
1stSP	2ndSP	3rdSP	4thSP	5thSP	6thSP	7thSP	8thSP		
X1880	X18E0	X1940	X19A0	X1A00	X1A60	X1AC0	X1B20		
X1881	X18E1	X1941	X19A1	X1A01	X1A61	X1AC1	X1B21		
X1882	X18E2	X1942	X19A2	X1A02	X1A62	X1AC2	X1B22	SIGE	S command gear No. illegal
X1883	X18E3	X1943	X19A3	X1A03	X1A63	X1AC3	X1B23	SOVE	S command max./min. command value over
X1884	X18E4	X1944	X19A4	X1A04	X1A64	X1AC4	X1B24	SNGE	S command no gear selected
X1885	X18E5	X1945	X19A5	X1A05	X1A65	X1AC5	X1B25	GR1	Spindle gear shift command 1
X1886	X18E6	X1946	X19A6	X1A06	X1A66	X1AC6	X1B26	GR2	Spindle gear shift command 2
X1887	X18E7	X1947	X19A7	X1A07	X1A67	X1AC7	X1B27	-	(Always "0")

Device No.								Abbrev	Signal name
1stSP	2ndSP	3rdSP	4thSP	5thSP	6thSP	7thSP	8thSP		
X1888	X18E8	X1948	X19A8	X1A08	X1A68	X1AC8	X1B28	ORAO2	Spindle 2nd in-position
X1889	X18E9	X1949	X19A9	X1A09	X1A69	X1AC9	X1B29	CDO	Current detection
X188A	X18EA	X194A	X19AA	X1A0A	X1A6A	X1ACA	X1B2A	VRO	Speed detection
X188B	X18EB	X194B	X19AB	X1A0B	X1A6B	X1ACB	X1B2B	FLO	In spindle alarm
X188C	X18EC	X194C	X19AC	X1A0C	X1A6C	X1ACC	X1B2C	ZSO	Zero speed
X188D	X18ED	X194D	X19AD	X1A0D	X1A6D	X1ACD	X1B2D	USO	Spindle up-to-speed
X188E	X18EE	X194E	X19AE	X1A0E	X1A6E	X1ACE	X1B2E	ORAO	Spindle in-position
X188F	X18EF	X194F	X19AF	X1A0F	X1A6F	X1ACF	X1B2F	LCSA	In L coil selection

2 Input/Output Signals with Controller

Device No.									
1stSP	2ndSP	3rdSP	4thSP	5thSP	6thSP	7thSP	8thSP	Abbrev	Signal name
X1890	X18F0	X1950	X19B0	X1A10	X1A70	X1AD0	X1B30	SMA	Spindle ready-ON
X1891	X18F1	X1951	X19B1	X1A11	X1A71	X1AD1	X1B31	SSA	Spindle servo-ON
X1892	X18F2	X1952	X19B2	X1A12	X1A72	X1AD2	X1B32	SEMG	In spindle emergency stop
X1893	X18F3	X1953	X19B3	X1A13	X1A73	X1AD3	X1B33	SSRN	In spindle forward run
X1894	X18F4	X1954	X19B4	X1A14	X1A74	X1AD4	X1B34	SSRI	In spindle reverse run
X1895	X18F5	X1955	X19B5	X1A15	X1A75	X1AD5	X1B35		Z phase passed
X1896	X18F6	X1956	X19B6	X1A16	X1A76	X1AD6	X1B36	SIMP	Position loop in-position
X1897	X18F7	X1957	X19B7	X1A17	X1A77	X1AD7	X1B37	STLQ	In spindle torque limit

Device No.									
1stSP	2ndSP	3rdSP	4thSP	5thSP	6thSP	7thSP	8thSP	Abbrev	Signal name
X1898	X18F8	X1958	X19B8	X1A18	X1A78	X1AD8	X1B38		
X1899	X18F9	X1959	X19B9	X1A19	X1A79	X1AD9	X1B39		
X189A	X18FA	X195A	X19BA	X1A1A	X1A7A	X1ADA	X1B3A		Spindle torque limit reached
X189B	X18FB	X195B	X19BB	X1A1B	X1A7B	X1ADB	X1B3B		
X189C	X18FC	X195C	X19BC	X1A1C	X1A7C	X1ADC	X1B3C		
X189D	X18FD	X195D	X19BD	X1A1D	X1A7D	X1ADD	X1B3D	SD2	Speed detection 2
X189E	X18FE	X195E	X19BE	X1A1E	X1A7E	X1ADE	X1B3E	MCSA	In M coil selection
X189F	X18FF	X195F	X19BF	X1A1F	X1A7F	X1ADF	X1B3F		Index positioning completion

Device No.									
1stSP	2ndSP	3rdSP	4thSP	5thSP	6thSP	7thSP	8thSP	Abbrev	Signal name
X18A0	X1900	X1960	X19C0	X1A20	X1A80	X1AE0	X1B40	ENB	Spindle enable
X18A1	X1901	X1961	X19C1	X1A21	X1A81	X1AE1	X1B41	LRUC	In changeover to L coil [C80]
X18A2	X1902	X1962	X19C2	X1A22	X1A82	X1AE2	X1B42	HRUC	In changeover to H coil [C80]
X18A3	X1903	X1963	X19C3	X1A23	X1A83	X1AE3	X1B43		
X18A4	X1904	X1964	X19C4	X1A24	X1A84	X1AE4	X1B44	CSTOV	Spindle control: Coil changeover time-out [C80]
X18A5	X1905	X1965	X19C5	X1A25	X1A85	X1AE5	X1B45		
X18A6	X1906	X1966	X19C6	X1A26	X1A86	X1AE6	X1B46		
X18A7	X1907	X1967	X19C7	X1A27	X1A87	X1AE7	X1B47		Spindle synchronization speed detect ▲

Device No.									
1stSP	2ndSP	3rdSP	4thSP	5thSP	6thSP	7thSP	8thSP	Abbrev	Signal name
X18A8	X1908	X1968	X19C8	X1A28	X1A88	X1AE8	X1B48	SPSYN 1	In spindle synchronization
X18A9	X1909	X1969	X19C9	X1A29	X1A89	X1AE9	X1B49	FSPRV	Spindle rotation speed synchronization completion
X18AA	X190A	X196A	X19CA	X1A2A	X1A8A	X1AEA	X1B4A	FSPPH	Spindle phase synchronization completion
X18AB	X190B	X196B	X19CB	X1A2B	X1A8B	X1AEB	X1B4B	SPSYN 2	In spindle synchronization 2
X18AC	X190C	X196C	X19CC	X1A2C	X1A8C	X1AEC	X1B4C	SPCMP	Chuck close confirmation
X18AD	X190D	X196D	X19CD	X1A2D	X1A8D	X1AED	X1B4D	TSS1	Tool spindle synchronization I (Polygon)
X18AE	X190E	X196E	X19CE	X1A2E	X1A8E	X1AEE	X1B4E	SPSYN 3	In tool spindle synchronization II
X18AF	X190F	X196F	X19CF	X1A2F	X1A8F	X1AEF	X1B4F	SPNCH	Spindle superimposition control: Speed change disabled

2 Input/Output Signals with Controller

Device No.								Abbrev	Signal name
1stSP	2ndSP	3rdSP	4thSP	5thSP	6thSP	7thSP	8thSP		
X18B0	X1910	X1970	X19D0	X1A30	X1A90	X1AF0	X1B50	SPPHO V	Spindle synchronization phase error over
X18B1	X1911	X1971	X19D1	X1A31	X1A91	X1AF1	X1B51	SPILE	Spindle superimposition control ON
X18B2	X1912	X1972	X19D2	X1A32	X1A92	X1AF2	X1B52	SPLCR	Spindle superimposition control: Spindle superimposition clamped
X18B3	X1913	X1973	X19D3	X1A33	X1A93	X1AF3	X1B53	PHOVR	Hob axis delay excess
X18B4	X1914	X1974	X19D4	X1A34	X1A94	X1AF4	X1B54		
X18B5	X1915	X1975	X19D5	X1A35	X1A95	X1AF5	X1B55	EXOFN	Holding power of spindle increased
X18B6	X1916	X1976	X19D6	X1A36	X1A96	X1AF6	X1B56	SPOFF A	In spindle off
X18B7	X1917	X1977	X19D7	X1A37	X1A97	X1AF7	X1B57	SSRD	Spindle speed fluctuation detection: Spindle speed out of setting range [M8]

Device No.								Abbrev	Signal name
1stSP	2ndSP	3rdSP	4thSP	5thSP	6thSP	7thSP	8thSP		
X18C0	X1920	X1980	X19E0	X1A40	X1AA0	X1B00	X1B60		
X18C1	X1921	X1981	X19E1	X1A41	X1AA1	X1B01	X1B61	SVMD	Spindle position control (Spindle/C axis control): C axis mode ON
X18C2	X1922	X1982	X19E2	X1A42	X1AA2	X1B02	X1B62	GO1	Spindle gear selection output 1
X18C3	X1923	X1983	X19E3	X1A43	X1AA3	X1B03	X1B63	GO2	Spindle gear selection output 2
X18C4	X1924	X1984	X19E4	X1A44	X1AA4	X1B04	X1B64		
X18C5	X1925	X1985	X19E5	X1A45	X1AA5	X1B05	X1B65		
X18C6	X1926	X1986	X19E6	X1A46	X1AA6	X1B06	X1B66		
X18C7	X1927	X1987	X19E7	X1A47	X1AA7	X1B07	X1B67		

Device No.								Abbrev	Signal name
1stSP	2ndSP	3rdSP	4thSP	5thSP	6thSP	7thSP	8thSP		
X18C8	X1928	X1988	X19E8	X1A48	X1AA8	X1B08	X1B68		Spindle oscillation in progress [M8]
X18C9	X1929	X1989	X19E9	X1A49	X1AA9	X1B09	X1B69	SPRTCT	Spindle protection: Mode in progress [M8]
X18CA	X192A	X198A	X19EA	X1A4A	X1AAA	X1B0A	X1B6A	VGHLD	Real-time tuning 1: Speed control gain changeover hold-down ON [M8]
X18CB	X192B	X198B	X19EB	X1A4B	X1AAB	X1B0B	X1B6B		
X18CC	X192C	X198C	X19EC	X1A4C	X1AAC	X1B0C	X1B6C		
X18CD	X192D	X198D	X19ED	X1A4D	X1AAD	X1B0D	X1B6D		
X18CE	X192E	X198E	X19EE	X1A4E	X1AAE	X1B0E	X1B6E		
X18CF	X192F	X198F	X19EF	X1A4F	X1AAF	X1B0F	X1B6F		

Device	Abbrev.	Signal name	Device	Abbrev.	Signal name
X1CD0		Handy terminal key 1 [M8]	X1CD8		Handy terminal key 9 [M8]
X1CD1		Handy terminal key 2 [M8]	X1CD9		Handy terminal key 10 [M8]
X1CD2		Handy terminal key 3 [M8]	X1CDA		Handy terminal key 11 [M8]
X1CD3		Handy terminal key 4 [M8]	X1CDB		Handy terminal key 12 [M8]
X1CD4		Handy terminal key 5 [M8]	X1CDC		Handy terminal key 13 [M8]
X1CD5		Handy terminal key 6 [M8]	X1CDD		Handy terminal key 14 [M8]
X1CD6		Handy terminal key 7 [M8]	X1CDE		Handy terminal key 15 [M8]
X1CD7		Handy terminal key 8 [M8]	X1CDF		Handy terminal key 16 [M8]

2 Input/Output Signals with Controller

Device	Abbrev.	Signal name	Device	Abbrev.	Signal name
X1CE0		Handy terminal key 17 [M8]	X1CE8		Handy terminal key 25 [M8]
X1CE1		Handy terminal key 18 [M8]	X1CE9		Handy terminal key 26 [M8]
X1CE2		Handy terminal key 19 [M8]	X1CEA		Handy terminal key 27 [M8]
X1CE3		Handy terminal key 20 [M8]	X1CEB		Handy terminal key 28 [M8]
X1CE4		Handy terminal key 21 [M8]	X1CEC		Handy terminal key 29 [M8]
X1CE5		Handy terminal key 22 [M8]	X1CED		Handy terminal key 30 [M8]
X1CE6		Handy terminal key 23 [M8]	X1CEE		Handy terminal key 31 [M8]
X1CE7		Handy terminal key 24 [M8]	X1CEF		Handy terminal key 32 [M8]

Device	Abbrev.	Signal name	Device	Abbrev.	Signal name
X1CF0		Handy terminal key 33 [M8]	X1CF8		Handy terminal key 41 [M8]
X1CF1		Handy terminal key 34 [M8]	X1CF9		Handy terminal key 42 [M8]
X1CF2		Handy terminal key 35 [M8]	X1CFA		Handy terminal key 43 [M8]
X1CF3		Handy terminal key 36 [M8]	X1CFB		Handy terminal key 44 [M8]
X1CF4		Handy terminal key 37 [M8]	X1CFC		Handy terminal key 45 [M8]
X1CF5		Handy terminal key 38 [M8]	X1CFD		
X1CF6		Handy terminal key 39 [M8]	X1CFE		
X1CF7		Handy terminal key 40 [M8]	X1CFF		

Device No.								Abbrev.	Signal name
\$1	\$2	\$3	\$4	\$5	\$6	\$7	\$8		
X1D00	X1D20	X1D40	X1D60	X1D80	X1DA0	X1DC0	X1DE0	PSW1	Position switch 1
X1D01	X1D21	X1D41	X1D61	X1D81	X1DA1	X1DC1	X1DE1	PSW2	Position switch 2
X1D02	X1D22	X1D42	X1D62	X1D82	X1DA2	X1DC2	X1DE2	PSW3	Position switch 3
X1D03	X1D23	X1D43	X1D63	X1D83	X1DA3	X1DC3	X1DE3	PSW4	Position switch 4
X1D04	X1D24	X1D44	X1D64	X1D84	X1DA4	X1DC4	X1DE4	PSW5	Position switch 5
X1D05	X1D25	X1D45	X1D65	X1D85	X1DA5	X1DC5	X1DE5	PSW6	Position switch 6
X1D06	X1D26	X1D46	X1D66	X1D86	X1DA6	X1DC6	X1DE6	PSW7	Position switch 7
X1D07	X1D27	X1D47	X1D67	X1D87	X1DA7	X1DC7	X1DE7	PSW8	Position switch 8

Device No.								Abbrev.	Signal name
\$1	\$2	\$3	\$4	\$5	\$6	\$7	\$8		
X1D08	X1D28	X1D48	X1D68	X1D88	X1DA8	X1DC8	X1DE8	PSW9	Position switch 9
X1D09	X1D29	X1D49	X1D69	X1D89	X1DA9	X1DC9	X1DE9	PSW10	Position switch 10
X1D0A	X1D2A	X1D4A	X1D6A	X1D8A	X1DAA	X1DCA	X1DEA	PSW11	Position switch 11
X1D0B	X1D2B	X1D4B	X1D6B	X1D8B	X1DAB	X1DCB	X1DEB	PSW12	Position switch 12
X1D0C	X1D2C	X1D4C	X1D6C	X1D8C	X1DAC	X1DCC	X1DEC	PSW13	Position switch 13
X1D0D	X1D2D	X1D4D	X1D6D	X1D8D	X1DAD	X1DCD	X1DED	PSW14	Position switch 14
X1D0E	X1D2E	X1D4E	X1D6E	X1D8E	X1DAE	X1DCE	X1DEE	PSW15	Position switch 15
X1D0F	X1D2F	X1D4F	X1D6F	X1D8F	X1DAF	X1DCF	X1DEF	PSW16	Position switch 16

Device No.								Abbrev.	Signal name
\$1	\$2	\$3	\$4	\$5	\$6	\$7	\$8		
X1D10	X1D30	X1D50	X1D70	X1D90	X1DB0	X1DD0	X1DF0	PSW17	Position switch 17
X1D11	X1D31	X1D51	X1D71	X1D91	X1DB1	X1DD1	X1DF1	PSW18	Position switch 18
X1D12	X1D32	X1D52	X1D72	X1D92	X1DB2	X1DD2	X1DF2	PSW19	Position switch 19
X1D13	X1D33	X1D53	X1D73	X1D93	X1DB3	X1DD3	X1DF3	PSW20	Position switch 20
X1D14	X1D34	X1D54	X1D74	X1D94	X1DB4	X1DD4	X1DF4	PSW21	Position switch 21
X1D15	X1D35	X1D55	X1D75	X1D95	X1DB5	X1DD5	X1DF5	PSW22	Position switch 22
X1D16	X1D36	X1D56	X1D76	X1D96	X1DB6	X1DD6	X1DF6	PSW23	Position switch 23
X1D17	X1D37	X1D57	X1D77	X1D97	X1DB7	X1DD7	X1DF7	PSW24	Position switch 24

2.2 PLC Input Signals (Data type: R^{***})

(Note) Signal with "▲" is prepared for a specific machine tool builder.

Device	Abbrev.	Signal name	Device	Abbrev.	Signal name
R0	AI1	Analog input 1	R8		KEY IN 1
R1	AI2	Analog input 2	R9		
R2	AI3	Analog input 3	R10		
R3	AI4	Analog input 4	R11		Clock data Year/Month
R4	AI5	Analog input 5	R12		Clock data Date/Hour
R5	AI6	Analog input 6	R13		Clock data Minute/Second
R6	AI7	Analog input 7	R14		
R7	AI8	Analog input 8	R15		
Device	Abbrev.	Signal name	Device	Abbrev.	Signal name
R16		CNC software version code A	R24		
R17		CNC software version code B	R25		PC high-speed process time
R18		CNC software version code C1	R26		Turret interference check status
R19		CNC software version code C2	R27		Interference object alarm information
R20			R28		
R21			R29		
R22			R30		Remote program input error information ▲
R23			R31		Diagnosis data output
Device	Abbrev.	Signal name	Device	Abbrev.	Signal name
R32			R40		ASYNC error: exceptional occurrence R register number ▲
R33			R41		
R34			R42		
R35			R43		
R36			R44		
R37		PLC window parameter status	R45		
R38		ASYNC error: exceptional occurrence ▲	R46		
R39		step number	R47		
Device	Abbrev.	Signal name	Device	Abbrev.	Signal name
R48			R56		Battery drop cause
R49			R57		Temperature warning cause
R50			R58		5V/24V error cause
R51			R59		
R52			R60		Control unit temperature
R53			R61		
R54			R62		Tool ID communication error information ▲
R55			R63		

Device	Abbrev.	Signal name	Device	Abbrev.	Signal name
R64			R72		Ball screw thermal displacement compensation Compensation amount 1st [M] axis
R65			R73		Ball screw thermal displacement compensation Compensation amount 2nd [M] axis
R66			R74		Ball screw thermal displacement compensation Compensation amount 3rd [M] axis
R67			R75		Ball screw thermal displacement compensation Compensation amount 4th [M] axis
R68		PLC main scan time	R76		
R69		Emergency stop cause	R77		
R70		DIO card information [M8]	R78		
R71			R79		
Device	Abbrev.	Signal name	Device	Abbrev.	Signal name
R80			R88		
R81			R89		
R82			R90		Modbus/TCP connection request monitor ▲
R83		Modbus/RTU received packet monitor ▲	R91		Modbus/TCP number of connections monitor ▲
R84		Modbus/RTU communication error monitor ▲	R92		Modbus/TCP received packet monitor ▲
R85		Modal task data update cycle	R93		Modbus/TCP communication error monitor ▲
R86			R94		Modbus/TCP protocol error packet monitor ▲
R87			R95		
Device	Abbrev.	Signal name	Device	Abbrev.	Signal name
R96	SMDOEN	Speed monitor door open possible	R104		
R97			R105		
R98	SOPFN	Multi-step speed monitor selected speed output [M8]	R106		
R99			R107		
R100	SODIO2	Safety observation I/O signal state 2 ▲	R108		
R101		Interference check between part systems: Setting error alarm information [M8]	R109		
R102		Interference check between part systems: Alarm information [M8]	R110		
R103			R111		

Device	Abbrev.	Signal name	Device	Abbrev.	Signal name
R112			R120	DTPPC	Power consumption computation: Present consumption of entire drive system(L)
R113	SMPSTS	NC data sampling: Sampling state ▲	R121		Power consumption computation: Present consumption of entire drive system(H)
R114		PLC axis position switch 1 to 16 [C80]	R122	DTIPC1	Power consumption computation: Accumulated consumption of entire drive system 1(L)
R115		PLC axis position switch 17 to 32 [C80]	R123		Power consumption computation: Accumulated consumption of entire drive system 1(H)
R116	HS1PCNT	Handle feed: 1st handle pulse counter	R124	DTIPC2	Power consumption computation: Accumulated consumption of entire drive system 2(L)
R117	HS2PCNT	Handle feed: 2nd handle pulse counter	R125		Power consumption computation: Accumulated consumption of entire drive system 2(H)
R118	HS3PCNT	Handle feed: 3rd handle pulse counter	R126	DTIPC3	Power consumption computation: Accumulated consumption of entire drive system 3(L)
R119			R127		Power consumption computation: Accumulated consumption of entire drive system 3(H)
Device	Abbrev.	Signal name	Device	Abbrev.	Signal name
R128	DTIPC4	Power consumption computation: Accumulated consumption of devices other than drive system 1(L)	R136	NDIPC4	Power consumption computation: Accumulated consumption of devices other than drive system 4(L)
R129		Power consumption computation: Accumulated consumption of devices other than drive system 1(H)	R137		Power consumption computation: Accumulated consumption of devices other than drive system 4(H)
R130	NDIPC1	Power consumption computation: Accumulated consumption of devices other than drive system 1(L)	R138	ITF3CHW GOBJ	Interference check III: Entry in interference warning area interfering object information [M8]
R131		Power consumption computation: Accumulated consumption of devices other than drive system 1(H)	R139	ITF3CHAL OBJ	Interference check III: Interference detection interfering object information [M8]
R132	NDIPC2	Power consumption computation: Accumulated consumption of devices other than drive system 2(L)	R140	ITF3TRAL OBJ	Interference check III: Entry in interference alarm area interfering object information [M8]
R133		Power consumption computation: Accumulated consumption of devices other than drive system 2(H)	R141	ITF3DTER 1	Interference check III: Data setting error information 1 [M8]
R134	NDIPC3	Power consumption computation: Accumulated consumption of devices other than drive system 3(L)	R142	ITF3DTER 2	Interference check III: Data setting error information 2 [M8]
R135		Power consumption computation: Accumulated consumption of devices other than drive system 3(H)	R143		
Device	Abbrev.	Signal name	Device	Abbrev.	Signal name
R144	ITF3DTER 2	Interference check III: Data setting error information 2	R152	HS6PCNT	Handle feed: 6th handle pulse counter [C80]
R145			R153	HS7PCNT	Handle feed: 7th handle pulse counter [C80]
R146			R154	HS8PCNT	Handle feed: 8th handle pulse counter [C80]
R147			R155	HS9PCNT	Handle feed: 9th handle pulse counter [C80]
R148			R156		
R149			R157		
R150	HS4PCNT	Handle feed: 4th handle pulse counter [C80]	R158		
R151	HS5PCNT	Handle feed: 5th handle pulse counter [C80]	R159		

2 Input/Output Signals with Controller

Device	Abbrev.	Signal name	Device	Abbrev.	Signal name
R160			R168		PLC axis alarm/warning No. 1st axis
R161			R169		PLC axis alarm/warning No. 2nd axis
R162			R170		PLC axis alarm/warning No. 3rd axis
R163			R171		PLC axis alarm/warning No. 4th axis
R164			R172		PLC axis alarm/warning No. 5th axis
R165			R173		PLC axis alarm/warning No. 6th axis
R166			R174		PLC axis alarm/warning No. 7th axis
R167			R175		PLC axis alarm/warning No. 8th axis

Device	Abbrev.	Signal name	Device	Abbrev.	Signal name
R176			R184		
R177			R185		
R178			R186		
R179			R187		
R180		ZR device No. in which DDRD/DDWR command error has occurred (L) [C80]	R188		
R181		ZR device No. in which DDRD/DDWR command error has occurred (H) [C80]	R189		
R182		Common variable read/write error part [C80]	R190		
R183		Common variable read/write error code [C80]	R191		

Device	Abbrev.	Signal name	Device	Abbrev.	Signal name
R192					
R193					
R194					
R195		Direct screen selection completion notification [C80]			
R196		Displayed screen No. [C80]			
R197		Detailed screen No. [C80]			
R198		High-speed simple program check:Time measurement output (L) [C80]			
R199		High-speed simple program check:Time measurement output (M) [C80]			

Device No.								Abbrev.	Signal name
\$1	\$2	\$3	\$4	\$5	\$6	\$7	\$8		
R500	R700	R900	R1100	R1300	R1500	R1700	R1900		External search status
R501	R701	R901	R1101	R1301	R1501	R1701	R1901		External search: Program return complete status
R502	R702	R902	R1102	R1302	R1502	R1702	R1902		
R503	R703	R903	R1103	R1303	R1503	R1703	R1903		
R504	R704	R904	R1104	R1304	R1504	R1704	R1904		M code data 1 (L)
R505	R705	R905	R1105	R1305	R1505	R1705	R1905		M code data 1 (H)
R506	R706	R906	R1106	R1306	R1506	R1706	R1906		M code data 2 (L)
R507	R707	R907	R1107	R1307	R1507	R1707	R1907		M code data 2 (H)

Device No.								Abbrev.	Signal name
\$1	\$2	\$3	\$4	\$5	\$6	\$7	\$8		
R508	R708	R908	R1108	R1308	R1508	R1708	R1908		M code data 3 (L)
R509	R709	R909	R1109	R1309	R1509	R1709	R1909		M code data 3 (H)
R510	R710	R910	R1110	R1310	R1510	R1710	R1910		M code data 4 (L)
R511	R711	R911	R1111	R1311	R1511	R1711	R1911		M code data 4 (H)
R512	R712	R912	R1112	R1312	R1512	R1712	R1912		S code data 1 (L)
R513	R713	R913	R1113	R1313	R1513	R1713	R1913		S code data 1 (H)
R514	R714	R914	R1114	R1314	R1514	R1714	R1914		S code data 2 (L)
R515	R715	R915	R1115	R1315	R1515	R1715	R1915		S code data 2 (H)

2 Input/Output Signals with Controller

Device No.									
\$1	\$2	\$3	\$4	\$5	\$6	\$7	\$8	Abbrev.	Signal name
R516	R716	R916	R1116	R1316	R1516	R1716	R1916		S code data 3 (L)
R517	R717	R917	R1117	R1317	R1517	R1717	R1917		S code data 3 (H)
R518	R718	R918	R1118	R1318	R1518	R1718	R1918		S code data 4 (L)
R519	R719	R919	R1119	R1319	R1519	R1719	R1919		S code data 4 (H)
R520	R720	R920	R1120	R1320	R1520	R1720	R1920		S code data 5 (L)
R521	R721	R921	R1121	R1321	R1521	R1721	R1921		S code data 5 (H)
R522	R722	R922	R1122	R1322	R1522	R1722	R1922		S code data 6 (L)
R523	R723	R923	R1123	R1323	R1523	R1723	R1923		S code data 6 (H)
Device No.									
\$1	\$2	\$3	\$4	\$5	\$6	\$7	\$8	Abbrev.	Signal name
R524	R724	R924	R1124	R1324	R1524	R1724	R1924		S code data 7 (L)
R525	R725	R925	R1125	R1325	R1525	R1725	R1925		S code data 7 (H)
R526	R726	R926	R1126	R1326	R1526	R1726	R1926		S code data 8 (L)
R527	R727	R927	R1127	R1327	R1527	R1727	R1927		S code data 8 (H)
R528	R728	R928	R1128	R1328	R1528	R1728	R1928		
R529	R729	R929	R1129	R1329	R1529	R1729	R1929		
R530	R730	R930	R1130	R1330	R1530	R1730	R1930		
R531	R731	R931	R1131	R1331	R1531	R1731	R1931		
Device No.									
\$1	\$2	\$3	\$4	\$5	\$6	\$7	\$8	Abbrev.	Signal name
R532	R732	R932	R1132	R1332	R1532	R1732	R1932		M code data 5 (L) [C80]
R533	R733	R933	R1133	R1333	R1533	R1733	R1933		M code data 5 (H) [C80]
R534	R734	R934	R1134	R1334	R1534	R1734	R1934		M code data 6 (L) [C80]
R535	R735	R935	R1135	R1335	R1535	R1735	R1935		M code data 6 (H) [C80]
R536	R736	R936	R1136	R1336	R1536	R1736	R1936		T code data 1 (L)
R537	R737	R937	R1137	R1337	R1537	R1737	R1937		T code data 1 (H)
R538	R738	R938	R1138	R1338	R1538	R1738	R1938		T code data 2 (L)
R539	R739	R939	R1139	R1339	R1539	R1739	R1939		T code data 2 (H)
Device No.									
\$1	\$2	\$3	\$4	\$5	\$6	\$7	\$8	Abbrev.	Signal name
R540	R740	R940	R1140	R1340	R1540	R1740	R1940		T code data 3 (L)
R541	R741	R941	R1141	R1341	R1541	R1741	R1941		T code data 3 (H)
R542	R742	R942	R1142	R1342	R1542	R1742	R1942		T code data 4 (L)
R543	R743	R943	R1143	R1343	R1543	R1743	R1943		T code data 4 (H)
R544	R744	R944	R1144	R1344	R1544	R1744	R1944		2nd M function data 1 (L)
R545	R745	R945	R1145	R1345	R1545	R1745	R1945		2nd M function data 1 (H)
R546	R746	R946	R1146	R1346	R1546	R1746	R1946		2nd M function data 2 (L)
R547	R747	R947	R1147	R1347	R1547	R1747	R1947		2nd M function data 2 (H)
Device No.									
\$1	\$2	\$3	\$4	\$5	\$6	\$7	\$8	Abbrev.	Signal name
R548	R748	R948	R1148	R1348	R1548	R1748	R1948		2nd M function data 3 (L)
R549	R749	R949	R1149	R1349	R1549	R1749	R1949		2nd M function data 3 (H)
R550	R750	R950	R1150	R1350	R1550	R1750	R1950		2nd M function data 4 (L)
R551	R751	R951	R1151	R1351	R1551	R1751	R1951		2nd M function data 4 (H)
R552	R752	R952	R1152	R1352	R1552	R1752	R1952		
R553	R753	R953	R1153	R1353	R1553	R1753	R1953		
R554	R754	R954	R1154	R1354	R1554	R1754	R1954		Chopping error No.
R555	R755	R955	R1155	R1355	R1555	R1755	R1955		Manual measurement status

2 Input/Output Signals with Controller

Device No.									
\$1	\$2	\$3	\$4	\$5	\$6	\$7	\$8	Abbrev.	Signal name
R564	R764	R964	R1164	R1364	R1564	R1764	R1964		Load monitor I : Warning axis ▲
R565	R765	R965	R1165	R1365	R1565	R1765	R1965		Load monitor I : Alarm axis ▲
R566	R766	R966	R1166	R1366	R1566	R1766	R1966		Load monitor I : Data error information ▲
R567	R767	R967	R1167	R1367	R1567	R1767	R1967		Group in tool life management
R568	R768	R968	R1168	R1368	R1568	R1768	R1968		
R569	R769	R969	R1169	R1369	R1569	R1769	R1969		
R570	R770	R970	R1170	R1370	R1570	R1770	R1970		
R571	R771	R971	R1171	R1371	R1571	R1771	R1971		Load monitor I : Adaptive control override ▲
Device No.									
\$1	\$2	\$3	\$4	\$5	\$6	\$7	\$8	Abbrev.	Signal name
R572	R772	R972	R1172	R1372	R1572	R1772	R1972		CNC completion standby status
R573	R773	R973	R1173	R1373	R1573	R1773	R1973		Error code [C80]
R574	R774	R974	R1174	R1374	R1574	R1774	R1974		In initialization
R575	R775	R975	R1175	R1375	R1575	R1775	R1975		Initialization incompleteness
R576	R776	R976	R1176	R1376	R1576	R1776	R1976		Reference position adjustment value parameter setting completed
R577	R777	R977	R1177	R1377	R1577	R1777	R1977	APIER	User macro section and sub-section designated execution result [M8]
R578	R778	R978	R1178	R1378	R1578	R1778	R1978		Measurement tool tip point No. ▲
R579	R779	R979	R1179	R1379	R1579	R1779	R1979		
Device No.									
\$1	\$2	\$3	\$4	\$5	\$6	\$7	\$8	Abbrev.	Signal name
R580	R780	R980	R1180	R1380	R1580	R1780	R1980		Near reference position (per reference position) 1st to 4th axis
R581	R781	R981	R1181	R1381	R1581	R1781	R1981		Near reference position (per reference position) 5th to 8th axis
R582	R782	R982	R1182	R1382	R1582	R1782	R1982		Presetter contact
R583	R783	R983	R1183	R1383	R1583	R1783	R1983		Presetter interlock
R584	R784	R984	R1184	R1384	R1584	R1784	R1984		Area signal X axis ON/OFF ▲
R585	R785	R985	R1185	R1385	R1585	R1785	R1985		Area signal Z axis ON/OFF ▲
R586	R786	R986	R1186	R1386	R1586	R1786	R1986		Area signal X axis (-) ON/OFF ▲
R587	R787	R987	R1187	R1387	R1587	R1787	R1987		Area signal Z axis (-) ON/OFF ▲
Device No.									
\$1	\$2	\$3	\$4	\$5	\$6	\$7	\$8	Abbrev.	Signal name
R588	R788	R988	R1188	R1388	R1588	R1788	R1988		Takt time (ms) (L)
R589	R789	R989	R1189	R1389	R1589	R1789	R1989		Takt time (ms) (H)
R590	R790	R990	R1190	R1390	R1590	R1790	R1990		Takt time (min) (L)
R591	R791	R991	R1191	R1391	R1591	R1791	R1991		Takt time (min) (H)
R592	R792	R992	R1192	R1392	R1592	R1792	R1992		
R593	R793	R993	R1193	R1393	R1593	R1793	R1993		
R594	R794	R994	R1194	R1394	R1594	R1794	R1994		
R595	R795	R995	R1195	R1395	R1595	R1795	R1995		

2 Input/Output Signals with Controller

Device No.									
\$1	\$2	\$3	\$4	\$5	\$6	\$7	\$8	Abbrev.	Signal name
R596	R796	R996	R1196	R1396	R1596	R1796	R1996		Load monitor I : Status output (1) ▲
R597	R797	R997	R1197	R1397	R1597	R1797	R1997		Load monitor I : Status output (2) ▲
R598	R798	R998	R1198	R1398	R1598	R1798	R1998		Load monitor I : Status output (3) ▲
R599	R799	R999	R1199	R1399	R1599	R1799	R1999		Load monitor I : Status output (4) ▲
R600	R800	R1000	R1200	R1400	R1600	R1800	R2000		Load monitor I : Status output (5) ▲
R601	R801	R1001	R1201	R1401	R1601	R1801	R2001		Load monitor I : Status output (6) ▲
R602	R802	R1002	R1202	R1402	R1602	R1802	R2002		Load monitor I : Status output (7) ▲
R603	R803	R1003	R1203	R1403	R1603	R1803	R2003		Load monitor I : Status output (8) ▲
Device No.									
\$1	\$2	\$3	\$4	\$5	\$6	\$7	\$8	Abbrev.	Signal name
R604	R804	R1004	R1204	R1404	R1604	R1804	R2004		Load monitor I : Status output (9) ▲
R605	R805	R1005	R1205	R1405	R1605	R1805	R2005		Load monitor I : Status output (10) ▲
R606	R806	R1006	R1206	R1406	R1606	R1806	R2006		No. of work machining (current value) (L)
R607	R807	R1007	R1207	R1407	R1607	R1807	R2007		No. of work machining (current value) (H)
R608	R808	R1008	R1208	R1408	R1608	R1808	R2008		No. of work machining (maximum value) (L)
R609	R809	R1009	R1209	R1409	R1609	R1809	R2009		No. of work machining (maximum value) (H)
R610	R810	R1010	R1210	R1410	R1610	R1810	R2010		
R611	R811	R1011	R1211	R1411	R1611	R1811	R2011		
Device No.									
\$1	\$2	\$3	\$4	\$5	\$6	\$7	\$8	Abbrev.	Signal name
R612	R812	R1012	R1212	R1412	R1612	R1812	R2012		
R613	R813	R1013	R1213	R1413	R1613	R1813	R2013		
R614	R814	R1014	R1214	R1414	R1614	R1814	R2014		
R615	R815	R1015	R1215	R1415	R1615	R1815	R2015		
R616	R816	R1016	R1216	R1416	R1616	R1816	R2016	SBSID	Sub part system control: Sub part system control II identification No.
R617	R817	R1017	R1217	R1417	R1617	R1817	R2017	SBSCL	Sub part system control: Calling sub part system
R618	R818	R1018	R1218	R1418	R1618	R1818	R2018	SBSWT	Sub part system control: Waiting for sub part system completion
R619	R819	R1019	R1219	R1419	R1619	R1819	R2019	SBSSY	Sub part system control: Caller of sub part system
Device No.									
\$1	\$2	\$3	\$4	\$5	\$6	\$7	\$8	Abbrev.	Signal name
R620	R820	R1020	R1220	R1420	R1620	R1820	R2020		
R621	R821	R1021	R1221	R1421	R1621	R1821	R2021		
R622	R822	R1022	R1222	R1422	R1622	R1822	R2022		
R623	R823	R1023	R1223	R1423	R1623	R1823	R2023		
R624	R824	R1024	R1224	R1424	R1624	R1824	R2024		Constant torque control: Axis under constant torque/proportional torque stopper control [M8]
R625	R825	R1025	R1225	R1425	R1625	R1825	R2025		Constant torque control: Constant torque droop cancel axis status [M8]
R626	R826	R1026	R1226	R1426	R1626	R1826	R2026		
R627	R827	R1027	R1227	R1427	R1627	R1827	R2027		

Device No.									
\$1	\$2	\$3	\$4	\$5	\$6	\$7	\$8	Abbrev.	Signal name
R628	R828	R1028	R1228	R1428	R1628	R1828	R2028		Tool life usage data (L)
R629	R829	R1029	R1229	R1429	R1629	R1829	R2029		Tool life usage data (H)
R630	R830	R1030	R1230	R1430	R1630	R1830	R2030		Number of registered tool life control tools
R631	R831	R1031	R1231	R1431	R1631	R1831	R2031		
R632	R832	R1032	R1232	R1432	R1632	R1832	R2032		
R633	R833	R1033	R1233	R1433	R1633	R1833	R2033		
R634	R834	R1034	R1234	R1434	R1634	R1834	R2034		
R635	R835	R1035	R1235	R1435	R1635	R1835	R2035		
Device No.									
\$1	\$2	\$3	\$4	\$5	\$6	\$7	\$8	Abbrev.	Signal name
R636	R836	R1036	R1236	R1436	R1636	R1836	R2036		Circular feed in manual mode Current position H (L) [M]
R637	R837	R1037	R1237	R1437	R1637	R1837	R2037		Circular feed in manual mode Current position H (H) [M]
R638	R838	R1038	R1238	R1438	R1638	R1838	R2038		
R639	R839	R1039	R1239	R1439	R1639	R1839	R2039		
R640	R840	R1040	R1240	R1440	R1640	R1840	R2040		Circular feed in manual mode Current position V (L) [M]
R641	R841	R1041	R1241	R1441	R1641	R1841	R2041		Circular feed in manual mode Current position V (H) [M]
R642	R842	R1042	R1242	R1442	R1642	R1842	R2042		
R643	R843	R1043	R1243	R1443	R1643	R1843	R2043		
Device No.									
\$1	\$2	\$3	\$4	\$5	\$6	\$7	\$8	Abbrev.	Signal name
R644	R844	R1044	R1244	R1444	R1644	R1844	R2044		
R645	R845	R1045	R1245	R1445	R1645	R1845	R2045		
R646	R846	R1046	R1246	R1446	R1646	R1846	R2046		Machining mode state ▲
R647	R847	R1047	R1247	R1447	R1647	R1847	R2047		
R648	R848	R1048	R1248	R1448	R1648	R1848	R2048		Thread recutting status
R649	R849	R1049	R1249	R1449	R1649	R1849	R2049		Thread recutting execution status
R650	R850	R1050	R1250	R1450	R1650	R1850	R2050		Thread recutting spindle No.
R651	R851	R1051	R1251	R1451	R1651	R1851	R2051		Thread recutting lead axis No.
Device No.									
\$1	\$2	\$3	\$4	\$5	\$6	\$7	\$8	Abbrev.	Signal name
R652	R852	R1052	R1252	R1452	R1652	R1852	R2052	TLMSLNO1	Sensor ON Tool length compensation No. (BCD output) ▲
R653	R853	R1053	R1253	R1453	R1653	R1853	R2053	TLMSWNO1	Sensor ON Tool wear compensation No. (BCD output) ▲
R654	R854	R1054	R1254	R1454	R1654	R1854	R2054	TLMSLNO2	Compensation data update Tool length compensation No. (BCD output) ▲
R655	R855	R1055	R1255	R1455	R1655	R1855	R2055	TLMSWNO2	Compensation data update Tool wear compensation No. (BCD output) ▲
R656	R856	R1056	R1256	R1456	R1656	R1856	R2056	RPAROUT	Rotary axis configuration parameter output
R657	R857	R1057	R1257	R1457	R1657	R1857	R2057		
R658	R858	R1058	R1258	R1458	R1658	R1858	R2058		
R659	R859	R1059	R1259	R1459	R1659	R1859	R2059		Ext. machine coordinate: number input compensation offset valid axis ▲

2 Input/Output Signals with Controller

Device No.									
\$1	\$2	\$3	\$4	\$5	\$6	\$7	\$8	Abbrev.	Signal name
R660	R860	R1060	R1260	R1460	R1660	R1860	R2060	RSWRK	R-Navi: selecting work number [M8]
R661	R861	R1061	R1261	R1461	R1661	R1861	R2061	RSSRF	R-Navi: selecting machine surface number [M8]
R662	R862	R1062	R1262	R1462	R1662	R1862	R2062	CAXSVFO	Spindle position control (spindle/C axis control): Servo OFF state during Spindle/C axis mode n-th axis ▲
R663	R863	R1063	R1263	R1463	R1663	R1863	R2063	SPGNCI	Spindle position control (spindle/C axis control): Position loop gain switch at C axis mode in progress ▲
R664	R864	R1064	R1264	R1464	R1664	R1864	R2064		
R665	R865	R1065	R1265	R1465	R1665	R1865	R2065		
R666	R866	R1066	R1266	R1466	R1666	R1866	R2066		
R667	R867	R1067	R1267	R1467	R1667	R1867	R2067		

Device No.									
\$1	\$2	\$3	\$4	\$5	\$6	\$7	\$8	Abbrev.	Signal name
R668	R868	R1068	R1268	R1468	R1668	R1868	R2068	SVESTAF	Optimum acceleration/deceleration selection : NC axis estimated resonance frequency (in estimating inertia) ▲
R669	R869	R1069	R1269	R1469	R1669	R1869	R2069	SVESTST	Optimum acceleration/deceleration selection: NC axis estimated inertia state ▲
R670	R870	R1070	R1270	R1470	R1670	R1870	R2070	ITF3CHW	Interference check III: Entry in interference warn area solid information [M8]
R671	R871	R1071	R1271	R1471	R1671	R1871	R2071	GSLD	
R672	R872	R1072	R1272	R1472	R1672	R1872	R2072	ITF3CHAL	Interference check III: Interference detection solid information [M8]
R673	R873	R1073	R1273	R1473	R1673	R1873	R2073	SLD	
R674	R874	R1074	R1274	R1474	R1674	R1874	R2074	ITF3TRAL	Interference check III: Entry in interference alarm area solid information [M8]
R675	R875	R1075	R1275	R1475	R1675	R1875	R2075	SLD	

Device No.									
\$1	\$2	\$3	\$4	\$5	\$6	\$7	\$8	Abbrev.	Signal name
R684	R884	R1084	R1284	R1484	R1684	R1884	R2084		Specific user NC status 1 ▲
R685	R885	R1085	R1285	R1485	R1685	R1885	R2085		
R686	R886	R1086	R1286	R1486	R1686	R1886	R2086		
R687	R887	R1087	R1287	R1487	R1687	R1887	R2087		
R688	R888	R1088	R1288	R1488	R1688	R1888	R2088		Specific user Manual skip Axis in skip motion ▲
R689	R889	R1089	R1289	R1489	R1689	R1889	R2089		Specific user Manual skip Skip motion direction ▲
R690	R890	R1090	R1290	R1490	R1690	R1890	R2090		Specific user Error/Warning detail ▲
R691	R891	R1091	R1291	R1491	R1691	R1891	R2091		

Device	Abbrev.	Signal name	Device	Abbrev.	Signal name
R2400		3D Machine Interference Check : Requested shape group No.1 [M8]	R2408		
R2401		3D Machine Interference Check : Requested shape group No.2 [M8]	R2409		
R2402		3D Machine Interference Check : Requested shape group No.3 [M8]	R2410		
R2403		3D Machine Interference Check : Requested shape group No.4 [M8]	R2411		
R2404			R2412		
R2405			R2413		
R2406			R2414		
R2407			R2415		

2 Input/Output Signals with Controller

Device No.				Abbrev.	Signal name
\$1	\$2	\$3	\$4		
R4500	R4532	R4564	R4596		Machine position 1st axis (L) [M]
R4501	R4533	R4565	R4597		Machine position 1st axis (H) [M]
R4502	R4534	R4566	R4598		
R4503	R4535	R4567	R4599		
R4504	R4536	R4568	R4600		Machine position 2nd axis (L) [M]
R4505	R4537	R4569	R4601		Machine position 2nd axis (H) [M]
R4506	R4538	R4570	R4602		
R4507	R4539	R4571	R4603		
Device No.				Abbrev.	Signal name
\$1	\$2	\$3	\$4		
R4508	R4540	R4572	R4604		Machine position 3rd axis (L) [M]
R4509	R4541	R4573	R4605		Machine position 3rd axis (H) [M]
R4510	R4542	R4574	R4606		
R4511	R4543	R4575	R4607		
R4512	R4544	R4576	R4608		Machine position 4th axis (L) [M]
R4513	R4545	R4577	R4609		Machine position 4th axis (H) [M]
R4514	R4546	R4578	R4610		
R4515	R4547	R4579	R4611		
Device No.				Abbrev.	Signal name
\$1	\$2	\$3	\$4		
R4516	R4548	R4580	R4612		Machine position 5th axis (L) [M]
R4517	R4549	R4581	R4613		Machine position 5th axis (H) [M]
R4518	R4550	R4582	R4614		
R4519	R4551	R4583	R4615		
R4520	R4552	R4584	R4616		Machine position 6th axis (L) [M]
R4521	R4553	R4585	R4617		Machine position 6th axis (H) [M]
R4522	R4554	R4586	R4618		
R4523	R4555	R4587	R4619		
Device No.				Abbrev.	Signal name
\$1	\$2	\$3	\$4		
R4524	R4556	R4588	R4620		Machine position 7th axis (L) [M]
R4525	R4557	R4589	R4621		Machine position 7th axis (H) [M]
R4526	R4558	R4590	R4622		
R4527	R4559	R4591	R4623		
R4528	R4560	R4592	R4624		Machine position 8th axis (L) [M]
R4529	R4561	R4593	R4625		Machine position 8th axis (H) [M]
R4530	R4562	R4594	R4626		
R4531	R4563	R4595	R4627		
Device No.				Abbrev.	Signal name
\$1	\$2	\$3	\$4		
R4628	R4660	R4692	R4724		Feedback machine position 1st axis (L) [M]
R4629	R4661	R4693	R4725		Feedback machine position 1st axis (H) [M]
R4630	R4662	R4694	R4726		
R4631	R4663	R4695	R4727		
R4632	R4664	R4696	R4728		Feedback machine position 2nd axis (L) [M]
R4633	R4665	R4697	R4729		Feedback machine position 2nd axis (H) [M]
R4634	R4666	R4698	R4730		
R4635	R4667	R4699	R4731		

2 Input/Output Signals with Controller

Device No.				Abbrev.	Signal name
\$1	\$2	\$3	\$4		
R4636	R4668	R4700	R4732		Feedback machine position 3rd axis (L) [M]
R4637	R4669	R4701	R4733		Feedback machine position 3rd axis (H) [M]
R4638	R4670	R4702	R4734		
R4639	R4671	R4703	R4735		
R4640	R4672	R4704	R4736		Feedback machine position 4th axis (L) [M]
R4641	R4673	R4705	R4737		Feedback machine position 4th axis (H) [M]
R4642	R4674	R4706	R4738		
R4643	R4675	R4707	R4739		
Device No.				Abbrev.	Signal name
\$1	\$2	\$3	\$4		
R4644	R4676	R4708	R4740		Feedback machine position 5th axis (L) [M]
R4645	R4677	R4709	R4741		Feedback machine position 5th axis (H) [M]
R4646	R4678	R4710	R4742		
R4647	R4679	R4711	R4743		
R4648	R4680	R4712	R4744		Feedback machine position 6th axis (L) [M]
R4649	R4681	R4713	R4745		Feedback machine position 6th axis (H) [M]
R4650	R4682	R4714	R4746		
R4651	R4683	R4715	R4747		
Device No.				Abbrev.	Signal name
\$1	\$2	\$3	\$4		
R4652	R4684	R4716	R4748		Feedback machine position 7th axis (L) [M]
R4653	R4685	R4717	R4749		Feedback machine position 7th axis (H) [M]
R4654	R4686	R4718	R4750		
R4655	R4687	R4719	R4751		
R4656	R4688	R4720	R4752		Feedback machine position 8th axis (L) [M]
R4657	R4689	R4721	R4753		Feedback machine position 8th axis (H) [M]
R4658	R4690	R4722	R4754		
R4659	R4691	R4723	R4755		
Device No.				Abbrev.	Signal name
\$1	\$2	\$3	\$4		
R4756	R4772	R4788	R4804		Servo deflection amount 1st axis (L) [M]
R4757	R4773	R4789	R4805		Servo deflection amount 1st axis (H) [M]
R4758	R4774	R4790	R4806		Servo deflection amount 2nd axis (L) [M]
R4759	R4775	R4791	R4807		Servo deflection amount 2nd axis (H) [M]
R4760	R4776	R4792	R4808		Servo deflection amount 3rd axis (L) [M]
R4761	R4777	R4793	R4809		Servo deflection amount 3rd axis (H) [M]
R4762	R4778	R4794	R4810		Servo deflection amount 4th axis (L) [M]
R4763	R4779	R4795	R4811		Servo deflection amount 4th axis (H) [M]
Device No.				Abbrev.	Signal name
\$1	\$2	\$3	\$4		
R4764	R4780	R4796	R4812		Servo deflection amount 5th axis (L) [M]
R4765	R4781	R4797	R4813		Servo deflection amount 5th axis (H) [M]
R4766	R4782	R4798	R4814		Servo deflection amount 6th axis (L) [M]
R4767	R4783	R4799	R4815		Servo deflection amount 6th axis (H) [M]
R4768	R4784	R4800	R4816		Servo deflection amount 7th axis (L) [M]
R4769	R4785	R4801	R4817		Servo deflection amount 7th axis (H) [M]
R4770	R4786	R4802	R4818		Servo deflection amount 8th axis (L) [M]
R4771	R4787	R4803	R4819		Servo deflection amount 8th axis (H) [M]

Device No.				Abbrev.	Signal name
\$1	\$2	\$3	\$4		
R4820	R4836	R4852	R4868		Motor rotation speed 1st axis (L)
R4821	R4837	R4853	R4869		Motor rotation speed 1st axis (H)
R4822	R4838	R4854	R4870		Motor rotation speed 2nd axis (L)
R4823	R4839	R4855	R4871		Motor rotation speed 2nd axis (H)
R4824	R4840	R4856	R4872		Motor rotation speed 3rd axis (L)
R4825	R4841	R4857	R4873		Motor rotation speed 3rd axis (H)
R4826	R4842	R4858	R4874		Motor rotation speed 4th axis (L)
R4827	R4843	R4859	R4875		Motor rotation speed 4th axis (H)
Device No.				Abbrev.	Signal name
\$1	\$2	\$3	\$4		
R4828	R4844	R4860	R4876		Motor rotation speed 5th axis (L)
R4829	R4845	R4861	R4877		Motor rotation speed 5th axis (H)
R4830	R4846	R4862	R4878		Motor rotation speed 6th axis (L)
R4831	R4847	R4863	R4879		Motor rotation speed 6th axis (H)
R4832	R4848	R4864	R4880		Motor rotation speed 7th axis (L)
R4833	R4849	R4865	R4881		Motor rotation speed 7th axis (H)
R4834	R4850	R4866	R4882		Motor rotation speed 8th axis (L)
R4835	R4851	R4867	R4883		Motor rotation speed 8th axis (H)
Device No.				Abbrev.	Signal name
\$1	\$2	\$3	\$4		
R4884	R4900	R4916	R4932		Motor load current 1st axis (L)
R4885	R4901	R4917	R4933		Motor load current 1st axis (H)
R4886	R4902	R4918	R4934		Motor load current 2nd axis (L)
R4887	R4903	R4919	R4935		Motor load current 2nd axis (H)
R4888	R4904	R4920	R4936		Motor load current 3rd axis (L)
R4889	R4905	R4921	R4937		Motor load current 3rd axis (H)
R4890	R4906	R4922	R4938		Motor load current 4th axis (L)
R4891	R4907	R4923	R4939		Motor load current 4th axis (H)
Device No.				Abbrev.	Signal name
\$1	\$2	\$3	\$4		
R4892	R4908	R4924	R4940		Motor load current 5th axis (L)
R4893	R4909	R4925	R4941		Motor load current 5th axis (H)
R4894	R4910	R4926	R4942		Motor load current 6th axis (L)
R4895	R4911	R4927	R4943		Motor load current 6th axis (H)
R4896	R4912	R4928	R4944		Motor load current 7th axis (L)
R4897	R4913	R4929	R4945		Motor load current 7th axis (H)
R4898	R4914	R4930	R4946		Motor load current 8th axis (L)
R4899	R4915	R4931	R4947		Motor load current 8th axis (H)

Device No.				Abbrev.	Signal name
\$1	\$2	\$3	\$4		
R4948	R4980	R5012	R5044		Skip coordinate position 1st axis (L) [M]
R4949	R4981	R5013	R5045		Skip coordinate position 1st axis (H) [M]
R4950	R4982	R5014	R5046		
R4951	R4983	R5015	R5047		
R4952	R4984	R5016	R5048		Skip coordinate position 2nd axis (L) [M]
R4953	R4985	R5017	R5049		Skip coordinate position 2nd axis (H) [M]
R4954	R4986	R5018	R5050		
R4955	R4987	R5019	R5051		
Device No.				Abbrev.	Signal name
\$1	\$2	\$3	\$4		
R4956	R4988	R5020	R5052		Skip coordinate position 3rd axis (L) [M]
R4957	R4989	R5021	R5053		Skip coordinate position 3rd axis (H) [M]
R4958	R4990	R5022	R5054		
R4959	R4991	R5023	R5055		
R4960	R4992	R5024	R5056		Skip coordinate position 4th axis (L) [M]
R4961	R4993	R5025	R5057		Skip coordinate position 4th axis (H) [M]
R4962	R4994	R5026	R5058		
R4963	R4995	R5027	R5059		
Device No.				Abbrev.	Signal name
\$1	\$2	\$3	\$4		
R4964	R4996	R5028	R5060		Skip coordinate position 5th axis (L) [M]
R4965	R4997	R5029	R5061		Skip coordinate position 5th axis (H) [M]
R4966	R4998	R5030	R5062		
R4967	R4999	R5031	R5063		
R4968	R5000	R5032	R5064		Skip coordinate position 6th axis (L) [M]
R4969	R5001	R5033	R5065		Skip coordinate position 6th axis (H) [M]
R4970	R5002	R5034	R5066		
R4971	R5003	R5035	R5067		
Device No.				Abbrev.	Signal name
\$1	\$2	\$3	\$4		
R4972	R5004	R5036	R5068		Skip coordinate position 7th axis (L) [M]
R4973	R5005	R5037	R5069		Skip coordinate position 7th axis (H) [M]
R4974	R5006	R5038	R5070		
R4975	R5007	R5039	R5071		
R4976	R5008	R5040	R5072		Skip coordinate position 8th axis (L) [M]
R4977	R5009	R5041	R5073		Skip coordinate position 8th axis (H) [M]
R4978	R5010	R5042	R5074		
R4979	R5011	R5043	R5075		
Device No.				Abbrev.	Signal name
\$1	\$2	\$3	\$4		
R5076	R5092	R5108	R5124		Synchronous error amount 1st, 9th, 17th, 25th axis (L) [M]
R5077	R5093	R5109	R5125		Synchronous error amount 1st, 9th, 17th, 25th axis (H) [M]
R5078	R5094	R5110	R5126		Synchronous error amount 2nd, 10th, 18th, 26th axis (L) [M]
R5079	R5095	R5111	R5127		Synchronous error amount 2nd, 10th, 18th, 26th axis (H) [M]
R5080	R5096	R5112	R5128		Synchronous error amount 3rd, 11th, 19th, 27th axis (L) [M]
R5081	R5097	R5113	R5129		Synchronous error amount 3rd, 11th, 19th, 27th axis (H) [M]
R5082	R5098	R5114	R5130		Synchronous error amount 4th, 12th, 20th, 28th axis (L) [M]
R5083	R5099	R5115	R5131		Synchronous error amount 4th, 12th, 20th, 28th axis (H) [M]

2 Input/Output Signals with Controller

Device No.				Abbrev.	Signal name	
\$1	\$2	\$3	\$4			
R5084	R5100	R5116	R5132		Synchronous error amount 5th, 13th, 21st, 29th axis (L)	[M]
R5085	R5101	R5117	R5133		Synchronous error amount 5th, 13th, 21st, 29th axis (H)	[M]
R5086	R5102	R5118	R5134		Synchronous error amount 6th, 14th, 22nd, 30th axis (L)	[M]
R5087	R5103	R5119	R5135		Synchronous error amount 6th, 14th, 22nd, 30th axis (H)	[M]
R5088	R5104	R5120	R5136		Synchronous error amount 7th, 15th, 23rd, 31st axis (L)	[M]
R5089	R5105	R5121	R5137		Synchronous error amount 7th, 15th, 23rd, 31st axis (H)	[M]
R5090	R5106	R5122	R5138		Synchronous error amount 8th, 16th, 24th, 32nd axis (L)	[M]
R5091	R5107	R5123	R5139		Synchronous error amount 8th, 16th, 24th, 32nd axis (H)	[M]
Device No.				Abbrev.	Signal name	
\$1	\$2	\$3	\$4			
R5140	R5148	R5156	R5164		Optimum acceleration/deceleration parameter group currently selected [axis] 1st axis	▲
R5141	R5149	R5157	R5165		Optimum acceleration/deceleration parameter group currently selected [axis] 2nd axis	▲
R5142	R5150	R5158	R5166		Optimum acceleration/deceleration parameter group currently selected [axis] 3rd axis	▲
R5143	R5151	R5159	R5167		Optimum acceleration/deceleration parameter group currently selected [axis] 4th axis	▲
R5144	R5152	R5160	R5168		Optimum acceleration/deceleration parameter group currently selected [axis] 5th axis	▲
R5145	R5153	R5161	R5169		Optimum acceleration/deceleration parameter group currently selected [axis] 6th axis	▲
R5146	R5154	R5162	R5170		Optimum acceleration/deceleration parameter group currently selected [axis] 7th axis	▲
R5147	R5155	R5163	R5171		Optimum acceleration/deceleration parameter group currently selected [axis] 8th axis	▲
Device No.				Abbrev.	Signal name	
\$1	\$2	\$3	\$4			
R5172	R5204	R5236	R5268		Cutting feed movement amount 1st axis (L)	[M]
R5173	R5205	R5237	R5269		Cutting feed movement amount 1st axis (H)	[M]
R5174	R5206	R5238	R5270			
R5175	R5207	R5239	R5271			
R5176	R5208	R5240	R5272		Cutting feed movement amount 2nd axis (L)	[M]
R5177	R5209	R5241	R5273		Cutting feed movement amount 2nd axis (H)	[M]
R5178	R5210	R5242	R5274			
R5179	R5211	R5243	R5275			
Device No.				Abbrev.	Signal name	
\$1	\$2	\$3	\$4			
R5180	R5212	R5244	R5276		Cutting feed movement amount 3rd axis (L)	[M]
R5181	R5213	R5245	R5277		Cutting feed movement amount 3rd axis (H)	[M]
R5182	R5214	R5246	R5278			
R5183	R5215	R5247	R5279			
R5184	R5216	R5248	R5280		Cutting feed movement amount 4th axis (L)	[M]
R5185	R5217	R5249	R5281		Cutting feed movement amount 4th axis (H)	[M]
R5186	R5218	R5250	R5282			
R5187	R5219	R5251	R5283			

Device No.				Abbrev.	Signal name
\$1	\$2	\$3	\$4		
R5188	R5220	R5252	R5284		Cutting feed movement amount 5th axis (L) [M]
R5189	R5221	R5253	R5285		Cutting feed movement amount 5th axis (H) [M]
R5190	R5222	R5254	R5286		
R5191	R5223	R5255	R5287		
R5192	R5224	R5256	R5288		Cutting feed movement amount 6th axis (L) [M]
R5193	R5225	R5257	R5289		Cutting feed movement amount 6th axis (H) [M]
R5194	R5226	R5258	R5290		
R5195	R5227	R5259	R5291		
Device No.				Abbrev.	Signal name
\$1	\$2	\$3	\$4		
R5196	R5228	R5260	R5292		Cutting feed movement amount 7th axis (L) [M]
R5197	R5229	R5261	R5293		Cutting feed movement amount 7th axis (H) [M]
R5198	R5230	R5262	R5294		
R5199	R5231	R5263	R5295		
R5200	R5232	R5264	R5296		Cutting feed movement amount 8th axis (L) [M]
R5201	R5233	R5265	R5297		Cutting feed movement amount 8th axis (H) [M]
R5202	R5234	R5266	R5298		
R5203	R5235	R5267	R5299		
Device No.				Abbrev.	Signal name
\$1	\$2	\$3	\$4		
R5332	R5340	R5348	R5356		Servo alarm/warning No. 1st axis
R5333	R5341	R5349	R5357		Servo alarm/warning No. 2nd axis
R5334	R5342	R5350	R5358		Servo alarm/warning No. 3rd axis
R5335	R5343	R5351	R5359		Servo alarm/warning No. 4th axis
R5336	R5344	R5352	R5360		Servo alarm/warning No. 5th axis
R5337	R5345	R5353	R5361		Servo alarm/warning No. 6th axis
R5338	R5346	R5354	R5362		Servo alarm/warning No. 7th axis
R5339	R5347	R5355	R5363		Servo alarm/warning No. 8th axis
Device No.				Abbrev.	Signal name
\$1	\$2	\$3	\$4		
R5364	R5396	R5428	R5460		Skip coordinate position 1st axis feature coordinate (L) [M]
R5365	R5397	R5429	R5461		Skip coordinate position 1st axis feature coordinate (H) [M]
R5366	R5398	R5430	R5462		
R5367	R5399	R5431	R5463		
R5368	R5400	R5432	R5464		Skip coordinate position 2nd axis feature coordinate (L) [M]
R5369	R5401	R5433	R5465		Skip coordinate position 2nd axis feature coordinate (H) [M]
R5370	R5402	R5434	R5466		
R5371	R5403	R5435	R5467		
Device No.				Abbrev.	Signal name
\$1	\$2	\$3	\$4		
R5372	R5404	R5436	R5468		Skip coordinate position 3rd axis feature coordinate (L) [M]
R5373	R5405	R5437	R5469		Skip coordinate position 3rd axis feature coordinate (H) [M]
R5374	R5406	R5438	R5470		
R5375	R5407	R5439	R5471		
R5376	R5408	R5440	R5472		Skip coordinate position 4th axis feature coordinate (L) [M]
R5377	R5409	R5441	R5473		Skip coordinate position 4th axis feature coordinate (H) [M]
R5378	R5410	R5442	R5474		
R5379	R5411	R5443	R5475		

2 Input/Output Signals with Controller

Device No.				Abbrev.	Signal name
\$1	\$2	\$3	\$4		
R5380	R5412	R5444	R5476		Skip coordinate position 5th axis feature coordinate (L) [M]
R5381	R5413	R5445	R5477		Skip coordinate position 5th axis feature coordinate (H) [M]
R5382	R5414	R5446	R5478		
R5383	R5415	R5447	R5479		
R5384	R5416	R5448	R5480		Skip coordinate position 6th axis feature coordinate (L) [M]
R5385	R5417	R5449	R5481		Skip coordinate position 6th axis feature coordinate (H) [M]
R5386	R5418	R5450	R5482		
R5387	R5419	R5451	R5483		
Device No.				Abbrev.	Signal name
\$1	\$2	\$3	\$4		
R5388	R5420	R5452	R5484		Skip coordinate position 7th axis feature coordinate (L) [M]
R5389	R5421	R5453	R5485		Skip coordinate position 7th axis feature coordinate (H) [M]
R5390	R5422	R5454	R5486		
R5391	R5423	R5455	R5487		
R5392	R5424	R5456	R5488		Skip coordinate position 8th axis feature coordinate (L) [M]
R5393	R5425	R5457	R5489		Skip coordinate position 8th axis feature coordinate (L) [M]
R5394	R5426	R5458	R5490		
R5395	R5427	R5459	R5491		
Device No.				Abbrev.	Signal name
\$1	\$2	\$3	\$4		
R5492	R5500	R5508	R5516		Load monitor I : Cutting torque output value 1st axis
R5493	R5501	R5509	R5517		Load monitor I : Cutting torque output value 2nd axis
R5494	R5502	R5510	R5518		Load monitor I : Cutting torque output value 3rd axis
R5495	R5503	R5511	R5519		Load monitor I : Cutting torque output value 4th axis
R5496	R5504	R5512	R5520		Load monitor I : Cutting torque output value 5th axis
R5497	R5505	R5513	R5521		Load monitor I : Cutting torque output value 6th axis
R5498	R5506	R5514	R5522		Load monitor I : Cutting torque output value 7th axis
R5499	R5507	R5515	R5523		Load monitor I : Cutting torque output value 8th axis
Device No.				Abbrev.	Signal name
\$1	\$2	\$3	\$4		
R5524	R5532	R5540	R5548		Actual machining time 1st axis ▲
R5525	R5533	R5541	R5549		Actual machining time 2nd axis ▲
R5526	R5534	R5542	R5550		Actual machining time 3rd axis ▲
R5527	R5535	R5543	R5551		Actual machining time 4th axis ▲
R5528	R5536	R5544	R5552		Actual machining time 5th axis ▲
R5529	R5537	R5545	R5553		Actual machining time 6th axis ▲
R5530	R5538	R5546	R5554		Actual machining time 7th axis ▲
R5531	R5539	R5547	R5555		Actual machining time 8th axis ▲

Device No.				Abbrev.	Signal name	
\$1	\$2	\$3	\$4			
R5556	R5564	R5572	R5580	SVINER1	Optimum Acceleration/Deceleration Selection : NC axis estimated inertia ratio 1st axis	▲
R5557	R5565	R5573	R5581	SVINER2	Optimum Acceleration/Deceleration Selection : NC axis estimated inertia ratio 2nd axis	▲
R5558	R5566	R5574	R5582	SVINER3	Optimum Acceleration/Deceleration Selection : NC axis estimated inertia ratio 3rd axis	▲
R5559	R5567	R5575	R5583	SVINER4	Optimum Acceleration/Deceleration Selection : NC axis estimated inertia ratio 4th axis	▲
R5560	R5568	R5576	R5584	SVINER5	Optimum Acceleration/Deceleration Selection : NC axis estimated inertia ratio 5th axis	▲
R5561	R5569	R5577	R5585	SVINER6	Optimum Acceleration/Deceleration Selection : NC axis estimated inertia ratio 6th axis	▲
R5562	R5570	R5578	R5586	SVINER7	Optimum Acceleration/Deceleration Selection : NC axis estimated inertia ratio 7th axis	▲
R5563	R5571	R5579	R5587	SVINER8	Optimum Acceleration/Deceleration Selection : NC axis estimated inertia ratio 8th axis	▲

Device No.				Abbrev.	Signal name	
\$1	\$2	\$3	\$4			
R5588	R5596	R5604	R5612	SVAFLT1	Optimum Acceleration/Deceleration Selection : NC axis estimated resonance frequency 1st axis	▲
R5589	R5597	R5605	R5613	SVAFLT2	Optimum Acceleration/Deceleration Selection : NC axis estimated resonance frequency 2nd axis	▲
R5590	R5598	R5606	R5614	SVAFLT3	Optimum Acceleration/Deceleration Selection : NC axis estimated resonance frequency 3rd axis	▲
R5591	R5599	R5607	R5615	SVAFLT4	Optimum Acceleration/Deceleration Selection : NC axis estimated resonance frequency 4th axis	▲
R5592	R5600	R5608	R5616	SVAFLT5	Optimum Acceleration/Deceleration Selection : NC axis estimated resonance frequency 5th axis	▲
R5593	R5601	R5609	R5617	SVAFLT6	Optimum Acceleration/Deceleration Selection : NC axis estimated resonance frequency 6th axis	▲
R5594	R5602	R5610	R5618	SVAFLT7	Optimum Acceleration/Deceleration Selection : NC axis estimated resonance frequency 7th axis	▲
R5595	R5603	R5611	R5619	SVAFLT8	Optimum Acceleration/Deceleration Selection : NC axis estimated resonance frequency 8th axis	▲

Device No.				Abbrev.	Signal name
\$1	\$2	\$3	\$4		
R5620	R5628	R5636	R5644		Load monitoring I: Effective torque output 1st axis [M8]
R5621	R5629	R5637	R5645		Load monitoring I: Effective torque output 2nd axis [M8]
R5622	R5630	R5638	R5646		Load monitoring I: Effective torque output 3rd axis [M8]
R5623	R5631	R5639	R5647		Load monitoring I: Effective torque output 4th axis [M8]
R5624	R5632	R5640	R5648		Load monitoring I: Effective torque output 5th axis [M8]
R5625	R5633	R5641	R5649		Load monitoring I: Effective torque output 6th axis [M8]
R5626	R5634	R5642	R5650		Load monitoring I: Effective torque output 7th axis [M8]
R5627	R5635	R5643	R5651		Load monitoring I: Effective torque output 8th axis [M8]

Device No.								Abbrev.	Signal name
\$1	\$2	\$3	\$4	\$5	\$6	\$7	\$8		
R6372	R6380	R6388	R6396	R6404	R6412	R6420	R6428		User macro output #1132 (NC -> PLC) (L)
R6373	R6381	R6389	R6397	R6405	R6413	R6421	R6429		User macro output #1132 (NC -> PLC) (H)
R6374	R6382	R6390	R6398	R6406	R6414	R6422	R6430		User macro output #1133 (NC -> PLC) (L)
R6375	R6383	R6391	R6399	R6407	R6415	R6423	R6431		User macro output #1133 (NC -> PLC) (H)
R6376	R6384	R6392	R6400	R6408	R6416	R6424	R6432		User macro output #1134 (NC -> PLC) (L)
R6377	R6385	R6393	R6401	R6409	R6417	R6425	R6433		User macro output #1134 (NC -> PLC) (H)
R6378	R6386	R6394	R6402	R6410	R6418	R6426	R6434		User macro output #1135 (NC -> PLC) (L)
R6379	R6387	R6395	R6403	R6411	R6419	R6427	R6435		User macro output #1135 (NC -> PLC) (H)

Device No.								Abbrev.	Signal name
1stSP	2ndSP	3rdSP	4thSP	5thSP	6thSP	7thSP	8thSP		
R6500	R6550	R6600	R6650	R6700	R6750	R6800	R6850		Spindle command rotation speed input (L)
R6501	R6551	R6601	R6651	R6701	R6751	R6801	R6851		Spindle command rotation speed input (H)
R6502	R6552	R6602	R6652	R6702	R6752	R6802	R6852		Spindle command final data (rotation speed) (L)
R6503	R6553	R6603	R6653	R6703	R6753	R6803	R6853		Spindle command final data (rotation speed) (H)
R6504	R6554	R6604	R6654	R6704	R6754	R6804	R6854		Spindle command final data (12-bit binary) (L)
R6505	R6555	R6605	R6655	R6705	R6755	R6805	R6855		Spindle command final data (12-bit binary) (H)
R6506	R6556	R6606	R6656	R6706	R6756	R6806	R6856		Spindle actual speed (L)
R6507	R6557	R6607	R6657	R6707	R6757	R6807	R6857		Spindle actual speed (H)
Device No.								Abbrev.	Signal name
1stSP	2ndSP	3rdSP	4thSP	5thSP	6thSP	7thSP	8thSP		
R6508	R6558	R6608	R6658	R6708	R6758	R6808	R6858		
R6509	R6559	R6609	R6659	R6709	R6759	R6809	R6859		
R6510	R6560	R6610	R6660	R6710	R6760	R6810	R6860		
R6511	R6561	R6611	R6661	R6711	R6761	R6811	R6861		
R6512	R6562	R6612	R6662	R6712	R6762	R6812	R6862		
R6513	R6563	R6613	R6663	R6713	R6763	R6813	R6863		
R6514	R6564	R6614	R6664	R6714	R6764	R6814	R6864		Optimum acceleration/deceleration estimated inertia ratio [spindle] ▲
R6515	R6565	R6615	R6665	R6715	R6765	R6815	R6865		Optimum acceleration/deceleration parameter group currently selected [spindle] ▲
Device No.								Abbrev.	Signal name
1stSP	2ndSP	3rdSP	4thSP	5thSP	6thSP	7thSP	8thSP		
R6516	R6566	R6616	R6666	R6716	R6766	R6816	R6866		Spindle synchronization phase error /Hob axis delay angle
R6517	R6567	R6617	R6667	R6717	R6767	R6817	R6867		Spindle synchronization Maximum phase error/ Maximum hob axis delay angle
R6518	R6568	R6618	R6668	R6718	R6768	R6818	R6868		Spindle synchronization Phase offset data
R6519	R6569	R6619	R6669	R6719	R6769	R6819	R6869		Spindle synchronization Phase error monitor
R6520	R6570	R6620	R6670	R6720	R6770	R6820	R6870		Spindle synchronization Phase error monitor (lower limit)
R6521	R6571	R6621	R6671	R6721	R6771	R6821	R6871		Spindle synchronization Phase error monitor (upper limit)
R6522	R6572	R6622	R6672	R6722	R6772	R6822	R6872		Spindle synchronization Phase error 1
R6523	R6573	R6623	R6673	R6723	R6773	R6823	R6873		Spindle synchronization Phase error 2
Device No.								Abbrev.	Signal name
1stSP	2ndSP	3rdSP	4thSP	5thSP	6thSP	7thSP	8thSP		
R6524	R6574	R6624	R6674	R6724	R6774	R6824	R6874		
R6525	R6575	R6625	R6675	R6725	R6775	R6825	R6875		Spindle motor load ratio
R6526	R6576	R6626	R6676	R6726	R6776	R6826	R6876	SPTM P	Spindle temperature output [M8]
R6527	R6577	R6627	R6677	R6727	R6777	R6827	R6877		Spindle actual machining time ▲
R6528	R6578	R6628	R6678	R6728	R6778	R6828	R6878		Load monitor I : Spindle cutting torque output value ▲
R6529	R6579	R6629	R6679	R6729	R6779	R6829	R6879		Spindle alarm/warning No.
R6530	R6580	R6630	R6680	R6730	R6780	R6830	R6880		
R6531	R6581	R6631	R6681	R6731	R6781	R6831	R6881		

2 Input/Output Signals with Controller

Device No.								Abbrev.	Signal name
1stSP	2ndSP	3rdSP	4thSP	5thSP	6thSP	7thSP	8thSP		
R6532	R6582	R6632	R6682	R6732	R6782	R6832	R6882		Synchronous tapping Current error width (L)
R6533	R6583	R6633	R6683	R6733	R6783	R6833	R6883		Synchronous tapping Current error width (H)
R6534	R6584	R6634	R6684	R6734	R6784	R6834	R6884		Synchronous tapping Maximum error width (L)
R6535	R6585	R6635	R6685	R6735	R6785	R6835	R6885		Synchronous tapping Maximum error width (H)
R6536	R6586	R6636	R6686	R6736	R6786	R6836	R6886		Synchronous tapping Current error angle (L)
R6537	R6587	R6637	R6687	R6737	R6787	R6837	R6887		Synchronous tapping Current error angle (H)
R6538	R6588	R6638	R6688	R6738	R6788	R6838	R6888		Synchronous tapping Maximum error angle (L)
R6539	R6589	R6639	R6689	R6739	R6789	R6839	R6889		Synchronous tapping Maximum error angle (H)

Device No.								Abbrev.	Signal name
1stSP	2ndSP	3rdSP	4thSP	5thSP	6thSP	7thSP	8thSP		
R6540	R6590	R6640	R6690	R6740	R6790	R6840	R6890		
R6541	R6591	R6641	R6691	R6741	R6791	R6841	R6891		Load monitoring I: Estimated spindle disturbance torque output [M8]
R6542	R6592	R6642	R6692	R6742	R6792	R6842	R6892		Load monitoring I: Effective spindle torque output [M8]
R6543	R6593	R6643	R6693	R6743	R6793	R6843	R6893	MCNGI TSPST S	Machining interruption spindle status [C80]
R6544	R6594	R6644	R6694	R6744	R6794	R6844	R6894		
R6545	R6595	R6645	R6695	R6745	R6795	R6845	R6895		
R6546	R6596	R6646	R6696	R6746	R6796	R6846	R6896		
R6547	R6597	R6647	R6697	R6747	R6797	R6847	R6897	SPCHG STS	Tool head hot swapping: Spindle switch status [M8]

Device No.								Abbrev.	Signal name
1stSP	2ndSP	3rdSP	4thSP	5thSP	6thSP	7thSP	8thSP		
R7024	R7074	R7124	R7174	R7224	R7274	R7324	R7374	VCC_S	VCC: Spindle rotation speed
R7025	R7075	R7125	R7175	R7225	R7275	R7325	R7375	PREV	

Device	Abbrev.	Signal name	Device	Abbrev.	Signal name
R10000		RIO1 No. of error occurrences 1st ch [M8]	R10008		RIO2 No. of error occurrences 1st ch [M8]
R10001		RIO1 No. of error occurrences 2nd ch [M8]	R10009		RIO2 No. of error occurrences 2nd ch [M8]
R10002		RIO1 No. of error occurrences 3rd ch [M8]	R10010		RIO2 No. of error occurrences 3rd ch [M8]
R10003		RIO1 No. of error occurrences 4th ch [M8]	R10011		RIO2 No. of error occurrences 4th ch [M8]
R10004		RIO1 No. of error occurrences 5th ch [M8]	R10012		RIO2 No. of error occurrences 5th ch [M8]
R10005		RIO1 No. of error occurrences 6th ch [M8]	R10013		RIO2 No. of error occurrences 6th ch [M8]
R10006		RIO1 No. of error occurrences 7th ch [M8]	R10014		RIO2 No. of error occurrences 7th ch [M8]
R10007		RIO1 No. of error occurrences 8th ch [M8]	R10015		RIO2 No. of error occurrences 8th ch [M8]

Device	Abbrev.	Signal name	Device	Abbrev.	Signal name
R10016		RIO3 No. of error occurrences 1st ch [M8]	R10024		
R10017		RIO3 No. of error occurrences 2nd ch [M8]	R10025		
R10018		RIO3 No. of error occurrences 3rd ch [M8]	R10026		
R10019		RIO3 No. of error occurrences 4th ch [M8]	R10027		
R10020		RIO3 No. of error occurrences 5th ch [M8]	R10028		
R10021		RIO3 No. of error occurrences 6th ch [M8]	R10029		
R10022		RIO3 No. of error occurrences 7th ch [M8]	R10030		
R10023		RIO3 No. of error occurrences 8th ch [M8]	R10031		

2 Input/Output Signals with Controller

Device	Abbrev.	Signal name	Device	Abbrev.	Signal name
R10064		Connection status of each channel RIO1,2 [M8]	R10072		
R10065		Connection status of each channel RIO3 [M8]	R10073		
R10066			R10074		
R10067			R10075		
R10068		CRC warning channel RIO1,2 [M8]	R10076		
R10069		CRC warning channel RIO3 [M8]	R10077		
R10070			R10078		
R10071			R10079		

Device	Abbrev.	Signal name	Device	Abbrev.	Signal name
R10176			R10184		
R10177			R10185		
R10178			R10186		
R10179			R10187		
R10180			R10188		Base PLC mounting check (L)
R10181			R10189		Base PLC mounting check (H)
R10182			R10190		
R10183			R10191		

Device No.								Abbrev.	Signal name
\$1	\$2	\$3	\$4	\$5	\$6	\$7	\$8		
R11800	R11850	R11900	R11950	R12000	R12050	R12100	R12150		T life mgmt (M system) Spare tool: Group No. (L)
R11801	R11851	R11901	R11951	R12001	R12051	R12101	R12151		Spare tool: Group No. (H)
R11802	R11852	R11902	R11952	R12002	R12052	R12102	R12152		Spare tool: Tool No. (L)
R11803	R11853	R11903	R11953	R12003	R12053	R12103	R12153		Spare tool: Tool No. (H)
R11804	R11854	R11904	R11954	R12004	R12054	R12104	R12154		Spare tool: Tool data flag/Status
R11805	R11855	R11905	R11955	R12005	R12055	R12105	R12155		Spare tool: Auxiliary data
R11806	R11856	R11906	R11956	R12006	R12056	R12106	R12156		Spare tool: Cumulative usage time (L)
R11807	R11857	R11907	R11957	R12007	R12057	R12107	R12157		Spare tool: Cumulative usage time (H)

Device No.								Abbrev.	Signal name
\$1	\$2	\$3	\$4	\$5	\$6	\$7	\$8		
R11808	R11858	R11908	R11958	R12008	R12058	R12108	R12158		Spare tool: Service lifetime (L)
R11809	R11859	R11909	R11959	R12009	R12059	R12109	R12159		Spare tool: Service lifetime (H)
R11810	R11860	R11910	R11960	R12010	R12060	R12110	R12160		Spare tool: Cumulative usage count
R11811	R11861	R11911	R11961	R12011	R12061	R12111	R12161		Spare tool: Service life count
R11812	R11862	R11912	R11962	R12012	R12062	R12112	R12162		Spare tool: Cumulative usage wear amount (L)
R11813	R11863	R11913	R11963	R12013	R12063	R12113	R12163		Spare tool: Cumulative usage wear amount (H)
R11814	R11864	R11914	R11964	R12014	R12064	R12114	R12164		Spare tool: Service life wear amount (L)
R11815	R11865	R11915	R11965	R12015	R12065	R12115	R12165		Spare tool: Service life wear amount (H)

2 Input/Output Signals with Controller

Device No.								Abbrev.	Signal name
\$1	\$2	\$3	\$4	\$5	\$6	\$7	\$8		
R11816	R11866	R11916	R11966	R12016	R12066	R12116	R12166		Spare tool: Length compensation amount (L)
R11817	R11867	R11917	R11967	R12017	R12067	R12117	R12167		Spare tool: Length compensation amount (H)
R11818	R11868	R11918	R11968	R12018	R12068	R12118	R12168		Spare tool: Radius compensation amount (L)
R11819	R11869	R11919	R11969	R12019	R12069	R12119	R12169		Spare tool: Radius compensation amount (H)
R11820	R11870	R11920	R11970	R12020	R12070	R12120	R12170		Spare tool: Length wear amount (L)
R11821	R11871	R11921	R11971	R12021	R12071	R12121	R12171		Spare tool: Length wear amount (H)
R11822	R11872	R11922	R11972	R12022	R12072	R12122	R12172		Spare tool: Radius wear amount (L)
R11823	R11873	R11923	R11973	R12023	R12073	R12123	R12173		Spare tool: Radius wear amount (H)
Device No.								Abbrev.	Signal name
\$1	\$2	\$3	\$4	\$5	\$6	\$7	\$8		
R11824	R11874	R11924	R11974	R12024	R12074	R12124	R12174		T life mgmt (M system) Active tool: Group No. (L)
R11825	R11875	R11925	R11975	R12025	R12075	R12125	R12175		Active tool: Group No. (H)
R11826	R11876	R11926	R11976	R12026	R12076	R12126	R12176		Active tool: Tool No. (L)
R11827	R11877	R11927	R11977	R12027	R12077	R12127	R12177		Active tool: Tool No. (H)
R11828	R11878	R11928	R11978	R12028	R12078	R12128	R12178		Active tool: Tool data flag/Status
R11829	R11879	R11929	R11979	R12029	R12079	R12129	R12179		Active tool: Auxiliary data
R11830	R11880	R11930	R11980	R12030	R12080	R12130	R12180		Active tool: Cumulative usage time (L)
R11831	R11881	R11931	R11981	R12031	R12081	R12131	R12181		Active tool: Cumulative usage time (H)
Device No.								Abbrev.	Signal name
\$1	\$2	\$3	\$4	\$5	\$6	\$7	\$8		
R11832	R11882	R11932	R11982	R12032	R12082	R12132	R12182		Active tool: Service lifetime (L)
R11833	R11883	R11933	R11983	R12033	R12083	R12133	R12183		Active tool: Service lifetime (H)
R11834	R11884	R11934	R11984	R12034	R12084	R12134	R12184		Active tool: Cumulative usage count
R11835	R11885	R11935	R11985	R12035	R12085	R12135	R12185		Active tool: Service life count
R11836	R11886	R11936	R11986	R12036	R12086	R12136	R12186		Active tool: Cumulative usage wear amount (L)
R11837	R11887	R11937	R11987	R12037	R12087	R12137	R12187		Active tool: Cumulative usage wear amount (H)
R11838	R11888	R11938	R11988	R12038	R12088	R12138	R12188		Active tool: Service life wear amount (L)
R11839	R11889	R11939	R11989	R12039	R12089	R12139	R12189		Active tool: Service life wear amount (H)
Device No.								Abbrev.	Signal name
\$1	\$2	\$3	\$4	\$5	\$6	\$7	\$8		
R11840	R11890	R11940	R11990	R12040	R12090	R12140	R12190		Active tool: Length compensation amount (L)
R11841	R11891	R11941	R11991	R12041	R12091	R12141	R12191		Active tool: Length compensation amount (H)
R11842	R11892	R11942	R11992	R12042	R12092	R12142	R12192		Active tool: Radius compensation amount (L)
R11843	R11893	R11943	R11993	R12043	R12093	R12143	R12193		Active tool: Radius compensation amount (H)
R11844	R11894	R11944	R11994	R12044	R12094	R12144	R12194		Active tool: Length wear amount (L)
R11845	R11895	R11945	R11995	R12045	R12095	R12145	R12195		Active tool: Length wear amount (H)
R11846	R11896	R11946	R11996	R12046	R12096	R12146	R12196		Active tool: Radius wear amount (L)
R11847	R11897	R11947	R11997	R12047	R12097	R12147	R12197		Active tool: Radius wear amount (H)

2 Input/Output Signals with Controller

Device	Abbrev.	Signal name	Device	Abbrev.	Signal name
R14000		EcoMonitorLight connection: Station #1	R14008		
R14001		consumed power [M8]	R14009		
R14002		EcoMonitorLight connection: Station #1	R14010		EcoMonitorLight connection: Station #2
R14003		regenerated power [M8]	R14011		consumed power [M8]
R14004			R14012		EcoMonitorLight connection: Station #2
R14005			R14013		regenerated power [M8]
R14006			R14014		
R14007			R14015		
Device	Abbrev.	Signal name	Device	Abbrev.	Signal name
R14016			R14024		
R14017			R14025		
R14018			R14026		
R14019			R14027		
R14020		EcoMonitorLight connection: Station #3	R14028		
R14021		consumed power [M8]	R14029		
R14022		EcoMonitorLight connection: Station #3	R14030		EcoMonitorLight connection: Station #4
R14023		regenerated power [M8]	R14031		consumed power [M8]
Device	Abbrev.	Signal name	Device	Abbrev.	Signal name
R14032		EcoMonitorLight connection: Station #4	R14040		EcoMonitorLight connection: Station #5
R14033		regenerated power [M8]	R14041		consumed power [M8]
R14034			R14042		EcoMonitorLight connection: Station #5
R14035			R14043		regenerated power [M8]
R14036			R14044		
R14037			R14045		
R14038			R14046		
R14039			R14047		
Device	Abbrev.	Signal name	Device	Abbrev.	Signal name
R14048			R14056		
R14049			R14057		
R14050		EcoMonitorLight connection: Station #6	R14058		
R14051		consumed power [M8]	R14059		
R14052		EcoMonitorLight connection: Station #6	R14060		EcoMonitorLight connection: Station #7
R14053		regenerated power [M8]	R14061		consumed power [M8]
R14054			R14062		EcoMonitorLight connection: Station #7
R14055			R14063		regenerated power [M8]
Device	Abbrev.	Signal name	Device	Abbrev.	Signal name
R14064			R14072		EcoMonitorLight connection: Station #8
R14065			R14073		regenerated power [M8]
R14066			R14074		
R14067			R14075		
R14068			R14076		
R14069			R14077		
R14070		EcoMonitorLight connection: Station #8	R14078		
R14071		consumed power [M8]	R14079		

2 Input/Output Signals with Controller

Device	Abbrev.	Signal name	Device	Abbrev.	Signal name
R14080		EcoMonitorLight connection: Station #9 consumed power [M8]	R14088		
R14081			R14089		
R14082		EcoMonitorLight connection: Station #9 regenerated power [M8]	R14090		EcoMonitorLight connection: Station #10 consumed power [M8]
R14083			R14091		
R14084			R14092		EcoMonitorLight connection: Station #10 regenerated power [M8]
R14085			R14093		
R14086			R14094		
R14087			R14095		
Device	Abbrev.	Signal name	Device	Abbrev.	Signal name
R14096			R14104		
R14097			R14105		
R14098			R14106		
R14099			R14107		
R14100		EcoMonitorLight connection: Station #11 consumed power [M8]	R14108		
R14101			R14109		
R14102		EcoMonitorLight connection: Station #11 regenerated power [M8]	R14110		EcoMonitorLight connection: Station #12 consumed power [M8]
R14103			R14111		
Device	Abbrev.	Signal name	Device	Abbrev.	Signal name
R14112		EcoMonitorLight connection: Station #12 regenerated power [M8]	R14120		EcoMonitorLight connection: Station #13 consumed power [M8]
R14113			R14121		
R14114			R14122		EcoMonitorLight connection: Station #13 regenerated power [M8]
R14115			R14123		
R14116			R14124		
R14117			R14125		
R14118			R14126		
R14119			R14127		
Device	Abbrev.	Signal name	Device	Abbrev.	Signal name
R14128			R14136		
R14129			R14137		
R14130		EcoMonitorLight connection: Station #14 consumed power [M8]	R14138		
R14131			R14139		
R14132		EcoMonitorLight connection: Station #14 regenerated power [M8]	R14140		EcoMonitorLight connection: Station #15 consumed power [M8]
R14133			R14141		
R14134			R14142		EcoMonitorLight connection: Station #15 regenerated power [M8]
R14135			R14143		
Device	Abbrev.	Signal name	Device	Abbrev.	Signal name
R14144			R14152		EcoMonitorLight connection: Station #16 regenerated power [M8]
R14145			R14153		
R14146			R14154		
R14147			R14155		
R14148			R14156		
R14149			R14157		
R14150		EcoMonitorLight connection: Station #16 consumed power [M8]	R14158		
R14151			R14159		

2 Input/Output Signals with Controller

Device	Abbrev.	Signal name	Device	Abbrev.	Signal name
R14192			R14200		EcoMonitorLight connection: Station #1 number of reception errors [M8]
R14193			R14201		EcoMonitorLight connection: Station #1 maximum number of successive reception errors [M8]
R14194			R14202		EcoMonitorLight connection: Station #1 number of transmission errors [M8]
R14195			R14203		EcoMonitorLight connection: Station #1 maximum number of successive transmission errors [M8]
R14196			R14204		
R14197			R14205		
R14198			R14206		
R14199			R14207		
Device Abbrev. Signal name Device Abbrev. Signal name					
R14208			R14216		
R14209			R14217		
R14210		EcoMonitorLight connection: Station #2 number of reception errors [M8]	R14218		
R14211		EcoMonitorLight connection: Station #2 maximum number of successive reception errors [M8]	R14219		
R14212		EcoMonitorLight connection: Station #2 number of transmission errors [M8]	R14220		EcoMonitorLight connection: Station #3 number of reception errors [M8]
R14213		EcoMonitorLight connection: Station #2 maximum number of successive transmission errors [M8]	R14221		EcoMonitorLight connection: Station #3 maximum number of successive reception errors [M8]
R14214			R14222		EcoMonitorLight connection: Station #3 number of transmission errors [M8]
R14215			R14223		EcoMonitorLight connection: Station #3 maximum number of successive transmission errors [M8]
Device Abbrev. Signal name Device Abbrev. Signal name					
R14224			R14232		EcoMonitorLight connection: Station #4 number of transmission errors [M8]
R14225			R14233		EcoMonitorLight connection: Station #4 maximum number of successive transmission errors [M8]
R14226			R14234		
R14227			R14235		
R14228			R14236		
R14229			R14237		
R14230		EcoMonitorLight connection: Station #4 number of reception errors [M8]	R14238		
R14231		EcoMonitorLight connection: Station #4 maximum number of successive reception errors [M8]	R14239		

2 Input/Output Signals with Controller

Device	Abbrev.	Signal name	Device	Abbrev.	Signal name
R14240		EcoMonitorLight connection: Station #5 number of reception errors [M8]	R14248		
R14241		EcoMonitorLight connection: Station #5 maximum number of successive reception errors [M8]	R14249		
R14242		EcoMonitorLight connection: Station #5 number of transmission errors [M8]	R14250		EcoMonitorLight connection: Station #6 number of reception errors [M8]
R14243		EcoMonitorLight connection: Station #5 maximum number of successive transmission errors [M8]	R14251		EcoMonitorLight connection: Station #6 maximum number of successive reception errors [M8]
R14244			R14252		EcoMonitorLight connection: Station #6 number of transmission errors [M8]
R14245			R14253		EcoMonitorLight connection: Station #6 maximum number of successive transmission errors [M8]
R14246			R14254		
R14247			R14255		
Device	Abbrev.	Signal name	Device	Abbrev.	Signal name
R14256			R14264		
R14257			R14265		
R14258			R14266		
R14259			R14267		
R14260		EcoMonitorLight connection: Station #7 number of reception errors [M8]	R14268		
R14261		EcoMonitorLight connection: Station #7 maximum number of successive reception errors [M8]	R14269		
R14262		EcoMonitorLight connection: Station #7 number of transmission errors [M8]	R14270		EcoMonitorLight connection: Station #8 number of reception errors [M8]
R14263		EcoMonitorLight connection: Station #7 maximum number of successive transmission errors [M8]	R14271		EcoMonitorLight connection: Station #8 maximum number of successive reception errors [M8]
Device	Abbrev.	Signal name	Device	Abbrev.	Signal name
R14272		EcoMonitorLight connection: Station #8 number of transmission errors [M8]	R14280		EcoMonitorLight connection: Station #9 number of reception errors [M8]
R14273		EcoMonitorLight connection: Station #8 maximum number of successive transmission errors [M8]	R14281		EcoMonitorLight connection: Station #9 maximum number of successive reception errors [M8]
R14274			R14282		EcoMonitorLight connection: Station #9 number of transmission errors [M8]
R14275			R14283		EcoMonitorLight connection: Station #9 maximum number of successive transmission errors [M8]
R14276			R14284		
R14277			R14285		
R14278			R14286		
R14279			R14287		

2 Input/Output Signals with Controller

Device	Abbrev.	Signal name	Device	Abbrev.	Signal name
R14288			R14296		
R14289			R14297		
R14290		EcoMonitorLight connection: Station #10 number of reception errors [M8]	R14298		
R14291		EcoMonitorLight connection: Station #10 maximum number of successive reception errors [M8]	R14299		
R14292		EcoMonitorLight connection: Station #10 number of transmission errors [M8]	R14300		EcoMonitorLight connection: Station #11 number of reception errors [M8]
R14293		EcoMonitorLight connection: Station #10 maximum number of successive transmission errors [M8]	R14301		EcoMonitorLight connection: Station #11 maximum number of successive reception errors [M8]
R14294			R14302		EcoMonitorLight connection: Station #11 number of transmission errors [M8]
R14295			R14303		EcoMonitorLight connection: Station #11 maximum number of successive transmission errors [M8]
Device	Abbrev.	Signal name	Device	Abbrev.	Signal name
R14304			R14312		EcoMonitorLight connection: Station #12 number of transmission errors [M8]
R14305			R14313		EcoMonitorLight connection: Station #12 maximum number of successive transmission errors [M8]
R14306			R14314		
R14307			R14315		
R14308			R14316		
R14309			R14317		
R14310		EcoMonitorLight connection: Station #12 number of reception errors [M8]	R14318		
R14311		EcoMonitorLight connection: Station #12 maximum number of successive reception errors [M8]	R14319		
Device	Abbrev.	Signal name	Device	Abbrev.	Signal name
R14320		EcoMonitorLight connection: Station #13 number of reception errors [M8]	R14328		
R14321		EcoMonitorLight connection: Station #13 maximum number of successive reception errors [M8]	R14329		
R14322		EcoMonitorLight connection: Station #13 number of transmission errors [M8]	R14330		EcoMonitorLight connection: Station #14 number of reception errors [M8]
R14323		EcoMonitorLight connection: Station #13 maximum number of successive transmission errors [M8]	R14331		EcoMonitorLight connection: Station #14 maximum number of successive reception errors [M8]
R14324			R14332		EcoMonitorLight connection: Station #14 number of transmission errors [M8]
R14325			R14333		EcoMonitorLight connection: Station #14 maximum number of successive transmission errors [M8]
R14326			R14334		
R14327			R14335		

2 Input/Output Signals with Controller

Device	Abbrev.	Signal name	Device	Abbrev.	Signal name
R14336			R14344		
R14337			R14345		
R14338			R14346		
R14339			R14347		
R14340		EcoMonitorLight connection: Station #15 number of reception errors [M8]	R14348		
R14341		EcoMonitorLight connection: Station #15 maximum number of successive reception errors [M8]	R14349		
R14342		EcoMonitorLight connection: Station #15 number of transmission errors [M8]	R14350		EcoMonitorLight connection: Station #16 number of reception errors [M8]
R14343		EcoMonitorLight connection: Station #15 maximum number of successive transmission errors [M8]	R14351		EcoMonitorLight connection: Station #16 maximum number of successive reception errors [M8]
Device	Abbrev.	Signal name	Device	Abbrev.	Signal name
R14352		EcoMonitorLight connection: Station #16 number of transmission errors [M8]	R14360		
R14353		EcoMonitorLight connection: Station #16 maximum number of successive transmission errors [M8]	R14361		
R14354			R14362		
R14355			R14363		
R14356			R14364		
R14357			R14365		
R14358			R14366		
R14359			R14367		
Device	Abbrev.	Signal name	Device	Abbrev.	Signal name
R14400		EcoMonitorLight connection: Completion bit [M8]			
R14401		EcoMonitorLight connection: Completion status [M8]			
R14402		EcoMonitorLight connection: Acquired data [M8]			
R14403					
R14404					
R14405					
R14406					
R14407					
Device	Abbrev.	Signal name	Device	Abbrev.	Signal name
R14500		MES interface library: Serial number [M8]	R14508		MES interface library: Serial number [M8]
R14501			R14509		
R14502			R14510		
R14503			R14511		
R14504			R14512		
R14505			R14513		
R14506			R14514		
R14507			R14515		

2 Input/Output Signals with Controller

Device	Abbrev.	Signal name	Device	Abbrev.	Signal name
R14516		MES interface library: Serial number [M8]	R14524		MES interface library: Serial number [M8]
R14517			R14525		
R14518			R14526		
R14519			R14527		
R14520			R14528		
R14521			R14529		
R14522			R14530		
R14523			R14531		
Device	Abbrev.	Signal name	Device	Abbrev.	Signal name
R14532		MES interface library: Operator ID [M8]	R14540		MES interface library: Operator ID [M8]
R14533			R14541		
R14534			R14542		
R14535			R14543		
R14536			R14544		
R14537			R14545		
R14538			R14546		
R14539			R14547		
Device	Abbrev.	Signal name	Device	Abbrev.	Signal name
R14548		MES interface library: Operator ID [M8]	R14556		MES interface library: Operator ID [M8]
R14549			R14557		
R14550			R14558		
R14551			R14559		
R14552			R14560		
R14553			R14561		
R14554			R14562		
R14555			R14563		
Device	Abbrev.	Signal name	Device	Abbrev.	Signal name
R14564		MES interface library: NC unit number [M8]	R14572		MES interface library: Line number [M8]
R14565			R14573		
R14566			R14574		
R14567			R14575		
R14568			R14576		
R14569			R14577		
R14570			R14578		
R14571			R14579		
Device	Abbrev.	Signal name	Device	Abbrev.	Signal name
R14580		MES interface library: Line number [M8]	R14588		MES interface library: Machine type [M8]
R14581			R14589		MES interface library: Database connection status [M8]
R14582			R14590		MES interface library: Database operation request register [M8]
R14583			R14591		MES interface library: Database operation reception register [M8]
R14584			R14592		MES interface library: Database operation result register [M8]
R14585			R14593		
R14586			R14594		
R14587				R14595	

Device	Abbrev.	Signal name	Device	Abbrev.	Signal name
R14596		MES interface library: Database operation result register [M8]	R14604		MES interface library: G code modal registration selection [M8]
R14597			R14605		
R14598		MES interface library: DB operation selection [M8]	R14606		
R14599		MES interface library: Operation table selection [M8]	R14607		
R14600		MES interface library: Function selection at machining end [M8]	R14608		
R14601		MES interface library: Function selection at alarm [M8]	R14609		
R14602		MES interface library: Function selection at user's option [M8]	R14610		
R14603			R14611		
Device	Abbrev.	Signal name	Device	Abbrev.	Signal name
R20000	FLSYSM	FL-net : System monitor ▲	R20008	RULS	FL-net : Upper layer status of reference node ▲
R20001	LNA	FL-net : Local node address ▲	R20009	RCAD1	FL-net : Common memory area 1 data top address of reference node ▲
R20002	LULS	FL-net : Upper layer status of local node ▲	R20010	RCSZ1	FL-net : Common memory area 1 data size of reference node ▲
R20003	LLKS	FL-net : Link status of local node ▲	R20011	RCAD2	FL-net : Common memory area 2 data top address of reference node ▲
R20004	LSTS	FL-net : Status of local node ▲	R20012	RCSZ2	FL-net : Common memory area 2 data size of reference node ▲
R20005	PNADSP	FL-net : Participating node top address on display ▲	R20013	RLKS	FFL-net : Link status of reference node ▲
R20006	PNALST	FL-net : List of participating nodes ▲	R20014	RMFT	FL-net : Allowable minimum frame interval time of reference node ▲
R20007	RNADSP	FL-net : Reference node address on display ▲	R20015	RCTNO W	FL-net : Present value of refresh cycle measurement time ▲
Device	Abbrev.	Signal name	Device	Abbrev.	Signal name
R20016	RVCYR	FL-net : API return value of cyclic transmission read ▲	R20024		NC warning display: Alarm 3D accumulation counter ▲
R20017	RVCYW	FL-net : API return value of cyclic transmission write ▲	R20025		
R20018			R20026		
R20019			R20027		
R20020			R20028		
R20021			R20029		
R20022			R20030		
R20023			R20031		

2 Input/Output Signals with Controller

Device	Abbrev.	Signal name	Device	Abbrev.	Signal name
R20032		NC warning display: Alarm 3D frequency counter ▲	R20040		NC warning display: "Z48 Power supply voltage error warning at acceleration/ deceleration" state ▲
R20033			R20041	*SVIDDD S	Diagnosis data output: Handling for servo motor insulation deterioration detection (PLC axis) [C80]
R20034			R20042	*SVIDDD W	Diagnosis data output: Waiting for servo motor insulation deterioration detection (PLC axis) [C80]
R20035			R20043	SVIDDD	Diagnosis data output: Servomotor insulation degradation detection in progress (PLC axis)
R20036			R20044	*SVIDDC A	Diagnosis data output: Caution in servo motor insulation deterioration detection (PLC axis) [C80]
R20037			R20045	*SVIDDC H	Diagnosis data output: Servo motor exchange due to insulation deterioration detection (PLC axis) [C80]
R20038			R20046	*SPIDDD S	Diagnosis data output: Handling for spindle motor insulation deterioration detection [C80]
R20039			R20047	*SPIDDD W	Diagnosis data output: Waiting for spindle motor insulation deterioration detection [C80]

Device	Abbrev.	Signal name	Device	Abbrev.	Signal name
R20048	SPIDDD	Diagnosis data output: Spindle motor insulation degradation detection in progress	R20056		
R20049	*SPIDDC A	Diagnosis data output: Caution in spindle motor insulation deterioration detection [C80]	R20057		
R20050	*SPIDDC H	Diagnosis data output: Spindle motor exchange due to insulation deterioration detection [C80]	R20058		PLC window: number of continuous writes detected [M8]
R20051			R20059		PLC window: continuous write window No. [M8]
R20052			R20060		
R20053			R20061		
R20054			R20062		
R20055			R20063		

Device	Abbrev.	Signal name	Device	Abbrev.	Signal name
R20180	VAMOD On	In hypothetical axis command mode [C80]			
R20181					
R20182					
R20183					
R20184					
R20185					
R20186					
R20187					

Device No.								Abbrev.	Signal name
\$1	\$2	\$3	\$4	\$5	\$6	\$7	\$8		
R20500	R20700	R20900	R21100	R21300	R21500	R21700	R21900		Current spatial error compensation value (orthogonal coordinate horizontal axis) [M8]
R20501	R20701	R20901	R21101	R21301	R21501	R21701	R21901		
R20502	R20702	R20902	R21102	R21302	R21502	R21702	R21902		Current spatial error compensation value (orthogonal coordinate vertical axis) [M8]
R20503	R20703	R20903	R21103	R21303	R21503	R21703	R21903		
R20504	R20704	R20904	R21104	R21304	R21504	R21704	R21904		Current spatial error compensation value (orthogonal coordinate height axis) [M8]
R20505	R20705	R20905	R21105	R21305	R21505	R21705	R21905		
R20506	R20706	R20906	R21106	R21306	R21506	R21706	R21906		Current spatial error compensation value (1st rotary axis) [M8]
R20507	R20707	R20907	R21107	R21307	R21507	R21707	R21907		

2 Input/Output Signals with Controller

Device No.									
\$1	\$2	\$3	\$4	\$5	\$6	\$7	\$8	Abbrev.	Signal name
R20508	R20708	R20908	R21108	R21308	R21508	R21708	R21908		Current spatial error compensation value (2nd rotary axis) [M8]
R20509	R20709	R20909	R21109	R21309	R21509	R21709	R21909		
R20510	R20710	R20910	R21110	R21310	R21510	R21710	R21910		
R20511	R20711	R20911	R21111	R21311	R21511	R21711	R21911		
R20512	R20712	R20912	R21112	R21312	R21512	R21712	R21912		
R20513	R20713	R20913	R21113	R21313	R21513	R21713	R21913		
R20514	R20714	R20914	R21114	R21314	R21514	R21714	R21914		
R20515	R20715	R20915	R21115	R21315	R21515	R21715	R21915		
Device No.									
\$1	\$2	\$3	\$4	\$5	\$6	\$7	\$8	Abbrev.	Signal name
R20516	R20716	R20916	R21116	R21316	R21516	R21716	R21916		Appropriate machining diagnosis error axis ▲
R20517	R20717	R20917	R21117	R21317	R21517	R21717	R21917	TRTNCNT	Tool retract and return 2 : Number of transit points stored ▲
R20518	R20718	R20918	R21118	R21318	R21518	R21718	R21918		
R20519	R20719	R20919	R21119	R21319	R21519	R21719	R21919		NC warning display: "Z48 Power supply voltage error warning at acceleration/deceleration" state ▲
R20520	R20720	R20920	R21120	R21320	R21520	R21720	R21920	*SVIDDDS	Diagnosis data output: Handling for servo motor insulation deterioration detection [C80]
R20521	R20721	R20921	R21121	R21321	R21521	R21721	R21921	*SVIDDDW	Diagnosis data output: Waiting for servo motor insulation deterioration detection [C80]
R20522	R20722	R20922	R21122	R21322	R21522	R21722	R21922	SVIDDD	Diagnosis data output: Servomotor insulation degradation detection in progress
R20523	R20723	R20923	R21123	R21323	R21523	R21723	R21923	*SVIDDCA	Diagnosis data output: Caution in servo motor insulation deterioration detection [C80]
Device No.									
\$1	\$2	\$3	\$4	\$5	\$6	\$7	\$8	Abbrev.	Signal name
R20524	R20724	R20924	R21124	R21324	R21524	R21724	R21924	*SVIDDCH	Diagnosis data output: Servo motor exchange due to insulation deterioration detection [C80]
R20525	R20725	R20925	R21125	R21325	R21525	R21725	R21925		
R20526	R20726	R20926	R21126	R21326	R21526	R21726	R21926		
R20527	R20727	R20927	R21127	R21327	R21527	R21727	R21927		
R20528	R20728	R20928	R21128	R21328	R21528	R21728	R21928		
R20529	R20729	R20929	R21129	R21329	R21529	R21729	R21929		
R20530	R20730	R20930	R21130	R21330	R21530	R21730	R21930		
R20531	R20731	R20931	R21131	R21331	R21531	R21731	R21931		
Device No.									
\$1	\$2	\$3	\$4	\$5	\$6	\$7	\$8	Abbrev.	Signal name
R20532	R20732	R20932	R21132	R21332	R21532	R21732	R21932		
R20533	R20733	R20933	R21133	R21333	R21533	R21733	R21933		
R20534	R20734	R20934	R21134	R21334	R21534	R21734	R21934		
R20535	R20735	R20935	R21135	R21335	R21535	R21735	R21935		
R20536	R20736	R20936	R21136	R21336	R21536	R21736	R21936		
R20537	R20737	R20937	R21137	R21337	R21537	R21737	R21937		L system T code data
R20538	R20738	R20938	R21138	R21338	R21538	R21738	R21938		
R20539	R20739	R20939	R21139	R21339	R21539	R21739	R21939		

2 Input/Output Signals with Controller

Device No.								Abbrev.	Signal name
\$1	\$2	\$3	\$4	\$5	\$6	\$7	\$8		
R20540	R20740	R20940	R21140	R21340	R21540	R21740	R21940		
R20541	R20741	R20941	R21141	R21341	R21541	R21741	R21941		
R20542	R20742	R20942	R21142	R21342	R21542	R21742	R21942		
R20543	R20743	R20943	R21143	R21343	R21543	R21743	R21943		
R20544	R20744	R20944	R21144	R21344	R21544	R21744	R21944		
R20545	R20745	R20945	R21145	R21345	R21545	R21745	R21945		
R20546	R20746	R20946	R21146	R21346	R21546	R21746	R21946	MCNGITS TS	Machining interruption command [C80]
R20547	R20747	R20947	R21147	R21347	R21547	R21747	R21947		

Device No.								Abbrev.	Signal name
\$1	\$2	\$3	\$4	\$5	\$6	\$7	\$8		
R20556	R20756	R20956	R21156	R21356	R21556	R21756	R21956	VCC_VIB	VCC: Number of vibrations
R20557	R20757	R20957	R21157	R21357	R21557	R21757	R21957	VCC_FRQ	VCC: Frequency
R20558	R20758	R20958	R21158	R21358	R21558	R21758	R21958	VCC_VIBAX	VCC: Vibrating axis
R20559	R20759	R20959	R21159	R21359	R21559	R21759	R21959	VCC_FACT	VCC: Cause of non-vibration
R20560	R20760	R20960	R21160	R21360	R21560	R21760	R21960		
R20561	R20761	R20961	R21161	R21361	R21561	R21761	R21961		
R20562	R20762	R20962	R21162	R21362	R21562	R21762	R21962		
R20563	R20763	R20963	R21163	R21363	R21563	R21763	R21963		

Device No.				Abbrev.	Signal name
\$1	\$2	\$3	\$4		
R24500	R24532	R24564	R24596		NC warning display: Alarm 3D accumulation counter 1st axis ▲
R24501	R24533	R24565	R24597		NC warning display: Alarm 3D accumulation counter 2nd axis ▲
R24502	R24534	R24566	R24598		NC warning display: Alarm 3D accumulation counter 3rd axis ▲
R24503	R24535	R24567	R24599		NC warning display: Alarm 3D accumulation counter 4th axis ▲
R24504	R24536	R24568	R24600		NC warning display: Alarm 3D accumulation counter 5th axis ▲
R24505	R24537	R24569	R24601		NC warning display: Alarm 3D accumulation counter 6th axis ▲
R24506	R24538	R24570	R24602		NC warning display: Alarm 3D accumulation counter 7th axis ▲
R24507	R24539	R24571	R24603		NC warning display: Alarm 3D accumulation counter 8th axis ▲

Device No.				Abbrev.	Signal name
\$1	\$2	\$3	\$4		
R24508	R24540	R24572	R24604		NC warning display: Alarm 3D frequency counter 1st axis ▲
R24509	R24541	R24573	R24605		NC warning display: Alarm 3D frequency counter 2nd axis ▲
R24510	R24542	R24574	R24606		NC warning display: Alarm 3D frequency counter 3rd axis ▲
R24511	R24543	R24575	R24607		NC warning display: Alarm 3D frequency counter 4th axis ▲
R24512	R24544	R24576	R24608		NC warning display: Alarm 3D frequency counter 5th axis ▲
R24513	R24545	R24577	R24609		NC warning display: Alarm 3D frequency counter 6th axis ▲
R24514	R24546	R24578	R24610		NC warning display: Alarm 3D frequency counter 7th axis ▲
R24515	R24547	R24579	R24611		NC warning display: Alarm 3D frequency counter 8th axis ▲

2 Input/Output Signals with Controller

Device No.				Abbrev.	Signal name
\$1	\$2	\$3	\$4		
R24884	R24916	R24948	R24980		Total distance traveled by 1st axis during automatic operation [M8] [M]
R24885	R24917	R24949	R24981		
R24886	R24918	R24950	R24982		
R24887	R24919	R24951	R24983		
R24888	R24920	R24952	R24984		Total distance traveled by 2nd axis during automatic operation [M8] [M]
R24889	R24921	R24953	R24985		
R24890	R24922	R24954	R24986		
R24891	R24923	R24955	R24987		

Device No.				Abbrev.	Signal name
\$1	\$2	\$3	\$4		
R24892	R24924	R24956	R24988		Total distance traveled by 3rd axis during automatic operation [M8] [M]
R24893	R24925	R24957	R24989		
R24894	R24926	R24958	R24990		
R24895	R24927	R24959	R24991		
R24896	R24928	R24960	R24992		Total distance traveled by 4th axis during automatic operation [M8] [M]
R24897	R24929	R24961	R24993		
R24898	R24930	R24962	R24994		
R24899	R24931	R24963	R24995		

Device No.				Abbrev.	Signal name
\$1	\$2	\$3	\$4		
R24900	R24932	R24964	R24996		Total distance traveled by 5th axis during automatic operation [M8] [M]
R24901	R24933	R24965	R24997		
R24902	R24934	R24966	R24998		
R24903	R24935	R24967	R24999		
R24904	R24936	R24968	R25000		Total distance traveled by 6th axis during automatic operation [M8] [M]
R24905	R24937	R24969	R25001		
R24906	R24938	R24970	R25002		
R24907	R24939	R24971	R25003		

Device No.				Abbrev.	Signal name
\$1	\$2	\$3	\$4		
R24908	R24940	R24972	R25004		Total distance traveled by 7th axis during automatic operation [M8] [M]
R24909	R24941	R24973	R25005		
R24910	R24942	R24974	R25006		
R24911	R24943	R24975	R25007		
R24912	R24944	R24976	R25008		Total distance traveled by 8th axis during automatic operation [M8] [M]
R24913	R24945	R24977	R25009		
R24914	R24946	R24978	R25010		
R24915	R24947	R24979	R25011		

Device No.				Abbrev.	Signal name
\$1	\$2	\$3	\$4		
R25012	R25020	R25028	R25036	AXCHGSTS1	Tool head hot swapping: NC axis switch status 1st axis [M8]
R25013	R25021	R25029	R25037	AXCHGSTS2	Tool head hot swapping: NC axis switch status 2nd axis [M8]
R25014	R25022	R25030	R25038	AXCHGSTS3	Tool head hot swapping: NC axis switch status 3rd axis [M8]
R25015	R25023	R25031	R25039	AXCHGSTS4	Tool head hot swapping: NC axis switch status 4th axis [M8]
R25016	R25024	R25032	R25040	AXCHGSTS5	Tool head hot swapping: NC axis switch status 5th axis [M8]
R25017	R25025	R25033	R25041	AXCHGSTS6	Tool head hot swapping: NC axis switch status 6th axis [M8]
R25018	R25026	R25034	R25042	AXCHGSTS7	Tool head hot swapping: NC axis switch status 7th axis [M8]
R25019	R25027	R25035	R25043	AXCHGSTS8	Tool head hot swapping: NC axis switch status 8th axis [M8]

2.3 PLC Output Signals (Bit type: Y***)

(Note) Signals with "▲" are prepared for specific machine tool builders.

Device	Abbrev.	Signal name	Device	Abbrev.	Signal name
Y700	IPCC1	Power consumption computation: Clear consumption accumulation 1	Y708	*KEY1	Data protect key 1
Y701	IPCC2	Power consumption computation: Clear consumption accumulation 2	Y709	*KEY2	Data protect key 2
Y702	IPCC3	Power consumption computation: Clear consumption accumulation 3	Y70A	*KEY3	Data protect key 3
Y703	IPCC4	Power consumption computation: Clear consumption accumulation 4	Y70B		
Y704	RHD1	Integration time input 1	Y70C	PDISP	Program display during operation ▲
Y705	RHD2	Integration time input 2	Y70D		Handle pulse encoder communication connector priority
Y706	MDBUSR ST1	Modbus Time-out 1 cancel ▲	Y70E		
Y707	MDBUSR ST2	Modbus Time-out 2 cancel ▲	Y70F		
Device	Abbrev.	Signal name	Device	Abbrev.	Signal name
Y710			Y718	*PCD1	PLC axis near point detection 1st axis
Y711		Optimum acceleration/deceleration parameter switch request [spindle] ▲	Y719	*PCD2	PLC axis near point detection 2nd axis
Y712			Y71A	*PCD3	PLC axis near point detection 3rd axis
Y713			Y71B	*PCD4	PLC axis near point detection 4th axis
Y714			Y71C	*PCD5	PLC axis near point detection 5th axis
Y715			Y71D	*PCD6	PLC axis near point detection 6th axis
Y716			Y71E	*PCD7	PLC axis near point detection 7th axis
Y717			Y71F	*PCD8	PLC axis near point detection 8th axis
Device	Abbrev.	Signal name	Device	Abbrev.	Signal name
Y720	HS1P	PLC axis 1st handle valid	Y728	CRTFN	CRT changeover completion [M8]
Y721	HS2P	PLC axis 2nd handle valid	Y729	SCRON	Screen display request [M8]
Y722	HS3P	PLC axis 3rd handle valid	Y72A		
Y723		PLC axis control buffering mode valid	Y72B		Collecting diagnosis data stop
Y724	IPCE1	Power consumption computation: Enable consumption accumulation 1	Y72C	SMPTRG	Sampling start/stop
Y725	IPCE2	Power consumption computation: Enable consumption accumulation 2	Y72D		
Y726	IPCE3	Power consumption computation: Enable consumption accumulation 3	Y72E		Pallet program registration In APC execution [M8]
Y727	IPCE4	Power consumption computation: Enable consumption accumulation 4	Y72F		Pallet program registration Ext. workpiece coordinate transfer ready [M8]
Device	Abbrev.	Signal name	Device	Abbrev.	Signal name
Y730	DISP1	Display changeover \$1	Y738		
Y731	DISP2	Display changeover \$2	Y739		
Y732	DISP3	Display changeover \$3	Y73A	MSBK	Single block between part systems
Y733	DISP4	Display changeover \$4	Y73B		
Y734	DISP5	Display changeover \$5	Y73C	MORR	Manual arbitrary reverse run mode
Y735	DISP6	Display changeover \$6	Y73D	MORSP	Manual arbitrary reverse run speed selection
Y736	DISP7	Display changeover \$7	Y73E	SMLK	High-speed simple program check mode
Y737	DISP8	Display changeover \$8	Y73F	CCHK	Interference check between part systems: Interference check enabled [M8]

Device	Abbrev.	Signal name	Device	Abbrev.	Signal name
Y740		Tool IC new read ▲	Y748		PLC skip 1
Y741		Tool IC exchange read ▲	Y749		PLC skip 2
Y742	MCT	Contactorf shutoff test	Y74A		PLC skip 3
Y743			Y74B		PLC skip 4
Y744			Y74C		PLC skip 5
Y745			Y74D		PLC skip 6
Y746			Y74E		PLC skip 7
Y747		Turret interference check valid	Y74F		PLC skip 8
Device	Abbrev.	Signal name	Device	Abbrev.	Signal name
Y750			Y758		
Y751			Y759		
Y752			Y75A		
Y753			Y75B		
Y754			Y75C		
Y755			Y75D		Automatic power OFF request [M8]
Y756			Y75E		
Y757			Y75F		
Device	Abbrev.	Signal name	Device	Abbrev.	Signal name
Y760			Y768		Door open I
Y761	MRCMD	Actual cutting mode (thread, tap) in manual arbitrary reverse run	Y769	ITF3VLD T	Interference check III: Enable interfering object selection data [M8]
Y762			Y76A	ITF3CMD	Interference check III: Interference check III mode [M8]
Y763			Y76B	SPSC	High-speed simple program check: Enable coordinate position check
Y764		Encoder 1 arbitrary pulse selection	Y76C		Remote program input start ▲
Y765		Encoder 2 arbitrary pulse selection	Y76D		Tool ID data read ▲
Y766		Encoder 1 arbitrary pulse valid	Y76E		Tool ID data write ▲
Y767		Encoder 2 arbitrary pulse valid	Y76F		Tool ID data erase ▲
Device	Abbrev.	Signal name	Device	Abbrev.	Signal name
Y770		PLC axis control valid 1st axis	Y778	GBON	G/B spindle synchronization valid [M8]
Y771		PLC axis control valid 2nd axis	Y779		
Y772		PLC axis control valid 3rd axis	Y77A	GBPHS	G/B spindle synchronization: phase alignment [M8]
Y773		PLC axis control valid 4th axis	Y77B	GBPHM	G/B spindle synchronization: phase memory [M8]
Y774		PLC axis control valid 5th axis	Y77C	GBCMON	G/B spindle synchronization: position error compensation [M8]
Y775		PLC axis control valid 6th axis	Y77D	GBOFF	G/B spindle synchronization: temporary cancel [M8]
Y776		PLC axis control valid 7th axis	Y77E	GBCMKP	G/B spindle synchronization: keep position error compensation amount signal [M8]
Y777		PLC axis control valid 8th axis	Y77F	HISAVE	Operation history retract [C80]

Device No.					
\$1	\$2	\$3	\$4	Abbrev.	Signal name
Y780	Y788	Y790	Y798	DTCH1	Control axis detachment 1st axis
Y781	Y789	Y791	Y799	DTCH2	Control axis detachment 2nd axis
Y782	Y78A	Y792	Y79A	DTCH3	Control axis detachment 3rd axis
Y783	Y78B	Y793	Y79B	DTCH4	Control axis detachment 4th axis
Y784	Y78C	Y794	Y79C	DTCH5	Control axis detachment 5th axis
Y785	Y78D	Y795	Y79D	DTCH6	Control axis detachment 6th axis
Y786	Y78E	Y796	Y79E	DTCH7	Control axis detachment 7th axis
Y787	Y78F	Y797	Y79F	DTCH8	Control axis detachment 8th axis
Device No.					
\$1	\$2	\$3	\$4	Abbrev.	Signal name
Y7A0	Y7A8	Y7B0	Y7B8	*SVF1	Servo OFF 1st axis
Y7A1	Y7A9	Y7B1	Y7B9	*SVF2	Servo OFF 2nd axis
Y7A2	Y7AA	Y7B2	Y7BA	*SVF3	Servo OFF 3rd axis
Y7A3	Y7AB	Y7B3	Y7BB	*SVF4	Servo OFF 4th axis
Y7A4	Y7AC	Y7B4	Y7BC	*SVF5	Servo OFF 5th axis
Y7A5	Y7AD	Y7B5	Y7BD	*SVF6	Servo OFF 6th axis
Y7A6	Y7AE	Y7B6	Y7BE	*SVF7	Servo OFF 7th axis
Y7A7	Y7AF	Y7B7	Y7BF	*SVF8	Servo OFF 8th axis
Device No.					
\$1	\$2	\$3	\$4	Abbrev.	Signal name
Y7C0	Y7C8	Y7D0	Y7D8	MI1	Mirror image 1st axis
Y7C1	Y7C9	Y7D1	Y7D9	MI2	Mirror image 2nd axis
Y7C2	Y7CA	Y7D2	Y7DA	MI3	Mirror image 3rd axis
Y7C3	Y7CB	Y7D3	Y7DB	MI4	Mirror image 4th axis
Y7C4	Y7CC	Y7D4	Y7DC	MI5	Mirror image 5th axis
Y7C5	Y7CD	Y7D5	Y7DD	MI6	Mirror image 6th axis
Y7C6	Y7CE	Y7D6	Y7DE	MI7	Mirror image 7th axis
Y7C7	Y7CF	Y7D7	Y7DF	MI8	Mirror image 8th axis
Device No.					
\$1	\$2	\$3	\$4	Abbrev.	Signal name
Y7E0	Y7E8	Y7F0	Y7F8	*+EDT1	External deceleration+ 1st axis
Y7E1	Y7E9	Y7F1	Y7F9	*+EDT2	External deceleration+ 2nd axis
Y7E2	Y7EA	Y7F2	Y7FA	*+EDT3	External deceleration+ 3rd axis
Y7E3	Y7EB	Y7F3	Y7FB	*+EDT4	External deceleration+ 4th axis
Y7E4	Y7EC	Y7F4	Y7FC	*+EDT5	External deceleration+ 5th axis
Y7E5	Y7ED	Y7F5	Y7FD	*+EDT6	External deceleration+ 6th axis
Y7E6	Y7EE	Y7F6	Y7FE	*+EDT7	External deceleration+ 7th axis
Y7E7	Y7EF	Y7F7	Y7FF	*+EDT8	External deceleration+ 8th axis

(Note) The CNC control and CNC status signals are arbitrarily assigned to the device and axis numbers by the parameter "#1603 PLCdev_no" for each axis.

For details of setting, refer to the "PLC I/F axis random device assignment" in the "PLC Programming Manual".

Device No.					
\$1	\$2	\$3	\$4	Abbrev.	Signal name
Y800	Y808	Y810	Y818	*-EDT1	External deceleration- 1st axis
Y801	Y809	Y811	Y819	*-EDT2	External deceleration- 2nd axis
Y802	Y80A	Y812	Y81A	*-EDT3	External deceleration- 3rd axis
Y803	Y80B	Y813	Y81B	*-EDT4	External deceleration- 4th axis
Y804	Y80C	Y814	Y81C	*-EDT5	External deceleration- 5th axis
Y805	Y80D	Y815	Y81D	*-EDT6	External deceleration- 6th axis
Y806	Y80E	Y816	Y81E	*-EDT7	External deceleration- 7th axis
Y807	Y80F	Y817	Y81F	*-EDT8	External deceleration- 8th axis
Device No.					
\$1	\$2	\$3	\$4	Abbrev.	Signal name
Y820	Y828	Y830	Y838	*+AIT1	Automatic interlock+ 1st axis
Y821	Y829	Y831	Y839	*+AIT2	Automatic interlock+ 2nd axis
Y822	Y82A	Y832	Y83A	*+AIT3	Automatic interlock+ 3rd axis
Y823	Y82B	Y833	Y83B	*+AIT4	Automatic interlock+ 4th axis
Y824	Y82C	Y834	Y83C	*+AIT5	Automatic interlock+ 5th axis
Y825	Y82D	Y835	Y83D	*+AIT6	Automatic interlock+ 6th axis
Y826	Y82E	Y836	Y83E	*+AIT7	Automatic interlock+ 7th axis
Y827	Y82F	Y837	Y83F	*+AIT8	Automatic interlock+ 8th axis
Device No.					
\$1	\$2	\$3	\$4	Abbrev.	Signal name
Y840	Y848	Y850	Y858	*-AIT1	Automatic interlock- 1st axis
Y841	Y849	Y851	Y859	*-AIT2	Automatic interlock- 2nd axis
Y842	Y84A	Y852	Y85A	*-AIT3	Automatic interlock- 3rd axis
Y843	Y84B	Y853	Y85B	*-AIT4	Automatic interlock- 4th axis
Y844	Y84C	Y854	Y85C	*-AIT5	Automatic interlock- 5th axis
Y845	Y84D	Y855	Y85D	*-AIT6	Automatic interlock- 6th axis
Y846	Y84E	Y856	Y85E	*-AIT7	Automatic interlock- 7th axis
Y847	Y84F	Y857	Y85F	*-AIT8	Automatic interlock- 8th axis
Device No.					
\$1	\$2	\$3	\$4	Abbrev.	Signal name
Y860	Y868	Y870	Y878	*+MIT1	Manual interlock+ 1st axis
Y861	Y869	Y871	Y879	*+MIT2	Manual interlock+ 2nd axis
Y862	Y86A	Y872	Y87A	*+MIT3	Manual interlock+ 3rd axis
Y863	Y86B	Y873	Y87B	*+MIT4	Manual interlock+ 4th axis
Y864	Y86C	Y874	Y87C	*+MIT5	Manual interlock+ 5th axis
Y865	Y86D	Y875	Y87D	*+MIT6	Manual interlock+ 6th axis
Y866	Y86E	Y876	Y87E	*+MIT7	Manual interlock+ 7th axis
Y867	Y86F	Y877	Y87F	*+MIT8	Manual interlock+ 8th axis

(Note) The CNC control and CNC status signals are arbitrarily assigned to the device and axis numbers by the parameter "#1603 PLCdev_no" for each axis.

For details of setting, refer to the "PLC I/F axis random device assignment" in the "PLC Programming Manual".

Device No.				Abbrev.	Signal name
\$1	\$2	\$3	\$4		
Y880	Y888	Y890	Y898	*-MIT1	Manual interlock- 1st axis
Y881	Y889	Y891	Y899	*-MIT2	Manual interlock- 2nd axis
Y882	Y88A	Y892	Y89A	*-MIT3	Manual interlock- 3rd axis
Y883	Y88B	Y893	Y89B	*-MIT4	Manual interlock- 4th axis
Y884	Y88C	Y894	Y89C	*-MIT5	Manual interlock- 5th axis
Y885	Y88D	Y895	Y89D	*-MIT6	Manual interlock- 6th axis
Y886	Y88E	Y896	Y89E	*-MIT7	Manual interlock- 7th axis
Y887	Y88F	Y897	Y89F	*-MIT8	Manual interlock- 8th axis
Device No.				Abbrev.	Signal name
\$1	\$2	\$3	\$4		
Y8A0	Y8A8	Y8B0	Y8B8	AMLK1	Automatic machine lock 1st axis
Y8A1	Y8A9	Y8B1	Y8B9	AMLK2	Automatic machine lock 2nd axis
Y8A2	Y8AA	Y8B2	Y8BA	AMLK3	Automatic machine lock 3rd axis
Y8A3	Y8AB	Y8B3	Y8BB	AMLK4	Automatic machine lock 4th axis
Y8A4	Y8AC	Y8B4	Y8BC	AMLK5	Automatic machine lock 5th axis
Y8A5	Y8AD	Y8B5	Y8BD	AMLK6	Automatic machine lock 6th axis
Y8A6	Y8AE	Y8B6	Y8BE	AMLK7	Automatic machine lock 7th axis
Y8A7	Y8AF	Y8B7	Y8BF	AMLK8	Automatic machine lock 8th axis
Device No.				Abbrev.	Signal name
\$1	\$2	\$3	\$4		
Y8C0	Y8C8	Y8D0	Y8D8	MMLK1	Manual machine lock 1st axis
Y8C1	Y8C9	Y8D1	Y8D9	MMLK2	Manual machine lock 2nd axis
Y8C2	Y8CA	Y8D2	Y8DA	MMLK3	Manual machine lock 3rd axis
Y8C3	Y8CB	Y8D3	Y8DB	MMLK4	Manual machine lock 4th axis
Y8C4	Y8CC	Y8D4	Y8DC	MMLK5	Manual machine lock 5th axis
Y8C5	Y8CD	Y8D5	Y8DD	MMLK6	Manual machine lock 6th axis
Y8C6	Y8CE	Y8D6	Y8DE	MMLK7	Manual machine lock 7th axis
Y8C7	Y8CF	Y8D7	Y8DF	MMLK8	Manual machine lock 8th axis
Device No.				Abbrev.	Signal name
\$1	\$2	\$3	\$4		
Y8E0	Y8E8	Y8F0	Y8F8	+J1	Feed axis selection+ 1st axis
Y8E1	Y8E9	Y8F1	Y8F9	+J2	Feed axis selection+ 2nd axis
Y8E2	Y8EA	Y8F2	Y8FA	+J3	Feed axis selection+ 3rd axis
Y8E3	Y8EB	Y8F3	Y8FB	+J4	Feed axis selection+ 4th axis
Y8E4	Y8EC	Y8F4	Y8FC	+J5	Feed axis selection+ 5th axis
Y8E5	Y8ED	Y8F5	Y8FD	+J6	Feed axis selection+ 6th axis
Y8E6	Y8EE	Y8F6	Y8FE	+J7	Feed axis selection+ 7th axis
Y8E7	Y8EF	Y8F7	Y8FF	+J8	Feed axis selection+ 8th axis

(Note) The CNC control and CNC status signals are arbitrarily assigned to the device and axis numbers by the parameter "#1603 PLCdev_no" for each axis.

For details of setting, refer to the "PLC I/F axis random device assignment" in the "PLC Programming Manual".

Device No.				Abbrev.	Signal name
\$1	\$2	\$3	\$4		
Y900	Y908	Y910	Y918	-J1	Feed axis selection- 1st axis
Y901	Y909	Y911	Y919	-J2	Feed axis selection- 2nd axis
Y902	Y90A	Y912	Y91A	-J3	Feed axis selection- 3rd axis
Y903	Y90B	Y913	Y91B	-J4	Feed axis selection- 4th axis
Y904	Y90C	Y914	Y91C	-J5	Feed axis selection- 5th axis
Y905	Y90D	Y915	Y91D	-J6	Feed axis selection- 6th axis
Y906	Y90E	Y916	Y91E	-J7	Feed axis selection- 7th axis
Y907	Y90F	Y917	Y91F	-J8	Feed axis selection- 8th axis
Device No.				Abbrev.	Signal name
\$1	\$2	\$3	\$4		
Y920	Y928	Y930	Y938	MAE1	Manual/Automatic simultaneous valid 1st axis
Y921	Y929	Y931	Y939	MAE2	Manual/Automatic simultaneous valid 2nd axis
Y922	Y92A	Y932	Y93A	MAE3	Manual/Automatic simultaneous valid 3rd axis
Y923	Y92B	Y933	Y93B	MAE4	Manual/Automatic simultaneous valid 4th axis
Y924	Y92C	Y934	Y93C	MAE5	Manual/Automatic simultaneous valid 5th axis
Y925	Y92D	Y935	Y93D	MAE6	Manual/Automatic simultaneous valid 6th axis
Y926	Y92E	Y936	Y93E	MAE7	Manual/Automatic simultaneous valid 7th axis
Y927	Y92F	Y937	Y93F	MAE8	Manual/Automatic simultaneous valid 8th axis
Device No.				Abbrev.	Signal name
\$1	\$2	\$3	\$4		
Y940	Y948	Y950	Y958	FBE1	Manual feedrate B valid 1st axis
Y941	Y949	Y951	Y959	FBE2	Manual feedrate B valid 2nd axis
Y942	Y94A	Y952	Y95A	FBE3	Manual feedrate B valid 3rd axis
Y943	Y94B	Y953	Y95B	FBE4	Manual feedrate B valid 4th axis
Y944	Y94C	Y954	Y95C	FBE5	Manual feedrate B valid 5th axis
Y945	Y94D	Y955	Y95D	FBE6	Manual feedrate B valid 6th axis
Y946	Y94E	Y956	Y95E	FBE7	Manual feedrate B valid 7th axis
Y947	Y94F	Y957	Y95F	FBE8	Manual feedrate B valid 8th axis
Device No.				Abbrev.	Signal name
\$1	\$2	\$3	\$4		
Y960	Y968	Y970	Y978	AZS1	Zero point initialization set mode 1st axis
Y961	Y969	Y971	Y979	AZS2	Zero point initialization set mode 2nd axis
Y962	Y96A	Y972	Y97A	AZS3	Zero point initialization set mode 3rd axis
Y963	Y96B	Y973	Y97B	AZS4	Zero point initialization set mode 4th axis
Y964	Y96C	Y974	Y97C	AZS5	Zero point initialization set mode 5th axis
Y965	Y96D	Y975	Y97D	AZS6	Zero point initialization set mode 6th axis
Y966	Y96E	Y976	Y97E	AZS7	Zero point initialization set mode 7th axis
Y967	Y96F	Y977	Y97F	AZS8	Zero point initialization set mode 8th axis

(Note) The CNC control and CNC status signals are arbitrarily assigned to the device and axis numbers by the parameter "#1603 PLCdev_no" for each axis.

For details of setting, refer to the "PLC I/F axis random device assignment" in the "PLC Programming Manual".

2 Input/Output Signals with Controller

Device No.					
\$1	\$2	\$3	\$4	Abbrev.	Signal name
Y980	Y988	Y990	Y998	ZST1	Zero point initialization set start 1st axis
Y981	Y989	Y991	Y999	ZST2	Zero point initialization set start 2nd axis
Y982	Y98A	Y992	Y99A	ZST3	Zero point initialization set start 3rd axis
Y983	Y98B	Y993	Y99B	ZST4	Zero point initialization set start 4th axis
Y984	Y98C	Y994	Y99C	ZST5	Zero point initialization set start 5th axis
Y985	Y98D	Y995	Y99D	ZST6	Zero point initialization set start 6th axis
Y986	Y98E	Y996	Y99E	ZST7	Zero point initialization set start 7th axis
Y987	Y98F	Y997	Y99F	ZST8	Zero point initialization set start 8th axis
Device No.					
\$1	\$2	\$3	\$4	Abbrev.	Signal name
Y9A0	Y9A8	Y9B0	Y9B8	ILC1	Current limit changeover 1st axis
Y9A1	Y9A9	Y9B1	Y9B9	ILC2	Current limit changeover 2nd axis
Y9A2	Y9AA	Y9B2	Y9BA	ILC3	Current limit changeover 3rd axis
Y9A3	Y9AB	Y9B3	Y9BB	ILC4	Current limit changeover 4th axis
Y9A4	Y9AC	Y9B4	Y9BC	ILC5	Current limit changeover 5th axis
Y9A5	Y9AD	Y9B5	Y9BD	ILC6	Current limit changeover 6th axis
Y9A6	Y9AE	Y9B6	Y9BE	ILC7	Current limit changeover 7th axis
Y9A7	Y9AF	Y9B7	Y9BF	ILC8	Current limit changeover 8th axis
Device No.					
\$1	\$2	\$3	\$4	Abbrev.	Signal name
Y9C0	Y9C8	Y9D0	Y9D8	DOR1	Droop cancel request 1st axis
Y9C1	Y9C9	Y9D1	Y9D9	DOR2	Droop cancel request 2nd axis
Y9C2	Y9CA	Y9D2	Y9DA	DOR3	Droop cancel request 3rd axis
Y9C3	Y9CB	Y9D3	Y9DB	DOR4	Droop cancel request 4th axis
Y9C4	Y9CC	Y9D4	Y9DC	DOR5	Droop cancel request 5th axis
Y9C5	Y9CD	Y9D5	Y9DD	DOR6	Droop cancel request 6th axis
Y9C6	Y9CE	Y9D6	Y9DE	DOR7	Droop cancel request 7th axis
Y9C7	Y9CF	Y9D7	Y9DF	DOR8	Droop cancel request 8th axis
Device No.					
\$1	\$2	\$3	\$4	Abbrev.	Signal name
Y9E0	Y9E8	Y9F0	Y9F8		Workpiece coordinate Measurement 1st axis (Spare)
Y9E1	Y9E9	Y9F1	Y9F9		Workpiece coordinate Measurement 2nd axis
Y9E2	Y9EA	Y9F2	Y9FA		Workpiece coordinate Measurement 3rd axis (Spare)
Y9E3	Y9EB	Y9F3	Y9FB		Workpiece coordinate Measurement 4th axis (Spare)
Y9E4	Y9EC	Y9F4	Y9FC		Workpiece coordinate Measurement 5th axis (Spare)
Y9E5	Y9ED	Y9F5	Y9FD		Workpiece coordinate Measurement 6th axis (Spare)
Y9E6	Y9EE	Y9F6	Y9FE		Workpiece coordinate Measurement 7th axis (Spare)
Y9E7	Y9EF	Y9F7	Y9FF		Workpiece coordinate Measurement 8th axis (Spare)

(Note) The CNC control and CNC status signals are arbitrarily assigned to the device and axis numbers by the parameter "#1603 PLCdev_no" for each axis.

For details of setting, refer to the "PLC I/F axis random device assignment" in the "PLC Programming Manual".

Device No.				Abbrev.	Signal name
\$1	\$2	\$3	\$4		
YA00	YA08	YA10	YA18	DTCH21	Control axis detachment 2 1st axis
YA01	YA09	YA11	YA19	DTCH22	Control axis detachment 2 2nd axis
YA02	YA0A	YA12	YA1A	DTCH23	Control axis detachment 2 3rd axis
YA03	YA0B	YA13	YA1B	DTCH24	Control axis detachment 2 4th axis
YA04	YA0C	YA14	YA1C	DTCH25	Control axis detachment 2 5th axis
YA05	YA0D	YA15	YA1D	DTCH26	Control axis detachment 2 6th axis
YA06	YA0E	YA16	YA1E	DTCH27	Control axis detachment 2 7th axis
YA07	YA0F	YA17	YA1F	DTCH28	Control axis detachment 2 8th axis
Device No.				Abbrev.	Signal name
\$1	\$2	\$3	\$4		
YA20	YA28	YA30	YA38	UCLPF1	Unclamp completion 1st axis
YA21	YA29	YA31	YA39	UCLPF2	Unclamp completion 2nd axis
YA22	YA2A	YA32	YA3A	UCLPF3	Unclamp completion 3rd axis
YA23	YA2B	YA33	YA3B	UCLPF4	Unclamp completion 4th axis
YA24	YA2C	YA34	YA3C	UCLPF5	Unclamp completion 5th axis
YA25	YA2D	YA35	YA3D	UCLPF6	Unclamp completion 6th axis
YA26	YA2E	YA36	YA3E	UCLPF7	Unclamp completion 7th axis
YA27	YA2F	YA37	YA3F	UCLPF8	Unclamp completion 8th axis
Device No.				Abbrev.	Signal name
\$1	\$2	\$3	\$4		
YA40	YA48	YA50	YA58		Each axis reference position return 1st axis
YA41	YA49	YA51	YA59		Each axis reference position return 2nd axis
YA42	YA4A	YA52	YA5A		Each axis reference position return 3rd axis
YA43	YA4B	YA53	YA5B		Each axis reference position return 4th axis
YA44	YA4C	YA54	YA5C		Each axis reference position return 5th axis
YA45	YA4D	YA55	YA5D		Each axis reference position return 6th axis
YA46	YA4E	YA56	YA5E		Each axis reference position return 7th axis
YA47	YA4F	YA57	YA5F		Each axis reference position return 8th axis
Device No.				Abbrev.	Signal name
\$1	\$2	\$3	\$4		
YA60	YA68	YA70	YA78		Mixed control (cross axis control) request 1st axis
YA61	YA69	YA71	YA79		Mixed control (cross axis control) request 2nd axis
YA62	YA6A	YA72	YA7A		Mixed control (cross axis control) request 3rd axis
YA63	YA6B	YA73	YA7B		Mixed control (cross axis control) request 4th axis
YA64	YA6C	YA74	YA7C		Mixed control (cross axis control) request 5th axis
YA65	YA6D	YA75	YA7D		Mixed control (cross axis control) request 6th axis
YA66	YA6E	YA76	YA7E		Mixed control (cross axis control) request 7th axis
YA67	YA6F	YA77	YA7F		Mixed control (cross axis control) request 8th axis

(Note) The CNC control and CNC status signals are arbitrarily assigned to the device and axis numbers by the parameter "#1603 PLCdev_no" for each axis.

For details of setting, refer to the "PLC I/F axis random device assignment" in the "PLC Programming Manual".

Device No.				Abbrev.	Signal name
\$1	\$2	\$3	\$4		
YA80	YA88	YA90	YA98	SYNC1	Synchronous control request 1st axis
YA81	YA89	YA91	YA99	SYNC2	Synchronous control request 2nd axis
YA82	YA8A	YA92	YA9A	SYNC3	Synchronous control request 3rd axis
YA83	YA8B	YA93	YA9B	SYNC4	Synchronous control request 4th axis
YA84	YA8C	YA94	YA9C	SYNC5	Synchronous control request 5th axis
YA85	YA8D	YA95	YA9D	SYNC6	Synchronous control request 6th axis
YA86	YA8E	YA96	YA9E	SYNC7	Synchronous control request 7th axis
YA87	YA8F	YA97	YA9F	SYNC8	Synchronous control request 8th axis
Device No.				Abbrev.	Signal name
\$1	\$2	\$3	\$4		
YAA0	YAA8	YAB0	YAB8	PILE1	Superimposition control request 1st axis
YAA1	YAA9	YAB1	YAB9	PILE2	Superimposition control request 2nd axis
YAA2	YAAA	YAB2	YABA	PILE3	Superimposition control request 3rd axis
YAA3	YAAB	YAB3	YABB	PILE4	Superimposition control request 4th axis
YAA4	YAAC	YAB4	YABC	PILE5	Superimposition control request 5th axis
YAA5	YAAD	YAB5	YABD	PILE6	Superimposition control request 6th axis
YAA6	YAAE	YAB6	YABE	PILE7	Superimposition control request 7th axis
YAA7	YAAF	YAB7	YABF	PILE8	Superimposition control request 8th axis
Device No.				Abbrev.	Signal name
\$1	\$2	\$3	\$4		
YAC0	YAC8	YAD0	YAD8		NC axis control selection 1st axis
YAC1	YAC9	YAD1	YAD9		NC axis control selection 2nd axis
YAC2	YACA	YAD2	YADA		NC axis control selection 3rd axis
YAC3	YACB	YAD3	YADB		NC axis control selection 4th axis
YAC4	YACC	YAD4	YADC		NC axis control selection 5th axis
YAC5	YACD	YAD5	YADD		NC axis control selection 6th axis
YAC6	YACE	YAD6	YADE		NC axis control selection 7th axis
YAC7	YACF	YAD7	YADF		NC axis control selection 8th axis
Device No.				Abbrev.	Signal name
\$1	\$2	\$3	\$4		
YAE0	YAE8	YAF0	YAF8		Vertical axis pull-up prevention request 1st axis
YAE1	YAE9	YAF1	YAF9		Vertical axis pull-up prevention request 2nd axis
YAE2	YAEA	YAF2	YAFA		Vertical axis pull-up prevention request 3rd axis
YAE3	YAEB	YAF3	YAFB		Vertical axis pull-up prevention request 4th axis
YAE4	YAEC	YAF4	YAFB		Vertical axis pull-up prevention request 5th axis
YAE5	YAED	YAF5	YAFD		Vertical axis pull-up prevention request 6th axis
YAE6	YAEF	YAF6	YAFE		Vertical axis pull-up prevention request 7th axis
YAE7	YAEF	YAF7	YAFF		Vertical axis pull-up prevention request 8th axis

(Note) The CNC control and CNC status signals are arbitrarily assigned to the device and axis numbers by the parameter "#1603 PLCdev_no" for each axis.

For details of setting, refer to the "PLC I/F axis random device assignment" in the "PLC Programming Manual".

Device No.				Abbrev.	Signal name
\$1	\$2	\$3	\$4		
YB00	YB08	YB10	YB18	CLPF1	Clamp completion 1st axis
YB01	YB09	YB11	YB19	CLPF2	Clamp completion 2nd axis
YB02	YB0A	YB12	YB1A	CLPF3	Clamp completion 3rd axis
YB03	YB0B	YB13	YB1B	CLPF4	Clamp completion 4th axis
YB04	YB0C	YB14	YB1C	CLPF5	Clamp completion 5th axis
YB05	YB0D	YB15	YB1D	CLPF6	Clamp completion 6th axis
YB06	YB0E	YB16	YB1E	CLPF7	Clamp completion 7th axis
YB07	YB0F	YB17	YB1F	CLPF8	Clamp completion 8th axis
Device No.				Abbrev.	Signal name
\$1	\$2	\$3	\$4		
YB20	YB28	YB30	YB38	HOBRTV1	Hob machining: retract amount selection 1st axis
YB21	YB29	YB31	YB39	HOBRTV2	Hob machining: retract amount selection 2nd axis
YB22	YB2A	YB32	YB3A	HOBRTV3	Hob machining: retract amount selection 3rd axis
YB23	YB2B	YB33	YB3B	HOBRTV4	Hob machining: retract amount selection 4th axis
YB24	YB2C	YB34	YB3C	HOBRTV5	Hob machining: retract amount selection 5th axis
YB25	YB2D	YB35	YB3D	HOBRTV6	Hob machining: retract amount selection 6th axis
YB26	YB2E	YB36	YB3E	HOBRTV7	Hob machining: retract amount selection 7th axis
YB27	YB2F	YB37	YB3F	HOBRTV8	Hob machining: retract amount selection 8th axis
Device No.				Abbrev.	Signal name
\$1	\$2	\$3	\$4		
YB40	YB48	YB50	YB58	ROTSPC1	Spindle-mode rotary axis control command 1st axis [M8]
YB41	YB49	YB51	YB59	ROTSPC2	Spindle-mode rotary axis control command 2nd axis [M8]
YB42	YB4A	YB52	YB5A	ROTSPC3	Spindle-mode rotary axis control command 3rd axis [M8]
YB43	YB4B	YB53	YB5B	ROTSPC4	Spindle-mode rotary axis control command 4th axis [M8]
YB44	YB4C	YB54	YB5C	ROTSPC5	Spindle-mode rotary axis control command 5th axis [M8]
YB45	YB4D	YB55	YB5D	ROTSPC6	Spindle-mode rotary axis control command 6th axis [M8]
YB46	YB4E	YB56	YB5E	ROTSPC7	Spindle-mode rotary axis control command 7th axis [M8]
YB47	YB4F	YB57	YB5F	ROTSPC8	Spindle-mode rotary axis control command 8th axis [M8]
Device No.				Abbrev.	Signal name
\$1	\$2	\$3	\$4		
YB60	YB68	YB70	YB78	SLMC1	Stored stroke limit I :Change request 1st axis
YB61	YB69	YB71	YB79	SLMC2	Stored stroke limit I :Change request 2nd axis
YB62	YB6A	YB72	YB7A	SLMC3	Stored stroke limit I :Change request 3rd axis
YB63	YB6B	YB73	YB7B	SLMC4	Stored stroke limit I :Change request 4th axis
YB64	YB6C	YB74	YB7C	SLMC5	Stored stroke limit I :Change request 5th axis
YB65	YB6D	YB75	YB7D	SLMC6	Stored stroke limit I :Change request 6th axis
YB66	YB6E	YB76	YB7E	SLMC7	Stored stroke limit I :Change request 7th axis
YB67	YB6F	YB77	YB7F	SLMC8	Stored stroke limit I :Change request 8th axis

(Note) The CNC control and CNC status signals are arbitrarily assigned to the device and axis numbers by the parameter "#1603 PLCdev_no" for each axis.

For details of setting, refer to the "PLC I/F axis random device assignment" in the "PLC Programming Manual".

2 Input/Output Signals with Controller

Device No.					
\$1	\$2	\$3	\$4	Abbrev.	Signal name
YB80	YB88	YB90	YB98	VGHLDC1	Real-time tuning 1: Speed control gain changeover hold-down command 1st axis [M8]
YB81	YB89	YB91	YB99	VGHLDC2	Real-time tuning 1: Speed control gain changeover hold-down command 2nd axis [M8]
YB82	YB8A	YB92	YB9A	VGHLDC3	Real-time tuning 1: Speed control gain changeover hold-down command 3rd axis [M8]
YB83	YB8B	YB93	YB9B	VGHLDC4	Real-time tuning 1: Speed control gain changeover hold-down command 4th axis [M8]
YB84	YB8C	YB94	YB9C	VGHLDC5	Real-time tuning 1: Speed control gain changeover hold-down command 5th axis [M8]
YB85	YB8D	YB95	YB9D	VGHLDC6	Real-time tuning 1: Speed control gain changeover hold-down command 6th axis [M8]
YB86	YB8E	YB96	YB9E	VGHLDC7	Real-time tuning 1: Speed control gain changeover hold-down command 7th axis [M8]
YB87	YB8F	YB97	YB9F	VGHLDC8	Real-time tuning 1: Speed control gain changeover hold-down command 8th axis [M8]

Device No.					
\$1	\$2	\$3	\$4	Abbrev.	Signal name
YBA0	YBA8	YBB0	YBB8	CNT01	Counter zero 1st axis [C80]
YBA1	YBA9	YBB1	YBB9	CNT02	Counter zero 2nd axis [C80]
YBA2	YBAA	YBB2	YBBA	CNT03	Counter zero 3rd axis [C80]
YBA3	YBAB	YBB3	YBBB	CNT04	Counter zero 4th axis [C80]
YBA4	YBAC	YBB4	YBBC	CNT05	Counter zero 5th axis [C80]
YBA5	YBAD	YBB5	YBBD	CNT06	Counter zero 6th axis [C80]
YBA6	YBAE	YBB6	YBBE	CNT07	Counter zero 7th axis [C80]
YBA7	YBAF	YBB7	YBBF	CNT08	Counter zero 8th axis [C80]

Device No.					
\$1	\$2	\$3	\$4	Abbrev.	Signal name
YBC0	YBC8	YBD0	YBD8	NPCHGREQ1	NC axis/PLC axis switchover request 1st axis
YBC1	YBC9	YBD1	YBD9	NPCHGREQ2	NC axis/PLC axis switchover request 2nd axis
YBC2	YBCA	YBD2	YBDA	NPCHGREQ3	NC axis/PLC axis switchover request 3rd axis
YBC3	YBCB	YBD3	YBDB	NPCHGREQ4	NC axis/PLC axis switchover request 4th axis
YBC4	YBCC	YBD4	YBDC	NPCHGREQ5	NC axis/PLC axis switchover request 5th axis
YBC5	YBCD	YBD5	YBDD	NPCHGREQ6	NC axis/PLC axis switchover request 6th axis
YBC6	YBCE	YBD6	YBDE	NPCHGREQ7	NC axis/PLC axis switchover request 7th axis
YBC7	YBCF	YBD7	YBDF	NPCHGREQ8	NC axis/PLC axis switchover request 8th axis

Device No.				Abbrev.	Signal name
YBE0	YBE8	YBF0	YBF8	GQEMGn	Machine group-based alarm stop: Machine group-based PLC interlock Group "n" (n = 1 to 32)
YBE1	YBE9	YBF1	YBF9		
YBE2	YBEA	YBF2	YBFA		
YBE3	YBEB	YBF3	YBFB		
YBE4	YBEC	YBF4	YBFC		
YBE5	YBED	YBF5	YBFD		
YBE6	YBEE	YBF6	YBFE		
YBE7	YBEF	YBF7	YBFF		

(Note) The CNC control and CNC status signals are arbitrarily assigned to the device and axis numbers by the parameter "#1603 PLCdev_no" for each axis.
 For details of setting, refer to the "PLC I/F axis random device assignment" in the "PLC Programming Manual".

2 Input/Output Signals with Controller

Device No.									
\$1	\$2	\$3	\$4	\$5	\$6	\$7	\$8	Abbrev.	Signal name
YC00	YD40	YE80	YFC0	Y1100	Y1240	Y1380	Y14C0	J	Jog mode
YC01	YD41	YE81	YFC1	Y1101	Y1241	Y1381	Y14C1	H	Handle mode
YC02	YD42	YE82	YFC2	Y1102	Y1242	Y1382	Y14C2	S	Incremental mode
YC03	YD43	YE83	YFC3	Y1103	Y1243	Y1383	Y14C3	PTP	Manual arbitrary feed mode
YC04	YD44	YE84	YFC4	Y1104	Y1244	Y1384	Y14C4	ZRN	Reference position return mode
YC05	YD45	YE85	YFC5	Y1105	Y1245	Y1385	Y14C5	AST	Automatic initialization mode
YC06	YD46	YE86	YFC6	Y1106	Y1246	Y1386	Y14C6		
YC07	YD47	YE87	YFC7	Y1107	Y1247	Y1387	Y14C7		
Device No.									
\$1	\$2	\$3	\$4	\$5	\$6	\$7	\$8	Abbrev.	Signal name
YC08	YD48	YE88	YFC8	Y1108	Y1248	Y1388	Y14C8	MEM	Memory mode
YC09	YD49	YE89	YFC9	Y1109	Y1249	Y1389	Y14C9	T	Tape mode
YC0A	YD4A	YE8A	YFCA	Y110A	Y124A	Y138A	Y14CA		Online operation mode (Computer link B)
YC0B	YD4B	YE8B	YFCB	Y110B	Y124B	Y138B	Y14CB	D	MDI mode
YC0C	YD4C	YE8C	YFCC	Y110C	Y124C	Y138C	Y14CC		
YC0D	YD4D	YE8D	YFCD	Y110D	Y124D	Y138D	Y14CD		
YC0E	YD4E	YE8E	YFCE	Y110E	Y124E	Y138E	Y14CE	SBSM	Sub part system control: Sub part system control I mode
YC0F	YD4F	YE8F	YFCF	Y110F	Y124F	Y138F	Y14CF		
Device No.									
\$1	\$2	\$3	\$4	\$5	\$6	\$7	\$8	Abbrev.	Signal name
YC10	YD50	YE90	YFD0	Y1110	Y1250	Y1390	Y14D0	ST	Automatic operation "start" command (Cycle start)
YC11	YD51	YE91	YFD1	Y1111	Y1251	Y1391	Y14D1	*SP	Automatic operation "pause" command (Feed hold)
YC12	YD52	YE92	YFD2	Y1112	Y1252	Y1392	Y14D2	SBK	Single block
YC13	YD53	YE93	YFD3	Y1113	Y1253	Y1393	Y14D3	*BSL	Block start interlock
YC14	YD54	YE94	YFD4	Y1114	Y1254	Y1394	Y14D4	*CSL	Cutting block start interlock
YC15	YD55	YE95	YFD5	Y1115	Y1255	Y1395	Y14D5	DRN	Dry run
YC16	YD56	YE96	YFD6	Y1116	Y1256	Y1396	Y14D6		
YC17	YD57	YE97	YFD7	Y1117	Y1257	Y1397	Y14D7	ERD	Error detection
Device No.									
\$1	\$2	\$3	\$4	\$5	\$6	\$7	\$8	Abbrev.	Signal name
YC18	YD58	YE98	YFD8	Y1118	Y1258	Y1398	Y14D8	NRST1	NC reset 1
YC19	YD59	YE99	YFD9	Y1119	Y1259	Y1399	Y14D9	NRST2	NC reset 2
YC1A	YD5A	YE9A	YFDA	Y111A	Y125A	Y139A	Y14DA	RRW	Reset & rewind
YC1B	YD5B	YE9B	YFDB	Y111B	Y125B	Y139B	Y14DB	*CDZ	Chamfering
YC1C	YD5C	YE9C	YFDC	Y111C	Y125C	Y139C	Y14DC	ARST	Automatic restart
YC1D	YD5D	YE9D	YFDD	Y111D	Y125D	Y139D	Y14DD		External search strobe
YC1E	YD5E	YE9E	YFDE	Y111E	Y125E	Y139E	Y14DE	FIN1	M function finish 1
YC1F	YD5F	YE9F	YFDF	Y111F	Y125F	Y139F	Y14DF	FIN2	M function finish 2

2 Input/Output Signals with Controller

Device No.									
\$1	\$2	\$3	\$4	\$5	\$6	\$7	\$8	Abbrev.	Signal name
YC20	YD60	YEA0	YFE0	Y1120	Y1260	Y13A0	Y14E0	TLM	Tool length measurement 1
YC21	YD61	YEA1	YFE1	Y1121	Y1261	Y13A1	Y14E1	TLMS	Tool length measurement 2
YC22	YD62	YEA2	YFE2	Y1122	Y1262	Y13A2	Y14E2		Synchronization correction mode
YC23	YD63	YEA3	YFE3	Y1123	Y1263	Y13A3	Y14E3	PRST	Program restart
YC24	YD64	YEA4	YFE4	Y1124	Y1264	Y13A4	Y14E4	PB	Playback
YC25	YD65	YEA5	YFE5	Y1125	Y1265	Y13A5	Y14E5	UIT	Macro interrupt
YC26	YD66	YEA6	YFE6	Y1126	Y1266	Y13A6	Y14E6	RT	Rapid traverse
YC27	YD67	YEA7	YFE7	Y1127	Y1267	Y13A7	Y14E7	VRV	Reverse run

Device No.									
\$1	\$2	\$3	\$4	\$5	\$6	\$7	\$8	Abbrev.	Signal name
YC28	YD68	YEA8	YFE8	Y1128	Y1268	Y13A8	Y14E8	ABS	Manual absolute
YC29	YD69	YEA9	YFE9	Y1129	Y1269	Y13A9	Y14E9	DLK	Display lock
YC2A	YD6A	YEA0	YFEA	Y112A	Y126A	Y13AA	Y14EA	F1D	F1-digit speed change valid
YC2B	YD6B	YEA0	YFEB	Y112B	Y126B	Y13AB	Y14EB	CRQ	Recalculation request

Device	Abbrev.	Signal name	Device	Abbrev.	Signal name
YC2C	QEMG	PLC emergency stop			

Device No.									
\$1	\$2	\$3	\$4	\$5	\$6	\$7	\$8	Abbrev.	Signal name
YC2D	YD6D	YEA0	YFED	Y112D	Y126D	Y13AD	Y14ED	RTN	Reference position retract
YC2E	YD6E	YEA0	YFEE	Y112E	Y126E	Y13AE	Y14EE	PIT	PLC interrupt
YC2F	YD6F	YEA0	YFEF	Y112F	Y126F	Y13AF	Y14EF		

Device No.									
\$1	\$2	\$3	\$4	\$5	\$6	\$7	\$8	Abbrev.	Signal name
YC30	YD70	YEB0	YFF0	Y1130	Y1270	Y13B0	Y14F0	CHPS	Chopping
YC31	YD71	YEB1	YFF1	Y1131	Y1271	Y13B1	Y14F1	RSST	Search & start
YC32	YD72	YEB2	YFF2	Y1132	Y1272	Y13B2	Y14F2		
YC33	YD73	YEB3	YFF3	Y1133	Y1273	Y13B3	Y14F3		
YC34	YD74	YEB4	YFF4	Y1134	Y1274	Y13B4	Y14F4		Chopping parameter valid
YC35	YD75	YEB5	YFF5	Y1135	Y1275	Y13B5	Y14F5		Inclined axis control valid
YC36	YD76	YEB6	YFF6	Y1136	Y1276	Y13B6	Y14F6		Inclined axis control: No Z axis compensation
YC37	YD77	YEB7	YFF7	Y1137	Y1277	Y13B7	Y14F7	BDT1	Optional block skip 1

Device No.									
\$1	\$2	\$3	\$4	\$5	\$6	\$7	\$8	Abbrev.	Signal name
YC38	YD78	YEB8	YFF8	Y1138	Y1278	Y13B8	Y14F8	BDT2	Optional block skip 2
YC39	YD79	YEB9	YFF9	Y1139	Y1279	Y13B9	Y14F9	BDT3	Optional block skip 3
YC3A	YD7A	YEB0	YFFA	Y113A	Y127A	Y13BA	Y14FA	BDT4	Optional block skip 4
YC3B	YD7B	YEB1	YFFB	Y113B	Y127B	Y13BB	Y14FB	BDT5	Optional block skip 5
YC3C	YD7C	YEB2	YFFC	Y113C	Y127C	Y13BC	Y14FC	BDT6	Optional block skip 6
YC3D	YD7D	YEB3	YFFD	Y113D	Y127D	Y13BD	Y14FD	BDT7	Optional block skip 7
YC3E	YD7E	YEB4	YFFE	Y113E	Y127E	Y13BE	Y14FE	BDT8	Optional block skip 8
YC3F	YD7F	YEB5	YFFF	Y113F	Y127F	Y13BF	Y14FF	BDT9	Optional block skip 9

Device No.									
\$1	\$2	\$3	\$4	\$5	\$6	\$7	\$8	Abbrev.	Signal name
YC40	YD80	YEC0	Y1000	Y1140	Y1280	Y13C0	Y1500	HS11	1st handle axis selection code 1
YC41	YD81	YEC1	Y1001	Y1141	Y1281	Y13C1	Y1501	HS12	1st handle axis selection code 2
YC42	YD82	YEC2	Y1002	Y1142	Y1282	Y13C2	Y1502	HS14	1st handle axis selection code 4
YC43	YD83	YEC3	Y1003	Y1143	Y1283	Y13C3	Y1503	HS18	1st handle axis selection code 8
YC44	YD84	YEC4	Y1004	Y1144	Y1284	Y13C4	Y1504	HS116	1st handle axis selection code 16
YC45	YD85	YEC5	Y1005	Y1145	Y1285	Y13C5	Y1505		
YC46	YD86	YEC6	Y1006	Y1146	Y1286	Y13C6	Y1506		
YC47	YD87	YEC7	Y1007	Y1147	Y1287	Y13C7	Y1507	HS1S	1st handle valid
Device No.									
\$1	\$2	\$3	\$4	\$5	\$6	\$7	\$8	Abbrev.	Signal name
YC48	YD88	YEC8	Y1008	Y1148	Y1288	Y13C8	Y1508	HS21	2nd handle axis selection code 1
YC49	YD89	YEC9	Y1009	Y1149	Y1289	Y13C9	Y1509	HS22	2nd handle axis selection code 2
YC4A	YD8A	YECA	Y100A	Y114A	Y128A	Y13CA	Y150A	HS24	2nd handle axis selection code 4
YC4B	YD8B	YECB	Y100B	Y114B	Y128B	Y13CB	Y150B	HS28	2nd handle axis selection code 8
YC4C	YD8C	YECC	Y100C	Y114C	Y128C	Y13CC	Y150C	HS216	2nd handle axis selection code 16
YC4D	YD8D	YECD	Y100D	Y114D	Y128D	Y13CD	Y150D		
YC4E	YD8E	YECE	Y100E	Y114E	Y128E	Y13CE	Y150E		
YC4F	YD8F	YECF	Y100F	Y114F	Y128F	Y13CF	Y150F	HS2S	2nd handle valid
Device No.									
\$1	\$2	\$3	\$4	\$5	\$6	\$7	\$8	Abbrev.	Signal name
YC50	YD90	YED0	Y1010	Y1150	Y1290	Y13D0	Y1510	HS31	3rd handle axis selection code 1
YC51	YD91	YED1	Y1011	Y1151	Y1291	Y13D1	Y1511	HS32	3rd handle axis selection code 2
YC52	YD92	YED2	Y1012	Y1152	Y1292	Y13D2	Y1512	HS34	3rd handle axis selection code 4
YC53	YD93	YED3	Y1013	Y1153	Y1293	Y13D3	Y1513	HS38	3rd handle axis selection code 8
YC54	YD94	YED4	Y1014	Y1154	Y1294	Y13D4	Y1514	HS316	3rd handle axis selection code 16
YC55	YD95	YED5	Y1015	Y1155	Y1295	Y13D5	Y1515		
YC56	YD96	YED6	Y1016	Y1156	Y1296	Y13D6	Y1516		
YC57	YD97	YED7	Y1017	Y1157	Y1297	Y13D7	Y1517	HS3S	3rd handle valid
Device No.									
\$1	\$2	\$3	\$4	\$5	\$6	\$7	\$8	Abbrev.	Signal name
YC58	YD98	YED8	Y1018	Y1158	Y1298	Y13D8	Y1518	OVC	Override cancel
YC59	YD99	YED9	Y1019	Y1159	Y1299	Y13D9	Y1519	OVSL	Manual override method selection
YC5A	YD9A	YEDA	Y101A	Y115A	Y129A	Y13DA	Y151A	AFL	Miscellaneous function lock
YC5B	YD9B	YEDB	Y101B	Y115B	Y129B	Y13DB	Y151B		
YC5C	YD9C	YEDC	Y101C	Y115C	Y129C	Y13DC	Y151C	TRV	Tap retract
YC5D	YD9D	YEDD	Y101D	Y115D	Y129D	Y13DD	Y151D		
YC5E	YD9E	YEDE	Y101E	Y115E	Y129E	Y13DE	Y151E		Tool handle feed mode [M8]
YC5F	YD9F	YEDF	Y101F	Y115F	Y129F	Y13DF	Y151F		

2 Input/Output Signals with Controller

Device No.									
\$1	\$2	\$3	\$4	\$5	\$6	\$7	\$8	Abbrev.	Signal name
YC60	YDA0	YEE0	Y1020	Y1160	Y12A0	Y13E0	Y1520	*FV1	Cutting feedrate override code 1
YC61	YDA1	YEE1	Y1021	Y1161	Y12A1	Y13E1	Y1521	*FV2	Cutting feedrate override code 2
YC62	YDA2	YEE2	Y1022	Y1162	Y12A2	Y13E2	Y1522	*FV4	Cutting feedrate override code 4
YC63	YDA3	YEE3	Y1023	Y1163	Y12A3	Y13E3	Y1523	*FV8	Cutting feedrate override code 8
YC64	YDA4	YEE4	Y1024	Y1164	Y12A4	Y13E4	Y1524	*FV16	Cutting feedrate override code 16
YC65	YDA5	YEE5	Y1025	Y1165	Y12A5	Y13E5	Y1525		
YC66	YDA6	YEE6	Y1026	Y1166	Y12A6	Y13E6	Y1526	FV2E	2nd cutting feedrate override valid
YC67	YDA7	YEE7	Y1027	Y1167	Y12A7	Y13E7	Y1527	FVS	Cutting feedrate override method selection
Device No.									
\$1	\$2	\$3	\$4	\$5	\$6	\$7	\$8	Abbrev.	Signal name
YC68	YDA8	YEE8	Y1028	Y1168	Y12A8	Y13E8	Y1528	ROV1	Rapid traverse override code 1
YC69	YDA9	YEE9	Y1029	Y1169	Y12A9	Y13E9	Y1529	ROV2	Rapid traverse override code 2
YC6A	YDAA	YEEA	Y102A	Y116A	Y12AA	Y13EA	Y152A		
YC6B	YDAB	YEEB	Y102B	Y116B	Y12AB	Y13EB	Y152B		
YC6C	YDAC	YEEC	Y102C	Y116C	Y12AC	Y13EC	Y152C		
YC6D	YDAD	YEE D	Y102D	Y116D	Y12AD	Y13ED	Y152D		
YC6E	YDAE	YEEE	Y102E	Y116E	Y12AE	Y13EE	Y152E		
YC6F	YDAF	YEEF	Y102F	Y116F	Y12AF	Y13EF	Y152F	ROVS	Rapid traverse override method selection
Device No.									
\$1	\$2	\$3	\$4	\$5	\$6	\$7	\$8	Abbrev.	Signal name
YC70	YDB0	YEF0	Y1030	Y1170	Y12B0	Y13F0	Y1530	*JV1	Manual feedrate code 1
YC71	YDB1	YEF1	Y1031	Y1171	Y12B1	Y13F1	Y1531	*JV2	Manual feedrate code 2
YC72	YDB2	YEF2	Y1032	Y1172	Y12B2	Y13F2	Y1532	*JV4	Manual feedrate code 4
YC73	YDB3	YEF3	Y1033	Y1173	Y12B3	Y13F3	Y1533	*JV8	Manual feedrate code 8
YC74	YDB4	YEF4	Y1034	Y1174	Y12B4	Y13F4	Y1534	*JV16	Manual feedrate code 16
YC75	YDB5	YEF5	Y1035	Y1175	Y12B5	Y13F5	Y1535		
YC76	YDB6	YEF6	Y1036	Y1176	Y12B6	Y13F6	Y1536	MCLMP	Manual speed clamp ON
YC77	YDB7	YEF7	Y1037	Y1177	Y12B7	Y13F7	Y1537	JVS	Manual feedrate method selection
Device No.									
\$1	\$2	\$3	\$4	\$5	\$6	\$7	\$8	Abbrev.	Signal name
YC78	YDB8	YEF8	Y1038	Y1178	Y12B8	Y13F8	Y1538	PCF1	Feedrate least increment code 1
YC79	YDB9	YEF9	Y1039	Y1179	Y12B9	Y13F9	Y1539	PCF2	Feedrate least increment code 2
YC7A	YDBA	YEFA	Y103A	Y117A	Y12BA	Y13FA	Y153A		
YC7B	YDBB	YEFB	Y103B	Y117B	Y12BB	Y13FB	Y153B	JHAN	Jog handle synchronous
YC7C	YDBC	YEF C	Y103C	Y117C	Y12BC	Y13FC	Y153C		Each axis manual feedrate B valid
YC7D	YDBD	Yefd	Y103D	Y117D	Y12BD	Y13FD	Y153D		Manual feedrate B surface speed control valid [M8]
YC7E	YDBE	YEFE	Y103E	Y117E	Y12BE	Y13FE	Y153E		Circular feed in manual mode valid [M8]
YC7F	YDBF	YEFF	Y103F	Y117F	Y12BF	Y13FF	Y153F		Coordinate rotation by parameter: Coordinate switch for manual feed [M8]

Device No.									
\$1	\$2	\$3	\$4	\$5	\$6	\$7	\$8	Abbrev.	Signal name
YC80	YDC0	YF00	Y1040	Y1180	Y12C0	Y1400	Y1540	MP1	Handle/incremental feed magnification code 1
YC81	YDC1	YF01	Y1041	Y1181	Y12C1	Y1401	Y1541	MP2	Handle/incremental feed magnification code 2
YC82	YDC2	YF02	Y1042	Y1182	Y12C2	Y1402	Y1542	MP4	Handle/incremental feed magnification code 4
YC83	YDC3	YF03	Y1043	Y1183	Y12C3	Y1403	Y1543		
YC84	YDC4	YF04	Y1044	Y1184	Y12C4	Y1404	Y1544		
YC85	YDC5	YF05	Y1045	Y1185	Y12C5	Y1405	Y1545		
YC86	YDC6	YF06	Y1046	Y1186	Y12C6	Y1406	Y1546		Magnification valid for each handle
YC87	YDC7	YF07	Y1047	Y1187	Y12C7	Y1407	Y1547	MPS	Handle/incremental feed magnification method selection
Device No.									
\$1	\$2	\$3	\$4	\$5	\$6	\$7	\$8	Abbrev.	Signal name
YC88	YDC8	YF08	Y1048	Y1188	Y12C8	Y1408	Y1548	TAL1	Tool alarm 1/Tool-skip
YC89	YDC9	YF09	Y1049	Y1189	Y12C9	Y1409	Y1549	TAL2	Tool alarm 2
YC8A	YDCA	YF0A	Y104A	Y118A	Y12CA	Y140A	Y154A	TCEF	Usage data count valid
YC8B	YDCB	YF0B	Y104B	Y118B	Y12CB	Y140B	Y154B	TLF1	Tool life management input
YC8C	YDCC	YF0C	Y104C	Y118C	Y12CC	Y140C	Y154C	TRST	Tool change reset
YC8D	YDCD	YF0D	Y104D	Y118D	Y12CD	Y140D	Y154D		Tool escape and return Transit point designation [M8]
YC8E	YDCE	YF0E	Y104E	Y118E	Y12CE	Y140E	Y154E		Manual tool length measurement interlock temporarily canceled ▲
YC8F	YDCF	YF0F	Y104F	Y118F	Y12CF	Y140F	Y154F		
Device No.									
\$1	\$2	\$3	\$4	\$5	\$6	\$7	\$8	Abbrev.	Signal name
YC90	YDD0	YF10	Y1050	Y1190	Y12D0	Y1410	Y1550	ZSL1	Reference position selection code 1
YC91	YDD1	YF11	Y1051	Y1191	Y12D1	Y1411	Y1551	ZSL2	Reference position selection code 2
YC92	YDD2	YF12	Y1052	Y1192	Y12D2	Y1412	Y1552		Tool length compensation along the tool axis Compensation amount change mode [M8]
YC93	YDD3	YF13	Y1053	Y1193	Y12D3	Y1413	Y1553	RTNST	Tool retract and return 2 : Tool return start ▲
YC94	YDD4	YF14	Y1054	Y1194	Y12D4	Y1414	Y1554	FFC	Thread cutting: Feed-forward control request
YC95	YDD5	YF15	Y1055	Y1195	Y12D5	Y1415	Y1555		In balance cut timing synchronization invalid ▲
YC96	YDD6	YF16	Y1056	Y1196	Y12D6	Y1416	Y1556		
YC97	YDD7	YF17	Y1057	Y1197	Y12D7	Y1417	Y1557		Reference position selection method
Device No.									
\$1	\$2	\$3	\$4	\$5	\$6	\$7	\$8	Abbrev.	Signal name
YC98	YDD8	YF18	Y1058	Y1198	Y12D8	Y1418	Y1558		Tool life management: Temporary cancel of tool life expiration
YC99	YDD9	YF19	Y1059	Y1199	Y12D9	Y1419	Y1559		Tool life management: Temporary cancel of tool group life expiration
YC9A	YDDA	YF1A	Y105A	Y119A	Y12DA	Y141A	Y155A	PRTN	External search: Program return
YC9B	Yddb	YF1B	Y105B	Y119B	Y12DB	Y141B	Y155B		MES interface library: User arbitrary information send request [M8]
YC9C	YDDC	YF1C	Y105C	Y119C	Y12DC	Y141C	Y155C		
YC9D	YDDD	YF1D	Y105D	Y119D	Y12DD	Y141D	Y155D		Manual speed command valid
YC9E	YDDE	YF1E	Y105E	Y119E	Y12DE	Y141E	Y155E		Manual speed command sign reversed
YC9F	YDDF	YF1F	Y105F	Y119F	Y12DF	Y141F	Y155F		Manual speed command reverse run valid

2 Input/Output Signals with Controller

Device No.									
\$1	\$2	\$3	\$4	\$5	\$6	\$7	\$8	Abbrev.	Signal name
YCA0	YDE0	YF20	Y1060	Y11A0	Y12E0	Y1420	Y1560	CX11	Manual arbitrary feed 1st axis selection code 1
YCA1	YDE1	YF21	Y1061	Y11A1	Y12E1	Y1421	Y1561	CX12	Manual arbitrary feed 1st axis selection code 2
YCA2	YDE2	YF22	Y1062	Y11A2	Y12E2	Y1422	Y1562	CX14	Manual arbitrary feed 1st axis selection code 4
YCA3	YDE3	YF23	Y1063	Y11A3	Y12E3	Y1423	Y1563	CX18	Manual arbitrary feed 1st axis selection code 8
YCA4	YDE4	YF24	Y1064	Y11A4	Y12E4	Y1424	Y1564	CX116	Manual arbitrary feed 1st axis selection code 16
YCA5	YDE5	YF25	Y1065	Y11A5	Y12E5	Y1425	Y1565		
YCA6	YDE6	YF26	Y1066	Y11A6	Y12E6	Y1426	Y1566		
YCA7	YDE7	YF27	Y1067	Y11A7	Y12E7	Y1427	Y1567	CX1S	Manual arbitrary feed 1st axis valid
Device No.									
\$1	\$2	\$3	\$4	\$5	\$6	\$7	\$8	Abbrev.	Signal name
YCA8	YDE8	YF28	Y1068	Y11A8	Y12E8	Y1428	Y1568	CX21	Manual arbitrary feed 2nd axis selection code 1
YCA9	YDE9	YF29	Y1069	Y11A9	Y12E9	Y1429	Y1569	CX22	Manual arbitrary feed 2nd axis selection code 2
YCAA	YDEA	YF2A	Y106A	Y11AA	Y12EA	Y142A	Y156A	CX24	Manual arbitrary feed 2nd axis selection code 4
YCAB	YDEB	YF2B	Y106B	Y11AB	Y12EB	Y142B	Y156B	CX28	Manual arbitrary feed 2nd axis selection code 8
YCAC	YDEC	YF2C	Y106C	Y11AC	Y12EC	Y142C	Y156C	CX216	Manual arbitrary feed 2nd axis selection code 16
YCAD	YDED	YF2D	Y106D	Y11AD	Y12ED	Y142D	Y156D		
YCAE	YDEE	YF2E	Y106E	Y11AE	Y12EE	Y142E	Y156E		
YCAF	YDEF	YF2F	Y106F	Y11AF	Y12EF	Y142F	Y156F	CX2S	Manual arbitrary feed 2nd axis valid
Device No.									
\$1	\$2	\$3	\$4	\$5	\$6	\$7	\$8	Abbrev.	Signal name
YCB0	YDF0	YF30	Y1070	Y11B0	Y12F0	Y1430	Y1570	CX31	Manual arbitrary feed 3rd axis selection code 1
YCB1	YDF1	YF31	Y1071	Y11B1	Y12F1	Y1431	Y1571	CX32	Manual arbitrary feed 3rd axis selection code 2
YCB2	YDF2	YF32	Y1072	Y11B2	Y12F2	Y1432	Y1572	CX34	Manual arbitrary feed 3rd axis selection code 4
YCB3	YDF3	YF33	Y1073	Y11B3	Y12F3	Y1433	Y1573	CX38	Manual arbitrary feed 3rd axis selection code 8
YCB4	YDF4	YF34	Y1074	Y11B4	Y12F4	Y1434	Y1574	CX316	Manual arbitrary feed 3rd axis selection code 16
YCB5	YDF5	YF35	Y1075	Y11B5	Y12F5	Y1435	Y1575		
YCB6	YDF6	YF36	Y1076	Y11B6	Y12F6	Y1436	Y1576		
YCB7	YDF7	YF37	Y1077	Y11B7	Y12F7	Y1437	Y1577	CX3S	Manual arbitrary feed 3rd axis valid
Device No.									
\$1	\$2	\$3	\$4	\$5	\$6	\$7	\$8	Abbrev.	Signal name
YCB8	YDF8	YF38	Y1078	Y11B8	Y12F8	Y1438	Y1578	CXS1	Manual arbitrary feed Smoothing off
YCB9	YDF9	YF39	Y1079	Y11B9	Y12F9	Y1439	Y1579	CXS2	Manual arbitrary feed Axis independent
YCBA	YDFA	YF3A	Y107A	Y11BA	Y12FA	Y143A	Y157A	CXS3	Manual arbitrary feed EX.F/MODAL.F
YCBB	YDFB	YF3B	Y107B	Y11BB	Y12FB	Y143B	Y157B	CXS4	Manual arbitrary feed G0/G1
YCBC	YDFC	YF3C	Y107C	Y11BC	Y12FC	Y143C	Y157C	CXS5	Manual arbitrary feed MC/WK
YCBD	YDFD	YF3D	Y107D	Y11BD	Y12FD	Y143D	Y157D	CXS6	Manual arbitrary feed ABS/INC
YCBE	YDFE	YF3E	Y107E	Y11BE	Y12FE	Y143E	Y157E	*CXS7	Manual arbitrary feed Stop
YCBF	YDFE	YF3F	Y107F	Y11BF	Y12FF	Y143F	Y157F	CXS8	Manual arbitrary feed Strobe

2 Input/Output Signals with Controller

Device No.									
\$1	\$2	\$3	\$4	\$5	\$6	\$7	\$8	Abbrev.	Signal name
YCC0	YE00	YF40	Y1080	Y11C0	Y1300	Y1440	Y1580	ILM1	Current limit mode 1
YCC1	YE01	YF41	Y1081	Y11C1	Y1301	Y1441	Y1581	ILM2	Current limit mode 2
YCC2	YE02	YF42	Y1082	Y11C2	Y1302	Y1442	Y1582		
YCC3	YE03	YF43	Y1083	Y11C3	Y1303	Y1443	Y1583	LDWT	Load monitor I : Teaching/Monitor execution ▲
YCC4	YE04	YF44	Y1084	Y11C4	Y1304	Y1444	Y1584		Load monitor I : Teaching mode ▲
YCC5	YE05	YF45	Y1085	Y11C5	Y1305	Y1445	Y1585		Load monitor I : Monitor mode ▲
YCC6	YE06	YF46	Y1086	Y11C6	Y1306	Y1446	Y1586		Load monitor I : Alarm reset ▲
YCC7	YE07	YF47	Y1087	Y11C7	Y1307	Y1447	Y1587		Load monitor I : Warning reset ▲
Device No.									
\$1	\$2	\$3	\$4	\$5	\$6	\$7	\$8	Abbrev.	Signal name
YCC8	YE08	YF48	Y1088	Y11C8	Y1308	Y1448	Y1588	*ZRIT	2nd reference position return interlock
YCC9	YE09	YF49	Y1089	Y11C9	Y1309	Y1449	Y1589		Load monitor I : Adaptive control execution ▲
YCCA	YE0A	YF4A	Y108A	Y11CA	Y130A	Y144A	Y158A		Small diameter deep hole drilling cycle [M8]
YCCB	YE0B	YF4B	Y108B	Y11CB	Y130B	Y144B	Y158B		Chuck barrier ON
YCCC	YE0C	YF4C	Y108C	Y11CC	Y130C	Y144C	Y158C		High-speed retract function valid ▲
YCCD	YE0D	YF4D	Y108D	Y11CD	Y130D	Y144D	Y158D		
YCCE	YE0E	YF4E	Y108E	Y11CE	Y130E	Y144E	Y158E		
YCCF	YE0F	YF4F	Y108F	Y11CF	Y130F	Y144F	Y158F		Tool retract start ▲
Device No.									
\$1	\$2	\$3	\$4	\$5	\$6	\$7	\$8	Abbrev.	Signal name
YCD0	YE10	YF50	Y1090	Y11D0	Y1310	Y1450	Y1590		Waiting ignore
YCD1	YE11	YF51	Y1091	Y11D1	Y1311	Y1451	Y1591		Spindle-spindle polygon cancel
YCD2	YE12	YF52	Y1092	Y11D2	Y1312	Y1452	Y1592		Synchronous tapping command polarity reversal
YCD3	YE13	YF53	Y1093	Y11D3	Y1313	Y1453	Y1593		Spindle OFF mode
YCD4	YE14	YF54	Y1094	Y11D4	Y1314	Y1454	Y1594		Longitudinal hole drilling axis selection
YCD5	YE15	YF55	Y1095	Y11D5	Y1315	Y1455	Y1595		Optimum acceleration/deceleration parameter switching request [axis] ▲
YCD6	YE16	YF56	Y1096	Y11D6	Y1316	Y1456	Y1596	TRVEC	Tap retract possible state cancel
YCD7	YE17	YF57	Y1097	Y11D7	Y1317	Y1457	Y1597	CHPRCR	Chopping compensation update prevention request
Device No.									
\$1	\$2	\$3	\$4	\$5	\$6	\$7	\$8	Abbrev.	Signal name
YCD8	YE18	YF58	Y1098	Y11D8	Y1318	Y1458	Y1598		Barrier valid (left)
YCD9	YE19	YF59	Y1099	Y11D9	Y1319	Y1459	Y1599		Barrier valid (right)
YCDA	YE1A	YF5A	Y109A	Y11DA	Y131A	Y145A	Y159A		Tool presetter sub-side valid ▲
YCDB	YE1B	YF5B	Y109B	Y11DB	Y131B	Y145B	Y159B		
YCDC	YE1C	YF5C	Y109C	Y11DC	Y131C	Y145C	Y159C		
YCDD	YE1D	YF5D	Y109D	Y11DD	Y131D	Y145D	Y159D		
YCDE	YE1E	YF5E	Y109E	Y11DE	Y131E	Y145E	Y159E	HOBTRR	Hob machining: retract request
YCDF	YE1F	YF5F	Y109F	Y11DF	Y131F	Y145F	Y159F	HOBARTC	Hob machining: alarm retract control

Device No.									
\$1	\$2	\$3	\$4	\$5	\$6	\$7	\$8	Abbrev.	Signal name
YCE0	YE20	YF60	Y10A0	Y11E0	Y1320	Y1460	Y15A0		
YCE1	YE21	YF61	Y10A1	Y11E1	Y1321	Y1461	Y15A1		Door open II
YCE2	YE22	YF62	Y10A2	Y11E2	Y1322	Y1462	Y15A2		Door open signal input (spindle speed monitor)
YCE3	YE23	YF63	Y10A3	Y11E3	Y1323	Y1463	Y15A3		Door interlock spindle speed clamp
YCE4	YE24	YF64	Y10A4	Y11E4	Y1324	Y1464	Y15A4		
YCE5	YE25	YF65	Y10A5	Y11E5	Y1325	Y1465	Y15A5		
YCE6	YE26	YF66	Y10A6	Y11E6	Y1326	Y1466	Y15A6	MFIN5	Miscellaneous Function Command High-speed Output: M function finish 5 [C80]
YCE7	YE27	YF67	Y10A7	Y11E7	Y1327	Y1467	Y15A7	MFIN6	Miscellaneous Function Command High-speed Output: M function finish 6 [C80]
Device No.									
\$1	\$2	\$3	\$4	\$5	\$6	\$7	\$8	Abbrev.	Signal name
YCE8	YE28	YF68	Y10A8	Y11E8	Y1328	Y1468	Y15A8		Door open II (2 channels per 1 part system)
YCE9	YE29	YF69	Y10A9	Y11E9	Y1329	Y1469	Y15A9		
YCEA	YE2A	YF6A	Y10AA	Y11EA	Y132A	Y146A	Y15AA		
YCEB	YE2B	YF6B	Y10AB	Y11EB	Y132B	Y146B	Y15AB		
YCEC	YE2C	YF6C	Y10AC	Y11EC	Y132C	Y146C	Y15AC		
YCED	YE2D	YF6D	Y10AD	Y11ED	Y132D	Y146D	Y15AD		
YCEE	YE2E	YF6E	Y10AE	Y11EE	Y132E	Y146E	Y15AE		
YCEF	YE2F	YF6F	Y10AF	Y11EF	Y132F	Y146F	Y15AF		Load monitor I : Cutting torque estimation execution ▲
Device No.									
\$1	\$2	\$3	\$4	\$5	\$6	\$7	\$8	Abbrev.	Signal name
YCF0	YE30	YF70	Y10B0	Y11F0	Y1330	Y1470	Y15B0		
YCF1	YE31	YF71	Y10B1	Y11F1	Y1331	Y1471	Y15B1	VFTCI	Variable feed thread cutting invalid ▲
YCF2	YE32	YF72	Y10B2	Y11F2	Y1332	Y1472	Y15B2		
YCF3	YE33	YF73	Y10B3	Y11F3	Y1333	Y1473	Y15B3		
YCF4	YE34	YF74	Y10B4	Y11F4	Y1334	Y1474	Y15B4	BCHK	Barrier check invalid
YCF5	YE35	YF75	Y10B5	Y11F5	Y1335	Y1475	Y15B5		
YCF6	YE36	YF76	Y10B6	Y11F6	Y1336	Y1476	Y15B6		
YCF7	YE37	YF77	Y10B7	Y11F7	Y1337	Y1477	Y15B7		
Device No.									
\$1	\$2	\$3	\$4	\$5	\$6	\$7	\$8	Abbrev.	Signal name
YCF8	YE38	YF78	Y10B8	Y11F8	Y1338	Y1478	Y15B8	MSYNC	Synchronization between part systems OFF
YCF9	YE39	YF79	Y10B9	Y11F9	Y1339	Y1479	Y15B9		
YCFA	YE3A	YF7A	Y10BA	Y11FA	Y133A	Y147A	Y15BA	DRNC	Dry run invalid
YCFB	YE3B	YF7B	Y10BB	Y11FB	Y133B	Y147B	Y15BB	AUTED	Automatic error detection [M8]
YCFC	YE3C	YF7C	Y10BC	Y11FC	Y133C	Y147C	Y15BC	MRPSG	Manual arbitrary reverse run: MSTB reverse run prohibited
YCFD	YE3D	YF7D	Y10BD	Y11FD	Y133D	Y147D	Y15BD		G71 Shape judgement disable ▲
YCFE	YE3E	YF7E	Y10BE	Y11FE	Y133E	Y147E	Y15BE		Appropriate machining diagnosis in progress ▲
YCFE	YE3E	YF7E	Y10BE	Y11FE	Y133E	Y147E	Y15BE		Appropriate machining diagnosis error reset ▲
YCFF	YE3F	YF7F	Y10BF	Y11FF	Y133F	Y147F	Y15BF		Appropriate machining diagnosis error reset ▲

Device No.									
\$1	\$2	\$3	\$4	\$5	\$6	\$7	\$8	Abbrev.	Signal name
YD00	YE40	YF80	Y10C0	Y1200	Y1340	Y1480	Y15C0	PFCHR	Program format switch request [M8]
YD01	YE41	YF81	Y10C1	Y1201	Y1341	Y1481	Y15C1	RBSSY	Manual arbitrary reverse run: Reverse run block stop designated part system
YD02	YE42	YF82	Y10C2	Y1202	Y1342	Y1482	Y15C2		
YD03	YE43	YF83	Y10C3	Y1203	Y1343	Y1483	Y15C3		
YD04	YE44	YF84	Y10C4	Y1204	Y1344	Y1484	Y15C4		
YD05	YE45	YF85	Y10C5	Y1205	Y1345	Y1485	Y15C5		
YD06	YE46	YF86	Y10C6	Y1206	Y1346	Y1486	Y15C6		
YD07	YE47	YF87	Y10C7	Y1207	Y1347	Y1487	Y15C7		
Device No.									
\$1	\$2	\$3	\$4	\$5	\$6	\$7	\$8	Abbrev.	Signal name
YD08	YE48	YF88	Y10C8	Y1208	Y1348	Y1488	Y15C8	RVSP	Reverse run from block start
YD09	YE49	YF89	Y10C9	Y1209	Y1349	Y1489	Y15C9	RVIT	Macro interrupt priority
YD0A	YE4A	YF8A	Y10CA	Y120A	Y134A	Y148A	Y15CA	RVMD	Reverse run control mode
YD0B	YE4B	YF8B	Y10CB	Y120B	Y134B	Y148B	Y15CB	ACCG	Rapid traverse time constant: Switchover request
YD0C	YE4C	YF8C	Y10CC	Y120C	Y134C	Y148C	Y15CC	RT2CHGA	Real-time tuning 2: Acceleration/deceleration time constant in automatic switchover [M8]
YD0D	YE4D	YF8D	Y10CD	Y120D	Y134D	Y148D	Y15CD	RT2CHGM	Real-time tuning 2: Acceleration/deceleration time constant in manual switchover [M8]
YD0E	YE4E	YF8E	Y10CE	Y120E	Y134E	Y148E	Y15CE	RT2RST	Real-time tuning 2: Acceleration/deceleration time constant reset [M8]
YD0F	YE4F	YF8F	Y10CF	Y120F	Y134F	Y148F	Y15CF	TWIN	Request for reflecting reserved tool wear compensation [M8]
Device No.									
\$1	\$2	\$3	\$4	\$5	\$6	\$7	\$8	Abbrev.	Signal name
YD10	YE50	YF90	Y10D0	Y1210	Y1350	Y1490	Y15D0		
YD11	YE51	YF91	Y10D1	Y1211	Y1351	Y1491	Y15D1		
YD12	YE52	YF92	Y10D2	Y1212	Y1352	Y1492	Y15D2		
YD13	YE53	YF93	Y10D3	Y1213	Y1353	Y1493	Y15D3		
YD14	YE54	YF94	Y10D4	Y1214	Y1354	Y1494	Y15D4		3D coordinate conversion : Manual feed coordinates conversion [M8]
YD15	YE55	YF95	Y10D5	Y1215	Y1355	Y1495	Y15D5	RCEE	Rotation center error compensation enabled [M8]
YD16	YE56	YF96	Y10D6	Y1216	Y1356	Y1496	Y15D6		
YD17	YE57	YF97	Y10D7	Y1217	Y1357	Y1497	Y15D7	SECE	Spatial error compensation enabled [M8]
Device No.									
\$1	\$2	\$3	\$4	\$5	\$6	\$7	\$8	Abbrev.	Signal name
YD18	YE58	YF98	Y10D8	Y1218	Y1358	Y1498	Y15D8	MJCT	3D manual feed (JOG, INC) in tool axis coordinate system
YD19	YE59	YF99	Y10D9	Y1219	Y1359	Y1499	Y15D9	MJCB	3D manual feed (JOG, INC) in table coordinate system
YD1A	YE5A	YF9A	Y10DA	Y121A	Y135A	Y149A	Y15DA	MJCF	3D manual feed (JOG, INC) in feature coordinate system
YD1B	YE5B	YF9B	Y10DB	Y121B	Y135B	Y149B	Y15DB	MH1CT	3D manual feed (1st handle) in tool axis coordinate system
YD1C	YE5C	YF9C	Y10DC	Y121C	Y135C	Y149C	Y15DC	MH1CB	3D manual feed (1st handle) in table coordinate system
YD1D	YE5D	YF9D	Y10DD	Y121D	Y135D	Y149D	Y15DD	MH1CF	3D manual feed (1st handle) in feature coordinate system
YD1E	YE5E	YF9E	Y10DE	Y121E	Y135E	Y149E	Y15DE	MH2CT	3D manual feed (2nd handle) in tool axis coordinate system
YD1F	YE5F	YF9F	Y10DF	Y121F	Y135F	Y149F	Y15DF	MH2CB	3D manual feed (2nd handle) in table coordinate system

2 Input/Output Signals with Controller

Device No.									
\$1	\$2	\$3	\$4	\$5	\$6	\$7	\$8	Abbrev.	Signal name
YD20	YE60	YFA0	Y10E0	Y1220	Y1360	Y14A0	Y15E0	MH2CF	3D manual feed (2nd handle) in feature coordinate system
YD21	YE61	YFA1	Y10E1	Y1221	Y1361	Y14A1	Y15E1	MH3CT	3D manual feed (3rd handle) in tool axis coordinate system
YD22	YE62	YFA2	Y10E2	Y1222	Y1362	Y14A2	Y15E2	MH3CB	3D manual feed (3rd handle) in table coordinate system
YD23	YE63	YFA3	Y10E3	Y1223	Y1363	Y14A3	Y15E3	MH3CF	3D manual feed (3rd handle) in feature coordinate system
YD24	YE64	YFA4	Y10E4	Y1224	Y1364	Y14A4	Y15E4		
YD25	YE65	YFA5	Y10E5	Y1225	Y1365	Y14A5	Y15E5		
YD26	YE66	YFA6	Y10E6	Y1226	Y1366	Y14A6	Y15E6		
YD27	YE67	YFA7	Y10E7	Y1227	Y1367	Y14A7	Y15E7	TCPRC	Tool center point rotation
Device No.									
\$1	\$2	\$3	\$4	\$5	\$6	\$7	\$8	Abbrev.	Signal name
YD28	YE68	YFA8	Y10E8	Y1228	Y1368	Y14A8	Y15E8	MFIN1	Miscellaneous Function Command High-speed Output : M function finish 1
YD29	YE69	YFA9	Y10E9	Y1229	Y1369	Y14A9	Y15E9	MFIN2	Miscellaneous Function Command High-speed Output : M function finish 2
YD2A	YE6A	YFAA	Y10EA	Y122A	Y136A	Y14AA	Y15EA	MFIN3	Miscellaneous Function Command High-speed Output : M function finish 3
YD2B	YE6B	YFAB	Y10EB	Y122B	Y136B	Y14AB	Y15EB	MFIN4	Miscellaneous Function Command High-speed Output : M function finish 4
YD2C	YE6C	YFAC	Y10EC	Y122C	Y136C	Y14AC	Y15EC	SFIN1	Miscellaneous Function Command High-speed Output : S function finish 1
YD2D	YE6D	YFAD	Y10ED	Y122D	Y136D	Y14AD	Y15ED	SFIN2	Miscellaneous Function Command High-speed Output : S function finish 2
YD2E	YE6E	YFAE	Y10EE	Y122E	Y136E	Y14AE	Y15EE	SFIN3	Miscellaneous Function Command High-speed Output : S function finish 3
YD2F	YE6F	YFAF	Y10EF	Y122F	Y136F	Y14AF	Y15EF	SFIN4	Miscellaneous Function Command High-speed Output : S function finish 4
Device No.									
\$1	\$2	\$3	\$4	\$5	\$6	\$7	\$8	Abbrev.	Signal name
YD30	YE70	YFB0	Y10F0	Y1230	Y1370	Y14B0	Y15F0	TFIN1	Miscellaneous Function Command High-speed Output : T function finish 1
YD31	YE71	YFB1	Y10F1	Y1231	Y1371	Y14B1	Y15F1	TFIN2	Miscellaneous Function Command High-speed Output : T function finish 2
YD32	YE72	YFB2	Y10F2	Y1232	Y1372	Y14B2	Y15F2	TFIN3	Miscellaneous Function Command High-speed Output : T function finish 3
YD33	YE73	YFB3	Y10F3	Y1233	Y1373	Y14B3	Y15F3	TFIN4	Miscellaneous Function Command High-speed Output : T function finish 4
YD34	YE74	YFB4	Y10F4	Y1234	Y1374	Y14B4	Y15F4	BFIN1	Miscellaneous Function Command High-speed Output : 2nd M function finish 1
YD35	YE75	YFB5	Y10F5	Y1235	Y1375	Y14B5	Y15F5	BFIN2	Miscellaneous Function Command High-speed Output : 2nd M function finish 2
YD36	YE76	YFB6	Y10F6	Y1236	Y1376	Y14B6	Y15F6	BFIN3	Miscellaneous Function Command High-speed Output : 2nd M function finish 3
YD37	YE77	YFB7	Y10F7	Y1237	Y1377	Y14B7	Y15F7	BFIN4	Miscellaneous Function Command High-speed Output : 2nd M function finish 4

2 Input/Output Signals with Controller

Device No.								Abbrev.	Signal name
\$1	\$2	\$3	\$4	\$5	\$6	\$7	\$8		
YD38	YE78	YFB8	Y10F8	Y1238	Y1378	Y14B8	Y15F8	SFIN5	Miscellaneous Function Command High-speed Output : S function finish 5
YD39	YE79	YFB9	Y10F9	Y1239	Y1379	Y14B9	Y15F9	SFIN6	Miscellaneous Function Command High-speed Output : S function finish 6
YD3A	YE7A	YFBA	Y10FA	Y123A	Y137A	Y14BA	Y15FA	SFIN7	Miscellaneous Function Command High-speed Output : S function finish 7
YD3B	YE7B	YFBB	Y10FB	Y123B	Y137B	Y14BB	Y15FB	SFIN8	Miscellaneous Function Command High-speed Output : S function finish 8 [M8]
YD3C	YE7C	YFBC	Y10FC	Y123C	Y137C	Y14BC	Y15FC		
YD3D	YE7D	YFBD	Y10FD	Y123D	Y137D	Y14BD	Y15FD		
YD3E	YE7E	YFBE	Y10FE	Y123E	Y137E	Y14BE	Y15FE		
YD3F	YE7F	YFBF	Y10FF	Y123F	Y137F	Y14BF	Y15FF		

Device	Abbrev.	Signal name	Device	Abbrev.	Signal name
Y1870			Y1878		Edit/search
Y1871			Y1879		
Y1872			Y187A		
Y1873			Y187B		
Y1874			Y187C		
Y1875			Y187D		
Y1876			Y187E		
Y1877			Y187F		

Device No.								Abbrev.	Signal name
1stSP	2ndSP	3rdSP	4thSP	5thSP	6thSP	7thSP	8thSP		
Y1880	Y18E0	Y1940	Y19A0	Y1A00	Y1A60	Y1AC0	Y1B20		
Y1881	Y18E1	Y1941	Y19A1	Y1A01	Y1A61	Y1AC1	Y1B21		
Y1882	Y18E2	Y1942	Y19A2	Y1A02	Y1A62	Y1AC2	Y1B22		
Y1883	Y18E3	Y1943	Y19A3	Y1A03	Y1A63	Y1AC3	Y1B23		
Y1884	Y18E4	Y1944	Y19A4	Y1A04	Y1A64	Y1AC4	Y1B24		
Y1885	Y18E5	Y1945	Y19A5	Y1A05	Y1A65	Y1AC5	Y1B25	GFIN	Gear shift completion
Y1886	Y18E6	Y1946	Y19A6	Y1A06	Y1A66	Y1AC6	Y1B26		
Y1887	Y18E7	Y1947	Y19A7	Y1A07	Y1A67	Y1AC7	Y1B27		

Device No.								Abbrev.	Signal name
1stSP	2ndSP	3rdSP	4thSP	5thSP	6thSP	7thSP	8thSP		
Y1888	Y18E8	Y1948	Y19A8	Y1A08	Y1A68	Y1AC8	Y1B28	SP1	Spindle speed override code 1
Y1889	Y18E9	Y1949	Y19A9	Y1A09	Y1A69	Y1AC9	Y1B29	SP2	Spindle speed override code 2
Y188A	Y18EA	Y194A	Y19AA	Y1A0A	Y1A6A	Y1ACA	Y1B2A	SP4	Spindle speed override code 4
Y188B	Y18EB	Y194B	Y19AB	Y1A0B	Y1A6B	Y1ACB	Y1B2B		
Y188C	Y18EC	Y194C	Y19AC	Y1A0C	Y1A6C	Y1ACC	Y1B2C		
Y188D	Y18ED	Y194D	Y19AD	Y1A0D	Y1A6D	Y1ACD	Y1B2D		
Y188E	Y18EE	Y194E	Y19AE	Y1A0E	Y1A6E	Y1ACE	Y1B2E		
Y188F	Y18EF	Y194F	Y19AF	Y1A0F	Y1A6F	Y1ACF	Y1B2F	SPS	Spindle override method selection

Device No.								Abbrev.	Signal name
1stSP	2ndSP	3rdSP	4thSP	5thSP	6thSP	7thSP	8thSP		
Y1890	Y18F0	Y1950	Y19B0	Y1A10	Y1A70	Y1AD0	Y1B30	GI1	Spindle gear selection code 1
Y1891	Y18F1	Y1951	Y19B1	Y1A11	Y1A71	Y1AD1	Y1B31	GI2	Spindle gear selection code 2
Y1892	Y18F2	Y1952	Y19B2	Y1A12	Y1A72	Y1AD2	Y1B32		
Y1893	Y18F3	Y1953	Y19B3	Y1A13	Y1A73	Y1AD3	Y1B33	EXOBS	Increase holding power of spindle
Y1894	Y18F4	Y1954	Y19B4	Y1A14	Y1A74	Y1AD4	Y1B34	SSTP	Spindle stop
Y1895	Y18F5	Y1955	Y19B5	Y1A15	Y1A75	Y1AD5	Y1B35	SSFT	Spindle gear shift
Y1896	Y18F6	Y1956	Y19B6	Y1A16	Y1A76	Y1AD6	Y1B36	SORC	Spindle orientation
Y1897	Y18F7	Y1957	Y19B7	Y1A17	Y1A77	Y1AD7	Y1B37		Spindle command invalid

2 Input/Output Signals with Controller

Device No.									
1stSP	2ndSP	3rdSP	4thSP	5thSP	6thSP	7thSP	8thSP	Abbrev.	Signal name
Y1898	Y18F8	Y1958	Y19B8	Y1A18	Y1A78	Y1AD8	Y1B38	SRN	Spindle forward run start
Y1899	Y18F9	Y1959	Y19B9	Y1A19	Y1A79	Y1AD9	Y1B39	SRI	Spindle reverse run start
Y189A	Y18FA	Y195A	Y19BA	Y1A1A	Y1A7A	Y1ADA	Y1B3A	TL1	Spindle torque limit 1
Y189B	Y18FB	Y195B	Y19BB	Y1A1B	Y1A7B	Y1ADB	Y1B3B	TL2	Spindle torque limit 2
Y189C	Y18FC	Y195C	Y19BC	Y1A1C	Y1A7C	Y1ADC	Y1B3C	WRN	Spindle forward run index
Y189D	Y18FD	Y195D	Y19BD	Y1A1D	Y1A7D	Y1ADD	Y1B3D	WRI	Spindle reverse run index
Y189E	Y18FE	Y195E	Y19BE	Y1A1E	Y1A7E	Y1ADE	Y1B3E	ORC	Spindle orientation command
Y189F	Y18FF	Y195F	Y19BF	Y1A1F	Y1A7F	Y1ADF	Y1B3F	LRSL	L coil selection
Device No.									
1stSP	2ndSP	3rdSP	4thSP	5thSP	6thSP	7thSP	8thSP	Abbrev.	Signal name
Y18A0	Y1900	Y1960	Y19C0	Y1A20	Y1A80	Y1AE0	Y1B40		
Y18A1	Y1901	Y1961	Y19C1	Y1A21	Y1A81	Y1AE1	Y1B41		
Y18A2	Y1902	Y1962	Y19C2	Y1A22	Y1A82	Y1AE2	Y1B42		
Y18A3	Y1903	Y1963	Y19C3	Y1A23	Y1A83	Y1AE3	Y1B43		
Y18A4	Y1904	Y1964	Y19C4	Y1A24	Y1A84	Y1AE4	Y1B44		
Y18A5	Y1905	Y1965	Y19C5	Y1A25	Y1A85	Y1AE5	Y1B45	CMOD	Spindle position control (Spindle/C axis control): C axis selection
Y18A6	Y1906	Y1966	Y19C6	Y1A26	Y1A86	Y1AE6	Y1B46	LRSM	M coil selection
Y18A7	Y1907	Y1967	Y19C7	Y1A27	Y1A87	Y1AE7	Y1B47		
Device No.									
1stSP	2ndSP	3rdSP	4thSP	5thSP	6thSP	7thSP	8thSP	Abbrev.	Signal name
Y18A8	Y1908	Y1968	Y19C8	Y1A28	Y1A88	Y1AE8	Y1B48	SWS	Spindle selection
Y18A9	Y1909	Y1969	Y19C9	Y1A29	Y1A89	Y1AE9	Y1B49		
Y18AA	Y190A	Y196A	Y19CA	Y1A2A	Y1A8A	Y1AEA	Y1B4A	SPRR	Spindle rotation reversal
Y18AB	Y190B	Y196B	Y19CB	Y1A2B	Y1A8B	Y1AEB	Y1B4B	SPRS	Spindle rotation direction switch method selection
Y18AC	Y190C	Y196C	Y19CC	Y1A2C	Y1A8C	Y1AEC	Y1B4C		
Y18AD	Y190D	Y196D	Y19CD	Y1A2D	Y1A8D	Y1AED	Y1B4D		
Y18AE	Y190E	Y196E	Y19CE	Y1A2E	Y1A8E	Y1AEE	Y1B4E		
Y18AF	Y190F	Y196F	Y19CF	Y1A2F	Y1A8F	Y1AEF	Y1B4F	MPCSL	PLC coil changeover
Device No.									
1stSP	2ndSP	3rdSP	4thSP	5thSP	6thSP	7thSP	8thSP	Abbrev.	Signal name
Y18B0	Y1910	Y1970	Y19D0	Y1A30	Y1A90	Y1AF0	Y1B50	SPSY	Spindle synchronization
Y18B1	Y1911	Y1971	Y19D1	Y1A31	Y1A91	Y1AF1	Y1B51	SPPHS	Spindle phase synchronization
Y18B2	Y1912	Y1972	Y19D2	Y1A32	Y1A92	Y1AF2	Y1B52	SPSDR	Spindle synchronous rotation direction
Y18B3	Y1913	Y1973	Y19D3	Y1A33	Y1A93	Y1AF3	Y1B53	SSPHM	Phase shift calculation request
Y18B4	Y1914	Y1974	Y19D4	Y1A34	Y1A94	Y1AF4	Y1B54	SSPHF	Phase offset request
Y18B5	Y1915	Y1975	Y19D5	Y1A35	Y1A95	Y1AF5	Y1B55	SPDRPO	Error temporary cancel
Y18B6	Y1916	Y1976	Y19D6	Y1A36	Y1A96	Y1AF6	Y1B56		
Y18B7	Y1917	Y1977	Y19D7	Y1A37	Y1A97	Y1AF7	Y1B57		

Device No.								Abbrev.	Signal name
1stSP	2ndSP	3rdSP	4thSP	5thSP	6thSP	7thSP	8thSP		
Y18B8	Y1918	Y1978	Y19D8	Y1A38	Y1A98	Y1AF8	Y1B58	SPSYC	Spindle synchronization/ superimposition cancel
Y18B9	Y1919	Y1979	Y19D9	Y1A39	Y1A99	Y1AF9	Y1B59	SPCMPC	Chuck close
Y18BA	Y191A	Y197A	Y19DA	Y1A3A	Y1A9A	Y1AFA	Y1B5A		
Y18BB	Y191B	Y197B	Y19DB	Y1A3B	Y1A9B	Y1AFB	Y1B5B		
Y18BC	Y191C	Y197C	Y19DC	Y1A3C	Y1A9C	Y1AFC	Y1B5C		
Y18BD	Y191D	Y197D	Y19DD	Y1A3D	Y1A9D	Y1AFD	Y1B5D		
Y18BE	Y191E	Y197E	Y19DE	Y1A3E	Y1A9E	Y1AFE	Y1B5E		
Y18BF	Y191F	Y197F	Y19DF	Y1A3F	Y1A9F	Y1AFF	Y1B5F	SPOFF	Exclude spindle

Device No.								Abbrev.	Signal name
1stSP	2ndSP	3rdSP	4thSP	5thSP	6thSP	7thSP	8thSP		
Y18C8	Y1928	Y1988	Y19E8	Y1A48	Y1AA8	Y1B08	Y1B68		Spindle oscillation command [M8]
Y18C9	Y1929	Y1989	Y19E9	Y1A49	Y1AA9	Y1B09	Y1B69	WGTSC	Spindle control : Coil changeover gate cutoff timer interruption [C80]
Y18CA	Y192A	Y198A	Y19EA	Y1A4A	Y1AAA	Y1B0A	Y1B6A	VGHLDC	Real-time tuning 1: Speed control gain changeover hold-down command [M8]
Y18CB	Y192B	Y198B	Y19EB	Y1A4B	Y1AAB	Y1B0B	Y1B6B		
Y18CC	Y192C	Y198C	Y19EC	Y1A4C	Y1AAC	Y1B0C	Y1B6C		
Y18CD	Y192D	Y198D	Y19ED	Y1A4D	Y1AAD	Y1B0D	Y1B6D		
Y18CE	Y192E	Y198E	Y19EE	Y1A4E	Y1AAE	Y1B0E	Y1B6E		
Y18CF	Y192F	Y198F	Y19EF	Y1A4F	Y1AAF	Y1B0F	Y1B6F		

Device	Abbrev.	Signal name	Device	Abbrev.	Signal name
Y1C80		MES interface library: Operation trigger [M8]	Y1C88	ENC1PC LR	External encoder 1: Position output clear request [M8]
Y1C81	*KEY_MemC	Data protect key (memory card) [M8]	Y1C89		
Y1C82	*KEY_DS	Data protect key (DS) [M8]	Y1C8A		
Y1C83	BZR	Buzzer sound control: Buzzer ON [M8]	Y1C8B		
Y1C84	EQLDWR	Spindle protection: Resetting alarm of equivalent load factor over limit [M8]	Y1C8C		
Y1C85			Y1C8D		
Y1C86	DLDREQ	FTP download request [C80]	Y1C8E		
Y1C87		Parameter input error cancel [C80]	Y1C8F		

Device	Abbrev.	Signal name	Device	Abbrev.	Signal name
Y1CA0	HS4P	PLC axis 4th handle valid [C80]	Y1CA8		
Y1CA1	HS5P	PLC axis 5th handle valid [C80]	Y1CA9		
Y1CA2	HS6P	PLC axis 6th handle valid [C80]	Y1CAA		
Y1CA3	HS7P	PLC axis 7th handle valid [C80]	Y1CAB		
Y1CA4	HS8P	PLC axis 8th handle valid [C80]	Y1CAC		
Y1CA5	HS9P	PLC axis 9th handle valid [C80]	Y1CAD		
Y1CA6			Y1CAE		
Y1CA7			Y1CAF		

2 Input/Output Signals with Controller

Device	Abbrev.	Signal name	Device	Abbrev.	Signal name
Y1CB0	HS4P		Y1CB8	TWR	Reservation of tool wear compensation [M8]
Y1CB1	HS5P		Y1CB9		
Y1CB2	HS6P		Y1CBA		
Y1CB3	HS7P		Y1CBB		
Y1CB4	HS8P		Y1CBC		
Y1CB5	HS9P		Y1CBD		
Y1CB6			Y1CBE		
Y1CB7			Y1CBF		

Device No.								Abbrev.	Signal name
\$1	\$2	\$3	\$4	\$5	\$6	\$7	\$8		
Y1D00	Y1D20	Y1D40	Y1D60	Y1D80	Y1DA0	Y1DC0	Y1DE0		Position switch 1 interlock
Y1D01	Y1D21	Y1D41	Y1D61	Y1D81	Y1DA1	Y1DC1	Y1DE1		Position switch 2 interlock
Y1D02	Y1D22	Y1D42	Y1D62	Y1D82	Y1DA2	Y1DC2	Y1DE2		Position switch 3 interlock
Y1D03	Y1D23	Y1D43	Y1D63	Y1D83	Y1DA3	Y1DC3	Y1DE3		Position switch 4 interlock
Y1D04	Y1D24	Y1D44	Y1D64	Y1D84	Y1DA4	Y1DC4	Y1DE4		Position switch 5 interlock
Y1D05	Y1D25	Y1D45	Y1D65	Y1D85	Y1DA5	Y1DC5	Y1DE5		Position switch 6 interlock
Y1D06	Y1D26	Y1D46	Y1D66	Y1D86	Y1DA6	Y1DC6	Y1DE6		Position switch 7 interlock
Y1D07	Y1D27	Y1D47	Y1D67	Y1D87	Y1DA7	Y1DC7	Y1DE7		Position switch 8 interlock

Device No.								Abbrev.	Signal name
\$1	\$2	\$3	\$4	\$5	\$6	\$7	\$8		
Y1D08	Y1D28	Y1D48	Y1D68	Y1D88	Y1DA8	Y1DC8	Y1DE8		Position switch 9 interlock
Y1D09	Y1D29	Y1D49	Y1D69	Y1D89	Y1DA9	Y1DC9	Y1DE9		Position switch 10 interlock
Y1D0A	Y1D2A	Y1D4A	Y1D6A	Y1D8A	Y1DAA	Y1DCA	Y1DEA		Position switch 11 interlock
Y1D0B	Y1D2B	Y1D4B	Y1D6B	Y1D8B	Y1DAB	Y1DCB	Y1DEB		Position switch 12 interlock
Y1D0C	Y1D2C	Y1D4C	Y1D6C	Y1D8C	Y1DAC	Y1DCC	Y1DEC		Position switch 13 interlock
Y1D0D	Y1D2D	Y1D4D	Y1D6D	Y1D8D	Y1DAD	Y1DCD	Y1DED		Position switch 14 interlock
Y1D0E	Y1D2E	Y1D4E	Y1D6E	Y1D8E	Y1DAE	Y1DCE	Y1DEE		Position switch 15 interlock
Y1D0F	Y1D2F	Y1D4F	Y1D6F	Y1D8F	Y1DAF	Y1DCF	Y1DEF		Position switch 16 interlock

Device No.								Abbrev.	Signal name
\$1	\$2	\$3	\$4	\$5	\$6	\$7	\$8		
Y1D10	Y1D30	Y1D50	Y1D70	Y1D90	Y1DB0	Y1DD0	Y1DF0		Position switch 17 interlock
Y1D11	Y1D31	Y1D51	Y1D71	Y1D91	Y1DB1	Y1DD1	Y1DF1		Position switch 18 interlock
Y1D12	Y1D32	Y1D52	Y1D72	Y1D92	Y1DB2	Y1DD2	Y1DF2		Position switch 19 interlock
Y1D13	Y1D33	Y1D53	Y1D73	Y1D93	Y1DB3	Y1DD3	Y1DF3		Position switch 20 interlock
Y1D14	Y1D34	Y1D54	Y1D74	Y1D94	Y1DB4	Y1DD4	Y1DF4		Position switch 21 interlock
Y1D15	Y1D35	Y1D55	Y1D75	Y1D95	Y1DB5	Y1DD5	Y1DF5		Position switch 22 interlock
Y1D16	Y1D36	Y1D56	Y1D76	Y1D96	Y1DB6	Y1DD6	Y1DF6		Position switch 23 interlock
Y1D17	Y1D37	Y1D57	Y1D77	Y1D97	Y1DB7	Y1DD7	Y1DF7		Position switch 24 interlock

2.4 PLC Output Signals (Data type: R^{***})

(Note) Signal with "▲" is prepared for a specific machine tool builder.

Device	Abbrev.	Signal name	Device	Abbrev.	Signal name
R200	AO1	Analog output 1	R208		
R201	AO2	Analog output 2	R209		
R202	AO3	Analog output 3	R210		Displayed screen No.
R203	AO4	Analog output 4	R211		
R204			R212		KEY OUT 1
R205			R213		
R206			R214		
R207			R215		Power OFF indication Y device No. [M8]
Device	Abbrev.	Signal name	Device	Abbrev.	Signal name
R216		Detailed screen No.	R224		User sequence program version code A [M8]
R217			R225		User sequence program version code B [M8]
R218			R226		User sequence program version code C [M8]
R219			R227		User sequence program version code D [M8]
R220			R228		
R221			R229		
R222			R230		
R223			R231		
Device	Abbrev.	Signal name	Device	Abbrev.	Signal name
R232		User sequence program version code 2 A [M8]	R240		APLC version A
R233		User sequence program version code 2 B [M8]	R241		APLC version B
R234		User sequence program version code 2 C [M8]	R242		APLC version C
R235		User sequence program version code 2 D [M8]	R243		APLC version D
R236		User sequence program version code 2 E [M8]	R244		
R237		User sequence program version code 2 F [M8]	R245		
R238		User sequence program version code 2 G [M8]	R246		
R239		User sequence program version code 2 H [M8]	R247		
Device	Abbrev.	Signal name	Device	Abbrev.	Signal name
R248		OT ignored (Axis 1 to 8 for part system 1,2)	R256		
R249		OT ignored (Axis 1 to 8 for part system 3,4)	R257		
R250			R258		
R251			R259		
R252			R260		
R253			R261		
R254			R262		
R255		PLC axis OT ignored	R263		

Device	Abbrev.	Signal name	Device	Abbrev.	Signal name
R264			R272		Near-point dog ignored (Axis 1 to 8 for part system 1,2)
R265			R273		Near-point dog ignored (Axis 1 to 8 for part system 3,4)
R266			R274		
R267			R275		
R268			R276		
R269			R277		
R270			R278		
R271			R279		PLC axis near-point dog ignored
Device	Abbrev.	Signal name	Device	Abbrev.	Signal name
R296	SOMD	Speed monitor mode	R304	NDPC	Power consumption computation: Consumption of devices other than drive system(L)
R297		Handy terminal Data area top address [M8]	R305		Power consumption computation: Consumption of devices other than drive system(H)
R298		Handy terminal Data valid number of registers [M8]	R306	DFPCC	Power consumption computation: Drive system's fixed consumption correction(L)
R299		Handy terminal Cause of communication error [M8]	R307		Power consumption computation: Drive system's fixed consumption correction(H)
R300			R308		Operator message I/F 1 [M8]
R301			R309		Operator message I/F 2 [M8]
R302			R310		Operator message I/F 3 [M8]
R303			R311		Operator message I/F 4 [M8]
Device	Abbrev.	Signal name	Device	Abbrev.	Signal name
R328			R336		Tool I/D R/W pot No. designation ▲
R329			R337		Large diameter tool information ▲
R330			R338		Tool weight (spindle tool) ▲
R331			R339		Tool weight (standby tool) ▲
R332			R340		Unset tool information ▲
R333			R341		
R334			R342		Specified shape interference Shape No. designation
R335			R343		
Device	Abbrev.	Signal name	Device	Abbrev.	Signal name
R344			R352		Remote program input No. (L) ▲
R345			R353		Remote program input No. (H) ▲
R346			R354		Machine manufacturer macro password No. (L)
R347		Skip retract valid	R355		Machine manufacturer macro password No. (H)
R348		Skip retract amount (L) [M]	R356		Direct screen selection A
R349		Skip retract amount (H) [M]	R357		Direct screen selection B
R350		Skip retract speed (L) [M]	R358		Direct screen selection C
R351		Skip retract speed (H) [M]	R359		Direct screen selection D

Device	Abbrev.	Signal name	Device	Abbrev.	Signal name
R360			R368		
R361		User level-based data protection: Operation level	R369		
R362			R370		
R363			R371		
R364		Machine Parameter Lock I/F [M8]	R372		High-speed simple program check: Time measurement output (L)
R365		Measures against tool setter chattering Movement amount	R373		High-speed simple program check: Time measurement output (H)
R366			R374		
R367			R375		Manual arbitrary reverse run handle selection

Device	Abbrev.	Signal name	Device	Abbrev.	Signal name
R376			R384		
R377			R385		
R378		High-speed simple program check: Time reduction coefficient	R386		
R379		Manual arbitrary reverse run speed multiplier	R387		
R380			R388		
R381			R389		
R382			R390		G/B spindle synchronization: position error compensation scale, and the number of times of compensations [M8]
R383			R391		Optimum acceleration/deceleration parameter switching axis (spindle and bit selection) ▲

Device	Abbrev.	Signal name	Device	Abbrev.	Signal name
R392			R400		Ball screw thermal displacement compensation Offset amount 1st axis [M]
R393			R401		Ball screw thermal displacement compensation Max. compensation amount 1st axis [M]
R394			R402		Ball screw thermal displacement compensation Part-system, axis No. 1st axis
R395			R403		Ball screw thermal displacement compensation Offset amount 2nd axis [M]
R396		User PLC info program format info	R404		Ball screw thermal displacement compensation Max. compensation amount 2nd axis [M]
R397			R405		Ball screw thermal displacement compensation Part-system, axis No. 2nd axis
R398			R406		Ball screw thermal displacement compensation Offset amount 3rd axis [M]
R399			R407		Ball screw thermal displacement compensation Max. compensation amount 3rd axis [M]

Device	Abbrev.	Signal name	Device	Abbrev.	Signal name
R408		Ball screw thermal displacement compensation Part-system, axis No. 3rd axis	R416		
R409		Ball screw thermal displacement compensation Offset amount 4th axis [M]	R417		
R410		Ball screw thermal displacement compensation Max. compensation amount 3rd axis [M]	R418		
R411		Ball screw thermal displacement compensation Part-system, axis No. 4th axis	R419		
R412			R420		
R413			R421		
R414			R422		
R415			R423		
Device	Abbrev.	Signal name	Device	Abbrev.	Signal name
R424		PLC window Reading start R register 1	R432		PLC window Reading start R register 3
R425		PLC window Number of read windows 1	R433		PLC window Number of read windows 3
R426		PLC window Writing start R register 1	R434		PLC window Writing start R register 3
R427		PLC window Number of write windows 1	R435		PLC window Number of write windows 3
R428		PLC window Reading start R register 2	R436		
R429		PLC window Number of read windows 2	R437		
R430		PLC window Writing start R register 2	R438		
R431		PLC window Number of write windows 2	R439		
Device	Abbrev.	Signal name	Device	Abbrev.	Signal name
R440		PLC axis control information address 1st axis [M8]	R448		PLC axis control buffering mode information address [M8]
R441		PLC axis control information address 2nd axis [M8]	R449		PLC axis control: droop cancel invalid axis [C80]
R442		PLC axis control information address 3rd axis [M8]	R450		
R443		PLC axis control information address 4th axis [M8]	R451		
R444		PLC axis control information address 5th axis [M8]	R452		
R445		PLC axis control information address 6th axis [M8]	R453		
R446		PLC axis control information address 7th axis [M8]	R454		
R447		PLC axis control information address 8th axis [M8]	R455		

2 Input/Output Signals with Controller

Device	Abbrev.	Signal name	Device	Abbrev.	Signal name
R456		Encoder 1 arbitrary pulse 1	R464		G/B spindle synchronization: maximum value of the relative position error during the steady state [M8]
R457		Encoder 1 arbitrary pulse 2	R465		G/B spindle synchronization: position error compensation amount [M8]
R458		Encoder 2 arbitrary pulse 1	R466		G/B spindle synchronization: phase shift amount [M8]
R459		Encoder 2 arbitrary pulse 2	R467		
R460		G/B spindle synchronization: maximum range of the relative position error [M8]	R468		Interference check between part systems: Data address [M8]
R461		G/B spindle synchronization: maximum value of the relative position error [M8]	R469	SKPIGN	Skip signal ignore ▲
R462		G/B spindle synchronization: average value of the relative position error during the steady state [M8]	R470		Modbus block 1 transfer position ▲
R463		G/B spindle synchronization: maximum range of the relative position error during the steady state [M8]	R471		Modbus block 1 number of transfer ▲

Device	Abbrev.	Signal name	Device	Abbrev.	Signal name
R472		Modbus block 2 transfer position ▲	R480		
R473		Modbus block 2 number of transfers ▲	R481		
R474		Modbus block 3 transfer position ▲	R482		
R475		Modbus block 3 number of transfers ▲	R483		
R476		Modbus block 4 transfer position ▲	R484		
R477		Modbus block 4 number of transfers ▲	R485		
R478		Modbus transfer cycle ▲	R486		
R479		Modbus time-out period ▲	R487		

Device No.								Abbrev.	Signal name
\$1	\$2	\$3	\$4	\$5	\$6	\$7	\$8		
R2500	R2700	R2900	R3100	R3300	R3500	R3700	R3900		1st cutting feedrate override
R2501	R2701	R2901	R3101	R3301	R3501	R3701	R3901		2nd cutting feedrate override
R2502	R2702	R2902	R3102	R3302	R3502	R3702	R3902		Rapid traverse override
R2503	R2703	R2903	R3103	R3303	R3503	R3703	R3903	CHPOV	Chopping override
R2504	R2704	R2904	R3104	R3304	R3504	R3704	R3904		Manual feedrate (L) [M]
R2505	R2705	R2905	R3105	R3305	R3505	R3705	R3905		Manual feedrate (H) [M]
R2506	R2706	R2906	R3106	R3306	R3506	R3706	R3906		Manual feedrate B (L) [M]
R2507	R2707	R2907	R3107	R3307	R3507	R3707	R3907		Manual feedrate B (H) [M]

Device No.								Abbrev.	Signal name
\$1	\$2	\$3	\$4	\$5	\$6	\$7	\$8		
R2508	R2708	R2908	R3108	R3308	R3508	R3708	R3908		1st handle/incremental feed magnification (L)
R2509	R2709	R2909	R3109	R3309	R3509	R3709	R3909		1st handle/incremental feed magnification (H)
R2510	R2710	R2910	R3110	R3310	R3510	R3710	R3910		2nd handle feed magnification (L)
R2511	R2711	R2911	R3111	R3311	R3511	R3711	R3911		2nd handle feed magnification (H)
R2512	R2712	R2912	R3112	R3312	R3512	R3712	R3912		3rd handle feed magnification (L)
R2513	R2713	R2913	R3113	R3313	R3513	R3713	R3913		3rd handle feed magnification (H)
R2514	R2714	R2914	R3114	R3314	R3514	R3714	R3914		
R2515	R2715	R2915	R3115	R3315	R3515	R3715	R3915		

2 Input/Output Signals with Controller

Device No.								Abbrev.	Signal name
\$1	\$2	\$3	\$4	\$5	\$6	\$7	\$8		
R2516	R2716	R2916	R3116	R3316	R3516	R3716	R3916		
R2517	R2717	R2917	R3117	R3317	R3517	R3717	R3917		
R2518	R2718	R2918	R3118	R3318	R3518	R3718	R3918		PLC interrupt program number (L)
R2519	R2719	R2919	R3119	R3319	R3519	R3719	R3919		PLC interrupt program number (H)
R2520	R2720	R2920	R3120	R3320	R3520	R3720	R3920		
R2521	R2721	R2921	R3121	R3321	R3521	R3721	R3921		
R2522	R2722	R2922	R3122	R3322	R3522	R3722	R3922		
R2523	R2723	R2923	R3123	R3323	R3523	R3723	R3923		
Device No.								Abbrev.	Signal name
\$1	\$2	\$3	\$4	\$5	\$6	\$7	\$8		
R2524	R2724	R2924	R3124	R3324	R3524	R3724	R3924		Manual feedrate B override
R2525	R2725	R2925	R3125	R3325	R3525	R3725	R3925		External search device No.
R2526	R2726	R2926	R3126	R3326	R3526	R3726	R3926		External search program No. (L)
R2527	R2727	R2927	R3127	R3327	R3527	R3727	R3927		External search program No. (H)
R2528	R2728	R2928	R3128	R3328	R3528	R3728	R3928		External search sequence No. (L)
R2529	R2729	R2929	R3129	R3329	R3529	R3729	R3929		External search sequence No. (H)
R2530	R2730	R2930	R3130	R3330	R3530	R3730	R3930		External search block No. (L)
R2531	R2731	R2931	R3131	R3331	R3531	R3731	R3931		External search block No. (H)
Device No.								Abbrev.	Signal name
\$1	\$2	\$3	\$4	\$5	\$6	\$7	\$8		
R2540	R2740	R2940	R3140	R3340	R3540	R3740	R3940		Handle polarity [M8]
R2541	R2741	R2941	R3141	R3341	R3541	R3741	R3941		
R2542	R2742	R2942	R3142	R3342	R3542	R3742	R3942		
R2543	R2743	R2943	R3143	R3343	R3543	R3743	R3943		
R2544	R2744	R2944	R3144	R3344	R3544	R3744	R3944		Manual arbitrary feed 1st axis travel amount (L) [M]
R2545	R2745	R2945	R3145	R3345	R3545	R3745	R3945		Manual arbitrary feed 1st axis travel amount (H) [M]
R2546	R2746	R2946	R3146	R3346	R3546	R3746	R3946		External search block No. (L)
R2547	R2747	R2947	R3147	R3347	R3547	R3747	R3947		External search block No. (H)
Device No.								Abbrev.	Signal name
\$1	\$2	\$3	\$4	\$5	\$6	\$7	\$8		
R2548	R2748	R2948	R3148	R3348	R3548	R3748	R3948		Manual arbitrary feed 2nd axis travel amount (L) [M]
R2549	R2749	R2949	R3149	R3349	R3549	R3749	R3949		Manual arbitrary feed 2nd axis travel amount (H) [M]
R2550	R2750	R2950	R3150	R3350	R3550	R3750	R3950		
R2551	R2751	R2951	R3151	R3351	R3551	R3751	R3951		
R2552	R2752	R2952	R3152	R3352	R3552	R3752	R3952		Manual arbitrary feed 3rd axis travel amount (L) [M]
R2553	R2753	R2953	R3153	R3353	R3553	R3753	R3953		Manual arbitrary feed 3rd axis travel amount (H) [M]
R2554	R2754	R2954	R3154	R3354	R3554	R3754	R3954		
R2555	R2755	R2955	R3155	R3355	R3555	R3755	R3955		
Device No.								Abbrev.	Signal name
\$1	\$2	\$3	\$4	\$5	\$6	\$7	\$8		
R2556	R2756	R2956	R3156	R3356	R3556	R3756	R3956		Alarm message I/F 1 [M8]
R2557	R2757	R2957	R3157	R3357	R3557	R3757	R3957		Alarm message I/F 2 [M8]
R2558	R2758	R2958	R3158	R3358	R3558	R3758	R3958		Alarm message I/F 3 [M8]
R2559	R2759	R2959	R3159	R3359	R3559	R3759	R3959		Alarm message I/F 4 [M8]
R2560	R2760	R2960	R3160	R3360	R3560	R3760	R3960		Operator message I/F [M8]
R2561	R2761	R2961	R3161	R3361	R3561	R3761	R3961		
R2562	R2762	R2962	R3162	R3362	R3562	R3762	R3962		Search & start program No. (L)
R2563	R2763	R2963	R3163	R3363	R3563	R3763	R3963		Search & start program No. (H)

2 Input/Output Signals with Controller

Device No.								Abbrev.	Signal name
\$1	\$2	\$3	\$4	\$5	\$6	\$7	\$8		
R2564	R2764	R2964	R3164	R3364	R3564	R3764	R3964		Manual skip I/F 1 (Manual skip control) ▲
R2565	R2765	R2965	R3165	R3365	R3565	R3765	R3965		Manual skip I/F 2 (Manual skip axis stop/read request) ▲
R2566	R2766	R2966	R3166	R3366	R3566	R3766	R3966		Manual skip I/F 3 (Manual skip axis stop mode) ▲
R2567	R2767	R2967	R3167	R3367	R3567	R3767	R3967		Encoder selection
R2568	R2768	R2968	R3168	R3368	R3568	R3768	R3968		C axis selection
R2569	R2769	R2969	R3169	R3369	R3569	R3769	R3969		
R2570	R2770	R2970	R3170	R3370	R3570	R3770	R3970		
R2571	R2771	R2971	R3171	R3371	R3571	R3771	R3971		
Device No.								Abbrev.	Signal name
\$1	\$2	\$3	\$4	\$5	\$6	\$7	\$8		
R2580	R2780	R2980	R3180	R3380	R3580	R3780	R3980		Load monitor I : Axis selection [M8]
R2581	R2781	R2981	R3181	R3381	R3581	R3781	R3981		Load monitor I : Load change rate detection axis ▲
R2582	R2782	R2982	R3182	R3382	R3582	R3782	R3982		Load monitor I : Teaching data sub-No. ▲
R2583	R2783	R2983	R3183	R3383	R3583	R3783	R3983		Load monitor I : Adaptive control reference axis selection ▲
R2584	R2784	R2984	R3184	R3384	R3584	R3784	R3984		Each axis reference position selection
R2585	R2785	R2985	R3185	R3385	R3585	R3785	R3985		
R2586	R2786	R2986	R3186	R3386	R3586	R3786	R3986		
R2587	R2787	R2987	R3187	R3387	R3587	R3787	R3987		Chopping control data address
Device No.								Abbrev.	Signal name
\$1	\$2	\$3	\$4	\$5	\$6	\$7	\$8		
R2588	R2788	R2988	R3188	R3388	R3588	R3788	R3988		Tool life management data sort
R2589	R2789	R2989	R3189	R3389	R3589	R3789	R3989		Synchronous control operation method
R2590	R2790	R2990	R3190	R3390	R3590	R3790	R3990		Tool group No. designation (L)
R2591	R2791	R2991	R3191	R3391	R3591	R3791	R3991		Tool group No. designation (H)
R2592	R2792	R2992	R3192	R3392	R3592	R3792	R3992		Reference position adjustment completion
R2593	R2793	R2993	R3193	R3393	R3593	R3793	R3993		Current limit changeover
R2594	R2794	R2994	R3194	R3394	R3594	R3794	R3994		Wear compensation No. (tool presetter)
R2595	R2795	R2995	R3195	R3395	R3595	R3795	R3995		
Device No.								Abbrev.	Signal name
\$1	\$2	\$3	\$4	\$5	\$6	\$7	\$8		
R2596	R2796	R2996	R3196	R3396	R3596	R3796	R3996		Turret interference object tool No. designation
R2597	R2797	R2997	R3197	R3397	R3597	R3797	R3997		
R2598	R2798	R2998	R3198	R3398	R3598	R3798	R3998		
R2599	R2799	R2999	R3199	R3399	R3599	R3799	R3999		Workpiece coordinate selection ▲
R2600	R2800	R3000	R3200	R3400	R3600	R3800	R4000		Workpiece coordinate offset Measurement tool compensation No./Selected compensation tool No.(main) (L) (Note 1)
R2601	R2801	R3001	R3201	R3401	R3601	R3801	R4001		Workpiece coordinate offset Measurement tool compen. No./Selected compen. tool No.(main) (H)
R2602	R2802	R3002	R3202	R3402	R3602	R3802	R4002		Workpiece coordinate offset Measurement tool No./ Selected tool No.(main) (L) (Note 1)
R2603	R2803	R3003	R3203	R3403	R3603	R3803	R4003		Workpiece coordinate offset Measurement tool No./ Selected tool No.(main) (H)

(Note 1) When the chuck barrier is checked, "Selected tool compensation No.(main):R2600, R2601" and "Selected tool No.(main):R2602, R2603" are applied.

2 Input/Output Signals with Controller

Device No.									
\$1	\$2	\$3	\$4	\$5	\$6	\$7	\$8	Abbrev.	Signal name
R2604	R2804	R3004	R3204	R3404	R3604	R3804	R4004		Selected tool compensation No.(sub) (L)
R2605	R2805	R3005	R3205	R3405	R3605	R3805	R4005		Selected tool compensation No.(sub) (H)
R2606	R2806	R3006	R3206	R3406	R3606	R3806	R4006		Selected tool wear No. (sub) (L)
R2607	R2807	R3007	R3207	R3407	R3607	R3807	R4007		Selected tool wear No. (sub) (H)
R2608	R2808	R3008	R3208	R3408	R3608	R3808	R4008		Tool mounting information 1-16
R2609	R2809	R3009	R3209	R3409	R3609	R3809	R4009		Tool mounting information 17-32
R2610	R2810	R3010	R3210	R3410	R3610	R3810	R4010		Tool mounting information 33-48
R2611	R2811	R3011	R3211	R3411	R3611	R3811	R4011		Tool mounting information 49-64
Device No.									
\$1	\$2	\$3	\$4	\$5	\$6	\$7	\$8	Abbrev.	Signal name
R2612	R2812	R3012	R3212	R3412	R3612	R3812	R4012		Tool mounting information (65 - 80)
R2613	R2813	R3013	R3213	R3413	R3613	R3813	R4013	MTAPn	n-th spindle synchronous tapping valid [C80]
R2614	R2814	R3014	R3214	R3414	R3614	R3814	R4014	SLSPNO	Multiple-spindle control I: Selected spindle No.
R2615	R2815	R3015	R3215	R3415	R3615	R3815	R4015	RPARCH G	Rotary axis configuration parameter switch
R2616	R2816	R3016	R3216	R3416	R3616	R3816	R4016		Ext. machine coordinate: compensation No. ▲
R2617	R2817	R3017	R3217	R3417	R3617	R3817	R4017		Optimum acceleration/deceleration parameter switching axis (axis and bit selection) ▲
R2618	R2818	R3018	R3218	R3418	R3618	R3818	R4018		Tool length measurement 2 Tool No. (L)
R2619	R2819	R3019	R3219	R3419	R3619	R3819	R4019		Tool length measurement 2 Tool No. (H)
Device No.									
\$1	\$2	\$3	\$4	\$5	\$6	\$7	\$8	Abbrev.	Signal name
R2620	R2820	R3020	R3220	R3420	R3620	R3820	R4020		Constant torque control: Constant torque/proportional torque stopper control request axis [M8]
R2621	R2821	R3021	R3221	R3421	R3621	R3821	R4021		Constant torque control: Constant torque droop cancel request axis [M8]
R2622	R2822	R3022	R3222	R3422	R3622	R3822	R4022		
R2623	R2823	R3023	R3223	R3423	R3623	R3823	R4023		
R2624	R2824	R3024	R3224	R3424	R3624	R3824	R4024		
R2625	R2825	R3025	R3225	R3425	R3625	R3825	R4025		Servo ready completion output designation
R2626	R2826	R3026	R3226	R3426	R3626	R3826	R4026		Thread recutting command
R2627	R2827	R3027	R3227	R3427	R3627	R3827	R4027		Thread recutting execution operation
Device No.									
\$1	\$2	\$3	\$4	\$5	\$6	\$7	\$8	Abbrev.	Signal name
R2628	R2828	R3028	R3228	R3428	R3628	R3828	R4028		Mechanical axis specifications 1st rotary axis angle (L)
R2629	R2829	R3029	R3229	R3429	R3629	R3829	R4029		Mechanical axis specifications 1st rotary axis angle (H)
R2630	R2830	R3030	R3230	R3430	R3630	R3830	R4030		Mechanical axis specifications 2nd rotary axis angle (L)
R2631	R2831	R3031	R3231	R3431	R3631	R3831	R4031		Mechanical axis specifications 2nd rotary axis angle (H)
R2632	R2832	R3032	R3232	R3432	R3632	R3832	R4032		
R2633	R2833	R3033	R3233	R3433	R3633	R3833	R4033		
R2634	R2834	R3034	R3234	R3434	R3634	R3834	R4034	TANGOF	Simple inclined surface machining command: Tool axis rotation angle compensation amount [M8]
R2635	R2835	R3035	R3235	R3435	R3635	R3835	R4035	S	

Device No.								Abbrev.	Signal name
\$1	\$2	\$3	\$4	\$5	\$6	\$7	\$8		
R2636	R2836	R3036	R3236	R3436	R3636	R3836	R4036		Circular feed in manual mode Operation mode data (L) [M8]
R2637	R2837	R3037	R3237	R3437	R3637	R3837	R4037		Circular feed in manual mode Operation mode data (H) [M8]
R2638	R2838	R3038	R3238	R3438	R3638	R3838	R4038		Circular feed in manual mode Part system designation [M8]
R2639	R2839	R3039	R3239	R3439	R3639	R3839	R4039		
R2640	R2840	R3040	R3240	R3440	R3640	R3840	R4040		Circular feed in manual mode Horizontal axis designation [M8]
R2641	R2841	R3041	R3241	R3441	R3641	R3841	R4041		Circular feed in manual mode Vertical axis designation [M8]
R2642	R2842	R3042	R3242	R3442	R3642	R3842	R4042		
R2643	R2843	R3043	R3243	R3443	R3643	R3843	R4043		
Device No.								Abbrev.	Signal name
\$1	\$2	\$3	\$4	\$5	\$6	\$7	\$8		
R2644	R2844	R3044	R3244	R3444	R3644	R3844	R4044		Circular feed in manual mode Basic point H data (L) [M8]
R2645	R2845	R3045	R3245	R3445	R3645	R3845	R4045		Circular feed in manual mode Basic point H data (H) [M8]
R2646	R2846	R3046	R3246	R3446	R3646	R3846	R4046		
R2647	R2847	R3047	R3247	R3447	R3647	R3847	R4047		
R2648	R2848	R3048	R3248	R3448	R3648	R3848	R4048		Circular feed in manual mode Basic point V data (L) [M8]
R2649	R2849	R3049	R3249	R3449	R3649	R3849	R4049		Circular feed in manual mode Basic point V data (H) [M8]
R2650	R2850	R3050	R3250	R3450	R3650	R3850	R4050		
R2651	R2851	R3051	R3251	R3451	R3651	R3851	R4051		
Device No.								Abbrev.	Signal name
\$1	\$2	\$3	\$4	\$5	\$6	\$7	\$8		
R2652	R2852	R3052	R3252	R3452	R3652	R3852	R4052		Circular feed in manual mode Travel range H (+) data (L) [M8]
R2653	R2853	R3053	R3253	R3453	R3653	R3853	R4053		Circular feed in manual mode Travel range H (+) data (H) [M8]
R2654	R2854	R3054	R3254	R3454	R3654	R3854	R4054		
R2655	R2855	R3055	R3255	R3455	R3655	R3855	R4055		
R2656	R2856	R3056	R3256	R3456	R3656	R3856	R4056		Circular feed in manual mode Travel range H (-) data (L) [M8]
R2657	R2857	R3057	R3257	R3457	R3657	R3857	R4057		Circular feed in manual mode Travel range H (-) data (H) [M8]
R2658	R2858	R3058	R3258	R3458	R3658	R3858	R4058		
R2659	R2859	R3059	R3259	R3459	R3659	R3859	R4059		
Device No.								Abbrev.	Signal name
\$1	\$2	\$3	\$4	\$5	\$6	\$7	\$8		
R2660	R2860	R3060	R3260	R3460	R3660	R3860	R4060		Circular feed in manual mode Travel range V (+) data (L) [M8]
R2661	R2861	R3061	R3261	R3461	R3661	R3861	R4061		Circular feed in manual mode Travel range V (+) data (H) [M8]
R2662	R2862	R3062	R3262	R3462	R3662	R3862	R4062		
R2663	R2863	R3063	R3263	R3463	R3663	R3863	R4063		
R2664	R2864	R3064	R3264	R3464	R3664	R3864	R4064		Circular feed in manual mode Travel range V (-) data (L) [M8]
R2665	R2865	R3065	R3265	R3465	R3665	R3865	R4065		Circular feed in manual mode Travel range V (-) data (H) [M8]
R2666	R2866	R3066	R3266	R3466	R3666	R3866	R4066		
R2667	R2867	R3067	R3267	R3467	R3667	R3867	R4067		

2 Input/Output Signals with Controller

Device No.									
\$1	\$2	\$3	\$4	\$5	\$6	\$7	\$8	Abbrev.	Signal name
R2668	R2868	R3068	R3268	R3468	R3668	R3868	R4068		Circular feed in manual mode Gradient/arc center H data (L) [M8]
R2669	R2869	R3069	R3269	R3469	R3669	R3869	R4069		Circular feed in manual mode Gradient/arc center H data (H) [M8]
R2670	R2870	R3070	R3270	R3470	R3670	R3870	R4070		
R2671	R2871	R3071	R3271	R3471	R3671	R3871	R4071		
R2672	R2872	R3072	R3272	R3472	R3672	R3872	R4072		Circular feed in manual mode Gradient/arc center V data (L) [M8]
R2673	R2873	R3073	R3273	R3473	R3673	R3873	R4073		Circular feed in manual mode Gradient/arc center V data (H) [M8]
R2674	R2874	R3074	R3274	R3474	R3674	R3874	R4074		
R2675	R2875	R3075	R3275	R3475	R3675	R3875	R4075		

Device No.									
\$1	\$2	\$3	\$4	\$5	\$6	\$7	\$8	Abbrev.	Signal name
R2676	R2876	R3076	R3276	R3476	R3676	R3876	R4076		
R2677	R2877	R3077	R3277	R3477	R3677	R3877	R4077		
R2678	R2878	R3078	R3278	R3478	R3678	R3878	R4078		
R2679	R2879	R3079	R3279	R3479	R3679	R3879	R4079		
R2680	R2880	R3080	R3280	R3480	R3680	R3880	R4080	CAXSVF	Spindle position control (spindle/C axis control): Servo OFF request during Spindle/C axis mode ▲
R2681	R2881	R3081	R3281	R3481	R3681	R3881	R4081	SPGNCO	Spindle position control (spindle/C axis control): Position loop gain switch at C axis mode in progress ▲
R2682	R2882	R3082	R3282	R3482	R3682	R3882	R4082	UAC	U-axis tool control: U-axis tool zero point reaching request ▲
R2683	R2883	R3083	R3283	R3483	R3683	R3883	R4083		

Device No.									
\$1	\$2	\$3	\$4	\$5	\$6	\$7	\$8	Abbrev.	Signal name
R2684	R2884	R3084	R3284	R3484	R3684	R3884	R4084		For specific users NC control signal 1 ▲
R2685	R2885	R3085	R3285	R3485	R3685	R3885	R4085		
R2686	R2886	R3086	R3286	R3486	R3686	R3886	R4086		
R2687	R2887	R3087	R3287	R3487	R3687	R3887	R4087		
R2688	R2888	R3088	R3288	R3488	R3688	R3888	R4088		Specific users Manual skip motion direction (-) ▲
R2689	R2889	R3089	R3289	R3489	R3689	R3889	R4089		Specific users Manual skip motion direction (+) ▲
R2690	R2890	R3090	R3290	R3490	R3690	R3890	R4090		
R2691	R2891	R3091	R3291	R3491	R3691	R3891	R4091		

Device	Abbrev.	Signal name	Device	Abbrev.	Signal name
R4400		3D Machine Interference Check : Enabled shape group No.1 [M8]			
R4401		3D Machine Interference Check : Enabled shape group No.2 [M8]			
R4402		3D Machine Interference Check : Enabled shape group No.3 [M8]			
R4403		3D Machine Interference Check : Enabled shape group No.4 [M8]			
R4404					
R4405					
R4406					
R4407					

Device No.				Abbrev.	Signal name
\$1	\$2	\$3	\$4		
R5700	R5716	R5732	R5748		Ext. machine coordinate system offset data 1st axis (L) [M]
R5701	R5717	R5733	R5749		Ext. machine coordinate system offset data 1st axis (H) [M]
R5702	R5718	R5734	R5750		Ext. machine coordinate system offset data 2nd axis (L) [M]
R5703	R5719	R5735	R5751		Ext. machine coordinate system offset data 2nd axis (H) [M]
R5704	R5720	R5736	R5752		Ext. machine coordinate system offset data 3rd axis (L) [M]
R5705	R5721	R5737	R5753		Ext. machine coordinate system offset data 3rd axis (H) [M]
R5706	R5722	R5738	R5754		Ext. machine coordinate system offset data 4th axis (L) [M]
R5707	R5723	R5739	R5755		Ext. machine coordinate system offset data 4th axis (H) [M]

Device No.				Abbrev.	Signal name
\$1	\$2	\$3	\$4		
R5708	R5724	R5740	R5756		Ext. machine coordinate system offset data 5th axis (L) [M]
R5709	R5725	R5741	R5757		Ext. machine coordinate system offset data 5th axis (H) [M]
R5710	R5726	R5742	R5758		Ext. machine coordinate system offset data 6th axis (L) [M]
R5711	R5727	R5743	R5759		Ext. machine coordinate system offset data 6th axis (H) [M]
R5712	R5728	R5744	R5760		Ext. machine coordinate system offset data 7th axis (L) [M]
R5713	R5729	R5745	R5761		Ext. machine coordinate system offset data 7th axis (H) [M]
R5714	R5730	R5746	R5762		Ext. machine coordinate system offset data 8th axis (L) [M]
R5715	R5731	R5747	R5763		Ext. machine coordinate system offset data 8th axis (H) [M]

Device No.				Abbrev.	Signal name
\$1	\$2	\$3	\$4		
R5764	R5780	R5796	R5812		Each axis manual feedrate B 1st axis (L) [M]
R5765	R5781	R5797	R5813		Each axis manual feedrate B 1st axis (H) [M]
R5766	R5782	R5798	R5814		Each axis manual feedrate B 2nd axis (L) [M]
R5767	R5783	R5799	R5815		Each axis manual feedrate B 2nd axis (H) [M]
R5768	R5784	R5800	R5816		Each axis manual feedrate B 3rd axis (L) [M]
R5769	R5785	R5801	R5817		Each axis manual feedrate B 3rd axis (H) [M]
R5770	R5786	R5802	R5818		Each axis manual feedrate B 4th axis (L) [M]
R5771	R5787	R5803	R5819		Each axis manual feedrate B 4th axis (H) [M]

Device No.				Abbrev.	Signal name
\$1	\$2	\$3	\$4		
R5772	R5788	R5804	R5820		Each axis manual feedrate B 5th axis (L) [M]
R5773	R5789	R5805	R5821		Each axis manual feedrate B 5th axis (H) [M]
R5774	R5790	R5806	R5822		Each axis manual feedrate B 6th axis (L) [M]
R5775	R5791	R5807	R5823		Each axis manual feedrate B 6th axis (H) [M]
R5776	R5792	R5808	R5824		Each axis manual feedrate B 7th axis (L) [M]
R5777	R5793	R5809	R5825		Each axis manual feedrate B 7th axis (H) [M]
R5778	R5794	R5810	R5826		Each axis manual feedrate B 8th axis (L) [M]
R5779	R5795	R5811	R5827		Each axis manual feedrate B 8th axis (H) [M]

Device No.				Abbrev.	Signal name
\$1	\$2	\$3	\$4		
R6052	R6060	R6068	R6076		External deceleration speed selection 1st axis [C80]
R6053	R6061	R6069	R6077		External deceleration speed selection 2nd axis [C80]
R6054	R6062	R6070	R6078		External deceleration speed selection 3rd axis [C80]
R6055	R6063	R6071	R6079		External deceleration speed selection 4th axis [C80]
R6056	R6064	R6072	R6080		External deceleration speed selection 5th axis [C80]
R6057	R6065	R6073	R6081		External deceleration speed selection 6th axis [C80]
R6058	R6066	R6074	R6082		External deceleration speed selection 7th axis [C80]
R6059	R6067	R6075	R6083		External deceleration speed selection 8th axis [C80]

2 Input/Output Signals with Controller

Device No.				Abbrev.	Signal name
\$1	\$2	\$3	\$4		
R6084	R6092	R6100	R6108		Optimum acceleration/deceleration parameter group selection 1st axis ▲
R6085	R6093	R6101	R6109		Optimum acceleration/deceleration parameter group selection 2nd axis ▲
R6086	R6094	R6102	R6110		Optimum acceleration/deceleration parameter group selection 3rd axis ▲
R6087	R6095	R6103	R6111		Optimum acceleration/deceleration parameter group selection 4th axis ▲
R6088	R6096	R6104	R6112		Optimum acceleration/deceleration parameter group selection 5th axis ▲
R6089	R6097	R6105	R6113		Optimum acceleration/deceleration parameter group selection 6th axis ▲
R6090	R6098	R6106	R6114		Optimum acceleration/deceleration parameter group selection 7th axis ▲
R6091	R6099	R6107	R6115		Optimum acceleration/deceleration parameter group selection 8th axis ▲

Device No.				Abbrev.	Signal name
\$1	\$2	\$3	\$4		
R6116	R6124	R6132	R6140		Target machining time 1st axis ▲
R6117	R6125	R6133	R6141		Target machining time 2nd axis ▲
R6118	R6126	R6134	R6142		Target machining time 3rd axis ▲
R6119	R6127	R6135	R6143		Target machining time 4th axis ▲
R6120	R6128	R6136	R6144		Target machining time 5th axis ▲
R6121	R6129	R6137	R6145		Target machining time 6th axis ▲
R6122	R6130	R6138	R6146		Target machining time 7th axis ▲
R6123	R6131	R6139	R6147		Target machining time 8th axis ▲

Device No.								Abbrev.	Signal name
\$1	\$2	\$3	\$4	\$5	\$6	\$7	\$8		
R6436	R6444	R6452	R6460	R6468	R6476	R6484	R6492		User macro input #1032 (PLC -> NC) (L)
R6437	R6445	R6453	R6461	R6469	R6477	R6485	R6493		User macro input #1032 (PLC -> NC) (H)
R6438	R6446	R6454	R6462	R6470	R6478	R6486	R6494		User macro input #1033 (PLC -> NC) (L)
R6439	R6447	R6455	R6463	R6471	R6479	R6487	R6495		User macro input #1033 (PLC -> NC) (H)
R6440	R6448	R6456	R6464	R6472	R6480	R6488	R6496		User macro input #1034 (PLC -> NC) (L)
R6441	R6449	R6457	R6465	R6473	R6481	R6489	R6497		User macro input #1034 (PLC -> NC) (H)
R6442	R6450	R6458	R6466	R6474	R6482	R6490	R6498		User macro input #1035 (PLC -> NC) (L)
R6443	R6451	R6459	R6467	R6475	R6483	R6491	R6499		User macro input #1035 (PLC -> NC) (H)

Device No.								Abbrev.	Signal name
1stSP	2ndSP	3rdSP	4thSP	5thSP	6thSP	7thSP	8thSP		
R7000	R7050	R7100	R7150	R7200	R7250	R7300	R7350		Spindle command rotation speed output (L)
R7001	R7051	R7101	R7151	R7201	R7251	R7301	R7351		Spindle command rotation speed output (H)
R7002	R7052	R7102	R7152	R7202	R7252	R7302	R7352	SLSP	Spindle command selection
R7003	R7053	R7103	R7153	R7203	R7253	R7303	R7353		Optimum acceleration/deceleration parameter group selection [spindle] ▲
R7004	R7054	R7104	R7154	R7204	R7254	R7304	R7354		Spindle target machining time ▲
R7005	R7055	R7105	R7155	R7205	R7255	R7305	R7355		
R7006	R7056	R7106	R7156	R7206	R7256	R7306	R7356		
R7007	R7057	R7107	R7157	R7207	R7257	R7307	R7357		

2 Input/Output Signals with Controller

Device No.									
1stSP	2ndSP	3rdSP	4thSP	5thSP	6thSP	7thSP	8thSP	Abbrev.	Signal name
R7008	R7058	R7108	R7158	R7208	R7258	R7308	R7358		S command override
R7009	R7059	R7109	R7159	R7209	R7259	R7309	R7359		Multi-point orientation position data
R7010	R7060	R7110	R7160	R7210	R7260	R7310	R7360	ORDIR	Orientation rotation direction ▲
R7011	R7061	R7111	R7161	R7211	R7261	R7311	R7361	MCNGITS PCMD	Machining interruption spindle command [C80]
R7012	R7062	R7112	R7162	R7212	R7262	R7312	R7362	ANSLD	Interface of load meter for analog I/F spindle [M8]
R7013	R7063	R7113	R7163	R7213	R7263	R7313	R7363		
R7014	R7064	R7114	R7164	R7214	R7264	R7314	R7364		
R7015	R7065	R7115	R7165	R7215	R7265	R7315	R7365		

Device No.									
1stSP	2ndSP	3rdSP	4thSP	5thSP	6thSP	7thSP	8thSP	Abbrev.	Signal name
R7016	R7066	R7116	R7166	R7216	R7266	R7316	R7366		Spindle synchronization reference spindle selection
R7017	R7067	R7117	R7167	R7217	R7267	R7317	R7367		Spindle synchronization Synchronized spindle selection
R7018	R7068	R7118	R7168	R7218	R7268	R7318	R7368		Spindle synchronization Phase shift amount
R7019	R7069	R7119	R7169	R7219	R7269	R7319	R7369		Spindle synchronization Phase error tolerance
R7020	R7070	R7120	R7170	R7220	R7270	R7320	R7370		Spindle oscillation amplitude [M8]
R7021	R7071	R7121	R7171	R7221	R7271	R7321	R7371		Spindle oscillation frequency [M8]
R7022	R7072	R7122	R7172	R7222	R7272	R7322	R7372		
R7023	R7073	R7123	R7173	R7223	R7273	R7323	R7373		

Device No.									
1stSP	2ndSP	3rdSP	4thSP	5thSP	6thSP	7thSP	8thSP	Abbrev.	Signal name
R7026	R7076	R7126	R7176	R7226	R7276	R7326	R7376	SPCHGC- MD	Tool head hot swapping: Spindle switch [M8]
R7027	R7077	R7127	R7177	R7227	R7277	R7327	R7377		
R7028	R7078	R7128	R7178	R7228	R7278	R7328	R7378		
R7029	R7079	R7129	R7179	R7229	R7279	R7329	R7379		
R7030	R7080	R7130	R7180	R7230	R7280	R7330	R7380		
R7031	R7081	R7131	R7181	R7231	R7281	R7331	R7381		

Device	Abbrev.	Signal name	Device	Abbrev.	Signal name
R10600 to R11779		Refer to "2.7 Classified for Each Application".			

Device No.									
\$1	\$2	\$3	\$4	\$5	\$6	\$7	\$8	Abbrev.	Signal name
R12200	R12210	R12220	R12230	R12240	R12250	R12260	R12270		Spindle tool No. (L)
R12201	R12211	R12221	R12231	R12241	R12251	R12261	R12271		Spindle tool No. (H)
R12202	R12212	R12222	R12232	R12242	R12252	R12262	R12272		Standby tool No. (L)
R12203	R12213	R12223	R12233	R12243	R12253	R12263	R12273		Standby tool No. (H)

2 Input/Output Signals with Controller

Device No.								Abbrev.	Signal name
\$1	\$2	\$3	\$4	\$5	\$6	\$7	\$8		
R14700	R14950	R15200	R15450	R15700	R15950	R16200	R16450		MES interface library: Machining start time [M8]
R14701	R14951	R15201	R15451	R15701	R15951	R16201	R16451		
R14702	R14952	R15202	R15452	R15702	R15952	R16202	R16452		
R14703	R14953	R15203	R15453	R15703	R15953	R16203	R16453		MES interface library: Machining end time [M8]
R14704	R14954	R15204	R15454	R15704	R15954	R16204	R16454		
R14705	R14955	R15205	R15455	R15705	R15955	R16205	R16455		MES interface library: Cycle time [M8]
R14706	R14956	R15206	R15456	R15706	R15956	R16206	R16456		MES interface library: Program number at machining start [M8]
R14707	R14957	R15207	R15457	R15707	R15957	R16207	R16457		

Device No.								Abbrev.	Signal name
\$1	\$2	\$3	\$4	\$5	\$6	\$7	\$8		
R14708	R14958	R15208	R15458	R15708	R15958	R16208	R16458		MES interface library: Program number at machining start [M8]
R14709	R14959	R15209	R15459	R15709	R15959	R16209	R16459		
R14710	R14960	R15210	R15460	R15710	R15960	R16210	R16460		
R14711	R14961	R15211	R15461	R15711	R15961	R16211	R16461		
R14712	R14962	R15212	R15462	R15712	R15962	R16212	R16462		
R14713	R14963	R15213	R15463	R15713	R15963	R16213	R16463		
R14714	R14964	R15214	R15464	R15714	R15964	R16214	R16464		
R14715	R14965	R15215	R15465	R15715	R15965	R16215	R16465		

Device No.								Abbrev.	Signal name
\$1	\$2	\$3	\$4	\$5	\$6	\$7	\$8		
R14716	R14966	R15216	R15466	R15716	R15966	R16216	R16466		MES interface library: Program number at machining start [M8]
R14717	R14967	R15217	R15467	R15717	R15967	R16217	R16467		
R14718	R14968	R15218	R15468	R15718	R15968	R16218	R16468		
R14719	R14969	R15219	R15469	R15719	R15969	R16219	R16469		
R14720	R14970	R15220	R15470	R15720	R15970	R16220	R16470		
R14721	R14971	R15221	R15471	R15721	R15971	R16221	R16471		
R14722	R14972	R15222	R15472	R15722	R15972	R16222	R16472		MES interface library: N number at machining start [M8]
R14723	R14973	R15223	R15473	R15723	R15973	R16223	R16473		

Device No.								Abbrev.	Signal name
\$1	\$2	\$3	\$4	\$5	\$6	\$7	\$8		
R14724	R14974	R15224	R15474	R15724	R15974	R16224	R16474		MES interface library: B number at machining start [M8]
R14725	R14975	R15225	R15475	R15725	R15975	R16225	R16475		
R14726	R14976	R15226	R15476	R15726	R15976	R16226	R16476		MES interface library: Spindle 1 maximum load [M8]
R14727	R14977	R15227	R15477	R15727	R15977	R16227	R16477		MES interface library: Spindle 2 maximum load [M8]
R14728	R14978	R15228	R15478	R15728	R15978	R16228	R16478		MES interface library: Power consumption amount [M8]
R14729	R14979	R15229	R15479	R15729	R15979	R16229	R16479		
R14730	R14980	R15230	R15480	R15730	R15980	R16230	R16480		MES interface library: Power regeneration amount [M8]
R14731	R14981	R15231	R15481	R15731	R15981	R16231	R16481		

Device No.								Abbrev.	Signal name
\$1	\$2	\$3	\$4	\$5	\$6	\$7	\$8		
R14732	R14982	R15232	R15482	R15732	R15982	R16232	R16482		MES interface library: Tool number 1 [M8]
R14733	R14983	R15233	R15483	R15733	R15983	R16233	R16483		
R14734	R14984	R15234	R15484	R15734	R15984	R16234	R16484		MES interface library: Tool number 2 [M8]
R14735	R14985	R15235	R15485	R15735	R15985	R16235	R16485		
R14736	R14986	R15236	R15486	R15736	R15986	R16236	R16486		MES interface library: Tool number 3 [M8]
R14737	R14987	R15237	R15487	R15737	R15987	R16237	R16487		
R14738	R14988	R15238	R15488	R15738	R15988	R16238	R16488		MES interface library: Tool number 4 [M8]
R14739	R14989	R15239	R15489	R15739	R15989	R16239	R16489		

2 Input/Output Signals with Controller

Device No.								Abbrev.	Signal name
\$1	\$2	\$3	\$4	\$5	\$6	\$7	\$8		
R14740	R14990	R15240	R15490	R15740	R15990	R16240	R16490		MES interface library: Tool number 5 [M8]
R14741	R14991	R15241	R15491	R15741	R15991	R16241	R16491		
R14742	R14992	R15242	R15492	R15742	R15992	R16242	R16492		
R14743	R14993	R15243	R15493	R15743	R15993	R16243	R16493		
R14744	R14994	R15244	R15494	R15744	R15994	R16244	R16494		
R14745	R14995	R15245	R15495	R15745	R15995	R16245	R16495		
R14746	R14996	R15246	R15496	R15746	R15996	R16246	R16496		
R14747	R14997	R15247	R15497	R15747	R15997	R16247	R16497		

Device No.								Abbrev.	Signal name
\$1	\$2	\$3	\$4	\$5	\$6	\$7	\$8		
R14748	R14998	R15248	R15498	R15748	R15998	R16248	R16498		MES interface library: Tool length offset 1 [M8]
R14749	R14999	R15249	R15499	R15749	R15999	R16249	R16499		
R14750	R15000	R15250	R15500	R15750	R16000	R16250	R16500		MES interface library: Tool length offset 2 [M8]
R14751	R15001	R15251	R15501	R15751	R16001	R16251	R16501		
R14752	R15002	R15252	R15502	R15752	R16002	R16252	R16502		MES interface library: Tool length offset 3 [M8]
R14753	R15003	R15253	R15503	R15753	R16003	R16253	R16503		
R14754	R15004	R15254	R15504	R15754	R16004	R16254	R16504		MES interface library: Tool length offset 4 [M8]
R14755	R15005	R15255	R15505	R15755	R16005	R16255	R16505		

Device No.								Abbrev.	Signal name
\$1	\$2	\$3	\$4	\$5	\$6	\$7	\$8		
R14756	R15006	R15256	R15506	R15756	R16006	R16256	R16506		MES interface library: Tool length offset 5 [M8]
R14757	R15007	R15257	R15507	R15757	R16007	R16257	R16507		
R14758	R15008	R15258	R15508	R15758	R16008	R16258	R16508		MES interface library: Tool radius offset 1 [M8]
R14759	R15009	R15259	R15509	R15759	R16009	R16259	R16509		
R14760	R15010	R15260	R15510	R15760	R16010	R16260	R16510		MES interface library: Tool radius offset 2 [M8]
R14761	R15011	R15261	R15511	R15761	R16011	R16261	R16511		
R14762	R15012	R15262	R15512	R15762	R16012	R16262	R16512		MES interface library: Tool radius offset 3 [M8]
R14763	R15013	R15263	R15513	R15763	R16013	R16263	R16513		

Device No.								Abbrev.	Signal name
\$1	\$2	\$3	\$4	\$5	\$6	\$7	\$8		
R14764	R15014	R15264	R15514	R15764	R16014	R16264	R16514		MES interface library: Tool radius offset 4 [M8]
R14765	R15015	R15265	R15515	R15765	R16015	R16265	R16515		
R14766	R15016	R15266	R15516	R15766	R16016	R16266	R16516		MES interface library: Tool radius offset 5 [M8]
R14767	R15017	R15267	R15517	R15767	R16017	R16267	R16517		
R14768	R15018	R15268	R15518	R15768	R16018	R16268	R16518		MES interface library: Tool length wear amount 1 [M8]
R14769	R15019	R15269	R15519	R15769	R16019	R16269	R16519		
R14770	R15020	R15270	R15520	R15770	R16020	R16270	R16520		MES interface library: Tool length wear amount 2 [M8]
R14771	R15021	R15271	R15521	R15771	R16021	R16271	R16521		

Device No.								Abbrev.	Signal name
\$1	\$2	\$3	\$4	\$5	\$6	\$7	\$8		
R14772	R15022	R15272	R15522	R15772	R16022	R16272	R16522		MES interface library: Tool length wear amount 3 [M8]
R14773	R15023	R15273	R15523	R15773	R16023	R16273	R16523		
R14774	R15024	R15274	R15524	R15774	R16024	R16274	R16524		MES interface library: Tool length wear amount 4 [M8]
R14775	R15025	R15275	R15525	R15775	R16025	R16275	R16525		
R14776	R15026	R15276	R15526	R15776	R16026	R16276	R16526		MES interface library: Tool length wear amount 5 [M8]
R14777	R15027	R15277	R15527	R15777	R16027	R16277	R16527		
R14778	R15028	R15278	R15528	R15778	R16028	R16278	R16528		MES interface library: Tool radius wear amount 1 [M8]
R14779	R15029	R15279	R15529	R15779	R16029	R16279	R16529		

2 Input/Output Signals with Controller

Device No.								Abbrev.	Signal name
\$1	\$2	\$3	\$4	\$5	\$6	\$7	\$8		
R14780	R15030	R15280	R15530	R15780	R16030	R16280	R16530		MES interface library: Tool radius wear amount 2 [M8]
R14781	R15031	R15281	R15531	R15781	R16031	R16281	R16531		
R14782	R15032	R15282	R15532	R15782	R16032	R16282	R16532		
R14783	R15033	R15283	R15533	R15783	R16033	R16283	R16533		
R14784	R15034	R15284	R15534	R15784	R16034	R16284	R16534		
R14785	R15035	R15285	R15535	R15785	R16035	R16285	R16535		MES interface library: Tool radius wear amount 4 [M8]
R14786	R15036	R15286	R15536	R15786	R16036	R16286	R16536		
R14787	R15037	R15287	R15537	R15787	R16037	R16287	R16537		

Device No.								Abbrev.	Signal name
\$1	\$2	\$3	\$4	\$5	\$6	\$7	\$8		
R14788	R15038	R15288	R15538	R15788	R16038	R16288	R16538		MES interface library: Tool life 1 [M8]
R14789	R15039	R15289	R15539	R15789	R16039	R16289	R16539		
R14790	R15040	R15290	R15540	R15790	R16040	R16290	R16540		MES interface library: Tool life 2 [M8]
R14791	R15041	R15291	R15541	R15791	R16041	R16291	R16541		
R14792	R15042	R15292	R15542	R15792	R16042	R16292	R16542		
R14793	R15043	R15293	R15543	R15793	R16043	R16293	R16543		MES interface library: Tool life 3 [M8]
R14794	R15044	R15294	R15544	R15794	R16044	R16294	R16544		
R14795	R15045	R15295	R15545	R15795	R16045	R16295	R16545		MES interface library: Tool life 4 [M8]

Device No.								Abbrev.	Signal name
\$1	\$2	\$3	\$4	\$5	\$6	\$7	\$8		
R14796	R15046	R15296	R15546	R15796	R16046	R16296	R16546		MES interface library: Tool life 5 [M8]
R14797	R15047	R15297	R15547	R15797	R16047	R16297	R16547		
R14798	R15048	R15298	R15548	R15798	R16048	R16298	R16548		MES interface library: Time of alarm occurrence [M8]
R14799	R15049	R15299	R15549	R15799	R16049	R16299	R16549		
R14800	R15050	R15300	R15550	R15800	R16050	R16300	R16550		
R14801	R15051	R15301	R15551	R15801	R16051	R16301	R16551		MES interface library: Alarm number 1 [M8]
R14802	R15052	R15302	R15552	R15802	R16052	R16302	R16552		
R14803	R15053	R15303	R15553	R15803	R16053	R16303	R16553		

Device No.								Abbrev.	Signal name
\$1	\$2	\$3	\$4	\$5	\$6	\$7	\$8		
R14804	R15054	R15304	R15554	R15804	R16054	R16304	R16554		MES interface library: Alarm number 1 [M8]
R14805	R15055	R15305	R15555	R15805	R16055	R16305	R16555		
R14806	R15056	R15306	R15556	R15806	R16056	R16306	R16556		
R14807	R15057	R15307	R15557	R15807	R16057	R16307	R16557		
R14808	R15058	R15308	R15558	R15808	R16058	R16308	R16558		
R14809	R15059	R15309	R15559	R15809	R16059	R16309	R16559		
R14810	R15060	R15310	R15560	R15810	R16060	R16310	R16560		
R14811	R15061	R15311	R15561	R15811	R16061	R16311	R16561		

Device No.								Abbrev.	Signal name
\$1	\$2	\$3	\$4	\$5	\$6	\$7	\$8		
R14812	R15062	R15312	R15562	R15812	R16062	R16312	R16562		MES interface library: Alarm number 1 [M8]
R14813	R15063	R15313	R15563	R15813	R16063	R16313	R16563		
R14814	R15064	R15314	R15564	R15814	R16064	R16314	R16564		
R14815	R15065	R15315	R15565	R15815	R16065	R16315	R16565		
R14816	R15066	R15316	R15566	R15816	R16066	R16316	R16566		MES interface library: Alarm number 2 [M8]
R14817	R15067	R15317	R15567	R15817	R16067	R16317	R16567		
R14818	R15068	R15318	R15568	R15818	R16068	R16318	R16568		
R14819	R15069	R15319	R15569	R15819	R16069	R16319	R16569		

2 Input/Output Signals with Controller

Device No.								Abbrev.	Signal name
\$1	\$2	\$3	\$4	\$5	\$6	\$7	\$8		
R14820	R15070	R15320	R15570	R15820	R16070	R16320	R16570	MES interface library: Alarm number 2 [M8]	
R14821	R15071	R15321	R15571	R15821	R16071	R16321	R16571		
R14822	R15072	R15322	R15572	R15822	R16072	R16322	R16572		
R14823	R15073	R15323	R15573	R15823	R16073	R16323	R16573		
R14824	R15074	R15324	R15574	R15824	R16074	R16324	R16574		
R14825	R15075	R15325	R15575	R15825	R16075	R16325	R16575		
R14826	R15076	R15326	R15576	R15826	R16076	R16326	R16576		
R14827	R15077	R15327	R15577	R15827	R16077	R16327	R16577		

Device No.								Abbrev.	Signal name
\$1	\$2	\$3	\$4	\$5	\$6	\$7	\$8		
R14828	R15078	R15328	R15578	R15828	R16078	R16328	R16578	MES interface library: Alarm number 2 [M8]	
R14829	R15079	R15329	R15579	R15829	R16079	R16329	R16579		
R14830	R15080	R15330	R15580	R15830	R16080	R16330	R16580		
R14831	R15081	R15331	R15581	R15831	R16081	R16331	R16581		
R14832	R15082	R15332	R15582	R15832	R16082	R16332	R16582	MES interface library: Alarm number 3 [M8]	
R14833	R15083	R15333	R15583	R15833	R16083	R16333	R16583		
R14834	R15084	R15334	R15584	R15834	R16084	R16334	R16584		
R14835	R15085	R15335	R15585	R15835	R16085	R16335	R16585		

Device No.								Abbrev.	Signal name
\$1	\$2	\$3	\$4	\$5	\$6	\$7	\$8		
R14836	R15086	R15336	R15586	R15836	R16086	R16336	R16586	MES interface library: Alarm number 3 [M8]	
R14837	R15087	R15337	R15587	R15837	R16087	R16337	R16587		
R14838	R15088	R15338	R15588	R15838	R16088	R16338	R16588		
R14839	R15089	R15339	R15589	R15839	R16089	R16339	R16589		
R14840	R15090	R15340	R15590	R15840	R16090	R16340	R16590		
R14841	R15091	R15341	R15591	R15841	R16091	R16341	R16591		
R14842	R15092	R15342	R15592	R15842	R16092	R16342	R16592		
R14843	R15093	R15343	R15593	R15843	R16093	R16343	R16593		

Device No.								Abbrev.	Signal name
\$1	\$2	\$3	\$4	\$5	\$6	\$7	\$8		
R14844	R15094	R15344	R15594	R15844	R16094	R16344	R16594	MES interface library: Alarm number 3 [M8]	
R14845	R15095	R15345	R15595	R15845	R16095	R16345	R16595		
R14846	R15096	R15346	R15596	R15846	R16096	R16346	R16596		
R14847	R15097	R15347	R15597	R15847	R16097	R16347	R16597		
R14848	R15098	R15348	R15598	R15848	R16098	R16348	R16598	MES interface library: Alarm number 4 [M8]	
R14849	R15099	R15349	R15599	R15849	R16099	R16349	R16599		
R14850	R15100	R15350	R15600	R15850	R16100	R16350	R16600		
R14851	R15101	R15351	R15601	R15851	R16101	R16351	R16601		

Device No.								Abbrev.	Signal name
\$1	\$2	\$3	\$4	\$5	\$6	\$7	\$8		
R14852	R15102	R15352	R15602	R15852	R16102	R16352	R16602	MES interface library: Alarm number 4 [M8]	
R14853	R15103	R15353	R15603	R15853	R16103	R16353	R16603		
R14854	R15104	R15354	R15604	R15854	R16104	R16354	R16604		
R14855	R15105	R15355	R15605	R15855	R16105	R16355	R16605		
R14856	R15106	R15356	R15606	R15856	R16106	R16356	R16606		
R14857	R15107	R15357	R15607	R15857	R16107	R16357	R16607		
R14858	R15108	R15358	R15608	R15858	R16108	R16358	R16608		
R14859	R15109	R15359	R15609	R15859	R16109	R16359	R16609		

2 Input/Output Signals with Controller

Device No.								Abbrev.	Signal name
\$1	\$2	\$3	\$4	\$5	\$6	\$7	\$8		
R14860	R15110	R15360	R15610	R15860	R16110	R16360	R16610		MES interface library: Alarm number 4 [M8]
R14861	R15111	R15361	R15611	R15861	R16111	R16361	R16611		
R14862	R15112	R15362	R15612	R15862	R16112	R16362	R16612		
R14863	R15113	R15363	R15613	R15863	R16113	R16363	R16613		
R14864	R15114	R15364	R15614	R15864	R16114	R16364	R16614		MES interface library: Power ON time [M8]
R14865	R15115	R15365	R15615	R15865	R16115	R16365	R16615		
R14866	R15116	R15366	R15616	R15866	R16116	R16366	R16616		MES interface library: Program number at alarm [M8]
R14867	R15117	R15367	R15617	R15867	R16117	R16367	R16617		

Device No.								Abbrev.	Signal name
\$1	\$2	\$3	\$4	\$5	\$6	\$7	\$8		
R14868	R15118	R15368	R15618	R15868	R16118	R16368	R16618		MES interface library: Program number at alarm [M8]
R14869	R15119	R15369	R15619	R15869	R16119	R16369	R16619		
R14870	R15120	R15370	R15620	R15870	R16120	R16370	R16620		
R14871	R15121	R15371	R15621	R15871	R16121	R16371	R16621		
R14872	R15122	R15372	R15622	R15872	R16122	R16372	R16622		
R14873	R15123	R15373	R15623	R15873	R16123	R16373	R16623		
R14874	R15124	R15374	R15624	R15874	R16124	R16374	R16624		
R14875	R15125	R15375	R15625	R15875	R16125	R16375	R16625		

Device No.								Abbrev.	Signal name
\$1	\$2	\$3	\$4	\$5	\$6	\$7	\$8		
R14876	R15126	R15376	R15626	R15876	R16126	R16376	R16626		MES interface library: Program number at alarm [M8]
R14877	R15127	R15377	R15627	R15877	R16127	R16377	R16627		
R14878	R15128	R15378	R15628	R15878	R16128	R16378	R16628		
R14879	R15129	R15379	R15629	R15879	R16129	R16379	R16629		
R14880	R15130	R15380	R15630	R15880	R16130	R16380	R16630		
R14881	R15131	R15381	R15631	R15881	R16131	R16381	R16631		
R14882	R15132	R15382	R15632	R15882	R16132	R16382	R16632		MES interface library: Subprogram number at alarm [M8]
R14883	R15133	R15383	R15633	R15883	R16133	R16383	R16633		

Device No.								Abbrev.	Signal name
\$1	\$2	\$3	\$4	\$5	\$6	\$7	\$8		
R14884	R15134	R15384	R15634	R15884	R16134	R16384	R16634		MES interface library: Subprogram number at alarm [M8]
R14885	R15135	R15385	R15635	R15885	R16135	R16385	R16635		
R14886	R15136	R15386	R15636	R15886	R16136	R16386	R16636		
R14887	R15137	R15387	R15637	R15887	R16137	R16387	R16637		
R14888	R15138	R15388	R15638	R15888	R16138	R16388	R16638		
R14889	R15139	R15389	R15639	R15889	R16139	R16389	R16639		
R14890	R15140	R15390	R15640	R15890	R16140	R16390	R16640		
R14891	R15141	R15391	R15641	R15891	R16141	R16391	R16641		

Device No.								Abbrev.	Signal name
\$1	\$2	\$3	\$4	\$5	\$6	\$7	\$8		
R14892	R15142	R15392	R15642	R15892	R16142	R16392	R16642		MES interface library: Subprogram number at alarm [M8]
R14893	R15143	R15393	R15643	R15893	R16143	R16393	R16643		
R14894	R15144	R15394	R15644	R15894	R16144	R16394	R16644		
R14895	R15145	R15395	R15645	R15895	R16145	R16395	R16645		
R14896	R15146	R15396	R15646	R15896	R16146	R16396	R16646		
R14897	R15147	R15397	R15647	R15897	R16147	R16397	R16647		
R14898	R15148	R15398	R15648	R15898	R16148	R16398	R16648		MES interface library: N number at alarm [M8]
R14899	R15149	R15399	R15649	R15899	R16149	R16399	R16649		

2 Input/Output Signals with Controller

Device No.								Abbrev.	Signal name
\$1	\$2	\$3	\$4	\$5	\$6	\$7	\$8		
R14900	R15150	R15400	R15650	R15900	R16150	R16400	R16650		MES interface library: B number at alarm [M8]
R14901	R15151	R15401	R15651	R15901	R16151	R16401	R16651		
R14902	R15152	R15402	R15652	R15902	R16152	R16402	R16652		MES interface library: G code modal status [M8]
R14903	R15153	R15403	R15653	R15903	R16153	R16403	R16653		
R14904	R15154	R15404	R15654	R15904	R16154	R16404	R16654		
R14905	R15155	R15405	R15655	R15905	R16155	R16405	R16655		
R14906	R15156	R15406	R15656	R15906	R16156	R16406	R16656		
R14907	R15157	R15407	R15657	R15907	R16157	R16407	R16657		

Device No.								Abbrev.	Signal name
\$1	\$2	\$3	\$4	\$5	\$6	\$7	\$8		
R14908	R15158	R15408	R15658	R15908	R16158	R16408	R16658		MES interface library: G code modal status [M8]
R14909	R15159	R15409	R15659	R15909	R16159	R16409	R16659		
R14910	R15160	R15410	R15660	R15910	R16160	R16410	R16660		
R14911	R15161	R15411	R15661	R15911	R16161	R16411	R16661		
R14912	R15162	R15412	R15662	R15912	R16162	R16412	R16662		
R14913	R15163	R15413	R15663	R15913	R16163	R16413	R16663		
R14914	R15164	R15414	R15664	R15914	R16164	R16414	R16664		
R14915	R15165	R15415	R15665	R15915	R16165	R16415	R16665		

Device No.								Abbrev.	Signal name
\$1	\$2	\$3	\$4	\$5	\$6	\$7	\$8		
R14916	R15166	R15416	R15666	R15916	R16166	R16416	R16666		MES interface library: G code modal status [M8]
R14917	R15167	R15417	R15667	R15917	R16167	R16417	R16667		
R14918	R15168	R15418	R15668	R15918	R16168	R16418	R16668		
R14919	R15169	R15419	R15669	R15919	R16169	R16419	R16669		
R14920	R15170	R15420	R15670	R15920	R16170	R16420	R16670		
R14921	R15171	R15421	R15671	R15921	R16171	R16421	R16671		
R14922	R15172	R15422	R15672	R15922	R16172	R16422	R16672		
R14923	R15173	R15423	R15673	R15923	R16173	R16423	R16673		

Device No.								Abbrev.	Signal name
\$1	\$2	\$3	\$4	\$5	\$6	\$7	\$8		
R14924	R15174	R15424	R15674	R15924	R16174	R16424	R16674		MES interface library: G code modal status [M8]
R14925	R15175	R15425	R15675	R15925	R16175	R16425	R16675		
R14926	R15176	R15426	R15676	R15926	R16176	R16426	R16676		
R14927	R15177	R15427	R15677	R15927	R16177	R16427	R16677		
R14928	R15178	R15428	R15678	R15928	R16178	R16428	R16678		
R14929	R15179	R15429	R15679	R15929	R16179	R16429	R16679		
R14930	R15180	R15430	R15680	R15930	R16180	R16430	R16680		
R14931	R15181	R15431	R15681	R15931	R16181	R16431	R16681		

Device No.								Abbrev.	Signal name
\$1	\$2	\$3	\$4	\$5	\$6	\$7	\$8		
R14932	R15182	R15432	R15682	R15932	R16182	R16432	R16682		MES interface library: G code modal status [M8]
R14933	R15183	R15433	R15683	R15933	R16183	R16433	R16683		
R14934	R15184	R15434	R15684	R15934	R16184	R16434	R16684		MES interface library: Spindle load value [M8]
R14935	R15185	R15435	R15685	R15935	R16185	R16435	R16685		MES interface library: Spindle 2 load value [M8]
R14936	R15186	R15436	R15686	R15936	R16186	R16436	R16686		MES interface library: Tool number [M8]
R14937	R15187	R15437	R15687	R15937	R16187	R16437	R16687		
R14938	R15188	R15438	R15688	R15938	R16188	R16438	R16688		MES interface library: Tool offset number [M8]
R14939	R15189	R15439	R15689	R15939	R16189	R16439	R16689		

2 Input/Output Signals with Controller

Device No.								Abbrev.	Signal name
\$1	\$2	\$3	\$4	\$5	\$6	\$7	\$8		
R14940	R15190	R15440	R15690	R15940	R16190	R16440	R16690		MES interface library: Tool length offset [M8]
R14941	R15191	R15441	R15691	R15941	R16191	R16441	R16691		
R14942	R15192	R15442	R15692	R15942	R16192	R16442	R16692		MES interface library: Tool radius offset [M8]
R14943	R15193	R15443	R15693	R15943	R16193	R16443	R16693		
R14944	R15194	R15444	R15694	R15944	R16194	R16444	R16694		MES interface library: Tool length wear amount [M8]
R14945	R15195	R15445	R15695	R15945	R16195	R16445	R16695		
R14946	R15196	R15446	R15696	R15946	R16196	R16446	R16696		MES interface library: Tool radius wear amount [M8]
R14947	R15197	R15447	R15697	R15947	R16197	R16447	R16697		

Device No.								Abbrev.	Signal name
\$1	\$2	\$3	\$4	\$5	\$6	\$7	\$8		
R14948	R15198	R15448	R15698	R15948	R16198	R16448	R16698		MES interface library: Tool life [M8]
R14949	R15199	R15449	R15699	R15949	R16199	R16449	R16699		

Device	Abbrev.	Signal name	Device	Abbrev.	Signal name
R20200		Skip coordinate (PLC axis 1st axis) ▲	R20208		Skip coordinate (PLC axis 3rd axis) ▲
R20201			R20209		
R20202			R20210		
R20203			R20211		
R20204		Skip coordinate (PLC axis 2nd axis) ▲	R20212		Skip coordinate (PLC axis 4th axis) ▲
R20205			R20213		
R20206			R20214		
R20207			R20215		

Device	Abbrev.	Signal name	Device	Abbrev.	Signal name
R20216		Skip coordinate (PLC axis 5th axis) ▲	R20224		
R20217			R20225		
R20218			R20226		
R20219			R20227		
R20220		Skip coordinate (PLC axis 6th axis) ▲	R20228		
R20221			R20229		
R20222			R20230		
R20223			R20231		

Device	Abbrev.	Signal name	Device	Abbrev.	Signal name
R20232		Feedback machine position axis (PLC axis 1st axis) ▲	R20240		Feedback machine position axis (PLC axis 3rd axis) ▲
R20233			R20241		
R20234			R20242		
R20235			R20243		
R20236		Feedback machine position axis (PLC axis 2nd axis) ▲	R20244		Feedback machine position axis (PLC axis 4th axis) ▲
R20237			R20245		
R20238			R20246		
R20239			R20247		

Device	Abbrev.	Signal name	Device	Abbrev.	Signal name
R20248		Feedback machine position axis (PLC axis 5th axis) ▲	R20256		
R20249			R20257		
R20250			R20258		
R20251			R20259		
R20252		Feedback machine position axis (PLC axis 6th axis) ▲	R20260		
R20253			R20261		
R20254			R20262		
R20255			R20263		

Device	Abbrev.	Signal name	Device	Abbrev.	Signal name
R20264		Servo deflection amount (PLC axis 1st axis) ▲	R20272		Servo deflection amount (PLC axis 5th axis) ▲
R20265			R20273		
R20266		Servo deflection amount (PLC axis 2nd axis) ▲	R20274		Servo deflection amount (PLC axis 6th axis) ▲
R20267			R20275		
R20268		Servo deflection amount (PLC axis 3rd axis) ▲	R20276		
R20269			R20277		
R20270		Servo deflection amount (PLC axis 4th axis) ▲	R20278		
R20271			R20279		

Device	Abbrev.	Signal name	Device	Abbrev.	Signal name
R20280	RNASP	FL-net : Reference node address designation ▲	R20288		EcoMonitorLight connection: Read start bit [M8]
R20281	PNASP	FL-net : Participating node top address designation ▲	R20289		EcoMonitorLight connection: Station No. [M8]
R20282			R20290		EcoMonitorLight connection: Register address [M8]
R20283			R20291		EcoMonitorLight connection: Size of data to read [M8]
R20284			R20292		
R20285			R20293		
R20286			R20294		
R20287			R20295		

Device	Abbrev.	Signal name	Device	Abbrev.	Signal name
R20296			R20304		Interference check III: Interfering object enable/disable designation [M8]
R20297			R20305		Spare [M8]
R20298			R20306		Interference check III: 1st interfering object selection [M8]
R20299			R20307		Interference check III: 1st interfering object specification [M8]
R20300			R20308		Interference check III: 1st interfering model coordinate system I axis offset 1 (L) [M8]
R20301			R20309		Interference check III: 1st interfering model coordinate system I axis offset 1 (H) [M8]
R20302			R20310		Interference check III: 1st interfering model coordinate system J axis offset 1 (L) [M8]
R20303			R20311		Interference check III: 1st interfering model coordinate system J axis offset 1 (H) [M8]

2 Input/Output Signals with Controller

Device	Abbrev.	Signal name	Device	Abbrev.	Signal name
R20312		Interference check III: 1st interfering model coordinate system K axis offset 1 (L) [M8]	R20320		Interference check III: 2nd interfering model coordinate system K axis offset 1 (L) [M8]
R20313		Interference check III: 1st interfering model coordinate system K axis offset 1 (H) [M8]	R20321		Interference check III: 2nd interfering model coordinate system K axis offset 1 (H) [M8]
R20314		Interference check III: 2nd interfering object selection [M8]	R20322		Interference check III: 3rd interfering object selection [M8]
R20315		Interference check III: 2nd interfering object specification [M8]	R20323		Interference check III: 3rd interfering object specification [M8]
R20316		Interference check III: 2nd interfering model coordinate system I axis offset 1 (L) [M8]	R20324		Interference check III: 3rd interfering model coordinate system I axis offset 1 (L) [M8]
R20317		Interference check III: 2nd interfering model coordinate system I axis offset 1 (H) [M8]	R20325		Interference check III: 3rd interfering model coordinate system I axis offset 1 (H) [M8]
R20318		Interference check III: 2nd interfering model coordinate system J axis offset 1 (L) [M8]	R20326		Interference check III: 3rd interfering model coordinate system J axis offset 1 (L) [M8]
R20319		Interference check III: 2nd interfering model coordinate system J axis offset 1 (H) [M8]	R20327		Interference check III: 3rd interfering model coordinate system J axis offset 1 (H) [M8]

Device	Abbrev.	Signal name	Device	Abbrev.	Signal name
R20328		Interference check III: 3rd interfering model coordinate system K axis offset 1 (L) [M8]	R20336		Interference check III: 4th interfering model coordinate system K axis offset 1 (L) [M8]
R20329		Interference check III: 3rd interfering model coordinate system K axis offset 1 (H) [M8]	R20337		Interference check III: 4th interfering model coordinate system K axis offset 1 (H) [M8]
R20330		Interference check III: 4th interfering object selection [M8]	R20338		Interference check III: 5th interfering object selection [M8]
R20331		Interference check III: 4th interfering object specification [M8]	R20339		Interference check III: 5th interfering object specification [M8]
R20332		Interference check III: 4th interfering model coordinate system I axis offset 1 (L) [M8]	R20340		Interference check III: 5th interfering model coordinate system I axis offset 1 (L) [M8]
R20333		Interference check III: 4th interfering model coordinate system I axis offset 1 (H) [M8]	R20341		Interference check III: 5th interfering model coordinate system I axis offset 1 (H) [M8]
R20334		Interference check III: 4th interfering model coordinate system J axis offset 1 (L) [M8]	R20342		Interference check III: 5th interfering model coordinate system J axis offset 1 (L) [M8]
R20335		Interference check III: 4th interfering model coordinate system J axis offset 1 (H) [M8]	R20343		Interference check III: 5th interfering model coordinate system J axis offset 1 (H) [M8]

Device	Abbrev.	Signal name	Device	Abbrev.	Signal name
R20344		Interference check III: 5th interfering model coordinate system K axis offset 1 (L) [M8]	R20352		Interference check III: 6th interfering model coordinate system K axis offset 1 (L) [M8]
R20345		Interference check III: 5th interfering model coordinate system K axis offset 1 (H) [M8]	R20353		Interference check III: 6th interfering model coordinate system K axis offset 1 (H) [M8]
R20346		Interference check III: 6th interfering object selection [M8]	R20354		Interference check III: 7th interfering object selection [M8]
R20347		Interference check III: 6th interfering object specification [M8]	R20355		Interference check III: 7th interfering object specification [M8]
R20348		Interference check III: 6th interfering model coordinate system I axis offset 1 (L) [M8]	R20356		Interference check III: 7th interfering model coordinate system I axis offset 1 (L) [M8]
R20349		Interference check III: 6th interfering model coordinate system I axis offset 1 (H) [M8]	R20357		Interference check III: 7th interfering model coordinate system I axis offset 1 (H) [M8]
R20350		Interference check III: 6th interfering model coordinate system J axis offset 1 (L) [M8]	R20358		Interference check III: 7th interfering model coordinate system J axis offset 1 (L) [M8]
R20351		Interference check III: 6th interfering model coordinate system J axis offset 1 (H) [M8]	R20359		Interference check III: 7th interfering model coordinate system J axis offset 1 (H) [M8]

2 Input/Output Signals with Controller

Device	Abbrev.	Signal name	Device	Abbrev.	Signal name
R20360		Interference check III: 7th interfering model coordinate system K axis offset 1 (L) [M8]	R20368		Interference check III: 8th interfering model coordinate system K axis offset 1 (L) [M8]
R20361		Interference check III: 7th interfering model coordinate system K axis offset 1 (H) [M8]	R20369		Interference check III: 8th interfering model coordinate system K axis offset 1 (H) [M8]
R20362		Interference check III: 8th interfering object selection [M8]	R20370		Interference check III: 9th interfering object selection [M8]
R20363		Interference check III: 8th interfering object specification [M8]	R20371		Interference check III: 9th interfering object specification [M8]
R20364		Interference check III: 8th interfering model coordinate system I axis offset 1 (L) [M8]	R20372		Interference check III: 9th interfering model coordinate system I axis offset 1 (L) [M8]
R20365		Interference check III: 8th interfering model coordinate system I axis offset 1 (H) [M8]	R20373		Interference check III: 9th interfering model coordinate system I axis offset 1 (H) [M8]
R20366		Interference check III: 8th interfering model coordinate system J axis offset 1 (L) [M8]	R20374		Interference check III: 9th interfering model coordinate system J axis offset 1 (L) [M8]
R20367		Interference check III: 8th interfering model coordinate system J axis offset 1 (H) [M8]	R20375		Interference check III: 9th interfering model coordinate system J axis offset 1 (H) [M8]

Device	Abbrev.	Signal name	Device	Abbrev.	Signal name
R20376		Interference check III: 9th interfering model coordinate system K axis offset 1 (L) [M8]	R20384		Interference check III: 10th interfering model coordinate system K axis offset 1 (L) [M8]
R20377		Interference check III: 9th interfering model coordinate system K axis offset 1 (H) [M8]	R20385		Interference check III: 10th interfering model coordinate system K axis offset 1 (H) [M8]
R20378		Interference check III: 10th interfering object selection [M8]	R20386		Interference check III: 11th interfering object selection [M8]
R20379		Interference check III: 10th interfering object specification [M8]	R20387		Interference check III: 11th interfering object specification [M8]
R20380		Interference check III: 10th interfering model coordinate system I axis offset 1 (L) [M8]	R20388		Interference check III: 11th interfering model coordinate system I axis offset 1 (L) [M8]
R20381		Interference check III: 10th interfering model coordinate system I axis offset 1 (H) [M8]	R20389		Interference check III: 11th interfering model coordinate system I axis offset 1 (H) [M8]
R20382		Interference check III: 10th interfering model coordinate system J axis offset 1 (L) [M8]	R20390		Interference check III: 11th interfering model coordinate system J axis offset 1 (L) [M8]
R20383		Interference check III: 10th interfering model coordinate system J axis offset 1 (H) [M8]	R20391		Interference check III: 11th interfering model coordinate system J axis offset 1 (H) [M8]

Device	Abbrev.	Signal name	Device	Abbrev.	Signal name
R20392		Interference check III: 11th interfering model coordinate system K axis offset 1 (L) [M8]	R20400		Interference check III: 12th interfering model coordinate system K axis offset 1 (L) [M8]
R20393		Interference check III: 11th interfering model coordinate system K axis offset 1 (H) [M8]	R20401		Interference check III: 12th interfering model coordinate system K axis offset 1 (H) [M8]
R20394		Interference check III: 12th interfering object selection [M8]	R20402		Interference check III: 13th interfering object selection [M8]
R20395		Interference check III: 12th interfering object specification [M8]	R20403		Interference check III: 13th interfering object specification [M8]
R20396		Interference check III: 12th interfering model coordinate system I axis offset 1 (L) [M8]	R20404		Interference check III: 13th interfering model coordinate system I axis offset 1 (L) [M8]
R20397		Interference check III: 12th interfering model coordinate system I axis offset 1 (H) [M8]	R20405		Interference check III: 13th interfering model coordinate system I axis offset 1 (H) [M8]
R20398		Interference check III: 12th interfering model coordinate system J axis offset 1 (L) [M8]	R20406		Interference check III: 13th interfering model coordinate system J axis offset 1 (L) [M8]
R20399		Interference check III: 12th interfering model coordinate system J axis offset 1 (H) [M8]	R20407		Interference check III: 13th interfering model coordinate system J axis offset 1 (H) [M8]

2 Input/Output Signals with Controller

Device	Abbrev.	Signal name	Device	Abbrev.	Signal name
R20408		Interference check III: 13th interfering model coordinate system K axis offset 1 (L) [M8]	R20416		Interference check III: 14th interfering model coordinate system K axis offset 1 (L) [M8]
R20409		Interference check III: 13th interfering model coordinate system K axis offset 1 (H) [M8]	R20417		Interference check III: 14th interfering model coordinate system K axis offset 1 (H) [M8]
R20410		Interference check III: 14th interfering object selection [M8]	R20418		Interference check III: 15th interfering object selection [M8]
R20411		Interference check III: 14th interfering object specification [M8]	R20419		Interference check III: 15th interfering object specification [M8]
R20412		Interference check III: 14th interfering model coordinate system I axis offset 1 (L) [M8]	R20420		Interference check III: 15th interfering model coordinate system I axis offset 1 (L) [M8]
R20413		Interference check III: 14th interfering model coordinate system I axis offset 1 (H) [M8]	R20421		Interference check III: 15th interfering model coordinate system I axis offset 1 (H) [M8]
R20414		Interference check III: 14th interfering model coordinate system J axis offset 1 (L) [M8]	R20422		Interference check III: 15th interfering model coordinate system J axis offset 1 (L) [M8]
R20415		Interference check III: 14th interfering model coordinate system J axis offset 1 (H) [M8]	R20423		Interference check III: 15th interfering model coordinate system J axis offset 1 (H) [M8]

Device	Abbrev.	Signal name	Device	Abbrev.	Signal name
R20424		Interference check III: 15th interfering model coordinate system K axis offset 1 (L) [M8]	R20432		Interference check III: 16th interfering model coordinate system K axis offset 1 (L) [M8]
R20425		Interference check III: 15th interfering model coordinate system K axis offset 1 (H) [M8]	R20433		Interference check III: 16th interfering model coordinate system K axis offset 1 (H) [M8]
R20426		Interference check III: 16th interfering object selection [M8]	R20434		1st interfering object Interference check III: Specifying disabled interfering object [M8]
R20427		Interference check III: 16th interfering object specification [M8]	R20435		2nd interfering object Interference check III: Specifying disabled interfering object [M8]
R20428		Interference check III: 16th interfering model coordinate system I axis offset 1 (L) [M8]	R20436		3rd interfering object Interference check III: Specifying disabled interfering object [M8]
R20429		Interference check III: 16th interfering model coordinate system I axis offset 1 (H) [M8]	R20437		4th interfering object Interference check III: Specifying disabled interfering object [M8]
R20430		Interference check III: 16th interfering model coordinate system J axis offset 1 (L) [M8]	R20438		5th interfering object Interference check III: Specifying disabled interfering object [M8]
R20431		Interference check III: 16th interfering model coordinate system J axis offset 1 (H) [M8]	R20439		6th interfering object Interference check III: Specifying disabled interfering object [M8]

Device	Abbrev.	Signal name	Device	Abbrev.	Signal name
R20440		7th interfering object Interference check III: Specifying disabled interfering object [M8]	R20448		15th interfering object Interference check III: Specifying disabled interfering object [M8]
R20441		8th interfering object Interference check III: Specifying disabled interfering object [M8]	R20449		16th interfering object Interference check III: Specifying disabled interfering object [M8]
R20442		9th interfering object Interference check III: Specifying disabled interfering object [M8]	R20450	SVIDDD AX	Diagnosis data output: Select axis for servomotor insulation degradation detection (PLC axis) [M8]
R20443		10th interfering object Interference check III: Specifying disabled interfering object [M8]	R20451	SPIDDD AX	Diagnosis data output: Select spindle for motor insulation degradation detection [M8]
R20444		11th interfering object Interference check III: Specifying disabled interfering object [M8]	R20452		
R20445		12th interfering object Interference check III: Specifying disabled interfering object [M8]	R20453		
R20446		13th interfering object Interference check III: Specifying disabled interfering object [M8]	R20454		
R20447		14th interfering object Interference check III: Specifying disabled interfering object [M8]	R20455		

2 Input/Output Signals with Controller

Device	Abbrev.	Signal name	Device	Abbrev.	Signal name
R20472			R20480	TP_INVALID	Touchscreen operation disabled
R20473			R20481	IDDD	Diagnosis data output: Motor insulation degradation detection request [M8]
R20474			R20482	VAMODn	Hypothetical axis command mode [C80]
R20475			R20483		
R20476			R20484		
R20477			R20485		
R20478			R20486		
R20479			R20487		

Device No.								Abbrev.	Signal name
\$1	\$2	\$3	\$4	\$5	\$6	\$7	\$8		
R22500	R22700	R22900	R23100	R23300	R23500	R23700	R23900		Program restart : Restart position return check invalid
R22501	R22701	R22901	R23101	R23301	R23501	R23701	R23901	SVIDDDAX	Diagnosis data output: Select axis for servomotor insulation degradation detection [M8]
R22502	R22702	R22902	R23102	R23302	R23502	R23702	R23902		
R22503	R22703	R22903	R23103	R23303	R23503	R23703	R23903		
R22504	R22704	R22904	R23104	R23304	R23504	R23704	R23904	MCNGITCMD	Machining interruption command [C80]
R22505	R22705	R22905	R23105	R23305	R23505	R23705	R23905		
R22506	R22706	R22906	R23106	R23306	R23506	R23706	R23906		
R22507	R22707	R22907	R23107	R23307	R23507	R23707	R23907		

Device No.								Abbrev.	Signal name
\$1	\$2	\$3	\$4	\$5	\$6	\$7	\$8		
R22508	R22708	R22908	R23108	R23308	R23508	R23708	R23908	HS4n	4th handle axis selection code 1,2,4,8,16 [C80]
R22509	R22709	R22909	R23109	R23309	R23509	R23709	R23909	HS5n	5th handle axis selection code 1,2,4,8,16 [C80]
R22510	R22710	R22910	R23110	R23310	R23510	R23710	R23910	HS6n	6th handle axis selection code 1,2,4,8,16 [C80]
R22511	R22711	R22911	R23111	R23311	R23511	R23711	R23911	HS7n	7th handle axis selection code 1,2,4,8,16 [C80]
R22512	R22712	R22912	R23112	R23312	R23512	R23712	R23912	HS8n	8th handle axis selection code 1,2,4,8,16 [C80]
R22513	R22713	R22913	R23113	R23313	R23513	R23713	R23913	HS9n	9th handle axis selection code 1,2,4,8,16 [C80]
R22514	R22714	R22914	R23114	R23314	R23514	R23714	R23914		
R22515	R22715	R22915	R23115	R23315	R23515	R23715	R23915		

Device No.								Abbrev.	Signal name
\$1	\$2	\$3	\$4	\$5	\$6	\$7	\$8		
R22532	R22732	R22932	R23132	R23332	R23532	R23732	R23932	VCC_INVAX	VCC: Temporary cancel of axis vibration
R22533	R22733	R22933	R23133	R23333	R23533	R23733	R23933		
R22534	R22734	R22934	R23134	R23334	R23534	R23734	R23934		
R22535	R22735	R22935	R23135	R23335	R23535	R23735	R23935		
R22536	R22736	R22936	R23136	R23336	R23536	R23736	R23936		
R22537	R22737	R22937	R23137	R23337	R23537	R23737	R23937		
R22538	R22738	R22938	R23138	R23338	R23538	R23738	R23938		
R22539	R22739	R22939	R23139	R23339	R23539	R23739	R23939		

Device No.								Abbrev.	Signal name
\$1	\$2	\$3	\$4	\$5	\$6	\$7	\$8		
R22692	R22892	R23092	R23292	R23492	R23692	R23892	R24092		Load monitor I : Cutting torque estimation target axis ▲
R22693	R22893	R23093	R23293	R23493	R23693	R23893	R24093		Hob machining: work piece axis selection ▲
R22694	R22894	R23094	R23294	R23494	R23694	R23894	R24094	SPPWS	Tool spindle synchronization IB : Spindle-spindle polygon cut workpiece axis selection ▲
R22695	R22895	R23095	R23295	R23495	R23695	R23895	R24095		
R22696	R22896	R23096	R23296	R23496	R23696	R23896	R24096		
R22697	R22897	R23097	R23297	R23497	R23697	R23897	R24097		
R22698	R22898	R23098	R23298	R23498	R23698	R23898	R24098		
R22699	R22899	R23099	R23299	R23499	R23699	R23899	R24099		

Device No.				Abbrev.	Signal name
\$1	\$2	\$3	\$4		
R25684	R25692	R25700	R25708	AXCHGCMD1	Tool head hot swapping: NC axis switch 1st axis [M8]
R25685	R25693	R25701	R25709	AXCHGCMD2	Tool head hot swapping: NC axis switch 2nd axis [M8]
R25686	R25694	R25702	R25710	AXCHGCMD3	Tool head hot swapping: NC axis switch 3rd axis [M8]
R25687	R25695	R25703	R25711	AXCHGCMD4	Tool head hot swapping: NC axis switch 4th axis [M8]
R25688	R25696	R25704	R25712	AXCHGCMD5	Tool head hot swapping: NC axis switch 5th axis [M8]
R25689	R25697	R25705	R25713	AXCHGCMD6	Tool head hot swapping: NC axis switch 6th axis [M8]
R25690	R25698	R25706	R25714	AXCHGCMD7	Tool head hot swapping: NC axis switch 7th axis [M8]
R25691	R25699	R25707	R25715	AXCHGCMD8	Tool head hot swapping: NC axis switch 8th axis [M8]

2.5 Special Relay/Register

Device	Abbrev.	Signal name	Device	Abbrev.	Signal name
SM00			SM08		
SM01			SM09		
SM02			SM10		
SM03			SM11		
SM04			SM12		
SM05			SM13		
SM06			SM14		
SM07			SM15		

Device	Abbrev.	Signal name	Device	Abbrev.	Signal name
SM16		Temperature rise	SM24		
SM17			SM25		
SM18			SM26		
SM19			SM27		
SM20			SM28		
SM21			SM29		
SM22			SM30		
SM23			SM31		

Device	Abbrev.	Signal name	Device	Abbrev.	Signal name
SM32			SM40		
SM33			SM41		
SM34			SM42		
SM35			SM43		
SM36			SM44		
SM37			SM45		
SM38			SM46		
SM39			SM47		

Device	Abbrev.	Signal name	Device	Abbrev.	Signal name
SM48			SM56		
SM49			SM57		
SM50			SM58		
SM51			SM59		
SM52			SM60		
SM53			SM61		
SM54			SM62		
SM55			SM63		

2 Input/Output Signals with Controller

Device	Abbrev.	Signal name	Device	Abbrev.	Signal name
SM64			SM72		
SM65			SM73		
SM66			SM74		
SM67			SM75		
SM68			SM76		
SM69			SM77		
SM70			SM78		
SM71			SM79		

Device	Abbrev.	Signal name	Device	Abbrev.	Signal name
SM80			SM88		
SM81			SM89		
SM82			SM90		
SM83			SM91		
SM84			SM92		
SM85			SM93		
SM86			SM94		
SM87			SM95		

Device	Abbrev.	Signal name	Device	Abbrev.	Signal name
SM96			SM104		
SM97			SM105		
SM98			SM106		
SM99			SM107		
SM100			SM108		
SM101			SM109		
SM102			SM110		
SM103			SM111		

Device	Abbrev.	Signal name	Device	Abbrev.	Signal name
SM112			SM120		
SM113			SM121		
SM114			SM122		
SM115			SM123		
SM116			SM124		
SM117			SM125		
SM118			SM126		
SM119			SM127		

2.6 ZR Devices

(1) Smart safety observation

PLC->CNC

Device [M8]	Device [C80]	Abbrev.	Signal name
ZR256	ZR128	*SLSRm	SLS OBSERVATION REQUEST (CONTROL AXIS) 1st axis to 16th axis
ZR257	ZR129	*SLSRm	SLS OBSERVATION REQUEST (CONTROL AXIS) 17th axis to 32nd axis
ZR258	ZR130	*SLPRm	SLP OBSERVATION REQUEST (CONTROL AXIS) 1st axis to 16th axis
ZR259	ZR131	*SLPRm	SLP OBSERVATION REQUEST (CONTROL AXIS) 17th axis to 32nd axis
ZR260	ZR132	*SSMRm	SSM REQUEST (CONTROL AXIS) 1st axis to 16th axis
ZR261	ZR133	*SSMRm	SSM REQUEST (CONTROL AXIS) 17th axis to 32nd axis
ZR262	ZR134	*SCARm	SAFE CAM REQUEST (CONTROL AXIS) 1st axis to 16th axis
ZR263	ZR135	*SCARm	SAFE CAM REQUEST (CONTROL AXIS) 17th axis to 32nd axis
ZR264	ZR136	*SOSRm	SOS OBSERVATION REQUEST (CONTROL AXIS) 1st axis to 16th axis
ZR265	ZR137	*SOSRm	SOS OBSERVATION REQUEST (CONTROL AXIS) 17th axis to 32nd axis
ZR266	ZR138	*SS1Rm	SAFE STOP 1 REQUEST (CONTROL AXIS) 1st axis to 16th axis
ZR267	ZR139	*SS1Rm	SAFE STOP 1 REQUEST (CONTROL AXIS) 17th axis to 32nd axis
ZR268	ZR140	*SS2Rm	SAFE STOP 2 REQUEST (CONTROL AXIS) 1st axis to 16th axis
ZR269	ZR141	*SS2Rm	SAFE STOP 2 REQUEST (CONTROL AXIS) 17th axis to 32nd axis
ZR270	ZR142	*STORm	SAFE TORQUE OFF REQUEST (CONTROL AXIS) 1st axis to 16th axis
ZR271	ZR143	*STORm	SAFE TORQUE OFF REQUEST (CONTROL AXIS) 17th axis to 32nd axis
ZR272	ZR144	*SBCRm	SBC MOTOR BRAKE STARTING REQUEST (CONTROL AXIS) 1st axis to 16th axis
ZR273	ZR145	*SBCRm	SBC MOTOR BRAKE STARTING REQUEST (CONTROL AXIS) 17th axis to 32nd axis
ZR274	ZR146	SBTSTEXm	EXTERNAL BRAKE SBT START (CONTROL AXIS) 1st axis to 16th axis
ZR275	ZR147	SBTSTEXm	EXTERNAL BRAKE SBT START (CONTROL AXIS) 17th axis to 32nd axis
ZR276	ZR148	SBTSTMOm	MOTOR BRAKE SBT START (CONTROL AXIS) 1st axis to 16th axis
ZR277	ZR149	SBTSTMOm	MOTOR BRAKE SBT START (CONTROL AXIS) 17th axis to 32nd axis
ZR278	ZR150	SFABSPFXm	SAFETY ABSOLUTE POSITION CONFIRM (CONTROL AXIS) 1st axis to 16th axis
ZR279	ZR151	SFABSPFXm	SAFETY ABSOLUTE POSITION CONFIRM (CONTROL AXIS) 17th axis to 32nd axis
ZR280	ZR152	SRSTm	SAFETY RESET (CONTROL AXIS) 1st axis to 16th axis
ZR281	ZR153	SRSTm	SAFETY RESET (CONTROL AXIS) 17th axis to 32nd axis

Device [M8]	Device [C80]	Abbrev.	bit	Signal name
ZR312 to ZR343	ZR184 to ZR215	SLSMlmn	bit0	SLS SPEED CHANGE INPUT (CONTROL AXIS) 1st axis to 32nd axis
		SLSMlmn	bit1	SLS SPEED CHANGE INPUT (CONTROL AXIS) 1st axis to 32nd axis
			bit2	vacant
			bit3	vacant
		SLSOVRlmn	bit4	SLS SPEED OVERRIDE INPUT (CONTROL AXIS) 1st axis to 32nd axis
		SLSOVRlmn	bit5	SLS SPEED OVERRIDE INPUT (CONTROL AXIS) 1st axis to 32nd axis
		SLSOVRlmn	bit6	SLS SPEED OVERRIDE INPUT (CONTROL AXIS) 1st axis to 32nd axis
		SLSOVRlmn	bit7	SLS SPEED OVERRIDE INPUT (CONTROL AXIS) 1st axis to 32nd axis
			bit8	vacant
			bit9	vacant
			bitA	vacant
			bitB	vacant
			bitC	vacant
			bitD	vacant
			bitE	vacant
			bitF	vacant

Device [M8]	Device [C80]	Abbrev.	bit	Signal name
ZR344 to ZR375	ZR216 to ZR247	SLPImn	bit0	SLP POSITION CHANGE INPUT (CONTROL AXIS) 1st axis to 32nd axis
		SLPImn	bit1	SLP POSITION CHANGE INPUT (CONTROL AXIS) 1st axis to 32nd axis
			bit2	vacant
			bit3	vacant
			bit4	vacant
			bit5	vacant
			bit6	vacant
			bit7	vacant
			bit8	vacant
			bit9	vacant
			bitA	vacant
			bitB	vacant
			bitC	vacant
			bitD	vacant
	bitE	vacant		
	bitF	vacant		

Device [M8]	Device [C80]	Abbrev.	Signal name
ZR440	ZR312	*SLSSRm	SLS OBSERVATION REQUEST (SPINDLE) 1st SP to 8th SP
ZR442	ZR314	*SSMSRm	SSM REQUEST (SPINDLE) 1st SP to 8th SP
ZR444	ZR316	*SOSSRm	SOS OBSERVATION REQUEST (SPINDLE) 1st SP to 8th SP
ZR445	ZR317	*SS1SRm	SAFE STOP 1 REQUEST (SPINDLE) 1st SP to 8th SP
ZR446	ZR318	*SS2SRm	SAFE STOP 2 REQUEST (SPINDLE) 1st SP to 8th SP
ZR447	ZR319	*STOSRm	SAFE TORQUE OFF REQUEST (SPINDLE) 1st SP to 8th SP
ZR452	ZR324	SRSTSm	SAFETY REQUEST (SPINDLE) 1st SP to 8th SP

Device [M8]	Device [C80]	Abbrev.	bit	Signal name
ZR468 to ZR475	ZR340 to ZR347	SLSSMImn	bit0	SLS SPEED CHANGE INPUT (SPINDLE) 1st SP to 8th SP
		SLSSMImn	bit1	SLS SPEED CHANGE INPUT (SPINDLE) 1st SP to 8th SP
			bit2	vacant
			bit3	vacant
		SLSSOVRImn	bit4	SLS SPEED OVERRIDE INPUT (SPINDLE) 1st SP to 8th SP
		SLSSOVRImn	bit5	SLS SPEED OVERRIDE INPUT (SPINDLE) 1st SP to 8th SP
		SLSSOVRImn	bit6	SLS SPEED OVERRIDE INPUT (SPINDLE) 1st SP to 8th SP
		SLSSOVRImn	bit7	SLS SPEED OVERRIDE INPUT (SPINDLE) 1st SP to 8th SP
			bit8	vacant
			bit9	vacant
			bitA	vacant
			bitB	vacant
			bitC	vacant
			bitD	vacant
	bitE	vacant		
	bitF	vacant		

Device [M8]	Device [C80]	Abbrev.	Signal name
ZR532	ZR404	SARLS	SPECIAL SAFETY ALARM CANCEL (SYSTEM COMMON)
ZR1280	-	SIOFFCHK	OUTPUT OFF CHECK REQUEST
-	ZR416	SIORREQ	SAFETY I/O OBSERVATION REQUEST
-	ZR736,7	SCNSNDDAT	SAFETY COMMUNICATION SEND DATA
-	ZR744	SCNCMD	SAFETY COMMUNICATION COMMAND

CNC->PLC

Device [M8]	Device [C80]	Abbrev.	Signal name
ZR544	ZR1664	SLSEm	SLS OBSERVATION IS ACTIVE (CONTROL AXIS) 1st axis to 16th axis
ZR545	ZR1665	SLSEm	SLS OBSERVATION IS ACTIVE (CONTROL AXIS) 17th axis to 32nd axis
ZR546	ZR1666	SLSSm	UNDER SLS LIMIT (CONTROL AXIS) 1st axis to 16th axis
ZR547	ZR1667	SLSSm	UNDER SLS LIMIT (CONTROL AXIS) 17th axis to 32nd axis
ZR548	ZR1668	SLPEm	SLP OBSERVATION IS ACTIVE (CONTROL AXIS) 1st axis to 16th axis
ZR549	ZR1669	SLPEm	SLP OBSERVATION IS ACTIVE (CONTROL AXIS) 17th axis to 32nd axis
ZR550	ZR1670	SLPSm	IN SLP RANGE (CONTROL AXIS) 1st axis to 16th axis
ZR551	ZR1671	SLPSm	IN SLP RANGE (CONTROL AXIS) 17th axis to 32nd axis
ZR552	ZR1672	SSMEm	SSM IS ACTIVE (CONTROL AXIS) 1st axis to 16th axis
ZR553	ZR1673	SSMEm	SSM IS ACTIVE (CONTROL AXIS) 17th axis to 32nd axis
ZR554	ZR1674	SCAEm	SAFE CAM IS ACTIVE (CONTROL AXIS) 1st axis to 16th axis
ZR555	ZR1675	SCAEm	SAFE CAM IS ACTIVE (CONTROL AXIS) 17th axis to 32nd axis
ZR556	ZR1676	SOSEm	SOS IS ACTIVE (CONTROL AXIS) 1st axis to 16th axis
ZR557	ZR1677	SOSEm	SOS IS ACTIVE (CONTROL AXIS) 17th axis to 32nd axis
ZR558	ZR1678	SOSSm	IN SOS STOP (CONTROL AXIS) 1st axis to 16th axis
ZR559	ZR1679	SOSSm	IN SOS STOP (CONTROL AXIS) 17th axis to 32nd axis
ZR560	ZR1680	SS1Em	SS1 IS ACTIVE (CONTROL AXIS) 1st axis to 16th axis
ZR561	ZR1681	SS1Em	SS1 IS ACTIVE (CONTROL AXIS) 17th axis to 32nd axis
ZR562	ZR1682	SS1Sm	IN SAFE STOP 1 (CONTROL AXIS) 1st axis to 16th axis
ZR563	ZR1683	SS1Sm	IN SAFE STOP 1 (CONTROL AXIS) 17th axis to 32nd axis
ZR564	ZR1684	SS2Em	SS2 IS ACTIVE (CONTROL AXIS) 1st axis to 16th axis
ZR565	ZR1685	SS2Em	SS2 IS ACTIVE (CONTROL AXIS) 17th axis to 32nd axis
ZR566	ZR1686	STOEm	STO IS ACTIVE (CONTROL AXIS) 1st axis to 16th axis
ZR567	ZR1687	STOEm	STO IS ACTIVE (CONTROL AXIS) 17th axis to 32nd axis
ZR568	ZR1688	STOSm	IN SAFE TORQUE OFF (CONTROL AXIS) 1st axis to 16th axis
ZR569	ZR1689	STOSm	IN SAFE TORQUE OFF (CONTROL AXIS) 17th axis to 32nd axis
ZR570	ZR1690	SBCEm	IN SBC MOTOR BRAKE ENABLED (CONTROL AXIS) 1st axis to 16th axis
ZR571	ZR1691	SBCEm	IN SBC MOTOR BRAKE ENABLED (CONTROL AXIS) 17th axis to 32nd axis
ZR572	ZR1692	SBCSm	IN SBC MOTOR BRAKE START SIGNAL (CONTROL AXIS) 1st axis to 16th axis
ZR573	ZR1693	SBCSm	IN SBC MOTOR BRAKE START SIGNAL (CONTROL AXIS) 17th axis to 32nd axis
ZR574	ZR1694	SBTNFEXm	EXTERNAL BRAKE SBT INCOMPLETE (CONTROL AXIS) 1st axis to 16th axis
ZR575	ZR1695	SBTNFEXm	EXTERNAL BRAKE SBT INCOMPLETE (CONTROL AXIS) 17th axis to 32nd axis
ZR576	ZR1696	SBTEXBRm	IN SBT EXTERNAL BRAKE TEST (CONTROL AXIS) 1st axis to 16th axis
ZR577	ZR1697	SBTEXBRm	IN SBT EXTERNAL BRAKE TEST (CONTROL AXIS) 17th axis to 32nd axis
ZR578	ZR1698	SBTNFMOm	MOTOR BRAKE SBT INCOMPLETE (CONTROL AXIS) 1st axis to 16th axis
ZR579	ZR1699	SBTNFMOm	MOTOR BRAKE SBT INCOMPLETE (CONTROL AXIS) 17th axis to 32nd axis
ZR580	ZR1700	SFABSPESTm	IN SAFETY ABSOLUTE POSITION ESTABLISHING (CONTROL AXIS) 1st axis to 16th axis
ZR581	ZR1701	SFABSPESTm	IN SAFETY ABSOLUTE POSITION ESTABLISHING (CONTROL AXIS) 17th axis to 32nd axis
ZR582	ZR1702	SFERR_SVm	SMART SAFETY OBSERVATION ERROR OCCURING SERVO AXIS (CONTROL AXIS) 1st axis to 16th axis
ZR583	ZR1703	SFERR_SVm	SMART SAFETY OBSERVATION ERROR OCCURING SERVO AXIS (CONTROL AXIS) 17th axis to 32nd axis
ZR584	ZR1704	SFWRG_SVm	SMART SAFETY OBSERVATION WARNING OCCURING SERVO AXIS (CONTROL AXIS) 1st axis to 16th axis
ZR585	ZR1705	SFWRG_SVm	SMART SAFETY OBSERVATION WARNING OCCURING SERVO AXIS (CONTROL AXIS) 17th axis to 32nd axis

Device [M8]	Device [C80]	Abbrev.	bit	Signal name
ZR608 to ZR639	ZR1728 to ZR1759	SLSMOmn	bit0	SLS SPEED CHANGE OUTPUT (CONTROL AXIS) 1st axis to 32nd axis
		SLSMOmn	bit1	SLS SPEED CHANGE OUTPUT (CONTROL AXIS) 1st axis to 32nd axis
			bit2	vacant
			bit3	vacant
		SLSOVROmn	bit4	SLS SPEED OVERRIDE OUTPUT (CONTROL AXIS) 1st axis to 32nd axis
		SLSOVROmn	bit5	SLS SPEED OVERRIDE OUTPUT (CONTROL AXIS) 1st axis to 32nd axis
		SLSOVROmn	bit6	SLS SPEED OVERRIDE OUTPUT (CONTROL AXIS) 1st axis to 32nd axis
		SLSOVROmn	bit7	SLS SPEED OVERRIDE OUTPUT (CONTROL AXIS) 1st axis to 32nd axis
			bit8	vacant
			bit9	vacant
			bitA	vacant
			bitB	vacant
			bitC	vacant
	bitD	vacant		
	bitE	vacant		
	bitF	vacant		

Device [M8]	Device [C80]	Abbrev.	Signal name
ZR640 to ZR671	ZR1760 to ZR1791	SLPMOmn	SLP POSITION CHANGE OUTPUT (CONTROL AXIS) 1st axis to 32nd axis
ZR672 to ZR703	ZR1792 to ZR1823	SSMSmn	UNDER SSM SAFE SPEED (CONTROL AXIS) 1st axis to 32nd axis
ZR704 to ZR767	ZR1824 to ZR1887	SCASmn	SAFE CAM POSITION (CONTROL AXIS) 1st axis to 32nd axis
ZR768 to ZR893	ZR1888 to ZR2013	SBTPOSm	SBT START POSITION (CONTROL AXIS) 1st axis to 32nd axis

Device [M8]	Device [C80]	Abbrev.	Signal name
ZR1024	ZR2144	SLSSEm	SLS OBSERVATION IS ACTIVE (SPINDLE) 1st SP to 8th SP
ZR1025	ZR2145	SLSSSm	UNDER SLS LIMIT (SPINDLE) 1st SP to 8th SP
ZR1028	ZR2148	SSMSEm	SSM IS ACTIVE (SPINDLE) 1st SP to 8th SP
ZR1030	ZR2150	SOSSEm	SOS IS ACTIVE (SPINDLE) 1st SP to 8th SP
ZR1031	ZR2151	SOSSSm	IN SOS STOP (SPINDLE) 1st SP to 8th SP
ZR1032	ZR2152	SS1SEm	SS1 IS ACTIVE (SPINDLE) 1st SP to 8th SP
ZR1033	ZR2153	SS1SSm	IN SAFE STOP (SPINDLE) 1st SP to 8th SP
ZR1034	ZR2154	SS2SEm	SS2 IS ACTIVE (SPINDLE) 1st SP to 8th SP
ZR1035	ZR2155	STOSEm	STO IS ACTIVE (SPINDLE) 1st SP to 8th SP
ZR1036	ZR2156	STOSSm	IN SAFE TORQUE OFF (SPINDLE) 1st SP to 8th SP
ZR1043	ZR2163	SFERR_SPm	SMART SAFETY OBSERVATION ERROR OCCURRING SPINDLE (SPINDLE) 1st SP to 8th SP
ZR1044	ZR2164	SFWRG_SPm	SMART SAFETY OBSERVATION WARNING OCCURRING SPINDLE (SPINDLE) 1st SP to 8th SP

Device [M8]	Device [C80]	Abbrev.	bit	Signal name
ZR1056 to ZR1063	ZR2176 to ZR2183	SLSSMOmn	bit0	SLS SPEED CHANGE OUTPUT (SPINDLE) 1st SP to 8th SP
		SLSSMOmn	bit1	SLS SPEED CHANGE OUTPUT (SPINDLE) 1st SP to 8th SP
			bit2	vacant
			bit3	vacant
		SLSSOVRO mn	bit4	SLS SPEED OVERRIDE OUTPUT (SPINDLE) 1st SP to 8th SP
		SLSSOVRO mn	bit5	SLS SPEED OVERRIDE OUTPUT (SPINDLE) 1st SP to 8th SP
		SLSSOVRO mn	bit6	SLS SPEED OVERRIDE OUTPUT (SPINDLE) 1st SP to 8th SP
		SLSSOVRO mn	bit7	SLS SPEED OVERRIDE OUTPUT (SPINDLE) 1st SP to 8th SP
			bit8	vacant
			bit9	vacant
			bitA	vacant
			bitB	vacant
			bitC	vacant
			bitD	vacant
			bitE	vacant
	bitF	vacant		

Device [M8]	Device [C80]	Abbrev.	Signal name
ZR1088 to ZR1095	ZR2208 to ZR2215	SSMSSmn	UNDER SSM SAFE SPEED (SPINDLE) 1st SP to 8th SP

Device [M8]	Device [C80]	Abbrev.	Signal name
ZR1264	ZR2384	SEXTMG	IN SAFETY EXTERNAL EMERGENCY STOP (SYSTEM COMMON)
ZR1268	ZR2388	SFERR_VNO	V NUMBER OF SMART SAFETY OBSERVATION ERROR (SYSTEM COMMON)
ZR1269	ZR2389	SFERR_ENO	E NUMBER OF SMART SAFETY OBSERVATION ERROR (SYSTEM COMMON)
ZR1270	ZR2390	SFWRG_VN O	V NUMBER OF SMART SAFETY OBSERVATION WARNING (SYSTEM COMMON)
ZR1271	ZR2391	SFWRG_EN O	W NUMBER OF SMART SAFETY OBSERVATION WARNING (SYSTEM COMMON)

Device [M8]	Device [C80]	Abbrev.	Signal name
ZR1536	ZR2400	SIOERRSTS	SAFETY I/O OBSERVATION STATE
ZR1538	ZR2402	SIOERRUNIT	SAFETY I/O UNIT OBSERVATION STATE
ZR1540	ZR2404	SIOERRUNIT STS1n	SAFETY I/O UNIT OBSERVATION ERROR DETAILS Unit1
ZR1541	ZR2405	SIOERRUNIT STS2n	SAFETY I/O UNIT OBSERVATION ERROR DETAILS Unit2
ZR1542	ZR2406	SIOERRUNIT STS3n	SAFETY I/O UNIT OBSERVATION ERROR DETAILS Unit3
ZR1543	-	SIOERRUNIT STS4n	SAFETY I/O UNIT OBSERVATION ERROR DETAILS Unit4
ZR1544	-	SIOERRUNIT STS5n	SAFETY I/O UNIT OBSERVATION ERROR DETAILS Unit5
ZR1545	-	SIOERRUNIT STS6n	SAFETY I/O UNIT OBSERVATION ERROR DETAILS Unit6
ZR1546	-	SIOERRUNIT STS7n	SAFETY I/O UNIT OBSERVATION ERROR DETAILS Unit7
ZR1547	-	SIOERRUNIT STS8n	SAFETY I/O UNIT OBSERVATION ERROR DETAILS Unit8

Device [M8]	Device [C80]	Abbrev.	Signal name
-	ZR2412, ZR2413	SIOERRUNITSIG	Safety I/O device observation error signal Unit1
-	ZR2414, ZR2415	SIOERRUNITSIG	Safety I/O device observation error signal Unit2
-	ZR2416, ZR2417	SIOERRUNITSIG	Safety I/O device observation error signal Unit3
-	ZR2420	SIOWRGUNIT	Safety I/O device observation warning status
-	ZR2422	SIOWRGUNITSTS	Safety I/O device observation warning details Unit1
-	ZR2423	SIOWRGUNITSTS	Safety I/O device observation warning details Unit2
-	ZR2424	SIOWRGUNITSTS	Safety I/O device observation warning details Unit3
-	ZR2430, ZR2431	SIOWRGUNITSIG	Safety I/O device observation warning signal Unit1
-	ZR2432, ZR2433	SIOWRGUNITSIG	Safety I/O device observation warning signal Unit2
-	ZR2434, ZR2435	SIOWRGUNITSIG	Safety I/O device observation warning signal Unit3

Device [M8]	Device [C80]	Abbrev.	Signal name
-	ZR2784,5	SCNRCVDAT	Safety communication receipt data
-	ZR2792	SCNSTS	Safety communication status
-	ZR2793	SCNCOMSTS	Safety station communication status

(2) Memory switch (PLC switch) [M8]

Device	Signal name
ZR3200 to ZR3205	PLC switch non-display

(3) MES interface library [M8]

Device	Signal name
ZR10000 to ZR10031	MES interface library: Common user area C1
ZR10032 to ZR10051	MES interface library: Common user area L1 to L10
ZR10054	MES interface library: Condition register (Extract sort condition)
ZR10055	MES interface library: Condition register (Combination condition)
ZR10056	MES interface library: Condition register (Field value) 1st set
ZR10057	MES interface library: Condition register (Comparison condition) 1st set
ZR10058 to ZR10089	MES interface library: Condition register (Condition value) 1st set
ZR10090	MES interface library: Condition register (Field value) 2nd set
ZR10091	MES interface library: Condition register (Comparison condition) 2nd set
ZR10092 to ZR10123	MES interface library: Condition register (Condition value) 2nd set
ZR10330 to ZR10913	Data I/O register for MES interface library (For update/extract)
ZR10940 to ZR10971	MES interface library: User area C1 at machining end
ZR10972 to ZR10991	MES interface library: User area L1 to L10 at machining end
ZR10994 to ZR11025	MES interface library: User area C1 at alarm
ZR11026 to ZR11045	MES interface library: User area L1 to L10 at alarm
ZR11048 to ZR11079	MES interface library: Arbitrary user area C1
ZR11080 to ZR11099	MES interface library: Arbitrary user area S1 to S20
ZR11100 to ZR11119	MES interface library: Arbitrary user area L1 to L10

(4) Diagnosis data output

Device	Signal name
ZR12404, ZR12405	Diagnosis data output: Battery exchange [M8]
ZR12608, ZR12609 to ZR12670, ZR12671	Diagnosis data output: Battery exchange (drive)(servo)
ZR12784, ZR12785 to ZR12846, ZR12847	Diagnosis data output: Motor insulation resistance (motor)(servo)
ZR12848, ZR12849 to ZR12862, ZR12863	Diagnosis data output: Motor insulation resistance (motor)(spindle)
ZR12945	Diagnosis data output: Automatic log clear time [M8]
ZR12946, ZR12947 to ZR13008, ZR13009	Diagnosis data output: Accumulated travel distance (motor)(servo)

(5) Spindle protection [M8]

Device	Abbrev.	Signal name
ZR13010	SPEQLD	Spindle protection: Motor equivalent load factor
ZR13018	PRSPERR	Spindle protection: Number of times log output error occurred

(6) External encoder position output I/F [M8]

Device	Abbrev.	Signal name
ZR13020	ENC1POS	External encoder 1: Position output

(7) Machine contact input/output I/F [M8]

Device	Abbrev.	Signal name
ZR13028 to ZR13039	TIn	Thermistor input n
ZR13040	TIOPN	Thermistor disconnection
ZR13041	TISRT	Thermistor short-circuit
ZR13050 to ZR13065	MAn	Multi-analog input ch n
ZR13066 to ZR13081	MASTSn	Multi-analog input status ch n

(8) Common variable [C80]

Device	Signal name
ZR81000 to ZR97999	Assignment to common variable

(9) GOT window [C80]

Manual setting window

Device	Signal name
ZR20000	[PLC -> CNC] Data modification request
ZR20002	[CNC -> PLC] Data modification completion

[PLC -> CNC] Command area

Device	Signal name
ZR20020 to ZR20083	Window command 1
ZR20084 to ZR20147	Window command 2
ZR20148 to ZR20211	Window command 3
ZR20212 to ZR20275	Window command 4
ZR20276 to ZR20339	Window command 5
ZR20340 to ZR20403	Window command 6
ZR20404 to ZR20467	Window command 7
ZR20468 to ZR20531	Window command 8
ZR20532 to ZR20595	Window command 9
ZR20596 to ZR20659	Window command 10

[CNC -> PLC] Response area

Device	Signal name
ZR21300 to ZR21427	Window result 1
ZR21428 to ZR21555	Window result 2
ZR21556 to ZR21683	Window result 3
ZR21684 to ZR21811	Window result 4
ZR21812 to ZR21939	Window result 5
ZR21940 to ZR22067	Window result 6
ZR22068 to ZR22195	Window result 7
ZR22196 to ZR22323	Window result 8
ZR22324 to ZR22451	Window result 9
ZR22452 to ZR22579	Window result 10

Automatic setting window

Device	Signal name
ZR20001	[PLC -> CNC] Automatic setting modification request (for changing from the PLC)
ZR20003	[CNC -> PLC] Automatic setting modification completion (for changing from the PLC)

[PLC -> CNC] Automatic setting modification information (for changing from the PLC)

Device	Signal name
ZR20004	Type of coordinate value (Target window No. 1 and 6)
ZR20005	Coordinate value type (Target window No. 1, 2, 6 and 7)
ZR20006	Number of programs to output (Target window No. 4 and 9)
ZR20007	Number of characters in one line of the program (Target window No. 4 and 9)
ZR20008	Number of alarm messages to be output (Target window No. 5 and 10)
ZR20009	Type of message (Target window 5 and 10)

[GOT <--> CNC] Automatic setting modification request (for changing from GOT)

Device	Signal name
ZR20016	Automatic setting modification request

[GOT -> CNC] Automatic setting modification information (for changing from GOT)

Device	Signal name
ZR20010	Type of coordinate value (Target window No. 1 and 6)
ZR20011	Coordinate value type (Target window No. 1, 2, 6 and 7)
ZR20012	Number of programs to output (Target window No. 4 and 9)
ZR20013	Number of characters in one line of the program (Target window No. 4 and 9)
ZR20014	Number of alarm messages to be output (Target window No. 5 and 10)
ZR20015	Type of message (Target window 5 and 10)

[CNC -> PLC] Automatic setting window response area

Device	Signal name
ZR22580 to ZR22707	Window result 1
ZR22708 to ZR22835	Window result 2
ZR22836 to ZR22963	Window result 3
ZR22964 to ZR23091	Window result 4
ZR23092 to ZR23219	Window result 5
ZR23220 to ZR23347	Window result 6
ZR23348 to ZR23475	Window result 7
ZR23476 to ZR23603	Window result 8
ZR23604 to ZR23731	Window result 9
ZR23732 to ZR23859	Window result 10

(10) PROFIBUS-DP [M8]

PLC→CNC

Device [M8]	Abbrev.	Signal name
ZR3613		PROFIBUS-DP:Diagnosis data acquisition request start/end flag
ZR3614		PROFIBUS-DP:Station No. of slave requesting diagnosis data acquisition
ZR3615		PROFIBUS-DP:Diagnosis data acquisition request command No.
ZR3616		PROFIBUS-DP:Diagnosis data-storing device type
ZR3617		PROFIBUS-DP:Top device No. for storing diagnosis data
ZR3623		PROFIBUS-DP:Aperiodic data communication (Acyclic communication): Request start/end flag
ZR3624		PROFIBUS-DP:Aperiodic data communication (Acyclic communication): Request command No.
ZR3625		PROFIBUS-DP:Aperiodic data communication (Acyclic communication): Request source slave station No.
ZR3626		PROFIBUS-DP:Aperiodic data communication (Acyclic communication): Request source slave station slot No.
ZR3627		PROFIBUS-DP:Aperiodic data communication (Acyclic communication): Request source slave station index
ZR3628		PROFIBUS-DP:Aperiodic data communication (Acyclic communication): Request source data length
ZR3629		PROFIBUS-DP:Aperiodic data communication (Acyclic communication): Send time-out
ZR3630		PROFIBUS-DP:Aperiodic data communication (Acyclic communication): Features supported
ZR3631		PROFIBUS-DP:Aperiodic data communication (Acyclic communication): Features supported 2
ZR3632		PROFIBUS-DP:Aperiodic data communication (Acyclic communication): Profile features supported
ZR3633		PROFIBUS-DP:Aperiodic data communication (Acyclic communication): Profile features supported 2
ZR3634		PROFIBUS-DP:Aperiodic data communication (Acyclic communication): Profile ID number
ZR3635		PROFIBUS-DP:Aperiodic data communication (Acyclic communication): S_Type
ZR3636		PROFIBUS-DP:Aperiodic data communication (Acyclic communication): S_Len
ZR3637		PROFIBUS-DP:Aperiodic data communication (Acyclic communication): D_Type
ZR3638		PROFIBUS-DP:Aperiodic data communication (Acyclic communication): D_Len
ZR3639		PROFIBUS-DP:Aperiodic data communication (Acyclic communication): Destination connection No.
ZR3642		PROFIBUS-DP:Aperiodic data communication (Acyclic communication): Type of device for storing data to write
ZR3643		PROFIBUS-DP:Aperiodic data communication (Acyclic communication): Top device No. for storing data to write
ZR3644		PROFIBUS-DP:Aperiodic data communication (Acyclic communication): Type of device for storing additional address parameter table
ZR3645		PROFIBUS-DP:Aperiodic data communication (Acyclic communication): Top device No. for storing additional address parameter table
ZR3646		PROFIBUS-DP:Aperiodic data communication (Acyclic communication): Subnet
ZR3647		PROFIBUS-DP:Aperiodic data communication (Acyclic communication): Instance
ZR3648		PROFIBUS-DP:Aperiodic data communication (Acyclic communication): ReasonCode
ZR3664		PROFIBUS-DP:Alarm data acquisition request start/end flag
ZR3665		PROFIBUS-DP:Alarm data acquisition request command No.
ZR3666		PROFIBUS-DP:Station No. of slave requesting alarm data acquisition
ZR3667		PROFIBUS-DP:Alarm data-storing device type
ZR3668		PROFIBUS-DP:Top device No. for storing alarm data
ZR3673		PROFIBUS-DP:ACK send request start/end flag
ZR3674		PROFIBUS-DP:ACK send request command No.
ZR3675		PROFIBUS-DP:ACK send request destination slave station No.
ZR3676		PROFIBUS-DP:Type of alarm occurring on ACK send request destination slave station
ZR3677		PROFIBUS-DP:Slot No. of ACK send request destination slave station
ZR3678		PROFIBUS-DP:Alarm specifier of ACK send request destination slave station

CNC→PLC

Device [M8]	Abbrev.	Signal name
ZR3600		PROFIBUS-DP:Startup complete (*1)
ZR3601		PROFIBUS-DP:Diagnosis data acquisition in progress
ZR3602		PROFIBUS-DP:Aperiodic data communication (Acyclic communication) in progress
ZR3603		PROFIBUS-DP:Alarm data acquisition active flag
ZR3604		PROFIBUS-DP:Alarm ACK send active flag
ZR3605		PROFIBUS-DP: Error occurrence state in the slave station (Station No. 0 to 15)
ZR3606		PROFIBUS-DP: Error occurrence state in the slave station (Station No. 16 to 31)
ZR3607		PROFIBUS-DP: Error occurrence state in the slave station (Station No. 32 to 47)
ZR3608		PROFIBUS-DP: Error occurrence state in the slave station (Station No. 48 to 63)
ZR3609		PROFIBUS-DP: Error occurrence state in the slave station (Station No. 64 to 79)
ZR3610		PROFIBUS-DP: Error occurrence state in the slave station (Station No. 80 to 95)
ZR3611		PROFIBUS-DP: Error occurrence state in the slave station (Station No. 96 to 111)
ZR3612		PROFIBUS-DP: Error occurrence state in the slave station (Station No. 112 to 125)
ZR3618		PROFIBUS-DP:Diagnosis data acquisition response command No.
ZR3619		PROFIBUS-DP:Diagnosis data acquisition status (H)
ZR3620		PROFIBUS-DP:Diagnosis data acquisition status (L)
ZR3621		PROFIBUS-DP:Station No. of slave that acquired diagnosis data
ZR3622		PROFIBUS-DP:Diagnosis data length
ZR3630		PROFIBUS-DP:Aperiodic data communication (Acyclic communication): Features supported
ZR3631		PROFIBUS-DP:Aperiodic data communication (Acyclic communication): Features supported 2
ZR3632		PROFIBUS-DP:Aperiodic data communication (Acyclic communication): Profile features supported
ZR3633		PROFIBUS-DP:Aperiodic data communication (Acyclic communication): Profile features supported 2
ZR3634		PROFIBUS-DP:Aperiodic data communication (Acyclic communication): Profile ID number
ZR3635		PROFIBUS-DP:Aperiodic data communication (Acyclic communication): S_Type
ZR3636		PROFIBUS-DP:Aperiodic data communication (Acyclic communication): S_Len
ZR3637		PROFIBUS-DP:Aperiodic data communication (Acyclic communication): D_Type
ZR3638		PROFIBUS-DP:Aperiodic data communication (Acyclic communication): D_Len
ZR3640		PROFIBUS-DP:Aperiodic data communication (Acyclic communication): Type of devices for storing read data
ZR3641		PROFIBUS-DP:Aperiodic data communication (Acyclic communication): Top device No. for storing read data
ZR3649		PROFIBUS-DP:Aperiodic data communication (Acyclic communication): Response command No.
ZR3650		PROFIBUS-DP:Aperiodic data communication (Acyclic communication): Execution status (H)
ZR3651		PROFIBUS-DP:Aperiodic data communication (Acyclic communication): Execution status (L)
ZR3652		PROFIBUS-DP:Aperiodic data communication (Acyclic communication): Execution station No.
ZR3653		PROFIBUS-DP:Aperiodic data communication (Acyclic communication): Execution slot
ZR3654		PROFIBUS-DP:Aperiodic data communication (Acyclic communication): Execution index
ZR3655		PROFIBUS-DP:Aperiodic data communication (Acyclic communication): Execution data length
ZR3656		PROFIBUS-DP:Aperiodic data communication (Acyclic communication): Connection-established connection No.
ZR3657		PROFIBUS-DP:Aperiodic data communication (Acyclic communication): Maximum data unit length
ZR3658		PROFIBUS-DP:Aperiodic data communication (Acyclic communication): Connection reference value
ZR3659		PROFIBUS-DP:Aperiodic data communication (Acyclic communication): Error decode
ZR3660		PROFIBUS-DP:Aperiodic data communication (Acyclic communication): Error code 1

Device [M8]	Abbrev.	Signal name
ZR3661		PROFIBUS-DP:Aperiodic data communication (Acyclic communication): Error code 2
ZR3662		PROFIBUS-DP:Aperiodic data communication (Acyclic communication): Additional error data
ZR3663		PROFIBUS-DP:Alarm-occurring station No.
ZR3669		PROFIBUS-DP:Alarm data acquisition response command No.
ZR3670		PROFIBUS-DP:Alarm data acquisition status(H)
ZR3671		PROFIBUS-DP:Alarm data acquisition status(L)
ZR3672		PROFIBUS-DP:Acquired alarm data length
ZR3679		PROFIBUS-DP:ACK send response command No.
ZR3680		PROFIBUS-DP:ACK send status (H)
ZR3681		PROFIBUS-DP:ACK send status (L)
ZR3682		PROFIBUS-DP:ACK send execution station No.
ZR3683		PROFIBUS-DP:ACK send execution alarm type
ZR3684		PROFIBUS-DP:ACK send execution slot No.
ZR3685		PROFIBUS-DP:ACK send execution alarm specifier
ZR3686		PROFIBUS-DP:ACK send error decode
ZR3687		PROFIBUS-DP:ACK send error code 1
ZR3688		PROFIBUS-DP:ACK send error code 2
ZR3692		PROFIBUS-DP: Communication error flag
ZR3693		PROFIBUS-DP: Global error bit
ZR3694		PROFIBUS-DP: Configuration status of slave station (Station No. 0 to 15)
ZR3695		PROFIBUS-DP: Configuration status of slave station (Station No. 16 to 31)
ZR3696		PROFIBUS-DP: Configuration status of slave station (Station No. 32 to 47)
ZR3697		PROFIBUS-DP: Configuration status of slave station (Station No. 48 to 63)
ZR3698		PROFIBUS-DP: Configuration status of slave station (Station No. 64 to 79)
ZR3699		PROFIBUS-DP: Configuration status of slave station (Station No. 80 to 95)
ZR3700		PROFIBUS-DP: Configuration status of slave station (Station No. 96 to 111)
ZR3701		PROFIBUS-DP: Configuration status of slave station (Station No. 112 to 125)
ZR3702		PROFIBUS-DP: Communication status of slave station (Station No. 0 to 15)
ZR3703		PROFIBUS-DP: Communication status of slave station (Station No. 16 to 31)
ZR3704		PROFIBUS-DP: Communication status of slave station (Station No. 32 to 47)
ZR3705		PROFIBUS-DP: Communication status of slave station (Station No. 48 to 63)
ZR3706		PROFIBUS-DP: Communication status of slave station (Station No. 64 to 79)
ZR3707		PROFIBUS-DP: Communication status of slave station (Station No. 80 to 95)
ZR3708		PROFIBUS-DP: Communication status of slave station (Station No. 96 to 111)
ZR3709		PROFIBUS-DP: Communication status of slave station (Station No. 112 to 125)

(*1) NC checks for the presence of slave stations for two times: when PROFIBUS-DP function extension unit is turned ON and when the time set to the parameter "#1332 Fieldbus" has passed since the startup. As a result of the check, if no slave stations is detected, the "Startup complete" signal (ZR3600) does not turn ON.

When ZR3600 does not turn ON, check the communication status of slave stations with ZR3702 to ZR3709, and adjust the slave stations and review the setting time of the parameter (#1332).

(11) BiSS encoder I/F [M8]

Device	Abbrev.	Signal name
ZR13090	BENCSTS	BiSS encoder I/F: Communication status
ZR13091 to ZR13094	BENC1DATn	BiSS encoder I/F: Encoder 1 data output n

(12) ATC control parameter [M8]

Device	Signal name
ZR4000 to ZR4639	Magazine tool data (Pot 121 to Pot 200)
ZR4160 to ZR4719	Magazine tool data (AUX.D) (Pot 121 to Pot 200)

Refer to "2.7 Classified for Each Application".

2.7 Classified for Each Application

(Note) Signals with "▲" are prepared for specific machine tool builders.

(1) PLC axis indexing interfaces

Device No.		Abbrev.	Signal name
	bit		
R8098	bit0		PLC indexing axis operation adjustment mode valid (common for all axes)

PLC indexing axis								Abbrev.	Signal name
1st axis	2nd axis	3rd axis	4th axis	5th axis	6th axis	7th axis	8th axis		
R8050	R8056	R8062	R8068	R8074	R8080	R8086	R8092	AUXCM4	PLC axis indexing control command 4
R8051	R8057	R8063	R8069	R8075	R8081	R8087	R8093	AUXCM3	PLC axis indexing control command 3
R8052	R8058	R8064	R8070	R8076	R8082	R8088	R8094	AUXCM2	PLC axis indexing control command 2
R8053	R8059	R8065	R8071	R8077	R8083	R8089	R8095	AUXCM1	PLC axis indexing control command 1
R8054	R8060	R8066	R8072	R8078	R8084	R8090	R8096		PLC axis indexing control command position (L)
R8055	R8061	R8067	R8073	R8079	R8085	R8091	R8097		PLC axis indexing control command position (H)

Device No.		Abbrev.	Signal name
	bit		
R8048	bit0		PLC indexing axis in operation adjustment mode 1st axis
	bit1		PLC indexing axis in operation adjustment mode 2nd axis
	bit2		PLC indexing axis in operation adjustment mode 3rd axis
	bit3		PLC indexing axis in operation adjustment mode 4th axis
	bit4		PLC indexing axis in operation adjustment mode 5th axis
	bit5		PLC indexing axis in operation adjustment mode 6th axis

PLC indexing axis								Abbrev.	Signal name
1st axis	2nd axis	3rd axis	4th axis	5th axis	6th axis	7th axis	8th axis		
R8000	R8006	R8012	R8018	R8024	R8030	R8036	R8042	AUXST4	PLC axis indexing control status 4
R8001	R8007	R8013	R8019	R8025	R8031	R8037	R8043	AUXST3	PLC axis indexing control status 3
R8002	R8008	R8014	R8020	R8026	R8032	R8038	R8044	AUXST2	PLC axis indexing control status 2
R8003	R8009	R8015	R8021	R8027	R8033	R8039	R8045	AUXST1	PLC axis indexing control status 1
R8004	R8010	R8016	R8022	R8028	R8034	R8040	R8046		PLC axis indexing control machine position (L)
R8005	R8011	R8017	R8023	R8029	R8035	R8041	R8047		PLC axis indexing control machine position (H)

(2) Other file registers (R)

Device No.	Signal name		
R2100 to R2397	Pallet program data (Drive unit -> PLC) [M8]		
R4100 to R4103	Pallet program data (PLC -> Drive unit) [M8]		
R7500 to R7799	PLC constant parameters (corresponds to parameters #18001 to #18150)		
R7800 to R7897	PLC bit selection parameters (corresponds to parameters #6401 to #6596)*		
R7898 to R7947	PLC bit selection parameters (corresponds to parameters #59001 to #59100) ▲		
R8260 to R8289	Option status export to PLC [M8]		
R8290 to R8299	Optimum acceleration/deceleration estimated inertia level (spindle) ▲		
R12800 to R13099	Computer link interfaces		
R13200 to R13299	Special table interfaces		
R17300 to R18299	Modbus input/output device ▲		
	M system		L system
R10600 to R11779	ATC command control information	R10600 and later	Tool life management interfaces I, II
R11800 and later	Tool life management interfaces		
R24884 to R25011	Total distance traveled by n-th axis during automatic operation [M8]		
R27500 to R28099	PLC constant parameters (corresponds to parameters #59301 to #59600) ▲		

* Some bits are used only for C80. Refer to Alarm/Parameter Manual.

(3) Memory switch (PLC switch) [M8]

Device No.	Signal name
X680 to X6BF	PLC switch #1 to 64
X1C40 to X1C5F	PLC switch #65 to 96
X6F8 to X6FF	Skip input 1 to 8 for monitor
Y680 to Y6BF	PLC switch reversed display #1 to 64
Y1C40 to Y1C5F	PLC switch reversed display #65 to 96
Y6C0 to Y6FF	PLC switch for reverse #1 to 64
Y1C60 to Y1C7F	PLC switch for reverse #65 to 96
ZR3200 to ZR3205	PLC switch non-display

(4) Fixed (semi-fixed) devices

Device No.	Signal name
X18 to X1B	Reference position return near-point detection 1 to 4
X20 to X23	Stroke end (-) 1 to 4
X28 to X2B	Stroke end (+) 1 to 4
X5C to X5F	Reference position return near-point detection 5 to 8
X64 to X67	Stroke end (-) 5 to 8
X6C to X6F	Stroke end (+) 5 to 8

Up to NC 8th axis can be set for fixed devices. The 9th axis or later cannot be set.

(5) Maintenance

Device No.	Signal name
R13170	CRC count (servo #1)
R13171	CRC count (servo #2)
R13172	Address illegal (servo #1)
R13173	Address illegal (servo #2)
R13174	CRC count (display unit)
R13175	Address illegal (display unit)
R13176	CRC count (servo #3)
R13177	Address illegal (servo #3)

(6) Spindle related devices

CNC -> PLC

Device No.								Abbrev.	Signal name
1stSP	2ndSP	3rdSP	4thSP	5thSP	6thSP	7thSP	8thSP		
X1882	X18E2	X1942	X19A2	X1A02	X1A62	X1AC2	X1B22	SIGE	S command gear No. illegal
X1883	X18E3	X1943	X19A3	X1A03	X1A63	X1AC3	X1B23	SOVE	S command max./min. command value over
X1884	X18E4	X1944	X19A4	X1A04	X1A64	X1AC4	X1B24	SNGE	S command no gear selected
X1885	X18E5	X1945	X19A5	X1A05	X1A65	X1AC5	X1B25	GR1	Spindle gear shift command 1
X1886	X18E6	X1946	X19A6	X1A06	X1A66	X1AC6	X1B26	GR2	Spindle gear shift command 2
X1887	X18E7	X1947	X19A7	X1A07	X1A67	X1AC7	X1B27	-	(Always "0")
X1888	X18E8	X1948	X19A8	X1A08	X1A68	X1AC8	X1B28	ORAO2	Spindle 2nd in-position
X1889	X18E9	X1949	X19A9	X1A09	X1A69	X1AC9	X1B29	CDO	Current detection
X188A	X18EA	X194A	X19AA	X1A0A	X1A6A	X1ACA	X1B2A	VRO	Speed detection
X188B	X18EB	X194B	X19AB	X1A0B	X1A6B	X1ACB	X1B2B	FLO	In spindle alarm
X188C	X18EC	X194C	X19AC	X1A0C	X1A6C	X1ACC	X1B2C	ZSO	Zero speed
X188D	X18ED	X194D	X19AD	X1A0D	X1A6D	X1ACD	X1B2D	USO	Spindle up-to-speed
X188E	X18EE	X194E	X19AE	X1A0E	X1A6E	X1ACE	X1B2E	ORAO	Spindle in-position
X188F	X18EF	X194F	X19AF	X1A0F	X1A6F	X1ACF	X1B2F	LCSA	In L coil selection
X1890	X18F0	X1950	X19B0	X1A10	X1A70	X1AD0	X1B30	SMA	Spindle ready-ON
X1891	X18F1	X1951	X19B1	X1A11	X1A71	X1AD1	X1B31	SSA	Spindle servo-ON
X1892	X18F2	X1952	X19B2	X1A12	X1A72	X1AD2	X1B32	SEMG	In spindle emergency stop
X1893	X18F3	X1953	X19B3	X1A13	X1A73	X1AD3	X1B33	SSRN	In spindle forward run
X1894	X18F4	X1954	X19B4	X1A14	X1A74	X1AD4	X1B34	SSRI	In spindle reverse run
X1895	X18F5	X1955	X19B5	X1A15	X1A75	X1AD5	X1B35		Z phase passed
X1896	X18F6	X1956	X19B6	X1A16	X1A76	X1AD6	X1B36	SIMP	Position loop in-position
X1897	X18F7	X1957	X19B7	X1A17	X1A77	X1AD7	X1B37	STLQ	In spindle torque limit
X1898	X18F8	X1958	X19B8	X1A18	X1A78	X1AD8	X1B38		
X1899	X18F9	X1959	X19B9	X1A19	X1A79	X1AD9	X1B39		
X189A	X18FA	X195A	X19BA	X1A1A	X1A7A	X1ADA	X1B3A		Spindle torque limit reached
X189D	X18FD	X195D	X19BD	X1A1D	X1A7D	X1ADD	X1B3D	SD2	Speed detection 2
X189E	X18FE	X195E	X19BE	X1A1E	X1A7E	X1ADE	X1B3E	MCSA	In M coil selection
X189F	X18FF	X195F	X19BF	X1A1F	X1A7F	X1ADF	X1B3F		Index positioning completion

Device No.								Abbrev.	Signal name
1stSP	2ndSP	3rdSP	4thSP	5thSP	6thSP	7thSP	8thSP		
X18A0	X1900	X1960	X19C0	X1A20	X1A80	X1AE0	X1B40	ENB	Spindle enable
X18A8	X1908	X1968	X19C8	X1A28	X1A88	X1AE8	X1B48	SPSYN1	In spindle synchronization
X18A9	X1909	X1969	X19C9	X1A29	X1A89	X1AE9	X1B49	FSPRV	Spindle rotation speed synchronization completion
X18AA	X190A	X196A	X19CA	X1A2A	X1A8A	X1AEA	X1B4A	FSPPH	Spindle phase synchronization completion
X18AB	X190B	X196B	X19CB	X1A2B	X1A8B	X1AEB	X1B4B	SPSYN2	In spindle synchronization 2
X18AC	X190C	X196C	X19CC	X1A2C	X1A8C	X1AEC	X1B4C	SPCMP	Chuck close confirmation
X18AD	X190D	X196D	X19CD	X1A2D	X1A8D	X1AED	X1B4D	TSS1	Tool spindle synchronization I (Polygon)
X18AE	X190E	X196E	X19CE	X1A2E	X1A8E	X1AEE	X1B4E	SPSYN3	In tool spindle synchronization II
X18AF	X190F	X196F	X19CF	X1A2F	X1A8F	X1AEF	X1B4F	SPNCH	Spindle superimposition control: Speed change disabled
X18B0	X1910	X1970	X19D0	X1A30	X1A90	X1AF0	X1B50	SPPHOV	Spindle synchronization phase error over
X18B1	X1911	X1971	X19D1	X1A31	X1A91	X1AF1	X1B51	SPILE	Spindle superimposition control ON
X18B2	X1912	X1972	X19D2	X1A32	X1A92	X1AF2	X1B52	SPLCR	Spindle superimposition control: Spindle superimposition clamped
X18B3	X1913	X1973	X19D3	X1A33	X1A93	X1AF3	X1B53	PHOVR	Hob axis delay excess
X18B5	X1915	X1975	X19D5	X1A35	X1A95	X1AF5	X1B55	EXOFN	Holding power of spindle increased
X18B6	X1916	X1976	X19D6	X1A36	X1A96	X1AF6	X1B56	SPOFFA	In spindle off
X18C1	X1921	X1981	X19E1	X1A41	X1AA1	X1B01	X1B61	SVMD	Spindle position control (Spindle/C axis control): C axis mode ON
X18C2	X1922	X1982	X19E2	X1A42	X1AA2	X1B02	X1B62	GO1	Spindle gear selection output 1
X18C3	X1923	X1983	X19E3	X1A43	X1AA3	X1B03	X1B63	GO2	Spindle gear selection output 2
X18C8	X1928	X1988	X19E8	X1A48	X1AA8	X1B08	X1B68		Spindle oscillation in progress [M8]
X18C9	X1929	X1989	X19E9	X1A49	X1AA9	X1B09	X1B69	SPRTCT	Spindle protection: Mode in progress [M8]
X18CA	X192A	X198A	X19EA	X1A4A	X1AAA	X1B0A	X1B6A	VGHLD	Real-time tuning 1: Speed control gain changeover hold-down ON [M8]

Device No.								Abbrev.	Signal name
\$1	\$2	\$3	\$4	\$5	\$6	\$7	\$8		
XC64	XDA4	XEE4	X1024	X1164	X12A4	X13E4	X1524	SF1	S function strobe 1
XC65	XDA5	XEE5	X1025	X1165	X12A5	X13E5	X1525	SF2	S function strobe 2
XC66	XDA6	XEE6	X1026	X1166	X12A6	X13E6	X1526	SF3	S function strobe 3
XC67	XDA7	XEE7	X1027	X1167	X12A7	X13E7	X1527	SF4	S function strobe 4
XC70	XDB0	XEF0	X1030	X1170	X12B0	X13F0	X1530	SF5	S function strobe 5
XC71	XDB1	XEF1	X1031	X1171	X12B1	X13F1	X1531	SF6	S function strobe 6
XC72	XDB2	XEF2	X1032	X1172	X12B2	X13F2	X1532	SF7	S function strobe 7
XC73	XDB3	XEF3	X1033	X1173	X12B3	X13F3	X1533	SF8	S function strobe 8
XCB0	XDF0	XF30	X1070	X11B0	X12F0	X1430	X1570		In spindle-NC axis polygon mode
XCB2	XDF2	XF32	X1072	X11B2	X12F2	X1432	X1572		In spindle-spindle polygon mode
XCB3	XDF3	XF33	X1073	X11B3	X12F3	X1433	X1573		Spindle-spindle polygon synchronization completion

CNC -> PLC

Device No.								Abbrev.	Signal name
1stSP	2ndSP	3rdSP	4thSP	5thSP	6thSP	7thSP	8thSP		
R6500	R6550	R6600	R6650	R6700	R6750	R6800	R6850		Spindle command rotation speed input (L)
R6501	R6551	R6601	R6651	R6701	R6751	R6801	R6851		Spindle command rotation speed input (H)
R6502	R6552	R6602	R6652	R6702	R6752	R6802	R6852		Spindle command final data (rotation speed) (L)
R6503	R6553	R6603	R6653	R6703	R6753	R6803	R6853		Spindle command final data (rotation speed) (H)
R6504	R6554	R6604	R6654	R6704	R6754	R6804	R6854		Spindle command final data (12-bit binary) (L)
R6505	R6555	R6605	R6655	R6705	R6755	R6805	R6855		Spindle command final data (12-bit binary) (H)
R6506	R6556	R6606	R6656	R6706	R6756	R6806	R6856		Spindle actual speed (L)
R6507	R6557	R6607	R6657	R6707	R6757	R6807	R6857		Spindle actual speed (H)
R6508	R6558	R6608	R6658	R6708	R6758	R6808	R6858		
R6514	R6564	R6614	R6664	R6714	R6764	R6814	R6864		Optimum acceleration/deceleration estimated inertia ratio [spindle] ▲
R6515	R6565	R6615	R6665	R6715	R6765	R6815	R6865		Optimum acceleration/deceleration parameter group currently selected [spindle] ▲
R6516	R6566	R6616	R6666	R6716	R6766	R6816	R6866		Spindle synchronization phase error /Hob axis delay angle
R6517	R6567	R6617	R6667	R6717	R6767	R6817	R6867		Spindle synchronization Maximum phase error/Maximum hob axis delay angle
R6518	R6568	R6618	R6668	R6718	R6768	R6818	R6868		Spindle synchronization Phase offset data
R6519	R6569	R6619	R6669	R6719	R6769	R6819	R6869		Spindle synchronization Phase error monitor
R6520	R6570	R6620	R6670	R6720	R6770	R6820	R6870		Spindle synchronization Phase error monitor (lower limit)
R6521	R6571	R6621	R6671	R6721	R6771	R6821	R6871		Spindle synchronization Phase error monitor (upper limit)
R6522	R6572	R6622	R6672	R6722	R6772	R6822	R6872		Spindle synchronization Phase error 1
R6523	R6573	R6623	R6673	R6723	R6773	R6823	R6873		Spindle synchronization Phase error 2
R6525	R6575	R6625	R6675	R6725	R6775	R6825	R6875		Spindle motor load ratio
R6526	R6576	R6626	R6676	R6726	R6776	R6826	R6876	SPT M P	Spindle temperature output [M8]
R6527	R6577	R6627	R6677	R6727	R6777	R6827	R6877		Spindle actual machining time ▲
R6528	R6578	R6628	R6678	R6728	R6778	R6828	R6878		Load monitor I : Spindle cutting torque output value ▲
R6529	R6579	R6629	R6679	R6729	R6779	R6829	R6879		Spindle alarm/warning No.
R6532	R6582	R6632	R6682	R6732	R6782	R6832	R6882		Synchronous tapping Current error width (L)
R6533	R6583	R6633	R6683	R6733	R6783	R6833	R6883		Synchronous tapping Current error width (H)
R6534	R6584	R6634	R6684	R6734	R6784	R6834	R6884		Synchronous tapping Maximum error width (L)
R6535	R6585	R6635	R6685	R6735	R6785	R6835	R6885		Synchronous tapping Maximum error width (H)
R6536	R6586	R6636	R6686	R6736	R6786	R6836	R6886		Synchronous tapping Current error angle (L)
R6537	R6587	R6637	R6687	R6737	R6787	R6837	R6887		Synchronous tapping Current error angle (H)
R6538	R6588	R6638	R6688	R6738	R6788	R6838	R6888		Synchronous tapping Maximum error angle (L)
R6539	R6589	R6639	R6689	R6739	R6789	R6839	R6889		Synchronous tapping Maximum error angle (H)
R6541	R6591	R6641	R6691	R6741	R6791	R6841	R6891		Load monitoring I: Estimated spindle disturbance torque output
R6542	R6592	R6642	R6692	R6742	R6792	R6842	R6892		Load monitoring I: Effective spindle torque output

Device No.								Abbrev.	Signal name
\$1	\$2	\$3	\$4	\$5	\$6	\$7	\$8		
R512	R712	R912	R1112	R1312	R1512	R1712	R1912		S code data 1 (L)
R513	R713	R913	R1113	R1313	R1513	R1713	R1913		S code data 1 (H)
R514	R714	R914	R1114	R1314	R1514	R1714	R1914		S code data 2 (L)
R515	R715	R915	R1115	R1315	R1515	R1715	R1915		S code data 2 (H)
R516	R716	R916	R1116	R1316	R1516	R1716	R1916		S code data 3 (L)
R517	R717	R917	R1117	R1317	R1517	R1717	R1917		S code data 3 (H)
R518	R718	R918	R1118	R1318	R1518	R1718	R1918		S code data 4 (L)
R519	R719	R919	R1119	R1319	R1519	R1719	R1919		S code data 4 (H)
R520	R720	R920	R1120	R1320	R1520	R1720	R1920		S code data 5 (L)
R521	R721	R921	R1121	R1321	R1521	R1721	R1921		S code data 5 (H)
R522	R722	R922	R1122	R1322	R1522	R1722	R1922		S code data 6 (L)
R523	R723	R923	R1123	R1323	R1523	R1723	R1923		S code data 6 (H)
R524	R724	R924	R1124	R1324	R1524	R1724	R1924		S code data 7 (L)
R525	R725	R925	R1125	R1325	R1525	R1725	R1925		S code data 7 (H)
R526	R726	R926	R1126	R1326	R1526	R1726	R1926		S code data 8 (L)
R527	R727	R927	R1127	R1327	R1527	R1727	R1927		S code data 8 (H)

PLC -> CNC

Device No.								Abbrev.	Signal name
1stSP	2ndSP	3rdSP	4thSP	5thSP	6thSP	7thSP	8thSP		
Y1885	Y18E5	Y1945	Y19A5	Y1A05	Y1A65	Y1AC5	Y1B25	GFIN	Gear shift completion
Y1888	Y18E8	Y1948	Y19A8	Y1A08	Y1A68	Y1AC8	Y1B28	SP1	Spindle speed override code 1
Y1889	Y18E9	Y1949	Y19A9	Y1A09	Y1A69	Y1AC9	Y1B29	SP2	Spindle speed override code 2
Y188A	Y18EA	Y194A	Y19AA	Y1A0A	Y1A6A	Y1ACA	Y1B2A	SP4	Spindle speed override code 4
Y188F	Y18EF	Y194F	Y19AF	Y1A0F	Y1A6F	Y1ACF	Y1B2F	SPS	Spindle override method selection
Y1890	Y18F0	Y1950	Y19B0	Y1A10	Y1A70	Y1AD0	Y1B30	GI1	Spindle gear selection code 1
Y1891	Y18F1	Y1951	Y19B1	Y1A11	Y1A71	Y1AD1	Y1B31	GI2	Spindle gear selection code 2
Y1893	Y18F3	Y1953	Y19B3	Y1A13	Y1A73	Y1AD3	Y1B33	EXOBS	Increase holding power of spindle
Y1894	Y18F4	Y1954	Y19B4	Y1A14	Y1A74	Y1AD4	Y1B34	SSTP	Spindle stop
Y1895	Y18F5	Y1955	Y19B5	Y1A15	Y1A75	Y1AD5	Y1B35	SSFT	Spindle gear shift
Y1896	Y18F6	Y1956	Y19B6	Y1A16	Y1A76	Y1AD6	Y1B36	SORC	Spindle orientation
Y1897	Y18F7	Y1957	Y19B7	Y1A17	Y1A77	Y1AD7	Y1B37		Spindle command invalid
Y1898	Y18F8	Y1958	Y19B8	Y1A18	Y1A78	Y1AD8	Y1B38	SRN	Spindle forward run start
Y1899	Y18F9	Y1959	Y19B9	Y1A19	Y1A79	Y1AD9	Y1B39	SRI	Spindle reverse run start
Y189A	Y18FA	Y195A	Y19BA	Y1A1A	Y1A7A	Y1ADA	Y1B3A	TL1	Spindle torque limit 1
Y189B	Y18FB	Y195B	Y19BB	Y1A1B	Y1A7B	Y1ADB	Y1B3B	TL2	Spindle torque limit 2
Y189C	Y18FC	Y195C	Y19BC	Y1A1C	Y1A7C	Y1ADC	Y1B3C	WRN	Spindle forward run index
Y189D	Y18FD	Y195D	Y19BD	Y1A1D	Y1A7D	Y1ADD	Y1B3D	WRI	Spindle reverse run index
Y189E	Y18FE	Y195E	Y19BE	Y1A1E	Y1A7E	Y1ADE	Y1B3E	ORC	Spindle orientation command
Y189F	Y18FF	Y195F	Y19BF	Y1A1F	Y1A7F	Y1ADF	Y1B3F	LRSL	L coil selection
Y18A2	Y1902	Y1962	Y19C2	Y1A22	Y1A82	Y1AE2	Y1B42		
Y18A3	Y1903	Y1963	Y19C3	Y1A23	Y1A83	Y1AE3	Y1B43		
Y18A5	Y1905	Y1965	Y19C5	Y1A25	Y1A85	Y1AE5	Y1B45	CMOD	Spindle position control (Spindle/C axis control): C axis selection
Y18A6	Y1906	Y1966	Y19C6	Y1A26	Y1A86	Y1AE6	Y1B46	LRSM	M coil selection
Y18A8	Y1908	Y1968	Y19C8	Y1A28	Y1A88	Y1AE8	Y1B48	SWS	Spindle selection
Y18AA	Y190A	Y196A	Y19CA	Y1A2A	Y1A8A	Y1AEA	Y1B4A	SPRR	Spindle rotation reversal
Y18AB	Y190B	Y196B	Y19CB	Y1A2B	Y1A8B	Y1AEB	Y1B4B	SPRS	Spindle rotation direction switch method selection
Y18AF	Y190F	Y196F	Y19CF	Y1A2F	Y1A8F	Y1AEF	Y1B4F	MPCSL	PLC coil changeover
Y18B0	Y1910	Y1970	Y19D0	Y1A30	Y1A90	Y1AF0	Y1B50	SPSY	Spindle synchronization
Y18B1	Y1911	Y1971	Y19D1	Y1A31	Y1A91	Y1AF1	Y1B51	SPPHS	Spindle phase synchronization
Y18B2	Y1912	Y1972	Y19D2	Y1A32	Y1A92	Y1AF2	Y1B52	SPSDR	Spindle synchronization rotation direction
Y18B3	Y1913	Y1973	Y19D3	Y1A33	Y1A93	Y1AF3	Y1B53	SSPHM	Phase shift calculation request
Y18B4	Y1914	Y1974	Y19D4	Y1A34	Y1A94	Y1AF4	Y1B54	SSPHF	Phase offset request
Y18B5	Y1915	Y1975	Y19D5	Y1A35	Y1A95	Y1AF5	Y1B55	SPDRP O	Error temporary cancel
Y18B8	Y1918	Y1978	Y19D8	Y1A38	Y1A98	Y1AF8	Y1B58	SPSYC	Spindle synchronization/ superimposition cancel
Y18B9	Y1919	Y1979	Y19D9	Y1A39	Y1A99	Y1AF9	Y1B59	SPCMP C	Chuck close
Y18BF	Y191F	Y197F	Y19DF	Y1A3F	Y1A9F	Y1AFF	Y1B5F	SPOFF	Spindle Off Request
Y18C8	Y1928	Y1988	Y19E8	Y1A48	Y1AA8	Y1B08	Y1B68		Spindle oscillation command [M8]
Y18C9	Y1929	Y1989	Y19E9	Y1A49	Y1AA9	Y1B09	Y1B69	WGTC	Spindle control : Coil changeover gate cutoff timer interruption [C80]
Y18CA	Y192A	Y198A	Y19EA	Y1A4A	Y1AAA	Y1B0A	Y1B6A	VGHLC	Real-time tuning 1: Speed control gain changeover hold-down command [M8]

PLC -> CNC

Device No.								Abbrev.	Signal name
\$1	\$2	\$3	\$4	\$5	\$6	\$7	\$8		
YCD1	YE11	YF51	Y1091	Y11D1	Y1311	Y1451	Y1591		Spindle-spindle polygon cancel
YCD2	YE12	YF52	Y1092	Y11D2	Y1312	Y1452	Y1592		Synchronized tapping command polarity reversal
YCD3	YE13	YF53	Y1093	Y11D3	Y1313	Y1453	Y1593		Spindle OFF mode
YCE1	YE21	YF61	Y10A1	Y11E1	Y1321	Y1461	Y15A1		Door open II
YCE2	YE22	YF62	Y10A2	Y11E2	Y1322	Y1462	Y15A2		Door open signal input (spindle speed monitor)
YCE3	YE23	YF63	Y10A3	Y11E3	Y1323	Y1463	Y15A3		Door interlock spindle speed clamp

PLC -> CNC

Device No.								Abbrev.	Signal name
1stSP	2ndSP	3rdSP	4thSP	5thSP	6thSP	7thSP	8thSP		
R7000	R7050	R7100	R7150	R7200	R7250	R7300	R7350		Spindle command rotation speed output (L)
R7001	R7051	R7101	R7151	R7201	R7251	R7301	R7351		Spindle command rotation speed output (H)
R7002	R7052	R7102	R7152	R7202	R7252	R7302	R7352	SLSP	Spindle command selection
R7003	R7053	R7103	R7153	R7203	R7253	R7303	R7353		Optimum acceleration/deceleration parameter group selection [spindle] ▲
R7004	R7054	R7104	R7154	R7204	R7254	R7304	R7354		Spindle target machining time ▲
R7008	R7058	R7108	R7158	R7208	R7258	R7308	R7358		S command override
R7009	R7059	R7109	R7159	R7209	R7259	R7309	R7359		Multi-point orientation position data
R7010	R7060	R7110	R7160	R7210	R7260	R7310	R7360	ORDIR	Orientation rotation direction ▲
R7016	R7066	R7116	R7166	R7216	R7266	R7316	R7366		Spindle synchronization Reference spindle selection
R7017	R7067	R7117	R7167	R7217	R7267	R7317	R7367		Spindle synchronization synchronized spindle selection
R7018	R7068	R7118	R7168	R7218	R7268	R7318	R7368		Spindle synchronization Phase shift amount
R7019	R7069	R7119	R7169	R7219	R7269	R7319	R7369		Spindle synchronization phase error tolerance
R7020	R7070	R7120	R7170	R7220	R7270	R7320	R7370		Spindle oscillation amplitude [M8]
R7021	R7071	R7121	R7171	R7221	R7271	R7321	R7371		Spindle oscillation frequency [M8]

Device No.								Abbrev.	Signal name
\$1	\$2	\$3	\$4	\$5	\$6	\$7	\$8		
R2567	R2767	R2967	R3167	R3367	R3567	R3767	R3967		Encoder selection

(7) ATC file register (PLC dedicated instruction)

Device	Abbrev.	Signal name	Device	Abbrev.	Signal name
R10600		ATC control parameter	R10610		No.1 magazine number of magazines designation
R10601			R10611		No.2 magazine number of magazines designation
R10602			R10612		No.3 magazine number of magazines designation
R10603		Display tool selection parameter	R10613		No.4 magazine number of magazines designation
R10604		AUX data	R10614		No.5 magazine number of magazines designation
R10605			R10615		No.1 magazine pointer designation
R10606			R10616		No.2 magazine pointer designation
R10607			R10617		No.3 magazine pointer designation
R10608			R10618		No.4 magazine pointer designation
R10609			R10619		No.5 magazine pointer designation

Tool data			Signal name
T4-digit command	T8-digit command	Aux. D	
R10620	R10620/R10621	R10670	No.1 magazine spindle tool
R10621	R10622/R10623	R10671	No.1 magazine standby 1 tool
R10622	R10624/R10625	R10672	No.1 magazine standby 2 tool
R10623	R10626/R10627	R10673	No.1 magazine standby 3 tool
R10624	R10628/R10629	R10674	No.1 magazine standby 4 tool
R10630	R10630/R10631	R10675	No.2 magazine spindle tool
R10631	R10632/R10633	R10676	No.2 magazine standby 1 tool
R10632	R10634/R10635	R10677	No.2 magazine standby 2 tool
R10633	R10636/R10637	R10678	No.2 magazine standby 3 tool
R10634	R10638/R10639	R10679	No.2 magazine standby 4 tool

Tool data			Signal name
T4-digit command	T8-digit command	Aux. D	
R10640	R10640/R10641	R10680	No.3 magazine spindle tool
R10641	R10642/R10643	R10681	No.3 magazine standby 1 tool
R10642	R10644/R10645	R10682	No.3 magazine standby 2 tool
R10643	R10646/R10647	R10683	No.3 magazine standby 3 tool
R10644	R10648/R10649	R10684	No.3 magazine standby 4 tool
R10650	R10650/R10651	R10685	No.4 magazine spindle tool
R10651	R10652/R10653	R10686	No.4 magazine standby 1 tool
R10652	R10654/R10655	R10687	No.4 magazine standby 2 tool
R10653	R10656/R10657	R10688	No.4 magazine standby 3 tool
R10654	R10658/R10659	R10689	No.4 magazine standby 4 tool
R10660	R10660/R10661	R10690	No.5 magazine spindle tool
R10661	R10662/R10663	R10691	No.5 magazine standby 1 tool
R10662	R10664/R10665	R10692	No.5 magazine standby 2 tool
R10663	R10666/R10667	R10693	No.5 magazine standby 3 tool
R10664	R10668/R10669	R10694	No.5 magazine standby 4 tool

Device	Abbrev.	Signal name
R10695		No.1 magazine pot head No.
R10696		No.2 magazine pot head No.
R10697		No.3 magazine pot head No.
R10698		No.4 magazine pot head No.
R10699		No.5 magazine pot head No.

[Not assigned arbitrarily (No.1 magazine)] (common to part systems)

Tool data (No.1 magazine)			Pot		Tool data (No.1 magazine)			Pot
T4-digit command	T8-digit command	Aux. D			T4-digit command	T8-digit command	Aux. D	
R10700	R10700/R10701	R10940	Pot 1		R10740	R10780/R10781	R10980	Pot 41
R10701	R10702/R10703	R10941	Pot 2		R10741	R10782/R10783	R10981	Pot 42
R10702	R10704/R10705	R10942	Pot 3		R10742	R10784/R10785	R10982	Pot 43
R10703	R10706/R10707	R10943	Pot 4		R10743	R10786/R10787	R10983	Pot 44
R10704	R10708/R10709	R10944	Pot 5		R10744	R10788/R10789	R10984	Pot 45
R10705	R10710/R10711	R10945	Pot 6		R10745	R10790/R10791	R10985	Pot 46
R10706	R10712/R10713	R10946	Pot 7		R10746	R10792/R10793	R10986	Pot 47
R10707	R10714/R10715	R10947	Pot 8		R10747	R10794/R10795	R10987	Pot 48
R10708	R10716/R10717	R10948	Pot 9		R10748	R10796/R10797	R10988	Pot 49
R10709	R10718/R10719	R10949	Pot 10		R10749	R10798/R10799	R10989	Pot 50
R10710	R10720/R10721	R10950	Pot 11		R10750	R10800/R10801	R10990	Pot 51
R10711	R10722/R10723	R10951	Pot 12		R10751	R10802/R10803	R10991	Pot 52
R10712	R10724/R10725	R10952	Pot 13		R10752	R10804/R10805	R10992	Pot 53
R10713	R10726/R10727	R10953	Pot 14		R10753	R10806/R10807	R10993	Pot 54
R10714	R10728/R10729	R10954	Pot 15		R10754	R10808/R10809	R10994	Pot 55
R10715	R10730/R10731	R10955	Pot 16		R10755	R10810/R10811	R10995	Pot 56
R10716	R10732/R10733	R10956	Pot 17		R10756	R10812/R10813	R10996	Pot 57
R10717	R10734/R10735	R10957	Pot 18		R10757	R10814/R10815	R10997	Pot 58
R10718	R10736/R10737	R10958	Pot 19		R10758	R10816/R10817	R10998	Pot 59
R10719	R10738/R10739	R10959	Pot 20		R10759	R10818/R10819	R10999	Pot 60
R10720	R10740/R10741	R10960	Pot 21		R10760	R10820/R10821	R11000	Pot 61
R10721	R10742/R10743	R10961	Pot 22		R10761	R10822/R10823	R11001	Pot 62
R10722	R10744/R10745	R10962	Pot 23		R10762	R10824/R10825	R11002	Pot 63
R10723	R10746/R10747	R10963	Pot 24		R10763	R10826/R10827	R11003	Pot 64
R10724	R10748/R10749	R10964	Pot 25		R10764	R10828/R10829	R11004	Pot 65
R10725	R10750/R10751	R10965	Pot 26		R10765	R10830/R10831	R11005	Pot 66
R10726	R10752/R10753	R10966	Pot 27		R10766	R10832/R10833	R11006	Pot 67
R10727	R10754/R10755	R10967	Pot 28		R10767	R10834/R10835	R11007	Pot 68
R10728	R10756/R10757	R10968	Pot 29		R10768	R10836/R10837	R11008	Pot 69
R10729	R10758/R10759	R10969	Pot 30		R10769	R10838/R10839	R11009	Pot 70
R10730	R10760/R10761	R10970	Pot 31		R10770	R10840/R10841	R11010	Pot 71
R10731	R10762/R10763	R10971	Pot 32		R10771	R10842/R10843	R11011	Pot 72
R10732	R10764/R10765	R10972	Pot 33		R10772	R10844/R10845	R11012	Pot 73
R10733	R10766/R10767	R10973	Pot 34		R10773	R10846/R10847	R11013	Pot 74
R10734	R10768/R10769	R10974	Pot 35		R10774	R10848/R10849	R11014	Pot 75
R10735	R10770/R10771	R10975	Pot 36		R10775	R10850/R10851	R11015	Pot 76
R10736	R10772/R10773	R10976	Pot 37		R10776	R10852/R10853	R11016	Pot 77
R10737	R10774/R10775	R10977	Pot 38		R10777	R10854/R10855	R11017	Pot 78
R10738	R10776/R10777	R10978	Pot 39		R10778	R10856/R10857	R11018	Pot 79
R10739	R10778/R10779	R10979	Pot 40		R10779	R10858/R10859	R11019	Pot 80

Tool data (No.1 magazine)			Pot		Tool data (No.1 magazine) (*1)			Pot
T4-digit command	T8-digit command	Aux. D			T4-digit command	T8-digit command	Aux. D	
R10780	R10860/R10861	R11020	Pot 81		ZR4000	ZR4000/ZR4001	ZR4160	Pot 121
R10781	R10862/R10863	R11021	Pot 82		ZR4001	ZR4002/ZR4003	ZR4161	Pot 122
R10782	R10864/R10865	R11022	Pot 83		ZR4002	ZR4004/ZR4005	ZR4162	Pot 123
R10783	R10866/R10867	R11023	Pot 84		ZR4003	ZR4006/ZR4007	ZR4163	Pot 124
R10784	R10868/R10869	R11024	Pot 85		ZR4004	ZR4008/ZR4009	ZR4164	Pot 125
R10785	R10870/R10871	R11025	Pot 86		ZR4005	ZR4010/ZR4011	ZR4165	Pot 126
R10786	R10872/R10873	R11026	Pot 87		ZR4006	ZR4012/ZR4013	ZR4166	Pot 127
R10787	R10874/R10875	R11027	Pot 88		ZR4007	ZR4014/ZR4015	ZR4167	Pot 128
R10788	R10876/R10877	R11028	Pot 89		ZR4008	ZR4016/ZR4017	ZR4168	Pot 129
R10789	R10878/R10879	R11029	Pot 90		ZR4009	ZR4018/ZR4019	ZR4169	Pot 130
R10790	R10880/R10881	R11030	Pot 91		ZR4010	ZR4020/ZR4021	ZR4170	Pot 131
R10791	R10882/R10883	R11031	Pot 92		ZR4011	ZR4022/ZR4023	ZR4171	Pot 132
R10792	R10884/R10885	R11032	Pot 93		ZR4012	ZR4024/ZR4025	ZR4172	Pot 133
R10793	R10886/R10887	R11033	Pot 94		ZR4013	ZR4026/ZR4027	ZR4173	Pot 134
R10794	R10888/R10889	R11034	Pot 95		ZR4014	ZR4028/ZR4029	ZR4174	Pot 135
R10795	R10890/R10891	R11035	Pot 96		ZR4015	ZR4030/ZR4031	ZR4175	Pot 136
R10796	R10892/R10893	R11036	Pot 97		ZR4016	ZR4032/ZR4033	ZR4176	Pot 137
R10797	R10894/R10895	R11037	Pot 98		ZR4017	ZR4034/ZR4035	ZR4177	Pot 138
R10798	R10896/R10897	R11038	Pot 99		ZR4018	ZR4036/ZR4037	ZR4178	Pot 139
R10799	R10898/R10899	R11039	Pot 100		ZR4019	ZR4038/ZR4039	ZR4179	Pot 140
R10800	R10900/R10901	R11040	Pot 101		ZR4020	ZR4040/ZR4041	ZR4180	Pot 141
R10801	R10902/R10903	R11041	Pot 102		ZR4021	ZR4042/ZR4043	ZR4181	Pot 142
R10802	R10904/R10905	R11042	Pot 103		ZR4022	ZR4044/ZR4045	ZR4182	Pot 143
R10803	R10906/R10907	R11043	Pot 104		ZR4023	ZR4046/ZR4047	ZR4183	Pot 144
R10804	R10908/R10909	R11044	Pot 105		ZR4024	ZR4048/ZR4049	ZR4184	Pot 145
R10805	R10910/R10911	R11045	Pot 106		ZR4025	ZR4050/ZR4051	ZR4185	Pot 146
R10806	R10912/R10913	R11046	Pot 107		ZR4026	ZR4052/ZR4053	ZR4186	Pot 147
R10807	R10914/R10915	R11047	Pot 108		ZR4027	ZR4054/ZR4055	ZR4187	Pot 148
R10808	R10916/R10917	R11048	Pot 109		ZR4028	ZR4056/ZR4057	ZR4188	Pot 149
R10809	R10918/R10919	R11049	Pot 110		ZR4029	ZR4058/ZR4059	ZR4189	Pot 150
R10810	R10920/R10921	R11050	Pot 111		ZR4030	ZR4060/ZR4061	ZR4190	Pot 151
R10811	R10922/R10923	R11051	Pot 112		ZR4031	ZR4062/ZR4063	ZR4191	Pot 152
R10812	R10924/R10925	R11052	Pot 113		ZR4032	ZR4064/ZR4065	ZR4192	Pot 153
R10813	R10926/R10927	R11053	Pot 114		ZR4033	ZR4066/ZR4067	ZR4193	Pot 154
R10814	R10928/R10929	R11054	Pot 115		ZR4034	ZR4068/ZR4069	ZR4194	Pot 155
R10815	R10930/R10931	R11055	Pot 116		ZR4035	ZR4070/ZR4071	ZR4195	Pot 156
R10816	R10932/R10933	R11056	Pot 117		ZR4036	ZR4072/ZR4073	ZR4196	Pot 157
R10817	R10934/R10935	R11057	Pot 118		ZR4037	ZR4074/ZR4075	ZR4197	Pot 158
R10818	R10936/R10937	R11058	Pot 119		ZR4038	ZR4076/ZR4077	ZR4198	Pot 159
R10819	R10938/R10939	R11059	Pot 120		ZR4039	ZR4078/ZR4079	ZR4199	Pot 160

(*1) The devices ZR4000 to ZR4719 can be used in only M8 Series.

Tool data (No.1 magazine) (*1)			Pot
T4-digit command	T8-digit command	Aux. D	
ZR4040	ZR4080/ZR4081	ZR4200	Pot 161
ZR4041	ZR4082/ZR4083	ZR4201	Pot 162
ZR4042	ZR4084/ZR4085	ZR4202	Pot 163
ZR4043	ZR4086/ZR4087	ZR4203	Pot 164
ZR4044	ZR4088/ZR4089	ZR4204	Pot 165
ZR4045	ZR4090/ZR4091	ZR4205	Pot 166
ZR4046	ZR4092/ZR4093	ZR4206	Pot 167
ZR4047	ZR4094/ZR4095	ZR4207	Pot 168
ZR4048	ZR4096/ZR4097	ZR4208	Pot 169
ZR4049	ZR4098/ZR4099	ZR4209	Pot 170
ZR4050	ZR4100/ZR4101	ZR4210	Pot 171
ZR4051	ZR4102/ZR4103	ZR4211	Pot 172
ZR4052	ZR4104/ZR4105	ZR4212	Pot 173
ZR4053	ZR4106/ZR4107	ZR4213	Pot 174
ZR4054	ZR4108/ZR4109	ZR4214	Pot 175
ZR4055	ZR4110/ZR4111	ZR4215	Pot 176
ZR4056	ZR4112/ZR4113	ZR4216	Pot 177
ZR4057	ZR4114/ZR4115	ZR4217	Pot 178
ZR4058	ZR4116/ZR4117	ZR4218	Pot 179
ZR4059	ZR4118/ZR4119	ZR4219	Pot 180
ZR4060	ZR4120/ZR4121	ZR4220	Pot 181
ZR4061	ZR4122/ZR4123	ZR4221	Pot 182
ZR4062	ZR4124/ZR4125	ZR4222	Pot 183
ZR4063	ZR4126/ZR4127	ZR4223	Pot 184
ZR4064	ZR4128/ZR4129	ZR4224	Pot 185
ZR4065	ZR4130/ZR4131	ZR4225	Pot 186
ZR4066	ZR4132/ZR4133	ZR4226	Pot 187
ZR4067	ZR4134/ZR4135	ZR4227	Pot 188
ZR4068	ZR4136/ZR4137	ZR4228	Pot 189
ZR4069	ZR4138/ZR4139	ZR4229	Pot 190
ZR4070	ZR4140/ZR4141	ZR4230	Pot 191
ZR4071	ZR4142/ZR4143	ZR4231	Pot 192
ZR4072	ZR4144/ZR4145	ZR4232	Pot 193
ZR4073	ZR4146/ZR4147	ZR4233	Pot 194
ZR4074	ZR4148/ZR4149	ZR4234	Pot 195
ZR4075	ZR4150/ZR4151	ZR4235	Pot 196
ZR4076	ZR4152/ZR4153	ZR4236	Pot 197
ZR4077	ZR4154/ZR4155	ZR4237	Pot 198
ZR4078	ZR4156/ZR4157	ZR4238	Pot 199
ZR4079	ZR4158/ZR4159	ZR4239	Pot 200

(*1) The devices ZR4000 to ZR4719 can be used in only M8 Series.

[Not assigned arbitrarily (No.2 magazine)] (common to part systems)

Tool data (No.2 magazine)			Pot		Tool data (No.2 magazine)			Pot
T4-digit command	T8-digit command	Aux. D			T4-digit command	T8-digit command	Aux. D	
R11060	R11060/R11061	R11300	Pot 1		R11100	R11140/R11141	R11340	Pot 41
R11061	R11062/R11063	R11301	Pot 2		R11101	R11142/R11143	R11341	Pot 42
R11062	R11064/R11065	R11302	Pot 3		R11102	R11144/R11145	R11342	Pot 43
R11063	R11066/R11067	R11303	Pot 4		R11103	R11146/R11147	R11343	Pot 44
R11064	R11068/R11069	R11304	Pot 5		R11104	R11148/R11149	R11344	Pot 45
R11065	R11070/R11071	R11305	Pot 6		R11105	R11150/R11151	R11345	Pot 46
R11066	R11072/R11073	R11306	Pot 7		R11106	R11152/R11153	R11346	Pot 47
R11067	R11074/R11075	R11307	Pot 8		R11107	R11154/R11155	R11347	Pot 48
R11068	R11076/R11077	R11308	Pot 9		R11108	R11156/R11157	R11348	Pot 49
R11069	R11078/R11079	R11309	Pot 10		R11109	R11158/R11159	R11349	Pot 50
R11070	R11080/R11081	R11310	Pot 11		R11110	R11160/R11161	R11350	Pot 51
R11071	R11082/R11083	R11311	Pot 12		R11111	R11162/R11163	R11351	Pot 52
R11072	R11084/R11085	R11312	Pot 13		R11112	R11164/R11165	R11352	Pot 53
R11073	R11086/R11087	R11313	Pot 14		R11113	R11166/R11167	R11353	Pot 54
R11074	R11088/R11089	R11314	Pot 15		R11114	R11168/R11169	R11354	Pot 55
R11075	R11090/R11091	R11315	Pot 16		R11115	R11170/R11171	R11355	Pot 56
R11076	R11092/R11093	R11316	Pot 17		R11116	R11172/R11173	R11356	Pot 57
R11077	R11094/R11095	R11317	Pot 18		R11117	R11174/R11175	R11357	Pot 58
R11078	R11096/R11097	R11318	Pot 19		R11118	R11176/R11177	R11358	Pot 59
R11079	R11098/R11099	R11319	Pot 20		R11119	R11178/R11179	R11359	Pot 60
R11080	R11100/R11101	R11320	Pot 21		R11120	R11180/R11181	R11360	Pot 61
R11081	R11102/R11103	R11321	Pot 22		R11121	R11182/R11183	R11361	Pot 62
R11082	R11104/R11105	R11322	Pot 23		R11122	R11184/R11185	R11362	Pot 63
R11083	R11106/R11107	R11323	Pot 24		R11123	R11186/R11187	R11363	Pot 64
R11084	R11108/R11109	R11324	Pot 25		R11124	R11188/R11189	R11364	Pot 65
R11085	R11110/R11111	R11325	Pot 26		R11125	R11190/R11191	R11365	Pot 66
R11086	R11112/R11113	R11326	Pot 27		R11126	R11192/R11193	R11366	Pot 67
R11087	R11114/R11115	R11327	Pot 28		R11127	R11194/R11195	R11367	Pot 68
R11088	R11116/R11117	R11328	Pot 29		R11128	R11196/R11197	R11368	Pot 69
R11089	R11118/R11119	R11329	Pot 30		R11129	R11198/R11199	R11369	Pot 70
R11090	R11120/R11121	R11330	Pot 31		R11130	R11200/R11201	R11370	Pot 71
R11091	R11122/R11123	R11331	Pot 32		R11131	R11202/R11203	R11371	Pot 72
R11092	R11124/R11125	R11332	Pot 33		R11132	R11204/R11205	R11372	Pot 73
R11093	R11126/R11127	R11333	Pot 34		R11133	R11206/R11207	R11373	Pot 74
R11094	R11128/R11129	R11334	Pot 35		R11134	R11208/R11209	R11374	Pot 75
R11095	R11130/R11131	R11335	Pot 36		R11135	R11210/R11211	R11375	Pot 76
R11096	R11132/R11133	R11336	Pot 37		R11136	R11212/R11213	R11376	Pot 77
R11097	R11134/R11135	R11337	Pot 38		R11137	R11214/R11215	R11377	Pot 78
R11098	R11136/R11137	R11338	Pot 39		R11138	R11216/R11217	R11378	Pot 79
R11099	R11138/R11139	R11339	Pot 40		R11139	R11218/R11219	R11379	Pot 80

Tool data (No.2 magazine)			Pot		Tool data (No.2 magazine) (*1)			Pot
T4-digit command	T8-digit command	Aux. D			T4-digit command	T8-digit command	Aux. D	
R11140	R11220/R11221	R11380	Pot 81		ZR4240	ZR4240/ZR4241	ZR4400	Pot 121
R11141	R11222/R11223	R11381	Pot 82		ZR4241	ZR4242/ZR4243	ZR4401	Pot 122
R11142	R11224/R11225	R11382	Pot 83		ZR4242	ZR4244/ZR4245	ZR4402	Pot 123
R11143	R11226/R11227	R11383	Pot 84		ZR4243	ZR4246/ZR4247	ZR4403	Pot 124
R11144	R11228/R11229	R11384	Pot 85		ZR4244	ZR4248/ZR4249	ZR4404	Pot 125
R11145	R11230/R11231	R11385	Pot 86		ZR4245	ZR4250/ZR4251	ZR4405	Pot 126
R11146	R11232/R11233	R11386	Pot 87		ZR4246	ZR4252/ZR4253	ZR4406	Pot 127
R11147	R11234/R11235	R11387	Pot 88		ZR4247	ZR4254/ZR4255	ZR4407	Pot 128
R11148	R11236/R11237	R11388	Pot 89		ZR4248	ZR4256/ZR4257	ZR4408	Pot 129
R11149	R11238/R11239	R11389	Pot 90		ZR4249	ZR4258/ZR4259	ZR4409	Pot 130
R11150	R11240/R11241	R11390	Pot 91		ZR4250	ZR4260/ZR4261	ZR4410	Pot 131
R11151	R11242/R11243	R11391	Pot 92		ZR4251	ZR4262/ZR4263	ZR4411	Pot 132
R11152	R11244/R11245	R11392	Pot 93		ZR4252	ZR4264/ZR4265	ZR4412	Pot 133
R11153	R11246/R11247	R11393	Pot 94		ZR4253	ZR4266/ZR4267	ZR4413	Pot 134
R11154	R11248/R11249	R11394	Pot 95		ZR4254	ZR4268/ZR4269	ZR4414	Pot 135
R11155	R11250/R11251	R11395	Pot 96		ZR4255	ZR4270/ZR4271	ZR4415	Pot 136
R11156	R11252/R11253	R11396	Pot 97		ZR4256	ZR4272/ZR4273	ZR4416	Pot 137
R11157	R11254/R11255	R11397	Pot 98		ZR4257	ZR4274/ZR4275	ZR4417	Pot 138
R11158	R11256/R11257	R11398	Pot 99		ZR4258	ZR4276/ZR4277	ZR4418	Pot 139
R11159	R11258/R11259	R11399	Pot 100		ZR4259	ZR4278/ZR4279	ZR4419	Pot 140
R11160	R11260/R11261	R11400	Pot 101		ZR4260	ZR4280/ZR4281	ZR4420	Pot 141
R11161	R11262/R11263	R11401	Pot 102		ZR4261	ZR4282/ZR4283	ZR4421	Pot 142
R11162	R11264/R11265	R11402	Pot 103		ZR4262	ZR4284/ZR4285	ZR4422	Pot 143
R11163	R11266/R11267	R11403	Pot 104		ZR4263	ZR4286/ZR4287	ZR4423	Pot 144
R11164	R11268/R11269	R11404	Pot 105		ZR4264	ZR4288/ZR4289	ZR4424	Pot 145
R11165	R11270/R11271	R11405	Pot 106		ZR4265	ZR4290/ZR4291	ZR4425	Pot 146
R11166	R11272/R11273	R11406	Pot 107		ZR4266	ZR4292/ZR4293	ZR4426	Pot 147
R11167	R11274/R11275	R11407	Pot 108		ZR4267	ZR4294/ZR4295	ZR4427	Pot 148
R11168	R11276/R11277	R11408	Pot 109		ZR4268	ZR4296/ZR4297	ZR4428	Pot 149
R11169	R11278/R11279	R11409	Pot 110		ZR4269	ZR4298/ZR4299	ZR4429	Pot 150
R11170	R11280/R11281	R11410	Pot 111		ZR4270	ZR4300/ZR4301	ZR4430	Pot 151
R11171	R11282/R11283	R11411	Pot 112		ZR4271	ZR4302/ZR4303	ZR4431	Pot 152
R11172	R11284/R11285	R11412	Pot 113		ZR4272	ZR4304/ZR4305	ZR4432	Pot 153
R11173	R11286/R11287	R11413	Pot 114		ZR4273	ZR4306/ZR4307	ZR4433	Pot 154
R11174	R11288/R11289	R11414	Pot 115		ZR4274	ZR4308/ZR4309	ZR4434	Pot 155
R11175	R11290/R11291	R11415	Pot 116		ZR4275	ZR4310/ZR4311	ZR4435	Pot 156
R11176	R11292/R11293	R11416	Pot 117		ZR4276	ZR4312/ZR4313	ZR4436	Pot 157
R11177	R11294/R11295	R11417	Pot 118		ZR4277	ZR4314/ZR4315	ZR4437	Pot 158
R11178	R11296/R11297	R11418	Pot 119		ZR4278	ZR4316/ZR4317	ZR4438	Pot 159
R11179	R11298/R11299	R11419	Pot 120		ZR4279	ZR4318/ZR4319	ZR4439	Pot 160

(*1) The devices ZR4000 to ZR4719 can be used in only M8 Series.

Tool data (No.2 magazine) (*1)			Pot
T4-digit command	T8-digit command	Aux. D	
ZR4280	ZR4320/ZR4321	ZR4440	Pot 161
ZR4281	ZR4322/ZR4323	ZR4441	Pot 162
ZR4282	ZR4324/ZR4325	ZR4442	Pot 163
ZR4283	ZR4326/ZR4327	ZR4443	Pot 164
ZR4284	ZR4328/ZR4329	ZR4444	Pot 165
ZR4285	ZR4330/ZR4331	ZR4445	Pot 166
ZR4286	ZR4332/ZR4333	ZR4446	Pot 167
ZR4287	ZR4334/ZR4335	ZR4447	Pot 168
ZR4288	ZR4336/ZR4337	ZR4448	Pot 169
ZR4289	ZR4338/ZR4339	ZR4449	Pot 170
ZR4290	ZR4340/ZR4341	ZR4450	Pot 171
ZR4291	ZR4342/ZR4343	ZR4451	Pot 172
ZR4292	ZR4344/ZR4345	ZR4452	Pot 173
ZR4293	ZR4346/ZR4347	ZR4453	Pot 174
ZR4294	ZR4348/ZR4349	ZR4454	Pot 175
ZR4295	ZR4350/ZR4351	ZR4455	Pot 176
ZR4296	ZR4352/ZR4353	ZR4456	Pot 177
ZR4297	ZR4354/ZR4355	ZR4457	Pot 178
ZR4298	ZR4356/ZR4357	ZR4458	Pot 179
ZR4299	ZR4358/ZR4359	ZR4459	Pot 180
ZR4300	ZR4360/ZR4361	ZR4460	Pot 181
ZR4301	ZR4362/ZR4363	ZR4461	Pot 182
ZR4302	ZR4364/ZR4365	ZR4462	Pot 183
ZR4303	ZR4366/ZR4367	ZR4463	Pot 184
ZR4304	ZR4368/ZR4369	ZR4464	Pot 185
ZR4305	ZR4370/ZR4371	ZR4465	Pot 186
ZR4306	ZR4372/ZR4373	ZR4466	Pot 187
ZR4307	ZR4374/ZR4375	ZR4467	Pot 188
ZR4308	ZR4376/ZR4377	ZR4468	Pot 189
ZR4309	ZR4378/ZR4379	ZR4469	Pot 190
ZR4310	ZR4380/ZR4381	ZR4470	Pot 191
ZR4311	ZR4382/ZR4383	ZR4471	Pot 192
ZR4312	ZR4384/ZR4385	ZR4472	Pot 193
ZR4313	ZR4386/ZR4387	ZR4473	Pot 194
ZR4314	ZR4388/ZR4389	ZR4474	Pot 195
ZR4315	ZR4390/ZR4391	ZR4475	Pot 196
ZR4316	ZR4392/ZR4393	ZR4476	Pot 197
ZR4317	ZR4394/ZR4395	ZR4477	Pot 198
ZR4318	ZR4396/ZR4397	ZR4478	Pot 199
ZR4319	ZR4398/ZR4399	ZR4479	Pot 200

(*1) The devices ZR4000 to ZR4719 can be used in only M8 Series.

[Not assigned arbitrarily (No.3 magazine)] (common to part systems)

Tool data (No.3 magazine)			Pot		Tool data (No.3 magazine)			Pot
T4-digit command	T8-digit command	Aux. D			T4-digit command	T8-digit command	Aux. D	
R11420	R11420/R11421	R11660	Pot 1		R11460	R11500/R11501	R11700	Pot 41
R11421	R11422/R11423	R11661	Pot 2		R11461	R11502/R11503	R11701	Pot 42
R11422	R11424/R11425	R11662	Pot 3		R11462	R11504/R11505	R11702	Pot 43
R11423	R11426/R11427	R11663	Pot 4		R11463	R11506/R11507	R11703	Pot 44
R11424	R11428/R11429	R11664	Pot 5		R11464	R11508/R11509	R11704	Pot 45
R11425	R11430/R11431	R11665	Pot 6		R11465	R11510/R11511	R11705	Pot 46
R11426	R11432/R11433	R11666	Pot 7		R11466	R11512/R11513	R11706	Pot 47
R11427	R11434/R11435	R11667	Pot 8		R11467	R11514/R11515	R11707	Pot 48
R11428	R11436/R11437	R11668	Pot 9		R11468	R11516/R11517	R11708	Pot 49
R11429	R11438/R11439	R11669	Pot 10		R11469	R11518/R11519	R11709	Pot 50
R11430	R11440/R11441	R11670	Pot 11		R11470	R11520/R11521	R11710	Pot 51
R11431	R11442/R11443	R11671	Pot 12		R11471	R11522/R11523	R11711	Pot 52
R11432	R11444/R11445	R11672	Pot 13		R11472	R11524/R11525	R11712	Pot 53
R11433	R11446/R11447	R11673	Pot 14		R11473	R11526/R11527	R11713	Pot 54
R11434	R11448/R11449	R11674	Pot 15		R11474	R11528/R11529	R11714	Pot 55
R11435	R11450/R11451	R11675	Pot 16		R11475	R11530/R11531	R11715	Pot 56
R11436	R11452/R11453	R11676	Pot 17		R11476	R11532/R11533	R11716	Pot 57
R11437	R11454/R11455	R11677	Pot 18		R11477	R11534/R11535	R11717	Pot 58
R11438	R11456/R11457	R11678	Pot 19		R11478	R11536/R11537	R11718	Pot 59
R11439	R11458/R11459	R11679	Pot 20		R11479	R11538/R11539	R11719	Pot 60
R11440	R11460/R11461	R11680	Pot 21		R11480	R11540/R11541	R11720	Pot 61
R11441	R11462/R11463	R11681	Pot 22		R11481	R11542/R11543	R11721	Pot 62
R11442	R11464/R11465	R11682	Pot 23		R11482	R11544/R11545	R11722	Pot 63
R11443	R11466/R11467	R11683	Pot 24		R11483	R11546/R11547	R11723	Pot 64
R11444	R11468/R11469	R11684	Pot 25		R11484	R11548/R11549	R11724	Pot 65
R11445	R11470/R11471	R11685	Pot 26		R11485	R11550/R11551	R11725	Pot 66
R11446	R11472/R11473	R11686	Pot 27		R11486	R11552/R11553	R11726	Pot 67
R11447	R11474/R11475	R11687	Pot 28		R11487	R11554/R11555	R11727	Pot 68
R11448	R11476/R11477	R11688	Pot 29		R11488	R11556/R11557	R11728	Pot 69
R11449	R11478/R11479	R11689	Pot 30		R11489	R11558/R11559	R11729	Pot 70
R11450	R11480/R11481	R11690	Pot 31		R11490	R11560/R11561	R11730	Pot 71
R11451	R11482/R11483	R11691	Pot 32		R11491	R11562/R11563	R11731	Pot 72
R11452	R11484/R11485	R11692	Pot 33		R11492	R11564/R11565	R11732	Pot 73
R11453	R11486/R11487	R11693	Pot 34		R11493	R11566/R11567	R11733	Pot 74
R11454	R11488/R11489	R11694	Pot 35		R11494	R11568/R11569	R11734	Pot 75
R11455	R11490/R11491	R11695	Pot 36		R11495	R11570/R11571	R11735	Pot 76
R11456	R11492/R11493	R11696	Pot 37		R11496	R11572/R11573	R11736	Pot 77
R11457	R11494/R11495	R11697	Pot 38		R11497	R11574/R11575	R11737	Pot 78
R11458	R11496/R11497	R11698	Pot 39		R11498	R11576/R11577	R11738	Pot 79
R11459	R11498/R11499	R11699	Pot 40		R11499	R11578/R11579	R11739	Pot 80

Tool data (No.3 magazine)			Pot		Tool data (No.3 magazine) (*1)			Pot
T4-digit command	T8-digit command	Aux. D			T4-digit command	T8-digit command	Aux. D	
R11500	R11580/R11581	R11740	Pot 81		ZR4480	ZR4480/ZR4481	ZR4640	Pot 121
R11501	R11582/R11583	R11741	Pot 82		ZR4481	ZR4482/ZR4483	ZR4641	Pot 122
R11502	R11584/R11585	R11742	Pot 83		ZR4482	ZR4484/ZR4485	ZR4642	Pot 123
R11503	R11586/R11587	R11743	Pot 84		ZR4483	ZR4486/ZR4487	ZR4643	Pot 124
R11504	R11588/R11589	R11744	Pot 85		ZR4484	ZR4488/ZR4489	ZR4644	Pot 125
R11505	R11590/R11591	R11745	Pot 86		ZR4485	ZR4490/ZR4491	ZR4645	Pot 126
R11506	R11592/R11593	R11746	Pot 87		ZR4486	ZR4492/ZR4493	ZR4646	Pot 127
R11507	R11594/R11595	R11747	Pot 88		ZR4487	ZR4494/ZR4495	ZR4647	Pot 128
R11508	R11596/R11597	R11748	Pot 89		ZR4488	ZR4496/ZR4497	ZR4648	Pot 129
R11509	R11598/R11599	R11749	Pot 90		ZR4489	ZR4498/ZR4499	ZR4649	Pot 130
R11510	R11600/R11601	R11750	Pot 91		ZR4490	ZR4500/ZR4501	ZR4650	Pot 131
R11511	R11602/R11603	R11751	Pot 92		ZR4491	ZR4502/ZR4503	ZR4651	Pot 132
R11512	R11604/R11605	R11752	Pot 93		ZR4492	ZR4504/ZR4505	ZR4652	Pot 133
R11513	R11606/R11607	R11753	Pot 94		ZR4493	ZR4506/ZR4507	ZR4653	Pot 134
R11514	R11608/R11609	R11754	Pot 95		ZR4494	ZR4508/ZR4509	ZR4654	Pot 135
R11515	R11610/R11611	R11755	Pot 96		ZR4495	ZR4510/ZR4511	ZR4655	Pot 136
R11516	R11612/R11613	R11756	Pot 97		ZR4496	ZR4512/ZR4513	ZR4656	Pot 137
R11517	R11614/R11615	R11757	Pot 98		ZR4497	ZR4514/ZR4515	ZR4657	Pot 138
R11518	R11616/R11617	R11758	Pot 99		ZR4498	ZR4516/ZR4517	ZR4658	Pot 139
R11519	R11618/R11619	R11759	Pot 100		ZR4499	ZR4518/ZR4519	ZR4659	Pot 140
R11520	R11620/R11621	R11760	Pot 101		ZR4500	ZR4520/ZR4521	ZR4660	Pot 141
R11521	R11622/R11623	R11761	Pot 102		ZR4501	ZR4522/ZR4523	ZR4661	Pot 142
R11522	R11624/R11625	R11762	Pot 103		ZR4502	ZR4524/ZR4525	ZR4662	Pot 143
R11523	R11626/R11627	R11763	Pot 104		ZR4503	ZR4526/ZR4527	ZR4663	Pot 144
R11524	R11628/R11629	R11764	Pot 105		ZR4504	ZR4528/ZR4529	ZR4664	Pot 145
R11525	R11630/R11631	R11765	Pot 106		ZR4505	ZR4530/ZR4531	ZR4665	Pot 146
R11526	R11632/R11633	R11766	Pot 107		ZR4506	ZR4532/ZR4533	ZR4666	Pot 147
R11527	R11634/R11635	R11767	Pot 108		ZR4507	ZR4534/ZR4535	ZR4667	Pot 148
R11528	R11636/R11637	R11768	Pot 109		ZR4508	ZR4536/ZR4537	ZR4668	Pot 149
R11529	R11638/R11639	R11769	Pot 110		ZR4509	ZR4538/ZR4539	ZR4669	Pot 150
R11530	R11640/R11641	R11770	Pot 111		ZR4510	ZR4540/ZR4541	ZR4670	Pot 151
R11531	R11642/R11643	R11771	Pot 112		ZR4511	ZR4542/ZR4543	ZR4671	Pot 152
R11532	R11644/R11645	R11772	Pot 113		ZR4512	ZR4544/ZR4545	ZR4672	Pot 153
R11533	R11646/R11647	R11773	Pot 114		ZR4513	ZR4546/ZR4547	ZR4673	Pot 154
R11534	R11648/R11649	R11774	Pot 115		ZR4514	ZR4548/ZR4549	ZR4674	Pot 155
R11535	R11650/R11651	R11775	Pot 116		ZR4515	ZR4550/ZR4551	ZR4675	Pot 156
R11536	R11652/R11653	R11776	Pot 117		ZR4516	ZR4552/ZR4553	ZR4676	Pot 157
R11537	R11654/R11655	R11777	Pot 118		ZR4517	ZR4554/ZR4555	ZR4677	Pot 158
R11538	R11656/R11657	R11778	Pot 119		ZR4518	ZR4556/ZR4557	ZR4678	Pot 159
R11539	R11658/R11659	R11779	Pot 120		ZR4519	ZR4558/ZR4559	ZR4679	Pot 160

(*1) The devices ZR4000 to ZR4719 can be used in only M8 Series.

Tool data (No.3 magazine) (*1)			Pot
T4-digit command	T8-digit command	Aux. D	
ZR4520	ZR4560/ZR4561	ZR4680	Pot 161
ZR4521	ZR4562/ZR4563	ZR4681	Pot 162
ZR4522	ZR4564/ZR4565	ZR4682	Pot 163
ZR4523	ZR4566/ZR4567	ZR4683	Pot 164
ZR4524	ZR4568/ZR4569	ZR4684	Pot 165
ZR4525	ZR4570/ZR4571	ZR4685	Pot 166
ZR4526	ZR4572/ZR4573	ZR4686	Pot 167
ZR4527	ZR4574/ZR4575	ZR4687	Pot 168
ZR4528	ZR4576/ZR4577	ZR4688	Pot 169
ZR4529	ZR4578/ZR4579	ZR4689	Pot 170
ZR4530	ZR4580/ZR4581	ZR4690	Pot 171
ZR4531	ZR4582/ZR4583	ZR4691	Pot 172
ZR4532	ZR4584/ZR4585	ZR4692	Pot 173
ZR4533	ZR4586/ZR4587	ZR4693	Pot 174
ZR4534	ZR4588/ZR4589	ZR4694	Pot 175
ZR4535	ZR4590/ZR4591	ZR4695	Pot 176
ZR4536	ZR4592/ZR4593	ZR4696	Pot 177
ZR4537	ZR4594/ZR4595	ZR4697	Pot 178
ZR4538	ZR4596/ZR4597	ZR4698	Pot 179
ZR4539	ZR4598/ZR4599	ZR4699	Pot 180
ZR4540	ZR4600/ZR4601	ZR4700	Pot 181
ZR4541	ZR4602/ZR4603	ZR4701	Pot 182
ZR4542	ZR4604/ZR4605	ZR4702	Pot 183
ZR4543	ZR4606/ZR4607	ZR4703	Pot 184
ZR4544	ZR4608/ZR4609	ZR4704	Pot 185
ZR4545	ZR4610/ZR4611	ZR4705	Pot 186
ZR4546	ZR4612/ZR4613	ZR4706	Pot 187
ZR4547	ZR4614/ZR4615	ZR4707	Pot 188
ZR4548	ZR4616/ZR4617	ZR4708	Pot 189
ZR4549	ZR4618/ZR4619	ZR4709	Pot 190
ZR4550	ZR4620/ZR4621	ZR4710	Pot 191
ZR4551	ZR4622/ZR4623	ZR4711	Pot 192
ZR4552	ZR4624/ZR4625	ZR4712	Pot 193
ZR4553	ZR4626/ZR4627	ZR4713	Pot 194
ZR4554	ZR4628/ZR4629	ZR4714	Pot 195
ZR4555	ZR4630/ZR4631	ZR4715	Pot 196
ZR4556	ZR4632/ZR4633	ZR4716	Pot 197
ZR4557	ZR4634/ZR4635	ZR4717	Pot 198
ZR4558	ZR4636/ZR4637	ZR4718	Pot 199
ZR4559	ZR4638/ZR4639	ZR4719	Pot 200

(*1) The devices ZR4000 to ZR4719 can be used in only M8 Series.

(8) PLC axis control data**[M8]**

Refer to the "PLC Programming Manual".

[C80]

<Sequencer → CNC>

Signal name	Abbrev.	Common(\$)
PLC axis near point detection n-th axis	*PCDn	Y718 to Y71F
PLC axis n-th handle valid	PCHn	Y720 to Y722, Y1CA0 to Y1CA5

Signal name	Abbrev.	Common(\$)
PLC axis OT ignored		R255
PLC axis near-point dog ignored		R279
PLC axis control: droop cancel invalid axis [C80]		R449

Signal name	PLC axis No.							
	1st	2nd	3rd	4th	5th	6th	7th	8th
PLC axis control valid n-th axis	Y770	Y771	Y772	Y773	Y774	Y775	Y776	Y777

Signal name	Common to all PLC axes
PLC axis control buffering mode valid	Y723

<PLC axis status: CNC → sequencer>

Signal name	PLC axis No.								Buffering mode		
	1st	2nd	3rd	4th	5th	6th	7th	8th	Data A	Data B	Data C
Status	D1540	D1550	D1560	D1570	D1580	D1590	D1600	D1610	D1620	D1630	D1640
Alarm contents	D1541	D1551	D1561	D1571	D1581	D1591	D1601	D1611	D1621	D1631	D1641
Machine position	D1542	D1552	D1562	D1572	D1582	D1592	D1602	D1612	D1622	D1632	D1642
	D1543	D1553	D1563	D1573	D1583	D1593	D1603	D1613	D1623	D1633	D1643
Remaining distance	D1544	D1554	D1564	D1574	D1584	D1594	D1604	D1614	D1624	D1634	D1644
	D1545	D1555	D1565	D1575	D1585	D1595	D1605	D1615	D1625	D1635	D1645
Status 2	D1546	D1556	D1566	D1576	D1586	D1596	D1606	D1616	-	-	-

<PLC axis command: sequencer → CNC>

Signal name	PLC axis No.								Buffering mode		
	1st	2nd	3rd	4th	5th	6th	7th	8th	Data A	Data B	Data C
Axis designation (*1)	Not used	Not used	Not used	Not used	Not used	Not used	Not used	Not used	D5400	D5410	D5420
Operation mode	D5321	D5331	D5341	D5351	D5361	D5371	D5381	D5391	D5401	D5411	D5421
Feedrate	D5322	D5332	D5342	D5352	D5362	D5372	D5382	D5392	D5402	D5412	D5422
	D5323	D5333	D5343	D5353	D5363	D5373	D5383	D5393	D5403	D5413	D5423
Travel amount	D5324	D5334	D5344	D5354	D5364	D5374	D5384	D5394	D5404	D5414	D5424
	D5325	D5335	D5345	D5355	D5365	D5375	D5385	D5395	D5405	D5415	D5425
Control signal	D5326	D5336	D5346	D5356	D5366	D5376	D5386	D5396	D5406	D5416	D5426
Control signal 2	D5327	D5337	D5347	D5357	D5367	D5377	D5387	D5397	D5407	D5417	D5427

(*1) Axis designation is valid only in the buffering mode.

Other Devices

In addition to X, Y and R devices described above, the following devices exist:

Name	Symbol	Description
Internal relay Latch relay	M F L	(1) Internal and latch relays are auxiliary relays in the sequence that cannot directly be output to the external. (2) The latch relay L will be backed up even if the power is turned OFF. (3) The internal relay F may be used as the interface for the alarm message display.
Timer	T ST	(1) Timers T are count-up timers. (2) Timer T and ST can set the timer value from either the sequence program or setting and display unit. (3) The 100ms, 10ms and 100ms integral timer are available.
Counter	C	(1) Counters C are count-up counters. (2) Counter C can set the counter value from either the sequence program or setting and display unit.
Data register	D	(1) The data register stores sequence data. (2) One data register consists of 16 bits and can be read or written in 16-bit units. To handle 32-bit data, two data registers are used. The data register addressed by a 32-bit command is used as the low-order 16 bits; the data register addressed by the specified data register number +1 is used as the high-order 16 bits.
File register	R	(1) The file register release area can be used in the same manner as the data register. (2) To handle 32-bit data, two file registers are used. The file register addressed by a 32-bit command is used as the low-order 16 bits; the file register addressed by the specified file register number +1 is used as the high-order 16 bits.

The assignment tables are on the following pages. Copy and use them as necessary.

<Format>

Device	Abbreviation	Signal name	Device	Abbreviation	Signal name
Device	Abbreviation	Signal name	Device	Abbreviation	Signal name
Device	Abbreviation	Signal name	Device	Abbreviation	Signal name
Device	Abbreviation	Signal name	Device	Abbreviation	Signal name

Explanation of Interface Signals

[How to read the signals]

Cont.	Signal name	Abbrev.	Common(\$)
B	DATA PROTECT KEY 1	* KEY1	Y708
↑ (1)	↑ (2)	↑ (3)	↑ (4)

No.	Description
(1)	Types of contact A : Becomes valid when turned ON (A contact) B : Becomes valid when turned OFF (B contact) (Note) An asterisk "*" is prefixed to a B-contact signal abbreviation.
(2)	Signal name
(3)	Signal abbreviation
(4)	Device No. Common(\$) : Device No. common for part systems \$1 ~ \$n : Device No. per part system or axis device No. 1st SP ~ 8th SP : Device No. per spindle

4.1 PLC Input Signals (Bit Type: X***)

Cont.	Signal name	Abbrev.	Common(\$)
A	BOARD RESET	BRST	X2F0

[Function]

This signal indicates that the NC keyboard or the soft keyboard reset button is pressed.

[Operation]

When the NC keyboard or the soft keyboard reset button is pressed, this signal turns ON; and then it turns OFF after 10ms.

NC will not be reset even if this signal is turned ON. In order to reset the NC, check the status of this signal with ladder, and turn NC reset (NRST1), etc. ON/OFF.

[Related signals]

- (1) NC reset 1 (NRST1)
- (2) NC reset 2 (NRST2)
- (3) Reset & rewind (RRW)

Cont.	Signal name	Abbrev.	Common(\$)
A	POWER CONSUMPTION COMPUTATION: CONSUMPTION ACCUMULATION ON 1 to 4	IPCE1 to 4	X700 to 3

[Function]

This signal notifies that "Power consumption computation: Enable consumption accumulation 1 to 4" is ON.

[Operation]

When the "Power consumption computation: Enable consumption accumulation 1 to 4" signal (Y724 or later) is turned ON, this signal turns ON.

When the "Power consumption computation: Enable consumption accumulation 1 to 4" signal (Y724 or later) is turned OFF, this signal turns OFF.

[Related signals]

- (1) Power consumption computation: Enable consumption accumulation 1 to 4 (IPCE1 to 4:Y724 to 7)

Cont.	Signal name	Abbrev.	Common(\$)
A	POWER OFF PROCESSING [M8]		X707

[Function][Operation]

This signal notifies that the power OFF processing is in execution.

This signal remains ON until the control unit's power is turned OFF.

Refer to the "Automatic power OFF request" signal (Y75D) for details.

- 0: Not executed
- 1: During execution

[Related signals]

- (1) Automatic power OFF request (Y75D)
- (2) Power OFF indication Y device No. (R215)

Cont.	Signal name	Abbrev.	Common(\$)
A	POWER CONSUMPTION COMPUTATION: CLEARING CONSUMPTION ACCUMULATION 1 to 4 COMPLETE	IPCCC1 to 4	X708 to B

[Function]

This signal notifies that "Power consumption computation: Clear consumption accumulation 1 to 4" is completed.

[Operation]

When the "Power consumption computation: Clear consumption accumulation 1 to 4" signal (Y700 or later) is turned ON, this signal turns ON.

When the "Power consumption computation: Clear consumption accumulation 1 to 4" signal (Y700 or later) is turned OFF, this signal turns OFF.

[Caution]

- (Note 1) When this signal is ON, turn OFF the "Power consumption computation: Clear consumption accumulation 1 to 4" signal (Y700 or later) OFF.

[Related signals]

- (1) Power consumption computation: Clear consumption accumulation 1 to 4 (IPCC1 to 4:Y700 to 3)

Cont.	Signal name	Abbrev.	Common(\$)
A	BATTERY WARNING	BATWR	X70E

[Function]

This signal indicates that the battery voltage that is supplied to the control equipment (NC controller or graphic control unit) to save data and to the absolute encoders has dropped below the battery warning detection threshold.

[Operation]

The signal turns ON when:

- (1) The battery voltage for saving data, which is checked constantly, has dropped below the battery warning detection threshold.

The alarm message "Z52 Battery fault 0001" is displayed for NC control unit; "Z52 Battery fault 0010" for graphic control unit; and "Z52 Battery fault 0011" for both units.

The alarm display is cleared by reset, but the signal does not turn OFF.

- (2) A drop in the battery voltage that is supplied to the absolute encoder is detected.

The alarm messages "Z73 Battery for abs data fault 0001" and "S52 Servo warning 009F" are displayed.

Even if this signal is ON, it is possible to start cycle operation.

The signal turns OFF when:

- (1) The battery voltage drops below the battery alarm detection threshold, and the battery alarm (BATAL) signal turns ON.
- (2) Reset is done after battery replacement (if the signal is turned ON by the condition (1)).

[Caution]

- (1) When this signal (X70E) turns ON, battery replacement is recommended.
- (2) When the detection of battery alarm or battery warning is disabled (#6449 bit4=1), this signal will not turn ON, and no alarm messages are displayed.

[Related signals]

- (1) Battery alarm (BATAL:X70F)
- (2) Battery drop cause (R56)

4 Explanation of Interface Signals

Cont.	Signal name	Abbrev.	Common(\$)
A	BATTERY ALARM	BATAL	X70F

[Function]

This signal indicates that the battery voltage that is supplied to the control equipment (NC controller or graphic control unit) to save data and to the absolute encoders has dropped below the battery alarm detection threshold.

[Operation]

The signal turns ON when:

- (1) The battery voltage for saving data, which is checked constantly, has dropped below the battery alarm detection threshold.
The alarm message "Z52 Battery fault 0003" is displayed for NC control unit; "Z52 Battery fault 0030" for graphic control unit; and "Z52 Battery fault 0033" for both units.
- (2) An error is detected in the circuit to monitor the battery voltage for saving data.
The alarm message "Z52 Battery fault 0002" is displayed for NC control unit; "Z52 Battery fault 0020" for graphic control unit; and "Z52 Battery fault 0022" for both units.
- (3) The drop in the voltage of backup power supply (battery voltage) in an absolute encoder is detected.
The alarm message "Z71 AbsEncoder: Backup voltage drop 0001" is displayed.
- (4) The absolute position is lost due to the drop in the voltage of backup power supply (battery voltage) in an absolute encoder.
The alarm message "Z70 Abs posn error (servo alm 25) 0101" is displayed.

When this signal is ON, cycle operation cannot be started.

The signal turns OFF when:

- (1) Reset is done after battery replacement (if the signal is turned ON by the condition (1)).
- (2) Reset is done after the error in power supply voltage is eliminated (if the signal is turned ON by the condition (2) or (3)).

[Caution]

- (1) When the battery alarm occurs, especially due to the turn-ON condition (1), if the control equipment is powered OFF without battery replacement, stored data (e.g. machining programs) will be corrupted.
Replace the battery and confirm that this signal has been turned OFF before powering OFF the control equipment. If the battery alarm is already pending when the control equipment is powered up, especially due to the turn-ON condition (1), it must be assumed that stored data (e.g. machining programs) have been corrupted.
- (2) If detection of battery alarm of battery warning is disabled (#6449 bit4 = 1), this signal is not turned ON, and no alarm messages are displayed.
- (3) As a precaution against this alarm, ensure that data in control equipment are backed up.

[Related signals]

- (1) Battery warning (BATWR: X70E)
- (2) Battery drop cause (R56)

Cont.	Signal name	Abbrev.	Common(\$)
A	IN MACRO SINGLE VALID [C80]	MSON	X710

[Function]

This signal notifies the macro single is valid.

Macro single is used to stop the user macro command block by block during single block operation.

[Operation]

When the control parameter "#8101 MACRO SINGLE" is set to "1" (valid), the signal will be turned on.

[Related signals]

- (1) Single block (SBK:YC12)

4 Explanation of Interface Signals

Cont.	Signal name	Abbrev.	Common(\$)
A	HIGH-SPEED SIMPLE PROGRAM CHECK MODE ON	SMLKO	X712

[Function]

This signal indicates that the high-speed simple program check mode has been entered.

[Operation]

This signal turns ON when the "High-speed simple program check mode" signal (SMLK:Y73E) is input.

[Related signals]

(1) High-speed simple program check mode (SMLK:Y73E)

Cont.	Signal name	Abbrev.	Common(\$)
A	HIGH-SPEED SIMPLE PROGRAM CHECK: COORDINATE POSITION CHECK ON	SPSCO	X713

[Function]

This signal informs that the coordinate position check is enabled during the high-speed simple program check.

[Operation]

This signal turns ON when the "High-speed simple program check: Enable coordinate position check" signal (Y76B) is ON.

This signal turns OFF when the "High-speed simple program check: Enable coordinate position check" signal (Y76B) is OFF.

[Related signals]

- (1) High-speed simple program check mode (SMLK:Y73E)
- (2) High-speed simple program check mode ON (SMLKO:X712)
- (3) High-speed simple program check: Enable coordinate position check (SPSC:Y76B)

Cont.	Signal name	Abbrev.	Common(\$)
A	MANUAL ARBITRARY REVERSE RUN: ACTUAL CUTTING MODE ON [M8]	PNCMDO	X714

[Function]

When the parameter "#1260 set32/bit0 (Switching to actual cutting mode during automatic operation)" is set to "1", this signal indicates that the actual cutting mode in manual arbitrary reverse run is valid.

When "#1260 set32/bit0" is set to "0", this signal does not turn ON/OFF.

[Operation]

This signal turns ON when:

- Except for the specific movement block during thread cutting, thread cutting cycle and tapping cycle, Manual arbitrary reverse run mode ON (X715) is turned ON and Actual cutting mode (thread, tap) in manual arbitrary reverse run (Y761) is turned ON.

This signal turns OFF when:

- Except for the specific movement block during thread cutting, thread cutting cycle and tapping cycle, Manual arbitrary reverse run mode ON (X715) is turned OFF and Actual cutting mode (thread, tap) in manual arbitrary reverse run (Y761) is turned OFF.

* For the specific movement block, refer to the section "Actual cutting mode (thread, tap) in manual arbitrary reverse run (Y761)".

[Related signals]

- (1) Manual arbitrary reverse run mode (MORR:Y73C)
- (2) Manual arbitrary reverse run mode ON (PCHKO:X715)
- (3) Manual arbitrary reverse run speed selection (MORSP:Y73D)
- (4) Actual cutting mode (thread, tap) in manual arbitrary reverse run (MRCMD:Y761)
- (5) Manual arbitrary reverse run: MSTB reverse run prohibited (MRPSG:YCFC)
- (6) Manual arbitrary reverse run speed multiplier (R379)
- (7) Manual arbitrary reverse run: Reverse run ON (MOREV:X716)
- (8) Manual arbitrary reverse run handle selection (R375)

4 Explanation of Interface Signals

Cont.	Signal name	Abbrev.	Common(\$)
A	Manual arbitrary reverse run mode ON	PCHKO	X715

[Function]

This signal informs that the manual arbitrary reverse run mode is in operation.

[Operation]

This signal is turned ON while the manual arbitrary reverse run mode is in operation.

This signal is turned OFF when the manual arbitrary reverse run mode is cancelled.

[Operation sequence]

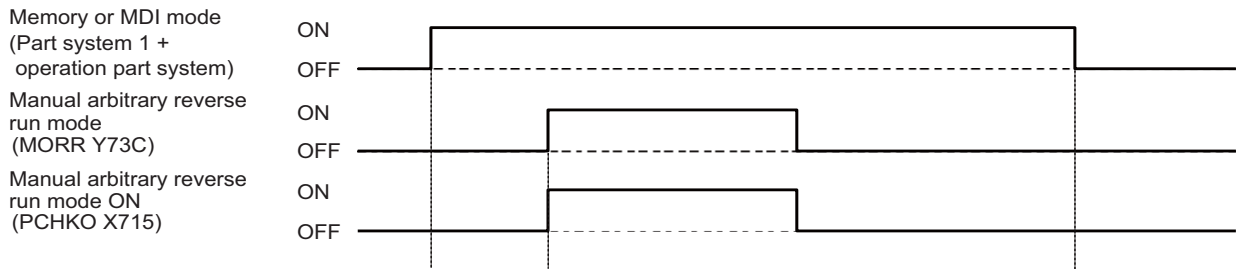

[Related signals]

- (1) Manual arbitrary reverse run: Reverse run ON (MOREV:X716)
- (2) Thread, tap block stopping in manual arbitrary reverse run (MBSTP:X74D)
- (3) Thread, tap reverse run prohibition alarm in manual arbitrary reverse run (MRVNG:X74E)
- (4) Manual arbitrary reverse run mode (MORR:Y73C)
- (5) Manual arbitrary reverse run speed selection (MORSP:Y73D)
- (6) Actual cutting mode (thread, tap) in manual arbitrary reverse run (MRCMD:Y761)
- (7) Manual arbitrary reverse run: Reverse run block stop designated part system (RBSSY:YD01)
- (8) Manual arbitrary reverse run: Reverse run block stop designated part system (MRPSG:YCFC)
- (9) Manual arbitrary reverse run handle selection (R375)
- (10) Manual arbitrary reverse run speed multiplier (R379)

Cont.	Signal name	Abbrev.	Common(\$)
A	MANUAL ARBITRARY REVERSE RUN: REVERSE RUN ON	MOREV	X716

[Function]

This signal indicates the forward/reverse status during the manual arbitrary reverse run.

[Operation]

This signal turns ON when reverse run is performed during the manual arbitrary reverse run.

This signal is OFF during forward run.

[Related signals]

- (1) Manual arbitrary reverse run mode ON (PCHKO:X715)
- (2) Thread, tap block stopping in manual arbitrary reverse run (MBSTP:X74D)
- (3) Thread, tap reverse run prohibition alarm in manual arbitrary reverse run (MRVNG:X74E)
- (4) Manual arbitrary reverse run mode (MORR:Y73C)
- (5) Manual arbitrary reverse run speed selection (MORSP:Y73D)
- (6) Actual cutting mode (thread, tap) in manual arbitrary reverse run (MRCMD:Y761)
- (7) Manual arbitrary reverse run: MSTB reverse run prohibited (MRPSG:YCFC)
- (8) Manual arbitrary reverse run: Reverse run block stop designated part system (RBSSY:YD01)
- (9) Manual arbitrary reverse run handle selection (R375)
- (10) Manual arbitrary reverse run speed multiplier (R379)

4 Explanation of Interface Signals

Cont.	Signal name	Abbrev.	Common(\$)
A	COLLECTING DIAGNOSIS DATA		X723

[Function]

This signal informs that collecting history data is being executed by the operation history function.

[Operation]

This signal turns ON while collecting history data is executed.

[Related signals]

- (1) Collecting diagnosis data stop (Y72B)

Cont.	Signal name	Abbrev.	Common(\$)
A	POWER OFF REQUIRED AFTER PARAMETER CHANGE		X72F

[Function]

This signal informs that the set parameter is not valid without rebooting the power.

[Operation]

When the following operation is executed, the "Power OFF required after parameter change" signal is output, and the display symbol "PR" is displayed in the operation status section.

- (1) The parameters to be valid after rebooting the power are set. / Such parameter data is input.
- (2) The auxiliary axis parameters to be valid after rebooting the power are set. / Such data is input. / Such data backed up before is input.
- (3) The maintenance data for the ALL1 is input.
- (4) The backup data is input with the SRAM backup function.

If the power is rebooted, the "Power OFF required after parameter change" signal will turn OFF, and the "PR" display will disappear.

- (Note 1) Even if the same value is set to the parameter which needs to reboot the power, the "Power OFF required parameter change" signal is output, and the "PR" is displayed.
- (Note 2) Even if the value is returned to the original value after setting the parameter which needs to reboot the power, the "Power OFF required after parameter change" signal remains ON, and the "PR" also remains displayed.
- (Note 3) The parameters which do not need to reboot the power are targeted for rewriting the parameters with DDB or G10, so the "Power OFF required after parameter change" signal is not output, and the "PR" is not displayed.

Cont.	Signal name	Abbrev.	Common(\$)
A	THREAD, TAP BLOCK STOPPING IN MANUAL ARBITRARY REVERSE RUN	MBSTP	X74D

[Function]

This signal notifies the PLC that a block stop occurred before moving to thread cutting or tapping during the manual arbitrary reverse run.

[Operation]

When the "Actual cutting mode (thread, tap) in manual arbitrary reverse run" signal (MRCMD) is ON, a block stop occurs before moving to thread cutting and tapping.

This signal turns ON when this block stop occurs.

If cycle start is executed in this state, thread cutting and tapping start and this signal turns OFF.

[Related signals]

- (1) Manual arbitrary reverse run mode ON (PCHKO:X715)
- (2) Manual arbitrary reverse run: Reverse run ON (MOREV:X716)
- (3) Thread, tap reverse run prohibition alarm in manual arbitrary reverse run (MRVNG:X74E)
- (4) Manual arbitrary reverse run mode (MORR:Y73C)
- (5) Manual arbitrary reverse run speed selection (MORSP:Y73D)
- (6) Actual cutting mode (thread, tap) in manual arbitrary reverse run (MRCMD:Y761)
- (7) Manual arbitrary reverse run: MSTB reverse run prohibited (MRPSG:YCFC)
- (8) Manual arbitrary reverse run: Reverse run block stop designated part system (RBSSY:YD01)
- (9) Manual arbitrary reverse run handle selection (R375)
- (10) Manual arbitrary reverse run speed multiplier (R379)

4 Explanation of Interface Signals

Cont.	Signal name	Abbrev.	Common(\$)
A	THREAD, TAP REVERSE RUN PROHIBITION ALARM IN MANUAL ARBITRARY REVERSE RUN	MRVNG	X74E

[Function]

This signal notifies the PLC that the reverse run prohibition alarm occurred at the thread cutting or tapping block during the manual arbitrary reverse run.

[Operation]

If the "Actual cutting mode (thread, tap) in manual arbitrary reverse run" signal (MRCMD) is ON, the thread cutting and tapping blocks are not executed when reverse run is performed.

This reverse run prohibition alarm turns ON at these blocks.

The alarm signal is kept ON and turned OFF when forward run is executed.

[Related signals]

- (1) Manual arbitrary reverse run mode ON (PCHKO:X715)
- (2) Manual arbitrary reverse run: Reverse run ON (MOREV:X716)
- (3) Thread, tap block stopping in manual arbitrary reverse run (MBSTP:X74D)
- (4) Manual arbitrary reverse run mode (MORR:Y73C)
- (5) Manual arbitrary reverse run speed selection (MORSP:Y73D)
- (6) Actual cutting mode (thread, tap) in manual arbitrary reverse run (MRCMD:Y761)
- (7) Manual arbitrary reverse run: MSTB reverse run prohibited (MRPSG:YCFC)
- (8) Manual arbitrary reverse run: Reverse run block stop designated part system (RBSSY:YD01)
- (9) Manual arbitrary reverse run handle selection (R375)
- (10) Manual arbitrary reverse run speed multiplier (R379)

Cont.	Signal name	Abbrev.	Common(\$)
A	MES interface library: Operation trigger status [M8]		X74F

[Function]

This signal notifies that one of the update, delete, or extraction operation requests is being sent to the database.

[Operation]

0: This signal notifies that update, delete, or extraction operation request is not being sent to the database.

1: This signal notifies that update, delete, or extraction operation request is being sent to the database.

[Related signals]

- (1) MES interface library: DB operation selection [M8] (R14598)
- (2) MES interface library: Operation table selection [M8] (R14599)
- (3) MES interface library: Operation trigger [M8] (Y1C80)

Cont.	Signal name	Abbrev.	Common(\$)
A	24 HOURS CONTINUOUS OPERATION	CNOP	X752

[Function]

This signal notifies that the contactor status of the drive power has been ON for over 24 hours.

[Operation]

This signal turns OFF when the contactor shutoff is confirmed by the contactor shutoff test.

Turn the "contactor shutoff test" signal ON to carry out this test.

[Caution]

There is a possibility that the contactor is welded and so your safety may not be secured when "24 hours continuous operation" signal is output. Thus, under this condition, do not input "speed monitor mode" signal to open the door.

[Related signals]

- (1) Contactor shutoff test (MCT:Y742)
- (2) Speed monitor mode (SOMD:R296)

4 Explanation of Interface Signals

Cont.	Signal name	Abbrev.	Common(\$)
A	IN MULTI-STEP SPEED MONITOR [M8]	MSOE	X753

[Function]

This signal turns ON when the multi-step speed monitor is valid and in the speed monitor mode.

[Operation]

When turning ON the contactor shutoff test signal (Y742) and after confirming that the contactor is shutoff with the contactor shutoff test, 24 hours continuous operation signal (X752) turns OFF. When the multi-step speed monitor is valid and any one of the door group (bit) of door open enable signal turns ON, this signal turns ON.

When the speed monitor mode turns OFF and all door open enable signals turn OFF, this signal turns OFF.

While the multi-step speed monitor is invalid, even in the speed monitor mode, this signal does not turn ON.

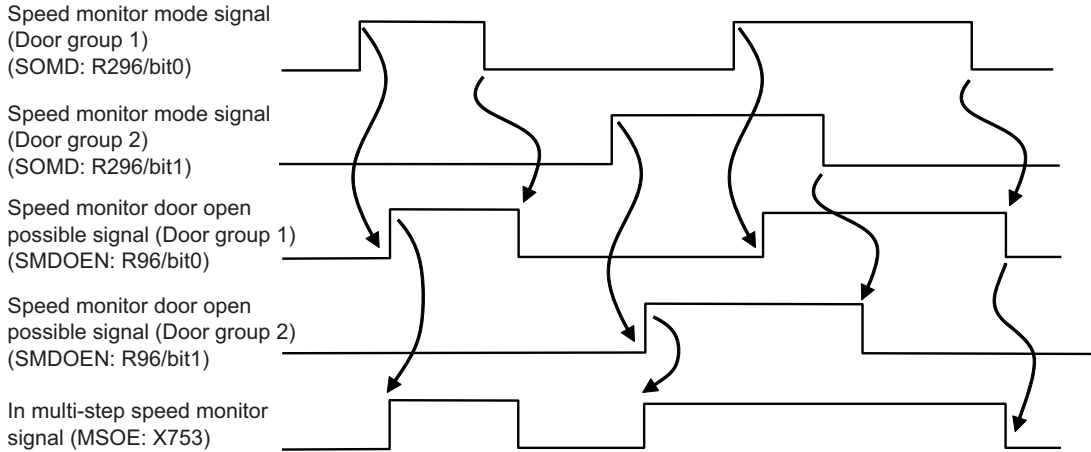

[Related signals]

- (1) Speed monitor mode (SOMD: R296)
- (2) Speed monitor door open possible (SMDOEN: R96)
- (3) Multi-step speed monitor selected speed output [M8] (SOPFN: R98)

Cont.	Signal name	Abbrev.	Common(\$)
A	PALLET PROGRAM REGISTRATION EXT. WORKPIECE COORDINATE TRANSFER COMPLETION [M8]		X758

[Function][Operation]

Completion of transfer from extension workpiece coordinate to external workpiece coordinate offset (EXT) during pallet 4 page registration is displayed.

This signal turns ON at the completion of transfer processing.

This signal turns OFF when external workpiece coordinate transfer ready is turned OFF.

The transferred external workpiece coordinate offset (EXT) will be effective as soon as when this signal is turned ON.

[Timing chart]

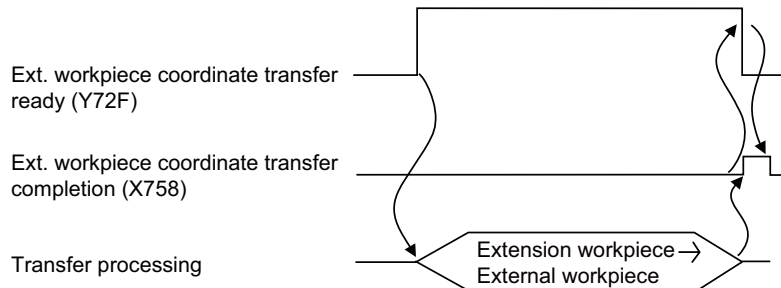

[Related signals]

- (1) Pallet program registration Ext. workpiece coordinate transfer ready (Y72F)

4 Explanation of Interface Signals

Cont.	Signal name	Abbrev.	Common(\$)
A	GRAPHIC CHECK (CHECK METHOD II) IN PROGRESS [M8]		X759

[Function]

This signal notifies that "Graphic check (Check method II)" is in progress.

[Operation]

The signal turns ON when:

- (1) The program check is in operation by the Graphic check (Check method II).

The signal turns OFF when:

- (1) The program check by the Graphic check (Check method II) is completed.
(Except for the program stop by check step)

Cont.	Signal name	Abbrev.	Common(\$)
A	FTP DOWNLOAD IN PROGRESS [C80]	DLOAD0	X75D

[Function]

This signal informs that download from FTP server is started.

[Operation]

The signal turns ON when:

- Downloading a file from FTP server is normally started.

The signal turns OFF when:

- Download is completed.
- Download is interrupted as the data transfer error occurred during the download process. If it happens, the error code will be stored.

[Related signal]

- (1) FTP download request (DLDREQ: Y1C86)
- (2) FTP download completed (DLDFIN: X75E)
- (3) FTP download error (DLDERR: X75F)

Cont.	Signal name	Abbrev.	Common(\$)
A	FTP DOWNLOAD COMPLETED [C80]	DLDFIN	X75E

[Function]

This signal informs that a download from FTP server is successfully completed.

[Operation]

The signal turns ON when:

- Downloading a file from FTP server is started.

The signal turns OFF when:

- "FTP download request" signal is turned OFF

[Related signal]

- (1) FTP download request (DLDREQ: Y1C86)
- (2) FTP download in progress (DLOAD0: X75D)
- (3) FTP download error (DLDERR: X75F)

4 Explanation of Interface Signals

Cont.	Signal name	Abbrev.	Common(\$)
A	FTP DOWNLOAD ERROR [C80]	DLDERR	X75F

[Function]

This signal informs that an error occurred when download is requested to FTP server.

This signal informs that an error occurred while downloading from FTP server.

[Operation]

The signal turns ON when:

- An error occurred when requesting download to FTP server but download cannot be started.
- Download is interrupted as an error occurred while downloading from FTP server.
- Download is requested without the FTP function specification. (In this case, the alarm for communication error will not occur simultaneously.)

The signal turns OFF when:

- "FTP download request" signal (DODREQ: Y1C86) is turned OFF.

[Related signal]

- (1) FTP download request (DLDREQ: Y1C86)
- (2) FTP download completed (DLDFIN: X75E)
- (3) FTP download in progress (DLOAD0: X75D)

Cont.	Signal name	Abbrev.	Common(\$)
A	\$1 to \$8 DISPLAY		X760 to 7

[Function]

This signal indicates the part system displayed on the screen.

[Operation]

This signal turns ON when the part-system display has been changed by pressing the \$<=>\$ key, by turning ON the "Display changeover \$1 to \$8" signal (DISP1 to 8), or with the touchscreen.

[Related signals]

- (1) Display changeover \$1 to \$8 (DISP1 to 8: Y730 to 737)

Cont.	Signal name	Abbrev.	Common(\$)
A	INTERFERENCE CHECK III: INTERFERING OBJECT SELECTION DATA SETTING COMPLETED [M8]	ITF3DTF	X771

[Function]

This signal notifies that the interference check III interfering object selection data setting is enabled.

[Operation]

This signal turns ON when the interfering object selection data defined in the system variables (#40000 to #40097) or Interference check III: interfering object selection (R20304 to R20449) has successfully been incorporated into NC as the interference check III execution data.

This signal turns OFF once the "Interference check III: Enable interfering object selection data" (Y769) is turned OFF.

[Related signals]

- (1) Interference check III: Enable interfering object selection data (ITF3VLDT:Y769)

Cont.	Signal name	Abbrev.	Common(\$)
A	INTERFERENCE CHECK III: IN INTERFERENCE CHECK III MODE [M8]	ITF3MD	X772

[Function]

This signal notifies that the interference check III is in execution.

[Operation]

This signal turns ON while the interference check III is in execution.

This signal turns OFF once the "Interference check III: mode" (Y76A) is turned OFF.

(Note) While the operation error (M03 0001) is occurring, this signal is not turned OFF even though "Interference check III: mode" (Y76A) is turned OFF.

[Related signals]

- (1) Interference check III: mode (ITF3CMD:Y76A)

4 Explanation of Interface Signals

Cont.	Signal name	Abbrev.	Common(\$)
A	Interference check between part systems: Mode is active [M8]		X773

[Function]

This signal notifies that the interference check between part systems is in execution.

[Operation]

This signal turns ON while the interference check between part systems is in execution.

This signal turns OFF once "Interference check between part systems: Interference check enabled" (Y73F) is turned OFF.

[Related signals]

- (1) Interference check between part systems: Interference check enabled [M8] (Y73F)

Cont.	Signal name	Abbrev.	Common(\$)
A	G/B SPINDLE SYNCHRONIZING MODE [M8]	GBMOD	X778

[Function]

This signal notifies that the guide bushing (G/B) spindle synchronization mode is in execution.

[Operation]

This signal is ON while the G/B spindle synchronization valid (GBON) is ON.

This signal turns OFF at an emergency stop or when the G/B spindle synchronization: temporary cancel (GBOFF) turns ON.

[Related signals]

- (1) G/B spindle synchronization valid (GBON: Y778)
- (2) G/B spindle synchronization: temporary cancel (GBOFF: Y77D)

Cont.	Signal name	Abbrev.	Common(\$)
A	G/B SPINDLE SYNCHRONIZATION: POSITION CONTROL SYNCHRONIZING [M8]	GBSYN	X779

[Function]

This signal notifies that the reference spindle and the guide bushing (G/B) spindle are in the spindle synchronization state.

[Operation]

This signal is ON while the reference spindle and the guide bushing spindle are in the spindle synchronization state.

This signal turns OFF at an emergency stop or when the G/B spindle synchronization: temporary cancel (GBOFF) turns ON.

[Related signals]

- (1) G/B spindle synchronization valid (GBON:Y778)
- (2) G/B spindle synchronization: temporary cancel (GBOFF: Y77D)

Cont.	Signal name	Abbrev.	Common(\$)
A	G/B spindle synchronization: phase alignment complete [M8]	GBPHF	X77A

[Function]

This signal notifies that the phase alignment of the reference spindle and the guide bushing (G/B) spindle is completed.

[Operation]

This signal turns ON when the phase alignment of the phase gap (relative position) of the reference spindle and the guide bushing spindle that has been saved is completed.

[Related signals]

- (1) G/B spindle synchronization valid (GBON:Y778)
- (2) G/B spindle synchronization: phase alignment (GBPHS:Y77A)

Cont.	Signal name	Abbrev.	Common(\$)
A	G/B spindle synchronization: position error compensating [M8]	GBPCM	X77B

[Function]

This signal notifies that guide bushing (G/B) spindle synchronization position error compensation is in execution.

[Operation]

This signal turns ON when the guide bushing spindle synchronization position error compensation becomes in execution and when refreshing the compensation amount is completed to be repeated by the number of times set in R390 (Guide bushing spindle synchronization position error compensation scale and the number of times of compensations).

This signal turns OFF:

- When both G/B spindle synchronization: keep position error compensation amount (GBCMKP) and the G/B spindle synchronization: position error compensation (GBCMON) are turned OFF
- When the guide bushing spindle synchronization mode is canceled
- During measuring the guide bushing spindle synchronization position error compensation amount.

[Related signals]

- (1) G/B spindle synchronization valid (GBON:Y778)
- (2) G/B spindle synchronization: position error compensation (GBCMON:Y77C)
- (3) G/B spindle synchronization: keep position error compensation amount (GBCMKP:Y77E)
- (4) G/B spindle synchronization: position error compensation scale and the number of times of compensations (R390)
- (5) G/B spindle synchronization: position error compensation amount (R465)

4 Explanation of Interface Signals

Cont.	Signal name	Abbrev.	\$1	\$2	\$3	\$4
A	SERVO READY n-TH AXIS	RDY1 to 8	X780 to 7	X788 to F	X790 to 7	X798 to F

[Function]

This signal indicates that the drive section of the nth axis is ready for operation.

[Operation]

The signal turns ON when:

- (1) The power supply of the controller is turned ON and the diagnosis on the servo system has been completed successfully.
- (2) Servo alarm has been reset.
- (3) Emergency stop has been reset.
- (4) "Servo off"(*SVFn) signal is reset.

The signal turns OFF when:

- (1) Servo alarm occurs.
- (2) Emergency stop is issued.
- (3) "Servo off"(*SVFn) signal is input.

[Operation sequence]

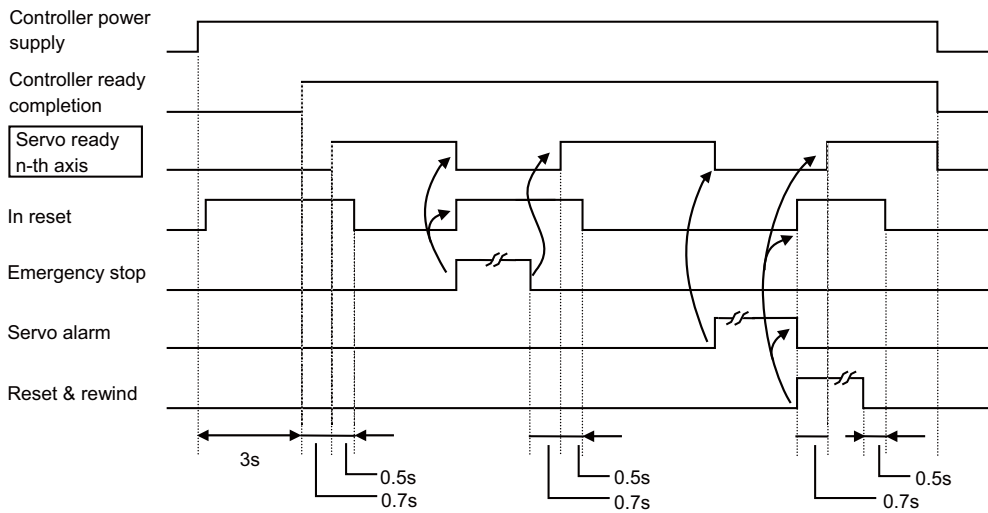

[Related signals]

- (1) Servo ready completion (SA: XC11)

4 Explanation of Interface Signals

Cont.	Signal name	Abbrev.	\$1	\$2	\$3	\$4
A	AXIS SELECTED n-TH AXIS	AX1 to 8	X7A0 to 7	X7A8 to F	X7B0 to 7	X7B8 to F

[Function]

This signal indicates that motion command is issued to the control axis.

[Operation]

This signal turns ON and OFF as follows:

(1) Automatic operation

The signal is ON while the motion command is issued to the end of movement, or to when automatic operation pause turns ON.

(2) Manual operation

(a) For JOG mode

The signal is ON while "Feed axis selection +/-" (+Jn and -Jn) signal is ON.

(b) For HANDLE mode

When "1st to 3rd handle axis selection code m" (HS1mn to HS3mn) and "Handle valid" signal (HS1Sn, HS2Sn, HS3Sn) have been selected, the "Axis selected" signal for the axis specified by the "1st to 3rd handle axis selection code m" (HS1mn to HS3mn) signal is ON.

(c) For INCREMENTAL mode

The signal turns ON when "Feed axis selection +/-" (+Jn, -Jn) signal turns ON, and turns OFF when the specified motion is completed.

(d) For MANUAL ARBITRARY FEED mode

The signal turns ON when "Manual arbitrary feed strobe" (CXS8n) signal turns ON, and turns OFF when the specified motion is completed.

(e) For REFERENCE POSITION RETURN mode

The signal is ON while "Feed axis selection +/-" (+Jn and -Jn) signal is ON. After "Reference position return near point detection" signal is detected, and the motion speed changes to approach (creeping) speed, the "Axis selected" signal remains ON until the motion stops at the reference position, even when "Feed axis selection +/-" (+Jn and -Jn) signal turns OFF.

(3) Other conditions

(a) The signal can turn ON even during machine lock (Z-axis is in cancellation). However, it does not turn ON during machine lock in manual operation mode.

(b) The signal remains on even when motion stops due to feedrate override set at 0%, manual control feedrate set at 0 mm/min, or 0 inch/min.

(c) Interlock does not affect status of this signal (the signal remains ON, or turns ON).

(d) "Servo off" signal does not affect status of this signal.

(e) The signal cannot be turned ON by G04 and G92.

(f) The signal turns OFF with "controller Reset & Rewind", or "Emergency stop".

(Example)

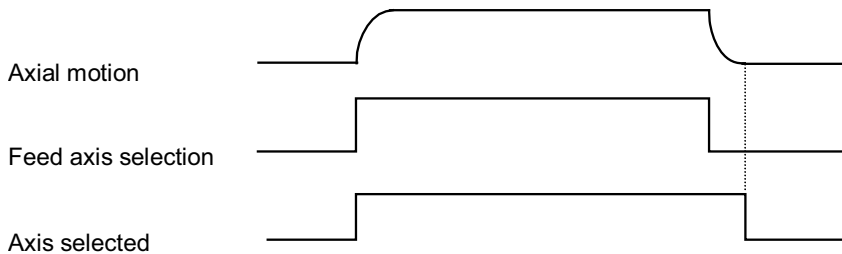

4 Explanation of Interface Signals

Cont.	Signal name	Abbrev.	\$1	\$2	\$3	\$4
A	IN AXIS PLUS MOTION n-TH AXIS	MVP1 to 8	X7C0 to 7	X7C8 to F	X7D0 to 7	X7D8 to F

[Function]

This signal indicates that the specified axial motion is in plus (+) direction.

This signal is available per control axis, and the last number of the signal name indicates the control axis No.

[Operation]

The signal turns ON when:

- (1) The specified axial component starts moving in the plus direction or when moving.

The signal turns OFF when:

- (2) The specified control axis stops moving or moves in the minus direction.

An example of the timing chart for the jog mode is shown below.

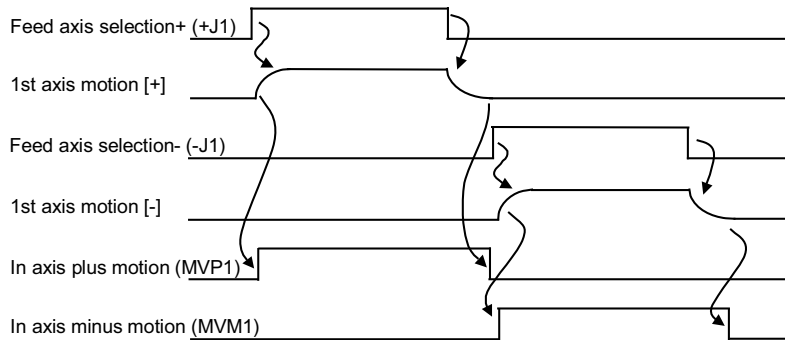

(Note 1) This signal operates regardless of the operation mode.

(Note 2) The real movement direction is indicated.

(Note 3) The signal does not turn ON during machine lock.

[Related signals]

- (1) In axis minus motion n-th axis (MVM1 to 8: X7E0 to 7)

Cont.	Signal name	Abbrev.	\$1	\$2	\$3	\$4
A	IN AXIS MINUS MOTION n-TH AXIS	MVM1 to 8	X7E0 to 7	X7E8 to F	X7F0 to 7	X7F8 to F

[Function]

This signal indicates that the control axis is moving in the minus direction

[Operation]

This motion direction is the reverse of the plus motion, and the operation is the same as IN AXIS PLUS MOTION + (MVPn).

[Related signals]

- (1) In axis plus motion n-th axis (MVP1 to 8: X7C0 to 7)

Cont.	Signal name	Abbrev.	\$1	\$2	\$3	\$4
A	1ST REFERENCE POSITION REACHED n-TH AXIS	ZP11 to 18	X800 to 7	X808 to F	X810 to 7	X818 to F

[Function]

This signal indicates that the axial component of the nth axis is ON the 1st reference position.

Each control axis is provided with this signal. The last number (n = 1, 2, 3...) of the signal abbreviation indicates the control axis No.

[Operation]

(1) The signal turns ON when:

- "1st reference position reached" is attained with reference position return mode in manual operation.
Refer to the REFERENCE POSITION RETURN (ZRNn) section for details on returning.
- "1st reference position reached" is attained with G28 command in automatic operation.

(Note 1) If "1st reference position reached" is achieved in other operation mode, or by other command, the signal does not turn ON.

(2) The signal turns OFF when:

- The axial component in position is relocated from the 1st reference position by motion command.
- "Emergency stop" signal is input or servo alarm occurs, causing stop to the machine.

(3) Reference position return operation pattern

○ Dog-type reference position return

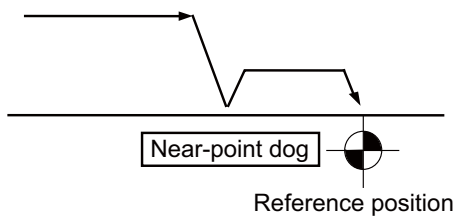

- When basic machine coordinate system is not established.
- When dog-type return is selected with setup parameters, basic specification parameter "#1063 mandog" in the manual mode.

○ High-speed reference position return

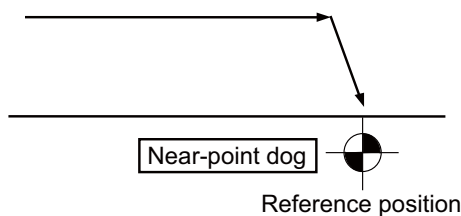

- When basic machine coordinate system is established.
- When high-speed return is selected with setup parameters, basic specification parameter "#1063 mandog" in the manual mode.

(Note)

Reference position return will be the high-speed return when the basic machine coordinate system is established (2nd time and following).

[Related signals]

- (1) 2nd reference position reached n-th axis (ZP21 to 28: X820 to 7)
- (2) 3rd reference position reached n-th axis (ZP31 to 38: X840 to 7)
- (3) 4th reference position reached n-th axis (ZP41 to 48: X860 to 7)

4 Explanation of Interface Signals

Cont.	Signal name	Abbrev.	\$1	\$2	\$3	\$4
A	2ND REFERENCE POSITION REACHED n-TH AXIS	ZP21 to 28	X820 to 7	X828 to F	X830 to 7	X838 to F

[Function]

This signal indicates that the axial component of the nth axis is on the 2nd reference position.

Each control axis is provided with this signal. The last number (n = 1, 2, 3...) of the signal abbreviation indicates the control axis No.

[Operation]

(1) The signal turns ON when:

- "2nd reference position reached" is attained with G30 command (G30 P2) in automatic operation.
- "2nd reference position reached" is attained with reference position return mode of automatic operation (Reference position selection code 1, 2).

(Note) If "2nd reference position reached" is achieved in other operation mode, or by other command, the signal does not turn ON.

(2) The signal turns OFF when:

- The axial component in position is relocated from the 1st reference position by motion command.
- "Emergency stop" signal is input or servo alarm occurs, causing stop to the machine.

[Related signals]

- (1) 1st reference position reached n-th axis (ZP11 to 18: X800 to 7)
- (2) 3rd reference position reached n-th axis (ZP31 to 38: X840 to 7)
- (3) 4th reference position reached n-th axis (ZP41 to 48: X860 to 7)
- (4) Reference position selection code m (ZSLmn: YC190,1)

Cont.	Signal name	Abbrev.	\$1	\$2	\$3	\$4
A	3RD REFERENCE POSITION REACHED n-TH AXIS	ZP31 to 38	X840 to 7	X848 to F	X850 to 7	X858 to F

[Function][Operation]

This signal informs that the control axis is on the 3rd reference position.

Function and operation are the same as the 2nd reference position reached, but the reference position and G command are different.

- Reference position: 3rd reference position
- G command: G30 P3

Cont.	Signal name	Abbrev.	\$1	\$2	\$3	\$4
A	4TH REFERENCE POSITION REACHED n-TH AXIS	ZP41 to 48	X860 to 7	X868 to F	X870 to 7	X878 to F

[Function][Operation]

This signal informs that the control axis is on the 4th reference position.

Function and operation are the same as the 2nd reference position reached, but the reference position and G command are different.

- Reference position: 4th reference position
- G command: G30 P4

4 Explanation of Interface Signals

Cont.	Signal name	Abbrev.	\$1	\$2	\$3	\$4
A	NEAR REFERENCE POSITION n-TH AXIS	NRF1 to 8	X880 to 7	X888 to F	X890 to 7	X898 to F

[Function]

This signal indicates that the control axis is near the 1st reference position in the absolute position detection system.

[Operation]

This signal turns ON when the control axis is in the range of the parameter set using the 1st reference position as a base point, and turns OFF when the range is exceeded. The parameter is set with #2057 (nrefp) and #2058 (nrefn) in the [ABS. POSI PARAM] screen.

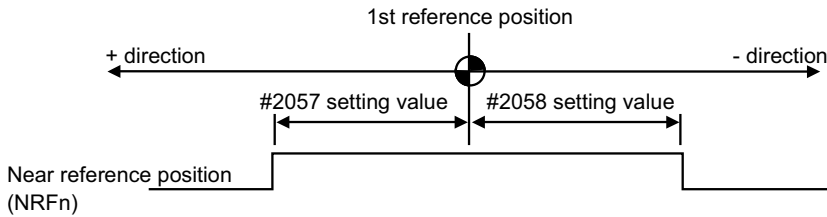

- (Note 1) The "Near reference position" signal is output even while the axis is moving, but there may be deviation with the actual machine position.
 Rapid traverse: Approx. 19mm at 20m/min.
 Cutting feed: Approx. 9.5mm at 10m/min.
- (Note 2) This signal is valid only with the absolute position detection system.
- (Note 3) When 0 is set for #2057 (nrefp) and #2058 (nrefn) in the [ABS. POSI PARAM] screen, it will be same as when the grid width is set.

Cont.	Signal name	Abbrev.	\$1	\$2	\$3	\$4
A	ARBITRARY AXIS SUPERIMPOSITION COMPLETE n-TH AXIS [M8]	PLFN1 to 8	X8A0 to 7	X8A8 to F	X8B0 to 7	X8B8 to F

[Function]

This signal indicates that which axis is controlled as the superimposition axis during the arbitrary axis superimposition control.

- 0: Axis not in the arbitrary axis superimposition control
- 1: Axis in the arbitrary axis superimposition control

[Operation]

This signal turns ON when the arbitrary axis superimposition control is established after the arbitrary axis superimposition control "start" is commanded.
 This signal turns OFF when the arbitrary axis superimposition control "end" is commanded.

4 Explanation of Interface Signals

Cont.	Signal name	Abbrev.	\$1	\$2	\$3	\$4
A	ZERO POINT INITIALIZATION SET COMPLETED n-TH AXIS	ZSF1 to 8	X8C0 to 7	X8C8 to F	X8D0 to 7	X8D8 to F

[Function]

This signal notifies that the basic machine coordinate system has been set (established) during zero point initialization set using the marked point alignment method in the absolute position detection system.

[Operation]

This signal is valid when "#2049 TYPE" on the [ABS. POSI PARAM] screen is set to "2", and turns ON when the basic machine coordinate system is set (established).

This signal will turn OFF if initializing is carried out again or if the power is turned ON again.

<Zero point initialization set method using marked point alignment method, and timing chart>

[Outline of zero point initialization set method]

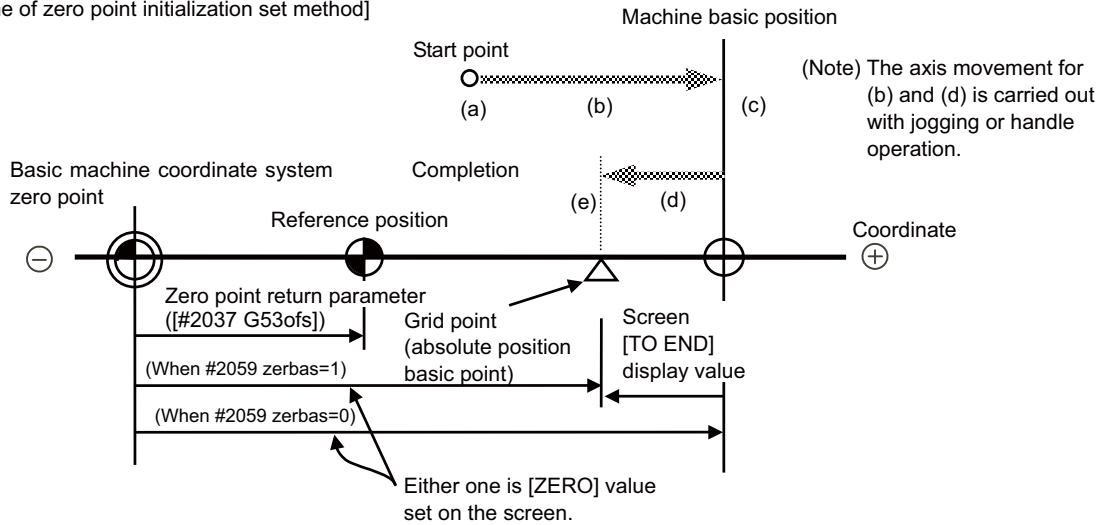

[Time chart] ((a) to (e) in the figure correspond to (a) to (e) above)

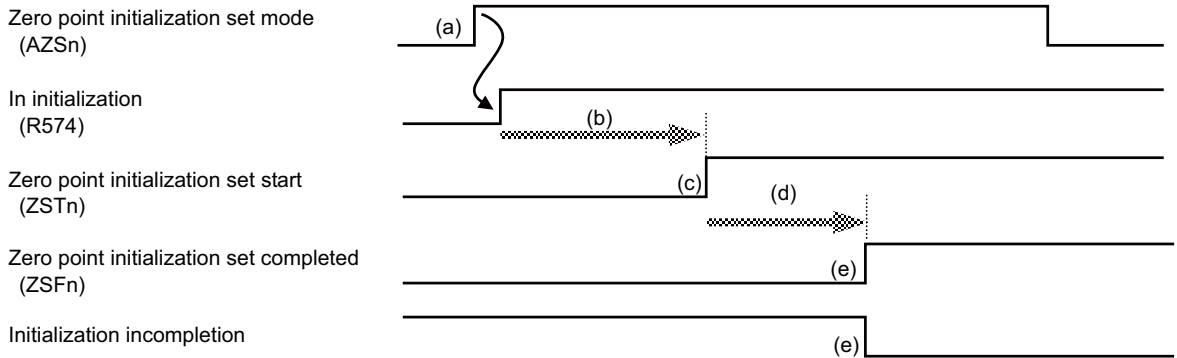

[Related signals]

- (1) Zero point initialization set error completed (ZSE1 to 8: X8E0 to 7)
- (2) In initialization (R574)
- (3) Initialization incompletion (R575)
- (4) Zero point initialization set mode (AZS1 to 8: Y960 to 7)
- (5) Zero point initialization set start (ZST1 to 8: Y980 to 7)

4 Explanation of Interface Signals

Cont.	Signal name	Abbrev.	\$1	\$2	\$3	\$4
A	ZERO POINT INITIALIZATION SET ERROR COMPLETED n-TH AXIS	ZSE1 to 8	X8E0 to 7	X8E8 to F	X8F0 to 7	X8F8 to F

[Function]

This signal is output when initializing is not possible during the marked point alignment method of the absolute position detection system.

[Operation]

This signal turns ON when the initializing is not possible at the rising edge of the "Zero point initialization set start" (ZSTn) signal.

This signal is invalidated in the following cases:

- During emergency stop
- During reset
- When "Zero point initialization set start" (ZSTn) signal is turned ON before the "Zero point initialization set mode" (AZSn) signal
- When grid has not been passed even once after the power has been turned ON. (Depends on the encoder type)

[Related signals]

- (1) Zero point initialization set completed (ZSF1 to 8: X8C0 to 7)
- (2) In initialization (R574)
- (3) Initialization incompleteness (R575)
- (4) Zero point initialization set mode (AZS1 to 8: Y960 to 7)
- (5) Zero point initialization set start (ZST1 to 8: Y980 to 7)

Cont.	Signal name	Abbrev.	\$1	\$2	\$3	\$4
A	IN CURRENT LIMIT n-TH AXIS	ILI1 to 8	X900 to 7	X908 to F	X910 to 7	X918 to F

[Function][Operation]

This signal turns ON during the current limit.

[Related signals]

- (1) Current limit reached n-th axis (ILA1 to 8: X920 to 7)
- (2) Current limit changeover n-th axis (ILC1 to 8: Y9A0 to 7)
- (3) Droop cancel request n-th axis (DOR1 to 8: Y9C0 to 7)
- (4) Current limit mode 1,2 (ILM1,2: YCC0,1)
- (5) Current limit changeover (R2593)

Cont.	Signal name	Abbrev.	\$1	\$2	\$3	\$4
A	CURRENT LIMIT REACHED n-TH AXIS	ILA1 to 8	X920 to 7	X928 to F	X930 to 7	X938 to F

[Function][Operation]

This signal turns ON when the current reaches its limit during the current limit control.

[Related signals]

- (1) In current limit n-th axis (ILI1 to 8: X900 to 7)
- (2) Current limit changeover n-th axis (ILC1 to 8: Y9A0 to 7)
- (3) Droop cancel request n-th axis (DOR1 to 8: Y9C0 to 7)
- (4) Current limit mode 1,2 (ILM1,2: YCC0,1)
- (5) Current limit changeover (R2593)

4 Explanation of Interface Signals

Cont.	Signal name	Abbrev.	\$1	\$2	\$3	\$4
A	NC AXIS UP-TO-SPEED n-TH AXIS	ARRFn	X940 to 7	X948 to F	X950 to 7	X958 to F

[Function]

This signal indicates that the actual axis feedrate has reached the feedrate commanded for each axis.

[Operation]

This signal turns ON when the difference of the speed commanded for each axis and the motor feedback feedrate is within a set range (approx. ±15%).

This signal turns OFF when the speed difference exceeds the set range.

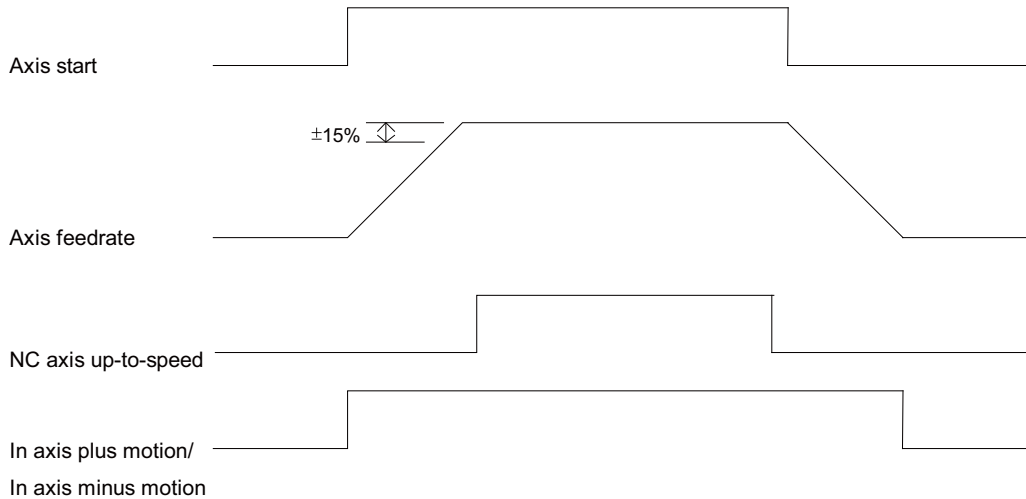

[Related signals]

- (1) In axis plus motion n-th axis (MVP1 to 8: X7C0 to 7)
- (2) In axis minus motion n-th axis (MVM1 to 8: X7E0 to 7)

Cont.	Signal name	Abbrev.	\$1	\$2	\$3	\$4
A	UNCLAMP COMMAND n-TH AXIS	UCLPn	X960 to 7	X968 to F	X970 to 7	X978 to F

[Function]

This signal is output when movement of the axis selected as the index table indexing axis is commanded.

[Operation]

Selecting either "Type A" or "Type B" is set in the parameter "#1282 ext18/bit3 (Index table clamp type)".

- (1) Type A (#1282 ext18/bit3 = 0)

When this signal turns ON, the index table indexing axis clamp is released by the PLC, and the unclamp completion (UCLPFn) signal is set.

This signal turns OFF when movement of the index table indexing axis is completed.

This signal will not turn OFF if the axis movement is interrupted with an interlock or automatic operation pause, etc.

When unclamp completion signal turns OFF during the movement of index table indexing axis in automatic operation, the index table indexing axis decelerates and stops as the unclamp command is ON.

Other axes commanded in the same block decelerate and stop in the same manner except non-interpolation commands.

When the axis movement is stopped by reset or emergency stop, etc., the unclamp command is turned OFF even if the axis is not in the indexing position. Make sure not to clamp it.

The signal turns ON when:

- Movement of the indexing axis is commanded during automatic operation.

This signal turns OFF when:

- Movement of the index table indexing axis is completed during automatic operation.
- The axis movement is forcibly ended with reset or emergency stop, etc.

4 Explanation of Interface Signals

(2) Type B (#1282 ext18/bit3 = 1)

When this signal turns ON, the index table indexing axis clamp is released by the PLC, and the "unclamp completion" (UCLPFn) signal is set.

The signal turns ON when:

- Movement of the index table indexing axis is commanded during automatic operation.

This signal turns OFF when:

- The unclamp completion signal turns ON by PLC. (including during the axis movement).
- The axis movement is forcibly ended with reset or emergency stop, etc.

(Note1) This signal is turned ON and OFF when the index table indexing axis acceleration/deceleration has completed. Thus, if the in-position has to be confirmed during the clamp/unclamp operation, confirm with the PLC.

(Note2) Refer to the Programming Manual for operation details of type A and type B respectively.

[Related signals]

- (1) Unclamp completion (UCLPFn:YA20 to 7)
- (2) Clamp command (CLPn: XB00 to XB07)
- (3) Clamp completion (CLPFn:YB00 to YB07)

Cont.	Signal name	Abbrev.	\$1	\$2	\$3	\$4
A	IN MIXED CONTROL (CROSS AXIS CONTROL) n-TH AXIS		X980 to 7	X988 to F	X990 to 7	X998 to F

[Function]

This signal is a status signal that indicates a state commanded by the "mixed control(cross axis control) request" signal.

[Operation]

The axis in the in mixed control(cross axis control) is "1".

(Example)

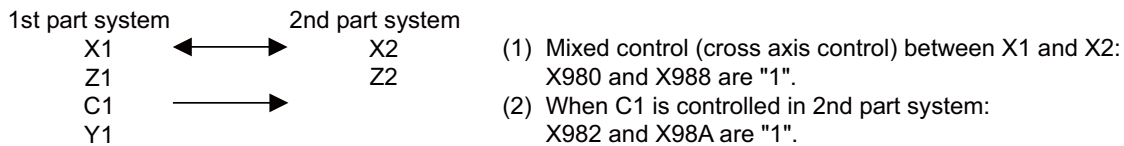

[Related signals]

- (1) Mixed control (cross axis control) request n-th axis (YA60 to 7)

Cont.	Signal name	Abbrev.	\$1	\$2	\$3	\$4
A	IN SYNCHRONOUS/SUPERIMPOSITION CONTROL n-TH AXIS		X9A0 to 7	X9A8 to F	X9B0 to 7	X9B8 to F

[Function]

This signal informs the axis in the control axis synchronization between part systems/superimposition control.

0: Axis not in control axis synchronization between part systems/superimposition control

1: Axis in control axis synchronization between part systems/superimposition control

[Operation]

The synchronized axis/superimposed axis and synchronized reference axis/superimposed reference axis are indicated.

[Caution]

- (1) Since the control axis synchronization between part systems and the control axis superimposition control functions cannot be used simultaneously, when this signal is set to "1", it indicates that the axis is either in synchronization control or superimposition control at all times.

[Related signals]

- (1) Synchronous control request n-th axis (YA80 to F)
- (2) Superimposition control request n-th axis (YAA0 to 7)

4 Explanation of Interface Signals

Cont.	Signal name	Abbrev.	\$1	\$2	\$3	\$4
A	IN MIRROR IMAGE n-TH AXIS	MIRn	X9C0 to 7	X9C8 to F	X9D0 to 7	X9D8 to F

[Function]

This signal indicates that a control axis is in mirror image.

There is a signal for each control axis. The last digit in the signal name indicates the control axis No.

[Operation]

The signal turns ON during:

- (1) Programmable mirror image
- (2) Parameter setting mirror image
- (3) External input mirror image
- (4) Facing turret mirror image

The signal turns OFF when:

- (1) The mirror image above is canceled.

Cont.	Signal name	Abbrev.	\$1	\$2	\$3	\$4
A	REFERENCE POSITION ESTABLISHMENT n-TH AXIS		X9E0 to 7	X9E8 to F	X9F0 to 7	X9F8 to F

[Function]

This signal indicates that a reference position is established.

There is a signal for each control axis. The last digit in the signal name indicates the control axis No.

[Operation]

The signal turns ON when:

- (1) Manual reference position return is completed and a reference position is established.
- (2) A reference position is confirmed by the absolute encoder when the power is turned ON.

The signal turns OFF when:

- (1) The reference position is lost

Cont.	Signal name	Abbrev.	\$1	\$2	\$3	\$4
A	REFERENCE POSITION RETURN DIRECTION n-TH AXIS		XA00 to 7	XA08 to F	XA10 to 7	XA18 to F

[Function]

This signal indicates that whether the reference position selected by "Reference position selection code 1,2" or "Each axis reference position selection" is in the plus direction or minus direction with respect to the current position.

[Operation]

The signal turns ON when:

- (1) The reference position selected by "Reference position selection code 1,2" (ZSL1, ZSL2: YC90, YC91) or "Each axis reference position selection" (R2584) is in the minus direction while reference position is established.

The signal turns OFF when:

- (1) The reference position is in the plus direction.
- (2) The current position is on the reference position
- (3) The reference position is lost

(Note 1) If the rotation axis type is other than all coordinate linear type, this signal turns ON when $0^\circ < \theta \leq 180^\circ$, and turns OFF when $180^\circ < \theta \leq 360^\circ (0^\circ)$.

(Note 2) "Reference position return direction" signal is not output for the reference position commanded by the machining program in an automatic operation.

(Note 3) "Reference position selection code 1,2" and "Each axis reference position selection" hold the state of the reference position return start in the reference position return mode.

(Note 4) When the zero point is changed during reference position return while "Reference position selection code 1,2" is valid, the "Reference position return direction" is output to the zero point prior to the change.

(Note 5) When the zero point is changed during reference position return while "Each axis reference position selection" is valid, the "Reference position return direction" is output to the zero point after the change.

[Related signals]

- (1) Reference position establishment (X9E0 to X9E7)
- (2) Reference position selection method (M:YC97)
- (3) Reference position selection code 1,2 (ZSL1, 2: YC90, YC91)
- (4) Each axis reference position selection (R2584)

4 Explanation of Interface Signals

Cont.	Signal name	Abbrev.	\$1	\$2	\$3	\$4
A	IN NC AXIS CONTROL n-TH AXIS	-	XA20 to 7	XA28 to F	XA30 to 7	XA38 to F

[Function]

This signal indicates the control status (NC control or PLC control) of the NC axis which can be operated under PLC control.

[Operation]

This signal turns ON when the NC axis is under NC control.

This signal turns OFF when the NC axis is under the PLC control.

The following shows the correspondence of axis Nos. and device Nos.

Device No.	Signal name	Device No.	Signal name
XA20	In NC axis control 1st axis	XA24	In NC axis control 5th axis
XA21	In NC axis control 2nd axis	XA25	In NC axis control 6th axis
XA22	In NC axis control 3rd axis	XA26	In NC axis control 7th axis
XA23	In NC axis control 4th axis	XA27	In NC axis control 8th axis

[Caution]

- "The NC axis which can be operated under PLC control" has the axis No. for PLC axis indexing, designated by "#12800 chgauxno".
- If the axis is moving, turning ON/OFF the "NC axis control selection n-th axis" leads an operation error. The signal is changed to ON/OFF after the axis has decelerated and stopped.

[Related signals]

- NC axis control selection n-th axis (YAC0 to YAC7)

Cont.	Signal name	Abbrev.	\$1	\$2	\$3	\$4
A	EXT. MACHINE COORDINATE SYSTEM OFFSET DATA ILLEGAL n-TH AXIS	ECIL1 to 8	XA40 to 7	XA48 to F	XA50 to 7	XA58 to F

[Function]

This signal indicates that the external machine coordinate system offset data is illegal, as the changed amount by the data will exceed the rapid traverse feedrate.

[Operation]

This signal turns ON when the external machine coordinate system offset data is illegal.

Then the change of the external machine coordinate system offset data is ignored. The compensation is executed with the set value unchanged.

[Related signals]

- Ext. machine coordinate system offset data n-th axis (R5700 to R5715)

Cont.	Signal name	Abbrev.	\$1	\$2	\$3	\$4
A	VERTICAL AXIS PULL-UP PREVENTED n-TH AXIS		XA60 to 7	XA68 to F	XA70 to 7	XA78 to F

[Function]

This signal indicates that the vertical axis pull-up function has been prevented.

[Operation]

This signal is ON while the vertical axis pull-up function is prevented.

[Related signals]

- Vertical axis pull-up prevention request (YAE0 to YAE7)

4 Explanation of Interface Signals

Cont.	Signal name	Abbrev.	\$1	\$2	\$3	\$4
A	CLAMP COMMAND n-TH AXIS	CLPn	XB00 to 7	XB08 to F	XB10 to 7	XB18 to F

[Function]

This signal is output when movement of the axis selected as the index table indexing axis is completed.

[Operation]

Selecting either "Type A" or "Type B" is set in the parameter "#1282 ext18/bit3 (Index table clamp type)".

(1) Type A (#1282 ext18/bit3 = 0)

This signal is not used.

(2) Type B (#1282 ext18/bit3 = 1)

When this signal turns ON, the index table indexing axis is clamped by the PLC, and the clamp completion signal is turned ON.

The signal turns ON when:

- Movement of the indexing axis is completed during automatic operation.

This signal turns OFF when:

- Clamp completion signal is turned ON by PLC.
- Reset or emergency stop.

(Note 1) This signal is turned ON and OFF when the index table indexing axis acceleration/deceleration has completed. Thus, if the in-position has to be confirmed during the clamp/unclamp operation, confirm with the PLC.

(Note 2) When this is stopped by reset during movement of indexing axis in automatic operation, the clamp command is not output. Take necessary processing by PLC.

(Note 3) Refer to the programming manual for each operation detail of type A and B.

[Related signals]

(1) Unclamp command (UCLPn: X960 to X967)

(2) Unclamp completion (UCLPFn: YA20 to YA27)

(3) Clamp completion (CLPFn: YB00 to YB07)

Cont.	Signal name	Abbrev.	\$1	\$2	\$3	\$4
A	SPINDLE-MODE ROTARY AXIS CONTROL MODE n-TH AXIS [M8]	ROTSPM1 to 8	XB40 to 7	XB48 to F	XB50 to 7	XB58 to F

[Function]

This signal indicates that the control axis for which the rotary axis spindle control is enabled in the parameter setting is currently in the spindle mode.

Each control axis is provided with this signal. The last number of the signal name indicates the control axis No.

[Related signals]

(1) Spindle-mode rotary axis control command n-th axis (ROTSPCn:YB40 and following)

4 Explanation of Interface Signals

Cont.	Signal name	Abbrev.	\$1	\$2	\$3	\$4
A	EACH AXIS IN-POSITION n-TH AXIS	AXINP1 to 8	XB60 to 7	XB68 to F	XB70 to 7	XB78 to F

[Function]

This signal informs the PLC that the control axis of the control unit is in-position state.

[Operation]

The signal turns ON when:

- (1) There is no acceleration/deceleration delay in control axis, and servo errors (remaining pulses) in positioning are within the range set by the parameter.

The signal turns OFF when:

- (1) Acceleration/deceleration motion is delayed in a control axis.
 - (2) Servo positioning error (remaining pulses) for a control axis exceeds the range set by the parameter.
- (Note 1) The "Each axis in-position" signal may turn ON even during motion if the motion is an extremely low speed.

When all of "Each axis in-position" signal within the part system turn ON, "All axes in-position" signal will turn ON.

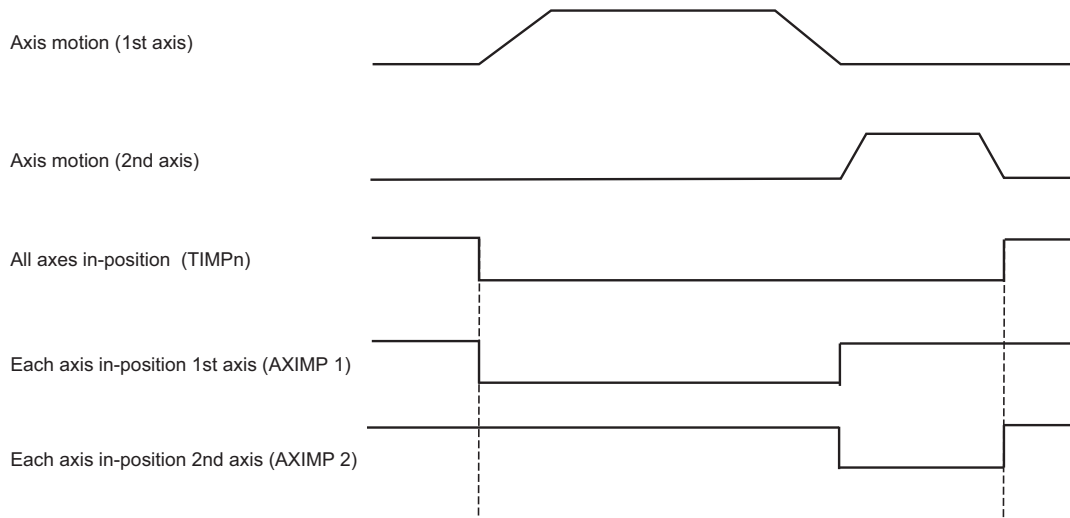

[Caution]

- (1) When the operation with machine lock is performed and variable-acceleration pre-interpolation acceleration/ deceleration is enabled by the function such as high-accuracy control, "Each axis in-position" signal is always ON.
- (2) "Each axis in-position" signal can not be used during the synchronous operation.

[Related signals]

- (1) All axes in-position (TIMP: XC19)

4 Explanation of Interface Signals

Cont.	Signal name	Abbrev.	\$1	\$2	\$3	\$4
A	REAL-TIME TUNING 1: SPEED CONTROL GAIN CHANGEOVER HOLD-DOWN ON [M8]	VGHLD1 to 8	XB80 to 7	XB88 to F	XB90 to 7	XB98 to F

[Function]

This signal indicates that speed control gain switching is currently stopped in the real-time tuning 1 function.

[Operation]

This signal indicates that speed control gain switching is stopped and the value of speed control gain is retained.

This signal is output when the "Speed control gain changeover hold-down command" is ON or when the cutting command modal is effective, regardless of whether this function is enabled or disabled.

This signal is not output when speed control gain switching is performed. Also, the signal is not output when the additional specification of real-time tuning 1 is set to OFF.

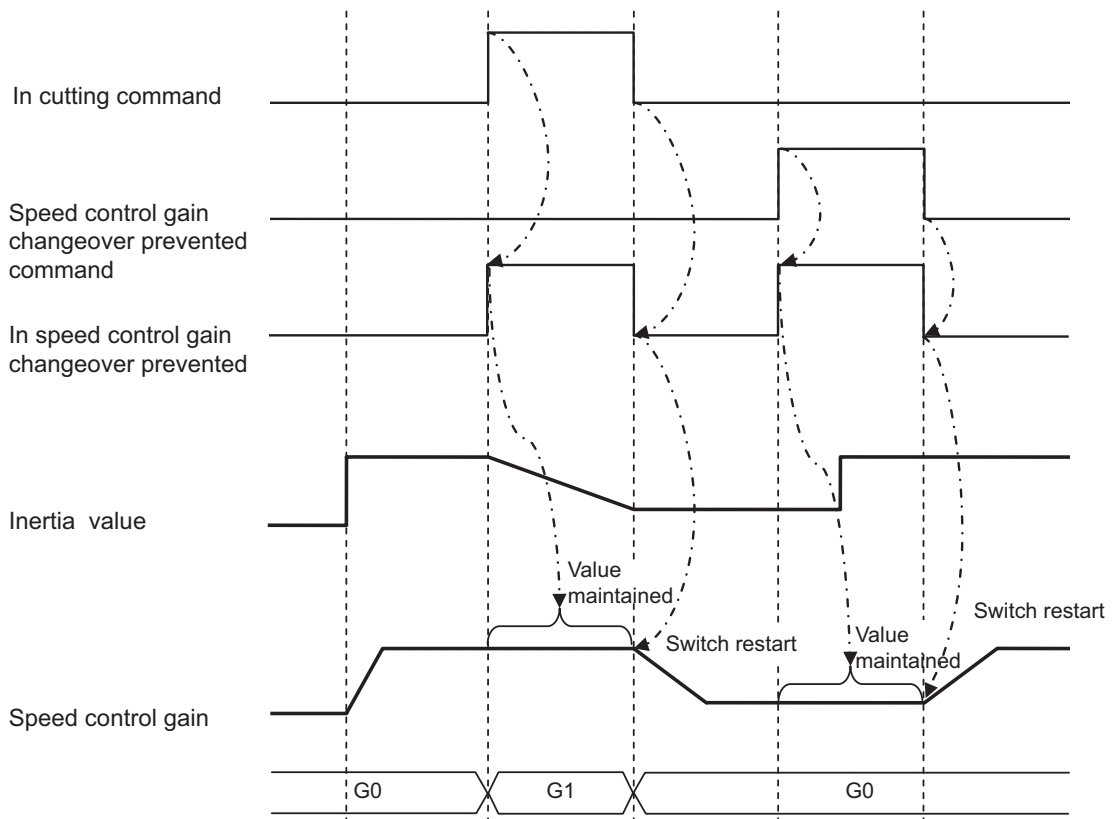

[Related signals]

- (1) Real-time tuning 1: Speed control gain changeover hold-down command (VGHLDC1:YB80)

4 Explanation of Interface Signals

Cont.	Signal name	Abbrev.	\$1	\$2	\$3	\$4
A	NC AXIS/PLC AXIS SWITCHOVER INVALID STATUS	NPCHGIS1 to 8	XBA0 to 7	XBA8 to F	XBB0 to 7	XBB8 to F

[Function]

This signal indicates that the NC axis/PLC axis switchover is disabled for the axis that is subject to the switchover.

This signal is available per control axis.

[Operation]

This signal turns ON when the following conditions apply to the axis for which the NC axis/PLC axis switchover is valid. When the NC axis/PLC axis switchover is performed with this signal ON, an operation error (M01 1250) will occur.

- While the axis is in motion (*)
- When the movement is stopped by the override zero or feed hold
- During the Servo OFF
- While the axis is being removed
- While the axis is stopped for interlock
- During the current limit
- During the droop cancel
- During the H/W OT or soft limit
- During the manual machine lock
- The reference axis or superimposed axis that is under the control axis superimposition
- The reference axis or synchronized axis that is under the control axis synchronization between part systems
- The chopping axis during the chopping
- The rotary tool axis during the tool spindle synchronization II (polygon)
- The workpiece axis during the tool spindle synchronization II (hobbing)
- The axis of the part system which is during the high-speed machining mode II/high-speed high-accuracy control II

* When travel command is given to multiple axes in one program block, and the switchover target axis is at a stop after the completion of movement, the switchover is disabled if any other axis is still moving.

[Related signals]

- (1) NC axis/PLC axis in switchover (NPCHGMOD1 to 8:XBC0 to 7)
- (2) NC axis/PLC axis switchover request (NPCHGREQ1 to 8:YBC0 to 7)

Cont.	Signal name	Abbrev.	\$1	\$2	\$3	\$4
A	NC AXIS/PLC AXIS SWITCHOVER n-TH AXIS IN PROCESS	NPCHG-MOD1 to 8	XBC0 to 7	XBC8 to F	XBD0 to 7	XBD8 to F

[Function]

This signal notifies that the NC axis/PLC axis switching axis can be controlled as a PLC axis.

This signal is available per control axis.

[Operation]

This signal is turned OFF while the NC axis is controlled and it is turned ON while the PLC axis is controlled.

[Related signals]

- (1) NC axis/PLC axis switchover invalid status (NPCHGIS1 to 8:XBA0 to 7)
- (2) NC axis/PLC axis switchover request (NPCHGREQ1 to 8:YBC0 to 7)

Cont.	Signal name	Abbrev.	Device			
A	MACHINE GROUP-BASED ALARM STOP: MACHINE GROUP-BASED PLC INTERLOCK ON	GQEMGO _n	XBE0 to 7	XBE8 to F	XBF0 to 7	XBF8 to F

[Function]

This signal indicates that operation is stopped for "Machine group-based PLC interlock".

[Operation]

This signal indicates that operation has been stopped because the machine group-based alarm stop function was executed.

This signal is not output when the axis is not stopped or when the axis is stopped by an alarm other than that caused by the machine group-based alarm stop function.

4 Explanation of Interface Signals

The signals for each group are assigned as follows.

Group 1	Group 2	Group 3	Group 4	Group 5	Group 6	Group 7	Group 8
XBE0	XBE1	XBE2	XBE3	XBE4	XBE5	XBE6	XBE7
Group 9	Group 10	Group 11	Group 12	Group 13	Group 14	Group 15	Group 16
XBE8	XBE9	XBEA	XBEB	XBEC	XBED	XBEE	XBEF
Group 17	Group 18	Group 19	Group 20	Group 21	Group 22	Group 23	Group 24
XBF0	XBF1	XBF2	XBF3	XBF4	XBF5	XBF6	XBF7
Group 25	Group 26	Group 27	Group 28	Group 29	Group 30	Group 31	Group 32
XBF8	XBF9	XBFA	XBFB	XBFC	XBFD	XBFE	XBFF

Cont.	Signal name	Abbrev.	\$1	\$2	\$3	\$4	\$5	\$6	\$7	\$8
A	IN JOG MODE	JO	XC00	XD40	XE80	XFC0	X1100	X1240	X1380	X14C0

[Function]

This signal indicates that JOG mode is selected.

[Operation]

Mode is changed to JOG mode from other mode after "All axes smoothing zero" (TSMZ) (command acceleration/ deceleration delay is zero) is verified.

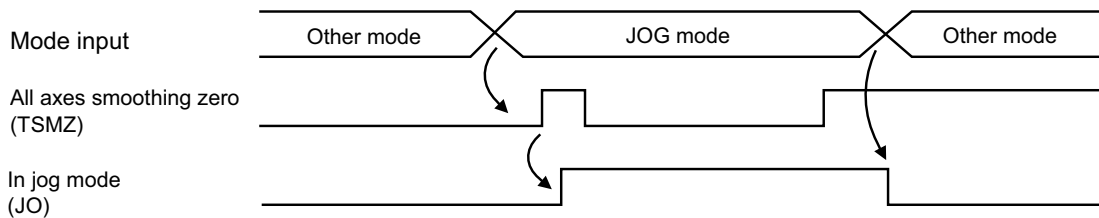

[Related signals]

- (1) All axes smoothing zero (TSMZ:XC1A)

Cont.	Signal name	Abbrev.	\$1	\$2	\$3	\$4	\$5	\$6	\$7	\$8
A	IN HANDLE MODE	HO	XC01	XD41	XE81	XFC1	X1101	X1241	X1381	X14C1

[Function]

This signal indicates that HANDLE mode is selected.

[Operation]

Mode is changed to HANDLE mode from other mode after "All axes smoothing zero" (TSMZn) (command acceleration/ deceleration delay is zero) is verified.

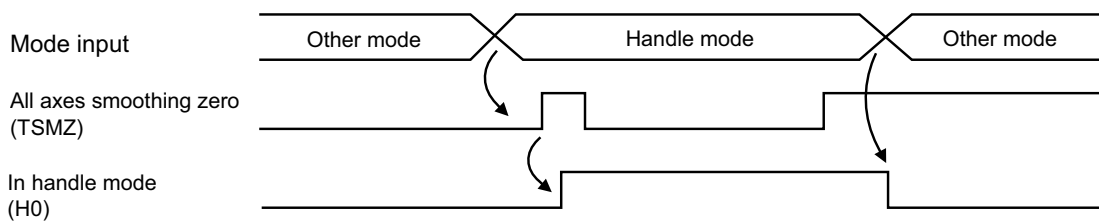

[Related signals]

- (1) All axes smoothing zero (TSMZ:XC1A)

4 Explanation of Interface Signals

Cont.	Signal name	Abbrev.	\$1	\$2	\$3	\$4	\$5	\$6	\$7	\$8
A	IN INCREMENTAL MODE	SO	XC02	XD42	XE82	XFC2	X1102	X1242	X1382	X14C2

[Function]

This signal indicates that INCREMENTAL mode is selected.

[Operation]

Mode is changed to INCREMENTAL mode from other mode after "All axes smoothing zero" (command acceleration/ deceleration delay is zero) is verified.

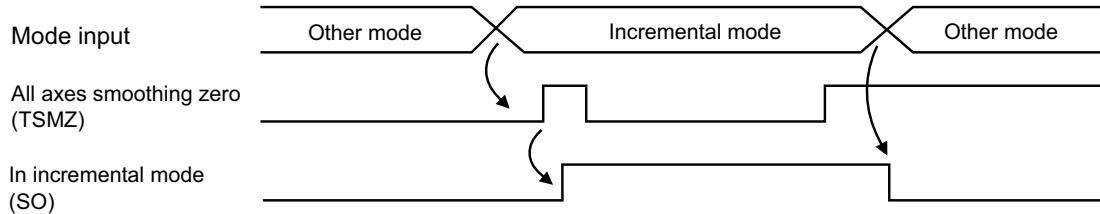

[Related signals]

(1) All axes smoothing zero (TSMZ:XC1A)

Cont.	Signal name	Abbrev.	\$1	\$2	\$3	\$4	\$5	\$6	\$7	\$8
A	IN MANUAL ARBITRARY FEED MODE	PTPO	XC03	XD43	XE83	XFC3	X1103	X1243	X1383	X14C3

[Function]

This signal indicates that MANUAL ARBITRARY FEED mode is selected.

[Operation]

Mode is changed to MANUAL ARBITRARY FEED mode from other mode after "All axes smoothing zero" (command acceleration/deceleration delay is zero) is verified.

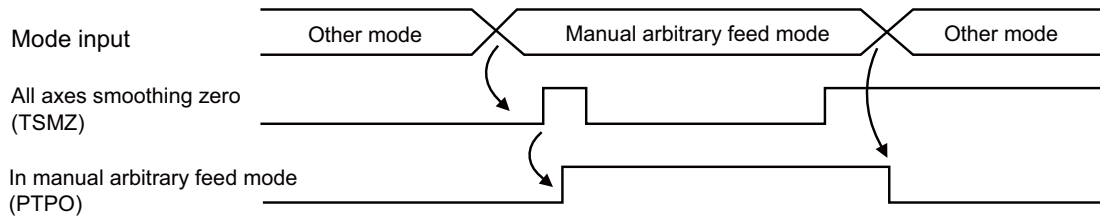

[Related signals]

(1) All axes smoothing zero (TSMZ:XC1A)

Cont.	Signal name	Abbrev.	\$1	\$2	\$3	\$4	\$5	\$6	\$7	\$8
A	IN REFERENCE POSITION RETURN MODE	ZRNO	XC04	XD44	XE84	XFC4	X1104	X1244	X1384	X14C4

[Function]

This signal indicates that REFERENCE POSITION RETURN mode is selected.

[Operation]

Mode is changed from other mode to REFERENCE POSITION RETURN mode after "All axes smoothing zero" (command acceleration/deceleration delay is zero) has been verified.

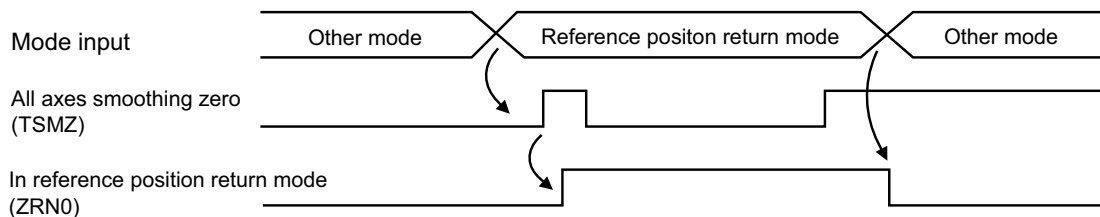

[Related signals]

(1) All axes smoothing zero (TSMZ:XC1A)

4 Explanation of Interface Signals

Cont.	Signal name	Abbrev.	\$1	\$2	\$3	\$4	\$5	\$6	\$7	\$8
A	IN AUTOMATIC INITIAL SET MODE	ASTO	XC05	XD45	XE85	XFC5	X1105	X1245	X1385	X14C5

[Function]

This signal indicates that AUTOMATIC INITIAL SET MODE is selected.

[Operation]

Mode is changed over from other mode to IN AUTOMATIC INITIAL SET MODE mode after "All axes smoothing zero" (command acceleration/deceleration delay is zero) has been verified.

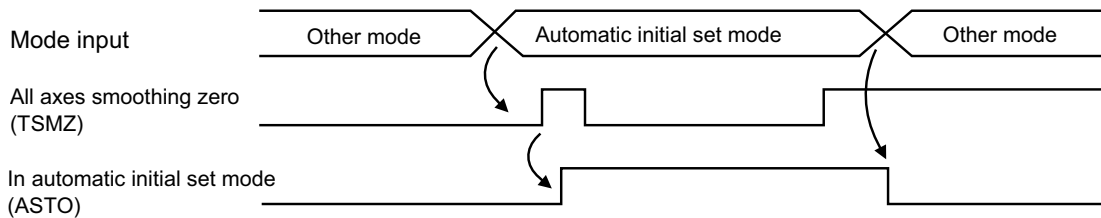

[Related signals]

- (1) All axes smoothing zero (TSMZ:XC1A)

Cont.	Signal name	Abbrev.	\$1	\$2	\$3	\$4	\$5	\$6	\$7	\$8
A	IN JOG-HANDLE SIMULTANEOUS MODE	JHANO	XC06	XD46	XE86	XFC6	X1106	X1246	X1386	X14C6

[Function]

This signal indicates that the simultaneous operation of JOG and handle mode has been entered.

[Operation]

- (1) This signal turns ON regardless of "All axes smoothing zero" (TSMZ) signal which informs there is no delay caused by the acceleration/deceleration time constants.
- (2) This signal will not turn ON when the "Jog Mode" (J) signal is OFF, even if the "Jog-handle synchronous" (JHAN) signal is ON.

[Timing chart]

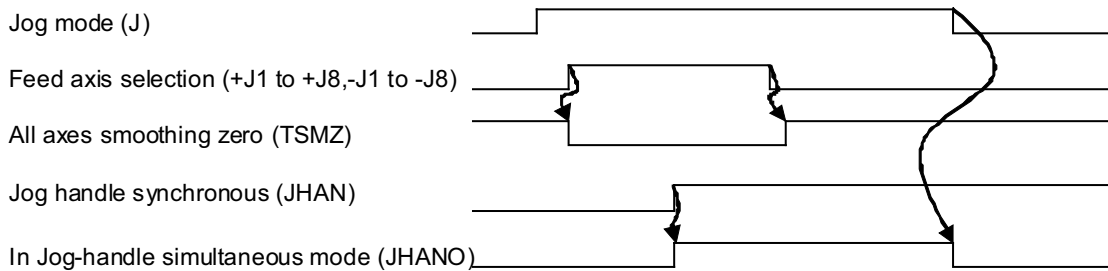

[Related signals]

- (1) Jog mode (J:YC00)
- (2) Jog handle synchronous (JHAN:YC7B)
- (3) All axes smoothing zero (TSMZ:XC1A)

4 Explanation of Interface Signals

Cont.	Signal name	Abbrev.	\$1	\$2	\$3	\$4	\$5	\$6	\$7	\$8
A	IN MEMORY MODE	MEMO	XC08	XD48	XE88	XFC8	X1108	X1248	X1388	X14C8

[Function]

This signal indicates that MEMORY mode is selected.

[Operation]

Mode is changed from other mode to MEMORY mode after "All axes smoothing zero" (command acceleration/ deceleration delay is zero) is verified.

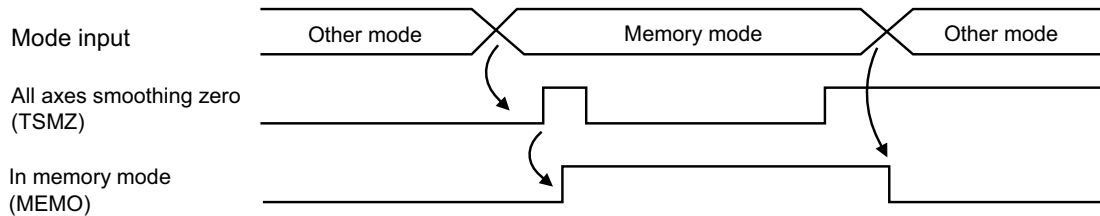

[Related signals]

(1) All axes smoothing zero (TSMZ:XC1A)

Cont.	Signal name	Abbrev.	\$1	\$2	\$3	\$4	\$5	\$6	\$7	\$8
A	IN TAPE MODE	TO	XC09	XD49	XE89	XFC9	X1109	X1249	X1389	X14C9

[Function]

This signal indicates TAPE mode is selected.

[Operation]

Mode is changed from other mode to TAPE mode when "All axes smoothing zero" (TSMZ)(command acceleration/ deceleration delay is zero) is verified.

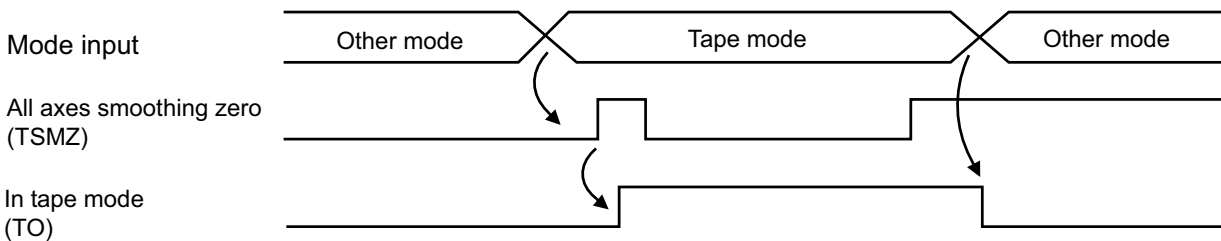

[Related signals]

(1) All axes smoothing zero (TSMZ:XC1A)

Cont.	Signal name	Abbrev.	\$1	\$2	\$3	\$4	\$5	\$6	\$7	\$8
A	IN MDI MODE	DO	XC0B	XD4B	XE8B	XFCB	X110B	X124B	X138B	X14CB

[Function]

This signal indicates that MDI mode is selected.

[Operation]

Mode is changed from other mode to MDI mode when "All axes smoothing zero" (command acceleration/ deceleration delay is zero) is verified.

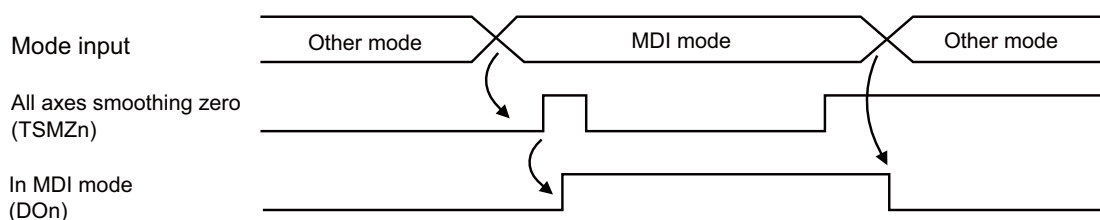

[Related signals]

(1) All axes smoothing zero (TSMZ:XC1A)

4 Explanation of Interface Signals

Cont.	Signal name	Abbrev.	\$1	\$2	\$3	\$4	\$5	\$6	\$7	\$8
A	SUB PART SYSTEM CONTROL: SUB PART SYSTEM CONTROL I MODE ON	SBSMO	XC0E	XD4E	XE8E	XFCE	X110E	X124E	X138E	X14CE

[Function]

This signal indicates that "Sub part system control I mode" is selected for the operation mode.

The sub part system can be started using the sub part system control I command (G122) when this signal is ON.

[Operation]

This signal is ON at the sub part system while the "Sub part system control: Sub part system control I mode" signal (SBSM) is ON.

[Related signals]

(1) Sub part system control: Sub part system control I mode (SBSM: YC0E)

Cont.	Signal name	Abbrev.	\$1	\$2	\$3	\$4	\$5	\$6	\$7	\$8
A	CONTROLLER READY COMPLETION	MA	XC10	XD50	XE90	XFD0	X1110	X1250	X1390	X14D0

[Function]

This signal indicates that the controller is ready for normal operation.

[Operation]

The signal turns ON when:

- (1) The controller starts working successfully after it is turned ON or when no off-condition exists.

The signal turns OFF when:

- (1) The controller is turned OFF.
- (2) Trouble occurs with the controller (such as failure in the CPU, memory, etc.).
- (3) A servo alarm which cannot be reset without turning OFF the power of the controller has occurred.

Cont.	Signal name	Abbrev.	\$1	\$2	\$3	\$4	\$5	\$6	\$7	\$8
A	SERVO READY COMPLETION	SA	XC11	XD51	XE91	XFD1	X1111	X1251	X1391	X14D1

[Function]

This signal indicates that the servo system is ready for normal operation.

In other words, the servo system (position control) is not working when this signal is OFF.

[Operation]

The signal turns ON when:

- (1) The diagnosis on the servo system is completed successfully after the control unit is turned ON.
- (2) "Servo alarm", if occurs, is reset. (Resetting may not be possible depending on the servo alarm contents.)
- (3) "Emergency stop" input is removed.
- (4) The power is turned OFF and ON again by entering the decryption code upon expiration set in the system lock.

The signal turns OFF when:

- (1) "Servo alarm" occurs.
- (2) "Emergency stop" is input.
- (3) The power supply of controller is turned OFF.
- (4) Trouble occurs with the controller (such as failure in the CPU or memory).
- (5) The decryption code has not been entered to the controller by the specified expiration date in the system lock.

(Note 1) This signal (SA) cannot be turned OFF only with the "Servo OFF" (*SVFn) signal.

 CAUTION Do not refer to this signal for a machine on which the system lock function is enabled. If this signal is referred to, unexpected motion may occur when the valid term has been expired.

[Related signals]

(1) Servo ready completion output designation (R2625)

4 Explanation of Interface Signals

Cont.	Signal name	Abbrev.	\$1	\$2	\$3	\$4	\$5	\$6	\$7	\$8
A	IN AUTOMATIC OPERATION "RUN"	OP	XC12	XD52	XE92	XFD2	X1112	X1252	X1392	X14D2

[Function]

This signal indicates that the controller is in automatic operation caused by "Auto operation "start" command" signal.

[Operation]

This signal stays ON from when automatic operation starts with the "Automatic operation "start" command (ST)" signal in the memory, MDI or tape mode, until the operation is reset.

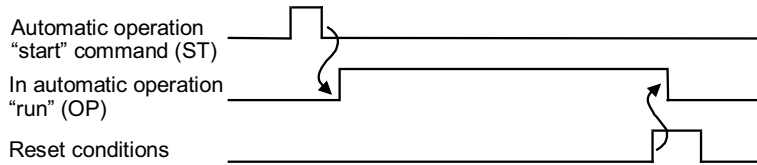

(1) Reset conditions include the followings:

- "Reset & rewind (RRW)" is input.
- "Emergency stop" signal or "Servo alarm" signal is input.

(2) Signals that indicates status of automatic operation are "In automatic operation "start"(STL)" and "In automatic operation pause (SPL)" besides "In automatic operation "run"(OP)".

The ON/OFF state of these signals in each state are shown below.

	n automatic operation "RUN" (OP)	In automatic operation "START" (STL)	In automatic operation "PAUSE" (SPL)
Reset condition	0	0	0
Automatic operation stop condition	1	0	0
Automatic operation pause condition	1	0	1
Automatic operation start condition	1	1	0

The outline of each condition is as follows:

- Reset condition

Automatic operation is stopped by one of reset conditions described above.
(All states not in automatic operation are this state.)

- Automatic operation stop condition

Automatic operation is stopped after completion of one block.
(This state is entered during single block stop.)

- Automatic operation pause condition

Automatic operation suspended in the course of execution of one block.
(This state is entered when the "Automatic operation "pause" command" signal (*SP) is OFF.)

- Automatic operation start condition

Automatic operation is being executed.

[Related signals]

- (1) In automatic operation "start" (STL:XC13)
- (2) In automatic operation "pause" (SPL:XC14)

4 Explanation of Interface Signals

Cont.	Signal name	Abbrev.	\$1	\$2	\$3	\$4	\$5	\$6	\$7	\$8
A	IN AUTOMATIC OPERATION "START"	STL	XC13	XD53	XE93	XFD3	X1113	X1253	X1393	X14D3

[Function]

This signal informs the PLC that the controller is started by automatic operation and motion command or M,S, T, B processing is in execution.

[Operation]

The signal turns ON by the "Automatic operation "start" command" signal (ST) in memory, MDI or tape mode, and OFF when automatic operation pause, block stop or reset condition occurs.

The "In automatic operation "start"" signal (STL) timing chart, including automatic operation "pause" and block stop, is shown below.

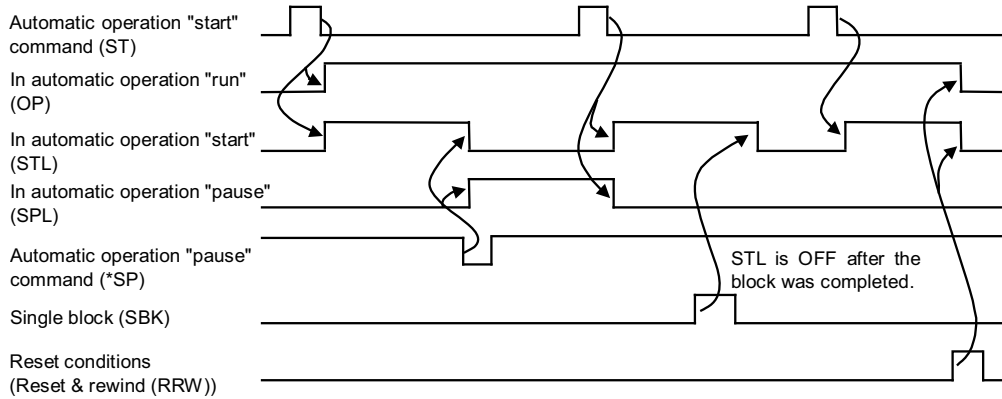

(Note) For reset conditions, refer to the section on "In automatic operation "run"" (OP).

[Related signals]

- (1) In automatic operation "run" (OP:XC12)
- (2) In automatic operation "pause" (SPL:XC14)
- (3) Automatic operation "start" command (ST:YC10)

4 Explanation of Interface Signals

Cont.	Signal name	Abbrev.	\$1	\$2	\$3	\$4	\$5	\$6	\$7	\$8
A	IN AUTOMATIC OPERATION "PAUSE"	SPL	XC14	XD54	XE94	XFD4	X1114	X1254	X1394	X14D4

[Function]

This signal informs that the controller operation has been stopped due to the "Auto operation "pause" command" signal, etc., during motion command or miscellaneous function command.

[Operation]

The "In automatic operation "pause"" signal (SPL) turns ON with the following factors during automatic operation using the memory, MDI or tape mode.

- (1) When "Automatic operation "pause" command" signal (*SP) turns OFF.
- (2) When mode changes to manual operation mode (jog, handle, incremental, reference position return mode, etc.).

This signal turns ON even during machine lock or a miscellaneous function (M, S, T, B) command.

This signal turns OFF in the following cases.

- (1) When "Automatic operation "start" command" signal (ST) turns OFF from ON. However, this will be invalid if the "Automatic operation "pause" command" signal (*SP) is not turned back ON or if the mode is not automatic operation (memory, MDI, tape).
- (2) When reset conditions are input.

The timing chart for the "In automatic operation "pause"" signal (SPL) is shown below.

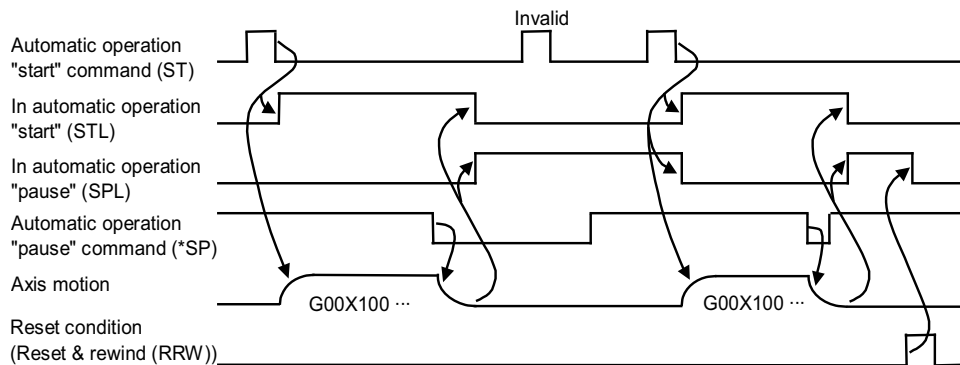

(Note 1) Refer to the section on "In automatic operation "run"" (OP) for the rest conditions.

[Related signals]

- (1) In automatic operation (OP:XC12)
- (2) In automatic operation "start" (STL:XC13)
- (3) Automatic operation "start" command (ST:YC10)
- (4) Automatic operation "pause" command (*SP:YC11)

Cont.	Signal name	Abbrev.	\$1	\$2	\$3	\$4	\$5	\$6	\$7	\$8
A	IN "RESET"	RST	XC15	XD55	XE95	XFD5	X1115	X1255	X1395	X14D5

[Function]

This signal informs that the controller is in reset condition.

[Operation]

The signal turns ON:

- (1) For about 4 to 5 seconds after the power is turned ON.
- (2) While "Reset and rewind" (RRWn) signal is ON, and for about 0.5 to 1 seconds after "Reset and rewind" (RRWn) signal turns OFF.
- (3) While "Emergency stop" signal is being input, and for 1 to 1.5 seconds after "Emergency stop" signal turns OFF.
- (4) During "Servo alarm", and for 1 to 1.5 seconds after "Servo alarm" is removed.

4 Explanation of Interface Signals

Cont.	Signal name	Abbrev.	\$1	\$2	\$3	\$4	\$5	\$6	\$7	\$8
A	IN MANUAL ARBITRARY FEED	CXN	XC16	XD56	XE96	XFD6	X1116	X1256	X1396	X14D6

[Function]

This signal is output during execution of manual arbitrary feed command.

[Operation]

The signal turns ON:

- (1) "Manual arbitrary feed strobe" signal (CXS8n) turns ON during MANUAL ARBITRARY FEED mode.

The signal turns OFF:

- (1) Commanded feed has been completed.
- (2) When "Reset 1", "Reset 2", or "Reset & Rewind" signal is input during execution of manual arbitrary feed command.

[Timing chart]

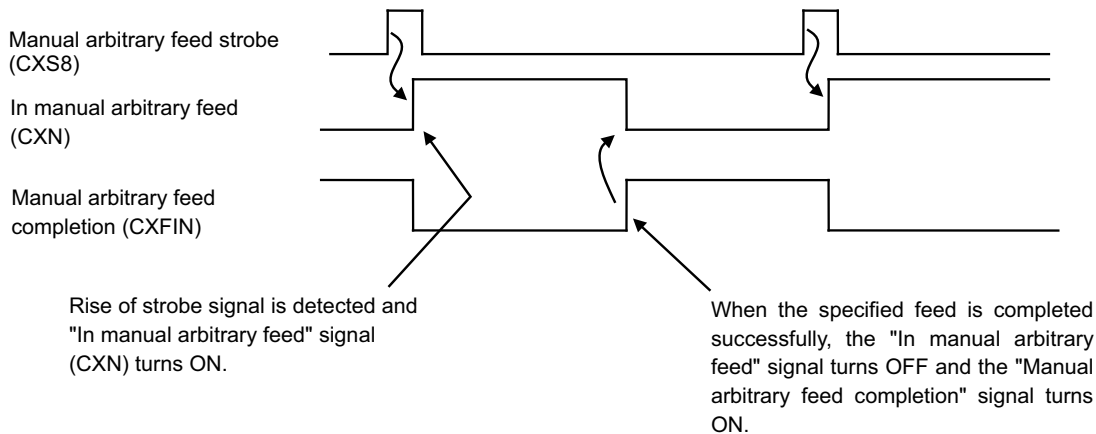

[Related signals]

- (1) Manual arbitrary feed strobe (CXS8:YCBF)
- (2) In manual arbitrary feed (CXFIN:XC1C)

Cont.	Signal name	Abbrev.	\$1	\$2	\$3	\$4	\$5	\$6	\$7	\$8
A	IN REWIND	RWD	XC17	XD57	XE97	XFD7	X1117	X1257	X1397	X14D7

[Function]

This signal informs that the controller is indexing the memory mode.

[Operation]

The signal turns ON when "Reset & rewind" (RRWn) signal is turned ON by the PLC in memory mode (with M02 or M30 command), and turns OFF when the controller completes indexing the program in execution.

(Note 1) Since indexing of program in memory mode ends immediately, it may not be verified by user PLC.

[Related signals]

- (1) Reset & rewind (RRW:YC1A)

4 Explanation of Interface Signals

Cont.	Signal name	Abbrev.	\$1	\$2	\$3	\$4	\$5	\$6	\$7	\$8
A	MOTION COMMAND COMPLETION	DEN	XC18	XD58	XE98	XFD8	X1118	X1258	X1398	X14D8

[Function]

This signal notifies that the commanded motion has been completed by the controller.

In the machining program when the motion command and miscellaneous function (M, S, T, B) command are specified in the same block, this signal can be used as a synchronization signal to determine whether miscellaneous function command is executed simultaneously with or after the motion command.

[Operation]

The signal turns ON when:

- (1) The system is initialized after the power is turned ON.
- (2) Execution of motion command is completed in automatic operation.
- (3) Reset condition occurs.

(For reset conditions, refer to the section on "In automatic operation "run"" (OPn) signal.)

The timing chart for the "Motion command completion" (DENn) signal is shown below.

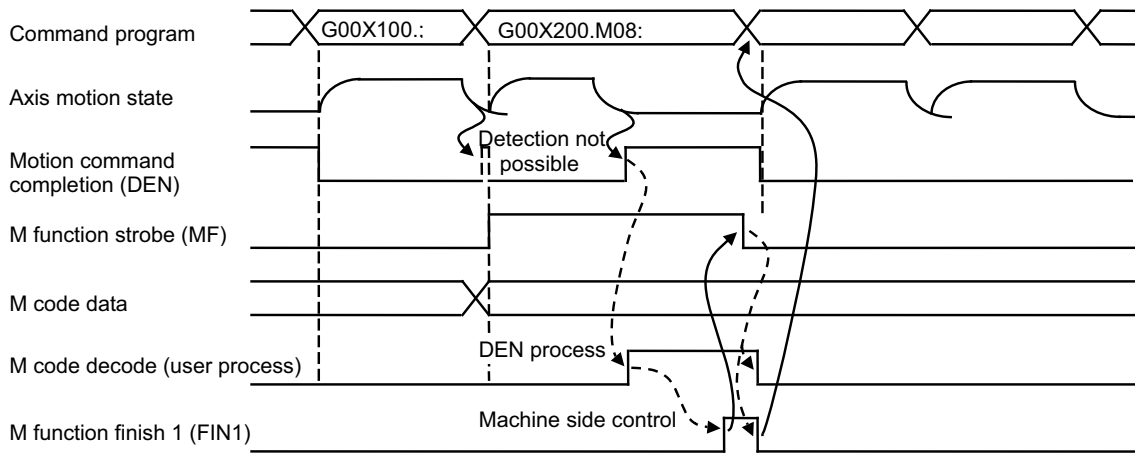

(Note 1) The "Motion command completion" signal is output even during machine lock.

(Note 2) Unless commanded motion is completed, this signal does not turn ON even when motion is suspended by interlock function or "Auto operation "pause" command" signal.

4 Explanation of Interface Signals

Cont.	Signal name	Abbrev.	\$1	\$2	\$3	\$4	\$5	\$6	\$7	\$8
A	ALL AXES IN-POSITION	TIMP	XC19	XD59	XE99	XFD9	X1119	X1259	X1399	X14D9

[Function]

This signal informs the PLC that the all axis components of the controller are in commanded positions.

[Operation]

The signal turns ON when:

- (1) when there is no acceleration/deceleration delay in all control axes and servo errors (remaining pulses) in positioning are within the specified range.

The signal turns OFF when:

- (1) Acceleration/deceleration motion is delayed in a control axis.
- (2) Servo positioning error (remaining pulses) for a control axis exceeds the specified range.

(Note 1) The signal may turn ON even during motion if the motion is an extremely low speed.

(Note 2) The condition where the servo errors must be in a specific range to turn ON the signal can be invalidated with parameters. In this case, the signal will turn ON/OFF depending on whether there is any delay in the acceleration/deceleration.

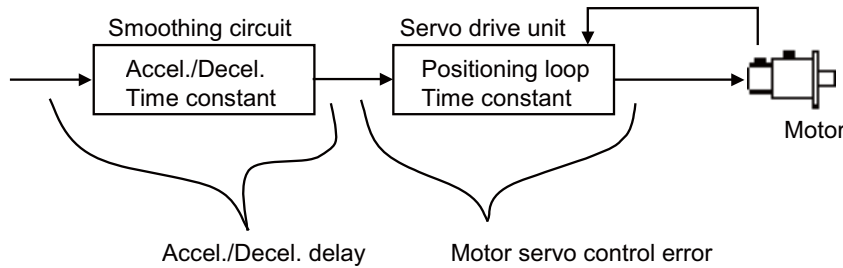

[Related signals]

- (1) All axes smoothing zero (TSMZ:XC1A)

Cont.	Signal name	Abbrev.	\$1	\$2	\$3	\$4	\$5	\$6	\$7	\$8
A	ALL AXES SMOOTHING ZERO	TSMZ	XC1A	XD5A	XE9A	XFDA	X111A	X125A	X139A	X14DA

[Function]

This signal informs the PLC that there is no delay (caused by the acceleration/deceleration time constants) in any of the controller control axis command system.

The PLC axis is not included in the control axis.

[Operation]

The signal turns ON when the movement amount commanded in automatic or manual operation, including delay amount of acceleration/deceleration time constant, is successfully output.

The signal turns OFF during execution of movement command, or if delay exists in acceleration/deceleration time constant.

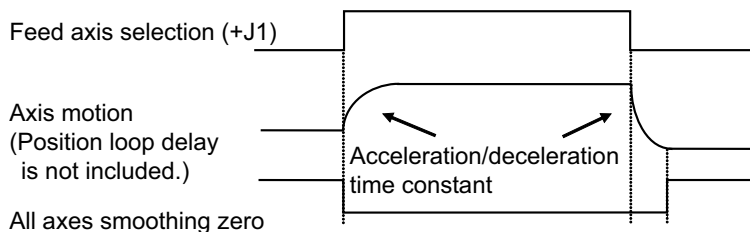

(Note 1) The signal can turn ON even during machine lock.

(Note 2) The signal may turn ON during motion if the motion is an extremely low speed.

(Note 3) "In axis plus/minus motion" signals are OFF while "All axes smoothing zero" is ON.

[Related signals]

- (1) All axes in-position (TIMP:XC19)
- (2) In axis plus motion n-th axis (MVP1 to MVP8:X7C0 to 7)
- (3) In axis minus motion n-th axis (MVM1 to MVM8:X7E0 to 7)

4 Explanation of Interface Signals

Cont.	Signal name	Abbrev.	\$1	\$2	\$3	\$4	\$5	\$6	\$7	\$8
A	MANUAL ARBITRARY FEED COMPLETION	CXFIN	XC1C	XD5C	XE9C	XFDC	X111C	X125C	X139C	X14DC

[Function]

This signal is output when motion commanded in manual arbitrary feed mode is completed.

[Operation]

The signal turns ON when:

- (1) The motion commanded in manual arbitrary feed mode is completed.

The signal turns OFF when:

- (1) During motion in manual arbitrary feed mode.
(The signal stays OFF when motion is interrupted by "Reset 1", "Reset 2", or "Reset & Rewind" signal.)
- (2) The power is turned ON.

[Timing chart]

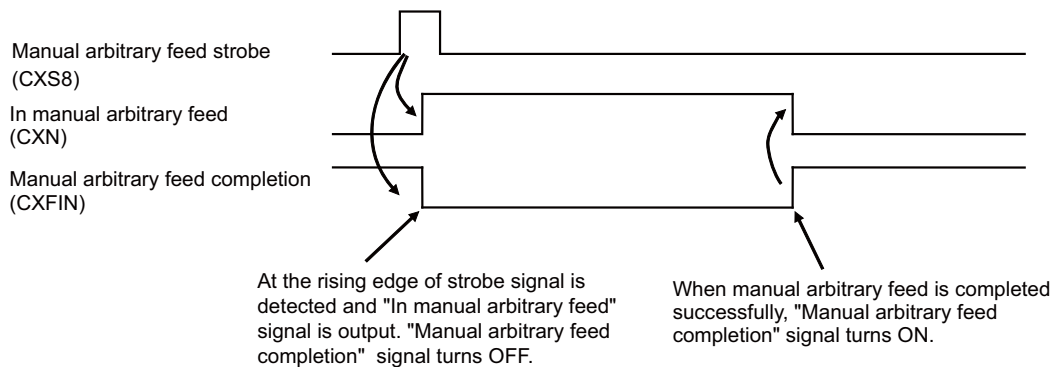

[Related signals]

- (1) Manual arbitrary feed strobe (CXS8:YCBF)
- (2) In manual arbitrary feed (CXN:XC16)

Cont.	Signal name	Abbrev.	\$1	\$2	\$3	\$4	\$5	\$6	\$7	\$8
A	EXTERNAL SEARCH FINISHED		XC1D	XD5D	XE9D	XFDD	X111D	X125D	X139D	X14DD

[Function][Operation]

This turns ON when the external search is finished. This also turns ON when an error occurs.

This signal turns OFF when the "External search strobe signal (YC1D)" signal is turned OFF from the user PLC.

[Timing chart]

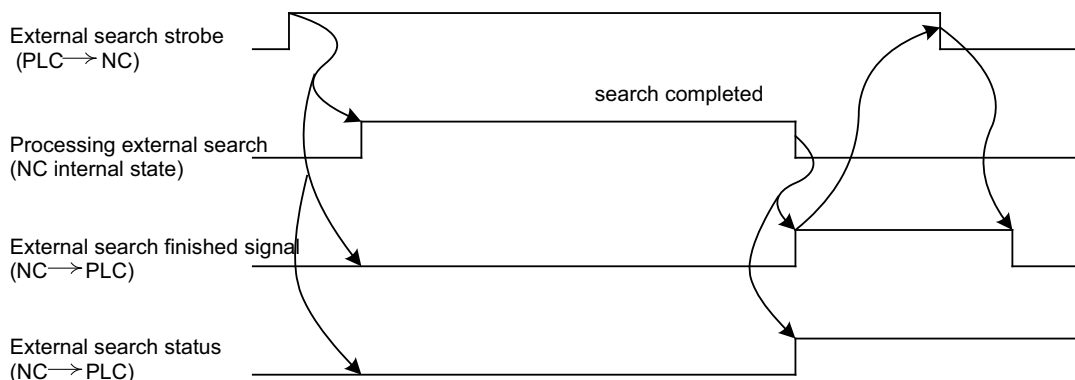

[Related signal]

- (1) External search strobe (YC1D)

4 Explanation of Interface Signals

Cont.	Signal name	Abbrev.	\$1	\$2	\$3	\$4	\$5	\$6	\$7	\$8
A	IN HIGH-SPEED MACHINING MODE (G05)		XC1F	XD5F	XE9F	XFD F	X111F	X125F	X139F	X14DF

[Function]

This signal notifies that the operation is in high-speed machining mode.

[Operation]

This signal turns ON when:

- (1) The high-speed machining mode is commanded in the machining program.

This signal turns OFF when:

- (1) The cancelation of the high-speed machining mode is commanded in the machining program.
- (2) The high-speed machining mode was finished with an operation such as NC reset.

Cont.	Signal name	Abbrev.	\$1	\$2	\$3	\$4	\$5	\$6	\$7	\$8
A	IN RAPID TRAVERSE	RPN	XC20	XD60	XEA0	XFE0	X1120	X1260	X13A0	X14E0

[Function]

This signal is output during rapid traverse motion in automatic operation (memory, MDI, tape).

[Operation]

(1) The signal is ON when:

- Rapid traverse motion in automatic operation.

Fixed cycle positioning and reference position return (G28), etc., are included in the automatic operation rapid traverse besides the motion command by the G00 command.

(2) The signal turns OFF when:

- The block in rapid traverse motion is completed during automatic operation.
- Rapid traverse motion is stopped by "Automatic operation "pause" command (Feed hold)" (*SPn) signal during automatic operation.
- Rapid traverse motion axis is stopped by interlock during automatic operation.
- The ratio of the "Cutting feedrate override code m" (*FVmn) becomes 0% during automatic rapid traverse operation.
- A stroke end (hardware or software) occurs during automatic rapid traverse operation.
- Reset condition occurs.

(Note 1) "In rapid traverse" (RPNn) signal can turn ON and OFF even during machine lock.

(Note 2) The signal is not output in manual operation.

(Note 3) For reset condition, refer to the section on "In automatic operation "run"" (OPn) signal.

The timing chart for "In rapid traverse" (RPNn) signal is shown below.

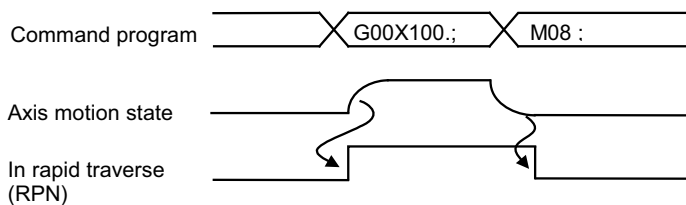

4 Explanation of Interface Signals

Cont.	Signal name	Abbrev.	\$1	\$2	\$3	\$4	\$5	\$6	\$7	\$8
A	IN CUTTING FEED	CUT	XC21	XD61	XEA1	XFE1	X1121	X1261	X13A1	X14E1

[Function]

This signal informs that given motion command is executed for cutting feed in automatic operation (memory, MDI, tape).

[Operation]

The signal turns ON when:

- (1) Motion command is given for cutting feed in automatic operation.

The signal turns OFF when:

- (1) The block in cutting feed in automatic operation is completed.
- (2) Execution of cutting feed is suspended by "Automatic operation "pause" command" signal (*SP).
- (3) Execution of cutting feed is stopped by interlock during automatic operation.
- (4) The ratio of the cutting feedrate override becomes 0% during automatic cutting feed operation.
- (5) A stroke end (hardware or software) occurs during automatic cutting feed operation.
- (6) Reset condition occurs.

(Note 1) The signal (CUT) can be turned ON and OFF during cutting feed even if machine interlock is applied.

(Note 2) Cutting feed commands in automatic operation include G01, G02, G03 and G31.

(Note 3) The signal is not output in manual operation.

(Note 4) For reset condition, refer to the section on "In automatic operation "run"" signal (OP).

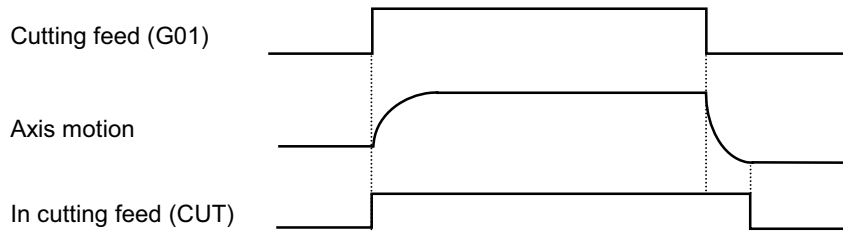

Cont.	Signal name	Abbrev.	\$1	\$2	\$3	\$4	\$5	\$6	\$7	\$8
A	IN TAPPING	TAP	XC22	XD62	XEA2	XFE2	X1122	X1262	X13A2	X14E2

[Function]

This signal informs that commanded motion in automatic operation (memory, MDI, tape) is executed in canned tapping cycle, or tapping mode is selected for execution of commanded motion.

[Operation]

(1) The signal turns ON when:

- Commanded motion in automatic operation is being executed in canned tapping cycle.
- Commanded motion in automatic operation is being executed in tapping mode (G63).

(2) The signal turns OFF when:

- Commanded motion is not being executed in fixed tapping cycle, nor in tapping mode.

The signal is reset by G80 or "01" group G command (G00, G01, G02, G03, G33) during canned tapping cycle, and by G61,

G62 and G64 during tapping mode.

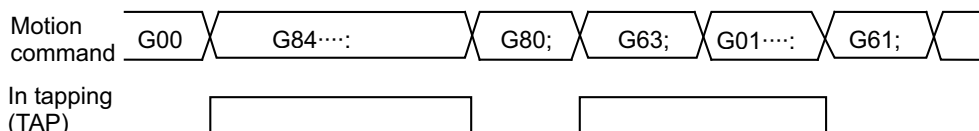

(Note 1) This signal is output even during machine lock.

4 Explanation of Interface Signals

Cont.	Signal name	Abbrev.	\$1	\$2	\$3	\$4	\$5	\$6	\$7	\$8
A	IN THREAD CUTTING	THRD	XC23	XD63	XEA3	XFE3	X1123	X1263	X13A3	X14E3

[Function]

This signal is output during execution of thread cutting command.

[Operation]

The signal turns ON when:

- (1) Thread cutting command is given.

The signal turns OFF when:

- (1) Motion command other than thread cutting command is given.
- (2) Reset condition occurs during thread cutting.

(Note) Spindle override is invalid (100%) during thread cutting.

Cont.	Signal name	Abbrev.	\$1	\$2	\$3	\$4	\$5	\$6	\$7	\$8
A	IN SYNCHRONOUS FEED	SYN	XC24	XD64	XEA4	XFE4	X1124	X1264	X13A4	X14E4

[Function]

This signal is output during execution of synchronous feed command.

[Operation]

The signal turns ON when:

- (1) Synchronous feed command (G95) is given.

The signal turns OFF when:

- (1) Asynchronous feed command (G94) is given.

Cont.	Signal name	Abbrev.	\$1	\$2	\$3	\$4	\$5	\$6	\$7	\$8
A	IN CONSTANT SURFACE SPEED	CSS	XC25	XD65	XEA5	XFE5	X1125	X1265	X13A5	X14E5

[Function]

This signal informs that automatic operation is under constant circumferential (surface) speed control.

[Operation]

The signal turns ON when:

- (1) Constant surface speed control mode (G96) is selected during automatic operation.

The signal turns OFF when:

- (1) Constant surface speed control off command (G97) is given.

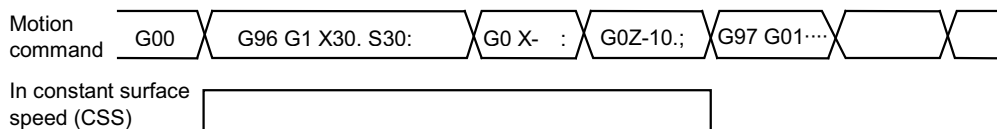

(Note 1) This signal (CSS) is output even during machine lock.

Cont.	Signal name	Abbrev.	\$1	\$2	\$3	\$4	\$5	\$6	\$7	\$8
A	IN SKIP	SKIP	XC26	XD66	XEA6	XFE6	X1126	X1266	X13A6	X14E6

[Function]

This signal is output while skip command (G31) is being executed.

[Operation]

The signal turns ON when:

- (1) Skip command (G31) is being executed with automatic operation.

The signal turns OFF when:

- (1) Block having a skip command is completed.

4 Explanation of Interface Signals

Cont.	Signal name	Abbrev.	\$1	\$2	\$3	\$4	\$5	\$6	\$7	\$8
A	IN REFERENCE POSITION RETURN	ZRNN	XC27	XD67	XEA7	XFE7	X1127	X1267	X13A7	X14E7

[Function]

This signal is output while reference position return command is being executed.

[Operation]

The signal turns ON when:

- (1) G28 command is executed.
- (2) G30 command is executed.
- (3) Manual reference position return mode is selected.

The signal turns OFF when:

- (1) All cases other than above.

Cont.	Signal name	Abbrev.	\$1	\$2	\$3	\$4	\$5	\$6	\$7	\$8
A	IN INCH UNIT SELECTION	INCH	XC28	XD68	XEA8	XFE8	X1128	X1268	X13A8	X14E8

[Function]

This signal informs that the controller uses inch unit for data input.

[Operation]

This signal turns ON when inch unit is selected.

During G20 (Inch unit command) modal, "In inch unit selection" signal turns ON.

change with machine parameter "#1041 I_inch".

Cont.	Signal name	Abbrev.	\$1	\$2	\$3	\$4	\$5	\$6	\$7	\$8
A	IN DISPLAY LOCK	DLNK	XC29	XD69	XEA9	XFE9	X1129	X1269	X13A9	X14E9

[Function]

This signal informs that the results of the movement command executed by the control unit are not reflected onto POSITION screen (display locked).

[Operation]

This signal turns ON while the display lock signal (DLK) is input.

The display lock operation is validated immediately after the display lock signal (DLK) turns ON.

[Related signals]

- (1) Display lock (DLK:YC29)

Cont.	Signal name	Abbrev.	\$1	\$2	\$3	\$4	\$5	\$6	\$7	\$8
A	F1-DIGIT COMMANDED	F1DN	XC2A	XD6A	XEAA	XFEA	X112A	X126A	X13AA	X14EA

[Function]

This signal informs that the controller uses F1-digit commands (F1 to 5) to control operation.

[Operation]

The signal turns ON when:

- (1) F1-digit command (F1 to 5) is selected for feedrate command currently being executed.

The signal turns OFF when:

- (1) Block having a motion command specified with F1-digit code is completed.
- (2) Operation is stopped by "Automatic operation "pause" command" signal (*SP) during execution of motion command by F1-digit command.
- (3) Operation is stopped by "Interlock" signal during execution of motion command by F1-digit command.
- (4) Reset condition occurs.

(For details of reset conditions, refer to the description about "In automatic operation "run"" signal (OP).)

(Note) To validate the F1-digit command, validate the parameter either "#1079 F1digit" or "#8145 Validate F1 digit".

[Related signals]

- (1) F1-digit No. code (F11 to 18:XC30 to XC33)

4 Explanation of Interface Signals

Cont.	Signal name	Abbrev.	\$1	\$2	\$3	\$4	\$5	\$6	\$7	\$8
A	IN TOOL LIFE MANAGEMENT	TLFO	XC2B	XD6B	XEAB	XFEB	X112B	X126B	X13AB	X14EB

[Function]

This signal is output during the tool life management.

[Operation]

In tool life management signal turns ON when the parameter of tool life management (#1103 T_Life) is ON.

Cont.	Signal name	Abbrev.	\$1	\$2	\$3	\$4	\$5	\$6	\$7	\$8
A	TOOL LIFE MANAGEMENT: TEMPORARY CANCEL OF TOOL LIFE EXPIRATION ON		XC2C	XD6C	XEAC	XFEC	X112C	X126C	X13AC	X14EC

[Function]

This signal indicates that the "Tool life over" signal is temporarily canceled.

[Operation]

This signal turns ON when:

- The "Temporary cancel of tool life expiration" signal turns ON.

This signal turns OFF when:

- The "Tool life over" signal is OFF at the falling edge of the "Temporary cancel of tool life expiration" signal.
(However, this signal remains ON even when the "Tool life over" signal is ON because it is canceled temporarily.)
- The NC is reset.
- The "Tool life over" signal turns OFF while this signal is output.

[Related signals]

- (1) Tool life over (TLOV:XC2E)
- (2) Tool life management: Temporary cancel of tool life expiration (YC98)

Cont.	Signal name	Abbrev.	\$1	\$2	\$3	\$4	\$5	\$6	\$7	\$8
A	TOOL LIFE MANAGEMENT: TEMPORARY CANCEL OF TOOL GROUP LIFE EXPIRATION ON		XC2D	XD6D	XEAD	XFED	X112D	X126D	X13AD	X14ED

[Function]

This signal indicates that the "Tool group life over" signal is temporarily canceled.

[Operation]

This signal turns ON when:

- The "Temporary cancel of tool group life expiration" signal turns ON.

This signal turns OFF when:

- The "Tool group life over" signal is OFF at the falling edge of the "Temporary cancel of tool group life expiration" signal.
(However, this signal remains ON even when the "Tool group life over" signal is ON because it is canceled temporarily.)
- The NC is reset.
- The "Tool group life over" signal turns OFF while this signal is output.

[Related signals]

- (1) Tool group life over (XC2F)
- (2) Tool life management: Temporary cancel of tool group life expiration (YC99)

4 Explanation of Interface Signals

Cont.	Signal name	Abbrev.	\$1	\$2	\$3	\$4	\$5	\$6	\$7	\$8
A	TOOL LIFE OVER	TLOV	XC2E	XD6E	XEAE	XFEE	X112E	X126E	X13AE	X14EE

[Function]

This signal notifies that a tool has reached the end of tool life (Cumulative tool usage data \geq Estimated tool life data).

[Operation]

The signal turns ON when cumulative tool usage data of tool is same as or has exceeded estimated tool life data. Note that this signal is only output and does not stop automatic operation or other operations of the controller.

<For Tool life management I or III for M system>

ON condition	#1246 set18/bit4 = 0	The currently selected tool has reached the end of tool life (cumulative tool usage data \geq estimated tool life data). (Time-count method: While cutting feed is performed) (Number of cuttings-count method: At the start of cutting feed for the Type 1, and at the Reset for the Type 2)
		The selected tool has already reached the end of tool life at the time of tool selection. (Same timing as "Tool function strobe 1" signal)
ON condition	#1246 set18/bit4 = 1	Even one tool in the currently selected group (or all the registered tool for Tool life management 3) has reached the end of tool life (cumulative tool usage data \geq estimated tool life data). (Time-count method: While cutting feed is performed) (Number of cuttings-count method: At the start of cutting feed for the Type 1, and at the Reset for the Type 2)
		Even one tool in the group has reached the end of tool life at the time of group selection. (Same timing as "Tool function strobe 1" signal)
OFF condition	#1246 set18/bit4 = 0	The tool selection has been completed. (At a T command. Note that the signal remains ON if the next tool has reached the end of tool life.)
		The tool status of the currently selected tool is cleared.
	#1246 set18/bit4 = 1	The group selection has been completed. (At a T command. Note that the signal remains ON if the next selected group contains any expired tool.)
		The cumulative tool usage data is smaller than the estimated tool life data (cumulative tool usage data < estimated tool life data).
		At the falling edge (1 -> 0) of the "Temporary cancel of tool life expiration" signal of corresponding part system. (However, this signal is turned ON again if the spindle tool used has reached the end of tool life when the NC is reset.)

<For Tool life management I for L system>

ON condition		T command is given after a currently selected tool has reached the end of tool life (cumulative tool usage data \geq estimated tool life data)
		The selected tool has already reached the end of tool life at the time of tool selection (Same timing as "T function strobe 1" signal)
OFF condition	#1262 set34/bit3 = 0	"M function finish (FIN)" signal is turned ON.
	#1262 set34/bit3 = 1	The tool selection has been completed. (At a T command. Note that the signal remains ON if the next tool has reached the end of tool life.)
	At the falling edge (1 -> 0) of the "Temporary cancel of tool life expiration" signal of corresponding part system. (However, this signal is turned ON again if the tool currently being used has reached the end of tool life when the NC is reset.)	

4 Explanation of Interface Signals

<For Tool life management II for M and L system>

ON condition	The currently selected tool has reached the end of tool life (cumulative tool usage data \geq estimated tool life data). (Time-count method: While cutting feed is performed) (Number of cuttings-count method: At the start of cutting feed for the Type 1, and at the Reset for the Type 2)
	All tools in the group have reached the end of tool lives at the time of group selection. (Same timing as "Tool function strobe 1" signal)
OFF condition	The group selection has been completed. (At a T command. Note that the signal remains ON if the next group is an expired group.)
	The cumulative tool usage data for the currently selected group is cleared.
	At the falling edge (1 \rightarrow 0) of the "Temporary cancel of tool life expiration" signal of corresponding part system. (However, this signal is turned ON again if the tool currently being used has reached the end of tool life when the NC is reset.)

[Related signals]

(1) Temporary cancel of tool life expiration signal (YC98 to Y1558)

Cont.	Signal name	Abbrev.	\$1	\$2	\$3	\$4	\$5	\$6	\$7	\$8
A	TOOL GROUP LIFE OVER		XC2F	XD6F	XEAF	XFEF	X112F	X126F	X13AF	X14EF

[Function]

This signal notifies that all tools in the tool group have reached the end of tool lives.

This signal is valid only for tool life management II.

The output condition can be selected by the parameter "#1277 ext 13/bit0". The count method of usage count will also be switched by this parameter.

[Operation]

The signal turns ON when all tools in the group mounted on the spindle have reached the end of tool lives or malfunction.

<Type 1> (#1277 ext13/bit0: 0)

This signal notifies that all tools in a group have reached the end of tool lives.

ON condition	The last tool of a currently selected group is determined as life-expired. (Note) (Time-count type: While cutting feed is performed) (Number of cuttings-count type: At the start of cutting feed for the Type 1, and at the Reset for the Type 2)
	"Tool skip" signal (to be described) is input to the last tool of a currently selected group.
	All the tools of the selected group are life-expired at the time of group selection. (Same timing as TF output)
OFF condition	Group selection is finished. (When T command is issued. Note that the signal remains ON if the next group is an expired group)
	The cumulative tool usage data of a currently selected group is cleared. (When the "Tool change reset" signal (to be described) is input, for example)
	The tool life management is disabled.
	At the falling edge (1 \rightarrow 0) of the "Temporary cancel of tool life expiration" signal of corresponding part system. (However, this signal is turned ON again if all the tools in the mounted group have reached the end of tool lives when the NC is reset.)

(Note) The criterion to judge the end of tool life depends on the parameter "#1220 aux04/bit0".

<Type 2> (#1277 ext13/bit0: 1)

This signal notifies that there is a life-expired group among all the registered groups.

(Life-expired group: a group in which there is no usable tool (no "Unused" and "Used" tools).)

ON condition	There is any life-expired group among all the registered groups. (The condition when a group is determined as life-expired is the same as for Type 1.)
OFF condition	The life-expired group is cleared. (The condition when life-expired state of a group is canceled is the same as for Type 1.)

[Caution]

(1) When this signal is used in the tool life management II, refer to the next ladder cycle after the spindle tool is changed.

(This signal will not change in the same cycle in which the spindle tool was changed.)

(2) This signal is only output and does not stop automatic operation or other operations of the controller.

4 Explanation of Interface Signals

Cont.	Signal name	Abbrev.	\$1	\$2	\$3	\$4	\$5	\$6	\$7	\$8
A	F1-DIGIT NO. CODE (1, 2, 4, 8)	F11 to F18	XC30 to 3	XD70 to 3	XEB0 to 3	XFF0 to 3	X1130 to 3	X1270 to 3	X13B0 to 3	X14F0 to 3

[Function]

F1-digit feed function No. is output.

[Operation]

When F1-digit feed command specified in memory, MDI or tape operation is executed, No. of that F1-digit feed function is set with a code.

Cont.	Signal name	Abbrev.	\$1	\$2	\$3	\$4	\$5	\$6	\$7	\$8
A	TIMING SYNCHRONIZATION BETWEEN PART SYSTEMS		XC34	XD74	XEB4	XFF4	X1134	X1274	X13B4	X14F4

[Function]

This signal informs that the timing synchronization between part systems is being executed.

[Operation]

- 1 : This signal is output while the timing synchronization between part systems is commanded in one part system to when the corresponding timing synchronization between system command is commanded in the other part system (during the timing synchronization between part systems).
- 0 : When the timing synchronization between part systems is not executed, this signal is not output.

Cont.	Signal name	Abbrev.	\$1	\$2	\$3	\$4	\$5	\$6	\$7	\$8
A	IN PLC INTERRUPT	PCINO	XC35	XD75	XEB5	XFF5	X1135	X1275	X13B5	X14F5

[Function] [Operation]

This signal turns ON at the beginning of a PLC interruption. Turns OFF when the PLC interruption is completed by M99 or a reset.

[Related signals]

- (1) PLC interrupt (PIT:YC2E)
(2) PLC interrupt program number (R2518, R2519)

Cont.	Signal name	Abbrev.	\$1	\$2	\$3	\$4	\$5	\$6	\$7	\$8
A	ILLEGAL AXIS SELECTED	ASLE	XC37	XD77	XEB7	XFF7	X1137	X1277	X13B7	X14F7

[Function]

This signal is output if axis (No.) selected in handle mode or manual arbitrary feed mode is illegal.

[Operation]

The signal turns ON when:

- (1) For handle mode.If specified handle axis No. is beyond the maximum number of control axes.
(2) For manual arbitrary feed mode.If specified manual arbitrary feed axis No. is beyond the maximum number of control axes.

4 Explanation of Interface Signals

Cont.	Signal name	Abbrev.	\$1	\$2	\$3	\$4	\$5	\$6	\$7	\$8
A	M CODE INDEPENDENT OUTPUT M00	DM00	XC40	XD80	XEC0	X1000	X1140	X1280	X13C0	X1500

[Function]

This signal informs that a special miscellaneous function (M00) is selected and commanded. When a special M function is specified, "Normal miscellaneous function strobe" signal and "M code data" are output.

M code independent outputs include M01, M02 and M30.

[Operation]

When M00, M01, M02 or M30 is specified during auto operation (memory, MDI or tape), or by manually set numerical command, this signal turns ON. The signal turns OFF when M function finish signal, reset signal or reset & rewind signal is given.

Machining program	M code independent output	Abbr.	Answer back to controller
M00	M00	DM00	Fin 1 or Fin 2
M01	M01	DM01	Fin 1 or Fin 2
M02	M02	DM02	Reset & rewind signal ("Fin" is not sent back)
M30	M30	DM30	Reset & rewind signal ("Fin" is not sent back)

If motion command and/or dwell is present in the same block, the signal turns ON after completion of dwell. However, the signal is not output if M function finish signal turns ON before completion of motion command or dwell.

Generally, each M code is used for the following purpose:

M00 Program stop

M01 Optional stop

M02, M30 Program end

Operation on user PLC side

(1) For M00

When M00 is input, single block signal (SBK) is turned ON and M function finish signal (Fin 1 or Fin 2) is sent back.

(2) For M01

When M01 is input, optional stop switch setting (ON or OFF) is checked. If the setting is "ON", single block signal is turned ON and M function finish signal is sent back, like the case with M00. If the setting is "OFF", M function finish signal is sent back immediately.

(3) For M02, M30

When motion where M02 or M30 was input (spindle stop, coolant stop, etc.) is completed, reset & rewind signal (RRW) is sent back instead of M function finish signal. If M function finish (Fin 1, Fin 2) signal is sent back, "program error" may occur.

[Related signals]

(1) M code independent output M01 (DM01:XC41)

(2) M code independent output M02 (DM02:XC42)

(3) M code independent output M30 (DM30:XC43)

Cont.	Signal name	Abbrev.	\$1	\$2	\$3	\$4	\$5	\$6	\$7	\$8
A	M CODE INDEPENDENT OUTPUT M01	DM01	XC41	XD81	XEC1	X1001	X1141	X1281	X13C1	X1501

[Function][Operation]

Refer to "M CODE INDEPENDENT OUTPUT M00".

Cont.	Signal name	Abbrev.	\$1	\$2	\$3	\$4	\$5	\$6	\$7	\$8
A	M CODE INDEPENDENT OUTPUT M02	DM02	XC42	XD82	XEC2	X1002	X1142	X1282	X13C2	X1502

[Function][Operation]

Refer to "M CODE INDEPENDENT OUTPUT M00".

4 Explanation of Interface Signals

Cont.	Signal name	Abbrev.	\$1	\$2	\$3	\$4	\$5	\$6	\$7	\$8
A	M CODE INDEPENDENT OUTPUT M30	DM30	XC43	XD83	XEC3	X1003	X1143	X1283	X13C3	X1503

[Function][Operation]

Refer to "M CODE INDEPENDENT OUTPUT M00".

Cont.	Signal name	Abbrev.	\$1	\$2	\$3	\$4	\$5	\$6	\$7	\$8
A	IN MANUAL SPEED COMMAND VALID		XC48	XD88	XEC8	X1008	X1148	X1288	X13C8	X1508

[Function]

This signal indicates that the "Manual speed command valid" signal has turned ON and the manual speed command is valid in the controller.

[Operation]

This signal turns ON when the "Manual speed command valid" signal has turned ON and the manual speed command has been enabled in NC.

This signal turns OFF when the "Manual speed command valid" signal has turned OFF and the manual speed command has been disabled in NC.

[Related signals]

- (1) Manual speed command valid (YC9D)

Cont.	Signal name	Abbrev.	\$1	\$2	\$3	\$4	\$5	\$6	\$7	\$8
A	MANUAL NUMERICAL COMMAND	MMS	XC49	XD89	XEC9	X1009	X1149	X1289	X13C9	X1509

[Function]

This signal informs that M, S, T or B (2nd miscellaneous function) command is given with a specific display format selected on the setting and display unit. With the signal, user PLC discriminates the command from that given in normal automatic operation.

[Operation]

The signal turns ON when M, S, T or B signal is specified with a specific display format in manual or automatic operation (other than cycle start). Like M function strobe signal, the signal turns OFF when M function finish 1 or 2 signal turns ON, or in case of reset.

(Example)

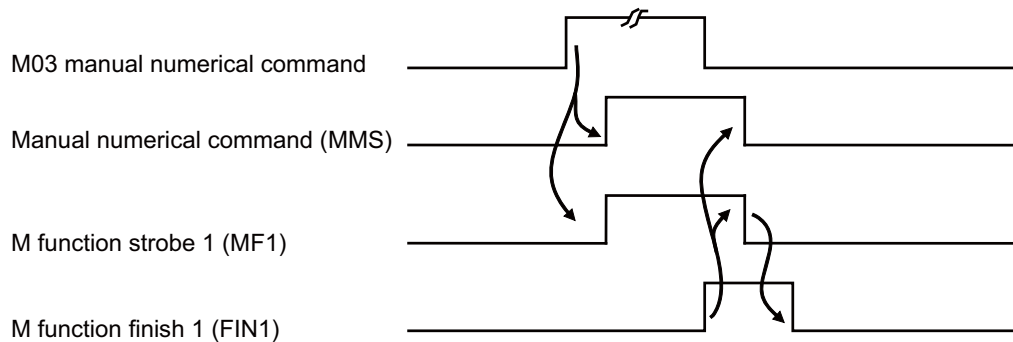

[Related signals]

- (1) M function strobe (MFn:XC60)
- (2) S function strobe (SFn:XC64)
- (3) T function strobe 1 (TF1:XC68)
- (4) 2nd M function strobe 1 (BF1:XC6C)
- (5) M function finish 1 (FIN 1:YC1E)
- (6) M function finish 2 (FIN 2:YC1F)

4 Explanation of Interface Signals

Cont.	Signal name	Abbrev.	\$1	\$2	\$3	\$4	\$5	\$6	\$7	\$8
A	IN TOOL ESCAPE AND RETURN MODE [M8]		XC4A	XD8A	XECA	X100A	X114A	X128A	X13CA	X150A

[Function]

This signal indicates in tool escape and return mode.

[Operation]

In order to designate a halted point, turn ON a transit point switch when operation is stopped by feed hold or single block. When recognition of the halted point is completed, this signal turns ON and the tool escape and return mode will be established.

Statuses of each signal after the machining program is halted are explained below.

The following (a) to (e) correspond to (a) to (e) in the figure below.

- (a) The recognition of the transit point is performed in automatic operation but not in automatic operation start.
- (b) When a user turns ON the "tool escape and return transit point designation" signal (YC8D), NC turns on the "tool escape and return transit point recognition finish" signal (XC87) and recognition will be completed.
- (c) When the "tool escape and return transit point recognition finish" signal (XC87) turns ON, the user turns OFF the "tool escape and return transit point designation" signal (YC8D).
- (d) When the "tool escape and return transit point designation" signal (YC8D) is OFF, NC also turns OFF the "tool escape and return transit point recognition finish" signal (XC87).
- (e) The "in tool escape and return mode" signal turns OFF when a tool reaches the halted point, or when reset1/reset2 or reset & rewind or emergency stop is performed.

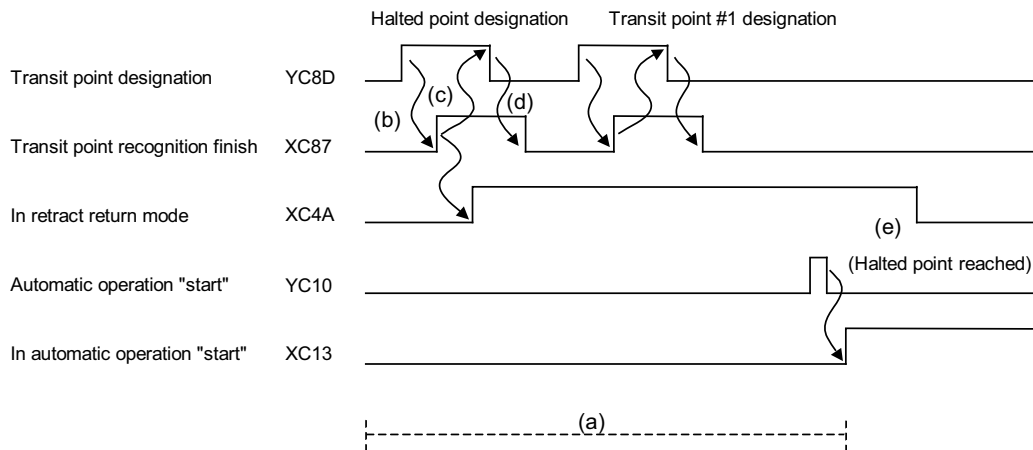

(Note) When reset1, reset2, reset & rewind or emergency stop is attempted during the escape and return mode, the memorized transit point and halted point will be canceled. The in escape and return mode will be reset and finished.

[Related signals]

- (1) Tool escape and return transit point recognition finish (XC87)
- (2) Tool escape and return transit point designation (YC8D)

4 Explanation of Interface Signals

Cont.	Signal name	Abbrev.	\$1	\$2	\$3	\$4	\$5	\$6	\$7	\$8
A	SUB PART SYSTEM CONTROL: SUB PART SYSTEM PROCESSING	SBS	XC4E	XD8E	XECE	X100E	X114E	X128E	X13CE	X150E

[Function]

This signal notifies that the system is started as a sub part system.

If there is a PLC processing to be executed only when the sub part system is started, use this signal to check whether the sub part system is already started or not.

[Operation]

This signal turns ON at the sub part system when the system is started with the sub part system "start" command.

The PLC input signals related to the sub part system control return "0" when the "Sub part system control: Sub part system processing" signal (SBS) is OFF.

The following shows which part system outputs PLC input signals related to the sub part system control. Also, the output values and operation examples are given.

PLC input signal	Part system that outputs signals	Output signal value
Sub part system control: Sub part system processing (SBS:XC4E)	Sub part system	1: ON / 0: OFF
Sub part system control: Sub part system control II identification No. (SBSID:R616) (Note)	Sub part system	Sub part system identification No.
Sub part system control: Calling sub part system (SBSC:R617)	Calling sub part system	System bit of sub part system
Sub part system control: Waiting for sub part system completion (SBSWT:R618)	Calling sub part system	System bit of sub part system
Sub part system control: Caller of sub part system (SBSSY:R619)	Sub part system	System bit of calling sub part system

(Note) The "Sub part system control: Sub part system control II identification No." (SBSID) signal is used only for the sub part system control II.

The signal is not output from a sub part system started with the sub part system control I.

4 Explanation of Interface Signals

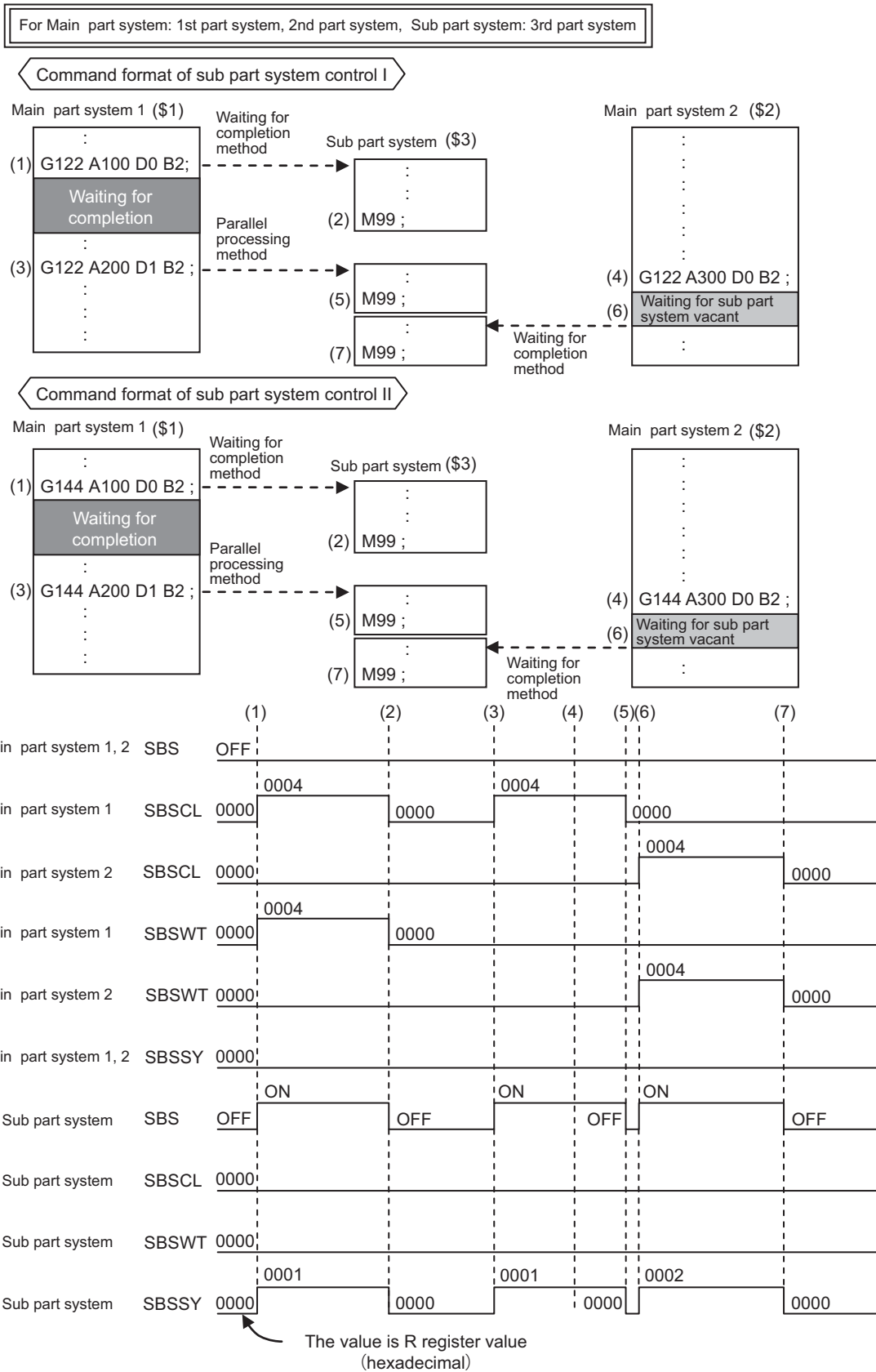

[Related signals]

- (1) Sub part system control: Sub part system control II identification No. (SBSID:R616)
- (2) Sub part system control: Calling sub part system (SBSCL:R617)
- (3) Sub part system control: Waiting for sub part system completion (SBSWT:R618)
- (4) Sub part system control: Caller of sub part system (SBSSY:R619)

4 Explanation of Interface Signals

Cont.	Signal name	Abbrev.	\$1	\$2	\$3	\$4	\$5	\$6	\$7	\$8
A	IN CIRCULAR FEED IN MANUAL MODE [M8]		XC4F	XD8F	XECF	X100F	X114F	X128F	X13CF	X150F

[Function]

This signal indicates that the circular feed in manual mode is valid.

[Operation]

This signal turns ON when the "Circular feed in manual mode valid" signal turns ON.

[Caution]

This signal does not turn ON in the following conditions.

- (1) Either H axis or V axis is in machine lock. (In this case, even machine lock is not performed.)
- (2) The reference position return of either H axis or V axis is not completed.
- (3) Either H axis or V axis is in servo OFF.
- (4) Either H axis or V axis is detached.
- (5) When the NC is in one of the following states.
 - Automatic operation (OP)
 - Emergency stop
 - Reset
- (6) The current position is outside of the specified movable range.
- (7) The setting value which is specified with R register is illegal.

[Related signals]

- (1) Circular feed in manual mode valid (YC7E)
- (2) Circular feed in manual mode operation mode data (R2636,7)
- (3) Circular feed in manual mode basic point H data (R2644,5)
- (4) Circular feed in manual mode basic point V data (R2648,9)
- (5) Circular feed in manual mode gradient/arc center H data (R2668,9)
- (6) Circular feed in manual mode gradient/arc center V data (R2672,3)
- (7) Circular feed in manual mode travel range H (+) data (R2652,3)
- (8) Circular feed in manual mode travel range H (-) data (R2656,7)
- (9) Circular feed in manual mode travel range V (+) data (R2660,1)
- (10) Circular feed in manual mode travel range V (-) data (R2664,5)
- (11) Circular feed in manual mode current position H (R636,7)
- (12) Circular feed in manual mode current position V (R640,1)

4 Explanation of Interface Signals

Cont.	Signal name	Abbrev.	\$1	\$2	\$3	\$4	\$5	\$6	\$7	\$8
A	COORDINATE ROTATION BY PARAMETER: MANUAL FEED COORDINATE SYSTEM [M8]		XC5F	XD9F	XEDF	X101F	X115F	X129F	X13DF	X151F

[Function]

This signal notifies the coordinate system which operates with the manual operation (jog feed, incremental feed and manual handle feed) during the coordinate rotation by parameter.

[Operation]

When this signal is turned OFF, the manual operation will be operated with the machine coordinate system.

When this signal is turned ON, the manual operation will be operated with the coordinate system rotated by the coordinate rotation by parameter.

When the coordinate rotation by parameter is invalid, this signal will be turned OFF even though the Coordinate rotation by parameter: Coordinate switch for manual feed (YC7F) is turned ON.

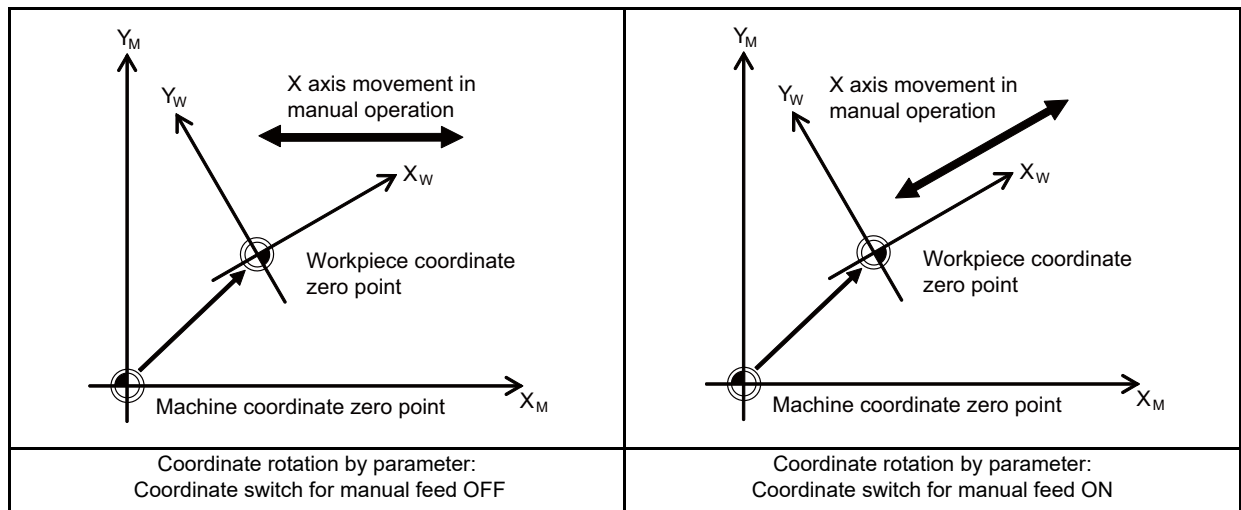

[Related signals]

- (1) Coordinate rotation by parameter: Coordinate switch for manual feed (YC7F)

4 Explanation of Interface Signals

Cont.	Signal name	Abbrev.	\$1	\$2	\$3	\$4	\$5	\$6	\$7	\$8
A	M FUNCTION STROBE 1	MF1	XC60	XDA0	XEE0	X1020	X1160	X12A0	X13E0	X1520
A	M FUNCTION STROBE 2	MF2	XC61	XDA1	XEE1	X1021	X1161	X12A1	X13E1	X1521
A	M FUNCTION STROBE 3	MF3	XC62	XDA2	XEE2	X1022	X1162	X12A2	X13E2	X1522
A	M FUNCTION STROBE 4	MF4	XC63	XDA3	XEE3	X1023	X1163	X12A3	X13E3	X1523
A	M FUNCTION STROBE 5 [C80]	MF5	XC76	XDB6	XEF6	X1036	X1176	X12B6	X13F6	
A	M FUNCTION STROBE 6 [C80]	MF6	XC77	XDB7	XEF7	X1037	X1177	X12B7	X13F7	

[Function]

This signal informs that the miscellaneous functions (M code) is commanded with the automatic operation (memory, MDI, tape) machining program or manual numerical command input.

The miscellaneous function is also called the M function, and is used to issue miscellaneous functions such as ON/OFF of the cutting oil, and normal/reverse/stop of the spindle, etc., for the target machine.

[Operation]

[Normal method (if parameter "#1278 ext14/bit1"= "0")]

This signal turns ON when:

- (1) The M function (M code) is specified in automatic operation (memory, MDI or tape mode).
- (2) M function (M code) is specified by manual numerical command input.

The signal turns OFF when:

- (1) M function finish 1 signal (FIN1) or M function finish 2 signal (FIN2) turns ON.
- (2) Reset condition occurs.(Refer to the "In automatic operation "run"" signal (OP) section for details on the reset conditions.)

(Note 1) When built-in PLC is used, multiple sets of M functions can be specified. Up to six sets of M functions can be specified in a block for C80.

The number of sets that can be specified varies depending on the settings of the parameter "#12005 Mfig". The relation of the machining program and M function strobe is shown below.

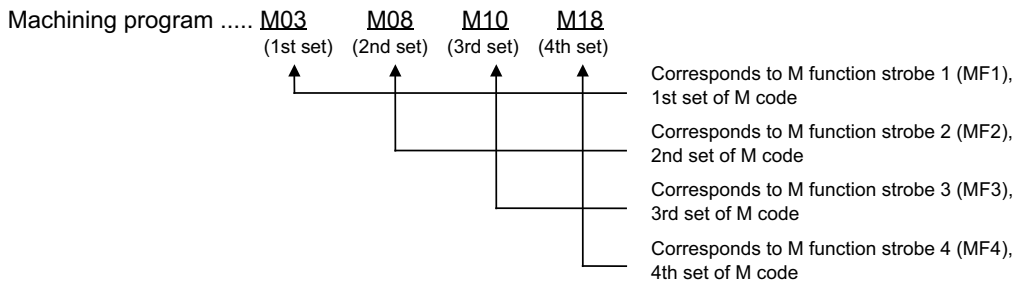

(Note 2) During operation with miscellaneous function lock (AFL signal ON), the "M function strobe" will not be output. However, this signal will be output when the M code is commanded independently (M00, M01, M02, M30).

(Note 3) Since M98 (read of subprogram call), M99 (return from subprogram), etc. are handled within the controller, "M function strobe" is not output.

(Note 4) The "M function strobe" will not be output when the M function is output if the "M function finish 1" signal (FIN1) or "M function finish 2" signal (FIN 2) is ON.

(Note 5) When the miscellaneous function command (M command) is executed by the manual numerical command, the "M function strobe 1" signal (MF1) is output.

An example of the timing chart for the M function strobe signal (MF1, MF2 and MF3) is shown below.

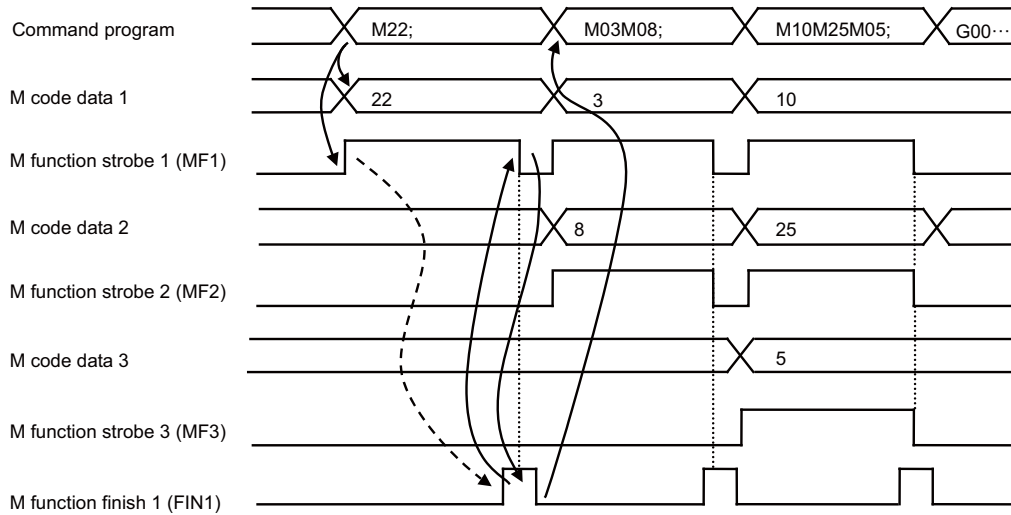

Point: The following points must be observed in the sequence process.

- (a) When the M function is commanded, the MF_n and M code data n is output.
- (b) MF_n is always the trigger in the sequence process to start the M function process.
- (c) When the designated M function process is completed, the "M function finish" signal is returned to the controller.
- (d) The controller waits for the rising edge of the M function finish signal and then turns MF_n OFF.
- (e) MF_n OFF is confirmed in the sequence process and then the "M function finish" signal is turned OFF.

This completes the series of M function processes.

Handshaking with the controller and an accurate sequence process possible if the M_{fn} conditions are inserted at the M function start and completed signals.

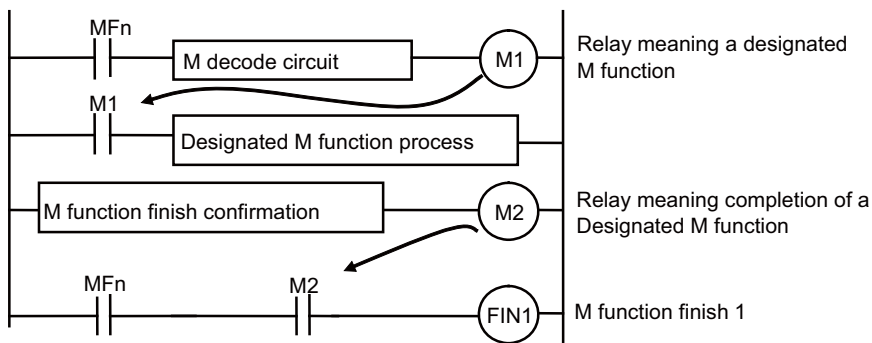

[High-speed method (if parameter "#1278 ext14/bit1"= "1")]

Refer to the Miscellaneous Function Command High-speed Output : M function finish n signal (MF_{INn}).

[Related signals]

- (1) M function finish 1 (FIN1:YC1E)
- (2) M function finish 2 (FIN2:YC1F)
- (3) M code data n (R504)
- (4) Miscellaneous Function Command High-speed Output : M function finish n (MF_{INn}:YD28)

4 Explanation of Interface Signals

Cont.	Signal name	Abbrev.	\$1	\$2	\$3	\$4	\$5	\$6	\$7	\$8
A	S FUNCTION STROBE 1 to 8	SF1 to 4 SF5 to 8	XC64 to 7	XDA4 to 7	XEE4 to 7	X1024 to 7	X1164 to 7	X12A4 to 7	X13E4 to 7	X1524 to 7
			XC70 to 3	XDB0 to 3	XEF0 to 3	X1030 to 3	X1170 to 3	X12B0 to 3	X13F0 to 3	X1530 to 3

[Function]

This signal informs that S (spindle) function (S code) is specified in automatic operation (memory, MDI or tape mode) machining program or by manual numerical command input.

The spindle function is also called the S function, and is used to command the spindle speed.

With the signal, user PLC receives S code data (1 to 8) respectively.

[Operation]

[Normal method (if parameter "#1278 ext14/bit1"= "0")]

The signal turns ON when:

- (1) S function (S code) is specified in automatic operation (memory, MDI or tape mode).
- (2) S function is specified by manual numerical command input.

The signal turns OFF when:

- (1) "M function finish 1" signal (FIN1) or "M function finish 2" signal (FIN2) turns ON.
- (2) Reset condition occurs.(Refer to the "In automatic operation "run"" signal (OP) section for details on the reset conditions.)

(Note 1) The S function strobe is not output during operation with M function lock (AFL signal ON).

(Note 2) When the S function is commanded, the "Spindle gear shift" signal (GR1, GR2) and "S command no gear selected" signal (SNGE) are output in addition to this signal (SF_n). Refer to the sections of each signal for details.

(Note 3) By combining this signal (SF_n), "Spindle gear selection code 1,2" signal (GI1, GI2) and "Gear shift completion" signal (GFIN), the data can be converted into S command data.(Data is transferred when the spindle controller is the high-speed serial connection specification type.)

(Note 4) The "S function strobe1 to 8" signals (SF1 to 8) correspond to spindle function (S code) commands to the 1st to 8th spindles respectively.

An example of the timing chart for the "S function strobe" signal (SF1) is shown below.

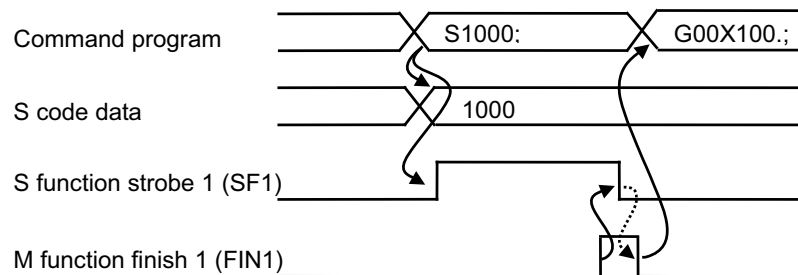

[High-speed method (if parameter "#1278 ext14/bit1"= "1")]

Refer to the Miscellaneous Function Command High-speed Output : S function finish signals (SFIN 1).

[Related signals]

- (1) S code data 1 to 8(R512 to 27)
- (2) Spindle gear shift (GR1, GR2: X1885, 6)
- (3) S command no gear selected (SNGE: X1884)
- (4) Spindle gear selection code 1, 2 (GI1, GI2: Y1890, Y1891)
- (5) Gear shift completion (GFIN: Y1885)
- (6) M function finish 1 (FIN1: YC1E)
- (7) M function finish 2 (FIN2: YC1F)
- (8) Miscellaneous Function Command High-speed Output : S function finish 1 to 8(SFIN1 to 4, SFIN5 to 8: YD2C to F, YD38 to B)

4 Explanation of Interface Signals

Cont.	Signal name	Abbrev.	\$1	\$2	\$3	\$4	\$5	\$6	\$7	\$8
A	T FUNCTION STROBE 1 to 4	TF1 to 4	XC68 to B	XDA8 to B	XEE8 to B	X1028 to B	X1168 to B	X12A8 to B	X13E8 to B	X1528 to B

[Function]

This signal informs that the tool function (T code) is specified in automatic operation (memory, MDI or tape mode) machining program or by manual numerical command input.

The tool function is also called the T function, and is used to command the tool No. In the lathe specification controller, the tool compensation (tool length compensation, tool nose wear compensation) Nos. are also indicated.

The user PLC receives the T code data 1 to 4 with this signal.

[Operation]

[Normal method (if parameter "#1278 ext14/bit1"= "0")]

The signal turns ON when:

- (1) The T function (T code) is specified in automatic operation (memory, MDI or tape mode).
- (2) T function (T) is specified by manual numerical command input.

The signal turns OFF when:

- (1) "M function finish 1" signal (FIN1) or "M function finish 2" signal (FIN2) turns ON.
- (2) Reset condition occurs.(Refer to the "In automatic operation "run" signal (OP) section for details on the reset conditions.)

(Note 1) Up to four T commands can be issued in one block.

The relationship between machining program and T function strobe is shown below.

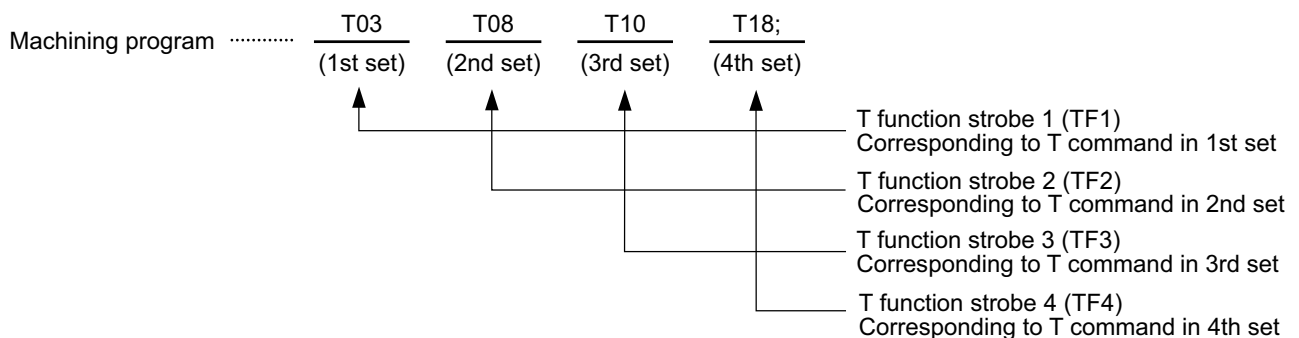

(Note 2) The "T function strobe 1 to 4" (TF1 to 4) is not output during operation with the M function lock (AFL signal ON).

(Note 3) Outputs from manual numerical command always correspond to the "T function strobe 1".

An example of the timing chart for the "T function strobe 1" signal (TF1) is shown below.

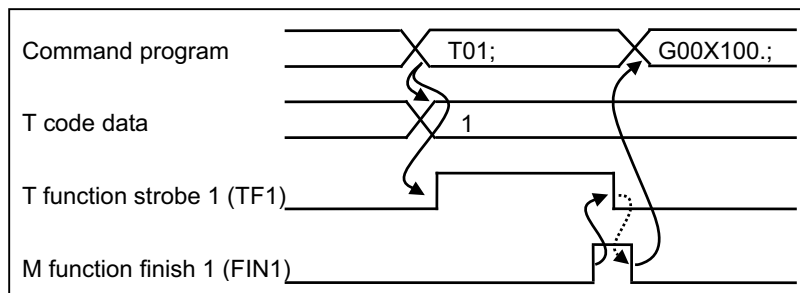

[High-speed method (if parameter "#1278 ext14/bit1"= "1")]

Refer to the Miscellaneous Function Command High-speed Output : T function finish 1 to 4 signals (TFIN 1 to 4).

[Related signals]

- (1) T code data 1 to 4(R536 to 43)
- (2) M function finish 1 (FIN1:YC1E)
- (3) M function finish 2 (FIN2:YC1F)
- (4) Miscellaneous Function Command High-speed Output : T function finish 1 to 4(TFIN1 to 4:YD30 to 3)

4 Explanation of Interface Signals

Cont.	Signal name	Abbrev.	\$1	\$2	\$3	\$4	\$5	\$6	\$7	\$8
A	2ND M FUNCTION STROBE 1 to 4	BF1 to 4	XC6C to F	XDAC to F	XEEC to F	X102C to F	X116C to F	X12AC to F	X13EC to F	X152C to F

[Function]

This signal informs that the 1st set of 2nd M function is selected in automatic operation (memory, MDI or tape) machining program or by manual numerical command input.

The 2nd M function is also called the B function.

With the signal (BF1), user PLC receives 2nd M function data 1 to 4.

[Operation]

[Normal method (if parameter "#1278 ext14/bit1"= "0")]

The signal turns ON when:

- (1) The 2nd M function (B code) is specified in automatic operation (memory, MDI or tape).
- (2) 2nd M function (B code) is issued by manual numerical command input.

The signal turns OFF when:

- (1) "M function finish 1" signal (FIN1) or "M function finish 2" signal (FIN2) is turned ON.
- (2) Reset condition occurs.(Refer to the "In automatic operation "run"" signal (OP) section for details on the reset conditions.)

(Note 1) Four 2nd M functions can be issued in one block at a time.

The relationship between machining program and 2nd M function strobe is shown below.

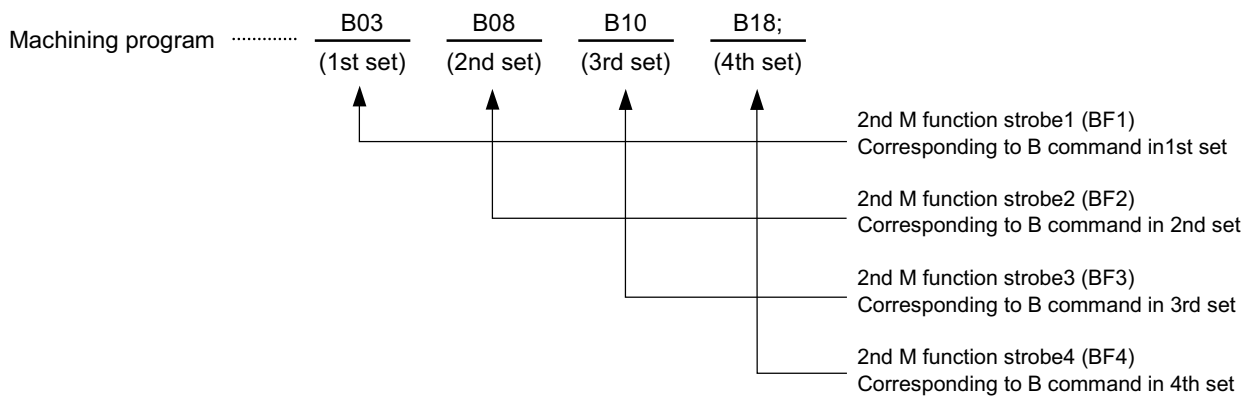

(Note 2) The "2nd M function strobe 1 to 4" (BF1 to 4) is not output during operation with M function lock (AFL signal ON).

(Note 3) In the case of manual numerical command input, outputs are in accordance with "2nd M function strobe 1" (BF1).

(Note 4) Address for 2nd M function can be selected from addresses A, B and C by using machine parameter. Set so that the address is different from the axis address.

[High-speed method (if parameter "#1278 ext14/bit1"= "1")]

Refer to the Miscellaneous Function Command High-speed Output : 2nd M function finish 1 to 4 signals (BFIN 1 to 4).

[Related signals]

- (1) M function finish 1 (FIN1:YC1E)
- (2) M function finish 2 (FIN2:YC1F)
- (3) Miscellaneous Function Command High-speed Output : 2nd M function finish 1 to 4(BFIN1 to 4:YD34 to 7)

4 Explanation of Interface Signals

Cont.	Signal name	Abbrev.	\$1	\$2	\$3	\$4	\$5	\$6	\$7	\$8
A	CHOPPING COMPENSATION UPDATED PREVENTED	CHPRCC	XC7F	XDBF	XEFF	X103F	X117F	X12BF	X13FF	X153F

[Function]

This signal indicates that the machine is in the state where it does not update the chopping compensation amount.

[Operation]

While this signal is turned ON:

- The chopping compensation amount is not updated.
- The stroke compensation completion signal does not OFF.

When the control data is updated, turn this signal OFF and then update the chopping compensation amount.

[Related signals]

(1) Chopping compensation update prevention request (CHPRCR:YCD7)

Cont.	Signal name	Abbrev.	\$1	\$2	\$3	\$4	\$5	\$6	\$7	\$8
A	IN CHOPPING START	CHOP	XC80	XDC0	XF00	X1040	X1180	X12C0	X1400	X1540

[Function][Operation]

This signal turns ON in the state of chopping start.

Cont.	Signal name	Abbrev.	\$1	\$2	\$3	\$4	\$5	\$6	\$7	\$8
A	BASIC POSITION → UPPER DEAD POINT PATH FLAG	CHP1	XC81	XDC1	XF01	X1041	X1181	X12C1	X1401	X1541

[Function][Operation]

This signal turns ON while moving from the basic position to the upper dead center point.

Cont.	Signal name	Abbrev.	\$1	\$2	\$3	\$4	\$5	\$6	\$7	\$8
A	UPPER DEAD POINT → BOTTOM DEAD POINT PATH FLAG	CHP2	XC82	XDC2	XF02	X1042	X1182	X12C2	X1402	X1542

[Function][Operation]

This signal turns ON while moving from the upper dead center point to the bottom dead center point.

Cont.	Signal name	Abbrev.	\$1	\$2	\$3	\$4	\$5	\$6	\$7	\$8
A	BOTTOM DEAD POINT → UPPER DEAD POINT PATH FLAG	CHP3	XC83	XDC3	XF03	X1043	X1183	X12C3	X1403	X1543

[Function][Operation]

This signal turns ON while moving from the bottom dead center point to the upper dead center point.

Cont.	Signal name	Abbrev.	\$1	\$2	\$3	\$4	\$5	\$6	\$7	\$8
A	UPPER DEAD POINT → BASIC POSITION PATH BASIC POSITION PATH	CHP4	XC84	XDC4	XF04	X1044	X1184	X12C4	X1404	X1544

[Function][Operation]

This signal turns ON while moving from the upper dead center point to the basic position.

Cont.	Signal name	Abbrev.	\$1	\$2	\$3	\$4	\$5	\$6	\$7	\$8
A	IN CHOPPING MODE	CHPMD	XC85	XDC5	XF05	X1045	X1185	X12C5	X1405	X1545

[Function][Operation]

This signal turns ON in the state of chopping mode.

Cont.	Signal name	Abbrev.	\$1	\$2	\$3	\$4	\$5	\$6	\$7	\$8
A	STROKE COMPENSATION COMPLETION		XC86	XDC6	XF06	X1046	X1186	X12C6	X1406	X1546

[Function][Operation]

This signal turns ON when the difference between the commanded stroke and the actual stroke has reached the tolerance specified with the parameter (#2080 chwid) as a result of compensation of the commanded position.

When speed fluctuates, such as when movement is stopped or chopping control data is changed, this signal is turned OFF.

4 Explanation of Interface Signals

Cont.	Signal name	Abbrev.	\$1	\$2	\$3	\$4	\$5	\$6	\$7	\$8
A	TOOL ESCAPE AND RETURN TRANSIT POINT RECOGNITION COMPLETED [M8]		XC87	XDC7	XF07	X1047	X1187	X12C7	X1407	X1547

[Function]

With the tool escape and return function, a transit point can be designated by pressing the transit point switch while tool escapes. The tool returns to the machining halted point, passing through the transit point designated.

This signal notifies that NC memorized the transit point.

[Operation]

Refer to the section on "In tool escape and return mode signal" (XC4A).

[Related signals]

- (1) In tool escape and return mode (XC4A)
- (2) Tool escape and return transit point designation (YC8D)

Cont.	Signal name	Abbrev.	\$1	\$2	\$3	\$4	\$5	\$6	\$7	\$8
A	SEARCH & START ERROR	SSE	XC8A	XDCA	XF0A	X104A	X118A	X12CA	X140A	X154A

[Function]

This signal is output when the program No. to be searched with search & start is illegally designated.

[Operation]

This signal is output when the No. of the program to be searched with search & start is illegal. Cycle start will not be carried out if this signal is output. This signal will turn OFF if the program No. is correctly input to execute search & start again, or when the reset signal is issued.

Refer to the "Search & start" signal (RSST) for details.

When the multi-part system program management is valid, the signal for \$1 is output as common signal for all part systems.

[Related signals]

- (1) Search & start (RSST:YC31)

Cont.	Signal name	Abbrev.	\$1	\$2	\$3	\$4	\$5	\$6	\$7	\$8
A	SEARCH & START SEARCH	SSG	XC8B	XDCB	XF0B	X104B	X118B	X12CB	X140B	X154B

[Function]

This signal is output when searching for a program is started with search & start.

[Operation]

Informs the PLC that the NC is searching for the program with search & start.

Hold the "search & start" signal until the "search & start (search)" signal turns ON.

If the No. of the program to be searched is illegal, the "search & start (error)" signal (SSE) will be output.

When the multi-part system program management is valid, the signal for \$1 is output as common signal for all part systems.

[Related signals]

- (1) Search & start program No. (R2562, 2563)
- (2) Search & start Error (SSE:XC8A)
- (3) Search & start (RSST:YC31)

4 Explanation of Interface Signals

Cont.	Signal name	Abbrev.	\$1	\$2	\$3	\$4	\$5	\$6	\$7	\$8
A	Punchtap cycle in progress [M8]	PTAPn	XC8E	XDCE	XF0E	X104E	X118E	X12CE	X140E	X154E

[Function]

This signal indicates that the Punchtap cycle is executed during the automatic operation (memory, MDI).

[Operation]

The signal turns ON when:

- (1) The travel command of automatic operation is executed during the Punchtap cycle.

This signal turns ON also during the machine lock.

The signal turns OFF when:

- (1) The machining status is no longer in the Punchtap cycle.

The Punchtap cycle is canceled by G80 or G command which is belonged in the G code group 01 (G00, G01, G02, G03, G33).

Cont.	Signal name	Abbrev.	\$1	\$2	\$3	\$4	\$5	\$6	\$7	\$8
A	TOOL CHANGE POSITION RETURN COMPLETION	TCP	XC93	XDD3	XF13	X1053	X1193	X12D3	X1413	X1553

[Function]

This signal notifies that the axis commanded with the tool change position return command has completed return to the tool change position.

[Operation]

This signal turns ON when all axes commanded with the tool change position return command (G30.n) have moved to the tool change position. This signal turns OFF when even one of the axes moved to the tool change position with the command has moved from the tool change position.

Refer to the Programming Manual for details on the tool change return command.

[Timing chart]

Example: When G30.1 command, additional axis tool change position return is valid

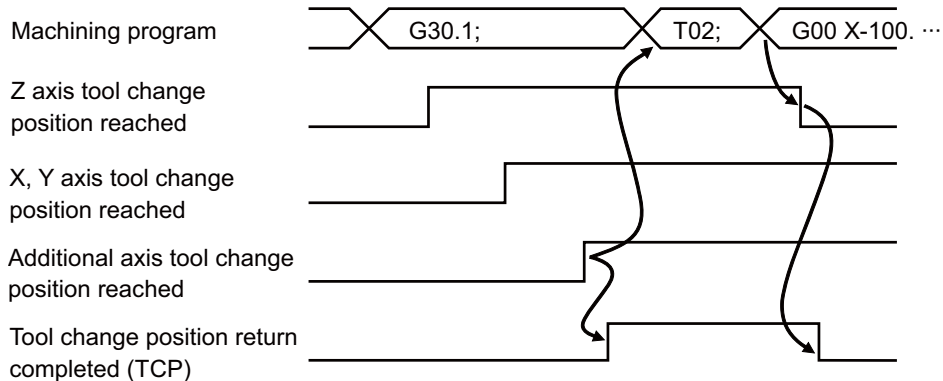

Cont.	Signal name	Abbrev.	\$1	\$2	\$3	\$4	\$5	\$6	\$7	\$8
A	NEW TOOL CHANGE	TCRQ	XC94	XDD4	XF14	X1054	X1194	X12D4	X1414	X1554

[Function]

This signal notifies that a new tool (unused tool) in the group is selected in the tool life management II.

[Operation]

The signal turns ON when:

- (1) The tool selected by T command tool selection is unused (status 0).

The signal turns OFF when:

- (1) When T command is completed due to the M function finish signal (FIN1, FIN2).

4 Explanation of Interface Signals

Cont.	Signal name	Abbrev.	\$1	\$2	\$3	\$4	\$5	\$6	\$7	\$8
A	TOOL LIFE PREDICTION		XC96	XDD6	XF16	X1056	X1196	X12D6	X1416	X1556

[Function]

This signal notifies that the tool in use or the last tool in a group has reached the end of tool life.

"Tool has reached the end of tool life" means that the value obtained by subtracting usage data from estimated tool life data has reached the remaining tool life prediction setting value.

[Operation]

The life prediction is valid when the "#1277 ext13 bit1" is set to "1". The signal will not be output when the remaining tool life prediction setting value is "0" or larger than the estimated tool life data.

Signal output judgment condition varies depending on the following parameter setting.

#1277 ext13/bit2 (Tool life management II life end signal timing)

Select the timing when the "Tool life prediction" signal (XC96) is output with the tool life management II.

0: Estimated tool life data - Cumulative usage data = Remaining tool life prediction setting value

1: Estimated tool life data - Cumulative usage data ≤ Remaining tool life prediction setting value

#1277 ext13/bit3 (Tool life management II life end signal tool)

Select the tool to which the "Tool life prediction" signal (XC96) is output with the tool life management II.

0: The signal is output for each tool.

1: The signal is output for the last tool of a group.

The signal turns ON when:

(1) Remaining tool life data (Estimated tool life data - Cumulative usage data) has reached its remaining tool life prediction setting value. (Same timing as count up of usage data)

(2) Remaining tool life data (Estimated tool life data - Cumulative usage data) has reached its remaining tool life prediction setting value at the time of tool selection. (Same timing as TF output)

The signal turns OFF when:

(1) The group currently selected is canceled.

(When the T command was issued. Note that if the next selected group has a condition of turning ON the signal, the signal remains ON.)

(2) Tool has reached the end of its tool life. (Same timing as count up of cumulative usage data)

(3) The cumulative usage data for the group currently selected is cleared.

(e.g., when the "tool change reset" signal (YC8C: TRST) is input)

Cont.	Signal name	Abbrev.	\$1	\$2	\$3	\$4	\$5	\$6	\$7
A	FTP WAITING FOR DOWN-LOAD [C80]	DLWAIT	XC97	XDD7	XF17	X1057	X1197	X12D7	X1417

[Function]

This signal informs that no reading data is in the buffer memory so it is idle and waiting for receiving data during FTP operation.

If the download is completed, it does not enter into idle mode and an program error (P36) occurs.

[Operation]

The signal turns ON when:

- It is idle and waiting for data to be received as the buffer memory for FTP operation is empty during the download from FTP server.

The signal turns OFF when:

- The waiting for data to be received state, as described above, is released.

- When download is completed. (If the download is completed while in the waiting for data to be received state, an program error (P36) occurs.)

[Related signal]

(1) FTP download completed (DLDFIN: X75E)

(2) FTP download in progress (DLOAD0: X75D)

4 Explanation of Interface Signals

Cont.	Signal name	Abbrev.	\$1	\$2	\$3	\$4	\$5	\$6	\$7	\$8
A	NC ALARM 1	AL1	XC98	XDD8	XF18	X1058	X1198	X12D8	X1418	X1558

[Function]

This signal informs that system error occurred in the controller.

[Operation]

If "watch dog error", "memory parity check error", etc. occurs on the controller side, the signal turns ON.

The system error can be reset by turning OFF.

(Note 1) "NC alarm 1" (AL1) may not be detected as signal.

(Note 2) For details of system alarms, refer to the relevant Instruction Manual or Alarm/Parameter Manual.

Cont.	Signal name	Abbrev.	\$1	\$2	\$3	\$4	\$5	\$6	\$7	\$8
A	NC ALARM 2 (Servo alarm)	AL2	XC99	XDD9	XF19	X1059	X1199	X12D9	X1419	X1559

[Function]

This signal informs that the controller is in servo alarm condition.

If servo alarm occurs, "Servo ready completion" signal (SA) turns OFF.

[Operation]

The signal turns ON when:

(1) Servo alarm occurs. Servo alarms include the following:

- Servo failure (overcurrent, overvoltage, etc.)
- Initial parameter error (parameter transferred to drive unit when the power is turned ON is illegal)
- Drive unit not mounted (cable is not connected between controller and servo controller).
- Parameter error (a parameter that will disrupt movement of the control axis was found).

Alarm can be reset by turning OFF the power, or using controller reset, or by setting parameter again, etc., depending on type of alarm.

For details of alarm resetting, and servo alarm, refer to the relevant Instruction Manual or Alarm/Parameter Manual.

Cont.	Signal name	Abbrev.	\$1	\$2	\$3	\$4	\$5	\$6	\$7	\$8
A	NC ALARM 3 (Program error)	AL3	XC9A	XDDA	XF1A	X105A	X119A	X12DA	X141A	X155A

[Function]

This signal informs that the controller is in program error condition.

[Operation]

This type of alarm occurs during automatic operation in memory, MDI or tape mode, mainly due to use of faulty machining program, or program incompatible with the controller specifications.

Some typical examples of program error are shown below. For details, refer to the relevant Instruction Manual or Alarm/Parameter Manual.

- (1) Illegal address (address not covered by the specifications is used)
- (2) Absence of F command
- (3) Arc end point excessive deviation
- (4) Return incomplete axis found (a motion command was issued to an axis that has not completed reference position return)
- (5) Program end error (M02 or M30 command is not inserted or reset & rewind process has not been performed)

4 Explanation of Interface Signals

Cont.	Signal name	Abbrev.	\$1	\$2	\$3	\$4	\$5	\$6	\$7	\$8
A	NC ALARM 4 (Operation error)	AL4	XC9B	XDDB	XF1B	X105B	X119B	X12DB	X141B	X155B

[Function]

This signal informs that the controller is in operation error condition.

[Operation]

The signal turns ON in case of operation alarm, and OFF when the alarm condition is removed.

Some typical examples of operation errors are shown below. For details, refer to the relevant instruction manual of each model or "Alarm/Parameter Manual".

- (1) Hardware axis motion stroke end
- (2) Software axis motion stroke end
- (3) No operation mode set
- (4) Cutting feedrate override set to "zero"
- (5) Manual feedrate zero
- (6) External interlock axis exists
- (7) Warning regarding absolute position detection

(Note) When parameter "#1238 set10/bit7" is valid (when the "NC alarm 5" (XCB1) is valid), the following alarms are not output to the "NC alarm 4".

Error No.	Details
0004	External interlock axis exists
0102	Cutting override zero
0103	External feed speed zero
0109	Block start interlock
0110	Cutting block start interlock
0125	Rapid traverse override zero
0200	Interference check disabled
0205	Tool interfere. check disabled [M8]
1033	Spindle-Spindle polygon (G51.2/G251) cutting interlock

Cont.	Signal name	Abbrev.	\$1	\$2	\$3	\$4	\$5	\$6	\$7	\$8
A	NC WARNING (SERVO WARNING)	WR1	XC9C	XDDC	XF1C	X105C	X119C	X12DC	X141C	X155C

[Function]

This signal notifies that the servo warning (S52) occurs in the drive unit.

[Operation]

- (1) For servo drive unit
 - This signal turns ON when:
 - A warning in servo drive unit is occurring on one or more axes within the part system.
 - This signal turns OFF when:
 - There is no warning occurring on any axis within the part system.
- (2) For spindle/PLC axis drive unit
 - When the warning occurs, the signal for the 1st part system is output.

(Note) This signal is not output if the servo warning "S52 00E6" (Control axis detachment warning) or "S52 00E7" (In NC emergency stop state) occurs.

[Related signals]

- (1) Servo alarm/warning No. (R5332 to R5339)
- (2) Spindle alarm/warning No. (R6529)
- (3) PLC axis alarm warning No. n-th axis (R168 to R175)

4 Explanation of Interface Signals

Cont.	Signal name	Abbrev.	\$1	\$2	\$3	\$4	\$5	\$6	\$7	\$8
A	THREAD CUTTING: FEED-FORWARD CONTROL ON	FFCO	XCA4	XDE4	XF24	X1064	X11A4	X12E4	X1424	X1564

[Function]

This signal notifies that the feed forward control is valid in the thread cutting command.

[Operation]

This signal is turned ON when all the following conditions are met.

- (1) During the cutting mode (G64) modal.
- (2) While the Thread cutting: Feed-forward control request (FFC: YC94) is ON.
- (3) While any of the commands in the table below is commanded.

G code	Function name
G32, G33	Thread cutting
G34	Variable lead thread cutting
G35	Arc thread cutting CW
G36	Arc thread cutting CCW

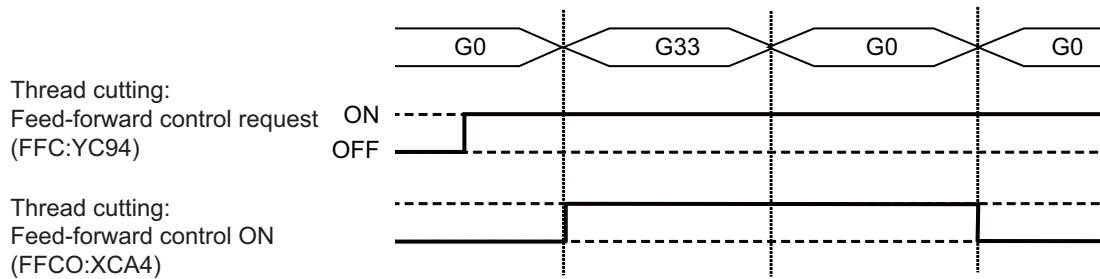

This signal is turned OFF when:

- (1) All the conditions listed above for turning ON the signal are not satisfied. However, when the Thread cutting: Feed-forward control request (FFC: YC94) is turned ON -> OFF during the thread cutting command (G32 to G36) under the feed forward control, the Thread cutting: Feed-forward control ON (FFCO: XCA4) will be held until the cutting up of the thread cutting command ends.

[Related signals]

- (1) Thread cutting: Feed-forward control request (FFC: YC94)

4 Explanation of Interface Signals

Cont.	Signal name	Abbrev.	\$1	\$2	\$3	\$4	\$5	\$6	\$7	\$8
A	TAP RETRACT POSSIBLE	TRVE	XCA5	XDE5	XF25	X1065	X11A5	X12E5	X1425	X1565

[Function]

This signal informs that tap retract is possible, and is output if operation is stopped during tap cycle execution.

The "Tap retract" signal (TRV) will be valid when this signal (TRVE) is ON.

(Note) When the parameter "#1234 set06/bit3" is set to "0", all the axes are interlocked while the "Tap retract possible" signal (XCA5) is ON. If the automatic or manual axis movement is commanded, the operation error (M01 0057) occurs. To cancel the interlocked state, turn ON the "Tap retract possible state cancel" signal (YCD6). (Doing so turns this signal (XCA5) OFF.)

[Operation]

(1) This signal turns ON when tap cycle is stopped in the cutting feed area due to the following causes:

- Emergency stop.
- Reset stop.
- Power OFF (only in absolute position detection system).

Refer to the section on the "Tap retract" signal (YC5C: TRV) for the tap retract operation.

(2) This signal turns OFF in the following cases:

- Tap retract is executed and completed.
- The target axis for the tap retract is moved automatically or with manual mode.

However, it is moved only when the following conditions are met:

- The parameter "#1234 set06/bit3" is set to "1".
- The "Tap retract" (TRV) is OFF.
- The target axis for the tap retract is stopped.
- After confirming the rising edge of the "Tap retract possible state cancel" (TRVEC).

[Caution]

(1) When the parameter "#1234 set06/bit4" is set to "1", the "Tap retract possible" signal (XCA5: TRVE) is turned OFF by turning the power ON while the "Tap retract possible state cancel" (YCD6: TRVEC) is ON even if the "Tap retract possible" signal (XCA5: TRVE) is ON at power OFF. [M8]

(2) Refer to the section on the "Tap retract" signal (YC5C: TRV) for the other cautions of the tap retract.

[Related signals]

- (1) Tap retract (TRV: YC5C)
- (2) Tap retract possible state cancel (TRVEC: YCD6)

Cont.	Signal name	Abbrev.	\$1	\$2	\$3	\$4	\$5	\$6	\$7	\$8
A	NO. OF WORK MACHINING OVER	PCNT	XCA6	XDE6	XF26	X1066	X11A6	X12E6	X1426	X1566

[Function]

This signal is output when the No. of work machining matches or exceeds the maximum No. of work machining.

[Operation]

This signal turns ON when the No. of work machining matches or exceeds the maximum work value (WRK LIMIT) set in the [Process parameter] screen.

(Note 1) This signal turns ON when the No. of work machining matches or exceeds the maximum work value regardless of the count up by the controller or user PLC.

(Note 2) This signal is not output when "0" is set for the maximum work value.

[Related signals]

- (1) No. of work machining (current value) (R606, 7)
- (2) No. of work machining (maximum value) (R608, 9)

4 Explanation of Interface Signals

Cont.	Signal name	Abbrev.	\$1	\$2	\$3	\$4	\$5	\$6	\$7	\$8
A	ABSOLUTE POSITION WARNING	ABSW	XCA7	XDE7	XF27	X1067	X11A7	X12E7	X1427	X1567

[Function]

This signal notifies that the amount moved while the power is OFF has exceeded to the tolerable amount when using the absolute position detection system.

[Operation]

This signal turns ON when the difference of the machine position at power OFF and at power ON exceeds the tolerable value ([ABS. POSI PARAM] "#2051 check" setting value) when using the absolute position detection system.

(Note) The movement amount during power OFF depends on the "PON POS (power ON position)" and "POF POS (power OFF position)" on the [ABS SERVO MONITOR (absolute position monitor)] screen.

Cont.	Signal name	Abbrev.	\$1	\$2	\$3	\$4	\$5	\$5	\$7	\$8
A	IN AXIS NAME SWITCH		XCA9	XDE9	XF29	X1069	X11A9	X12E9	X1429	X1569

[Function]

This signal informs that the axis name is being switched.

[Operation]

This signal turns ON by the axis name switch command (G111).

Cont.	Signal name	Abbrev.	\$1	\$2	\$3	\$4	\$5	\$5	\$7	\$8
A	HOB MACHINING: RETRACTING	HOBRTM	XCAE	XDEE	XF2E	X106E	X11AE	X12EE	X142E	X156E

[Function]

This signal informs that hob retract operation is running.

[Operation]

This signal turns ON when:

- (1) Retract operation started by hob machining: retract request during hob machining mode.
- (2) Retract operation started by program error or operation error during hob machining mode.

This signal turns OFF when:

- (1) Retract operation is finished.
- (2) The power is turned OFF and ON.
- (3) Retract operation is stopped due to reset or emergency stop.

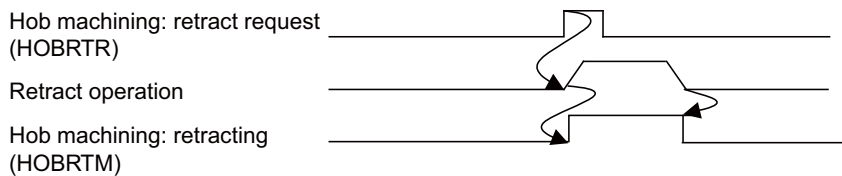

[Related signals]

- (1) Hob machining: retract request (HOBTR:YCDE)
- (2) Hob machining: retract amount selection (HOBRTV:YB20)
- (3) Hob machining: retract complete (HOBRTF:XCAF)

4 Explanation of Interface Signals

Cont.	Signal name	Abbrev.	\$1	\$2	\$3	\$4	\$5	\$5	\$7	\$8
A	HOB MACHINING: RETRACT COMPLETE	HOBRTF	XCAF	XDEF	XF2F	X106F	X11AF	X12EF	X142F	X156F

[Function]

This signal informs that hob retract operation has been finished.

[Operation]

This signal turns ON when:

- (1) Retract by hob machining: retract request (HOBRTM) is conducted during hob machining mode and the retract operations for all axes are finished.
- (2) Program error or operation error is executed during hob machining mode and the retract operations for all axes are finished.

This signal turns OFF when:

- (1) The power is turned OFF and ON.
- (2) Reset or emergency stop is input, or automatic operation is restarted.
- (3) Retract axis moves.

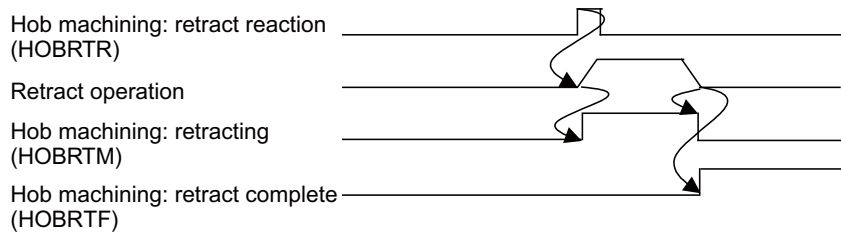

[Related signals]

- (1) Hob machining: retract request (HOBRTM:YCDE)
- (2) Hob machining: retract amount selection (HOBRTV:YB20)
- (3) Hob machining: retracting (HOBRTM:XCAE)

Cont.	Signal name	Abbrev.	\$1	\$2	\$3	\$4	\$5	\$5	\$7	\$8
A	IN SPINDLE-NC AXIS POLYGON MODE		XCB0	XDF0	XF30	X1070	X11B0	X12F0	X1430	X1570

[Function]

This signal informs the PLC that polygon machining (spindle-NC axis) mode is entered.

(Note) Refer to the "In spindle-spindle polygon mode" signal for details on the spindle-spindle polygon.

- #1501 polyax ≠ 0: Polygon machining (spindle-NC axis)
- #1501 polyax = 0: Spindle-spindle polygon (spindle-spindle)

[Operation]

This signal turns ON by the polygon machining start command (G51.2/G251), and is held during the polygon machining mode.

This signal turns OFF when the polygon machining mode is canceled (G50.2/G250, reset, etc.), and remains OFF in modes other than the polygon machining mode.

[Related signals]

- (1) In spindle-spindle polygon mode (XCB2)

4 Explanation of Interface Signals

Cont.	Signal name	Abbrev.	\$1	\$2	\$3	\$4	\$5	\$5	\$7	\$8
A	NC ALARM 5	AL5	XCB1	XDF1	XF31	X1071	X11B1	X12F1	X1431	X1571

[Function]

This signal informs that the controller is in operation alarm (error) condition.

[Operation]

The signal turns ON when:

- (1) The parameter "#1238 set10/bit7" is ON and the operation alarms below occur.

The signal turns OFF when:

- (1) The parameter "#1238 set10/bit7" is OFF.
- (2) The parameter "#1238 set10/bit7" is ON and the operation alarm conditions below do not exist.

For details on the operation alarms, refer to relevant instruction manual of each model.

<Operation alarms output to NC alarm 5>

- External interlock axis exists (M01 0004)
- Override zero (M01 0102)
- External feed speed zero (M01 0103)
- Block start interlock (M01 0109)
- Cutting block start interlock (M01 0110)
- Rapid traverse override zero (M01 0125)
- Interference check disabled (M02 0200)
- Tool interfere. check disabled (M01 0205) [M8]
- Spindle-spindle polygon (G51.2/G251) cutting interlock (M01 1033)

Cont.	Signal name	Abbrev.	\$1	\$2	\$3	\$4	\$5	\$5	\$7	\$8
A	IN SPINDLE-SPINDLE POLYGON MODE		XCB2	XDF2	XF32	X1072	X11B2	X12F2	X1432	X1572

[Function]

This signal informs that the spindle-spindle polygon machining mode is being executed.

(Note) Refer to the explanation of "In Spindle-NC axis polygon mode" signal for details on the spindle-NC axis polygon.

- #1501 polyax ≠ 0: Polygon machining (spindle-NC axis)
- #1501 polyax = 0: Spindle-spindle polygon (spindle-spindle)

[Operation]

The signal turns ON when:

- (1) The G51.2/G251 is commanded, and the spindle-spindle polygon machining is executed.

The signal turns OFF when:

- (1) The G50.2/G250 is commanded, and the spindle-spindle polygon machining is canceled.
- (2) The "Spindle synchronization cancel" signal is input, and the spindle-spindle polygon machining is canceled.
- (3) "Emergency stop" occurs.
- (4) "Reset" is input.

When this signal turns ON and the spindle-spindle polygon synchronization is completed, "spindle-spindle polygon synchronization completion" signal turns ON.

[Related signals]

- (1) Spindle-spindle polygon cancel (YCD1)
- (2) Spindle-spindle polygon synchronization completion (XCB3)
- (3) In Spindle-NC axis polygon mode (XCB0)

4 Explanation of Interface Signals

Cont.	Signal name	Abbrev.	\$1	\$2	\$3	\$4	\$5	\$5	\$7	\$8
A	SPINDLE-SPINDLE POLYGON SYNCHRONIZATION COMPLETION		XCB3	XDF3	XF33	X1073	X11B3	X12F3	X1433	X1573

[Function]

This signal informs that the workpiece spindle and rotary tool spindle are in the synchronized rotation state.

[Operation]

The signal turns ON when:

- (1) The rotary tool spindle rotation speed, in respect to the rotation speed following the rotary tool spindle and workpiece spindle rotation ratio command, reaches the value set for the spindle-spindle polygon synchronization rotation speed attainment level during the spindle-spindle polygon machining mode.

The signal turns OFF when:

- (1) The rotary tool spindle rotation speed, in respect to the rotation speed following the rotary tool spindle and workpiece spindle rotation ratio command, deviates from the value set for the spindle-spindle polygon synchronization rotation speed attainment level during the spindle-spindle polygon machining mode.
- (2) The spindle-spindle polygon synchronization mode is canceled.

[Related signals]

- (1) Spindle-spindle polygon cancel (YCD1)
- (2) In spindle-spindle polygon mode (XCB2)

Cont.	Signal name	Abbrev.	\$1	\$2	\$3	\$4	\$5	\$5	\$7	\$8
A	IN 3-DIMENSIONAL COORDINATE CONVERSION		XCB9	XDF9	XF39	X1079	X11B9	X12F9	X1439	X1579

[Function]

This signal notifies that the controller is in 3-dimensional coordinate conversion.

[Operation]

This signal turns ON when:

- (1) G68 (M system)/G68.1 (L system) (3-dimensional coordinate conversion) is commanded

This signal turns OFF when:

- (1) G69 (M system)/G69.1 (L system) (3-dimensional coordinate conversion cancel) is commanded
- (2) G68/G68.1 (3-dimensional coordinate conversion) modal is cleared by reset

4 Explanation of Interface Signals

Cont.	Signal name	Abbrev.	\$1	\$2	\$3	\$4	\$5	\$5	\$7	\$8
A	N SYNCHRONIZED TAPPING SELECTION (M COMMAND)	RTAP	XCC0	XE00	XF40	X1080	X11C0	X1300	X1440	X1580

[Function]

This signal informs that the synchronized tapping mode is active.

(This signal is output only when the M function synchronized tapping cycle valid parameter (#1272 ext08 bit1) is ON.)

[Operation]

(1) ON timing

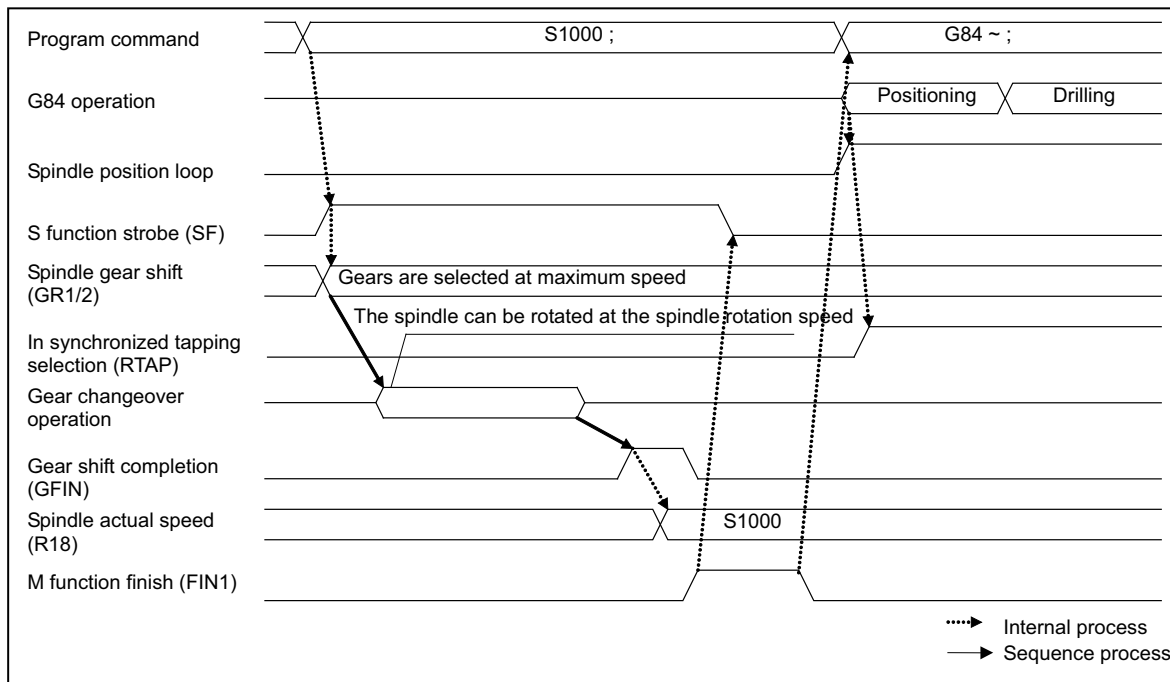

(Note 1) Spindle position loop and in synchronized tapping selection turn ON only during synchronized tapping.

(Note 2) If synchronized tapping is applied even during tap retract, "in synchronized tapping selection" signal will turn ON.

(2) OFF timing

This signal turns OFF when reset, G80 (hole drilling fixed cycle cancel), 01 group G codes or other fixed cycle G codes are commanded.

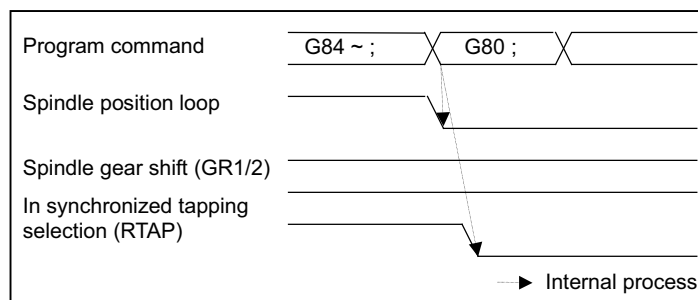

(Note 1) The gears are not selected until the S command is issued again.

(Note 2) This signal turns OFF when tap retract is canceled or completed.

[Related signals]

(1) Gear shift completion (GFIN:Y1885)

(2) Spindle actual speed (R6506)

4 Explanation of Interface Signals

Cont.	Signal name	Abbrev.	\$1	\$2	\$3	\$4	\$5	\$5	\$7	\$8
A	In small diameter deep hole cycle [M8]		XCC1	XE01	XF41	X1081	X11C1	X1301	X1441	X1581

[Function]

This signal outputs the state of "in drilling operation" of small diameter deep hole cycle.

[Operation]

This signal is output between the positioning to the R point for drilling axis and returning to the R point/initial point after finishing the drilling.

[Related signals]

- (1) Small diameter deep hole drilling cycle (YCCA)

Cont.	Signal name	Abbrev.	\$1	\$2	\$3	\$4	\$5	\$6	\$7	\$8
A	IN BARRIER VALID (LEFT)		XCC8	XE08	XF48	X1088	X11C8	X1308	X1448	X1588

Cont.	Signal name	Abbrev.	\$1	\$2	\$3	\$4	\$5	\$6	\$7	\$8
A	IN BARRIER VALID (RIGHT)		XCC9	XE09	XF49	X1089	X11C9	X1309	X1449	X1589

[Function]

This signal informs that the barrier area of left side (right side) is valid in the chuck/tailstock barrier function.

[Operation]

When all conditions below are satisfied and the barrier area is valid, this signal is turned ON. (When this signal is OFF, the barrier check is not executed.)

- (1) The additional specification of chuck barrier check function is valid.
- (2) The setting of parameter "#8310 Barrier ON" on the barrier data screen is "1". (Excluding when using the special display unit)
- (3) The setting of parameter "#8315 BARRIER TYPE (L)" ("#8316 BARRIER TYPE (R)") on the barrier data screen is other than "0".
- (4) The "Barrier valid" signal input above is ON, or the G22 modal is valid.

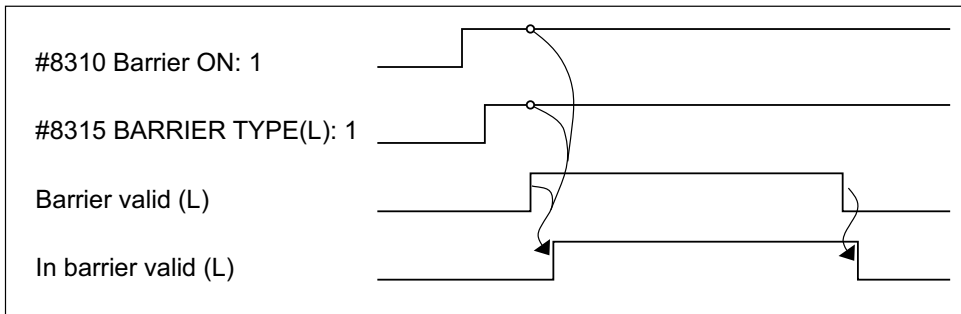

[Related signals]

- (1) Barrier valid (left) (YCD8)
- (2) Barrier valid (right) (YCD9)

4 Explanation of Interface Signals

Cont.	Signal name	Abbrev.	\$1	\$2	\$3	\$4	\$5	\$5	\$7	\$8
A	DOOR OPEN ENABLE	DROPNS	XCD8	XE18	XF58	X1098	X11D8	X1318	X1458	X1598

[Function]

This signal informs the PLC that the drive power to all axes is turned OFF due to the "Door open I/II" (DOOR1/2) signal, or that the same status is canceled.

[Operation]

This signal turns ON when the drive power to all axes is turned OFF due to the "Door open I/II" (DOOR1/2) signal turning ON.

This signal turns OFF at all axes ready ON and at all servo axes servo ON, due to the "Door open I/II" (DOOR1/2) signal turning OFF.

Release of the door lock is enabled at the rising edge of the "Door open enable" signal.

The operation is in a READY status at the falling edge of the "Door open enable" signal.

[Caution]

(1) Handling of the PLC axis

Set so the "Door open I/II" (DOOR1/2) signal is output to the NC after the PLC axis is stopped by the PLC.

If the "Door open I/II" (DOOR1/2) signal is input without stopping the PLC axis, the axis will stop with a dynamic brake method due to the ready OFF state.

The remaining distance will be held in the R register being used in the PLC axis control.

(2) Handling of the analog spindle

When an analog spindle is connected, it is not possible to confirm that the spindle has completely stopped with the NC. Thus, confirm that the spindle has completely stopped using the PLC, before opening the door.

Because the spindle may start rotating again immediately after the door is closed, for safety turn the forward run and reverse run signals OFF when the door is open.

(3) Opening the door during ATC operation

When opening the door during ATC operation, apply an interlock with the user PLC.

[Related signals]

(1) Door open I (DOOR1:Y768)

(2) Door open II (DOOR2:YCE1)

Cont.	Signal name	Abbrev.	\$1	\$2	\$3	\$4	\$5	\$5	\$7	\$8
A	External search: Program return completed		XCEA	XE2A	XF6A	X10AA	X11EA	X132A	X146A	X15AA

[Function][Operation]

This signal turns ON when the program return is completed by inputting the program return signal. This also turns ON when an error occurs.

This signal turns OFF when the program return signal is turned OFF from the user PLC.

The timing chart for program return is shown below.

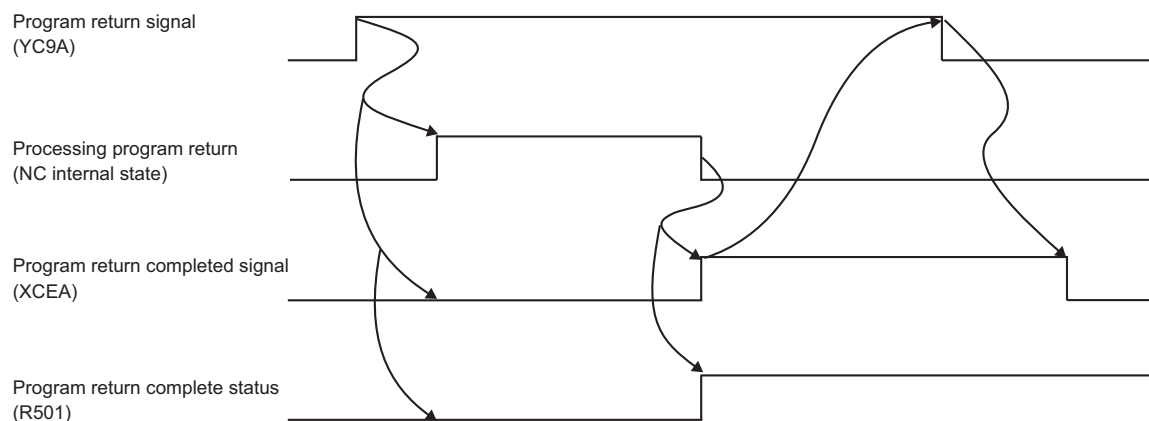

4 Explanation of Interface Signals

Cont.	Signal name	Abbrev.	\$1	\$2	\$3	\$4	\$5	\$6	\$7	\$8
A	Program format switch in progress [M8]	PFCHS	XCF0	XE30	XF70	X10B0	X11F0	X1330	X1470	X15B0

[Function]

This signal informs of the program format switch state.

- 0: Program format switch not in progress
- 1: Program format switch in progress

[Operation]

This signal notifies the PLC of the part system where program format switch is enabled.

When the program format switch request (PFCHR:YD00) has turned ON and the format switch is completed, the PFCHS signal turns ON. When you start automatic operation with the PFCHS signal ON, the control runs a program based on the switched program format (G code system).

L-system operation example

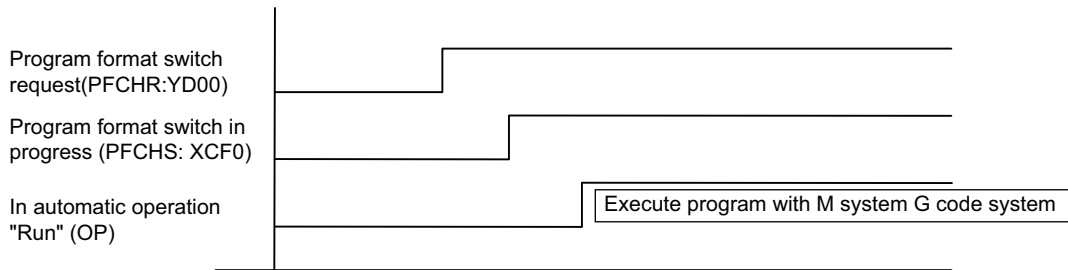

[Caution]

- (1) If you execute cycle start after turning ON PFCHR, wait until the Program format switch request (PFCHR:YD00) signal turns ON. Otherwise, it cannot be assured that "the control runs a program based on the switched G code system from the top block of the program".

[Related signals]

- (1) Program format switch request [M8] (PFCHR:YD00)

Cont.	Signal name	Abbrev.	\$1	\$2	\$3	\$4	\$5	\$6	\$7	\$8
A	TORQUE LIMITATION SKIP: G160 TORQUE LIMIT ON	GLMT	XCF9	XE39	XF79	X10B9	X11F9	X1339	X1479	X15B9

[Function]

This signal indicates that the torque skip ON occurred while the torque skip (G160) is commanded.

[Operation]

This signal turns ON when:

- (1) The torque skip ON occurs while the torque skip (G160) is commanded.

This signal turns OFF when:

- (1) The "Reset 1", "Reset 2", or "Reset & rewind" signal is input for the target part system.
- (2) An emergency stop occurred.
- (3) Axis motion is commanded for the target part system with a machining program in the next or later block for the target part system.

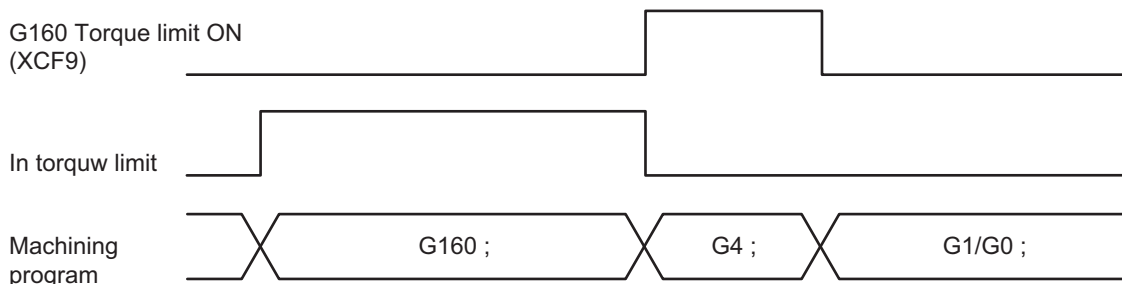

4 Explanation of Interface Signals

Cont.	Signal name	Abbrev.	\$1	\$2	\$3	\$4	\$5	\$6	\$7	\$8
A	RAPID TRAVERSE TIME CONSTANT : IN SWITCHOVER	G0AC	XD0B	XE4B	XF8B	X10CB	X120B	X134B	X148B	X15CB

[Function]

This signal indicates the currently selected rapid traverse time constant.

[Operation]

This signal turns ON when the rapid traverse time constant has already been switched to the axis specifications parameter "#2598 G0tL_2" or the rapid traverse time constant (primary delay) / second-step time constant for soft acceleration/deceleration has been switched to the axis specifications parameter "#2599 G0t1_2".

This signal turns OFF when the rapid traverse time constant has already been switched to the axis specifications parameter "#2004 G0tL" or the rapid traverse time constant (primary delay) / second-step time constant for soft acceleration/deceleration has been switched to the axis specifications parameter "#2005 G0t1".

[Related signals]

(1) Rapid traverse time constant : Switchover request (ACCG: YDOB)

Cont.	Signal name	Abbrev.	\$1	\$2	\$3	\$4	\$5	\$6	\$7	\$8
A	Real-time tuning 2: Acceleration/ deceleration time constant in switchover [M8]	RT2CHG	XD0C	XE4C	XF8C	X10CC	X120C	X134C	X148C	X15CC

[Function]

This signal indicates that the switching process of acceleration/deceleration time constant is being performed in the real-time tuning 2 function.

[Operation]

This signal is ON while switching process of the acceleration/deceleration time constant is being performed.

This signal is OFF while switching process of the acceleration/deceleration time constant is not performed or real-time tuning 2 function is disabled.

[Related signals]

(1) Real-time tuning 2: Acceleration/deceleration time constant in automatic switchover (RT2CHGA:YD0C)

(2) Real-time tuning 2: Acceleration/deceleration time constant in manual switchover (RT2CHGM:YD0D)

(3) Real-time tuning 2: Acceleration/deceleration time constant reset (RT2RST:YD0E)

Cont.	Signal name	Abbrev.	\$1	\$2	\$3	\$4	\$5	\$6	\$7	\$8
A	Reserved tool wear compensation not reflected	TWNIN	XD0E	XE4E	XF8E	X10CE	X120E	X134E	X148E	X15CE

[Function]

This signal notifies the PLC that the reserved tool wear compensation memory has not been reflected to the tool wear compensation memory yet.

[Operation]

Refer to the page of the "Request for reflecting reserved tool wear compensation" signal (TWIN: YD0F).

[Related signals]

(1) Reservation of tool wear compensation (TWR: Y1CB8)

(2) Request for reflecting reserved tool wear compensation (TWIN: YD0F)

(3) Reflection of reserved tool wear compensation is complete (TWOUT: XD0F)

4 Explanation of Interface Signals

Cont.	Signal name	Abbrev.	\$1	\$2	\$3	\$4	\$5	\$6	\$7	\$8
A	Reflection of reserved tool wear compensation is complete	TWOUT	XD0F	XE4F	XF8F	X10CF	X120F	X134F	X148F	X15CF

[Function]

This signal notifies the PLC that the contents of the reserved tool wear compensation memory have been reflected to the tool wear compensation memory.

[Operation]

Refer to the page of the "Request for reflecting reserved tool wear compensation" signal (TWIN: YD0F).

When the "Request for reflecting reserved tool wear compensation" signal (TWIN) turns OFF, this signal also turns OFF.

[Related signals]

- (1) Reservation of tool wear compensation (TWR: Y1CB8)
- (2) Request for reflecting reserved tool wear compensation (TWIN: YD0F)
- (3) Reserved tool wear compensation not reflected (TWNIN: XD0E)

Cont.	Signal name	Abbrev.	\$1	\$2	\$3	\$4	\$5	\$6	\$7	\$8
A	3D coordinate conversion: Manual feed valid [M8]		XD14	XE54	XF94	X10D4	X1214	X1354	X1494	X15D4

[Function]

While this signal is ON, the coordinate system for manual operation is selected by the "3D coordinate conversion: Manual feed coordinates switch" signal (YD14).

While this signal is OFF, manual feed is carried out with respect to the machine coordinate system.

[Operation]

This signal turns ON when the following conditions are all satisfied:

- (1) Jog, incremental or handle mode is being selected.
- (2) G68 (M system)/G68.1 (L system) (3D coordinate conversion) has been given at least once.

If the command is canceled by G69 (M system)/G69.1 (L system) (3D coordinate conversion cancel); however, the signal will not turn ON until G68/G68.1 is given again.

[Related signals]

- (1) 3D coordinate conversion: Manual feed coordinates conversion [M8] (YD14)

Cont.	Signal name	Abbrev.	\$1	\$2	\$3	\$4	\$5	\$6	\$7	\$8
A	ROTATION CENTER ERROR COMPENSATION IN PROGRESS [M8]	RCEI	XD15	XE55	XF95	X10D5	X1215	X1355	X1495	X15D5

[Function]

This signal indicates that the rotation center error compensation is valid.

[Operation]

This signal turns "1" when the additional specification of rotation center error compensation is enabled and the "Rotation center error compensation enabled" signal (RCEE) is "1".

When the rotation center error compensation is disabled, this signal is "0".

[Related signals]

- (1) Rotation center error compensation enabled (RCEE:YD15)

4 Explanation of Interface Signals

Cont.	Signal name	Abbrev.	\$1	\$2	\$3	\$4	\$5	\$6	\$7	\$8
A	Spatial error compensation in progress [M8]	SECI	XD17	XE57	XF97	X10D7	X1217	X1357	X1497	X15D7

[Function]

This signal indicates that the spatial error compensation is valid and error compensation can be performed.

[Operation]

When the spatial error compensation is invalid, this signal is "0".

When the spatial error compensation enabled signal (SECE: YD17) is ON and the option of the spatial error compensation is valid, this signal is "1".

The spatial error compensation function can compensate for an error in the first part system only.

[Timing chart]

Without the spatial error compensation option

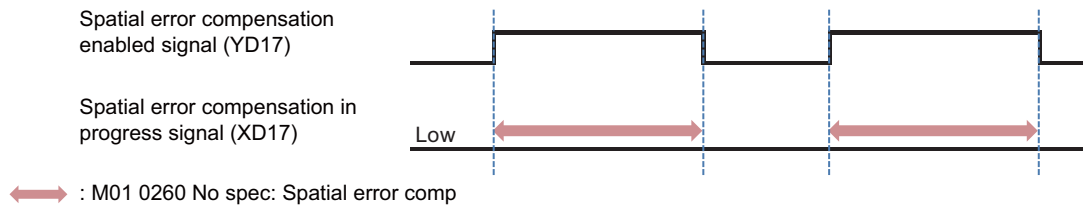

With the spatial error compensation option

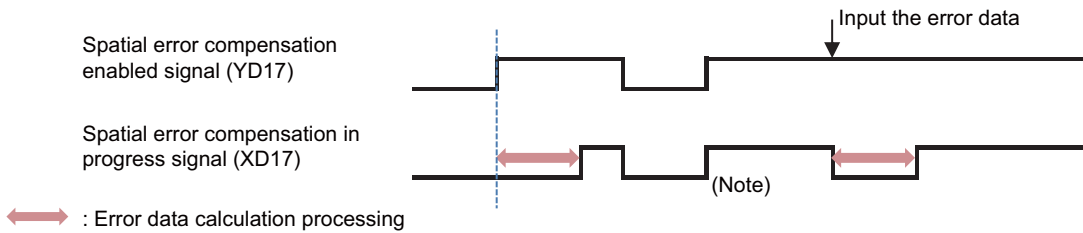

(Note) When the spatial error compensation is valid, and if the error data is the same as the last time, the calculation processing is not performed.

[Related signals]

- (1) Spatial error compensation enabled [M8] (SECE: YD17)

4 Explanation of Interface Signals

Cont.	Signal name	Abbrev.	\$1	\$2	\$3	\$4	\$5	\$5	\$7	\$8
A	Tool axis coordinate system in 3D manual feed (JOG,INC)	MJST	XD18	XE58	XF98	X10D8	X1218	X1358	X1498	X15D8
A	Table coordinate system in 3D manual feed (JOG,INC)	MJSB	XD19	XE59	XF99	X10D9	X1219	X1359	X1499	X15D9
A	Feature coordinate system in 3D manual feed (JOG,INC)	MJSF	XD1A	XE5A	XF9A	X10DA	X121A	X135A	X149A	X15DA

[Function]

This signal indicates the coordinate system in which the 3D manual feed is carried out by the jog or incremental feed. When this signal is ON, jog feed or incremental feed is carried out in the coordinate system of the signal.

[Operation]

This signal turns ON when:

- (1) The hypothetical coordinate system for the 3D manual feed (JOG, INC) has been selected during jog feed or incremental feed.

This signal turns OFF when:

- (1) The hypothetical coordinate selection for the 3D manual feed (JOG, INC) is turned OFF.
- (2) The jog feed or incremental feed mode is turned OFF.

[Related signals]

- (1) In jog mode (JO:XC00)
- (2) In incremental mode (SO:XC02)
- (3) 3D manual feed (JOG,INC) in tool axis coordinate system
- (4) 3D manual feed (JOG,INC) in table coordinate system
- (5) 3D manual feed (JOG,INC) in feature coordinate system
- (6) In tool center point rotation (TCPRS:XD27)

Cont.	Signal name	Abbrev.	\$1	\$2	\$3	\$4	\$5	\$5	\$7	\$8
A	Tool axis coordinate system in 3D manual feed (1st handle)	MH1ST	XD1B	XE5B	XF9B	X10DB	X121B	X135B	X149B	X15DB
A	Table coordinate system in 3D manual feed (1st handle)	MH1SB	XD1C	XE5C	XF9C	X10DC	X121C	X135C	X149C	X15DC
A	Feature coordinate system in 3D manual feed (1st handle)	MH1SF	XD1D	XE5D	XF9D	X10DD	X121D	X135D	X149D	X15DD

[Function]

This signal indicates the coordinate system in which the 3D manual feed is carried out on the 1st handle axis. When this signal is ON, the feed on the 1st handle axis is carried out in the coordinate system of the signal.

[Operation]

This signal turns ON when:

- (1) The 1st handle feed is valid, the axis selection signal is ON and the hypothetical coordinate system for 3D manual feed (1st handle) is selected.

This signal turns OFF when:

- (1) The selection of the hypothetical coordinate system for 3D manual feed (1st handle) is turned OFF.
- (2) The 1st handle valid signal is turned OFF.
- (3) The axis selection signal is turned OFF.

[Related signals]

- (1) 1st handle axis selection code (HS11 to HS116:YC40 to 4)
- (2) 1st handle valid (HS1S:YC47)
- (3) 3D manual feed (1st handle) in tool axis coordinate system
- (4) 3D manual feed (1st handle) in table coordinate system
- (5) 3D manual feed (1st handle) in feature coordinate system
- (6) In tool center point rotation (TCPRS:XD27)

4 Explanation of Interface Signals

Cont.	Signal name	Abbrev.	\$1	\$2	\$3	\$4	\$5	\$5	\$7	\$8
A	Tool axis coordinate system in 3D manual feed (2nd handle)	MH2ST	XD1E	XE5E	XF9E	X10DE	X121E	X135E	X149E	X15DE
A	Table coordinate system in 3D manual feed(2nd handle)	MH2SB	XD1F	XE5F	XF9F	X10DF	X121F	X135F	X149F	X15DF
A	Feature coordinate system in 3D manual feed (2nd handle)	MH2SF	XD20	XE60	XFA0	X10E0	X1220	X1360	X14A0	X15E0

[Function]

This signal indicates the coordinate system in which the 3D manual feed is carried out on the 2nd handle axis. When this signal is ON, the feed on the 2nd handle axis is carried out in the coordinate system of the signal.

[Operation]

This signal turns ON when:

- (1) The 2nd handle feed is valid, the axis selection signal is ON and the hypothetical coordinate system for 3D manual feed (2nd handle) is selected.

This signal turns OFF when:

- (1) The selection of the hypothetical coordinate system for 3D manual feed (2nd handle) is turned OFF.
- (2) The 2nd handle valid signal is turned OFF.
- (3) The axis selection signal is turned OFF.

[Related signals]

- (1) 2nd handle axis selection code (HS21 to HS216:YC48 to C)
- (2) 2nd handle valid (HS2S:YC4F)
- (3) 3D manual feed (2nd handle) in tool axis coordinate system
- (4) 3D manual feed (2nd handle) in table coordinate system
- (5) 3D manual feed (2nd handle) in feature coordinate system
- (6) In tool center point rotation (TCPRS:XD27)

Cont.	Signal name	Abbrev.	\$1	\$2	\$3	\$4	\$5	\$5	\$7	\$8
A	Tool axis coordinate system in 3D manual feed (3rd handle)	MH3ST	XD21	XE61	XFA1	X10E1	X1221	X1361	X14A1	X15E1
A	Table coordinate system in 3D manual feed (3rd handle)	MH3SB	XD22	XE62	XFA2	X10E2	X1222	X1362	X14A2	X15E2
A	Feature coordinate system in 3D manual feed (3rd handle)	MH3SF	XD23	XE63	XFA3	X10E3	X1223	X1363	X14A3	X15E3

[Function]

This signal indicates the coordinate system in which the 3D manual feed is carried out on the 3rd handle axis. When this signal is ON, the manual feed on the 3rd handle axis is carried out in the coordinate system of the signal.

[Operation]

This signal turns ON when:

- (1) The 3rd handle feed is valid, the axis selection signal is ON and the hypothetical coordinate system for 3D manual feed (3rd handle) is selected.

This signal turns OFF when:

- (1) The selection of the hypothetical coordinate system for 3D manual feed (3rd handle) is turned OFF.
- (2) The 3rd handle valid signal is turned OFF.
- (3) The axis selection signal is turned OFF.

[Related signals]

- (1) 3rd handle axis selection code (HS31 to HS316:YC50 to 4)
- (2) 3rd handle valid (HS3S:YC57)
- (3) 3D manual feed (3rd handle) in tool axis coordinate system
- (4) 3D manual feed (3rd handle) in table coordinate system
- (5) 3D manual feed (3rd handle) in feature coordinate system
- (6) In tool center point rotation (TCPRS:XD27)

4 Explanation of Interface Signals

Cont.	Signal name	Abbrev.	\$1	\$2	\$3	\$4	\$5	\$5	\$7	\$8
A	In tool center point rotation	TCPRS	XD27	XE67	XFA7	X10E7	X1227	X1367	X14A7	X15E7

[Function]

This signal informs the operation of the rotation axis of 3D manual feed (JOG/incremental/handle).

[Operation]

This signal informs that it operates with keeping the positional relationship of tool center point looking from the workpiece, when the rotation axis of 3D manual feed (JOG/incremental/handle) is operated.

[Related signals]

- (1) Tool axis coordinate system in 3D manual feed (JOG,INC)
- (2) Table coordinate system in 3D manual feed (JOG,INC)
- (3) Feature coordinate system in 3D manual feed (JOG,INC)
- (4) Tool axis coordinate system in 3D manual feed (1st handle)
- (5) Table coordinate system in 3D manual feed (1st handle)
- (6) Feature coordinate system in 3D manual feed (1st handle)
- (7) Tool axis coordinate system in 3D manual feed (2nd handle)
- (8) Table coordinate system in 3D manual feed (2nd handle)
- (9) Feature coordinate system in 3D manual feed (2nd handle)
- (10) Tool axis coordinate system in 3D manual feed (3rd handle)
- (11) Table coordinate system in 3D manual feed (3rd handle)
- (12) Feature coordinate system in 3D manual feed (3rd handle)

Cont.	Signal name	Abbrev.	\$1	\$2	\$3	\$4	\$5	\$5	\$7	\$8
A	R-NAVI: MACHINING SURFACE BEING SELECTED [M8]	RSSCT	XD28	XE68	XFA8	X10E8	X1228	X1368	X14A8	X15E8

[Function]

This signal notifies that a machining surface is being selected by the R-Navi function.

[Operation]

This signal turns ON when:

- (1) A machining surface is selected on [Surface select] of the Monitor screen.

This signal turns OFF when:

- (1) The machining surface is cancelled.
- (2) The machining surface is cancelled with emergency stop.

(Note) This signal will not turn ON while a machining surface is being called by a program.

[Related signals]

- (1) R-Navi: machining surface being indexed (RSIND:XD29)
- (2) R-Navi: machining surface indexing completion (RSIDF:XD2A)

4 Explanation of Interface Signals

Cont.	Signal name	Abbrev.	\$1	\$2	\$3	\$4	\$5	\$5	\$7	\$8
A	R-NAVI: MACHINING SURFACE BEING INDEXED [M8]	RSIND	XD29	XE69	XFA9	X10E9	X1229	X1369	X14A9	X15E9

[Function]

This signal notifies that a selected machining surface is being indexed by the R-Navi function.

[Operation]

This signal turns ON when:

"#11037 R-Navi Index Type" is "0"

- (1) The [Index exec] menu is pressed on [Surface Selection] of the Monitor screen while a machining surface is being selected.

"#11037 R-Navi Index Type" is "1"

- (1) The [Index exec] menu is pressed on [Surface Selection] of the Monitor screen and then a tool length offset No. is entered while a machining surface is being selected.

This signal turns OFF when:

- (1) Indexing is completed.
- (2) NC reset is input.
- (3) Emergency stop is input.

[Related signals]

- (1) R-Navi: machining surface being selected (RSSCT:XD28)
- (2) R-Navi: machining surface indexing completion (RSIDF:XD2A)

Cont.	Signal name	Abbrev.	\$1	\$2	\$3	\$4	\$5	\$5	\$7	\$8
A	R-NAVI: MACHINING SURFACE INDEXING COMPLETION [M8]	RSIDF	XD2A	XE6A	XFAA	X10EA	X122A	X136A	X14AA	X15EA

[Function]

This signal notifies that indexing of a selected machining surface is completed by the R-Navi function.

[Operation]

This signal turns ON when:

- (1) Machining surface indexing is completed, and Smoothing zero is turned ON.

This signal turns OFF when:

- (1) The machining surface is cancelled.
- (2) Another machining surface is selected while the surface is being selected (surfaces are switched).
- (3) The machining surface is cancelled with emergency stop.

[Related signals]

- (1) R-NNavi: machining surface being selected (RSSCT:XD28)
- (2) R-Navi: machining surface being indexed (RSIND:XD29)

4 Explanation of Interface Signals

Cont.	Signal name	Abbrev.	\$1	\$2	\$3	\$4	\$5	\$6	\$7	\$8
A	Simple inclined surface machining/Inclined surface control command ON [M8]	SLOP	XD2F	XE6F	XFAF	X10EF	X122F	X136F	X14AF	X15EF

[Function]

This signal notifies that the inclined surface machining command and simple inclined surface control command are in modal.

[Operation]

This signal turns ON when:

- (1) A block of inclined surface machining command (G68.2) is executed.
- (2) A block of simple inclined surface control command (G176) is executed.
- (3) The parameter "#1247 set19/bit1" is set to "1" and the power is turned OFF and ON again during the simple inclined surface control command.

This signal turns OFF when:

- (1) A cancel block of inclined surface machining command and simple inclined surface control command (G69.1) are executed.
- (2) The parameter "#1247 set19/bit1" is set to "0" and the emergency stop is turned ON.
- (3) The inclined surface machining command and simple inclined surface control command are canceled by reset.

The inclined surface machining command and simple inclined surface control command are canceled when:

#1151 rstint (Reset initial)	#1210 RstGmd/bitF (Modal G code reset)	Reset 1	Reset 2	Reset & rewind
0	0	Retains all modals.	Cancel	Cancel
	1	Retains all modals.	Retains only the inclined surface.	Retains only the inclined surface.
1	0	Cancel	Cancel	Cancel
	1	Retains only the inclined surface.	Retains only the inclined surface.	Retains only the inclined surface.

Cont.	Signal name	Abbrev.	\$1	\$2	\$3	\$4	\$5	\$6	\$7	\$8
A	MES interface library: Sending user arbitrary information [M8]		XD30	XE70	XFB0	X10F0	X1230	X1370	X14B0	X15F0

[Function]

This signal notifies that DB operation is being performed to the arbitrary information accumulation table in the database.

[Operation]

This signal notifies that whether the DB operation is being performed to the arbitrary information accumulation table in the database.

0: The DB operation is not performing to the arbitrary information accumulation table in the database.

1: The DB operation is performing to the arbitrary information accumulation table in the database.

"0" is set when MES interface library function is invalid.

[Related signals]

- (1) MES interface library: User arbitrary information send request [M8] (YC9B to Y155B)

4 Explanation of Interface Signals

Cont.	Signal name	Abbrev.	\$1	\$2	\$3	\$4	\$5	\$6	\$7	\$8
A	MANUAL ARBITRARY REVERSE RUN: REVERSE RUN INVALID STATUS [M8]		XD31	XE71	XFB1	X10F1	X1231	X1371	X14B1	X15F1

[Function]

This signal notifies that the reverse run is not possible.

[Operation]

This signal notifies that the reverse run is not possible when the reverse run is performed in the block where the reverse run is prohibited during manual arbitrary reverse.

This signal turns ON at the timing when the reverse run is performed in the block where the reverse run is prohibited.

After that, as the state of the signal is retained, the signal continues to be output even when the reverse run stops. This signal turns OFF at the time of reset/emergency stop or forward run start.

Also, this signal turns OFF when manual arbitrary reverse run is canceled during reverse run invalid status.

[Related signals]

- (1) Manual arbitrary reverse run mode (MORR:Y73C)
- (2) Manual arbitrary reverse run mode ON (PCHKO:X715)
- (3) Manual arbitrary reverse run speed selection (MORSP:Y73D)
- (4) Actual cutting mode (thread, tap) in manual arbitrary reverse run (MRCMD:Y761)
- (5) Manual arbitrary reverse run: MSTB reverse run prohibited (MRPSG:YCFC)
- (6) Manual arbitrary reverse run speed multiplier (R379)
- (7) Manual arbitrary reverse run: Reverse run ON (MOREV:X716)
- (8) Manual arbitrary reverse run handle selection (R375)

Cont.	Signal name	Abbrev.	\$1	\$2	\$3	\$4	\$5	\$6	\$7	\$8
A	VCC: Mode in execution	VCC	X1810	X1811	X1812	X1813	X1814	X1815	X1816	X1817

[Function]

This signal notifies that the vibration cutting mode is being executed.

[Operation]

This signal turns ON during the vibration cutting mode.

This signal turns OFF when the vibration cutting mode is canceled.

[Related signals]

- (1) Vibration cutting: Mode in execution (VCC: X1810)
- (2) Vibration cutting: Numbers of vibrations (VCC_VIB: R20556)
- (3) Vibration cutting: Frequency (VCC_FRQ: R20557)
- (4) Vibration cutting: Spindle rotation speed (VCC_SPREV: R7024, R7025)
- (5) Vibration cutting: Vibrating axis (VCC_VIBAX: R20558)
- (6) Vibration cutting: Temporary cancel of axis vibration (VCC_INVAX: R22532)
- (7) Vibration cutting: Cause of non-vibration (VCC_FACT: R20559)

Cont.	Signal name	Abbrev.	Common(\$)
A	EDIT/SEARCH WINDOW DISPLAYED		X1878

[Function]

This signal indicates that the "Edit/Search" window is displayed.

[Operation]

This signal is turned ON when the "Edit/Search" window is displayed on the monitor screen, and turned OFF when the window is closed.

[Related signals]

- (1) Edit/Search (Y1878)

Cont.	Signal name	Abbrev.	1stSP	2ndSP	3rdSP	4thSP	5thSP	6thSP	7thSP	8thSP
A	S COMMAND GEAR NO. ILLEGAL	SIGE	X1882	X18E2	X1942	X19A2	X1A02	X1A62	X1AC2	X1B22

[Function]

This signal is output if specified gear No. is illegal.

[Operation]

The signal turns ON if gear No. specified by user is beyond the maximum system gear No.

4 Explanation of Interface Signals

Cont.	Signal name	Abbrev.	1stSP	2ndSP	3rdSP	4thSP	5thSP	6thSP	7thSP	8thSP
A	S COMMAND MAX./MIN. COMMAND VALUE OVER	SOVE	X1883	X18E3	X1943	X19A3	X1A03	X1A63	X1AC3	X1B23

[Function]

This signal is output when S command value is clamped to the maximum or minimum value.

[Operation]

The signal turns ON if S command value is larger than spindle maximum speed parameter (Smaxn) value, or smaller than spindle minimum speed parameter (Smin) value.

Cont.	Signal name	Abbrev.	1stSP	2ndSP	3rdSP	4thSP	5thSP	6thSP	7thSP	8thSP
A	S COMMAND NO GEAR SELECTED	SNGE	X1884	X18E4	X1944	X19A4	X1A04	X1A64	X1AC4	X1B24

[Function]

This signal is output if gear is not present for S function (S code) issued by automatic operation.

[Operation]

This signal will turn ON when the S function (S code) is issued during automatic operation, and the S code does not match any gear set in the spindle maximum speed parameters.

This signal (SNGE) is output simultaneously with spindle function strobe signal (SF).

[Related signals]

- (1) Spindle function strobe (SFn:XC64)
- (2) Spindle gear shift (GR1, GR2:X1885, 6)

Cont.	Signal name	Abbrev.	1stSP	2ndSP	3rdSP	4thSP	5thSP	6thSP	7thSP	8thSP
A	SPINDLE GEAR SHIFT 1,2	GR1,2	X1885,6	X18E5,6	X1945,6	X19A5,6	X1A05,6	X1A65,6	X1AC5,6	X1B25,6

[Function]

This signal informs which gear stage in the spindle applies to the S command (S code) issued in the automatic operation (memory, MDI or tape) machining program.

For machines that have gear stage shift, the gear will be shifted on the machine side when this signal is received.

[Operation]

When the S command (S code) is issued in automatic operation, the gear stage for the commanded S code is output with a 2-bit (GR1, GR2) code from the preset parameters (spindle max. speed).

The relation of the spindle max. speed parameter (Smax1 to Smax4) and the "Spindle gear shift" (GR1, GR2) signal output is shown below.

Gear stage	Max. spindle speed	Spindle gear shift		
		GR2	GR1	
1	Smax1	0	0	← Range "S0 to S (Smax1)"
2	Smax2	0	1	← Range "S (Smax1)+1 to S (Smax2)"
3	Smax3	1	0	← Range "S (Smax2)+1 to S (Smax3)"
4	Smax4	1	1	← When range over "S (Smax3)+1" is specified.

This signal (GR1, GR2) is output simultaneously with the "Spindle function strobe" (SFn).

(Note 1) If the commanded S code does not match any of the gear stages, the "S command no gear selected" (SNGE) signal will be output separately from this signal.

In this case the outputs of these signals vary depending on the settings of Smax1 to Smax4.

- When a spindle speed exceeding Smax4 is commanded while Smax1 up to Smax4 are set: GR2=1, GR1=1
- When a spindle speed exceeding Smax3 is commanded while Smax1 up to Smax3 are set: GR2=1, GR1=0
- When a spindle speed exceeding Smax2 is commanded while Smax1 and Smax2 are set: GR2=0, GR1=1
- When a spindle speed exceeding Smax1 is commanded while only Smax1 is set: GR2=0, GR1=0

[Related signals]

- (1) Spindle function strobe (SFn:XC64)
- (2) S command no gear selected (SNGE:X1884)

4 Explanation of Interface Signals

Cont.	Signal name	Abbrev.	1stSP	2ndSP	3rdSP	4thSP	5thSP	6thSP	7thSP	8thSP
A	SPINDLE 2ND IN-POSITION	ORAO2	X1888	X18E8	X1948	X19A8	X1A08	X1A68	X1AC8	X1B28

[Function]

This signal informs that the spindle is positioned in the set range in accordance with spindle orientation command. The information is sent earlier than by the "Spindle in-position" signal. Since orientation completion can be predicted using this signal, it is possible to eliminate the sequence delay time, etc. for tool changes and other such operations, thereby achieving a shorter takt time.

[Operation]

This signal turns ON with the "Spindle orientation command" (ORC), and the difference between the orientation position and the feedback position reaches the 2nd in-position range.

- (1) The in-position range is set with the spindle parameter "#3132 ori_inp2".
- (2) The signal is turned OFF when the "Spindle orientation command" (ORC) is turned OFF.

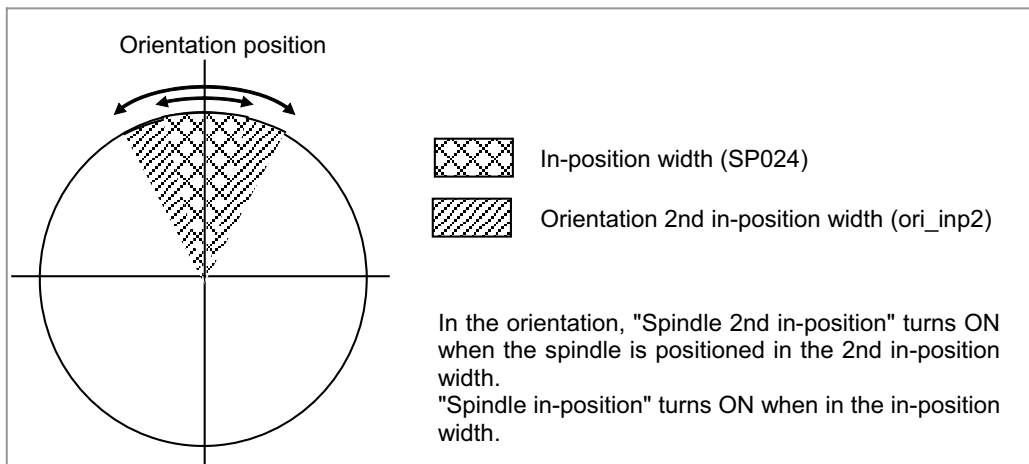
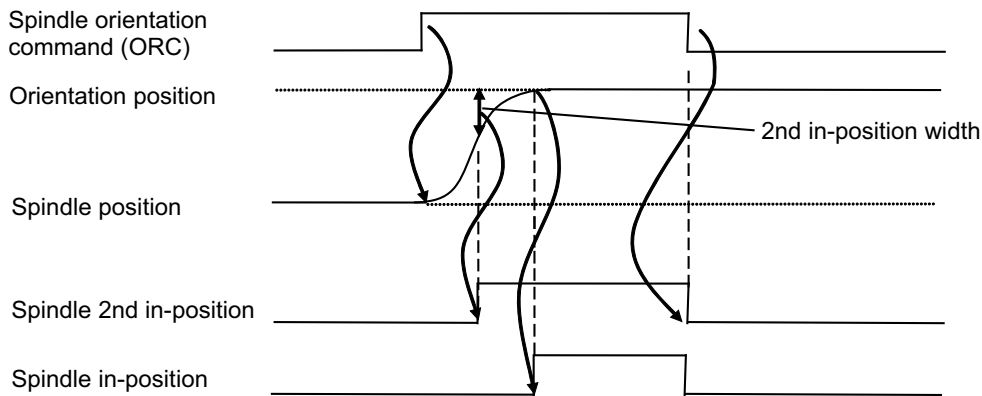

- (Note 1) When spindle orientation command is given, orientation starts regardless of the "Spindle forward run start (SRN)" or "Spindle reverse run start (SRI)".
- (Note 2) This signal is not available when an analog connection is used.
- (Note 3) While the spindle is in position, it is under servo lock condition. However, if the spindle is rotated by external force, the signal may be turned OFF.

[Related signals]

- (1) Spindle in-position (ORAO:X188E)
- (2) Spindle orientation command (ORC:Y189E)

4 Explanation of Interface Signals

Cont.	Signal name	Abbrev.	1stSP	2ndSP	3rdSP	4thSP	5thSP	6thSP	7thSP	8thSP
A	CURRENT DETECTION	CDO	X1889	X18E9	X1949	X19A9	X1A09	X1A69	X1AC9	X1B29

[Function]

This signal is output from the high-speed serial connection specification spindle controller (spindle drive) and informs that drive motor current is about to reach the permissible maximum current. The signal can be used to prevent stabbing of cutter into workpiece, for example.

[Operation]

The signal (CDO) turns ON if motor current goes up to a threshold (110% output) close to the permissible maximum current (120%).

(Note 1) This signal is valid only for the system that is high-speed serial connection with the controller.

Cont.	Signal name	Abbrev.	1stSP	2ndSP	3rdSP	4thSP	5thSP	6thSP	7thSP	8thSP
A	SPEED DETECTION	VRO	X188A	X18EA	X194A	X19AA	X1A0A	X1A6A	X1ACA	X1B2A

[Function]

This signal is output from the high-speed serial connection specification spindle controller (spindle drive) and informs that motor speed is dropped below the speed specified by parameter.

[Operation]

The signal (VRO) turns ON when motor speed (motor rotation speed) drops below the speed specified by the spindle parameter "#13028 SP028 (Speed detection set value)".

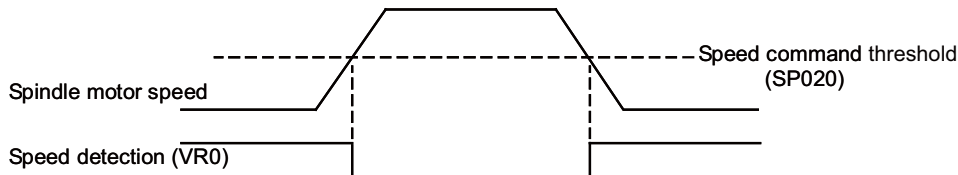

(Note 1) This signal is valid only for the system that is high-speed serial connection with the controller.

[Related signals]

(1) Speed detection 2 (SD2:X189D)

Cont.	Signal name	Abbrev.	1stSP	2ndSP	3rdSP	4thSP	5thSP	6thSP	7thSP	8thSP
A	IN SPINDLE ALARM	FLO	X188B	X18EB	X194B	X19AB	X1A0B	X1A6B	X1ACB	X1B2B

[Function]

This signal is output from the high-speed serial connection specification spindle controller (spindle drive) and informs that failure occurs in spindle controller.

[Operation]

The signal turns ON if alarm which occurs in the spindle controller is detected.

To cancel alarm, reset the controller (by reset & rewind), turn the controller power OFF or turn the spindle controller power supply OFF. Note that reset method depends on type of alarm.

Typical examples of alarm are listed below. For details of alarm contents and cancel procedure, refer to the Instruction Manual for the spindle drive unit.

- (1) Overcurrent
- (2) Breaker trip
- (3) Motor overheat

(Note 1) This signal is valid only for the system that is high-speed serial connected with the controller.

4 Explanation of Interface Signals

Cont.	Signal name	Abbrev.	1stSP	2ndSP	3rdSP	4thSP	5thSP	6thSP	7thSP	8thSP
A	ZERO SPEED	ZSO	X188C	X18EC	X194C	X19AC	X1A0C	X1A6C	X1ACC	X1B2C

[Function]

This signal is output from the high-speed serial connection specification spindle controller (spindle drive) and informs that motor speed has dropped below the set speed threshold.

[Operation]

This signal turns ON when:

- The actual spindle motor speed drops to the speed specified by the spindle parameter "#13027 SP027 ZSP" (Motor zero speed) or less.

This signal turns OFF when:

- The actual spindle motor speed reached the rotation speed which was added 15 (r/min) to the set value of the spindle parameter "#13027 SP027 ZSP" (Motor zero speed), then approximately 200 (ms) has passed.

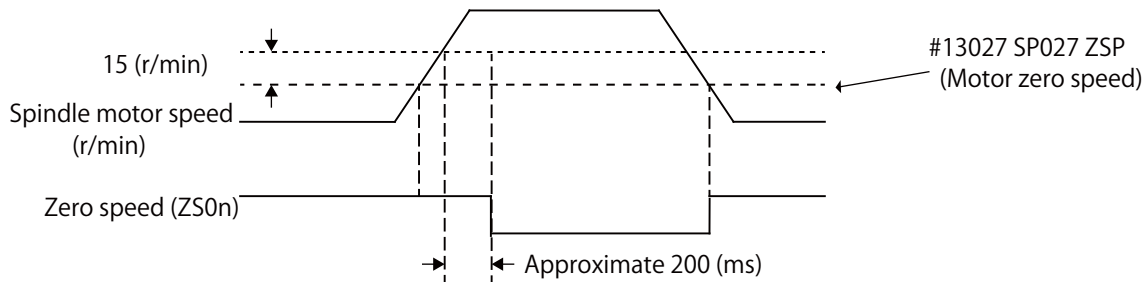

- (Note 1) The signal is output, no matter whether direction of rotation is "Spindle forward run start" signal (SRN) or "Spindle reverse run start" signal (SRI).
- (Note 2) Minimum output pulse width of the signal is approximately 200 (ms).
- (Note 3) Speed at which the signal is output can be set within range from 1 (r/min) to 1000 (r/min) with the spindle parameter "#13027 SP027" (motor zero speed).
- (Note 4) This signal is valid only for the system that is high-speed serial connected with the controller.

4 Explanation of Interface Signals

Cont.	Signal name	Abbrev.	1stSP	2ndSP	3rdSP	4thSP	5thSP	6thSP	7thSP	8thSP
A	SPINDLE UP-TO-SPEED	USO	X188D	X18ED	X194D	X19AD	X1A0D	X1A6D	X1ACD	X1B2D

[Function]

This signal is output from the high-speed serial connection specification spindle controller (spindle drive) and informs that actual spindle motor speed reaches the range set with the parameter "#3105 sut"(standard setting $\pm 15\%$).
 This signal is used for the S command completion conditions or control axis interlock during automatic operation.

[Operation]

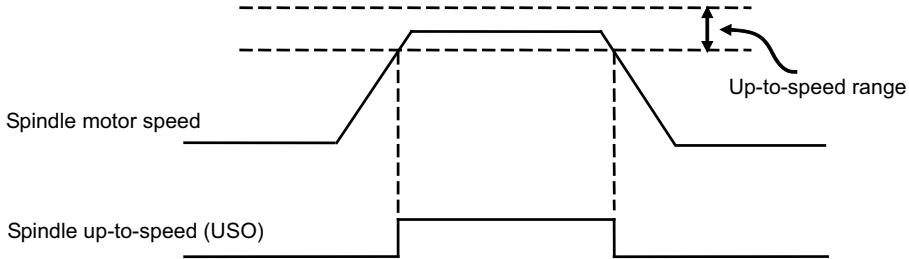

When a command is given to change motor rotation from "forward" to "reverse", spindle motor speed starts going down and the signal (USO) is turned OFF. When motor speed enters the specified detection range, the signal turns ON.

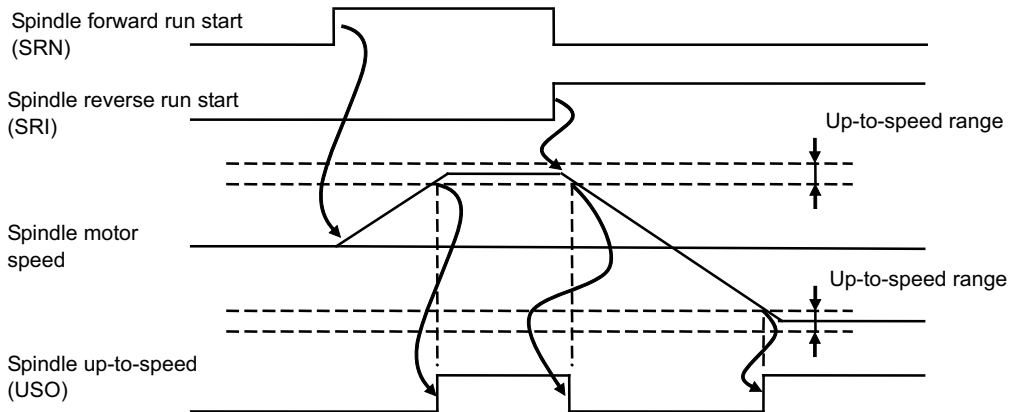

- (Note 1) The signal cannot be output if neither "Spindle forward run start" (SRN) signal nor "Spindle reverse run start" (SRI) signal is ON.
- (Note 2) This signal is not output when operating with a command that is not a speed command such as synchronous tap.
- (Note 3) This signal is valid only for the system that is high-speed serial connected with the controller.

Cont.	Signal name	Abbrev.	1stSP	2ndSP	3rdSP	4thSP	5thSP	6thSP	7thSP	8thSP
A	SPINDLE IN-POSITION	ORAO	X188E	X18EE	X194E	X19AE	X1A0E	X1A6E	X1ACE	X1B2E

[Function]

This signal informs that the spindle is positioned in the set range in accordance with spindle orientation command.

[Operation]

When the spindle positioning in the set range completes, this signal will turn ON. The spindle orientation is started by "Spindle orientation command" signal (ORC).

(1) The in-position range is set with the spindle parameter "#13024 SP024 (INP) ".

(2) The signal is turned OFF when the "Spindle orientation command" (ORC) is turned OFF.

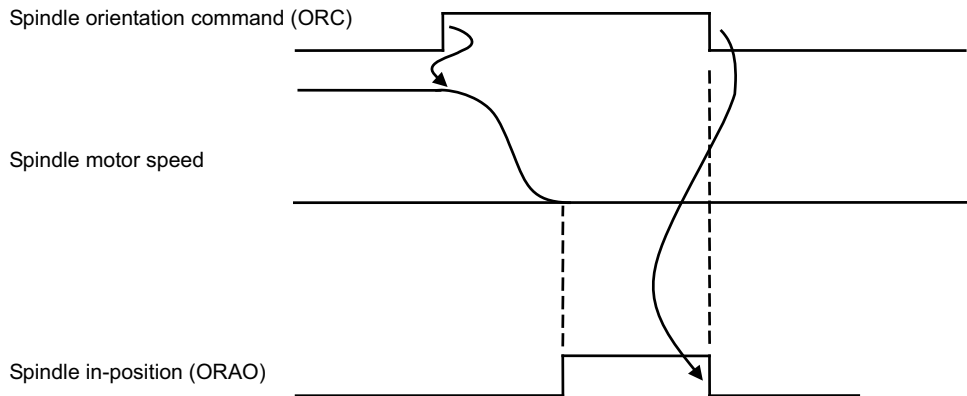

(Note 1) When spindle orientation command is given, orientation starts regardless of the "Spindle forward run start (SRN)" or "Spindle reverse run start (SRI)".

(Note 2) This signal is not available when an analog connection is used.

(Note 3) While the spindle is in position, it is under servo lock condition. However, if the spindle is rotated by external force, the signal (ORAO) may be turned OFF.

[Related signals]

(1) Spindle 2nd in-position (ORAO2:X1888)

(2) Spindle orientation command (ORC:Y189E)

4 Explanation of Interface Signals

Cont.	Signal name	Abbrev.	1stSP	2ndSP	3rdSP	4thSP	5thSP	6thSP	7thSP	8thSP
A	IN L COIL SELECTION	LCSA	X188F	X18EF	X194F	X19AF	X1A0F	X1A6F	X1ACF	X1B2F

[Function]

This signal indicates that the low-speed coil is being selected in the spindle coil changeover function.

[Operation]

The high-speed coil and low-speed coil are changed over only with the "L coil selection" (LRSL) in the 2-step coil changeover specification. The high-speed coil, middle-speed coil and low-speed coil are changed over with the combination of the "L coil selection" (LRSL) and "M coil selection" (LRSM) in the 3-step coil changeover specification.

(1) 2-step coil changeover

Selected coil	L coil selection(LRSL)	In L coil selection(LCSA)
High-speed (H)	OFF	OFF
Low-speed (L)	ON	ON

(2) 3-step coil changeover

Selected coil	L coil selection (LRSL)	M coil selection (LRSM)	In L coil selection (LCSA)	In M coil selection (MCSA)
High-speed (H)	OFF	OFF	OFF	OFF
Middle-speed(M)	OFF	ON	OFF	ON
Low-speed(L)	ON	OFF	ON	OFF
	ON	ON	ON	ON

[Related signals]

- (1) L coil selection (LRSL:Y189F)
- (2) M coil selection (LRSM:Y18A6)
- (3) In M coil selection (MCSA:X189E)

Cont.	Signal name	Abbrev.	1stSP	2ndSP	3rdSP	4thSP	5thSP	6thSP	7thSP	8thSP
A	SPINDLE READY-ON	SMA	X1890	X18F0	X1950	X19B0	X1A10	X1A70	X1AD0	X1B30

[Function]

This signal is output from the high-speed serial connection specification spindle controller (spindle drive) and informs that the spindle can operate.

[Operation]

This signal (SMA) turns ON when the spindle controller is ready for operation. The signal turns OFF (ready off) in the following conditions.

- (1) A spindle alarm is generated.
- (2) "Ready-on" signal (internal signal) from controller is OFF.

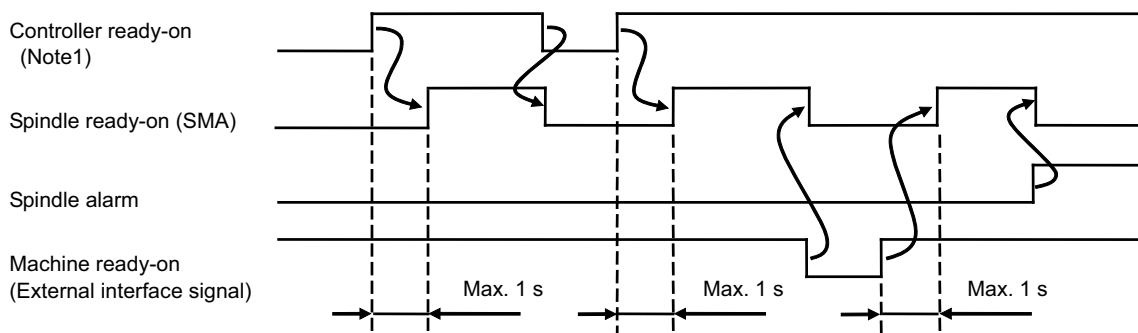

(Note 1) The ready on signal is output from the controller to the spindle controller.

(Note 2) This signal is valid only for the system that is high-speed serial connected with the controller.

4 Explanation of Interface Signals

Cont.	Signal name	Abbrev.	1stSP	2ndSP	3rdSP	4thSP	5thSP	6thSP	7thSP	8thSP
A	SPINDLE SERVO-ON	SSA	X1891	X18F1	X1951	X19B1	X1A11	X1A71	X1AD1	X1B31

[Function]

This signal is output from the high-speed serial connection specification spindle controller (spindle drive) and informs that the spindle is under the position control state (synchronous tap control, C-axis control).

[Operation]

The "Spindle servo-on" signal (SSA) turns ON when the spindle is ready (SMA signal is ON), the servo-on command has been transferred from the controller to the spindle controller, and the spindle controller is in the servo-on state.

Note that this signal turns OFF during rotation with "spindle forward run start"(SRN)/"spindle reverse run start"(SRI) (except during spindle synchronization) or spindle orientation.

This signal (SSA) turns OFF when the servo-on command is canceled.

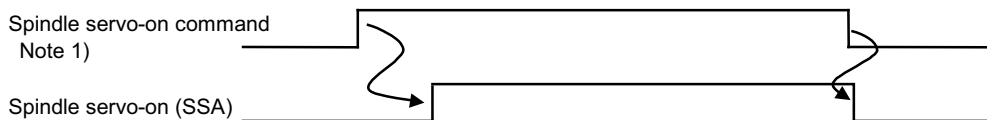

(Note 1) The spindle servo-on command is output from the controller to the spindle controller, and is mainly output during synchronous tap control.

(Note 2) While the "Spindle servo-on" signal is ON, all input signals for "Spindle forward run start" (SRN), "Spindle reverse run start" (SRI), and "Spindle orientation command" (ORC) are ignored.

(Note 3) This signal is valid only for the system that is high-speed serial connected with the controller.

Cont.	Signal name	Abbrev.	1stSP	2ndSP	3rdSP	4thSP	5thSP	6thSP	7thSP	8thSP
A	IN SPINDLE FORWARD RUN	SSRN	X1893	X18F3	X1953	X19B3	X1A13	X1A73	X1AD3	X1B33

[Function]

This signal is output from the high-speed serial connection specification spindle controller (spindle drive) and informs that the spindle is rotating in the forward direction.

[Operation]

The "In spindle forward run" signal (SSRN) turns ON when the spindle motor is rotating in the forward direction. This will also turn ON if the spindle motor is rotating in the forward direction during orientation or synchronous tap.

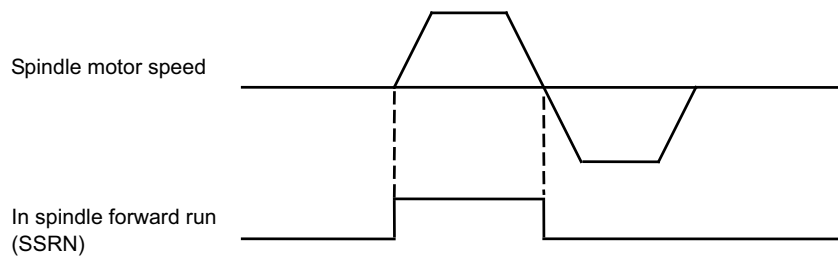

(Note 1) The "In spindle forward run" signal (SSRN) turns ON and OFF while the spindle motor is in the stop state with servo rigidity during oriented motion or synchronous tap.

(Note 2) This signal is valid only for the system that is high-speed serial connected with the controller.

4 Explanation of Interface Signals

Cont.	Signal name	Abbrev.	1stSP	2ndSP	3rdSP	4thSP	5thSP	6thSP	7thSP	8thSP
A	IN SPINDLE REVERSE RUN	SSRI	X1894	X18F4	X1954	X19B4	X1A14	X1A74	X1AD4	X1B34

[Function]

This signal is output from the high-speed serial connection specification spindle controller (spindle drive) and informs that the spindle motor is rotating in the reverse direction.

[Operation]

The "In spindle reverse run" (SSRI) signal turns ON when the spindle motor rotates in the reverse direction. It also turns ON even during oriented motion or synchronous tap if the spindle motor rotates in the reverse.

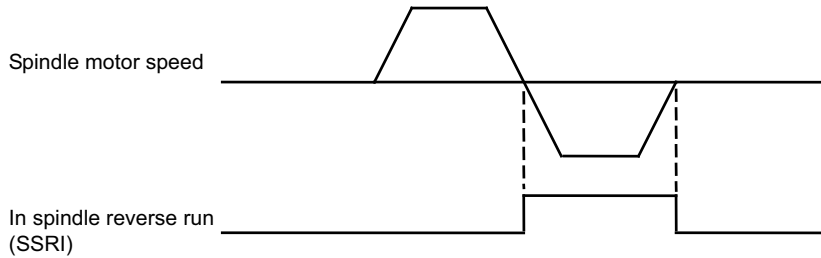

(Note 1) The "In spindle reverse run" (SSRI) signal turns ON and OFF while the spindle motor is in the stop state with servo rigidity during oriented motion or synchronous tap.

(Note 2) This signal is valid only for the system that is high-speed serial connected with the controller.

Cont.	Signal name	Abbrev.	1stSP	2ndSP	3rdSP	4thSP	5thSP	6thSP	7thSP	8thSP
A	POSITION LOOP IN-POSITION	SIMP	X1896	X18F6	X1956	X19B6	X1A16	X1A76	X1AD6	X1B36

[Function]

If the spindle controller is connected with high-speed serial connection, this signal will inform that the spindle is in the in-position state during synchronous tap.

[Operation]

The signal will turn ON when:

- (1) The droop amount (servo tracking delay error) is within the in-position range during synchronous tap control (servo on).
- (2) Synchronous tap control is not commanded. ((A)in following drawing)

The signal will turn OFF when:

- (1) The droop amount (servo tracking delay error) has exceeded the in-position range during synchronous tap control (servo on).

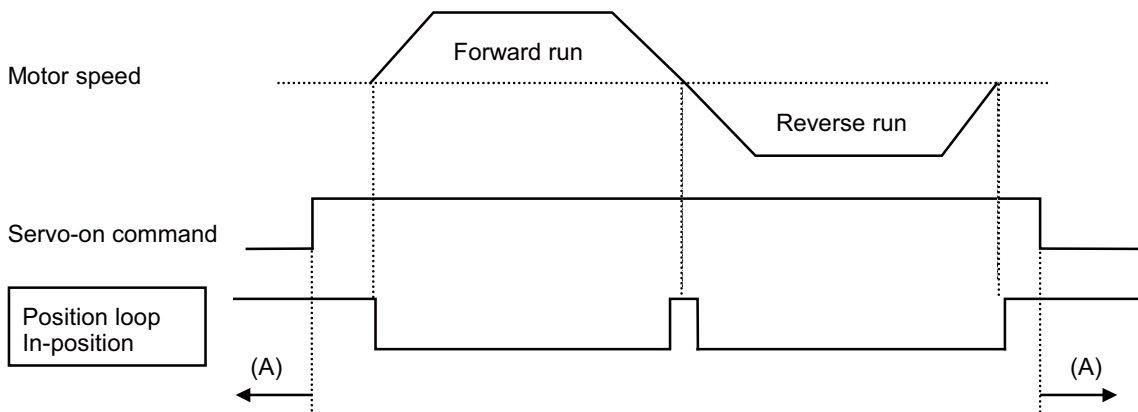

4 Explanation of Interface Signals

Cont.	Signal name	Abbrev.	1stSP	2ndSP	3rdSP	4thSP	5thSP	6thSP	7thSP	8thSP
A	IN SPINDLE TORQUE LIMIT	STLQ	X1897	X18F7	X1957	X19B7	X1A17	X1A77	X1AD7	X1B37

[Function]

This signal is output from the high-speed serial connection specification spindle controller (spindle drive) and informs that the spindle is in position under C-axis control or synchronous tap control.

[Operation]

The "STLQ" signal turns ON when:

- (1) "Spindle torque limit 1" (TL1) or "Spindle torque limit 2" (TL2) signal is ON.

The "STLQ" signal turns OFF when:

- (1) "Spindle torque limit 1" (TL1) or "Spindle torque limit 2" (TL2) signal is OFF.

(Note 1) This signal is valid only for the system that is high-speed serial connected with the controller.

[Related signals]

- (1) Spindle torque limit 1 (TL1:Y189A)
- (2) Spindle torque limit 2 (TL2:Y189B)

Cont.	Signal name	Abbrev.	1stSP	2ndSP	3rdSP	4thSP	5thSP	6thSP	7thSP	8thSP
A	Spindle torque limit reached		X189A	X18FA	X195A	X19BA	X1A1A	X1A7A	X1ADA	X1B3A

[Function]

This signal informs that the actual torque has reached the limit on the torque limit target spindle.

[Operation]

The signal turns ON when:

- (1) The actual torque has reached the limit on the torque limit target spindle.

The signal turns OFF when:

- (1) The actual torque of the torque limit target spindle is under its limit.

[Related signals]

- (1) In spindle torque limit (STLQ:X1897)
- (2) Spindle torque limit 1 (TL1:Y189A)
- (3) Spindle torque limit 2 (TL2:Y189B)

Cont.	Signal name	Abbrev.	1stSP	2ndSP	3rdSP	4thSP	5thSP	6thSP	7thSP	8thSP
A	SPEED DETECTION 2	SD2	X189D	X18FD	X195D	X19BD	X1A1D	X1A7D	X1ADD	X1B3D

[Function]

This signal is output from the high-speed serial connection specification spindle controller (spindle drive) and informs that motor speed is dropped below the speed specified by the parameter.

[Operation]

This signal (SD2) turns ON if the motor speed (motor rotation speed) drops the detection threshold specified by the parameter "#13030 SP030".

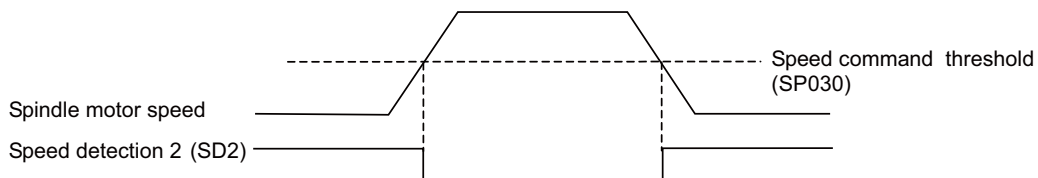

(Note) This signal is valid only with the system that is high-speed serial connection with the spindle controller.

[Related signals]

- (1) Speed detection (VRO:X188A)

4 Explanation of Interface Signals

Cont.	Signal name	Abbrev.	1stSP	2ndSP	3rdSP	4thSP	5thSP	6thSP	7thSP	8thSP
A	IN M COIL SELECTION	MCSA	X189E	X18FE	X195E	X19BE	X1A1E	X1A7E	X1ADE	X1B3E

[Function]

This signal indicates that the middle-speed coil is being selected in the 3-step coil changeover specification of the spindle coil changeover function.

[Operation]

The state of the selected coil is combined with the "In L coil selection" (LCSA), and that is output.

Selected coil	L coil selection (LRSL)	M coil selection (LRSM)	In L coil selection (LCSA)	In M coil selection (MCSA)
High-speed (H)	OFF	OFF	OFF	OFF
Middle-speed (M)	OFF	ON	OFF	ON
Low-speed (L)	ON	OFF	ON	OFF
	ON	ON	ON	ON

[Related signals]

- (1) L coil selection (LRSL:Y189F)
- (2) M coil selection (LRSM:Y18A6)
- (3) In L coil selection (LCSA:X188F)

Cont.	Signal name	Abbrev.	1stSP	2ndSP	3rdSP	4thSP	5thSP	6thSP	7thSP	8thSP
A	INDEX POSITIONING COMPLETION		X189F	X18FF	X195F	X19BF	X1A1F	X1A7F	X1ADF	X1B3F

[Function]

This signal informs that positioning for the spindle forward run and reverse run indexing functions has been completed.

[Operation]

- (1) When "Spindle forward run index" signal (WRN: Y189C) or "Spindle reverse run index" signal (WRI: Y189D) is turned ON, this signal is turned OFF.
- (2) For the turret indexing, when the time set in the parameter "3126 tret_fin_off" (Index positioning complete signal OFF time) has passed after "Spindle forward run index" signal (WRN: Y189C) or "Spindle reverse run index" signal (WRI: Y189D) is turned ON, this signal is turned ON. Even when the indexing moving is completed, this signal is not turned ON until the time set in the parameter #3126 passes.

If you use this signal, program the sequence so that the signal is referred to after the time set in the parameter #3126 has passed.

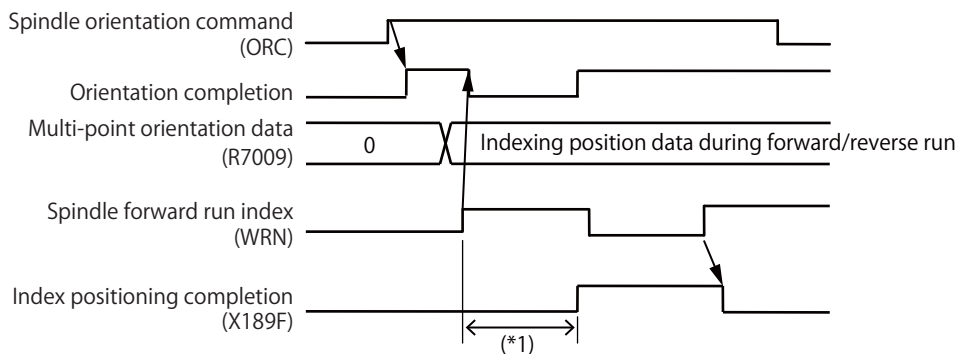

(*1) For the turret indexing, this signal turns ON when the time set to the parameter #3126 has passed.

[Related signals]

- (1) Spindle orientation command (ORC: Y189E)
- (2) Spindle forward run index (WRN: Y189C)
- (3) Spindle reverse run index (WRI: Y189D)
- (4) Multi-point orientation position data (R7009)

4 Explanation of Interface Signals

Cont.	Signal name	Abbrev.	1stSP	2ndSP	3rdSP	4thSP	5thSP	6thSP	7thSP	8thSP
A	SPINDLE ENABLE	ENB	X18A0	X1900	X1960	X19C0	X1A20	X1A80	X1AE0	X1B40

[Function]

This signal informs whether there are command outputs to the spindle or not.

- 0: No command output to spindle
- 1: With command output to spindle

[Related signals]

- (1) Spindle selection (SWS:Y18A8)
- (2) Spindle command selection (SLSP:R7002)
- (3) Spindle stop (SSTP:Y1894)
- (4) Encoder selection (R2567)
- (5) Spindle forward run start (SRN:Y1898)
- (6) Spindle reverse run start (SRI:Y1899)

Cont.	Signal name	Abbrev.	1stSP	2ndSP	3rdSP	4thSP	5thSP	6thSP	7thSP
A	IN CHANGEOVER TO L COIL [C80]	LRUC	X18A1	X1901	X1961	X19C1	X1A21	X1A81	X1AE1

[Function]

This signal informs that the drive is in changeover from the H coil to the L coil.

[Operation]

When the drive is in changeover status after the L coil selection command is turned ON, this signal is turned ON.

When the drive is not in changeover status, this signal is turned OFF.

An example of the timing chart for the In changeover to L coil signal for the 1st spindle is shown below.

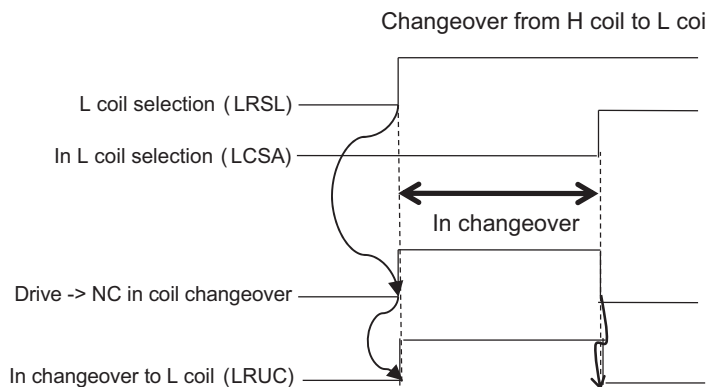

[Related signals]

- (1) Spindle control: Coil changeover gate cutoff timer interruption (WGTSC:Y18C9)
- (2) In L coil selection (LCSA:X188F)

Cont.	Signal name	Abbrev.	1stSP	2ndSP	3rdSP	4thSP	5thSP	6thSP	7thSP
A	IN CHANGEOVER TO H COIL [C80]	HRUC	X18A2	X1902	X1962	X19C2	X1A22	X1A82	X1AE2

[Function]

This signal informs that the drive is in changeover from the L coil to the H coil.

[Operation]

When the drive is in changeover status after the L coil selection command is turned OFF, this signal is turned ON.

When the drive is not in changeover status, this signal is turned OFF.

An example of the timing chart for the In changeover to H coil signal for the 1st spindle is shown below.

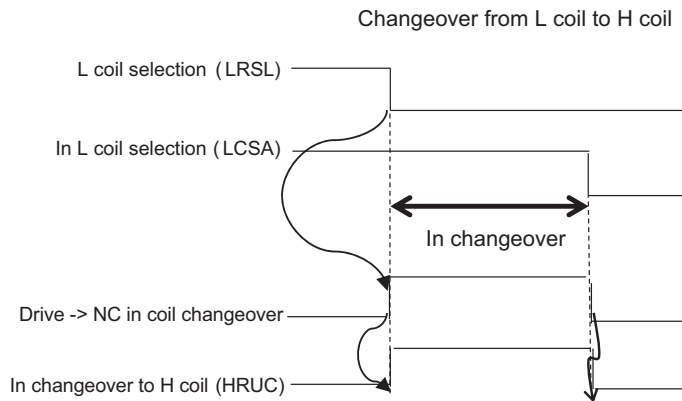

[Related signals]

- (1) Spindle control: Coil changeover gate cutoff timer interruption (WGTSC:Y18C9)
- (2) In L coil selection (LCSA:X188F)

4 Explanation of Interface Signals

Cont.	Signal name	Abbrev.	1stSP	2ndSP	3rdSP	4thSP	5thSP	6thSP	7thSP
A	SPINDLE CONTROL: COIL CHANGEOVER TIME-OUT [C80]	CSTOV	X18A4	X1904	X1964	X19C4	X1A24	X1A84	X1AE4

[Function]

This signal informs that the coil changeover was not complete in monitoring time.

[Operation]

When the coil changeover was not completed in monitoring time, this signal is turned ON.

The monitoring time is determined by the following two parameters.

"#13114 SP114 MKT" (Coil changeover gate cutoff timer)

"#11760 MKT_Rate" (Ratio of coil changeover monitoring time)

Coil changeover monitoring time (ms)

$(\text{"#13114 SP114 MKT"} \times \text{"#11760 MKT_Rate"}) / 100$

When this signal is turned ON, apply an interlock to prevent the spindle stopping and machining program continuing.

This signal is turned OFF when the emergency stop is released.

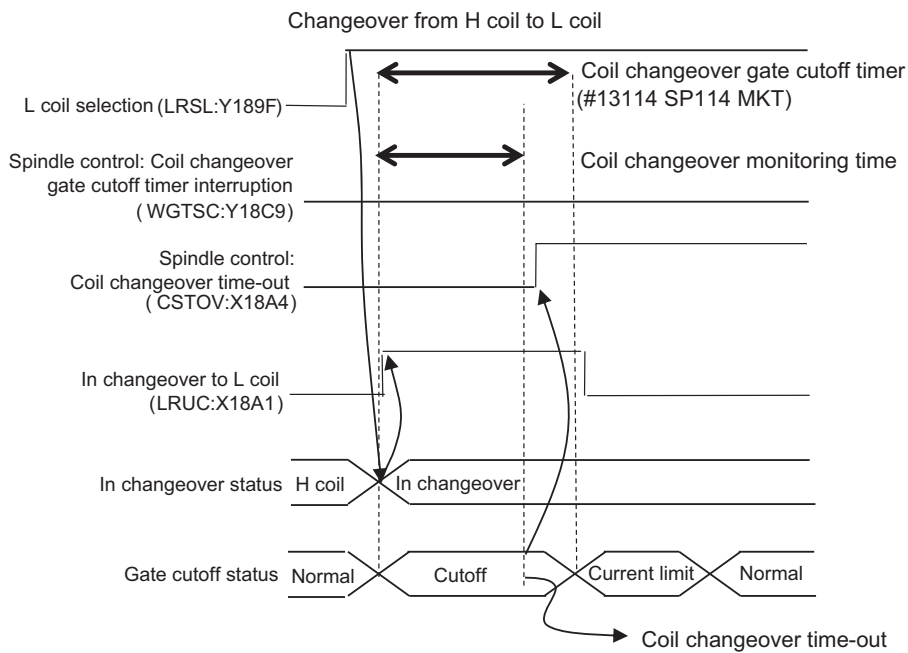

[Related signals]

- (1) Spindle control: Coil changeover gate cutoff timer interruption (WGTSC:Y18C9)
- (2) In changeover to L coil (LRUC:X18A1)
- (3) In changeover to H coil (HRUC:X18A2)

Cont.	Signal name	Abbrev.	1stSP	2ndSP	3rdSP	4thSP	5thSP	6thSP	7thSP	8thSP
A	IN SPINDLE SYNCHRONIZATION	SPSYN1	X18A8	X1908	X1968	X19C8	X1A28	X1A88	X1AE8	X1B48

[Function]

This signal informs that the spindle synchronous control mode has been entered.

[Operation]

The signal turns ON when:

- (1) The G114.1 is commanded, and spindle synchronous control is entered. (Spindle synchronization control I)
- (2) The spindle synchronous control signal (SPSY) turns ON. (Spindle synchronization control II)

The signal turns OFF when:

- (1) Spindle synchronous control is canceled with the G113 or G113.1 [C80] command. Or, when the spindle synchronization cancel signal (SPSYC) turns ON. (Spindle synchronization control I)
- (2) When the spindle synchronous control signal (SPSY) turns OFF. (Spindle synchronization control II)

(Note 1) Refer to the signal of the 1st spindle if "#1440 multi_sp_syn" (Enable multiple sets of spindle synchronization) is "0".

(Note 2) Refer to the signal of the synchronized spindle if "#1440 multi_sp_syn" (Enable multiple sets of spindle synchronization) is "1".

[Related signals]

- (1) Spindle rotation speed synchronization completion (FSPRV:X18A9)
- (2) Spindle phase synchronization completion (FSPPH:X18AA)
- (3) Spindle synchronization (SPSY:Y18B0)
- (4) Spindle phase synchronization (SPPHS:Y18B1)
- (5) Spindle synchronization cancel (SPSYC:Y18B8)

Cont.	Signal name	Abbrev.	1stSP	2ndSP	3rdSP	4thSP	5thSP	6thSP	7thSP	8thSP
A	SPINDLE ROTATION SPEED SYNCHRONIZATION COMPLETION	FSPRV	X18A9	X1909	X1969	X19C9	X1A29	X1A89	X1AE9	X1B49

[Function]

This signal informs that the spindle synchronization state mode is entered.

(Note) This signal uses the 1st spindle signal regardless of the hob spindle's number.

[Operation]

The signal turns ON when:

- (1) Both the reference and synchronized spindle speeds reach the commanded synchronization speed during rotation synchronization mode. (Spindle synchronization I)
- (2) The workpiece axis rotation speed reaches the value set for the spindle synchronization rotation speed attainment level corresponding to the workpiece axis and rotary tool axis rotation ratio command in spindle synchronization (no R command) mode. (Polygon)
- (3) The workpiece axis rotation speed completes phase alignment at the rotation speed corresponding to the rotation ratio command for the workpiece axis and rotary tool axis in spindle synchronization (with R command) mode. (Polygon)
- (4) The CNC is reset (any of Reset1, Reset2, or Reset & rewind) with the parameter "#1239 bit3" set to "1". (Polygon)

The signal turns OFF when:

- (1) The actual rotation speed of the reference spindle or synchronized spindle, in respect to the spindle synchronous rotation speed command value, widely exceeds or deviates value set for the spindle synchronization rotation speed attainment level during the rotation synchronization mode.
- (2) The spindle synchronous control mode is canceled.

(Note 1) Refer to the signal of the 1st spindle if "#1440 multi_sp_syn" (Enable multiple sets of spindle synchronization) is "0".

(Note 2) Refer to the signal of the hob axis during hobbing, or refer to the signal of the synchronized spindle during other machinings if "#1440 multi_sp_syn" (Enable multiple sets of spindle synchronization) is "1".

[Related signals]

- (1) In spindle synchronization (SPSYN1:X18A8)
- (2) Spindle phase synchronization completion (FSPPH:X18AA)
- (3) Spindle synchronization (SPSY:Y18B0)
- (4) Spindle phase synchronization (SPPHS:Y18B1)

4 Explanation of Interface Signals

Cont.	Signal name	Abbrev.	1stSP	2ndSP	3rdSP	4thSP	5thSP	6thSP	7thSP	8thSP
A	SPINDLE PHASE SYNCHRONIZATION COMPLETION	FSPPH	X18AA	X190A	X196A	X19CA	X1A2A	X1A8A	X1AEA	X1B4A

[Function]

This signal informs that the spindle synchronization state is entered.

[Operation]

The signal turns ON when:

- (1) The phase alignment of the reference spindle and synchronized spindle is completed during the phase synchronization mode.

The signal turns OFF when:

- (1) The phase difference of the reference spindle and synchronized spindle exceeds the value set for the spindle synchronization phase attainment level during the phase synchronization mode.
- (2) The spindle synchronous control mode is canceled.

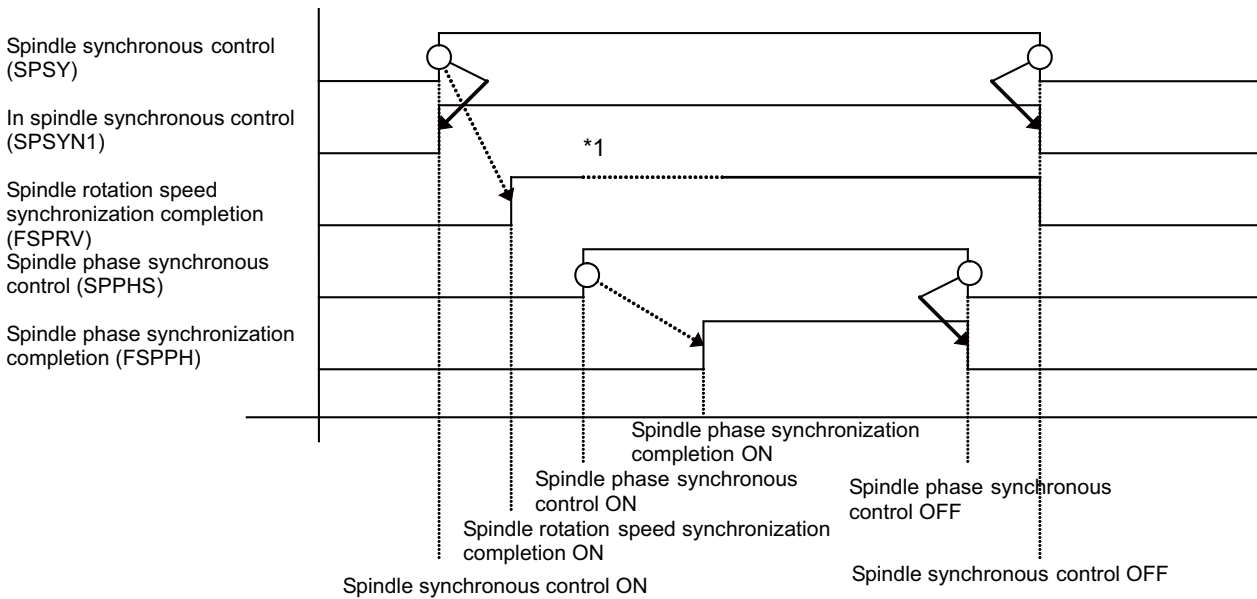

*1 Temporary turn OFF to change the rotation speed during the phase synchronization.

(Note 1) Refer to the signal of the 1st spindle if "#1440 multi_sp_syn" (Enable multiple sets of spindle synchronization) is "0".

(Note 2) Refer to the signal of the synchronized spindle if "#1440 multi_sp_syn" (Enable multiple sets of spindle synchronization) is "1".

[Related signals]

- (1) In spindle synchronization (SPSYN1:X18A8)
- (2) Spindle rotation speed synchronization completion (FSPRV:X18A9)
- (3) Spindle synchronization (SPSY:Y18B0)
- (4) Spindle phase synchronization (SPPHS:Y18B1)

Cont.	Signal name	Abbrev.	1stSP	2ndSP	3rdSP	4thSP	5thSP	6thSP	7thSP	8thSP
A	IN SPINDLE SYNCHRONIZATION 2	SPSYN2	X18AB	X190B	X196B	X19CB	X1A2B	X1A8B	X1AEB	X1B4B

[Function]

This signal informs that the spindle-spindle polygon machining is started.

[Operation]

This signal turns ON when:

- (1) G114.2 is commanded, and the spindle-spindle polygon machining is started.

This signal turns OFF when:

- (1) G113/G113.1 is commanded, and the spindle-spindle polygon machining is canceled.
- (2) When the spindle synchronization cancel signal (SPSYC) is input, and spindle-spindle polygon machining is canceled.

(Note 1) Refer to the signal of the 1st spindle if "#1440 multi_sp_syn" (Enable multiple sets of spindle synchronization) is "0".

(Note 2) Refer to the signal of the synchronized spindle if "#1440 multi_sp_syn" (Enable multiple sets of spindle synchronization) is "1".

[Related signals]

- (1) Spindle synchronization cancel (SPSYC:Y18B8)
- (2) Spindle rotation speed synchronization completion (FSPRV:X18A9)

4 Explanation of Interface Signals

Cont.	Signal name	Abbrev.	1stSP	2ndSP	3rdSP	4thSP	5thSP	6thSP	7thSP	8thSP
A	CHUCK CLOSE CONFIRMATION	SPCMP	X18AC	X190C	X196C	X19CC	X1A2C	X1A8C	X1AEC	X1B4C

[Function]

This signal informs that chuck close (SPCMPC) is input during spindle synchronous control.

[Operation]

This signal turns ON when the "Chuck close" (SPCMPC) is ON.

This signal turns OFF when the "Chuck close" (SPCMPC) is OFF.

This signal turns OFF when the spindle synchronous control is canceled.

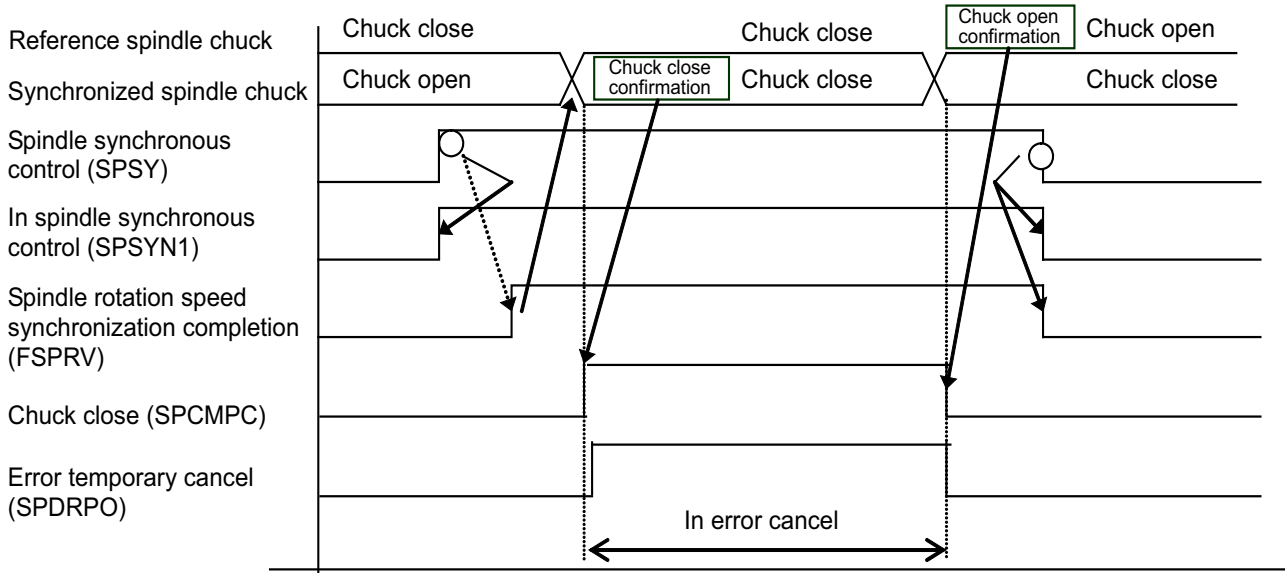

(Note 1) Refer to the signal of the 1st spindle if "#1440 multi_sp_syn" (Enable multiple sets of spindle synchronization) is "0".

(Note 2) Refer to the signal of the synchronized spindle if "#1440 multi_sp_syn" (Enable multiple sets of spindle synchronization) is "1".

(Note 3) Use "error temporary cancel" signal only when the position error between two spindles still occurs even after the "Chuck close" signal is turned ON.

[Related signals]

- (1) Chuck close (SPCMPC:Y18B9)
- (2) In spindle synchronization (SPSYN1:X18A8)
- (3) Spindle rotation speed synchronization completion (FSPRV:X18A9)
- (4) Spindle synchronization (SPSY:Y18B0)
- (5) Error temporary cancel (SPDRPO:Y18B5)

4 Explanation of Interface Signals

Cont.	Signal name	Abbrev.	1stSP	2ndSP	3rdSP	4thSP	5thSP	6thSP	7thSP	8thSP
A	TOOL SPINDLE SYNCHRONIZATION I (POLYGON)	TSS1	X18AD	X190D	X196D	X19CD	X1A2D	X1A8D	X1AED	X1B4D

[Function]

This signal informs that the tool spindle synchronization I (polygon) mode has been entered.

[Operation]

This signal turns ON when:

(1) The G114.2 is commanded, and the tool spindle synchronization I is entered.

This signal turns OFF when:

(1) The tool spindle synchronization I is canceled with the G113/G113.1 command.

(2) The tool spindle synchronization I is canceled with the "Spindle synchronization/ superimposition cancel" signal (SPSYC).

(Note 1) Refer to the signal of the 1st spindle if "#1440 multi_sp_syn" (Enable multiple sets of spindle synchronization) is "0".

(Note 2) Refer to the signal of the synchronized spindle if "#1440 multi_sp_syn" (Enable multiple sets of spindle synchronization) is "1".

[Related signals]

(1) Spindle rotation speed synchronization completion (FSPRV: X18A9)

(2) Spindle synchronization/ superimposition cancel (SPSYC: Y18B8)

Cont.	Signal name	Abbrev.	1stSP	2ndSP	3rdSP	4thSP	5thSP	6thSP	7thSP	8thSP
A	IN TOOL SPINDLE SYNCHRONIZATION II	SPSYN3	X18AE	X190E	X196E	X19CE	X1A2E	X1A8E	X1AEE	X1B4E

[Function]

This signal informs that the tool spindle synchronization II (hob machining) is being executed.

(Note) This signal uses the 1st spindle signal regardless of the hob spindle's number.

[Operation]

This signal turns ON when:

(1) Tool spindle synchronization II (hob machining) is started with a G114.3 command.

This signal turns OFF when:

(1) Spindle synchronous control is canceled with a G113/G113.1 command, or when the "Spindle synchronization cancel" (SPSYC) signal turns ON.

(Note 1) Refer to the signal of the 1st spindle if "#1440 multi_sp_syn" (Enable multiple sets of spindle synchronization) is "0".

(Note 2) Refer to the signal of the hob axis if "#1440 multi_sp_syn" (Enable multiple sets of spindle synchronization) is "1".

(Note 3) For the G code system 6 and 7, substitute G114.3 with G81.4 and G113/G113.1 with G80.4/G113.1. [M8]

[Related signals]

(1) Spindle synchronization/superimposition cancel (SPSYC:Y18B8)

4 Explanation of Interface Signals

Cont.	Signal name	Abbrev.	1stSP	2ndSP	3rdSP	4thSP	5thSP	6thSP	7thSP	8thSP
A	SPINDLE SUPERIMPOSITION CONTROL: CHANGE DISABLED	SPNCH	X18AF	X190F	X196F	X19CF	X1A2F	X1A8F	X1AEF	X1B4F

[Function]

This signal indicates that the spindle rotation speed command is invalid in the following situation: the spindle rotation speed is commanded to the reference spindle while a tapping or synchronized tapping cycle is executed for the superimposed spindle in the spindle superimposition control.

[Operation]

This signal turns ON when:

- (1) The spindle rotation speed is commanded to the reference spindle while a tapping or synchronized tapping cycle is executed for the superimposed spindle in the spindle superimposition control mode.

This signal turns OFF when:

- (1) A tapping or synchronized tapping cycle for the superimposed spindle in the spindle superimposition control is completed, and commands to the reference spindle become valid.
 - (2) The spindle superimposition mode is canceled.
- (Note) Refer to the signal of the superimposed spindle.

(Note 1) Refer to the signal of the 1st spindle if "#1440 multi_sp_syn" (Enable multiple sets of spindle synchronization) is "0".

(Note 2) Refer to the signal of the superimposed spindle if "#1440 multi_sp_syn" (Enable multiple sets of spindle synchronization) is "1".

[Related signals]

- (1) Spindle synchronization/ superimposition cancel (SPSYC:Y18B8)
- (2) Spindle superimposition control ON (SPILE:X18B1)
- (3) Spindle rotation speed synchronization completion (FSPRV:X18A9)
- (4) Spindle superimposition control: Spindle superimposition clamped (SPLCR:X18B2)

Cont.	Signal name	Abbrev.	1stSP	2ndSP	3rdSP	4thSP	5thSP	6thSP	7thSP	8thSP
A	Spindle synchronization phase error over	SPPHOV	X18B0	X1910	X1970	X19D0	X1A30	X1A90	X1AF0	X1B50

[Function]

This signal informs that, after the phase alignment is completed under the absolute position spindle synchronization, the spindle synchronization phase error between the reference and synchronized spindles (R6516) is greater than the spindle synchronization phase error tolerance (R7019).

[Operation]

This signal turns ON when:

- (1) the phase error between the reference and synchronized spindles with respect to the position command has exceeded the spindle synchronization phase error tolerance (R7019) after the phase alignment under the absolute position spindle synchronization.

This signal turns OFF when:

- (1) the spindle synchronization control I mode is cancelled.
- (Note 1) Use the 1st spindle's signal while "#1440 multi_sp_syn" (Multiple spindle synchronization valid) is "0".
- (Note 2) Use the synchronized spindle's signal while "#1440 multi_sp_syn" (Multiple spindle synchronization valid) is "1".

[Related signals]

- (1) Chuck close (SPCMPC:Y18B9)
- (2) In spindle synchronization (SPSYN1:X18A8)
- (3) Spindle rotation speed synchronization completion (FSPRV:X18A9)
- (4) Spindle phase synchronization completion (FSPPH:X18AA)
- (5) Spindle synchronization phase error/Hob axis delay angle (R6516)
- (6) Spindle synchronization Maximum phase error/Maximum hob axis delay angle (R6517)
- (7) Error temporary cancel (SPDRPO:Y18B5)
- (8) Spindle synchronization phase error tolerance (R7019)

4 Explanation of Interface Signals

Cont.	Signal name	Abbrev.	1stSP	2ndSP	3rdSP	4thSP	5thSP	6thSP	7thSP	8thSP
A	SPINDLE SUPERIMPOSITION CONTROL ON	SPILE	X18B1	X1911	X1971	X19D1	X1A31	X1A91	X1AF1	X1B51

[Function]

This signal indicates that the spindle superimposition control mode has been entered.

[Operation]

This signal turns ON when:

- (1) The G164 is commanded, and the spindle superimposition control mode is entered.

This signal turns OFF when:

- (1) The spindle superimposition control is canceled with the G113 or G113.1 [C80] command.
- (2) The spindle superimposition control is canceled with the "Spindle synchronization/ superimposition cancel" signal (SPSYC).

(Note 1) Refer to the signal of the 1st spindle if "#1440 multi_sp_syn" (Enable multiple sets of spindle synchronization) is "0".

(Note 2) Refer to the signal of the superimposed spindle if "#1440 multi_sp_syn" (Enable multiple sets of spindle synchronization) is "1".

[Related signals]

- (1) Spindle superimposition control: Speed change disabled (SPNCH:X18AF)
- (2) Spindle synchronization/ superimposition cancel (SPSYC:Y18B8)
- (3) Spindle rotation speed synchronization completion (FSPRV:X18A9)
- (4) Spindle superimposition control: Spindle superimposition clamped (SPLCR:X18B2)

Cont.	Signal name	Abbrev.	1stSP	2ndSP	3rdSP	4thSP	5thSP	6thSP	7thSP	8thSP
A	SPINDLE SUPERIMPOSITION CONTROL: SPINDLE SUPERIMPOSITION CLAMPED	SPLCR	X18B2	X1912	X1972	X19D2	X1A32	X1A92	X1AF2	X1B52

[Function]

This signal indicates that the following event occurred during the spindle superimposition control: the reference spindle was clamped at the maximum rotation speed of the superimposed spindle, or the superimposed spindle was clamped during superimposition (the sum of the command rotation speeds determined based on the rotation direction of the reference and superimposed spindles has exceeded the maximum rotation speed of the superimposed spindle).

[Operation]

This signal turns ON when:

- (1) The reference spindle was clamped at the maximum rotation speed of the superimposed spindle during the spindle superimposition control.
- (2) The superimposed spindle was clamped during superimposition (the sum of the command rotation speeds determined based on the rotation direction of the reference and superimposed spindles has exceeded the maximum rotation speed of the superimposed spindle).

This signal turns OFF when:

- (1) The rotation speed of the reference spindle falls below the maximum rotation speed of the superimposed spindle during the spindle superimposition control.
- (2) The rotation speed of the superimposed spindle falls below the maximum rotation speed of the superimposed spindle during the spindle superimposition control.
- (3) The spindle superimposition control mode is canceled.

(Note 1) Refer to the signal of the 1st spindle if "#1440 multi_sp_syn" (Enable multiple sets of spindle synchronization) is "0".

(Note 2) Refer to the signal of the superimposed spindle if "#1440 multi_sp_syn" (Enable multiple sets of spindle synchronization) is "1".

[Related signals]

- (1) Spindle superimposition control: Speed change disabled (SPNCH:X18AF)
- (2) Spindle synchronization/ superimposition cancel (SPSYC:Y18B8)
- (3) Spindle superimposition control ON (SPILE:X18B1)
- (4) Spindle rotation speed synchronization completion (FSPRV:X18A9)

4 Explanation of Interface Signals

Cont.	Signal name	Abbrev.	1stSP	2ndSP	3rdSP	4thSP	5thSP	6thSP	7thSP	8thSP
A	HOB AXIS DELAY EXCESS	PHOVR	X18B3	X1913	X1973	X19D3	X1A33	X1A93	X1AF3	X1B53

[Function]

This signal informs that, after the spindle rotation speed synchronization completion in the tool spindle synchronization II (Hobbing), the hob axis tracking delay between the actual position and the commanded position exceeds the delay allowable angle.

(Note) This signal uses the 1st spindle signal regardless of the hob spindle's number.

[Operation]

This signal turns ON when:

- (1) The spindle rotation speed synchronization has been completed and the maximum delay angle of the hob axis (spindle) exceeds the delay allowable angle designated with "#3133 spherr".

This signal turns OFF when:

- (1) The tool spindle synchronization II is canceled.

(Note 1) Refer to the signal of the 1st spindle if "#1440 multi_sp_syn" (Enable multiple sets of spindle synchronization) is "0".

(Note 2) Refer to the signal of the hob axis if "#1440 multi_sp_syn" (Enable multiple sets of spindle synchronization) is "1".

[Timing chart]

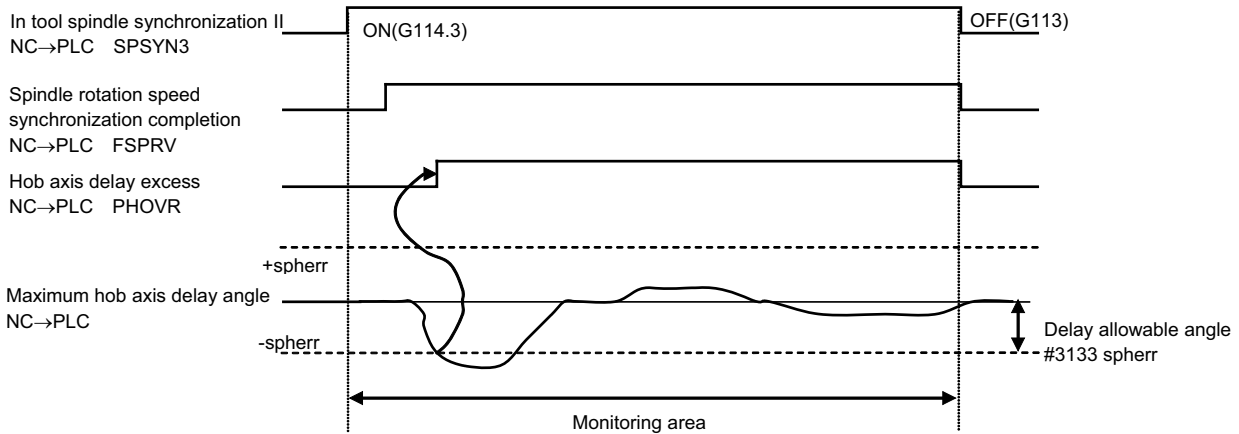

[Related signals]

- (1) In tool spindle synchronization II (SPSYN3:X18AE)
- (2) Spindle phase synchronization completion (FSPRV:X18A9)
- (3) Spindle synchronization Maximum phase error/Maximum hob axis delay angle (R6517)

4 Explanation of Interface Signals

Cont.	Signal name	Abbrev.	1stSP	2ndSP	3rdSP	4thSP	5thSP	6thSP	7thSP	8thSP
A	IN SPINDLE HOLDING FORCE UP	EXOFN	X18B5	X1915	X1975	X19D5	X1A35	X1A95	X1AF5	X1B55

[Function]

The increase holding power of spindle (disturbance observer) state is output to this signal.

[Operation]

This signal turns ON when the "Increase holding power of spindle" (EXOBS) signal turns ON and the spindle drive unit validates the disturbance observer.

Turning OFF the "Increase holding power of spindle" (EXOBS) signal turns this signal OFF.

[Related signals]

(1) Increase holding power of spindle (EXOBS:Y1893)

Cont.	Signal name	Abbrev.	1stSP	2ndSP	3rdSP	4thSP	5thSP	6thSP	7thSP	8thSP
A	IN SPINDLE OFF	SPOFFA	X18B6	X1916	X1976	X19D6	X1A36	X1A96	X1AF6	X1B56

[Function]

The signal communicates that the spindle is being excluded from CNC control.

[Operation]

This signal turns ON when the spindle is being excluded from CNC control due to the signal "EXCLUDE SPINDLE (SPOFF)".

Any commands towards the spindle for which this signal is ON are invalid.

[Related signals]

(1) SPINDLE OFF REQUEST (SPOFF:Y18BF)

4 Explanation of Interface Signals

Cont.	Signal name	Abbrev.	1stSP	2ndSP	3rdSP	4thSP	5thSP	6thSP	7thSP	8thSP
A	Spindle speed fluctuation detection: Spindle speed out of setting range [M8]	SSRD	X18B7	X1917	X1977	X19D7	X1A37	X1A97	X1AF7	X1B57

[Function]

This signal indicates that the spindle speed fluctuation detection function has detected a fluctuation in the actual spindle speed.

[Operation]

This signal is turned ON when the actual spindle speed exceeds the tolerance for the spindle speed command set with the Spindle speed fluctuation detection command (G162) or the parameter.

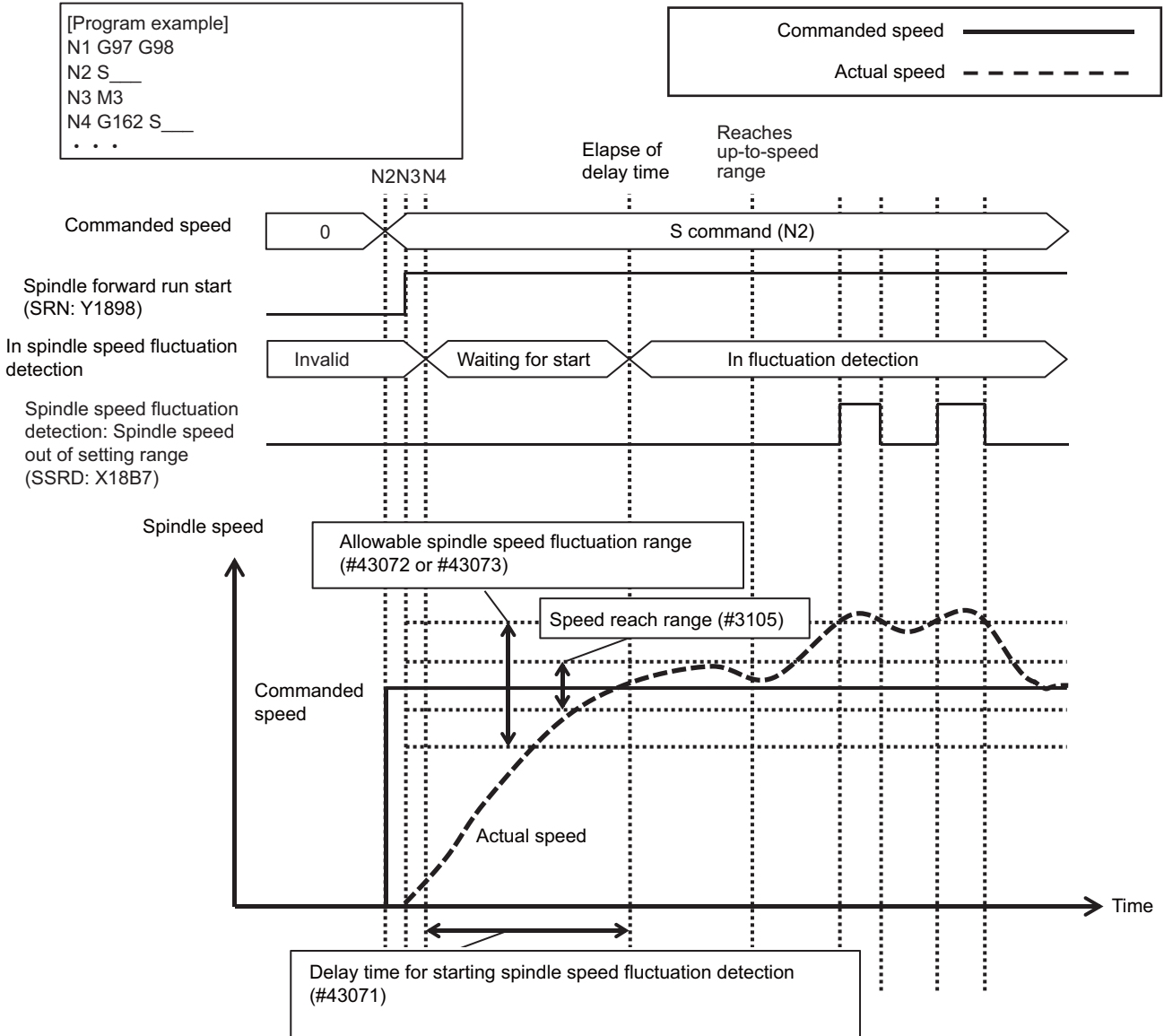

This signal is turned OFF when:

- (1) the detection is canceled with the Spindle speed fluctuation detection cancel command (G163).
- (2) the actual spindle speed returns back within the tolerance range.
- (3) there is a change in the spindle command speed (including the spindle override and speed change for each function).
- (4) there is a change in the spindle state (forward run, reverse run or stop).
- (5) the reset is input.
- (6) the emergency stop occurs.
- (7) the spindle is in the C axis mode of spindle synchronous tapping, spindle orientation or spindle position control.

[Related signals]

- (1) Spindle stop (SSPT: Y1894)
- (2) Spindle forward run start (SRN: Y1898)
- (3) Spindle reverse run start (SRI: Y1899)
- (4) Spindle selection (SWS: Y18A8)
- (5) Spindle command final data (rotation speed) (R6502)
- (6) Spindle command selection (SLSP: R7002)

Cont.	Signal name	Abbrev.	1stSP	2ndSP	3rdSP	4thSP	5thSP	6thSP	7thSP	8thSP
A	SPINDLE POSITION CONTROL (SPINDLE/C AXIS CONTROL): C AXIS MODE ON	SVMD	X18C1	X1921	X1981	X19E1	X1A41	X1AA1	X1B01	X1B61

[Function]

This signal indicates that the mode is the C axis mode or spindle mode when the program command method ("#3129 cax_spec/bit0" = "1") is selected for the spindle in the spindle position control.

[Operation]

This signal turns ON when changing to the C axis mode is commanded, and it remains ON until changing to the spindle mode is commanded. This signal indicates that a mode change command was executed.

(Note) The "Spindle position control (Spindle/C axis control): C axis mode ON" signal (SVMD) does not turn ON when the mode was changed with the Servo OFF signal (*SVFn) or the "Spindle position control (Spindle/C axis control): C axis selection" signal (CMOD).

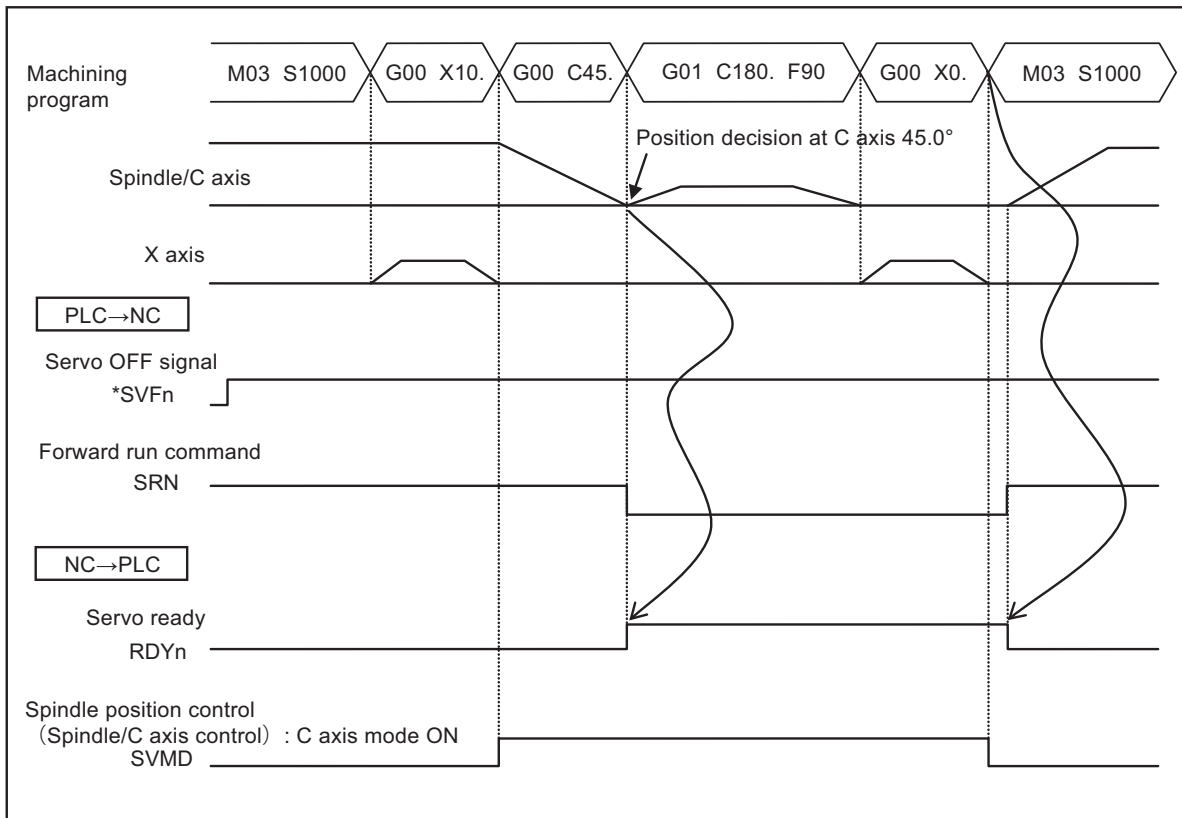

4 Explanation of Interface Signals

Cont.	Signal name	Abbrev.	1stSP	2ndSP	3rdSP	4thSP	5thSP	6thSP	7thSP	8thSP
A	SPINDLE GEAR SELECTION OUTPUT 1,2	GO1,2	X18C2,3	X1922,3	X1982,3	X19E2,3	X1A42,3	X1AA2,3	X1B02,3	X1B62,3

[Function]

This signal informs which gear stage the spindle gear is at.

[Operation]

The gear stage of the spindle gear is output with a 2-bit (GO1, GO2) code.

Mismatch between the "Spindle gear selection code 1, 2" signal (GI1, GI2) and the "Spindle gear selection output" signal (GO1, GO2) during gear shift means that the gear shift operation is in progress.

When gear shift is completed, the gear stage of the "Spindle gear selection output" signal (GO1, GO2) changes and becomes the same as the "Spindle gear selection code 1, 2" signal (GI1, GI2).

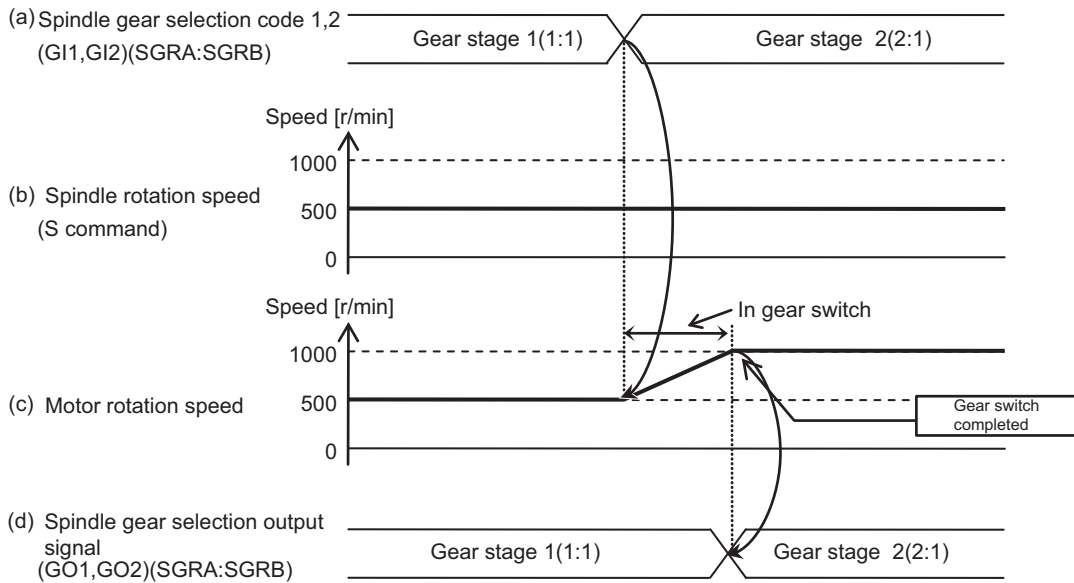

The relation of the gear stage and the "Spindle gear selection output (GO1, GO2)" signal is shown in the following table.

Gear stage	Spindle gear selection output	
	GO1	GO2
1	0	0
2	1	0
3	0	1
4	1	1

Cont.	Signal name	Abbrev.	1stSP	2ndSP	3rdSP	4thSP	5thSP	6thSP	7thSP	8thSP
A	Spindle oscillation in progress [M8]		X18C8	X1928	X1988	X19E8	X1A48	X1AA8	X1B08	X1B68

[Function]

This signal informs that the spindle oscillation is in operation.

[Operation]

This signal turns ON when the spindle oscillation is started.

This signal turns OFF when the spindle oscillation is stopped.

[Related signals]

- (1) Spindle oscillation command (Y18C8)

4 Explanation of Interface Signals

Cont.	Signal name	Abbrev.	1stSP	2ndSP	3rdSP	4thSP	5thSP	6thSP	7thSP	8thSP
A	Spindle protection: Mode in progress [M8]	SPRTCT	X18C9	X1929	X1989	X19E9	X1A49	X1AA9	X1B09	X1B69

[Function]

This signal notifies that the acceleration/deceleration time constant of the spindle motor has changed for protection because of detecting overheat of the spindle motor.

[Operation]

This signal turns ON when the spindle starts rotating from speed zero with the motor already being overheated. The overheated state refers to the range of the spindle temperature from which is at or above the spindle protection start temperature (#43084) until which drops below the spindle protection cancel temperature (#43085). If the motor temperature reaches the spindle protection start temperature (#43084) during rotation of the spindle, this signal will not turn ON.

This signal turns OFF when the spindle rotation speed is "0".

Example 1: Status of the "Spindle protection: Mode in progress" signal when the spindle starts to rotate in an overheated state (1)

(When the spindle temperature is at or above the spindle protection start temperature (#43084) at the start of rotation)

Spindle rotation speed

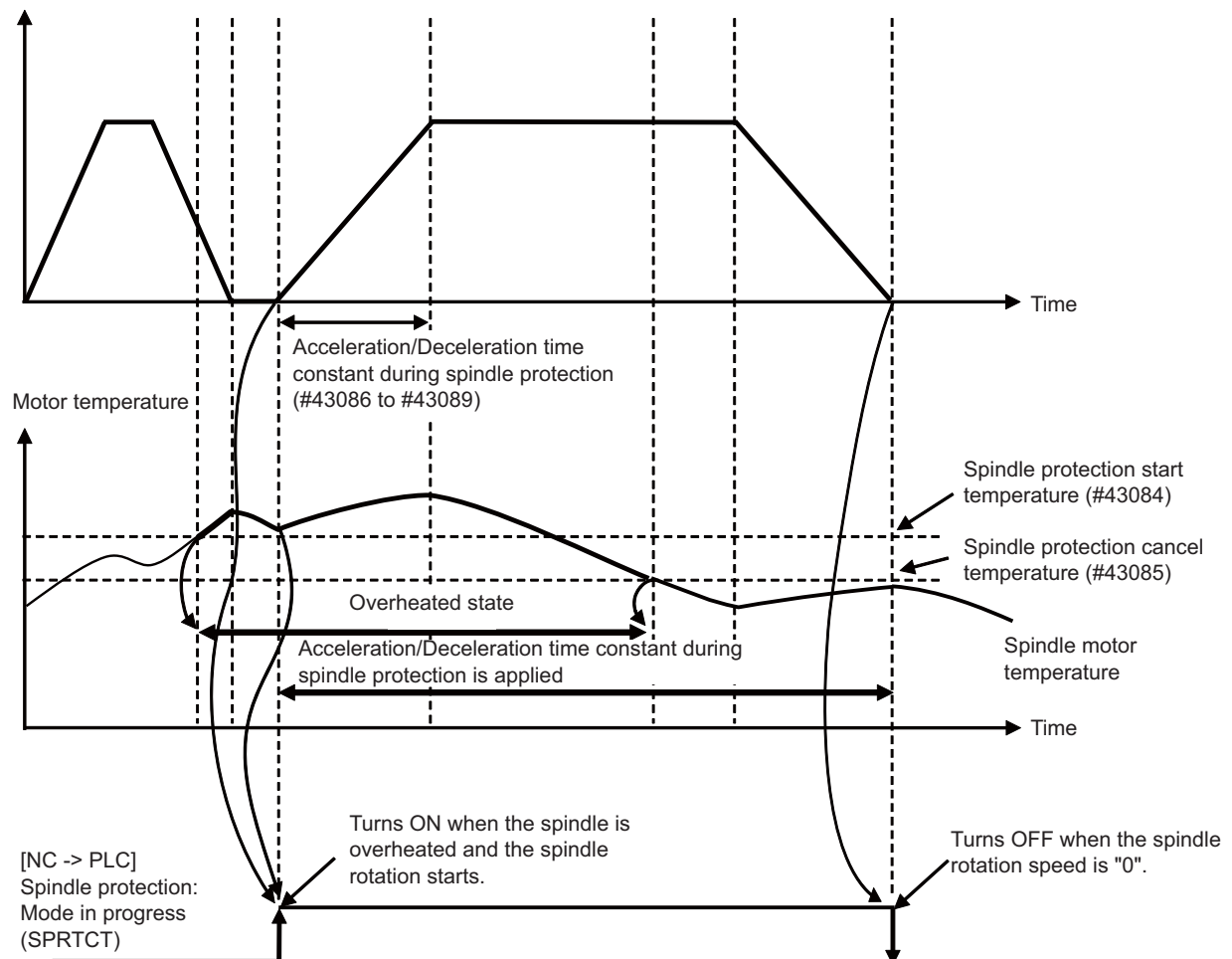

4 Explanation of Interface Signals

When the spindle rotation is started after its temperature has reached the spindle protection start temperature (#43084) but before it drops below the spindle protection cancel temperature (#43085), the acceleration/deceleration time constant during spindle protection is applied and this signal is turned ON.

Example 2: Status of the "Spindle protection: Mode in progress" signal when the spindle starts to rotate in an overheated state (2)

(When the spindle temperature is lower than the spindle protection start temperature (#43084) at the start of rotation)

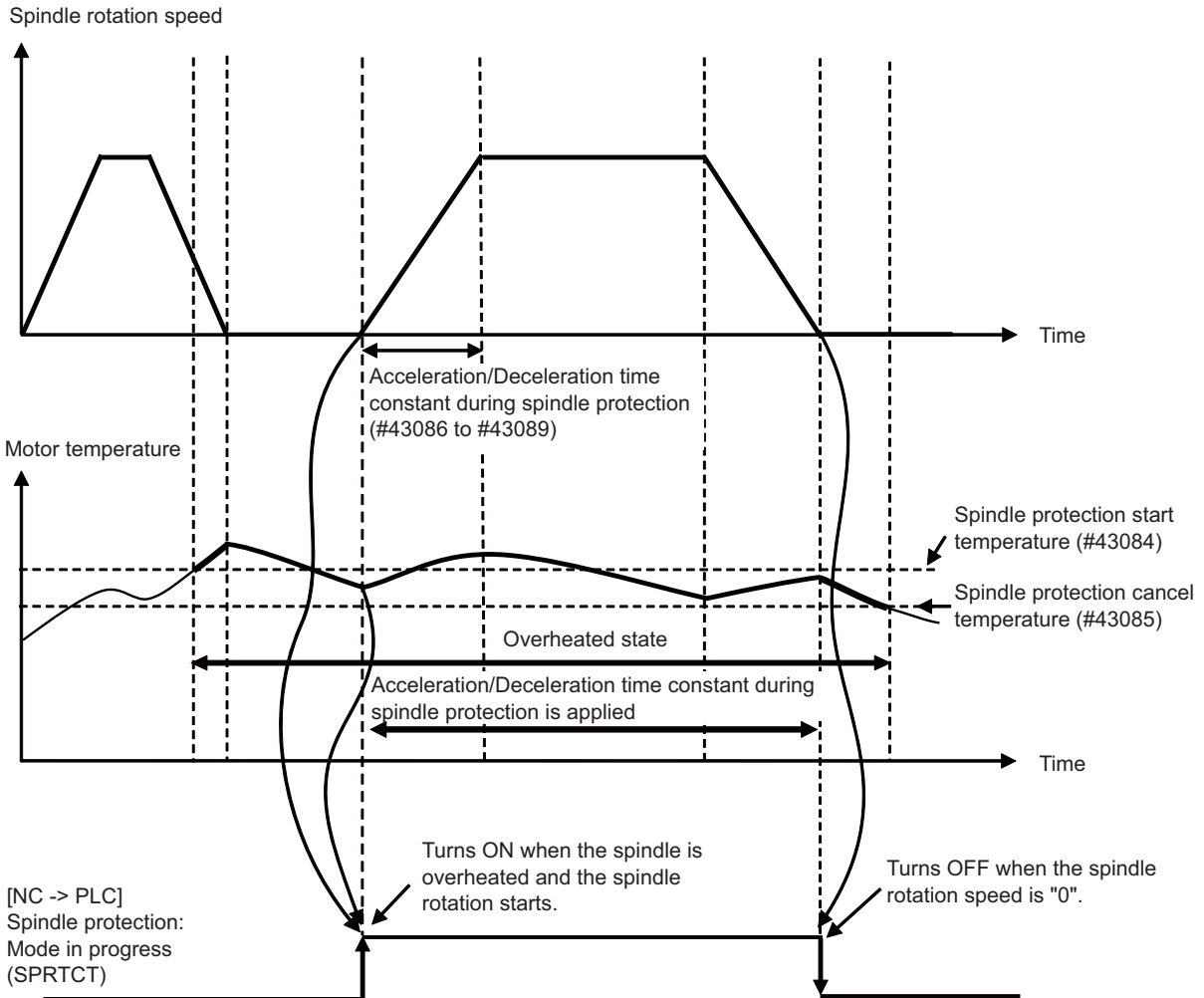

4 Explanation of Interface Signals

Cont.	Signal name	Abbrev.	1stSP	2ndSP	3rdSP	4thSP	5thSP	6thSP	7thSP	8thSP
A	REAL-TIME TUNING 1: SPEED CONTROL GAIN CHANGEOVER HOLD-DOWN ON [M8]	VGHLD	X18CA	X192A	X198A	X19EA	X1A4A	X1AAA	X1B0A	X1B6A

[Function]

This signal indicates that speed control gain switching is currently stopped in the real-time tuning 1 function.

[Operation]

This signal indicates that speed control gain switching is stopped and the value of speed control gain is retained. This signal is output when the "Speed control gain changeover hold-down command" is ON or when the cutting command modal is effective regardless of whether this function is enabled or disabled.

This signal is not output when speed control gain switching is performed. Also, the signal is not output when the additional specification of real-time tuning 1 is set to OFF.

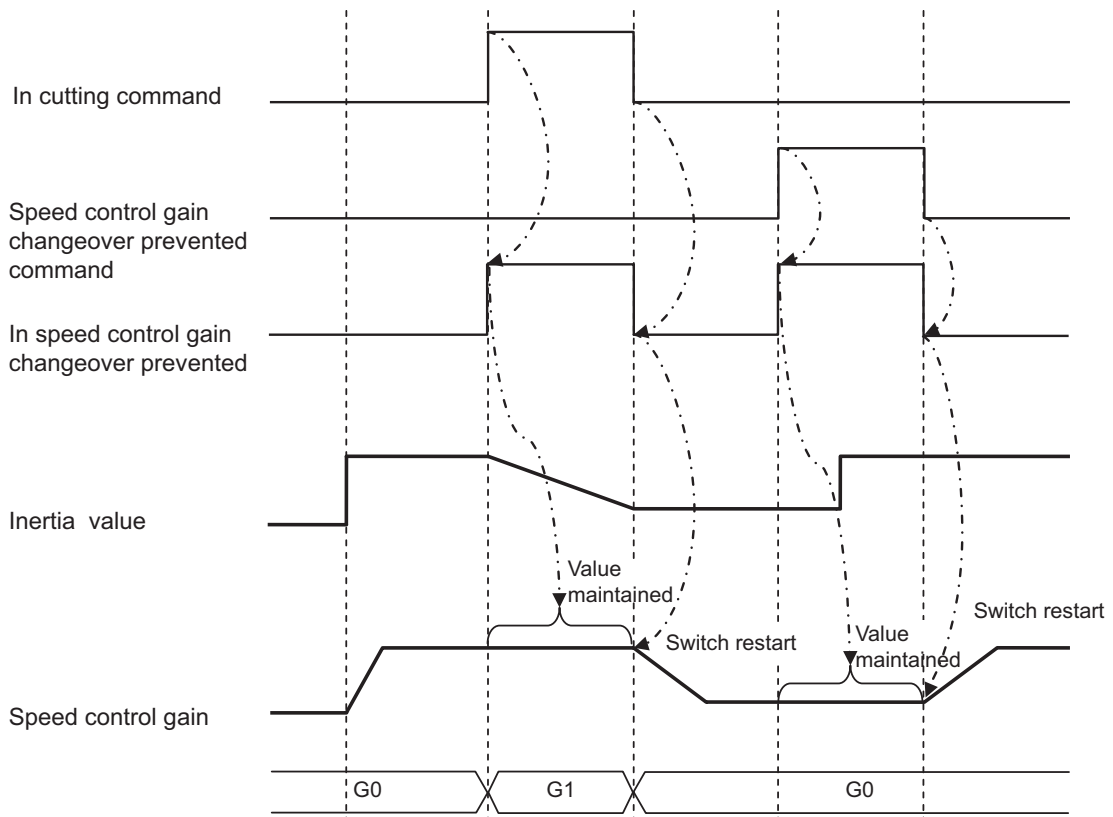

[Related signals]

- (1) Real-time tuning 1: Speed control gain changeover hold-down command (VGHLD:Y18CA)

Cont.	Signal name	Abbrev.	Common(\$)
A	HANDY TERMINAL KEY 1 TO 45 [M8]		X1CD0 to FC

[Function] [Operation]

This signal indicates the status of handy terminal key 1 to 45.

[Related signals]

- (1) Handle pulse encoder communication connector priority (Y70D)
- (2) Handle/Incremental feed magnification code m (MP1, MP2, MP4: YC80, YC81, YC82)
- (3) Handle/incremental feed magnification method selection (MPS: YC87)
- (4) Handy terminal Data area top address (R297)
- (5) Handy terminal Data valid number of registers (R298)
- (6) Handy terminal Cause of communication error (R299)
- (7) 1st handle/incremental feed magnification (R2508, R2509)

4 Explanation of Interface Signals

Cont.	Signal name	Abbrev.	1stSP	2ndSP	3rdSP	4thSP	5thSP	6thSP	7thSP	8thSP
A	POSITION SWITCH 1 to 24	PSW1 to 24	X1D00 to 17	X1D20 to 37	X1D40 to 57	X1D60 to 77	X1D80 to 97	X1DA0 to B7	X1DC0 to D7	X1DE0 to F7

[Function]

This signal notifies that the machine position is within the area set by the parameters.

[Operation]

This signal turns ON when the control axis machine position reaches the range set by the parameters, and turns OFF when the range is left. The axis name and range are set in parameters #7501 to #7734.

The validity of this signal differs in the following manner depending on the absolute position detection or incremental detection.

<For absolute position detection system>

This signal is valid when the power is turned ON after zero point initialization is completed.

<For incremental position detection system>

This signal is not validated until the first reference position return is completed after the power is turned ON. (PSW1 to PSW24 will all remain OFF until this signal is validated.)

Example of signal output

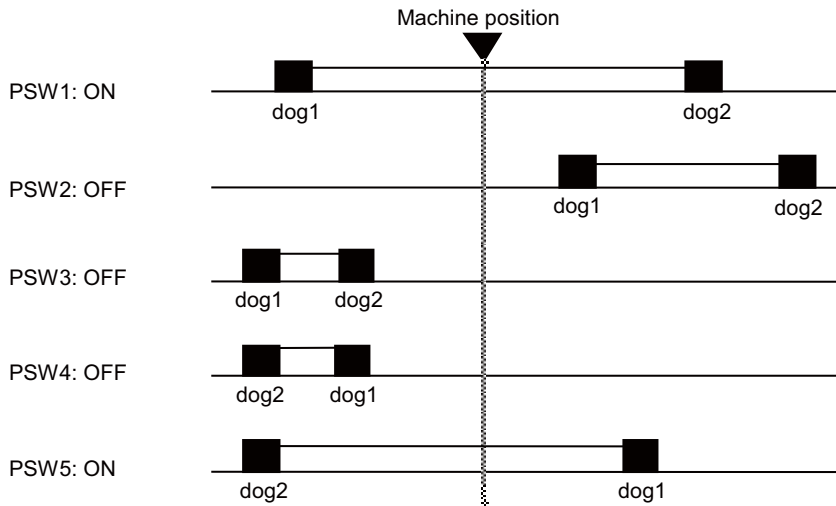

The setting range of the position switch uses the basic machine coordinate system as a reference.

Regardless of the setting values of dog1 and dog2, the position switch signal turns ON when the axis moves between dog1 and dog2. When dog1 and dog2 are set to the same value, the signal turns ON at the position.

A slight delay will occur in the output signal fluctuation due to the actual machine position. This maximum delay time (tmax), which depends on the area check method parameters #7504 to #7734, is as follows. Also consider the delay by the scan time as it depends on scan time for the ladder.

When parameter is set to "0" (commanded machine position)	When parameter is set to "1" (encoder FB position)
tmax = 0.004 - TP [s] TP : Position loop time constant ($\frac{1}{\text{PGN}}$ [s]) PGN : Position loop gain	tmax = 0.004 [s]

4.2 PLC Input Signals (Data Type: R***)

Cont.	Signal name	Abbrev.	Common(\$)
A	ANALOG INPUT m	Aln	R0 to 7

[Function]

When an analog voltage is input to the designated connector on the remote I/O unit or built-in AI/AO, which has the analog input function, the corresponding data can be read into the specified file register.

[Operation]

The following shows the interfaces.

Channel	File register	Data update cycle
AI0	R0	< Remote I/O unit with the analog input function > One channel is input per PC high-speed cycle. If one station has four channels, the four channels are input in four PC high-speed cycle times.
AI1	R1	
AI2	R2	
AI3	R3	
AI4	R4	< Built-in AI/AO > All channels are input per PC high-speed cycle. All analog input of four channels are input in one PC high-speed cycle time.
AI5	R5	
AI6	R6	
AI7	R7	

<How input voltages are read into the file registers>

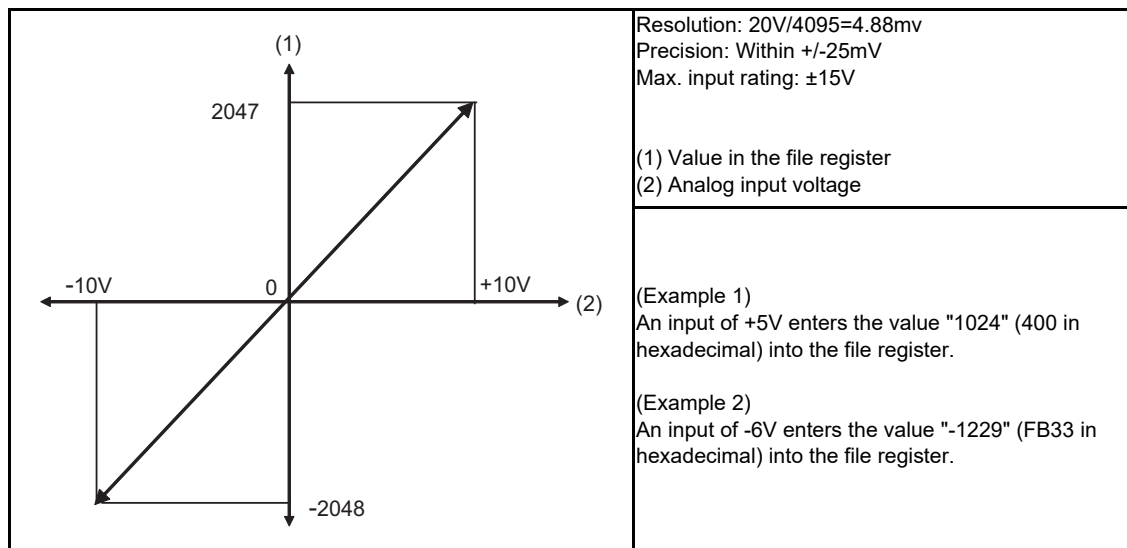

Cont.	Signal name	Abbrev.	Common(\$)
A	KEY IN 1		R8

[Function]

Operator's key operation can be monitored on the user PLC side.

[Operation]

While operator is using the keyboard, the corresponding data is set to KEY-IN 1.

[Related signals]

- (1) KEY OUT 1 (R212)

4 Explanation of Interface Signals

Cont.	Signal name	Abbrev.	Common(\$)
A	CLOCK DATA YEAR/MONTH		R11
A	CLOCK DATA DATE/HOUR		R12
A	CLOCK DATA MINUTE/SECOND		R13

[Function]

The year, month, date, hour, minute, second and millisecond data is informed by the controller to the PLC as the current clock information.

[Operation]

The date and time data is output as shown below. The data is output as binary data.

R11	Month	Year
R12	Hour	Date
R13	Second	Minute

(Example) For September 26, 2004, 14:56:36.

$$R11 \dots \underbrace{00001010}_{\text{October}} \underbrace{00000010}_{\text{2002}} = 0A02H$$

$$R12 \dots \underbrace{00001110}_{\text{14 hundred hours}} \underbrace{00011010}_{\text{26th day}} = 0E1AH$$

$$R13 \dots \underbrace{00100100}_{\text{36 seconds}} \underbrace{00111000}_{\text{56 minutes}} = 2438H$$

(Note 1) The time is displayed with the 24-hour system.

(Note 2) The data and time are set with the [TIME] screen on the setting and display unit.

4 Explanation of Interface Signals

Cont.	Signal name	Abbrev.	Common(\$)
A	CNC SOFTWARE VERSION CODE		R16 to 9

[Function]

This indicates the CNC software version.

[Operation]

The version displayed at "MP" on the [Software Directory] screen is indicated.

```
[S/W MODULE TREE]  ALARM/DIAGN 8.1/2
MP BND - 1003W002 - A0A  SV1  BND-
OFFM
```

The file registers R16 to 19 are set to the following data.

(Example) BND-1003W002-A0A

(1) (2) (3)

Item	File register	Type	Example
(1) Model function No.	R19	Binary	1003=03EBH
(2) Serial No.	R18	Binary	002=0002H
(3) Version	Bits F to 8 of R17	ASCII code	A=41H
	Bits 7 to 0 of R17	ASCII code	0=30H
	Bits F to 8 of R16	ASCII code (Note1)	A=41H
-	Bits 7 to 0 of R16	Always 20H (Note2)	

(Note 1) If the version is a 2-digit No., bits F to 8 of R16 are set to "20H".

(Note 2) Bits 7 to 0 on the R16 are always "20H".

Cont.	Signal name	Abbrev.	Common(\$)
A	BATTERY DROP CAUSE		R56

[Function]

This signal provides information about under voltage.

[Operation]

The voltage in the battery voltage that is supplied to the control equipment (NC controller or graphic control unit) for saving data is monitored, and the status battery is indicated for each control unit.

- (1) When the voltage is above the battery warning detection threshold, this signal is "0".
(Note) When the detection of battery alarm or battery warning is disabled (#6449 bit4=1), this signal is always "0".
- (2) When the voltage is above the battery alarm detection threshold and below the battery warning detection threshold, this signal is "1".
- (3) For the encoder errors, this signal is "2".
- (4) When the voltage is below the battery alarm detection threshold, this signal is "3".

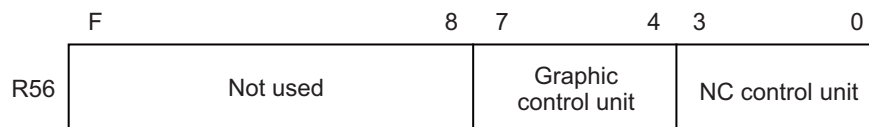

[Related signals]

- (1) Battery warning (BATWR: X70E)
- (2) Battery alarm (BATAL: X70F)

4 Explanation of Interface Signals

Cont.	Signal name	Abbrev.	Common(\$)
A	TEMPERATURE WARNING CAUSE		R57/bit0

[Function]

If the internal temperature of the control unit exceeds a certain level, the overheat will be detected, and the following states will occur.

- (1) The "Temperature rise" (SM16) is turned ON.
- (2) The "Temperature warning cause" (R57/bit0) is turned ON.
- (3) The alarm message (Z53) is displayed on the screen.

If the machine is in automatic operation, the operation will be continued, but restarting will not be possible after resetting or stopping with M02/M30. (Starting will be possible after block stop or feed hold.)

[Operation]

<The "Temperature warning cause" is turned ON when:>

- The internal temperature of the control unit rises above the temperature at which the alarm occurs (Alarm temperature).
(This temperature depends on the model.)

Model	Alarm temperature
M800W main card	84.5 °C
M800S main card	81.0 °C
M80W main card	81.5 °C
M80 main card	81.0 °C
E80 main card	81.0 °C
C80 main card	96.5 °C

<The "Temperature warning cause" is turned OFF when:>

- The internal temperature of control unit drops below Alarm temperature.

The "Temperature warning cause" is a bit unit signal.

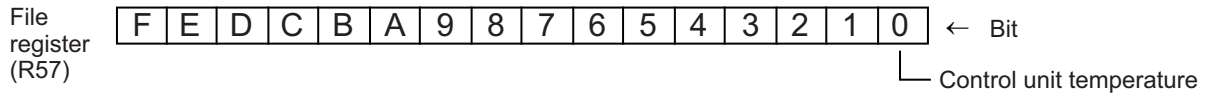

<Operation example>

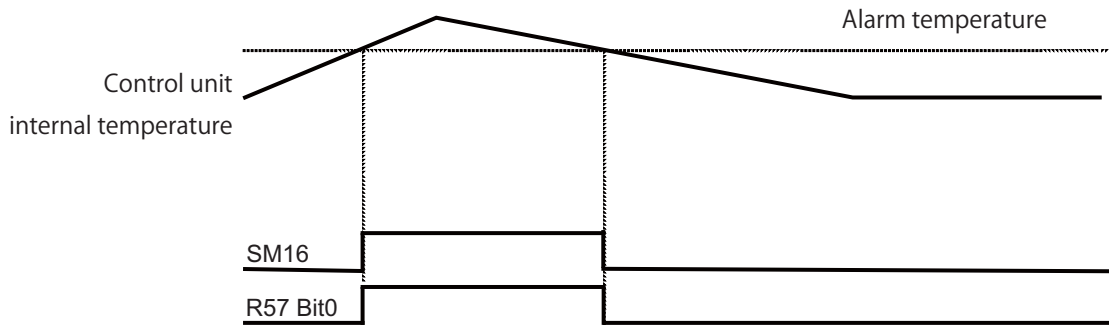

[Related signals]

- (1) Temperature rise (SM16)
- (2) Control unit temperature (R60)

4 Explanation of Interface Signals

Cont.	Signal name	Abbrev.	Common(\$)
A	CONTROL UNIT TEMPERATURE		R60

[Function]

This signal indicates the temperature in the control unit.

[Operation]

This signal indicates the temperature in the control unit. The unit is "°C".

[Related signals]

- (1) Temperature rise (SM16)
- (2) Temperature warning cause (R57/bit1)

Cont.	Signal name	Abbrev.	Common(\$)
A	PLC MAIN SCAN TIME		R68

[Function]

Time taken for scanning in user PLC can be monitored.

[Operation]

Scanning time for user PLC main processing is continuously updated and set.
 <File register contents and time calculation>

File register

F	E	D	C	B	A	9	8	7	6	5	4	3	2	1	0
---	---	---	---	---	---	---	---	---	---	---	---	---	---	---	---

Time calculation

$$\frac{\text{Data}}{256} \times 3.5 \text{ (ms)}$$

(Example)

F	E	D	C	B	A	9	8	7	6	5	4	3	2	1	0
0	0	0	0	0	0	0	0	1	1	0	1	0	0	0	0

$$\frac{\text{Data}=208}{256} \times 3.5 \text{ (ms)}$$

(Note 1) For this data, mean scanning time is about 0.9sec.

(Note 2) I/O processing time for PLC control software (PLC BASIC) is included in this data processing time.

4 Explanation of Interface Signals

Cont.	Signal name	Abbrev.	Common(\$)
A	EMERGENCY STOP CAUSE		R69

[Function]

The causes of emergency stop are shown with bit correspondence.

[Operation]

The cause of the emergency stop state is shown as follows with bit correspondence.
 If there are multiple causes, the multiple bits corresponding to each cause are output.
 The bit of this signal that is set to "0" is the emergency stop cause.

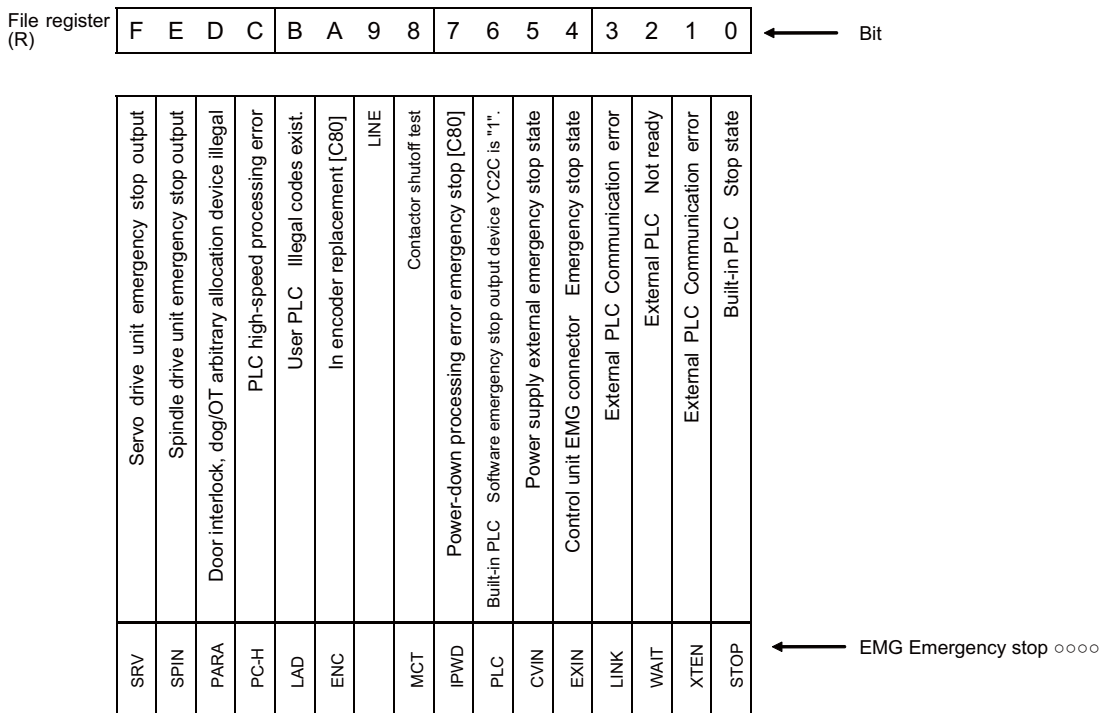

4 Explanation of Interface Signals

Cont.	Signal name	Abbrev.	Common(\$)
A	DIO CARD INFORMATION [M8]		R70

[Function]

The remote I/O unit connected to the controller can be found with the user PLC.

The user PLC finds the connection state of the remote I/O unit with this data.

[Operation]

- (1) When a remote I/O card is connected "1" is set, and when not connected "0" is set. Note that for remote I/O unit, DX230, DX231 and DX654, two stations are occupied per unit, and for DX651, three stations are occupied per unit. So the two or three bits corresponding to the connected unit will be set to "1".

(Note) Only information from the 1st to 8th stations is output to R70. (Information about 9th and following stations is not output.)

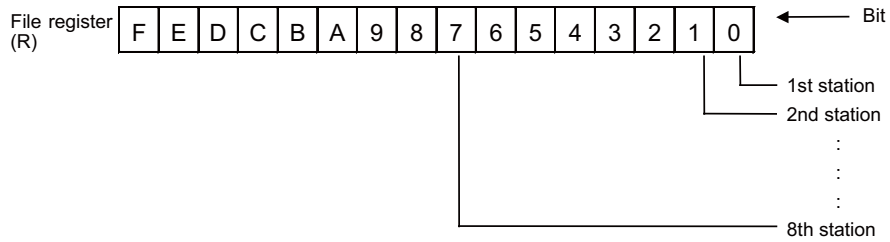

- (2) Number of occupied stations of remote I/O unit (DX***)

Unit	Number of occupied stations
DX220,DX202,DX213	1
DX230,DX231,DX654	2
DX651	3

- (3) The position of the bit that turns ON depends on the rotary switch on the remote I/O unit.

Cont.	Signal name	Abbrev.	Common(\$)
A	BALL SCREW THERMAL DISPLACEMENT COMPENSATION COMPENSATION AMOUNT n-TH AXIS		R72 to 5

[Function] [Operation]

Thermal expansion compensation amount for the current machine position is set by NC.

Refer to the section on "Ball screw thermal displacement compensation offset amount" (R400) for details.

Device No.	Signal name
R72	Ball screw thermal displacement compensation compensation amount 1st axis
R73	Ball screw thermal displacement compensation compensation amount 2nd axis
R74	Ball screw thermal displacement compensation compensation amount 3rd axis
R75	Ball screw thermal displacement compensation compensation amount 4th axis

[Related signals]

- (1) Ball screw thermal displacement compensation offset amount n-th axis (R400)
- (2) Ball screw thermal displacement compensation max. compensation amount n-th axis (R401)
- (3) Ball screw thermal displacement compensation part system, axis No. n-th axis (R402)

4 Explanation of Interface Signals

Cont.	Signal name	Abbrev.	Common(\$)
A	SPEED MONITOR DOOR OPEN POSSIBLE	SMDOEN	R96

[Function]

This signal executes speed monitor function for the control axis for which a valid door No. is selected with parameter "#2118 SscDrSel" and the spindle for which a valid door No. is selected with parameter "#3071 SscDrSelSP". Then the signal notifies that the selected door can be opened.

The door No. corresponds to the following bits.

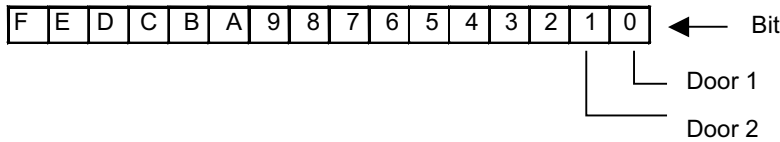

[Operation]

When both NC and drive unit start the speed monitor function with the speed monitor mode turned ON and speed monitor parameter check completed, the speed monitor door open signal will turn ON. When the speed monitor mode is OFF, the speed monitor door open possible signal is OFF as well. After the "Speed monitor door open possible" signal is turned OFF, cancel the speed limit.

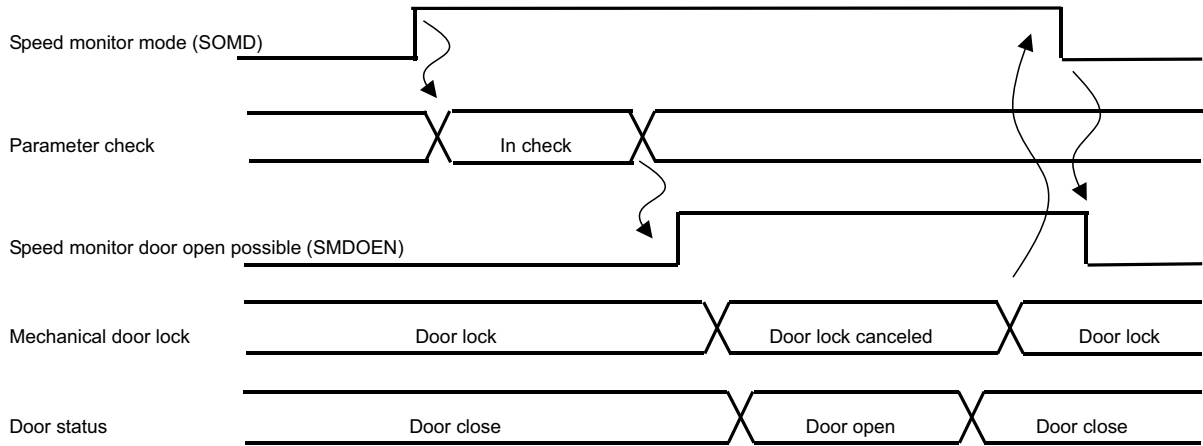

[Caution]

When using the speed monitor function, create user PLC that enables door open when the speed monitor door open possible signal is ON.

[Related signals]

- (1) Speed monitor mode (SOMD:R296)

4 Explanation of Interface Signals

Cont.	Signal name	Abbrev.	Common(\$)
A	MULTI-STEP SPEED MONITOR SELECTED SPEED OUTPUT [M8]	SOPFN	R98

[Function]

This signal outputs the number of selected observation speed steps.

The following table shows the R register status and the selected number of observation speed steps.

Bit2	Bit1	Bit0	Observation speed
0	0	0	Observation speed 1 (#2181, #3141)
0	0	1	Observation speed 2 (#2182, #3142)
0	1	0	Observation speed 3 (#2183, #3143)
0	1	1	Observation speed 4 (#2184, #3144)
1	0	0	Observation speed 5 (#2185, #3149)
1	0	1	Observation speed 6 (#2186, #3150)
1	1	0	Observation speed 7 (#2191, #3151)
1	1	1	Observation speed 8 (#2192, #3152)

[Operation]

Observation speed change is performed with the observation speed change signal. When the observation speed actually switches, the multi-step speed monitor selected speed output outputs the number of selected observation speed steps. Even when the speed monitor mode turns OFF, this signal outputs corresponding to the observation speed change signal.

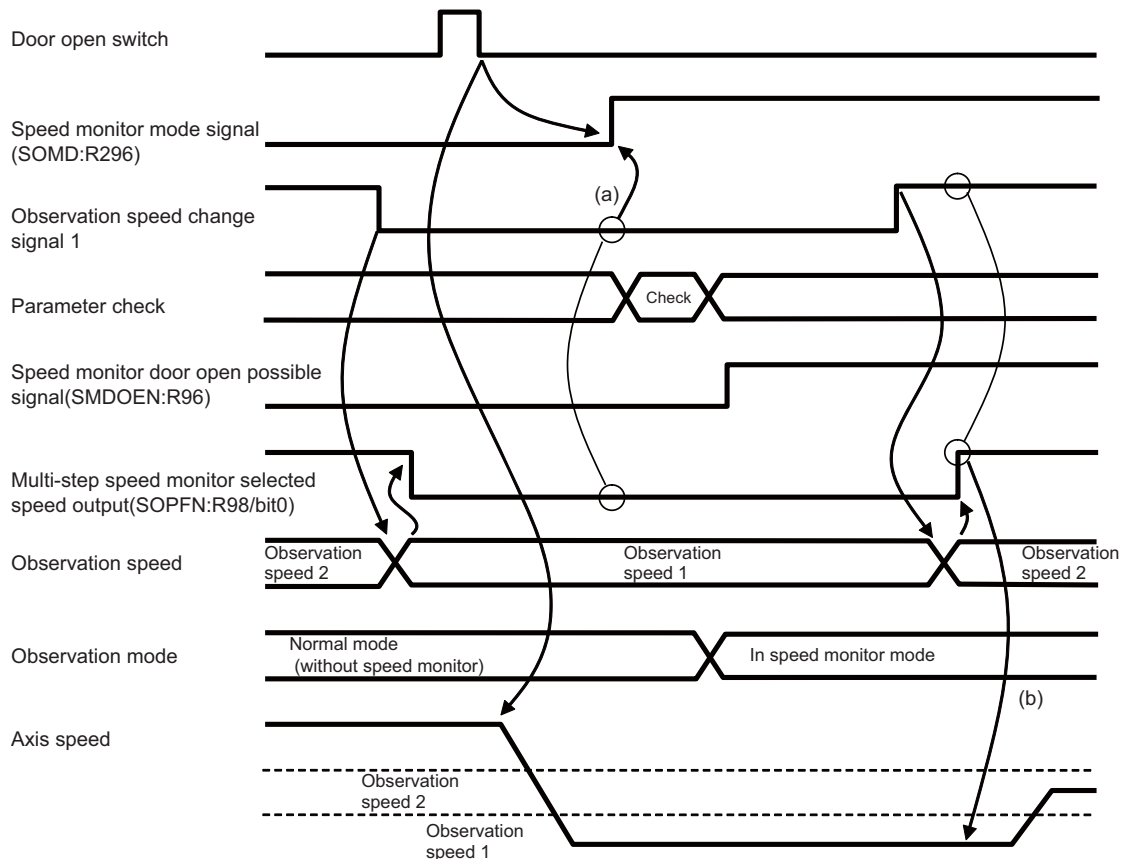

- (a) After confirming that the observation speed change signal and multi-step speed monitor selected speed output (R98) match on user PLC side, turn ON the speed monitor mode signal (R296). After confirming that the observation speed change signal and multi-step speed monitor selected speed output (R98) match on user PLC side and the axis speed becomes less than the observation speed, turn ON the speed monitor mode signal.
- (b) When increasing the observation speed, after the observation speed change signal and the multi-step speed monitor selected speed output (R98) match on the user PLC side, increase the axis speed.

4 Explanation of Interface Signals

If the axis speed is equal to or higher than the changed observation speed when the observation speed change signal is changed in observation speed change during speed monitor, the alarm (Y21 0001) is output and the observation speed is not switched until the axis speed becomes smaller than the changed observation speed.

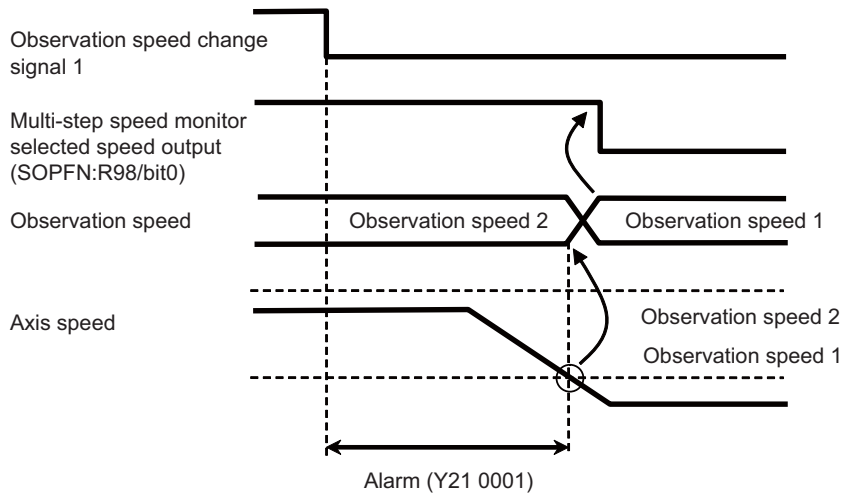

Cont.	Signal name	Abbrev.	Common(\$)
A	Interference check between part systems: Setting error alarm information [M8]		R101

[Function]

This signal notifies of the cause of the alarm with the value of bitC to bitF when the operation alarm (M01 1050) occurs. This signal notifies which interfering object has setting error with bit0 to bit5 when the value of bitC to bitF is between 5 and 8.

[Operation]

When the operation alarm (M01 1050) occurs, the value of bitC to bitF is as follows depending on the cause:

Value of bitC to bitF (represented in binary)	Cause of the operation alarm (M01 1050)
1 (0001)	You attempted to start the interference check between part systems in a system configured with a single part system.
2 (0010)	Interference check between part systems: Data address (R468) is an odd number.
3 (0011)	The value set in "number of defined interference objects" is out of the setting range.
4 (0100)	Same axis has been set multiple times in one part system of "reference axis corresponding axes for each part system".
5 (0101)	The value set in "interfering object, moving object/ fixed object selection" is out of the setting range, or of a nonexistent part system.
6 (0110)	Three or more fixed objects have been set in "interfering object, moving object/ fixed object selection".
7 (0111)	Two or more moving objects have been set in "interfering object, moving object/ fixed object selection" of one part system.
8 (1000)	"0" has been set in length I, J or K.

When a value of bitC to bitF is between 5 and 8, the bit which corresponds to the interfering object with setting error is turned ON.

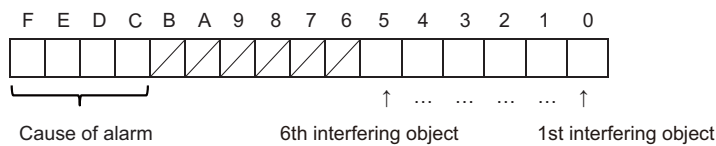

[Related signals]

- (1) Interference check between part systems: Alarm information [M8] (R102)
- (2) Interference check between part systems: Interference check enabled [M8] (CCHK: Y73F)

4 Explanation of Interface Signals

Cont.	Signal name	Abbrev.	Common(\$)
A	Interference check between part systems: Alarm information [M8]		R102

[Function]

This signal notifies which interfering object is in the interference state when the operation alarm (M01 1051 or M01 1052) occurs.

[Operation]

The bit which corresponds to the interfering object in the interference state is turned ON.

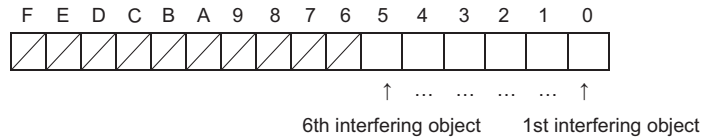

[Related signals]

- (1) Interference check between part systems: Setting error alarm information [M8] (R101)
- (2) Interference check between part systems: Interference check enabled [M8] (CCHK: Y73F)

Cont.	Signal name	Abbrev.	Common(\$)
A	PLC AXIS POSITION SWITCH 1 to 32 [C80]		R114,5

[Function]

This signal notifies that the machine position is within the area set by the parameters.

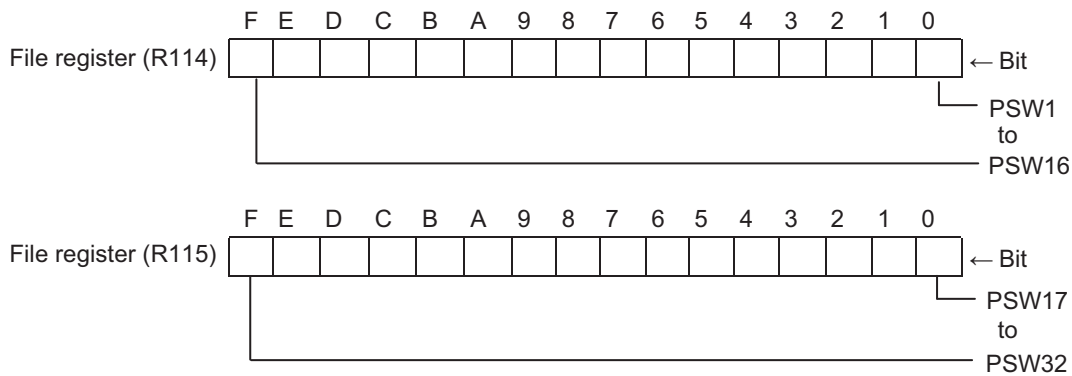

[Operation]

This signal turns ON when the control axis machine position reaches the range set by the parameters, and turns OFF when the range is left.

4 Explanation of Interface Signals

Cont.	Signal name	Abbrev.	Common(\$)
A	HANDLE FEED: 1ST HANDLE PULSE COUNTER	HS1PCNT	R116
A	HANDLE FEED: 2ND HANDLE PULSE COUNTER	HS2PCNT	R117
A	HANDLE FEED: 3RD HANDLE PULSE COUNTER	HS3PCNT	R118

[Function]

Cumulative pulses of the 1st to 3rd handles are output in this signal.

Cumulative pulses of 4th to 9th handles are output in R150 to R155. [C80]

[Operation]

The number of pulses are increased/decreased according to the direction in which the 1st to 3rd handles are turned. (Range of increase/decrease: -32768 to 32767)

The following examples show how the number of pulses changes as you turn the handle.

Example 1) Change of pulses when you turn the handle continuously in plus direction

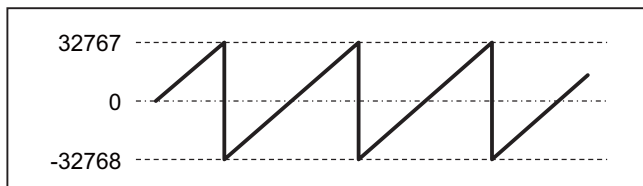

Example 2) Change of pulses when you turn the handle continuously in minus direction

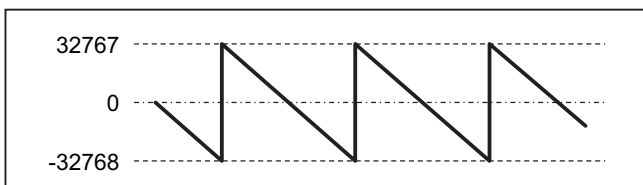

Example 3) Change of pulses when you turn the handle in plus and minus directions alternately

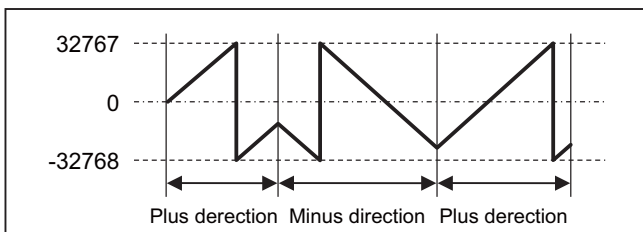

When the power supply is turned ON, the number of pulses is "0".

This value can be changed arbitrarily using the ladder, etc.

After the change, the number of pulses will increase/decrease starting from the changed value.

Example 4) Change of pulses when the value is changed during plus-direction operation.

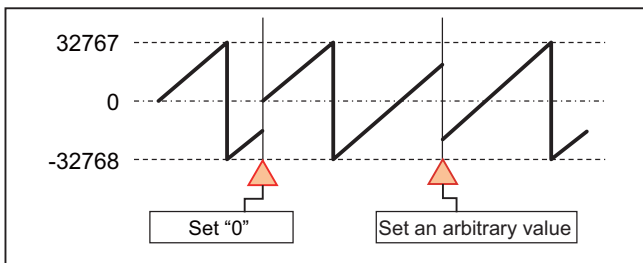

The number of pulses will increase/decrease as you turn the handle regardless of the operation mode.

For both 5V handle and 12V handle, the number of pulses will increase/decrease in increments of 1 pulse per notch.

Regardless of the setting of the handle feed magnification, the number of pulses will increase/decrease in increments of 1 pulse per notch.

The handle rotation direction can be determined by calculating the amount of change per scan in the ladder.

Cont.	Signal name	Abbrev.	Common(\$)
A	POWER CONSUMPTION COMPUTATION: PRESENT CONSUMPTION OF ENTIRE DRIVE SYSTEM	DTPPC	R120, 1

[Function]

This signal notifies the present consumption of entire drive system.

[Operation]

The present consumption of entire drive system is set.

The present consumption of entire drive system is the sum of present power consumption of servo axis in drive system (fluctuating part), present power consumption of spindle in drive system (fluctuating part), drive system's fixed consumption (parameter "#1372 DrvBasePwr"), and drive system's fixed consumption correction (R306, 7).

Setting size = 2 words, Setting unit = 1 (W), Setting range = -2147483648 to 2147483647 (W)

[Caution]

(Note 1) The positive value represents power consumption and the negative value represents power regeneration.

[Related signals]

(1) Power consumption computation: Drive system's fixed consumption correction (DFPCC:R306, 7)

Cont.	Signal name	Abbrev.	Common(\$)
A	POWER CONSUMPTION COMPUTATION: ACCUMULATED CONSUMPTION OF ENTIRE DRIVE SYSTEM 1 to 4	DTIPC1 to 4	R122 to 9

[Function]

This signal notifies the accumulated consumption of entire drive system.

[Operation]

The accumulated consumption of entire drive unit is set.

The accumulated consumption of entire drive system is the accumulation of present power consumption of servo axis in drive system (fluctuating part), present power consumption of spindle in drive system (fluctuating part), drive system's fixed consumption (parameter "#1372 DrvBasePwr"), and drive system's fixed consumption correction (R306, 7).

Setting size = 2 words, Setting unit = 1 (Wh), Setting range = -2147483648 to 2147483647 (Wh)

[Caution]

(Note 1) When the power is turned ON again, the state prior to the power ON is held.

(Note 2) The positive value represents power consumption and the negative value represents power regeneration.

(Note 3) When the accumulated value exceeds the maximum or minimum value of the setting range, each value is clamped to the maximum/minimum value.

[Related signals]

(1) Power consumption computation: Clear consumption accumulation 1 to 4 (IPCC1 to 4:Y700 to 3)

(2) Power consumption computation: Enable consumption accumulation 1 to 4 (IPCE1 to 4:Y724 to 7)

(3) Power consumption computation: Drive system's fixed consumption correction (DFPCC:R306, 7)

4 Explanation of Interface Signals

Cont.	Signal name	Abbrev.	Common(\$)
A	POWER CONSUMPTION COMPUTATION: ACCUMULATED CONSUMPTION OF DEVICES OTHER THAN DRIVE SYSTEM 1 to 4	NDIPC1 to 4	R130 to 7

[Function]

This signal notifies the accumulated value of total power consumption of devices other than drive system.

[Operation]

The accumulated consumption of devices other than drive system is set.

The accumulated consumption of devices other than drive system is the accumulation of power consumption of devices other than drive system (R304, 5).

Setting size = 2 words, Setting unit = 1 (Wh), Setting range = -2147483648 to 2147483647 (Wh)

[Caution]

(Note 1) When the power is turned ON again, the state prior to the power ON is held.

(Note 2) The positive value represents power consumption and the negative value represents power regeneration.

(Note 3) When the accumulated value exceeds the maximum or minimum value of the setting range, each value is clamped to the maximum/minimum value.

[Related signals]

(1) Power consumption computation: Clear consumption accumulation 1 to 4 (IPCC1 to 4:Y700 to 3)

(2) Power consumption computation: Enable consumption accumulation 1 to 4 (IPCE1 to 4:Y724 to 7)

(3) Power consumption computation: Consumption of devices other than drive system (NDPC:R304, 5)

Cont.	Signal name	Abbrev.	Common(\$)
A	INTERFERENCE CHECK III: ENTRY IN INTERFERENCE WARNING AREA INTERFERING OBJECT INFORMATION [M8]	ITF3CHWG- OBJ	R138

[Function][Operation]

This signal notifies the interfering object No. of the interfering object selection in which the operation alarm (M03 0003) has occurred.

bit 0: 1st interfering object entry in the interference warning area

:

bit F: 16th interfering object entry in the interference warning area

* If more than one interfering object enters the interference warning area, all bits corresponding to the interfering objects which have entered the interference warning area are turned ON.

Cont.	Signal name	Abbrev.	Common(\$)
A	INTERFERENCE CHECK III: INTERFERENCE DETECTION INTERFERING OBJECT INFORMATION [M8]	ITF3CHAL- OBJ	R139

[Function][Operation]

This signal notifies the interfering object No. of the interfering object selection in which the operation alarm (M03 0001) has occurred.

bit 0: 1st interfering object interference detection

:

bit F: 16th interfering object interference detection

* If the entry of more than one interfering object to the interference alarm area has been detected, all bits corresponding to the interfering objects in which the entry to the interference alarm area is detected are turned ON.

Cont.	Signal name	Abbrev.	Common(\$)
A	INTERFERENCE CHECK III: ENTRY IN INTERFERENCE ALARM AREA INTERFERING OBJECT INFORMATION [M8]	ITF3TRAL- OBJ	R140

[Function][Operation]

This signal notifies the interfering object No. of the interfering object selection in which the operation alarm (M03 0002) has occurred.

bit 0: 1st interfering object entry in the interference alarm area

:

bit F: 16th interfering object entry in the interference alarm area

* If more than one interfering object enters the interference alarm area, all bits corresponding to the interfering objects which have entered the interference alarm area are turned ON.

4 Explanation of Interface Signals

Cont.	Signal name	Abbrev.	Common(\$)
A	INTERFERENCE CHECK III: DATA SETTING ERROR INFORMATION 1 [M8]	ITF3DTER1	R141

[Function][Operation]

This signal notifies that the error of the data (operationalarm (M03 300*)) set in the interfering object selection has occurred when the "Interference check III: Enable interfering object selection data" (Y769) is ON.

bit 0: 1st interfering object selection setting error

:

bit F: 16th interfering object selection setting error

Cont.	Signal name	Abbrev.	Common(\$)
A	INTERFERENCE CHECK III: DATA SETTING ERROR INFORMATION 2 [M8]	ITF3DTER2	R142 to R149

[Function][Operation]

This signal notifies that the error of the data (operationalarm (M03 200*)) set in the interfering object definition has occurred when the "Interference check III: Enable interfering object selection data" (Y769) is ON.

< R142 >

bit 0: 1st interfering object definition setting error

:

bit F: 16th interfering object definition setting error

< R149 >

bit 0: 113th interfering object definition setting error

:

bit F: 128th interfering object definition setting error

Cont.	Signal name	Abbrev.	Common(\$)
A	HANDLE FEED: 4TH TO 9TH HANDLE PULSE COUNTER [C80]	HS4PCNT to HS9PCNT	R150 to R155

[Function]

This signal outputs the 4th to 9th handles cumulative pulses.

[Operation]

The number of pulses are increased/decreased according to the direction in which the 4th to 9th handles are turned.

(Range of increase/decrease: -32768 to 32767)

Refer to the items in "1st handle pulse counter (HS1PCNT: R116)" for additional descriptions.

Cont.	Signal name	Abbrev.	Common(\$)
A	PLC AXIS ALARM/WARNING NO. n-TH AXIS		R168 to R175

[Function]

This signal indicates the alarm No./warning No. of the servo drive unit for PLC axis. (hexadecimal 2 digits)

This signal sets the 4-digit alarm No. which is displayed on the NC screen.

[Operation]

This signal is set up when the alarm/waring occurs in the servo drive unit for PLC axis.

This signal will be cleared when the alarm/warning is canceled.

This signal does not set if the servo warning "S52 00E6" (Control axis detachment warning) or "S52 00E7" (In NC emergency stop state) occurs.

If more than one alarm/warning occurs, the value displayed in the [LED display] of [Drv mon]-[Servo unit] screen is set.

[Related signals]

(1) NC warning (servo warning) (XC9C)

4 Explanation of Interface Signals

Cont.	Signal name	Abbrev.	Common(\$)
A	ZR DEVICE NO. IN WHICH DDRD/DDWR COMMAND ERROR HAS OCCURRED [C80]		R180,1

[Function]

This signal outputs the No. of ZR device in which an error has occurred during read or write of common variables.

[Operation]

CNC sets the No. of ZR device in which an error has occurred first at the execution of the DDWR/DDRD instruction.

If no error has occurred, "0" is set.

This device value is kept until read/write of common variables is executed with the next DDWR/DDRD instruction.

Cont.	Signal name	Abbrev.	Common(\$)
A	COMMON VARIABLE READ/WRITE ERROR PART [C80]		R182

[Function]

This signal outputs the part system No. and common variable No. in which an error has occurred when the common variable is read with ZR device from GOT.

[Operation]

The thousand's digit represents the part system where the error has occurred, and the hundred's to one's digits indicate the common variable No.

(Example)

Value Contents

520 The common variable #520 is an error.

2150 The common variable #150 of 2nd part system is an error.

If multiple errors occur when the common variable is read, one of the occurring error codes will be set. It is uncertain which error cause of common variable will be output.

The value is kept until the error cause is removed.

Cont.	Signal name	Abbrev.	Common(\$)
A	COMMON VARIABLE READ/WRITE ERROR CODE [C80]		R183

[Function]

This signal outputs the error cause of the common variable No. in which an error has occurred when the common variable is read with ZR device from GOT.

[Operation]

The error codes are set by CNC. The error causes are as follows.

Error code	Error cause
0x0001	The specified common variable is empty.
0x0002	The common variable value is illegal (infinity, etc.).
0x0004	The common variable value is out of the range from -214748.3648 to 214748.3647.
0x0008	The specified common variable is outside of the allowed setting range (subject to additional specifications).

If multiple errors occur when the common variable is read, one of the occurring error codes will be set. It is uncertain which error code of common variable will be output.

The value is kept until the error cause is removed.

4 Explanation of Interface Signals

Cont.	Signal name	Abbrev.	\$1	\$2	\$3	\$4	\$5	\$6	\$7	\$8
A	EXTERNAL SEARCH STATUS		R500	R700	R900	R1100	R1300	R1500	R1700	R1900

[Function][Operation]

The status at the end of the external search is output.

The correspondence of the external search status values and details output from the NC based on the external search is shown below.

External search status value	Details	Remedy
0	Normally finished.	-
1	Operation search is being carried out.	Wait for other function's operation search to finish before searching.
2	Search was attempted while external search was invalid.	Stop the program before searching. Cancel the emergency stop or reset before searching.
3	Any non-existent or inoperative device has been designated.	Confirm the presence of the device, and that the device is within the specifications.
4	The program file is not designated.	Designate the program No. or sequence No.
5	The block with the designated program No., sequence No. or block No. was not found.	Check the machining program.
6	-	-
7	The designated device does not support the batch program search across all part systems.	Designate a device which supports the batch program search across all part systems.

[Related signal]

(1) External search finished (XC1D)

Cont.	Signal name	Abbrev.	\$1	\$2	\$3	\$4	\$5	\$6	\$7	\$8
A	External search: Program return complete status		R501	R701	R901	R1101	R1301	R1501	R1701	R1901

[Function][Operation]

This signal outputs the status of when the program return completed signal is ON.

The correspondence of the program return complete status values and details output from the NC based on the result of returning to the machining program before the external search is shown below.

Status value	Details	Remedy
0	Normally finished	-
1	Function is invalid	Check the parameter setting
2	Program return was attempted during the operation, reset, or emergency stop.	Input the signal after stopping the program operation. Confirm the cancellation of the emergency stop or reset, and then input the signal.
3	Program return is disabled because the external search has not been performed or due to any restriction.	Execute the external search first, and then input the signal. Do not execute a function that is restricted after the external search.

The timing chart for program return is shown below.

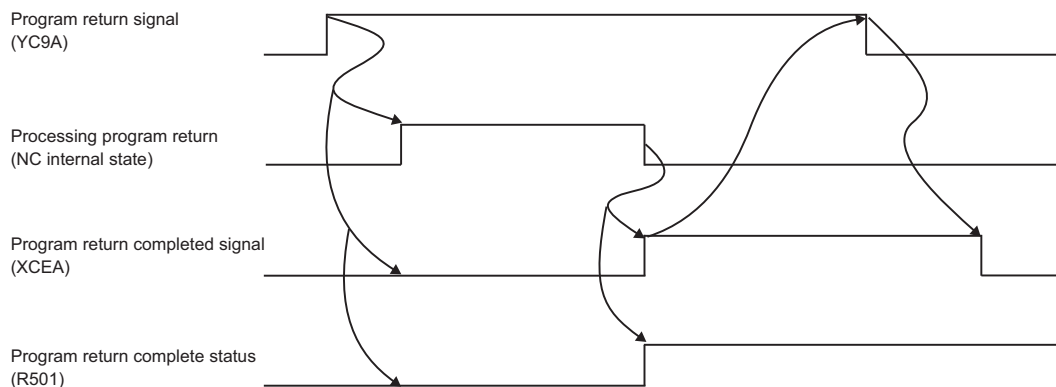

4 Explanation of Interface Signals

Cont.	Signal name	Abbrev.	\$1	\$2	\$3	\$4	\$5	\$6	\$7	\$8
A	M CODE DATA 1		R504,5	R704,5	R904,5	R1104,5	R1304,5	R1504,5	R1704,5	R1904,5
A	M CODE DATA 2		R506,7	R706,7	R906,7	R1106,7	R1306,7	R1506,7	R1706,7	R1906,7
A	M CODE DATA 3		R508,9	R708,9	R908,9	R1108,9	R1308,9	R1508,9	R1708,9	R1908,9
A	M CODE DATA 4		R510,1	R710,1	R910,1	R1110,1	R1310,1	R1510,1	R1710,1	R1910,1
A	M CODE DATA 5 [C80]		R532,3	R732,3	R932,3	R1132,3	R1332,3	R1532,3	R1732,3	
A	M CODE DATA 6 [C80]		R534,5	R734,5	R934,5	R1134,5	R1334,5	R1534,5	R1734,5	

[Function]

When M function is specified, value following address "M" can be identified. The M code data output from the controller can be selected from 8-digit BCD data, unsigned 32-bit binary data, or signed 32-bit binary data, by the parameter "#12006 Mbin".

[Operation]

M code data n is updated when:

- (1) "M***" is issued in automatic operation (tape, memory or MDI).
- (2) "M***" in fixed cycle causes motion during execution of the fixed cycle.
- (3) "M***" is executed by manual numerical command input.

M code data is also updated when an "M code independent output" command is issued even during M function lock. The data is kept unchanged after "M function finish" signal (FIN1, FIN2) is sent back. "Reset" or "Emergency stop" does not clear the data.

[Caution]

- (1) Multiple sets of the miscellaneous functions (M functions) can be specified in a block. Up to six sets of M functions can be specified for C80. When multiple M functions are placed in one block, the signals are output in the order at programming.

When the number of sets of the M commands in a block are more than the settings of the parameter "#12005 Mfig", the latter commands are valid.

Program example

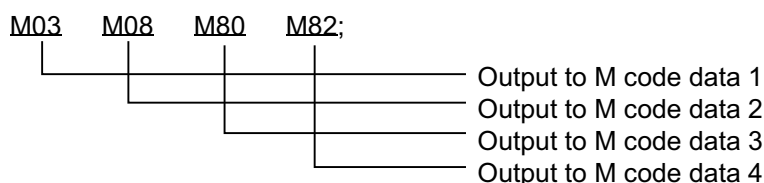

- (2) M98 (read of subprogram), M99 (return to main program), etc. are processed within the CNC, and not output as M code data.

[Related signals]

- (1) M function strobe n (MF_n:XC60)

Cont.	Signal name	Abbrev.	\$1	\$2	\$3	\$4	\$5	\$6	\$7	\$8
A	S CODE DATA 1 to 8		R512 to 27	R712 to 27	R912 to 27	R1112 to 27	R1312 to 27	R1512 to 27	R1712 to 27	R1912 to 27

[Function]

When S function is specified, value following address "S" can be identified. The S code data output from the controller can be selected from 8-digit BCD data, unsigned 32-bit binary data, or signed 32-bit binary data, by the parameter "#12008 Sbin".

[Operation]

S code data (1 to 8) is updated when:

- (1) "S***" is specified in automatic operation (tape, memory or MDI).
- (2) "S***" is executed by manual numerical command input.

Data remain unchanged even when "M function finish" signal (FIN1 or FIN2) is sent back. "Reset" and "Emergency stop" does not clear this data.

4 Explanation of Interface Signals

The S code data is issued in the following manner.

Signal name	Register							
	\$1	\$2	\$3	\$4	\$5	\$6	\$7	\$8
S code data 1	R512,3	R712,3	R912,3	R1112,3	R1312,3	R1512,3	R1712,3	R1912,3
S code data 2	R514,5	R714,5	R914,5	R1114,5	R1314,5	R1514,5	R1714,5	R1914,5
S code data 3	R516,7	R716,7	R916,7	R1116,7	R1316,7	R1516,7	R1716,7	R1916,7
S code data 4	R518,9	R718,9	R918,9	R1118,9	R1318,9	R1518,9	R1718,9	R1918,9
S code data 5	R520,1	R720,1	R920,1	R1120,1	R1320,1	R1520,1	R1720,1	R1920,1
S code data 6	R522,3	R722,3	R922,3	R1122,3	R1322,3	R1522,3	R1722,3	R1922,3
S code data 7	R524,5	R724,5	R924,5	R1124,5	R1324,5	R1524,5	R1724,5	R1924,5
S code data 8	R526,7	R726,7	R926,7	R1126,7	R1326,7	R1526,7	R1726,7	R1926,7

[Caution]

(1) If two or more S codes for one spindle are issued in a block, the S code defined last will be valid.

[Related signals]

(1) S function strobe (SFn:XC64)

Cont.	Signal name	Abbrev.	\$1	\$2	\$3	\$4	\$5	\$6	\$7	\$8
A	T CODE DATA 1 to 4		R536 to 43	R736 to 43	R936 to 43	R1136 to 43	R1336 to 43	R1536 to 43	R1736 to 43	R1936 to 43

[Function]

When T function is specified, value following address "T" can be identified. The T code data output from the controller can be selected from 8-digit BCD data, unsigned 32-bit binary data, or signed 32-bit binary data, by the parameter "#12010 Tbin".

[Operation]

T code data (1 to 4) is updated when:

- (1) "T**" is specified in automatic operation (tape, memory or MDI).
- (2) "T**" is executed by manual numerical command input.

Data remain unchanged even when "M function finish" signal (FIN1 or FIN2) is sent back. "Reset" and "Emergency stop" does not clear this data.

T code data is issued in the following manner.

Signal name	Register			
	\$1	\$2	\$3	\$4
T code data 1	R536,7	R736,7	R936,7	R1136,7
T code data 2	R538,9	R738,9	R938,9	R1138,9
T code data 3	R540,1	R740,1	R940,1	R1140,1
T code data 4	R542,3	R742,3	R942,3	R1142,3

[Caution]

(1) Up to four T codes can be commanded in one block. The latter code will be valid if more than one code is commanded in one block.

[M system]

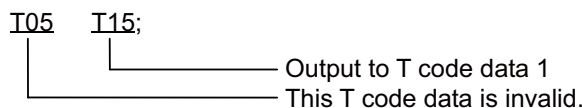

[L system]

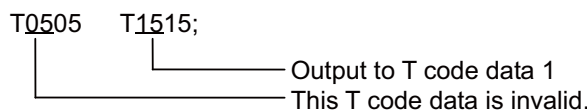

[Related signals]

(1) Tool function strobe 1 (TF1:XC68)

4 Explanation of Interface Signals

Cont.	Signal name	Abbrev.	\$1	\$2	\$3	\$4	\$5	\$6	\$7	\$8
A	2ND M FUNCTION DATA 1 to 4		R544 to 51	R744 to 51	R944 to 51	R1144 to 51	R1344 to 51	R1544 to 51	R1744 to 51	R1944 to 51

[Function]

When 2nd M function is specified, value following address "B" can be identified.

The 2nd M function data output from the controller can be selected from 8-digit BCD data, unsigned 32-bit binary data, or signed 32-bit binary data, by the parameter "#12012 Bbin".

Signed binary data can also be output by setting "#1045 nskno".

(Note) Select an address for the 2nd M function address from the machine parameters basic specification parameter "#1170 M2name" A, B or C address that is not being used for "#1013 axname" or "#1014 incax".

[Operation]

2ND M FUNCTION DATA (1 to 4) are updated when:

- (1) "B (A, C)***" is specified in automatic operation (tape, memory or MDI).
- (2) "B (A, C)***" is executed by manual numerical command input.

Data remain unchanged even when "M function finish" signal (FIN1 or FIN2) is sent back. "Reset" and "Emergency stop" does not clear this data.

2nd M function data is allocated as shown below.

Signal name	Register			
	\$1	\$2	\$3	\$4
2nd M function data 1	R544,5	R744,5	R944,5	R1144,5
2nd M function data 2	R546,7	R746,7	R946,7	R1146,7
2nd M function data 3	R548,9	R748,9	R948,9	R1148,9
2nd M function data 4	R550,1	R750,1	R950,1	R1150,1

[Caution]

- (1) Up to four 2nd M functions can be commanded in one block. The latter code will be valid if more than five codes are commanded in one block.

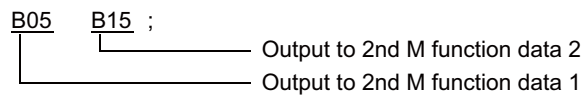

[Related signals]

- (1) 2nd M function strobe 1 (BF1:XC6C)

4 Explanation of Interface Signals

Cont.	Signal name	Abbrev.	\$1	\$2	\$3	\$4	\$5	\$6	\$7	\$8
A	CHOPPING ERROR NO.		R554	R754	R954	R1154	R1354	R1554	R1754	R1954

[Function]

This signal notifies the user PLC of the alarm details when an alarm occurs during chopping operation.

[Operation]

Chopping error No. and the details are as shown below.

Error No.	Details	Classification
0	No error	-
1	Number of cycles for chopping is zero. (Operates when the number of cycles is 1)	A
2	The speed exceeds the cutting feed clamp speed. (The feedrate is clamped at the cutting feed clamp speed.)	A
3	The acceleration determined based on the parameter exceeds the value of parameter "#2002 clamp" or "#2141 chtL". (The number of cycles decreases because the acceleration is clamped at "#2002 clamp" or "#2141 chtL".)	A
4	The number of cycles exceeds 1056/min. (The number of cycles for chopping is clamped at 1056/min.)	A
5	Chopping axis zero point return is not completed.	B
6	Chopping override is zero.	B
7	Commanded axis is the chopping axis.	B
8	The bottom dead center point position is zero.	B
9	The chopping axis is a manual feed axis.	B
10	Interlock	B
11	Stored stroke limit or stroke end	B
12	The function that cannot be used concurrently is valid. [M8]	B
13	An interference is detected in the interference check III, or an entry in the interference alarm area occurs. [M8]	B
20	There is no specification for chopping. Or, the chopping function cannot be used.	-
21	Chopping control data area exceeds the R register area designated for the chopping control data. Chopping control data area and compensation amount record area are overlapped. Compensation amount record area exceeds R register's backup area (R8300 to R9799). ("Rm + 14 × N sets + 4" exceeds 9799)	C
22	Multiple chopping axes are specified by the PLC interface.	C
23	Chopping axis is not specified by either PLC interface or parameter.	C
24	Compensation method is set to other than 0/1.	C
25	The mode for the compensation value fixed method is set to other than "0" (playback mode) or "1" (record mode).	C
26	Data No. for the control data is a negative value.	C
27	Chopping axis's "#2081 chclsp" (Chopping clamp speed) and "#2002 clamp" (Cutting clamp speed) are both set to "0".	C
28	Chopping axis was changed during chopping operation. (Chopping axis cannot be changed during chopping.)	C
29	Rotary axis was specified as chopping axis.	C
30	Rapid traverse override valid/invalid is set to other than "0" (invalid) or "1" (valid).	A
31	The setting unit of the chopping override is set to other than "0" (1%) or "1" (0.01%). [M8]	A

Classification A:	The error is retained during chopping operation. The error is cleared at the rising edge of the "Chopping parameter valid" signal (YC34) after the chopping control data is corrected, or when the NC is reset.
Classification B:	The error is cleared after the alarm factor is removed, or when the NC is reset.
Classification C:	The error is cleared at the falling edge of the "Chopping parameter valid" signal (YC34), or when the NC is reset. The chopping control data is not enabled when this alarm occurs. [M8]

[Related signals]

(1) Chopping signal (CHPS:YC30)

4 Explanation of Interface Signals

Cont.	Signal name	Abbrev.	\$1	\$2	\$3	\$4	\$5	\$6	\$7	\$8
A	MANUAL MEASUREMENT STATUS		R555	R755	R955	R1155	R1355	R1555	R1755	R1955

[Function]

This signal indicates measurement status during measurement corresponding to bit.

[Operation]

Measurement status during manual measurement is indicated corresponding to bit.

This register value is displayed on the screen during manual measurement shown as below.

R555	Display	Meaning
bit0	On mea0	Status other than "On mea1 to 6".
bit1	On mea1	Status when a skip signal is input during manual measurement. It will shift to "On mea2" state after deceleration stop is confirmed.
bit2	On mea2	Status during the first retract operation. It will shift to "On mea3" state after completing retraction by the retract amount.
bit3	On mea3	Status in which retract has completed by the retract amount. If the skip signal is ON after confirming deceleration stop, a warning will appear, and status display will remain the same. It will shift to "On mea0" state by resetting.
bit4	On mea4	Status during the second measurement. If the skip signal is not input, even if moving to the designated position, a warning will appear, and status display will remain the same. It will shift to "On mea0" state by resetting.
bit5	On mea5	Status when a skip signal is input during the second measurement. It will shift to "On mea6" state after deceleration stop is confirmed.
bit6	On mea6	Status during the second retract operation. It will shift to "On mea0" state after completing retraction by the retract amount.

[Related signals]

(1) Tool length measurement 1 (TLM:YC20)

Cont.	Signal name	Abbrev.	\$1	\$2	\$3	\$4	\$5	\$6	\$7	\$8
A	GROUP IN TOOL LIFE MANAGEMENT		R567	R767	R967	R1167	R1367	R1567	R1767	R1967

[Function][Operation]

This signal outputs group No. currently in life management with the tool life management II.

Cont.	Signal name	Abbrev.	\$1	\$2	\$3	\$4	\$5	\$6	\$7	\$8
A	CNC COMPLETION STANDBY STATUS		R572	R772	R972	R1172	R1372	R1572	R1772	R1972

[Function]

The NC's operation state when the machine seems to be not operated in automatic operation without alarms occurring is output by the bit unit. The alarm messages can be displayed using this signal in the user PLC.

[Operation]

The corresponding bit below turns ON.

Bit0 :Complete standby status of M,S,T,B

Bit1 :In rapid traverse deceleration check

Bit2 :In cutting feed deceleration check

Bit3 :Waiting for spindle orientation complete

Bit4 :Waiting for spindle position loop

Bit7 :Door opened

Bit8 :In executing dwell

BitB :Waiting for unclamp signal

The following figure shows the bit correspondence.

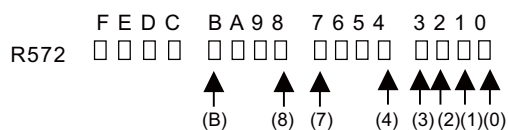

4 Explanation of Interface Signals

Cont.	Signal name	Abbrev.	\$1	\$2	\$3	\$4	\$5	\$6	\$7
A	ERROR CODE [C80]		R573	R773	R973	R1173	R1373	R1573	R1773

[Function]

This signal outputs the alarm occurring in NCCPU with a code in four hexadecimal digits.

[Operation]

Each part system has the R register that stores one set of error code.

The register in which no errors are stored is set to "0".

The error code which is common for part systems is stored in the 1st part system.

Cont.	Signal name	Abbrev.	\$1	\$2	\$3	\$4	\$5	\$6	\$7	\$8
A	IN INITIALIZATION		R574	R774	R974	R1174	R1374	R1574	R1774	R1974

[Function]

This signal is output when zero point initialization is being carried out in the absolute position detection system.

[Operation]

The axis for which "1" is set in #0 INIT. SET on the [ABS. POSITION SET] screen is set to "1", and is held until the power is turned OFF. The stored stroke limit and stroke end signals are invalid while this signal is set to "1", and the current limit during initialization is valid. This signal is also set to "1" when the "Zero point initialization mode" (AZS1 to 8) signal is ON.

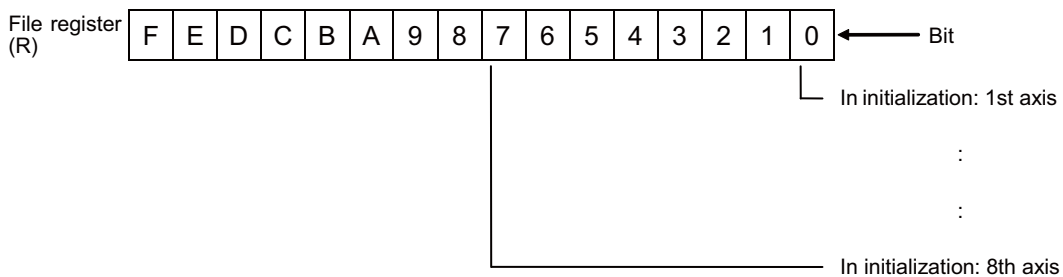

Cont.	Signal name	Abbrev.	\$1	\$2	\$3	\$4	\$5	\$6	\$7	\$8
A	INITIALIZATION INCOMPLETION		R575	R775	R975	R1175	R1375	R1575	R1775	R1975

[Function]

This signal is output when the absolute position is not established in the absolute position detection system.

[Operation]

This signal indicates that the zero point initialization has not been established once or that the absolute position has been lost.

The stored stroke limit of the axis for which this signal is set to "1" in the absolute position detection system is invalid.

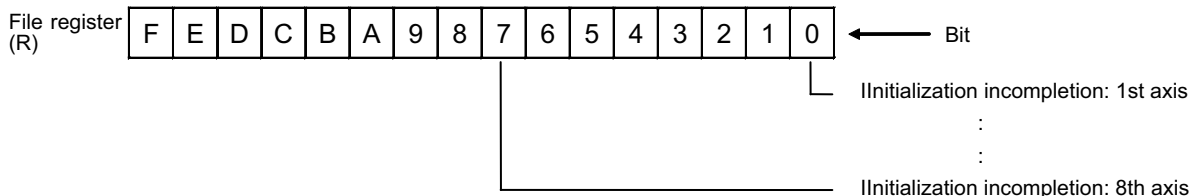

4 Explanation of Interface Signals

Cont.	Signal name	Abbrev.	\$1	\$2	\$3	\$4	\$5	\$6	\$7	\$8
A	REFERENCE POSITION ADJUSTMENT VALUE PARAMETER SETTING COMPLETED		R576	R776	R976	R1176	R1376	R1576	R1776	R1976

[Function] [Operation]

NC receives the "Reference position adjustment completion" signal's ON from PLC. If the axis is controlled for the dog-type reference position return in the synchronization at zero point initialization ("#1493 ref_syn=1"), NC sets the reference position adjustment value to "#2036 slv_adjust" and then turns ON the bit corresponding to the master axis in the part system.

Turn OFF the "Reference position adjustment value completion" signal after this signal is ON.

NC turns this signal OFF when the "Reference position adjustment completion" signal is changed from ON to OFF.

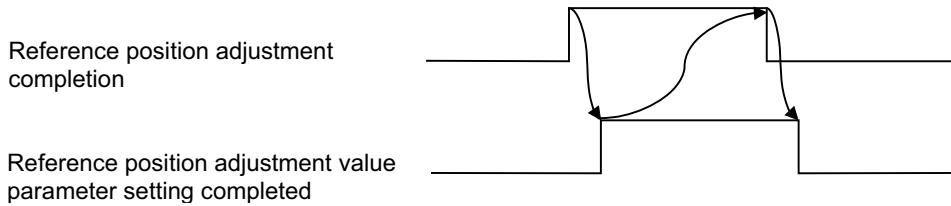

[Caution]

(1) Parameter screen is also available to change the reference position adjustment value (#2036 slv_adjust), which does not turn this signal ON.

[Related signals]

(1) Reference position adjustment completion (R2592)

Cont.	Signal name	Abbrev.	\$1	\$2	\$3	\$4	\$5	\$6	\$7	\$8
A	USER MACRO SECTION AND SUB-SECTION DESIGNATED EXECUTION RESULT [M8]	APIER	R577	R777	R977	R1177	R1377	R1577	R1777	R1977

[Function] [Operation]

Execution result is stored when NC data is read or written using the system variables (#100050 to #100054). (M8 only)

Execution contents	Results	Data to be stored in R register
Read	Successful completion	0x0000
	Section No. error	0x0191
	Sub-section No. error	0x0192
	Part system designation error	0x0190
	Axis designation error	0x01A0
	Write-only data	0x019F
Write	Successful completion	0x0000
	Section No. error	0x0291
	Sub-section No. error	0x0292
	Part system designation error	0x0290
	Axis designation error	0x02A0
	Read-only data	0x029B
	Unable to write data	0x029E

[Caution]

(1) The values are updated when NC data is read or written.

4 Explanation of Interface Signals

Cont.	Signal name	Abbrev.	\$1	\$2	\$3	\$4	\$5	\$6	\$7	\$8
A	NEAR REFERENCE POSITION (PERREFERENCE POSITION)		R580,1	R780,1	R980,1	R1180,1	R1380,1	R1580,1	R1780,1	R1980,1

[Function]

This signal indicates that the control axis is near the reference position when using the absolute position detection system.

This signal is output for the 1st reference position to the 4th reference position.

Near the 1st reference position, the time for outputting the signal is shorter than the "near reference position n-th axis (NRFn)" signal (the ON/OFF timing accuracy during axis movement is improved).

[Operation]

(1) Using the n-th reference position as a reference, when the control axis is in the range set with the parameters, this signal turns ON, and turns OFF when the axis is not within the range.

(2) The near reference position signal is output with four bits for each axis.

(a) R register and corresponding axes

R580

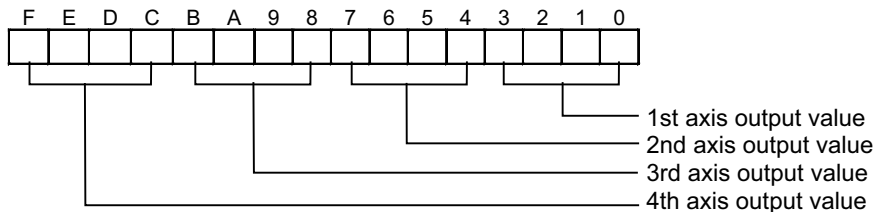

R581

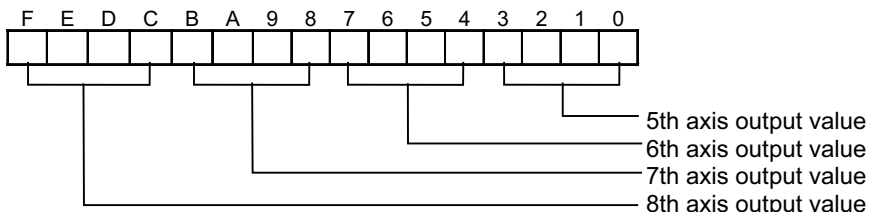

(b) Output value and near n-th reference position

High-order bit	<----->		Low-order bit	Near n-th reference position
0	0	0	1	Near 1st reference position
0	0	1	0	Near 2nd reference position
0	1	0	0	Near 3rd reference position
1	0	0	0	Near 4th reference position

(Note 1) The near reference position signal devices include X devices (NRF1 and following) which output signal only for the 1st reference position, and the R registers (R580/R581) which outputs a signal for each reference position (1st reference position to 4th reference position).

(Note 2) The near reference position signal output width is set with the absolute position parameters "#2057 nrefp" and "#2058 nrefn". The near reference position signal output width is the same width for the 1st reference position to the 4th reference position.

(Note 3) Near the 1st reference position, the signals are output to the conventional X device (NRF1 and following) and the R registers (R580/R581) which output signals to each reference position.

[Related signals]

(1) Near reference position n-th axis (NRF1 to 8:X880 to 7)

4 Explanation of Interface Signals

Cont.	Signal name	Abbrev.	\$1	\$2	\$3	\$4	\$5	\$6	\$7	\$8
A	PRESETTER CONTACT		R582	R782	R982	R1182	R1382	R1582	R1782	R1982

[Function]

The axis movement direction at the moment when the "Skip" signal is entered is output in the tool presetter.

[Operation]

The axis movement direction at the moment when the tool contacts the sensor ("Skip" signal ON) during the tool measurement mode (TLMS ON) is set to the corresponding bit.

This signal is turned OFF by the sensor OFF.

This signal turns OFF when the "Tool measurement mode" signal is turned OFF.

This signal is not output when the tool measurement mode is not entered.

This signal is "0xFFFF" when an axis with no movement contacts the sensor.

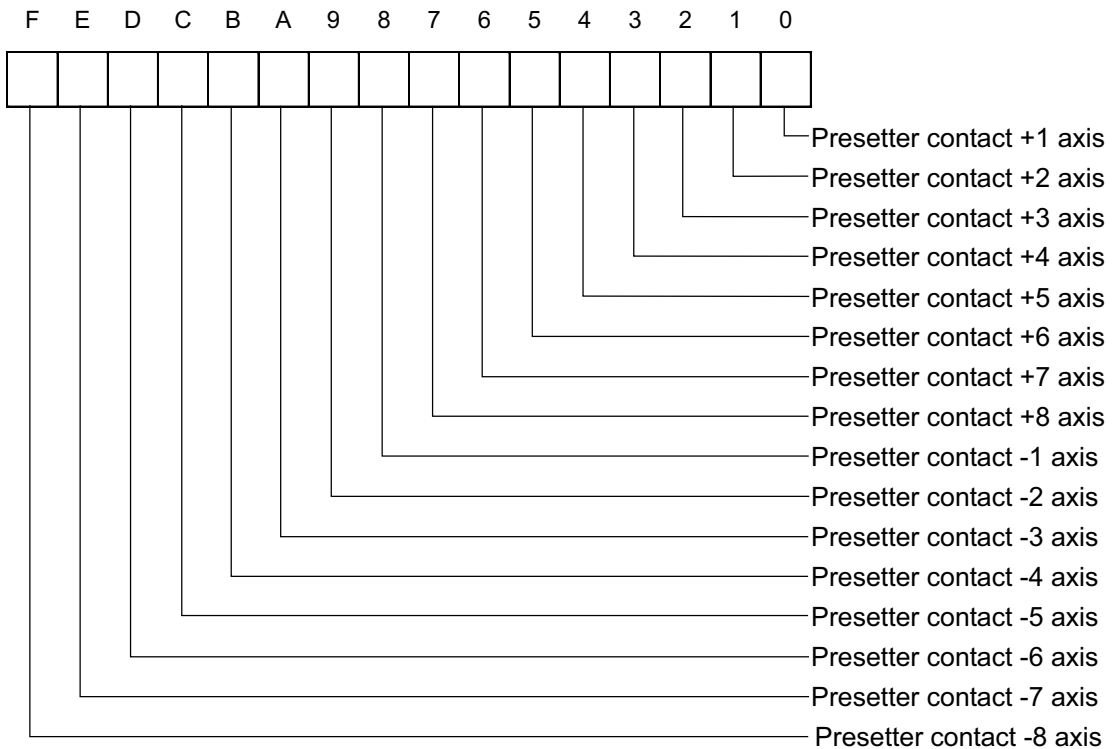

1:Sensor ON

0:Sensor OFF or tool measurement mode OFF

[Related signals]

(1) Tool length measurement 2 (TLMS:YC21)

4 Explanation of Interface Signals

Cont.	Signal name	Abbrev.	\$1	\$2	\$3	\$4	\$5	\$6	\$7	\$8
A	PRESETTER INTERLOCK		R583	R783	R983	R1183	R1383	R1583	R1783	R1983

[Function]

The interlock direction in the CNC is output after the sensor is entered in the tool presetter.

[Operation]

The interlock direction to the entrance direction in the CNC is output after the sensor is entered during the tool measurement mode (TLMS ON).

This signal is turned OFF when the escape operation completion conditions are satisfied.

This signal turns OFF when the "Tool measurement mode" signal is turned OFF.

This signal is not output when the tool measurement mode is not entered.

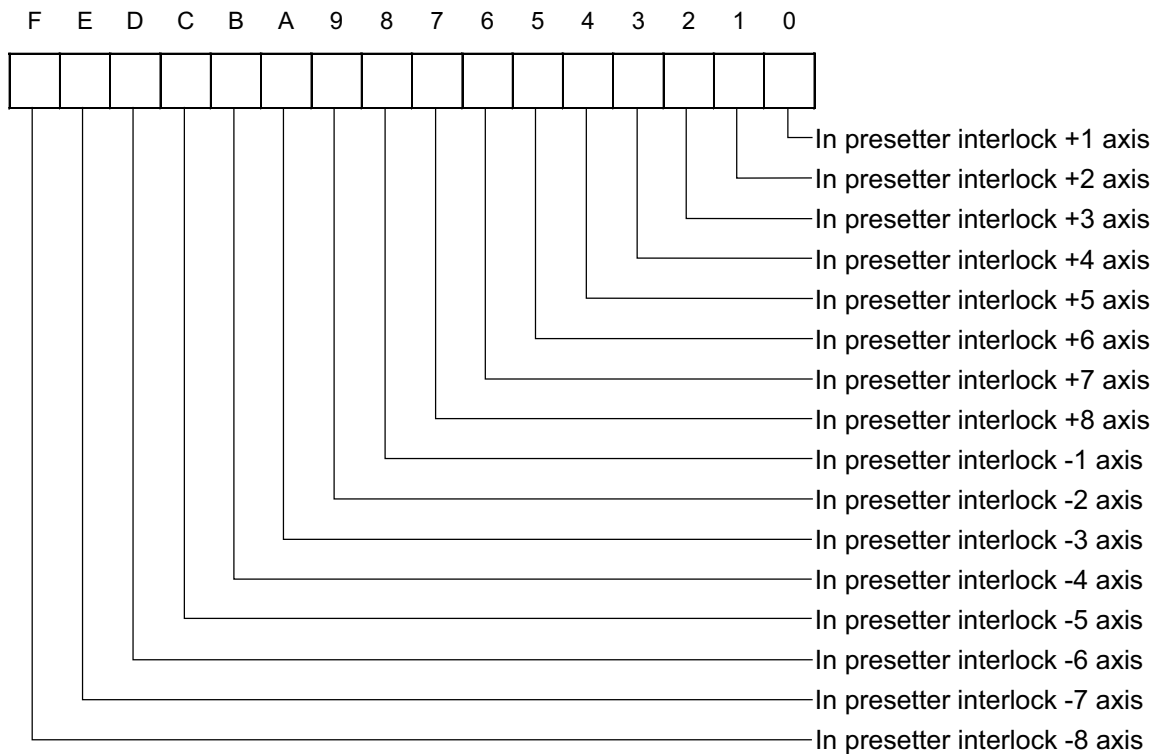

1:In interlock

0:Interlock cancel or tool measurement mode OFF

[Related signals]

- (1) Tool length measurement 2 (TLMS:YC21)

4 Explanation of Interface Signals

Cont.	Signal name	Abbrev.	\$1	\$2	\$3	\$4	\$5	\$6	\$7	\$8
A	NO. OF WORK MACHINING (current value)		R606,7	R806,7	R1006,7	R1206,7	R1406,7	R1606,7	R1806,7	R2006,7
A	NO. OF WORK MACHINING (maximum value)		R608,9	R808,9	R1008,9	R1208,9	R1408,9	R1608,9	R1808,9	R2008,9

[Function]

The No. of work machining current value and maximum value are notified by the controller to the PLC.

[Operation]

If data is set in the No. of work machining (WRK COUNT M) and work machining maximum value (WRK LIMIT) of the [Process parameters], the current value or maximum value of the No. of work machining is output.

(For 1st part system)

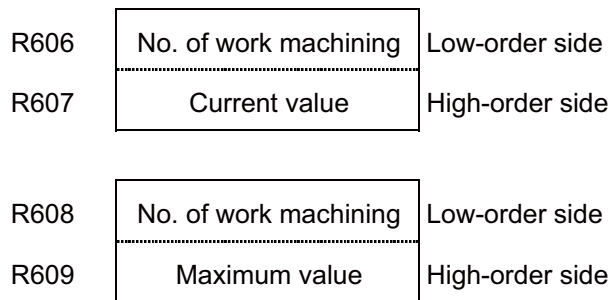

(Note 1) If data is not set in "WRK COUNT M" and "WRK LIMIT" on the [Process Parameter] screen, data will not be output to the file register.

(Note 2) If the No. of work machining matches or exceeds maximum value, the No. of work machining over signal (XCA6) turns ON.

<Counting of No. of work machining using user PLC>

- (1) Set "0" in "WRK COUNT M" on the [Process Parameter] screen. With this setting, the controller side will not count up.
- (2) Add "1" to R606, 7 with the user PLC
- (3) The controller will display R606, 7 as the No. of work machining on the [COORDINATE] screen. Even in this case, if the No. of work machining matches or exceeds the work maximum value, the No. of work machining over signal (XCA6) will turn ON.

4 Explanation of Interface Signals

Cont.	Signal name	Abbrev.	\$1	\$2	\$3	\$4	\$5	\$6	\$7	\$8
A	SUB PART SYSTEM CONTROL: SUB PART SYSTEM CONTROL II IDENTIFICATION NO.	SBSID	R616	R816	R1016	R1216	R1416	R1616	R1816	R2016

[Function]

This signal indicates the identification numbers of sub part systems.

Refer to this signal if it is necessary to identify the G144 command that is controlling the sub part system.

[Operation]

A sub part system under the sub part system control II outputs the sub part system identification number while the "Sub part system control: Sub part system processing" signal (SBS) is ON.

The value is "0" when sub part system processing is not performed.

PLC input signal	Part system that outputs signals	Output signal value
Sub part system control: Sub part system processing (SBS:XC4E)	Sub part system	1: ON / 0: OFF
Sub part system control: Sub part system control II identification No. (SBSID: R616)	Sub part system	Sub part system identification No.

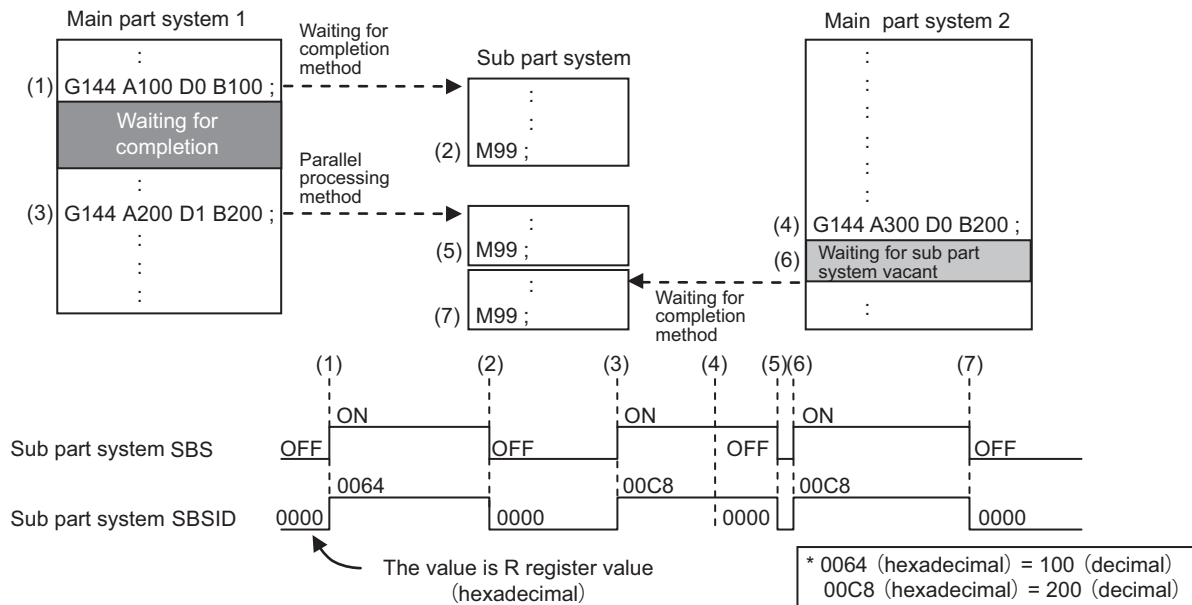

[Related signals]

(1) Sub part system control: Sub part system processing (SBS:XC4E)

4 Explanation of Interface Signals

Cont.	Signal name	Abbrev.	\$1	\$2	\$3	\$4	\$5	\$6	\$7	\$8
A	SUB PART SYSTEM CONTROL: CALLING SUB PART SYSTEM	SBSCL	R617	R817	R1017	R1217	R1417	R1617	R1817	R2017

[Function]

This signal indicates the system bit data of a part system which is started as a sub part system.

To divide the PLC processing of the calling part system based on the sub part system, use this signal to find out which number of the sub part system is started.

[Operation]

The system bit of the sub part system is ON at the calling part system while the "Sub part system control: Sub part system processing" signal (SBS: XC4E) is ON. The value is "0" when sub part system processing is not performed.

BITF	BITE	BITD	BITC	BITB	BITA	BIT9	BIT8	BIT7	BIT6	BIT5	BIT4	BIT3	BIT2	BIT1	BIT0
Not used								\$8	\$7	\$6	\$5	\$4	\$3	\$2	\$1

PLC input signal	Part system that outputs signals	Output signal value
Sub part system control: Sub part system processing (SBS: XC4E)	Sub part system	1: ON / 0: OFF
Sub part system control: Calling sub part system (SBSCL: R617)	Calling part system	System bit of sub part system

When the 1st part system and the 2nd part system are Main part systems and the 3rd part system is Sub part system.

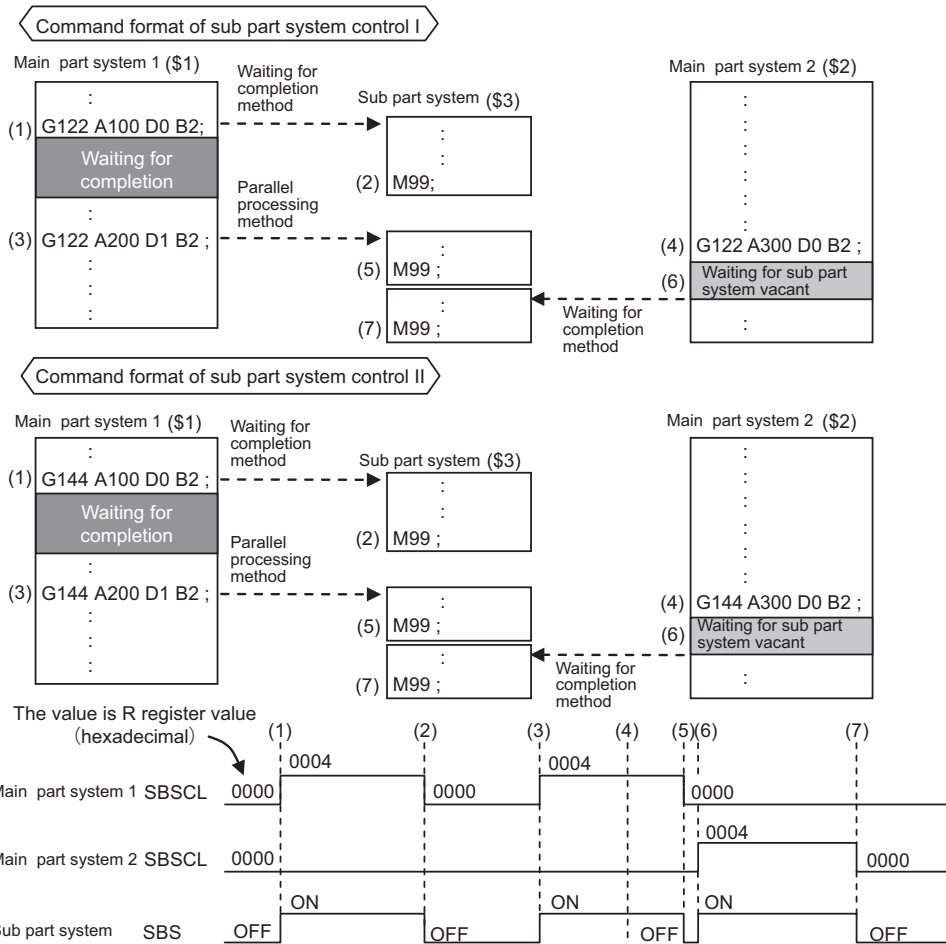

[Related signals]

(1) Sub part system control: Sub part system processing (SBS: XC4E)

4 Explanation of Interface Signals

Cont.	Signal name	Abbrev.	\$1	\$2	\$3	\$4	\$5	\$6	\$7	\$8
A	SUB PART SYSTEM CONTROL: WAITING FOR SUB PART SYSTEM COMPLETION	SBSWT	R618	R818	R1018	R1218	R1418	R1618	R1818	R2018

[Function]

This signal indicates which part system's completion the calling part system is waiting for.

To divide the PLC processing of the calling part system based on the starting method of the sub part system, use this signal to distinguish between the completion waiting method performed with this signal and the parallel processing method.

[Operation]

If a sub part system is started with the completion waiting method, the system bit of the sub part system whose completion is waited remains ON at the calling part system while the "Sub part system control: Sub part system processing" signal (SBS) is ON. The value is "0" when sub part system processing is not performed.

B17F	B17E	B17D	B17C	B17B	B17A	B179	B178	B177	B176	B175	B174	B173	B172	B171	B170
Not used								\$8	\$7	\$6	\$5	\$4	\$3	\$2	\$1

PLC input signal	Part system that outputs signals	Output signal value
Sub part system control: Sub part system processing (SBS: XC4E)	Sub part system	1: ON / 0: OFF
Sub part system control: Waiting for sub part system completion (SBSWT: R618)	Calling part system	System bit of sub part system

When the 1st part system and the 2nd part system are Main part systems and the 3rd part system is Sub part system.

Command format of sub part system control I

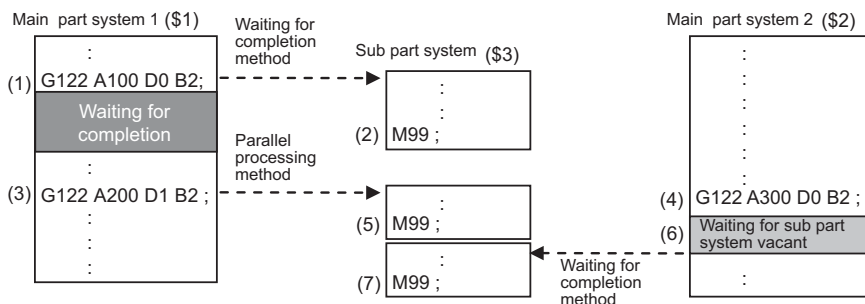

Command format of sub part system control II

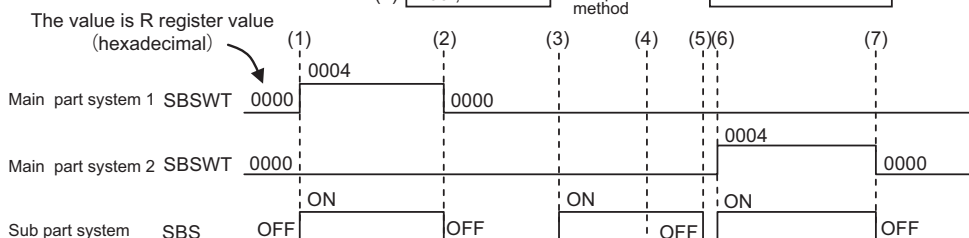
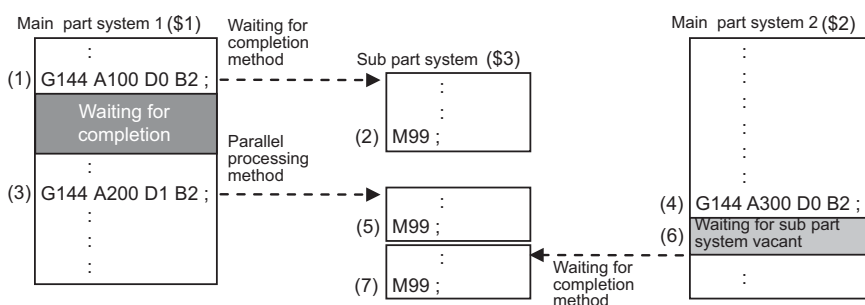

[Related signals]

(1) Sub part system control: Sub part system processing (SBS: XC4E)

4 Explanation of Interface Signals

Cont.	Signal name	Abbrev.	\$1	\$2	\$3	\$4	\$5	\$6	\$7	\$8
A	SUB PART SYSTEM CONTROL: CALLER OF SUB PART SYSTEM	SBSSY	R619	R819	R1019	R1219	R1419	R1619	R1819	R2019

[Function]

This signal indicates the part system that called the sub part system.

To divide the PLC processing of the sub part system based on the calling part system, use this signal to find out which part system (number) called the sub part system.

[Operation]

The system bit of the calling part system remains ON at the sub part system while the "Sub part system control: Sub part system processing" signal (SBS) is ON. The value is "0" when sub part system processing is not performed.

BITF	BITE	BITD	BITC	BITB	BITA	BIT9	BIT8	BIT7	BIT6	BIT5	BIT4	BIT3	BIT2	BIT1	BIT0
Not used								\$8	\$7	\$6	\$5	\$4	\$3	\$2	\$1

PLC input signal	Part system that outputs signals	Output signal value
Sub part system control: Sub part system processing (SBS: XC4E)	Sub part system	1: ON / 0: OFF
Sub part system control: Caller of sub part system (SBSSY: R619)	Sub part system	System bit of calling part system

When the 1st part system and the 2nd part system are Main part systems and the 3rd part system is Sub part system.

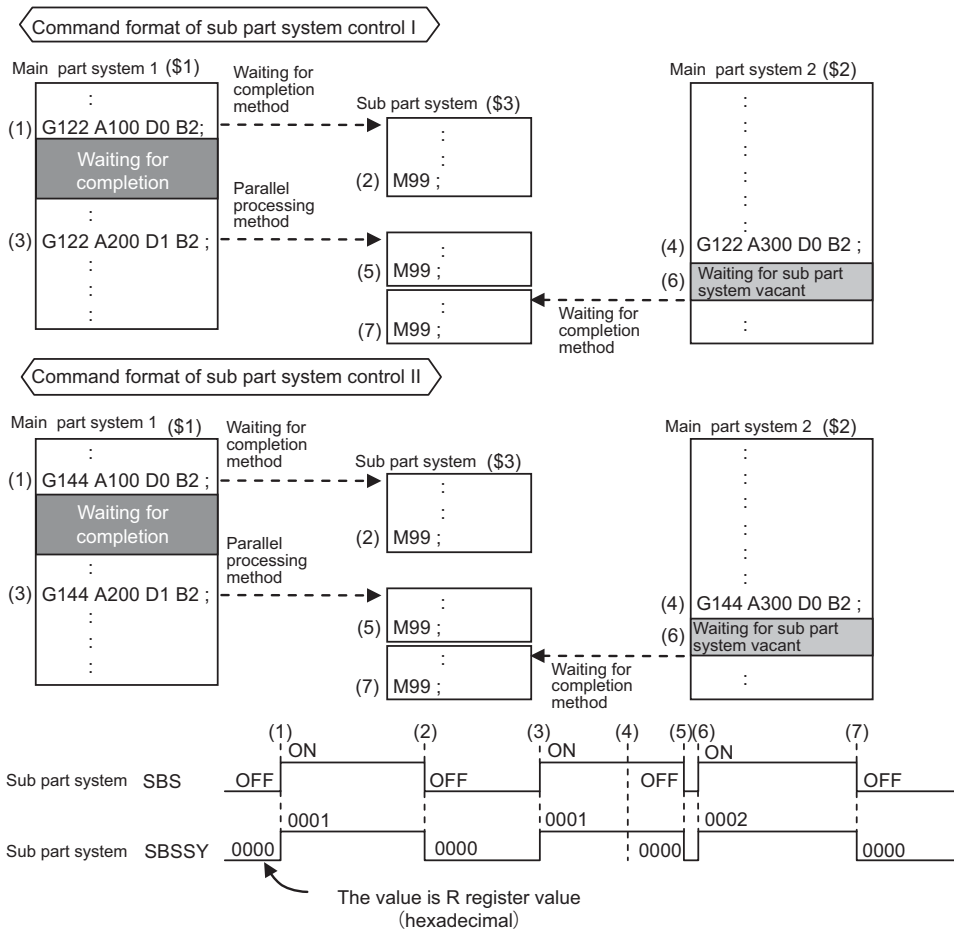

[Related signals]

- (1) Sub part system control: Sub part system processing (SBS: XC4E)

4 Explanation of Interface Signals

Cont.	Signal name	Abbrev.	\$1	\$2	\$3	\$4	\$5	\$6	\$7	\$8
A	CONSTANT TORQUE CONTROL: AXIS UNDER CONSTANT TORQUE/ PROPORTIONAL TORQUE STOPPER CONTROL [M8]		R624	R824	R1024	R1224	R1424	R1624	R1824	R2024

[Function]

With bit data, this signal indicates which axis is under constant torque control or proportional torque stopper control.

BIT	F	E	D	C	B	A	9	8	7	6	5	4	3	2	1	0
Axis	8	7	6	5	4	3	2	1	8	7	6	5	4	3	2	1
	Axis in proportional torque stopper control							Axis in constant torque control								

(Note) The axis bit configuration for part systems are the same as the basic axis configuration.

[Operation]

(1) High-order 8 bits: Axis in proportional torque stopper control

The axis bit corresponding to the axis to which proportional torque stopper control is commanded with the "Proportional torque stopper control request axis" signal (R2620/high-order 8 bits) turns ON.

The axis bit corresponding to the axis for which proportional torque stopper control is canceled with the "Proportional torque stopper control request axis" signal turns OFF.

(2) Low-order 8 bits: Axis in torque constant control

The axis bit corresponding the axis to which constant torque control is commanded with the "Constant torque control request axis" signal (R2620/low-order 8 bits) turns ON.

The axis bit corresponding the axis for which constant torque control is canceled with the "Constant torque control request axis" signal turns OFF.

[Related signals]

(1) Constant torque control: Constant torque/proportional torque stopper control request axis (R2620)

Cont.	Signal name	Abbrev.	\$1	\$2	\$3	\$4	\$5	\$6	\$7	\$8
A	CONSTANT TORQUE CONTROL: CONSTANT TORQUE DROOP CANCEL AXIS STATUS [M8]		R625	R825	R1025	R1225	R1425	R1625	R1825	R2025

[Function]

With bit data, this signal indicates the axis for which constant torque droop cancellation is being executed or the axis for which constant torque droop cancellation is completed.

BIT	F	E	D	C	B	A	9	8	7	6	5	4	3	2	1	0
Axis	8	7	6	5	4	3	2	1	8	7	6	5	4	3	2	1
	Axis for which constant torque droop cancellation is completed							Axis for which constant torque droop cancellation is being executed								

(Note) The axis bit configuration for part systems are the same as the basic axis configuration.

[Operation]

(1) High-order 8 bits: Axis for which constant torque droop cancellation is completed

The axis bit corresponding to the axis for which droop cancellation commanded with the "Constant torque droop cancel request axis" signal (R2621/high-order 8 bits) is completed turns ON.

When the axis bit of the "Constant torque droop cancel request axis" signal turns OFF, the corresponding axis bit of this signal turns OFF.

(2) Lower-order 8 bits: Axis for which constant torque droop cancellation is being executed

The axis bit corresponding to the axis for which droop cancellation commanded with the "Constant torque droop cancel request axis" signal (R2621/low-order 8 bits) is being executed turns ON.

When the axis bit of the "Constant torque droop cancel request axis" signal turns OFF, the corresponding axis bit of this signal turns OFF.

[Related signals]

(1) Constant torque control: Constant torque droop cancel request axis (R2621)

4 Explanation of Interface Signals

Cont.	Signal name	Abbrev.	\$1	\$2	\$3	\$4	\$5	\$6	\$7	\$8
A	TOOL LIFE USAGE DATA		R628,9	R828,9	R1028,9	R1228,9	R1428,9	R1628,9	R1828,9	R2028,9

[Function][Operation]

This signal output usage data of tools currently being used with the tool life management II. (When multiple compensation Nos. are used, the total usage data per compensation No. is output.)

Cont.	Signal name	Abbrev.	\$1	\$2	\$3	\$4	\$5	\$6	\$7	\$8
A	NUMBER OF REGISTERED TOOL LIFE CONTROL TOOLS		R630	R830	R1030	R1230	R1430	R1630	R1830	R2030

[Function] [Operation]

This signal indicates number of tools currently in life management.

Cont.	Signal name	Abbrev.	\$1	\$2	\$3	\$4	\$5	\$6	\$7	\$8
A	CIRCULAR FEED IN MANUAL MODE CURRENT POSITION H [M8]		R636,7	R836,7	R1036,7	R1236,7	R1436,7	R1636,7	R1836,7	R2036,7
A	CIRCULAR FEED IN MANUAL MODE CURRENT POSITION V [M8]		R640,1	R840,1	R1040,1	R1240,1	R1440,1	R1640,1	R1840,1	R2040,1

[Function]

The current positions of H' and V' axes on the hypothetical coordinate are set when the circular feed in manual mode is valid.

[Operation]

The current positions of H' and V' axes on the hypothetical coordinate are set while the "Circular feed in manual mode valid" signal is ON.

In the "circular-linear" mode, the current position of H' on the hypothetical coordinate is set by the angle (0.000° to 360.000°) from the basic point.

The hypothetical coordinate value to be set is in the following state.

"Linear-linear" hypothetical coordinate	V' axis: mirror image is not valid
"Circular-linear" hypothetical coordinate	H' axis: "+" indicates the inverse (CW) direction V' axis: mirror image is not valid

[Caution]

- (1) This data is valid only when the "Circular feed in manual mode being valid" signal is ON. If the signal is OFF, the current position data is uncertain. (The value is not ensured.)
- (2) The current positions are output with "0.5*PLC setting unit".
- (3) When "1" is set to the parameter "#1040 M_inch", this data is output by inch.

[Related signals]

- (1) In circular feed in manual mode (XC4F)

Cont.	Signal name	Abbrev.	\$1	\$2	\$3	\$4	\$5	\$6	\$7	\$8
A	THREAD RECUTTING STATUS		R648	R848	R1048	R1248	R1448	R1648	R1848	R2048

[Function]

This signal indicates the status of operation commanded with the "Thread recutting command" signal.

When the thread recutting operation from the ladder (#1258 set30/bit4 = 1) is selected, the NC outputs the status of thread recutting operation to this signal.

The status is not output when the thread recutting operation from the CNC screen (#1258 set30/bit4 = 0) is selected.

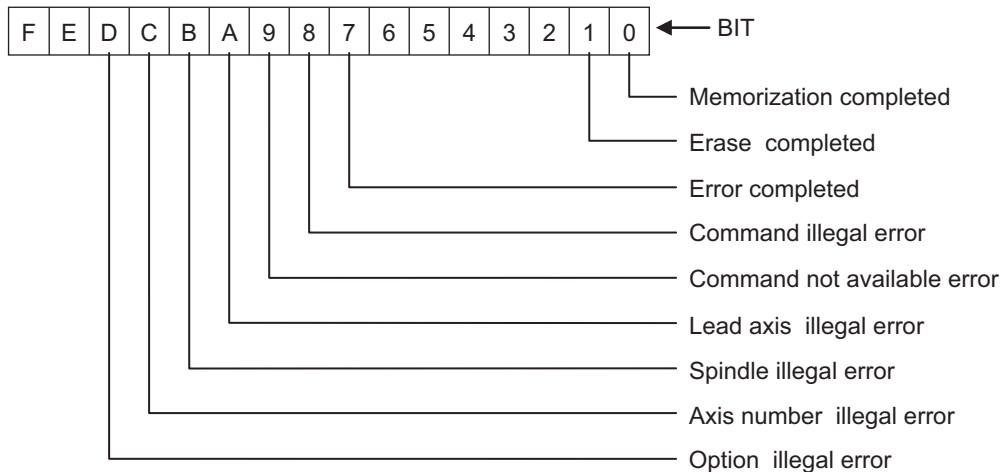
**[Operation]**

BIT0 [memory completed]:

This bit turns ON after the "memory" operation commanded with the "Thread recutting command" (R2626) signal is normally completed.

BIT1 [erase completed]:

This bit turns ON after the "erase" operation commanded with the "Thread recutting command" (R2626) signal is normally completed.

BIT7 [error completed]:

This bit turns ON when the "memory" or "erase" operation commanded with the "Thread recutting command" (R2626) signal is not normally completed.

BIT8 [command illegal error]:

This bit turns ON when operation was executed while both "memory" and "erase" of the "Thread recutting command" (R2626) signal are OFF or ON.

BIT9 [command unavailable error]:

This bit turns ON when conditions are not met to execute "memory" or "erase" operation commanded with the "Thread recutting command" (R2626) signal.

BITA [lead axis illegal error]:

This bit turns ON if the lead axis coordinates is not established when the "memory" operation is commanded with the "Thread recutting command" (R2626) signal.

BITA [spindle illegal error]:

This bit turns ON if the spindle has not rotated at least one revolution after power ON when "memory" operation is commanded with the "Thread recutting command" (R2626) signal.

BITC [axis number illegal error]:

This bit turns ON if the lead axis number or spindle number is "0" or larger than the number of connected axes when the "memory" operation is commanded with the "Thread recutting command" (R2626) signal.

BITD [Option illegal error]:

This bit turns ON if the optional specification of thread recutting is disabled when the "memory" or "erase" operation is commanded with the "Thread recutting command" (R2626) signal.

4 Explanation of Interface Signals

- (1) The bits of this signal turn ON only when bit7 (Command execution) of the "Thread recutting command" signal (R2626) is ON.
- (2) All bits of this signal turn OFF at the falling edge of bit7 (Command execution) of the "Thread recutting command" signal (R2626). Other signals such as a resetting signal cannot be used to turn this signal OFF.

[Related signals]

- (1) Thread recutting command (R2626)
- (2) Thread recutting spindle No. (R650)
- (3) Thread recutting lead axis No. (R651)

Cont.	Signal name	Abbrev.	\$1	\$2	\$3	\$4	\$5	\$6	\$7	\$8
A	THREAD RECUTTING EXECUTION STATUS		R649	R849	R1049	R1249	R1449	R1649	R1849	R2049

[Function]

This signal indicates whether thread recutting can be executed or not.
 When the thread recutting operation from the ladder (#1258 set30/bit4 = 1) is selected, the NC outputs the status of thread recutting operation to this signal.
 The status is not output when the thread recutting operation from the CNC screen (#1258 set30/bit4 = 0) is selected.

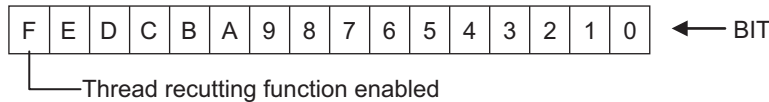

[Operation]

BITF [Thread recutting function enabled]:
 Thread recutting is performed if you execute thread cutting while this bit is ON.
 This bit turns ON when BITF of the "Thread recutting execution operation" (R2627) signal is input and the data required to execute thread recutting is stored in the memory.

[Related signals]

- (1) Thread recutting execution operation (R2627)

Cont.	Signal name	Abbrev.	\$1	\$2	\$3	\$4	\$5	\$6	\$7	\$8
A	THREAD RECUTTING SPINDLE NO.		R650	R850	R1050	R1250	R1450	R1650	R1850	R2050

[Function][Operation]

With binary data, this signal outputs the spindle number for which the position within one spindle revolution is memorized.

- 0 : Not memorized
- 1 : 1st spindle / 1st axis
- 2 : 2nd spindle / 2nd axis
- 3 : 3rd spindle / 3rd axis
- ⋮
- (up to the number of connected axes)

When the thread recutting operation from the ladder (#1258 set30/bit4 = 1) is selected, the NC outputs the status of thread recutting operation to this signal.

The status is not output when the thread recutting operation from the CNC screen (#1258 set30/bit4 = 0) is selected.

[Related signals]

- (1) Encoder selection (R2567)
- (2) Thread recutting command (R2626)

Cont.	Signal name	Abbrev.	\$1	\$2	\$3	\$4	\$5	\$6	\$7	\$8
A	THREAD RECUTTING LEAD AXIS NO.		R651	R851	R1051	R1251	R1451	R1651	R1851	R2051

[Function][Operation]

With binary data, this signal outputs the lead axis number for which the lead axis coordinates is memorized.

0 : Not memorized

1 : 1st spindle / 1st axis

2 : 2nd spindle / 2nd axis

3 : 3rd spindle / 3rd axis

:

(up to the number of connected axes)

This signal needs to be set from the ladder when the thread recutting operation from the ladder ("#1258 set30/bit4" is set to "1") is selected.

When the thread recutting operation on the CNC screen ("#1258 set30/bit4" is set to "0") is selected, thread recutting operation is disabled even if this signal is set.

[Related signals]

(1) Encoder selection (R2567)

(2) Thread recutting command (R2626)

4 Explanation of Interface Signals

Cont.	Signal name	Abbrev.	\$1	\$2	\$3	\$4	\$5	\$6	\$7	\$8
A	ROTARY AXIS CONFIGURATION PARAMETER OUTPUT	RPAROUT	R656	R856	R1056	R1256	R1456	R1656	R1856	R2056

[Function]

This signal notifies configuration No. and switching status for the rotary axis configuration parameter that is being applied.

[Operation]

- (1) Low-order 8 bits: Configuration No. of rotary axis configuration parameter
 This notifies the configuration No. of the rotary axis configuration parameter that is being applied.
 "0" is notified when there are no applicable rotary axis configuration parameters.
- (2) High-order 8 bits: Switching status of rotary axis configuration parameter
 This notifies the switching status of rotary axis configuration parameter.
 When switching the rotary axis configuration parameters after the "Rotary axis configuration parameter switch request signal" is completed, "Rotary axis configuration parameter switch completion signal (bit8)" is turned ON. By turning OFF the "Rotary axis configuration parameter switch request signal", "Rotary axis configuration parameter switch completion signal" will also be turned OFF.

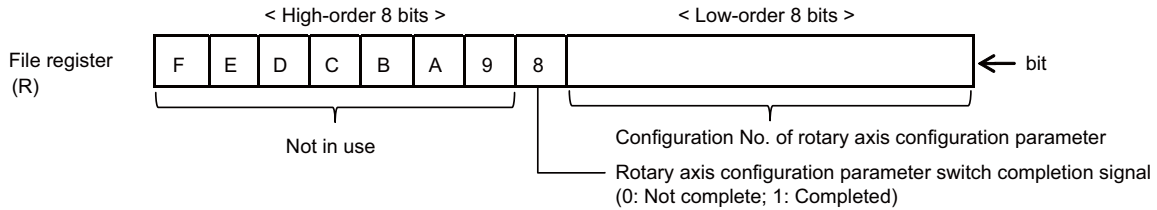

(Note 1) Regardless of the setting of the parameter "#1450 5axis_Spec/bit2 (Application of rotary axis configuration parameters)", "Configuration No. of rotary axis configuration parameter" (R656/low-order 8 bits) is output. However, "Rotary axis configuration parameter switch completion signal" (R656/bit8) is turned ON only when "#1450 5axis_Spec/bit2" is specified to "1" (PLC signal method).

[Timing chart]

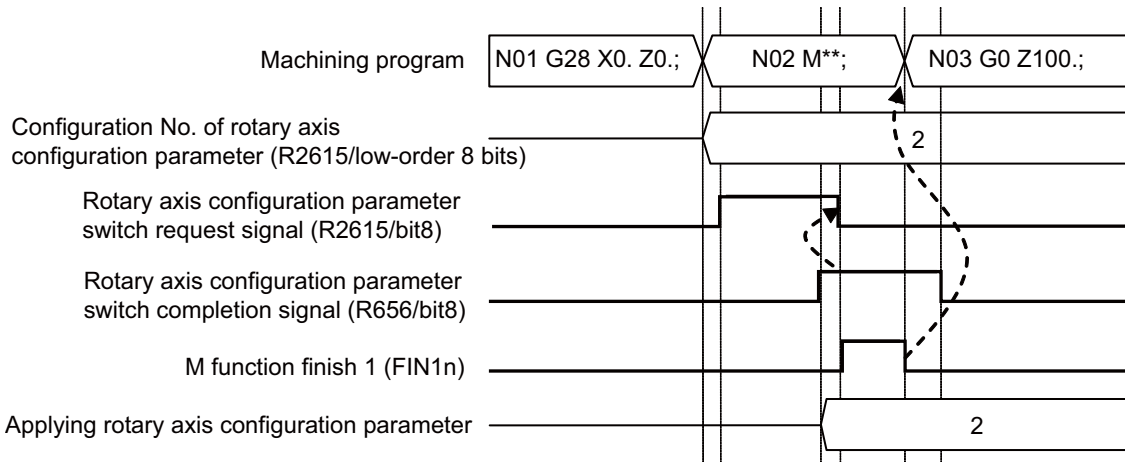

[Related signals]

- (1) Rotary axis configuration parameter switch (RPARCHG: R2615)

4 Explanation of Interface Signals

Cont.	Signal name	Abbrev.	\$1	\$2	\$3	\$4	\$5	\$6	\$7	\$8
A	R-NAVI: SELECTED WORKPIECE NO. [M8]	RSWRK	R660	R860	R1060	R1260	R1460	R1660	R1860	R2060

[Function]

These signals notify the workpiece No. of the machining surface being selected by the R-Navi function.

[Operation]

These signals are set when:

- (1) A machining surface is selected on [Surface Selection] of the Monitor screen.

These signals are cleared when:

- (1) The machining surface is cancelled.
- (2) The machining surface is cancelled with emergency stop.

(Note) These signals will not be set while a machining surface is being called by a program.

[Related signals]

- (1) R-Navi: machining surface being selected (RSSCT:XD28)

Cont.	Signal name	Abbrev.	\$1	\$2	\$3	\$4	\$5	\$6	\$7	\$8
A	R-NAVI: SELECTED MACHINING SURFACE NO. [M8]	RSSRF	R661	R861	R1061	R1261	R1461	R1661	R1861	R2061

[Function]

These signals notify the surface No. of the machining surface being selected by the R-Navi function.

[Operation]

These signals are set when:

- (1) A machining surface is selected on [Surface Selection] of the Monitor screen.

These signals are cleared when:

- (1) The machining surface is cancelled.
- (2) The machining surface is cancelled with emergency stop.

(Note) These signals will not be set while a machining surface is being called by a program.

[Related signals]

- (1) R-Navi: machining surface being selected (RSSCT:XD28)

Cont.	Signal name	Abbrev.	\$1	\$2	\$3	\$4	\$5	\$6	\$7	\$8
A	INTERFERENCE CHECK III: ENTRY IN INTERFERENCE WARN AREA SOLID INFORMATION [M8]	ITF3CH WGSLD	R670,1	R870,1	R1070,1	R1270,1	R1470,1	R1670,1	R1870,1	R2070,1

[Function][Operation]

This signal notifies the solid which has entered the interference warning area at the occurrence of the operation alarm (M03 0003).

This signal notifies the interfering object definition information (the interfering object No. (high 8bits) and configured solid No. (low 8bits) of the interfering objects) for the pair of interfering objects in which interference has occurred.

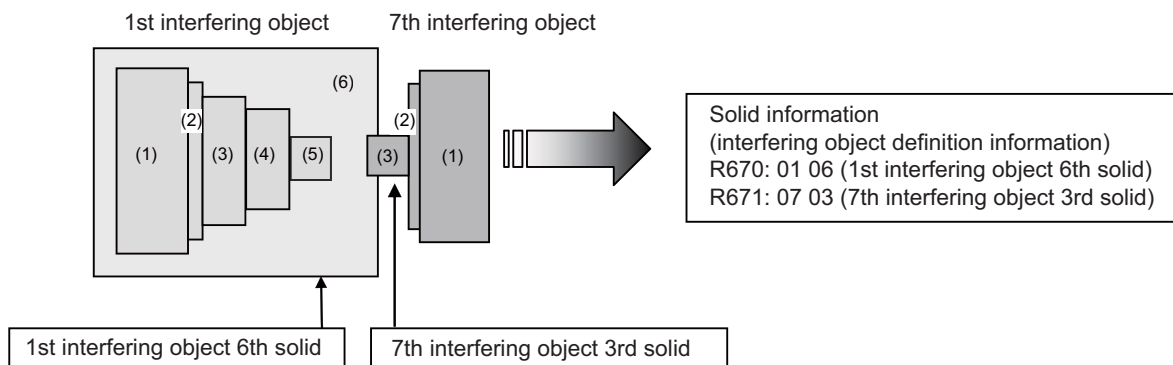

* If more than one solid enters the interference warning area, this signal notifies the interfering object No. and configured solid No. of the interfering object which has first entered the interference warning area.

4 Explanation of Interface Signals

Cont.	Signal name	Abbrev.	\$1	\$2	\$3	\$4	\$5	\$6	\$7	\$8
A	INTERFERENCE CHECK III: INTERFERENCE DETECTION SOLID INFORMATION [M8]	ITF3CHA LSLD	R672,3	R872,3	R1072,3	R1272,3	R1472,3	R1672,3	R1872,3	R2072,3

[Function][Operation]

This signal notifies the solid for which the entry to the interference alarm area has been detected at the occurrence of the operation alarm (M03 0001).

This signal notifies the interfering object definition information (the interfering object No. (high 8bits) and configured solid No. (low 8bits) of the interfering objects) for the pair of interfering objects in which interference has occurred.

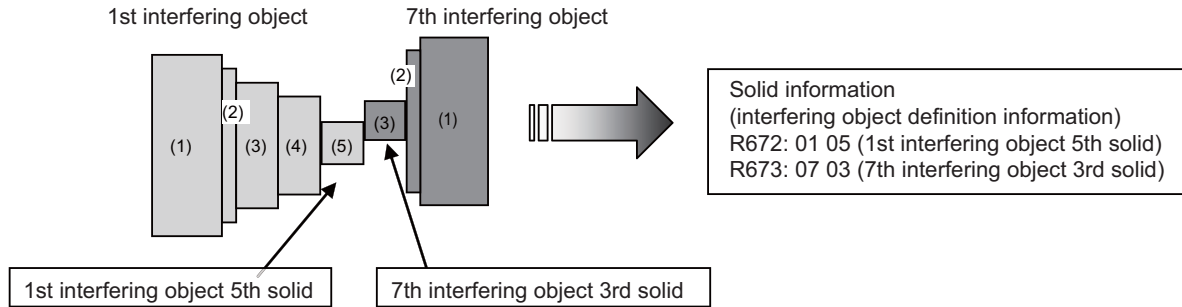

* If the entry of more than one solid to the interfering alarm area has been detected, this signal notifies the interfering object No. and configured solid No. of the interfering object which has first entered the interfering alarm area.

Cont.	Signal name	Abbrev.	\$1	\$2	\$3	\$4	\$5	\$6	\$7	\$8
A	INTERFERENCE CHECK III: ENTRY IN INTERFERENCE ALARM AREA SOLID INFORMATION [M8]	ITF3- TRALSL D	R674,5	R874,5	R1074,5	R1274,5	R1474,5	R1674,5	R1874,5	R2074,5

[Function][Operation]

This signal notifies the solid which has entered the interference alarm area at the occurrence of the operation alarm (M03 0002).

This signal notifies the interfering object definition information (the interfering object No. (high 8bits) and configured solid No. (low 8bits) of the interfering objects) for the pair of interfering objects in which interference has occurred.

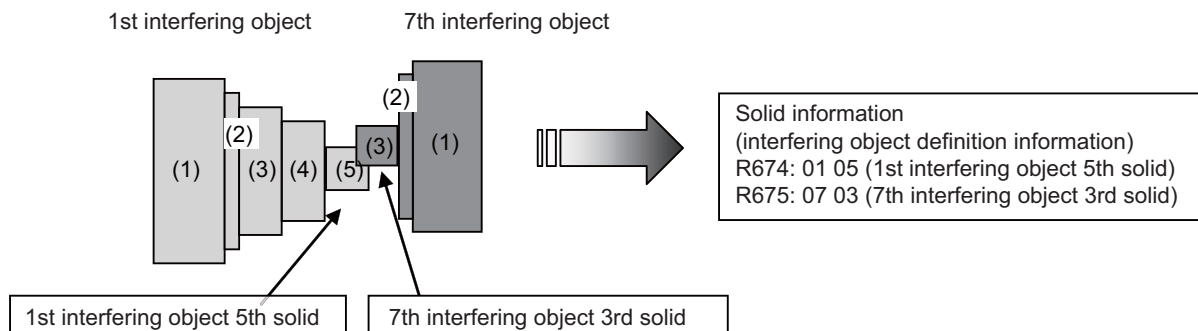

* If more than one solid enters the interference alarm area, this signal notifies the interfering object No. and configured solid No. of the interfering object which has first entered the interference alarm area.

4 Explanation of Interface Signals

Cont.	Signal name	Abbrev.	Common(\$)
A	3D MACHINE INTERFERENCE CHECK : REQUESTED SHAPE GROUP NO. 1 to 4 [M8]		R2400 to 3

[Function]

This signal outputs the No. of shape group which has been selected as the target of 3D machine interference check on the shape selection screen.

[Operation]

This signal is updated when the target shape group is changed on the shape selection screen.

Change of the "Requested shape group No." does not affect the interference check.

To reflect the "Requested shape group No." in the interference check, update the "3D Machine Interference Check : Enabled shape group No."

(Note 1) Shapes defined in Group 1 are within the scope of the interference check, but those of Groups 2 to 4 are outside that scope.

[Related signals]

(1) 3D Machine Interference Check : Enabled shape group No. (R4400)

Cont.	Signal name	Abbrev.	\$1	\$2	\$3	\$4
A	MACHINE POSITION n-TH AXIS		R4500,1 to R4528,9	R4532,3 to R4560,1	R4564,5 to R4592,3	R4596,7 to R4624,5

[Function]

This signal outputs the position (n-th axis) on the machine coordinate system by the PLC setting unit.

Cont.	Signal name	Abbrev.	\$1	\$2	\$3	\$4
A	FEEDBACK MACHINE POSITION n-TH AXIS		R4628,9 to R4656,7	R4660,1 to R4688,9	R4692,3 to R4720,1	R4724,5 to R4552,3

[Function]

This signal outputs motor feedback position (n-th axis) on the machine coordinate system by the PLC setting unit.

Cont.	Signal name	Abbrev.	\$1	\$2	\$3	\$4
A	SERVO DEFLECTION AMOUNT n-TH AXIS		R4756 to 71	R4772 to 87	R4788 to 803	R4804 to 19

[Function]

The deflection amount of the servo n-th axis is output always in the command unit.

[Operation]

Servo 1st part system 1st axis: R4756 (LOW) R4757 (HIGH)

:

Servo 1st part system 8th axis: R4770 (LOW) R4771 (HIGH)

Servo 2nd part system 1st axis: R4772 (LOW) R4773 (HIGH)

:

Servo 2nd part system 8th axis: R4786 (LOW) R4787 (HIGH)

4 Explanation of Interface Signals

Cont.	Signal name	Abbrev.	\$1	\$2	\$3	\$4
A	MOTOR ROTATION SPEED n-TH AXIS		R4820,1 to R4834,5	R4836,7 to R4850,1	R4852,3 to R4866,7	R4868,9 to R4882,3

[Function]

This signal outputs motor rotation speed (n-th axis) with r/min.

[Operation]

The motor rotation speed is assigned as below.

Signal name	File register			
	\$1	\$2	\$3	\$4
Motor rotation speed 1st axis	R4820,1	R4836,7	R4852,3	R4868,9
Motor rotation speed 2nd axis	R4822,3	R4838,9	R4854,5	R4870,1
Motor rotation speed 3rd axis	R4824,5	R4840,1	R4856,7	R4872,3
Motor rotation speed 4th axis	R4826,7	R4842,3	R4858,9	R4874,5
Motor rotation speed 5th axis	R4828,9	R4844,5	R4860,1	R4876,7
Motor rotation speed 6th axis	R4830,1	R4846,7	R4862,3	R4878,9
Motor rotation speed 7th axis	R4832,3	R4848,9	R4864,5	R4880,1
Motor rotation speed 8th axis	R4834,5	R4850,1	R4866,7	R4882,3

Cont.	Signal name	Abbrev.	\$1	\$2	\$3	\$4
A	MOTOR LOAD CURRENT n-TH AXIS		R4884,5 to R4898,9	R4900,1 to R4914,5	R4916,7 to R4930,1	R4932,3 to R4946,7

[Function]

This signal outputs motor load current (n-th axis) with continuous current (%) during stalling.

[Operation]

The motor load current is assigned as below.

Signal name	File register			
	\$1	\$2	\$3	\$4
Motor load current 1st axis	R4884,5	R4900,1	R4916,7	R4932,3
Motor load current 2nd axis	R4886,7	R4902,3	R4918,9	R4934,5
Motor load current 3rd axis	R4888,9	R4904,5	R4920,1	R4936,7
Motor load current 4th axis	R4890,1	R4906,7	R4922,3	R4938,9
Motor load current 5th axis	R4892,3	R4908,9	R4924,5	R4940,1
Motor load current 6th axis	R4894,5	R4910,1	R4926,7	R4942,3
Motor load current 7th axis	R4896,7	R4912,3	R4928,9	R4944,5
Motor load current 8th axis	R4898,9	R4914,5	R4930,1	R4946,7

Cont.	Signal name	Abbrev.	\$1	\$2	\$3	\$4
A	SKIP COORDINATE POSITION n-TH AXIS		R4948,9 to R4976,7	R4980,1 to R5008,9	R5012,3 to R5040,1	R5044,5 to R5072,3

[Function]

This signal outputs skip coordinate position Y (n-th axis) with PLC setting unit.

4 Explanation of Interface Signals

Cont.	Signal name	Abbrev.	\$1	\$2	\$3	\$4
A	SYNCHRONOUS ERROR AMOUNT n-TH AXIS		R5076,7 to R5090,1	R5092,3 to R5106,7	R5108,9 to R5122,3	R5124,5 to R5138,9

[Function]

The synchronization error amount during the synchronous control is output. (Unit: command unit)

[Operation]

The synchronization error amount between the reference axis and synchronized axis during the synchronous control is output to the synchronized axis.

(The axis Nos. are not for each part system, but for the entire system.)

Synchronization error amount	R register	Synchronization error amount	R register
1st axis	R5076(L)/R5077(H)	17th axis	R5108(L)/R5109(H)
2nd axis	R5078(L)/R5079(H)	18th axis	R5110(L)/R5111(H)
3rd axis	R5080(L)/R5081(H)	19th axis	R5112(L)/R5113(H)
4th axis	R5082(L)/R5083(H)	20th axis	R5114(L)/R5115(H)
5th axis	R5084(L)/R5085(H)	21st axis	R5116(L)/R5117(H)
6th axis	R5086(L)/R5087(H)	22nd axis	R5118(L)/R5119(H)
7th axis	R5088(L)/R5089(H)	23rd axis	R5120(L)/R5121(H)
8th axis	R5090(L)/R5091(H)	24th axis	R5122(L)/R5123(H)
9th axis	R5092(L)/R5093(H)	25th axis	R5124(L)/R5125(H)
10th axis	R5094(L)/R5095(H)	26th axis	R5126(L)/R5127(H)
11th axis	R5096(L)/R5097(H)	27th axis	R5128(L)/R5129(H)
12th axis	R5098(L)/R5099(H)	28th axis	R5130(L)/R5131(H)
13th axis	R5100(L)/R5101(H)	29th axis	R5132(L)/R5133(H)
14th axis	R5102(L)/R5103(H)	30th axis	R5134(L)/R5135(H)
15th axis	R5104(L)/R5105(H)	31st axis	R5136(L)/R5137(H)
16th axis	R5106(L)/R5107(H)	32nd axis	R5138(L)/R5139(H)

[Related signals]

- (1) Synchronous control request (SYNC1 to 8: YA80 to 7)
- (2) Superimposition control request (PILE1 to 8: YAA0 to 7)

Cont.	Signal name	Abbrev.	\$1	\$2	\$3	\$4
A	SERVO ALARM/WARNING NO.		R5332 to R5339	R5340 to R5347	R5348 to R5355	R5356 to R5363

[Function]

This signal indicates the alarm No./warning No. of servo drive unit. (hexadecimal 2 digits)

This signal sets the 4-digit alarm No. which is displayed on the NC screen.

[Operation]

This signal is set up when the alarm/waring occurs in the servo drive unit.

This signal will be cleared when the alarm/warning is canceled.

This signal is not set if the servo warning "S52 00E6" (Control axis detachment warning) or "S52 00E7" (In NC emergency stop state) occurs.

If more than one alarm/warning occurs, the value displayed in the [LED display] of [Drv mon]-[Servo unit] screen is set.

[Related signals]

- (1) NC warning (servo warning) (XC9C)

Cont.	Signal name	Abbrev.	\$1	\$2	\$3	\$4
A	SKIP COORDINATE POSITION n-TH AXIS FEATURE COORDINATE		R5364,5 to R5392,3	R5396,7 to R5424,5	R5428,9 to R5456,7	R5460,1 to R5488,9

[Function]

This signal outputs skip coordinate position (n-th axis) by the PLC setting unit.

4 Explanation of Interface Signals

Cont.	Signal name	Abbrev.	\$1	\$2	\$3	\$4
A	Load monitoring I: Cutting torque output n-th axis [M8]		R5492 to R5499	R5500 to R5507	R5508 to R5515	R5516 to R5523

[Function]

The cutting torque (estimated disturbance torque) of the servo axis is output to this signal.

The content to be output is specified with the parameter "#1232 set04/bit0".

When "#1232/bit0" is set to "1", the estimated disturbance torque is output.

For the drive axes (vertical axes), the unbalance torque offset (setting value of the parameter "#2232 SV032") is contained.

[Operation]

The cutting torque (estimated disturbance torque) is output to this signal.

Output unit: Stall current %

A value "0x64" is output when the cutting torque (estimated disturbance torque) reaches 100%.

A value "0xFFFF" is output when the cutting torque (estimated disturbance torque) reaches -1%.

R5492	Cutting torque (estimated disturbance torque) output 1st axis
R5493	Cutting torque (estimated disturbance torque) output 2nd axis
R5494	Cutting torque (estimated disturbance torque) output 3rd axis
R5495	Cutting torque (estimated disturbance torque) output 4th axis
R5496	Cutting torque (estimated disturbance torque) output 5th axis
R5497	Cutting torque (estimated disturbance torque) output 6th axis
R5498	Cutting torque (estimated disturbance torque) output 7th axis
R5499	Cutting torque (estimated disturbance torque) output 8th axis

[Related signals]

- (1) Load monitoring I: Axis selection (R2580)
- (2) Load monitoring I: Effective torque output n-th axis (R5620)
- (3) Load monitoring I: Estimated spindle disturbance torque output (R6541)
- (4) Load monitoring I: Effective spindle torque output (R6542)

Cont.	Signal name	Abbrev.	\$1	\$2	\$3	\$4
A	LOAD MONITOR I : EFFECTIVE TORQUE OUTPUT n-TH AXIS [M8]		R5620 to R5627	R5628 to R5635	R5636 to R5643	R5644 to R5651

[Function]

The effective torque of the servo axis is output to these devices.

[Operation]

The effective torque of the servo axis is output to this signal.

R5620	Effective torque output 1st axis
R5621	Effective torque output 2nd axis
R5622	Effective torque output 3rd axis
R5623	Effective torque output 4th axis
R5624	Effective torque output 5th axis
R5625	Effective torque output 6th axis
R5626	Effective torque output 7th axis
R5627	Effective torque output 8th axis

[Related signals]

- (1) Load monitor I : Axis selection (R2580)
- (2) Load monitoring I: Cutting torque output n-th axis (R5492)
- (3) Load monitoring I: Estimated spindle disturbance torque output (R6541)
- (4) Load monitor I : Effective spindle torque output (R6542)

4 Explanation of Interface Signals

Cont.	Signal name	Abbrev.	\$1	\$2	\$3	\$4	\$5	\$6	\$7	\$8
A	USER MACRO OUTPUT #1132 (NC -> PLC)		R6372,3	R6380,1	R6388,9	R6396,7	R6404,5	R6412,3	R6420,1	R6428,9

[Function]

This is interface function used to coordinate user PLC to user macro.

[Operation]

When a value is set in the system variables #1100 to #1131 or #1132 with the user macro system, the user PLC output to the file register Rn and Rn+1 corresponding to the user PLC can be referred to with that value.

The relationship between system variable and file register is as follows:

System variable	Points	Interface output signal	System variable	Points	Interface output signal
#1100	1	Register R6372 bit 0	#1116	1	Register R6373 bit 0
#1101	1	Register R6372 bit 1	#1117	1	Register R6373 bit 1
#1102	1	Register R6372 bit 2	#1118	1	Register R6373 bit 2
#1103	1	Register R6372 bit 3	#1119	1	Register R6373 bit 3
#1104	1	Register R6372 bit 4	#1120	1	Register R6373 bit 4
#1105	1	Register R6372 bit 5	#1121	1	Register R6373 bit 5
#1106	1	Register R6372 bit 6	#1122	1	Register R6373 bit 6
#1107	1	Register R6372 bit 7	#1123	1	Register R6373 bit 7
#1108	1	Register R6372 bit 8	#1124	1	Register R6373 bit 8
#1109	1	Register R6372 bit 9	#1125	1	Register R6373 bit 9
#1110	1	Register R6372 bit 10	#1126	1	Register R6373 bit 10
#1111	1	Register R6372 bit 11	#1127	1	Register R6373 bit 11
#1112	1	Register R6372 bit 12	#1128	1	Register R6373 bit 12
#1113	1	Register R6372 bit 13	#1129	1	Register R6373 bit 13
#1114	1	Register R6372 bit 14	#1130	1	Register R6373 bit 14
#1115	1	Register R6372 bit 15	#1131	1	Register R6373 bit 15

System variable	Points	Interface output signal
#1132	32	Register R6372, R6373
#1133	32	Register R6374, R6375
#1134	32	Register R6376, R6377
#1135	32	Register R6378, R6379

This correspondence table shows the example for file registers R6372 and R6373.

File registers R6372 and R6373 correspond to system variables #1100 to #1131, and #1132 (32-bit data).

To use the R register of the 2nd and subsequent part system, set "#1230 set02/bit7" to "1".

[Related signals]

- (1) User macro output #1133, #1134, #1135 (R6374/6375, R6376/6377, R6378/6379)
- (2) User macro input #1032, #1033, #1034, #1035 (R6436/6437, R6438/6439, R6440/6441, R6442/66443)

4 Explanation of Interface Signals

Cont.	Signal name	Abbrev.	\$1	\$2	\$3	\$4	\$5	\$6	\$7	\$8
A	USER MACRO OUTPUT #1133 (NC -> PLC)		R6374,5	R6382,3	R6390,1	R6398,9	R6406,7	R6414,5	R6422,3	R6430,1

[Function]

This provides interface function used to coordinate user PLC to user macro.

[Operation]

When a value is set in the system variable #1133 with the user macro system, the user PLC output to the file register Rn and Rn+1 corresponding to the user PLC can be referred to with that value.

(Example)

User macro program

Sequence program

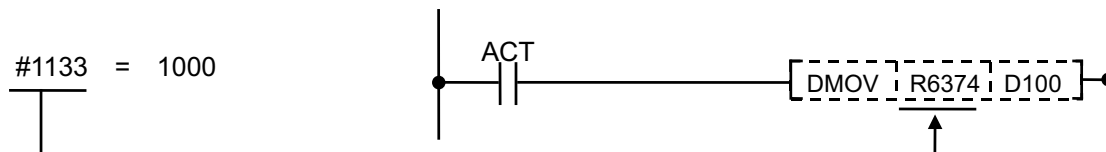

1000 is input in D100 and 101 when the ACT signal turns ON.

[Related signals]

- (1) User macro output #1132, #1134, #1135, #1100 to #1131 (R6372/6373, R6376/6377, R6378/6379)
- (2) User macro input #1032, #1033, #1034, #1035, #1000 to #1031 (R6436/6437, R6438/6439, R6440/6441, R6442/6443)

Cont.	Signal name	Abbrev.	\$1	\$2	\$3	\$4	\$5	\$6	\$7	\$8
A	USER MACRO OUTPUT #1134 (NC -> PLC)		R6376,7	R6384,5	R6392,3	R6400,1	R6408,9	R6416,7	R6424,5	R6432,3

[Function][Operation]

The function operation, etc. are the same as those of "USER MACRO OUTPUT #1133".

Cont.	Signal name	Abbrev.	\$1	\$2	\$3	\$4	\$5	\$6	\$7	\$8
A	USER MACRO OUTPUT #1135 (NC -> PLC)		R6378,9	R6386,7	R6394,5	R6402,3	R6410,1	R6418,9	R6426,7	R6434,5

[Function][Operation]

The function operation, etc. are the same as those of "USER MACRO OUTPUT #1133".

4 Explanation of Interface Signals

Cont.	Signal name	Abbrev.	\$1	\$2	\$3	\$4	\$5	\$6	\$7	\$8
A	SPINDLE COMMAND ROTATION SPEED INPUT		R6500,1	R6550,1	R6600,1	R6650,1	R6700,1	R6750,1	R6800,1	R6850,1

[Function]

This signal informs that spindle speed reference signal (S) specified in automatic operation (memory, MDI or tape) or by manual numerical data input. "Spindle command rotation input" speed output from the controller is binary data. Under the S command mode, the data can be monitored in the "S display" on the command value screen.

"Spindle command rotation speed input" directly denotes spindle speed (r/min) specified as S function command.

[Operation]

Set "Spindle command rotation speed input" is renewed when:

- "S*" is specified in automatic operation (memory, MDI or tape) and "M function finish 1 or 2" signal (FIN1 or FIN2) or "Gear shift completion" signal (GFIN) is sent back to the controller.
- "S*" is specified by manual numerical command input and "M function finish 1 or 2" signal (FIN1 or FIN2) or "Gear shift completion" signal (GFIN) is sent back to the controller. (Data cannot be cleared by "Reset" or "Emergency stop".)

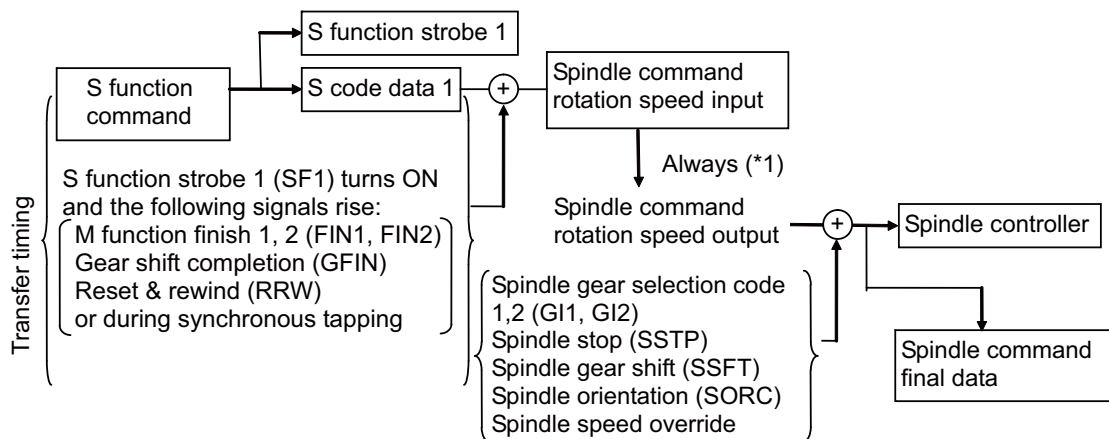

When the system is under constant surface speed control, constant surface speed data is set for "Spindle command rotation speed input".

(*1) For C80, data need to be transferred by the sequence program.

[Related signals]

- Spindle speed command rotation output (R7000, R7001)
- Spindle command final data (R6502, R6503)

Cont.	Signal name	Abbrev.	1stSP	2ndSP	3rdSP	4thSP	5thSP	6thSP	7thSP	8thSP
A	SPINDLE COMMAND FINAL DATA (rotation speed)		R6502,3	R6552,3	R6602,3	R6652,3	R6702,3	R6752,3	R6802,3	R6852,3

[Function]

The command value is indicated to the spindle controller.

[Operation]

The "Spindle command rotation speed input" indicates the value for the spindle function (S) data commanded with the automatic operation or manual numeric value command, whereas this data indicates a value to which the "Spindle override", "Spindle gear selection code 1,2" (G1, G12), "Spindle stop" (SSTP), "Spindle gear shift" (SSFT) and "Spindle orientation" (SORC) conditions have been considered.

[Related signals]

- Spindle command rotation speed input (R6500, 1)
- Spindle command rotation speed output (R7000, 1)

4 Explanation of Interface Signals

Cont.	Signal name	Abbrev.	1stSP	2ndSP	3rdSP	4thSP	5thSP	6thSP	7thSP	8thSP
A	SPINDLE ACTUAL SPEED		R6506,7	R6556,7	R6606,7	R6656,7	R6706,7	R6756,7	R6806,7	R6856,7

[Function]

When the system has spindle equipped with encoder, actual spindle speed can be monitored.

[Operation]

True spindle speed is always set by feedback signal from spindle encoder.

Data are multiplied by 1000, and stored.

Cont.	Signal name	Abbrev.	1stSP	2ndSP	3rdSP	4thSP	5thSP	6thSP	7thSP	8thSP
A	SPINDLE SYNCHRONIZATION PHASE ERROR/HOB AXIS DELAY ANGLE		R6516	R6566	R6616	R6666	R6716	R6766	R6816	R6866

[Function]

The synchronized spindle delay to the reference spindle is output in the spindle synchronized function.

The delay of the workpiece axis to the hob axis is output in the tool spindle synchronization II (Hobbing).

The 1st spindle signal is normally used.

(Note) This signal uses the 1st spindle signal regardless of the hob spindle's number.

[Operation]

The synchronized spindle delay to the reference spindle is output.

The delay of the workpiece axis to the hob axis is output in the tool spindle synchronization II (Hobbing).

Unit: 360° /4096

(Note 1) Refer to the signal of the 1st spindle if "#1440 multi_sp_syn" (Enable multiple sets of spindle synchronization) is "0".

(Note 2) Refer to the signal of the hob axis during hobbing, or refer to the signal of the synchronized spindle during other machinings if "#1440 multi_sp_syn" (Enable multiple sets of spindle synchronization) is "1".

(Note 3) If the phase can not be calculated because, for instance, the reference spindle or synchronized spindle (hob axis or workpiece axis) has not passed the Z-phase, "-1" will be output.

(Note 4) This data is output only during the phase shift calculation or the spindle phase synchronization.

[Related signals]

- (1) Phase shift calculation request (SSPHM:Y18B3)
- (2) Phase offset request (SSPHF:Y18B4)
- (3) Spindle synchronization phase offset data (R6518)
- (4) Spindle synchronization Maximum phase error/Maximum hob axis delay angle (R6517)

4 Explanation of Interface Signals

Cont.	Signal name	Abbrev.	1stSP	2ndSP	3rdSP	4thSP	5thSP	6thSP	7thSP	8thSP
A	SPINDLE SYNCHRONIZATION MAXIMUM PHASE ERROR/ MAXIMUM HOB AXIS DELAY ANGLE		R6517	R6567	R6617	R6667	R6717	R6767	R6817	R6867

[Function]

In spindle synchronization, the maximum value of the phase error between the reference spindle and the synchronized spindle is output.

In tool spindle synchronization II (Hobbing), when the hob axis and work axis rotate in synchronization, the maximum delay (advance) of the hob axis from the commanded position is output by angle.

(Note) This signal uses 1st spindle signal regardless of hob spindle number.

[Operation]

In spindle synchronization, the maximum value of the "Spindle synchronization phase error" (R6516) is output.

In the tool spindle synchronization II (Hobbing), when the hob axis and work axis rotate in synchronization, the maximum delay (advance) of the hob axis from the commanded position is output by angle.

The maximum value output is retained until the next spindle synchronization / tool spindle synchronization II turns ON or until the power turns OFF.

(Note 1) Refer to the signal of the 1st spindle if "#1440 multi_sp_syn" (Enable multiple sets of spindle synchronization) is "0".

(Note 2) Refer to the signal of the hob axis during hobbing, or refer to the signal of the synchronized spindle during other machinings if "#1440 multi_sp_syn" (Enable multiple sets of spindle synchronization) is "1".

[Related signals]

(1) Hob axis delay excess (PHOVR:X18B3)

(2) Spindle synchronization phase error/Hob axis delay angle (R6516)

Cont.	Signal name	Abbrev.	1stSP	2ndSP	3rdSP	4thSP	5thSP	6thSP	7thSP	8thSP
A	SPINDLE SYNCHRONIZATION PHASE OFFSET DATA		R6518	R6568	R6618	R6668	R6718	R6768	R6818	R6868

[Function]

With the spindle phase shift amount calculation function, the phase error of the reference spindle and synchronized spindle is obtained and memorized by turning the PLC signal ON at executing the spindle synchronization. The synchronized spindle can be rotated with the handle during the spindle phase shift calculation, so the phase relation between two spindles can be adjusted by seeing.

If the "Spindle phase synchronous control" (SPPHS) signal is input while the "Phase offset request" signal (SSPHF) is ON, the phase error will be aligned based on the position shifted by the memorized phase shift amount.

Such operation makes the phase alignment easy when clamping a profile material over.

[Operation]

The phase error memorized by the phase shift calculation is output.

Unit: 360°/4096

(Note 1) Refer to the signal of the 1st spindle if "#1440 multi_sp_syn" (Enable multiple sets of spindle synchronization) is "0".

(Note 2) Refer to the signal of the synchronized spindle if "#1440 multi_sp_syn" (Enable multiple sets of spindle synchronization) is "1".

(Note 3) This data is output only during the spindle synchronous control.

[Related signals]

(1) Spindle phase synchronization (SPPHS:Y18B1)

(2) Phase shift calculation request (SSPHM:Y18B3)

(3) Phase offset request (SSPHF:Y18B4)

(4) Spindle synchronization phase error/Hob axis delay angle (R6516)

4 Explanation of Interface Signals

Cont.	Signal name	Abbrev.	1stSP	2ndSP	3rdSP	4thSP	5thSP	6thSP	7thSP	8thSP
A	SPINDLE SYNCHRONIZATION PHASE ERROR MONITOR		R6519	R6569	R6619	R6669	R6719	R6769	R6819	R6869

[Function]

The phase error during the spindle phase synchronous state can be monitored.

[Operation]

The phase error during the spindle phase synchronous control is output by the pulse unit.

(Note 1) Refer to the signal of the 1st spindle if "#1440 multi_sp_syn" (Enable multiple sets of spindle synchronization) is "0".

(Note 2) Refer to the signal of the synchronized spindle if "#1440 multi_sp_syn" (Enable multiple sets of spindle synchronization) is "1".

[Related signals]

- (1) Spindle synchronization phase error monitor (lower limit) (R6520)
- (2) Spindle synchronization phase error monitor (upper limit) (R6521)

Cont.	Signal name	Abbrev.	1stSP	2ndSP	3rdSP	4thSP	5thSP	6thSP	7thSP	8thSP
A	SPINDLE SYNCHRONIZATION PHASE ERROR MONITOR (lower limit)		R6520	R6570	R6620	R6670	R6720	R6770	R6820	R6870

[Function]

The phase error during the spindle phase synchronous state can be monitored.

[Operation]

The lower limit value of the phase error during the spindle phase synchronous control is output by the pulse unit.

(Note 1) Refer to the signal of the 1st spindle if "#1440 multi_sp_syn" (Enable multiple sets of spindle synchronization) is "0".

(Note 2) Refer to the signal of the synchronized spindle if "#1440 multi_sp_syn" (Enable multiple sets of spindle synchronization) is "1".

[Related signals]

- (1) Spindle synchronization phase error monitor (R6519)
- (2) Spindle synchronization phase error monitor (upper limit) (R6521)

Cont.	Signal name	Abbrev.	1stSP	2ndSP	3rdSP	4thSP	5thSP	6thSP	7thSP	8thSP
A	SPINDLE SYNCHRONIZATION PHASE ERROR MONITOR (upper limit)		R6521	R6571	R6621	R6671	R6721	R6771	R6821	R6871

[Function]

The phase error during the spindle phase synchronous state can be monitored.

[Operation]

The upper limit value of the phase error during the spindle phase synchronous control is output by the pulse unit.

(Note 1) Refer to the signal of the 1st spindle if "#1440 multi_sp_syn" (Enable multiple sets of spindle synchronization) is "0".

(Note 2) Refer to the signal of the synchronized spindle if "#1440 multi_sp_syn" (Enable multiple sets of spindle synchronization) is "1".

[Related signals]

- (1) Spindle synchronization phase error monitor (R6519)
- (2) Spindle synchronization phase error monitor (lower limit) (R6520)

4 Explanation of Interface Signals

Cont.	Signal name	Abbrev.	1stSP	2ndSP	3rdSP	4thSP	5thSP	6thSP	7thSP	8thSP
A	SPINDLE SYNCHRONIZATION PHASE ERROR 1		R6522	R6572	R6622	R6672	R6722	R6772	R6822	R6872

[Function]

- (1) During spindle synchronous function (G114.1)

This signal informs the phase error (value including the phase error memorized with the spindle synchronization phase shift calculation function) when the phase synchronization (with R command) or the "Phase shift calculation request" signal (SSPHM) is ON. The phase error is output by 1° increment.

- (2) During phase synchronization of polygon machining between spindles (G114.2)

This signal informs the phase error corresponding to the commanded phase shift amounts by 1° increment.

The data has no meaning in cases other than above.

[Operation]

- (1) During spindle synchronous function (G114.1)

When the phase synchronization (with R command) or the "Phase shift calculation request" signal (SSPHM) is ON, and when the speeds of the reference spindle and the synchronized spindle are constant, the phase error between the reference spindle and the synchronized spindle is output.

- (2) During phase synchronization of polygon machining between spindles (G114.2)

This signal informs the phase error corresponding to the commanded phase shift amounts by 1° increment.

(Note 1) Refer to the signal of the 1st spindle if "#1440 multi_sp_syn" (Enable multiple sets of spindle synchronization) is "0".

(Note 2) Refer to the signal of the synchronized spindle if "#1440 multi_sp_syn" (Enable multiple sets of spindle synchronization) is "1".

[Related signals]

- (1) Phase shift calculation request (SSPHM:Y18B3)

Cont.	Signal name	Abbrev.	1stSP	2ndSP	3rdSP	4thSP	5thSP	6thSP	7thSP	8thSP
A	SPINDLE SYNCHRONIZATION PHASE ERROR 2		R6523	R6573	R6623	R6673	R6723	R6773	R6823	R6873

[Function]

- (1) During spindle synchronous function (G114.1)

This signal informs the phase error (value excluding the phase error memorized with the spindle synchronization phase shift calculation function) when the phase synchronization (with R command) or the "Phase shift calculation request" signal (SSPHM) is ON. The phase error is output by 1° increment.

- (2) During phase synchronization of polygon machining between spindles (G114.2)

This signal informs the phase error corresponding to the commanded phase shift amounts by 1° increment. (Same as R6522.)

The data has no meaning in cases other than above.

[Operation]

- (1) During spindle synchronous function (G114.1)

When the phase synchronization (with R command) or the "Phase shift calculation request" signal (SSPHM) is ON, and when the speeds of the reference spindle and the synchronized spindle are constant, the phase error between the reference spindle and the synchronized spindle is output.

- (2) During phase synchronization of polygon machining between spindles (G114.2)

This signal informs the phase error corresponding to the commanded phase shift amounts by 1° increment. (Same as R6522.)

(Note 1) Refer to the signal of the 1st spindle if "#1440 multi_sp_syn" (Enable multiple sets of spindle synchronization) is "0".

(Note 2) Refer to the signal of the synchronized spindle if "#1440 multi_sp_syn" (Enable multiple sets of spindle synchronization) is "1".

[Related signals]

- (1) Phase shift calculation request (SSPHM:Y18B3)

4 Explanation of Interface Signals

Cont.	Signal name	Abbrev.	1stSP	2ndSP	3rdSP	4thSP	5thSP	6thSP	7thSP	8thSP
A	Spindle motor load ratio		R6525	R6575	R6625	R6675	R6725	R6775	R6825	R6875

[Function]

The spindle load is output with 0.01% increment.

[Operation]

When the parameter "#1256 set28/bit2" is set to "1", the spindle load is output with 0.01% increment. When the parameter "#1256 set28/bit2" is set to "0", "0" is output.

Cont.	Signal name	Abbrev.	1stSP	2ndSP	3rdSP	4thSP	5thSP	6thSP	7thSP	8thSP
A	Spindle temperature output [M8]	SPTTEMP	R6526	R6576	R6626	R6676	R6726	R6776	R6826	R6876

[Function] [Operation]

The spindle motor temperature is output to this register. The temperature is expressed in degrees Celsius (°C). The temperature is output as a signed integer between 0x0000 and 0xFFFF (-32768 (°C) to 32767 (°C)).

Cont.	Signal name	Abbrev.	1stSP	2ndSP	3rdSP	4thSP	5thSP	6thSP	7thSP	8thSP
A	SPINDLE ALARM/WARNING NO.		R6529	R6579	R6629	R6679	R6729	R6779	R6829	R6879

[Function]

This signal indicates the alarm No./warning No. of spindle drive unit. (hexadecimal 2 digits)

This signal sets the 4-digit alarm No. which is displayed on the NC screen.

[Operation]

This signal is set up when the alarm/waring occurs in the spindle drive unit.

This signal will be cleared when the alarm/warning is canceled.

This signal is not set if the servo warning "S52 00E6" (Control axis detachment warning) or "S52 00E7" (In NC emergency stop state) occurs.

If more than one alarm/warning occurs, the value displayed in the [LED display] of [Drv mon]-[Spindle unit] screen is set.

[Related signals]

(1) NC warning (servo warning) (XC9C)

Cont.	Signal name	Abbrev.	1stSP	2ndSP	3rdSP	4thSP	5thSP	6thSP	7thSP	8thSP
A	SYNCHRONOUS TAPPING CURRENT ERROR WIDTH		R6532,3	R6582,3	R6632,3	R6682,3	R6732,3	R6782,3	R6832	R6882

[Function] [Operation]

The current value of the synchronous tapping error width (motor tracking delay from each position commands on the spindle and the tapping axis) is output during the synchronous tapping.

Positive output value means that the tapping axis is delayed, while negative output value means that the spindle is delayed. The output range is -99999.999 to 99999.999mm.

[Caution]

- (1) The synchronous tapping error is not output during the spindle orientation or the R point positioning.
- (2) The current value is kept retrieved during the synchronous tapping.
- (3) If the synchronous tapping error is over the output range, the maximum value of the range is output.
- (4) Execute the synchronous tap R-point in-position check before using this signal. Unless the synchronous tap R-point in-position check is executed, an illegal value of the synchronous tapping error may be detected.

[Related signals]

- (1) Synchronous tapping Maximum error width (R6534, 6535)
- (2) Synchronous tapping Current error angle (R6536, 6537)
- (3) Synchronous tapping Maximum error angle (R6538, 6539)

4 Explanation of Interface Signals

Cont.	Signal name	Abbrev.	1stSP	2ndSP	3rdSP	4thSP	5thSP	6thSP	7thSP	8thSP
A	SYNCHRONOUS TAPPING MAXIMUM ERROR WIDTH		R6534,5	R6584,5	R6634,5	R6684,5	R6734,5	R6784,5	R6834,5	R6884,5

[Function] [Operation]

The largest absolute value of the synchronous tapping error width (-99999.999 to 99999.999mm) is output during the synchronous tapping.

The value is initialized to "0" when the synchronous tapping starts or the power turns ON again.

[Caution]

- (1) The synchronous tapping error is not output during the spindle orientation or the R point positioning.
- (2) This output value is the largest one throughout the synchronous tapping mode.
- (3) If the synchronous tapping error is over the output range, the maximum value of the range is output.
- (4) Execute the synchronous tap R-point in-position check before using this signal. Unless the synchronous tap R-point in-position check is executed, an illegal value of the synchronous tapping error may be detected.

[Related signals]

- (1) Synchronous tapping Current error width (R6532, 6533)
- (2) Synchronous tapping Current error angle (R6536, 6537)
- (3) Synchronous tapping Maximum error angle (R6538, 6539)

Cont.	Signal name	Abbrev.	1stSP	2ndSP	3rdSP	4thSP	5thSP	6thSP	7thSP	8thSP
A	SYNCHRONOUS TAPPING CURRENT ERROR ANGLE		R6536,7	R6586,7	R6636,7	R6686,7	R6736,7	R6786,7	R6836,7	R6886,7

[Function] [Operation]

The synchronous tapping error (motor tracking delay from each position commands on the spindle and the tapping axis) is output with angle during the synchronous tapping.

Positive output value means that the tapping axis is delayed, while negative output value means that the spindle is delayed. The output range is -99999.999 to 99,999.999°.

[Caution]

- (1) The synchronous tapping error is not output during the spindle orientation or the R point positioning.
- (2) The current value is kept retrieved during the synchronous tapping.
- (3) If the synchronous tapping error is over the output range, the maximum value of the range is output.
- (4) Execute the synchronous tap R-point in-position check before using this signal. Unless the synchronous tap R-point in-position check is executed, an illegal value of the synchronous tapping error may be detected.

[Related signals]

- (1) Synchronous tapping Current error width (R6532, 6533)
- (2) Synchronous tapping Maximum error width (R6534, 6535)
- (3) Synchronous tapping Maximum error angle (R6538, 6539)

Cont.	Signal name	Abbrev.	1stSP	2ndSP	3rdSP	4thSP	5thSP	6thSP	7thSP	8thSP
A	SYNCHRONOUS TAPPING MAXIMUM ERROR ANGLE		R6538,9	R6588,9	R6638,9	R6688,9	R6738,9	R6788,9	R6838,9	R6888,9

[Function][Operation]

The largest absolute value of the synchronous tapping error angle (-99999.999 to 99,999.999°) is output during the synchronous tapping.

The value is initialized to "0" when the synchronous tapping starts or the power turns ON again. The value is kept retrieved and displayed during the synchronous tapping.

[Caution]

- (1) The synchronous tapping error is not output during the spindle orientation or the R point positioning.
- (2) This output value is the largest one throughout the synchronous tapping mode.
- (3) If the synchronous tapping error is over the output range, the maximum value of the range is output.
- (4) Execute the synchronous tap R-point in-position check before using this signal. Unless the synchronous tap R-point in-position check is executed, an illegal value of the synchronous tapping error may be detected.

[Related signals]

- (1) Synchronous tapping Current error width (R6532, 6533)
- (2) Synchronous tapping Maximum error width (R6534, 6535)
- (3) Synchronous tapping Current error angle (R6536, 6537)

4 Explanation of Interface Signals

Cont.	Signal name	Abbrev.	1stSP	2ndSP	3rdSP	4thSP	5thSP	6thSP	7thSP	8thSP
A	LOAD MONITOR I : ESTIMATED SPINDLE DISTURBANCE TORQUE OUTPUT [M8]		R6541	R6591	R6641	R6691	R6741	R6791	R6841	R6891

[Function]

The estimated disturbance torque of the spindle is output to these devices.

[Operation]

The estimated disturbance torque of the spindle is output to this signal.

Output unit: Stall current 0.01%

A value "0x2710" is output when the estimated disturbance torque reaches 100%.

A value "0xFF9C" is output when the estimated disturbance torque reaches -1%.

[Caution]

(1) Use this signal when the spindle rotation speed is within the constant output range of the spindle motor (IM).

(2) This signal is assumed to be used for an induction motor (IM motor) or a tool spindle motor. When an IPM motor is used, the correct value is not output.

[Related signals]

(1) Load monitoring I: Axis selection (R2580)

(2) Load monitoring I: Cutting torque output n-th axis (R5492)

(3) Load monitoring I: Effective torque output n-th axis (R5620)

(4) Load monitoring I: Effective spindle torque output (R6542)

Cont.	Signal name	Abbrev.	1stSP	2ndSP	3rdSP	4thSP	5thSP	6thSP	7thSP	8thSP
A	LOAD MONITOR I : EFFECTIVE SPINDLE TORQUE OUTPUT [M8]		R6542	R6592	R6642	R6692	R6742	R6792	R6842	R6892

[Function]

The effective torque of the spindle is output to these devices.

[Operation]

The effective torque is output to this signal.

Output unit: Stall current % (#2634 SrvFunc01/bit0=0)

A value "0x64" is output when the effective torque reaches 100%.

A value "0xFFFF" is output when the effective torque reaches -1%.

[Caution]

(1) Use this signal when the spindle rotation speed is within the constant output range of the spindle motor (IM).

(2) This signal is assumed to be used for an induction motor (IM motor) or a tool spindle motor. When an IPM motor is used, the correct value is not output.

[Related signals]

(1) Load monitoring I: Axis selection (R2580)

(2) Load monitoring I: Cutting torque output n-th axis (R5492)

(3) Load monitoring I: Effective torque output n-th axis (R5620)

(4) Load monitoring I: Estimated spindle disturbance torque output (R6541)

Cont.	Signal name	Abbrev.	SP1	SP2	SP3	SP4	SP5	SP6	SP7
A	MACHINING INTERRUPTION SPINDLE STATUS [C80]	MCNGITSPSTS	R6543	R6593	R6643	R6693	R6743	R6793	R6843

[Function][Operation]

Bit	Description	Bit	Description
bit0	Stop status restoration request	bit8	Reserved
bit1	Forward run start restoration request	bit9	Reserved
bit2	Reverse run start restoration request	bit10	Reserved
bit3	Orientation command restoration request	bit11	Reserved
bit4	Reserved	bit12	Reserved
bit5	Reserved	bit13	Reserved
bit6	Reserved	bit14	Reserved
bit7	Reserved	bit15	Reserved

bit0: Stop status restoration request

This signal notifies the PLC of a request to restore the spindle to the stop status.

This signal turns ON when the spindle is restored to the stop status during the machining interruption function. After a required process (e.g., turning OFF the "Forward run start" or "Reverse run start" signal) is done by the PLC, the "Spindle status restoration completed" signal (MCNGITSPCMD: R7011/bit0) needs to be turned ON to turn this signal OFF.

When the restoration process of the spindle status is canceled by Reset, this signal is also turned OFF.

While this signal is ON (or "Spindle status restoration completed" signal is ON), the block in execution remains incomplete.

[Related signal]

Spindle status restoration completed (MCNGITSPCMD: R7011/bit0)

bit1: Forward run start restoration request

This signal notifies the PLC of a request to restore the spindle to the forward run status.

This signal turns ON when the spindle is restored to the forward run status during the machining interruption function.

After a required process (e.g., turning ON the "Forward run start" signal or detecting "Spindle up-to-speed") is done by the PLC, the "Spindle status restoration completed" signal (MCNGITSPCMD: R7011/bit0) needs to be turned ON to turn this signal OFF.

When the restoration process of the spindle status is canceled by Reset, this signal is also turned OFF.

While this signal is ON (or "Spindle status restoration completed" signal is ON), the block in execution remains incomplete.

[Related signal]

Spindle status restoration completed (MCNGITSPCMD: R7011/bit0)

bit2: Reverse run start restoration request

This signal notifies the PLC of a request to restore the spindle to the reverse run status.

This signal turns ON when the spindle is restored to the reverse run status during the machining interruption function.

After a required process (e.g., turning ON the "Reverse run start" signal or detecting "Spindle up-to-speed") is done by the PLC, the "Spindle status restoration completed" signal (MCNGITSPCMD: R7011/bit0) needs to be turned ON to turn this signal OFF.

When the restoration process of the spindle status is canceled by Reset, this signal is also turned OFF.

While this signal is ON (or "Spindle status restoration completed" signal is ON), the block in execution remains incomplete.

[Related signal]

Spindle status restoration completed (MCNGITSPCMD: R7011/bit0)

4 Explanation of Interface Signals

bit3: Orientation command restoration request

This signal notifies the PLC of a request to restore the spindle to the orientation completed status. This signal turns ON when the spindle is restored to the orientation completed status during the machining interruption function.

After a required process (e.g., turning ON the "Spindle orientation command" signal or confirmation of in-position status) is done by the PLC, the "Spindle status restoration completed" signal (MCNGITSPCMD: R7011/bit0) needs to be turned ON to turn this signal OFF.

When the restoration process of the spindle status is canceled by Reset, this signal is also turned OFF.

While this signal is ON (or "Spindle status restoration completed" signal is ON), the block in execution remains incomplete.

[Related signal]

Spindle status restoration completed (MCNGITSPCMD: R7011/bit0)

Cont.	Signal name	Abbrev.	1stSP	2ndSP	3rdSP	4thSP	5thSP	6thSP	7thSP	8thSP
A	Tool head hot swapping: Spindle switch status [M8]	SP-CHGSTS	R6547	R6597	R6647	R6697	R6747	R6797	R6847	R6897

[Function]

This signal notifies the PLC of the spindle switch state.

[Operation]

<Low-order 8 bits: In-use spindle switch setting number>

This indicates the switch setting number used in the spindle switch. The value is set at the timing when the spindle switch is completed.

<High-order 8 bits: Spindle switch state>

The "Spindle switch in progress" signal (R6547/bit8) is ON while the spindle switch is performed, and turns OFF when the switch is completed.

The "Spindle switch completion" signal (R6547/bit9) is ON during the period from when the switch is completed until the "Spindle switch request" signal (R7026/bit8) is turned OFF.

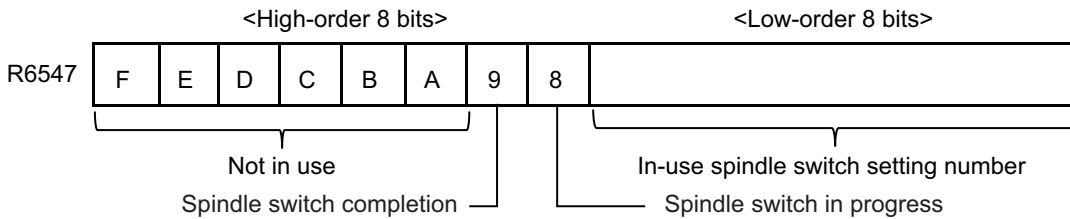

Refer to the timing chart of the "Tool head hot swapping: Spindle switch" signal (R7026: SPCHGCMD).

[Related signals]

- (1) Tool head hot swapping: Spindle switch (R7026: SPCHGCMD)
- (2) Exclude spindle (Y18BF: SPOFF)
- (3) In spindle off (X18B6: SPOFFA)

4 Explanation of Interface Signals

Cont.	Signal name	Abbrev.	1stSP	2ndSP	3rdSP	4thSP	5thSP	6thSP	7thSP	8thSP
A	VCC: Spindle rotation speed	VC- C_SPRE V	R7024,5	R7074,5	R7124,5	R7174,5	R7224,5	R7274,5	R7324,5	R7374,5

[Function]

This signal notifies PLC of the spindle rotation speed in the vibration cutting mode.

[Operation]

The rotation speed of the spindle selected in the part system in the vibration cutting mode is stored.

"0" is output for the spindle that is not used for vibration cutting control.

[Related signals]

- (1) Vibration cutting: Mode in execution (VCC: X1810)
- (2) Vibration cutting: Numbers of vibrations (VCC_VIB: R20556)
- (3) Vibration cutting: Frequency (VCC_FRQ: R20557)
- (4) Vibration cutting: Spindle rotation speed (VCC_SPREV: R7024, R7025)
- (5) Vibration cutting: Vibrating axis (VCC_VIBAX: R20558)
- (6) Vibration cutting: Temporary cancel of axis vibration (VCC_INVAX: R22532)
- (7) Vibration cutting: Cause of non-vibration (VCC_FACT: R20559)

Signal name	Abbrev.	1st axis	2nd axis	3rd axis	4th axis	5th axis	6th axis	7th axis	8th axis
PLC AXIS INDEXING CONTROL STATUS 4	AUXST4	R8000	R8006	R8012	R8018	R8024	R8030	R8036	R8042

Cont.	Signal name	Abbrev.	bit
A	Position switch 1 to 15	PSW1 to PSW15	AUXST4/bit0 to 7 AUXST3/bit9 to F

[Function][Operation]

This signal turns ON when the axis is within the setting range of the respective position switches.

Cont.	Signal name	Abbrev.	bit
A	Start not possible	NST	AUXST4/bitB

[Function][Operation]

This signal turns ON when the Operation start signal is turned ON for non PLC indexing axis.

Signal name	Abbrev.	1st axis	2nd axis	3rd axis	4th axis	5th axis	6th axis	7th axis	8th axis
PLC AXIS INDEXING CONTROL STATUS 3	AUXST3	R8001	R8007	R8013	R8019	R8025	R8031	R8037	R8043

Cont.	Signal name	Abbrev.	bit
A	Station position 1 to 256	STO1 to STO256	AUXST3/bit0 to 8

[Function][Operation]

This signal shows a 9-digit binary No. of the present station.

This signal outputs the station position when Set position reached (JST) is ON, "0" when Set position reached is OFF.

Signal name	Abbrev.	1st axis	2nd axis	3rd axis	4th axis	5th axis	6th axis	7th axis	8th axis
PLC AXIS INDEXING CONTROL STATUS 2	AUXST2	R8002	R8008	R8014	R8020	R8026	R8032	R8038	R8044

Cont.	Signal name	Abbrev.	bit
A	In automatic operation mode	AUTO	AUXST2/bit0

[Function][Operation]

This signal indicates that the automatic operation mode has been selected.

4 Explanation of Interface Signals

Cont.	Signal name	Abbrev.	bit
A	In manual operation mode	MANO	AUXST2/bit1

[Function][Operation]

This signal indicates that the manual operation mode has been selected.

Cont.	Signal name	Abbrev.	bit
A	In JOG operation mode	JO	AUXST2/bit2

[Function][Operation]

This signal indicates that the JOG operation mode has been selected.

Cont.	Signal name	Abbrev.	bit
A	In reference position return	ARNN	AUXST2/bit3

[Function][Operation]

This signal indicates that the machine is in the reference position return.

Cont.	Signal name	Abbrev.	bit
A	In reference position return mode	ZRNO	AUXST2/bit4

[Function][Operation]

This signal indicates that the reference position return mode has been selected.

Cont.	Signal name	Abbrev.	bit
A	In basic point initialization setting mode	AZSO	AUXST2/bit6

[Function][Operation]

This signal indicates that the basic point initialization setting mode has been selected.

Cont.	Signal name	Abbrev.	bit
A	In incremental mode	SO	AUXST2/bit7

[Function][Operation]

This signal indicates that the incremental mode has been selected.

Cont.	Signal name	Abbrev.	bit
A	Alarm 1	AL1	AUXST2/bit8

[Function][Operation]

This signal indicates that an alarm has occurred requiring the power to be turned ON again after the cause is removed.

Cont.	Signal name	Abbrev.	bit
A	Alarm 2	AL2	AUXST2/bit9

[Function][Operation]

This signal indicates that an alarm has occurred which can be released by the Master reset (MRST) signal after the cause is removed.

Cont.	Signal name	Abbrev.	bit
A	Alarm 4	AL4	AUXST2/bitA

[Function][Operation]

This signal indicates that an operation alarm or absolute position alarm has occurred.

Cont.	Signal name	Abbrev.	bit
A	Absolute position power shutoff movement over	ABS	AUXST2/bitC

[Function][Operation]

This signal indicates that the axis moved beyond the tolerable amount while the control power was OFF in the absolute position system.

4 Explanation of Interface Signals

Cont.	Signal name	Abbrev.	bit
A	Absolute position data loss	ZSN	AUXST2/bitD

[Function][Operation]

This signal indicates that the absolute position data has been lost in the absolute position system.

Cont.	Signal name	Abbrev.	bit
A	Initialization setting completed	ZSF	AUXST2/bitE

[Function][Operation]

This signal indicates that in the absolute position system the basic point initialization setting has completed normally, and that the absolute position coordinates have been established.

Cont.	Signal name	Abbrev.	bit
A	Initialization setting error completed	ZSE	AUXST2/bitF

[Function][Operation]

This signal indicates that the basic point initialization setting has not finished normally in the absolute position system.

Signal name	Abbrev.	1st axis	2nd axis	3rd axis	4th axis	5th axis	6th axis	7th axis	8th axis
PLC AXIS INDEXING CONTROL STATUS 1	AUXST1	R8003	R8009	R8015	R8021	R8027	R8033	R8039	R8045

Cont.	Signal name	Abbrev.	bit
A	Servo ready	RDY	AUXST1/bit0

[Function]

This signal indicates that the servo system is in an operable status.

[Operation]

This signal turns ON when:

- (1) The servo system diagnosis is normally completed after turning the power ON.
- (2) The servo alarm, which had occurred, has been released by Master reset (MRST).
- (3) The emergency stop has been released.
- (4) Ready OFF (RDF) or Servo OFF (SVF) has been released.

This signal turns OFF when:

- (1) Servo ready completion (SA) is turned OFF.
- (2) The Servo OFF signal is input and the drive unit is in a servo OFF state.

[Related signals]

- (1) Master reset (MRST: AUXCM1/bit3)
- (2) Ready OFF (RDF: AUXCM1/bit6)
- (3) Servo OFF (SVF: AUXCM1/bit0)
- (4) Servo ready completion (SA: AUXST1/bitC)

4 Explanation of Interface Signals

Cont.	Signal name	Abbrev.	bit
A	In-position	INP	AUXST1/bit1

[Function]

This signal notifies that the control axis is in-position.

[Operation]

This signal turns ON when:

- (1) Smoothing zero (SMZ) is turned ON and the droop is within the range set in the parameters.

This signal turns OFF when:

- (1) Smoothing zero (SMZ) is turned OFF. (When there is a movement command.)
- (2) The droop exceeds the range set in the parameters.

[Caution]

- (1) In-position (INP) may turn ON, even during movement, when the axis is moving at extremely low speeds.
- (2) The in-position detection range is set in the parameter "#2224 SV024 In-position detection width".
- (3) In the servo ready OFF state, Smoothing zero (SMZ) turns OFF when the travel amount of servomotor is detected. Therefore, In-position (INP) also turns OFF. In axis plus motion (MVP) or In axis minus motion (MVN) turns ON depending on the detected movement direction. Note that Smoothing zero (SMZ), In axis plus motion (MVP) and In axis minus motion (MVN) will not change in the servo OFF state without error correction, because detected servomotor travel amount becomes a droop amount.

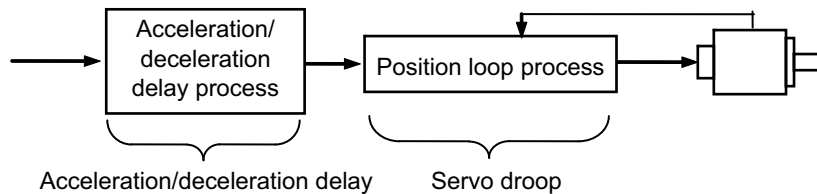

[Related signals]

- (1) Smoothing zero (SMZ: AUXST1/bit2)

Cont.	Signal name	Abbrev.	bit
A	Smoothing zero	SMZ	AUXST1/bit2

[Function][Operation]

This signal indicates that the acceleration/deceleration process in the built-in controller is finished, and that no command to the control section remains.

Cont.	Signal name	Abbrev.	bit
A	Axis selection output	AX1	AUXST1/bit3

[Function]

This signal indicates that the control axis has received the movement command.

[Operation]

This signal turns ON in the following cases, and turns OFF after Smoothing zero (SMZ) is detected.

- (1) In automatic operation mode

This signal turns ON while Operation start (ST) is ON and the axis is moving.

- (2) In manual operation mode

This signal turns ON while Operation start (ST) is ON and the axis is moving.

- (3) In JOG operation mode

This signal turns ON while Operation start (ST) is ON and the axis is moving.

- (4) In reference position return mode

This signal turns ON while Operation start (ST) is ON and the axis is moving.

When an interlock is applied, this signal remains ON even when the servo is OFF. This signal turns OFF at the emergency stop.

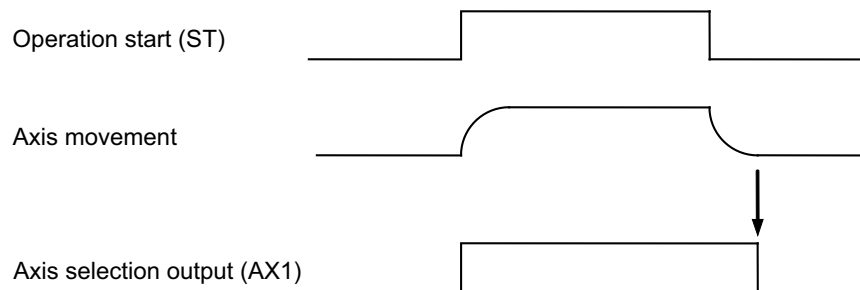
**[Related signals]**

- (1) Operation start (ST: AUXCM2/bit0)

Cont.	Signal name	Abbrev.	bit
A	In axis plus motion	MVP	AUXST1/bit4

[Function]

This signal indicates that the axis is moving in the (+) direction.

[Operation]

This signal turns ON when the axis starts moving in the (+) direction, turns OFF after Smoothing zero (SMZ) is detected or the axis starts moving in the (-) direction.

[Related signals]

- (1) Smoothing zero (SMZ: AUXST1/bit2)

Cont.	Signal name	Abbrev.	bit
A	In axis minus motion	MVM	AUXST1/bit5

[Function]

This signal indicates that the axis is moving in the (-) direction.

[Operation]

This signal turns ON when the axis starts moving in the (-) direction, turns OFF after Smoothing zero (SMZ) is detected or the axis starts moving in the (+) direction.

[Related signals]

- (1) Smoothing zero (SMZ: AUXST1/bit2)

Cont.	Signal name	Abbrev.	bit
A	In torque limit	TLQ	AUXST1/bit6

[Function][Operation]

This signal indicates that the control axis is at the current limit value. This signal turns ON when the motor output torque (motor current) is limited at the torque limit value of the selected operation parameter group.

4 Explanation of Interface Signals

Cont.	Signal name	Abbrev.	bit
A	Reference position reached	ZP	AUXST1/bit8

[Function]

This signal indicates that the control axis is on the reference position.

[Operation]

This signal turns ON when the reference position is reached in the reference position return mode.

If the reference position is reached in other operation modes or by other commands, the signal will not turn ON.

This signal turns OFF when:

- (1) The axis is moved by a travel command, etc.
- (2) An emergency stop has been activated due to an emergency stop input or a servo alarm occurrence, etc.
- (3) The axis has moved in the servo OFF state.

[Related signals]

- (1) Reference position return mode (ZRN: AUXCM1/bitB)

Cont.	Signal name	Abbrev.	bit
A	In reset	RST	AUXST1/bit9

[Function]

This signal indicates that the built-in controller is being reset.

[Operation]

The signal turns ON when:

- (1) Master reset (MRST) is turned ON.
- (2) Master reset (MRST) is turned ON and the built-in controller is being reset.
- (3) In an emergency stop status.

[Related signals]

- (1) Master reset (MRST: AUXCM1/bit3)

Cont.	Signal name	Abbrev.	bit
A	In handle feed operation mode	HO	AUXST1/bitA

[Function][Operation]

This signal indicates that handle feed operation mode is selected.

Cont.	Signal name	Abbrev.	bit
A	Controller ready completion	MA	AUXST1/bitB

[Function]

This signal indicates that the controller is in a status to carry out normal operation.

[Operation]

This signal turns ON when:

- (1) Normal operation has begun after the power ON.

This signal turns OFF when:

- (1) The power is turned OFF.
- (2) An error with the controller, such as CPU error or memory error, has been detected.
- (3) A servo alarm which cannot be reset without turning OFF the power of the controller has occurred.

Cont.	Signal name	Abbrev.	bit
A	Servo ready completion	SA	AUXST1/bitC

[Function]

This signal indicates that the servo system is ready for normal operation. In other words, the servo system (position control) is not working when the signal is OFF.

[Operation]

The signal turns ON when:

- (1) The servo system diagnosis is normally completed after the power ON.
- (2) The servo alarm, which had occurred, has been released by Master reset (MRST).
- (3) The emergency stop has been released.
- (4) Ready OFF (RDF) is turned ON.

This signal turns OFF when:

- (1) Controller ready completion (MA) is turned OFF.
- (2) A servo alarm has occurred.
- (3) Emergency stop is issued.
- (4) Ready OFF (RDF) is turned OFF.

[Caution]

- (1) With Servo OFF (SVF), Servo ready completion (SA) will not turn OFF as long as there are no separate conditions for turning the SA OFF.
- (2) In an emergency stop status, all I/O output points will turn OFF.

[Related signals]

- (1) Master reset (MRST: AUXCM1/bit3)
- (2) Ready OFF (RDF: AUXCM1/bit6)
- (3) Controller ready completion (MA: AUXST1/bitB)

Cont.	Signal name	Abbrev.	bit
A	Automatic set position reached	JSTA	AUXST1/bitD

[Function]

In the automatic operation, this signal notifies that the positioning to the commanded station No. is completed. The tolerable ON width is as same as that of Set position reached (JST).

[Operation]

The signal turns ON when:

- (1) The positioning to the designated station No. is completed in the automatic operation mode. The signal actually turns ON before the positioning is completed, when the tolerable width is entered.

The signal turns OFF when:

- (1) When the Operation start signal is input in any of the operation modes.
- (2) When the axis deviates outside the tolerable width.

[Caution]

- (1) In automatic operation, this signal does not turn ON when positioning to the nearest station is carried out by the Operation start signal OFF.
- (2) When this signal is ON, it does not turn OFF if the same station No. index is started.
- (3) When the positioning to the station is completed in manual mode and the same station No. index is started, this signal turns ON. However, there is no movement.
- (4) Once turned OFF, this signal does not turn ON again even if the axis returns within the tolerable width.
- (5) During the emergency stop or the servo OFF, the axis movement, once deviated outside the output width of Set position reached, returns within the tolerable width, turns this signal ON again if "#12802 aux_Cont1/bit4" is OFF; does not turn it ON if "#12802 aux_Cont1/bit4" is ON.

4 Explanation of Interface Signals

Cont.	Signal name	Abbrev.	bit
A	Set position reached	JST	AUXST1/bitE

[Function]

This signal notifies that the positioning to the station position has been completed. It is ON when the machine position is at any of the station positions. The tolerable ON width is set with a parameter.

[Operation]

The signal turns ON when:

- (1) The positioning to the station is completed in automatic or manual operation. The signal actually turns ON before the positioning is completed, when the tolerable width is entered.
- (2) The stop position after JOG operation is the station position or within the tolerable width.
- (3) The reference position return position corresponds to those of the stop position in (2).

Other than the above conditions, this signal normally monitors the machine position, and carries out comparisons between stations. Therefore, this signal is output even when the machine moves to a station position outside the operation.

The signal turns OFF when:

- (1) The Operation start signal is input in any of the operation modes. When the operation is started by the Operation start signal, this signal will not turn ON, even when a station position is passed during operation.
- (2) The axis deviates outside the tolerable width.

Cont.	Signal name	Abbrev.	bit
A	Near set position	NEAR	AUXST1/bitF

[Function]

This signal notifies that the machine position is near the station.

[Operation]

It operates in the same manner as the Set position reached (JST), but the tolerable width is set with a different parameter. The tolerable width is generally set larger than that of Set position reached. This signal is generally used at the mechanical clamp or the like just before the completion of the positioning.

Cont.	Signal name	Abbrev.	Common(\$)
A	Option status export to PLC [M8]		R8260 to R8289

[Function]

The status for each additional specification (valid or invalid) is exported to the R register (R8260 to R8289).

By confirming the R register to which the information is exported, ladders and macro programs can be shared between the machines with different additional specification status. In addition, the custom screens dedicated to the respective additional specification can be displayed or non-displayed.

For the PLC bit location and the corresponding additional specification for each bit, refer to "Chapter 8 Appx. 4 List of option status exported to PLC [M8]".

[Operation]

The status of additional specification is automatically registered to the R register when the NC is started.

Cont.	Signal name	Abbrev.	Common(\$)
A	RION NO. OF ERROR OCCURRENCES n-TH CH [M8]		R10000 to 23

[Function]

Counts communication errors occurred between control unit and remote I/O unit (channel) and outputs.

[Operation]

R register's high-order 8 bits output the number of CRC error occurrences (highest value), and the low-order 8 bits output the number of connection error occurrences (highest value).

4 Explanation of Interface Signals

R register allocations are as shown below.

Remote I/O unit connection system	1st ch	2nd ch	3rd ch	4th ch	5th ch	6th ch	7th ch	8th ch
RIO1	R10000	R10001	R10002	R10003	R10004	R10005	R10006	R10007
RIO2	R10008	R10009	R10010	R10011	R10012	R10013	R10014	R10015
RIO3	R10016	R10017	R10018	R10019	R10020	R10021	R10022	R10023

[Caution]

- (1) Control unit cannot identify the remote I/O unit with no power cable or communication cable connected, or with no power supplied. Therefore, issuance of remote I/O error will not be carried out even if a malfunction exists in those remote I/O units.
- (2) Performance check for the physically existed remote I/O unit can be done, using either "Connection status output" or "No. of error occurrences output".
- (3) Once the number of error occurrences exceeds 255, a remote I/O error occurs and "Error occurrences output" is clamped to 255.
- (4) "No. of error occurrences output" is saved in full when rebooting.
However, when the value exceeds the specified value to lead a remote I/O error, the data of the channel is cleared.

[Related signals]

- (1) Connection status of each channel RIO1,2 (R10064)
- (2) Connection status of each channel RIO3 (R10065)

Cont.	Signal name	Abbrev.	Common(\$)
A	CONNECTION STATUS OF EACH CHANNEL RIO1,2 [M8]		R10064

[Function]

Connection status of remote I/O unit channel 1 & 2 is constantly output to R register.

[Operation]

When remote I/O unit is connected, "1" is set; when not connected, "0" is set. R register's high-order 8 bits output the connection status of each channel within RI01, and the lower 8 bits output the connection status of each channel within RI02.

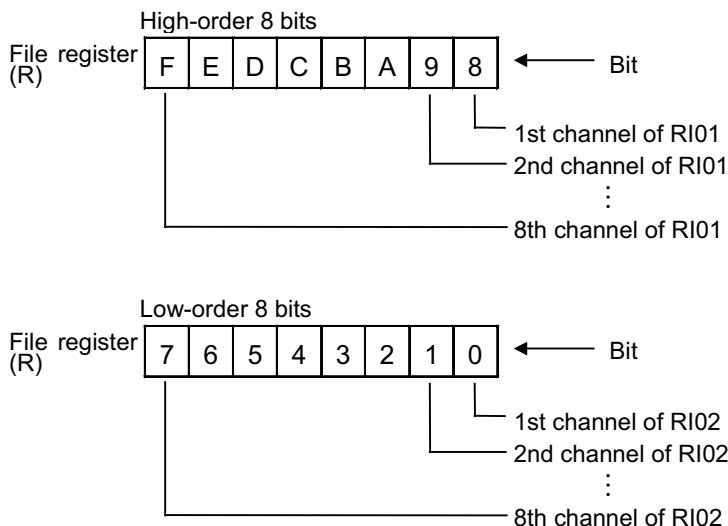

[Caution]

- (1) Control unit cannot identify the remote I/O unit with no power cable or communication cable connected, or with no power supplied. Therefore, the "Connection status output" for those remote I/O units is "0".
- (2) Performance check for the physically existed remote I/O unit can be done, using either "Connection status output" or "No. of error occurrences output".

[Related signals]

- (1) Connection status of each channel RIO3 (R10065)
- (2) No. of error occurrences (R10000 to 23)

4 Explanation of Interface Signals

Cont.	Signal name	Abbrev.	Common(\$)
A	CONNECTION STATUS OF EACH CHANNEL RIO3 [M8]		R10065

[Function]

Connection status of remote I/O unit channel 3 is constantly output to R register.

[Operation]

When remote I/O unit is connected, "1" is set; when not connected, "0" is set. R register's high-order 8 bits output the connection status of each channel within RI03.

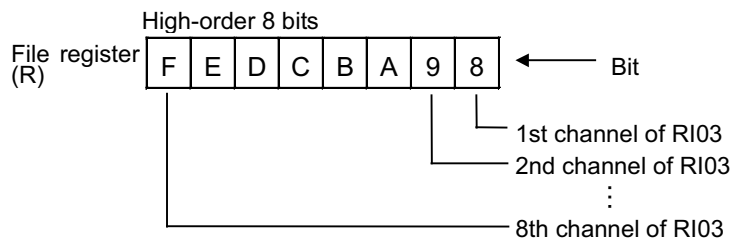

[Caution]

- (1) Control unit cannot identify the remote I/O unit with no power cable or communication cable connected, or with no power supplied. Therefore, the "Connection status output" for those remote I/O units is "0".
- (2) Performance check for the physically existed remote I/O unit can be done, using either "Connection status output" or "No. of error occurrences output".

[Related signals]

- (1) Connection status of each channel RIO1,2 (R10064)
- (2) No. of error occurrences (R10000 to 23)

Cont.	Signal name	Abbrev.	Common(\$)
A	Base PLC mounting check		R10188,9

[Function][Operation]

This signal indicates the base PLC mounting status. (High priority from the top)

Value	Status
0xFFFFFFFF	Not mounted (no option) ("#11003 APLCvalid" is "0" or invalid configuration)
0xFFFFFFFFE	Not mounted (failed to register the initialize function)
0xFFFFFFFFD	Not mounted (exceeded the SRAM size) [C80]
0xFFFFFFFFC	Not mounted (main module is not mounted) [C80]
0x00000000	Mounted

4 Explanation of Interface Signals

Cont.	Signal name	Abbrev.	Common(\$)
A	EcoMonitorLight CONNECTION : STATION #1 to #16 CONSUMED POWER [M8]		R14000, 1 to R14150, 1

[Function]

This signal stores the consumed power of EcoMonitorLight which is collected at a fixed period.

The consumed power is stored across two words of register; the values of first to 1000th digit are stored to R14000 and the values of 10000th digit and above are stored to R14001.

Station No.	Device No.	Station No.	Device No.
Station #1	R14000, 1	Station #9	R14080, 1
Station #2	R14010, 1	Station #10	R14090, 1
Station #3	R14020, 1	Station #11	R14100, 1
Station #4	R14030, 1	Station #12	R14110, 1
Station #5	R14040, 1	Station #13	R14120, 1
Station #6	R14050, 1	Station #14	R14130, 1
Station #7	R14060, 1	Station #15	R14140, 1
Station #8	R14070, 1	Station #16	R14150, 1

[Operation]

Updated every 1.5 seconds.

Cont.	Signal name	Abbrev.	Common(\$)
A	EcoMonitorLight CONNECTION : STATION #1 to #16 REGENERATED POWER [M8]		R14002, 3 to R14152, 3

[Function]

This signal stores the regenerated power of EcoMonitorLight which is collected at a fixed period.

The regenerated power is stored across two words of register; the values of first to 1000th digit are stored to R14002 and the values of 10000th digit and above are stored to R14003.

Station No.	Device No.	Station No.	Device No.
Station #1	R14002, 3	Station #9	R14082, 3
Station #2	R14012, 3	Station #10	R14092, 3
Station #3	R14022, 3	Station #11	R14102, 3
Station #4	R14032, 3	Station #12	R14112, 3
Station #5	R14042, 3	Station #13	R14122, 3
Station #6	R14052, 3	Station #14	R14132, 3
Station #7	R14062, 3	Station #15	R14142, 3
Station #8	R14072, 3	Station #16	R14152, 3

[Operation]

Updated every 1.5 seconds.

4 Explanation of Interface Signals

Cont.	Signal name	Abbrev.	Common(\$)
A	EcoMonitorLight CONNECTION: STATION #1 to #16 NUMBER OF RECEPTION ERRORS [M8]		R14200 to R14350
A	EcoMonitorLight CONNECTION: STATION #1 to #16 MAXIMUM NUMBER OF SUCCESSIVE RECEPTION ERRORS [M8]		R14201 to R14351
A	EcoMonitorLight CONNECTION: STATION #1 to #16 NUMBER OF TRANSMISSION ERRORS [M8]		R14202 to R14352
A	EcoMonitorLight CONNECTION: STATION #1 to #16 MAXIMUM NUMBER OF SUCCESSIVE TRANSMISSION ERRORS [M8]		R14203 to R14353

[Function]

This signal stores the number of reception errors, maximum number of successive reception errors, number of transmission errors, and maximum number of successive transmission errors of EcoMonitorLight.

Device No.				
Station No.	No. of reception errors	Max. No. of successive reception errors	No. of transmission errors	Max. No. of successive transmission errors
Station #1	R14200	R14201	R14202	R14203
Station #2	R14210	R14211	R14212	R14213
Station #3	R14220	R14221	R14222	R14223
Station #4	R14230	R14231	R14232	R14233
Station #5	R14240	R14241	R14242	R14243
Station #6	R14250	R14251	R14252	R14253
Station #7	R14260	R14261	R14262	R14263
Station #8	R14270	R14271	R14272	R14273
Station #9	R14280	R14281	R14282	R14283
Station #10	R14290	R14291	R14292	R14293
Station #11	R14300	R14301	R14302	R14303
Station #12	R14310	R14311	R14312	R14313
Station #13	R14320	R14321	R14322	R14323
Station #14	R14330	R14331	R14332	R14333
Station #15	R14340	R14341	R14342	R14343
Station #16	R14350	R14351	R14352	R14353

[Operation]

The number of reception errors and the number of transmission errors is updated when an error occurs on the communication with EcoMonitorLight.

The increment stops when the reception or transmission was completed without an error.

The maximum number of successive reception errors is updated when the number of successive communication error is larger than the value of R14201 (for the case of station #1).

The maximum number of successive transmission error is updated when the number of successive communication error is larger than the value of R14203 (for the case of station #1).

Cont.	Signal name	Abbrev.	Common(\$)
A	EcoMonitorLight CONNECTION: COMPLETION BIT [M8]		R14400

[Function]

This bit indicates the completion of the power value collecting function.

[Operation]

Bit0 becomes 1 upon completion of collection.

The bit is cleared to zero in the next cycle.

4 Explanation of Interface Signals

Cont.	Signal name	Abbrev.	Common(\$)
A	EcoMonitorLight CONNECTION: COMPLETION STATUS [M8]		R14401

[Function]

This signal stores the completion status information of the power value collecting function.

[Operation]

0 indicates the completion.

Non-zero indicates the error.

Error code	Error description
1	Address setting illegal
2	Reception timeout error
3	Reception frame error (CRC error)
4	Function setting illegal
5	Station No. setting illegal
6	Size setting illegal
7	Transmission timeout error

Cont.	Signal name	Abbrev.	Common(\$)
A	EcoMonitorLight CONNECTION: ACQUIRED DATA [M8]		R14402 to R14405

[Function]

This signal stores the acquired data of the power value collecting function.

[Operation]

The data which corresponds to the register address (R20290) of station specified by "EcoMonitorLight CONNECTION: STATION NO." (R20289) is stored. The data size is the size specified by "EcoMonitorLight CONNECTION: SIZE OF DATA TO READ" (R20291).

Cont.	Signal name	Abbrev.	Common(\$)
A	MES interface library: Serial number [M8]		R14500 to R14531

[Function]

The serial number of the workpiece is stored here.

[Operation]

The ASCII code (hex number) corresponding to the desirable character is set.

Cont.	Signal name	Abbrev.	Common(\$)
A	MES interface library: Operator ID [M8]		R14532 to R14563

[Function]

The operator ID is stored here.

[Operation]

The ASCII code (hex number) corresponding to the desirable character is set.

Cont.	Signal name	Abbrev.	Common(\$)
A	MES interface library: NC unit number [M8]		R14564 to R14571

[Function]

The CNC unit number which sends the information to the database is stored here.

[Operation]

This data is automatically set at NC startup.

If the unit has a product number, the ASCII code (hex number) corresponding to the product number is set.

If the unit does not have a product number, this is set to "0".

When the MES interface library function is invalid, this signal is set to "0".

4 Explanation of Interface Signals

Cont.	Signal name	Abbrev.	Common(\$)
A	MES interface library: Line number [M8]		R14572 to R14587

[Function]

The line number is stored here.

[Operation]

The ASCII code (hex number) corresponding to the desirable character is set.

Cont.	Signal name	Abbrev.	Common(\$)
A	MES interface library: Machine type [M8]		R14588

[Function]

The machine type (machining center or lathe) of the machine is stored here.

[Operation]

This data is automatically set at NC startup.

The ASCII code (hex number) corresponding to "M" (0x4D) is set for the machining center system, or "L" (0x4C) is set for the lathe system.

When the MES interface library function is invalid, this signal is set to "0".

Cont.	Signal name	Abbrev.	Common(\$)
A	MES interface library: Database connection status [M8]		R14589

[Function]

The connection status between the NC and database, or the cause of DB operation failure is stored here.

[Operation]

The result that NC requested an operation to the database is set.

bit0: 0 (Not connected), 1 (Connected)

bit1: "1" is set when DB operation request condition is disabled.

bit2: "1" is set when no DB operation is selected.

bit3: "1" is set when the record corresponding to retrieval conditions does not exist during updating, deleting or extraction operation.

*Bit1 to 3 are cleared to "0" when the next operation is requested.

When the MES interface library function is invalid, this signal is set to "0".

Cont.	Signal name	Abbrev.	Common(\$)
A	MES interface library: Database operation request register [M8]		R14590

[Function]

The content of an operation which NC requested to the database is stored here.

[Operation]

bit0: "1" is set when requesting the database operation for the machining result table.

bit1: "1" is set when requesting the database operation for the alarm history table.

bit2: "1" is set when requesting the database operation for the arbitrary information accumulation table.

When "1" is set in the bit which corresponds to "database operation request register" (R14591), this signal is set to "0".

[Related signals]

(1) MES interface library: Database operation reception register [M8] (R14591)

(2) MES interface library: Database operation result register [M8] (R14592 to R14597)

4 Explanation of Interface Signals

Cont.	Signal name	Abbrev.	Common(\$)
A	MES interface library: Database operation reception register [M8]		R14591

[Function]

The reception status of the database for the database operation from the NC is stored here.

[Operation]

- bit0: "1" is set while accepting the database operation for the machining result table.
 - bit1: "1" is set while accepting the database operation for the alarm history table.
 - bit2: "1" is set while accepting the database operation for the arbitrary information accumulation table.
- This signal is set to "0" when the database operation is finished.

[Related signals]

- (1) MES interface library: Database operation request register [M8] (R14590)
- (2) MES interface library: Database operation result register [M8] (R14592 to R14597)

Cont.	Signal name	Abbrev.	Common(\$)
A	MES interface library: Database operation result register [M8]		R14592 to R14597

[Function]

The result of the database operation is stored here.

[Operation]

- 0: Normal end
 - Other than 0: Occurrence of an error
- Which registers to be used varies for each data table of the target database operations.
- R14592 R14593: Notifies the result of the database operation for the machining result table.
 - R14594 R14595: Notifies the result of the database operation for the alarm history table.
 - R14596 R14597: Notifies the result of the database operation for the arbitrary information accumulation table.

[Related signals]

- (1) MES interface library: Database operation request register [M8] (R14590)
- (2) MES interface library: Database operation reception register [M8] (R14591)

The timing chart for the request register, the reception register and the result register is as follows.

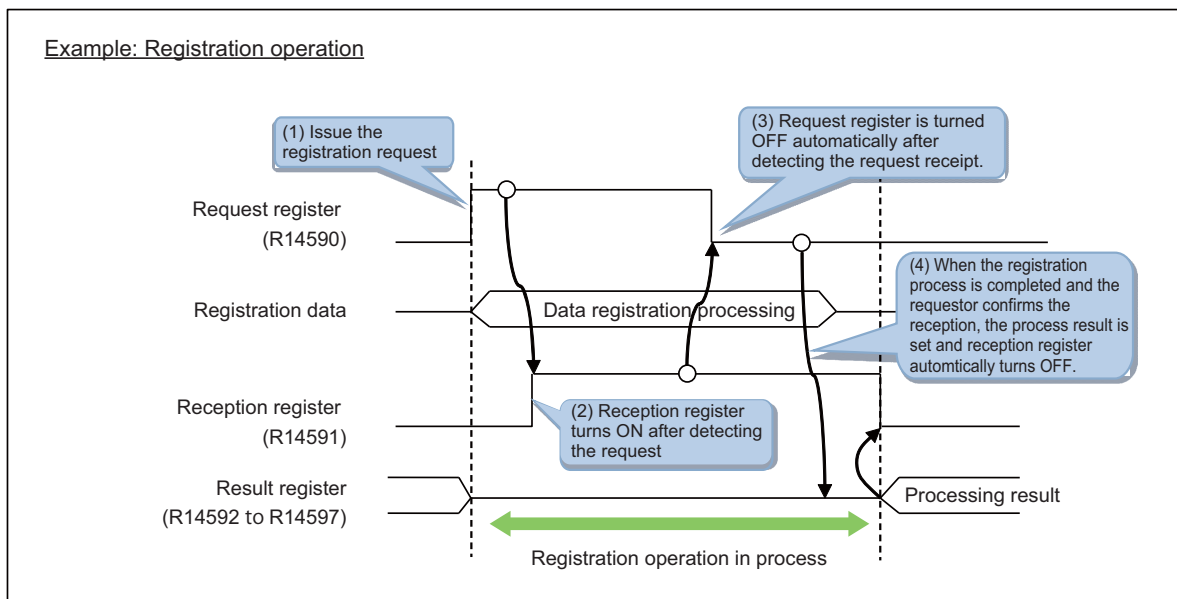

Cont.	Signal name	Abbrev.	Common(\$)
A	MES interface library: DB operation selection [M8]		R14598

[Function]

This signal is used to select the database operation at the machining end, alarm occurrence, user's option, and rising edge of operation trigger.

[Operation]

Specify "1" to each bit below to set the database operation at the time of machining end.

- bit0: Selecting the registration operation at the time of machining end
- bit1: Selecting the updating operation at the time of machining end
- bit2: Selecting the deleting operation at the time of machining end
- bit3: Selecting the extraction operation at the time of machining end
- bit4: Selecting the registration operation at the time of alarm occurrence
- bit5: Selecting the updating operation at the time of alarm occurrence
- bit6: Selecting the deleting operation at the time of alarm occurrence
- bit7: Selecting the extraction operation at the time of alarm occurrence
- bit8: Selecting the registration operation at the time of user's option
- bit9: Selecting the updating operation at the time of user's option
- bitA: Selecting the deleting operation at the time of user's option
- bitB: Selecting the extraction operation at the time of user's option
- (bitC: No DB operation)
- bitD: Selecting the updating operation at the rising edge of operation trigger
- bitE: Selecting the deleting operation at the rising edge of operation trigger
- bitF: Selecting the extraction operation at the rising edge of operation trigger

"0" is set when the power is turned OFF and ON.

When the bit0 to bit3 are all set to "0", select the registration operation at the time of machining end while "0" is specified in R14600/bit0 and the DB operation does not perform at the time of machining end while "1" is specified in R14600/bit0.

When the bit4 to bit7 are all set to "0", select the registration operation at the time of alarm occurrence while "0" is specified in R14601/bit0 and the DB operation does not perform at the time of alarm occurrence while "1" is specified in R14601/bit0.

When the bit8 to bitB are all set to "0", select the registration operation at the time of user's option while "0" is specified in R14602/bit0 and the DB operation does not perform at the time of user's option while "1" is specified in R14602/bit0.

When the bitD to bitF are all set to "0", the DB operation does not perform at the rising edge of operation trigger.

When MES interface library function is invalid, this signal is set to "0".

The tables below indicate the database operation combined each bit of DB operation selection (R14598) with the followings:

- Selecting the DB operation when "0" is specified for function selection at machining end (R14600/bit0)
- Selecting the DB operation when "0" is specified for function selection at alarm (R14601/bit)
- Selecting the DB operation when "0" is specified for function selection at user's option (R14602/bit0)

R14598				R14600	Operation at machining end
bit0	bit1	bit2	bit3	bit0	
1	0/1	0/1	0/1	0/1	register
0	1	0/1	0/1	0/1	update
0	0	1	0/1	0/1	delete
0	0	0	1	0/1	extract
0	0	0	0	1	no operation
0	0	0	0	0	register

4 Explanation of Interface Signals

R14598				R14601	Operation at alarm
bit4	bit5	bit6	bit7	bit0	
1	0/1	0/1	0/1	0/1	register
0	1	0/1	0/1	0/1	update
0	0	1	0/1	0/1	delete
0	0	0	1	0/1	extract
0	0	0	0	1	no operation
0	0	0	0	0	register

R14598				R14602	Operation at user's option
bit8	bit9	bitA	bitB	bit0	
1	0/1	0/1	0/1	0/1	register
0	1	0/1	0/1	0/1	update
0	0	1	0/1	0/1	delete
0	0	0	1	0/1	extract
0	0	0	0	1	no operation
0	0	0	0	0	register

R14598				Operation at rising edge of operation trigger
bitC	bitD	bitE	bitF	
0/1	1	0/1	0/1	update
0/1	0	1	0/1	delete
0/1	0	0	1	extract
0/1	0	0	0	no operation

[Related signals]

MES interface library: Operation trigger [M8] (Y1C80)

MES interface library: Function selection at machining end [M8] (R14600)

MES interface library: Function selection at alarm [M8] (R14601)

MES interface library: Function selection at user's option [M8] (R14602)

Cont.	Signal name	Abbrev.	Common(\$)
A	MES interface library: Operation table selection [M8]		R14599

[Function]

This signal is used to select the data table to be the operation target at the rising edge of operation trigger.

[Operation]

Specify the data table to be the operation target at the rising edge of operation trigger as follows.

- 1: Machining result table
- 2: Alarm history table
- 3: Arbitrary information accumulated table

If you specify "0", none of the operations perform even if you turn ON each bit of the operation trigger.

When MES interface library function is invalid, this signal is set to "0".

[Related signals]

(1) MES interface library: Operation trigger [M8] (Y1C80)

Cont.	Signal name	Abbrev.	Common(\$)
A	MES interface library: Function selection at machining end [M8]		R14600

[Function]

This signal is used to select the database operation-related functions at the time of machining completion.

[Operation]

bit0: Selecting the DB operation when "0" is specified

0: When "0" is specified to R14598/bit0 to 3, registration operation is selected.

1: When "0" is specified to R14598/bit0 to 3, DB operation does not perform.

bit1: Selecting the setting for data I/O register for MES interface library at the time of update

0: When the machining is completed while update operation is selected, common data or machining-related data is not set to the data I/O register for MES interface library.

1: When the machining is completed while update operation is selected, common data and machining-related data are set to the data I/O register for MES interface library.

When MES interface library function is invalid, this signal is set to "0".

[Related signals]

(1) MES interface library: DB operation selection [M8] (R14598)

Cont.	Signal name	Abbrev.	Common(\$)
A	MES interface library: Function name selection at alarm [M8]		R14601

[Function]

This signal is used to select the database operation-related functions when an alarm occurs.

[Operation]

bit0: Selecting the DB operation when "0" is specified

0: When "0" is specified to R14598/bit4 to 7, registration operation is selected.

1: When "0" is specified to R14598/bit4 to 7, DB operation does not perform.

bit1: Selecting the setting for data I/O register for MES interface library at the time of update

0: When an alarm occurs while update operation is selected, common data or alarm-related data is not set to the data I/O register for MES interface library.

1: When an alarm occurs while update operation is selected, common data and alarm-related data are set to the data I/O register for MES interface library.

When MES interface library function is invalid, this signal is set to "0".

[Related signals]

(1) MES interface library: DB operation selection [M8] (R14598)

Cont.	Signal name	Abbrev.	Common(\$)
A	MES interface library: Function selection at user's option [M8]		R14602

[Function]

This signal is used to select the function related to DB operation at the time of user's option.

[Operation]

bit0: Selecting the operation when "0" is specified

0: When "0" is specified to R14598/bit8 to B, registration operation is selected.

1: When "0" is specified to R14598/bit8 to B, DB operation does not perform.

When MES interface library function is invalid, this signal is set to "0".

[Related signals]

(1) MES interface library: DB operation selection [M8] (R14598)

4 Explanation of Interface Signals

Cont.	Signal name	Abbrev.	Common(\$)
A	MES interface library: G code modal registration selection [M8]		R14604,5

[Function]

This signal is used to set the group of information "G code modal" registered in the database at the time of alarm occurrence.

[Operation]

The G code modal group to be registered to the database is specified in bit units.

Set "1" to the bits corresponding to the group number to be registered.

Group numbers 1 to 19 can be specified.

A total of 12 group numbers can be registered.

When more than 12 group numbers are specified, the 12 groups are registered in ascending order.

When less than 12 group numbers are specified, a total of 12 group numbers, the unspecified group numbers in ascending order in addition to the specified group numbers, are registered.

The following indicates the operation when setting "1" to the bit of each register.

R14604 bit0: (not used)

R14604 bit1 to F: registers the G code modal in the group 1 to 15

R14605 bit0 to 3: registers the G code modal in the group 16 to 19

R14605 bit4 to F: (not used)

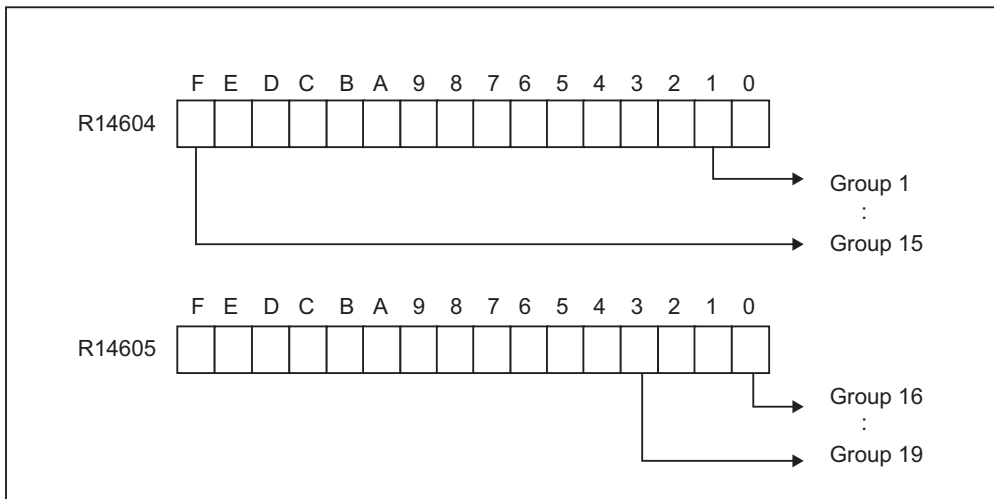

4 Explanation of Interface Signals

(Example 1) When setting the group numbers from 1 to 15 (R14604 = 0xFFFE, R14605 = 0x0000)

Register the G code modal belonging in the group numbers 1 to 12.

(G code modals belonging in the group number 13 to 15 are not registered.)

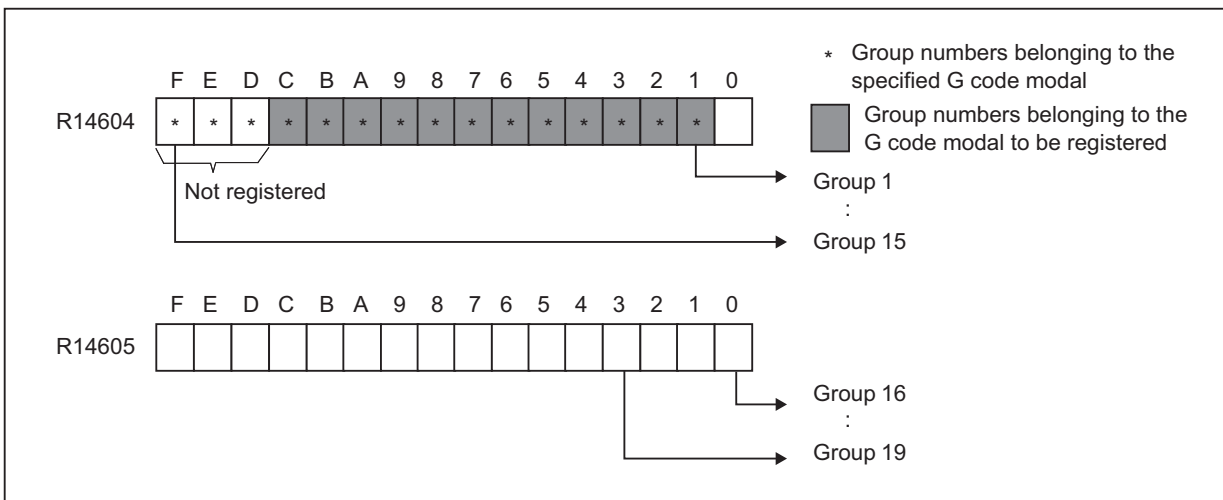

(Example 2) When setting the group numbers from 8 to 15 (R14604 = 0xFF00, R14605 = 0x0000)

Register the G code modal belonging in the group numbers 1 to 4 and 8 to 15.

(G code modals belonging in the group number 1 to 4 are also registered even if R14604 is not specified.)

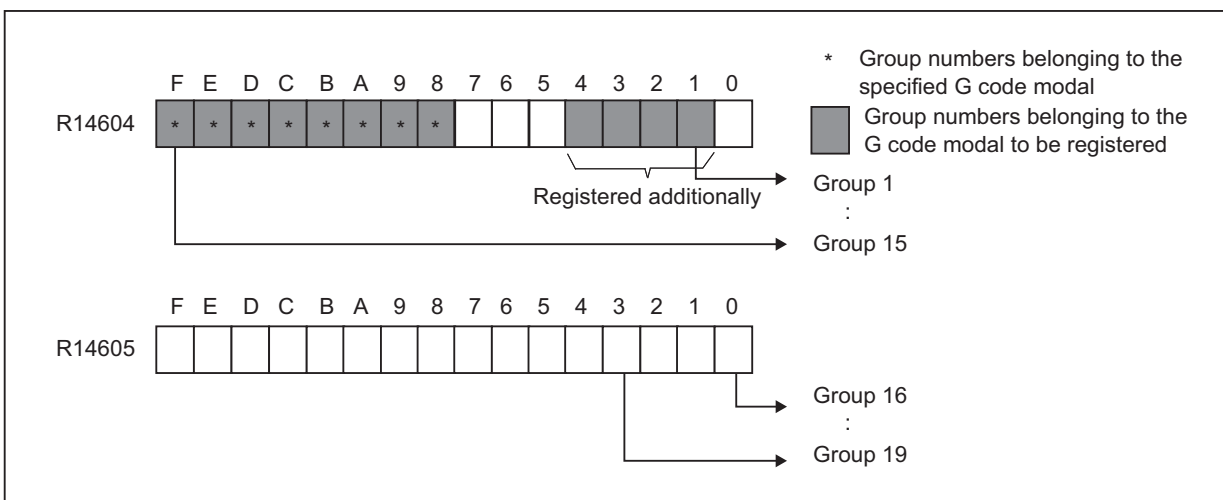

[Related signals]

(1) MES interface library: G code modal status [M8] (R14902 to R14933)

4 Explanation of Interface Signals

Cont.	Signal name	Abbrev.	Common(\$)
B	DIAGNOSIS DATA OUTPUT: HANDLING FOR SERVO MOTOR INSULATION DETERIORATION DETECTION (PLC AXIS) [C80]	*SVIDDDS	R20041

[Function]

This signal notifies the axis connected to the drive unit corresponding to the insulation deterioration detection.

[Operation]

This signal notifies the axis connected to the drive unit corresponding to the insulation deterioration detection. The bit of the axis connected to the corresponding drive unit becomes "1".

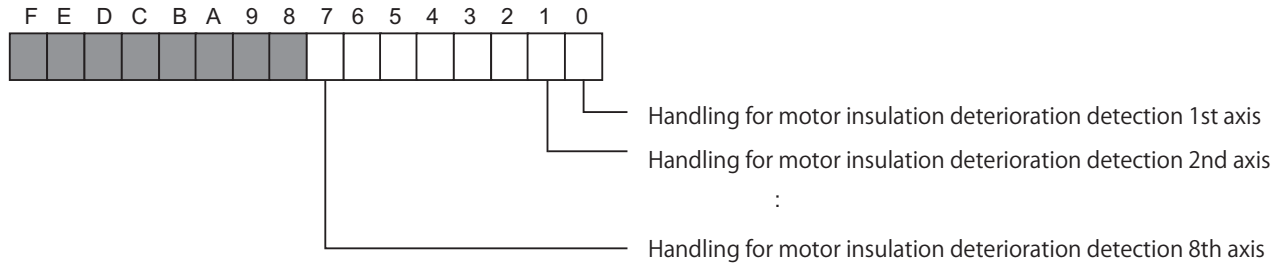

[Related signals]

- (1) Diagnosis data output: Waiting for servo motor insulation deterioration detection [C80] (*SVIDDDW:R20521)
- (2) Diagnosis data output: Waiting for spindle motor insulation deterioration detection [C80] (*SPIDDDW:R20047)
- (3) Diagnosis data output: Servomotor insulation degradation detection in progress (SVIDDD:R20522)
- (4) Diagnosis data output: Spindle motor insulation degradation detection in progress (SPIDDD:R20048)
- (5) Diagnosis data output: Caution in servo motor insulation deterioration detection [C80] (*SVIDDCA:R20523)
- (6) Diagnosis data output: Caution in spindle motor insulation deterioration detection [C80] (*SPIDDCA:R20049)
- (7) Diagnosis data output: Servo motor exchange due to insulation deterioration detection [C80] (*SVIDDCH:R20524)
- (8) Diagnosis data output: Spindle motor exchange due to insulation deterioration detection [C80] (*SPIDDCH:R20050)

4 Explanation of Interface Signals

Cont.	Signal name	Abbrev.	Common(\$)
B	DIAGNOSIS DATA OUTPUT: WAITING FOR SERVO MOTOR INSULATION DETERIORATION DETECTION (PLC AXIS) [C80]	*SVIDDDW	R20042

[Function]

This signal notifies the waiting for insulation deterioration detection state.

[Operation]

This signal outputs the waiting for insulation deterioration detection state to each axis and spindle per part system. When all of the following conditions are met, the bit of the corresponding axis becomes "1".

(1) The axis where the diagnosis data output: Handling for servo motor insulation deterioration detection (*SVIDDDS:R20520) is "1".

(2) The parameter "#6456/bit 4" is "1" and in an emergency stop state.

The bit of axis where the diagnosis data output: Servomotor insulation degradation detection in progress (SVIDDD:R20522) is turned ON due to the ready ON becomes "0".

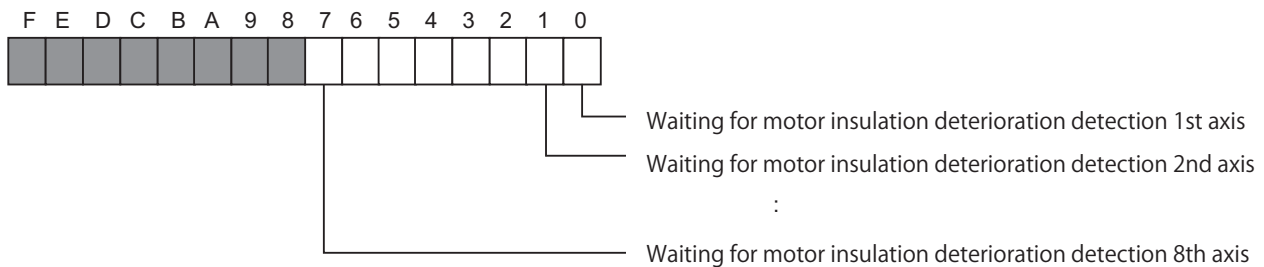

[Related signals]

- (1) Diagnosis data output: Handling for servo motor insulation deterioration detection [C80] (*SVIDDDS:R20520)
- (2) Diagnosis data output: Handling for spindle motor insulation deterioration detection [C80] (*SPIDDDS:R20046)
- (3) Diagnosis data output: Servomotor insulation degradation detection in progress (SVIDDD:R20522)
- (4) Diagnosis data output: Spindle motor insulation degradation detection in progress (SPIDDD:R20048)
- (5) Diagnosis data output: Caution in servo motor insulation deterioration detection [C80] (*SVIDDCA:R20523)
- (6) Diagnosis data output: Caution in spindle motor insulation deterioration detection [C80] (*SPIDDCA:R20049)
- (7) Diagnosis data output: Servo motor exchange due to insulation deterioration detection [C80] (*SVIDDCH:R20524)
- (8) Diagnosis data output: Spindle motor exchange due to insulation deterioration detection [C80] (*SPIDDCH:R20050)

4 Explanation of Interface Signals

Cont.	Signal name	Abbrev.	Common(\$)
A	DIAGNOSIS DATA OUTPUT: SERVOMOTOR INSULATION DEGRADATION DETECTION IN PROGRESS (PLC AXIS)	SVIDDD	R20043

[Function]

This signal notifies that the PLC axis connected to the drive unit is under insulation resistance measurement.

[Operation]

This signal outputs that the PLC axis connected to the drive unit is under insulation degradation detection to each axis and spindle per part system.

When the insulation resistance measurement starts, the corresponding bit turns ON.

When the insulation resistance measurement finishes, the corresponding bit turns OFF.

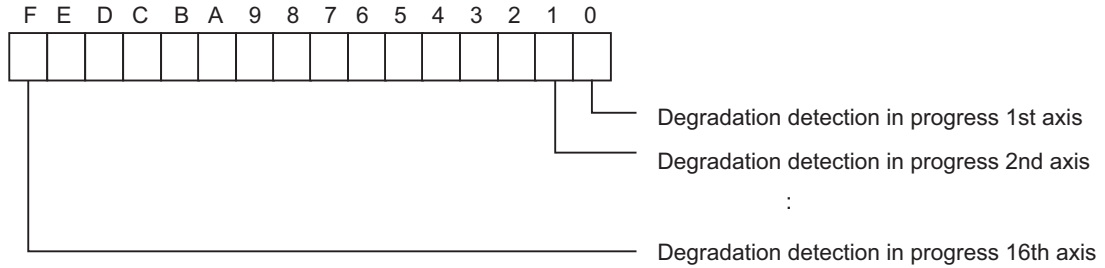

[Related signals]

- (1) Diagnosis data output: Motor insulation degradation detection request [M8] (IDDD: R20481)
- (2) Diagnosis data output: Handling for servo motor insulation deterioration detection [C80] (*SVIDDDS:R20520)
- (3) Diagnosis data output: Handling for spindle motor insulation deterioration detection [C80] (*SPIDDDS:R20046)
- (4) Diagnosis data output: Waiting for servo motor insulation deterioration detection [C80] (*SVIDDDW:R20521)
- (5) Diagnosis data output: Waiting for spindle motor insulation deterioration detection [C80] (*SPIDDDW:R20047)
- (6) Diagnosis data output: Caution in servo motor insulation deterioration detection [C80] (*SVIDDCA:R20523)
- (7) Diagnosis data output: Caution in spindle motor insulation deterioration detection [C80] (*SPIDDCA:R20049)
- (8) Diagnosis data output: Servo motor exchange due to insulation deterioration detection [C80] (*SVIDDCH:R20524)
- (9) Diagnosis data output: Spindle motor exchange due to insulation deterioration detection [C80] (*SPIDDCH:R20050)

4 Explanation of Interface Signals

Cont.	Signal name	Abbrev.	Common(\$)
B	DIAGNOSIS DATA OUTPUT: CAUTION IN SERVO MOTOR INSULATION DETERIORATION DETECTION (PLC AXIS) [C80]	*SVIDDCA	R20044

[Function]

This signal outputs the status of the alarm "Z38 Insulation deterioration wrn 0001".

[Operation]

This signal outputs the status of the alarm "Z38 Insulation deterioration wrn 0001" to each axis and spindle per part system.

The bit of axis where a warning occurs becomes "1".

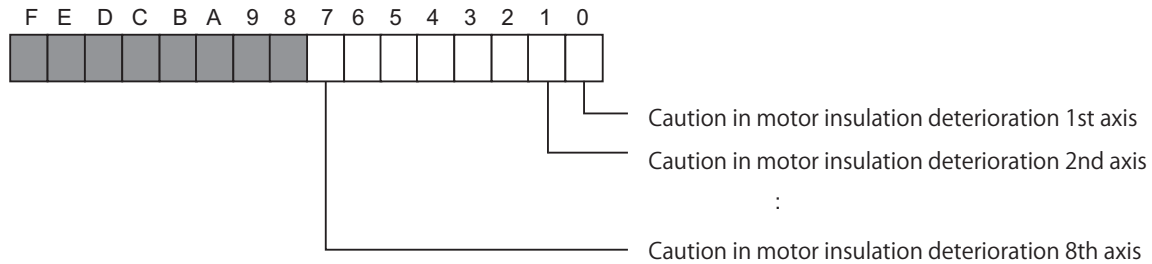

[Caution]

- (1) This signal becomes "0" when the NC and drive unit are turned OFF.
- (2) When the servo axis is in the state of the alarm "Z38 Insulation deterioration wrn 0003", this signal becomes "0".

[Related signals]

- (1) Diagnosis data output: Handling for servo motor insulation deterioration detection [C80] (*SVIDDDS:R20520)
- (2) Diagnosis data output: Handling for spindle motor insulation deterioration detection [C80] (*SPIDDDS:R20046)
- (3) Diagnosis data output: Waiting for servo motor insulation deterioration detection [C80] (*SVIDDDW:R20521)
- (4) Diagnosis data output: Waiting for spindle motor insulation deterioration detection [C80] (*SPIDDDW:R20047)
- (5) Diagnosis data output: Servomotor insulation degradation detection in progress (SVIDDD:R20522)
- (6) Diagnosis data output: Spindle motor insulation degradation detection in progress (SPIDDD:R20048)
- (7) Diagnosis data output: Servo motor exchange due to insulation deterioration detection [C80] (*SVIDDCH:R20524)
- (8) Diagnosis data output: Spindle motor exchange due to insulation deterioration detection [C80] (*SPIDDCH:R20050)

4 Explanation of Interface Signals

Cont.	Signal name	Abbrev.	Common(\$)
B	DIAGNOSIS DATA OUTPUT: SERVO MOTOR EXCHANGE DUE TO INSULATION DETERIORATION DETECTION (PLC AXIS) [C80]	*SVIDDCH	R20045

[Function]

This signal outputs the status of the alarm "Z38 Insulation deterioration wrn 0002".

[Operation]

This signal outputs the status of the alarm "Z38 Insulation deterioration wrn 0002" to each axis and spindle per part system.

The bit of axis where a warning occurs becomes "1".

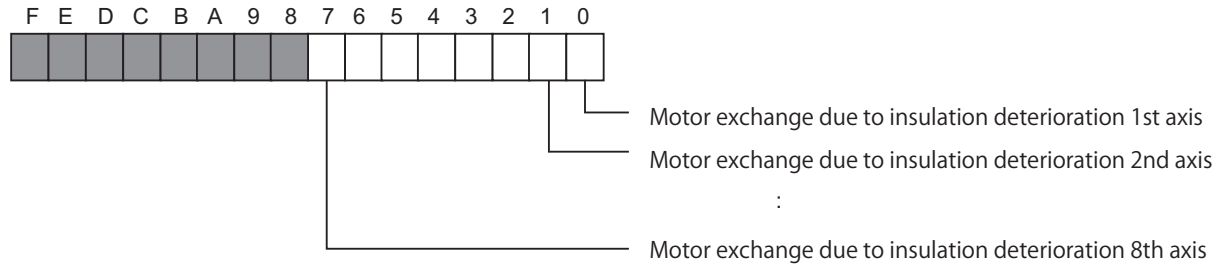

[Caution]

- (1) This signal becomes "0" when the NC and drive unit are turned OFF.
- (2) When the servo axis is in the state of the alarm "Z38 Insulation deterioration wrn 0003", this signal becomes "0".

[Related signals]

- (1) Diagnosis data output: Handling for servo motor insulation deterioration detection [C80] (*SVIDDD:R20520)
- (2) Diagnosis data output: Handling for spindle motor insulation deterioration detection [C80] (*SPIDDD:R20046)
- (3) Diagnosis data output: Waiting for servo motor insulation deterioration detection [C80] (*SVIDDDW:R20521)
- (4) Diagnosis data output: Waiting for spindle motor insulation deterioration detection [C80] (*SPIDDDW:R20047)
- (5) Diagnosis data output: Servomotor insulation degradation detection in progress (SVIDDD:R20522)
- (6) Diagnosis data output: Spindle motor insulation degradation detection in progress (SPIDDD:R20048)
- (7) Diagnosis data output: Caution in servo motor insulation deterioration detection [C80] (*SVIDDCA:R20523)
- (8) Diagnosis data output: Caution in spindle motor insulation deterioration detection [C80] (*SPIDDCA:R20049)

Cont.	Signal name	Abbrev.	Common(\$)
B	DIAGNOSIS DATA OUTPUT: HANDLING FOR SPINDLE MOTOR INSULATION DETERIORATION DETECTION [C80]	*SPIDDD	R20046

[Function] [Operation] [Related signals]

Refer to the section on "Diagnosis data output: Handling for servo motor insulation deterioration detection (PLC axis) [C80] (*SVIDDD:R20041)".

Cont.	Signal name	Abbrev.	Common(\$)
B	DIAGNOSIS DATA OUTPUT: WAITING FOR SPINDLE MOTOR INSULATION DETERIORATION DETECTION [C80]	*SPIDDDW	R20047

[Function] [Operation] [Related signals]

Refer to the section on "Diagnosis data output: Waiting for servo motor insulation deterioration detection (PLC axis) [C80] (*SVIDDDW:R20042)".

Cont.	Signal name	Abbrev.	Common(\$)
A	DIAGNOSIS DATA OUTPUT: SPINDLE MOTOR INSULATION DEGRADATION DETECTION IN PROGRESS	SPIDDD	R20048

[Function] [Operation] [Related signals]

Refer to the section on "Diagnosis data output: Servomotor insulation degradation detection in progress (PLC axis) (SVIDDD:R20043)".

4 Explanation of Interface Signals

Cont.	Signal name	Abbrev.	Common(\$)
B	DIAGNOSIS DATA OUTPUT: CAUTION IN SPINDLE MOTOR INSULATION DETERIORATION DETECTION [C80]	*SPIDDCA	R20049

[Function] [Operation] [Related signals]

Refer to the section of "Diagnosis data output: Caution in servo motor insulation deterioration detection (PLC axis) [C80] (*SVIDDCA:R20044)".

Cont.	Signal name	Abbrev.	Common(\$)
B	DIAGNOSIS DATA OUTPUT: SPINDLE MOTOR EXCHANGE DUE TO INSULATION DETERIORATION DETECTION [C80]	*SPIDDCH	R20050

[Function] [Operation] [Related signals]

Refer to the section on "Diagnosis data output: Servo motor exchange due to insulation deterioration detection (PLC axis) [C80] (*SVIDDCH:R20045)".

Cont.	Signal name	Abbrev.	Device
A	In hypothetical axis command mode [C80]	VAMODOn	R20180

[Function]

This signal indicates that the hypothetical axis command mode has been selected in the hypothetical linear axis control.

[Operation]

When the "Hypothetical axis command mode" signal (R20482) turns ON and the mode is changed to the hypothetical axis command mode, this signal (R20180) turns ON.

When the hypothetical linear axis control is disabled, this signal is always OFF.

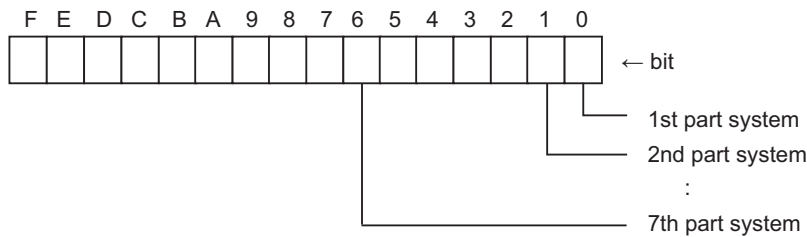

[Related signals]

(1) Hypothetical axis command mode (R20482: VAMODn)

Cont.	Signal name	Abbrev.	\$1	\$2	\$3	\$4	\$5	\$6	\$7	\$8
A	Current spatial error compensation value (orthogonal coordinate horizontal axis) [M8]		R20500, 1	R20700, 1	R20900, 1	R21100, 1	R21300, 1	R21500, 1	R21700, 1	R21900, 1
A	Current spatial error compensation value (orthogonal coordinate vertical axis) [M8]		R20502, 3	R20702, 3	R20902, 3	R21102, 3	R21302, 3	R21502, 3	R21702, 3	R21902, 3
A	Current spatial error compensation value (orthogonal coordinate height axis) [M8]		R20504, 5	R20704, 5	R20904, 5	R21104, 5	R21304, 5	R21504, 5	R21704, 5	R21904, 5
A	Current spatial error compensation value (1st rotary axis) [M8]		R20506, 7	R20706, 7	R20906, 7	R21106, 7	R21306, 7	R21506, 7	R21706, 7	R21906, 7
A	Current spatial error compensation value (2nd rotary axis) [M8]		R20508, 9	R20708, 9	R20908, 9	R21108, 9	R21308, 9	R21508, 9	R21708, 9	R21908, 9

[Function]

This signal indicates the current compensation value for each axis.

[Operation]

When the compensation values for each axis are set, these R registers are updated.

The spatial error compensation function can compensate errors only in the first part system.

[Related signals]

(1) Spatial error compensation in progress [M8] (SECI: XD17)

4 Explanation of Interface Signals

Cont.	Signal name	Abbrev.	\$1	\$2	\$3	\$4	\$5	\$6	\$7
B	DIAGNOSIS DATA OUTPUT: HANDLING FOR SERVO MOTOR INSULATION DETERIORATION DETECTION [C80]	*SVIDDD S	R20520	R20720	R20920	R21120	R21320	R21520	R21720

[Function] [Operation] [Related signals]

Refer to the section on "Diagnosis data output: Handling for servo motor insulation deterioration detection (PLC axis) [C80] (*SVIDDDS:R20041)".

Cont.	Signal name	Abbrev.	\$1	\$2	\$3	\$4	\$5	\$6	\$7
B	DIAGNOSIS DATA OUTPUT: WAITING FOR SERVO MOTOR INSULATION DETERIORATION DETECTION [C80]	*SVIDDD W	R20521	R20721	R20921	R21121	R21321	R21521	R21721

[Function] [Operation] [Related signals]

Refer to the section on "Diagnosis data output: Waiting for servo motor insulation deterioration detection (PLC axis) [C80] (*SVIDDDW:R20042)".

Cont.	Signal name	Abbrev.	\$1	\$2	\$3	\$4	\$5	\$6	\$7	\$8
A	DIAGNOSIS DATA OUTPUT: SERVOMOTOR INSULATION DEGRADATION DETECTION IN PROGRESS	SVIDDD	R20522	R20722	R20922	R21122	R21322	R21522	R21722	R21922

[Function] [Operation] [Related signals]

Refer to the section on "Diagnosis data output: Servomotor insulation degradation detection in progress (PLC axis) (SVIDDD:R20043)".

Cont.	Signal name	Abbrev.	\$1	\$2	\$3	\$4	\$5	\$6	\$7
B	DIAGNOSIS DATA OUTPUT: CAUTION IN SERVO MOTOR INSULATION DETERIORATION DETECTION [C80]	*SVID- DCA	R20523	R20723	R20923	R21123	R21323	R21523	R21723

[Function] [Operation] [Related signals]

Refer to the section of "Diagnosis data output: Caution in servo motor insulation deterioration detection (PLC axis) [C80] (*SVIDDCA:R20044)".

Cont.	Signal name	Abbrev.	\$1	\$2	\$3	\$4	\$5	\$6	\$7
B	DIAGNOSIS DATA OUTPUT: SERVO MOTOR EXCHANGE DUE TO INSULATION DETERIORATION DETECTION [C80]	*SVID- DCH	R20524	R20724	R20924	R21124	R21324	R21524	R21724

[Function] [Operation] [Related signals]

Refer to the section on "Diagnosis data output: Servo motor exchange due to insulation deterioration detection (PLC axis) [C80] (*SVIDDCH:R20045)".

4 Explanation of Interface Signals

Cont.	Signal name	Abbrev.	\$1	\$2	\$3	\$4	\$5	\$6	\$7	\$8
A	T CODE DATA FOR L SYSTEM		R20536, 7	R20736, 7	R20936, 7	R21136, 7	R21336, 7	R21536, 7	R21736, 7	R21936, 7

[Function]

When and "#11038 T disp typ" is set to "1" in a lathe system and a tool function is commanded by automatic operation (memory, MDI), it will notify number of tool function address T. T code data 1-4 notify the tool number only, but this signal notifies the tool command number that is commanded by machining program.

T code data that is output by controller can be selected from 8-digit BCD data, a unsigned 32-bit binary data, or signed 32-bit binary data, by parameter "#12010 Tbin".

[Operation]

Program example

O100

N010 G28XYZ

N020 T0102

(1) In case of executing N020 T0102 command when "#11038 T disp typ" is set to "1":

L system T code data (R20536) = 0x66

T code data (R536) = 0x01

(2) In case of executing N020 T0102 command when "#11038 T disp typ" is set to "0"

L system T code data (R20536) = 0

T code data (R536) = 0x01

Data remain unchanged even when "M function finish" signal (FIN1 or FIN2) is sent back. "Reset" or "Emergency stop" does not clear the data.

[Caution]

(1) Commanding "Txx" by manual numerical input would not update this signal. It is T code data 1 that will be updated.

(2) When "#11038 T disp typ" is set to "0", this signal will be cleared.

(3) In a M (machining center) system, this signal will be cleared.

[Related signals]

(1) T function strobe 1 (TF1:XC68)

(2) T code data 1 (R536-R537)

Cont.	Signal name	Abbrev.	\$1	\$2	\$3	\$4	\$5	\$6	\$7
A	MACHINING INTERRUPTION STATUS [C80]	MCNGITSTS	R20546	R20746	R20946	R21146	R21346	R21546	R21746

[Function][Operation]

Bit	Description	Bit	Description
bit0	Retraction executable	bit8	Reserved
bit1	Retraction in execution	bit9	Reserved
bit2	Stopping at machining start point	bit10	Reserved
bit3	Stopping at machining end point	bit11	Reserved
bit4	Stopping at process start point	bit12	Reserved
bit5	Reserved	bit13	Reserved
bit6	Reserved	bit14	Reserved
bit7	Reserved	bit15	Reserved

bit0: Retraction executable

This signal indicates that retraction has been enabled by the "Retraction start" signal (MCNGITCMD: R22504/bit1).

This signal turns ON when the execution of the machining start point block starts, while it turns OFF when the machining end point block starts.

This signal turns OFF when the "Retraction in execution" signal is turned ON by the "Retraction start" signal.

This signal also turns OFF when the retraction cannot be executed because of other reasons (such as reset and execution of the MDI interruption).

While this signal is ON, the "Retraction start" signal is valid.

[Related signal]

Retraction start (MCNGITCMD: R22504/bit1)

bit1: Retraction in execution

This signal indicates that the execution of the retraction program is in progress.

The signal turns ON when the retraction by program starts, while it turns OFF when the retraction program is canceled and the machining stops at the machining start point.

During the execution of the retraction program, this signal remains ON even if block stop occurs.

The signal turns OFF if the program is reset during the execution of the retraction program.

[Related signal]

Retraction start (MCNGITCMD: R22504/bit1)

bit2: Stopping at machining start point

This signal indicates that block stop has occurred at the machining start point.

When a block of the machining start point is detected during the "Operation mode with single block at selected point", a block stop occurs and this signal is output.

Also when the retraction program is completed and the control returns to the process start point, block stop occurs and the signal is output.

The state of this signal being output represents that the machining stops at a block; however, the block has not been executed yet.

Thus, the commands in the block and following blocks are executed when "Automatic operation "start" command (Cycle start)" is input. If "Automatic operation "start" command (Cycle start)" is input after the execution of the retraction program completes and the control returns to the machining start point, the S command and the "Spindle state restoration request" signal will be output to restore the spindle state.

[Related signal]

Stop status restoration request (MCNGITSPSTS: R6543/bit0)

Forward run start restoration request (MCNGITSPSTS: R6543/bit1)

Reverse run start restoration request (MCNGITSPSTS: R6543/bit2)

Orientation command restoration request (MCNGITSPSTS: R6543/bit3)

4 Explanation of Interface Signals

bit3: Stopping at machining end point

This signal indicates that block stop has occurred at the machining end point.

When a block of the machining end point is detected during the "Operation mode with single block at selected point", a block stop occurs and this signal is output.

The state of this signal being output represents that the machining stops at a block; however, the block has not been executed yet. Thus, the commands in the block and following blocks are executed when "Automatic operation "start" command (Cycle start)" is input.

While the operation is being stopped at the machining end point, the retraction executable status remains, thus retraction start can be performed.

bit4: Stopping at process start point

This signal indicates that block stop has occurred at the process start point.

When a block of the process start point is detected during the "Operation mode with single block at selected point", a block stop occurs and this signal is output.

The state of this signal being output represents that the machining stops at a block; however, the block has not been executed yet.

Thus, the commands in the block and following blocks are executed when "Automatic operation "start" command (Cycle start)" is input.

Cont.	Signal name	Abbrev.	\$1	\$2	\$3	\$4	\$5	\$6	\$7	\$8
A	VCC: Number of vibrations	VCC_VIB	R20556	R20756	R20956	R21156	R21356	R21556	R21756	R21956

[Function]

This signal notifies PLC of the number of vibrations in vibration cutting mode.

[Operation]

The value obtained by multiplying the number of vibrations per spindle rotation in the vibration cutting mode by "100" is stored in this register.

This signal is retained even after the vibration cutting mode is canceled. When the commanded spindle speed is "0", the previous information is retained.

[Caution]

The number of vibration in vibration cutting mode is a value rounded off to the second decimal place of the actual numbers of vibrations.

[Related signals]

- (1) Vibration cutting: Mode in execution (VCC: X1810)
- (2) Vibration cutting: Numbers of vibrations (VCC_VIB: R20556)
- (3) Vibration cutting: Frequency (VCC_FRQ: R20557)
- (4) Vibration cutting: Spindle rotation speed (VCC_SPREV: R7024, R7025)
- (5) Vibration cutting: Vibrating axis (VCC_VIBAX: R20558)
- (6) Vibration cutting: Temporary cancel of axis vibration (VCC_INVAX: R22532)
- (7) Vibration cutting: Cause of non-vibration (VCC_FACT: R20559)

4 Explanation of Interface Signals

Cont.	Signal name	Abbrev.	\$1	\$2	\$3	\$4	\$5	\$6	\$7	\$8
A	VCC: Frequency	VCC - FRQ	R20557	R20757	R20957	R21157	R21357	R21557	R21757	R21957

[Function]

This signal notifies PLC of the frequency in the vibration cutting mode.

[Operation]

The value obtained by multiplying the frequency in the vibration cutting mode by "100" is stored.

This signal is retained even after the vibration cutting mode is canceled. When the commanded spindle speed is "0", the previous information is retained.

[Caution]

The number of vibrations in the vibration cutting mode is a value rounded off to the second decimal place of the actual number of vibrations.

[Related signals]

Refer to the section of the "VCC: Number of vibrations" signal (VCC_VIB: R20556).

Cont.	Signal name	Abbrev.	\$1	\$2	\$3	\$4	\$5	\$6	\$7	\$8
A	VCC: Vibrating axis	VC- C_VIBAX	R20558	R20758	R20958	R21158	R21358	R21558	R21758	R21958

[Function]

This signal notifies PLC of the vibrating axes with bit data.

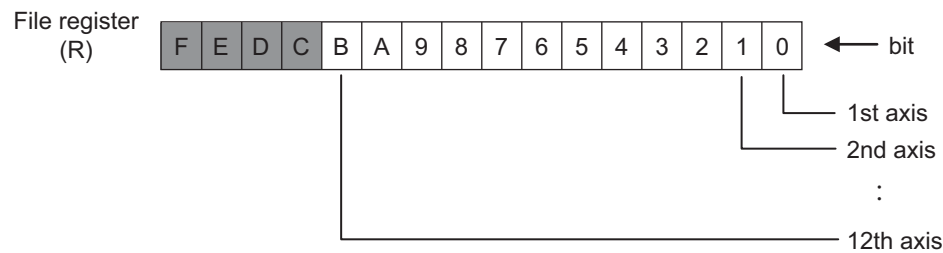

(Note) Switching an axis does not change a bit position.

[Operation]

When the control axis starts to vibrate in the vibration cutting mode, the bit corresponding to the control axis turns ON.

When vibration of the control axis converges, the corresponding bit turns OFF.

[Caution]

Only one axis in the programmed part system vibrates. Even for a cutting command with two or more axes such as taper, only the specified one axis vibrates.

[Related signals]

Refer to the section of the "VCC: Number of vibrations" signal (VCC_VIB: R20556).

4 Explanation of Interface Signals

Cont.	Signal name	Abbrev.	\$1	\$2	\$3	\$4	\$5	\$6	\$7	\$8
A	VCC: Cause of non-vibration	VCC_ FACT	R20559	R20759	R20959	R21159	R21359	R21559	R21759	R21959

[Function]

This signal notifies PLC of the cause of cutting without axis vibration in the cutting blocks or performing unintended vibration even during the vibration cutting mode.



[Operation]

When there is non-vibrating axis in the cutting blocks during the vibration cutting mode, the bit which is corresponding to the cause turns ON.

Each bit for devices and the corresponding cause of non-vibration for each vibration cutting mode are shown below.

Bit	Cause	
0	OMR-FF is disabled. ("#2313 SV113/bit0" is not set to "1".) Vibration cutting is performed with OMR-FF invalid.	
1	Not used.	
2	The vibration target axis is the vibration cutting invalid axis. The "vibration cutting disabled axis" here refers to an axis whose corresponding bit of the "VCC: Temporarily disabled axis" signal (R22532 to R23932) is ON.	
3	Vibration condition cannot be obtained. (Example 1) The G94 (feed per minute) is executed and spindles rotation speed is commanded to "0". (Example 2) "G08.5" with different type of vibration condition was commanded to the spindle for which the vibration cutting is being executed in other part system.	
4	There is a superimposed axis during an control axis superimposition or arbitrary axis superimposition among the feed axes.	
5 to 6	Not used.	
7	The vibration target axis is not specified. (Example) When a cutting command for two or more axes is issued without specifying the axis that vibrates at the address "α" in the command "G08.5 P2".	
	Program example	Operation explanation
	N01 M03 S3500;	The first spindle rotates at 3500 (r/min).
	N02 G95;	The mode is set to feed per revolution (synchronous feed) mode.
	N03 G08.5 P2;	The vibration cutting mode starts.
	N04 G01 Z-1.0 F0.04;	Cutting is performed while vibrating the feed axis (Z axis).
	N05 G01 X1.0;	Cutting is performed while vibrating the feed axis (X axis).
	N06 G01 Z-2.0 X2.0;	Since the address "α" was omitted in the vibration cutting mode start command of the N03 block, the vibration cutting control of the N06 block is temporarily disabled. At this time, bit7 of the "Vibration cutting: Cause of non-vibration" is turned ON.
N07 G08.5 P0;	The vibration cutting mode is canceled.	
8 to E	Not used.	
F	The vibration cutting control is temporarily disabled by the ",V0" command.	

[Related signals]

Refer to the section of the "VCC: Number of vibrations" signal (VCC_VIB: R20556).

4 Explanation of Interface Signals

Cont.	Signal name	Abbrev.	\$1	\$2	\$3	\$4
A	Total distance traveled by n-th axis during automatic operation [M8]		R24884,5 to R24914,5	R24916,7 to R24946,7	R24948,9 to R24978,9	R24980,1 to R25010,1

[Function] [Operation]

The R register stores the accumulated value of movement amounts that were output to the drive unit. Values to be stored depend on the settings of the parameter "#1005 plcunit" (PLC unit). The value is initialized to "0" at the power ON.

[Caution]

- (1) The movement amounts are not added to the total when the traveling direction reverses, for example, at quadrant transitions for circular contours or at joints of the blocks where direction reverses.
- (2) Values to be stored in the R register may decrease by the fractions which are caused by converting units to the one set in the parameter (#1005).

[Related signals]

- (1) Cutting feed movement amount n-th axis (R5172)

Cont.	Signal name	Abbrev.	\$1	\$2	\$3	\$4
A	Tool head hot swapping: NC axis switch status n-th axis [M8]	AX-CHGSTS1 to 8	R25012 to 19	R25020 to 27	R25028 to 35	R25036 to 43

[Function]

This signal notifies the PLC of the NC axis switch state.

[Operation]

<Low-order 8 bits: In-use NC axis switch setting number>

This indicates the switch setting number used in the NC axis switch. The value is set at the timing when the NC axis switch is completed.

<High-order 8 bits: NC axis switch state>

The "NC axis switch in progress" signal (R25012/bit8) is ON while the NC axis switch is performed, and turns OFF when the switch is completed.

The "NC axis switch completion" signal (R25012/bit9) is ON during the period from when the switch is completed until the "NC axis switch request" signal (R25684/bit8) turns OFF.

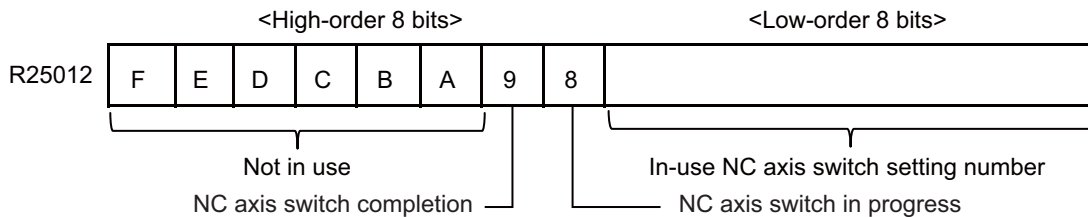

Refer to the timing chart of the "Tool head hot swapping: NC axis switch n-th axis" signal (R25684: AXCHGCMdN).

[Related signals]

- (1) Control axis detachment n-th axis (Y780: DTCHn)
- (2) Tool head hot swapping: NC axis switch n-th axis (R25684: AXCHGCMdN)

4.3 PLC Output Signals (Bit Type: Y***)

Cont.	Signal name	Abbrev.	Common(\$)
A	POWER CONSUMPTION COMPUTATION: CLEAR CONSUMPTION ACCUMULATION 1 to 4	IPCC1 to 4	Y700 to 3

[Function]

This signal clears a variety of accumulated power consumption.

[Operation]

The following accumulated power consumption is cleared at the rising edge of this signal.

- Accumulated consumption of entire drive system 1 to 4 (R122 to 9)
- Accumulated consumption of devices other than drive system 1 to 4 (R130 to 7)
- Total accumulated consumption 1 to 4
- Drive system's fixed consumption correction 1 to 4
- Accumulated consumption of servo axis in drive system (fluctuating part) 1 to 4
- Accumulated regeneration of servo axis in drive system (fluctuating part) 1 to 4
- Accumulated consumption of spindle in drive system (fluctuating part) 1 to 4
- Accumulated regeneration of spindle in drive system (fluctuating part) 1 to 4

[Related signals]

- (1) Power consumption computation: Clearing consumption accumulation 1 to 4 complete (IPCCC1 to 4: X708 to B)
- (2) Power consumption computation: Accumulated consumption of entire drive system 1 to 4 (DTIPC1 to 4: R122 to 9)
- (3) Power consumption computation: Accumulated consumption of devices other than drive system 1 to 4 (NDIPC1 to 4:R130 to 7)

Cont.	Signal name	Abbrev.	Common(\$)
A	INTEGRATION TIME INPUT 1	RHD1	Y704

[Function]

The total duration of a signal specified by a user PLC can be counted and displayed. For this, integration time input 1 and 2 are available.

[Operation]

The INTEGRAL TIME during this signal (RHD1) has been ON is displayed in hours, minutes, and seconds.

The counted (integrated) time is held even when the power is turned OFF. The integration time can be preset or reset.

Cont.	Signal name	Abbrev.	Common(\$)
A	INTEGRATION TIME INPUT 2	RHD2	Y705

[Function][Operation]

Both functions and operations are the same as those of "Integration time input 1 (RHD1)". See the descriptions on "Integration time input 1 (RHD1)".

4 Explanation of Interface Signals

Cont.	Signal name	Abbrev.	Common(\$)
B	DATA PROTECT KEY 1	*KEY1	Y708

[Function]

Data pertinent to tool functions, and coordinate data (origin reset) can be protected with this signal.

[Operation]

When this signal is turned OFF (0), the tool data setting operation is prohibited.

[Caution]

- (1) When a setting is attempted to change while this signal is OFF, a message of "DATA PROTECT" appears in the message section of screen.
- (2) Even when this signal is set to OFF (0), the setting of the tool wear compensation amount can be changed by the setting of the parameter "#1760 cfgPR10/bit6" (Wear compensation amount edit in Data protection ON). [M8]
- (3) This signal is set to ON (1) when the power is turned ON. This means that data protection has been canceled. Therefore, when the sequence program has no line to use data protection key, the signal is always turned ON (1). [M8]
- (4) For C80, this signal is not set to ON (1) when the power is turned ON. Perform sequence processing if necessary.

[Related signals]

- (1) Data protect key 2 (*KEY2: Y709)
- (2) Data protect key 3 (*KEY3: Y70A)
- (3) Data protect key (memory card)(*KEY_MemC: Y1C81)
- (4) Data protect key (DS)(*KEY_DS: Y1C82)

Cont.	Signal name	Abbrev.	Common(\$)
B	DATA PROTECT KEY 2	*KEY2	Y709

[Function]

Various data such as user parameters, common variables, Email notification to operator, range setting screen, and data related to machining condition selection can be protected.

[Operation]

When this signal is turned OFF (0), the following data settings and operations are prohibited.

- User parameters
- Common variables
- Email notification to operator
- Data on range setting screen
- Switching selection parameter (machining condition selection)
- Setting application name and condition name (machining condition selection)
- Performing initialization (machining condition selection)

[Caution]

- (1) When a setting is attempted to change while this signal is OFF, a message of "DATA PROTECT" appears in the message section of the screen.
- (2) This signal is set to ON (1) when the power is turned ON. This means that data protection has been canceled. Therefore, when the sequence program has no line to use data protection key, the signal is always turned ON (1). [M8]
- (3) For C80, this signal is not set to ON (1) when the power is turned ON. Perform sequence processing if necessary.

[Related signals]

- (1) Data protect key 1 (*KEY1: Y708)
- (2) Data protect key 3 (*KEY3: Y70A)
- (3) Data protect key (memory card)(*KEY_MemC: Y1C81)
- (4) Data protect key (DS)(*KEY_DS: Y1C82)

4 Explanation of Interface Signals

Cont.	Signal name	Abbrev.	Common(\$)
B	DATA PROTECT KEY 3	*KEY3	Y70A

[Function]

Data pertinent to machining program can be protected.

[Operation]

When this signal is turned OFF (0), the editing of the machining program is prohibited.

The target devices are memory and memory 2 (C80).

[Caution]

- (1) When an editing is attempted to do while this signal is OFF, a message of "DATA PROTECT" appears in the message section of the screen.
- (2) This signal is set to ON (1) when the power is turned ON. This means that data protection has been canceled. Therefore, when the sequence program has no line to use data protection key, the signal is always turned ON (1).
[M8]
- (3) For C80, this signal is not set to ON (1) when the power is turned ON. Perform sequence processing if necessary.

[Related signals]

- (1) Data protect key 1 (*KEY1: Y708)
- (2) Data protect key 2 (*KEY2: Y709)
- (3) Data protect key (memory card)(*KEY_MemC: Y1C81)
- (4) Data protect key (DS)(*KEY_DS: Y1C82)

Cont.	Signal name	Abbrev.	Common(\$)
A	HANDLE PULSE ENCODER COMMUNICATION CONNECTOR PRIORITY		Y70D

[Function][Operation]

Priority of handle input pulse is determined when the parameter "#1239 set11 bit1" (handle I/F selection) is OFF.

0: Remote I/O connecting handle priority

1: Handle pulse encoder communication connector connecting handle priority

[Related signals]

- (1) Handy terminal key 1 to 45 (X1CD0 to X1CFC)
- (2) Handle/Incremental feed magnification code m (MP1, MP2, MP4: YC80, YC81, YC82)
- (3) Handle/incremental feed magnification method selection (MPS: YC87)
- (4) Handy terminal Data area top address (R297)
- (5) Handy terminal Data valid number of registers (R298)
- (6) Handy terminal Cause of communication error (R299)
- (7) 1st handle/incremental feed magnification (R2508, R2509)

4 Explanation of Interface Signals

Cont.	Signal name	Abbrev.	Common(\$)
B	PLC AXIS NEAR POINT DETECTION n-TH AXIS	*PCD1 to 8	Y718 to F

[Function]

The near point dog signal of the PLC axis reference position return is input.

[Operation]

Set the near point dog signal of the PLC axis reference position return for the following devices in the PLC.

Device No.		Signal name
Y718	PCD1	PLC axis near point detection 1st axis
Y719	PCD2	PLC axis near point detection 2nd axis
Y71A	PCD3	PLC axis near point detection 3rd axis
Y71B	PCD4	PLC axis near point detection 4th axis
Y71C	PCD5	PLC axis near point detection 5th axis
Y71D	PCD6	PLC axis near point detection 6th axis
Y71E	PCD7	PLC axis near point detection 7th axis
Y71F	PCD8	PLC axis near point detection 8th axis

(Note) If the dog signal is set during the PLC middle-speed process, the response will be poorer than when the dog signal is set with the PLC high-speed process.

Cont.	Signal name	Abbrev.	Common(\$)
A	PLC AXIS 1ST to 3RD HANDLE VALID	PCH1 to 3	Y720 to 2

[Function]

This is designated when handle feeds using 1st to 3rd handles are to be carried out with the PLC axis.

To carry out handle feeds of 4th to 9th handles, designate the signals in Y1CA0 to Y1CA5. [C80]

[Operation]

Designate with the following devices when carrying out handle feed with the PLC axis.

Device No.		Signal name
Y720	PCH1	PLC axis 1st handle valid
Y721	PCH2	PLC axis 2nd handle valid
Y722	PCH3	PLC axis 3rd handle valid
Y1CA0	PCH4	PLC axis 4th handle valid [C80]
Y1CA1	PCH5	PLC axis 5th handle valid [C80]
Y1CA2	PCH6	PLC axis 6th handle valid [C80]
Y1CA3	PCH7	PLC axis 7th handle valid [C80]
Y1CA4	PCH8	PLC axis 8th handle valid [C80]
Y1CA5	PCH9	PLC axis 9th handle valid [C80]

(Note 1) When this signal is ON, each handle will be exclusive for the PLC axis. The handle will not be valid for the NC control axis.

The "n-th handle axis selection code" (HSn1 to HSn16) and the "n-th handle valid" (HSnS) are used to select each handle axis.

(Note 2) The handle feed magnification is common with that for the NC control axis.

4 Explanation of Interface Signals

Cont.	Signal name	Abbrev.	Common(\$)
A	PLC AXIS CONTROL BUFFERING MODE VALID	PABMI	Y723

[Function] [Operation]

In buffering mode, the PLC axis command (control information data) can be commanded to multiple blocks. This enables a smooth changeover of commands.

<Control information data>

The control data for the buffering mode is set in three blocks. The contents of each control information data have the same configuration as the normal control information data.

When executing, the axis moves in the order that each control information data has been started. When the movement is completed, it will move to the next block.

(If the start signals are turned ON simultaneously, it will be performed in the order of A, B, and C.)

[M8]

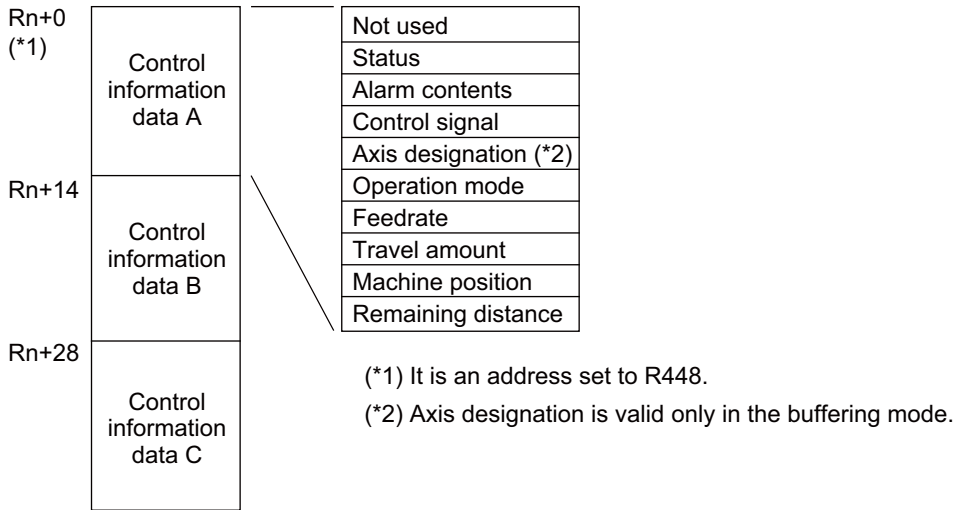

[C80]

<PLC axis command: sequencer to CNC>

<PLC axis status: CNC to sequencer>

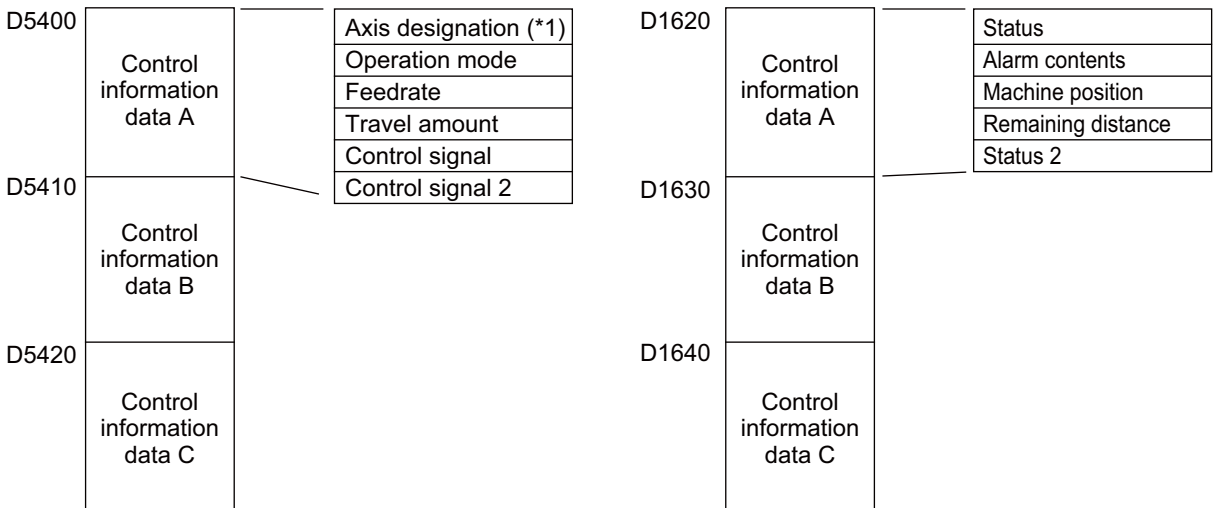

(*1) Axis designation is valid only in the buffering mode.

Refer to "2.7 Classified for Each Application" for details of D device.

[Timing chart]

G1→G1→G0→G1 (Same axis)

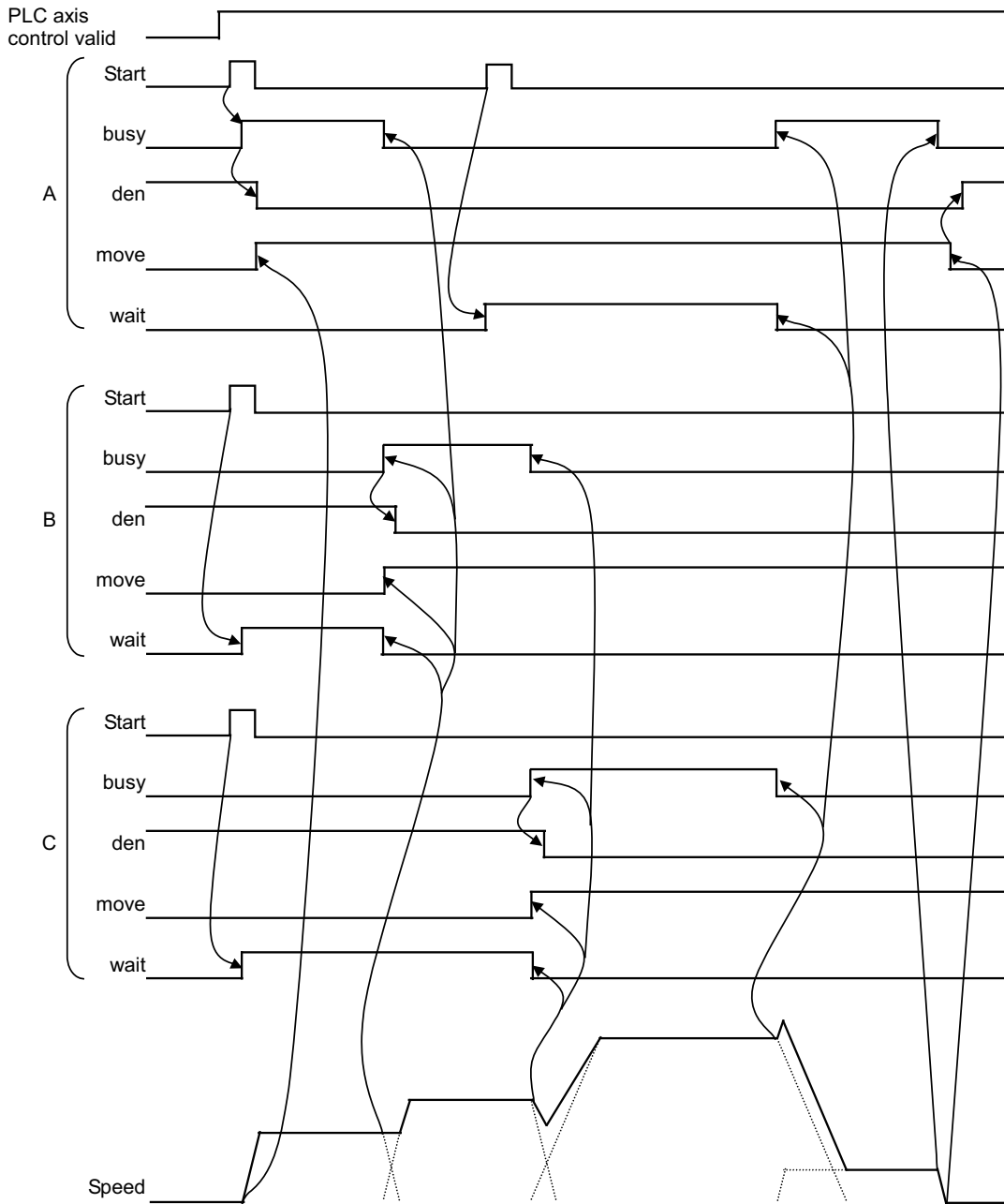

(Note) Change and start the data after the busy signal turns OFF. Starting while the busy signal is ON will be ignored.

G0→G1→G1→G0 (Two axes)

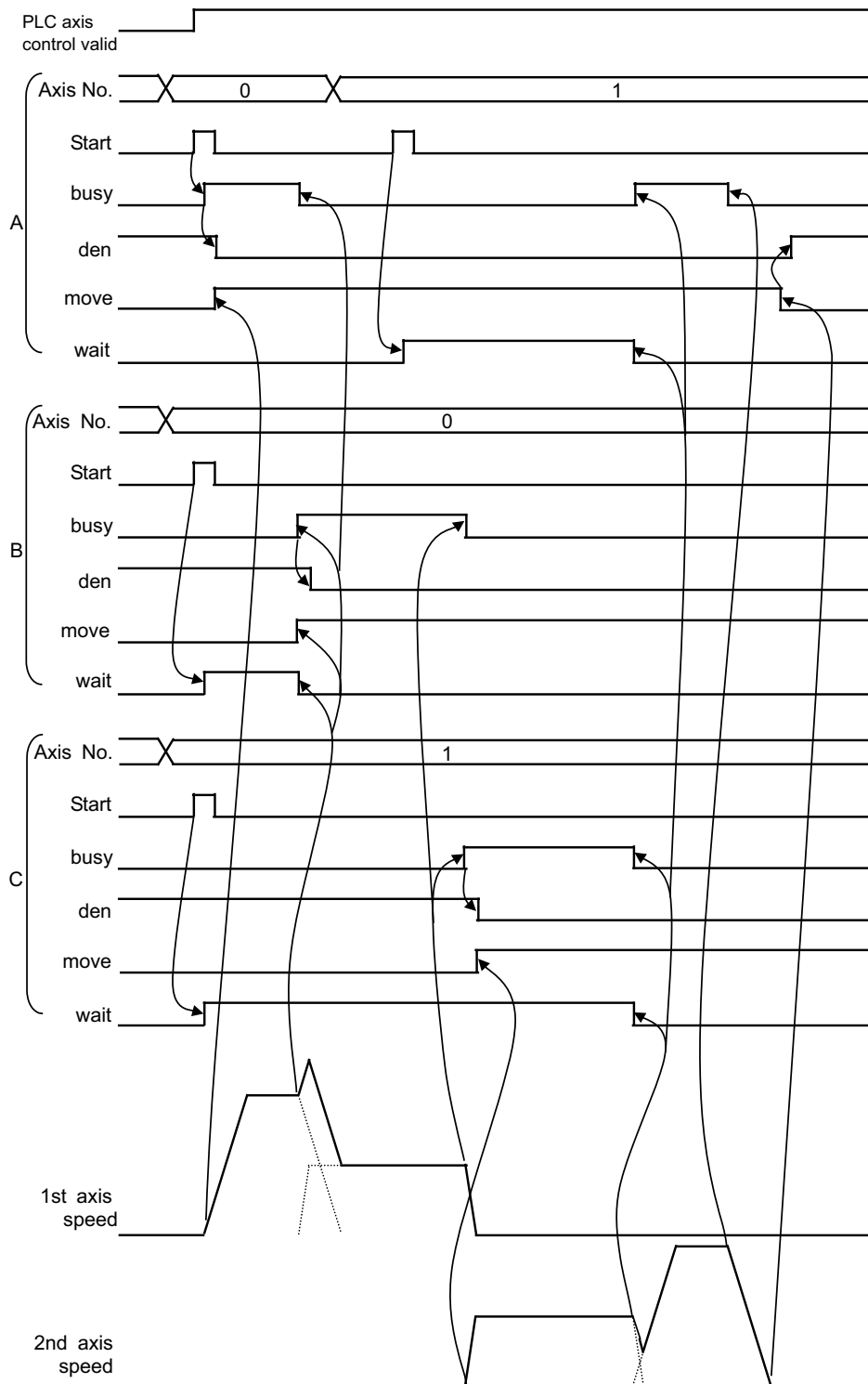

[Caution]

Only one set of buffering mode can be commanded. When two or more sets are commanded simultaneously, the sets commanded later will cause an alarm.

[Related signals]

- (1) PLC axis control buffering mode information address [M8] (R448)

4 Explanation of Interface Signals

Cont.	Signal name	Abbrev.	Common(\$)
A	POWER CONSUMPTION COMPUTATION: ENABLE CONSUMPTION ACCUMULATION 1 to 4	IPCE1 to 4	Y724 to 7

[Function]

This signal enables "Consumption accumulation 1 to 4".

[Operation]

The following kinds of consumption accumulation are performed while this signal is ON.

- Accumulated consumption of entire drive system 1 to 4 (R122 to 9)
- Accumulated consumption of devices other than drive system 1 to 4 (R130 to 7)
- Total accumulated consumption 1 to 4
- Drive system's fixed consumption correction 1 to 4
- Accumulated consumption of servo axis in drive system (fluctuating part) 1 to 4
- Accumulated regeneration of servo axis in drive system (fluctuating part) 1 to 4
- Accumulated consumption of spindle in drive system (fluctuating part) 1 to 4
- Accumulated regeneration of spindle in drive system (fluctuating part) 1 to 4

[Related signals]

- (1) Power consumption computation: Consumption accumulation ON 1 to 4 (IPCE1 to 4:X700 to 3)
- (2) Power consumption computation: Accumulated consumption of entire drive system 1 to 4 (DTIPC1 to 4:R122 to 9)
- (3) Power consumption computation: Accumulated consumption of devices other than drive system 1 to 4 (NDIPC1 to 4:R130 to 7)
- (4) Power consumption computation: Consumption of devices other than drive system (NDPC:R304, 5)
- (5) Power consumption computation: Drive system's fixed consumption correction (DFPCC:R306, 7)

Cont.	Signal name	Abbrev.	Common(\$)
A	CRT CHANGEOVER COMPLETION [M8]	CRTFN	Y728

[Function]

When using one setting and display unit for multiple controller display units, this signal is used to inform the controller that it has been changed as a display unit.

[Operation]

When this signal turns ON, the currently selected screen will display at the rising edge. For the setting and display unit screen, the screen on the controller before the changeover will remain, so when this signal is input, the local screen display will be changed to.

[Timing chart]

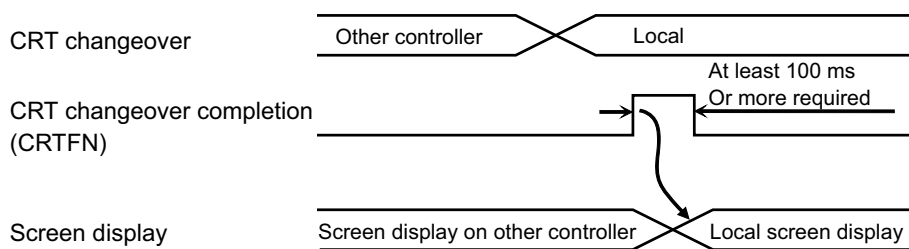

4 Explanation of Interface Signals

Cont.	Signal name	Abbrev.	Common(\$)
A	SCREEN DISPLAY REQUEST	SCRON	Y729 [M8]

[Function]

The screen backlight, which was turned OFF with the screen saver function, can be turned ON again.

[Operation]

- (1) The backlight is turned ON again at the rising edge of this signal. Counting of the time to turn the backlight OFF will start when this signal turns OFF.
- (2) If this signal is output to the CNC while the screen is ON, counting of the time to turn the screen OFF will restart.

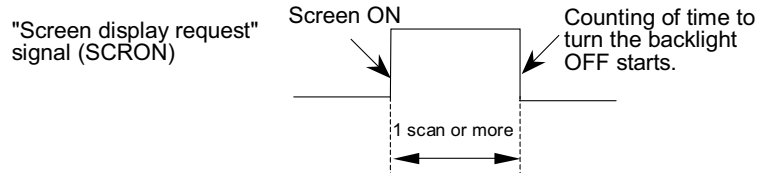

- (Note 1) The backlight is not turned OFF with "#8078 Screen saver time" while the "Screen display request" signal is ON, but the backlight can be turned OFF using the and keys.
- (Note 2) If the "Screen display request" signal (Y729) is changed again after that has changed once, intervals of 1scan or more must be taken.

Cont.	Signal name	Abbrev.	Common(\$)
A	COLLECTING DIAGNOSIS DATA STOP		Y72B

[Function]

Data collection will be stopped by turning this signal ON while collecting history data using operation history function. Data collection will be started (resumed) by turning the signal OFF in data stop mode.

[Operation]

- (1) "Collecting diagnosis data stop" signal stops data collection during rising edge movement following the signal turned ON from OFF. This signal starts data collection during falling edge movement following the signal turned OFF from ON.
- (2) Data collection will be stopped when this signal is turned ON while executing diagnosis data collection (when "collecting diagnosis data" signal is turned ON). Data collection will be stopped in approx. 500ms after the signal is turned ON. "Collecting diagnosis data" signal is turned OFF when data collection is stopped.
- (3) Data collection will be started when this signal is turned OFF while diagnosis data collection is stopped (when "collecting diagnosis data" signal is turned OFF). Data collection will be started in approx. 500ms after the signal is turned OFF. "Collecting diagnosis data" signal is turned ON when data collection is started.

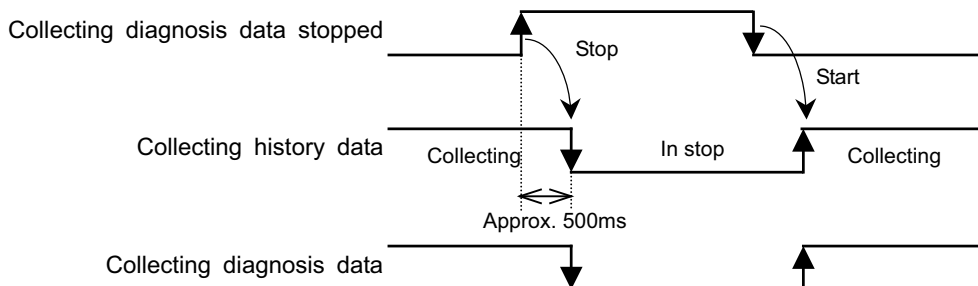

- (Note 1) This signal will be ignored even if issued at the first one scan after turning the power ON.

[Related signals]

- (1) Collecting diagnosis data (X723)

4 Explanation of Interface Signals

Cont.	Signal name	Abbrev.	Common(\$)
A	Sampling start/stop	SMPTRG	Y72C

[Function]

This signal is used when NC data sampling is started/terminated with PLC device.

[Operation]

- (1) When "2" (PLC device) is selected for "Start condition" and then this signal is turned ON while "Start sampling" is being set to "1 (Start sampling)", data sampling will be executed.
- (2) If "2 (PLC device)" is selected for "Termination condition", the sampling will be terminated when this signal is turned OFF during sampling.
- (3) This signal will be ignored in the following cases:
 - When neither "Start condition" nor "Termination condition" is set to "2"
 - When "Start sampling" is set to "0 (Stop sampling)"

Cont.	Signal name	Abbrev.	Common(\$)
A	PALLET PROGRAM REGISTRATION EXT. WORKPIECE COORDINATE TRANSFER READY [M8]		Y72F

[Function][Operation]

When transferring external workpiece coordinate offset (EXT) in the pallet 4 page registration, turn this signal ON. NC starts transfer processing at the rising edge of this signal.

When the external workpiece coordinate transfer completion signal is turned ON, turn this signal OFF.

It takes approx. 8ms from the start to the end of transfer processing. If the transfer completion signal is not turned ON even after 8ms has passed since the transfer ready signal was turned ON, reconsider the value of R register 4100 and 4102.

NC turns the external workpiece coordinate transfer completion signal OFF at the falling edge of this signal.

When turning the transfer ready signal ON from the machining program, recalculation request and M function finish (FIN1 or FIN2) must be turned ON after the external workpiece coordinate transfer completion signal is turned ON.

When recalculation is not requested, operation of the pre-read machining program will be carried out using the external workpiece coordinate offset prior to the change.

When M function has been completed before transfer is completed, the external workpiece coordinate offset data to be used in the machining program will not be changed from the one prior to the change until the transfer completion signal is turned ON.

This signal must be turned ON while the external workpiece coordinate transfer completion signal is OFF.

[Timing chart]

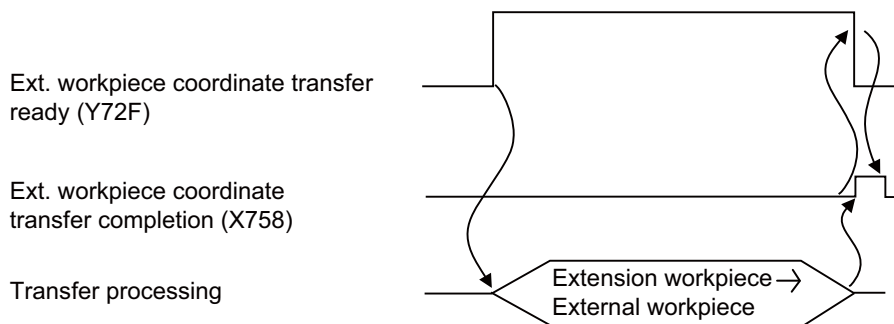

[Related signals]

- (1) Pallet program registration Ext. workpiece coordinate transfer completion (X758)

4 Explanation of Interface Signals

Cont.	Signal name	Abbrev.	Common(\$)
A	DISPLAY CHANGEOVER \$1 to \$8	DISP1 to 8	Y730 to 7

[Function]

The displayed part system of the multiple part systems can be changed.

[Operation]

The screen display for the multiple part systems is a screen for displaying one of the part systems. Thus, which part system to be displayed is determined by these signals.

If both of these signals are started up simultaneously, they will be invalid.

If "#11035 Sys. change limit" is set to "2", this signal will be invalid.

The displayed part system is changed when the "Display changeover \$1 to \$8" signal (Y730) is changed.

An example of the displayed part system change is as follows.

Example: When there are three effective part systems

	State A	→ State B	→ State C	→ State D	→ State E	→ State F
Y730(\$1)	0	0	0	0	0	0
Y731(\$2)	0	0	1	1	0	1
Y732(\$3)	0	1	1	0	0	1
Y733(\$4)	0	1	0	0	0	0
Y734(\$5)	0	0	0	0	0	0
Y735(\$6)	0	0	0	0	0	0
Y736(\$7)	0	0	0	0	0	0
Y737(\$8)	0	0	0	0	0	0
The state of display	Part system 1 is displayed (Note 1)	Change to Part system 3. (Note 2)	Part system 3 remains displayed.	Change to Part system 2.	Part system 2 remains displayed.	Part system 2 remains displayed. (Note 3)

(Note 1) If all signals are "0" at the time of power ON, part system 1 is displayed.

(Note 2) If a signal of any inactive part system is changed, the displayed part system is unchanged.

(Note 3) If a signal of two or more part systems are changed at a time, the displayed part system is unchanged.

Cont.	Signal name	Abbrev.	Common(\$)
A	SINGLE BLOCK BETWEEN PART SYSTEMS	MSBK	Y73A

[Function]

This signal enables the "Single block between part systems" operation.

In a multi-part system, this signal is used to perform single-block operation while keeping synchronization of part systems during operation that uses 2 or more part systems.

[Operation]

In a multi-part system in which single-block operation is performed while the "Single block between part systems" signal is ON, if single-block stop occurs in a part system, automatic operation pause occurs in other part systems.

This signal is enabled if any of the part systems is in single-block operation. If all part systems are in continuous operation, this signal is disabled.

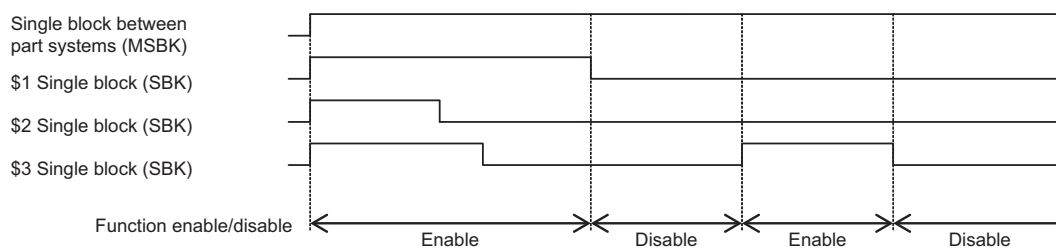

[Related signals]

- (1) Single block (SBK:YC12)
- (2) Synchronization between part systems OFF (MSYNC:YCF8)

Cont.	Signal name	Abbrev.	Common(\$)
A	MANUAL ARBITRARY REVERSE RUN MODE	MORR	Y73C

[Function]

This signal enables manual arbitrary reverse run function.

The manual arbitrary reverse run is performed by controlling the feedrate during automatic operation in the memory or MDI mode. The feedrate is controlled in proportion to the manual (jog) feed speed or manual rotation speed (handle).

[Operation]

The manual arbitrary reverse run is enabled only when the memory or MDI mode is entered and this signal is ON. The manual mode (handle or jog) must be turned ON at the same time as this signal turns ON, as the axis is moved in the manual mode (handle or jog) during the manual arbitrary reverse run.

Speed control during manual arbitrary reverse run is also enabled if the Manual arbitrary reverse run speed selection (MORSP) and Manual arbitrary reverse run speed multiplier (R379) is commanded.

However, when the parameter "#1260 set32/bit0 (Switching to actual cutting mode during automatic operation)" is set to "1", in the specific operation block during thread cutting, thread cutting cycle and tapping cycle, Manual arbitrary reverse run mode ON (X715) cannot be switched to ON/OFF even if this signal is switched to ON/OFF. For the specific movement block, refer to the section "Actual cutting mode (thread, tap) in manual arbitrary reverse run (Y761)". [M8]

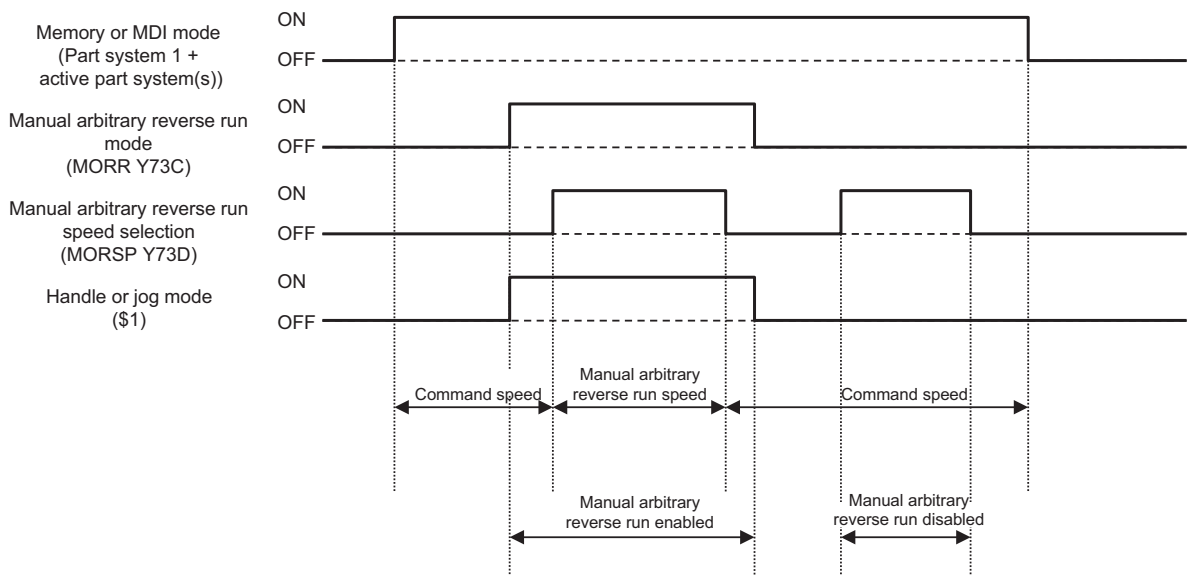
[Operation sequence]**[Related signals]**

- (1) Manual arbitrary reverse run mode ON (PCHKO:X715)
- (2) Manual arbitrary reverse run: Reverse run ON (MOREV:X716)
- (3) Thread, tap block stopping in manual arbitrary reverse run (MBSTP:X74D)
- (4) Thread, tap reverse run prohibition alarm in manual arbitrary reverse run (MRVNG:X74E)
- (5) Manual arbitrary reverse run speed selection (MORSP:Y73D)
- (6) Actual cutting mode (thread, tap) in manual arbitrary reverse run (MRCMD:Y761)
- (7) Manual arbitrary reverse run: MSTB reverse run prohibited (MRPSG:YCF8)
- (8) Manual arbitrary reverse run: Reverse run block stop designated part system (RBSSY:YD01)
- (9) Manual arbitrary reverse run handle selection (R375)
- (10) Manual arbitrary reverse run speed multiplier (R379)

Cont.	Signal name	Abbrev.	Common(\$)
A	MANUAL ARBITRARY REVERSE RUN SPEED SELECTION	MORSP	Y73D

[Function]

In speed control during manual arbitrary reverse run, this signal enables the program check speed constant.

[Operation]

When this signal is ON, the program check speed constant is used for speed control. When this signal is OFF, the command speed in the normal machining program is used.

The feedrate for manual arbitrary reverse run is controlled by the Manual arbitrary reverse run speed multiplier (R379) when operation is in jog mode. When in handle mode, the feedrate is controlled with the ratio of the handle pulses per time unit to "#19007 program check constant".

When this signal is OFF, the command speed in the normal machining program is used.

The speed used when the Manual arbitrary reverse run speed selection (MORSP) is ON

(1) When jog mode is selected:

The manual arbitrary reverse run speed can be calculated from the following formula.

$$\frac{\text{Manual arbitrary reverse run speed multiplier}}{\text{Program check speed constant}} \times \text{Command speed in the machining program}$$

(2) When handle mode is selected:

The manual arbitrary reverse run speed can be calculated from the following formula.

$$\frac{(\text{Change amount of handle pulse per unit time} \times \text{Manual arbitrary reverse run speed multiplier})}{\text{Program check speed constant}} \times \text{Command speed in the machining program}$$

- Rapid traverse override or cutting override can be exerted on the command speed in the machining program.
- Reverse motion is performed if the value of the manual arbitrary reverse run speed calculated with the above formula is a negative value.
- As the same rate of change of the manual arbitrary reverse run speed is applied to all part systems, synchronization of the part systems can be maintained. However, synchronization is not guaranteed when rapid traverse override or cutting override, which may cause a loss of synchronization, is used.
- If the value of the Manual arbitrary reverse run speed multiplier (R379) or the amount of change of handle pulses exceeds "#19007 program check constant", the value is clamped at "#19007 program check constant". The manual arbitrary reverse run speed never exceeds the command speed.

[Related signals]

- (1) Manual arbitrary reverse run mode ON (PCHKO:X715)
- (2) Manual arbitrary reverse run: Reverse run ON (MOREV:X716)
- (3) Thread, tap block stopping in manual arbitrary reverse run (MBSTP:X74D)
- (4) Thread, tap reverse run prohibition alarm in manual arbitrary reverse run (MRVNG:X74E)
- (5) Manual arbitrary reverse run mode (MORR:Y73C)
- (6) Actual cutting mode (thread, tap) in manual arbitrary reverse run (MRCMD:Y761)
- (7) Manual arbitrary reverse run: MSTB reverse run prohibited (MRPSG:YCFC)
- (8) Manual arbitrary reverse run: Reverse run block stop designated part system (RBSSY:YD01)
- (9) Manual arbitrary reverse run handle selection (R375)
- (10) Manual arbitrary reverse run speed multiplier (R379)

Cont.	Signal name	Abbrev.	Common(\$)
A	HIGH-SPEED SIMPLE PROGRAM CHECK MODE	SMLK	Y73E

[Function]

This signal enables the high-speed simple program check function.

[Operation]

When this signal is enabled, the machining program is executed while all axes are in machine lock.

In this operation, the feedrate of the machining program changes according to the the value of High-speed simple program check: Time reduction coefficient (R378).

[Related signals]

- (1) High-speed simple program check mode ON (SMLKO:X712)
- (2) High-speed simple program check: Time reduction coefficient (R378)
- (3) High-speed simple program check: Time measurement output (R372,3[M8]/R198,9[C80])

Cont.	Signal name	Abbrev.	Common(\$)
A	Interference check between part systems: Interference check enabled [M8]	CCHK	Y73F

[Function]

This signal enables interference check between part systems.

[Operation]

When you turn ON this signal, the interference check between part systems is started.

When you turn OFF this signal, the interference check between part systems is finished.

[Related signals]

- (1) Interference check between part systems: Mode is active [M8] (X773)
- (2) Interference check between part systems: Setting error alarm information [M8] (R101)
- (3) Interference check between part systems: Alarm information [M8] (R102)

4 Explanation of Interface Signals

Cont.	Signal name	Abbrev.	Common(\$)
A	CONTACTOR SHUTOFF TEST	MCT	Y742

[Function]

This signal carries out a contactor shutoff test.

[Operation]

Send a "ready OFF" command to the drive unit at the contactor shutoff test signal's rising edge and shut the drive unit side contactor OFF. Then, turn MC_ct1 of I/O unit connector (contactor shutoff output 1) output [M8] (Drive section power shutoff signal of safety signal unit [C80]) OFF and shut the NC side contactor OFF.

Confirm that the contactor's status is OFF by monitoring contactor's auxiliary b contact signal, then send a "ready ON" command to the drive unit to turn the drive unit side contactor ON. Turn ON the safety monitor connector output [M8] (Drive section power shutoff signal of safety signal unit [C80]), then the NC side contactor. After that, turn the 24 hours continuous operation signal OFF.

If the contactor shutoff could not be confirmed within 5 seconds, the alarm (Y20 0008) is output and the status turns to the emergency stop.

When STO function is enabled, if the motor power shutoff could not be confirmed with STO within 5 seconds, the alarm (Y20 0013) is output and the status turns to the emergency stop.

[Timing chart]

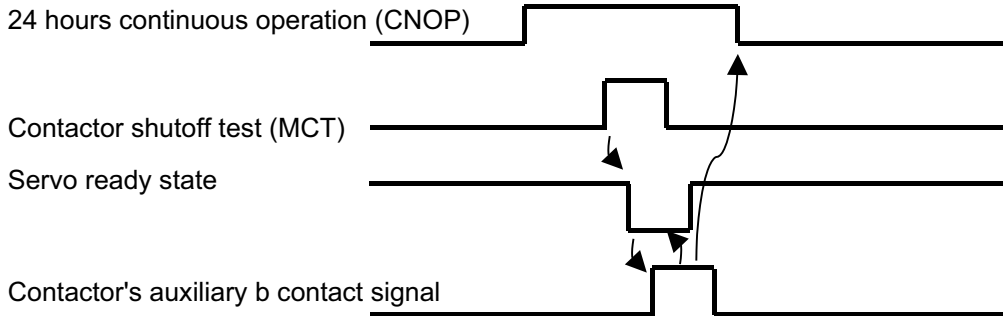

[Caution]

Contactor shutoff test must be carried out when the drive power can be shut off without causing any problem.

Vertical axis requires brake circuit, etc. for a drop prevention.

This signal cannot be used in the safety sequence. Use this in the machine sequence. [C80]

[Related signals]

- (1) 24 hours continuous operation (X752)
- (2) Emergency stop cause (R69)

Cont.	Signal name	Abbrev.	Common(\$)
A	PLC SKIP 1 to 8		Y748 to F

[Function]

This is the skip input signal from the PLC.

[Operation]

This can be used for the skip related functions. (G31 skip, tool length measurement, etc.)

[Caution]

- (1) The "PLC skip" signal is output to the skip input.
- (2) When PLC skip is used, the coasting amount from the skip signal input will be slightly longer than the high speed skip.

4 Explanation of Interface Signals

Cont.	Signal name	Abbrev.	Common(\$)
A	AUTOMATIC POWER OFF REQUEST [M8]		Y75D

[Function]

Automatic power OFF function notifies that the control unit's power can be turned OFF after shutting the display unit down (do not turn OFF the power) by entering "automatic power OFF" signal from user PLC to NC. FCU8-DU191 display unit is required for M800W/M80W Series to shut the display unit down automatically.

[Operation]

When the user PLC turns ON the "automatic power OFF request" signal (Y75D), NC requests the display unit to be shut down after turning ON the "power OFF processing" signal (X707).

- M800W/M80W Series

The device specified by the "power OFF indication Y device No." (R215) signal is turned ON after NC has received the shutdown completion notification from the display unit or the timeout time has passed.

When control unit and display unit use a different power supply, turn OFF the control unit's power after confirming the Y device (Y device designated with R215) which notifies that the power is turned OFF has turned ON.

- M800S/M80/E80 Series

One second after the "power OFF processing" signal (X707) is turned ON, turn ON the device specified by the "power OFF indication Y device No." (R215) signal. Turn OFF the control unit's power after confirming the Y device (Y device designated with R215) which notifies that the power is turned OFF has turned ON.

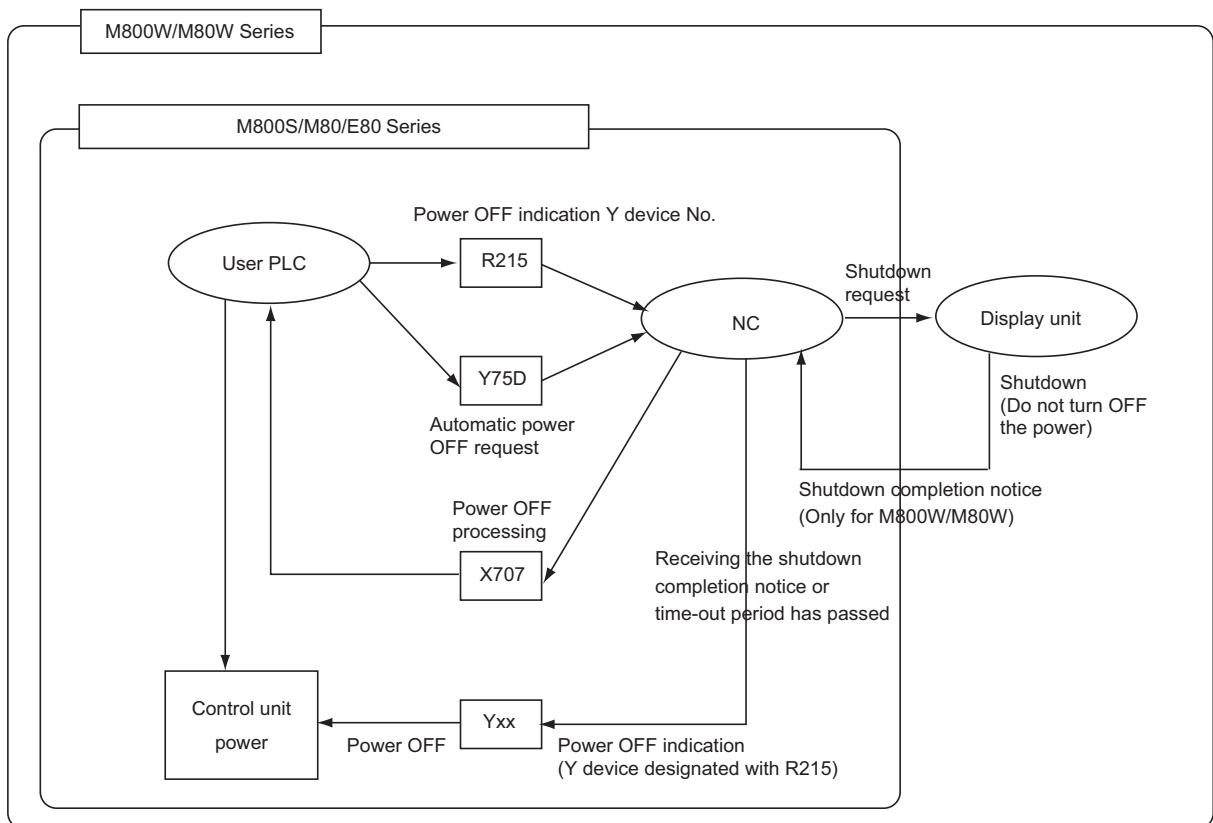

[Timing chart]

- M800W/M80W Series

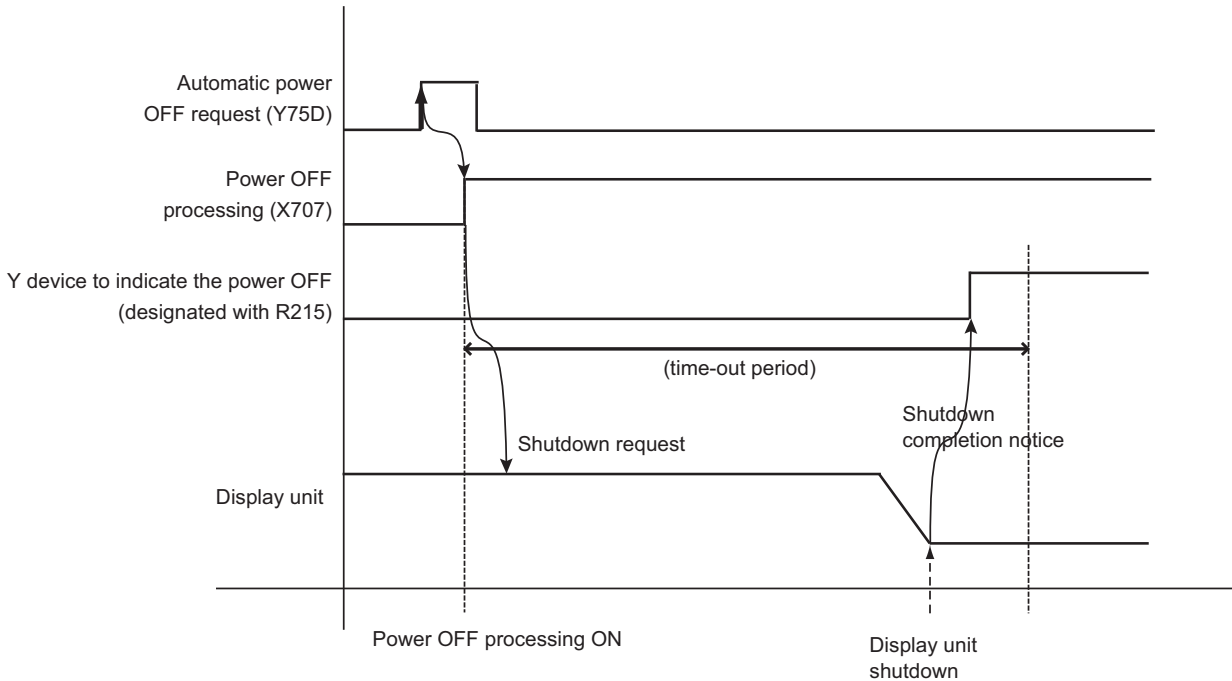

- M800S/M80/E80 Series

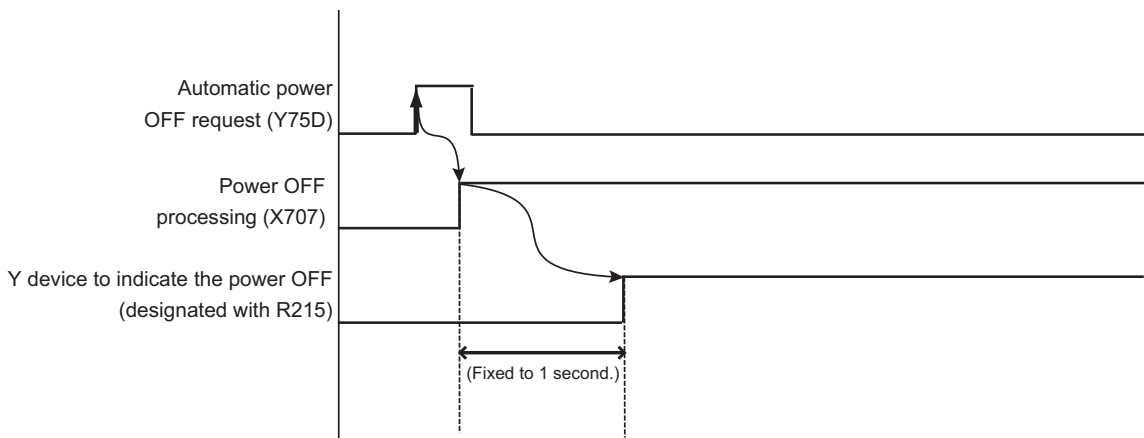

[Caution]

- (1) Time including the time required for HMI application termination and Windows shutdown has to be set in the machine parameter "#11007 PC Timeout".
- (2) Normal power OFF processing is executed when the control unit's power is turned OFF during automatic power OFF processing.
- (3) When an illegal IP address is set to the machine parameter "#11005 PC IP address", the PC on the network may be turned OFF.
- (4) Do not execute the automatic power OFF function during editing or file I/O operation, etc.
- (5) The automatic power OFF function is carried out to the display unit set to the machine parameter "#11005 PC IP address".
- (6) During spindle rotation or control axis movement, execute automatic power OFF after these actions stopped.

[Related signals]

- (1) Power OFF processing (X707)
- (2) Power OFF indication Y device No. (R215)

4 Explanation of Interface Signals

Cont.	Signal name	Abbrev.	Common(\$)
A	ACTUAL CUTTING MODE (THREAD, TAP) IN MANUAL ARBITRARY REVERSE RUN	MRCMD	Y761

[Function]

This signal determines operation concerning the thread cutting and tapping blocks during manual arbitrary reverse run.

[Operation]

[M8]

When this signal is ON, thread cutting and tapping during manual arbitrary reverse run operate in the actual cutting mode (the command speed of the machining program).

When this signal is turned OFF, the thread cutting and tapping during manual arbitrary reverse run operate in dry run operation mode (program check speed).

However, even if this signal is switched to ON/OFF in the specific operation block during reverse run, thread cutting, thread cutting cycle and tapping cycle, Manual arbitrary reverse run: Actual cutting mode ON (X714) is not switched.

Specific operation block

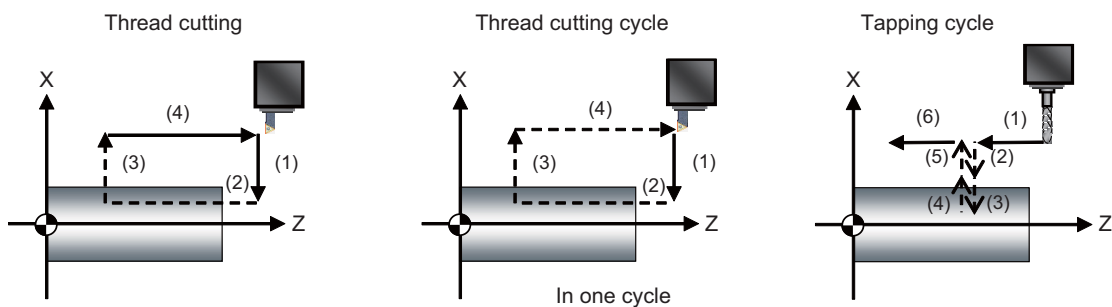

----- Specific operation block

In the figure above, when this signal turns ON/OFF while the block with dotted line is moving, Manual arbitrary reverse run: Actual cutting mode ON (X714) is switched to ON/OFF at the following timing:

- Thread cutting: At the end point of (3) block
- Thread cutting cycle: At the end point of (4) block
- Tapping cycle: At the end point of (5) block

The following shows the operation sequence when this signal turns ON while (2) block of thread cutting is executed in the figure above.

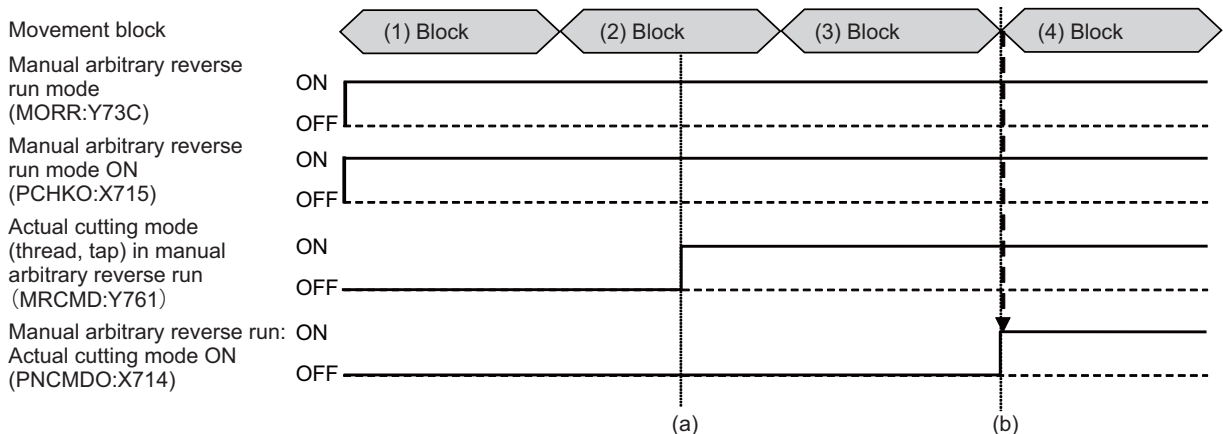

* Manual arbitrary reverse run: Actual cutting mode ON (PNCMDO:X714) does not turn ON at the timing when Actual cutting mode (thread, tap) in manual arbitrary reverse run (MRCMD:Y761) turns ON. ((a) in the operation sequence) At the end point of "(3) Block", Manual arbitrary reverse run: Actual cutting mode ON (PNCMDO:X714) turns ON. ((b) in the operation sequence)

4 Explanation of Interface Signals

[C80]

When this signal is ON, a block stop occurs before moving for thread cutting and tapping during manual arbitrary reverse run.

Also, execution of the thread cutting and tapping blocks is prevented when reverse run is performed.

If thread cutting during manual arbitrary reverse run is disabled, axes movement in the thread cutting and tapping blocks will be the same as other blocks.

[Related signals]

- (1) Manual arbitrary reverse run: Actual cutting mode ON [M8] (PNCMDO:X714)
- (2) Manual arbitrary reverse run mode ON (PCHKO:X715)
- (3) Manual arbitrary reverse run: Reverse run ON (MOREV:X716)
- (4) Thread, tap block stopping in manual arbitrary reverse run (MBSTP:X74D)
- (5) Thread, tap reverse run prohibition alarm in manual arbitrary reverse run (MRVNG:X74E)
- (6) Manual arbitrary reverse run mode (MORR:Y73C)
- (7) Manual arbitrary reverse run speed selection (MORSP:Y73D)
- (8) Manual arbitrary reverse run: MSTB reverse run prohibited (MRPSG:YCFC)
- (9) Manual arbitrary reverse run: Reverse run block stop designated part system (RBSSY:YD01)
- (10) Manual arbitrary reverse run handle selection (R375)
- (11) Manual arbitrary reverse run speed multiplier (R379)

Cont.	Signal name	Abbrev.	Common(\$)
A	ENCODER 1 ARBITRARY PULSE SELECTION		Y764
A	ENCODER 2 ARBITRARY PULSE SELECTION		Y765

[Function]

These signals select encoder arbitrary pulse.

[Operation]

Device No.	Signal name	Details
Y764	ENCODER 1 ARBITRARY PULSE SELECTION	Select arbitrary pulse input 1 and 2 set in R register when entering arbitrary pulse with encoder input 1. 0: Encoder 1 arbitrary pulse 1 1: Encoder 1 arbitrary pulse 2
Y765	ENCODER 2 ARBITRARY PULSE SELECTION	Select arbitrary pulse input 1 and 2 set in R register when entering arbitrary pulse with encoder input 2. 0: Encoder 2 arbitrary pulse 1 1: Encoder 2 arbitrary pulse 2

[Timing chart]

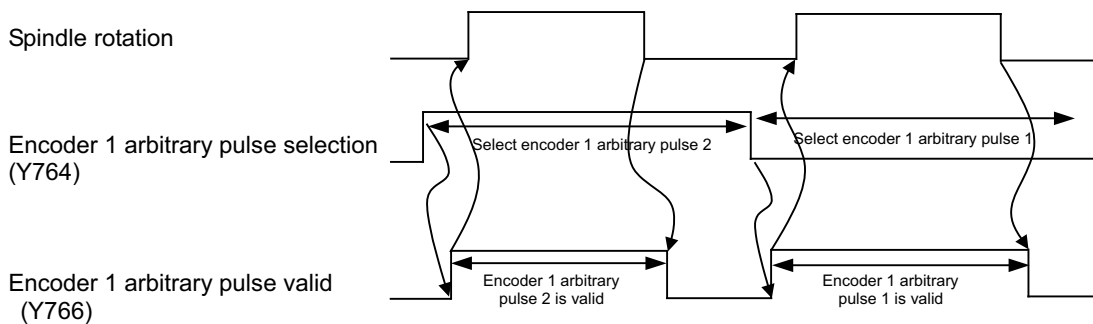

[Caution]

Switching each encoder's arbitrary pulse selection (Y764 and 765) must be carried out during the spindle stop.

[Related signals]

- (1) Encoder 1 arbitrary pulse valid (Y766)
- (2) Encoder 2 arbitrary pulse valid (Y767)
- (3) Encoder 1 arbitrary pulse 1 (R456)
- (4) Encoder 1 arbitrary pulse 2 (R457)
- (5) Encoder 2 arbitrary pulse 1 (R458)
- (6) Encoder 2 arbitrary pulse 2 (R459)

Cont.	Signal name	Abbrev.	Common(\$)
A	ENCODER 1 ARBITRARY PULSE VALID		Y766
A	ENCODER 2 ARBITRARY PULSE VALID		Y767

[Function]

These signals select valid/invalid for encoder arbitrary pulse.

[Operation]

Device No.	Signal name	Details
Y766	ENCODER 1 ARBITRARY PULSE VALID	Select valid/invalid for arbitrary pulse with the encoder input 1. 0: Invalid (conventional 1024 pulse fixed input) 1: Valid (arbitrary pulse input)
Y767	ENCODER 2 ARBITRARY PULSE VALID	Select valid/invalid for arbitrary pulse with the encoder input 2. 0: Invalid (conventional 1024 pulse fixed input) 1: Valid (arbitrary pulse input)

Turn OFF the arbitrary pulse valid signal when using the conventional 1024 pulse encoder.

[Caution]

Turning ON/OFF the encoder arbitrary pulse valid (Y766 and Y767) of the each encoder must be carried out during the spindle stop.

[Related signals]

- (1) Encoder 1 arbitrary pulse selection (Y764)
- (2) Encoder 2 arbitrary pulse selection (Y765)
- (3) Encoder 1 arbitrary pulse 1 (R456)
- (4) Encoder 1 arbitrary pulse 2 (R457)
- (5) Encoder 2 arbitrary pulse 1 (R458)
- (6) Encoder 2 arbitrary pulse 2 (R459)

4 Explanation of Interface Signals

Cont.	Signal name	Abbrev.	Common(\$)
A	DOOR OPEN I	DOOR1	Y768

[Function]

This signal stops all axes, and cuts OFF contactor power.

[Operation]

The NC carries out the following operations when the "Door open I" signal turns ON.

- (1) A deceleration stop is carried out for all axes (servo axes and spindles).
- (2) A ready OFF state occurs after all axes stop, and the contactor power of each drive unit is cut OFF.
- (3) The "Door open enable" signal turns ON.

The NC carries out the following operations when the "Door open I" signal turns OFF.

- (1) A ready ON and servo ON state occurs for all axes.
- (2) The "Door open enable" signal turns OFF.

[Caution]

- (1) Handling of the PLC axis

Set so a "Door open I" signal is output to the NC after the PLC axis is stopped by the PLC.

If a "Door open I" signal is input without stopping the PLC axis, the axis will stop with a dynamic brake method due to the ready OFF state.

- (2) Handling of the analog spindle

When an analog spindle is connected, it is not possible to confirm that the spindle has completely stopped with the NC. Thus, confirm that the spindle has completely stopped using the PLC, before opening the door. Because the spindle may start rotating again immediately after the door is closed, for safety turn the forward run and reverse run signals OFF when the door is open.

- (3) Opening the door during ATC operation

When opening the door during ATC operation, apply an interlock with the user PLC.

[Related signals]

- (1) Door open enable (DROPNS:XCD8)

Cont.	Signal name	Abbrev.	Common(\$)
A	INTERFERENCE CHECK III: ENABLE INTERFERING OBJECT SELECTION DATA [M8]	ITF3VLDT	Y769

[Function] [Operation]

This signal enables the interfering object selection set in the system variables (#40000 to #40097) or Interference check III: Interfering object selection (R20304 to R20449).

The Interference check III: Interfering object selection is incorporated into NC as the interference check III execution data at the rising edge of this signal.

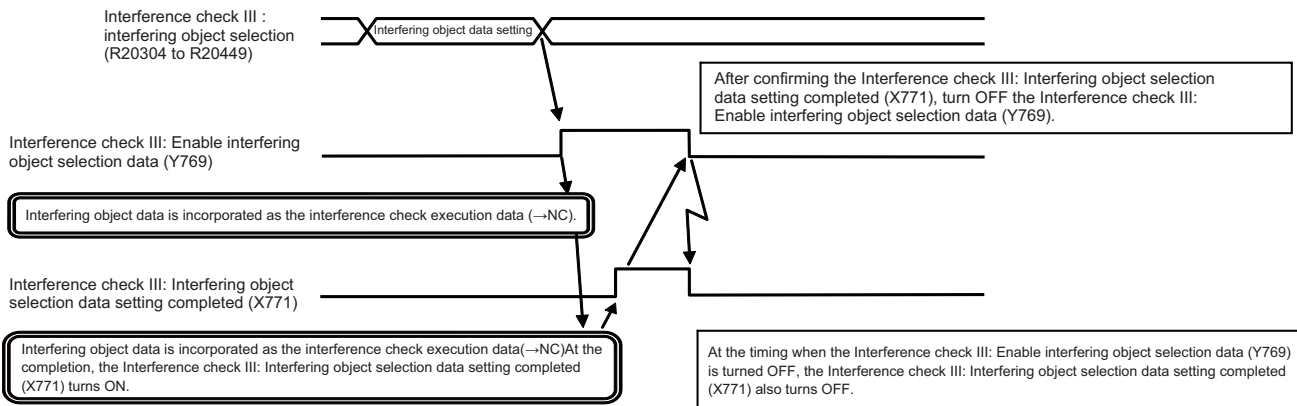

[Related signals]

- (1) Interference check III: Interfering object selection data setting completed (ITF3DTF:X771)

4 Explanation of Interface Signals

Cont.	Signal name	Abbrev.	Common(\$)
A	INTERFERENCE CHECK III: INTERFERENCE CHECK III MODE [M8]	ITF3CMD	Y76A

[Function]

The interference check III is executed.

[Operation]

While this signal is ON, interference check between interfering objects is performed using the interfering object data set. If the interfering object selection is changed while this signal is ON, the interference check is performed using the changed data at the completion of the interfering object selection.

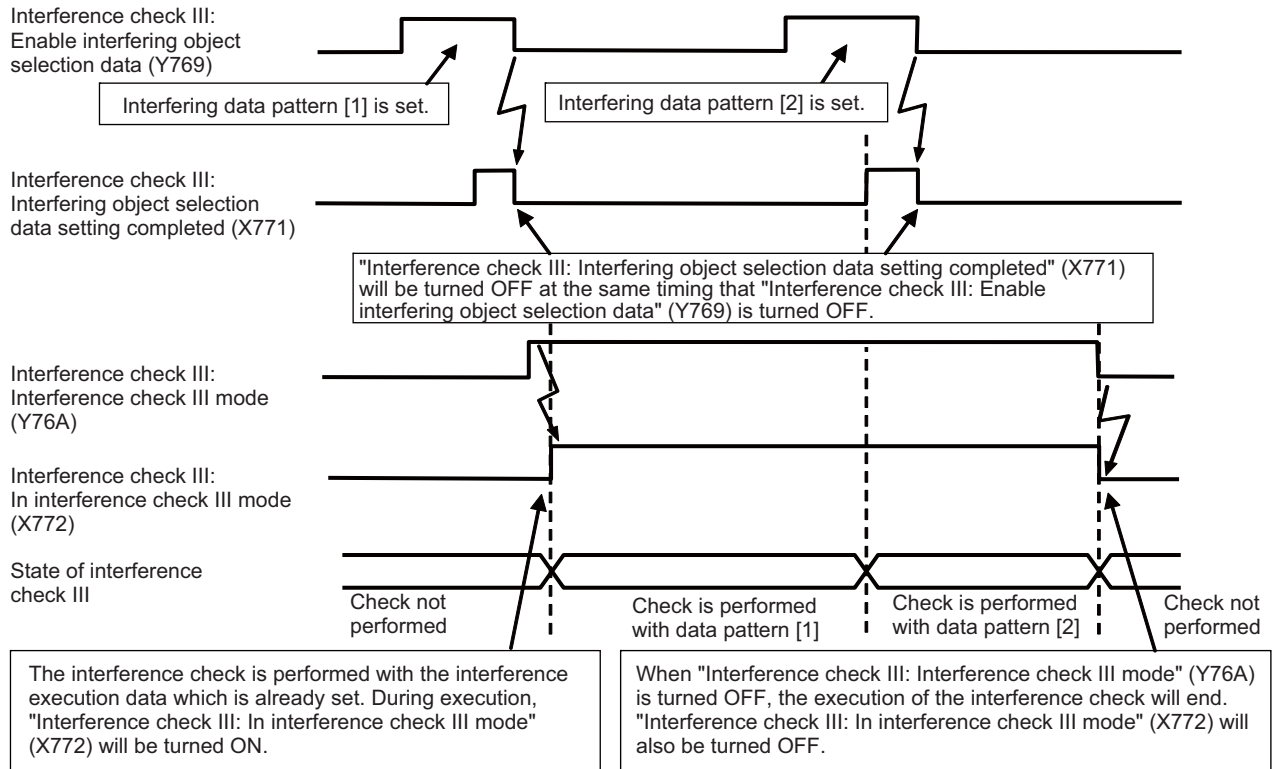

[Related signals]

- (1) Interference check III: In interference check III mode (ITF3MD:X772)

4 Explanation of Interface Signals

Cont.	Signal name	Abbrev.	Common(\$)
A	HIGH-SPEED SIMPLE PROGRAM CHECK: ENABLE COORDINATE POSITION CHECK	SPSC	Y76B

[Function]

This signal enables the following check when NC reset is input during high-speed simple program check: difference check for the workpiece coordinate position and command machine coordinate position at the beginning of the machining program and at NC reset input.

[Operation]

If the following conditions are met, the workpiece coordinate position and command machine coordinate position at the beginning of the machining program are compared with these positions at NC reset input: this signal is turned ON during high-speed simple program check and NC reset is input while the "High-speed simple program check: Coordinate position check ON" signal (X713) is ON.

If any difference is detected, an operation error occurs.

This check is performed only for the following axes: the axes for which workpiece coordinate position/ command machine coordinate position checks are enabled with parameters "#8226 work position check" and "#8227 machine position check".

[Timing chart]

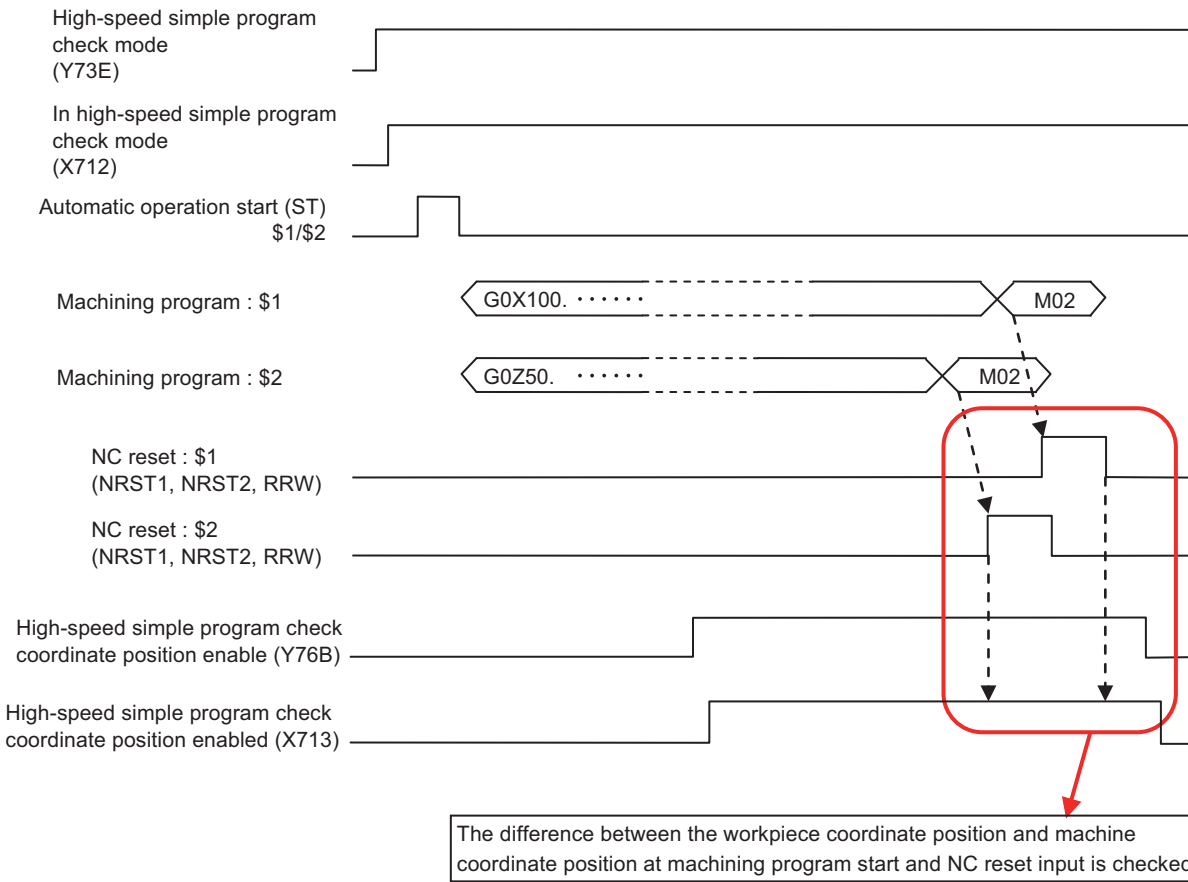

[Related signals]

- (1) High-speed simple program check mode (SMLK:Y73E)
- (2) High-speed simple program check mode ON (SMLKO:X712)
- (3) High-speed simple program check: Coordinate position check ON (SPSCO:X713)

4 Explanation of Interface Signals

Cont.	Signal name	Abbrev.	Common(\$)
A	PLC AXIS CONTROL VALID n-TH AXIS	PLCAEn	Y770 to 7

[Function]

PLC axis control process is executed with the control information data while the PLC axis control valid signal is ON.

[Operation]

When turning ON the PLC axis control valid signal, designate with the following device.

Device No.	Signal name
Y770	PLC axis control valid 1st axis
Y771	PLC axis control valid 2nd axis
Y772	PLC axis control valid 3rd axis
Y773	PLC axis control valid 4th axis
Y774	PLC axis control valid 5th axis
Y775	PLC axis control valid 6th axis
Y776	PLC axis control valid 7th axis
Y777	PLC axis control valid 8th axis

(Note) Reset state is activated when the PLC axis control valid signal is turned OFF.

[Related signals]

- (1) PLC axis control buffering mode valid (PABMI:Y723)
- (2) PLC axis control information address (R440 to R447)

Cont.	Signal name	Abbrev.	Common(\$)
A	G/B SPINDLE SYNCHRONIZATION VALID [M8]	GBON	Y778

[Function]

This signal enables the Guide bushing (G/B) spindle synchronization function.

[Operation]

The spindle synchronization state is entered by turning ON this signal.

[Related signals]

- (1) G/B spindle synchronizing mode (GBMOD:X778)
- (2) G/B spindle synchronization: position control synchronizing (GBSYN:X779)
- (3) G/B spindle synchronization: phase shift amount (R466)

Cont.	Signal name	Abbrev.	Common(\$)
A	G/B SPINDLE SYNCHRONIZATION: PHASE ALIGNMENT [M8]	GBPHS	Y77A

[Function]

This signal aligns the phase (relative position) of the rotating reference spindle and the guide bushing (G/B) spindle.

[Operation]

When this signal is ON, and when the reference spindle and the guide bushing spindle are in the synchronous state (the G/B spindle synchronization signal is ON) and also when they are in the steady rotation state, a phase alignment of the reference spindle and the G/B spindle is carried out targeting the phase gap (relative position) between the reference spindle and the G/B spindle that have been saved by the G/B spindle synchronization phase memory (GBPHM).

[Related signals]

- (1) G/B spindle synchronization valid (GBON:Y778)
- (2) G/B spindle synchronization: phase memory (GBPHM:Y77B)
- (3) G/B synchronization: phase alignment complete (GBPHF:X77A)
- (4) Spindle up-to-speed (USO: X188D)

4 Explanation of Interface Signals

Cont.	Signal name	Abbrev.	Common(\$)
A	G/B SPINDLE SYNCHRONIZATION: PHASE MEMORY [M8]	GBPHM	Y77B

[Function]

This signal saves the phase gap (relative position) between the reference spindle and the guide bushing (G/B) spindle in the NC.

[Operation]

Rotate the reference spindle and the guide bushing spindle by one revolution or more (until the Z phase is passed) in synchronous state (the G/B spindle synchronization valid (GBON) ON) then stop them. After both of them stop, the NC saves the phase gap (relative position) at the rising edge of this signal.

[Related signals]

- (1) G/B spindle synchronization valid (GBON:Y778)
- (2) Z phase passed (SZPH:X1895)
- (3) Zero speed (ZSO:X188C)
- (4) G/B spindle synchronization: phase shift amount (R466)

Cont.	Signal name	Abbrev.	Common(\$)
A	G/B SPINDLE SYNCHRONIZATION: POSITION ERROR COMPENSATION [M8]	GBCMON	Y77C

[Function]

This signal carries out compensation by finding the position error compensation amount based on the position error of the reference spindle and the guide bushing (G/B) spindle caused by a square bar's torsion.

[Operation]

When this signal is turned ON, the position error compensation amount of the reference spindle and the guide bushing spindle is found, and the guide bushing spindle synchronization position error compensation starts.

[Related signals]

- (1) G/B spindle synchronization valid (GBON:Y778)
- (2) G/B spindle synchronization: keep position error compensation amount signal (GBCMKP:Y77E)
- (3) G/B spindle synchronization: position error compensation scale and the number of times of compensations (R390)
- (4) G/B spindle synchronization: position error compensating (GBPCM:X77B)
- (5) G/B spindle synchronization: position error compensation amount (R465)

Cont.	Signal name	Abbrev.	Common(\$)
A	G/B SPINDLE SYNCHRONIZATION: TEMPORARY CANCEL [M8]	GBOFF	Y77D

[Function]

The reference spindle and the guide bushing (G/B) spindle can be controlled independently by temporarily canceling the guide bushing spindle synchronization using this signal.

[Operation]

ON: Guide bushing spindle synchronization temporarily canceled

OFF: Guide bushing spindle synchronization can be enabled

The following signals are disabled when this signal is ON, and they are enabled when this signal is OFF.

- Y778 (G/B spindle synchronization valid)
- Y77A (G/B spindle synchronization: phase alignment)
- Y77B (G/B spindle synchronization: phase memory)
- Y77C (G/B spindle synchronization: position error compensation)
- Y77E (G/B spindle synchronization: keep position error compensation amount)

Operation error (M01 1137) occurs if this signal is turned ON/OFF when the reference spindle or the guide bushing spindle is in any of the following modes.

- During rotation (when not stopped)
- During tap cycle synchronization mode
- During spindle synchronization mode/tool-spindle synchronization I (polygon machining) mode/tool-spindle synchronization II (hobbing) mode
- During spindle C axis control C axis mode
- During orientation/indexing

Cont.	Signal name	Abbrev.	Common(\$)
A	G/B SPINDLE SYNCHRONIZATION: KEEP POSITION ERROR COMPENSATION AMOUNT SIGNAL [M8]	GBCMKP	Y77E

[Function]

Select whether to cancel or hold the guide bushing (G/B) spindle synchronization position error compensation execution state when the G/B spindle synchronization: position error compensation (GBCMON) is OFF.

[Operation]

- OFF: Position error compensation execution state is canceled
(The guide bushing spindle returns to the position before compensation. The guide bushing spindle synchronization position error compensation execution state is canceled.)
- ON: Position error compensation execution state is held
(The guide bushing spindle does not return to the position before compensation. The guide bushing spindle synchronization position error compensation execution state is held.)

[Related signals]

- (1) G/B spindle synchronization valid (Y778)
- (2) G/B spindle synchronization: position error compensation (GBCMON:Y77C)
- (3) G/B spindle synchronization: position error compensation scale and the number of times of compensations (R390)
- (4) G/B spindle synchronization: position error compensating (GBPCM:X77B)
- (5) G/B spindle synchronization: position error compensation amount (R465)

4 Explanation of Interface Signals

Cont.	Signal name	Abbrev.	Common(\$)
A	OPERATION HISTORY RETRACT [C80]	HISAVE	Y77F

[Function]

This signal saves all the operation history information to the saving area.

[Operation]

When this signal is turned ON, all the history information will be saved in the saving area.

The information can be used for troubleshooting an error.

The saved operation history will be retained even after the power is turned OFF.

Cont.	Signal name	Abbrev.	\$1	\$2	\$3	\$4
A	CONTROL AXIS DETACHMENT n-TH AXIS	DTCH1 to 8	Y780 to 7	Y788 to F	Y790 to 7	Y798 to F

[Function]

Desired control axis can be specified to be exempted from control function.

Each control axis is provided with this signal. The last numeric of signal name indicates axis No. to be detached.

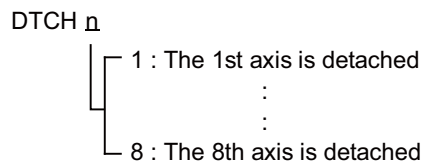

[Operation]

When "Control axis detachment" signal (DTCHn) turns ON, the corresponding axis is exempted from control.

- (1) Specified axis is not under any positioning control (oriented spindle stop, index, etc.)
 - (2) "Servo alarm", "Stroke end alarm" and other alarms are not applied to specified axis.
 - (3) Interlock signal applied to specified axis is deemed to be ON.
 - (4) Specified axis is displayed in the position counter on the screen.
- (Note 1) The same function can be used by setting parameter on the screen. (See below)

The control axis detachment is valid when the following are valid:

Basic specification parameter
"#1070 axoff" (axis detachment), and
"Control axis detachment n-th axis"
signal (DTCHn)

or

Basic specification parameter
"#1070 axoff" (axis detachment), and
axis parameter of machining parameter
"#8201 AX. RELEASE"

4 Explanation of Interface Signals

Cont.	Signal name	Abbrev.	\$1	\$2	\$3	\$4
B	SERVO OFF n-TH AXIS	*SVF1 to 8	Y7A0 to 7	Y7A8 to F	Y7B0 to 7	Y7B8 to F

[Function]

Control axis (axis motion under control) can be set to "Servo OFF" (i.e., servo motor remains still). In servo OFF condition, positioning control is impossible but the position detect function is alive. Each control axis is provided with this signal. The last number (n = 1, 2, 3...) of the signal abbreviation indicates the control axis No.

[Operation]

When "Servo OFF" signal (*SVFn) turns OFF, the corresponding control axis is set to servo OFF condition. Whether displacement which was caused during servo OFF by external force is corrected when "Servo ON" signal is given, or not, can be determined by setting parameter. (#1064 svof Error correction)

(1) When displacement is corrected (follow-up):

- An amount of motion equal to the displacement is commanded so that positioning error becomes zero.
- In this case, machine position remains deviated from in-position when "Servo OFF" signal is restored. The current position read by position counter is corrected and the machine position is corrected when the next absolute motion command is given ("Manual absolute" (ABS_n) signal is turned ON when manual operation is selected).

(2) When displacement is not corrected:

- In this case, machine position should be corrected when "Servo OFF" signal is restored.

(Example) Servo-OFF during motion

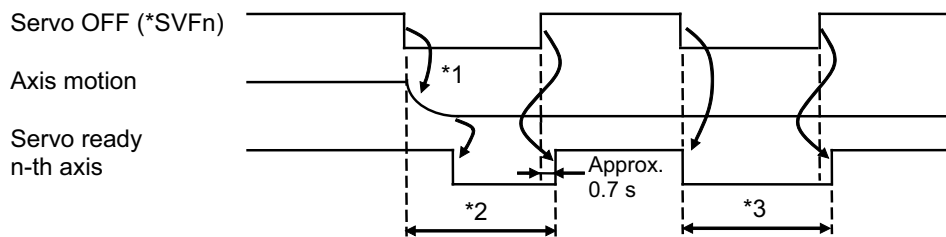

*1: Servo turns OFF after deceleration and stopping during axis motion.

*2, 3: Controller internal interlock by servo OFF (axis motion not possible)

[Caution]

These signals are all handled as B contacts.

Cont.	Signal name	Abbrev.	\$1	\$2	\$3	\$4
A	MIRROR IMAGE n-TH AXIS	MI1 to 8	Y7C0 to 7	Y7C8 to F	Y7D0 to 7	Y7D8 to F

[Function]

This signal is used to machine a symmetrical shape by reversing the sign for the movement amount per block. Each control axis is provided with this signal. The last number of signal name indicates No. of control axis.

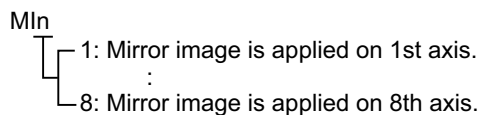

[Operation]

Symmetrical cutting is enabled by reversing the sign of the value commanded for memory or MDI operation.

- (1) Regardless of whether the coordinate is commanded with an incremental command or absolute command, the mirror image is applied on the incremental amount to be executed for all axes that can be controlled.

[Caution]

- (1) The mirror image is changed after block stop.
- (2) Even when this signal (Y7C0 and later) is turned ON for the axis used in the loader-dedicated part system, the mirror image is not applied. (Even when the axis parameter "#8211 MIRR. IMAGE" is enabled for the axes used in the loader-dedicated part system, the parameter setting is ignored.)

[Related signals]

- (1) In mirror image n-th axis (MIRn:X9C7)

4 Explanation of Interface Signals

Cont.	Signal name	Abbrev.	\$1	\$2	\$3	\$4
B	EXTERNAL DECELERATION+ n-TH AXIS	*+EDT1 to 8	Y7E0 to 7	Y7E8 to F	Y7F0 to 7	Y7F8 to F

[Function]

The feedrate when the control axis is moving in the + direction can be controlled while this signal (*+EDTn) is OFF, at a constant speed set with the parameters.
 This signal is present for each control axis. The end numbers in the signal name indicate the control axis No.

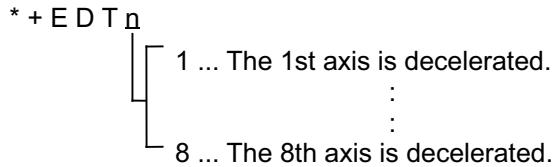

[Operation]

During manual mode when the "External deceleration" signal (*+EDTn) turns OFF, each axis decelerates independently. However, during automatic mode, all axes will decelerate at the same deceleration speed when even one axis matches the external deceleration conditions. The deceleration occurs when the movement axis direction matches the "External deceleration" signal direction of the corresponding axis.

- (1) The external deceleration speed can be randomly set with the parameters. (#1216 extdcc)
- (2) When the speed is less than the external deceleration speed, it will not be affected even if this signal is OFF.
- (3) The deceleration speed during automatic operation will be the combined deceleration speed, if the deceleration conditions match and the external deceleration speed is exceeded.
- (4) When returning in the reverse direction, the speed will immediately return to the correct command speed.
- (5) For G28, G29 and G30 commands, the speed will become the external deceleration speed for that axis only, even in automatic operation.
- (6) The speed will become the external deceleration speed even in rapid traverse during synchronous tapping.

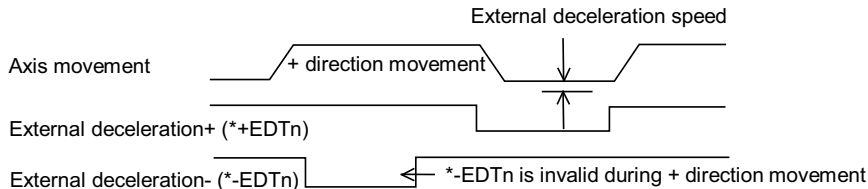

[Caution]

- (1) The external deceleration signal is handled as a B contact (*) signal, but changes to 1 (ON) when the power is turned ON. When not being used, it is not necessary be concerned with external deceleration when programming. [M8]

- (2) On C80, as "1" is not set when the power is turned ON, perform the sequence process as necessary.

Cont.	Signal name	Abbrev.	\$1	\$2	\$3	\$4
B	EXTERNAL DECELERATION- n-TH AXIS	*-EDT1 to 8	Y800 to 7	Y808 to F	Y810 to 7	Y818 to F

[Function][Operation]

The functions and operations of this signal are the same as those of "External deceleration+ n-th axis" signal (*+EDTn). The deceleration occurs when the movement is in the minus direction and the "External deceleration- n-th axis" signal (*-EDTn) is OFF.

4 Explanation of Interface Signals

Cont.	Signal name	Abbrev.	\$1	\$2	\$3	\$4
B	AUTOMATIC INTERLOCK+ n-TH AXIS	*+AIT1 to 8	Y820 to 7	Y828 to F	Y830 to 7	Y838 to F

[Function]

All axis motions of machine can be decelerated and stopped immediately during automatic operation when motion of a specific axis (n-th axis) in plus direction activates the interlock function.

These signals are for each control axis, and the number at the end of the signal name indicates the control axis No.

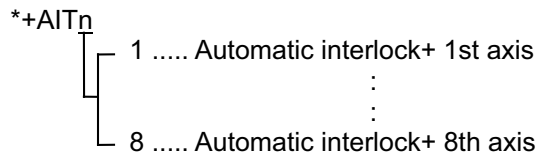

[Operation]

When this signal turns OFF for a specific axis in motion in the plus direction under automatic operation mode (memory, MDI, tape), motion of all axis decelerates and stops with "M01 operation error code 004" displayed.

With this signal set OFF from the beginning, the system completes calculation for axis motion but makes it remain stopped with the same operation error code displayed. In either case, setting the signal ON resumes or starts axis motion.

[Caution]

- (1) All automatic interlock signals are for B contact.
- (2) The "Automatic interlock" signal is set to 1 when the power is turned ON, so an interlock cancel state in the sequence program does not need to be created for the axis not being used. [M8]
- (3) On C80, as "1" is not set when the power is turned ON, perform the sequence process as necessary.

[Related signals]

- (1) Automatic interlock- n-th axis (*-AITn: Y840)
- (2) Manual interlock+/- n-th axis (*+/-MITn: Y860/Y880)

Cont.	Signal name	Abbrev.	\$1	\$2	\$3	\$4
B	AUTOMATIC INTERLOCK- n-TH AXIS	*-AIT1 to 8	Y840 to 7	Y848 to F	Y850 to 7	Y858 to F

[Function][Operation]

The details are the same as the "Automatic interlock+ n-th axis" signal, except that the direction is opposite.

The "Automatic interlock+ n-th axis" signal is valid for the axis moving in the plus direction, and this signal is valid for the axis moving in the minus direction.

These signals are for each control axis, and the number at the end of the signal name indicates the control axis No.

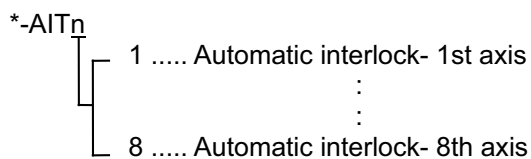

[Related signals]

- (1) Automatic interlock+ n-th axis (*+AITn: Y820)
- (2) Manual interlock+/- n-th axis (*+/-MITn: Y860/Y880)

4 Explanation of Interface Signals

Cont.	Signal name	Abbrev.	\$1	\$2	\$3	\$4
B	MANUAL INTERLOCK+ n-TH AXIS	*+MIT1 to 8	Y860 to 7	Y868 to F	Y870 to 7	Y878 to F

[Function]

When the corresponding axis is moving in the plus direction with manual operation (jog, manual, incremental, reference position return), only the corresponding axis can be decelerated and stopped by turning OFF this signal that corresponds to that axis.

These signals are for each control axis, and the number at the end of the signal name indicates the control axis No.

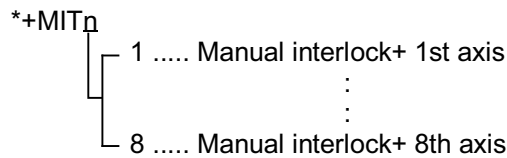

[Operation]

When this signal turns OFF (0) for a specific axis in motion in the plus direction under manual operation mode (jog, handle, incremental, reference position return), motion of the axis decelerates and stops with NC alarm "M01 OPERATION ERROR 0004" displayed.

With this signal set OFF from the beginning, the system completes calculation for axis motion but makes it remain stopped with the same operation error code displayed. In either case, setting the signal ON (1) resumes or starts axis motion.

[Caution]

- (1) All interlock signals are for B contact.
- (2) The "Manual interlock" signal is set to 1 when the power is turned ON, so an interlock cancel state in the sequence program does not need to be created for the axis not being used. [M8]
- (3) On C80, as "1" is not set when the power is turned ON, perform the sequence process as necessary.

[Related signals]

- (1) Manual interlock- n-th axis (*-MITn: Y880)
- (2) Automatic interlock+/- n-th axis (*+/-AITn: Y820/Y840)

Cont.	Signal name	Abbrev.	\$1	\$2	\$3	\$4
B	MANUAL INTERLOCK- n-TH AXIS	*-MIT1 to 8	Y880 to 7	Y888 to F	Y890 to 7	Y898 to F

[Function][Operation]

The details are the same as the "Manual interlock+ n-th axis" signal, except that the direction is opposite.

The "Manual interlock+ n-th axis" signal is valid for the axis moving in the plus direction, and this signal is valid for the axis moving in the minus direction.

These signals are for each control axis, and the number at the end of the signal name indicates the control axis No.

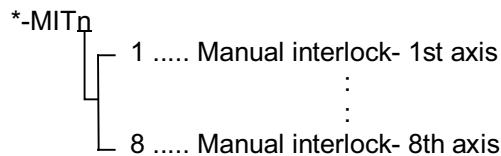

[Related signals]

- (1) Manual interlock+ n-th axis (*+MITn: Y860)
- (2) Automatic interlock+/- n-th axis (*+/-AITn: Y820/Y840)

Cont.	Signal name	Abbrev.	\$1	\$2	\$3	\$4
A	AUTOMATIC MACHINE LOCK n-TH AXIS	AMLK1 to 8	Y8A0 to 7	Y8A8 to F	Y8B0 to 7	Y8B8 to F

[Function]

During automatic operation, current position (counter) can be changed without actual machine motion to check program. These signals are for each control axis, and the number at the end of the signal name indicates the control axis No.

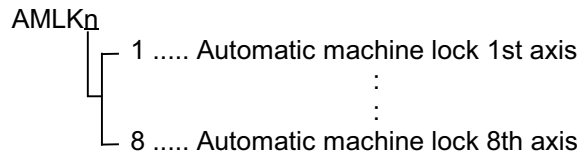
**[Operation]**

In the automatic operation (memory, MDI or tape), when this signal is ON, the current position (counter) can be changed on a specific axis (for which the signal is ON) without actual machine motion. If the signal turns ON in the middle of a block (during motion), block termination occurs after the completion of that block, and then the machine lock will be valid for the following blocks.

[Caution]

- (1) If "Automatic machine lock" signal changes during automatic operation, block stop occurs after completion of the block in execution.
- (2) To move only the table without drilling to confirm the drilling position, turn ON the signal for the 3rd axis (AMLK3) if the drilling axis is the 3rd axis. (Equivalent to Z axis cancel)

[Related signals]

- (1) Manual machine lock, n-th axis (MMLK_n: Y8C0)

Cont.	Signal name	Abbrev.	\$1	\$2	\$3	\$4
A	MANUAL MACHINE LOCK n-TH AXIS	MMLK1 to 8	Y8C0 to 7	Y8C8 to F	Y8D0 to 7	Y8D8 to F

[Function]

During manual operation, current position (counter) can be changed without actual machine motion to check program.

[Operation]

When this signal is ON, current position can be changed on a specific axis (n-th axis) without actual machine motion. If the signal turns ON or OFF during execution of a block, the operation continues until it is completed. It is required to stop motion of all axes to validate the machine lock.

These signals are for each control axis, and the number at the end of the signal name indicates the control axis No.

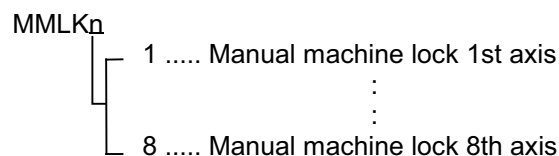
**[Related signals]**

- (1) Automatic machine lock n-th axis (AMLK_n: Y8A0)

4 Explanation of Interface Signals

Cont.	Signal name	Abbrev.	\$1	\$2	\$3	\$4
A	FEED AXIS SELECTION+ n-TH AXIS	+J1 to 8	Y8E0 to 7	Y8E8 to F	Y8F0 to 7	Y8F8 to F

[Function]

This signal is used to start motion (jog feed, incremental feed or reference position return mode) in plus direction during manual operation.

These signals are for each control axis, and the number at the end of the signal name indicates the control axis No.

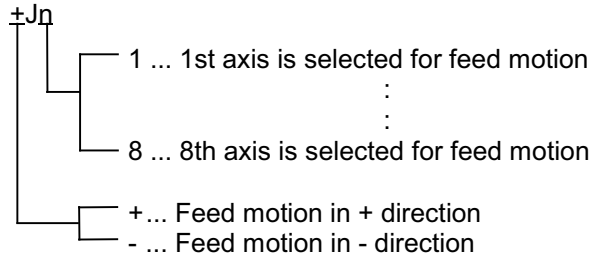

[Operation]

When "Feed axis selection" signal (+Jn) turns ON, the following motion occurs.

- (1) When jog feed, incremental feed or reference position return is possible, motion in plus direction occurs on the selected axis.
- (2) In jog feed, motion continues while the signal is ON.

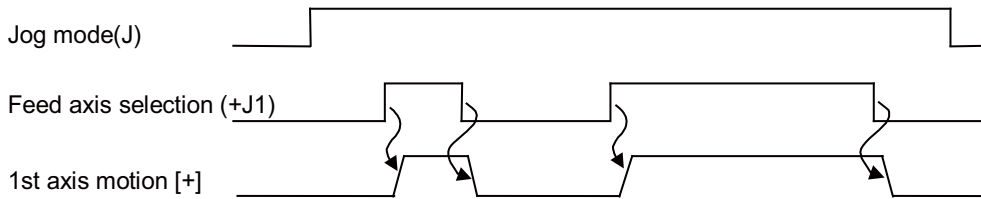

- (3) In incremental feed, amount (length) of motion depends on setting of "Handle/Incremental feed magnification code m". The motion is in plus direction. Even when signal (+Jn) turns OFF during motion, the motion (feed) does not stop. To start the motion again, turn ON the signal after the preceding motion has been completed.

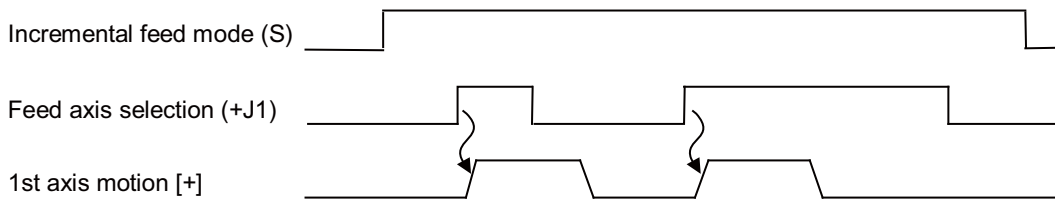

- (4) After reference position return mode is decelerated to approach speed by the near point detection dog, the motion continues, even after the feed axis selection signal is turned OFF, until motion reaches the reference position.

- (Note 1) If feed axis selection plus [+] and minus [-] signals turn ON at the same time, neither plus signal nor minus signal is selected (same as the case where feed axis selection signal is OFF.)
- (Note 2) If "Feed axis selection" signal turns ON before jog, incremental or reference position return mode is selected, the "Feed axis selection" signal is ignored. In this case, the signal should be turned OFF and then ON.
- (Note 3) If reset is exerted while "Feed axis selection" signal is ON, or "Feed axis selection" signal turns ON during reset, the "Feed axis selection" signal is ignored even when the reset condition is canceled. In this case, the signal should be turned OFF and then ON.
- (Note 4) The "Feed axis selection" signal will be invalid even if turned ON while the corresponding axis is decelerating (when command output is not completed). The signal must be turned OFF and ON again after the deceleration has completed completely (command output is completed). Special care is required when the feed axis direction changes.
- (Note 5) In the 2nd part system specifications, even if the 1st part system and 2nd part system feed axis selection turn ON in the same cycle (scan) of the sequence, the start up may not be completely simultaneous.

[Related signals]

- (1) Feed axis selection- n-th axis (-Jn: Y900)

Cont.	Signal name	Abbrev.	\$1	\$2	\$3	\$4
A	FEED AXIS SELECTION- n-TH AXIS	-J1 to 8	Y900 to 7	Y908 to F	Y910 to 7	Y918 to F

[Function]

This signal is used to feed the axis in the minus (-) direction during jog feed, incremental feed or reference position return mode in manual operation.

These signals are for each control axis, and the number at the end of the signal name indicates the control axis No.

(Refer to the "Feed axis selection+ n-th axis" for details.)

[Operation]

The operation is the same as the feed axis selection+.

Use this signal to move in the minus (-) direction.

[Related signals]

- (1) Feed axis selection+ n-th axis (+Jn: Y8E0)

4 Explanation of Interface Signals

Cont.	Signal name	Abbrev.	\$1	\$2	\$3	\$4
A	MANUAL/AUTOMATIC SIMULTANEOUS VALID n-TH AXIS	MAE1 to 8	Y920 to 7	Y928 to F	Y930 to 7	Y938 to F

[Function]

The automatic mode (tape, MDI, memory) and manual mode (handle, step, jog, manual reference position return) can be simultaneously selected allowing manual operation during automatic operation. (Arbitrary feed with the PLC is also possible.)

[Operation]

The manual/automatic simultaneous mode is entered when the automatic mode and manual mode are selected simultaneously. The manual operation axis operated during the manual/automatic simultaneous mode are selected by this signal.

The axis selected with this signal can be operated in the manual mode during automatic operation.

- (Note 1) If an axis command is issued to an axis selected by this signal from the automatic mode, the "M01 OPERATION ERROR 0005" will occur. The automatic operation will be interlocked until the operation error is canceled.
- (Note 2) During the automatic mode (when manual is not selected and manual/automatic simultaneous mode is not entered), this signal will be invalid and the interlock will not be applied.
- (Note 3) If this signal turns ON in respect to an axis commanded with automatic during the manual/automatic simultaneous mode, an interlock will be applied on the axis, and the axis will immediately decelerate and stop. (The "M01 OPERATION ERROR 0005" will occur.)
After decelerating and stopping, operation with the manual mode will be possible. Note that the interlock will also be applied during the tap modal.
- (Note 4) During the manual/automatic simultaneous mode and the automatic mode, the manual axis command for which this signal is OFF will be invalid. Note that interruption with the manual handle will be possible.
- (Note 5) The feedrates for the automatic command axis and the manual command axis are different. The acceleration/ deceleration mode (rapid traverse, cutting feed) are also independent.
- (Note 6) The rapid traverse override, cutting feed override and 2nd cutting feedrate override are valid for both the automatic command axis and manual command axis. (Note that the cutting and 2nd cutting overrides to the manual command axis are valid when the manual cutting override is valid.) Override cancel is valid for the automatic command axis.
- (Note 7) The manual interlock is valid for the manual command axis, and the automatic interlock is valid for the automatic command axis.
- (Note 8) The in-cutting feed and in-rapid traverse signals will follow the automatic command axis movement mode.
- (Note 9) The axis moving with manual movement will not stop with single block stop or feed hold.
- (Note 10) If the G92 and G53 commands are issued in the manual mode to an axis for which this signal is ON, the G92 and G53 commands will be executed after the manual axis movement stops. (An axis command with G53 will cause an operation error after the manual axis movement stops.)
- (Note 11) If a soft limit or OT is applied on the manual command axis during the manual/automatic simultaneous mode, the automatic command axis will also decelerate to a stop, and will enter the feed hold state.
- (Note 12) When the high-accuracy control or high-speed high-accuracy control mode is valid, if this signal has been changed during execution of movement blocks for the pre-interpolation acceleration/deceleration, the change to this signal is not enabled immediately even if the axis is not moving. The change is enabled when all the axes of the part system decelerate to stop.

<Relation with manual handle interrupt>

The operation of the automatic handle interruption during the manual/auto mode is as follows.

		Axis for which manual/automatic valid signal is ON	Axis for which manual/automatic valid signal is OFF
Handle mode selection	Automatic handle interrupt	The specifications of the manual/automatic simultaneous mode will be followed. The automatic axis command will cause an operation error, and only the manual axis command will be valid.	The specifications of the automatic handle interruption will be followed. Interruption with the handle can be applied in respect to the automatic axis movement.
Manual mode other than handle		Same as above	Same as above

Cont.	Signal name	Abbrev.	\$1	\$2	\$3	\$4
A	MANUAL FEEDRATE B VALID n-TH AXIS	FBE _n	Y940 to 7	Y948 to F	Y950 to 7	Y958 to F

[Function]

This signal validates manual feed using the manual feedrate B.

[Operation]

If this signal is validated when carrying out manual feed in the jog mode, the axis will move at the speed commanded by manual feedrate B which is commanded separately from the manual feedrate.

This signal is independent for the axes.

<Using the manual feedrate B> (Example for 1st part system)

(1) To set the feedrate common for all axes as the manual feedrate B

- (a) Select the JOG mode signal (J).
- (b) Turn ON the "Manual feedrate B valid n-th axis" signal (this signal) for the axis to be moved at the manual feedrate B.
- (c) Set the feedrate set as manual feedrate B in the "Manual feedrate B" register.
- (d) Turn ON the "Feed axis selection+" signal or "Feed axis selection-" signal for the axis to be moved at the manual feedrate B.

(2) To set the feedrate independent for each axis as the manual feedrate B

- (a) Select the JOG mode signal (J).
- (b) Turn ON the "Manual feedrate B valid n-th axis" signal (this signal) for the axis to be moved at the manual feedrate B. Also turn ON the "Each axis manual feedrate B valid" signal.
- (c) Set the feedrate set as each axis manual feedrate B in the "Each axis manual feedrate B n-th axis" register.
- (d) Turn ON the "Feed axis selection+" signal or "Feed axis selection-" signal for the axis to be moved at the each axis manual feedrate B.

(Note 1) Manual feedrate B is valid only for JOG feed, and is invalid in all other manual modes.

(Note 2) The rapid traverse mode is invalid for the manual feedrate B valid axis.

(Note 3) Manual override is invalid for the manual feedrate B valid axis.

(Note 4) The axis moving at the manual feedrate B will decelerate and stop when NC reset is input. To move the axis at the manual feedrate B again, cancel the NC reset, and then turn the axis selection signal OFF and ON.

(Note 5) Even if the feed axis selection signal is turned ON when the command speed is "0", an error will occur and the manual feedrate B valid axis will not move.

(Note 6) The manual/automatic simultaneous signal must be valid to move a random axis at the manual feedrate B during automatic operation.

(Note 7) The JOG mode signal must be validated simultaneously to move a random axis at the manual feedrate B during a manual operation mode other than the JOG mode.

(Note 8) During synchronous control, the "Manual feedrate B valid n-th axis" signal is invalid for the synchronized axis. The manual feedrate B signal issued for the reference axis is also valid for the synchronized axis.

[Related signals]

- (1) JOG MODE (J: YC00)
- (2) MANUAL FEEDRATE B (R2506, R2507)
- (3) Each axis manual feedrate B valid (YC7C)
- (4) Each axis manual feedrate B n-th axis (R5764 to R5779)

4 Explanation of Interface Signals

Cont.	Signal name	Abbrev.	\$1	\$2	\$3	\$4
A	ZERO POINT INITIALIZATION SET MODE n-TH AXIS	AZS1 to 8	Y960 to 7	Y968 to F	Y970 to 7	Y978 to F

[Function]

This selects the zero point initialization set with the marked point alignment method in the absolute position detection system.

[Operation]

The zero point initialization set is selected with this signal.

Refer to the section on "Zero point initialization set completed" (ZSFn) signal for details on the operations.

(Note 1) This signal is a function signal for zero point initialization set, and is not a signal that selects the operation mode. Select the jog mode or handle mode to move the axis to a required position.

(Note 2) This signal is valid for the following specifications.- When servo detection specification (motor encoder, servo system) is the absolute position detection system.- When "TYPE" on the [ABS. POSI PARAM] screen is set to "2".

[Related signals]

- (1) Zero point initialization set completed (ZSFn: X8C0 to 7)
- (2) Zero point initialization set error completed (ZSEn: X8E0 to 7)
- (3) In initialization (R574)
- (4) Initialization incompleteness (R575)
- (5) Zero point initialization set start (ZSTn: Y980 to 7)

Cont.	Signal name	Abbrev.	\$1	\$2	\$3	\$4
A	ZERO POINT INITIALIZATION SET START n-TH AXIS	ZST1 to 8	Y980 to 7	Y988 to F	Y990 to 7	Y998 to F

[Function]

This is used to set a random position as the origin during zero point initialization set using the marked point alignment method in the absolute position detection system.

[Operation]

This signal turns ON when a corresponding axis is moved in the zero point initialization set mode, and the position to be set as the zero point is reached.

Refer to the section on "Zero point initialization set completed" (ZSFn) signal for details on the operations.

(Note 1) This signal is a function signal for zero point initialization set, and is not a signal that selects the operation mode. Select the jog mode or handle mode to move the axis to a required position.

(Note 2) This signal is valid for the following specifications.

- When servo detection specification (motor encoder, servo system) is the absolute position detection system.
- When "TYPE" on the [ABS. POSI PARAM] screen is set to "2".

(Note 3) This signal will be invalid in the following states.

- During emergency stop
- During reset
- When the "Zero point initialization set start" (ZSTn) signal is turned ON before the "Zero point initialization set mode" (AZSn) signal.

In this case, turn this signal OFF once, and then turn it ON again.

- When the grid (Z-phase signal provided per motor rotation) has not been passed once after the power is turned ON.

[Related signals]

- (1) Zero point initialization set completed (ZSFn: X8C0 to 7)
- (2) Zero point initialization set error completed (ZSEn: X8E0 to 7)
- (3) In initialization (R574)
- (4) Initialization incompleteness (R575)
- (5) Zero point initialization set mode (AZSn: Y960 to 7)

4 Explanation of Interface Signals

Cont.	Signal name	Abbrev.	\$1	\$2	\$3	\$4
A	CURRENT LIMIT CHANGEOVER n-TH AXIS	ILC1 to 8	Y9A0 to 7	Y9A8 to F	Y9B0 to 7	Y9B8 to F

[Function]

This signal switches current limit value.

[Operation]

This signal turns ON when the current limit is enabled.

The current limit parameter is switched from SV013 to SV014. When the position droop exceeds a certain level, the "Current limit reached" signal (ILA) turns ON.

When the current limit is canceled (from ON to OFF), the parameter is switched from SV014 to SV013. After confirming smoothing zero, cancel the accumulated position droop and adjust the command position to the machine position.

To cancel the droop while the current limit is enabled, turn ON the "Droop cancel request" signal (DOR) instead of turning OFF the "Current limit changeover" signal (ILC) in the timing chart below.

To cancel the current limit without canceling the droop, set the parameter "#1236/bit2" to "1" or turn ON the bit of the target axis of the "Current limit changeover" signal (ILC).

The "In current limit" signal (ILI) turns ON when current limit is enabled. When the current limit is canceled, the signal turns OFF after waiting for the droop to be canceled and the current limit value to be switched.

The user can select whether to interlock when the current limit is reached by the "Current limit mode 1" signal (ILM1) and the "Current limit mode 2" signal (ILM2).

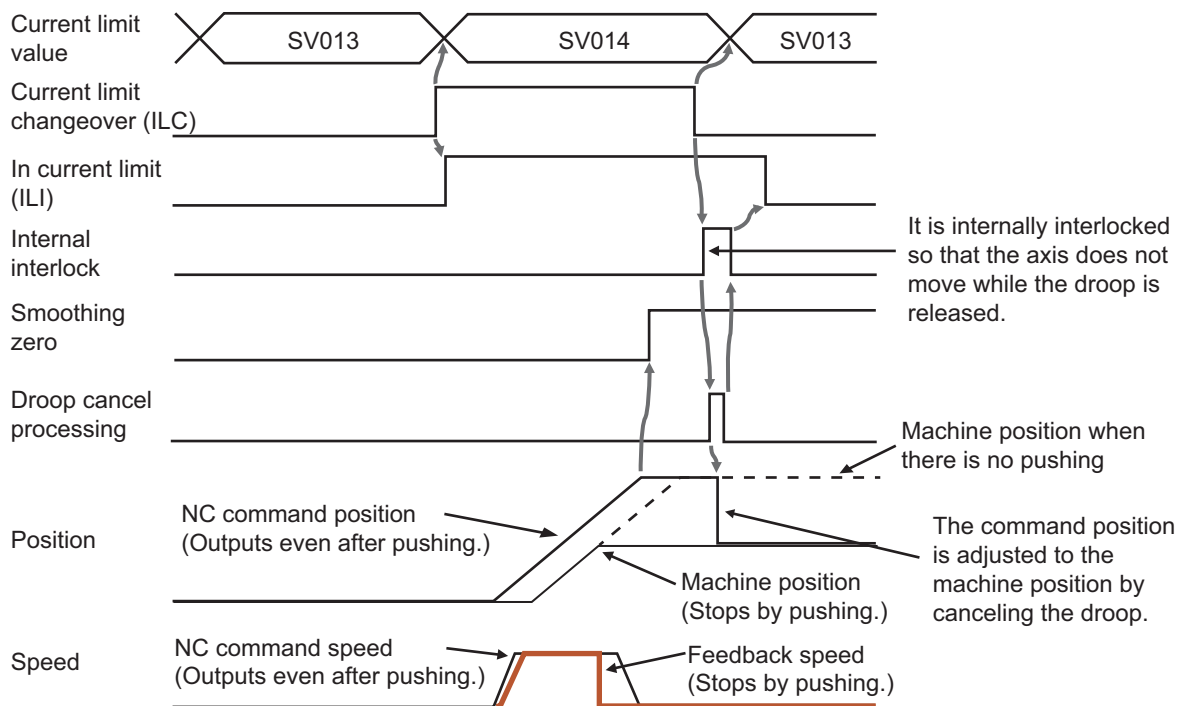

[Related signals]

- (1) In current limit n-th axis (IL1 to 8: X900 to 7)
- (2) Current limit reached n-th axis (ILA1 to 8: X920 to 7)
- (3) Droop cancel request n-th axis (DOR1 to 8: Y9C0 to 7)
- (4) Current limit mode 1 and 2 (ILM1,2: YCC0,1)
- (5) Current limit changeover (R2593)

4 Explanation of Interface Signals

Cont.	Signal name	Abbrev.	\$1	\$2	\$3	\$4
A	DROOP CANCEL REQUEST n-TH AXIS	DOR1 to 8	Y9C0 to 7	Y9C8 to F	Y9D0 to 7	Y9D8 to F

[Function][Operation]

During the current limit control, the droop generated by the current limit can be released.

[Related signals]

- (1) In current limit n-th axis (IL1 to 8: X900 to 7)
- (2) Current limit reached n-th axis (ILA1 to 8: X920 to 7)
- (3) Current limit changeover n-th axis (ILC1 to 8: Y9A0 to 7)
- (4) Current limit mode 1 and 2 (ILM1,2: YCC0,1)
- (5) Current limit changeover (R2593)

Cont.	Signal name	Abbrev.	\$1	\$2	\$3	\$4
A	WORKPIECE COORDINATE MEASUREMENT 2ND AXIS		Y9E1	Y9E9	Y9F1	Y9F9

[Function] (L system)

The Z axis external workpiece coordinate offset data can be set by cutting the workpiece face with manual operations and inputting workpiece coordinate measurement 2nd axis.

[Operation]

- (1) Mode selection
Set the mode selection switch to the manual mode ([Handle], [Jog] or [Rapid Traverse]).
- (2) Tool measurement mode signal input
Set the tool measurement mode signal to "1".
- (3) Main/sub selection
Using the tool presetter sub-side valid signal, select whether to measure the workpiece coordinates on the main spindle side or sub-spindle side.
<Tool presetter sub-side valid signal>
OFF : The compensation No. is retrieved from the main spindle side R registers.
ON : The compensation No. is retrieved from the sub-spindle side R registers.
(Note 1) Hold the state of this signal until the measurement with the selected tool is completed.
- (4) Tool selection
Issue the T command with MDI operation, etc., and select the tool.
(Note 1) Set the selected tool compensation No. in the R register.
The set R register differs according to the parameter setting and the state of the tool presetter sub-side valid signal.
(Note 2) Set the "tool length/wear data" for the tool being used beforehand.
Compensation No. R registers

#1098 TIno.	#1130 set_t	#1218 aux02 bit4	Tool length compensation No.		Tool nose wear compensation No.	
			Main side	Sub-side	Main side	Sub-side
0	0	0/1	R2600,R2601	R2604,R2605	R2600,R2601	R2604,R2605
	1	0/1				
1	0	0	R536,R537		R2600,R2601	R2604,R2605
		1	R2602,R2603	R2606,R2607	R2600,R2601	R2604,R2605
	1	0/1	R2602,R2603	R2606,R2607	R2600,R2601	R2604,R2605

- When the compensation No. is 0, the compensation amount will be calculated as "0".
- If the compensation No. exceeds the number of specified offset sets, the "Compensation No. illegal" error will occur.
- Whether to use the main side or sub-side is selected with the tool presetter sub-side valid signal. (OFF: Main side, ON: Sub-side)

(5) Cutting the workpiece face

If the workpiece face has not been cut, cut the workpiece face slightly to even it.

(Note 1) Do not move the tool in the detection of Z axis after cutting the workpiece face.

(Note 2) If the workpiece does not need to be cut, carry out positioning to the measurement position.

4 Explanation of Interface Signals

- (6) Setting the Z axis external workpiece coordinate offset data with the workpiece coordinate measurement 2nd axis signal input

Input the workpiece coordinate measurement 2nd axis signal (this signal). The Z axis external workpiece coordinate offset data is automatically calculated from the tool compensation data of the used tool and the machine value at the point this signal is input. The results are set as the data.

- (a) Details of automatic calculation expression

The external workpiece coordinate offset data is automatically calculated with the following expression.

$$\text{External workpiece coordinate offset} = \text{Machine coordinate value} - \text{tool compensation data}$$

The tool compensation data used for the measurement is selected with the base specification parameter "#1226 aux10 bit0".

aux10 bit0	Tool compensation data
0	Tool length data + nose wear data
1	Tool length data

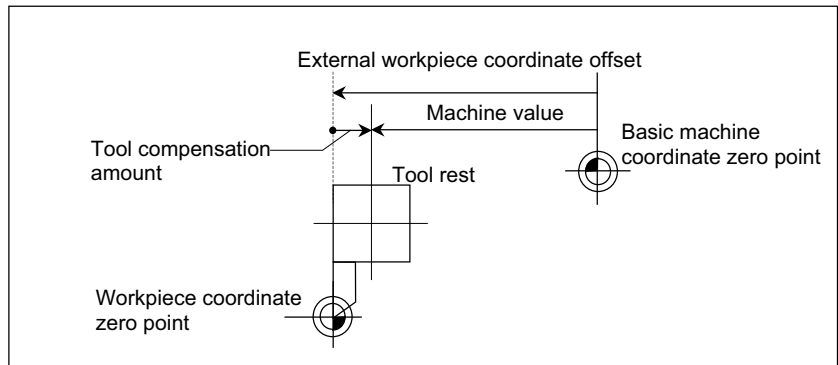

- (7) Turning the tool measurement mode signal OFF
Measurement of the external workpiece coordinate offset is completed.

[Related signals]

- (1) Tool compensation No. (Main side: R2600 to R2603, Sub side: R2604 to R2607)
- (2) Tool length measurement 2 (TLMS: YC21)

Cont.	Signal name	Abbrev.	\$1	\$2	\$3	\$4
A	CONTROL AXIS DETACHMENT 2 n-TH AXIS	DTCH21 to 28	YA00 to 7	YA08 to F	YA10 to 7	YA18 to F

[Function]

A control axis can be excluded from the control targets with this function. This signal is present for each control axis. The end numbers in the signal name indicate the control axis No.

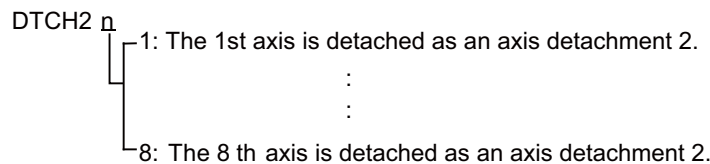

[Operation]

When the "Control axis detachment 2" signal (DTCH2n) turns ON, the corresponding axis is excluded from the control targets.

- (1) Position control cannot be carried out, but the position is not lost because the position detection is valid.
- (2) The "Interlock" signal of the corresponding axis is considered turned ON.
- (3) Specified axis is displayed in the position counter on the screen.

[Related signals]

- (1) Control axis detachment n-th axis (DTCHn: Y780)

4 Explanation of Interface Signals

Cont.	Signal name	Abbrev.	\$1	\$2	\$3	\$4
A	UNCLAMP COMPLETION n-TH AXIS	UCLPFn	YA20 to 7	YA28 to F	YA30 to 7	YA38 to F

[Function]

This signal indicates that unclamping has been completed in respect to the unclamp command from the CNC.

[Operation]

Selecting either "Type A" or "Type B" is set in the parameter "#1282 ext18/bit3 (Index table clamp type)".

(1) Type A (#1282 ext18/bit3 = 0)

When the unclamp command signal turns ON, the clamp on the corresponding axis is released by the PLC, and then this signal turns ON.

When the unclamp command turns OFF, the corresponding axis is clamped by the PLC, and then this signal is turned OFF.

(2) Type B (#1282 ext18/bit3 = 1)

When the unclamp command signal turns ON, the clamp on the corresponding axis is released by the PLC, and the unclamp completion signal is turned ON. This signal is turned OFF by the PLC after the unclamp command signal turns OFF.

This signal turns ON when:

- When the unclamp command turns ON, the clamp on the corresponding axis is by the PLC. (then this signal turns ON)

This signal turns OFF when:

- Unclamp command signal is turned OFF by the CNC.

(Note) Refer to the programming manual for each operation detail of type A and B.

[Related signals]

- (1) Unclamp command (UCLPn: X960 to X967)
- (2) Clamp command (CLPn: XB00 to XB07)
- (3) Clamp completion (CLPFn: YB00 to YB07)

Cont.	Signal name	Abbrev.	\$1	\$2	\$3	\$4
A	MIXED CONTROL (CROSS AXIS CONTROL) REQUEST n-TH AXIS	CRS1 to 8	YA60 to 7	YA68 to F	YA70 to 7	YA78 to F

[Function]

The mixed control (cross axis control) is turned ON and OFF with the PLC signal. By using parameter, designate which axis enters mixed control (cross axis control) state by this signal.

[Operation]

(1) Mixed control (cross axis control) control command using PLC signals

There are "mixed control (cross axis control) request" signals (CRS1 to CRS8) for eight axes in each part system. (There are signals for eight axes regardless of the actual number of axes.)

Cross machining is carried out by exchanging the axis for which the PLC signal is input and the axis designated with parameter at the rising edge (0 to 1) of this signal. If an axis is not mounted at the section where the PLC signal is input, the axis designated with the parameter will be moved from another part system.

The axis cross machining state is canceled at the falling edge (1 to 0) of this signal, and normal control is applied.

(2) Commanding in the machining program

Turn the "mixed control (cross axis control) " signal ON/OFF using M or T command, etc. to carry out the mixed control (cross axis control).

Carry out timing synchronization operation before the M command and T command, etc., for mixed control (cross axis control) so that the timing for the mixed control (cross axis control) matches.

[Related signals]

- (1) In mixed control (cross axis control)(X980 to X987)

4 Explanation of Interface Signals

Cont.	Signal name	Abbrev.	\$1	\$2	\$3	\$4
A	SYNCHRONOUS CONTROL REQUEST n-TH AXIS	SYNC1 to 8	YA80 to 7	YA88 to F	YA90 to 7	YA98 to F

[Function]

Whether to start or cancel synchronous control is selected with a signal corresponding to the synchronized axis.

1 → 0 (falling edge) Synchronous control cancel

0 → 1 (rising edge) Synchronous control start

[Operation]

Synchronous control is started and canceled with the rising edge (OFF to ON) or falling edge (ON to OFF) of the PLC signal (SYNC1 to 8) corresponding to the synchronized axis.

Thus, if synchronous control is canceled by a cause other than the PLC signal turning OFF, such as by emergency stop, and synchronous control is to be started again, turn the PLC signal OFF and then ON again.

The synchronization reference axis corresponding to each synchronized axis is set with the parameter "#2088 bsax_sy".

The movement direction of the synchronized axis in respect to the movement of the synchronized reference axis is determined by the value set for parameter "#2087 syncnt".

0 : moves in the same direction as the reference axis

1 : moves in the opposite direction of the reference axis

[Caution]

- (1) The two axes related to control (synchronous/superimposition control) are both controlled in the smoothing zero state. Control is started after the axis movement has ended and smoothing zero is established.
- (2) Control (synchronous/superimposition control) are affected by the state of the two target part systems. Thus, attention must be paid to the timing synchronization between part systems. Always command synchronization before commanding the control PLC signal.
- (3) Control (synchronous/superimposition control) cannot be commanded to an axis in inclined axis control. An operation error will occur if this type of command is issued.
- (4) Before control (synchronous/superimposition control) is started, the target axis must have completed reference position return after the power was turned ON, or the absolute position must be established. An operation error will occur if the above state is not established.
- (5) A movement command cannot be issued to a synchronized axis during synchronous control. An operation error will occur if movement is commanded.
- (6) An axis in synchronous control cannot be commanded as the superimposition control axis. An operation error will occur if this type of command is issued.
- (7) A synchronized axis in synchronous control cannot be commanded as the synchronized axis for other synchronous control. An operation error will occur if this type of command is issued. Note that a single axis can be designated as the synchronized reference axis for several synchronized controls.

[Related signals]

- (1) In synchronous/superimposition control (X9A0 to X9A7)
- (2) Synchronous error amount (R5076 to R5091)

Cont.	Signal name	Abbrev.	\$1	\$2	\$3	\$4
A	SUPERIMPOSITION CONTROL REQUEST n-TH AXIS	PILE1 to 8	YAA0 to 7	YAA8 to F	YAB0 to 7	YAB8 to F

[Function]

Whether to start or cancel superimposition control is selected with a signal corresponding to the superimposed axis.

- 1 → 0 (falling edge) Superimposition control cancel
- 0 → 1 (rising edge) Superimposition control start

[Operation]

Superimposition control is started and canceled with the rising edge (OFF to ON) or falling edge (ON to OFF) of the PLC signal (PILE1 to 8) corresponding to the superimposed axis.

Thus, if superimposition control is canceled by a cause other than the PLC signal turning OFF, such as by emergency stop, and superimposition control is to be started again, turn the PLC signal OFF and then ON again.

The reference axis corresponding to each superimposed axis set with the parameter "#2089 bsax_pl".

The movement direction of the superimposed axis in respect to the movement of the reference axis is determined by the value set for parameter "#2143 polar".

- 0 : moves in the same direction as the reference axis
- 1 : moves in the opposite direction of the reference axis

[Caution]

- (1) This signal will be ignored if 0 is set to the parameter "#1280 ext16/bit7".
- (2) Make sure to command a timing synchronization for the superimposed axis and the reference axis in a previous or next block of the block to command this signal.

[Related signals]

- (1) In synchronous/superimposition control signal (X9A0 to 7)

4 Explanation of Interface Signals

Cont.	Signal name	Abbrev.	\$1	\$2	\$3	\$4
A	NC AXIS CONTROL SELECTION n-TH AXIS	-	YAC0 to 7	YAC8 to F	YAD0 to 7	YAD8 to F

[Function]

This signal is used to select the control method over the NC axes which can be operated under PLC control.

- 0: PLC control
- 1: NC control

[Operation]

When this signal is ON, the axis is controlled with a machining program. (The axis is handled as NC axis.)

When this signal is OFF, the axis is controlled with the PLC axis indexing interfaces. (The axis is handled as PLC axis.)

The following shows the correspondence of axis Nos. and device Nos.

Device No.	Signal name	Device No.	Signal name
YAC0	NC axis control selection 1st axis	YAC4	NC axis control selection 5th axis
YAC1	NC axis control selection 2nd axis	YAC5	NC axis control selection 6th axis
YAC2	NC axis control selection 3rd axis	YAC6	NC axis control selection 7th axis
YAC3	NC axis control selection 4th axis	YAC7	NC axis control selection 8th axis

[Timing chart]

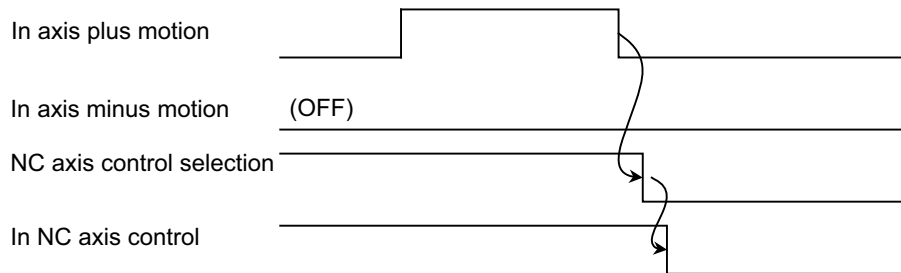

[Caution]

- (1) This signal is available only for the NC axis which can be operated under PLC control. "The NC axis which can be operated under PLC control" has the axis No. for PLC axis indexing, designated by "#12800 chgauxno".
- (2) Turn ON/OFF this signal after confirming that the axis is not moving.

Turning this signal ON/OFF during the axis movement leads an operation error. The axis decelerates and stops then.

(Usage example) When the parameters are set as follows

Axis No.	1	2	3	4	5
#1013 axname	X	Y	Z	A	C
#12800 chgauxno	0	0	0	1	2

A-axis and C-axis can be operated under PLC control. To operate the A-axis under NC control, turn the signal YAC3 ON. The signals YAC0 to YAC2 and YAC5 to YAC7 are not available.

[Related signals]

- (1) In NC axis control n-th axis (XA20 to XA27)

4 Explanation of Interface Signals

Cont.	Signal name	Abbrev.	\$1	\$2	\$3	\$4
A	VERTICAL AXIS PULL-UP PREVENTION REQUEST n-TH AXIS		YAE0 to 7	YAE8 to F	YAF0 to 7	YAF8 to F

[Function]

This signal prevents the vertical axis pull-up function: the vertical axis will not be pulled up.

[Operation]

When this signal turns ON, NC will operate as follows.

- (1) Command the drive unit to prevent vertical axis pull-up.
- (2) Turns ON the "Vertical axis pull-up prevented" signal.

When this signal turns OFF, NC will operate as follows.

- (1) Command the drive unit to cancel the prevention of vertical axis pull-up.
- (2) Turns OFF the "Vertical axis pull-up prevented" signal.

[Related signals]

- (1) Vertical axis pull-up prevented (XA60 to 7)

Cont.	Signal name	Abbrev.	\$1	\$2	\$3	\$4
A	CLAMP COMPLETION n-TH AXIS	CLPFn	YB00 to 7	YB08 to F	YB10 to 7	YB18 to F

[Function]

This signal indicates that clamping has been completed in respect to the clamp command from the CNC.

[Operation]

Selecting either "Type A" or "Type B" is set in the parameter "#1282 ext18/bit3 (Index table clamp type)".

- (1) Type A (#1282 ext18/bit3 = 0)

This signal is not used.

- (2) Type B (#1282 ext18/bit3 = 1)

When the clamp command signal turns ON, the index table indexing axis is clamped by the PLC, and the clamp completion signal is turned ON. This signal is turned OFF by the PLC after the clamp command signal turns OFF.

The signal turns ON when:

- When the clamp command turns ON, the corresponding axis is clamped by the PLC. (then this signal turns ON)

This signal turns OFF when:

- Clamp command signal is turned OFF by the CNC.

(Note) Refer to the programming manual for each operation detail of type A and B.

[Related signals]

- (1) Unclamp command (UCLPn: X960 to X967)
- (2) Clamp command (CLPn: XB00 to XB07)
- (3) Unclamp completion (UCLPFn: YA20 to YA27)

Cont.	Signal name	Abbrev.	\$1	\$2	\$3	\$4
A	HOB MACHINING: RETRACT AMOUNT SELECTION n-TH AXIS	HOBRTVn	YB20 to 7	YB28 to F	YB30 to 7	YB38 to F

[Function]

This signal is used to select the parameter for setting the travel distance in hob retract.

[Operation]

When the signal is OFF:

The setting value of "#8219 Hob retract amount 1" is used.

When the signal is ON:

The setting value of "#8220 Hob retract amount 2" is used.

[Related signals]

- (1) Hob machining: retract request (HOBTR:YCDE)
- (2) Hob machining: retracting (HOBRTM:XCAE)
- (3) Hob machining: retracting complete (HOBRTF:XCAF)

4 Explanation of Interface Signals

Cont.	Signal name	Abbrev.	\$1	\$2	\$3	\$4
A	SPINDLE-MODE ROTARY AXIS CONTROL COMMAND n-TH AXIS [M8]	ROTSPC1 to 8	YB40 to 7	YB48 to F	YB50 to 7	YB58 to F

[Function]

This signal turns ON when controlling an axis, for which rotary axis spindle control is enabled with the parameter, as a spindle (spindle control mode).

This signal turns OFF when the axis is controlled as a rotary axis (servo axis control mode).

Each control axis is provided with this signal. The last number of the signal name indicates the control axis No.

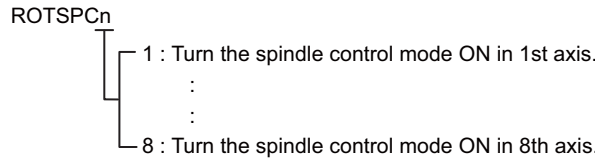

[Operation]

- (1) The axis for which rotary axis spindle control is enabled enters the spindle control mode when the following operation is performed: turning the Spindle-mode rotary axis control command (ROTSPCn) ON while the Reference position establishment (1st axis: X9E0 to 8th axis: X9E7 of part system 1, and following) is ON and the All axes smoothing zero is (TSMZ) ON.
- (2) When the spindle control mode is entered, the Spindle-mode rotary axis control mode (ROTSPMn) turns ON. The axis can be controlled as a spindle by executing S commands after checking that this signal is ON.
- (3) The control mode changes from the spindle control mode to servo axis control mode when the Spindle-mode rotary axis control command (ROTSPCn) turns OFF. The Spindle-mode rotary axis control mode (ROTSPMn) turns OFF when the servo axis control mode is entered.

[Related signals]

- (1) Spindle-mode rotary axis control mode n-th axis (ROTSPMn:XB40-)

Cont.	Signal name	Abbrev.	\$1	\$2	\$3	\$4
A	STORED STROKE LIMIT I : CHANGE REQUEST n-TH AXIS	SLMCn	YB60 to YB67	YB68 to YB6F	YB70 to YB77	YB78 to YB7F

[Function]

This signal is used to update the range of stored stroke limit I to the one set in R registers.

[Operation]

At the rising edge (OFF → ON) of this signal, the range of stored stroke limit I changes to the values of the R registers specified by the parameter "#2190 OT_Rreg". Note however that the limit range is updated at the rising edge of this signal only when the parameter "#1278 ext14/bit2" is ON and when a user area's R register number is set in the parameter "#2190 OT_Rreg" of the corresponding axis.

User area	R8300 to R9799	1500 points of backup area
	R9800 to R9899	100 points of non-backup area
	R18300 to R19799	1500 points of backup area
	R19800 to R19899	100 points of non-backup area
	R28300 to R29799	1500 points of backup area
	R29800 to R29899	100 points of non-backup area

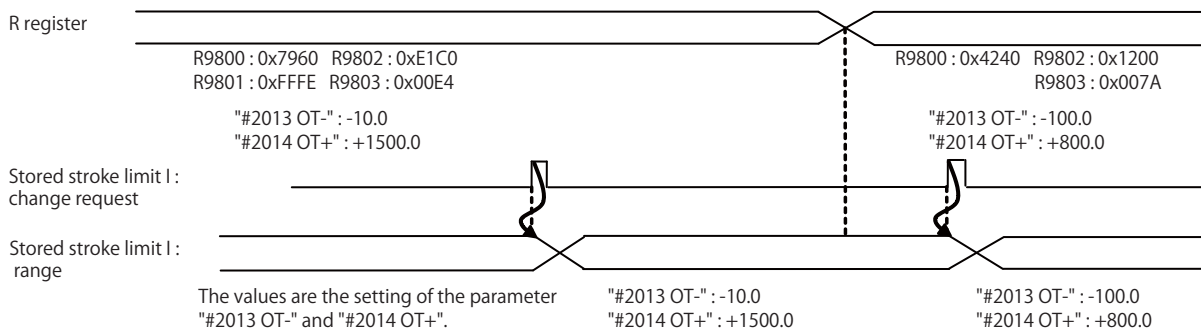

4 Explanation of Interface Signals

Cont.	Signal name	Abbrev.	\$1	\$2	\$3	\$4
A	REAL-TIME TUNING 1: SPEED CONTROL GAIN CHANGEOVER HOLD-DOWN COMMAND [M8]	VGHLDC1 to 8	YB80 to 7	YB88 to F	YB90 to 7	YB98 to F

[Function]

This signal is used to stop speed control gain switching of the real-time tuning 1 function. Speed control gain switching is stopped if this signal turns ON while this function is enabled.

[Operation]

- ON: Speed control gain switching is stopped.
- OFF: Speed control gain switching is not stopped.

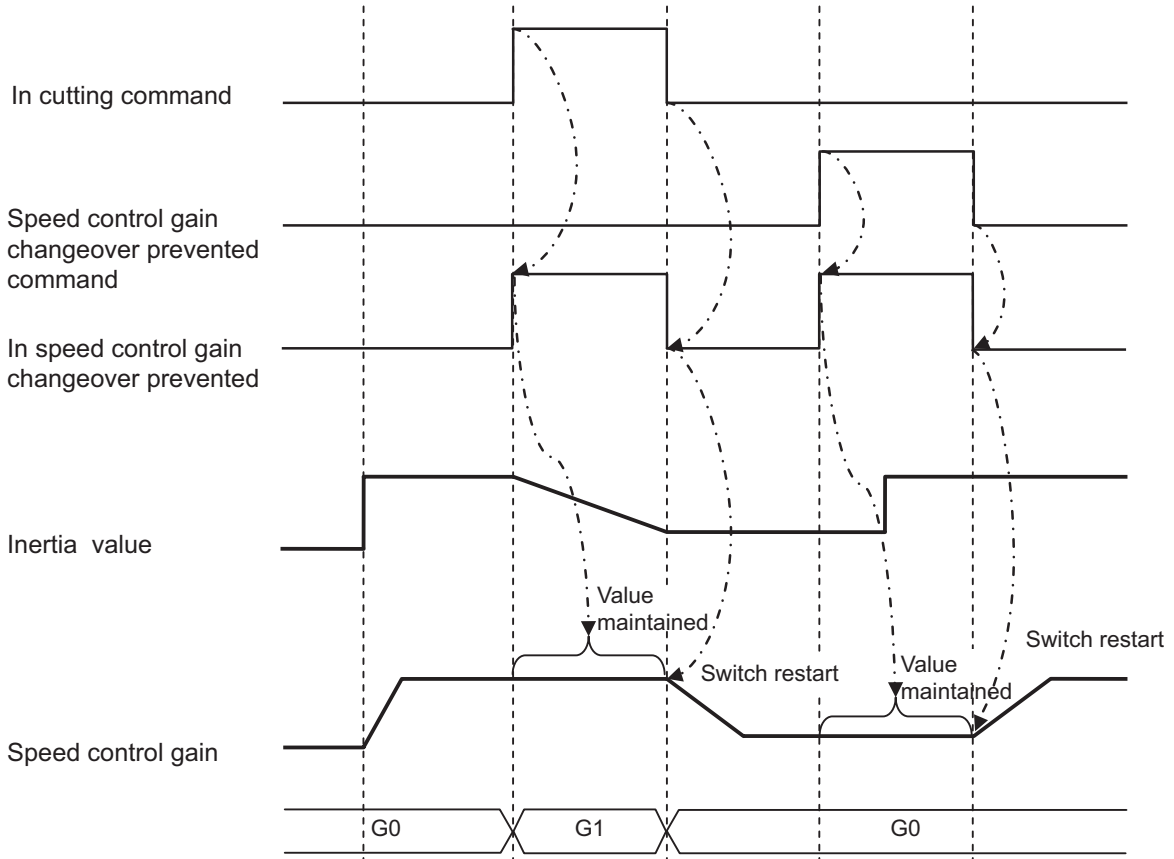

[Related signals]

- (1) Real-time tuning 1: Speed control gain changeover hold-down ON (VGHLDC1:XB80)

Cont.	Signal name	Abbrev.	\$1	\$2	\$3	\$4
A	COUNTER ZERO [C80]	CNT01 to 8	YBA0 to 7	YBA8 to F	YBB0 to 7	YBB8 to F

[Function]

Set each axis's relative values displayed to "0".

[Operation]

The relative value counter of corresponding axis is set to "0" when this signal is ON.

[Caution]

- (1) Only the relative value counter is set to "0" when this signal is ON. Workpiece coordinate value and the machine position counter will not change.
- (2) This signal is valid during the program operation.
- (3) The relative values of the master axis and the slave axis will both be set to "0" when this signals for the master axis during the synchronous control is ON.
- (4) This signal for the slave axis is invalid during the synchronous control.
- (5) The signal must be ON for at least 15ms.

4 Explanation of Interface Signals

Cont.	Signal name	Abbrev.	\$1	\$2	\$3	\$4
A	NC AXIS/PLC AXIS SWITCHOVER REQUEST	NPCH-GREQ1 to 8	YBC0 to 7	YBC8 to F	YBD0 to 7	YBD8 to F

[Function]

This function switches the control mode for the NC axis/PLC axis switching axis (whether to use the axis as an NC axis or a PLC axis).

This signal is available per control axis.

[Operation]

Turn ON this signal to control the NC axis/PLC axis switchover axis as a PLC axis, or turn OFF the signal to control the axis as an NC axis. Make sure that the NC axis/PLC axis switchover invalid status signal is OFF before switching this signal.

When switching between NC axis and PLC axis is executed while the NC axis/PLC axis switchover invalid status signal is ON, an operation error (M01 1250) will occur. When the NC axis/PLC axis switchover invalid status signal is OFF after that, the control will be switched and the alarm will be cleared.

If this signal is switched while the axis is moving, the control is switched at the time when the movement command is completed and the NC axis/PLC axis switchover invalid status signal is OFF.

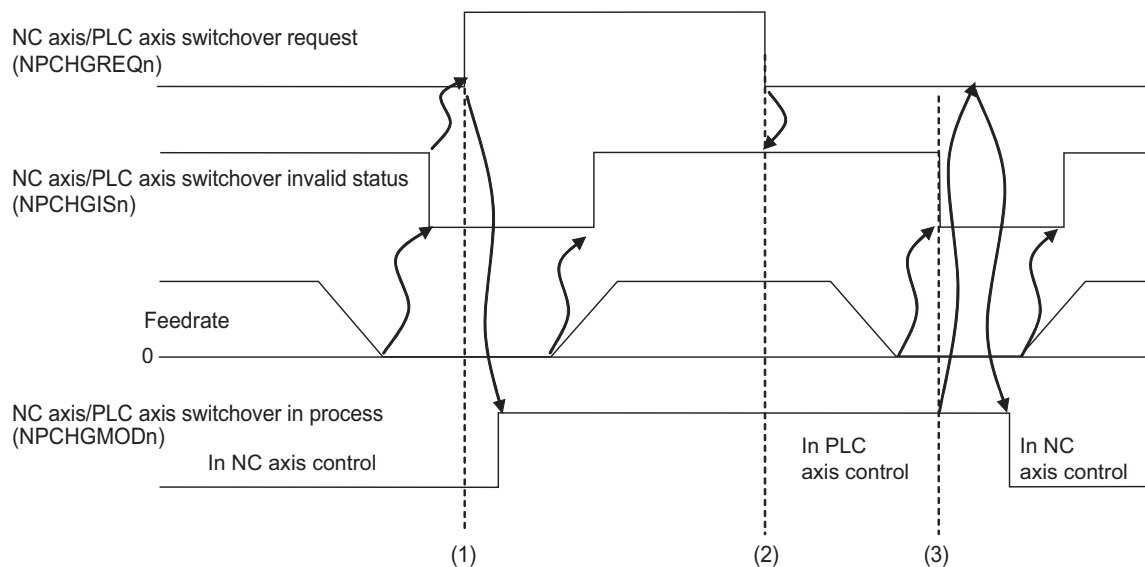
[Operation sequence]

- (1) The NC axis/PLC axis switchover request signal is switched from OFF to ON, and the NC axis/PLC axis switchover invalid status signal is turned OFF (switching is permitted). So the control is switched to PLC axis and the NC axis/PLC axis switchover in process signal is turned ON.
- (2) The NC axis/PLC axis switchover request signal is turned OFF, but the NC axis/PLC axis switchover invalid status signal is ON. So the control does not move to NC axis and an operation error (M01 1250) occurs.
- (3) The axis movement is completed, and the NC axis/PLC axis switchover invalid status signal is turned OFF. Then the control is switched to NC axis, and the NC axis/PLC axis switchover in process signal is turned OFF.

[Related signals]

- (1) NC axis/PLC axis switchover invalid status (NPCHGIS1 to 8:XBA0 to 7)
- (2) NC axis/PLC axis switchover in process (NPCHGMOD1 to 8:XBC0 to 7)

4 Explanation of Interface Signals

Cont.	Signal name	Abbrev.	Device			
A	MACHINE GROUP-BASED ALARM STOP: MACHINE GROUP-BASED PLC INTERLOCK	GQEMGn	YBE0 to 7	YBE8 to F	YBF0 to 7	YBF8 to F

[Function]

In each machine group, the control axis belonging in the group is interlocked.

[Operation]

When this signal (YBE0) is turned ON, the control axis belonging in the group is interlocked. The "Machine group-based alarm stop: Machine group-based PLC interlock ON" signal (XBE0: GQEMGO) of the group turns ON.

The signals for each group are assigned as follows.

Group 1	Group 2	Group 3	Group 4	Group 5	Group 6	Group 7	Group 8
YBE0	YBE1	YBE2	YBE3	YBE4	YBE5	YBE6	YBE7
Group 9	Group 10	Group 11	Group 12	Group 13	Group 14	Group 15	Group 16
YBE8	YBE9	YBEA	YBEB	YBEC	YBED	YBEE	YBEF
Group 17	Group 18	Group 19	Group 20	Group 21	Group 22	Group 23	Group 24
YBF0	YBF1	YBF2	YBF3	YBF4	YBF5	YBF6	YBF7
Group 25	Group 26	Group 27	Group 28	Group 29	Group 30	Group 31	Group 32
YBF8	YBF9	YBFA	YBFB	YBFC	YBFD	YBFE	YBFF

Cont.	Signal name	Abbrev.	\$1	\$2	\$3	\$4	\$5	\$6	\$7	\$8
A	JOG MODE	J	YC00	YD40	YE80	YFC0	Y1100	Y1240	Y1380	Y14C0

[Function]

JOG operation mode (manual operation) is selected.

[Operation]

When JOG mode signal (J) turns ON, JOG operation mode is selected.

Axis motion is started by turning ON the "Feed axis selection+ (+J1 to 8) or Feed axis selection- (-J1 to 8)" signal after turning ON the jog mode and setting the manual feedrate code (*JV1 to 16).

The axis travel speed is set in "#2642 jogfeed (Jog feed rate)" or by PLC signal selected by the Manual feedrate method selection signal (YC77).

For rapid traverse, "Rapid traverse" signal (RT) is turned ON together with this signal (J).

When the operation mode conflicts with any other mode or when no mode is selected, the NC alarm "M01 OPERATION ERROR 0101" will occur.

[Related signals]

- (1) Feed axis selection (+J1 to 8: Y8E0, -J1 to 8: Y900)
- (2) Manual feedrate method selection (JVS: YC77)
- (3) Manual feedrate code m (*JV1 to 16: YC70 to 4)
- (4) Manual feedrate (method selection) (R2504, R2505)
- (5) Rapid traverse (RT: YC26)

4 Explanation of Interface Signals

Cont.	Signal name	Abbrev.	\$1	\$2	\$3	\$4	\$5	\$6	\$7	\$8
A	HANDLE MODE	H	YC01	YD41	YE81	YFC1	Y1101	Y1241	Y1381	Y14C1

[Function]

"Handle feed operation" mode (manual operation) is selected.

[Operation]

When HANDLE mode signal (H) is turned ON, HANDLE FEED mode is selected.

Axis motion starts when the manual pulse generator handwheel is rotated after axis is selected by the "n-th handle axis selection code" (HSn1 to HSn16) and the "n-th handle valid" (HSnS), and this signal is turned ON. Speed of the axis motion depends on setting of feedrate magnification (MP1 to 4).

When the operation mode conflicts with any other mode or when no mode is selected, the NC alarm "M01 OPERATION ERROR 0101" will occur.

"Automatic operation handle interruption function" is valid when the handle mode signal is turned ON in automatic mode selection.

[Related signals]

- (1) 1st handle axis selection code (HS11 to 116: YC40), 1st handle valid (HS1S: YC47)
- (2) 2nd handle axis selection code (HS21 to 216: YC48), 2nd handle valid (HS2S: YC4F)
: Valid only for handle 2-axis spec.
- (3) 3rd handle axis selection code (HS31 to 316: YC50), 3rd handle valid (HS3S: YC57)
: Valid only for handle 3-axis spec.
- (4) 4th handle axis selection code (HS41 to HS416: R22508/bit0 to 4), 4th handle valid (HS4S: R22508/bit7)
: Valid only for handle 4-axis spec. [C80]
- (5) 5th handle axis selection code (HS51 to HS516: R22509/bit0 to 4), 5th handle valid (HS5S: R22509/bit7)
: Valid only for handle 5-axis spec. [C80]
- (6) 6th handle axis selection code (HS61 to HS616: R22510/bit0 to 4), 6th handle valid (HS6S: R22510/bit7)
: Valid only for handle 6-axis spec. [C80]
- (7) 7th handle axis selection code (HS71 to HS716: R22511/bit0 to 4), 7th handle valid (HS7S: R22511/bit7)
: Valid only for handle 7-axis spec. [C80]
- (8) 8th handle axis selection code (HS81 to HS816: R22512/bit0 to 4), 8th handle valid (HS8S: R22512/bit7)
: Valid only for handle 8-axis spec. [C80]
- (9) 9th handle axis selection code (HS91 to HS916: R22513/bit0 to 4), 9th handle valid (HS9S: R22513/bit7)
: Valid only for handle 9-axis spec. [C80]
- (10) Handle/Incremental feed magnification code m (MP1 to 4: YC80 to YC82)

Cont.	Signal name	Abbrev.	\$1	\$2	\$3	\$4	\$5	\$6	\$7	\$8
A	INCREMENTAL MODE	S	YC02	YD42	YE82	YFC2	Y1102	Y1242	Y1382	Y14C2

[Function]

INCREMENTAL FEED mode (manual operation) is selected.

[Operation]

When incremental mode command signal (S) is turned ON, INCREMENTAL FEED mode is selected.

Each time "Feed axis selection" signal (+J1 to 8, -J1 to 8) for desired axis is turned ON, axis motion starts. Speed of the axis motion (incremental feed) depends on setting of "Handle/Incremental feed magnification code m" (MP1 to 4).

When "Rapid traverse" signal (RT) is ON, speed is the rapid traverse speed. When signal (RT) is OFF, speed is equal to "Manual feedrate" (*JV1 to 16).

When the operation mode conflicts with any other mode or when no mode is selected, the NC alarm "M01 OPERATION ERROR 0101" will occur.

(Note 1) The incremental mode is also called as step mode.

[Related signals]

- (1) Handle/Incremental feed magnification code m (MP1 to 4: YC80 to YC82)
- (2) Feed axis selection (+J1 to 8: Y8E0, -J1 to 8: Y900)
- (3) Manual feedrate code m (*JV1 to 16: YC70)
- (4) Rapid traverse (RT: YC26)

4 Explanation of Interface Signals

Cont.	Signal name	Abbrev.	\$1	\$2	\$3	\$4	\$5	\$6	\$7	\$8
A	MANUAL ARBITRARY FEED MODE	PTP	YC03	YD43	YE83	YFC3	Y1103	Y1243	Y1383	Y14C3

[Function]

MANUAL ARBITRARY FEED mode in manual operation is selected.

[Operation]

MANUAL ARBITRARY FEED mode is selected when this signal is turned ON (1).

[Caution]

To turn the MANUAL ARBITRARY FEED mode ON (1), the rest of the manual modes and the automatic mode must be OFF (0).

Otherwise, this mode cannot be selected. (Note that this mode can be selected simultaneously when manual or automatic simultaneous is turned ON (1).)

[Related signals]

(1) Signals from PLC to controller

Device No.				Abbrev.	Signal name
\$1	\$2	\$3	\$4		
YCA0	YDE0	YF20	Y1060	CX11	Manual arbitrary feed 1st axis selection code 1
YCA1	YDE1	YF21	Y1061	CX12	Manual arbitrary feed 1st axis selection code 2
YCA2	YDE2	YF22	Y1062	CX14	Manual arbitrary feed 1st axis selection code 4
YCA3	YDE3	YF23	Y1063	CX18	Manual arbitrary feed 1st axis selection code 8
YCA4	YDE4	YF24	Y1064	CX116	Manual arbitrary feed 1st axis selection code 16
YCA5	YDE5	YF25	Y1065		
YCA6	YDE6	YF26	Y1066		
YCA7	YDE7	YF27	Y1067	CX1S	Manual arbitrary feed 1st axis valid

Device No.				Abbrev.	Signal name
\$1	\$2	\$3	\$4		
YCA8	YDE8	YF28	Y1068	CX21	Manual arbitrary feed 2nd axis selection code 1
YCA9	YDE9	YF29	Y1069	CX22	Manual arbitrary feed 2nd axis selection code 2
YCAA	YDEA	YF2A	Y106A	CX24	Manual arbitrary feed 2nd axis selection code 4
YCAB	YDEB	YF2B	Y106B	CX28	Manual arbitrary feed 2nd axis selection code 8
YCAC	YDEC	YF2C	Y106C	CX216	Manual arbitrary feed 2nd axis selection code 16
YCAD	YDED	YF2D	Y106D		
YCAE	YDEE	YF2E	Y106E		
YCAF	YDEF	YF2F	Y106F	CX2S	Manual arbitrary feed 2nd axis valid

Device No.				Abbrev.	Signal name
\$1	\$2	\$3	\$4		
YCB0	YDF0	YF30	Y1070	CX31	Manual arbitrary feed 3rd axis selection code 1
YCB1	YDF1	YF31	Y1071	CX32	Manual arbitrary feed 3rd axis selection code 2
YCB2	YDF2	YF32	Y1072	CX34	Manual arbitrary feed 3rd axis selection code 4
YCB3	YDF3	YF33	Y1073	CX38	Manual arbitrary feed 3rd axis selection code 8
YCB4	YDF4	YF34	Y1074	CX316	Manual arbitrary feed 3rd axis selection code 16
YCB5	YDF5	YF35	Y1075		
YCB6	YDF6	YF36	Y1076		
YCB7	YDF7	YF37	Y1077	CX3S	Manual arbitrary feed 3rd axis valid

4 Explanation of Interface Signals

Device No.				Abbrev.	Signal name
\$1	\$2	\$3	\$4		
YCB8	YDF8	YF38	Y1078	CXS1	Manual arbitrary feed smoothing off
YCB9	YDF9	YF39	Y1079	CXS2	Manual arbitrary feed axis independent
YCBA	YDFA	YF3A	Y107A	CXS3	Manual arbitrary feed EX. F/MODAL.F
YCBB	YDFB	YF3B	Y107B	CXS4	Manual arbitrary feed G0/G1
YCBC	YDFC	YF3C	Y107C	CXS5	Manual arbitrary feed MC/WK
YCBD	YDFD	YF3D	Y107D	CXS6	Manual arbitrary feed ABS/INC
YCBE	YDFE	YF3E	Y107E	*CXS7	Manual arbitrary feed stop
YCBF	YDFE	YF3F	Y107F	CXS8	Manual arbitrary feed strobe

Device No.				Abbrev.	Signal name
\$1	\$2	\$3	\$4		
R2508	R2708	R2908	R3108		1st handle/incremental feed magnification
R2509	R2709	R2909	R3109		
R2510	R2710	R2910	R3110		2nd handle feed magnification
R2511	R2711	R2911	R3111		
R2512	R2712	R2912	R3112		3rd handle feed magnification
R2513	R2713	R2913	R3113		
R2544	R2744	R2944	R3144		Manual arbitrary feed 1st axis travel amount
R2545	R2745	R2945	R3145		
R2546	R2746	R2946	R3146		
R2547	R2747	R2947	R3147		Manual arbitrary feed 2nd axis travel amount
R2548	R2748	R2948	R3148		
R2549	R2749	R2949	R3149		
R2550	R2750	R2950	R3150		Manual arbitrary feed 3rd axis travel amount
R2551	R2751	R2951	R3151		
R2552	R2752	R2952	R3152		
R2553	R2753	R2953	R3153		
R2554	R2754	R2954	R3154		
R2555	R2755	R2955	R3155		

(2) Signals from controller to PLC

- (a) In manual arbitrary feed mode (PTPO: XC03)
- (b) In manual arbitrary feed (CXN: XC16)
- (c) Manual arbitrary feed completion (CXFIN: XC1C)

(3) Other

- (a) Feedrate least increment code 1, 2 (PCF1: YC78, PCF2: YC79)
- (b) Manual/Automatic simultaneous valid n-th axis (MAE1 to 8)

Cont.	Signal name	Abbrev.	\$1	\$2	\$3	\$4	\$5	\$6	\$7	\$8
A	REFERENCE POSITION RETURN MODE	ZRN	YC04	YD44	YE84	YFC4	Y1104	Y1244	Y1384	Y14C4

[Function]

REFERENCE POSITION RETURN mode is selected.

"Reference position return" is that axis motion component (tool, table, etc.) is returned to the position previously determined for individual machine.

[Operation]

The reference position return mode is selected when the "Reference position return mode" signal (ZRN) is turned ON. Select the reference position return mode, and turn ON the "Feed axis selection" signal (+J1 to 8, -J1 to 8) of designated axis to return to the reference position.

When the operation mode conflicts with any other mode or when no mode is selected, the NC alarm "M01 OPERATION ERROR 0101" will occur.

The first reference position return after the controller power is turned ON is the dog-type return (excluding when the basic machine coordinate system is established for the absolute position detection specifications). After the second manual reference position return (when basic machine coordinate system is established), the dog-type or high-speed return is selected with the machine parameters, basic specification parameter "#1063 mandog".

(1) Dog-type reference position return pattern

The return pattern is determined by the final entry method of the machine parameter reference position return.

(a) Operation when axis is moved in same direction as the final entry method, and dog is tripped.

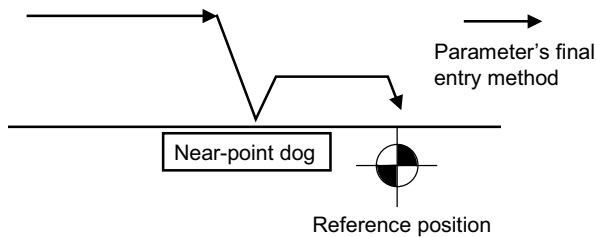

(b) When axis is moved in opposite direction from final entry method, and dog is tripped.

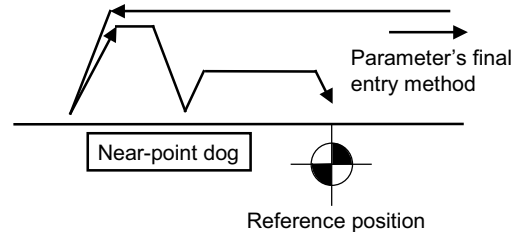

- After the near-point dog is detected and the approach speed is applied, the axis will move to the reference position even if the "Feed axis selection" signal is turned OFF. Thus, after the approach speed is applied, another axis can be switched to and reference position return executed.
- The entry direction (final entry direction) after the near-point dog is tripped is set with parameters.
- The feedrate before the approach speed is the reference position return feedrate if the "Rapid traverse" signal (RT) is ON, and the "Manual feedrate" (*JV1 to 16) is OFF.
- The approach speed is set with the parameters.
- When the reference position is reached, the movement will stop even if the feed axis selection signal is ON, and the "1st reference position reached" signal (ZP1n) will turn ON.

(2) High-speed reference position return

- The axis will move toward the reference position. The motion speed will be rapid traverse if the rapid traverse signal is ON, and manual feedrate if OFF.
- When the reference position is reached, the movement will stop even if the feed axis selection signal is ON, and the "1st reference position reached" signal (ZP1n) will turn ON.
- The feed axis selection signal for high-speed return is valid only in the reference position direction. If the opposite direction signal is designated, the NC alarm "M01 Operation error 0003" will occur.

[Related signals]

- (1) Feed axis selection (+J1 to 8: Y8E0, -J1 to 8: Y900)
- (2) Manual feedrate code m (*JV1 to 16: YC70)
- (3) Rapid traverse (RT: YC26)
- (4) 1st reference position reached (ZP11 to 18: X800 to 7)

4 Explanation of Interface Signals

Cont.	Signal name	Abbrev.	\$1	\$2	\$3	\$4	\$5	\$6	\$7	\$8
A	AUTOMATIC INITIALIZATION MODE	AST	YC05	YD45	YE85	YFC5	Y1105	Y1245	Y1385	Y14C5

[Function]

The automatic initialization mode is selected.

[Operation]

This mode is selected when automatic initialization is to be carried out with the machine end stopper method of absolute position detection.

The initialization is started when the automatic initialization mode is selected, and the "Feed axis selection" (+Jn, -Jn) signal in the direction of the machine end of the axis to be initialized is turned ON.

(Note 1) The automatic initialization mode is invalid when the absolute position encoder is not provided and when the machine end stopper method is not selected for the absolute position detection.

(During feed axis selection, "M01 OPERATION ERROR 0024" will occur.)

(Note 2) This mode will not start in the following cases of the machine end stopper method absolute position detection.

(The message "Start not possible" will display.

- When "#0 Absolute posn set" on the [ABS. POSITION SET] screen is not set to "1".
- When "#2 Zero-P" on the [ABS. POSITION SET] screen has not been set.
- When "#2055 pushf" on the [ABS. POSITION PARAMETER] screen has not been set.
- When "Z71 0005" has occurred.

Cont.	Signal name	Abbrev.	\$1	\$2	\$3	\$4	\$5	\$6	\$7	\$8
A	MEMORY MODE	MEM	YC08	YD48	YE88	YFC8	Y1108	Y1248	Y1388	Y14C8

[Function]

MEMORY mode of automatic operation is selected.

In this mode of operation, automatic operation is based on programs stored in the memory.

[Operation]

- MEMORY mode is selected when "Memory mode" signal (MEM) turns ON.
- The program is started with the "Automatic operation "start" command" signal (ST).
- When the mode conflicts with any other automatic operation mode or when no automatic operation mode is selected while automatic operation is active, the NC alarm "M01 OPERATION ERROR 0101" will occur, and the operation will stop at the end of the block.

(Note 1) Also when automatic operation is inactive, any improper mode of operation will trigger the operation error.

[Related signals]

- (1) Automatic operation "start" command (ST: YC10)
- (2) Automatic operation "pause" command (*SP: YC11)

Cont.	Signal name	Abbrev.	\$1	\$2	\$3	\$4	\$5	\$6	\$7	\$8
A	TAPE MODE	T	YC09	YD49	YE89	YFC9	Y1109	Y1249	Y1389	Y14C9

[M8]**[Function]**

TAPE mode of automatic operation is selected.

In this mode of operation, automatic operation is based on tape command (RS232-C input) programs stored in NC tape.

[Operation]

- Tape mode is selected when "Tape mode" (T) signal turns ON.
- The program is started with the "Automatic operation "start" command" signal (ST).
- When the mode conflicts with any other automatic operation mode or when no automatic operation mode is selected while automatic operation is active, the NC alarm "M01 OPERATION ERROR 0101" will occur, and the operation will stop at the end of the block.

(Note 1) Also when automatic operation is inactive, any improper mode of operation will trigger the operation error.

[Related signals]

- (1) Automatic operation "start" command (ST: YC10)
- (2) Automatic operation "pause" command (*SP: YC11)

[C80]**[Function]**

Select "Tape mode" for the operation mode.

[Operation]

If cycle start is carried out in TAPE mode, execution of the machining program downloaded to the buffer memory starts.

[Related signals]

- (1) Automatic operation "start" command (ST: YC10)
- (2) Automatic operation "pause" command (*SP: YC11)

Cont.	Signal name	Abbrev.	\$1	\$2	\$3	\$4	\$5	\$6	\$7	\$8
A	MDI MODE	D	YC0B	YD4B	YE8B	YFCB	Y110B	Y124B	Y138B	Y14CB

[Function]

MDI (Manual Data Input) mode of automatic operation is selected.

Automatic operation is performed with the program set in the MDI screen.

[Operation]

- MDI mode is selected when "MDI mode" (D) signal turns ON.
- The program is started with the "Automatic operation "start" command" signal (ST).
- When the mode conflicts with any other automatic operation mode or when no automatic operation mode is selected while automatic operation is active, the NC alarm "M01 OPERATION ERROR 0101" will occur, and the operation will stop at the end of the block.

(Note 1) Also when automatic operation is inactive, any improper mode of operation will trigger the operation error.

[Related signals]

- (1) Automatic operation "start" command (ST: YC10)
- (2) Automatic operation "pause" command (*SP: YC11)

Cont.	Signal name	Abbrev.	\$1	\$2	\$3	\$4	\$5	\$6	\$7	\$8
A	SUB PART SYSTEM CONTROL: SUB PART SYSTEM CONTROL I MODE	SBSM	YC0E	YD4E	YE8E	YFCE	Y110E	Y124E	Y138E	Y14CE

[Function]

This signal specifies the sub part system used in the Sub part system control I.

After this signal turns ON and the Sub part system control I mode is entered, the sub part system can be started by executing the Sub part system control I (G122) commands.

[Operation]

The part system for which this signal turned ON outputs the "Sub part system control: Sub part system control I mode ON" signal (SBSMO:XC0E) to the PLC.

[Related signals]

- (1) Sub part system control: Sub part system control I mode ON (SBSMO: XC0E)

Cont.	Signal name	Abbrev.	\$1	\$2	\$3	\$4	\$5	\$6	\$7	\$8
A	AUTOMATIC OPERATION "START" COMMAND (Cycle start)	ST	YC10	YD50	YE90	YFD0	Y1110	Y1250	Y1390	Y14D0

[Function]

This signal is used to start automatic operation in MEMORY mode, MDI mode or TAPE mode, or to restart after automatic operation pause (halt) or block stop.

[Operation]

- (1) "Automatic operation "start" command" (ST) signal arises when the pressed "auto operation start" pushbutton is released (i.e. at the time the signal turns OFF). The signal must be ON for a min. of 100msec. For C80, when "#1761 cfgPR11/bit2" is set to "1", the operation starts at the rising edge of this signal.
- (2) "In automatic operation "start"" signal (status signal "STL") turns ON when the pressed "auto operation start" pushbutton is released, and turns OFF when "auto operation pause (or halt)" pushbutton is pressed or block stop occurs in single-block operation.
- (3) Signal (ST) is invalid when:
 - Automatic operation starts.
 - Automatic operation "pause" command" (*SP) signal is OFF.
 - During reset ("Reset & rewind" signal is ON).
 - During alarm.
 - Sequence No. is being searched for.
- (4) Automatic operation stops or is suspended or block stops when:
 - Automatic operation "pause" command" (*SP) signal turns OFF.
 - Reset occurs ("Reset & rewind" signal turns ON).
 - Alarm which causes stop to automatic operation occurs.
 - Automatic operation mode is changed to manual operation mode.
 - Mode is changed to other automatic operation mode and then the block in execution is completed.
 - Block in execution is completed after "Single-block" (SBK) signal turns ON.
 - Block in execution is completed after "Automatic machine lock" signal (AMKL) turns ON.
 - Program specified in MDI mode has been executed completely.

[Related signals]

- (1) Memory mode (MEM: YC08)
- (2) Tape mode (T: YC09)
- (3) MDI mode (D: YC0B)

4 Explanation of Interface Signals

Cont.	Signal name	Abbrev.	\$1	\$2	\$3	\$4	\$5	\$6	\$7	\$8
B	AUTOMATIC OPERATION "PAUSE" COMMAND (Feed hold)	*SP	YC11	YD51	YE91	YFD1	Y1111	Y1251	Y1391	Y14D1

[Function]

During automatic operation, axis motion can be decelerated and stopped with this command signal. To restart, press "Automatic operation "start" command" (ST) signal pushbutton.

[Operation]

- (1) When "Automatic operation "pause" command" (*SP) signal turns OFF, automatic operation stops.
 - During automatic operation, the operation stops. "In automatic operation "pause"" (SPL) occurs.
 - Restart with the automatic start (ST) button. (Press after turning *SP signal.)
- (2) In the following cases, automatic operation does not immediately stop.
 - During tapping in fixed cycle.
Automatic operation stops when tapping is completed and the tool returns to "R" point.
 - During thread cutting.
Automatic operation stops when a block for axis motion (other than thread cutting), which comes first after the "Automatic operation "pause" command" (*SP) signal turns OFF, is completed. If the "Automatic operation "pause" command" (*SP) signal remains OFF, however, automatic operation stops immediately after a block (other than thread cutting) is given.
 - When control variable "feed hold invalid" has been set by user macro. Automatic operation stops immediately after a block where the control variable "feed hold invalid" is cleared starts.
- (3) "Automatic operation "pause" command" (*SP) signal is valid even during machine lock.

[Related signals]

- (1) Memory mode (MEM: YC08)
- (2) Tape mode (T: YC09)
- (3) MDI mode (D: YC0B)
- (4) Automatic operation "start" command (ST: YC10)

Cont.	Signal name	Abbrev.	\$1	\$2	\$3	\$4	\$5	\$6	\$7	\$8
A	SINGLE BLOCK	SBK	YC12	YD52	YE92	YFD2	Y1112	Y1252	Y1392	Y14D2

[Function]

Machining program can be executed block by block in automatic operation.

[Operation]

- (1) When "Single block" signal (SBK) turns ON, operation of controller is as follows:
 - During automatic operation
After the block in execution has been completed, automatic operation stops. To start execution of the next block, "Automatic operation "start" command" (ST) must be turned ON to OFF.
 - There will be no operation when automatic operation is not being executed but if automatic operation is started with the "Single block" signal (SBK) ON, one block will be executed and then will stop. This allows the commanded program to be executed one block at a time.
- (2) If the "Single block" signal (SBK) is ON at the end of a block, operation will normally stop immediately. However, in the following case, operation will continue to where stopping is possible, and then will stop.
 - During cycle operation such as a fixed cycle.
The block where single block is being received will differ according to each cycle. Refer to the cycle sections in the Programming Manual.

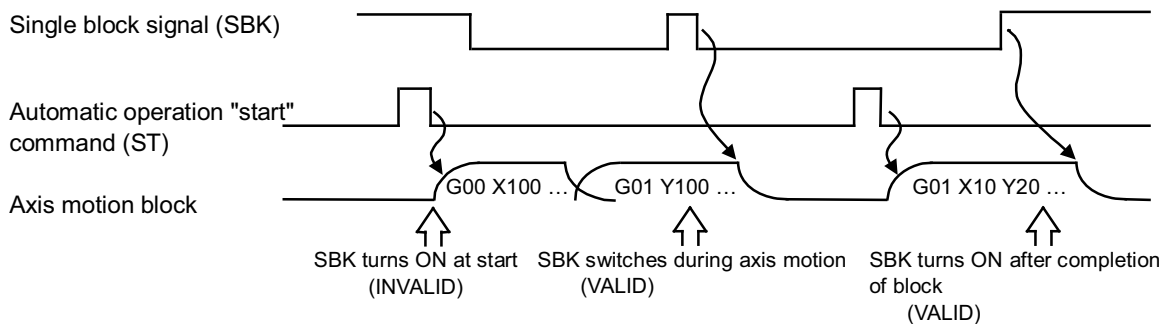

4 Explanation of Interface Signals

Cont.	Signal name	Abbrev.	\$1	\$2	\$3	\$4	\$5	\$6	\$7	\$8
B	BLOCK START INTERLOCK	*BSL	YC13	YD53	YE93	YFD3	Y1113	Y1253	Y1393	Y14D3

[Function]

This signal prohibits start of the next block in automatic operation (memory, MDI or tape).

[Operation]

While the "Block start interlock" (*BSL) signal is OFF, execution of the next block may not be started in automatic operation. When the signal is given during execution of a block, the execution of the block continues until it is completed. Since the signal does not cause stop or suspension of automatic operation, execution of program starts when the "Block start interlock" (*BSL) signal turns ON.

(Note 1) This signal is valid to all blocks including blocks internally generated in controller by fixed cycle, etc.

(Note 2) The signal (*BSL) is ON when the power is turned ON. When the signal is not used, programming on the PLC is not required for this signal. [M8]

(Note 3) On C80, as "1" is not set when the power is turned ON, perform the sequence process as necessary.

(Note 4) When selecting or cancelling to select the machining surface while the "Block start interlock" (*BSL) signal is OFF in the R-Navi function, the operation error (M01 0109) occurs. After turning ON the "block start interlock" (*BSL) again, the machining surface is selected or cancelled to select.

When the axis is moved automatically or manually in machining surface indexing, the operation error (M01 0109) occurs in both cases. [M8]

[Related signals]

(1) Cutting block start interlock (*CSL: YC14)

Cont.	Signal name	Abbrev.	\$1	\$2	\$3	\$4	\$5	\$6	\$7	\$8
B	CUTTING BLOCK START INTERLOCK	*CSL	YC14	YD54	YE94	YFD4	Y1114	Y1254	Y1394	Y14D4

[Function]

This signal prohibits start of an axis motion command block other than that for positioning in automatic operation (memory, MDI, tape).

[Operation]

While the "Cutting block start interlock" (*CSL) signal is OFF, execution of an axis motion command block other than that for positioning may not be started in automatic operation. When the signal is given during execution of a block, the execution of the block continues until it is completed.

Since the signal does not cause stop or suspension of automatic operation, execution of program starts when the "Cutting block start interlock" (*CSL) signal is turned ON.

(Note 1) This signal is valid to all blocks including blocks internally generated by fixed cycle, etc.

(Note 2) The signal (*CSL) is ON when the power is turned ON. When the signal is not used, programming on the PLC is not required for this signal. [M8]

(Note 3) On C80, as "1" is not set when the power is turned ON, perform the sequence process as necessary.

[Related signals]

(1) Block start interlock (*BSL: YC13)

Cont.	Signal name	Abbrev.	\$1	\$2	\$3	\$4	\$5	\$6	\$7	\$8
A	DRY RUN	DRN	YC15	YD55	YE95	YFD5	Y1115	Y1255	Y1395	Y14D5

[Function]

Feedrate in automatic operation is specified by manually set value instead of program command value (F value).

[Operation]

- (1) DRY RUN signal given during cutting feed
 - When "Rapid traverse" (RT) signal is ON, the cutting feedrate is equal to the maximum cutting feedrate. In this case, "cutting feedrate override" and "rapid traverse override" are ignored.
 - When "Rapid traverse" (RT) signal is OFF, the set manual feedrate (*JV1 to 16) will apply. Cutting feed override will also be valid if the "Manual override method selection" (OVSL) signal is ON.
- (2) Dry run signal given during rapid traverse
 - The parameter must be turned ON to validate dry run for rapid traverse (G0, G27, G28, G29, G30).
 - When "Rapid traverse" (RT) signal is ON, the "Dry run" signal is ignored.
 - When "Rapid traverse" (RT) signal is OFF, the speed is equal to manually set speed.

(Note 1) Dry run is not applicable to manual operation.
 (Note 2) Dry run is valid even during G84 or G74 operation.
- (3) Dry run during thread cutting
 - Whether to enable or disable dry run during thread cutting is determined in "#1279 ext15/bit4 (Dry run OFF during thread cutting).
 When "#1279 ext15/bit4 (dry run OFF during thread cutting)" is "1", dry run is disabled. However, while the spindle OFF mode signal is ON, dry run is enabled regardless of the parameter, so the status of dry run is determined by the dry run signal.
 - The feedrate by the dry run does not synchronize with the spindle rotation.
 - The dry run signal is checked at the start of thread cutting. If the signal is changed during thread cutting, the change is ignored.

[Related signals]

- (1) Manual feedrate code m (*JV1 to 16: YC70)
- (2) Rapid traverse (RT: YC26)
- (3) Manual override method selection (OVSL: YC59)
- (4) Spindle OFF mode (YCD3)

4 Explanation of Interface Signals

Cont.	Signal name	Abbrev.	\$1	\$2	\$3	\$4	\$5	\$6	\$7	\$8
A	ERROR DETECTION	ERD	YC17	YD57	YE97	YFD7	Y1117	Y1257	Y1397	Y14D7

[Function]

Machine motion is stopped momentarily in transition from a cutting feed block to other block during automatic operation to provide time for determination whether in-position check is made or not before start of the next block.

Block-to-block transition may cause rounding in cutting because of delay caused by acceleration or deceleration, and servo response delay. Rounding can be eliminated by stopping the machine motion between the blocks by turning the "Error detection" signal (ERD) ON.

[Operation]

When this "Error detection" signal (ERD) is ON in block-to-block transition during cutting in automatic operation, in-position check is accomplished. If the signal is OFF, the next block starts after completion of the preceding block without stop.

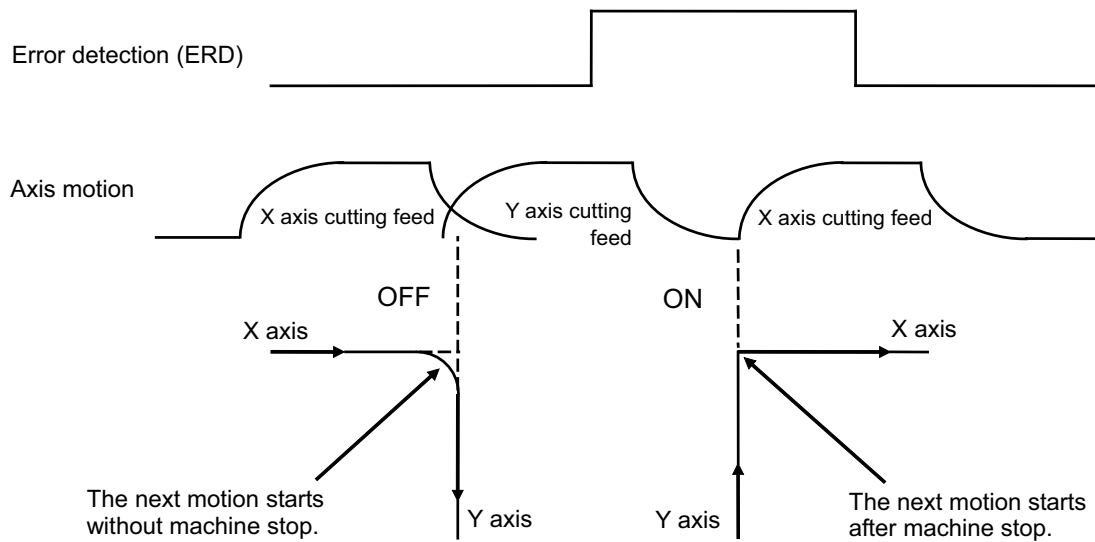

(Note 1) In general practice, the signal (ERD) is turned ON and OFF using an appropriate miscellaneous function (M code, etc.) so that command program can determine whether machine motion should be stopped or not. When the signal is ON, the status is same as the case where G09 is specified by the command program. Consequently, it is recommended to use G function unless otherwise required especially.

4 Explanation of Interface Signals

Cont.	Signal name	Abbrev.	\$1	\$2	\$3	\$4	\$5	\$6	\$7	\$8
A	NC RESET 1	NRST1	YC18	YD58	YE98	YFD8	Y1118	Y1258	Y1398	Y14D8

[Function]

This signal is used to reset the control unit.

[Operation]

When this signal (NRST1) is turned ON, the control unit can be reset.

Generally, the signal for the reset button of the NC operation board is set to "NC reset 1" (NRST1). At this time, the control unit will take the following actions.

- (1) The G command modal will be held.
- (2) The tool compensation data will be held.
- (3) The memory will be indexed.
- (4) The error/alarm will be reset.
- (5) The MST code output will be held.
- (6) The M code independent output (M00, M01, M02, M30) will turn OFF.
- (7) The axis movement will stop.
- (8) The "In reset" signal (RST) will be output.

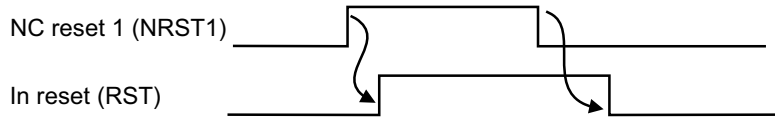

[Related signals]

- (1) NC reset 2 (NRST2: YC19)
- (2) Reset & rewind (RRW: YC1A)
- (3) In "reset" (RST: XC15)

Cont.	Signal name	Abbrev.	\$1	\$2	\$3	\$4	\$5	\$6	\$7	\$8
A	NC RESET 2	NRST2	YC19	YD59	YE99	YFD9	Y1119	Y1259	Y1399	Y14D9

[Function]

This signal is used to reset the control unit.

[Operation]

When this signal (NRST2) is turned ON, the control unit can be reset.

Generally, this is turned ON when the miscellaneous function M02 or M30 is executed. In some cases, the "Reset & Rewind" (RRW) explained later is used.

At this time, the control unit will take the following actions.

- (1) The G command modal will be initialized.
- (2) The tool compensation data will be canceled. (Will not be applied.)
- (3) The memory will not be indexed.
- (4) The error/alarm will be reset.
- (5) The MST code output will be held.
- (6) The M code independent output (M00, M01, M02, M30) will turn OFF.
- (7) The axis movement will stop.
- (8) The "In reset" signal (RST) will be output.

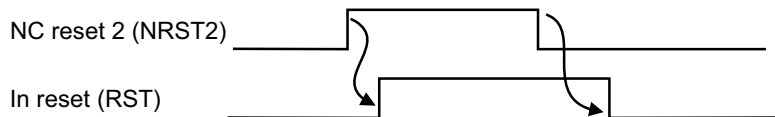

[Related signals]

- (1) NC reset 1 (NRST1: YC18)
- (2) Reset & rewind (RRW: YC1A)
- (3) In "reset" (RST: XC15)

4 Explanation of Interface Signals

Cont.	Signal name	Abbrev.	\$1	\$2	\$3	\$4	\$5	\$6	\$7	\$8
A	RESET & REWIND	RRW	YC1A	YD5A	YE9A	YFDA	Y111A	Y125A	Y139A	Y14DA

[Function]

This signal resets the controller.

During memory operation, the head of the machining program currently being run can be called out.

The reset key in the communication terminal is also set to YC1A by the sequence program.

[Operation]

When this signal (RRW) turns ON:

- (1) Ongoing axis motion is decelerated and stopped.
- (2) CNC is reset after axis motion stops. In about 0.5 second after CNC is reset, "In reset" signal (status signal RST) turns ON.
- (3) At the same time as CNC is reset, "In rewind" (RWD) signal turns ON.
- In memory operation mode, the head of program in execution is read (memory index).
- (4) While the signal (RRW) is ON, automatic operation and manual operation are impossible.
- (5) G command modal is initialized.
- (6) Tool compensation (offset) data are canceled (no motion).
- (7) Error/alarm is reset.
- (8) M, S, T code outputs are held. (Strobe signal turns OFF.)
- (9) M code independent output (M00, M01, M02 and M30) is turned OFF.

<Operation example>

The process when M02 or M30 are commanded in the program is shown below.

Generally, when M02 (or M30) is executed by the program, this signal (RRW) will be returned when the designated operation is completed. M function finish 1 (FIN1) and M function finish 2 (FIN2) will not be returned. (Refer to *1 in the following drawing.)

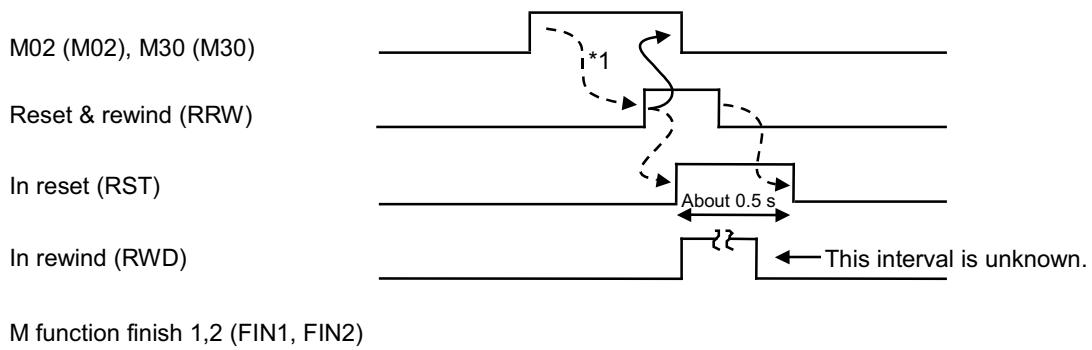

[Related signals]

- (1) In reset (RST: XC15)
- (2) In rewind (RWD: XC17)

Cont.	Signal name	Abbrev.	\$1	\$2	\$3	\$4	\$5	\$6	\$7	\$8
B	CHAMFERING	*CDZ	YC1B	YD5B	YE9B	YFDB	Y111B	Y125B	Y139B	Y14DB

[Function]

In thread cutting cycle, chamfering can be ignored.

[Operation]

Status of this signal is determined at start of thread cutting cycle.

- CHAMFERING (*CDZ) is OFF.

Chamfering (at end of thread cutting) is accomplished.

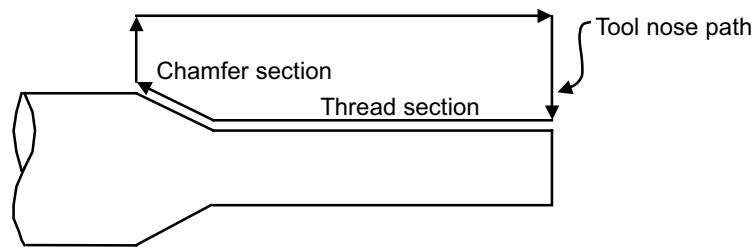

- CHAMFERING (*CDZ) is ON.

Chamfering is not accomplished (signal is ignored).

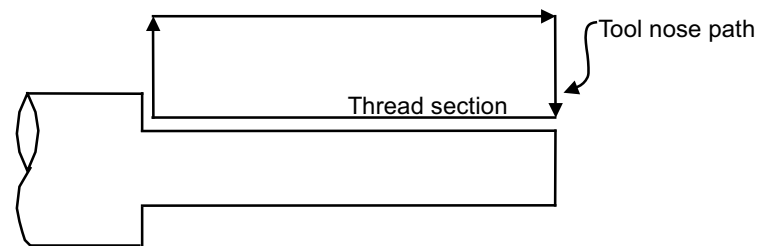

4 Explanation of Interface Signals

Cont.	Signal name	Abbrev.	\$1	\$2	\$3	\$4	\$5	\$6	\$7	\$8
A	AUTOMATIC RESTART	ARST	YC1C	YD5C	YE9C	YFDC	Y111C	Y125C	Y139C	Y14DC

[Function]

If this signal is turned ON after the end of the machining program execution, the same machining program will be restarted.

[Operation]

The same machining program will restart if this signal is turned ON during cycle start.

[Timing chart]

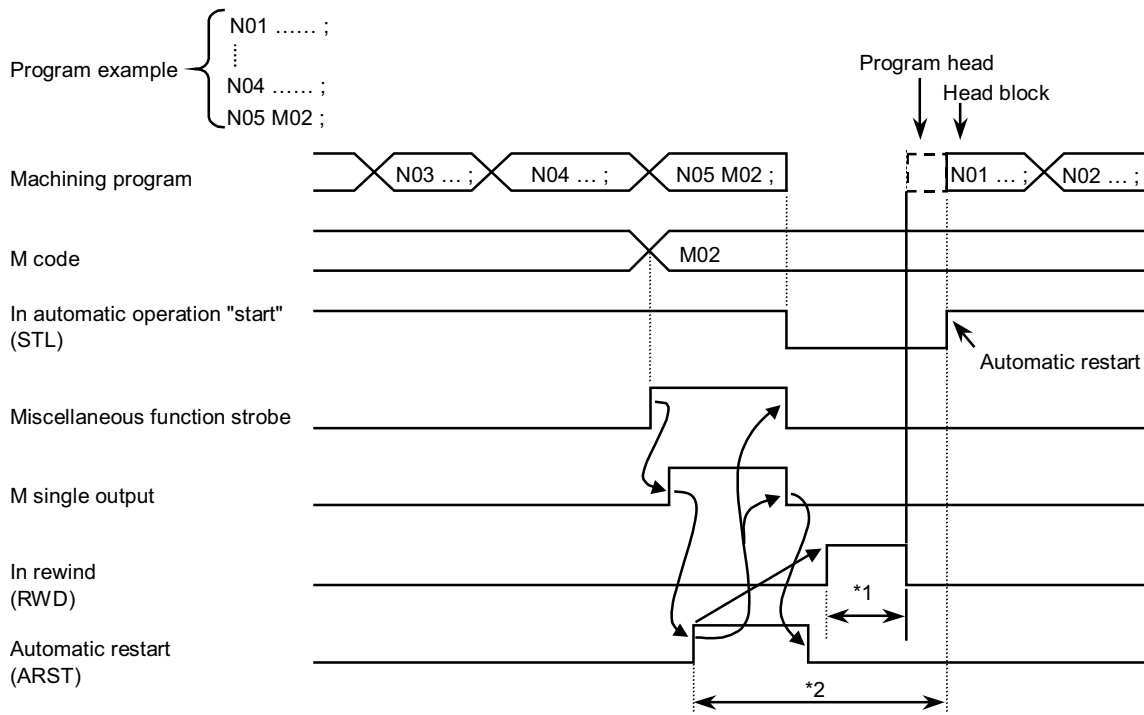

*1: Rewind time During memory operation ... approx. 0.1 [s] + α (α is the PC cycle time)
 During tape operation ... according to length of tape
 *2: Refer to Note 8.

- (Note 1) The modal is initialized with this signal.
- (Note 2) This signal is valid only during cycle start.
- (Note 3) This signal is valid during the memory and MDI automatic operation modes.
- (Note 4) Normally, "M code independent output" signal for M02 or M30 is input into this signal, but in this case, do not input the M02 or M30 completion signal (FIN1, FIN2).
- (Note 5) If the "Automatic operation "pause" command" (*SP) signal is valid, the "Automatic restart" signal will be invalid.
- (Note 6) This signal is invalid during single block stop.
- (Note 7) Note that if an M command other than M02 or M30 is input into this signal, the program will return to the start point without completing the program, and the program will be restarted.
- (Note 8) If "Reset & rewind" (RRW) are applied during the automatic restart process (*2 section in time chart above), the modal will be initialized and the tape will be rewound, but the "Automatic restart" signal will be invalid.

Cont.	Signal name	Abbrev.	\$1	\$2	\$3	\$4	\$5	\$6	\$7	\$8
A	EXTERNAL SEARCH STROBE		YC1D	YD5D	YE9D	YFDD	Y111D	Y125D	Y139D	Y14DD

[Function][Operation]

The NC starts the external search at the rising edge of this signal.

A block specified with program No. (R2526), sequence No. (R2528), and block No. (R2530) is searched for operation.

When program No. and/or sequence No. is omitted, the operation changes as shown in the following table.

Program No. (R2526)	Sequence No. (R2528)	Starting point for searching the block No. (R2530)
Designated	Designated	Designated sequence No. for designated program
Designated	Not designated (*1)	Head of designated program
Not designated (*1)	Designated	Designated sequence No. in currently selected program
Not designated (*1)	Not designated (*1)	Error : 4 Refer to "External search status" (R500).

(*1) "Not designated" indicates that the signal's value is "0" (OFF).

[Related signal]

- (1) External search finished (XC1D)
- (2) External search device No. (R2525)
- (3) External search program No. (R2526)
- (4) External search sequence No. (R2528)
- (5) External search block No. (R2530)

4 Explanation of Interface Signals

Cont.	Signal name	Abbrev.	\$1	\$2	\$3	\$4	\$5	\$6	\$7	\$8
A	M FUNCTION FINISH 1	FIN1	YC1E	YD5E	YE9E	YFDE	Y111E	Y125E	Y139E	Y14DE

[Function]

This status signal informs the controller that specified miscellaneous (M) function, spindle (S) function, tool (T) function or 2nd miscellaneous function (A, B or C) is accomplished on the PLC side.

[Operation]

If the M, S, T or 2nd M function command is executed during automatic operation, the code and each function strobe (MF_n, SF_n, TF_n, BF_n) will turn ON.

When the PLC verifies that one or more M, S, T and/or B function has been specified, it performs that function(s) and, after completion of the function(s), "M function finish 1" (FIN1) signal turns ON.

When the controller verifies that signal FIN1 turns ON, it turns OFF strobe signal of corresponding function.

The PLC checks that each strobe signal turns OFF, then turns OFF FIN1.

With the signal FIN1 turned OFF, the controller proceeds to the next block.

An example of timing chart, where M function is specified, is as follows:

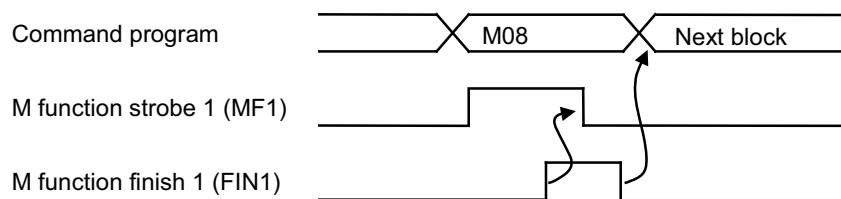

There are two "M function finish" signals, namely, "M function finish 1" and "M function finish 2" (refer to the next page). The only difference is if the next block is proceeded to at the falling edge or at the rising edge. These can be used separately per operation in one PLC.

(Note 1) "M function finish 1" (FIN1) signal is common to M, S, T and B functions.

(Note 2) The "M function finish 1" signal is also the signal for upgrading the spindle speed output (S command data, etc.) during S function execution.

(Note 3) If signal FIN1 has been ON before M, S, T or B function is specified, data pertinent to M, S, T or B function are not output. To output, the signal FIN1 should be turned OFF once.

(Note 4) When "Reset & rewind" (RRW) signal is sent to the controller by M02 or M30, "M function finish 1 or 2" signal should not be sent back. If the "M function finish 1 (2)" signal is return with the M02 command at the end of the machining program, the NC alarm program error (P36) will occur.

(Note 5) This signal is not used when the high-speed method (parameter "#1278 ext14/bit1"= "1").

[Related signals]

- (1) M function finish 2 (FIN2: YC1F)
- (2) M function strobe n (MF_n: XC60)
- (3) S function strobe n (SF_n: XC64)
- (4) T function strobe n (TF_n: XC68)
- (5) 2nd M function strobe n (BF_n: XC6C)
- (6) M, S, T, B function data (output to file register R: R504 and later)
- (7) Reset & rewind (RRW: YC1A)

Cont.	Signal name	Abbrev.	\$1	\$2	\$3	\$4	\$5	\$6	\$7	\$8
A	M FUNCTION FINISH 2	FIN2	YC1F	YD5F	YE9F	YFDF	Y111F	Y125F	Y139F	Y14DF

[Function]

This status signal informs the controller that specified miscellaneous (M) function, spindle (S) function, tool (T) function or 2nd miscellaneous function (A, B or C) is accomplished on the PLC side. When too much signals FIN1 must be used, this signal can be used instead of signal FIN1 to save time.

[Operation]

If the M, S, T or 2nd M function command is executed during automatic operation, the code and each function strobe (MF_n, SF_n, TF_n, BF_n) will turn ON.

When the PLC verifies that one or more M, S, T and/or 2nd M function has been specified, it performs that function(s) and, after completion of the function(s), "M function finish 2 (FIN2)" signal turns ON.

When the controller verifies that signal FIN2 turns ON, it turns OFF strobe signal of corresponding function.

When each strobe signal turns OFF, the PLC turns OFF signal FIN2. With the signal FIN2 turned OFF, the controller proceeds to the next block.

An example of timing chart, where M function is specified, is as follows:

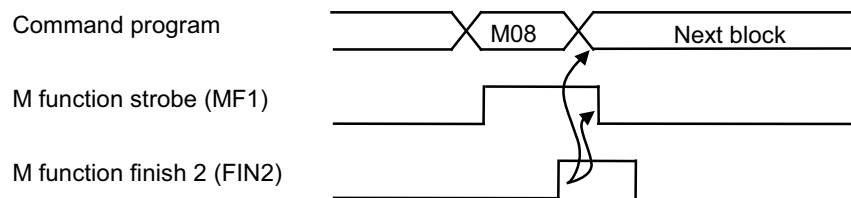

There are two types of M function finish signals, namely, "M function finish 1" (refer to the previous page) and "M function finish 2". The only difference is if the next block is proceeded to at the falling edge or at the rising edge. These can be used separately per operation in one PLC.

(Note 1) "M function finish 2 (FIN2)" signal is common to M, S, T and B functions.

(Note 2) The M function finish 2 signal is also the signal for upgrading the spindle speed output (S analog data, etc.) during S function execution.

(Note 3) If signal FIN2 has been ON before M, S, T or B function is specified, data pertinent to M, S, T or B function are not output.

(Note 4) When "Reset & rewind" signal (RRW) is sent to the controller by M02 or M30, "M function finish" 2 or 1 signal should not be sent back. If the "M function finish 2 (1)" signal is return with the M02 command at the end of the machining program, the NC alarm program error (P36) will occur.

(Note 5) This signal is not used when the high-speed method (parameter "#1278 ext14/bit1"= "1").

[Related signals]

- (1) M function finish 1 (FIN1: YC1E)
- (2) M function strobe n (MF_n: XC60)
- (3) S function strobe n (SF_n: XC64)
- (4) T function strobe n (TF_n: XC68)
- (5) 2nd M function strobe n (BF_n: XC6C)
- (6) M, S, T, B function data (output to file register R: R504 and later)
- (7) Reset & rewind (RRW: YC1A)

4 Explanation of Interface Signals

Cont.	Signal name	Abbrev.	\$1	\$2	\$3	\$4	\$5	\$6	\$7	\$8
A	TOOL LENGTH MEASUREMENT 1	TLM	YC20	YD60	YEA0	YFE0	Y1120	Y1260	Y13A0	Y14E0

[Function]

"Tool length manual measurement 1" is selected by this signal.

For M system, "Tool length manual measurement 1 and 2" functions are used by this signal.

[Operation]

When the signal (TLM) is turned ON (1), amount of tool length to be corrected is calculated automatically in the controller.

[Caution]

- (1) This signal is invalid if the tool length screen is not selected.
- (2) Turn this signal OFF before executing a program with manual speed command.

Cont.	Signal name	Abbrev.	\$1	\$2	\$3	\$4	\$5	\$6	\$7	\$8
A	TOOL LENGTH MEASUREMENT 2	TLMS	YC21	YD61	YEA1	YFE1	Y1121	Y1261	Y13A1	Y14E1

[Function]

"Tool length measurement 2" is selected by this signal.

[Operation]

When the signal (TLMS) is turned ON, calculation of tool length compensation amount is automatically started in the controller.

When skip signal is input during tool length measurement, amount of tool length to be corrected is calculated.

[Timing chart]

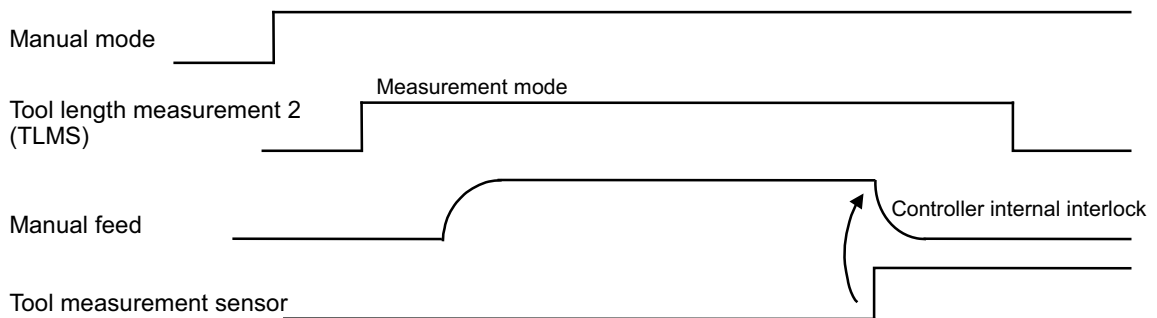

[Caution]

- (1) To use the tool length measurement 2 function, select manual operation mode. Otherwise, tool length measurement mode cannot be established.
- (2) "Tool length measurement 2" can be used with a machine equipped with tool measurement sensor.
- (3) The calculation result is read automatically inside the controller.
- (4) With tool length measurement 2, multiple part systems cannot be measured simultaneously.

[Related signals]

- (1) Tool length measurement 2 Tool No. (R2618)

4 Explanation of Interface Signals

Cont.	Signal name	Abbrev.	\$1	\$2	\$3	\$4	\$5	\$6	\$7	\$8
A	SYNCHRONIZATION CORRECTION MODE	SYCM	YC22	YD62	YEA2	YFE2	Y1122	Y1262	Y13A2	Y14E2

[Function]

When the "M01 OPERATION ERROR 0051" (Synchronization error too large) occurs, the occurring error is corrected without changing the operation method with this mode.

[Operation]

In the correction mode, the operation is as follows.

- (1) The synchronous control is not carried out even in the synchronized axis, and the reference axis and synchronized axis are handled as independent two axes in the each control part. Thus, the reference axis and synchronized axis can be moved individually.
- (2) If the zero point has established, the synchronization error check is carried out.
- (3) If the correction mode switch is turned ON during selecting the mode except the handle or manual arbitrary feed mode, the "M01 OPERATION ERROR 0120" (Synchronization correction mode ON) will occur.

In the handle or manual arbitrary feed mode, if the correction mode switch is turned ON, the correction mode can be set and "CORRECTION MODE" will be displayed in the operation mode display position.

The operation procedure is shown below.

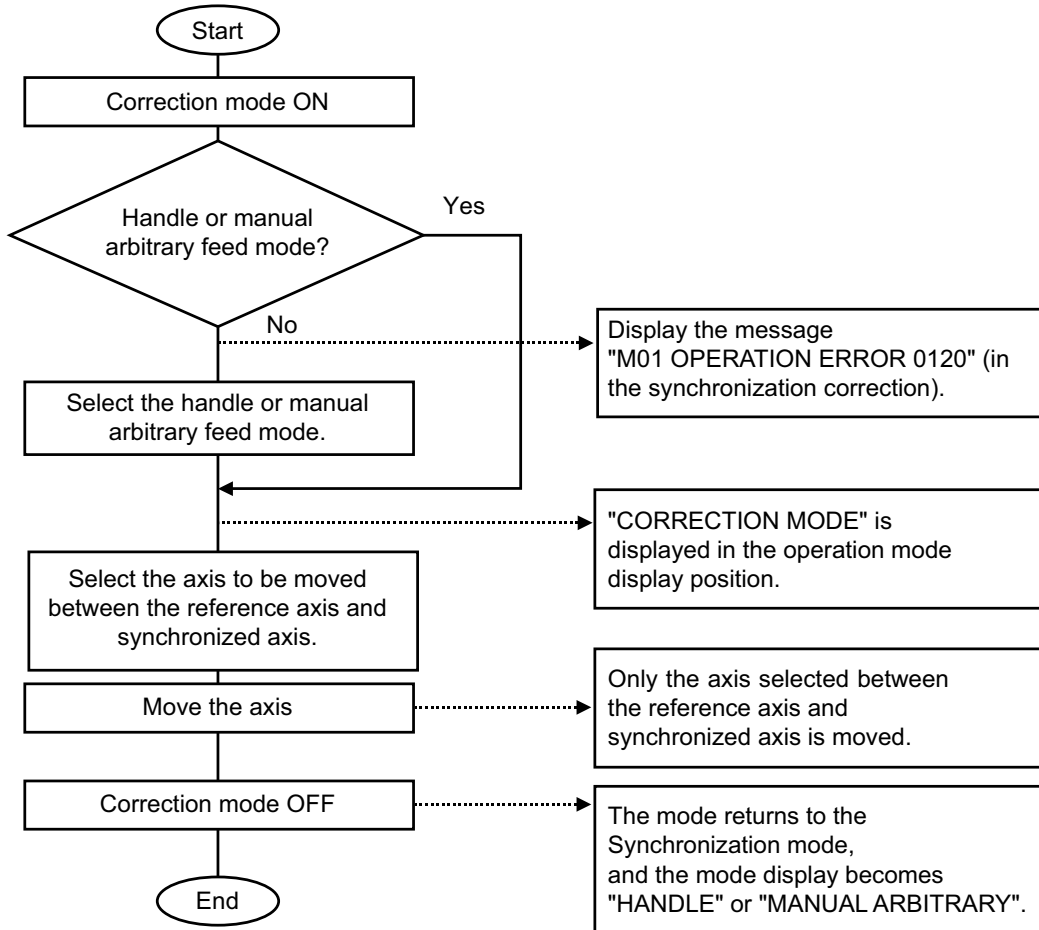

[Related signals]

- (1) Synchronous control operation method (R2589)

4 Explanation of Interface Signals

Cont.	Signal name	Abbrev.	\$1	\$2	\$3	\$4	\$5	\$6	\$7	\$8
A	PROGRAM RESTART	PRST	YC23	YD63	YEA3	YFE3	Y1123	Y1263	Y13A3	Y14E3

[Function]

With the program restart function, when the axis is returned to the restart position with the manual mode after the restart search is performed, the direction can be checked, or the axis can be stopped at the restart position.

[Operation]

If the "Program restart" signal (PRST) is turned ON after the restart search is performed and the axis is moved to the restart position direction with the manual mode, the axis is stopped at the restart position automatically. The [RESTART-R] values on the program restart screen are set to zero and "RP" appears by the side of the [RESTART-P] values. If the axis is moved in the opposite direction to the restart position, an OPERATION ERROR will occur.

[RESTART – (G54)]	[RESTART – R]
X - 130.000RP	X 0.000
Y -10.000RP	Y 0.000
Z 0.000RP	Z 0.000

When the parameter "#1302 AutoRP" (Automatic return by program restart) is set to "1", there is no need to use this signal (PRST: YC23). This is because when the parameter is set to "1", the machining is restarted after the axis has returned to the restart position at the same speed as when the "Dry run" signal (YC15) is turned ON at cycle start and all the axes have returned. Even when the parameter "#1302 AutoRP" is set to "1", the axis can be returned to the restart position manually by turning ON this signal (YC23).

Cont.	Signal name	Abbrev.	\$1	\$2	\$3	\$4	\$5	\$6	\$7	\$8
A	PLAYBACK	PB	YC24	YD64	YEA4	YFE4	Y1124	Y1264	Y13A4	Y14E4

[Function]

This signal is used to convert amount of axis motion into controller command data for generation of operation program.

[Operation]

When the "Playback" (PB) signal turns ON, the playback display mode appears on the communication terminal. By moving and stopping axis motion components (tool or table) with JOG feed, rapid traverse or handle feed, the displayed coordinate value is read and converted into NC data in accordance with the operation program format. By repeating data read, an operation program can be created.

4 Explanation of Interface Signals

Cont.	Signal name	Abbrev.	\$1	\$2	\$3	\$4	\$5	\$6	\$7	\$8
A	MACRO INTERRUPT	UIT	YC25	YD65	YEA5	YFE5	Y1125	Y1265	Y13A5	Y14E5

[Function]

When the controller is ready for user macro interrupt, the program being in execution can be interrupted, or other program can be executed after the former program has been executed, by turning ON "Macro interrupt" (UIT) signal.

[Operation]

When "Macro interrupt" (UIT) signal turns ON within time interval starting with M96 command(Note 1) and ending with M97 command or reset, the program being in execution can be interrupted for execution of other program.

"Macro interrupt" (UIT) signal becomes valid when:

- (1) Memory, tape or MDI is selected.
- (2) Automatic operation is selected (signal STL is ON).
- (3) Other user macro is not being executed.

"Macro interrupt" (UIT) signal is accepted in "status trigger" method or "edge trigger" method, either one of which can be selected by parameter #1112.

(1) Status trigger method

While "Macro interrupt" (UIT) signal is ON, the signal can be accepted.

When M96 is used to make acceptable user macro interrupt, the inserted program is executed when the signal (UIT) turns ON.

With the signal (UIT) kept turned ON, inserted program can be executed repeatedly.

(2) Edge trigger method

The signal (UIT) is accepted when its status changes from "OFF" to "ON" (i.e., with rise edge of signal).

This method is advantageous when inserted program is executed only once.

<Command format>

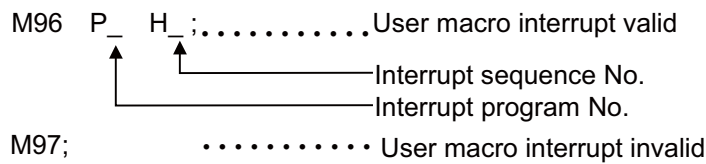

Refer to the relevant Programming Manual for details on the user macro interrupt function such as interrupt method and call method for when the "Macro interrupt" (UIT) signal is ON.

(Note 1) M96 and M97 can be changed to other M code by using a parameter.

(Note 2) User macro interrupt control M code is processed internally and not output to an external source (PLC).

4 Explanation of Interface Signals

Cont.	Signal name	Abbrev.	\$1	\$2	\$3	\$4	\$5	\$6	\$7	\$8
A	RAPID TRAVERSE	RT	YC26	YD66	YEA6	YFE6	Y1126	Y1266	Y13A6	Y14E6

[Function]

Speed or feedrate of axis motion in "JOG" mode, "incremental feed" mode or "reference position return" mode can be changed to rapid traverse speed.

[Operation]

When the signal (RT) is turned ON:

- (1) The jog and incremental feedrate will be the rapid traverse feedrate set with parameters.
- (2) The speed until the near-point detection dog signal is detected during dog-type reference position return will be the reference position return rapid traverse feedrate set with parameters.
- (3) Speed or feedrate is changed at the same time as the signal is turned ON. When the signal (RT) is turned OFF, rapid traverse speed changes to the previous speed or feedrate. "Feed axis selection" signal ($\pm J1$ to 8) may be kept turned ON.
- (4) The speed will be the rapid traverse feedrate until the near point dog signal is detected during jog, incremental feed or reference position return. The rapid traverse override will also be valid.
- (5) The "Rapid traverse override code 1,2" (ROV1, ROV2) will be validated when the "Rapid traverse" signal is ON.

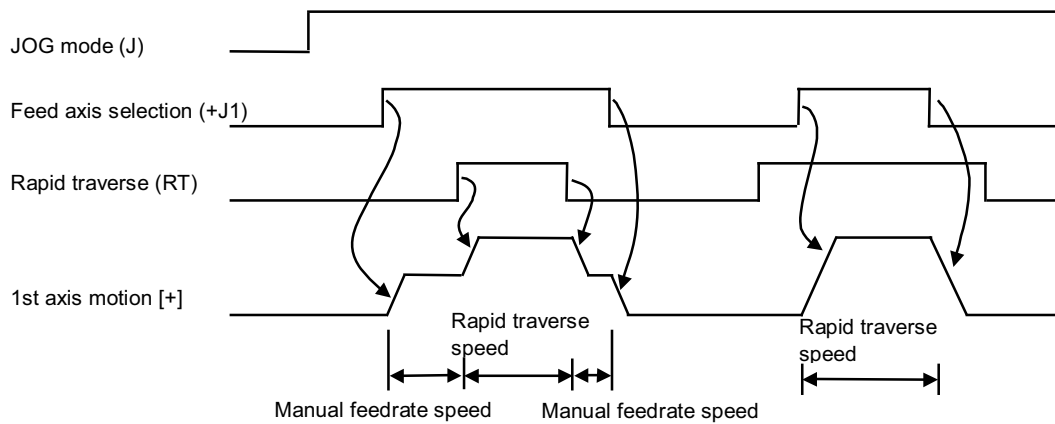

- (Note 1) "Rapid traverse" (RT) signal does not act as mode signal, but serves as interrupt signal for "JOG" mode, "INCREMENTAL FEED" mode, etc.
- (Note 2) This signal can be used likewise during machine lock.
- (Note 3) For handling of "Rapid traverse" (RT) signal during dry run, refer to the description about dry run signal (DRN).

[Related signals]

- (1) Rapid traverse override code 1,2 (ROV1, ROV2: YC68, YC69)

Cont.	Signal name	Abbrev.	\$1	\$2	\$3	\$4	\$5	\$6	\$7	\$8
A	REVERSE RUN	VRV	YC27	YD67	YEA7	YFE7	Y1127	Y1267	Y13A7	Y14E7

[Function]

This signal is used to select reverse/forward run in the arbitrary reverse run.

[Operation]

Forward run is executed when this signal is OFF.
 Reverse run is executed when this signal is ON.
 This signal is available only in the reverse run control mode.

[Related signals]

- (1) Reverse run from block start (RVSP: YD08)
- (2) Macro interrupt priority (RVIT: YD09)
- (3) Reverse run control mode (RVMD: YD0A)

4 Explanation of Interface Signals

Cont.	Signal name	Abbrev.	\$1	\$2	\$3	\$4	\$5	\$6	\$7	\$8
A	MANUAL ABSOLUTE	ABS	YC28	YD68	YEA8	YFE8	Y1128	Y1268	Y13A8	Y14E8

[Function]

This signal selects whether to update the program coordinate system the amount moved with manual operation (jog, handle, etc.).

[Operation]

(1) When "Manual absolute" signal (ABS) is OFF:

The amount moved with manual operation is not added to the absolute position register in the controller. Thus, if manual is used during automatic operation, the axis will move in parallel the amount moved manually at the end point of the block and the end point of the following blocks. (The axis will move in parallel regardless of the absolute/incremental command in the machining program.)

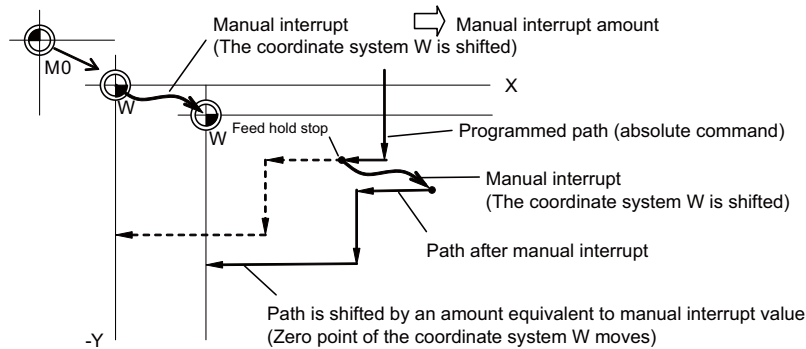

(2) When "Manual absolute" signal (ABS) is ON:

The amount moved by manual operation is added to the absolute position register in the controller, and the coordinate system is not changed. Thus, if manual operation is used during automatic operation by absolute command, the axis will return to the position commanded at the end of the inserted block and following blocks. However, if the manual interrupt is an incremental command, the axis will move in parallel the amount moved manually. (The axis will move in parallel regardless of the absolute/incremental command at the end of the inserted block.)

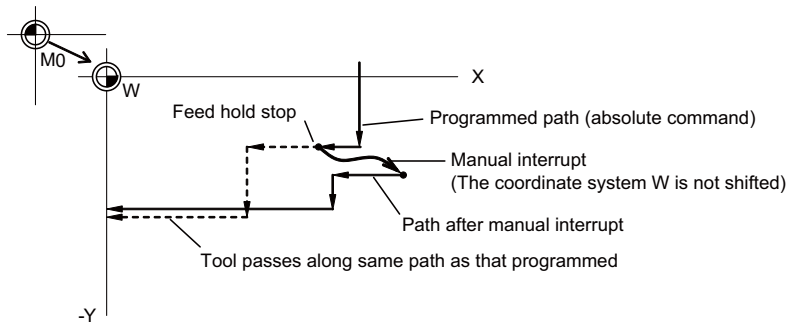

Cont.	Signal name	Abbrev.	\$1	\$2	\$3	\$4	\$5	\$6	\$7	\$8
A	DISPLAY LOCK	DLK	YC29	YD69	YEA9	YFE9	Y1129	Y1269	Y13A9	Y14E9

[Function]

By using this signal, the current position displayed on the display unit is not updated even if the machine is moved with automatic operation or manual operation.

[Operation]

When the display lock signal (DLK) is ON, the machine movement and program coordinate system are updated in the normal state, but the current position displayed on the display unit is locked.

(Note 1) This signal (DLK) is valid at all times, and can be turned ON and OFF immediately.

(Note 2) This signal is valid during machine lock operation.

[Related signals]

(1) In display lock (DLKN: XC29)

Cont.	Signal name	Abbrev.	\$1	\$2	\$3	\$4	\$5	\$6	\$7	\$8
A	F1-DIGIT SPEED CHANGE VALID	F1D	YC2A	YD6A	YEAA	YFEA	Y112A	Y126A	Y13AA	Y14EA

[Function]

When this signal is ON and F1-digit feed is commanded, the feedrate registered in the parameters can be increased or decreased by turning the manual handle.

[Operation]

- (1) Enabling conditions of the speed change with the handle

When the F1-digit command is valid, the feedrate can be increased/decreased by operating the first manual handle. (The feedrate cannot be changed by the 2nd and 3rd handles.)

Changing the feedrate by the handle is available satisfying the following conditions:

- (a) The operation must be in automatic start.
 - (b) The operation must be in cutting feed, and F1-digit feedrate command must be issued.
 - (c) The F1-digit feed parameter must be ON.
 - (d) The F1-digit feed switch must be ON.
 - (e) The operation must not be in handle mode.
 - (f) The operation must not be in dry run.
 - (g) Upper limit of F1-digit feedrate ("#1506 F1_FM") and F1-digit feedrate change constant ("#1507 F1_K F1") are not zero.
- (2) Conversion of the F1-digit feedrate changing with handle operation

Once the F1-digit feedrate is changed with manual handle, the changed feedrate is valid until parameter is changed or the power is turned OFF. Changed feedrate can be checked only during the operation. Note that if the parameter "#1246 set18 (bit16)" (switch over of the F1-digit feedrate changing method) is set to "1", even after the power is turned OFF, operation is kept at the changed feedrate because the parameter of F1-digit feedrate has been changed. In this case, if the screen is not switched, the changed parameter values are not reflected to the display. The increase/decrease amount per handle gradient is expressed with the following equation.

$$\Delta F = \Delta P \times (FM / K)$$

ΔP : Handle pulse (\pm)

FM: Upper limit of F1-digit feedrate (#1506 F1_FM)

K: F1-digit feedrate change constant (#1507 F1_K)

(Example) When the handle scale unit is to be made ± 10 mm/min.

If FM is made 3600mm/min, feedrate change constant (K) must be set "360" according to the following formula.

$$\Delta F = 10 = 1 \times (3600 / K)$$

- (*1) If F1-digit feedrate changing valid signal is turned ON when F1-digit feed is commanded and changing feedrate with the manual handle is valid, it is clamped at the upper limit of F1-digit feedrate if the F1-digit feedrate is greater than the upper limit of F1-digit feedrate.
- (*2) When the F1-digit feedrate is 0 with the handle operation during the F1-digit feedrate command, the alarm "M01 F1-digit feedrate zero 0104" will occur. This alarm can be eliminated when the F1-digit feedrate is set in larger value than 0 with the handle operation.
- (*3) When K is 0, the speed is not changed.

[Related signals]

- (1) F1-digit commanded (F1DN: XC2A)
- (2) F1-digit No. code (F11 to F18: XC30 to XC33)

4 Explanation of Interface Signals

Cont.	Signal name	Abbrev.	\$1	\$2	\$3	\$4	\$5	\$6	\$7	\$8
A	RECALCULATION REQUEST	CRQ	YC2B	YD6B	YEAB	YFEB	Y112B	Y126B	Y13AB	Y14EB

[Function]

This signal is turned ON if a calculated block (next block) is recalculated during operation of the machining program.

[Operation]

For example, to operate mirror image, etc., with the miscellaneous (M) command in the program.

```

:
N1 M45; To apply mirror image with this M command
N2 G0X100;
:
    
```

When the N1 block is reached in the above program example, the "Recalculate request" signal will turn ON before FIN is output or simultaneously with FIN. This will validate the mirror image from the N2 block.

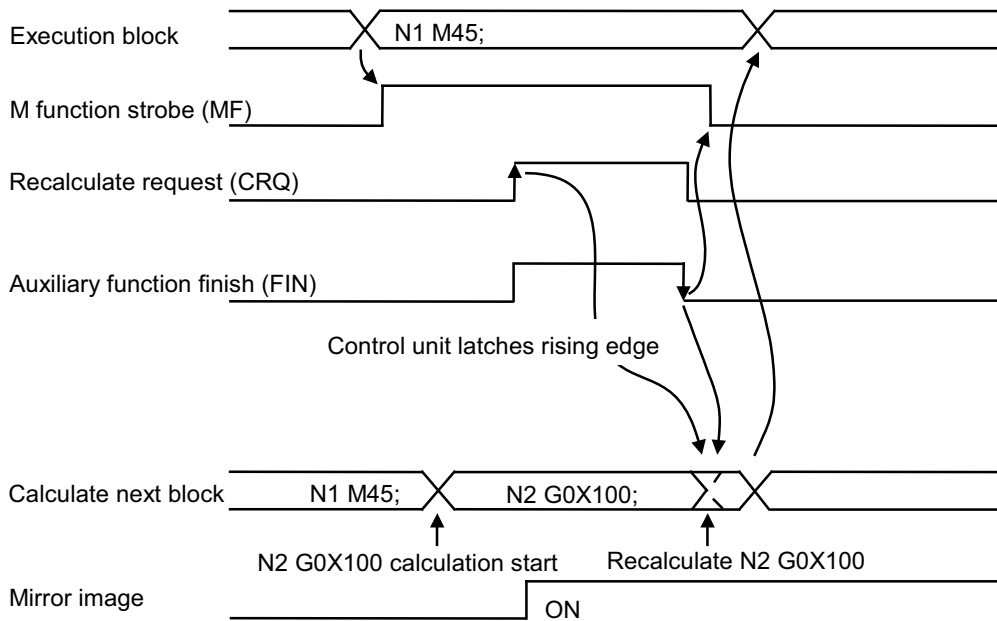

[Caution]

The "Recalculation request" (CRQ) signal latches the rising edge in the controller. Thus, even if the "Recalculation request" (CRQ) signal is ON (1), the "recalculation" will not take place unless at the rising edge.

Cont.	Signal name	Abbrev.	Common(\$)
A	PLC EMERGENCY STOP	QEMG	YC2C

[Function]

The controller can be set to emergency stop condition, like the case where emergency stop signal is given by user PLC.

[Operation]

When this signal is turned ON, emergency stop occurs in the controller and the signals such as "Servo ready completion" signal (SA: XC11) are turned OFF.

The "Machine group-based alarm stop: Machine group-based PLC interlock ON" signal (XBE0: GQEMGO) for all sets of groups turns ON.

(Note) Since the "PLC emergency stop" signal (YC2C) is processed in software, response is somewhat slower, as compared with external emergency stop signal. Approximate response is equal to 1 scan by user PLC plus 100ms.

4 Explanation of Interface Signals

Cont.	Signal name	Abbrev.	\$1	\$2	\$3	\$4	\$5	\$6	\$7	\$8
A	REFERENCE POSITION RETRACT	RTN	YC2D	YD6D	YEAD	YFED	Y112D	Y126D	Y13AD	Y14ED

[Function]

This function returns immediately to a set reference position when the return signal is input. This function is used to return to a set position for changing the tool.

[Operation]

Reference position return is executed when this signal is turned ON. At the rising edge of the signal, the program is automatically reset (reset & rewind) and then reference position return is executed.

During the automatic or MDI operation, the operation is interrupted and stopped by the reset, and reference position return is executed.

If this signal is input during execution of a tap cycle in the automatic or MDI operation modes, the "Tap retract possible" signal will be output by the reset interruption, and the return operation will be the tap retract operation. The tap retract is completed at the initial point, and after that the reference position return will be carried out.

- (1) If there are two or more axes, set the return order with parameter "#2019 revnum".
- (2) When the reference position is reached, the corresponding "Reference position reached" signal will be output.
- (3) This signal must be held until the "Reference position reached" signal is output. If it is turned OFF midway, the return operation will be interrupted and stop. If the signal is input again, the operation will restart from execution of resetting.
- (4) The reference position return speed is handled in the same manner as the normal reference position return speed.
- (5) The reference position returned to during reference position retract depends on the YC90 and YC91 reference position selection code 1,2.
- (6) Even if the return signal is input during the thread cutting cycle, it will be invalid. However, if the return signal is executed in a block other than the thread cutting block, the return operation will be executed.
- (7) The return signal is invalid if the coordinate system is not established. An alarm "M01 Ref point retract invalid" will occur when the return signal is input.

[Timing chart]

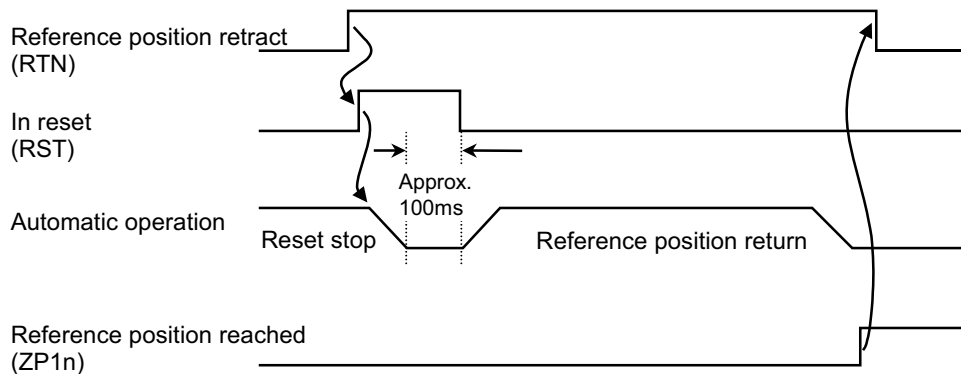

[Related signals]

- (1) Tap retract possible (TRVE: XCA5)
- (2) Tap retract (TRV: YC5C)

4 Explanation of Interface Signals

Cont.	Signal name	Abbrev.	\$1	\$2	\$3	\$4	\$5	\$6	\$7	\$8
A	PLC INTERRUPT	PIT	YC2E	YD6E	YEAE	YFEE	Y112E	Y126E	Y13AE	Y14EE

[Function]

Interruption is executed with the interrupt program set with the R register when a signal is issued from the PLC during single block stop in automatic operation, or not in the automatic operation.

[Operation]

PLC interrupt categorized as "start during the automatic operation" and "start with other mode" and some operations differ. If it is in automatic operation is determine by whether the "In automatic operation" signal (OP) is output.

(1) Operation when the interrupt starts during the automatic operation

The following operation is performed when this signal is turned ON at a single block stop during the cycle operation.

- The PLC interruption is not executed if this signal is turned ON while the automatic operation is activated.

The operation error (M01 0129) occurs. Cancel the alarm by turning OFF or reset the "PLC interrupt" signal.

- In memory mode, when a cycle operation is started, the program resumes from the next block of the block which was completed immediately before the interruption. When MDI operation is interrupted, the MDI program after the interrupted block is canceled.

<Operation example>

(Example 1) When program is interrupted during memory operation single block stop

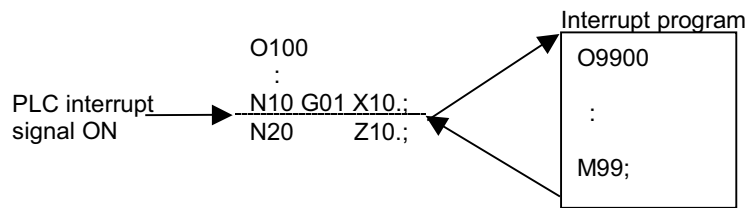

After the O100 N10 block ends, the designated interrupt program (O9900) is called when this signal turns ON. The PLC interrupt ends at the M99 block, and the block will stop. (When the block stops, it is possible to turn this signal ON and then execute the PLC interruption again.) O100 N20 is executed from the next cycle start.

(Example 2) When program is interrupted during MDI operation single block stop

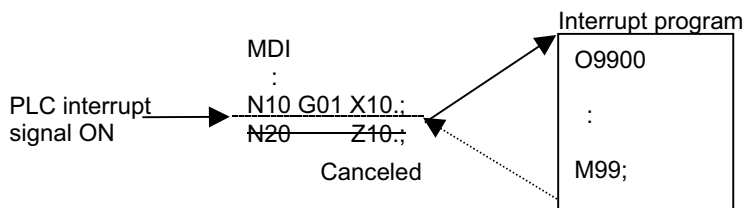

After the MDI N10 block ends, the designated interrupt program (O9900) is called when this signal is turned ON. The PLC interrupt ends at the M99 block, and the block will stop. The next and subsequent blocks of the MDI program are canceled so operation cannot be continued.

- (2) Operation when the interruption starts during other than automatic operation

Following operation is performed if this signal is turned ON when the machine is in manual mode such as jog mode or handle mode etc. or when the machine is not in program operation even it is in the memory mode.

<Operation example> When program is interrupted during manual mode

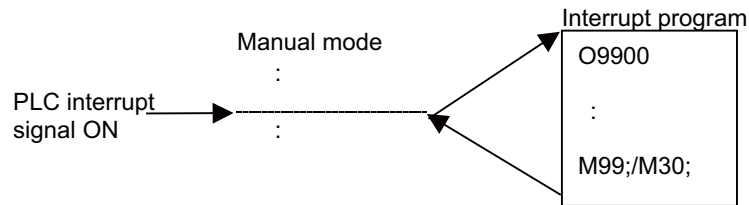

During manual mode, the designated interrupt program (O9900) is called when this signal turns ON. The PLC interruption will be reset and finished at the M99 block, and the machine enters into the manual mode. Note that the interrupt program will not be executed when this signal is turned ON during manual feed.

(Note 1) To turn this signal ON during the manual mode, use the manual/automatic simultaneous function concurrently.

(Note 2) Interrupt program is finished at M99 and reset 1 is input automatically.

[Caution]

- (1) Single block operation and automatic operation pause are valid even when the interrupt program is executed. To invalidate single block during the interrupt program execution, set system variable #3003. To invalidate automatic operation pause, set system variable #3004.
- (2) Other PLC interrupt and MDI interrupt cannot be commanded during execution of the interrupt program.
- (3) To disable the display of the interrupt program being executed on the Monitor screen, set the basic specification parameter "#1122 pglk_c" to 1 or 2. (Extended area (memory 2) is not supported. [C80])
- (4) The PLC interrupt signal is ignored even if it is turned ON during cycle start or automatic operation pause.
- (5) "In cycle start" signal (OP) is output while the interrupt program is executed regardless of the operation mode which is active before the interruption.
- (6) PLC interrupt is valid for each part system.
- (7) If PLC interrupt is executed when there is no interrupt program or when program search has not been executed, a program error (P232) will occur when M99 is commanded.
- (8) If the interrupt program No. set in the R register is not within the setting range, a program error (P232) will occur.
- (9) Cancel the program error (P232) with reset.
- (10) The interruption is not executed in the part system where the PLC interrupt signal is OFF.
- (11) "In automatic operation "run"" signal (OP) and "In automatic operation "start"" signal (STL) are output during the PLC interrupt program execution.
Likewise, they are output during the PLC interrupt program execution in other than automatic operation.
- (12) As for PLC interrupt operation of program in extended area (memory 2), only the program of extended area (memory 2) can be called. [C80]
- (13) Even though the "Memory mode" signal (MEM) is OFF, such as in manual feed mode or handle feed mode, when a PLC interruption is executed, the macro is automatically started and the CNC will be in cycle operation mode. At this time, when the "Single block" signal (SBK) is ON, a single block stop occurs. However, even though the "Automatic operation "start" command" signal (ST) is turned ON, the next block cannot be executed. Make sure that a single block stop does not occur by turning ON the system variable "#3003/bit0" at the beginning of the macro to be called in advance.
Similarly, when the "Automatic operation "pause" command" signal (*SP) is turned ON, the machine decelerates and stops.
However, the operation cannot be resumed even though the "Automatic operation "start" command" signal (ST) is turned ON.
Suppress feed hold by taking actions such as turning ON the system variable "#3004/bit0" at the beginning of the macro to be called.
When a single block stop or a feed hold stop occurs in a mode other than memory mode, reset the CNC.

[Related signals]

- (1) PLC interrupt program No. (R2518)
- (2) In PLC interrupt (PCINO: XC35)

Cont.	Signal name	Abbrev.	\$1	\$2	\$3	\$4	\$5	\$6	\$7	\$8
A	CHOPPING	CHPS	YC30	YD70	YEB0	YFF0	Y1130	Y1270	Y13B0	Y14F0

[Function]

This signal validates the chopping function.

[Operation]

The chopping mode is entered at the rising edge of this signal.

[Caution]

- (1) To use synchronous control and chopping together, turn this signal (YC30) ON or OFF during synchronous operation. When the synchronous operation is started for the axis in chopping operation, the operation error (M01 1036) occurs, and the synchronous operation is not started. When the synchronous operation is ended while the synchronous operation and the chopping are used together, the operation error (M01 1270) occurs, and all the axes decelerate and stop. [M8]
- (2) When the synchronous control is performed, designate only master axis as the chopping axis. If the slave axis is designated as the chopping axis and the chopping is started, the operation error (M01 1272) occurs and the chopping operation is not performed. [M8]
- (3) Simple synchronous control and chopping cannot be used together. For the axis to be used for the simple synchronous control, do not set and start the chopping. [M8]
- (4) In the loader-dedicated part system, chopping cannot be used. Even when the "Chopping" signal (YC30) is turned ON in the loader-dedicated part system, the mode is not changed to the chopping mode, and an error is output to the "Chopping error No." signal (R554).
- (5) With C80 series, synchronous control and chopping cannot be used together. [C80]

4 Explanation of Interface Signals

Cont.	Signal name	Abbrev.	\$1	\$2	\$3	\$4	\$5	\$6	\$7	\$8
A	SEARCH & START	RSST	YC31	YD71	YEB1	YFF1	Y1131	Y1271	Y13B1	Y14F1

[Function]

This signal is input into the controller when executing operation search in the memory mode and carrying out cycle start.

[Operation]

If this signal is input when the memory operation mode is selected, an operation search of the machining program with the designated No. (R2562, R2563) will be carried out. After the search, the program will carry out cycle start.

If this signal is input during automatic operation, the program will be reset before the search. After the resetting is completed, the search and cycle start operations will be executed.

(Example1) Search & start is executed by designating O900 machining program from the reset state.

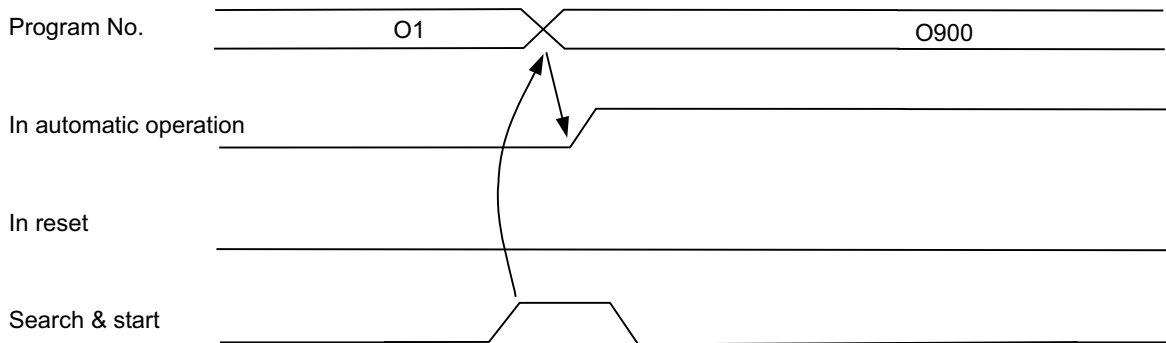

(Example2) When O900 machining program is designated during operation of the O1 machining program, and search & start is executed.

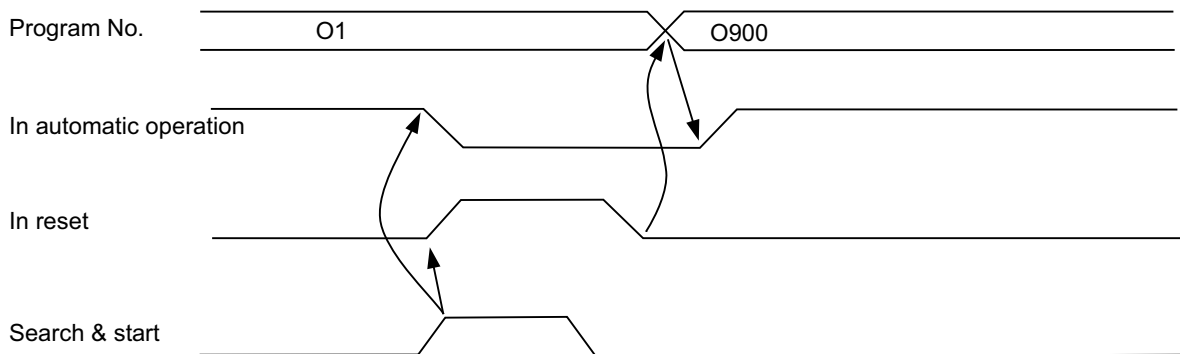

[Caution]

- (1) This signal is valid only when the memory mode is selected. (For C80, the signal is valid in TAPE mode as well.)
- (2) An error signal will be output if the machining program No. is not designated or if the designated program No. is illegal (0 or exceeding 99999999).
- (3) This signal is valid at the rising edge.
- (4) If this signal is input during resetting, the search & start will not be executed.
- (5) When the multi-part system program management is valid, the search is executed for all part systems in batch with the signal for \$1. Only the programs with "0" No. are searched.
- (6) If the signal is turned ON in high-speed program server operation function, program is downloaded from FTP server and cycle start is carried out. If the signal is input when the TAPE mode is selected, the program whose program number specified by "Search & start program No. (R2562)" is downloaded from FTP server. When the download is completed, cycle start operation is performed. Maintain the signal until the "FTP download completed (DLDFIN: X75E)" signal or the "FTP download error (DLDERR: X75F)" signal is turned ON. If the signal is turned OFF when the program is being downloaded, download is interrupted. [C80]

[Related signals]

- (1) Search & start program No. (R2562, R2563)
- (2) Search & start error (SSE: XC8A)

4 Explanation of Interface Signals

Cont.	Signal name	Abbrev.	\$1	\$2	\$3	\$4	\$5	\$6	\$7	\$8
A	CHOPPING PARAMETER VALID		YC34	YD74	YEB4	YFF4	Y1134	Y1274	Y13B4	Y14F4

[Function]

This signal enables the chopping control data assigned to R register.

[Operation]

The control data set to the R registers are validated at the rising edge of this signal (YC34). These R registers are designated by the "Chopping control data address" signal (R2587).

This signal (YC34) must be turned OFF after confirming that the "Chopping start ready completion" bit of the control status (Rn) in the control data is turned ON.

The "chopping start ready completion" is included in the control status of the chopping control data.

Cont.	Signal name	Abbrev.	\$1	\$2	\$3	\$4	\$5	\$6	\$7	\$8
A	INCLINED AXIS CONTROL VALID		YC35	YD75	YEB5	YFF5	Y1135	Y1275	Y13B5	Y14F5

[Function]

This signal validates the inclined axis control.

[Operation]

When this signal is turned ON, the inclined axis control is executed following the set parameter.

If this signal is turned OFF from ON, the inclined axis control will be invalid.

[Caution]

Even if this signal is changed over during the axis movement or the automatic operation, this signal will not be valid.

If this signal is changed over during the axis movement, this signal will be valid after the axis movement is stopped.

If this signal is changed over during the automatic operation, the block stop will occur.

Cont.	Signal name	Abbrev.	\$1	\$2	\$3	\$4	\$5	\$6	\$7	\$8
A	INCLINED AXIS CONTROL NO Z AXIS COMPENSATION		YC36	YD76	YEB6	YFF6	Y1136	Y1276	Y13B6	Y14F6

[Function]

Select whether the movement for the inclined axis in the manual operation is affected to the corresponding basic axis or not.

[Operation]

When this signal is turned ON and the manual operation for the inclined axis is executed, the corresponding basic axis is not moved.

When this signal is turned OFF and the manual operation for the inclined axis is executed, the compensation operation attending the movement of the inclined axis is executed to the corresponding basic axis.

[Caution]

Even if this signal is changed over during the axis movement, this signal will not be valid.

If this signal is changed over during the axis movement, this signal will be valid after the axis movement is stopped.

4 Explanation of Interface Signals

Cont.	Signal name	Abbrev.	\$1	\$2	\$3	\$4	\$5	\$6	\$7	\$8
A	OPTIONAL BLOCK SKIP m	BDT1 to 9	YC37 to F	YD77 to F	YEB7 to F	YFF7 to F	Y1137 to F	Y1277 to F	Y13B7 to F	Y14F7 to F

[Function]

Block accompanying "/n (n: 1 to 9)" (slash) can be skipped.

By creating a machining program with a "/" code inserted, a different part can be machined with one program.

[Operation]

(1) When a program having a block with "/n" (slash code) placed at the head of block is executed with "Optional block skip" signal turned ON, the block is skipped. The block with the "/n" code in the middle instead of at the head will be executed.

When the signal is OFF, block with "/n" is executed.

(Example) If machining the two parts as illustrated below, create the following program. When machining with the "Optional block skip" signal ON, part 1 will be provided. With the signal OFF, part 2 will be provided.

<Program>

```

N1 G54;
N2 G90G81X50. Z-20. R3. F100;
/1N3 X30.;
N4 X10.;
N5 G80;
M02;
    
```

Part 1
Optional block skip ON

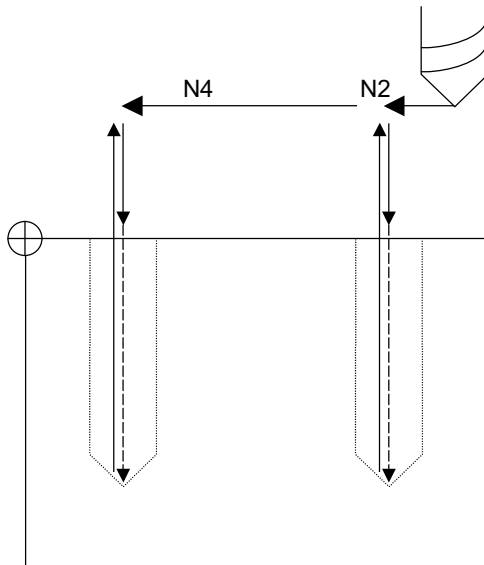

Part 2
Optional block skip OFF

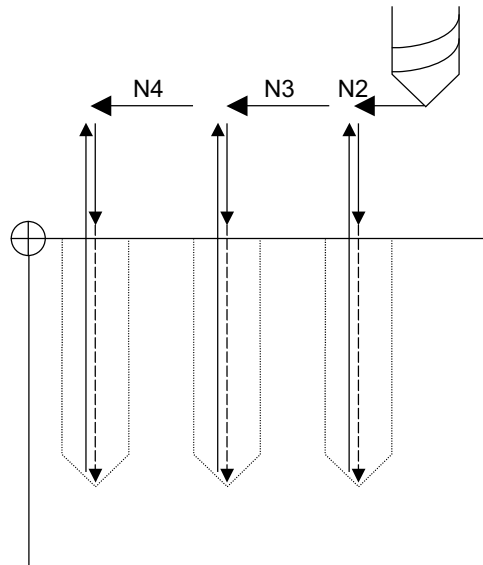

4 Explanation of Interface Signals

Cont.	Signal name	Abbrev.	\$1	\$2	\$3	\$4	\$5	\$6	\$7	\$8
A	1ST HANDLE AXIS SELECTION CODE m	HS11 to 116	YC40 to 4	YD80 to 4	YEC0 to 4	Y1000 to 4	Y1140 to 4	Y1280 to 4	Y13C0 to 4	Y1500 to 4

[Function]

In HANDLE mode (handwheel is operated), axis component to be moved is selected.

This signal is used to select the axis to be moved for the 1st handle.

The axis for the 2nd handle is selected with YC48, while that of the 3rd handle is selected with YC50.

The axes for the 4th to 9th handles are selected with R22508 to R22513 respectively. [C80]

[Operation]

- (1) Select HANDLE mode.
- (2) Specify axis No. for n-th handle axis selection code
- (3) Turn ON "n-th handle valid" (HSnS) signal (Refer to the table below, "Relationship between "handle axis No." and "corresponding axis"").
- (4) By turning the handle (handwheel), the axis moves in accordance with the magnification (MP1 to MP4) at the time.

Relationship between "handle axis No." and "motion axis"

Motion axis	n-th handle valid (HSnS)	n-th handle axis selection code				
		HSn16	HSn8	HSn4	HSn2	HSn1
X axis (1st axis) selected	1	0	0	0	0	1
Y axis (2nd axis) selected	1	0	0	0	1	0
Z axis (3rd axis) selected	1	0	0	0	1	1
#4 axis (4th axis) selected	1	0	0	1	0	0
#5 axis (5th axis) selected	1	0	0	1	0	1
#6 axis (6th axis) selected	1	0	0	1	1	0
#7 axis (7th axis) selected	1	0	0	1	1	1
#8 axis (8th axis) selected	1	0	1	0	0	0

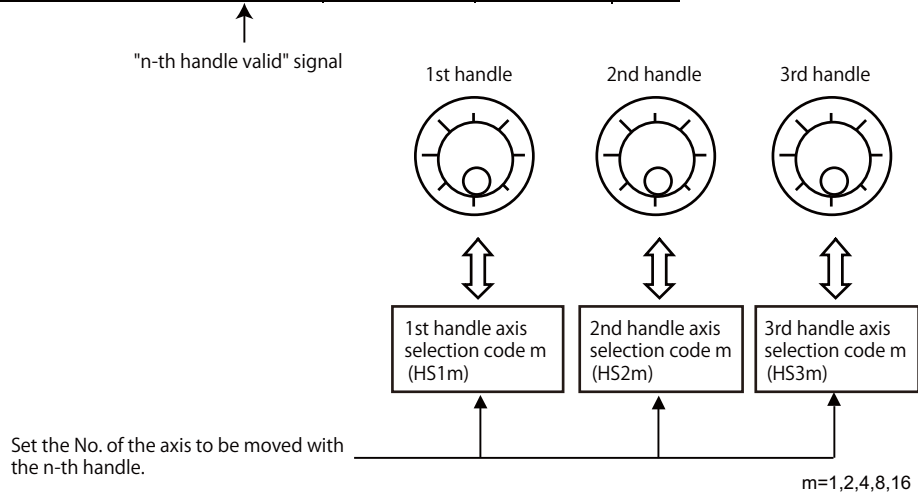

[Related signals]

- (1) Handle mode (H: YC01)
- (2) 1st handle valid (HS1S: YC47)

4 Explanation of Interface Signals

Cont.	Signal name	Abbrev.	\$1	\$2	\$3	\$4	\$5	\$6	\$7	\$8
A	1ST HANDLE VALID	HS1S	YC47	YD87	YEC7	Y1007	Y1147	Y1287	Y13C7	Y1507

[Function]

In HANDLE mode, axis No. of axis motion component to be moved is set for 1st handle axis selection code (HS11 to HS116). To make valid the specified handle axis No., this signal is used.

The axis No. for the 2nd handle is enabled with YC4F, while that of the 3rd handle is enabled with YC57.

The axis Nos. for the 4th to 9th handles are enabled with R22508 to R22513 respectively. [C80]

[Operation]

Axis motion does not start when the 1st handle (handwheel) is rotated after HANDLE mode is selected and the desired axis No. is set for the 1st handle axis selection code if this signal (HS1S) is not given. Although either the "1st handle axis selection code" signal or the "1st handle valid" signal can be given first, these two signals are to be given when manual axis motion is started.

[Related signals]

(1) 1st handle axis selection code m (HS11 to 116: YC40 to 4)

Cont.	Signal name	Abbrev.	\$1	\$2	\$3	\$4	\$5	\$6	\$7	\$8
A	2ND HANDLE AXIS SELECTION CODE m	HS21 to 216	YC48 to C	YD88 to C	YEC8 to C	Y1008 to C	Y1148 to C	Y1288 to C	Y13C8 to C	Y1508 to C

[Function]

This signal is used to select the axis to be moved for the 2nd handle.

[Operation][Related signals]

Refer to the items in "1st handle axis selection code m (HS11 to 116: YC40 to 4)".

Cont.	Signal name	Abbrev.	\$1	\$2	\$3	\$4	\$5	\$6	\$7	\$8
A	2ND HANDLE VALID	HS2S	YC4F	YD8F	YECF	Y100F	Y114F	Y128F	Y13CF	Y150F

[Function][Operation]

This signal is the same as "1st handle valid" signal in function and operation.

Refer to the above table for the relation with the "2nd handle axis selection code" (HS21 to 216).

[Related signals]

(1) 2nd handle axis selection code m (HS21 to 216: YC48 to C)

Cont.	Signal name	Abbrev.	\$1	\$2	\$3	\$4	\$5	\$6	\$7	\$8
A	3RD HANDLE AXIS SELECTION CODE m	HS31 to 316	YC50 to 4	YD90 to 4	YED0 to 4	Y1010 to 4	Y1150 to 4	Y1290 to 4	Y13D0 to 4	Y1510 to 4

[Function]

This signal is used to select the axis to be moved for the 3rd handle.

[Operation][Related signals]

Refer to the items in "1st handle axis selection code m (HS11 to 116: YC40 to 4)".

Cont.	Signal name	Abbrev.	\$1	\$2	\$3	\$4	\$5	\$6	\$7	\$8
A	3RD HANDLE VALID	HS3S	YC57	YD97	YED7	Y1017	Y1157	Y1297	Y13D7	Y1517

[Function][Operation]

This signal is the same as "1st handle valid" signal in function and operation.

Refer to the above table for the relation with the "3rd handle axis selection code" (HS31 to HS316).

[Related signals]

(1) 3rd handle axis selection code m (HS31 to HS316: YC50 to YC4)

4 Explanation of Interface Signals

Cont.	Signal name	Abbrev.	\$1	\$2	\$3	\$4	\$5	\$6	\$7	\$8
A	OVERRIDE CANCEL	OVC	YC58	YD98	YED8	Y1018	Y1158	Y1298	Y13D8	Y1518

[Function]

With this signal, override to cutting feedrate input to the controller during automatic operation is ignored.

[Operation]

When the signal (OVC) turns ON ...

- (1) Cutting feedrate override code (*FV1 to 16) is ignored and feedrate specified by F command is selected.
- (2) When cutting feedrate override is set at "0%", the signal (OVC) is not valid (feedrate is zero and no motion occurs).
- (3) The signal does not affect to "Manual feedrate override" and "Rapid traverse override".

[Related signals]

- (1) Cutting feedrate override code m (*FV1 to 16: YC60)

Cont.	Signal name	Abbrev.	\$1	\$2	\$3	\$4	\$5	\$6	\$7	\$8
A	MANUAL OVERRIDE METHOD SELECTION	OVSL	YC59	YD99	YED9	Y1019	Y1159	Y1299	Y13D9	Y1519

[Function]

Override can be exerted on "manual feedrate" (feedrate in JOG feed, incremental feed, etc. during manual operation).

[Operation]

When this signal (OVSL) is turned ON when manual feedrate has been set, the previously set cutting feedrate override (%) is applied to that feedrate.

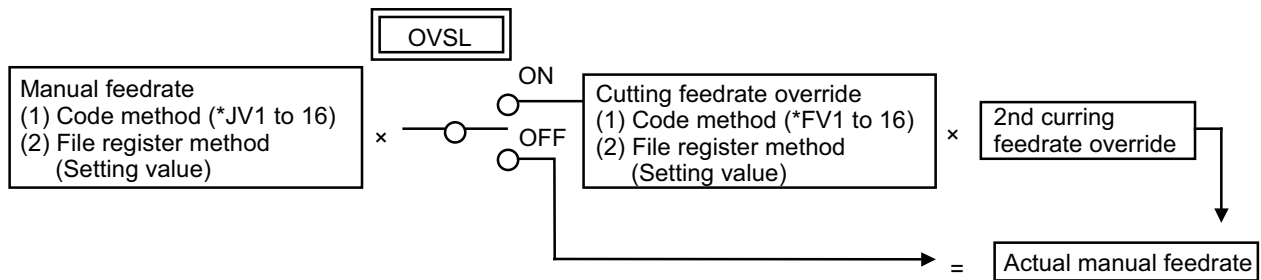

(Note) For details of "manual feedrate", "cutting feedrate override" and "2nd cutting feedrate override", refer to the relevant descriptions.

4 Explanation of Interface Signals

Cont.	Signal name	Abbrev.	\$1	\$2	\$3	\$4	\$5	\$6	\$7	\$8
A	MISCELLANEOUS FUNCTION LOCK	AFL	YC5A	YD9A	YEDA	Y101A	Y115A	Y129A	Y13DA	Y151A

[Function]

Strobe signal for miscellaneous function (M, S, T and B) specified during automatic operation cannot be output when this signal is used. The signal (AFL) can be used to check machining program, for example.

[Operation]

When the signal (AFL) turns ON:

- (1) Miscellaneous function (M, S, T and B) specified in automatic operation cannot be executed, i.e. output of code data and function strobe signal (MF_n, SF_n, TF_n, BF_n) are withheld.
- (2) If the signal turns ON after code data is output, that output is accepted and the corresponding function can be completed (FIN1 or FIN2 is received and strobe signal is set to "0").
- (3) Miscellaneous function M00, M01, M02 or M30 is, however, accepted and realized even when the signal (AFL) is ON and the decode signals, code data and "M function strobe" signal are output.
- (4) Miscellaneous function which is executed within the controller and does not output its code data and "M function strobe" signal, such as M98 and M99, is executed even when the signal is ON.

(Note) As for S command data (output), the value before "Miscellaneous function lock" signal (AFL) is turned ON will be retained even when this signal is ON. When the signal is ON at NC power ON, S command data will be 0V.

[Related signals]

- (1) M function strobe (MF_n: XC60)
- (2) M code data (R504)
- (3) S function strobe (SF_n: XC64)
- (4) S code data (R512)
- (5) T function strobe (TF_n: XC68)
- (6) T code data (R536)
- (7) 2nd M function strobe (BF_n: XC6C)
- (8) 2nd M function data (R544)

4 Explanation of Interface Signals

Cont.	Signal name	Abbrev.	\$1	\$2	\$3	\$4	\$5	\$6	\$7	\$8
A	TAP RETRACT	TRV	YC5C	YD9C	YEDC	Y101C	Y115C	Y129C	Y13DC	Y151C

[Function]

This function is used to remove the tap from the workpiece when the tap cycle is interrupted by emergency stop, etc.

[Operation]

If the "Tap retract" signal (TRV) is turned ON while the "Tap retract possible" signal (TRVE) is ON due to an interruption in the tap cycle, the tap retract operation can be started.

(1) The following items are conditions for tap retract. (The "Tap retract possible" signal will turn ON at this time.)

- Emergency stop during tap cycle
- Reset during tap cycle
- Power OFF during tap cycle (Only in absolute position detection system)

(2) Tap retract is executed as follows:

- Execute the synchronous tap cycle command.→(a)
- The tap cycle is interrupted by emergency stop.→(b)
- The "Tap retract possible" signal (TRVE) turns ON. →(c)
- Release the emergency stop. (The "Servo ready completion" signal (SA) turns ON.)→(d)
- Turn ON the "Tap retract" signal (TRV).→(e)
- The spindle will rotate in reverse, and the tap axis will move toward the tap cycle's initial point. Refer to "Feedrate at the tap retract" for the feedrate. → (f)
- When the tap axis reaches the tap cycle initial point, the spindle and tap axis will stop, and tap retract will be completed.→(g)
- The "Tap retract possible" signal (TRVE) will turn OFF.

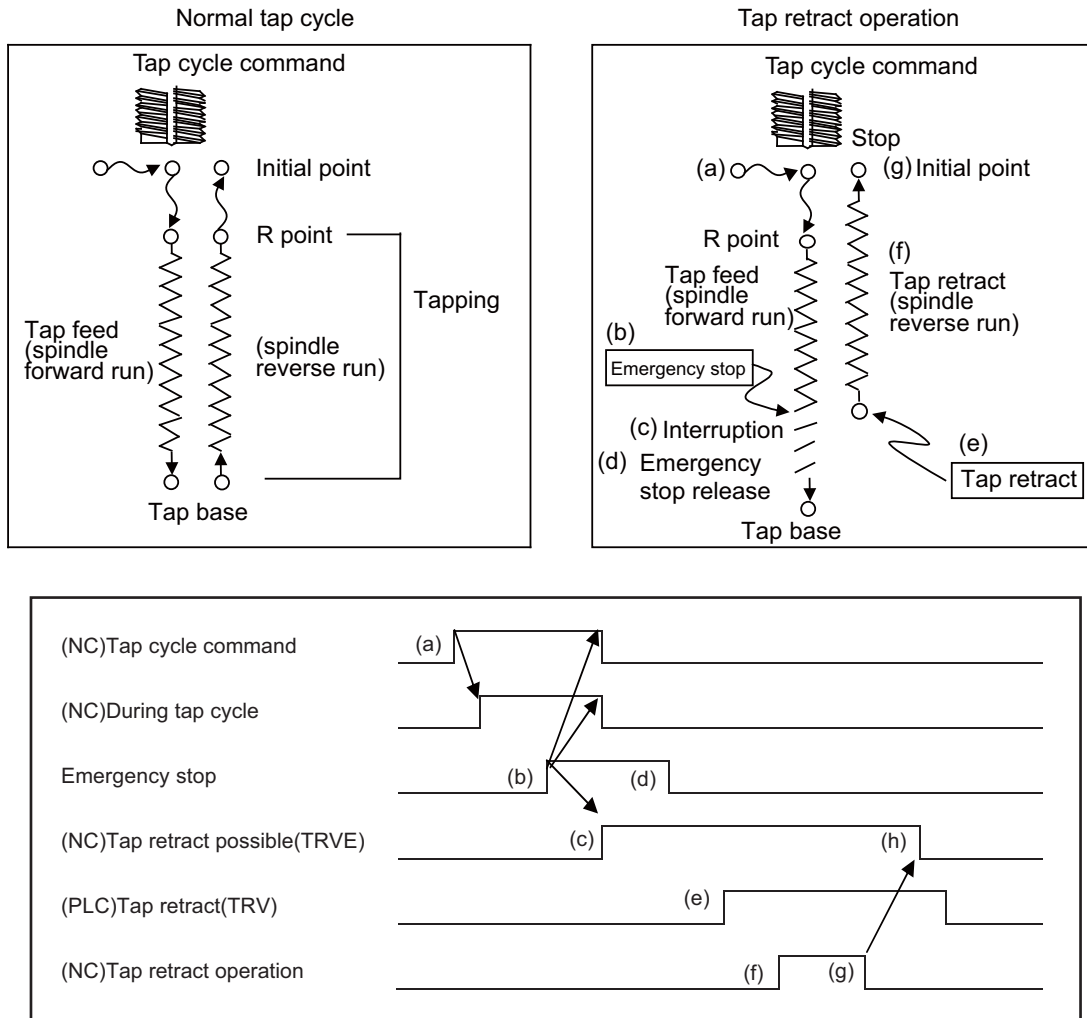

Tap retract operation

- (Note 1) The "Tap retract possible" signal (XCA5) is turned ON when the reset or emergency stop occurs during tapping operation. (The "Tap retract possible" signal (XCA5) is not turned ON even when the reset or the emergency stop occurs in the area other than the area between R point and tap bottom.)
- (Note 2) The tap retract is started when the "Tap retract" signal (YC5C) is turned ON while the "Tap retract possible" signal (XCA5) is ON. The tap retract is interrupted when the "Tap retract" signal (YC5C) is turned OFF during the tap retract.
- (Note 3) When an emergency stop or reset occurs, the tap retract is not performed even if the "Tap retract" signal (YC5C: TRV) is turned ON.
- (Note 4) When the parameter "#1234 set06/bit3" is set to "0", the tap retract operation is not performed even if the "Tap retract" signal (YC5C: TRV) is turned ON while the operation error (M01 0057) occurs.
- (Note 5) Even in the R point return mode, the tap retract is performed till the initial point.

<Feedrate at the tap retract>

The tap retract is performed at the following feedrate.

Tap retract feedrate = Tap cycle feedrate x Tapping retract override
(The tapping retract override is set with the parameter "#1171 taprov".)

However, after the power is turned ON again, the tap retract is performed at the Z phase detection speed when "#3106 zrn_typ/bit3" is set to "1" (Phase Z detection operation ON) and the Z phase detection speed is less than the tap retract feedrate. [M8]

[Caution]

- (1) When the parameter "#1234 set06/bit3" is set to "1", the axis interlock control is not performed on the CNC side even if the tapping is interrupted by emergency stop, etc. The axis moves according to the movement command even during the tap retract operation. Safety measures are required on the machine side.
- (2) When the parameter "#13018 SP018 SPEC2/bit5" is set to "1" and "#1239 set11/bit0" is set to "0", perform the coil changeover, and then turn ON the "Tap retract" signal (YC5C) after the total time set to the parameter "#13114 SP114 MKT" and the parameter "#13115 SP115 MKT2" has passed. [M8]

Each parameter means as follows.

No.	Name	Meaning
#13018	SP018 SPEC2/bit5	0: Coil changeover is invalid. 1: Coil changeover is valid.
#1239	set11/bit0	0: Coil changeover is performed via PLC. 1: Coil changeover is performed by the NC internal process.
#13114	SP114 MKT	Coil changeover gate cutoff timer
#13115	SP115 MKT2	Coil changeover current limit timer

[Related signals]

- (1) Tap retract possible (TRVE: XCA5)
- (2) Tap retract possible state cancel (TRVEC: YCD6)

Cont.	Signal name	Abbrev.	\$1	\$2	\$3	\$4	\$5	\$6	\$7	\$8
A	TOOL HANDLE FEED MODE [M8]		YC5E	YD9E	YEDE	Y101E	Y115E	Y129E	Y13DE	Y151E

[Function]

When this signal is turned ON, tool handle feed mode will be activated.

In the tool handle feed mode, axis can be moved with the manual pulse generator in tool axis direction, tool radius direction X and Y within the hypothetical coordinate system over the tool axis.

[Operation]

When the tool handle feed mode is selected, axis moves with the manual pulse generator in tool axis direction, tool radius direction X and Y.

Operate in the following procedure.

- (1) Select handle mode at the mode selection
- (2) Turn ON the signal (YC5E)
- (3) Move in tool axis direction, tool radius direction X and Y.

Handle feed magnification is shown as below.

Handle feed magnification	YC82	YC81	YC80
1-fold	0/1	0	0
10-fold	0/1	0	1
100-fold	0/1	1	0
1000-fold	0/1	1	1

(Note1) When the signal (YC5E) is "0", it is considered as normal handle mode.

4 Explanation of Interface Signals

Cont.	Signal name	Abbrev.	\$1	\$2	\$3	\$4	\$5	\$6	\$7	\$8
B	CUTTING FEEDRATE OVERRIDE CODE m	*FV1 to 16	YC60 to 4	YDA0 to 4	YEE0 to 4	Y1020 to 4	Y1160 to 4	Y12A0 to 4	Y13E0 to 4	Y1520 to 4

[Function]

Override (multiplication) can be exerted to cutting feedrate (F feedrate) during automatic operation with this signal.

[Operation]

When the signal is valid, true feedrate is the product obtained by multiplying referenced speed by override ratio (%) specified by the signal.

Override is 100%, even when the signal is given, in the following cases:

- (1) When "Override cancel" (YC58) signal is ON.
- (2) During tapping mode.
- (3) During thread cutting.

These signals (*FV1 to 16) are set with the code method. The relation is shown below.

*FV16	*FV8	*FV4	*FV2	*FV1	Cutting feedrate override
1	1	1	1	1	0%
1	1	1	1	0	10%
1	1	1	0	1	20%
1	1	1	0	0	30%
1	1	0	1	1	40%
1	1	0	1	0	50%
1	1	0	0	1	60%
1	1	0	0	0	70%
1	0	1	1	1	80%
1	0	1	1	0	90%
1	0	1	0	1	100%
1	0	1	0	0	110%
1	0	0	1	1	120%
1	0	0	1	0	130%
1	0	0	0	1	140%
1	0	0	0	0	150%
0	1	1	1	1	160%
0	1	1	1	0	170%
0	1	1	0	1	180%
0	1	1	0	0	190%
0	1	0	1	1	200%
0	1	0	1	0	210%
0	1	0	0	1	220%
0	1	0	0	0	230%
0	0	1	1	1	240%
0	0	1	1	0	250%
0	0	1	0	1	260%
0	0	1	0	0	270%
0	0	0	1	1	280%
0	0	0	1	0	290%
0	0	0	0	1	300%

Generally, the rotary switch (5-step, 21-notch, compliment binary code output) is connected to the operation board, and used between 0 and 200%.

If *FV1 to *FV16 are all OFF, the previous value will be maintained.
The value will change to 0% when the power is turned OFF.

(Note) Only when override value is 0%, override is exerted even on rapid traverse speed.

In this case, the operation error (M01 0102) occurs.

[Related signals]

- (1) Override cancel (YC58:OVC)
- (2) 2nd cutting feedrate override valid (YC66:FV2E)
- (3) Cutting feedrate override method selection (YC67:FVS)

4 Explanation of Interface Signals

Cont.	Signal name	Abbrev.	\$1	\$2	\$3	\$4	\$5	\$6	\$7	\$8
A	2ND CUTTING FEEDRATE OVERRIDE VALID	FV2E	YC66	YDA6	YEE6	Y1026	Y1166	Y12A6	Y13E6	Y1526

[Function]

Override normally exerted on cutting feedrate in automatic operation is within a range from 0% to 300%. When this signal is used, another override (ranging from 0% to 327.67%) can be exerted on overridden feedrate.

[Operation]

When the signal (FV2E) is ON, override can be exerted on feedrate previously overridden in code method (*FV1 to 16), or file register method (by setting numerals manually). Applicable range of the 2nd override is 0% to 327.6% (0.01% increment). Value (override ratio) is set to file register in binary code.

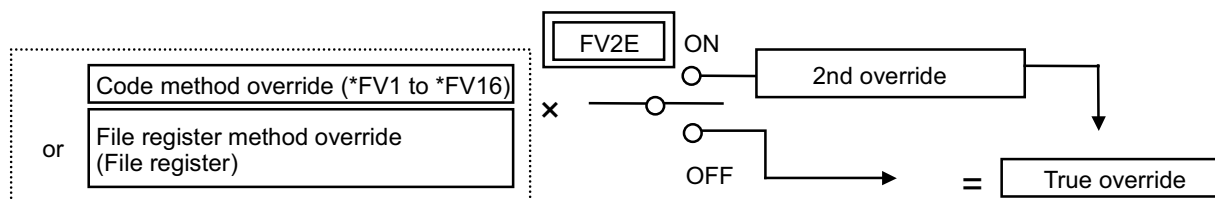

Cont.	Signal name	Abbrev.	\$1	\$2	\$3	\$4	\$5	\$6	\$7	\$8
A	CUTTING FEEDRATE OVERRIDE METHOD SELECTION	FVS	YC67	YDA7	YEE7	Y1027	Y1167	Y12A7	Y13E7	Y1527

[Function]

When override is exerted on cutting feedrate in automatic operation, override method can be selected between "code method" and "file register method".

[Operation]

When the signal (FVS) is OFF, code method (*FV1 to 16) is selected.

When the signal (FVS) is ON, file register method (value is specified by manual setting) is selected.

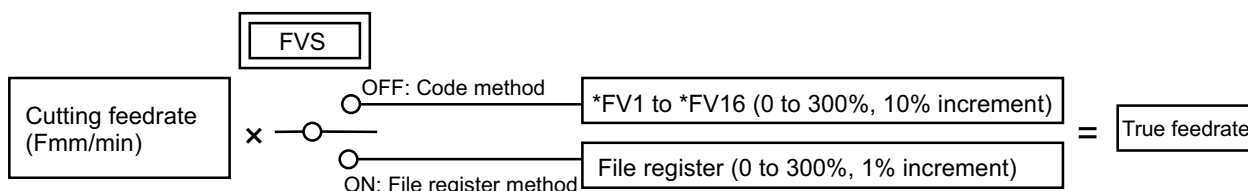

(Note) For details of code method and file register method, refer to the relevant descriptions.

A	RAPID TRAVERSE OVERRIDE CODE 1	ROV1	YC68	YDA8	YEE8	Y1028	Y1168	Y12A8	Y13E8	Y1528
A	RAPID TRAVERSE OVERRIDE CODE 2	ROV2	YC69	YDA9	YEE9	Y1029	Y1169	Y12A9	Y13E9	Y1529

[Function]

These signals are used to exert override on rapid traverse speed set by parameter (for rapid traverse) in automatic operation (memory, MDI or tape) or manual operation.

[Operation]

The true rapid traverse speed is that obtained by multiplying rapid traverse speed (set by parameter) by override ratio specified by these signals.

These signals are invalid if the "Rapid traverse" signal (RT) is OFF during cutting feed during automatic operation or during manual operation.

4 Explanation of Interface Signals

These signals (YC68, YC69) are set with the code method. The relation is shown below.

ROV2	ROV1	Rapid traverse override
0	0	100%
0	1	50%
1	0	25%
1	1	1%

(Note) When the cutting feed override is 0%, the rapid traverse stops.

[Related signals]

- (1) Rapid traverse override method selection (YC6F:ROVS)
- (2) Rapid traverse override (R2502)

Cont.	Signal name	Abbrev.	\$1	\$2	\$3	\$4	\$5	\$6	\$7	\$8
A	RAPID TRAVERSE OVERRIDE METHOD SELECTION	ROVS	YC6F	YDAF	YEEF	Y102F	Y116F	Y12AF	Y13EF	Y152F

[Function]

When speed override is exerted on rapid traverse speed specified in automatic operation or manual operation, override method is selected between code method and file register method (manually set).

[Operation]

When the signal (ROVS) is OFF, code method (ROV1, 2) is used.
 When the signal (ROVS) is ON, file register method is used.

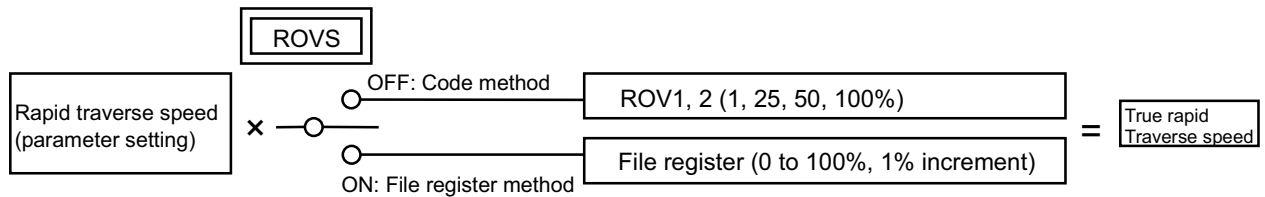

(Note) For details of "code method override" and "file register method", refer to the respective description.

[Related signals]

- (1) Rapid traverse override code 1 (YC68: ROV1)
- (2) Rapid traverse override (R2502)

Cont.	Signal name	Abbrev.	\$1	\$2	\$3	\$4	\$5	\$6	\$7	\$8
B	MANUAL FEEDRATE CODE m	*JV1 to 16	YC70 to 4	YDB0 to 4	YEF0 to 4	Y1030 to 4	Y1170 to 4	Y12B0 to 4	Y13F0 to 4	Y1530 to 4

[Function]

Feedrate in manual operation (JOG mode, incremental feed mode, etc.) or in dry run of automatic operation (memory, MDI, tape) is selected.

[Operation]

This signal is valid in the following cases, but will be invalid when the "Rapid traverse" signal (RT) is ON.

- (1) Jog mode, incremental mode or reference position return mode is ON.
- (2) During cutting feed in automatic operation and "Dry run" signal (DRN) is ON.
- (3) Dry run signal is ON during rapid traverse in the automatic operation. Note that parameter "#1085 G00 dry run" must be ON.

These signals (*JV1 to 16) are set with the code method. The relation is shown below.

4 Explanation of Interface Signals

*JV16	*JV8	*JV4	*JV2	*JV1	Manual feedrate			
					Machine parameter set in meters		Machine parameter set in inches	
					Metric mode (mm/min)	Inch mode (inch/min)	Metric mode (mm/min)	Inch mode (inch/min)
1	1	1	1	1	0.00	0.000	0.00	0.000
1	1	1	1	0	1.00	0.040	0.51	0.020
1	1	1	0	1	1.40	0.054	0.71	0.028
1	1	1	0	0	2.00	0.079	1.02	0.040
1	1	0	1	1	2.70	0.106	1.37	0.054
1	1	0	1	0	3.70	0.146	1.88	0.074
1	1	0	0	1	5.20	0.205	2.64	0.104
1	1	0	0	0	7.20	0.283	3.66	0.144
1	0	1	1	1	10.00	0.394	5.08	0.200
1	0	1	1	0	14.00	0.551	7.11	0.280
1	0	1	0	1	20.00	0.787	10.16	0.400
1	0	1	0	0	27.00	1.060	13.72	0.540
1	0	0	1	1	37.00	1.460	18.80	0.740
1	0	0	1	0	52.00	2.050	26.42	1.040
1	0	0	0	1	72.00	2.830	36.58	1.440
1	0	0	0	0	100.00	3.940	50.80	2.000
0	1	1	1	1	140.00	5.510	71.12	2.800
0	1	1	1	0	200.00	7.870	101.60	4.000
0	1	1	0	1	270.00	10.600	137.16	5.400
0	1	1	0	0	370.00	14.600	187.96	7.400
0	1	0	1	1	520.00	20.500	264.16	10.400
0	1	0	1	0	720.00	28.300	365.76	14.400
0	1	0	0	1	1000.00	39.400	508.00	20.000
0	1	0	0	0	1400.00	55.100	711.20	28.000
0	0	1	1	1	2000.00	78.700	990.60	39.000
0	0	1	1	0	2700.00	106.000	1371.60	54.000
0	0	1	0	1	3700.00	146.000	1879.60	74.000
0	0	1	0	0	5200.00	205.000	2641.60	104.000
0	0	0	1	1	7200.00	283.000	3657.60	144.000
0	0	0	1	0	10000.00	394.000	5080.00	200.000
0	0	0	0	1	14000.00	551.000	7112.00	280.000

*JV 1 to *JV16 are all OFF, the previous value will be maintained. The value will be set to 0 when the power is turned OFF.

(Note 1) In JOG mode, true feedrate changes if this signal changes during feed motion.

(Note 2) In incremental feed mode, true feedrate does not change if this signal changes during feed motion.

[Related signals]

- (1) Manual feedrate method selection (JVS:YC77)
- (2) Manual override method selection (OVSL:YC59)

4 Explanation of Interface Signals

Cont.	Signal name	Abbrev.	\$1	\$2	\$3	\$4	\$5	\$6	\$7	\$8
A	MANUAL SPEED CLAMP ON	MCLMP	YC76	YDB6	YEF6	Y1036	Y1176	Y12B6	Y13F6	Y1536

[Function]

This signal selects the maximum speed for handle feed or jog feed during manual operation.

[Operation]

When "#1449 m_clamp_on" (Manual speed clamp ON) is set to "0: Invalid"

ON: The speed designated with "#2641 m_clamp" (Manual feed clamp speed) is used as the maximum speed.

OFF: The speed designated with "#2001 rapid" (Rapid traverse speed) is used as the maximum speed.

When "#1449 m_clamp_on" (Manual speed clamp ON) is set to "1: Valid"

The speed designated with "#2641 m_clamp" (Manual feed clamp speed) is used as the maximum speed regardless of the state of this signal.

Cont.	Signal name	Abbrev.	\$1	\$2	\$3	\$4	\$5	\$6	\$7	\$8
A	MANUAL FEEDRATE METHOD SELECTION	JVS	YC77	YDB7	YEF7	Y1037	Y1177	Y12B7	Y13F7	Y1537

[Function]

When feedrate is specified in manual operation (JOG mode, incremental feed mode, etc.) or dry run (automatic operation), feedrate command method is selected between code method and file register method.

[Operation]

When the signal (JVS) is OFF, code method (*JV1 to *JV16) is selected.

When the signal (JVS) is ON, file register method is selected.

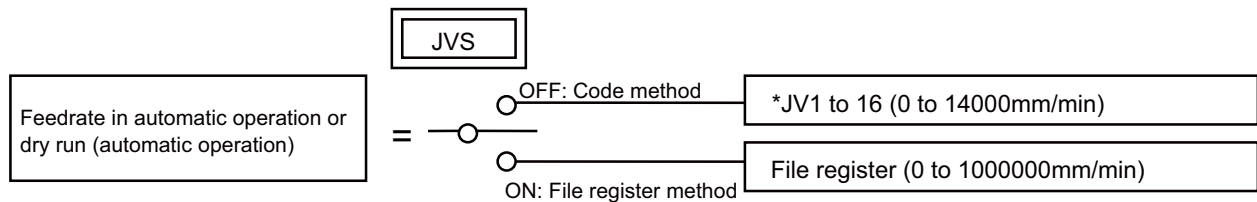

(Note 1) For details of "code method feedrate" and "file register method feedrate", refer to the relevant description.

(Note 2) If "#2642 jogfeed (jog feedrate)" is nonzero, the setting value is treated as the feedrate of the axis.

Cont.	Signal name	Abbrev.	\$1	\$2	\$3	\$4	\$5	\$6	\$7	\$8
A	FEEDRATE LEAST INCREMENT CODE 1,2	PCF1,2	YC78,9	YDB8,9	YEF8,9	Y1038,9	Y1178,9	Y12B8,9	Y13F8,9	Y1538,9

[Function]

When manual feedrate is specified in file register method (JVS: "ON") or in arbitrary manual feed mode, file registers R (R2504 and R2505) are used. In this case, least increment of feedrate entered into file registers R2504 and R2505 is specified by this signal.

[Operation]

The relationship between PCF1/PCF2 and least feed increment is as follows:

PCF2	PCF1	Least increment (mm/min or inch/min)	Operation
0	0	10	10mm/min (inch/min) when "1" is set in file registers.
0	1	1	1mm/min (inch/min) when "1" is set in file registers.
1	0	0.1	0.1mm/min (inch/min) when "1" is set in file registers.
1	1	0.01	0.01mm/min (inch/min) when "1" is set in file registers.

4 Explanation of Interface Signals

Cont.	Signal name	Abbrev.	\$1	\$2	\$3	\$4	\$5	\$6	\$7	\$8
A	JOG HANDLE SYNCHRONOUS	JHAN	YC7B	YDBB	YEFB	Y103B	Y117B	Y12BB	Y13FB	Y153B

[Function]

Jog feed and handle feed can be carried out without changing the operation mode.

[Operation]

If the "Jog mode" (J) signal and this signal are input simultaneously, the "jog/handle synchronous mode" will be entered. If the "Rapid traverse" (RT) signal is turned ON during the "jog/handle synchronous mode", the jog feed will be carried out at the rapid traverse feedrate. When the "Rapid traverse" turns OFF, the jog feed will be carried out at the manual feedrate.

Operation mode	Jog handle synchronous signal (YC7B)	Rapid traverse signal (YC26)	Operation during jog feed	Handle feed
Jog feed	On	On	Rapid traverse feedrate	Possible
		Off	Manual feedrate	Possible
	Off	On	Rapid traverse feedrate	Impossible
		Off	Manual feedrate	Impossible

(1) During "jog/handle synchronous mode", jog feed and handle feed can be carried out randomly. However, jog feed and handle feed cannot be carried out simultaneously on the same axis. If carried out simultaneously, the jog feed will have a priority. The changeover between jog feed and handle feed on the same axis is carried out when the relevant axis has stopped.

- If handle feed is carried out on an axis that is being jog fed, the jog feed will have a priority, so after movement with jog feed has completed (the axis has stopped), handle feed movement will start.

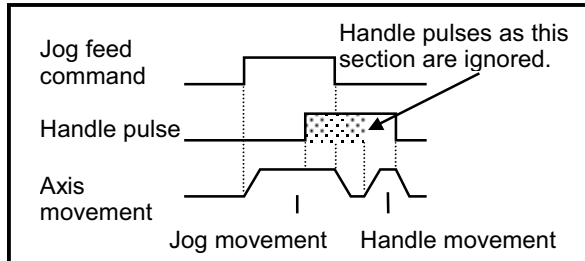

- If jog feed is carried out on an axis that is being handle fed, the handle feed movement will stop at the rising edge of the jog feed command. After the axis stops, the jog feed movement will start.

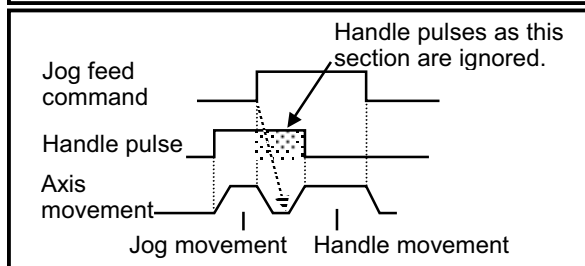

(Note) If only the "Jog handle synchronous" signal is output, "M01 OPERATION ERROR 0101" will occur. If the "Jog handle synchronous" signal is input simultaneously with an operation mode signal other than the jog mode, the "Jog handle synchronous" signal will be ignored.

4 Explanation of Interface Signals

Cont.	Signal name	Abbrev.	\$1	\$2	\$3	\$4	\$5	\$6	\$7	\$8
A	EACH AXIS MANUAL FEEDRATE B VALID		YC7C	YDBC	YEFC	Y103C	Y117C	Y12BC	Y13FC	Y153C

[Function]

This signal validates manual feed using each axis manual feedrate B.

[Operation]

- (1) If this signal and the manual feedrate B valid signal for the corresponding axis are validated when carrying out manual feed in the jog mode, the axis will move at the speed commanded by each axis manual feedrate B which is commanded separately from the manual feedrate or manual feedrate B.
- (2) This signal is common for all axes.

[Related signals]

- (1) Manual feedrate B valid (FBEn: Y940 to Y947)
- (2) Each axis manual feedrate B (R5764 to R5779)

Cont.	Signal name	Abbrev.	\$1	\$2	\$3	\$4	\$5	\$6	\$7	\$8
A	MANUAL FEEDRATE B SURFACE SPEED CONTROL VALID [M8]		YC7D	YDBD	YEFD	Y103D	Y117D	Y12BD	Y13FD	Y153D

[Function]

This signal validates manual feedrate B surface speed control.

[Operation]

It validates the manual feedrate B surface speed control for a rotary axis selected by the manual feedrate B valid signal. If "0" is set, it will be invalid.

This signal is common for all axes.

When machining by moving the orthogonal axis while rotating the rotary table with the manual feedrate B surface speed control function, the tool nose and workpiece's relative speed will drop as the tool nears the rotation center if the table rotation speed remains under the set conditions.

The table rotation speed can be controlled according to the distance from the rotation center by validating the manual feedrate B surface speed control.

As shown below, the distances (radiuses) from the rotation center to two points (R1 and R2) and the rotary axis speed at the two points (R1 and R2) are set as parameters. When the "manual feedrate B surface speed control valid" signal (YC7D) is turned ON, the rotary axis speed is calculated automatically in accordance with a current radius.

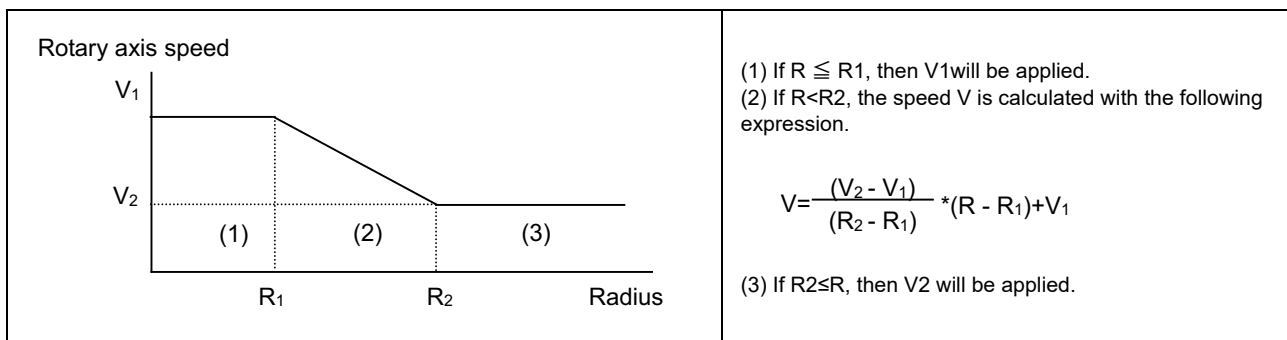

Override can be applied in the range of 0 to 200% in respect to the rotary axis speed.

[Caution]

- (1) For a linear axis, the manual feedrate B surface speed control is not valid; however, the manual feedrate B override is valid.
- (2) When the power is turned ON, validate the manual feedrate B surface speed control after returning the orthogonal axis to the reference position, establishing the coordinate system. If the surface speed control is applied to the rotary axis without establishing the coordinate system, the rotary axis moves at unexpected speed.

[Related signals]

- (1) Manual feedrate B valid (FBEn: Y940 to Y947)
- (2) Manual feedrate B override (R2524)

4 Explanation of Interface Signals

Cont.	Signal name	Abbrev.	\$1	\$2	\$3	\$4	\$5	\$6	\$7	\$8
A	CIRCULAR FEED IN MANUAL MODE VALID [M8]		YC7E	YDBE	YEFE	Y103E	Y117E	Y12BE	Y13FE	Y153E

[Function]

This signal is used to execute JOG or handle feed for the H and V axes on the specified coordinate ("linear-linear" or "circular-linear").

[Operation]

After this signal turns ON in the JOG or handle mode, the H and V axes move on the specified hypothetical coordinate. (The coordinate and so on are specified with the R registers explained below.)

[Caution]

- (1) This signal does not affect the operation of the axes other than H and V axes, nor the PLC axis.
- (2) This signal does not turn ON in the following conditions.
 - (a) Either H axis or V axis is in machine lock. (In this case, even machine lock is not performed.)
 - (b) The reference position return of either H axis or V axis is not completed.
 - (c) Either H axis or V axis is in servo OFF.
 - (d) Either H axis or V axis is detached.
 - (e) When the NC is in one of the following states.
 - Automatic operation (OP)
 - Emergency stop
 - Reset
 - (f) The current position is outside of the specified movable range.
 - (g) The setting value which is specified with R register is illegal.

[Related signals]

- (1) In circular feed in manual mode (XC4F)
- (2) Circular feed in manual mode operation mode data (R2636,7)
- (3) Circular feed in manual mode basic point H data (R2644,5)
- (4) Circular feed in manual mode basic point V data (R2648,9)
- (5) Circular feed in manual mode gradient/arc center H data (R2668,9)
- (6) Circular feed in manual mode gradient/arc center V data (R2672,3)
- (7) Circular feed in manual mode travel range H (+) data (R2652,3)
- (8) Circular feed in manual mode travel range H (-) data (R2656,7)
- (9) Circular feed in manual mode travel range V (+) data (R2660,1)
- (10) Circular feed in manual mode travel range V (-) data (R2664,5)
- (11) Circular feed in manual mode current position H (R636,7)
- (12) Circular feed in manual mode current position V (R640,1)

Cont.	Signal name	Abbrev.	\$1	\$2	\$3	\$4	\$5	\$6	\$7	\$8
A	COORDINATE ROTATION BY PARAMETER: COORDINATE SWITCH FOR MANUAL FEED [M8]		YC7F	YDBF	YEFF	Y103F	Y117F	Y12BF	Y13FF	Y153F

[Function]

This signal specifies whether or not the manual operation (jog feed, incremental feed, manual handle feed) operates with the coordinate system rotated by the coordinate rotation by parameter.

[Operation]

When this signal is turned OFF, the manual operation will be operated with the machine coordinate system.

When this signal is turned ON, the manual operation will be operated with the coordinate system rotated by the coordinate rotation by parameter.

[Related signals]

- (1) Coordinate rotation by parameter: Manual feed coordinate system (XC5F)

4 Explanation of Interface Signals

Cont.	Signal name	Abbrev.	\$1	\$2	\$3	\$4	\$5	\$6	\$7	\$8
A	HANDLE/INCREMENTAL FEED MAGNIFICATION CODE m	MP1 to 4	YC80 to 2	YDC0 to 2	YF00 to 2	Y1040 to 2	Y1180 to 2	Y12C0 to 2	Y1400 to 2	Y1540 to 2

[Function]

This signal is used to specify the magnification factor per pulse at the handle in HANDLE feed mode, or the amount of feed motion per shot in incremental feed mode ($\pm J1$ to 8: "ON").

When the "Handle/incremental feed magnification method selection" signal (MPS) is OFF, this magnification is applied for the hand pulse from handy terminal.

[Operation]

This signal (MP1 to 4) is set with the code method.

The travel amount per movement (*1) by handle feed or incremental feed is determined by multiplying the original feed amount by the magnification defined by MP1, MP2 and MP4.

(*1) The travel amount per movement depends on the feed method.

- Handle feed: Feed amount obtained by once pulse.
- Incremental feed: Axis movement amount obtained by turning the "+Jn" signal or "-Jn" signal OFF once then turning it ON again.

When parameter "#1003 iunit" is either "B" or "C", only a value 1000 or smaller can be set regardless of MP4's ON/OFF status.

The relationship between multiplier code (MP1 to 4) and multiplication in each feed mode is as follows.

MP4	MP2	MP1	Amount of motion per handle feed or incremental feed	
			#1003 iunit: B,C	#1003 iunit: Other than B or C
0	0	0	1	1
0	0	1	10	10
0	1	0	100	100
0	1	1	1000	1000
1	0	0	1	5000
1	0	1	10	10000
1	1	0	100	50000
1	1	1	1000	100000

[Related signals]

- (1) Handle mode (H: YC01)
- (2) Incremental mode (S: YC02)
- (3) Handle/incremental feed magnification method selection (MPS: YC87)

4 Explanation of Interface Signals

Cont.	Signal name	Abbrev.	\$1	\$2	\$3	\$4	\$5	\$6	\$7	\$8
A	MAGNIFICATION VALID FOR EACH HANDLE	MPP	YC86	YDC6	YF06	Y1046	Y1186	Y12C6	Y1406	Y1546

[Function] [Operation]

This signal sets magnification per each handle when setting magnification of feed arbitrarily.

(1) When the signal is ON

When setting magnification of feed with an arbitrary value, magnification can be set per each handle.

When selecting magnification with code method, a common magnification of feed will be applied for all handles.

Handle	Magnification of feed	
	File register method	Code method
1st handle	R2508, 2509	YC80 to YC82
2nd handle	R2510, 2511	
3rd handle	R2512, 2513	
4th handle [C80]	R22514, 22515	
5th handle [C80]	R22516, 22517	
6th handle [C80]	R22518, 22519	
7th handle [C80]	R22520, 22521	
8th handle [C80]	R22522, 22523	
9th handle [C80]	R22524, 22525	

(2) When the signal is OFF

When setting magnification of feed with an arbitrary value, magnification of 1st handle/incremental feed (R2508, R2509) will be applied for all handles.

When selecting magnification with code method, a common magnification of feed will be applied for all handles.

[Related signals]

(1) Handle/incremental feed magnification method selection (MPS: YC87)

(2) Handle/incremental feed magnification code m (MP1, MP2, MP4: YC80, YC81, YC82)

(3) 1st handle/incremental feed magnification (R2508, R2509)

Cont.	Signal name	Abbrev.	\$1	\$2	\$3	\$4	\$5	\$6	\$7	\$8
A	HANDLE/INCREMENTAL FEED MAGNIFICATION METHOD SELECTION	MPS	YC87	YDC7	YF07	Y1047	Y1187	Y12C7	Y1407	Y1547

[Function]

Feed magnification method in handle feed or incremental feed is selected between "code method" and "file register method" by this signal.

[Operation]

When the signal (MPS) is OFF, "code feed magnification method" is selected.

When the signal (MPS) is ON, "file register magnification method" is selected.

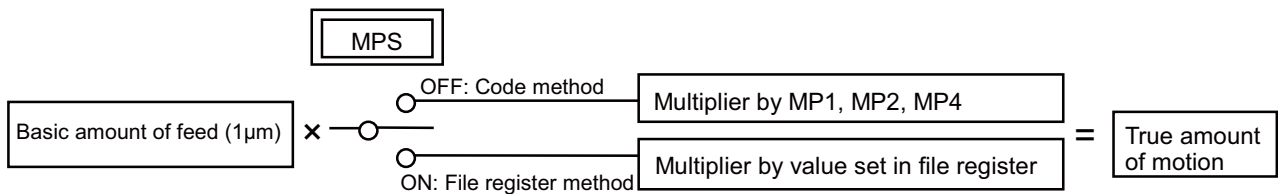

(Note) For details of the motion corresponding to the code method or file register method, refer to the relevant descriptions.

[Related signals]

(1) Handle/Incremental feed magnification code m (MP1, MP2, MP4: YC80, YC81, YC82)

(2) 1st Handle/Incremental feed magnification (R2508, R2509)

4 Explanation of Interface Signals

Cont.	Signal name	Abbrev.	\$1	\$2	\$3	\$4	\$5	\$6	\$7	\$8
A	TOOL ALARM 1	TAL1	YC88	YDC8	YF08	Y1048	Y1188	Y12C8	Y1408	Y1548

[Function]

This signal sets the spindle tool status during tool life management to status 3 (Tool alarm 1/Tool skip).

[Operation]

By turning ON the signal in the tool life management specification, the tool status of a spindle tool or a tool selected when a tool group No. is designated can be changed to "3".

This signal is validated when tool life management input signal (YC8B) is ON.

Cont.	Signal name	Abbrev.	\$1	\$2	\$3	\$4	\$5	\$6	\$7	\$8
A	TOOL ALARM 2	TAL2	YC89	YDC9	YF09	Y1049	Y1189	Y12C9	Y1409	Y1549

[Function]

This signal sets the tool data status during tool life management to status 4 (Tool alarm 2).

[Operation]

By turning ON the signal in the tool life management specification, the tool status of a spindle tool or a tool selected when a tool group No. is designated can be changed to "4".

This signal is validated when tool life management input signal (YC8B) is ON.

Cont.	Signal name	Abbrev.	\$1	\$2	\$3	\$4	\$5	\$6	\$7	\$8
A	USAGE DATA COUNT VALID	TCEF	YC8A	YDCA	YF0A	Y104A	Y118A	Y12CA	Y140A	Y154A

[Function]

This signal validates tool life count during the tool life management.

[Operation]

The tool life count (usage time or usage count corresponding to tool) is validated in the tool life management specification.

This signal is validated when tool life management input signal (YC8B) is ON.

Cont.	Signal name	Abbrev.	\$1	\$2	\$3	\$4	\$5	\$6	\$7	\$8
A	TOOL LIFE MANAGEMENT INPUT	TLF1	YC8B	YDCB	YF0B	Y104B	Y118B	Y12CB	Y140B	Y154B

[Function]

This signal validates the tool life management.

[Operation]

By turning ON the signal in the tool life management specification, the tool life management process is executed.

Cont.	Signal name	Abbrev.	\$1	\$2	\$3	\$4	\$5	\$6	\$7	\$8
A	TOOL CHANGE RESET	TRST	YC8C	YDCC	YF0C	Y104C	Y118C	Y12CC	Y140C	Y154C

[Function]

This signal is used to turn all the tools of a group into an unused state in the tool life management II.

[Operation]

Select with the tool group No. designation (file register R2590, 2591) whether all groups that have exceeded their lifetimes or specific group to turn the tool into an unused state.

After this signal is input, the first tool of the group will be selected at the next group selection.

(Note) When the tool change reset or the tool skip is performed on the group currently selected, usage data count will be carried out on the tool used at the time of signal input until the next tool selection. Therefore, if a tool selected needs to be changed along with the signal input, select a group again. However, a tool may not be selected due to a preceding process if there is no movement command up to the next group selection after the signal input. In this case, contents of the preceding process can be invalidated by turning ON the "recalculation request" (CRQ) signal before selecting the group.

[Related signals]

- (1) Recalculation request (CRQ: YC2B)

4 Explanation of Interface Signals

Cont.	Signal name	Abbrev.	\$1	\$2	\$3	\$4	\$5	\$6	\$7	\$8
A	TOOL ESCAPE AND RETURN TRANSIT POINT DESIGNATION [M8]		YC8D	YDCD	YF0D	Y104D	Y118D	Y12CD	Y140D	Y154D

[Function]

With the tool escape and return function, a transit point can be designated by pressing the transit point switch when tool escapes. The tool returns to the machining halted point, passing through the transit point designated.

This signal turns ON when the transit point switch is pressed and turns OFF when recognition of the transit point is completed.

[Operation]

Refer to the section on "In tool escape and return mode signal" (XC4A).

[Related signals]

- (1) In tool escape and return mode (XC4A)
- (2) Tool escape and return transit point recognition finish (XC87)

Cont.	Signal name	Abbrev.	\$1	\$2	\$3	\$4	\$5	\$6	\$7	\$8
A	REFERENCE POSITION SELECTION CODE 1,2	ZSL1,2	YC90,1	YDD0,1	YF10,1	Y1050,1	Y1190,1	Y12D0,1	Y1410,1	Y1550,1

[Function]

It is also possible to return to the nth reference position in the manual reference position return mode. This signal is used to select the number of the reference position (n) to return to. Normally both the "Reference position selection code 1, 2" (ZSL1n, ZSL2n) signals are turned OFF, and 1st point reference position return is performed.

[Operation]

The reference position to be returned to is selected among the 1st to the 4th reference positions by using these signals (YC90, YC91).

Reference position selection code 2	Reference position selection code 1	Return position
0	0	1st reference position
0	1	2nd reference position
1	0	3rd reference position
1	1	4th reference position

To perform the 2nd, the 3rd, or the 4th reference position return, establish the 1st reference position beforehand.

For the absolute position detection system, when the coordinate system is set, all the reference position returns can be performed after the power is turned ON.

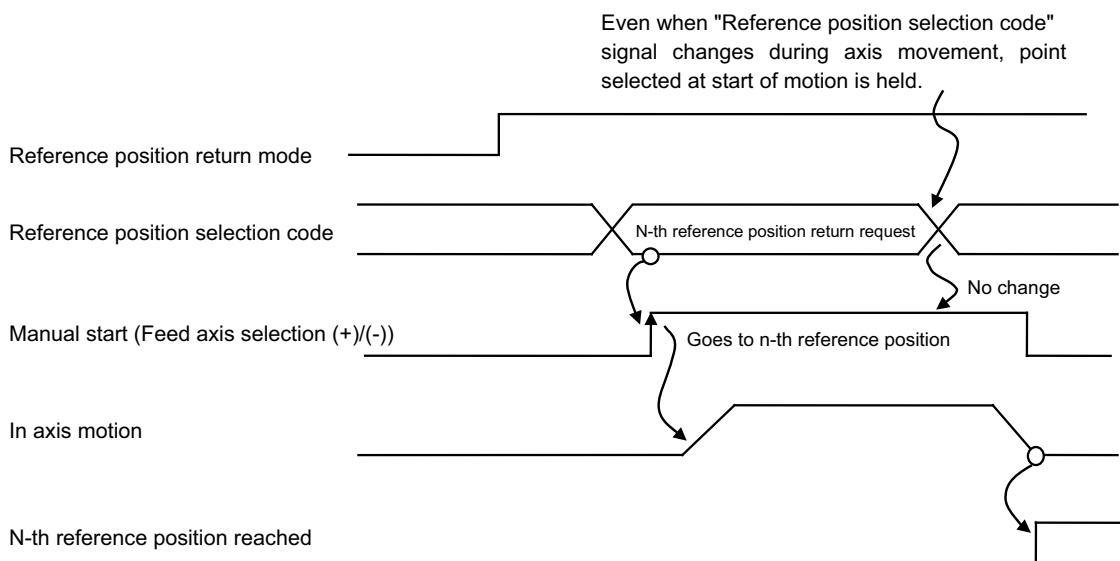

4 Explanation of Interface Signals

[Related signals]

- (1) Reference position return mode (ZRN: YC04)
- (2) Feed axis selection (+Jn: Y1D8, -Jn: Y900)
- (3) N-th reference position reached (ZP11 to 48: X800 to X867)

Cont.	Signal name	Abbrev.	\$1	\$2	\$3	\$4	\$5	\$6	\$7	\$8
A	TOOL LENGTH COMPENSATION ALONG THE TOOL AXIS COMPENSATION AMOUNT CHANGE MODE [M8]		YC92	YDD2	YF12	Y1052	Y1192	Y12D2	Y1412	Y1552

[Function]

This signal controls the tool length compensation along the tool axis compensation amount change mode.

[Operation]

- (1) When the signal is ON:
When the handle is operated, only compensation amount of tool length compensation along the tool axis will be changed. Handle interrupt function will be invalid.
- (2) When the signal is OFF:
Compensation amount of tool length compensation along the tool axis cannot be changed by the manual handle even during the tool length compensation along the tool axis mode.

[Related signals]

- (1) Mechanical axis specifications 1st rotary axis angle / 2nd rotary axis angle (R2628,R2629 / R2630,R2631)

Cont.	Signal name	Abbrev.	\$1	\$2	\$3	\$4	\$5	\$6	\$7	\$8
A	THREAD CUTTING: FEED-FORWARD CONTROL REQUEST	FFC	YC94	YDD4	YF14	Y1054	Y1194	Y12D4	Y1414	Y1554

[Function]

This signal activates the feed forward control during the thread cutting.

[Operation]

When this signal is turned ON, the feed forward control will be valid during the thread cutting.
Turn on this signal prior to the thread cutting command which performs the feed forward control.

[Related signals]

- (1) Thread cutting: Feed-forward control ON (FFCO:XCA4)

Cont.	Signal name	Abbrev.	\$1	\$2	\$3	\$4	\$5	\$6	\$7	\$8
A	REFERENCE POSITION SELECTION METHOD	M	YC97	YDD7	YF17	Y1057	Y1197	Y12D7	Y1417	Y1557

[Function]

This signal selects whether the reference position selection is common for all axes or independent for each axis.

[Operation]

When this signal is OFF, the reference position selection is common for all axes, and ZSL1 and ZSL2 are valid.
When this signal is ON, the reference position selection is independent for each axis, and "Each axis reference position selection" is valid.

[Related signals]

- (1) Reference position selection code 1,2 (ZSL1, 2: YC90, YC91)
- (2) Each axis reference position selection (R2584)

4 Explanation of Interface Signals

Cont.	Signal name	Abbrev.	\$1	\$2	\$3	\$4	\$5	\$6	\$7	\$8
A	TOOL LIFE MANAGEMENT: TEMPORARY CANCEL OF TOOL LIFE EXPIRATION		YC98	YDD8	YF18	Y1058	Y1198	Y12D8	Y1418	Y1558

[Function]

This signal temporarily cancels the Tool life over signal.

[Operation]

If the corresponding Tool life over signal is ON at the falling edge, this signal turns the Tool life over signal OFF.

The Tool life over signal that was temporarily canceled with this signal turns ON again if the lifetime of the tool that is used is expired after NC reset.

The timing chart for this signal is shown below.

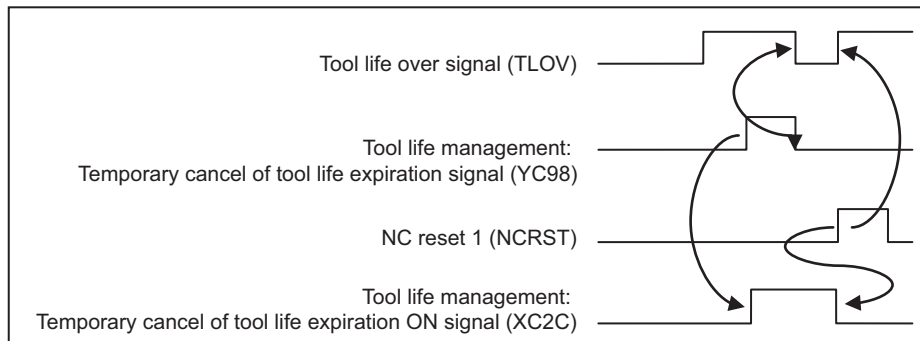

[Caution]

This signal is used only for resetting the Tool life over signal temporarily and does not affect other operations.

[Related signals]

- (1) Tool life over (TLOV:XC2E)
- (2) NC reset 1 (NRST1:YC18)
- (3) NC reset 2 (NRST2:YC19)
- (4) Reset & rewind (RRW:YC1A)

Cont.	Signal name	Abbrev.	\$1	\$2	\$3	\$4	\$5	\$6	\$7	\$8
A	TOOL LIFE MANAGEMENT: TEMPORARY CANCEL OF TOOL GROUP LIFE EXPIRATION		YC99	YDD9	YF19	Y1059	Y1199	Y12D9	Y1419	Y1559

[Function]

This signal temporarily cancels the Tool group life over signal.

[Operation]

If the corresponding Tool group life over signal is ON at the falling edge, this signal turns the Tool group life over signal OFF.

The Tool group life over signal that was temporarily canceled with this signal turns ON again if the lifetimes of all tools in a group that are mounted after NC reset are expired.

The timing chart for this signal is shown below.

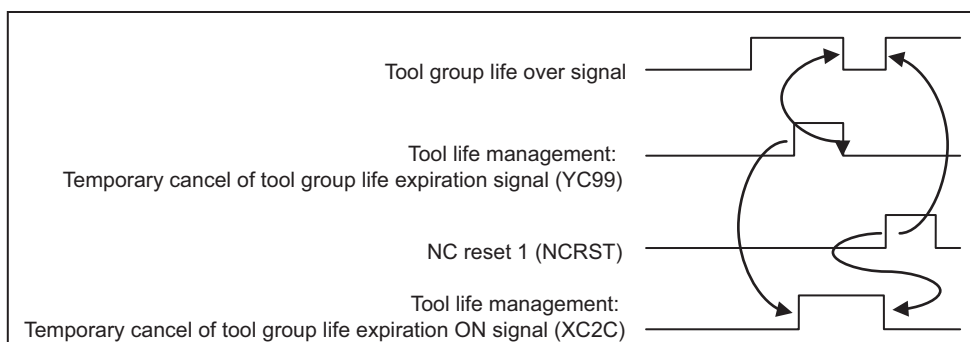

[Caution]

This signal is used only for resetting the Tool group life over signal temporarily and does not affect other operations.

4 Explanation of Interface Signals

[Related signals]

- (1) Tool group life over (XC2F)
- (2) NC reset 1 (NRST1:YC18)
- (3) NC reset 2 (NRST2:YC19)
- (4) Reset & rewind (RRW:YC1A)

Cont.	Signal name	Abbrev.	\$1	\$2	\$3	\$4	\$5	\$6	\$7	\$8
A	External search: Program return	PRTN	YC9A	YDDA	YF1A	Y105A	Y119A	Y12DA	Y141A	Y155A

[Function]

After the completion of external search, this signal is input to the control unit to return the previous program selected before the external search.

[Operation]

The control returns the previous program selected before the external search at the rising edge of this signal.

To enable this signal, set "#1288 ext24/bit3 (Restore previous program before external search by Program restore signal)" to "1".

[Caution]

- (1) When "#1288 ext24/bit3 (Restore previous program before external search by Program restore signal)" is "0", the program will not return to the previous one selected before the external search even if this signal is turned ON.
- (2) When another search operation is executed after the external search, the program will not return to the previous one selected before the external search even if this signal is turned ON.
- (3) When the macro interruption function is executed after the external search or while operating the externally searched program, the program will not return to the previous one selected before the external search even if this signal is turned ON.
- (4) Even if this signal is turned ON while operating the externally searched program, the program will not return to the previous one selected before the external search.

Cont.	Signal name	Abbrev.	\$1	\$2	\$3	\$4	\$5	\$6	\$7	\$8
A	MES interface library: User arbitrary information send request [M8]		YC9B	YDDB	YF1B	Y105B	Y119B	Y12DB	Y141B	Y155B

[Function]

This signal sends the request of DB operation to the arbitrary information accumulation table in the database.

[Operation]

The processing of DB operation for the arbitrary information accumulation table in the database starts at the rising edge of this signal.

[Related signals]

- (1) MES interface library: Sending user arbitrary information [M8] (XD30 to X15F0)
- (2) MES interface library: DB operation selection [M8] (R14598)

4 Explanation of Interface Signals

Cont.	Signal name	Abbrev.	\$1	\$2	\$3	\$4	\$5	\$6	\$7	\$8
A	MANUAL SPEED COMMAND VALID		YC9D	YDDD	YF1D	Y105D	Y119D	Y12DD	Y141D	Y155D

[Function]

This signal is used to run the machining program with handle feedrate or JOG feedrate (manual feedrate).

[Operation]

After this signal is ON, manual speed (handle or manual feedrate) is applied to the axis feedrate in the whole automatic operation: the speed commanded in the program is not used.

If the program has not started, the automatic operation start is executed with handle or manual feedrate.

The manual operation mode decides whether the manual feedrate or handle feedrate is used.

- In handle mode

The program under operation is executed at the feedrate of the 1st handle, 1st axis.

During the reset, block stop or pause in the automatic operation mode, the automatic operation starts at the time when the handle feedrate has been commanded.

When the reverse run is valid, a command in the (+) direction makes the movement as in the program, while a command in (-) direction reverses the movement against the program. The reversed movement, however, is available only within the current block.

- In JOG mode

The program under operation is executed at the manual feedrate as long as the JOG mode signal is ON for the 1st axis.

During the reset, block stop or pause in the automatic operation mode, the automatic operation starts at the time when the JOG mode has been turned ON.

When the reverse run is valid, a command in the (+) direction makes the movement as in the program, while a command in (-) direction reverses the movement against the program. The reversed movement, however, is available only within the current block.

When the "Rapid traverse" signal is ON, the axis moves at the rapid traverse feedrate.

[Caution]

- (1) Turning ON this signal in the automatic operation leads to an automatic operation pause.
- (2) While this signal is ON, the "Automatic operation "start" command" signal is not valid.
- (3) When the automatic operation is carried out with the manual speed command, the "In automatic operation "pause"" signal is output regardless of the axis movement.
- (4) The manual speed command makes the movement follow the command on the 1st axis, even though the other axis is commanded in the program. Any commands to the other axes lead "M01 OPERATION ERROR 0005" (Internal interlock axis exists).
- (5) The following G commands or modal make the movement different from that in the normal automatic operation.
 - G00: The manual feedrate is applied, not the rapid traverse feedrate.
 - G28: The manual feedrate is applied, not the reference position return feedrate.
 - G31: The manual feedrate is applied, not the skip feedrate. The movement when the skip signal is input, however, is the same as in the normal operation.
 - G33, G34 to 36 (L system): The thread cutting (G33), the variable lead thread cutting (G34: L system only), and the arc thread cutting (G35/36: L system only) operate the same as the dry run. The manual feedrate is applied. (When the parameter "#1247 set19/bit1" is set to "1", it operates according to the program command.)
 - G95: The feed per rotation operates the same as the dry run.
 - F1-digit feed: The manual feedrate is applied, not the F1-digit feedrate. The "F1-digit commanded" signal is not output, either.
- (6) Only the 1st handle is used. The other handles are ignored.
- (7) When this signal is valid, the feedrate is not changed by the Inch/Metric changeover command (G20/G21), nor by the rotary axis command speed tenfold.
- (8) The manual interruption and the thread cutting cycle retract are available when this signal is ON. The automatic handle interruption, as well as the manual operation in the manual/auto simultaneous mode, cannot be used on the 1st axis because the axis applies the manual input upon this signal.

[Related signals]

- (1) Manual speed command sign reversed (YC9E)
- (2) Manual speed command reverse run valid (YC9F)
- (3) In automatic operation "pause" (SPL: XC14)
- (4) In manual speed command valid (XC48)

Cont.	Signal name	Abbrev.	\$1	\$2	\$3	\$4	\$5	\$6	\$7	\$8
A	MANUAL SPEED COMMAND SIGN REVERSED		YC9E	YDDE	YF1E	Y105E	Y119E	Y12DE	Y141E	Y155E

[Function]

When the manual speed is commanded, this signal reverses the direction that has been commanded with the handle feed or JOG feed.

[Operation]

When this signal is ON, a speed command in the (+) direction reverses the movement against the program. (Note that this operation is not available unless the reverse run is valid.) A command in the (-) direction makes the movement as commanded in the program.

Manual speed command Reverse run valid	Manual speed command Sign reversed	Movement direction	
		by (+) operation	by (-) operation
OFF	(Invalid)	+	+
ON	OFF	+	-
ON	ON	-	+
In the modals that do not allow the reverse run (thread cutting and synchronous tapping)		+	The operation is ignored

[Caution]

This signal is not valid when the "Manual speed command Reverse run valid" signal is OFF.

[Related signals]

- (1) Manual speed command valid (YC9D)
- (2) Manual speed command reverse run valid (YC9F)

4 Explanation of Interface Signals

Cont.	Signal name	Abbrev.	\$1	\$2	\$3	\$4	\$5	\$6	\$7	\$8
A	MANUAL SPEED COMMAND REVERSE RUN VALID		YC9F	YDDF	YF1F	Y105F	Y119F	Y12DF	Y141F	Y155F

[Function]

This signal allows the manual speed command in the (-) direction to reverse the movement against the program.

[Operation]

When this signal turns ON during the manual speed is commanded, a speed command in the (-) direction in handle or JOG mode reverses the movement against the program.

When this signal is OFF, a command in the (-) direction makes the same movement as commanded in the (+) direction: the movement follows the program.

[Caution]

- (1) The reverse run is available within the block in execution. The reversed axis movement stops at the start point of the block in execution.
- (2) Unless all the axes stop, this signal cannot be changed ON/OFF. The ON/OFF change of this signal during the axis movement is realized after all the axes have stopped.
- (3) The reverse run is not allowed in the following operations. The axis stays stopped if a speed command is given in the (-) direction.
 - (a) In the reference position return (G28, G29). When G28 is commanded, however, the reverse run is available from the start point and to the intermediate point. When G29 is commanded, the reverse run is available from the intermediate point to the end point.
 - (b) In cutting cycle in the synchronous or asynchronous tap.
 - (c) In shift amount operation in a fixed cycle.
 - (d) In tool center point control.
 - (e) In normal line control.
 - (f) In milling interpolation, pole coordinate rotation or cylindrical interpolation.
 - (g) When the thread cutting command (G33) is given.
 - (h) In exponential interpolation.
 - (i) In spline interpolation.
 - (j) In NURBS interpolation.
 - (k) In tool change position return or 2nd/3rd/4th reference position return (from the intermediate point to the block end).

[Related signals]

- (1) Manual speed command valid (YC9D)
- (2) Manual speed command sign reversed (YC9E)

4 Explanation of Interface Signals

Cont.	Signal name	Abbrev.	\$1	\$2	\$3	\$4	\$5	\$6	\$7	\$8
A	MANUAL ARBITRARY FEED 1ST AXIS SELECTION CODE m	CX11 to 116	YCA0 to 4	YDE0 to 4	YF20 to 4	Y1060 to 4	Y11A0 to 4	Y12E0 to 4	Y1420 to 4	Y1560 to 4

[Function]

This signal specifies a number of the axis component to move in manual arbitrary feed mode.

Components of up to three axes can be moved simultaneously in manual arbitrary feed mode. This signal is used to specify one of them.

[Operation]

- (1) The "Manual arbitrary feed 1st axis selection code m" (CX11 to CX116) must be set before strobe signal CXS8 is turned ON. An attempt to set it during motion shall fail.
- (2) Besides this signal (CX11 to CX116), there are two signals to specify a "Manual arbitrary feed 2nd axis selection code m" (CX21 to CX216) and a "Manual arbitrary feed 3rd axis selection code m" (CX31 to CX316). The axis numbers need not be specified in ascending order.
- (3) The "Manual arbitrary feed 1st axis selection code m" is validated by turning ON the "Manual arbitrary feed 1st axis valid" (CX1S) signal explained later. Similarly, the "specific validity" signals (CX2S and CX3S) are also provided for the 2nd and 3rd axis number signals.
- (4) Axis numbers can be specified as follows:

n: 1 to 3

Signal Axis specification	Signal							
	CXnS	—	—	CXn16	CXn8	CXn4	CXn2	CXn1
1st axis	1	—	—	0	0	0	0	1
2nd axis	1	—	—	0	0	0	1	0
3rd axis	1	—	—	0	0	0	1	1
4th axis	1	—	—	0	0	1	0	0

└── Validity signal
└── Axis number

- (5) Motion of the specified axis component is as follows:
 - (a) The motion of the axis component specified by the "Manual arbitrary feed 1st axis selection code m" signal corresponds to the contents of "Manual arbitrary feed 1st axis travel amount" (R2544 and R2545).
 - (b) The motion of the axis component specified by the "Manual arbitrary feed 2nd axis selection code m" signal corresponds to the contents of "Manual arbitrary feed 2nd axis travel amount" (R2548 and R2549).
 - (c) The motion of the axis component specified by the "Manual arbitrary feed 3rd axis selection code m" signal corresponds to the contents of "Manual arbitrary feed 3rd axis travel amount" (R2552 and R2553).

[Related signals]

For related signals, see the section "Manual arbitrary feed mode (PTP: YC03)."

Cont.	Signal name	Abbrev.	\$1	\$2	\$3	\$4	\$5	\$6	\$7	\$8
A	MANUAL ARBITRARY FEED 1ST AXIS VALID	CX1S	YCA7	YDE7	YF27	Y1067	Y11A7	Y12E7	Y1427	Y1567

[Function]

This signal is used to validate the axis specified by the "Manual arbitrary feed 1st axis selection code m" signal so that the axis component can move in manual arbitrary feed mode.

[Operation]

- (1) The specification of the axis by the "Manual arbitrary feed 1st axis selection code m" signal explained earlier is validated only when the "CX1S" signal is turned ON.

[Related signals]

For related signal, see the section "Manual arbitrary feed mode (PTP: YC03)."

4 Explanation of Interface Signals

Cont.	Signal name	Abbrev.	\$1	\$2	\$3	\$4	\$5	\$6	\$7	\$8
A	MANUAL ARBITRARY FEED 2ND AXIS SELECTION CODE m	CX21 to 216	YCA8 to C	YDE8 to C	YF28 to C	Y1068 to C	Y11A8 to C	Y12E8 to C	Y1428 to C	Y1568 to C

[Function][Operation]

See the descriptions on the "Manual arbitrary feed 1st axis selection code m" signal (CX11 to CX116: YCA0 to 4) explained above.

Cont.	Signal name	Abbrev.	\$1	\$2	\$3	\$4	\$5	\$6	\$7	\$8
A	MANUAL ARBITRARY FEED 2ND AXIS VALID	CX2S	YCAF	YDEF	YF2F	Y106F	Y11AF	Y12EF	Y142F	Y156F

[Function][Operation]

See the descriptions on the "Manual arbitrary feed 1st axis valid" signal (CX1S: YCA7).

Cont.	Signal name	Abbrev.	\$1	\$2	\$3	\$4	\$5	\$6	\$7	\$8
A	MANUAL ARBITRARY FEED 3RD AXIS SELECTION CODE m	CX31 to 316	YCB0 to 4	YDF0 to 4	YF30 to 4	Y1070 to 4	Y11B0 to 4	Y12F0 to 4	Y1430 to 4	Y1570 to 4

[Function][Operation]

See the descriptions on the "Manual arbitrary feed 1st axis selection code m" signal (CX11 to CX116: YCA0 to 4) explained above.

Cont.	Signal name	Abbrev.	\$1	\$2	\$3	\$4	\$5	\$6	\$7	\$8
A	MANUAL ARBITRARY FEED 3RD AXIS VALID	CX3S	YCB7	YDF7	YF37	Y1077	Y11B7	Y12F7	Y1437	Y1577

[Function][Operation]

See the descriptions on the "Manual arbitrary feed 1st axis valid" signal (CX1S: YCA7).

Cont.	Signal name	Abbrev.	\$1	\$2	\$3	\$4	\$5	\$6	\$7	\$8
A	MANUAL ARBITRARY FEED SMOOTHING OFF	CXS1	YCB8	YDF8	YF38	Y1078	Y11B8	Y12F8	Y1438	Y1578

[Function]

This signal is used to move an axis component under the condition where the acceleration/ deceleration time constant is 0 in manual arbitrary feed mode.

[Operation]

With the "Manual arbitrary feed smoothing off" (CXS1) signal set ON, axis motion in manual arbitrary feed mode is performed under the same conditions as when the acceleration/deceleration time constant is set to 0.

(Note 1) When using this signal to move an axis component under the condition where the acceleration/deceleration time constant is 0, move it at a slow speed. Otherwise, a servo alarm (excess error) may occur.

[Related signals]

For related signal, see the section "Manual arbitrary feed mode" (PTP: YC03) mode.

4 Explanation of Interface Signals

Cont.	Signal name	Abbrev.	\$1	\$2	\$3	\$4	\$5	\$6	\$7	\$8
A	MANUAL ARBITRARY FEED AXIS INDEPENDENT	CXS2	YCB9	YDF9	YF39	Y1079	Y11B9	Y12F9	Y1439	Y1579

[Function]

When moving two or more axis components simultaneously in "manual arbitrary feed" mode, this signal can be used to position each axis independently without performing interpolation.

[Operation]

When a manual arbitrary feed is executed for two or more axes at the same time with CXS2 ON, each axis is positioned independently without being subjected to interpolation. The "CXS2" signal is generally used when the "Manual arbitrary feed G0/G1" signal (CXS4) explained later is OFF (G0 selected).

The following is an example where the rapid traverse speeds of X-axis and Z-axis are both set to 9,600 mm/min, and the amounts of movement of X-axis and Z-axis are set to 300mm and 200mm respectively.

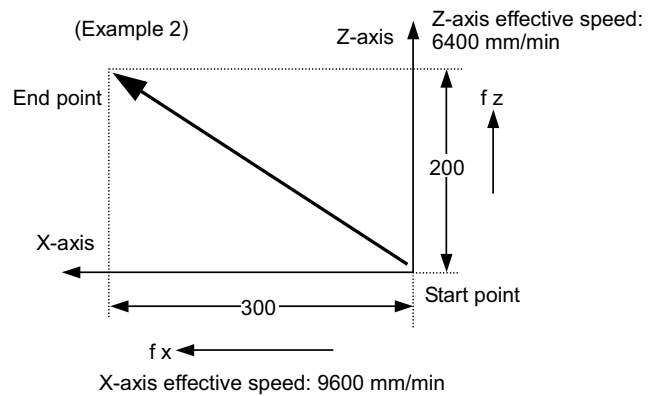
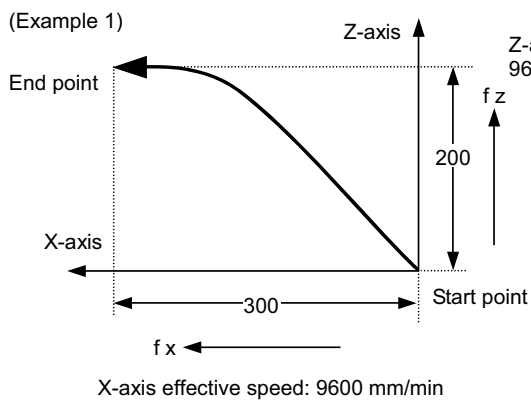

[Related signals]

For related signal, see the section "Manual arbitrary feed mode (PTP: YC03)."

4 Explanation of Interface Signals

Cont.	Signal name	Abbrev.	\$1	\$2	\$3	\$4	\$5	\$6	\$7	\$8
A	MANUAL ARBITRARY FEED EX. F/MODAL. F	CXS3	YCBA	YDFA	YF3A	Y107A	Y11BA	Y12FA	Y143A	Y157A

[Function]

This signal selects whether a manual arbitrary feed in G1 mode is done at manual feed rate or at modal speed in automatic operation.

[Operation]

When the "Manual arbitrary feed G0/G1" (CXS4) signal explained later is ON n, the "CXS3" signal works as follows:

- (1) When Manual arbitrary feed EX.F/MODAL.F (CXS3) is OFF:

When the "Manual feedrate method selection (JVS)" signal is OFF, the speed selected by the manual feedrate code (*JV1 to 16) applies. When the "Manual feedrate method selection (JVS)" signal is ON, the applicable speed is determined by the relation between the contents of the corresponding file register (R) and the "Feedrate least increment code 1,2" signal (PCF1 or PCF2).
- (2) When Manual arbitrary feed EX.F/MODAL.F (CXS3) is ON:

Manual arbitrary feed is done at a modal speed (F***) set in automatic operation. However, manual arbitrary feed will not be done, if no F command has been executed before.

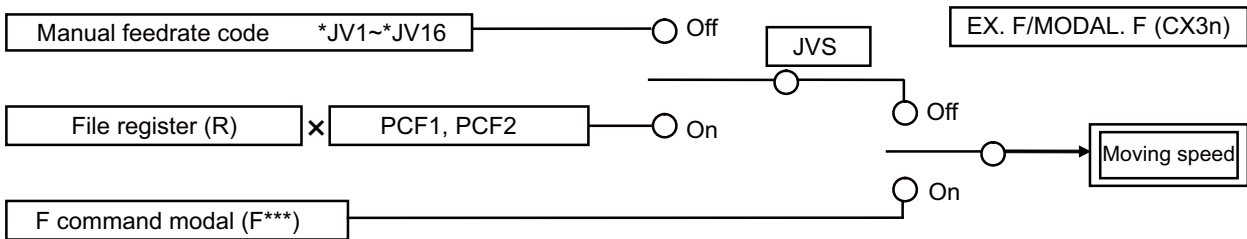

[Related signals]

For related signal, see the section "Manual arbitrary feed mode (PTP: YC03)."

Cont.	Signal name	Abbrev.	\$1	\$2	\$3	\$4	\$5	\$6	\$7	\$8
A	MANUAL ARBITRARY FEED G0/G1	CXS4	YCBB	YDFB	YF3B	Y107B	Y11BB	Y12FB	Y143B	Y157B

[Function]

This signal selects a manual feed speed or rapid traverse speed in manual arbitrary feed mode.

[Operation]

This signal operates as shown below depending on the status of the "Manual arbitrary feed G0/G1" (CXS4) signal.

- (1) When the "Manual arbitrary feed G0/G1" signal is OFF:

The rapid traverse speed originally set to the corresponding axis applies. Rapid traverse override is also valid. The rapid traverse speed applicable when moving two or more axis components at the same time varies with the status of the "Manual arbitrary feed axis independent (CXS2)" signal. See the descriptions on the "Manual arbitrary feed axis independent (CXS2)" signal.
- (2) When the "Manual arbitrary feed G0/G1" signal is ON:

The manual feed speed or the speed specified by the F command in automatic operation apply. For details, see the description on the Manual arbitrary feed EX.F/MODAL.F (CXS3).
 "Cutting override", "2nd cutting override" and "Override cancel" are valid as well.

[Related signals]

For related signal, see the section "Manual arbitrary feed mode (PTP: YC03)."

4 Explanation of Interface Signals

Cont.	Signal name	Abbrev.	\$1	\$2	\$3	\$4	\$5	\$6	\$7	\$8
A	MANUAL ARBITRARY FEED MC/WK	CXS5	YCBC	YDFC	YF3C	Y107C	Y11BC	Y12FC	Y143C	Y157C

[Function]

This signal selects a machine coordinate system or a modal workpiece coordinate system on which positioning is done in manual arbitrary feed mode.

[Operation]

The "Manual arbitrary feed MC/WK (CXS5)" signal becomes valid when the "Manual arbitrary feed ABS/INC (CXS6)" signal explained later is OFF in manual arbitrary feed mode.

- (1) When the "Manual arbitrary feed MC/WK" signal is OFF:

"Manual arbitrary feed n-th axis travel amount" set in a file register (R) is used for positioning on the machine coordinate system.

$$\boxed{\text{Amount of motion}} =$$

$$\boxed{\text{Manual arbitrary feed n-th travel amount}} - \boxed{\text{Coordinate value on machine coordinate system}}$$

- (2) When the "Manual arbitrary feed MC/WK" signal is ON:

"Manual arbitrary feed n-th axis travel amount" set in a file register (R) is used for positioning on the modal workpiece coordinate system.

$$\boxed{\text{Amount of motion}} =$$

$$\boxed{\text{Manual arbitrary feed n-th travel amount}} - \boxed{\text{Coordinate value on modal workpiece coordinate system}}$$

[Related signals]

For related signal, see the section "Manual arbitrary feed mode (PTP: YC03)."

Cont.	Signal name	Abbrev.	\$1	\$2	\$3	\$4	\$5	\$6	\$7	\$8
A	MANUAL ARBITRARY FEED ABS/INC	CXS6	YCBD	YDFD	YF3D	Y107D	Y11BD	Y12FD	Y143D	Y157D

[Function]

This signal is used to select whether the traveling data given for the manual arbitrary feed is to be handled as positioning point (absolute position) or as travel distance (incremental value).

[Operation]

- (1) When the "Manual arbitrary feed ABS/INC" (CXS6) signal is OFF:

"Manual arbitrary feed n-th axis travel amount" set in a file register (R) is handled as a positioning point (absolute position).

For the coordinate systems, see the descriptions on the "Manual arbitrary feed MC/WK (CXS5)" signal explained before.

- (2) When the "Manual arbitrary feed ABS/INC" signal is ON:

"Manual arbitrary feed n-th axis travel amount" set in a file register (R) is handled as a travel distance (incremental value).

[Related signals]

For related signal, see the section "Manual arbitrary feed mode (PTP: YC03)."

4 Explanation of Interface Signals

Cont.	Signal name	Abbrev.	\$1	\$2	\$3	\$4	\$5	\$6	\$7	\$8
B	MANUAL ARBITRARY FEED STOP	*CXS7	YCBE	YDFE	YF3E	Y107E	Y11BE	Y12FE	Y143E	Y157E

[Function]

This signal stops an ongoing axis component halfway in manual arbitrary feed mode.

The function of this signal is equivalent to those of the "Manual interlock+ n-th axis" (*+MITn) and "Manual interlock- n-th axis" (*-MITn) signals.

[Operation]

Turning the "Manual arbitrary feed stop" signal (*CXS7) OFF (0) causes the following:

- (1) Motion of axis in manual arbitrary feed mode is decelerated and stopped.
- (2) The axis component which is going to move in manual arbitrary feed mode remains stopped.

When the "Manual arbitrary feed stop" (*CXS7) signal is turned ON (1) while an axis component is in the stop state, it immediately restarts the operation.

(Note 1) When the power is turned ON, the "Manual arbitrary feed stop" (*CXS7) signal is automatically set to "1". If the "Manual arbitrary feed stop" signal is not to be used, there is no need to make a sequence program for it. [M8]

(Note 2) On C80, as "1" is not set when the power is turned ON, perform the sequence process as necessary.

[Related signals]

For related signal, see the "Manual arbitrary feed mode (PTP: YC03)."

Cont.	Signal name	Abbrev.	\$1	\$2	\$3	\$4	\$5	\$6	\$7	\$8
A	MANUAL ARBITRARY FEED STROBE	CXS8	YCBF	YDFE	YF3F	Y107F	Y11BF	Y12FF	Y143F	Y157F

[Function]

This signal is a trigger signal for moving an axis component in manual arbitrary feed mode. The axis component starts moving at the rising edge of this signal.

[Operation]

The "Manual arbitrary feed strobe" signal (CXS8) should be turned ON after all signal values necessary for manual arbitrary feed are set appropriately.

(1) The following signals must be appropriately set before turning ON this strobe signal:

- (a) Manual arbitrary feed mode (PTP)
- (b) Manual arbitrary feed n-th axis selection code (CXn1 to CXn16)
- (c) Manual arbitrary feed n-th axis valid (CXnS)
- (d) Manual arbitrary feed n-th axis travel amount (file registers R2544 to R2553)
- (e) Manual arbitrary feed smoothing OFF (CXS1)
- (f) Manual arbitrary feed axis independent (CXS2)
- (g) Manual arbitrary feed EX.F/MODAL.F (CXS3)
- (h) Manual arbitrary feed G0/G1 (CXS4)
- (i) Manual arbitrary feed MC/WK (CXS5)
- (j) Manual arbitrary feed ABS/INC (CXS6)

(2) The following signals can be changed even after this strobe signal is turned ON:

- (k) Manual feed speed code m
- (l) Rapid traverse override for a rapid traverse speed when the "Manual arbitrary feed G0/G1" signal (CXS4) is OFF.
- (m) Manual arbitrary feed stop (*CXS7)

4 Explanation of Interface Signals

(Note 1) This strobe signal can be accepted even when the "Manual arbitrary feed stop" signal (*CXS7) is OFF (0).

Example of operation timing chart

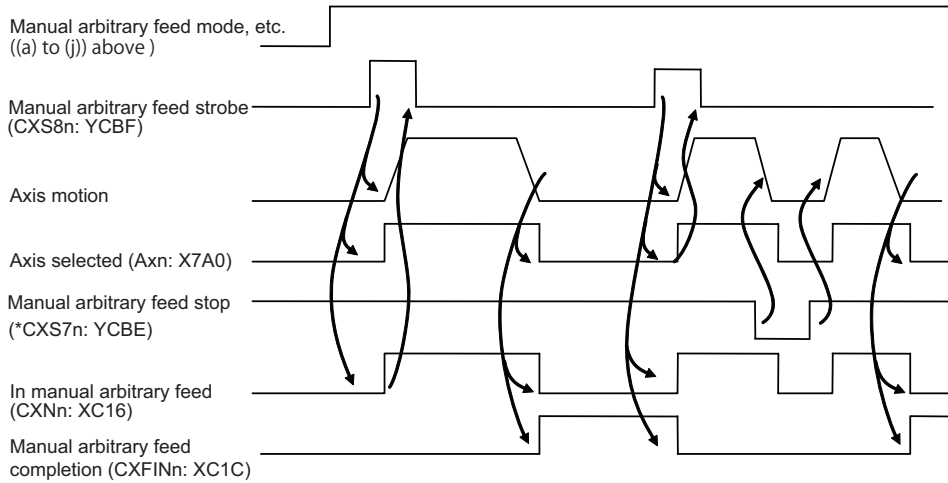

(Note 2) This strobe signal (CXS8) must be ON for at least 100 ms.

[Related signals]

Signals listed in (a) to (m) above

Cont.	Signal name	Abbrev.	\$1	\$2	\$3	\$4	\$5	\$6	\$7	\$8
A	CURRENT LIMIT MODE 1	ILM1	YCC0	YE00	YF40	Y1080	Y11C0	Y1300	Y1440	Y1580
A	CURRENT LIMIT MODE 2	ILM2	YCC1	YE01	YF41	Y1081	Y11C1	Y1301	Y1441	Y1581

[Function]

This signal selects process of current limit reached.

[Operation]

When the current reaches its limit during current control, the "current limit reached" signal will be output, and the following mode will be selected and performed.

Current limit mode 2	Current limit mode 1	Mode
0	0	Normal
0	1	Interlock
1	0	Normal
1	1	Normal

(1) Normal mode

Movement command is executed in the current state.

In automatic operation, the movement command is executed to the end and moves to the next block with droops accumulated.

(2) Interlock mode

Movement command is blocked (internal interlock).

In automatic operation, the operation stops at the corresponding block and does not move to the next block.

In manual operation, the subsequent commands to the same direction will be ignored.

[Related signals]

- (1) In current limit n-th axis (ILI1 to 8: X900 to X907)
- (2) Current limit reached n-th axis (ILA1 to 8: X920 to X927)
- (3) Current limit changeover n-th axis (ILC1 to 8: Y9A0 to Y9A7)
- (4) Droop cancel request n-th axis (DOR1 to 8: Y9C0 to Y9C7)
- (5) Current limit changeover (R2593)

4 Explanation of Interface Signals

Cont.	Signal name	Abbrev.	\$1	\$2	\$3	\$4	\$5	\$6	\$7	\$8
B	2ND REFERENCE POSITION RETURN INTERLOCK	*ZRIT	YCC8	YE08	YF48	Y1088	Y11C8	Y1308	Y1448	Y1588

[Function]

The axis is interlocked at a designated position during manual 2nd reference position return.

[Operation]

During 2nd reference point return while this signal is valid (base specification parameter "#1505 ckref2" is "1"), if this signal turns OFF, movement of axes that have reached the designated position will stop, and an interlock will be applied. Axes that have not reached the designated position will be interlocked after reaching the designated position. When this signal is ON, the axis movement will not stop, and the 2nd reference position return will continue.

Cont.	Signal name	Abbrev.	\$1	\$2	\$3	\$4	\$5	\$6	\$7	\$8
A	SMALL DIAMETER DEEP HOLE DRILLING CYCLE [M8]		YCCA	YE0A	YF4A	Y108A	Y11CA	Y130A	Y144A	Y158A

[Function]

The cutting operation of the small diameter deep hole drilling cycle is skipped.

[Operation]

The remaining cutting command is skipped and move on to the next operation by turning ON this signal during the cutting operation of the small diameter deep hole drilling cycle.

[Caution]

The cutting operation is skipped when this signal is turned ON.

[Related signals]

(1) In small diameter deep hole cycle (XCC1)

Cont.	Signal name	Abbrev.	\$1	\$2	\$3	\$4	\$5	\$6	\$7	\$8
A	TIMING SYNCHRONIZATION IGNORE		YCD0	YE10	YF50	Y1090	Y11D0	Y1310	Y1450	Y1590

[Function]

This signal designates the part system to ignore the timing synchronization command. The timing synchronization command in the machining program can be ignored. The operation is possible only in the single part system without deleting the timing synchronization command in the machining program.

[Operation]

1: The timing synchronization is not executed. The timing synchronization command issued during the machining program is ignored.

0: The timing synchronization is executed.

(Note) This signal is valid only when "#1279 ext15/bit0 (Timing synchronization between part systems method)" is set to "1" (Timing synchronization between part systems ignore method).

Cont.	Signal name	Abbrev.	\$1	\$2	\$3	\$4	\$5	\$6	\$7	\$8
A	SPINDLE-SPINDLE POLYGON CANCEL		YCD1	YE11	YF51	Y1091	Y11D1	Y1311	Y1451	Y1591

[Function]

Spindle-spindle polygon machining is canceled.

[Operation]

If this signal is input during spindle-spindle polygon, the spindle-spindle polygon machining mode will be canceled.

[Related signals]

(1) In spindle-spindle polygon mode (XCB2)

(2) Spindle-spindle polygon synchronization completion (XCB3)

4 Explanation of Interface Signals

Cont.	Signal name	Abbrev.	\$1	\$2	\$3	\$4	\$5	\$6	\$7	\$8
A	SYNCHRONOUS TAPPING COMMAND POLARITY REVERSAL		YCD2	YE12	YF52	Y1092	Y11D2	Y1312	Y1452	Y1592

[Function]

Designate whether to rotate the spindle in reverse during synchronous tapping.

[Operation]

When the "Synchronous tapping command polarity reversal" signal is ON, the spindle will rotate in reverse during synchronous tapping.

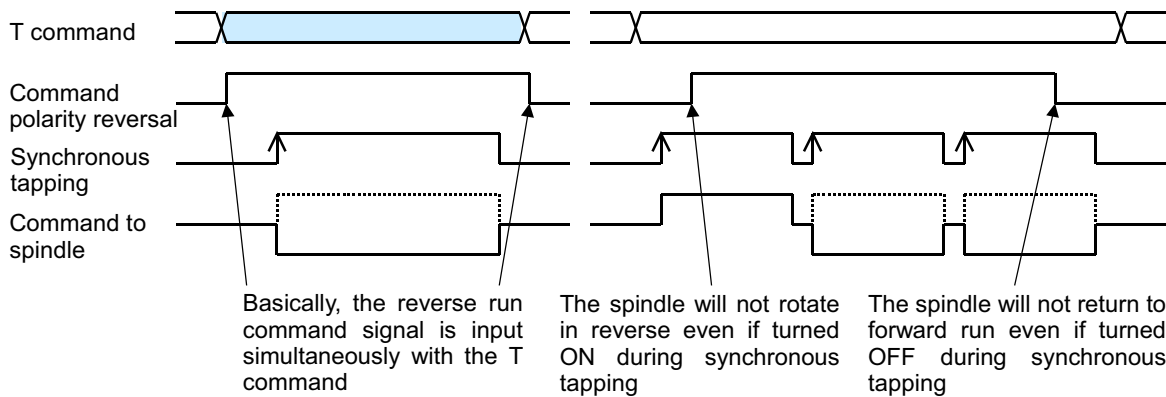

Cont.	Signal name	Abbrev.	\$1	\$2	\$3	\$4	\$5	\$6	\$7	\$8
A	SPINDLE OFF MODE		YCD3	YE13	YF53	Y1093	Y11D3	Y1313	Y1453	Y1593

[Function]

This function is used to check the program by moving the machine without rotating the spindle.

[Operation]

- (1) Synchronized tapping mode

When the spindle OFF mode is turned ON, the spindle will not rotate even if the servo is turned ON.

During the synchronized tapping mode, the operation up to when the synchronized tapping mode turns OFF will not change even if the spindle OFF mode is changed.

This signal should be ON from the start of operation.
- (2) Asynchronous tapping mode
 - (a) During synchronous (per revolution) feed

In addition to M03, M04 processing and dry run signal, turn the spindle OFF mode ON. The program will advance when the signal is turned ON.
 - (b) During asynchronous feed (per minute) feed

The program will advance even if the spindle OFF mode is not turned ON.
- (3) Thread cutting

If "#1279 ext15/bit4 (dry run OFF during thread cutting)" is "1", the dry run is disabled for thread cutting. However, when the spindle OFF mode signal is ON, dry run is enabled regardless of the parameter, so the status of dry run is determined by the dry run signal.

ext15/bit4	Dry run	Spindle OFF mode	Thread cutting motion
0	0	0/1	Command speed
0	1	0/1	Dry run speed
1	0	0/1	Command speed
1	1	0	Command speed
1	1	1	Dry run speed

[Related signals]

- (1) Dry run (DRN:YC15)

4 Explanation of Interface Signals

Cont.	Signal name	Abbrev.	\$1	\$2	\$3	\$4	\$5	\$6	\$7	\$8
A	Longitudinal hole drilling axis selection		YCD4	YE14	YF54	Y1094	Y11D4	Y1314	Y1454	Y1594

[Function]

This signal is used to specify the hole drilling axis for the longitudinal hole drilling fixed cycle (G87, G88, G88.1, G89).

[Operation]

When this signal is OFF (0), the X axis becomes the hole drilling axis.

When this signal is ON (1), the Y axis becomes the hole drilling axis.

When a hole edge chamfering cycle is executed while this signal is ON, the program error (P188) occurs. [M8]

Cont.	Signal name	Abbrev.	\$1	\$2	\$3	\$4	\$5	\$6	\$7	\$8
A	TAP RETRACT POSSIBLE STATE CANCEL	TRVEC	YCD6	YE16	YF56	Y1096	Y11D6	Y1316	Y1456	Y1596

[Function]

Turning ON this signal allows to move the axis, both automatically and manually, without tap retract.

This signal is used when the spindle rotation with tap retract may cause danger; when the tap is damaged, for example.

[Operation]

Turning this signal ON turns OFF the "Tap retract possible" (TRVE) signal.

[Related signals]

- (1) Tap retract (TRV: YC5C)
- (2) Tap retract possible (TRVE: XCA5)

Cont.	Signal name	Abbrev.	\$1	\$2	\$3	\$4	\$5	\$6	\$7	\$8
A	CHOPPING COMPENSATION UPDATE PREVENTION REQUEST	CHPRCR	YCD7	YE17	YF57	Y1097	Y11D7	Y1317	Y1457	Y1597

[Function] [Operation]

The chopping compensation amount is not updated while this signal (YCD7) is ON.

[Related signals]

- (1) Chopping compensation update prevented (CHPRCC)

Cont.	Signal name	Abbrev.	\$1	\$2	\$3	\$4	\$5	\$6	\$7	\$8
A	BARRIER VALID (LEFT)		YCD8	YE18	YF58	Y1098	Y11D8	Y1318	Y1458	Y1598
A	BARRIER VALID (RIGHT)		YCD9	YE19	YF59	Y1099	Y11D9	Y1319	Y1459	Y1599

[Function]

This signal is used to validate the left (right) barrier range for the chuck/tailstock barrier function.

[Operation]

The chuck/tailstock barrier function's barrier range is validated when this signal turns ON. If the tool nose attempts to enter the range, an error will occur.

Note that to validate the barrier function, this signal must be ON, and the parameter "#8310 Barrier ON" must be set to "1", and "#8315 BARRIER TYPE (L)" ("#8316 BARRIER TYPE (R)") must not be set to "0" on the BARRIER screen.

(Excluding when using a special display unit.)

The barrier range validity can also be changed with the G22/G23 command instead of this signal input. In this case, the left and right settings will change simultaneously. (There are some systems with which G22/G23 cannot be commanded because of the selected G code system.)

4 Explanation of Interface Signals

Cont.	Signal name	Abbrev.	\$1	\$2	\$3	\$4	\$5	\$6	\$7	\$8
A	HOB MACHINING: RETRACT REQUEST	HOBRTTR	YCDE	YE1E	YF5E	Y109E	Y11DE	Y131E	Y145E	Y159E

[Function]

This signal is used to implement retract during hob machining.

[Operation]

When signal is ON during hobbing, it starts retract (moving axis): and stops automatic operation.

Retracing speed and movement amount are set by the parameter below

Movement amount: "#8219 hob retract amount 1" and "#8220 hob retract amount 2"

Speed: "#8221 hob retract speed"

Retract operation will continue even if the signal is turned OFF during retract operation.

[Related signals]

- (1) Hob machining: retract amount selection (HOBRTV:YB20)
- (2) Hob machining: retracting (HOBRTM:XCAE)
- (3) Hob machining: retract complete (HOBRTF:XCAF)

Cont.	Signal name	Abbrev.	\$1	\$2	\$3	\$4	\$5	\$6	\$7	\$8
A	HOB MACHINING: ALARM RETRACT INHIBIT	HO- BARTC	YCDF	YE1F	YF5F	Y109F	Y11DF	Y131F	Y145F	Y159F

[Function]

This signal is used to inhibit retract operation caused by an alarm during hob machining.

[Operation]

While this signal is ON, retract operation is not carried out even if a program error or operation error occurs during hob machining.

Whether to perform retract at a program error or operation error while this signal is OFF is determined by the parameter "#19406 Hob retract ON at alarm".

Retract operation will not stop if this signal is turned ON during retracting.

4 Explanation of Interface Signals

Cont.	Signal name	Abbrev.	\$1	\$2	\$3	\$4	\$5	\$6	\$7	\$8
A	DOOR OPEN II	DOOR2	YCE1	YE21	YF61	Y10A1	Y11E1	Y1321	Y1461	Y15A1

[Function]

This signal stops all axes, and cuts OFF contactor power.

[Operation]

The NC carries out the following operations when the "Door open II" signal turns ON.

- (1) A deceleration stop is carried out for all axes (servo axes and spindles). (Axis interlock)
- (2) After all axes stop, the contactor power of each drive unit is cut OFF. The "Servo ready completion" signal (SA) does not turn OFF.
- (3) The "Door open enable" signal turns ON.

The NC carries out the following operations when the "Door open II" signal turns OFF.

- (1) A ready ON and servo ON state occurs for all axes.
- (2) The "Door open enable" signal turns OFF.

[Caution]

- (1) Handling of the PLC axis

Set so a "Door open" signal is output to the NC after the PLC axis is stopped by the PLC.

If a "Door open" signal is input without stopping the PLC axis, the axis will stop with a dynamic brake method due to the ready OFF state.

The remaining distance will be held in the R register being used in the PLC axis control.

- (2) Handling of the analog spindle

When an analog spindle is connected, it is not possible to confirm that the spindle has completely stopped with the NC. Thus, confirm that the spindle has completely stopped using the PLC, before opening the door.

Because the spindle may start rotating again immediately after the door is closed, for safety turn the forward run and reverse run signals OFF when the door is open.

- (3) Opening the door during ATC operation

When opening the door during ATC operation, apply an interlock with the user PLC.

[Related signals]

- (1) Door open enable (DROPNS: XCD8)

Cont.	Signal name	Abbrev.	\$1	\$2	\$3	\$4	\$5	\$6	\$7	\$8
A	DOOR OPEN SIGNAL INPUT (spindle speed monitor)		YCE2	YE22	YF62	Y10A2	Y11E2	Y1322	Y1462	Y15A2

[Function]

This signal informs the door open or close state to the spindle drive unit with the spindle speed monitor function.

[Operation]

"1" is entered in the door open state.

The compatibility check of this signal and the door close signal connected with the spindle drive unit is performed in the spindle drive unit.

If those signals are not compatible for continuous 3 seconds, the servo alarm (S01 5D) occurs.

[Related signals]

- (1) Door open enable (DROPNS: XCD8)

Cont.	Signal name	Abbrev.	\$1	\$2	\$3	\$4	\$5	\$6	\$7	\$8
A	DOOR INTERLOCK SPINDLE SPEED CLAMP		YCE3	YE23	YF63	Y10A3	Y11E3	Y1323	Y1463	Y15A3

[Function]

This signal is used to change the spindle's clamp speed.

[Operation]

When the "Door interlock spindle speed clamp" signal is turned ON, the spindle rotation speed will be limited by the set clamp speed value.

4 Explanation of Interface Signals

The relation of the "Door interlock spindle speed clamp" signal and the clamp speed parameter in each operation is shown below.

Spindle operation	Clamp speed parameter (spindle parameter)	
	Door interlock spindle speed clamp OFF	Door interlock spindle speed clamp ON
Orientation (multi-point orientation)	#3205 SP005	#3315 SP115
Turret indexing	#3312 SP112	#3211 SP011
Synchronized tapping (zero point return)	#3414 SP214	#3315 SP115
Spindle C axis (C axis zero point return)	#3349 SP149	#3315 SP115

[Caution]

- (1) This signal is valid only when the door interlock spindle clamp speed valid parameter "#1239 set11 BIT5" is set to "1".
- (2) The clamp speed parameter setting value validated when the "Door interlock spindle speed clamp" signal is ON must always be set smaller than the original clamp speed setting value (clamp speed valid when signal is OFF). The clamp speed will change when the signal turns ON regardless of the size of the parameter setting values.
- (3) Do not change the state of the "Door interlock spindle speed clamp" signal during multi-point indexing. The clamp speed will change if the signal state is changed during operation.
- (4) Even if the "Door interlock spindle speed clamp" signal is changed during orientation, during zero point return at synchronized tapping, or during reference position return after changing from the spindle mode to the C axis mode under the spindle/C-axis control function, the clamp speed will not change. The rotation speed is clamped by the clamp speed set with the signal state before each operation is executed.
- (5) The target for changing the clamp speed with the "Door interlock spindle speed clamp" signal differs according to the "#1154 pdoor" setting and system configuration. The combinations are shown below.

#1154 pdoor setting value	No. of part systems	Door interlock spindle speed clamp
0	1	YCE3
0	2	YCE3
1	1	YCE3
1	2	YCE3

Cont.	Signal name	Abbrev.	\$1	\$2	\$3	\$4	\$5	\$6	\$7	\$8
A	BARRIER CHECK INVALID	BCHK	YCF4	YE34	YF74	Y10B4	Y11F4	Y1334	Y1474	Y15B4

[Function]

This signal invalidates barriers of chuck barrier and tail stock barrier (G22).

[Operation]

When the signal is ON, it invalidates chuck barrier and tail stock barrier regardless of chuck barrier and tail stock barrier command (G22/G23) ON/OFF in machining program.

Cont.	Signal name	Abbrev.	\$1	\$2	\$3	\$4	\$5	\$6	\$7	\$8
A	SYNCHRONIZATION BETWEEN PART SYSTEMS OFF	MSYNC	YCF8	YE38	YF78	Y10B8	Y11F8	Y1338	Y1478	Y15B8

[Function]

This signal disables the functions for synchronization between part systems such as the "Single block between part systems" (MSBK) operation.

[Operation]

If the "Synchronization between part systems OFF" (MSYNC) signal is ON, the functions for synchronization between part systems such as the "Single block between part systems" (MSBK) operation are ignored.

4 Explanation of Interface Signals

Cont.	Signal name	Abbrev.	\$1	\$2	\$3	\$4	\$5	\$6	\$7	\$8
A	DRY RUN INVALID	DRNC	YCFA	YE3A	YF7A	Y10BA	Y11FA	Y133A	Y147A	Y15BA

[Function]

This signal invalidates dry run in dry run operation.

[Operation]

When the "dry run invalid (DRNC)" signal is ON, NC operates at designated speed, ignoring the dry run function (DRN).

[Related signals]

Dry run (DRN: YC15)

Cont.	Signal name	Abbrev.	\$1	\$2	\$3	\$4	\$5	\$6	\$7	\$8
A	AUTOMATIC ERROR DETECTION [M8]	AUTED	YCFB	YE3B	YF7B	Y10BB	Y11FB	Y133B	Y147B	Y15BB

[Function]

With the "Automatic error detection" (AUTED) signal, the timing for starting the next cutting block is controlled until the amount of position error becomes equal to or less than the parameter value (corner deceleration check width), in order to cut edges with high precision.

The timing for starting the next block is controlled when the result of corner angle calculation is smaller than the parameter value (corner deceleration check angle).

[Operation]

The following operation is performed when the "Automatic error detection" (AUTED) signal is ON.

<Corner angle calculation control>

The timing for starting the next cutting block is controlled only when the corner angle θ (interior angle) calculated for consecutive cutting blocks is equal to or smaller than the parameter value (corner deceleration check angle). The timing for starting the next cutting block is not controlled when the corner angle is larger than the parameter value. Angle calculation is performed for the plane axis selected with the plane selection command. Angle calculation is not performed for the rotational axes.

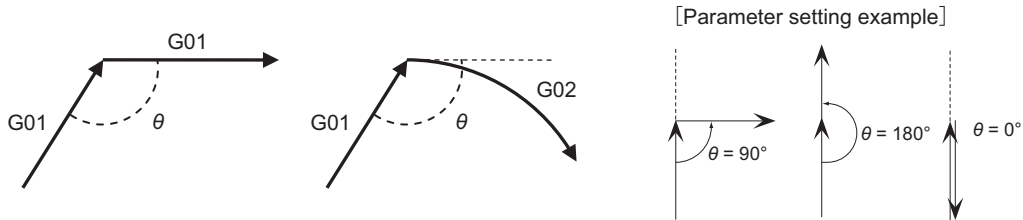

<Start timing control>

Checking the amount of error is started after deceleration starts in the currently executed block. The next cutting block starts when the amount of error (remaining distance after composition) between the machine position of the target axis and the feedback machine position becomes equal to or less than the parameter value (corner deceleration check width).

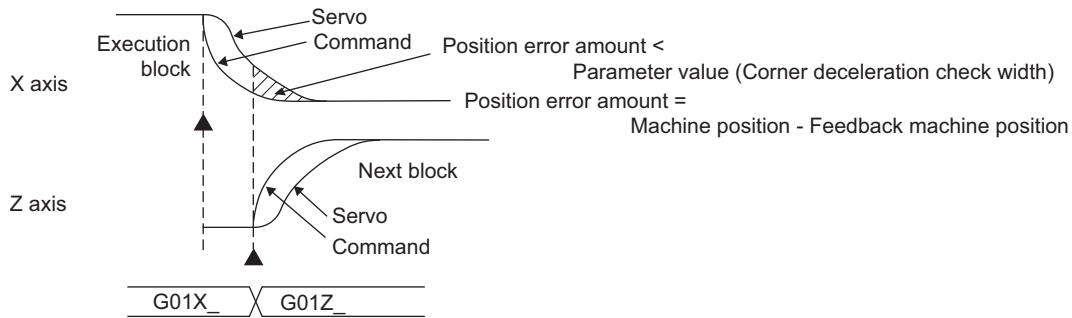

(Note) Turn OFF the normally used Error detection (ERD) signal before using the "Automatic error detection" (AUTED) signal. If the Error detection (ERD) signal is ON, the normal error detection is given priority.

[Related signals]

(1) Error detection (ERD:YC17)

4 Explanation of Interface Signals

Cont.	Signal name	Abbrev.	\$1	\$2	\$3	\$4	\$5	\$6	\$7	\$8
A	MANUAL ARBITRARY REVERSE RUN: MSTB REVERSE RUN PROHIBITED	MRPSG	YCFC	YE3C	YF7C	Y10BC	Y11FC	Y133C	Y147C	Y15BC

[Function]

Turning this signal ON can prohibit reverse run of an MSTB command, which is executed when manual arbitrary reverse run operation is in the forward run, in a part system.

[Operation]

By inputting the "MSTB reverse run prohibited" signal from the ladder, reverse run of any MSTB in a machining program can be prohibited.

If this signal turns ON when an MSTB is completed in the forward run, reverse run prohibition that can be set for each part system is set for the MSTB block.

[Caution]

(1) This signal is enabled only when an MSTB is completed (when the NC inputs FIN signal) in the forward run. This signal is disabled in the reverse run.

(2) If this signal is input when the Miscellaneous Function High-speed Output is enabled, the NC inputs FIN signal in a block that follows the MSTB command block. Therefore, reverse run prohibition is set for a block being executed when FIN signal is input.

G0 X100. ;

M10;

← If this M command is the Miscellaneous Function High-speed Output command, operation goes to the next block without waiting for FIN signal.

G1 Z200. ;

G0 X50. ;

← If FIN signal and the "MSTB reverse run prohibited" signal are input while this block is executed, reverse run is prohibited for this block.

:
:

[Related signals]

- (1) Manual arbitrary reverse run mode ON (PCHKO:X715)
- (2) Manual arbitrary reverse run: Reverse run ON (MOREV:X716)
- (3) Thread, tap block stopping in manual arbitrary reverse run (MBSTP:X74D)
- (4) Thread, tap reverse run prohibition alarm in manual arbitrary reverse run (MRVNG:X74E)
- (5) Manual arbitrary reverse run mode (MORR:Y73C)
- (6) Manual arbitrary reverse run speed selection (MORSP:Y73D)
- (7) Actual cutting mode (thread, tap) in manual arbitrary reverse run (MRCMD:Y761)
- (8) Manual arbitrary reverse run: Reverse run block stop designated part system (RBSSY:YD01)
- (9) Manual arbitrary reverse run speed multiplier (R379)

4 Explanation of Interface Signals

Cont.	Signal name	Abbrev.	\$1	\$2	\$3	\$4	\$5	\$6	\$7	\$8
A	Program format switch request [M8]	PFCHR	YD00	YE40	YF80	Y10C0	Y1200	Y1340	Y1480	Y15C0

[Function]

This signal starts or ends the program format switch.

[Operation]

When this signal turns ON, the control starts the program format switch. When this signal turns OFF, the program format switch is finished (canceled).

L-system operation example

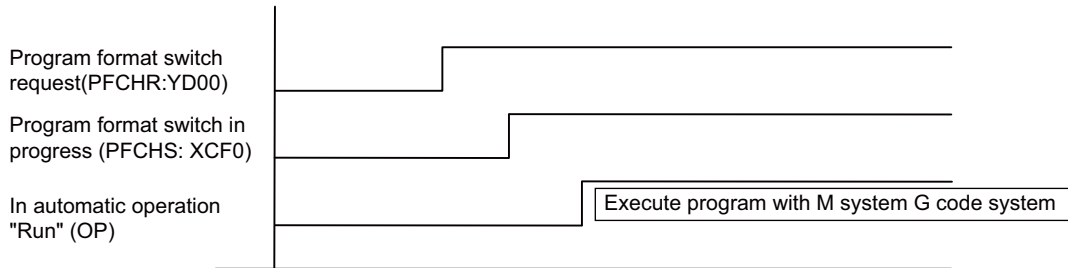

There are two types of means to switch the program format: G code method and PLC I/F method (this signal). The two methods interact with each other. Thus "Program format being switched" (PFCHS is ON) does not always mean the Program format switch in progress (PFCHS:XCF0) is ON. (The Program format switch in progress (PFCHS:XCF0) is dynamically changed by G188/G189 during automatic operation. After automatic operation is finished; however, the Program format switch in progress (PFCHS:XCF0) is updated based on this signal, regardless of whether the Program format switch in progress (PFCHS:XCF0) is ON or OFF at the completion of automatic operation.)

Interaction with G code method

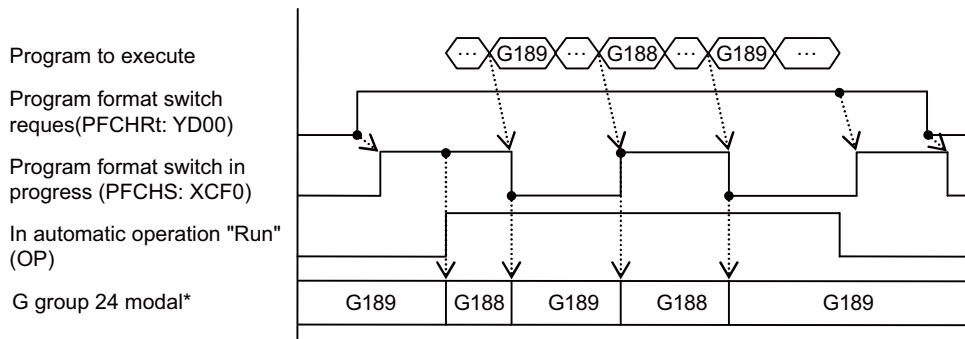

*The G group 24 modal state is refreshed only during automatic operation.

[Caution]

- (1) If you turn ON this signal during automatic cycle operation (while In automatic operation "Run" (OP: XC12) is ON), the operation error (M01 0215) occurs and the program format switch is not implemented. (The warning disappears when you turn OFF PFCHR again.)
- (2) If you turn ON this signal, and then start automatic operation while the format switch-disabled G modal state is active, the program error (P29) occurs and the automatic operation is not implemented.
- (3) After turning ON this signal, wait until the Program format switch in progress (PFCHS: XCF0) turns ON before you execute automatic cycle operation. Otherwise, it cannot be assured that "the control runs a program based on the switched G code system from the top block of the program".
- (4) Program format switch is available for the maximum number of M-system part systems specified by the system. If you turn ON this signal for a part system where the switch is disabled, the signal is ignored.
- (5) When the parameter "#1319 Grp24_mdrst_off" is "0" and the modal retention reset is performed, the state of the program format switch or the switch cancel is held even if the automatic operation is started with this signal OFF.

[Related signals]

- (1) Program format switch in progress [M8] (PFCHS: XCF0)

4 Explanation of Interface Signals

Cont.	Signal name	Abbrev.	\$1	\$2	\$3	\$4	\$5	\$6	\$7	\$8
A	MANUAL ARBITRARY REVERSE RUN: REVERSE RUN BLOCK STOP DESIGNATED PART SYSTEM	RBSSY	YD01	YE41	YF81	Y10C1	Y1201	Y1341	Y1481	Y15C1

[Function]

Turning this signal ON specifies the part system in which single-block stop occurs when reverse run is executed during the manual arbitrary reverse run.

[Operation]

- This signal is ON.
- The "Single block between part systems" is ON
- Modal information memory block

Block stop occurs for reverse run only when all of the above three conditions are met.

[Related signals]

- (1) Manual arbitrary reverse run mode ON (PCHKO:X715)
- (2) Manual arbitrary reverse run: Reverse run ON (MOREV:X716)
- (3) Thread, tap block stopping in manual arbitrary reverse run (MBSTP:X74D)
- (4) Thread, tap reverse run prohibition alarm in manual arbitrary reverse run (MRVNG:X74E)
- (5) Single block between part systems (MSBK:Y73A)
- (6) Manual arbitrary reverse run mode (MORR:Y73C)
- (7) Manual arbitrary reverse run speed selection (MORSP:Y73D)
- (8) Actual cutting mode (thread, tap) in manual arbitrary reverse run (MRCMD:Y761)
- (9) Manual arbitrary reverse run: MSTB reverse run prohibited (MRPSG:YCFC)
- (10) Manual arbitrary reverse run handle selection (R375)
- (11) Manual arbitrary reverse run speed multiplier (R379)

Cont.	Signal name	Abbrev.	\$1	\$2	\$3	\$4	\$5	\$6	\$7	\$8
A	REVERSE RUN FROM BLOCK START	RVSP	YD08	YE48	YF88	Y10C8	Y1208	Y1348	Y1488	Y15C8

[Function]

This signal is used to designate where a reverse run starts in the arbitrary reverse run.

[Operation]

When this signal is OFF, a reverse run starts from the block stop point.

When this signal is ON, a reverse run starts from the start point of the block where the movement stopped.

Return to the start point for the reverse run from block start, turn this signal ON, and then start an automatic operation.

Keep this signal ON until the "In auto operation "start"" signal (STL) turns ON.

This signal is available only in the reverse run control mode.

[Related signals]

- (1) Macro interrupt priority (RVIT: YD09)
- (2) Reverse run control mode (RVMD: YD0A)
- (3) Reverse run (VRV: YC27)

4 Explanation of Interface Signals

Cont.	Signal name	Abbrev.	\$1	\$2	\$3	\$4	\$5	\$6	\$7	\$8
A	MACRO INTERRUPT PRIORITY	RVIT	YD09	YE49	YF89	Y10C9	Y1209	Y1349	Y1489	Y15C9

[Function]

In the arbitrary reverse run, turning ON the "Macro interrupt" (UIT) signal executes a block stop during the reverse run. Then this signal is used to select the operation when an automatic operation is started while the "Reverse run" (VRV) signal is OFF.

[Operation]

When this signal is OFF, a forward run is executed with the falling edge of the "Automatic operation "start" command" signal.

When this signal is ON, a macro interrupt program is executed with the falling edge of the "Automatic operation "start" command" signal.

This signal is available only in the reverse run control mode.

[Related signals]

- (1) Reverse run from block start (RVSP: YD08)
- (2) Reverse run control mode (RVMD: YD0A)
- (3) Reverse run (VRV: YC27)

Cont.	Signal name	Abbrev.	\$1	\$2	\$3	\$4	\$5	\$6	\$7	\$8
A	REVERSE RUN CONTROL MODE	RVMD	YD0A	YE4A	YF8A	Y10CA	Y120A	Y134A	Y148A	Y15CA

[Function]

This signal is used to save the reverse run information used for the reverse run control in the arbitrary reverse run.

[Operation]

When this signal is ON, the reverse run information is saved.

Turn this signal ON at the start of the block where the reverse run control is executed. Turn it OFF when resetting.

Turn ON the "Recalculation request" signal (CRQ) when turning ON this signal.

Unless the recalculation is requested, the reverse run information does not include the block that has been created by pre-reading.

[Related signals]

- (1) Reverse run from block start (RVSP: YD08)
- (2) Macro interrupt priority (RVIT: YD09)
- (3) Reverse run (VRV: YC27)
- (4) Recalculation request (CRQ: YC2B)

Cont.	Signal name	Abbrev.	\$1	\$2	\$3	\$4	\$5	\$6	\$7	\$8
A	RAPID TRAVERSE TIME CONSTANT SWITCHOVER REQUEST	ACCG	YD0B	YE4B	YF8B	Y10CB	Y120B	Y134B	Y148B	Y15CB

[Function]

The rapid traverse time constant can be switched over.

1: Switch the rapid traverse time constant of all the axes of the part system to the axis specifications parameter "#2598 G0tL_2", and the rapid traverse time constant (primary delay) / second-step time constant for soft acceleration/ deceleration to the axis specifications parameter "#2599 G0t1_2".

0: Switch the rapid traverse time constant of all the axes of the part system back to the axis specifications parameter "#2004 G0tL", and the rapid traverse time constant (primary delay) / second-step time constant for soft acceleration/ deceleration back to the axis specifications parameter "#2005 G0tL".

[Operation]

When this signal turns ON(1), the NC will operate as follows:

- When any axis of the part system is moving, the time constant will be switched after all the axes of the part system decelerate to a stop.
- When any axis of the part system is at a standstill, the time constant will be switched immediately.

When this signal turns OFF(0), the NC will operate as follows:

- When any axis of the part system is moving, the time constant will be switched back after all the axes of the part system decelerate to a stop.
- When any axis of the part system is at a standstill, the time constant will be switched back immediately.

[Related signals]

- (1) Rapid traverse time constant : In switchover (G0AC: XD0B)

4 Explanation of Interface Signals

Cont.	Signal name	Abbrev.	\$1	\$2	\$3	\$4	\$5	\$6	\$7	\$8
A	Real-time tuning 2: Acceleration/deceleration time constant in automatic switchover [M8]	RT2CH- GA	YD0C	YE4C	YF8C	Y10CC	Y120C	Y134C	Y148C	Y15CC

[Function]

This signal automatically switches acceleration/deceleration time constant in the real-time tuning 2 function.

[Operation]

While this signal is ON, the control always switches the acceleration/deceleration time constant to the value based on the current estimated inertia ratio.

While this signal is OFF, the switching process is not performed for the acceleration/deceleration time constant.

[Related signals]

(1) Real-time tuning 2: Acceleration/deceleration time constant in switchover (RT2CHG:XD0C)

Cont.	Signal name	Abbrev.	\$1	\$2	\$3	\$4	\$5	\$6	\$7	\$8
A	Real-time tuning 2: Acceleration/deceleration time constant in manual switchover [M8]	RT2CH- GM	YD0D	YE4D	YF8D	Y10CD	Y120D	Y134D	Y148D	Y15CD

[Function]

This signal manually switches acceleration/deceleration time constant in the real-time tuning 2 function.

This signal is valid only during rising edge of the signal.

[Operation]

While this signal is ON, you can manually switches acceleration/deceleration time constant to the value based on the current estimated inertia ratio.

While this signal is OFF, the switching process is not performed for the acceleration/deceleration time constant.

[Related signals]

(1) Real-time tuning 2: Acceleration/deceleration time constant in switchover (RT2CHG:XD0C)

Cont.	Signal name	Abbrev.	\$1	\$2	\$3	\$4	\$5	\$6	\$7	\$8
A	Real-time tuning 2: Acceleration/deceleration time constant reset [M8]	RT2RST	YD0E	YE4E	YF8E	Y10CE	Y120E	Y134E	Y148E	Y15CE

[Function]

This signal maximizes the value of acceleration/deceleration time constant in the real-time tuning 2 function.

This signal is valid only during rising edge of the signal.

[Operation]

While this signal is ON, the control maximizes the value of acceleration/deceleration time constant.

While this signal is OFF, the maximizing process is not performed for acceleration/deceleration time constant.

[Related signals]

(1) Real-time tuning 2: Acceleration/deceleration time constant in switchover (RT2CHG:XD0C)

4 Explanation of Interface Signals

Cont.	Signal name	Abbrev.	\$1	\$2	\$3	\$4	\$5	\$6	\$7	\$8
A	Request for reflecting reserved tool wear compensation	TWIN	YD0F	YE4F	YF8F	Y10CF	Y120F	Y134F	Y148F	Y15CF

[Function]

Reserved tool wear compensation memory is reflected to tool wear compensation memory.

[Operation]

This signal is available when the reservation of tool wear compensation function is valid.

- (a) When the reserved tool wear compensation memory or the tool wear compensation memory is set, the "Reserved tool wear compensation not reflected" signal (TWNIN) is turned ON.
 - (b) When the "Request for reflecting reserved tool wear compensation" signal (TWIN) is turned ON, reflection of data from the reserved tool wear compensation memory to the tool wear compensation memory starts.
 - (c) When the reserved value has been reflected, "Reflection of reserved tool wear compensation is complete" signal (TWOUT) turns ON and the "Reserved tool wear compensation not reflected" signal (TWNIN) turns OFF.
- However, when any data is set to the reserved tool wear compensation memory or the tool wear compensation memory while reserved value is being reflected, the "Reserved tool wear compensation not reflected" signal (TWNIN) does not turn OFF because data reflection is not guaranteed. In that case, turn OFF the "Request for reflecting reserved tool wear compensation" signal once, then turn it ON again.
- (d) When the "Request for reflecting reserved tool wear compensation" signal (TWIN) is turned OFF, the "Reflection of reserved tool wear compensation is complete" signal (TWOUT) also turns OFF.

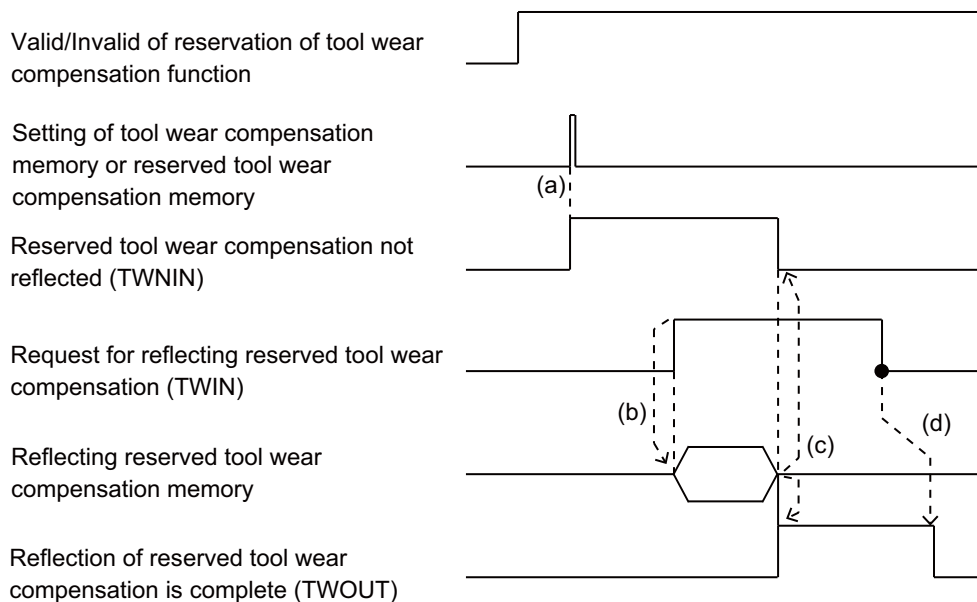

(Note) When the parameter "#1051 MemTol" is set to "1", operation of the reserved tool wear compensation becomes common to all the part systems.

[Related signals]

- (1) Reservation of tool wear compensation (TWR: Y1CB8)
- (2) Reflection of reserved tool wear compensation is complete (TWOUT: XD0F)
- (3) Reserved tool wear compensation not reflected (TWNIN: XD0E)

4 Explanation of Interface Signals

Cont.	Signal name	Abbrev.	\$1	\$2	\$3	\$4	\$5	\$6	\$7	\$8
A	3D coordinate conversion: Manual feed coordinates conversion [M8]		YD14	YE54	YF94	Y10D4	Y1214	Y1354	Y1494	Y15D4

[Function]

When the "3D coordinate conversion: Manual feed valid signal" signal (XD14) is "1", manual operation (jog feed, incremental feed, or manual handle feed) can be performed on the coordinate system generated by the 3D coordinate conversion command (G68 for M system or G68.1 for L system).

[Operation]

This signal is enabled while 3D coordinate conversion: Manual feed valid signal (XD14) is "1".

When this signal is "0", manual operation is performed with respect to the machine coordinate system.

When this signal is "1", manual operation is performed with respect to the G68/G68.1 program coordinate system.

[Related signals]

(1) 3D coordinate conversion: Manual feed valid [M8] (XD14)

Cont.	Signal name	Abbrev.	\$1	\$2	\$3	\$4	\$5	\$6	\$7	\$8
A	ROTATION CENTER ERROR COMPENSATION ENABLED [M8]	RCEE	YD15	YE55	YF95	Y10D5	Y1215	Y1355	Y1495	Y15D5

[Function]

The signal enables the rotation center error compensation.

[Operation]

While this signal is "1", rotation center error compensation is enabled.

(Note) Do not switch ON/OFF of this signal during machining.

If the signal is switched, the error compensation amount will immediately be reflected on the machine travel amount.

[Related signals]

(1) Rotation center error compensation in progress (RCEI: XD15)

Cont.	Signal name	Abbrev.	\$1	\$2	\$3	\$4	\$5	\$6	\$7	\$8
A	Spatial error compensation enabled [M8]	SECE	YD17	YE57	YF97	Y10D7	Y1217	Y1357	Y1497	Y15D7

[Function]

This signal enables the spatial error compensation.

Do not switch ON/OFF this signal during machining. If the signal is switched, the error compensation amount is immediately reflected on the machine travel amount.

[Operation]

When this signal is "0", the spatial error compensation is invalid.

When this signal is "1", the spatial error compensation is valid.

The spatial error compensation function can compensate errors only in the first part system.

[Related signals]

(1) Spatial error compensation in progress [M8] (SECI: XD17)

4 Explanation of Interface Signals

Cont.	Signal name	Abbrev.	\$1	\$2	\$3	\$4	\$5	\$6	\$7	\$8
A	3D manual feed (JOG, INC) in tool axis coordinate system	MJCT	YD18	YE58	YF98	Y10D8	Y1218	Y1358	Y1498	Y15D8
A	3D manual feed (JOG, INC) in table coordinate system	MJCB	YD19	YE59	YF99	Y10D9	Y1219	Y1359	Y1499	Y15D9
A	3D manual feed (JOG, INC) in feature coordinate system	MJCF	YD1A	YE5A	YF9A	Y10DA	Y121A	Y135A	Y149A	Y15DA

[Function]

This signal is used to select the hypothetical coordinate system in which the 3D manual feed is carried out. It is possible to set different coordinate systems for each mode or handle.

[Operation]

This signal is used to select the coordinate system in which the 3D manual feed is carried out by jog feed or incremental feed.

[Related signals]

- (1) Jog mode (J: YC00)
- (2) Incremental mode (S: YC02)
- (3) Tool center point rotation (TCPRC: YD27)

Cont.	Signal name	Abbrev.	\$1	\$2	\$3	\$4	\$5	\$6	\$7	\$8
A	3D manual feed (1st handle) in tool axis coordinate system	MH1CT	YD1B	YE5B	YF9B	Y10DB	Y121B	Y135B	Y149B	Y15DB
A	3D manual feed (1st handle) in table coordinate system	MH1CB	YD1C	YE5C	YF9C	Y10DC	Y121C	Y135C	Y149C	Y15DC
A	3D manual feed (1st handle) in feature coordinate system	MH1CF	YD1D	YE5D	YF9D	Y10DD	Y121D	Y135D	Y149D	Y15DD

[Function]

This signal is used to select the hypothetical coordinate system, in which the 3D manual feed is carried out. It is possible to set different coordinate systems for each mode or handle.

[Operation]

This signal is used to select the coordinate system in which the 3D manual feed is carried out on the 1st handle axis.

[Related signals]

- (1) 1st handle axis selection code (HS11 to HS116:YC40 to 4)
- (2) 1st handle valid (HS1S:YC47)
- (3) Tool center point rotation (TCPRC:YD27)

Cont.	Signal name	Abbrev.	\$1	\$2	\$3	\$4	\$5	\$6	\$7	\$8
A	3D manual feed (2nd handle) in tool axis coordinate system	MH2CT	YD1E	YE5E	YF9E	Y10DE	Y121E	Y135E	Y149E	Y15DE
A	3D manual feed (2nd handle) in table coordinate system	MH2CB	YD1F	YE5F	YF9F	Y10DF	Y121F	Y135F	Y149F	Y15DF
A	3D manual feed (2nd handle) in feature coordinate system	MH2CF	YD20	YE60	YFA0	Y10E0	Y1220	Y1360	Y14A0	Y15E0

[Function]

This signal is used to select the hypothetical coordinate system, in which the 3D manual feed is carried out. It is possible to set different coordinate systems for each mode or handle.

[Operation]

This signal is used to select the coordinate system in which the 3D manual feed is carried out on the 2nd handle axis.

[Related signals]

- (1) 2nd handle axis selection code (HS21 to HS216:YC48 to C)
- (2) 2nd handle valid (HS2S:YC4F)
- (3) Tool center point rotation (TCPRC:YD27)

4 Explanation of Interface Signals

Cont.	Signal name	Abbrev.	\$1	\$2	\$3	\$4	\$5	\$6	\$7	\$8
A	3D manual feed (3rd handle) in tool axis coordinate system	MH3CT	YD21	YE61	YFA1	Y10E1	Y1221	Y1361	Y14A1	Y15E1
A	3D manual feed (3rd handle) in table coordinate system	MH3CB	YD22	YE62	YFA2	Y10E2	Y1222	Y1362	Y14A2	Y15E2
A	3D manual feed (3rd handle) in feature coordinate system	MH3CF	YD23	YE63	YFA3	Y10E3	Y1223	Y1363	Y14A3	Y15E3

[Function]

This signal is used to select the hypothetical coordinate system, in which the 3D manual feed is carried out. It is possible to set different coordinate systems for each mode or handle.

[Operation]

This signal is used to select the coordinate system in which the 3D manual feed is carried out on the 3rd handle axis.

[Related signals]

- (1) 3rd handle axis selection code (HS31 to HS316:YC50 to 4)
- (2) 3rd handle valid (HS3S:YC57)
- (3) Tool center point rotation (TCPRC:YD27)

Cont.	Signal name	Abbrev.	\$1	\$2	\$3	\$4	\$5	\$6	\$7	\$8
A	Tool center point rotation	TCPRC	YD27	YE67	YFA7	Y10E7	Y1227	Y1367	Y14A7	Y15E7

[Function]

This signal informs the operation of the rotation axis of 3D manual feed (JOG/incremental/handle).

[Operation]

It operates with keeping the positional relationship of tool center point looking from the workpiece, when the rotation axis of 3D manual feed (JOG/incremental/handle) is operated.

#7912 NO_MANUAL	Input				output	
	Hypothetical coordinate system selection signal			Tool center point rotation signal	Selection coordinate system	Tool center point rotary valid/invalid
	YD18	YD19	YD1A	YD27		
Valid	All 0			0	Machine coordinate system selection	Invalid
				1		Valid
	Only any one of them is 1			0	In accordance with the hypothetical coordinate system selection signal	Invalid
				1		Valid
Other than above			0 / 1	The operation error (M01 0231)		
Invalid	0/1	0/1	0/1	0 / 1	Machine coordinate system selection	Invalid

[Related signals]

- (1) 3D manual feed (JOG, INC) in tool axis coordinate system (MJCT:YD18)
- (2) 3D manual feed (JOG, INC) in table coordinate system (MJCB:YD19)
- (3) 3D manual feed (JOG, INC) in feature coordinate system (MJCF:YD1A)
- (4) 3D manual feed (1st handle) in tool axis coordinate system (MH1CT:YD1B)
- (5) 3D manual feed (1st handle) in table coordinate system (MH1CB:YD1C)
- (6) 3D manual feed (1st handle) in feature coordinate system (MH1CF:YD1D)
- (7) 3D manual feed (2nd handle) in tool axis coordinate system (MH2CT:YD1E)
- (8) 3D manual feed (2nd handle) in table coordinate system (MH2CB:YD1F)
- (9) 3D manual feed (2nd handle) in feature coordinate system (MH2CF:YD20)
- (10) 3D manual feed (3rd handle) in tool axis coordinate system (MH3CT:YD21)
- (11) 3D manual feed (3rd handle) in table coordinate system (MH3CB:YD22)
- (12) 3D manual feed (3rd handle) in feature coordinate system (MH3CF:YD23)

4 Explanation of Interface Signals

Cont.	Signal name	Abbrev.	\$1	\$2	\$3	\$4	\$5	\$6	\$7	\$8
A	MISCELLANEOUS FUNCTION COMMAND HIGH-SPEED OUTPUT : M FUNCTION FINISH 1 to 4	MFIN 1 to 4	YD28 to B	YE68 to B	YFA8 to B	Y10E8 to B	Y1228 to B	Y1368 to B	Y14A8 to B	Y15E8 to B
A	MISCELLANEOUS FUNCTION COMMAND HIGH-SPEED OUTPUT: M FUNCTION FINISH 5 to 6 [C80]	MFIN 5 to 6	YCE6,7	YE26,7	YF66,7	Y10A6,7	Y11E6,7	Y1326,7	Y1466,7	

[Function]

This status signal informs the controller that specified miscellaneous (M) function is accomplished on the PLC side when the high-speed method is selected for the miscellaneous command completion method.

[Operation]

If the M function command is executed during automatic operation, the M function data will be output and the "M function strobe" signals (MF_n) will be logically inverted.

When the PLC verifies that one or more M function has been specified, it performs that function(s) and, after completion of the function(s), those signals are logically inverted.

When the controller verifies that the "M function strobe" and the "High-speed M function finish" have become the same logic level, the M function is considered to be completed and the controller will proceed to the next block.

An example of timing chart, where M function is specified, is as follows:

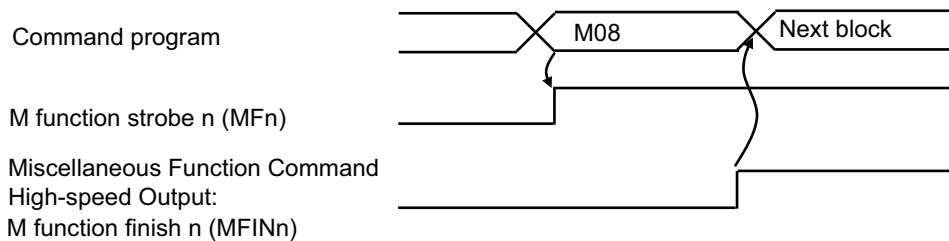

(Note 1) At NC reset, those signals must be set to "0" because the "M function strobe" signals (MF_n) are also set to "0" at NC reset.

(Note 2) This signal is not used when the normal method (parameter "#1278 ext14/bit1"= "0").

[Related signals]

- (1) M function strobe n (MF_n: XC60)
- (2) M, S, T, B function data (output to file register R: R504 and later)

4 Explanation of Interface Signals

Cont.	Signal name	Abbrev.	\$1	\$2	\$3	\$4	\$5	\$6	\$7	\$8
A	MISCELLANEOUS FUNCTION COMMAND HIGH-SPEED OUTPUT: S FUNCTION FINISH 1 to 8	SFIN1 to 8	YD2C to F, YD38 to B	YE6C to F, YE78 to B	YFAC to F, YFB8 to B	Y10EC to F, Y10F8 to B	Y122C to F, Y1238 to B	Y136C to F, Y1378 to B	Y14AC to F, Y14B8 to B	Y15EC to F, Y15F8 to B

[Function]

This status signal informs the controller that specified spindle (S) function is accomplished on the PLC side when the high-speed method is selected for the miscellaneous command completion method.

[Operation]

If the S function command is executed during automatic operation, the S function data will be output and the "S function strobe" signals (SF_n) will be logically inverted.

When the PLC verifies that one or more S function has been specified, it performs that function(s) and, after completion of the function(s), those signals are logically inverted.

When the controller verifies that the "S function strobe" and the "High-speed S function finish" have become the same logic level, the S function is considered to be completed and the controller will proceed to the next block.

An example of timing chart, where S function is specified, is as follows:

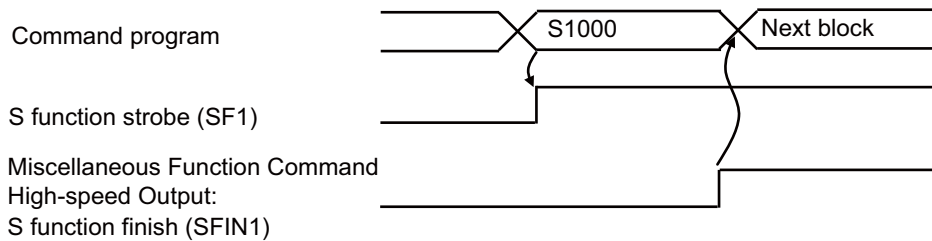

(Note 1) At NC reset, those signals must be set to "0" because the "S function strobe" signals (SF_n) are also set to "0" at NC reset.

(Note 2) This signal is not used when the normal method (parameter "#1278 ext14/bit1"= "0").

[Related signals]

- (1) S function strobe n (SF_n: XC64)
- (2) M, S, T, B function data (output to file register R: R504 and later)

4 Explanation of Interface Signals

Cont.	Signal name	Abbrev.	\$1	\$2	\$3	\$4	\$5	\$6	\$7	\$8
A	MISCELLANEOUS FUNCTION COMMAND HIGH-SPEED OUTPUT : T FUNCTION FINISH 1 to 4	TFIN1 to 4	YD30 to 3	YE70 to 3	YFB0 to 3	Y10F0 to 3	Y1230 to 3	Y1370 to 3	Y14B0 to 3	Y15F0 to 3

[Function]

This status signal informs the controller that specified tool (T) function is accomplished on the PLC side when the high-speed method is selected for the miscellaneous command completion method.

[Operation]

If the T function command is executed during automatic operation, the T function data will be output and the "T function strobe" signals (TF1 to 4) will be logically inverted.

When the PLC verifies that one or more T function has been specified, it performs that function(s) and, after completion of the function(s), those signals are logically inverted.

When the controller verifies that the "T function strobe" and the "High-speed T function finish" have become the same logic level, the T function is considered to be completed and the controller will proceed to the next block.

An example of timing chart, where T function is specified, is as follows:

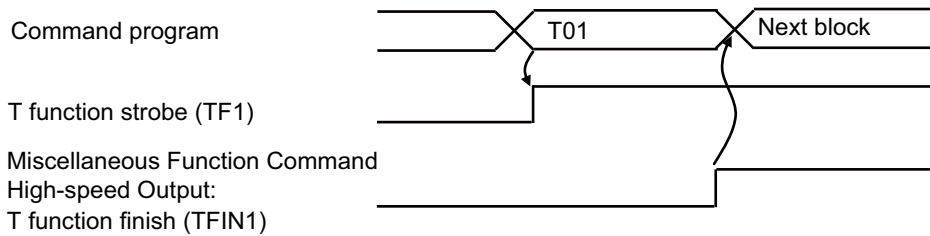

(Note 1) At NC reset, those signals must be set to "0" because the "T function strobe" signals (TF 1 to 4) are also set to "0" at NC reset.

(Note 2) This signal is not used when the normal method (parameter "#1278 ext14/bit1"= "0").

[Related signals]

- (1) T function strobe 1 to 4 (TF1 to 4: XC68)
- (2) M, S, T, B function data (output to file register R: R504 and later)

4 Explanation of Interface Signals

Cont.	Signal name	Abbrev.	\$1	\$2	\$3	\$4	\$5	\$6	\$7	\$8
A	MISCELLANEOUS FUNCTION COMMAND HIGH-SPEED OUTPUT : 2ND M FUNCTION FINISH 1 to 4	BFIN1 to 4	YD34 to 7	YE74 to 7	YFB4 to 7	Y10F4 to 7	Y1234 to 7	Y1374 to 7	Y14B4 to 7	Y15F4 to 7

[Function]

This status signal informs the controller that specified 2nd miscellaneous (B) function is accomplished on the PLC side when the high-speed method is selected for the miscellaneous command completion method.

[Operation]

If the B function command is executed during automatic operation, the B function data will be output and the "2nd M function strobe" signals (BF1 to 4) will be logically inverted.

When the PLC verifies that one or more B function has been specified, it performs that function(s) and, after completion of the function(s), those signals are logically inverted.

When the controller verifies that the "2nd M function strobe" and the "High-speed 2nd M function finish" have become the same logic level, the B function is considered to be completed and the controller will proceed to the next block.

An example of timing chart, where 2nd miscellaneous (B) function is specified, is as follows:

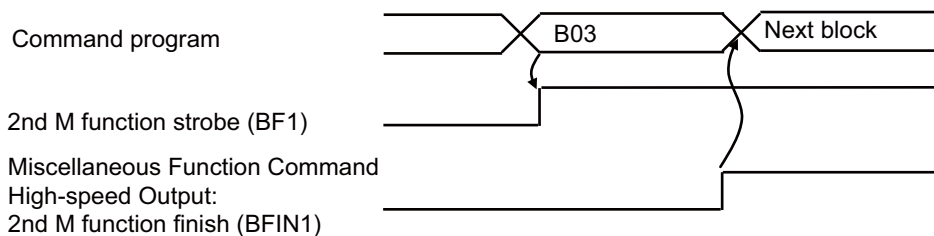

(Note 1) At NC reset, those signals must be set to "0" because the "2nd M function strobe" signals (BF 1 to 4) are also set to "0" at NC reset.

(Note 2) This signal is not used when the normal method (parameter "#1278 ext14/bit1"= "0").

[Related signals]

- (1) 2nd M function strobe 1 to 4 (BF1 to 4: XC6C)
- (2) M, S, T, B function data (output to file register R: R504 and later)

4 Explanation of Interface Signals

Cont.	Signal name	Abbrev.	Common(\$)
A	EDIT/SEARCH		Y1878

[Function]

This signal indicates that the edit/search state has been entered.

[Operation]

Turning this signal ON identifies the edit/search state, displaying the Edit/Search window on the Monitor screen when the basic specification parameter "#11031 Cursor pos search" is set to "2". Moving the cursor at a position in the Edit/Search window and turning this signal OFF will start an operation search of the cursor position.

Allow at least 500ms between turning the "Edit/Search" signal ON and OFF.

[Timing chart]

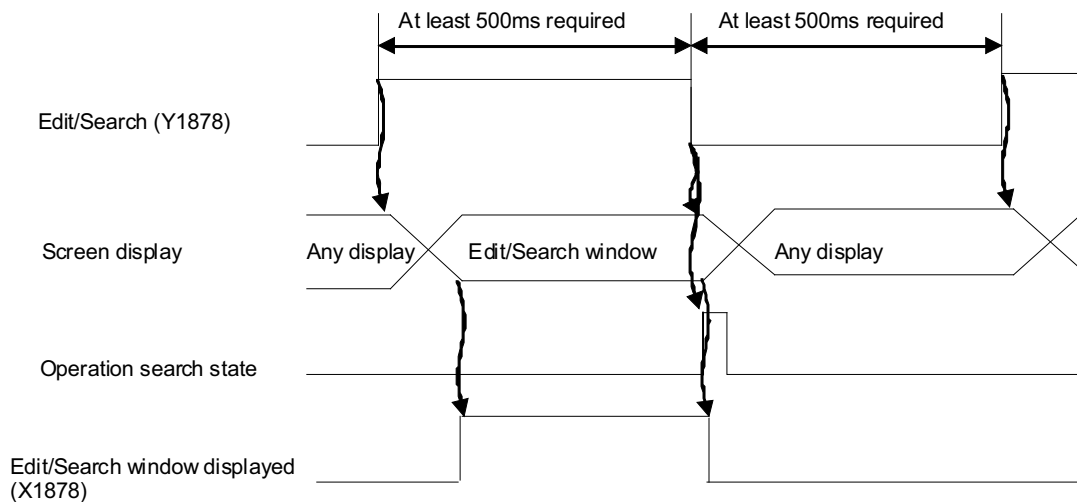

[Related signals]

- (1) Edit/Search window displayed (X1878)

4 Explanation of Interface Signals

Cont.	Signal name	Abbrev.	1stSP	2ndSP	3rdSP	4thSP	5thSP	6thSP	7thSP	8thSP
A	GEAR SHIFT COMPLETION	GFIN	Y1885	Y18E5	Y1945	Y19A5	Y1A05	Y1A65	Y1AC5	Y1B25

[Function]

This signal changes the spindle speed to the speed (S command) specified in the machining program.

This signal is used to smoothly perform the spindle speed (S command, etc.) control.

[Operation]

To change the spindle speed to the speed specified by the S command during automatic operation (memory, MDI, or tape), it is needed to turn ON the "Gear shift completion" (GFIN), or "M function finish 1 (FIN1, FIN2)" signal.

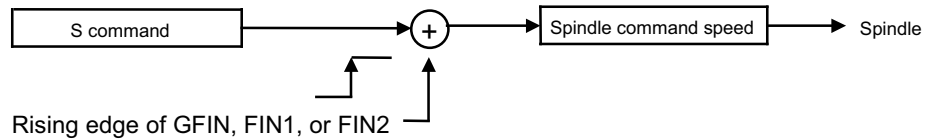

When using the "Gear shift completion" signal, the following two conditions should be considered:

- Whether gear shift (gear change) is applicable (whether there are two or more states of gear shift).
- Whether "Spindle up-to-speed" signal output from the spindle controller is used for verification of spindle speed.

(Operation example 1) There is no gear shift and the "Spindle up-to-speed" signal is not used.

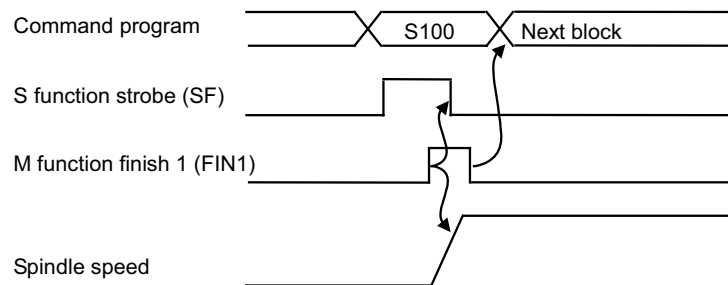

(Operation example 2) There is no gear shift, but the "Spindle up-to-speed" signal is used.

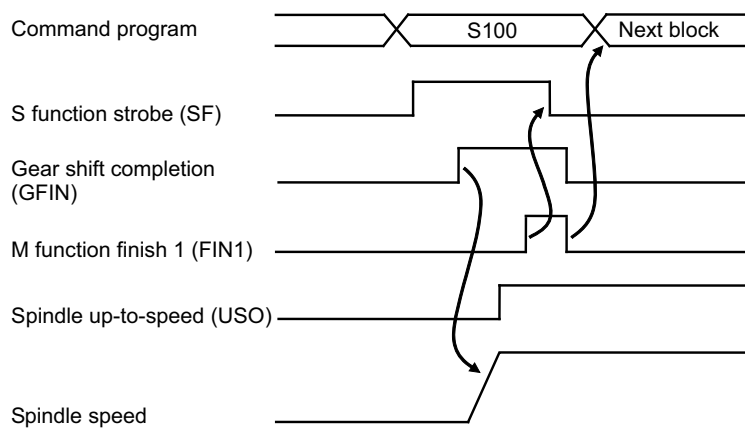

4 Explanation of Interface Signals

(Operation example 3) There is gear shift, but the "Spindle up-to-speed" signal is not used.

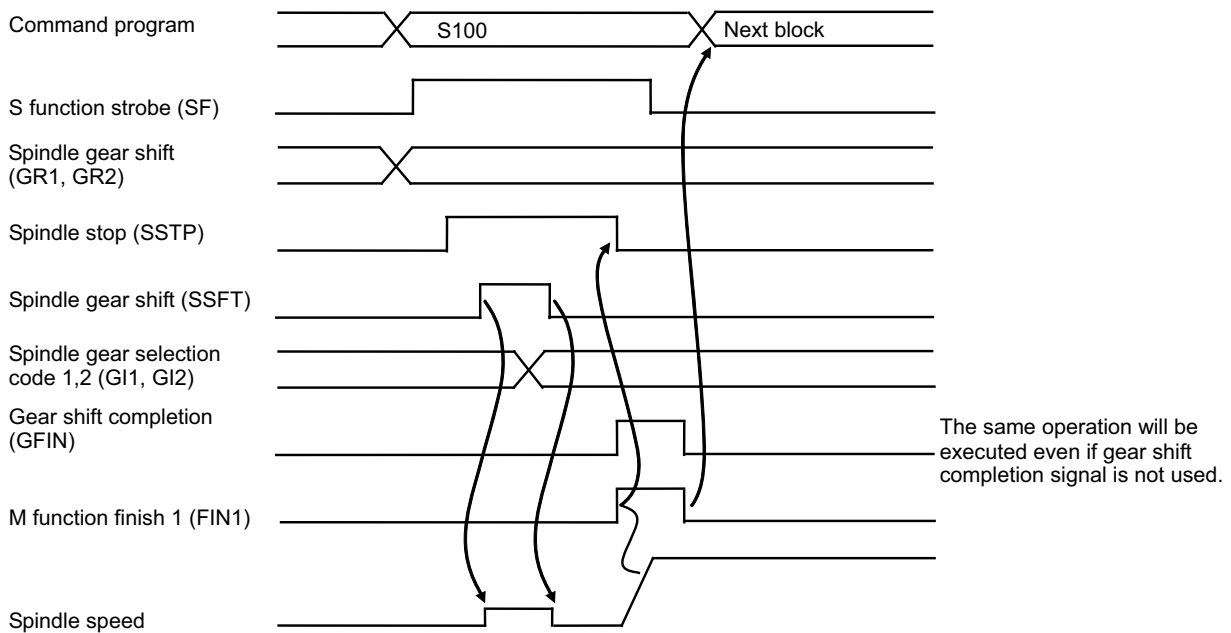

(Operation example 4) There is gear shift and "Spindle up-to-speed" signal are used.

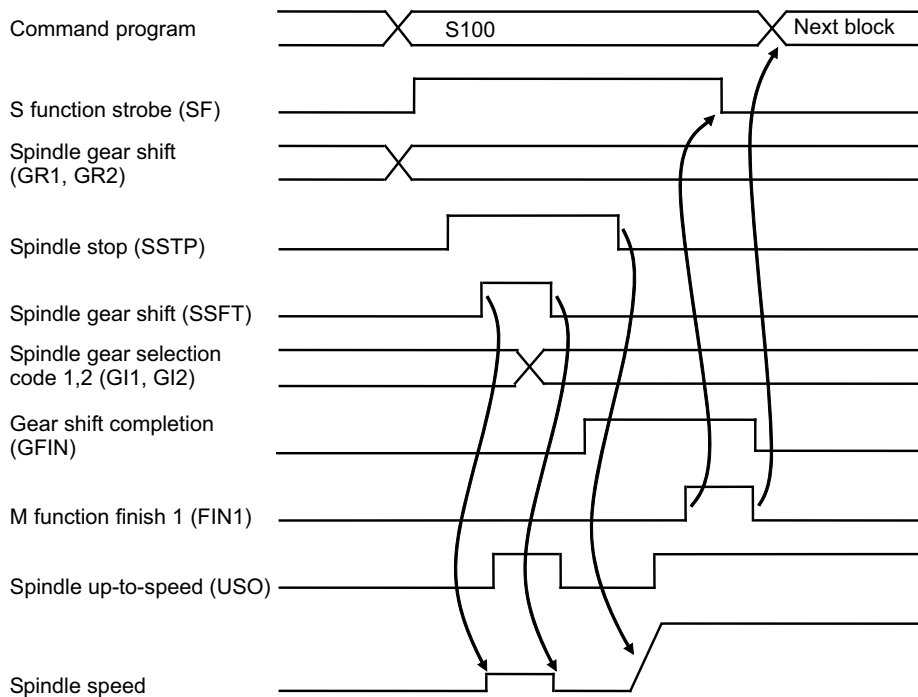

[Related signals]

- (1) S function strobe (SFn: XC64)
- (2) Spindle gear shift (GR1, GR2: X1885, X1886)
- (3) M function finish (FIN1, FIN2: YC1E, YC1F)
- (4) Spindle gear selection code 1,2 (GI1, GI2: Y1890, Y1891)
- (5) Spindle stop (SSTP: Y1894), Spindle gear shift (SSFT: Y1895)

4 Explanation of Interface Signals

Cont.	Signal name	Abbrev.	1stSP	2ndSP	3rdSP	4thSP	5thSP	6thSP	7thSP	8thSP
A	SPINDLE SPEED OVERRIDE CODE m	SP1 to 4	Y1888 to A	Y18E8 to A	Y1948 to A	Y19A8 to A	Y1A08 to A	Y1A68 to A	Y1AC8 to A	Y1B28 to A

[Function]

This signal applies override (multiplication) on the S command issued in the automatic operation (memory, MDI, tape).

[Operation]

When "Spindle override method selection" (SPS) signal is OFF, this signal is valid.

By selecting "Spindle speed override code m" (SP1 to 4) signal, override ratio can be selected within range from 50% to 120% (increment: 10%).

Override cannot be set when:

- (1) "Spindle stop" signal is ON.
- (2) TAP mode is selected.
- (3) Thread cutting mode is selected.

This signal (SP1 to 4) is set with the code method. The relation is shown below.

SP4	SP2	SP1	Spindle override
1	1	1	50%
0	1	1	60%
0	1	0	70%
1	1	0	80%
1	0	0	90%
0	0	0	100%
0	0	1	110%
1	0	1	120%

[Related signals]

- (1) Spindle override method selection (SPS: Y188F)

Cont.	Signal name	Abbrev.	1stSP	2ndSP	3rdSP	4thSP	5thSP	6thSP	7thSP	8thSP
A	SPINDLE OVERRIDE METHOD SELECTION	SPS	Y188F	Y18EF	Y194F	Y19AF	Y1A0F	Y1A6F	Y1ACF	Y1B2F

[Function]

When override is applied on the S command issued in automatic operation (memory, MDI or tape), "code method" or "file register method" is selected for override method.

[Operation]

When the "Spindle override method selection" (SPS) is OFF, code method override (signal SP1 to 4 is applicable) is selected.

When the "Spindle override method selection" (SPS) is ON, register method override (value set in file register is applicable) is selected.

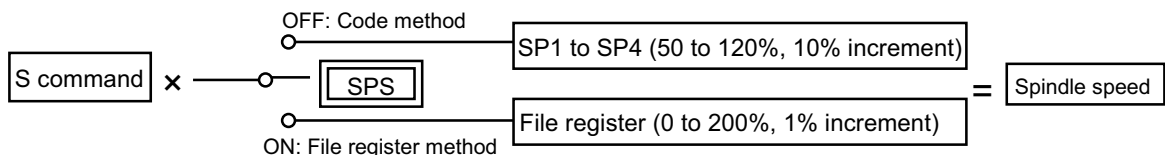

(Note 1) For details of "code method override" and "file register method override", refer to the respective description.

4 Explanation of Interface Signals

Cont.	Signal name	Abbrev.	1stSP	2ndSP	3rdSP	4thSP	5thSP	6thSP	7thSP	8thSP
A	SPINDLE GEAR SELECTION CODE 1,2	GI1,2	Y1890,1	Y18F0,1	Y1950,1	Y19B0,1	Y1A10,1	Y1A70,1	Y1AD0,1	Y1B30,1

[Function]

This signal informs the controller which spindle gear has been selected on the machine side.

[Operation]

This signal is set according to the machine's spindle gear stage. The controller calculates the S command data (data is transferred when the spindle controller is the high-speed serial connection specification) based on this signal.

The flow after the S command is executed and output to the spindle is shown below.

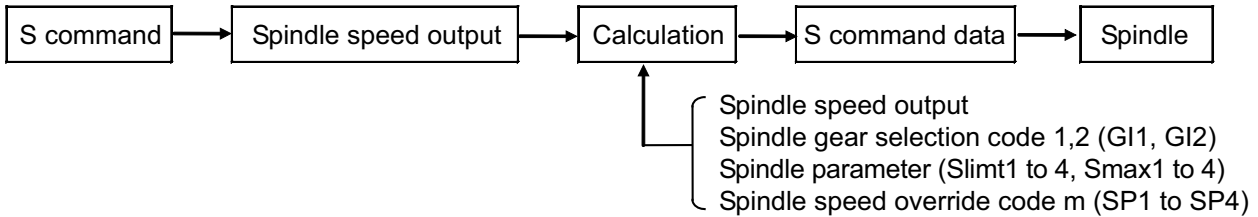

The relation of the gear stage, spindle gear selection code signal and spindle limit speed is as shown below.

Gear stage	Spindle gear selection code signal		Spindle speed limit
	GI2	GI1	
1	0	0	Slimt1
2	0	1	Slimt2
3	1	0	Slimt3
4	1	1	Slimt4

- (1) Slimt1 to 4 are set with parameters. The spindle speed for when the S command data is the max. (the motor is run at the max. speed) is set.

This setting is used for each gear unit, and is determined by the deceleration ratio (gear ratio) of the motor and spindle.

For example, if the max. motor speed is 6000 r/min, and the 1st gear stage is decelerated to half, "3000" will be set in parameter Slimt1.

- (2) The controller calculates the spindle speed output data as shown below.

For example, if S command is issued, gear selection input is the 2nd stage (GI1=ON, GI2=OFF), spindle override value (%) is SOVR, and S command data's max. value is "10":

$$S \text{ command data} = \frac{S \text{ command}}{S_{limt2}} \times \frac{SOVR}{100} \times 10$$

- (3) If S1300 is executed when using S command output (max. 10V), Slimt2 = "2000", and spindle override "100%":

$$S \text{ command output} = \frac{1300}{2000} \times \frac{100}{100} \times 10 \text{ (V)} = 6.5 \text{ (V)}$$

- (4) The S command is clamped with the Smaxn (n=1 to 4).

If Smax2="1000" in the above state, the S command output will be:

$$S \text{ command output} = \frac{1000}{2000} \times \frac{100}{100} \times 10 \text{ (V)} = 5.0 \text{ (V)}$$

4 Explanation of Interface Signals

Cont.	Signal name	Abbrev.	1stSP	2ndSP	3rdSP	4thSP	5thSP	6thSP	7thSP	8thSP
A	INCREASE HOLDING POWER OF SPINDLE	EXOBS	Y1893	Y18F3	Y1953	Y19B3	Y1A13	Y1A73	Y1AD3	Y1B33

[Function]

This signal is used to validate the disturbance observer of the spindle drive unit to increase the spindle torque up.

[Operation]

- (1) Confirm the spindle is stopped and turn this signal ON.
- (2) Turning ON this signal validates the disturbance observer.
- (3) When the spindle holding force gets high enough to execute the cutting, NC outputs the Holding power of spindle increased (EXOFN) signal.
- (4) To cancel the increase holding power of spindle, confirm the spindle is stopped and then turn this signal OFF.

[Related signals]

- (1) Holding power of spindle increased (EXOFN: X18B5)

Cont.	Signal name	Abbrev.	1stSP	2ndSP	3rdSP	4thSP	5thSP	6thSP	7thSP	8thSP
A	SPINDLE STOP	SSTP	Y1894	Y18F4	Y1954	Y19B4	Y1A14	Y1A74	Y1AD4	Y1B34

[Function]

In spindle control, S command data (spindle speed) can be set to "0" by using this signal (SSTP). Usually, the signal is not used alone, but combined with "Spindle gear shift" signal (SSFT) explained later.

[Operation]

When the signal (SSTP) is turned ON, S command data is set to "0". Analog data is restored when the signal is turned OFF.

When "Spindle gear shift" (SSFT) signal turns ON while the signal is ON, S command data which corresponds to speed set by the spindle speed parameter is output.

"Spindle speed override code m" (SP1 to 4) is ignored while the signal is ON.

4 Explanation of Interface Signals

Cont.	Signal name	Abbrev.	1stSP	2ndSP	3rdSP	4thSP	5thSP	6thSP	7thSP	8thSP
A	SPINDLE GEAR SHIFT	SSFT	Y1895	Y18F5	Y1955	Y19B5	Y1A15	Y1A75	Y1AD5	Y1B35

[Function]

This signal is used to run the spindle motor at low speed, when spindle gear is shifted, so that spindle gear can be engaged smoothly.

[Operation]

When the signal (SSFTn) turns ON, the S command data equivalent to the low speed previously set by parameter is output.

If gears are not engaged properly, the signal is turned ON. It should be noted that "Spindle stop" (SSTPn) signal should be ON beforehand to use the signal (SSFTn).

Together with this signal (SSFTn), the forward run signal or the reverse run signal needs to be turned ON.

Spindle gear shift speed is selected by "Spindle gear selection code m" (G1mn).The relation is as follows:

Gearstage	Spindle gearselection codesignal		Spindle speed atgear shift	Spindle speedlimit
	GI2n	GI1n		
1	0	0	Ssift1	Slimt1
2	0	1	Ssift2	Slimt2
3	1	0	Ssift3	Slimt3
4	1	1	Ssift4	Slimt4

S command data (spindle speed data) while "Spindle gear shift" (SSFTn) signal is ON can be determined from the formula shown below.

For example, if the "Spindle gear selection code m" (G1mn) is the 1st stage (GI1n=OFF, GI2n=OFF), the spindle rotation speed data is as follows:

$$\text{Spindle rotation speed (Motor rotation speed)} = \frac{\text{Ssift1}}{\text{Slimt1}} \times \text{Maximum motor rotation speed}$$

Actual value is as follows:

$$\text{Spindle command final data (SBINn)} = \text{Ssift1} / \text{Slimt1} * 4095$$

When the spindle command final data (SBINn) is "4095", the rotation speed of the motor becomes maximum.

4 Explanation of Interface Signals

Cont.	Signal name	Abbrev.	1stSP	2ndSP	3rdSP	4thSP	5thSP	6thSP	7thSP	8thSP
A	SPINDLE ORIENTATION	SORC	Y1896	Y18F6	Y1956	Y19B6	Y1A16	Y1A76	Y1AD6	Y1B36

[Function]

This signal is used to run the spindle motor at low speed when executing mechanical orientation (Note) during spindle control.

<Supplement>

Since most spindle drive/control units recently marketed are equipped with spindle orientation function, and therefore this signal is rarely used for mechanical orientation. The signal (SORCn) is used for application such as rotating the spindle by constant rotation speed.

(Note) The mechanical orientation assumes to operate the orientation by performing as follows.

- (1) Rotate the spindle at low speed.
- (2) It detects when the spindle has reached the area where such as proximity switch is used and then stops the spindle. The spindle stops after the speed is slowed to some extent.
- (3) The position (the orientation position) is decided by hitting the pin against the spindle under the status of (2).

[Operation]

When the signal (SORCn) turns ON, spindle speed is changed to the low speed previously set by parameter. It should be noted that "Spindle stop" (SSTPn) signal must be ON to use the signal (SORCn). Together with this signal (SORCn), the forward run signal or the reverse run signal is required.

The table below shows the relationship between the oriented spindle speed and the "Spindle gear selection code m" (G1mn) signal.

Gearstage	Spindle gearselection codesignal		Orientantion spindle speed	Spindle speedlimit
	G12n	G11n		
1	0	0	SORI	Slimt1
2	0	1		Slimt2
3	1	0		Slimt3
4	1	1		Slimt4

Spindle speed data while "Spindle orientation" (SORCn) signal is ON can be determined from the formula shown below. When "Spindle gear selection code m" (G1mn) signal combination is G12n=0 and G11n=1, the spindle rotation speed data is as follows:

$$\text{Orientation spindle speed data (Motor rotation speed)} = \frac{\text{SORI}}{\text{Slimt2}} \times \text{Maximum motor rotation speed}$$

Actual spindle rotation speed is as follows:

$$\text{Spindle command final data (SBINn)} = \text{SORI} / \text{Slimt2} * 4095$$

When the spindle command final data (SBINn) is "4095", the motor becomes the maximum rotation speed.

Cont.	Signal name	Abbrev.	1stSP	2ndSP	3rdSP	4thSP	5thSP	6thSP	7thSP	8thSP
A	SPINDLE FORWARD RUN START	SRN	Y1898	Y18F8	Y1958	Y19B8	Y1A18	Y1A78	Y1AD8	Y1B38

For high-speed serial connection specification spindle controller (spindle drive):

[Function]

When the signal turns ON, the spindle motor starts rotating in CCW direction as viewed from the shaft side.

[Operation]

Spindle starts running at speed specified by S command (S command data) when the signal is turned ON.

When the signal is turned OFF, spindle motion decelerates and stops.

When the signal is turned OFF during acceleration of spindle forward rotation, the acceleration will be interrupted and the spindle will decelerate to stop immediately.

When the signal is turned OFF during deceleration to stop of spindle forward rotation, the spindle deceleration will be interrupted and the acceleration will start immediately.

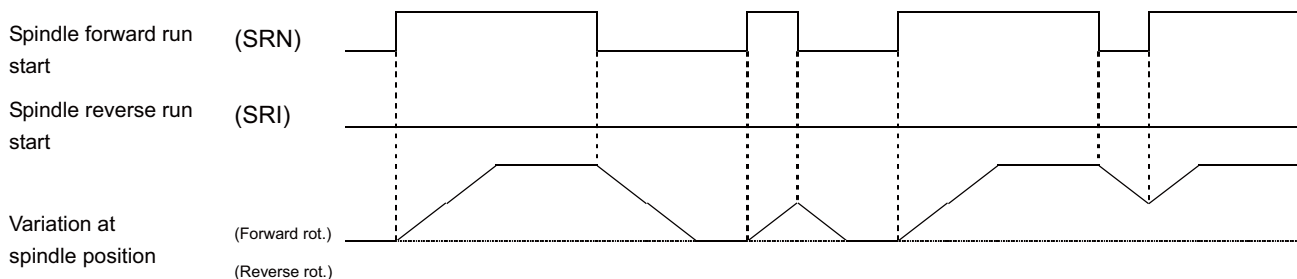

- (1) Spindle decelerates to stop if the signal and "Spindle reverse run start" signal (SRI) are turned ON at the same time. To resume forward run, turn OFF both signals once and then turn ON the signal.
- (2) The operation may stop during forward run due to emergency stop, spindle alarm or resetting. Turn the signal OFF and ON once after the "Servo ready completion" signal (SA) turns ON.
- (3) The motor will not run if the S command data is 0. The motor will run at the corresponding rotation speed when the S command data changes.
- (4) When "Spindle orientation command" signal (ORC) is turned ON at the same as "Spindle forward run start" signal (SRN) is turned ON, priority is given to the former signal.
- (5) Servo ON command (SRV) of the spindle control input signal is controlled on the NC side to turn ON when the spindle rotation starts, and to turn OFF when the spindle decelerates to stop.

[Related signals]

- (1) Spindle reverse run start (SRI: Y1899)
- (2) Spindle orientation command (ORC: Y189E)

For spindle control with pulse train output:

[Function]

This signal initiates the forward rotation of the spindle by outputting pulse trains for forward spindle rotation from RIO1 and RIO2.

[Operation]

When this signal is turned ON for the pulse train output spindle, the spindle starts rotating in the forward direction at the current S command speed, when the NC outputs the command without performing acceleration/deceleration.

Note that "spindle orientation command" signal (ORC: Y189E) becomes invalid.

[Related signals]

- (1) Spindle reverse run start (SRI: Y1899)
- (2) Spindle orientation command (ORC: Y189E)

4 Explanation of Interface Signals

Cont.	Signal name	Abbrev.	1stSP	2ndSP	3rdSP	4thSP	5thSP	6thSP	7thSP	8thSP
A	SPINDLE REVERSE RUN START	SRI	Y1899	Y18F9	Y1959	Y19B9	Y1A19	Y1A79	Y1AD9	Y1B39

For high-speed serial connection specification spindle controller (spindle drive):

[Function]

When the signal turns ON, the spindle motor starts rotating in CW direction as viewed from the shaft side.

[Operation]

Spindle starts running at speed specified by S command (S command data) when the signal is turned ON. (The operation with the signal is the same as one with "Spindle forward run start" (SRN) except for its rotation direction.)

When the signal is turned OFF, spindle motion decelerates and stops.

When the signal is turned OFF during acceleration of spindle reverse rotation, the acceleration will be interrupted and the spindle will decelerate to stop immediately.

When the signal is turned OFF during deceleration to stop of spindle reverse rotation, the spindle deceleration will be interrupted and the acceleration will start immediately.

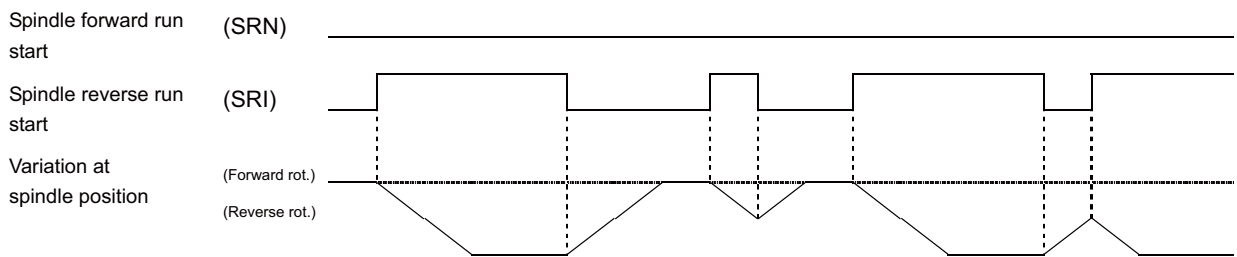

- (1) Spindle decelerates to stop if the signal and "Spindle forward run start" signal (SRN) turn ON at the same time. To resume reverse run, both signals OFF once and then turn the signal ON.
- (2) The operation may stop during reverse run due to emergency stop, spindle alarm or resetting. Turn the signal OFF and ON once after the "Servo ready completion" signal (SA) turns ON.

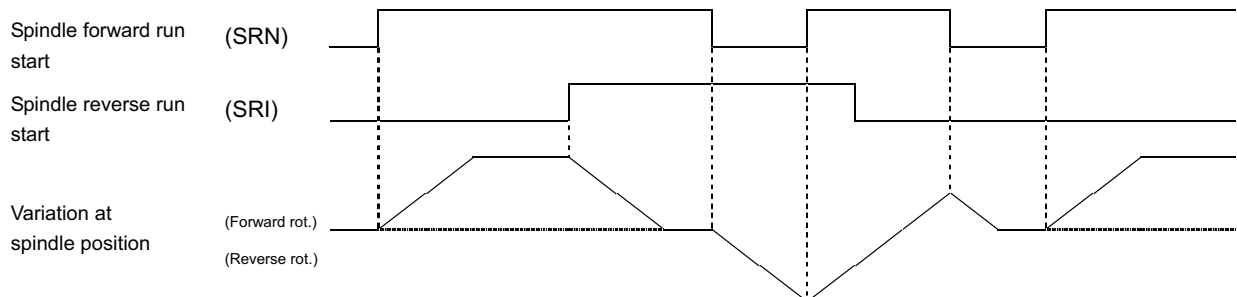

- (3) The motor will not run if the S command data is 0. The motor will run at the corresponding rotation speed when the S command data changes.
- (4) When "Spindle orientation command" signal (ORC) is turned ON at the same time "Spindle reverse run start" signal (SRI) is turned ON, priority is given to the former signal.
- (5) Servo ON command (SRV) of the spindle control input signal is controlled on the NC side to turn ON when the spindle rotation starts, and to turn OFF when the spindle decelerates to stop.

[Related signals]

- (1) Spindle forward run start (SRN: Y1898)
- (2) Spindle orientation command (ORC: Y189E)

4 Explanation of Interface Signals

For spindle control with pulse train output:

[Function]

This signal initiates the reverse rotation of the spindle by outputting pulse trains for reverse spindle rotation from RIO1 and RIO2.

[Operation]

When this signal is turned ON for the pulse train output spindle, the spindle starts rotating in the reverse direction at the current S command speed, when the NC outputs the command without performing acceleration/deceleration.

Note that "spindle orientation command" signal (ORC: Y189E) becomes invalid.

[Related signals]

- (1) Spindle forward run start (SRN: Y1898)
- (2) Spindle orientation command (ORC: Y189E)

Cont.	Signal name	Abbrev.	1stSP	2ndSP	3rdSP	4thSP	5thSP	6thSP	7thSP	8thSP
A	SPINDLE TORQUE LIMIT 1	TL1	Y189A	Y18FA	Y195A	Y19BA	Y1A1A	Y1A7A	Y1ADA	Y1B3A
A	SPINDLE TORQUE LIMIT 2	TL2	Y189B	Y18FB	Y195B	Y19BB	Y1A1B	Y1A7B	Y1ADB	Y1B3B

[Function]

This signal is issued to the high-speed serial connection specification spindle controller (spindle drive). When the signal turns ON, spindle motor torque is reduced temporarily.

The signal is used in mechanical oriented spindle stop, or gear shift.

[Operation]

There are spindle torque limit 1 (TL1) and spindle torque limit 2 (TL2) signals.

Torque limit ratio is determined depending on the combination of spindle torque limit 1 (TL1) and 2 (TL2), and the output torque will drop accordingly.

Signal Selection	Spindle torque limit (TL1)	Spindle torque limit (TL2)	Note
Torque limit invalid	0	0	
Torque limit 001	1	0	Limits with value of the spindle parameter SP065
002	0	1	Limits with value of the spindle parameter SP066
003	1	1	Limits with value of the spindle parameter SP067

(Example) When TL1=1, TL2=1 and SP067=50

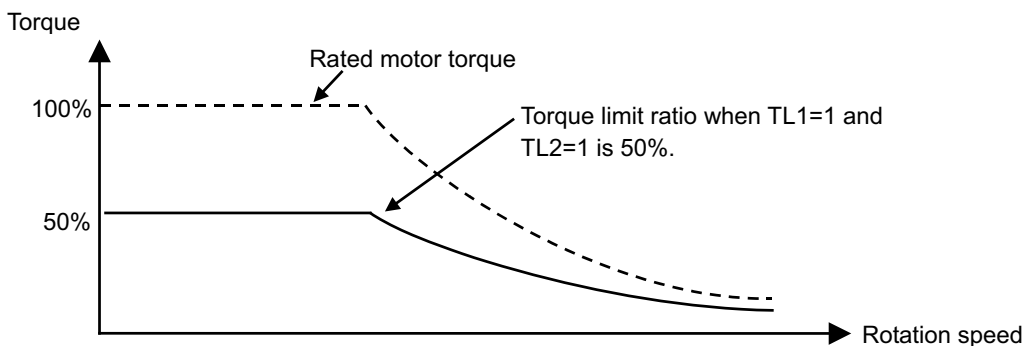

(Note 1) This signal is valid only for systems that are connected with the spindle controller via high-speed serial interface.

Cont.	Signal name	Abbrev.	1stSP	2ndSP	3rdSP	4thSP	5thSP	6thSP	7thSP	8thSP
A	SPINDLE FORWARD RUN INDEX	WRN	Y189C	Y18FC	Y195C	Y19BC	Y1A1C	Y1A7C	Y1ADC	Y1B3C

[Function]

This signal is used for the spindle forward run index in multi-point indexing.

[Operation]

- (1) Multi-point indexing
 - (a) This signal turns ON after the "Spindle in-position (ORAO)" signal is output.
 - (b) Continuous indexing can be carried out by turning this signal ON and OFF while the "Spindle orientation command" (ORC) signal is ON.
 - (c) If this signal is turned ON before the "Spindle orientation command" (ORC) signal is turned ON and the "Spindle in-position" (ORAO) signal is output, first the "Spindle orientation command" (ORC) signal will turn ON, and the orientation will be completed at the multi-point orientation position data (R7009) read in. Then, the spindle will be indexed to the position command value read in when this signal is turned ON. If the position command value is the same when the "Spindle orientation command" (ORC) turns ON and this signal turns ON, the indexing operation will not be carried out.
 - (d) The index position command value is read in at the rising edge of this signal. Thus, even if the index position command value is changed after this signal is input, the stop position will not change.
 - (e) Even if this signal is turned OFF while the "Spindle orientation command" (ORC) is ON, the spindle will continue to stop at the position before this signal was turned OFF. Even if this signal is turned OFF during the indexing operation, the spindle will stop at the position command value read at the rising edge of this signal.
 - (f) If the stop point and index position command value are close (within the in-position range), the "Spindle in-position" (ORAO) signal may not turn OFF and the indexing may be carried out.
 - (g) If the "Spindle orientation command" (ORC) signal is turned OFF during indexing or when stopped, the servo lock will turn OFF and the motor will coast. Orientation must be carried out again when executing indexing again.

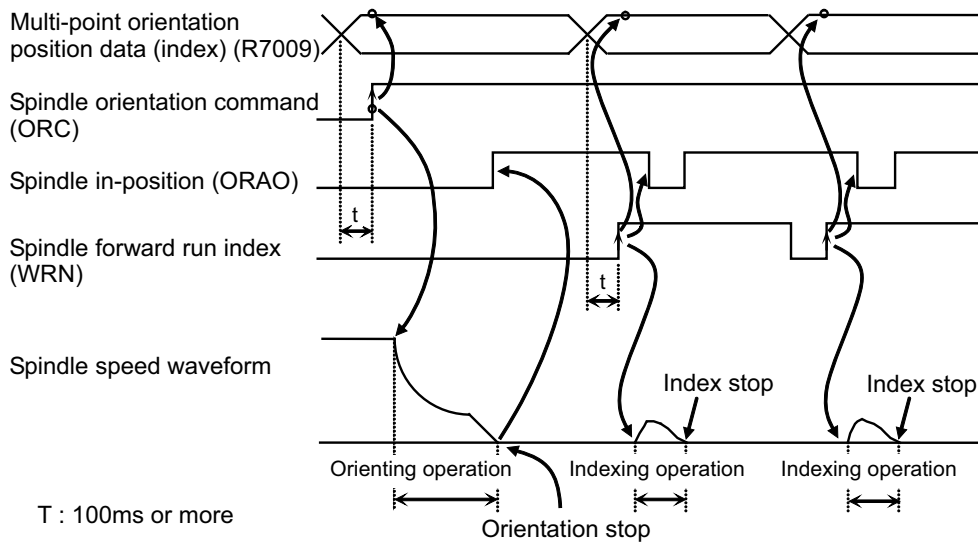

[Indexing operation according to encoder installation direction]

	Case 1	Case 2
Installation method		
Indexing		
Orienting		

(Note) Case 1 above applies when using the motor built-in encoder with Z-phase.

[Related signals]

- (1) Multi-point orientation position data (R7009)
- (2) Spindle in-position (ORAO: X188E)
- (3) Spindle orientation command (ORC: Y189E)

Cont.	Signal name	Abbrev.	1stSP	2ndSP	3rdSP	4thSP	5thSP	6thSP	7thSP	8thSP
A	SPINDLE REVERSE RUN INDEX	WRI	Y189D	Y18FD	Y195D	Y19BD	Y1A1D	Y1A7D	Y1ADD	Y1B3D

[Function]

This signal is used for the spindle reverse run index in multi-point indexing.

[Operation]

The operation is the same as forward run indexing, except that the direction is different. Refer to the section on "Spindle forward run index".

[Related signals]

- (1) Spindle forward run index (WRN: Y189C)

4 Explanation of Interface Signals

Cont.	Signal name	Abbrev.	1stSP	2ndSP	3rdSP	4thSP	5thSP	6thSP	7thSP	8thSP
A	SPINDLE ORIENTATION COMMAND	ORC	Y189E	Y18FE	Y195E	Y19BE	Y1A1E	Y1A7E	Y1ADE	Y1B3E

[Function]

When the signal is turned ON, the spindle is indexed in position.

[Operation]

If the "Spindle orientation command" signal (ORC) turns ON during spindle rotation or when stopped, the spindle will start orientation (stopping at set position). When positioning at the set position is completed, the "Spindle in-position" signal (ORAO) will be output, and orientation will stop.

While oriented spindle is at a standstill, the spindle is in "servo lock" state. Servo lock is released when the signal (ORC) is turned OFF. When servo lock must be maintained, the signal, therefore, should be kept turned ON.

The encoder or proximity switch method can be used for orientation.

The orientation rotation direction is determined with the parameters.

The orientation stop position is determined by the Z-phase for the encoder method, and by the sensor installation position for the proximity switch method. The stopping position can be changed with the following items when using the encoder method.

- (1) By parameters (position shift amount)
- (2) By multi-point orientation position data (data specification by R7009) value
The multi-point orientation position data by the parameter and R7009 is added.

The timing chart for basic orientation is shown below.

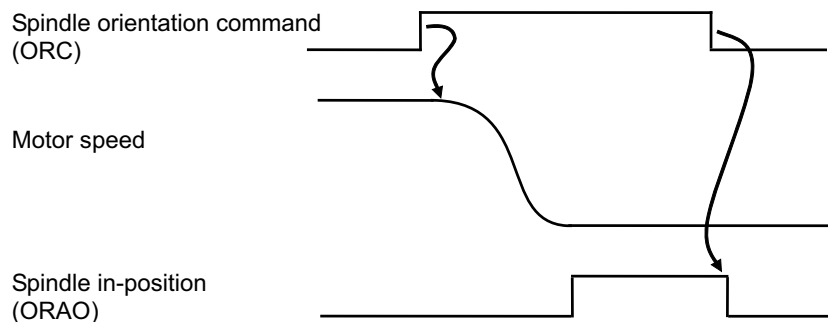

(Note 1) The "Spindle orientation command" (ORC) takes precedence over the forward run (SRN) and reverse run (SRI) commands.

(Note 2) This signal is valid only for systems that are high-speed serial connected with the spindle controller.

[Related signals]

- (1) Multi-point orientation position data (R7009)
- (2) Spindle in-position (ORAO: X188E)
- (3) Spindle 2nd in-position (ORAO2: X1888)

4 Explanation of Interface Signals

Cont.	Signal name	Abbrev.	1stSP	2ndSP	3rdSP	4thSP	5thSP	6thSP	7thSP	8thSP
A	L COIL SELECTION	LRSL	Y189F	Y18FF	Y195F	Y19BF	Y1A1F	Y1A7F	Y1ADF	Y1B3F

[Function]

This signal is used to select the low-speed coil in the spindle coil changeover function.

[Operation]

The high-speed coil and low-speed coil are changed over only with the "L coil selection" (LRSL) in the 2-step coil changeover specification. The high-speed coil, middle-speed coil and low-speed coil are changed over with the combination of the "L coil selection" (LRSL) and "M coil selection" (LRSM) in the 3-step coil changeover specification.

(Note) The coil is not changed over during the position loop control mode even if this signal is changed.

The coil selected immediately before the position loop control mode is entered is retained.

(1) 2-step coil changeover

Selected coil	L coil selection (LRSL)	In L coil selection (LCSA)
High-speed (H)	OFF	OFF
Low-speed (L)	ON	ON

(2) 3-step coil changeover

Selected coil	L coil selection (LRSL)	M coil selection (LRSM)	In L coil selection (LCSA)	In M coil selection (MCSA)
High-speed (H)	OFF	OFF	OFF	OFF
Middle-speed (M)	OFF	ON	OFF	ON
Low-speed (L)	ON	OFF	ON	OFF
	ON	ON	ON	ON

[Related signals]

- (1) M coil selection (LRSM: Y18A6)
- (2) In L coil selection (LCSA: X188F)
- (3) In M coil selection (MCSA: X189E)

Cont.	Signal name	Abbrev.	1stSP	2ndSP	3rdSP	4thSP	5thSP	6thSP	7thSP	8thSP
A	SPINDLE POSITION CONTROL (SPINDLE/C AXIS CONTROL): C AXIS SELECTION	CMOD	Y18A5	Y1905	Y1965	Y19C5	Y1A25	Y1A85	Y1AE5	Y1B45

[Function]

When the program command method ("#3129 cax_spec" /bit0 = "1") is selected for the spindle in position control, this signal can be used to switch between the C axis mode and spindle mode during manual operation.

[Operation]

The C axis mode is entered when this C axis selection signal turns ON, and the spindle mode is entered when this signal turns OFF.

(Note 1) This signal is valid only when the program command method is selected for spindle position control.

(Note 2) The "Spindle position control (Spindle/C axis control): C axis mode ON" signal (SVMD), which gives the mode information during spindle position control in the program command method, does not notified when switching is performed by selecting the C axis.

When the mode is switched from the spindle mode to the C axis mode by this signal (Y18A5), or when the power is turned ON while "Mode selection at power ON" is "C axis mode" (#3129 cax_spec/bit2 = 1), the operation differs depending on the combination of the parameters. [M8]

#1711 cfg11 bit3	#3106 zrn_typ bit8	Operation
0	-	Zero point return type
1	0	
		1

4 Explanation of Interface Signals

The following is the C axis switch timing chart during the manual operation mode.
 <Zero point return type> [M8][C80]

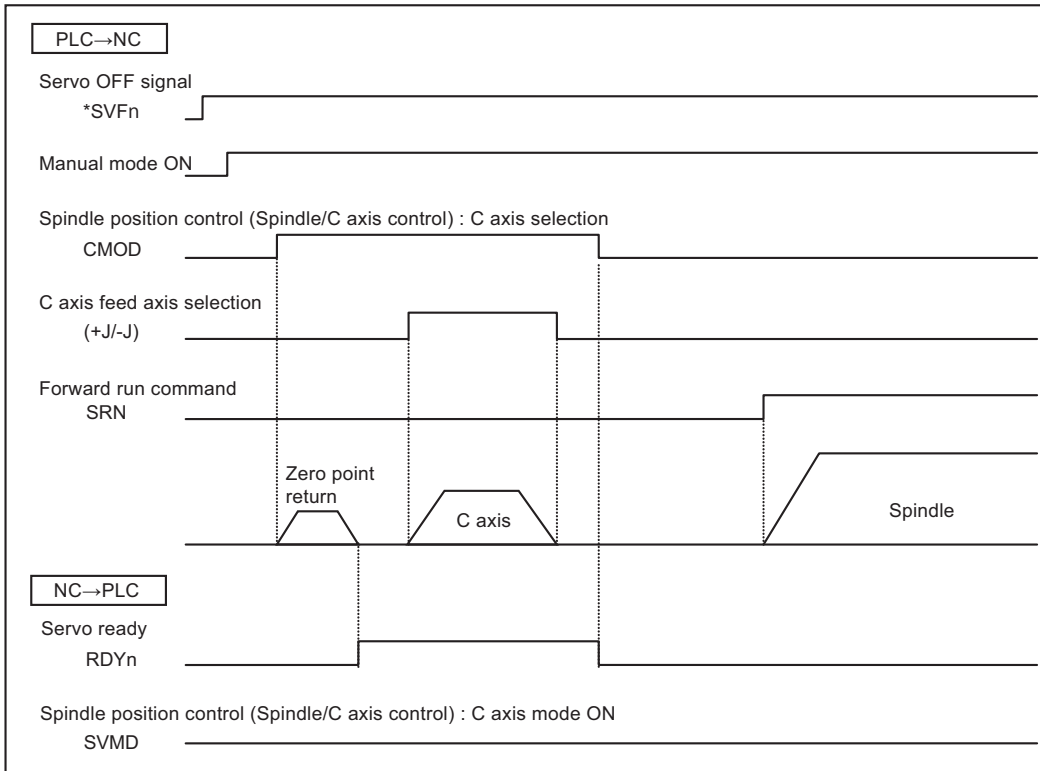

<Deceleration stop type> [M8]

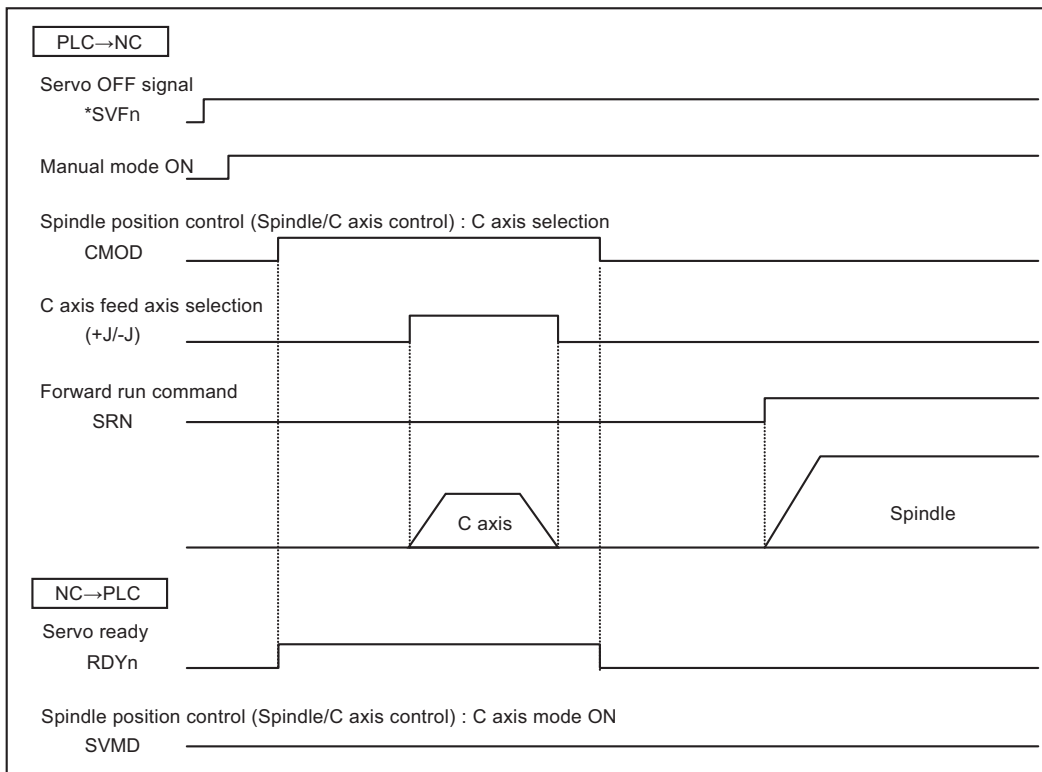

Cont.	Signal name	Abbrev.	1stSP	2ndSP	3rdSP	4thSP	5thSP	6thSP	7thSP	8thSP
A	M COIL SELECTION	LRSM	Y18A6	Y1906	Y1966	Y19C6	Y1A26	Y1A86	Y1AE6	Y1B46

[Function]

This signal is used to select the middle-speed coil in the 3-step coil changeover specification of the spindle coil changeover function.

[Operation]

The coil is selected depending on the combination of this signal and the "L coil selection" (LRSL).

(Note) The coil is not changed over during the position loop control mode even if this signal is changed.

The coil selected immediately before the position loop control mode is entered is retained.

Selected coil	L coil selection (LRSL)	M coil selection (LRSM)	In L coil selection (LCSA)	In M coil selection (MCSA)
High-speed (H)	OFF	OFF	OFF	OFF
Middle-speed (M)	OFF	ON	OFF	ON
Low-speed (L)	ON	OFF	ON	OFF
	ON	ON	ON	ON

[Related signals]

- (1) L coil selection (LRSL: Y189F)
- (2) In L coil selection (LCSA: X188F)
- (3) In M coil selection (MCSA: X189E)

4 Explanation of Interface Signals

Cont.	Signal name	Abbrev.	1stSP	2ndSP	3rdSP	4thSP	5thSP	6thSP	7thSP	8thSP
A	SPINDLE SELECTION	SWS	Y18A8	Y1908	Y1968	Y19C8	Y1A28	Y1A88	Y1AE8	Y1B48

[Function]

The spindle to which the S command for the spindle is output is selected when the multi-spindle control II is valid.

- 0: Not select
- 1: Select

[Operation]

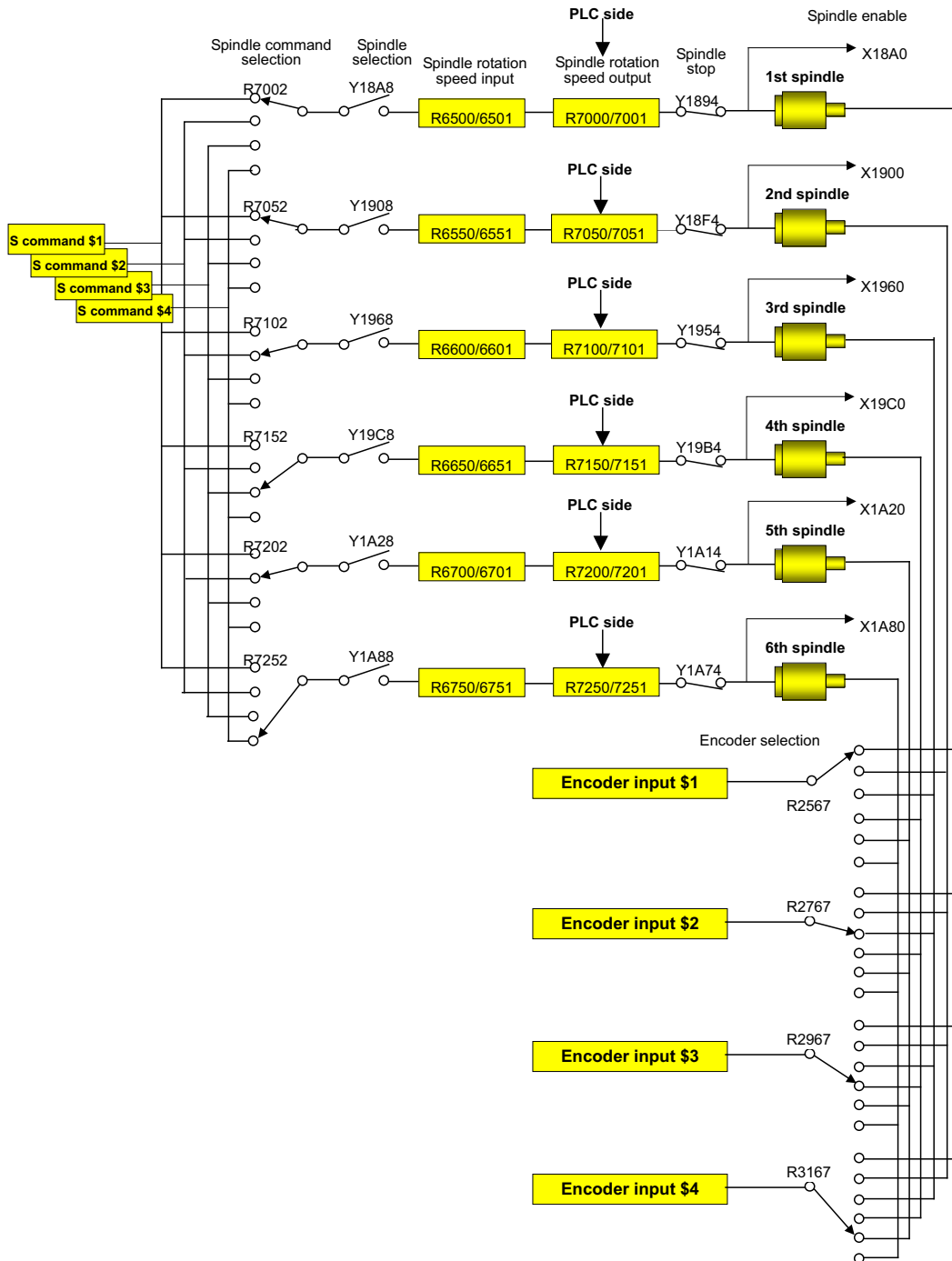

If an S command is given while the spindle selection (SWS) and spindle command selection (SLSP) have already been input through different blocks, this S command is handled as a rotation speed command of the selected spindle. The selected spindle rotates at the rotation speed which was output. The spindles which were deselected by the "Spindle selection" signal (SWS) OFF continue to rotate at the same rotation speed as the speed immediately before their de-selection. This allows each spindle to be rotated simultaneously at a different rotation speed. The "Spindle command selection" signal is used to select which of the spindles is to receive the S command from which part system.

[Caution]

If the spindle selection (SWS) or spindle command selection (SLSP) is executed through an M code given in the same block as an S code, the spindle selection (spindle rotation speed) will not be updated.

[Related signals]

- (1) Spindle command selection (SLSP: R7002)
- (2) Spindle stop (SSTP: Y1894)
- (3) Spindle enable (ENB: X18A0)
- (4) Encoder selection (R2567)
- (5) Spindle forward run start (SRN: Y1898)
- (6) Spindle reverse run start (SRI: Y1899)

Cont.	Signal name	Abbrev.	1stSP	2ndSP	3rdSP	4thSP	5thSP	6thSP	7thSP	8thSP
A	Spindle rotation reversal	SPRR	Y18AA	Y190A	Y196A	Y19CA	Y1A2A	Y1A8A	Y1AEA	Y1B4A

[Function]

The signal is intended for a spindle controller (spindle drive). The signal is able to reverse the spindle rotation signals ("Spindle forward run start" signal (SRN: Y1898) and "Spindle reverse run start" signal (SRI: Y1899)).

This signal is valid only when the "spindle rotation direction switch method selection" signal (SPRS:Y18AB) is ON.

[Operation]

Turning ON this signal reverses the direction of the spindle rotation command.

Rotation signal	Spindle rotation reversal (SPRR: Y18AA)	Motor rotation direction
Spindle forward run start (SRN: Y1898)	OFF	Foward rotation
	ON	Reverse rotation
Spindle reverse run start (SRI: Y1899)	OFF	Reverse rotation
	ON	Foward rotation

This signal is also valid for the following functions.

(1) Synchronous tapping cycle command

The signal reverses the rotation direction of the tapping spindle motor.

(2) Spindle synchronization

The signal reverses the rotation direction of the reference and synchronized spindles.

(3) Tool spindle synchronization I A (Spindle-Spindle, Polygon)

The signal reverses the rotation direction of the reference and synchronized spindles.

(4) Tool spindle synchronization I B (Spindle-Spindle, Polygon)

The signal reverses the rotation direction of the workpiece and rotary tool spindles.

(5) Tool spindle synchronization I C (Spindle-NC axis, Polygon)

The signal reverses the rotation direction of the polygon-related spindles.

(6) Tool spindle synchronization II (Hobbing)

The signal reverses the rotation direction of the reference spindle.

(7) Spindle superimposition control

The signal reverses the rotation direction of the reference and superimposed spindles.

(Note 1) While the above functions are being executed, a change of this signal is disabled for the target spindle.

Thus, change this signal before executing the program command of each function.

If none of the above functions are executed, this signal is enabled immediately upon input.

(Note 2) This signal is disabled for the following functions and conditions.

- At zero point return in the C axis mode of spindle position control (spindle/C axis control)
- In C axis mode of spindle position control (spindle/C axis control)
- Spindle orientation command
- Spindle forward run indexing/spindle reverse run indexing
- Turret indexing

(1) Synchronous tapping cycle command

Turning ON the "spindle rotation reversal" signal (SPRR: Y18AA) reverses the spindle rotation direction at the synchronous tapping cycle command.

The "spindle rotation reversal" signal is enabled for the tapping spindle specified in the synchronous tapping cycle command.

As listed below, the direction of the tapping spindle varies according to the combination of the "spindle rotation reversal" signal and "#3052 spplr" (spindle motor spindle relative polarity).

Forward tapping command

(when a synchronous tapping command is given with the unsigned D (tapping spindle No.))

Spindle rotation reversal (SPRR: Y18AA)	spplr	Spindle motor rotation in the cutting	Spindle motor rotation in the returning
OFF	0	Foward rotation	Reverse rotation
	1	Reverse rotation	Foward rotation
ON	0	Reverse rotation	Foward rotation
	1	Foward rotation	Reverse rotation

Reverse tapping command

(when a synchronous tapping command is given, the sign of the tapping spindle No. (D address) is "-")

Spindle rotation reversal (SPRR: Y18AA)	spplr	Spindle motor rotation in the cutting	Spindle motor rotation in the returning
OFF	0	Reverse rotation	Foward rotation
	1	Foward rotation	Reverse rotation
ON	0	Foward rotation	Reverse rotation
	1	Reverse rotation	Foward rotation

(Note 1) Turn ON the "spindle rotation reversal" signal for the tapping spindle before the synchronous tapping cycle command is issued.

Even though the "spindle rotation reversal" signal is switched from ON to OFF or from OFF to ON during the synchronous tapping cycle, the direction of the spindle motor rotation does not change.

4 Explanation of Interface Signals

(2) Spindle synchronization control command

Turning ON the "spindle rotation reversal" signal (SPRR: Y18AA) reverses the rotation direction of the reference and synchronized spindle motors at the spindle synchronization control command.

When the "spindle rotation reversal" signal is ON for the reference spindle, the reference spindle motor rotates in the direction opposite to the spindle rotation signal ("spindle forward run start" signal (SRN: Y1898) or "spindle reverse run start" signal (SRI: Y1899)). However, the synchronized spindle motor remains in the same rotation direction as when the "spindle rotation reversal" signal is OFF for the reference spindle.

When the "spindle rotation reversal" signal is ON for the synchronized spindle, the rotation direction of the synchronized spindle motor is reversed.

<Motion example>

Listed below are the state of the "spindle rotation reversal" signal and the rotation direction of the reference and synchronized spindle motors when you execute a spindle synchronous control command that rotates the reference and synchronized spindles in the same direction while the forward run command is issued for the reference spindle.

Rotation signal	Reference spindle		Synchronized spindle	
	Spindle rotation reversal (SPRR: Y18AA)	Motor rotation direction	Spindle rotation reversal (SPRR: Y18AA)	Motor synchronous rotation direction
Spindle forward run start (SRN: Y1898)	Invalid	Foward rotation	Invalid	Foward rotation
			Valid	Reverse rotation
	Valid	Reverse rotation	Invalid	Foward rotation
			Valid	Reverse rotation
Spindle reverse run start (SRI: Y1899)	Invalid	Reverse rotation	Invalid	Reverse rotation
			Valid	Foward rotation
	Valid	Foward rotation	Invalid	Reverse rotation
			Valid	Foward rotation

(Note 1) Turn ON the "spindle rotation reversal" signal for the reference spindle and the synchronized spindle before the spindle synchronization control command is issued.

Even though the "spindle rotation reversal" signal is switched from ON to OFF or from ON to OFF during the spindle synchronization, the direction of the spindle motor rotation does not change.

4 Explanation of Interface Signals

(3) Tool spindle synchronization I A (Spindle-Spindle, Polygon) command

Turning ON the "spindle rotation reversal" signal (SPRR: Y18AA) reverses the rotation direction of the reference and synchronized spindle motors at the tool spindle synchronization I A command.

When the "spindle rotation reversal" signal is ON for the reference spindle, the reference spindle motor rotates in the direction opposite to the spindle rotation signal ("spindle forward run start" signal (SRN: Y1898) or "spindle reverse run start" signal (SRI: Y1899)). However, the synchronized spindle motor remains in the same rotation direction as when the "spindle rotation reversal" signal is OFF for the reference spindle.

When the "spindle rotation reversal" signal is ON for the synchronized spindle, the rotation direction of the synchronized spindle motor is reversed.

<Motion example>

Listed below are the state of the "spindle rotation reversal" signal and the rotation direction of the reference and synchronized spindle motors when you execute a tool spindle synchronization control I A command that rotates the reference and synchronized spindles in the same direction while the forward run command is issued for the reference spindle.

Reference spindle			Synchronized spindle	
Rotation signal	Spindle rotation reversal (SPRR: Y18AA)	Motor rotation direction	Spindle rotation reversal (SPRR: Y18AA)	Motor synchronous rotation direction
Spindle forward run start (SRN: Y1898)	Invalid	Forward rotation	Invalid	Foward rotation
			Valid	Reverse rotation
	Valid	Reverse rotation	Invalid	Foward rotation
			Valid	Reverse rotation
Spindle reverse run start (SRI: Y1899)	Invalid	Reverse rotation	Invalid	Reverse rotation
			Valid	Foward rotation
	Valid	Forward rotation	Invalid	Reverse rotation
			Valid	Foward rotation

(Note 1) Turn ON the "spindle rotation reversal" signal for the reference spindle and synchronized spindle before the tool spindle synchronization control I A command is issued.

Even though the "spindle rotation reversal" signal is switched from ON to OFF or from OFF to ON during the tool spindle synchronization I A, the direction of the spindle motor rotation does not change.

4 Explanation of Interface Signals

(4) Tool spindle synchronization I B (Spindle-Spindle, Polygon) command

Turning ON the "spindle rotation reversal" signal (SPRR: Y18AA) reverses the rotation direction of the workpiece and rotary tool spindle motors at the tool spindle synchronization I B command.

When the "spindle rotation reversal" signal is ON for the workpiece spindle, the workpiece spindle motor rotates in the direction opposite to the spindle rotation signal ("spindle forward run start" signal (SRN: Y1898) or "spindle reverse run start" signal (SRI: Y1899)). However, the rotary tool spindle motor remains in the same rotation direction as when the "spindle rotation reversal" signal is OFF for the workpiece spindle.

When the "spindle rotation reversal" signal is ON for the rotary tool spindle, the synchronized rotation direction of the rotary tool spindle motor is reversed.

<Motion example>

Listed below are the state of the "spindle rotation reversal" signal and the rotation direction of the workpiece and rotary tool spindle motors when you execute a tool spindle synchronization control I B command that rotates the workpiece and rotary tool spindles in the same direction while the forward run command is issued for the workpiece spindle.

Workpiece spindle			Rotary tool spindle	
Rotation signal	Spindle rotation reversal (SPRR: Y18AA)	Motor rotation direction	Spindle rotation reversal (SPRR: Y18AA)	Motor synchronous rotation direction
Spindle forward run start (SRN: Y1898)	Invalid	Foward rotation	Invalid	Foward rotation
			Valid	Reverse rotation
	Valid	Reverse rotation	Invalid	Foward rotation
			Valid	Reverse rotation
Spindle reverse run start (SRI: Y1899)	Invalid	Reverse rotation	Invalid	Reverse rotation
			Valid	Foward rotation
	Valid	Foward rotation	Invalid	Reverse rotation
			Valid	Foward rotation

(Note 1) Turn ON the "spindle rotation reversal" signal for the workpiece spindle and rotary tool spindle before the tool spindle synchronization control I B command is issued.

Even though the "spindle rotation reversal" signal is switched from ON to OFF or from OFF to ON during the ltool spindle synchronization I B, the direction of the spindle motor rotation does not change.

4 Explanation of Interface Signals

(6) Tool spindle synchronization II (Hobbing) command

Turning ON the "spindle rotation reversal" signal (SPRR: Y18AA) reverses the rotation direction of the reference spindle motor at the tool spindle synchronization II command.

When the "spindle rotation reversal" signal is ON for the reference spindle, the reference spindle motor rotates in the direction opposite to the spindle rotation signal ("spindle forward run start" signal (SRN: Y1898) or "spindle reverse run start" signal (SRI: Y1899)). However, the C axis motor remains in the same rotation direction as when the "spindle rotation reversal" signal is OFF for the reference spindle in the spindle synchronization and spindle superimposition controls.

<Motion example>

Listed below are the state of the "spindle rotation reversal" signal and the rotation direction of the reference and synchronized spindle motors when you execute a tool spindle synchronization control II command that rotates the C axis motor to CCW direction in the reference spindle motor forward run while the forward run command is issued for the reference spindle.

Reference spindle			C axis
Rotation signal	Spindle rotation reversal (SPRR: Y18AA)	Motor rotation direction	Motor synchronous rotation direction
Spindle forward run start (SRN: Y1898)	Invalid	Foward rotation	CCW
	Valid	Reverse rotation	
Spindle reverse run start (SRI: Y1899)	Invalid	Reverse rotation	CW
	Valid	Foward rotation	

(Note 1) Select the "spindle rotation reversal" signal for the reference spindle before the tool spindle synchronization control II command is issued. Even though the "spindle rotation reversal" signal is switched from ON to OFF or from OFF to ON during the tool spindle synchronization II, the direction of the spindle motor rotation does not change.

(7) Spindle superimposition control command

Turning ON the "spindle rotation reversal" signal (SPRR: Y18AA) reverses the rotation direction of the workpiece and rotary tool spindle motors at the spindle superimposition control command.

When the "spindle rotation reversal" signal is ON for the reference spindle, the reference spindle motor rotates in the direction opposite to the spindle rotation signal ("spindle forward run start" signal (SRN: Y1898) or "spindle reverse run start" signal (SRI: Y1899)). However, the spindle superimposition motor remains in the same rotation direction as when the "spindle rotation reversal" signal is OFF for the reference spindle. The superimposed spindle motor for the spindle rotation signal ("spindle forward run start" signal (SRN: Y1898) or "spindle reverse run start" signal (SRI: Y1899)) rotates in the same direction of the command.

When the "spindle rotation reversal" signal is ON for the superimposed spindle, the rotation direction of the superimposed spindle motor is reversed. The superimposed spindle motor for the spindle rotation signal ("spindle forward run start" signal (SRN: Y1898) or "spindle reverse run start" signal (SRI: Y1899)) rotates in the direction opposite to the command.

4 Explanation of Interface Signals

<Motion example>

Listed below are the state of the "spindle rotation reversal" signal and the rotation direction of the reference and superimposed spindle motors when you execute a spindle superimposition control command that rotates the reference and superimposed spindles in the same direction while the forward run command is issued for the reference spindle.

Reference spindle			Superimposed spindle					
Rotation signal	Spindle rotation reversal (SPRR: Y18AA)	Motor rotation direction	Spindle rotation reversal (SPRR: Y18AA)	Motor synchronous rotation direction (Synchronous rotation for the reference spindle)	Rotation signal	Motor synchronous rotation direction (Rotation command for the superimposed spindle)		
Spindle forward run start (SRN: Y1898)	Invalid	Foward rotation	Invalid	Foward rotation	Spindle forward run start	Foward rotation		
					Spindle reverse run start	Reverse rotation		
			Valid	Reverse rotation	Valid	Reverse rotation	Spindle forward run start	Reverse rotation
							Spindle reverse run start	Foward rotation
	Valid	Reverse rotation	Invalid	Foward rotation	Spindle forward run start	Foward rotation		
					Spindle reverse run start	Reverse rotation		
			Valid	Reverse rotation	Valid	Reverse rotation	Spindle forward run start	Reverse rotation
							Spindle reverse run start	Foward rotation
Spindle reverse run start (SRI: Y1899)	Invalid	Reverse rotation	Invalid	Reverse rotation	Spindle forward run start	Foward rotation		
					Spindle reverse run start	Reverse rotation		
			Valid	Foward rotation	Valid	Foward rotation	Spindle forward run start	Reverse rotation
							Spindle reverse run start	Foward rotation
	Valid	Foward rotation	Invalid	Reverse rotation	Spindle forward run start	Foward rotation		
					Spindle reverse run start	Reverse rotation		
			Valid	Foward rotation	Valid	Foward rotation	Spindle forward run start	Reverse rotation
							Spindle reverse run start	Foward rotation

(Note 1) Turn ON the "spindle rotation reversal" signal for the reference spindle and superimposed spindle before the spindle superimposition control command is issued.

Even though the "spindle rotation reversal" signal is switched from ON to OFF or from OFF to ON during the spindle superimposition control, the direction of the spindle motor rotation does not change.

4 Explanation of Interface Signals

Cont.	Signal name	Abbrev.	1stSP	2ndSP	3rdSP	4thSP	5thSP	6thSP	7thSP	8thSP
A	Spindle rotation direction switch method selection	SPRS	Y18AB	Y190B	Y196B	Y19CB	Y1A2B	Y1A8B	Y1AEB	Y1B4B

[Function]

This signal is used to select the method to reverse the rotation signals (forward run start and reverse run start) of the spindle.

[Operation]

Depending on the status of this signal, the spindle rotation signal (forward run start or reverse run start) can be switched to the opposite direction by "#3127 SPECSP/bit3" (Spindle specification/Spindle rotation direction) or the "spindle rotation reversal" signal (SPRR: Y18AA).

OFF: Switched by "#3127 SPECSP/bit3" (Spindle specification/Spindle rotation direction).

ON: Switched by the "spindle rotation reversal" signal (SPRR: Y18AA).

Cont.	Signal name	Abbrev.	1stSP	2ndSP	3rdSP	4thSP	5thSP	6thSP	7thSP	8thSP
A	PLC COIL CHANGEOVER	MPCSL	Y18AF	Y190F	Y196F	Y19CF	Y1A2F	Y1A8F	Y1AEF	Y1B4F

[Function]

When the coil changeover is the NC internal process, the coil changeover with the PLC signal can be performed with this signal.

[Operation]

If the coil changeover is the NC internal process, the NC internal process selection is interrupted and changed to the selection with the PLC signal when this signal is turned ON.

The coil changeover in the NC internal process and the coil changeover via the PLC are changed over with the parameter #1239 set11/bit0.

0: Via PLC

1: NC internal process

(1) H/L coil changeover

- The L -> H coil changeover is changed over at the same time when the H coil selection is entered.
- The H -> L coil changeover is not changed over during the "Speed detection" signal (VRO) OFF even if the L coil selection is entered.

The coil changeover is changed over after the "Speed detection" signal (SD) is turned ON.

(2) H/M/L coil changeover

- The L -> M coil changeover is changed over at the same time when the M coil selection is entered.
- The L -> H coil changeover is changed over at the same time when the H coil selection is entered.
- The M -> H coil changeover is changed over at the same time when the M coil selection is entered.
- The H -> M coil changeover is not changed over during the "Speed detection 2" signal (SD2) OFF even if the M coil selection is entered. The coil changeover is changed over after the "Speed detection 2" signal (SD2) is turned ON.
- The H -> L coil changeover is not changed over during the "Speed detection" signal (VRO) OFF even if the L coil selection is entered. The coil changeover is changed over after the "Speed detection" signal (VRO) is turned ON.
- The M -> L coil changeover is not changed over during the "Speed detection" signal (VRO) OFF even if the L coil selection is entered. The coil changeover is changed over after the "Speed detection" signal (VRO) is turned ON.

(Note) This signal must be turned ON after the "L coil selection" (LRSL)/ "M coil selection" (LRSM) signal has been decided. The NC internal changeover process is entered when this signal is turned OFF, so note the spindle rotation speed.

[Related signals]

- (1) L coil selection (LRSL: Y189F)
- (2) M coil selection (LRSM: Y18A6)
- (3) In L coil selection (LCSA: X188F)
- (4) In M coil selection (MCSA: X189E)

4 Explanation of Interface Signals

Cont.	Signal name	Abbrev.	1stSP	2ndSP	3rdSP	4thSP	5thSP	6thSP	7thSP	8thSP
A	SPINDLE SYNCHRONIZATION	SPSY	Y18B0	Y1910	Y1970	Y19D0	Y1A30	Y1A90	Y1AF0	Y1B50

[Function]

The spindle synchronous control mode is entered by turning this signal ON.

[Operation]

The spindle synchronous control mode is entered by inputting the "Spindle synchronous control" signal (SPSY). During the spindle synchronous control mode, the synchronized spindle is controlled in synchronization with the rotation speed commanded for the reference spindle.

Set the reference spindle, synchronized spindle and rotation direction beforehand.

Device No.	Signal name	Abbrev	Explanation
R7016	Spindle synchronous control reference spindle selection	-	Select a serially connected spindle to be controlled as the reference spindle. (0: 1st spindle), 1: 1st spindle, 2: 2nd spindle, 3: 3rd spindle, 4: 4th spindle, 5: 5th spindle, 6: 6th spindle (Note 1) Spindle synchronization control will not take place if a spindle not connected in serial is selected. (Note 2) If "0" is designated, the 1st spindle will be controlled as the reference spindle.
R7017	Spindle synchronous control synchronized spindle selection	-	Select a serially connected spindle to be controlled as the synchronized spindle. (0: 2nd spindle), 1: 1st spindle, 2: 2nd spindle, 3: 3rd spindle, 4: 4th spindle, 5: 5th spindle, 6: 6th spindle (Note 3) Spindle synchronization control will not take place if a spindle not connected in serial is selected or if the same spindle as the reference spindle is selected. (Note 4) If "0" is designated, the 2nd spindle will be controlled as the synchronized spindle.
Y18B2	Spindle synchronous rotation direction	-	Designate the reference spindle and synchronized spindle rotation directions for spindle synchronization control. 0: The synchronized spindle rotates in the same direction as the reference spindle. 1: The synchronized spindle rotates in the reverse direction of the reference spindle.

(Note 1) If "#1440 multi_sp_syn" (Enable multiple sets of spindle synchronization) is "0", use the signal of the 1st spindle. [C80]

(Note 2) If "#1440 multi_sp_syn" (Enable multiple sets of spindle synchronization) is "1", use the signal of the hob axis during hobbing, the signal of the superimposed spindle during spindle superimposition, and the signal of the synchronized spindle during other machinings. [C80]

[Related signals]

- (1) In spindle synchronization (SPSYN1: X18A8)
- (2) Spindle rotation speed synchronization completion (FSPRV: X18A9)
- (3) Spindle synchronous rotation direction (SPSDR: Y18B2)
- (4) Spindle phase synchronization (SPPHS: Y18B1)
- (5) Spindle phase synchronization completion (FSPPH: X18AA)
- (6) Spindle synchronous control reference spindle selection (R7016)
- (7) Spindle synchronous control synchronized spindle selection (R7017)

4 Explanation of Interface Signals

Cont.	Signal name	Abbrev.	1stSP	2ndSP	3rdSP	4thSP	5thSP	6thSP	7thSP	8thSP
A	SPINDLE PHASE SYNCHRONIZATION	SPPHS	Y18B1	Y1911	Y1971	Y19D1	Y1A31	Y1A91	Y1AF1	Y1B51

[Function]

Spindle phase synchronization starts when this signal is turned ON during the spindle synchronous control mode.

[Operation]

Spindle phase synchronization starts when the "Spindle phase synchronous control" signal (SPPHS) is input during the spindle synchronous control mode. The "Spindle phase synchronization completion" signal is output when the spindle phase synchronization attainment level setting value (#3051 spplv) is reached.

- (Note 1) This signal will be ignored even if it is turned ON during a mode other than the spindle synchronous control mode.
- (Note 2) If "#1440 multi_sp_syn" (Enable multiple sets of spindle synchronization) is "0", use the signal of the 1st spindle. [C80]
- (Note 3) If "#1440 multi_sp_syn" (Enable multiple sets of spindle synchronization) is "1", use the signal of the hob axis during hobbing, the signal of the superimposed spindle during spindle superimposition, and the signal of the synchronized spindle during other machinings. [C80]

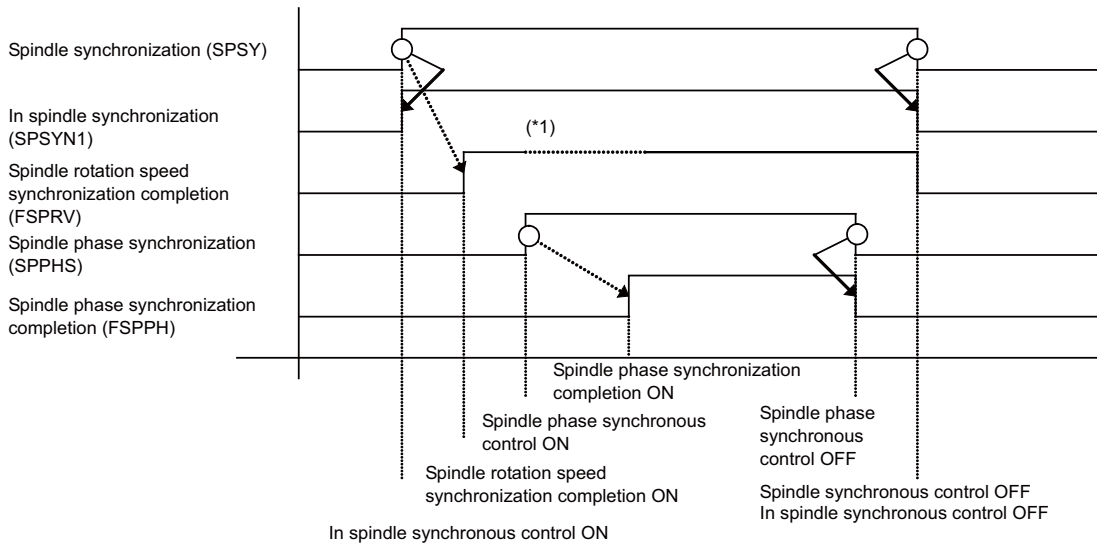

(*1) This is turned OFF once to change the rotation speed during phase synchronization.

[Related signals]

- (1) In spindle synchronization (SPSYN1: X18A8)
- (2) Spindle rotation speed synchronization completion (FSPRV: X18A9)
- (3) Spindle synchronization (SPSY: Y18B0)
- (4) Spindle synchronous rotation direction (SPSDR: Y18B2)
- (5) Spindle phase synchronization completion (FSPPH: X18AA)
- (6) Spindle synchronization phase shift amount (R7018)

Cont.	Signal name	Abbrev.	1stSP	2ndSP	3rdSP	4thSP	5thSP	6thSP	7thSP	8thSP
A	SPINDLE SYNCHRONOUS ROTATION DIRECTION	SPSDR	Y18B2	Y1912	Y1972	Y19D2	Y1A32	Y1A92	Y1AF2	Y1B52

[Function]

The synchronized spindle's rotation direction is designated with this signal. Select whether the direction is the same as or the reverse of the reference spindle.

[Operation]

Designate the rotation direction for the reference spindle and synchronized spindle during spindle synchronous control.

0: Synchronized spindle rotates in same direction as reference spindle.

1: Synchronized spindle rotates in reverse direction of reference spindle.

(Note 1) If "#1440 multi_sp_syn" (Enable multiple sets of spindle synchronization) is "0", use the signal of the 1st spindle. [C80]

(Note 2) If "#1440 multi_sp_syn" (Enable multiple sets of spindle synchronization) is "1", use the signal of the hob axis during hobbing, the signal of the superimposed spindle during spindle superimposition, and the signal of the synchronized spindle during other machinings. [C80]

[Related signals]

- (1) In spindle synchronization (SPSYN1: X18A8)
- (2) Spindle rotation speed synchronization completion (FSPRV: X18A9)
- (3) Spindle synchronization (SPSY: Y18B0)
- (4) Spindle phase synchronization (SPPHS: Y18B1)
- (5) Spindle phase synchronization completion (FSPPH: X18AA)
- (6) Spindle synchronization phase shift amount (R7018)

4 Explanation of Interface Signals

Cont.	Signal name	Abbrev.	1stSP	2ndSP	3rdSP	4thSP	5thSP	6thSP	7thSP	8thSP
A	PHASE SHIFT CALCULATION REQUEST	SSPHM	Y18B3	Y1913	Y1973	Y19D3	Y1A33	Y1A93	Y1AF3	Y1B53

[Function]

This signal calculates the phase error of the reference spindle during rotation synchronization, and requests that it be saved in the NC memory.

[Operation]

The phase error of the reference spindle and synchronized spindle is saved in the NC memory when this signal is ON and the rotation synchronization command's (with no R address command) spindle synchronization is completed (when "Spindle rotation speed synchronization completion" signal is ON).

This signal turns ON when the spindle rotation is stopped before the rotation synchronization command.

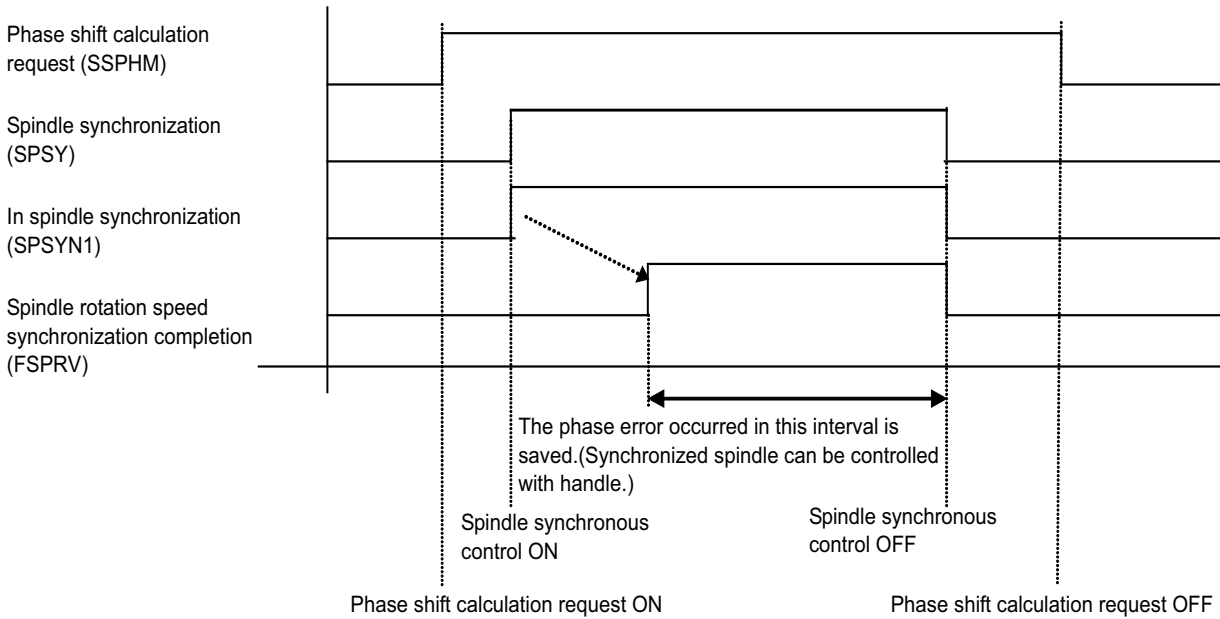

- (Note 1) The phase cannot be aligned when calculating the phase shift. To perform the phase alignment, cancel the spindle synchronization once. [C80]
- (Note 2) If the handle mode is selected as the manual operation mode, the synchronized spindle cannot be rotated with the handle.
- (Note 3) If "#1440 multi_sp_syn" (Enable multiple sets of spindle synchronization) is "0", use the signal of the 1st spindle. [C80]
- (Note 4) If "#1440 multi_sp_syn" (Enable multiple sets of spindle synchronization) is "1", use the signal of the hob axis during hobbing, the signal of the superimposed spindle during spindle superimposition, and the signal of the synchronized spindle during other machinings. [C80]

[Related signals]

- (1) Phase offset request (SSPHF: Y18B4)
- (2) Spindle synchronization phase error/Hob axis delay angle (R6516)
- (3) Spindle synchronization Phase offset data (R6518)

Cont.	Signal name	Abbrev.	1stSP	2ndSP	3rdSP	4thSP	5thSP	6thSP	7thSP	8thSP
A	PHASE OFFSET REQUEST	SSPHF	Y18B4	Y1914	Y1974	Y19D4	Y1A34	Y1A94	Y1AF4	Y1B54

[Function]

This signal requests that the phase be aligned to the value obtained by adding the value commanded with the phase synchronization command's R address to the phase error of the reference spindle and synchronized spindle saved with the "Phase shift calculation request" signal (SSPHM).

[Operation]

If phase synchronization is commanded (with R address command) while this signal is ON, the reference spindle and synchronized spindle phases will be aligned to attain the phase error obtained by adding the value commanded with the R address command to the phase error of the reference spindle and synchronized spindle saved in the NC memory.

(Note 1) Refer to the signal of the 1st spindle if "#1440 multi_sp_syn" (Enable multiple sets of spindle synchronization) is "0".

(Note 2) Refer to the signal of the synchronized spindle if "#1440 multi_sp_syn" (Enable multiple sets of spindle synchronization) is "1".

[Related signals]

- (1) Phase shift calculation request (SSPHM: Y18B3)
- (2) Spindle synchronization phase error/Hob axis delay angle (R6516)
- (3) Spindle synchronization Phase offset data (R6518)

4 Explanation of Interface Signals

Cont.	Signal name	Abbrev.	1stSP	2ndSP	3rdSP	4thSP	5thSP	6thSP	7thSP	8thSP
A	ERROR TEMPORARY CANCEL	SPDRPO	Y18B5	Y1915	Y1975	Y19D5	Y1A35	Y1A95	Y1AF5	Y1B55

[Function]

This signal cancels the error caused by the speed fluctuation when the chuck is closed.

When the chuck is closed, the speed will fluctuate due to external causes. An error will occur between the reference spindle's position and the synchronized spindle's position due to this speed fluctuation. This signal is used to cancel this error. (If spindle synchronization is attempted when closing the chuck without canceling this error, torsion could occur.)

[Operation]

The error between the reference spindle's position and synchronized spindle's position is saved when this signal changes from OFF to ON. The saved error is canceled and the spindle is synchronized while this signal is ON. (Even if the chuck close signal is OFF, the error will be canceled while the "Error temporary cancel" signal is ON.)

(Note 1) Refer to the signal of the 1st spindle if "#1440 multi_sp_syn" (Enable multiple sets of spindle synchronization) is "0".

(Note 2) Refer to the signal of the synchronized spindle if "#1440 multi_sp_syn" (Enable multiple sets of spindle synchronization) is "1".

(Note 3) Turn this signal ON after the chucks on both the reference spindle side and synchronized spindle side have closed and grasped the workpiece.

(Note 4) Turn this signal OFF when the either the reference spindle side or synchronized spindle side chuck is open.

(Example)

- (1) Close the reference spindle side chuck.
- (2) Start spindle synchronization (G114.1).
- (3) Close the synchronized spindle side chuck.
(The speed will fluctuate due to external causes at this time, and an error will occur.)
- (4) Using the "Chuck close confirmation" (SPCMP) signal, check that the chucks are closed.
- (5) Turn the "Error temporary cancel" (SPDRPO) signal ON, and cancel the error.
- (6) Execute machining with spindle synchronous control.
- (7) Open the chuck on the synchronized spindle side.
- (8) Using the "Chuck close confirmation" (SPCMP) signal, check that the chuck is opened.
- (9) Turn the "Error temporary cancel" (SPDRPO) signal OFF, and stop the error cancellation.

[Related signals]

- (1) In spindle synchronization (SPSYN1: X18A8)
- (2) Spindle rotation speed synchronization completion (FSPRV: X18A9)
- (3) Spindle phase synchronization completion (FSPPH: X18AA)
- (4) Chuck close confirmation (SPCMP: X18AC)
- (5) Chuck close (SPCMPC: Y18B9)

4 Explanation of Interface Signals

Cont.	Signal name	Abbrev.	1stSP	2ndSP	3rdSP	4thSP	5thSP	6thSP	7thSP	8thSP
A	SPINDLE SYNCHRONIZATION/ SUPERIMPOSITION CANCEL	SPSYC	Y18B8	Y1918	Y1978	Y19D8	Y1A38	Y1A98	Y1AF8	Y1B58

[Function]

This signal is used to cancel the spindle synchronous control and spindle superimposition with the G114.n command. The spindle synchronous control with the "Spindle synchronization" (Y18B0) is not canceled.

[Operation]

The spindle synchronous control mode and spindle superimposition can be canceled by turning this signal ON.

(Note 1) Refer to the signal of the 1st spindle if "#1440 multi_sp_syn" (Enable multiple sets of spindle synchronization) is "0".

(Note 2) Refer to the signal of the hob axis during hobbing, or refer to the signal of the synchronized spindle during other machinings if "#1440 multi_sp_syn" (Enable multiple sets of spindle synchronization) is "1".

[Related signals]

- (1) In spindle synchronization (SPSYN1: X18A8)
- (2) Spindle rotation speed synchronization completion (FSPRV: X18A9)
- (3) Spindle phase synchronization completion (FSPPH: X18AA)
- (4) Spindle phase synchronization (SPPHS: Y18B1)
- (5) Spindle synchronization phase error 1 (R6522)
- (6) Spindle synchronization phase error 2 (R6523)

Cont.	Signal name	Abbrev.	1stSP	2ndSP	3rdSP	4thSP	5thSP	6thSP	7thSP	8thSP
A	CHUCK CLOSE	SPCMPC	Y18B9	Y1919	Y1979	Y19D9	Y1A39	Y1A99	Y1AF9	Y1B59

[Function]

This signal is turned ON while the reference spindle and synchronized spindle clamp the same work.

[Operation]

The "Spindle chuck close confirmation" signal is turned ON when the "Chuck close" signal is ON.

The "Spindle chuck close confirmation" signal is turned OFF when the "Chuck close" signal is OFF.

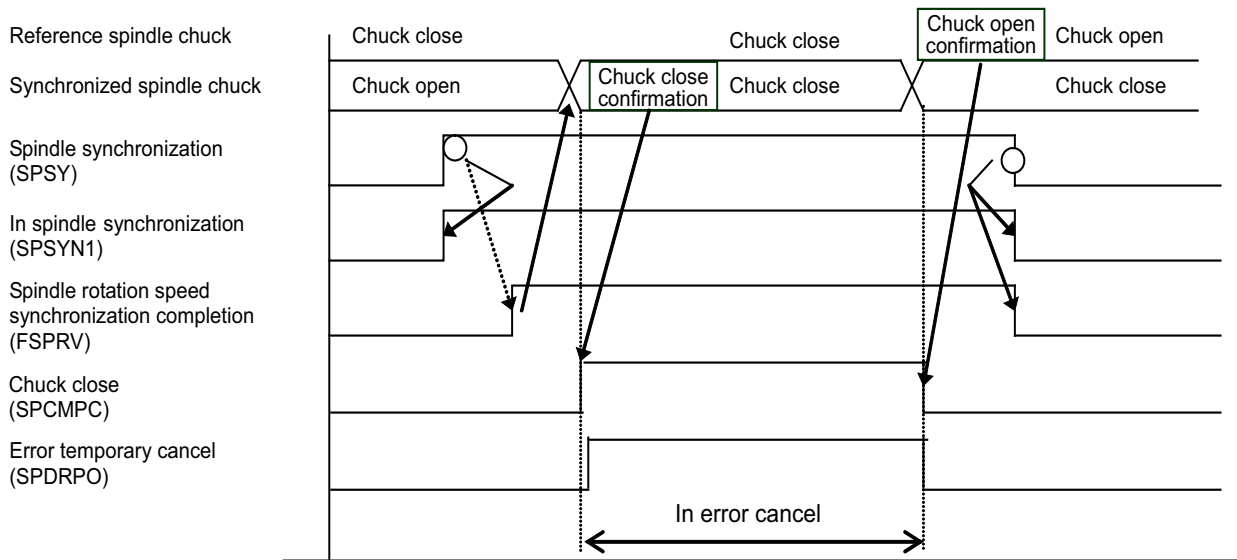

(Note 1) Refer to the signal of the 1st spindle if "#1440 multi_sp_syn" (Enable multiple sets of spindle synchronization) is "0".

(Note 2) Refer to the signal of the synchronized spindle if "#1440 multi_sp_syn" (Enable multiple sets of spindle synchronization) is "1".

(Note 3) Use the "Error temporary cancel" only when the rotation error between the reference spindle and synchronized spindle occurs because of the "Chuck close" signal.

[Related signals]

- (1) "Chuck close confirmation" signal (SPCMP: X18AC)

4 Explanation of Interface Signals

Cont.	Signal name	Abbrev.	1stSP	2ndSP	3rdSP	4thSP	5thSP	6thSP	7thSP	8thSP
A	SPINDLE OFF REQUEST	SPOFF	Y18BF	Y191F	Y197F	Y19DF	Y1A3F	Y1A9F	Y1AFF	Y1B5F

[Function]

This signal commands to exclude the spindle from CNC control.

[Operation]

The corresponding spindle will be excluded from CNC control when this signal is ON.

[Related signals]

- (1) IN SPINDLE OFF (SPOFFA:X18B6)

Cont.	Signal name	Abbrev.	1stSP	2ndSP	3rdSP	4thSP	5thSP	6thSP	7thSP	8thSP
A	Spindle oscillation command [M8]		Y18C8	Y1928	Y1988	Y19E8	Y1A48	Y1AA8	Y1B08	Y1B68

[Function]

This signal is used to start or stop the spindle oscillation.

[Operation]

The spindle oscillation is started by turning this signal ON.

The spindle oscillation is stopped by turning this signal OFF.

[Related signals]

- (1) Spindle oscillation amplitude (R7020)
- (2) Spindle oscillation frequency (R7021)
- (3) Spindle oscillation in progress (X18C8)

Cont.	Signal name	Abbrev.	1stSP	2ndSP	3rdSP	4thSP	5thSP	6thSP	7thSP
A	Spindle control: Coil changeover gate cutoff timer interruption [C80]	WGTSC	Y18C9	Y1929	Y1989	Y19E9	Y1A49	Y1AA9	Y1B09

[Function]

This signal interrupts the coil changeover gate cutoff timer set in "#13114 SP114 MKT".

[Operation]

The coil changeover gate cutoff timer can be interrupted by turning this signal ON even if the coil changeover gate cutoff timer is not complete.

(Note 1) When this signal is not used, the gate cutoff is released after the elapse of the coil changeover gate cutoff timer.

(Note 2) Set the value of "#13114 SP114 MKT" longer than the OFF/ON time of the coil changeover contactor.

(Note 3) This signal should be used after taking measures to prevent incorrect OFF/ON detection of the coil changeover contactor by chattering.

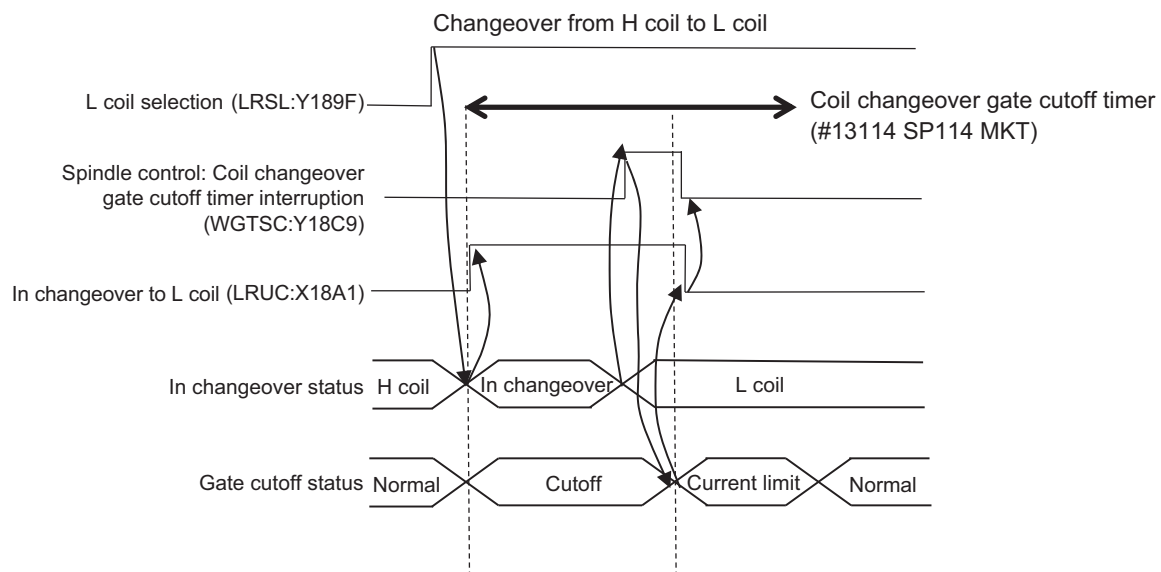

[Related signals]

- (1) Coil changeover time-out (CSTOV:X18A4)
- (2) In changeover to L coil (LRUC:X18A1)
- (3) In changeover to H coil (HRUC:X18A2)

4 Explanation of Interface Signals

Cont.	Signal name	Abbrev.	1stSP	2ndSP	3rdSP	4thSP	5thSP	6thSP	7thSP	8thSP
A	REAL-TIME TUNING 1: SPEED CONTROL GAIN CHANGEOVER HOLD-DOWN COMMAND [M8]	VGHLDC	Y18CA	Y192A	Y198A	Y19EA	Y1A4A	Y1AAA	Y1B0A	Y1B6A

[Function]

This signal is used to stop speed control gain switching of the real-time tuning 1 function. Speed control gain switching is stopped if this signal turns ON while this function is enabled.

[Operation]

- ON: Speed control gain switching is stopped.
- OFF: Speed control gain switching is not stopped.

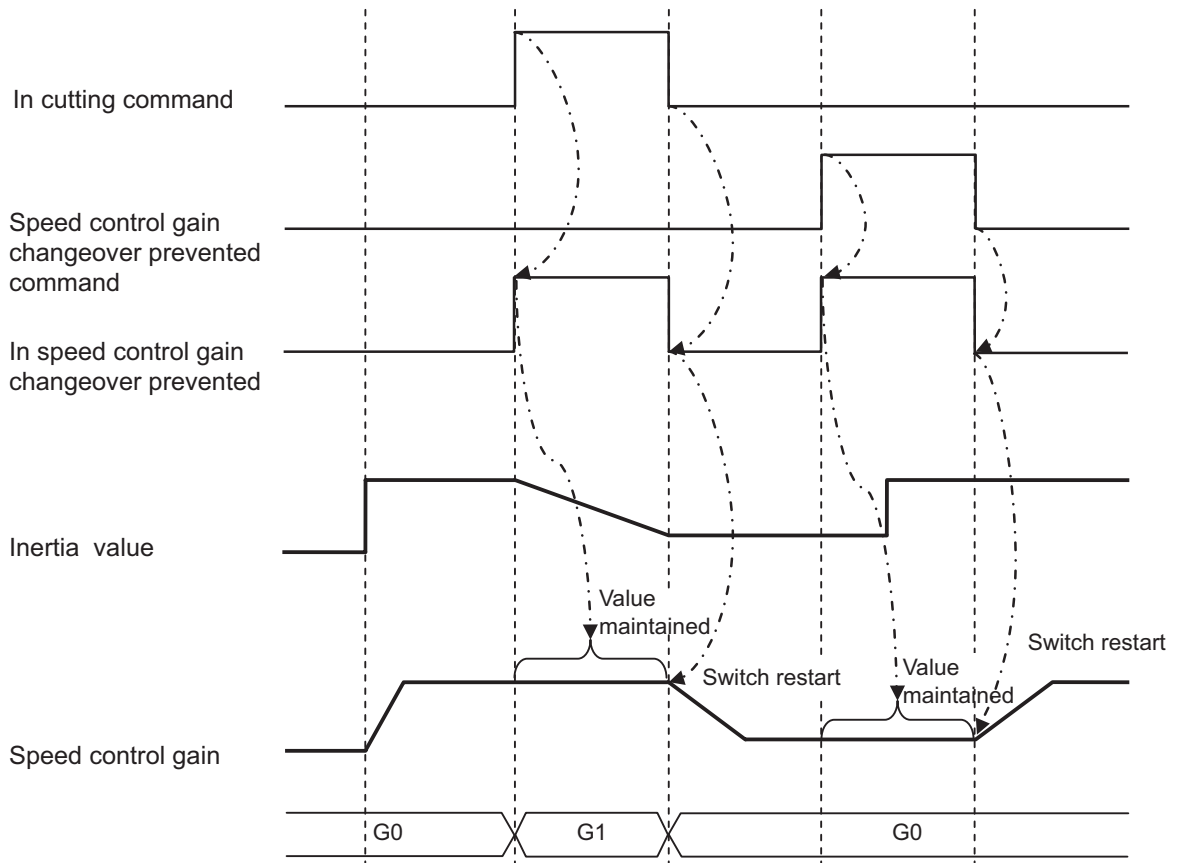

[Related signals]

- (1) Real-time tuning 1: Speed control gain changeover hold-down ON (VGHLDC:Y18CA)

Cont.	Signal name	Abbrev.	Common(\$)
A	MES interface library: Operation trigger [M8]		Y1C80

[Function]

This signal sends the request of one of the update, delete, or extraction operations to the database.

[Operation]

The operations perform for the database at the rising edge of this signal. The operation details follow the R14598 DB operation selection bitD to bitF, and operation target table follows R14599 Operation table selection.

[Related signals]

- (1) MES interface library: DB operation selection [M8] (R14598)
- (2) MES interface library: Operation table selection [M8] (R14599)
- (3) MES interface library: Operation trigger status [M8] (X74F)

4 Explanation of Interface Signals

Cont.	Signal name	Abbrev.	Common(\$)
B	DATA PROTECT KEY (MEMORY CARD) [M8]	*KEY_MemC	Y1C81

[Function]

This signal protects the data on the front side SD (memory card).

[Operation]

When the Data protection key (memory card) is turned OFF (0), the editing operation of the memory card will be prohibited.

[Caution]

- (1) If a setting is changed while the Data protection key (memory card) is OFF (0), "DATA PROTECT" appears in the message section of the screen.
- (2) This signal is set to ON (1) when the power is turned ON. This means that data protection has been canceled. Therefore, when the sequence program has no line to use data protection key, the signal is always turned ON (1).

[Related signals]

- (1) Data protect key 1 (*KEY1: Y708)
- (2) Data protect key 2 (*KEY2: Y709)
- (3) Data protect key 3 (*KEY3: Y70A)
- (4) Data protect key (DS) (*KEY_DS: Y1C82)

Cont.	Signal name	Abbrev.	Common(\$)
B	DATA PROTECT KEY (DS) [M8]	*KEY_DS	Y1C82

[Function]

This signal protects the data on the back side SD2 (DS).

[Operation]

When the Data protection key (DS) is turned OFF (0), the editing operation of the DS will be prohibited.

[Caution]

- (1) If a setting is changed while the Data protection key (DS) is OFF (0), "DATA PROTECT" appears in the message section of the screen.
- (2) This signal is set to ON (1) when the power is turned ON. This means that data protection has been canceled. Therefore, when the sequence program has no line to use data protection key, the signal is always turned ON (1).

[Related signals]

- (1) Data protect key 1 (*KEY1: Y708)
- (2) Data protect key 2 (*KEY2: Y709)
- (3) Data protect key 3 (*KEY3: Y70A)
- (4) Data protect key (memory card) (*KEY_MemC: Y1C81)

Cont.	Signal name	Abbrev.	Common(\$)
A	BUZZER SOUND CONTROL: BUZZER ON [M8]	BZR	Y1C83

[Function]

This signal turns ON the buzzer.

[Operation]

While this signal is turned ON, the buzzer keeps sounding.

The buzzer will stop by turning OFF this signal.

Cont.	Signal name	Abbrev.	Common(\$)
A	Spindle protection: Resetting alarm of equivalent load factor over limit [M8]	EQLDWR	Y1C84

[Function]

This signal resets the warning of equivalent load factor over limit.

[Operation]

When this signal is turned ON, the operation error (M01 1120) is reset.

4 Explanation of Interface Signals

Cont.	Signal name	Abbrev.	Common(\$)
A	FTP DOWNLOAD REQUEST [C80]	DLDREQ	Y1C86

[Function]

This signal is used to request FTP server to download the files.

[Operation]

When this signal is turned ON, the file transfer is requested to FTP server.

When the designated file exists, it is downloaded to the buffer memory.

This signal should be ON until download is finished. If this signal is turned OFF during the download, download will be interrupted and the "FTP download in progress" signal will also be turned OFF.

The file transfer does not begin during the TAPE mode operation (OP). Turn this signal ON again after the operation is finished.

[Related signal]

- (1) FTP download in progress (DLOAD0: X75D)
- (2) FTP download completed (DLDFIN: X75E)
- (3) FTP download error (DLDERR: X75F)

Cont.	Signal name	Abbrev.	Common(\$)
A	Parameter input error cancel [C80]		Y1C87

[Function]

This signal is used to cancel the parameter input error display.

[Operation]

When this signal is turned ON, the "Z43 Parameter input error" alarm display on HMI screen can be erased.

Cont.	Signal name	Abbrev.	Common(\$)
A	External encoder 1: Position output clear request [M8]	ENC1PCLR	Y1C88

[Function]

This signal clears the external encoder 1 position output.

[Operation]

Input this signal as a pulse instruction.

At the rising edge of this signal, the external encoder 1 position output (ENC1POS: ZR13020,1) is cleared to zero.

[Related signals]

- (1) External encoder 1: Position output [M8] (ENC1POS: ZR13020,1)

Cont.	Signal name	Abbrev.	Common(\$)
A	PLC AXIS 4TH TO 9TH HANDLE VALID [C80]	PCH4 to 9	Y1CA0 to Y1CA5

[Function]

These are designated when handle feed of the 4th to 9th handles are to be carried out with the PLC axis.

Designate the signals with Y20 to Y22 to carry out handle feed of 1st to 3rd handles.

[Operation]

Refer to the items in "PLC axis 1st to 3rd handles valid (PCH1 to 3: Y720 to 2)".

Cont.	Signal name	Abbrev.	Common(\$)
A	Reservation of tool wear compensation	TWR	Y1CB8

[Function]

The reservation of tool wear compensation function is enabled.

[Operation]

The reservation of tool wear compensation function is enabled when this signal is turned ON after the parameter "#8140 Reserve T wear com" set to "1" and then the power is turned ON again.

When this signal is turned OFF, the "Reserved tool wear compensation not reflected" signal (TWNIN) does not turn ON.

The "Request for reflecting reserved tool wear compensation" signal (TWIN) cannot be used either.

[Related signals]

- (1) Request for reflecting reserved tool wear compensation (TWIN: YD0F)
- (2) Reflection of reserved tool wear compensation is complete (TWOUT: XD0F)
- (3) Reserved tool wear compensation not reflected (TWNIN: XD0E)

4 Explanation of Interface Signals

Cont.	Signal name	Abbrev.	\$1	\$2	\$3	\$4	\$5	\$6	\$7	\$8
A	POSITION SWITCH n INTERLOCK		Y1D00 to 17	Y1D20 to 37	Y1D40 to 57	Y1D60 to 77	Y1D80 to 97	Y1DA0 to B7	Y1DC0 to D7	Y1DE0 to F7

[Function]

An interlock is applied on the axis when outside the position switch range, and movement of the axis targeted by the position switch is prohibited.

[Operation]

When this signal turns ON and the axis targeted for the corresponding position switch is outside the range, an interlock will be applied on the axis, and movement will be prohibited. Movement is possible within the set range.

- Movement in interlock range

[For linear axis]

The axis can move only in the direction toward the position switch range. If a command is issued in the direction that moves away from the position switch range, "M01 OPERATION ERROR 0004 **" (* is axis name) will occur.

[For rotary axis]

If axis movement is commanded in the interlock state, "M01 OPERATION ERROR 0004 **" (* is axis name) will occur. To move the axis, turn the "Position switch interlock" signal input OFF and cancel the interlock state.

Note that even if the axis is moved away from the position switch range in this state, the interlock will not be applied.

- Coasting distance

The coasting distance when outside the position switch range by axis movement depends on the commanded speed and parameter setting.

[Coasting distance for position switch interlock]

Pcheck	<check>	Coasting distance
0	0	The acceleration/deceleration delay is added to the movement distance within the commanded speed \times 0.060 [s] or less.
0	1	Same as the above distance. (When Pcheck is 0, the <check> setting is invalid.)
1	0	Within commanded speed \times 0.015 [s] or less (During manual mode, commanded speed \times 0.030 [s] or less)
1	1	Acceleration/deceleration delay or position loop gain delay is added to above distance.

[Caution]

- (1) When moving from the set range to outside the range, the coasting distance up to when the axis stops will differ according to the position switch method.
- (2) The position switch interlock is invalid for a reference position return incomplete axis (incremental specifications) absolute position initialization incomplete axis and an axis for which absolute position initialization is being carried out.
- (3) The position switch range is judged with the machine coordinate system. Thus, the inclined axis is judged with the oblique (actual axis).

If the basic axis moves with a command issued for the inclined axis, the axis interlock will not be applied even if the basic axis moves out of the position switch range. (The interlock is valid only for the commanded axis.)

[Related signals]

- (1) Position switch (PSW1 to 24: X1D00 to X1D17)

4.4 PLC Output Signals (Data Type: R***)

Cont.	Signal name	Abbrev.	Common(\$)
A	ANALOG OUTPUT m	AOn	R200 to 3

[Function]

An analog voltage can be output from the designated connector on the remote I/O unit with analog output or built-in AI/AO by setting designated data in the file registers.

[Operation]

"Analog voltage" signal (for speed control) can be output by setting signed binary data to the corresponding file register. The analog output interface is explained below.

Channel	File register (R)
AO1	R200
AO2	R201
AO3	R202
AO4	R203

<Relation of file register details and analog output voltage>

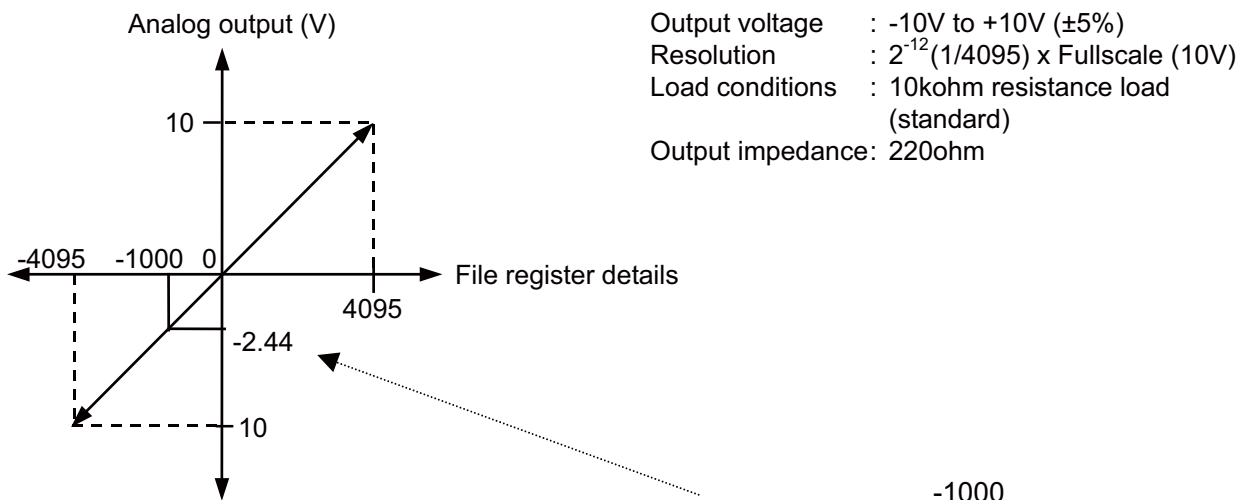

$$\text{Output voltage} = \frac{-1000}{4095} \times 10V = -2.44V$$

<Relation of file register details and output voltage>

Rn n = 100 to 103															
2^{15}	2^{14}	2^{13}	2^{12}	2^{11}	2^{10}	2^9	2^8	2^7	2^6	2^5	2^4	2^3	2^2	2^1	2^0
1	1	1	1	1	1	0	0	0	0	0	1	1	0	0	0

← When -1000 (FC18 with hexadecimal)

The output voltage is

The data is input as binary coded data.

Cont.	Signal name	Abbrev.	Common(\$)
A	DISPLAYED SCREEN NO.		R210 [M8] R196 [C80]

[Function][Operation]

The No. of the displayed screen is output. The following table shows the corresponding Nos. to be output to this register.

4 Explanation of Interface Signals

Screen	Displayed screen No. to be output to the R register
Monitor	1
Setup	2
Edit	3
Diagnosis	4
Maintenance	5
SFP	9*
F0	10*
Window display	13*
Window selection	14*

*: M8 only

[Caution]

- (1) This register is not retained after the power OFF. The data is initialized to "0" at the power ON.
- (2) The displayed screen No. is not output to this register when the PLC onboard or the custom application (EXE) is closed without the screen change keys (with [], [Close] buttons and so on). When the standard screen is displayed in the forefront after the application has been closed, the displayed screen No. on the standard screen is output to this register.

Cont.	Signal name	Abbrev.	Common(\$)
A	KEY OUT 1		R212 [M8]

[Function]

When this signal is used, key data can be entered on the user PLC side instead of the CNC keyboard.

[Operation]

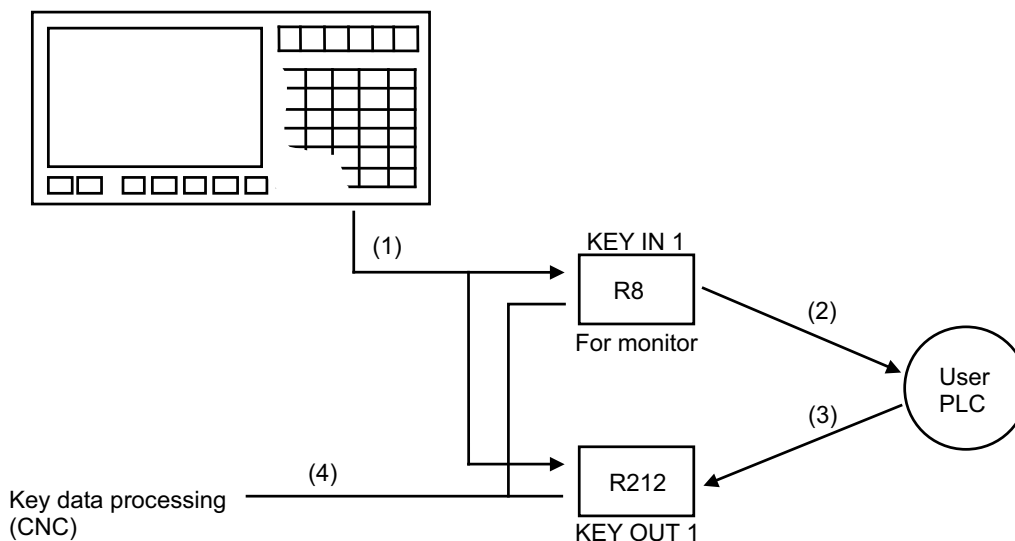

- (1) Key data is set to file registers R8 and R212 at the head of user PLC main program.
- (2) The user PLC refers to the key data, and performs required processing.
- (3) The user PLC sets the key data which meets the keyboard currently in use to register R212.
- (4) The controller processes the effective key data after the main program of user PLC has been processed, referring to the settings of R8 and R212.

[Related signals]

- (1) KEY IN 1 (R8)

4 Explanation of Interface Signals

Cont.	Signal name	Abbrev.	Common(\$)
A	KEY OUT 1		R212[C80]

[Function]

When this signal is used, key data can be entered on the PLC side instead of the CNC keyboard.

[Operation]

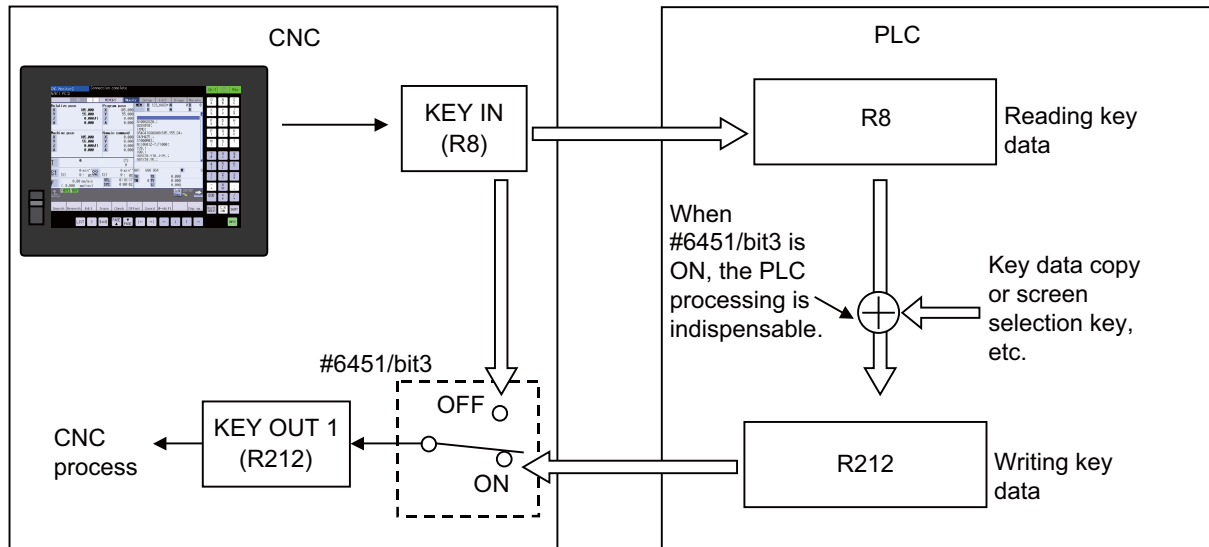

Process of the key data changing/issuing by the PLC program is as follows.

- (1) Parameter "#6451/bit3" is ON.
- (2) The key data is set to "KEY IN".
- (3) The PLC refers to "Reading key data".
- (4) Either of the following processes is carried out. (Data is written in "Writing key data".)
Usually, (a) is processed, (b) and (c) are processed if necessary.
 - (a) Always copies "Reading key data" to "Writing key data" without change.
 - (b) Data that is rewritten according to the content of "Reading key data" is written to "Writing key data".
When deleting the key data, etc.
 - (c) The substitute of the operator
When the alarm is generated, the key data which selects the alarm diagnosis screen is written in "Writing key data", etc.
- (5) CNC processes the valid key data according to the contents of "KEY OUT".

[Caution]

- (1) When the key data is rewritten from the PLC, maintain the key data at 50ms or more.
- (2) When the key data is rewritten by the PLC program, parameter "#6451/bit3" is turned ON. It is necessary to write the key data to the PLC program when turning ON.
The key data does not pass PLC program when turning OFF.

[Related signals]

- (1)KEY IN 1 (R8)

Cont.	Signal name	Abbrev.	Common(\$)
A	POWER OFF INDICATION Y DEVICE NO. [M8]		R215

[Function][Operation]

This signal sets the Y device to notify the control unit's power OFF.
The setting range is 0 to 5FF(HEX).
Set the Y device No. taking the hardware configuration into consideration.
Designate binary data for Y device No.
When a Y device No. outside the setting range is set, this signal will not be output to the Y device.
Refer to the "Automatic power OFF request" signal (Y75D) for details.

[Related signals]

- (1) Power OFF processing (X707)
- (2) Automatic power OFF request (Y75D)

4 Explanation of Interface Signals

Cont.	Signal name	Abbrev.	Common(\$)
A	DETAILED SCREEN NO.		R216[M8] R197[C80]

[Function][Operation]

The detailed screen No. of the displayed screen is output.

The following table shows the correspondence between the menu keys and the detailed screen numbers set in this register.

Monitr		Setup		Edit		Diagn		Mainte	
Monitor Screens	100	T-ofs	201	Edit	301	Config	401	Mainte	501
Search	101	T-meas	202	Check (3D)*	302	Option	402	Param	502
Reserch	102	T-reg	203	Check (2D)*	351	I/F dia	403	I/O	503
Edit	103	T-life	204	NAVI MILL*	10001	Drv mon	404		
Trace (2D)*	104	Coord	205	NAVI LATHE*	10301	Mem dia	405	All backup*	551
Trace (3D)*	152	W-meas	206	I/O	305	Alarm	406	HMI config. *	552
Check (3D)*	105	User	207			-	-	Adjust S-ana*	553
Check (2D)*	151	MDI	208			-	-	To Abs pos	554
Cnt exp	106	Cnt set	209			-	-	Protect setting	555
Offset	107	MST	210			-	-	Servo diagn	556
Coord	108	T-list*	211			Selfdia	411	Collect set	557
Cnt set	109	Pallet*	212			NC Smp	412	Open device*	558
MST	110	T-Mng.	213					Open SRAM*	559
Modal	111	-	-					Ext PLC link*	560
Tree	112	Storage	215						
Time	113	Surf*	216					RCE mea	562
Com var	114	Mac cond	217						
Loc var	115	Barrier data	218					Home screen*	601
P corr	116	E-mail*	219						
PLC SW*	117	WE mea.*	220					PLC onboard*	11000
G92 set	118	Range *	221						
Col stp	119								
LD MTR	120								
Sp-stby	121								
TipDisp	122								
All sp	123								
Dsp sw.	(*1)								
-	-								
S-sel*	126								
Next axis	(*1)								
W-shift*	128								

*: M8 only

Custom open screen	
F0 open (compile method, interpreter method)	6000 to 7999
Menu open (compile method, interpreter method)	8000 to 9999
Menu open (execution file registration method)	20000 to 20099
F0 open (execution file registration method)	20100

(*1) As there is no screen for [Next axis] and [Dsp change] menu keys, use the detailed screen No. for the operation screen, "100".

[Caution]

- (1) This register is not retained when the power is turned OFF. The data is initialized to "0" when the power is turned ON.
- (2) When the application is terminated with a key other than the screen switching keys ([x], [Close] button, etc.) while the PLC onboard or custom application (EXE) is displayed, the detailed screen No. is not output to this register. However, when the standard screen is displayed in the forefront after the application has been closed, the detailed screen No. on the standard screen is output to this register.
- (3) Even though the guidance screen and the menu list screen are displayed, the display screen No. and detailed screen No. are not output.
The previously displayed screen No. and detailed screen No. remain the same.

4 Explanation of Interface Signals

Cont.	Signal name	Abbrev.	Common(\$)
A	USER SEQUENCE PROGRAM VERSION CODE [M8]		R224 to 7

[Function]

The user sequence program version can be displayed with the software version that controls the other controller on the setting and display unit (communication terminal) DIAGNOSIS screen.

[Operation]

Characters to be displayed are placed in ASCII code.
<Display format>

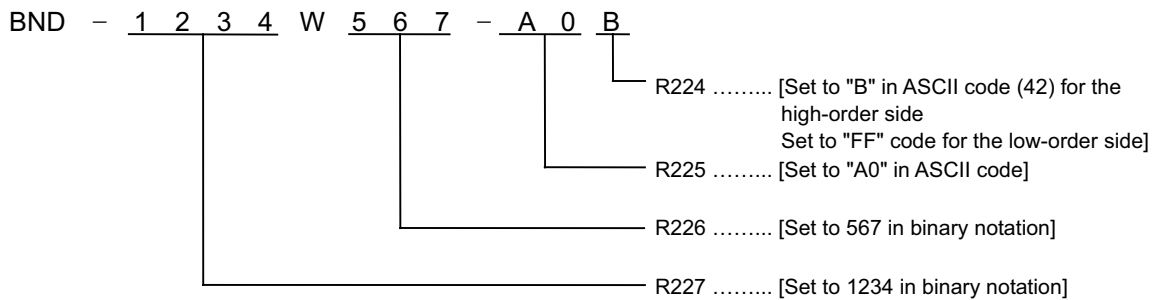
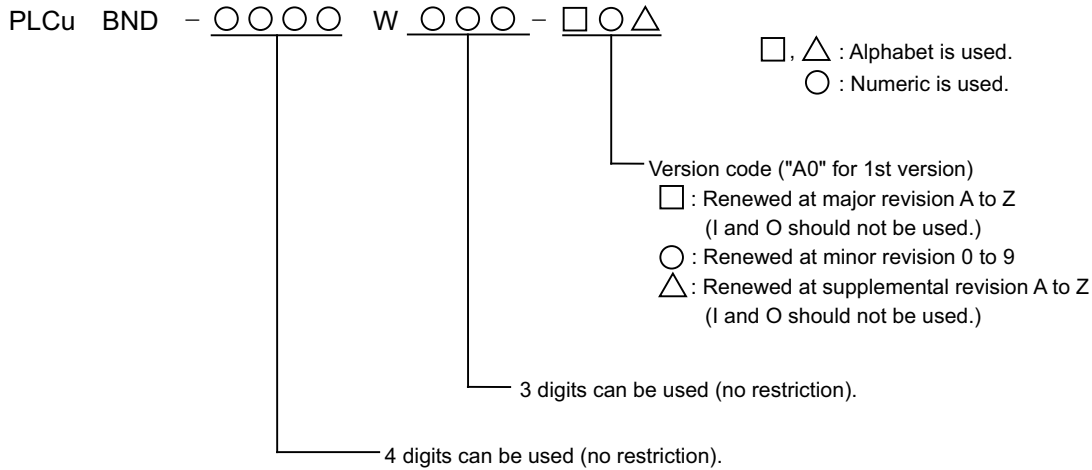

(Program example)

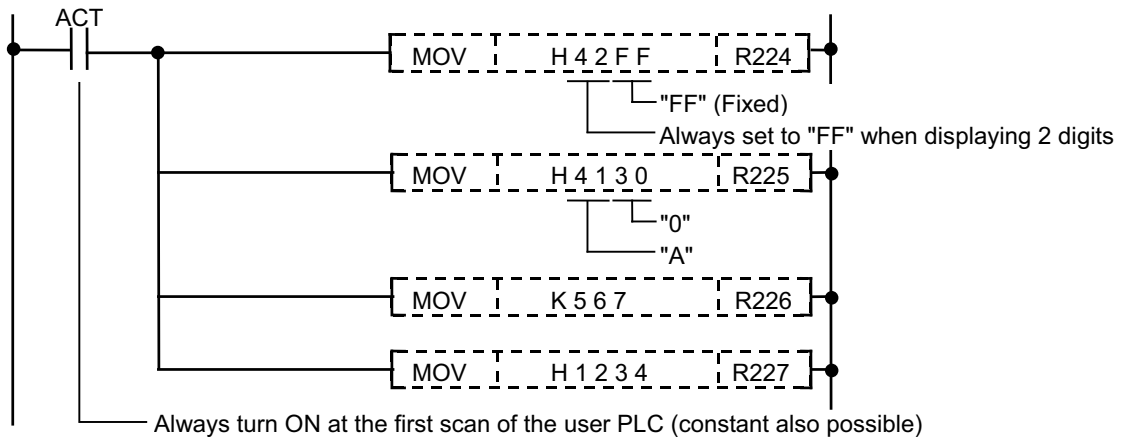

4 Explanation of Interface Signals

Cont.	Signal name	Abbrev.	Common(\$)
A	USER SEQUENCE PROGRAM VERSION CODE 2 [M8]		R232 to 9

[Function]

This signal enables the user sequence program version to be displayed, together with the software version controlling another control unit, in the DIAGNOSIS screen of the setting display unit (communication terminal).

[Operation]

The ASCII code that corresponds to the character to be displayed in the version display interface is set.

<Display format and usage example>

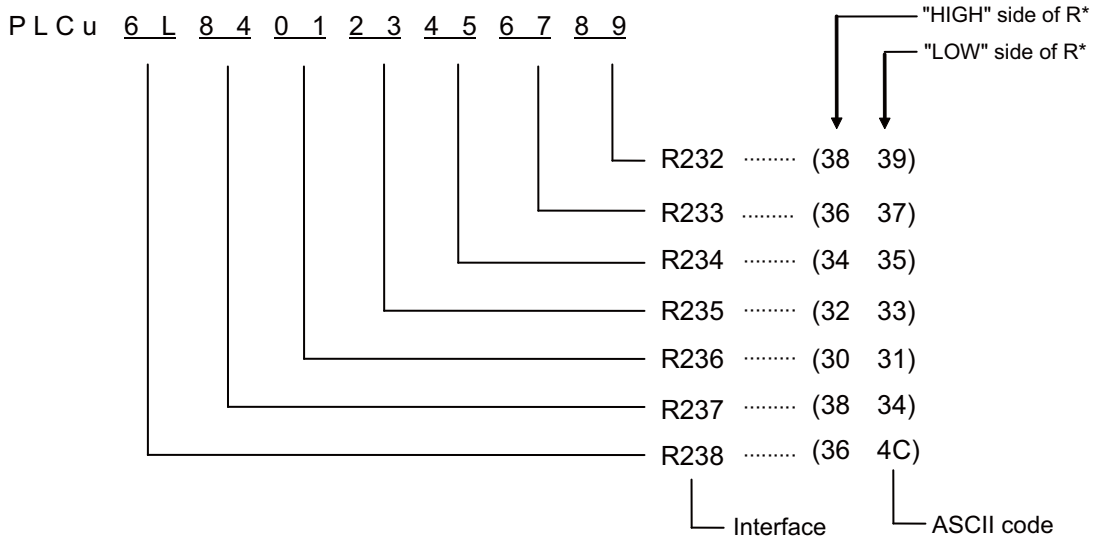
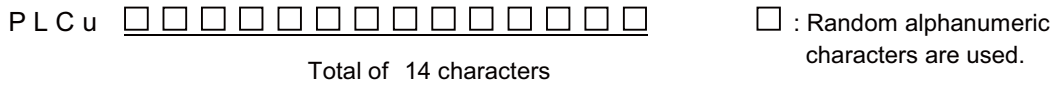

(Program example)

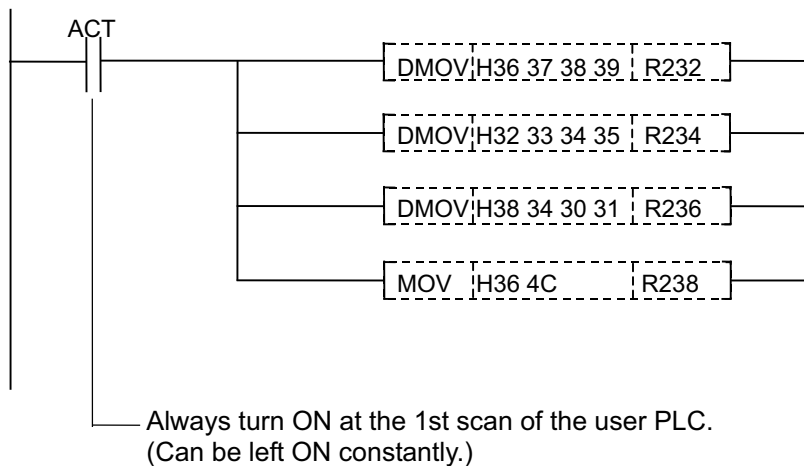

Cont.	Signal name	Abbrev.	Common(\$)
A	APLC VERSION		R240 to 3

[Function]

This signal indicates APLC software version.

[Operation]

File register R240 to R243 is as the following data.

R240 to R243 is as the following data.

(Example) BND-1003W400-A0B

(1) (2) (3)

Item		File register	Type	Example
(1)	Model function No.	R240	Binary	1003=03EBH
(2)	Serial No.	R241	Binary	400=0190H
(3)	Version	Bits 7 to 0 of R242	ASCII code	A=41H
		Bits F to 8 of R242	ASCII code (Note1)	0=30H
		Bits 7 to 0 of R243	ASCII code (Note1)	B=42H
-	-	Bits F to 8 of R243	Always FFH (Note2)	FFH

(Note1) If the version is 1-digit No., set the version in bits 7 to 0 of R242, and set "00H" in bits F to 8 of R242 and bits 7 to 0 of R243.

(Note2) Always set "FFH" in bits F to 8 of R243. If not, it will not be displayed correctly.

4 Explanation of Interface Signals

Cont.	Signal name	Abbrev.	Common(\$)
A	OT IGNORED		R248,9

[Function]

When this signal is used, "stroke end error" can be avoided without external wiring for stroke end signal (remote I/O connector pin No. fixed signal) provided for each axis. "Stroke end" signal on axis for which the "OT ignored" signal is set can be used for other purpose.

[Operation]

"Stroke end error" signal associated with a specific axis motion can be ignored.

The interface for this signal is as follows:

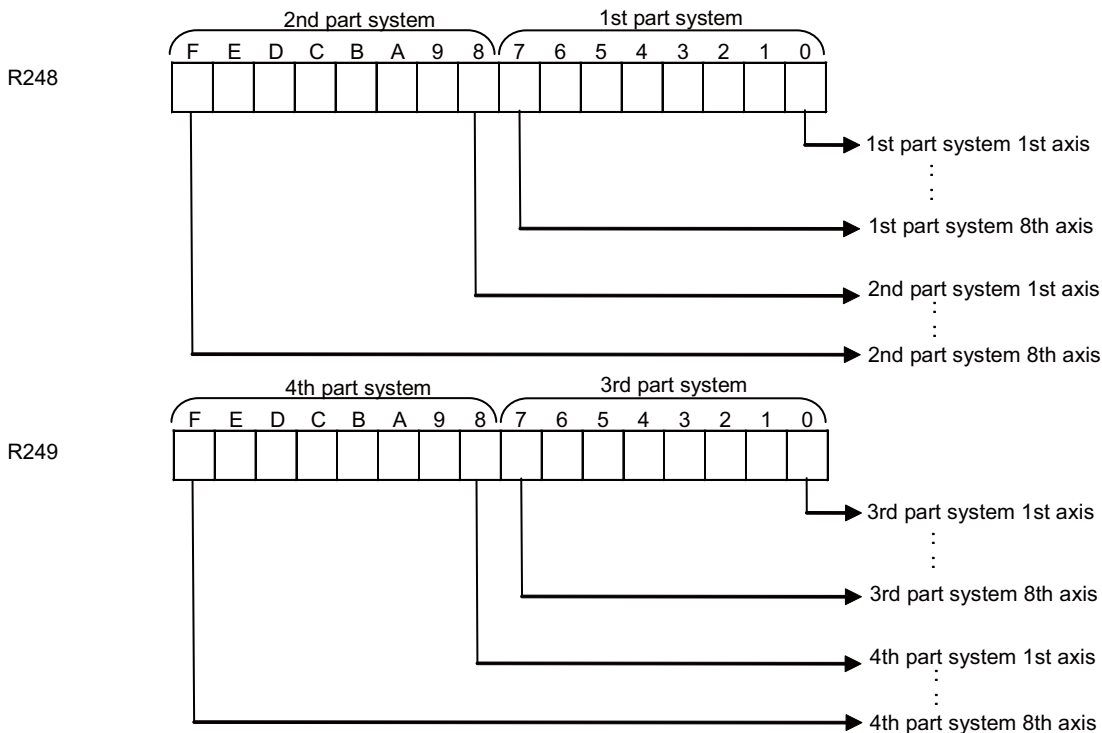

(Note 1) The signal is applicable to (+) and (-) motion at the same time (ignored when "ON").

(Note 2) "OT" is abbreviation of "Over Travel".

Cont.	Signal name	Abbrev.	Common(\$)
A	PLC AXIS OT IGNORED		R255

[Function]

When this signal is used, "stroke end error" can be avoided without external wiring for stroke end signal (remote I/O connector pin No. fixed signal) provided for each axis. "Stroke end" signal on axis for which the "PLC axis OT ignored" signal is set can be used for other purpose.

[Operation]

"Stroke end error" signal associated with a specific axis motion can be ignored.

The interface for this signal is as follows:

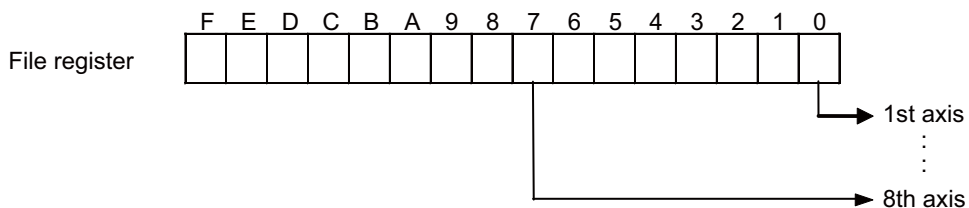

(Note 1) The signal is applicable to (+) and (-) motion at the same time (ignored when "ON").

(Note 2) "OT" is abbreviation of "Over Travel".

4 Explanation of Interface Signals

Cont.	Signal name	Abbrev.	Common(\$)
A	NEAR-POINT DOG IGNORED		R272,3

[Function]

When this signal is used, "Near point detection" signal (remote I/O connector pin No. fixed signal) which is used for dog type reference position return can be ignored (dog not-passed state).

Furthermore, the "Near point detection" signal for an axis to which the "Near-point ignored" signal is set can be used for other applications.

[Operation]

When the signal is turned ON, "Near point detection" signal for the corresponding control axis can be ignored.

The interface is shown below:

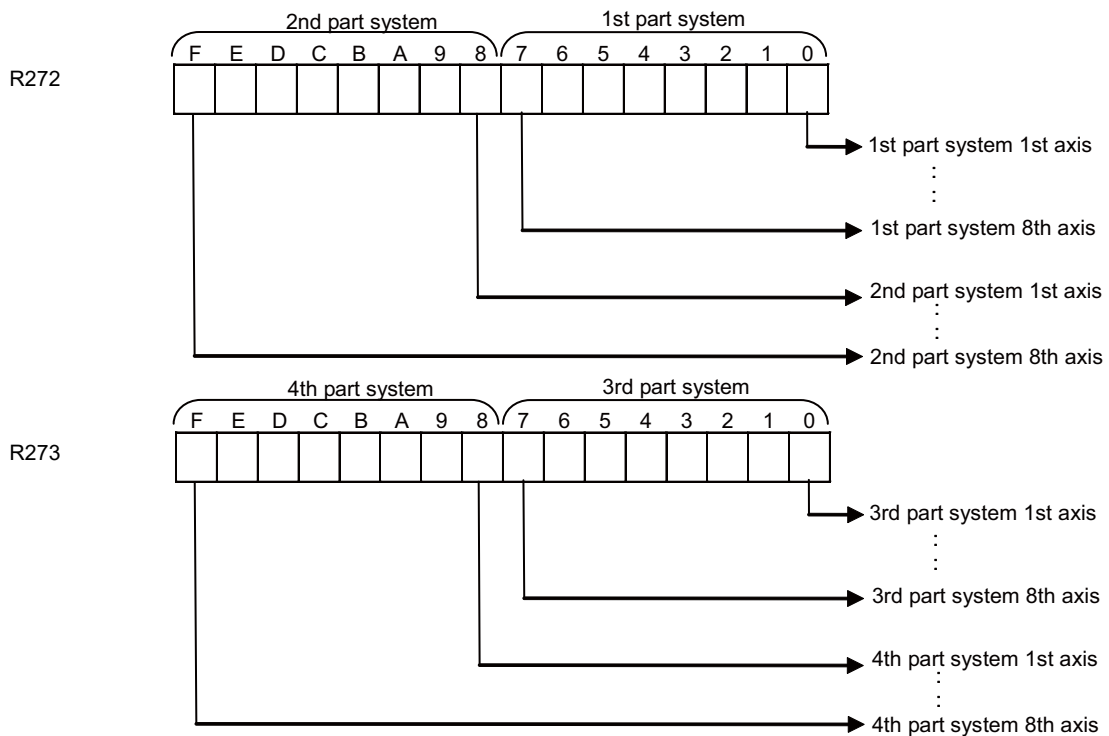

Cont.	Signal name	Abbrev.	Common(\$)
A	PLC AXIS NEAR-POINT DOG IGNORED		R279

[Function]

When this signal is used, "Near point detection" signal (remote I/O connector pin No. fixed signal) which is used for dog type reference position return can be ignored (dog not-passed state).

Furthermore, the "Near point detection" signal for an axis to which the "PLC axis near-point ignored" signal is set can be used for other applications.

[Operation]

When the signal is turned ON, "Near point detection" signal for the corresponding control axis can be ignored.

The interface is shown below:

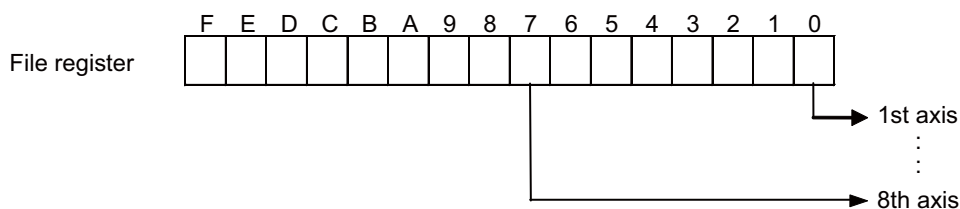

4 Explanation of Interface Signals

Cont.	Signal name	Abbrev.	Common(\$)
A	SPEED MONITOR MODE	SOMD	R296

[Function]

This signal executes speed monitor function for the control axis for which a valid door No. is selected with parameter "#2118 SscDrSel" and the spindle for which a valid door No. is selected with parameter "#3071 SscDrSelSp".
The door No. corresponds to the following bits.

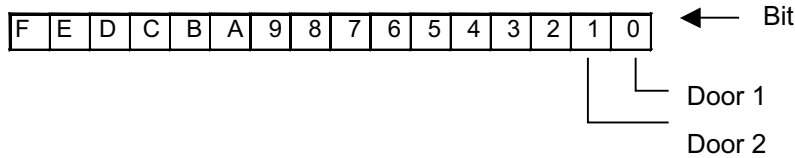

[Operation]

NC performs as follows by turning the speed monitor signal ON.

- (1) Checks compatibility of speed monitor parameter
- (2) Checks if NC's speed monitor parameter matches with the speed monitor parameter sent to servo drive unit and spindle drive unit.
- (3) Notifies speed monitor command to the drive unit
- (4) Executes the speed monitor function on NC
- (5) Turns ON speed monitor door open possible signal when NC receives the in speed monitor mode signal from the drive unit

The followings are performed while the speed monitor function is executed.

Item	Details
Monitoring command speed	When a command speed NC outputs to the drive unit exceeds a safety speed set with parameter, an emergency stop occurs.
Monitoring feed back speed	When a motor rotation speed sent to NC from the drive unit exceeds a safety rotation speed set with parameter, an emergency stop occurs.
Monitoring feed back position	When a difference between feedback position sent to NC from the drive unit and a position commanded by NC is large, an emergency stop occurs.

[Caution]

- (1) Be sure to turn ON the speed monitor mode signal (SOMD) after confirming deceleration of all axes. If the speed monitor mode signal (SOMD) is turned ON without deceleration, and the motor rotation speed exceeds the set speed, a speed monitor alarm will occur, resulting in an emergency stop state. Then, power of the drive section will be shut off.
- (2) Turn OFF the speed monitor mode signal after confirming the door lock is OFF.
- (3) Even if the speed monitor mode signal (SOMD) is turned ON while parameter error is output, speed monitoring is not initiated. Set the parameter with appropriate value, and then turn ON the speed monitor mode signal (SOMD).
- (4) While the axis is being removed, it will be taken off from the watch list even if the parameters "#2313 SV113/bit F (safety observation function)" and "#13229 SP229/bit F" are ON.
However, removing all axes in the group which the door state signal is turned ON with "#2282 SV082/bit F-C (dis Digital signal input selection)" and "#13227 SP227/bit F-C (dis Digital signal input selection)" causes the emergency stop.
Do not remove the axis which the door state signal is to be input.

[Related signals]

- (1) Speed monitor door open possible (SMDOEN: R96)

4 Explanation of Interface Signals

Cont.	Signal name	Abbrev.	Common(\$)
A	HANDY TERMINAL DATA AREA TOP ADDRESS [M8]		R297

[Function]

Set the top address of the area in which data to be transmitted/received to/from the handy terminal is stored.

[Operation]

Set the CNC side R register top address corresponding to the handy terminal side D0 to "Handy terminal Data area top address (R297)", and set the number of registers to communicate into "Handy terminal Data valid number of registers (R298)".

<Setting example>

The following is the setting value used for allocating the data from R9800 to R9849, the CNC side user area, by using 50 registers from D0 to D49 in the handy terminal side.

"9800 (0x2648) for "Handy terminal Data area top address (R297)"

"50 (0x32) for "Handy terminal Data valid number of registers (R298)"

Image drawing of internal register

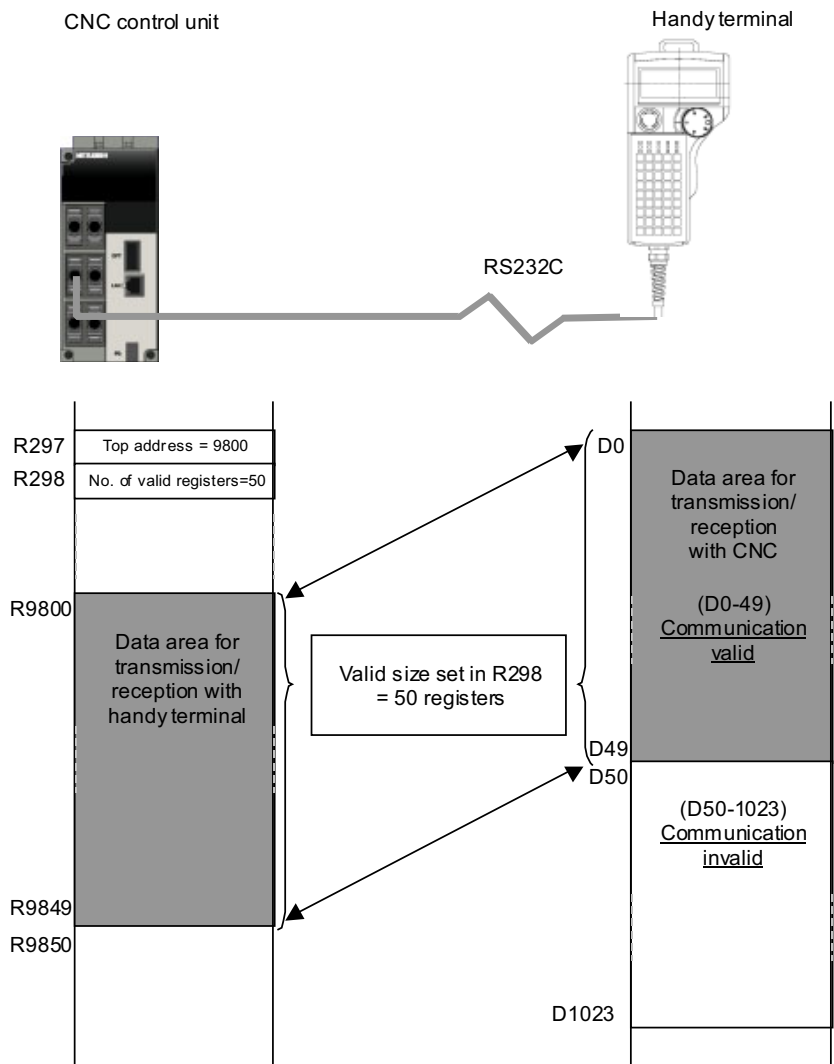

4 Explanation of Interface Signals

[Related signals]

- (1) Handy terminal key 1 to 45 (X1CD0 to X1CFC)
- (2) Handle pulse encoder communication connector priority (Y70D)
- (3) Handle/Incremental feed magnification code m (MP1, MP2, MP4: YC80, YC81, YC82)
- (4) Handle/incremental feed magnification method selection (MPS: YC87)
- (5) Handy terminal Data valid number of registers (R298)
- (6) Handy terminal Cause of communication error (R299)
- (7) 1st handle/incremental feed magnification (R2508, R2509)

Cont.	Signal name	Abbrev.	Common(\$)
A	HANDY TERMINAL DATA VALID NUMBER OF REGISTERS [M8]		R298

[Function][Operation]

Set the number of valid registers from D0 within the handy terminal transmission/reception area (D0 to 1023).

With CNC, the range of handy terminal transmission/reception area is the number of registers set starting from "Handy terminal Data area top address (R297)".

Refer to the section on "Handy terminal Data top address" for details.

[Related signals]

- (1) Handy terminal key 1 to 45 (X1CD0 to X1CFC)
- (2) Handle pulse encoder communication connector priority (Y70D)
- (3) Handle/Incremental feed magnification code m (MP1, MP2, MP4: YC80, YC81, YC82)
- (4) Handle/incremental feed magnification method selection (MPS: YC87)
- (5) Handy terminal Data area top address (R297)
- (6) Handy terminal Cause of communication error (R299)
- (7) 1st handle/incremental feed magnification (R2508,R2509)

Cont.	Signal name	Abbrev.	Common(\$)
A	HANDY TERMINAL CAUSE OF COMMUNICATION ERROR [M8]		R299

[Function][Operation]

For details on communication error, refer to the table below.

Hexadecimal (HEX)	Decimal (DEC)	Details
0000	0	No error
FFFE	-2	Serial port in use
FFFC	-4	Timeout terminated
FFF9	-7	Serial driver forcibly terminated
FFF6	-10	Serial driver not ready (SIO cable is disconnected)
FFF1	-15	Parity error
FFEF	-17	Number of received characters over
FFEC	-20	Flaming error, H/W error
FC18	-1000	Handy terminal data area illegal (Out of user area)

[Related signals]

- (1) Handy terminal key 1 to 45 (X1CD0 to X1CFC)
- (2) Handle pulse encoder communication connector priority (Y70D)
- (3) Handle/Incremental feed magnification code m (MP1, MP2, MP4: YC80, YC81, YC82)
- (4) Handle/incremental feed magnification method selection (MPS: YC87)
- (5) Handy terminal Data valid number of registers (R298)
- (6) Handy terminal Cause of communication error (R299)
- (7) 1st handle/incremental feed magnification (R2508, R2509)

4 Explanation of Interface Signals

Cont.	Signal name	Abbrev.	Common(\$)
A	POWER CONSUMPTION COMPUTATION: CONSUMPTION OF DEVICES OTHER THAN DRIVE SYSTEM	NDPC	R304, 5

[Function]

This signal sets the power consumption of devices other than drive system.

[Operation]

This data is set with the PLC.

Setting size = 2 words, Setting unit = 1 (W), Setting range = -2147483648 to 2147483647 (W)

[Caution]

(Note 1) When the power is turned ON again, the state prior to the power ON is held.

(Note 2) The positive value represents power consumption and the negative value represents power regeneration.

[Related signals]

- (1) Power consumption computation: Enable consumption accumulation 1 to 4 (IPCE1 to 4:Y724 to 7)
- (2) Power consumption computation: Accumulated consumption of devices other than drive system 1 to 4 (NDIPC1 to 4:R130 to 137)

Cont.	Signal name	Abbrev.	Common(\$)
A	POWER CONSUMPTION COMPUTATION: DRIVE SYSTEM'S FIXED CONSUMPTION CORRECTION	DFPCC	R306, 7

[Function]

This signal sets the drive system's fixed consumption correction amount.

[Operation]

This data is set with the PLC.

With this data, the parameter "#1372 DrvBasePwr" (Fixed drive system power consumption) can be adjusted by the ladder.

Setting size = 2 words, Setting unit = 1 (W), Setting range = -2147483648 to 2147483647 (W)

[Caution]

(Note 1) When the power is turned ON again, the state prior to the power ON is held.

(Note 2) The positive value represents power consumption and the negative value represents power regeneration.

[Related signals]

- (1) Power consumption computation: Enable consumption accumulation 1 to 4 (IPCE1 to 4:Y724 to 7)
- (2) Power consumption computation: Present consumption of entire drive system (DTPPC:R120, 1)
- (3) Power consumption computation: Accumulated consumption of entire drive system 1 to 4 (DTIPC1 to 4:R122 to 9)

Cont.	Signal name	Abbrev.	Common(\$)
A	Operator message I/F 1 to 4		R308 to R311

[Function]

Desired operator message prepared using PLC development tool (personal computer) can be displayed by setting value (binary code) to operator message interface file register (Rn). Operator message appears in ALARM DIAGNOSIS screen of the setting and display unit.

[Operation]

If table No. of previously prepared operator message table has been set to operator message interface file register, operator message can be displayed in ALARM DIAGNOSIS screen. Operator message can be cleared by setting "0" to operator message interface file register.

For details of operator messages, refer to the "PLC Programming Manual".

[Caution]

- (1) Set the machine parameter PLC "#6450 bit 2" to 1 to display the operator messages.
- (2) There are two types of interface for an operator message: type R which uses a file register (R) and type F which uses a temporary memory. The selection of type R or F is made by the machine parameter PLC "#6455 bit 3".
- (3) Displaying an operator message does not cause any alarm on the controller side for type R or F. If the controller needs to be stopped, take appropriate action on the PLC side, including Automatic operation pause (*SP), Single block (SBK) and Interlock.
- (4) R2560 and R308 cannot be used at a time. When you use R308, set "0" to R2560. R309 to R311 can be used regardless of the value of R2560.

4 Explanation of Interface Signals

Cont.	Signal name	Abbrev.	Common(\$)
A	MACHINE MANUFACTURER MACRO PASSWORD NO.		R354,5

[Function]

This function uses a password No. to prohibit editing and input/output of the user PLCs to prevent these user PLCs prepared by the machine manufacturer from being incorrect overwritten by the end user.

[Operation]

The machine manufacturer's original password No. is registered in R354[L]/R355[H] with the user PLCs.

Set the password No. in the range of "2" to "99999999". "0" and "1" cannot be set. Note that if the R354/R355 value is "0" or "1", "5963" (default value) will be used as the password No..

Cont.	Signal name	Abbrev.	Common(\$)
A	DIRECT SCREEN SELECTION [M8]		R356 to 9

[Function]

This signal allows an automatic transition to a desired screen by setting the screen selection information in the file register through the user PLC.

[Operation]

The descriptions of file registers is listed in the following table.

Register No.	Signal name	Meaning	Details	Supplementary information
R356	R_DRCTSTS	Selection request completion data	1) User PLC confirms the initial state (=0), and then sets data in R357 to R359. 2) User PLC sets Screen selection request (=1). 3) NC confirms the screen selection request, and sets Screen selection completion (=4) to perform screen transition. 4) After the transition, User PLC confirms the screen selection completion (=4) and then sets the initial state (=0).	0: Initial state 1: Screen selection request 4: Screen selection completion 8: No screen selection request application
R357	R_DRCTFUNCTION	Function No.	Set "4" when transitioning to the alarm message display screen.	Selection request
R358	R_DRCTMANMENU	Main menu No.	Set "6" when transitioning to the alarm message display screen.	
		Menu No.	Set "1" when specifying the 1st menu of a customized screen.	
		Screen No.	Set "6001" when transitioning to the customized screen No. 6001.	
R359	R_DRCTSUBMENU	Sub menu No.	Set "1" when transitioning to the NC alarm display screen, or "2" when transitioning to the PLC alarm display screen.	
		Window No.	Set "8002" when displaying the window No. 8002 of a customized screen.	

4 Explanation of Interface Signals

- (1) Specify the function No., main menu No. (or menu and screen Nos. of a customized screen), and sub menu No. (or window No. of a customized screen). Then, set the selection request completion data to "1" at the end.
- (2) Make sure to specify the function No. If not specified, screen transition is not performed.
- (3) If you omit specifying the main menu No. (or menu and screen of a customized screen) (if you leave the No. zero), the NC transitions to a screen specified with the function No. To which screen to transition is determined according to the destination assigned to each function key.
- (4) When the sub menu No. has been set, the main menu No. has also to be set. If no main menu No. is set, the transition is as same as when only the function No. is set.
- (5) If you specify a screen No., the NC opens the customized screen of the specified function No., and then transitions to the screen of the specified screen No.
- (6) If you specify a window No., the window of the specified No. appears after the screen transition (or after displaying the specified screen, if a screen No. is also specified). Thus, even when you specify no screen number (0), you can display a window by specifying the window No.
- (7) If you specify either the function No., main menu No. (or screen No.), or sub menu No. that is out of range, the screen transition is not executed. In this case, the selection request/completion data (R356: R_DRCTSTS) remains 1.

Specify the values in the following table for each file register.

Setting options of R358/R359 are different according to the specified function No.

Screen	R357 value Function No.	R358 value	R359 value
Monitor	1	Main menu (0 to 30)	Sub menu (0 to 70)
Setup	2		
Edit	3		
Diagnostic	4		
Maintenance	5		

Main menu No. (R358) and sub menu No. (R359) are designated using the position from the left-end of menu.

Menu No. = Number of menu changes × 10 + Position from the left-end of menu (1 to 10)

- * If you specify no menu, set main menu No. and sub menu No. to "0".
- * Refer to Direct Screen Selection Specifications Manual to enable direct screen selection for customized screens.

[Timing Chart]

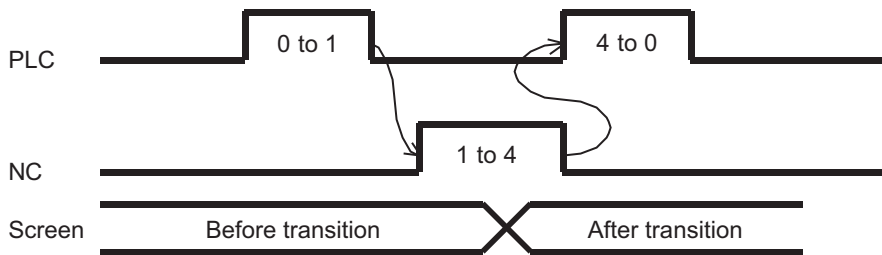

- Set the screen selection completion (R356=4) after completion of screen transition.
- If screen transition is disabled, the selection completion data (R356) may remain "1".
If R356 remains unchanged for two seconds or longer after the screen selection request (R356=1), set "0" in R356 through the PLC.

[Precautions and restrictions]

- (1) If screen selection request is made while any screen process is executed, the subsequent operation will be the same as when a key that causes a screen transition (a function key, for example) is pressed. The operation examples are given below.
 - During file edit on the Edit screen: Screen transition is carried out after the file save is completed.
 - During data input/output: Screen transition is immediately carried out. At this time, the input/output is executed in the background.
 - During buffer correction: Screen transition is immediately carried out. The buffer correction data is not saved.
 - During operation search: Screen transition is carried out after the operation search is completed.
- (2) For a screen that requires a password entry before being able to display, a screen transition to the said screen is disabled if no password has been input.
- (3) If the target main menu designation or screen No. designation is not processed, processing of sub menu or window No. will not be carried out.
- (4) When screen transition is disabled, no specific error is set or displayed, and the selection completion data (R356) remains "1". Thus, if there is no changes for 2 seconds or longer after the screen selection request (R356=1), set "0" in R356 through the PLC. However, if the control fails to find the application for the direct screen selection request, "8" is set in R356.
- (5) This function implements a screen transition to each display screen of Monitor, Setup, Edit, Diagnosis, Maintenance and customized screens, except for the execution file registration type customized screens.
- (6) If a transition to the identical window screen is carried out, the target window screen is closed once, and then displayed again.
- (7) The menu No. specified for direct screen selection (R358) is applied to the menus configured when the menu selection parameter "#11032 Menu sel para lkof (Validate menu selection parameter setting)" is either "0" or "1". Thus, the control may transition to a screen not intended by the machine tool builder.
- (8) While NAVI MILL or LATHE is displayed, screen transition may fail depending on the working condition.

4 Explanation of Interface Signals

Cont.	Signal name	Abbrev.	Common(\$)
A	DIRECT SCREEN SELECTION [C80]		R356 to 9, R195

[Function]

This is a function designed to provide an automatic transition to a desired screen. This is accomplished by setting the screen selection information in the file register through the user PLC.

[Operation]

The descriptions of file registers is listed in the following table.

Register No.	Signal name	Meaning	Details	Supplementary information
R356	R_DRCTREQUEST	Selection request completion data	1) User PLC confirms the initial state (=0), and then sets data in R357 to R359. 2) User PLC sets Screen selection request (=1). 3) User PLC confirms R195 screen selection completion notice and then sets the initial state (R356=0).	0: Initial state 1: Screen selection request
R357	R_DRCTFUNCTION	Function No.	Set "4" when transitioning to the alarm message display screen.	Selection request
R358	R_DRCTMANMENU	Main menu No.	Set "6" when transitioning to the alarm message display screen.	
R359	R_DRCTSUBMENU	Sub menu No.	Set "1" when transitioning to the NC alarm display screen, or "2" when transitioning to the PLC alarm display screen.	
R195	R_DRCTSTS	Screen selection completion notice	"4" is set when the screen selection is completed. "8" is set when there is no screen selection request application. R195 turns to "0" by returning screen selection request R356 to "0".	4: Screen selection completion 8: No screen selection request application

- (1) Make sure to specify the function No. If not specified, screen transition is not performed.
- (2) If you omit specifying the main menu No. (or menu and screen of a customized screen) (if you leave the No. zero), the NC transitions to a screen specified with the function No. To which screen to transition is determined according to the destination assigned to each function key.
- (3) When the sub menu No. has been set, the main menu No. has also to be set. If no main menu No. is set, the transition is as same as when only the function No. is set.
- (4) If you specify an invalid value in the function No., main menu No., or sub menu No., the screen transition is not executed. In this case, screen selection completion notice (R195) remains "0".

Specify the values in the following table for each file register.

Setting options of R358/R359 are different according to the specified function No.

Screen	R357 value Function No.	R358 value	R359 value
Monitor	1	Main menu (0 to 30)	Sub menu (0 to 70)
Setup	2		
Edit	3		
Diagnostic	4		
Maintenance	5		

Main menu No. (R358) and sub menu No. (R359) are designated using the position from the left-end of menu.
Menu No. = Number of menu changes × 10 + Position from the left-end of menu (1 to 10)

* If you specify no menu, set main menu No. and sub menu No. to "0".

[Timing Chart]

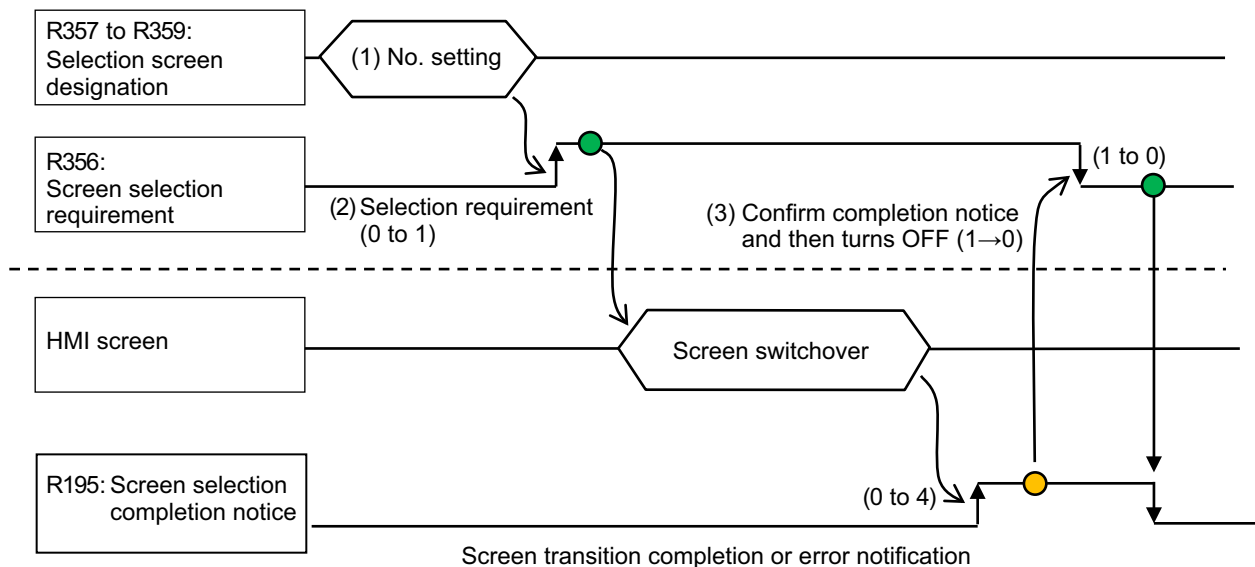

- (1) Confirm that the selection requirement/completion data (R356) is set to the initial state "0" and then set function No. (R357), main menu No. (R358) and sub menu No. (R359).
- (2) Set screen selection requirement (R356) to "1".
- (3) When the screen switchover is completed, completion notice (R195) is set to "4". After confirming completion notice, return screen selection request (R356) to "0".
When the screen selection requirement (R356) returns to "0", the screen selection completion notice (R195) turns to "0".

[Precautions and restrictions]

- (1) If screen selection request is made while any screen process is executed, the subsequent operation will be the same as when a key that causes a screen transition (a function key, for example) is pressed. The operation examples are given below.
 - During file edit on the Edit screen: Screen transition is carried out after the file save is completed.
 - During data input/output: Screen transition is immediately carried out. At this time, the input/output is executed in the background.
 - During buffer correction: Screen transition is immediately carried out. The buffer correction data is not saved.
 - During operation search: Screen transition is carried out after the operation search is completed.
- (2) The menus designated by menu No. (R358) depends on the menu configuration set by parameter "#11032 Menu sel para lkof (Validate menu selection parameter setting)", "#11101-11130 Monitr menu (MTB) 1 to 30 (Monitor main menu (MTB) 1 to 30)", "#11151-11180 Setup menu (MTB) 1 to 30 (Setup main menu (MTB) 1 to 30)" and "#11201-11230 Edit menu (MTB) 1 to 30 (Edit main menu (MTB) 1 to 30)". When hiding the menus or changing the display position with the menu selection paramters, adjust the menu No. (R358) designation.
- (3) If the target main menu designation or screen No. designation is not processed, processing of sub menu or window No. will not be carried out.
- (4) For a screen that requires a password entry before being able to display, a screen transition to the said screen is disabled if no password has been input.
- (5) When screen transition is disabled, error display or completion notice is not executed. Selection completion data (R195) remains "0". if there is no changes in R195 for 2 seconds or longer after the screen selection request (R356=1), set "0" in R356 through the PLC.

4 Explanation of Interface Signals

Cont.	Signal name	Abbrev.	Common(\$)
A	USER LEVEL-BASED DATA PROTECTION: OPERATION LEVEL		R361

[Function]

This operation level signal switches the the protection level of various data.

The operation levels with R361 setting value are as follows.

- Other than 1 to 3: Operation level 0
- 1 : Operation level 1
- 2 : Operation level 2
- 3 : Operation level 3

[Operation]

The operation level is switched depending on the state of the user level-based data protection operation level signal. Various data is protected according to the operation level.

Cont.	Signal name	Abbrev.	Common(\$)
A	MACHINE PARAMETER LOCK I/F [M8]		R364

[Function]

When the parameter "#11018 M password hold" is valid and the parameter "#1222 aux06/bit3" is valid, this signal switches the lock/release state of the setup parameter.

The lock/release state corresponds to the following bits.

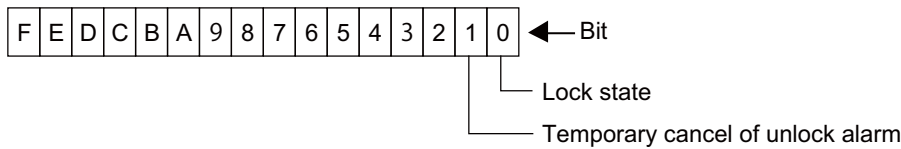

[Operation]

Turning ON the machine parameter lock I/F signal releases the machine parameter lock.

Turning OFF this signal locks the machine parameter.

Cont.	Signal name	Abbrev.	Common(\$)
A	HIGH-SPEED SIMPLE PROGRAM CHECK: TIME MEASUREMENT OUTPUT		R372,3 [M8] R198,9 [C80]

[Function]

This signal outputs an estimated machining time during the high-speed simple program check.

The unit of time output is [ms].

[Operation]

During the high-speed simple program check, this signal outputs the time from the start of the machining program execution until NC reset.

[Related signals]

- (1) High-speed simple program check mode (SMLK:Y73E)
- (2) High-speed simple program check mode ON (SMLKO:X712)
- (3) High-speed simple program check: Time reduction coefficient (R378)

4 Explanation of Interface Signals

Cont.	Signal name	Abbrev.	Common(\$)
A	Manual arbitrary reverse run handle selection		R375

[Function]

This signal is used to select which handle to use for the manual arbitrary reverse run.

[Operation]

The setting value "n" of this signal (R375) corresponds to the ordinal number of the handle. For example, when the setting value is "2", the machine follows the pulse input of the handle selected in "#1396 H2_pno (2nd handle selection)".

The handle selected at the start of the manual arbitrary reverse run mode is used during the mode.

If any non-existent handle number is set in the manual arbitrary reverse run selection (R375) at the start of the mode, the 1st handle is used.

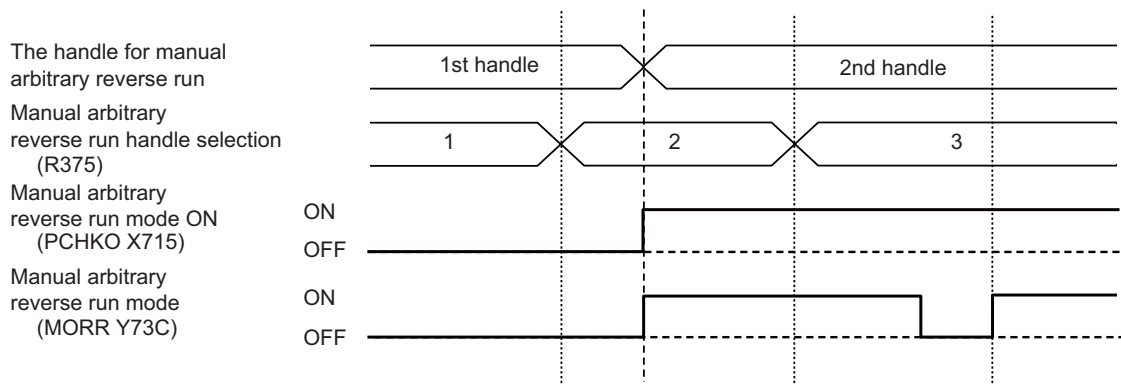
[Operation sequence]**[Related signals]**

- (1) Manual arbitrary reverse run mode ON (PCHKO:X715)
- (2) Manual arbitrary reverse run: Reverse run ON (MOREV:X716)
- (3) Thread, tap block stopping in manual arbitrary reverse run (MBSTP:X74D)
- (4) Thread, tap reverse run prohibition alarm in manual arbitrary reverse run (MRVNG:X74E)
- (5) Manual arbitrary reverse run mode (MORR:Y73C)
- (6) Manual arbitrary reverse run speed selection (MORSP:Y73D)
- (7) Actual cutting mode (thread, tap) in manual arbitrary reverse run (MRCMD:Y761)
- (8) Manual arbitrary reverse run: Reverse run block stop designated part system (RBSSY:YD01)
- (9) Manual arbitrary reverse run: MSTB reverse run prohibited (MRPSG:YCFC)
- (10) Manual arbitrary reverse run speed multiplier (R379)

Cont.	Signal name	Abbrev.	Common(\$)
A	HIGH-SPEED SIMPLE PROGRAM CHECK: TIME REDUCTION COEFFICIENT		R378

[Function]

This signal reduces an execution time for the high-speed simple program check.

[Operation]

With the time reduction coefficient, the time for operations such as axis movement and dwell can be reduced.

If a machining program that requires T seconds for normal execution is performed while the "High-speed simple program check mode ON" (SMLKO:X712) is ON, the execution time is calculated by the following formula.

- (1) When the "High-speed simple program check mode ON" (SMLKO:X712) is ON
Execution time = $T \times (1/2^n)$ n: High-speed simple program check: Time reduction coefficient
- (2) When the "High-speed simple program check mode ON" (SMLKO:X712) is OFF
Execution time = T

[Related signals]

- (1) High-speed simple program check mode (SMLK:Y73E)
- (2) High-speed simple program check mode ON (SMLKO:X712)
- (3) High-speed simple program check: Time measurement output (R372,3[M8]/R198,9[C80])

Cont.	Signal name	Abbrev.	Common(\$)
A	MANUAL ARBITRARY REVERSE RUN SPEED MULTIPLIER		R379

[Function]

This signal adjusts the speed for manual arbitrary reverse run when jog mode or handle mode is selected for speed control during manual arbitrary reverse run.

[Operation]

If the "Manual arbitrary reverse run speed selection" (MORSP) signal turns ON, the parameter "#19007 program check constant" is used for speed control. If the "Manual arbitrary reverse run speed selection" (MORSP) signal is OFF, the command speed of the normal machining program is used.

The feedrate for manual arbitrary reverse run is controlled by the ratio of the Manual arbitrary reverse run speed multiplier (R379) and the parameter "#19007 program check constant" when operation is in jog mode. When in handle mode, the feedrate is controlled by the sum of the handle pulses per time unit and manual arbitrary reverse run speed multiplier, and the ratio of the parameter "#19007 program check constant".

If the "Manual arbitrary reverse run speed selection" (MORSP) is OFF, the command speed of the normal machining program is used.

The speed used when the Manual arbitrary reverse run speed selection (MORSP) is ON

(1) When jog mode is selected:

The manual arbitrary reverse run speed can be calculated from the following formula.

$$\frac{\text{Manual arbitrary reverse run speed multiplier}}{\text{Program check speed constant}} \times \text{Command speed in the machining program}$$

(2) When handle mode is selected:

The manual arbitrary reverse run speed can be calculated from the following formula.

$$\frac{(\text{Change amount of handle pulse per unit time} \times \text{Manual arbitrary reverse run speed multiplier})}{\text{Program check speed constant}} \times \text{Command speed in the machining program}$$

- Rapid traverse override or cutting override can be exerted on the command speed in the machining program.
- Reverse motion is performed if the value of the manual arbitrary reverse run speed calculated with the above formula is a negative value.
- As the same rate of change of the manual arbitrary reverse run speed is applied to all part systems, synchronization of the part systems can be maintained. However, synchronization is not guaranteed when rapid traverse override or cutting override, which may cause a loss of synchronization, is used.
- If the value of the Manual arbitrary reverse run speed multiplier (R379) or the amount of change of handle pulses exceeds "#19007 program check constant", the value is clamped at the program check constant. The manual arbitrary reverse run speed never exceeds the command speed.

[Related signals]

- (1) Manual arbitrary reverse run: Reverse run ON (MOREV: X716)
- (2) Thread, tap block stopping in manual arbitrary reverse run (MBSTP: X74D)
- (3) Thread, tap reverse run prohibition alarm in manual arbitrary reverse run (MRVNG: X74E)
- (4) Manual arbitrary reverse run mode (MORR: Y73C)
- (5) Manual arbitrary reverse run speed selection (MORSP: Y73D)
- (6) Actual cutting mode (thread, tap) in manual arbitrary reverse run (MRCMD: Y761)
- (7) Manual arbitrary reverse run: Reverse run block stop designated part system (RBSSY: YD01)
- (8) Manual arbitrary reverse run: MSTB reverse run prohibited (MRPSG: YCFC)

4 Explanation of Interface Signals

Cont.	Signal name	Abbrev.	Common(\$)
A	G/B SPINDLE SYNCHRONIZATION: POSITION ERROR COMPENSATION SCALE, AND THE NUMBER OF TIMES OF COMPENSATIONS [M8]		R390

[Function]

Set the following: The scale applied to the position error compensation amount found for the first time after the G/B spindle synchronization: position error compensation (GBCMON) is turned ON, and how many times the position error compensation amount is refreshed.

[Operation]

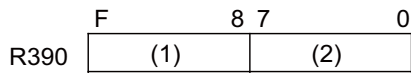

- (1) Compensation scale applied to the first compensation
- (2) The number of times of compensations

- In "Compensation scale applied to the first compensation", set the scale applied to the first position error compensation after turning on the G/B spindle synchronization: position error compensation (GBCMON). (Setting increment: 1/10 times)
When 0 is set, the scale is once.
- In "The number of times of compensations", set how many times the G/B spindle synchronization: position error compensation (GBCMON) is refreshed after turning ON the G/B spindle synchronization position error compensation.
When 0 is set, compensation is repeated by 16 times.

4 Explanation of Interface Signals

- Setting example

Compensation scale applied to the first compensation	The number of times of compensations	R390's setting value
1.5 times	5 times	0F05 (HEX)

<Operation example: When R390 is set to "0F05">

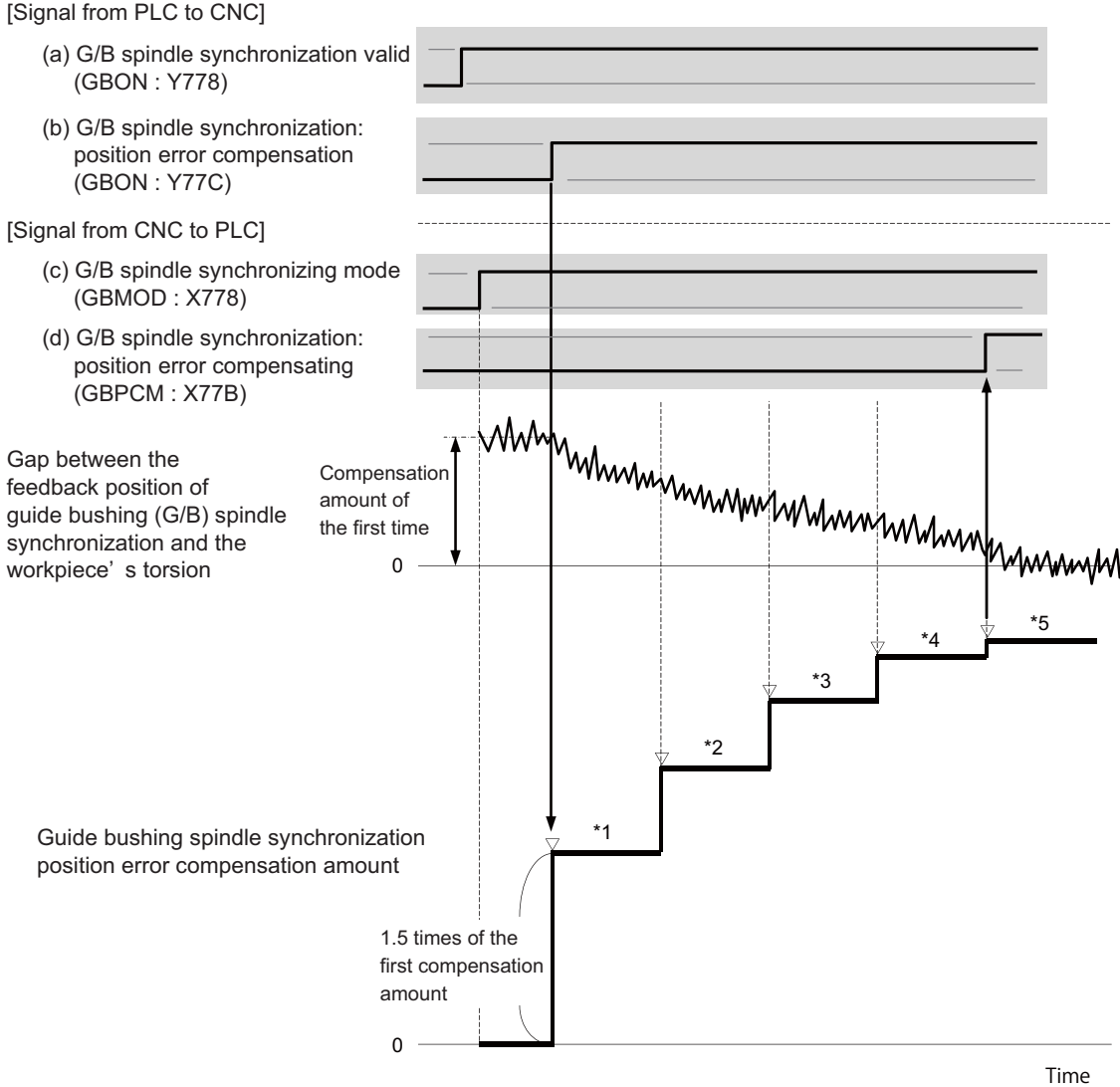

<Refreshing the position error compensation amount after turning ON the G/B spindle synchronization position error compensation (GBCMON)>

When the G/B spindle synchronization position error compensation (GBCMON) is turned ON, the first position error compensation amount is measured, and compensation is carried out. (*1 in the figure above)

Next, the second position error compensation amount is measured, and compensation is carried out. (*2 in the figure above)

In the same manner, the third and fourth measurements are carried out.

The data of the fifth measurement are dealt as the final data to carry out the compensation. (*5 in the figure above)

The compensation scale is applied only to the first position error compensation.

[Related signals]

- (1) G/B spindle synchronization valid (GBON:Y778)
- (2) G/B spindle synchronization: position error compensation (GBCMON:Y77C)
- (3) G/B spindle synchronization: keep position error compensation amount (GBCMKP:Y77E)
- (4) G/B spindle synchronization: position error compensating (GBPCM:X77B)
- (5) G/B spindle synchronization: position error compensation amount (R465)

4 Explanation of Interface Signals

Cont.	Signal name	Abbrev.	1stAX	2ndAX	3rdAX	4thAX
A	BALL SCREW THERMAL DISPLACEMENT COMPENSATION OFFSET AMOUNT n-TH AXIS		R400	R403	R406	R409
A	BALL SCREW THERMAL DISPLACEMENT COMPENSATION MAX. COMPENSATION AMOUNT n-TH AXIS		R401	R404	R407	R410
A	BALL SCREW THERMAL DISPLACEMENT COMPENSATION PART-SYSTEM, AXIS NO. n-TH AXIS		R402	R405	R408	R411

[Function]

These signals use R register as interface for PLC and NC. Up to 4 sets of axis can be set in R register, including axis No., offset amount, and max. compensation amount in one set.

[Operation]

- (1) Part-system, axis No.(raxno): R402

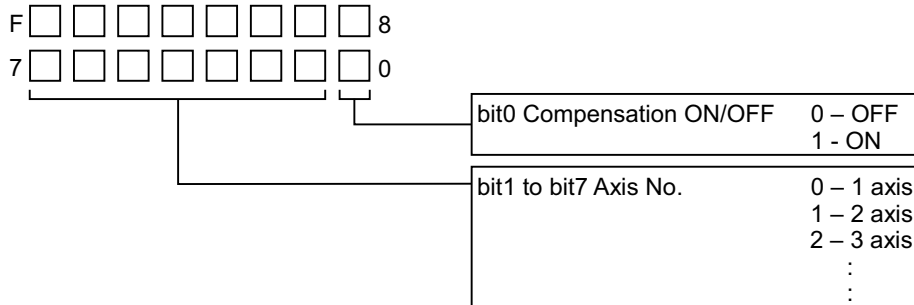

- (2) Offset amount (offset): R400
Set compensation amount for the farthest negative side (mdvno position) in the compensation range by using ladder, etc.
 - (3) Max. compensation amount (maxcmp): R401
Set compensation amount for the farthest positive side (pdvno position) in the compensation range by using ladder, etc. This compensation amount is a value using offset position as a criterion.
 - (4) Compensation amount (legcmp): R72
This is compensation amount for the current machine position set by NC.
Refer to the section on "Ball screw thermal displacement compensation Compensation amount" (R72) for details.
- (Note 1) Raxno, offset, and maxcmp cannot be set from the program or NC screen. Set them in R register by using ladder, etc.
- (Note 2) Unit for (2) to (4) above follows the setting of "#1006 Machine error compensation unit".
Parameters (backlash and pitch error compensation, etc.) regarding machine error compensation and external machine coordinate system compensation also follow this unit.

4 Explanation of Interface Signals

[Setting example]

When only the ball screw thermal displacement compensation is valid:

(Example 1)

Compensation range

cmpax X
 drcax X
 rdvno 4105
 mdvno 4101
 pdvno 4110
 spcdv 1000

Compensation amount

offset -600
 maxcmp 1000
 raxno 1

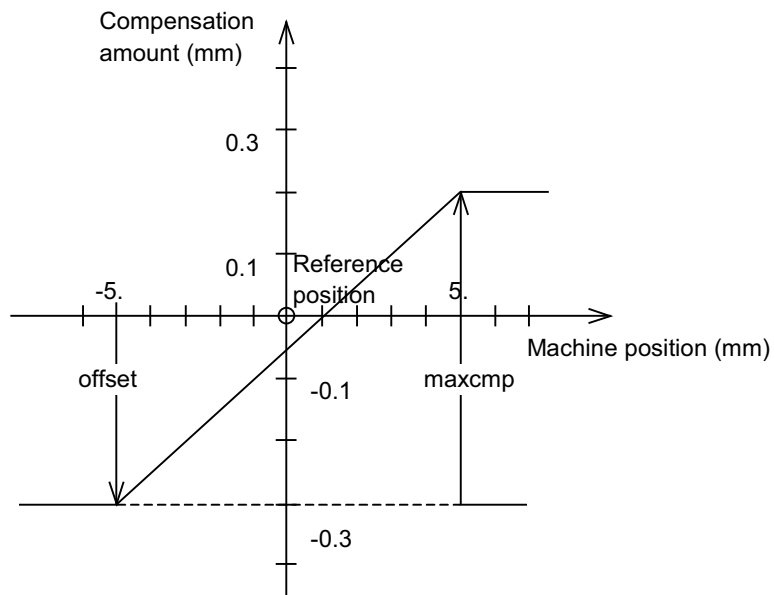

When the ball screw thermal displacement compensation is used with the machine error compensation:

(Example 2)

Compensation range

cmpax X
 drcax X
 rdvno 4105
 mdvno 4101
 pdvno 4110
 spcdv 1000

(Absolute value method)

Division No.	Compensation amount
1	200
2	200
3	100
4	100
5	-100
6	-200
7	-200
8	-300
9	-200
10	-100

Compensation amount

offset -600
 maxcmp 1000
 raxno 1

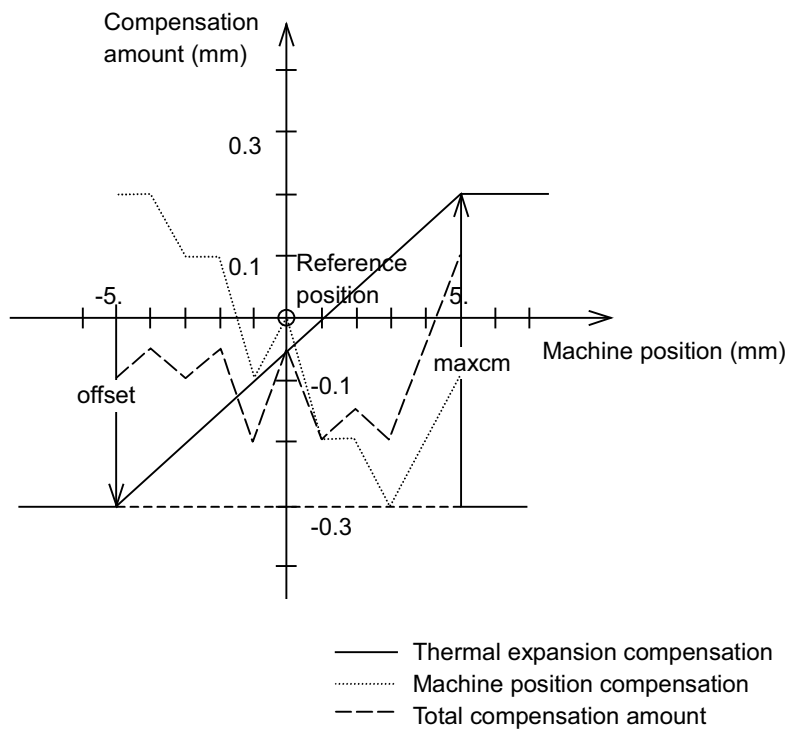

[Related signals]

- (1) Ball screw thermal displacement compensation offset amount n-th axis (R400)
- (2) Ball screw thermal displacement compensation Max. compensation amount n-th axis (R401)
- (3) Ball screw thermal displacement compensation part-system, axis No. n-th axis (R402)
- (4) Thermal expansion compensation amount (R72)

4 Explanation of Interface Signals

Cont.	Signal name	Abbrev.	Common(\$)
A	PLC AXIS CONTROL INFORMATION ADDRESS n-TH AXIS [M8]		R440 to 7

[Function]

The PLC axis control information address stores control information head R register for each PLC axis.

[Operation]

PLC axis control information address is designated by the following devices.

Device No.	Signal name
R440	PLC axis control information address 1st axis
R441	PLC axis control information address 2nd axis
R442	PLC axis control information address 3rd axis
R443	PLC axis control information address 4th axis
R444	PLC axis control information address 5th axis
R445	PLC axis control information address 6th axis
R446	PLC axis control information address 7th axis
R447	PLC axis control information address 8th axis

- (Note) The following R registers can be used.
- R8300 to R9799 (Battery backup area)
 - R9800 to R9899 (Non battery backup area)
 - R18300 to R19799 (Battery backup area)
 - R19800 to R19899 (Non battery backup area)
 - R28300 to R29799 (Battery backup area)
 - R29800 to R29899 (Non battery backup area)

[Related signals]

- (1) PLC axis control buffering mode valid (PABMI:Y723)
- (2) PLC axis control valid (PLCAEn:Y770 to Y775)

Cont.	Signal name	Abbrev.	Common(\$)
A	PLC AXIS CONTROL BUFFERING MODE INFORMATION ADDRESS [M8]		R448

[Function][Operation]

The PLC axis control buffering mode information is stored in the R device set in this register and succeeding area.

[Related signals]

- (1) PLC axis control buffering mode valid (PABMI: Y723)

Cont.	Signal name	Abbrev.	Common(\$)
A	PLC AXIS CONTROL: DROOP CANCEL INVALID AXIS [C80]		R449

[Function]

This signal specifies the PLC axis for which droop cancel is not performed at the current limit switchover.

[Operation]

The droop cancel for a specific axis can be invalid by turning on the PLC axis droop cancel invalid signal as required. The following shows the interface. Droop cancel is disabled while the PLC axis droop cancel invalid signal is ON.

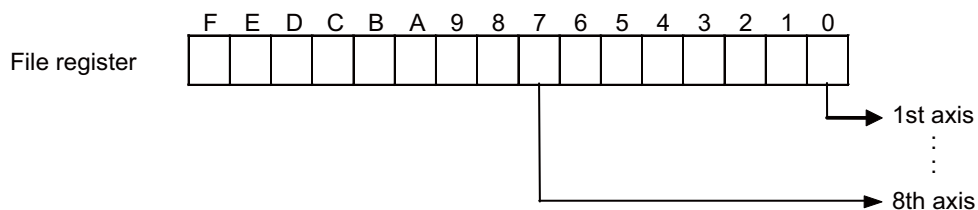

(Note 1) This signal is also valid at the droop cancel request.

(Note 2) This signal is invalid if the current does not reach its limit at the current limit switchover.

4 Explanation of Interface Signals

Cont.	Signal name	Abbrev.	Common(\$)
A	ENCODER 1 ARBITRARY PULSE 1		R456
A	ENCODER 1 ARBITRARY PULSE 2		R457
A	ENCODER 2 ARBITRARY PULSE 1		R458
A	ENCODER 2 ARBITRARY PULSE 2		R459

[Function]

Encoder pulse input used to be fixed to 1024 pulse input on the conventional analogue I/F. With this function, arbitrary pulse can be input by parameters set in R register. The maximum number of input pulse is 76800.

[Operation]

In order to input encoder arbitrary pulse, set the number of pulses necessary in R register. Switch encoder to be used by ON/OFF on the PLC device, and turn ON the arbitrary pulse input valid signal.

Turn OFF the arbitrary pulse input valid signal when using the conventional 1024 pulse encoder.

Device No.	Signal name	Details	
R456	Encoder 1 arbitrary pulse 1	This signal is selected when the encoder 1 arbitrary pulse selection (Y764) is OFF.	Input 1/2 of the number of pulses necessary for arbitrary pulse input with the encoder input 1. This number of pulses must be in hexadecimal but not in quad edge evaluation. The setting range is 0x200(512) to 0x9600(38400).
R457	Encoder 1 arbitrary pulse 2	This signal is selected when the encoder 1 arbitrary pulse selection (Y764) is ON.	
R458	Encoder 2 arbitrary pulse 1	This signal is selected when the encoder 2 arbitrary pulse selection (Y765) is OFF.	Input 1/2 of the number of pulses necessary for arbitrary pulse input with the encoder input 2. This number of pulses must be in hexadecimal but not in quad edge evaluation. The setting range is 0x200(512) to 0x9600(38400).
R459	Encoder 2 arbitrary pulse 2	This signal is selected when the encoder 2 arbitrary pulse selection (Y765) is ON.	

[Caution]

- (1) Arbitrary pulse cannot be input from a bus-connected encoder.
- (2) Input 1/2 of the number of pulses actually used with the encoder 1 arbitrary pulse 1 and 2 (R456 to 457), and the encoder 2 arbitrary pulse 1 and 2 (R458 to 459) in hexadecimal. If a different number of pulses is input, the speed at feed per rotation changes.
- (3) When 0 to 0x1FF are set in R456 to R459, the encoder input pulse will be 1024 pulse input. When a value exceeding 0x9600 is set, it will be 76800 pulse input.

[Related signals]

- (1) Encoder 1 arbitrary pulse selection (Y764)
- (2) Encoder 2 arbitrary pulse selection (Y765)
- (3) Encoder 1 arbitrary pulse valid (Y766)
- (4) Encoder 2 arbitrary pulse valid (Y767)

4 Explanation of Interface Signals

Cont.	Signal name	Abbrev.	Common(\$)
A	G/B SPINDLE SYNCHRONIZATION: MAXIMUM RANGE OF THE RELATIVE POSITION ERROR [M8]		R460

[Function]

This signal outputs the maximum range of the relative position error during acceleration/deceleration after the spindle motor completes the acceleration/deceleration.

[Operation]

During guide bushing spindle (G/B) synchronization mode, the following five values are calculated based on the relative position error between the reference spindle and the guide bushing spindle, and they are output to the registers when the state changes between the acceleration/deceleration state and the steady state. (Unit is pulse, 1pulse ≈ 0.088°)

- (1) Maximum range of the relative position error during acceleration/deceleration
- (2) Maximum value of the relative position error during acceleration/deceleration
- (3) Maximum range of the relative position error during the steady state
- (4) Maximum value of the relative position error during the steady state
- (5) Average value of the relative position error during the steady state

This sampling is constantly carried out during the guide bushing spindle synchronization mode. It stops when the guide bushing spindle synchronization mode is canceled.

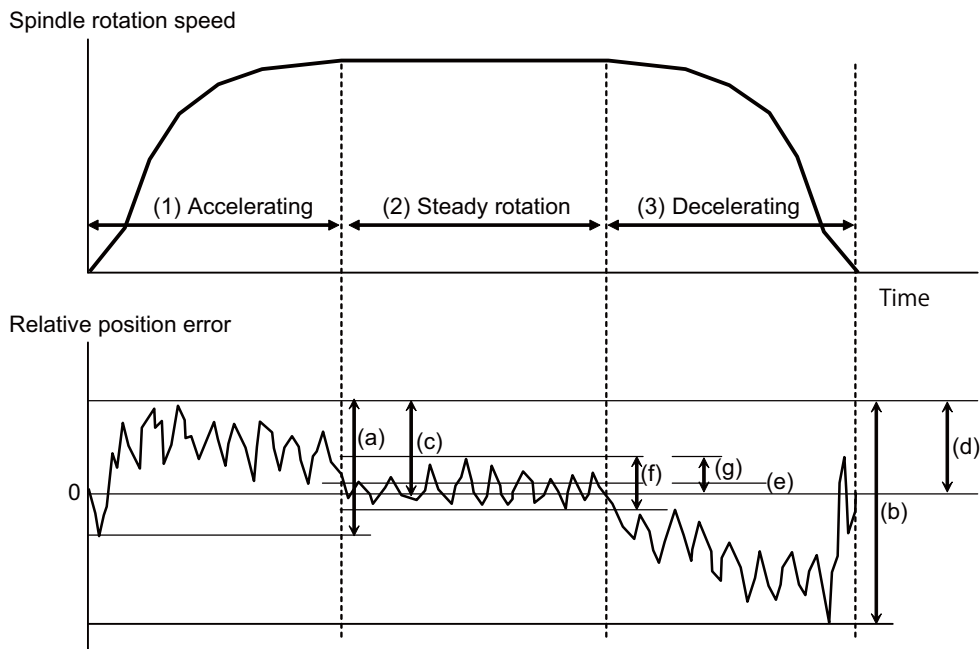

- R460 Maximum range ((a) above) of the relative position error is written after the spindle motor completes acceleration.
- R461 Maximum range ((b) above) of the relative position error is written after the spindle motor decelerates and stops.
- R462 Average value ((e) above) of the relative position error is written after the spindle motor finishes steady rotation.
- R463 Maximum range ((f) above) of the relative position error is written after the spindle motor finishes steady rotation.
- R464 Maximum value ((g) above) of the relative position error is written after the spindle motor finishes steady rotation.

(Note 1) The relative position error is calculated by "Reference spindle's feedback position – guide bushing spindle's feedback position".

[Related signals]

- (1) G/B spindle synchronization valid (GBON:Y778)

4 Explanation of Interface Signals

Cont.	Signal name	Abbrev.	Common(\$)
A	G/B SPINDLE SYNCHRONIZATION: MAXIMUM VALUE OF THE RELATIVE POSITION ERROR [M8]		R461

[Function]

This signal outputs the maximum value of the relative position error after the spindle motor completes the acceleration/ deceleration.

[Operation]

Refer to R460 (G/B spindle synchronization: Maximum range of the relative position error) .

[Related signals]

- (1) G/B spindle synchronization valid (GBON:Y778)
- (2) G/B spindle synchronization: Maximum range of the relative position error (R460)

Cont.	Signal name	Abbrev.	Common(\$)
A	G/B SPINDLE SYNCHRONIZATION: AVERAGE VALUE OF THE RELATIVE POSITION ERROR DURING THE STEADY STATE [M8]		R462

[Function]

This signal outputs the average value of the relative position error during steady rotation after the spindle motor completes steady rotation.

[Operation]

Refer to R460 (G/B spindle synchronization: Maximum range of the relative position error).

[Related signals]

- (1) G/B spindle synchronization valid (GBON:Y778)
- (2) G/B spindle synchronization: Maximum range of the relative position error (R460)

Cont.	Signal name	Abbrev.	Common(\$)
A	G/B SPINDLE SYNCHRONIZATION : MAXIMUM RANGE OF THE RELATIVE POSITION ERROR DURING THE STEADY STATE [M8]		R463

[Function]

This signal outputs the maximum range of the relative position error during steady rotation after the spindle motor completes steady rotation.

[Operation]

Refer to R460 (G/B spindle synchronization: Maximum range of the relative position error).

[Related signals]

- (1) G/B spindle synchronization valid (GBON:Y778)
- (2) G/B spindle synchronization: Maximum range of the relative position error (R460)

Cont.	Signal name	Abbrev.	Common(\$)
A	G/B SPINDLE SYNCHRONIZATION: MAXIMUM VALUE OF THE RELATIVE POSITION ERROR DURING THE STEADY STATE [M8]		R464

[Function]

This signal outputs the maximum value of the relative position error during steady rotation after the spindle motor completes steady rotation.

[Operation]

Refer to R460 (G/B spindle synchronization: Maximum range of the relative position error).

[Related signals]

- (1) G/B spindle synchronization valid (GBON:Y778)
- (2) G/B spindle synchronization: Maximum range of the relative position error (R460)

4 Explanation of Interface Signals

Cont.	Signal name	Abbrev.	Common(\$)
A	G/B SPINDLE SYNCHRONIZATION: POSITION ERROR COMPENSATION AMOUNT [M8]		R465

[Function]

This signal outputs the position error compensation amount in the guide bushing (G/B) spindle synchronization position error compensation state.

[Operation]

When the G/B spindle synchronization: position error compensation (GBCMON) is turned ON, this signal outputs the position error compensation amount during the guide bushing spindle synchronization position error compensation. (Unit is pulse, 1pulse \approx 0.088°)

When the guide bushing spindle synchronization position error compensation is finished, this signal becomes "0".

[Related signals]

- (1) G/B spindle synchronization valid (GBON:Y778)
- (2) G/B spindle synchronization: position error compensation (GBCMON:Y77C)
- (3) G/B spindle synchronization: keep position error compensation amount (GBCMKP:Y77E)
- (4) G/B spindle synchronization: position error compensation scale and the number of times of compensations (R390)
- (5) G/B spindle synchronization: position error compensating (GBPCM:X77B)

Cont.	Signal name	Abbrev.	Common(\$)
A	G/B SPINDLE SYNCHRONIZATION: PHASE SHIFT AMOUNT [M8]		R466

[Function]

This signal outputs the phase error (relative position) of the reference spindle and guide bushing (G/B) spindle saved when the G/B spindle synchronization: phase memory (GBPHM) was turned ON.

[Operation]

This signal displays the phase error (relative position) of the reference spindle and guide bushing spindle saved when the G/B spindle synchronization: phase memory (GBPHM) was turned ON during guide bushing spindle synchronization. (Unit is pulse, 1pulse \approx 0.088°)

When guide bushing spindle synchronization is canceled, this signal becomes "0".

[Related signals]

- (1) G/B spindle synchronization valid (GBON:Y778)
- (2) G/B spindle synchronization: phase memory (GBPHM:Y77B)

Cont.	Signal name	Abbrev.	Common(\$)
A	Interference check between part systems: Data address [M8]		R468

[Function][Operation]

This signal designates the R register head No. which is used for the setting of the interfering object or coordinate system of the interference check between part systems.

[Caution]

Set an even number in the R register.

Set the R register number within the range of user backup area or user work area.

[Related signals]

- (1) Interference check between part systems: Setting error alarm information [M8] (R101)

4 Explanation of Interface Signals

Cont.	Signal name	Abbrev.	\$1	\$2	\$3	\$4	\$5	\$6	\$7	\$8
A	1ST CUTTING FEEDRATE OVERRIDE		R2500	R2700	R2900	R3100	R3300	R3500	R3700	R3900

[Function]

When "Cutting feedrate override method selection" (YC67) is set to "file register method", override (0 to 300%, 1% increment) can be exerted on the cutting feedrate. Desired value is set to file register (R) in binary code.

[Operation]

When override is exerted to the preset feedrate, the true feedrate is the product obtained by multiplying the preset feedrate by the specified override ratio (provided that "2nd cutting feedrate override" is not valid).

The override ratio is fixed to 100%, irrespective of "1st feedrate override" setting, under the following condition:

- (1) "Override cancel" (YC58) signal is ON.
- (2) During tapping in fixed cycle.
- (3) During TAPPING mode.
- (4) During thread cutting.

(Note) Only when override setting is 0%, override is exerted even on rapid traverse speed. That is, cutting feed as well as rapid traverse stop if the 1st feedrate override is set to 0% during automatic operation.

In this case, the operation error (M01 0102) occurs.

[Related signals]

- (1) Cutting feedrate override code m (YC60:*FV1 to *FV16)
- (2) Cutting feedrate override method selection (YC67:FVS)
- (3) 2nd cutting feedrate override valid (YC66:FV2E)
- (4) 2nd cutting feedrate override (R2501)

(Note) For relationship among these signals, refer to the description the cutting feedrate override.

Cont.	Signal name	Abbrev.	\$1	\$2	\$3	\$4	\$5	\$6	\$7	\$8
A	2ND CUTTING FEEDRATE OVERRIDE		R2501	R2701	R2901	R3101	R3301	R3501	R3701	R3901

[Function]

When the "2nd cutting feedrate override valid" function (YC66) is used, another override can be exerted on "Cutting feedrate override code" (YC60 and later), or "1st cutting feedrate override" (R2500) when the "Cutting feedrate override method selection" (YC67) is set to file register method. The 2nd feedrate override can be set within range from 0% to 327.67% with 0.01% increment. The value is set in the file register (R) in binary.

[Operation]

When this override function is used, the true feedrate is the product obtained by multiplying commanded feedrate (F) by "1st cutting feedrate override" ratio and "2nd cutting feedrate override" ratio.

Since the least increment of 2nd feedrate override is 0.01%, override setting "10000" corresponds to 100%.

The override ratio is fixed to 100%, irrespective of "1st cutting feedrate override" or "2nd cutting feedrate override" setting, under the following condition:

- (1) "Override cancel" (YC58) signal is ON.
- (2) During tapping in fixed cycle.
- (3) During TAPPING mode.
- (4) During thread cutting.

(Note) Only when the 1st cutting feedrate override or 2nd cutting feedrate override is 0% or both of them are 0%, override is exerted even on rapid traverse speed. That is, cutting feed as well as rapid traverse stop if the 1st override feedrate is set to 0% during automatic operation.

In this case, the operation error (M01 0102) occurs.

[Related signals]

- (1) Cutting feedrate override code m (YC60:*FV1 to *FV16)
- (2) Cutting feedrate override method selection (YC67:FVS)
- (3) 2nd cutting feedrate override valid (YC66:FV2E)
- (4) 1st cutting feedrate override (R2500)

(Note) For relationship among these signals, refer to the description about the cutting feedrate override.

4 Explanation of Interface Signals

Cont.	Signal name	Abbrev.	\$1	\$2	\$3	\$4	\$5	\$6	\$7	\$8
A	RAPID TRAVERSE OVERRIDE		R2502	R2702	R2902	R3102	R3302	R3502	R3702	R3902

[Function]

When "Rapid traverse override method selection" signal (ROVS) is set to "file register method", override can be exerted, besides the code method override (ROV1, ROV2), by setting within the range of 0% to 100% by 1% increments. The value is set in the file register (R) in binary.

[Operation]

During rapid traverse in the automatic or manual operation, the actual feedrate will be the result of multiplying the rapid traverse speed set in a parameter by this override ratio.

(Note 1) The override will be clamped at 100%.

(Note 2) The operation error (M01 0125) occurs if the override value is 0%.

(Note 3) Even when rapid traverse override is not 0%, when the cutting feed override is 0%, the rapid traverse stops.

[Related signals]

- (1) Rapid traverse override code 1,2 (YC68,YC69:ROV1,ROV2)
- (2) Rapid traverse override method selection (YC6F:ROVS)

Cont.	Signal name	Abbrev.	\$1	\$2	\$3	\$4	\$5	\$6	\$7	\$8
A	CHOPPING OVERRIDE	CHPOV	R2503	R2703	R2903	R3103	R3303	R3503	R3703	R3903

[Function]

This signal is used to designate the override value for the operation between the upper dead center and the bottom dead center of the chopping axis.

[Operation]

- (1) Set the override value (0% to 100%) for the operation between the upper dead center and the bottom dead center with a numerical value.
If a value outside the range is set, the override value is 100%.
- (2) Select the setting unit 1% or 0.01% with the control data "the setting unit of the chopping override".
(Example) When the setting unit is 1% and R2503 is set to "100" (0x0064), the override value is 100%.
When the setting unit is 0.01% and R2503 is set to "10000" (0x2710), the override value is 100%.
- (3) When the override value is set to "0", the operation error (M01 0150) occurs.
- (4) As for the override value for the operation between the basic position and the upper dead center, select valid or invalid with the control data "rapid traverse override valid/invalid". When it is valid, rapid traverse override (code method or value-setting method) is performed.

[Related signals]

- (1) Chopping (CHPS: YC30)
- (2) Chopping parameter valid (YC34)
- (3) Chopping control data address (R2587)
- (4) Rapid traverse override method selection (ROVS: YC6F, R2502)
- (5) Rapid traverse override code 1, 2 (ROV1, ROV2: YC68, YC69)

4 Explanation of Interface Signals

Cont.	Signal name	Abbrev.	\$1	\$2	\$3	\$4	\$5	\$6	\$7	\$8
A	MANUAL FEEDRATE		R2504,5	R2704,5	R2904,5	R3104,5	R3304,5	R3504,5	R3704,5	R3904,5

[Function]

When "Manual feedrate method selection" signal (JVS) is set to "file register method", feedrate can be specified, besides code method (*JV1 to 16) setting, by setting desired feedrate ratio manually. The value is set in the file register (R) in binary.

[Operation]

This mode of feedrate setting can be used in JOG feed, incremental feed, reference position return feed and manual arbitrary feed mode. For JOG, incremental and reference position return mode, "Rapid traverse speed" (RT) signal should be OFF. For manual arbitrary feed mode, "Manual arbitrary feed EX.F/MODAL.F" signal (CXS3) should be OFF. Feedrate specified in this mode can be applied to feed motion in dry run (automatic operation).

The use of this signal is conditioned as follows:

- (1) When "Manual override method selection" signal (OVSL) is OFF, the originally set feedrate is applied.
- (2) When "Manual override method selection" signal (OVSL) is ON, the actual feedrate can be obtained by multiplying the feedrate specified by the 1st/2nd cutting feed override value.
- (3) Manual feedrate is set to file registers Rn and Rn+1. The feedrate depends on "Feedrate least increment code 1,2" (PCF1, PCF2) as listed below.

PCF2	PCF1	Least increment (mm/min or inch/min)	Operation
0	0	10	10mm/min (inch/min) when "1" is set in file registers.
0	1	1	1mm/min (inch/min) when "1" is set in file registers.
1	0	0.1	0.1mm/min (inch/min) when "1" is set in file registers.
1	1	0.01	0.01mm/min (inch/min) when "1" is set in file registers.

- (4) Feedrate clamp (max. feedrate) depends on setting of axis parameter (cutting feedrate clamp) when "Rapid traverse" signal (RT) is OFF.

(Note 1) During incremental feed mode, the true feedrate does not change even when the manual feedrate setting is changed while feed motion is going on.

(Note 2) As for file registers (Rn and Rn+1), Rn is of low order.

Of the file registers Rn and Rn+1 to designate the feedrate, if the value is 2-bytes (one word), the high-order side does not need to do anything.

[Related signals]

- (1) Manual feedrate code m (*JV1 to *JV16: YC70 to YC74)
- (2) Manual feedrate method selection (JVS: YC77)

Cont.	Signal name	Abbrev.	\$1	\$2	\$3	\$4	\$5	\$6	\$7	\$8
A	MANUAL FEEDRATE B		R2506,7	R2706,7	R2906,7	R3106,7	R3306,7	R3506,7	R3706,7	R3906,7

[Function][Operation]

Designate the manual feedrate for the axis selected with the manual feedrate B valid signal.

[Caution]

- (1) The speed designated with this register is valid for the manual feedrate of an axis for which the manual feedrate B valid signal is valid.
- (2) Cutting override and manual override are invalid for this register's speed.
- (3) This register is not related to the dry run speed.
- (4) A binary value is directly set for this register. The setting unit is 0.01mm/min (°/min).
- (5) This signal is a register common for all axes.

[Related signals]

- (1) Manual feedrate B valid (FBEn:Y940 to 947)

4 Explanation of Interface Signals

Cont.	Signal name	Abbrev.	\$1	\$2	\$3	\$4	\$5	\$6	\$7	\$8
A	1ST HANDLE/INCREMENTAL FEED MAGNIFICATION		R2508,9	R2708,9	R2908,9	R3108,9	R3308,9	R3508,9	R3708,9	R3908,9

[Function]

By selecting the handle/incremental feed magnification method (MPS), an arbitrary magnification can be designated separately from magnification set by regular code method. Magnification value (multiplier) is set in file register (R) in binary.

When the "handle/incremental feed magnification method selection" signal (MPS) is ON, this magnification factor is applied for the hand pulse from handy terminal.

[Operation]

Magnification is applied to amount of feed per pulse in handle feed mode (output from manual pulse generator), or to amount of feed per signal in incremental feed mode (+J1, -J1, etc.).

When multiplier is "500" and one pulse is given in handle feed mode, for example, 500 μ m of feed motion occurs. When multiplier is "30000" and one feed command signal is given in incremental feed mode, 30mm of feed motion occurs (time constant for feed motion is equal to time constant for rapid traverse or step).

(Note 1) Change of magnification setting during feed motion is ignored.

(Note 2) Since considerably large magnification can be used, the signal should be used carefully.

[Related signals]

- (1) Handle mode (H: YC01)
- (2) Incremental mode (S: YC02)
- (3) Handle/Incremental feed magnification code m (MP1, MP2, MP4: YC80, YC81, YC82)
- (4) Handle/Incremental feed magnification method selection (MPS: YC87)

Cont.	Signal name	Abbrev.	\$1	\$2	\$3	\$4	\$5	\$6	\$7	\$8
A	2ND HANDLE FEED MAGNIFICATION		R2510,1	R2710,1	R2910,1	R3110,1	R3310,1	R3510,1	R3710,1	R3910,1
A	3RD HANDLE FEED MAGNIFICATION		R2512,3	R2712,3	R2912,3	R3112,3	R3312,3	R3512,3	R3712,3	R3912,3

[Function]

By selecting the handle/incremental feed magnification method, an arbitrary magnification can be designated separately from magnification set by regular code method. Magnification value (multiplier) is set in file register (R) in binary.

When the 2nd or 3rd handle is used, the arbitrary magnification is designated here.

When the 4th to 9th handles are used, the arbitrary magnification is designated with R22514 to R22525. [C80]

[Operation]

When 1 pulse is sent by 2nd or 3rd handle, its feed amount conforms to this feed magnification.

For example, when 1 pulse is sent in handle mode with magnification set at "500", its feed amount will be 500 μ m.

(Note 1) Changing magnification during feed motion is invalid.

(Note 2) Considerably large magnification can be set in the handle/incremental feed magnification method. Pay extra attention when setting magnification.

[Related signals]

- (1) Handle mode (H: YC01)
- (2) Incremental mode (S: YC02)
- (3) Handle/incremental feed magnification code m (MP1,MP2,MP4:YC80,C81,C82)
- (4) 1st handle/incremental feed magnification (R2508)
- (5) Handle/incremental feed magnification method selection (MPS:YC87)
- (6) 4th to 9th handle feed magnification [C80] (R22514,5 to R22524,5)

Cont.	Signal name	Abbrev.	\$1	\$2	\$3	\$4	\$5	\$6	\$7	\$8
A	PLC INTERRUPT PROGRAM NO.		R2518,9	R2718,9	R2918,9	R3118,9	R3318,9	R3518,9	R3718,9	R3918,9

[Function]

Set the program No. to execute the PLC interrupt.

[Operation][Caution]

Refer to "PLC interrupt (PIT)" for details of PLC interrupt operation.

[Related signals]

- (1) PLC interrupt (PIT:YC2E)
- (2) In PLC interrupt (PCINO:XC35)

4 Explanation of Interface Signals

Cont.	Signal name	Abbrev.	\$1	\$2	\$3	\$4	\$5	\$6	\$7	\$8
A	MANUAL FEEDRATE B OVERRIDE		R2524	R2724	R2924	R3124	R3324	R3524	R3724	R3924

[Function]

Override for manual feedrate B valid axis is set.

[Operation]

The override set with this register will be valid for the axis selected with the manual feedrate B valid signal.

This register can be set within the range of 0 to 200% in 0.01% increment.

If a value larger than 200%(setting value=20000) is set, the value is regarded as 200% when operating.

This register is common for axes.

[Caution]

- (1) When the manual feedrate B override commanded by the user PLC is "0"%, even if the feed axis selection signal for the axis selected by the manual feedrate B valid signal is turned ON, an error occurs and the axis will not move.
- (2) For a linear axis, the manual feedrate B surface speed control is not valid. However, the manual feedrate B override is valid.
- (3) In order to use manual feedrate B override, the additional specification of the manual feedrate B surface speed control is required.

[Related signals]

- (1) Manual feedrate B valid (FBEn:Y940 to Y947)
- (2) Manual feedrate B surface speed control valid [M8] (YC7D)

Cont.	Signal name	Abbrev.	\$1	\$2	\$3	\$4	\$5	\$6	\$7	\$8
A	EXTERNAL SEARCH DEVICE NO.		R2525	R2725	R2925	R3125	R3325	R3525	R3725	R3925

[Function][Operation]

The device storing the machining program to be searched is designated with a No.

When a front-side SD card is selected in M800S/M80 series, select either "2" or "4" for the device number.

When a rear-side SD card is selected in M800S/M80 series, select "1" for the device number.

When a front USB port of the display unit is selected, select "6" for the device number. [M8]

HD operation with industrial personal computer (IPC) connection can be specified only for M80 Series.

To enable HD operation with industrial personal computer, the following parameter settings are required.

- Set "#1760 cfgPR10/bit2" (Enable HD mode on IPC) to "1"
- IP address of industrial personal computer to connect to "#11005 PC IP address" (IP address setting)

Device number	Device
0	Memory
1	Display unit-side high-speed program server [M8] / extended area (memory 2) [C80]
2	Memory card (E drive), front-side SD card [M8]
3	-
4	Control unit-side high-speed program server
5	Tape (RS232C)
6	Front-side USB port of display unit [M8]
7	HD for industrial personal computer (D: /NCFILE) [M8]

[Related signal]

- (1) External search program No. (R2526)
- (2) External search sequence No. (R2528)
- (3) External search block No. (R2530)
- (4) External search strobe (YC1D)

4 Explanation of Interface Signals

Cont.	Signal name	Abbrev.	\$1	\$2	\$3	\$4	\$5	\$6	\$7	\$8
A	EXTERNAL SEARCH PROGRAM NO.		R2526,7	R2726,7	R2926,7	R3126,7	R3326,7	R3526,7	R3726,7	R3926,7

[Function][Operation]

Designate the No. of the machining program to be searched as a binary. (0 to 99999999 (8 digits))

[Related signal]

- (1) External search device No. (R2525)
- (2) External search sequence No. (R2528)
- (3) External search block No. (R2530)
- (4) External search strobe (YC1D)

Cont.	Signal name	Abbrev.	\$1	\$2	\$3	\$4	\$5	\$6	\$7	\$8
A	EXTERNAL SEARCH SEQUENCE NO.		R2528,9	R2728,9	R2928,9	R3128,9	R3328,9	R3528,9	R3728,9	R3928,9

[Function][Operation]

Designate the sequence No. of the machining program to be searched as a binary. (0 to 99999999 (8 digits))

[Related signal]

- (1) External search device No. (R2525)
- (2) External search program No. (R2526)
- (3) External search block No. (R2530)
- (4) External search strobe (YC1D)

Cont.	Signal name	Abbrev.	\$1	\$2	\$3	\$4	\$5	\$6	\$7	\$8
A	EXTERNAL SEARCH BLOCK NO.		R2530,1	R2730,1	R2930,1	R3130,1	R3330,1	R3530,1	R3730,1	R3930,1

[Function][Operation]

Designate the block No. as a binary. (0 to 999999999 (9 digits))

[Related signal]

- (1) External search device No. (R2525)
- (2) External search program No. (R2526)
- (3) External search sequence No. (R2528)
- (4) External search strobe (YC1D)

4 Explanation of Interface Signals

Cont.	Signal name	Abbrev.	\$1	\$2	\$3	\$4	\$5	\$6	\$7	\$8
A	HANDLE POLARITY [M8]		R2540	R2740	R2940	R3140	R3340	R3540	R3740	R3940

[Function]

In handle mode, the axis movement direction for the pulse of manual pulse generator can be reversed.

[Operation]

When the handle polarity signal turns ON, the axis corresponding to the bit moves in the reverse direction of the pulse of manual pulse generator.

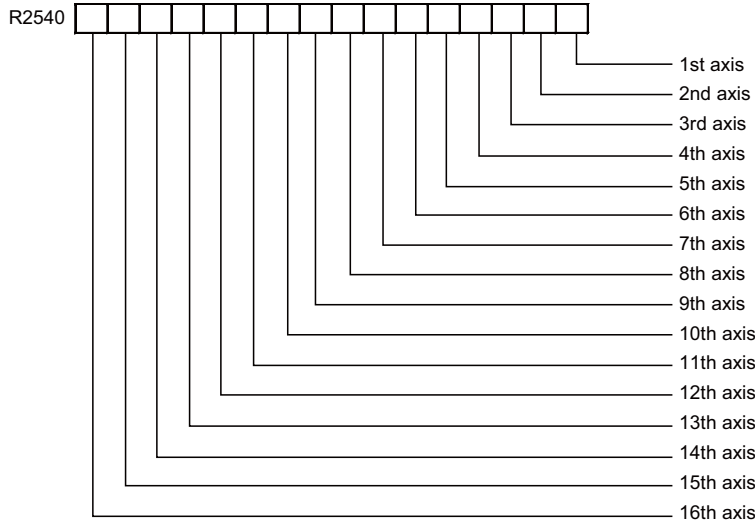

The handle polarity signal when the axis to be moved is selected (when the n-th handle valid signal turns ON while the n-th handle axis selection code signal is set, or when the n-th handle axis selection code signal is changed with the n-th handle valid signal ON) is used. When changing the handle polarity signal, select the axis to be moved again.

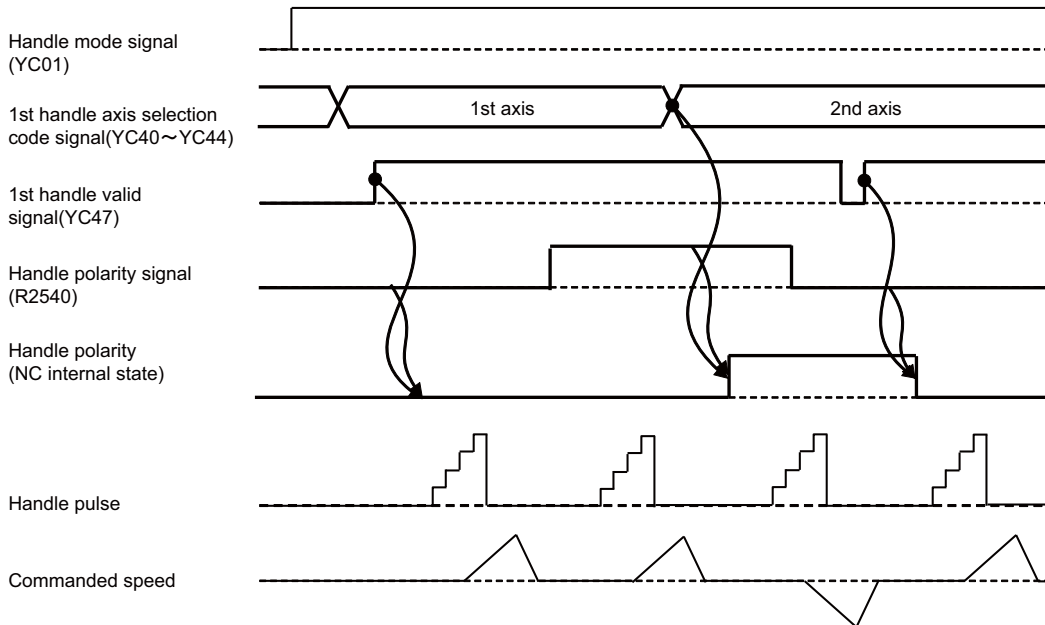

[Caution]

- (1) During the manual speed command, the handle polarity with handle polarity signal cannot be switched. In order to reverse the command direction input with the handle during manual speed command, use Manual speed command sign reversed signal (YC9E).
- (2) During the manual arbitrary reverse run, the handle polarity cannot be switched with handle polarity signal.

[Related signals]

- (1) 1st handle axis selection code (HS11 to HS116:YC40 to YC44), 1st handle valid (HS1S:YC47)
- (2) 2nd handle axis selection code (HS21 to HS216:YC48 to YC4C), 2nd handle valid (HS2S:YC4F)
- (3) 3rd handle axis selection code (HS31 to HS316:YC50 to YC54), 3rd handle valid (HS3S:YC57)

4 Explanation of Interface Signals

Cont.	Signal name	Abbrev.	\$1	\$2	\$3	\$4	\$5	\$6	\$7	\$8
A	MANUAL ARBITRARY FEED 1ST AXIS TRAVEL AMOUNT		R2544,5	R2744,5	R2944,5	R3144,5	R3344,5	R3544,5	R3744,5	R3944,5

[Function]

This data specifies the travel amount or positioning point in manual arbitrary feed mode.

[Operation]

"Manual arbitrary feed 1st axis travel amount" is for the axis whose number is specified by "Manual arbitrary feed 1st axis selection code m" (CX11 to 116: YCA0 to YCA4).

"Manual arbitrary feed 1st axis travel amount" means differently depending on the statuses of the "Manual arbitrary feed MC/WK (CXS5)" and "Manual arbitrary feed ABS/INC (CXS6)" signals.

(1) When the Manual arbitrary feed ABS/INC (CXS6) signal is ON:

"Manual arbitrary feed 1st axis travel amount" specifies travel amount (increment).

(2) When the "Manual arbitrary feed ABS/INC (CXS6)" signal is OFF, it depends on the status of the "Manual arbitrary feed MC/WK (CXS5)" signal as follows:

(a) When the "Manual arbitrary feed MC/WK (CXS5)" signal is OFF:

"Manual arbitrary feed 1st axis travel amount" specifies a coordinate position (positioning point) of the machine coordinate system.

(b) When the "Manual arbitrary feed MC/WK (CXS5)" signal is ON:

"Manual arbitrary feed 1st axis travel amount" specifies a coordinate position (positioning point) of the modal workpiece coordinate system.

"Manual arbitrary feed 1st axis travel amount" is written in binary notation with a sign. The unit of the specified value matches that of data entered.

(Ex.)When (R2545, R2544)=1 is specified in micrometer system, axis motion is 1 μ m (at incremental specification).

[Caution]

(1) Set the data in millimeters. The data cannot be set by inch system.

(2) "Manual arbitrary feed 1st axis travel amount" forms a data item by R2544 and R2545 or R2744 and R2745. Handle negative data carefully.

(3) Travel amount is within 360° when a positioning is carried out with the absolute command for the following axes.
(The axis does not move in the short-cut direction.)

- A rotation-type rotary axis

- A linear-type rotary axis of workpiece coordinate (to be positioned on the machine coordinate system)

[Related signals]

For related signals, see the descriptions on "Manual arbitrary feed mode (PTP: YC03)".

Cont.	Signal name	Abbrev.	\$1	\$2	\$3	\$4	\$5	\$6	\$7	\$8
A	MANUAL ARBITRARY FEED 2ND AXIS TRAVEL AMOUNT		R2548,9	R2748,9	R2948,9	R3148,9	R3348,9	R3548,9	R3748,9	R3948,9

[Function][Operation]

"Manual arbitrary feed 2nd axis travel amount" is for the axis whose number is specified by "Manual arbitrary feed 2nd axis selection code m (CX21 to CX216)".

The other conditions are the same as for "Manual arbitrary feed 1st axis travel amount" explained in the previous section.

Cont.	Signal name	Abbrev.	\$1	\$2	\$3	\$4	\$5	\$6	\$7	\$8
A	MANUAL ARBITRARY FEED 3RD AXIS TRAVEL AMOUNT		R2552,3	R2752,3	R2952,3	R3152,3	R3352,3	R3552,3	R3752,3	R3952,3

[Function][Operation]

"Manual arbitrary feed 3rd axis travel amount" is for the axis whose number is specified by "Manual arbitrary feed 3rd axis selection code m (CX31 to CX316)".

The other conditions are the same as for "Manual arbitrary feed 1st axis travel amount" explained in the previous section.

4 Explanation of Interface Signals

Cont.	Signal name	Abbrev.	\$1	\$2	\$3	\$4	\$5	\$6	\$7	\$8
A	ALARM MESSAGE I/F 1 to 4		R2556 to 9	R2756 to 9	R2956 to 9	R3156 to 9	R3356 to 9	R3556 to 9	R3756 to 9	R3956 to 9

[Function]

Desired alarm messages prepared using PLC development tool (personal computer) can be displayed in ALARM DIAGNOSIS screen of the setting and display unit by setting values (binary code) to alarm interface file registers (Rn, Rn+1, Rn+2, Rn+3).

[Operation]

If table No. of previously prepared alarm message table has been set to alarm interface file registers, alarm message, if alarm occurs, can be displayed in ALARM DIAGNOSIS screen. Maximum 4 alarm messages can be displayed at the same time.

Alarm message can be cleared by setting "0" to alarm interface file registers.

For details of alarm message display, refer to the "PLC Programming Manual".

[Caution]

- (1) Set machine parameter PLC "#6450 bit 0" to 1 to display the alarm messages.
- (2) For alarm message interface, file register (R method) or temporary storage (F method) can be used. The selection is made with machine parameter PLC "#6450 bit 1".
- (3) In both R method (file register) and F method (temporary storage), alarm does extend to the controller. When it is desirable to stop controller operation according to alarm type, signals such as "Automatic operation "pause" command" (*SP) signal, "Single block" (SBK) signal and "Interlock" signal should be processed on the PLC side.

Cont.	Signal name	Abbrev.	\$1	\$2	\$3	\$4	\$5	\$6	\$7	\$8
A	OPERATOR MESSAGE I/F		R2560	R2760	R2960	R3160	R3360	R3560	R3760	R3960

[Function]

Desired operator message prepared using PLC development tool (personal computer) can be displayed by setting value (binary code) to operator message interface file register (Rn). Operator message appears in ALARM DIAGNOSIS screen of the setting and display unit.

[Operation]

If table No. of previously prepared operator message table has been set to operator message interface file register, operator message can be displayed in ALARM DIAGNOSIS screen. Operator message can be cleared by setting "0" to operator message interface file register.

For details of operator messages, refer to the "PLC Programming Manual".

[Caution]

- (1) Set the machine parameter PLC "#6450 bit 2" to 1 to display the operator messages.
- (2) There are two types of interface for an operator message: type R which uses a file register (R) and type F which uses a temporary memory. The selection of type R or F is made by the machine parameter PLC "#6455 bit 3".
- (3) Displaying an operator message does not cause any alarm on the controller side for type R or F. If the controller needs to be stopped, take appropriate action on the PLC side, including Automatic operation pause (*SP), Single block (SBK) and Interlock.
- (4) R2560 and R308 cannot be used at a time. When you use R308, set "0" to R2560. R309 to R311 can be used regardless of the value of R2560.

Cont.	Signal name	Abbrev.	\$1	\$2	\$3	\$4	\$5	\$6	\$7	\$8
A	SEARCH & START PROGRAM NO.		R2562,3	R2762,3	R2962,3	R3162,3	R3362,3	R3562,3	R3762,3	R3962,3

[Function]

The No. of the program to be searched with search & start is designated.

[Operation]

Set the No. of the program to be searched with search & start with a binary value.

(Note 1) The program No. must be set before the "Search & start" signal is input.

(Note 2) If a machining program No. is not designated or if an illegal No. is designated, and error signal will be output when the search operation is executed.

[Related signals]

- (1) Search & start (RSST: YC31)
- (2) Search & start Error (SEE: XC8A)

4 Explanation of Interface Signals

Cont.	Signal name	Abbrev.	\$1	\$2	\$3	\$4	\$5	\$6	\$7	\$8
A	ENCODER SELECTION		R2567	R2767	R2967	R3167	R3367	R3567	R3767	R3967

[Function]

Using a binary setting, select which spindle's encoder feedback to use.

0: 1st spindle 1: 2nd spindle 2: 3rd spindle 3: 4th spindle 4: 5th spindle 5: 6th spindle 6: 7th spindle 7: 8th spindle

(Note) If a setting exceeds the number of connected spindles, it will be interpreted that a selection has not been made.

[Related signals]

- (1) Spindle selection (SWS: X18A8)
- (2) Spindle command selection (SLSP: R7002)
- (3) Spindle stop (SSTP: Y1894)
- (4) Spindle enable (ENB: X18A0)
- (5) Spindle forward run start (SRN: Y1898)
- (6) Spindle reverse run start (SRI: Y1899)

Cont.	Signal name	Abbrev.	\$1	\$2	\$3	\$4	\$5	\$6	\$7	\$8
A	C AXIS SELECTION		R2568	R2768	R2968	R3168	R3368	R3568	R3768	R3968

[Function]

The "C axis selection" signal is used to issue the commands with the axis name command address to the axis selected from the Spindle/C-axis having the same axis name in the part system.

[Operation]

Using the axis number, set which spindle or C axis to output the commands to.

0: First C axis, 1: 1st axis, 2: 2nd axis, 3: 3rd axis, 4: 4th axis, ... 8: 8th axis

The setting is made with the axis number used in the part system.

(Note 1) This signal must always be input simultaneously with the "Recalculation request" signal (CRQ).

(Note 2) This signal is valid even when the multi-spindle function is invalid.

(Note 3) If an axis name (#1013 axname) is different from the initial C axis name, "M01 OPERATION ERROR 1031" will occur.

Cont.	Signal name	Abbrev.	\$1	\$2	\$3	\$4
A	LOAD MONITOR I : AXIS SELECTION [M8]		R2580	R2780	R2980	R3180

[Function]

The axes to perform the effective torque output, cutting torque (estimated disturbance torque) output and disturbance torque output of the spindle and servo axis are designated.

[Operation]

The cutting torque (estimated disturbance torque), disturbance torque and effective torque output for all the spindle and servo axis designated with this signal are output simultaneously.

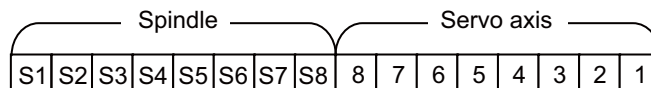

[Caution]

Specify the servo axes in the devices of each part system.

Specify the spindle in the device of the 1st part system.

[Related signals]

- (1) Load monitoring I: Cutting torque output n-th axis (R5492)
- (2) Load monitoring I: Effective torque output n-th axis (R5620)
- (3) Load monitoring I: Estimated spindle disturbance torque output (R6541)
- (4) Load monitoring I: Effective spindle torque output (R6542)

4 Explanation of Interface Signals

Cont.	Signal name	Abbrev.	\$1	\$2	\$3	\$4	\$5	\$6	\$7	\$8
A	EACH AXIS REFERENCE POSITION SELECTION		R2584	R2784	R2984	R3184	R3384	R3584	R3784	R3984

[Function]

Select the each axis reference position return position for manual reference position return.

[Operation]

- (1) This signal is valid when the reference position select method is ON.
- (2) Two bits are used for each axis to select the reference position.
 - (a) R register and corresponding axis
Each axis reference position selection

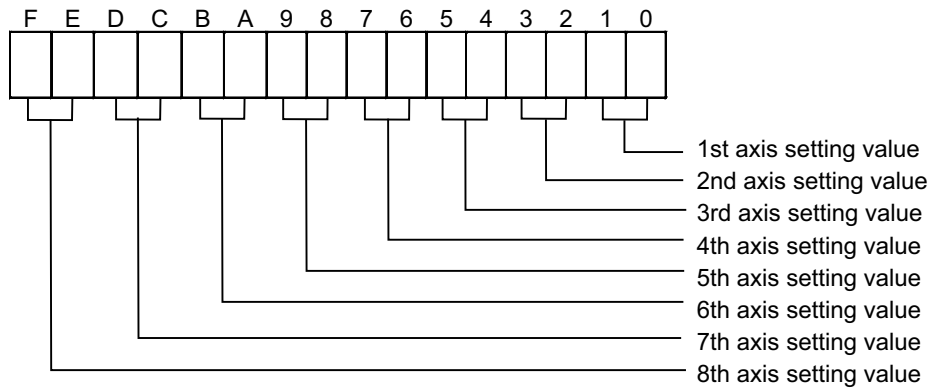

- (b) Setting value and reference position No.

High-order bit	Low-order bit	Return position
0	0	1st reference position
0	1	2nd reference position
1	0	3rd reference position
1	1	4th reference position

[Related signals]

- (1) Reference position selection method (M:YC97)

Cont.	Signal name	Abbrev.	\$1	\$2	\$3	\$4	\$5	\$6	\$7	\$8
A	CHOPPING CONTROL DATA ADDRESS		R2587	R2787	R2987	R3187	R3387	R3587	R3787	R3987

[Function][Operation]

This signal designates the chopping control data head No. (R register No.) assigned to R register.

R register area that can be used for assigning the chopping control data is as shown below.

R8300 to R9768 (Backup area)

R9800 to R9886 (Non back up area)

[Caution]

- (1) Setting error occurs if an odd number is set.
- (2) When the backup area is used, set the area ahead of the compensation amount record area (#1324 chop_R).
- (3) Error occurs if the chopping control data overlaps with the other part system or the compensation amount record area.

Cont.	Signal name	Abbrev.	\$1	\$2	\$3	\$4	\$5	\$6	\$7	\$8
A	TOOL LIFE MANAGEMENT DATA SORT		R2588	R2788	R2988	R3188	R3388	R3588	R3788	R3988

[Function][Operation]

This signal is a flag for tool life data sort necessary/unnecessary.

4 Explanation of Interface Signals

Cont.	Signal name	Abbrev.	\$1	\$2	\$3	\$4	\$5	\$6	\$7	\$8
A	SYNCHRONOUS CONTROL OPERATION METHOD		R2589	R2789	R2989	R3189	R3389	R3589	R3789	R3989

Synchronous control:

[Function] [Operation]

Synchronous control for the 1st part system is designated with the R2589 register, and for the 2nd part system with the R2789 register.

Synchronous control can be turned ON and OFF by setting the bits corresponding to each axis in the R2589/2789/2989/3189 registers. The CNC changes the operation when all axes reach the in-position state.

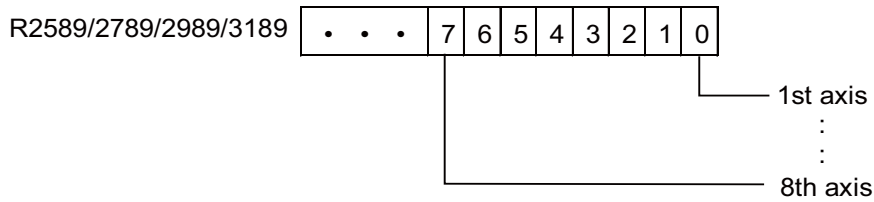

(a) Designating the synchronous operation method

Turn ON both of bits corresponding to the axes, which are in a master-slave relationship, with the base specification parameter "#1068 slavno".

(Example) To operate the 2nd axis (master axis) and 3rd axis (slave axis) in synchronization

	7	6	5	4	3	2	1	0	HEX
R2589	0	0	0	0	0	0	0	0	00
	0	0	0	0	0	1	1	0	06

(b) Designating the independent operation method

Turn ON only the bit corresponding to only one of the axes to be moved with the master axis command.

(Example) To move only the 3rd axis (slave axis)

	7	6	5	4	3	2	1	0	HEX
R2589	0	0	0	0	0	0	0	0	00
	0	0	0	0	0	1	0	0	04

If, due to the machine structure, the synchronous state must always be entered immediately after the power is turned ON, set the R2589 register with the first ladder after the power is turned ON.

Example of ladder creation

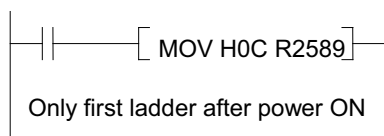

(Note) The registers R2789 and later are used for the 2nd to 4th part system.

When changing the operation with the R2589/2789/2989/3189 register during automatic operation, calculate the coordinates again.

After slave axis independent operation is carried out, the end point coordinates of the slave axis are substituted in the program end point coordinates for the master axis. Thus, unless the coordinates are recalculated, the master axis' movement command is not created properly.

Request recalculation immediately after the R2589/2789/2989/3189 register is changed.

4 Explanation of Interface Signals

<Example of ladder creation>

Master axis: 2nd axis Slave axis: 3rd axis

When M code is assigned to each:

M10: Asynchronous operation

M20: Independent operation

M40: Synchronous operation

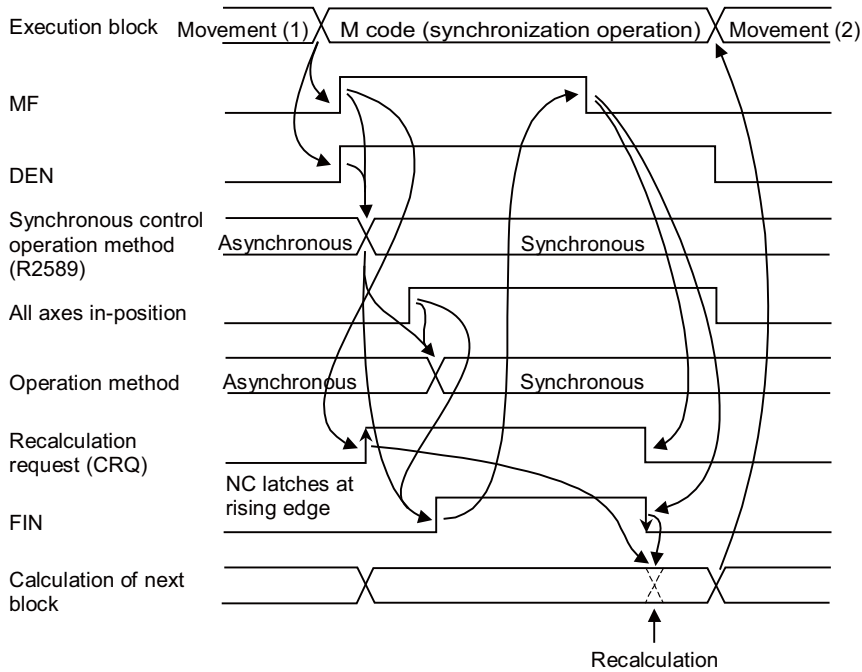
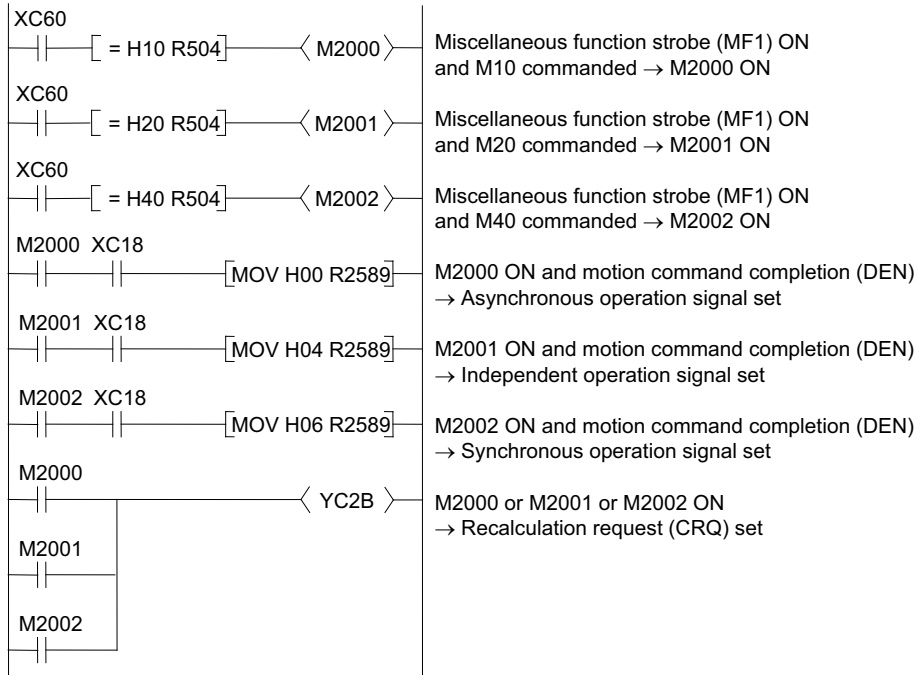

[Caution]

- (1) During synchronous operation or independent operation, the master axis signals are valid for the "Interlock" and "Machine lock" signals, etc.
- (2) The conditions of the "Reference position reached" signal (X800) of the master axis in the synchronous operation method follow the setting of the parameter "#1282 ext18/bit1".
- (3) When any of G27, G28 and G30 is commanded during the slave axis independent operation, the slave axis returns to its own zero point.
- (4) The position switches are processed independently for the master axis and slave axis.
- (5) When bit5 of the parameter #1261 is OFF, use the same "Stroke end" signal for the master axis and slave axis.

[M8]

Use the same "Stroke end" signal for the master axis and slave axis. [C80]

Set the same soft limit value for the master axis and slave axis.

If the above settings cannot be made because of the machine specifications, observe the following points.

- If stroke end or soft limit occurs during the manual operation mode, the master axis does not stop even when an alarm occurs for the slave axis. Thus, make sure that the master axis alarm turns ON before the slave axis alarm.
 - Stroke end during the manual operation mode causes the slave axis to stop when the "stroke end" signal for only the master axis turns ON. The master axis is stopped by the position controller, and the slave axis is stopped by the NC control unit. Thus, there may be a difference in their stop positions. If an excessive error alarm occurs because of stroke end, enter the correction mode, and cancel the alarm.
- (6) In the slave axis independent operation, even when the machine lock signal is ON, the current value counter of the master axis is updated. The master axis and the slave axis are not identified in the playback. The movement amount of the specified axis is set as it is.
 - (7) The master axis independent operation is handled as asynchronous. Therefore, the PLC input/output signal is not reflected on the slave axis.
 - (8) When the parameter "#1281 ext17/bit6" is ON, changing the "Synchronous control operation method" immediately changes the compensation amount of the slave axis in the external machine coordinate system compensation or the ball screw thermal expansion compensation:
 - When the synchronous operation is changed to the independent operation; the master axis compensation amount changes to the slave axis compensation amount.
 - When the independent operation is changed to the synchronous operation; the slave axis compensation amount changes to the master axis compensation amount.
 - (9) When the parameter "#1281 ext17/bit6" is ON and the synchronous operation method is designated, the slave axis is compensated with the master axis compensation amount in the ball screw thermal expansion compensation, and the compensation amount of each axis is output to "Ball screw thermal displacement compensation: Compensation amount" (R72 to R75).
 - (10) When the "Synchronous control operation method" (R2589) is changed (when the independent operation or synchronous operation is finished) for the axis (master axis or slave axis) where both synchronous operation and chopping are performed, the operation error (M01 1270) occurs and all the axes decelerate and stop. [M8]
 - (11) While the operation error (M01 1036) is occurring, the axes other than the chopping axis is interlocked and the synchronous control operation method cannot be changed. [M8]
 - (12) While the operation error "M01 1270", "M01 1271" or "M01 1272" is occurring, all the axes are interlocked and the synchronous control operation method cannot be changed. [M8]
 - (13) The "Reference position reached" signal (ZP1n to Zp4n) (X800) of the main axis and the sub axis in the simple synchronous control (*1) is output when the main axis reaches the reference position.
 - (14) In the simple synchronous control, the signals to output to the sub axis (from NC to PLC) are uncertain except for the "Reference position reached" signal.
 - (15) In the simple synchronous control, the signals to input to the sub axis (from PLC to NC) are ignored.
The sub axis in the simple synchronous control follows the "Servo OFF" signal (*SVFn) (Y7A0) of the main axis in the simple synchronous control.
When the main axis in the simple synchronous control is used as the slave axis in the synchronous control, it follows the "Servo OFF" signal of the master axis.
 - (16) Simple synchronous control and chopping cannot be used together.

(*1) Simple synchronous control can be used in only M8 Series.

Multiple-axis synchronization control [M8] :

[Function] [Operation]

Multiple-axis synchronization control for the 1st part system is designated with the R2589 register, and for the 2nd part system with the R2789 register.

Multiple-axis synchronization control can be turned ON and OFF by setting the bits corresponding to each axis in the R2589/2789/2989/3189 registers. The CNC changes the operation when all axes reach the in-position state.

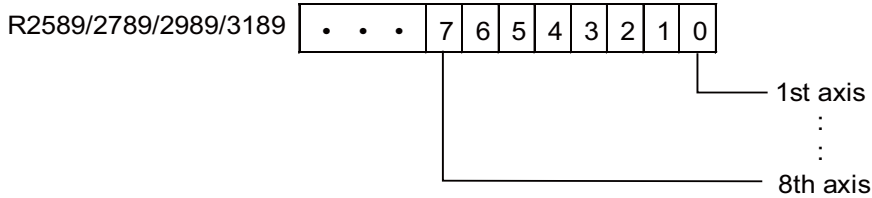

(a) Designating the synchronous operation method

Turn ON both of bits corresponding to the axes, which are in a master-slave relationship, with the axis specification parameter "#2674 primno".

(Example) To operate the 2nd axis (master axis), 3rd axis (slave axis) and 4th axis (slave axis) in synchronization

	7	6	5	4	3	2	1	0	HEX
R2589	0	0	0	0	0	0	0	0	00
	0	0	0	0	1	1	1	0	0E

(b) Designating the independent operation method

This does not support the independent operation method.

If, due to the machine structure, the synchronous state must always be entered immediately after the power is turned ON, set the R2589 register with the first ladder after the power is turned ON.

Example of ladder creation

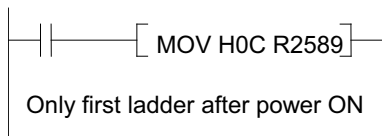

(Note) The registers R2789 and later are used for the 2nd to 4th part system.

When changing the operation with the R2589/2789/2989/3189 register during automatic operation, turn ON the "Recalculation request" signal (YC2B) to calculate the coordinates again.

Request recalculation immediately after the R2589/2789/2989/3189 register is changed.

[Caution]

- (1) When bit5 of the parameter #1261 is OFF, use the same "Stroke end" signal (OT) for the master axis and slave axis.
Set the same soft limit value for the master axis and slave axis.
If the above settings cannot be made because of the machine specifications, observe the following points.
- If stroke end or soft limit occurs during the manual operation mode, the master axis does not stop even when an alarm occurs for the slave axis. Thus, make sure that the master axis alarm turns ON before the slave axis alarm.
 - Stroke end during the manual operation mode causes the slave axis to stop when the "Stroke end" signal (OT) for the master axis turns ON; however, there may be a difference in their stop positions.
- (2) Set the same value of the SBT operation setting parameter for the master axis and slave axis.
The safe brake test (SBT: Safe Brake Test) of the master axis and slave axis is started by inputting the SBT start signal to the master axis during multiple-axis synchronization control.
When the SBT start signal is input to the slave axis, the smart safety observation alarm (V51 0005) occurs during multiple-axis synchronization control.
- (3) When the following signals are turned ON during multiple-axis synchronization control, the operation error (M01 0186) occurs.
When the multiple-axis synchronization control is performed while these functions are valid, the operation error (M50 5005) occurs.
- "Tool handle feed mode" signal (YC5E)
 - "Rotation center error compensation enabled" signal (YD15)
 - "Spatial error compensation enabled" signal (YD17) (Machine with 4 axes or machine with 5 axes)
- (4) During multiple-axis synchronization operation, the master axis signals are valid for the "Interlock" and "Machine lock" signals, etc.
- (5) Do not turn OFF only the bit of the master axis while both bits of master axis and slave axis of this signal (R2589) are ON. To turn ON only the bit of the slave axis of this signal (R2589), once turn OFF all the bits of this signal (R2589), and then turn ON the bit of the slave axis.

Cont.	Signal name	Abbrev.	\$1	\$2	\$3	\$4	\$5	\$6	\$7	\$8
A	TOOL GROUP NO. DESIGNATION		R2590,1	R2790,1	R2990,1	R3190,1	R3390,1	R3590,1	R3790,1	R3990,1

[Function]

The group No. is designated when the unused tool of a group that has exceeded lifetime with the tool life management II or when forcibly changing tools currently in use.

[Operation]

The group designation range is as follows.

For group designation: 1 to 9999 of group No.

For all groups: 65535(all 1)

4 Explanation of Interface Signals

Cont.	Signal name	Abbrev.	\$1	\$2	\$3	\$4	\$5	\$6	\$7	\$8
A	REFERENCE POSITION ADJUSTMENT COMPLETION		R2592	R2792	R2992	R3192	R3392	R3592	R3792	R3992

[Function][Operation]

Upon the completion of the reference position adjustment to establish the reference position in the dog-type reference position return, input the bit, which corresponds to the master axis in the part system, from PLC. Then, turn OFF this signal after the corresponding bit of "Reference position adjustment value parameter setting completed" signal is turned ON. When the axis is outside the position switch range, execute an interlock on the axis and prohibit the movement of the axis targeted at by the position switch.

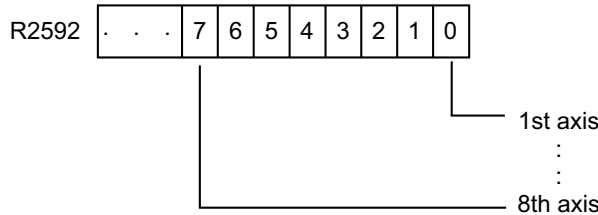

(Example) If the 2nd axis is the master axis, set the bits as follows after the completion of the reference position adjustment for the slave axis.

	7 6 5 4 3 2 1 0 HEX
R2592	0 0 0 0 0 0 0 0 0 0
	0 0 0 0 0 0 1 0 0 2

[Caution]

A change of the reference position adjustment value requires another reference position return. If the automatic operation starts without the reference position return, an alarm occurs to inform the uncompleted return.

[Related signals]

- (1) Reference position adjustment value parameter setting completed (R576)

Cont.	Signal name	Abbrev.	\$1	\$2	\$3	\$4	\$5	\$6	\$7	\$8
A	CURRENT LIMIT CHANGEOVER		R2593	R2793	R2993	R3193	R3393	R3593	R3793	R3993

[Function][Operation]

Droop will be released when the corresponding bit for the droop cancel request signal is OFF.

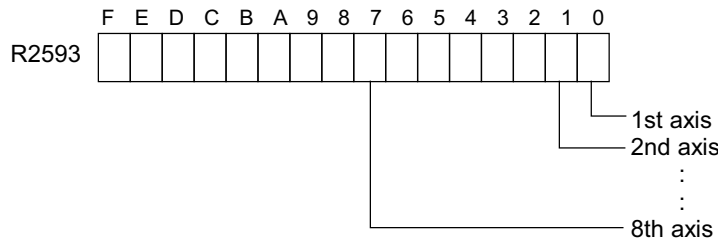

[Related signals]

- (1) In current limit n-th axis (IL1 to 8: X900 to 7)
- (2) Current limit reached n-th axis (ILA1 to 8: X920 to 7)
- (3) Current limit changeover n-th axis (ILC1 to 8: Y9A0 to 7)
- (4) Droop cancel request n-th axis (DOR1 to 8: Y9C0 to 7)
- (5) Current limit mode 1 and 2 (ILM1,2: YCC0,1)

4 Explanation of Interface Signals

Cont.	Signal name	Abbrev.	\$1	\$2	\$3	\$4	\$5	\$6	\$7	\$8
A	WEAR COMPENSATION NO. (Tool presetter)		R2594	R2794	R2994	R3194	R3394	R3594	R3794	R3994

[Function]

To clear the wear compensation amount after measuring the tool compensation amount with manual tool length measurement, set the wear compensation No. in a BCD code.

[Operation]

When the sensor is touched by the tool, wear data of the compensation No. automatically specified will be cleared to 0. If 0 or a non-existing compensation No. is set, the wear data will not be cleared.

Cont.	Signal name	Abbrev.	\$1	\$2	\$3	\$4	\$5	\$6	\$7	\$8
A	WORKPIECE COORDINATE OFFSET MEASUREMENT TOOL COMPENSATION NO./ SELECTED COMPENSATION TOOL NO.		R2600,1	R2800,1	R3000,1	R3200,1	R3400,1	R3600,1	R3800,1	R4000,1

[Function]

- (1) External workpiece coordinate offset measurement function
Set the tool No. (R2602, 2603) and the tool compensation No. (R2600, 2601) used for workpiece coordinate offset measurement in a BCD code.
- (2) Chuck barrier check
Set the tool No. (R2602, 2603) and the compensation No. (R2600, 2601) selected for the chuck barrier check.

[Operation]

- (1) External workpiece coordinate offset measurement function
Set the tool No. and the tool compensation No. used for workpiece coordinate offset measurement in a BCD code. This is set with the user PLC. This tool No. (R2602, 2603) is interpreted as the tool offset No. by the CNC.
- (2) Chuck barrier check
The file register used differs according to the parameter (#1097 TIno.)

#1097 TIno.	R2600,2601/R2800,2801	R2602,2603/R2802,2803
0	Tool length, tool nose wear offset No.	Tool No.
1	Tool nose wear offset No.	Tool No., tool length compensation No.

If the tool length compensation No. is not designated (if the contents are 0), the tool length and tool nose wear offset will both follow the T command modal.

The T command modal will also be followed if the designated offset No. is not within the specified range.

If the T command modal value is 0, the compensation amount will be interpreted as 0.

Cont.	Signal name	Abbrev.	\$1	\$2	\$3	\$4	\$5	\$6	\$7	\$8
A	WORKPIECE COORDINATE OFFSET MEASUREMENT TOOL NO. / SELECTED TOOL NO. (Main)		R2602,3	R2802,3	R3002,3	R3202,3	R3402,3	R3602,3	R3802,3	R4002,3

[Function][Operation]

Refer to the explanation for R2600 and R2601 for details.

4 Explanation of Interface Signals

Cont.	Signal name	Abbrev.	\$1	\$2	\$3	\$4	\$5	\$6	\$7	\$8
A	SELECTION TOOL COMPENSATION NO. (Sub)		R2604,5	R2804,5	R3004,5	R3204,5	R3404,5	R3604,5	R3804,5	R4004,5

[Function]

- (1) Workpiece coordinate offset measurement function
Set the tool compensation No. used in the sub spindle side for external workpiece coordinate offset measurement in a BCD code.
- (2) Chuck barrier check
Designate the tool No. and compensation No. selected on the sub-spindle side for chuck barrier check.

[Operation]

- (1) Workpiece coordinate offset measurement function
Set the tool compensation No. used in the sub spindle side for external workpiece coordinate offset measurement in a BCD code.
- (2) Chuck barrier check
The file register used differs according to the parameter (#1097 Tlno.)

#1097 Tlno.	R2604,2605/R2804,2805	R2606,2607/R2806,2807
0	Tool length, tool nose wear offset No.	Tool No.
1	Tool nose wear offset No.	Tool No., tool length compensation No.

If the tool length compensation No. is not designated (if the contents are 0), both the tool length and tool nose wear offset follow the details designated for the main spindle. The details for the main spindle will also be set if the designated offset No. is not within the specified range.

Cont.	Signal name	Abbrev.	\$1	\$2	\$3	\$4	\$5	\$6	\$7	\$8
A	SELECTION TOOL WEAR NO. (Sub)		R2606,7	R2806,7	R3006,7	R3206,7	R3406,7	R3606,7	R3806,7	R4006,7

[Function][Operation]

Refer to the section for the "Selection tool compensation No. (sub) (R2604, 5)".

Cont.	Signal name	Abbrev.	\$1	\$2	\$3	\$4	\$5	\$6	\$7	\$8
A	TOOL MOUNTING INFORMATION m		R2608,9	R2808,9	R3008,9	R3208,9	R3408,9	R3608,9	R3808,9	R4008,9

[Function]

Designate the presence of a tool mounted on the tool post (tool compensation amount validity).

[Operation]

When the tool designated for tool mounting is selected, the tool compensation amount will be added to the chuck barrier check.

<Bit allocation>

Tool mounting information (high order) R2609/R2809	bitF	bitE	bitD	bitC	bitB	bitA	bit9	bit8
	Tool 32	Tool 31	Tool 30	Tool 29	Tool 28	Tool 27	Tool 26	Tool 25
	bit7	bit6	bit5	bit4	bit3	bit2	bit1	bit0
	Tool 24	Tool 23	Tool 22	Tool 21	Tool 20	Tool 19	Tool 18	Tool 17

Tool mounting information (low order) R2608/R2808	bitF	bitE	bitD	bitC	bitB	bitA	bit9	bit8
	Tool 16	Tool 15	Tool 14	Tool 13	Tool 12	Tool 11	Tool 10	Tool 9
	bit7	bit6	bit5	bit4	bit3	bit2	bit1	bit0
	Tool 8	Tool 7	Tool 6	Tool 5	Tool 4	Tool 3	Tool 2	Tool 1

Bit OFF: Tool not mounted (tool compensation amount not added)

Bit ON: Tool mounted (tool compensation amount added)

In a machine that uses tools 1 to 12 on the main spindle's tool post and tools 17 to 28 on the sub-spindle's tool post, if the tools are mounted in either tool post, H0FFF is set for both R2608 and R2609.

When tool 28 is detached from the sub-spindle side next, R2609 will be set to H07FF.

[Remark]

This signal is initialized to HFFFF when the power is turned ON.

Thus, if this signal is not used, the tool compensation amount will always be added to the chuck barrier check.

4 Explanation of Interface Signals

Cont.	Signal name	Abbrev.	\$1	\$2	\$3	\$4	\$5	\$6	\$7
A	n-TH SPINDLE SYNCHRONOUS TAPPING VALID [C80]	MTAP1 to 7	R2613	R2813	R3013	R3213	R3413	R3613	R3813

[Function]

This signal selects a spindle which executes synchronous tapping with multiple spindles.

[Operation]

The 1st spindle synchronous tapping valid signal corresponds to the 1st spindle. The 7th spindle synchronous tapping valid signal corresponds to the 7th spindle.

The 1st spindle is the first spindle in the spindle parameter. If any unspecified spindle is selected, it will be ignored for the normal synchronous tapping.

By selecting only one of the spindles, the synchronous tapping with one spindle can be executed.

When no spindles are selected, the synchronous tapping will be executed with the spindle which is valid by the normal synchronous tapping.

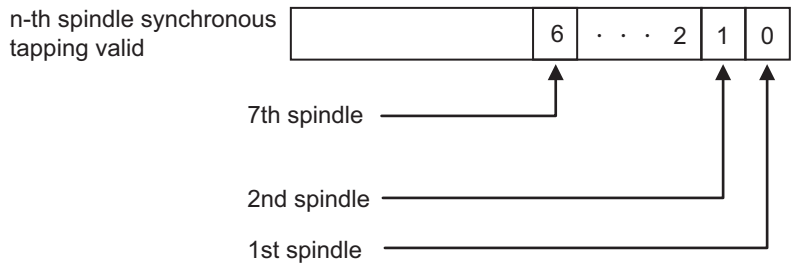

Turn ON the bit corresponding to each spindle to select the spindle which executes the synchronous tapping.

[Timing chart]

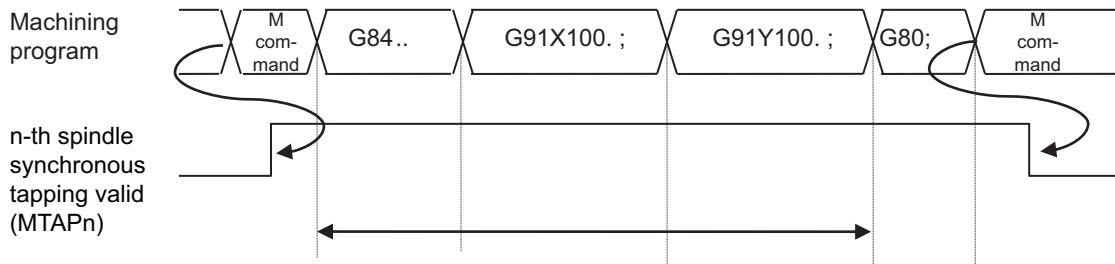

Multiple spindles synchronous tapping valid area = In synchronous tapping

4 Explanation of Interface Signals

Cont.	Signal name	Abbrev.	\$1	\$2	\$3	\$4	\$5	\$6	\$7	\$8
A	MULTIPLE-SPINDLE CONTROL I: SELECTED SPINDLE NO.	SLSPNO	R2614	R2814	R3014	R3214	R3414	R3614	R3814	R4014

[Function]

This signal gives information on the selected spindle (G43.1/G44.1 mode, spindle number) of each part system.

(Note 1) The given information is the spindle number, not spindle name.

(Note 2) BIT8 and BIT0-BIT7 become "0" when G47.1 (all spindle selection) mode is entered.

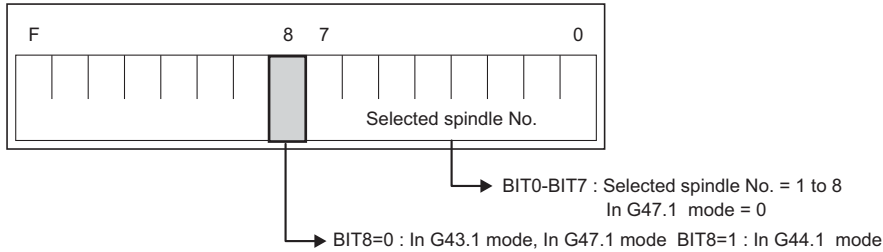

[Operation]

The information on selected spindle is output at the following timing.

(1) At power ON /NC reset

The information on the currently selected spindle is output based on the parameter settings.

(Example)

\$1: Initial G43.1 mode (#1199 Sselect = 0, #12090 SnG43.1 = 1, #1534 SnG44.1 = 2)

R register for part systems (\$1)		
R2614	BIT8 = 0	1

\$2: Initial G44.1 mode (#1199 Sselect = 1, #12090 SnG43.1 = 1, #1534 SnG44.1 = 2)

R register for part systems (\$2)		
R2814	BIT8 = 1	2

\$3: Initial G47.1 mode (#1199 Sselect = 2)

R register for part systems (\$3)		
R3014	BIT8 = 0	0

4 Explanation of Interface Signals

(2) When G43.1/G44.1/G47.1 is commanded

When G43.1/G44.1/G47.1 command is executed, the information on selected spindle after command execution is output.

(Example)

- 1st spindle Spindle name: 1 (#3077 Sname = 1)
#12090 SnG43.1 = 1
- 2nd spindle Spindle name: 2 (#3077 Sname = 2)
#1534 SnG44.1 = 2

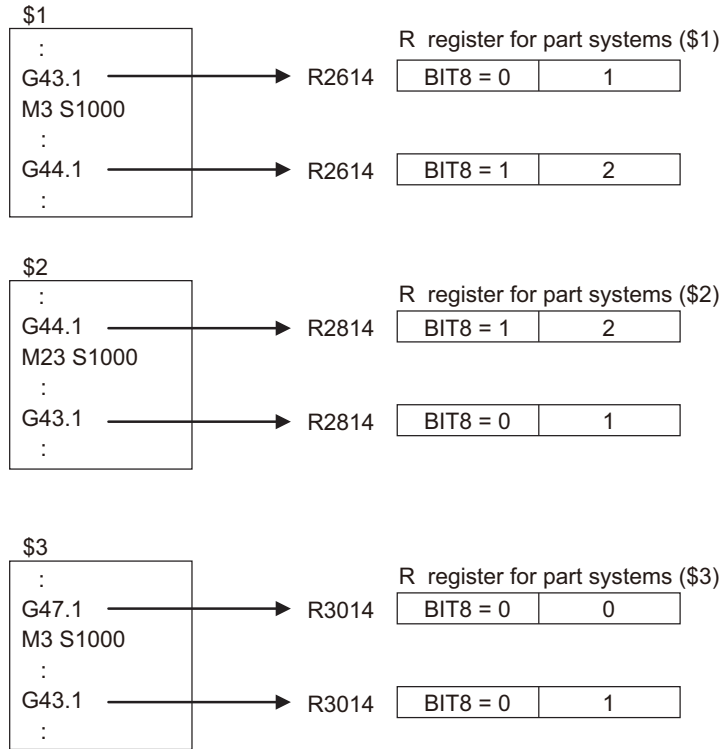

(3) When G44.1D is commanded

When G44.1D command is executed, the information on selected spindle after command execution is output.

(Example)

- 1st spindle Spindle name: 1 (#3077 Sname = 1)
- 2nd spindle Spindle name: 2 (#3077 Sname = 2)
- 3rd spindle Spindle name: 5 (#3077 Sname = 5)
- 4th spindle Spindle name: 8 (#3077 Sname = 8)
- #1534 SnG44.1 = 2

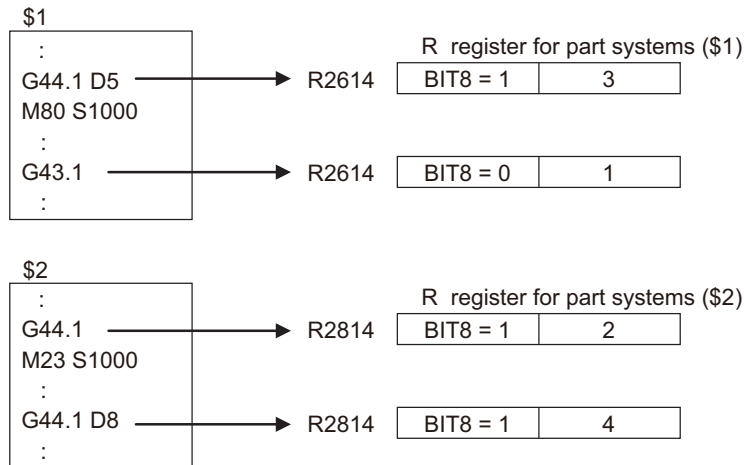

4 Explanation of Interface Signals

Cont.	Signal name	Abbrev.	\$1	\$2	\$3	\$4	\$5	\$6	\$7	\$8
A	ROTARY AXIS CONFIGURATION PARAMETER SWITCH	RPARCH G	R2615	R2815	R3015	R3215	R3415	R3615	R3815	R4015

[Function]

This switches the rotary axis configuration parameters.

[Operation]

- (1) Low-order 8 bits: Configuration No. of rotary axis configuration parameter
 This specifies the configuration No. of rotary axis configuration parameter.
 Setting range: 1 to the number of effective part systems (*1)
 (*1) The setting range is 1 to 8 when the tool head hot swapping specification is valid. [M8]
- (2) High-order 8 bits: Switching command of rotary axis configuration parameter
 When "Rotary axis configuration parameter switch request signal (bit8)" turns ON, the configuration set to the "Configuration No. of rotary axis configuration parameter" will be valid.

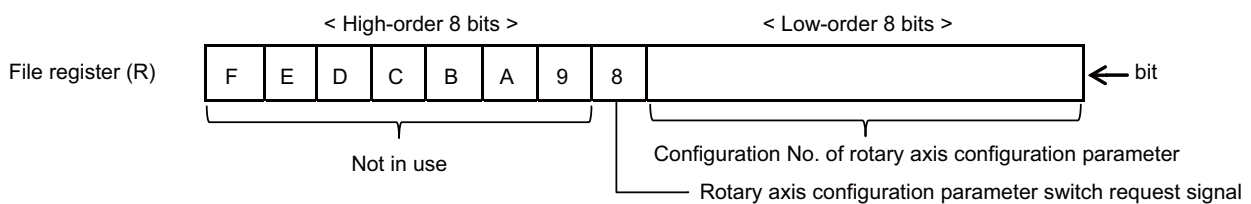

- *1 This register will be cleared when the power is turned ON.
- *2 Turn ON the "Rotary axis configuration parameter switch request signal" before using the following functions. If you turn ON the "Rotary axis configuration parameter switch request signal" while performing the following functions, an operation error (M01 0187) occurs.
 - Tool center point control [M8]
 - Inclined surface machining
 - Workpiece installation error compensation [M8]
 - Tool length compensation along the tool axis [M8]
 - Simple inclined surface machining [M8]
 - 3-dimensional tool radius compensation (Tool's vertical-direction compensation) [M8]
 - 3-dimensional manual feed
 - Tool handle feed & interruption [M8]
 - R-Navi [M8]
- *3 This signal is valid only when "#1450 5axis_Spec/bit0 Axis name setting method of rotary axis configuration parameter" is set to "1" and "#1450 5axis_Spec/bit2 Application of rotary axis configuration parameters" is set to "1".

[Timing chart]

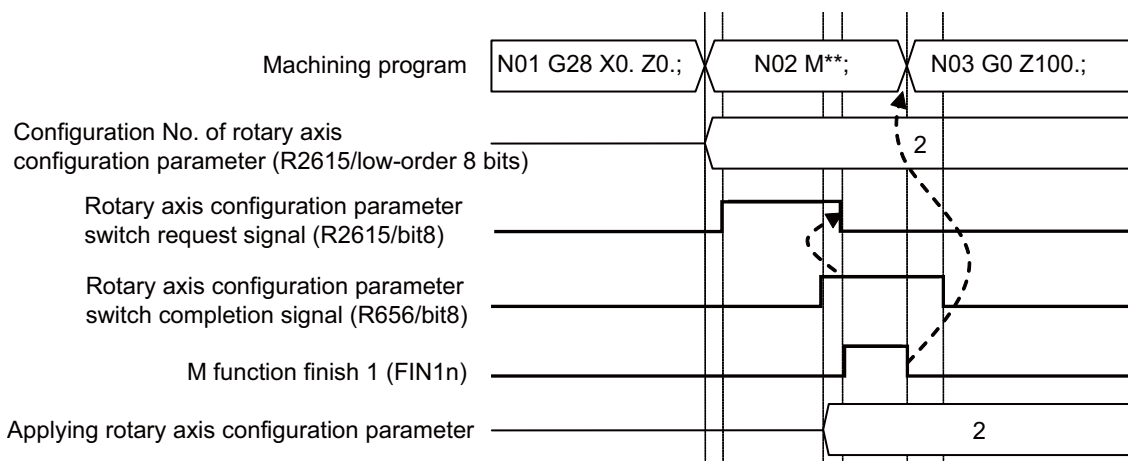

[Related signals]

4 Explanation of Interface Signals

(1) Rotary axis configuration parameter output (R656: RPAROUT)

Cont.	Signal name	Abbrev.	\$1	\$2	\$3	\$4	\$5	\$6	\$7	\$8
A	TOOL LENGTH MEASUREMENT 2 TOOL NO.		R2618	R2818	R3018	R3218	R3418	R3618	R3818	R4018

[Function]

Set the compensation No. of the tool data for setting the measurement result during manual tool length measurement II. This is set in BCD code.

[Operation]

When the sensor is touched by the tool, compensation amount will be written into the tool data of the compensation No. automatically specified.

This tool No. is interpreted as the tool compensation No. by the CNC.

[Related signals]

- (1) Wear compensation No. (R2594)
- (2) Tool length measurement 2 (TLMS: YC21)

Cont.	Signal name	Abbrev.	\$1	\$2	\$3	\$4	\$5	\$6	\$7	\$8
A	CONSTANT TORQUE CONTROL: CONSTANT TORQUE/ PROPORTIONAL TORQUE STOPPER CONTROL REQUEST AXIS [M8]		R2620	R2820	R3020	R3220	R3420	R3620	R3820	R4020

[Function]

This signal commands constant torque control or proportional torque stopper control. By turning the axis bit of a part system ON, constant torque control or proportional torque stopper control is performed for the corresponding axis.

BIT	F	E	D	C	B	A	9	8	7	6	5	4	3	2	1	0
Axis	8	7	6	5	4	3	2	1	8	7	6	5	4	3	2	1
	Proportional torque stopper control request axis								Constant torque control request axis							

(Note 1) The axis bit configuration for part systems are the same as the basic axis configuration.

[Operation]

(1) High-order 8 bits: The Proportional torque stopper control request axis bit

When the bit of the specified axis turns ON, the servomotor for the axis generates a constant torque in the stopper direction according to the value that is set in "#2296 SV096 TQC" (Stopper torque for constant torque control).

When a position droop occurs, the stopper position is maintained with a torque generated in proportion of the position droop.

(2) Low-order 8 bits: The Constant torque control request axis bit

When the bit of the specified axis turns ON, the servomotor for the axis outputs a constant torque in a constant direction according to the value that is set in "#2296 SV096 TQC" (Stopper torque for constant torque control).

[Related signals]

- (1) Constant torque control: Axis under constant torque/proportional torque stopper control (R624)

4 Explanation of Interface Signals

Cont.	Signal name	Abbrev.	\$1	\$2	\$3	\$4	\$5	\$6	\$7	\$8
A	CONSTANT TORQUE CONTROL: CONSTANT TORQUE DROOP CANCEL REQUEST AXIS [M8]		R2621	R2821	R3021	R3221	R3421	R3621	R3821	R4021

[Function]

This signal commands constant torque droop cancellation. By turning the axis bit of a part system ON, constant torque droop cancellation is performed for the corresponding axis.

BIT	F	E	D	C	B	A	9	8	7	6	5	4	3	2	1	0
Axis	8	7	6	5	4	3	2	1	8	7	6	5	4	3	2	1
	Not used							Constant torque droop cancellation request axis								

(Note 1) The axis bit configuration for part systems are the same as the basic axis configuration.

[Operation]

Position droop cancellation and command position update are performed when the axis bit is turned ON for an axis for which you want to clear the position droop generated during constant torque control.

[Related signals]

(1) Constant torque control: Constant torque droop cancel axis status (R625)

Cont.	Signal name	Abbrev.	\$1	\$2	\$3	\$4	\$5	\$6	\$7	\$8
A	SERVO READY COMPLETION OUTPUT DESIGNATION		R2625	R2825	R3025	R3225	R3425	R3625	R3825	R4025

[Function]

"Servo ready completion" (SA) signal indicates that the servo system is ready for normal operation. The signal can be output to a Y device of remote I/O, which is designated by this register.

The direct transfer of the signal from CNC to remote I/O allows the output of the signal during PLC is stopped.

[Operation]

The first setting data since the power ON is valid. Only the first setting is valid. The value changed later is invalid.

The setting range is 1 to 5FF (HEX), except for 2C0 to 2FF.

If the first setting of Y device No. is out of range, the signal is not output to the Y device. To output the signal, turn the power ON again and then set the Y device No. again within the range.

[Caution]

- (1) Setting "0" does not mean the output to Y0. This setting is invalid.
- (2) If the "Servo ready completion" signal is OFF on either of the R registers (among R2625/R2825/R3025/R3225) with the overlapped setting value, the signals to be output to Y device turn OFF.
- (3) Y2C0 to 2FF, which are used by the system, cannot be set as servo ready completion output designation.
- (4) This register, if designated after the "Servo ready completion" signal is ON without initial ladders, turns valid from the time of the setting and the signal is output to Y device.
- (5) The devices Y300 to Y5FF are available when the external PLC link such as PROFIBUS-DP and CC-Link is connected.
- (6) Do not control the designated Y devices with user PLC. When the device is controlled with user PLC, the "Servo ready completion" signal is overwritten and turns invalid.
- (7) If the servo ready completion output designation, which has not been set with this register, is written twice in 1 scan of user PLC, the latter setting is valid.

[Related signals]

(1) Servo ready completion (SA: XC11)

4 Explanation of Interface Signals

Cont.	Signal name	Abbrev.	\$1	\$2	\$3	\$4	\$5	\$6	\$7	\$8
A	THREAD RECUTTING COMMAND		R2626	R2826	R3026	R3226	R3426	R3626	R3826	R4026

[Function]

This signal commands memorization or deletion of the position data that is used by the thread recutting function. This signal needs to be set from the ladder when the thread recutting operation from the ladder ("#1258 set30/bit4" is set to "1") is selected. When the thread recutting operation on the CNC screen ("#1258 set30/bit4" is set to "0") is selected, thread recutting operation is disabled even if this signal is set.

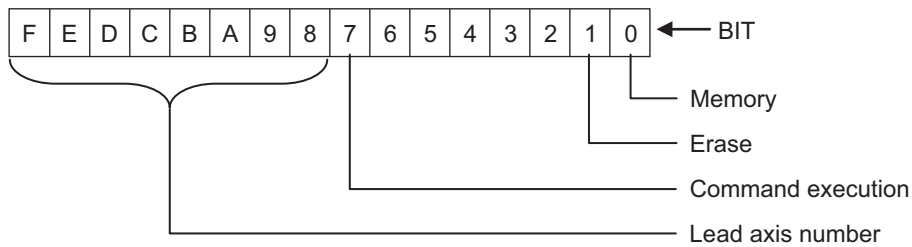

[Operation]

- BIT0 [Memory]: If this bit is ON when the command is executed, the NC stores "spindle number", "spindle position", "lead axis number" and "lead axis machine coordinate" in the NC memory.
- BIT1 [Erase]: If this bit is ON when the command is executed, the NC erases "spindle number", "spindle angle", "lead axis number" and "lead axis machine coordinate" from the NC memory.
- BIT7 [Command execution]: The NC performs "memory" (BIT0) or "erase" (BIT1) operation at the rising edge of this bit. An error occurs if both "memory" and "erase" bits are ON or OFF.
- BIT8 to F [Lead axis number]: The lead axis number of the axis that performs thread recutting is set in binary using these bits. The range of numbers that can be set is 0x00 to 0xFF. Set the 1st axis to "1" in the command. The number in the command is memorized as the lead axis number.

[Related signals]

- (1) Thread recutting status (R648)
- (2) Thread recutting lead axis No. (R651)

Cont.	Signal name	Abbrev.	\$1	\$2	\$3	\$4	\$5	\$6	\$7	\$8
A	THREAD RECUTTING EXECUTION OPERATION		R2627	R2827	R3027	R3227	R3427	R3627	R3827	R4027

[Function]

This signal commands various operations related to thread recutting. This signal needs to be set from the ladder when the thread recutting operation from the ladder ("#1258 set30/bit4" is set to "1") is selected. When the thread recutting operation on the CNC screen ("#1258 set30/bit4" is set to "0") is selected, thread recutting operation is disabled even if this signal is set.

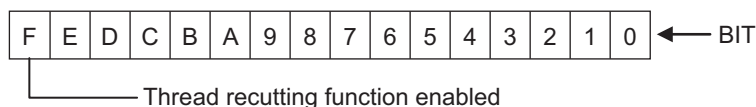

[Operation]

- BITF [Thread recutting function enabled]: Turn this bit ON to perform thread recutting. When thread recutting can be performed, BIT F of the "Thread recutting execution status" (R649) signal turns ON. To perform normal thread cutting, turn this bit OFF.

[Related signals]

- (1) Thread recutting execution status (R649)

4 Explanation of Interface Signals

Cont.	Signal name	Abbrev.	\$1	\$2	\$3	\$4	\$5	\$6	\$7	\$8
A	MECHANICAL AXIS SPECIFICATIONS 1ST ROTARY AXIS ANGLE		R2628,9	R2828,9	R3028,9	R3228,9	R3428,9	R3628,9	R3828,9	R4028,9
A	MECHANICAL AXIS SPECIFICATIONS 2ND ROTARY AXIS ANGLE		R2630,1	R2830,1	R3030,1	R3230,1	R3430,1	R3630,1	R3830,1	R4030,1

[Function]

This signal sets rotary axis angle of the mechanical axis specifications.
The setting range is 0 to ±720000(1degree/1000).

[Operation]

When handle-feeding to tool axis direction/tool radius direction in the mechanical axis specifications, the rotary axis angle can be input by writing the angle in R register with the user PLC.

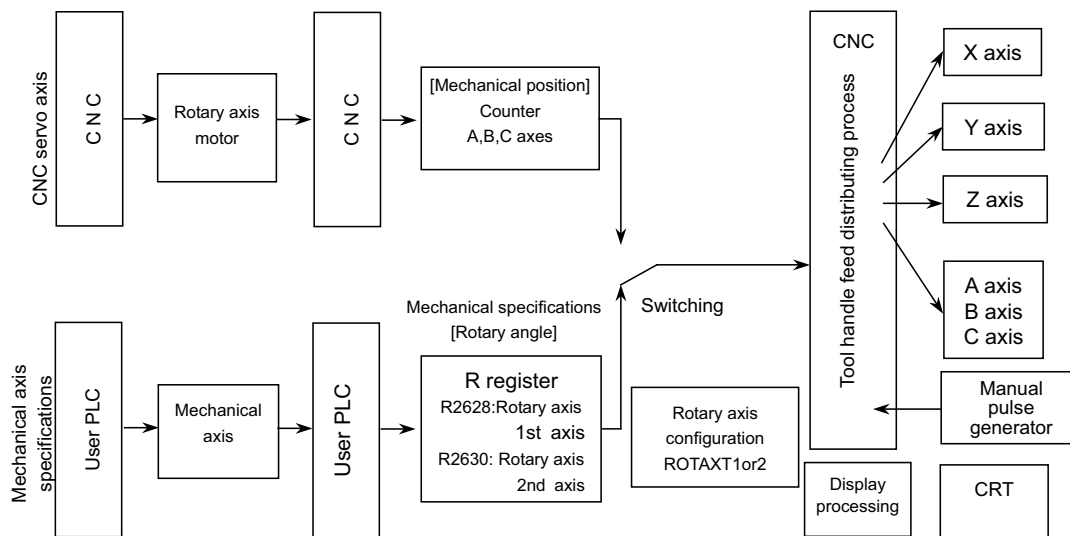

R register	Details	Input range
R2628 R2629	Mechanical specifications rotary axis 1st angle R2628(low order)/R2629(high order)	0 to ±720000 (1degree/1000)
R2630 R2631	Mechanical specifications rotary axis 2nd angle R2630(low order)/R2631(high order)	0 to ±720000 (1degree/1000)

(Example) Writing 90 degree on A axis and 180 degree on C axis with A-C axes configuration is shown as below.

$$\begin{array}{l} \text{A axis: } 90 \quad \times \quad 1000 \quad = \quad 90000 \\ \text{angle } 1/1000\text{degree} \quad \text{System unit} \end{array} \quad \text{+ |---[DMOV K90000 R2628]---|}$$

$$\begin{array}{l} \text{C axis: } 180 \quad \times \quad 1000 \quad = \quad 180000 \\ \text{angle } 1/1000\text{degree} \quad \text{System unit} \end{array} \quad \text{+ |---[DMOV K180000 R2630]---|}$$

[Caution]

- (1) Tool center point rotary mode cannot be used during the mechanical axis in use.
- (2) Do not change the rotary axis angle of the mechanical axis during tool handle feed & interruption.
- (3) When angle of the mechanical axis is written in R register, only for the tool center point value counter on the position display screen will be updated. Other counters will not be updated.

4 Explanation of Interface Signals

Cont.	Signal name	Abbrev.	\$1	\$2	\$3	\$4	\$5	\$6	\$7	\$8
A	Simple inclined surface machining command: Tool axis rotation angle compensation amount [M8]	TAN-GOFS	R2634,5	R2834,5	R3034,5	R3234,5	R3434,5	R3634,5	R3834,5	R4034,5

[Function]

This signal is to compensate the reference position of rotation angle for the rotary axis of tool side during the modal of simple tool center point control (G174) or when tool axis direction control (G53.1) is commanded.

R register of the part system where the rotary axis exists is applied by the reset condition.

[Operation]

The angle of tool side rotary axis is based on the angle set in the tool axis rotation angle compensation amount.

The tool axis rotation angle compensation amount validates the data at the time of G174/G53.1 command. However, when the data is changed during G174 mode, it will not be valid.

Setting range: -359999 to 359999 (Increment 0.001[°])

Regardless of the input unit, a value is incremented by 0.001[°] .

(Note 1)The tool axis rotation angle compensation amount is cleared at the power ON. Set this signal before commanding G174/G53.1.

(Note 2)When using a tool with turret, set the offset angle information of the tool for the reference position rotation angle to this compensation amount. It is possible to perform machining using an arbitrary tool on the turret by setting the angle information before commanding G174/G53.1.

4 Explanation of Interface Signals

Cont.	Signal name	Abbrev.	\$1	\$2	\$3	\$4	\$5	\$6	\$7	\$8
A	CIRCULAR FEED IN MANUAL MODE OPERATION MODE DATA [M8]		R2636,7	R2836,7	R3036,7	R3236,7	R3436,7	R3636,7	R3836,7	R4036,7

[Function]

The operation mode for the circular feed in manual mode is designated.

[Operation]

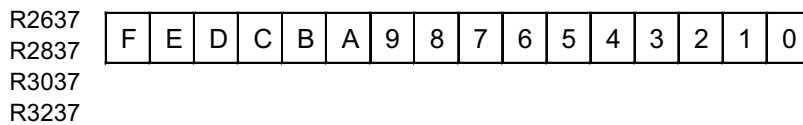
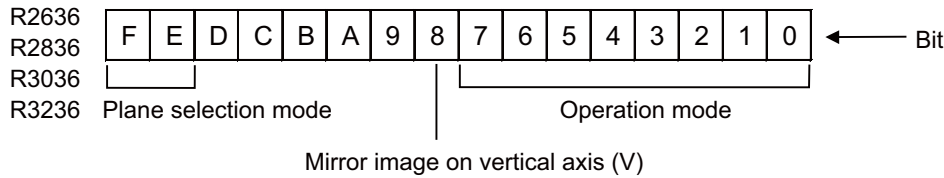

Operation mode: Designate the coordinate setting.

Setting value	Description
1	Linear-linear coordinate is selected.
2	Circular-linear coordinate is selected. ("+" indicates the CW direction of the horizontal axis (H).)
3	Circular-linear coordinate is selected. ("+" indicates the CCW direction of the horizontal axis (H).)

The setting value other than above is invalid.

Vertical axis (V) image: Reverse the "+" direction of the vertical axis (V).

Vertical axis (V) is determined by the plane selection mode.

Setting value	Description
0	Vertical axis (V) mirror image is not valid.
1	Vertical axis (V) mirror image is valid.

Plane selection mode: Specifies a virtual coordinate system plane on the machine coordinate system.

Plane selection mode		Plane	Horizontal axis (H)	Vertical axis (V)
bitF	bitE			
0	0	Not specified	1st axis of NC	2nd axis of NC axis
0	1	XY	#1026 Base axis I	#1027 Base axis J
1	0	ZX	#1028 Base axis K	#1026 Base axis I
1	1	YZ	#1027 Base axis J	#1028 Base axis K

[Caution]

- (1) This data is enabled at the rising edge of the "Circular feed in manual mode valid" signal.
- (2) The data is not enabled even if it is changed while the "Circular feed in manual mode valid" signal is ON.

[Related signals]

- (1) Circular feed in manual mode valid (YC7E)

4 Explanation of Interface Signals

Cont.	Signal name	Abbrev.	\$1	\$2	\$3	\$4	\$5	\$6	\$7	\$8
A	CIRCULAR FEED IN MANUAL MODE BASIC POINT H DATA [M8]		R2644,5	R2844,5	R3044,5	R3244,5	R3444,5	R3644,5	R3844,5	R4044,5
A	CIRCULAR FEED IN MANUAL MODE BASIC POINT V DATA [M8]		R2648,9	R2848,9	R3048,9	R3248,9	R3448,9	R3648,9	R3848,9	R4048,9

[Function]

Designate a basic point on the hypothetical coordinate.

[Operation]

Designate a basic point on the hypothetical coordinate using the machine coordinate system.

The setting range differs in each PLC setting unit.

	PLC setting unit	
	mm	inch
(B)	±99999.999 mm	±3937.0078 inch
(C)	±9999.9999 mm	±393.70078 inch

[Caution]

- (1) This data is enabled at the rising edge of the "Circular feed in manual mode valid" signal.
- (2) The data is not enabled even if it is changed while the "Circular feed in manual mode valid" signal is ON.
- (3) The basic point coordinate is designated with "0.5*PLC setting unit".
- (4) When the parameter "#1040 M_inch" is set to "1", the data is set in inches.

[Related signals]

- (1) Circular feed in manual mode valid (YC7E)

Cont.	Signal name	Abbrev.	\$1	\$2	\$3	\$4	\$5	\$6	\$7	\$8
A	CIRCULAR FEED IN MANUAL MODE TRAVEL RANGE H (+) DATA [M8]		R2652,3	R2852,3	R3052,3	R3252,3	R3452,3	R3652,3	R3852,3	R4052,3
A	CIRCULAR FEED IN MANUAL MODE TRAVEL RANGE H (-) DATA [M8]		R2656,7	R2856,7	R3056,7	R3256,7	R3456,7	R3656,7	R3856,7	R4056,7
A	CIRCULAR FEED IN MANUAL MODE TRAVEL RANGE V (+) DATA [M8]		R2660,1	R2860,1	R3060,1	R3260,1	R3460,1	R3660,1	R3860,1	R4060,1
A	CIRCULAR FEED IN MANUAL MODE TRAVEL RANGE V (-) DATA [M8]		R2664,5	R2864,5	R3064,5	R3264,5	R3464,5	R3664,5	R3864,5	R4064,5

[Function]

Designate the travel range on the hypothetical coordinate.

[Operation]

Designate the travel ranges with the value in the "+" or "-" direction on the hypothetical coordinate. Set the hypothetical coordinate value in the following state.

"Linear-linear" hypothetical coordinate	V' axis: mirror image is not valid
"Circular-linear" hypothetical coordinate	H' axis: "+" indicates the inverse (CW) direction V' axis: mirror image is not valid

In the "circular-linear" mode, set the travel range of H' by the angle from the basic point on the hypothetical coordinate. The setting range differs in each PLC setting unit.

	PLC setting unit		
	mm	inch	angle
(B)	±99999.999 mm	±3937.0078 inch	±360.000 °
(C)	±9999.9999 mm	±393.70078 inch	±360.0000 °

[Caution]

- (1) The data is enabled as soon as it is changed while the "Circular feed in manual mode valid" signal is ON.
- (2) The basic point is treated as zero point on the hypothetical coordinate.
- (3) The moving range is designated with "0.5*PLC setting unit".
- (4) When the parameter "#1040 M_inch" is set to "1", the data is set in inches.

4 Explanation of Interface Signals

[Related signals]

(1) Circular feed in manual mode valid (YC7E)

Cont.	Signal name	Abbrev.	\$1	\$2	\$3	\$4	\$5	\$6	\$7	\$8
A	CIRCULAR FEED IN MANUAL MODE GRADIENT/ARC CENTER H DATA [M8]		R2668,9	R2868,9	R3068,9	R3268,9	R3468,9	R3668,9	R3868,9	R4068,9
A	CIRCULAR FEED IN MANUAL MODE GRADIENT/ARC CENTER V DATA [M8]		R2672,3	R2872,3	R3072,3	R3272,3	R3472,3	R3672,3	R3872,3	R4072,3

[Function]

Designate the gradient on the "linear-linear" hypothetical coordinate, or the arc center on the "circular-linear" hypothetical coordinate.

[Operation]

How to designate differs in each operation mode.

Operation mode is "Linear-linear" (*1)	Use the H-V ratio to designate the gradients of H axis on the machine coordinate and H' axis on the hypothetical coordinate. Signs are available. "+" indicates the CCW direction from the H axis. If the gradient is 45°, H and V should have the same value. The designation unit follows the PLC setting unit. PLC setting unit(B) : ±99999.999 PLC setting unit(C) : ±9999.9999
Operation mode is "Arc-linear" (*1)	Designate an arc center on the hypothetical coordinate using the machine coordinate system. The designation unit follows the PLC setting unit. [Millimeter] PLC setting unit(B) : ±99999.999 [mm] PLC setting unit(C) : ±9999.9999 [mm] [Inch] PLC setting unit(B) : ±3937.0078 [inch] PLC setting unit(C) : ±393.70078 [inch]

(*1) Refer to the section on "Circular feed in manual mode operation mode data" (R2636) for the operation mode.

[Caution]

- (1) This data is enabled at the rising edge of the "Circular feed in manual mode valid" signal.
- (2) The data is not enabled even if it is changed while the "Circular feed in manual mode valid" signal is ON.
- (3) The arc center coordinate and gradient are designated with "0.5*PLC setting unit".
- (4) When the parameter "#1040 M_inch" is set to "1", the data is set in inches.

[Related signals]

(1) Circular feed in manual mode valid (YC7E)

4 Explanation of Interface Signals

Cont.	Signal name	Abbrev.	Common(\$)
A	3D MACHINE INTERFERENCE CHECK : ENABLED SHAPE GROUP NO. 1 to 4 [M8]		R4400 to 3

[Function]

This signal is used to update the shape group of the 3D machine interference check. Set the No. of shape group which is currently specified as the interference check target. This signal is enabled while the 3D machine interference check is being performed.

If you select a shape group on the [3D Monitor] screen, the group No. is set in the "3D Machine Interference Check : Requested shape group No.". Then set this value in the "Enabled shape group No." signal.

[Operation]

When the "Enabled shape group No." changes, the jig or workpiece model is updated. The 3D machine interference check is implemented using the updated model.

If the setting is changed during axis movement, the axis will decelerate to a stop while the model is being updated.

(Note 1) This signal is inoperative during automatic operation.

(Note 2) Shapes defined in Group 1 are within the scope of the interference check, but those of Groups 2 to 4 are outside that scope.

[Related signals]

(1) 3D Machine Interference Check : Requested shape group No. (R2400)

Cont.	Signal name	Abbrev.	\$1	\$2	\$3	\$4
A	EXT. MACHINE COORDINATE SYSTEM OFFSET DATA n-TH AXIS		R5700 to 15	R5716 to 31	R5732 to 47	R5748 to 63

[Function]

This data compensates the basic machine coordinate system. The axis moves the amount equivalent to the set data (machine error compensation unit). The entire coordinate system value, including the basic machine coordinate system, will not change.

[Operation]

When the "Ext. machine coordinate system offset data" (R5700 to 15) is set, the axis will move the amount equivalent to that set value.

The entire coordinate system value, including the basic machine coordinate system, will not change.

If the changed amount of the set value exceeds the rapid traverse feedrate, the set value turns invalid: the compensation is executed with the set value unchanged.

<Data range>

80000000 (HEX) to 7FFFFFFF (HEX) (Absolute compensation amount -2147483648 to 2147483647)

Unit: Machine error compensation unit

[Related signals]

(1) Ext. machine coordinate system offset data illegal n-th axis (XA40 to XA47)

Cont.	Signal name	Abbrev.	\$1	\$2	\$3	\$4
A	EACH AXIS MANUAL FEEDRATE B n-TH AXIS		R5764 to R5779	R5780 to R5795	R5796 to R5811	R5812 to R5827

[Function]

When the each axis manual feedrate B valid signal is valid, designate the manual feedrate for the axis selected with the manual feedrate B valid signal.

[Operation]

(1) When the each axis manual feedrate B valid signal is valid, the each axis speed designated with this register is valid for the manual feedrate of an axis for which the manual feedrate B valid signal is valid.

(2) Cutting override and manual override are invalid for this register's speed.

(3) This register is not related to the dry run speed.

(4) A binary value is directly set for this register. The setting unit is 0.01mm/min (°/min).

(5) This signal is a register independent for each axis.

[Related signals]

(1) Manual feedrate B valid (FBEn:Y940 to Y947)

(2) Each axis manual feedrate B valid (YC7C)

4 Explanation of Interface Signals

Cont.	Signal name	Abbrev.	\$1	\$2	\$3	\$4
A	EXTERNAL DECELERATION SPEED SELECTION n-TH AXIS [C80]		R6052 to 59	R6060 to 67	R6068 to 75	R6076 to 83

[Function]

When the external deceleration signal is valid, the external deceleration parameter for each axis is selected by the value set in the R register.

[Operation]

When the external deceleration + n-th axis (*+EDTn) or the external deceleration - n-th axis (*-EDTn) is valid, the n-th axis is decelerated to the speed which is set in the parameter selected by the PLC. To enable the external deceleration speed selection, store the selection values in these registers in advance.

When the selected axis travels at the external deceleration speed or less, it will not be affected even if the external deceleration signal is valid.

These R registers will be valid only when the external deceleration speed setting for each axis (#1239 set11/bit6=1) is valid.

These R registers will be cleared to "0" when the power is turned ON.

The following shows the relationship between the selection value of the R register and the external deceleration speed:

The selection value of the external deceleration speed selection n-th axis (R register)	External deceleration speed (for each axis)
0	External deceleration speed (#2086 exdcax)
1	External deceleration speed 1 (#2161 exdcax1)
2	External deceleration speed 2 (#2162 exdcax2)
3	External deceleration speed 3 (#2163 exdcax3)
4	External deceleration speed 4 (#2164 exdcax4)
5	External deceleration speed 5 (#2165 exdcax5)
Other than the above.	External deceleration speed (#2086 exdcax)

[Related signals]

- (1) The external deceleration + n-th axis (*+EDT1 to 8:Y7E0 to 7)
- (2) The external deceleration - n-th axis (*-EDT1 to 8:Y800 to 7)

4 Explanation of Interface Signals

Cont.	Signal name	Abbrev.	\$1	\$2	\$3	\$4	\$5	\$6	\$7	\$8
A	USER MACRO INPUT #1032 (PLC -> NC)		R6436,7	R6444,5	R6452,3	R6460,1	R6468,9	R6476,7	R6484,5	R6492,3

[Function]

This is interface function used to coordinate user PLC to user macro.

(Note) The other signals from R0 to R99 are PLC inputs, but this signal is output to the NC from PLC.

[Operation]

The data set in file registers Rn and Rn+1 with the user PLCs, can be referred to on the user macro side with the user macro system variables #1000 to #1031 or #1032.

The relationship between system variable and file register is as follows:

System variable	Points	Interface input signal	System variable	Points	Interface input signal
#1000	1	Register R6436 bit 0	#1016	1	Register R6437 bit 0
#1001	1	Register R6436 bit 1	#1017	1	Register R6437 bit 1
#1002	1	Register R6436 bit 2	#1018	1	Register R6437 bit 2
#1003	1	Register R6436 bit 3	#1019	1	Register R6437 bit 3
#1004	1	Register R6436 bit 4	#1020	1	Register R6437 bit 4
#1005	1	Register R6436 bit 5	#1021	1	Register R6437 bit 5
#1006	1	Register R6436 bit 6	#1022	1	Register R6437 bit 6
#1007	1	Register R6436 bit 7	#1023	1	Register R6437 bit 7
#1008	1	Register R6436 bit 8	#1024	1	Register R6437 bit 8
#1009	1	Register R6436 bit 9	#1025	1	Register R6437 bit 9
#1010	1	Register R6436 bit 10	#1026	1	Register R6437 bit 10
#1011	1	Register R6436 bit 11	#1027	1	Register R6437 bit 11
#1012	1	Register R6436 bit 12	#1028	1	Register R6437 bit 12
#1013	1	Register R6436 bit 13	#1029	1	Register R6437 bit 13
#1014	1	Register R6436 bit 14	#1030	1	Register R6437 bit 14
#1015	1	Register R6436 bit 15	#1031	1	Register R6437 bit 15

System variable	Points	Interface input signal
#1032	32	Register R6436, R6437
#1033	32	Register R6438, R6439
#1034	32	Register R6440, R6441
#1035	32	Register R6442, R6443

This correspondence table shows the example for file registers R6436 and R6437.

File registers R6436 and R6437 correspond to system variables #1000 to #1031, and #1032 (32-bit data).

To use the R register of the 2nd and subsequent part system, set "#1230 set02/bit7" to "1".

[Related signals]

- (1) User macro input #1033, #1034, #1035 (R6436/6437, R6438/6439, R6440/6441, R6442/6443)
- (2) User macro output #1132, #1133, #1134, #1135 (R6372/6373, R6374/6375, R6376/6377, R6378/6379)

4 Explanation of Interface Signals

Cont.	Signal name	Abbrev.	\$1	\$2	\$3	\$4	\$5	\$6	\$7	\$8
A	USER MACRO INPUT #1033 (PLC -> NC)		R6438,9	R6446,7	R6454,5	R6462,3	R6470,1	R6478,9	R6486,7	R6494,5

[Function]

This provides interface function used to coordinate user PLC to user macro.

[Operation]

The data set in file registers Rn and Rn+1 with the user PLCs, can be referred to on the user macro side with the user macro system variables #1033.

(Example)

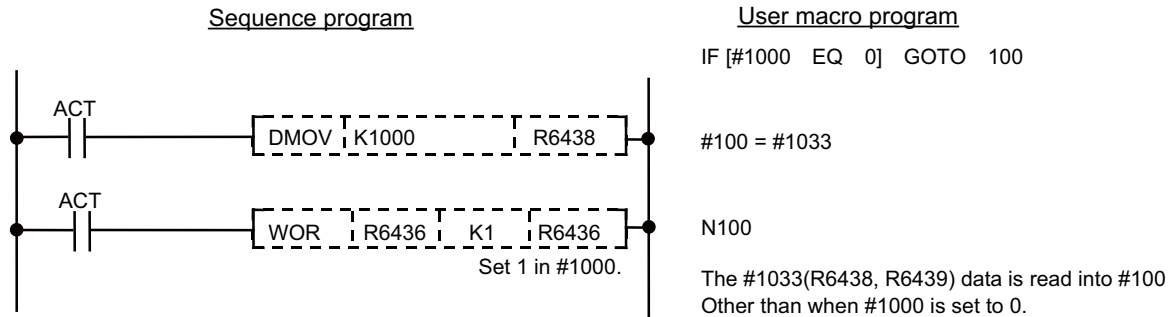

[Related signals]

- (1) User macro input #1032, #1034, #1035 (R6436/6437,R6440/6441,R6442/6443)
- (2) User macro output #1132, #1133, #1134, #1135 (R6372/6373,R6374/6375,R6376/6377,R6378/6379)

Cont.	Signal name	Abbrev.	\$1	\$2	\$3	\$4	\$5	\$6	\$7	\$8
A	USER MACRO INPUT #1034 (PLC -> NC)		R6440,1	R6448,9	R6456,7	R6464,5	R6472,3	R6480,1	R6488,9	R6496,7

[Function][Operation]

The function, operation, etc. are the same as those of "USER MACRO INPUT #1033".

Cont.	Signal name	Abbrev.	\$1	\$2	\$3	\$4	\$5	\$6	\$7	\$8
A	USER MACRO INPUT #1035 (PLC -> NC)		R6442,3	R6450,1	R6458,9	R6466,7	R6474,5	R6482,3	R6490,1	R6498,9

[Function][Operation]

The function, operation, etc. are the same as those of "USER MACRO INPUT #1033".

Cont.	Signal name	Abbrev.	1stSP	2ndSP	3rdSP	4thSP	5thSP	6thSP	7thSP	8thSP
A	SPINDLE COMMAND ROTATION SPEED OUTPUT		R7000,1	R7050,1	R7100,1	R7150,1	R7200,1	R7250,1	R7300,1	R7350,1

[Function]

By setting data of desired spindle speed to this signal, the spindle can be run at that speed.

[Operation]

When this signal is used, operation is same as the case where usual spindle command rotation speed input signal (R6500, 1) is given. Difference is that when data is set by user PLC, priority is given to that data over spindle (S) command data specified in automatic operation, or by manual command setting.

User PLC main (medium-speed) operation pattern

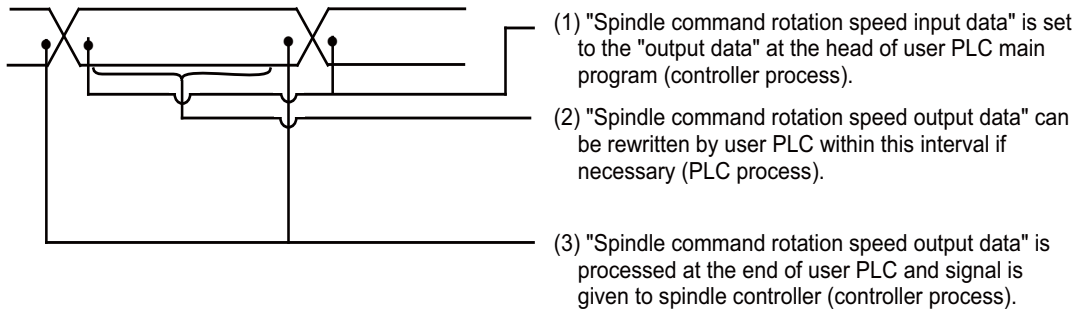

(Note 1) "Spindle command rotation speed output data" is rewritten by user PLC for each scan (constant).

(Note 2) "Spindle speed override", "Spindle gear selection code 1,2 (GI1, GI2)", "Spindle stop (SSTP)", "Spindle gear shift (SSFT)" and "Spindle orientation (SORC)" conditions are added to "Spindle command rotation speed output data" and sent to the spindle controller.

(Note 3) For flow of spindle (S) function command data, data update timing, etc., refer to the section for normal "Spindle command rotation speed input" signal (R6500, 1).

[Related signals]

- (1) Spindle command rotation speed input (R6500, R6501)
- (2) Spindle command final data (R6502, R6503)

Cont.	Signal name	Abbrev.	1stSP	2ndSP	3rdSP	4thSP	5thSP	6thSP	7thSP	8thSP
A	SPINDLE COMMAND SELECTION	SLSP	R7002	R7052	R7102	R7152	R7202	R7252	R7302	R7352

[Function]

Set which the part system the S command is output from when the multiple-spindle control II is valid.

- 0: 1st part system
- 1: 2nd part system
- 2: 3rd part system
- 3: 4th part system

(Note) If a setting value exceeds the maximum number of part systems determined by specifications, it will be interpreted that a selection has not been made.

[Operation]

If an S command is given while the spindle selection (SWS) and spindle command selection (SLSP) have already been input through different blocks, this S command is handled as a rotation speed command of the selected spindle. The selected spindle rotates at the rotation speed which was output. The spindles which were de-selected by the "Spindle selection" signal (SWS) OFF continue to rotate at the same rotation speed as the speed immediately before their de-selection. This allows each spindle to be rotated simultaneously at a different rotation speed. The "Spindle command selection" signal is used to select which of the spindles is to receive the S command from which part system.

[Caution]

If the spindle selection (SWS) or spindle command selection (SLSP) is executed through an M code given in the same block as an S code, the spindle selection (spindle rotation speed) will not be updated.

[Related signals]

- (1) Spindle selection (SWS: Y18A8)
- (2) Spindle stop (SSTP: Y1894)
- (3) Spindle enable (ENB: X18A0)
- (4) Encoder selection (R2567)
- (5) Spindle forward run start (SRN: Y1898)
- (6) Spindle reverse run start (SRI: Y1899)

4 Explanation of Interface Signals

Cont.	Signal name	Abbrev.	1stSP	2ndSP	3rdSP	4thSP	5thSP	6thSP	7thSP	8thSP
A	S COMMAND OVERRIDE		R7008	R7058	R7108	R7158	R7208	R7258	R7308	R7358

[Function]

When "Spindle override method selection" signal is set to "file register method", override can be exerted on the spindle rotation speed besides the code method override (SP1 to SP4). Override can be exerted within range of 0% to 200% (1% increment). The value is set in the file register (R) in binary.

[Operation]

When this function is used, the true spindle speed is obtained by multiplying the originally set spindle speed by override ratio set with this signal.

Clamp spindle speed is the maximum or minimum speed set with parameters, which depends on "Spindle gear selection code 1,2" signal (G11, G12).

Even when spindle speed exceeds the maximum or minimum speed at the currently selected gear stage, due to change of override setting, "Spindle gear shift" signal (GR1, GR2) does not automatically change.

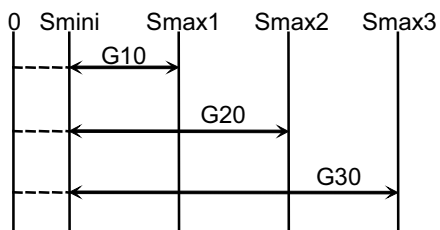

Applicable override range at gear stage 3

- GR10 : Applicable override range at gear stage
- GR20 : Applicable override range at gear stage
- GR30 : Applicable override range at gear stage
- Smini : Minimum spindle speed (parameter)
- Smax1: Maximum spindle speed at gear stage 1 (parameter)
- Smax2: Maximum spindle speed at gear stage 2 (parameter)
- Smax3: Maximum spindle speed at gear stage 3 (parameter)

(Note) Override is not valid (100%) under the following condition:

- (1) "Spindle stop" signal (SSTP) is ON.
- (2) During tapping mode.
- (3) During thread cutting.

[Related signals]

- (1) Spindle speed override code m (SPn: Y1888)
- (2) Spindle override method selection (SPS: Y188F)
- (3) Spindle gear selection code 1,2 (G11, G12: Y1890, Y1891)
- (4) Spindle stop (SSTP: Y1894)
- (5) Spindle gear shift (SSFT: Y1895)
- (6) Spindle orientation (SORC: Y1896)

4 Explanation of Interface Signals

Cont.	Signal name	Abbrev.	1stSP	2ndSP	3rdSP	4thSP	5thSP	6thSP	7thSP	8thSP
A	MULTI-POINT ORIENTATION POSITION DATA		R7009	R7059	R7109	R7159	R7209	R7259	R7309	R7359

[Function]

This signal has the following two functions:

- (1) Notification of orientation position to control unit (spindle controller) at orientation command.
Position data where the "Spindle orientation command" (ORC) is turned ON.
- (2) During multi-point indexing, notification of indexing position during forward run indexing or reverse run indexing to control unit (spindle controller).
Position data where the "Spindle forward run index" (WRN), the "Spindle reverse run index" (WRI) is turned ON.

[Operation]

- (1) Orientation command
The orientation position, at which the "Spindle orientation command" (ORC) turns ON, is input.
The values designated with the spindle specification parameter (position shift amount for orientation) and with "Multi-point orientation position data" signal are totaled to determine the orientation position.
- (2) Multi-point indexing
Each time the "Spindle forward run index" (WRN) and "Spindle reverse run index" (WRI) turn ON, the axis rotates by the amount designated with the multi-point orientation position data.
Command value is handled as 16-bit binary data and its increment is as follows.
Command increment = 360/36000 (0.01°)
- (3) Turret indexing
The turret angle is designated when the turret indexing is valid (when "#3121 tret" is set to "1").
The spindle rotation angle will be the multi-point orientation position data which is multiplied by the turret side gear ratio (in "#3122 GRC").

This signal must be validated before the "Spindle orientation command" signal turns ON (at least 100 ms before).

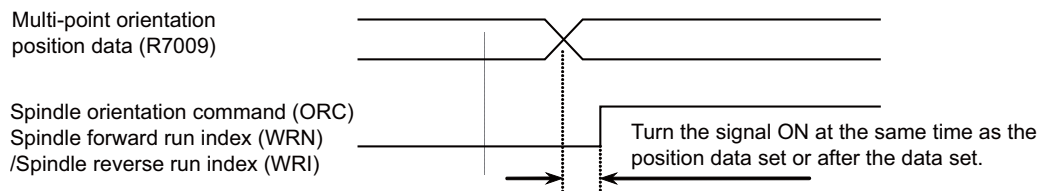

[Related signals]

- (1) Spindle orientation command (ORC: Y189E)
- (2) Spindle forward run index (WRN: Y189C)
- (3) Spindle reverse run index (WRI: Y189D)

4 Explanation of Interface Signals

Cont.	Signal name	Abbrev.	SP1	SP2	SP3	SP4	SP5	SP6	SP7
A	MACHINING INTERRUPTION SPINDLE COMMAND [C80]	MCNGITSP CMD	R7011	R7061	R7111	R7161	R7211	R7261	R7311

[Function][Operation]

Bit	Description	Bit	Description
bit0	Spindle status restoration completed	bit8	Reserved
bit1	Reserved	bit9	Reserved
bit2	Reserved	bit10	Reserved
bit3	Reserved	bit11	Reserved
bit4	Reserved	bit12	Reserved
bit5	Reserved	bit13	Reserved
bit6	Reserved	bit14	Reserved
bit7	Reserved	bit15	Reserved

bit0: Spindle status restoration completed

This signal notifies the controller that the restoration requested is completed.

After a process required for the requested restoration ("Machining interruption spindle status" signal (MCNGITSPSTS: R6543)) is performed, this signal needs to be turned ON to notify the controller of the completion of restoration.

Upon notification, the status restoration request is turned OFF, which triggers this signal to turn OFF.

[Related signal]

Stop status restoration request (MCNGITSPSTS: R6543/bit0)

Forward run start restoration request (MCNGITSPSTS: R6543/bit1)

Reverse run start restoration request (MCNGITSPSTS: R6543/bit2)

Orientation command restoration request (MCNGITSPSTS: R6543/bit3)

Cont.	Signal name	Abbrev.	1stSP	2ndSP	3rdSP	4thSP	5thSP	6thSP	7thSP	8thSP
A	Interface of load meter for analog I/F spindle [M8]	ANSLD	R7012	R7062	R7112	R7162	R7212	R7262	R7312	R7362

[Function][Operation]

When the parameter "#3024 sout" (spindle connection) is set to "2" to "5", the value set in this signal appears as an absolute value in the "Load" (%) on the load meter display screen. The graphical display for load meter varies depending on the value set in this signal.

Set the load in the range of "-999" to "999".

When the set value exceeds the setting range, a value clamped with the upper or lower limit is displayed.

(Note 1) The unit is percentage (%).

(Note 2) The data format is signed binary.

Cont.	Signal name	Abbrev.	1stSP	2ndSP	3rdSP	4thSP	5thSP	6thSP	7thSP	8thSP
A	SPINDLE SYNCHRONIZATION REFERENCE SPINDLE SELECTION		R7016	R7066	R7116	R7166	R7216	R7266	R7316	R7366

[Function]

Select the reference spindle to be used for synchronous control from the PLC.

[Operation]

Select the spindle to be controlled as the reference spindle from the serially connected spindles.

(0: 1st spindle), 1: 1st spindle, 2: 2nd spindle, 3: 3rd spindle, 4: 4th spindle, 5: 5th spindle, 6: 6th spindle, 7: 7th spindle, 8: 8th spindle

(Note 1) If a spindle that is not serially connected is selected, spindle synchronous control will not be executed.

(Note 2) If "0" is designated, the 1st spindle will be controlled as the reference spindle.

(Note 3) If "#1440 multi_sp_syn" (Enable multiple sets of spindle synchronization) is "0", use the signal of the 1st spindle. [C80]

(Note 4) If "#1440 multi_sp_syn" (Enable multiple sets of spindle synchronization) is "1", use the signal of the hob axis during hobbing, the signal of the superimposed spindle during spindle superimposition, and the signal of the synchronized spindle during other machinings. [C80]

4 Explanation of Interface Signals

Cont.	Signal name	Abbrev.	1stSP	2ndSP	3rdSP	4thSP	5thSP	6thSP	7thSP	8thSP
A	SPINDLE SYNCHRONIZATION SYNCHRONIZED SPINDLE SELECTION		R7017	R7067	R7117	R7167	R7217	R7267	R7317	R7367

[Function]

Select the synchronized spindle to be used for synchronous control from the PLC.

[Operation]

Select the spindle to be controlled as the synchronized spindle from the serially connected spindles.

(0: 2nd spindle), 1: 1st spindle, 2: 2nd spindle, 3: 3rd spindle, 4: 4th spindle, 5: 5th spindle, 6: 6th spindle, 7: 7th spindle, 8: 8th spindle

(Note 1) If a spindle that is not serially connected is selected or if the same spindle as the reference spindle is selected, spindle synchronous control will not be executed.

(Note 2) If "0" is designated, the 2nd spindle will be controlled as the synchronized spindle.

Cont.	Signal name	Abbrev.	1stSP	2ndSP	3rdSP	4thSP	5thSP	6thSP	7thSP	8thSP
A	SPINDLE SYNCHRONIZATION PHASE SHIFT AMOUNT		R7018	R7068	R7118	R7168	R7218	R7268	R7318	R7368

[Function]

The synchronized spindle's phase shift amount can be designated from the PLC.

[Operation]

Designate the phase shift amount for the synchronized spindle.

Unit: 360°/4096

(Note 1) If "#1440 multi_sp_syn" (Enable multiple sets of spindle synchronization) is "0", use the signal of the 1st spindle. [C80]

(Note 2) If "#1440 multi_sp_syn" (Enable multiple sets of spindle synchronization) is "1", use the signal of the hob axis during hobbing, the signal of the superimposed spindle during spindle superimposition, and the signal of the synchronized spindle during other machinings. [C80]

[Related signals]

- (1) In spindle synchronization (SPSYN1: X18A8)
- (2) Spindle rotation speed synchronization completion (FSPRV: X18A9)
- (3) Spindle phase synchronization completion (FSPPH: X18AA)
- (4) Spindle synchronization (SPSY: Y18B0)
- (5) Spindle phase synchronization (SPPHS: Y18B1)
- (6) Spindle synchronous rotation direction (Y18B2)

4 Explanation of Interface Signals

Cont.	Signal name	Abbrev.	1stSP	2ndSP	3rdSP	4thSP	5thSP	6thSP	7thSP	8thSP
A	Spindle synchronization phase error tolerance		R7019	R7069	R7119	R7169	R7219	R7269	R7319	R7369

[Function]

This signal specifies the tolerable range of the actual position delay (or advance) of the reference and synchronized spindles with respect to the position command, which is applied after the phase alignment under the absolute position spindle synchronization. The tolerance is specified by the angle.

[Operation]

Delay or advance angle of the actual position with respect to the commanded position

<Data range>

F001 (HEX) to 0FFF (HEX) (-359.9° to 359.9°)

Unit: 360 / 4096°

(Note 1) Output the 1st spindle's signal while "#1440 multi_sp_syn" (Multiple spindle synchronization valid) is "0".

(Note 2) Output the synchronized spindle's signal while "#1440 multi_sp_syn" (Multiple spindle synchronization valid) is "1".

[Related signals]

- (1) In spindle synchronization (SPSYN1: X18A8)
- (2) Spindle rotation speed synchronization completion (FSPRV: X18A9)
- (3) Spindle phase synchronization completion (FSPPH: X18AA)
- (4) Spindle synchronization cancel (SPSYC:Y18B8)
- (5) Spindle synchronization phase error over (SPPHOV: X18B0)
- (6) Spindle synchronization phase error/Hob axis delay angle (R6516)
- (7) Spindle synchronization Maximum phase error/Maximum hob axis delay angle (R6517)

Cont.	Signal name	Abbrev.	1stSP	2ndSP	3rdSP	4thSP	5thSP	6thSP	7thSP	8thSP
A	Spindle oscillation amplitude [M8]		R7020	R7070	R7120	R7170	R7220	R7270	R7320	R7370

[Function]

This signal is used to set the amplitude of the spindle oscillation.

The effective setting range: 1 to 32767 [0.01°]

[Related signals]

- (1) Spindle oscillation command (Y18C8)
- (2) Spindle oscillation frequency (R7021)

Cont.	Signal name	Abbrev.	1stSP	2ndSP	3rdSP	4thSP	5thSP	6thSP	7thSP	8thSP
A	Spindle oscillation frequency [M8]		R7021	R7071	R7121	R7171	R7221	R7271	R7321	R7371

[Function]

This signal is used to set the frequency of the spindle oscillation.

The effective setting range: 1 to 140 [Hz]

[Related signals]

- (1) Spindle oscillation command (Y18C8)
- (2) Spindle oscillation amplitude (R7020)

Cont.	Signal name	Abbrev.	1stSP	2ndSP	3rdSP	4thSP	5thSP	6thSP	7thSP	8thSP
A	Tool head hot swapping: Spindle switch [M8]	SPCHG-CMD	R7026	R7076	R7126	R7176	R7226	R7276	R7326	R7376

[Function]

The setting for installing another spindle motor on the detached spindle can be transferred to the drive unit.

[Operation]

<Low-order 8 bits: Spindle switch setting number>

Set the parameter number used in spindle switch. When "0" is set, the switch is performed by using the setting value of the original spindle parameters (#13001 or later).

Setting range: 0 to 8

4 Explanation of Interface Signals

<High-order 8 bits: Spindle switch command>

When the "Spindle switch request" signal (bit8) turns ON, the spindle switch parameter of the set for the number will be valid.

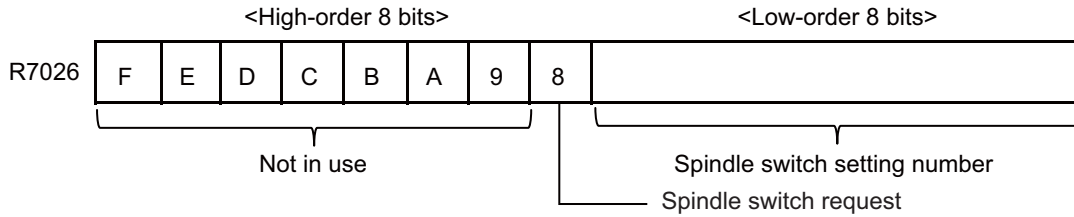

[Timing chart]

In the following example, the spindle switch is performed for the first spindle by using the second set of the spindle switch parameters.

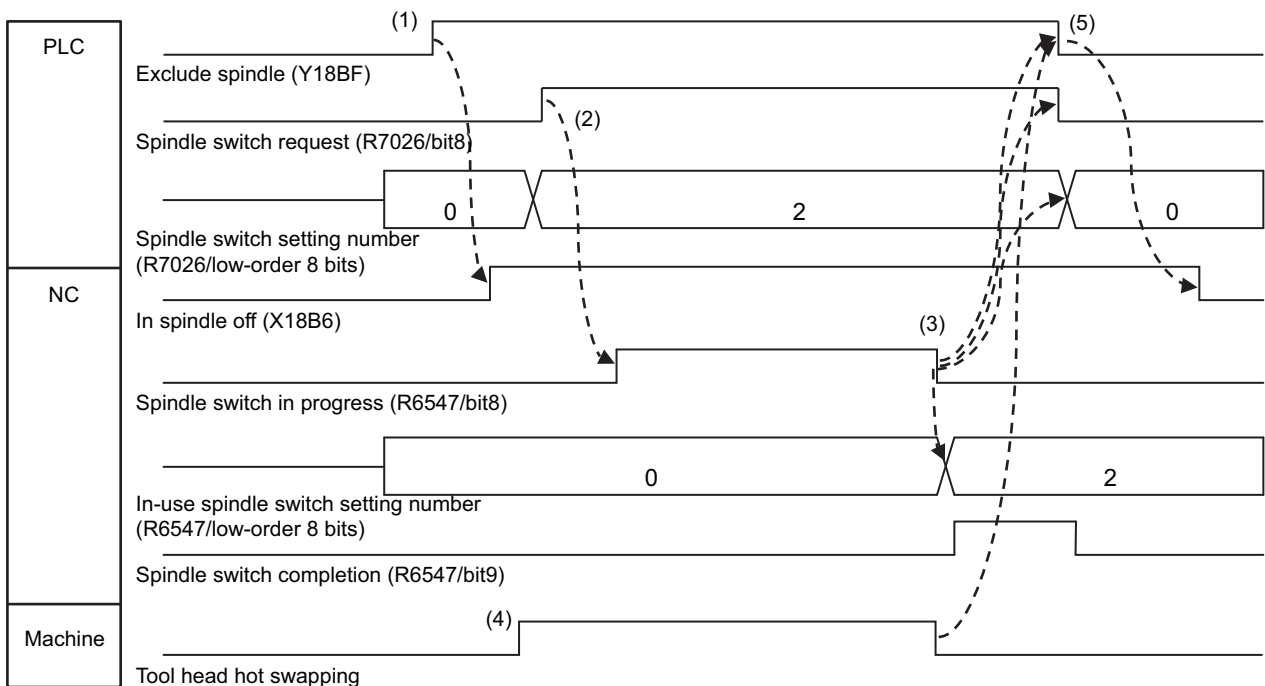

- (1) When the "Exclude spindle" signal (Y18BF) turns ON, the spindle is detached from CNC, and the "In spindle off" signal (X18B6) turns ON.
- (2) When the spindle switch is requested while the spindle is detached from CNC, the target spindle turns to the state of spindle switch in progress, and the setting data of spindle switch parameter is transferred to the drive unit according to the value of "Spindle switch setting number" (R7026/low-order 8 bits).
- (3) When the transfer is completed, the "Spindle switch in progress" signal (R6547/bit8) turns OFF, and a value is set to the "In-use spindle switch setting number" (R6547/low-order 8 bits).
- (4) Change the tool head while the spindle is detached. (This operation is available even while the spindle switch is in progress and can be started at the same time as the (2) operation.)
- (5) When (2), (3) and (4) are completed, the spindle switch is completed. When the "Exclude spindle" signal (Y18BF) and the "Spindle switch request" signal (R7026/bit8) turn OFF, the spindle control is enabled again and operation is possible using the setting after the switch.

[Related signals]

- (1) Tool head hot swapping: Spindle switch status (R6547: SPCHGSTS)
- (2) Exclude spindle (Y18BF: SPOFF)
- (3) In spindle off (X18B6: SPOFFA)

4 Explanation of Interface Signals

Signal name	Abbrev.	1st axis	2nd axis	3rd axis	4th axis	5th axis	6th axis	7th axis	8th axis
PLC AXIS INDEXING CONTROL COMMAND 4	AUXCM4	R8050	R8056	R8062	R8068	R8074	R8080	R8086	R8092

Cont.	Signal name	Abbrev.	bit
A	Speed override 1 to 64	OV1 to OV64	AUXCM4/bit0 to 6

[Function][Operation]

This signal designates the override value added to the selected feedrate. Set a binary value for the override. Values over 100% are regarded as 100%.

Effective feedrate = (Selected speed * Speed override) / 100

Cont.	Signal name	Abbrev.	bit
A	Speed override valid	OVR	AUXCM4/bit7

[Function][Operation]

This is a signal to validate the speed override. When this signal is turned OFF, the set feedrate becomes the operation speed without calculating the override.

Signal name	Abbrev.	1st axis	2nd axis	3rd axis	4th axis	5th axis	6th axis	7th axis	8th axis
PLC AXIS INDEXING CONTROL COMMAND 3	AUXCM3	R8051	R8057	R8063	R8069	R8075	R8081	R8087	R8093

Cont.	Signal name	Abbrev.	bit
A	Station selection 1 to 256	ST1 to ST256	AUXCM3/bit0 to 8

[Function]

This signal designates an index station No. in the automatic operation mode.

[Operation]

Set an index station No. before inputting Operation start (ST) in the automatic operation mode.

Input a 9-digit binary number. An input "000000001" corresponds to station No.1.

This signal is read in at the rising edge of Operation start (ST). The signal changes are ignored after the startup.

When this signal is set to "000000000" and the automatic operation is started, a one station rotation special command will result. (Note that this cannot be used when the station positions are determined in non-uniform assignments.)

4 Explanation of Interface Signals

Signal name	Abbrev.	1st axis	2nd axis	3rd axis	4th axis	5th axis	6th axis	7th axis	8th axis
PLC AXIS INDEXING CONTROL COMMAND 2	AUXCM2	R8052	R8058	R8064	R8070	R8076	R8082	R8088	R8094

Cont.	Signal name	Abbrev.	bit
A	Operation start	ST	AUXCM2/bit0

[Function][Operation]

When this signal is turned ON in an operation mode, the operation will start. The Operation start signal is handled as a status, so the ON status must be maintained until the operation is finished.

Operation movement in each operation mode

(1) Automatic operation mode

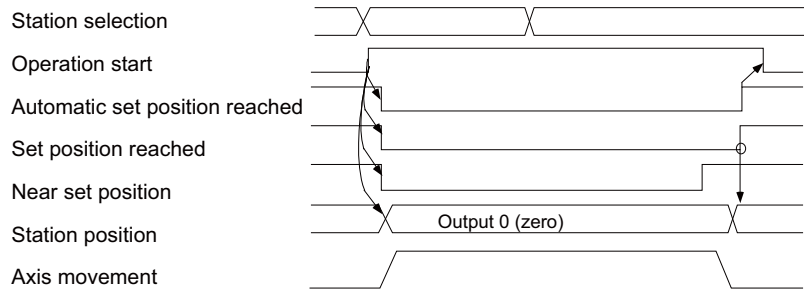

Station selection (ST1 to ST256) and Operation parameter selection (PR1, PR2) are established before inputting the Operation start signal. These two signals are read in by the rising edge of the Operation start signal, so they are held even if they are changed after the startup.

When the Operation start signal is input, the output signals related to the set position all turn OFF. Station position will be output as "0". When the positioning is completed, Automatic set position reached (JSTA) and Set position reached (JST) is output. Then turn the Operation start signal OFF.

When the Operation start signal is turned OFF during axis movement, the axis will stop at the nearest station. Note that for a linear axis, if there is not a nearest point in the movement direction, the commanded station becomes the nearest point.

(Note) When the shortcut function is OFF for the rotating axis, the positioning direction can be designated with Rotation direction (DIR).

(2) Manual operation mode

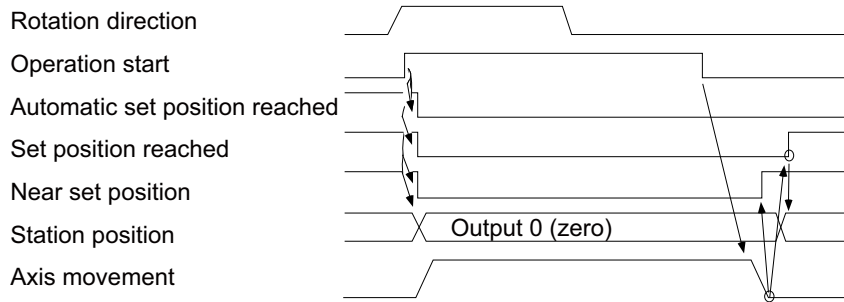

Rotation direction (DIR) and Operation parameter selection (PR1, PR2) are established before inputting the Operation start signal. These two signals are read in by the rising edge of the Operation start signal, so they are held even if they are changed after the startup.

When the Operation start signal is input, the output signals related to the set position all turn OFF. Station position will be output as "0".

While the Operation start signal is ON, the rotation continues in the designated direction. When the Operation start signal is turned OFF, a positioning is carried out to the nearest station where the axis can stop in the rotation direction. Note that for a linear axis, if there is no nearest point in the movement direction, the axis will immediately decelerate to a stop.

When the positioning is completed, Set position reached (JST) is output.

(Note) Automatic set position reached (JSTA) will not be output.

(3) JOG operation mode

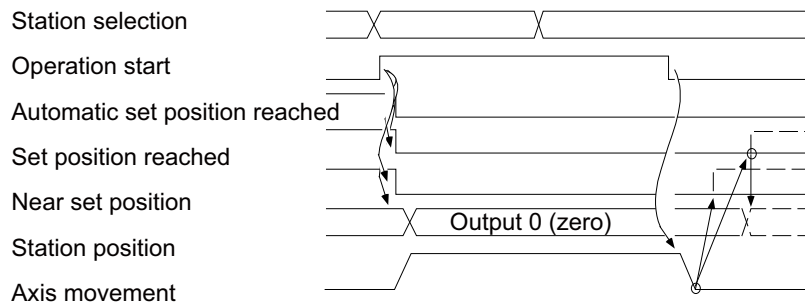

Rotation direction (DIR) and Operation parameter selection (PR1, PR2) are established before inputting the Operation start signal. These two signals are read in by the rising edge of the Operation start signal, so they are held even if they are changed after the startup.

When the Operation start signal is input, the output signals related to the set position all turn OFF. Station position will be output as "0". While the Operation start signal is ON, the rotation continues in the designated direction. When the Operation start signal is turned OFF, the axis decelerates to a stop. Set position reached (JST) and Near set position (NEAR) are output if the axis is stopped within each tolerable width from the station position.

Cont.	Signal name	Abbrev.	bit
A	Rotation direction	DIR	AUXCM2/bit1

[Function]

This signal designates the rotation direction of the operation in each operation mode.

[Operation]

Turn this signal ON to designate the rotation direction before inputting the Operation start (ST) signal.

This signal is invalid in the automatic operation mode when the shortcut control is set and selected by the parameter.

When the shortcut control is not selected, a positioning is carried out in the direction designated by this signal.

This signal is read in at the rising edge of Operation start (ST). The signal changes are ignored after the startup.

DIR	Axis rotation direction	Station movement direction
0	Forward run	Direction of increasing station No.
1	Reverse run	Direction of decreasing station No.

The actual motor rotation direction is reversed by changing the setting of parameter "#1018 ccw".

[Related signals]

- (1) Operation start (ST: AUXCM2/bit0)

Cont.	Signal name	Abbrev.	bit
A	Arbitrary point feed command valid	STS	AUXCM2/bit2

[Function][Operation]

This signal selects the mode that executes the positioning, with the command unit specified by "#1005 plcunit", to the arbitrary position (coordinate) transferred from the NC. Automatic operation mode (AUT) must be turned ON simultaneously with Arbitrary point feed command valid.

[Related signals]

- (1) Automatic operation mode (AUT: AUXCM1/bit8)

Cont.	Signal name	Abbrev.	bit
A	Incremental feed magnification 1, 2	MP1,MP2	AUXCM2/bit4,5

[Function][Operation]

This signal selects the incremental feed amount and the handle feed magnification. In the handle feed, the movement amount per handle pulse is selected.

MP2	MP1	Feed amount
0	0	0.001°
0	1	0.01°
1	0	0.1°
1	1	1°

4 Explanation of Interface Signals

Cont.	Signal name	Abbrev.	bit
A	Operation parameter selection 1, 2	PR1,PR2	AUXCM2/bit6,7

[Function][Operation]

This signal selects one parameter group to be actually used from four parameter groups that designate the axis feed operation. The parameter group cannot be changed while Operation start (ST) is ON. (The group is held in NC.) If Smoothing zero is confirmed for the target axis, the operation parameter group can be changed with the Operation start. Changing the parameter setting values of the time constant, torque limit value and excessive error detection width, however, is not possible unless Smoothing zero is confirmed for all the NC axes. The parameter values, if changed during the NC axis movement, are valid after the smoothing zero is confirmed.

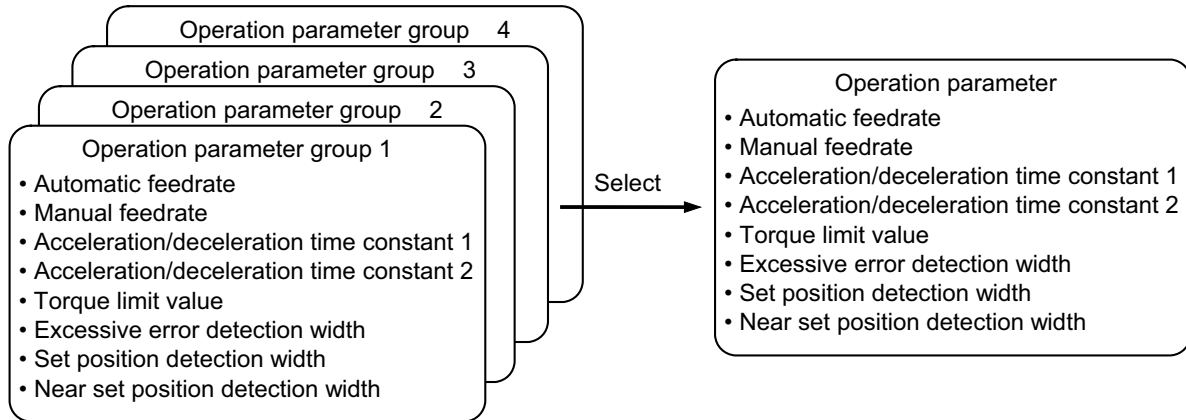

PR2	PR1	Selected operation parameter group
0	0	1
0	1	2
1	0	3
1	1	4

Cont.	Signal name	Abbrev.	bit
B	EXTERNAL DECELERATION+ [C80]	*EDT+	AUXCM2/bit8

[Function][Operation]

The feedrate in the + direction is controlled by the external deceleration speed while this signal is OFF. Set the external deceleration speed to the axis parameter. The external deceleration speed can be set from 6 levels and can be arbitrarily selected with the external deceleration speed selection signal.

Cont.	Signal name	Abbrev.	bit
B	EXTERNAL DECELERATION- [C80]	*EDT-	AUXCM2/bit9

[Function][Operation]

The feedrate in the - direction is controlled by the external deceleration speed while this signal is OFF. The operations of this signal are the same as those of "External deceleration+" (*EDT+).

4 Explanation of Interface Signals

Cont.	Signal name	Abbrev.	bit
A	ARBITRARY POSITION COMMAND INCREMENTAL COMMAND SELECTION [C80]	STSINC	AUXCM2/bitA

[Function][Operation]

Control command position input from the PLC is handled as absolute coordinate value when this signal is OFF, and handled as incremental command value from current position when this signal is ON during arbitrary position command operation.

This signal is read in at the rising edge of Operation start (ST). The signal changes are ignored after the startup.

Signal	Meaning of control command position
0	Absolute coordinate value
1	Incremental movement amount

Cont.	Signal name	Abbrev.	bit
A	EXTERNAL DECELERATION SPEED SELECTION 1 to 4 [C80]	EDT1 to EDT4	AUXCM2/bitC to bitF

[Function][Operation]

Select the value from external deceleration speed 1 to 6. The following is the levels selected according to the 4 bit combination.

Setting value (Numerical data)	External deceleration speed	External deceleration speed parameter
0	External deceleration speed 1	#2086 exdcax
1	External deceleration speed 2	#2161 exdcax1
2	External deceleration speed 3	#2162 exdcax2
3	External deceleration speed 4	#2163 exdcax3
4	External deceleration speed 5	#2164 exdcax4
5	External deceleration speed 6	#2165 exdcax5
Others	External deceleration speed 1	#2086 exdcax

4 Explanation of Interface Signals

Signal name	Abbrev.	1st axis	2nd axis	3rd axis	4th axis	5th axis	6th axis	7th axis	8th axis
PLC AXIS INDEXING CONTROL COMMAND 1	AUXCM1	R8053	R8059	R8065	R8071	R8077	R8083	R8089	R8095

Cont.	Signal name	Abbrev.	bit
B	Servo OFF	*SVF	AUXCM1/bit0

[Function][Operation]

When the Servo OFF signal is set to "0" (B contact), the control axis enters the servo OFF status. No matter which operation mode the servo is in and turned OFF, the axis movement will stop, and the servo will turn OFF. The axis movement restarts when the servo is turned ON again.

If the axis moves for any reason while the servo is OFF, it can be selected whether to compensate that movement amount when the servo turns ON the next time. Select with parameter "#1064 svof".

- (1) When carrying out movement amount compensation (#1064 svof = 1)
When the servo is OFF, the coordinates are always updated by the amount the axis has moved. When the servo is OFF, the coordinates show the machine position.
- (2) When not carrying out movement amount compensation (#1064 svof = 0)
When the servo is OFF, the coordinates are not updated even when the axis moves. When the servo is OFF, the coordinates show the machine position when the servo is OFF.
When the servo is turned ON, the axis is moved to the position where the servo was turned OFF.
When the servo is OFF and the axis movement exceeds the excessive error width (designated with parameter "#2226 SV026"), a servo alarm occurs.

[Caution]

- (1) The actual servo OFF operation is validated after In-position (INP) is completed. When using a mechanical clamp, carry out the clamp operation after confirming the in-position status.
- (2) When the power is turned ON, the Servo OFF signal turns OFF ("0") and the servo OFF function becomes valid. It is necessary before operation to turn the Servo OFF signal ON ("1") in the PLC program to release the servo OFF.

Cont.	Signal name	Abbrev.	bit
A	Master reset	MRST	AUXCM1/bit3

[Function]

This signal resets the PLC indexing axis.

[Operation]

When this signal is ON, the following reset operations are carried out.

- (1) The axis movement decelerates to a stop.
- (2) Alarms that can be released by the reset are released.
- (3) The In reset (RST) signal is output.
- (4) The operation alarm is released while resetting.

[Related signals]

- (1) In reset (RST: AUXST1/bit9)

Cont.	Signal name	Abbrev.	bit
A	Interlock+	*IT+	AUXCM1/bit4

[Function][Operation]

When the control axis is moving in the (+) direction, this signal decelerates and stops the axis movement immediately.

When this signal is OFF from before movement, the motion is stopped in the same manner as without starting. In any case the movement is started or restarted by turning this signal ON.

Cont.	Signal name	Abbrev.	bit
A	Interlock-	*IT-	AUXCM1/bit5

[Function][Operation]

This is the same as the Interlock + (IT+) signal, the only difference being the direction.

4 Explanation of Interface Signals

Cont.	Signal name	Abbrev.	bit
A	Ready OFF	RDF	AUXCM1/bit6

[Function]

This is a signal to turn OFF the READY status.

[Operation]

When put into a READY OFF status, the power supply to the servomotor is shut off, and the contactor control output is simultaneously turned OFF. If the motor is in operation, it will stop by a dynamic brake stop or a deceleration control stop. Servo ready completion (SA) and Servo ready (RDY) are also turned OFF, but an alarm does not occur. When this signal is turned OFF, the machine immediately returns to the original state.

[Related signals]

- (1) Servo ready completion (SA: AUXST1/bitC)
- (2) Servo ready (RDY: AUXST1/bit0)

Cont.	Signal name	Abbrev.	bit
A	Handle feed operation mode	H	AUXCM1/bit7

[Function]

This signal selects the handle feed operation mode.

[Operation]

The axis will move for the amount determined by input pulse multiplied by feed magnification after this signal is turned ON, each signal [Operation parameter selection (PR1, PR2) and Incremental feed magnification (MP1, MP2)] is determined, and the handle pulse is input.

[Caution]

- (1) Turning this signal ON when other operation modes are ON will result in the operation error (M01 0101).
- (2) The handle mode acceleration/deceleration time is the acceleration/deceleration time constant 2 linear acceleration/deceleration of the selected operation parameter group.

[Related signals]

- (1) Operation parameter selection 1, 2 (PR1, PR2: AUXCM2/bit6,7)
- (2) Incremental feed magnification 1, 2 (MP1, MP2: AUXCM2/bit4,5)

Cont.	Signal name	Abbrev.	bit
A	Automatic operation mode	AUT	AUXCM1/bit8

[Function]

This signal selects the automatic operation mode.

[Operation]

Turn this signal ON, set Station selection 1 to 256 (ST1 to ST256) and then turn Operation start (ST) ON to move the axis to the designated station. The shortcut control or the rotation direction can be selected with parameters.

[Caution]

Turning this signal ON when other operation modes are ON will result in the operation error (M01 0101).

[Related signals]

- (1) Rotation direction (DIR: AUXCM2/bit1)
- (2) Operation parameter selection 1, 2 (PR1, PR2: AUXCM2/bit6,7)
- (3) Station selection 1 to 256 (ST1 to ST256: AUXCM3/bit0 to 8)

4 Explanation of Interface Signals

Cont.	Signal name	Abbrev.	bit
A	Manual operation mode	MAN	AUXCM1/bit9

[Function]

This signal selects the manual operation mode.

[Operation]

When the rotation direction is designated and Operation start (ST) is turned ON, the axis will begin moving, and the rotation will continue in the designated direction until Operation start is turned OFF. When Operation start turns OFF, the axis will be positioned to the nearest station.

[Caution]

Turning this signal ON when other operation modes are ON will result in the operation error (M01 0101).

[Related signals]

- (1) Rotation direction (DIR: AUXCM2/bit1)
- (2) Operation parameter selection 1, 2 (PR1, PR2: AUXCM2/bit6,7)

Cont.	Signal name	Abbrev.	bit
A	JOG operation mode	J	AUXCM1/bitA

[Function]

This signal selects the JOG operation mode.

[Operation]

When the rotation direction is designated and Operation start (ST) is turned ON, the axis will begin moving, and the rotation will continue in the designated direction until Operation start is turned OFF. Unlike the manual operation mode, when Operation start is turned OFF, the axis immediately decelerate to a stop.

[Caution]

Turning this signal ON when other operation modes are ON will result in the operation error (M01 0101).

[Related signals]

- (1) Rotation direction (DIR: AUXCM2/bit1)
- (2) Operation parameter selection 1, 2 (PR1, PR2: AUXCM2/bit6,7)

Cont.	Signal name	Abbrev.	bit
A	Reference position return mode	ZRN	AUXCM1/bitB

[Function]

This signal selects the reference position return mode.

[Operation]

When this signal (ZRN) is turned ON, the reference position return mode is designated. To start the reference position return, turn this signal ON, select the operation parameter group, then turn ON the Operation start (ST) signal.

When the absolute position coordinate system has been established in the absolute position specifications, the high-speed return will be applied in every operation.

[Related signals]

- (1) Operation parameter selection 1, 2 (PR1, PR2: AUXCM2/bit6,7)

Cont.	Signal name	Abbrev.	bit
A	Basic point initialization setting mode	AZS	AUXCM1/bitD

[Function]

This signal selects the mode that initializes the basic point for the absolute position detection system.

[Operation]

When this signal is turned ON, the basic point initialization setting mode is held until the NC power is turned OFF. (Cannot be canceled)

When the stopper method is selected by setting "1" to "#2049 type", the torque limit value and the excessive error detection width in the operation parameter group 4 are automatically selected.

4 Explanation of Interface Signals

Cont.	Signal name	Abbrev.	bit
A	Basic point setting	ZST	AUXCM1/bitE

[Function]

This signal turns ON when designating the basic point with the basic point initialization in the absolute position detection system.

[Operation]

When this signal is turned ON in the basic point initialization setting mode, the designated position is set as the absolute position basic point.

Cont.	Signal name	Abbrev.	bit
A	Incremental mode	S	AUXCM1/bitF

[Function]

This signal selects the incremental mode.

[Operation]

After turning ON this signal, designate the operation parameter group (with PR1 and PR2), the incremental feed magnification (with MP1 and MP2) and the rotation direction (with DIR). Then turn ON the Operation start (ST) signal to move the axis.

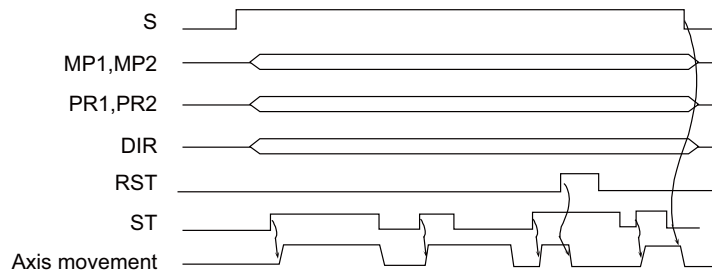

[Caution]

- (1) Turning this signal ON when other operation modes are ON will result in the operation error (M01 0101).
- (2) In the incremental mode, the axis travel will be maintained at a constant amount, even if the Operation start signal is OFF.

[Related signals]

- (1) Operation parameter selection 1, 2 (PR1, PR2: AUXCM2/bit6,7)

4 Explanation of Interface Signals

Cont.	Signal name	Abbrev.	Common(\$)
A	ATC CONTROL PARAMETER		R10600

[Function]

Combination of the number of digits for tool No. to be displayed, magazine No. start value, and spindle and standby tool to be displayed are designated.
 Refer to "PLC Programming Manual" for details.

[Operation]

(1) Control parameter details

R10600

F	E	D	C	B	A	9	8	7	6	5	4	3	2	1	0
---	---	---	---	---	---	---	---	---	---	---	---	---	---	---	---

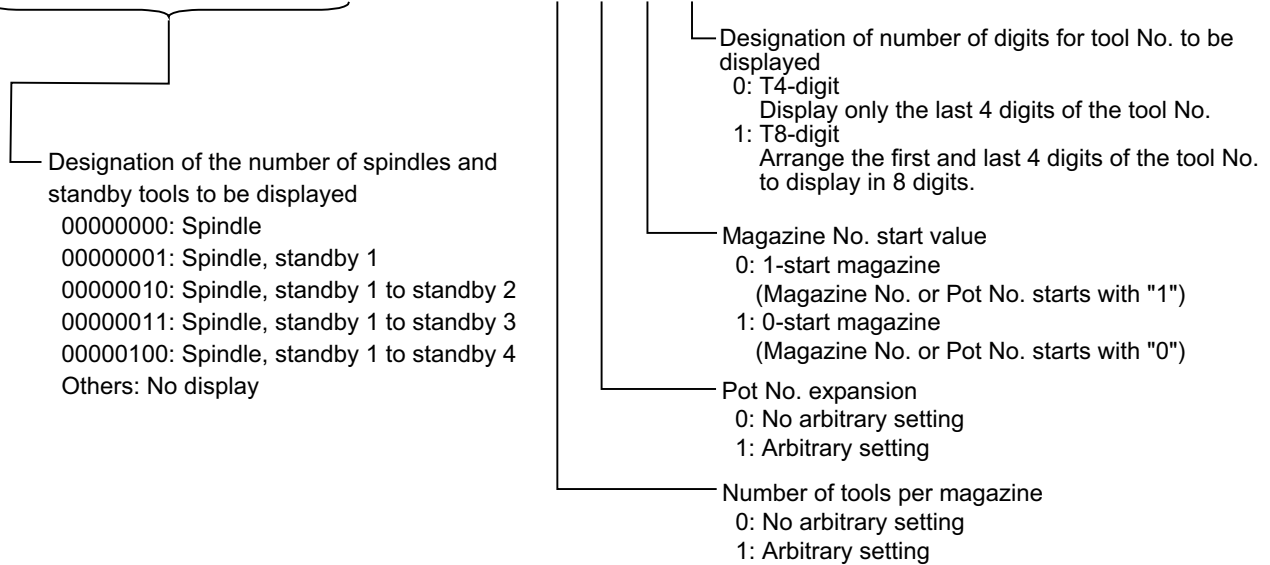

(2) Pot No. expansion

This function allows pot head No. for each magazine to be set arbitrarily.

(a) Do not set arbitrarily

The pot head No. for each magazine is "1" or "0", depending on the setting of ATC control parameter "magazine No. start value" (R10600 bit1).

(Example 1) When Magazine No. starts with "1" (R10600/bit1 = 0)

Set the following R registers.
 R10600 : 0x0000
 → Number of digits for tool No. to be displayed : T4-digit
 → Magazine No. start value: 1-start magazine
 → Pot No. expansion : No arbitrary setting
 → Number of tools per magazine : No arbitrary setting
 R10610 : 0x000C
 → Number of tools for magazine 1 : 12



Pot	Tool No.	-D
1	25	0
2	7	0
3	10	0
4	58	0
5	0	0
6	0	0
7	0	0
8	0	0
9	0	0
10	0	0
11	0	0
12	0	0

4 Explanation of Interface Signals

(Example 2) When Magazine No. starts with "0" (R10600/bit1 = 1)

Set the following R registers.
 R10600 : 0x0002
 → Number of digits for tool No. to be displayed : T4-digit
 → Magazine No. start value: 0-start magazine
 → Pot No. expansion : No arbitrary setting
 → Number of tools per magazine : No arbitrary setting
 R10610 : 0x000C
 → Number of tools for magazine 1 : 12



Pot	Tool No.	-D
0	25	0
1	7	0
2	10	0
3	58	0
4	0	0
5	0	0
6	0	0
7	0	0
8	0	0
9	0	0
10	0	0
11	0	0

(b) To set arbitrarily

Set pot head No. for each magazine in the "each magazine pot head No. designation" register.

1st magazine pot head No. (R10695) 2nd magazine pot head No. (R10696)

3rd magazine pot head No. (R10697) 4th magazine pot head No. (R10698)

5th magazine pot head No. (R10699)

(Note 1) The pot head No. for each magazine is the value set in the register for "pot head No. for each magazine (R10695 to R10699)" regardless of the ATC control parameter "magazine No. start value (R10600 bit1)"

(Note 2) Numerical value 0 to 8999 can be set in the register for "pot head No. for each magazine (R10695 to R10699)". When a value outside the range is set, pot head No. is displayed from 1 or 0, depending on the setting of "magazine No. start value (R10600 bit1)".

(Example 1) Pot head No. for each magazine: 10; number of magazines: 12

Set the following R registers.
 R10600 : 0x0004
 → Number of digits for tool No. to be displayed: T4-digit
 → Magazine No. start value: 1-start magazine
 → Pot No. expansion : Arbitrary setting
 → Number of tools per magazine : No arbitrary setting
 R10610 : 0x000C
 → Number of tools for magazine 1 : 12
 R10695 : 0x000A
 → Pot head No. for magazine 1: 10



Pot	Tool No.	-D
10	25	0
11	7	0
12	10	0
13	58	0
14	0	0
15	0	0
16	0	0
17	0	0
18	0	0
19	0	0
20	0	0
21	0	0

If the pot head No. for each magazine is outside the range of 0 to 8999, the display depends on the setting of "magazine No. start value".

(Example 2) Pot head No. for each magazine: 9000; number of magazines: 12;
 magazine No. start value: 1 (0-start magazine)

Set the following R registers.
 R10600 : 0x0006
 → Number of digits for tool No. to be displayed : T4-digit
 → Magazine No. start value : 0-start magazine
 → Pot No. expansion : Arbitrary setting
 → Number of tools per magazine : No arbitrary setting
 R10610 : 0x000C
 → Number of tools for magazine 1 : 12
 R10695 : 0x2328
 → Pot head No. for magazine 1: 9000



Pot	Tool No.	-D
0	25	0
1	7	0
2	10	0
3	58	0
4	0	0
5	0	0
6	0	0
7	0	0
8	0	0
9	0	0
10	0	0
11	0	0

(3) Number of tools per magazine

This function allows the number of tools per magazine to be set arbitrarily.

(a) When not setting arbitrarily

There is a maximum of three rows of magazine, and the maximum number of tools that can be registered per magazine differs depending on the model.

M8 Series: Maximum 200 tools

C80 Series: Maximum 120 tools

Magazine tool data assignment is fixed.

Refer to "(a) Example of tool data assignment when not setting arbitrarily" of (4) for details.

(b) When setting arbitrarily

There is a maximum of five rows of magazine, and the total number of tools that can be registered for all the magazines differs depending on the model.

M8 Series: Total 600 tools

C80 Series: Total 360 tools

Set the number of tools per magazine in the "number of magazine designation" register.

(If there are any magazines not being used, set the designation register to "0". To set the magazine tool arbitrarily, make sure that the number of tools is an even number.)

"Number of magazine designation" register

No.1 magazine	R10610		No.2 magazine	R10611
No.3 magazine	R10612		No.4 magazine	R10613
No.5 magazine	R10614			

The magazine tool data is assigned for the number of tools set in order from No. 1 magazine based on the set number of tools.

4 Explanation of Interface Signals

(4) ATC file register

The file registers used with ATC are as shown below.

Magazine	Corresponding file register (R)										Data type
	No.1 magazine		No.2 magazine		No.3 magazine		No.4 magazine		No.5 magazine		
T4-digit/T8-digit specifications	T4-digit	T8-digit	T4-digit	T8-digit	T4-digit	T8-digit	T4-digit	T8-digit	T4-digit	T8-digit	
ATC control parameter	R10600	←	←	←	←	←	←	←	←	←	BIN
Number of magazines designation	R10610	←	R10611	←	R10612	←	R10613	←	R10614	←	BIN
Pointer designation	R10615	←	R10616	←	R10617	←	R10618	←	R10619	←	BIN
Spindle tool	R10620	R10620 R10621	R10630	R10630 R10631	R10640	R10640 R10641	R10650	R10650 R10651	R10660	R10660 R10661	BCD
Standby 1 tool	R10621	R10622 R10623	R10631	R10632 R10633	R10641	R10642 R10643	R10651	R10652 R10653	R10661	R10662 R10663	BCD
Standby 2 tool	R10622	R10624 R10625	R10632	R10634 R10635	R10642	R10644 R10645	R10652	R10654 R10655	R10662	R10664 R10665	BCD
Standby 3 tool	R10623	R10626 R10627	R10633	R10636 R10637	R10643	R10646 R10647	R10653	R10656 R10657	R10663	R10666 R10667	BCD
Standby 4 tool	R10624	R10628 R10629	R10634	R10638 R10639	R10644	R10648 R10649	R10654	R10658 R10659	R10664	R10668 R10669	BCD
Spindle tool D	R10670	←	R10675	←	R10680	←	R10685	←	R10690	←	BIN
Standby 1 tool D	R10671	←	R10676	←	R10681	←	R10686	←	R10691	←	BIN
Standby 2 tool D	R10672	←	R10677	←	R10682	←	R10687	←	R10692	←	BIN
Standby 3 tool D	R10673	←	R10678	←	R10683	←	R10688	←	R10693	←	BIN
Standby 4 tool D	R10674	←	R10679	←	R10684	←	R10689	←	R10694	←	BIN
AUX data	R10604	←	←	←	←	←	←	←	←	←	BIN
Pot head No. for each magazine	R10695	←	R10696	←	R10697	←	R10698	←	R10699	←	BIN
Magazine tool data	Pot 1 (MG1):	- When not setting arbitrarily Magazine tool data assignment is fixed. Refer to "(3) Number of tools per magazine" and "(a) Example of tool data assignment when not setting arbitrarily" of (4) for details.									
Magazine tool data (Aux. D)	Pot 1:	- When setting arbitrarily The tool data assignment varies. Refer to "(3) Number of tools per magazine" and "(b) Example of tool data assignment when setting arbitrarily" of (4) for details.									

4 Explanation of Interface Signals

- (a) Example of tool data assignment when not setting arbitrarily
[Magazine tool data]

Pot	No.1 magazine		No.2 magazine		No.3 magazine		No.4 magazine		No.5 magazine		Data type
	T4-digit	T8-digit	T4-digit	T8-digit	T4-digit	T8-digit	T4-digit	T8-digit	T4-digit	T8-digit	
Pot 1 (MG1)	R10700	R10700 R10701	R11060	R11060 R11061	R11420	R11420 R11421	—	—	—	—	BCD
Pot 2 (MG2)	R10701	R10702 R10703	R11061	R11062 R11063	R11421	R11422 R11423	—	—	—	—	BCD
Pot 3 (MG3)	R10702	R10704 R10705	R11062	R11064 R11065	R11422	R11424 R11425	—	—	—	—	BCD
:											
Pot n (*1) (MGn)	R10700+ (n-1)	R10700+ 2(n-1) R10701+ 2(n-1)	R11060+ (n-1)	R11060+ 2(n-1) R11061+ 2(n-1)	R11420+ (n-1)	R11420+ 2(n-1) R11421+ 2(n-1)	—	—	—	—	BCD
:											
Pot 119 (MG119)	R10818	R10936 R10937	R11178	R11296 R11297	R11538	R11656 R11657	—	—	—	—	BCD
Pot 120 (MG120)	R10819	R10938 R10939	R11179	R11298 R11299	R11539	R11658 R11659	—	—	—	—	BCD
Pot 121 (MG121)	ZR4000	ZR4000 ZR4001	ZR4240	ZR4240 ZR4241	ZR4480	ZR4480 ZR4481	—	—	—	—	BCD
Pot 122 (MG122)	ZR4001	ZR4002 ZR4003	ZR4241	ZR4242 ZR4243	ZR4481	ZR4482 ZR4483	—	—	—	—	BCD
:											
Pot m (*1) (MGm)	ZR4000+ (m-121)	ZR4000+ 2(m-121) ZR4001+ 2(m-121)	ZR4240+ (m-121)	ZR4240+ 2(m-121) ZR4241+ 2(m-121)	ZR4480+ (m-121)	ZR4480+ 2(m-121) ZR4481+ 2(m-121)	—	—	—	—	BCD
:											
Pot 200 (MG200)	ZR4079	ZR4158 ZR4159	ZR4319	ZR4398 ZR4399	ZR4559	ZR4638 ZR4639	—	—	—	—	BCD

[Magazine tool data (Aux. D)]

Pot	No.1 magazine		No.2 magazine		No.3 magazine		No.4 magazine		No.5 magazine		Data type
	T4-digit	T8-digit	T4-digit	T8-digit	T4-digit	T8-digit	T4-digit	T8-digit	T4-digit	T8-digit	
Pot 1	R10940	←	R11300	←	R11660	←	—	—	—	—	BIN
Pot 2	R10941	←	R11301	←	R11661	←	—	—	—	—	BIN
Pot 3	R10942	←	R11302	←	R11662	←	—	—	—	—	BIN
:											
Pot n (*1)	R10940+ (n-1)	←	R11300+ (n-1)	←	R11660+ (n-1)	←	—	—	—	—	BIN
:											
Pot 119	R11058	←	R11418	←	R11778	←	—	—	—	—	BIN
Pot 120	R11059	←	R11419	←	R11779	←	—	—	—	—	BIN
Pot 121	ZR4160	←	ZR4400	←	ZR4640	←	—	—	—	—	BIN
Pot 122	ZR4161	←	ZR4401	←	ZR4641	←	—	—	—	—	BIN
:											
Pot m (*1)	ZR4160+ (m-121)	←	ZR4400+ (m-121)	←	ZR4640+ (m-121)	←	—	—	—	—	BIN
:											
Pot 200	ZR4239	←	ZR4479	←	ZR4719	←	—	—	—	—	BIN

(*1) "n" and "m" indicate the Pot No. (n: 1 to 120, m: 121 to 200)

4 Explanation of Interface Signals

(b) Example of tool data assignment when setting arbitrarily

The magazine tool data is assigned for the number of tools set in order from No.1 magazine.

(Example) Number of magazines: 5 magazines

Number of tools: 180 tools in each of No.1 magazine and No.2 magazine

50 tools in each of No.3 to No.5 magazines [M8]

[Magazine tool data]

Pot	No.1 magazine		No.2 magazine		No.3 magazine		No.4 magazine		No.5 magazine		Data type
	T4-digit	T8-digit	T4-digit	T8-digit	T4-digit	T8-digit	T4-digit	T8-digit	T4-digit	T8-digit	
Pot 1 (MG1)	R10700	R10700 R10701	R11240	R11240 R11241	ZR4000	ZR4000 ZR4001	ZR4150	ZR4150 ZR4151	ZR4300	ZR4300 ZR4301	BCD
Pot 2 (MG2)	R10701	R10702 R10703	R11241	R11242 R11243	ZR4001	ZR4002 ZR4003	ZR4151	ZR4152 ZR4153	ZR4301	ZR4302 ZR4303	BCD
Pot 3 (MG3)	R10702	R10704 R10705	R11242	R11244 R11245	ZR4002	ZR4004 ZR4005	ZR4152	ZR4154 ZR4155	ZR4302	ZR4304 ZR4305	BCD
:											
Pot n (*1) (MGn)	R10700+ (n-1)	R10700+ 2(n-1) R10701+ 2(n-1)	R11240+ (n-1)	R11240+ 2(n-1) R11241+ 2(n-1)	ZR4000+ (n-1)	ZR4000+ 2(n-1) ZR4001+ 2(n-1)	ZR4150+ (n-1)	ZR4150+ 2(n-1) ZR4151+ 2(n-1)	ZR4300+ (n-1)	ZR4300+ 2(n-1) ZR4301+ 2(n-1)	BCD
:											
Pot 49 (MG49)	R10748	R10796 R10797	R11288	R11336 R11337	ZR4048	ZR4096 ZR4097	ZR4198	ZR4246 ZR4247	ZR4348	ZR4396 ZR4397	BCD
Pot 50 (MG50)	R10749	R10798 R10799	R11289	R11338 R11339	ZR4049	ZR4098 ZR4099	ZR4199	ZR4248 ZR4249	ZR4349	ZR4398 ZR4399	BCD
Pot 51 (MG51)	R10750	R10800 R10801	R11290	R11340 R11341	—	—	—	—	—	—	BCD
:											
Pot 179 (MG179)	R10878	R11056 R11057	R11418	R11596 R11597	—	—	—	—	—	—	BCD
Pot 180 (MG180)	R10879	R11058 R11059	R11419	R11598 R11599	—	—	—	—	—	—	BCD

[Magazine tool data (Aux. D)]

Pot	No.1 magazine		No.2 magazine		No.3 magazine		No.4 magazine		No.5 magazine		Data type
	T4-digit	T8-digit	T4-digit	T8-digit	T4-digit	T8-digit	T4-digit	T8-digit	T4-digit	T8-digit	
Pot 1	R11060	←	R11600	←	ZR4100	←	ZR4250	←	ZR4400	←	BIN
Pot 2	R11061	←	R11601	←	ZR4101	←	ZR4251	←	ZR4401	←	BIN
Pot 3	R11062	←	R11602	←	ZR4102	←	ZR4252	←	ZR4402	←	BIN
:											
Pot n (*1)	R11060+ (n-1)	←	R11600+ (n-1)	←	ZR4100+ (n-1)	←	ZR4250+ (n-1)	←	ZR4400+ (n-1)	←	BIN
:											
Pot 49	R11108	←	R11648	←	ZR4148	←	ZR4298	←	ZR4448	←	BIN
Pot 50	R11109	←	R11649	←	ZR4149	←	ZR4299	←	ZR4449	←	BIN
Pot 51	R11110	←	R11650	←	—	—	—	—	—	—	BIN
:											
Pot 179	R11238	←	R11778	←	—	—	—	—	—	—	BIN
Pot 180	R11239	←	R11779	←	—	—	—	—	—	—	BIN

(*1) "n" indicates the Pot No.

[Related signals]

(1) Display tool selection parameter (R10603)

4 Explanation of Interface Signals

Cont.	Signal name	Abbrev.	Common(\$)
A	DISPLAY TOOL SELECTION PARAMETER		R10603

[Function]

This is used to specify whether or not the spindle/standby tools names are displayed on the comment display area of the tool registration screen.

[Operation]

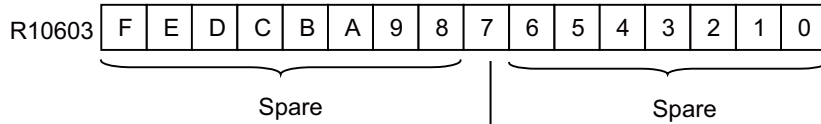

1: Displays the spindle/standby tools names
 0: Does not display the spindle/standby tools names

[Related signals]

(1) ATC control parameter (R10600)

Cont.	Signal name	Abbrev.	\$1	\$2	\$3	\$4	\$5	\$6	\$7	\$8
A	SPINDLE TOOL NO.		R12200, 1	R12210, 1	R12220, 1	R12230, 1	R12240, 1	R12250, 1	R12260, 1	R12270, 1

[Function][Operation]

This signal indicates spindle No. in use.

Cont.	Signal name	Abbrev.	\$1	\$2	\$3	\$4	\$5	\$6	\$7	\$8
A	STANDBY TOOL NO.		R12202, 3	R12212, 3	R12222, 3	R12232, 3	R12242, 3	R12252, 3	R12262, 3	R12272, 3

[Function][Operation]

This signal indicates standby tool No.

Cont.	Signal name	Abbrev.	\$1	\$2	\$3	\$4	\$5	\$6	\$7	\$8
A	MES interface library: Machining start time [M8]		R14700, 1	R14950, 1	R15200, 1	R15450, 1	R15700, 1	R15950, 1	R16200, 1	R16450, 1

[Function]

The time at which the machining starts is stored in the total (seconds) from January 1, 1970.

[Operation]

When the machining is completed, this sets the time of cycle start automatically.
 The time is not set in the case of restarting after automatic operation pause (halt) or block stop.
 In the case of repeating with M99, the time at which the machining is completed is set as the start time of the next cycle.
 When the MES interface library function is invalid, this signal is set to "0".

Cont.	Signal name	Abbrev.	\$1	\$2	\$3	\$4	\$5	\$6	\$7	\$8
A	MES interface library: Machining end time [M8]		R14702, 3	R14952, 3	R15202, 3	R15452, 3	R15702, 3	R15952, 3	R16202, 3	R16452, 3

[Function]

The time at which the machining is complete is stored in the total (seconds) from January 1, 1970.

[Operation]

When the M code registered to "#8001 WRK COUNT M" is executed, this sets the time of execution automatically.
 If "#8001 WORK COUNT M" is 0 and when M02 or M03 is executed, this sets the time of execution automatically.
 When the MES interface library function is invalid, this signal is set to "0".

4 Explanation of Interface Signals

Cont.	Signal name	Abbrev.	\$1	\$2	\$3	\$4	\$5	\$6	\$7	\$8
A	MES interface library: Cycle time [M8]		R14704, 5	R14954, 5	R15204, 5	R15454, 5	R15704, 5	R15954, 5	R16204, 5	R16454, 5

[Function]

The cycle time is stored here in "ms" unit.

[Operation]

This signal specifies the time (ms), which is from cycle start until performing the M code registered to "#8001 WRK COUNT M". If you set "0" in "#8001 WRK COUNT M", this signal specifies the time (ms) from cycle start until performing the M02 or M30.

When the cycle time exceeds "499:59:59.999", this signal is set to "1799999999".

When the MES interface library function is disabled, this signal is set to "0".

Cont.	Signal name	Abbrev.	\$1	\$2	\$3	\$4	\$5	\$6	\$7	\$8
A	MES interface library: Program number at machining start [M8]		R14706 to R14721	R14956 to R14971	R15206 to R15221	R15456 to R15471	R15706 to R15721	R15956 to R15971	R16206 to R16221	R16456 to R16471

[Function]

The program number at the time of the machining start is stored here.

[Operation]

When the machining is completed, this sets the ASCII code (hex number) corresponding to the program number of that machining start automatically.

When the MES interface library function is invalid, this signal is set to "0".

Cont.	Signal name	Abbrev.	\$1	\$2	\$3	\$4	\$5	\$6	\$7	\$8
A	MES interface library: N number at machining start [M8]		R14722, 3	R14972, 3	R15222, 3	R15472, 3	R15722, 3	R15972, 3	R16222, 3	R16472, 3

[Function]

The N number at the time of the machining start is stored here.

[Operation]

When the machining is completed, this sets the N number of that machining start automatically.

When the MES interface library function is invalid, this signal is set to "0".

Cont.	Signal name	Abbrev.	\$1	\$2	\$3	\$4	\$5	\$6	\$7	\$8
A	MES interface library: B number at machining start [M8]		R14724, 5	R14974, 5	R15224, 5	R15474, 5	R15724, 5	R15974, 5	R16224, 5	R16474, 5

[Function]

The B number at the time of the machining start is stored here.

[Operation]

When the machining is completed, this sets the B number of that machining start automatically.

When the MES interface library function is invalid, this signal is set to "0".

Cont.	Signal name	Abbrev.	\$1	\$2	\$3	\$4	\$5	\$6	\$7	\$8
A	MES interface library: Spindle 1 maximum load [M8]		R14726	R14976	R15226	R15476	R15726	R15976	R16226	R16476

[Function]

The maximum current of the 1st spindle at the time of the machining completion is stored here.

[Operation]

When the machining is completed, the maximum current of the 1st spindle since the machining start is automatically set. The maximum current is set by 1% increments regardless of the value of "#1256 set28/bit2" (Change current FB (load) output unit).

When the MES interface library function is invalid, this signal is set to "0".

4 Explanation of Interface Signals

Cont.	Signal name	Abbrev.	\$1	\$2	\$3	\$4	\$5	\$6	\$7	\$8
A	MES interface library: Spindle 2 maximum load [M8]		R14727	R14977	R15227	R15477	R15727	R15977	R16227	R16477

[Function]

The maximum current of the 2nd spindle at the time of the machining completion is stored here.

[Operation]

When the machining is completed, the maximum current of the 2nd spindle since the machining start is automatically set. The maximum current is set by 1% increments regardless of the value of "#1256 set28/bit2" (Change current FB (load) output unit).

When the MES interface library function is invalid, this signal is set to "0".

Cont.	Signal name	Abbrev.	\$1	\$2	\$3	\$4	\$5	\$6	\$7	\$8
A	MES interface library: Power consumption amount [M8]		R14728, 9	R14978, 9	R15228, 9	R15478, 9	R15728, 9	R15978, 9	R16228, 9	R16478, 9

[Function]

The power consumption amount at the time of the machining completion is stored here.

[Operation]

When the machining is completed, the power consumption amount (Wh) obtained by EcoMonitorLight station #1 is automatically set.

When the MES interface library function is invalid or the device is not connected with EcoMonitorLight, this signal is set to "0".

[Related signals]

(1) EcoMonitorLight connection: Station #1 consumed power (R14000,1)

Cont.	Signal name	Abbrev.	\$1	\$2	\$3	\$4	\$5	\$6	\$7	\$8
A	MES interface library: Power regeneration amount [M8]		R14730, 1	R14980, 1	R15230, 1	R15480, 1	R15730, 1	R15980, 1	R16230, 1	R16480, 1

[Function]

The power regeneration amount at the time of machining completion is stored here.

[Operation]

When the machining is completed, the power regeneration amount (Wh) obtained by EcoMonitorLight station #1 is automatically set.

When the MES interface library function is invalid or the device is not connected with EcoMonitorLight, this signal is set to "0".

[Related signals]

(1) EcoMonitorLight connection: Station #1 regenerated power (R14002,3)

Cont.	Signal name	Abbrev.	\$1	\$2	\$3	\$4	\$5	\$6	\$7	\$8
A	MES interface library: Tool number 1 to 5 [M8]		R14732, 3 to R14740, 1	R14982, 3 to R14990, 1	R15232, 3 to R15240, 1	R15482, 3 to R15490, 1	R15732, 3 to R15740, 1	R15982, 3 to R15990, 1	R16232, 3 to R16240, 1	R16482, 3 to R16490, 1

[Function]

This signal displays the tool number.

[Operation]

The tool number displayed on the R register "T code data 1" commanded by the T command is automatically set when machining is completed.

Up to five tool number histories from the latest are stored in the R registers "Tool number 1" to "Tool number 5".

The latest is set in the R register "Tool number 1".

When the MES interface library function is invalid, this signal is set to "0".

[Related signals]

(1) T code data (R536,7)

4 Explanation of Interface Signals

Cont.	Signal name	Abbrev.	\$1	\$2	\$3	\$4	\$5	\$6	\$7	\$8
A	MES interface library: Tool offset number 1 to 5 [M8]		R14742 to R14746	R14992 to R14996	R15242 to R15246	R15492 to R15496	R15742 to R15746	R15992 to R15996	R16242 to R16246	R16492 to R16496

[Function]

The tool offset number is stored here.

[Operation]

The tool offset number commanded by the T command is automatically set when machining is completed.

Up to five tool offset number histories from the latest are set in the R registers "Tool offset number 1" to "Tool offset number 5".

The latest is set in the R register "Tool offset number 1".

Compensation number is set for the machining center system, or tool length offset number is set for the lathe system.

When the MES interface library function is invalid, this signal is set to "0".

Cont.	Signal name	Abbrev.	\$1	\$2	\$3	\$4	\$5	\$6	\$7	\$8
A	MES interface library: Tool length offset 1 to 5 [M8]		R14748, 9 to R14756, 7	R14998, 9 to R15006, 7	R15248, 9 to R15256, 7	R15498, 9 to R15506, 7	R15748, 9 to R15756, 7	R15998, 9 to R16006, 7	R16248, 9 to R16256, 7	R16498, 9 to R16506, 7

[Function]

The tool length offset (M system) or the X axis tool length offset (L system) is stored here.

[Operation]

The tool length offset commanded by the T command is automatically set when machining is completed.

Up to five tool length offset histories from the latest are set in the R registers "Tool length offset 1" to "Tool length offset 5".

The latest is set in the R register "Tool length offset 1".

Offset type I: offset amount, II: length dimension, and III: Z axis tool length offset amount are displayed for the machining center system, or the X axis tool length offset amount is displayed for the lathe system.

If the tool length offset cannot be set such as when the tool number is not designated, "0" will be set.

The unit is [μm].

When the MES interface library function is invalid, this signal is set to "0".

Cont.	Signal name	Abbrev.	\$1	\$2	\$3	\$4	\$5	\$6	\$7	\$8
A	MES interface library: Tool radius offset 1 to 5 [M8]		R14758, 9 to R14766, 7	R15008, 9 to R15016, 7	R15258, 9 to R15266, 7	R15508, 9 to R15516, 7	R15758, 9 to R15766, 7	R16008, 9 to R16016, 7	R16258, 9 to R16266, 7	R16508, 9 to R16516, 7

[Function]

The tool radius offset (M system) or the tool nose radius offset (L system) is stored here.

[Operation]

The tool radius offset commanded by the T command is automatically set when machining is completed.

Up to five tool radius offset histories from the latest are set in the R registers "Tool radius offset 1" to "Tool radius offset 5".

The latest is set in the R register "Tool radius offset 1".

Offset type I: offset amount, II: radius dimension, and III: tool nose radius offset are displayed for the machining center system, or the tool nose radius offset is displayed for the lathe system.

If the tool radius offset cannot be set such as when the tool number is not designated, "0" will be set.

The unit is [μm].

When the MES interface library function is invalid, this signal is set to "0".

4 Explanation of Interface Signals

Cont.	Signal name	Abbrev.	\$1	\$2	\$3	\$4	\$5	\$6	\$7	\$8
A	MES interface library: Tool length wear amount 1 to 5 [M8]		R14768, 9 to R14776, 7	R15018, 9 to R15026, 7	R15268, 9 to R15276, 7	R15518, 9 to R15526, 7	R15768, 9 to R15776, 7	R16018, 9 to R16026, 7	R16268, 9 to R16276, 7	R16518, 9 to R16526, 7

[Function]

The tool length wear amount (M system) or the X axis tool length amount (L system) is stored here.

[Operation]

The tool length wear amount is automatically set when a T command is commanded.

Up to five tool length wear amount histories from the latest tool length wear amount are set in the R register "Tool length wear amount 1" to "Tool length wear amount 5".

The latest is set in the R register "Tool length wear amount 1".

The followings are displayed for M system:

Compensation type I: compensation amount, type II: length wear, type III: Z axis tool wear

X axis tool wear is displayed for L system.

"0" is set if you cannot specify the tool length wear amount such as tool number is unspecified.

The unit is [μm].

When the MES interface library function is disabled, this signal is set to "0".

Cont.	Signal name	Abbrev.	\$1	\$2	\$3	\$4	\$5	\$6	\$7	\$8
A	MES interface library: Tool radius wear amount 1 to 5 [M8]		R14778, 9 to R14786, 7	R15028, 9 to R15036, 7	R15278, 9 to R15286, 7	R15528, 9 to R15536, 7	R15778, 9 to R15786, 7	R16028, 9 to R16036, 7	R16278, 9 to R16286, 7	R16528, 9 to R16536, 7

[Function]

The tool radius wear amount (M system) or the X axis tool radius amount (L system) is stored here.

[Operation]

The tool radius wear amount is automatically set when a T command is commanded.

Up to five tool radius wear amount histories from the latest tool radius wear amount are set in the R register "Tool radius wear amount 1" to "Tool radius wear amount 5".

The latest is set in the R register "Tool radius wear amount1".

The followings are displayed for M system:

Compensation type I: compensation amount, type II: radius wear, type III: tool nose radius wear

Tool nose radius wear is displayed for L system.

"0" is set if you cannot specify the tool radius wear amount such as tool number is unspecified.

The unit is [μm].

When the MES interface library function is disabled, this signal is set to "0".

4 Explanation of Interface Signals

Cont.	Signal name	Abbrev.	\$1	\$2	\$3	\$4	\$5	\$6	\$7	\$8
A	MES interface library: Tool life 1 to 5 [M8]		R14788, 9 to R14796, 7	R15038, 9 to R15046, 7	R15288, 9 to R15296, 7	R15538, 9 to R15546, 7	R15788, 9 to R15796, 7	R16038, 9 to R16046, 7	R16288, 9 to R16296, 7	R16538, 9 to R16546, 7

[Function]

The tool lives at the time of machining completion are stored here.

[Operation]

The tool lives (cumulative cutting hours or cumulative number of cuttings) for the tools set in the R register "Tool number 1" to "Tool number 5" (R14732 to R14741) are automatically set at the time of the machining completion. Five tool life histories from the latest tool life are set in the R register "Tool life 1" to R register "Tool life 5".

The latest is set in the R register "Tool life 1".

Specify the tool lives only when the tool life management 1 is valid for both M and L systems.

"0" is set when tool life management II or III is valid or tool life management function is invalid.

Data type is depending on the setting of management method for M system. Specify the data type in minutes in the case of usage time and specify it by the number of times in the case of usage count. Specify usage time in minutes for L system.

"0" is set when tool lives are unsettable such as tool numbers are unspecified.

When the MES interface library function is disabled, this signal is set to "0".

Cont.	Signal name	Abbrev.	\$1	\$2	\$3	\$4	\$5	\$6	\$7	\$8
A	MES interface library: Time of alarm occurrence [M8]		R14798, 9	R15048, 9	R15298, 9	R15548, 9	R15798, 9	R16048, 9	R16298, 9	R16548, 9

[Function]

The time at which an alarm occurs is stored in the total (seconds) from January 1, 1970.

[Operation]

When an alarm occurs, the time of alarm occurrence is automatically set.

When the MES interface library function is invalid, this signal is set to "0".

Cont.	Signal name	Abbrev.	\$1	\$2	\$3	\$4	\$5	\$6	\$7	\$8
A	MES interface library: Alarm number 1 [M8]		R14800 to R14815	R15050 to R15065	R15300 to R15315	R15550 to R15565	R15800 to R15815	R16050 to R16065	R16300 to R16315	R16550 to R16565
A	MES interface library: Alarm number 2 [M8]		R14816 to R14831	R15066 to R15081	R15316 to R15331	R15566 to R15581	R15816 to R15831	R16066 to R16081	R16316 to R16331	R16566 to R16581
A	MES interface library: Alarm number 3 [M8]		R14832 to R14847	R15082 to R15097	R15332 to R15347	R15582 to R15597	R15832 to R15847	R16082 to R16097	R16332 to R16347	R16582 to R16597
A	MES interface library: Alarm number 4 [M8]		R14848 to R14863	R15098 to R15113	R15348 to R15363	R15598 to R15613	R15848 to R15863	R16098 to R16113	R16348 to R16363	R16598 to R16613

[Function]

The alarm numbers at the alarm occurrence are stored here.

[Operation]

When an alarm occurs, the latest alarm number is automatically set.

Up to four alarm number histories from the latest are set in the R registers "Alarm number 1" to "Alarm number 4".

The latest is set in the R register "Alarm number 1".

When the MES interface library function is invalid, this signal is set to "0".

4 Explanation of Interface Signals

Cont.	Signal name	Abbrev.	\$1	\$2	\$3	\$4	\$5	\$6	\$7	\$8
A	MES interface library: Power ON time [M8]		R14864, 5	R15114, 5	R15364, 5	R15614, 5	R15864, 5	R16114, 5	R16364, 5	R16614, 5

[Function]

The power ON time at the alarm occurrence is stored in "seconds".

[Operation]

When an alarm occurs, the power ON time is automatically set.

The power ON time is the total integrated time of the time from NC power ON to OFF.

When the power ON time exceeds "59999:59:59", this is set to "215999999".

When the MES interface library function is invalid, this signal is set to "0".

Cont.	Signal name	Abbrev.	\$1	\$2	\$3	\$4	\$5	\$6	\$7	\$8
A	MES interface library: Program number at alarm [M8]		R14866 to R14881	R15116 to R15131	R15366 to R15381	R15616 to R15631	R15866 to R15881	R16116 to R16131	R16366 to R16381	R16616 to R16631

[Function]

The program number at the alarm occurrence is stored here.

[Operation]

When an alarm occurs, this automatically sets the ASCII code (hex number) corresponding to the program number of that time.

When the MES interface library function is invalid, this signal is set to "0".

Cont.	Signal name	Abbrev.	\$1	\$2	\$3	\$4	\$5	\$6	\$7	\$8
A	MES interface library: Subprogram number at alarm [M8]		R14882 to R14897	R15132 to R15147	R15382 to R15397	R15632 to R15647	R15882 to R15897	R16132 to R16147	R16382 to R16397	R16632 to R16647

[Function]

The subprogram number at the alarm occurrence is stored here.

[Operation]

If an alarm occurs, the ASCII code (hex number) corresponding to the subprogram at that time is specified automatically. "0" is specified while subprogram is not in execution.

When the MES interface library function is disabled, this signal is set to "0".

Cont.	Signal name	Abbrev.	\$1	\$2	\$3	\$4	\$5	\$6	\$7	\$8
A	MES interface library: N number at alarm [M8]		R14898, 9	R15148, 9	R15398, 9	R15648, 9	R15898, 9	R16148, 9	R16398, 9	R16648, 9

[Function]

The sequence number at the alarm occurrence is stored here.

[Operation]

When an alarm occurs, the sequence number of that time is automatically set.

When the MES interface library function is invalid, this signal is set to "0".

Cont.	Signal name	Abbrev.	\$1	\$2	\$3	\$4	\$5	\$6	\$7	\$8
A	MES interface library: B number at alarm [M8]		R14900, 1	R15150, 1	R15400, 1	R15650, 1	R15900, 1	R16150, 1	R16400, 1	R16650, 1

[Function]

The block number at the alarm occurrence is stored here.

[Operation]

When an alarm occurs, the block number of that time is automatically set.

When the MES interface library function is invalid, this signal is set to "0".

4 Explanation of Interface Signals

Cont.	Signal name	Abbrev.	\$1	\$2	\$3	\$4	\$5	\$6	\$7	\$8
A	MES interface library: G code modal status [M8]		R14902 to R14933	R15152 to R15183	R15402 to R15433	R15652 to R15683	R15902 to R15933	R16152 to R16183	R16402 to R16433	R16652 to R16683

[Function]

The G code at the alarm occurrence is stored here.

[Operation]

When an alarm occurs, the G code corresponding to the G code modal is set in ASCII code.

The modal status of G code is set according to R register "G code modal registration selection (R14604,5)".

When the MES interface library function is invalid, this signal is set to "0".

[Related signals]

MES interface library: G code modal registration selection [M8] (R14604,5)

Cont.	Signal name	Abbrev.	\$1	\$2	\$3	\$4	\$5	\$6	\$7	\$8
A	MES interface library: Spindle 1 load [M8]		R14934	R15184	R15434	R15684	R15934	R16184	R16434	R16684

[Function]

The current of the 1st spindle at the alarm occurrence is stored here.

[Operation]

When an alarm occurs, the current of the 1st spindle is automatically set.

The current is set by 1% increments regardless of the value of "#1256 set28/bit2 (Change current FB (load) output unit)".

When the MES interface library function is invalid, this signal is set to "0".

Cont.	Signal name	Abbrev.	\$1	\$2	\$3	\$4	\$5	\$6	\$7	\$8
A	MES interface library: Spindle 2 load [M8]		R14935	R15185	R15435	R15685	R15935	R16185	R16435	R16685

[Function]

The current of the 2nd spindle at the alarm occurrence is stored here.

[Operation]

When an alarm occurs, the current of the 2nd spindle is automatically set.

The current is set by 1% increments regardless of the value of "#1256 set28/bit2 (Change current FB (load) output unit)".

When the MES interface library function is invalid, this signal is set to "0".

Cont.	Signal name	Abbrev.	\$1	\$2	\$3	\$4	\$5	\$6	\$7	\$8
A	MES interface library: Tool number [M8]		R14936, 7	R15186, 7	R15436, 7	R15686, 7	R15936, 7	R16186, 7	R16436, 7	R16686, 7

[Function]

The tool number at the alarm occurrence is stored here.

[Operation]

When an alarm occurs, this automatically sets the tool number displayed on the R register "T code data 1" at that time.

When the MES interface library function is invalid, this signal is set to "0".

[Related signals]

(1) T code data (R536,7)

Cont.	Signal name	Abbrev.	\$1	\$2	\$3	\$4	\$5	\$6	\$7	\$8
A	MES interface library: Tool offset number [M8]		R14938	R15188	R15438	R15688	R15938	R16188	R16438	R16688

[Function]

The tool offset number at the alarm occurrence is stored here.

[Operation]

When an alarm occurs, the tool offset number of that time is automatically set.

Compensation number is set for the machining center system, or tool length offset number is set for the lathe system.

4 Explanation of Interface Signals

Cont.	Signal name	Abbrev.	\$1	\$2	\$3	\$4	\$5	\$6	\$7	\$8
A	MES interface library: Tool length offset [M8]		R14940, 1	R15190, 1	R15440, 1	R15690, 1	R15940, 1	R16190, 1	R16440, 1	R16690, 1

[Function]

The tool length offset (M system) or the X axis tool length offset (L system) at the alarm occurrence is stored here.

[Operation]

When an alarm occurs, the tool length offset of that time is automatically set.

Offset type I: offset amount, II: length dimension, and III: Z axis tool length offset amount are displayed for the machining center system, or the X axis tool length offset amount is displayed for the lathe system.

If the tool length offset cannot be set such as when the tool number is not designated, "0" will be set.

The unit is [μm].

When the MES interface library function is invalid, this signal is set to "0".

Cont.	Signal name	Abbrev.	\$1	\$2	\$3	\$4	\$5	\$6	\$7	\$8
A	MES interface library: Tool radius offset [M8]		R14942, 3	R15192, 3	R15442, 3	R15692, 3	R15942, 3	R16192, 3	R16442, 3	R16692, 3

[Function]

The tool radius offset (M system) or the tool nose radius offset (L system) is stored here.

[Operation]

When an alarm occurs, the tool radius offset of that time is automatically set.

Offset type I: offset amount, II: radius dimension, and III: tool nose radius offset are displayed for the machining center system, or the tool nose radius offset is displayed for the lathe system.

If the tool radius offset cannot be set such as when the tool number is not designated, "0" will be set.

The unit is [μm].

When the MES interface library function is invalid, this signal is set to "0".

Cont.	Signal name	Abbrev.	\$1	\$2	\$3	\$4	\$5	\$6	\$7	\$8
A	MES interface library: Tool length wear amount [M8]		R14944, 5	R15194, 5	R15444, 5	R15694, 5	R15944, 5	R16194, 5	R16444, 5	R16694, 5

[Function]

The tool length wear amount (M system) or the X axis tool wear amount (L system) when an alarm occurs is stored here.

[Operation]

The tool length wear amount at the time of alarm occurrence is automatically set.

The followings are displayed.

For M system, Compensation type I: compensation amount, type II: length wear, type III: Z axis tool wear

For L system, X axis tool wear is displayed.

"0" is set if the tool length wear amount is unsettable such as tool number is unspecified.

The unit is [μm].

When MES interface library function is invalid, this signal is set to "0".

Cont.	Signal name	Abbrev.	\$1	\$2	\$3	\$4	\$5	\$6	\$7	\$8
A	MES interface library: Tool radius wear amount [M8]		R14946, 7	R15196, 7	R15446, 7	R15696, 7	R15946, 7	R16196, 7	R16446, 7	R16696, 7

[Function]

The tool radius wear amount (M system) or the tool nose radius wear amount (L system) is stored here.

[Operation]

The tool radius wear amount at the time of alarm occurrence is automatically set.

The followings are displayed.

For M system, Compensation type I: compensation amount, type II: radius wear, type III: tool nose radius wear

For L system, tool nose radius wear is displayed.

"0" is set if the tool radius wear amount is unsettable such as tool number is unspecified.

The unit is [μm].

When MES interface library function is invalid, this signal is set to "0".

4 Explanation of Interface Signals

Cont.	Signal name	Abbrev.	\$1	\$2	\$3	\$4	\$5	\$6	\$7	\$8
A	MES interface library: Tool life [M8]		R14948, 9	R15198, 9	R15448, 9	R15698, 9	R15948, 9	R16198, 9	R16448, 9	R16698, 9

[Function]

The tool life data when an alarm occurs is stored.

[Operation]

The tool life (cumulative cutting hours and cumulative number of cuttings) for the tool being used at the time of alarm occurrence is automatically set.

The tool life data is set only when the tool life management I is valid for both M and L systems.

"0" is set when tool life management II or III is valid or tool life management function is invalid.

Data type is depending on the setting of management method for M system. Specify the data type in minutes in the case of usage time and specify it by the number of times in the case of usage count. Specify usage time in minutes for L system.

"0" is set when tool lives are unsettable such as tool numbers are unspecified.

When MES interface library function is invalid, this signal is set to "0".

Cont.	Signal name	Abbrev.	Common(\$)
A	EcoMonitorLight CONNECTION: READ START BIT [M8]		R20288

[Function]

This start bit executes the power value collection.

[Operation]

The power value collecting function is executed based on the setting value which has been written in R20289 to R20291 by writing 1 to Bit0.

The bit is cleared to zero in the next cycle.

Bit0 1: Start

0: Stop

This register holds the value even after the power OFF.

[Related signals]

- (1) EcoMonitorLight connection: Completion bit (R14400)
- (2) EcoMonitorLight connection: Completion status (R14401)
- (3) EcoMonitorLight connection: Acquired data (R14402 to R14405)
- (4) EcoMonitorLight connection: Station No.(R20289)
- (5) EcoMonitorLight connection: Register address (R20290)
- (6) EcoMonitorLight connection: Size of data to read (R20291)

Cont.	Signal name	Abbrev.	Common(\$)
A	EcoMonitorLight CONNECTION: STATION NO. [M8]		R20289
A	EcoMonitorLight CONNECTION: REGISTER ADDRESS [M8]		R20290
A	EcoMonitorLight CONNECTION: SIZE OF DATA TO READ [M8]		R20291

[Function]

This register sets the information required for the power value collection.

[Operation]

The required information is set with user's ladder program.

These data is read into CNC by writing 1 to R20288.

This register holds the value even after the power OFF.

[Related signals]

- (1) EcoMonitorLight connection: Read start bit (R20288)
- (2) EcoMonitorLight connection: Completion bit (R14400)
- (3) EcoMonitorLight connection: Completion status (R14401)
- (4) EcoMonitorLight connection: Acquired data (R14402 to R14405)

4 Explanation of Interface Signals

Cont.	Signal name	Abbrev.	Common(\$)
A	INTERFERENCE CHECK III: INTERFERING OBJECT SELECTION [M8]	ITF3DFTH	R20304 to R20449

[Function] [Operation]

An interfering object to be used in the interference check III is selected.

System variable	R register	Item	Details	Setting range (unit) Upper: System variable Lower: R register
#40000	R20304	Interfering object enable/disable designation	Set enable/disable for each interfering object. Bit designation (0: enable 1: disable) bit0: Disable 1st interfering object : bitF: Disable 16th interfering object	0 to 65535 (decimal) 0x0000 to 0xFFFF (hexadecimal)
#40001	R20305	Spare		0 0
#40002	R20306	1st interfering object selection	Select interfering object definition No. to use.	0 to 128 (0: not selected) 0 to 128 (0: not selected)
#40003	R20307	1st interfering object specification	In the configured solid specification of the interfering object definition, specify alarm area/warning area/solid setting invalid of the solid in which switching method is selected. 0, 1: Alarm area 2: Warning area 3: Solid setting invalid	0 to 3 0 to 3
#40004	R20308 (L) R20309 (H)	1st interfering model coordinate system I axis offset 1	Set the interfering model coordinate system offset with a radius value. (I axis direction) (*1)	-99999.999 to 99999.999 (mm) (radius value)
#40005	R20310 (L) R20311 (H)	1st interfering model coordinate system J axis offset 1	Set the interfering model coordinate system offset with a radius value. (J axis direction) (*1)	-99999999 to 99999999 (μm) (radius value)
#40006	R20312 (L) R20313 (H)	1st interfering model coordinate system K axis offset 1	Set the interfering model coordinate system offset with a radius value. (K axis direction) (*1)	-99999999 to 99999999 (μm) (radius value)
:	:			
#40077	R20426	16th interfering object selection	Same as above	Same as above
#40078	R20427	16th interfering object specification selection	Same as above	Same as above
#40079	R20428 (L) R20429 (H)	16th interfering model coordinate system I axis offset 1	Same as above	Same as above
#40080	R20430 (L) R20431 (H)	16th interfering model coordinate system J axis offset 1	Same as above	Same as above
#40081	R20432 (L) R20433 (H)	16th interfering model coordinate system K axis offset 1	Same as above	Same as above

System variable	R register	Item	Details	Setting range (unit) Upper: System variable Lower: R register
#40082	R20434	1st interfering object Interference check III: Specifying disabled interference object	Select an interfering object that you do not check the interference with the 1st interfering object. bit0: Disable 1st interfering object (inaction data) bit1: Disable 2nd interfering object : bitF: Disable 16th interfering object	0 to 65535 (decimal) 0x0000 to 0xFFFF (hexadecimal)
#40083	R20435	2nd interfering object Interference check III: Specifying disabled interference object	Select an interfering object that you do not check the interference with the 2nd interfering object. bit0: Disable 1st interfering object bit1: Disable 2nd interfering object (inaction data) : bitF: Disable 16th interfering object	0 to 65535 (decimal) 0x0000 to 0xFFFF (hexadecimal)
:	:			
#40097	R20449	16th interfering object Interference check III: Specifying disabled interference object	Select an interfering object that you do not check the interference with the 16th interfering object. bit0: Disable 1st interfering object bit1: Disable 2nd interfering object : bitF: Disable 16th interfering object (inaction data)	0 to 65535 (decimal) 0x0000 to 0xFFFF (hexadecimal)

(*1) The interfering model coordinate system offset is the sum of interfering model coordinate system offsets 1 and 2.

Cont.	Signal name	Abbrev.	Common(\$)
A	DIAGNOSIS DATA OUTPUT: SELECT AXIS FOR SERVOMOTOR INSULATION DEGRADATION DETECTION (PLC AXIS) [M8]	SVIDDDAX	R20450

[Function]

This signal is used to select the PLC axis for insulation resistance measurement.

[Operation]

When the control starts measuring the motor insulation resistance, the measurement starts on the PLC axis for which the signal is ON.

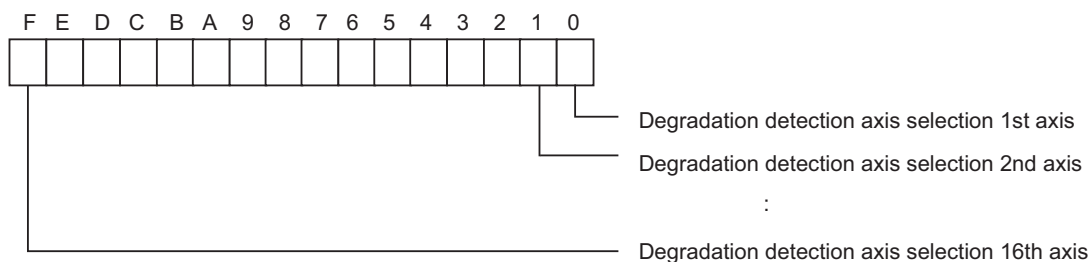

[Related signals]

(1) Diagnosis data output: Motor insulation degradation detection request (IDDD:R20481)

4 Explanation of Interface Signals

Cont.	Signal name	Abbrev.	Common(\$)
A	DIAGNOSIS DATA OUTPUT: SELECT SPINDLE FOR MOTOR INSULATION DEGRADATION DETECTION [M8]	SPIDDDAX	R20451

[Function]

This signal is used to select the spindle for insulation resistance measurement.

[Operation]

When the control starts measuring the motor insulation resistance, the measurement starts on the spindle for which the signal is ON.

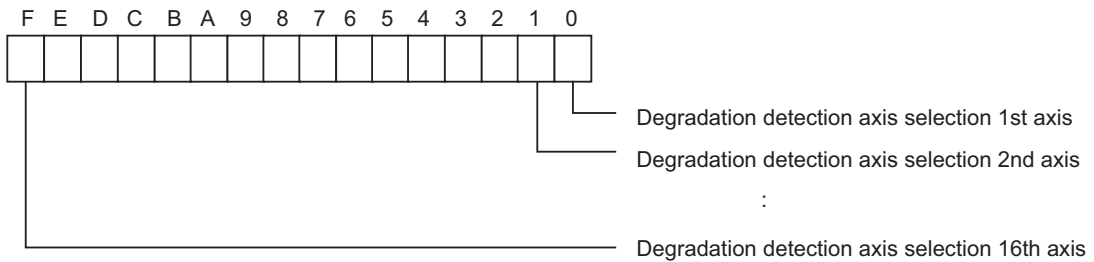

[Related signals]

(1) Diagnosis data output: Motor insulation degradation detection request (IDDD:R20481)

Cont.	Signal name	Abbrev.	Common(\$)
A	Touchscreen operation disabled	TP_INVALID	R20480

[Function]

Touchscreen operation can be temporarily disabled by using this signal (TP_INVALID).

[Operation]

When you turn ON (disable) R20480 bit0, the touchscreen operation is disabled. When you change R20480 bit0 from OFF (enable) to ON (disable) with the touchscreen pressed, the touch is interpreted to be released at the time of ON. When you change R20480 bit0 from ON (disable) to OFF (enable) with the touchscreen pressed, the touch is interpreted to be made at the time of OFF.

Cont.	Signal name	Abbrev.	Common(\$)
A	DIAGNOSIS DATA OUTPUT: MOTOR INSULATION DEGRADATION DETECTION REQUEST [M8]	IDDD	R20481

[Function]

This signal enables the measurement of motor insulation resistance.

[Operation]

The insulation resistance measurement starts when you cancel emergency stop with R20481/bit0 ON. The measurement is performed for the axis selected by "Select axis for servomotor insulation degradation detection" or for the spindle selected by "Select spindle for motor insulation degradation detection". The servo ready sequence is held until the measurement of insulation resistance is completed.

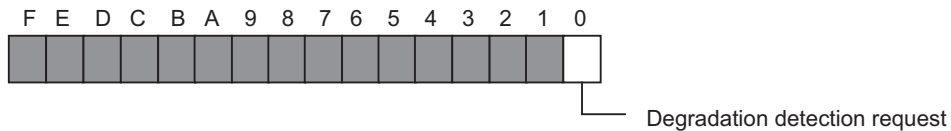

Irrespective of this signal, if you cancel emergency stop for the first time after turning ON the NC power with "#6456/bit4 (Motor insulation deterioration detection ON)" set to 1, the insulation resistance measurement takes place.

4 Explanation of Interface Signals

[Operation sequence]

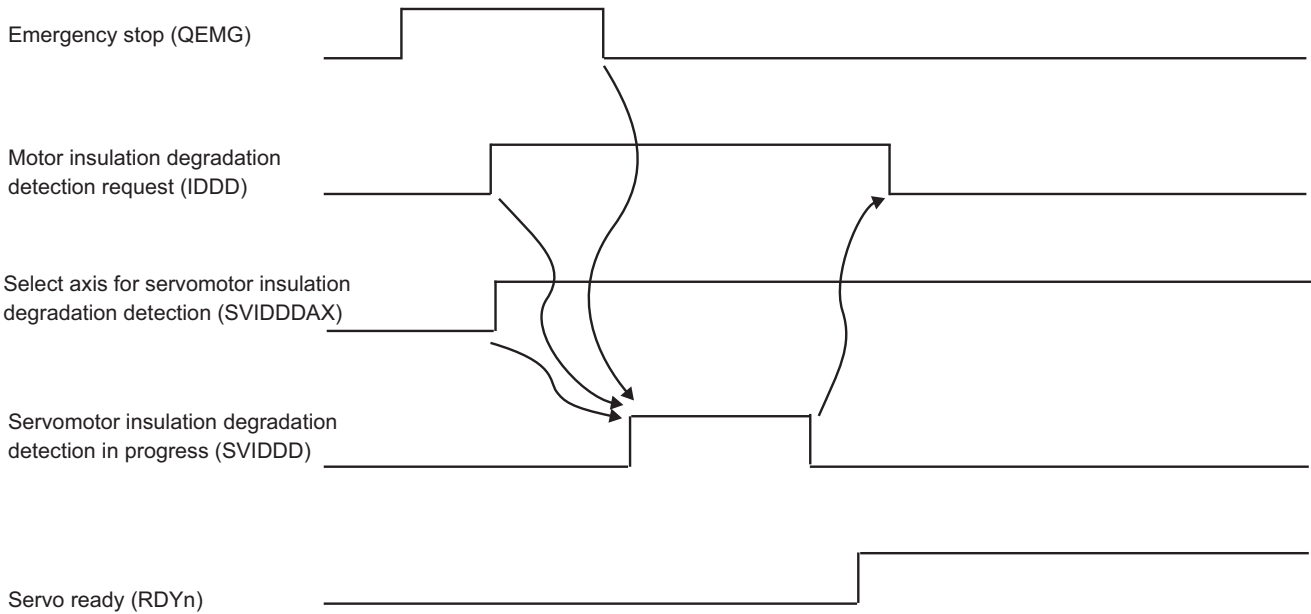

[Related signals]

- (1) Diagnosis data output: Servomotor insulation degradation detection in progress (SVIDDD: R20522)
- (2) Diagnosis data output: Spindle motor insulation degradation detection in progress (SPIDDD: R20048)
- (3) Diagnosis data output: Select axis for servomotor insulation degradation detection (SVIDDDAX: R22501)
- (4) Diagnosis data output: Select spindle for motor insulation degradation detection (SPIDDDAX: R20451)

Cont.	Signal name	Abbrev.	Device
A	Hypothetical axis command mode [C80]	VAMODn	R20482

[Function]

In the hypothetical linear axis control, select whether a command is issued to the hypothetical axis in the hypothetical plane or to the actual axis.

[Operation]

The hypothetical axis command mode can be selected by turning ON this signal. In the hypothetical axis command mode, a command can be issued to the hypothetical axis and the actual axis out of the hypothetical plane. The actual axis command mode can be selected by turning OFF this signal. In the actual axis command mode, a command can be issued to the actual axis.

When this signal (R20482) is turned ON while the hypothetical liner axis control is disabled, the operation error (M01 0148) occurs and the "In hypothetical axis command mode" signal (R20180) does not turn ON.

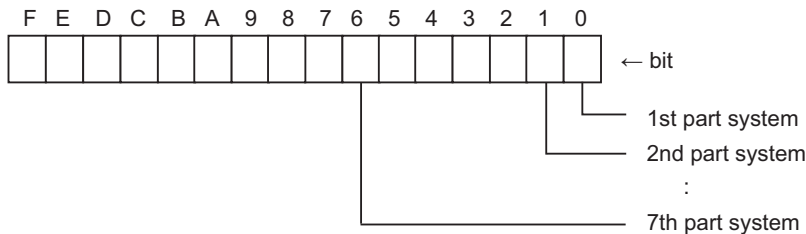

[Related signals]

- (1) In hypothetical axis command mode (R20180: VAMODOn)

4 Explanation of Interface Signals

Cont.	Signal name	Abbrev.	\$1	\$2	\$3	\$4	\$5	\$6	\$7	\$8
A	PROGRAM RESTART : RESTART POSITION RETURN CHECK INVALID		R22500	R22700	R22900	R23100	R23300	R23500	R23700	R23900

[Function]

This signal disables the program restart function from checking whether the axis has returned to the restart position after restart search.

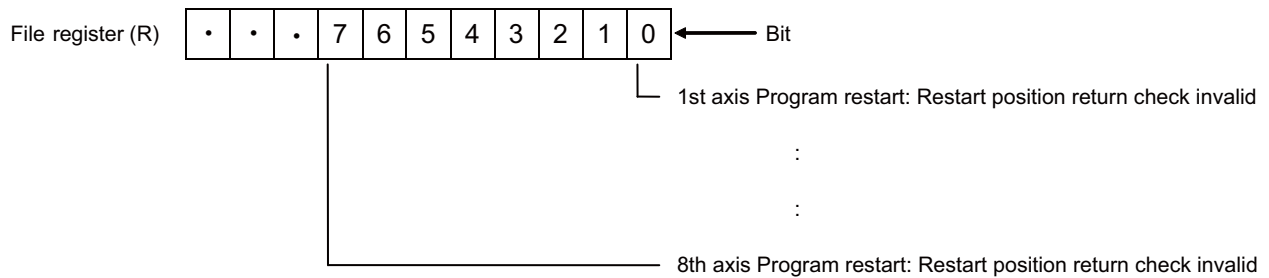

[Operation]

When restarting a machining program after restart search while this signal is ON, NC will not check if the axis selected by the bit of this signal has returned to the restart position, regardless of whether the command is programmed or not. The program operation restarts at cycle start even when the said axis has not returned to the restart position. Finish the restart search, then turn on this signal before restart the cycle. Keep this signal ON until the In automatic operation "Run" (OP: XC12) signal turns ON.

[Caution]

- While this signal is ON, restart position return operation is not performed on an axis for which the parameter "#1302 AutoRP" is 1 (Automatic return to restart position) and the parameter "#2082 a_rstax" is other than 0.
- If an axis selected by the bit of this signal is programmed while this signal is ON, the program is able to restart even when the axis is not in the restart position. This may change the tool path after the program restart. Thus before executing a cycle start, make sure that the said axis is in a position where the program is possible to restart.

Cont.	Signal name	Abbrev.	\$1	\$2	\$3	\$4	\$5	\$6	\$7	\$8
A	DIAGNOSIS DATA OUTPUT: SELECT AXIS FOR SERVOMOTOR INSULATION DEGRADATION DETECTION [M8]	SVIDDD AX	R22501	R22701	R22901	R23101	R23301	R23501	R23701	R23901

[Function]

This signal is used to select the servo axis for insulation resistance measurement.

[Operation]

When the control starts measuring the motor insulation resistance, the measurement starts on the axis for which the signal is ON.

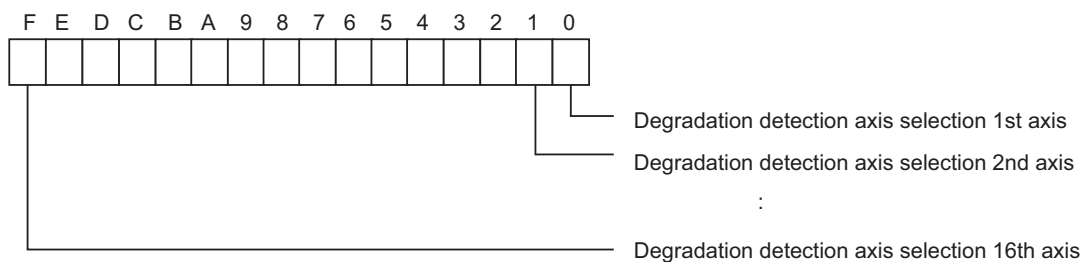

[Related signals]

- Diagnosis data output: Motor insulation degradation detection request (IDDD:R20481)

4 Explanation of Interface Signals

Cont.	Signal name	Abbrev.	\$1	\$2	\$3	\$4	\$5	\$6	\$7
A	MACHINING INTERRUPTION COMMAND [C80]	MCNGITCMD	R22504	R22704	R22904	R23104	R23304	R23504	R23704

[Function][Operation]

Bit	Description	Bit	Description
bit0	Operation mode with single block at selected point	bit8	Reserved
bit1	Retraction start	bit9	Reserved
bit2	Reserved	bit10	Reserved
bit3	Reserved	bit11	Reserved
bit4	Reserved	bit12	Reserved
bit5	Reserved	bit13	Reserved
bit6	Reserved	bit14	Reserved
bit7	Reserved	bit15	Reset servo alarm

bit0: Operation mode with single block at selected point

While this mode is valid, the operation is progressed performing block stop at each block of the machining start point, machining end point, and process start point during the memory operation.

When this signal is turned ON, block stop occurs at each block of the machining start point, machining end point, and process start point. Various interruption operations can be started from the state that machining stopped at each point.

When this signal is turned ON, macro single becomes valid. (The program stops at the macro block during the single block operation.)

[Related signal]

Retraction start (MCNGITCMD: R22504/bit1)

bit1: Retraction start

When this signal is turned ON, the running program is canceled and the retraction program is executed.

If the signal is turned ON with the "Retraction executable" signal (MCNGITSTS: R20546/bit0) being ON, the control immediately branches to the designated retraction program.

After the control branches to the retraction program, the "Retraction in execution" signal (MCNGITSTS: R20546/bit1) turns ON and the program goes into the state of retraction in progress.

Single block stop occurs even if the retraction program is being executed. In this case, the next block is started with this signal. The retraction program will not be executed even if the signal is turned ON while the "Retraction executable" signal is OFF.

If the retraction start is done during the execution of the MSTB commands, each strobe signal of MSTB is turned OFF and the control immediately branches to the retraction program.

When "Retraction program end" (M99) is commanded, the control returns to the last machining start point and the operation stops at the point. (The program stops also when "Operation mode with single block at selected point" is inactive). When the cycle start is executed after that, the S command and the spindle status restoration requests will be output to restore the spindle command at the machining start point.

[Related signal]

Operation mode with single block at selected point (MCNGITCMD: R22504/bit0)

Retraction executable (MCNGITSTS: R20546/bit0)

Retraction in execution (MCNGITSTS: R20546/bit1)

Stop status restoration request (MCNGITSPSTS: R6543/bit0)

Forward run start restoration request (MCNGITSPSTS: R6543/bit1)

Reverse run start restoration request (MCNGITSPSTS: R6543/bit2)

Orientation command restoration request (MCNGITSPSTS: R6543/bit3)

4 Explanation of Interface Signals

bit15: Reset servo alarm

When this bit is turned ON, servo alarms (NR) of the NC axes and the spindles are canceled.

If an alarm which can be canceled by Reset, such as "Excessive error", has occurred, the servo alarm (NR) will be reset with this signal so that the program can be resumed.

While this signal is ON, alarm reset is commanded to the NC axes in the part system and all the spindles.

The program will not be reset during the cycle operation.

Cont.	Signal name	Abbrev.	\$1	\$2	\$3	\$4	\$5	\$6	\$7
A	4TH HANDLE AXIS SELECTION CODE m [C80]	HS41 to 416	R22508 bit0 to 4	R22708 bit0 to 4	R22908 bit0 to 4	R23108 bit0 to 4	R23308 bit0 to 4	R23508 bit0 to 4	R23708 bit0 to 4
A	5TH HANDLE AXIS SELECTION CODE m [C80]	HS51 to 516	R22509 bit0 to 4	R22709 bit0 to 4	R22909 bit0 to 4	R23109 bit0 to 4	R23309 bit0 to 4	R23509 bit0 to 4	R23709 bit0 to 4
A	6TH HANDLE AXIS SELECTION CODE m [C80]	HS61 to 616	R22510 bit0 to 4	R22710 bit0 to 4	R22910 bit0 to 4	R23110 bit0 to 4	R23310 bit0 to 4	R23510 bit0 to 4	R23710 bit0 to 4
A	7TH HANDLE AXIS SELECTION CODE m [C80]	HS71 to 716	R22511 bit0 to 4	R22711 bit0 to 4	R22911 bit0 to 4	R23111 bit0 to 4	R23311 bit0 to 4	R23511 bit0 to 4	R23711 bit0 to 4
A	8TH HANDLE AXIS SELECTION CODE m [C80]	HS81 to 816	R22512 bit0 to 4	R22712 bit0 to 4	R22912 bit0 to 4	R23112 bit0 to 4	R23312 bit0 to 4	R23512 bit0 to 4	R23712 bit0 to 4
A	9TH HANDLE AXIS SELECTION CODE m [C80]	HS91 to 916	R22513 bit0 to 4	R22713 bit0 to 4	R22913 bit0 to 4	R23113 bit0 to 4	R23313 bit0 to 4	R23513 bit0 to 4	R23713 bit0 to 4

[Function]

In HANDLE mode, axis component to be moved is selected.

This signal is used to select the axis to be moved for the 4th to 9th handles.

1st to 3rd handles are selected with YC40 to YC44, YC48 to YC4C, or YC50 to YC54.

[Operation][Related signal]

Refer to the items in "1st handle axis selection code m (HS11 to 116: YC40 to 4)".

Cont.	Signal name	Abbrev.	\$1	\$2	\$3	\$4	\$5	\$6	\$7
A	4TH HANDLE VALID [C80]	HS4S	R22508 bit7	R22708 bit7	R22908 bit7	R23108 bit7	R23308 bit7	R23508 bit7	R23708 bit7
A	5TH HANDLE VALID [C80]	HS5S	R22509 bit7	R22709 bit7	R22909 bit7	R23109 bit7	R23309 bit7	R23509 bit7	R23709 bit7
A	6TH HANDLE VALID [C80]	HS6S	R22510 bit7	R22710 bit7	R22910 bit7	R23110 bit7	R23310 bit7	R23510 bit7	R23710 bit7
A	7TH HANDLE VALID [C80]	HS7S	R22511 bit7	R22711 bit7	R22911 bit7	R23111 bit7	R23311 bit7	R23511 bit7	R23711 bit7
A	8TH HANDLE VALID [C80]	HS8S	R22512 bit7	R22712 bit7	R22912 bit7	R23112 bit7	R23312 bit7	R23512 bit7	R23712 bit7
A	9TH HANDLE VALID [C80]	HS9S	R22513 bit7	R22713 bit7	R22913 bit7	R23113 bit7	R23313 bit7	R23513 bit7	R23713 bit7

[Function]

In HANDLE mode, axis No. of axis motion component to be moved is set for the n-th handle axis selection code (HSn1 to HSn16). These signals are used to validate the specified handle axis Nos.

YC47, YC4F, or YC57 are used to validate the axis Nos. for the the 1st to 3rd handles.

[Operation][Related signal]

Refer to the items in "1st handle valid (HS1S: YC47)".

4 Explanation of Interface Signals

Cont.	Signal name	Abbrev.	\$1	\$2	\$3	\$4	\$5	\$6	\$7
A	4TH HANDLE FEED MAGNIFICATION [C80]		R22514,5	R22714,5	R22914,5	R23114,5	R23314,5	R23514,5	R23714,5
A	5TH HANDLE FEED MAGNIFICATION [C80]		R22516,7	R22716,7	R22916,7	R23116,7	R23316,7	R23516,7	R23716,7
A	6TH HANDLE FEED MAGNIFICATION [C80]		R22518,9	R22718,9	R22918,9	R23118,9	R23318,9	R23518,9	R23718,9
A	7TH HANDLE FEED MAGNIFICATION [C80]		R22520,1	R22720,1	R22920,1	R23120,1	R23320,1	R23520,1	R23720,1
A	8TH HANDLE FEED MAGNIFICATION [C80]		R22522,3	R22722,3	R22922,3	R23122,3	R23322,3	R23522,3	R23722,3
A	9TH HANDLE FEED MAGNIFICATION [C80]		R22524,5	R22724,5	R22924,5	R23124,5	R23324,5	R23524,5	R23724,5

[Function]

By selecting the handle/incremental feed magnification method, an arbitrary magnification can be designated separately from magnification set by regular code method. Magnification value (multiplier) is set in file register (R) in binary.

Arbitrary magnification for the 4th to 9th handles are designated here.

Arbitrary magnification for the 1st to 3rd handles are designated with R2508, R2510, or R2512.

[Operation][Related signal]

Refer to the items in "2nd handle feed magnification (R2510, 1)".

Cont.	Signal name	Abbrev.	\$1	\$2	\$3	\$4	\$5	\$6	\$7	\$8
A	VCC: Temporary cancel of axis vibration	VCC_INVAX	R22532	R22732	R22932	R23132	R23332	R23532	R23732	R23932

[Function]

This signal is used to temporarily disable the vibration cutting control. (This can be set for each axis.)

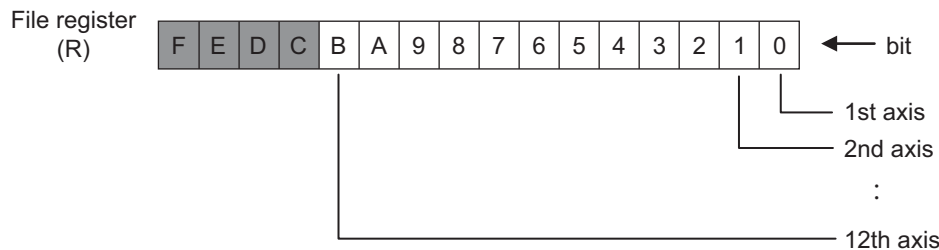

(Note) Switching an axis does not change a bit position.

[Operation]

Turning this signal ON can temporarily disable the vibration cutting control of the control axis corresponding to the bits.

When this signal is ON for the axis to be vibrated at the time of cutting command in the vibration cutting mode, the operation error (M01 1302) occurs. Machining continues without the vibration cutting control.

[Caution]

After all axes in the part system are stopped, the setting of this signal becomes valid from the subsequent program blocks. When the axes are moving, the previous status of the signal is retained. However, when the axis is stopped during the fixed cycle execution, the signal retains its status at the start of fixed cycle.

[Related signals]

- (1) Vibration cutting: Mode in execution (VCC: X1810)
- (2) Vibration cutting: Numbers of vibrations (VCC_VIB: R20556)
- (3) Vibration cutting: Frequency (VCC_FRQ: R20557)
- (4) Vibration cutting: Spindle rotation speed (VCC_SPREV: R7024, R7025)
- (5) Vibration cutting: Vibrating axis (VCC_VIBAX: R20558)
- (6) Vibration cutting: Temporary cancel of axis vibration (VCC_INVAX: R22532)
- (7) Vibration cutting: Cause of non-vibration (VCC_FACT: R20559)

Cont.	Signal name	Abbrev.	\$1	\$2	\$3	\$4
A	Tool head hot swapping: NC axis switch n-th axis [M8]	AXCHGC-MD1 to 8	R25684 to 91	R25692 to 99	R25700 to 07	R25708 to 15

[Function]

The setting for installing another servo motor on the detached NC axis can be transferred to the drive unit.

[Operation]

<Low-order 8 bits: NC axis switch setting number>

Set the parameter number used in NC axis switch. When "0" is set, the switch is performed by using the setting value of the original servo parameters (#2201 or later).

Setting range: 0 to 16

<High-order 8 bits: NC axis switch command>

When the "NC axis switch request" signal (bit8) turns ON, the NC axis switch parameters of the set number will be valid.

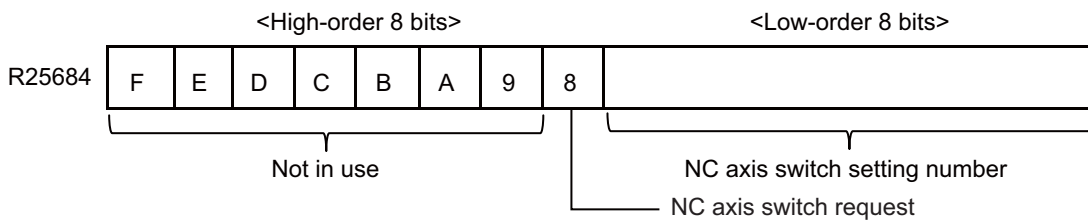

[Timing chart]

In the following example, the NC axis switch is performed for the first axis by using the first set of the NC axis switch parameters.

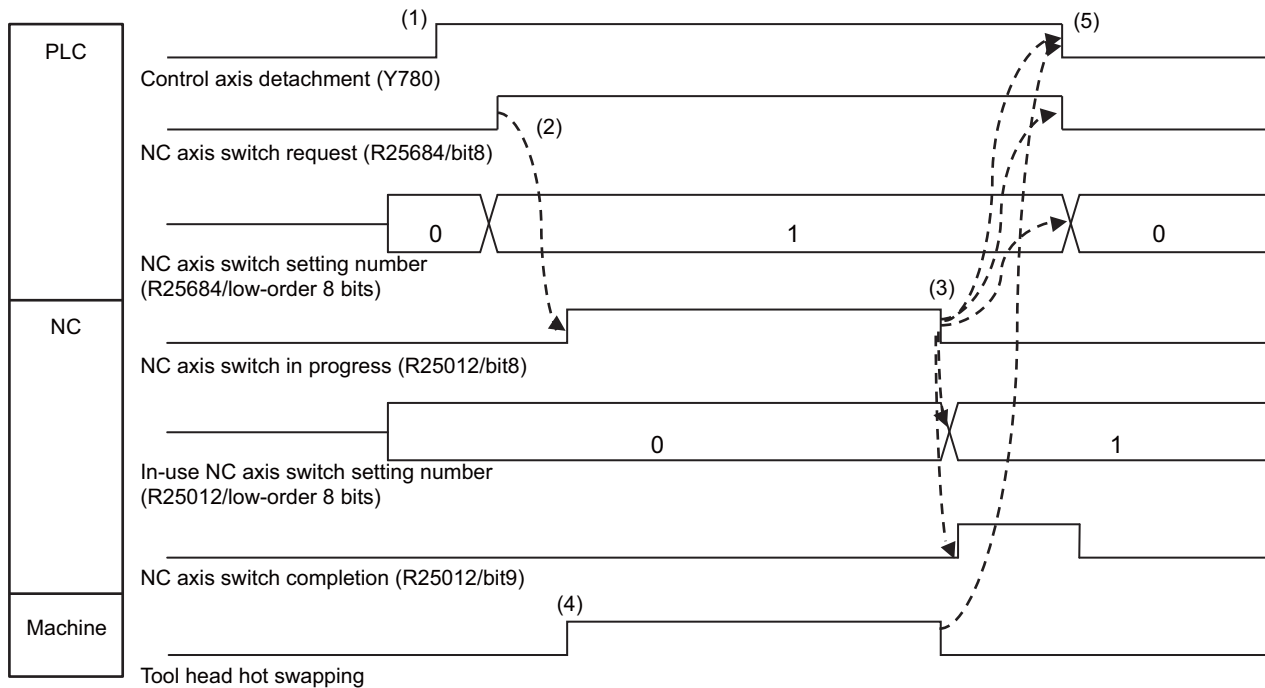

- (1) When the "Control axis detachment" signal (Y780) turns ON, the axis is detached from CNC.
- (2) When the NC axis switch is requested while the axis is detached from CNC, the target axis turns to the state of NC axis switch in progress, and the setting data of NC axis switch parameter is transferred to the drive unit according to the value of "NC axis switch setting number" (R25684/low-order 8 bits).
- (3) When the transfer is completed, the "NC axis switch in progress" signal (R25012/bit8) turns OFF, and a value is set to the "In-use NC axis switch setting number" signal (R25012/low-order 8 bits).
- (4) Change the tool head while the axis is detached. (This operation is available even while the NC axis switch is in progress and can be started at the same time as the (2) operation.)
- (5) When (2), (3) and (4) are completed, the NC axis switch is completed. When the "Control axis detachment" signal (Y780) turns OFF, NC axis control is enabled again and operation is possible using the setting after the switch.

[Related signals]

- (1) Control axis detachment n-th axis (Y780: DTCHn)
- (2) Tool head hot swapping: NC axis switch status n-th axis (R25012: AXCHGSTS_n)

4.5 Explanation of Special Relays (SM^{***})

Cont.	Signal name	Abbrev.	Common(\$)
A	TEMPERATURE RISE		SM16

[Function][Operation]

If the alarm is displayed when an overheat alarm is detected in the control unit or communication terminal, the overheat signal will be output simultaneously. If the machine is in automatic operation, the operation will be continued, but restarting will not be possible after resetting or stopping with M02/M30. (Starting will be possible after block stop or feed hold.)

For details on the operation, etc., refer to "Temperature warning cause".



CAUTION

1. If the temperature rise detection function is invalidated with the parameters, the control could be disabled when the temperature is excessive. This could result in machine damage or personal injuries due to runaway axis, and could damage the device. Enable the detection function for normal use.

[Related signals]

- (1) Temperature warning cause (R57/bit1)
- (2) Control unit temperature (R60)

4.6 Explanation of ZR device

4.6.1 Smart Safety Observation

4.6.1.1 PLC → CNC

Cont.	Signal name	Abbrev.	1st axis	2nd axis	3rd axis	4th axis	5th axis	6th axis	7th axis	8th axis
B	SLS OBSERVATION REQUEST (CONTROL AXIS)[M8]	*SLSRm	ZR256 bit0	ZR256 bit1	ZR256 bit2	ZR256 bit3	ZR256 bit4	ZR256 bit5	ZR256 bit6	ZR256 bit7
			9th axis	10th axis	11th axis	12th axis	13th axis	14th axis	15th axis	16th axis
			ZR256 bit8	ZR256 bit9	ZR256 bit10	ZR256 bit11	ZR256 bit12	ZR256 bit13	ZR256 bit14	ZR256 bit15
			17th axis	18th axis	19th axis	20th axis	21st axis	22nd axis	23rd axis	24th axis
			ZR257 bit0	ZR257 bit1	ZR257 bit2	ZR257 bit3	ZR257 bit4	ZR257 bit5	ZR257 bit6	ZR257 bit7
			25th axis	26th axis	27th axis	28th axis	29th axis	30th axis	31st axis	32nd axis
			ZR257 bit8	ZR257 bit9	ZR257 bit10	ZR257 bit11	ZR257 bit12	ZR257 bit13	ZR257 bit14	ZR257 bit15

Cont.	Signal name	Abbrev.	1st axis	2nd axis	3rd axis	4th axis	5th axis	6th axis	7th axis	8th axis
B	SLS OBSERVATION REQUEST (CONTROL AXIS)[C80]	*SLSRm	ZR128 bit0	ZR128 bit1	ZR128 bit2	ZR128 bit3	ZR128 bit4	ZR128 bit5	ZR128 bit6	ZR128 bit7
			9th axis	10th axis	11th axis	12th axis	13th axis	14th axis	15th axis	16th axis
			ZR128 bit8	ZR128 bit9	ZR128 bit10	ZR128 bit11	ZR128 bit12	ZR128 bit13	ZR128 bit14	ZR128 bit15
			17th axis	18th axis	19th axis	20th axis	21st axis	22nd axis	23rd axis	24th axis
			ZR129 bit0	ZR129 bit1	ZR129 bit2	ZR129 bit3	ZR129 bit4	ZR129 bit5	ZR129 bit6	ZR129 bit7
			25th axis	26th axis	27th axis	28th axis	29th axis	30th axis	31st axis	32nd axis
			ZR129 bit8	ZR129 bit9	ZR129 bit10	ZR129 bit11	ZR129 bit12	ZR129 bit13	ZR129 bit14	ZR129 bit15

[Function]

This signal is used to start execution of the SLS observation function on the control axis.

This signal is available when SLS is enabled by the parameter (#51002 SLS_Enable).

(This signal is ignored when SLS is disabled by #51002 SLS_Enable.)

[Operation]

When the SLS observation request signal is turned OFF (when SLS is requested), the NC carries out the following:

- (1) Checks the SLS parameters to be used.
- (2) Executes the NC's SLS observation function, and turns ON SLS observation is active (SLSEm).
- (3) Turns ON the Under SLS limit (SLSSm) signal when the axis is confirmed to have decelerated to the safely-limited speed or below.

[Related signals]

- (1) SLS speed change input (SLSMImn)
- (2) SLS speed change output (SLSMOmn)
- (3) SLS speed override input (SLSOVRImn)
- (4) SLS speed override output (SLSOVROmn)
- (5) SLS observation is active (SLSEm)
- (6) Under SLS limit (SLSSm)

4 Explanation of Interface Signals

Cont.	Signal name	Abbrev.	1st axis	2nd axis	3rd axis	4th axis	5th axis	6th axis	7th axis	8th axis
B	SLP OBSERVATION REQUEST (CONTROL AXIS)[M8]	*SLPRm	ZR258 bit0	ZR258 bit1	ZR258 bit2	ZR258 bit3	ZR258 bit4	ZR258 bit5	ZR258 bit6	ZR258 bit7
			9th axis	10th axis	11th axis	12th axis	13th axis	14th axis	15th axis	16th axis
			ZR258 bit8	ZR258 bit9	ZR258 bit10	ZR258 bit11	ZR258 bit12	ZR258 bit13	ZR258 bit14	ZR258 bit15
			17th axis	18th axis	19th axis	20th axis	21st axis	22nd axis	23rd axis	24th axis
			ZR259 bit0	ZR259 bit1	ZR259 bit2	ZR259 bit3	ZR259 bit4	ZR259 bit5	ZR259 bit6	ZR259 bit7
			25th axis	26th axis	27th axis	28th axis	29th axis	30th axis	31st axis	32nd axis
			ZR259 bit8	ZR259 bit9	ZR259 bit10	ZR259 bit11	ZR259 bit12	ZR259 bit13	ZR259 bit14	ZR259 bit15

Cont.	Signal name	Abbrev.	1st axis	2nd axis	3rd axis	4th axis	5th axis	6th axis	7th axis	8th axis
B	SLP OBSERVATION REQUEST (CONTROL AXIS)[C80]	*SLPRm	ZR130 bit0	ZR130 bit1	ZR130 bit2	ZR130 bit3	ZR130 bit4	ZR130 bit5	ZR130 bit6	ZR130 bit7
			9th axis	10th axis	11th axis	12th axis	13th axis	14th axis	15th axis	16th axis
			ZR130 bit8	ZR130 bit9	ZR130 bit10	ZR130 bit11	ZR130 bit12	ZR130 bit13	ZR130 bit14	ZR130 bit15
			17th axis	18th axis	19th axis	20th axis	21st axis	22nd axis	23rd axis	24th axis
			ZR131 bit0	ZR131 bit1	ZR131 bit2	ZR131 bit3	ZR131 bit4	ZR131 bit5	ZR131 bit6	ZR131 bit7
			25th axis	26th axis	27th axis	28th axis	29th axis	30th axis	31st axis	32nd axis
			ZR131 bit8	ZR131 bit9	ZR131 bit10	ZR131 bit11	ZR131 bit12	ZR131 bit13	ZR131 bit14	ZR131 bit15

[Function]

This signal is used to start execution of the SLP observation function on the control axis.

This signal is available when SLP is enabled by the parameter (#51003 SLP_Enable).

(This signal is ignored when SLP is disabled by #51003 SLP_Enable.)

[Operation]

When the SLP observation request signal is turned OFF (when SLP is requested), the NC carries out the following:

- (1) Checks the SLP parameters to be used.
- (2) Executes the NC's SLP observation function, and turns ON SLP observation is active (SLPEm).
- (3) Turns ON the In SLP range (SLPSm) signal when the axis is confirmed to be in the SLP position tolerance range.

[Related signals]

- (1) SLP position change input (SLPMImn)
- (2) SLP position change output (SLPMOmn)
- (3) SLP observation is active (SLPEm)
- (4) In SLP range (SLPSm)

4 Explanation of Interface Signals

Cont.	Signal name	Abbrev.	1st axis	2nd axis	3rd axis	4th axis	5th axis	6th axis	7th axis	8th axis
B	SSM REQUEST (CONTROL AXIS)[M8]	*SSMRm	ZR260 bit0	ZR260 bit1	ZR260 bit2	ZR260 bit3	ZR260 bit4	ZR260 bit5	ZR260 bit6	ZR260 bit7
			9th axis	10th axis	11th axis	12th axis	13th axis	14th axis	15th axis	16th axis
			ZR260 bit8	ZR260 bit9	ZR260 bit10	ZR260 bit11	ZR260 bit12	ZR260 bit13	ZR260 bit14	ZR260 bit15
			17th axis	18th axis	19th axis	20th axis	21st axis	22nd axis	23rd axis	24th axis
			ZR261 bit0	ZR261 bit1	ZR261 bit2	ZR261 bit3	ZR261 bit4	ZR261 bit5	ZR261 bit6	ZR261 bit7
			25th axis	26th axis	27th axis	28th axis	29th axis	30th axis	31st axis	32nd axis
			ZR261 bit8	ZR261 bit9	ZR261 bit10	ZR261 bit11	ZR261 bit12	ZR261 bit13	ZR261 bit14	ZR261 bit15

Cont.	Signal name	Abbrev.	1st axis	2nd axis	3rd axis	4th axis	5th axis	6th axis	7th axis	8th axis
B	SSM REQUEST (CONTROL AXIS)[C80]	*SSMRm	ZR132 bit0	ZR132 bit1	ZR132 bit2	ZR132 bit3	ZR132 bit4	ZR132 bit5	ZR132 bit6	ZR132 bit7
			9th axis	10th axis	11th axis	12th axis	13th axis	14th axis	15th axis	16th axis
			ZR132 bit8	ZR132 bit9	ZR132 bit10	ZR132 bit11	ZR132 bit12	ZR132 bit13	ZR132 bit14	ZR132 bit15
			17th axis	18th axis	19th axis	20th axis	21st axis	22nd axis	23rd axis	24th axis
			ZR133 bit0	ZR133 bit1	ZR133 bit2	ZR133 bit3	ZR133 bit4	ZR133 bit5	ZR133 bit6	ZR133 bit7
			25th axis	26th axis	27th axis	28th axis	29th axis	30th axis	31st axis	32nd axis
			ZR133 bit8	ZR133 bit9	ZR133 bit10	ZR133 bit11	ZR133 bit12	ZR133 bit13	ZR133 bit14	ZR133 bit15

[Function]

This signal is used to start execution of SSM on the control axis.

This signal is available when SSM is enabled by the parameter (#51004 SSM_Enable).

(This signal is ignored when SSM is disabled by #51004 SSM_Enable.)

[Operation]

When SSM request is turned OFF (When SSM is requested), the NC carries out the following:

- (1) Checks the SSM parameters to be used.
- (2) Executes the NC's Safe speed monitor function, and turns ON the SSM is active (SSMEm) signal.
- (3) Turns ON the Under SSM safe speed 1 to 4 (SSMSmn) signal when the axis is confirmed to be at the safe speed or below.

[Related signals]

- (1) SSM is active (SSMEm)
- (2) Under SSM safe speed (SSMSmn)

4 Explanation of Interface Signals

Cont.	Signal name	Abbrev.	1st axis	2nd axis	3rd axis	4th axis	5th axis	6th axis	7th axis	8th axis
B	SAFE CAM REQUEST (CONTROL AXIS)[M8]	*SCARm	ZR262 bit0	ZR262 bit1	ZR262 bit2	ZR262 bit3	ZR262 bit4	ZR262 bit5	ZR262 bit6	ZR262 bit7
			9th axis	10th axis	11th axis	12th axis	13th axis	14th axis	15th axis	16th axis
			ZR262 bit8	ZR262 bit9	ZR262 bit10	ZR262 bit11	ZR262 bit12	ZR262 bit13	ZR262 bit14	ZR262 bit15
			17th axis	18th axis	19th axis	20th axis	21st axis	22nd axis	23rd axis	24th axis
			ZR263 bit0	ZR263 bit1	ZR263 bit2	ZR263 bit3	ZR263 bit4	ZR263 bit5	ZR263 bit6	ZR263 bit7
			25th axis	26th axis	27th axis	28th axis	29th axis	30th axis	31st axis	32nd axis
			ZR263 bit8	ZR263 bit9	ZR263 bit10	ZR263 bit11	ZR263 bit12	ZR263 bit13	ZR263 bit14	ZR263 bit15

Cont.	Signal name	Abbrev.	1st axis	2nd axis	3rd axis	4th axis	5th axis	6th axis	7th axis	8th axis
B	SAFE CAM REQUEST (CONTROL AXIS)[C80]	*SCARm	ZR134 bit0	ZR134 bit1	ZR134 bit2	ZR134 bit3	ZR134 bit4	ZR134 bit5	ZR134 bit6	ZR134 bit7
			9th axis	10th axis	11th axis	12th axis	13th axis	14th axis	15th axis	16th axis
			ZR134 bit8	ZR134 bit9	ZR134 bit10	ZR134 bit11	ZR134 bit12	ZR134 bit13	ZR134 bit14	ZR134 bit15
			17th axis	18th axis	19th axis	20th axis	21st axis	22nd axis	23rd axis	24th axis
			ZR135 bit0	ZR135 bit1	ZR135 bit2	ZR135 bit3	ZR135 bit4	ZR135 bit5	ZR135 bit6	ZR135 bit7
			25th axis	26th axis	27th axis	28th axis	29th axis	30th axis	31st axis	32nd axis
			ZR135 bit8	ZR135 bit9	ZR135 bit10	ZR135 bit11	ZR135 bit12	ZR135 bit13	ZR135 bit14	ZR135 bit15

[Function]

This signal is used to start execution of the Safe cam function on the control axis.

This signal is available when SCA is enabled by the parameter (#51005 SCA_Enable).

(This signal is ignored when SCA is disabled by #51005 SCA_Enable.)

[Operation]

When the Safe cam request signal is turned OFF (When SCA is requested), the NC carries out the following:

- (1) Checks the SCA parameters to be used.
- (2) Executes the NC's Safe cam function and turns ON the Safe cam is active (SCAEm) signal.
- (3) Outputs the safe cam position status to the Safe cam position (SCASm) signal.

[Related signals]

- (1) Safe cam is active (SCAEm)
- (2) Safe cam position (SCASmn)

4 Explanation of Interface Signals

Cont.	Signal name	Abbrev.	1st axis	2nd axis	3rd axis	4th axis	5th axis	6th axis	7th axis	8th axis
B	SOS OBSERVATION REQUEST (CONTROL AXIS)[M8]	*SOSRm	ZR264 bit0	ZR264 bit1	ZR264 bit2	ZR264 bit3	ZR264 bit4	ZR264 bit5	ZR264 bit6	ZR264 bit7
			9th axis	10th axis	11th axis	12th axis	13th axis	14th axis	15th axis	16th axis
			ZR264 bit8	ZR264 bit9	ZR264 bit10	ZR264 bit11	ZR264 bit12	ZR264 bit13	ZR264 bit14	ZR264 bit15
			17th axis	18th axis	19th axis	20th axis	21st axis	22nd axis	23rd axis	24th axis
			ZR265 bit0	ZR265 bit1	ZR265 bit2	ZR265 bit3	ZR265 bit4	ZR265 bit5	ZR265 bit6	ZR265 bit7
			25th axis	26th axis	27th axis	28th axis	29th axis	30th axis	31st axis	32nd axis
			ZR265 bit8	ZR265 bit9	ZR265 bit10	ZR265 bit11	ZR265 bit12	ZR265 bit13	ZR265 bit14	ZR265 bit15

Cont.	Signal name	Abbrev.	1st axis	2nd axis	3rd axis	4th axis	5th axis	6th axis	7th axis	8th axis
B	SOS OBSERVATION REQUEST (CONTROL AXIS)[C80]	*SOSRm	ZR136 bit0	ZR136 bit1	ZR136 bit2	ZR136 bit3	ZR136 bit4	ZR136 bit5	ZR136 bit6	ZR136 bit7
			9th axis	10th axis	11th axis	12th axis	13th axis	14th axis	15th axis	16th axis
			ZR136 bit8	ZR136 bit9	ZR136 bit10	ZR136 bit11	ZR136 bit12	ZR136 bit13	ZR136 bit14	ZR136 bit15
			17th axis	18th axis	19th axis	20th axis	21st axis	22nd axis	23rd axis	24th axis
			ZR137 bit0	ZR137 bit1	ZR137 bit2	ZR137 bit3	ZR137 bit4	ZR137 bit5	ZR137 bit6	ZR137 bit7
			25th axis	26th axis	27th axis	28th axis	29th axis	30th axis	31st axis	32nd axis
			ZR137 bit8	ZR137 bit9	ZR137 bit10	ZR137 bit11	ZR137 bit12	ZR137 bit13	ZR137 bit14	ZR137 bit15

[Function]

This signal is used to start execution of the SOS observation function on the control axis.

This signal is available when the parameter (#51006 SOS_Enable) is set to 1 (Enable).

(If #51006 SOS_Enable is 0 (Disable), this signal is ignored.)

[Operation]

When SOS observation request is turned OFF (When SOS is requested), the NC carries out the following:

- (1) Checks the SOS parameters to be used.
- (2) Executes the NC's Safe operating stop function, and turns ON the SOS is active (SOSEm) signal.
- (3) Turns ON the In SOS stop (SOSSm) signal when the safe standstill state of the axis is confirmed.

[Related signals]

- (1) SOS is active (SOSEm)
- (2) In SOS stop (SOSSm)

4 Explanation of Interface Signals

Cont.	Signal name	Abbrev.	1st axis	2nd axis	3rd axis	4th axis	5th axis	6th axis	7th axis	8th axis
B	SAFE STOP 1 REQUEST (CONTROL AXIS)[M8]	*SS1Rm	ZR266 bit0	ZR266 bit1	ZR266 bit2	ZR266 bit3	ZR266 bit4	ZR266 bit5	ZR266 bit6	ZR266 bit7
			9th axis	10th axis	11th axis	12th axis	13th axis	14th axis	15th axis	16th axis
			ZR266 bit8	ZR266 bit9	ZR266 bit10	ZR266 bit11	ZR266 bit12	ZR266 bit13	ZR266 bit14	ZR266 bit15
			17th axis	18th axis	19th axis	20th axis	21st axis	22nd axis	23rd axis	24th axis
			ZR267 bit0	ZR267 bit1	ZR267 bit2	ZR267 bit3	ZR267 bit4	ZR267 bit5	ZR267 bit6	ZR267 bit7
			25th axis	26th axis	27th axis	28th axis	29th axis	30th axis	31st axis	32nd axis
			ZR267 bit8	ZR267 bit9	ZR267 bit10	ZR267 bit11	ZR267 bit12	ZR267 bit13	ZR267 bit14	ZR267 bit15

Cont.	Signal name	Abbrev.	1st axis	2nd axis	3rd axis	4th axis	5th axis	6th axis	7th axis	8th axis
B	SAFE STOP 1 REQUEST (CONTROL AXIS)[C80]	*SS1Rm	ZR138 bit0	ZR138 bit1	ZR138 bit2	ZR138 bit3	ZR138 bit4	ZR138 bit5	ZR138 bit6	ZR138 bit7
			9th axis	10th axis	11th axis	12th axis	13th axis	14th axis	15th axis	16th axis
			ZR138 bit8	ZR138 bit9	ZR138 bit10	ZR138 bit11	ZR138 bit12	ZR138 bit13	ZR138 bit14	ZR138 bit15
			17th axis	18th axis	19th axis	20th axis	21st axis	22nd axis	23rd axis	24th axis
			ZR139 bit0	ZR139 bit1	ZR139 bit2	ZR139 bit3	ZR139 bit4	ZR139 bit5	ZR139 bit6	ZR139 bit7
			25th axis	26th axis	27th axis	28th axis	29th axis	30th axis	31st axis	32nd axis
			ZR139 bit8	ZR139 bit9	ZR139 bit10	ZR139 bit11	ZR139 bit12	ZR139 bit13	ZR139 bit14	ZR139 bit15

[Function]

This signal is used to start execution of Safe stop 1 on the control axis.

This signal is available when the parameter (#51007 SS1_Enable) is set to 1 (Enable).

(If #51007 SS1_Enable is 0 (Disable), this signal is ignored.)

[Operation]

When the Safe stop 1 request signal is turned OFF (When SS1 is requested), the NC carries out the following:

- (1) Checks the SS1 parameters to be used.
- (2) Executes the NC's Safe stop 1 function, and turns ON the SS1 is active (SS1Em) signal.
- (3) Turns ON the In Safe stop 1 (SS1Sm) signal when the axis deceleration is confirmed.

[Related signals]

- (1) SS1 is active (SS1Em)
- (2) In Safe stop 1 (SS1Sm)

4 Explanation of Interface Signals

Cont.	Signal name	Abbrev.	1st axis	2nd axis	3rd axis	4th axis	5th axis	6th axis	7th axis	8th axis
B	SAFE STOP 2 REQUEST (CONTROL AXIS)[M8]	*SS2Rm	ZR268 bit0	ZR268 bit1	ZR268 bit2	ZR268 bit3	ZR268 bit4	ZR268 bit5	ZR268 bit6	ZR268 bit7
			9th axis	10th axis	11th axis	12th axis	13th axis	14th axis	15th axis	16th axis
			ZR268 bit8	ZR268 bit9	ZR268 bit10	ZR268 bit11	ZR268 bit12	ZR268 bit13	ZR268 bit14	ZR268 bit15
			17th axis	18th axis	19th axis	20th axis	21st axis	22nd axis	23rd axis	24th axis
			ZR269 bit0	ZR269 bit1	ZR269 bit2	ZR269 bit3	ZR269 bit4	ZR269 bit5	ZR269 bit6	ZR269 bit7
			25th axis	26th axis	27th axis	28th axis	29th axis	30th axis	31st axis	32nd axis
			ZR269 bit8	ZR269 bit9	ZR269 bit10	ZR269 bit11	ZR269 bit12	ZR269 bit13	ZR269 bit14	ZR269 bit15

Cont.	Signal name	Abbrev.	1st axis	2nd axis	3rd axis	4th axis	5th axis	6th axis	7th axis	8th axis
B	SAFE STOP 2 REQUEST (CONTROL AXIS)[C80]	*SS2Rm	ZR140 bit0	ZR140 bit1	ZR140 bit2	ZR140 bit3	ZR140 bit4	ZR140 bit5	ZR140 bit6	ZR140 bit7
			9th axis	10th axis	11th axis	12th axis	13th axis	14th axis	15th axis	16th axis
			ZR140 bit8	ZR140 bit9	ZR140 bit10	ZR140 bit11	ZR140 bit12	ZR140 bit13	ZR140 bit14	ZR140 bit15
			17th axis	18th axis	19th axis	20th axis	21st axis	22nd axis	23rd axis	24th axis
			ZR141 bit0	ZR141 bit1	ZR141 bit2	ZR141 bit3	ZR141 bit4	ZR141 bit5	ZR141 bit6	ZR141 bit7
			25th axis	26th axis	27th axis	28th axis	29th axis	30th axis	31st axis	32nd axis
			ZR141 bit8	ZR141 bit9	ZR141 bit10	ZR141 bit11	ZR141 bit12	ZR141 bit13	ZR141 bit14	ZR141 bit15

[Function]

This signal is used to start execution of the Safe stop 2 function on the control axis.

This signal is available when SS2 is enabled by the parameter (#51008 SS2_Enable).

(This signal is ignored when SS2 is disabled by #51008 SS2_Enable.)

[Operation]

When Safe stop 2 request is turned OFF (When SS2 is requested), the NC carries out the following:

- (1) Checks the SS2 parameters to be used.
- (2) Executes the NC's Safe stop 2 function, and turns ON the SS2 is active (SS2Em) signal.
- (3) Executes Safe operating stop (SOS) when the axis deceleration is confirmed.

[Related signals]

- (1) SS2 is active (SS2Em)

4 Explanation of Interface Signals

Cont.	Signal name	Abbrev.	1st axis	2nd axis	3rd axis	4th axis	5th axis	6th axis	7th axis	8th axis
B	SAFE TORQUE OFF REQUEST (CONTROL AXIS)[M8]	*STORm	ZR270 bit0	ZR270 bit1	ZR270 bit2	ZR270 bit3	ZR270 bit4	ZR270 bit5	ZR270 bit6	ZR270 bit7
			9th axis	10th axis	11th axis	12th axis	13th axis	14th axis	15th axis	16th axis
			ZR270 bit8	ZR270 bit9	ZR270 bit10	ZR270 bit11	ZR270 bit12	ZR270 bit13	ZR270 bit14	ZR270 bit15
			17th axis	18th axis	19th axis	20th axis	21st axis	22nd axis	23rd axis	24th axis
			ZR271 bit0	ZR271 bit1	ZR271 bit2	ZR271 bit3	ZR271 bit4	ZR271 bit5	ZR271 bit6	ZR271 bit7
			25th axis	26th axis	27th axis	28th axis	29th axis	30th axis	31st axis	32nd axis
			ZR271 bit8	ZR271 bit9	ZR271 bit10	ZR271 bit11	ZR271 bit12	ZR271 bit13	ZR271 bit14	ZR271 bit15

Cont.	Signal name	Abbrev.	1st axis	2nd axis	3rd axis	4th axis	5th axis	6th axis	7th axis	8th axis
B	SAFE TORQUE OFF REQUEST (CONTROL AXIS)[C80]	*STORm	ZR142 bit0	ZR142 bit1	ZR142 bit2	ZR142 bit3	ZR142 bit4	ZR142 bit5	ZR142 bit6	ZR142 bit7
			9th axis	10th axis	11th axis	12th axis	13th axis	14th axis	15th axis	16th axis
			ZR142 bit8	ZR142 bit9	ZR142 bit10	ZR142 bit11	ZR142 bit12	ZR142 bit13	ZR142 bit14	ZR142 bit15
			17th axis	18th axis	19th axis	20th axis	21st axis	22nd axis	23rd axis	24th axis
			ZR143 bit0	ZR143 bit1	ZR143 bit2	ZR143 bit3	ZR143 bit4	ZR143 bit5	ZR143 bit6	ZR143 bit7
			25th axis	26th axis	27th axis	28th axis	29th axis	30th axis	31st axis	32nd axis
			ZR143 bit8	ZR143 bit9	ZR143 bit10	ZR143 bit11	ZR143 bit12	ZR143 bit13	ZR143 bit14	ZR143 bit15

[Function]

This signal is used to start execution of the Safe torque off function on the control axis.

This signal is available when STO is enabled by the parameter (#51009 STO_Enable).

(This signal is ignored when STO is disabled by #51009 STO_Enable.)

[Operation]

When the Safe torque off request signal is turned OFF (When STO is requested), the NC carries out the following:

- (1) Checks the STO parameters to be used.
- (2) Executes the NC's Safe torque off function, and turns ON the STO is active (STOEm) signal.
- (3) Turns ON the In Safe torque off signal (STOSm) when the main drive power to the axis has been shut OFF.

[Related signals]

- (1) STO is active (STOEm)
- (2) In Safe torque off (STOSm)

4 Explanation of Interface Signals

Cont.	Signal name	Abbrev.	1st axis	2nd axis	3rd axis	4th axis	5th axis	6th axis	7th axis	8th axis
B	SBC MOTOR BRAKE STARTING REQUEST (CONTROL AXIS)[M8]	*SBCRm	ZR272 bit0	ZR272 bit1	ZR272 bit2	ZR272 bit3	ZR272 bit4	ZR272 bit5	ZR272 bit6	ZR272 bit7
			9th axis	10th axis	11th axis	12th axis	13th axis	14th axis	15th axis	16th axis
			ZR272 bit8	ZR272 bit9	ZR272 bit10	ZR272 bit11	ZR272 bit12	ZR272 bit13	ZR272 bit14	ZR272 bit15
			17th axis	18th axis	19th axis	20th axis	21st axis	22nd axis	23rd axis	24th axis
			ZR273 bit0	ZR273 bit1	ZR273 bit2	ZR273 bit3	ZR273 bit4	ZR273 bit5	ZR273 bit6	ZR273 bit7
			25th axis	26th axis	27th axis	28th axis	29th axis	30th axis	31st axis	32nd axis
			ZR273 bit8	ZR273 bit9	ZR273 bit10	ZR273 bit11	ZR273 bit12	ZR273 bit13	ZR273 bit14	ZR273 bit15

Cont.	Signal name	Abbrev.	1st axis	2nd axis	3rd axis	4th axis	5th axis	6th axis	7th axis	8th axis
B	SBC MOTOR BRAKE STARTING REQUEST (CONTROL AXIS)[C80]	*SBCRm	ZR144 bit0	ZR144 bit1	ZR144 bit2	ZR144 bit3	ZR144 bit4	ZR144 bit5	ZR144 bit6	ZR144 bit7
			9th axis	10th axis	11th axis	12th axis	13th axis	14th axis	15th axis	16th axis
			ZR144 bit8	ZR144 bit9	ZR144 bit10	ZR144 bit11	ZR144 bit12	ZR144 bit13	ZR144 bit14	ZR144 bit15
			17th axis	18th axis	19th axis	20th axis	21st axis	22nd axis	23rd axis	24th axis
			ZR145 bit0	ZR145 bit1	ZR145 bit2	ZR145 bit3	ZR145 bit4	ZR145 bit5	ZR145 bit6	ZR145 bit7
			25th axis	26th axis	27th axis	28th axis	29th axis	30th axis	31st axis	32nd axis
			ZR145 bit8	ZR145 bit9	ZR145 bit10	ZR145 bit11	ZR145 bit12	ZR145 bit13	ZR145 bit14	ZR145 bit15

[Function]

This signal executes the motor brake start by Safety Brake Control.

This signal can be used only when the parameter #51010 SBC_Enable is set enabled.

(This signal is ignored when #51010 SBC_Enable is set disabled.)

[Operation]

By turning OFF (requesting) this signal, NC outputs the Motor brake starting request to the drive unit.

When the motor brake starts, the In SBC Motor brake start signal (SBCSm) turns ON.

When the power is shut OFF (at Safety related error, at the *STORM signal OFF, and the *SS1Rm signal OFF), it automatically carries out the motor brake start. In the case of starting the motor brake independently, turn this signal OFF.

[Caution]

Turning OFF this signal to the axis where the parameter "#51200 SFSPEC1/bit3" is "1" is ignored.

[Related signals]

- (1) Safe torque off request (*STORM)
- (2) Safe stop 1 request (*SS1Rm)
- (3) In SBC Motor brake enabled (*SBCEm)
- (4) In SBC Motor brake start (SBCSm)

4 Explanation of Interface Signals

Cont.	Signal name	Abbrev.	1st axis	2nd axis	3rd axis	4th axis	5th axis	6th axis	7th axis	8th axis
A	EXTERNAL BRAKE SBT START(CONTROL AXIS)[M8]	SBTSTEXm	ZR274 bit0	ZR274 bit1	ZR274 bit2	ZR274 bit3	ZR274 bit4	ZR274 bit5	ZR274 bit6	ZR274 bit7
			9th axis	10th axis	11th axis	12th axis	13th axis	14th axis	15th axis	16th axis
			ZR274 bit8	ZR274 bit9	ZR274 bit10	ZR274 bit11	ZR274 bit12	ZR274 bit13	ZR274 bit14	ZR274 bit15
			17th axis	18th axis	19th axis	20th axis	21st axis	22nd axis	23rd axis	24th axis
			ZR275 bit0	ZR275 bit1	ZR275 bit2	ZR275 bit3	ZR275 bit4	ZR275 bit5	ZR275 bit6	ZR275 bit7
			25th axis	26th axis	27th axis	28th axis	29th axis	30th axis	31st axis	32nd axis
			ZR275 bit8	ZR275 bit9	ZR275 bit10	ZR275 bit11	ZR275 bit12	ZR275 bit13	ZR275 bit14	ZR275 bit15

Cont.	Signal name	Abbrev.	1st axis	2nd axis	3rd axis	4th axis	5th axis	6th axis	7th axis	8th axis
A	EXTERNAL BRAKE SBT START(CONTROL AXIS)[C80])	SBTSTEXm	ZR146 bit0	ZR146 bit1	ZR146 bit2	ZR146 bit3	ZR146 bit4	ZR146 bit5	ZR146 bit6	ZR146 bit7
			9th axis	10th axis	11th axis	12th axis	13th axis	14th axis	15th axis	16th axis
			ZR146 bit8	ZR146 bit9	ZR146 bit10	ZR146 bit11	ZR146 bit12	ZR146 bit13	ZR146 bit14	ZR146 bit15
			17th axis	18th axis	19th axis	20th axis	21st axis	22nd axis	23rd axis	24th axis
			ZR147 bit0	ZR147 bit1	ZR147 bit2	ZR147 bit3	ZR147 bit4	ZR147 bit5	ZR147 bit6	ZR147 bit7
			25th axis	26th axis	27th axis	28th axis	29th axis	30th axis	31st axis	32nd axis
			ZR147 bit8	ZR147 bit9	ZR147 bit10	ZR147 bit11	ZR147 bit12	ZR147 bit13	ZR147 bit14	ZR147 bit15

[Function]

This signal is for executing the test of external brake that uses Safety Brake Control.

This signal can be used only when the parameter #51010 SBC_Enable is set enabled and #51186 SBTEX_Enable is set enabled.

(This signal is ignored when the parameter #51010 SBC_Enable is set disabled, or #51186 SBTEX_Enable is set disabled.)

[Operation]

When turning ON the NC, and after the elapse of a certain period of time since the last brake test (parameter #51011 SBT_INT), the External brake SBT incomplete signal (SBTNFEXm) turns ON as the warning.

Turn ON SBTSTEXm and execute the brake test, and when the test completes successfully, SBTNFEXm will be OFF.

The test can be temporarily stopped by turning OFF the SBTSTEXm during the test.

After the temporary stop, the test can be resumed by turning ON the SBTSTEXm.

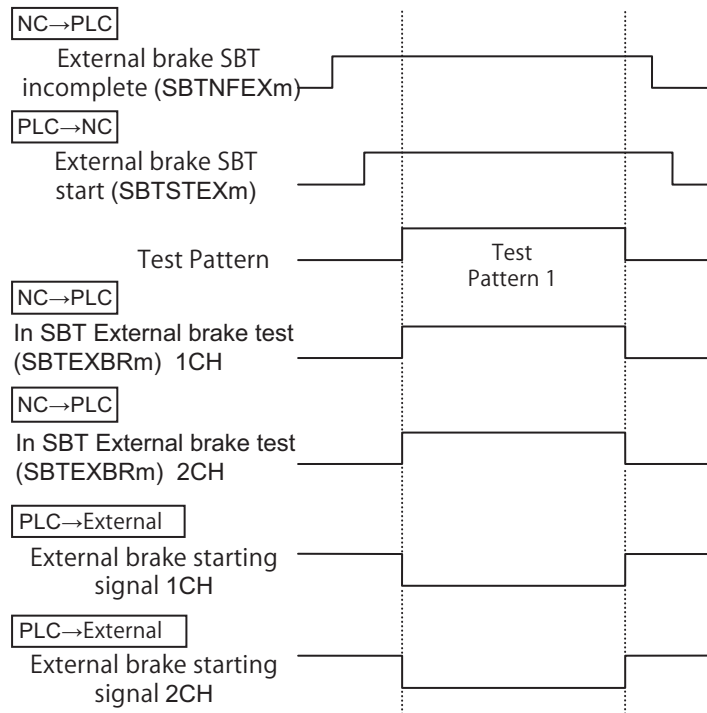
**[Caution]**

When SBTSTEXm is turned ON without meeting the following conditions, the brake test does not start. When this signal is turned ON without meeting the (Condition 1) to (Condition 12), the smart safety monitor alarm (V51 0001) occurs.

(Condition 1) All part systems are not in automatic operation.

(Condition 2) The target axis for the test is in in-position.

(Condition 3) The target axis is in servo ON state.

(Condition 4) The target axis is not in current limit.

(Condition 5) The target axis is not the slave axis in the synchronous control.

(Condition 6) The target axis is not in superimposition control.

(Condition 7) There is no axis which is in arbitrary axis exchange control within the part system to which target axis belongs.

(Condition 8) There is no axis which is in mixed control within the part system to which target axis belongs.

(Condition 9) The parameter "#51191 SBT_ILIM" (SBT current limit value) of the target axis to be tested is not set to "0".

(Condition 10) The parameter "#51193 SBT_FD" (SBT command movement amount) of the target axis to be tested is not set to "0".

(Condition 11) The parameter "#51194 SBT_FDRATE" (SBT command speed) of the target axis to be tested is not set to "0".

(Condition 12) The "Reference position establishment" signal of the target axis to be tested is ON.

(Condition 13) The target axis to be tested is not in the PLC axis mode of the NC axis/PLC axis switchover function.

[Related signals]

(1) External brake SBT Incomplete (SBTNFEXm)

(2) In SBT External brake test (SBTEXBRm)

4 Explanation of Interface Signals

Cont.	Signal name	Abbrev.	1st axis	2nd axis	3rd axis	4th axis	5th axis	6th axis	7th axis	8th axis
A	MOTOR BRAKE SBT START (CONTROL AXIS)[M8]	SBTSTMom	ZR276 bit0	ZR276 bit1	ZR276 bit2	ZR276 bit3	ZR276 bit4	ZR276 bit5	ZR276 bit6	ZR276 bit7
			9th axis	10th axis	11th axis	12th axis	13th axis	14th axis	15th axis	16th axis
			ZR276 bit8	ZR276 bit9	ZR276 bit10	ZR276 bit11	ZR276 bit12	ZR276 bit13	ZR276 bit14	ZR276 bit15
			17th axis	18th axis	19th axis	20th axis	21st axis	22nd axis	23rd axis	24th axis
			ZR277 bit0	ZR277 bit1	ZR277 bit2	ZR277 bit3	ZR277 bit4	ZR277 bit5	ZR277 bit6	ZR277 bit7
			25th axis	26th axis	27th axis	28th axis	29th axis	30th axis	31st axis	32nd axis
			ZR277 bit8	ZR277 bit9	ZR277 bit10	ZR277 bit11	ZR277 bit12	ZR277 bit13	ZR277 bit14	ZR277 bit15

Cont.	Signal name	Abbrev.	1st axis	2nd axis	3rd axis	4th axis	5th axis	6th axis	7th axis	8th axis
A	MOTOR BRAKE SBT START (CONTROL AXIS)[C80]	SBTSTMom	ZR148 bit0	ZR148 bit1	ZR148 bit2	ZR148 bit3	ZR148 bit4	ZR148 bit5	ZR148 bit6	ZR148 bit7
			9th axis	10th axis	11th axis	12th axis	13th axis	14th axis	15th axis	16th axis
			ZR148 bit8	ZR148 bit9	ZR148 bit10	ZR148 bit11	ZR148 bit12	ZR148 bit13	ZR148 bit14	ZR148 bit15
			17th axis	18th axis	19th axis	20th axis	21st axis	22nd axis	23rd axis	24th axis
			ZR149 bit0	ZR149 bit1	ZR149 bit2	ZR149 bit3	ZR149 bit4	ZR149 bit5	ZR149 bit6	ZR149 bit7
			25th axis	26th axis	27th axis	28th axis	29th axis	30th axis	31st axis	32nd axis
			ZR149 bit8	ZR149 bit9	ZR149 bit10	ZR149 bit11	ZR149 bit12	ZR149 bit13	ZR149 bit14	ZR149 bit15

[Function]

This signal is for executing the test of motor brake that uses Safety Brake Control.

This signal can be used only when the parameter #51010 SBC_Enable is set enabled and #51187 SBTMO_Enable is set enabled.

(This signal is ignored when the parameter #51010 SBC_Enable is set disabled, or #51187 SBTMO_Enable is set disabled.)

[Operation]

When turning ON the NC, and after the elapse of a certain period of time since the last brake test (parameter #51011 SBT_INT), the Motor brake SBT incomplete signal (SBTNFMom) turns ON as the warning.

Turn ON SBTSTMom and execute the brake test, and when the test completes successfully, SBTNFMom will be OFF. The test can be temporarily stopped by turning OFF the SBTSTMom during the test.

After the temporary stop, the test can be resumed from the test pattern1 by turning ON the SBTSTMom.

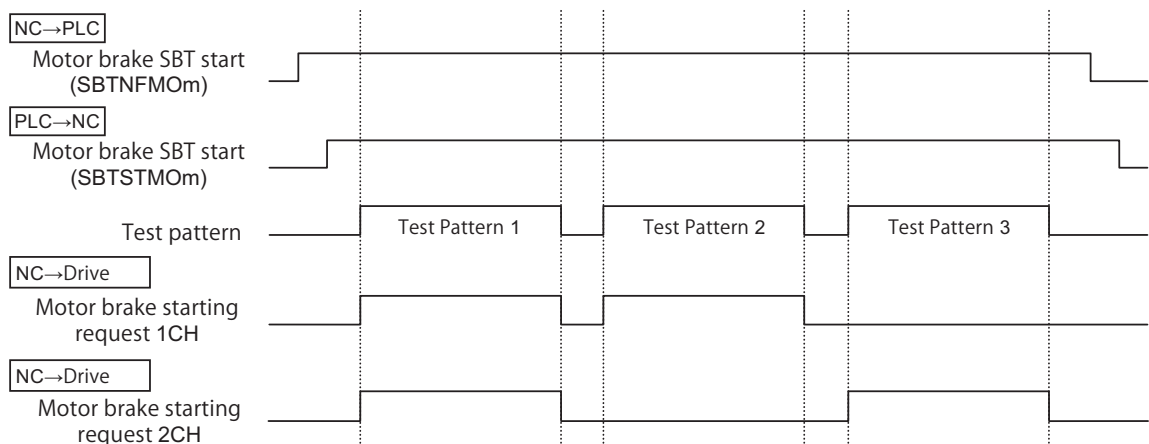

[Caution]

When SBTSTMOm is turned ON without meeting the following conditions, the brake test does not start. When this signal is turned ON without meeting the (Condition 1) to (Condition 12), the smart safety monitor alarm (V51 0001) occurs.

(Condition 1) All part systems are not in automatic operation.

(Condition 2) The target axis for the test is in in-position.

(Condition 3) The target axis is in servo ON state.

(Condition 4) The target axis is not in current limit.

(Condition 5) The target axis is not the slave axis in the synchronous control.

(Condition 6) The target axis is not in superimposition control.

(Condition 7) There is no axis which is in arbitrary axis exchange control within the part system to which target axis belongs.

(Condition 8) There is no axis which is in mixed control within the part system to which target axis belongs.

(Condition 9) The parameter "#51191 SBT_ILIM" (SBT current limit value) of the target axis to be tested is not set to "0".

(Condition 10) The parameter "#51193 SBT_FD" (SBT command movement amount) of the target axis to be tested is not set to "0".

(Condition 11) The parameter "#51194 SBT_FDRATE" (SBT command speed) of the target axis to be tested is not set to "0".

(Condition 12) The "Reference position establishment" signal of the target axis to be tested is ON.

(Condition 13) The target axis to be tested is not in the PLC axis mode of the NC axis/PLC axis switchover function.

[Related signals]

(1) Motor brake SBT incomplete (SBTNFMOm)

4 Explanation of Interface Signals

Cont.	Signal name	Abbrev.	1st axis	2nd axis	3rd axis	4th axis	5th axis	6th axis	7th axis	8th axis
A	SAFETY ABSOLUTE POSITION CONFIRM (CONTROL AXIS)[M8]	SFABSPFXm	ZR278 bit0	ZR278 bit1	ZR278 bit2	ZR278 bit3	ZR278 bit4	ZR278 bit5	ZR278 bit6	ZR278 bit7
			9th axis	10th axis	11th axis	12th axis	13th axis	14th axis	15th axis	16th axis
			ZR278 bit8	ZR278 bit9	ZR278 bit10	ZR278 bit11	ZR278 bit12	ZR278 bit13	ZR278 bit14	ZR278 bit15
			17th axis	18th axis	19th axis	20th axis	21st axis	22nd axis	23rd axis	24th axis
			ZR279 bit0	ZR279 bit1	ZR279 bit2	ZR279 bit3	ZR279 bit4	ZR279 bit5	ZR279 bit6	ZR279 bit7
			25th axis	26th axis	27th axis	28th axis	29th axis	30th axis	31st axis	32nd axis
			ZR279 bit8	ZR279 bit9	ZR279 bit10	ZR279 bit11	ZR279 bit12	ZR279 bit13	ZR279 bit14	ZR279 bit15

Cont.	Signal name	Abbrev.	1st axis	2nd axis	3rd axis	4th axis	5th axis	6th axis	7th axis	8th axis
A	SAFETY ABSOLUTE POSITION CONFIRM (CONTROL AXIS)[C80]	SFABSPFXm	ZR150 bit0	ZR150 bit1	ZR150 bit2	ZR150 bit3	ZR150 bit4	ZR150 bit5	ZR150 bit6	ZR150 bit7
			9th axis	10th axis	11th axis	12th axis	13th axis	14th axis	15th axis	16th axis
			ZR150 bit8	ZR150 bit9	ZR150 bit10	ZR150 bit11	ZR150 bit12	ZR150 bit13	ZR150 bit14	ZR150 bit15
			17th axis	18th axis	19th axis	20th axis	21st axis	22nd axis	23rd axis	24th axis
			ZR151 bit0	ZR151 bit1	ZR151 bit2	ZR151 bit3	ZR151 bit4	ZR151 bit5	ZR151 bit6	ZR151 bit7
			25th axis	26th axis	27th axis	28th axis	29th axis	30th axis	31st axis	32nd axis
			ZR151 bit8	ZR151 bit9	ZR151 bit10	ZR151 bit11	ZR151 bit12	ZR151 bit13	ZR151 bit14	ZR151 bit15

[Function]

This signal is used to cancel the alarm "Safe absol. posn unestablished" and establish the safety absolute position in SLP/SCA encoder diagnosis during power OFF.

[Operation]

When the "Safe absol. posn unestablished" alarm is occurring, turning ON this signal will cancel the alarm and bring it to the safety absolute position established state (the In safety position establishing signal is ON.).

By establishing the safety absolute position, the observation with SLP and the signal output with SCA is possible.

(SLP/SCA will not operate while "Safe absol. posn unestablished" alarm is occurring.)

[Caution]

This alarm is to show that users checked the correctness of the absolute position. Before turning ON this signal, move the axis by manual operation to the position where the coordinate value is clear (the position that is marked or the reference position etc.)

(When in the relative position detection system, operate the reference position return.) then compare the actual position and the displayed position to confirm the both position is corresponding.

[Related signals]

(1) In safety absolute position establishing (Control axis) (SFABSPESTm)

4 Explanation of Interface Signals

Cont.	Signal name	Abbrev.	1st axis	2nd axis	3rd axis	4th axis	5th axis	6th axis	7th axis	8th axis
A	SAFETY RESET (CONTROL AXIS)[M8]	SRSTm	ZR280 bit0	ZR280 bit1	ZR280 bit2	ZR280 bit3	ZR280 bit4	ZR280 bit5	ZR280 bit6	ZR280 bit7
			9th axis	10th axis	11th axis	12th axis	13th axis	14th axis	15th axis	16th axis
			ZR280 bit8	ZR280 bit9	ZR280 bit10	ZR280 bit11	ZR280 bit12	ZR280 bit13	ZR280 bit14	ZR280 bit15
			17th axis	18th axis	19th axis	20th axis	21st axis	22nd axis	23rd axis	24th axis
			ZR281 bit0	ZR281 bit1	ZR281 bit2	ZR281 bit3	ZR281 bit4	ZR281 bit5	ZR281 bit6	ZR281 bit7
			25th axis	26th axis	27th axis	28th axis	29th axis	30th axis	31st axis	32nd axis
			ZR281 bit8	ZR281 bit9	ZR281 bit10	ZR281 bit11	ZR281 bit12	ZR281 bit13	ZR281 bit14	ZR281 bit15

Cont.	Signal name	Abbrev.	1st axis	2nd axis	3rd axis	4th axis	5th axis	6th axis	7th axis	8th axis
A	SAFETY RESET (CONTROL AXIS)[C80]	SRSTm	ZR152 bit0	ZR152 bit1	ZR152 bit2	ZR152 bit3	ZR152 bit4	ZR152 bit5	ZR152 bit6	ZR152 bit7
			9th axis	10th axis	11th axis	12th axis	13th axis	14th axis	15th axis	16th axis
			ZR152 bit8	ZR152 bit9	ZR152 bit10	ZR152 bit11	ZR152 bit12	ZR152 bit13	ZR152 bit14	ZR152 bit15
			17th axis	18th axis	19th axis	20th axis	21st axis	22nd axis	23rd axis	24th axis
			ZR153 bit0	ZR153 bit1	ZR153 bit2	ZR153 bit3	ZR153 bit4	ZR153 bit5	ZR153 bit6	ZR153 bit7
			25th axis	26th axis	27th axis	28th axis	29th axis	30th axis	31st axis	32nd axis
			ZR153 bit8	ZR153 bit9	ZR153 bit10	ZR153 bit11	ZR153 bit12	ZR153 bit13	ZR153 bit14	ZR153 bit15

[Function]

This signal is used to reset the alarm for the control axis's safety function.

When the alarm for the safety function is not occurring, this signal is ignored.

[Operation]

By turning ON this signal, the NC carries out the following.

- (1) Check whether the occurring alarm for safety function is in the state that is possible to cancel*.

* The alarm is possible to cancel in any of the following status.

- When the function corresponding to the occurring alarm (SLS/SLP/SOS/SS1/SS2) are enabled, the function enabled is determined to be in safety status. (In Safely-limited speed/ In Safely-limited position/ In Safe operating stop/ In Safe stop 1 are ON. (The safety status of SS2 is determined by In Safe operating stop.))
- The function corresponding to the occurring alarm is (SLS/SLP/SOS/SS1/SS2) is disabled. (The request signal is OFF.)

- (2) Cancel the alarm after the check proves the alarm status is possible to cancel.

- (3) Turn back the drive power ON.

[Caution]

When the safety functions alarm, including the parameter error, are not in state that to be canceled, (In Safely-limited speed/ In Safely-limited position/ In Safe operating stop/ In Safe stop 1 are OFF in enabled SLS, SLP, SOS, SS1, and SS2), the alarm will not be canceled even when this signal is turned ON. (This signal will be ignored.)

4 Explanation of Interface Signals

Cont.	Signal name	Abbrev.	1st axis	2nd axis	3rd axis	4th axis	5th axis	6th axis	7th axis	8th axis
A	SLS SPEED CHANGE INPUT (CONTROL AXIS)[M8]	SLSMImn	ZR312	ZR313	ZR314	ZR315	ZR316	ZR317	ZR318	ZR319
			9th axis	10th axis	11th axis	12th axis	13th axis	14th axis	15th axis	16th axis
			ZR320	ZR321	ZR322	ZR323	ZR324	ZR325	ZR326	ZR327
			17th axis	18th axis	19th axis	20th axis	21st axis	22nd axis	23rd axis	24th axis
			ZR328	ZR329	ZR330	ZR331	ZR332	ZR333	ZR334	ZR335
			25th axis	26th axis	27th axis	28th axis	29th axis	30th axis	31st axis	32nd axis
			ZR336	ZR337	ZR338	ZR339	ZR340	ZR341	ZR342	ZR343

Cont.	Signal name	Abbrev.	1st axis	2nd axis	3rd axis	4th axis	5th axis	6th axis	7th axis	8th axis
A	SLS SPEED CHANGE INPUT (CONTROL AXIS)[C80]	SLSMImn	ZR184	ZR185	ZR186	ZR187	ZR188	ZR189	ZR190	ZR191
			9th axis	10th axis	11th axis	12th axis	13th axis	14th axis	15th axis	16th axis
			ZR192	ZR193	ZR194	ZR195	ZR196	ZR197	ZR198	ZR199
			17th axis	18th axis	19th axis	20th axis	21st axis	22nd axis	23rd axis	24th axis
			ZR200	ZR201	ZR202	ZR203	ZR204	ZR205	ZR206	ZR207
			25th axis	26th axis	27th axis	28th axis	29th axis	30th axis	31st axis	32nd axis
			ZR208	ZR209	ZR210	ZR211	ZR212	ZR213	ZR214	ZR215

[Function]

This signal specifies the SLS speed tolerance to be used for the SLS observation function.
This signal is available when SLS is enabled by the parameter (#51002 SLS_Enable).
(This signal is ignored when SLS is disabled by #51002 SLS_Enable.)

SLS speed input selection method

SLS speed change input		No. of step to be selected	Corresponding SLS speed tolerance parameter
Bit1	Bit0		
0	0	1	#51103 SLS_Speed1
0	1	2	#51104 SLS_Speed2
1	0	3	#51105 SLS_Speed3
1	1	4	#51106 SLS_Speed4

[Operation]

When this signal is changed, SLS speed change output (SLSMOmn) is also changed.
(SLSMOmn is changed even though SLS observation request (*SLSRm) is ON (when SLS is not requested).)

[Related signals]

- (1) SLS speed change output (SLSMOmn)
- (2) SLS speed override input (SLSOVRImn)
- (3) SLS speed override output (SLSOVROmn)
- (4) SLS observation request (*SLSRm)
- (5) SLS observation is active (SLSEm)
- (6) Under SLS limit (SLSSm)

4 Explanation of Interface Signals

Cont.	Signal name	Abbrev.	1st axis	2nd axis	3rd axis	4th axis	5th axis	6th axis	7th axis	8th axis
A	SLS SPEED OVERRIDE INPUT (CONTROL AXIS)[M8]	SLSOVRI _{mn}	ZR312	ZR313	ZR314	ZR315	ZR316	ZR317	ZR318	ZR319
			9th axis	10th axis	11th axis	12th axis	13th axis	14th axis	15th axis	16th axis
			ZR320	ZR321	ZR322	ZR323	ZR324	ZR325	ZR326	ZR327
			17th axis	18th axis	19th axis	20th axis	21st axis	22nd axis	23rd axis	24th axis
			ZR328	ZR329	ZR330	ZR331	ZR332	ZR333	ZR334	ZR335
			25th axis	26th axis	27th axis	28th axis	29th axis	30th axis	31st axis	32nd axis
			ZR336	ZR337	ZR338	ZR339	ZR340	ZR341	ZR342	ZR343

Cont.	Signal name	Abbrev.	1st axis	2nd axis	3rd axis	4th axis	5th axis	6th axis	7th axis	8th axis
A	SLS SPEED OVERRIDE INPUT (CONTROL AXIS)[C80]	SLSOVRI _{mn}	ZR184	ZR185	ZR186	ZR187	ZR188	ZR189	ZR190	ZR191
			9th axis	10th axis	11th axis	12th axis	13th axis	14th axis	15th axis	16th axis
			ZR192	ZR193	ZR194	ZR195	ZR196	ZR197	ZR198	ZR199
			17th axis	18th axis	19th axis	20th axis	21st axis	22nd axis	23rd axis	24th axis
			ZR200	ZR201	ZR202	ZR203	ZR204	ZR205	ZR206	ZR207
			25th axis	26th axis	27th axis	28th axis	29th axis	30th axis	31st axis	32nd axis
			ZR208	ZR209	ZR210	ZR211	ZR212	ZR213	ZR214	ZR215

[Function]

This signal specifies the SLS speed override to be used for the SLS observation function.

This signal is available when SLS is enabled by the parameter (#51002 SLS_Enable).

(This signal is ignored when SLS is disabled by #51002 SLS_Enable.)

SLS speed override selection method

SLS speed override input				No. of step to be selected	Corresponding SLS speed override parameter
Bit7	Bit6	Bit5	Bit4		
0	0	0	0	1	#51107 SLS_Override1
0	0	0	1	2	#51108 SLS_Override2
0	0	1	0	3	#51109 SLS_Override3
0	0	1	1	4	#51110 SLS_Override4
0	1	0	0	5	#51111 SLS_Override5
0	1	0	1	6	#51112 SLS_Override6
0	1	1	0	7	#51113 SLS_Override7
0	1	1	1	8	#51114 SLS_Override8
1	0	0	0	9	#51115 SLS_Override9
1	0	0	1	10	#51116 SLS_Override10
1	0	1	0	11	#51117 SLS_Override11
1	0	1	1	12	#51118 SLS_Override12
1	1	0	0	13	#51119 SLS_Override13
1	1	0	1	14	#51120 SLS_Override14
1	1	1	0	15	#51121 SLS_Override15
1	1	1	1	16	#51122 SLS_Override16

[Operation]

When this signal is changed, SLS speed override output (SLSOVRO_{mn}) is also changed.

(SLSOVRO_{mn} is changed even though SLS observation request (*SLSR_m) is ON (when SLS is not requested).)

[Related signals]

- (1) SLS speed change input (SLSMI_{mn})
- (2) SLS speed change output (SLSMO_{mn})
- (3) SLS speed override output (SLSOVRO_{mn})
- (4) SLS observation request (*SLSR_m)
- (5) SLS observation is active (SLSE_m)
- (6) Under SLS limit (SLSS_m)

4 Explanation of Interface Signals

Cont.	Signal name	Abbrev.	1st axis	2nd axis	3rd axis	4th axis	5th axis	6th axis	7th axis	8th axis
A	SLP POSITION CHANGE INPUT (CONTROL AXIS)[M8]	SLPMImn	ZR344	ZR345	ZR346	ZR347	ZR348	ZR349	ZR350	ZR351
			9th axis	10th axis	11th axis	12th axis	13th axis	14th axis	15th axis	16th axis
			ZR352	ZR353	ZR354	ZR355	ZR356	ZR357	ZR358	ZR359
			17th axis	18th axis	19th axis	20th axis	21st axis	22nd axis	23rd axis	24th axis
			ZR360	ZR361	ZR362	ZR363	ZR364	ZR365	ZR366	ZR367
			25th axis	26th axis	27th axis	28th axis	29th axis	30th axis	31st axis	32nd axis
			ZR368	ZR369	ZR370	ZR371	ZR372	ZR373	ZR374	ZR375

Cont.	Signal name	Abbrev.	1st axis	2nd axis	3rd axis	4th axis	5th axis	6th axis	7th axis	8th axis
A	SLP POSITION CHANGE INPUT (CONTROL AXIS)[C80]	SLPMImn	ZR216	ZR217	ZR218	ZR219	ZR220	ZR221	ZR222	ZR223
			9th axis	10th axis	11th axis	12th axis	13th axis	14th axis	15th axis	16th axis
			ZR224	ZR225	ZR226	ZR227	ZR228	ZR229	ZR230	ZR231
			17th axis	18th axis	19th axis	20th axis	21st axis	22nd axis	23rd axis	24th axis
			ZR232	ZR233	ZR234	ZR235	ZR236	ZR237	ZR238	ZR239
			25th axis	26th axis	27th axis	28th axis	29th axis	30th axis	31st axis	32nd axis
			ZR240	ZR241	ZR242	ZR243	ZR244	ZR245	ZR246	ZR247

[Function]

This signal specifies the SLP position tolerance to be used for the SLP observation function.

This signal is available when SLP is enabled by the parameter (#51003 SLP_Enable).

(This signal is ignored when SLP is disabled by #51003 SLP_Enable.)

SLP position input selection method

SLP position change input		No. of step to be selected	Corresponding SLP position tolerance parameter
Bit1	Bit0		
0	0	1	#51126/51127 SLP_Position(P/M)1
0	1	2	#51128/51129 SLP_Position(P/M)2
1	0	3	#51130/51131 SLP_Position(P/M)3
1	1	4	#51132/51133 SLP_Position(P/M)4

[Operation]

When this signal is changed, SLP position change output (SLPMOmn) is also changed.

(SLPMOmn is changed even though SLP observation request (*SLPRm) is ON (when SLP is not requested).)

[Related signals]

- (1) SLP position change output (SLPMOmn)
- (2) SLP observation request (*SLPRm)
- (3) SLP observation is active (SLPEm)
- (4) In SLP range (SLPSm)

4 Explanation of Interface Signals

Cont.	Signal name	Abbrev.	1st SP	2nd SP	3rd SP	4th SP	5th SP	6th SP	7th SP	8th SP
B	SLS OBSERVATION REQUEST (SPINDLE)[M8]	*SLSSRm	ZR440 bit0	ZR440 bit1	ZR440 bit2	ZR440 bit3	ZR440 bit4	ZR440 bit5	ZR440 bit6	ZR440 bit7

Cont.	Signal name	Abbrev.	1st SP	2nd SP	3rd SP	4th SP	5th SP	6th SP	7th SP	8th SP
B	SLS OBSERVATION REQUEST (SPINDLE)[C80]	*SLSSRm	ZR312 bit0	ZR312 bit1	ZR312 bit2	ZR312 bit3	ZR312 bit4	ZR312 bit5	ZR312 bit6	ZR312 bit7

[Function]

This signal starts execution of the SLS observation function on the spindle.

This signal is available when SLS is enabled by the parameter (#51002 SLS_Enable).

(This signal is ignored when SLS is disabled by #51002 SLS_Enable.)

[Operation]

When the SLS observation request signal is turned OFF (when SLS is requested), the NC carries out the following:

- (1) Checks the SLS parameters to be used.
- (2) Executes the NC's SLS observation function, and turns ON SLS observation is active (SLSSEm).
- (3) Turns ON the Under SLS limit (SLSSSm) signal when the spindle is confirmed to have decelerated to the safely-limited speed or lower.

[Related signals]

- (1) SLS speed change input (SLSSMImn)
- (2) SLS speed change output (SLSSMOmn)
- (3) SLS speed override input (SLSSOVImn)
- (4) SLS speed override output (SLSSOVROmn)
- (5) SLS observation is active (SLSSEm)
- (6) Under SLS limit (SLSSSm)

Cont.	Signal name	Abbrev.	1st SP	2nd SP	3rd SP	4th SP	5th SP	6th SP	7th SP	8th SP
B	SSM REQUEST (SPINDLE)[M8]	*SSMSRm	ZR442 bit0	ZR442 bit1	ZR442 bit2	ZR442 bit3	ZR442 bit4	ZR442 bit5	ZR442 bit6	ZR442 bit7

Cont.	Signal name	Abbrev.	1st SP	2nd SP	3rd SP	4th SP	5th SP	6th SP	7th SP	8th SP
B	SSM REQUEST (SPINDLE)[C80]	*SSMSRm	ZR314 bit0	ZR314 bit1	ZR314 bit2	ZR314 bit3	ZR314 bit4	ZR314 bit5	ZR314 bit6	ZR314 bit7

[Function]

This signal is used to start execution of the Safe speed monitor function on the control axis.

This signal is available when SSM is enabled by the parameter (#51004 SSM_Enable).

(This signal is ignored when SSM is disabled by #51004 SSM_Enable.)

[Operation]

When SSM request is turned OFF (When SSM is requested), the NC carries out the following:

- (1) Checks the SSM parameters to be used.
- (2) Execute the NC's Safe speed monitor function, and turns ON the SSM is active (SSMSEm) signal.
- (3) Turns ON the Under SSM safe speed 1 to 4 (SSMSSmn) signal when the spindle is confirmed to be at the safe speed or below.

[Related signals]

- (1) SSM is active (SSMSEm)
- (2) Under SSM safe speed (SSMSSmn)

4 Explanation of Interface Signals

Cont.	Signal name	Abbrev.	1st SP	2nd SP	3rd SP	4th SP	5th SP	6th SP	7th SP	8th SP
B	SOS OBSERVATION REQUEST (SPINDLE)[M8]	*SOSSRm	ZR444 bit0	ZR444 bit1	ZR444 bit2	ZR444 bit3	ZR444 bit4	ZR444 bit5	ZR444 bit6	ZR444 bit7

Cont.	Signal name	Abbrev.	1st SP	2nd SP	3rd SP	4th SP	5th SP	6th SP	7th SP	8th SP
B	SOS OBSERVATION REQUEST (SPINDLE)[C80]	*SOSSRm	ZR316 bit0	ZR316 bit1	ZR316 bit2	ZR316 bit3	ZR316 bit4	ZR316 bit5	ZR316 bit6	ZR316 bit7

[Function]

This signal is used to start execution of the SOS observation function on the spindle.

This signal is available when the parameter (#51006 SOS_Enable) is set to 1 (Enable).

(If #51006 SOS_Enable is 0 (Disable), this signal is ignored.)

[Operation]

When SOS observation request is turned OFF (When SOS is requested), the NC carries out the following:

- (1) Checks the SOS parameters to be used.
- (2) Executes the NC's Safe operating stop function and turns ON the SOS is active (SOSSEm) signal.
- (3) Turns ON In SOS stop (SOSSSm) when the safe standstill state of the spindle is confirmed.

[Related signals]

- (1) SOS is active (SOSSEm)
- (2) In SOS stop (SOSSSm)

Cont.	Signal name	Abbrev.	1st SP	2nd SP	3rd SP	4th SP	5th SP	6th SP	7th SP	8th SP
B	SAFE STOP 1 REQUEST (SPINDLE)[M8]	*SS1SRm	ZR445 bit0	ZR445 bit1	ZR445 bit2	ZR445 bit3	ZR445 bit4	ZR445 bit5	ZR445 bit6	ZR445 bit7

Cont.	Signal name	Abbrev.	1st SP	2nd SP	3rd SP	4th SP	5th SP	6th SP	7th SP	8th SP
B	SAFE STOP 1 REQUEST (SPINDLE)[C80]	*SS1SRm	ZR317 bit0	ZR317 bit1	ZR317 bit2	ZR317 bit3	ZR317 bit4	ZR317 bit5	ZR317 bit6	ZR317 bit7

[Function]

This signal is used to start execution of Safe stop 1 on the spindle.

This signal is available when the parameter (#51007 SS1_Enable) is set to 1 (Enable).

(If #51007 SS1_Enable is 0 (Disable), this signal is ignored.)

[Operation]

When the Safe stop 1 request signal is turned OFF (When SS1 is requested), the NC carries out the following:

- (1) Checks the SS1 parameters to be used.
- (2) Executes the NC's Safe stop 1 function, and turns ON the SS1 is active (SS1SEm) signal.
- (3) Turns ON the In SS1 stop (SS1SSm) signal when the spindle deceleration is confirmed.

[Related signals]

- (1) SS1 is active (SS1SEm)
- (2) In SS1 stop (SS1SSm)

4 Explanation of Interface Signals

Cont.	Signal name	Abbrev.	1st SP	2nd SP	3rd SP	4th SP	5th SP	6th SP	7th SP	8th SP
B	SAFE STOP 2 REQUEST (SPINDLE)[M8]	*SS2SRm	ZR446 bit0	ZR446 bit1	ZR446 bit2	ZR446 bit3	ZR446 bit4	ZR446 bit5	ZR446 bit6	ZR446 bit7

Cont.	Signal name	Abbrev.	1st SP	2nd SP	3rd SP	4th SP	5th SP	6th SP	7th SP	8th SP
B	SAFE STOP 2 REQUEST (SPINDLE)[C80]	*SS2SRm	ZR318 bit0	ZR318 bit1	ZR318 bit2	ZR318 bit3	ZR318 bit4	ZR318 bit5	ZR318 bit6	ZR318 bit7

[Function]

This signal is used to start execution of Safe stop 2 on the spindle.

This signal is available when SS2 is enabled by the parameter (#51008 SS2_Enable).

(This signal is ignored when SS2 is disabled by #51008 SS2_Enabl.)

[Operation]

When Safe stop 2 request is turned OFF (When SS2 is requested), the NC carries out the following:

- (1) Checks the SS2 parameters to be used.
- (2) Executes Safe stop 2, and turns ON the SS2 is active (SS2SEm) signal.
- (3) Executes Safe operating stop (SOS) when the spindle deceleration is confirmed.

[Related signals]

- (1) SS2 is active (SS2SEm)

Cont.	Signal name	Abbrev.	1st SP	2nd SP	3rd SP	4th SP	5th SP	6th SP	7th SP	8th SP
B	SAFE TORQUE OFF REQUEST (SPINDLE)[M8]	*STOSRm	ZR447 bit0	ZR447 bit1	ZR447 bit2	ZR447 bit3	ZR447 bit4	ZR447 bit5	ZR447 bit6	ZR447 bit7

Cont.	Signal name	Abbrev.	1st SP	2nd SP	3rd SP	4th SP	5th SP	6th SP	7th SP	8th SP
B	SAFE TORQUE OFF REQUEST (SPINDLE)[C80]	*STOSRm	ZR319 bit0	ZR319 bit1	ZR319 bit2	ZR319 bit3	ZR319 bit4	ZR319 bit5	ZR319 bit6	ZR319 bit7

[Function]

This signal is used to start execution of the Safe torque off function on the spindle.

This signal is available when STO is enabled by the parameter (#51009 STO_Enable).

(This signal is ignored when STO is disabled by #51009 STO_Enable.)

[Operation]

When the Safe torque off request signal is turned OFF (When STO is requested), the NC carries out the following:

- (1) Checks the STO parameters to be used.
- (2) Executes the NC's Safe torque off function, and turns ON the STO is active (STOSEm) signal.
- (3) Turns ON the In Safe torque off (STOSSm) signal when the main drive power to the spindle has been shut OFF.

[Related signals]

- (1) STO is active (STOSEm)
- (2) In Safe torque off (STOSSm)

4 Explanation of Interface Signals

Cont.	Signal name	Abbrev.	1st SP	2nd SP	3rd SP	4th SP	5th SP	6th SP	7th SP	8th SP
A	SAFE RESET (SPINDLE)[M8]	SRSTSm	ZR452 bit0	ZZR452 bit1	ZR452 bit2	ZR452 bit3	ZR452 bit4	ZR452 bit5	ZR452 bit6	ZR452 bit7

Cont.	Signal name	Abbrev.	1st SP	2nd SP	3rd SP	4th SP	5th SP	6th SP	7th SP	8th SP
A	SAFE RESET (SPINDLE)[C80]	SRSTSm	ZR324 bit0	ZZR324 bit1	ZR324 bit2	ZR324 bit3	ZR324 bit4	ZR324 bit5	ZR324 bit6	ZR324 bit7

[Function]

This signal is used to reset the safety function's alarm. When the safety function's alarm is not occurring, this signal is ignored.

[Operation]

By turning ON this signal, NC carries out the following:

(1) Check whether the occurring alarm for safety function is in the state that is possible to cancel*.

* The alarm is possible to cancel in any of the following status.

- When the function corresponding to the occurring alarm (SLS/SOS/SS1/SS2) are enabled, the function enabled is determined to be in safety status. (In Safely-limited speed/ In Safe operating stop/ In Safe stop 1 are ON. (The safety status of SS2 is determined by Safe operating stop.))

- The function corresponding to the occurring alarm is (SLS/SLP/SOS/SS1/SS2) is disabled. (The request signal is OFF.)

(2) Cancel the alarm after the check proves the alarm status is possible to cancel.

(3) Turn back the drive power ON.

[Caution]

When the safety functions alarm, including the parameter error, are not in state that to be canceled, (In Safely-limited speed, In Safe operating stop, and In Safe stop 1 are OFF in enabled SLS, SOS, SS1, and SS2), the alarm will not be canceled even when this signal is turned ON. (This signal will be ignored.)

Cont.	Signal name	Abbrev.	1st SP	2nd SP	3rd SP	4th SP	5th SP	6th SP	7th SP	8th SP
A	SLS SPEED CHANGE INPUT(SPINDLE)[M8]	SLSSMImn	ZR468	ZR469	ZR470	ZR471	ZR472	ZR473	ZR474	ZR475

Cont.	Signal name	Abbrev.	1st SP	2nd SP	3rd SP	4th SP	5th SP	6th SP	7th SP	8th SP
A	SLS SPEED CHANGE INPUT(SPINDLE)[C80]	SLSSMImn	ZR340	ZR341	ZR342	ZR343	ZR344	ZR345	ZR346	ZR347

[Function]

This signal specifies the SLS speed tolerance to be used for the SLS observation function.

This signal is available when SLS is enabled by the parameter (#51002 SLS_Enable).

(This signal is ignored when SLS is disabled by #51002 SLS_Enable.)

SLS speed input selection method

SLS speed change input		No. of step to be selected	Corresponding SLS speed tolerance parameter
Bit1	Bit0		
0	0	1	#51303 SLS_SSpeed1
0	1	2	#51304 SLS_SSpeed2
1	0	3	#51305 SLS_SSpeed3
1	1	4	#51306 SLS_SSpeed4

[Operation]

When this signal is changed, SLS speed change output (SLSSMOmn) is also changed.

(SLSSMOmn is changed even though SLS observation request (*SLSSRm) is ON (when SLS is not requested).)

4 Explanation of Interface Signals

[Related signals]

- (1) SLS speed change output (SLSSMOmn)
- (2) SLS speed override input (SLSSOVRImn)
- (3) SLS speed override output (SLSSOVROmn)
- (4) SLS observation request (*SLSSRm)
- (5) SLS observation is active (SLSSEm)
- (6) Under SLS limit (SLSSSm)

Cont.	Signal name	Abbrev.	1st SP	2nd SP	3rd SP	4th SP	5th SP	6th SP	7th SP	8th SP
A	SLS SPEED OVERRIDE INPUT(SPINDLE)[M8]	SLSS-OVRImn	ZR468	ZR469	ZR470	ZR471	ZR472	ZR473	ZR474	ZR475

Cont.	Signal name	Abbrev.	1st SP	2nd SP	3rd SP	4th SP	5th SP	6th SP	7th SP	8th SP
A	SLS SPEED OVERRIDE INPUT(SPINDLE)[C80]	SLSS-OVRImn	ZR340	ZR341	ZR342	ZR343	ZR344	ZR345	ZR346	ZR347

[Function]

- This signal specifies the SLS speed override to be used for the SLS observation function.
 This signal is available when SLS is enabled by the parameter (#51002 SLS_Enable).
 (This signal is ignored when SLS is disabled by #51002 SLS_Enable.)

SLS speed override selection method

SLS speed override input				No. of step to be selected	Corresponding SLS speed override parameter
Bit7	Bit6	Bit5	Bit4		
0	0	0	0	1	#51307 SLS_SOOverride1
0	0	0	1	2	#51308 SLS_SOOverride2
0	0	1	0	3	#51309 SLS_SOOverride3
0	0	1	1	4	#51310 SLS_SOOverride4
0	1	0	0	5	#51311 SLS_SOOverride5
0	1	0	1	6	#51312 SLS_SOOverride6
0	1	1	0	7	#51313 SLS_SOOverride7
0	1	1	1	8	#51314 SLS_SOOverride8
1	0	0	0	9	#51315 SLS_SOOverride9
1	0	0	1	10	#51316 SLS_SOOverride10
1	0	1	0	11	#51317 SLS_SOOverride11
1	0	1	1	12	#51318 SLS_SOOverride12
1	1	0	0	13	#51319 SLS_SOOverride13
1	1	0	1	14	#51320 SLS_SOOverride14
1	1	1	0	15	#51321 SLS_SOOverride15
1	1	1	1	16	#51322 SLS_SOOverride16

[Operation]

- When this signal is changed, SLS speed override output (SLSSOVROmn) is also changed.
 (SLSSOVROmn is changed even though SLS observation request (*SLSSRm) is ON (when SLS is not requested).)

[Related signals]

- (1) SLS speed change input (SLSSMIImn)
- (2) SLS speed change output (SLSSMOmn)
- (3) SLS speed override output (SLSSOVROmn)
- (4) SLS observation request (*SLSSRm)
- (5) SLS observation is active (SLSSEm)
- (6) Under SLS limit (SLSSSm)

4 Explanation of Interface Signals

Cont.	Signal name	Abbrev.	Common(\$)
A	SPECIAL SAFETY ALARM CANCEL (SYSTEM COMMON) [M8]	SARLS	ZR532 bit0

Cont.	Signal name	Abbrev.	Common(\$)
A	SPECIAL SAFETY ALARM CANCEL (SYSTEM COMMON) [C80]	SARLS	ZR404 bit0

[Function]

This signal is used to turn the cancel prevention alarm into the cancel possible mode. The cancel prevention alarm occurs in the Smart safety observation diagnosis function.

[Operation]

When the cancel prevention alarm is occurring, NC can be in special safety alarm cancel mode by turning ON this signal. With this alarm ON, turn OFF -> ON -> OFF the Alarm reset signal (SRSTm/SRSTSm) for the alarm cancel target axis, the cancel prevention alarm and be canceled.

[Caution]

The cancel operation of the cancel prevention alarm should be carried out after solving the cause of the alarm occurrence (replacing the encoder/ replacing the motor etc.)

[Related signals]

- (1) Safety reset (Control axis) (SRSTm)
- (2) Safety reset (Spindle) (SRSTSm)

Cont.	Signal name	Abbrev.	Common(\$)
A	OUTPUT OFF CHECK REQUEST[M8]	SIOFFCHK	ZR1280 bit0

[Function]

This signal enables the output OFF check function. This function can also be enabled while the "Output OFF check not complete" signal (SIOERRSTS/bit2) is OFF.

[Operation]

When this signal is turned ON (set to 1), the NC carries out the following:

- (1) Turns OFF all the output signals of the dual signal unit.
- (2) Confirms that the feedback input signals of the output signals turn OFF within a certain period of time.
- (3) Returns the output statuses to the original.

4 Explanation of Interface Signals

Cont.	Signal name	Abbrev.	Common(\$)
A	SAFETY I/O OBSERVATION REQUEST [C80]	SIORREQ	ZR416

[Function] [Operation]

Bit	Description	Bit	Description
bit0	Output off check request	bit8	Reserved
bit1	Safety related I/O observation start request	bit9	Reserved
bit2	Reserved	bit10	Reserved
bit3	Reserved	bit11	Reserved
bit4	Reserved	bit12	Reserved
bit5	Reserved	bit13	Reserved
bit6	Reserved	bit14	Reserved
bit7	Reserved	bit15	Reserved

bit0: Output off check request

This signal enables the output OFF check function. This function can also be enabled while the Output OFF check not complete signal (ZR2400/bit2) is OFF.

When this signal is turned ON (set to 1), the NC carries out the followings:

- (1) Turns ON the output off check not complete signal and turns OFF all the output signals of the dual signal unit.
- (2) Confirms that the feedback input signals of the output signals turn OFF within a certain period of time.
- (3) Turns OFF the output off check not complete signal and returns the output statuses to the original.

bit1: Safety related I/O observation start request

This signal starts the safety related I/O observation.

This signal can be used only when the parameter "#51595 SIO_StartCond" is set to "1".

(If the parameter "#51595 SIO_StartCond" is set to "0", the safety related I/O observation is started automatically when the controller is turned ON whether this signal is turned ON or OFF.)

When the parameter "#51595 SIO_StartCond" is set to "1" (*1), after the power supplies to the safety I/O device (*2), the safety related I/O observation (observation of the output OFF check and signal mismatch) is started by turning ON this signal.

*1 If the power cannot supply to the safety I/O device when the controller is turned ON, the start of the safety related I/O observation can be suppressed by setting the parameter "#51595 SIO_StartCond" to "1".

While the safety related I/O observation is suppressed, the state is as follows:

- Output off check not complete signal is turned ON
- Controller ready completion (MA) signal is turned ON
- Emergency stop MCT occurs

When the safety related I/O observation is started by turning ON this signal and the output off check is completed (normally finished), these states are canceled (output off check not complete signal OFF, controller ready completion (MA) ON and emergency stop MCT canceled).

*2 Do not turn ON this signal before the power supplies to the safety I/O device. The safety related I/O observation cannot be performed properly.

[Related signals]

- (1) Output OFF check not complete (ZR2400/bit2)

4 Explanation of Interface Signals

Cont.	Signal name	Abbrev.	Common(\$)
A	SAFETY COMMUNICATION SEND DATA [C80]	SCNSNDDAT	ZR736,7

[Function]

The safety data to send to the master station.

[Operation]

This data is sent to the master station, and it will be stored in the safety device (32 bits).

The safety device to store the data is configured by the parameter on the master station side (receive data storage device).

Cont.	Signal name	Abbrev.	Common(\$)
A	SAFETY COMMUNICATION COMMAND [C80]	SCNCMD	ZR744

[Function][Operation]

Bit	Description	Bit	Description
bit0	Safety station interlock cancel request	bit8	Reserved
bit1	Error clear request	bit9	Reserved
bit2	Reserved	bit10	Reserved
bit3	Reserved	bit11	Reserved
bit4	Reserved	bit12	Reserved
bit5	Reserved	bit13	Reserved
bit6	Reserved	bit14	Reserved
bit7	Reserved	bit15	Reserved

bit0: Safety station interlock cancel request

After the communication error which caused interlock is canceled, interlock state is canceled by turning ON this signal.

bit1: Error clear request

This signal cancels the safety communication error occurring in the CNC CPU by turning ON the signal.

The following shows the safety communication errors that can be canceled.

No.	Name
1A40	Safety communication master station error
1A60/1A61/1A62/1A63/1A64/1A65	In safety communication timeout
1A70/1A71/1A72	Safety communication receipt data error

Interlock state of the safety station communication error and the safety communication will not be canceled.

When restarting the safety communication, execute safety station interlock cancel.

[Related signals]

In safety station interlock (SCNSTS/bit0)

4.6.1.2 CNC → PLC

Cont.	Signal name	Abbrev.	1st axis	2nd axis	3rd axis	4th axis	5th axis	6th axis	7th axis	8th axis
A	SLS OBSERVATION IS ACTIVE (CONTROL AXIS)[M8]	SLSEm	ZR544 bit0	ZR544 bit1	ZR544 bit2	ZR544 bit3	ZR544 bit4	ZR544 bit5	ZR544 bit6	ZR544 bit7
			9th axis	10th axis	11th axis	12th axis	13th axis	14th axis	15th axis	16th axis
			ZR544 bit8	ZR544 bit9	ZR544 bit10	ZR544 bit11	ZR544 bit12	ZR544 bit13	ZR544 bit14	ZR544 bit15
			17th axis	18th axis	19th axis	20th axis	21st axis	22nd axis	23rd axis	24th axis
			ZR545 bit0	ZR545 bit1	ZR545 bit2	ZR545 bit3	ZR545 bit4	ZR545 bit5	ZR545 bit6	ZR545 bit7
			25th axis	26th axis	27th axis	28th axis	29th axis	30th axis	31st axis	32nd axis
ZR545 bit8	ZR545 bit9	ZR545 bit10	ZR545 bit11	ZR545 bit12	ZR545 bit13	ZR545 bit14	ZR545 bit15			

Cont.	Signal name	Abbrev.	1st axis	2nd axis	3rd axis	4th axis	5th axis	6th axis	7th axis	8th axis
A	SLS OBSERVATION IS ACTIVE (CONTROL AXIS)[C80]	SLSEm	ZR1664 bit0	ZR1664 bit1	ZR1664 bit2	ZR1664 bit3	ZR1664 bit4	ZR1664 bit5	ZR1664 bit6	ZR1664 bit7
			9th axis	10th axis	11th axis	12th axis	13th axis	14th axis	15th axis	16th axis
			ZR1664 bit8	ZR1664 bit9	ZR1664 bit10	ZR1664 bit11	ZR1664 bit12	ZR1664 bit13	ZR1664 bit14	ZR1664 bit15
			17th axis	18th axis	19th axis	20th axis	21st axis	22nd axis	23rd axis	24th axis
			ZR1665 bit0	ZR1665 bit1	ZR1665 bit2	ZR1665 bit3	ZR1665 bit4	ZR1665 bit5	ZR1665 bit6	ZR1665 bit7
			25th axis	26th axis	27th axis	28th axis	29th axis	30th axis	31st axis	32nd axis
ZR1665 bit8	ZR1665 bit9	ZR1665 bit10	ZR1665 bit11	ZR1665 bit12	ZR1665 bit13	ZR1665 bit14	ZR1665 bit15			

[Function]

This signal indicates that SLS observation has been enabled on the control axis.

[Operation]

This signal turns ON when SLS observation request (*SLSRm) is turned OFF (when SLS is requested), and so the NC starts execution of SLS. This signal turns OFF when SLS observation request (*SLSRm) is turned ON (when SLS is not requested).

[Related signals]

- (1) SLS observation request (*SLSRm)
- (2) Under SLS limit (SLSSm)

4 Explanation of Interface Signals

Cont.	Signal name	Abbrev.	1st axis	2nd axis	3rd axis	4th axis	5th axis	6th axis	7th axis	8th axis
A	UNDER SLS LIMIT (CONTROL AXIS)[M8]	SLSSm	ZR546 bit0	ZR546 bit1	ZR546 bit2	ZR546 bit3	ZR546 bit4	ZR546 bit5	ZR546 bit6	ZR546 bit7
			9th axis	10th axis	11th axis	12th axis	13th axis	14th axis	15th axis	16th axis
			ZR546 bit8	ZR546 bit9	ZR546 bit10	ZR546 bit11	ZR546 bit12	ZR546 bit13	ZR546 bit14	ZR546 bit15
			17th axis	18th axis	19th axis	20th axis	21st axis	22nd axis	23rd axis	24th axis
			ZR547 bit0	ZR547 bit1	ZR547 bit2	ZR547 bit3	ZR547 bit4	ZR547 bit5	ZR547 bit6	ZR547 bit7
			25th axis	26th axis	27th axis	28th axis	29th axis	30th axis	31st axis	32nd axis
			ZR547 bit8	ZR547 bit9	ZR547 bit10	ZR547 bit11	ZR547 bit12	ZR547 bit13	ZR547 bit14	ZR547 bit15

Cont.	Signal name	Abbrev.	1st axis	2nd axis	3rd axis	4th axis	5th axis	6th axis	7th axis	8th axis
A	UNDER SLS LIMIT (CONTROL AXIS)[C80]	SLSSm	ZR1666 bit0	ZR1666 bit1	ZR1666 bit2	ZR1666 bit3	ZR1666 bit4	ZR1666 bit5	ZR1666 bit6	ZR1666 bit7
			9th axis	10th axis	11th axis	12th axis	13th axis	14th axis	15th axis	16th axis
			ZR1666 bit8	ZR1666 bit9	ZR1666 bit10	ZR1666 bit11	ZR1666 bit12	ZR1666 bit13	ZR1666 bit14	ZR1666 bit15
			17th axis	18th axis	19th axis	20th axis	21st axis	22nd axis	23rd axis	24th axis
			ZR1667 bit0	ZR1667 bit1	ZR1667 bit2	ZR1667 bit3	ZR1667 bit4	ZR1667 bit5	ZR1667 bit6	ZR1667 bit7
			25th axis	26th axis	27th axis	28th axis	29th axis	30th axis	31st axis	32nd axis
			ZR1667 bit8	ZR1667 bit9	ZR1667 bit10	ZR1667 bit11	ZR1667 bit12	ZR1667 bit13	ZR1667 bit14	ZR1667 bit15

[Function]

This signal indicates that SLS observation has been enabled on the control axis and that the axis is at the safely-limited speed or lower.

[Operation]

This signal turns ON when SLS observation request (*SLSRm) is turned OFF (when SLS is requested), the NC starts execution of SLS, and then the speed of the control axis drops to the safely-limited speed or lower. This signal remains OFF if the axis' speed is exceeding the safely-limited speed. This signal turns OFF when SLS observation request (*SLSRm) is turned ON (when SLS is not requested).

[Related signals]

- (1) SLS observation request (*SLSRm)
- (2) SLS observation is active (SLSEm)

4 Explanation of Interface Signals

Cont.	Signal name	Abbrev.	1st axis	2nd axis	3rd axis	4th axis	5th axis	6th axis	7th axis	8th axis
A	SLP OBSERVATION IS ACTIVE (CONTROL AXIS)[M8]	SLPEm	ZR548 bit0	ZR548 bit1	ZR548 bit2	ZR548 bit3	ZR548 bit4	ZR548 bit5	ZR548 bit6	ZR548 bit7
			9th axis	10th axis	11th axis	12th axis	13th axis	14th axis	15th axis	16th axis
			ZR548 bit8	ZR548 bit9	ZR548 bit10	ZR548 bit11	ZR548 bit12	ZR548 bit13	ZR548 bit14	ZR548 bit15
			17th axis	18th axis	19th axis	20th axis	21st axis	22nd axis	23rd axis	24th axis
			ZR549 bit0	ZR549 bit1	ZR549 bit2	ZR549 bit3	ZR549 bit4	ZR549 bit5	ZR549 bit6	ZR549 bit7
			25th axis	26th axis	27th axis	28th axis	29th axis	30th axis	31st axis	32nd axis
			ZR549 bit8	ZR549 bit9	ZR549 bit10	ZR549 bit11	ZR549 bit12	ZR549 bit13	ZR549 bit14	ZR549 bit15

Cont.	Signal name	Abbrev.	1st axis	2nd axis	3rd axis	4th axis	5th axis	6th axis	7th axis	8th axis
A	SLP OBSERVATION IS ACTIVE (CONTROL AXIS)[C80]	SLPEm	ZR1668 bit0	ZR1668 bit1	ZR1668 bit2	ZR1668 bit3	ZR1668 bit4	ZR1668 bit5	ZR1668 bit6	ZR1668 bit7
			9th axis	10th axis	11th axis	12th axis	13th axis	14th axis	15th axis	16th axis
			ZR1668 bit8	ZR1668 bit9	ZR1668 bit10	ZR1668 bit11	ZR1668 bit12	ZR1668 bit13	ZR1668 bit14	ZR1668 bit15
			17th axis	18th axis	19th axis	20th axis	21st axis	22nd axis	23rd axis	24th axis
			ZR1669 bit0	ZR1669 bit1	ZR1669 bit2	ZR1669 bit3	ZR1669 bit4	ZR1669 bit5	ZR1669 bit6	ZR1669 bit7
			25th axis	26th axis	27th axis	28th axis	29th axis	30th axis	31st axis	32nd axis
			ZR1669 bit8	ZR1669 bit9	ZR1669 bit10	ZR1669 bit11	ZR1669 bit12	ZR1669 bit13	ZR1669 bit14	ZR1669 bit15

[Function]

This signal indicates that SLP observation has been enabled on the control axis.

[Operation]

This signal turns ON when SLP observation request (*SLPRm) is turned OFF (when SLP is requested), and so the NC starts execution of SLP. This signal turns OFF when SLP observation request (*SLPRm) is turned ON (when SLP is not requested).

[Related signals]

- (1) SLP observation request (*SLPRm)
- (2) In SLP range (SLPSm)

4 Explanation of Interface Signals

Cont.	Signal name	Abbrev.	1st axis	2nd axis	3rd axis	4th axis	5th axis	6th axis	7th axis	8th axis
A	IN SLP RANGE (CONTROL AXIS)[M8]	SLPsm	ZR550 bit0	ZR550 bit1	ZR550 bit2	ZR550 bit3	ZR550 bit4	ZR550 bit5	ZR550 bit6	ZR550 bit7
			9th axis	10th axis	11th axis	12th axis	13th axis	14th axis	15th axis	16th axis
			ZR550 bit8	ZR550 bit9	ZR550 bit10	ZR550 bit11	ZR550 bit12	ZR550 bit13	ZR550 bit14	ZR550 bit15
			17th axis	18th axis	19th axis	20th axis	21st axis	22nd axis	23rd axis	24th axis
			ZR551 bit0	ZR551 bit1	ZR551 bit2	ZR551 bit3	ZR551 bit4	ZR551 bit5	ZR551 bit6	ZR551 bit7
			25th axis	26th axis	27th axis	28th axis	29th axis	30th axis	31st axis	32nd axis
			ZR551 bit8	ZR551 bit9	ZR551 bit10	ZR551 bit11	ZR551 bit12	ZR551 bit13	ZR551 bit14	ZR551 bit15

Cont.	Signal name	Abbrev.	1st axis	2nd axis	3rd axis	4th axis	5th axis	6th axis	7th axis	8th axis
A	IN SLP RANGE (CONTROL AXIS)[C80]	SLPsm	ZR1670 bit0	ZR1670 bit1	ZR1670 bit2	ZR1670 bit3	ZR1670 bit4	ZR1670 bit5	ZR1670 bit6	ZR1670 bit7
			9th axis	10th axis	11th axis	12th axis	13th axis	14th axis	15th axis	16th axis
			ZR1670 bit8	ZR1670 bit9	ZR1670 bit10	ZR1670 bit11	ZR1670 bit12	ZR1670 bit13	ZR1670 bit14	ZR1670 bit15
			17th axis	18th axis	19th axis	20th axis	21st axis	22nd axis	23rd axis	24th axis
			ZR1671 bit0	ZR1671 bit1	ZR1671 bit2	ZR1671 bit3	ZR1671 bit4	ZR1671 bit5	ZR1671 bit6	ZR1671 bit7
			25th axis	26th axis	27th axis	28th axis	29th axis	30th axis	31st axis	32nd axis
			ZR1671 bit8	ZR1671 bit9	ZR1671 bit10	ZR1671 bit11	ZR1671 bit12	ZR1671 bit13	ZR1671 bit14	ZR1671 bit15

[Function]

This signal indicates that SLP observation has been enabled on the control axis and that the axis is in the SLP position tolerance range.

[Operation]

This signal turns ON when SLP observation request (*SLPRm) is turned OFF (when SLP is requested), the NC starts execution of SLP, and then the position of the control axis reaches the SLP position tolerance range. This signal remains OFF if the axis' position is outside the SLP position tolerance range. This signal turns OFF when SLP observation request (*SLPRm) is turned ON (when SLP is not requested).

[Related signals]

- (1) SLP observation request (*SLPRm)
- (2) SLP observation is active (SLPEm)

4 Explanation of Interface Signals

Cont.	Signal name	Abbrev.	1st axis	2nd axis	3rd axis	4th axis	5th axis	6th axis	7th axis	8th axis
A	SSM IS ACTIVE (CONTROL AXIS)[M8]	SSMEm	ZR552 bit0	ZR552 bit1	ZR552 bit2	ZR552 bit3	ZR552 bit4	ZR552 bit5	ZR552 bit6	ZR552 bit7
			9th axis	10th axis	11th axis	12th axis	13th axis	14th axis	15th axis	16th axis
			ZR552 bit8	ZR552 bit9	ZR552 bit10	ZR552 bit11	ZR552 bit12	ZR552 bit13	ZR552 bit14	ZR552 bit15
			17th axis	18th axis	19th axis	20th axis	21st axis	22nd axis	23rd axis	24th axis
			ZR553 bit0	ZR553 bit1	ZR553 bit2	ZR553 bit3	ZR553 bit4	ZR553 bit5	ZR553 bit6	ZR553 bit7
			25th axis	26th axis	27th axis	28th axis	29th axis	30th axis	31st axis	32nd axis
			ZR553 bit8	ZR553 bit9	ZR553 bit10	ZR553 bit11	ZR553 bit12	ZR553 bit13	ZR553 bit14	ZR553 bit15

Cont.	Signal name	Abbrev.	1st axis	2nd axis	3rd axis	4th axis	5th axis	6th axis	7th axis	8th axis
A	SSM IS ACTIVE (CONTROL AXIS)[C80]	SSMEm	ZR1672 bit0	ZR1672 bit1	ZR1672 bit2	ZR1672 bit3	ZR1672 bit4	ZR1672 bit5	ZR1672 bit6	ZR1672 bit7
			9th axis	10th axis	11th axis	12th axis	13th axis	14th axis	15th axis	16th axis
			ZR1672 bit8	ZR1672 bit9	ZR1672 bit10	ZR1672 bit11	ZR1672 bit12	ZR1672 bit13	ZR1672 bit14	ZR1672 bit15
			17th axis	18th axis	19th axis	20th axis	21st axis	22nd axis	23rd axis	24th axis
			ZR1673 bit0	ZR1673 bit1	ZR1673 bit2	ZR1673 bit3	ZR1673 bit4	ZR1673 bit5	ZR1673 bit6	ZR1673 bit7
			25th axis	26th axis	27th axis	28th axis	29th axis	30th axis	31st axis	32nd axis
			ZR1673 bit8	ZR1673 bit9	ZR1673 bit10	ZR1673 bit11	ZR1673 bit12	ZR1673 bit13	ZR1673 bit14	ZR1673 bit15

[Function]

This signal indicates that Safe speed monitor has been enabled on the control axis.

[Operation]

This signal turns ON when SSM request (*SSMRm) is turned OFF (when SSM is requested) and the NC starts execution of SSM.

This signal turns OFF when SSM request (*SSMRm) is turned ON (when SSM is not requested).

[Related signals]

- (1) SSM request (*SSMRm)
- (2) Under SSM safe speed (SSMSmn)

4 Explanation of Interface Signals

Cont.	Signal name	Abbrev.	1st axis	2nd axis	3rd axis	4th axis	5th axis	6th axis	7th axis	8th axis
A	SAFE CAM IS ACTIVE (CONTROL AXIS)[M8]	SCAEm	ZR554 bit0	ZR554 bit1	ZR554 bit2	ZR554 bit3	ZR554 bit4	ZR554 bit5	ZR554 bit6	ZR554 bit7
			9th axis	10th axis	11th axis	12th axis	13th axis	14th axis	15th axis	16th axis
			ZR554 bit8	ZR554 bit9	ZR554 bit10	ZR554 bit11	ZR554 bit12	ZR554 bit13	ZR554 bit14	ZR554 bit15
			17th axis	18th axis	19th axis	20th axis	21st axis	22nd axis	23rd axis	24th axis
			ZR555 bit0	ZR555 bit1	ZR555 bit2	ZR555 bit3	ZR555 bit4	ZR555 bit5	ZR555 bit6	ZR555 bit7
			25th axis	26th axis	27th axis	28th axis	29th axis	30th axis	31st axis	32nd axis
			ZR555 bit8	ZR555 bit9	ZR555 bit10	ZR555 bit11	ZR555 bit12	ZR555 bit13	ZR555 bit14	ZR555 bit15

Cont.	Signal name	Abbrev.	1st axis	2nd axis	3rd axis	4th axis	5th axis	6th axis	7th axis	8th axis
A	SAFE CAM IS ACTIVE (CONTROL AXIS)[C80]	SCAEm	ZR1674 bit0	ZR1674 bit1	ZR1674 bit2	ZR1674 bit3	ZR1674 bit4	ZR1674 bit5	ZR1674 bit6	ZR1674 bit7
			9th axis	10th axis	11th axis	12th axis	13th axis	14th axis	15th axis	16th axis
			ZR1674 bit8	ZR1674 bit9	ZR1674 bit10	ZR1674 bit11	ZR1674 bit12	ZR1674 bit13	ZR1674 bit14	ZR1674 bit15
			17th axis	18th axis	19th axis	20th axis	21st axis	22nd axis	23rd axis	24th axis
			ZR1675 bit0	ZR1675 bit1	ZR1675 bit2	ZR1675 bit3	ZR1675 bit4	ZR1675 bit5	ZR1675 bit6	ZR1675 bit7
			25th axis	26th axis	27th axis	28th axis	29th axis	30th axis	31st axis	32nd axis
			ZR1675 bit8	ZR1675 bit9	ZR1675 bit10	ZR1675 bit11	ZR1675 bit12	ZR1675 bit13	ZR1675 bit14	ZR1675 bit15

[Function]

This signal indicates that Safe cam has been enabled on the control axis.

[Operation]

This signal turns ON when Safe cam request (*SCARm) is turned OFF (when SCA is requested) and so the NC starts execution of SCA. This signal turns OFF when Safe cam request (*SCARm) is turned ON (when SCA is not requested).

[Related signals]

- (1) Safe cam request (*SCARm)
- (2) Safe cam position (SCASmn)

4 Explanation of Interface Signals

Cont.	Signal name	Abbrev.	1st axis	2nd axis	3rd axis	4th axis	5th axis	6th axis	7th axis	8th axis
A	SOS IS ACTIVE (CONTROL AXIS)[M8]	SOSEm	ZR556 bit0	ZR556 bit1	ZR556 bit2	ZR556 bit3	ZR556 bit4	ZR556 bit5	ZR556 bit6	ZR556 bit7
			9th axis	10th axis	11th axis	12th axis	13th axis	14th axis	15th axis	16th axis
			ZR556 bit8	ZR556 bit9	ZR556 bit10	ZR556 bit11	ZR556 bit12	ZR556 bit13	ZR556 bit14	ZR556 bit15
			17th axis	18th axis	19th axis	20th axis	21st axis	22nd axis	23rd axis	24th axis
			ZR557 bit0	ZR557 bit1	ZR557 bit2	ZR557 bit3	ZR557 bit4	ZR557 bit5	ZR557 bit6	ZR557 bit7
			25th axis	26th axis	27th axis	28th axis	29th axis	30th axis	31st axis	32nd axis
			ZR557 bit8	ZR557 bit9	ZR557 bit10	ZR557 bit11	ZR557 bit12	ZR557 bit13	ZR557 bit14	ZR557 bit15

Cont.	Signal name	Abbrev.	1st axis	2nd axis	3rd axis	4th axis	5th axis	6th axis	7th axis	8th axis
A	SOS IS ACTIVE (CONTROL AXIS)[C80]	SOSEm	ZR1676 bit0	ZR1676 bit1	ZR1676 bit2	ZR1676 bit3	ZR1676 bit4	ZR1676 bit5	ZR1676 bit6	ZR1676 bit7
			9th axis	10th axis	11th axis	12th axis	13th axis	14th axis	15th axis	16th axis
			ZR1676 bit8	ZR1676 bit9	ZR1676 bit10	ZR1676 bit11	ZR1676 bit12	ZR1676 bit13	ZR1676 bit14	ZR1676 bit15
			17th axis	18th axis	19th axis	20th axis	21st axis	22nd axis	23rd axis	24th axis
			ZR1677 bit0	ZR1677 bit1	ZR1677 bit2	ZR1677 bit3	ZR1677 bit4	ZR1677 bit5	ZR1677 bit6	ZR1677 bit7
			25th axis	26th axis	27th axis	28th axis	29th axis	30th axis	31st axis	32nd axis
			ZR1677 bit8	ZR1677 bit9	ZR1677 bit10	ZR1677 bit11	ZR1677 bit12	ZR1677 bit13	ZR1677 bit14	ZR1677 bit15

[Function]

This signal indicates that Safety operating stop has been enabled on the control axis in response to SOS observation request (*SOSRm). Note that if SOS is activated by a start request from SS2, there is no output to this signal.

[Operation]

This signal turns ON when SOS observation request (*SOSRm) is turned OFF (when SOS is requested), and so the NC starts execution of SOS. This signal turns OFF when SOS observation request (*SOSRm) is turned ON (when SOS is not requested).

[Related signals]

- (1) SOS observation request (*SOSRm)
- (2) In SOS stop (SOSSm)

4 Explanation of Interface Signals

Cont.	Signal name	Abbrev.	1st axis	2nd axis	3rd axis	4th axis	5th axis	6th axis	7th axis	8th axis
A	IN SOS STOP (CONTROL AXIS)[M8]	SOSSm	ZR558 bit0	ZR558 bit1	ZR558 bit2	ZR558 bit3	ZR558 bit4	ZR558 bit5	ZR558 bit6	ZR558 bit7
			9th axis	10th axis	11th axis	12th axis	13th axis	14th axis	15th axis	16th axis
			ZR558 bit8	ZR558 bit9	ZR558 bit10	ZR558 bit11	ZR558 bit12	ZR558 bit13	ZR558 bit14	ZR558 bit15
			17th axis	18th axis	19th axis	20th axis	21st axis	22nd axis	23rd axis	24th axis
			ZR559 bit0	ZR559 bit1	ZR559 bit2	ZR559 bit3	ZR559 bit4	ZR559 bit5	ZR559 bit6	ZR559 bit7
			25th axis	26th axis	27th axis	28th axis	29th axis	30th axis	31st axis	32nd axis
			ZR559 bit8	ZR559 bit9	ZR559 bit10	ZR559 bit11	ZR559 bit12	ZR559 bit13	ZR559 bit14	ZR559 bit15

Cont.	Signal name	Abbrev.	1st axis	2nd axis	3rd axis	4th axis	5th axis	6th axis	7th axis	8th axis
A	IN SOS STOP (CONTROL AXIS)[C80]	SOSSm	ZR1678 bit0	ZR1678 bit1	ZR1678 bit2	ZR1678 bit3	ZR1678 bit4	ZR1678 bit5	ZR1678 bit6	ZR1678 bit7
			9th axis	10th axis	11th axis	12th axis	13th axis	14th axis	15th axis	16th axis
			ZR1678 bit8	ZR1678 bit9	ZR1678 bit10	ZR1678 bit11	ZR1678 bit12	ZR1678 bit13	ZR1678 bit14	ZR1678 bit15
			17th axis	18th axis	19th axis	20th axis	21st axis	22nd axis	23rd axis	24th axis
			ZR1679 bit0	ZR1679 bit1	ZR1679 bit2	ZR1679 bit3	ZR1679 bit4	ZR1679 bit5	ZR1679 bit6	ZR1679 bit7
			25th axis	26th axis	27th axis	28th axis	29th axis	30th axis	31st axis	32nd axis
			ZR1679 bit8	ZR1679 bit9	ZR1679 bit10	ZR1679 bit11	ZR1679 bit12	ZR1679 bit13	ZR1679 bit14	ZR1679 bit15

[Function]

This signal indicates that the SOS is active (SOSEm) signal of the axis has been turned ON or a start request has been made by SS2, and that the control axis is at a standstill.

[Operation]

This signal turns ON when the NC has started execution of SOS due to turning-OFF of SOS observation request (*SOSRm) (SOS requested) or due to a start request from SS2, and so the control axis has been set to a standstill. This signal remains OFF while the control axis is not at a standstill. This signal turns OFF when SOS observation request (*SOSRm) is turned ON (when SOS is not requested) and when SS2 makes no request.

[Related signals]

- (1) SOS observation request (*SOSRm)
- (2) SOS is active (SOSEm)

4 Explanation of Interface Signals

Cont.	Signal name	Abbrev.	1st axis	2nd axis	3rd axis	4th axis	5th axis	6th axis	7th axis	8th axis
A	SS1 IS ACTIVE (CONTROL AXIS)[M8]	SS1Em	ZR560 bit0	ZR560 bit1	ZR560 bit2	ZR560 bit3	ZR560 bit4	ZR560 bit5	ZR560 bit6	ZR560 bit7
			9th axis	10th axis	11th axis	12th axis	13th axis	14th axis	15th axis	16th axis
			ZR560 bit8	ZR560 bit9	ZR560 bit10	ZR560 bit11	ZR560 bit12	ZR560 bit13	ZR560 bit14	ZR560 bit15
			17th axis	18th axis	19th axis	20th axis	21st axis	22nd axis	23rd axis	24th axis
			ZR561 bit0	ZR561 bit1	ZR561 bit2	ZR561 bit3	ZR561 bit4	ZR561 bit5	ZR561 bit6	ZR561 bit7
			25th axis	26th axis	27th axis	28th axis	29th axis	30th axis	31st axis	32nd axis
			ZR561 bit8	ZR561 bit9	ZR561 bit10	ZR561 bit11	ZR561 bit12	ZR561 bit13	ZR561 bit14	ZR561 bit15

Cont.	Signal name	Abbrev.	1st axis	2nd axis	3rd axis	4th axis	5th axis	6th axis	7th axis	8th axis
A	SS1 IS ACTIVE (CONTROL AXIS)[C80]	SS1Em	ZR1680 bit0	ZR1680 bit1	ZR1680 bit2	ZR1680 bit3	ZR1680 bit4	ZR1680 bit5	ZR1680 bit6	ZR1680 bit7
			9th axis	10th axis	11th axis	12th axis	13th axis	14th axis	15th axis	16th axis
			ZR1680 bit8	ZR1680 bit9	ZR1680 bit10	ZR1680 bit11	ZR1680 bit12	ZR1680 bit13	ZR1680 bit14	ZR1680 bit15
			17th axis	18th axis	19th axis	20th axis	21st axis	22nd axis	23rd axis	24th axis
			ZR1681 bit0	ZR1681 bit1	ZR1681 bit2	ZR1681 bit3	ZR1681 bit4	ZR1681 bit5	ZR1681 bit6	ZR1681 bit7
			25th axis	26th axis	27th axis	28th axis	29th axis	30th axis	31st axis	32nd axis
			ZR1681 bit8	ZR1681 bit9	ZR1681 bit10	ZR1681 bit11	ZR1681 bit12	ZR1681 bit13	ZR1681 bit14	ZR1681 bit15

[Function]

This signal indicates that Safe stop 1 has been enabled in response to Safe stop 1 request (*SS1Rm).

Note that if SS1 is activated due to occurrence of a smart safety observation error, there is no output to this signal.

[Operation]

This signal turns ON when Safe stop 1 request (*SS1Rm) is turned OFF (when SS1 is requested), and so the NC starts execution of SS1. This signal turns OFF when Safe stop 1 request (*SS1Rm) is turned ON (when SS1 is not requested).

[Related signals]

- (1) Safe stop 1 request (*SS1Rm)
- (2) In SS1 stop (SS1Sm)

4 Explanation of Interface Signals

Cont.	Signal name	Abbrev.	1st axis	2nd axis	3rd axis	4th axis	5th axis	6th axis	7th axis	8th axis
A	IN SS1 STOP (CONTROL AXIS)[M8]	SS1Sm	ZR562 bit0	ZR562 bit1	ZR562 bit2	ZR562 bit3	ZR562 bit4	ZR562 bit5	ZR562 bit6	ZR562 bit7
			9th axis	10th axis	11th axis	12th axis	13th axis	14th axis	15th axis	16th axis
			ZR562 bit8	ZR562 bit9	ZR562 bit10	ZR562 bit11	ZR562 bit12	ZR562 bit13	ZR562 bit14	ZR562 bit15
			17th axis	18th axis	19th axis	20th axis	21st axis	22nd axis	23rd axis	24th axis
			ZR563 bit0	ZR563 bit1	ZR563 bit2	ZR563 bit3	ZR563 bit4	ZR563 bit5	ZR563 bit6	ZR563 bit7
			25th axis	26th axis	27th axis	28th axis	29th axis	30th axis	31st axis	32nd axis
			ZR563 bit8	ZR563 bit9	ZR563 bit10	ZR563 bit11	ZR563 bit12	ZR563 bit13	ZR563 bit14	ZR563 bit15

Cont.	Signal name	Abbrev.	1st axis	2nd axis	3rd axis	4th axis	5th axis	6th axis	7th axis	8th axis
A	IN SS1 STOP (CONTROL AXIS)[C80]	SS1Sm	ZR1682 bit0	ZR1682 bit1	ZR1682 bit2	ZR1682 bit3	ZR1682 bit4	ZR1682 bit5	ZR1682 bit6	ZR1682 bit7
			9th axis	10th axis	11th axis	12th axis	13th axis	14th axis	15th axis	16th axis
			ZR1682 bit8	ZR1682 bit9	ZR1682 bit10	ZR1682 bit11	ZR1682 bit12	ZR1682 bit13	ZR1682 bit14	ZR1682 bit15
			17th axis	18th axis	19th axis	20th axis	21st axis	22nd axis	23rd axis	24th axis
			ZR1683 bit0	ZR1683 bit1	ZR1683 bit2	ZR1683 bit3	ZR1683 bit4	ZR1683 bit5	ZR1683 bit6	ZR1683 bit7
			25th axis	26th axis	27th axis	28th axis	29th axis	30th axis	31st axis	32nd axis
			ZR1683 bit8	ZR1683 bit9	ZR1683 bit10	ZR1683 bit11	ZR1683 bit12	ZR1683 bit13	ZR1683 bit14	ZR1683 bit15

[Function]

This signal indicates that SS1 has been executed due to turning-ON of the SS1 is active (SS1Em) signal, or due to occurrence of a smart safety observation error, and that the control axis is at a standstill.

[Operation]

When Safe stop 1 request (*SS1Rm) is turned OFF (When SS1 is requested) or when a smart safety observation error occurs, SS1 starts to be executed. When the control axis decelerates to a stop, this signal is turned ON. This signal remains OFF while the axis concerned is not at a standstill. This signal turns OFF when Safe stop 1 request (*SS1Rm) is turned ON (when SS1 is not requested) and when SS1 is not executed due to occurrence of a smart safety observation error.

[Related signals]

- (1) Safe stop 1 request (*SS1Rm)
- (2) SS1 is active (SS1Em)

4 Explanation of Interface Signals

Cont.	Signal name	Abbrev.	1st axis	2nd axis	3rd axis	4th axis	5th axis	6th axis	7th axis	8th axis
A	SS2 IS ACTIVE (CONTROL AXIS)[M8]	SS2Em	ZR564 bit0	ZR564 bit1	ZR564 bit2	ZR564 bit3	ZR564 bit4	ZR564 bit5	ZR564 bit6	ZR564 bit7
			9th axis	10th axis	11th axis	12th axis	13th axis	14th axis	15th axis	16th axis
			ZR564 bit8	ZR564 bit9	ZR564 bit10	ZR564 bit11	ZR564 bit12	ZR564 bit13	ZR564 bit14	ZR564 bit15
			17th axis	18th axis	19th axis	20th axis	21st axis	22nd axis	23rd axis	24th axis
			ZR565 bit0	ZR565 bit1	ZR565 bit2	ZR565 bit3	ZR565 bit4	ZR565 bit5	ZR565 bit6	ZR565 bit7
			25th axis	26th axis	27th axis	28th axis	29th axis	30th axis	31st axis	32nd axis
			ZR565 bit8	ZR565 bit9	ZR565 bit10	ZR565 bit11	ZR565 bit12	ZR565 bit13	ZR565 bit14	ZR565 bit15

Cont.	Signal name	Abbrev.	1st axis	2nd axis	3rd axis	4th axis	5th axis	6th axis	7th axis	8th axis
A	SS2 IS ACTIVE (CONTROL AXIS)[C80]	SS2Em	ZR1684 bit0	ZR1684 bit1	ZR1684 bit2	ZR1684 bit3	ZR1684 bit4	ZR1684 bit5	ZR1684 bit6	ZR1684 bit7
			9th axis	10th axis	11th axis	12th axis	13th axis	14th axis	15th axis	16th axis
			ZR1684 bit8	ZR1684 bit9	ZR1684 bit10	ZR1684 bit11	ZR1684 bit12	ZR1684 bit13	ZR1684 bit14	ZR1684 bit15
			17th axis	18th axis	19th axis	20th axis	21st axis	22nd axis	23rd axis	24th axis
			ZR1685 bit0	ZR1685 bit1	ZR1685 bit2	ZR1685 bit3	ZR1685 bit4	ZR1685 bit5	ZR1685 bit6	ZR1685 bit7
			25th axis	26th axis	27th axis	28th axis	29th axis	30th axis	31st axis	32nd axis
			ZR1685 bit8	ZR1685 bit9	ZR1685 bit10	ZR1685 bit11	ZR1685 bit12	ZR1685 bit13	ZR1685 bit14	ZR1685 bit15

[Function]

This signal indicates that Safe stop 2 has been enabled on the axis.

[Operation]

This signal turns ON when Safe stop 2 request (*SS2Rm) is turned OFF (When SS2 is requested), and so the NC starts execution of SS2. This signal turns OFF when Safe stop 2 request (*SS2Rm) is turned ON (when SS2 is not requested).

[Related signals]

- (1) Safe stop 2 request (*SS2Rm)

4 Explanation of Interface Signals

Cont.	Signal name	Abbrev.	1st axis	2nd axis	3rd axis	4th axis	5th axis	6th axis	7th axis	8th axis
A	STO IS ACTIVE (CONTROL AXIS)[M8]	STOEm	ZR566 bit0	ZR566 bit1	ZR566 bit2	ZR566 bit3	ZR566 bit4	ZR566 bit5	ZR566 bit6	ZR566 bit7
			9th axis	10th axis	11th axis	12th axis	13th axis	14th axis	15th axis	16th axis
			ZR566 bit8	ZR566 bit9	ZR566 bit10	ZR566 bit11	ZR566 bit12	ZR566 bit13	ZR566 bit14	ZR566 bit15
			17th axis	18th axis	19th axis	20th axis	21st axis	22nd axis	23rd axis	24th axis
			ZR567 bit0	ZR567 bit1	ZR567 bit2	ZR567 bit3	ZR567 bit4	ZR567 bit5	ZR567 bit6	ZR567 bit7
			25th axis	26th axis	27th axis	28th axis	29th axis	30th axis	31st axis	32nd axis
			ZR567 bit8	ZR567 bit9	ZR567 bit10	ZR567 bit11	ZR567 bit12	ZR567 bit13	ZR567 bit14	ZR567 bit15

Cont.	Signal name	Abbrev.	1st axis	2nd axis	3rd axis	4th axis	5th axis	6th axis	7th axis	8th axis
A	STO IS ACTIVE (CONTROL AXIS)[C80]	STOEm	ZR1686 bit0	ZR1686 bit1	ZR1686 bit2	ZR1686 bit3	ZR1686 bit4	ZR1686 bit5	ZR1686 bit6	ZR1686 bit7
			9th axis	10th axis	11th axis	12th axis	13th axis	14th axis	15th axis	16th axis
			ZR1686 bit8	ZR1686 bit9	ZR1686 bit10	ZR1686 bit11	ZR1686 bit12	ZR1686 bit13	ZR1686 bit14	ZR1686 bit15
			17th axis	18th axis	19th axis	20th axis	21st axis	22nd axis	23rd axis	24th axis
			ZR1687 bit0	ZR1687 bit1	ZR1687 bit2	ZR1687 bit3	ZR1687 bit4	ZR1687 bit5	ZR1687 bit6	ZR1687 bit7
			25th axis	26th axis	27th axis	28th axis	29th axis	30th axis	31st axis	32nd axis
			ZR1687 bit8	ZR1687 bit9	ZR1687 bit10	ZR1687 bit11	ZR1687 bit12	ZR1687 bit13	ZR1687 bit14	ZR1687 bit15

[Function]

This signal indicates that the Safe torque off function has been enabled on the control axis in response to Safe torque off request (*STORm). Note that if STO is activated due to occurrence of a smart safety observation error, there is no output to this signal.

[Operation]

This signal turns ON when Safe torque off request (*STORm) is turned OFF (when STO is requested), and so the NC starts execution of STO. This signal turns OFF when Safe torque off request (*STORm) is turned ON (when STO is not requested).

[Related signals]

- (1) Safe torque off request (*STORm)
- (2) In Safe torque off (STOSm)

4 Explanation of Interface Signals

Cont.	Signal name	Abbrev.	1st axis	2nd axis	3rd axis	4th axis	5th axis	6th axis	7th axis	8th axis
A	IN SAFE TORQUE OFF (CONTROL AXIS)[M8]	STOSm	ZR568 bit0	ZR568 bit1	ZR568 bit2	ZR568 bit3	ZR568 bit4	ZR568 bit5	ZR568 bit6	ZR568 bit7
			9th axis	10th axis	11th axis	12th axis	13th axis	14th axis	15th axis	16th axis
			ZR568 bit8	ZR568 bit9	ZR568 bit10	ZR568 bit11	ZR568 bit12	ZR568 bit13	ZR568 bit14	ZR568 bit15
			17th axis	18th axis	19th axis	20th axis	21st axis	22nd axis	23rd axis	24th axis
			ZR569 bit0	ZR569 bit1	ZR569 bit2	ZR569 bit3	ZR569 bit4	ZR569 bit5	ZR569 bit6	ZR569 bit7
			25th axis	26th axis	27th axis	28th axis	29th axis	30th axis	31st axis	32nd axis
			ZR569 bit8	ZR569 bit9	ZR569 bit10	ZR569 bit11	ZR569 bit12	ZR569 bit13	ZR569 bit14	ZR569 bit15

Cont.	Signal name	Abbrev.	1st axis	2nd axis	3rd axis	4th axis	5th axis	6th axis	7th axis	8th axis
A	IN SAFE TORQUE OFF (CONTROL AXIS)[C80]	STOSm	ZR1688 bit0	ZR1688 bit1	ZR1688 bit2	ZR1688 bit3	ZR1688 bit4	ZR1688 bit5	ZR1688 bit6	ZR1688 bit7
			9th axis	10th axis	11th axis	12th axis	13th axis	14th axis	15th axis	16th axis
			ZR1688 bit8	ZR1688 bit9	ZR1688 bit10	ZR1688 bit11	ZR1688 bit12	ZR1688 bit13	ZR1688 bit14	ZR1688 bit15
			17th axis	18th axis	19th axis	20th axis	21st axis	22nd axis	23rd axis	24th axis
			ZR1689 bit0	ZR1689 bit1	ZR1689 bit2	ZR1689 bit3	ZR1689 bit4	ZR1689 bit5	ZR1689 bit6	ZR1689 bit7
			25th axis	26th axis	27th axis	28th axis	29th axis	30th axis	31st axis	32nd axis
			ZR1689 bit8	ZR1689 bit9	ZR1689 bit10	ZR1689 bit11	ZR1689 bit12	ZR1689 bit13	ZR1689 bit14	ZR1689 bit15

[Function]

This signal indicates that STO has been executed due to turning-ON of the STO is active (STOEm) signal or due to occurrence of a smart safety observation error, and that the shutoff of the drive main power is completed.

[Operation]

This signal turns ON when the NC has started execution of STO due to turning-OFF of Safe torque off request (*STORm) (STO request) or due to occurrence of a smart safety observation error, and so the main drive power for the axis has been shut off. This signal remains OFF while the main drive power for the axis has not been shut off. This signal turns OFF when Safe torque off request (*STORm) is turned ON (when STO is not requested) and when STO is not executed due to occurrence of a smart safety observation error.

[Related signals]

- (1) Safe torque off request (STORm)
- (2) STO is active (STOEm)

4 Explanation of Interface Signals

Cont.	Signal name	Abbrev.	1st axis	2nd axis	3rd axis	4th axis	5th axis	6th axis	7th axis	8th axis
A	IN SBC MOTOR BRAKE ENABLED (CONTROL AXIS)[M8]	SBCEm	ZR570 bit0	ZR570 bit1	ZR570 bit2	ZR570 bit3	ZR570 bit4	ZR570 bit5	ZR570 bit6	ZR570 bit7
			9th axis	10th axis	11th axis	12th axis	13th axis	14th axis	15th axis	16th axis
			ZR570 bit8	ZR570 bit9	ZR570 bit10	ZR570 bit11	ZR570 bit12	ZR570 bit13	ZR570 bit14	ZR570 bit15
			17th axis	18th axis	19th axis	20th axis	21st axis	22nd axis	23rd axis	24th axis
			ZR571 bit0	ZR571 bit1	ZR571 bit2	ZR571 bit3	ZR571 bit4	ZR571 bit5	ZR571 bit6	ZR571 bit7
			25th axis	26th axis	27th axis	28th axis	29th axis	30th axis	31st axis	32nd axis
			ZR571 bit8	ZR571 bit9	ZR571 bit10	ZR571 bit11	ZR571 bit12	ZR571 bit13	ZR571 bit14	ZR571 bit15

Cont.	Signal name	Abbrev.	1st axis	2nd axis	3rd axis	4th axis	5th axis	6th axis	7th axis	8th axis
A	IN SBC MOTOR BRAKE ENABLED (CONTROL AXIS)[C80]	SBCEm	ZR1690 bit0	ZR1690 bit1	ZR1690 bit2	ZR1690 bit3	ZR1690 bit4	ZR1690 bit5	ZR1690 bit6	ZR1690 bit7
			9th axis	10th axis	11th axis	12th axis	13th axis	14th axis	15th axis	16th axis
			ZR1690 bit8	ZR1690 bit9	ZR1690 bit10	ZR1690 bit11	ZR1690 bit12	ZR1690 bit13	ZR1690 bit14	ZR1690 bit15
			17th axis	18th axis	19th axis	20th axis	21st axis	22nd axis	23rd axis	24th axis
			ZR1691 bit0	ZR1691 bit1	ZR1691 bit2	ZR1691 bit3	ZR1691 bit4	ZR1691 bit5	ZR1691 bit6	ZR1691 bit7
			25th axis	26th axis	27th axis	28th axis	29th axis	30th axis	31st axis	32nd axis
			ZR1691 bit8	ZR1691 bit9	ZR1691 bit10	ZR1691 bit11	ZR1691 bit12	ZR1691 bit13	ZR1691 bit14	ZR1691 bit15

[Function]

This signal shows that the SBC Motor brake starting request of the axis corresponding to the signal is enabled.

[Operation]

This signal turns ON when the SBC Motor brake starting request signal (*SBCRm) is OFF (requesting). Additionally, this signal turns OFF when the SBC Motor brake starting request signal is ON (not requesting). While this signal is ON, NC outputs the motor brake start command to the drive unit.

[Related signals]

- (1) SBC Motor brake starting request (*SBCRm)
- (2) In SBC Motor brake start signal (SBCEm)

4 Explanation of Interface Signals

Cont.	Signal name	Abbrev.	1st axis	2nd axis	3rd axis	4th axis	5th axis	6th axis	7th axis	8th axis
A	IN SBC MOTOR BRAKE START SIGNAL (CONTROL AXIS)[M8]	SBCSm	ZR572 bit0	ZR572 bit1	ZR572 bit2	ZR572 bit3	ZR572 bit4	ZR572 bit5	ZR572 bit6	ZR572 bit7
			9th axis	10th axis	11th axis	12th axis	13th axis	14th axis	15th axis	16th axis
			ZR572 bit8	ZR572 bit9	ZR572 bit10	ZR572 bit11	ZR572 bit12	ZR572 bit13	ZR572 bit14	ZR572 bit15
			17th axis	18th axis	19th axis	20th axis	21st axis	22nd axis	23rd axis	24th axis
			ZR573 bit0	ZR573 bit1	ZR573 bit2	ZR573 bit3	ZR573 bit4	ZR573 bit5	ZR573 bit6	ZR573 bit7
			25th axis	26th axis	27th axis	28th axis	29th axis	30th axis	31st axis	32nd axis
			ZR573 bit8	ZR573 bit9	ZR573 bit10	ZR573 bit11	ZR573 bit12	ZR573 bit13	ZR573 bit14	ZR573 bit15

Cont.	Signal name	Abbrev.	1st axis	2nd axis	3rd axis	4th axis	5th axis	6th axis	7th axis	8th axis
A	IN SBC MOTOR BRAKE START SIGNAL (CONTROL AXIS)[C80]	SBCSm	ZR1692 bit0	ZR1692 bit1	ZR1692 bit2	ZR1692 bit3	ZR1692 bit4	ZR1692 bit5	ZR1692 bit6	ZR1692 bit7
			9th axis	10th axis	11th axis	12th axis	13th axis	14th axis	15th axis	16th axis
			ZR1692 bit8	ZR1692 bit9	ZR1692 bit10	ZR1692 bit11	ZR1692 bit12	ZR1692 bit13	ZR1692 bit14	ZR1692 bit15
			17th axis	18th axis	19th axis	20th axis	21st axis	22nd axis	23rd axis	24th axis
			ZR1693 bit0	ZR1693 bit1	ZR1693 bit2	ZR1693 bit3	ZR1693 bit4	ZR1693 bit5	ZR1693 bit6	ZR1693 bit7
			25th axis	26th axis	27th axis	28th axis	29th axis	30th axis	31st axis	32nd axis
			ZR1693 bit8	ZR1693 bit9	ZR1693 bit10	ZR1693 bit11	ZR1693 bit12	ZR1693 bit13	ZR1693 bit14	ZR1693 bit15

[Function]

This signal shows that the Motor brake of the axis corresponding to the signal is in start.

[Operation]

The motor brake is started at the time of the SBC Motor brake starting request (*SBCRm) turning OFF (requesting), or at the time of the power shut OFF (at Safety related error, at *STORM signal OFF, at *SS1Rm signal OFF). After the motor brake start is complete, this signal turns ON.

[Caution]

This signal does not turn ON in the case of the axis where the parameter "#51200 SFSPEC1/bit3" is "1".

[Related signals]

- (1) SBC Motor brake starting request (*SBCRm)
- (2) Safe torque off request (*STORM)
- (3) Safe stop 1 request (*SS1Rm)
- (4) In SBC Motor brake enabled (SBCEm)

4 Explanation of Interface Signals

Cont.	Signal name	Abbrev.	1st axis	2nd axis	3rd axis	4th axis	5th axis	6th axis	7th axis	8th axis
A	EXTERNAL BRAKE SBT INCOMPLETE (CONTROL AXIS)[M8]	SBTNFEXm	ZR574 bit0	ZR574 bit1	ZR574 bit2	ZR574 bit3	ZR574 bit4	ZR574 bit5	ZR574 bit6	ZR574 bit7
			9th axis	10th axis	11th axis	12th axis	13th axis	14th axis	15th axis	16th axis
			ZR574 bit8	ZR574 bit9	ZR574 bit10	ZR574 bit11	ZR574 bit12	ZR574 bit13	ZR574 bit14	ZR574 bit15
			17th axis	18th axis	19th axis	20th axis	21st axis	22nd axis	23rd axis	24th axis
			ZR575 bit0	ZR575 bit1	ZR575 bit2	ZR575 bit3	ZR575 bit4	ZR575 bit5	ZR575 bit6	ZR575 bit7
			25th axis	26th axis	27th axis	28th axis	29th axis	30th axis	31st axis	32nd axis
			ZR575 bit8	ZR575 bit9	ZR575 bit10	ZR575 bit11	ZR575 bit12	ZR575 bit13	ZR575 bit14	ZR575 bit15

Cont.	Signal name	Abbrev.	1st axis	2nd axis	3rd axis	4th axis	5th axis	6th axis	7th axis	8th axis
A	EXTERNAL BRAKE SBT INCOMPLETE (CONTROL AXIS)[C80]	SBTNFEXm	ZR1694 bit0	ZR1694 bit1	ZR1694 bit2	ZR1694 bit3	ZR1694 bit4	ZR1694 bit5	ZR1694 bit6	ZR1694 bit7
			9th axis	10th axis	11th axis	12th axis	13th axis	14th axis	15th axis	16th axis
			ZR1694 bit8	ZR1694 bit9	ZR1694 bit10	ZR1694 bit11	ZR1694 bit12	ZR1694 bit13	ZR1694 bit14	ZR1694 bit15
			17th axis	18th axis	19th axis	20th axis	21st axis	22nd axis	23rd axis	24th axis
			ZR1695 bit0	ZR1695 bit1	ZR1695 bit2	ZR1695 bit3	ZR1695 bit4	ZR1695 bit5	ZR1695 bit6	ZR1695 bit7
			25th axis	26th axis	27th axis	28th axis	29th axis	30th axis	31st axis	32nd axis
			ZR1695 bit8	ZR1695 bit9	ZR1695 bit10	ZR1695 bit11	ZR1695 bit12	ZR1695 bit13	ZR1695 bit14	ZR1695 bit15

[Function]

This signal shows that the certain period of time has passed since the last safe brake test of the External brake was executed.

Execute the brake test as soon as possible when this signal turns ON.

[Operation]

When turning ON the NC, and after the elapse of a certain period of time since the last brake test (parameter #51011 SBT_INT), this signal turns ON. To turn OFF this signal, turn ON the External brake SBT start signal (SBTSTEXm) and execute the brake test. The test needs to be completed successfully.

Refer to the signal description of SBTSTEXm for the operation sequence of this signal.

[Related signals]

(1) External brake SBT start (SBTSTEXm)

4 Explanation of Interface Signals

Cont.	Signal name	Abbrev.	1st axis	2nd axis	3rd axis	4th axis	5th axis	6th axis	7th axis	8th axis
A	IN SBT EXTERNAL BRAKE TEST (CONTROL AXIS)[M8]	SBTEXBRm	ZR576 bit0	ZR576 bit1	ZR576 bit2	ZR576 bit3	ZR576 bit4	ZR576 bit5	ZR576 bit6	ZR576 bit7
			9th axis	10th axis	11th axis	12th axis	13th axis	14th axis	15th axis	16th axis
			ZR576 bit8	ZR576 bit9	ZR576 bit10	ZR576 bit11	ZR576 bit12	ZR576 bit13	ZR576 bit14	ZR576 bit15
			17th axis	18th axis	19th axis	20th axis	21st axis	22nd axis	23rd axis	24th axis
			ZR577 bit0	ZR577 bit1	ZR577 bit2	ZR577 bit3	ZR577 bit4	ZR577 bit5	ZR577 bit6	ZR577 bit7
			25th axis	26th axis	27th axis	28th axis	29th axis	30th axis	31st axis	32nd axis
			ZR577 bit8	ZR577 bit9	ZR577 bit10	ZR577 bit11	ZR577 bit12	ZR577 bit13	ZR577 bit14	ZR577 bit15

Cont.	Signal name	Abbrev.	1st axis	2nd axis	3rd axis	4th axis	5th axis	6th axis	7th axis	8th axis
A	IN SBT EXTERNAL BRAKE TEST (CONTROL AXIS)[C80]	SBTEXBRm	ZR1696 bit0	ZR1696 bit1	ZR1696 bit2	ZR1696 bit3	ZR1696 bit4	ZR1696 bit5	ZR1696 bit6	ZR1696 bit7
			9th axis	10th axis	11th axis	12th axis	13th axis	14th axis	15th axis	16th axis
			ZR1696 bit8	ZR1696 bit9	ZR1696 bit10	ZR1696 bit11	ZR1696 bit12	ZR1696 bit13	ZR1696 bit14	ZR1696 bit15
			17th axis	18th axis	19th axis	20th axis	21st axis	22nd axis	23rd axis	24th axis
			ZR1697 bit0	ZR1697 bit1	ZR1697 bit2	ZR1697 bit3	ZR1697 bit4	ZR1697 bit5	ZR1697 bit6	ZR1697 bit7
			25th axis	26th axis	27th axis	28th axis	29th axis	30th axis	31st axis	32nd axis
			ZR1697 bit8	ZR1697 bit9	ZR1697 bit10	ZR1697 bit11	ZR1697 bit12	ZR1697 bit13	ZR1697 bit14	ZR1697 bit15

[Function]

This signal shows that the axis corresponding to the signal is in the External brake test.

[Operation]

After the External brake SBT start signal (SBTSTEXm) turns ON, this signal's ON/OFF switches.

Incorporate the signal processing logic at the user side to actually start the external brake at the time of this signal ON.

Test pattern of the External brake starting method

	SBTEXBRm 1CH	SBTEXBRm 2CH	External brake starting signal 1CH	External brake starting signal 2CH
Test pattern1	ON	ON	OFF	OFF

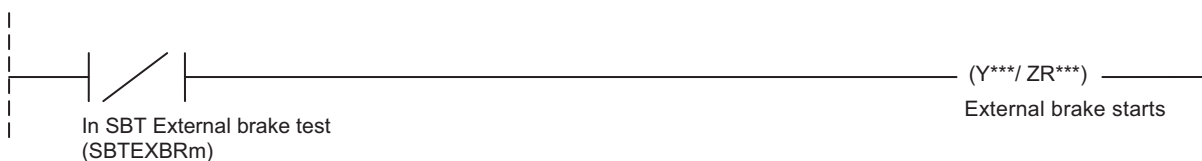

Example of the signal processing logic for External brake test

[Related signals]

- (1) External brake SBT start (SBTSTEXm)

4 Explanation of Interface Signals

Cont.	Signal name	Abbrev.	1st axis	2nd axis	3rd axis	4th axis	5th axis	6th axis	7th axis	8th axis
A	MOTOR BRAKE SBT INCOMPLETE (CONTROL AXIS)[M8]	SBTNFMOM	ZR578 bit0	ZR578 bit1	ZR578 bit2	ZR578 bit3	ZR578 bit4	ZR578 bit5	ZR578 bit6	ZR578 bit7
			9th axis	10th axis	11th axis	12th axis	13th axis	14th axis	15th axis	16th axis
			ZR578 bit8	ZR578 bit9	ZR578 bit10	ZR578 bit11	ZR578 bit12	ZR578 bit13	ZR578 bit14	ZR578 bit15
			17th axis	18th axis	19th axis	20th axis	21st axis	22nd axis	23rd axis	24th axis
			ZR579 bit0	ZR579 bit1	ZR579 bit2	ZR579 bit3	ZR579 bit4	ZR579 bit5	ZR579 bit6	ZR579 bit7
			25th axis	26th axis	27th axis	28th axis	29th axis	30th axis	31st axis	32nd axis
			ZR579 bit8	ZR579 bit9	ZR579 bit10	ZR579 bit11	ZR579 bit12	ZR579 bit13	ZR579 bit14	ZR579 bit15

Cont.	Signal name	Abbrev.	1st axis	2nd axis	3rd axis	4th axis	5th axis	6th axis	7th axis	8th axis
A	MOTOR BRAKE SBT INCOMPLETE (CONTROL AXIS)[C80]	SBTNFMOM	ZR1698 bit0	ZR1698 bit1	ZR1698 bit2	ZR1698 bit3	ZR1698 bit4	ZR1698 bit5	ZR1698 bit6	ZR1698 bit7
			9th axis	10th axis	11th axis	12th axis	13th axis	14th axis	15th axis	16th axis
			ZR1698 bit8	ZR1698 bit9	ZR1698 bit10	ZR1698 bit11	ZR1698 bit12	ZR1698 bit13	ZR1698 bit14	ZR1698 bit15
			17th axis	18th axis	19th axis	20th axis	21st axis	22nd axis	23rd axis	24th axis
			ZR1699 bit0	ZR1699 bit1	ZR1699 bit2	ZR1699 bit3	ZR1699 bit4	ZR1699 bit5	ZR1699 bit6	ZR1699 bit7
			25th axis	26th axis	27th axis	28th axis	29th axis	30th axis	31st axis	32nd axis
			ZR1699 bit8	ZR1699 bit9	ZR1699 bit10	ZR1699 bit11	ZR1699 bit12	ZR1699 bit13	ZR1699 bit14	ZR1699 bit15

[Function]

This signal shows that the certain period of time has passed since the last safe brake test of the Motor brake was executed.

Execute the brake test as soon as possible when this signal turns ON.

[Operation]

When turning ON the NC, and after the elapse of a certain period of time since the last brake test (parameter #51011 SBT_INT), this signal turns ON. To turn OFF this signal, turn ON the Motor brake SBT start signal (SBTSTMOM) and execute the brake test. The test needs to be completed successfully.

Refer to the signal description of SBTSTMOM for the operation sequence of this signal.

[Related signals]

(1) Motor brake SBT start (SBTSTMOM)

4 Explanation of Interface Signals

Cont.	Signal name	Abbrev.	1st axis	2nd axis	3rd axis	4th axis	5th axis	6th axis	7th axis	8th axis
A	IN SAFETY ABSOLUTE POSITION ESTABLISHING (CONTROL AXIS)[M8]	SFABSPE-STm	ZR580 bit0	ZR580 bit1	ZR580 bit2	ZR580 bit3	ZR580 bit4	ZR580 bit5	ZR580 bit6	ZR580 bit7
			9th axis	10th axis	11th axis	12th axis	13th axis	14th axis	15th axis	16th axis
			ZR580 bit8	ZR580 bit9	ZR580 bit10	ZR580 bit11	ZR580 bit12	ZR580 bit13	ZR580 bit14	ZR580 bit15
			17th axis	18th axis	19th axis	20th axis	21st axis	22nd axis	23rd axis	24th axis
			ZR581 bit0	ZR581 bit1	ZR581 bit2	ZR581 bit3	ZR581 bit4	ZR581 bit5	ZR581 bit6	ZR581 bit7
			25th axis	26th axis	27th axis	28th axis	29th axis	30th axis	31st axis	32nd axis
			ZR581 bit8	ZR581 bit9	ZR581 bit10	ZR581 bit11	ZR581 bit12	ZR581 bit13	ZR581 bit14	ZR581 bit15

Cont.	Signal name	Abbrev.	1st axis	2nd axis	3rd axis	4th axis	5th axis	6th axis	7th axis	8th axis
A	IN SAFETY ABSOLUTE POSITION ESTABLISHING (CONTROL AXIS)[C80]	SFABSPE-STm	ZR1700 bit0	ZR1700 bit1	ZR1700 bit2	ZR1700 bit3	ZR1700 bit4	ZR1700 bit5	ZR1700 bit6	ZR1700 bit7
			9th axis	10th axis	11th axis	12th axis	13th axis	14th axis	15th axis	16th axis
			ZR1700 bit8	ZR1700 bit9	ZR1700 bit10	ZR1700 bit11	ZR1700 bit12	ZR1700 bit13	ZR1700 bit14	ZR1700 bit15
			17th axis	18th axis	19th axis	20th axis	21st axis	22nd axis	23rd axis	24th axis
			ZR1701 bit0	ZR1701 bit1	ZR1701 bit2	ZR1701 bit3	ZR1701 bit4	ZR1701 bit5	ZR1701 bit6	ZR1701 bit7
			25th axis	26th axis	27th axis	28th axis	29th axis	30th axis	31st axis	32nd axis
			ZR1701 bit8	ZR1701 bit9	ZR1701 bit10	ZR1701 bit11	ZR1701 bit12	ZR1701 bit13	ZR1701 bit14	ZR1701 bit15

[Function]

This signal shows that the Safety absolute position is established for executing SLP/SCA.

[Operation]

When the warning "Safe absol. posn unestablished" occurs, this signal turns ON after the Safety absolute position check signal is turned ON and the warning is canceled (it will be in the state of the Safety absolute position established.).

Additionally, when the warning "Safe absol. posn unestablished" occurs, this signal turns OFF.

Once this signal is ON, the ON status is held until the warning "Safe absol. posn unestablished" occurs even when the power is turned OFF and ON again. While this signal is ON, the observation by SLP and the signal output by SCA can be carried out. (When this signal is OFF, SLP/SCA does not operate.)

[Related signals]

(1) Safety absolute position check (control axis) (SFABSPFXm)

4 Explanation of Interface Signals

Cont.	Signal name	Abbrev.	1st axis	2nd axis	3rd axis	4th axis	5th axis	6th axis	7th axis	8th axis
A	SMART SAFETY OBSERVATION ERROR OCCURRING SERVO AXIS (CONTROL AXIS)[M8]	SFERR_SVm	ZR582 bit0	ZR582 bit1	ZR582 bit2	ZR582 bit3	ZR582 bit4	ZR582 bit5	ZR582 bit6	ZR582 bit7
			9th axis	10th axis	11th axis	12th axis	13th axis	14th axis	15th axis	16th axis
			ZR582 bit8	ZR582 bit9	ZR582 bit10	ZR582 bit11	ZR582 bit12	ZR582 bit13	ZR582 bit14	ZR582 bit15
			17th axis	18th axis	19th axis	20th axis	21st axis	22nd axis	23rd axis	24th axis
			ZR583 bit0	ZR583 bit1	ZR583 bit2	ZR583 bit3	ZR583 bit4	ZR583 bit5	ZR583 bit6	ZR583 bit7
			25th axis	26th axis	27th axis	28th axis	29th axis	30th axis	31st axis	32nd axis
			ZR583 bit8	ZR583 bit9	ZR583 bit10	ZR583 bit11	ZR583 bit12	ZR583 bit13	ZR583 bit14	ZR583 bit15

Cont.	Signal name	Abbrev.	1st axis	2nd axis	3rd axis	4th axis	5th axis	6th axis	7th axis	8th axis
A	SMART SAFETY OBSERVATION ERROR OCCURRING SERVO AXIS (CONTROL AXIS)[C80]	SFERR_SVm	ZR1702 bit0	ZR1702 bit1	ZR1702 bit2	ZR1702 bit3	ZR1702 bit4	ZR1702 bit5	ZR1702 bit6	ZR1702 bit7
			9th axis	10th axis	11th axis	12th axis	13th axis	14th axis	15th axis	16th axis
			ZR1702 bit8	ZR1702 bit9	ZR1702 bit10	ZR1702 bit11	ZR1702 bit12	ZR1702 bit13	ZR1702 bit14	ZR1702 bit15
			17th axis	18th axis	19th axis	20th axis	21st axis	22nd axis	23rd axis	24th axis
			ZR1703 bit0	ZR1703 bit1	ZR1703 bit2	ZR1703 bit3	ZR1703 bit4	ZR1703 bit5	ZR1703 bit6	ZR1703 bit7
			25th axis	26th axis	27th axis	28th axis	29th axis	30th axis	31st axis	32nd axis
			ZR1703 bit8	ZR1703 bit9	ZR1703 bit10	ZR1703 bit11	ZR1703 bit12	ZR1703 bit13	ZR1703 bit14	ZR1703 bit15

[Function]

This signal shows the servo axis which the Smart safety observation error occurred.

[Operation]

When the Smart safety observation error for each axis is occurring, it turns ON the BIT corresponding to the servo axis that the error occurred.

It outputs 0 when Smart safety observation error for each axis is not in occurrence state.

[Caution]

It outputs 0 when Smart safety observation error which does not display the message of the axis name is in occurrence state.

[Related signals]

- (1) V number of smart safety observation error (SFERR_VNO)
- (2) E number of smart safety observation error (SFERR_ENO)
- (3) Smart safety observation error occurring spindle (SFERR_SPM)

4 Explanation of Interface Signals

Cont.	Signal name	Abbrev.	1st axis	2nd axis	3rd axis	4th axis	5th axis	6th axis	7th axis	8th axis
A	SMART SAFETY OBSERVATION WARNING OCCURING SERVO AXIS (CONTROL AXIS)[M8]	SF- WRG_SVm	ZR584 bit0	ZR584 bit1	ZR584 bit2	ZR584 bit3	ZR584 bit4	ZR584 bit5	ZR584 bit6	ZR584 bit7
			9th axis	10th axis	11th axis	12th axis	13th axis	14th axis	15th axis	16th axis
			ZR584 bit8	ZR584 bit9	ZR584 bit10	ZR584 bit11	ZR584 bit12	ZR584 bit13	ZR584 bit14	ZR584 bit15
			17th axis	18th axis	19th axis	20th axis	21st axis	22nd axis	23rd axis	24th axis
			ZR585 bit0	ZR585 bit1	ZR585 bit2	ZR585 bit3	ZR585 bit4	ZR585 bit5	ZR585 bit6	ZR585 bit7
			25th axis	26th axis	27th axis	28th axis	29th axis	30th axis	31st axis	32nd axis
			ZR585 bit8	ZR585 bit9	ZR585 bit10	ZR585 bit11	ZR585 bit12	ZR585 bit13	ZR585 bit14	ZR585 bit15

Cont.	Signal name	Abbrev.	1st axis	2nd axis	3rd axis	4th axis	5th axis	6th axis	7th axis	8th axis
A	SMART SAFETY OBSERVATION WARNING OCCURING SERVO AXIS (CONTROL AXIS)[C80]	SF- WRG_SVm	ZR1704 bit0	ZR1704 bit1	ZR1704 bit2	ZR1704 bit3	ZR1704 bit4	ZR1704 bit5	ZR1704 bit6	ZR1704 bit7
			9th axis	10th axis	11th axis	12th axis	13th axis	14th axis	15th axis	16th axis
			ZR1704 bit8	ZR1704 bit9	ZR1704 bit10	ZR1704 bit11	ZR1704 bit12	ZR1704 bit13	ZR1704 bit14	ZR1704 bit15
			17th axis	18th axis	19th axis	20th axis	21st axis	22nd axis	23rd axis	24th axis
			ZR1705 bit0	ZR1705 bit1	ZR1705 bit2	ZR1705 bit3	ZR1705 bit4	ZR1705 bit5	ZR1705 bit6	ZR1705 bit7
			25th axis	26th axis	27th axis	28th axis	29th axis	30th axis	31st axis	32nd axis
			ZR1705 bit8	ZR1705 bit9	ZR1705 bit10	ZR1705 bit11	ZR1705 bit12	ZR1705 bit13	ZR1705 bit14	ZR1705 bit15

[Function]

This signal shows the Servo axis which the Smart safety observation warning occurred.

[Operation]

When the Smart safety observation warning for each axis is occurring, it turns ON the BIT corresponding to the servo axis that the warning occurred.

It outputs 0 when Smart safety observation warning is not in occurrence state.

[Caution]

It outputs 0 when Smart safety observation warning which does not display the message of the axis name occurs.

[Related signals]

- (1) V number of smart safety observation warning (SFWRG_VNO)
- (2) W number of smart safety observation warning (SFWRG_WNO)
- (3) Smart safety observation warning occurring spindle (SFWRG_SPm)

4 Explanation of Interface Signals

Cont.	Signal name	Abbrev.	1st axis	2nd axis	3rd axis	4th axis	5th axis	6th axis	7th axis	8th axis
A	SLS SPEED CHANGE OUTPUT (CONTROL AXIS)[M8]	SLSMOmn	ZR608	ZR609	ZR610	ZR611	ZR612	ZR613	ZR614	ZR615
			9th axis	10th axis	11th axis	12th axis	13th axis	14th axis	15th axis	16th axis
			ZR616	ZR617	ZR618	ZR619	ZR620	ZR621	ZR622	ZR623
			17th axis	18th axis	19th axis	20th axis	21st axis	22nd axis	23rd axis	24th axis
			ZR624	ZR625	ZR626	ZR627	ZR628	ZR629	ZR630	ZR631
			25th axis	26th axis	27th axis	28th axis	29th axis	30th axis	31st axis	32nd axis
			ZR632	ZR633	ZR634	ZR635	ZR636	ZR637	ZR638	ZR639

Cont.	Signal name	Abbrev.	1st axis	2nd axis	3rd axis	4th axis	5th axis	6th axis	7th axis	8th axis
A	SLS SPEED CHANGE OUTPUT (CONTROL AXIS)[C80]	SLSMOmn	ZR1728	ZR1729	ZR1730	ZR1731	ZR1732	ZR1733	ZR1734	ZR1735
			9th axis	10th axis	11th axis	12th axis	13th axis	14th axis	15th axis	16th axis
			ZR1736	ZR1737	ZR1738	ZR1739	ZR1740	ZR1741	ZR1742	ZR1743
			17th axis	18th axis	19th axis	20th axis	21st axis	22nd axis	23rd axis	24th axis
			ZR1744	ZR1745	ZR1746	ZR1747	ZR1748	ZR1749	ZR1750	ZR1751
			25th axis	26th axis	27th axis	28th axis	29th axis	30th axis	31st axis	32nd axis
			ZR1752	ZR1753	ZR1754	ZR1755	ZR1756	ZR1757	ZR1758	ZR1759

[Function]

This signal outputs the currently selected SLS speed tolerance's step No.

This signal is available when SLS is enabled by the parameter (#51002 SLS_Enable).

(When SLS is disabled by #51002 SLS_Enable, always zero is output to all the bits of this signal (SLS speed tolerance 1).)

SLS speed change output status

SLS speed change output		No. of step to be selected	Corresponding SLS speed parameter
Bit1	Bit0		
0	0	1	#51103 SLS_Speed1
0	1	2	#51104 SLS_Speed2
1	0	3	#51105 SLS_Speed3
1	1	4	#51106 SLS_Speed4

[Operation]

When SLS speed change input (SLSMImn) is changed, this signal is also changed.

(This signal is changed even though SLS observation request (*SLSRm) is ON (when SLS is not requested).)

[Related signals]

- (1) SLS speed change input (SLSMImn)
- (2) SLS speed override input (SLSOVRImn)
- (3) SLS speed override output (SLSOVROmn)
- (4) SLS observation request (*SLSRm)
- (5) SLS observation is active (SLSEm)
- (6) Under SLS limit (SLSSm)

4 Explanation of Interface Signals

Cont.	Signal name	Abbrev.	1st axis	2nd axis	3rd axis	4th axis	5th axis	6th axis	7th axis	8th axis
A	SLS SPEED OVERRIDE OUTPUT (CONTROL AXIS)[M8]	SLSOV-ROmn	ZR608	ZR609	ZR610	ZR611	ZR612	ZR613	ZR614	ZR615
			9th axis	10th axis	11th axis	12th axis	13th axis	14th axis	15th axis	16th axis
			ZR616	ZR617	ZR618	ZR619	ZR620	ZR621	ZR622	ZR623
			17th axis	18th axis	19th axis	20th axis	21st axis	22nd axis	23rd axis	24th axis
			ZR624	ZR625	ZR626	ZR627	ZR628	ZR629	ZR630	ZR631
			25th axis	26th axis	27th axis	28th axis	29th axis	30th axis	31st axis	32nd axis
			ZR632	ZR633	ZR634	ZR635	ZR636	ZR637	ZR638	ZR639

Cont.	Signal name	Abbrev.	1st axis	2nd axis	3rd axis	4th axis	5th axis	6th axis	7th axis	8th axis
A	SLS SPEED OVERRIDE OUTPUT (CONTROL AXIS)[C80]	SLSOV-ROmn	ZR1728	ZR1729	ZR1730	ZR1731	ZR1732	ZR1733	ZR1734	ZR1735
			9th axis	10th axis	11th axis	12th axis	13th axis	14th axis	15th axis	16th axis
			ZR1736	ZR1737	ZR1738	ZR1739	ZR1740	ZR1741	ZR1742	ZR1743
			17th axis	18th axis	19th axis	20th axis	21st axis	22nd axis	23rd axis	24th axis
			ZR1744	ZR1745	ZR1746	ZR1747	ZR1748	ZR1749	ZR1750	ZR1751
			25th axis	26th axis	27th axis	28th axis	29th axis	30th axis	31st axis	32nd axis
			ZR1752	ZR1753	ZR1754	ZR1755	ZR1756	ZR1757	ZR1758	ZR1759

[Function]

This signal outputs the currently selected SLS speed override.

This signal is available when SLS is enabled by the parameter (#51002 SLS_Enable).

(When SLS is disabled by #51002 SLS_Enable, always zero is output to all the bits of this signal (SLS speed override 1).)

SLS speed override output status

SLS speed override input				No. of step to be selected	Corresponding SLS speed override parameter
Bit7	Bit6	Bit5	Bit4		
0	0	0	0	1	#51107 SLS_Override1
0	0	0	1	2	#51108 SLS_Override2
0	0	1	0	3	#51109 SLS_Override3
0	0	1	1	4	#51110 SLS_Override4
0	1	0	0	5	#51111 SLS_Override5
0	1	0	1	6	#51112 SLS_Override6
0	1	1	0	7	#51113 SLS_Override7
0	1	1	1	8	#51114 SLS_Override8
1	0	0	0	9	#51115 SLS_Override9
1	0	0	1	10	#51116 SLS_Override10
1	0	1	0	11	#51117 SLS_Override11
1	0	1	1	12	#51118 SLS_Override12
1	1	0	0	13	#51119 SLS_Override13
1	1	0	1	14	#51120 SLS_Override14
1	1	1	0	15	#51121 SLS_Override15
1	1	1	1	16	#51122 SLS_Override16

[Operation]

When SLS speed override input (SLSOVRImn) is changed, this signal is also changed.

(This signal is changed even though SLS observation request (*SLSRm) is ON (when SLS is not requested).)

[Related signals]

- (1) SLS speed change input (SLSMImn)
- (2) SLS speed change output (SLSMOmn)
- (3) SLS speed override input (SLSOVRImn)
- (4) SLS observation request (*SLSRm)
- (5) SLS observation is active (SLSEm)
- (6) Under SLS limit (SLSSm)

4 Explanation of Interface Signals

Cont.	Signal name	Abbrev.	1st axis	2nd axis	3rd axis	4th axis	5th axis	6th axis	7th axis	8th axis
A	SLP POSITION CHANGE OUTPUT (CONTROL AXIS)[M8]	SLPMOmn	ZR640	ZR641	ZR642	ZR643	ZR644	ZR645	ZR646	ZR647
			9th axis	10th axis	11th axis	12th axis	13th axis	14th axis	15th axis	16th axis
			ZR648	ZR649	ZR650	ZR651	ZR652	ZR653	ZR654	ZR655
			17th axis	18th axis	19th axis	20th axis	21st axis	22nd axis	23rd axis	24th axis
			ZR656	ZR657	ZR658	ZR659	ZR660	ZR661	ZR662	ZR663
			25th axis	26th axis	27th axis	28th axis	29th axis	30th axis	31st axis	32nd axis
			ZR664	ZR665	ZR666	ZR667	ZR668	ZR669	ZR670	ZR671

Cont.	Signal name	Abbrev.	1st axis	2nd axis	3rd axis	4th axis	5th axis	6th axis	7th axis	8th axis
A	SLP POSITION CHANGE OUTPUT (CONTROL AXIS)[C80]	SLPMOmn	ZR1760	ZR1761	ZR1762	ZR1763	ZR1764	ZR1765	ZR1766	ZR1767
			9th axis	10th axis	11th axis	12th axis	13th axis	14th axis	15th axis	16th axis
			ZR1768	ZR1769	ZR1770	ZR1771	ZR1772	ZR1773	ZR1774	ZR1775
			17th axis	18th axis	19th axis	20th axis	21st axis	22nd axis	23rd axis	24th axis
			ZR1776	ZR1777	ZR1778	ZR1779	ZR1780	ZR1781	ZR1782	ZR1783
			25th axis	26th axis	27th axis	28th axis	29th axis	30th axis	31st axis	32nd axis
			ZR1784	ZR1785	ZR1786	ZR1787	ZR1788	ZR1789	ZR1790	ZR1791

[Function]

This signal outputs the step No. of the currently selected SLP position tolerance.

This signal is available when SLP is enabled by the parameter (#51003 SLP_Enable).

(When SLP is disabled by #51003 SLP_Enable, always zero is output to all the bits of this signal (SLP position tolerance 1).)

SLP position change output status

SLP position change output		No. of step to be selected	Corresponding SLP position parameter
Bit1	Bit0		
0	0	1	#51126/51127 SLP_Position(P/M)1
0	1	2	#51128/51129 SLP_Position(P/M)2
1	0	3	#51130/51131 SLP_Position(P/M)3
1	1	4	#51132/51133 SLP_Position(P/M)4

[Operation]

When SLP position change input (SLPMImn) is changed, this signal is also changed.

(This signal is changed even though SLP observation request (*SLPRm) is ON (when SLP is not requested).)

[Related signals]

- (1) SLP position change input (SLPMImn)
- (2) SLP observation request (*SLPRm)
- (3) SLP observation is active (SLPEm)
- (4) In SLP range (SLPSm)

4 Explanation of Interface Signals

Cont.	Signal name	Abbrev.	1st axis	2nd axis	3rd axis	4th axis	5th axis	6th axis	7th axis	8th axis
A	UNDER SSM SAFE SPEED (CONTROL AXIS)[M8]	SSMSmn	ZR672	ZR673	ZR674	ZR675	ZR676	ZR677	ZR678	ZR679
			9th axis	10th axis	11th axis	12th axis	13th axis	14th axis	15th axis	16th axis
			ZR680	ZR681	ZR682	ZR683	ZR684	ZR685	ZR686	ZR687
			17th axis	18th axis	19th axis	20th axis	21st axis	22nd axis	23rd axis	24th axis
			ZR688	ZR689	ZR690	ZR691	ZR692	ZR693	ZR694	ZR695
			25th axis	26th axis	27th axis	28th axis	29th axis	30th axis	31st axis	32nd axis
			ZR696	ZR697	ZR698	ZR699	ZR700	ZR701	ZR702	ZR703

Cont.	Signal name	Abbrev.	1st axis	2nd axis	3rd axis	4th axis	5th axis	6th axis	7th axis	8th axis
A	UNDER SSM SAFE SPEED (CONTROL AXIS)[C80]	SSMSmn	ZR1792	ZR1793	ZR1794	ZR1795	ZR1796	ZR1797	ZR1798	ZR1799
			9th axis	10th axis	11th axis	12th axis	13th axis	14th axis	15th axis	16th axis
			ZR1800	ZR1801	ZR1802	ZR1803	ZR1804	ZR1805	ZR1806	ZR1807
			17th axis	18th axis	19th axis	20th axis	21st axis	22nd axis	23rd axis	24th axis
			ZR1808	ZR1809	ZR1810	ZR1811	ZR1812	ZR1813	ZR1814	ZR1815
			25th axis	26th axis	27th axis	28th axis	29th axis	30th axis	31st axis	32nd axis
			ZR1816	ZR1817	ZR1818	ZR1819	ZR1820	ZR1821	ZR1822	ZR1823

[Function]

This signal indicates that Safe speed monitor has been enabled on the control axis, and that the axis speed is under the safe speed.

Correspondence between Under SSM safe speed signals and parameters

Under SSM safe speed		Corresponding SSM speed parameter
bit0	Under SSM safe speed 1	#51135 SSM_Speed1, #51139 SSM_Hysteresis1
bit1	Under SSM safe speed 2	#51136 SSM_Speed2, #51140 SSM_Hysteresis2
bit2	Under SSM safe speed 3	#51137 SSM_Speed3, #51141 SSM_Hysteresis3
bit3	Under SSM safe speed 4	#51138 SSM_Speed4, #51142 SSM_Hysteresis4

[Operation]

This signal turns ON when SSM request (*SSMRm) is turned OFF (When SSM is requested), the NC starts execution of SSM, and then the speed of the control axis drops to the safe speed or lower. This signal remains OFF while the control axis speed is exceeding the safe speed. This signal turns OFF when SSM request (*SSMRm) is turned ON (when SSM is not requested).

[Related signals]

- (1) SSM request (*SSMRm)
- (2) SSM is active (SSMEm)

4 Explanation of Interface Signals

Cont.	Signal name	Abbrev.	1st axis	2nd axis	3rd axis	4th axis	5th axis	6th axis	7th axis	8th axis
A	SAFE CAM POSITION (CONTROL AXIS)[M8]	SCASmn	ZR704	ZR706	ZR708	ZR710	ZR712	ZR714	ZR716	ZR718
			ZR705	ZR707	ZR709	ZR711	ZR713	ZR715	ZR717	ZR719
			9th axis	10th axis	11th axis	12th axis	13th axis	14th axis	15th axis	16th axis
			ZR720	ZR722	ZR724	ZR726	ZR728	ZR730	ZR732	ZR734
			ZR721	ZR723	ZR725	ZR727	ZR729	ZR731	ZR733	ZR735
			17th axis	18th axis	19th axis	20th axis	21st axis	22nd axis	23rd axis	24th axis
			ZR736	ZR738	ZR740	ZR742	ZR744	ZR746	ZR748	ZR750
ZR737	ZR739	ZR741	ZR743	ZR745	ZR747	ZR749	ZR751			
25th axis	26th axis	27th axis	28th axis	29th axis	30th axis	31st axis	32nd axis			
ZR752	ZR754	ZR756	ZR758	ZR760	ZR762	ZR764	ZR766			
ZR753	ZR755	ZR757	ZR759	ZR761	ZR763	ZR765	ZR767			

Cont.	Signal name	Abbrev.	1st axis	2nd axis	3rd axis	4th axis	5th axis	6th axis	7th axis	8th axis
A	SAFE CAM POSITION (CONTROL AXIS)[C80]	SCASmn	ZR1824	ZR1826	ZR1828	ZR1830	ZR1832	ZR1834	ZR1836	ZR1838
			ZR1825	ZR1827	ZR1829	ZR1831	ZR1833	ZR1835	ZR1837	ZR1839
			9th axis	10th axis	11th axis	12th axis	13th axis	14th axis	15th axis	16th axis
			ZR1840	ZR1842	ZR1844	ZR1846	ZR1848	ZR1850	ZR1852	ZR1854
			ZR1841	ZR1843	ZR1845	ZR1847	ZR1849	ZR1851	ZR1853	ZR1855
			17th axis	18th axis	19th axis	20th axis	21st axis	22nd axis	23rd axis	24th axis
			ZR1856	ZR1858	ZR1860	ZR1862	ZR1864	ZR1866	ZR1868	ZR1870
ZR1857	ZR1859	ZR1861	ZR1863	ZR1865	ZR1867	ZR1869	ZR1871			
25th axis	26th axis	27th axis	28th axis	29th axis	30th axis	31st axis	32nd axis			
ZR1872	ZR1874	ZR1876	ZR1878	ZR1880	ZR1882	ZR1884	ZR1886			
ZR1873	ZR1875	ZR1877	ZR1879	ZR1881	ZR1883	ZR1885	ZR1887			

[Function]

This signal indicates the safe cam position status of the control axis.

Correspondence between Safe cam position signals and parameters (for the 1st axis)

Safe cam position		Corresponding SCA position parameter
SCAS11/bit0	Safe cam position 1(-)	#51144 SCA_PositionM1
SCAS12/bit1	Safe cam position 2(-)	#51146 SCA_PositionM2
:	:	:
SCAS115/bit14	Safe cam position 15(-)	#51172 SCA_PositionM15
SCAS116/bit15	Safe cam position 16(-)	#51174 SCA_PositionM16
SCAS117/bit0	Safe cam position 1(+)	#51143 SCA_PositionP1
SCAS118/bit1	Safe cam position 2(+)	#51145 SCA_PositionP2
:	:	:
SCAS131/bit14	Safe cam position 15(+)	#51171 SCA_PositionP15
SCAS132/bit15	Safe cam position 16(+)	#51173 SCA_PositionP16

[Operation]

When the NC has started execution of SCA in response to turning-OFF of Safe cam request (*SCARm) (SCA request), and the control axis has reached the safe position (+/-) * or further, the corresponding bit of this signal turns ON.

* Safe position (+/-) is determined based on the axis position status, which means based on SCA position (#51143 SCA_PositionM1 to #51174 SCA_PositionP16) and SCA hysteresis width (#51175 SCA_Hysteresis).

(a) When Safe cam position n (+/-) is ON

Safe position n (+/-) = SCA position n (+/-) - SCA hysteresis width (n = 1 to 16)

(b) When Safe cam position n (+/-) is OFF

Safe position n (+/-) = SCA position (+/-) n (n = 1 to 16)

Listed below is the correspondence between the statuses of Safe cam position n (-) and Safe cam position n (+) and the axis position status. (When SCA position n (+) > SCA position n (-))

Safe cam position n (-)	Safe cam position n (+)	Axis position status
0	0	Smaller than Safe position n (-)
1	0	Between Safe position n (-) and Safe position n (+)
0	1	-
1	1	In Safe position n (+) or greater

When Safe cam request (*SCARm) is turned ON (When SCA is not requested), this signal is all turned OFF.

[Related signals]

- (1) Safe cam request (*SCARm)
- (2) Safe cam is active (SCAE_m)

4 Explanation of Interface Signals

Cont.	Signal name	Abbrev.	1st axis	2nd axis	3rd axis	4th axis	5th axis	6th axis	7th axis	8th axis
A	SBT START POSITION (CONTROL AXIS)[M8]	SBTPOS _m	ZR768	ZR772	ZR776	ZR780	ZR784	ZR788	ZR792	ZR796
			ZR769	ZR773	ZR777	ZR781	ZR785	ZR789	ZR793	ZR797
			9th axis	10th axis	11th axis	12th axis	13th axis	14th axis	15th axis	16th axis
			ZR800	ZR804	ZR808	ZR812	ZR816	ZR820	ZR824	ZR828
			ZR801	ZR805	ZR809	ZR813	ZR817	ZR821	ZR825	ZR829
			17th axis	18th axis	19th axis	20th axis	21st axis	22nd axis	23rd axis	24th axis
			ZR832	ZR836	ZR840	ZR844	ZR848	ZR852	ZR856	ZR860
ZR833	ZR837	ZR841	ZR845	ZR849	ZR853	ZR857	ZR861			
25th axis	26th axis	27th axis	28th axis	29th axis	30th axis	31st axis	32nd axis			
ZR864	ZR868	ZR872	ZR876	ZR880	ZR884	ZR888	ZR892			
ZR865	ZR869	ZR873	ZR877	ZR881	ZR885	ZR889	ZR893			

Cont.	Signal name	Abbrev.	1st axis	2nd axis	3rd axis	4th axis	5th axis	6th axis	7th axis	8th axis
A	SBT START POSITION (CONTROL AXIS)[C80]	SBTPOS _m	ZR1888	ZR1892	ZR1896	ZR1900	ZR1904	ZR1908	ZR1912	ZR1916
			ZR1889	ZR1893	ZR1897	ZR1901	ZR1905	ZR1909	ZR1913	ZR1917
			9th axis	10th axis	11th axis	12th axis	13th axis	14th axis	15th axis	16th axis
			ZR1920	ZR1924	ZR1928	ZR1932	ZR1936	ZR1940	ZR1944	ZR1948
			ZR1921	ZR1925	ZR1929	ZR1933	ZR1937	ZR1941	ZR1945	ZR1949
			17th axis	18th axis	19th axis	20th axis	21st axis	22nd axis	23rd axis	24th axis
			ZR1952	ZR1956	ZR1960	ZR1964	ZR1968	ZR1972	ZR1976	ZR1980
ZR1953	ZR1957	ZR1961	ZR1965	ZR1969	ZR1973	ZR1977	ZR1981			
25th axis	26th axis	27th axis	28th axis	29th axis	30th axis	31st axis	32nd axis			
ZR1984	ZR1988	ZR1992	ZR1996	ZR2000	ZR2004	ZR2008	ZR2012			
ZR1985	ZR1989	ZR1993	ZR1997	ZR2001	ZR2005	ZR2009	ZR2013			

[Function]

This signal is used to indicate the position of the safe brake test start of the external brake test or the motor brake test.

[Operation]

This signal saves the current position on the machine coordinate at the start of the safe brake test.

This data is updated at the execution of the safe brake test. (The same value continues to be output unless the safe brake test is executed.)

[M8]

The output unit differs depending on the parameter "#1040 M_inch (Constant input (inch))". If the target axis is an rotary axis, the output unit is 0.0001° regardless of the parameter "#1040 M_inch (Constant input (inch))".

(1) For a linear axis and M_inch = 0 (metric system)

The output unit is submicron (0.0001mm).

Example) The case where the machine position of the 1st axis (linear axis) is 123.4567mm

Machine position 123.4567mm -> ZR768: D687

ZR769: 0012

(2) For a linear axis and M_inch = 1 (inch system)

The output unit is 0.00001 inch.

Example) The case where the machine position of the 1st axis (linear axis) is 1.23456 inch

Machine position 1.23456 inch -> ZR768: E240

ZR769: 0001

(3) For the linear type rotary axis or the rotation-type rotary axis

The output unit is 0.0001°.

Example) The case where the machine coordinate of the 1st axis (rotary axis) is 1.23456°

Machine position 12.3456° -> ZR768: E240

ZR769: 0001

4 Explanation of Interface Signals

[C80]

The output unit is submicron.

Ex.) The case where the machine position of the 1st axis is 123456.7[μm](123.4567[mm])

Machine position 123456.7[μm] -> ZR1888:D687

ZR1889:0012

[Related signals]

- (1) External brake SBT start (SBTSTEXm)
- (2) Motor brake SBT start (SBTSTMOM)

Cont.	Signal name	Abbrev.	1st SP	2nd SP	3rd SP	4th SP	5th SP	6th SP	7th SP	8th SP
A	SLS OBSERVATION IS ACTIVE (SPINDLE)[M8]	SLSSEm	ZR1024 bit0	ZR1024 bit1	ZR1024 bit2	ZR1024 bit3	ZR1024 bit4	ZR1024 bit5	ZR1024 bit6	ZR1024 bit7

Cont.	Signal name	Abbrev.	1st SP	2nd SP	3rd SP	4th SP	5th SP	6th SP	7th SP	8th SP
A	SLS OBSERVATION IS ACTIVE (SPINDLE)[C80]	SLSSEm	ZR2144 bit0	ZR2144 bit1	ZR2144 bit2	ZR2144 bit3	ZR2144 bit4	ZR2144 bit5	ZR2144 bit6	ZR2144 bit7

[Function]

This signal indicates that SLS observation has been enabled on the spindle.

[Operation]

This signal turns ON when SLS observation request (*SLSSRm) is turned OFF (when SLS is requested), and so the NC starts execution of the SLS observation function. This signal turns OFF when SLS observation request (*SLSSRm) is turned ON (when SLS is not requested).

[Related signals]

- (1) SLS observation request (*SLSSRm)
- (2) Under SLS limit (SLSSSm)

Cont.	Signal name	Abbrev.	1st SP	2nd SP	3rd SP	4th SP	5th SP	6th SP	7th SP	8th SP
A	UNDER SLS LIMIT (SPINDLE)[M8]	SLSSSm	ZR1025 bit0	ZR1025 bit1	ZR1025 bit2	ZR1025 bit3	ZR1025 bit4	ZR1025 bit5	ZR1025 bit6	ZR1025 bit7

Cont.	Signal name	Abbrev.	1st SP	2nd SP	3rd SP	4th SP	5th SP	6th SP	7th SP	8th SP
A	UNDER SLS LIMIT (SPINDLE)[C80]	SLSSSm	ZR2145 bit0	ZR2145 bit1	ZR2145 bit2	ZR2145 bit3	ZR2145 bit4	ZR2145 bit5	ZR2145 bit6	ZR2145 bit7

[Function]

This signal indicates that SLS observation has been enabled on the spindle and that the spindle is at the safely-limited speed or lower.

[Operation]

This signal turns ON when SLS observation request (*SLSSRm) is turned OFF (when SLS is requested), the NC starts execution of the SLS observation function, and then the speed of the spindle drops to the safely-limited speed or lower. This signal remains OFF if the spindle's speed is exceeding the safely-limited speed.

This signal turns OFF when SLS observation request (*SLSSRm) is turned ON (when SLS is not requested).

[Related signals]

- (1) SLS observation request (*SLSSRm)
- (2) SLS observation is active (SLSSEm)

4 Explanation of Interface Signals

Cont.	Signal name	Abbrev.	1st SP	2nd SP	3rd SP	4th SP	5th SP	6th SP	7th SP	8th SP
A	SSM IS ACTIVE (SPINDLE)[M8]	SSMSEm	ZR1028 bit0	ZR1028 bit1	ZR1028 bit2	ZR1028 bit3	ZR1028 bit4	ZR1028 bit5	ZR1028 bit6	ZR1028 bit7

Cont.	Signal name	Abbrev.	1st SP	2nd SP	3rd SP	4th SP	5th SP	6th SP	7th SP	8th SP
A	SSM IS ACTIVE (SPINDLE)[C80]	SSMSEm	ZR2148 bit0	ZR2148 bit1	ZR2148 bit2	ZR2148 bit3	ZR2148 bit4	ZR2148 bit5	ZR2148 bit6	ZR2148 bit7

[Function]

This signal indicates that Safe speed monitor has been enabled on the spindle.

[Operation]

This signal turns ON when SSM request (*SSMSRm) is turned OFF (when SSM is requested), and so the NC starts execution of SSM. This signal turns OFF when SSM request (*SSMSRm) is turned ON (when SSM is not requested).

[Related signals]

- (1) SSM request (*SSMSRm)
- (2) Under SSM safe speed (SSMSSmn)

Cont.	Signal name	Abbrev.	1st SP	2nd SP	3rd SP	4th SP	5th SP	6th SP	7th SP	8th SP
A	SOS IS ACTIVE (SPINDLE)[M8]	SOSSEm	ZR1030 bit0	ZR1030 bit1	ZR1030 bit2	ZR1030 bit3	ZR1030 bit4	ZR1030 bit5	ZR1030 bit6	ZR1030 bit7

Cont.	Signal name	Abbrev.	1st SP	2nd SP	3rd SP	4th SP	5th SP	6th SP	7th SP	8th SP
A	SOS IS ACTIVE (SPINDLE)[C80]	SOSSEm	ZR2150 bit0	ZR2150 bit1	ZR2150 bit2	ZR2150 bit3	ZR2150 bit4	ZR2150 bit5	ZR2150 bit6	ZR2150 bit7

[Function]

This signal indicates that Safe operating stop has been enabled on the spindle in response to SOS observation request (*SOSSRm). Note that if SOS is activated by a start request from SS2, there is no output to this signal.

[Operation]

This signal turns ON when SOS observation request (*SOSSRm) is turned OFF (when SOS is requested), and so the NC starts execution of SOS. This signal turns OFF when SOS observation request (*SOSSRm) is turned ON (when SOS is not requested).

[Related signals]

- (1) SOS observation request (*SOSSRm)
- (2) In SOS stop (SOSSSm)

Cont.	Signal name	Abbrev.	1st SP	2nd SP	3rd SP	4th SP	5th SP	6th SP	7th SP	8th SP
A	IN SOS STOP (SPINDLE)[M8]	SOSSSm	ZR1031 bit0	ZR1031 bit1	ZR1031 bit2	ZR1031 bit3	ZR1031 bit4	ZR1031 bit5	ZR1031 bit6	ZR1031 bit7

Cont.	Signal name	Abbrev.	1st SP	2nd SP	3rd SP	4th SP	5th SP	6th SP	7th SP	8th SP
A	IN SOS STOP (SPINDLE)[C80]	SOSSSm	ZR2151 bit0	ZR2151 bit1	ZR2151 bit2	ZR2151 bit3	ZR2151 bit4	ZR2151 bit5	ZR2151 bit6	ZR2151 bit7

[Function]

This signal indicates that the SOS is active (SOSSEm) signal of the spindle has been turned ON or a start request has been made by SS2, and that the spindle is at a standstill.

[Operation]

This signal turns ON when the NC has started execution of SOS due to turning-OFF of SOS observation request (*SOSSRm) (SOS request) or due to a start request from SS2, and so the spindle has been set to a standstill. This signal remains OFF while the spindle is not at a standstill. This signal turns OFF when SOS observation request (*SOSSRm) is turned ON (when SOS is not requested) and when SS2 makes no request.

[Related signals]

- (1) SOS observation request (*SOSSRm)
- (2) SOS is active (SOSSEm)

4 Explanation of Interface Signals

Cont.	Signal name	Abbrev.	1st SP	2nd SP	3rd SP	4th SP	5th SP	6th SP	7th SP	8th SP
A	SS1 IS ACTIVE (SPINDLE)[M8]	SS1SEm	ZR1032 bit0	ZR1032 bit1	ZR1032 bit2	ZR1032 bit3	ZR1032 bit4	ZR1032 bit5	ZR1032 bit6	ZR1032 bit7

Cont.	Signal name	Abbrev.	1st SP	2nd SP	3rd SP	4th SP	5th SP	6th SP	7th SP	8th SP
A	SS1 IS ACTIVE (SPINDLE)[C80]	SS1SEm	ZR2152 bit0	ZR2152 bit1	ZR2152 bit2	ZR2152 bit3	ZR2152 bit4	ZR2152 bit5	ZR2152 bit6	ZR2152 bit7

[Function]

This signal indicates that SS1 has been enabled in response to Safe stop 1 request (*SS1SRm).

Note that if SS1 has been activated by occurrence of a smart safety observation error, there is no output to this signal.

[Operation]

This signal turns ON when Safe stop 1 request (*SS1SRm) is turned OFF (when SS1 is requested) and so the NC starts execution of the Safe stop 1 function. This signal turns OFF when Safe stop 1 request (*SS1SRm) is turned ON (when SS1 is not requested).

[Related signals]

- (1) Safe stop 1 request (*SS1SRm)
- (2) In SS1 stop (SS1SSm)

Cont.	Signal name	Abbrev.	1st SP	2nd SP	3rd SP	4th SP	5th SP	6th SP	7th SP	8th SP
A	IN SS1 STOP (SPINDLE)[M8]	SS1SSm	ZR1033 bit0	ZR1033 bit1	ZR1033 bit2	ZR1033 bit3	ZR1033 bit4	ZR1033 bit5	ZR1033 bit6	ZR1033 bit7

Cont.	Signal name	Abbrev.	1st SP	2nd SP	3rd SP	4th SP	5th SP	6th SP	7th SP	8th SP
A	IN SS1 STOP (SPINDLE)[C80]	SS1SSm	ZR2153 bit0	ZR2153 bit1	ZR2153 bit2	ZR2153 bit3	ZR2153 bit4	ZR2153 bit5	ZR2153 bit6	ZR2153 bit7

[Function]

This signal indicates that SS1 has been executed due to turning-ON of the SS1 is active (SS1SEm) signal or due to occurrence of a smart safety observation error, and that the spindle is at a standstill.

[Operation]

When Safe stop 1 request (*SS1SRm) is turned OFF (When SS1 is requested) or when a smart safety observation error occurs, SS1 starts to be executed. When the spindle decelerates to a stop, this signal is turned ON. This signal remains OFF while the spindle concerned is not at a standstill. This signal turns OFF when Safe stop 1 request (*SS1SRm) is turned ON (when SS1 is not requested) and when SS1 is not executed due to occurrence of an smart safety observation error.

[Related signals]

- (1) Safe stop 1 request (*SS1SRm)
- (2) SS1 is active (SS1SEm)

Cont.	Signal name	Abbrev.	1st SP	2nd SP	3rd SP	4th SP	5th SP	6th SP	7th SP	8th SP
A	SS2 IS ACTIVE (SPINDLE)[M8]	SS2SEm	ZR1034 bit0	ZR1034 bit1	ZR1034 bit2	ZR1034 bit3	ZR1034 bit4	ZR1034 bit5	ZR1034 bit6	ZR1034 bit7

Cont.	Signal name	Abbrev.	1st SP	2nd SP	3rd SP	4th SP	5th SP	6th SP	7th SP	8th SP
A	SS2 IS ACTIVE (SPINDLE)	SS2SEm	ZR2154 bit0	ZR2154 bit1	ZR2154 bit2	ZR2154 bit3	ZR2154 bit4	ZR2154 bit5	ZR2154 bit6	ZR2154 bit7

[Function]

This signal indicates that Safe stop 2 has been enabled on the spindle.

[Operation]

This signal turns ON when Safe stop 2 request (*SS2SRm) is turned OFF (when SS2 is requested), and so the NC starts execution of SS2. This signal turns OFF when Safe stop 2 request (*SS2SRm) is turned ON (when SS2 is not requested).

[Related signals]

- (1) Safe stop 2 request (*SS2SRm)

4 Explanation of Interface Signals

Cont.	Signal name	Abbrev.	1st SP	2nd SP	3rd SP	4th SP	5th SP	6th SP	7th SP	8th SP
A	STO IS ACTIVE (SPINDLE)[M8]	STOSEm	ZR1035 bit0	ZR1035 bit1	ZR1035 bit2	ZR1035 bit3	ZR1035 bit4	ZR1035 bit5	ZR1035 bit6	ZR1035 bit7

Cont.	Signal name	Abbrev.	1st SP	2nd SP	3rd SP	4th SP	5th SP	6th SP	7th SP	8th SP
A	STO IS ACTIVE (SPINDLE)[C80]	STOSEm	ZR2155 bit0	ZR2155 bit1	ZR2155 bit2	ZR2155 bit3	ZR2155 bit4	ZR2155 bit5	ZR2155 bit6	ZR2155 bit7

[Function]

This signal indicates that the Safe torque off function has been enabled on the spindle in response to Safe torque off request (*STOSRm). Note that if STO is activated due to occurrence of a smart safety observation error, there is no output to this signal.

[Operation]

This signal turns ON when Safe torque off request (*STOSRm) is turned OFF (when STO is requested) and so the NC starts execution of STO. This signal turns OFF when Safe torque off request (*STOSRm) is turned ON (when STO is not requested).

[Related signals]

- (1) Safe torque off request (*STOSRm)
- (2) In Safe torque off (STOSSm)

Cont.	Signal name	Abbrev.	1st SP	2nd SP	3rd SP	4th SP	5th SP	6th SP	7th SP	8th SP
A	IN SAFE TORQUE OFF (SPINDLE)[M8]	STOSSm	ZR1036 bit0	ZR1036 bit1	ZR1036 bit2	ZR1036 bit3	ZR1036 bit4	ZR1036 bit5	ZR1036 bit6	ZR1036 bit7

Cont.	Signal name	Abbrev.	1st SP	2nd SP	3rd SP	4th SP	5th SP	6th SP	7th SP	8th SP
A	IN SAFE TORQUE OFF (SPINDLE)[C80]	STOSSm	ZR2156 bit0	ZR2156 bit1	ZR2156 bit2	ZR2156 bit3	ZR2156 bit4	ZR2156 bit5	ZR2156 bit6	ZR2156 bit7

[Function]

This signal indicates that STO has been executed due to turning-ON of the STO is active (STOSEm) signal or due to occurrence of a smart safety observation error, and that the shutoff of the drive main power is completed.

[Operation]

This signal turns ON when the NC has started execution of STO due to turning-OFF of Safe torque off request (*STOSRm) (STO request) or due to occurrence of a smart safety observation error, and so the main drive power for the spindle has been shut off. This signal remains OFF while the main drive power for the spindle has not been shut off. This signal turns OFF when Safe torque off request (*STOSRm) is turned ON (when STO is not requested) and when STO is not executed due to occurrence of a smart safety observation error.

[Related signals]

- (1) Safe torque off request (*STOSRm)
- (2) STO is active (STOSEm)

4 Explanation of Interface Signals

Cont.	Signal name	Abbrev.	1st SP	2nd SP	3rd SP	4th SP	5th SP	6th SP	7th SP	8th SP
A	SMART SAFETY OBSERVATION ERROR OCCURRING SPINDLE (SPINDLE)[M8]	SFERR_SPm	ZR1043 bit0	ZR1043 bit1	ZR1043 bit2	ZR1043 bit3	ZR1043 bit4	ZR1043 bit5	ZR1043 bit6	ZR1043 bit7

Cont.	Signal name	Abbrev.	1st SP	2nd SP	3rd SP	4th SP	5th SP	6th SP	7th SP	8th SP
A	SMART SAFETY OBSERVATION ERROR OCCURRING SPINDLE (SPINDLE)[C80]	SFERR_SPm	ZR2163 bit0	ZR2163 bit1	ZR2163 bit2	ZR2163 bit3	ZR2163 bit4	ZR2163 bit5	ZR2163 bit6	ZR2163 bit7

[Function]

This signal shows the Spindle which the Smart safety observation error occurred.

[Operation]

When the Smart safety observation error for each axis is occurring, it turns ON the BIT corresponding to the Spindle that the error occurred. It outputs 0 when Smart safety observation error for each axis is not in occurrence state.

[Caution]

It outputs 0 when Smart safety observation error which does not display the message of the axis name is in occurrence state.

[Related signals]

- (1) V number of smart safety observation error (SFERR_VNO)
- (2) E number of smart safety observation error (SFERR_ENO)
- (3) Smart safety observation error occurring servo axis (SFERR_SVm)

Cont.	Signal name	Abbrev.	1st SP	2nd SP	3rd SP	4th SP	5th SP	6th SP	7th SP	8th SP
A	SMART SAFETY OBSERVATION WARNING OCCURRING SPINDLE(SPINDLE)[M8]	SF- WRG_SPm	ZR1044 bit0	ZR1044 bit1	ZR1044 bit2	ZR1044 bit3	ZR1044 bit4	ZR1044 bit5	ZR1044 bit6	ZR1044 bit7

Cont.	Signal name	Abbrev.	1st SP	2nd SP	3rd SP	4th SP	5th SP	6th SP	7th SP	8th SP
A	SMART SAFETY OBSERVATION WARNING OCCURRING SPINDLE(SPINDLE)[C80]	SF- WRG_SPm	ZR2164 bit0	ZR2164 bit1	ZR2164 bit2	ZR2164 bit3	ZR2164 bit4	ZR2164 bit5	ZR2164 bit6	ZR2164 bit7

[Function]

This signal shows the Spindle which the Smart safety observation warning occurred.

[Operation]

When the Smart safety observation warning for each axis is occurring, it turns ON the BIT corresponding to the Spindle that the warning occurred. It outputs 0 when Smart safety observation warning is not in occurrence state.

[Caution]

It outputs 0 when Smart safety observation warning which does not display the message of the axis name occurs.

[Related signals]

- (1) V number of smart safety observation warning (SFWRG_VNO)
- (2) W number of smart safety observation warning (SFWRG_WNO)
- (3) Smart safety observation warning occurring servo axis (SFWRG_SVm)

4 Explanation of Interface Signals

Cont.	Signal name	Abbrev.	1st SP	2nd SP	3rd SP	4th SP	5th SP	6th SP	7th SP	8th SP
A	SLS SPEED CHANGE OUTPUT (SPINDLE)[M8]	SLSSMOmn	ZR1056	ZR1057	ZR1058	ZR1059	ZR1060	ZR1061	ZR1062	ZR1063

Cont.	Signal name	Abbrev.	1st SP	2nd SP	3rd SP	4th SP	5th SP	6th SP	7th SP	8th SP
A	SLS SPEED CHANGE OUTPUT (SPINDLE)[C80]	SLSSMOmn	ZR2176	ZR2177	ZR2178	ZR2179	ZR2180	ZR2181	ZR2182	ZR2183

[Function]

This signal outputs the currently selected SLS speed tolerance's step No.

This signal is available when SLS is enabled by the parameter (#51002 SLS_Enable).

(When SLS is disabled by #51002 SLS_Enable, always zero is output to all the bits of this signal (SLS speed tolerance 1).

SLS speed change output status

SLS speed change output		No. of step to be selected	Corresponding SLS speed parameter
Bit1	Bit0		
0	0	1	#51303 SLS_SSpeed1
0	1	2	#51304 SLS_SSpeed2
1	0	3	#51305 SLS_SSpeed3
1	1	4	#51306 SLS_SSpeed4

[Operation]

When SLS speed change input (SLSSMImn) is changed, this signal is also changed.

(This signal is changed even though SLS observation request (*SLSSRm) is ON (when SLS is not requested).)

[Related signals]

- (1) SLS speed change input (SLSSMImn)
- (2) SLS speed override input (SLSSOVRImn)
- (3) SLS speed override output (SLSSOVROmn)
- (4) SLS observation request (*SLSSRm)
- (5) SLS observation is active (SLSSEm)
- (6) Under SLS limit (SLSSSm)

4 Explanation of Interface Signals

Cont.	Signal name	Abbrev.	1st SP	2nd SP	3rd SP	4th SP	5th SP	6th SP	7th SP	8th SP
A	SLS SPEED OVERRIDE OUTPUT (SPINDLE)[M8]	SLSSOV-ROmn	ZR1056	ZR1057	ZR1058	ZR1059	ZR1060	ZR1061	ZR1062	ZR1063

Cont.	Signal name	Abbrev.	1st SP	2nd SP	3rd SP	4th SP	5th SP	6th SP	7th SP	8th SP
A	SLS SPEED OVERRIDE OUTPUT (SPINDLE)[C80]	SLSSOV-ROmn	ZR2176	ZR2177	ZR2178	ZR2179	ZR2180	ZR2181	ZR2182	ZR2183

[Function]

This signal outputs the currently selected SLS speed override.

This signal is available when SLS is enabled by the parameter (#51002 SLS_Enable).

(When SLS is disabled by #51002 SLS_Enable, always zero is output to all the bits of this signal (SLS speed override 1).)

SLS speed override output status

SLS speed override input				No. of step to be selected	Corresponding SLS speed override parameter
Bit7	Bit6	Bit5	Bit4		
0	0	0	0	1	#51307 SLS_SOOverride1
0	0	0	1	2	#51308 SLS_SOOverride2
0	0	1	0	3	#51309 SLS_SOOverride3
0	0	1	1	4	#51310 SLS_SOOverride4
0	1	0	0	5	#51311 SLS_SOOverride5
0	1	0	1	6	#51312 SLS_SOOverride6
0	1	1	0	7	#51313 SLS_SOOverride7
0	1	1	1	8	#51314 SLS_SOOverride8
1	0	0	0	9	#51315 SLS_SOOverride9
1	0	0	1	10	#51316 SLS_SOOverride10
1	0	1	0	11	#51317 SLS_SOOverride11
1	0	1	1	12	#51318 SLS_SOOverride12
1	1	0	0	13	#51319 SLS_SOOverride13
1	1	0	1	14	#51320 SLS_SOOverride14
1	1	1	0	15	#51321 SLS_SOOverride15
1	1	1	1	16	#51322 SLS_SOOverride16

[Operation]

When SLS speed override input (SLSSOVRImn) is changed, this signal is also changed.

(This signal is changed even though SLS observation request (*SLSSRm) is ON (when SLS is not requested).)

[Related signals]

- (1) SLS speed change input (SLSSMIImn)
- (2) SLS speed change output (SLSSMOmn)
- (3) SLS speed override input (SLSSOVRImn)
- (4) SLS observation request (*SLSSRm)
- (5) SLS observation is active (SLSSEm)
- (6) Under SLS limit (SLSSSm)

4 Explanation of Interface Signals

Cont.	Signal name	Abbrev.	1st SP	2nd SP	3rd SP	4th SP	5th SP	6th SP	7th SP	8th SP
A	UNDER SSM SAFE SPEED (SPINDLE)[M8]	SSMSSmn	ZR1088	ZR1089	ZR1090	ZR1091	ZR1092	ZR1093	ZR1094	ZR1095

Cont.	Signal name	Abbrev.	1st SP	2nd SP	3rd SP	4th SP	5th SP	6th SP	7th SP	8th SP
A	UNDER SSM SAFE SPEED (SPINDLE)[C80]	SSMSSmn	ZR2208	ZR2209	ZR2210	ZR2211	ZR2212	ZR2213	ZR2214	ZR2215

[Function]

This signal indicates that Safe speed monitor has been enabled on the spindle and that the spindle speed is under the safe speed.

Correspondence between Under SSM safe speed signals and parameters

Under SSM safe speed		Corresponding SSM speed parameter
bit0	Under SSM safe speed 1	#51326 SSM_SSpeed1, #51330 SSM_SHysteresis1
bit1	Under SSM safe speed 2	#51327 SSM_SSpeed2, #51331 SSM_SHysteresis2
bit2	Under SSM safe speed 3	#51328 SSM_SSpeed3, #51332 SSM_SHysteresis3
bit3	Under SSM safe speed 4	#51329 SSM_SSpeed4, #51333 SSM_SHysteresis4

[Operation]

This signal turns ON when SSM request (*SSMSRm) is turned OFF (when SSM is requested), the NC starts execution of SSM, and then the speed of the spindle drops to the safe speed or lower. This signal remains OFF while the spindle speed is exceeding the safe speed. This signal turns OFF when SSM request (*SSMSRm) is turned ON (when SSM is not requested).

[Related signals]

- (1) SSM request (*SSMSRm)
- (2) SSM is active (SSMSEm)

Cont.	Signal name	Abbrev.	Common(\$)
A	IN SAFETY EXTERNAL EMERGENCY STOP (SYSTEM COMMON)[M8]	SEXTEMG	ZR1264 bit0

Cont.	Signal name	Abbrev.	Common(\$)
A	IN SAFETY EXTERNAL EMERGENCY STOP (SYSTEM COMMON)[C80]	SEXTEMG	ZR2384 bit0

[Function]

This signal indicates that Safety external emergency stop is being executed.

[Operation]

This signal turns ON when Safety external emergency stop is enabled (when the emergency stop signal device No. is set in the safety I/O assignment parameter), the emergency stop signal turns OFF (open status), the axis for which the parameter SF_Disable / SF_SDisable is set to OFF enters STO status, and all the axes are set in Ready OFF status. This signal turns OFF when the emergency stop signal turns ON (close status) and both the STO status of the axis for which SF_Disable / SF_SDisable is set to OFF, and the Ready OFF status of all the axes are cancelled.

4 Explanation of Interface Signals

Cont.	Signal name	Abbrev.	Common(\$)
A	V NUMBER OF SMART SAFETY OBSERVATION ERROR (SYSTEM COMMON)[M8]	SFERR_VNO	ZR1268

Cont.	Signal name	Abbrev.	Common(\$)
A	V NUMBER OF SMART SAFETY OBSERVATION ERROR (SYSTEM COMMON)[C80]	SFERR_VNO	ZR2388

[Function]

This signal shows the category numbers of Smart safety observation error (V number).

[Operation]

When the Smart safety observation error occurs, it outputs the number (V number) that shows the category of the error occurred.

It outputs 0 when Smart safety observation error is not in occurrence state.

Ex.) When the Smart safety observation error "V04 0003 Safe IO disabled: connect err" occurs,

V number of smart safety observation error (system common) (SFERR_VNO) : 0004

[Related signals]

- (1) E number of smart safety observation error (SFERR_ENO)
- (2) Smart safety observation error occurring servo axis (SFERR_SVm)
- (3) Smart safety observation error occurring spindle (SFERR_SPM)

Cont.	Signal name	Abbrev.	Common(\$)
A	E NUMBER OF SMART SAFETY OBSERVATION ERROR (SYSTEM COMMON)[M8]	SFERR_ENO	ZR1269

Cont.	Signal name	Abbrev.	Common(\$)
A	E NUMBER OF SMART SAFETY OBSERVATION ERROR (SYSTEM COMMON)[C80]	SFERR_ENO	ZR2389

[Function]

This signal shows the error numbers of Smart safety observation error (E number).

[Operation]

When the Smart safety observation error occurs, it outputs the number (E number) that shows which error occurred in the error category (V number).

It outputs 0 when Smart safety observation error is not in occurrence state.

Ex.) When the Smart safety observation error "V04 0003 Safe IO disabled: connect err" occurs,

E number of smart safety observation error (system common) (SFERR_ENO): 0003

[Related signals]

- (1) V number of smart safety observation error (SFERR_VNO)
- (2) Smart safety observation error occurring servo axis (SFERR_SVm)
- (3) Smart safety observation error occurring spindle (SFERR_SPM)

Cont.	Signal name	Abbrev.	Common(\$)
A	V NUMBER OF SMART SAFETY OBSERVATION WARNING (SYSTEM COMMON)[M8]	SFWRG_VNO	ZR1270

Cont.	Signal name	Abbrev.	Common(\$)
A	V NUMBER OF SMART SAFETY OBSERVATION WARNING (SYSTEM COMMON)[C80]	SFWRG_VNO	ZR2390

[Function]

This signal shows the category numbers of Smart safety observation warning (V number).

[Operation]

When the Smart safety observation warning occurs, it outputs the number (V number) that shows the category of the warning occurred.

It outputs 0 when Smart safety observation warning is not in occurrence state.

Ex.) When the Smart safety observation warning "V51 0005 SBT warning 4" occurs,

V number of smart safety observation warning (system common) (SFWRG_VNO) : 0033 (51 in decimal)

[Related signals]

- (1) W number of smart safety observation warning (SFWRG_WNO)
- (2) Smart safety observation warning occurring servo axis (SFWRG_SVm)
- (3) Smart safety observation warning occurring spindle (SFWRG_SPM)

4 Explanation of Interface Signals

Cont.	Signal name	Abbrev.	Common(\$)
A	W NUMBER OF SMART SAFETY OBSERVATION WARNING (SYSTEM COMMON)[M8]	SFWRG_WNO	ZR1271

Cont.	Signal name	Abbrev.	Common(\$)
A	W NUMBER OF SMART SAFETY OBSERVATION WARNING (SYSTEM COMMON)[C80]	SFWRG_WNO	ZR2391

[Function]

This signal shows the warning numbers of Smart safety observation warning (W number).

[Operation]

When the Smart safety observation warning occurs, it outputs the number (W number) that shows which warning occurred in the warning category (V number).

It outputs 0 when Smart safety observation warning is not in occurrence state.

Ex.) When the Smart safety observation warning "V51 0005 SBT warning 4" occurs,

W number of smart safety observation warning (system common) (SFWRG_WNO) : 0005

[Related signals]

- (1) V number of smart safety observation warning (SFWRG_VNO)
- (2) Smart safety observation warning occurring servo axis (SFWRG_SVm)
- (3) Smart safety observation warning occurring spindle (SFWRG_SPM)

Cont.	Signal name	Abbrev.	Common(\$)
A	SAFETY I/O OBSERVATION STATE [M8]	SIOERRSTS	ZR1536

Cont.	Signal name	Abbrev.	Common(\$)
A	SAFETY I/O OBSERVATION STATE [C80]	SIOERRSTS	ZR2400

[Function]

This signal outputs the state of safety I/O-related observation function.

Bit	Description	Bit	Description
bit0	Safety I/O unit observation error	bit8	Reserved
bit1	Drive's safety signal compare error	bit9	Reserved
bit2	Output OFF check not complete	bit10	Reserved
bit3	Safety I/O unit I/O start [M8]	bit11	Reserved
bit4	Reserved	bit12	Reserved
bit5	Reserved	bit13	Reserved
bit6	Reserved	bit14	Reserved
bit7	Reserved	bit15	Reserved

[Operation]

When an error occurs on a safety I/O related observation function, the corresponding error information is output.

[Related signals]

- (1) Safety I/O unit observation state (SIOERRUNIT)
- (2) Safety I/O unit observation error details (SIOERRUNITSTS)
- (3) Safety I/O device observation error signal (SIOERRUNITSIG)[C80]

4 Explanation of Interface Signals

Cont.	Signal name	Abbrev.	Common(\$)
A	SAFETY I/O UNIT OBSERVATION STATE [M8]	SIOERRUNIT	ZR1538

Cont.	Signal name	Abbrev.	Common(\$)
A	SAFETY I/O UNIT OBSERVATION STATE [C80]	SIOERRUNIT	ZR2402

[Function]

This signal outputs the state of safety I/O unit observation error for each safety I/O unit.

[M8]			
Bit	Description	Bit	Description
bit0	Safety I/O unit Unit 1 error occurring	bit8	Reserved
bit1	Safety I/O unit Unit 2 error occurring	bit9	Reserved
bit2	Safety I/O unit Unit 3 error occurring	bit10	Reserved
bit3	Safety I/O unit Unit 4 error occurring	bit11	Reserved
bit4	Safety I/O unit Unit 5 error occurring	bit12	Reserved
bit5	Safety I/O unit Unit 6 error occurring	bit13	Reserved
bit6	Safety I/O unit Unit 7 error occurring	bit14	Reserved
bit7	Safety I/O unit Unit 8 error occurring	bit15	Reserved

[C80]			
Bit	Description	Bit	Description
bit0	Safety I/O unit Unit 1 error occurring	bit8	Reserved
bit1	Safety I/O unit Unit 2 error occurring	bit9	Reserved
bit2	Safety I/O unit Unit 3 error occurring	bit10	Reserved
bit3	Reserved	bit11	Reserved
bit4	Reserved	bit12	Reserved
bit5	Reserved	bit13	Reserved
bit6	Reserved	bit14	Reserved
bit7	Reserved	bit15	Reserved

For the safety I/O unit, the devices are assigned with the parameters.

The following table lists the device assignment for the safety I/O unit.

[M8]								
	Unit1	Unit2	Unit3	Unit4	Unit5	Unit6	Unit7	Unit8
Channel No.	#51501	#51511	#51521	#51531	#51541	#51551	#51561	#51571
Station No.	#51502	#51512	#51522	#51532	#51542	#51552	#51562	#51572
Input device name	#51503	#51513	#51523	#51533	#51543	#51553	#51563	#51573
Input device No.	#51504	#51514	#51524	#51534	#51544	#51554	#51564	#51574
Output device name	#51505	#51515	#51525	#51535	#51545	#51555	#51565	#51575
Output device No.	#51506	#51516	#51526	#51536	#51546	#51556	#51566	#51576

[C80]			
	Unit1	Unit2	Unit3
Channel No.	#51501	#51511	#51521
Station No.	#51502	#51512	#51522
Input device name	#51503	#51513	#51523
Input device No.	#51504	#51514	#51524
Output device name	#51505	#51515	#51525
Output device No.	#51506	#51516	#51526

[Operation]

When an error occurs in a safety I/O unit observation function, the error information is output.

4 Explanation of Interface Signals

[Related signals]

- (1) Safety I/O observation state (SIOERRSTS)
- (2) Safety I/O unit observation error details (SIOERRUNITSTS)
- (3) Safety I/O device observation error signal (SIOERRUNITSIG) [C80]

Cont.	Signal name	Abbrev.	Unit1	Unit2	Unit3	Unit4	Unit5	Unit6	Unit7	Unit8
A	SAFETY I/O UNIT OBSERVATION ERROR DETAILS [M8]	SIOER- RUNITSTS	ZR1540	ZR1541	ZR1542	ZR1543	ZR1544	ZR1545	ZR1546	ZR1547

Cont.	Signal name	Abbrev.	Unit1	Unit2	Unit3
A	SAFETY I/O UNIT OBSERVATION ERROR DETAILS [C80]	SIOER- RUNITSTS	ZR2404	ZR2405	ZR2406

[Function]

This signal outputs details of safety I/O unit observation error for each safety I/O unit.

[M8]					
Bit	Description		Bit	Description	
bit0	Slave station communication error 1		bit8	Host station communication error 1	
bit1	Slave station communication error 2		bit9	Host station communication error 2	
bit2	Slave station communication error 3		bit10	Host station communication error 3	
bit3	Slave station data compare error		bit11	Output signal cross-check error	
bit4	Output OFF check error		bit12	Reserved	
bit5	Output return signal cross-check error		bit13	Reserved	
bit6	Transmission cross-check error		bit14	Reserved	
bit7	Reception cross-check error		bit15	Reserved	

[C80]					
Bit	Description		Bit	Description	
bit0	Reserved		bit8	Reserved	
bit1	Reserved		bit9	Reserved	
bit2	Reserved		bit10	Host station communication error 3	
bit3	Reserved		bit11	Reserved	
bit4	Output OFF check error		bit12	Reserved	
bit5	Output return signal cross-check error		bit13	Reserved	
bit6	Transmission cross-check error		bit14	Output signal cross-check error	
bit7	Reception cross-check error		bit15	Reserved	

For the safety I/O unit, the devices are assigned with the parameters.

For the device assignment of the safety I/O unit, refer to the descriptions of safety I/O unit observation state (SIOERRUNIT).

[Operation]

When an error occurs in a safety I/O unit observation function, the error details are output.

[Related signals]

- (1) Safety I/O observation state (SIOERRSTS)
- (2) Safety I/O unit observation state (SIOERRUNIT)
- (3) Safety I/O device observation error signal (SIOERRUNITSIG) [C80]

4 Explanation of Interface Signals

Cont.	Signal name	Abbrev.	Unit1	Unit2	Unit3
A	SAFETY I/O DEVICE OBSERVATION ERROR SIGNAL [C80]	SIOER-RUNITSIG	ZR2412 ZR2413	ZR2414 ZR2415	ZR2416 ZR2417

[Function]

This signal outputs the signals that safety I/O unit observation error occurred for each safety I/O unit.

For the safety I/O unit, the devices are assigned with the parameters.

For the device assignment of the safety I/O unit, refer to the descriptions of safety I/O unit observation state (SIOERRUNIT).

[Operation]

The signals that the error occurred in a safety I/O unit observation function are output.

[Related signals]

- (1) Safety I/O observation state (SIOERRSTS)
- (2) Safety I/O unit observation state (SIOERRUNIT)
- (3) Safety I/O unit observation error details (SIOERRUNITSTS)

Cont.	Signal name	Abbrev.	Common(\$)
A	SAFETY I/O DEVICE OBSERVATION WARNING STATUS [C80]	SIOWR-GUNIT	ZR2420

[Function]

This signal outputs the state of safety I/O unit observation warning for each safety I/O unit.

Bit	Description	Bit	Description
bit0	Safety I/O unit Unit 1 warning occurring	bit8	Reserved
bit1	Safety I/O unit Unit 2 warning occurring	bit9	Reserved
bit2	Safety I/O unit Unit 3 warning occurring	bit10	Reserved
bit3	Reserved	bit11	Reserved
bit4	Reserved	bit12	Reserved
bit5	Reserved	bit13	Reserved
bit6	Reserved	bit14	Reserved
bit7	Reserved	bit15	Reserved

For the safety I/O unit, the devices are assigned with the parameters.

For the device assignment of the safety I/O unit, refer to the descriptions of safety I/O unit observation state (SIOERRUNIT).

[Operation]

When a warning occurs in a safety I/O unit observation function, the warning information is output.

[Related signals]

- (1) Safety I/O device observation warning details (SIOWRGUNITSTS)
- (2) Safety I/O device observation warning signal (SIOWRGUNITSIG)

4 Explanation of Interface Signals

Cont.	Signal name	Abbrev.	Unit1	Unit2	Unit3
A	SAFETY I/O DEVICE OBSERVATION WARNING DETAILS [C80]	SIOWR- GUNITSTS	ZR2422	ZR2423	ZR2424

[Function]

This signal outputs the warning details of safety I/O unit observation for each safety I/O unit.

Bit	Description	Bit	Description
bit0	Warning on 24Hr continuous ON	bit8	Reserved
bit1	Reserved	bit9	Reserved
bit2	Reserved	bit10	Reserved
bit3	Reserved	bit11	Reserved
bit4	Reserved	bit12	Reserved
bit5	Reserved	bit13	Reserved
bit6	Reserved	bit14	Reserved
bit7	Reserved	bit15	Reserved

For the safety I/O unit, the devices are assigned with the parameters.

For the device assignment of the safety I/O unit, refer to the descriptions of safety I/O unit observation state (SIOERRUNIT).

[Operation]

When a warning occurs in a safety I/O unit observation function, the warning details is output.

[Related signals]

- (1) Safety I/O device observation warning status (SIOWRGUNIT)
- (2) Safety I/O device observation warning signal (SIOWRGUNITSIG)

Cont.	Signal name	Abbrev.	Unit1	Unit2	Unit3
A	SAFETY I/O DEVICE OBSERVATION WARNING SIGNAL [C80]	SIOWR- GUNITSIG	ZR2430 ZR2431	ZR2432 ZR2433	ZR2434 ZR2435

[Function]

This signal outputs the signals that safety I/O unit observation warning occurred for each safety I/O unit.

For the safety I/O unit, the devices are assigned with the parameters.

For the device assignment of the safety I/O unit, refer to the descriptions of safety I/O unit observation state (SIOERRUNIT).

[Operation]

The signals that the warning occurred in a safety I/O unit observation function are output.

[Related signals]

- (1) Safety I/O device observation warning status (SIOWRGUNIT)
- (2) Safety I/O device observation warning details (SIOWRGUNITSTS)

Cont.	Signal name	Abbrev.	Common(\$)
A	SAFETY COMMUNICATION RECEIPT DATA [C80]	SCNRCVDAT	ZR2784,5

[Function]

The safety data received from the master station.

[Operation]

The safety device (32 bits) sent from the master station will be stored in this data.

The safety device to be sent is configured by the parameter on the master station side (send data storage device).

Cont.	Signal name	Abbrev.	Common(\$)
A	SAFETY COMMUNICATION STATUS [C80]	SCNSTS	ZR2792

[Function][Operation]

Bit	Description	Bit	Description
bit0	In safety station interlock	bit8	Reserved
bit1	Safety station communication error	bit9	Reserved
bit2	Reserved	bit10	Reserved
bit3	Reserved	bit11	Reserved
bit4	Reserved	bit12	Reserved
bit5	Reserved	bit13	Reserved
bit6	Reserved	bit14	Reserved
bit7	Reserved	bit15	Reserved

bit0: In safety station interlock

After the safety communication error is detected, this signal is turned ON when in interlock state.

After the safety communication error is canceled, this signal is turned OFF by turning ON "Safety station interlock cancel request" (SCNCMD/bit0).

bit1: Safety station communication error

This signal indicates when safety refresh is not executed.

This signal is turned ON when safety station communication status (SCNCOMSTS) is other than "(0) In safety refresh communication".

[Related signals]

- (1) Safety station interlock cancel request (SCNCMD/bit0)
- (2) Safety station communication status (SCNCOMSTS)

Cont.	Signal name	Abbrev.	Common(\$)
A	SAFETY STATION COMMUNICATION STATUS [C80]	SCNCOMSTS	ZR2793

[Function]

This signal stores the safety communication status.

[Operation]

0x0000: In safety refresh communication

0x0010 to 0x0015: In safety initial communication

Other: Multiple CPU error number related to safety connection (1A40/1A50/1A60 etc.)

4.6.2 Memory Switch (PLC Switch)

Cont.	Signal name	Abbrev.	Common(\$)
A	PLC SWITCH NON-DISPLAY [M8]		ZR3200 to ZR3205

[Function]

This signal designates the PLC switch (#1 to 96) to be non-displayed.

[Operation]

When this signal is turned ON, the corresponding PLC switch (#1 to 96) on the PLC switch screen will be non-displayed and cannot be set from the screen.

The below shows the interface. Each bit correspond the PLC switch NO.

This PLC switch will be non-displayed when this signal is turned ON.

	bitF																		bit0
ZR3200	#16																		#1
ZR3201	#32																		#17
ZR3202	#48																		#33
ZR3203	#64																		#49
ZR3204	#80																		#65
ZR3205	#96																		#81

4.6.3 MES Interface Library [M8]

Cont.	Signal name	Abbrev.	Common(\$)
A	MES interface library: Common user area C1		ZR10000 to ZR10031

[Function]

This signal is used to specify the desirable arbitrary character to register to the database.

[Operation]

Specify the desirable ASCII code (hex number) corresponding to the character to set.

Cont.	Signal name	Abbrev.	Common(\$)
A	MES interface library: Common user area L1 to L10		ZR10032,3 to ZR10050,1

[Function]

This signal is used to specify the desirable arbitrary 32-bit integer data to register to the database.

[Operation]

Specify the desirable 32-bit integer data to set.

Cont.	Signal name	Abbrev.	Common(\$)
A	MES INTERFACE LIBRARY: CONDITION REGISTER (EXTRACT SORT CONDITION)		ZR10054

[Function]

For extraction operation, this signal is used to specify the record to be extracted when multiple records corresponding to the condition exist.

[Operation]

Specify the record to be extracted when the concerned record is sorted in ascending or descending order in the field "Update Time".

0: Searches and extracts the most recent record for the field "Update Time".

1: Searches and extracts the oldest record for the field "Update Time".

+n: Searches and extracts the (n-1)th in ascending order from the oldest record for the field "Update Time". ($2 \leq n \leq 100$)

-n: Searches and extracts the nth in descending order from the most recent record for the field "Update Time". ($1 \leq n \leq 100$)

When $-n \leq (\text{the number of the concerned records}) \times (-1)$, the record whose update time is the oldest among the concerned records will be extracted.

When $+n \leq (\text{the number of the concerned records}) \times (-1)$, the record whose update time is the most recent among the concerned records will be extracted.

When $n \geq 101$ is set, it will be processed for specifying $n = 100$.

When there is one concerned record, any concerned records will be extracted regardless of the specified values.

4 Explanation of Interface Signals

Cont.	Signal name	Abbrev.	Common(\$)
A	MES interface library: Condition register (Combination condition)		ZR10055

[Function]

This signal is used to specify the relation between 1st set and 2nd set in the condition setting for updating, deleting, or extraction operation.

[Operation]

Specify the logical operator to show the conditions relation with the bit values below.

Bit0 0: AND Execute the operation if the conditions both before and after the operator are true.

1: OR Execute the operation if the condition either before or after the operator is true.

[Related signals]

- (1) MES interface library: Condition register (Field value) 1st set (ZR10056)
- (2) MES interface library: Condition register (Condition value) 1st set (ZR10058 to 89)
- (3) MES interface library: Condition register (Comparison condition) 1st set (ZR10057)
- (4) MES interface library: Condition register (Field value) 2nd set (ZR10090)
- (5) MES interface library: Condition register (Condition value) 2nd set (ZR10092 to 123)
- (6) MES interface library: Condition register (Comparison condition) 2nd set (ZR10091)

Cont.	Signal name	Abbrev.	Common(\$)
A	MES interface library: Condition register (Field value) 1st set		ZR10056
A	MES interface library: Condition register (Field value) 2nd set		ZR10090

[Function]

This signal is used to specify the field value to be the condition target in the condition setting for updating, deleting, or extraction operation.

[Operation]

Specify the field number to be the condition target.

[Related signals]

- (1) MES interface library: Condition register (Condition value) 1st set (ZR10058 to 89)
- (2) MES interface library: Condition register (Comparison condition) 1st set (ZR10057)
- (3) MES interface library: Condition register (Condition value) 2nd set (ZR10092 to 123)
- (4) MES interface library: Condition register (Comparison condition) 2nd set (ZR10091)
- (5) MES interface library: Condition register (Combination condition) (ZR10055)

Cont.	Signal name	Abbrev.	Common(\$)
A	MES interface library: Condition register (Comparison condition) 1st set		ZR10057
A	MES interface library: Condition register (Comparison condition) 2nd set		ZR10091

[Function]

This signal is used to specify the relation between condition value and field value to be the condition target in the condition setting for update, delete, or extraction operation.

[Operation]

Specify the comparison operator that shows the relation between the condition value and the field value to be the condition target as follows.

- 1: = Field value equals to condition value.
- 2: ≠Field value does not equal to condition value.
- 3: < Field value is smaller than condition value.
- 4: > Field value is larger than condition value.
- 5: ≤ Field value is equal or smaller than condition value.
- 6: ≥ Field value is equal or larger than condition value.

The condition sets are invalid when you specify "0".

[Related signals]

- (1) MES interface library: Condition register (Field value) 1st set (ZR10056)
- (2) MES interface library: Condition register (Condition value) 1st set (ZR10058 to 89)
- (3) MES interface library: Condition register (Field value) 2nd set (ZR10090)
- (4) MES interface library: Condition register (Condition value) 2nd set (ZR10092 to 123)
- (5) MES interface library: Condition register (Combination condition) (ZR10055)

4 Explanation of Interface Signals

Cont.	Signal name	Abbrev.	Common(\$)
A	MES interface library: Condition register (Condition value) 1st set		ZR10058 to ZR10089
A	MES interface library: Condition register (Condition value) 2nd set		ZR10092 to ZR10123

[Function]

This signal is used to specify the condition value corresponding to the field value to be the condition target in the condition setting for updating, deleting, or extraction operation.

[Operation]

Specify the condition value corresponding to the field value to be the condition target.

[Related signals]

- (1) MES interface library: Condition register (Field value) 1st set (ZR10056)
- (2) MES interface library: Condition register (Comparison condition) 1st set (ZR10057)
- (3) MES interface library: Condition register (Field value) 2nd set (ZR10090)
- (4) MES interface library: Condition register (Comparison condition) 2nd set (ZR10091)
- (5) MES interface library: Condition register (Combination condition) (ZR10055)

Cont.	Signal name	Abbrev.	Common(\$)
A	DATA I/O REGISTER FOR MES INTERFACE LIBRARY (Serial number)		ZR10330 to ZR10361

[Function]

This signal is used to set the workpiece serial number after the update at the time of the update operation.
The workpiece serial number extracted from the database is stored at the time of the extraction operation.

[Operation]

For the update operation, specify the ASCII code (hex number) corresponding to the serial number.

For the extraction operation, the ASCII code (hex number) corresponding to the serial number is stored.

Cont.	Signal name	Abbrev.	Common(\$)
A	DATA I/O REGISTER FOR MES INTERFACE LIBRARY (Operator ID)		ZR10362 to ZR10393

[Function]

This signal is used to set the operator ID after the update at the time of the update operation.
The operator ID extracted from the database is stored at the time of the extraction operation.

[Operation]

For the update operation, specify the ASCII code (hex number) corresponding to the operator ID.

For the extraction operation, the ASCII code (hex number) corresponding to the operator ID is stored.

Cont.	Signal name	Abbrev.	Common(\$)
A	DATA I/O REGISTER FOR MES INTERFACE LIBRARY (NC unit number)		ZR10394 to ZR10401

[Function]

This signal is used to set the NC unit number after the update at the time of the update operation.
The NC unit number extracted from the database is stored at the time of the extraction operation.

[Operation]

For the update operation, specify the ASCII code (hex number) corresponding to the NC unit number.

For the extraction operation, the ASCII code (hex number) corresponding to the NC unit number is stored.

4 Explanation of Interface Signals

Cont.	Signal name	Abbrev.	Common(\$)
A	DATA I/O REGISTER FOR MES INTERFACE LIBRARY (Line number)		ZR10402 to ZR10417

[Function]

This signal is used to set the line number after the update at the time of the update operation.

The line number extracted from the database is stored at the time of the extraction operation.

[Operation]

For the update operation, specify the ASCII code (hex number) corresponding to the line number.

For the extraction operation, the ASCII code (hex number) corresponding to the line number is stored.

Cont.	Signal name	Abbrev.	Common(\$)
A	DATA I/O REGISTER FOR MES INTERFACE LIBRARY (Machine type)		ZR10418

[Function]

This signal is used to set the machine type after the update at the time of the update operation.

The machine type extracted from the database is stored at the time of the extraction operation.

[Operation]

Specify the machine type after the update at the time of the update operation.

The machine type extracted from database is stored at the time of the extraction operation.

Cont.	Signal name	Abbrev.	Common(\$)
A	DATA I/O REGISTER FOR MES INTERFACE LIBRARY (Common user area C1)		ZR10420 to ZR10451

[Function]

This signal is used to set the character after the update at the time of the update operation.

The character extracted from the database is stored at the time of the extraction operation.

[Operation]

Specify the ASCII code (hex number) corresponding to the character after the update at the time of the update operation.

The ASCII code (hex number) corresponding to the character extracted from the database is stored at the time of the extraction operation.

Cont.	Signal name	Abbrev.	Common(\$)
A	DATA I/O REGISTER FOR MES INTERFACE LIBRARY (Common user area L1 to L10)		ZR10452,3 to ZR10470,1

[Function]

This signal is used to set the 32-bit integer data after the update at the time of the update operation.

The 32-bit integer data extracted from the database is stored at the time of the extraction operation.

[Operation]

Specify the 32-bit integer data after the update at the time of the update operation.

The 32-bit integer data extracted from the database is stored at the time of the extraction operation.

Cont.	Signal name	Abbrev.	Common(\$)
A	DATA I/O REGISTER FOR MES INTERFACE LIBRARY (Machining start time)		ZR10474,5

[Function]

This signal is used to set the machining start time after the update at the time of the update operation.

The machining start time extracted from the database is stored at the time of the extraction operation.

[Operation]

For the update operation, specify the machining start time in total seconds from January 1, 1970.

For the extraction operation, the machining start time in total seconds from January 1, 1970 is stored.

4 Explanation of Interface Signals

Cont.	Signal name	Abbrev.	Common(\$)
A	DATA I/O REGISTER FOR MES INTERFACE LIBRARY (Machining end time)		ZR10476,7

[Function]

This signal is used to set the machining end time after the update at the time of the update operation.

The machining end time extracted from the database is stored at the time of the extraction operation.

[Operation]

For the update operation, specify the machining end time in total seconds from January 1, 1970.

For the extraction operation, the machining end time in total seconds from January 1, 1970 is stored.

Cont.	Signal name	Abbrev.	Common(\$)
A	DATA I/O REGISTER FOR MES INTERFACE LIBRARY (Cycle time)		ZR10478,9

[Function]

This signal is used to set the cycle time after the update at the time of the update operation.

The cycle time extracted from the database is stored at the time of the extraction operation.

[Operation]

For the update operation, specify the value of cycle time [ms].

For the extraction operation, the value of cycle time [ms] is stored.

Cont.	Signal name	Abbrev.	Common(\$)
A	DATA I/O REGISTER FOR MES INTERFACE LIBRARY (Program number at machining start)		ZR10480 to ZR10495

[Function]

This signal is used to set the program number after the update at the time of the update operation.

The program number extracted from the database is stored at the time of the extraction operation.

[Operation]

For the update operation, specify the value in the ASCII code (hex number) corresponding to that program number.

For the extraction operation, the value in the ASCII code (hex number) corresponding to that program number is stored.

Cont.	Signal name	Abbrev.	Common(\$)
A	DATA I/O REGISTER FOR MES INTERFACE LIBRARY (N number at machining start)		ZR10496,7

[Function]

This signal is used to set the sequence number after the update at the time of the update operation.

The sequence number extracted from the database is stored at the time of the extraction operation.

[Operation]

For the update operation, specify the value of the sequence number.

For the extraction operation, the sequence number is stored.

Cont.	Signal name	Abbrev.	Common(\$)
A	DATA I/O REGISTER FOR MES INTERFACE LIBRARY (B number at machining start)		ZR10498,9

[Function]

This signal is used to set the block number after the update at the time of the update operation.

The block number extracted from the database is stored at the time of the extraction operation.

[Operation]

For the update operation, specify the value of the block number.

For the extraction operation, the block number is stored.

Cont.	Signal name	Abbrev.	Common(\$)
A	DATA I/O REGISTER FOR MES INTERFACE LIBRARY (Spindle 1 maximum load)		ZR10500

[Function]

This signal is used to set the 1st spindle's maximum current value after the update at the time of the update operation.

The 1st spindle's maximum current value extracted from the database is stored at the time of the extraction operation.

[Operation]

For the update operation, specify the maximum current value [%] of the 1st spindle.

For the extraction operation, the maximum current value [%] of the 1st spindle is stored.

4 Explanation of Interface Signals

Cont.	Signal name	Abbrev.	Common(\$)
A	DATA I/O REGISTER FOR MES INTERFACE LIBRARY (Spindle 2 maximum load)		ZR10501

[Function]

This signal is used to set the 2nd spindle's maximum current value after the update at the time of the update operation.

The 2nd spindle's maximum current value extracted from the database is stored at the time of the extraction operation.

[Operation]

For the update operation, specify the maximum current value [%] of the 2nd spindle.

For the extraction operation, the maximum current value [%] of the 2nd spindle is stored.

Cont.	Signal name	Abbrev.	Common(\$)
A	DATA I/O REGISTER FOR MES INTERFACE LIBRARY (Power consumption amount)		ZR10502,3

[Function]

This signal is used to set the power consumption amount after the update at the time of the update operation.

The consumption amount extracted from the database is stored at the time of the extraction operation.

[Operation]

For the update operation, specify the value of power consumption amount [Wh].

For the extraction operation, the power consumption amount [Wh] is stored.

Cont.	Signal name	Abbrev.	Common(\$)
A	DATA I/O REGISTER FOR MES INTERFACE LIBRARY (Power regeneration amount)		ZR10504,5

[Function]

This signal is used to set the power regeneration amount after the update at the time of the update operation.

The power regeneration amount extracted from the database is stored at the time of the extraction operation.

[Operation]

For the update operation, specify the value of power regeneration amount [Wh].

For the extraction operation, the power regeneration amount [Wh] is stored.

Cont.	Signal name	Abbrev.	Common(\$)
A	DATA I/O REGISTER FOR MES INTERFACE LIBRARY (Number of machined workpieces)		ZR10506,7

[Function]

This signal is used to set the number of machined workpieces after the update at the time of the update operation.

The number of machined workpieces extracted from the database is stored at the time of the extraction operation.

[Operation]

For the update operation, specify the number of the machined workpieces.

For the extraction operation, the number of the machined workpieces is stored.

Cont.	Signal name	Abbrev.	Common(\$)
A	DATA I/O REGISTER FOR MES INTERFACE LIBRARY (Tool number 1 to 5)		ZR10508,9 to ZR10516,7

[Function]

This signal is used to set the tool number after the update at the time of the update operation.

The tool number extracted from the database is stored at the time of the extraction operation.

[Operation]

For the update operation, specify the value of the tool number.

For the extraction operation, the tool number is stored.

4 Explanation of Interface Signals

Cont.	Signal name	Abbrev.	Common(\$)
A	DATA I/O REGISTER FOR MES INTERFACE LIBRARY (Tool offset number 1 to 5)		ZR10518 to ZR10522

[Function]

This signal is used to set the tool compensation number after the update at the time of the update operation.

The tool compensation number extracted from the database is stored at the time of the extraction operation.

[Operation]

For the update operation, specify the value of the tool compensation number.

For the extraction operation, the tool compensation number is stored.

Cont.	Signal name	Abbrev.	Common(\$)
A	DATA I/O REGISTER FOR MES INTERFACE LIBRARY (Tool length offset 1 to 5)		ZR10524,5 to ZR10532,3

[Function]

This signal is used to set the tool length compensation amount after the update at the time of the update operation.

The tool length compensation amount extracted from the database is stored at the time of the extraction operation.

[Operation]

For the update operation, specify the value of the tool length compensation amount.

For the extraction operation, the tool length compensation amount is stored.

Cont.	Signal name	Abbrev.	Common(\$)
A	DATA I/O REGISTER FOR MES INTERFACE LIBRARY (Tool radius offset 1 to 5)		ZR10534,5 to ZR10542,3

[Function]

This signal is used to set the tool radius compensation amount after the update at the time of the update operation.

The tool radius compensation amount extracted from the database is stored at the time of the extraction operation.

[Operation]

For the update operation, specify the value of the tool radius compensation amount.

For the extraction operation, the tool radius compensation amount is stored.

Cont.	Signal name	Abbrev.	Common(\$)
A	DATA I/O REGISTER FOR MES INTERFACE LIBRARY (Tool length wear amount 1 to 5)		ZR10544,5 to ZR10552,3

[Function]

This signal is used to set the tool length wear amount after the update at the time of the update operation.

The tool length wear amount extracted from the database is stored at the time of the extraction operation.

[Operation]

For the update operation, specify the value of tool length wear amount.

For the extraction operation, the tool length wear amount is stored.

Cont.	Signal name	Abbrev.	Common(\$)
A	DATA I/O REGISTER FOR MES INTERFACE LIBRARY (Tool radius wear amount 1 to 5)		ZR10554,5 to ZR10562,3

[Function]

This signal is used to set the tool radius wear amount after the update at the time of the update operation.

The tool radius wear amount extracted from the database is stored at the time of the extraction operation.

[Operation]

For the update operation, specify the value of tool radius wear amount.

For the extraction operation, the tool radius wear amount is stored.

4 Explanation of Interface Signals

Cont.	Signal name	Abbrev.	Common(\$)
A	DATA I/O REGISTER FOR MES INTERFACE LIBRARY (Tool life 1 to 5)		ZR10564,5 to ZR10572,3

[Function]

This signal is used to set the tool life after the update at the time of the update operation.

The tool life extracted from the database is stored at the time of the extraction operation.

[Operation]

For the update operation, specify the value of the tool life.

For the extraction operation, the tool life is stored.

Cont.	Signal name	Abbrev.	Common(\$)
A	DATA I/O REGISTER FOR MES INTERFACE LIBRARY (User arbitrary C1 at machining end)		ZR10576 to ZR10607

[Function]

This signal is used to set the character after the update at the time of the update operation.

The character extracted from the database is stored at the time of the extraction operation.

[Operation]

Specify the ASCII code (hex number) corresponding to the character after the update at the time of the update operation.

The value in the ASCII code (hex number) corresponding to the character extracted from the database is stored at the time of the extraction operation.

Cont.	Signal name	Abbrev.	Common(\$)
A	DATA I/O REGISTER FOR MES INTERFACE LIBRARY (User arbitrary L1 to L10 at machining end)		ZR10608,9 to ZR10626,7

[Function]

This signal is used to set the 32-bit integer data after the update at the time of the update operation.

The 32-bit integer data extracted from the database is stored at the time of the extraction operation.

[Operation]

Specify the 32-bit integer data after the update at the time of the update operation.

The value with 32-bit integer data extracted from the database is stored at the time of the extraction operation.

Cont.	Signal name	Abbrev.	Common(\$)
A	DATA I/O REGISTER FOR MES INTERFACE LIBRARY (Time of alarm occurrence)		ZR10632,3

[Function]

This signal is used to set the alarm occurrence time after the update at the time of the update operation.

The alarm occurrence time extracted from the database is stored at the time of the extraction operation.

[Operation]

For the update operation, specify the time of alarm occurrence in total seconds from January 1, 1970.

For the extraction operation, the time of alarm occurrence in total seconds from January 1, 1970 is stored.

4 Explanation of Interface Signals

Cont.	Signal name	Abbrev.	Common(\$)
A	DATA I/O REGISTER FOR MES INTERFACE LIBRARY (Alarm number 1)		ZR10634 to ZR10649
A	DATA I/O REGISTER FOR MES INTERFACE LIBRARY (Alarm number 2)		ZR10650 to ZR10665
A	DATA I/O REGISTER FOR MES INTERFACE LIBRARY (Alarm number 3)		ZR10666 to ZR10681
A	DATA I/O REGISTER FOR MES INTERFACE LIBRARY (Alarm number 4)		ZR10682 to ZR10697

[Function]

This signal is used to set the alarm number after the update at the time of the update operation.

The alarm number extracted from the database is stored at the time of the extraction operation.

[Operation]

For the update operation, specify the value in the ASCII code (hex number) corresponding to that alarm.

For the extraction operation, the value in the ASCII code (hex number) corresponding to that alarm number is stored.

Cont.	Signal name	Abbrev.	Common(\$)
A	DATA I/O REGISTER FOR MES INTERFACE LIBRARY (Time of power ON)		ZR10698,9

[Function]

This signal is used to set the power ON time after the update at the time of the update operation.

The power ON time extracted from the database is stored at the time of the extraction operation.

[Operation]

For the update operation, specify the power ON time in seconds.

For the extraction operation, the power ON time in seconds is stored.

Cont.	Signal name	Abbrev.	Common(\$)
A	DATA I/O REGISTER FOR MES INTERFACE LIBRARY (Program number at alarm)		ZR10700 to ZR10715

[Function]

This signal is used to set the program number after the update at the time of the update operation.

The program number extracted from the database is stored at the time of the extraction operation.

[Operation]

For the update operation, specify the value in the ASCII code (hex number) corresponding to the program number.

For the extraction operation, the value in the ASCII code (hex number) corresponding to the program number is stored.

Cont.	Signal name	Abbrev.	Common(\$)
A	DATA I/O REGISTER FOR MES INTERFACE LIBRARY (Subprogram number at alarm)		ZR10716 to ZR10731

[Function]

This signal is used to set the subprogram number after the update at the time of the update operation.

The subprogram number extracted from the database is stored at the time of the extraction operation.

[Operation]

For the update operation, specify the value in the ASCII code (hex number) corresponding to the subprogram number.

For the extraction operation, the value in the ASCII code (hex number) corresponding to the subprogram number is stored.

4 Explanation of Interface Signals

Cont.	Signal name	Abbrev.	Common(\$)
A	DATA I/O REGISTER FOR MES INTERFACE LIBRARY (N number at alarm)		ZR10732,3

[Function]

This signal is used to set the sequence number after the update at the time of the update operation.

The sequence number extracted from the database is stored at the time of the extraction operation.

[Operation]

For the update operation, specify the value of the sequence number.

For the extraction operation, the sequence number is stored.

Cont.	Signal name	Abbrev.	Common(\$)
A	DATA I/O REGISTER FOR MES INTERFACE LIBRARY (B number at alarm)		ZR10734,5

[Function]

This signal is used to set the block number after the update at the time of the update operation.

The block number extracted from the database is stored at the time of the extraction operation.

[Operation]

For the update operation, specify the value of the block number.

For the extraction operation, the block number is stored.

Cont.	Signal name	Abbrev.	Common(\$)
A	DATA I/O REGISTER FOR MES INTERFACE LIBRARY (G code modal)		ZR10736 to ZR10767

[Function]

This signal is used to set the G code modal after the update at the time of the update operation.

The G code modal extracted from the database is stored at the time of the extraction operation.

[Operation]

For the update operation, specify the value in the ASCII code (hex number) corresponding to the G code modal.

For the extraction operation, the value in the ASCII code (hex number) corresponding to the G code modal is stored.

Cont.	Signal name	Abbrev.	Common(\$)
A	DATA I/O REGISTER FOR MES INTERFACE LIBRARY (Spindle 1 load value)		ZR10768

[Function]

This signal is used to set the 1st spindle's current value after the update at the time of the update operation.

The 1st spindle's current value extracted from the database is stored at the time of the extraction operation.

[Operation]

For the update operation, specify the current value [%] of the 1st spindle.

For the extraction operation, the current value [%] of the 1st spindle is stored.

Cont.	Signal name	Abbrev.	Common(\$)
A	DATA I/O REGISTER FOR MES INTERFACE LIBRARY (Spindle 2 load value)		ZR10769

[Function]

This signal is used to set the 2nd spindle's current value after the update at the time of the update operation.

The 2nd spindle's current value extracted from the database is stored at the time of the extraction operation.

[Operation]

For the update operation, specify the current value [%] of the 2nd spindle.

For the extraction operation, the current value [%] of the 2nd spindle is stored.

Cont.	Signal name	Abbrev.	Common(\$)
A	DATA I/O REGISTER FOR MES INTERFACE LIBRARY (Tool number)		ZR10770,1

[Function]

This signal is used to set the tool number after the update at the time of the update operation.

The tool number extracted from the database is stored at the time of the extraction operation.

[Operation]

For the update operation, specify the value of the tool number.

For the extraction operation, the tool number is stored.

4 Explanation of Interface Signals

Cont.	Signal name	Abbrev.	Common(\$)
A	DATA I/O REGISTER FOR MES INTERFACE LIBRARY (Tool offset number)		ZR10772

[Function]

This signal is used to set the tool compensation number after the update at the time of the update operation.
The tool compensation number extracted from the database is stored at the time of the extraction operation.

[Operation]

For the update operation, specify the value of the tool compensation number.
For the extraction operation, the tool compensation number is stored.

Cont.	Signal name	Abbrev.	Common(\$)
A	DATA I/O REGISTER FOR MES INTERFACE LIBRARY (Tool length offset)		ZR10774,5

[Function]

This signal is used to set the tool length compensation amount after the update at the time of the update operation.
The tool length compensation amount extracted from the database is stored at the time of the extraction operation.

[Operation]

For the update operation, specify the value of the tool length compensation amount.
For the extraction operation, the tool length compensation amount is stored.

Cont.	Signal name	Abbrev.	Common(\$)
A	DATA I/O REGISTER FOR MES INTERFACE LIBRARY (Tool radius offset)		ZR10776,7

[Function]

This signal is used to set the tool radius compensation amount after the update at the time of the update operation.
The tool radius compensation amount extracted from the database is stored at the time of the extraction operation.

[Operation]

For the update operation, specify the value of the tool radius compensation amount.
For the extraction operation, the tool radius compensation amount is stored.

Cont.	Signal name	Abbrev.	Common(\$)
A	DATA I/O REGISTER FOR MES INTERFACE LIBRARY (Tool length wear amount)		ZR10778,9

[Function]

This signal is used to set the tool length wear amount after the update at the time of the update operation.
The tool length wear amount extracted from the database is stored at the time of the extraction operation.

[Operation]

For the update operation, specify the value of the tool length wear amount.
For the extraction operation, the tool length wear amount is stored.

Cont.	Signal name	Abbrev.	Common(\$)
A	DATA I/O REGISTER FOR MES INTERFACE LIBRARY (Tool radius wear amount)		ZR10780,1

[Function]

This signal is used to set the tool radius wear amount after the update at the time of the update operation.
The tool radius wear amount extracted from the database is stored at the time of the extraction operation.

[Operation]

For the update operation, specify the value of the tool radius wear amount.
For the extraction operation, the tool radius wear amount is stored.

Cont.	Signal name	Abbrev.	Common(\$)
A	DATA I/O REGISTER FOR MES INTERFACE LIBRARY (Tool life)		ZR10782,3

[Function]

This signal is used to set the tool life after the update at the time of the update operation.
The tool life extracted from the database is stored at the time of the extraction operation.

[Operation]

For the update operation, specify the value of the tool life.
For the extraction operation, the tool life is stored.

4 Explanation of Interface Signals

Cont.	Signal name	Abbrev.	Common(\$)
A	DATA I/O REGISTER FOR MES INTERFACE LIBRARY (User area C1 at alarm)		ZR10786 to ZR10817

[Function]

This signal is used to set the character after the update at the time of the update operation.
The character extracted from the database is stored at the time of the extraction operation.

[Operation]

Specify the ASCII code (hex number) corresponding to the character after the update at the time of update operation.
The value in the ASCII code (hex number) corresponding to the character extracted from the database is stored at the time of the extraction operation.

Cont.	Signal name	Abbrev.	Common(\$)
A	DATA I/O REGISTER FOR MES INTERFACE LIBRARY (User area L1 to L10 at alarm)		ZR10818,9 to ZR10836,7

[Function]

This signal is used to set the 32-bit integer data after the update at the time of the update operation.
The 32-bit integer data extracted from the database is stored at the time of the extraction operation.

[Operation]

Specify the 32-bit integer data after the update at the time of the update operation.
The value with 32-bit integer data extracted from the database is stored at the time of the extraction operation.

Cont.	Signal name	Abbrev.	Common(\$)
A	DATA I/O REGISTER FOR MES INTERFACE LIBRARY (Arbitrary user area C1)		ZR10842 to ZR10873

[Function]

This signal is used to set the character after the update at the time of the update operation.
The character extracted from the database is stored at the time of the extraction operation.

[Operation]

Specify the ASCII code (hex number) corresponding to the character after the update at the time of update operation.
The value in the ASCII code (hex number) corresponding to the character extracted from the database is stored at the time of the extraction operation.

Cont.	Signal name	Abbrev.	Common(\$)
A	DATA I/O REGISTER FOR MES INTERFACE LIBRARY (Arbitrary user area S1 to S20)		ZR10874 to ZR10893

[Function]

This signal is used to set the 16-bit integer data after the update at the time of the update operation.
The 16-bit integer data extracted from the database is stored at the time of the extraction operation.

[Operation]

Specify the 16-bit integer data after the update at the time of the update operation.
The value with 16-bit integer data extracted from the database is stored at the time of the extraction operation.

Cont.	Signal name	Abbrev.	Common(\$)
A	DATA I/O REGISTER FOR MES INTERFACE LIBRARY (Arbitrary user area L1 to L10)		ZR10894,5 to ZR10912,3

[Function]

This signal is used to set the 32-bit integer data after the update at the time of the update operation.
The 32-bit integer data extracted from the database is stored at the time of the extraction operation.

[Operation]

Specify the 32-bit integer data after the update at the time of the update operation.
The value with 32-bit integer data extracted from the database is stored at the time of the extraction operation.

4 Explanation of Interface Signals

Cont.	Signal name	Abbrev.	\$1	\$2	\$3	\$4	\$5	\$6	\$7	\$8
A	MES interface library: User area C1 at machining end		ZR10940 to ZR10971	ZR11120 to ZR11151	ZR11300 to ZR11331	ZR11480 to ZR11511	ZR11660 to ZR11691	ZR11840 to ZR11871	ZR12020 to ZR12051	ZR12200 to ZR12231

[Function]

This signal is used to set the desirable arbitrary character to register to the database when the machining is completed.

[Operation]

Specify the ASCII code (hex number) corresponding to the desirable character to set.

This data is sent to the database at the time of machining completion.

Cont.	Signal name	Abbrev.	\$1	\$2	\$3	\$4	\$5	\$6	\$7	\$8
A	MES interface library: User area L1 to L10 at machining end		ZR10972, 3 to ZR10990, 1	ZR11152, 3 to ZR11170, 1	ZR11332, 3 to ZR11350, 1	ZR11512, 3 to ZR11530, 1	ZR11692, 3 to ZR11710, 1	ZR11872, 3 to ZR11890, 1	ZR12052, 3 to ZR12070, 1	ZR12232, 3 to ZR12250, 1

[Function]

This signal is used to set the desirable arbitrary 32-bit integer data to register to the database at the time of machining completion.

[Operation]

Specify the desirable 32-bit integer data to set.

This data is sent to the database at the time of machining completion.

Cont.	Signal name	Abbrev.	\$1	\$2	\$3	\$4	\$5	\$6	\$7	\$8
A	MES interface library: User area C1 at alarm		ZR10994 to ZR11025	ZR11174 to ZR11205	ZR11354 to ZR11385	ZR11534 to ZR11565	ZR11714 to ZR11745	ZR11894 to ZR11925	ZR12074 to ZR12105	ZR12254 to ZR12285

[Function]

This signal is used to set the desirable arbitrary character to register to the database when an alarm occurs.

[Operation]

Specify the ASCII code (hex number) corresponding to the desirable character to set.

This data is sent to the database at the time of alarm occurrence.

Cont.	Signal name	Abbrev.	\$1	\$2	\$3	\$4	\$5	\$6	\$7	\$8
A	MES interface library: User area L1 to L10 at alarm		ZR11026, 7 to ZR11044, 5	ZR11206, 7 to ZR11224, 5	ZR11386, 7 to ZR11404, 5	ZR11566, 7 to ZR11584, 5	ZR11746, 7 to ZR11764, 5	ZR11926, 7 to ZR11944, 5	ZR12106, 7 to ZR12124, 5	ZR12286, 7 to ZR12304, 5

[Function]

This signal is used to set the desirable arbitrary 32-bit integer data to register to the database when an alarm occurs.

[Operation]

Specify the desirable 32-bit integer data to set.

This data is sent to the database at the time of alarm occurrence.

Cont.	Signal name	Abbrev.	\$1	\$2	\$3	\$4	\$5	\$6	\$7	\$8
A	MES interface library: Arbitrary user area C1		ZR11048 to ZR11079	ZR11228 to ZR11259	ZR11408 to ZR11439	ZR11588 to ZR11619	ZR11768 to ZR11799	ZR11948 to ZR11979	ZR12128 to ZR12159	ZR12308 to ZR12339

[Function]

This signal is used to set the desirable arbitrary character to register to the database at the time of user's option.

[Operation]

Specify the ASCII code (hex number) corresponding to the desirable character to set.

This data is sent to the database at the time of user's option.

4 Explanation of Interface Signals

Cont.	Signal name	Abbrev.	\$1	\$2	\$3	\$4	\$5	\$6	\$7	\$8
A	MES interface library: Arbitrary user area S1 to S20		ZR11080 to ZR11099	ZR11260 to ZR11279	ZR11440 to ZR11459	ZR11620 to ZR11639	ZR11800 to ZR11819	ZR11980 to ZR11999	ZR12160 to ZR12179	ZR12340 to ZR12359

[Function]

This signal is used to set the desirable arbitrary 16-bit integer data to register to the database at the time of user's option.

[Operation]

Specify the desirable 16-bit integer data to set.

This data is sent to the database at the time of user's option.

Cont.	Signal name	Abbrev.	\$1	\$2	\$3	\$4	\$5	\$6	\$7	\$8
A	MES interface library: Arbitrary user area L1 to L10		ZR11100, 1 to ZR11118, 9	ZR11280, 1 to ZR11298, 9	ZR11460, 1 to ZR11478, 9	ZR11640, 1 to ZR11658, 9	ZR11820, 1 to ZR11838, 9	ZR12000, 1 to ZR12018, 9	ZR12180, 1 to ZR12198, 9	ZR12360, 1 to ZR12378, 9

[Function]

This signal is used to set the desirable arbitrary 32-bit integer data to register to the database at the time of user's option.

[Operation]

Specify the desirable 32-bit integer data to set.

This data is sent to the database at the time of user's option.

4.6.4 Diagnosis Data Output

Cont.	Signal name	Abbrev.	Common(\$)
A	Diagnosis data output: Battery exchange [M8]		ZR12404 ZR12405

[Function][Operation]

The accumulated use time of the NC unit battery is set in the register. (0 to 4, 294, 967, 295)

The register is cleared to zero at the time of NC unit replacement.

[Caution]

- (1) The data is in the units of 1.0 min.
- (2) The data format is unsigned binary.
- (3) The data remains unchanged even when you input the backup data using the SRAM backup function.

Cont.	Signal name	Abbrev.	1st axis	2nd axis	3rd axis	4th axis	5th axis	6th axis	7th axis	8th axis
A	Diagnosis data output: Battery exchange (drive)		ZR12608	ZR12610	ZR12612	ZR12614	ZR12616	ZR12618	ZR12620	ZR12622
			ZR12609	ZR12611	ZR12613	ZR12615	ZR12617	ZR12619	ZR12621	ZR12623
			9th axis	10th axis	11th axis	12th axis	13th axis	14th axis	15th axis	16th axis
			ZR12624	ZR12626	ZR12628	ZR12630	ZR12632	ZR12634	ZR12636	ZR12638
			ZR12625	ZR12627	ZR12629	ZR12631	ZR12633	ZR12635	ZR12637	ZR12639
			17th axis	18th axis	19th axis	20th axis	21st axis	22nd axis	23rd axis	24th axis
			ZR12640	ZR12642	ZR12644	ZR12646	ZR12648	ZR12650	ZR12652	ZR12654
			ZR12641	ZR12643	ZR12645	ZR12647	ZR12649	ZR12651	ZR12653	ZR12655
			25th axis	26th axis	27th axis	28th axis	29th axis	30th axis	31st axis	32nd axis
			ZR12656	ZR12658	ZR12660	ZR12662	ZR12664	ZR12666	ZR12668	ZR12670
			ZR12657	ZR12659	ZR12661	ZR12663	ZR12665	ZR12667	ZR12669	ZR12671

[Function] [Operation]

The accumulated use time of the drive unit battery is set in the register.

The register is cleared to zero at the time of drive unit replacement.

[Caution]

- (1) The unit depends on the model.
M8 Series: 1.0 hour
C80 Series: 1.0 day
- (2) The data format is unsigned binary.
- (3) The data of servo axes (NC and PLC axes) is output to these registers, in the order of the axis specified with the base axis specification parameter.
- (4) The data remains unchanged even when you input the backup data using the SRAM backup function.
- (5) When the NC control unit is replaced, this ZR register is cleared to "0". To keep the value before the replacement, take a note of the data and change the ZR register value when the replacement is completed.
- (6) The data is updated at the following timing.
M8 Series: Always
C80 Series: When the NC power is turned ON

4 Explanation of Interface Signals

Cont.	Signal name	Abbrev.	1st axis	2nd axis	3rd axis	4th axis	5th axis	6th axis	7th axis	8th axis
A	Diagnosis data output: Motor insulation resistance (motor)		ZR12784	ZR12786	ZR12788	ZR12790	ZR12792	ZR12794	ZR12796	ZR12798
			ZR12785	ZR12787	ZR12789	ZR12791	ZR12793	ZR12795	ZR12797	ZR12799
			9th axis	10th axis	11th axis	12th axis	13th axis	14th axis	15th axis	16th axis
			ZR12800	ZR12802	ZR12804	ZR12806	ZR12808	ZR12810	ZR12812	ZR12814
			ZR12801	ZR12803	ZR12805	ZR12807	ZR12809	ZR12811	ZR12813	ZR12815
			17th axis	18th axis	19th axis	20th axis	21st axis	22nd axis	23rd axis	24th axis
			ZR12816	ZR12818	ZR12820	ZR12822	ZR12824	ZR12826	ZR12828	ZR12830
			ZR12817	ZR12819	ZR12821	ZR12823	ZR12825	ZR12827	ZR12829	ZR12831
			25th axis	26th axis	27th axis	28th axis	29th axis	30th axis	31st axis	32nd axis
			ZR12832	ZR12834	ZR12836	ZR12838	ZR12840	ZR12842	ZR12844	ZR12846
			ZR12833	ZR12835	ZR12837	ZR12839	ZR12841	ZR12843	ZR12845	ZR12847

[Function] [Operation]

The present insulation resistance of the motor is set in the register.

If the insulation resistance is less than 1MΩ, 0 is set.

If the insulation resistance is 100MΩ or greater, 100 is set.

If your drive unit does not support this function, or if the data has not been obtained from the drive unit, -1 (0xFFFFFFFF) is set in the register.

[Caution]

- (1) The data is in the units of 1.0MΩ.
- (2) The data format is signed binary.
- (3) The data of servo axes (NC and PLC axes) is output to these registers, in the order of the axis specified with the base axis specification parameter.
- (4) The effective value can be obtained only when the drive unit is MDS-E/EH Series (when the drive unit S/W version is A3 or later, and the H/W supports the insulation degradation detection function.).

Cont.	Signal name	Abbrev.	1st SP	2nd SP	3rd SP	4th SP	5th SP	6th SP	7th SP	8th SP
A	Diagnosis data output: Motor insulation resistance (motor)		ZR12848 ZR12849	ZR12850 ZR12851	ZR12852 ZR12853	ZR12854 ZR12855	ZR12856 ZR12857	ZR12858 ZR12859	ZR12860 ZR12861	ZR12862 ZR12863

[Function] [Operation]

The present insulation resistance of the motor is set in the register.

If the insulation resistance is less than 1MΩ, 0 is set.

If the insulation resistance is 100MΩ or greater, 100 is set.

If your drive unit does not support this function, or if the data has not been obtained from the drive unit, -1 (0xFFFFFFFF) is set in the register.

[Caution]

- (1) The data is in the units of 1.0MΩ.
- (2) The data format is signed binary.
- (3) The effective value can be obtained only when the drive unit is MDS-E/EH Series (Drive unit S/W version A3 or later and H/W corresponding to the insulation degradation detection function).

Cont.	Signal name	Abbrev.	Common(\$)
A	Diagnosis data output: Automatic log clear time [M8]		ZR12945

[Function] [Operation]

Set the length of time before automatic log clear takes place.

[Caution]

- (1) Set the time in increments of 1.0 hour.
- (2) If this signal is unspecified, the default time (24hr) is applied.

Cont.	Signal name	Abbrev.	1st axis	2nd axis	3rd axis	4th axis	5th axis	6th axis	7th axis	8th axis
A	Diagnosis data output: Accumulated travel distance (motor)		ZR12946	ZR12948	ZR12950	ZR12952	ZR12954	ZR12956	ZR12958	ZR12960
			ZR12947	ZR12949	ZR12951	ZR12953	ZR12955	ZR12957	ZR12959	ZR12961
			9th axis	10th axis	11th axis	12th axis	13th axis	14th axis	15th axis	16th axis
			ZR12962	ZR12964	ZR12966	ZR12968	ZR12970	ZR12972	ZR12974	ZR12976
			ZR12963	ZR12965	ZR12967	ZR12969	ZR12972	ZR12973	ZR12975	ZR12977
			17th axis	18th axis	19th axis	20th axis	21st axis	22nd axis	23rd axis	24th axis
			ZR12978	ZR12980	ZR12982	ZR12984	ZR12986	ZR12988	ZR12990	ZR12992
			ZR12979	ZR12981	ZR12983	ZR12985	ZR12987	ZR12989	ZR12991	ZR12993
			25th axis	26th axis	27th axis	28th axis	29th axis	30th axis	31st axis	32nd axis
			ZR12994	ZR12996	ZR12998	ZR13000	ZR13002	ZR13004	ZR13006	ZR13008
			ZR12995	ZR12997	ZR12999	ZR13001	ZR13003	ZR13005	ZR13007	ZR13009

[Function] [Operation]

The accumulated travel distance of the servo axis is set in the register.

[Caution]

- (1) The data is in the units of 1.0 (m). For a rotary axis, the unit is 1.0 (revolution).
When the rotation axis type is all coordinate linear type, the data is output in the unit of 1.0 (m).
- (2) The data format is unsigned binary.
- (3) The data of servo axes (NC and PLC axes) is output to these registers, in the order of the axis specified with the base axis specification parameter.
- (4) The data remains unchanged even when you input the backup data using the SRAM backup function.
- (5) Even when the drive unit or motor is replaced, this register is not automatically reset. To reset the accumulated travel distance, write "0" in this register.
- (6) When the NC control unit is replaced, this register is cleared to "0". To keep the value before the replacement, take a note of the data and change the ZR register value when the replacement is completed.
- (7) The accumulated travel distance is not added while the axis is being removed.

4.6.5 Spindle protection [M8]

Cont.	Signal name	Abbrev.	1st SP	2nd SP	3rd SP	4th SP	5th SP	6th SP	7th SP	8th SP
A	Spindle protection: Motor equivalent load factor	SPEQLD	ZR13010	ZR13011	ZR13012	ZR13013	ZR13014	ZR13015	ZR13016	ZR13017

[Function]

This signal outputs the spindle motor equivalent load factor from the start of the last automatic operation to the current operation with 1% increment.

The output value can be adjusted by the parameter "#43101 sp_rated_ratio" setting.

[Operation]

Values are cleared to zero at the following timings:

When the automatic operation starts

When M99 command is issued by the main program

Cont.	Signal name	Abbrev.	Common(\$)
A	Spindle protection: Number of times log output error occurred	PRSPERR	ZR13018

[Function]

This signal outputs the number of errors which occurred at the time the log was output with the spindle protection function.

[Operation]

When the error occurs at the time the log was output with the spindle protection function, ZR13018 is incremented.

4.6.6 External encoder position output I/F [M8]

Cont.	Signal name	Abbrev.	Common(\$)
A	External encoder 1: Position output	ENC1POS	ZR13020,1

[Function]

This signal outputs the position (angle) calculated based on the pulse input of the external encoder 1 in the PLC setting units.

[Operation]

When the PLC setting unit is B (0.001mm), 0 to 359999 [0.001°] is output.

The value of this register is held even when the power is OFF.

(Note) When the power is OFF, the position change cannot be detected.

[Related signals]

(1) External encoder 1: Position output clear request [M8] (ENC1PCLR: Y1C88)

4.6.7 Machine contact input/output I/F [M8]

Cont.	Signal name	Abbrev.	Common(\$)
A	Thermistor input n	TIn	ZR13028 to ZR13039

[Function]

This signal enables the following temperature value to be read from the file register: temperature acquired with the thermistor that is connected to the designated connector of the thermistor input-equipped remote I/O unit.

[Operation]

This signal outputs the temperature value acquired with the thermistor in 0.1°C units.

Example: 0x01F5 = 501 → 50.1°C

When the thermistor is disconnected or short-circuited, this register is not updated.

The below shows the data update cycle of the thermistor input and the interface:

Channel	File register	Data update cycle
TI0	ZR13028	The thermistor voltage acquired with the thermistor input-equipped remote I/O unit is input after converted to a temperature value per PLC medium-speed cycle. One station of remote I/O has 4 thermistor inputs, thus 4 PLC medium-speed cycles are required for the inputs of one station.
TI1	ZR13029	
TI2	ZR13030	
TI3	ZR13031	
TI4	ZR13032	
TI5	ZR13033	
TI6	ZR13034	
TI7	ZR13035	
TI8	ZR13036	
TI9	ZR13037	
TI10	ZR13038	
TI11	ZR13039	

[Related signals]

- (1) Thermistor disconnection (TIOPN: ZR13040)
- (2) Thermistor short-circuit (TISRT: ZR13041)

Cont.	Signal name	Abbrev.	Common(\$)
A	Thermistor disconnection	TIOPN	ZR13040

[Function]

This signal notifies that the thermistor is not connected to the thermistor input-equipped remote I/O unit, or the thermistor is disconnected or ground-fault.

[Operation]

When the thermistor is unconnected, disconnected or ground-fault, the bit of the corresponding channel is turned ON. The thermistor input (TI0 to TI11) of the channel which is disconnected or ground-fault is not updated.

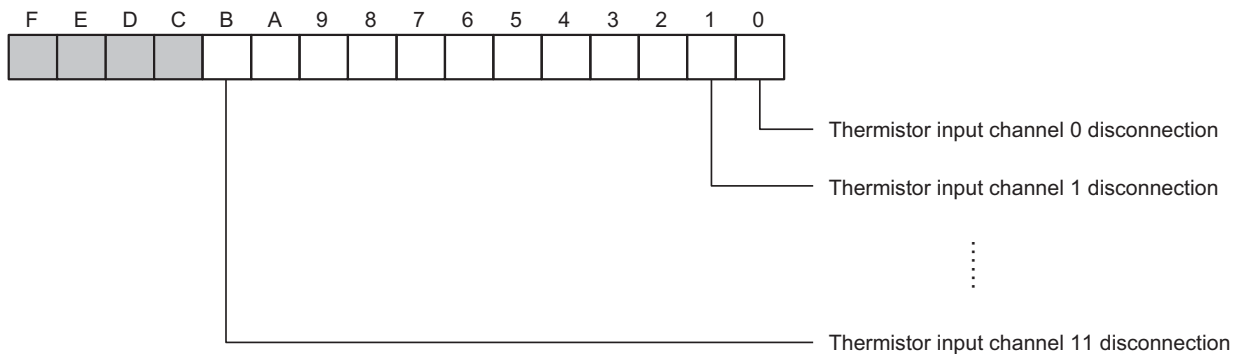

[Related signals]

- (1) Thermistor input (TI0 to TI11: ZR13028 to 13039)

4 Explanation of Interface Signals

Cont.	Signal name	Abbrev.	Common(\$)
A	Thermistor short-circuit	TISRT	ZR13041

[Function]

This signal notifies that the thermistor input of the thermistor input-equipped remote I/O unit is short-circuited.

[Operation]

When the thermistor input is short-circuited, the bit of the corresponding channel is turned ON.

The thermistor input (TI0 to TI11) of the channel which is short-circuited is not updated.

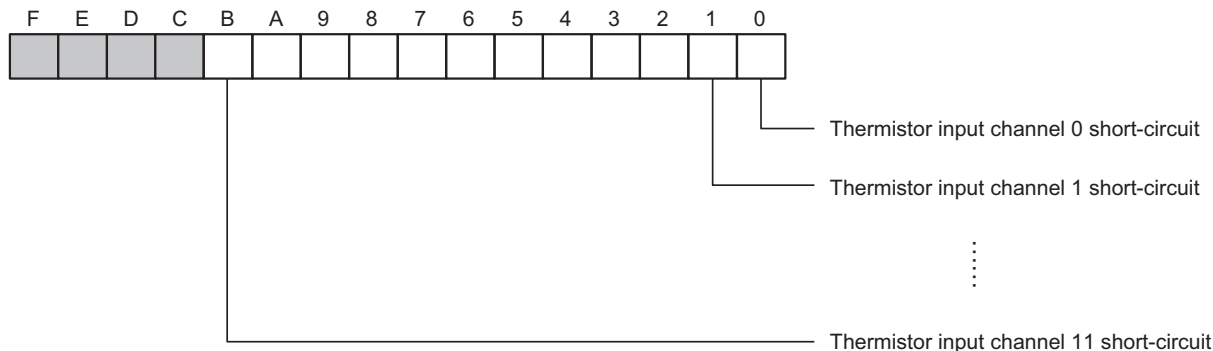

[Related signals]

(1) Thermistor input (TI0 to TI11: ZR13028 to 13039)

Cont.	Signal name	Abbrev.	Common(\$)
A	MULTI-ANALOG INPUT CH N	MA _n	ZR13050 to ZR13065

[Function]

This signal can read the data of analog voltage, current or temperature acquired from the remote I/O unit with multi-analog input.

[Operation]

The data acquired from the remote I/O unit with multi-analog input is output in the format selected with the parameters "#11351 manasel_00" to "#11366 manasel_15 (Multi-analog input data type ch0 to ch15).

#11351	Data type	Register output range *	Accuracy guarantee range	Output unit	Corresponding data	
		(decimal)	(decimal)		Register output range	Accuracy guarantee range
0	Analog voltage	±32000	±32000	312.5μV	±10V	±10V
1	Analog current	±16000	±16000	1.25μA	±20mA	±20mA
2 to 5	Temperature (resistance thermometer bulb, normal)	-700 to 3200	-500 to 3000	0.1 °C	-70.0 to 320.0 °C	-50.0 to 300.0 °C
6 to 9	Temperature (resistance thermometer bulb, high-accuracy)	-7000 to 32000	-5000 to 30000	0.01 °C	-70.00 to 320.00 °C	-50.00 to 300.00 °C
10	Temperature (thermocouple (K))	-600 to 6200	-400 to 6000	0.1 °C	-60.0 to 620.0 °C	-40.0 to 600.0 °C
11	Temperature (thermocouple (J))	-600 to 6200	-400 to 6000	0.1 °C	-60.0 to 620.0 °C	-40.0 to 600.0 °C

* Output in hexadecimal to the register.

4 Explanation of Interface Signals

If the normal analog input value cannot be acquired from the remote I/O unit with multi-analog input (due to disconnection detection or input value error), this register is not updated. The error cause is output to the multi-analog input status (MASTS_n).

A thermocouple can measure temperature relative to the reference junction. For the multi-analog input unit, the unit's connector part serves as the reference junction. While the connector part is not at 0 °C, cold junction compensation is required. The compensation uses a Pt100 resistor.

[Related signals]

(1) Multi-analog input status (MASTS00 to 15: ZR13066 to ZR13081)

Cont.	Signal name	Abbrev.	Common(\$)
A	MULTI-ANALOG INPUT STATUS CH N	MASTS _n	ZR13066 to ZR13081

[Function]

This signal outputs the input data type and error status of the remote I/O unit with multi-analog input.

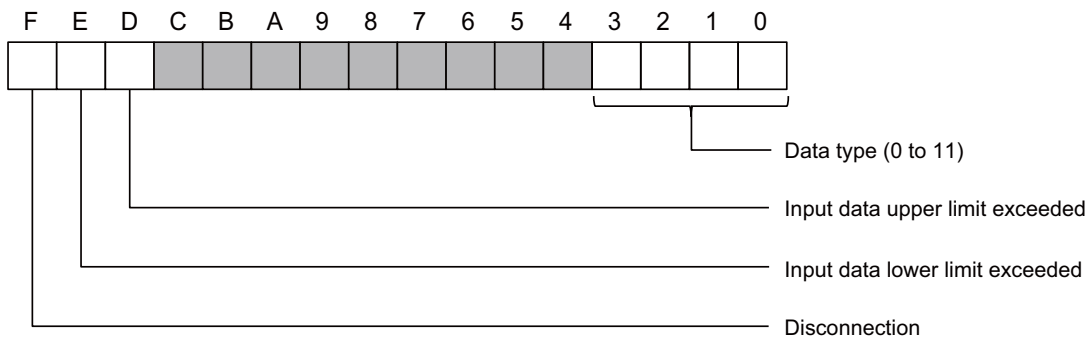

[Operation]

BIT0 to 3 [Data type]:

Data type selected with the parameter "#11351 manasel_00" to "#11366 manasel_15 (Multi-analog input data type ch0 to ch15) is output.

- 0: Analog voltage
- 1: Analog current
- 2: Temperature (resistance thermometer bulb, normal, Pt100, 3-wire)
- 3: Temperature (resistance thermometer bulb, normal, Pt100, 4-wire)
- 4: Temperature (resistance thermometer bulb, normal, Pt1000, 3-wire)
- 5: Temperature (resistance thermometer bulb, normal, Pt1000, 4-wire)
- 6: Temperature (resistance thermometer bulb, high-accuracy, Pt100, 3-wire)
- 7: Temperature (resistance thermometer bulb, high-accuracy, Pt100, 4-wire)
- 8: Temperature (resistance thermometer bulb, high-accuracy, Pt1000, 3-wire)
- 9: Temperature (resistance thermometer bulb, high-accuracy, Pt1000, 4-wire)
- 10: Temperature (thermocouple (K))
- 11: Temperature (thermocouple (J))

BITD [Input data upper limit exceeded]:

When the input value from the remote I/O unit with multi-analog input exceeds the upper limit of accuracy guarantee range, this turns ON.

BITE [Input data lower limit exceeded]:

When the input value from the remote I/O unit with multi-analog input exceeds the lower limit of accuracy guarantee range, this turns ON.

BITF [Disconnection]:

When the remote I/O unit with multi-analog input detects the disconnection of temperature sensor, this turns ON.

[Related signals]

(1) Multi-analog input (MA00 to 15: ZR13050 to ZR13065)

4.6.8 Common Variables [C80]

ZR devices are assigned as shown in the following table corresponding to each common variable.

Two ZR devices (2 words) are assigned to one variable. When creating a drawing part for GOT, be sure to specify 32 bits (2 words).

Extensions of ZR devices cannot be read by specifying bits.

The following table indicates the maximum specifications. However, an error occurs when the part exceeding your CNC's specifications is specified.

The variables #100 to #199 and #500 to #999 can be switched between common and independent system by specifying the range with the parameters. An error occurs when an outside of the range is specified.

The variables #100100 to #800199 have no ZR device assignment.

Variable classification	Corresponding ZR device No.		Valid condition
	Part system common	Part system independent	
#100 to #199	ZR81000 to ZR81199	\$1: ZR81000 to ZR81199 \$2: ZR82000 to ZR82199 \$3: ZR83000 to ZR83199 \$4: ZR84000 to ZR84199 \$5: ZR85000 to ZR85199 \$6: ZR86000 to ZR86199 \$7: ZR87000 to ZR87199 (*3)	Common/independent switchover - "#1052 MemVal" is set to "1". - "#1303 V1comN" (boundary setting) The range of variables differs depending on the number of sets. (*1)
#400 to #499	ZR90400 to ZR90599	-	Valid only when "#1336 #400_Valtype" is set to "1". Valid only when the number of sets is 700 sets or more.
#500 to #999	ZR80000 to ZR80999 (*3)	\$1: ZR91000 to ZR91999 \$2: ZR92000 to ZR92999 \$3: ZR93000 to ZR93999 \$4: ZR94000 to ZR94999 \$5: ZR95000 to ZR95999 \$6: ZR96000 to ZR96999 \$7: ZR97000 to ZR97999	Common/independent switchover - "#1052 MemVal" is set to "1". - "#1304 V0comN" (boundary setting) The range of variables differs depending on the number of sets. (*2)
#50000 to #50749 (*4)	ZR50000 to ZR51499 (R8300 to R9799)	-	-
#51000 to #51749 (*4)	ZR52000 to ZR53499 (R18300 to R19799)	-	-
#52000 to #52749 (*4)	ZR53000 to ZR54499 (R28300 to R29799)	-	-
#100100 to #100199 #200100 to #200199 #300100 to #300199 #400100 to #400199 #500100 to #500199 #600100 to #600199 #700100 to #700199 #800100 to #800199 #900000 to #907399	-	-	Valid only when "#1316 CrossCom" is set to "1". Valid only when the number of sets is 600 sets or more.

(*1) The following is the variable range according to the number of sets.

The number of sets	Variable range
100 sets	100 to 149
200 sets or more	100 to 199

(*2) The following is the variable range according to the number of sets.

The number of sets	Variable range
100 sets	500 to 549
200 sets	500 to 599
300 sets	500 to 699
600 sets or more	500 to 999

(*3) These variables are compatible with C70.

(*4) #50000 to #50749 are assigned to the parameters #18151 to 18900 as PLC constants. Thus they are also output to parameter files.

For #50000 to #50749 input by parameter files and common variable files, the last setting value that was input is applied.

4.6.9 GOT Window [C80]

For ZR device of GOT window, refer to the chapter "GOT Window [C80]".

4.6.10 BiSS Encoder I/F [M8]

Cont.	Signal name	Abbrev.	Common(\$)
A	BiSS encoder I/F: Communication status	BENCSTS	ZR13090

[Function] [Operation]

The communication status of BiSS encoder I/F is output to this register.

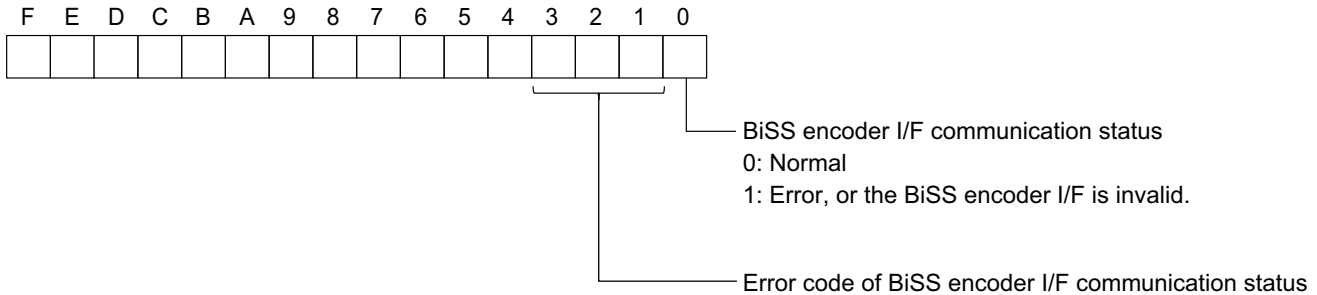

Create a sequence program not to use data of the "BiSS encoder I/F: Encoder 1 data output n" signal (ZR13091: BENC1DATn) while bit0 of this register is "1". (Refer to the figure below.)

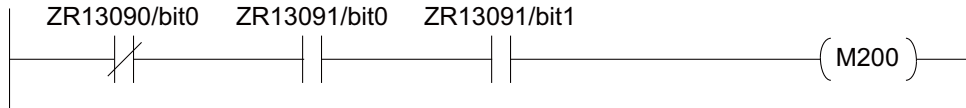

When a communication error occurs, the operation error corresponding to the error code is displayed. Restart CNC when the communication error occurs.

Error code (ZR13090/bit1, bit2, bit3)	Operation errors
001	M01 0350
010	M01 0351
110	M01 0352

[Related signals]

(1) BiSS encoder I/F: Encoder 1 data output n (BENC1DATn: ZR13091 to ZR13094)

Cont.	Signal name	Abbrev.	Common(\$)
A	BiSS encoder I/F: Encoder 1 data output 1 to 4	BENC1DAT1 to 4	ZR13091 to ZR13094

[Function]

Data of BiSS encoder 1 is output to this signal.

[Operation]

Data received from BiSS encoder is output to this signal.

The unit of this signal does not depend on the parameter "#1040 M_inch" setting.

The update cycle of this signal depends on the parameter "#1334 DI/DO refresh cycl" setting.

The value of this signal is not updated when a communication error is detected on the CNC side and an error code is being output to the "BiSS encoder I/F: Communication status" signal (ZR13090).

Create a sequence program not to use data of this register while an error occurs on the BiSS encoder side (*1).

When this function is invalid (the parameter "#1762 cfgPR12/bit5" is set to "0"), the value of this register is "0".

(*1) This indicates the period when bit0 of the "BiSS encoder I/F: Communication status" signal (ZR13090: BENCSTS) is "1".

[Related signals]

(1) BiSS encoder I/F: Communication status (ZR13090: BENCSTS)

Appx.1: PLC window [M8]/PLC window [C80]

PLC window [M8]/PLC window [C80] is a function that uses the "read window" or "write window" arbitrary assigned to the R register [M8]/D register [C80] user area to read and write the CNC operation status, axis information, parameters and tool data, etc.

5.1 Details

The PLC window [M8]/PLC window [C80] has "read window" for read and "write window" for write.

[M8]

The "read window" and "write window" designate arbitrary position of the R register with parameters (window start R register). Up to three window areas can be specified simultaneously for both "read window" area and "write window" area. This enables read/write window area to be split and used even when a part of the user area is fixed.

R registers that can be used

User area	R8300 to R9799	Backup area 1500 points
	R9800 to R9899	Non backup area 100 points
	R18300 to R19799	Backup area 1500 points
	R19800 to R19899	Non backup area 100 points
	R28300 to R29799	Backup area 1500 points
	R29800 to R29899	Non backup area 100 points

(Note that R register for window start must be an even number.)

[C80]

Assignment is fixed for "read window" and "write window" and the number of windows is 50.

D registers that can be used

Application	Device
Control data (MELSEC -> CNC)	D4096 to D5295 (1200 words)
Read data status (CNC -> MELSEC)	D1024 to D1523 (500 words)

16 R register [M8]/D register [C80] are used for one read window or write window. ([M8] 18 registers for when extended interface is used.)

The read window is further divided into the "read control window" and "read data window". The write window is also divided into the "write control window" and "write data window". Up to four data items can be successively read or written from the data designated in one read window or write window.

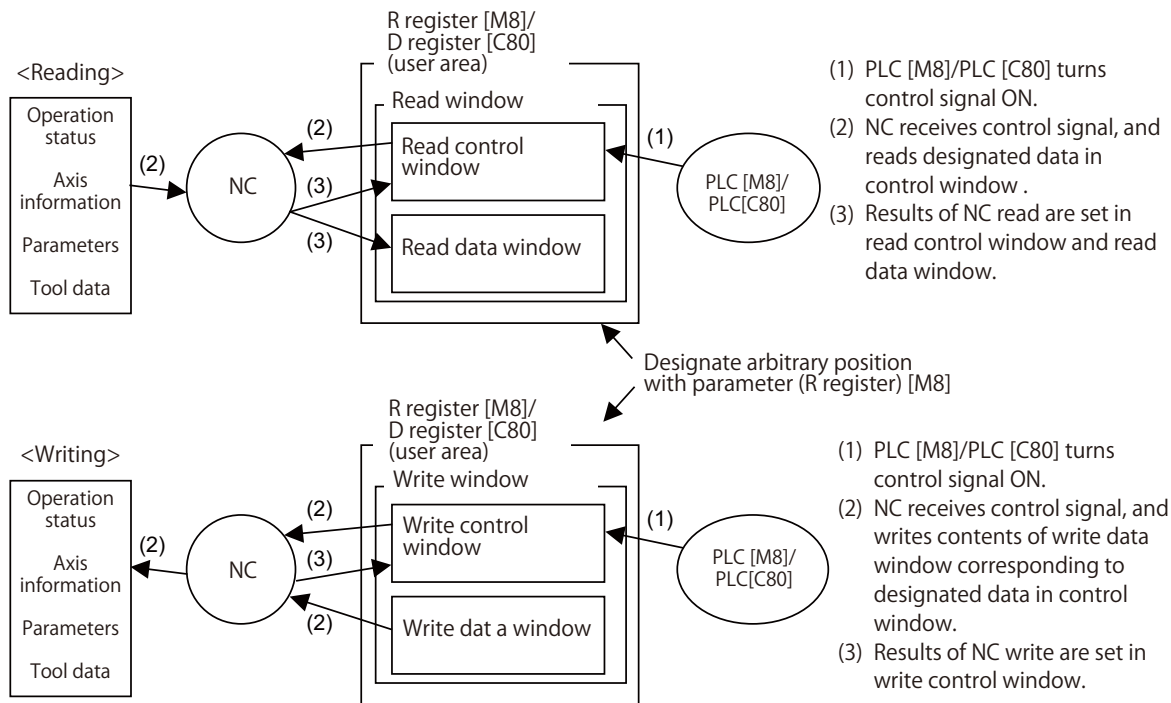

Outline drawing for PLC window [M8]/PLC window [C80]

After reading, whether reading succeeded or failed and the number of data read will be displayed on the "read control window", and details on the "read data window".

After writing, whether writing succeeded or failed and number of data written will be displayed on the "writing control window"

When reading/writing is finished, bit0 (Refer to the section on "read window interface", "write window interface".) turns ON regardless of reading/writing successfulness. Number of data read/written is defined by the number of data actually read or written. When all reading /writing failed, it shows 0.

When two or more data are read/written, it finishes as soon as reading/writing is failed. For example, when the second reading/writing is illegal, it finishes on the right spot, even if the third data may be read/written normally. Consequently, the first data is the only one read/written successfully, resulting the number of data read/written to 1.

5.1.1 Data Flow of PLC Window Function [C80]

Data flow using the window function between MELSEC CPU and CNC CPU is shown in the below figure:

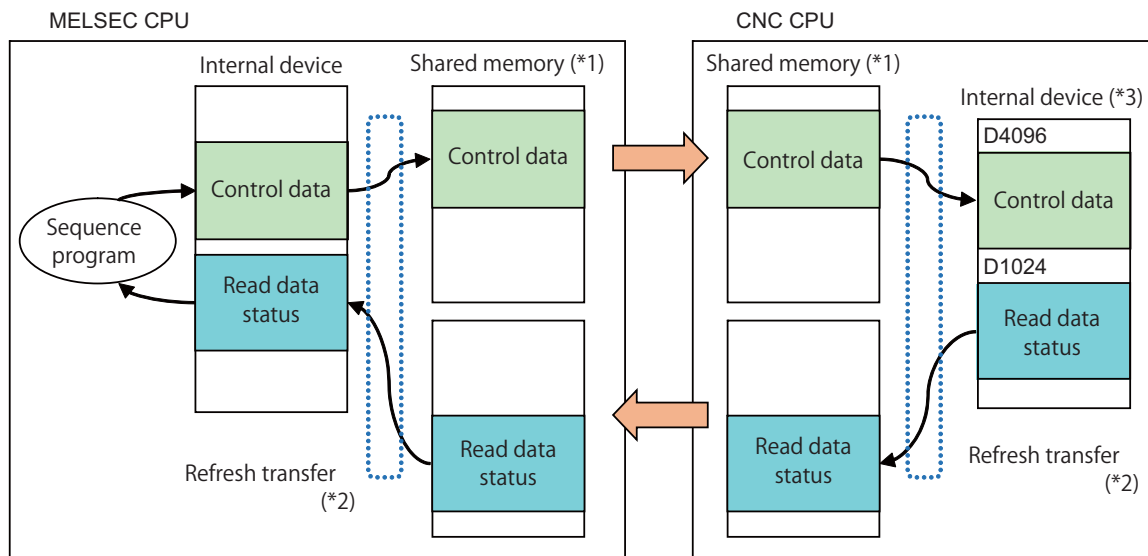

- (*1) Shared memory refers to the memory used to exchange the data between CPUs such as MELSEC CPU and CNC CPU.
- (*2) Refresh transfer between the internal devices of each CPU and the shared memory is automatically performed according to the setting to each CPU.
- (*3) For the internal devices in CNC CPU, the assignment is fixed.

5.1.2 Read/Write Operation [M8]

Read operation

Procedure to read data is as follows:

- (1) On "Read control window", specify the data to read with "Section No.", "Section sub-ID No.", "Sub-section No." and "Data No."
- (2) Specify "Number to be read (max. 4 data)" and "Read method" when "Number to be read" is two or more. For "Read method", specify either 0: "Data No.", 1: "Sub-section No." or 2: "Section sub-ID No." to read the continuous data from the data of the specified items.
- (3) Turn ON bit0 of "Control signal" to start the read operation. (Refer to (3) in the below timing chart.)
- (4) Check the read result on "Read control window".

The "Result" of read result is valid after the read operation is completed. (Refer to (4)-1 in the below timing chart.)

If you want to read with one-shot, turn OFF bit0 of control signal on "Read control window" when "Status" of read result shows read completed status. (Refer to the section of "One-shot read" in the below timing chart.)

If you want to read all the time, always turn ON bit0 of control signal on "Read control window". With this ON, NC performs the read operation every time. (Refer to the section of "Continuous read" in the below timing chart.)

For both "One-shot read" and "Continuous read", when bit0 of control signal on "Read control window" is turned OFF, the read result "Status (bit0)" on "Read control window" is turned OFF. (Refer to (4)-2 in the below timing chart.)

If necessary, check "Status" and "Result" of the read result on "Read control window" and then perform the next operation.

<Timing chart of read operation>

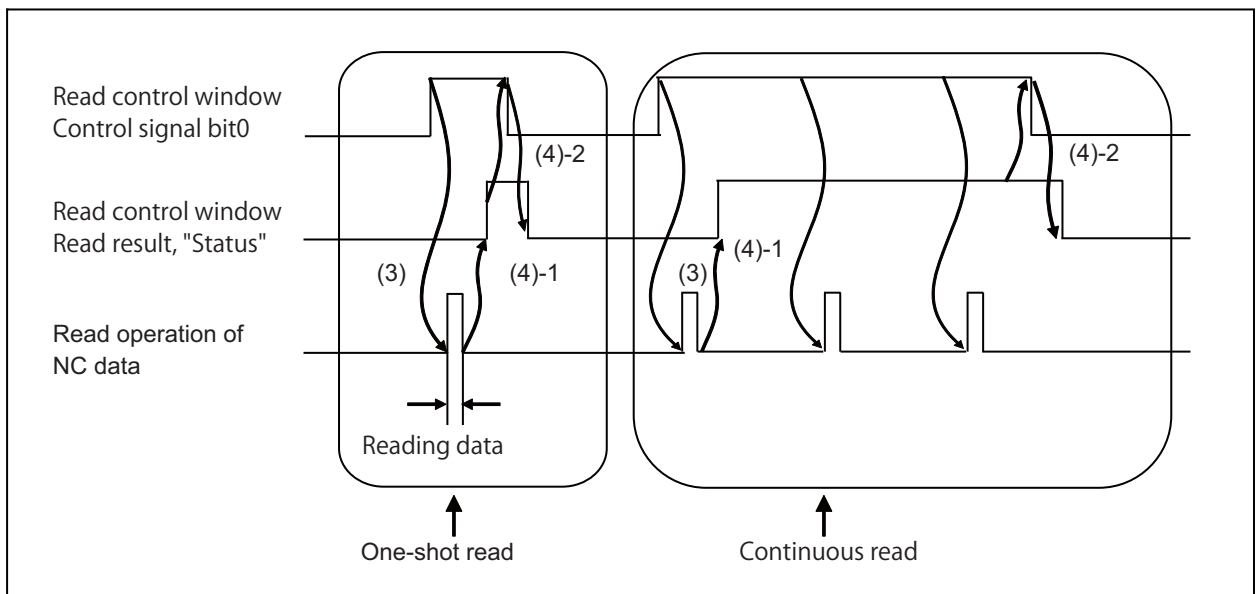

Write operation

Procedure to write data is as follows:

- (1) On "Write control window", specify the data to write with "Section No.", "Section sub-ID No.", "Sub-section No." and "Data No."
- (2) Specify "Number to be written (max. 4 data)" and "Write method" when "Number to be written" is two or more. For "Write method", specify either 0: "Data No.", 1: "Sub-section No." or 2: "Section sub-ID No." to write the continuous data from the data of the specified items.
- (3) Turn ON bit0 of "Control signal" to start the write operation. (Refer to (3) in the below timing chart.)
- (4) Check the write result on "Write control window".

The "Result" of write result is valid after the write operation is completed. (Refer to (4)-1 in the below timing chart.)

If you want to write with one-shot, turn OFF bit0 of control signal on "Write control window" when "Status" of write result shows write completed status. (Refer to the section of "One-shot write" in the below timing chart.)

If you want to write all the time, always turn ON bit0 of control signal on "Write control window". With this ON, NC performs the write operation every time. (Refer to the section of "Continuous write" in the below timing chart.)

However, for the parameter data, write it with one-shot. When you write parameters consecutively, the operation alarm (M50 5003) occurs.

For both "One-shot write" and "Continuous write", when bit0 of control signal on "Write control window" is turned OFF, the write result "Status (bit0)" on "Write control window" is turned OFF. (Refer to (4)-2 in the below timing chart.)

If necessary, check "Status" and "Result" of the write result on "Write control window" and then perform the next operation.

<Timing chart of write operation>

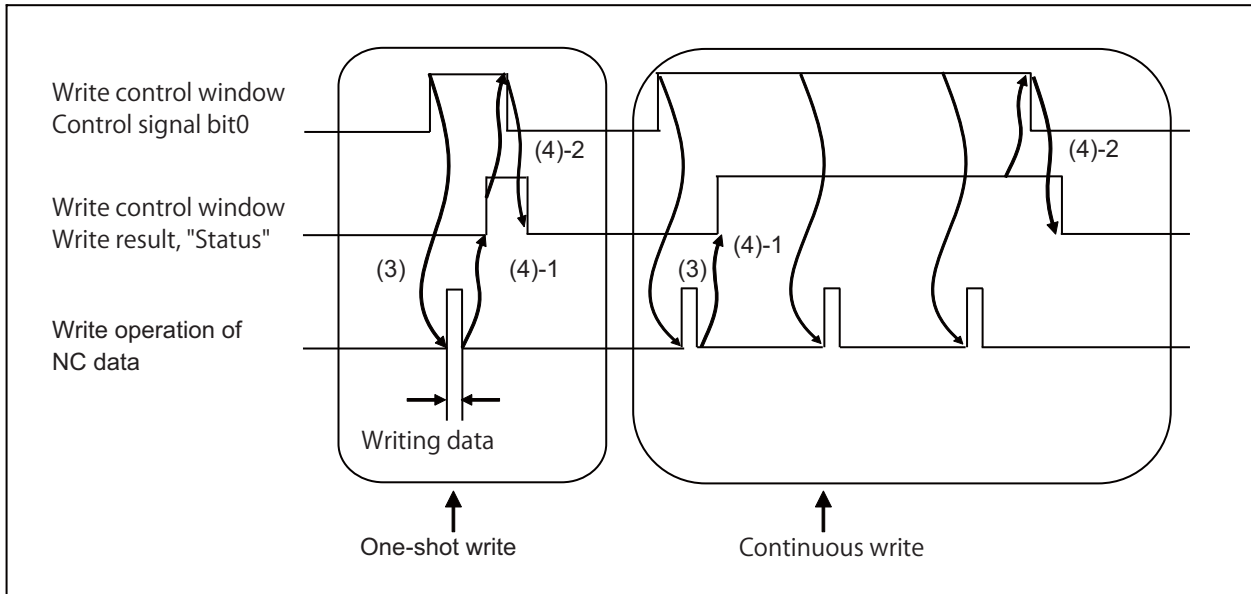

<Parameter update timing>

When a parameter is written, update timing of the parameter is as follows according to the setting of the parameter "#1254 set26/bit3" (Select timing for updating axis parameter).

#1254 set26/bit3	Axis parameter update	Spindle parameter update
0	Performed after smoothing zero of NC axes (excluding PLC axes) in all the part systems.	
1	Performed after smoothing zero of all axes in the part system including the axis.。	<p>While the spindle is in any of the following states, update is waited.</p> <p>When these states are no longer applied, update is performed. Smoothing zero of NC axes or PLC axes is not waited.</p> <ul style="list-style-type: none"> - The spindle is in motion by spindle position control (spindle/C axis control). - Synchronous tapping is in execution. - Tool spindle synchronization I C (spindle-NC axis, polygon) is in execution. - Tool spindle synchronization II (hobbing) is in execution.

5.1.3 Read/Write Operation [C80]

Read operation

Procedure to read data is as follows:

- (1) Designate the data to read by setting "section No.", "section sub-ID No.", "sub-section No.", "data No.", and "data size" to the "read control command".
- (2) Designate "number to be read" (max. 4 data) and "read method" to the same "read control command".
For "Read method", specify either 0: "Data No.", 1: "Sub-section No." or 2: "Section sub-ID No." to read the continuous data from the data of the specified items.
- (3) If bit0 of "control signal" is turned ON, the read operation starts (Refer to (A) in the below timing chart). The read operation continues as long as bit0 is ON.
If bit1 of "control signal" is turned ON, one-shot read operation starts (Refer to (B) in the below timing chart).
- (4) After the read operation is completed, CNC sets the "status" in "read result" (Refer to (C) in the below timing chart).
If "status" is set while one-shot read is ON, data is not read.
- (5) If the control signal of "read control command" is turned OFF, "status (bit0)" in "read result" is also turned OFF.
The operation is the same for both one-shot and continuous read. (Refer to (D) in the below timing chart.)
- (6) "Read data window" stores the read data. Check the "status" and "result" in "read result" before using the read data.

<Timing chart of read operation>

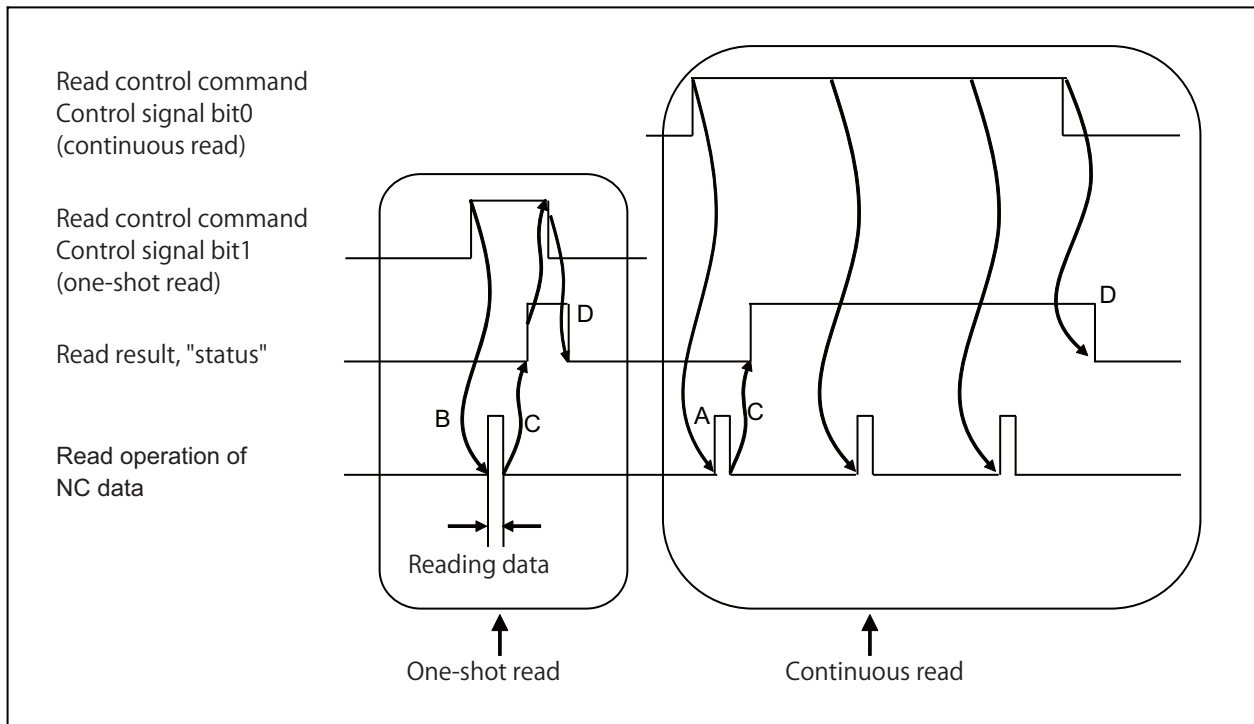

Write operation

Procedure to write data is as follows:

- (1) Designate the data to write by setting "section No.", "section sub-ID No.", "sub-section No.", "data No.", and "data size" to the "write control command".
- (2) Designate "number to be written" (max. 4 data) and "write method" to the same "write control command".
For "Write method", specify either 0: "Data No.", 1: "Sub-section No." or 2: "Section sub-ID No." to write the continuous data from the data of the specified items.
- (3) If bit0 of "control signal" is turned ON, the write operation starts (Refer to (A) in the below timing chart). The write operation continues as long as bit0 is ON.
If bit1 of "control signal" is turned ON, one-shot write operation starts (Refer to (B) in the below timing chart).
- (4) After the write operation is completed, CNC sets the "status" in "write result" (Refer to (C) in the below timing chart).
If "status" is set while one-shot write is ON, CNC does not write data.
- (5) If the control signal of "write control command" is turned OFF, "status (bit0)" in "write result" is also turned OFF. The operation is the same for both one-shot and continuous read. (Refer to (D) in the below timing chart.)
- (6) Check the "status" and "result" in "write result" before executing other operations to the written data.

<Timing chart of write operation>

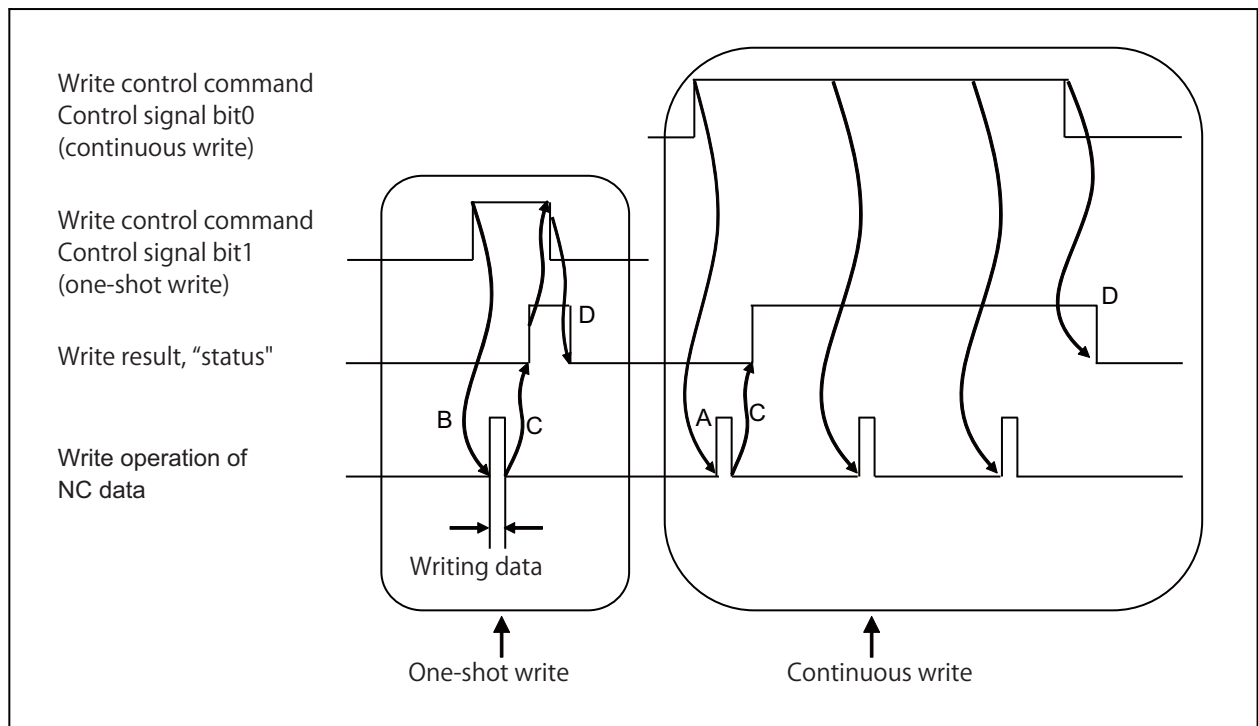

<Parameter update timing>

When a parameter is written, update timing of the parameter is as follows according to the setting of the parameter "#1254 set26/bit3" (Select timing for updating axis parameter).

#1254 set26/bit3	Axis parameter update	Spindle parameter update
0	Performed after smoothing zero of NC axes (excluding PLC axes) in all the part systems.	
1	Performed after smoothing zero of all axes in the part system including the axis..	While the spindle is in any of the following states, update is waited. When these states are no longer applied, update is performed. Smoothing zero of NC axes or PLC axes is not waited. - The spindle is in motion by spindle position control (spindle/C axis control). - Synchronous tapping is in execution. - Tool spindle synchronization I C (spindle-NC axis, polygon) is in execution. - Tool spindle synchronization II (hobbing) is in execution.

<Current limit parameter update timing>

When the servo parameters "#2213 SV013" and "#2214 SV014" of current limit value are written, update timing of these parameters is as follows according to the setting of the parameter "#1701 cfg01/bit6" (Switch timing for updating of current limit parameter).

#1701 cfg01/bit6	Operation
0	Update after confirming the axis stop. The update timing can be selected by the setting of "#1254 set26/bit3".
1	Update is executed immediately even if any of the axes, including the corresponding axis, is moving.

- When the servo parameters are written using any method other than via PLC window, the effective value is updated after the axis stop is confirmed, regardless of this parameter setting.
- The current limit value of PLC axis indexing axis is set in the operation parameter group, and the parameter group is switched at operation start. Therefore, even if the servo parameters are written by this function, they are overwritten at operation start.
- The current limit value in normal servo ON state is set in the parameter "#2213 SV013". Pay extra attention to rewrite it.
- When the torque limitation skip function is performed, the effective value of the servo parameter "#2214 SV014" is temporarily rewritten. When "#2214 SV014" is rewritten via the PLC window while the torque limitation skip command is issued, the effective value written later is effective. The behavior may be different from that estimated. Careful attention is required. At the end of the torque limitation skip command (G160) or at reset stop, the effective value of SV014 returns to the original one.

5.2 PLC Window Interface

5.2.1 Parameter Interface [M8]

NC → PLC interface signal

For the PLC window interface, specify the start R register and the number of windows of read window 1,2,3, and write window 1,2,3 in the parameter (R424 to R435). Error status is set in (R37) when an error is found in the set parameter.

For the read window or write window, the arbitrary assigned area of the R register's user area is used.

(For the area to be used, refer to "Details".)

(R424 to R435 and R37 are non-backup area.)

16 R registers are used for one read window or write window.

When the number of read windows or write windows is set to "1001" to "1100", an extended interface can be used, which enables to specify the sub-section No. and data No. as DWORD-available data.

With this interface, the data can be read or written even if the data No. exceeds the allowable range of WORD-type data.

In this case, the number of windows is handled as "1" to "100". When the extended interface is used, 18 R registers are used for one read window or one write window.

(1) PLC window parameter error status (R37)

It is set when an error is found in the values set for R424 to R435.

When value is already set, it does not read or write.

Values of R37	Error details
0x8001	One of the values set for R424 to R427 exceed the setting range.
0x8002	Area of read window exceeds the R register's user area 1.
0x8003	Area of write window exceeds the R register's user area 1.
0x8004	Write window is found on the read window.
0x8005	Read window is found on the write window.
0x8006	Read window is found on the read window.
0x8007	Write window is found on the write window.
0x8008	Odd number is set for Reading/Writing start R register 1.
0x8101	One of the values set for R428 to R431 exceed the setting range.
0x8102	Area of read window 2 exceeds the R register's user area.
0x8103	Area of write window 2 exceeds the R register's user area.
0x8108	Odd number is set for Reading/Writing start R register 2.
0x8201	One of the values set for R432 to R435 exceed the setting range.
0x8202	Area of read window 3 exceeds the R register's user area.
0x8203	Area of write window 3 exceeds the R register's user area.
0x8208	Odd number is set for Reading/Writing start R register 3. The area is exceeded.

(Note) If an error occurs in one of the windows to be used, read/write is not possible in all the windows.

Set from R424 to R435 without letting the window area overlap.

PLC → NC interface signals

Signal name	R register (Common for part systems)		
	n=1	n=2	n=3
PLC window Reading start R register n	R424	R428	R432
PLC window Number of read windows n	R425	R429	R433
PLC window Writing start R register n	R426	R430	R434
PLC window Number of write windows n	R427	R431	R435

(1) PLC window Reading start R register 1 to 3 (R424, R428, R432)

It sets the PLC window Reading start R register 1 to 3.

The setting range is 8300 to 9884, 18300 to 19884 and 28300 to 29884. (Even number only)

R register	Details
R424	The value is not checked when the value of R425 is 0.
R428	The value is not checked when the value of R429 is 0.
R432	The value is not checked when the value of R433 is 0.

(2) PLC window Number of read windows 1 to 3 (R425, R429, R433)

It designates the number of read windows 1 to 3.

The setting range is 0 to 100. When it is 0, it does not read.

When a number from "1001" to "1100" is set, the number of windows of the extended interface is handled as "1" to "100".

R register	Details
R425	The read windows 1 will be the consecutive area for the number of windows designated. The read windows start from the R register designated with R424.
R429	The read windows 2 will be the consecutive area for the number of windows designated. The read windows start from the R register designated with R428.
R433	The read windows 3 will be the consecutive area for the number of windows designated. The read windows start from the R register designated with R432.

(3) PLC window Writing start R register 1 to 3 (R426, R430, R434)

It sets PLC window Writing start R register 1 to 3.

The setting range is 8300 to 9884, 18300 to 19884 and 28300 to 29884. (Even number only)

R register	Details
R426	The value is not checked when the value of R427 is 0.
R430	The value is not checked when the value of R431 is 0.
R434	The value is not checked when the value of R435 is 0.

(4) PLC window Number of write windows 1 to 3 (R427, R431, R435)

It designates number of write windows 1 to 3.

The setting range is 0 to 100. When it is 0, it does not write.

When a number from "1001" to "1100" is set, the number of windows of the extended interface is handled as "1" to "100".

R register	Details
R427	The write windows 1 will be the consecutive area for the number of windows designated. The write windows start from the R register designated with R426.
R431	The write windows 2 will be the consecutive area for the number of windows designated. The write windows start from the R register designated with R430.
R435	The write windows 3 will be the consecutive area for the number of windows designated. The write windows start from the R register designated with R434.

5.2.2 Read Window Interface

- (1) Read control window
 (Area where both PLC and NC set data [M8])
 (Area where PLC sets data [C80])

R register [M8]	D register [C80]	Item		Details
RA	DA	Read control window	Control signal(*1)(*3)	[M8] Data will be read by turning bit0 ON. NC and PLC read asynchronously. When the reading is finished, the bit0 under "Status" of the reading results turns ON. When the bit0 under "Status" turns ON, turn OFF the bit0 of the control signal. In case of reading in constant, leave the bit0 ON. [C80] bit0: ON Starts continuous read OFF Stops continuous read bit1: ON Starts one-shot read OFF Stops one-shot read * When both bit0 and bit1 are turned ON, continuous read is operated.
RA+1	DA+1		Section No.(*1)	Designate data type
RA+2	DA+2		Section sub-ID No.(*1)	Designate part system No. (1 to maximum number of part system for each model)
RA+3	DA+3		Sub-section No.(*1)	Designate data
RA+4	DA+4		Data No.(*1)	Designate axis No. used in the part system and variable No., etc. (The axis No. is 1 to maximum number of axes for each model)
RA+5	DA+5		Reading method(*1)	0: Read up to 4 consecutive data from the designated data No. 1: Read up to 4 consecutive data from the designated sub-section No. 2: Read up to 4 consecutive data from the designated section sub-ID No.
RA+6	DA+6		Number to be read(*1)	Designate number to be read. Maximum number of data to be read is 4. If 5 or more is designated, the number of data is regarded as 4.
RA+7	DA+7		Reading results[M8] (*2)	<Status> (bit0 to bit7) bit0: Read finished (It turns ON when reading is finished regardless of reading successfulness) bit1: blank bit2 to 7: Read error The value and its meaning when the control signal is ON are as below: 0x01: Normally finished 0x41: Address illegal 0x45: Section No. illegal 0x49: Sub-section No. illegal 0x59: Not fit in the buffer 0x5D: Data type illegal 0x75: Unable to read 0x7D: Read write-only data 0x81: Axis designation illegal 0x85: Data No. illegal <Results> (bit8 to bitF) Number of data read
		System reserve [C80]	System reserve	

(*1) These items are set by PLC [M8]/PLC [C80].

(*2) This item is set by NC [M8].

(*3) Turn ON the control signal after setting Section No., Section sub-ID No., Sub-section No., Data No., Reading method, and Number to be read.

(2) Read data window (Area where NC sets data)

R register [M8]	D register [C80]	Item		Detail
RA+8 to 9	Da+0 to 1	Read data window	Read data 1	Store the read data.
RA+10 to 11	Da+2 to 3		Read data 2	
RA+12 to 13	Da+4 to 5		Read data 3	
RA+14 to 15	Da+6 to 7		Read data 4	

(3) Read result (Area where NC set data) [C80]

D register	Item		Details
D1024+n (n = Number of windows)	Low (bit0 to bit7)	Read status	bit0: Read finished (This bit is turned ON when the read operation finished, regardless of whether the operation succeeded or not.) bit1: Blank bit2 to 7: Read error Values and meanings when the control signal is turned ON 0x01: Normally finished 0x41: Address illegal 0x45: Section No. illegal 0x49: Sub-section No. illegal 0x59: Not fit in the buffer 0x5D: Data type illegal 0x75: Unable to read 0x7D: Read write-only data 0x81: Axis designation illegal 0x85: Data No. illegal
	High (bit8 to bitF)	Read result	Number of data read

5.2.3 Write Window Interface

- (1) Writing control window
 (Area where both PLC and NC set data [M8])
 (Area where PLC sets data [C80])

R register [M8]	D register [C80]	Item		Details
RB	DB	Writing control window	Control signal(*1)(*3)	[M8] Data will be written by turning bit0 ON. NC and PLC write asynchronously. When the writing is finished, The bit0 under "Status" of the writing result turns ON. When the bit0 under "Status" turns ON, turn OFF the bit0 of the control signal. [C80] bit0: ON Starts continuous read OFF Stops continuous read bit1: ON Starts one-shot read OFF Stops one-shot read bit2: ON Addition write OFF Direct write *1 When both bit0 and bit1 are turned ON, continuous write is operated. *2 For addition write of bit2, only the integer type data is valid. (If addition write is performed with character string type, the write error 0x5D Data type illegal occurs.)
RB+1	DB+1		Section No. (*1)	Designate data type
RB+2	DB+2		Section sub-ID No. (*1)	Designate part system No. (1 to maximum number of part system for each model)
RB+3	DB+3		Sub-section No. (*1)	Designate data
RB+4	DB+4		Data No. (*1)	Designate axis No. used in the part system and variable No., etc. (The axis No. is 1 to maximum number of axes for each model)
RB+5	DB+5		Writing method (*1)	0: Write up to 4 consecutive data from the designated data No. 1: Write up to 4 consecutive data from the designated sub-section No. 2: Write up to 4 consecutive data from the designated section sub-ID No.
RB+6	DB+6		Number to be written (*1)	Designate number of data to be written. Maximum number of data to be written is 4. If 5 or more is designated, the number of data is regarded as 4.
RB+7	DB+7		Writing results [M8] (*2)	<Status> (bit0 to bit7) bit0: Write finished (It turns ON when the writing is finished regardless of writing successfulness) bit1: Blank bit2 to 7: Write error The value and its meaning when the control signal is ON are as below: 0x01: Normally finished 0x41: Address illegal 0x45: Section No. illegal 0x49: Sub-section No. illegal 0x59: Not fit in the buffer 0x5D: Data type illegal 0x6D: Written in read-only data 0x79: Unable to write data 0x81: Axis designation illegal 0x85: Data No. illegal <Results> (bit8 to bitF) Number of data written
		System reserve [C80]	System reserve	

(*1) These items are set by PLC [M8]/PLC [C80].

(*2) This item is set by NC [M8].

(*3) Turn ON the control signal after setting Section No., Section sub-ID No., Sub-section No., Data No., Writing method, Number to be written, and write data 1 to 4 in the write data window.

(2) Write data window (Area where PLC [M8]/PLC [C80] sets data)

R register [M8]	D register [C80]	Item		Details
RB+8 to 9	Db+0 to 1	Write data window	Write data 1	Store the write data.
RB+10 to 11	Db+2 to 3		Write data 2	
RB+12 to 13	Db+4 to 5		Write data 3	
RB+14 to 15	Db+6 to 7		Write data 4	

(3) Write result (Area where NC set data) [C80]

D register	Item		Details
D1074+n (n = Number of windows)	Low (bit0 to bit7)	Write status	bit0: Write finished (This bit is turned ON when the write operation finished, regardless of whether the operation succeeded or not.) bit1: Blank bit2 to 7: Write error Values and meanings when the control signal is turned ON 0x01: Normally finished 0x41: Address illegal 0x45: Section No. illegal 0x49: Sub-section No. illegal 0x59: Not fit in the buffer 0x5D: Data type illegal 0x6D: Written in read-only data 0x79: Unable to write data 0x81: Axis designation illegal 0x85: Data No. illegal
	High (bit8 to bitF)	Write result	Number of data written

5.2.4 Read Window Expanded Interface [M8]

(1) Read control window (Area where both PLC and NC set data)

R register	Item	Details
RA	Control signal(*1)(*3)	Data will be read by turning bit0 ON. NC and PLC read asynchronously. When the reading is finished, the bit0 under "Status" of the reading results turns ON. When the bit0 under "Status" turns ON, turn OFF the bit0 of the control signal. In case of reading in constant, leave the bit0 ON.
RA+1	Section No.(*1)	Designate data type
RA+2	Section sub-ID No.(*1)	Designate part system No. (1 to maximum number of part system for each model)
RA+3 to 4	Sub-section No.(*1)	Designate data
RA+5 to 6	Data No.(*1)	Designate axis No. used in the part system and variable No., etc. (The axis No. is 1 to maximum number of axes for each model)
RA+7	Reading method(*1)	0: Read up to 4 consecutive data from the designated data No. 1: Read up to 4 consecutive data from the designated sub-section No. 2: Read up to 4 consecutive data from the designated section sub-ID No.
RA+8	Number to be read(*1)	Designate number to be read. Maximum number of data to be read is 4. If 5 or more is designated, the number of data is regarded as 4.
RA+9	Reading results(*2)	<Status> (bit0 to bit7) bit0: Read finished (It turns ON when reading is finished regardless of reading successfulness) bit1: blank bit2 to 7: Read error The value and its meaning when the control signal is ON are as below: 0x01: Normally finished 0x41: Address illegal 0x45: Section No. illegal 0x49: Sub-section No. illegal 0x59: Not fit in the buffer 0x5D: Data type illegal 0x75: Unable to read 0x7D: Read write-only data 0x81: Axis designation illegal 0x85: Data No. illegal <Results> (bit8 to bitF) Number of data read

(*1) These items are set by PLC.

(*2) This item is set by NC.

(*3) Turn ON the control signal after setting the data of RA+1 to RA+8.

(2) Read data window (Area where NC sets data)

R register	Item	Detail
RB+10 to 11	Read data 1	Store the read data.
RB+12 to 13	Read data 2	
RB+14 to 15	Read data 3	
RB+16 to 17	Read data 4	

5.2.5 Write Window Expanded Interface [M8]

(1) Writing control window (Area where both PLC and NC set data)

R register	Item	Details
RB	Control signal(*1)(*3)	Data will be written by turning bit0 ON. NC and PLC write asynchronously. When the writing is finished, the bit0 under "Status" of the writing result turns ON. When the bit0 under "Status" turns ON, turn OFF the bit0 of the control signal.
RB+1	Section No.(*1)	Designate data type
RB+2	Section sub-ID No.(*1)	Designate part system No. (1 to maximum number of part system for each model)
RB+3 to 4	Sub-section No.(*1)	Designate data
RB+5 to 6	Data No.(*1)	Designate axis No. used in the part system and variable No., etc. (The axis No. is 1 to maximum number of axes for each model)
RB+7	Writing method(*1)	0: Write up to 4 consecutive data from the designated data No. 1: Write up to 4 consecutive data from the designated sub-section No. 2: Write up to 4 consecutive data from the designated section sub-ID No.
RB+8	Number to be written(*1)	Designate number of data to be written. Maximum number of data to be written is 4. If 5 or more is designated, the number of data is regarded as 4.
RB+9	Writing results(*2)	<Status> (bit0 to bit7) bit0: Write finished (It turns ON when the writing is finished regardless of writing successfulness) bit1: Blank bit2 to 7: Write error The value and its meaning when the control signal is ON are as below: 0x01: Normally finished 0x41: Address illegal 0x45: Section No. illegal 0x49: Sub-section No. illegal 0x59: Not fit in the buffer 0x5D: Data type illegal 0x6D: Written in read-only data 0x79: Unable to write data 0x81: Axis designation illegal 0x85: Data No. illegal <Results> (bit8 to bitF) Number of data written

(*1) These items are set by PLC.

(*2) This item is set by NC.

(*3) Turn ON the control signal after setting the data of RB+1 to RB+8 and RB+10 to RB+17 in the write data window.

(2) Write data window (Area where PLC sets data)

R register	Item	Detail
RB+10 to 11	Write data 1	Store the write data.
RB+12 to 13	Write data 2	
RB+14 to 15	Write data 3	
RB+16 to 17	Write data 4	

5.2.6 Interface for Consecutive Writes Detection Log [M8]

(1) Detection log area (Area where NC sets data)

R register	Item	Details
R20058	Number of consecutive writes detected	The NC detects that consecutive write of parameters was performed through the write window. The number of detections is stored in R20058. This number is counted up only at the first detection after the NC power is turned ON. This number is retained even after the power is turned OFF.
R20059	Consecutive write window No.	The NC detects that consecutive write of parameters was performed through the write window. The head register number of write window at the detection is stored in R20059. Regardless of the number of consecutive write operations, the head R register number of the first detected window after turning ON the power.

5.3 Data Type

Data type	Description	Unit (when the control unit and minimum setting unit are 1μm)
PLC setting unit	This is position data, and is input and output in the minimum setting unit which is specified by the machine parameter. This data is not changed by the initial inch parameter or constant inch input (M_inch) parameter. This data may change depending on the PLC setting unit.	μm
PLC setting unit per minute	This is speed data, and is input and output at the minimum setting unit/min. This data is not changed by the initial inch parameter or constant inch input (M_inch) parameter. However, this data may change depending on the PLC setting unit.	μm/min
Machine error compensation unit	The unit of this data is one half of the NC control unit. The control unit depends on the specification.	0.5μm
Fixed point	This is real number type data in a unit other than the above or without a unit. The input/output specification of the decimal point data for the PLC window can be selected with "#1259 set31/bit2" (Disabling decimal point for PLC window). 0: Enable decimal point Fraction data is output as the fixed fraction information. (The numbers of digits in the integer and fraction parts are the same as of the on-screen specifications.) 1: Disable decimal point (cut off all digits after decimal point) Only the integer part is input/output.	Unit specific to data This data is not changed by the control unit or minimum setting unit.
Integer	This is data in a unit other than the above types or the data without a unit.	-
Character string	This is character string data. Up to two characters can be input and output.	-

5.4 Read/Write PLC Axis Data

The section No. to read/write PLC axis data differs from the section No. to read/write NC axis data. The section No. related to the axis data described in "6. Appx.2: List of PLC Window Data[M8]/PLC Window Data [C80]" is for the NC axis. Refer to the following section No. for PLC axis data.

Sub-section No. is same for both NC axis and PLC axis.

Data section	NC axis Section No.	PLC axis Section No.
Axis status	36	Not applicable (*1)
Counter	37	Not applicable (*2)
Servo monitor	59	60
Reference position return parameters	95	131
Servo parameters	96	132
Absolute position parameters	101	133
Base parameters	126	Same as NC axis Section No.
Axis parameters	127	130

(*1) Refer to the PLC axis control device for axis status.

(*2) Refer to the PLC axis control device or the information in servo monitor (Section No. 60) for counter (machine position and remaining distance).

5.5 Precautions

Precautions [M8]

- (1) Set the read window start R register (R424, R428, R432) and the write window start R register (R426, R430, R434), securing enough space for the number of windows in between. When mistakenly set in the area, it does not read or write correctly. Up to 16 R registers are needed for one read window or write window. (18 R registers are necessary when the extended interface is used.)
(Example) In case the reading starts at R8300 and the number of read windows is set to 10, it uses 160 registers in total. Therefore, the writing start R register must be set in R8460 or later.
- (2) Area of read/write window must be within the user area. When reading/writing is attempted exceeding the user area, reading/writing finishes on the right spot.
Set the reading/writing start R registers and the numbers of read/write windows properly to ensure that all the R registers to be used fit within the user area.
- (3) With this function, up to 100 windows can be read or written. Scan time in ladder may be extended, depending on the number of read/write windows.
- (4) When 4 consecutive data are first read and then 3 consecutive data are read using the same window, the forth data will not be set to "0", leaving the first data read.
- (5) When read control signal and write control signal are ON at the PLC stop, reading and writing are conducted because this function operates even while PLC is stopped.
- (6) Read/write window area 1, 2, or 3 can be specified in an arbitrary order, as long as they are specified within R register user area.
- (7) Using this function, do not create PLC in which parameters are written each time scan is performed. It might affect some performance. It might also affect the measurement tool such as NC Analyzer2. If parameters are written consecutively on the PLC, the operation alarm (M50 5003) occurs.
- (8) When the parameter "#1251 set23/bit5" is set to "1", the operation alarm (M50 5003) display can be released. However, use this as a temporary setting until the user PLC is corrected because the operation may become unstable.
- (9) If you create such a PLC program that write servo or spindle parameter per scan, the operation error (M01 0292) will occur upon the execution of the following functions:
 - Spindle/C axis switch
 - Speed monitor mode signal ON
 - High-speed synchronous tapping
 - PLC axis indexing
 However, when the parameter "#1282 ext18/bit7" has been set to "1", the writing of the servo parameter or spindle parameter stops temporarily to execute the functions above so that this error does not occur.
- (10) The range of value to write/read is within the setting range of the R register.
However, the value to write/read for the PLC window may be limited according to the combination of the control units and the PLC setting units.
(Example) When the value of the data converted from the PLC setting units to the control unit exceeds the maximum command value of the NC.
- (11) When data is read from a diameter specification axis (an axis where "#1019 dia" is set to "1"), the data is converted to a radius value, and then output to the read window. When data is written to the diameter specification axis, data input in the write window is handled as a radius value, and the data is converted to a diameter value before written. To input/output the diameter value on the PLC window, set the parameter "#1752 cfgPR02/bit0" (PLC window diameter specification valid) to "1".

Precautions [C80]

- (1) Using this function, do not create PLC in which parameters are written each time scan is performed. It might affect some performance. It might also affect the measurement tool such as NC Analyzer2.

If you create such a PLC program that write servo or spindle parameter per scan, the operation error (M01 0292) will occur upon the execution of the following functions:

- Spindle/C axis switch
- Speed monitor mode signal ON
- High-speed synchronous tapping
- PLC axis indexing

However, when the parameter "#1282 ext18/bit7" has been set to "1", the writing of the servo parameter or spindle parameter stops temporarily to execute the functions above so that this error does not occur.

5.6 Usage Example [M8]

(Example 1) G54 workpiece coordinate offset of the 1st to 4th axes in the 1st part system is read with one-shot.

(1) Set the data to be read as follows:

```
G54
X1      100.000
Y1      150.000
Z1      200.000
V1      250.000
B1      0.000
```

(2) Set the read window 1.

R0424	0x2328	The R register of the read window start is R9000.
R0425	0x0001	The number of the read window is 1. (*1)

(*1) For the data of the number of windows to be used, the continuous areas will be secured from the register designated with R0424. For example, when 0x2328 (9000) is set in R0424 and 0x0003 is set in R0425, the area from R9000 to R9047 serves as read window area.

(3) Set the data in the read window.

R9001	0x0008	Section No. 8
R9002	0x0001	Section sub-ID No. 1
R9003	0x0036	Sub-section No. 54
R9004	0x0001	Data No. 1
R9005	0x0000	Reading method 0
R9006	0x0004	Number to be read 4

(4) Turn ON the control signal of the read control window.

R9000	0x0001
-------	--------

(5) Confirm the read result on the read control window.

R9007	0x0403	R9007	0x0403
-------	--------	-------	--------

(Upper 8 bits: the number of read is "4".

For lower 8 bits, see below:

- bit0: Read is completed.
- bit2 to bit7: Read error contents)

(6) After bit0 (the read result) is turned ON, the control signal that was turned ON in (4) is turned OFF.

(7) Confirm the read data on the read data window.

R9008	0x86A0	1st axis: 100000 = 100.000
R9009	0x0001	
R9010	0x49F0	2nd axis: 150000 = 150.000
R9011	0x0002	
R9012	0x0D40	3rd axis: 200000 = 200.000
R9013	0x0003	
R9014	0xD090	4th axis: 250000 = 250.000
R9015	0x0003	

(Example 2) Write the data to the workpiece coordinate offset G54, G55 and G56.

(1) Set the offset amount of all the axes of the workpiece coordinate offset G54, G55 and G56 to "0.000".

(2) Set the write window 1.

R0426	0x2328	The start R register of the write window 1 is R9000.
R0427	0x0001	The number of the write window is 1.

Set the write window 2.

R0430	0x22C4	The start R register of the write window 2 is R8900.
R0431	0x0001	The number of the write window is 1.

Set the write window 3.

R0434	0x2260	The start R register of the write window 3 is R8800.
R0435	0x0001	The number of the write window is 1.

(3) Set the data in the write control window 1.

R9001	0x0008	Section No.: 8
R9002	0x0001	Section sub-ID No.: 1
R9003	0x0036	Sub-section No.: 54
R9004	0x0001	Data No.: 1
R9005	0x0000	Writing method: 0
R9006	0x0004	Number to be written: 4
R9007	0x0000	Writing results: 0
R9008	0xC350	1st axis: 50000 = 50.000
R9009	0x0000	
R9010	0x86A0	2nd axis: 100000 = 100.000
R9011	0x0001	
R9012	0x49F0	3rd axis: 150000 = 150.000
R9013	0x0002	
R9014	0x0D40	4th axis: 200000 = 200.000
R9015	0x0003	

(4) Set the data in the write control window 2.

R8901	0x0008	Section No.: 8
R8902	0x0001	Section sub-ID No.: 1
R8903	0x0037	Sub-section No.: 55
R8904	0x0001	Data No.: 1
R8905	0x0000	Writing method: 0
R8906	0x0004	Number to be written: 4
R8907	0x0000	Writing results: 0
R8908	0xEA60	1st axis: 60000 = 60.000
R8909	0x0000	
R8910	0xADB0	2nd axis: 110000 = 110.000
R8911	0x0001	
R8912	0x7100	3rd axis: 160000 = 160.000
R8913	0x0002	
R8914	0x3450	4th axis: 210000 = 210.000
R8915	0x0003	

- (5) Set the data in the write control window 3.

R8801	0x0008	Section No.: 8
R8802	0x0001	Section sub-ID No.: 1
R8803	0x0038	Sub-section No.: 56
R8804	0x0001	Data No.: 1
R8805	0x0000	Writing method: 0
R8806	0x0004	Number to be written: 4
R8807	0x0000	Writing results: 0
R8808	0x1170	1st axis: 70000 = 70.000
R8809	0x0001	
R8810	0xD4C0	2nd axis: 120000 = 120.000
R8811	0x0001	
R8812	0x9810	3rd axis: 170000 = 170.000
R8813	0x0002	
R8814	0x5B60	4th axis: 220000 = 220.000
R8815	0x0003	

- (6) Turn ON the control signal in the write control window.

R8800: 0x0001, R8900: 0x0001, R9000: 0x0001

- (7) Confirm the writing results in the write control window.

R8807: 0x0403, R8907: 0x0403, R9907: 0x0403

- (8) Turn OFF the control signal which was turned ON in (6).

R8800: 0x0000, R8900: 0x0000, R9000: 0x0000

- (9) Confirm that the data were written.

Confirm that the workpiece coordinate offset screen is as follows:

G54		G55		G56	
X1	50.000	X1	60.000	X1	70.000
Y1	100.000	Y1	110.000	Y1	120.000
Z1	150.000	Z1	160.000	Z1	170.000
V1	200.000	V1	210.000	V1	220.000
B1	0.000	B1	0.000	B1	0.000

5.7 Device Assignment List [C80]

Details on device assignment (PLC -> CNC)

Device	Data	Application	Device	Data	Application	Device	Data	Application
D4096	Control signal	Read control window 1	D4144	Control signal	Read control window 7	D4192	Control signal	Read control window 13
D4097	Section No.		D4145	Section No.		D4193	Section No.	
D4098	Section sub-ID No.		D4146	Section sub-ID No.		D4194	Section sub-ID No.	
D4099	Sub-section No.		D4147	Sub-section No.		D4195	Sub-section No.	
D4100	Data No.		D4148	Data No.		D4196	Data No.	
D4101	Read method		D4149	Read method		D4197	Read method	
D4102	Number to be read		D4150	Number to be read		D4198	Number to be read	
D4103			D4151			D4199		
D4104	Control signal	Read control window 2	D4152	Control signal	Read control window 8	D4200	Control signal	Read control window 14
D4105	Section No.		D4153	Section No.		D4201	Section No.	
D4106	Section sub-ID No.		D4154	Section sub-ID No.		D4202	Section sub-ID No.	
D4107	Sub-section No.		D4155	Sub-section No.		D4203	Sub-section No.	
D4108	Data No.		D4156	Data No.		D4204	Data No.	
D4109	Read method		D4157	Read method		D4205	Read method	
D4110	Number to be read		D4158	Number to be read		D4206	Number to be read	
D4111			D4159			D4207		
D4112	Control signal	Read control window 3	D4160	Control signal	Read control window 9	D4208	Control signal	Read control window 15
D4113	Section No.		D4161	Section No.		D4209	Section No.	
D4114	Section sub-ID No.		D4162	Section sub-ID No.		D4210	Section sub-ID No.	
D4115	Sub-section No.		D4163	Sub-section No.		D4211	Sub-section No.	
D4116	Data No.		D4164	Data No.		D4212	Data No.	
D4117	Read method		D4165	Read method		D4213	Read method	
D4118	Number to be read		D4166	Number to be read		D4214	Number to be read	
D4119			D4167			D4215		
D4120	Control signal	Read control window 4	D4168	Control signal	Read control window 10	D4216	Control signal	Read control window 16
D4121	Section No.		D4169	Section No.		D4217	Section No.	
D4122	Section sub-ID No.		D4170	Section sub-ID No.		D4218	Section sub-ID No.	
D4123	Sub-section No.		D4171	Sub-section No.		D4219	Sub-section No.	
D4124	Data No.		D4172	Data No.		D4220	Data No.	
D4125	Read method		D4173	Read method		D4221	Read method	
D4126	Number to be read		D4174	Number to be read		D4222	Number to be read	
D4127			D4175			D4223		
D4128	Control signal	Read control window 5	D4176	Control signal	Read control window 11	D4224	Control signal	Read control window 17
D4129	Section No.		D4177	Section No.		D4225	Section No.	
D4130	Section sub-ID No.		D4178	Section sub-ID No.		D4226	Section sub-ID No.	
D4131	Sub-section No.		D4179	Sub-section No.		D4227	Sub-section No.	
D4132	Data No.		D4180	Data No.		D4228	Data No.	
D4133	Read method		D4181	Read method		D4229	Read method	
D4134	Number to be read		D4182	Number to be read		D4230	Number to be read	
D4135			D4183			D4231		
D4136	Control signal	Read control window 6	D4184	Control signal	Read control window 12	D4232	Control signal	Read control window 18
D4137	Section No.		D4185	Section No.		D4233	Section No.	
D4138	Section sub-ID No.		D4186	Section sub-ID No.		D4234	Section sub-ID No.	
D4139	Sub-section No.		D4187	Sub-section No.		D4235	Sub-section No.	
D4140	Data No.		D4188	Data No.		D4236	Data No.	
D4141	Read method		D4189	Read method		D4237	Read method	
D4142	Number to be read		D4190	Number to be read		D4238	Number to be read	
D4143			D4191			D4239		

Device	Data	Application	Device	Data	Application	Device	Data	Application
D4240	Control signal	Read control window 19	D4296	Control signal	Read control window 26	D4352	Control signal	Read control window 33
D4241	Section No.		D4297	Section No.		D4353	Section No.	
D4242	Section sub-ID No.		D4298	Section sub-ID No.		D4354	Section sub-ID No.	
D4243	Sub-section No.		D4299	Sub-section No.		D4355	Sub-section No.	
D4244	Data No.		D4300	Data No.		D4356	Data No.	
D4245	Read method		D4301	Read method		D4357	Read method	
D4246	Number to be read		D4302	Number to be read		D4358	Number to be read	
D4247			D4303			D4359		
D4248	Control signal	Read control window 20	D4304	Control signal	Read control window 27	D4360	Control signal	Read control window 34
D4249	Section No.		D4305	Section No.		D4361	Section No.	
D4250	Section sub-ID No.		D4306	Section sub-ID No.		D4362	Section sub-ID No.	
D4251	Sub-section No.		D4307	Sub-section No.		D4363	Sub-section No.	
D4252	Data No.		D4308	Data No.		D4364	Data No.	
D4253	Read method		D4309	Read method		D4365	Read method	
D4254	Number to be read		D4310	Number to be read		D4366	Number to be read	
D4255			D4311			D4367		
D4256	Control signal	Read control window 21	D4312	Control signal	Read control window 28	D4368	Control signal	Read control window 35
D4257	Section No.		D4313	Section No.		D4369	Section No.	
D4258	Section sub-ID No.		D4314	Section sub-ID No.		D4370	Section sub-ID No.	
D4259	Sub-section No.		D4315	Sub-section No.		D4371	Sub-section No.	
D4260	Data No.		D4316	Data No.		D4372	Data No.	
D4261	Read method		D4317	Read method		D4373	Read method	
D4262	Number to be read		D4318	Number to be read		D4374	Number to be read	
D4263			D4319			D4375		
D4264	Control signal	Read control window 22	D4320	Control signal	Read control window 29	D4376	Control signal	Read control window 36
D4265	Section No.		D4321	Section No.		D4377	Section No.	
D4266	Section sub-ID No.		D4322	Section sub-ID No.		D4378	Section sub-ID No.	
D4267	Sub-section No.		D4323	Sub-section No.		D4379	Sub-section No.	
D4268	Data No.		D4324	Data No.		D4380	Data No.	
D4269	Read method		D4325	Read method		D4381	Read method	
D4270	Number to be read		D4326	Number to be read		D4382	Number to be read	
D4271			D4327			D4383		
D4272	Control signal	Read control window 23	D4328	Control signal	Read control window 30	D4384	Control signal	Read control window 37
D4273	Section No.		D4329	Section No.		D4385	Section No.	
D4274	Section sub-ID No.		D4330	Section sub-ID No.		D4386	Section sub-ID No.	
D4275	Sub-section No.		D4331	Sub-section No.		D4387	Sub-section No.	
D4276	Data No.		D4332	Data No.		D4388	Data No.	
D4277	Read method		D4333	Read method		D4389	Read method	
D4278	Number to be read		D4334	Number to be read		D4390	Number to be read	
D4279			D4335			D4391		
D4280	Control signal	Read control window 24	D4336	Control signal	Read control window 31	D4392	Control signal	Read control window 38
D4281	Section No.		D4337	Section No.		D4393	Section No.	
D4282	Section sub-ID No.		D4338	Section sub-ID No.		D4394	Section sub-ID No.	
D4283	Sub-section No.		D4339	Sub-section No.		D4395	Sub-section No.	
D4284	Data No.		D4340	Data No.		D4396	Data No.	
D4285	Read method		D4341	Read method		D4397	Read method	
D4286	Number to be read		D4342	Number to be read		D4398	Number to be read	
D4287			D4343			D4399		
D4288	Control signal	Read control window 25	D4344	Control signal	Read control window 32	D4400	Control signal	Read control window 39
D4289	Section No.		D4345	Section No.		D4401	Section No.	
D4290	Section sub-ID No.		D4346	Section sub-ID No.		D4402	Section sub-ID No.	
D4291	Sub-section No.		D4347	Sub-section No.		D4403	Sub-section No.	
D4292	Data No.		D4348	Data No.		D4404	Data No.	
D4293	Read method		D4349	Read method		D4405	Read method	
D4294	Number to be read		D4350	Number to be read		D4406	Number to be read	
D4295			D4351			D4407		

Device	Data	Application	Device	Data	Application	Device	Data	Application
D4408	Control signal	Read control window 40	D4456	Control signal	Read control window 46	D4504	Data 1	Write data window 1
D4409	Section No.		D4457	Section No.		D4505		
D4410	Section sub-ID No.		D4458	Section sub-ID No.		D4506	Data 2	
D4411	Sub-section No.		D4459	Sub-section No.		D4507		
D4412	Data No.		D4460	Data No.		D4508	Data 3	
D4413	Read method		D4461	Read method		D4509		
D4414	Number to be read		D4462	Number to be read		D4510	Data 4	
D4415			D4463			D4511		
D4416	Control signal	Read control window 41	D4464	Control signal	Read control window 47	D4512	Control signal	Write control window 2
D4417	Section No.		D4465	Section No.		D4513	Section No.	
D4418	Section sub-ID No.		D4466	Section sub-ID No.		D4514	Section sub-ID No.	
D4419	Sub-section No.		D4467	Sub-section No.		D4515	Sub-section No.	
D4420	Data No.		D4468	Data No.		D4516	Data No.	
D4421	Read method		D4469	Read method		D4517	Write method	
D4422	Number to be read		D4470	Number to be read		D4518	Number to be written	
D4423			D4471			D4519		
D4424	Control signal	Read control window 42	D4472	Control signal	Read control window 48	D4520	Data 1	Write data window 2
D4425	Section No.		D4473	Section No.		D4521		
D4426	Section sub-ID No.		D4474	Section sub-ID No.		D4522	Data 2	
D4427	Sub-section No.		D4475	Sub-section No.		D4523		
D4428	Data No.		D4476	Data No.		D4524	Data 3	
D4429	Read method		D4477	Read method		D4525		
D4430	Number to be read		D4478	Number to be read		D4526	Data 4	
D4431			D4479			D4527		
D4432	Control signal	Read control window 43	D4480	Control signal	Read control window 49	D4528	Control signal	Write control window 3
D4433	Section No.		D4481	Section No.		D4529	Section No.	
D4434	Section sub-ID No.		D4482	Section sub-ID No.		D4530	Section sub-ID No.	
D4435	Sub-section No.		D4483	Sub-section No.		D4531	Sub-section No.	
D4436	Data No.		D4484	Data No.		D4532	Data No.	
D4437	Read method		D4485	Read method		D4533	Write method	
D4438	Number to be read		D4486	Number to be read		D4534	Number to be written	
D4439			D4487			D4535		
D4440	Control signal	Read control window 44	D4488	Control signal	Read control window 50	D4536	Data 1	Write data window 3
D4441	Section No.		D4489	Section No.		D4537		
D4442	Section sub-ID No.		D4490	Section sub-ID No.		D4538	Data 2	
D4443	Sub-section No.		D4491	Sub-section No.		D4539		
D4444	Data No.		D4492	Data No.		D4540	Data 3	
D4445	Read method		D4493	Read method		D4541		
D4446	Number to be read		D4494	Number to be read		D4542	Data 4	
D4447			D4495			D4543		
D4448	Control signal	Read control window 45	D4496	Control signal	Write control window 1	D4544	Control signal	Write control window 4
D4449	Section No.		D4497	Section No.		D4545	Section No.	
D4450	Section sub-ID No.		D4498	Section sub-ID No.		D4546	Section sub-ID No.	
D4451	Sub-section No.		D4499	Sub-section No.		D4547	Sub-section No.	
D4452	Data No.		D4500	Data No.		D4548	Data No.	
D4453	Read method		D4501	Write method		D4549	Write method	
D4454	Number to be read		D4502	Number to be written		D4550	Number to be written	
D4455			D4503			D4551		

Device	Data	Application	Device	Data	Application	Device	Data	Application
D4552	Data 1	Write data window 4	D4600	Data 1	Write data window 7	D4648	Data 1	Write data window 10
D4553			D4601			D4649		
D4554	Data 2		D4602	Data 2		D4650	Data 2	
D4555			D4603			D4651		
D4556	Data 3		D4604	Data 3		D4652	Data 3	
D4557			D4605			D4653		
D4558	Data 4		D4606	Data 4		D4654	Data 4	
D4559			D4607			D4655		
D4560	Control signal	Write control window 5	D4608	Control signal	Write control window 8	D4656	Control signal	Write control window 11
D4561	Section No.		D4609	Section No.		D4657	Section No.	
D4562	Section sub-ID No.		D4610	Section sub-ID No.		D4658	Section sub-ID No.	
D4563	Sub-section No.		D4611	Sub-section No.		D4659	Sub-section No.	
D4564	Data No.		D4612	Data No.		D4660	Data No.	
D4565	Write method		D4613	Write method		D4661	Write method	
D4566	Number to be written		D4614	Number to be written		D4662	Number to be written	
D4567			D4615			D4663		
D4568	Data 1	Write data window 5	D4616	Data 1	Write data window 8	D4664	Data 1	Write data window 11
D4569			D4617			D4665		
D4570	Data 2		D4618	Data 2		D4666	Data 2	
D4571			D4619			D4667		
D4572	Data 3		D4620	Data 3		D4668	Data 3	
D4573			D4621			D4669		
D4574	Data 4		D4622	Data 4		D4670	Data 4	
D4575			D4623			D4671		
D4576	Control signal	Write control window 6	D4624	Control signal	Write control window 9	D4672	Control signal	Write control window 12
D4577	Section No.		D4625	Section No.		D4673	Section No.	
D4578	Section sub-ID No.		D4626	Section sub-ID No.		D4674	Section sub-ID No.	
D4579	Sub-section No.		D4627	Sub-section No.		D4675	Sub-section No.	
D4580	Data No.		D4628	Data No.		D4676	Data No.	
D4581	Write method		D4629	Write method		D4677	Write method	
D4582	Number to be written		D4630	Number to be written		D4678	Number to be written	
D4583			D4631			D4679		
D4584	Data 1	Write data window 6	D4632	Data 1	Write data window 9	D4680	Data 1	Write data window 12
D4585			D4633			D4681		
D4586	Data 2		D4634	Data 2		D4682	Data 2	
D4587			D4635			D4683		
D4588	Data 3		D4636	Data 3		D4684	Data 3	
D4589			D4637			D4685		
D4590	Data 4		D4638	Data 4		D4686	Data 4	
D4591			D4639			D4687		
D4592	Control signal	Write control window 7	D4640	Control signal	Write control window 10	D4688	Control signal	Write control window 13
D4593	Section No.		D4641	Section No.		D4689	Section No.	
D4594	Section sub-ID No.		D4642	Section sub-ID No.		D4690	Section sub-ID No.	
D4595	Sub-section No.		D4643	Sub-section No.		D4691	Sub-section No.	
D4596	Data No.		D4644	Data No.		D4692	Data No.	
D4597	Write method		D4645	Write method		D4693	Write method	
D4598	Number to be written		D4646	Number to be written		D4694	Number to be written	
D4599			D4647			D4695		

Device	Data	Application	Device	Data	Application	Device	Data	Application
D4696	Data 1	Write data window 13	D4744	Data 1	Write data window 16	D4792	Data 1	Write data window 19
D4697			D4745			D4793		
D4698	Data 2		D4746	Data 2		D4794	Data 2	
D4699			D4747			D4795		
D4700	Data 3		D4748	Data 3		D4796	Data 3	
D4701			D4749			D4797		
D4702	Data 4		D4750	Data 4		D4798	Data 4	
D4703			D4751			D4799		
D4704	Control signal	Write control window 14	D4752	Control signal	Write control window 17	D4800	Control signal	Write control window 20
D4705	Section No.		D4753	Section No.		D4801	Section No.	
D4706	Section sub-ID No.		D4754	Section sub-ID No.		D4802	Section sub-ID No.	
D4707	Sub-section No.		D4755	Sub-section No.		D4803	Sub-section No.	
D4708	Data No.		D4756	Data No.		D4804	Data No.	
D4709	Write method		D4757	Write method		D4805	Write method	
D4710	Number to be written		D4758	Number to be written		D4806	Number to be written	
D4711			D4759			D4807		
D4712	Data 1	Write data window 14	D4760	Data 1	Write data window 17	D4808	Data 1	Write data window 20
D4713			D4761			D4809		
D4714	Data 2		D4762	Data 2		D4810	Data 2	
D4715			D4763			D4811		
D4716	Data 3		D4764	Data 3		D4812	Data 3	
D4717			D4765			D4813		
D4718	Data 4		D4766	Data 4		D4814	Data 4	
D4719			D4767			D4815		
D4720	Control signal	Write control window 15	D4768	Control signal	Write control window 18	D4816	Control signal	Write control window 21
D4721	Section No.		D4769	Section No.		D4817	Section No.	
D4722	Section sub-ID No.		D4770	Section sub-ID No.		D4818	Section sub-ID No.	
D4723	Sub-section No.		D4771	Sub-section No.		D4819	Sub-section No.	
D4724	Data No.		D4772	Data No.		D4820	Data No.	
D4725	Write method		D4773	Write method		D4821	Write method	
D4726	Number to be written		D4774	Number to be written		D4822	Number to be written	
D4727			D4775			D4823		
D4728	Data 1	Write data window 15	D4776	Data 1	Write data window 18	D4824	Data 1	Write data window 21
D4729			D4777			D4825		
D4730	Data 2		D4778	Data 2		D4826	Data 2	
D4731			D4779			D4827		
D4732	Data 3		D4780	Data 3		D4828	Data 3	
D4733			D4781			D4829		
D4734	Data 4		D4782	Data 4		D4830	Data 4	
D4735			D4783			D4831		
D4736	Control signal	Write control window 16	D4784	Control signal	Write control window 19	D4832	Control signal	Write control window 22
D4737	Section No.		D4785	Section No.		D4833	Section No.	
D4738	Section sub-ID No.		D4786	Section sub-ID No.		D4834	Section sub-ID No.	
D4739	Sub-section No.		D4787	Sub-section No.		D4835	Sub-section No.	
D4740	Data No.		D4788	Data No.		D4836	Data No.	
D4741	Write method		D4789	Write method		D4837	Write method	
D4742	Number to be written		D4790	Number to be written		D4838	Number to be written	
D4743			D4791			D4839		

Device	Data	Application	Device	Data	Application	Device	Data	Application
D4840	Data 1	Write data window 22	D4888	Data 1	Write data window 25	D4936	Data 1	Write data window 28
D4841			D4889			D4937		
D4842	Data 2		D4890	Data 2		D4938	Data 2	
D4843			D4891			D4939		
D4844	Data 3		D4892	Data 3		D4940	Data 3	
D4845			D4893			D4941		
D4846	Data 4		D4894	Data 4		D4942	Data 4	
D4847			D4895			D4943		
D4848	Control signal	Write control window 23	D4896	Control signal	Write control window 26	D4944	Control signal	Write control window 29
D4849	Section No.		D4897	Section No.		D4945	Section No.	
D4850	Section sub-ID No.		D4898	Section sub-ID No.		D4946	Section sub-ID No.	
D4851	Sub-section No.		D4899	Sub-section No.		D4947	Sub-section No.	
D4852	Data No.		D4900	Data No.		D4948	Data No.	
D4853	Write method		D4901	Write method		D4949	Write method	
D4854	Number to be written		D4902	Number to be written		D4950	Number to be written	
D4855			D4903			D4951		
D4856	Data 1	Write data window 23	D4904	Data 1	Write data window 26	D4952	Data 1	Write data window 29
D4857			D4905			D4953		
D4858	Data 2		D4906	Data 2		D4954	Data 2	
D4859			D4907			D4955		
D4860	Data 3		D4908	Data 3		D4956	Data 3	
D4861			D4909			D4957		
D4862	Data 4		D4910	Data 4		D4958	Data 4	
D4863			D4911			D4959		
D4864	Control signal	Write control window 24	D4912	Control signal	Write control window 27	D4960	Control signal	Write control window 30
D4865	Section No.		D4913	Section No.		D4961	Section No.	
D4866	Section sub-ID No.		D4914	Section sub-ID No.		D4962	Section sub-ID No.	
D4867	Sub-section No.		D4915	Sub-section No.		D4963	Sub-section No.	
D4868	Data No.		D4916	Data No.		D4964	Data No.	
D4869	Write method		D4917	Write method		D4965	Write method	
D4870	Number to be written		D4918	Number to be written		D4966	Number to be written	
D4871			D4919			D4967		
D4872	Data 1	Write data window 24	D4920	Data 1	Write data window 27	D4968	Data 1	Write data window 30
D4873			D4921			D4969		
D4874	Data 2		D4922	Data 2		D4970	Data 2	
D4875			D4923			D4971		
D4876	Data 3		D4924	Data 3		D4972	Data 3	
D4877			D4925			D4973		
D4878	Data 4		D4926	Data 4		D4974	Data 4	
D4879			D4927			D4975		
D4880	Control signal	Write control window 25	D4928	Control signal	Write control window 28	D4976	Control signal	Write control window 31
D4881	Section No.		D4929	Section No.		D4977	Section No.	
D4882	Section sub-ID No.		D4930	Section sub-ID No.		D4978	Section sub-ID No.	
D4883	Sub-section No.		D4931	Sub-section No.		D4979	Sub-section No.	
D4884	Data No.		D4932	Data No.		D4980	Data No.	
D4885	Write method		D4933	Write method		D4981	Write method	
D4886	Number to be written		D4934	Number to be written		D4982	Number to be written	
D4887			D4935			D4983		

Device	Data	Application	Device	Data	Application	Device	Data	Application
D4984	Data 1	Write data window 31	D5032	Data 1	Write data window 34	D5080	Data 1	Write data window 37
D4985			D5033			D5081		
D4986	Data 2		D5034	Data 2		D5082	Data 2	
D4987			D5035			D5083		
D4988	Data 3		D5036	Data 3		D5084	Data 3	
D4989			D5037			D5085		
D4990	Data 4		D5038	Data 4		D5086	Data 4	
D4991			D5039			D5087		
D4992	Control signal	Write control window 32	D5040	Control signal	Write control window 35	D5088	Control signal	Write control window 38
D4993	Section No.		D5041	Section No.		D5089	Section No.	
D4994	Section sub-ID No.		D5042	Section sub-ID No.		D5090	Section sub-ID No.	
D4995	Sub-section No.		D5043	Sub-section No.		D5091	Sub-section No.	
D4996	Data No.		D5044	Data No.		D5092	Data No.	
D4997	Write method		D5045	Write method		D5093	Write method	
D4998	Number to be written		D5046	Number to be written		D5094	Number to be written	
D4999			D5047			D5095		
D5000	Data 1	Write data window 32	D5048	Data 1	Write data window 35	D5096	Data 1	Write data window 38
D5001			D5049			D5097		
D5002	Data 2		D5050	Data 2		D5098	Data 2	
D5003			D5051			D5099		
D5004	Data 3		D5052	Data 3		D5100	Data 3	
D5005			D5053			D5101		
D5006	Data 4		D5054	Data 4		D5102	Data 4	
D5007			D5055			D5103		
D5008	Control signal	Write control window 33	D5056	Control signal	Write control window 36	D5104	Control signal	Write control window 39
D5009	Section No.		D5057	Section No.		D5105	Section No.	
D5010	Section sub-ID No.		D5058	Section sub-ID No.		D5106	Section sub-ID No.	
D5011	Sub-section No.		D5059	Sub-section No.		D5107	Sub-section No.	
D5012	Data No.		D5060	Data No.		D5108	Data No.	
D5013	Write method		D5061	Write method		D5109	Write method	
D5014	Number to be written		D5062	Number to be written		D5110	Number to be written	
D5015			D5063			D5111		
D5016	Data 1	Write data window 33	D5064	Data 1	Write data window 36	D5112	Data 1	Write data window 39
D5017			D5065			D5113		
D5018	Data 2		D5066	Data 2		D5114	Data 2	
D5019			D5067			D5115		
D5020	Data 3		D5068	Data 3		D5116	Data 3	
D5021			D5069			D5117		
D5022	Data 4		D5070	Data 4		D5118	Data 4	
D5023			D5071			D5119		
D5024	Control signal	Write control window 34	D5072	Control signal	Write control window 37	D5120	Control signal	Write control window 40
D5025	Section No.		D5073	Section No.		D5121	Section No.	
D5026	Section sub-ID No.		D5074	Section sub-ID No.		D5122	Section sub-ID No.	
D5027	Sub-section No.		D5075	Sub-section No.		D5123	Sub-section No.	
D5028	Data No.		D5076	Data No.		D5124	Data No.	
D5029	Write method		D5077	Write method		D5125	Write method	
D5030	Number to be written		D5078	Number to be written		D5126	Number to be written	
D5031			D5079			D5127		

Device	Data	Application	Device	Data	Application	Device	Data	Application
D5128	Data 1	Write data window 40	D5176	Data 1	Write data window 43	D5224	Data 1	Write data window 46
D5129			D5177			D5225		
D5130	Data 2		D5178	Data 2		D5226	Data 2	
D5131			D5179			D5227		
D5132	Data 3		D5180	Data 3		D5228	Data 3	
D5133			D5181			D5229		
D5134	Data 4		D5182	Data 4		D5230	Data 4	
D5135			D5183			D5231		
D5136	Control signal	Write control window 41	D5184	Control signal	Write control window 44	D5232	Control signal	Write control window 47
D5137	Section No.		D5185	Section No.		D5233	Section No.	
D5138	Section sub-ID No.		D5186	Section sub-ID No.		D5234	Section sub-ID No.	
D5139	Sub-section No.		D5187	Sub-section No.		D5235	Sub-section No.	
D5140	Data No.		D5188	Data No.		D5236	Data No.	
D5141	Write method		D5189	Write method		D5237	Write method	
D5142	Number to be written		D5190	Number to be written		D5238	Number to be written	
D5143			D5191			D5239		
D5144	Data 1	Write data window 41	D5192	Data 1	Write data window 44	D5240	Data 1	Write data window 47
D5145			D5193			D5241		
D5146	Data 2		D5194	Data 2		D5242	Data 2	
D5147			D5195			D5243		
D5148	Data 3		D5196	Data 3		D5244	Data 3	
D5149			D5197			D5245		
D5150	Data 4		D5198	Data 4		D5246	Data 4	
D5151			D5199			D5247		
D5152	Control signal	Write control window 42	D5200	Control signal	Write control window 45	D5248	Control signal	Write control window 48
D5153	Section No.		D5201	Section No.		D5249	Section No.	
D5154	Section sub-ID No.		D5202	Section sub-ID No.		D5250	Section sub-ID No.	
D5155	Sub-section No.		D5203	Sub-section No.		D5251	Sub-section No.	
D5156	Data No.		D5204	Data No.		D5252	Data No.	
D5157	Write method		D5205	Write method		D5253	Write method	
D5158	Number to be written		D5206	Number to be written		D5254	Number to be written	
D5159			D5207			D5255		
D5160	Data 1	Write data window 42	D5208	Data 1	Write data window 45	D5256	Data 1	Write data window 48
D5161			D5209			D5257		
D5162	Data 2		D5210	Data 2		D5258	Data 2	
D5163			D5211			D5259		
D5164	Data 3		D5212	Data 3		D5260	Data 3	
D5165			D5213			D5261		
D5166	Data 4		D5214	Data 4		D5262	Data 4	
D5167			D5215			D5263		
D5168	Control signal	Write control window 43	D5216	Control signal	Write control window 46	D5264	Control signal	Write control window 49
D5169	Section No.		D5217	Section No.		D5265	Section No.	
D5170	Section sub-ID No.		D5218	Section sub-ID No.		D5266	Section sub-ID No.	
D5171	Sub-section No.		D5219	Sub-section No.		D5267	Sub-section No.	
D5172	Data No.		D5220	Data No.		D5268	Data No.	
D5173	Write method		D5221	Write method		D5269	Write method	
D5174	Number to be written		D5222	Number to be written		D5270	Number to be written	
D5175			D5223			D5271		

Device	Data	Application	Device	Data	Application	Device	Data	Application	
D5272	Data 1	Write data window 49							
D5273									
D5274	Data 2								
D5275									
D5276	Data 3								
D5277									
D5278	Data 4								
D5279									
D5280	Control signal		Write control window 50						
D5281	Section No.								
D5282	Section sub-ID No.								
D5283	Sub-section No.								
D5284	Data No.								
D5285	Write method								
D5286	Number to be written								
D5287									
D5288	Data 1	Write data window 50							
D5289									
D5290	Data 2								
D5291									
D5292	Data 3								
D5293									
D5294	Data 4								
D5295									

Details on device assignment (CNC -> PLC)

Device	Data	Application	Device	Data	Application	Device	Data	Application
D1024	Read result 1	Read result	D1064	Read result 41	Read result	D1104	Write result 31	Write result
D1025	Read result 2		D1065	Read result 42		D1105	Write result 32	
D1026	Read result 3		D1066	Read result 43		D1106	Write result 33	
D1027	Read result 4		D1067	Read result 44		D1107	Write result 34	
D1028	Read result 5		D1068	Read result 45		D1108	Write result 35	
D1029	Read result 6		D1069	Read result 46		D1109	Write result 36	
D1030	Read result 7		D1070	Read result 47		D1110	Write result 37	
D1031	Read result 8		D1071	Read result 48		D1111	Write result 38	
D1032	Read result 9		D1072	Read result 49		D1112	Write result 39	
D1033	Read result 10		D1073	Read result 50		D1113	Write result 40	
D1034	Read result 11		D1074	Write result 1	D1114	Write result 41		
D1035	Read result 12		D1075	Write result 2	D1115	Write result 42		
D1036	Read result 13		D1076	Write result 3	D1116	Write result 43		
D1037	Read result 14		D1077	Write result 4	D1117	Write result 44		
D1038	Read result 15		D1078	Write result 5	D1118	Write result 45		
D1039	Read result 16		D1079	Write result 6	D1119	Write result 46		
D1040	Read result 17		D1080	Write result 7	D1120	Write result 47		
D1041	Read result 18		D1081	Write result 8	D1121	Write result 48		
D1042	Read result 19		D1082	Write result 9	D1122	Write result 49		
D1043	Read result 20		D1083	Write result 10	D1123	Write result 50		
D1044	Read result 21		D1084	Write result 11				
D1045	Read result 22		D1085	Write result 12				
D1046	Read result 23		D1086	Write result 13				
D1047	Read result 24		D1087	Write result 14				
D1048	Read result 25		D1088	Write result 15				
D1049	Read result 26		D1089	Write result 16				
D1050	Read result 27		D1090	Write result 17				
D1051	Read result 28		D1091	Write result 18				
D1052	Read result 29		D1092	Write result 19				
D1053	Read result 30		D1093	Write result 20				
D1054	Read result 31	D1094	Write result 21					
D1055	Read result 32	D1095	Write result 22					
D1056	Read result 33	D1096	Write result 23					
D1057	Read result 34	D1097	Write result 24					
D1058	Read result 35	D1098	Write result 25					
D1059	Read result 36	D1099	Write result 26					
D1060	Read result 37	D1100	Write result 27					
D1061	Read result 38	D1101	Write result 28					
D1062	Read result 39	D1102	Write result 29					
D1063	Read result 40	D1103	Write result 30					

Device	Data	Application	Device	Data	Application	Device	Data	Application
D1124	Data 1	Read data window 1	D1180	Data 1	Read data window 8	D1236	Data 1	Read data window 15
D1125			D1181			D1237		
D1126	Data 2		D1182	Data 2		D1238	Data 2	
D1127			D1183			D1239		
D1128	Data 3		D1184	Data 3		D1240	Data 3	
D1129			D1185			D1241		
D1130	Data 4		D1186	Data 4		D1242	Data 4	
D1131			D1187			D1243		
D1132	Data 1	Read data window 2	D1188	Data 1	Read data window 9	D1244	Data 1	Read data window 16
D1133			D1189			D1245		
D1134	Data 2		D1190	Data 2		D1246	Data 2	
D1135			D1191			D1247		
D1136	Data 3		D1192	Data 3		D1248	Data 3	
D1137			D1193			D1249		
D1138	Data 4		D1194	Data 4		D1250	Data 4	
D1139			D1195			D1251		
D1140	Data 1	Read data window 3	D1196	Data 1	Read data window 10	D1252	Data 1	Read data window 17
D1141			D1197			D1253		
D1142	Data 2		D1198	Data 2		D1254	Data 2	
D1143			D1199			D1255		
D1144	Data 3		D1200	Data 3		D1256	Data 3	
D1145			D1201			D1257		
D1146	Data 4		D1202	Data 4		D1258	Data 4	
D1147			D1203			D1259		
D1148	Data 1	Read data window 4	D1204	Data 1	Read data window 11	D1260	Data 1	Read data window 18
D1149			D1205			D1261		
D1150	Data 2		D1206	Data 2		D1262	Data 2	
D1151			D1207			D1263		
D1152	Data 3		D1208	Data 3		D1264	Data 3	
D1153			D1209			D1265		
D1154	Data 4		D1210	Data 4		D1266	Data 4	
D1155			D1211			D1267		
D1156	Data 1	Read data window 5	D1212	Data 1	Read data window 12	D1268	Data 1	Read data window 19
D1157			D1213			D1269		
D1158	Data 2		D1214	Data 2		D1270	Data 2	
D1159			D1215			D1271		
D1160	Data 3		D1216	Data 3		D1272	Data 3	
D1161			D1217			D1273		
D1162	Data 4		D1218	Data 4		D1274	Data 4	
D1163			D1219			D1275		
D1164	Data 1	Read data window 6	D1220	Data 1	Read data window 13	D1276	Data 1	Read data window 20
D1165			D1221			D1277		
D1166	Data 2		D1222	Data 2		D1278	Data 2	
D1167			D1223			D1279		
D1168	Data 3		D1224	Data 3		D1280	Data 3	
D1169			D1225			D1281		
D1170	Data 4		D1226	Data 4		D1282	Data 4	
D1171			D1227			D1283		
D1172	Data 1	Read data window 7	D1228	Data 1	Read data window 14	D1284	Data 1	Read data window 21
D1173			D1229			D1285		
D1174	Data 2		D1230	Data 2		D1286	Data 2	
D1175			D1231			D1287		
D1176	Data 3		D1232	Data 3		D1288	Data 3	
D1177			D1233			D1289		
D1178	Data 4		D1234	Data 4		D1290	Data 4	
D1179			D1235			D1291		

Device	Data	Application	Device	Data	Application	Device	Data	Application
D1292	Data 1	Read data window 22	D1348	Data 1	Read data window 29	D1404	Data 1	Read data window 36
D1293			D1349			D1405		
D1294	Data 2		D1350	Data 2		D1406	Data 2	
D1295			D1351			D1407		
D1296	Data 3		D1352	Data 3		D1408	Data 3	
D1297			D1353			D1409		
D1298	Data 4		D1354	Data 4		D1410	Data 4	
D1299			D1355			D1411		
D1300	Data 1	Read data window 23	D1356	Data 1	Read data window 30	D1412	Data 1	Read data window 37
D1301			D1357			D1413		
D1302	Data 2		D1358	Data 2		D1414	Data 2	
D1303			D1359			D1415		
D1304	Data 3		D1360	Data 3		D1416	Data 3	
D1305			D1361			D1417		
D1306	Data 4		D1362	Data 4		D1418	Data 4	
D1307			D1363			D1419		
D1308	Data 1	Read data window 24	D1364	Data 1	Read data window 31	D1420	Data 1	Read data window 38
D1309			D1365			D1421		
D1310	Data 2		D1366	Data 2		D1422	Data 2	
D1311			D1367			D1423		
D1312	Data 3		D1368	Data 3		D1424	Data 3	
D1313			D1369			D1425		
D1314	Data 4		D1370	Data 4		D1426	Data 4	
D1315			D1371			D1427		
D1316	Data 1	Read data window 25	D1372	Data 1	Read data window 32	D1428	Data 1	Read data window 39
D1317			D1373			D1429		
D1318	Data 2		D1374	Data 2		D1430	Data 2	
D1319			D1375			D1431		
D1320	Data 3		D1376	Data 3		D1432	Data 3	
D1321			D1377			D1433		
D1322	Data 4		D1378	Data 4		D1434	Data 4	
D1323			D1379			D1435		
D1324	Data 1	Read data window 26	D1380	Data 1	Read data window 33	D1436	Data 1	Read data window 40
D1325			D1381			D1437		
D1326	Data 2		D1382	Data 2		D1438	Data 2	
D1327			D1383			D1439		
D1328	Data 3		D1384	Data 3		D1440	Data 3	
D1329			D1385			D1441		
D1330	Data 4		D1386	Data 4		D1442	Data 4	
D1331			D1387			D1443		
D1332	Data 1	Read data window 27	D1388	Data 1	Read data window 34	D1444	Data 1	Read data window 41
D1333			D1389			D1445		
D1334	Data 2		D1390	Data 2		D1446	Data 2	
D1335			D1391			D1447		
D1336	Data 3		D1392	Data 3		D1448	Data 3	
D1337			D1393			D1449		
D1338	Data 4		D1394	Data 4		D1450	Data 4	
D1339			D1395			D1451		
D1340	Data 1	Read data window 28	D1396	Data 1	Read data window 35	D1452	Data 1	Read data window 42
D1341			D1397			D1453		
D1342	Data 2		D1398	Data 2		D1454	Data 2	
D1343			D1399			D1455		
D1344	Data 3		D1400	Data 3		D1456	Data 3	
D1345			D1401			D1457		
D1346	Data 4		D1402	Data 4		D1458	Data 4	
D1347			D1403			D1459		

Device	Data	Application	Device	Data	Application	Device	Data	Application
D1460	Data 1	Read data window 43	D1516	Data 1	Read data window 50			
D1461			D1517					
D1462	Data 2		D1518	Data 2				
D1463			D1519					
D1464	Data 3		D1520	Data 3				
D1465			D1521					
D1466	Data 4		D1522	Data 4				
D1467			D1523					
D1468	Data 1							
D1469								
D1470	Data 2	Read data window 44						
D1471								
D1472	Data 3							
D1473								
D1474	Data 4							
D1475								
D1476	Data 1	Read data window 45						
D1477								
D1478	Data 2							
D1479								
D1480	Data 3							
D1481								
D1482	Data 4							
D1483								
D1484	Data 1	Read data window 46						
D1485								
D1486	Data 2							
D1487								
D1488	Data 3							
D1489								
D1490	Data 4							
D1491								
D1492	Data 1	Read data window 47						
D1493								
D1494	Data 2							
D1495								
D1496	Data 3							
D1497								
D1498	Data 4							
D1499								
D1500	Data 1	Read data window 48						
D1501								
D1502	Data 2							
D1503								
D1504	Data 3							
D1505								
D1506	Data 4							
D1507								
D1508	Data 1	Read data window 49						
D1509								
D1510	Data 2							
D1511								
D1512	Data 3							
D1513								
D1514	Data 4							
D1515								

Appx.2: List of PLC Window Data[M8]/ PLC Window Data [C80]

6.1 Section No. List

Section No.	Details	Write	Axis designation	Part system designation	Remarks
1	System information (For each part system)	Not possible	Invalid	Valid	
2	System information (Common for part systems)	Not possible	Invalid	Invalid	
3	File System information	Not possible	Invalid	Valid	
4	Common variable (For each part system #100-)	Possible	Invalid	Valid	
5	Common variable (Common for part systems #400-)	Possible	Invalid	Invalid	
6	Local variables	Not possible	Invalid	Valid	
8	Workpiece coordinate system offset (Workpiece coordinate)	Possible	Valid	Valid	
9	Workpiece coordinate system offset (Extension workpiece coordinate)	Possible	Valid	Valid	
10	Workpiece coordinate system offset (Local coordinate)	Possible	Valid	Valid	
11	Workpiece coordinate system offset (Other coordinate system)	Possible	Valid	Valid	
12	Tool offset for each part-system (Type1)	Possible	Invalid	Valid	
13	Tool offset for each part-system (Type2)	Possible	Invalid	Valid	
14	Tool offset for each part-system (Type3)	Possible	Invalid	Valid	
18	Life management data M system only, no group No. In the order of registration	Possible (partially not possible)	Invalid	Valid	
19	Life management information	Not possible	Invalid	Valid	
20	Tool registration	Possible (partially not possible)	Invalid	Valid (partially invalid)	
21	Spindle standby	Not possible (partially possible)	Invalid	Magazine No. (partially invalid)	
22	Tool measurement	Not possible	Invalid (partially valid)	Valid	
25	File information	Not possible	Invalid	Invalid	
33	Speed information	Not possible	Invalid	Valid	
34	Spindle information	Not possible	Valid	Invalid	
35	Operation status	Not possible	Invalid	Valid (partially invalid)	
36	Axis status	Not possible	Valid (partially invalid)	Valid	
37	Counter	Not possible	Valid (partially invalid)	Valid	
38	MSTB execution status	Possible (partially not possible)	Invalid	Invalid (partially valid)	
40	Cumulative time	Possible (partially not possible)	Invalid (partially valid)	Invalid (partially valid)	
41	G modal	Not possible	Invalid (partially valid)	Valid	
42	F modal	Not possible	Invalid	Valid	
43	MSTB modal	Not possible	Invalid	Invalid	
45	Program execution status	Not possible	Invalid	Valid	
46	Program tree	Not possible	Invalid	Valid	
47	Program tree for graphic check	Not possible	Invalid	Valid	
59	Servo monitor	Not possible	Valid	Invalid	
60	Servo motor (PLC axis)	Not possible (partially possible)	Valid	Invalid	
62	Synchronous error monitor	Not possible	Invalid	Invalid	
63	Spindle monitor	Not possible (partially possible)	Valid	Invalid	

Section No.	Details	Write	Axis designation	Part system designation	Remarks
64	Power supply monitor	Not possible (partially possible)	Valid	Invalid	
65	Auxiliary axis drive unit monitor	Not possible	Valid	Invalid	
66	Hardware configuration	Not possible	Invalid	Invalid	
67	Software configuration	Not possible	Invalid	Invalid	
72	Auxiliary axis control	Possible (partially not possible)	Valid (partially invalid)	Invalid	
74	Sampling parameters	Possible (partially not possible)	Invalid	Invalid	
95	Reference position return parameters	Possible	Valid	Invalid	
96	Servo parameters	Possible	Valid	Invalid	
97	Spindle specification parameters	Possible	Valid	Invalid	
98	Spindle parameters	Possible	Valid	Invalid	
100	Auxiliary axis:axis parameters	Possible	Valid	Invalid	
101	Absolute position parameters	Possible	Valid	Invalid	
102	Machine error compensation parameters	Possible	Invalid	Invalid	
104	Position switch	Possible	Invalid	Valid (partially invalid)	
106	Macro list	Possible	Invalid	Invalid	
107	PLC constants	Possible	Invalid	Invalid	
108	PLC timer	Possible (partially not possible)	Invalid	Invalid	[M8]
109	PLC counter	Possible (partially not possible)	Invalid	Invalid	[M8]
110	PLC bit selection	Possible	Invalid	Invalid	
111	Open param 1	Possible	Invalid	Invalid	
112	Open param 2	Possible	Invalid	Invalid	
120	PLC switch	Possible (partially not possible)	Invalid	Invalid	[M8]
121	Operation parameters	Possible	Invalid	Invalid	
122	Input/Output parameters	Possible	Invalid	Invalid	
123	Computer link parameters	Possible	Invalid	Invalid	
124	Ethernet parameters	Possible	Invalid	Invalid	
125	Barrier	Possible	Invalid	Invalid (partially valid)	
126	Base parameters	Possible (partially not possible)	Invalid	Valid (partially invalid)	
127	Axis parameters	Possible	Valid	Valid	
128	Rotary axis configuration parameters	Possible	Invalid	Valid	
140	Ladder I/F (common)	Not possible	Invalid	Valid (partially invalid)	
150	User open I/F parameter	Not possible (partially possible)	Invalid	Invalid	
151	User open I/F data	Not possible (partially possible)	Invalid	Invalid	

6.2 Sub-section No. List

Section No. : 1 System information (Separate for part systems)

Sub-ID	Significance of data No.	Sub-section No.	Details of Sub-section No.	Data type	R/W
System No.	Not used	1	Number of axes in part system (Cross configuration)	Integer	R
		2	Number of axes in part system (Base configuration)		
		100	Number of common variable (#100-) sets		

Section No. : 2 System information (Common to part systems)

Sub-ID	Significance of data No.	Sub-section No.	Details of Sub-section No.	Data type	R/W
Not used	Not used	1	Number of part systems	Integer	R
		2	Total number of NC axes (NC)		
		3	Total number of control axes (NC+PLC+SP)		
		4	Number of spindles		
		5	Number of PLC axes		
		6	Number of auxiliary axes		
		7	File system		
		8	Number of common variable (#500-) sets		
		9	Information on maximum number of registered machining programs		
		10	Number of power supply axes (SV+SP)		
		100	NC type		
101	PLC device assignment type [M8]				

Section No. : 3 File system information

Sub-ID	Significance of data No.	Sub-section No.	Details of Sub-section No.	Data type	R/W
System No.	Not used	1	Tool offset type	Character string	R
		2	Number of tool offset sets	Integer	
		3	Number of workpiece offset sets		

Section No. : 4 Common variable (Separate for part systems #100-)

Sub-ID	Significance of data No.	Sub-section No.	Details of Sub-section No.	Data type	R/W
System No.	Not used	700 + n	100 to 199 (n=100 to 199)	Integer	RW

Section No. : 5 Common variable (Common variables #400-)

Sub-ID	Significance of data No.	Sub-section No.	Details of Sub-section No.	Data type	R/W
Not used	Not used	900 + n	Common variable Variable (Common for part systems #400 to #999) (n=400 to 999)	Integer	RW
		2000 + n	Common variable Comment (Common for part systems #500 to #519) (n=500 to 519)	Character string	
		10000 + n	Common variable Variable (Common for part systems #100100 to #100199) (n=100 to 199)	Integer	
		11000 + n	Common variable Variable (Common for part systems #200100 to #200199) (n=100 to 199)		
		12000 + n	Common variable Variable (Common for part systems #300100 to #300199) (n=100 to 199)		
		13000 + n	Common variable Variable (Common for part systems #400100 to #400199) (n=100 to 199)		
		14000 + n	Common variable Variable (Common for part systems #500100 to #500199) (n=100 to 199)		
		15000 + n	Common variable Variable (Common for part systems #600100 to #600199) (n=100 to 199)		
		16000 + n	Common variable Variable (Common for part systems #700100 to #700199) (n=100 to 199)		
		17000 + n	Common variable Variable (Common for part systems #800100 to #800199) (n=100 to 199)		
20000 + n	Common variable Variable (Common for part systems #900000 to #907399) (n=0 to 7399)				

Section No. : 6 Local variables

Sub-ID	Significance of data No.	Sub-section No.	Details of Sub-section No.	Data type	R/W
System No.	Not used	1000 + n	Local variables (level 0)(n=1 to 33)	Integer	R
		1100 + n	Local variables (level 1)(n=1 to 33)		
		1200 + n	Local variables (level 2)(n=1 to 33)		
		1300 + n	Local variables (level 3)(n=1 to 33)		
		1400 + n	Local variables (level 4)(n=1 to 33)		
		2000	Local variables Blank variable		

Section No. : 8 Workpiece coordinate system offset (Workpiece coordinate)

Sub-ID	Significance of data No.	Sub-section No.	Details of Sub-section No.	Data type	R/W
System No.	Axis No. in part system	n	Gn (n=54 to 59) Workpiece coordinate system offset	PLC setting unit	RW

Section No. : 9 Workpiece coordinate system offset (The expansion workpiece coordinate)

Sub-ID	Significance of data No.	Sub-section No.	Details of Sub-section No.	Data type	R/W
System No.	Axis No. in part system	n	G54.1Pn (n=1 to 96)	PLC setting unit	RW

Section No. : 10 Workpiece coordinate system offset (A local coordinate)

Sub-ID	Significance of data No.	Sub-section No.	Details of Sub-section No.	Data type	R/W
System No.	Axis No. in part system	1	Local coordinate system offset (G54)	PLC setting unit	RW
		2	Local coordinate system offset (G55)		
		3	Local coordinate system offset (G56)		
		4	Local coordinate system offset (G57)		
		5	Local coordinate system offset (G58)		
		6	Local coordinate system offset (G59)		

Section No. : 11 Workpiece coordinate system offset (Other coordinate system)

Sub-ID	Significance of data No.	Sub-section No.	Details of Sub-section No.	Data type	R/W
System No.	Axis No. in part system	1	External workpiece offset (EXT)	PLC setting unit	RW

Section No. : 12 Tool separate for part systems offset (Type1)

Sub-ID	Significance of data No.	Sub-section No.	Details of Sub-section No.	Data type	R/W
System No.	Not used	n	Compensation data (n=1 to 999)	PLC setting unit	RW

Section No. : 13 Tool separate for part systems offset (Type2)

Sub-ID	Significance of data No.	Sub-section No.	Details of Sub-section No.	Data type	R/W
System No.	Not used	n	Length dimension (n=1 to 999)	PLC setting unit	RW
		1000 + n	Radius dimension (n=1 to 999)		
		2000 + n	Length wear (n=1 to 999)		
		3000 + n	Radius wear (n=1 to 999)		

Section No. : 14 Tool separate for part systems offset (Type3)

Sub-ID	Significance of data No.	Sub-section No.	Details of Sub-section No.	Data type	R/W
System No.	Not used	n	Nose point P (n=1 to 999)	Integer	RW
		1000 + n	Tool length X (n=1 to 999)	PLC setting unit	
		2000 + n	Tool length Y (n=1 to 999)		
		3000 + n	Tool length Z (n=1 to 999)		
		4000 + n	Nose point R (n=1 to 999)	Integer	
		5000 + n	Wear X (n=1 to 999)	PLC setting unit	
		6000 + n	Wear Y (n=1 to 999)		
		7000 + n	Wear Z (n=1 to 999)		
8000 + n	Wear R (n=1 to 999)				

Section No. : 18 Life management data M system only, no group No. In the order of registration.

Sub-ID	Significance of data No.	Sub-section No.	Details of Sub-section No.	Data type	R/W	
System No.	Not used	1000 + n	Tool No. (n=1 to 1000)	Integer	RW	
		2000 + n	Status (n=1 to 1000)			
		3000 + n	Method (n=1 to 1000)			
		4000 + n	Length compensation (n=1 to 1000)	PLC setting unit		
		5000 + n	Radius compensation (n=1 to 1000)			
		6000 + n	Usage (time, times, wear amount) (n=1 to 1000)	Integer		
		7000 + n	Life (time, times, wear amount) (n=1 to 1000)			
		8000 + n	Miscellaneous (n=1 to 1000)			
		9000 + n	Group No. (n=1 to 1000)			
		10003	Group ID of the designated group No.			
		11000 + n	Group No. of the designated group ID (n=1 to 1000)			
		12000 + n	Head record ID of the designated group ID (n=1 to 1000)			R
		13000 + n	Number of tools registered in the designated group ID (n=1 to 1000)			
		16000 + n	Tool information of the designated record (n=1 to 1000)			

Section No. : 19 Life management information

Sub-ID	Significance of data No.	Sub-section No.	Details of Sub-section No.	Data type	R/W
System No.	Not used	1	Life management number of registered tool	Integer	R
		2	Life management number of registration groups		
		3	Life management data renewal flag		
		4	Life management maximum number of registered tools		
	Group No.	100	Life management next tool No. (for L system type II only)		

Section No. : 20 Tool registration

Sub-ID	Significance of data No.	Sub-section No.	Details of Sub-section No.	Data type	R/W
System No.	Not used	n	Tool registration data (pot No.) (n=1 to 360)	Integer	R
		1000 + n	Tool registration data (tool No.) (n=1 to 360)		RW
		2000 + n	Tool registration data (miscellaneous: D) (n=1 to 360)		

Section No. : 21 Spindle Alarms - Wait

Sub-ID	Significance of data No.	Sub-section No.	Details of Sub-section No.	Data type	R/W
Magazine No.	Not used	n	Spindle standby (tool No.) (n=0 to 4)	Integer	RW
Not used		10 + n	Spindle standby (miscellaneous D) (n=0 to 4)		
		200	Number of spindle standby displays		
Magazine No.		1000	Tool life management data for spindle tool	PLC setting unit	R
		1001	Tool life management data for standby tool		

Section No. : 22 Tool measurement mode

Sub-ID	Significance of data No.	Sub-section No.	Details of Sub-section No.	Data type	R/W
System No.	Not used	1	TLM switch	Integer	R
	Axis No.	2	Final movement direction		
	Not used	3	Final movement axis		
		4	Second skip contact		

Section No. : 25 File information

Sub-ID	Significance of data No.	Sub-section No.	Details of Sub-section No.	Data type	R/W
Not used	Not used	1	Machining program number of registrations	Integer	R
		2	Machining program number of remains		
		3	Machining program number of memory characters		
		4	Machining program number of remaining characters		
		10	melCopyFile transferred data size		

Section No. : 33 Speed information

Sub-ID	Significance of data No.	Sub-section No.	Details of Sub-section No.	Data type	R/W
System No.	Not used	1	FC (resultant speed)	PLC setting unit/min.	R
		2	FA: F command feedrate		
		101	Feedrate display FC (resultant speed)		

Section No. : 34 Spindle information

Sub-ID	Significance of data No.	Sub-section No.	Details of Sub-section No.	Data type	R/W
Not used	Axis No.	1	Spindle rotation speed (rev/min)	Integer	R

Section No. : 35 Running conditions

Sub-ID	Significance of data No.	Sub-section No.	Details of Sub-section No.	Data type	R/W
System No.	Not used	1	Macro execution level	Integer	R
		2	In collation and stop		RW
		10	Operation status 1 (operation status)	Character string	R
		11	Operation status 2 (operation mode)		
		20	Automatic operation is starting	Integer	
		21	In automatic operation		
		22	In automatic operation stop		
		100	Data protect key 1		
		101	Data protect key 2		
		102	Data protect key 3		
		103	Data protect key (memory card) [M8]		
		104	Data protect key (DS) [M8]		
		200	External input signal 1		
		201	JOG mode (special) signal		
		202	NC status output signal 1		
		203	Alarm status signal		
		204	Operation (automatic) mode related signal		
		205	Operation (manual) mode related signal		
		206	Restart search status		
		207	Restart search type 1 valid		
		208	Extended operation search status		
		209	Current search line No. during search mode		
210	In checking mode				
Not used		220	Parameter flag to prompt a reboot		
		221	PLC Run/Stop status [M8]		
System No.		222	MDI setting status		

Section No. : 36 Axis status

Sub-ID	Significance of data No.	Sub-section No.	Details of Sub-section No.	Data type	R/W
System No.	Axis No.	1	Axis status (axis detachment)	Integer	R
		2	Axis status (servo OFF)		
		3	Axis status (1st ref)		
		4	Axis status (2nd ref)		
		5	Axis status (3rd ref)		
		6	Axis status (4th ref)		
		7	Axis status (mirror image)		
		8	Axis status (restart search RP)		
	Not used	100	Axis status (servo OFF) all axes		
		101	Axis status (1st ref) all axes		
		102	Axis status (2nd ref) all axes		
		103	Axis status (3rd ref) all axes		
		104	Axis status (4th ref) all axes		
		105	Axis status (mirror image) all axes		
		106	Axis status (restart search RP) all axes		
200	Program mirror axis (all axes)				

Section No. : 37 Counter

Sub-ID	Significance of data No.	Sub-section No.	Details of Sub-section No.	Data type	R/W
System No.	Axis No.	1	Workpiece coordinate position counter	PLC setting unit	R
		2	Machine position counter		
		3	Current position counter		
		4	Absolute position counter		
		5	Program position counter		
		6	Remain command		
		7	Skip coordinate counter (workpiece coordinate)		
		8	Manual interrupt amount 1 (ABS Off)		
		9	Manual interrupt amount 2 (ABS On)		
		10	Next command		
		11	Restart position counter (workpiece coordinate)		
		12	Restart remaining distance counter		
		13	Restart position counter (machine coordinate)		
		14	Program position counter 2		
		15	TLM position counter		
		16	TLM skip position counter		
		17	TLM position counter		
		18	Skip coordinate counter (machine coordinate)		
		19	Skip remaining distance counter		
	Not used	20	Interpolation composite vector length	Interpolation unit	
	Axis No.	21	Current position B counter	PLC setting unit	
		22	Skip machine value		
		23	Skip coordinate position (skip coordinate counter)		
		24	Measurement position		
		32	Machine position on the orthogonal coordinate		
		33	Feedback position		

Section No. : 38 MSTB execute conditions

Sub-ID	Significance of data No.	Sub-section No.	Details of Sub-section No.	Data type	R/W
Not used	Not used	1 + n	M Command / Manual numerical value command (M1 to M4) (n = 0 to 3)	Integer	RW
		101 + n	M Command / Manual numerical value command (S1 to S6) (n = 0 to 5)		
		201	M Command / Manual numerical value command (T1)		
		301 + n	M Command / Manual numerical value command (B1 to B4) (n = 0 to 3)		
System No.		401	Restart search T command history	Character string	R
Not used		411 + n	Restart search S1 to S6 command history (n = 0 to 5)		
System No.		421	Restart search B command history		
		431	Restart search M command history		

Section No. : 40 Cumulative time

Sub-ID	Significance of data No.	Sub-section No.	Details of Sub-section No.	Data type	R/W
Not used	Not used	1	Power ON time	Character string	RW
		2	Automatic operation time		
		3	Cycle start time		
		4	External cumulative time 1		
		5	External cumulative time 2		
		6	Date		
		7	Time		
System No.		8	Cycle time		R

Section No. : 41 G modal

Sub-ID	Significance of data No.	Sub-section No.	Details of Sub-section No.	Data type	R/W
System No.	Not used	n	G code (n=group 1 to 27)	Integer	R
		51	Tool compensation No. for shape (radius) compensation modal		
		52	Compensation amount for shape (radius) compensation modal	PLC setting unit	
		53	Wear amount for shape (radius) compensation modal		
		54	Tool wear No. for radius compensation modal	Integer	
	101	Tool compensation No. for length compensation modal			
	Axis No.	102	Axis name of length compensation modal	Character string	
	Not used	103	Compensation amount of length compensation modal	PLC setting unit	
		104	Wear amount for length compensation modal		
		105	Axis information during length compensation (all axes)	Integer	
	Axis No.	106	Tool compensation No. of length compensation modal		
	Not used	201	Scaling factor (G50P_)[Grp11]	Character string	
		202	Coordinate rotation angle (G68R_)[Grp16]		
		203	High-speed machining mode (G5P_)	Integer	
		204	gmov cutting/non-cutting command		
		205	Extended workpiece coordinate selection (G54.1P_)	Character string	
		206	Information during cutting		
		207	Scaling factor (G50P_)[Grp11] (Magic compatible) [M8]	Character string	
		208	Coordinate rotation angle (G68R_)[Grp16] (Magic compatible) [M8]		
209		3-dimensional coordinate conversion status (to display workpiece coordinate selection G68) [M8]			

Section No. : 42 F modal

Sub-ID	Significance of data No.	Sub-section No.	Details of Sub-section No.	Data type	R/W
System No.	Not used	1	Program command F modal (FA)	Integer	R
		2	Manual feedrate (FM)	PLC setting unit/min.	
		3	Synchronous feedrate (FS)		
		4	Thread cutting lead (FE)		
		5	Dwell remaining time	Integer	
		10 + n	Constant surface speed control (surface speed S) (n=1 to 6)		

Section No. : 43 MSTB modal

Sub-ID	Significance of data No.	Sub-section No.	Details of Sub-section No.	Data type	R/W
Not used	Not used	n	S modal (S1 to S6) (n=1 to 6)	Integer	R
		100 + n	T modal (T1 to T2) (n=1 to 2)		
		200 + n	M modal (M1 to M4) (n=1 to 4)		
		300 + n	B modal (B1 to B4) (n=1 to 4)		

Section No. : 45 Program execution status

Sub-ID	Significance of data No.	Sub-section No.	Details of Sub-section No.	Data type	R/W	
System No.	Not used	1	Nest level of the sub-program currently operating	Integer	R	
		2	Invalid status: Single block · MST finish			
		3	Invalid status: Feed hold · override · exact			
		100	Main program path during execution	Character string		
		101	Main program during execution	O No.		Integer
		102	Main program during execution	N No.		
		103	Main program during execution	B No.		
		201	Sub program during execution	O No.		
		202	Sub program during execution	N No.		
		203	Sub program during execution	B No.		
		300	Last operated program path			Character string
		301	Last operated main program	O No.		Integer
		302	Last operated main program	N No.		
		303	Last operated main program	B No.		
		401	Last operated sub program	O No.		
		402	Last operated sub program	N No.		
403	Last operated sub program	B No.				

Section No. : 46 Program tree

Sub-ID	Significance of data No.	Sub-section No.	Details of Sub-section No.	Data type	R/W
System No.	Not used	1	Main program during execution Device name	Character string	R
		2	Main program during execution O No.	Integer	
		3	Main program during execution N No.		
		4	Main program during execution B No.		
		100 + n	Sub 1 to 10 device name (n=1 to 10) during execution	Character string	
		200 + n	Sub program 1 to 10 during execution O No. (n=1 to 10)		
		300 + n	Sub program 1 to 10 during execution N No. (n=1 to 10)		
		400 + n	Sub program 1 to 10 during execution B No. (n=1 to 10)		
		500 + n	Sub program 1 to 10 during execution Number of repetitions (n=1 to 10)	Integer	
		1000	Program tree information (ONB, Path) during execution		

Section No. : 47 Program tree for graphic check [M8]

Sub-ID	Significance of data No.	Sub-section No.	Details of Sub-section No.	Data type	R/W
System No.	Not used	1	Execution main O No. for checking	Integer	R
		2	Execution main N No. for checking		
		3	Execution main B No. for checking		

Section No. : 59 Servo monitor

Sub-ID	Significance of data No.	Sub-section No.	Details of Sub-section No.	Data type	R/W
Not used	Axis No.	1	Gain	Integer	R
		2	Droop		
		3	Rotation speed	PLC setting unit/min.	
		4	Load current (%)	Integer	
		5	MAX current 1		
		6	MAX current 2		
		7	Overload		
		8	Regenerative load	Character string	
		9	Drive unit display		
		10 + n	Alarm 1 to 4 (n = 0 to 3)	Integer	
		14	Cycle counter		
		15	Grid spacing		
		16	Grid amount	PLC setting unit	
		17	Machine position		
		18	Motor side FB		
		19	Machine side FB		
		20	FB error		
		21	DFB compensation amount		
		22	Remain command		
		23	Current value (2)		
		24	Manual interrupt amount	Character string	
		25	Detection system		
		26	Power ON position	PLC setting unit	
		27	Power OFF position		
		28	Current position		
		29	R0 (multi-rotation counter at basic point setting)	Integer	
		30	P0 (position within 1 rotation at basic point setting)		
		31	E0 (absolute position error at basic point setting)		
		32	Rn (multi-rotation counter)		
		33	Pn (position within 1 rotation)		
		34	En (absolute position error at power OFF)		
		35	ABS0 (absolute position basic counter)		
		36	ABSn (absolute position counter)		
		37	MPOS (initial offset amount)		
		38	Drive unit type	Character string	
		39	Drive unit serial No.		
		40	S/W version		
		41	Control method		
		42	Motor side encoder		
		43	Machine side encoder		
		44	Motor type		
45	Work time				
46 + n	Alarm history 1 to 8 (time) (n = 0 to 7)				
54 + n	Alarm history 1 to 8 (alarm No.) (n = 0 to 7)				
62 + n	Maintenance history (MNT1 to 4) (n = 0 to 3)				
66	/SYS				
214	Motor temperature [C80]	Integer			

Section No. : 60 Servo monitor(PLC axis)

Sub-section No. is equivalent to the section No. 59.

Section No. : 62 Synchronous error monitor

Sub-ID	Significance of data No.	Sub-section No.	Details of Sub-section No.	Data type	R/W
Not used	Not used	1 + n	Command error (1st to 3rd set) (n = 0 to 2)	PLC setting unit	R
		11 + n	FB error (1st to 3rd set) (n = 0 to 2)		
		21 + n	Machine position (1st to 3rd set) (n = 0 to 2)		

Section No. : 63 Spindle monitor

Sub-ID	Significance of data No.	Sub-section No.	Details of Sub-section No.	Data type	R/W
Not used	Axis No.	1	Gain	Integer	R
		2	Droop	Integer	
		3	Rotation speed	PLC setting unit/min.	
		4	Load	Integer	
		5	Drive unit display	Character string	
		6 + n	Alarm 1 to 4 (n = 0 to 3)	Integer	
		10	Cycle counter	Integer	
		11	Control input 1L	Character string	
		12	Control input 1H		
		13	Control input 2L		
		14	Control input 2H		
		15	Control input 3L		
		16	Control input 3H		
		17	Control input 4L		
		18	Control input 4H		
		19	Control output 1L		
		20	Control output 1H		
		21	Control output 2L		
		22	Control output 2H		
		23	Control output 3L		
		24	Control output 3H		
		25	Control output 4L		
		26	Control output 4H		
		27	Drive unit type	Integer	
		28	Drive unit serial No.		
		29	S/W version		
		30	Work time	RW	
		31 + n	Alarm history 1 to 8 (time) (n = 0 to 7)	R	
		39 + n	Alarm history 1 to 8 (alarm No.) (n = 0 to 7)		
		47 + n	Maintenance history (MNT1 to 4) (n = 0 to 3)		
		51	/SYS		
		52 + n	Control input 1 to 4 (n = 0 to 3)		
56 + n	Control output 1 to 4 (n = 0 to 3)				
60	Spindle angle	Integer			
221	Spindle thermistor temperature				

Section No. : 64 Power supply monitor

Sub-ID	Significance of data No.	Sub-section No.	Details of Sub-section No.	Data type	R/W
Not used	Axis No.	1	Unit type	Character string	R
		2	Unit No.		
		3	S/W version		
		4	Work time		
		5 + n	Alarm history 1 to 8 (time) (n = 0 to 7)		
		13 + n	Alarm history 1 to 8 (alarm No.) (n = 0 to 7)		
		21 + n	Maintenance history (MNT1 to 4) (n = 0 to 3)		
		25	/SYS		
		26	Connection drive		

Section No. : 65 Auxiliary axis drive unit monitor

Sub-ID	Significance of data No.	Sub-section No.	Details of Sub-section No.	Data type	R/W	
Not used	Axis No.	1	Droop	Integer	R	
		2	Rotation speed	PLC setting unit/min.		
		3	Load current	Integer		
		4	MAX current 1			
		5	MAX current 2			
		6	Overload			
		7	Regenerative load			
		8	Current station No.			
		9	Current position			PLC setting unit
		10	Target station No.			Integer
		11	Command position	PLC setting unit		
		12	Auxiliary axis name	Character string		
		13	Position control gain 1	Integer		
		14	Speed control gain 1			
		15	Position control gain 2			
		16	Speed control gain 2			
		17	Speed integral compensation			
		18	Load inertia ratio			
		19	Unit type	Character string		
		20	S/W version			
		21	Motor type			
		22 + n	Alarm 1 to 4 (n = 0 to 3)			
		26	Unit serial No.			
		30 + n	Alarm history 1 to 6 (alarm No.) (n=1 to 6)			
		50 + n	Alarm history 1 to 6 (Detailed information of alarm) (n=1 to 6)			
		70 + n	Alarm history 1 to 6 (n=1 to 6)			

Section No. : 66 Hardware Configuration [M8]

Sub-ID	Significance of data No.	Sub-section No.	Details of Sub-section No.	Data type	R/W
Not used	Not used	4000 + (x)	RIO unit (x=1 to 256)	Character string	R
		100 + n	Terminal RIO unit 1 to 4		
		200	Control unit (NC card)		
		201	Extension unit		

Section No. : 67 Software Configuration [M8]

Sub-ID	Significance of data No.	Sub-section No.	Details of Sub-section No.	Data type	R/W	
Not used	Not used	1	NC system version	Character string	R	
		2	PLC version			
		3	PLCe version (extension external alarm message)			
		4	3rd language version			
		5	4th language version			
	Axis No.	6	Servo drive unit version			
		7	Spindle drive unit version			
	Not used	Not used	8			OS version
			9			APLC version
			20			NC system version (4-digit display)

Section No. : 72 Auxiliary Axis control

Sub-ID	Significance of data No.	Sub-section No.	Details of Sub-section No.	Data type	R/W
Not used	Axis No.	1	Operation adjustment mode	Integer	RW
		2	Absolute position set		R
		3	Position set method		
		4	Position set status		RW
		5	Operation mode		
		6	Operation parameter group		
		7	Scale		
		8	Operation status		
		9	Auxiliary axis basic point set		
	Not used	Not used	1000	Auxiliary axis parameter SRAM backup	

Section No. : 74 Sampling parameters

Sub-ID	Significance of data No.	Sub-section No.	Details of Sub-section No.	Data type	R/W	
Not used	Not used	1	Sampling trigger	Integer	RW	
		2	Sampling cycle			
		3	Number of sampling data			
		4	Sampling data storing address	Character string		
		5	Sampling data storing size	Integer		
		6 + n	Sampling address #1 to #8 (M625 conventional compatibility) (n = 0 to 7)	Character string		
		20 + n	Sampling address #1 to #8 (n = 0 to 7)			
		41 + n	Sampling address for AT #1 to #8 (n = 0 to 7)			
		50	Buffer designation (0: built-in memory, 1: cassette memory)	Integer		RW
		51	Buffer capacity (1024 x (setting value +1) byte)			
		52	Starting condition			
		53	Processing format (0: 1shot, 1: repeat, 2: ring buffer)			
		54	Ending condition			
		55	Variables No. (0: #1299, other than 0: common variables)			
		56	PLC device		Character string	
		57	Condition address			
		58	Condition data			
		59	Condition data mask			
		70	Sampling status (for automatic tuning)	Integer	R	
		71	Sampling delay time (for automatic tuning)		RW	
72	Cycle start request (for automatic tuning)	W				
73	Cycle start restriction (for automatic tuning)	RW				
74	Number of samplings (for automatic tuning)	R				
75	OP check information (for automatic tuning)	RW				
100	Number of sampling data	R				

Section No. : 95 Reference position return parameters

Sub-ID	Significance of data No.	Sub-section No.	Details of Sub-section No.	Data type	R/W
Not used	Axis No.	2025, 2026	Refer to the "Alarm/Parameter Manual" for axis specifications parameters.	PLC setting unit/min.	RW
		2027, 2028		PLC setting unit	
		2029 to 2033		Integer	
		2037 to 2040		PLC setting unit	

Section No. : 96 Servo parameters

Sub-ID	Significance of data No.	Sub-section No.	Details of Sub-section No.	Data type	R/W
Not used	Axis No.	1 to 65, 73, 81 to 256	SVn (n= Sub-section No.) Refer to the "Alarm/Parameter Manual" for servo parameters.	Integer	RW

Section No. : 97 Spindle specification parameters

Sub-ID	Significance of data No.	Sub-section No.	Details of Sub-section No.	Data type	R/W
Not used	Axis No.	1 to 31, 35, 37 to 72, 101 to 118, 120 to 138, 3098 [C80], 3099 [C80]	"3000 + n" equals to parameter No. ("n": Sub-section No.) Refer to the "Alarm/Parameter Manual" for spindle parameters.	Integer	RW

Section No. : 98 Spindle parameters

Sub-ID	Significance of data No.	Sub-section No.	Details of Sub-section No.	Data type	R/W
Not used	Axis No.	1001 to 1003	SPn (n=Sub-section No.-1000) Refer to the section on "Spindle parameter" in the "Alarm/Parameter Manual" for details.	Integer	RW
		1004		(Not used)	
		1005 to 1010		Integer	
		1011 to 1013		(Not used)	
		1014 to 1029		Integer	
		1030		(Not used)	
		1031 to 1050		Integer	
		1051,1052		(Not used)	
		1053		Integer	
		1054		(Not used)	
		1055 to 1057		Integer	
		1058 to 1060		(Not used)	
		1061		Integer	
		1062 to 1064		(Not used)	
		1065 to 1084		Integer	
		1085,1086		(Not used)	
		1087,1088		Integer	
		1089 to 1112		(Not used)	
		1113 to 1117		Integer	
		1118 to 1120		(Not used)	
1121 to 1192	Integer				
1193 to 1224	(Not used)				
1125 to 1233	Integer				
1234 to 1236	(Not used)				
1237 to 1239	Integer				
1240	(Not used)				

Section No. : 101 Absolute position parameters

Sub-ID	Significance of data No.	Sub-section No.	Details of Sub-section No.	Data type	R/W
Not used	Axis No.	1, 2	"2048 + n" equals to parameter No. ("n": Sub-section No.) Refer to the "Alarm/Parameter Manual" for axis specifications parameters.	Integer	RW
		3		PLC setting unit	
		6		Integer	
		7		PLC setting unit/min.	
		8 to 10		PLC setting unit	
		11		Integer	
		12, 13		PLC setting unit	
		14		Integer	

Section No. : 102 Machine error compensation parameters

Sub-ID	Significance of data No.	Sub-section No.	Details of Sub-section No.	Data type	R/W
Not used	Not used	1	Compensation machine error compensation amount increment method	Integer	RW
		1 + n	1st to 28th axis basic axis (n=1 to 28)	Character string	
		29 + n	1st to 28th axis compensation axis (n=1 to 28)		
		57 + n	1st to 28th axis division point No. at reference position (n=1 to 28)	Integer	
		85 + n	1st to 28th axis division point No. at the most negative side (n=1 to 28)		
		113 + n	1st to 28th axis division point No. at the most positive side (n=1 to 28)		
		141 + n	1st to 28th axis compensation scale factor (n=1 to 28)	PLC setting unit	
		169 + n	1st to 28th axis division interval (n=1 to 28)		
		198 + n	Pitch error compensation amount (n=0 to 1023)	Integer	

Section No. : 104 Position switch

Sub-ID	Significance of data No.	Sub-section No.	Details of Sub-section No.	Data type	R/W
Not used	Not used	1	PSW selection	Integer	RW
System No.		2	1st position switch axis name	Character string	
		3	1st position switch imaginary dog position 1	PLC setting unit	
		4	1st position switch imaginary dog position 2		
		5	1st position switch PSW check method changeover	Integer	
		6 + n	2nd Position switch axis name/Position switch imaginary dog position 1/Position switch imaginary dog position 2/Position switch PSW check method changeover		
		10 + n	3rd Position switch axis name/Position switch imaginary dog position 1/Position switch imaginary dog position 2/Position switch PSW check method changeover		
		14 + n	4th Position switch axis name/Position switch imaginary dog position 1/Position switch imaginary dog position 2/Position switch PSW check method changeover		
		18 + n	5th Position switch axis name/Position switch imaginary dog position 1/Position switch imaginary dog position 2/Position switch PSW check method changeover		
		22 + n	6th Position switch axis name/Position switch imaginary dog position 1/Position switch imaginary dog position 2/Position switch PSW check method changeover		
		26 + n	7th Position switch axis name/Position switch imaginary dog position 1/Position switch imaginary dog position 2/Position switch PSW check method changeover		
		30 + n	8th Position switch axis name/Position switch imaginary dog position 1/Position switch imaginary dog position 2/Position switch PSW check method changeover		
		100 + n	9th to 24th position switch axis name (n=9 ~)	Character string	
		200 + n	9th to 24th position switch imaginary dog position 1 (x=9 ~)	PLC setting unit	
		300 + n	9th to 24th position switch imaginary dog position 2 (n=9 ~)		
		400 + n	9th to 24th position switch PSW check method changeover (n=9 ~)	Integer	

Section No. : 106 Macro List

Sub-ID	Significance of data No.	Sub-section No.	Details of Sub-section No.	Data type	R/W
Not used	Not used	1	M[01] Code	Integer	RW
		2	M[01] Type		
		3	M[01] Program No.		
		4 + n	M[02] Code/Type/Program No. (n = 0 to 2)		
		7 + n	M[03] Code/Type/Program No. (n = 0 to 2)		
		10 + n	M[04] Code/Type/Program No. (n = 0 to 2)		
		13 + n	M[05] Code/Type/Program No. (n = 0 to 2)		
		16 + n	M[06] Code/Type/Program No. (n = 0 to 2)		
		19 + n	M[07] Code/Type/Program No. (n = 0 to 2)		
		22 + n	M[08] Code/Type/Program No. (n = 0 to 2)		
		25 + n	M[09] Code/Type/Program No. (n = 0 to 2)		
		28 + n	M[10] Code/Type/Program No. (n = 0 to 2)		
		31	M2mac Type		
		32	M2mac Program No.		
		33	G[01] Code		
		34	G[01] Type		
		35	G[01] Program No.		
		36 + n	G[02] Code/Type/Program No. (n = 0 to 2)		
		39 + n	G[03] Code/Type/Program No. (n = 0 to 2)		
		42 + n	G[04] Code/Type/Program No. (n = 0 to 2)		
		45 + n	G[05] Code/Type/Program No. (n = 0 to 2)		
		48 + n	G[06] Code/Type/Program No. (n = 0 to 2)		
		51 + n	G[07] Code/Type/Program No. (n = 0 to 2)		
		54 + n	G[08] Code/Type/Program No. (n = 0 to 2)		
		57 + n	G[09] Code/Type/Program No. (n = 0 to 2)		
		60 + n	G[10] Code/Type/Program No. (n = 0 to 2)		
		63	Smac Type		
		64	Smac Program No.		
		65	Tmac Type		
		66	Tmac Program No.		
		System No.			
200 + n	ASCII[]ASCII code (n=1 to 2)				
300 + n	ASCII[] call type (0:M98, 1:G65, 2:G66, 3:G66.1) (n=1 to 2)			Integer	
400 + n	ASCII[] program No. (n=1 to 2)				
500 + n	ASCII[] common variable No. (100 to 149) (n=1 to 2)				

Section No. : 107 PLC constants

Sub-ID	Significance of data No.	Sub-section No.	Details of Sub-section No.	Data type	R/W
Not used	Not used	1 + n	PLC constants (n=0 to 95) Refer to the "Alarm/Parameter Manual" for PLC constants.	Integer	RW

Section No. : 108 | **PLC timer [M8]**

Sub-ID	Significance of data No.	Sub-section No.	Details of Sub-section No.	Data type	R/W
Not used	Not used	1 + n	10ms timer <10ms> (n=0 to 703)	Integer	RW
		1000 + n	100ms timer <100ms> (n=0 to 703)		
		2000 + n	100ms integral timer <100msINC> (n=0 to 63)		
		10000	Number of PLC timers (variable)		
		10001	Number of PLC integral timers (variable)	R	

Section No. : 109 | **PLC counter [M8]**

Sub-ID	Significance of data No.	Sub-section No.	Details of Sub-section No.	Data type	R/W
Not used	Not used	1 + n	Counter (n=0 to 255)	Integer	RW
		10000	Number of PLC counters (variable)		R

Section No. : 110 | **Selecting the PLC Bit**

Sub-ID	Significance of data No.	Sub-section No.	Details of Sub-section No.	Data type	R/W
Not used	Not used	1 + n	PLC bit selection (n=0 to 195)	Integer	RW

Section No. : 111 | **Open param 1**

Sub-ID	Significance of data No.	Sub-section No.	Details of Sub-section No.	Data type	R/W
Not used	Not used	n	Open parameter value 1 (long) (n=1 to 896)	Integer	RW

Section No. : 112 | **Open param 2**

Sub-ID	Significance of data No.	Sub-section No.	Details of Sub-section No.	Data type	R/W
Not used	Not used	n	Open parameter value 2 (double) (n=1 to 96)	Integer eight digits and four decimal places	R

Section No. : 120 | **PLC Switch [M8]**

Sub-ID	Significance of data No.	Sub-section No.	Details of Sub-section No.	Data type	R/W
Not used	Not used	0 + n	PLC switch X(IN) (n=1 to 64)	Integer	RW
		100 + n	PLC switch Y(OUT) (n=1 to 64)		R
		200	PLC switch X(IN)1 to 16		RW
		201	PLC switch X(IN)17 to 32		
		202	PLC switch X(IN)33 to 48		
		203	PLC switch X(IN)49 to 64		
		210	PLC switch Y(OUT)1 to 16		R
		211	PLC switch Y(OUT)17 to 32		
		212	PLC switch Y(OUT)33 to 48		
		213	PLC switch Y(OUT)49 to 64		

Section No. : 121 | **Operation parameters [M8]**

Sub-ID	Significance of data No.	Sub-section No.	Details of Sub-section No.	Data type	R/W
Not used	Not used	8900 + n	Counter type 1 to 6 (n=1 to 6)	Integer	RW
		8910	Edit undo valid		
		8920	Solid drawing tool compensation selection		

Section No. : 122 Input/Output parameters [M8]

Sub-ID	Significance of data No.	Sub-section No.	Details of Sub-section No.	Data type	R/W
Not used	Not used	1 to 32	"9000 + n" equals to parameter No. ("n": Sub-section No.) Refer to the "Alarm/Parameter Manual" for user parameters.	Integer	RW
		33 to 40		Character string	
		41 to 58		Integer	
		59 to 66		Character string	
		67 to 84		Integer	
		85 to 92		Character string	
		93 to 110		Integer	
		111 to 118		Character string	
		119 to 136		Integer	
		137 to 144		Character string	

Section No. : 123 Computer link parameters [M8]

Sub-ID	Significance of data No.	Sub-section No.	Details of Sub-section No.	Data type	R/W
Not used	Not used	1 to 24	"9600 + n" equals to parameter No. ("n": Sub-section No.) Refer to the "Alarm/Parameter Manual" for user parameters.	Integer	RW

Section No. : 124 Ethernet parameters

Sub-ID	Significance of data No.	Sub-section No.	Details of Sub-section No.	Data type	R/W
Not used	Not used	1	Service start	Integer	RW
		2	IP address	Character string	
		3	Subnet mask		
		4	Gateway		
		5	Port No.	Integer	
		6	Ethernet parameter before conversion (Host IP address)	Character string	
		7	Host port No.	Integer	
		50	Automatic IP address setting	Character string	
		51	IP address (PC)		
		52	Subnet mask (PC)		
		53	Gateway (PC)	Integer	
		54	Timeout		
		55	Host No. to use	Character string	
		100 + n	User name (Host A to D)(n = 0 to 3)		
		200 + n	Password (Host A to D)(n = 0 to 3)		
		300 + n	Directory (Host A to D)(n = 0 to 3)		
		400 + n	Host address (Host A to D)(n = 0 to 3)		
		500 + n	Host type (Host 1 to 4)(n = 0 to 3)	Integer	
		600 + n	Host Word position: File (Host 1 to 4)(n = 0 to 3)		
		700 + n	Host Word position: Size (Host 1 to 4)(n = 0 to 3)		
800 + n	Host Word position: <DIR> (Host 1 to 4)(n = 0 to 3)				
900 + n	Host Word position: Comment (Host 1 to 4)(n = 0 to 3)				
1000 + n	Host Word count: Comment (Host 1 to 4)(n = 0 to 3)				
1100 + n	Host Character remain (Host 1 to 4)(n = 0 to 3)				

Section No. : 125 Barrier

Sub-ID	Significance of data No.	Sub-section No.	Details of Sub-section No.	Data type	R/W
Not used	Not used	1	P0 X	PLC setting unit	RW
		2	P1 X		
		3	P1 Z		
		4	P2 X		
		5	P2 Z		
		6	P3 X		
		7	P3 Z		
		8	P4 X		
		9	P4 Z		
		10	P5 X		
		11	P5 Z		
		12	P6 X		
		13	P6 Z		
System No.		20	Barrier valid	Integer	RW
		21	P7 X	PLC setting unit	
		22	P8 X		
		23	P8 Z		
		24	P9 X		
		25	P10 X		
		26	P10 Z		
		27	Barrier type (left)	Integer	
		28	Barrier type (right)	Integer	
		29	Delivery axis name	Character string	
30	Tailstock angle (left)	Integer			
31	Tailstock angle (right)				

Section No. : 126 Base parameters

Sub-ID	Significance of data No.	Sub-section No.	Details of Sub-section No.	Data type	R/W	
System No.	Not used	1	System validation setup	Integer	RW	
Not used		2	System validation setup (PLC)			
System No.		3	Number of axes			
Not used		4	Number of axes (PLC)			
System No.		5	Input setting unit			
Not used		6	PLC unit			
System No.		7	Control unit			
Not used		8	Control unit (PLC)			
System No.		10	Initial plane selection	Character string		
		11	Base axis I			
		12	Base axis J			
		13	Base axis K			
		14	Flat axis I			
		15	Flat axis J			
System No.		20	Command type	Integer		
		Not used	21			Ladder selection
			22			Number of spindles
			23			Constant input (inch)
			24			Initial state (inch)
			25			PLC axis command (inch)
			26			Select language displayed
		System No.	27			MR-J2-CT Connections
			73			Initial absolute setting
			74			Initial synchronous feed
75			Initial G00			
Not used		76	ABS/INC address (for L system only)			
		77	Incremental command for diameter specification axis			
		78	Decimal point type 2			
		79	Validate F1 digit			
		80	Specify boring axis (for M system only)			
		81	Give priority to G code parameter			
System No.		82	Geometric			
		84	Arc error			
Not used		85	G00 dry run			
		86	G00 non-interpolation			
		87	Constant surface speed control by rapid traverse feed command			
		88	Disable G30 soft limit			
		91	Ignore middle point			
		92	Replace tools for additional axis			
		93	Synchronization between part systems method			
		94	Select life count for single block (for L system only)			
		95	TF output			
		96	Tool life management type			
System No.		97	Tool wear compensation number 1-digit command			
		98	Tool length offset number			
		99	Cancel tool compensation amount			

Sub-ID	Significance of data No.	Sub-section No.	Details of Sub-section No.	Data type	R/W
Not used		100	Tool compensation	Integer	R/W
		101	Tool compensation method		
		102	Manual tool length measuring system (for L system only)		
		103	Validate life management		
		104	Tool command method 2		
		105	Tool selection method 2		
		106	Life management (for L system only)		
		107	Split life management display screen (for L system only)		
System No.		108	Life management re-count M code (for L system only)		
		109	Validate substitute M code		
		110	M96 substitute M code		
Not used	Not used	111	M97 substitute M code		
		112	Validate status trigger method		
		113	Validate interrupt method type 2		
		114	Macro argument initialization		
		115	Waiting for retract after thread cutting		
		116	Invalidate soft limit (manual operation)		
		117	H_sens		
		118	Select how to set up the length of tools on cutter tables (opposed tables) (for L system only)		
		119	Select the mirror image of each facing turret with T command (for L system only)		
		120	Change macro variable		
		121	Edit lock C		
		122	Program display lock C		
		123	Origin set prohibit		
		124	Fix tool compensation No.		
		125	Actual feedrate display		
		126	Playback G90		
		127	DPRINT alignment		
		128	Clear variables by resetting		
		129	Clear variables by power-ON		
		130	Display selected tool number		
		132	brightness		
		135	Unit name		
		140 + n	M code number (n = 0 to 3)		
		System No.		144	MDI setup lock
				145	Manual ABS parameter
				146	Spindle rotation speed clamp function
		Not used		147	Minimum spindle rotation speed clamp type
				148	Initial high precision
149	Arc deceleration speed change				
151	Reset initial				
Not used		153	Hole bottom deceleration check		
		159	Fixed cycle editing		
		161	Simulation test		
System No.		162	Part system name		
		163	Second miscellaneous code		
		164	Tap return override		
		165	Tap return override		
		166	G04 skip condition		

Sub-ID	Significance of data No.	Sub-section No.	Details of Sub-section No.	Data type	R/W
System No.	Not used	167	G31 skip speed	PLC setting unit/min.	RW
		168	G31.1 skip condition	Integer	
		169	G31.2 skip speed	PLC setting unit/min.	
		170	G31.2 skip condition	Integer	
		171	G31.2 skip speed	PLC setting unit/min.	
		172	G31.3 skip condition	Integer	
		173	G31.3 skip speed	PLC setting unit/min.	
		176	Constant surface speed axis	Integer	
		177	Thread cutting speed	PLC setting unit/min.	
		178	M code for clamp	Integer	
		179	Dwelling time after outputting M code for unclamp		
		180 + n	F1 digit feedrate F1 to F5 (n = 0 to 4)	PLC setting unit/min.	
		185	Validate inclined axis control (for L system only)	Integer	
		186	Inclination angle (for L system only)		
		187	Compensation at reference position return (for L system only)		
		188	Deceleration check method 1/ Validate in-position check		
		189	Time constant 0 for handle feed		
		190	Macro call for M command		
		191	Macro call for S command		
		192	Macro call for T command		
		193	Macro call with 2nd miscellaneous code		
		194	Select initial spindle control		
		195	Validate acceleration and deceleration with constant-gradient G0	PLC setting unit	
		196	Validate acceleration and deceleration with constant-gradient G1		
		197	Distance between facing turrets (for L system only)	PLC setting unit	
		198	Select turrets as facing turrets with T command (for L system only)	Integer	
		199	Select turrets as facing turrets with T command (for L system only)		
		200	Acceleration and deceleration before G0 interpolation	PLC setting unit/min.	
		201	Maximum speed		
		202	Time constant	Integer	
		203	Circular radius error compensation factor	PLC setting unit/min.	
		204	Arc deceleration speed		
		205	Modal G code reset	Integer	
208	Side 1 of inclination angle (for L system only)	PLC setting unit			
209	Side 2 of inclination angle (for L system only)				
210	Side 3 of inclination angle (for L system only)				
211	External deceleration	PLC setting unit/min.			
Not used	Not used	300 + n	aux01 to 12 (n = 0 to 11)	Integer	
		350 + n	set01 to 12 (n = 0 to 11)		
		400 + n	ext01 to 36 (n = 0 to 35)		
		500	Near reference position check method		
		501	Automatic return by program restart		
		502	No. of #100 address part system common variables		
		503	No. of #500 address part system common variables		
		506	Deceleration check specification type		
		509	Switch command format		
		510	Minimum value for synchronization M code		
511	Maximum value for synchronization M code				

Sub-ID	Significance of data No.	Sub-section No.	Details of Sub-section No.	Data type	R/W
Not used		512	Tool life management standard number	Integer	RW
		513	Synchronous tap hole bottom wait time		
		514	Synchronous tap in-position check width (tap axis)		
		524	Chopping compensation value fixing method		
		527	Tool change method specification		
		528	Tool measurement standard positions election		
System No.		600	PLC unit		
		602	Machine error compensation unit		
System No.	Not used	1501 to 1503, 1505	Refer to the "Alarm/Parameter Manual" for base system parameter.	PLC setting unit/min.	
		1506		Integer	
		1507, 1510 to 1513		Character string	
		1514, 1515		Integer	
		1516 to 1522		PLC setting unit/min.	
		1523		Integer	
		1524		Character string	
		1533		Integer	
		1534		PLC setting unit	
		1535		Character string	
		1537 to 1544		Integer	
		1561 to 1563		PLC setting unit/min.	
		1564			
		1568 to 1574, 1590 to 1593		Integer	
		Not used		1901 to 1911	
System No.		8001 to 8003	Refer to the "Alarm/Parameter Manual" for user parameters.	PLC setting unit/min.	
		8004		PLC setting unit	
		8005, 8006		Integer	
		8007, 8008		PLC setting unit	
		8009 to 8013		Integer	
		8014, 8015		PLC setting unit	
		8016 to 8018		Integer	
		8019 to 8023, 8025, 8026		PLC setting unit	
		8027 to 8030		Integer	
		8033 to 8036		PLC setting unit	
		8037, 8041 to 8043		Integer	
		Not used		8044	

Sub-ID	Significance of data No.	Sub-section No.	Details of Sub-section No.	Data type	R/W	
System No.	Not used	8051 to 8054	Refer to the "Alarm/Parameter Manual" for user parameters.	PLC setting unit	RW	
		8055		Integer		
		8056, 8057		PLC setting unit		
		8058		Integer		
		8059		PLC setting unit		
		8071, 8072		Integer		
		8075		PLC setting unit		
Not used		8078		Integer		
System No.		8083				Integer
		8084				PLC setting unit
		8085, 8086				PLC setting unit/min.
		8090				Integer
		8091				PLC setting unit
		8092				Integer
	8093		PLC setting unit			
Not used	8094					
Not used	8101 to 8103, 8105 to 8114, 8116		Integer			
System No.	8621, 8622		Character string			
	8623 to 8626		PLC setting unit			
	8627		Integer			
	8701 to 8705		PLC setting unit			
	8706		PLC setting unit/min.			
	8707, 8708		PLC setting unit			
	8709, 8710					
	8711, 8712		Integer			
Not used	10001	G code format	Integer			
	10002	M2 Label O				
	10003	M2 Macro converter valid				
	10004	Coordinate rotation angle				
System No.	10005	Coordinate rotation center (Horizontal)				
	10006	Coordinate rotation center (Vertical)				
Not used	10007	Machine manufacturer macro password No.				
	10008	Parameter for M3/L3				
	10009	operat1				
	10010	operat2				
	10011	operat3				
	10012	operat5				
	10013	operat7				
	10035	masmac5				

Section No. : 127 Axis parameters

Sub-ID	Significance of data No.	Sub-section No.	Details of Sub-section No.	Data type	R/W
System No.	Axis No.	1	Axis name	Character string	RW
		2	Displayed axis name		
		3	Increment command axis name		
		4	Command unit	Integer	
		5	Output in inch		
		6	Rotational axis		
		7	Motor CCW		
		8	Diameter specification axis		
		9	Spindle interpolation		
		10	Drive unit I/F channel No.	Character string	
		12	Command address during cross machining		
		13	Incremental command address during cross machining	Integer	
		101	Manual ABS updating		
		102	Tool compensation function		
		103	Manual dog-type		
		104	Error correction		
		105	JOG response type	Character string	
		106	JOG start (+) Device selection		
		107	JOG start (-) Device selection	Integer	
		108	Slave axis No.		
		109	No_dsp		
		110	Axis name		
		111	Axis release		
		112	+/- JOG start signal device name		
		1010	Axis designated for chopping	Refer to the "Alarm/Parameter Manual" for axis specifications parameters.	
		2001, 2002	PLC setting unit/min.		
		2003 to 2010	Integer		
		2011, 2012	Interpolation unit		
		2013 to 2016	PLC setting unit		
		2017 to 2019	Integer		
		2020	PLC setting unit		
		2021	PLC setting unit/min.		
		2022	Integer		
2023	PLC setting unit/min.				
2024, 2061, 2062	PLC setting unit				
2063, 2068 to 2071	Integer				

Sub-ID	Significance of data No.	Sub-section No.	Details of Sub-section No.	Data type	R/W
System No.	Axis No.	2072	Refer to the "Alarm/Parameter Manual" for axis specifications parameters.	PLC setting unit	RW
		2073 to 2080		Integer	
		2081		PLC setting unit/min.	
		2082, 2084, 2087		Integer	
		2088, 2089		Character string	
		2090, 2091		PLC setting unit/min.	
		2092 to 2095		Integer	
		2096		PLC setting unit/min.	
		2097, 2098		PLC setting unit	
		2102, 2103, 2106		Integer	
		2109, 2110		PLC setting unit/min.	
		2111 to 2115, 2121 to 2129		Integer	
		2130 to 2133		PLC setting unit	
		2134 to 2137		Integer	
		2138		PLC setting unit	
		8201 to 8203		Integer	
		8204 to 8206		PLC setting unit	
		8207, 8208		Integer	
		8209		PLC setting unit	
		8210, 8211		Integer	
		10000		Character string	
		10001, 10002		PLC setting unit	
		10003, 10004		Integer	
		10101			
		10102		Cutting feed clamp speed(for integer setting)	

Section No. : 128 Rotary Axis Configuration Parameters

Sub-ID	Significance of data No.	Sub-section No.	Details of Sub-section No.	Data type	R/W
System No.	Not used	7900 to 7902	Refer to the "Alarm/Parameter Manual" for rotary axis configuration parameters.	Character string	RW
		7903 to 7907, 7920		Integer	
		7922		Character string	
		7923		Integer	
		7924 to 7926		PLC setting unit	
		7930		Integer	
		7932		Character string	
		7933		Integer	
		7934 to 7936		PLC setting unit	
		7940		Integer	
		7942		Character string	
		7943		Integer	
		7944 to 7946		PLC setting unit	
		7950		Integer	
		7952		Character string	
		7953		Integer	
7954 to 7956	PLC setting unit				

Section No. : 130 Axis parameters (PLC axis)

Sub-section No. is equivalent to the section No. 127.

Section No. : 131 Reference position return parameters (PLC axis)

Sub-section No. is equivalent to the section No. 95.

Section No. : 132 Servo parameters (PLC axis)

Sub-section No. is equivalent to the section No. 96.

Section No. : 133 Absolute position parameters (PLC axis)

Sub-section No. is equivalent to the section No. 101.

Section No. : 140 Ladder I/F(common) [M8]

Sub-ID	Significance of data No.	Sub-section No.	Details of Sub-section No.	Data type	R/W
Not used	Not used	n + 100	Spindle standby tool comment (n=0 to 4)	Character string	R
		n + 200	PLC switch message (n=1 to 64)		

Section No. : 150 User open I/F parameter

Sub-ID	Significance of data No.	Sub-section No.	Details of Sub-section No.	Data type	R/W
Not used	Not used	1	SRAM open usable amount	Integer	R
		2	SRAM open spare amount	Integer	R
		101	Device open parameter clear	Character string	W
		102	Device open parameter clear	Character string	W
		(x)	Device open parameter device allocation (x=40001 to 40100)	Character string	RW
		(10000 + (x))	Device open parameter data type (x=40001 to 40100)	Character string	RW
		(20000 + (x))	Device open parameter number of data (x=40001 to 40100)	Integer	RW
		(30000 + (x))	Device open parameter display format (x=40001 to 40100)	Character string	RW
		(x)	SRAM open parameter data type (x=41001 to 41100)	Character string	RW
		(10000 + (x))	SRAM open parameter numbef of data (x=41001 to 41100)	Integer	RW
		(20000 + (x))	SRAM open parameter display format (x=41001 to 41100)	Character string	RW

Section No. : 151 User open I/F data

Sub-ID	Significance of data No.	Sub-section No.	Details of Sub-section No.	Data type	R/W
Not used	Not used	(x)	#41001 SRAM open data(x=1-9999999)	Integer	RW
		(10000000 +(x))	#41002 SRAM open data(x=1-9999999)		
		(20000000 +(x))	#41003 SRAM open data(x=1-9999999)		
		(30000000 +(x))	#41004 SRAM open data(x=1-9999999)		
		(40000000 +(x))	#41005 SRAM open data(x=1-9999999)		
		(50000000 +(x))	#41006 SRAM open data(x=1-9999999)		
		(60000000 +(x))	#41007 SRAM open data(x=1-9999999)		
		(70000000 +(x))	#41008 SRAM open data(x=1-9999999)		
		(80000000 +(x))	#41009 SRAM open data(x=1-9999999)		
		(90000000 +(x))	#41010 SRAM open data(x=1-9999999)		
		(100000000 +(x))	#41011 SRAM open data(x=1-9999999)		
		(110000000 +(x))	#41012 SRAM open data(x=1-9999999)		
		(120000000 +(x))	#41013 SRAM open data(x=1-9999999)		
		(130000000 +(x))	#41014 SRAM open data(x=1-9999999)		
		(140000000 +(x))	#41015 SRAM open data(x=1-9999999)		
		(150000000 +(x))	#41016 SRAM open data(x=1-9999999)		
		(160000000 +(x))	#41017 SRAM open data(x=1-9999999)		
		(170000000 +(x))	#41018 SRAM open data(x=1-9999999)		
		(180000000 +(x))	#41019 SRAM open data(x=1-9999999)		
		(190000000 +(x))	#41020 SRAM open data(x=1-9999999)		
		(200000000 +(x))	#41021 SRAM open data(x=1-9999999)		
		(210000000 +(x))	#41022 SRAM open data(x=1-9999999)		
		(220000000 +(x))	#41023 SRAM open data(x=1-9999999)		
		(230000000 +(x))	#41024 SRAM open data(x=1-9999999)		
		(240000000 +(x))	#41025 SRAM open data(x=1-9999999)		
		(250000000 +(x))	#41026 SRAM open data(x=1-9999999)		
		(260000000 +(x))	#41027 SRAM open data(x=1-9999999)		
		(270000000 +(x))	#41028 SRAM open data(x=1-9999999)		
		(280000000 +(x))	#41029 SRAM open data(x=1-9999999)		
		(290000000 +(x))	#41030 SRAM open data(x=1-9999999)		
		(300000000 +(x))	#41031 SRAM open data(x=1-9999999)		
		(310000000 +(x))	#41032 SRAM open data(x=1-9999999)		
		(320000000 +(x))	#41033 SRAM open data(x=1-9999999)		
		(330000000 +(x))	#41034 SRAM open data(x=1-9999999)		
		(340000000 +(x))	#41035 SRAM open data(x=1-9999999)		
		(350000000 +(x))	#41036 SRAM open data(x=1-9999999)		
		(360000000 +(x))	#41037 SRAM open data(x=1-9999999)		
		(370000000 +(x))	#41038 SRAM open data(x=1-9999999)		
		(380000000 +(x))	#41039 SRAM open data(x=1-9999999)		
		(390000000 +(x))	#41040 SRAM open data(x=1-9999999)		
		(400000000 +(x))	#41041 SRAM open data(x=1-9999999)		
		(410000000 +(x))	#41042 SRAM open data(x=1-9999999)		
		(420000000 +(x))	#41043 SRAM open data(x=1-9999999)		
		(430000000 +(x))	#41044 SRAM open data(x=1-9999999)		
		(440000000 +(x))	#41045 SRAM open data(x=1-9999999)		
		(450000000 +(x))	#41046 SRAM open data(x=1-9999999)		
		(460000000 +(x))	#41047 SRAM open data(x=1-9999999)		
		(470000000 +(x))	#41048 SRAM open data(x=1-9999999)		
(480000000 +(x))	#41049 SRAM open data(x=1-9999999)				
(490000000 +(x))	#41050 SRAM open data(x=1-9999999)				

Sub-ID	Significance of data No.	Sub-section No.	Details of Sub-section No.	Data type	R/W
Not used	Not used	(500000000 +(x))	#41051 SRAM open data(x=1-9999999)	Integer	R/W
		(510000000 +(x))	#41052 SRAM open data(x=1-9999999)		
		(520000000 +(x))	#41053 SRAM open data(x=1-9999999)		
		(530000000 +(x))	#41054 SRAM open data(x=1-9999999)		
		(540000000 +(x))	#41055 SRAM open data(x=1-9999999)		
		(550000000 +(x))	#41056 SRAM open data(x=1-9999999)		
		(560000000 +(x))	#41057 SRAM open data(x=1-9999999)		
		(570000000 +(x))	#41058 SRAM open data(x=1-9999999)		
		(580000000 +(x))	#41059 SRAM open data(x=1-9999999)		
		(590000000 +(x))	#41060 SRAM open data(x=1-9999999)		
		(600000000 +(x))	#41061 SRAM open data(x=1-9999999)		
		(610000000 +(x))	#41062 SRAM open data(x=1-9999999)		
		(620000000 +(x))	#41063 SRAM open data(x=1-9999999)		
		(630000000 +(x))	#41064 SRAM open data(x=1-9999999)		
		(640000000 +(x))	#41065 SRAM open data(x=1-9999999)		
		(650000000 +(x))	#41066 SRAM open data(x=1-9999999)		
		(660000000 +(x))	#41067 SRAM open data(x=1-9999999)		
		(670000000 +(x))	#41068 SRAM open data(x=1-9999999)		
		(680000000 +(x))	#41069 SRAM open data(x=1-9999999)		
		(690000000 +(x))	#41070 SRAM open data(x=1-9999999)		
		(700000000 +(x))	#41071 SRAM open data(x=1-9999999)		
		(710000000 +(x))	#41072 SRAM open data(x=1-9999999)		
		(720000000 +(x))	#41073 SRAM open data(x=1-9999999)		
		(730000000 +(x))	#41074 SRAM open data(x=1-9999999)		
		(740000000 +(x))	#41075 SRAM open data(x=1-9999999)		
		(750000000 +(x))	#41076 SRAM open data(x=1-9999999)		
		(760000000 +(x))	#41077 SRAM open data(x=1-9999999)		
		(770000000 +(x))	#41078 SRAM open data(x=1-9999999)		
		(780000000 +(x))	#41079 SRAM open data(x=1-9999999)		
		(790000000 +(x))	#41080 SRAM open data(x=1-9999999)		
		(800000000 +(x))	#41081 SRAM open data(x=1-9999999)		
		(810000000 +(x))	#41082 SRAM open data(x=1-9999999)		
		(820000000 +(x))	#41083 SRAM open data(x=1-9999999)		
		(830000000 +(x))	#41084 SRAM open data(x=1-9999999)		
		(840000000 +(x))	#41085 SRAM open data(x=1-9999999)		
		(850000000 +(x))	#41086 SRAM open data(x=1-9999999)		
		(860000000 +(x))	#41087 SRAM open data(x=1-9999999)		
		(870000000 +(x))	#41088 SRAM open data(x=1-9999999)		
		(880000000 +(x))	#41089 SRAM open data(x=1-9999999)		
		(890000000 +(x))	#41090 SRAM open data(x=1-9999999)		
(900000000 +(x))	#41091 SRAM open data(x=1-9999999)				
(910000000 +(x))	#41092 SRAM open data(x=1-9999999)				
(920000000 +(x))	#41093 SRAM open data(x=1-9999999)				
(930000000 +(x))	#41094 SRAM open data(x=1-9999999)				
(940000000 +(x))	#41095 SRAM open data(x=1-9999999)				
(950000000 +(x))	#41096 SRAM open data(x=1-9999999)				
(960000000 +(x))	#41097 SRAM open data(x=1-9999999)				
(970000000 +(x))	#41098 SRAM open data(x=1-9999999)				
(980000000 +(x))	#41099 SRAM open data(x=1-9999999)				
(990000000 +(x))	#41100 SRAM open data(x=1-9999999)				

Appx.3: GOT Window [C80]

7.1 Outline

GOT window interface is for displaying various NC data on a GOT that is connected to a CNC CPU. By commanding device read instruction, GOT can read data such as current machining program No., current machining program and coordinate value.

Set a command to CNC CPU using GOT or PLC I/F command. Also create data that corresponds to the command on CNC CPU side.

As the area of up to ten commands is available, up to ten commands can be designated at a same time.

Also available are interfaces that allow a CNC to automatically set frequently-used commands at power ON, thereby enabling a GOT to refer to CNC data without a sequence program being created.

Sample screen shot and command examples

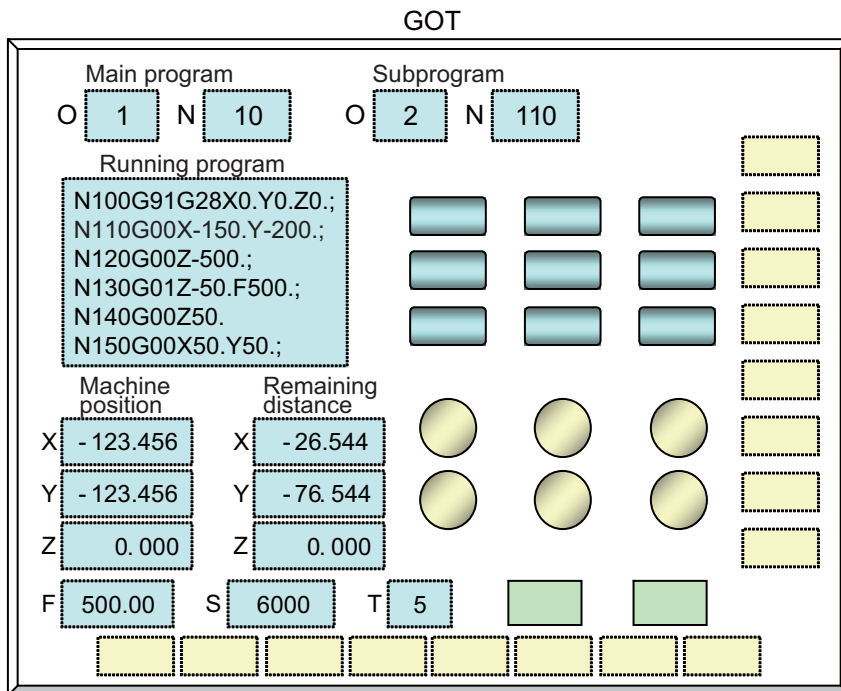

Data displayed	How to obtain these data
Current program	Using command code: 0xF01
Main/Sub/O/N number F command (modal) S command (modal) T command (modal)	Using command code: 0xF02
Machine position	Using command code: 0xF03
Remaining distance	

7.2 Manual Setting Window

7.2.1 Configuration

Assign command area to the devices from ZR20020 to ZR20659 and response area to the devices from ZR21300 to ZR22579. Designated data is set in command area, using PLC I/F command. And then, CNC stores the designated data in response area, and this data can be read and displayed on GOT as needed. Maximum of ten sets of window areas have been assigned. So, up to ten types of command can be designated at a time.

Configuration of manual window

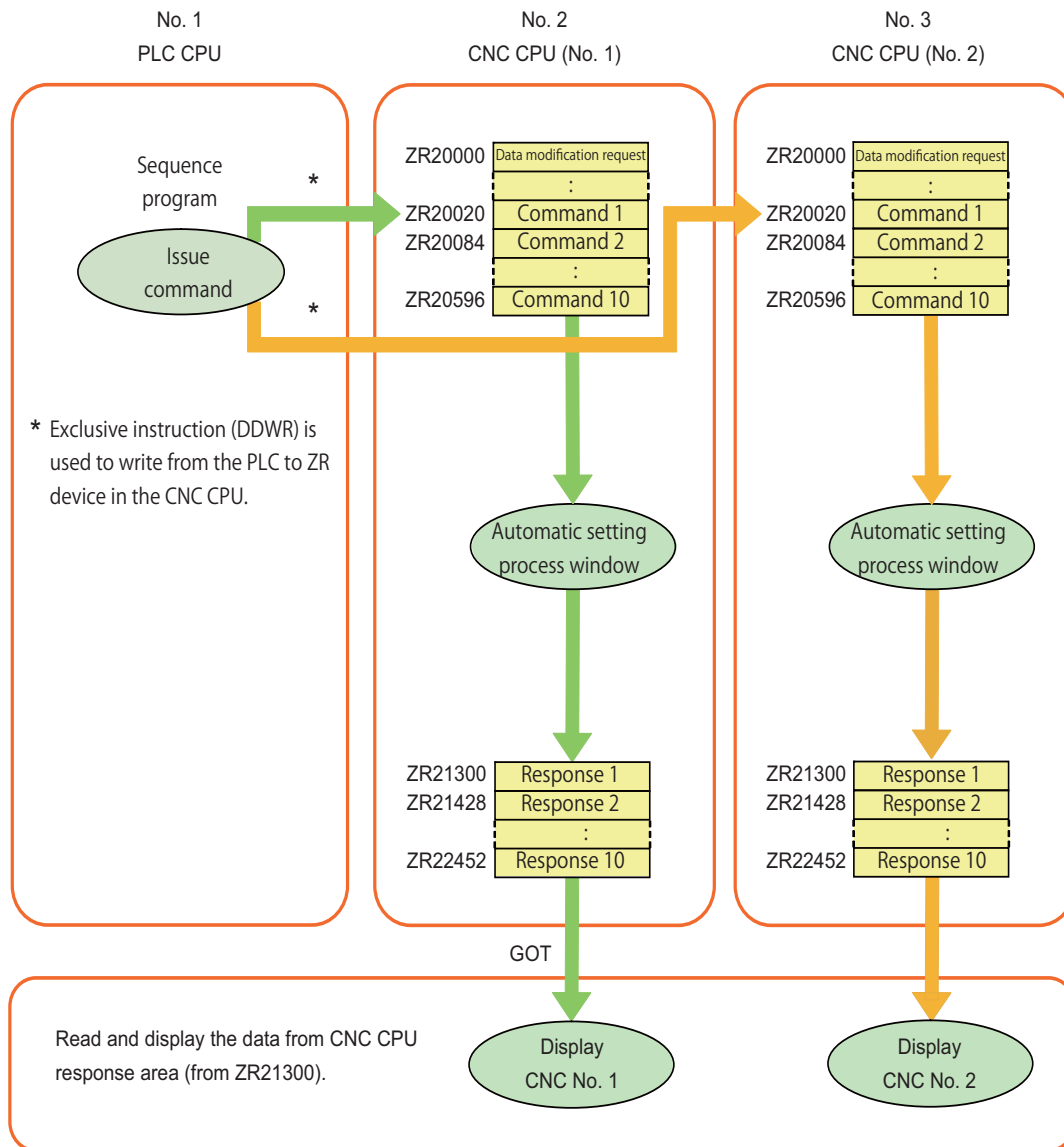

7.2.2 Used Area

[PLC -> CNC] Data modification request

Device	Description
ZR20000	BIT0: Window 1 Data modification request BIT1: Window 2 Data modification request BIT2: Window 3 Data modification request BIT3: Window 4 Data modification request BIT4: Window 5 Data modification request BIT5: Window 6 Data modification request BIT6: Window 7 Data modification request BIT7: Window 8 Data modification request BIT8: Window 9 Data modification request BIT9: Window 10 Data modification request BITA to F: Reserved

Turn ON this signal to set or change the command data and then reflect it to CNC. As a result, the data corresponding to the command which is currently set is stored in the response area.

Confirm that the command data is reflected to CNC (the data modification completion signal is ON) before turning OFF this signal.

[CNC -> PLC] Data modification completion

Device	Description
ZR20002	BIT0: Window 1 Data modification completion BIT1: Window 2 Data modification completion BIT2: Window 3 Data modification completion BIT3: Window 4 Data modification completion BIT4: Window 5 Data modification completion BIT5: Window 6 Data modification completion BIT6: Window 7 Data modification completion BIT7: Window 8 Data modification completion BIT8: Window 9 Data modification completion BIT9: Window 10 Data modification completion BITA to F: Reserved

This signal is turned ON when the response creation for the command data of the window where the data modification request is ON is completed.

The response data creation is continued even after this signal is turned ON.

When the data modification request is turned OFF, this signal is turned OFF, too.

[PLC -> CNC] Command area

Device	Description
ZR20020 to ZR20083	Window command 1
ZR20084 to ZR20147	Window command 2
ZR20148 to ZR20211	Window command 3
ZR20212 to ZR20275	Window command 4
ZR20276 to ZR20339	Window command 5
ZR20340 to ZR20403	Window command 6
ZR20404 to ZR20467	Window command 7
ZR20468 to ZR20531	Window command 8
ZR20532 to ZR20595	Window command 9
ZR20596 to ZR20659	Window command 10

These are the areas to specify the commands (to specify what data to store in the response areas).
The areas are prepared for each window, and 64 words are used per area.

Command data

Offset (*1)	Data
0	Data size (*2)
1	Reserved
2	Command code
3	Reserved
4 or later	Argument (*4)

[CNC -> PLC] Response area

Device	Description
ZR21300 to ZR21427	Window response 1
ZR21428 to ZR21555	Window response 2
ZR21556 to ZR21683	Window response 3
ZR21684 to ZR21811	Window response 4
ZR21812 to ZR21939	Window response 5
ZR21940 to ZR22067	Window response 6
ZR22068 to ZR22195	Window response 7
ZR22196 to ZR22323	Window response 8
ZR22324 to ZR22451	Window response 9
ZR22452 to ZR22579	Window response 10

The area to store the response (the data created corresponding to the command).
This is prepared for each window and 128 words are used per one area.

Response data

Offset (*1)	Data
0	Data size (*3)
1	Reserved
2	Command code
3	Reserved
4 to 5	Error coded (*5)
6 or later	Response (*4)

- *1 Offset is described in the word unit.
- *2 The size (in bytes) from the command code position to the last argument is set.
- *3 The size (in bytes) from the command code position to the last response data is stored.
- *4 The configurations differ depending on the command. For details, refer to the chapter "Usable Command".
- *5 For error codes, refer to the chapter "Error Code".

7.2.3 Operation Procedure

Procedures for setting and changing the command are as follows:

Once the command is set or changed, the response is always created (the response data is always updated).

- (1) Set necessary information (data size, command code and argument) to the command area.
- (2) Turn ON the data modification request (Make sure to perform (1) before turning ON).
- (3) Upon receiving the data modification request ON, perform the following processes:
 - Start creating the response data for the specified command.
 - Store the created response data in the response area.
 - Turn ON the data modification completion.
 Continue creating the response data and storing it in the response area.
- (4) Upon receiving the data modification completion ON, turn OFF the data modification request.
- (5) Upon the data modification request OFF, turn OFF the data modification completion.

The processes required on the PLC side are (1), (2) and (4) only.

Even when the command code or argument is changed, the same operation is required.

For the details on the command/response area, refer to the chapter "Usable Command".

When the data modification is performed with the data size set to "0", the response data is not created.

Command modification procedure/timing chart of the manual window

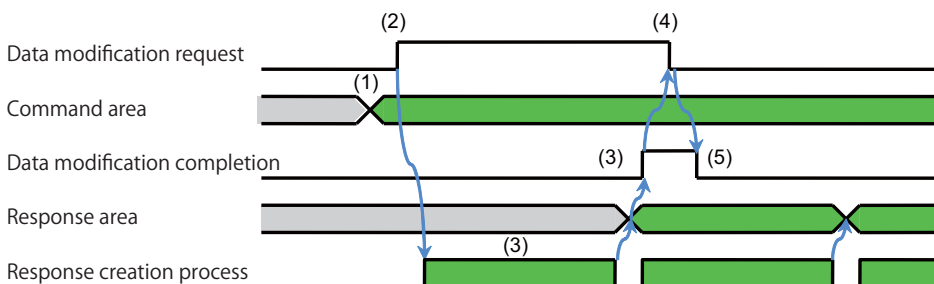
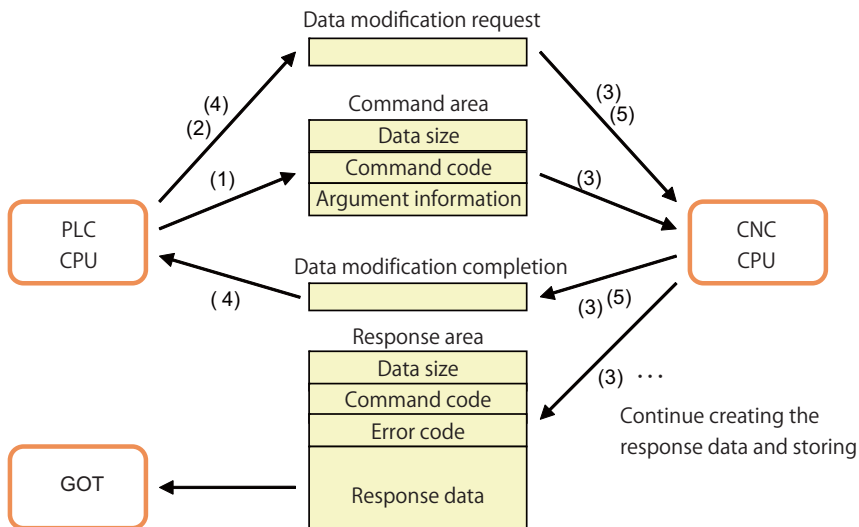

7.3 Automatic Setting Window

7.3.1 Configuration

Automatic setting window function allows a CNC to automatically set frequently-used commands at power ON, enabling a GOT to refer to CNC data without a sequence program being created. The response data is stored in accordance with the command which is automatically set. Some of the commands can change the acquiring data by changing the argument. The command's argument can be changed by both GOT and PLC program.

Configuration of automatic window

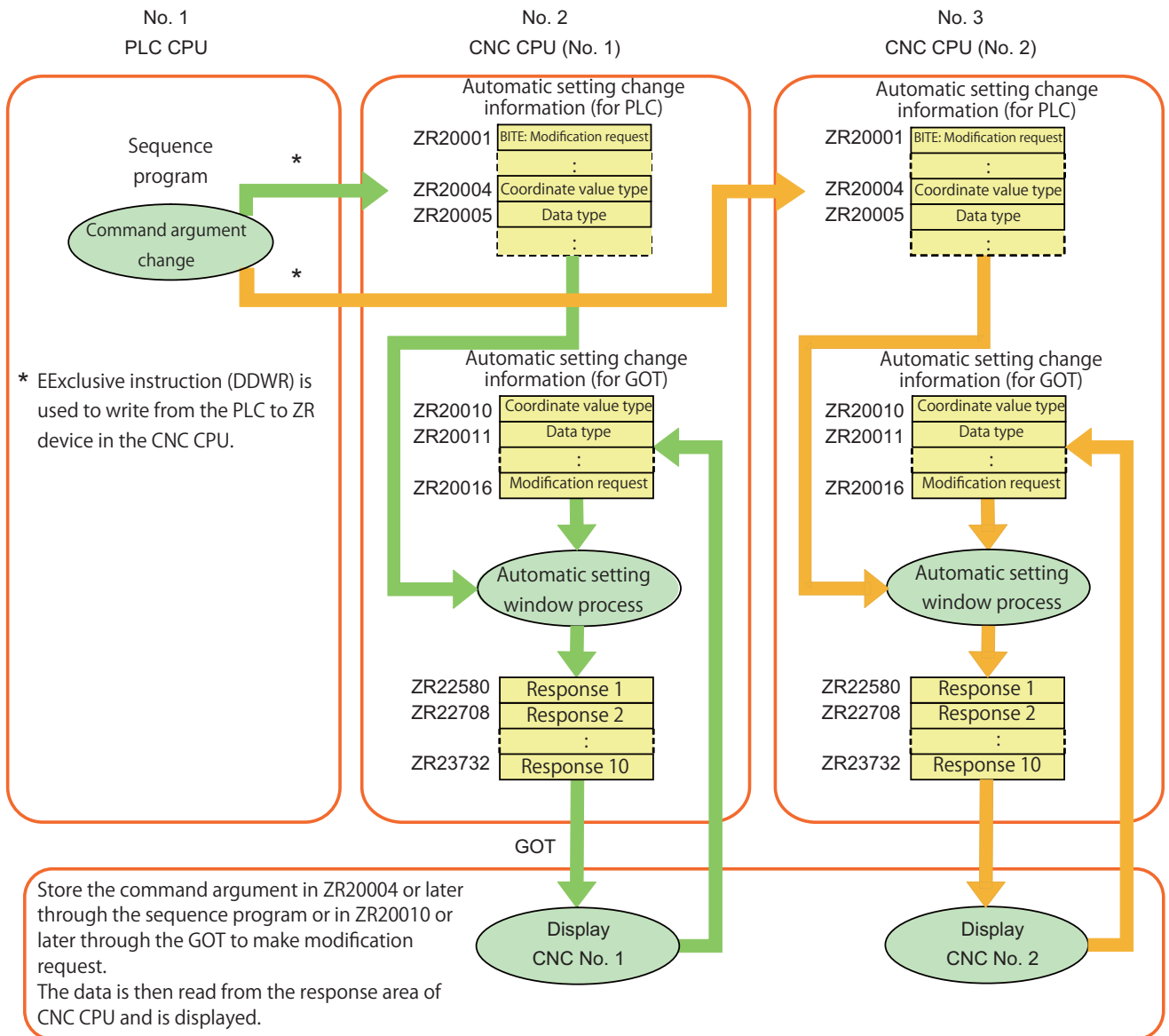

7.3.2 Used Area

[PLC -> CNC] Automatic setting modification request (for changing from the PLC)

Device	Description
ZR20001	BITE: Automatic setting modification request BIT0 to D and F: Reserved

Turn ON this signal to reflect the automatic setting modification information set with the PLC to the CNC. As a result, the data in the command area for the automatic setting window stored in the CNC is changed and the response data can be created with the data after the modification.

Confirm that the modification information is reflected to CNC (the automatic setting modification completion signal is ON) before turning OFF this signal.

[CNC -> PLC] Automatic setting modification completion (for changing from the PLC)

Device	Description
ZR20003	BITE: Automatic setting modification completion BIT0 to D and F: Reserved

When the automatic setting modification information is reflected to the command area for the automatic setting window stored in the CNC, this signal is turned ON.

When the automatic setting modification request is turned OFF, this signal is turned OFF, too.

[PLC -> CNC] Automatic setting modification information (for changing from the PLC)

Device	Description
ZR20004	Type of coordinate value (Target window No. 1 and 6) 1: Machine position 2: Relative position 3: Workpiece coordinate value 4: Remaining commands 5: Next command
ZR20005	Coordinate value type (Target window No. 1, 2, 6 and 7) 1: Binary type 2: Character string type 3: Extended character string type
ZR20006	Number of programs to output (Target window No. 4 and 9) 1 to 10
ZR20007	Number of characters in one line of the program (Target window No. 4 and 9) 1 to 240
ZR20008	Number of alarm messages to be output (Target window No. 5 and 10) 1 to 5
ZR20009	Type of message (Target window 5 and 10) BIT0: NC alarm BIT1: Stop code

Set the modification information (argument of each command) of the automatic setting window.

Set "0" to the argument which is not changed.

Make sure that the setting value depends on the specification of each command; however, some arguments (type of coordinate value and data type) have different specification.

[GOT <--> CNC] Automatic setting modification request (for changing from GOT)

Device	Description
ZR20016	Automatic setting modification request

Set "1" to this signal to set the automatic setting modification information with GOT and to reflect the content to CNC. As a result, the data in the command area for the automatic setting window stored in the CNC is changed and the response data can be created with the data after the modification.

Confirm that the modification information is reflected to command area before turning OFF this signal on CNC side.

[GOT -> CNC] Automatic setting modification information (for changing from GOT)

Device	Description
ZR20010	Same as automatic setting modification information (for changing from the PLC)
ZR20011	
ZR20012	
ZR20013	
ZR20014	
ZR20015	

[CNC -> PLC] Automatic setting window response area

Device	Description
ZR22580 to ZR22707	Window response 1
ZR22708 to ZR22835	Window response 2
ZR22836 to ZR22963	Window response 3
ZR22964 to ZR23091	Window response 4
ZR23092 to ZR23219	Window response 5
ZR23220 to ZR23347	Window response 6
ZR23348 to ZR23475	Window response 7
ZR23476 to ZR23603	Window response 8
ZR23604 to ZR23731	Window response 9
ZR23732 to ZR23859	Window response 10

7.3.3 Automatic Setting Command

The following settings are performed in the command areas of automatic setting window 1 to 10 when CNC is turned ON.

No.	Command name	Code	Part system	Other arguments (*2)
1	Get all axes' coordinate values	0xF03	1st part system	Machine position(*), extended character string type(*)
2				Remaining distance, character string type(*)
3	Modal information package acquisition	0xF02		
4	Acquisition of currently running program	0xF01		48 characters(*)×5lines(*), not line-wrap
5	Acquisition of alarm message which is occurring	0xF04		NC alarm(*), number of acquisitions: 5(*)
6	Same as 1st part system(*1)	Same as 1st part system	2nd part system	Same as 1st part system
7				
8				
9				
10				

*1 In the system with one part system, windows 6 to 10 are disabled (The response areas are all "0").

2 The command arguments with () can be changed. For how to change the arguments, refer to the chapter "Setting details modification procedure".

7.3.4 Setting Details Modification Procedure

Setting details (arguments) of automatic setting window can be changed from the PLC and GOT.
 Different device and procedure are required to change from the PLC side and GOT side.

When changing from the PLC side

- (1) Set the modification information (argument to be changed).
- (2) Turn ON the modification request (Make sure to perform (1) first).
- (3) Upon receiving the modification request ON, perform the following processes:
 - Reflect the contents of the modification information to the command area.
 - Turn ON the modification completion.
 Responses will be created based on the modified information (arguments).
- (4) Upon receiving the modification completion ON, turn OFF the modification request.
- (5) Upon the modification request OFF, turn OFF the modification completion.

The processes required on the PLC side are (1), (2) and (4) only. If the modification information is set in the 1st scan of the PLC (condition of SM402, etc.), however, the modification request is not required (the process (1) alone can change the setting of the automatic setting window).

Automatic setting modification procedure/timing chart of the manual window from the PLC

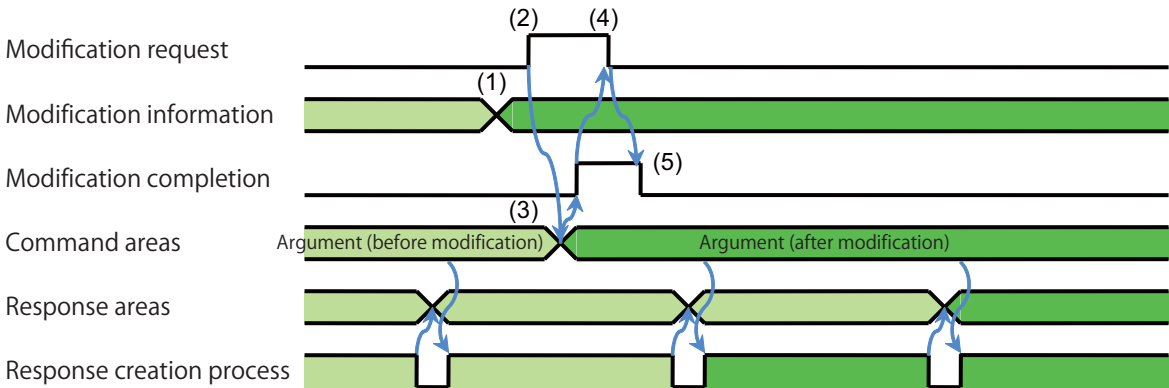
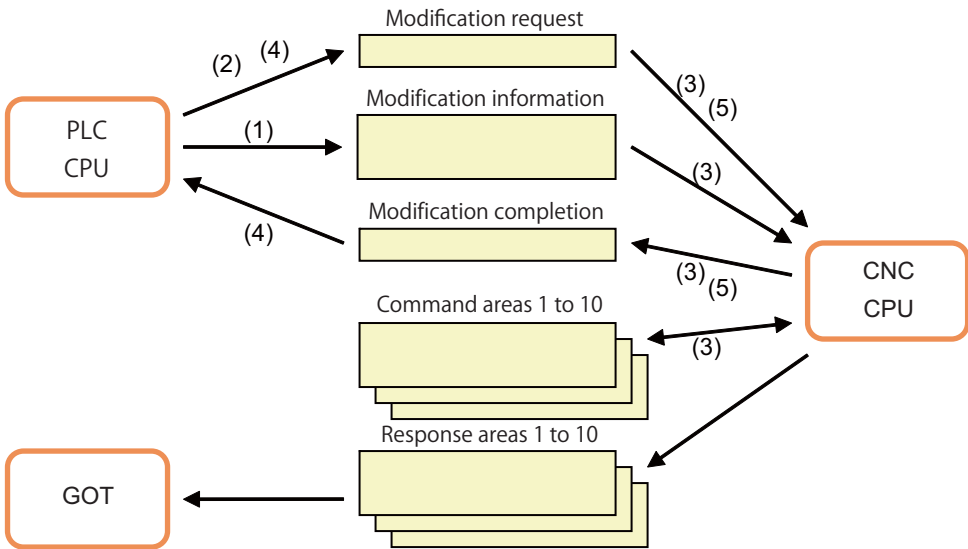

When changing from the GOT side

- (1) Set the modification information (argument of the command to be changed).
- (2) Turn ON the modification request (Make sure to perform (1) first).
- (3) Upon receiving the modification request ON, perform the following processes:
 - Reflect the contents of the modification information to the command area.
 - Turn OFF the modification request.
 Subsequent responses will be created based on the modified information (arguments).

The processes required on the GOT side are (1) and (2) only.

Automatic setting modification procedure/timing chart of the manual window from the GOT

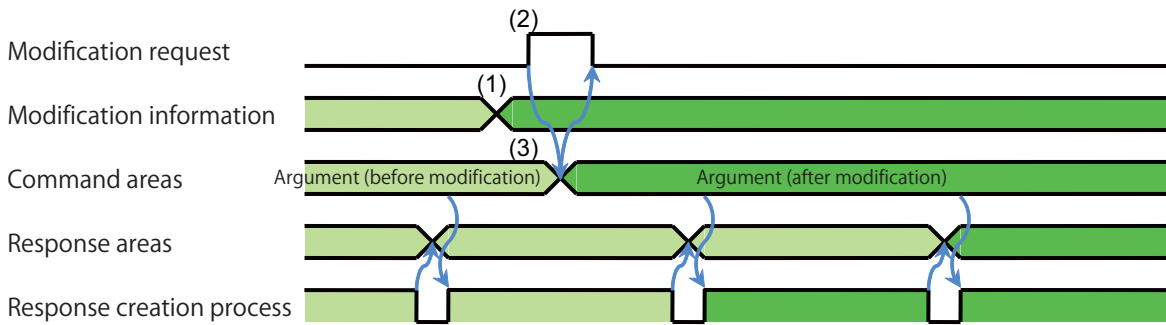
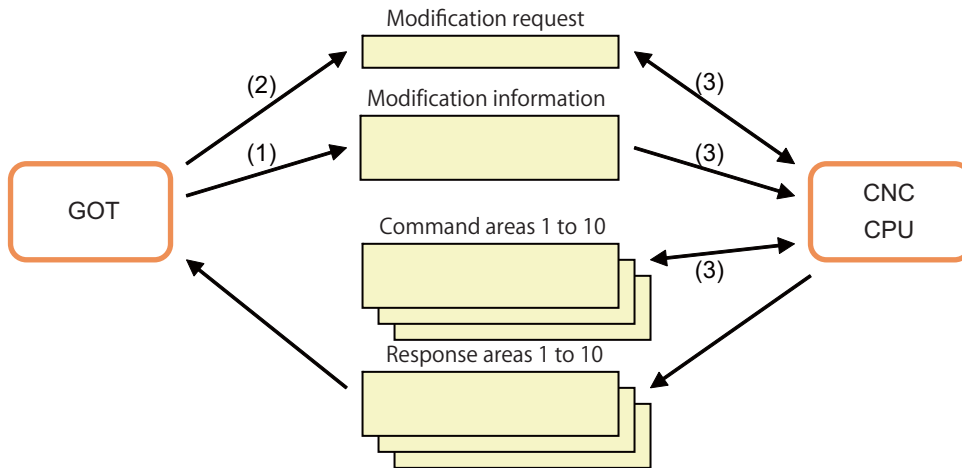

7.4 Usable Command

The following commands can be used on GOT window:

List of usable commands

Command code	Command name
0xF01	Acquisition of currently running program
0xF02	Modal information package acquisition
0xF03	Coordinate value package acquisition
0xF04	Acquisition of alarm message which is occurring
0xF05	Alarm history acquisition

[Common performance with all commands]

- When the command data size is set to "0", the response is not created.

(When the data modification request is turned ON, data modification completion is turned ON; however, the value is not stored in the response area.)

- If the value other than the normal completion (0x00000000) is stored in the error code, the data size of the response area becomes "8" and the data below the error code is disabled.

The following shows the details of each command:

* In this chapter, the offset is stated in word unit unless otherwise specified.

7.4.1 Acquisition of Currently Running Program (0xF01)

This command acquires the currently running program.

Command area

Offset	Data name	Setting detail
0	Data size (byte)	20 (16 *2)
1	Reserved	
2	Command code	0x0F01
3	Reserved	
4 to 5	Argument 1: Part system No.	1 to 7: 1st to 7th part systems ("0" is treated as 1st part system.)
6 to 7	Argument 2: Number of lines to acquire (*1)	1 to 10
8 to 9	Argument 3: Number of characters in one line (*1)	1 to 240
10 to 11	Argument 4: Line-wrap (*2)	0: Invalid, 1: Valid (the program block currently executed is output with line-wrap)

*1 Set "Number of lines to acquire x Number of characters in one line" to 240 or less.

When the number exceeds 240, "0x80040196" is output to the error code.

*2 When the line-wrap is not performed, the argument 4 can be omitted. In that case, set "16" to the data size.

Response area

Offset	Data name	Response detail
0	Data size (byte) (*3)	12 + mn
1	Reserved	0
2	Command code	0x0F01
3	Reserved	0
4 to 5	Error code (*3)	0: Normally finished (No error), Other than "0": Error
6 to 7	Status	[When the line-wrap is invalid] 0: Not in operation, 1: In operation (2nd line is the currently executed block) [When the line-wrap is valid](*4) The block with BIT0 to 9 (corresponding to 1st to 10th line) ON is the currently executed block.
8 to 8+n/2-1	Data in 1st line (Previous block)	After the 3rd line [When the line-wrap is invalid] Output one block to one line after the next block at a time. [When the line-wrap is valid] If the currently executed block cannot fit in (the number of characters in) one line, output the remaining after the 3rd line (with line-wrap). The line-wrap is performed as well in the next and subsequent block.(Line-wrap lines are included in the number of acquired lines.) - When it is not in operation, 1st and 2nd lines output the blank (0x20). - When the first block is being executed, 1st line outputs the blank. - Blanks are not included in the output program. - When the number of characters of the block is less than the number of the characters in one line (argument 3), the remaining letter outputs the blank. - When the number of lines of the program is less than the number of acquired lines (argument 2), the remaining line outputs the blank.
8+n/2 to 8+2n/2-1	Data in 2nd line (Currently executed block)	
8+2n/2 to 8+3n/2-1	Data in 3rd line	
8+3n/2 to 8+4n/2-1	Data in 4th line	
.	.	
.	.	
8+(m-1)n/2 to 8+mn/2-1	Data in mth line	

m: Number of acquired lines, n: Number of characters in one line

*3 Even when the program is not searched, no error occurs ("0" is output to the error code); however, the data size becomes "8" (valid up to the error code) and the status and all the subsequent data become "0".

*4 For example, when the status value is 0x00000006, that means that the 2nd and 3rd blocks are being executed.

BIT	1F to A	9	8	7	6	5	4	3	2	1	0
Data	0	0	0	0	0	0	0	0	1	1	0
Line position	-	10	9	8	7	6	5	4	3	2	1

[Usage example]

When N02 block of the following machining program is being executed

```
N01 G90 G28 X0. Y0. Z0.;
N02 G00 X-123.456 Y-123.456;
N03 M30 S1000;
N04 G01 Z-234.567 F1000;
M30;
```

<When the line-wrap is invalid>

Command

Response

Offset	Data name	Setting example	Offset	Data name	Response example
0	Data size	16	0	Data size	92
1	Reserved	0	1	Reserved	0
2	Command code	0x0F01	2	Command code	0x0F01
3	Reserved	0	3	Reserved	0
4 to 5	Part system No.	1	4 to 5	Error code	0x00000000
6 to 7	Number of acquired lines	5	6 to 7	Status	0x00000001
8 to 9	Number of characters in one line	16	8 to 15	Data in 1st line	"N01G90G28X0.Y0.Z"
			16 to 23	Data in 2nd line	"N02G00X-123.456Y"
			24 to 31	Data in 3rd line	"N03M30S1000; "
			32 to 39	Data in 4th line	"N04G01Z-234.567F"
			40 to 47	Data in 5th line	"M30; "

<When the line-wrap is valid>

Command

Response

Offset	Data name	Setting example	Offset	Data name	Response example
0	Data size	20	0	Data size	92
1	Reserved	0	1	Reserved	0
2	Command code	0x0F01	2	Command code	0x0F01
3	Reserved	0	3	Reserved	0
4 to 5	Part system No.	1	4 to 5	Error code	0x00000000
6 to 7	Number of acquired lines	5	6 to 7	Status	0x00000006
8 to 9	Number of characters in one line	16	8 to 15	Data in 1st line	"N01G90G28X0.Y0.Z"
10 to 11	Line-wrap	1	16 to 23	Data in 2nd line	"N02G00X-123.456Y"
			24 to 31	Data in 3rd line	"-123.456; "
			32 to 39	Data in 4th line	"N03M30S1000; "
			40 to 47	Data in 5th line	"N04G01Z-234.567F"

7.4.2 Modal Information Package Acquisition (0xF02)

This command acquires all modal information.

Command area

Offset	Data name	Setting detail
0	Data size (byte)	8
1	Reserved	
2	Command code	0x0F02
3	Reserved	
4 to 5	Argument 1: Part system No.	1 to 7: 1st to 7th part systems ("0" is treated as 1st part system.)

Response area

Offset	Data name	Response detail (*1)
0	Data size (byte)	190
1	Reserved	0
2	Command code	0x0F02
3	Reserved	0
4 to 5	Error code	0: Normally finished (No error), Other than "0": Error
6 to 9	S1 modal	S1 modal 8 characters (ASCII)
10 to 13	T modal	T modal 8 characters (ASCII)
14 to 18	F modal	F modal 10 characters (ASCII)
19 to 48	G modal	G modal (ASCII) of each G group (for up to 15 groups *4)
49	NC status 1	0: No occurring alarm, 1: Occurring alarm
50 to 68	NC status 2 (*2)	If there is no alarm: Operation status (ASCII) If there is alarm: Alarm message (38 characters)
69 to 72	Main program No.	Main program No. 8 characters (*3) (ASCII)
73 to 76	Main sequence No.	Main sequence No. 8 characters (ASCII)
77 to 80	Sub program No.	Sub program No. 8 characters (*3) (ASCII)
81 to 84	Sub sequence No.	Sub sequence No. 8 digits (ASCII)
85 to 88	S2 modal	S2 modal 8 characters (ASCII)
89 to 92	Current program No.	Current program No. 8 characters (*3) (ASCII)
93 to 96	Sequence No. of the program currently executed	Sequence No. of the program currently executed 8 characters (ASCII)

*1 Characters are output left aligned. (When output in eight characters, output for 12345 is "12345...".)

*2 Details on NC status 2
<Operation status>

ST1	ST2	ST3	ST4	ST5	ST6	ST7													
-----	-----	-----	-----	-----	-----	-----	--	--	--	--	--	--	--	--	--	--	--	--	--

- ST1: LSK (In operation)/HLD (In feed hold stop)/STP (In single block stop)
/RST (In reset)/EMG (In emergency stop), etc.
 - ST2: mm (Metric command mode)/in. (Inch command mode)
 - ST3: ABS (Absolute command mode)/INC (Incremental command mode)
 - ST4: G40/G41/G42, etc. (Tool radius compensation modal)
 - ST5: G54 to G59 (Workpiece coordinate system)/Pxx (Extended workpiece coordinate system G54.1 Pxx)
 - ST6: SBn (n: Subprogram nesting)/Blank when subprogram is not in execution
 - ST7: fix (In fixed cycle)/Blank when fixed cycle is not in execution
- The part without description is blank.

<Alarm message>

The alarm with the highest priority is output among the currently occurring alarms.
For details on format, refer to the description of response area in "Acquisition of alarm message which is occurring (0xF04)".

3 When the program name exceeds 8 characters, the 8th character becomes "" and the 9th and subsequent characters are not output.
(For example, the program name "123456789" is output as "1234567*").
For MDI program, the program No. is output as "MDI".

*4 G modal No. of each G group is left-justified and output with four characters at a time.
(G modal in three digits and with decimal point (G123.4, etc.) cannot be output. Four blank characters are output.)
The G groups to be output and the output order are as follows:

Offset	Relative	G group No. to be output		
		M system	L system (series 2)	L system (series 3)
19, 20	+ 0, 1	1	1	1
21, 22	+ 2, 3	2	2	2
23, 24	+ 4, 5	3	-	3
25, 26	+ 6, 7	5	5	5
27, 28	+ 8, 9	6	6	6
29, 30	+10, 11	7	7	7
31, 32	+12, 13	8	4	4
33, 34	+14, 15	9	9	9
35, 36	+16, 17	10	-	10
37, 38	+18, 19	12	12	12
39, 40	+20, 21	13	13	13
41, 42	+22, 23	14	14	14
43, 44	+24, 25	17	17	17
45, 46	+26, 27	19	18	18
47, 48	+28, 29	-	20	20

- : G group which is not output (Four blank characters are output.)

[Usage example]

Command

Response

Offset	Data name	Setting example	Offset	Data name	Response example
0	Data size	8	0	Data size	190
1	Reserved	0	1	Reserved	0
2	Command code	0x0F02	2	Command code	0x0F02
3	Reserved	0	3	Reserved	0
4 to 5	Part system No.	1	4 to 5	Error code	0x00000000
			6 to 9	S1 modal	"1000 "
			10 to 13	T modal	"13 "
			14 to 18	F modal	"1200.00 "
			19 to 48	G modal	"01 17 91 94 21 40 49 80 98 54 64 67 97 50.143.1"
			49	NC status 1	0x0000
			50 to 68	NC status 2	"LSK mm INC G40 G54"
			69 to 72	Main program No.	"100 "
			73 to 76	Main sequence No.	"110 "
			77 to 80	Sub program No.	"9990 "
			81 to 84	Sub sequence No.	"2000 "
			85 to 88	S2 modal	"2000 "
			89 to 92	Current program No.	"9990 "
			93 to 96	Sequence No. of the program currently executed	"2000 "

7.4.3 Coordinate Value Package Acquisition (0xF03)

This command acquires coordinate values of each axis.

Command area

Offset	Data name	Setting detail
0	Data size (byte)	20
1	Reserved	
2	Command code	0x0F03
3	Reserved	
4 to 5	Argument 1: Part system No. (*2)	1 to 7: 1st to 7th part systems ("0" is treated as 1st part system.)
6 to 7	Argument 2: Axis to be acquired (*1 and 2)	Acquire the axis coordinate where the setting in ON with BIT0 to 7 (corresponding to 1st to 8th axis in the part system).
8 to 9	Argument 3: Type of coordinate value	0: Machine position 1: Relative position (*) 2: Workpiece coordinate value (*) 3: Remaining command 4: Next command (*) The coordinate values with * cannot be acquired on PLC axis. ("0" is output for binary type and otherwise, the blank is output.)
10 to 11	Argument 4: Data type	0: Binary type (use 2 words) 1: Character string type (use 6 words) 2: Extended character string type (use 8 words)

- *1 When all BITs are turned OFF (0), all the axes in the part system are treated as being specified. Regardless of the specified part system No. or axis to acquire, the coordinate values of all the PLC axes mounted are acquired.
- *2 Even during the cross axis control, specify the part system and axis Nos. of the basic configuration. (The coordinate value can be acquired even when the specified axis is switched to a different part system or the axis No. is changed due to the cross axis control.)

Response area (for binary type)

Offset	Data name	Response detail
0	Data size (byte)	72
1	Reserved	0
2	Command code	0x0F03
3	Reserved	0
4 to 5	Error code	0: Normally finished (No error), Other than "0": Error
6 to 7	1st NC axis coordinate value in the part system	One signed two-word number per axis is output. The unit depends on the setting of "#1003 iunit". (*3) For an axis unspecified with argument 2 or an axis that exceeds the maximum number of NC axes in the part system, zero is stored in the coordinate value.
8 to 9	2nd NC axis coordinate value in the part system	
10 to 11	3rd NC axis coordinate value in the part system	
12 to 13	4th NC axis coordinate value in the part system	
14 to 15	5th NC axis coordinate value in the part system	
16 to 17	6th NC axis coordinate value in the part system	
18 to 19	7th NC axis coordinate value in the part system	
20 to 21	8th NC axis coordinate value in the part system	
22 to 23	1st PLC axis coordinate value	
24 to 25	2nd PLC axis coordinate value	
26 to 27	3rd PLC axis coordinate value	
28 to 29	4th PLC axis coordinate value	
30 to 31	5th PLC axis coordinate value	
32 to 33	6th PLC axis coordinate value	
34 to 35	7th PLC axis coordinate value	
36 to 37	8th PLC axis coordinate value	

*3 The unit is as follows depending on the setting of "#1003 iunit".

#1003 iunit	Diameter axis	Radius axis	Rotary axis
B	0.001 mm	0.0005 mm	0.0005 °
C or later	0.0001 mm	0.00005 mm	0.00005 °

(When "#1003 iunit" is "D" or later, the unit is the same as the case for "C".)

Response area (for character string type)

Offset	Data name	Response detail
0	Data size (byte)	200
1	Reserved	0
2	Command code	0x0F03
3	Reserved	0
4 to 5	Error code	0: Normally finished (No error), Other than "0": Error
6 to 11	1st NC axis coordinate value in the part system	12 characters (6 words) of ASCII code is output per one axis. - The coordinate value is output right justified. - The number of digits below decimal point is determined based on "#1003 iunit". (When "#1003 iunit" is "D" or later, the number of digits is the same as the case for "C".) - Blank is stored in the axis which is not specified with argument 2 and the coordinate value of the NC axis which exceeds the number of NC axes in the part system. - When the number of digits of the coordinate value exceeds 8-digits, "*" is output (****.***, etc.).
12 to 17	2nd NC axis coordinate value in the part system	
18 to 23	3rd NC axis coordinate value in the part system	
24 to 29	4th NC axis coordinate value in the part system	
30 to 35	5th NC axis coordinate value in the part system	
36 to 41	6th NC axis coordinate value in the part system	
42 to 47	7th NC axis coordinate value in the part system	
48 to 53	8th NC axis coordinate value in the part system	
54 to 59	1st PLC axis coordinate value	
60 to 65	2nd PLC axis coordinate value	
66 to 71	3rd PLC axis coordinate value	
72 to 77	4th PLC axis coordinate value	
78 to 83	5th PLC axis coordinate value	
84 to 89	6th PLC axis coordinate value	
90 to 95	7th PLC axis coordinate value	
96 to 101	8th PLC axis coordinate value	

Response area (for extended character string type)

Offset	Data name	Response detail
0	Data size (byte)	248
1	Reserved	0
2	Command code	0x0F03
3	Reserved	0
4 to 5	Error code	0: Normally finished (No error), Other than "0": Error
6 to 13	1st NC axis coordinate value in the part system	16 characters (8 words) of ASCII code is output per one axis. (Axis status (four characters) is added to the end of character string type.) The following restrictions are imposed on PLC axis: - The coordinate value of 8th PLC axis cannot be acquired. - The axis status which can be acquired is the servo off and removing the axis only. Other specifications conform the character string type. (*4)
14 to 21	2nd NC axis coordinate value in the part system	
22 to 29	3rd NC axis coordinate value in the part system	
30 to 37	4th NC axis coordinate value in the part system	
38 to 45	5th NC axis coordinate value in the part system	
46 to 53	6th NC axis coordinate value in the part system	
54 to 61	7th NC axis coordinate value in the part system	
62 to 69	8th NC axis coordinate value in the part system	
70 to 77	1st PLC axis coordinate value	
78 to 85	2nd PLC axis coordinate value	
86 to 93	3rd PLC axis coordinate value	
94 to 101	4th PLC axis coordinate value	
102 to 109	5th PLC axis coordinate value	
110 to 117	6th PLC axis coordinate value	
118 to 125	7th PLC axis coordinate value	

*4 Correspondence between axis status and character string

Priority	Axis status	Character string (for four characters)
1	While removing the axis	">< "
2	During the Servo OFF	"]["
3	Zero point arrival	"#1 ", etc.
4	In mirror image	"MR "
5	Auxiliary axis state	"CT "
-	Other than the above	" " (Blank)

[Usage example]

When acquiring the machine position of the 1st part system with the following status

```

          [1] [2] [PLC]
#1002 axisno  3  0  2
#1003 iunit   B   C
          <1> <2> <3> <4> <5>
#1013 axname X  Y  Z
#1019 dia     1  0  0  0  0

[Machine position]
X 12345.678 1st PLC axis 100.0000
Y -12345.678 2nd PLC axis 100.0000 ]
Z 12345.678 ><
    
```

<When the data type is binary type (0)>

Command

Response

Offset	Data name	Setting example	Offset	Data name	Response example
0	Data size	20	0	Data size	72
1	Reserved	0	1	Reserved	0
2	Command code	0x0F03	2	Command code	0x0F03
3	Reserved	0	3	Reserved	0
4 to 5	Part system No.	1	4 to 5	Error code	0x00000000
6 to 7	Axis to get	0 (all axes)	6 to 7	1st NC axis coordinate value in the part system	12345678(0x00BC614E)
8 to 9	Type of coordinate value	0 (machine position)	8 to 9	2nd NC axis coordinate value in the part system	-24691356(0xFE873D64)
10 to 11	Data type	0	10 to 11	3rd NC axis coordinate value in the part system	24691356(0x0178C29C)
			12 to 13	4th NC axis coordinate value in the part system	0
			14 to 15	5th NC axis coordinate value in the part system	0
			16 to 17	6th NC axis coordinate value in the part system	0
			18 to 19	7th NC axis coordinate value in the part system	0
			20 to 21	8th NC axis coordinate value in the part system	0
			22 to 23	1st PLC axis coordinate value	2000000(0x001E8480)
			24 to 25	2nd PLC axis coordinate value	2000000(0x001E8480)
			26 to 27	3rd PLC axis coordinate value	0
			28 to 29	4th PLC axis coordinate value	0
			30 to 31	5th PLC axis coordinate value	0
			32 to 33	6th PLC axis coordinate value	0
			34 to 35	7th PLC axis coordinate value	0
			36 to 37	8th PLC axis coordinate value	0

<When the data type is character string type (1)>

Command

Response

Offset	Data name	Setting example	Offset	Data name	Response example
0	Data size	20	0	Data size	200
1	Reserved	0	1	Reserved	0
2	Command code	0x0F03	2	Command code	0x0F03
3	Reserved	0	3	Reserved	0
4 to 5	Part system No.	1	4 to 5	Error code	0x00000000
6 to 7	Axis to get	0 (all axes)	6 to 11	1st NC axis coordinate value in the part system	" 12345.678 "
8 to 9	Type of coordinate value	0 (machine position)	12 to 17	2nd NC axis coordinate value in the part system	" -12345.678 "
10 to 11	Data type	1	18 to 23	3rd NC axis coordinate value in the part system	" 12345.678 "
			24 to 29	4th NC axis coordinate value in the part system	" "
			30 to 35	5th NC axis coordinate value in the part system	" "
			36 to 41	6th NC axis coordinate value in the part system	" "
			42 to 47	7th NC axis coordinate value in the part system	" "
			48 to 53	8th NC axis coordinate value in the part system	" "
			54 to 59	1st PLC axis coordinate value	" 100.0000 "
			60 to 65	2nd PLC axis coordinate value	" 100.0000 "
			66 to 71	3rd PLC axis coordinate value	" "
			72 to 77	4th PLC axis coordinate value	" "
			78 to 83	5th PLC axis coordinate value	" "
			84 to 89	6th PLC axis coordinate value	" "
			90 to 95	7th PLC axis coordinate value	" "
			96 to 101	8th PLC axis coordinate value	" "

[Coordinate value to be acquired]
 X 12345.678 1st PLC axis 100.0000
 Y -12345.678 2nd PLC axis 100.0000]]
 Z 12345.678 ><

Example of how to store 12345.678

+0	' '	' '
+1	'2'	'1'
+2	'4'	'3'
+3	'.'	'5'
+4	'7'	'6'
+5	' '	'8'

<When the data type is extended character string type (2)>

Command

Response

Offset	Data name	Setting example	Offset	Data name	Response example
0	Data size	20	0	Data size	248
1	Reserved	0	1	Reserved	0
2	Command code	0x0F03	2	Command code	0x0F03
3	Reserved	0	3	Reserved	0
4 to 5	Part system No.	1	4 to 5	Error code	0x00000000
6 to 7	Axis to get	0 (all axes)	6 to 13	1st NC axis coordinate value in the part system	" 12345.678 "
8 to 9	Type of coordinate value	0 (machine position)	14 to 21	2nd NC axis coordinate value in the part system	" -12345.678 "
10 to 11	Data type	2	22 to 29	3rd NC axis coordinate value in the part system	" 12345.678 >< "
			30 to 37	4th NC axis coordinate value in the part system	" "
			38 to 45	5th NC axis coordinate value in the part system	" "
			46 to 53	6th NC axis coordinate value in the part system	" "
			54 to 61	7th NC axis coordinate value in the part system	" "
			62 to 69	8th NC axis coordinate value in the part system	" "
			70 to 77	1st PLC axis coordinate value	" 100.0000 "
			78 to 85	2nd PLC axis coordinate value	" 100.0000][" "
			86 to 93	3rd PLC axis coordinate value	" "
			94 to 101	4th PLC axis coordinate value	" "
			102 to 109	5th PLC axis coordinate value	" "
			110 to 117	6th PLC axis coordinate value	" "
			118 to 125	7th PLC axis coordinate value	" "

[Coordinate value to be acquired]
 X 12345.678 1st PLC axis 100.0000
 Y -12345.678 2nd PLC axis 100.0000]["
 Z 12345.678 ><

Example of how to store 12345.678><

+0	' '	' '
+1	'2'	'1'
+2	'4'	'3'
+3	'.'	'5'
+4	'7'	'6'
+5	' '	'8'
+6	'<'	'>'
+7		

7.4.4 Acquisition of Alarm Message which is Occurring (0xF04)

This command acquires the alarm which is occurring.

Command area

Offset	Data name	Setting detail
0	Data size (byte)	16
1	Reserved	
2	Command code	0x0F04
3	Reserved	
4 to 5	Argument 1: Part system No.	1 to 7: 1st to 7th part systems ("0" specifies all part systems.)
6 to 7	Argument 2: Number of request messages	1 to 5
8 to 9	Argument 3: Alarm type	BIT0: NC alarm BIT1: Stop code Acquires the alarm message with the corresponding BIT ON.

Response area

Offset	Data name	Response detail
0	Data size (byte)	12 + 48 x Number of request messages
1	Reserved	0
2	Command code	0x0F04
3	Reserved	0
4 to 5	Error code	0: Normally finished (No error), Other than "0": Error
6 to 7	Number of acquired messages	1 to 5 (Number of acquired alarm messages)
8	Alarm code (1)	Alarm message (42 characters *1) - When the number of occurring alarms is less than 5, the rest is filled with zeros. - NC alarm/stop code language is set by "#1043 lang". Alarm code (n) - Error code of the alarm is stored with a two-word numerical value. - For the correspondence between the alarm and the error code, refer to "C80 Series Maintenance Manual". "0" is stored in all the reserved parts (4 characters).
9 to 10	Reserved	
11 to 31	Alarm message (1)	
32	Alarm code (2)	
33 to 34	Reserved	
35 to 55	Alarm message (2)	
56	Alarm code (3)	
57 to 58	Reserved	
59 to 79	Alarm message (3)	
80	Alarm code (4)	
81 to 82	Reserved	
83 to 103	Alarm message (4)	
104	Alarm code (5)	
105 to 106	Reserved	
107 to 127	Alarm message (5)	

*1 Format of alarm message (42 characters)

<NC alarm/stop code>

Message (20 characters)	(a)	(b)	\$n						
	(a)	(b)							

(a) Error No. 1 (4 or 5 characters)

(b) Error No. 2 (8 or 7 characters)

\$n Part system No.

The part without description is blank.

Axis name displayed in the error No. 1 or 2:

The axis name with alarm is output as follows depending on the axis type:

Axis type	Axis name
NC axis	Setting value by "#1013 axname"
PLC axis	PLC axis No. (For example, if it is PLC 1st axis, the name becomes "1".)
Spindle	S, T, M, N, P, Q, R from 1st spindle to 7th spindle in order.

[Usage example]

Command

Response

Offset	Data name	Setting example	Offset	Data name	Response example
0	Data size		0	Data size	252
1	Reserved	0	1	Reserved	0
2	Command code	0x0F04	2	Command code	0x0F04
3	Reserved	0	3	Reserved	0
4 to 5	Part system No.	1	4 to 5	Error code	0x00000000
6 to 7	Number of request messages	5	6 to 7	Number of acquired messages	2 (Number of actually acquired)
8 to 9	Alarm type	0x00000003	8	Alarm code (1)	0x1A8D
			9 to 10	Reserved	0
			11 to 31	Alarm message (1)	"S03Excessive error 1 0052 XYZ \$1 "
			32	Alarm code (2)	0x1B44
			33 to 34	Reserved	0
			35 to 55	Alarm message (2)	"EMG Emergency stop EXIN \$1 "
			56	Alarm code (3)	0
			57 to 58	Reserved	0
			59 to 79	Alarm message (3)	0
			80	Alarm code (4)	0
			81 to 82	Reserved	0
			83 to 103	Alarm message (4)	0
			104	Alarm code (5)	0
			105 to 106	Reserved	0
			107 to 127	Alarm message (5)	0

[Alarm which is occurring]
 S03 Servo alarm 0052 XYZ
 EMG Emergency stop EXIN

7.4.5 Alarm History Acquisition (0xF05)

This command acquires the alarm history.

Command area

Offset	Data name	Setting detail
0	Data size (byte)	12
1	Reserved	
2	Command code	0x0F05
3	Reserved	
4 to 5	Argument 1: Acquisition start history No. (*1)	0 to 511 (Specify how old the initial history is in the range of historical data to be acquired.)
6 to 7	Argument 2: Number of request histories (*1)	1 to 4

*1 When the acquisition start history No. is "m" and the number of request histories is "n", this command acquires the histories that start from the m-th from the most recent one and that end with the (m+n-1)-th.

(Example)

When acquiring four histories beginning with the most recent one ->

Acquisition start history No. = 0, Number of request histories = 4

When acquiring three histories preceding the last four histories ->

Acquisition start history No. = 4, Number of request histories = 3

Response area

Offset	Data name	Response detail
0	Data size (byte)	12 + 60 x Number of request histories
1	Reserved	0
2	Command code	0x0F05
3	Reserved	0
4 to 5	Error code	0: Normally finished (No error), Other than "0": Error
6 to 7	The number of history items got	1 to 4 (Number of acquired histories)
8 to 37	Alarm history (1)	Alarm history (60 characters *2) - Store the history within the requested range from the new one in order. - When the number of acquired histories is less than 4, blank is stored in the history data for that part. - Alarm message language is set by "#1043 lang".
38 to 67	Alarm history (2)	
68 to 97	Alarm history (3)	
98 to 127	Alarm history (4)	

*2 Format of history data

Y	Y	/	M	M	/	D	D		h	h	:	m	m	:	s	s		Alarm message (42 characters)
---	---	---	---	---	---	---	---	--	---	---	---	---	---	---	---	---	--	-------------------------------

YY/MM/DD: year/month/date

hh:mm:ss: hour/minute/second

Alarm message: The content is the same as Acquisition of alarm message which is occurring command (0xF04).

The part without description is blank.

[Usage example]

Command

Response

Offset	Data name	Setting example	Offset	Data name	Response example
0	Data size	12	0	Data size	252
1	Reserved	0	1	Reserved	0
2	Command code	0x0F05	2	Command code	0x0F05
3	Reserved	0	3	Reserved	0
4 to 5	Acquisition start history No.	0	4 to 5	Error code	0x00000000
6 to 7	Number of acquired histories	4	6 to 7	The number of history items got	4
			8 to 37	Alarm history (1)	"15/02/01 09:31:00 EMG Emergency stop EXIN \$2 "
			38 to 67	Alarm history (2)	"15/02/01 09:31:00 EMG Emergency stop EXIN \$1 "
			68 to 97	Alarm history (3)	"15/02/01 09:30:59 S03 Excessive error 1 0052 XYZ \$1 "
			98 to 127	Alarm history (4)	"15/01/31 16:59:10 M01 No operation mode 0101 \$1 "

7.5 Error Code

The details corresponding to the error code of response area are as follows:

List of error codes

Error code	Details
0x00000000	Normally finished (No error)
0x80010002	Command code is illegal.
0x80040190	Value which is out of the range is set to the argument.
0x80040196	The specified data cannot fit in the response area. (Example: With Acquisition of currently running program (0xF01), the value of number of acquired lines x number of characters in one line exceeds 240.)

Appx.4: List of Option Status Exported to PLC [M8]

R register No.	Bit location	Additional specification	R register No.	Bit location	Additional specification
R8260	0	Max. number of axes (32 axes)	R8262	0	
	1	Max. number of NC axes in a part system (12 axes)		1	
	2			2	
	3			3	
	4	Max. number of part systems (8 part systems)		4	
	5			5	
	6			6	
	7			7	
	8	Least command increment 0.01 μm (10 nm)		8	Feed per revolution (synchronous feed)
	9	Least command increment 0.001 μm (1 nm)		9	Inverse time feed
	A			A	Manual speed command
	B			B	G00 feedrate designation (,F command)
	C			C	
	D			D	
E		E			
F		F			
R8261	0	Program format switch	R8263	0	Rapid traverse constant-gradient multi-step acceleration/deceleration
	1			1	
	2			2	
	3			3	
	4			4	Thread cutting (lead/thread number designation)
	5	Unidirectional positioning		5	Pecking tapping cycle/Deep-hole tapping cycle
	6	Spiral/Conical interpolation		6	
	7	Cylindrical interpolation		7	Circular thread cutting
	8	Polar coordinate interpolation/Milling interpolation		8	
	9	Hypothetical axis interpolation		9	High-speed synchronous tapping (OMR-DD)
	A	Involute interpolation		A	
	B	Exponential interpolation		B	Thread recutting
	C	Spline interpolation (G05.1Q2/G61.2)		C	Thread cutting override
	D	NURBS interpolation		D	Variable feed thread cutting
E	3-dimensional circular interpolation	E			
F	Spline interpolation 2 (G61.4)	F			

8 Appx.4: List of Option Status Exported to PLC [M8]

R register No.	Bit location	Additional specification	R register No.	Bit location	Additional specification
R8264	0		R8266	0	
	1			1	Control unit-side SD card I/F [up to 32 GB]
	2			2	Computer link B
	3			3	Handy terminal connection
	4	Manual feedrate B surface speed control		4	
	5			5	
	6			6	
	7			7	
	8	Memory capacity (2560m) (1000 programs)		8	Spindle-mode servo motor control
	9	Memory capacity (5120m) (1000 programs)		9	Spindle-mode rotary axis control
	A			A	C axis control during Spindle synchronization
	B			B	Spindle synchronization I/Spindle synchronization II
	C			C	Guide bushing spindle synchronization
	D			D	Tool spindle synchronization IA/IB (spindle-spindle, polygon)
E		E	Tool spindle synchronization IC (spindle-NC axis, polygon)		
F		F	Tool spindle synchronization II (hobbing)		
R8265	0	Special program editing display for synchronization between part systems	R8267	0	Spindle oscillation
	1	Finish shape view programming		1	Spindle superimposition control
	2			2	Spindle speed fluctuation detection
	3			3	
	4			4	
	5			5	
	6			6	
	7			7	
	8	Machining program input mistake check warning		8	
	9	Remote desktop connection		9	
	A			A	
	B			B	
	C			C	Tool position compensation (G43.7)/Tool nose radius compensation (G40/41/42)
	D			D	
E		E			
F		F			

R register No.	Bit location	Additional specification	R register No.	Bit location	Additional specification
R8268	0	Number of tool offset sets (128 sets)	R8270	0	Tool retract and return
	1	Number of tool offset sets (256 sets)		1	
	2	Number of tool offset sets (400 sets)		2	
	3	Number of tool offset sets (999 sets)		3	
	4			4	
	5			5	
	6			6	
	7			7	
	8	Extended workpiece coordinate system selection (48 sets) G54.1P1 to P48		8	Figure rotation
	9	Extended workpiece coordinate system selection (96 sets) G54.1P1 to P96		9	Scaling
	A	Extended workpiece coordinate system selection (300 sets) G54.1P1 to P300		A	
	B			B	
	C			C	User macro
	D			D	
E		E			
F		F			
R8269	0	Workpiece coordinate system preset (G92.1)	R8271	0	Variable command (700 sets)
	1	Workpiece position offset for rotary axis		1	Variable command (8000 sets)
	2			2	
	3			3	
	4			4	
	5			5	
	6			6	
	7			7	
	8	Graphic check rotary axis drawing/Graphic trace rotary axis drawing		8	Special fixed cycle
	9	Manual arbitrary reverse run (program check operation)		9	Fixed cycle for turning machining
	A	High-speed simple program check		A	Compound type fixed cycle for turning machining
	B			B	Compound type fixed cycle for turning machining (type II)
	C			C	Small-diameter deep-hole drilling cycle
	D			D	
E		E			
F		F			

R register No.	Bit location	Additional specification	R register No.	Bit location	Additional specification
R8272	0		R8274	0	Control axis synchronization between part systems
	1			1	Two-part system simultaneous thread cutting
	2			2	Single block between part systems
	3			3	Dwell/Miscellaneous function time override
	4	Coordinate rotation by program		4	Synchronization between part systems OFF
	5	Coordinate rotation by parameter		5	Sub part system control I
	6	3-dimensional coordinate conversion		6	Sub part system control II
	7			7	
	8			8	
	9			9	
	A			A	
	B			B	
	C	Corner chamfering/Corner R		C	
	D	Linear angle command		D	
	E	Geometric command		E	
F	Polar coordinate command	F			
R8273	0		R8275	0	Rapid traverse block overlap (G0/G28/G30)
	1			1	
	2			2	
	3			3	
	4	Chopping		4	Automatic error detection
	5			5	
	6			6	
	7			7	
	8			8	High-speed machining mode I (G05P1)
	9			9	High-speed machining mode II (G05P2)
	A			A	
	B			B	
	C	Mixed control (cross axis control)		C	
	D	Arbitrary axis exchange control		D	High-accuracy control (G61.1/G08)
	E	Control axis superimposition		E	Multi-part system simultaneous high-accuracy control
F	Arbitrary axis superimposition control	F	SSS control		

R register No.	Bit location	Additional specification	R register No.	Bit location	Additional specification
R8276	0	Variable-acceleration pre-interpolation acceleration/deceleration	R8278	0	Position-dependent gradually increasing-type backlash compensation
	1	High-accuracy acceleration/deceleration time constant extension		1	Bidirectional pitch error compensation
	2	Axis-specific acceleration tolerance control		2	
	3			3	Spatial error compensation
	4			4	
	5	High-speed high-accuracy control I (G05.1Q1)		5	
	6	High-speed high-accuracy control II (G05P10000)		6	
	7	High-speed high-accuracy control III (G05P20000)		7	
	8			8	
	9			9	
	A			A	
	B	Smooth fairing		B	
	C	Direct command mode		C	
	D			D	OMR II (backlash with filter)
E		E			
F		F	OMR-FF		
R8277	0		R8279	0	
	1			1	
	2			2	
	3			3	
	4	Playback		4	
	5	Interactive cycle insertion		5	
	6	Simple programming (NAVI MILL/LATHE)		6	
	7			7	
	8			8	
	9			9	
	A			A	
	B			B	
	C	External machine coordinate system compensation		C	
	D	Circular radius error compensation		D	
E	Ball screw thermal expansion compensation	E	PLC skip		
F	Rotation center error compensation	F	Speed change skip		

8 Appx.4: List of Option Status Exported to PLC [M8]

R register No.	Bit location	Additional specification	R register No.	Bit location	Additional specification
R8280	0	Torque limitation skip	R8282	0	Chuck/Tailstock barrier check
	1	Workpiece coordinate offset measurement		1	Interlock
	2			2	Interference check III
	3			3	3D machine interference check
	4			4	Data protection by user's level
	5			5	
	6			6	Machine group-based alarm stop
	7			7	
	8			8	
	9			9	
	A			A	
	B			B	
	C	Tool life management IB		C	
	D	Tool life management IIB		D	
	E			E	
F		F			
R8281	0	Number of tool life management sets (128 sets)	R8283	0	Email notification to operator
	1	Number of tool life management sets (256 sets)		1	Safety observation/Smart Safety observation
	2	Number of tool life management sets (400 sets)		2	
	3	Number of tool life management sets (999 sets)		3	
	4			4	Pallet program registration
	5			5	
	6			6	
	7			7	
	8	Load monitoring I		8	Number of PLC projects: 3
	9			9	Number of PLC projects: 6
	A			A	
	B			B	
	C	Stored stroke limit IB		C	Memory switch (PLC switch) 64 points
	D	Stored stroke limit IIB		D	Memory switch (PLC switch) 96 points
	E	Stored stroke limit IC		E	
F	Stroke check before travel	F			

R register No.	Bit location	Additional specification	R register No.	Bit location	Additional specification
R8284	0	Large PLC capacity: 256000 steps	R8286	0	
	1	Large PLC capacity: 512000 steps		1	
	2			2	
	3			3	
	4	Synchronous control		4	Circular feed in manual mode
	5	Inclined axis control		5	
	6			6	NC axis/PLC axis switchover
	7	Tool length compensation along the tool axis		7	
	8	Tool handle feed & interruption		8	
	9	Tool center point control/Tool center coordinate display		9	
	A	Inclined surface machining command		A	
	B	Simple inclined surface machining command		B	
	C	3-dimensional tool radius compensation		C	
	D	3-dimensional tool radius compensation (tool's vertical-direction compensation)		D	
	E	Workpiece installation error compensation		E	
F	3-dimensional manual feed	F			
R8285	0	R-Navi	R8287	0	APLC release
	1			1	MES interface library
	2	Real-time tuning 1 (speed gain)		2	
	3	Real-time tuning 2 (rapid traverse time constant)		3	
	4			4	System lock
	5			5	
	6			6	
	7			7	
	8			8	
	9			9	
	A			A	
	B			B	
	C			C	
	D			D	
	E			E	
F		F			

R register No.	Bit location	Additional specification
R8288	0	
	1	
	2	
	3	
	4	
	5	
	6	
	7	
	8	
	9	
	A	
	B	
	C	
	D	
	E	
	F	
R8289	0	
	1	
	2	
	3	
	4	
	5	
	6	
	7	
	8	
	9	
	A	
	B	
	C	
	D	
	E	
	F	

Index

Numbers

\$1 to \$8 DISPLAY	168
1ST CUTTING FEEDRATE OVERRIDE	568
1ST HANDLE AXIS SELECTION CODE m	446
1ST HANDLE VALID	447
1ST HANDLE/INCREMENTAL FEED MAGNIFICATION	571
1ST REFERENCE POSITION REACHED n-TH AXIS	174
24 HOURS CONTINUOUS OPERATION	165
2ND CUTTING FEEDRATE OVERRIDE	568
2ND CUTTING FEEDRATE OVERRIDE VALID	454
2ND HANDLE AXIS SELECTION CODE m	447
2ND HANDLE FEED MAGNIFICATION	571
2ND HANDLE VALID	447
2ND M FUNCTION DATA 1 to 4	294
2ND M FUNCTION STROBE 1 to 4	218
2ND REFERENCE POSITION REACHED n-TH AXIS	175
2ND REFERENCE POSITION RETURN INTERLOCK	478
3D coordinate conversion: Manual feed coordinates conversion [M8]	491
3D coordinate conversion: Manual feed valid [M8]	236
3D MACHINE INTERFERENCE CHECK : ENABLED SHAPE GROUP NO. 1 to 4 [M8]	599
3D MACHINE INTERFERENCE CHECK : REQUESTED SHAPE GROUP NO. 1 to 4 [M8]	315
3D manual feed (1st handle) in feature coordinate system	492
3D manual feed (1st handle) in table coordinate system	492
3D manual feed (1st handle) in tool axis coordinate system	492
3D manual feed (2nd handle) in feature coordinate system	492
3D manual feed (2nd handle) in table coordinate system	492
3D manual feed (2nd handle) in tool axis coordinate system	492
3D manual feed (3rd handle) in feature coordinate system	493
3D manual feed (3rd handle) in table coordinate system	493
3D manual feed (3rd handle) in tool axis coordinate system	493
3D manual feed (JOG, INC) in feature coordinate system	492
3D manual feed (JOG, INC) in table coordinate system	492
3D manual feed (JOG, INC) in tool axis coordinate system	492
3RD HANDLE AXIS SELECTION CODE m	447
3RD HANDLE FEED MAGNIFICATION	571
3RD HANDLE VALID	447
3RD REFERENCE POSITION REACHED n-TH AXIS	175
4TH HANDLE AXIS SELECTION CODE m [C80]	643
4TH HANDLE FEED MAGNIFICATION [C80]	644
4TH HANDLE VALID [C80]	643
4TH REFERENCE POSITION REACHED n-TH AXIS	175
5TH HANDLE AXIS SELECTION CODE m [C80]	643
5TH HANDLE FEED MAGNIFICATION [C80]	644
5TH HANDLE VALID [C80]	643
6TH HANDLE AXIS SELECTION CODE m [C80]	643
6TH HANDLE FEED MAGNIFICATION [C80]	644
6TH HANDLE VALID [C80]	643
7TH HANDLE AXIS SELECTION CODE m [C80]	643

7TH HANDLE FEED MAGNIFICATION [C80]	644
7TH HANDLE VALID [C80]	643
8TH HANDLE AXIS SELECTION CODE m [C80]	643
8TH HANDLE FEED MAGNIFICATION [C80]	644
8TH HANDLE VALID [C80]	643
9TH HANDLE AXIS SELECTION CODE m [C80]	643
9TH HANDLE FEED MAGNIFICATION [C80]	644
9TH HANDLE VALID [C80]	643

A

Absolute position data loss	333
Absolute position power shutoff movement over	332
ABSOLUTE POSITION WARNING	227
ACTUAL CUTTING MODE (THREAD, TAP) IN MANUAL ARBITRARY REVERSE RUN	381
Alarm 1	332
Alarm 2	332
Alarm 4	332
ALARM MESSAGE I/F 1 to 4	576
ALL AXES IN-POSITION	197
ALL AXES SMOOTHING ZERO	197
ANALOG INPUT m	275
ANALOG OUTPUT m	537
APLC VERSION	544
ARBITRARY AXIS SUPERIMPOSITION COMPLETE n-TH AXIS [M8]	176
Arbitrary point feed command valid	614
ARBITRARY POSITION COMMAND INCREMENTAL COMMAND SELECTION [C80]	616
ATC CONTROL PARAMETER	621
AUTOMATIC ERROR DETECTION [M8]	484
AUTOMATIC INITIALIZATION MODE	417
AUTOMATIC INTERLOCK- n-TH AXIS	393
AUTOMATIC INTERLOCK+ n-TH AXIS	393
AUTOMATIC MACHINE LOCK n-TH AXIS	395
Automatic operation mode	618
AUTOMATIC OPERATION "PAUSE" COMMAND (Feed hold)	420
AUTOMATIC OPERATION "START" COMMAND (Cycle start)	419
AUTOMATIC POWER OFF REQUEST [M8]	379
AUTOMATIC RESTART	427
Automatic set position reached	337
AXIS SELECTED n-TH AXIS	172
Axis selection output	335

B

BALL SCREW THERMAL DISPLACEMENT COMPENSATION COMPENSATION AMOUNT n-TH AXIS	281
BALL SCREW THERMAL DISPLACEMENT COMPENSATION MAX. COMPENSATION AMOUNT n-TH AXIS	561
BALL SCREW THERMAL DISPLACEMENT COMPENSATION OFFSET AMOUNT n-TH AXIS	561
BALL SCREW THERMAL DISPLACEMENT COMPENSATION PART-SYSTEM, AXIS NO. n-TH AXIS	561
BARRIER CHECK INVALID	483
BARRIER VALID (LEFT)	480
BARRIER VALID (RIGHT)	480
Base PLC mounting check	340
Basic point initialization setting mode	619
Basic point setting	620
BASIC POSITION → UPPER DEAD POINT PATH FLAG	219
BATTERY ALARM	161
BATTERY DROP CAUSE	277
BATTERY WARNING	160
BiSS encoder I/F: Communication status	742
BiSS encoder I/F: Encoder 1 data output 1 to 4	742
BLOCK START INTERLOCK	421

BOARD RESET	159
BOTTOM DEAD POINT → UPPER DEAD POINT PATH FLAG	219
BUZZER SOUND CONTROL: BUZZER ON [M8]	534

C

C AXIS SELECTION	577
CHAMFERING	426
CHOPPING	442
CHOPPING COMPENSATION UPDATE PREVENTION REQUEST	480
CHOPPING COMPENSATION UPDATED PREVENTED	219
CHOPPING CONTROL DATA ADDRESS	578
CHOPPING ERROR NO.	295
CHOPPING OVERRIDE	569
CHOPPING PARAMETER VALID	444
CHUCK CLOSE	531
CHUCK CLOSE CONFIRMATION	262
CIRCULAR FEED IN MANUAL MODE BASIC POINT H DATA [M8]	597
CIRCULAR FEED IN MANUAL MODE BASIC POINT V DATA [M8]	597
CIRCULAR FEED IN MANUAL MODE CURRENT POSITION H [M8]	308
CIRCULAR FEED IN MANUAL MODE CURRENT POSITION V [M8]	308
CIRCULAR FEED IN MANUAL MODE GRADIENT/ARC CENTER H DATA [M8]	598
CIRCULAR FEED IN MANUAL MODE GRADIENT/ARC CENTER V DATA [M8]	598
CIRCULAR FEED IN MANUAL MODE OPERATION MODE DATA [M8]	596
CIRCULAR FEED IN MANUAL MODE TRAVEL RANGE H (-) DATA [M8]	597
CIRCULAR FEED IN MANUAL MODE TRAVEL RANGE H (+) DATA [M8]	597
CIRCULAR FEED IN MANUAL MODE TRAVEL RANGE V (-) DATA [M8]	597
CIRCULAR FEED IN MANUAL MODE TRAVEL RANGE V (+) DATA [M8]	597
CIRCULAR FEED IN MANUAL MODE VALID [M8]	460
CLAMP COMMAND n-TH AXIS	183
CLAMP COMPLETION n-TH AXIS	408
CLOCK DATA DATE/HOUR	276
CLOCK DATA MINUTE/SECOND	276
CLOCK DATA YEAR/MONTH	276
CNC COMPLETION STANDBY STATUS	296
CNC SOFTWARE VERSION CODE	277
COLLECTING DIAGNOSIS DATA	164
COLLECTING DIAGNOSIS DATA STOP	372
COMMON VARIABLE READ/WRITE ERROR CODE [C80]	290
COMMON VARIABLE READ/WRITE ERROR PART [C80]	290
CONNECTION STATUS OF EACH CHANNEL RIO3 [M8]	340
CONNECTION STATUS OF EACH CHANNEL RIO1,2 [M8]	339
CONSTANT TORQUE CONTROL: AXIS UNDER CONSTANT TORQUE/ PROPORTIONAL TORQUE STOPPER CONTROL [M8]	307
CONSTANT TORQUE CONTROL: CONSTANT TORQUE DROOP CANCEL AXIS STATUS [M8]	307
CONSTANT TORQUE CONTROL: CONSTANT TORQUE DROOP CANCEL REQUEST AXIS [M8]	592
CONSTANT TORQUE CONTROL: CONSTANT TORQUE/PROPORTIONAL TORQUE STOPPER CONTROL REQUEST AXIS [M8]	591
CONTACTOR SHUTOFF TEST	378
CONTROL AXIS DETACHMENT 2 n-TH AXIS ..	403
CONTROL AXIS DETACHMENT n-TH AXIS	390

CONTROL UNIT TEMPERATURE	279
CONTROLLER READY COMPLETION	191
Controller ready completion	336
COORDINATE ROTATION BY PARAMETER: COORDINATE SWITCH FOR MANUAL FEED [M8]	460
COORDINATE ROTATION BY PARAMETER: MANUAL FEED COORDINATE SYSTEM [M8]	213
COUNTER ZERO [C80]	410
CRT CHANGEOVER COMPLETION [M8]	371
CURRENT DETECTION	246
CURRENT LIMIT CHANGEOVER	584
CURRENT LIMIT CHANGEOVER n-TH AXIS	401
CURRENT LIMIT MODE 1	477
CURRENT LIMIT MODE 2	477
CURRENT LIMIT REACHED n-TH AXIS	178
Current spatial error compensation value (1st rotary axis) [M8]	356
Current spatial error compensation value (2nd rotary axis) [M8]	356
Current spatial error compensation value (orthogonal coordinate height axis) [M8]	356
Current spatial error compensation value (orthogonal coordinate horizontal axis) [M8]	356
Current spatial error compensation value (orthogonal coordinate vertical axis) [M8]	356
CUTTING BLOCK START INTERLOCK	421
CUTTING FEEDRATE OVERRIDE CODE m	453
CUTTING FEEDRATE OVERRIDE METHOD SELECTION	454

D

DATA I/O REGISTER FOR MES INTERFACE LIBRARY (Alarm number 1)	726
DATA I/O REGISTER FOR MES INTERFACE LIBRARY (Alarm number 2)	726
DATA I/O REGISTER FOR MES INTERFACE LIBRARY (Alarm number 3)	726
DATA I/O REGISTER FOR MES INTERFACE LIBRARY (Alarm number 4)	726
DATA I/O REGISTER FOR MES INTERFACE LIBRARY (Arbitrary user area C1)	729
DATA I/O REGISTER FOR MES INTERFACE LIBRARY (Arbitrary user area L1 to L10)	729
DATA I/O REGISTER FOR MES INTERFACE LIBRARY (Arbitrary user area S1 to S20)	729
DATA I/O REGISTER FOR MES INTERFACE LIBRARY (B number at alarm)	727
DATA I/O REGISTER FOR MES INTERFACE LIBRARY (B number at machining start)	722
DATA I/O REGISTER FOR MES INTERFACE LIBRARY (Common user area C1)	721
DATA I/O REGISTER FOR MES INTERFACE LIBRARY (Common user area L1 to L10)	721
DATA I/O REGISTER FOR MES INTERFACE LIBRARY (Cycle time)	722
DATA I/O REGISTER FOR MES INTERFACE LIBRARY (G code modal)	727
DATA I/O REGISTER FOR MES INTERFACE LIBRARY (Line number)	721
DATA I/O REGISTER FOR MES INTERFACE LIBRARY (Machine type)	721
DATA I/O REGISTER FOR MES INTERFACE LIBRARY (Machining end time)	722
DATA I/O REGISTER FOR MES INTERFACE LIBRARY (Machining start time)	721
DATA I/O REGISTER FOR MES INTERFACE LIBRARY (N number at alarm)	727
DATA I/O REGISTER FOR MES INTERFACE LIBRARY (N number at machining start)	722

DATA I/O REGISTER FOR MES INTERFACE LIBRARY (NC unit number)	720	DATA PROTECT KEY 3	366
DATA I/O REGISTER FOR MES INTERFACE LIBRARY (Number of machined workpieces)	723	DETAILED SCREEN NO.	540
DATA I/O REGISTER FOR MES INTERFACE LIBRARY (Operator ID)	720	Diagnosis data output: Accumulated travel distance (motor)	734
DATA I/O REGISTER FOR MES INTERFACE LIBRARY (Power consumption amount)	723	Diagnosis data output: Automatic log clear time [M8]	733
DATA I/O REGISTER FOR MES INTERFACE LIBRARY (Power regeneration amount)	723	Diagnosis data output: Battery exchange (drive)	732
DATA I/O REGISTER FOR MES INTERFACE LIBRARY (Program number at alarm)	726	Diagnosis data output: Battery exchange [M8]	732
DATA I/O REGISTER FOR MES INTERFACE LIBRARY (Program number at machining start)	722	DIAGNOSIS DATA OUTPUT: CAUTION IN SERVO MOTOR INSULATION DETERIORATION DETECTION (PLC AXIS) [C80]	354
DATA I/O REGISTER FOR MES INTERFACE LIBRARY (Serial number)	720	DIAGNOSIS DATA OUTPUT: CAUTION IN SERVO MOTOR INSULATION DETERIORATION DETECTION [C80]	357
DATA I/O REGISTER FOR MES INTERFACE LIBRARY (Spindle 1 load value)	727	DIAGNOSIS DATA OUTPUT: CAUTION IN SPINDLE MOTOR INSULATION DETERIORATION DETECTION [C80]	356
DATA I/O REGISTER FOR MES INTERFACE LIBRARY (Spindle 1 maximum load)	722	DIAGNOSIS DATA OUTPUT: HANDLING FOR SERVO MOTOR INSULATION DETERIORATION DETECTION (PLC AXIS) [C80]	351
DATA I/O REGISTER FOR MES INTERFACE LIBRARY (Spindle 2 load value)	727	DIAGNOSIS DATA OUTPUT: HANDLING FOR SERVO MOTOR INSULATION DETERIORATION DETECTION [C80]	357
DATA I/O REGISTER FOR MES INTERFACE LIBRARY (Spindle 2 maximum load)	723	DIAGNOSIS DATA OUTPUT: HANDLING FOR SPINDLE MOTOR INSULATION DETERIORATION DETECTION [C80]	355
DATA I/O REGISTER FOR MES INTERFACE LIBRARY (Subprogram number at alarm)	726	DIAGNOSIS DATA OUTPUT: MOTOR INSULATION DEGRADATION DETECTION REQUEST [M8]	639
DATA I/O REGISTER FOR MES INTERFACE LIBRARY (Time of alarm occurrence)	725	Diagnosis data output: Motor insulation resistance (motor)	733
DATA I/O REGISTER FOR MES INTERFACE LIBRARY (Time of power ON)	726	DIAGNOSIS DATA OUTPUT: SELECT AXIS FOR SERVOMOTOR INSULATION DEGRADATION DETECTION (PLC AXIS) [M8]	638
DATA I/O REGISTER FOR MES INTERFACE LIBRARY (Tool length offset 1 to 5)	724	DIAGNOSIS DATA OUTPUT: SELECT AXIS FOR SERVOMOTOR INSULATION DEGRADATION DETECTION [M8]	641
DATA I/O REGISTER FOR MES INTERFACE LIBRARY (Tool length offset)	728	DIAGNOSIS DATA OUTPUT: SELECT SPINDLE FOR MOTOR INSULATION DEGRADATION DETECTION [M8]	639
DATA I/O REGISTER FOR MES INTERFACE LIBRARY (Tool length wear amount 1 to 5)	724	DIAGNOSIS DATA OUTPUT: SERVO MOTOR EXCHANGE DUE TO INSULATION DETERIORATION DETECTION (PLC AXIS) [C80]	355
DATA I/O REGISTER FOR MES INTERFACE LIBRARY (Tool length wear amount)	728	DIAGNOSIS DATA OUTPUT: SERVO MOTOR EXCHANGE DUE TO INSULATION DETERIORATION DETECTION [C80]	357
DATA I/O REGISTER FOR MES INTERFACE LIBRARY (Tool life 1 to 5)	725	DIAGNOSIS DATA OUTPUT: SERVOMOTOR INSULATION DEGRADATION DETECTION IN PROGRESS	357
DATA I/O REGISTER FOR MES INTERFACE LIBRARY (Tool life)	728	DIAGNOSIS DATA OUTPUT: SERVOMOTOR INSULATION DEGRADATION DETECTION IN PROGRESS (PLC AXIS)	353
DATA I/O REGISTER FOR MES INTERFACE LIBRARY (Tool number 1 to 5)	723	DIAGNOSIS DATA OUTPUT: SPINDLE MOTOR INSULATION DEGRADATION DETECTION IN PROGRESS	355
DATA I/O REGISTER FOR MES INTERFACE LIBRARY (Tool number)	727	DIAGNOSIS DATA OUTPUT: SPINDLE MOTOR EXCHANGE DUE TO INSULATION DETERIORATION DETECTION [C80]	356
DATA I/O REGISTER FOR MES INTERFACE LIBRARY (Tool offset number 1 to 5)	724	DIAGNOSIS DATA OUTPUT: WAITING FOR SERVO MOTOR INSULATION DETERIORATION DETECTION (PLC AXIS) [C80]	352
DATA I/O REGISTER FOR MES INTERFACE LIBRARY (Tool offset number)	728	DIAGNOSIS DATA OUTPUT: WAITING FOR SERVO MOTOR INSULATION DETERIORATION DETECTION [C80]	357
DATA I/O REGISTER FOR MES INTERFACE LIBRARY (Tool radius offset 1 to 5)	724	DIAGNOSIS DATA OUTPUT: WAITING FOR SPINDLE MOTOR INSULATION DETERIORATION DETECTION [C80]	355
DATA I/O REGISTER FOR MES INTERFACE LIBRARY (Tool radius offset)	728	DIO CARD INFORMATION [M8]	281
DATA I/O REGISTER FOR MES INTERFACE LIBRARY (Tool radius wear amount 1 to 5)	724	DIRECT SCREEN SELECTION [C80]	554
DATA I/O REGISTER FOR MES INTERFACE LIBRARY (Tool radius wear amount)	728	DIRECT SCREEN SELECTION [M8]	551
DATA I/O REGISTER FOR MES INTERFACE LIBRARY (User arbitrary C1 at machining end)	725	DISPLAY CHANGEOVER \$1 to \$8	374
DATA I/O REGISTER FOR MES INTERFACE LIBRARY (User arbitrary L1 to L10 at machining end)	725	DISPLAY LOCK	436
DATA I/O REGISTER FOR MES INTERFACE LIBRARY (User area C1 at alarm)	729	DISPLAY TOOL SELECTION PARAMETER	627
DATA I/O REGISTER FOR MES INTERFACE LIBRARY (User area L1 to L10 at alarm)	729	DISPLAYED SCREEN NO.	537
DATA PROTECT KEY (DS) [M8]	534		
DATA PROTECT KEY (MEMORY CARD) [M8]	534		
DATA PROTECT KEY 1	365		
DATA PROTECT KEY 2	365		

DOOR INTERLOCK SPINDLE SPEED CLAMP	482
DOOR OPEN ENABLE	233
DOOR OPEN I	384
DOOR OPEN II	482
DOOR OPEN SIGNAL INPUT (spindle speed monitor)	482
DROOP CANCEL REQUEST n-TH AXIS	402
DRY RUN	422
DRY RUN INVALID	484

E

E NUMBER OF SMART SAFETY OBSERVATION ERROR (SYSTEM COMMON)[C80]	710
E NUMBER OF SMART SAFETY OBSERVATION ERROR (SYSTEM COMMON)[M8]	710
EACH AXIS IN-POSITION n-TH AXIS	184
EACH AXIS MANUAL FEEDRATE B n-TH AXIS	599
EACH AXIS MANUAL FEEDRATE B VALID	459
EACH AXIS REFERENCE POSITION SELECTION	578
EcoMonitorLight CONNECTION : STATION #1 to #16 CONSUMED POWER [M8]	341
EcoMonitorLight CONNECTION : STATION #1 to #16 REGENERATED POWER [M8]	341
EcoMonitorLight CONNECTION: ACQUIRED DATA [M8]	343
EcoMonitorLight CONNECTION: COMPLETION BIT [M8]	342
EcoMonitorLight CONNECTION: COMPLETION STATUS [M8]	343
EcoMonitorLight CONNECTION: READ START BIT [M8]	636
EcoMonitorLight CONNECTION: REGISTER ADDRESS [M8]	636
EcoMonitorLight CONNECTION: SIZE OF DATA TO READ [M8]	636
EcoMonitorLight CONNECTION: STATION #1 to #16 MAXIMUM NUMBER OF SUCCESSIVE TRANSMISSION ERRORS [M8]	342
EcoMonitorLight CONNECTION: STATION #1 to #16 MAXIMUM NUMBER OF SUCCESSIVE RECEPTION ERRORS [M8]	342
EcoMonitorLight CONNECTION: STATION #1 to #16 NUMBER OF RECEPTION ERRORS [M8]	342
EcoMonitorLight CONNECTION: STATION #1 to #16 NUMBER OF TRANSMISSION ERRORS [M8]	342
EcoMonitorLight CONNECTION: STATION NO. [M8]	636
EDIT/SEARCH	498
EDIT/SEARCH WINDOW DISPLAYED	243
EMERGENCY STOP CAUSE	280
ENCODER 1 ARBITRARY PULSE 1	564
ENCODER 1 ARBITRARY PULSE 2	564
ENCODER 1 ARBITRARY PULSE SELECTION	382
ENCODER 1 ARBITRARY PULSE VALID	383
ENCODER 2 ARBITRARY PULSE 1	564
ENCODER 2 ARBITRARY PULSE 2	564
ENCODER 2 ARBITRARY PULSE SELECTION	382
ENCODER 2 ARBITRARY PULSE VALID	383
ENCODER SELECTION	577
ERROR CODE [C80]	297
ERROR DETECTION	423
ERROR TEMPORARY CANCEL	530
EXT. MACHINE COORDINATE SYSTEM OFFSET DATA ILLEGAL n-TH AXIS	182
EXT. MACHINE COORDINATE SYSTEM OFFSET DATA n-TH AXIS	599
EXTERNAL BRAKE SBT INCOMPLETE (CONTROL AXIS)[C80]	689
EXTERNAL BRAKE SBT INCOMPLETE (CONTROL AXIS)[M8]	689
EXTERNAL BRAKE SBT START (CONTROL AXIS)[C80])	657

EXTERNAL BRAKE SBT START (CONTROL AXIS)[M8]	657
EXTERNAL DECELERATION- [C80]	615
EXTERNAL DECELERATION- n-TH AXIS	392
EXTERNAL DECELERATION SPEED SELECTION 1 to 4 [C80]	616
EXTERNAL DECELERATION SPEED SELECTION n-TH AXIS [C80]	600
EXTERNAL DECELERATION+ [C80]	615
EXTERNAL DECELERATION+ n-TH AXIS	392
External encoder 1: Position output	736
External encoder 1: Position output clear request [M8]	535
EXTERNAL SEARCH BLOCK NO.	573
EXTERNAL SEARCH DEVICE NO.	572
EXTERNAL SEARCH FINISHED	198
EXTERNAL SEARCH PROGRAM NO.	573
EXTERNAL SEARCH SEQUENCE NO.	573
EXTERNAL SEARCH STATUS	291
EXTERNAL SEARCH STROBE	428
External search: Program return	467
External search: Program return complete status [M8]	291
External search: Program return completed	233

F

F1-DIGIT COMMANDED	202
F1-DIGIT NO. CODE (1, 2, 4, 8)	206
F1-DIGIT SPEED CHANGE VALID	437
Feature coordinate system in 3D manual feed (1st handle)	238
Feature coordinate system in 3D manual feed (2nd handle)	239
Feature coordinate system in 3D manual feed (3rd handle)	239
Feature coordinate system in 3D manual feed (JOG,INC)	238
FEED AXIS SELECTION- n-TH AXIS	397
FEED AXIS SELECTION+ n-TH AXIS	396
FEEDBACK MACHINE POSITION n-TH AXIS	315
FEEDRATE LEAST INCREMENT CODE 1,2	457
FTP DOWNLOAD COMPLETED [C80]	167
FTP DOWNLOAD ERROR [C80]	168
FTP DOWNLOAD IN PROGRESS [C80]	167
FTP DOWNLOAD REQUEST [C80]	535
FTP WAITING FOR DOWNLOAD [C80]	222

G

G/B SPINDLE SYNCHRONIZATION : MAXIMUM RANGE OF THE RELATIVE POSITION ERROR DURING THE STEADY STATE [M8]	566
G/B SPINDLE SYNCHRONIZATION VALID [M8]	387
G/B SPINDLE SYNCHRONIZATION: POSITION ERROR COMPENSATION AMOUNT [M8]	567
G/B SPINDLE SYNCHRONIZATION: AVERAGE VALUE OF THE RELATIVE POSITION ERROR DURING THE STEADY STATE [M8]	566
G/B SPINDLE SYNCHRONIZATION: KEEP POSITION ERROR COMPENSATION AMOUNT SIGNAL [M8]	389
G/B SPINDLE SYNCHRONIZATION: MAXIMUM RANGE OF THE RELATIVE POSITION ERROR [M8]	565
G/B SPINDLE SYNCHRONIZATION: MAXIMUM VALUE OF THE RELATIVE POSITION ERROR [M8]	566
G/B SPINDLE SYNCHRONIZATION: MAXIMUM VALUE OF THE RELATIVE POSITION ERROR DURING THE STEADY STATE [M8]	566
G/B SPINDLE SYNCHRONIZATION: PHASE ALIGNMENT [M8]	387
G/B spindle synchronization: phase alignment complete [M8]	169

G/B SPINDLE SYNCHRONIZATION: PHASE MEMORY [M8]	388
G/B SPINDLE SYNCHRONIZATION: PHASE SHIFT AMOUNT [M8]	567
G/B SPINDLE SYNCHRONIZATION: POSITION CONTROL SYNCHRONIZING [M8]	169
G/B spindle synchronization: position error compensating [M8]	170
G/B SPINDLE SYNCHRONIZATION: POSITION ERROR COMPENSATION [M8]	388
G/B SPINDLE SYNCHRONIZATION: POSITION ERROR COMPENSATION SCALE, AND THE NUMBER OF TIMES OF COMPENSATIONS [M8]	559
G/B SPINDLE SYNCHRONIZATION: TEMPORARY CANCEL [M8]	389
G/B SPINDLE SYNCHRONIZING MODE [M8] ...	169
GEAR SHIFT COMPLETION	499
GRAPHIC CHECK (CHECK METHOD II) IN PROGRESS [M8]	167
GROUP IN TOOL LIFE MANAGEMENT	296

H

Handle feed operation mode	618
HANDLE FEED: 1ST HANDLE PULSE COUNTER	286
HANDLE FEED: 2ND HANDLE PULSE COUNTER	286
HANDLE FEED: 3RD HANDLE PULSE COUNTER	286
HANDLE FEED: 4TH TO 9TH HANDLE PULSE COUNTER [C80]	289
HANDLE MODE	413
HANDLE POLARITY [M8]	574
HANDLE PULSE ENCODER COMMUNICATION CONNECTOR PRIORITY	366
HANDLE/INCREMENTAL FEED MAGNIFICATION CODE m	461
HANDLE/INCREMENTAL FEED MAGNIFICATION METHOD SELECTION	462
HANDY TERMINAL CAUSE OF COMMUNICATION ERROR [M8]	549
HANDY TERMINAL DATA AREA TOP ADDRESS [M8]	548
HANDY TERMINAL DATA VALID NUMBER OF REGISTERS [M8]	549
HANDY TERMINAL KEY 1 TO 45 [M8]	273
HIGH-SPEED SIMPLE PROGRAM CHECK MODE	377
HIGH-SPEED SIMPLE PROGRAM CHECK MODE ON	162
HIGH-SPEED SIMPLE PROGRAM CHECK: COORDINATE POSITION CHECK ON	162
HIGH-SPEED SIMPLE PROGRAM CHECK: ENABLE COORDINATE POSITION CHECK	386
HIGH-SPEED SIMPLE PROGRAM CHECK: TIME MEASUREMENT OUTPUT	556
HIGH-SPEED SIMPLE PROGRAM CHECK: TIME REDUCTION COEFFICIENT	557
HOB AXIS DELAY EXCESS	266
HOB MACHINING: ALARM RETRACT INHIBIT	481
HOB MACHINING: RETRACT AMOUNT SELECTION n-TH AXIS	408
HOB MACHINING: RETRACT COMPLETE	228
HOB MACHINING: RETRACT REQUEST	481
HOB MACHINING: RETRACTING	227
Hypothetical axis command mode [C80]	640

I

ILLEGAL AXIS SELECTED	206
IN "RESET"	194
IN 3-DIMENSIONAL COORDINATE CONVERSION	230
IN AUTOMATIC INITIAL SET MODE	189
IN AUTOMATIC OPERATION "PAUSE"	194
IN AUTOMATIC OPERATION "RUN"	192
IN AUTOMATIC OPERATION "START"	193

In automatic operation mode	331
In axis minus motion	335
IN AXIS MINUS MOTION n-TH AXIS	173
IN AXIS NAME SWITCH	227
In axis plus motion	335
IN AXIS PLUS MOTION n-TH AXIS	173
IN BARRIER VALID (LEFT)	232
IN BARRIER VALID (RIGHT)	232
In basic point initialization setting mode	332
IN CHANGEOVER TO H COIL [C80]	256
IN CHANGEOVER TO L COIL [C80]	255
IN CHOPPING MODE	219
IN CHOPPING START	219
IN CIRCULAR FEED IN MANUAL MODE [M8] ...	212
IN CONSTANT SURFACE SPEED	201
IN CURRENT LIMIT n-TH AXIS	178
IN CUTTING FEED	200
IN DISPLAY LOCK	202
In handle feed operation mode	336
IN HANDLE MODE	187
IN HIGH-SPEED MACHINING MODE (G05)	199
In hypothetical axis command mode [C80]	356
IN INCH UNIT SELECTION	202
IN INCREMENTAL MODE	188
In incremental mode	332
IN INITIALIZATION	297
IN JOG MODE	187
In JOG operation mode	332
IN JOG-HANDLE SIMULTANEOUS MODE	189
IN L COIL SELECTION	250
IN M COIL SELECTION	254
IN MACRO SINGLE VALID [C80]	161
IN MANUAL ARBITRARY FEED	195
IN MANUAL ARBITRARY FEED MODE	188
In manual operation mode	332
IN MANUAL SPEED COMMAND VALID	208
IN MDI MODE	190
IN MEMORY MODE	190
IN MIRROR IMAGE n-TH AXIS	181
IN MIXED CONTROL (CROSS AXIS CONTROL) n-TH AXIS	180
IN MULTI-STEP SPEED MONITOR [M8]	166
IN NC AXIS CONTROL n-TH AXIS	182
IN PLC INTERRUPT	206
IN RAPID TRAVERSE	199
IN REFERENCE POSITION RETURN	202
In reference position return	332
IN REFERENCE POSITION RETURN MODE	188
In reference position return mode	332
In reset	336
IN REWIND	195
IN SAFE TORQUE OFF (CONTROL AXIS)[C80]	686
IN SAFE TORQUE OFF (CONTROL AXIS)[M8]	686
IN SAFE TORQUE OFF (SPINDLE)[C80]	705
IN SAFE TORQUE OFF (SPINDLE)[M8]	705
IN SAFETY ABSOLUTE POSITION ESTABLISHING (CONTROL AXIS)[C80]	692
IN SAFETY ABSOLUTE POSITION ESTABLISHING (CONTROL AXIS)[M8]	692
IN SAFETY EXTERNAL EMERGENCY STOP (SYSTEM COMMON)[C80]	709
IN SAFETY EXTERNAL EMERGENCY STOP (SYSTEM COMMON)[M8]	709
IN SBC MOTOR BRAKE ENABLED (CONTROL AXIS)[C80]	687
IN SBC MOTOR BRAKE ENABLED (CONTROL AXIS)[M8]	687
IN SBC MOTOR BRAKE START SIGNAL (CONTROL AXIS)[C80]	688
IN SBC MOTOR BRAKE START SIGNAL (CONTROL AXIS)[M8]	688
IN SBT EXTERNAL BRAKE TEST (CONTROL AXIS)[C80]	690
IN SBT EXTERNAL BRAKE TEST (CONTROL AXIS)[M8]	690
IN SKIP	201
IN SLP RANGE (CONTROL AXIS)[C80]	677
IN SLP RANGE (CONTROL AXIS)[M8]	677
In small diameter deep hole cycle [M8]	232

IN SOS STOP (CONTROL AXIS)[C80]	681	INTERFERENCE CHECK III: INTERFERENCE	
IN SOS STOP (CONTROL AXIS)[M8]	681	DETECTION INTERFERING OBJECT	
IN SOS STOP (SPINDLE)[C80]	703	INFORMATION [M8]	288
IN SOS STOP (SPINDLE)[M8]	703	INTERFERENCE CHECK III: INTERFERENCE	
IN SPINDLE ALARM	246	DETECTION SOLID INFORMATION [M8]	
IN SPINDLE FORWARD RUN	251		314
IN SPINDLE HOLDING FORCE UP	267	INTERFERENCE CHECK III: INTERFERING	
IN SPINDLE OFF	267	OBJECT SELECTION [M8]	637
IN SPINDLE REVERSE RUN	252	INTERFERENCE CHECK III: INTERFERING	
IN SPINDLE SYNCHRONIZATION	258	OBJECT SELECTION DATA SETTING	
IN SPINDLE SYNCHRONIZATION 2	261	COMPLETED [M8]	168
IN SPINDLE TORQUE LIMIT	253	Interlock-	617
IN SPINDLE-NC AXIS POLYGON MODE	228	Interlock+	617
IN SPINDLE-SPINDLE POLYGON MODE	229		
IN SS1 STOP(CONTROL AXIS)[C80]	683	J	
IN SS1 STOP(CONTROL AXIS)[M8]	683	JOG HANDLE SYNCHRONOUS	458
IN SS1 STOP(SPINDLE)[C80]	704	JOG MODE	412
IN SS1 STOP(SPINDLE)[M8]	704	JOG operation mode	619
IN SYNCHRONOUS FEED	201		
IN SYNCHRONOUS/SUPERIMPOSITION		K	
CONTROL n-TH AXIS	180	KEY IN 1	275
IN TAPE MODE	190	KEY OUT 1	538, 539
IN TAPPING	200		
IN THREAD CUTTING	201	L	
In tool center point rotation	240	L COIL SELECTION	512
IN TOOL ESCAPE AND RETURN MODE [M8]		LOAD MONITOR I : AXIS SELECTION [M8]	577
	209	LOAD MONITOR I : EFFECTIVE SPINDLE	
IN TOOL LIFE MANAGEMENT	203	TORQUE OUTPUT [M8]	328
IN TOOL SPINDLE SYNCHRONIZATION II	263	LOAD MONITOR I : EFFECTIVE TORQUE	
In torque limit	335	OUTPUT n-TH AXIS [M8]	318
INCLINED AXIS CONTROL NO Z AXIS		LOAD MONITOR I : ESTIMATED SPINDLE	
COMPENSATION	444	DISTURBANCE TORQUE OUTPUT [M8]	
INCLINED AXIS CONTROL VALID	444		328
INCREASE HOLDING POWER OF SPINDLE	503	Load monitoring I: Cutting torque output n-th axis	
Incremental feed magnification 1, 2	614	[M8]	318
INCREMENTAL MODE	413	Longitudinal hole drilling axis selection	480
Incremental mode	620		
INDEX POSITIONING COMPLETION	254	M	
INITIALIZATION INCOMPLETION	297	M CODE DATA 1	292
Initialization setting completed	333	M CODE DATA 2	292
Initialization setting error completed	333	M CODE DATA 3	292
In-position	334	M CODE DATA 4	292
INTEGRATION TIME INPUT 1	364	M CODE DATA 5 [C80]	292
INTEGRATION TIME INPUT 2	364	M CODE DATA 6 [C80]	292
Interface of load meter for analog I/F spindle [M8]		M CODE INDEPENDENT OUTPUT M00	207
	607	M CODE INDEPENDENT OUTPUT M01	207
Interference check between part systems:		M CODE INDEPENDENT OUTPUT M02	207
Alarm information [M8]	285	M CODE INDEPENDENT OUTPUT M30	208
Interference check between part systems:		M COIL SELECTION	514
Data address [M8]	567	M FUNCTION FINISH 1	429
Interference check between part systems:		M FUNCTION FINISH 2	430
Interference check enabled [M8]	377	M FUNCTION STROBE 1	214
Interference check between part systems:		M FUNCTION STROBE 2	214
Mode is active [M8]	169	M FUNCTION STROBE 3	214
Interference check between part systems:		M FUNCTION STROBE 4	214
Setting error alarm information [M8]	284	M FUNCTION STROBE 5 [C80]	214
INTERFERENCE CHECK III: DATA SETTING		M FUNCTION STROBE 6 [C80]	214
ERROR INFORMATION 1 [M8]	289	MACHINE GROUP-BASED ALARM STOP:	
INTERFERENCE CHECK III: DATA SETTING		MACHINE GROUP-BASED PLC	
ERROR INFORMATION 2 [M8]	289	INTERLOCK	412
INTERFERENCE CHECK III: ENABLE		MACHINE GROUP-BASED ALARM STOP:	
INTERFERING OBJECT SELECTION DATA		MACHINE GROUP-BASED PLC	
[M8]	384	INTERLOCK ON	186
INTERFERENCE CHECK III: ENTRY IN		MACHINE MANUFACTURER MACRO	
INTERFERENCE ALARM AREA		PASSWORD NO.	551
INTERFERING OBJECT INFORMATION		MACHINE PARAMETER LOCK I/F [M8]	556
[M8]	288	MACHINE POSITION n-TH AXIS	315
INTERFERENCE CHECK III: ENTRY IN		MACHINING INTERRUPTION COMMAND [C80]	
INTERFERENCE ALARM AREA SOLID			642
INFORMATION [M8]	314	MACHINING INTERRUPTION SPINDLE	
INTERFERENCE CHECK III: ENTRY IN		COMMAND [C80]	607
INTERFERENCE WARN AREA SOLID		MACHINING INTERRUPTION SPINDLE	
INFORMATION [M8]	313	STATUS [C80]	329
INTERFERENCE CHECK III: ENTRY IN		MACHINING INTERRUPTION STATUS [C80]	359
INTERFERENCE WARNING AREA		MACRO INTERRUPT	434
INTERFERING OBJECT INFORMATION [M8]	288	MACRO INTERRUPT PRIORITY	488
INTERFERENCE CHECK III: IN INTERFERENCE			
CHECK III MODE [M8]	168		
INTERFERENCE CHECK III: INTERFERENCE			
CHECK III MODE [M8]	385		

MAGNIFICATION VALID FOR EACH HANDLE	
.....	462
MANUAL ABSOLUTE	436
MANUAL ARBITRARY FEED 1ST AXIS TRAVEL	
AMOUNT	575
MANUAL ARBITRARY FEED 1ST AXIS VALID	
.....	471
MANUAL ARBITRARY FEED 2ND AXIS	
SELECTION CODE m	472
MANUAL ARBITRARY FEED 2ND AXIS TRAVEL	
AMOUNT	575
MANUAL ARBITRARY FEED 2ND AXIS VALID	
.....	472
MANUAL ARBITRARY FEED 3RD AXIS TRAVEL	
AMOUNT	575
MANUAL ARBITRARY FEED 3RD AXIS VALID	
.....	472
MANUAL ARBITRARY FEED ABS/INC	475
MANUAL ARBITRARY FEED AXIS INDEPENDENT	
.....	473
MANUAL ARBITRARY FEED COMPLETION	198
MANUAL ARBITRARY FEED EX. F/MODAL. F	
.....	474
MANUAL ARBITRARY FEED G0/G1	474
MANUAL ARBITRARY FEED MC/WK	475
MANUAL ARBITRARY FEED MODE	414
MANUAL ARBITRARY FEED SMOOTHING OFF	
.....	472
MANUAL ARBITRARY FEED STOP	476
MANUAL ARBITRARY FEED STROBE	476
MANUAL ARBITRARY FEED	
1ST AXIS SELECTION CODE m	471
MANUAL ARBITRARY FEED	
3RD AXIS SELECTION CODE m	472
Manual arbitrary reverse run handle selection	557
MANUAL ARBITRARY REVERSE RUN MODE	
.....	375
Manual arbitrary reverse run mode ON	163
MANUAL ARBITRARY REVERSE RUN SPEED	
MULTIPLIER	558
MANUAL ARBITRARY REVERSE RUN SPEED	
SELECTION	376
MANUAL ARBITRARY REVERSE RUN:	
ACTUAL CUTTING MODE ON [M8]	162
MANUAL ARBITRARY REVERSE RUN:	
MSTB REVERSE RUN PROHIBITED	485
MANUAL ARBITRARY REVERSE RUN:	
REVERSE RUN BLOCK STOP	
DESIGNATED PART SYSTEM	487
MANUAL ARBITRARY REVERSE RUN:	
REVERSE RUN INVALID STATUS [M8]	
.....	243
MANUAL ARBITRARY REVERSE RUN:	
REVERSE RUN ON	163
MANUAL FEEDRATE	570
MANUAL FEEDRATE B	570
MANUAL FEEDRATE B OVERRIDE	572
MANUAL FEEDRATE B SURFACE SPEED	
CONTROL VALID [M8]	459
MANUAL FEEDRATE B VALID n-TH AXIS	399
MANUAL FEEDRATE CODE m	455
MANUAL FEEDRATE METHOD SELECTION	457
MANUAL INTERLOCK- n-TH AXIS	394
MANUAL INTERLOCK+ n-TH AXIS	394
MANUAL MACHINE LOCK n-TH AXIS	395
MANUAL MEASUREMENT STATUS	296
MANUAL NUMERICAL COMMAND	208
Manual operation mode	619
MANUAL OVERRIDE METHOD SELECTION	448
MANUAL SPEED CLAMP ON	457
MANUAL SPEED COMMAND REVERSE RUN	
VALID	470
MANUAL SPEED COMMAND SIGN REVERSED	
.....	469
MANUAL SPEED COMMAND VALID	468
MANUAL/AUTOMATIC SIMULTANEOUS VALID	
n-TH AXIS	398
Master reset	617
MDI MODE	418
MECHANICAL AXIS SPECIFICATIONS	
1ST ROTARY AXIS ANGLE	594

MECHANICAL AXIS SPECIFICATIONS	
2ND ROTARY AXIS ANGLE	594
MEMORY MODE	417
MES interface library: Alarm number 1 [M8]	632
MES interface library: Alarm number 2 [M8]	632
MES interface library: Alarm number 3 [M8]	632
MES interface library: Alarm number 4 [M8]	632
MES interface library: Arbitrary user area C1	730
MES interface library: Arbitrary user area L1 to L10	
.....	731
MES interface library: Arbitrary user area	
S1 to S20	731
MES interface library: B number at alarm [M8]	633
MES interface library: B number at machining start	
[M8]	628
MES interface library: Common user area C1	718
MES interface library: Common user area	
L1 to L10	718
MES interface library: Condition register	
(Combination condition)	719
MES interface library: Condition register	
(Comparison condition) 1st set	719
MES interface library: Condition register	
(Comparison condition) 2nd set	719
MES interface library: Condition register	
(Condition value) 1st set	720
MES interface library: Condition register	
(Condition value) 2nd set	720
MES INTERFACE LIBRARY: CONDITION	
REGISTER (EXTRACT SORT CONDITION)	
.....	718
MES interface library: Condition register	
(Field value) 1st set	719
MES interface library: Condition register	
(Field value) 2nd set	719
MES interface library: Cycle time [M8]	628
MES interface library: Database connection status	
[M8]	344
MES interface library: Database operation	
reception register [M8]	345
MES interface library: Database operation	
request register [M8]	344
MES interface library: Database operation	
result register [M8]	345
MES interface library: DB operation selection [M8]	
.....	346
MES interface library: Function selection at alarm	
[M8]	348
MES interface library: Function selection	
at machining end [M8]	348
MES interface library: Function selection	
at user's option [M8]	348
MES interface library: G code modal registration	
selection [M8]	349
MES interface library: G code modal status [M8]	
.....	634
MES interface library: Line number [M8]	344
MES interface library: Machine type [M8]	344
MES interface library: Machining end time [M8]	
.....	627
MES interface library: Machining start time [M8]	
.....	627
MES interface library: N number at alarm [M8]	633
MES interface library: N number at machining	
start [M8]	628
MES interface library: NC unit number [M8]	343
MES interface library: Operation table selection	
[M8]	347
MES interface library: Operation trigger [M8]	533
MES interface library: Operation trigger status	
[M8]	165
MES interface library: Operator ID [M8]	343
MES interface library: Power consumption amount	
[M8]	629
MES interface library: Power ON time [M8]	633
MES interface library: Power regeneration amount	
[M8]	629
MES interface library: Program number at alarm	
[M8]	633
MES interface library: Program number	
at machining start [M8]	628

MES interface library: Sending user arbitrary information [M8]	242
MES interface library: Serial number [M8]	343
MES interface library: Spindle 1 load [M8]	634
MES interface library: Spindle 1 maximum load [M8]	628
MES interface library: Spindle 2 load [M8]	634
MES interface library: Spindle 2 maximum load [M8]	629
MES interface library: Subprogram number at alarm [M8]	633
MES interface library: Time of alarm occurrence [M8]	632
MES interface library: Tool length offset [M8]	635
MES interface library: Tool length offset 1 to 5 [M8]	630
MES interface library: Tool length wear amount [M8]	635
MES interface library: Tool length wear amount 1 to 5 [M8]	631
MES interface library: Tool life [M8]	636
MES interface library: Tool life 1 to 5 [M8]	632
MES interface library: Tool number [M8]	634
MES interface library: Tool number 1 to 5 [M8]	629
MES interface library: Tool offset number [M8]	634
MES interface library: Tool offset number 1 to 5 [M8]	630
MES interface library: Tool radius offset [M8]	635
MES interface library: Tool radius offset 1 to 5 [M8]	630
MES interface library: Tool radius wear amount [M8]	635
MES interface library: Tool radius wear amount 1 to 5 [M8]	631
MES interface library: User arbitrary information send request [M8]	467
MES interface library: User area C1 at alarm	730
MES interface library: User area C1 at machining end	730
MES interface library: User area L1 to L10 at alarm	730
MES interface library: User area L1 to L10 at machining end	730
MIRROR IMAGE n-TH AXIS	391
MISCELLANEOUS FUNCTION COMMAND HIGH-SPEED OUTPUT : 2ND M FUNCTION FINISH 1 to 4	497
MISCELLANEOUS FUNCTION COMMAND HIGH-SPEED OUTPUT : M FUNCTION FINISH 1 to 4	494
MISCELLANEOUS FUNCTION COMMAND HIGH-SPEED OUTPUT : T FUNCTION FINISH 1 to 4	496
MISCELLANEOUS FUNCTION COMMAND HIGH-SPEED OUTPUT: M FUNCTION FINISH 5 to 6 [C80]	494
MISCELLANEOUS FUNCTION COMMAND HIGH-SPEED OUTPUT: S FUNCTION FINISH 1 to 8	495
MISCELLANEOUS FUNCTION LOCK	449
MIXED CONTROL (CROSS AXIS CONTROL) REQUEST n-TH AXIS	404
MOTION COMMAND COMPLETION	196
MOTOR BRAKE SBT INCOMPLETE (CONTROL AXIS)[C80]	691
MOTOR BRAKE SBT INCOMPLETE (CONTROL AXIS)[M8]	691
MOTOR BRAKE SBT START (CONTROL AXIS) [C80]	659
MOTOR BRAKE SBT START (CONTROL AXIS) [M8]	659
MOTOR LOAD CURRENT n-TH AXIS	316
MOTOR ROTATION SPEED n-TH AXIS	316
MULTI-ANALOG INPUT CH N	738
MULTI-ANALOG INPUT STATUS CH N	739
MULTIPLE-SPINDLE CONTROL I: SELECTED SPINDLE NO.	588
MULTI-POINT ORIENTATION POSITION DATA	606
MULTI-STEP SPEED MONITOR SELECTED SPEED OUTPUT [M8]	283

N

N SYNCHRONIZED TAPPING SELECTION (M COMMAND)	231
NC ALARM 1	223
NC ALARM 2 (Servo alarm)	223
NC ALARM 3 (Program error)	223
NC ALARM 4 (Operation error)	224
NC ALARM 5	229
NC AXIS CONTROL SELECTION n-TH AXIS	407
NC AXIS UP-TO-SPEED n-TH AXIS	179
NC AXIS/PLC AXIS SWITCHOVER INVALID STATUS	186
NC AXIS/PLC AXIS SWITCHOVER n-TH AXIS IN PROCESS	186
NC AXIS/PLC AXIS SWITCHOVER REQUEST	411
NC RESET 1	424
NC RESET 2	424
NC WARNING (SERVO WARNING)	224
NEAR REFERENCE POSITION (PERREFERENCE POSITION)	299
NEAR REFERENCE POSITION n-TH AXIS	176
Near set position	338
NEAR-POINT DOG IGNORED	546
NEW TOOL CHANGE	221
NO. OF WORK MACHINING (current value)	302
NO. OF WORK MACHINING (maximum value)	302
NO. OF WORK MACHINING OVER	226
n-TH SPINDLE SYNCHRONOUS TAPPING VALID [C80]	587
NUMBER OF REGISTERED TOOL LIFE CONTROL TOOLS	308

O

OPERATION HISTORY RETRACT [C80]	390
Operation parameter selection 1, 2	615
Operation start	612
OPERATOR MESSAGE I/F	576
Operator message I/F 1 to 4	550
Option status export to PLC [M8]	338
OPTIONAL BLOCK SKIP m	445
OT IGNORED	545
OUTPUT OFF CHECK REQUEST[M8]	671
OVERRIDE CANCEL	448

P

PALLET PROGRAM REGISTRATION EXT. WORKPIECE COORDINATE TRANSFER COMPLETION [M8]	166
PALLET PROGRAM REGISTRATION EXT. WORKPIECE COORDINATE TRANSFER READY [M8]	373
Parameter input error cancel [C80]	535
PHASE OFFSET REQUEST	529
PHASE SHIFT CALCULATION REQUEST	528
PLAYBACK	433
PLC AXIS 1ST to 3RD HANDLE VALID	367
PLC AXIS 4TH TO 9TH HANDLE VALID [C80]	535
PLC AXIS ALARM/WARNING NO. n-TH AXIS	289
PLC AXIS CONTROL BUFFERING MODE INFORMATION ADDRESS [M8]	563
PLC AXIS CONTROL BUFFERING MODE VALID	368
PLC AXIS CONTROL INFORMATION ADDRESS n-TH AXIS [M8]	563
PLC AXIS CONTROL VALID n-TH AXIS	387
PLC AXIS CONTROL: DROOP CANCEL INVALID AXIS [C80]	563
PLC AXIS INDEXING CONTROL COMMAND 1	617
PLC AXIS INDEXING CONTROL COMMAND 2	612
PLC AXIS INDEXING CONTROL COMMAND 3	611

PLC AXIS INDEXING CONTROL COMMAND 4	611
PLC AXIS INDEXING CONTROL STATUS 1	333
PLC AXIS INDEXING CONTROL STATUS 2	331
PLC AXIS INDEXING CONTROL STATUS 3	331
PLC AXIS INDEXING CONTROL STATUS 4	331
PLC AXIS NEAR POINT DETECTION n-TH AXIS	367
PLC AXIS NEAR-POINT DOG IGNORED	546
PLC AXIS OT IGNORED	545
PLC AXIS POSITION SWITCH 1 to 32 [C80]	285
PLC COIL CHANGEOVER	524
PLC EMERGENCY STOP	438
PLC INTERRUPT	440
PLC INTERRUPT PROGRAM NO.	571
PLC MAIN SCAN TIME	279
PLC SKIP 1 to 8	378
PLC SWITCH NON-DISPLAY [M8]	717
POSITION LOOP IN-POSITION	252
Position switch 1 to 15	331
POSITION SWITCH 1 to 24	274
POSITION SWITCH n INTERLOCK	536
POWER CONSUMPTION COMPUTATION: ACCUMULATED CONSUMPTION OF DEVICES OTHER THAN DRIVE SYSTEM 1 to 4	288
POWER CONSUMPTION COMPUTATION: ACCUMULATED CONSUMPTION OF ENTIRE DRIVE SYSTEM 1 to 4	287
POWER CONSUMPTION COMPUTATION: CLEAR CONSUMPTION ACCUMULATION 1 to 4	364
POWER CONSUMPTION COMPUTATION: CLEARING CONSUMPTION ACCUMULATION 1 to 4 COMPLETE	159
POWER CONSUMPTION COMPUTATION: CONSUMPTION ACCUMULATION ON 1 to 4	159
POWER CONSUMPTION COMPUTATION: CONSUMPTION OF DEVICES OTHER THAN DRIVE SYSTEM	550
POWER CONSUMPTION COMPUTATION: DRIVE SYSTEM'S FIXED CONSUMPTION CORRECTION	550
POWER CONSUMPTION COMPUTATION: ENABLE CONSUMPTION ACCUMULATION 1 to 4	371
POWER CONSUMPTION COMPUTATION: PRESENT CONSUMPTION OF ENTIRE DRIVE SYSTEM	287
POWER OFF INDICATION Y DEVICE NO. [M8]	539
POWER OFF PROCESSING [M8]	159
POWER OFF REQUIRED AFTER PARAMETER CHANGE	164
PRESETTER CONTACT	300
PRESETTER INTERLOCK	301
Program format switch in progress [M8]	234
Program format switch request [M8]	486
PROGRAM RESTART	433
PROGRAM RESTART :RESTART POSITION RETURN CHECK INVALID	641
Punchtap cycle in progress [M8]	221

R

RAPID TRAVERSE	435
RAPID TRAVERSE OVERRIDE	569
RAPID TRAVERSE OVERRIDE CODE 1	454
RAPID TRAVERSE OVERRIDE CODE 2	454
RAPID TRAVERSE OVERRIDE METHOD SELECTION	455
RAPID TRAVERSE TIME CONSTANT : IN SWITCHOVER	235
RAPID TRAVERSE TIME CONSTANT : SWITCHOVER REQUEST	488
Ready OFF	618
REAL-TIME TUNING 1: SPEED CONTROL GAIN CHANGEOVER HOLD-DOWN COMMAND [M8]	410, 533

REAL-TIME TUNING 1: SPEED CONTROL GAIN CHANGEOVER HOLD-DOWN ON [M8]	185, 273
Real-time tuning 2: Acceleration/deceleration time constant in automatic switchover [M8]	489
Real-time tuning 2: Acceleration/deceleration time constant in manual switchover [M8]	489
Real-time tuning 2: Acceleration/deceleration time constant in switchover [M8]	235
Real-time tuning 2: Acceleration/deceleration time constant reset [M8]	489
RECALCULATION REQUEST	438
REFERENCE POSITION ADJUSTMENT COMPLETION	584
REFERENCE POSITION ADJUSTMENT VALUE PARAMETER SETTING COMPLETED	298
REFERENCE POSITION ESTABLISHMENT n-TH AXIS	181
Reference position reached	336
REFERENCE POSITION RETRACT	439
REFERENCE POSITION RETURN DIRECTION n-TH AXIS	181
REFERENCE POSITION RETURN MODE	416
Reference position return mode	619
REFERENCE POSITION SELECTION CODE 1,2	464
REFERENCE POSITION SELECTION METHOD	465
Reflection of reserved tool wear compensation is complete	236
Request for reflecting reserved tool wear compensation	490
Reservation of tool wear compensation	535
Reserved tool wear compensation not reflected	235
RESET & REWIND	425
REVERSE RUN	435
REVERSE RUN CONTROL MODE	488
REVERSE RUN FROM BLOCK START	487
RION NO. OF ERROR OCCURRENCES n-TH CH [M8]	338
R-NAVI: MACHINING SURFACE BEING INDEXED [M8]	241
R-NAVI: MACHINING SURFACE BEING SELECTED [M8]	240
R-NAVI: MACHINING SURFACE INDEXING COMPLETION [M8]	241
R-NAVI: SELECTED MACHINING SURFACE NO. [M8]	313
R-NAVI: SELECTED WORKPIECE NO. [M8]	313
ROTARY AXIS CONFIGURATION PARAMETER OUTPUT	312
ROTARY AXIS CONFIGURATION PARAMETER SWITCH	590
ROTATION CENTER ERROR COMPENSATION ENABLED [M8]	491
ROTATION CENTER ERROR COMPENSATION IN PROGRESS [M8]	236
Rotation direction	614

S

S CODE DATA 1 to 8	292
S COMMAND GEAR NO. ILLEGAL	243
S COMMAND MAX./MIN. COMMAND VALUE OVER	244
S COMMAND NO GEAR SELECTED	244
S COMMAND OVERRIDE	605
S FUNCTION STROBE 1 to 8	216
SAFE CAM IS ACTIVE (CONTROL AXIS)[C80]	679
SAFE CAM IS ACTIVE (CONTROL AXIS)[M8]	679
SAFE CAM POSITION (CONTROL AXIS)[C80]	699
SAFE CAM POSITION (CONTROL AXIS)[M8]	699
SAFE CAM REQUEST (CONTROL AXIS)[C80]	651
SAFE CAM REQUEST (CONTROL AXIS)[M8]	651

SAFE RESET (SPINDLE) [C80]	669	SERVO READY COMPLETION OUTPUT	
SAFE RESET (SPINDLE) [M8]	669	DESIGNATION	592
SAFE STOP 1 REQUEST (CONTROL AXIS)[C80]		SERVO READY n-TH AXIS	171
.....	653	Set position reached	338
SAFE STOP 1 REQUEST (CONTROL AXIS)[M8]		Simple inclined surface machining command:	
.....	653	Tool axis rotation angle compensation	
SAFE STOP 1 REQUEST (SPINDLE)[C80]	667	amount [M8]	595
SAFE STOP 1 REQUEST (SPINDLE)[M8]	667	Simple inclined surface machining/Inclined surface	
SAFE STOP 2 REQUEST (CONTROL AXIS)[C80]		control command ON [M8]	242
.....	654	SINGLE BLOCK	420
SAFE STOP 2 REQUEST (CONTROL AXIS)[M8]		SINGLE BLOCK BETWEEN PART SYSTEMS	374
.....	654	SKIP COORDINATE POSITION n-TH AXIS	316
SAFE STOP 2 REQUEST (SPINDLE)[C80]	668	SKIP COORDINATE POSITION n-TH AXIS	
SAFE STOP 2 REQUEST (SPINDLE)[M8]	668	FEATURE COORDINATE	317
SAFE TORQUE OFF REQUEST		SLP OBSERVATION IS ACTIVE	
(CONTROL AXIS)[C80]	655	(CONTROL AXIS)[C80]	676
SAFE TORQUE OFF REQUEST		SLP OBSERVATION IS ACTIVE	
(CONTROL AXIS)[M8]	655	(CONTROL AXIS)[M8]	676
SAFE TORQUE OFF REQUEST		SLP OBSERVATION REQUEST	
(SPINDLE)[C80]	668	(CONTROL AXIS)[C80]	649
SAFE TORQUE OFF REQUEST		SLP OBSERVATION REQUEST	
(SPINDLE)[M8]	668	(CONTROL AXIS)[M8]	649
SAFETY ABSOLUTE POSITION CONFIRM		SLP POSITION CHANGE INPUT	
(CONTROL AXIS)[C80]	661	(CONTROL AXIS)[C80]	665
SAFETY ABSOLUTE POSITION CONFIRM		SLP POSITION CHANGE INPUT	
(CONTROL AXIS)[M8]	661	(CONTROL AXIS)[M8]	665
SAFETY COMMUNICATION COMMAND [C80]		SLP POSITION CHANGE OUTPUT	
.....	673	(CONTROL AXIS)[C80]	697
SAFETY COMMUNICATION RECEIPT DATA [C80]		SLP POSITION CHANGE OUTPUT	
.....	715	(CONTROL AXIS)[M8]	697
SAFETY COMMUNICATION SEND DATA [C80]		SLS OBSERVATION IS ACTIVE (SPINDLE)[C80]	
.....	673	702
SAFETY COMMUNICATION STATUS [C80]	716	SLS OBSERVATION IS ACTIVE (SPINDLE)[M8]	
SAFETY I/O DEVICE OBSERVATION ERROR		702
SIGNAL [C80]	714	SLS OBSERVATION IS ACTIVE	
SAFETY I/O DEVICE OBSERVATION WARNING		(CONTROL AXIS)[C80]	674
DETAILS [C80]	715	(CONTROL AXIS)[M8]	674
SAFETY I/O DEVICE OBSERVATION WARNING		SLS OBSERVATION REQUEST	
SIGNAL [C80]	715	(CONTROL AXIS)[C80]	648
SAFETY I/O DEVICE OBSERVATION WARNING		SLS OBSERVATION REQUEST	
STATUS [C80]	714	(CONTROL AXIS)[M8]	648
SAFETY I/O OBSERVATION REQUEST [C80]		SLS OBSERVATION REQUEST	
.....	672	(SPINDLE)[C80]	666
SAFETY I/O OBSERVATION STATE [C80]	711	SLS OBSERVATION REQUEST	
SAFETY I/O OBSERVATION STATE [M8]	711	(SPINDLE)[M8]	666
SAFETY I/O UNIT OBSERVATION ERROR		SLS SPEED CHANGE INPUT	
DETAILS [C80]	713	(CONTROL AXIS)[C80]	663
SAFETY I/O UNIT OBSERVATION ERROR		SLS SPEED CHANGE INPUT	
DETAILS [M8]	713	(CONTROL AXIS)[M8]	663
SAFETY I/O UNIT OBSERVATION STATE [C80]		SLS SPEED CHANGE INPUT (SPINDLE)[C80]	
.....	712	669
SAFETY I/O UNIT OBSERVATION STATE [M8]		SLS SPEED CHANGE INPUT (SPINDLE)[M8]	669
.....	712	SLS SPEED CHANGE OUTPUT (SPINDLE)[C80]	
SAFETY RESET (CONTROL AXIS)[C80]	662	707
SAFETY RESET (CONTROL AXIS)[M8]	662	SLS SPEED CHANGE OUTPUT (SPINDLE)[M8]	
SAFETY STATION COMMUNICATION STATUS		707
[C80]	716	SLS SPEED CHANGE OUTPUT	
Sampling start/stop	373	(CONTROL AXIS)[C80]	695
SBC MOTOR BRAKE STARTING REQUEST		SLS SPEED CHANGE OUTPUT	
(CONTROL AXIS)[C80]	656	(CONTROL AXIS)[M8]	695
SBC MOTOR BRAKE STARTING REQUEST		SLS SPEED OVERRIDE INPUT	
(CONTROL AXIS)[M8]	656	(CONTROL AXIS)[C80]	664
SBT START POSITION		SLS SPEED OVERRIDE INPUT	
(CONTROL AXIS)[C80]	701	(CONTROL AXIS)[M8]	664
SBT START POSITION		SLS SPEED OVERRIDE INPUT (SPINDLE)[C80]	
(CONTROL AXIS)[M8]	701	670
SCREEN DISPLAY REQUEST	372	SLS SPEED OVERRIDE INPUT (SPINDLE)[M8]	
SEARCH & START	443	670
SEARCH & START ERROR	220	SLS SPEED OVERRIDE OUTPUT (SPINDLE)	
SEARCH & START PROGRAM NO.	576	[C80]	708
SEARCH & START SEARCH	220	SLS SPEED OVERRIDE OUTPUT (SPINDLE)	
SELECTION TOOL COMPENSATION NO. (Sub)		[M8]	708
.....	586	SLS SPEED OVERRIDE OUTPUT	
SELECTION TOOL WEAR NO. (Sub)	586	(CONTROL AXIS)[C80]	696
SERVO ALARM/WARNING NO.	317	SLS SPEED OVERRIDE OUTPUT	
SERVO DEFLECTION AMOUNT n-TH AXIS	315	(CONTROL AXIS)[M8]	696
Servo OFF	617	SMALL DIAMETER DEEP HOLE	
SERVO OFF n-TH AXIS	391	DRILLING CYCLE [M8]	478
Servo ready	333		
SERVO READY COMPLETION	191		
Servo ready completion	337		

SMART SAFETY OBSERVATION ERROR OCCURRING SERVO AXIS (CONTROL AXIS)[C80]	693	Spindle oscillation in progress [M8]	270
SMART SAFETY OBSERVATION ERROR OCCURRING SERVO AXIS (CONTROL AXIS)[M8]	693	SPINDLE OVERRIDE METHOD SELECTION ...	501
SMART SAFETY OBSERVATION ERROR OCCURRING SPINDLE (SPINDLE)[C80]	706	SPINDLE PHASE SYNCHRONIZATION	526
SMART SAFETY OBSERVATION ERROR OCCURRING SPINDLE (SPINDLE)[M8]	706	SPINDLE PHASE SYNCHRONIZATION COMPLETION	260
SMART SAFETY OBSERVATION WARNING OCCURRING SERVO AXIS (CONTROL AXIS)[C80]	694	SPINDLE POSITION CONTROL (SPINDLE/C AXIS CONTROL):C AXIS SELECTION	512
SMART SAFETY OBSERVATION WARNING OCCURRING SERVO AXIS (CONTROL AXIS)[M8]	694	SPINDLE POSITION CONTROL (SPINDLE/C AXIS CONTROL): C AXIS MODE ON	269
SMART SAFETY OBSERVATION WARNING OCCURRING SPINDLE (SPINDLE)[C80]	706	Spindle protection: Mode in progress [M8]	271
SMART SAFETY OBSERVATION WARNING OCCURRING SPINDLE (SPINDLE)[M8]	706	Spindle protection:	
Smoothing zero	334	Motor equivalent load factor	735
SOS IS ACTIVE (CONTROL AXIS)[C80]	680	Spindle protection: Number of times log output error occurred	735
SOS IS ACTIVE (CONTROL AXIS)[M8]	680	Spindle protection: Resetting alarm of equivalent load factor over limit [M8]	534
SOS IS ACTIVE (SPINDLE)[C80]	703	SPINDLE READY-ON	250
SOS IS ACTIVE (SPINDLE)[M8]	703	SPINDLE REVERSE RUN START	507
SOS OBSERVATION REQUEST (CONTROL AXIS)[C80]	652	SPINDLE REVERSE RUN INDEX	510
SOS OBSERVATION REQUEST (CONTROL AXIS)[M8]	652	Spindle rotation direction switch method selection	524
SOS OBSERVATION REQUEST (SPINDLE)[C80]	667	Spindle rotation reversal	517
SOS OBSERVATION REQUEST (SPINDLE)[M8]	667	SPINDLE ROTATION SPEED SYNCHRONIZATION COMPLETION	259
Spatial error compensation enabled [M8]	491	SPINDLE SELECTION	515
Spatial error compensation in progress [M8]	237	SPINDLE SERVO-ON	251
SPECIAL SAFETY ALARM CANCEL (SYSTEM COMMON) [C80]	671	Spindle speed fluctuation detection:	
SPECIAL SAFETY ALARM CANCEL (SYSTEM COMMON) [M8]	671	Spindle speed out of setting range [M8] ...	268
SPEED DETECTION	246	SPINDLE SPEED OVERRIDE CODE m	501
SPEED DETECTION 2	253	SPINDLE STOP	503
SPEED MONITOR DOOR OPEN POSSIBLE	282	SPINDLE SUPERIMPOSITION CONTROL ON	265
SPEED MONITOR MODE	547	SPINDLE SUPERIMPOSITION CONTROL: CHANGE DISABLED	264
Speed override 1 to 64	611	SPINDLE SUPERIMPOSITION CONTROL: SPINDLE SUPERIMPOSITION CLAMPED	265
Speed override valid	611	SPINDLE SYNCHRONIZATION	525
SPINDLE SYNCHRONIZATION/ SUPERIMPOSITION CANCEL	531	SPINDLE SYNCHRONIZATION	
SPINDLE 2ND IN-POSITION	245	MAXIMUM PHASE ERROR/ MAXIMUM HOB AXIS DELAY ANGLE ...	323
SPINDLE ACTUAL SPEED	322	SPINDLE SYNCHRONIZATION PHASE ERROR MONITOR	324
SPINDLE ALARM/WARNING NO.	326	SPINDLE SYNCHRONIZATION PHASE ERROR MONITOR (lower limit)	324
SPINDLE COMMAND FINAL DATA (rotation speed)	321	SPINDLE SYNCHRONIZATION PHASE ERROR MONITOR (upper limit)	324
SPINDLE COMMAND ROTATION SPEED INPUT	321	Spindle synchronization phase error over	264
SPINDLE COMMAND SELECTION	604	Spindle synchronization phase error tolerance ...	609
SPINDLE COMMAND ROTATION SPEED OUTPUT	603	SPINDLE SYNCHRONIZATION PHASE ERROR /HOB AXIS DELAY ANGLE	322
Spindle control: Coil changeover gate cutoff timer interruption [C80]	532	SPINDLE SYNCHRONIZATION PHASE OFFSET DATA	323
SPINDLE CONTROL: COIL CHANGEOVER TIME-OUT [C80]	257	SPINDLE SYNCHRONIZATION SYNCHRONIZED SPINDLE SELECTION	608
SPINDLE ENABLE	255	SPINDLE SYNCHRONIZATION PHASE ERROR 1	325
SPINDLE FORWARD RUN INDEX	509	SPINDLE SYNCHRONIZATION PHASE ERROR 2	325
SPINDLE FORWARD RUN START	506	SPINDLE SYNCHRONIZATION PHASE SHIFT AMOUNT	608
SPINDLE GEAR SELECTION CODE 1,2	502	SPINDLE SYNCHRONIZATION REFERENCE SPINDLE SELECTION	607
SPINDLE GEAR SELECTION OUTPUT 1,2	270	SPINDLE SYNCHRONOUS ROTATION DIRECTION	527
SPINDLE GEAR SHIFT	504	Spindle temperature output [M8]	326
SPINDLE GEAR SHIFT 1,2	244	SPINDLE TOOL NO.	627
SPINDLE IN-POSITION	249	SPINDLE TORQUE LIMIT 1	508
Spindle motor load ratio	326	SPINDLE TORQUE LIMIT 2	508
SPINDLE OFF MODE	479	Spindle torque limit reached	253
SPINDLE OFF REQUEST	532	SPINDLE UP-TO-SPEED	248
SPINDLE ORIENTATION	505	SPINDLE-MODE ROTARY AXIS CONTROL COMMAND n-TH AXIS [M8]	409
SPINDLE ORIENTATION COMMAND	511	SPINDLE-MODE ROTARY AXIS CONTROL MODE n-TH AXIS [M8]	183
Spindle oscillation amplitude [M8]	609	SPINDLE-SPINDLE POLYGON CANCEL	478
Spindle oscillation command [M8]	532	SPINDLE-SPINDLE POLYGON SYNCHRONIZATION COMPLETION	230
Spindle oscillation frequency [M8]	609	SS1 IS ACTIVE (CONTROL AXIS)[C80]	682
		SS1 IS ACTIVE (CONTROL AXIS)[M8]	682
		SS1 IS ACTIVE (SPINDLE)[C80]	704

TORQUE LIMITATION SKIP:	
G160 TORQUE LIMIT ON	234
Total distance traveled by n-th axis during	
automatic operation [M8]	363
Touchscreen operation disabled	639

U

UNCLAMP COMMAND n-TH AXIS	179
UNCLAMP COMPLETION n-TH AXIS	404
UNDER SLS LIMIT (SPINDLE)[C80]	702
UNDER SLS LIMIT (SPINDLE)[M8]	702
UNDER SLS LIMIT (CONTROL AXIS)[C80]	675
UNDER SLS LIMIT (CONTROL AXIS)[M8]	675
UNDER SSM SAFE SPEED (SPINDLE)[C80]	709
UNDER SSM SAFE SPEED (SPINDLE)[M8]	709
UNDER SSM SAFE SPEED(CONTROL AXIS)	
[C80]	698
UNDER SSM SAFE SPEED(CONTROL AXIS)	
[M8]	698
UPPER DEAD POINT → BASIC POSITION	
PATHBASIC POSITION PATH	219
UPPER DEAD POINT → BOTTOM DEAD POINT	
PATH FLAG	219
USAGE DATA COUNT VALID	463
USER LEVEL-BASED DATA PROTECTION:	
OPERATION LEVEL	556
USER MACRO INPUT #1032 (PLC -> NC)	601
USER MACRO INPUT #1033 (PLC -> NC)	602
USER MACRO INPUT #1034 (PLC -> NC)	602
USER MACRO INPUT #1035 (PLC -> NC)	602
USER MACRO OUTPUT #1132 (NC -> PLC)	319
USER MACRO OUTPUT #1133 (NC -> PLC)	320
USER MACRO OUTPUT #1134 (NC -> PLC)	320
USER MACRO OUTPUT #1135 (NC -> PLC)	320
USER MACRO SECTION AND SUB-SECTION	
DESIGNATED EXECUTION RESULT [M8]	
.....	298
USER SEQUENCE PROGRAM VERSION CODE	
[M8]	542
USER SEQUENCE PROGRAM VERSION CODE 2	
[M8]	543

V

V NUMBER OF SMART SAFETY OBSERVATION	
ERROR (SYSTEM COMMON)[C80]	710
V NUMBER OF SMART SAFETY OBSERVATION	
ERROR (SYSTEM COMMON)[M8]	710
V NUMBER OF SMART SAFETY OBSERVATION	
WARNING (SYSTEM COMMON)[C80]	710
V NUMBER OF SMART SAFETY OBSERVATION	
WARNING (SYSTEM COMMON)[M8]	710
VCC: Cause of non-vibration	362
VCC: Frequency	361
VCC: Mode in execution	243
VCC: Number of vibrations	360
VCC: Spindle rotation speed	331
VCC: Temporary cancel of axis vibration	644
VCC: Vibrating axis	361
VERTICAL AXIS PULL-UP PREVENTED	
n-TH AXIS	182
VERTICAL AXIS PULL-UP PREVENTION	
REQUEST n-TH AXIS	408

W

W NUMBER OF SMART SAFETY OBSERVATION	
WARNING (SYSTEM COMMON)[C80]	711
W NUMBER OF SMART SAFETY OBSERVATION	
WARNING (SYSTEM COMMON)[M8]	711
WEAR COMPENSATION NO. (Tool presetter) ...	585
WORKPIECE COORDINATE MEASUREMENT	
2ND AXIS	402
WORKPIECE COORDINATE OFFSET	
MEASUREMENT TOOL COMPENSATION	
NO./SELECTED COMPENSATION	
TOOL NO.	585

WORKPIECE COORDINATE OFFSET	
MEASUREMENT TOOL NO. / SELECTED	
TOOL NO. (Main)	585

Z

ZERO POINT INITIALIZATION SET COMPLETED	
n-TH AXIS	177
ZERO POINT INITIALIZATION SET ERROR	
COMPLETED n-TH AXIS	178
ZERO POINT INITIALIZATION SET MODE	
n-TH AXIS	400
ZERO POINT INITIALIZATION SET START	
n-TH AXIS	400
ZERO SPEED	247
ZR DEVICE NO. IN WHICH DDRD/DDWR	
COMMAND ERROR HAS OCCURRED	
[C80]	290

Revision History

Date of revision	Manual No.	Revision details
Apr. 2015	IB(NA)1501272-A	First edition created.
Sep. 2015	IB(NA)1501272-B	<p>The descriptions were revised to meet the specifications of Mitsubishi Electric CNC M800/M80 series software version A4.</p> <p>The Interface signals for the software version A4 were added to the following chapters.- Chapter 2 Input/Output Signals with Controller - Chapter 4 Explanation of Interface Signals</p> <p>Errors in writing were corrected.</p>
Mar. 2016	IB(NA)1501272-C	<p>The descriptions were revised to meet the specifications of Mitsubishi Electric CNC M800/M80 series software version B2.</p> <p>The interface signals for the software version B2 were added to the following chapters.- Chapter 2 Input/Output Signals with Controller - Chapter 4 Explanation of Interface Signals</p> <p>Errors in writing were corrected.</p>
Oct. 2016	IB(NA)1501272-D	<p>The descriptions were revised to meet the specifications of Mitsubishi Electric CNC M800/M80 series software version C1.</p> <p>The descriptions were revised to meet the specifications of Mitsubishi Electric CNC C80 series software version A1.</p> <p>The interface signals for M800/M80 series software version C1 and C80 series software version A1 were added to the following chapters. - Chapter 2 Input/Output Signals with Controller - Chapter 4 Explanation of Interface Signals</p> <p>Errors in writing were corrected.</p>
Mar. 2017	IB(NA)1501272-E	<p>The descriptions were revised to meet the specifications of Mitsubishi Electric CNC M800/M80 series software version C3.</p> <p>The interface signals for the software version C3 were added to the following chapters.- Chapter 2 Input/Output Signals with Controller - Chapter 4 Explanation of Interface Signals</p> <p>Errors in writing were corrected.</p>
Aug. 2017	IB(NA)1501272-F	<p>The descriptions were revised to meet the specifications of Mitsubishi Electric CNC C80 series software version A2.</p> <p>- Chapter 5 Appx.1: PLC Window [M8]/PLC Window [C80] - Chapter 6 Appx.2: List of PLC Window Data [M8]/PLC Window Data [C80] - Chapter 7 Appx.3: GOT Window [C80]</p> <p>The interface signals for the software version A2 were added to the following chapters. - Chapter 2 Input/Output Signals with Controller - Chapter 4 Explanation of Interface Signals</p> <p>Errors in writing were corrected.</p>
Dec. 2017	IB(NA)1501272-G	<p>The descriptions were revised to meet the specifications of Mitsubishi Electric CNC M800/M80 series software version C7.</p> <p>The interface signals for the software version C7 were added to the following chapters. - Chapter 2 Input/Output Signals with Controller - Chapter 4 Explanation of Interface Signals</p> <p>Errors in writing were corrected.</p>
Mar. 2018	IB(NA)1501272-H	<p>The descriptions were revised to meet the specifications of Mitsubishi Electric CNC E80 series.</p> <p>The descriptions were revised to meet the specifications of Mitsubishi Electric CNC M800/M80 series software version D1.</p> <p>The following chapter was revised. - Chapter 4 Explanation of Interface Signals</p> <p>The interface signals for the software version D3 were added to the following chapter. - Chapter 2 Input/Output Signals with Controller</p> <p>Errors in writing were corrected.</p>

Date of revision	Manual No.	Revision details
Sep. 2018	IB(NA)1501272-J	<p>The descriptions were revised to meet the specifications of Mitsubishi Electric CNC C80 series software version B0.</p> <p>The interface signals for the software version B0 were added to the following chapters.</p> <ul style="list-style-type: none"> - Chapter 2 Input/Output Signals with Controller - Chapter 4 Explanation of Interface Signals <p>Errors in writing were corrected.</p>
Apr. 2019	IB(NA)1501272-K	<p>The descriptions were revised to meet the specifications of Mitsubishi Electric CNC M800/M80/E80 series software version E0.</p> <p>The interface signals for the software version E0 were added and corrected to the following chapters.</p> <ul style="list-style-type: none"> - Chapter 2 Input/Output Signals with Controller - Chapter 4 Explanation of Interface Signals <p>The following chapter was added.</p> <ul style="list-style-type: none"> - Chapter 8 Appx.4: List of option status exported to PLC [M8] <p>Errors in writing were corrected.</p>
Sep. 2019	IB(NA)1501272-L	<p>The descriptions were revised to meet the specifications of Mitsubishi Electric CNC M800/M80/E80 series software version E1.</p> <p>The interface signals for the software version E1 were added and corrected to the following chapters.</p> <ul style="list-style-type: none"> - Chapter 2 Input/Output Signals with Controller - Chapter 4 Explanation of Interface Signals <p>Errors in writing were corrected.</p>
Jan. 2020	IB(NA)1501272-M	<p>The descriptions were revised to meet the specifications of Mitsubishi Electric CNC C80 series software version B5.</p> <p>The interface signals for the software version B5 were added and corrected to the following chapters.</p> <ul style="list-style-type: none"> - Chapter 2 Input/Output Signals with Controller - Chapter 4 Explanation of Interface Signals <p>Errors in writing were corrected.</p>
Jun. 2020	IB(NA)1501272-N	<p>The descriptions were revised to meet the specifications of Mitsubishi Electric CNC M800/M80/E80 series software version F1.</p> <p>The interface signals for the software version F1 were added and corrected to the following chapters.</p> <ul style="list-style-type: none"> - Chapter 2 Input/Output Signals with Controller - Chapter 4 Explanation of Interface Signals <p>Errors in writing were corrected.</p>
Mar. 2021	IB(NA)1501272-P	<p>The descriptions were revised to meet the specifications of Mitsubishi Electric CNC M800/M80/E80 series software version F4.</p> <p>The descriptions were revised to meet the specifications of Mitsubishi Electric CNC C80 series software version B7.</p> <p>The interface signals for the software versions were added and corrected to the following chapters.</p> <ul style="list-style-type: none"> - Chapter 2 Input/Output Signals with Controller - Chapter 4 Explanation of Interface Signals <p>Errors in writing were corrected.</p>
Jul. 2022	IB(NA)1501272-Q	<p>The descriptions were revised to meet the specifications of Mitsubishi Electric CNC M800/M80/E80 series software version F8.</p> <p>The descriptions were revised to meet the specifications of Mitsubishi Electric CNC C80 series software version BA.</p> <p>The interface signals for the software versions were added and corrected to the following chapters.</p> <ul style="list-style-type: none"> - Chapter 2 Input/Output Signals with Controller - Chapter 4 Explanation of Interface Signals - 5.4 Read/Write PLC Axis Data - 6.2 Sub-section No. List <p>Errors in writing were corrected.</p>

Date of revision	Manual No.	Revision details
Aug. 2023	IB(NA)1501272-R	<p>The descriptions were revised to meet the specifications of Mitsubishi Electric CNC M800/M80/E80 series software version FB.</p> <p>The descriptions were revised to meet the specifications of Mitsubishi Electric CNC C80 series software version BE.</p> <p>The interface signals for the software versions were added and corrected to the following chapters.</p> <ul style="list-style-type: none"> - Chapter 2 Input/Output Signals with Controller - Chapter 4 Explanation of Interface Signals - Chapter 5 PLC window [M8]/PLC window [C80] <p>Errors in writing were corrected.</p>

Global Service Network

AMERICA

MITSUBISHI ELECTRIC AUTOMATION INC. (AMERICA FA CENTER)

HQ and Central Region Service Center (Chicago)
500 CORPORATE WOODS PARKWAY, VERNON HILLS, ILLINOIS 60061, U.S.A.
TEL: +1-847-478-2500 / FAX: +1-847-478-2650
Minneapolis, MN Service Satellite
Detroit, MI Service Satellite
Grand Rapids, MI Service Satellite
Cleveland, OH Service Satellite
St. Louis, MO Service Satellite
Indianapolis, IN Service Satellite

South/East Region Service Center (Georgia)

1845 SATELLITE BOULEVARD STE. 450, DULUTH, GEORGIA 30097, U.S.A.
TEL: +1-678-258-4529 / FAX: +1-678-258-4519
Charleston, SC Service Satellite
Charlotte, NC Service Satellite
Raleigh, NC Service Satellite
Dallas, TX Service Satellite
Houston, TX Service Satellite
Hartford, CT Service Satellite
Knoxville, TN Service Satellite
Nashville, TN Service Satellite
Huntsville, AL Satellite
Pittsburg, PA Service Satellite
Tampa, FL Service Satellite
Miami, FL Satellite
Lafayette, LA Service Satellite
Allentown, PA Satellite

Western Region Service Center (California)

5900-B KATELLA AVE. - 5900-A KATELLA AVE. CYPRESS, CALIFORNIA 90630, U.S.A.
TEL: +1-714-699-2625 / FAX: +1-847-478-2650
San Francisco, CA Satellite
Seattle, WA Service Satellite
Denver, CO Service Satellite

Canada Region Service Center (Toronto)

4299 14TH AVENUE MARKHAM, ONTARIO L3R 0J2, CANADA
TEL: +1-905-475-7728 / FAX: +1-905-475-7935
Edmonton, AB Service Satellite
Montreal, QC Service Satellite

Mexico Region Service Center (Querétaro)

Parque Tecnológico Innovación Querétaro, Lateral Carretera Estatal 431, Km 2+200, Lote 91 Modulos 1 y 2
Hacienda la Machorra, CP 76246, El Marqués, Querétaro, México
TEL: +52-442-153-6050
Monterrey, NL Service Satellite
Mexico City, DF Service Satellite

BRAZIL

MITSUBISHI ELECTRIC DO BRASIL COMÉRCIO E SERVIÇOS LTDA.

Votorantim Office
AV. GISELE CONSTANTINO, 1578, PARQUE BELA VISTA, VOTORANTIM-SP, BRAZIL CEP:18.110-650
TEL: +55-15-3023-9000
Blumenau, Santa Catarina Office

EUROPE

MITSUBISHI ELECTRIC EUROPE B.V.

European Service Headquarters (Dusseldorf, GERMANY)
Mitsubishi-Electric-Platz 1 40882 RATINGEN, GERMANY
TEL: +49-2102-486-5000 / FAX: +49-2102-486-5910

South Germany Service Center (Stuttgart)

SCHELMENWASENSTRASSE 16-20, 70567 STUTTGART, GERMANY
TEL: +49-711-770598-123 / FAX: +49-711-770598-141

France Service Center (Paris)

2 RUE DE L'UNION, 92565 RUEIL-MALMAISON CEDEX, FRANCE
TEL: +33-1-41-02-83-13 / FAX: +33-1-49-01-07-25

France Service Satellite (Lyon)

240, ALLEE JACQUES MONOD 69800 SAINT PRIEST FRANCE
TEL: +33-1-41-02-83-13 / FAX: +33-1-49-01-07-25

Italy Service Center (Milan)

VIA ENERGY PARK 14, VIMERCATE 20871 (MB) ITALY
TEL: +39-039-6053-342 / FAX: +39-039-6053-206

Italy Service Satellite (Padova)

VIA G. SAVELLI, 24 - 35129 PADOVA, ITALY
TEL: +39-039-6053-342 / FAX: +39-039-6053-206

U.K. Service Center

TRAVELLERS LANE, HATFIELD, HERTFORDSHIRE, AL10 8XB, U.K.
TEL: +44-1707-288-780 / FAX: +44-1707-278-695

Spain Service Center

CTRA. RUBI, 76-80 8174 SAINT CUGAT DEL VALLES, BARCELONA, SPAIN
TEL: +34-935-65-2236 / FAX: +34-935-89-1579

Poland Service Center

UL.KRAKOWSKA 50, 32-083 BALICE, POLAND
TEL: +48-12-347-6500 / FAX: +48-12-630-4701

Hungary Service Center

MITSUBISHI ELECTRIC EUROPE B.V. HUNGARIAN BRANCH
BUDAÖRS OFFICE PARK, SZABADSÁG ÚT 117., 2040 BUDAÖRS, HUNGARY
TEL: +36-70-433-2263

Turkey Service Center

MITSUBISHI ELECTRIC TURKEY ELEKTRİK ÜRÜNLERİ A.Ş
SERIFALI MAHALLESİ KALE SOKAKI NO.41 34775
UMRANIYE, ISTANBUL, TURKEY
TEL: +90-216-969-2500 / FAX: +90-216-661-44-47

Czech Republic Service Center

MITSUBISHI ELECTRIC EUROPE B.V. PRAGUE OFFICE
Pekařská 621/7, 155 00 PRAHA 5, CZECH REPUBLIC
TEL: +420-734-402-587

Sweden Service Center

HAMMARBACKEN 14, P.O.BOX 750 SE-19127, SOLLENTUNA, SWEDEN
TEL: +46-8-6251200 / FAX: +46-8-6251014

Bulgaria Service Center

AKHNATON Ltd. (Service Partner)
4 ANDREJ LJAPCHEV BLVD. POB 21, BG-1756 SOFIA, BULGARIA
TEL: +359-2-8176009 / FAX: +359-2-9744061

Ukraine Service Center (Kiev)

CSC Automation Ltd. (Service Partner)
4 B. YEVHENA SVERSTYUKA STR., 02002 KIEV, UKRAINE
TEL: +380-44-494-3344 / FAX: +380-44-494-3366

South Africa Service Center

Adroit Technologies (Service Partner)
20 WATERFORD OFFICE PARK, WATERFORD DRIVE, CNR OF WITKOPPEN ROAD,
FOURWAYS JOHANNESBURG SOUTH AFRICA
TEL: +27-11-658-8100 / FAX: +27-11-658-8101

ASEAN**MITSUBISHI ELECTRIC ASIA PTE. LTD. (ASEAN FA CENTER)**

Singapore Service Center
307 ALEXANDRA ROAD MITSUBISHI ELECTRIC BUILDING SINGAPORE 159943
TEL: +65-6473-2308 / FAX: +65-6476-7439

PHILIPPINES**MELCO FACTORY AUTOMATION PHILIPPINES INC.**

Head Office
128 LOPEZ RIZAL STREET, BRGY., HIGHWAY HILLS, MANDALUYONG CITY, MM PHILIPPINES 1550
TEL: +63-2-8256-8042 / FAX: +63-2-8637-2294

Philippines Service Center

KM.23 WEST SERVICE ROAD SSH, CUPANG, MUNTINLUPA CITY, PHILIPPINES
TEL: +63-2-8807-0420 / FAX: +63-2-8842-5202

VIETNAM**MITSUBISHI ELECTRIC VIETNAM CO., LTD.**

Vietnam Ho Chi Minh Service Center
11TH & 12TH FLOOR, VIETTEL TOWER B, 285 CACH MANG THANG 8 STREET, WARD 12, DISTRICT 10, HO CHI MINH CITY, VIETNAM
TEL: +84-28-3910-5945 / FAX: +84-28-3910-5947

Vietnam Hanoi Service Center

14TH FLOOR, CAPITAL TOWER, 109 TRAN HUNG DAO STREET, CUA NAM WARD, HOAN KIEM DISTRICT, HA NOI CITY, VIETNAM
TEL: +84-24-3937-8075 / FAX: +84-24-3937-8076

INDONESIA**PT. MITSUBISHI ELECTRIC INDONESIA**

Indonesia Service Center (Cikarang)
JL. KENARI RAYA BLOK G2-07A, DELTA SILICON 5, LIPPO CIKARANG - BEKASI 17550, INDONESIA
TEL: +62-21-2961-7797 / FAX: +62-21-2961-7794

MALAYSIA**MITSUBISHI ELECTRIC SALES MALAYSIA SDN. BHD.**

Malaysia Service Center (Kuala Lumpur Service Center)
LOT 11, JALAN 219, P.O BOX 1036, 46880 PETALING JAYA, SELANGOR DARUL EHSAN, MALAYSIA
TEL: +60-3-7626-5032

Johor Bahru Service Center

25-G, Pusat Perniagaan Perdana Jaya, Jalan Permatang Rawa, 14000 Bukit Mertajam, Pulau Pinang
TEL: +60-4-510-1838 / Fax: +60-4-510-1835

Pulau Pinang Service Center

9, Jalan Perjiranan 4/6, Bandar Dato Onn, 81100 Johor.
TEL: 07-3642250 / 2256

THAILAND**MITSUBISHI ELECTRIC FACTORY AUTOMATION (THAILAND) CO., LTD.**

Thailand Service Center (Bangkok)
101, TRUE DIGITAL PARK OFFICE, 5TH FLOOR, SUKHUMVIT ROAD, BANGCHAK, PHRA KHANONG, BANGKOK, 10260 THAILAND
TEL: +66-2-092-8600 / FAX: +66-2-043-1231-33

INDIA**MITSUBISHI ELECTRIC INDIA PVT., LTD.**

Service Head office and South India Service Center (Bangalore)
CNC eXPerience Park, PLOT NO. 57/A, PEENYA PHASE 3, PEENYA INDUSTRIAL AREA, BANGALORE 560058, KARNATAKA, INDIA
TEL: +91-80-4655-2121
Chennai Service Satellite
Coimbatore Service Satellite
Hyderabad Service Satellite

North India Service Center (Gurgaon)

PLOT 517, GROUND FLOOR, UDYOG VIHAR PHASE-III, GURUGRAM 122008, HARYANA, INDIA
TEL: +91-124-463-0300
Ludhiana Service Satellite
Panthnagar Service Satellite
Delhi Service Satellite
Jamshedpur Service Satellite
Manesar Service Satellite

West India Service Center (Pune)

ICC-Devi GAURAV TECHNOLOGY PARK, UNIT NO.402, FOURTH FLOOR, NORTH WING, SURVEY NUMBER 191-192 (P), NEXT to INDIAN CARD CLOTHING COMPANY Ltd, OPP. VALLABH NAGAR, PIMPRI, PUNE- 411 018, MAHARASHTRA, INDIA
TEL: +91-20-6819-2274
Kolhapur Service Satellite
Aurangabad Service Satellite
Mumbai Service Satellite

West India Service Center (Ahmedabad)

204-209, 2ND FLOOR, 31FIVE, CORPORATE ROAD PRAHLADNAGAR, AHMEDABAD -380015, GUJARAT, INDIA
TEL: + 91-79-6777-7888
Rajkot Service Satellite

CHINA**MITSUBISHI ELECTRIC AUTOMATION (CHINA) LTD. (CHINA FA CENTER)**

CNC Call Center
TEL: +86-400-921-5130

Shanghai Service Center

NO.1386 HONG QIAO ROAD, CHANG NING QU, SHANGHAI 200336, CHINA
TEL: +86-21-2322-3030 / FAX: +86-21-2322-3000*8422

Qingdao Service Center**Suzhou Service Center****Wuhan Service Center****Ningbo Service Center****Hefei Service Center****Beijing Service Center****Tianjin Service Center****Xian Service Center****Dalian Service Center****Chengdu Service Center****Shenzhen Service Center**

LEVEL 8, GALAXY WORLD TOWER B, 1 YABAO ROAD, LONGGANG DISTRICT, SHENZHEN 518129, CHINA
TEL: +86-755-2399-8272 / FAX: +86-755-8229-3686

Dongguan Service Center**Xiamen Service Center****KOREA****MITSUBISHI ELECTRIC AUTOMATION KOREA CO., LTD. (KOREA FA CENTER)**

Korea Seoul Service Center
8F GANGSEO HANGANG XI-TOWER A, 401 YANGCHEON-RO, GANGSEO-GU, SEOUL 07528 KOREA
TEL: +82-2-3660-9631 / FAX: +82-2-3664-8668

Korea Daegu Service Center

2F KT BLDG. 8, HOGUK-RO, BUK-GU, DAEGU 41518, KOREA
TEL: +82-53-382-7401 / FAX: +82-53-382-7412

Korea Changwon Technical Center

#205, 888, CHANGWON-DAERO, SEONGSAN-GU, CHANGWON-SI, GYEONGSANGNAM-DO, 51532, KOREA
TEL: +82-55-261-5559 / FAX: +82-55-261-5558

TAIWAN**MITSUBISHI ELECTRIC TAIWAN CO., LTD. (TAIWAN FA CENTER)**

Taiwan Taichung Service Center
NO. 8-1, GONGYEQU 16TH RD., XITUN DIST., TAICHUNG CITY 40768, TAIWAN
TEL: +886-4-2359-0688 / FAX: +886-4-2359-0689

Taiwan Taipei Service Center

11F, NO.88, SEC.6, ZHONGSHAN N. RD., SHILIN DIST., TAIPEI CITY 11155, TAIWAN
TEL: +886-2-2833-5430 / FAX: +886-2-2833-5433

Taiwan Tainan Service Center

11F-1, NO.30, ZHONGZHENG S. RD., YONGKANG DIST., TAINAN CITY 71067, TAIWAN
TEL: +886-6-252-5030 / FAX: +886-6-252-5031

OCEANIA**MITSUBISHI ELECTRIC AUSTRALIA PTY. LTD.**

Oceania Service Center
348 VICTORIA ROAD, RYDALMERE, N.S.W. 2116 AUSTRALIA
TEL: +61-2-9684-7269 / FAX: +61-2-9684-7245

Notice

Every effort has been made to keep up with software and hardware revisions in the contents described in this manual. However, please understand that in some unavoidable cases simultaneous revision is not possible. Please contact your Mitsubishi Electric dealer with any questions or comments regarding the use of this product.

Duplication Prohibited

This manual may not be reproduced in any form, in part or in whole, without written permission from Mitsubishi Electric Corporation.

COPYRIGHT 2015-2023 MITSUBISHI ELECTRIC CORPORATION
ALL RIGHTS RESERVED

MITSUBISHI ELECTRIC CORPORATION

HEAD OFFICE : TOKYO BLDG.,2-7-3 MARUNOUCHI,CHIYODA-KU,TOKYO 100-8310,JAPAN

MODEL	M800/M80/E80/C80 Series
MODEL CODE	100-437
Manual No.	IB-1501272