

Numerical Control (CNC)

Instruction Manual

C80 Series

Introduction

This manual is a guide for using the Mitsubishi Electric CNC C80 Series.

This manual describes operations, production processes and maintenances for users who operate the Mitsubishi Electric CNC installed machine tool. Read this manual thoroughly before using CNC unit. Moreover study the "Precautions for Safety" on the next page before use to use the unit safely. Be sure to keep this manual always at hand.

CAUTION

- ⚠ **For items described as "Restrictions" or "Usable State" in this manual, the instruction manual issued by the machine tool builder (MTB) takes precedence over this manual.**
- ⚠ **Items not described in this manual must be interpreted as "not possible".**
- ⚠ **This manual is written on the assumption that all the applicable functions are included. Some of them, however, may not be available for your NC system. Refer to the specifications issued by the machine tool builder before use.**
- ⚠ **Refer to the Instruction Manual issued by each MTB for details on each machine tool.**
- ⚠ **Some screens and functions may differ depending on the NC system (or its version), and some functions may not be possible. Please confirm the specifications before use.**
- ⚠ **Do not connect NC system to the Internet-connected network.**
- ⚠ **To maintain the safety of the NC system against unauthorized access from external devices via the network, take appropriate measures.**

In this manual, the following abbreviations might be used.

L system: Lathe system

M system: Machining center system

MTB: Machine tool builder

Also refer to the manuals on "Manual List" as necessary.

Manual List

Manuals related to M800/M80/E80/C80 Series are listed as follows.

These manuals are written on the assumption that all optional functions are added to the targeted model.

Some functions or screens may not be available depending on the machine or specifications set by MTB. (Confirm the specifications before use.)

The manuals issued by MTB take precedence over these manuals.

Manual	IB No.	Purpose and Contents
M800/M80/E80 Series Instruction Manual	IB-1501274	<ul style="list-style-type: none"> ◆ Operation guide for NC ◆ Explanation for screen operation, etc.
C80 Series Instruction Manual	IB-1501453	<ul style="list-style-type: none"> ◆ Operation guide for NC ◆ Explanation for screen operation, etc.
M800/M80/E80/C80 Series Programming Manual (Lathe System) (1/2)	IB-1501275	<ul style="list-style-type: none"> ◆ G code programming for lathe system ◆ Basic functions, etc.
M800/M80/E80/C80 Series Programming Manual (Lathe System) (2/2)	IB-1501276	<ul style="list-style-type: none"> ◆ G code programming for lathe system ◆ Functions for multi-part system, high-accuracy function, etc.
M800/M80/E80/C80 Series Programming Manual (Machining Center System) (1/2)	IB-1501277	<ul style="list-style-type: none"> ◆ G code programming for machining center system ◆ Basic functions, etc.
M800/M80/E80/C80 Series Programming Manual (Machining Center System) (2/2)	IB-1501278	<ul style="list-style-type: none"> ◆ G code programming for machining center system ◆ Functions for multi-part system, high-accuracy function, etc.
M800/M80/E80 Series Alarm/Parameter Manual	IB-1501279	<ul style="list-style-type: none"> ◆ Alarms ◆ Parameters
C80 Series Alarm/Parameter Manual	IB-1501560	<ul style="list-style-type: none"> ◆ Alarms ◆ Parameters

Manuals for MTBs (NC)

Manual	IB No.	Purpose and Contents
M800/M80/E80/C80 Series Specifications Manual (Function)	IB-1501505	<ul style="list-style-type: none"> ♦ Model selection ♦ Outline of various functions
M800/M80/E80/C80 Series Specifications Manual (Hardware)	IB-1501506	<ul style="list-style-type: none"> ♦ Model selection ♦ Specifications of hardware unit
M800W/M80W Series Connection and Setup Manual	IB-1501268	<ul style="list-style-type: none"> ♦ Detailed specifications of hardware unit ♦ Installation, connection, wiring, setup (startup/adjustment)
M800S/M80/E80 Series Connection and Setup Manual	IB-1501269	<ul style="list-style-type: none"> ♦ Detailed specifications of hardware unit ♦ Installation, connection, wiring, setup (startup/adjustment)
C80 Series Connection and Setup Manual	IB-1501452	<ul style="list-style-type: none"> ♦ Detailed specifications of hardware unit ♦ Installation, connection, wiring, setup (startup/adjustment)
M800/M80/E80 Series PLC Development Manual	IB-1501270	<ul style="list-style-type: none"> ♦ Electrical design ♦ I/O relation (assignment, setting, connection), field network ♦ Development environment (PLC on-board, peripheral development environment), etc.
M800/M80/E80 Series PLC Programming Manual	IB-1501271	<ul style="list-style-type: none"> ♦ Electrical design ♦ Sequence programming ♦ PLC support functions, etc.
M800/M80/E80/C80 Series PLC Interface Manual	IB-1501272	<ul style="list-style-type: none"> ♦ Electrical design ♦ Interface signals between NC and PLC
M800/M80/E80 Series Maintenance Manual	IB-1501273	<ul style="list-style-type: none"> ♦ Cleaning and replacement for each unit ♦ Other items related to maintenance
C80 Series Maintenance Manual	IB-1501454	<ul style="list-style-type: none"> ♦ Cleaning and replacement for each unit ♦ Other items related to maintenance

Manuals for MTBs (drive section)

Manual	IB No.	Contents
MDS-E/EH Series Specifications Manual	IB-1501226	<ul style="list-style-type: none"> ♦ Specifications for power supply regeneration type
MDS-E/EH Series Instruction Manual	IB-1501229	<ul style="list-style-type: none"> ♦ Instruction for power supply regeneration type
MDS-EJ/EJH Series Specifications Manual	IB-1501232	<ul style="list-style-type: none"> ♦ Specifications for regenerative resistor type
MDS-EJ/EJH Series Instruction Manual	IB-1501235	<ul style="list-style-type: none"> ♦ Instruction for regenerative resistor type
MDS-EM/EMH Series Specifications Manual	IB-1501238	<ul style="list-style-type: none"> ♦ Specifications for multi-hybrid, power supply regeneration type
MDS-EM/EMH Series Instruction Manual	IB-1501241	<ul style="list-style-type: none"> ♦ Instruction for multi-hybrid, power supply regeneration type
DATA BOOK	IB-1501252	<ul style="list-style-type: none"> ♦ Specifications of servo drive unit, spindle drive unit, motor, etc.

Manuals for MTBs (Others)

Manual	No.	Purpose and Contents
GOT2000 Series User's Manual (Hardware)	SH-081194	♦ Outline of hardware such as part names, external dimensions, installation, wiring, maintenance, etc. of GOTs
GOT2000 Series User's Manual (Utility)	SH-081195	♦ Outline of utilities such as screen display setting, operation method, etc. of GOTs
GOT2000 Series User's Manual (Monitor)	SH-081196	♦ Outline of each monitor function of GOTs
GOT2000 Series Connection Manual (Mitsubishi Electric Products)	SH-081197	♦ Outline of connection types and connection method between GOT and Mitsubishi Electric connection devices
GT Designer3 (GOT2000) Screen Design Manual	SH-081220	♦ Outline of screen design method using screen creation software GT Designer3

■ For M800/M80/E80 Series

Manual	No.	Purpose and Contents
GOT2000/GOT1000 Series CC-Link Communication Unit User's Manual	IB-0800351	♦ Explanation for handling CC-Link communication unit (for GOT2000 series/GOT1000 series)
GX Developer Version 8 Operating Manual (Startup)	SH-080372E	♦ Explanation for system configuration, installation, etc. of PLC development tool GX Developer
GX Developer Version 8 Operating Manual	SH-080373E	♦ Explanation for operations using PLC development tool GX Developer
GX Converter Version 1 Operating Manual	IB-0800004E	♦ Explanation for operations using data conversion tool GX Converter
GX Works2 Installation Instructions	BCN-P5999-0944	♦ Explanation for the operating environment and installation method of GX Works2
GX Works2 Version 1 Operating Manual (Common)	SH-080779ENG	♦ Explanation for the system configuration of GX Works2 and the functions common to Simple project and Structured project such as parameter setting, operation method for the online function
GX Works2 Version 1 Operating Manual (Simple Project)	SH-080780ENG	♦ Explanation for methods for such as creating and monitoring programs in Simple project of GX Works2
GX Works2 Version 1 Operating Manual (Simple Project, Function Block)	SH-080984ENG	♦ Explanation for methods for such as creating function blocks, pasting function blocks to sequence programs, and operating FB library in Simple project of GX Works2
GX Works2 Version 1 Operating Manual (Structured Project)	SH-080781ENG	♦ Explanation for methods for such as creating and monitoring programs in Structured project of GX Works2
GX Works3 Installation Instructions	BCN-P5999-0391	♦ Explanation for the operating environment and installation method of GX Works3
MELSEC-Q CC-Link System Master/Local Module User's Manual	SH-080394E	♦ Explanation for system configuration, installation, wiring, etc. of master/local modules for CC-Link system
GOT2000 Series Connection Manual (Non-Mitsubishi Electric Products 1)	SH-081198ENG	♦ Explanation for connection types and connection method between GOT and other company's devices
GOT2000 Series Connection Manual (Non-Mitsubishi Electric Products 2)	SH-081199ENG	
GOT2000 Series Connection Manual (Microcomputers, MODBUS/Fieldbus Products, Peripherals)	SH-081200ENG	♦ Explanation for connection types and connection method between GOT and microcomputers, MODBUS/fieldbus products, peripherals
GT SoftGOT2000 Version1 Operating Manual	SH-081201ENG	♦ Explanation for system configuration, screen configuration and operation method of monitoring software GT SoftGOT2000

■ For C80 Series

Manual	No.	Purpose and Contents
MELSEC iQ-R Module Configuration Manual	SH-081262	♦ Outline of system configuration, specifications, installation, wiring, maintenance, etc.
MELSEC iQ-R CPU Module User's Manual (Startup)	SH-081263	♦ Outline of specifications, procedures before operation, troubleshooting, etc. for CPU module
MELSEC iQ-R CPU Module User's Manual (Application)	SH-081264	♦ Outline of memory, functions, devices, parameters, etc. for CPU module
MELSEC iQ-R CC-Link IE Field Network User's Manual (Application)	SH-081259	♦ Explanation for functions, parameter settings, programming, troubleshooting, etc. of the CC-Link IE Field Network function
QCPU User's Manual (Hardware Design, Maintenance and Inspection)	SH-080483	♦ Outline of specifications, necessary knowledge to configure the system and maintenance-related descriptions for Q series CPU module, etc.
GX Works3 Operating Manual	SH-081215	♦ Outline of functions, programming, etc.

Reference Manual for MTBs

Manual	No.	Purpose and Contents
M800/M80 Series Smart safety observation Specification manual	BNP-C3072-022	♦ Explanation for smart safety observation function
C80 Series Smart safety observation Specification manual	BNP-C3077-022	
M800/M80 Series CC-Link (Master/Local) Specification manual	BNP-C3072-089	♦ Explanation for CC-Link
M800/M80 Series PROFIBUS-DP Specification manual	BNP-C3072-118	♦ Explanation for PROFIBUS-DP communication function
M800/M80 Series Interactive cycle insertion (Customization) Specification manual	BNP-C3072-121-0003	♦ Explanation for interactive cycle insertion
M800/M80 Series EtherNet/IP Specifications manual	BNP-C3072-263	♦ Explanation for EtherNet/IP
M800/M80 Series CC-Link IE Field (Master/local) Specifications manual	BNP-C3072-283	♦ Explanation for CC-Link IE Field
M800/M80 Series GOT Connection Specifications manual	BNP-C3072-314	♦ Explanation for GOT connection
M800/M80 Series CC-Link IE Field Basic Specifications manual	BNP-C3072-337	♦ Explanation for CC-Link IE Field Basic

Precautions for Safety

Always read the specifications issued by the MTB, this manual, related manuals and attached documents before installation, operation, programming, maintenance or inspection to ensure correct use. Understand this numerical controller, safety items and cautions before using the unit.

This manual ranks the safety precautions into "DANGER", "WARNING" and "CAUTION".

DANGER

When the user may be subject to imminent fatalities or major injuries if handling is mistaken.

WARNING

When the user may be subject to fatalities or major injuries if handling is mistaken.

CAUTION

When the user may be subject to bodily injury or when physical damage may occur if handling is mistaken.

Note that even items ranked as " CAUTION", may lead to major results depending on the situation. In any case, important information that must always be observed is described.

The following signs indicate prohibition and compulsory.



This sign indicates prohibited behavior (must not do).

For example, "Keep fire away" is indicated by .



This sign indicates a thing that is critical (must do).

For example, "it must be grounded" is indicated by .

The meaning of each pictorial sign is as follows.

 CAUTION	 CAUTION rotate object	 CAUTION HOT	 Danger Electric shock risk	 Danger explosive
 Prohibited	 Disassembly is prohibited	 KEEP FIRE AWAY	 General instruction	 Earth ground

For Safe Use

Mitsubishi Electric CNC is designed and manufactured solely for applications to machine tools to be used for industrial purposes. Do not use this product in any applications other than those specified above, especially those which are substantially influential on the public interest or which are expected to have significant influence on human lives or properties.

DANGER



Not applicable in this manual.

WARNING

1. Items related to program development







-  Do not assign any startup switch for C80 on GOT's touch key. If a communication fault (including cable disconnection) occurs between GOT and CNC C80, the communication will be suspended and the GOT will become inoperative. In this case, even when you release your hands from the startup switch, CNC will fail to recognize the cutoff of startup signal, which may cause serious accidents.

2. Items related to operation

-  If the operation start position is set from a block in the program and the program is started, the program before the set block is not executed. Please confirm that G and F modal and coordinate values are appropriate. If there are coordinate system shift commands or M, S, T and B commands before the block set as the start position, carry out the required commands using the MDI, etc. If the program is run from the set block without carrying out these operations, there is a danger of interference with the machine or of machine operation at an unexpected speed, which may result in breakage of tools or machine tool or may cause damage to the operators.
-  Under the constant surface speed control (during G96 modal), if the axis targeted for the constant surface speed control moves toward the spindle center, the spindle rotation speed will increase and may exceed the allowable speed of the workpiece or chuck, etc. In this case, the workpiece, etc. may jump out during machining, which may result in breakage of tools or machine tool or may cause damage to the operators.

CAUTION



1. Items related to product and manual

-  For items described as "Restrictions" or "Usable State" in this manual, the instruction manual issued by the machine tool builder (MTB) takes precedence over this manual.
-  Items not described in this manual must be interpreted as "not possible"
-  This manual is written on the assumption that all the applicable functions are included. Some of them, however, may not be available for your NC system. Refer to the specifications issued by the machine tool builder before use.
-  Refer to the Instruction Manual issued by each MTB for details on each machine tool.
-  Some screens and functions may differ depending on the NC system (or its version), and some functions may not be possible. Please confirm the specifications before use.
-  Do not connect NC system to the Internet-connected network.
-  To maintain the safety of the NC system against unauthorized access from external devices via the network, take appropriate measures.



2. Items related to installation and assembly

-  Ground the signal cables to ensure stable system operation. Also ground the NC unit main frame, power distribution panel and machine to one point, so they all have the same potential.

3. Items related to preparation before use

-  Always set the stored stroke limit. Failure to set this could result in collision with the machine end.
-  Always turn the power OFF before connecting/disconnecting the input/output device cable. Failure to do so could damage the input/output device and NC unit.

4. Items related to screen operation

-  If the tool compensation amount or workpiece coordinate system offset amount is changed during automatic operation (including during single block stop), the changes will be valid from the command in next block or after several subsequent blocks.
-  All of the various data in the NC memory is erased when formatting. Be sure to use the transfer function to transfer all necessary data to another storage device before formatting.
-  Pay close attention to the sequence operation when carrying out forced data setting (forced output) in the I/F diagnosis screen during machine operation.

CAUTION

 The program including a character of any language other than the display language is not correctly displayed. Do not edit such a program. Any part of the program other than the comment part may also be changed if edited.

 To prevent influence from data omission and data transformation in the communication circuit, always verify the data after inputting and outputting machining programs.

 Do not change setup parameters without prior approval from the MTB.

5. Items related to programming

 If there is no value after the G command, the operation will be the "G00" operation when the program is run due to key chattering, etc., during editing.

 "; ", "EOB", "%", and "EOR" are symbols used for explanation. The actual codes for ISO are "CR, LF" ("LF") and "%". "%" and "EOR" are represented by "%" in ISO.

The programs created on the edit screen are stored in the NC memory in a "CR, LF" format, however, the programs created with external devices may be stored in an "LF" format.

The actual codes for EIA are "EOB (End of Block)" and "EOR (End of Record)".

 Do not change the fixed cycle program without prior approval from the MTB.

6. Items related to operation

 Do not enter the machine's movable range during automatic operation. During rotation, keep your hands, feet and face away from the spindle.

 Carry out dry operation before actually machining, and confirm the machining program, tool offset and workpiece coordinate system offset.

 If the operation start position is set from a block in the program and the program is started, the program before the set block is not executed. If there are coordinate system shift commands or M, S, T, and B commands before the block set as the starting position, carry out the required commands using the MDI, etc. There is a danger of interference with the machine if the operation is started from the set starting position block without carrying out these operations.

 Program so the mirror image function is turned ON/OFF at the mirror image center. The mirror image center will deviate if the function is turned ON/OFF at a position other than the mirror image center.

7. Items related to faults and abnormalities

 If the battery low warning is issued in the drive unit side, immediately replace the battery. Replace the batteries while applying the drive unit's control power.

 If the axis overruns or emits an abnormal noise, immediately press the emergency stop button and stop the axis movement.

 Turn OFF the power immediately if any smoke, abnormal noise or odor is generated from the controller, drive unit or motor.

8. Items related to maintenance

 Incorrect connections may damage the devices. Always connect the cables to the indicated connectors.

 Do not apply voltages other than those indicated according to specification on the connector. Failure to observe this could cause bursting, damage, etc.

 Do not connect or disconnect the connection cables between each unit while the power is ON.

 Do not connect the cable by pulling on the cable wire.

 Do not short circuit, charge, overheat, incinerate or disassemble the battery.

 Dispose the spent battery according to local laws.

 Dispose the spent cooling fan according to local laws.

 Do not replace each control unit while the power is ON.

 Do not replace the operation panel I/O unit while the power is ON.

 Do not replace the cooling fan while the power is ON.

⚠ CAUTION

- ⚠ Do not replace the battery while the power is ON.
- ⚠ Read the manual carefully and pay careful attention to safety for the on-line operation (especially program change, forced stop or operation change) performed by connecting peripheral devices to the CNC CPU module during operation. Erroneous operation may cause machine breakage or accident.
- ⚠ Never try to disassemble or modify modules. It may cause product failure, operation failure, injury or fire.
- ⚠ Use any radio communication device such as a cellular phone or a PHS phone more than 25cm away in all directions of C80. Failure to do so may cause a malfunction.
- ⚠ Completely turn off the externally supplied power used in the system before installation or removing the module. Not doing so could result in electric shock, damage to the module or operation failure.
- ⚠ Do not install/remove the module on to/from base unit or terminal block more than 50 times, after the first use of the product. Mounting/dismounting over 50 times may cause an operation failure.
- ⚠ Do not drop or impact the battery to be installed to the module. That may damage the battery, causing battery liquid to leak in the battery. Do not use the dropped or impacted battery, but dispose of it.
- ⚠ Before touching the unit, always touch a metal with a ground section to discharge any static electricity in the human body etc. If static electricity is not discharged, the breakdown and the malfunction of the unit are caused.
- ⚠ Do not directly touch the module's conductive parts and electronic components. Touching them could cause an operation failure or give damage to the module.
- ⚠ Do not touch the heat radiating fins of CNC CPU module while the power is ON and for a short time after the power is turned OFF. In this timing, these parts become very hot and may lead to burns. Remove the modules with close attention.

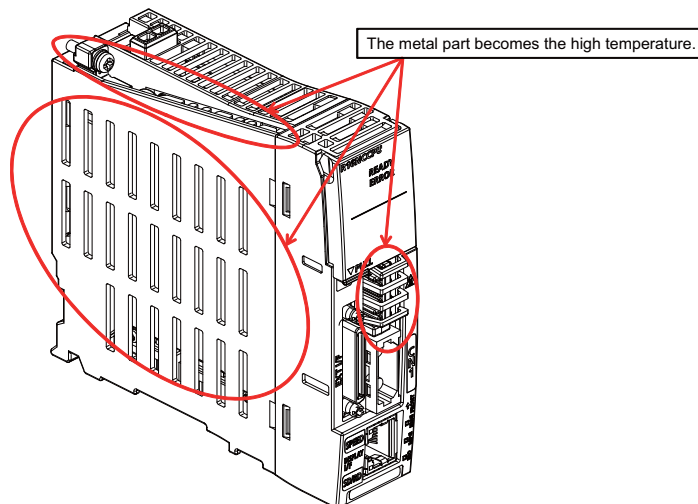

- ⚠ When connecting to a personal computer and a unit with the USB interface, an electric shock or a unit failure may occur.
Operate these correctly according to the manual of a unit and a personal computer.
Observe the following cautions when a personal computer in an AC power supply is used.
 - (1) For a personal computer that uses a 3-pin power plug or power plug with a ground lead type, make sure to use a plug socket including a ground input electrode or ground the earth lead, respectively.
And, ensure to ground a personal computer and a unit with Class D or higher grounding (Ground resistance: 100Ω or less).
 - (2) For a personal computer that uses a 2-pin power plug without ground lead, make sure to connect the unit to the personal computer according to the following procedures. And, it is recommended to supply the same power supply line to a personal computer and the unit.
 - (a) Pull out the power plug of the personal computer from the AC outlet.
 - (b) Confirm that the power plug of the personal computer has been pulled out from the AC outlet, and connect USB cables, the extension cable or the bus connection cable of a GOT.
 - (c) Insert the power plug of the personal computer into the AC outlet.
- ⚠ Before using this product after a long period of storage, performance check must be conducted. Otherwise contact the MTB of your machine tool.

 **CAUTION**

9. Other items

⚠ Mitsubishi Electric CNC C80, which is an open equipment, must be installed within a sealed metal control panel (IP54 or higher). C80 must also be used and stored under the conditions listed in the table of specifications below.

Item		Specification				
Ambient temperature	During operation	0 to 55 °C				
	During storage	-25 to 75 °C				
Ambient Humidity	During operation	5 to 95%RH, non-condensing				
	During storage	5 to 95%RH, non-condensing				
Vibration resistance	Compliant with JIS B 3502 and IEC 61131-2	Under intermittent vibration	Frequency	Constant acceleration	Half amplitude	Sweep count 10 times each in X, Y, Z directions (For 80 min.)
			5 to 8.4Hz	-	3.5mm	
		Under continuous vibration	8.4 to 150Hz	9.8m/s ²	-	
			5 to 8.4Hz	-	1.75mm	
8.4 to 150Hz	4.9m/s ²	-				
Shock resistance		147m/s ² , 3 times in each of 3 directions X, Y, Z				
Operating atmosphere		No corrosive gases nor inflammable gases				
Altitude		2000m or less (*3)				
Installation location		Inside control panel				
Overvoltage category (*1)		II or less				
Pollution level (*2)		2 or less				

(*1) This indicates the section of the power supply to which the equipment is assumed to be connected between the public electrical power distribution network and the machinery within premises.

- Category II applies to equipment for which electrical power is supplied from fixed facilities.
- The surge withstand voltage for the equipment up to the rated 300V is 2500V.

(*2) This index indicates the degree to which conductive material is generated in terms of the environment in which the equipment is used.

Pollution level 2 is when only non-conductive pollution occurs; however, a temporary conductivity caused by condensing must be expected occasionally.

(*3) Do not use or store C80 under pressure higher than the atmospheric pressure of altitude 0m. Doing so can cause an operation failure.

Note

(1) The following environment conditions are required for the layout design.

- No large amount of conductible dust, iron filings, oil mist, salt, or organic solvents
- No direct sunlight
- No strong electrical or magnetic fields
- No direct vibrations nor shocks on C80

Treatment of waste

The following two laws will apply when disposing of this product. Considerations must be made to each law. The following laws are in effect in Japan. Thus, when using this product overseas, the local laws will have a priority. If necessary, indicate or notify these laws to the final user of the product.

- (1) Requirements for "Law for Promotion of Effective Utilization of Resources"
 - (a) Recycle as much of this product as possible when finished with use.
 - (b) When recycling, often parts are sorted into steel scraps and electric parts, etc., and sold to scrap contractors. Mitsubishi recommends sorting the product and selling the members to appropriate contractors.

- (2) Requirements for "Law for Treatment of Waste and Cleaning"
 - (a) Mitsubishi recommends recycling and selling the product when no longer needed according to item (1) above. The user should make an effort to reduce waste in this manner.
 - (b) When disposing a product that cannot be resold, it shall be treated as a waste product.
 - (c) The treatment of industrial waste must be commissioned to a licensed industrial waste treatment contractor, and appropriate measures, including a manifest control, must be taken.
 - (d) Batteries correspond to "primary batteries", and must be disposed of according to local disposal laws.

Disposal



(Note) This symbol mark is for EU countries only.
This symbol mark is according to the directive 2006/66/EC Article 20 Information for end-users and Annex II.

Your MITSUBISHI ELECTRIC product is designed and manufactured with high quality materials and components which can be recycled and/or reused.

This symbol means that batteries and accumulators, at their end-of-life, should be disposed of separately from your household waste.

If a chemical symbol is printed beneath the symbol shown above, this chemical symbol means that the battery or accumulator contains a heavy metal at a certain concentration. This will be indicated as follows:

Hg: mercury (0,0005%), Cd: cadmium (0,002%), Pb: lead (0,004%)

In the European Union there are separate collection systems for used batteries and accumulators.

Please, dispose of batteries and accumulators correctly at your local community waste collection/recycling centre.

Please, help us to conserve the environment we live in!

Trademarks

MELDAS, MELSEC, EZSocket, EZMotion, iQ Platform, MELSEC iQ-R, MELSOFT, GOT, CC-Link, CC-Link/LT, CC-Link IE, CC-Link IE/field, EcoMonitorLight and SLMP are either trademarks or registered trademarks of Mitsubishi Electric Corporation in Japan and/or other countries.

Ethernet is a registered trademark of Xerox Corporation in the United States and/or other countries.

Microsoft®, Windows®, SQL Server® and Access® are either trademarks or registered trademarks of Microsoft Corporation in the United States and/or other countries.

SD logo and SDHC logo are either registered trademarks or trademarks of LLC.

UNIX is a registered trademark of The Open Group in the United States and/or other countries.

Intel® and Pentium® are either trademarks or registered trademarks of Intel Corporation in the United States and/or other countries.

MODBUS® is either a trademark or a registered trademark of Schneider Electric USA, Inc. or the affiliated companies in Japan and/or other countries.

EtherNet/IP is a trademark of Open DeviceNet Vendor Association, Inc.

PROFIBUS-DP and PROFINET are either trademarks of Profibus International.

Oracle® is a registered trademark of Oracle Corporation, the subsidiaries, or the affiliated companies in the United States and /or other countries.

VNC is a registered trademark of RealVNC Ltd. in the United States and other countries.

Other company and product names that appear in this manual are trademarks or registered trademarks of the respective companies.

本製品の取扱いについて

(日本語 /Japanese)

本製品は工業用(クラス A)電磁環境適合機器です。販売者あるいは使用者はこの点に注意し、住商業環境以外での使用をお願いいたします。

Handling of our product

(English)

This is a class A product. In a domestic environment this product may cause radio interference in which case the user may be required to take adequate measures.

본 제품의 취급에 대해서

(한국어 /Korean)

이 기기는 업무용(A급) 전자파적합기기로서 판매자 또는 사용자는 이 점을 주의하시기 바라며 가정외의 지역에서 사용하는 것을 목적으로 합니다.

Contents

1 Outline of Menu Items	1
2 Screen Operations	7
2.1 Graphic Operation Terminal (GOT)	8
2.1.1 Screen Operation of GOT	8
2.1.2 Explanations of the Screens	9
2.1.3 Messages	14
2.1.4 External memory interface	15
2.2 CNC Monitor2 Screen	16
2.2.1 Displayed Part System	18
2.2.2 NC Status	19
2.2.3 Operation mode/MDI status	20
2.2.4 Operation status	20
2.2.5 Alarms/Warnings	21
2.2.6 Operation messages	21
2.2.7 Changing the Screen Theme Color	22
2.2.8 Screen Transition Diagram	23
2.3 Setting Data	24
2.3.1 Setting Numerals and Alphabetical Characters	24
2.3.2 Inputting Operations	25
2.4 Guidance Function	27
2.4.1 Parameter Guidance	27
2.4.2 Alarm Guidance	29
2.4.3 G Code Guidance	32
2.5 Menu List	35
2.6 Touchscreen Functions	37
2.6.1 Basic Operation	37
2.6.2 Software Keyboard	39
2.6.3 Operating the Screen by Touch Gestures	44
2.7 Menu Customization Function	48
2.8 Changing the Operation Level (Protect Setting Screen)	50
3 Inputting a Machining Program and Defining Variables	51
3.1 Inputting a Machining Program	52
3.2 Creating and Editing a Machining Program	52
3.3 Registering and Editing the MDI Program	60
3.4 Registering and Editing the Fixed Cycle Program	62
3.4.1 Fixed Cycle Operation Parameters	62
3.4.2 Transmitting and Erasing the Fixed Cycle Program	62
3.5 Erasing a File	63
3.6 Editing Operations	64
3.6.1 Changing the Display	64
3.6.2 Displaying an Arbitrary Line	66
3.6.3 Rewriting Data	66
3.6.4 Inserting Data (Initial Data Overwrite Mode)	67
3.6.5 Overwriting Data (Initial Data Insertion Mode)	68
3.6.6 Deleting Data	68
3.6.7 Searching for Character Strings	70
3.6.8 Replacing Character Strings	72
3.6.9 Copying and Pasting Data	73
3.6.10 Undoing Program Changes	75
3.7 Program Editing Support Function	76
3.7.1 Performing Operation Search at the Cursor Position	76
3.7.2 Adding Sequence No. (N No.) Automatically	77
3.7.3 G Code Guidance	78
3.7.4 Playback Editing	79
3.8 Editing a Multi-part System Program	83
3.8.1 Multi-part System Simultaneous Program Editing	83
3.8.2 Special Program Editing Display for Synchronization between Part Systems	89
3.9 Defining Variables	90
3.9.1 Common Variables	90
3.9.2 Local Variables	95

4 Inputting and Outputting a Machining Program	99
4.1 Inputting and Outputting a Program.....	100
4.2 Selecting a Device, Directory and File.....	105
4.3 Transferring a File.....	108
4.4 Comparing Files (Compare)	111
4.5 Erasing a File.....	112
4.6 Changing a File Name (Rename).....	113
4.7 Creating a Directory.....	114
4.8 Other Functions	115
4.8.1 Merging a File	115
4.8.2 List of File Names	116
4.8.3 Edit Lock B and C	116
4.8.4 Program Display Lock.....	117
4.8.5 Data Protection Keys	117
4.8.6 Leading Zero	118
4.9 The Batch Input/Output the Machining Program of NC Memory	119
5 Setting a Tool and a Workpiece.....	123
5.1 Setting a Tool.....	124
5.2 Registering a Tool (Tool Registration Screen).....	124
5.2.1 Registering a Tool in the Magazine Pot	126
5.2.2 Setting the PLC Command	126
5.2.3 Setting and Erasing the Tool No. of Spindle/Standby Tools	127
5.2.4 Erasing the Tool Registration Data	127
5.3 Measuring a Tool (Tool Measurement Screen)	128
5.3.1 Tool Measurement (M System).....	128
5.3.2 Tool Measurement (L System).....	133
5.4 Setting Tool Compensation Amount (Tool Offset Screen).....	144
5.4.1 Setting the Tool Compensation Data	151
5.4.2 Switching the Input Method for the Tool Compensation Data	153
5.4.3 Erasing the Tool Compensation Data	154
5.4.4 Copying and Pasting the Tool Compensation Data	155
5.4.5 Undoing Change of Tool Compensation Data	155
5.4.6 Disabling the Setting of Tool Compensation Amount.....	156
5.4.7 Measuring Tool Compensation Amount.....	157
5.4.8 Moving to designated Compensation Number	159
5.5 Setting the Tool Management Data (Tool Management Screen)	160
5.5.1 List of Display Items	162
5.5.2 Data Setting Range.....	167
5.5.3 Menu Configuration.....	171
5.5.4 Registering New Tool Management Data	175
5.5.5 Switching the Item Type of the Tool Management Data Detailed Portion.....	175
5.5.6 Displaying Data by Designating Tool Management Data No.	176
5.5.7 Displaying Data by Designating Tool No.....	177
5.5.8 Sorting the Data by Tool No.....	178
5.5.9 Deleting the Tool Management Data	179
5.5.10 Copying and Pasting the Tool Management Data	180
5.5.11 Specifying Display Format and Setting Range of Additional Information.....	182
5.6 Tool Life Management	183
5.6.1 Displaying the Group List (M system: Tool life management I, II / L system: Tool life management II).....	185
5.6.2 Displaying the Life Management Data in Group Units (M system)	189
5.6.3 Displaying the Life Management Data (L system: Tool life management I).....	197
5.6.4 Displaying the Tool Life Management Data in Group Units (L system: Tool life Management II).....	199
5.7 Setting and Measuring a Workpiece.....	204
5.7.1 Workpiece Measurement (M System).....	204
5.7.1.1 Carrying Out Surface Measurement.....	208
5.7.1.2 Carrying Out Hole Measurement.....	209
5.7.1.3 Carrying Out Width Measurement.....	211
5.7.1.4 Carrying Out Rotation Measurement.....	213
5.7.1.5 Performing Automatic Recontact When Contacting the Workpiece	216
5.7.2 Workpiece Measurement (L System).....	217
5.8 Setting Workpiece Coordinate System Offset	223
5.8.1 Setting the Coordinate System Offset Amount	225
5.8.2 Erasing the Coordinate System Offset Amount	226
5.8.3 Setting the Workpiece Coordinate Origin.....	226
5.8.4 Changing the Coordinate System Display	227

5.9 Setting Workpiece Coordinate System Shift.....	228
5.9.1 Manually Setting the Workpiece Coordinate System Shift Value.....	232
5.9.2 Automatically Setting the Workpiece Coordinate System Shift Value.....	234
6 Setting Parameters	237
6.1 Setting User Parameters	238
6.1.1 Selecting the Parameter Number.....	240
6.1.2 Setting the Parameters	241
6.1.3 Copying and Pasting Parameters	242
6.1.4 Parameter Configuration	243
6.1.5 Echoback	243
6.1.6 Ethernet parameter	243
6.1.7 Precautions	243
6.2 Selecting High-accuracy Control Parameters (Machining Cond I Screen)	244
7 Setting Machine Movable Area	249
7.1 Setting the Stored Stroke Limit	250
7.1.1 Stored Stroke Limit II.....	251
7.2 Chuck Barrier/Tailstock Barrier (L System)	253
8 Other Setups.....	259
8.1 Integrated Time.....	260
8.1.1 Integrated Time Display	260
8.1.2 Setting the Integrated Time.....	261
8.1.3 Setting the Time Display Selection	262
8.2 Counter Setting.....	263
8.3 Origin Set, Origin Cancel.....	265
8.4 Manual Numerical Value Command	268
8.5 MDI Program Editing	271
8.6 Thread Recutting Function	273
8.6.1 Storing the Thread Groove Position.....	275
8.6.2 Switching the Stored Thread Groove ON/OFF	276
8.6.3 Erasing the Stored Thread Groove Position	276
9 Machining a Workpiece	277
9.1 Operation Search.....	278
9.1.1 Executing an Operation Search	280
9.1.2 Changing Whether to Show or Hide the Comment Field	281
9.1.3 Changing the Sorting Method	282
9.2 Checking the Movement under Machining (Monitor Screen).....	283
9.2.1 Screen Layout.....	283
9.2.2 Switching the Display Format.....	294
9.2.3 Switching the Counter Types	295
9.2.4 Switching the Spindle No. to be Displayed on Counter.....	298
9.2.5 Operation of 2-part System Simultaneous Display	298
9.2.6 Counter All-axis Display	300
9.2.7 Modal Display.....	302
9.2.8 Program Tree Display	308
9.2.9 Integrated Time Display	309
9.2.10 Load Meter Display	309
9.2.11 Spindle, Standby Display	310
9.2.12 Tool Center Coordinate Display	311
9.2.13 All Spindles' Rotation Speed Display	313
9.3 Restart Search.....	314
9.3.1 Main Screen.....	318
9.3.2 Top Search Screen	320
9.3.3 File Setting Screen.....	321
9.3.4 MSTB History Screen.....	322
9.3.5 Operation Sequence for Program Restart.....	323
9.3.6 Executing Restart Search (Restart Type 1)	325
9.3.7 Executing Restart Search (Restart Type 2)	326
9.3.8 Returning to the Restart Position	329
9.3.9 Executing the MSTB Commands.....	331
9.4 Collation and Stop	332

9.5 Correcting the Machining Program	336
9.5.1 Program Editing	336
9.5.2 Buffer Correction	342
10 Troubleshooting	347
10.1 Confirming the NC Message (Alarm Screen)	348
10.1.1 Alarm History	350
10.2 Checking Machine Status	352
10.2.1 System Configuration Screen	352
10.2.2 Option Display Screen	353
10.2.3 Drive Monitor Screen (Servo Unit)	354
10.2.4 Drive Monitor Screen (Spindle Unit)	359
10.2.5 Drive Monitor Screen (Power Supply Unit)	364
10.2.6 Drive Monitor Screen (Synchronous Error)	366
10.2.7 Clearing the Alarm History on Drive Monitor Screen	367
10.3 Diagnosis Screens	368
10.3.1 Self Diagnosis Screen	368
10.3.2 Checking Alarms of Drive Unit	371
10.3.3 Collecting the Data on the Diagnosis Data Collection Setting Screen	374
10.4 Advanced Diagnosis	377
10.4.1 Displaying and Setting the PLC Device Data (I/F Diagnosis Screen)	377
10.4.1.1 Displaying the PLC Device Data	379
10.4.1.2 Carrying Out Modal Output	380
10.4.1.3 Carrying Out One-shot Output	381
10.4.2 Writing and Reading the Data Using the NC Data Designation (NC Memory Diagnosis Screen)	382
10.4.3 Collecting the NC Data (Data Sampling Screen)	384
10.5 Safety Observation	385
10.5.1 Safety Observation Screen (Configuration Diagnosis)	385
10.5.2 Safety Observation Screen (Signal Monitor)	387
10.5.3 Safety Observation Screen (Drive Monitor)	389
10.5.4 Safety Observation Screen (Version Display)	392
11 Performing a Backup Operation	393
11.1 Selecting a Device, Directory and File	398
11.2 Transferring a File	404
11.3 Comparing Files (Compare)	407
11.4 Erasing a File	408
11.5 Changing a File Name (Rename)	409
11.6 Creating a Directory	410
11.7 Restrictions	411
11.7.1 Device Definition	411
11.7.2 List Display	411
11.7.3 Program Name	411
11.8 Other Functions	412
11.8.1 Merging a File	412
11.8.2 List of File Names	413
11.8.3 Edit Lock B and C	414
11.8.4 Data Protection Keys	415
11.8.5 The Batch Input/Output the Machining Program of NC Memory	415
11.9 Performing Backups of NC Memory Data	419
12 Appendix 1: List of Function Codes	423
13 Appendix 2: Other Functions for Reference	425
13.1 F1-digit Feed	426
14 Appendix 3: Daily Inspection of GOT	429



Outline of Menu Items

This chapter explains the outline of the menus for each screen.
Refer to the corresponding section for detailed operation.

Monitor screen (Monitr)

Menus	Details	Reference
Search	This executes operation search.	9.1 Operation Search
Reserch	This executes restart search.	9.3 Restart Search
Edit	This edits the searched machining program.	9.5 Correcting the Machining Program
Offset	This displays the tool compensation amount. A value can also be set for the tool compensation amount.	5.4 Setting Tool Compensation Amount (Tool Offset Screen)
Coord	This displays the workpiece coordinate system offset. A value can also be set for the workpiece coordinate system offset.	5.8 Setting Workpiece Coordinate System Offset
W-shift	This displays the workpiece coordinate system shift. <Note> ♦This menu is not displayed for M system, or when the parameter "#11056 Workshift invalid" is set to "1".	5.9 Setting Workpiece Coordinate System Shift
Dsp sw.	This displays the sub-menu to change the display type of the monitor screen.	9.2.2 Switching the Display Format
Modal	This displays the program modal.	9.2.7 Modal Display
Tree	This displays the program tree.	9.2.8 Program Tree Display
Time	This displays the date, time and integrated time, etc. The date, time and integrated time, etc., can also be set.	8.1 Integrated Time
Com var	This displays the common variables. A value can also be set for the common variable.	3.9.1 Common Variables
Loc var	This displays the local variables.	3.9.2 Local Variables
P corr	This corrects the buffer.	9.5.2 Buffer Correction
G92 set	This sets and cancels the origin.	8.3 Origin Set, Origin Cancel
Col stp	This executes collation and stop.	9.4 Collation and Stop

Menus	Details	Reference
LdMeter	This displays the spindle load, NC axis load, etc., with a bar graph. The display contents differ depending on MTB specification.	9.2.10 Load Meter Display
Sp-stby	This displays the current spindle tool number and the tool number that is standby to be used next. The display contents differ depending on MTB specification.	9.2.11 Spindle, Standby Display
TipDisp	Displays the tool tip coordinate, handle interruption amount (tool axis movement), and tool tip speed. <Note> ♦This menu is displayed when any of the additional specifications (tool center point control, tool length compensation along the tool axis, tool handle feed & interruption, inclined surface machining command, 3-dimensional tool radius compensation (tool's vertical-direction compensation) or 3-dimensional manual feed) is valid.	9.2.12 Tool Center Coordinate Display
All Sp	This displays the command rotation speed and actual rotation speed values of all spindles.	9.2.13 All Spindles' Rotation Speed Display
Next Ax	This switches the counter display to replace the currently displayed axis.	9.2.4 Switching the Spindle No. to be Displayed on Counter
Cnt exp	This enlarges the counter to display all axes.	9.2.6 Counter All-axis Display
Cnt set	An arbitrary value can be set in the relative position counter.	8.2 Counter Setting
MST	This executes a manual numerical value command.	8.4 Manual Numerical Value Command

Setup screen (Setup)

Menus	Details	Reference
T-ofs	This sets tool compensation amount. Depending on the setting of the parameter "#1037 cmdtyp", there are three types of tool compensation: tool compensation type I/II (M system only), and tool compensation type III. The number of tool compensation sets to be designated or displayed varies depending on the additional specifications.	5.4 Setting Tool Compensation Amount (Tool Offset Screen)
T-meas	This executes tool measurement. The distance from the basic point to the measurement point is measured by moving the tool to the measurement point manually, and this value can be set as the tool offset amount. <Note> ♦This menu is displayed when the parameter "#8932 Hide measure scrn" is set to "0".	5.3 Measuring a Tool (Tool Measurement Screen)
T-reg	This registers a tool. A tool No. is assigned to each tool to make the tools installed on the machine recognizable to the NC. The tool No. is registered corresponding to the magazine pot and spindle where that tool is installed, and the standby location.	5.2 Registering a Tool (Tool Registration Screen)

Menus	Details	Reference
T-life	This manages the tool life data. The life management data such as the tool usage is set and displayed. There are two types of the tool life management method.	5.6 Tool Life Management
Coord	This sets the workpiece coordinate system offset. The offset value managed by NC can be set and displayed.	5.8 Setting Workpiece Coordinate System Offset
W-meas	This executes workpiece measurement, it also sets and measures the workpiece coordinate system shift. <Note> ♦This menu appears under any of the following conditions: - The parameter "#8932 Hide measure scrn" is set to "0". - The parameter "#11056 Workshift invalid" is set to "0" for L system.	5.9 Setting Workpiece Coordinate System Shift
T-Mng.	This sets and displays the management data for each tool. These data are relevant to which displayed on the [T-ofs] or [T-life] screen, that can be set the tool information. Thus the mutually-referenced data can be set and displayed on this screen.	5.5 Setting the Tool Management Data (Tool Management Screen)
MDI	This edits an MDI program. The pop-up window appears to display the MDI program contents by pressing main menu [MDI].	8.5 MDI Program Editing
Cnt set	This is to set the relative value counter. This displays the pop-up window of the relative position counter to execute the counter setting.	8.2 Counter Setting
MST	This sets an arbitrary value for S, M, T and B. Manual numerical value command is set and executed by inputting an address key, such as S, M, T and B.	8.4 Manual Numerical Value Command
User	This sets the user parameters. The parameter can be set and displayed by switching types.	6.1 Setting User Parameters
Storage	This stores the thread groove position to enable re-thread machining. <Note> ♦This menu is not displayed when the additional specification for thread recutting is not added.	8.6 Thread Recutting Function
MacCond	This sets the high-accuracy parameter which meets the machining purpose or machining process. <Note> ♦This menu is not displayed when the additional specifications related to high-accuracy control are not added.	6.2 Selecting High-accuracy Control Parameters (Machining Cond I Screen)
Barrier	This sets and displays the chuck barrier and tailstock barrier. <Note> ♦For M system, this menu is not displayed.	7.2 Chuck Barrier/Tailstock Barrier (L System)

Edit screen

Menus	Details	Reference
Edit	This edits a machining program.	3 Inputting a Machining Program and Defining Variables
I/O	This inputs and outputs the program between the NC internal memory and the external input/output device. <Note> ♦This menu is not displayed when the parameter "#8923 Hide Edit-IO menu" is set to "1".	4 Inputting and Outputting a Machining Program

Diagnose screen (Diagn)

Menus	Details	Reference
Config	This displays the hardware and software (software No. and version) configurations.	10.2.1 System Configuration Screen
Option	This displays the details of the additional specifications registered in the NC memory.	10.2.2 Option Display Screen
I/F dia	This sets and displays input/output signals of the ladder program.	10.4.1 Displaying and Setting the PLC Device Data (I/F Diagnosis Screen)
Drv mon	This displays drive diagnostic information (servo/spindle/power supply unit).	10.2.3 Drive Monitor Screen (Servo Unit) 10.2.4 Drive Monitor Screen (Spindle Unit) 10.2.5 Drive Monitor Screen (Power Supply Unit) 10.2.6 Drive Monitor Screen (Synchronous Error) 10.2.7 Clearing the Alarm History on Drive Monitor Screen
Mem dia	This sets and displays NC internal data.	10.4.2 Writing and Reading the Data Using the NC Data Designation (NC Memory Diagnosis Screen)
Alarm	This displays a list of currently occurring alarms and their messages.	10.1 Confirming the NC Message (Alarm Screen)
Selfdia	This displays the status of the hardware and operation stop.	10.3.1 Self Diagnosis Screen
NC Smp	This displays the hardware and operation stop state.	10.4.3 Collecting the NC Data (Data Sampling Screen)
Safety	This executes the diagnosis related to functional safety. <Note> ♦This menu is displayed when the parameter "#1481 Enable S-safety" (Enable smart safety observation) is set to "1".	10.5 Safety Observation

Maintenance screen (Mainte)

Menus	Details	Reference
Mainte	This performs NC memory format, absolute position parameter setting and maintenance data backup.	10.3.2 Checking Alarms of Drive Unit 10.3.3 Collecting the Data on the Diagnosis Data Collection Setting Screen
Param	This sets and displays user parameters and machine parameters.	6 Setting Parameters
I/O	This inputs and outputs the various data between the NC memory and the external input/output device.	11 Performing a Backup Operation

Screen Operations

2.1 Graphic Operation Terminal (GOT)

2.1.1 Screen Operation of GOT

At the start, use one of the following methods to display CNC monitor2 screen on a GOT.

- Press  (CNC monitor2) button on the Utility screen.
- Press the "special function switch" (CNC monitor2) assigned to the user-customized screen. (*1)

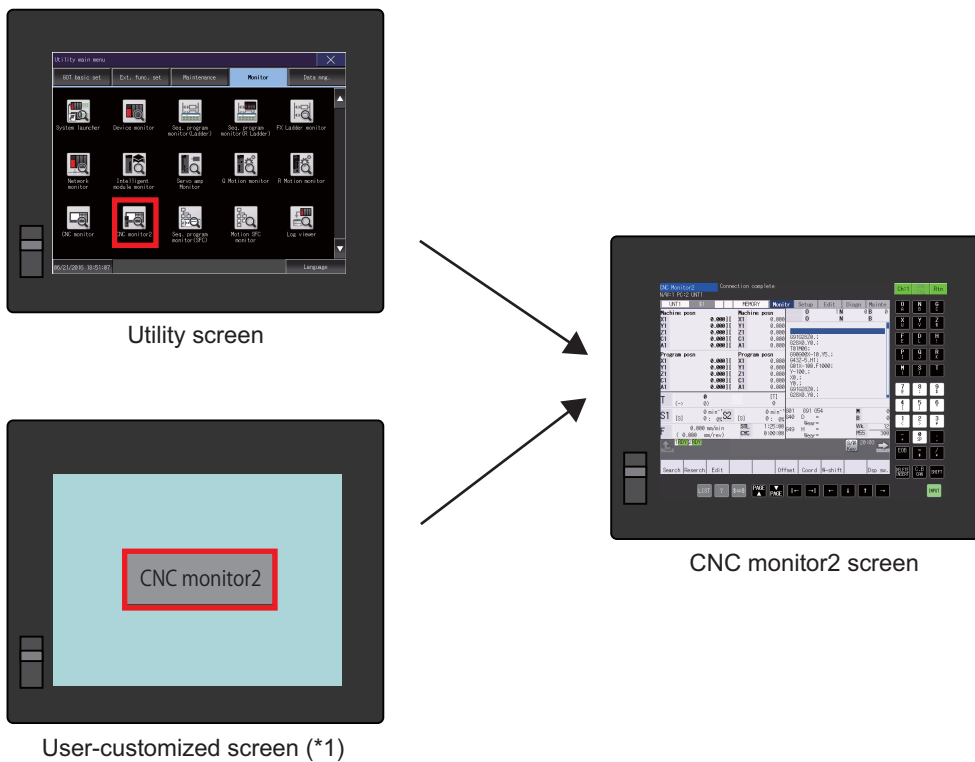

(*1) For details on the setting, refer to the instruction manual issued by the MTB.

How to display the utility screen

- (1) Press the screen at the top left.

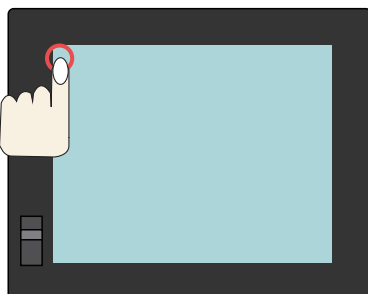

- (2) Press [Monitor] tab.

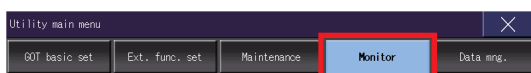

2.1.2 Explanations of the Screens

■XGA

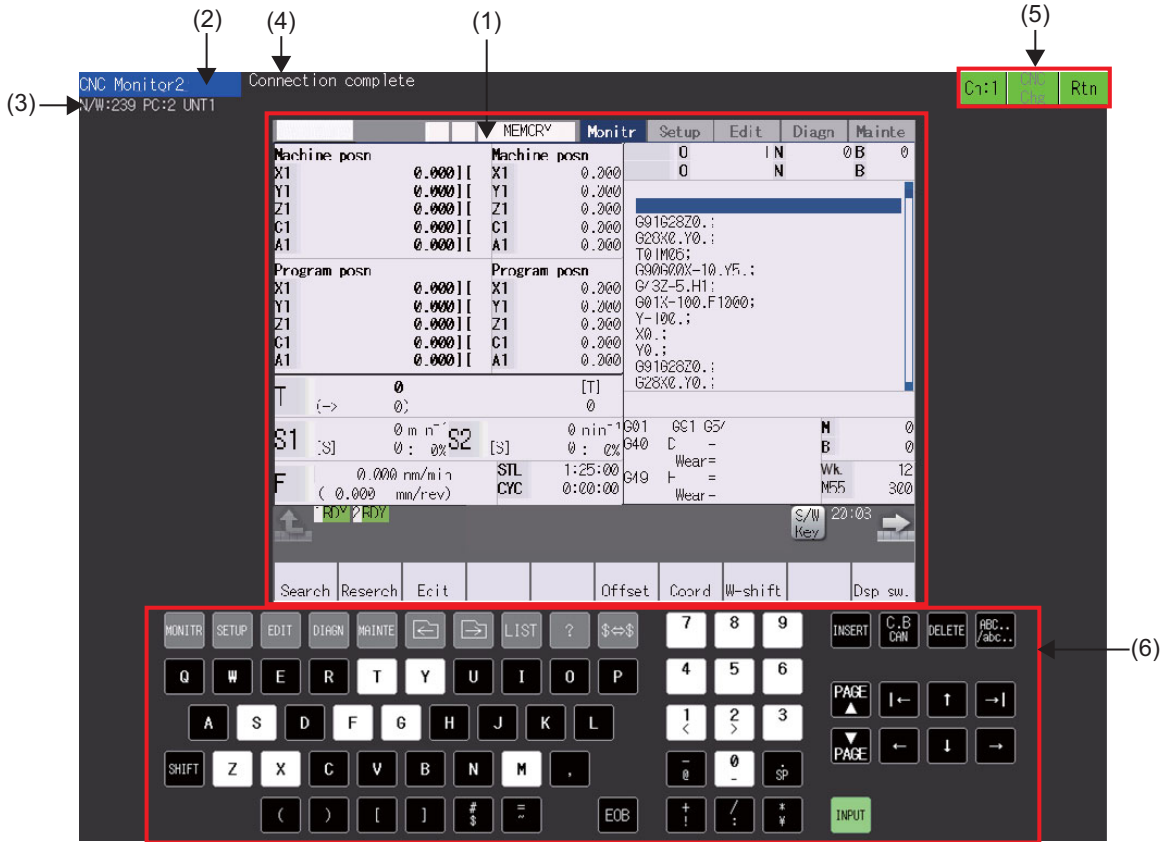

■SVGA

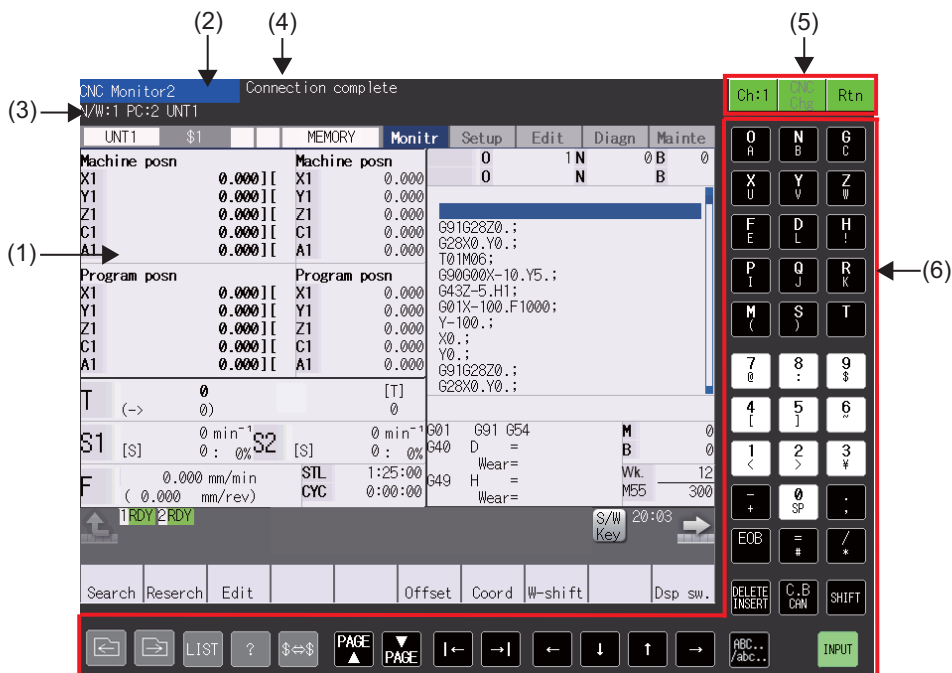

■VGA

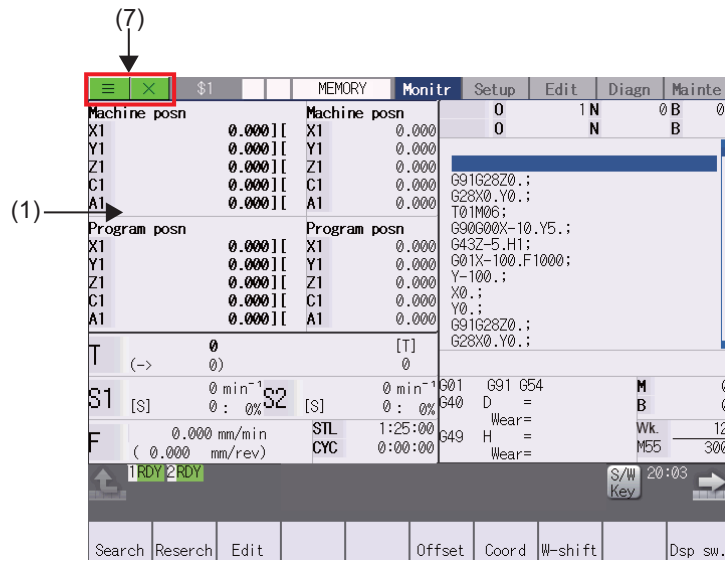

The function window appears at the top of the screen by pressing .

This window shows messages and machine status. You can also switch the CNCs through the window.

For some errors, such as "Communication error", the window appears automatically upon the occurrence.

If you perform the following operations while the function window is displayed, they will be done after the window is closed.

- You touch outside of the function window.
- The operation by the keyboard or mouse is attempted to be made.

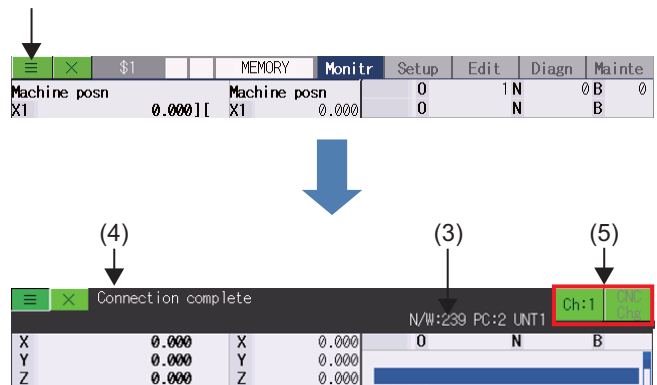

Press this button to display the function window.



Note



























(1) When inputting keys on the GOT with VGA resolutions, use the software keyboard. For details, refer to "2.6.2 Software Keyboard".

Display Items

Display items	Details
(1) Monitor area	Displays the image output from CNC. By touching the monitor area, the operations such as a screen transition can be performed. For details, refer to "2.2 CNC Monitor2 Screen". The display language in this area depends on the CNC parameter setting.
(2) Title display	Displays the title of the CNC monitor.
(3) Connected CNC display	Displays the network No., PC No. and unit name of the currently connected CNC. The unit name depends on the CNC parameter setting. <Note> •When a message which consists of two lines is displayed on the GOT with VGA resolutions, the information of connected CNC is not displayed.
(4) Message display	Displays the messages and warnings. For details, refer to "2.1.3 Messages".
(5) Channel selection button	Displays the currently selected channel No. Press this button to display the communication setting window. When you press this button while the connection is established, the connection will be canceled.
CNC changeover button	Changes the CNC which is connected. •Press this button to switch the currently Ethernet-connected CNC to that of the next setting No. If the current CNC has the last setting No., the No.1 CNC is connected to the GOT by pressing the button. •If the connected channel has one or no Ethernet connection setting, this button is grayed and unavailable.
Return button	Pressing this button takes you back to the application caller screen.
(6) Key board area	By pressing keys, the key codes will be sent to the CNC.
(7)  button	Press this button to display the function window while the window is hidden. Press the button to hide the function window while the window is displayed. When the operation right is not obtained, the color of the button becomes yellow. In this case, you can display or hide the function window in the same manner.
 button	Pressing this button takes you back to the application caller screen.

The following keys are provided on GOT keyboard.

These keys are displayed on the GOT with XGA or SVGA resolutions.

Key type	Key	Operation
Data setting key	A, B, C, D, E, F, G, H, I, J, K, L, M, N, O, P, Q, R, S, T, U, V, W, X, Y, Z 0 1 2 3 4 5 6 7 8 9 + - = / . ; EOB etc.	These keys are pressed to set alphabetic characters, numerals and operation symbols, etc.
Screen switching keys (*1)	    	Pressing the respective keys transits corresponding screen (Monitor, Edit, Setup, Diagnosis or Maintenance screen).
Frame switching keys	 	Displayed frame on the parameter guidance screen etc. can be switched to the previous or the next frame with these keys.
Menu list key		This is function that displays each screen's menu configuration as a list.
Help key		This displays the operation guidance, parameter guidance and alarm guidance corresponding to the current operation.
System switching key		When using a multi-part system NC, this displays the data of the next part system. The screen does not change if it is common to part systems or when only one part system is used.
Page up/down keys	 Page up key	When the displayed contents cover several pages, this displays the contents of the previous page.
	 Page down key	When the displayed contents cover several pages, this displays the contents of the next page.
Cursor keys	 	This moves the cursor up or down one when setting data in the screen display items.
	 	This moves the data input cursor one character to the left or right in the data setting area.
	 	This moves the cursor one item to the left or right when selecting data in the screen display items.
	 at cursor left end: Moves to the right end of previous line.  at cursor right end: Moves to left end of next line.	
Data correction keys	 (DELETE) Data delete key	This deletes the character just before the cursor position in the data setting area. When a program is being edited, the character of the cursor position is deleted. The data on the right side of the cursor will move to the left for one character.
	 (INSERT) Data insert key	This inputs the data insertion mode. When a data setting key is pressed, a character is inserted in front of the current cursor position. The overwrite mode is entered when the [DELETE], [C.B CAN], [INPUT], cursor or TAB, etc., keys are pressed, or when the screen is changed.
	 (C.B CAN)	This cancels the setting in the data setting area.
Shift key (*2)	 (SHIFT)	This validates the setting on the lower line of the data setting key. When any key other than the lower-case letter input key is pressed while the shift key is valid, the setting returns to the status with the shift key invalid.
Lower-case letter input key (*2)		This changes upper/lower-case of alphabet. The  key is highlighted when the lower-case-letter-setting is valid. The setting is retained until the key is pressed again.

Key type	Key	Operation
INPUT key	 (INPUT)	This fixes the data in the data setting area, and writes it to the internal data.

(*1) These keys are displayed only on the GOT with XGA resolutions.

(*2) The status of the shift key or the lower-case letter input key is valid on the GOT keyboard operation.

It is not compatible with the shift key or the lower-case letter input key on the software keyboard of the CNC monitor area, or the SHIFT key or the CapsLock key on a USB keyboard. These keys don't affect each other.

2.1.3 Messages

The following tables show the messages displayed at the top of the screen.

Operation messages

Display	Details
Select a channel.	This message appears at the first screen transition after power ON without connection setting. Select the channel which contains the CNC to connect.

Results messages

Display	Details
Connection complete. (*1)	The connection is completed. The monitor screen is displayed.
Connection complete. GOT and CNC language are different. Confirm the display language setting. (*1)	The connection is completed. The monitor screen is displayed. However, the display language is different between GOT and CNC. Confirm the display language setting.
Succeeded in acquiring the operation right. (*1)	The operation right of CNC is obtained. CNC operations are available.
Failed to acquire the operation right.	The operation right of CNC could not be obtained.
Unable to move to the designated screen.	The CNC could not transit to the designated screen. The monitor screen is not displayed. Review the drawing data setting. The designated screen may not exist in the CNC or the CNC designation may be wrong.
Unable to move to the designated system.	The CNC could not transit to the designated part system. The monitor screen is not displayed. Review the drawing data setting. The designated part system may not exist in the CNC. This message will not be displayed if an error that you cannot transit to the designated screen is occurring.
The Ethernet settings of the monitoring target CNC are not correct.	The setting of the designated access point cannot be found. Review the drawing data setting.
Unable to do drawing. Use the latest OS.	Drawing cannot be done because the version of the CNC OS and that of this application do not match. Install the latest OS.

(*1) These messages do not appear when the parameter "#1251 set23/bit3" (Non-display of completion message (display unit (GOT))) is set to "1". This parameter is obtained when CNC monitor2 starts to communicate with CNC. The parameter is valid for the project which is created by "GT Designer3" Ver. 1.195D or later.

State display message

Display	Details
Communication error	This message appears when the GOT cannot connect to the CNC, or cannot communicate with the connected CNC. Confirm the connection setting and the state of the cables. When the connection with the CNC is returned, the message "Connection complete" will be displayed.
Connecting	The connection with the CNC is being performed. Wait for a moment.
Right of operation is being acquired.	The operation right for the CNC is being obtained. Wait for a moment.
The file is being accessed.	The file is being accessed. Wait until it is completed.
Another display is being operated.	You do not have the exclusive authorization.
The file is being accessed by another display. Unable to get the operation right before end of process.	The file access such as copying and comparison is being performed between the CNC and the other display unit. Due to the state that the operation right cannot be obtained, wait until it is completed.

2.1.4 External memory interface

The external memory interfaces are mounted on the GOT.

Using the front-side USB memory interface, the input/output operations of the data such as machining programs are available.

For details on the I/O operation, refer to "Chapter 4 Inputting and Outputting a Machining Program" and "Chapter 11 Performing a Backup Operation".

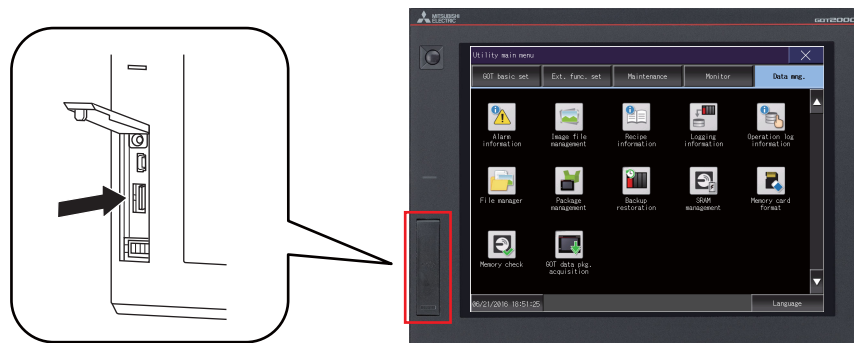

2.2 CNC Monitor2 Screen

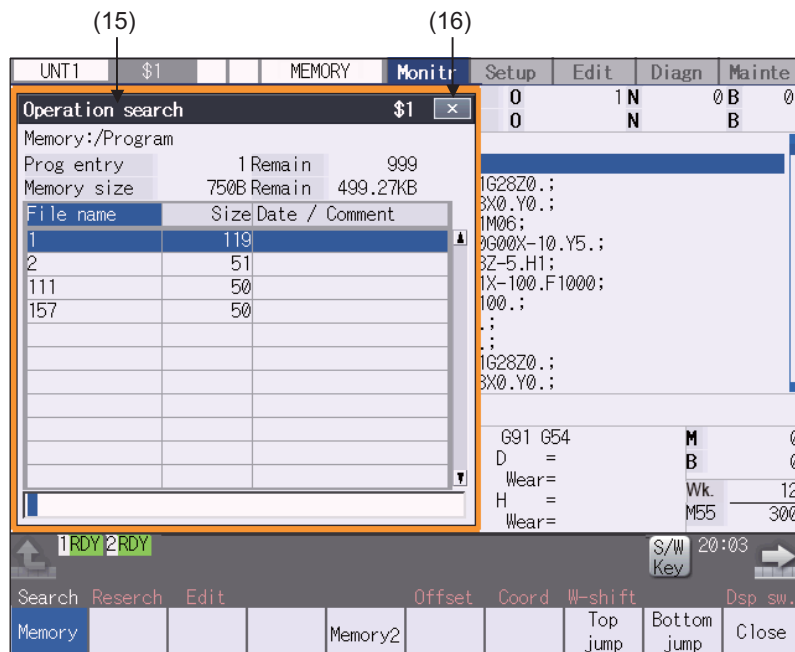
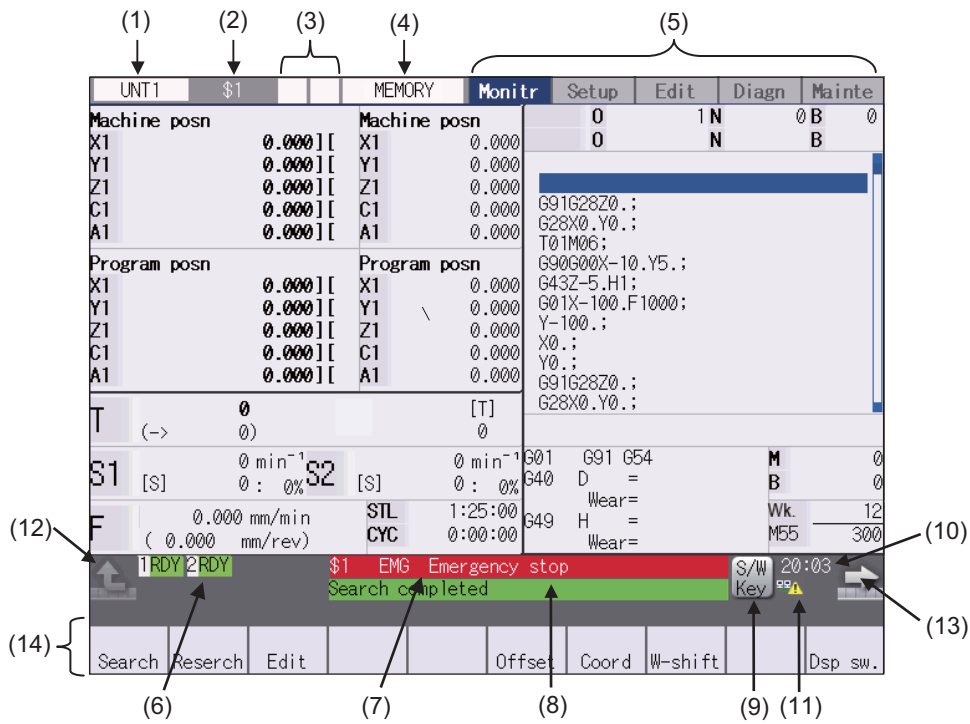

Display items

Display items	Details
(1) Unit name/icon display	The currently displayed unit name (name set in the parameter "#1135 unt_nm") is displayed. When the unit name is not set, it is not displayed.
(2) Part system name	When you use the multi-part system, the name of currently displayed part system (name set in the parameter "#1169 part system name", or name set in the parameter "#12059 SBS_name" for operating as the sub part system) is displayed. The part system name is not displayed for the 1-part system. When the values are not set in the parameter, "\$ + (part system number)" is displayed. (Example) \$2 for the 2nd part system. When the values are not set in the parameter for the name of sub part system, "SUB + (part system number)" is displayed. (Example) SUB2 for the 2nd part system.
(3) NC Status	The current NC status is displayed. When the status is multiple, the high-priority contents are displayed.
(4) Operation mode/MDI status	The displayed part system's operation status is displayed. The MDI status is also displayed when the MDI operation mode is selected.
(5) Screen group	The currently selected screen group is displayed.
(6) Operation status	The NC operation status is displayed.
(7) Alarm message	The highest-priority message among the currently occurring alarms or warnings is displayed.
(8) Operation message	The operation message is displayed.
(9) S/W Key button	When the button is touched, the software keyboard is displayed.
(10) Time	The current time is displayed. (hour:minute)
(11) Host connected status	This appears in the form of an icon when the parameter "#8931 Display/Set limit" is "0" or "1", and the other host PC or display unit is connected.
(12) Menu return button	The displayed screen operation menu is switched to the screen selection menu of the current screen group. This is also used to cancel the menu operations of the displayed screen.
(13) Menu change button	When all menus cannot be displayed at a time, the menus other than currently displayed menus are displayed.
(14) Menus	This is used to switch the screen, select the screen specific operation, etc.
(15) Window name	Then name of currently displayed window is displayed.
(16) Close button	When the button is touched, the window is closed.

2.2.1 Displayed Part System

Changing the part system with $\$ \leftrightarrow \$$ key

Press $\$ \leftrightarrow \$$ key to change the displayed part system.

The displayed part system No. is counted up by one each time the key is pressed. If the displayed part system No. exceeds the parameter "#11055 Disp. sysno", the displayed part system No. returns to "1".

Changing the part system with a touchscreen

Displayed part system will change when the part system name on the touchscreen is pressed. The displayed part system No. is counted up by one each time the key is pressed. If the displayed part system No. exceeds the parameter "#11055 Disp. sysno", the displayed part system No. returns to "1".

Restrictions when changing the displayed part system

The operation to change the displayed part system by the $\$ \leftrightarrow \$$ key or touchscreen is restricted by the setting of parameter "#11035 Sys. change limit".

Setting the color of displayed part system

The color combination for the top left of the screen can be changed with the setting of parameters "#8942 \$1 color" to "#8945 \$4 color", "#8962 \$5 color" to "#8964 \$7 color". Each part system can have a unique color combination which makes easy to understand the displayed part system.

When the part system is changed, the color of the upper left of the screen changes according to the setting with each parameter. A color set with "#8942 \$1 color" will be displayed for the 1st part system.

When the color of displayed part system is changed, the display of part system name changes to the button image.

[Setting example] When "1" is set to the parameter "#8942 \$1 color", "2" is set to the parameter "#8943 \$2 color", and "0" is set to the parameter "#11060 Screen theme color".

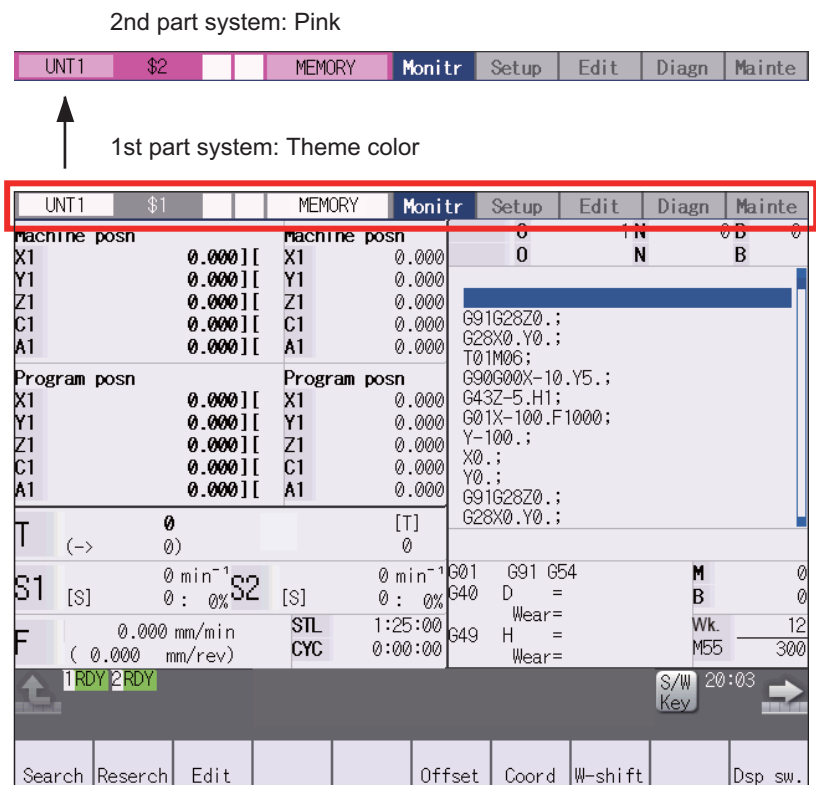

Note

(1) When "1" is set, the color is changed depending on the setting of the parameter "#11060 Screen theme color".

Displaying the sub part system name

When the part system operates, which is set to sub part system with the parameter "#12049 SBS_no", the sub part system name can be displayed as the part system name. The name can be set with parameter "#12059 SBS_name".

Display area for the part system names shown in the following figures can switch main/sub part system display according to NC operation status.

[1-part system display]

[2-part system display]

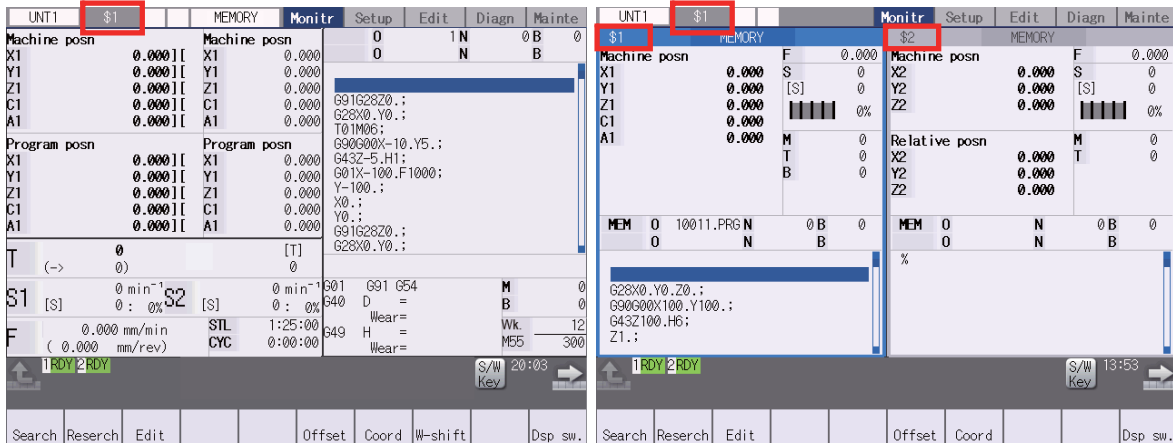

2.2.2 NC Status

The display area for NC status indicates current NC operation status. (nothing is displayed in normal condition.)

When the NC operates with three or more status, the higher-priority two status are displayed. (The items in the following table are listed in order of priority.)

While any status is being displayed, this indicator flashes at intervals of approximately 1 second.

Display position	Display items	Meaning
Left side	PR	The parameter has changed, and it requires turning the power ON again. The parameter will be validated after turning the power ON.
Right side	AT	Indicates when auto tuning is valid. In this case, the automatic start is disabled.
	HC	Indicates when the high cycle sampling is valid.
	RN	Indicates when selecting machining surface.
	BT	Indicates when backlash auto adjustment is ON.

2.2.3 Operation mode/MDI status

The displayed part system operation mode and MDI status are displayed.

When the operation mode or MDI status is changed, the display changes as follows.

Display	Details	Details
MEMORY	Memory operation	Automatic operation is based on programs stored in the memory.
TAPE	Tape mode	This mode is displayed when FTP high-speed program server mode operation (additional specification) is performed.
MDI NON	No MDI setting	Automatic operation is performed with the program set in the MDI screen.
MDI SET	MDI setting completed	
MDI RUN	MDI running	
JOG	Jog	The jog feed mode enables the axis to be moved by hand consecutively at the feed rate set by using the MANUAL FEED RATE switch.
HANDLE	Manual handle	The handle feed mode enables the axis to be moved by turning the manual handle. The travel distance per graduation of the handle depends on how the "HANDLE/INCREMENTAL MAGNIFICATION" switch is set.
STEP	Step	The step feed mode enables the axis to be moved by hand at feed rate when the "FEED AXIS SELECT" switch is ON. The travel distance per graduation of the handle depends on how the "HANDLE/INCREMENTAL MAGNIFICATION" switch is set.
MANUAL	Manual arbitrary feed	This mode enables to move manually with arbitrary amount or arbitrary positioning position.
ZERO-RTN	Reference position return	This mode enables a controlled axis to be returned manually to the defined position unique to the machine (reference position).
INIT-SET	Automatic dog-less reference position return	This mode enables this mode to manually push against the machine end stopper and carry out zero point return.
RAPID	Rapid traverse	The rapid traverse feed mode enables the machine to be moved consecutively at rapid traverse rate manually.
JOG+HND	Jog + Handle	This is the jog and handle synchronous feed mode.
RAP+HND	Rapid traverse + Handle	The rapid traverse and handle can be used simultaneously.
NO MODE	No operation mode	The operation mode is not selected.

2.2.4 Operation status

The operation status displays the currently selected NC operation status for each part system. (The maximum number of the part system which can be displayed.)

The inverted number expressing the part system No. is not displayed for 1-part system.

Symbol	Details	Character color	Background color
EMG	In emergency stop	White	Red
RST	Resetting NC	White	Dark gray
BST	In block stop	White	Dark gray
HLD	Operation halted	White	Dark gray
SYN	Synchronizing	White	Dark gray
CRS	Cross conversion waiting	White	Dark gray
AUT	In automatic operation	White	Dark gray
RDY	Operation completed state	Black	Green

2.2.5 Alarms/Warnings

When an alarm or warning occurs, the alarm No. and alarm message character string are displayed.

(Example) Warning message display

SYS2 M01 No operation mode

Type	Details	Character color	Background color
NC alarm message	The operation alarm, program error, MCP alarm, servo alarm, or system alarm which is currently occurred is displayed.	White	Red
NC warning message		Black	Yellow

2.2.6 Operation messages

(Example)

Search completed

Type	Details	Character color	Background color
Operation messages	This displays the messages for operation.	Black	Yellowish green

The operation message can be reset by pressing any key.

2.2.7 Changing the Screen Theme Color

The theme color (display color) of the entire screen can be changed with the setting of the parameter "#11060 Screen theme color".

[Parameter "#11060 Screen theme color" is set to "0" (standard color (gray tone))]

<Example of monitor screen>

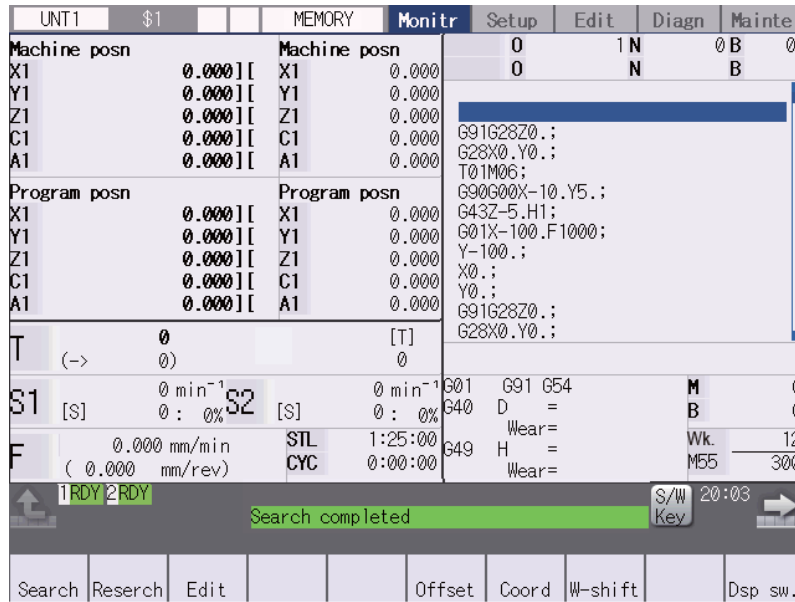

[Parameter "#11060 Screen theme color" is set to "1" (blue tone)]

<Example of monitor screen>

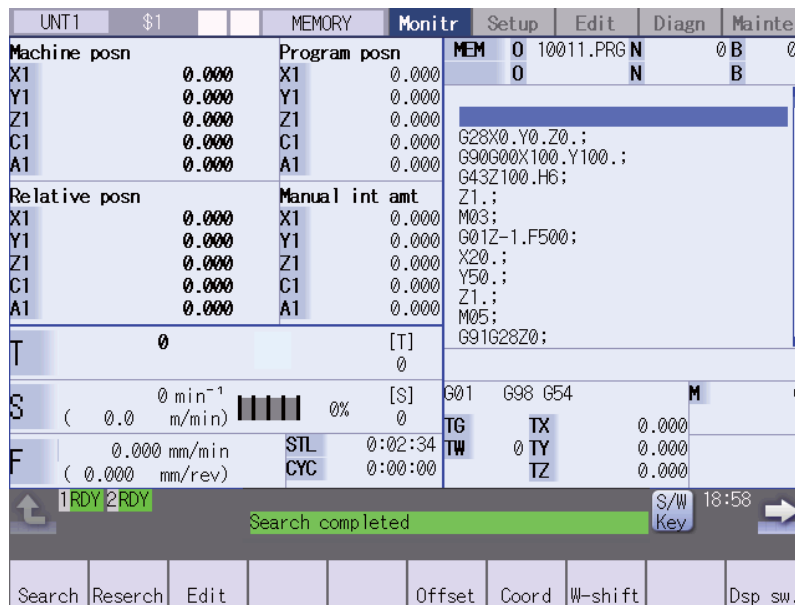

2.2.8 Screen Transition Diagram

The screen is configured of operation groups. The screen selection can be done by switching the tab on the top of the screen.

Note

- (1) The display contents differ depending on MTB settings.
- (2) You can freely relocate the main menus of the monitor (Monitr), setup (Setup) and edit (Edit) screens. For details, refer to "2.7 Menu Customization Function".

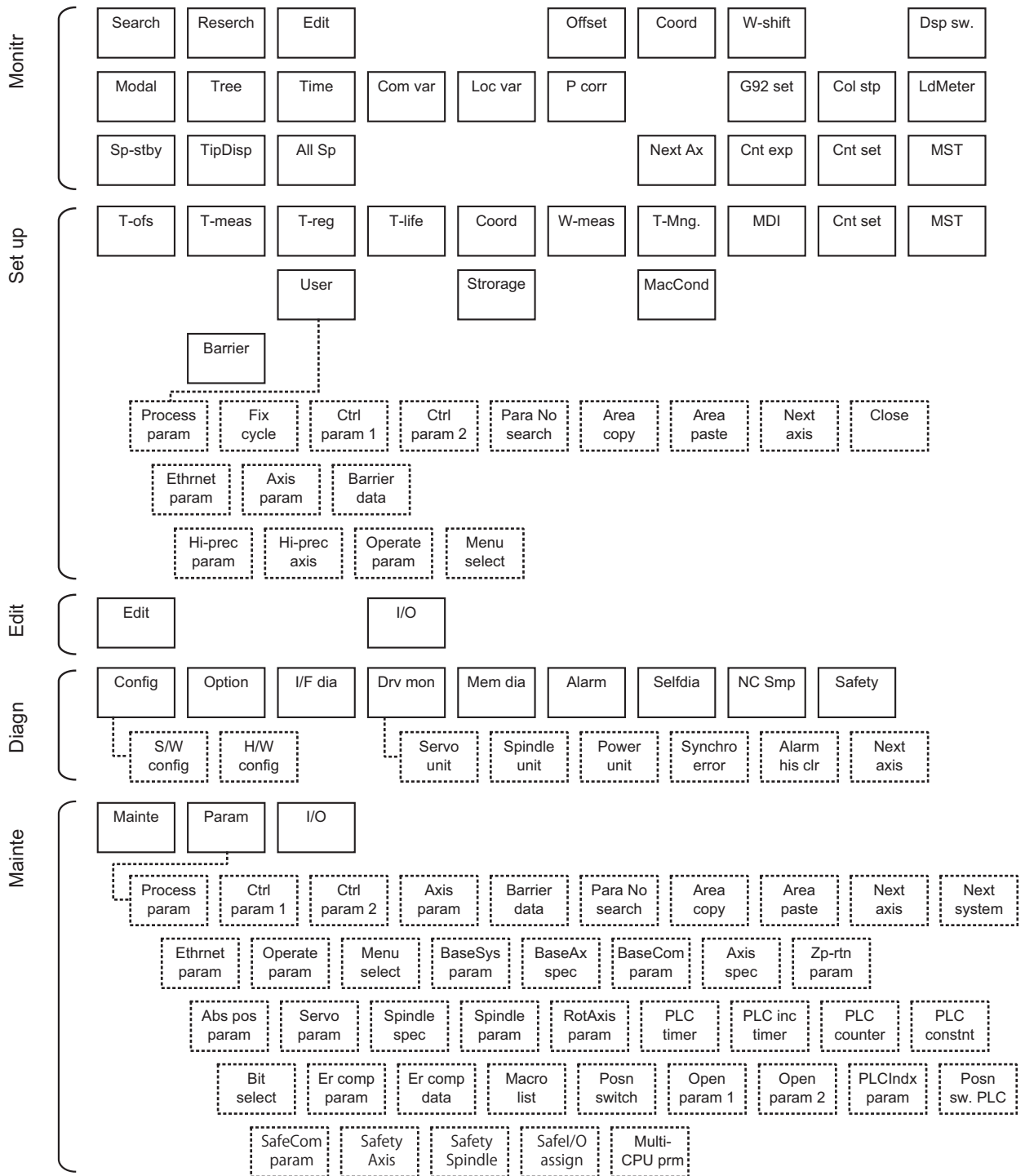

2.3 Setting Data

2.3.1 Setting Numerals and Alphabetical Characters

Operation method

The data is basically set with the following methods:

- (1) Menu selection
- (2) No. selection
- (3) Cursor movement
- (4) Data key input
- (5) [INPUT] key input

Note

- (1) The contents in the data setting area are only displayed until the [INPUT] key is pressed. These contents are invalidated if the screen is changed. The data is written into the memory when the [INPUT] key is pressed.
- (2) Special settings may be required depending on the data type. Refer to each item.
- (3) The cursor may move to the right of the display item depending on the data type.
- (4) If an illegal key is set, an error occurs when [INPUT] is pressed. Reset the correct data.

Operations in the data setting area

The key is input at the position where the cursor is displayed. If a cursor is not displayed, the key input is invalid. When a key is input, the data appears at the cursor position, and the cursor moves one character space to the right.

[→]/[←] keys: Moves the cursor one character to the left or right.

[INSERT] key: Enters the insert mode.

The mode returns to the overwrite mode when the [DELETE], [C.B CAN] keys are pressed, or when the screen is changed.

[DELETE] key: Deletes the character in front of the cursor.

[C.B] key: Deletes all characters in the data setting area.

Cursor operations on the screen

If a cursor is displayed on the screen, data is set in the data setting area and the [INPUT] key is pressed, the data appears at the cursor position on the screen. The cursor moves to the next position.

The following keys can be used to move the cursor with the cursor keys.

: Moves the cursor to the previous line.

: Moves the cursor to the next line.

: Moves the cursor one item to the left.

: Moves the cursor one item to the right.

2.3.2 Inputting Operations

In addition to the method of directly inputting numeric data for specific data settings, a method to input the operation results using four rules operators and function symbols can be used.

Input method



Numeric values, function symbols, operators and parentheses () are combined and set in the data setting area.

The operation results appear when the [INPUT] key is pressed. Data for the currently selected setting item will be set when [INPUT] key is pressed again. The contents in the data setting area are erased.

Examples of operator settings, and results		
Operation	Setting example	Operation results
Addition	=100+50	150
Subtraction	=100-50	50
Multiplication	=12.3*4	49.2
Division	=100/3	33.3333333
Function	=1.2 * (2.5 + SQRT(4))	5.4

Function symbols, setting examples and results			
Function	Function symbol	Setting example	Operation results
Absolute value	ABS	=ABS(50 - 60)	10
Square root	SQRT	=SQRT(3)	1.7320508
Sine	SIN	=SIN(30)	0.5
Cosine	COS	=COS(15)	0.9659258
Tangent	TAN	=TAN(45)	1
Arc tangent	ATAN	=ATAN(1.3)	52.431408

Operation examples

- (1) Set as shown below, and press the [INPUT] key.  The operation results appear in the data setting area.
=12*20 [INPUT] 240
- (2) Press the [INPUT] key again.  Data for the selected setting item is set.
The result is displayed on the screen.
The cursor moves to the next position.

Notes for using operators and functions

Division: Zero division causes an error.

Square root: If the value in the parentheses is negative, an error occurs.

Trigonometric function: The unit of angle θ is degree ($^{\circ}$).

Arc tangent: $-90 < \text{operation results} < 90$.

Restrictions

- (1) Always use "=" for the first character.
- (2) Do not use the following characters as the second character or last character.
Invalid as second character: * , /,)
Invalid as last character: * , /, (, +, -
- (3) Make sure that the left parentheses and right parentheses are balanced.
- (4) The 360° limit does not apply on the angle. SIN (500) is interpreted as SIN (140).
- (5) While the monitor screen or the setup screen displaying, if the axis name address, M, S, T, 2nd miscellaneous function code (B, etc.) is pressed when "=" is set in data setting area as the first character, the operation input is given to priority. So, the window does not open, and the cursor does not move.
- (6) The exponential setting, like "1.23E-4", cannot be used. The operation result is not displayed with exponential.
- (7) It is not possible to set characters exceeding the number of characters which can be input to the data setting area.
- (8) It is not possible to omit "0" before the decimal point, like ".5", when operation inputting. An error will occur.
- (9) The accuracy is guaranteed for the calculation with 15 digits or less. The calculation with over 15 digits does not guarantee its accuracy.
- (10) The operator or the function which does not exist in the above-mentioned, such as "ASIN", cannot be used. The operation message "Setting error" appears, and the display of the data setting area does not change.
- (11) Regardless of the input setting unit and metric system/inch system, the digit numbers below the decimal point of the operation result is seven digits or less.

2.4 Guidance Function

2.4.1 Parameter Guidance

The parameter guidance function displays the details of the parameters according to the state of the screen currently being displayed.

Screen Configuration

The parameter/alarm guidance window is displayed with the following type of configuration.

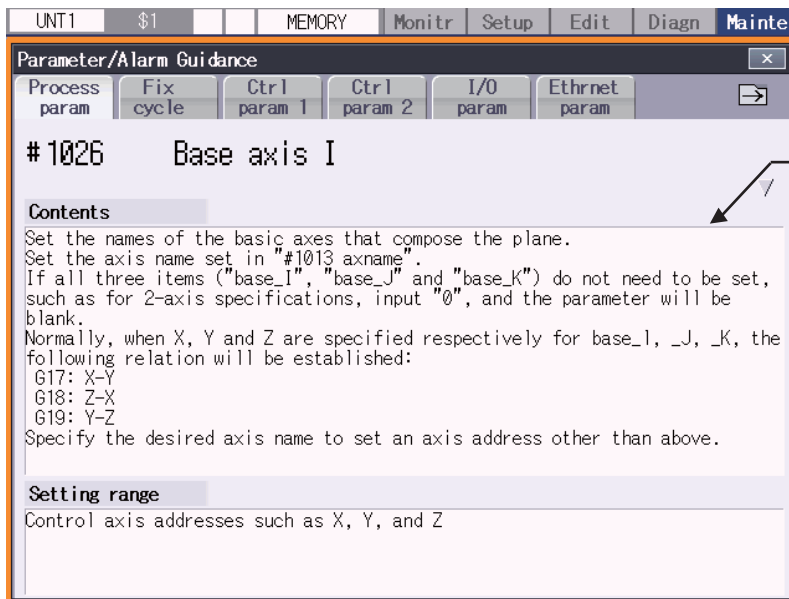

The parameter No., name, details and setting range are displayed.







Operation method

If the [?] key is pressed on any screen, the guidance window will open. If a pop-up window other than the guidance window is open, the guidance window will open over the currently opened pop-up window. In this case, the menu state does not change. If [?] key or [CANCEL] key is pressed again when the guidance window is open, the guidance window will close and the screen will return to the previous state in which the [?] key was pressed.

Displaying the parameter guidance (Example: "#8005 ZONE r")

- (1) Press the menu [Param] on maintenance screen. ➡ The parameter screen is displayed.
- (2) Press the [↓] key, and move the cursor to "#8005 ZONE r" parameter.
- (3) Press the [?] key. ➡ The guidance window is opened, and the detail of "#8005 ZONE r" parameter is displayed.

Note

- (1) The contents of the parameter "#8004 SPEED" (the previous parameter on the parameter screen) are displayed by pressing the  key. However, when the  key is pressed on the first parameter of each parameter type, the displayed contents do not change. The contents of the parameter "#8006 ZONE d" (next parameter on the parameter screen) are displayed by pressing the  key. However, when the  key is pressed on the last parameter of each parameter type, the displayed contents do not change.
 Pressing the [↑] or [↓] key scrolls the explanation contents of the parameter guidance in a page unit. When the [↓] key is pressed while the last line is displayed, next guidance appears. When the [↑] key is pressed while the top line is displayed, the previous guidance appears.
 However, when the [↑] key is pressed while the first parameter guidance is displayed, or when the [↓] key is pressed while the last parameter guidance is displayed, the display does not change.
- (2) The contents of the first parameter for the fixed cycle parameter are displayed by pressing the  key. While the parameter guidance window is displayed, the displayed parameter contents are recorded for each parameter type. When the parameter type is changed with  /  key, the contents of the previously displayed parameter are displayed.
- (3) When the parameter No. could not be acquired (when the cursor was non-display or was on a blank or comment line), the top of parameter guidance for each parameter appears.
- (4) The parameters whose contents/setting range are similar or same are collectively displayed.
 (Example: PLC integrated timer)

Precautions

- (1) If the [?] key is pressed when alarm occurs, the alarm guidance window will open.
- (2) Once the guidance data is read, the guidance can be displayed even when the memory card is removed.
- (3) Press the [?] key on a screen other than [Mainte] - [Param] and [Setup] - [User] when an alarm is not being occurred, and the head parameter guidance of parameters is displayed.

2.4.2 Alarm Guidance

The alarm guidance is the function that displays message, details and remedy for the currently occurring alarms.

Screen Configuration

The alarm guidance is displayed in "alarm" tab on "parameter/alarm guidance window".

The "alarm" tab is on the rightmost end of the guidance window.

A scroll bar appears when details and remedy, etc. do not fit in one page.

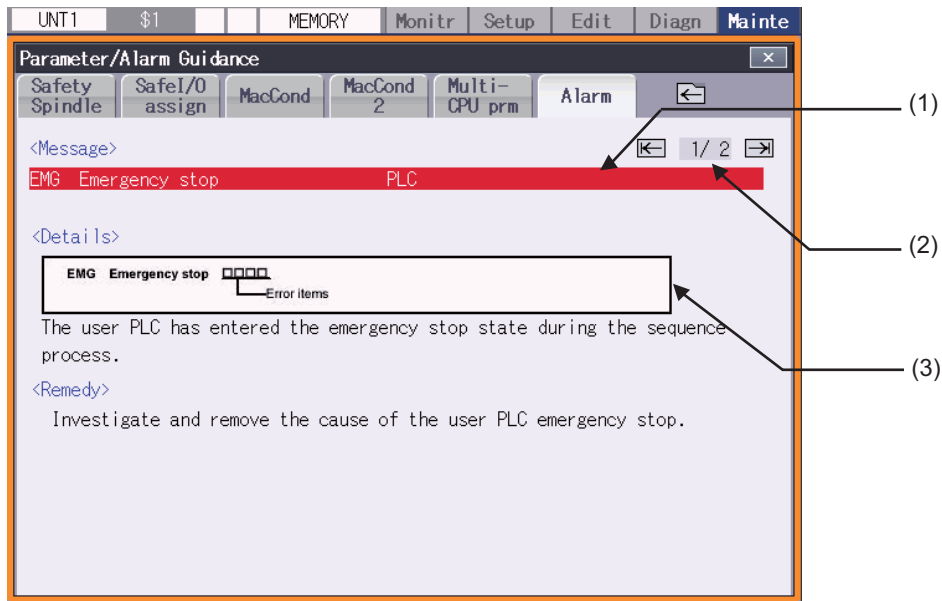

Display items

Display items	Details
(1) Messages	This displays the currently occurring "NC alarm" and "PLC alarm message". The displayed content is same as the content displayed in the alarm message of the diagnosis screen.
(2) Number of page	This displays "order of priority / total number of occurring alarms".
(3) Details/Remedy, etc.	This displays detail and remedy, etc. for alarm message.

Operation method

All alarms are displayed for alarm guidance regardless of part system.



If the [?] key or the  key is pressed on any screen when an alarm occurs, the alarm guidance window will open.

If a pop-up window other than the guidance window is open, the guidance window will open over the currently opened pop-up window. In this case, the menu state does not change. If [?] key or [CANCEL] key is pressed again when the guidance window is open, the guidance window will close and the screen will return to the previous state in which the [?] key was pressed.







Note

(1)  is displayed only on the software keyboard. For details, refer to "2.6.2 Software Keyboard".

Displaying the alarm guidance

- (1) Press the [?] key or the  key during occurring alarm on monitor screen.  The guidance window is opened while "alarm" tab is valid. The alarm details and remedy are displayed for "H/W stroke end axis exists" and another alarm occur.
- (Example) When "H/W stroke end axis exists" and another alarm occur.

Note

- (1)  is displayed only on the software keyboard. For details, refer to "2.6.2 Software Keyboard".
- (2) Pressing the  or  key scrolls the explanation contents by page.
- (3) Pressing the [↑] or [↓] key scrolls the explanation contents in a line unit.
- (4) When each parameter tab, such as the parameter, fixed cycle parameter, etc., is opened with the  key, the contents of first parameter in each parameter tab is displayed.
- (5) The alarm guidance is executed for the alarm that occurs when the [?] key or the  key has been pressed. Therefore, the guidance is not displayed for the alarm that has been handled or has occurred while the alarm guidance is displayed.
- (6) If the [?] key is pressed when an alarm is not occurring, the parameter guidance appears. In this state, if the "alarm" tab is selected with the  key, nothing is displayed in the alarm guidance panel. (These columns are blank.)
- (7) All the explanations of the alarm having the same error class and No. are displayed in the details column.
- (8) When no alarm or only one alarm occurs, the arrow next to the page number is not displayed.

Changing the alarm guidance

- (1) Press the [→] key or [→] key when the alarm guidance is displayed. ➡

The alarm guidance with one priority lower than the current alarm guidance is displayed.

If the [→] key or [→] key is pressed when the lowest priority alarm is displayed, the alarm with the highest priority is displayed.

(Example) When 3 alarms occur.



- (2) Press the [←] key or [←] key when the alarm guidance is displayed. ➡

The alarm guidance with one priority higher than the current alarm guidance is displayed.

If the [←] key or [←] key is pressed when the highest priority alarm is displayed, the alarm with the lowest priority is displayed.

(Example) When 3 alarms occur.

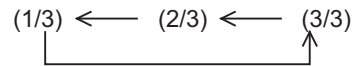
**Note**

- (1) Up to 18 alarm or warning messages can be displayed for alarm guidance from highest priority.
- (2) Even if the [→], [←], [←] or [→] key is pressed when only one alarm occurs, the screen display is not switched.

Precautions

- (1) The alarm guidance of stop code and operator message is not displayed.
- (2) The PLC device information, which is displayed for the PLC alarm message guidance, displays the PLC device status when the alarm guidance is displayed. Accordingly, even if the device value changes when the alarm guidance is being displayed, the displayed PLC device information is not updated automatically. To update the information, close the alarm guidance once and display it again by pressing the [?] key again. However, when the PLC device information is redisplayed with [→], [←], [←] or [→] key at occurrence of multiple alarms, the PLC device information is updated.
- (3) Once the guidance data is read, the guidance can be displayed even when the memory card is removed.

2.4.3 G Code Guidance

G code guidance is a function that shows the command format details or the outline of its operation for the G code being edited while creating or editing the machining program. With this function, the G code format can be confirmed immediately. G code guidance is also displayed in the same manner even when MDI program is displayed.

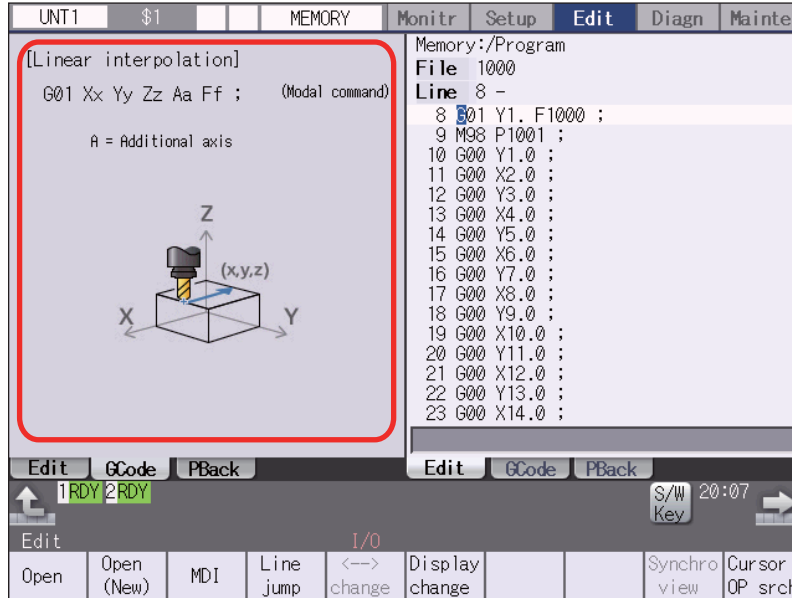

The contents displayed on the G code guidance area depends on the cursor position on the edit screen, and is refreshed when moving the cursor.

The G code that meets following conditions are displayed in this area.

- G code that exists between the head of block and cursor position including the cursor position.
- G code that exists immediately before the cursor if multiple G codes meet the above condition.

Specific example

- G91 G17 ; █ → The guidance is not refreshed because the cursor is out of the block.
- G91 G17 █ █ █ → The guidance for G17 is displayed.
- G91 █ G17 ; → The guidance for G91 is displayed.
- G91 G00 X100. █ Y100. ; → The guidance for G00 is displayed because G00 is the nearest G code to the cursor.

G codes displayed in the G code guidance area

With G code guidance function, the commands having "G" followed by 1 or more numbers are regarded as the G code. Thus, when "G" that is located immediately before the cursor is within the comment, the guidance will not be refreshed. In the same manner, when a G code is commanded using variables such as "G#100" or "G#500", etc. but numbers, the guidance will not be refreshed.

The G code that can be displayed in the guidance area is as follows.

Gnnnnnnn.m L ll ("n", "m", and "l" are arbitrary number.)

Commanded value	Number of valid digits	Remarks
n (integer)	1 to 8 digit	When including "0" before integer command value, unnecessary "0" is ignored.
m (decimal places)	0 to 1 digit	-
l (value commanded using "L")	0 to 2 digit	This is valid when "L" exists immediately after the integer command value or decimal command value and is followed by a command value. If the command with "L" address precedes G code, the "L" command will not be described in the guidance.

Note

(1) As for the G codes not included in the specifications, the guidance is not displayed even if the above condition is met.

- G00 X100. (GCODE) ; ➔ "G" included in the comment "GCODE" is ignored, thus, G code guidance is not refreshed.
- N11 GOTO1 ; ➔ "G" included in the command "GOTO" is ignored, thus, G code guidance is not refreshed.
- G91 G120 X100 Y100. ; ➔ G code "G120" is not included in the specifications, thus, G code guidance is not refreshed.
- G00000031.1 ; ➔ The guidance for G31.1 is displayed.
- G00000031.10 ; ➔ Commanded value exceeds the number of valid digits, thus, G code guidance is not refreshed.
- L50 G10 ; ➔ The guidance not for "G10 L50" but "G10" is displayed.

2.5 Menu List

The menu list is a function that displays each screen's menu configuration as a list. The Menu list window opens when the **LIST** key is pressed on each screen.

If a pop-up window other than the menu list is displayed, the Menu list window appears above the displayed pop-up window. The menu does not change in this case.

If the **LIST** or **X** key is pressed again while the Menu list window is open, the Menu list window closes, and the state before the **LIST** key was pressed is recovered.

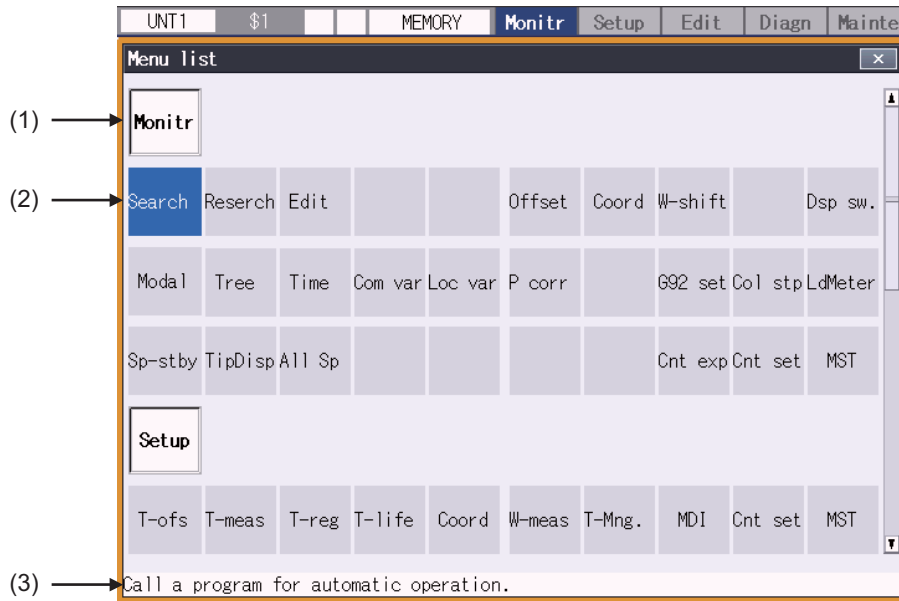

Display items

Display items	Details
(1) Screen name	The screen name is displayed. (Example) Monitr/Setup
(2) Menu name	A list of the menu names (functions) included on each screen is displayed. (Example) Search/Reserch
(3) Function outline display area	An outline of the currently selected menu name (function) is displayed.

Operation method

- (1) Press the  key.



The Menu list window appears showing the selected screen's menu list at the top.

If you press the  key while editing the file on the edit screen, a prompt to confirm whether to save the program appears before Menu list window opens.

- (2) Using the [↑], [↓], [→], [←], and page keys, move the cursor to the menu for which the function outline is to be displayed.



The function outline for the selected menu appears. The function outline does not appear if a menu with no name is selected.

The cursor does not move to the group name.

Each cursor key moves as follows.

[↑] key: The cursor moves up.

[↓] key: The cursor moves down.

[→] key: The cursor moves to the right.

[←] key: The cursor moves to the left.

 key: The screen scrolls down.

 key: The screen scrolls up.

<Note>

- Pressing the [←] key also moves the cursor in the same way as the [←] key.
- Pressing the [→] key also moves the cursor in the same way as the [→] key.

- (3) Press the [INPUT] key.



The selected menu function can be moved to directly. The menu is not moved to if a menu with no name is selected. The Menu list window closes after moving.

When using the touchscreen display, touching it once activates the menu where you touched. And then touch the menu again or press the [INPUT] key to display the menu screen.

2.6 Touchscreen Functions

Touchscreen operation is available with a touchscreen display.

2.6.1 Basic Operation

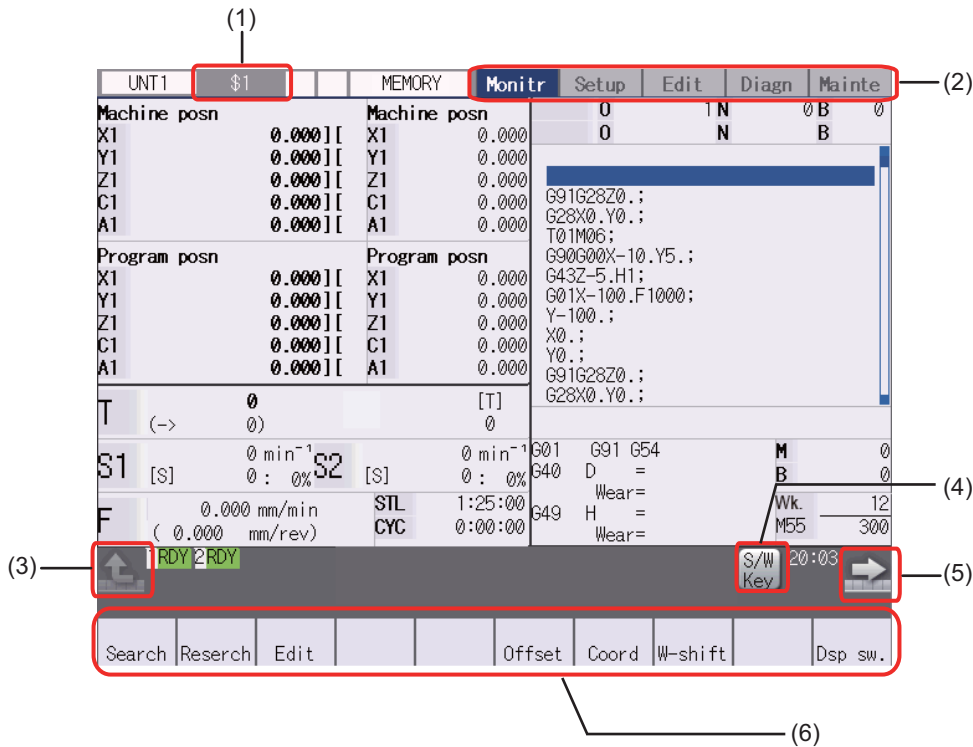

Display items

Display items	Details
(1) System change	This switches from the current part system to the next part system.
(2) Function change	A selected screen will open. As in the case with a screen change by key inputting, if a pop-up window is displayed, close it before changing screens. If there is a file under editing, confirm if the file is saved before changing screens.
(3) Menu operation cancel	The displayed screen operation menu is switched to the screen selection menu of the current screen group. This is also used to cancel the menu operations of the displayed screen.
(4) Software keyboard display	This displays the software keyboard on the screen.
(5) Menu change to the next	This switches to the next menu if available.
(6) Menu selection	When a menu is selected by touching, the menu's process is executed.

Page changing area by scroll bar

If you touch [▲] or [▼] of the scroll bar, the screen is scrolled up or down by one line. Also, if you touch the empty portion of the scroll bar, the page is switched to the next page or previous page.

Pages cannot be changed by dragging the slider.

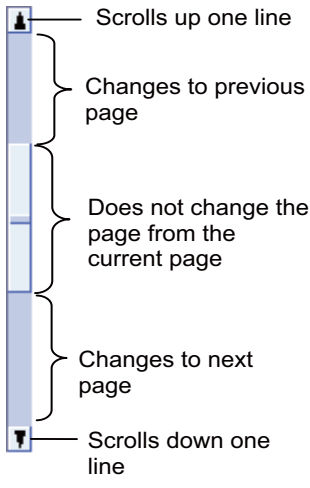
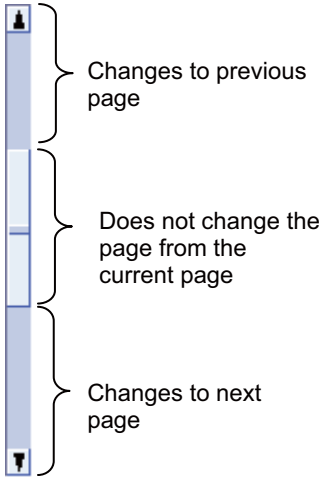
<Normal condition>	<Workpiece coordinate system offset window, W coordinate frame local variables, or T code list> (*1)
 <p>Scrolls up one line</p> <p>Changes to previous page</p> <p>Does not change the page from the current page</p> <p>Changes to next page</p> <p>Scrolls down one line</p>	 <p>Changes to previous page</p> <p>Does not change the page from the current page</p> <p>Changes to next page</p>

(*1) For the workpiece coordinate system offset window and local variable window on the monitor screen as well as coordinate system offset frame and T code list window on the setup screen, the page changes to the previous page when [▲] of scroll bar is touched, and the page changes to the next page when [▼] of scroll bar is touched. (It is not possible to scroll in a line unit.)

2.6.2 Software Keyboard

With the software keyboard, a key input is possible by a key menu on the software keyboard which is displayed on the screen. Software keyboard is displayed if [S/W Key] button is touched in each screen. In this case, screen or menu status will not change. Software keyboard is always displayed on the front screen. When the [CLOSE] key on the software keyboard is touched, the software keyboard will be closed.

Software keyboard is displayed automatically in a necessary state in accordance with the setting of the parameter "#11010 Software keyboard".

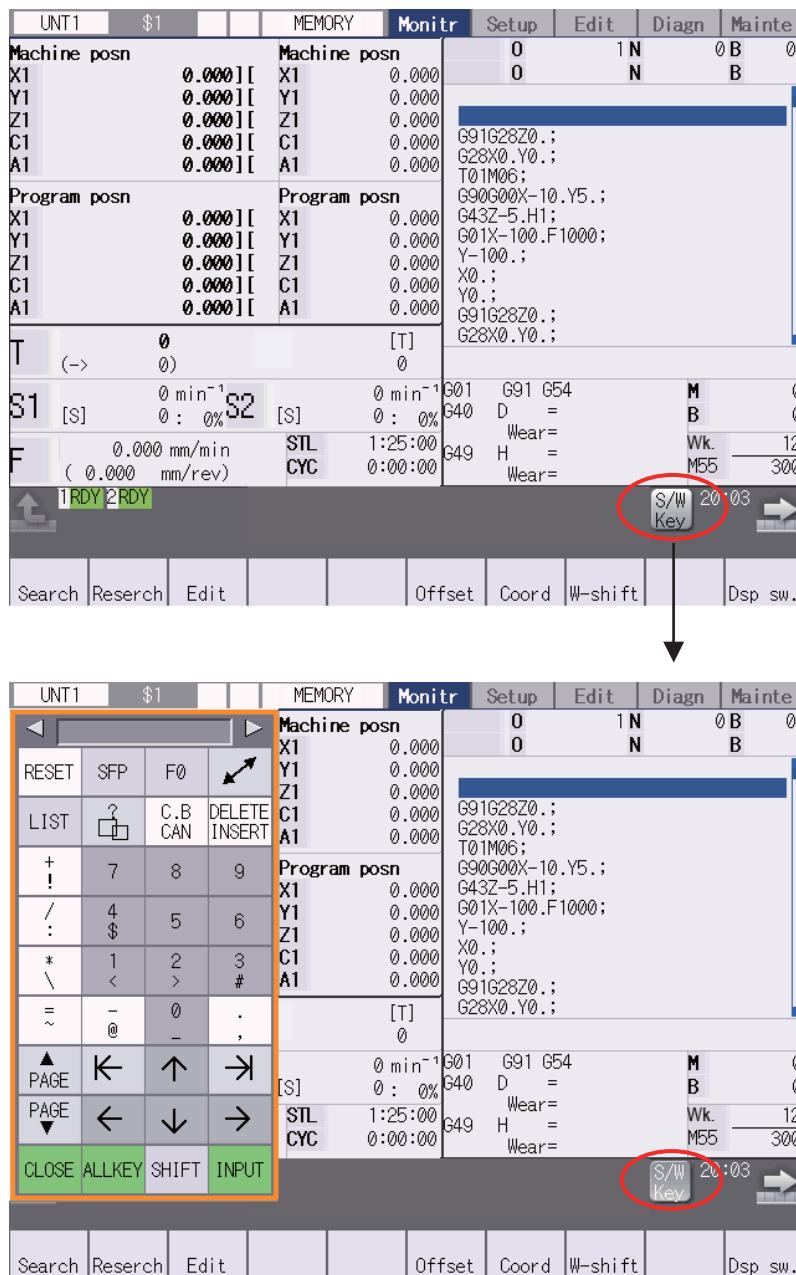

During the software keyboard is displayed, the [S/W Key] button is inverted.

[Numerical keypad display]

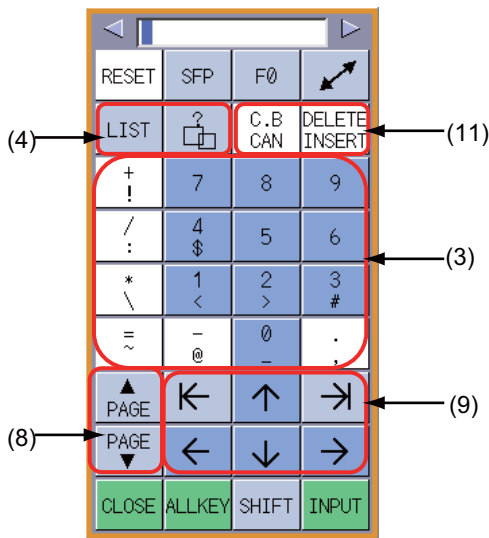

[All keys display]

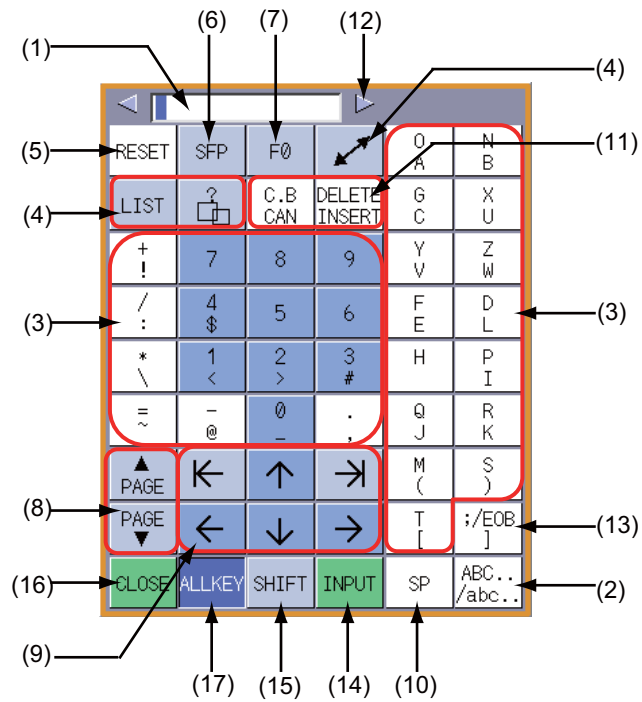

When the parameter "#11010 Software keyboard" is set to "4", the "Y/N" window is displayed instead of the software keyboard at the time of Yes/No confirmation. This "Y/N" window is automatically closed after either Y or N key is input. In this case, the software keyboard which was displayed before Yes/No confirmation will not appear.

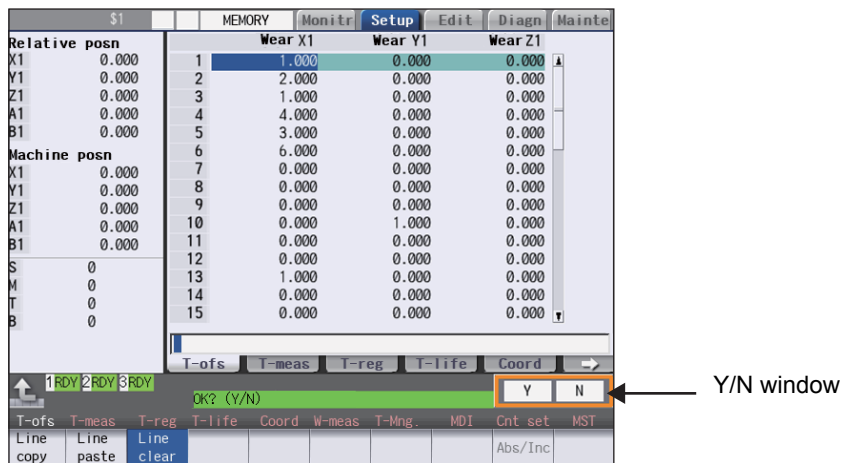

Display items

Display items	Details
(1) Input section	This displays a character string according to the keys touched by the operator.
(2) Lower-case letter input key	This changes upper/lower-case of alphabet. The [ABC../abc..] key is highlighted when the lower-case-letter-setting is valid.
(3) Data setting keys	This enters characters in the input area or screen.
(4) Window operation keys	[LIST]: This displays the menu list window. [?]: This displays the parameter/guidance window. [SHIFT] key + [LIST]: Switches the prototype screen and mass production screen.  : This changes active windows.
(5) RESET key	This resets the NC. (*1)
(6) SFP key	Not available.
(7) F0 key	Not available.
(8) Page up/down keys	This displays the contents in the previous/next page. When the numerical keypad display keyboard is displayed automatically at the time of Yes/No confirmation, [Y]/[N] keys are displayed instead of page up/down keys.
(9) Cursor keys	If data is set in the display items on the screen, the cursor is moved to vertically/horizontally.
(10) Blank key	This enters a blank.
(11) Data correction keys	[INSERT]: The mode changes to data insertion mode, and characters are input at the current cursor position when data setting key is pressed. When [DELETE], [C.B CAN], [INPUT], cursor key, or tab key, etc. is pressed, or when the screen is changed to another, the mode returns to overwriting mode. [DELETE]: This deletes a letter before the cursor position. [C.B]: This cancels the settings in the input area. [CAN]: This cancels.
(12) Display position switch	This switches the display position of the software keyboard.
(13) Block end key	This enters ";".
(14) INPUT key	This confirms the data entered in the input area or screen.
(15) SHIFT key	This validates the setting on the lower line of the data setting key. Once [SHIFT] key is selected, it will be valid until another key is pressed or the software keyboard is closed. Menus are displayed in highlight while [SHIFT] key is valid.
(16) CLOSE key	This closes the software keyboard.
(17) Key display switch key	This switches numerical keypad display/all keys display.

(*1) For details on the behavior of this button, refer to the device No. X2F0 (signal name: BOARD RESET, signal abbreviation: BRST) in "M800/M80/C80 Series PLC Interface Manual".

Input area of software keyboard



If the software keyboard is displayed while the input area exists on the screen, the input area of the software keyboard is displayed in the enable state. When the data setting key or data correction key is selected while the input area is enabled, enter a key in the input area of the software keyboard, and use the [INPUT] key to enter data in the screen.

Furthermore, if the software keyboard is displayed to edit a program file when the input area does not exist on the screen or while the editing window or MDI editing window is being displayed, the input area of the software keyboard is displayed into the disable state. In this case, directly enter a key in the screen.

When you enter a key to type the password, an asterisk "*" appears in the input area of the software keyboard.



Displaying/closing the software keyboard

Touching the [S/W Key] button on the lower left of the screen allows you to display the software keyboard on the screen.



- (1) Touch the [S/W Key] button.  The software keyboard is displayed on the front screen. The [S/W Key] button is highlighted.
- (2) Touch the [CLOSE] key.
Or, touch the [S/W Key] button again.  The software keyboard will close.





Switching the view mode (all keys display/numerical keypad display)

Touching the [ALLKEY] key on the software keyboard allows you to switch the software keyboard view mode between "numeric keypad view" and "all key view". "Numeric keypad view" is specified by default.



- (1) Touch the [S/W Key] button.  The software keyboard is displayed on the left side of the screen. The software keyboard is displayed as a numerical keypad.
- (2) Touch the [ALLKEY] key at the bottom of the software keyboard.  All keys, including alphabet character keys, are displayed. The [ALLKEY] key is highlighted.
- (3) Touch the [ALLKEY] key at the bottom of the software keyboard.  The display is switched to the numerical keypad only. The [ALLKEY] key is unhighlighted.

Changing the display position

Touching the  or  key on the top of the software keyboard allows you to move the software keyboard display position to the left or right.

- (1) Touch the [S/W Key] button.  The software keyboard is displayed on the left side of the screen. The [S/W Key] button is highlighted.
- (2) Touch the  key located at the upper right corner of the software keyboard.  The software keyboard moves to the right, and it appears on the center of the screen.
- (3) Touch the  key located at the upper right corner of the software keyboard.  The software keyboard moves to the right, and appears on the right side of the screen.

Note

- (1) When the  key is pressed, the software keyboard moves to the left.
- (2) If the  key is pressed when the [S/W Key] button appears on the left of the screen or if the  key is pressed when the [S/W Key] button appears on the right of the screen, the software keyboard does not move.

Entering data when the input area is enabled

If displaying the software keyboard while input area is being displayed on a screen, such as in the case where the operation search window or setup screen is being displayed, the software keyboard input area will be valid. At this time, the key selected on the software keyboard is temporarily displayed in the software keyboard input area, and then is input and set in the screen by selecting the [INPUT] key.

(Example) Set the value in T tool compensation amount

- | | | |
|--|---|---|
| (1) Display T compensation tab on the setup screen and touch the [S/W Key] button. | ➔ | The software keyboard is displayed on the left side of the screen.
Software keyboard input area will be invalid. |
| (2) Touch the [↑], [↓], [←], [→] keys to move the cursor to an arbitrary position. | ➔ | The cursor for tool compensation amount is moved. |
| (3) Touch the data setting key and enter the value.
Example: 15 | ➔ | "15" is displayed in the software keyboard input area. |
| (4) Touch the [INPUT] key. | ➔ | "15" is input at the tool compensation amount cursor position. |

Note

- (1) It is possible to make an operation input in the entry field of the software keyboard. For details on settings and operations, refer to "2.3.2 Inputting Operations".
- (2) If 20 or more characters are entered in the entry field of the software keyboard, character strings displayed in the input area are scrolled in sequence.
- (3) If you touch the [←] or [→] key while the input area of the software keyboard is enabled, the cursor will move in the relevant direction in the entry field.

Entering data when the input area is disabled

If software keyboard is displayed while edit window is displayed for program editing or input area is not displayed on a screen, or when the monitor screen main menu is displayed, software keyboard input area will be invalid. At this time, the key selected on the software keyboard is directly input to the screen.

- | | | |
|--|---|--|
| (1) Display the edit window on the monitor screen and touch the [S/W Key] button. | ➔ | Software keyboard is displayed.
Software keyboard input area will be invalid. |
| (2) Touch the [↑], [↓], [←], [→] keys to move the cursor to an arbitrary position. | ➔ | The cursor for the edit window is moved. |
| (3) Touch the data setting key and enter the value.
Example: G28 | ➔ | "G28" is displayed in the edit window. |
| (4) Touch the [INPUT] key. | ➔ | "G28" which has been input in the edit window is confirmed. |

2.6.3 Operating the Screen by Touch Gestures

The screen can also be operated by touch gestures.

This function can be used with the project which is created by "GT Designer3" Ver. 1.195D or later.

(1) Changing the menu display (Right-/left-flick)

If you flick the menu horizontally (quickly run your fingertip horizontally along the screen), the menu changes to the previous or next menu.

(2) Scrolling the displayed data (Up/down flick, drag)

If you flick the screen vertically (quickly run your fingertip across the screen) to edit a program or process various table data items such as the compensation amount and common variable, or you drag the screen (touch the surface and move your finger without up and down losing contact), the displayed data is scrolled.

(3) Changing a page (Right- or left-flick)

If you flick a page horizontally (quickly run your fingertip horizontally along the screen) to display the workpiece coordinate system offset or guidances such as the alarm and parameter guidances, the page changes to the right or left page.

(4) Displaying the next axis/next part system with right- or left-flick

If you flick (quickly run your fingertip horizontally along the screen) horizontally on the parameter screen, etc., the axis or part system to be displayed can be switched.

(5) Selecting or determining a file (Double-tap)

If you double-tap a target file on the file list screen, operations such as "Search execution", "Open file", and "Erase file" can be performed in the same way as when the [INPUT] key is pressed. However, the value of the input section is ignored.

[Gesture operation enabled judgment]

When you move your fingertip from the gesture-enabled range to the outside while keeping your finger touching the screen, the gesture operation is enabled until you take your finger off the screen. If you first touch the outside of the gesture-enabled range, the gesture operation is disabled until you take your finger off the screen, even when you move your fingertip in the gesture-enabled area.

Changing the menu display

If you flick the menu horizontally (quickly run your fingertip horizontally along the screen), the menu slides, and changes to the previous or next menu.

(Example)

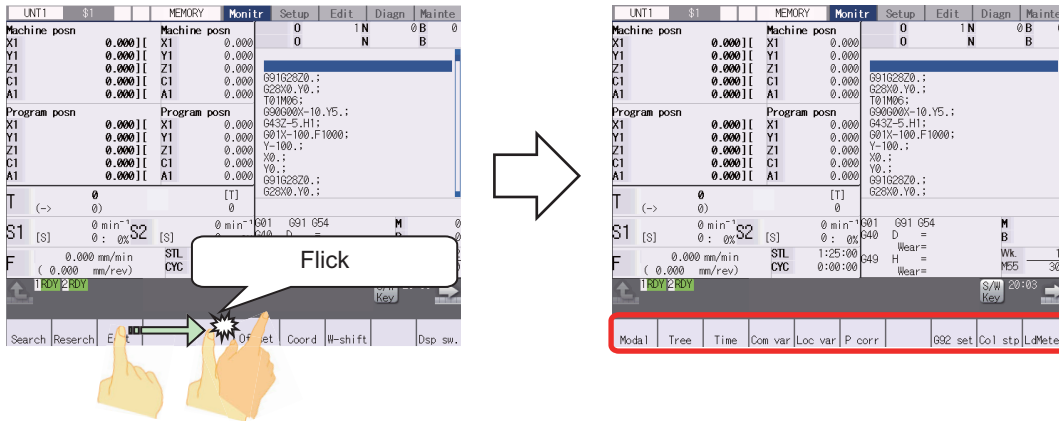

Scrolling the displayed data

If you flick the screen vertically (quickly run your fingertip across the screen) to edit the operation, setup, or editing program or process various table data items such as the compensation amount and common variable, or you drag the screen vertically (touch the surface and move your finger vertically without losing contact), the displayed data is scrolled.

(Example) Scroll by vertical flick

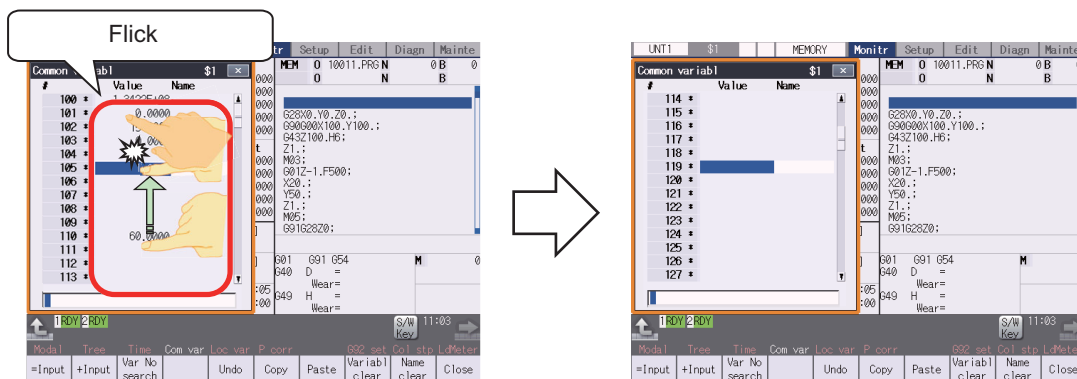

(Example) Scroll by vertical drag

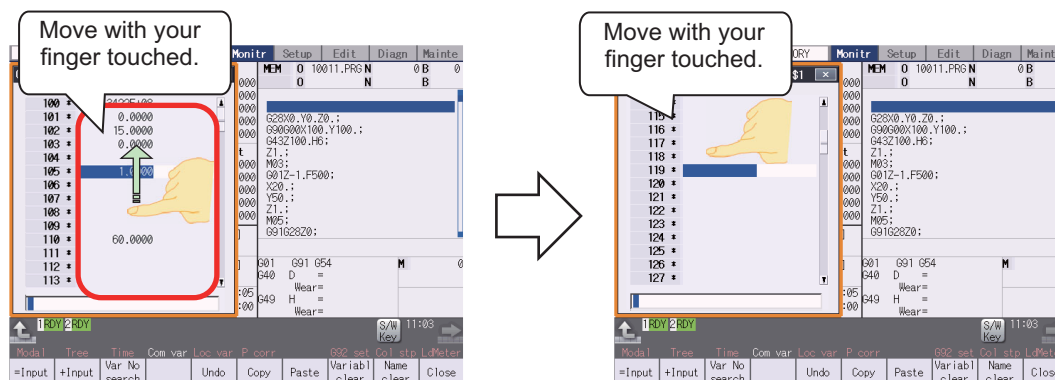

Changing a page

If you flick a page horizontally (quickly run your fingertip along the screen) to display the workpiece coordinate system offset or guidance such as the alarm and parameter guidance, the page changes to the right or left page.

(Example) Page changing for workpiece coordinate system offset

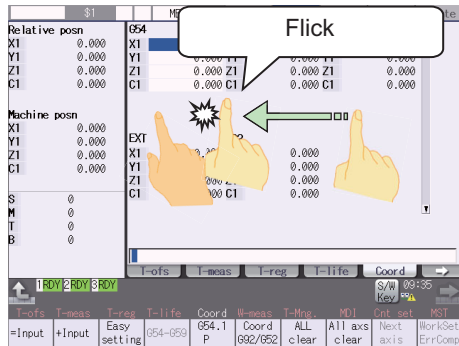

A workpiece coordinate system offset (G54-G56) is being displayed.



Changed to the next workpiece coordinate system offset (G57-G59) page.

(Example) Page changing for parameter guidance

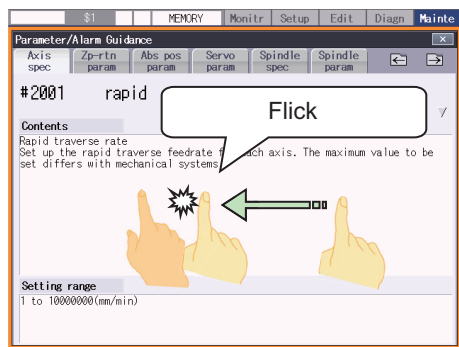

A parameter guidance (#2001) is being displayed.

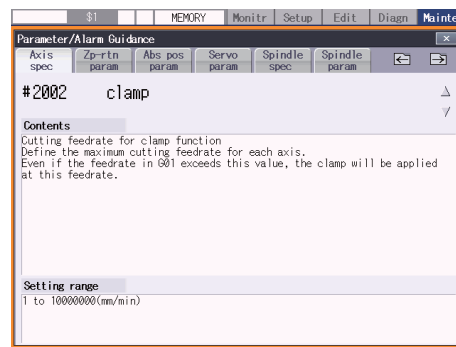

Changed to the next guidance (#2002) page.

Switching axis or part system

On the screen where you can switch the axes being displayed with the menu [Next axis] such as the axis parameter screen, flick (quickly run your fingertip across the screen) horizontally to switch an axis or a part system to be displayed.

(Example) Displaying the next axis of the axes' parameters.

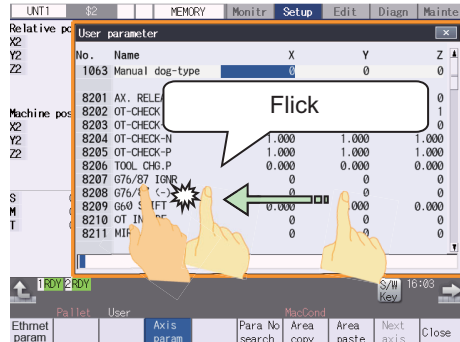

The axis parameters (X, Y and Z axes) are displayed.

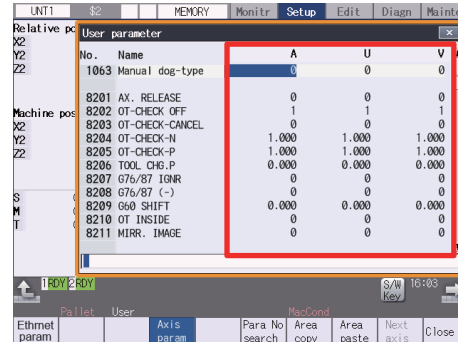

The next axes (A, U and V axes) are displayed.

Selecting or determining a file

If you double-tap a target file on a screen that displays a file list, for example, on the Operate search screen, operation is performed in the same way as when the [INPUT] key is pressed.

(Example) Double-tap on [Monitr] - [Search]

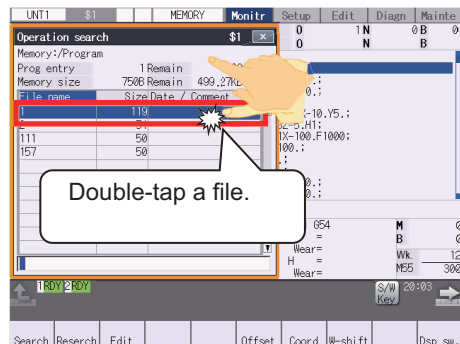

The Search screen is being displayed.

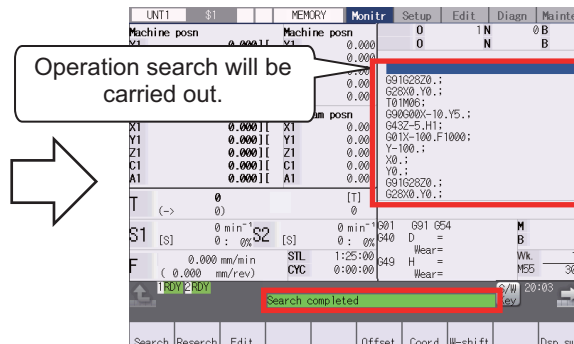

Search is executed.

Note

- (1) The subsequent operation varies depending on the target you double-tapped.
 - When the target is a file: The selected file name is specified.
 - When the target is a folder: The list of files in the selected folder is displayed.

2.7 Menu Customization Function

You can freely relocate the main menus of the monitor (Monitr), setup (Setup) and edit (Edit) screens.

This function enables to place the often-used keys in the first page.

It can be used when a parameter "#11032 Menu sel para lkof" (Validate menu selection parameter setting) is set to "2".

MTB password is required when it is set to "1".

The main menu of monitor screen, setup screen and edit screen correspond to the following parameters:

<Menu selection parameter>

Main menu for monitor screen: "#10501 Monitr main menu 1" to "#10530 Monitr main menu 30"

Main menu for setup screen: "#10551 Setup main menu 1" to "#10580 Setup main menu 30"

Main menu for edit screen: "#10601 Edit main menu 1" to "#10630 Edit main menu 30"

Refer to "Alarm/Parameter Manual" for details.

Setting example

Main menu for monitor screen is changed as follows.

The figure below is the default layout.

<Default layout>

#10501	#10502	#10503	#10504	#10505	#10506	#10507	#10508	#10509	#10510	Menu on page 1
Search	Reserch	Edit			Offset	Coord			Dsp sw.	
#10511	#10512	#10513	#10514	#10515	#10516	#10517	#10518	#10519	#10520	Menu on page 2
Modal	Tree	Time	Com var	Loc var	P corr		G92 set	Col stp	LdMeter	
#10521	#10522	#10523	#10524	#10525	#10526	#10527	#10528	#10529	#10530	Menu on page 3
Sp-stby	TipDisp	All Sp				Next Ax	Cnt exp	Cnt set	MST	

(1) Set the parameters "#10501 Monitr main menu 1" to "#10530 Monitr main menu 30" as shown in the right.



<Parameter>	<After>
#10501	3 (Edit)
#10503	1 (Search)
#10506	11 (Modal)
#10510	1 (Not display)
#10513	7 (Coord)
#10519	-1 (Not display)
#10525	3 (Edit)
#10527	16 (P corr)

Set "0" to the parameters other than the listed above.

(2) Turn the power ON again



The new layout of the monitor screen's main menu is displayed.

<After parameter change>

Edit	Reserch	Search		Modal	Coord			
------	---------	--------	--	-------	-------	--	--	--

Menu on page 1

Modal	Tree	Coord	Com var	Loc var	P corr		692 set		LdMeter
-------	------	-------	---------	---------	--------	--	---------	--	---------

Menu on page 2

Sp-stby	TipDisp	All Sp		Edit		P corr	Cnt exp	Cnt set	MST
---------	---------	--------	--	------	--	--------	---------	---------	-----

Menu on page 3

Precautions

- (1) When you set the number which the main menu is not allocated with the menu selection parameter, the menu is not displayed. Menu which is set with other menu non-display parameter ("#8923 Hide Edit-IO menu", "#8932 Hide measure scrn") is also not displayed even if it is set with the menu selection parameter.
- (2) A menu selection parameter setting will be reflected to the menu list.
- (3) Menus which are allocated to the short cut key (it is enabled after the axis address is input), such as [Counter Set] and [MST], become valid by pressing a short-cut key even if they are set as "Not display".
- (4) When the parameter "#11032 Menu sel para lkof" (Menu select param setting enabled) is set to "0", the menu [Menu select] is not displayed.
- (5) When the parameter "#11032 Menu sel para lkof (Menu select param setting enabled)" is set to "1" and the MTB password is not entered, the menu [Menu select] appears, but the menu select param setting screen does not appear even if you press the menu.

2.8 Changing the Operation Level (Protect Setting Screen)



Operating the maintenance screen reduces a phenomenon in which defective workpieces run out due to an operation mistake, by implementing a restriction with seven operation levels. The operation level varies depending on the MTB specifications. Refer to the instruction manual issued by the MTB for details.

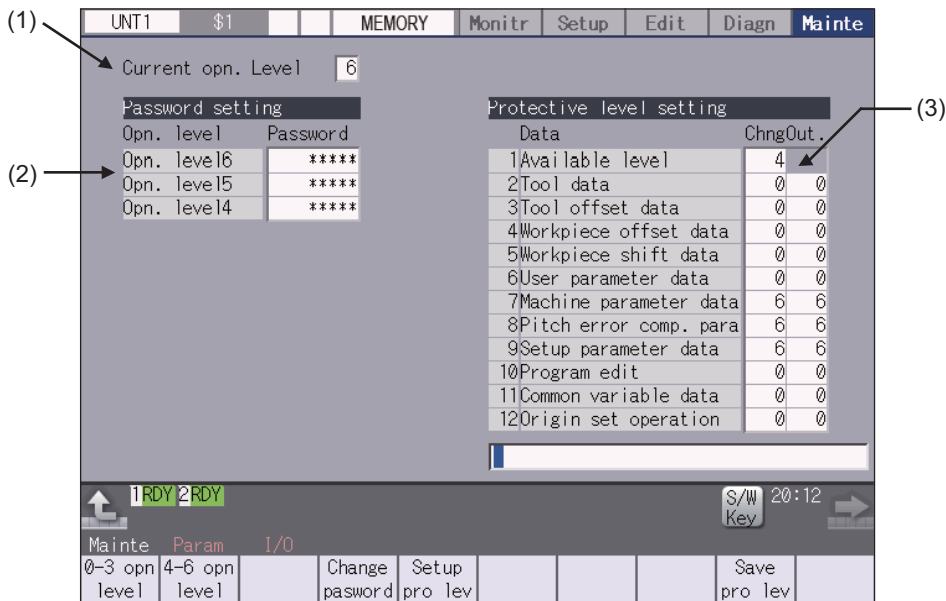

Display items

Display items	Details
(1) Current operation level	Displays the current operation level.
(2) Passwords at operation levels 4 to 6	Displays the passwords of operation levels 4 to 6 with "*****".
(3) Protection level of each data item	<p>Displays the protection level of each data item.</p> <p>The data set below the current operation level can be changed as needed. Changing the protection level displays the message "Pro lev change" at the upper right.</p> <p>Change: Specify the protection level to change data (including a case to input a file).</p> <p>Output: Specify the protection level to output a file.</p>

Inputting a Machining Program and Defining Variables

This chapter explains creating and editing the machining program. Generally, operations are performed on the edit (Edit) screen.

Refer to "Programming Manual" for details on G code programming.

3.1 Inputting a Machining Program

When using the program created by external device, input it to NC by using program input/output function. For information on the data input/output function, refer to "4.1 Inputting and Outputting a Program".

3.2 Creating and Editing a Machining Program



The program editing function performs add, delete and change in the NC memory.

This function is used for machining program, MDI program and fixed cycle program.

On the edit screen, editing (add, erase, change) and cursor position search can be performed.

There are 3 types of display as shown below:

Multi-program display type	Enables you to edit two programs using each editing area.
G-code guidance display type	Enables you to edit a program referring to the G code guidance.
Playback display type	Enables you to edit a program trying sample machining.

Selected display type is retained after screen transition.

The tab under the editing area is switched depending on the selected display type.

Some tabs may not be displayed depending on the specifications.



For details on switching the display type, refer to "3.6.1 Changing the Display".

You can edit the program on the monitor screen as well. For details, refer to "9.5 Correcting the Machining Program".

CAUTION

The program including a character of any language other than the display language is not correctly displayed. Do not edit such a program. Any part of the program other than the comment part may also be changed if edited.

■ Multi-program display type

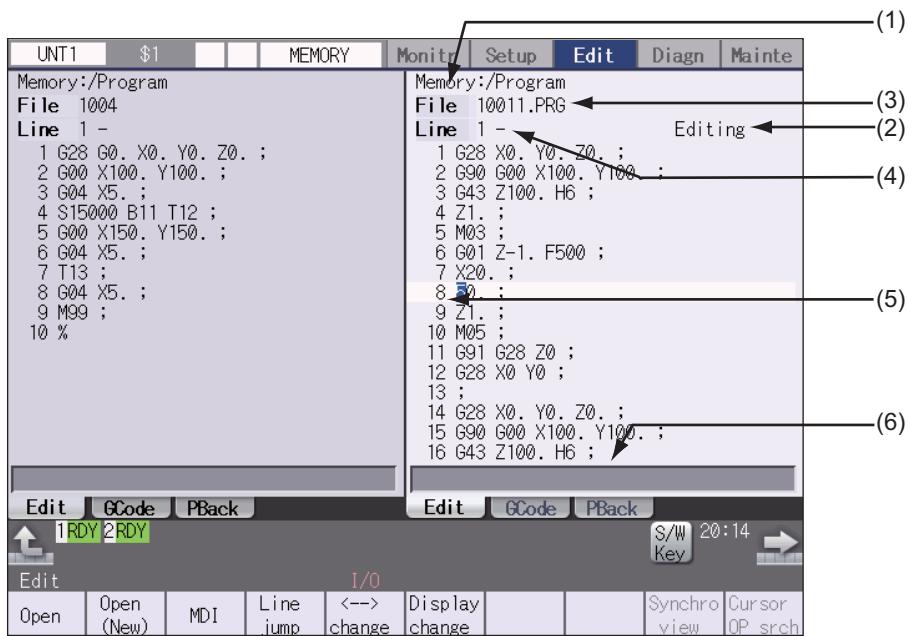

■ G-code guidance display type

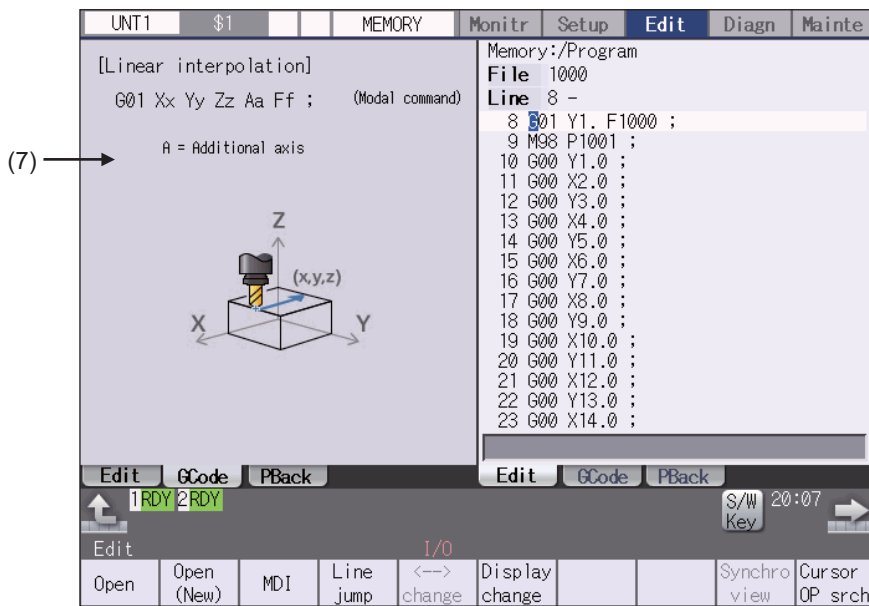

■ Playback display type

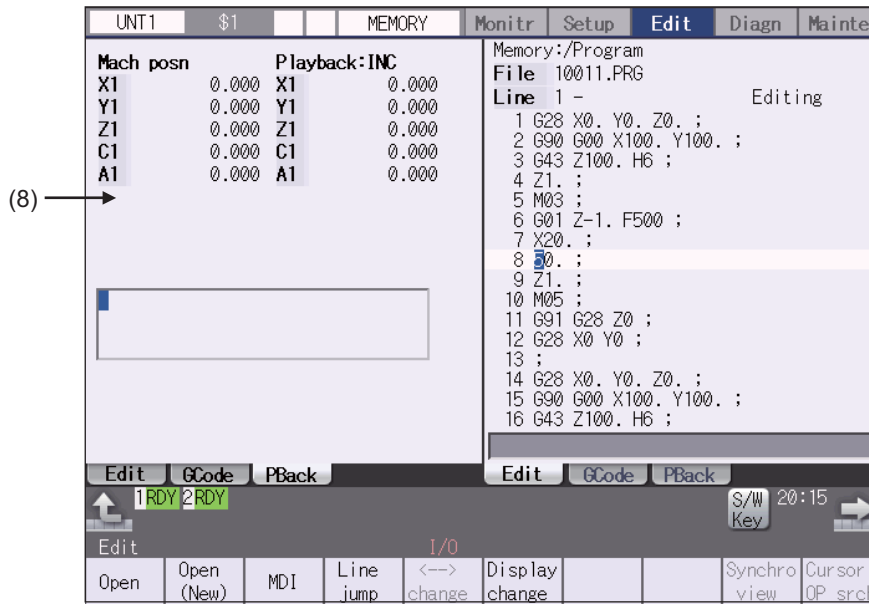

Display items

Display items	Details
(1) Path display	The path of the currently opened program file is displayed. (Example) Memory:/program When the path is too long, the characters exceeding the 37 characters (1-byte code) cannot be displayed.
(2) N No. incremental value display Current edit display "Editing" Insert mode display "INS"	<N No. incremental value display> This displays an automatic additional value of sequence No. <Current edit display "Editing"> This displays when performing edit operations after displaying the program. <Insert mode display "INS"> The overwrite mode and insert mode are switched by pressing the [INSERT] key. This is displayed when the insert mode is selected.
(3) Program name display	This displays the file name of the program currently being edited. This displays "MDI" when the MDI program name is being edited.
(4) Top line of the displayed program	This displays the top line of the displayed program.
(5) Line number Program display	<Line number> This displays the last 3 digits of the program line number. When over two or more lines are displayed on the screen because one line is long, the line No. does not attach to the beginning of the next line. <Program display> This displays the contents of the program (machining program, MDI program) currently being edited. The line that the cursor is on is highlighted.
(6) Input section	This inputs the program line number and search character string.
(7) G code guidance display	This displays G code guidance. For details, refer to "2.4.3 G Code Guidance".
(8) Playback display	This displays playback status. For details, refer to "3.7.4 Playback Editing".

Menus	
Menus	Details
Open	This edits and references the existing programs. When the program number is designated and the [INPUT] key is pressed, the program contents appear and can be edited.
Open (New)	This creates a new program. When the program number is set and the [INPUT] key is pressed, new comment or program contents can be created.
MDI	This edits the MDI program. When this menu key is pressed, the MDI program appears and can be edited.
Line jump	When the line number is set and the [INPUT] key is pressed, the program data for the set number and later is displayed on the screen. The cursor moves to the set line number.
<--> change	The area that can be edited is switched between the left and right areas. This menu can be selected for the multi-program display type.
Display change	The display type (multi-program display, G code guidance display, and playback display) is switched.
Synchro view	A blank line is inserted so that the timing synchronization symbols (the timing synchronization operations of the machining program) are aligned horizontally. <Note> • This menu is grayed out and non-selectable in the following cases. - When the parameter "#1285 ext21/bit0" (Multi-part system program management) is set to "0" (invalid). - When the program numbers displayed in the left and right editing areas are different.
Cursor OP srch	An operation search is carried out for the currently opened program with the block located by the cursor at the top. When the operation search is completed, the display switches to the monitor screen. <Note> • If the parameter "#1285 ext21/bit0" (Multi-part system program management) is set to "1" (valid), or the program is being edited, this menu is grayed out and non-selectable.
String search	When the character string is designated and the [INPUT] key is pressed, that character string is searched for.
String replace	If the character string to be searched for and the character string to be replaced are separated with a "/" and designated, when the [INPUT] key is pressed, the character string is replaced.
Line copy	This copies the designated line (multiple lines can be copied.)
Char copy	This copies the character string designated by the cursor (multiple lines can be copied.)
Paste	This inserts the most recently copied contents to the line before the cursor or the position before the cursor.
Line clear	This erases the designated line (multiple lines can be erased).
Undo	This returns the contents of the program to that prior to saving and display. This menu cannot be selected when parameter "#8910 Edit undo" is set to "0". <Note> • When the parameter "#8939 Undo confirm msg" is set to "1", the menu is highlighted while the operation message is displayed.
N auto add	The sequence No. can be added automatically by pressing the [INPUT] key after designating an additional value.
MDI regist	This registers the MDI program in the memory. This can be performed only when the MDI program is displayed.







Menus	Details
Erase file	This deletes the programs. When the name of the program to be erased is designated, the designated file is deleted.
Pback next ax	The axis to be displayed in the playback editing is switched from the first to fifth axes and among the sixth and further axes. <Note> ♦This menu is enabled if the playback editing (L system) is enabled and the number of axes is 6 or more.
File close	This closes the pop-up window and quits this function.

Sub-menus of [Open]/[Open (New)]/[Erase file] menus

Menus	Details
Memory	This selects NC memory.
Memory2	This select the expanded area of NC memory. This menu is grayed out and non-selectable, when the specification of program memory capacity 1000kB[2560m] or 2000kB[5120m] is invalid.
Top jump	This moves the cursor to the top line.
Bottom jump	This moves the cursor to the last line.
Close	This closes the pop-up window and return to the edit screen.
Comment switch	Pressing this menu switches display/non-display status and the display contents of the "Date/Comment" column of the program list as follows: Program comment -> the last updated date/time of the file (*1) -> not displayed
List update	This updates the list contents. (The latest contents of the currently selected device and directory are listed.)
Sort change	This changes the method that the list is sorted.

(*1) When the multi-part system program management is enabled (#1285 ext21/bit0 = 1) for the device [Memory], the last updated date/time of the file is not displayed.

Operation method (Creating a new machining program)

- (1) Press the menu [Open (New)] on the edit screen.
- (2) Select the device.
(Example) Menu [Memory]  The selected device name and directory (memory: /program) appear in the device name and directory display columns.
For the devices other than NC memory, root directory is selected.
The device on the side being edited is displayed first. If a file is not opened, NC memory will be opened.
- (3) (In case of the device other than NC memory.)
Press [↑], [↓], , or  key to move the cursor to the directory with the machining program or the directory to be newly created.
If the list contents differ from the actual device or directory, press the menu [List Update].
- (4) (For the devices other than NC memory)
Press the [INPUT] key.  Moves into the directory.
- (5) Enter the program file name to be newly created.
- (6) Press the [INPUT] key.  When new creation is enabled, an EOR-only program is created.
The list display is closed.
- (7) Edit the machining program.  Refer to "3.6 Editing Operations".
- (8) Press the [INPUT] key.  The edited machining program is saved to the device.



Precautions for creating a new machining program

- (1) If an existing program number is designated, it causes an error.
- (2) The part enclosed in parentheses () in the head block of the program is used as a comment.
- (3) If an existing file is set, the message "Designated file already exists" appears.
- (4) Single-byte digits, single-byte uppercase alphabet characters, and Windows-recognizable single-byte symbols are available for the file name or directory name. Therefore, a double-byte code file name such as a Japanese file name cannot be used.
Characters which cannot be used: \ / : , * ? " < > | a to z and space
Also, the followings cannot be treated as file names:
 - File name with extension "\$\$\$", "\$\$0", "\$\$1", "\$\$2", "\$\$3", "\$\$4", "\$\$5", "\$\$6", "\$\$7", "\$\$8", or "\$\$9"
 - "0" (File named "single-byte zero")
- (5) A program, which has a file name consisting of 33 or more characters, cannot be newly created.
- (6) If the parameter "#8936 Delete leading 0" is set to "1" and the file name is designated only by digits, the existing file, edit lock B, and edit lock C are checked by deleting "0" at the head.
For details, refer to "4.8.6 Leading Zero".



Operation method (editing machining program)

- (1) Press the menu [Open] on the edit screen.

- (2) Select the device.
(Example) Menu [Memory]  The selected device name and directory (memory: /program) appear in the device name and directory display columns.
For the devices other than NC memory, root directory is selected.
The device on the side being edited is displayed first. If a file is not opened, NC memory will be opened.

- (3) (In case of the device other than NC memory.)
Press [↑], [↓], , or  key to move the cursor to the directory with the machining program or the directory to be newly created.
If the list contents differ from the actual device or directory, press the menu [List Update].

- (4) (For the devices other than NC memory)  Moves into the directory.
Press the [INPUT] key.

- (5) Press [↑], [↓], , or  key to move the cursor to the machining program to be edited.
The name of the machining program to be edited can be input in the input area.

- (6) Press the [INPUT] key.  The program appears at the top if the file can be opened.
If the program name has been entered in the input area, the program contents is displayed. The cursor moves to the head character of the program. The mode changes to the overwrite mode. (When it is the initial insert mode, "INS" is displayed to the right of the file name and the mode changes to the insert mode.)
The list display is closed.

- (7) Edit the machining program.  Refer to "3.6 Editing Operations".

- (8) Press the [INPUT] key.  The edited machining program is saved to the device.

Precautions for editing machining program

- (1) An error occurs if a nonexistent program No. is set.
- (2) If the selected program is running or program restarting, it can be displayed but not edited.
An error occurs when the data is set or the [INPUT] key is pressed.
- (3) The fixed cycle program list is displayed when the parameter "#1166 fixpro" is set to "1".
- (4) Editable size differs depending on each device. When the editable size is exceeded, the operation message "Can't edit because of size over" appears.
- (5) "Loading" is displayed in flickering until the file is opened.
- (6) Editing is not possible for a program with 33 or more file name characters.
- (7) When the program in search was edited, the program is searched again as follows depending on the last operation.
 - ♦Search -> Edit: The position in which ONB is displayed is searched again.
 - ♦Search -> Reset 1-> Edit: The program top is searched again.
 - ♦Search -> Reset 2-> Edit: The search is not executed. If a program was added or deleted, the search position may shift.
 - ♦Search -> Reset & Rewind -> Edit: The program top is searched again.
- (8) If the protection level ("Program edit" data output) designated on the protection setting screen is higher than the current operation level, the machining program cannot be opened (message "data protection" is displayed). However, if the protection level is set to a higher value on the protection setting screen while a machining program remains opened, the machining program is kept opened even after the display has returned to the edit screen. To hide the machining program after changing the protection level, press the menu [Close] to close the machining program, and change the protection level on the protection setting screen. For details, refer to "2.8 Changing the Operation Level (Protect Setting Screen)".
- (9) Display will be changed as follows depending on the value set in the user parameter "#19006 EOR Disable".
 - <When the parameter "#19006 EOR Disable" = "0">
 - ♦When a file including "%" is opened in the edit screen, characters up to "%" will be displayed. By saving the file, characters after "%" will be discarded.
 - ♦When a file not including "%" is opened, "%" will be displayed at the end of the edit screen. By saving the file, "%" will also be saved.
 - <When the parameter "#19006 EOR Disable" = "1">
 - ♦The contents of a file is displayed on the edit screen as it is.
 - ♦When a file whose last character is other than "%" is opened, "%" will be displayed at the end of the edit screen. "%" will be saved by saving the file. For example, if the end of the file is "%" + "CRLF", an extra "%" will be added at the end.
 - ♦"Line copy" and "Line clear" can be made at the lines other than the last line which includes "%".

3.3 Registering and Editing the MDI Program



Operation method for editing MDI program

- | | | |
|--|---|--|
| (1) Press the menu [MDI] on the edit screen. | ➔ | <p>The menu is highlighted.
 The MDI program is displayed from the head of the editing side. The cursor moves to the head character of the program.
 The cursor moves to the head character of the program. The mode changes to the overwrite mode.
 (When it is the initial insert mode, "INS" is displayed to the right of the file name and the mode changes to the insert mode.)</p> |
| (2) Edit the MDI program. | ➔ | Refer to "3.6 Editing Operations". |

Note

- (1) Before starting MDI operation, confirm that the MDI settings are completed. If "Editing" or "MDI no setting" is displayed, the MDI operation cannot be started.
 When the [INPUT] key is pressed, the head block will be searched, and the message "MDI Set ended" will appear. The setting will then be completed.
 If the cursor is moved without editing, the block indicated by the cursor will be searched for when the [INPUT] key is pressed.
- (2) If the [INPUT] key is pressed when the number of MDI program characters including EOB (;) and EOR (%) exceeds 2000, "Memory capacity over" message will appear and the MDI program will not be searched for execution.
 Note that the contents edited after the MDI program is saved last will not be saved in the NC.
- (3) When the parameter "#1288 ext24/bit0" (MDI program clear) is set to "1", the MDI programs are cleared when MDI operation ends, the power is turned ON again, reset is input and emergency stop is canceled, and only % programs are saved.
 - When the parameter "#1285 ext21/bit0" (Multi-part system program management) is set to "1" (valid), the MDI program of the part system in which MDI operation ends or the reset signal issues is cleared.
 - The MDI programs before editing is cleared during the MDI program editing.
 - Reset input refers to NC reset 1, NC reset 2 and reset & rewind.
 - MDI program clear is performed regardless of operation mode.
 - When MDI program is cleared during the character string replacement confirmation waiting or line clear confirmation waiting, the character string replacement or line clear is canceled and each menu highlight returns to normal.
 - When MDI program is cleared after the range of the target block for line copy and line clear has been set, the designated machining program is de-highlighted.

Operation method for registering MDI program

- (1) Press the menu [MDI] on the edit screen.
- (2) Select the program to register, and then press the [INPUT] key.

Note

- (1) The program is registered as a general program of NC memory.
When the fixed cycle or MTB macro is selected with the parameter "#1166 fixpro" (Fixed cycle editing), the program cannot be registered. The "Save not possible" message appears.
- (2) Program cannot be registered while "Editing" is being displayed. The "Save not possible" message appears. Press the [INPUT] key to be "MDI Set ended".
- (3) When the general program remaining capacity is less than the value of MDI program to be registered, the program cannot be registered. The "Memory over" message appears.
- (4) When the number of remaining general programs is zero, the program cannot be registered. The "Program entry over" message appears.
- (5) When the [INPUT] key is pressed without entering the program name, "Setting error" occurs.
- (6) If the program name is input with only numbers when the parameter "#8936 Delete leading 0" is set to "1", the number without the leading zero is registered as the program name. However, when a number without a leading zero is outside the range 1 to 99999999, the leading zero is not deleted.
- (7) If the input program name already exists in the NC memory, the MDI program cannot be registered during the operation or program restart. The operation message "Executing automatic operation" or "Program restarting" appears.
If the program name is input with only numbers when the parameter "#8936 Delete leading 0" is set to "1", the program is checked with the leading zero deleted. (Example: If the MDI registration is specified as "0001" when the program "1" is in automatic operation, the "Executing automatic operation" message appears and the registration cannot be performed.)
- (8) When the input program name already exists in the NC memory and it is not being in operation, the "Overwrite this file?(Y/N)" message appears. When the [Y] or [INPUT] key is input, the program name is overwritten, and when a key other than those is pressed, the registration is canceled.
If the program name is input with only numbers when the parameter "#8936 Delete leading 0" is set to "1", the program is checked with the leading zero deleted. (Example: If the MDI registration is specified as "0002" when the program "2" already exists in the NC memory and it is not in the operation, the "Overwrite this file?(Y/N)" message appears.)
- (9) When the program name to be input is subject to edit lock (edit lock B: 8000 to 9999, edit lock C: 9000 to 9999), the message "Edit lock B" or "Edit lock C" appears, and the program name cannot be registered.
If the program name is input with only numbers when the parameter "#8936 Delete leading 0" is set to "1", the program is checked with the leading zero deleted. (Example: If the MDI registration is specified as "008000" when the edit lock B is valid, the "Edit lock B" message appears and the program cannot be registered.)

3.4 Registering and Editing the Fixed Cycle Program

The subprogram for the fixed cycle can be input, output and edited.



CAUTION



Do not change the fixed cycle program without prior approval from the MTB.

Note

- (1) Since the G.1 command is used to perform the movement of a fixed cycle program, do not edit the contents of the program being described before the G.1 command. Do not delete the contents or do not insert any other commands than the G.1 command. If you edit the program in such a manner, the fixed cycle program is not performed properly.
- (2) When a fixed cycle program is executed, the modal information of the dedicated group 01 is used. This intends that the modal of the main program, which calls the fixed cycle program, is not influenced by the fixed cycle program. Therefore, you can edit the fixed cycle program without considering the modal of the main program. In the fixed cycle program, the modal of the group 01 after the G.1 command is "G00".

Refer to "Programming Manual" for details on the fixed cycle program.

3.4.1 Fixed Cycle Operation Parameters

To input/output or edit the data of each fixed cycle subprogram, use the Data I/O and edit screens in the same way as when creating usual user-created work programs. In this case, the parameters must have been set. Set "1" in parameter "#1166 fixpro". If this parameter is valid, the IN/OUT and edit screens are usable only for operating a fixed cycle control subprogram. During this period, program file displays only fixed cycle programs. Thus, after the fixed cycle program operation, return the parameter to "0".

Note

- (1) Parameter "#1166 fixpro" will be set to "0" when the power is turned OFF.

3.4.2 Transmitting and Erasing the Fixed Cycle Program

Transmit/erase the fixed cycle program from the Data I/O screen. Check that fixed the parameter "#1166 fixpro" is valid. The operating procedure is the same as a user machining program.



3.5 Erasing a File





Operation method

- (1) Press the menu [Erase file] on the edit screen.
- (2) Select the device.
(Example) Menu [Memory]

➔

The selected device name and directory (memory: /program) appear in the device name and directory display columns.
For the devices other than NC memory, root directory is selected.
The device on the side being edited is displayed first.
If a file is not opened, NC memory will be opened.
- (3) (In case of the device other than NC memory.)
Press the [↑], [↓], , or  key to move the cursor to the directory with the machining program or the directory to be newly created.
If the list contents differ from the actual device or directory, press the menu [List Update].
- (4) (For the devices other than NC memory)
Press the [INPUT] key.

➔

Moves into the directory.
- (5) Press [↑], [↓], , or  key to move the cursor to the machining program to be edited.
The name of the machining program to be erased can be input in the input area.
- (6) Press the [INPUT] key.
When a name of machining program is inputted in the input area, the confirmation message appears.
- (7) Press the [Y] or [INPUT] key.
Press the [N] key to cancel.

Note

- (1) The file is not erased in the following cases.
 - The file that is to be erased is currently being used in automatic operation.
 - The file that is to be erased is subject to edit lock B or C.
 - Data protection is valid.
 - The file to be erased is in the "program restarting" state.

3.6 Editing Operations



When the program is edited, the key input data is directly written into the program display area. All data is overwritten from the cursor position. "Editing" appears on the right side of the file name display once input is started.

Press the [INPUT] key to save the program to the device and clear the "Editing" message.

The editing operations from when the file is actually opened are explained in this and the following sections. These editing operations are common for the machining program and MDI program.

Note

- (1) The initial mode (overwrite/insert) at start of editing and the [DELETE] key operation (DELETE/BackSpace) can be selected with the parameters. The operation with overwrite mode and DELETE operation is explained in this manual unless otherwise specified.



CAUTION

If there is no value after the G command, the operation will be the "G00" operation when the program is run due to key chattering, etc., during editing.

3.6.1 Changing the Display

Switching the active area

Switching the active area is possible only when the multi-program display type is selected.

Press the [←→ change] key to switch the active area between the left and right window.

Switching the display type

Press the menu [Displaychange] to switch the display type.

The same operation can be performed with the  key.

The display is switched in the order of multi-program display type -> G code guidance display type -> playback display type -> multi-program display type...

Note



- (1) Press  to switch in the inverse order.
- (2) Some tabs may not be displayed depending on the specifications. When only the edit tab is displayed, the menu [Displaychange] cannot be selected.



Changing the display using the page up/down keys ( : Previous page,  : Next page)

 key: This displays one page of preceding lines of the current top line.
 When there is less than one page of data, a page of data will be displayed including the data currently displayed.
 The cursor moves to the last line of the screen.

 key: This displays one page of following lines of the current bottom line.
 The cursor moves to the top line of the screen.



Changing the display with the cursor key

The cursor will move up one line in the program each time the cursor key (, ) is pressed.

If the  key is pressed at the top line of the program display area, the program will scroll up one line. If the  key is pressed at the end, the program will scroll down one line.

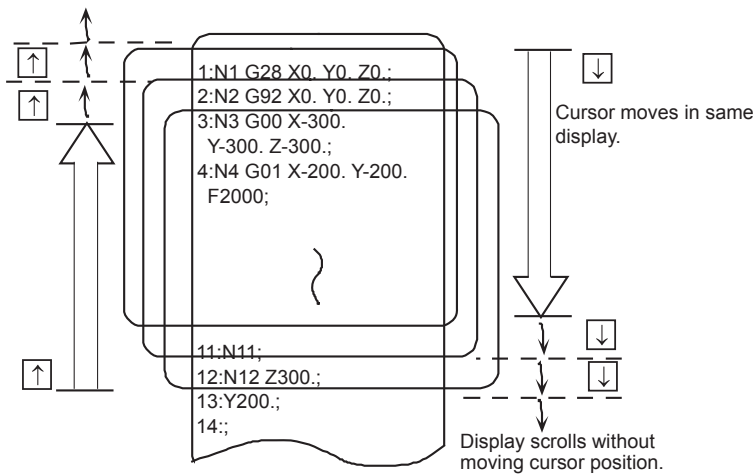
When a block is displayed over 2 or more lines, ,  keys move the cursor by block unit.



Move the cursor using the tab keys ( : back tab/  : tab)

 key : Moves to the start of the word where the cursor is currently positioned.

If the cursor is at the start of a word, it moves to the start of the previous word.

 key : Moves to the word after the word where the cursor is currently positioned.

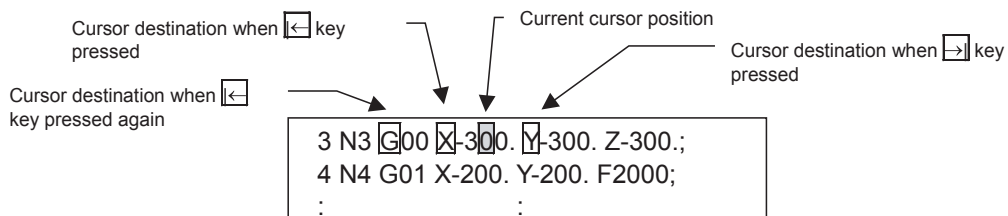

Split display by word unit

The program is split by word unit and displayed.

3.6.2 Displaying an Arbitrary Line

Operation method



- (1) Press the menu [Line jump].
- (2) Input the line No.
(Example) 6 [INPUT]  The program appears with the designated line No. at the head.

Note

- (1) When "0" is input, the cursor moves to the first line.
- (2) When "E" is input, the cursor moves to the end.

3.6.3 Rewriting Data



Operation method (Initial data overwrite mode)

- (1) Move the cursor to the position where data is to be inserted.
The cursor can be moved to one place to the right of EOB (;).
- (2) Set the data.  The message "Editing" appears when setting is started. The data is set from the position of the cursor. Data at the area is overwritten. The cursor moves one space (character) at a time to the right as the data is set.
- (3) When the setting is completed, press the [INPUT] key.  EOB (;) is added to the set data and the data is fixed. When newly creating data, the cursor moves to the head of the next line. When changing existing data, the cursor does not move.

Note

- (1) When the cursor is on or one place to the right of EOB (;), input data is inserted even if not in input mode (refer to "3.6.5 Overwriting Data (Initial Data Insertion Mode)".)

Operation method (Initial data insertion mode)



- (1) Move the cursor to the position where data is to be inserted.
The cursor can be moved to one place to the right of EOB (;).
- (2) Set the data.  The message "Editing" appears when setting is started. The data is set from the position of the cursor. The data from the cursor position moves to the right. The cursor moves one space (character) at a time to the right as the data is set.
- (3) When the setting is completed, press the [INPUT] key.  The set data is fixed. The cursor does not move, but if there is no EOB (;) at the end of the line, it will be added. Then, the cursor moves to the next line. The message "Editing" disappears.

Precautions



- (1) When changing to another function such as the program check, or to another screen such as the monitor screen when "Editing" displays, the operation message "Save current file?(Y/N)" displays. If [N] key is pressed changing to the other screen once, and the edit screen is selected again, the program before editing operation will be displayed. (Edited contents will be invalid.)
- (2) When changing to another function such as the program check, or to another screen such as the monitor screen when "Editing" displays, the operation message "Save current file?(Y/N)" displays. If the file could not be saved due to "Memory over", etc., even the [Y] key is pressed, the error message displays and the screen is not changed. The screen display varies depending on the succeeding operation (a) or (b) as follows.
When the file could not be saved and the error message displays due to "Memory over", etc., even the [INPUT] key is pressed before the screen change operation, the screen display also varies depending on the succeeding operation (a) or (b) as follows.
 - (a) When changing to another function such as the program check, or to another screen such as the monitor screen without editing, the screen transition is performed without displaying the operation message. If the display returns to the program edit screen again, the previously saved contents are displayed.
 - (b) When changing to another function such as the program check, or to another screen such as the monitor screen after editing (data setting key operation, data correction key operation, or the menu [Paste], [Line clear] or [String replace] operation), the operation message "Save current file?(Y/N)" is displayed.
- (3) Up to 255 characters can be input in one block.
- (4) "Saving" is displayed in flickering during saving.

3.6.4 Inserting Data (Initial Data Overwrite Mode)

Operation method

- (1) Move the cursor to the position where data is to be inserted.
- (2) Press the [INSERT] key.  The mode changes to the insertion mode. "INS" appears to the right of the file name. The cursor changes to "|".
- (3) Set the data.
- (4) When the setting is completed, press the [INPUT] key.  The set data is fixed. The cursor does not move, but if there is no EOB (;) at the end of the line, it will be added. Then, the cursor moves to the next line. The mode returns to the overwrite mode, and the message "Editing" disappears.

Note



- (1) Up to 256 characters can be set in one line.
- (2) The insertion mode will be finished if a key such as [DELETE], [C.B], [CAN], [INPUT], [↑], [↓], [←], [→], [|←], [→|],  or  pressed.
- (3) For normal editing, EOB(;) is added to a row without EOB(;), and the cursor moves to the next line. A row with EOB(;) is skipped, and the cursor moves to the next line. (No cursor movement.)

3.6.5 Overwriting Data (Initial Data Insertion Mode)

Operation method

- | | | | |
|-----|---|---|--|
| (1) | Move the cursor to the position where data is to be inserted. | | |
| (2) | Press the [INSERT] key. | ➔ | The mode changes to the overwrite mode. "INS" appears to the right of the file name. The cursor changes to '■'. |
| (3) | Set the data. | ➔ | The data is set from the position of the cursor. Data at the area is overwritten. The cursor moves one space (character) at a time to the right as the data is set. |
| (4) | When the setting is completed, press the [INPUT] key. | ➔ | The set data is fixed. The mode returns to the insertion mode, "INS" is displayed in the right side of the file name, and the message "Editing" disappears. The cursor returns to ' '. |

Note

- (1) The insertion mode will be finished if a key such as [DELETE], [C.B], [CAN], [INPUT], [↑], [↓], [←], [→], [|←], [|→],  or  pressed.
- (2) For normal editing, EOB(;) is added to a row without EOB(;), and the cursor moves to the next line. A row with EOB(;) is skipped, and the cursor moves to the next line. (No cursor movement.)

3.6.6 Deleting Data



Operation method (Deleting one character) (Deleting by DELETE key action ("#8967 DELETE key action" is set to "0"))

- | | | | |
|-----|---|---|---|
| (1) | Move the cursor to the character to be deleted. | | |
| (2) | Press the [DELETE] key. | ➔ | 1 character is deleted at the cursor position, and "Editing" appears. The data from the cursor position moves to the left. When this key is held down, the characters can be deleted one at a time. |
| (3) | Press the [INPUT] key. | ➔ | The edited machining program is saved to the device and "Editing" disappears. |

Operation method (Deleting one character) (Deleting by BackSpace key action ("#8967 DELETE key action" is set to "1"))

- | | | | |
|-----|---|---|--|
| (1) | Move the cursor to the right side of the character to be deleted. | | |
| (2) | Press the [DELETE] key. | ➔ | 1 character at the left side of the cursor position is deleted, and "Editing" appears. The data from the cursor position moves to the left. When this key is held down, the characters can be deleted one at a time. |
| (3) | Press the [INPUT] key. | ➔ | The edited machining program is saved to the device and "Editing" disappears. |

Operation method (Deleting one line)

- (1) Move the cursor to the line to be erased.
- (2) Press the [C.B] key.  1 line is deleted at the cursor position, and "Editing" appears. The lines following the cursor position are shifted upward. The cursor position does not change. When this key is held down, the line can be deleted one at a time.
- (3) Press the [INPUT] key.  The edited machining program is saved to the device and "Editing" disappears.

Note

- (1) In the case where the block for the deleted line covers multiple lines, these lines are also deleted.
- (2) Last line only with "%" cannot be deleted.
- (3) "Executing" is displayed during line clear. The message flashes every second.

Operation method (Deleting designated lines)

- (1) Press the menu [Line clear].
- (2) Designate the deletion range.  The background color for the range to be deleted turns light blue.



(Example) From line 8 to line 10
8/10 [INPUT]

When deleting 1 line, it is also possible to make a selection using the [↑], [↓] keys and designate by pressing the [INPUT] key.
- (3) Press the [Y] or [INPUT] key.
Press the [N] key not to delete.

Note

- (1) If the [INPUT] key is pressed without setting a line No., the line where the cursor is will be deleted.
- (2) If the last line of the file is the range to be deleted, the last line can be designated as "E".
(Example) From 8th line to last line: 8/E
From 1st line to last line: /E
- (3) "Executing" is displayed in flickering during line clear.

Operation method (Deleting several lines (one screen of data) displayed on a screen)

- (1) Press the [CAN] key.  The editing data (machining program) for one screen is deleted and "Editing" appears.
- (2) Press the [INPUT] key.  The edited machining program is saved to the device and "Editing" disappears.

3.6.7 Searching for Character Strings

Operation method



- (1) Press the menu [String search].
- (2) Set the character string to be searched for, and press the [INPUT] key. (Example) G20 [INPUT] → The character string is searched downward from the character after the current cursor position. If the character string is discovered, the cursor moves to the start of that character string. A message appears if there is no character string applicable to the program. Marking can be performed by adding an option to the character string being searched for. (Example) G20/MR :G20 are marked in red. (Refer to "Marking function" described later for further details.)
- (3) To continue searching, press the [INPUT] key again. → The next corresponding character string is searched for. The search finishes when the end of the program is reached.
<Note>
♦It is not possible to return to the head of the program and resume the search. To search from the head of the program, move the cursor to the top line and carry out the search operation again.
- (4) To end the search, press the menu key. → The menu highlight returns to normal, and the character string in the input area disappears. The search mode is held until the menu key is pressed. (The character string remains in the input area.)

Note

- (1) "Executing" is displayed in flickering during string search.

Marking function

Character strings to be searched for can be marked in colors.

Argument character string format	Details	Marking color
Search character string	The cursor moves to the character string searched for.	None
Search character string/MR	The cursor moves to the character string searched for. All displayed searched character strings are marked in red.	Red 
Search character string/MB	The cursor moves to the character string searched for. All displayed searched character strings are marked in blue.	Blue 
Search character string/MG	The cursor moves to the character string searched for. All displayed searched character strings are marked in green.	Green 
/MC	The marking for all marked character strings is cleared.	-
/MCR	The marking for character strings marked in red is cleared.	-
/MCB	The marking for character strings marked in blue is cleared.	-
/MCG	The marking for character strings marked in green is cleared.	-

Note

- (1) The marking status is maintained when another program is opened while character strings are still marked.
- (2) If the input mistake check warning function is enabled while character strings are still marked, the marking is given priority in the case where the input mistake location and the marked display overlap.
- (3) In the case where the search marking and input mistake check warning function are displayed simultaneously, the marking is cleared and the input mistake warning display remains.
- (4) With the multi-program display type, the search and marking is valid only in the area where the search and marking is carried out.
- (5) With the multi-program display type, the character string and color to be marked are not synchronized in the each editing area.
- (6) The marked status is maintained until the NC power is turned OFF.

Important points when performing search

- (1) If the designated character string cannot be found, the operation message "Designated character string not found" appears.
- (2) A search is performed for a character string containing the designated character string, irrespective of the characters before and after. As a result, if "G2" is designated, G20 - G29 and G200 etc. will also be the subject of a search.
Character string data setting example

Designated character string	Search character string example
N10	Character strings that include "N10" such as "N10" and "N100".
N10 X100.	Character string "N10 X100."
X-012.34	Character string "X-012.34" (A search is not performed for "X-12.34".)





3.6.8 Replacing Character Strings

A character string in a program can be searched for and replaced.

The following three methods can be used.

- The applicable character string is searched for and replaced one by one. (To search for the next character string, press the [INPUT] key.)
- All applicable character strings in the program are replaced in a batch. (Designate "/G" when setting.)
- The program character strings from the current cursor position to the last line are to be replaced in a batch. (Designate "/"E" when setting.)

Operation method

- | | |
|--|---|
| (1) Press the menu [String replace]. | |
| (2) Designate the character string to be searched and replaced.
(Example) Searching for "G02" to replace with "G03"
G02/G03 [INPUT] (*1) |  The character string is searched downward from the next character where the cursor is currently located. When the character string is found, the cursor moves to the first character of that string, and the operation message "Replace?(Y/N)" appears. If any character string is not found in the program, the cursor does not move. |
| (3) Press the [Y] or [INPUT] key.
Press the [N] key not to replace. |  The character string is replaced, and a search is performed for the next applicable character string. (If a batch replacement is performed, a search is not made as the replace operation has been completed.) The operation message "Designated character string not found" appears when the end of the program is reached. "Editing" appears if replace is performed. |
| (4) Press the [Y] or [INPUT] key again if continuing the search/replace. |  The same operation as above is performed. |
| (5) To end search/replace, press the [String replace]. |  The menu highlight returns to normal, and the character string in the input area disappears. The replacement mode is held until the menu key is pressed. (The character string remains in the setting area.) |

(*1) When batch replacing for all the character strings in the program, add "/G" to the above setting.

Character string to be searched/character string to be replaced/G

(Example) G02/G03/G

During batch replacement, after replacing all character strings to the end of the program, the process ends while showing the last character string replaced. Note that the replacement mode is held, and the character string remains in the input area.

Note

- (1) If the program character strings from the current cursor position to the last line are to be replaced in a batch, add "/"E" to the above setting.
Character string to be searched/character string to be replaced/E
(Example) G02/G03/E
- (2) With the multi-program display type, the replacement on the side which is not being edited is not performed.
- (3) "Executing" is displayed in flickering during the replacement.

3.6.9 Copying and Pasting Data

Operation method (Copying a line)

- (1) Press the menu [Line copy].
- (2) Designate the copy range.
(Example) From line 8 to line 10
8/10 [INPUT]

➔

 The background color for the range to be copied turns light blue.
 When copying 1 line, it is also possible to make a selection using the [↑] or [↓] key and designate by pressing the [INPUT] key.

Note

- (1) If [INPUT] key is input without setting a line No., the line where the cursor is at is copied.
- (2) The highlight of the copy target lines disappears when editing operations are resumed.
- (3) If the file is edited, or turned back to the previous saved status by pressing the menu [Undo] after the Line copy menu is pressed, the data copied in the line is canceled.
- (4) If the last line of the file is the range to be copied, the last line can be designated as "E".
(Example) From 8th line to last line: 8/E
- (5) The copied data is maintained while the copy source file is opened even if the display type or editing area is switched to another one. The data will be discarded after screen transition.

Operation method (Copying character)

- (1) Move the cursor to the head character to be copied.
- (2) Press the menu [Char copy].
- (3) Move the cursor to the end character to be copied, and press the [INPUT] key.

➔

 The background color for the range to be copied turns light blue. The range is fixed by pressing the [INPUT] key.

Note

- (1) Characters of up to 500 bytes can be copied at a time. When the size of the selected characters exceeds 500 bytes, the message "Can not copy more" appears and the cursor does not move.
- (2) The Copying will be canceled, if the [↑], [↓], [←], [→], [↵] or [→] key is pressed before pressing the [INPUT] key.
- (3) Light blue background for copy range will disappear when editing operation is resumed.
- (4) As long as the original file is opened, the copied content will be saved even if you change the display type or shift the display left and right side. The data will be discarded after screen transition.

Operation method (Pasting the copied data)

(1) Move the cursor to the line where the data is to be pasted.

(2) Press the menu [Paste].



<When copying a line data>

The copied data is inserted upward on the line where the cursor is positioned.

<When copying characters>

The copied data is inserted in front of the cursor position.

<Note>

- ◆In the overwrite mode, the data is inserted in front of the cursor position as well.

(3) Press the [INPUT] key.

Note

- (1) With multi-program display type, data can be copied and pasted between the each editing areas by pressing the [←→ change] key.
- (2) "Executing" is displayed in flickering during pasting.

3.6.10 Undoing Program Changes

This is used to return the program to the form when [INPUT] was last pressed to save. This operation is valid for the operation of "Rewriting program", "Insert", "Delete", "Line Paste", "Line Clear", "Character String Replace" and "Undo" functions.

Operation method

- | | |
|---|--|
| (1) Change the operation to memory mode, and then press the main menu [Edit]. | |
| (2) Move the cursor to the position to be corrected, and input a character.
(Example) 135
If [Undo] is pressed during "Editing", the system will be returned to the state saved last. | |
| (3) Press the [INPUT] key. | ➔ The edited machining program is saved to the device. The message "Editing" disappears. |
| (4) Press the menu [Undo]. | ➔ The contents of the file return to the same condition as when the editing was started. These contents of the file are saved to the device. |
| (5) Press the menu [Undo] again. | ➔ The contents of the file return to the same condition as when the file was saved in the procedure (3). These contents of the file are saved to the device. |

Note



- (1) This function is only valid when parameter "#8910 Edit undo" is set to "1".
- (2) When returned to the previous status, the cursor will move to the head line.
- (3) With the multi-program display type, returning to the previous contents is valid only in the active area.
- (4) When undoing is performed, the copied data will be canceled.
- (5) "Executing" is displayed in flickering during undoing.
- (6) When the parameter "#8939 Undo confirm msg" is set to "1", if [Undo] is pressed, the menu is highlighted and the operation message "OK?(Y/N)" appears. The program returns to the previous status by pressing [Y] or [INPUT] key. If other key is pressed, the operation is canceled. When the operation is canceled, the menu highlight returns to normal and the message is deleted.
- (7) When the program does not return to the previous status by pressing [Undo], [Undo] is not highlighted and the operation message "Data protect" or "Executing automatic operation" appears.

3.7 Program Editing Support Function



3.7.1 Performing Operation Search at the Cursor Position

By pressing the menu [Cursor OP srch] when the device is in the normal status (not being in status such as editing or character searching, etc.), operation search of the selected part system is carried out starting.

- (1) Select the part system that the cursor operation search is performed.
- (2) Open the program on the edit screen.  The program edit window appears.
- (3) Move the cursor to the block to be carried out the cursor operation search.
- (4) Press the menu [Cursor OP srch].  Operation search is carried out starting from the block that the cursor is positioned. During the search "Searing" will display blinking. After search is completed, the display returns to the monitor screen.

Note

- (1) When the parameter "#1285 ext21/bit0" (Multi-part system program management) is set to "1" (valid), the menu [Cursor OP srch] is disabled and the cursor operation search cannot be performed.
- (2) During program editing, the menu [Cursor OP srch] is disabled and the cursor operation search cannot be performed.
- (3) During the MDI program is displayed, the menu [Cursor OP srch] is disabled and the cursor operation search cannot be performed.
- (4) During automatic operation or restart search by selected part system, the cursor operation search cannot be performed displaying the messages "Executing automatic operation" and "Program restarting" for each status. In such cases, the display does not transit to the monitor screen. However, it is enabled when the parameter "#11039 Cusr pos srch typ" is set to "1" even if the operation is under single block stop. For details, refer to "Search during single block stop" in "9.5.1 Program Editing".
- (5) During automatic operation or restart search by other than the selected part system, the cursor operation search can be performed, and the messages "Executing automatic operation" and "Program restarting" will not appear. In this case, the display transits to the monitor screen.

3.7.2 Adding Sequence No. (N No.) Automatically

When the sequence No. (N No.) is input once, the sequence No. to which a constant value is added can be automatically added to each block of the machining program.

The added sequence No. data is to N2 to N99999999.

Operation method

(1) Press the menu [N auto add].

(2) Input the incremental value.
(Example) 10 [INPUT]

<When creating a new program>

(3) Press the menu [Open (New)], then press the menu [Memory].

(4) Input a file name not used, then press the [INPUT] key.
(Example) 101

(5) Input a program with N No.
(Example) N100G28XYZ

<When editing an existing program>

(3) Press the menu [Open], then press the menu [Memory].

(4) Select a file, then press the [INPUT] key.

(5) Move the cursor to the position where data is to be inserted. Press the [INSERT] key.

(6) Input " ; " (EOB).

(7) Input the second block data and " ; " (EOB).
(Example) G92X0.Y0.Z0.;

(8) Press the [INPUT] key.

Note

- (1) When the menu [N auto add] is pressed again while the menu is highlighting, N No. additional value display column is cleared, and N No. automatic addition is canceled.
- (2) The setting range is 1 to 1000. When "01" is input, "1" is set. When "0" is input, this function is canceled. When an illegal value or 9 characters or more is input, an error will occur.
- (3) When "0" is input, this function is canceled.
- (4) When an illegal value or 9 characters or more is input and [INPUT] is pressed, the "Setting error" appears.
- (5) The incremental value can be set even when the machining program has been not opened. Even if the machining program is opened again, the incremental value is not invalid.
- (6) The incremental value is not cleared with the screen transition.
- (7) Even if the same N No. exists by automatic addition, an error will not occur.
- (8) The system separately has N No. in a right area and left area of the edit screen.
- (9) When the previous block is leading zero like "N010", N No. automatic addition can be executed. However, "0" is not added, and "N10" is displayed.

Example when N No. is added

(1) When the previous block has N No. (When the cursor is located at the last character in the overwrite mode.)

N100 G28 X0 Y0 Z0 ; -> Input ";" -> N100 G28 X0 Y0 Z0;N110;
 N100 G28 X0 Y0 Z0 ; -> Input ";" -> N100 G28 X0 Y0 Z0 ;N110;
 N100 G28 X0 Y0 Z0 ; -> Input ";" -> N100 G28 X0 Y0 Z0 ;N110;

(2) When the previous block has N No. (When the insertion mode)

N100 G28 X0 Y0 Z0 ; -> Input ";" -> N100 G;N11028 X0 Y0 Z0 ;
 N100 G28 X0 Y0 Z0 ;N200G90X20.Y20.Z20.; -> Input ";" -> N100 G28 X0 Y0 Z0 ;N110N200G90X20.Y20.Z20.;

Example when N No. is not added

(1) When the previous block has no N No.

G00X10.% -> Input ";" -> G00X10.;%

(2) When the head of previous block has no N No.

•Usually

G00N100X10.% -> Input ";" -> G00N100X10.;%

•When any comment has been added

(N100)G00N100X10.% -> Input ";" -> (N100)G00N100X10.;%

•When the previous block has a space

N100G00N100X10.% -> Input ";" -> N100G00N100X10.;%

(3) When the N No. of previous block is over 9 characters.

N000001000% -> Input ";" -> N000001000;%

(4) When limits of total characters display per block is exceeded.

(5) When the N No. is over 100000000.

(6) When the N No. automatic additional value is not set.

(7) When the display character string in overwrite mode is interrupted.

N100 G28 X0 Y0 Z0 ; -> Input ";" -> N100 G28 X0;Y0 Z0 ;

3.7.3 G Code Guidance

For details, refer to "2.4.3 G Code Guidance".

3.7.4 Playback Editing



The playback function enables creation of a program while trying sample machining by manual (handle or jog) feed or mechanical handle feed. A machining program can be created with movement distance data obtained by manual operation used as programmed command values.

The playback counter and valid address key (X, Y, U, V, etc.) are different depending on the parameter "#1076 AbsInc" (ABS/INC address) setting. A parameter "#1076 AbsInc" can be set individually for each part system.

	#1076 AbsInc (For L system only)	#1126 PB_G90	Reference
M system	(This setting is meaningless.)	0 (Incremental position)	Absolute command/incremental command depending on G command
		1 (Absolute position)	
L system	0 (Absolute command/incremental command with G command)	(This setting is meaningless.)	Absolute command/incremental command depending on address code
	1 (Absolute command/incremental command with address code)		

<Absolute command/incremental command with G command (M/L System)>

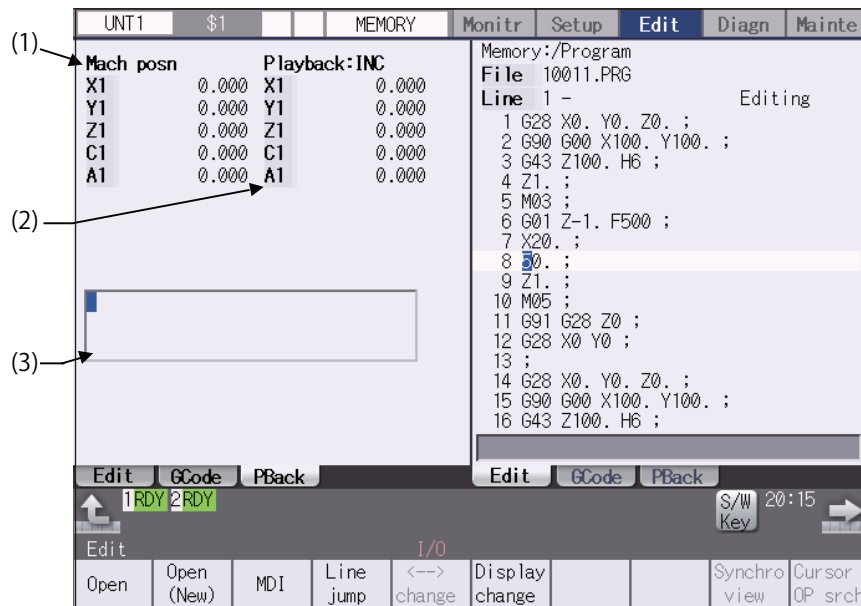

Display items

Display items	Details
(1) Machine position counter	This displays the machine position counter. Up to max. number of axes in a part system can be displayed. M system: Max. eight axes L system: Max. five axes, the sixth axis or later is switched by the menu [Next axis]. When the rotary axis (except for all coordinate linear type), the display range is 0.000° to 359.999°.
(2) Playback counter	This displays the playback movement amount (axis movement value). When the absolute command or incremental command depends on G command, the title and playback movement amount differs according to the parameter "#1126 PB_G90". (*1) When the absolute command or incremental command depends on address code, both titles are displayed. Up to max. number of axes in a part system can be displayed. M system: Max. eight axes L system: Max. five axes, the sixth axis or later is switched by the menu [Pback next ax]. When the rotary axis (except for all coordinate linear type), the display range is as below: For INC (Rotary type short-cut disabled, workpiece coordinate linear type): -359.999° to 359.999° For INC (Rotary type short-cut enabled): -180.000° to 179.999° For ABS: 0.000° to 359.999°
(3) Playback editing input area	The contents of playback editing is input. When the axis address keys such as X and Y are input, the playback counter value currently displayed is input after the axis address.

(*1) The displayed title and playback movement amount are as follows.

#1126 PB_G90	Title	Playback movement amount
0 (Incremental position)	Playback: INC	Playback movement amount before axis moves + axis movement amount
1 (Absolute position)	Playback: ABS	The program position + manual interrupt amount

Operation method (Absolute command/incremental command with G command)

- | | | |
|-----|---|---|
| (1) | Set "#1126 PB_G90" to "0" on the parameter screen. ➡ | Incremental value mode is set. |
| (2) | Press the main menu [Edit] on the edit screen, and press [Displaychange]. ➡ | The "playback display type" is displayed.
The menu [←→ change] cannot be used.
When the incremental value is set, the initial value is "0". |
| (3) | Open the program pressing [Edit] and [Open] on the edit screen. ➡ | The selected program is displayed in right area.

<Note>
•When the program is displayed on the right side, the playback edit is displayed on the right side.
•When the incremental value is set, playback movement amount will be cleared to "0" for all axes. |
| (4) | Move the axis during manual mode. ➡ | The axis movement amount is displayed in playback movement amount.
When the absolute position is set, "the program position + manual interrupt amount" is displayed as the playback movement amount.
In the incremental value mode, the axis movement amount by manual mode is added to currently playback movement amount. |
| (5) | Input the data such as the G codes in the area for playback editing. ➡ | The alphanumeric characters, [←], [→] and [DELETE] keys can be input in the area for playback editing.

<Note>
•If the [C.B] key is pressed, all the data in the playback editing area is deleted.
•When the [↑] or [↓] key is pressed, the program cursor in the program editing area will move.
•When the page up key or page down key is pressed, the program in the program editing area will scroll.
•When the menu key is pressed, the process corresponding to the program editing area will run.
When the cursor appears on input area of the program editing area by pressing [Line jump], [Line copy], [Line clear], [String search], [String replace], [MDI registration] or [N auto add], the key input is made to the input area of the program editing area.
When window is displayed by pressing [Open], [Open(New)] or [Erase file], the key input is made to the currently displayed window.
•The program cursor in the program editing area cannot move left and right, but can move only up and down. |
| (6) | Press the axis address key such as [X] or [Y]. ➡ | The playback movement amount is input after the axis address in the playback editing area. If the axis address key is pressed while the playback movement amount is being changed, the playback movement amount at the time the key was pressed will be input.

<Note>
•When inputting a comment, etc., the characters that are the same as the axis address will all be handled as the axis address. |

(7) Press the [INPUT] key.



The program in the playback editing area will be inserted at the block before the cursor position in the right area, is saved.

When there is no "EOB" (;) at the end of the character string, it is added automatically.

The cursor moves to the line head being cleared the content of the playback edit.

For an absolute position, the playback movement amount will not change.

For an incremental value, the difference of the axis command value for the axis used in step (6) and the playback movement amount will remain as the playback movement amount.

The program in the program editing area is saved.

Operation method (Absolute command/incremental command with address code)

(1) Confirm that the parameter "#1076 AbsInc" is "1".

(2) Edit a program the same as the procedure (2) to (7) of "Absolute command/incremental command with G command".

Notes for playback editing

(1) Playback editing of a program in automatic operation or program restart is not possible.

(2) Up to 95 characters can be edited in the playback editing area.

(3) If the program created by playback editing is not suffixed by "EOB(;)", it is automatically added by [INPUT].

(4) If the screen/part system is changed or the program file is opened when the input program is in the playback edit area, the program being edited will be aborted. The playback absolute counter has the G92 coordinate system preset released, and returns to "program position + manual interrupt amount". The playback increase counter is cleared to "0".

(5) Other files can be opened during playback editing. Playback editing can be continued even when other file is opened. However, if an incremental value is designated, the playback movement amount will be cleared to "0" for all axes. A new file can be created and edited, and MDI editing carried out in the same manner.

(6) If the program being playback edited automatically starts, playback editing cannot be continued.

(7) The playback movement amount after playback editing will differ according to the parameter "#1126 PB_G90" state and the commanded G code. The playback movement amount after [INPUT] is pressed is calculated for each block that has been playback edited.

X axis playback movement amount before editing	Details to be playback edited	X axis playback movement amount after [INPUT]	
		For an absolute position	For an incremental position
X 100.000	G01 X10.;	X 100.000 The program position + manual interrupt amount is inserted as the playback movement amount.	X 90.000 The difference of the axis command value (X10.) and playback movement amount before [INPUT] (X100.) is inserted as the playback movement amount.
	G92 X10.;	X 10.000 The command value (X10.) following G92 is inserted as the playback movement amount.	X 0.000 Regardless of the command value following G92, "0" is inserted as the playback movement amount.

(8) Do not set the same address to the parameter "#1013 axname" and "#1014 incax". If the same address is set, the absolute counter has priority. (However, the same address as the address used in other part system can be specified.)

(9) The playback editing cannot be enabled for an axis of auxiliary axis state. When an axis address of auxiliary axis state is input, a setting error will occur.

3.8 Editing a Multi-part System Program

The parameter "#1285 ext21/bit0" (Multi-part system program management) sets this function valid or invalid.

This function can be used when [Memory] is selected as a device.

3.8.1 Multi-part System Simultaneous Program Editing

When the parameter "#8977 Multi-\$ simul edit" is set to "1" (valid), if you perform the operation (*1) to open a machining program in NC memory on the edit screen, the specified machining program of the displayed part system in the currently selected editing area and the machining program (*2) of the same name in another part system in the deselected editing area are opened simultaneously in the right and left panes.

(*1) To open a machining program, follow the steps shown below. The details on each operation are described in the table later.

- ♦Select menu [Edit] - [Open] to open an existing machining program.
- ♦Select menu [Edit] - [Open(New)] to create and open a new machining program.
- ♦The parameter "#8938 Edit-Not show Prg" is set to "0" and the display changes to the edit screen after operation search has been carried out. Then, the searched machining program is opened automatically.

(*2) The machining program that satisfies the following conditions is opened in the deselected editing area.

- ♦Machining program in another part system of the same name as for the machining program that is to be opened in the currently selected editing area
- ♦If any machining program that satisfies machining program conditions is not registered in the smallest part system other than the currently selected part system, no machining program is opened in the deselected editing area. Then, the machining program opened in the deselected editing area is closed.

Note

- (1) If a machining program in NC memory is opened while the parameter "#8977 Multi-\$ simul edit" is set to "1" (valid), the machining program opened in the deselected editing area is closed.
- (2) The multi-part system simultaneous program editing is also available for MTB macro program and MDI.
- (3) When the machining program for multi-part system simultaneous program editing is opened while the display type is not set to the multi-program display type, if the display type is changed to the multi-program display type, the machining program that is in another part system, of the same name as for the machining program opened in the currently selected editing area is displayed in the deselected editing area.

Operation to select the menu [Edit] - [Open] and open an existing machining program (Case in which the 1st part system is set as the displayed part system)

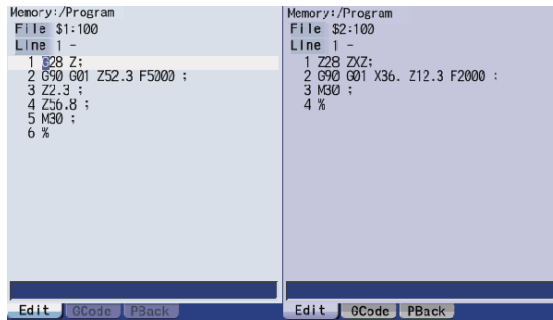

○: Machining program registered ×: No machining program registered

\$1	\$2 (*1)	Operation
○	○	A programs in the 1st part system is displayed in the currently selected editing area, and that in the 2nd part system is simultaneously displayed in the deselected editing area.
○	×	This displays a machining program in the 1st part system in the currently selected editing area. Then, if the machining program is opened in the deselected editing area, it is closed.
×	○	A confirmation message (*2) is then displayed. Selecting "Y" creates and displays a new empty file in the 1st part system in the currently selected editing area. Machining programs in the 2nd part system are displayed in the deselected editing area.
×	×	If the designated machining program does not exist in all part systems, the message "Designated file does not exist" appears, that machining program is not displayed.

(*1) For part systems other than the 1st part system, the 2nd part system is described as a typical one.

(*2) The operation message "Create new file?(Y/N)" appears. If "N" is selected, the message "A file does not exist" appears, and the target file is not opened. If "Y" is selected while the remaining number of registered machining programs is "0", the message "Program entry over" appears, and no machining program is displayed.

When the parameter "#1285 ext21/bit2" (Multi-part system program generation and operation) is ON, "Create new file?(Y/N)" does not appear and the file will not be opened.

Operation to select the menu [Edit] - [Open (New)] and open an existing machining program (Case in which the 1st part system is set as the displayed part system)

Multi-part system program generation and operation (#1285 ext21 bit2)	Operation
ON (Newly creates only a machining program in the displayed part system.)	This displays machining programs in the 1st part system in the currently selected editing area. When machining programs exist in the 2nd part system, they are simultaneously displayed in the deselected editing area. (*1) When no machining programs exist in the 2nd part system, the machining programs opened in the deselected editing area are closed. (*1)
OFF (Collectively creates new machining programs in all the part systems.)	When no machining programs exist in all the part systems, a machining program in the 1st part system is displayed in the currently selected editing area and a machining program in the 2nd part system is displayed in the deselected editing area simultaneously. (*1) When the machining programs in the 2nd part system exist, the message "Designated file already exists" appears and the file cannot be opened. (*1)

(*1) For part systems other than the 1st part system, the 2nd part system is described as a typical one.

Operation to automatically open the searched machining program (When the 1st part system is set as the displayed part system)

Currently selected editing area	Deselected editing area	Operation
A machining program is not opened.	A machining program is not opened.	A machining programs in the 1st part system is displayed in the currently selected editing area, and that in the 2nd part system is simultaneously displayed in the deselected editing area. (*1)

For the conditions other than the above, no operation is performed.

(*1) For part systems other than the 1st part system, the 2nd part system is described as a typical one.

Note

(1) If the searched machining program is not registered in the displayed part system, it is not opened. When the searched machining program is registered only in the displayed part system, no file is opened in the deselected editing area.

Operation method (Opening the existing machining programs of the same name in all part systems (When the 1st part system is set as the displayed part system))

Perform the following procedure to open the machining program, "100", under the following conditions.

- The parameter "#8977 Multi-\$ simul edit" is set to "1" (valid).
- The machining program, "100", is registered in all part systems of NC memory.

(1) Press the menu [Open].



The list appears as a pop-up window.

(2) Use the [↑], [↓], [←], and [→] keys to align the cursor with the target machining program (100), and press the [INPUT] key.



The machining program "100" in the 1st part system is displayed in the currently selected editing area, and the machining program "100" in the 2nd part system is displayed in the deselected editing area.

The same operation can also be performed by inputting the machining program name (100) to be edited in the input section and pressing the [INPUT] key.

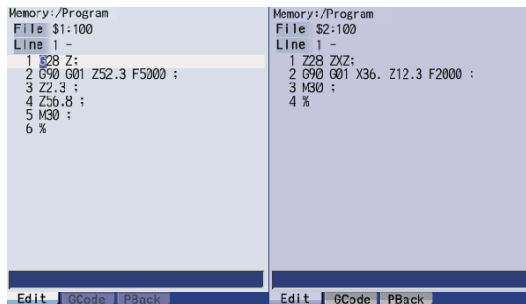

Operation method (Opening the existing machining programs of the same name in the 1st and 4th part systems (When the 1st part system is set as the displayed part system))

Perform the following procedure to open the machining program, "200", under the following conditions.

- The parameter "#8977 Multi-\$ simul edit" is set to "1" (valid).
- The machining program, "200", is registered in the 1st and 4th part systems of NC memory.

(1) Press the menu [Open].  The list appears as a pop-up window.

(2) Use the [↑], [↓], [←], and [→] keys to align the cursor with the target machining program (200), and press the [INPUT] key.  The machining program "200" in the 1st part system is displayed in the currently selected editing area, and the machining program "200" in the 4th part system is displayed in the deselected editing area.

The same operation can also be performed by inputting the machining program name (200) to be edited in the input section and pressing the [INPUT] key.

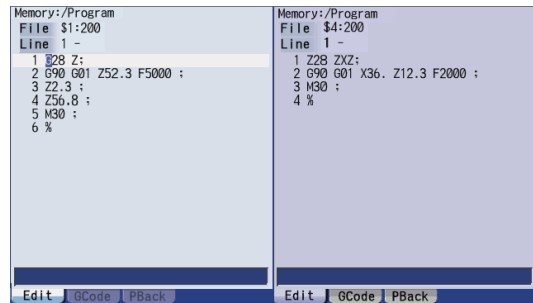

Operation method (Opening the existing machining programs only in the 1st part system (When the 1st part system is set as the displayed part system))

Perform the following procedure to open the machining program, "300", under the following conditions.

- The parameter "#8977 Multi-\$ simul edit" is set to "1" (valid).
- The machining program, "300", is registered in the 1st part system of NC memory.

(1) Press the menu [Open].  The list appears as a pop-up window.

(2) Use the [↑], [↓], [←], and [→] keys to align the cursor with the target machining program (300), and press the [INPUT] key.  The machining program "300" in the 1st part system is displayed in the currently selected editing area, and the machining program opened in the deselected editing area is closed.

The same operation can also be performed by inputting the machining program name (300) to be edited in the input section and pressing the [INPUT] key.

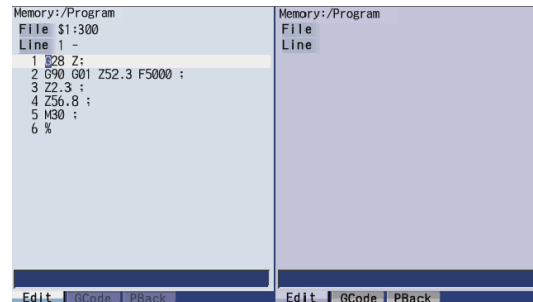

Operation method (Opening the existing machining programs only in the 3rd part system (When the parameter "#1285 ext21/bit2" is set OFF and the 1st part system is set as the displayed part system))

Perform the following procedure to open the machining program, "400", under the following conditions.

- The parameter "#8977 Multi-\$ simul edit" is set to "1" (valid).
- The machining program, "400", is registered in the 3rd part system of NC memory.

- (1) Press the menu [Open]. ➔ The list appears as a pop-up window.

- (2) Use the [↑], [↓], [←], and [→] keys to align the cursor with the target machining program (400), and press the [INPUT] key. ➔ The operation message "Create new file?(Y/N)" appears.
 The same operation can also be performed by inputting the machining program name (400) to be edited in the input section and pressing the [INPUT] key.

- (3) Press the [Y] key. ➔ The machining program, "400", is newly created in the 1st part system.
 The machining program "400" in the 1st part system is displayed in the currently selected editing area, and the machining program "400" in the 3rd part system is displayed in the deselected editing area.

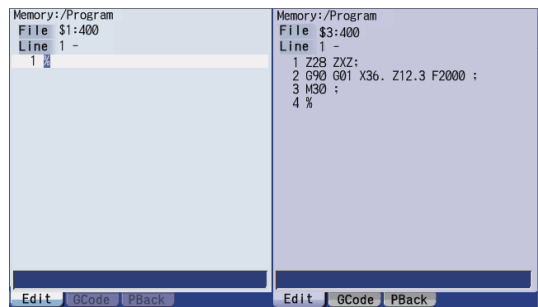

Operation method (Creating a new machining program (When the parameter "#1285 ext21/bit2" is set ON and the 1st part system is set as the displayed part system))

Perform the following procedure to create a new machining program, "500", under the following conditions.

- The parameter "#8977 Multi-\$ simul edit" is set to "1" (valid).
- The parameter "#1285 ext21/bit2" is set to "1" (to newly create only machining programs in the displayed part system).

- (1) Press the menu [Open(New)]. ➔ The list appears as a pop-up window.

- (2) Input the machining program name (500) to be newly created in the input section, then press the [INPUT] key. ➔ The machining program "500" in the 1st part system is displayed in the currently selected editing area, and the machining program opened in the deselected editing area is closed.

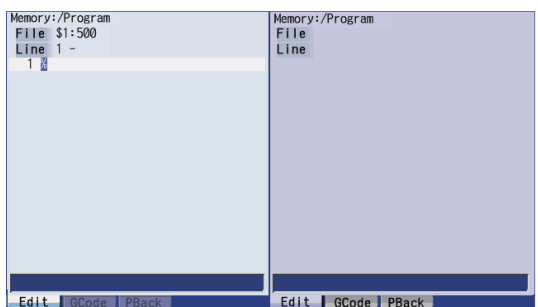

Operation method (Creating a new machining program (When the parameter "#1285 ext21/bit2" is set OFF and the 1st part system is set as the displayed part system))

Perform the following procedure to create a new machining program, "600", under the following conditions.

- The parameter "#8977 Multi-\$ simul edit" is set to "1" (valid).
- The parameter "#1285 ext21/bit2" is set to "0" (to collectively create new machining programs in all part systems).

(1) Press the menu [Open(New)].



The list appears as a pop-up window.

(2) Input the machining program name (600) to be newly created in the input section, then press the [INPUT] key.



The machining program "600" in the 1st part system is displayed in the currently selected editing area, and the machining program "600" in the 2nd part system is displayed in the deselected editing area.

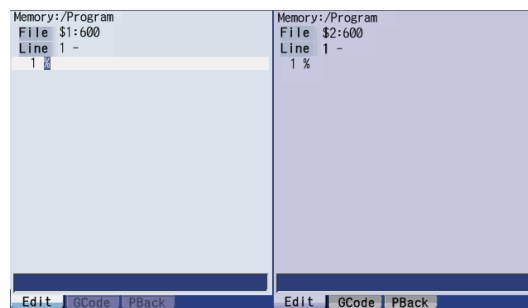

Operation to be performed when the menu [Open], [Open(New)], or [MDI] is pressed while editing a machining program

If the menu [Open], [Open(New)], or [MDI] is pressed during editing of a machining program while the parameter "#8977 Multi-\$ simul edit" is set to "1" (valid), whether to save both the contents of the currently selected editing area and those of the deselected editing area is confirmed regardless of whether the machining program to be opened actually is targeted for multi-part system simultaneous program editing.

Currently selected editing area	Deselected editing area	Operation
Not editing	Not editing	The operation of the pressed menu is performed.
Editing	Not editing	(1) The operation message "Save current file?(Y/N)" is displayed. (2) After any key has been pressed, the operation of the pressed menu is performed.
Not editing	Editing	(1) The message "Save right side file?(Y/N)" ("Save left side file?(Y/N)") is displayed. (2) After any key has been pressed, the operation of the pressed menu is performed.
Editing	Editing	(1) The operation message "Save current file?(Y/N)" is displayed. (2) After any key has been pressed, the operation message "Save right side file?(Y/N)" ("Save left side file?(Y/N)") is displayed. (3) After any key has been pressed, the operation of the pressed menu is performed.

3.8.2 Special Program Editing Display for Synchronization between Part Systems



Pressing the menu [Synchro view] enables synchronized display of the left- and right-side programs aligned when the following conditions are satisfied:

- The parameter "#1285 ext21/bit0" (Multi-part system program management) is set to "1" (valid).
- Multi-program display type is selected.
- The left and right edit areas are displaying the same named programs of different part systems stored on the NC memory.

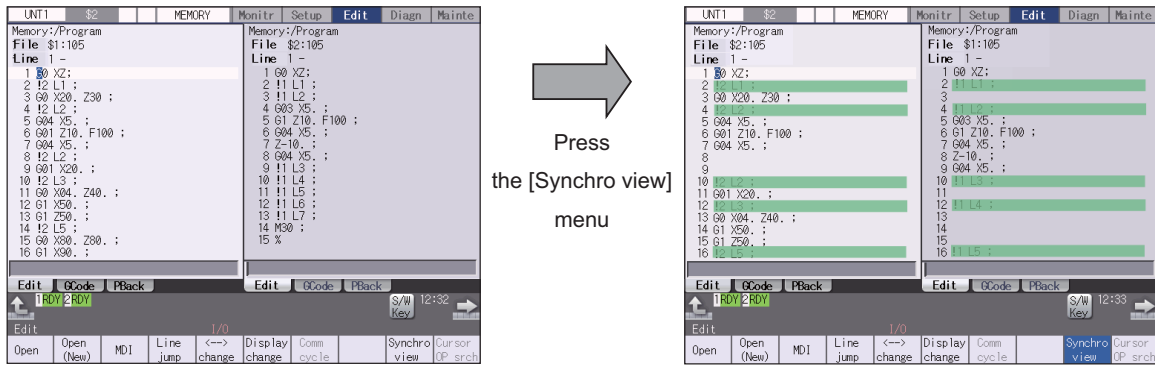

Press the [Synchro view] menu

Note

- (1) The synchronous display is also available for MTB macro program and MDI.
- (2) Editing can be performed in the selected editing area, and the synchronous display is disabled when "Editing" is being displayed. The synchronous display becomes enabled again when the edited contents are determined.
- (3) Blank lines, which are inserted automatically to align the left- and right-side programs for the synchronization position, cannot be pasted with the menu [Paste] operation when the blank lines are specified as the copying range with the menu [Copy] operation.
- (4) The editable machining program size is up to 240 KB per part system.
 - When the menu [Synchro view] is pressed in the state where a machining program exceeding 240 KB is opened, the "Can't edit because of size over" message is displayed and the synchronous display cannot be performed.
 - When a file exceeding 240 KB is opened with [Synchro view] highlighted, the "Can't edit because of size over" operation message is displayed and the machining program cannot be opened.
- (5) The state where the [Synchro view] is highlight is held until the power is turned OFF and ON, a machining program for which the synchronous display is not available is opened, or the display type is changed to other than "Multi-program display type".

[Display during synchronous view]

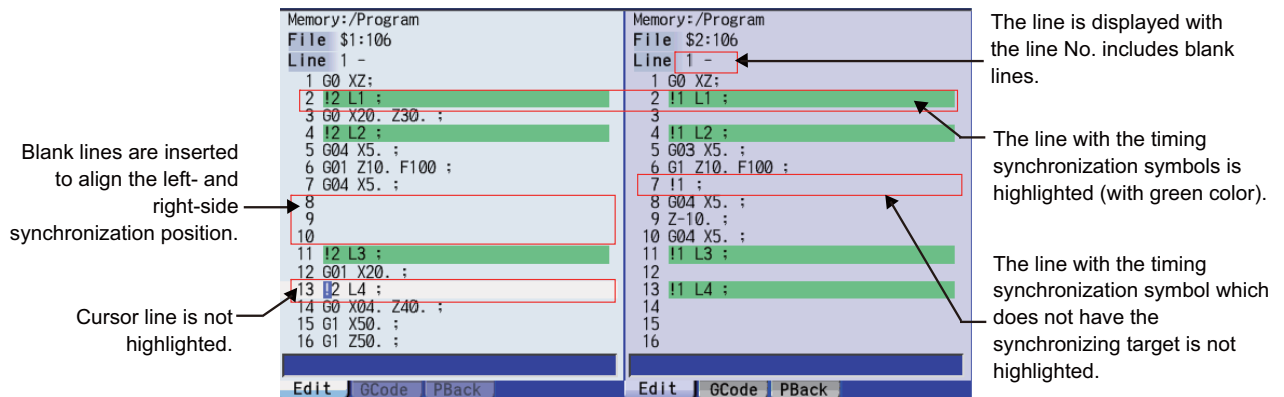

3.9 Defining Variables

Refer to "Programming Manual" for more details on variables.

3.9.1 Common Variables



Select [Com var] on the monitor (Monitr) screen to set or display the details of the common variables.

If there is a common variable command (*1) in the machining program, the variable value (variable name) set when the block is executed is displayed.

The number of common variable sets differs according to the specifications.

(*1) The variable names can be set for common variables #500 to #599.

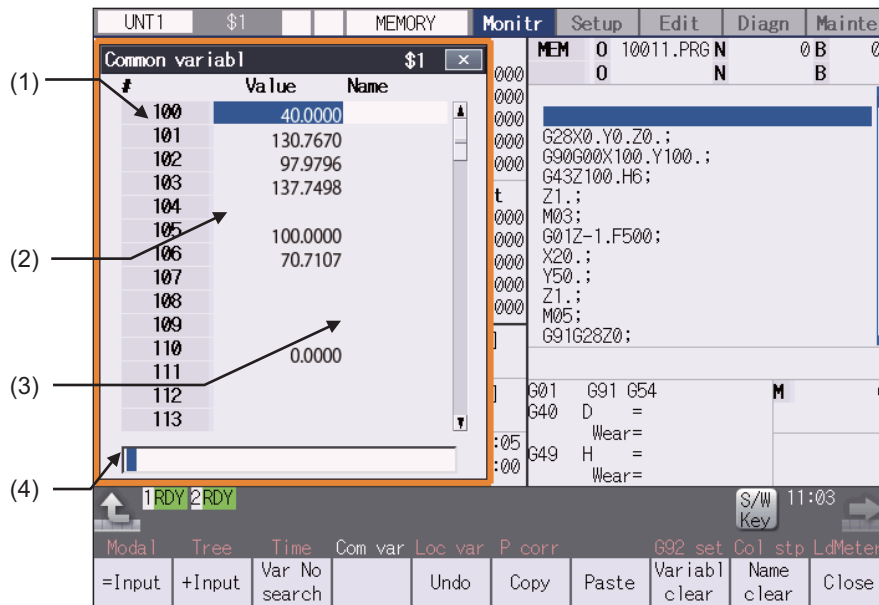

Display items

Display items	Details												
(1) Variable number	<p>This is the common variable No. There are common variable 1 (common to part systems) and common variable 2 (for each part system) (Refer to the table below). The #100 variables appear at the head when the power is turned ON. If "#1052 MemVal" is set to "1" (Designate No. of common variable common to part systems), "*" is attached to the variable that is common to part systems. (Note that if there is only one part system, "*" will not appear.)</p> <table border="1"> <thead> <tr> <th>Part system</th> <th>Number of sets</th> <th>Common variable 1 (common to part systems)</th> <th>Common variable 2 (for each part system)</th> </tr> </thead> <tbody> <tr> <td>One part system</td> <td>700 sets</td> <td>400 to 999 (*1) 100100 to 700199 (*2)</td> <td>100 to 199</td> </tr> <tr> <td>Multi-part system (n = number of part systems)</td> <td>600+100×n set(s)</td> <td>400 to 999 (*1) 100100 to 700199 (*2)</td> <td>100 to 199 ×n</td> </tr> </tbody> </table>	Part system	Number of sets	Common variable 1 (common to part systems)	Common variable 2 (for each part system)	One part system	700 sets	400 to 999 (*1) 100100 to 700199 (*2)	100 to 199	Multi-part system (n = number of part systems)	600+100×n set(s)	400 to 999 (*1) 100100 to 700199 (*2)	100 to 199 ×n
Part system	Number of sets	Common variable 1 (common to part systems)	Common variable 2 (for each part system)										
One part system	700 sets	400 to 999 (*1) 100100 to 700199 (*2)	100 to 199										
Multi-part system (n = number of part systems)	600+100×n set(s)	400 to 999 (*1) 100100 to 700199 (*2)	100 to 199 ×n										
(2) Variable value	<p>The setting range is -999,999,999 to 999,999,999 or blank. An exponential is displayed when 7 digits are set in the integer section and 5 digits or more are set in the decimal section. (Example) 1234567 -> 1.2346E+006, 0.00001 -> 1.0000E-005 The minimum setting unit that can be set is 1.0000E-099 (99 digits below decimal point). <Note> ♦When the setting is "blank", the setting will be handled as "0" in the calculations. However, when the conditional expressions EQ or NE are used, the blank will not be handled as "0".</p>												
(3) Variable name	<p>A variable name can be assigned for #500 to #599. Two-byte characters such as Chinese character can be displayed, however, only symbols and alphanumeric characters can be input on the screen. The maximum number of one-byte characters is 10.</p>												
(4) Input section	<p>This displays details of the key input.</p>												

(*1) Address #400s common variable can be used only when the sets of common variable is "700 sets or more" and the parameter "#1336 #400_Valtype" is "1".

(*2) When the parameter "#1316 CrossCom" is set to "1", the common variables #100100 to #700199 can be used common to part systems. The variables shown in the table below can be used common to part systems.

Common variables 1 (When "#1316 CrossCom" = "1")	
#100100 to #100199	Equivalent to # 100 to #199 in 1st part system
#200100 to #200199	Equivalent to # 100 to #199 in 2nd part system
#300100 to #300199	Equivalent to # 100 to #199 in 3rd part system
#400100 to #400199	Equivalent to # 100 to #199 in 4th part system
#500100 to #500199	Equivalent to # 100 to #199 in 5th part system
#600100 to #600199	Equivalent to # 100 to #199 in 6th part system
#700100 to #700199	Equivalent to # 100 to #199 in 7th part system



Menus

Menus	Details
=Input	This executes an absolute input. If "#8930 Disable=INPUT:var" is set to "1", this menu cannot be selected.
+Input	This executes an incremental input.
Var No search	This designates the variable No. to be displayed at the head. Common variable 1 (common to part systems) #400 to #999, common variable 1 (common to part systems) #100100 to #800199, and common variable 2 (for each part system) #100 to #199 are displayed in each area. When another area is displayed, press this menu and specify the common variable No.
Undo	This returns the last rewritten data to its previous value. This menu key is valid for "Data Input", "Paste" and "Undo" operations. Note that return to the original value is not possible after variable clear and comment clear operations. <Note> ♦When the parameter "#8939 Undo confirm msg" is set to "1", the menu is highlighted while the operation message is displayed.
Copy	This copies the variable value and variable name at the cursor position.
Paste	This pastes the copied variable value and variable name.
Variabl clear	This clears the variable value(s) at the cursor position or in the designated range. <Note> ♦The contents are not cleared to "0". The state with no data is entered.
Name clear	This clears the variable name(s) at the cursor position or in the designated range.
Close	This closes the pop-up window and quits this function.

Operation method (Setting "135.000" in variable No. 102)

(1) Press the menu [Var No search].

(2) Designate the variable No.
102 [INPUT]

The cursor can be moved to 102 using the [↑], [↓], , or  key.

(3) Input a numeric value.
135 [INPUT]

The value can also be designated by pressing the menu [=Input] instead of the [INPUT] key.
The value can also be input as an exponential.
(1.35E2 [INPUT] or 1.35E2 [=Input].)

Operation method (Adding "1.234" to variable No. 102)

(1) Select common variable 102 with the same procedure as steps (1) and (2) above.

(2) Input a numeric value.
1.234 [+Input]



The input value added to the original value is displayed.
(Example) If the original value is 135.000, 136.234 appears. (135.000 + 1.234 = 136.234)



Operation method (Setting "COUNTER" as the variable name for variable No. 509)

- (1) Select common variable 509 with the same procedure as steps (1) and (2) above.
- (2) Press the  key.
- (3) Input the variable name.
COUNTER [INPUT]

Note

- (1) The variable name can be set only for variable No. 100 to 199 or 500 to 599.

Operation method (Copying and pasting the common variable)

- (1) Select the variable to be copied.
One of the following methods can be used to select the variable.
 - Using the cursor movement key [\uparrow], [\downarrow], , or , move the cursor to the variable to be selected.
 - Press [Var No search] and set the variable No. in the input area, and press the [INPUT] key.
- (2) Press the menu [Copy].
- (3) Select the variable to be pasted, and press the menu [Paste].
The copied variable is held until a variable is newly copied.

Operation method (Erasing the variable value for variable number 102 to 104)

- (1) Press the menu [Variabl clear].
- (2) Input the No. (range) of the variable to be erased.
102/104 [INPUT]
To erase only one variable, input one variable No.
(102 [INPUT])
- (3) Press the [Y] key.

Note

- (1) The variable at the cursor position will become the target of the erasing if the [INPUT] key is pressed without designating a variable No.
- (2) The variables in the range below are the erasing target when /E is designated.

Input example	Erasing range	Supplement
100/E	100 to 199 100100 to 100199 (when the displayed part system is 1)	Only common variable in the displayed part system is cleared.
400/E	400 to 999 100100 to 800199 900000 to 907399	Range to be cleared varies depending on the number of common variable sets.

- (3) If you include a variable between 100s and 500s in the range designation, the erasing is not performed.
(Example) When you set "110/510", "setting error" is displayed and the variables are not erased.

Operation method (Erasing the variable name for variable No. 509)

- (1) Press the menu [Name clear].
- (2) Select the variable , and press the [INPUT] key.
509 [INPUT]
- (3) Press the [Y] key.  The variable name for 509 only is erased.
The variable value is not erased.

Note

- (1) The variable at the cursor position will become the target of the erasing if the [INPUT] key is pressed without designating a variable No.
- (2) The variables in the range below are the erasing target when /E is designated.

Input example	Erasing range	Supplement
100/E	100 to 199	Only variable name in the displayed part system is cleared.
500/E	500 to 599	

Switching the variable No.

Methods to switch the display areas are as follows.

- (1) Use the menu [Var No search].
- (2) Use the page up/down keys.
 - If you press the next page key during displaying the last page of the area, the first page of the next area will be displayed.
 - If you press the previous page key during displaying the first page of the area, the last page of the previous area will be displayed.
(Example) If you press the next page key during displaying the last page of the common variable 2 (for each part system) (#100 -), the first page of the common variable 1 (common to part systems) (#500 -) will be displayed.
- (3) Use a cursor key
 - When a cursor key is placed at the biggest variable No. in the area, the first page in the next area will be displayed by pressing [↓] or [→].
 - When a cursor key is placed at the first variable No. in the area, the biggest variable No. in the previous area will be displayed at the top by pressing [↑] or [←].
- (4) Use a scroll bar
 - The first page of the next area will be displayed by pressing ▼, while the last page of the area is displayed.
 - The biggest variable No. in the previous area is displayed at the head by pressing ▲, while the first page is displayed.

Variable numbers cannot be displayed continuously if another display area is inserted in between.

3.9.2 Local Variables



Select [Loc var] on the monitor (Monitr) screen, and the details of the local variables are displayed.

Local variables 1 to 33 are prepared for each user macro subprogram call level. Up to 33 local variable data items are displayed on one level. A 5-level configuration from level 0 to level 4 is used in page order. If there is a local variable command or an argument designation called by the user macro subprogram in the block, and that block is executed first, the set variable value (variable name) will be displayed.

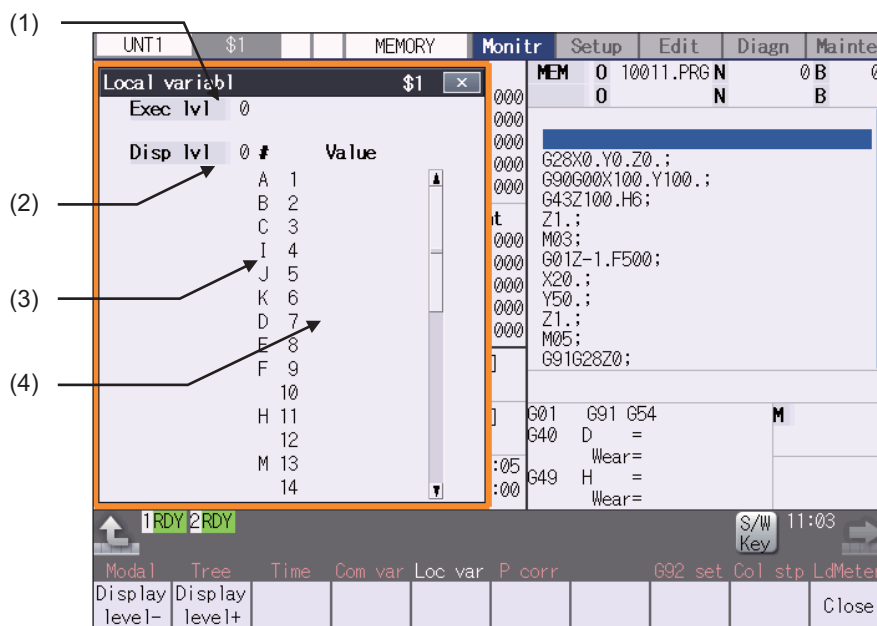

Display items

Display items	Details
(1) Execution level	This displays the nest level of the subprogram control called by the user macro. 0: Not in user macro call state 1: User macro call level 1 2: User macro call level 2 3: User macro call level 3 4: User macro call level 4
(2) Display level	This displays the nest level of the local variable displayed in the area.
(3) Variable number	This displays the local variable No. The alphabetic character before the local variable No. is the argument code. G, L, N, O, P cannot be used as arguments, and thus not displayed. There are 33 local variables (1 to 33) for each user macro subprogram call level.
(4) Variable value	This displays the local variable value. If the variable data is "blank", the display will be blank. An exponential is displayed when a 7 digits are set in the integer section and 5 digits or more as set in the decimal section. (Example)1234567 -> 1.2346E+006, 0.00001 -> 1.0000E-005 <Note> •When the setting is "blank", the setting will be handled as "0" in the calculations. However, when the conditional expressions EQ or NE are used, the blank will not be handled as "0".

Menus	
Menus	Details
Display level-	This lowers the local variable display level one by one. If this menu is pressed when the display level is 0, the level changes to display level 4.
Display level+	This increases the local variable display level one by one. If this menu is pressed when the display level is 4, the level changes to display level 0.
Close	This closes the pop-up window and quits this function.

Relation of user macro subprogram call execution level and display level

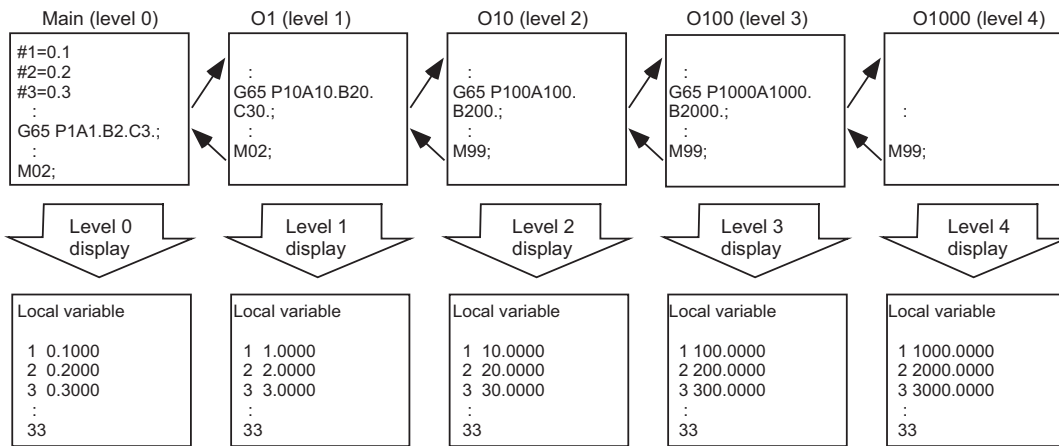

Precautions

The local variables are not erased when reset or when the power is turned OFF. They are erased at macro call.

Operation method (Displaying the next level)

When the current display level is 0

- (1) Press the menu [Display level +].



The level 1 local variables appear from the head.

When the menu [Display level +] is pressed again, the display level changes in the order of 2 -> 3 -> 4 -> 0 -> 1 -> 2 -> ... and so forth.

Operation method (Displaying the previous level)

When the current display level is 2



- (1) Press the menu [Display level -].



The level 1 local variables appear from the head.

When the menu [Display level -] is pressed again, the display level changes in the order of 0 -> 4 -> 3 -> 2 -> 1 -> 0 -> ... and so forth.

Operation method (Changing the displayed variable No.)

The displayed local variable No. changes when the page up/down keys (previous page , next page ) are pressed.

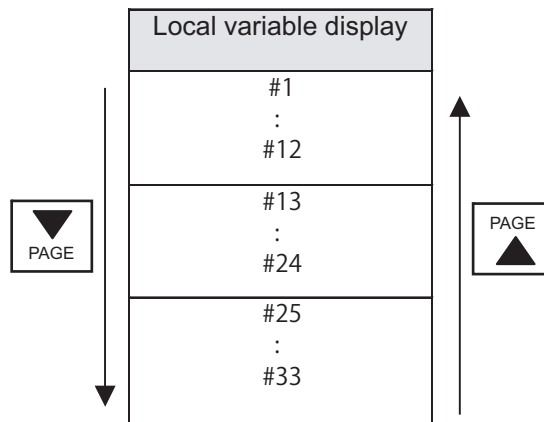

4

Inputting and Outputting a Machining Program

This chapter explains the details of Inputting and outputting the machining program mainly based on the menu [I/O] on the Edit screen.

This operation can be performed with the menu [I/O] on the Maintenance (Mainte) screen as well.

4.1 Inputting and Outputting a Program



The machining program can input/output between the NC internal memory and the external input/output device on the Edit screen.

Note

(1) When the program input/output function is used, set the parameter "#8923 Hide Edit-IO menu" to "0".

This function applies to the following devices.

- Memory
- Memory2
- Memory card (Mount on the back-side SD card drive of GOT)
- USB memory (Mount on the front-side USB drive of GOT)

<During file transmission>

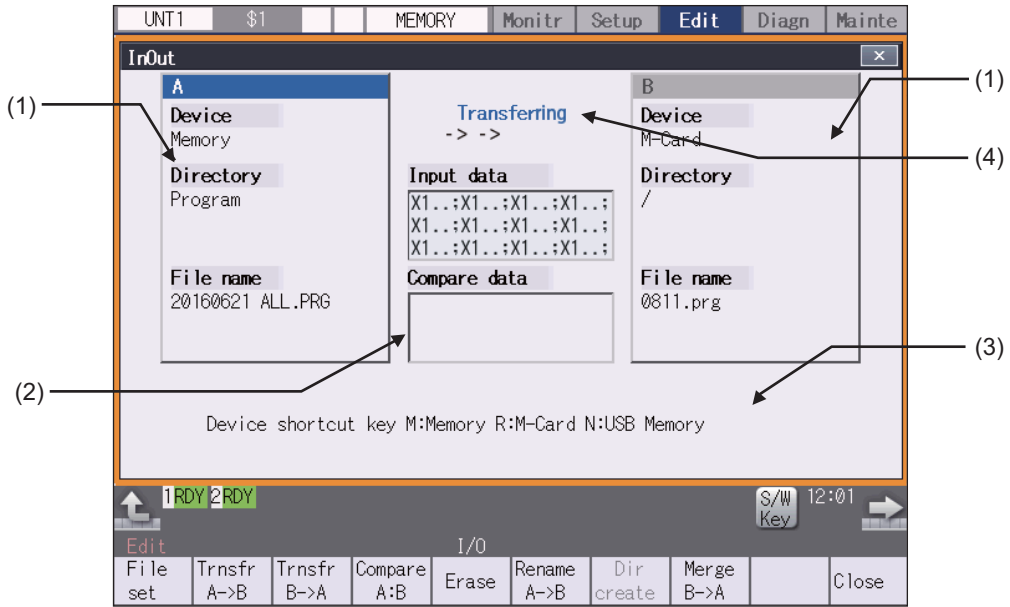

<During file setting>

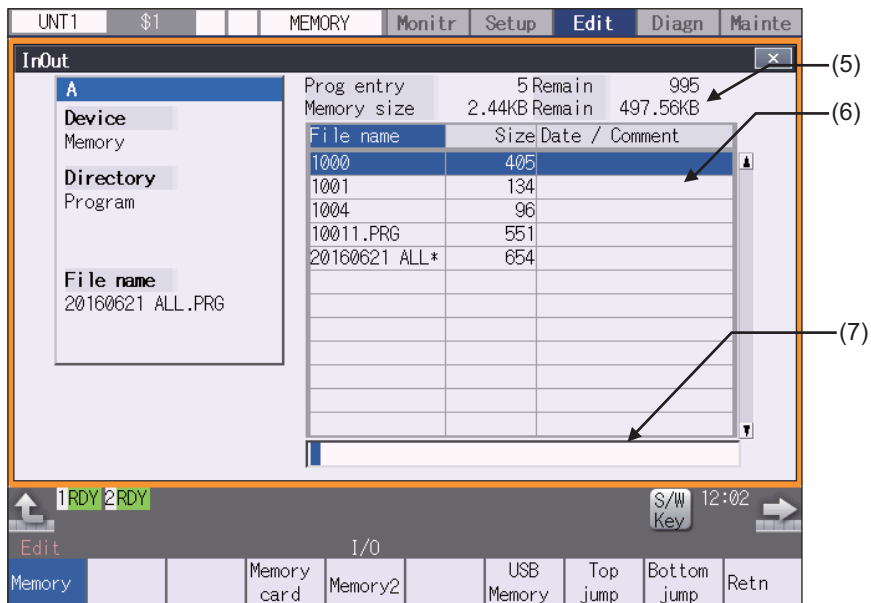

Display items	
Display items	Details
(1) Device, directory, file name setting area	This sets the device, directory, and file name for which the transmission, compare, and erase functions are used. When the number of characters exceeds the display possible number (directory: 63 in three lines, file name: 42 in two lines), the excess is not displayed. As for the device and directory, the setting values are retained even when the power is turned OFF.
(2) Input/compare data display	This displays data that is being transferred or compared. If an error occurs while comparing data, the block for which the error occurred is displayed.
(3) Guidance display area	This displays the device name shortcut key.
(4) Process progress display section	This displays the details and data input/output direction for the process currently being performed.
(5) Capacity display section (*1)(*2)	This displays the file (machining program) registration count information and memory capacity information for the selected device. Prog entry: Displays the number of programs that are already registered as the user's machining programs. Remain: This displays the remaining number of programs that can be registered. When memory is selected as the device, the total of the number of programs registered and the remainder is the maximum number of registrations set in the specifications. Memory size: Displays the capacity that is already registered as the user's machining programs. Remain: Displays the remaining capacity that can be registered. When memory is selected, the total of the memory capacity and the remaining capacity is used as the maximum memory capacity defined in the specifications.
(6) List display section	This displays the directory contents list (directory and file name) of the device A or B where the cursor is currently located. Up to 32 characters can be displayed in the "File name" column by pressing the menu [Comment switch] not to display the "Date/Comment" column. File name: <ul style="list-style-type: none"> ◆When "Memory" is selected for the device, this displays the file name (program No.) of the machining programs already registered. The file names are displayed in order from the smallest number, from 1 to 99999999. ◆When a device other than memory is selected, this displays the file name and directory to be included in the directory that is set in the current setting column. ◆When the number of characters exceeds the maximum (13 characters with the comment column, 32 characters without the comment column), the excess is indicated as "***". Size: <ul style="list-style-type: none"> ◆This displays the size of each file. (The number of characters in the machining program when the memory is selected for the device.) ◆When directory is selected, this displays "DIR". Date/Comment: <ul style="list-style-type: none"> ◆This displays the comment (up to 19 alphanumeric characters and symbols) of each file. ◆The date which the file is updated is displayed for the memory card or USB memory. ◆When the comment of the NC memory exceeds the number of display characters (19 characters), the exceeded part is not displayed. The excess is not abbreviated to "***".
(7) Input section	This displays the input key.

(*1) Some items may not be displayed depending on the device.

○: Displayed ×: Not displayed

Display item/Device	Memory	Memory2	Memory card	USB memory
Number of programs registered	○	○	○	○
Remain	○	○	×	×
Number of memory characters	○	○	○	○
Remain	○	○	○	○
List	○	○	○	○

(*2) When the device is not mounted, a registration count and a memory capacity are not displayed and an empty list is displayed.

Note

(1) As for the device and directory, the setting values are retained even when the power is turned OFF. However, by selecting directory, when the number of characters in the directory path (full path) from the root directory exceeds 100, the directory path is not retained, but a previously set directory path containing 100 characters or less retained. When the device is "Memory", the initial directory display is "Program".

Menus

Menus	Details
File set	This sets the device, directory and file name for which input/output operations are performed.
Trnsfr A->B	This copies the file in file setting column A (transfer origin) to the file setting column B (transfer destination). (The transfer origin file is not changed.)
Trnsfr B->A	This copies the file in file setting column B (transfer origin) to the file setting column A (transfer destination). (The transfer origin file is not changed.)
Compare A:B	This compares the files in file setting column A and file setting column B.
Erase	This erases the selected file in file setting column.
Rename A->B	This changes the name of the file in file setting column A to that of in file setting column B. <Note> ♦The same device must be selected for A and B.
Dir create	This creates a new directory in the selected file setting column. The directory can be created when the memory card or the USB memory is selected for the device.
Merge A->B	This adds the contents of the file in file setting column B to that of in file setting column A. (The file in file setting column B is not changed.)
Close	This closes the pop-up window and quits this function.
Stop	This interrupts the process (transfer, compare, etc.) during its execution.

Sub-menus of [File set] menu

Menus	Details
Memory	This selects NC memory.
Memory card	This selects the back-side SD card of GOT.
Memory2	This select the expanded area of NC memory. This menu is grayed out and non-selectable, when the specification of program memory capacity 1000kB[2560m] or 2000kB[5120m] is invalid.
USB Memory	This selects USB memory.
Top jump	This moves the cursor to the top line.
Bottom jump	This moves the cursor to the last line.
Comment switch	Pressing this menu switches display/non-display status and the display contents of the "Date/Comment" column of the program list as follows: Program comment (*1) -> the last updated date/time of the file (*2) -> not displayed
Program	This transfers a machining program as one file.
Program all	This transfers multiple programs as one file.
List update	This updates the list contents. (The latest contents of the currently selected device and directory are listed.)
Sort change	This changes the method that the list is sorted.
Retn	This returns to the main menu.

(*1) When the selected device is [Memory card] or [USB Memory], the program comment is not displayed.

(*2) When the multi-part system program management is enabled (#1285 ext21/bit0 = 1) for the device [Memory], the last updated date/time of the file is not displayed.

Switching the valid area

It is necessary to enable the areas including device, directory, and file name in the file setting column A or B in order to set those items.

Change the display area using the [←], [→], direction cursor keys or the [[←], [→]] tab keys.

For the touchscreen display, it is also possible to change the invalid area by touching the display area.

4.2 Selecting a Device, Directory and File



This section explains the file device, directory, and file name specification methods for the file transfer and erase commands etc. performed on the I/O screen of the edit (Edit) screen.

File operation procedure

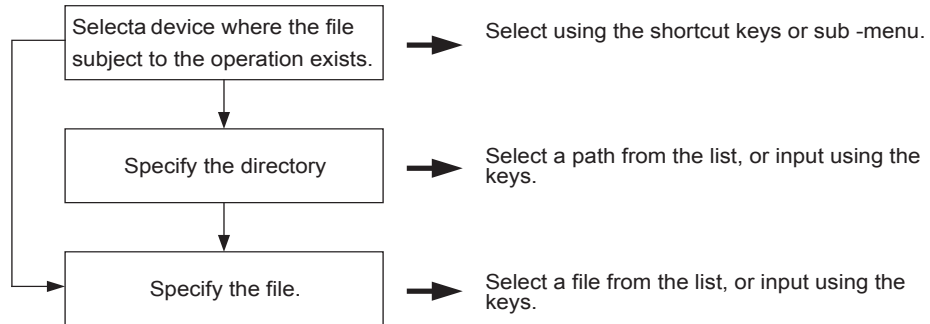

Outline of device, directory, and file name designating methods

Device	Designation target file	Designation method		
		Device	Directory	File name
NC memory	<ul style="list-style-type: none"> ♦Machining program ♦User macro program ♦Fixed cycle program 	Select from the submenu	— (Default)	Key input in the input area, then press the [INPUT] key.
		Designate using the shortcut key.		Select from the list.
Device other than the NC memory	All files	Select from the submenu	Key input in the input area, then press the [INPUT] key.	Key input in the input area, then press the [INPUT] key.
		Designate using the shortcut key.	Select from the list.	Select from the list.

- (1) The device can be selected using the sub-menu or shortcut keys.
(The devices that can be used will differ depending on the specifications.)
- (2) One of the following methods can be used to designate the directory (for devices other than the NC memory) and file name.
 - ♦Designate the directory path or file name in the input area and press the [INPUT] key.
 - ♦Move the cursor in the list display section to the target directory or file name and press the [INPUT] key.
A wildcard (*) can be used for the file name.

Note

- (1) When the number of characters of directory path (full path) exceeds 128, changing directories cannot be performed.

Notes when selecting a file

- (1) During directory and file name setting, the designated directory, path or file name will be set, even if it does not actually exist. This will not cause an error. Note that the previously set directory is overwritten.
- (2) When selecting a fixed cycle program, it is necessary to set the parameter "#1166 fixpro". Furthermore, select "Memory" for the device, and "Program" for the directory.

Operation method (Selecting an NC memory program)

- (1) Press the [M] short cut key. on the I/O screen of the edit screen. → The device name changes to "Memory". "Program" appears in the directory.
- (2) Press the menu [File set]. → The NC memory program list and input area appear.

By pressing the operation menu at this point, it is possible to change the device.

When the menu [Program] or [Program all] is selected, the setting of "File name" column is cleared.

Only when the device functions as the memory, the menu [Program] or [Program all] is valid.

<When selecting the file name from the list>

- (3) Move the cursor to the file name to be selected, and set.

[↑], [↓] [INPUT]

<When inputting the file name from the input area>

- (3) Input the file name.

10013 [INPUT]

Designating multiple files

A wildcard (*) can be used for the file name.

By using a wildcard, multiple files can be transferred, compared, and erased at one time.

- (Example 1) When programs 1 to 1000 exist in the NC memory.

Designate "*" in the file name: The target program is "1 to 1000".

Designate "*. *" in the file name: There is no target program.

Designate "1*" in the file name: The target program is "1, 10 to 19, 100 to 199, 1000".

Designate "1*.*" in the file name: There is no target program.

Designate "*1" in the file name: The target program is that where the position of the 1 is "1".

(1, 11, 21, 31, 101, 111, 981, 991)

Designate "*1*" in the file name: The target program is all of the programs containing "1".

(1, 10 to 19, 21, 31, 100 to 199, 201, 210, 981, 991,1000)

Designate "1*1" in the file name: The target program is "11, 111, 121, 131, 141, 151, 161, 171, 181, 191".

- (Example 2) When programs 1.PRG to 1000.PRG, and 1 to 1000 exist in the USB memory.





Designate "*" in the file name: The target program is "1 to 1000".

Designate "*.PRG" in the file name: The target program is "1.PRG to 1000.PRG".

Designate "1*" in the file name: The target program is "1, 10 to 19, 100 to 199, 1000".

Designate "1*.*" in the file name: The target program is "1.PRG, 10.PRG to 19.PRG, 100.PRG to 199.PRG, 1000.PRG".

Operation method (Selecting a file from a device other than the NC memory)

- (1) Press a device selection shortcut key on the I/O screen of the edit screen.  The device name changes to "USB memory". The root directory (/) appears in the directory.
(Example) [N]
- (2) Press the menu [File set].  The program list of the USB memory and the input area appear.
By pressing the operation menu at this point, it is possible to change the device.
Only when the device functions as the memory, the menu [Program] or [Program all] is valid.
- <When selecting the directory from the list>
- (3) Move the cursor to the directory to be selected and set.  The directory selected in the directory column appears. The contents of the selected directory appear in the list. Select "." to move to one directory above. There is no change when "." is selected.
[↑], [↓] [INPUT]
Repeat this operation until the cursor arrives at the target directory.
Next, refer to operation (4).
- <When inputting the directory from the input area>
- (3) Input the directory path.  The input directory path appears in the directory column.
(Example) /PRG/PRECUT [INPUT]
- <When selecting the file name from the list>
- (4) Move the cursor to the file name to be selected, and set.
[↑], [↓] [INPUT]
- <When inputting the file name from the input area>
- (4) Input the file name.
10013.PRG [INPUT]



4.3 Transferring a File



This section explains the method used to transfer files between different devices, or between the same device on the I/O screen of the edit (Edit) screen.

Refer to "4.2 Selecting a Device, Directory and File" for details of the device, directory, and file specification method.

Operation method

- (1) Use the [←] or [←] key to select file setting column A on the I/O screen of the edit screen.
- (2) Designate the transfer source device, directory and file name.  The designated file displays in file setting column A. A wildcard "*" can be used for the file name to designate multiple files.
- (3) Use the [→] or [→] key to select file setting column B.
- (4) Designate the transfer destination device, directory and file name.
- (5) Press the menu [Trnsfr A->B].
Press the menu [Trnsfr B->A] when transferring from device B to device A.
- (6) Press the [Y] or [INPUT] key.  File transfer is commenced. The process progress display area displays message indicating that transfer is in progress, and also indicates the transfer direction. The data being merged appears in the input/comparison data display area input data display column. A message appears indicating a transfer completion after transfer has been completed.

CAUTION

 ";", "EOB", "%", and "EOR" are symbols used for explanation. The actual codes for ISO are "CR, LF" ("LF") and "%". "%" and "EOR" are represented by "%" in ISO. The programs created on the edit screen are stored in the NC memory in a "CR, LF" format, however, the programs created with external devices may be stored in an "LF" format. The actual codes for EIA are "EOB (End of Block)" and "EOR (End of Record)".

 To prevent influence from data omission and data transformation in the communication circuit, always verify the data after inputting and outputting machining programs.

Precautions

■ Notes related to transferring in general

- (1) Depending on the type of file, some data cannot be transferred during automatic operation. Do not transfer during automatic operation.
- (2) When the capacity of the transfer destination is reached during file transfer, only the data transferred up to that point is registered as a file, and an error will occur.
- (3) During input to the NC memory or comparison, if the file format size on the NC memory side differs from the other side file format size (when the maximum number of registrations differs between the NC memory and the other side), processing is carried out matched to the smaller size.
 (Example 1) If a format size of 200 files is input for a format size of 1000 NC files, 200 files are registered.
 (Example 2) If 1000 files are input to the NC that formatted for 200 files, the files up to the 200th file can be registered and an error message appears. (The remaining files are not registered.)
- (4) Do not perform any file operation on the transfer source and destination files during the file transfer. The file may be damaged with the file operation.

■ Notes when transferring machining program files

- (1) The transfer speed is slower if there are many registrations.
- (2) The size of one block of the machining program should be 250 characters or less.
- (3) The characters that can be used for the file name and directory path are 1-byte number, 1-byte capital alphabetical letters, and 1-byte symbols recognized by the system. Note that the following characters cannot be used.
 |, /, :, ", " (comma), *, ?, ", <, >, a to z (small letters), space
 Up to 32 characters are allowed for the file name to create in or transfer to NC memory.
- (4) If the file whose name includes lower case alphabet is transferred to NC memory, the lower case letter will be converted into the capital letter.
- (5) When the MTB macro and fixed cycle program are input, change the program type with the parameter (#1166 fixpro). Also, set the device and directory as follows.
 Device: Memory, Directory: Program
- (6) With machining program created by the MELDAS500 Series or earlier model, "EOB" is registered as "LF". However, when these programs are stored in the C80 Series NC memory, "EOB" will be converted to "CR LF", and the number of characters will increase. Thus, when all of the machining programs output from an MELDAS500 Series or earlier model, having the same specifications as the maximum memory capacity, are stored in the C80 Series NC memory, the memory capacity may be exceeded.
- (7) When the file to be transferred (input) is running or in "program restarting" mode, the operation message "Executing automatic operation" or "Program restarting" is displayed and file will not be transferred (input).
- (8) When "#8936 Delete leading 0" is set to "1", if a file name consisting only of numerical figures is input, "0" at the head of the file name is deleted to be checked.
 However, if the file name is out of the range between 1 and 99999999, the leading "0" is not deleted. This also applies to MTB macros.
 Therefore, for example, while the program "1" is in automatic operation, if a file name to transfer (input) is named "0001", the operation message "Executing automatic operation" appears, and transfer cannot be carried out.
 In the case of fixed cycles, regardless of the setting of "#8936 Delete leading 0", the name of the file to transfer must be 9 digits, and it must not start from "0". Attempting to transfer a file whose name does not satisfy the conditions above will cause an error.
- (9) If the file to be transferred (input) is targeted for edit lock (edit lock B: 8000 to 9999 or edit lock C: 9000 to 9999), the operation message "Edit lock B" or "Edit lock C" is displayed, causing a transfer failure.
 If "#8936 Delete leading 0" is set to "1" and the program name consisting only of numerical figures is input, "0" at the head will be deleted and checking will be performed. (Example: If the transferring (inputting) file name is "008000", the operation message "Edit lock B" appears and it cannot be transferred.)
- (10) When the multi-part system program management is valid (#1285 ext21/bit0 = 1) and "#1285 ext21/bit2" (Multi-part system program generation and operation) is set to "1", the file transfer to the device [Memory] from the other device is executed with the machining programs in only displayed part system. In other cases, the machining programs are transferred across all part systems in batch.
- (11) When the multi-part system program management is valid (#1285 ext21/bit0 = 1) and "#1286 ext22/bit5" (Selection of multi-part system program input/output method) is set to "1", the file transfer from the device [Memory] to the other device is executed with the machining programs in only displayed part system. In other cases, the machining programs are transferred across all part systems in batch.

(12) The transfer range from the external device other than serial to NC memory will change depending on the value set in the parameter "#19006 EOR Disable".

<When the parameter "#19006 EOR disable" is set to "0">

The head line will not be transferred.

Up to "%" in the second line onward will be transferred, and data after "%" will not be transferred.

If there is no "%", all data will be transferred.

<When the parameter "#19006 EOR disable" is set to "1">

All file contents will be transferred.

(13) When a wildcard "*" is designated for the file to be transferred, the transfer is executed excluding the programs which are subject to the edit lock in accordance with the status of Edit lock B and C.

(14) If the device shown below and the directory are designated for the transfer destination, the following operation is performed depending on conditions.

- When an existing file is designated: The file is transferred with a temporary file name, and changed to the designated file name after transfer processing has been completed.

- When a new file is designated: A new file is transferred with a temporary file name, and changed to the designated file name after transfer processing has been completed.

(1) Transfer destination device: Memory

Directory: Machining program

(2) Transfer destination device: memory card, USB memory

A temporary file is designated by the file name that consists of 11 digits, beginning with the symbol "~".

After transfer is terminated properly, the temporary file is changed to the designated file name.

A temporary file remains in the cases below, but can be deleted in the same way as for a normal file.

- When the transfer has terminated abnormally, for example, because the destination's capacity became full.

- When the transfer has been interrupted.

4.4 Comparing Files (Compare)



This section explains method used compare files after transferring on the I/O screen of the edit (Edit) screen. Refer to "4.2 Selecting a Device, Directory and File" for details of the device, directory, and file specification method.

Operation method

- (1) Use the [←] or [←] key to select file setting column A on the I/O screen of the edit screen.
- (2) Designate the device, directory and file name to be compared.
- (3) Use the [→] or [→] key to select file setting column B.
- (4) Designate the other device, directory and file name to be compared.
- (5) Press the menu [Compare A:B].



The file comparison starts. The input data and comparison data appear in the input/comparison data display area. A message appears when the comparison is completed. If a comparison error occurs, the block with the error is displayed in the comparison data display column on the screen.

Note

- (1) Files that can be compared are text files only. Correct outcome will not be obtained through binary file comparison.
- (2) In a file comparison, even if "#8936 Delete leading 0" is set to "1", when comparing one separate file that contains one program, "0" at the head of the program name is not deleted. Designating the file name is required.
- (3) When a wildcard "*" is designated for the transfer source file, the comparison is executed excluding the programs which are subject to the edit lock in accordance with the status of Edit lock B and C.

4.5 Erasing a File



This section explains the method used to erase files on the I/O screen of the edit (Edit) screen. Refer to "4.2 Selecting a Device, Directory and File" for details of the device, directory, and file specification method.

Operation method (Erasing a file in file setting column A)

- (1) Use the [←] or [I←] key to select file setting column A on the I/O screen of the edit screen.
- (2) Designate the device, directory and file name to be erased.
- (3) Press the menu [Erase].
- (4) Press the [Y] or [INPUT] key.

Note

- (1) If the file to be erased is running, an error will occur, and the file will not be erased.
- (2) When a wildcard "*" is designated for the file to be erased, the erasing is executed excluding the programs which are subject to the edit lock in accordance with the status of Edit lock B and C.

Operation method (Erasing a file in file setting column B)

Use the [→] or [I→] key to select file setting column B, and designate the device, directory, and file name for file setting column B. Following this, the operation method is same as for "Erasing a file in file setting column A".

4.6 Changing a File Name (Rename)



This section explains the method used to change the file name on the I/O screen of the edit (Edit) screen.

Refer to "4.2 Selecting a Device, Directory and File" for details of the device, directory, and file specification method.

Changing a file name

- (1) Use the [←] or [←] key to select file setting column A on the I/O screen of the edit screen.
- (2) Designate the original device, directory and file name.
- (3) Use the [→] or [→] key to select file setting column B.
- (4) Designate the new device, directory and file name.
- (5) Press the menu [Rename A->B].
- (6) Press the [Y] or [INPUT] key.

Note

- (1) Make sure the original and new devices are the same.
- (2) If the file to be renamed is running or program restarting, an error will occur, and the name will not be changed.
- (3) If a file that does not exist is designated for the original file, or if an existing file name is designated for the new file selection, an error occurs, and the name is not changed.



4.7 Creating a Directory



This section explains the method used to newly create a directory.

Refer to "4.2 Selecting a Device, Directory and File" for details of the device, directory, and file specification method.

Operation method

- (1) Use the [←] or [|←] key to select file setting column A.
- (2) Designate the device.
- (3) Select a directory to be newly created from the list, or designate by inputting from the input area.
- (4) Set the new directory in the file setting column A.  The directory contents appear.
- (5) Press the menu [Dir create].
The directory can also be created in file setting column B.  The directory is created.

Note

- (1) Make sure that the directory path is less than 100 characters. When the path exceeds 100 characters, it cannot be recognized as a path.

4.8 Other Functions

Edit

—

I/O

4.8.1 Merging a File

This section explains the method used to add a file in file setting column B to a file in file setting column A on the I/O screen of the edit (Edit) screen.

Refer to "4.2 Selecting a Device, Directory and File" for details of the device, directory, and file specification method.

Operation method

- (1) Use the [←] or [←] key to select file setting column A on the I/O screen of the edit screen.
- (2) Designate the merge destination device, directory, and file name.
- (3) Use the [→] or [→] key to select file setting column B.
- (4) Designate the merge source device, directory, and file name.
- (5) Press the menu [Merg B->A].
- (6) Press the [Y] or [INPUT] key.



The file merge starts. The data being merged appears in the input/comparison data display area input data display column. Furthermore, a message indicating that merging is being performed, and an arrow from the merge source (file setting column B) to the merge destination (file setting column A) display in the process progress display area.

A message appears when the merge is completed. The details of the file in file setting column A will be as follows when the merge is completed.

<pre>(FILE A) G28 XYZ G90 F800 G00 X100. Y100.; (FILE B) G91 G28 XYZ F1000; G01 X200. Y200.; M02; %</pre>	} Details of file in file setting column A before merge.
	} Details of file in file setting column B before merge.

The details of the file in file setting column B do not change.

Note

- (1) If the merge destination file (file in file setting column A) is running, an error will occur, and the files will not be merged.
- (2) Do not perform the file operation on the merge source and destination files during the merge. The file may be damaged with the file operation.

4.8.2 List of File Names

There is a directory for each type of data in the device [Memory].

Each directory and file name (fixed) in the device is shown below.

Do not change the extensions (.XXX) when storing in a device other than [Memory].

Data type	NC memory directory path	File name
Machining program	/PRG/USER	(Program No.)
Fixed cycle program	/PRG/FIX	(Program No.)

4.8.3 Edit Lock B and C

This function prohibits editing, erasing, etc., of the machining programs B and C, and protects the machining programs in the device [Memory].

Machining program	Edit Lock B	Edit Lock C
A 1 to 7999 10000 to 99999999	---	---
B (user standard program) 8000 to 8999	Editing prohibited	---
C (MTB custom) 9000 to 9999	Editing prohibited	Editing prohibited

The operations below in the Edit MDI and the Input/Output screens are influenced by the edit lock setting.

An error will occur if operations that are not possible are attempted.

When the edit lock is valid, processing is executed (except the edit lock target program) by the input/output function.

○: Operation possible ×: Operation not possible

Screen	Operation	Edit Lock B			Edit Lock C		
		Machining program			Machining program		
		A	B	C	A	B	C
Edit	Search	○	○	×	○	○	×
	Edit	○	×	×	○	○	×
	MDI registration	○	×	×	○	○	×
Edit (Input/Output)	Transfer	○	×	×	○	○	×
	Compare	○	×	×	○	○	×
	Copy	○	×	×	○	○	×
	Merge	○	×	×	○	○	×
	Rename	○	×	×	○	○	×
	Erase	○	×	×	○	○	×
Monitor	Buffer Correction	○	×	×	○	○	×

Note

- (1) When the multiple part system specification is valid, the machining programs of all the part systems are protected by edit lock B and C.
- (2) When multiple serial files or a wildcard (*) is designated for input/output function, programs except subject to edit lock will be processed.
- (3) When a multiple programs are input to the memory without designating the file name like program batch input, the message "Edit lock B" or "Edit lock C" will be displayed and the input will be interrupted if the program which is subject to edit lock is detected.

4.8.4 Program Display Lock

Program display and operation search in the device [Memory] on the monitor or edit screen are affected as follows according to the setting of the parameter "#1122 pglk_c" (Program display lock).

Influences of program display lock parameter on monitor screen		
Screen operation #1122 pglk_c	1 (Display: Prohibited, Search: Possible)	2 (Display: Prohibited, Search: Prohibited)
Buffer display of operating program	The program contents are not displayed. Only "%" is displayed.	
When the menu [Edit] was pressed	The operation message "Program display lock C" appears. The window is opened. (When the edit lock B or C is valid, edit lock B or C is given to priority.)	
When the main menu [P corr] was pressed		
Search from the operation search window	The search can be executed.	The search cannot be executed. The operation message "Program display lock C" appears. The window is not closed. The contents of input area are not cleared.
Search from the restart search window		
Search from the top search window (of restart search)		

Influences of program display lock parameter on edit screen		
Screen operation #1122 pglk_c	1 (Display: Prohibited, Search: Possible)	2 (Display: Prohibited, Search: Prohibited)
The file is automatically opened when changing the edit screen (*1)	The program contents are not displayed. Only "%" is displayed.	- (It is not possible to search, so the file is never automatically opened when changing the edit screen.)
When the file is opened by the menu [Open].	The operation message "Program display lock C" appears. The window is not closed. (When the edit lock B or C is valid, edit lock B or C is given to priority.)	

(*1) When changing the edit screen, the file opened immediately before or operation searched is automatically opened.

4.8.5 Data Protection Keys

Data protection key prevents various data from being set or erased.

The key name differs according to the MTB. Refer to the instruction manual issued by the MTB for details.

The following data can be protected with the data protection key:

- All tool data and the coordinate system preset data using the origin set
- User parameters and common variables
- Machining programs

The data protection key is enabled to prohibit the setting, erasing, etc. while the PLC signal is OFF (B contact).

Data protection key has higher protection level than that of Data protection by user's level.

4.8.6 Leading Zero

When creating a new machining program

When the parameter "#8936 Delete leading 0" is set to "1", if a file name consisting only of numerical figures is input, the file is created with "0" at the head of the file name deleted.

However, if the file name is out of the range between 1 and 99999999, the leading "0" is not deleted. This also applies to MTB macros.

In the case of fixed cycles, regardless of the setting of "#8936 Delete leading 0", a file name to create must be 9 digits, and it must not start from "0". Attempting to create a name not following the conditions above will cause an error.

When "#8936 Delete leading 0" is set to "1", if a file name consisting only of numerical figures is input, the leading "0" is deleted when checking whether the file exists or not, and when checking edit lock B/edit lock C.

(Example) For a directory that has a file "1", if a file name "0001" is attempted to be input as a new file, an error will occur.

Example of deleting of leading zero

Input file name	Created file name	Remarks
0012345678	12345678	The leading "0"s are deleted
0123456789	0123456789	As this name is out of the range between 1 and 99999999, the leading "0" is not deleted
0123A	0123A	As a nonnumerical character (alphabet) is included, the leading "0" is not deleted
0123.PRG	0123.PRG	As a nonnumerical character (extension) is included, the leading "0" is not deleted

When transferring, or comparing files

In a file transfer with "#8936 Delete leading 0" set to "1", only when the file name of the transfer destination consists only of numerical figures, the leading "0" is deleted when the file is transferred.

However, if the file name is out of the range between 1 and 99999999, the leading "0" is not deleted. This also applies to MTB macros.

In the case of fixed cycles, regardless of the setting of "#8936 Delete leading 0", the name of the file to transfer must be 9 digits, and it must not start from "0". Attempting to transfer a file whose name does not satisfy the conditions above will cause an error.

In a file comparison, even if "#8936 Delete leading 0" is set to "1", when comparing one separate file that contains one program, "0" at the head of the program name is not deleted. Designating the file name is required.

■(Example 1) One file has one program

- (1) The files are transferred from the USB memory to the memory.

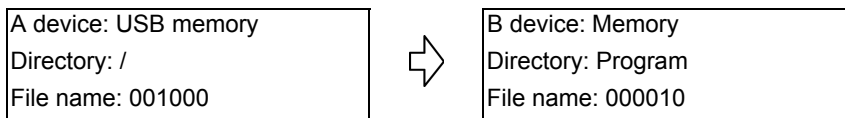

The files are transferred to the memory as follows.
The leading zero is deleted from the file name.

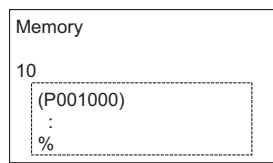

- (2) In order to carry out comparison, change the file name of the transfer destination to "10".
(In a comparison of one separate file that has one program, as "0" at the head of the program name is not deleted, if the file name remains "000010", it will be compared with the file "000010" of the transfer destination.)

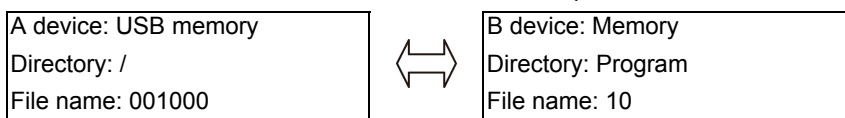

4.9 The Batch Input/Output the Machining Program of NC Memory

Edit

I/O

On the I/O screen of the edit (Edit) screen, one file which consists of two or more machining programs can be transferred to NC memory by dividing the file. The machining programs united with one file can be transferred to the external device. The targets are the machining programs of the user.

The target external devices are memory card and USB memory.

Batch input and verify to NC memory

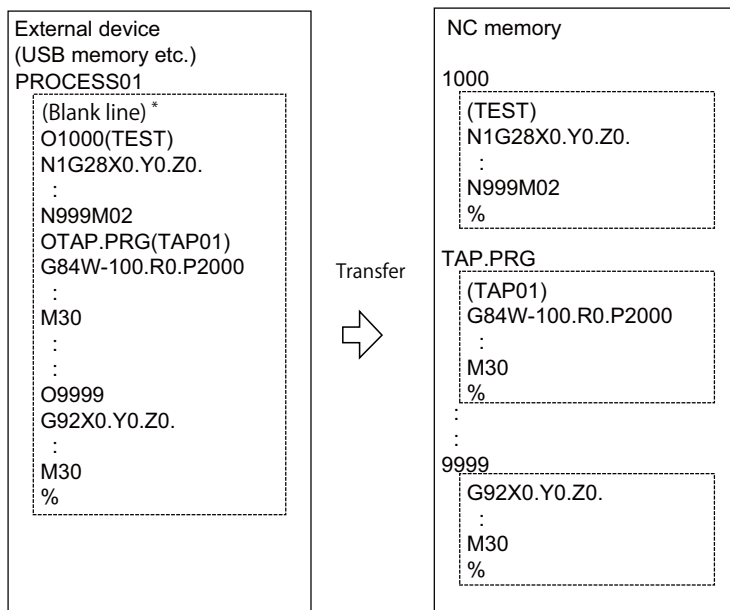

Example of "the external device -> NC memory" of machining program batch transfer



When the transfer direction file name is designated, the top program name of transfer source can be omitted ("O1000" can be omitted in above example).

Comment is not added after a program name when a program is output to an external device, however, if there is comment after a program name when a program is input, the comment is input to the head of the first part system.

- (1) Use the [←] or [←] key to select file setting column A on the I/O screen of the edit screen.
- (2) Designate the transfer source device and directory.
- (3) Designate the file which consists of two or more machining programs.
- (4) Use the [→] or [→] key to select file setting column B.
- (5) Designate the transfer direction device (memory).

- (6) Press the menu [Program all].
When the file name is designated, only the top program of transfer source is stored in the designated file. For example of "Example of "the external device -> NC memory" of machining program batch transfer", when "TESTCUT" is designated as the transfer direction file name, the top program is transferred as not "1000" but "TESTCUT".
- (7) Press the menu [Trnsfr A->B].
- (8) Press the [Y] or [INPUT] key.
When the same machining program already exists in transfer direction device, the operation message "Overwrite this file?(Y/N)" appears. The transferring the following program is continued by selecting [Y] or [N] key.  File transfer is commenced. Transmitting data is displayed in input data display column. The operation message "Transfer complete" appears upon the completion of transmission.
- (9) Press the menu [Compare A:B].  The file comparison starts. The verifying data is displayed. A message appears when the comparison is completed. When the verification error occurs, the error block is displayed in verification data display column and the operation message "Compare error. Compare next file?(Y/N)" appears.

Note

- (1) When programs are input in a batch to NC memory, always specify "Program batch" to NC memory directory as transfer direction. If "Program batch" is not specified, one file is transferred (No batch).
- (2) When the program which is subject to edit lock exists in transfer source, the message "Edit lock B" or "Edit lock C" appears, and transfer is interrupted. When the program which is not subject to edit lock is transferred, delete the program which is subject to edit lock in transfer source. (Refer to "4.8.3 Edit Lock B and C".)
- (3) When the protection of the machining program is valid, the program cannot be transferred/verified. (Refer to "4.8.5 Data Protection Keys".)
- (4) During the automatic operation, the program in program restart cannot be overwritten. The operation message "Executing automatic operation" or "Program restarting" appears, and transfer is interrupted.
- (5) The first line of the transfer source file is ignored.

Batch output and verify from NC memory

Example of "NC memory -> the external device" of machining program batch transfer

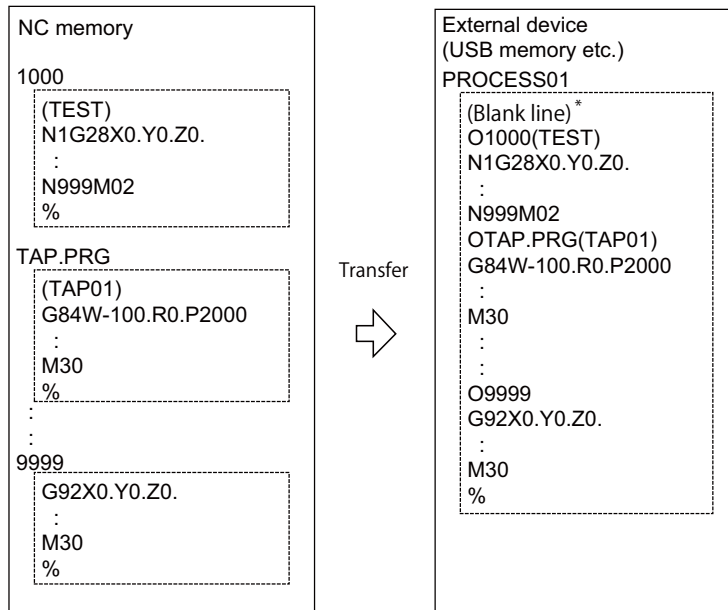

- (1) Use the [←] or [←] key to select file setting column A on the I/O screen of the edit screen.
 - (2) Designate the transfer source device (memory).
 - (3) Press the menu [Program all].
Do not specify the file name. If the name is specified, an error will occur.
 - (4) Use the [→] or [→] key to select file setting column B.
 - (5) Designate the transfer direction device and directory.
 - (6) Designate the transfer direction file to input multiple machining programs.
When the file name is not designated, output to the file "ALL.PRG" of the designated directory.
 - (7) Press the menu [Trnsfr A->B].
 - (8) Press the [Y] or [INPUT] key. File transfer is commenced. Transmitting data is displayed in input data display column. The operation message "Transfer complete" appears upon the completion of transmission.
- When the same machining program already exists in transfer direction device, the operation message "Overwrite this file?(Y/N)" appears. The transferring the following program is continued by selecting [Y] or [N] key.

(9) Press the menu [Compare A:B].



The file comparison starts. The verifying data is displayed. A message appears when the comparison is completed. When the verification error occurs, the error block is displayed in verification data display column and the operation message "Compare error. Compare next file?(Y/N)" appears.

Note

- (1) When programs are output in a batch from NC memory, always specify "Program batch" to NC memory directory as transfer source. If "Program batch" is not specified, the program is transferred by one program per one file.
- (2) When the programs which are subject to edit lock exists in NC memory, those file is not transferred. (The files are transferred excluding those files.) The verification is executed excluding the programs which are subject to edit lock. (Refer to "4.8.3 Edit Lock B and C".)
- (3) When the protection of the machining program is valid, the program cannot be transferred/verified. (Refer to "4.8.5 Data Protection Keys".)
- (4) When the device [Memory2] is selected, the name of batch output file is "ALL2.PRG".

Precautions

- (1) When the machining program batch input/output function of NC memory is used, "(" cannot be used for the machining program name. It is recognized that the inside of "(" is a comment.
- (2) The file name of file which consists of two or more machining program can have up to 32 characters, including the extension as well as the machining program.
- (3) When the "Program batch" is designated to NC memory directory, it is not possible to delete, rename and merge files. When the files are deleted in a batch, use "Program" for directory, and a wildcard (*) for file name.
- (4) For other precautions, refer to "4.3 Transferring a File".

Setting a Tool and a Workpiece

This chapter explains the details of tools and workpieces based on respective menus on the setup (Setup) screen.

5.1 Setting a Tool

Refer to the instruction manual issued by the MTB for details on the tool setting.

5.2 Registering a Tool (Tool Registration Screen)



A tool No. is assigned to each tool to make the tools installed on the machine recognizable to the NC on the tool registration (T-reg) screen of the Setup screen. The tool No. is registered corresponding to the magazine pot and spindle where that tool is installed, and the standby location.

When the tool No. and magazine pot are changed by a tool selection command or tool replacement command, the new tool No. is displayed.

When not making an arbitrary setting for the number of registered tools, there are maximum 3 magazines, and up to 120 tools can be registered for each magazines. When making an arbitrary setting, there are a maximum of 5 magazines, and up to 360 tools can be registered for all magazines.

This function differs depending on the specifications of the MTB. Refer to the instruction manual issued by the MTB for details.

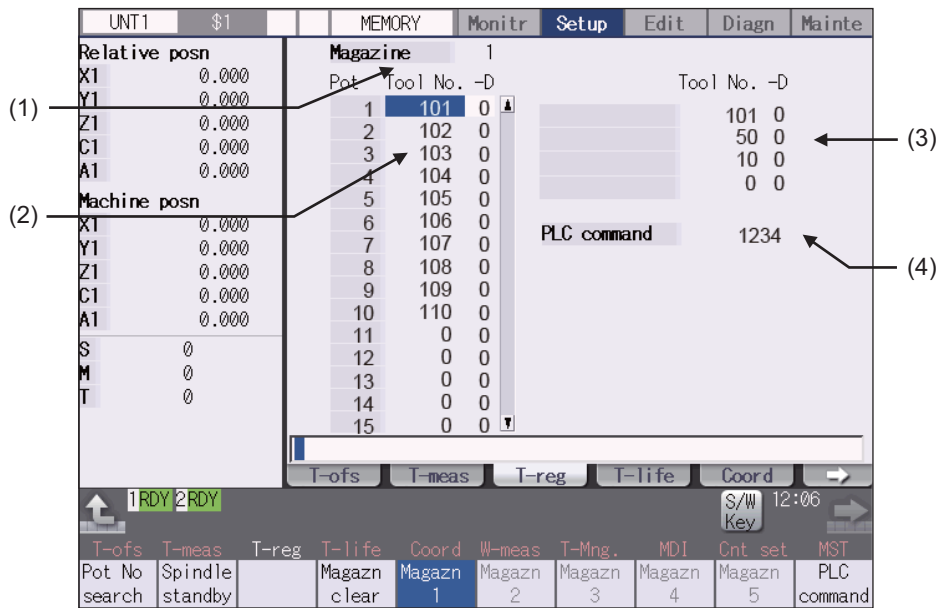

Manual numerical value command can be executed when manual numerical value command window is displayed by inputting an address key such as MST, etc.

Display items

Display items	Details
(1) Magazine	This displays the currently selected magazine No.
(2) Tool No.-D	A maximum of 8 digits of data can be input for a tool No. (Refer to the manual issued by the MTB for details on the "D" functions and purposes.) When the "Tool No." column is blank, confirm the tool first, since the tool could not be mounted, or the tool could not match the spindle. Setting "0" erases the registered tool.
(3) Spindle/Wait (used by PLC program)	This displays the magazine 1 spindle or standby tool No. (The name of this area differs depending on the output from the PLC program.)
(4) PLC command	This command is used to input data and perform sequence processing using the PLC program.

Menus

Menus	Details
Pot No search	Magazines are displayed sequentially with the selected pot number on the top of them. The cursor moves to the data of the configured pot number, and tool number can be entered.
Spindle standby	This sets or erases the tool No. of spindle and standby tools. The cursor will move to the top tool No. of the spindle and standby tools and the setting mode will be entered.
Magazn clear	This erases all the currently selected magazine tool data (tool number and D). <Note> ♦Unselected magazine tool data is not erased. ♦The spindle and standby data cannot be erased.
Magazn 1 : Magazn 5	This designates the magazine No. to be displayed on the screen. The displayed menu differs according to the machine specifications. For example, when there are two magazines, only the menus [Magazine 1] and [Magazine 2] display.
PLC command	The cursor moves to the PLC command setting area and the mode changes to the setting mode.

Tool registration duplication check

When the tool No. is set to the magazine pot and the spindle/standby, tool registration duplication can be checked. Either of "Executing the duplication check for all valid magazines", "The duplication check invalid" or "Executing the duplication check only in the selected magazine" can be selected by the parameter "#8922 T-reg-dup check".

<Priority of duplication check>

Operation	Setting of the operation parameter "#8922 T-reg-dup check"		
	0: Executing the duplication check for all valid magazines	1: The duplication check invalid	2: Executing the duplication check only in the selected magazine
Register tool to magazine pot (Refer to "5.2.1 Registering a Tool in the Magazine Pot".)	1. Magazine n (n =1,2...) 2. Spindle/standby	The duplication check is not executed.	1. Selected magazine 2. Spindle/standby
Set tool No. to spindle/standby (Refer to "5.2.3 Setting and Erasing the Tool No. of Spindle/Standby Tools".)	1. Spindle/standby 2. Magazine n (n =1,2...)	The duplication check is not executed.	1. Spindle/standby 2. Selected magazine

When the value of the parameter "#8922 T-reg-dup check" is out of the range, the check of setting "0" is performed (Executing the duplication check for all valid magazines).

5.2.1 Registering a Tool in the Magazine Pot

Operation method (Selecting a magazine No.)

- (1) Press the menu [Magazn 2].  The tool data of the set magazine No. appears.

Note

- (1) The No. of magazines differs according to the machine specification.

Operation method (Registering the tool in the magazine pot)



- (1) Designate the pot No.
[Pot No search] 21 [INPUT]
- (2) Input the tool number.
50 [INPUT]
- When the [INPUT] key is pressed without setting a value, the tool number does not change and the cursor moves to the "tool number" for the next pot number.
-  When the duplication check is valid, the operation message "Exists in magazine 1. Set?(Y/N)" or "Exists in spindle/standby. Set?(Y/N)", etc. appears if the input tool No. already exists invalid magazine, spindle/standby.

Note

- (1) Move the cursor with  key to set the "D" data. Refer to the manual issued by the MTB for details on the "D" functions and purposes.
- (2) The duplication check is executed for only the tool No. The check does not depend on the setting of "D".
- (3) If parameter "#8922 T-reg-dup check" is set to "1", the operation message will not appear even when the tool No. duplicates.
- (4) The magazine to be checked varies depending on the setting of the parameter "#8922 T-reg-dup check".

5.2.2 Setting the PLC Command

Operation method (Setting the PLC command)



- (1) Set the value after the menu [PLC command].
[PLC command] 12 [INPUT]  The set value displays in the PLC command setting field, and the PLC command setting mode is enabled. The function of the command depends on the MTB specifications.
- (2) Press the menu [PLC command], or the  key to  The PLC command setting mode is released, and the menu highlight returns to normal. complete the setting.

Note



- (1) Select the menu [PLC Command] again before pressing the [INPUT] key, then the menu highlight returns to normal, and the PLC command setting mode becomes disable.

5.2.3 Setting and Erasing the Tool No. of Spindle/Standby Tools

Operation method (Setting the tool No. of spindle/standby tools)

- (1) Press the menu [Spindle standby].
- (2) Move the cursor to the data to be set using the [↑], [↓] keys.
- (3) Input a new tool No.
50 [INPUT]
- (4) Press the menu [Spindle standby] or  to complete  The spindle/standby setting mode is canceled.
the setting.

Note

- (1) When the menu [Spindle standby] or  key is pressed before pressing the [INPUT] key, the spindle/standby setting mode will be canceled and the set data will be ignored.
- (2) Move the cursor with  key to set the "D" data.

Operation method (Erasing the tool No. of spindle/standby tools)

- (1) Press the menu [Spindle standby].
- (2) Move the cursor to the tool No. to be erased and input "0".
0 [INPUT]

Note

- (1) Move the cursor with  key and set "0" to erase the "D" data as the same manner as the tool No.

5.2.4 Erasing the Tool Registration Data

Operation method (Selecting a magazine number and erasing the tool registration data.)

- (1) Press the menu [Magazn 2].
- (2) Press the menu [Magazn clear].
- (3) Press the [Y] or [INPUT] key.  All selected magazine tool data (tool number and D) is erased.
Spindle/standby tool data is not erased.

5.3 Measuring a Tool (Tool Measurement Screen)



5.3.1 Tool Measurement (M System)

On the tool registration (T-reg) screen of the setup (Setup) screen, the movement distance from the basic point to the measurement point is measured by moving the tool to the measurement point manually, and this value can be set as the tool compensation amount.

Manual numerical value command can be executed when manual numerical value command window is displayed by inputting an address key such as MST, etc.

There are two types of tool measurement: Tool length measurement I, Tool length measurement II.

■ Tool length measurement I

When the tool is at the machine coordinate zero point, the distance from the tool tip to the measurement point (workpiece upper end) is measured, and can be set as tool compensation data.

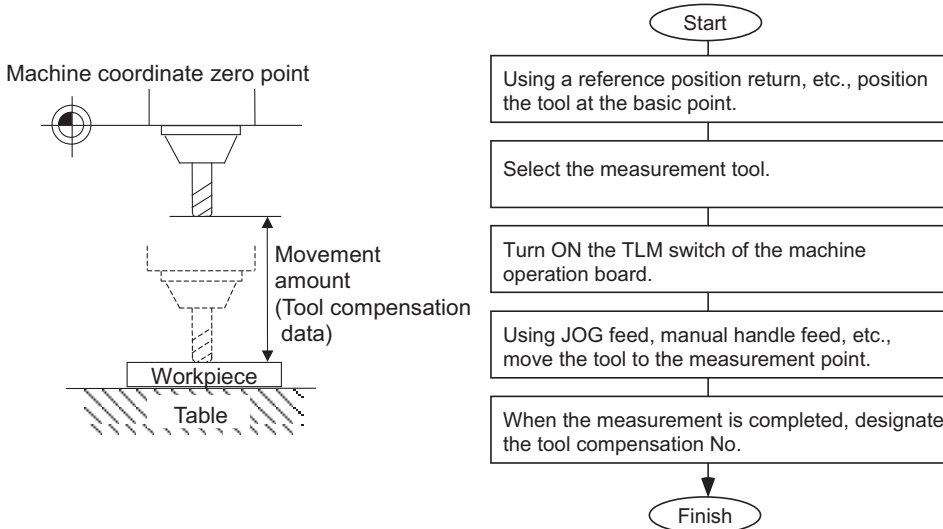

■ Tool length measurement II

When the tool is at the machine coordinate zero point, the distance from the machine coordinate zero point to the tool tip is measured, and can be set as tool compensation data.

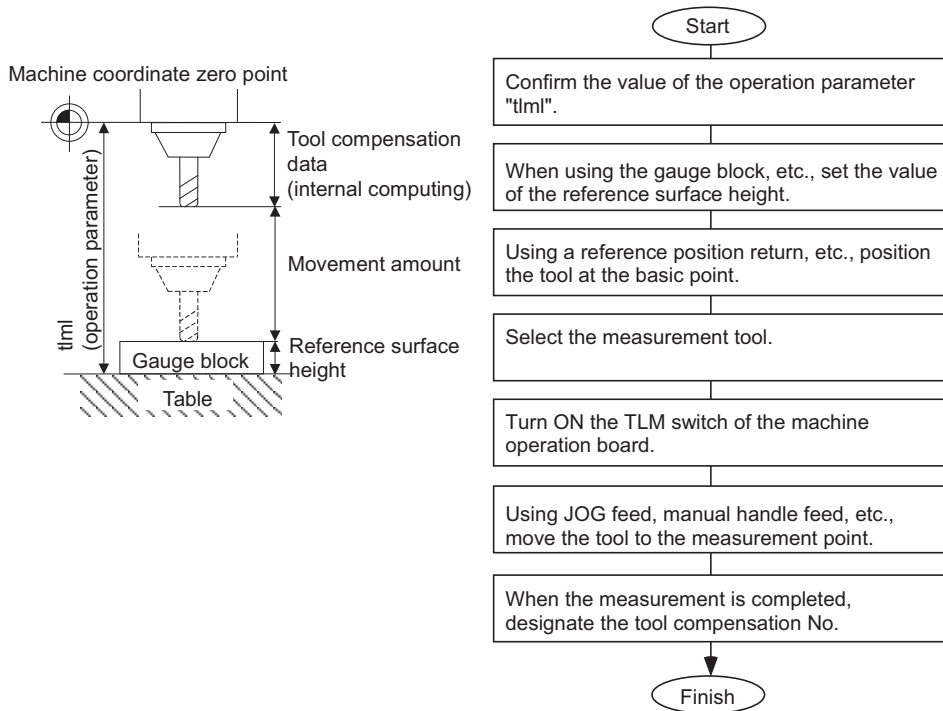

■ Note

(1) The tool measurement type is determined based on TLM reference length (parameter "#2016 tImI+" (TLM standard length)) of measurement axes (tool length measurement axis and tool radius measurement axis) at each measurement mode. When parameter "#2016 tImI+" (TLM standard length) is set to "0", and "Surface height #0 = 0" is set, the tool measurement type is tool length measurement I.

■ Screen image

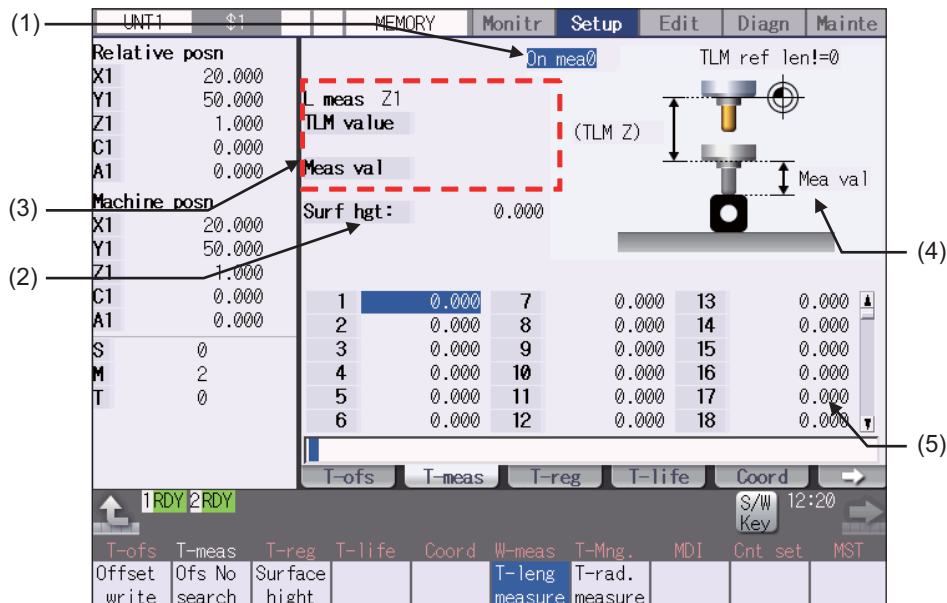

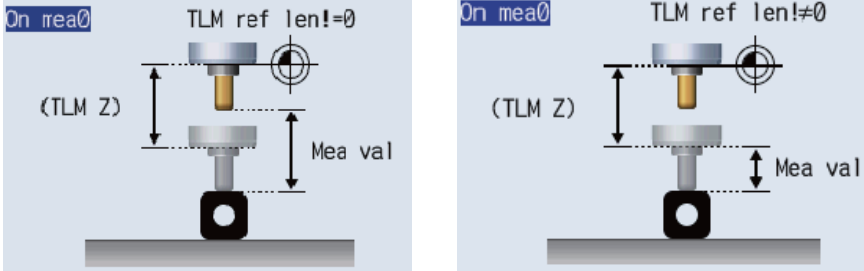
Display items	
Display items	Details
(1) Manual measurement status display	This displays the manual measurement status. Refer to "Manual measurement status display" described later in this section.
(2) Reference surface height	This displays a value for the reference surface height. Setting range: -99999.999 to 99999.999 (mm)
(3) Counter display	TLM value: This displays the value during measurement. (*1) This will be the same as the machine position until the sensor is contacted. This will be the skip coordinate position after the sensor is contacted. Measurement value: For tool length measurement type I: TLM value - Reference surface height For tool length measurement type II: TLM value - Reference surface height + TLM reference length For tool radius measurement, measurement result is displayed in absolute position.
L meas: (Axis name) R meas: (Axis name)	The axis selected in the parameters "#8711 TLM L meas axis" and "#8712 TLM D meas axis" is the target axis for the measurement.
(4) Guide graphic	Displays the measurement image. The contents of the guide drawing will differ depending on the tool length measurement (I or II). Tool length measurement I guide drawing Tool length measurement II guide drawing 
(5) Tool compensation data	Displays the tool compensation data. The contents of the tool compensation data to be displayed vary depending on the tool compensation type (I, II, or III). When tool compensation type III is selected, the display is the same as for tool compensation type II. Cursor movement, data input and part system changing operation are same as tool compensation types I and II.

(*1) The TLM value counter differs according to the parameter "#1328 TLM type" value.
 0: The position when the measurement switch was turned ON is displayed as 0.
 1: The display is based on the machine zero point.





Note

(1) If the parameter "#11017 T-ofs set at run" is set to "1", the tool compensation amount data can be measured in the automatic operation mode or operation pause mode.

Menus

Menus	Details
Offset write	This writes the value displayed in "Mea value" as the tool compensation amount. The wear amount is cleared to "0" for the tool compensation type II. The tool compensation amount cannot be written when the menu [Offset No.] or [Surface hight] is highlighted. <Note> •When the parameter "#8924 Meas. confirm msg" is "1", this menu is highlighted and the operation message "OK?(Y/N)" appears. The measurement result is written as tool compensation amount by pressing [Y] or [INPUT] key. Even if other key is pressed, the result is not written. When this menu is pressed again while displaying the message, the highlighting is canceled and the operation message is erased.
Ofs No search	When the compensation No. is set and the [INPUT] key is pressed, the tool compensation data with that number at its head appears. The cursor moves to the length dimension data of the top line of that data.
Surface hight	This sets the reference surface height data. (The cursor moves to the reference surface height.) When the data is set in the input area and the [INPUT] key is pressed, the reference surface height is set.
T-leng measure	This changes the mode to the tool length measurement mode. This mode is enabled when turning ON the power. (The cursor moves to the length dimension position for tool compensation type II or III.)
T-rad. measure	This changes the mode to the tool radius measurement mode. (The tool measurement type is valid only for tool length measurement II.) (The cursor moves to the radius dimension position for tool compensation type II or III.)

Carrying out tool length measurement

- (1) Turn ON the measurement switch.
Refer to "PLC Interface Manual" for details on measurement switch signals.  The message "On mea 0" appears.
- (2) Press the menu [T-leng measure].  The menu is highlighted, and the tool length measurement starts. The measurement values are displayed in "Meas value" during the measurement.
The menu [T-leng measure] is highlighted as a default after the power is turned ON.
- (3) Contact the measurement tool against the sensor, using manual feed and manual handle feed. Stop the feed when the tool contacts the sensor.  When the measurement tool contacts the sensor, the skip position displayed in the measurement values counter.
- (4) The cursor moves to the compensation No. that sets the measurement results.
(Example) [Ofs No search] 12 [INPUT]
The cursor display position differs depending on the measurement mode.
Tool length measurement mode: Length dimension
Tool radius measurement mode: Radius dimension
- (5) Press the menu [Offset write].  The measurement values are written as a tool compensation amount.
The wear amount is cleared to "0" for the tool compensation type II.
- (6) Turn OFF the measurement switch to finish measuring.

Note

- (1) The measurement values are not written if the cursor is in a position other than "Length" or "Radius".
- (2) The axis returns and stops after contacting the sensor, but be careful not to move the axis after that. If the axis moves after contacting the sensor, the distance that was actually moved will be added to the measurement values counter, and the skip position will not be held.

Manual measurement status display

The display will change as shown below during manual measurement.

Display	Meaning
On mea 1	This state is entered if a skip signal is input during manual measurement. The "On mea 2" state is shifted to after deceleration stop is confirmed.
On mea 2	This is the state during the first retract operation. The "On mea 3" state is shifted to after retracting the retract amount.
On mea 3	This is the state in which retract by the retract amount has completed. If the skip after deceleration stop confirmation signal is ON, the status display will remain the same. The "On mea 0" state is shifted to when this state is reset.
On mea 4	This is the state during the second measurement. If the skip signal is not input even after moving to the specified position, a warning will appear, and the status display will remain the same. The "On mea 0" state is shifted to when this state is reset.
On mea 5	This state is entered when the skip signal is input during the second measurement. The "On mea 6" state is shifted to after deceleration stop is confirmed.
On mea 6	This is the state during the second return operation. The "On mea 0" state is shifted to after retracting the retract amount.
On mea 0	This state is entered when not in the "On mea 1" to "On mea 6" states.

Carrying out tool radius measurement

The operating procedure of the tool radius measurement and submenu details are the same as when measuring tool length. (Use [T-rad. measure] instead of [T-leng measure].)

5.3.2 Tool Measurement (L System)

Manual tool length measurement I or II can be performed on the tool registration (T-reg) screen of the setup (Setup) screen. Either one is selected depending on the setting of measurement switch and operation mode.

Manual numerical value command can be executed when manual numerical value command window is displayed by inputting an address key such as MST, etc.

There are two types of key operation for Manual tool length measurement I: normal operation mode and simple operation mode, which can be selected by the parameter "#8957 T meas (L)-Simple".

#8957	Manual tool length measurement I operation mode
0	Normal operation mode
1	Simple operation mode

■ Manual tool length measurement I (when measurement switch is ON)

This is the function to calculate the tool length compensation amount automatically by moving the tool to the measurement point with manual feed.

Move the tool to the face or side, and calculate the tool compensation amount from the measurement position (machine position) and program zero point offset (L).

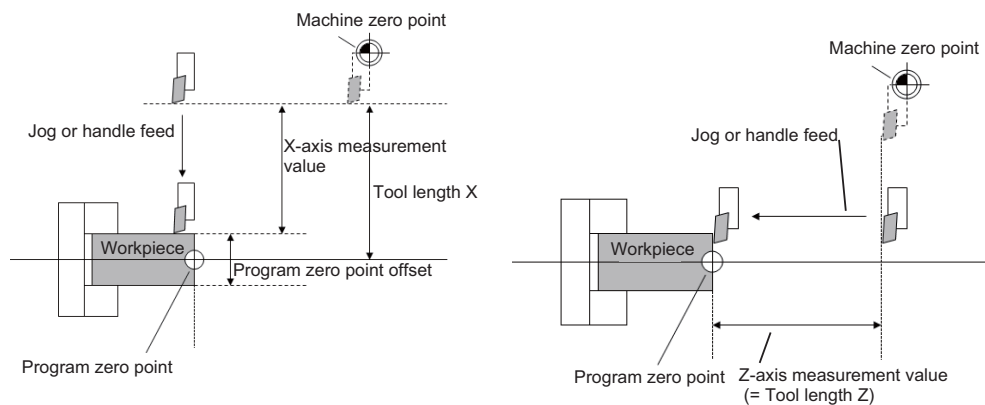

The tool length is automatically calculated by the following formula:

Tool length = Measurement position - Program zero point offset (L)

Note

- (1) For the program zero point offset (L), set the diameter value for a diameter axis (#1019 dia = 1) or the radius value for a radius axis (#1019 dia = 0).

■Manual tool length measurement II

<When operation mode is set to a handle mode ("JOG", "HANDLE", "RAPID" or "STEP") while the measurement switch is being ON>

By using a device having a touch probe, the tool compensation amount can be calculated just by contacting the tool nose against the touch probe with manual feed.

Set the measurement basic position (sensor position) with the parameter "#2015 tml-" and "#2016 tml+" when using the main spindle side, "#2097 tml-" and "#2098 tml+" when using the sub spindle side.

[Setting the measurement basic position]

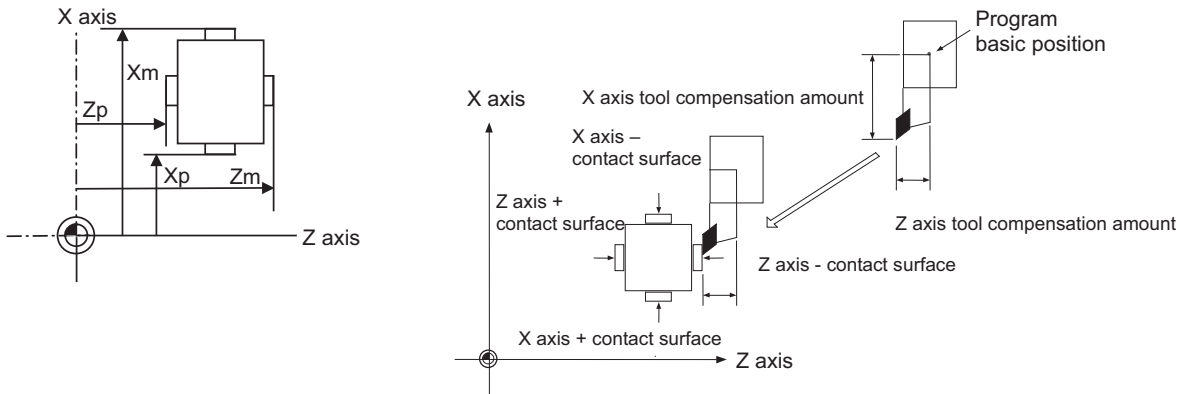

When measured at the main spindle side:

Xm: - sensor machine coordinate position X axis (position measured by moving in - direction) -> #2015 tml- X axis

Zm: - sensor machine coordinate position Z axis (position measured by moving in - direction) -> #2015 tml- Z axis

Xp: + sensor machine coordinate position X axis (position measured by moving in + direction) -> #2016 tml+ X axis

Zp: + sensor machine coordinate position Z axis (position measured by moving in + direction) -> #2016 tml+ Z axis

When measured at the sub spindle side:

Xm: - sensor machine coordinate position X axis (position measured by moving in - direction) -> #2097 tml2- X axis

Zm: - sensor machine coordinate position Z axis (position measured by moving in - direction) -> #2097 tml2- Z axis

Xp: + sensor machine coordinate position X axis (position measured by moving in + direction) -> #2098 tml2+ X axis

Zp: + sensor machine coordinate position Z axis (position measured by moving in + direction) -> #2098 tml2+ Z axis

Tool compensation amount = Machine coordinate position (machine coordinate position at the time of skip input) - Measurement basic position (sensor position)

The expression above is used for automatic calculation in Manual tool length measurement II.

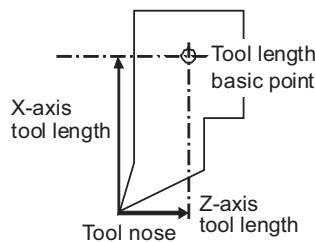

When the tool touches the touch probe while measurement switch is ON, the calculation result is set in the tool data of the compensation No. specified with "Tool No. (Tool length measurement 2)" (PLC device), and the wear data of the compensation No. set in "Wear compensation No. (Tool presetter)" (PLC device) is cleared.

Note

(1) The compensation No. cannot be selected by using [\uparrow], [\downarrow] or page changeover keys while the measurement switch is being ON. Operations such as selecting an axis, and moving cursor to the wear data or the tool length data, are available by using said keys.

When measuring the tool length of the basic axis and inclined axis during the inclined axis control, the measurement basic position (sensor position) is set on the sensor position within the orthogonal coordinate, not the position within the machine coordinate.

(Example) When X axis is the basic axis and Y axis is the inclined axis.

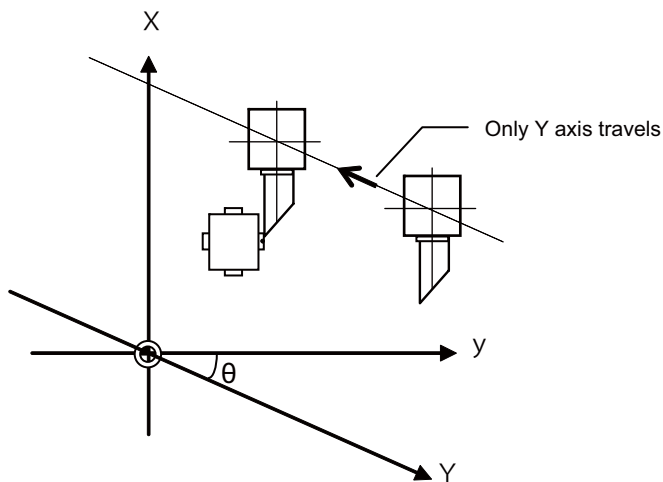

X: Actual X axis
Y: Actual Y axis
y: Orthogonal coordinate
 θ : Inclined angle

■Screen image

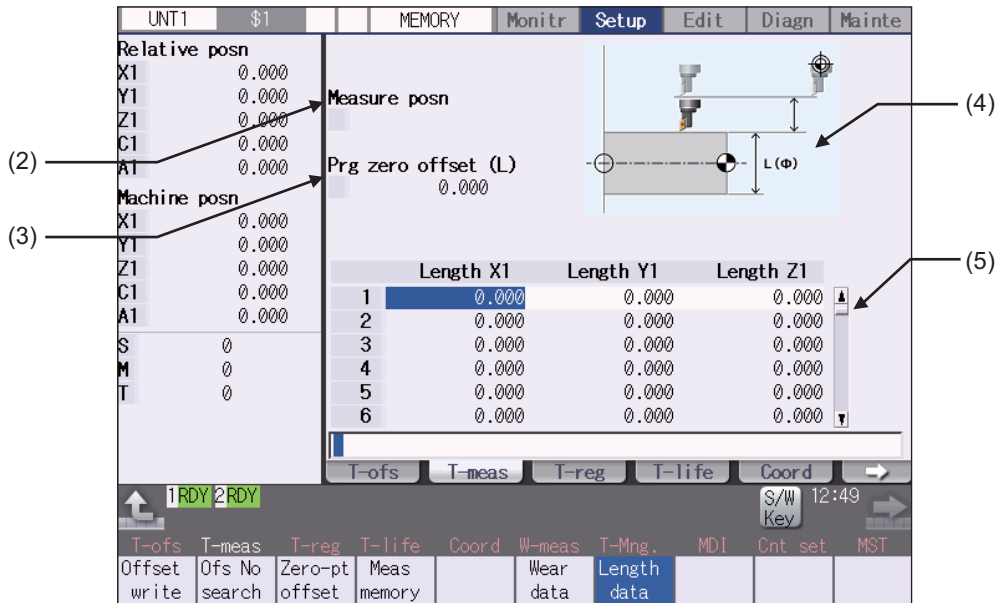

[Manual tool length measurement I]

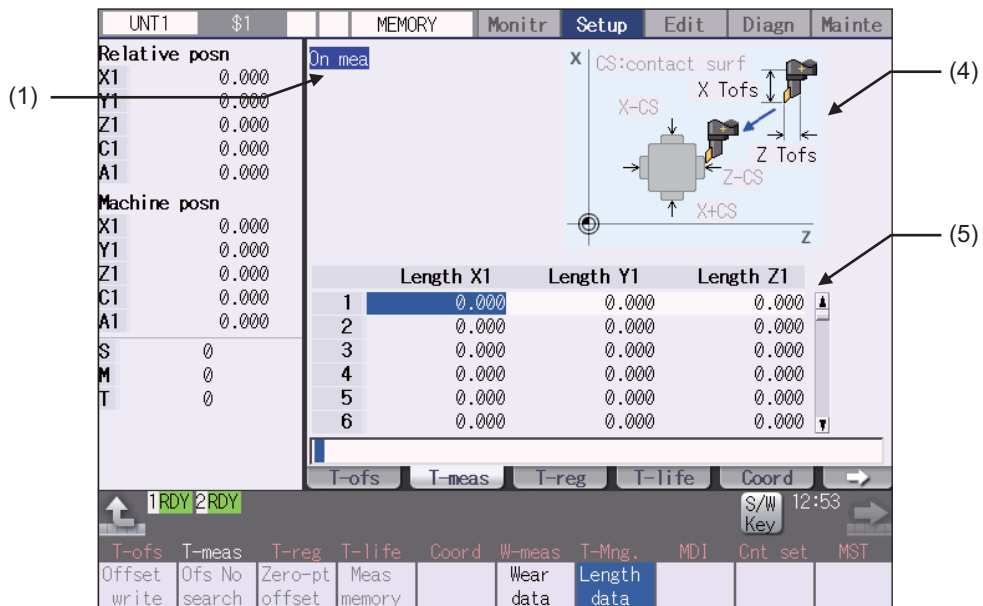

[Manual tool length measurement II]

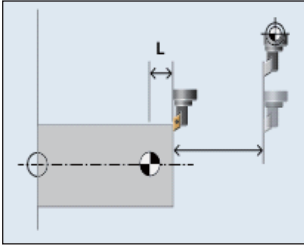
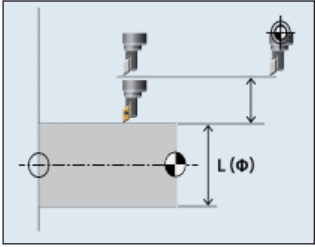
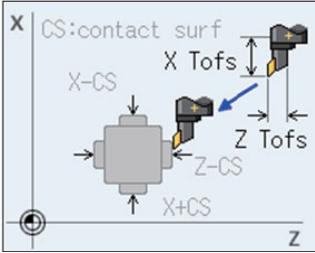

Display items	
Display items	Details
(1) On mea	<p>"On mea" is displayed when the measurement switch is ON.</p> <p><Note></p> <ul style="list-style-type: none"> ♦This is displayed only in "Manual tool length measurement II".
(2) Measure posn	<p>When "Manual tool length measurement I" is performed, the measurement result and measurement axis are displayed.</p> <p><Normal operation mode></p> <p>Measurement result is displayed by pressing the menu [Meas memory] when the cursor is placed at the axis to be measured.</p> <p>Measurement Position: Machine position when the menu operation is performed.</p> <p><Simple operation mode></p> <p>Measurement result for the axis selected using either the menu [Measure X] or the axis address key.</p> <p>Measurement Position: Machine position when the menu operation or address key operation is performed.</p> <p><Note></p> <ul style="list-style-type: none"> ♦This is displayed only in "Manual tool length measurement I". ♦The data of maximum 3 axes displays when "Manual tool length measurement I (Simple operation mode)" is selected. ♦The axis names set in the parameter "#1022 axname2" are displayed.
(3) Prg zero offset (L)	<p>Workpiece measurement result is set and displayed.</p> <p>Setting range: -99999.999 to 99999.999 (mm)</p> <p><Normal operation mode></p> <p>Setting is possible by pressing the menu [Zero-ptoffset] or touching the value area of the "Prg zero offset (L)".</p> <p><Simple operation mode></p> <p>Select the axis to measure using either the menu [Measure X] or the axis address key. Then the cursor moves to "Prg zero offset (L)", where setting a measured value is enabled.</p> <p><Note></p> <ul style="list-style-type: none"> ♦The data of maximum 3 axes displays when "Manual tool length measurement I (Simple operation mode)" is selected.

Display items	Details
<p>(4) Guide graphic</p>	<p>Displays the measurement image. The contents of the guide drawing will differ depending on which measurement type (Manual tool length measurement I or II) is selected.</p> <p><Manual tool length measurement I></p> <ul style="list-style-type: none"> •Normal operation mode The guide drawing is switched to the axis pointed by the cursor in the tool compensation data. •Simple operation mode The guide drawing is switched to the selected axis, when the handle mode is selected. <p><Z axis></p>  <p><Other axes></p>  <p><Manual tool measurement II></p> <p>The guide drawing when using the touch probe is displayed.</p> 
<p>(5) Tool compensation data</p>	<p>Displays the tool compensation data.</p> <p><Note></p> <ul style="list-style-type: none"> •Cursor movement, data input and part system changing operation are same as "Tool compensation type III (L system)". •Automatically jumps to the compensation No. registered in "Tool No. (Tool length measurement 2)" (PLC device) during manual tool length measurement II. (Jumps even when the wear data is being displayed.) Note that the [↑], [↓],  and  keys are disabled.

Note

- (1) The values of "Measure posn" and "Prg zero offset (L)" will be cleared when changing of part systems, screens and measurement modes are carried out.
- (2) When the parameter "#11017 T-ofs set at run" (Tool compensation amount setting during automatic operation enabled) is set to "1", the tool compensation amount data can be set even during automatic operation or operation pause.

Menus (Manual tool length measurement I (normal operation mode) and manual tool length measurement II)

Menus	Details
Offset write	<p>Depending on the mode, the following value is input as the tool compensation amount at the cursor position, and the wear amount is cleared to "0".</p> <p>Manual tool length measurement I Tool compensation amount = "Measure posn" value - "Prg zero offset (L)" value The values of "Meas posn" and "Prg zero offset (L)" will be cleared after compensation amount is written in "Manual tool length measurement I".</p> <p><Note></p> <ul style="list-style-type: none"> ♦ Tool compensation amount cannot be written in the following cases: <ul style="list-style-type: none"> - When the menu [Offset No.] and [Zero-ptoffset] are highlighted - When the wear data is being displayed - When the measurement result exceeds the setting range ♦ If "Manual tool length measurement II", this is grayed out and non-selectable. ♦ When the parameter "#8924 Meas. confirm msg" is "1", this menu is highlighted and the operation message "OK?(Y/N)" appears. The measurement result is written as tool compensation amount by pressing [Y] or [INPUT] key. Even if other key is pressed, the result is not written. When this menu is pressed again while displaying the message, the highlighting is canceled and the operation message is erased.
Ofs No search	<p>When the compensation No. is set and the [INPUT] key is pressed, the tool compensation data with that number at its head appears.</p> <p><Note></p> <ul style="list-style-type: none"> ♦ If the measurement switch is turned ON, this is grayed out and non-selectable.
Zero-pt offset	<p>This sets the "Prg zero offset (L)" value. If this menu is pressed, the cursor moves to the "Prg zero offset (L)" value.</p> <p>Point the cursor to the axis to be set, and set the data in the data setting area. Press the [INPUT] key to set the "Prg zero offset (L)" value.</p> <p><Note></p> <ul style="list-style-type: none"> ♦ If any mode other than "Manual tool length measurement I" is selected, this is grayed out and non-selectable.
Meas memory	<p>Measurement result is calculated from the current machine position and displayed.</p> <p><Note></p> <ul style="list-style-type: none"> ♦ If any mode other than "Manual tool length measurement I" is selected, this is grayed out and non-selectable.
Wear data	<p>Wear data is displayed in tool compensation data.</p>
Length data	<p>Tool length data is displayed in tool compensation data. This is the default mode when the power is initially turned ON.</p>

Note

- (1) The data displayed on the tool offset screen are not linked with the tool offset data on the tool measurement screen. (If the tool measurement screen is opened with tool wear data shown on the tool offset screen, the wear data will not always appear on the tool measurement screen.)

Menus (Manual tool length measurement I (simple operation mode))

Menus	Details
Offset write	<p>The following value is written as the tool compensation amount, and the wear is cleared to "0".</p> <p>Tool compensation amount = "Measure posn" value - "Prg zero offset (L)" value</p> <ul style="list-style-type: none"> ◆When the tool offset is written, the "Measure posn" and "Prg zero offset (L)" are cleared. The cursor moves to the tool compensation data. ◆The offset cannot be written in the following state. The operation message - "Can't write compensation data" is displayed. <ul style="list-style-type: none"> (a) When the menu [Offset number] is highlighted (b) During wear data display (c) When the measurement axis is not selected ◆If the tool compensation amount is outside the setting range, the offset writing fails. The operation message "Setting error" is displayed. <p><Note></p> <ul style="list-style-type: none"> ◆When the parameter "#8924 Meas. confirm msg" is set to "1", the menu "Offset write" is highlighted and confirmation message "OK?(Y/N)" is displayed. When you press the [Y] (or [INPUT]) key, the measurement position is written as the tool compensation amount. When you press any other key, the offset is not written. At this time, menu highlighting is canceled and the operation message is erased. <p>If you press the menu [Offset Write] again during operation message display, the reverse display is released and the operation message is also erased.</p>
Ofs No search	<p>When the compensation No. is set and the [INPUT] key is pressed, the tool compensation data with that number at its head appears.</p> <p>This operation will not change the column where the cursor is placed.</p> <p>If this operation is carried out with the cursor placed at "Prg zero offset (L)", the cursor will remain displayed at "Prg zero offset (L)".</p>
Measure X	<p>Select the axis to measure. The menu is highlighted when it is selected. Multiple axes can be selected. To cancel, press the menu key again or press [Cancel value]. (*1)</p>
Measure Z	<p>Select the axis to measure. The menu is highlighted when it is selected. Multiple axes can be selected. To cancel, press the menu key again or press [Cancel value]. (*1)</p>
Measure C	<p>Select the axis to measure. The menu is highlighted when it is selected. Multiple axes can be selected. To cancel, press the menu key again or press [Cancel value]. (*1)</p>
Wear data	<p>Wear data is displayed in tool compensation data.</p>
Length data	<p>Tool length data is displayed in tool compensation data.</p> <p>This mode is enabled when turning ON the power.</p>
Cancel value	<p>This cancels displaying the value of the measurement result and "Prg zero offset (L)". The cursor moves from "Prg zero offset (L)" to the tool compensation data.</p> <p>If any mode other than "Manual tool length measurement I" is selected, this menu will be grayed out and non-selectable.</p>

(*1) The axis name to be displayed follows the parameter "#1022 axname2".





Note

- (1) The data displayed on the tool offset screen are not linked with the tool offset data on the tool measurement screen. (If the tool measurement screen is opened with tool wear data shown on the tool offset screen, the wear data will not always appear on the tool measurement screen.)

Carrying out tool measurement (Manual tool length measurement I)





■ Normal operation mode

(Example) Carrying out tool measurement for compensation No.3, X axis

- (1) Select the tool to be measured with manual numerical value command. (Refer to "8.4 Manual Numerical Value Command" for details.)
- (2) Point the cursor to the position (compensation No. 3, X axis) where the measurement result are to be set.  The cursor is displayed at compensation No.3, X axis.
<Note>
 - In order to measure a different axis, point the cursor to the axis to be measured and perform the following operations.
- (3) Move the tool to the side surface of the workpiece. (In the case of Z-axis move the tool to the end surface of the workpiece.)
- (4) The menu [Meas memory] is pressed without retracting the tool.  Save the measurement result. Saved value is displayed in the measurement area.
- (5) Retract the tool and measure the workpiece. And then press the menu [Zero-ptoffset].  The menu [Zero-ptoffset] is highlighted and the cursor moves to the program zero-point offset (L) value.
- (6) Measure the workpiece and set the offset value from the tool position (side surface of the workpiece) to the program zero-point.
10 [INPUT]  10 is set for the "Prg zero offset (L)" value. Highlight of the menu [Zero-ptoffset] is canceled and the cursor moves to the tool compensation data.
<Note>
 - Compensation amount is written in diameter value for diameter command, or in radius value for radius command.
- (7) Press the menu [Offset write].  "Measurement result - workpiece measurement value" is set to compensation No.3, X axis.
<Note>
 - The values of "Measure posn" and "Prg zero offset (L)" are cleared.

■ Simple operation mode



(Example) Carrying out tool measurement for compensation No. 3, X axis

- (1) Select the tool to be measured with manual numerical value command. (Refer to "8.4 Manual Numerical Value Command" for details.)
- (2) Move the cursor to the position to input the measurement result (compensation No.3).  The cursor is displayed at compensation No.3.
- (3) Move the tool to the side surface of the workpiece. (In the case of Z-axis move the tool to the end surface of the workpiece.)
- (4) Press the address key of the axis to measure or the menu [Measure X], without retracting the tool.  Save the measurement result. The memorized value is displayed at "Prg zero offset (L)", and the cursor moves to "Work meas".
The operation message "Input program Z-point offset" displays.
- (5) To measure the other axes at the same time, repeat (3) to (4).  Save the measurement value of the selected axis. Saved value is displayed in the measurement area. The cursor will not move from the top line.
- (6) Retract the tool and measure the workpiece.
- (7) Measure the workpiece and set the offset value from the tool position (side surface of the workpiece) to the program zero-point. (Example) 10 [INPUT]  The value 10 is set in the top line of "Prg zero offset (L)". If there are two or more axes to measure, the cursor moves down to the next line.
<Note>
♦ Compensation amount is written in diameter value for diameter command, or in radius value for radius command.
- (8) To set the "Prg zero offset (L)" of the other axes, repeat (7). (Example) 5 [INPUT]  The value "5" is set to the 2nd line of "Work meas".
<Note>
♦ Compensation amount is written in diameter value for diameter command, or in radius value for radius command.
- (9) Press the menu [Offset write].
The result of "Meas val - Prg zero offset (L)" will be set as the compensation amount for X and Z axes of the compensation No.3 (where the cursor is currently positioned).
<Note>
♦ The values of "Measure posn" and "Prg zero offset (L)" are cleared, and the highlighted menus ([Measure X] - [Measure C]) will return to original status.

Precautions for manual tool measurement I

- (1) When compensation amount is written for an axis that has not completed zero point return, the operation message "TLM axis not returned to ref. position" will appear.
- (2) When the parameter "#8924 Meas. confirm msg" is set to "1", the menu "Offset write" is highlighted and confirmation message "OK?(Y/N)" is displayed. When you press the [Y] (or [INPUT]) key, the measurement position is written as the tool compensation amount. When you press any other key, the offset is not written. At this time, menu highlighting is canceled and the operation message is erased.
- (3) When the parameter "#1124 ofsfix" is set to "0", the cursor moves to the next offset No. However, when "#1124 ofsfix" is "1", the cursor does not move to the next offset No.
- (4) When the parameter "#11017 T-ofs set at run" (Tool compensation amount setting during automatic operation enabled) is set to "1", the tool compensation amount data can be set even during automatic operation or operation pause.

Carrying out tool measurement (Manual tool length measurement II)

- (1) Select the tool to be measured with manual numerical value command. (Refer to "8.4 Manual Numerical Value Command" for details.)
- (2) Set the compensation No. of the compensation data to be set in "Tool No. (Tool length measurement 2)" (PLC device).
- (3) Set the compensation No. of the wear data to be cleared in "wear compensation No. (tool presetter)" (PLC device).
- (4) Turn ON the measurement switch.  "On mea" is displayed.
Guide drawing for manual tool length measurement II is displayed.
Tool compensation data is displayed, placing the compensation No. set in "Tool No. (Tool length measurement 2)" (PLC device) at the top.
<Note>
♦The row at the cursor position will not be changed.
- (5) Move the additional axis in the minus direction by manual feed and have the tool nose contact with the touch probe.  Measurement value is set for the additional axis of the compensation No. set in "Tool No. (Tool length measurement2)" (PLC device).
- (6) Turn the measurement switch OFF.  "On mea" disappears.

Note

- (1) When entering the sensor area, the axis can be moved only in one direction selected from +X, -X, +Z, -Z, (+Y, -Y). If two axes are moved simultaneously, measurement will not be carried out. However the axis movement stops for safety with displaying "TLM axis is illegal".
- (2) If the tool nose is contacting the sensor, the axis can be moved only in the direction moving away from the sensor. Whether or not the tool nose is detached from the sensor can be judged by the following conditions.
 - ♦The sensor signal has been turned OFF for 500 ms or more.
 - ♦The tool nose is moved 100 μm or more after the sensor signal has turned OFF.
 The above conditions are set with parameter "#1227 aux11/bit2" (measures against tool setter chattering).

5.4 Setting Tool Compensation Amount (Tool Offset Screen)



The tool compensation data can be set and displayed tool offset (T-ofs) screen of the setup (Setup) screen.

Depending on the value of the parameter "#1037 cmdtyp", there are three types of tool compensation: M system tool compensation type I (cmdtyp=1), tool compensation type II (cmdtyp=2), and L system tool compensation type III (cmdtyp=3). The tool radius compensation can be carried out using the diameter value if the parameter "#8117 OFS Diam DESIGN" is set to ON.

The number of tool compensation sets to be designated or displayed varies depending on the specifications.

Tool compensation data can be set or displayed on the monitor (Monitr) screen.

Note

(1) When the tool compensation amount setting during automatic operation is enabled ("#11017 T-ofs set at run" = "1"), the tool compensation amount data can be set even during automatic operation or operation pause.

[Tool compensation type I] (M System): Parameter "#1037 cmdtyp" = 1

The combined amount of the shape compensation and wear compensation are set as the compensation data, with no distinction between shape compensation memory and wear compensation memory. (The tool compensation data is the shape compensation amount + wear compensation amount.)

The compensation data is used commonly for the tool length compensation, tool position offset, tool radius compensation, and 3-dimensional tool radius compensation.

UNT1	\$1	MEMORY	Monitr	Setup	Edit	Diagn	Mainte
Relative posn							
X1	0.000	1	0.000	16	0.000	31	0.000
Y1	0.000	2	0.000	17	0.000	32	0.000
Z1	0.000	3	0.000	18	0.000	33	0.000
C1	0.000	4	0.000	19	0.000	34	0.000
A1	0.000	5	0.000	20	0.000	35	0.000
Machine posn							
X1	0.000	7	0.000	22	0.000	37	0.000
Y1	0.000	8	0.000	23	0.000	38	0.000
Z1	0.000	9	0.000	24	0.000	39	0.000
C1	0.000	10	0.000	25	0.000	40	0.000
A1	0.000	11	0.000	26	0.000	41	0.000
S	0	12	0.000	27	0.000	42	0.000
M	0	13	0.000	28	0.000	43	0.000
T	0	14	0.000	29	0.000	44	0.000
		15	0.000	30	0.000	45	0.000

[Tool compensation type II] (M System): Parameter "#1037 cmdtyp" = 2

The shape compensation amount and wear compensation amount are set separately. The shape compensation amount is furthermore divided into length and radius dimensions.

Of the compensation data, the length dimension data is used for the tool length compensation and tool position offset, and the radius dimension data is used for the tool radius compensation and 3-dimensional tool radius compensation (compensation vector designation).

UNT1	\$1	MEMORY	Monitr	Setup	Edit	Diagn	Mainte
Relative posn							
X1	0.000	1	Length	L wear	Radius	R wear	0.000
Y1	0.000	2	0.000	0.000	0.000	0.000	0.000
Z1	0.000	3	0.000	0.000	0.000	0.000	0.000
C1	0.000	4	0.000	0.000	0.000	0.000	0.000
A1	0.000	5	0.000	0.000	0.000	0.000	0.000
Machine posn							
X1	0.000	7	0.000	0.000	0.000	0.000	0.000
Y1	0.000	8	0.000	0.000	0.000	0.000	0.000
Z1	0.000	9	0.000	0.000	0.000	0.000	0.000
C1	0.000	10	0.000	0.000	0.000	0.000	0.000
A1	0.000	11	0.000	0.000	0.000	0.000	0.000
S	0	12	0.000	0.000	0.000	0.000	0.000
M	0	13	0.000	0.000	0.000	0.000	0.000
T	0	14	0.000	0.000	0.000	0.000	0.000
		15	0.000	0.000	0.000	0.000	0.000

[Tool compensation type III] (L System): Parameter "#1037 cmdtyp" = 3

This type has 3 kinds of display such as wear data, tool length data, and nose data. The display can be switched by the sub menu.

■Wear data

Set the wear amount of nose for each tool you use.

When a tool compensation number is designated by the tool command (T command), the wear data is offset together with the tool length data and nose data.

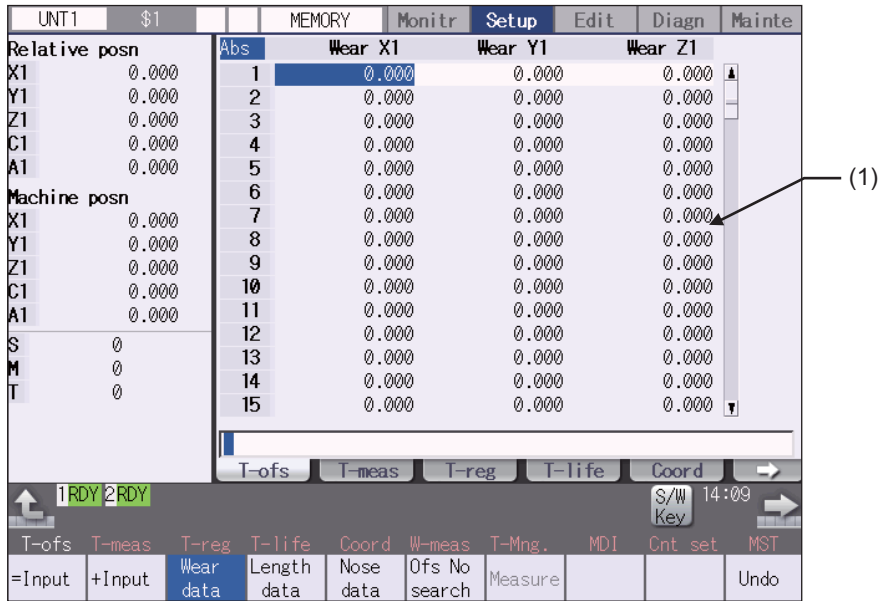

■Tool length data

Set the tool length according to the reference position of program for each tool used.

When a tool compensation number is designated by the tool command (T command), the tool length data is offset together with the wear data and nose data.

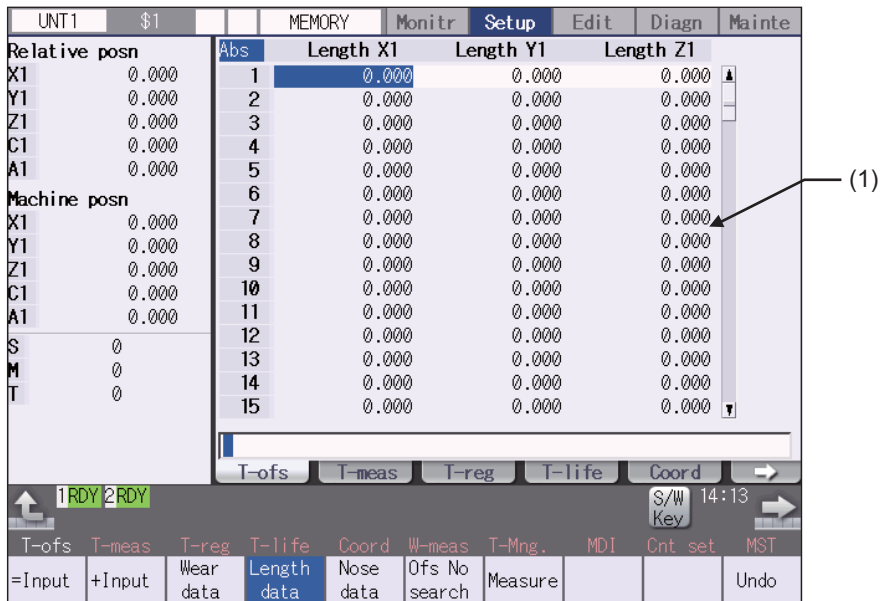

■Nose data





Set the radius (Nose R), wear radius (R-wear), and point (Point) of the nose that is mounted on the tool for each tool used.

When a tool compensation number is designated by the tool command (T command), the nose data is offset together with the tool length data and wear data.

Relative posn	Abs	Nose R	R-wear	Point
X1	0.000	0.000	0.000	0
Y1	0.000	0.000	0.000	0
Z1	0.000	0.000	0.000	0
C1	0.000	0.000	0.000	0
A1	0.000	0.000	0.000	0
Machine posn				
X1	0.000	0.000	0.000	0
Y1	0.000	0.000	0.000	0
Z1	0.000	0.000	0.000	0
C1	0.000	0.000	0.000	0
A1	0.000	0.000	0.000	0
S	0	0.000	0.000	0
M	0	0.000	0.000	0
T	0	0.000	0.000	0
		0.000	0.000	0

CAUTION
 If the tool compensation amount or workpiece coordinate system offset amount is changed during automatic operation (including during single block stop), the changes will be valid from the command in the next block or after several subsequent blocks.

Display items

Display items	Details
(1) Display area	<p>Displays the tool compensation data. The cursor is displayed, and you can set the data. The data exceeding the display area can be displayed by the following keys.</p> <p>   : Scroll one line at a time. </p> <p>   : Switches the display contents for each number of compensation data sets. </p> <p>Compensation number: This is a compensation data number.</p> <p>The other display items change depending on the tool compensation type. Refer to the following table for details.</p>

<Standard setting/display range >

The display range is when the minimum command unit is 1 μ m ("#1003 iunit"= B, "#1041 Initial inch" = 0).

Type	Setting item	Details	Setting/display range
I	Compensation data	Sets the tool length compensation amount. (*5)	-9999.999 to 9999.999
II	Length	Sets the tool length compensation amount. (*5)	Length dimension/Radius dimension
	L wear	Set the compensation amount of tool length wear. (*5)	-9999.999 to 9999.999
	Radius	Sets the tool radius compensation amount. (*5)	Length wear/Radius wear
	R wear	Set the tool radius wear compensation amount. (*5)	-9999.999 to 9999.999
III	Wear data	Sets the nose wear compensation of 1st axis, 2nd axis, and additional axes. (*1)(*2)(*5)	-9999.999 to 9999.999
	Tool length data	Sets the tool length data compensation amount of 1st axis, 2nd axis and additional axes. (*1)(*2)	-9999.999 to 9999.999
	Nose R (*3)(*6)	Sets the tool radius (Nose R).	-9999.999 to 9999.999
	R wear (*3)(*6)	Sets the tool radius (Nose R) wear.	-9999.999 to 9999.999
	Point (*4)	Sets the nose point (number).	0 to 9

(*1) Select the additional axis by specifying the parameter (#1281 ext17 bit1/#1520 Tchg34).

(*2) If the number of axes in the part system is 2 or less, the name of non-existing axis is displayed according to the parameter setting as follows. Setting the compensation amount to non-existing axis does not mean anything.

If "#1281 (PR) ext17/bit1" (Tool offset additional axis selection) is set to "0":

The axis name is not displayed.

If "#1281 (PR) ext17/bit1" (Tool offset additional axis selection) is set to "1":

If the 2nd axis does not exist, the axis name designated by "#1028 base_K" is displayed. If the additional axis does not exist, the axis name designated by "#1027 base_J" is displayed.

(*3) If parameter "#1019 dia" (Diameter command) is set to "0", set the radius. If it is set to "1", set the diameter.

(*4) The nose point is entered as the absolute value even if you press the menu [+ Input].

(*5) It may differ from the above display/setting range depending on the parameter setting of "#8010 ABS. MAX." or "#8011 INC. MAZ."

(*6) It may differ from the above display/setting range depending on the parameter setting of "#8010 ABS. MAX."

The setting/display ranges are as follows based on the combination of "#1003 iunit" (Input unit) and "#1041 Initial inch".

#1003 iunit	#1041 I_inch	Setting/display range		
		Type II (Length wear/Radius wear)	Type I	Type II (Length dimension/Radius dimension)
		Type III (Wear data/Radius wear)	Type III (Tool length data/Nose R)	
B	0	-999.999 to 999.999		
		-9999.999 to 9999.999		
	1	-99.9999 to 99.9999		
		-999.9999 to 999.9999		
C	0	-999.9999 to 999.9999		
		-9999.9999 to 9999.9999		
	1	-99.99999 to 99.99999		
		-999.99999 to 999.99999		
D	0	-999.99999 to 999.99999		
		-9999.99999 to 9999.99999		
	1	-99.999999 to 99.999999		
		-999.999999 to 999.999999		
E	0	-999.999999 to 999.999999		
		-9999.999999 to 9999.999999		
	1	-99.9999999 to 99.9999999		
		-999.9999999 to 999.9999999		

When data without the decimal point is input, a set unit can be specified by the parameter "#8119 Comp. unit switch".

The standard settings and display ranges are as follows.

Type	Display position
I	Top of display area (*1)
II	Left side of radius (*1)
	Left side of radius wear (*1)
III	Left side of axis name (*2)

(*1) It is displayed when the parameter "#8117 OFS Diam DESIGN" is "1".

(*2) It is displayed at the left of axis name when the parameter "#1019 dia" (Diameter command) is set to "1".

Menus



Menus	Details
=Input	This executes an absolute input. When "#8929 Disable=INPUT:comp" is set to "1", this menu cannot be selected.
+Input	This executes an incremental input.
Wear data	This switches to the wear data display. <Note> ♦This menu is displayed for type III only.
Length data	This switches to the tool length data display. <Note> ♦This menu is displayed for type III only.
Nose data	This switches to the nose data display. <Note> ♦This menu is displayed for type III only.
Ofs No search	When the compensation No. is set and the [INPUT] key is pressed, the tool compensation data with that number at its head appears. The cursor moves to the contents of that first line.
Measure	Measure the tool compensation amount. <Note> ♦This menu is displayed only for type III, and is valid for "L system" and "tool length data display".
Undo	This undoes the last changes to the tool compensation data. (This menu is valid for the "Data Input", "Paste Line" and "Undo" operations.) <Note> ♦When an operation parameter "#8939 Undo confirm msg" is set to "1", the menu is highlighted while the operation message is displayed.
Line copy	This copies the contents of the tool compensation data in the selected line (one line).
Line paste	The contents (one line) of the copied tool compensation data are written to the line where the cursor is. If the copied data is changed after the menu [Line copy] is pressed, the data before changing is written when pasted. The data in the copied line can be pasted as many times as is required until new data is copied.
Line clear	This erases the compensation data in the selected line (multiple lines can be erased). Selection method: Select the first and the last compensation number to be erased. (Example) 1/E: Set all compensation data to "0". If the [INPUT] key is pressed without selecting a line, the compensation data in the line where the cursor is currently positioned is erased.
Abs/Inc	Switch the setting method (absolute/incremental input) for the tool compensation data by [INPUT] key. <Note> ♦When a parameter "#8941 ABS/INC for T-ofs" is set to "0", it is fixed to an absolute input.

With type III, wear data is displayed when the power is turned ON.

After turning the power ON, the display selection for wear data, length data, and nose data will be retained.

5.4.1 Setting the Tool Compensation Data

Operation method (Setting "10.000" in the length wear data of compensation No. (102))

- (1) Press the menu [Ofs No search].
- (2) Designate the compensation No.
102 [INPUT]
The cursor can be moved to 102 using the [↑], [↓],
, or  keys.
- (3) Use the [→] key to move the cursor to the length wear position.
- (4) Input the length wear value.
10 [INPUT]
The value can also be designated by pressing the menu [=Input] instead of the [INPUT] key.

Note

- (1) If the parameter "#11017 T-ofs set at run" is set to "1", the tool compensation amount data during automatic operation or during pause of operation can be set.
- (2) When the parameter "#8929 Disable=INPUT:comp" is set to "1", the menu [=Input] will be grayed.
- (3) This setting may be disabled due to the parameter "#8933 Disable lngth comp" or "8934 Disable wear comp" setting. For details, refer to "5.4.6 Disabling the Setting of Tool Compensation Amount".
- (4) The above shows the setting of the tool compensation data when the parameter "#8941 ABS/INC for T-ofs" is set to "0". For details, refer to "5.4.2 Switching the Input Method for the Tool Compensation Data".
- (5) Any of the menu [=Input], [+Input] or [INPUT] key is pressed when the parameter "#1124 ofsfix" is set to "0", the cursor will move to the next compensation No.

Operation method ("0.012" is calculated and set in the length wear data of compensation No. 102)

(1) Use the same procedure as in the previous page to move the cursor to the compensation No. 102 length wear position.

(2) Input a numeric value.
0.012 [+Input]



The input value added to the original value is displayed.
(Example) When the original value is 10.000, the calculation formula is as follows:

$$10.000 + 0.012 = 10.012$$

Note

- (1) If the parameter "#11017 T-ofs set at run" is set to "1", the tool compensation amount data during automatic operation or during pause of operation can be set.
- (2) This setting may be disabled due to the parameter "#8933 Disable lngth comp" or "8934 Disable wear comp" setting. For details, refer to "5.4.6 Disabling the Setting of Tool Compensation Amount".
- (3) Any of the menu [=Input], [+Input] or [INPUT] key is pressed when the parameter "#1124 ofsfix" is set to "0", the cursor will move to the next compensation No.
- (4) When entering data without decimal points, you can select the 1-mm (or 1-inch) data input or the input in the minimum input unit (same as "#1003 iunit") by designating the "#8119 Comp. unit switch" parameter.

<1-mm unit: "#8119 Comp. unit switch" is "0".>

Input	➔	Result
1		1.000
100		100.000
10.		10.000
.012		0.012

<Minimum input unit (#1003 iunit B): "#8119 Comp. unit switch" is "1".>

Input	➔	Result
1		0.001
100		0.100
10.		10.000
.012		0.012

5.4.2 Switching the Input Method for the Tool Compensation Data

When a parameter "#8941 ABS/INC for T-ofs" is set to "1", the absolute/incremental input by the [INPUT] key can be switched. When attempting to switch it, the current input mode is displayed on the upper left of the tool compensation amount. The absolute/incremental input can be switched either by the short cut key ([I] key) or by pressing the menu [Abs/Inc]. The chosen method is kept after switching the screen and turning the power OFF.

(1) Absolute input mode

In this mode, the absolute input is applied when the tool compensation data is input by the [INPUT] key.

Displaying that this is the absolute input mode.

Abs					
1	0.000	16	0.000	31	0.000
2	0.000	17	0.000	32	0.000
3	0.000	18	0.000	33	0.000
4	0.000	19	0.000	34	0.000
5	0.000	20	0.000	35	0.000
6	0.000	21	0.000	36	0.000
7	0.000	22	0.000	37	0.000
8	0.000	23	0.000	38	0.000
9	0.000	24	0.000	39	0.000
10	0.000	25	0.000	40	0.000
11	0.000	26	0.000	41	0.000
12	0.000	27	0.000	42	0.000
13	0.000	28	0.000	43	0.000
14	0.000	29	0.000	44	0.000
15	0.000	30	0.000	45	0.000

T-ofs | T-meas | T-reg | T-life | Coord | →

(2) Incremental input mode

In this mode, the incremental input is applied when the tool compensation data is input by the [INPUT] key.



Displaying that this is the incremental input mode.

Inc					
1	0.000	16	0.000	31	0.000
2	0.000	17	0.000	32	0.000
3	0.000	18	0.000	33	0.000
4	0.000	19	0.000	34	0.000
5	0.000	20	0.000	35	0.000
6	0.000	21	0.000	36	0.000
7	0.000	22	0.000	37	0.000
8	0.000	23	0.000	38	0.000
9	0.000	24	0.000	39	0.000
10	0.000	25	0.000	40	0.000
11	0.000	26	0.000	41	0.000
12	0.000	27	0.000	42	0.000
13	0.000	28	0.000	43	0.000
14	0.000	29	0.000	44	0.000
15	0.000	30	0.000	45	0.000

T-ofs | T-meas | T-reg | T-life | Coord | →

5.4.3 Erasing the Tool Compensation Data

Operation method (Erasing one line of tool compensation data at the cursor position)

- (1) Move the cursor to the data to be erased using the [↑], [↓], , or  key.
- (2) Press the menu [Line clear] and the [INPUT] key.
- (3) Press the [Y] or [INPUT] key.
To cancel the erasing, press a key other than [Y] or [INPUT].  The selected line of data (one line amount) is cleared to "0".
The cleared data is displayed at the top of the compensation data.

Operation method (Erasing the compensation data from compensation number 122 to 125.)



- (1) Press the menu [Line clear].
- (2) Input the compensation number of the data range to be erased.
122/125 [INPUT]
- (3) Press the [Y] or [INPUT] key.
To cancel the erasing, press a key other than [Y] or [INPUT].  The compensation data for the selected compensation number is erased, and the menu highlight returns to normal.
The cleared data is displayed at the top of the compensation data.

Note

- (1) If the [INPUT] key is pressed without selecting an compensation number, the line where the cursor is located is erased.
- (2) If the parameter "#11017 T-ofs set at run" is set to "1", the tool compensation amount data during automatic operation or during pause of operation can be erased.
- (3) This setting may be disabled due to the parameter "#8933 Disable lngth comp" or "8934 Disable wear comp" setting. For details, refer to "5.4.6 Disabling the Setting of Tool Compensation Amount".

5.4.4 Copying and Pasting the Tool Compensation Data



Operation method (Copying/pasting one line of tool compensation data)

- (1) Move the cursor to the data to be copied using the [↑], [↓],  or  key.
- (2) Press the menu [Line copy].
- (3) Move the cursor to the line (compensation No.: 109) where the data is to be pasted.
- (4) Press the menu [Line paste].  The copied compensation data is written in the line where the cursor is.
The background color returns to normal.
The copied compensation data is held until another line is copied.

Note

- (1) If the compensation data for the copied line is changed after the menu [Line copy] is pressed, the data prior to the change is written when pasted.
- (2) In tool compensation type III, the copied data cannot be pasted to the different item (Wear/Length/Nose).
- (3) If the parameter "#11017 T-ofs set at run" is set to "1", the tool compensation amount data during automatic operation or during pause of operation can be erased.
- (4) This setting may be disabled due to the parameter "#8933 Disable lngth comp" or "#8934 Disable wear comp" setting. For details, refer to "5.4.6 Disabling the Setting of Tool Compensation Amount".

5.4.5 Undoing Change of Tool Compensation Data

- (1) Move the cursor to the data to be set using the [↑], [↓],  or  key.
- (2) Input a numeric value.
(Example) 10 [INPUT]
- (3) Press the menu [Undo].  The value is returned to the previous value.

Note

- (1) This setting will be disabled due to the parameter "#8933 Disable lngth comp" or "#8934 Disable wear comp" setting. For details, refer to "5.4.6 Disabling the Setting of Tool Compensation Amount".
- (2) When "#8939 Undo confirm msg" is set to "1", the menu [Undo] is highlighted and confirmation message "OK?(Y/N)" is displayed. The program returns to the previous status by pressing [Y] or [INPUT] key. If any key other than [Y] or [INPUT] is pressed, the operation to undo will be canceled. When the operation is canceled, the menu highlight returns to normal and the message disappears.
- (3) When the program does not return to the previous status by pressing [Undo], [Undo] is not highlighted and the operation message "Data protect" or "Cannot return to origin" appears.
- (4) The menu [Undo] cannot be used to clear multiple lines.

5.4.6 Disabling the Setting of Tool Compensation Amount

Depending on the setting of the parameter "#8933 Disable lngth comp"/"#8934 Disable wear comp", the setting of the shape compensation amount/wear compensation amount is disabled.

Depending on the tool compensation type, different operation will be disabled.

Tool compensation type		"#8933 Disable lngth comp" = "1"	"#8934 Disable wear comp" = "1"
Type I	----	The menus [=Input], [+Input], [Line copy], [Line paste], [Line clear], and [Undo] are grayed out and cannot be selected. Any setting by [INPUT] key is disabled.	----
Type II	----	The menus [Line copy], [Line paste], and [Line clear] are grayed out and cannot be selected. The length and radius setting by [=Input], [+Input], and [INPUT] keys are disabled.	The menus [Line copy], [Line paste], and [Line clear] are grayed out and cannot be selected. The length wear and radius wear setting by [=Input], [+Input], and [INPUT] keys are disabled.
Type III	"Wear"	----	The menus [=Input], [+Input], [Line copy], [Line paste], [Line clear], and [Undo] are grayed out and cannot be selected. Any setting by [INPUT] key is disabled.
	"Length"	The menus [=Input], [+Input], [Measure], [Line copy], [Line paste], [Line clear], and [Undo] are grayed out and cannot be selected. Any setting by [INPUT] key is disabled.	----
	"Nose"	The menus [Line copy], [Line paste], and [Line clear] are grayed out and cannot be selected. The nose R setting by [=Input], [+Input], and [INPUT] keys are disabled.	The menus [Line copy], [Line paste], and [Line clear] are grayed out and cannot be selected. The R wear setting by [=Input], [+Input], and [INPUT] keys are disabled.

5.4.7 Measuring Tool Compensation Amount

Operation method (Measuring the tool compensation amount of Z axis and X axis (diameter axis))

- (1) Select the tool to be measured with manual numerical value command. (Refer to "8.4 Manual Numerical Value Command" for details.)

(Example) T1003

- (2) Displays the tool compensation amount screen.
Menu [Offset]



The tool compensation amount screen is displayed. The tool compensation number of the selected tool is displayed at the top, and the cursor is located on the first line.

<Note>

- If the parameter "#8972 T code offset disp" is set to "0", the tool compensation number of selected tool is not displayed at the top. Locate the cursor onto the tool compensation number of the tool to be measured.

- (3) Press the menu [Length data].

- (4) Select the "Manual handle feed" mode or "Jog feed" mode.

- (5) Select the Z axis, and manually move the tool to the work end face (program origin).

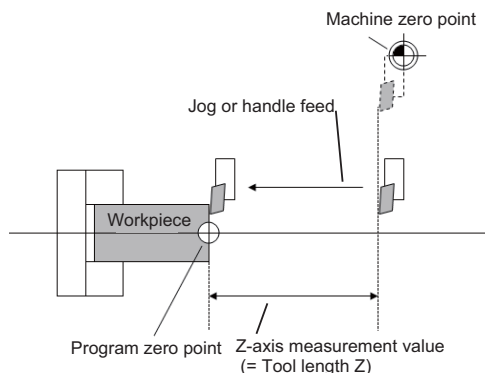

- (6) Enter the name of axis to be measured, and the measurement value (radius) of workpiece.
Z0.



When you enter "Z", the cursor is moved to the Z axis column.

<Note>

- If you input an axis name that does not exist, the cursor does not move.
 - The second and subsequent characters are not considered to be the axis name and, therefore, the cursor does not move. (Example: If you enter "XZ", the cursor moves on the X axis, but the cursor does not move on the Z axis.)
- Also, if anything other than tool length data is displayed, the cursor does not move even when the first input value is the axis name.

Value "Z0." is displayed in the input column.

- (7) Press the menu [Measure].

The measured value (Z axis machine position - Input value (0)) is set in the tool length data at the cursor position. The input column is cleared.

- (8) Select the X axis, and manually move the tool to the work side face.

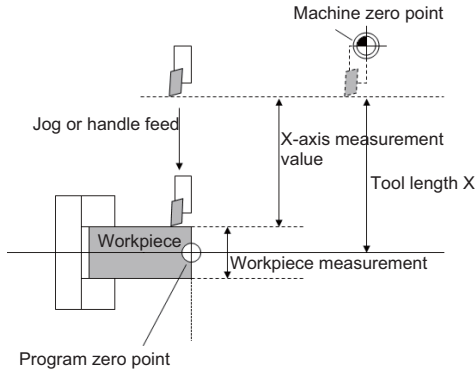

- (9) Enter the name of axis to be measured, and the measurement value (diameter) of workpiece.
 X20.



When you enter "X", the cursor is moved to the X-axis column.

<Note>

- If you input an axis name that does not exist, the cursor does not move.
 - The second and subsequent characters are not considered to be the axis name and, therefore, the cursor does not move. (Example: If you enter "XZ", the cursor moves on the X axis, but the cursor does not move on the Z axis.)
- Also, if anything other than tool length data is displayed, the cursor does not move even when the first input value is the axis name.

Value "X20." is displayed in the input column.

- (10) Press the menu [Measure].



The measured value (X-axis machine position - Input value (20)) is set in the tool length data at the cursor position. The input column is cleared.

Note

- (1) If the parameter "#11017 T-ofs set at run" is set to "1", the tool compensation amount data during automatic operation or during pause of operation can be measured.
- (2) This setting may be disabled due to the parameter "#8933 Disable lngth comp" or "8934 Disable wear comp" setting. For details, refer to "5.4.6 Disabling the Setting of Tool Compensation Amount".
- (3) When entering data without decimal points, you can select the 1-mm (or 1-inch) data input or the input in the minimum input unit (same as "#1003 iunit") by designating the "#8119 Comp. unit switch" parameter.

<1-mm unit: "#8119 Comp. unit switch" is "0".>

Input	Result
1	1.000
100	100.000
10.	10.000
.012	0.012



<Minimum input unit (#1003 iunit B): "#8119 Comp. unit switch" is "1".>

Input	Result
1	0.001
100	0.100
10.	10.000
.012	0.012



5.4.8 Moving to designated Compensation Number

There are two methods to switch from the designated compensation number display. You can switch the operation by using the "#8975 Change No. search" parameter.

(Example 1) Select compensation number 16. (If "#8975 Change No. search" is "0")

- (1) Displays the tool compensation amount screen.
- (2) Press the menu [Ofs No search].
- (3) Enter the compensation number you wish to display, and press [INPUT].
16 [INPUT]  The compensation number that you have set is displayed at the top, and the cursor is located on the first data. The highlighting of the menu [Ofs No. search] is canceled.

(Example 2) Select compensation number 16. (If "#8975 Change No. search" is "1")

- (1) Displays the tool compensation amount screen.
- (2) Enter the compensation number you wish to display.
16
- (3) Press the menu [Ofs No search].  The compensation number that you have set is displayed at the top, and the cursor is located on the first data.

Note

- (1) If an compensation number exceeding the limit is designated, the operation message "Setting error" is displayed.

5.5 Setting the Tool Management Data (Tool Management Screen)

Setup — T-Mng.

Tool management data can be set and displayed on the tool management (T-Mng.) screen. These data are relevant to which displayed on the [T-ofs] or [T-life] screen, that can be set the tool information. Thus the mutually-referenced data can be set and displayed on this screen.

■ List view

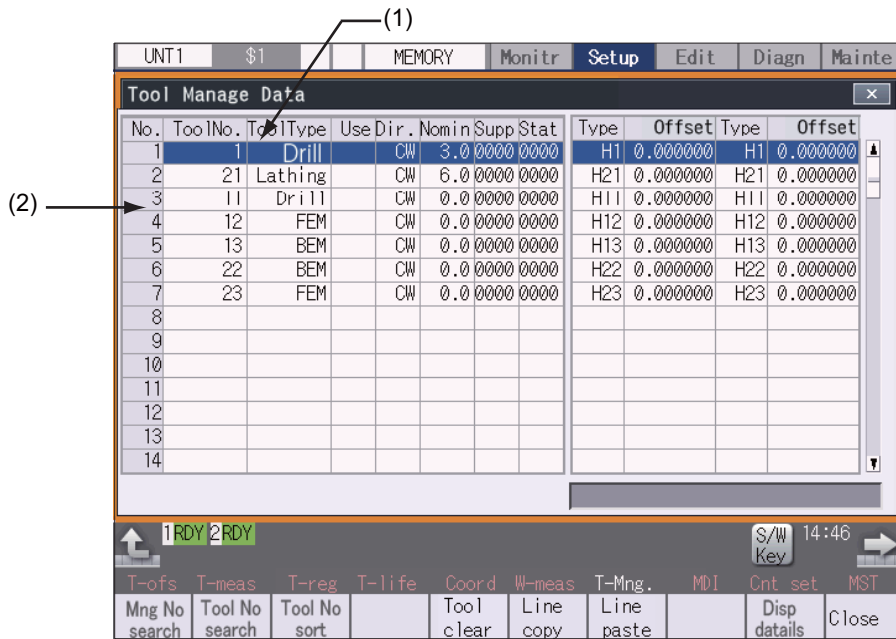

■ Detailed display

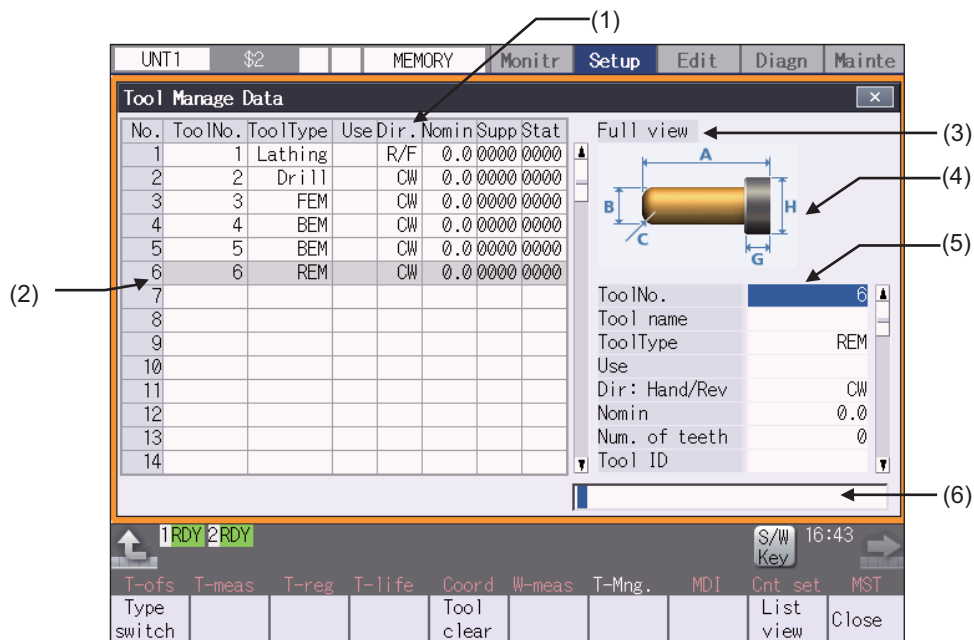

Display items

Display items	Details
(1) Tool management data list portion	The preset tool management data is listed. The tool management data list consists of the right side and left side parts. When you select the [Tool Manage Data - Detail View] and switch to the [Detail View], the right part of the tool management data list is switched to the detail view of tool management data.
(2) Data No.	Indicates the number of the tool management data.
(3) Display data type	It indicates the item type that is displayed in the detail view of tool management data. The display data type can be "Full view", "Basic info", "Shape info", "Cut cond.", "Offset", "T-life", or "Added info". "Full view" is displayed after the power is turned ON, the view is switched by pressing the menu [Type switch].
(4) Tool shape drawing	It displays the tool shape of the tool management data at cursor position according to the tool type. The display and hiding are switched according to the display data type.
(5) Tool management data detailed portion	Displays or sets the tool data that has been selected from the tool management data list. The display items are changed depending on the tool type and the display data type.
(6) Input section	This displays the input data.

5.5.1 List of Display Items

○: Display/setting enabled ●: Display only -: Non-display

Display data		Tool management data list portion		Tool management data detailed portion							
		Left side	Right side	Full view	Basic info	Shape info	Cut cond.	Offset	T-life	Added info	
Tool shape drawing		-	-	○	○	○	-	-	-	-	
Tool management data	Basic info	Tool No.	○	-	○	○	○	○	○	○	
		Tool name	-	-	○	○	-	-	-	-	-
		Tool type	○	-	○	○	○	○	○	○	○
		Use	○	-	○	○	-	-	-	-	-
		Dir: Hand/Rev (*1)	○	-	○	○	-	-	-	-	-
		Nomin	○	-	○	○	-	-	-	-	-
		Num. of teeth	-	-	○	○	-	○ (*8)	-	-	-
		Tool ID	-	-	○	○	-	-	-	-	-
		Supp	○	-	○	-	-	-	-	-	-
		Stat	●	-	●	-	-	-	-	-	-
		Setting Angle	-	-	○	-	○	-	-	-	-
	Shape info (*2)		-	-	○	-	○	-	-	-	-
	Cut cond.	Spindle rpm S	-	-	○	-	-	○	-	-	-
		Feedrate F	-	-	○	-	-	○	-	-	-
		Material	-	-	○	-	-	○	-	-	-
		Coolant M code	-	-	○	-	-	○	-	-	-
	Added info	Custom 1 to 12 (*3)	-	-	○ (*4)	-	-	-	-	-	○ (*4)
Life (*5)		-	-	-	-	-	-	-	○	-	
Compensation		-	○ (*6)	-	-	-	-	○ (*7)	-	-	

(*1) In case of mill tools, lathing drill and lathing tap, "rotation" is applied, while in case of lathe turning, groove and thread cut, "tool hand" is applied.

(*2) The display/setting contents differ depending on the tool types. Refer to "List of display items for shape info" in this section for details of setting items.

(*3) The display/setting format and setting range of display item names, number of items and setting values depend on MTB specifications.

(*4) When the parameter "#1445 Tol-Custom-nondisp" is set to "1", "Added info" is not displayed.

(*5) The display/setting contents differ depending on the tool compensation type and tool life management type. Refer to "List of display items for life data" in this section for details of setting items.

(*6) The display contents differ depending on the tool compensation type and parameter "#8969 Tool offset type 1" and "#8970 Tool offset type 2". Refer to "List of display items for compensation data (List view)" in this section for details of setting items.

(*7) The display/setting contents differ depending on the tool compensation type. Refer to "List of display items for compensation data (Disp details)" in this section for details of setting items.

(*8) The item displays between "Material" and "Coolant M code".

List of display items for shape info

The display contents of shape info differ depending on the selected tools.

[Mill tools]

○: Display/setting enabled

-: Not used

Item	Tool type							
	Not set	Ball end mill	Flat end mill	Drill	Radius end mill	Chamfer	Tap	Face mill
:A	Length							
:B	Diameter							
:C	-	-	-	Nose angle	Corner R	Tip angle	Pitch	Cutter L
:D	-	-	-	-	-	Tip dia.	Root dia.	Shank dia.
:E	-	-	-	-	-	-	-	-
:F	-	-	-	-	-	-	-	-
:G	Holder H							
:H	Holder D							
3D CHK Tool CR	3D CHK Tool CR							

[Turning tools]

○: Display/setting enabled

-: Not used

Item	Tool type				
	Lathe turning	Groove	Thread cut	Lathing drill	Lathing tap
:A	Tool length A				
:B	Tool length B				
:C	Nose R	Nose R	-	Nose angle	Pitch
:D	Nose angle	Nose width	-	-	Root dia.
:E	Cutting edge angle	Maximum groove depth	-	-	-
:F	Tool width	Tool width	Tool width	-	-
:G	Holder H				
:H	Holder D				
3D CHK Tool CR	3D CHK Tool CR				

List of display items of life data

○: Display/setting enabled ●: Display only -: Non-display

Display data (Life data)		M system		L system	
		Tool life management I/II	Tool life management III	Tool life management I	Tool life management II
Life	Group No.	○	-	-	○
	Status	○	○	-	○ (*2)
	Mthd	○	○	-	●
	H No.	○	○	-	-
	L compen	○	○	-	-
	D No.	○	○	-	-
	R compen	○	○	-	-
	Auxil.	○	○	-	-
	Ofset No	-	-	-	○
	Life (*1)	○	○	-	●
	Used (*1)	○	○	-	○
	Usage time (*1)	-	-	○	-
	Life time (*1)	-	-	○	-
	Usage count (*1)	-	-	○	-
	T life count (*1)	-	-	○	-
	Status A	-	-	○	-
Status B	-	-	○	-	

(*1) Setting values and units are displayed.

(*2) Status is displayed under "Used".

List of display items for compensation data (List view)

The parameter "#8969 Tool offset type 1" enables to switch the display items for 1st and 2nd column and the parameter "#8970 Tool offset type 2" enables to switch the display items for 3rd and 4th column on the right side of the list view.

[Tool compensation type I]

Tool compensation No. displays in the 1st column, tool compensation amount displays in the 2nd column and 3rd and 4th column are set to blank, irrespective of the value set by the parameter.

#8969 Tool offset type 1

Setting value	1st column (type)	2nd column (compensation amount)
0 to 9	H tool compensation No.	Length compensation

#8970 Tool offset type 2

—: Blank

Setting value	3rd column	4th column
0 to 9	-	-

[Tool compensation type II]

#8969 Tool offset type 1

Setting value	1st column (type)	2nd column (compensation amount)
0, 5 to 9	H tool compensation No.	Length compensation
1	H tool compensation No.	Length compensation
2	D tool compensation No.	Radius compensation
3	+H tool compensation No.	Length wear
4	+D tool compensation No.	Radius wear

#8970 Tool offset type 2

Setting value	3rd column (type)	4th column (compensation amount)
0, 5 to 9	D tool compensation No.	R compen
1	H tool compensation No.	L compen
2	D tool compensation No.	R compen
3	+H tool compensation No.	L wear
4	+D tool compensation No.	R wear

[Tool compensation type III]

#8969 Tool offset type 1

Setting value	1st column (type) (*1)	2nd column (compensation amount)
0	"1st axis name" tool compensation No.	1st axis tool length
1	"1st axis name" tool compensation No.	1st axis tool length
2	"2nd axis name" tool compensation No.	2nd axis tool length
3	"Additional axis name" tool compensation No.	Additional axis tool length
4	"+ 1st axis name" tool compensation No.	1st axis wear
5	"+ 2nd axis name" tool compensation No.	2nd axis wear
6	"+ Additional axis name" tool compensation No.	Additional axis wear
7	R	Nose R
8	+R	R wear
9	P	Point

#8970 Tool offset type 2

Setting value	3rd column (type) (*1)	4th column (compensation amount)
0	"2nd axis name" tool compensation No.	2nd axis tool length
1	"1st axis name" tool compensation No.	1st axis tool length
2	"2nd axis name" tool compensation No.	2nd axis tool length
3	"Additional axis name" tool compensation No.	Additional axis tool length
4	"+ 1st axis name" tool compensation No.	1st axis wear
5	"+ 2nd axis name" tool compensation No.	2nd axis wear
6	"+ Additional axis name" tool compensation No.	Additional axis wear
7	R	Nose R
8	+R	R wear
9	P	Point

(*1) Names set in "#1013 axname" corresponding to the axis are displayed in "**** axis name".

Note

(1) For the compensation amount, when "#1041 I_Inch" is set to "0" (metric system), the fraction part is fixed in 3 digits and when it is set to "1" (inch system), the fraction part is fixed in 4 digits, and the values after those digits are cut off.

List of display items for compensation data (Disp details)

○: Display/setting enabled -: Non-display

Display data (Compensation data)		Tool compensation type I	Tool compensation type II	Tool compensation type III
Compensation	H No.	○	○	-
	D No.	-	○	-
	Length	○	○	-
	L wear	-	○	-
	Radius (*3)	-	○	-
	R wear (*3)	-	○	-
	Tool L offset num	-	-	○
	Wear offset #	-	-	○
	Tool length "1st axis name" (*1)(*2)(*4)	-	-	○
	Tool length "2nd axis name" (*1)(*2)(*4)	-	-	○
	Tool length "Additional axis name" (*1)(*2)(*4)	-	-	○
	Wear "1st axis name" (*1)(*2)(*4)	-	-	○
	Wear "2nd axis name" (*1)(*2)(*4)	-	-	○
	Wear "Additional axis name" (*1)(*2)(*4)	-	-	○
	Nose R (*3)	-	-	○
	R wear (*3)	-	-	○
	Point	-	-	○

(*1) Names set by the parameter "#1022 axname2" corresponding to the axis are displayed in "**** axis name".

(*2) If the number of axes in the part system is 2 or less, the name of non-existing axis is displayed according to the setting of the parameter "#1281 ext17/bit1" (Selection of additional tool offset axis) as follows.

0: The axis name is not displayed.



1: The axis name designated by "#1028 base_K" is displayed in the 2nd axis, and the axis name designated by "#1027 base_J" is displayed in the additional axis.



(*3) When the parameter "#8117 OFS Diam DESIGN" is set to "1", the symbol "Φ" is displayed on the right side of the item name.

(*4) When "#1019 dia" (Diameter specification axis) is set to "1" for the axis, the symbol "Φ" is displayed on the right side of the item name.

5.5.2 Data Setting Range

The value of each item is maintained even after the power is turned OFF and ON.

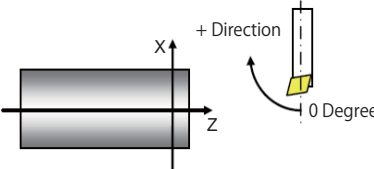
Setting item	Details	Setting range
Tool No.	Sets the tool No. A maximum of 8 digits of data can be input.	1 to 99999999
Name	Sets the tool name. A maximum of 8 alphanumeric characters and symbols can be set for the name. (*1)	A maximum of 8 characters
Type	Sets the tool type. The tool type will be "Drill" when no value is input.	1: Ball end mill 2: Flat end mill 3: Drill 4: Radius end mill 5: Chamfer 6: Tap 7: Face mill 51: Lathe turning 52: Groove 53: Thread cut 54: Lathing drill 55: Lathing tap
Use	Sets the usage of the tool.	0: None 1: Outer diameter 2: Inner diameter 3: End face
Dir: Hand/Rev	This sets the tool hand and spindle rotation direction. The items to be set vary depending on the tool type. <Tools that are set by spindle rotation direction> Mill tools, lathing drill and lathing tap <Tools that are set by tool hand> Lathe turning, groove, thread cut For turning tool or grooving tool, the tool direction will change depending on the tool hand setting. <Example of turning tool> <div style="display: flex; justify-content: space-around; align-items: center;"> <div style="text-align: center;"> <p>Right hand/Back Left hand/Back</p>  </div> <div style="text-align: center;"> <p>Right hand/Front Left hand/Front</p>  </div> </div>	<Spindle rotation direction> 0: CW 1: CCW <Tool hand> 0: Right/Front (R/F) 1: Left/Front (L/F) 2: Right/Back (R/B) 3: Left/Back (L/B) <Note> ♦The codes in parentheses are displayed in "Tool Manage Data" section.
Nomin	Sets the nominal of the tools. When milling tools are selected in types, "nominal diameter" can be set and when turning tools are selected, "nominal" can be set.	Setting range varies depending on the parameter "#1041 Initial inch". mm: 0.0 to 999.9 inch: 0.00 to 99.99
Num. of teeth	Sets the number of teeth of the tools with 1 digit. When lathe turning, groove and thread cut tools are selected, it is grayed out and cannot be set.	0 to 9
Tool ID	Sets the information arbitrarily to identify the tools such as tool model No. described in a catalog. A maximum of 8 alphanumeric characters and symbols can be set for the ID. (*1)	A maximum of 8 characters
Supp	Sets the supplementary information of the tools. The display/setting values depend on MTB specifications.	0x0000 to 0xFFFF
Stat	Displays the status of the tools. It cannot be set and only reference is available. The displayed values depend on MTB specifications.	-

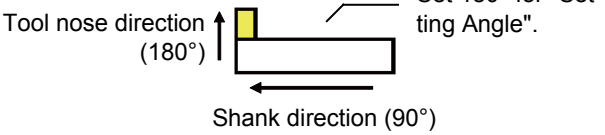
Setting item	Details	Setting range
Setting Angle	<p>Sets the tool installation angle. Specifies the angle, assuming the direction perpendicular to Z axis as 0 degrees with CW as positive (+).</p>  <p><Setting example> Setting angle = 90 Setting angle = 180 Setting angle = 270</p>  <p>When there is a tool rotary axis, set the angle assuming that the angle of the axis is 0 degrees.</p> <p>If the directions of the tool nose and shank are different such as internal diameter machining tool, set the tool nose angle for "Setting Angle".</p> <p><Example of grooving tool for front face machining></p> 	0 to 359.999 degrees

Setting item	Details	Setting range
Length : A	Tool type: all tools Sets the tool length.	<Length> Setting range varies depending on the parameter "#1041 Initial inch".
Diameter : B	Tool type: Mill tools, lathing drill and lathing tap Sets the tool diameter. (*2)	mm: 0.000 to 9999.999 inch: 0.0000 to 999.9999
Length : B	Tool type: Lathe turning, groove, thread cut Sets the tool length.	<Angle> 0.000 to 180.000 degrees
Nose angle : C	Tool type: Drill Sets the nose angle.	
Corner R : C	Tool type: Radius end mill Sets the corner R circular radius.	
Tip angle : C	Tool type: Chamfer Sets the tip angle.	
Pitch : C	Tool type: Tap Sets the pitch.	
Cutter L : C	Tool type: Face mill Sets the cutter length.	
Nose R : C	Tool type: Lathe turning, groove Sets the nose R.	
Tip dia. : D	Tool type: Chamfer Sets the tool tip diameter. (*2)	
Root dia. : D	Tool type: Tap Sets the root diameter.	
Shank dia. : D	Tool type: Face mill Sets the shank diameter. (*2)	
Nose angle : D	Tool type: Lathe turning Sets the nose angle.	
Nose width : D	Tool type: Groove Sets the nose width	
Edge angle : E	Tool type: Lathe turning Sets the edge angle.	
Max groove D: E	Tool type: Groove Sets the groove depth.	
Tool width: F	Tool type: Lathe turning, groove, thread cut Sets the tool width.	
Holder H: G	Tool type: all tools Sets the holder height.	
Holder D : H	Tool type: all tools Sets the holder diameter.	
3D CHK Tool CR	Sets the color to be used in 3D check screen. Tool type: all tools Red will be set when no value is input.	1: Gray 2: Red 3: Yellow 4: Blue 5: Green 6: Light blue 7: Purple 8: Pink
Spindle rpm S	Sets the spindle rotation speed.	0 to 99999999
Feedrate F	Sets the tool feedrate.	Setting range varies depending on the parameter "#1041 Initial inch". mm: 0 to 1000000 inch: 0 to 100000
Material	Sets the material of the tool. A maximum of 4 alphanumeric characters and symbols can be set for the name. (*1)	A maximum of 4 characters
Coolant M code	Sets the coolant M code.	0 to 99999999

Setting item	Details	Setting range
Custom 1 to 12	Sets the custom information.	Display format and setting range vary depending on the MTB specifications.
Group No.	Sets the group No. When the group No. is cleared, the life management data is also cleared.	0 to 99999999 Group No. is cleared when it is set to "0".
Status	Sets the status. (*3)	Setting range varies depending on the tool life management method. For details, refer to "5.6 Tool Life Management".
Method	Sets the method. (*4)(*5)	
H No.	Sets the H No. (*4)	
L compen	Sets the L offset. (*4)	
D No.	Sets the D No. (*4)	
R compen	Sets the R offset. (*4)	
Aux.	Sets the auxiliary data. (*4)	
Offset num	Sets the compensation No.	
Life	Sets the life. (*4)(*5)	
Used	Sets the used. (*3)	
Operating time	Sets the maximum life time.	
Life time	Sets the usage life time.	
T usage count	Sets the maximum life count.	
T life count	Sets the usage life count.	
Status A	Sets the status A.	
Status B	Sets the status B.	
H No.	Sets the H No.	Setting range varies depending on the tool compensation type. For details, refer to "5.4 Setting Tool Compensation Amount (Tool Offset Screen)".
D No.	Sets the D No.	
Length	Sets the tool length compensation amount.	
L wear	Sets the compensation amount of tool length wear.	
Radius	Sets the tool radius compensation amount.	
R wear	Sets the compensation amount of tool length wear.	
Tool L offset num	Set the tool L offset No.	
Wear offset #	Set the wear offset No.	
Tool length data	Sets the tool length data compensation of 1st axis, 2nd axis, and additional axes.	
Wear data	Sets the nose wear compensation of 1st axis, 2nd axis, and additional axes.	
Nose R	Sets the nose R.	
R-wear	Sets the R-wear.	
Point	Sets the point.	

(*1) The symbols "/" (Slash), "\" (Backslash), "" (Double quotes) and "=" (Equals) cannot be used for names or IDs. Also, "=" (Equals) cannot be used as the first character.

(*2) When the parameter "#8968 Tool shape radius" is set to "0", input the value of diameter. When the parameter is set to "1", input the value of radius.

(*3) In case of tool life management I/II for M system and tool life management II for L system, it cannot be set in the state that group No. is not set.







(*4) In case of tool life management I/II for M system, it cannot be set in the state that group No. is not set.

(*5) It cannot be set with tool life management II for L system. Only reference is available.

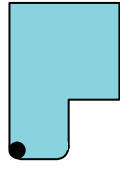
Note

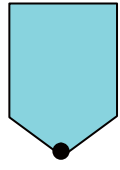
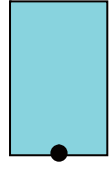
- (1) If a value outside of the setting range is entered, an error occurs, and the value cannot be set.
- (2) When the sorting of tool data is in progress, the operation message "Sorting of tool data is in progress" appears, and the data cannot be set.

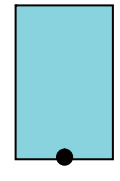
Refer to the figures below for the graphic and the nose position of each tool.

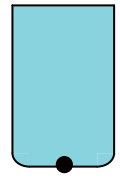
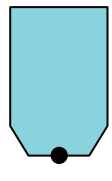
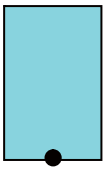
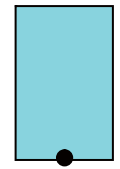
Lathe turning 	Groove 	Thread cut 	Lathing drill 	Lathing tap 
Ball end mill 	Flat end mill 	Drill 	Radius end mill 	Chamfer 
Tap 	Face mill 			

● indicates the tool nose position.

5.5.3 Menu Configuration

Menus (List view)

Menus	Details
Mng No search	Displays the tool management data with the designated tool management number at top.
Tool No search	Displays the tool management data with the designated tool number at top.
Tool No sort	Sorts the tool No. in ascending order.
Tool clear	Clears the tool management data from the cursor line. Setting method: First data number to be cleared/last data number (Example) 10/30: The line data of data numbers 10 to 30 is cleared. 10/E: All line data that has data number 10 or less is cleared. If you press the [INPUT] key without entering the data number, data at the current cursor line is cleared.
Line copy	Copies a single line of data locating at the cursor position.
Line paste	Writes the copied data (single line data) in the cursor line.
Disp details	Switches to the detail view of tool management data.
Close	This closes the pop-up window and quits this function.

Menus (when the cursor is at [ToolNo.] of [Disp details])

Menus	Details
Type switch	Switch the display data type of the detail view of tool management data by pressing the button.
Tool clear	Clear the tool management data of the currently selected tool number.
List view	Switch to the tool management data list.
Close	This closes the pop-up window and quits this function.

Menus (when the cursor is at [ToolType] of [Disp details])**Note**

- (1) For L system, the menus [Lathe turning] to [Lathing tap] are displayed on page 1, the menus [Ballendmill] to [Facemill] are displayed on page 2.

Menus	Details
Type switch	Switch the display data type of the detail view of tool management data by pressing the button.
Ball endmill	Select the [Ball endmill]. It is also selected if the value "1" is entered.
Flat endmill	Select the [Flat endmill]. It is also selected if the value "2" is entered.
Drill	Select the [Drill]. It is also selected if the value "3" is entered.
Bulnose endmill	Select the [Bulnoseendmill]. It is also selected if the value "4" is entered.
Chamfer	Select the [Chamfer]. It is also selected if the value "5" is entered.
Tap	Select the [Tap]. It is also selected if the value "6" is entered.
Face mill	Select the [Face mill]. It is also selected if the value "7" is entered.
Close	This closes the pop-up window and quits this function.
Lathe turning	Select the [Lathe turning]. It is also selected if the value "51" is entered.
Groove	Select the [Groove]. It is also selected if the value "52" is entered.
Thread cut	Select the [Thread cut]. It is also selected if the value "53" is entered.
Lathing drill	Select the [Lathing drill]. It is also selected if the value "54" is entered.
Lathing tap	Select the [Lathing tap]. It is also selected if the value "55" is entered.



Menus (when the cursor is at [3D CHK Tool CR] of [Disp details])

Menus	Details
Type switch	Switch the display data type of the detail view of tool management data by pressing the button.
Gray	Select the gray color. It is also selected if the value "1" is entered.
Red	Select the red color. It is also selected if the value "2" is entered.
Yellow	Select the yellow color. It is also selected if the value "3" is entered.
Blue	Select the blue color. It is also selected if the value "4" is entered.
Green	Select the green color. It is also selected if the value "5" is entered.
Light blue	Select the aqua color. It is also selected if the value "6" is entered.
Purple	Select the purple color. It is also selected if the value "7" is entered.
Pink	Select the pink color. It is also selected if the value "8" is entered.
Close	This closes the pop-up window and quits this function.



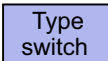
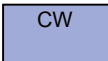
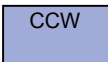

Menus (when the cursor is at [Use] of [Disp details])

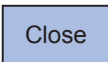
Menus	Details
Type switch	Switch the display data type of the detail view of tool management data by pressing the button.
Leave blank	Select the [Leave blank]. This column is set to blank. It is also selected if the value "0" is entered.
Outer dia.	Select the [Outer dia.]. It is also selected if the value "1" is entered.
Inner dia.	Select the [Inner dia.]. It is also selected if the value "2" is entered.
End face	Select the [End face]. It is also selected if the value "3" is entered.
List view	Switch to the tool management data list.
Close	This closes the pop-up window and quits this function.

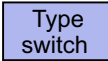

Menus (when the cursor is at [Spindle rotation direction] of [Disp details])

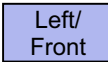
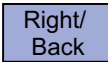
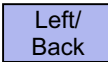
Menus	Details
	Switch the display data type of the detail view of tool management data by pressing the button.
	Select the [CW]. It is also selected if the value "0" is entered.
	Select the [CCW]. It is also selected if the value "1" is entered.
	Switch to the tool management data list.
	This closes the pop-up window and quits this function.

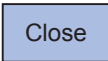
Menus (when the cursor is at [Tool hand] of [Disp details])

Menus	Details
	Switch the display data type of the detail view of tool management data by pressing the button.
	Select the [Right/Front]. It is also selected if the value "0" is entered.
	Select the [Left/Front]. It is also selected if the value "1" is entered.
	Select the [Right/Back]. It is also selected if the value "2" is entered.
	Select the [Left/Back]. It is also selected if the value "3" is entered.
	Switch to the tool management data list.
	This closes the pop-up window and quits this function.

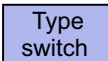
Menus (List Menu (when none of the above conditions is met))

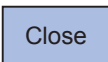
Menus	Details
	Switch the display data type of the detail view of tool management data by pressing the button.
	Switch to the tool management data list.
	This closes the pop-up window and quits this function.

5.5.4 Registering New Tool Management Data

Operation method

- | | | |
|---|---|--|
| (1) Display the tool management screen. | ➔ | The tool management data list is displayed. |
| If the details of tool management data is already displayed, press the menu [List view] and switch to the display of tool management data list. | | |
| (2) Use the [↑] or [↓] key to select the data number, which the tool No. is not specified yet. | | |
| (3) Press the [INPUT] key. | | |
| (4) Input the tool number.
100 [INPUT] | ➔ | The tool management data of tool number 100 is registered in the selected data number, and the cursor is shifted to the next lower position. |

5.5.5 Switching the Item Type of the Tool Management Data Detailed Portion

Operation method

- | | | |
|---|---|---|
| (1) Display the tool management screen. | ➔ | The tool management data list is displayed. |
| (2) Use the [↑] or [↓] key to select the data number to be displayed its details. | | |
| (3) Press the [INPUT] key. | | |
| (4) Press the menu [Type switch]. | ➔ | Each time you press the menu, the item type shown in the detailed view is switched in the following sequence. "Full view" -> "Basic info" -> "Shape info" -> "Cut cond." -> "Offset" -> "T-life" -> "Added info" (*1) -> "Full view". The cursor is moved to the top of the tool management data detail view. |

(*1) If the machine parameter "#1445 Tol-Custom-nondisp" (Hide added info on tool management screen) is set to "1", the "Added info" type is skipped and it is switched to the next type.

5.5.6 Displaying Data by Designating Tool Management Data No.

There are two methods to switch the display from the designated tool management data number. You can switch the operation by using the "#8975 No. search process" parameter.

Operation method

(Example 1) Select data number 12. ("#8975 No. search process" is "0")

(1) Display the tool management screen.  The tool management data list is displayed.

(2) Press the menu [Manage. No. search].

(3) Enter the tool management data number to display,
and press the [INPUT] key.
12 [INPUT]

(Example 2) Select data number 12. ("#8975 No. search process" is "1")

(1) Display the tool management screen.  The tool management data list is displayed.

(2) Enter the tool management data number to be displayed.
12

(3) Press the menu [Manage. No. search].  The specified data number is displayed at the top, and the cursor is located onto the first data.

Note

(1) If a data number exceeding the limit is designated, the operation message "Setting error" is displayed.

5.5.7 Displaying Data by Designating Tool No.

Operation method ("#8975 No. search process" is "0")

The designated tool number is searched from the tool management data under the cursor position, and the tool number is displayed at the top when it is found. If the designated tool number is not found until the end of the tool management data, the search is performed from the head.

(Example) Search data number 12.

- | | | |
|--|---|--|
| (1) Display the tool management screen. | ➔ | The tool management data list is displayed. |
| | | |
| (2) Press the menu [Tool No. search]. | | |
| | | |
| (3) Enter the tool management data number to display, and press the [INPUT] key.
12 [INPUT] | ➔ | After the search is completed, the operation message "Search complete" appears.
The input column is cleared.
The designated tool number is searched from the tool management data under the cursor position, and first-found tool management data is displayed at the top.
The cursor is shifted to the head line of the display.
The highlight of the menu [Tool No. search] returns to normal. |

Note

- (1) If the tool number cannot be found, the message "Designated tool number not found" is displayed, and the input section is not cleared.

Operation method ("#8975 No. search process" is "1")

(Example) Search tool number 12.

The designated tool number is searched from the tool management data under the cursor position, and the tool number is displayed at the top when it is found. If the designated tool number is not found until the end of the tool management data, the search is performed from the head.

When you press the menu [Tool No. search] again after the search is completed, the search restart for the previously searched tool No.

The previously searched tool number is maintained until the tool management screen is closed, or the display is switched to the detailed view.

- | | | |
|--|---|--|
| (1) Display the tool management screen. | ➔ | The tool management data list is displayed. |
| | | |
| (2) Enter the tool number you wish to display.
12 | | |
| | | |
| (3) Press the menu [Tool No. search]. | ➔ | After the search is completed, the operation message "Search complete" appears.
The input column is cleared.
The designated tool number is searched from the tool management data under the cursor position, and first-found tool management data is displayed at the top.
The cursor is shifted to the head line of the display. |

- (4) Press the menu [Tool No. search] again.

The search restart for the previously searched tool No. After the search is completed, the operation message "Search complete" appears.
The input column is cleared.
The designated tool number is searched from the tool management data under the cursor position, and first-found tool management data is displayed at the top.
The cursor is shifted to the head line of the display.



Note

- (1) If the tool number cannot be found, the message "Designated tool number not found" is displayed, and the input section is not cleared.

5.5.8 Sorting the Data by Tool No.

Sort the tool management data in ascending order of tool numbers.

Operation method

- | | | |
|---|---|--|
| (1) Display the tool management screen. |  | The tool management data list is displayed. |
| (2) Press the menu [Tool No sort]. | | |
| (3) Press the [Y] or [INPUT] key. |  | The operation message "Sorting of tool data is in progress" flashes during tool data sorting.
The operation message "Sorting of tool data is complete" is displayed after the tool data has been sorted.
The tool management data is sorted in ascending order of tool numbers, and they are displayed from the beginning. The cursor moves to the top line.
The highlight of the menu [Tool No. sort] returns to normal. |



Note

- (1) During data sorting in ascending order of tool numbers, you cannot stop this sorting on the way.
- (2) Once you have sorted the data in ascending order of tool numbers, you cannot return them to the previous sort order.
- (3) If the same tool number is found multiple times, data is sorted in the order in which they are found from the top.
- (4) If no tool number is set and if data is sorted, that line is skipped during display.
- (5) The tool data is sorted for the currently displayed part system.
- (6) During data sorting, you cannot operate on the screen. Operate the screen after data sorting.

5.5.9 Deleting the Tool Management Data

Deleting the tool management data in [List view]

■ Method 1: Delete the tool management data of the cursor line.

- (1) Display the tool management screen.  The tool management data list is displayed.
- (2) Use the [↑] or [↓] key to move the cursor onto the line to be deleted.
- (3) Delete the selected data.
Menu [Tool clear] [INPUT]
- (4) Press the [Y] or [INPUT] key.  Press any key except [Y] and [INPUT] keys to cancel. Once deleted, the data is empty.
To cancel the erasing, press a key other than [Y] or [INPUT].

■ Method 2: Delete the tool management data of the designated line.



- (1) Display the tool management screen.  The tool management data list is displayed.

If the details of tool management data is displayed, press the menu [List view] and switch to the display of tool management data list.
- (2) Press the menu [Tool clear].
- (3) Specify the line clear range, by separating the first and last data numbers by a slash (/) from each other, and press the [INPUT] key.
1/5 [INPUT]
To delete data down to the last line, set "E".
(Example) 5/E:
- (4) Press the [Y] or [INPUT] key.  The tool management data, that corresponds to the designated data number, is cleared and highlight of the menu display is released. Data of the cleared range is empty.
To cancel the erasing, press a key other than [Y] or [INPUT].

Note

- (1) If a value outside of the clear range is specified, the operation message "Setting error" is displayed.

Deleting the tool management data in [Disp details]



- (1) Display the tool management screen.  The tool management data list is displayed.
 If the details of tool management data is displayed, press the menu [Disp details] and switch to the display of tool management data list.
- (2) Use the [↑] or [↓] key to move the cursor onto the tool number.
- (3) Delete the selected data.
 Menu [Tool clear]
 The menu [Tool clear] is displayed only when the cursor is located on the tool number.
- (4) Press the [Y] or [INPUT] key.  The tool management data, that is displayed in the detailed view of tool management data, is erased.
 To cancel the erasing, press a key other than [Y] or [INPUT].

Note

- (1) If you wish to change the tool data to be deleted, locate the cursor onto the tool management data list and select a tool data again.

5.5.10 Copying and Pasting the Tool Management Data

Operation method

- (1) Display the tool management screen.  The tool management data list is displayed.
- (2) Use the [↑] or [↓] key to move the cursor onto the line to be copied.
- (3) Press the menu [Line copy].
- (4) Use the [↑] or [↓] key to move the cursor onto the line to be pasted.
- (5) Press the menu [Line paste].  The copied data is written in the line at the cursor position.
 The highlighted copy line is released.

Note

- (1) Once data is copied, it is held until the next tool management data is copied or until the tool management screen is closed.
- (2) For tool life management I, you cannot paste to the data that does not have the tool number. It causes a paste error.

(3) The following information is not copied or pasted.

×: Not copied or pasted

Display data	Common
Tool shape drawing	×

×: Not copied or pasted -: Not managed

Display data (Life data)		M system		L system	
		Tool life management I/II	Tool life management III	Tool life management I	Tool life management II
Life	Status	×	×	-	×
	Method	×	×	-	×
	H No.	×	×	-	-
	L offset	×	×	-	-
	D No.	×	×	-	-
	R offset	×	×	-	-
	Aux.	×	×	-	-
	Offset num	-	-	-	×
	Life	×	×	-	×
	Used	×	×	-	×
	Operating time	-	-	×	-
	Life time	-	-	×	-
	T usage count	-	-	×	-
	T life count	-	-	×	-
	Status A	-	-	×	-
	Status B	-	-	×	-

×: Not copied or pasted -: Not managed

Display data (Compensation data)		Tool compensation type I	Tool compensation type II	Tool compensation type III
Compensation	Length	×	×	-
	L wear	-	×	-
	Radius	-	×	-
	R wear	-	×	-
	Tool L offset num	-	-	×
	Wear offset #	-	-	×
	Length 1st axis name	-	-	×
	Length 2nd axis name	-	-	×
	Length additional axis name	-	-	×
	Wear 1st axis name	-	-	×
	Wear 2nd axis name	-	-	×
	Wear additional axis name	-	-	×
	Nose R	-	-	×
	R-wear	-	-	×
	Point	-	-	×

5.5.11 Specifying Display Format and Setting Range of Additional Information

The display format and setting range of additional information can be changed by entering tool data file (TOOLALL.DAT) described in the specified format.

[Setting]

No.	Addresses	Details	Data range (Meaning)	Supplement
1	N	Custom data No.	1 to 12	Custom 1 to 12
2	B	Number of bytes	0: 4 bytes 1: 1 bytes 2: 2 bytes 4: 4 bytes	
3	K	Type	0: Signed decimal 1: Unsigned decimal 2: Hexadecimal 3: Bit 4: With decimal point (fixed number of digits) 5: With decimal point (linked with iunit and I_inch) 6: With decimal point (linked with iunit) 7: With decimal point (linked with I_inch) 8: Character string	<ul style="list-style-type: none"> •Data with decimal point is valid only when it is 4 bytes and digits information is required. •Character string is valid only when it is 4 bytes.
4	D	Number of digits	0, 11 to 88 If the data is without decimal point, it is set to "0" is set. High-order is the number of digits of integer part Low-order is the number of fraction part <Note> •Designate the data so that the total of fraction and integer part does not exceed 10 digits.	<ul style="list-style-type: none"> •When the display data is linked with iunit and I_inch, the number of digits when iunit = B and I_inch = 0 (mm) is set. •When I_inch = 0 (inch), the integer part decreases 1 digit and the fraction part increases 1 digit. •When iunit = C, the fraction part increases 1 digit.
5	L	Maximum value	Specify the configurable maximum value and minimum value.	
6	S	Minimum value	<p>In case a check is not necessary, set that minimum value is larger than maximum value.</p> <p>When the kind is character string, the number of characters shall be 0 to 4.</p> <p>When the data with decimal point is selected for the kind, eliminate the decimal point from the value when iunit = B, and I_inch = 0 (mm).</p> <p>(Example 1) In case of 0.000 to 99.999 Minimum value: 0, Maximum value: 99999</p> <p>(Example 2) In case of -99.999 to 10.000 Minimum value: -99999, Maximum value: 10000</p>	

Note

(1) When the illegal value is set, it is handled as 4 bytes, signed decimal data without range check.

[Setting example]

```
N1B1K0D0L100S-100
N2B0K4D33L999999S-999999
```

5.6 Tool Life Management

Setup

— T-life

The life management data such as the tool usage is set and displayed on the tool life management (T-life) screen of the setup (Setup) screen.

There are some types of the tool life management method, two for M system and three for L system.

The management method can be changed by the parameter "#1096 T_Ltyp".

L system: Tool life management I (T_Ltyp = 1) and tool life management II (T_Ltyp = 2)

M system: Tool life management I (T_Ltyp = 1), tool life management II (T_Ltyp = 2) and tool life management III (T_Ltyp = 3)

Manual numerical value command can be executed when manual numerical value command window is displayed by inputting an address key such as MST, etc.

<M system>

■ Tool life management I

This method accumulates the cutting time, the number of cuttings, or the wear amount of the tool which is commanded by the program, and monitors the usage of the tool.

■ Tool life management II

This method is the same as tool life management I, but with a spare tool selection function added.

A spare tool is selected from the group of tool commands commanded in the program. Tool compensation (tool length compensation and tool radius compensation) is carried out for the selected tool.

The tool life management II related parameters (basic common parameters) include the following.

#	Name	Setting	Details
1103	T_Life	0	This ignores the tool life management data.
	T-life manage valid	1	This controls the tool life management.
1104	T_Com2 Tool cmd mthd 2 (When tool life management is valid.)	0	This treats the program tool command as a group No. Search for the tools that match with the group No. in the tool registration data, and select the spare tool from them.
		1	This treats the program tool command as a tool No. Search for the group No. that matches with the tool No. in the tool registration data, and select the spare tool from there.
1105	T_sel2 Tool select mthd 2 (When tool life management is valid.)	0	This selects the tool from the tools in use in the same group, following the registration No. order. If there are no "Tools in use", the tools are selected in order of "Tools not in use", "Normal life tools" and "Abnormal tools", following the registration No. order.
		1	This selects the tool with the maximum remaining life from the tools in use and not in use in the same group. When several tools have the same remaining life, the tools are selected in order of registration No. If there are no "Tools in use" or "Tools not in use", the tools are selected in order of "Tools not in use", "Normal life tools" and "Abnormal tools", following the registration No. order.

■ Tool life management III

It is not managed by the group number.

This method accumulates the cutting time, the number of cuttings, or the wear amount of the tool which is commanded by the program, and monitors the usage of the tool.

<L system>

■ Tool life management I - Tool life data display

This method accumulates the cutting time, or the number of cuttings of the tool which is commanded by the program, and monitors the usage of the tool.

Tool life management can be performed for a maximum of 80 tools (tool Nos. 1 to 80).

(1) Time based control

After the tool selection command (T) is issued, the cutting time (G01, G02, G33 etc.) is added to that of the designated tool. A warning appears if the actual cutting time exceeds the estimated cutting time when the tool selection command is issued.

(2) Control based on the number of cuttings

The actual number of cuttings corresponding to the designated tool No. increases each time the tool selection command (T) is issued.

A warning appears if the actual number of cuttings exceeds the estimated number of cuttings when the tool selection command is issued.

■ Tool life management II - Tool life data display / registration group list display

This method monitors the life (cutting time, number of cuttings) of each tool. When the tool life is reached to the estimated value, the same kind of spare tool in the group where the tool belongs is selected in sequence and exchanged.

Group count: Multi-part system spec. max. 40 groups for each part system / Single part system spec: max. 80 groups

No. of tools in group: Max. 16

The tool life management related parameters (basic shared parameters) are shown below.

#	Name	Setting	Details
1096	T_Ltyp Tool life management type	1, 3	Tool life management I
		2	Tool life management II
1103	T_life Enable tool life management	0	The tool life management is not performed.
		1	This controls the tool life management.
1107	TlIfsc (For L system only) Tool life management Display screen division	Set the no. of groups displayed at the tool life management II (L system) screen.	
		0	Displayed no. of groups: 1, Max. No of registered tools: 16
		1	Displayed no. of groups: 2, Max. No of registered tools: 8
		2	Displayed no. of groups: 4, Max. No of registered tools: 4

The tool life management screen is made up of the group list display screen and the life management data screen. (There is no group list display screen in L system tool life management I. Only the life management data screen exists.) Refer to the following sections and later for details of the display contents, menus, and an explanation of the operations for each screen.

"5.6.1 Displaying the Group List (M system: Tool life management I, II / L system: Tool life management II)"

"5.6.2 Displaying the Life Management Data in Group Units (M system)"

"5.6.3 Displaying the Life Management Data (L system: Tool life management I)"

"5.6.4 Displaying the Tool Life Management Data in Group Units (L system: Tool life Management II)"



5.6.1 Displaying the Group List (M system: Tool life management I, II / L system: Tool life management II)

Tool life management data groups can be registered and erased. Press [Group list] when displaying the group unit. When changing from a group unit display to the group list display, the cursor displays at the group No. at the group unit display.

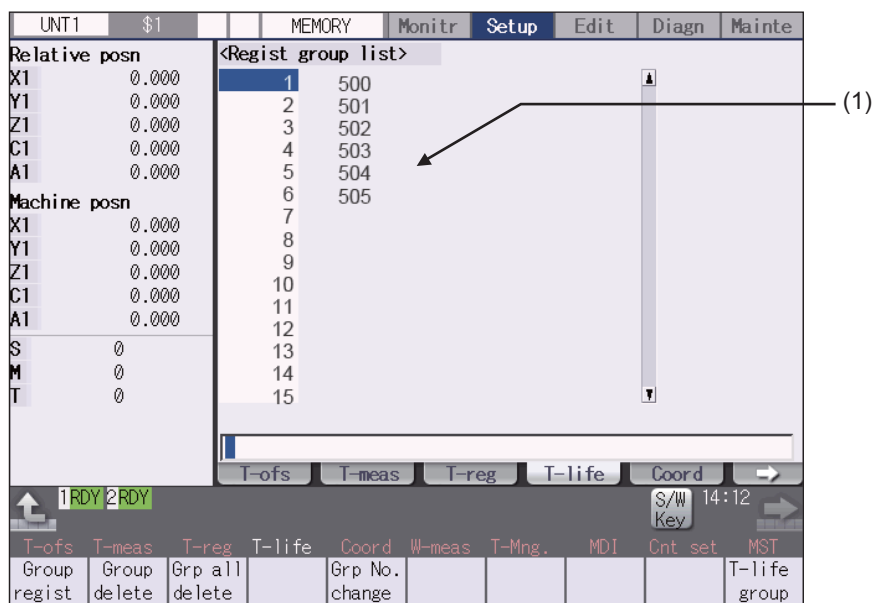
<M system>



Display items

Display items	Details
(1) Regist group list	<p>The group Nos. registered as the tool life management data are listed in ascending order.</p> <p>Group Nos. can be set from 1 to 99999999, and maximum 1000 groups can be set.</p> <p>Maximum 60 groups can be displayed at a time. Use the  and  keys to change the display if the No. of registered groups exceeds 60.</p> <p>An asterisk will be added to the No. of the group in which all tools have reached their lives.</p> <p><Note></p> <ul style="list-style-type: none"> •The maximum number of the registered groups depends on the specifications. •In tool life management II, when all the tools' statuses (ST) of the target group become 2 to 4, "*" is displayed.

<L system>

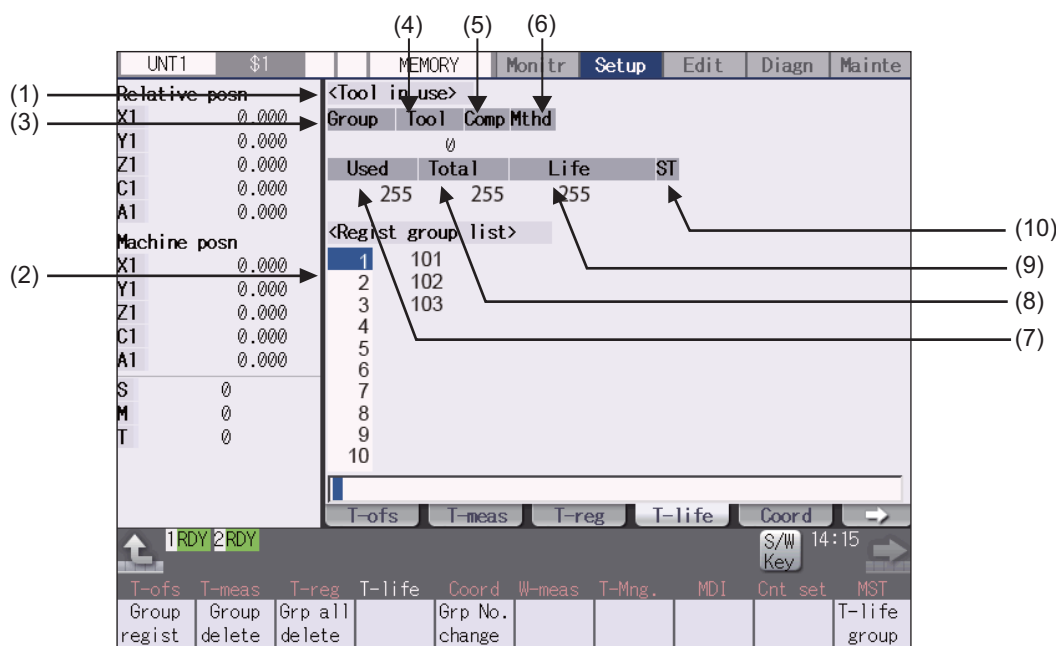

Display items

Display items	Details
(1) Tool in use	The life management information of the tool currently being used appears here.
(2) Regist group list	The group Nos. registered as the tool life management data are displayed in a list. Group Nos. can be set from 1 to 9999, and maximum 80 groups can be set. An asterisk will be added to the No. of the group in which all tools have reached their lives. <Note> •The maximum number of the registered groups depends on the specifications.

[CHOSEN TOOL]

Display items	Details	Display range
(3) Group	Displays the life management group No. currently being used.	1 to 9999
(4) Tool No.	Displays the tool No. currently being used.	1 to 999999
(5) Comp No.	Displays the compensation No. currently being used.	1 to 80
(6) Method	Displays whether the group currently being used is controlled by the cutting time or number of cuttings.	0: Cutting time 1: Number of cuttings
(7) Used	Displays the usage data for the tool currently being used.	Cutting time: 0 to 99999999 (sec) Number of cuttings: 0 to 999999
(8) Total	Displays the total usage data for the tool currently being used. In the case of tools using multiple compensation Nos., the total usage data for all compensation Nos. displays. In the case of only one compensation No., the same value as "Used" displays.	Cutting time: 0 to 99999999 (sec) Number of cuttings: 0 to 999999
(9) Life	Displays the life value for the tool currently being used.	Cutting time: 0 to 99999999 (sec) Number of cuttings: 0 to 999999
(10) ST	Displays the status of the tool currently being used.	0: Unused tool 1: Used tool 2: Normal life tool 3: Skipped tool

Menus (M system/L system)

Menus	Details
Group regist	Creates a new group and adds the group No. to the list.
Group delete	This erases all of the tool life management data included in the designated group No. If the group No. is not designated, the tool life management data for the group No. indicated by the cursor will be erased.
Grp all delete	This erases all groups and their tool life management data registered in the part system which is currently selected.
Grp No. change	This changes a group No. Specify a new group No. and press the [INPUT] key to change the group No. and then change the contents of the list. An error occurs if an existing group No. is specified.
T-life group	The tool life data for the group No. indicated by the cursor is displayed. This changes to the mode enabling tool life management data to be set and displayed with group unit Nos.

Operation method (Registering a group) (M system/L system)

- (1) Press the menu [Group regist].
- (2) For L system, set group No./method/life value.
(Example) 25/1/3000 [INPUT]
For M system, designate the group No. to be registered.
25 [INPUT]

Note

- (1) An error occurs if the group No. duplicates a pre-existing group No.
- (2) The group is not registered if one of the operations below is performed after registering a new group No.
 - ♦If the application is exited without registering even 1 item of tool life data.
 - ♦The screen is changed to that of other than the group unit display.
 - ♦The part system is changed.

Operation method (Erasing a group) (M system/L system)

- (1) Press the menu [Group delete].
- (2) Designate the group to be erased.  The selected group No. is erased.
72 [INPUT]

If nothing is input in the input area, the group at the cursor location is erased.

Operation method (Erasing all groups) (M system/L system)





- (1) Press the menu [Grp all delete].
- (2) Press the [Y] or [INPUT] key.  All the registered groups and their tool life management data is erased.

Note

- (1) If no group has been registered, the operation message "Can't delete all groups" will appear.



Operation method (Changing the group No.) (M system/L system)

(Example) Changing the group No. from 5 to 20

- (1) Use the [↑], [↓], , and  keys to move the cursor to group No. 5.
- (2) Press the menu [Grp No.change].  The menu is highlighted.
- (3) Designate the group No. after changing.
20 [INPUT]  The group No. changes to "20".



Operation method (Changing to the group unit display) (M system/L system)

(Example) Displaying the group No. 5 tool life data.

- (1) Use the [↑], [↓], , and  keys to move the cursor to group No. 5.
- (2) Press the menu [T-life group] or [INPUT] keys.  The screen changes to the group unit display and the group No. "5" tool life management data displays.

5.6.2 Displaying the Life Management Data in Group Units (M system)



The tool life management data of an arbitrary group is set and displayed. Press the menu [T-life group] when the group list is displayed.

Use the  and  keys to scroll between screens if all of the registered tools cannot be displayed on one screen.

<Normal display>

<Detailed display>

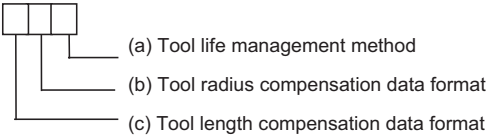
Display items		
Display items	Details	Setting range
(1) Group No.	This is the group No. of the tool for which tool life management is performed. (*1) Tools with the same group No. are regarded as spare tools.	1 to 99999999
(2) #	This is the data setting No. This is not the magazine pot No.	
(3) Tool No.	This is the No. corresponding to the each individual tool. Maximum 1000 tools can be registered. This is a fixed tool No. actually output for the tool command and so on.	1 to 99999999
(4) ST	 <p>Tool status MTB release</p> <p>Tool status 0: Unused tool Normally set to "0" when the tool is replaced with a new tool. 1: Tool in use This becomes "1" when the cutting actually starts. 2: Normal life tool This becomes "2" when the usage data (usage time and No. of uses) exceeds the tool life data. 3: Tool abnormality 1 tool (*2) 4: Tool abnormality 2 tool (*2)</p>	

Display items	Details	Setting range
(5) Method	 <p>(a) Tool life management method</p> <p>(b) Tool radius compensation data format</p> <p>(c) Tool length compensation data format</p> <p>(a) Tool life management method</p> <p>0: Cutting time This manages by the cutting execution time.</p> <p>1: Number of mounting times This manages by the number of times the tool is treated as a spindle tool at the tool replacement, etc. However, in case when no cutting feed command (G01, G02, G03 etc.) is issued for the spindle tool, the number of mounting times is not counted.</p> <p>2: Number of cuttings This is counted when the rapid traverse command (G00 etc.) is changed to the cutting feed command (G01, G02, G03 etc.). However, this is invalid in the case of a rapid traverse or cutting feed command with no movement.</p>  <p>(b) Tool radius compensation data format</p> <p>(c) Tool length compensation data format</p> <p>0, 2: Length dimension/Radius dimension Displays the length dimension or radius dimension of the tool compensation amount of the compensation number designated by HNo. or Dno. in the display item "L compen" or "R compen". If the value of the display item "L compen" or "R compen" is changed, the length dimension or radius dimension of the tool compensation amount is rewritten.</p> <p>1: Length wear/Radius wear Displays the length wear or radius wear of the tool compensation amount designated by HNo. or Dno. in the display item "L compen" or "R compen". If the value of the display item "L offset" or "R offset" is changed, the length wear or radius wear of the tool compensation amount is rewritten.</p>	
(6) HNo.	<p>Length compensation number.</p> <p>Entering a new tool number automatically assigns the same compensation number as the tool number.</p> <p>If a new tool number is entered that is outside the allowable compensation number range, the compensation number is assigned to "0".</p> <p>The compensation number can also be changed to any number as needed.</p>	1 to 999
(7) L compen	<p>Length compensation value.</p> <p>One of the following values is displayed depending on the tool length compensation data format utilized by the method.</p> <p>The value can be changed as needed.</p> <p>0, 2: Length dimension of tool compensation amount of the compensation number designated by HNo.</p> <p>1: Length wear of tool compensation amount of the compensation number designated by HNo.</p>	(*3)

Display items	Details	Setting range
(8) DNo.	Tool radius compensation number. Entering a new tool number automatically assigns the same compensation number as the tool number. If a new tool number is entered that is outside the allowable compensation number range, the compensation number is assigned to "0". The compensation number can also be changed to any number as needed.	1 to 999
(9) R compen	Tool radius compensation value. One of the following values is displayed depending on the tool radius compensation data format utilized by the method. The value can be changed as needed. 0, 2: Radius dimension of tool compensation amount of the compensation number designated by DNo. 1: Radius wear of tool compensation amount of the compensation number designated by DNo.	(*3)
(10) Aux.	This depends on the MTB specifications.	0 to 65535
(11) Life	Set one of the cutting time (minutes), number of mounting times (to spindle), or number of cuttings (holes to be drilled) to this column in accordance with the manner set in the "Method" column. The tool life is infinite when "0" is set.	Cutting time: 0 to 4000 (min) Number of mounting times: 0 to 65000 (set) Number of cuttings: 0 to 65000 (set)
(12) Used	This displays the usage data for individual tools based on the method specified for the tool life management method. <Note> ♦This data is not counted during machine lock, auxiliary function lock, dry run or for a single block.	Cutting time: 0 to 4000 (min) Number of mounting times: 0 to 65000 (set) Number of cuttings: 0 to 65000 (set)

(*1) The group No. is not displayed for the tool life management III.

(*2) This action differs depending on MTB specifications

(*3) The "Length compensation" and "Radius compensation" calculation/direct compensation amount setting/display range are as follows based on a combination of settings of "#1003 iunit" (input setup unit) and "#1041 Initial inch".

#1003 iunit	#1041 I_inch	Setting/display range
B	0	-9999.999 to 9999.999
	1	-999.9999 to 999.9999
C	0	-9999.9999 to 9999.9999
	1	-999.99999 to 999.99999
D	0	-9999.99999 to 9999.99999
	1	-999.999999 to 999.999999
E	0	-9999.999999 to 9999.999999
	1	-999.9999999 to 999.9999999

When data without the decimal point is input, a set unit can be specified by the parameter "#8119 Comp. unit switch".

Note

- (1) When the part system is changed while displayed on the group unit display, the registered data is not displayed because the screen enters the "data unregistered" state. To display the group unit of the changed part system, return to the group list display screen and execute the group unit display again.
- (2) If "Cutter compen. data format" or "T-length compen data format" is set to "0", "2" (Length/radius), or "1" (Length wear/radius wear), the tool compensation amount to be displayed by "L compen" and "R compen" are switched as follows:

Tool compensation type	Item	Method	Setting/display range
I	L compen	0	The compensation amount that is set in the designated compensation number
		1	
		2	
	R compen	0	The compensation amount that is set in the designated compensation number
		1	
		2	
II	L compen	0	The compensation amount that is set in the length of the designated compensation number
		1	The compensation amount that is set in the length wear of the designated compensation number
		2	The compensation amount that is set in the length of the designated compensation number
	R compen	0	The compensation amount that is set in the radius of the designated compensation number
		1	The compensation amount that is set in the radius wear of the designated compensation number
		2	The compensation amount that is set in the radius of the designated compensation number
III	L compen	0	The compensation amount that is set in the Z axis of tool length data of the designated compensation number
		1	The compensation amount that is set in the Z axis of wear data of the designated compensation number
		2	The compensation amount that is set in the Z axis of tool length data of the designated compensation number
	R compen	0	The compensation amount that is set in nose R of the designated compensation number
		1	The compensation amount that is set in the R wear of the designated compensation number
		2	The compensation amount that is set in nose R of the designated compensation number

Menus

Menus	Details
Group No.	This displays the data of a group when that group No. of tool life management data is set and the [INPUT] key is pressed. (*1) The group No. can be referred to in the group list.
Line copy	Copies one line of tool life management data where the cursor is located.
Line paste	The copied tool life management data is written to the data in the line where the cursor is located. If the copied data is changed after the menu [Line copy] is pressed, the data before changing is written when pasted. The copied data can be pasted as many times as is required until new data is copied.
Line clear	This erases a designated line (multiple lines possible) of tool life management data. The first and the last line No. of the data to be erased is specified with a "/" separating the Nos.. If the [INPUT] key is pressed without specifying a line, the data in the line where the cursor is located is erased.
Grp No. change	This changes a group No. (*1) If a new group No. is set and the [INPUT] key pressed, the group No. changes. An error occurs if an existing group No. is specified.
Disp details	Displays the pop-up window for details of the selected group.
Prev group	Displays the previous group No. data. (*1)
Next group	Displays the next group No. data. (*1)
Group list	This displays the list of tool life data groups. (*1)
Group regist	This creates a new group. (*2)
Group delete	This erases all tool life management data contained in the currently displayed group No. (*2)
Close	This closes the pop-up window for details of the selected group.

(*1) This menu is not valid for the tool life management III.

(*2) This menu is not displayed for the tool life management III.

Operation method (Designating a group No.)

- (1) Press the menu [Group No.].
- (2) Designate the group No. to be displayed.
12 [INPUT]

Note

- (1) If a group No. that does not exist is designated, a message appears to confirm the creation of a new No. A new group is created if [Y] or [INPUT] is pressed.



Operation method (Changing a group No.)

- (1) Press the menu [Grp No.change].
- (2) Designate the group No. after changing.
112 [INPUT]

Note

- (1) An error occurs if the group No. duplicates a pre-existing group No.

Operation method (Setting the tool life data)

- (1) Move the cursor to the data to be set using the , , [↑], [↓], [←] or [→] key.
It is possible to move to the line after the registered line.
Set a tool No. for this line to newly register tool life management data.
- (2) Set a value.
20 [INPUT]

Note

- (1) The other settings will be invalid when the tool ST (status) setting data are not set.
- (2) The same tool cannot be registered in more than one group.
- (3) If the tool No. is not set, the other data cannot be set.
- (4) Change the "Method" to initialize the related items.
Change the tool life management method (the 1st digit) to clear the "Life" and "Usage", and also change the units.
Change the tool radius compensation data (the 2nd digit) to clear the "Radius Compensation".
Change the tool length compensation data (the 3rd digit) to clear the "Length Compensation".
Figures after the decimal point are also changed in line with the specifications.

Operation method (Copying/pasting the tool life data)

- (1) Move the cursor to the line to be copied.
- (2) Press the menu [Line copy].
- (3) Move the cursor to the line where the data is to be pasted.
- (4) Press the menu [Line paste].

Note

- (1) It is not possible to paste into a line for which a tool No. has not been set.
- (2) Once copied, the data is held until a new data item is copied.

Operation method (Erasing one line of tool life management data)

- (1) Move the cursor to the line to be erased.
- (2) Press the menu [Line clear] and [INPUT] keys.
- (3) Press the [Y] or [INPUT] key.
Press a key other than [Y] or [INPUT] in order not to erase the data.

Operation method (Designating and erasing the multiple lines)

- (1) Press the menu [Line clear].
- (2) Set the range to be erased by marking the first and last # Nos. with a "/".
122/125 [INPUT]
- (3) Press the [Y] or [INPUT] key.
Press a key other than [Y] or [INPUT] in order not to erase the data.

Operation method (Registering a group)

- (1) Press the menu [Group regist].
- (2) Set the No. of the group to be registered.
25 [INPUT]



Note

- (1) An error occurs if the group No. duplicates a pre-existing group No.
- (2) The group is not registered if one of the operations below is performed after registering a new group No.
 - If the application is exited without registering even 1 item of tool life data.
 - The screen is changed to that of other than the group unit display.
 - The part system is changed.

Operation method (Erasing a group)

- (1) Move the cursor to the group No. to be erased.
- (2) Press the menu [Group delete] and [INPUT] key.
- (3) Press the [Y] or [INPUT] key.

5.6.3 Displaying the Life Management Data (L system: Tool life management I)

The tool life management data can be set and displayed. Use the  and  keys to scroll between screens if all of the registered tools cannot be displayed on one screen.

(1) #	(2) [Time]		(3) [Count]		(4) [Status]	
	Used	Life	Used	Life	A	B
1	0: 0: 0	0: 0	0	0	0	0
2	0: 0: 0	0: 0	0	0	0	0
3	0: 0: 0	0: 0	0	0	0	0
4	0: 0: 0	0: 0	0	0	0	0
5	0: 0: 0	0: 0	0	0	0	0
6	0: 0: 0	0: 0	0	0	0	0
7	0: 0: 0	0: 0	0	0	0	0
8	0: 0: 0	0: 0	0	0	0	0
9	0: 0: 0	0: 0	0	0	0	0
10	0: 0: 0	0: 0	0	0	0	0
11	0: 0: 0	0: 0	0	0	0	0
12	0: 0: 0	0: 0	0	0	0	0
13	0: 0: 0	0: 0	0	0	0	0
14	0: 0: 0	0: 0	0	0	0	0



Display items

Display items		Details	Setting range
(1) #		Tool No. The # No. is highlighted in the following cases. - The actual cutting time reaches the estimated tool life time. - The actual number of cuttings exceeds the estimated number of cuttings.	
(2) Time	Used	The integrated time the tool is used. The count goes up during cutting.	0:0 to 99:59 (h:min)
	Life	Estimated tool life time Set the estimated maximum tool life time. Unit of second is set to "0".	0:0 to 99:59 (h:min) (0:0 = no warning given)
(3) Count	Used	The integrated count the tool is used. The count goes up during cutting.	0 to 65000 (times)
	Life	Setting for estimated number of cuttings Set the estimated maximum number of cuttings.	0 to 65000 (times) (0:0 = no warning given)
(4) Status	A	The tool life management status is indicated. 0: Not used 1: Current tool (tool being used) 2: Estimated tool life time is exceeded.	0 to 2
	B	(Used by MTB)	0 to 99

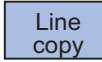
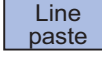
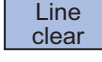
Menus

Menus	Details
	Copies one line of tool life management data where the cursor is located.
	The copied tool life management data is written to the data in the line where the cursor is located. If the copied data is changed after the menu [Line copy] is pressed, the data before changing is written when pasted. The copied data can be pasted as many times as is required until new data is copied.
	This erases a designated line (multiple lines possible) of tool life management data. The first and the last line No. of the data to be erased is specified with a "/" separating the Nos.. If the [INPUT] key is pressed without specifying a line, the data in the line where the cursor is located is erased.

Operation method (Setting the tool life data)

- (1) Move the cursor to the data to be set using the , , [↑], [↓], [←] and [→] keys.
It is possible to move to the line after the registered line.
- (2) Input the value.
20 [INPUT]

Operation method (Copying/pasting the tool life data)

- (1) Move the cursor to the line to be copied.
- (2) Press the menu [Line copy].
- (3) Move the cursor to the line where the data is to be pasted.
- (4) Press the menu [Line paste].

Note

- (1) Once copied, the data is held until a new data item is copied.

Operation method (Erasing one line of tool life management data)

- (1) Move the cursor to the line to be erased.
- (2) Press the menu [Line clear] and [INPUT] keys.
- (3) Press the [Y] or [INPUT] key.
Press a key other than [Y] or [INPUT] in order not to erase the data.

Operation method (Designating and erasing the multiple lines)



- (1) Press the menu [Line clear].
- (2) Set the erasing range by marking the first and last # Nos. with a "/", and press the [INPUT] key.
122/125 [INPUT]
- (3) Press the [Y] or [INPUT] key.
Press a key other than [Y] or [INPUT] in order not to erase the data.

Note

- (1) If the [INPUT] key is pressed without setting a # No., the line at the cursor is erased.

5.6.4 Displaying the Tool Life Management Data in Group Units (L system: Tool life Management II)

The tool life management data of an arbitrary group is set and displayed.

Use the  and  keys to scroll between screens if all of the registered tools cannot be displayed on one screen.

This screen is enabled only for tool life management II ("#1096 T_Ltyp" = 2).

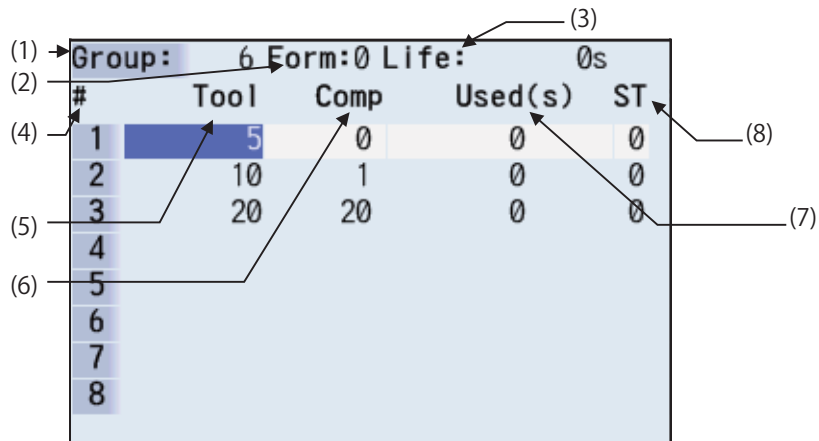

By setting parameter "#1107 TlIfsc", it is possible to select the life management data display mode for multiple groups.

"#1107 TlIfsc" setting value	0	1	2
No. of display groups	1	2	4
Max. No. of registered tools	16	8	4

<Group 1 display mode> (#1107 TlIfsc = 0)

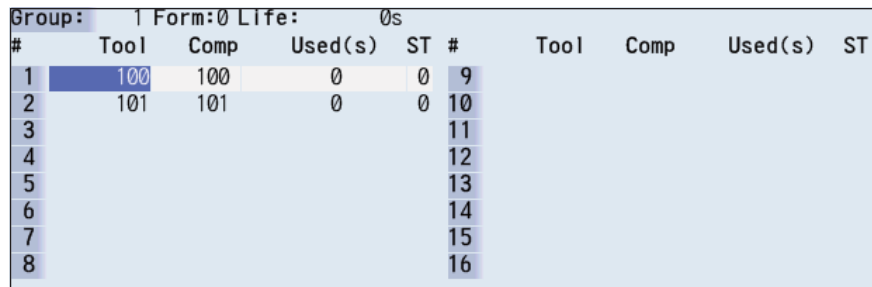

<Group 2 display mode> (#1107 TlIfsc = 1)

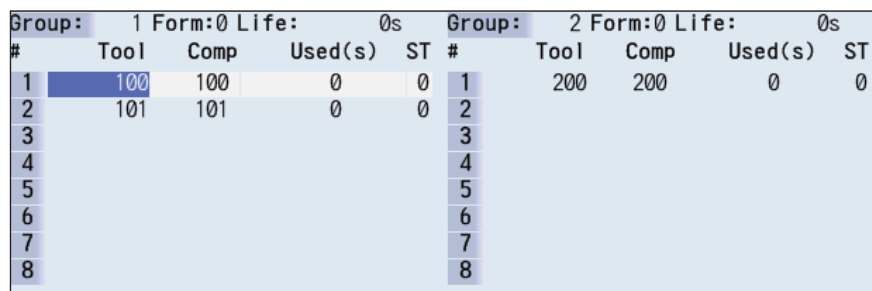

<Group 4 display mode> (#1107 TlIfsc = 2)

Group: 1 Form:0 Life: 0s					Group: 2 Form:0 Life: 0s				
#	Tool	Comp	Used(s)	ST	#	Tool	Comp	Used(s)	ST
1	100	100	0	0	1	200	200	0	0
2	101	101	0	0	2				
3					3				
4					4				
Group: 3 Form:0 Life: 0s					Group: 4 Form:0 Life: 0s				
#	Tool	Comp	Used(s)	ST	#	Tool	Comp	Used(s)	ST
1	300	300	0	0	1	400	400	0	0
2					2				
3					3				
4					4				

Display items

<Group information>

Display items	Details	Setting range
Group	Life management group No.	1 to 9999
Method	This displays whether the group currently being displayed is controlled by the cutting time or number of cuttings.	0: Cutting time 1: Number of cuttings
Life	This sets the tool life data for the currently displayed group. The following tool life data units display based on the control method. Cutting time: (s) Number of cuttings: (set)	Cutting time: 0 to 99999999 (sec) Number of cuttings: 0 to 999999 (set)

<Life management data within group>

Display items	Details	Setting range
#	This displays whether the tool for which the # No. is highlighted is a life tool (ST=2) or a skip tool (ST=3).	
Tool No.	This sets the tool No.	1 to 999999
Comp No.	This sets the compensation No.	1 to 80
Used	This sets the estimated data in case when the tool is not an unused tool, etc. When the data is not set, the value is "0". The following units for the estimated data is displayed based on the control method. Cutting time: (s) Number of cuttings: (set)	Cutting time: 0 to 99999999 (s) Number of cuttings: 0 to 999999 (set) (Setting can be omitted.)
ST	This sets the tool status. This becomes "0" when the tool status is not set. 0: Unused tool 1: Used tool 2: Normal life tool 3: Skipped tool	0 to 3 (Setting can be omitted.)

In the M system, if a part system is switched when the group unit is being displayed, registered data is not displayed, and you need to return to the group list once. However, in the L system: tool life management II, registered data is displayed, so you do not need to return to the group list.

Menus	
Menus	Details
Group No.	This displays the data of a group when that group No. of tool life management data is set and the [INPUT] key is pressed. The group No. can be referred to in the group list.
Line copy	Copies one line of tool life management data where the cursor is located.
Line paste	The copied tool life management data is written to the data in the line where the cursor is located. If the copied data is changed after the menu [Line copy] is pressed, the data before changing is written when pasted. The copied data can be pasted as many times as is required until new data is copied.
Line clear	This erases a designated line (multiple lines possible) of tool life management data. The first and the last line No. of the data to be erased is specified with a "/" separating the Nos.. If the [INPUT] key is pressed without specifying a line, the data in the line where the cursor is located is erased.
Grp No. change	This changes a group No. If a new group No. is specified and the [INPUT] key pressed, the group No. changes. An error occurs if an existing group No. is specified.
Group change	The group active area is changed if parameter "#1107 Tllfsc" is set to "1" or "2".
Multi group	Changes to the multiple group life management data display mode based on the parameter "#1107 Tllfsc" setting value.
Group regist	This creates a new group and displays the life management data containing no data.
Group list	This displays the list of tool life data groups.
Close	The multiple group life management data display mode is canceled.

Operation method (Designating a group No.)

- (1) Press the menu [Group No].
- (2) Designate the group No. to be displayed.
12 [INPUT]

Note

- (1) If a group No. that does not exist is set, a message appears to confirm the creation of a new No. A new group is created if [Y] or [INPUT] is pressed.
When creating a new group, set the method and life data at the end of the group No., separating the data with a "/". If the method and life data are omitted, a new group is created with method = 0 (cutting time), and tool life data = 0.



Operation method (Changing a group No.)

- (1) Press the menu [Grp No.change].
- (2) Designate the group No. after changing.
112 [INPUT]

Note

- (1) An error occurs if the group No. duplicates a pre-existing group No.

Operation method (Setting the tool life data)

- (1) Move the cursor to the data to be set using the , , [↑], [↓], [←] and [→] keys.
It is possible to move to the line after the registered line.
Set a tool No. for this line to newly register tool life management data.
- (2) Set a value.
20 [INPUT]

Note

- (1) It is not possible to set any other data if the tool No. and compensation No. have not been set.

Operation method (Copying/pasting the tool life data)

- (1) Move the cursor to the line to be copied.
- (2) Press the menu [Line copy].
- (3) Move the cursor to the line where the data is to be pasted.
- (4) Press the menu [Line paste].

Note

- (1) Once copied, the data is held until a new data item is copied.

Operation method (Erasing one line of tool life management data)

- (1) Move the cursor to the line to be erased.
- (2) Press the menu [Line clear] and [INPUT] keys.
- (3) Press the [Y] or [INPUT] key.
Press a key other than [Y] or [INPUT] in order not to erase the data.

Operation method (Designating and erasing the multiple lines)

- (1) Press the menu [Line clear].
- (2) Set the range to be erased by marking the first and last # Nos. with a "/".
1/5 [INPUT]
- (3) Press the [Y] or [INPUT] key.
Press a key other than [Y] or [INPUT] in order not to erase the data.

Note

- (1) If the [INPUT] key is pressed without setting a # No., the line at the cursor is erased.

Operation method (Registering a group)

- (1) Press the menu [Group regist].
- (2) Set the No. of the group to be registered.
25/1/3000 [INPUT]

Note

- (1) If the method and life data are omitted, a new group is created with method = 0 (cutting time), and tool life data = 0.
- (2) An error occurs if the group No. duplicates a pre-existing group No.
- (3) The group is not registered if one of the operations below is performed after registering a new group No.
 - If the application is exited without registering even 1 item of tool life data.
 - The screen is changed to that of other than the group unit display.
 - The part system is changed.

Operation method (Changing the active area for multiple group displays)

- (1) Press the menu [Group change].  The cursor indicating the active status moves to the next group.

5.7 Setting and Measuring a Workpiece

5.7.1 Workpiece Measurement (M System)

Setup — W-meas

The coordinate point for each axis can be measured on the workpiece measurement screen of the Setup screen. Install the sensor on the spindle, turn the measurement switch ON, and select manual feeding or handle feeding on the workpiece position measurement screen to bring the sensor into contact with the workpiece. Then, measure the coordinate point of each axis.

To make surface, hole, and width measurements, calculate each center coordinate from the measured coordinate, and set the obtained value to the workpiece coordinate system offset.

For the rotation measurement, the measurement result is set in the workpiece coordinate system offset (rotation center) and parameters "#8623 Coord rot centr(H)", "#8624 Coord rot centr(V)", and "#8627 Coord rot angle".

■For surface measurement (As for the hole or width measurement, the guide drawing (3) differs.)

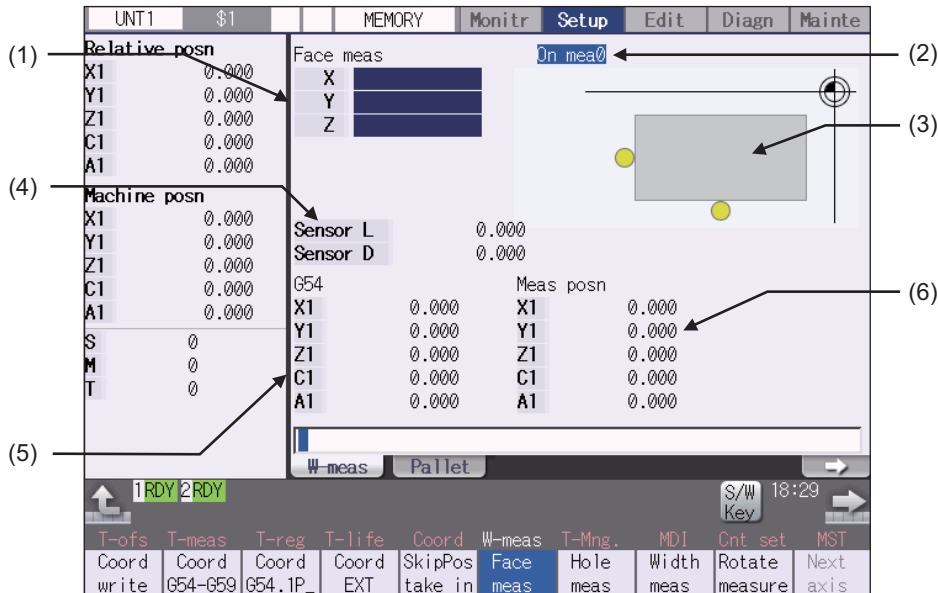

■For rotation measurement

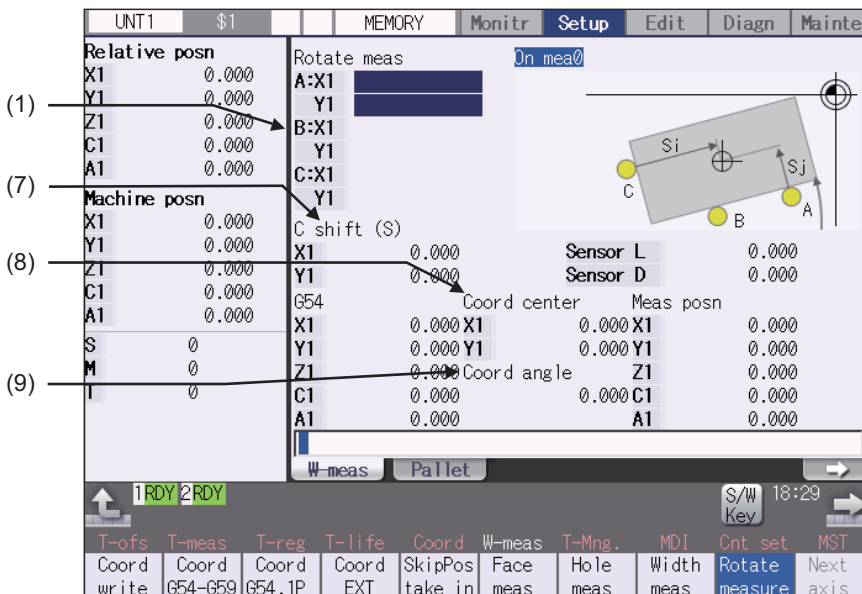

Manual numerical value command can be executed when manual numerical value command window is displayed by inputting an address key such as MST, etc.

Display items

Display items		Details
(1)	Measurement counter	Displays the measurement position. The measurement axis is compatible with parameters "#1026 base_I", "#1027 base_J", and "#1028 base_K". (Hereafter indicated as I=X, J=Y, and K=Z axes in this manual.) The measurement position becomes blank when setting the coordinate system offset amount, resetting the NC, or changing the measurement mode (when the menu [Face meas], [Hole meas], [Width meas], or [Rotate measure] is selected). The display contents differ depending on the measurement pattern (surface measurement, hole measurement, width measurement, or rotation measurement).
	Surface measurement counter	Displays the calculated measurement position from the skip position for each axis (X-, Y-, Z-axes).
	Hole measurement counter	Displays 3 (A, B, C) measurement positions.
	Width measurement counter	Displays 2 (A, B) measurement positions.
	Rotation measurement counter	Displays 3 (A, B, C) measurement positions (X-, Y-axes).
(2)	Display of measurement in progress	"On mea" is displayed when the measurement switch on the machine operation board is ON. Refer to "Manual measurement status display" in "5.3.1 Tool Measurement (M System)" for details.
(3)	Guide graphic	Displays the measurement image. The contents of the guide drawing differ depending on the measurement pattern (surface measurement, hole measurement, width measurement, or rotation measurement).
(4)	Sensor length and diameter	Sensor length: Displays the length to the tip of the touch probe. ("#8701 Tool Length" setting value) Sensor diameter: Displays the diameter of the ball at the tip of the touch probe. ("#8702 Tool Dia" setting value)
(5)	Coordinate system offset	Displays the currently selected coordinate system offset.
(6)	Measurement position counter	Displays the measurement position for all axes. X axis: X axis machine position + sensor radius +center compensation (Horizontal) Y axis: Y axis machine position + sensor radius +center compensation (Vertical) Z axis: Z axis machine position - sensor length 4th axis and over: Respective machine position Sensor length: "#8701 Tool Length" Sensor radius: "#8702 Tool Dia" /2 Center compensation (H): "#8703 OFFSET X" Center compensation (V): "#8704 OFFSET Y"
(7)	Center shift amount	Displays the shift amount of the coordinate rotation center.
(8)	Coordinate rotation center	Displays the coordinates that are the center during coordinate rotation. This is the setting value of "#8623 Coord rot centr (H)" and "#8624 Coord rot centr (V)".
(9)	Coordinate rotation angle	Displays the rotation angle during coordinate rotation. This is the setting value of "#8627 Coord rot angle".

Menus	
Menus	Details
Coord write	The results calculated from the measurement counter are set in the displayed workpiece coordinate system offset. Only the axis for which a value is displayed in the measurement counter can be set. <Note> <ul style="list-style-type: none"> •If the workpiece coordinate system to be set is G54 to G59, the local coordinate system offset value will be zero. (Only for the measured axis.) •When the parameter "#8924 Meas. confirm msg" is "1", this menu is highlighted and the operation message "OK?(Y/N)" appears. The measurement result is written as tool compensation amount by pressing [Y] or [INPUT] key. Even if other key is pressed, the result is not written. When this menu is pressed again while displaying the message, the highlighting is canceled and the operation message is erased.
Coord G54-G59	This selects the displayed workpiece coordinate system from the sub-menu (G54 - G59). Select the workpiece coordinate system to display the selected workpiece coordinate system offset in the coordinate system offset section. (Perform the offset amount setting at the menu [Coord write].)
Coord G54.1 P	Input the P number to display the selected extended workpiece coordinate system (G54.1 Pn) offset in the coordinate system offset section. (Perform the offset amount setting at the menu [Coord write].) This menu is not displayed if the extended workpiece coordinate system offset specification is disabled.
Coord EXT	This displays the external workpiece coordinate system offset in the coordinate system offset section. (Perform this setting at the menu [Coord write].)
SkipPos take in	This creates a false signal when performing simple measurement (measurement without using the touch probe) and reads the skip position. Press this menu to display the measurement position measured from the machine position of the axis moved last (axis 1 or 2) at the measurement counter. The skip position cannot be read for an axis of auxiliary axis state.
Face meas	This enables surface measurement. Surface measurement is possible when the power is turned ON.
Hole meas	This enables hole measurement. (The cursor moves to the measurement counter point A.)
Width meas	This enables width measurement. (The cursor moves to the measurement counter point A.)
Rotate measure	This enables rotation measurement. (The cursor moves to the measurement counter point A.)
Next axis	This changes the axes displayed at the coordinate system offset and measurement position counter every 5 axes. <Note> <ul style="list-style-type: none"> •This displays when the number of enabled axes is 6 or over.
Center shift	This sets the center shift amount. (The cursor moves to the 1st axis of "C shift (S)" when this is selected.)
Rotate center	This sets the coordinate rotation center. (The cursor moves to the 1st axis of "Coord center" when this is selected.)
Rotate angle	This sets the coordinate rotation angle. (The cursor moves to "Coord rot angle" when this is selected.)

Details of the "Measurement counter" and "Guide drawing" display areas

Menus	Measurement counter	Guide graphic
Face meas	Face meas X -1566.122 Y -433.368 Z	
Hole meas	Hole meas A:X -1566.122 Y -433.368 B:X Y C:X Y	
Width meas	Width meas A:X -1566.122 Y -433.368 Z B:X Y Z	
Rotate measure	Rotate meas A:X1 -1566.122 Y1 -433.368 B:X1 Y1 C:X1 Y1	

5.7.1.1 Carrying Out Surface Measurement

When carrying out surface measurement, the position of each axis is measured and the measurement results are set in the workpiece coordinates system offset. The measurement position displays at the measurement counter.

<Measurement using touch probe>

Measurement counter X = X axis skip position + sensor radius (*1)

Measurement counter Y = Y axis skip position + sensor radius (*1)

Measurement counter Z = Z axis skip position - sensor length

(*1) The sign (+ and -) changes depending on the direction of the axis moved last.

Item	Reference
Sensor radius	"#8702 Tool Dia"/2
Sensor length	"#8701 Tool Length"

<Simple measurement (measurement without using touch probe)>

Measurement counter X: X axis measurement position

Measurement counter Y: Y axis measurement position

Measurement counter Z: Z axis measurement position

Operation method

- (1) Press the menu [Face meas].
- (2) Perform the reference position return command, etc. to position the tool at the basic point.
- (3) Turn ON the measurement switch on the machine operation board.
- (4) Move the tool near the workpiece using manual feed and manual handle feed.

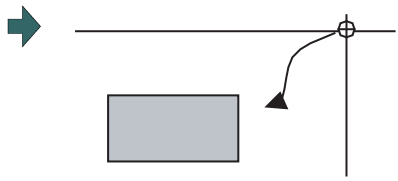



<Measurement using touch probe>

- (5) Move the tool in the X-direction until the sensor contacts the workpiece.

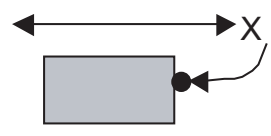
Upon contact, the axis automatically contacts the workpiece again. The measurement position measured from the skip position displays in the measurement counter X axis section.



<Simple measurement (without the touch probe)>

- (5) Move the tool in the X-direction to the arbitrary position and press the menu [SkipPos take in].  The skip position is calculated and the result displays in the measurement counter X axis section.
- (6) Select the workpiece coordinate system offset in which the measurement data will be set.
(Example) To select G55
Press the menus [Coord G54-G59] [G55].
- (7) Press the menu [Coord write].  The value achieved by adding or subtracting the external workpiece offset to or from the X axis measurement position based on the "#8709 Ext work sign rvs" is set in workpiece coordinate system selected at (6).
The measurement counter displays blank.
- (8) Carry out the operations in steps (4) to (7) in the same way for the Y and Z axes.
- (9) Return the tool to the reference position, and turn the measurement switch OFF.

5.7.1.2 Carrying Out Hole Measurement

For hole measurement, measure the measurement position coordinate of two axes (X and Y) at three points, calculate the center of the hole, and set the result to the designated workpiece coordinate offset. The measurement position coordinate is displayed on the measurement counter.

<Measurement using touch probe>

Measurement counter X = X axis skip position

Measurement counter Y = Y axis skip position

<Simple measurement (measurement without using touch probe)>

Measurement counter X = X axis machine position + center compensation (H) + skip past amount (Horizontal axis) (*1)

Measurement counter Y = Y axis machine position + center compensation (V) + skip past amount (Vertical axis) (*1)

(*1) The skip past amount is added for only the axis that moved last.

The sign (+ or -) of the past amount depends on the movement direction of the axis.

Item	Reference
Center compensation (H)	"#8703 OFFSET X"
Center compensation (V)	"#8704 OFFSET Y"
Skip past amount (H)	"#8707 Skip past amout(H)"
Skip past amount (V)	"#8708 Skip past amout(V)"

Operation method

- (1) Press the menu [Hole meas]. ➡ The menu is highlighted and the cursor displays at point A.
Use the [↑] or [↓] key to move to points B and C.
- (2) Perform the reference position return command, etc. to position the tool at the basic point.
- (3) Turn ON the measurement switch on the machine operation board.
- (4) Move the tool into the hole using manual feed and manual handle feed.

<Measurement using touch probe>

- (5) Position the tool against the inner wall of the hole. Contact is performed by moving a single axis. ➡

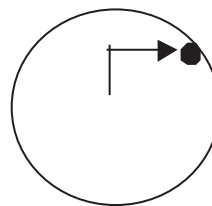

Upon contact, the axis automatically contacts the work-piece again. The skip position displays in the measurement counter point A, X and Y axis section. The cursor moves to point B. For point C, the cursor moves to point A.

<Without the touch probe (simple measurement)>

- (5) Move the tool to the arbitrary position and press the menu [SkipPos take in]. ➡

The skip position is calculated and the result is displayed for X and Y axes in the measurement counter A. The cursor moves to point B. For point C, the cursor moves to point A.

- (6) Measure points B and C in the same way.
- (7) Select the workpiece coordinate system offset in which the measurement data will be set.
(Example) To select G55
Press the menus [Coord G54-G59] [G55].
- (8) Press the menu [Coord write]. ➡
- (9) Return the tool to the reference position, and turn the measurement switch OFF.

The hole center position is measured, and based on the "#8709 Ext work sign rvs", value achieved by adding or subtracting the external workpiece to or from the measurement result is set in workpiece coordinate system selected at (7).
The measurement counter displays blank.

5.7.1.3 Carrying Out Width Measurement

With width measurement, two points of the measurement position coordinate for each axis are measured, and then calculates the center between the points to set it as the workpiece coordinate offset. The measurement position displays at the measurement counter.

<Measurement using touch probe>

Measurement counter X = X axis skip position

Measurement counter Y = Y axis skip position

Measurement counter Z = Z axis skip position - sensor length

<Simple measurement (measurement without using touch probe)>

Measurement counter X = X axis machine position + center compensation (H) + skip past amount (Horizontal axis) (*1)

Measurement counter Y = Y axis machine position + center compensation (V) + skip past amount (Vertical axis) (*1)

Measurement counter Z = Z axis machine position - sensor length

(*1) The skip past amount is added for only the axis that moved last.

The sign (+ or -) of the past amount depends on the movement direction of the axis.

Item	Reference
Sensor length	"#8701 Tool Length"
Center compensation (H)	"#8703 OFFSET X"
Center compensation (V)	"#8704 OFFSET Y"
Skip past amount (H)	"#8707 Skip past amout(H)"
Skip past amount (V)	"#8708 Skip past amout(V)"

Operation method

- (1) Press the menu [Width meas].  The menu is highlighted and the cursor displays at point A. Use the [↑] or [↓] key to move to points A and B.
- (2) Perform the reference position return command, etc. to position the tool at the basic point.
- (3) Turn ON the measurement switch on the machine operation board.
- (4) Move the tool to the center of the groove using manual feed or manual handle feed.

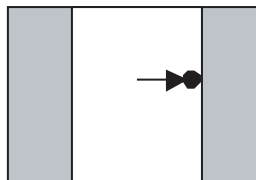

<Measurement using touch probe>

- (5) Position the tool against the inner wall of the groove.  Contact is performed by moving a single axis.



Upon contact, the axis automatically contacts the workpiece again. The skip position displays in the measurement counter point A. The cursor moves to point B. For point B, the cursor moves to point A.

<Simple measurement (without the touch probe)>

- (5) Move the tool to the arbitrary position and press the menu [SkipPos take in].  The skip position is calculated and the results displays in the movement axis section of the measurement counter A point.
The cursor moves to point B. For point B, the cursor moves to point A.
- (6) Similarly, position the tool against the opposite side.  Upon contact, the axis automatically contacts the workpiece again. The skip position displays in the measurement counter point B.
- (7) Select the workpiece coordinate system offset in which the measurement data will be set.
(Example) To select G55
Press the menus [Coord G54-G59] [G55].
- (8) Press the menu [Coord write].  The width center position is measured, and based on the "#8709 Ext work sign rvs", value achieved by adding or subtracting the external workpiece offset to or from the measurement result is set in workpiece coordinate system offset G55 (coordinate system selected at (7)). The measurement counter displays blank.
- (9) Carry out the operations in steps (4) to (8) in the same way for the Y and Z axes.
- (10) Return the tool to the reference position, and turn the measurement switch OFF.

5.7.1.4 Carrying Out Rotation Measurement

When carrying out rotation measurement, the offset (rotation center and rotation angle) of the rotary coordinate system is measured, and the results are set to the workpiece coordinate system offset (rotation center) and the parameters "#8623 Coord rot centr(H)", "#8624 Coord rot centr(V)", and "#8627 Coord rot angle".

<Measurement using touch probe>

Measurement counter X = X axis skip position

Measurement counter Y = Y axis skip position

<Simple measurement (measurement without using touch probe)>

Measurement counter X = X axis machine position + center compensation (H) + skip past amount (Horizontal axis) (*1)

Measurement counter Y = Y axis machine position + center compensation (V) + skip past amount (Vertical axis) (*1)

(*1) The skip past amount is added for only the axis that moved last.

The sign (+ or -) of the past amount depends on the movement direction of the axis.

Item	Reference
Center compensation (H)	"#8703 OFFSET X"
Center compensation (V)	"#8704 OFFSET Y"
Skip past amount (H)	"#8707 Skip past amount(H)"
Skip past amount (V)	"#8708 Skip past amount(V)"

Operation method (Setting the center shift amount)

- (1) Press the menu [Rotate measure].
- (2) Press the menu [Center shift].
- (3) Input the center shift amount (Si).
10.000 [INPUT]
- (4) Input the center shift amount (Sj).
-5.000 [INPUT]
- (5) Press the menu [Center shift].

Operation method (Setting the center and angle of the coordinate rotation)

The setting of the parameters "#8623 Coord rot centr(H)", "#8624 Coord rot centr(V)", and "#8627 Coord rot angle" can be changed.

- (1) Press the menu [Rotate measure].
- (2) Press the menu [Rotate center].
- (3) Input data in the 1st axis of "Coord center" column.
0 [INPUT]
- (4) Input data in the 2nd axis of "Coord center" column.
0 [INPUT]
- (5) Press the menu [Rotate center].

Note

- (1) Set the angle of the coordinate rotation in the same manner.

Operation method (Carrying out the rotation measurement using touch probe to set the measurement results to the workpiece coordinate offset)

- (1) Press the menu [Rotate measure].  The menu is highlighted and the cursor displays at point A.
The cursor can be moved to A, B, or C, using the [↑] or [↓] key.
 - (2) Set the parameter "#8116 Coord rot para invd" to "1" (invalid).
 - (3) Turn the manual absolute switch ON.
 - (4) Set the following parameters to "0".
#8623 Coord rot centr(H)
#8624 Coord rot centr(V)
#8627 Coord rot angle (*1)
 - (5) Perform the reference position return command, etc. to position the tool at the basic point.
 - (6) Turn ON the measurement switch on the machine operation board.
 - (7) Referring to "Setting the center shift amount", set the center shift amount.
This setting is not necessary if the coordinate rotation center is served as the workpiece coordinate zero point.
- (*1) These parameter should be set to "0" to set the measured value to them.
If the value other than "0" has been set, an error occurs when writing to the coordinate system.

(8) <Measurement using touch probe>

Make the spindle contact the workpiece using manual feed or manual handle feed. →

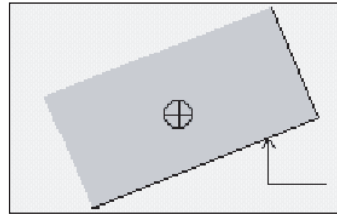

Upon contact, the skip position displays in the measurement counter point A.

The cursor moves to point B. For point C, the cursor moves to point A.

<Without the touch probe (simple measurement)>

Move the spindle to the arbitrary position and press the menu [SkipPos take in]. →

The skip position is calculated and the results appear in the measurement counter point A.

The cursor moves to point B. For point C, the cursor moves to point A.

(9) Measure points B and C in the same way.

(10) Select the workpiece coordinate system offset in which the measurement data will be set.

(Example) To select G55
Press the menus [Coord G54-G59] [G55].

(11) Press the menu [Coord write]. →

The hole center position is measured.

Based on the parameter "#8709 Ext work sign rvs" setting, the value achieved by adding or subtracting the external workpiece offset to or from the measurement result is set in workpiece coordinate system selected at (10).

The parameters "#8623 Coord rot centr(H)", "#8624 Coord rot centr(V)", and "#8627 Coord rot angle" are updated.

The measurement counter displays blank.

(12) Return the tool to the reference position, and turn the measurement switch OFF.

5.7.1.5 Performing Automatic Recontact When Contacting the Workpiece

When performing workpiece position measurement in either the JOG or handle mode, the following operations (automatic recontact) are performed after contacting the workpiece.

- (1) Moves to the measurement point using either the JOG or handle mode.

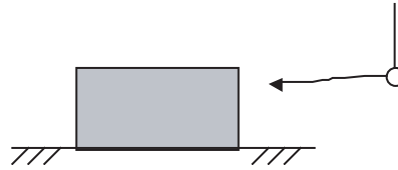

- (2) Stops at the measurement point.

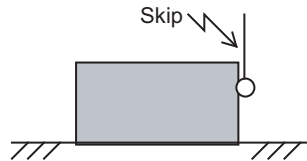

- (3) Returns by the measurement parameter return amount (#8705).

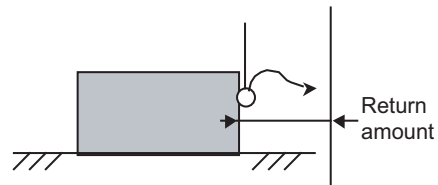

- (4) Moves to measurement point again at the measurement parameter feedrate (#8706).

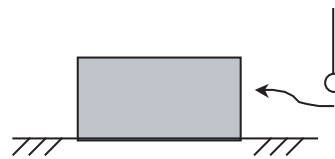

- (5) Stops at the measurement point.
(The skip position is read.)

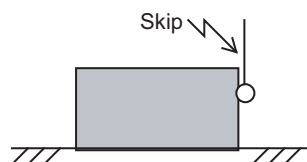

- (6) Returns by the measurement parameter return amount (#8705).

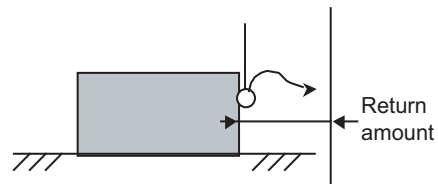

- (7) The next measurement can be performed after automatically contacting the workpiece again.

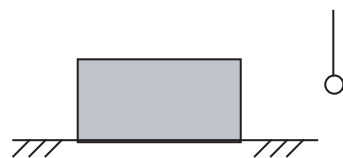

The return speed for (3) and (6) is 40 times the measurement parameter feedrate (#8706). However, if the return speed is faster than rapid traverse rate (override 100%), the rapid traverse rate will become the return speed.



Display items

Display items	Details
(1) External workpiece coordinate offset	This displays the external workpiece coordinate offset. When the workpiece measurement signal is input, the measurement result is set to 2nd axis of the external workpiece coordinate. <Note> •The 5th axis and following are not displayed.
(2) Tool L offset num	This displays the compensation No. of tool length data used by automatic calculation. <Note> •If an illegal value is set, the value is blank. ("0" is displayed.)
(3) Wear offset num	This displays the compensation No. of tool nose wear data used by automatic calculation. <Note> •If an illegal value is set or tool nose wear data is not used for measurement ("#1226 aux10/bit0" is 1), the value is blank. ("0" is displayed.)
(4) Coordinate system offset	This displays the coordinate system offset in which the measurement result is written when the menu [MeasVal take in] is pressed. G54 is displayed in default. When the menu [MeasVal take in] is pressed, the measurement result is set to 2nd axis of the external workpiece coordinate. <Note> •The 5th axis and following are not displayed. •The display of coordinate system offset area is switched by page up/down keys. For details, refer to "5.8.4 Changing the Coordinate System Display".
(5) On mea	When the measurement switch is ON and the operation mode is manual mode (handle, jog, rapid traverse, or step), "On mea" is displayed, and the workpiece can be measured by the workpiece measurement signal.
(6) Guide graphic	This displays the measurement area.

Menus

Menus	Details
Coord G54-G59	This selects the coordinate system offset which sets the measurement value when [MeasVal take in] is executed from sub-menu (G54 - G59). The workpiece coordinate system offset data is displayed after selected. However, the cursor is not displayed and the data cannot be set.
Coord G54.1 P	This selects the coordinate system offset which sets the measurement value when [MeasVal take in] is executed. Input the P No. to display the selected external workpiece coordinate system (G54.1 Pn) offset in the coordinate system offset area. However, the cursor is not displayed and the data cannot be set. If the extended workpiece coordinate system offset specification is invalid, this menu is grayed out and non-selectable.
MeasVal take in	This measures G54 - G59 and G54.1Pn. When this menu is pressed, the workpiece coordinate offset data is calculated from the machine coordinate, the used tool length, the tool nose wear compensation amount and the external workpiece coordinate offset, and the data is stored in Z axis of the selected coordinate system offset.

Operation method (When the workpiece measurement signal is used)

- | | | |
|---|---|--|
| (1) Execute the reference position return. |  | The coordinate system is established.
<Note>
•If the workpiece is measured without establishing the reference position return, the operation message "Meas axis not returned to ref. position" appears. |
| (2) Set the mode selection switch to the manual mode (handle, jog, rapid traverse, or step). | | |
| (3) Set the tool length measurement signal to "1". | | |
| (4) Select whether to measure the workpiece coordinate on the main spindle side or sub-spindle side by using tool presetter sub-side valid signal.
<Note>
•Hold the state of this signal until the measurement with the selected tool is completed. | | |
| (5) Issue the T command with MDI operation, etc. |  | The tool is selected.
<Note>
•Set the selected tool compensation No. in R register. The set R register differs according to parameter setting and the state of the tool presetter sub-side valid signal.
•Set the "tool length/wear data" for the tool being used beforehand. |
| (6) Cut the workpiece face slightly to even it.
<Note>
•Do not move the tool in the Z axis direction after cutting the workpiece face.
•If the workpiece does not need to be cut, carry out positioning to the measurement position. | | |
| (7) Input the workpiece measurement signal. |  | The Z axis external workpiece coordinate offset data is automatically calculated from the tool compensation data of the used tool and the machine value at the point this signal is input. The results are set as the data. |
| (8) Set the tool length measurement signal to OFF. | | |

Operation method (When the menu [MeasVal take in] is used)

- | | | |
|--|---|--|
| (1) Execute the reference position return. | ➔ | <p>The coordinate system is established.</p> <p><Note></p> <ul style="list-style-type: none"> ◆If the workpiece is measured without establishing the reference position return, the operation message "Meas axis not returned to ref. position" appears. |
| (2) Set the mode selection switch to the manual mode (handle, jog, rapid traverse, or step). | | |
| (3) Select an arbitrary coordinate system offset. | ➔ | <p>The designated coordinate system offset is selected.</p> <p><Note></p> <ul style="list-style-type: none"> ◆When switching to an arbitrary coordinate system offset display, press one of these menus; [Coord G54 - G59] [Coord G54.1P] or page key. |
| (4) Select whether to measure the workpiece coordinate on the main spindle side or sub-spindle side by using tool presetter sub-side valid signal. | | |
| <p><Note></p> <ul style="list-style-type: none"> ◆Hold the state of this signal until the measurement with the selected tool is completed. | | |
| (5) Issue the T command with MDI operation, etc. | ➔ | <p>The tool is selected.</p> <p><Note></p> <ul style="list-style-type: none"> ◆Set the selected tool compensation No. in R register. The set R register differs according to parameter setting and the state of the tool presetter sub-side valid signal. ◆Set the "tool length/wear data" for the tool being used beforehand. |
| (6) Cut the workpiece face slightly to even it. | | |
| <p><Note></p> <ul style="list-style-type: none"> ◆Do not move the tool in the Z axis direction after cutting the workpiece face. ◆If the workpiece does not need to be cut, carry out positioning to the measurement position. | | |
| (7) Press the menu [MeasVal take in]. | ➔ | <p>The workpiece measurement is executed.</p> <p>The operation message "OK?(Y/N)" appears, so press the [Y] or [INPUT].</p> <p>The Z axis external workpiece coordinate offset data is automatically calculated from the tool compensation data of the used tool and the machine value at the point this signal is input. The results are set as the data.</p> |

Details of automatic calculation formula (When the workpiece measurement signal is used)

The external workpiece coordinate offset data is automatically calculated with the following expression.

$$\text{External workpiece coordinate offset} = \text{Machine coordinate value} - \text{Tool compensation data}$$

The tool compensation data used for the measurement is selected with the parameter "#1226 aux10/bit0".

#1226 aux10/bit0	Tool compensation data
0	Tool length data + nose wear data
1	Tool length data

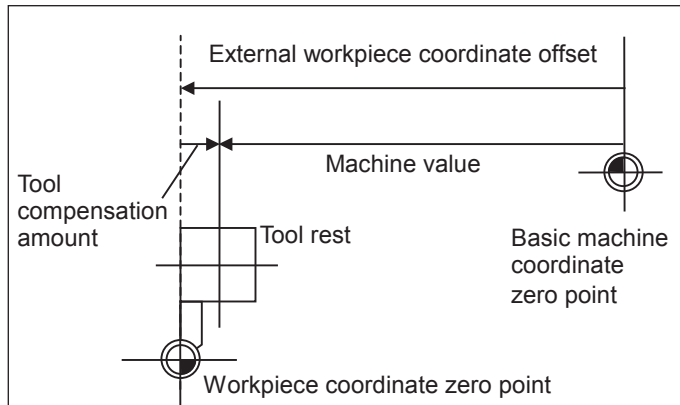

Details of automatic calculation formula (When the menu [MeasVal take in] is used)

The workpiece coordinate offset data is automatically calculated with the following expression.

The calculation formula changes depending on the parameter "#8709 Ext work sign rvs".

When "#8709" is "0":

$$\text{Workpiece coordinate offset} = \text{Machine coordinate value} - \text{External workpiece coordinate offset} - \text{Tool compensation data}$$

When "#8709" is "1":

$$\text{Workpiece coordinate offset} = \text{Machine coordinate value} + \text{External workpiece coordinate offset} - \text{Tool compensation data}$$

The tool compensation data used for the measurement is selected with the parameter "#1226 aux10/bit0".

#1226 aux10/bit0	Tool compensation data
0	Tool length data + nose wear data
1	Tool length data

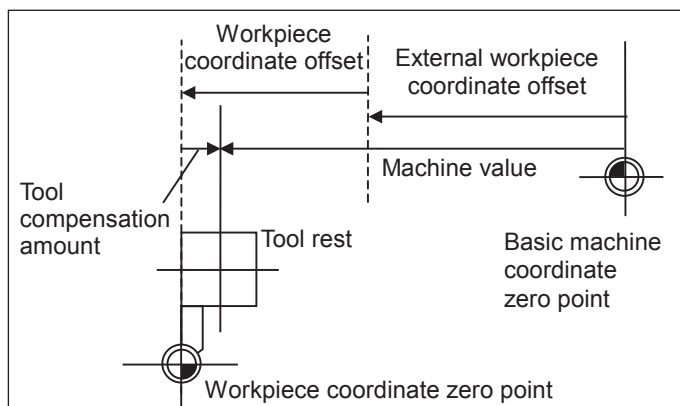

The selected tool compensation No.

For the compensation No. of the tool length and tool nose wear data used by automatic calculation, the No. set in R register in the following table is used.

#1098 TIno.	#1130 set_t	#1218 aux02 / bit4	Tool L offset num		Wear offset num	
			Main side	Sub-side	Main side	Sub-side
0	0/1	0/1	R2600, R2601	R2604, R2605	R2600, R2601	R2604, R2605
1	0	0	R536, R537		R2600, R2601	R2604, R2605
		1	R2602, R2603	R2606, R2607		
	1	0/1				

Note

- (1) When the compensation No. is 0, the compensation amount will be calculated as "0".
- (2) If the compensation No. exceeds the number of specified offset sets, the operation message "Offset No. not found" appears.
However, when the workpiece measurement screen is not displayed, the message will not appear.
- (3) If the input data exceeds the setting range, the operation message "Data range error" appears.
However, when the workpiece measurement screen is not displayed, the message will not appear.
- (4) If the data protection is valid, the operation message "Data protect" appears.
However, when the workpiece measurement screen is not displayed, the message will not appear.
- (5) Whether to use the main side or sub-side is selected with the tool presetter sub-side valid signal.
(OFF: Main side, ON: Sub-side)
However, when the workpiece measurement screen is not displayed, the message will not appear.
- (6) Set the compensation No. in R register by the BCD code.

5.8 Setting Workpiece Coordinate System Offset



The coordinate system offset controlled by the NC can be set and displayed on the monitor (Monitr) screen or the Setup screen.

Depending on the specifications, the number of coordinate system offset sets can be increased by 48, 96, or 300 sets.

Note

(1) The G92/G52 coordinate system offset cannot be set.

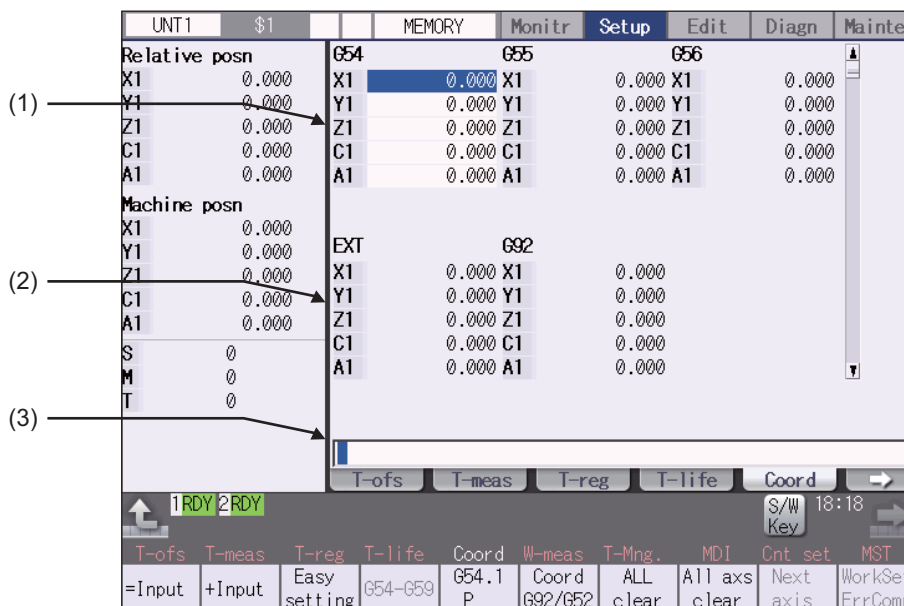

Manual numerical value command can be executed when manual numerical value command window is displayed by inputting an address key such as MST, etc.

Display items		Details
(1)	Coordinate system offset area	<p>This sets and displays the offset amount for the workpiece coordinate system (G54 - G59), or the extended workpiece coordinate system (G54.1Pn). Use the menu operation or page up/down keys to specify which workpiece coordinate system offset to display or set.</p> <p>The workpiece coordinate system offset data can be set in absolute or incremental mode.</p>
(2)	EXT offset area	This displays or sets the offset data for the external workpiece system.
(3)	G92/G52 offset area	This displays the offset amount for G92 or the local coordinate system. The offset amount of the corresponding local coordinate system (G52) is displayed only when the cursor is at G54 to G59.

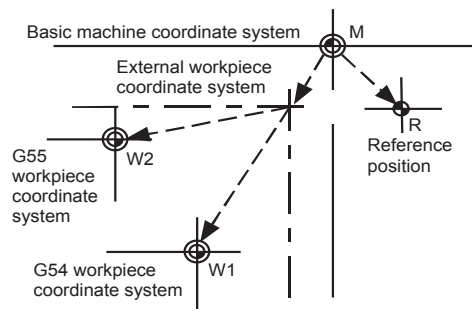

**CAUTION**

If the tool compensation amount or workpiece coordinate system offset amount is changed during automatic operation (including during single block stop), the changes will be valid from the command in the next block or after several subsequent blocks.







Menus

Menus	Details
=Input	This executes an absolute input. When "#8929 Disable=INPUT:comp" is set to "1", this menu cannot be selected.
+Input	This executes an incremental input.
Easy setting	This sets the workpiece coordinate system offset so that the current machine coordinate becomes the workpiece coordinate zero point. Only the axis at the cursor position is set. When "#8935 W COORD CONFIRM" is set to "1", a operation message is displayed, and the menu is highlighted.
G54-G59	This displays the G54 - G59 workpiece coordinate system offset amount. The cursor moves to the G54 offset. This menu can be used when the G54 - G59 offsets are not displayed.
G54.1 P	Enter the P number displayed at the screen to display the extended workpiece coordinate (G54.1 Pn) offset in the coordinate system offset area. This menu is not displayed if the extended workpiece coordinate system offset specification is disabled. If the local coordinate system offset (G52) displays in the G92/G52 area, the display changes to G92.
Coord G92/G52	This displays the G92 or G52 coordinate system offset amount. The G92 offset data is always displayed when the cursor is not at the G54 to G59 offset data.
All clear	Coordinate system offset All coordinate system offset amounts for all axes are erased with the exception of G92 and EXT.
All axs clear	Coordinate system offset This erases the local offset data for all axes corresponding to the offset data of the coordinate system where the cursor is located.
Next axis	This changes the axes displayed at the coordinate system offset and measurement position counter every five axes. <Note> ♦This displays when there are 6 or more axes.

5.8.1 Setting the Coordinate System Offset Amount

Operation method (Setting the workpiece coordinate system G54 - G59 offset amount)

- (1) Press the menu [G54-G59].  The G54 - G59 workpiece coordinate system offset displays.

- (2) Use the ( ) keys to move the cursor to the workpiece coordinate system offset to be set.
 Use the  and  page keys to change the coordinate system display.
 Refer to "Changing the coordinate system offset using the page up/down keys (previous page: , next page: )" in "5.8.4 Changing the Coordinate System Display" for details.)

- (3) Use the [\uparrow] or [\downarrow] key to move the cursor to the axis for which data is to be set.

- (4) Set the offset amount.
 122 [INPUT]
 The value can also be designated by pressing the menu [=Input] instead of the [INPUT] key.

- (5) Set other data using the same method.

Note



- (1) It is possible to perform incremental input by pressing the menu [+Input] key instead of the [INPUT] key or the menu [=Input].
 (Example) If the original data is 122.000:
 1.234 [+Input] -> 122.000 + 1.234 = 123.234

Setting the external coordinate system offset amount



Set the external coordinate system offset amount to keep the current workpiece coordinate system offset amounts from G54 to G59, and also apply an offset to the entire system.
 Furthermore, it is also possible to use the data transfer function to write data directly to the external coordinate system offset (EXT). (Refer to "Chapter 11 Performing a Backup Operation" for details of the data transfer function.)

5.8.2 Erasing the Coordinate System Offset Amount

Operation method (Erasing the coordinate system (excluding G92) offset amount where the cursor is displayed for all axes.)

- | | | |
|-------------------------------------|---|--|
| (1) Press the menu [All axc clear]. |  | A message displays confirming whether it is okay to erase the data. |
| (2) Press the [Y] key. |  | All of the coordinate system indicated by the cursor is cleared to zero.
In addition, all axes data of the local offset (G52) for the coordinate system will be erased. |

Operation method (Erasing all axis offset data of all coordinate systems (excluding G92 and EXT))

- | | | |
|---------------------------------|---|---|
| (1) Press the menu [All clear]. |  | A message displays confirming whether it is okay to erase the data. |
| (2) Press the [Y] key. |  | All coordinate system data is erased.
In addition, all axes data of the local offset (G52) for the G54 to G59 coordinate systems will be erased. |

Note

- (1) G92 data cannot be erased.

5.8.3 Setting the Workpiece Coordinate Origin

Press the menu [Easy setting] to set the coordinate system offset so that the current machine position (for all axes) becomes the workpiece coordinate origin. It is only possible to set those axes where the cursor is located.

If the menu [Easy setting] is pressed when there is the cursor in coordinate system offset (G54 to G59), the local offset (G52) data of the axis will be also erased.

5.8.4 Changing the Coordinate System Display

Using the tab keys (←/→) to change cursor position

The counter on which the cursor is displayed can be switched using the tab keys as shown below.

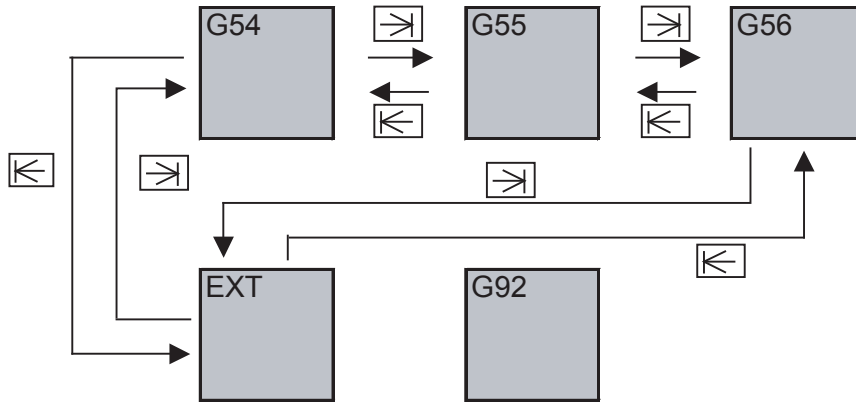

Using the page changeover keys (previous page: PAGE ↓, next page: PAGE ↑) to change counter display

The coordinate system offset display can be switched using the page changeover keys as shown below.

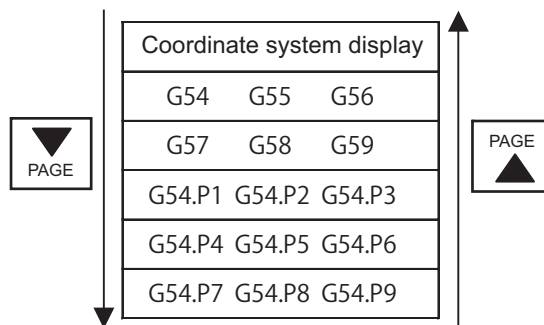

The additional specification is required for the G54.P1 - P300 workpiece coordinate system offset display.

5.9 Setting Workpiece Coordinate System Shift

Monitr — W-shift

Setup — W-meas

This function allows you to shift the workpiece coordinate system.

Workpiece coordinate system that is created at the machining program creation may not match to the coordinate system that actually programmed or programmed by automatic coordinate system setting. This function allows you to machine without changing the machining program by shifting from the measured coordinate system to the coordinate system that is assumed when the program is created. In addition, workpiece can be machined using the same program even if their shapes are changed.

The workpiece coordinate system shift value can be designated by manual setting or automatic setting.

Manual setting: Allows you to directly input the workpiece coordinate system shift value from the workpiece coordinate system shift screen or select the menu [Measure] to designate the workpiece coordinate system shift value.

Automatic setting: Allows you to designate the workpiece coordinate system shift value with the workpiece measurement signal.

The manual setting and automatic setting to designate the workpiece coordinate system shift value using the menu [Measure] are additional specifications.

When this function is enabled, the menu [W-shift] is displayed on the monitor (Monitr) screen. If the menu [W-meas] is selected on the setup (Setup) screen, the setting screen for the workpiece coordinate system shift screen is displayed.

Note

(1) When this function is disabled, the menu [W-shift] is not displayed on the monitor (Monitr) screen. If the menu [W-meas] is selected on the setup (Setup) screen, the external workpiece setting screen is displayed.

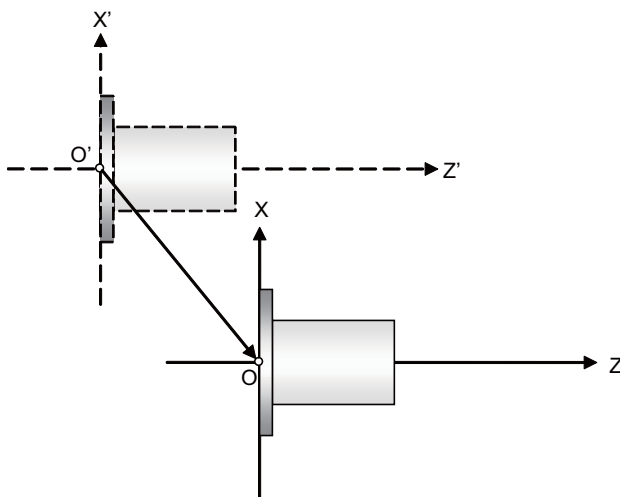

Set the shift value to O'- O as the shift value of the workpiece coordinate system shift value.

X' - Z': Measured coordinate system

X - Z: Coordinate system established when the program is created

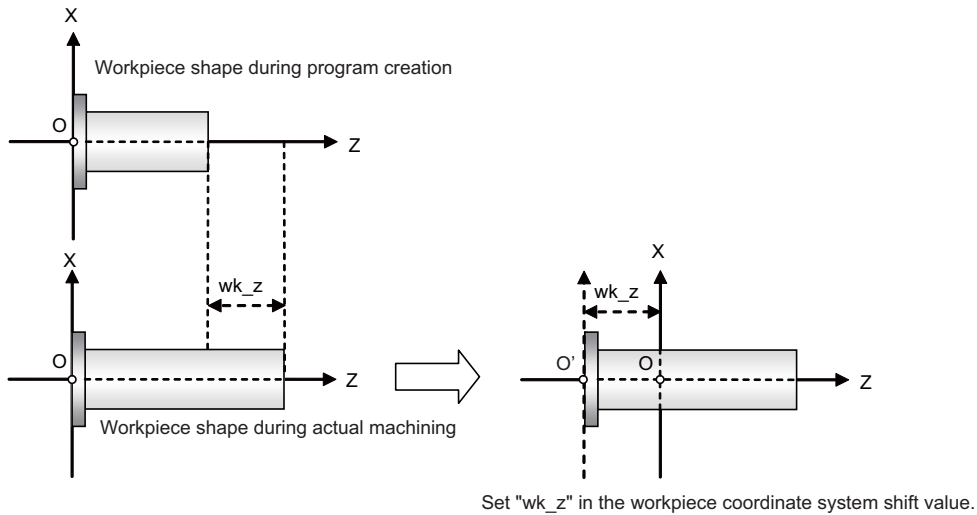

X - Z: Coordinate system established when the program is created

wk_z: The degree of change of the workpiece shape

<Monitor screen>

Machine posn		Program posn		MEM	
X1	0.000	X1	0.000	0	10011.PRGN
Y1	0.000	Y1	0.000	0	N B
Z1	0.000	Z1	0.000	G28X0.Y0.Z0.;	
C1	0.000	C1	0.000	G90G00X100.Y100.;	
A1	0.000	A1	0.000	G43Z100.H6;	
				Z1.;	

Relative posn		Manual int amt	
X1	0.000	X1	0
Y1	0.000	Y1	0
Z1	0.000	Z1	0
C1	0.000	C1	0
A1	0.000	A1	0

WK coordinate shift			
Work shift value		Measure posn	
X1	0.000	X1	0.000
Y1	0.000	Y1	0.000
Z1	0.000	Z1	0.000
C1	0.000	C1	0.000
A1	0.000	A1	0.000

(5) points to the 'Manual int amt' table.
 (6) points to the 'S' (Spindle speed) field.
 (7) points to the 'Measure posn' table.

<Setup screen>

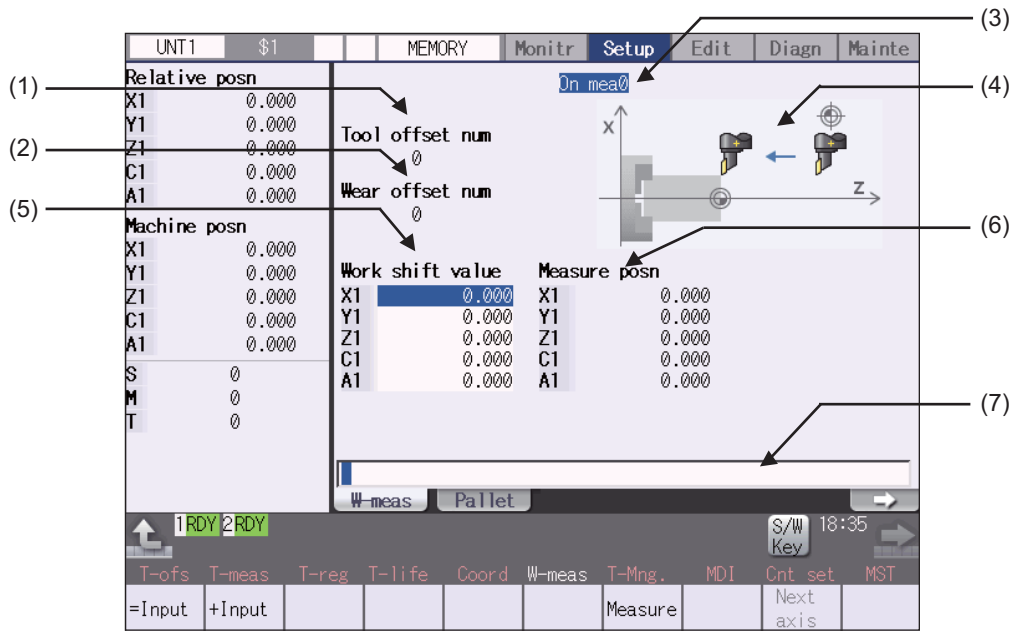

Display items

Display items	Details
(1) Tool L offset num	This displays the compensation No. of the tool length data used in the automatic setting. (*1)
(2) Wear offset num	This displays the compensation No. of the tool nose wear data used in the automatic setting. (*2)
(3) On mea	When the measurement switch is ON and the operation mode is manual mode (handle, jog, rapid traverse, or step), "On mea" is displayed, and the workpiece can be measured by the workpiece coordinate system shift write mode signal. (*3)
(4) Guide graphic	This displays the measurement area.
(5) Work shift value	This displays the currently designated workpiece coordinate system shift value. (*4) The initial cursor position is located at the 1st axis in all part systems. If the cursor position is changed using cursor movement keys or the menu [Next axis], it is held until the program is placed into the following status. Monitor screen: The cursor position is not held. Setup screen: The cursor position is held until the power is turned on again.
(6) Meas posn	The measurement position (machine position - tool length compensation amount of the T-commanded tool) is displayed. (*4)
(7) Input section	This displays the input data.

(*1) If an illegal value is set, the value is blank ("0" is displayed).



(*2) If an illegal value is set or tool nose wear data is not used for measurement (parameter "#1226 aux10/bit0" is "1"), the value is blank ("0" is displayed).

(*3) When the workpiece coordinate offset measurement specification is invalid, the value is not displayed during measurement even if the measurement switch is set ON.

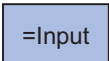
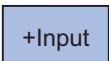
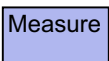

(*4) To display the 9th axis and after, use the menu [Next axis].

Menus

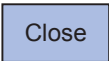
<Monitor screen>

Menus	Details
	This executes an absolute input. When the parameter "#8929 Disable=INPUT:comp" is set to "1", this menu is disabled.
	This executes an incremental input.
	The workpiece coordinate system shift value is measured.
	This changes the workpiece shift value and the axes displayed at the measurement position on a 8-axis basis. The cursor of the workpiece shift value then jumps to the top row. <Note> •When nine or more axes are included in a part system, this menu is enabled.
	This closes the pop-up window and quits this function.

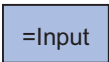
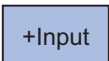
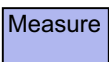
<Setup screen>

Menus	Details
	This executes an absolute input. When the parameter "#8929 Disable=INPUT:comp" is set to "1", this menu is disabled.
	This executes an incremental input.
	The workpiece coordinate system shift value is measured.
	This changes the workpiece shift value and the axes displayed at the measurement position on a 8-axis basis. The cursor of the workpiece shift value then jumps to the top row. <Note> •When nine or more axes are included in a part system, this menu is enabled.

5.9.1 Manually Setting the Workpiece Coordinate System Shift Value

Operation method (Set the absolute position "10.000" to the workpiece coordinate system shift value of the Z axis (2nd axis) on the Monitor screen.)

- | | | |
|--|---|---|
| (1) This displays the workpiece coordinate system shift.
<Monitor screen>
Press the menu [W-shift].
<Setup screen>
Press the menu [W-meas]. | ➔ | The workpiece coordinate system shift screen is displayed. |
| (2) Use the [↑] or [↓] key to move the cursor onto the Z axis. | ➔ | The cursor moves to the Z axis. |
| (3) Designate the workpiece coordinate system shift value.
10 [INPUT]
The value can also be designated by pressing the menu [=Input] instead of the [INPUT] key. | ➔ | The designated value appears.
The cursor moves to the next axis. |

Note

- (1) If the parameter "#11017 T-ofs set at run" (Tool compensation amount setting during automatic operation enabled) is set to "1", the workpiece coordinate system shift value can also be designated in the automatic operation mode or operation pause mode.

Operation method (Add the value "1.234" to the workpiece coordinate system shift value of the C axis (3rd axis) on the Monitor screen.)

- | | | |
|---|---|---|
| (1) This displays the workpiece coordinate system shift.
<Monitor screen>
Press the menu [W-shift].
<Setup screen>
Press the menu [W-meas]. | ➔ | The workpiece coordinate system shift screen is displayed. |
| (2) Use the [↑] or [↓] key to move the cursor onto the C axis. | | |
| (3) Input a numeric value.
1.234 [+Input] | ➔ | The input value added to the original value is displayed.
(Example) When the original value is set to "10.000",
"10.000 + 1.234 = 11.234" is displayed. |

Note

- (1) If the parameter "#11017 T-ofs set at run" (Tool compensation amount setting during automatic operation enabled) is set to "1", the workpiece coordinate system shift value can also be designated in the automatic operation mode or operation pause mode.

Operation method (Measure the workpiece coordinate system shift value of the Z axis (2nd axis) on the Monitor screen.)



- (1) Select the basic tool used to measure the workpiece shift value with the manual numerical value command.  The Manual numerical value command screen is displayed, and tool 1003 is selected.
- T1003
The T command can also be issued with MDI operation, etc. If one block contains multiple T commands, the last T command is used as the selected tool.

- (2) This displays the workpiece coordinate system shift.  The workpiece coordinate system shift screen is displayed.
- <Monitor screen>
Press the menu [W-shift].
<Setup screen>
Press the menu [W-meas].

- (3) Select the "Manual handle feed" mode or "Jog feed" mode.

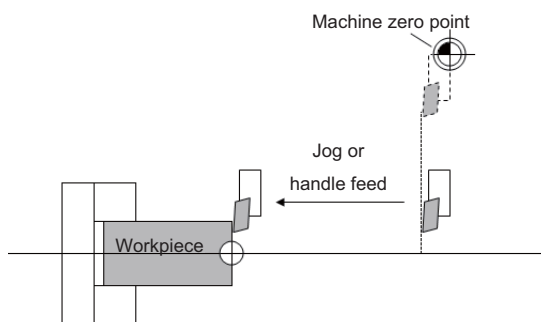
- (4) Select the Z axis, and manually move the tool to the work end face (program origin).



- (5) Input the name of the axis to be measured, and the measurement value from the workpiece to the tool nose.  When you input "Z0", the cursor moves to the Z axis column. Value "Z0." is displayed in the input column. If you input an axis name that does not exist, the cursor does not move. The second and subsequent characters are not considered to be the axis name and, therefore, the cursor does not move. (Example: If you enter "XZ", the cursor is moved on the X axis, but the cursor does not move on the Z axis.)
- Z0.
- (6) Press the menu [Measure].  The measurement result is set to the workpiece coordinate system shift value pointed by the cursor. The input column is cleared.

<Details on formula>

The measurement result is calculated in the following formula.

When the parameter "#8709 Ext work sign rvs" is set to "0":

$$\text{Measurement result} = (\text{Machine position of Z axis}) - (\text{Tool length compensation data of T-command tool}) - (\text{Input value})$$

When the parameter "#8709 Ext work sign rvs" is set to "1":

$$\text{Measurement result} = (\text{Machine position of Z axis}) - (\text{Tool compensation data of T-command tool}) * (-1) - (\text{Input value})$$

Select the tool compensation data used for the measurement with the parameter "#1226 aux10/bit0".

#1226 aux10/bit0	Tool compensation data
0	Tool length data + nose wear data
1	Tool length data





Note

- (1) If the parameter "#11017 T-ofs set at run" (Tool compensation amount setting during automatic operation enabled) is set to "1", the tool compensation amount data can be input in the automatic operation mode or operation pause mode.
- (2) If you press the menu [Measure] while the axis name designated in the input section is different from that pointed at the cursor, the operation message "Setting error" is displayed.

5.9.2 Automatically Setting the Workpiece Coordinate System Shift Value

Carry out the automatic setting for the workpiece coordinate system shift value using the workpiece measurement signal. The PLC device is set to the value of the 1st part system. For information on how to carry out automatic setting in another part system, refer to "PLC Interface Manual".

Operation method

- (1) Carry out the reference position return. If the workpiece is measured without establishing the reference position return, the operation message "Meas axis not returned to ref. position" appears. However, when the setup workpiece coordinate system shift screen is not displayed, the message will not appear.  After the power is turned on, carry out the dog-type reference position return, and establish the coordinate system. In the absolute position detection specification, configure the initial setting in advance if the absolute position is not established.
- (2) Select the mode.  Set the mode selection switch to the manual mode (handle, jog, rapid traverse, or step).
- (3) Input the tool measurement mode signal (YC21).  Set the tool length measurement signal to "1". "On mea" is displayed on the setup workpiece coordinate system shift screen.
- (4) Select the main or sub part system.  Select whether to measure the workpiece coordinate system shift value on the main spindle side or sub-spindle side by using tool presetter sub-side valid signal (YCDA). Hold the status of this signal until the workpiece coordinate system shift value measurement with the selected tool is completed.
- (5) Select a tool. Set the selected tool compensation No. in R register. The set R register differs according to parameter setting and the state of the tool presetter sub-side valid signal. Set the "tool length/wear data" for the tool being used beforehand.  Issue the T command by MDI operation, etc., then select tool.

- (6) Cut the workpiece face.
If the workpiece does not need to be cut, carry out positioning to the measurement position. If the workpiece face is not cut, cut the workpiece face slightly to even it.
Do not move the tool in the Z axis direction after cutting the workpiece face.
- (7) Input the workpiece measurement signal (Y9E1). Input the workpiece measurement signal. The Z axis external workpiece coordinate offset data is automatically calculated from the tool compensation data of the used tool and the machine value at the point this signal is input. The results are set as the data.

<Details on automatic calculation expression>

The workpiece coordinate system shift value is automatically calculated with the following expression:

When the parameter "#8709 Ext work sign rvs" is set to "0":

Workpiece coordinate system shift amount = Machine coordinate value - Tool compensation data
--

When the parameter "#8709 Ext work sign rvs" is set to "1":

Workpiece coordinate system shift value = -(Machine coordinate value - Tool compensation data) * (-1)

Select the tool compensation data used for the measurement with the parameter "#1226 aux10/bit0".

#1226 aux10/bit0	Tool compensation data
0	Tool length data + nose wear data
1	Tool length data

<Compensation No. of selected tool>

The compensation number of the tool length and nose wear data used for automatic calculation is determined by the PLC ladder.

<Note>

- ♦When the compensation No. is 0, the compensation amount will be calculated as "0".
- ♦If the compensation No. exceeds the number of specified offset sets, the operation message "Offset No. not found" appears. However, when the setup workpiece coordinate system shift screen is not displayed, the message will not appear.
- ♦If the input data exceeds the setting range, the operation message "Data range error" appears. However, when the setup workpiece coordinate system shift screen is not displayed, the message will not appear.
- ♦If the data protection is valid, the operation message "Data protect" appears. However, when the setup workpiece coordinate system shift screen is not displayed, the message will not appear.
- ♦Measurement is disabled for the part system with one-axis structure. The operation message "Can't measure" is displayed. However, when the setup workpiece coordinate system shift screen is not displayed, the message will not appear.
- ♦Whether to use the main side or sub-side is selected with the tool presetter sub-side valid signal (YCDA). (OFF: Main side, ON: Sub-side)

- (8) Set the tool length measurement signal to OFF. The measurement of the workpiece coordinate system shift value is completed.
Select the tool compensation data used for the measurement with the parameter "#1226 aux10/bit0".

Precautions

- (1) When the automatic setting is carried out for the workpiece coordinate system shift value without displaying the setup workpiece coordinate system shift screen, the message is not displayed even if an error occurs.

Setting Parameters

The parameters contain the user and machine parameters.

This chapter explains the details and operations for the user parameters on the Setup screen.

Refer to "Alarm/Parameter Manual" for details of each parameter.

Parameters can be set on the maintenance (Mainte) screen.

6.1 Setting User Parameters



Press the menu [User] on the Setup screen to display various user parameters.

Display example by part system (Switch the part system using the $\$ \leftrightarrow \$$ key.)

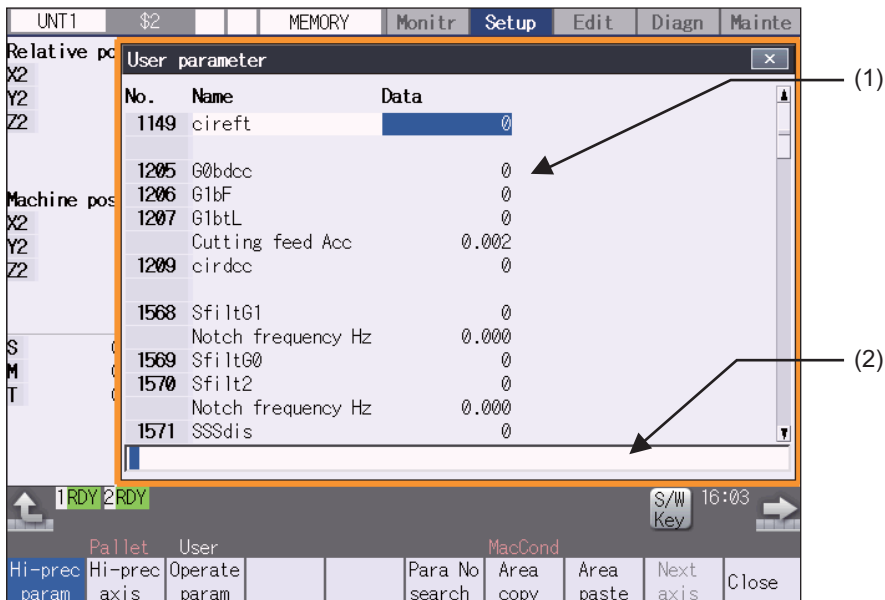

Display example by axis (Switch the fourth axis and after on the menu [Next axis].)

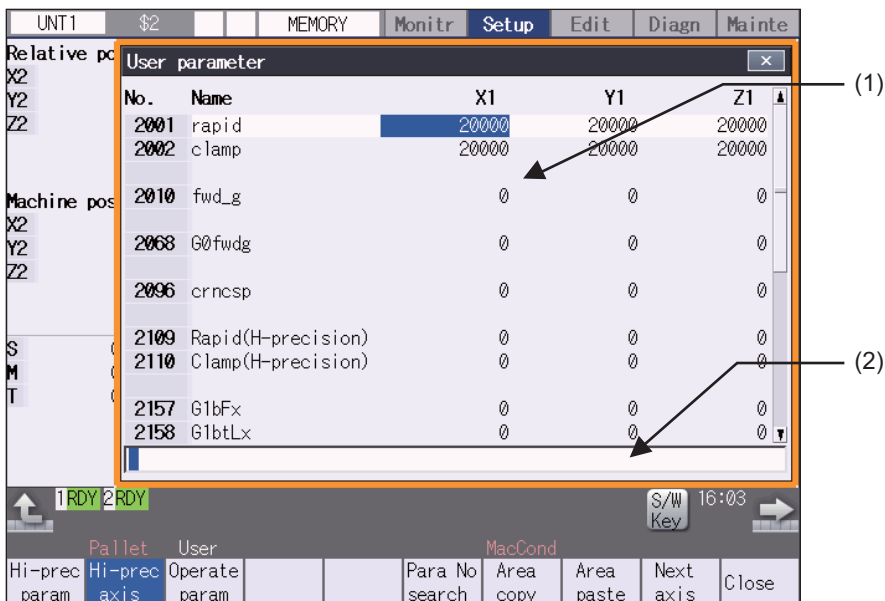

Display items

Display items	Details
(1) Parameter display area	Press the parameter selection menu [Process param] or [Hi-prec param] etc. to change the parameter display contents. The screen layout can be switched by part system (with [\$] key) or by axis.
(2) Input section	The set key displays. Press the [INPUT] key to set the display data in the parameter where the cursor is located.

Menus

Menus	Details
Process param	<p>This changes the display of each parameter type.</p> <p><Note></p> <ul style="list-style-type: none"> The barrier data appears only for L system. [Menu select] is displayed only when the parameter "#11032 Menu sel para lkof " (Menu select param setting enabled) is set to "1" or "2".
Fix Cycle	
Ctrl param 1	
Ctrl param 2	
Ethnet param	
Axis param	
Barrier data	
Hi-prec param	
Hi-prec axis	
Operate param	
Menu select	
Para No search	This selects an arbitrary parameter number. Set the parameter number and press the [INPUT] key to move that number to the top and display the parameter. The cursor also moves to that number.
Area copy	This copies the parameter setting values in the designated range. The range is designated with numbers.
Area paste	This pastes the range of parameters designated in area copy. They are pasted in a parameter corresponding to the axis or part system where the cursor is. Once copied, a parameter can be pasted any number of times until a new parameter is copied.
Next axis	This can be selected if the total number of part system display axes is 4 or more. This is used at the parameter screen with the array structure for each axis.
Close	This closes the pop-up window and quits this function.

6.1.1 Selecting the Parameter Number

There are two switching methods to display a screen by designating the parameter No. Use the parameter "#8975 No. search process" to switch the operation

Operation method ("#8975 No. search process" is "0") (Select "#1041 Initial inch")

- (1) Press the menu [Para No search].
- (2) Enter a parameter No. to be displayed, and then press the [INPUT] key.  "#1041 Initial inch" is displayed at the head. The cursor moves to "#1041 Initial inch".
1041 [INPUT]

Operation method ("#8975 No. search process" is "1") (Select "#1041 Initial inch")

- (1) Enter a parameter No. to be displayed.
1041
- (2) Press the menu [Para No search].  "#1041 Initial inch" is displayed at the head. The cursor moves to "#1041 Initial inch".

Note

- (1) When the parameter "#8975 No. search process" is set to "1" and the cursor is at the parameter to be echoed back, the set value is displayed in the input column. Delete the set value in the input column, and then perform the menu [Para No search] operation.

6.1.2 Setting the Parameters

The method of setting the parameters is explained. Refer to "Alarm/Parameter Manual" for details of each parameter setting range.

Operation method (Normal) (Set "100" for Y1 axis of "#2001 rapid")

- (1) Press the menu [Hi-prec axis].
- (2) Use the [↑], [↓], [←] and [→] keys to move the cursor to the setting position.
- (3) Input the value.
100 [INPUT]

Operation method (Batch data setting) (Set "4000" for Y1 axis and "3000" for Z1 axis for "#2002 clamp")

- (1) Press the menu [Hi-prec axis].
- (2) Use the [↑], [↓] keys to move the cursor to the setting position.
- (3) Input the value.
Input format: 1st column/2nd column/3rd column
/4000/3000 [INPUT]

Note

- (1) When a parameter is changed and [PR] displays at the top of the screen, reboot the machine to enable that parameter change.
- (2) When the [INPUT] key is pressed without inputting a value, the parameter setting value is not changed, and the cursor moves.
- (3) Parameters that can be set simultaneously must display within the currently displayed three columns.
- (4) If parameter values are simultaneously input in multiple columns, settings are made from the currently displayed column on the left side, no matter which column the cursor is positioned.

6.1.3 Copying and Pasting Parameters

Parameters can be copied and pasted in a parameter with the same number for another axis or part system.

Operation method (Specifying and copying the parameter where the cursor is located)

- (1) Press the menu [Area copy].
- (2) Move the cursor to the position of the parameter to be copied and press the [INPUT] key.

Operation method (Copying parameter numbers in a specific range)

- (1) Move the cursor to the display area of the axis or part system to be copied.
- (2) Press the menu [Area copy].
- (3) Designate the copy range.
Format: First No./Last No.
8701/8705 [INPUT]
An "E" can be used if the last number to be copied is the last number in the currently displayed parameter type.
(Example) 8701/E

Note

- (1) The selected area color of the copied area returns to normal when the copied data is pasted. However, the copied range can still be pasted until the parameter type display is changed.
- (2) Only the currently displayed parameter type can be copied.

Operation method (Pasting the copied parameters)

- (1) Move the cursor to the axis or part system display area where the data will be pasted.
- (2) Press the menu [Area paste].
- (3) Press the [Y] or [INPUT] key.

The copied data is not written in when the [N] key is pressed.



The copied data is written to the parameter with the same number in the area where the cursor is positioned.
The menu highlight returns to normal.

Note

- (1) If the relevant parameter is changed after specifying the range to be copied, the value after the change is pasted.

6.1.4 Parameter Configuration

The parameter number range and permissible operations for all parameter types are shown below.

○: Can be used Δ: Operable under certain conditions (Refer to the section below for conditions.)

Parameter type	Menu [Next axis]	System change key	Menu [Area copy]	Menu [Area paste]
Fixed cycle parameter	-	Δ (*3)	Δ (*3)	Δ (*3)
Fixed cycle	-	Δ (*3)	Δ (*3)	Δ (*3)
Control parameter 1	-	-	-	-
Control parameter 2	-	Δ (*3)	Δ (*3)	Δ (*3)
Ethernet parameter	-	-	-	-
Axis parameter	Δ (*1)	-	Δ (*2)	Δ (*2)
Barrier data (*4)	-	Δ (*3)	○	○
High-accuracy control parameter	-	Δ (*3)	Δ (*3)	Δ (*3)
High-accuracy control axis parameter	Δ (*1)	-	Δ (*2)	Δ (*2)
Operation parameter	-	-	-	-
Menu selection parameter	-	-	-	-

(*1) This is valid only when the total number of valid NC axes and PLC axes in the entire part system is four or more.

(*2) This is valid only when the total number of valid NC axes and PLC axes in the entire part system is two or more.

(*3) This is valid only when the number of valid part systems is two or more.

(*4) The barrier data appears only for L system.

6.1.5 Echoback

Some parameters (e.g. #1953 used for IP address setting) echo back their setting value in the input area when they are selected. You can reset the echo backed value.

6.1.6 Ethernet parameter

If the Ethernet parameter "Host 1 password" to "Host 4 password" is set, "*****" displays regardless of the password characters set in that data field.

6.1.7 Precautions

When the data protection is valid, the value cannot be set (including paste operation) for the high-accuracy control parameters (part system based) and high-accuracy control axis parameters.

6.2 Selecting High-accuracy Control Parameters (Machining Cond I Screen)



A machining which meets the machining purpose or machining process can be performed by switching the high-accuracy parameter set according to the machining object on the Machining cond (MacCond) screen. Multiple sets of high-accuracy parameter (parameter related to the high-accuracy control) can be configured in advance for each machining purpose (such as parts machining or die machining) and machining process (such as rough or finishing).

Procedure for using this function is as follows:

- (1) Initializing the machining condition parameter set
 - Initializing the machining condition parameter set in the "Machining cond" screen
 - Initializing the machining condition parameter set by data input/output
- (2) Setting the machining condition parameter set
 - Set the total of nine sets of machining condition parameter sets of "three applications x three conditions" in the "Machining cond" screen
- (3) Switching the machining condition parameter set
 - Switching the machining condition parameter set in the "Machining cond" screen
 - Switching the machining condition parameter set by G code command in the machining program

MTB password is required for operating this screen.

Machining condition selection I screen

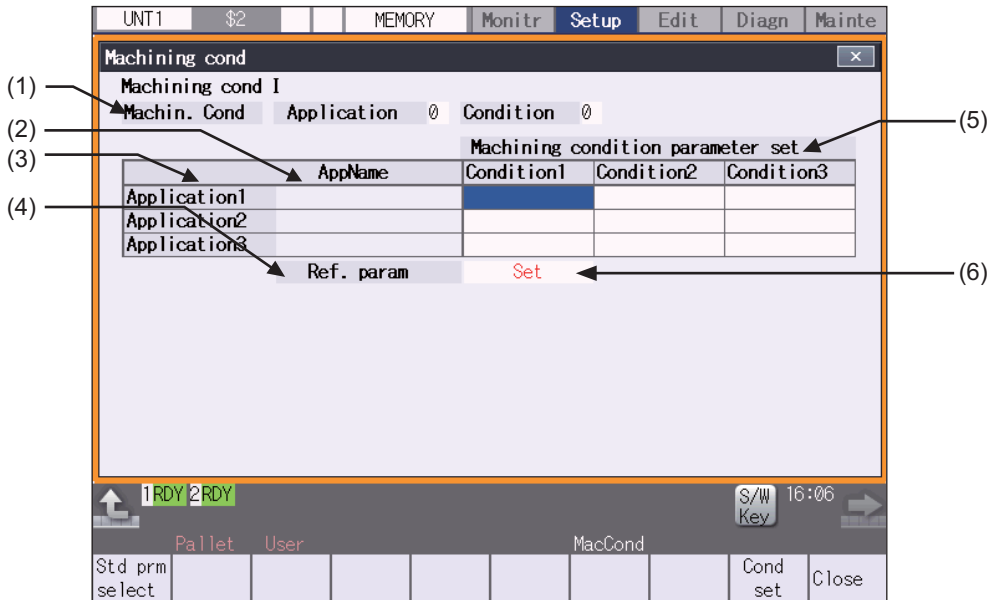

Display items

Display items	Details
(1) During machining condition	Displays the applications and conditions used for the current machining. This shows No. 0 through 3 of the machining applications and conditions, which you have selected on the [Machining condition selection] screen or switched with a G code command. While standard parameter is being selected, "0" is displayed on the applications and conditions.
(2) Application name	Displays the application name set in the menu [AppName set] in the "Machining cond screen".
(3) Application	Displays Application 1 to 3.
(4) Ref. param	"Set" is displayed in this column while the standard parameter is being selected.
(5) Machining condition parameter set	Displays the machining condition parameter set of application 1 to 3. "Set" is displayed in the column of the selected machining condition parameter set.
(6) Set	"Set" is displayed in the column of the selected machining condition parameter set. It will not update if an application/condition is switched by G code command. It will update when selected on the machining condition selection screen.

Menus

Menus	Details
Std prm select	Switches machining condition to standard parameter. After the menu is highlighted and the cursor moves to standard parameter, the confirmation message "Change to standard parameters?(Y/N)" will appear. If you press [Y] (or [INPUT]), the status of standard parameter changes to "Set". If you press any key other than [Y] (or [INPUT]), it will be canceled. The cursor will remain on standard parameter even when canceled.
Cond set	Changes to the "Machining cond" screen. <Note> •MTB password is required for the maintenance screen.
Close	This closes the pop-up window and quits this function.

Machining condition setting screen

The machining condition parameter to be displayed is switched by enabling or disabling tolerance control.

<When tolerance control is disabled>

		Machining condition parameter set		
No.	Name	Condition1	Condition2	Condition3
1206	G1bF	30000	30000	30000
1207	G1btL	0	0	0
	Cutting feed Acc	50.986	50.986	50.986
1568	SfiltG1	0	0	0
	Notch frequency Hz	0.000	0.000	0.000
1570	Sfilt2	0	0	0
	Notch frequency Hz	0.000	0.000	0.000
2010	fwd_g	0	0	0
8019	R COMP	0	0	0
	Theor R decrease	229.569	229.569	229.569
	R5mm arc dec speed	94868.422	94868.422	94868.422
	R1mm Arc dec speed	42426.448	42426.448	42426.448



<When tolerance control is enabled>

		Ref. param	Machining condition parameter set		
No.	Name		Condition1	Condition2	Condition3
1206	G1bF	5000	5000	5000	5000
1207	G1btL	50	50	50	50
	Cutting feed Acc	0.170	0.170	0.170	0.170
1568	SfiltG1	50	50	50	50
	Notch frequency Hz	0.000	20.000	20.000	20.000
2659	tolerance	5.000	5.000	5.000	5.000

Display items

Display items	Details
(1) Application	Displays the application being set. To change to the next machining purpose, press the menu [App change]. When machining purpose being selected, the background is emphasized in red. The background is not highlighted while the Standard parameter is selected.
(2) Parameter No.	Displays the number of a standard parameter.
(3) Parameter name	Displays the name of a standard parameter.
(4) Ref. param	Displays the value of the standard parameter designated on the parameter screen. This item is not displayed when the machining parameter "#12066 Tolerance ctrl ON" is set to "0". <Note> ♦"#2659 tolerance" indicates the setting value of the 1st axis in the 1st part system.
(5) Machining condition parameter set	Displays three sets of machining condition parameter set which belongs to the application purpose being set. The background of the selected machining condition is highlighted in red. The background is not highlighted while the Standard parameter is selected.

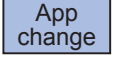
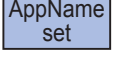
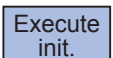
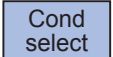
Menus

Menus	Details
	Switches the application being set to other application. It switches from Application1 -> Application2 -> Application3 -> Application1 -> ... each time this menu key is pressed.
	Sets the application name for the application being set. The name with up to 12 one-byte characters of numeric, English capital letter, and symbol can be set. <Note> ♦However, "\", "/", ", ", "*", "", "<", ">", " ", and "space" cannot be used as a one-byte symbol.
	Copies the setting values corresponding to the standard parameters to the all machining condition parameter sets.
	Changes to the machining condition selection screen.
	This closes the pop-up window and quits this function.

Initializing the machining condition parameter set

- (1) Press the menu [MacCond] in the setup screen.
- (2) Select the menu [Cond set] in the "Machining cond" screen.
- (3) Select the menu [Execute init].
- (4) Press the [Y] or [INPUT] key.



The setting value for the standard parameters corresponding to each machining condition parameter will be copied.

Setting the machining condition parameter set

- (1) Press the menu [MacCond] in the setup screen.
- (2) Select the menu [Cond set] in the "Machining cond" screen.
- (3) Move the cursor to the position of the parameter to be set.
- (4) Input the value, and then press [INPUT].

Note

- (1) It cannot be set without initializing the machining condition parameter set.

Switching the machining condition parameter set

- (1) Place the cursor on the position of the machining condition parameter set (application/condition) to be switched in the "Machining cond" screen.
- (2) Press the [INPUT] key.
- (3) Press the [Y] or [INPUT] key.

Note

- (1) The machining condition which is selected on the Machining cond screen applies to all part systems.
- (2) When the machining condition parameter set is switched, for the parameter "#2010 fwd_g" (Feed forward gain) and "#2659 tolerance", the same value is applied to all NC axes in the switched part system.

Canceling the machining condition parameter set and switch to standard parameter (Switch by cursor)

- (1) Move the cursor to the standard parameter and press [INPUT] key on the "Machining cond" screen.
- (2) Press the [Y] or [INPUT] key.

Canceling the machining condition parameter set and switch to standard parameter (Switch by menu [Std prmselect])

- (1) Select the menu [Std prmselect] in the "Machining cond" screen.
- (2) Press the [Y] or [INPUT] key.

Setting Machine Movable Area

This chapter describes the contents which can be set with the user parameters.

7.1 Setting the Stored Stroke Limit

The tool entry prohibited ranges can be set with stored stroke limit II or IIB.

Set the parameters to select the entry prohibited range, stored stroke limit II or IIB.

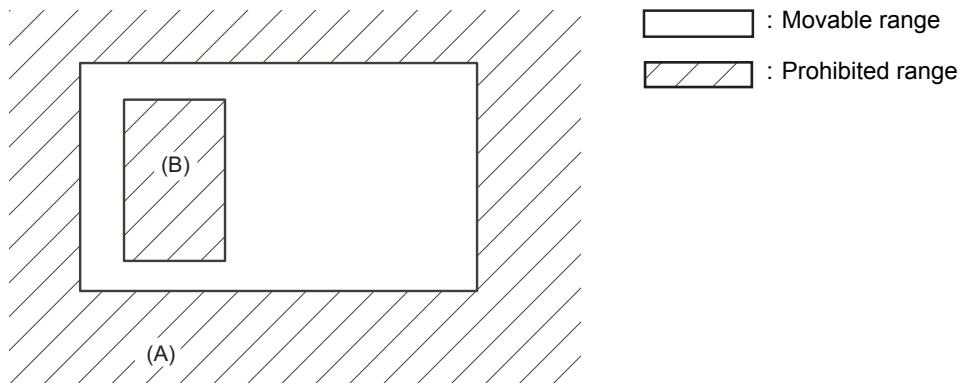

(A): Entry prohibited range by stored stroke limit II (outside)

(B): Entry prohibited range by stored stroke limit IIB (inside)

If the axis is moving over the set range, an alarm will appear and the axis will decelerate to a stop.

If the prohibited range is entered and an alarm occurs, movement will be possible only in the direction opposite the entry direction.

Enabling conditions of stored stroke limit

When using the relative position detection system, the stored stroke limit is invalid until the reference position return is completed after the power is turned ON.

Note

(1) If the absolute position detection is valid when using the absolute position detection system, the stored stroke limit will be validated immediately after the power is turned ON.

Stored stroke limit coordinates

The stored stroke limit check is carried out in the basic machine coordinate system established by the reference position return.

When the stored stroke limit has been validated while the reference position return has not been completed, the stored stroke limit check is executed with the basic machine coordinate system at the time of last power-OFF as temporary one. When the 1st dog-type reference position return is completed after the power is turned ON, the proper coordinate system is established.

Note

(1) While the reference position return has not been completed, only the manual and handle feed mode allow the axis movement. Automatic operation is validated after the reference position return is completed.

CAUTION

Always set the stored stroke limit. Failure to set this could result in collision with the machine end.

The stored stroke limit sets a prohibited range with the parameters or program command. The minimum and maximum values of the prohibited range are set as the coordinate value (radius value) on the machine coordinate system for each axis.

- The stroke check will not be executed when both maximum and minimum value are set to the same value.
- This function is valid after the reference position return if the system does not apply the absolute position detection system.
- Before the machine enters the prohibited range, an error "M01 Operation error 0007" (S/W stroke end) will occur, and the machine movement will stop. The alarm can be reset by moving the erroneous axis in the opposite direction.
- During automatic operation, if an alarm occurs with even one axis, all axes will decelerate to a stop.
- During manual operation, only the axis that caused the alarm will decelerate to a stop.
- The axis will always stop at a position before the prohibited range.
- The distance between the prohibited range and stop position will depend on the feedrate, etc.

The stored stroke limits II and IIB are handled as follows.

Type	Prohibited range	Details		Range setting parameters	Enabling conditions
II	Outside	Select II or IIB with the parameters.	♦"#8210 OT INSIDE" = "0"	"#8204 OT-CHECK-N" "#8205 OT-CHECK-P"	♦Reference position return is completed. ♦#8204 and #8205 are not set to the same value. ♦"#8202 OT-CHECK OFF" = "0"
IIB	Inside		♦"#8210 OT INSIDE" = "1"		

7.1.1 Stored Stroke Limit II

The boundary is set with the axis parameters "#8204 OT-CHECK-N" and "#8205 OT-CHECK-P" or with program commands. Either the inside or the outside of the set boundary is the prohibited range. Whether the inside or outside of the range is prohibited is determined by "#8210 OT-INSIDE". When the inside is selected, this function is called stored stroke limit IIB.

When using program commands, entry of the tool into the prohibited range is prohibited with G22, and entry into the prohibited range is enabled with G23.

The stored stroke limit II can be invalidated for each axis with setting "#8202 OT-CHECK OFF" to "1".

Prohibited range

X: Outside Z: Outside

X: Inside Z: Outside

X: Inside Z: Inside

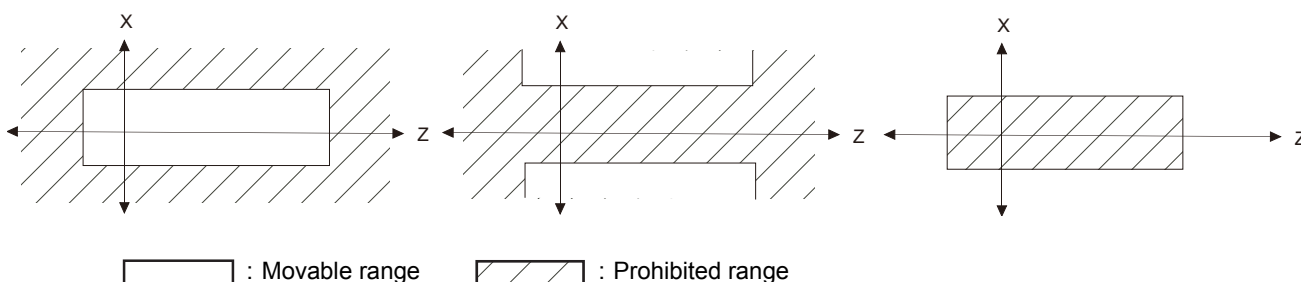

(1) Stored stroke limit II (When prohibited range is on outside)

When used with the stored stroke limit I function, the narrow range designated by the two types becomes the movement valid range.

The stored stroke limit I function is set by MTB.

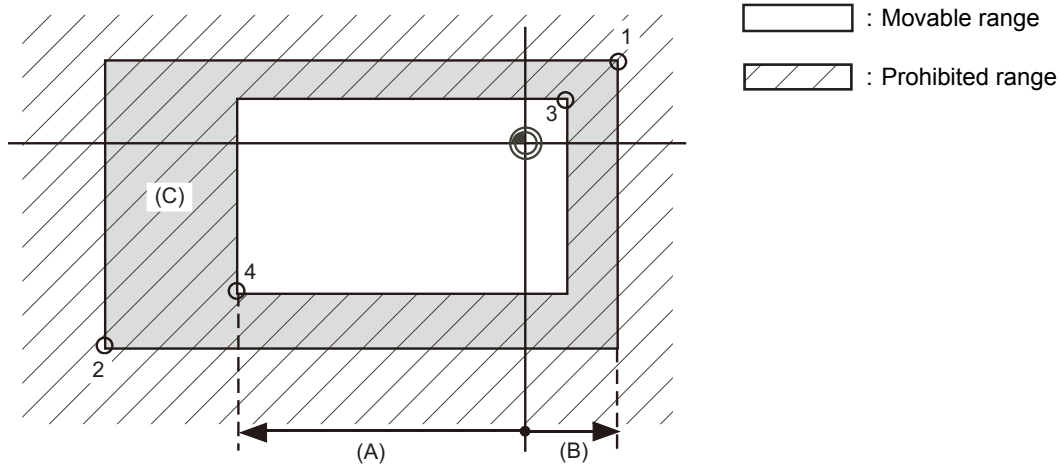

(A): Set value for (-) side

(B): Set value for (+) side

(C): The following ranges prohibited by stored stroke limit II are set with the coordinate values in the basic machine coordinate system.

Point 3: "#8205 OT-CHECK-P"

Point 4: "#8204 OT-CHECK-N"

Points 1 and 2 are the prohibited range set by MTB using the stored stroke limit I.

(2) Stored stroke limit IIB (When prohibited range is on inside)

A range except for that of the stored stroke limit I becomes the movement prohibited range.

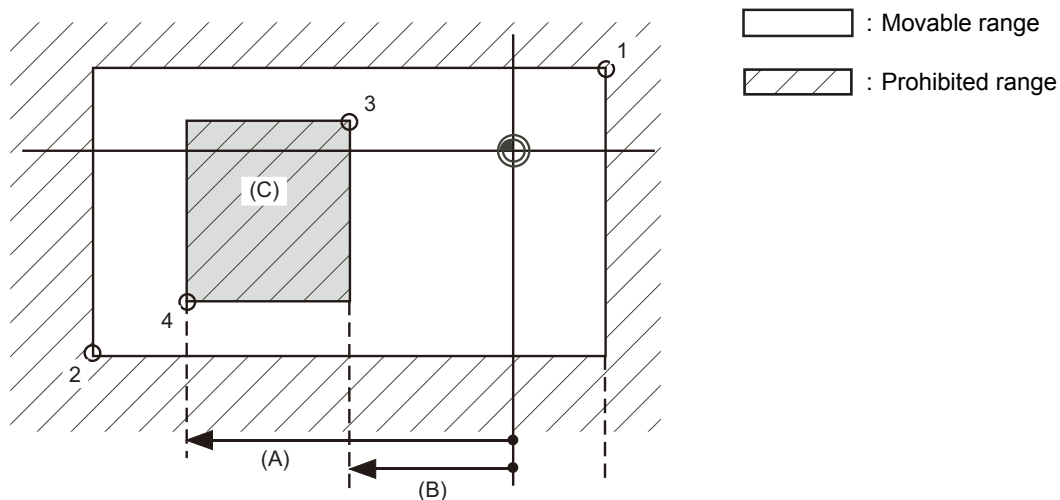

(A): Set value for (-) side

(B): Set value for (+) side

(C): The following ranges prohibited by stored stroke limit IIB are set with the coordinate values in the basic machine coordinate system.

Point 3: "#8205 OT-CHECK-P"

Point 4: "#8204 OT-CHECK-N"

Points 1 and 2 are the prohibited range set by MTB using the stored stroke limit I.

7.2 Chuck Barrier/Tailstock Barrier (L System)

Setup — Barrier

Use this function to set and display the chuck barrier and tailstock barrier.

By limiting the tool nose movement range, the chuck barrier and tailstock barrier prevent the tool from colliding with the chuck and tailstock due to programming errors.

Three points can be input for both the chuck barrier and tailstock barrier. Select either [Enter length] or [Enter coordin] to input (set) the barrier data.

- (1) Enter length: To set the barrier position of the chuck or tailstock with the length (length between P points).
- (2) Enter coordin: To set the barrier positions of the chuck and tailstock with the distance from the workpiece center coordinates (P0). Input the radius value to set the X axis.

(1) Enter length

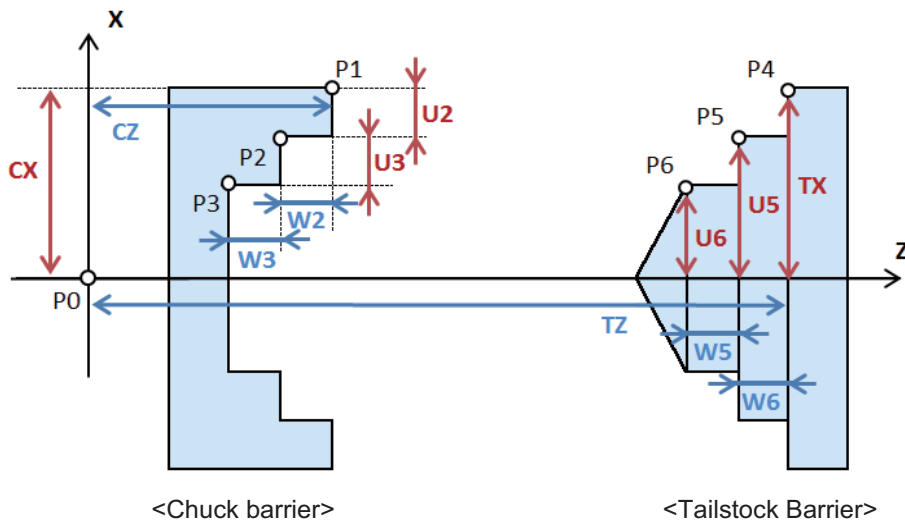

(2) Enter coordin

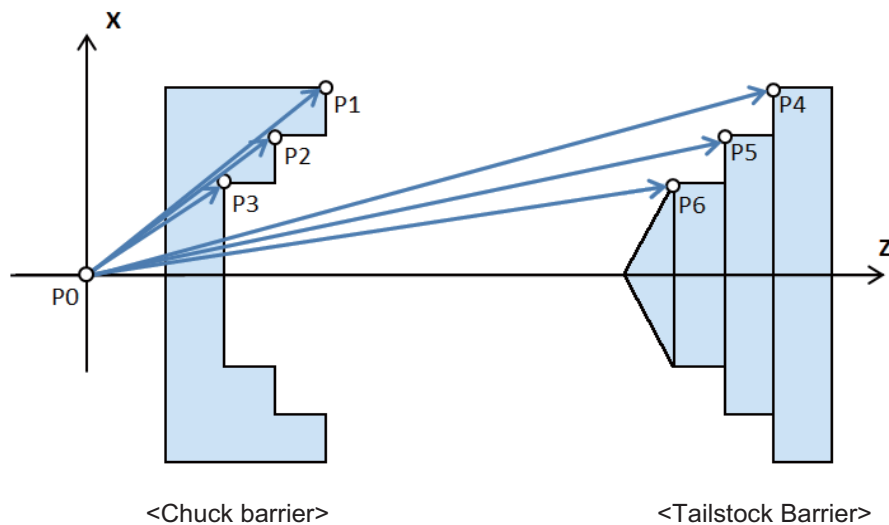

The barrier data which is set on this screen will be set to NC by converting to the parameter "#8301 P1" to "#8306 P6". Specify the workpiece center coordinates (P0) of X axis for the chuck and tailstock in advance with the parameter "#8300 P0" on the menu [Barrier data] of parameter screen. The workpiece center coordinates (P0) of Z axis are the machine coordinates zero point.

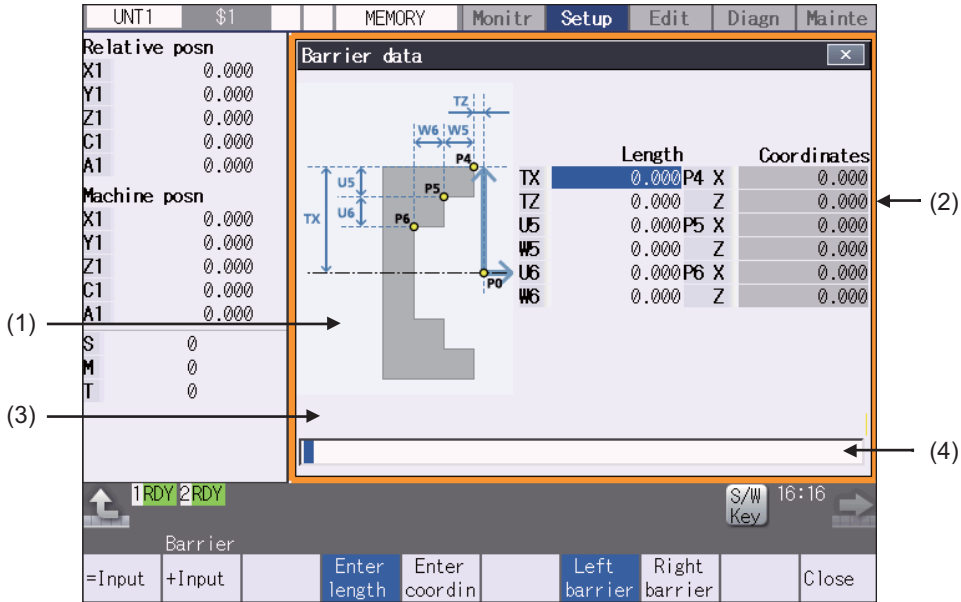

Display items

Display items	Details
(1) Guide graphic	<p>This displays the guide drawing of barrier type. The guide drawing is switched according to the selected barrier form. The drawing is the left-side barrier guide drawing.</p> <p>Chuck type 1 guide drawing</p> <p>Chuck type 2 guide drawing</p>

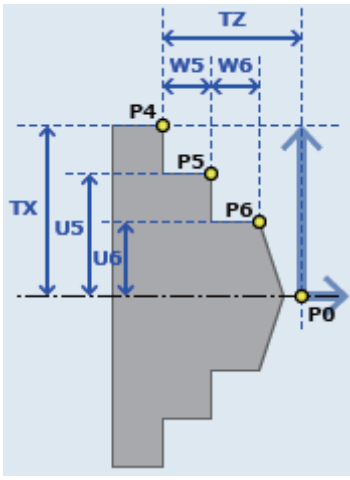
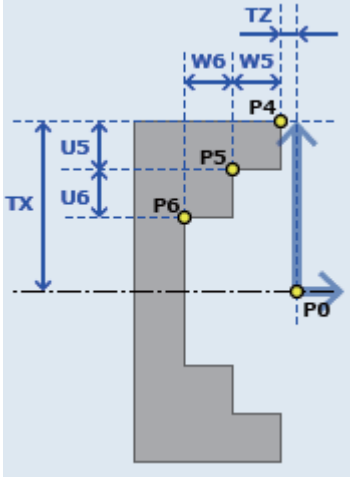
Display items	Details																																																																																																																																	
(1) Guide drawing (continued)	Tailstock type 1 guide drawing 	Tailstock type 2 guide drawing 																																																																																																																																
(2) Barrier data	<p>This displays the barrier data. The display items differ depending on the length/coordinates value input and left/right-side barrier. The setting range is from -99999.999 to 99999.999 (mm). However, minus data cannot be input for length data.</p> <p><Length input mode> Set the chuck or tailstock position with the length (length between P points). When the value is set, the coordinates data is also updated.</p> <table border="0" data-bbox="523 965 1401 1189"> <tr> <td colspan="4">Chuck barrier</td> <td colspan="4">Tailstock barrier</td> </tr> <tr> <td></td> <td>Length</td> <td>Coordinates</td> <td></td> <td></td> <td>Length</td> <td>Coordinates</td> <td></td> </tr> <tr> <td>CX</td> <td>10.000</td> <td>P1 X</td> <td>10.000</td> <td>TX</td> <td>0.000</td> <td>P4 X</td> <td>0.000</td> </tr> <tr> <td>CZ</td> <td>15.000</td> <td>Z</td> <td>15.000</td> <td>TZ</td> <td>0.000</td> <td>Z</td> <td>0.000</td> </tr> <tr> <td>U2</td> <td>3.000</td> <td>P2 X</td> <td>7.000</td> <td>U5</td> <td>0.000</td> <td>P5 X</td> <td>0.000</td> </tr> <tr> <td>W2</td> <td>5.000</td> <td>Z</td> <td>10.000</td> <td>W5</td> <td>0.000</td> <td>Z</td> <td>0.000</td> </tr> <tr> <td>U3</td> <td>4.000</td> <td>P3 X</td> <td>3.000</td> <td>U6</td> <td>0.000</td> <td>P6 X</td> <td>0.000</td> </tr> <tr> <td>W3</td> <td>2.000</td> <td>Z</td> <td>8.000</td> <td>W6</td> <td>0.000</td> <td>Z</td> <td>0.000</td> </tr> </table> <p><Coordinates input mode> Set the chuck or tailstock position with the distance from the workpiece center coordinates (P0). When the value is set, the length data is also updated.</p> <table border="0" data-bbox="523 1346 1401 1570"> <tr> <td colspan="4">Chuck barrier</td> <td colspan="4">Tailstock barrier</td> </tr> <tr> <td></td> <td>Length</td> <td>Coordinates</td> <td></td> <td></td> <td>Length</td> <td>Coordinates</td> <td></td> </tr> <tr> <td>CX</td> <td>10.000</td> <td>P1 X</td> <td>10.000</td> <td>TX</td> <td>0.000</td> <td>P4 X</td> <td>0.000</td> </tr> <tr> <td>CZ</td> <td>15.000</td> <td>Z</td> <td>15.000</td> <td>TZ</td> <td>0.000</td> <td>Z</td> <td>0.000</td> </tr> <tr> <td>U2</td> <td>3.000</td> <td>P2 X</td> <td>7.000</td> <td>U5</td> <td>0.000</td> <td>P5 X</td> <td>0.000</td> </tr> <tr> <td>W2</td> <td>5.000</td> <td>Z</td> <td>10.000</td> <td>W5</td> <td>0.000</td> <td>Z</td> <td>0.000</td> </tr> <tr> <td>U3</td> <td>4.000</td> <td>P3 X</td> <td>3.000</td> <td>U6</td> <td>0.000</td> <td>P6 X</td> <td>0.000</td> </tr> <tr> <td>W3</td> <td>2.000</td> <td>Z</td> <td>8.000</td> <td>W6</td> <td>0.000</td> <td>Z</td> <td>0.000</td> </tr> </table>		Chuck barrier				Tailstock barrier					Length	Coordinates			Length	Coordinates		CX	10.000	P1 X	10.000	TX	0.000	P4 X	0.000	CZ	15.000	Z	15.000	TZ	0.000	Z	0.000	U2	3.000	P2 X	7.000	U5	0.000	P5 X	0.000	W2	5.000	Z	10.000	W5	0.000	Z	0.000	U3	4.000	P3 X	3.000	U6	0.000	P6 X	0.000	W3	2.000	Z	8.000	W6	0.000	Z	0.000	Chuck barrier				Tailstock barrier					Length	Coordinates			Length	Coordinates		CX	10.000	P1 X	10.000	TX	0.000	P4 X	0.000	CZ	15.000	Z	15.000	TZ	0.000	Z	0.000	U2	3.000	P2 X	7.000	U5	0.000	P5 X	0.000	W2	5.000	Z	10.000	W5	0.000	Z	0.000	U3	4.000	P3 X	3.000	U6	0.000	P6 X	0.000	W3	2.000	Z	8.000	W6	0.000	Z	0.000
Chuck barrier				Tailstock barrier																																																																																																																														
	Length	Coordinates			Length	Coordinates																																																																																																																												
CX	10.000	P1 X	10.000	TX	0.000	P4 X	0.000																																																																																																																											
CZ	15.000	Z	15.000	TZ	0.000	Z	0.000																																																																																																																											
U2	3.000	P2 X	7.000	U5	0.000	P5 X	0.000																																																																																																																											
W2	5.000	Z	10.000	W5	0.000	Z	0.000																																																																																																																											
U3	4.000	P3 X	3.000	U6	0.000	P6 X	0.000																																																																																																																											
W3	2.000	Z	8.000	W6	0.000	Z	0.000																																																																																																																											
Chuck barrier				Tailstock barrier																																																																																																																														
	Length	Coordinates			Length	Coordinates																																																																																																																												
CX	10.000	P1 X	10.000	TX	0.000	P4 X	0.000																																																																																																																											
CZ	15.000	Z	15.000	TZ	0.000	Z	0.000																																																																																																																											
U2	3.000	P2 X	7.000	U5	0.000	P5 X	0.000																																																																																																																											
W2	5.000	Z	10.000	W5	0.000	Z	0.000																																																																																																																											
U3	4.000	P3 X	3.000	U6	0.000	P6 X	0.000																																																																																																																											
W3	2.000	Z	8.000	W6	0.000	Z	0.000																																																																																																																											
(3) Error message	This is displayed when barrier data setting is illegal.																																																																																																																																	
(4) Input section	This displays the input data.																																																																																																																																	

Menus

Menus	Details
=Input	This executes an absolute input.
+Input	This executes an incremental input.
Enter length	This changes to the length input.
Enter coordin	This changes to the coordinates value input.
Left barrier	This changes to the left-side barrier data setting. When the parameter "#8315 BARRIER TYPE (L)" is "0", this menu cannot be selected.
Right barrier	This changes to the right-side barrier data setting. When the parameter "#8316 BARRIER TYPE (R)" is "0", this menu cannot be selected.
Close	This closes the pop-up window and quits this function.

Menus when the menu [Left barrier] or [Right barrier] is pressed

Menus	Details
Chuck type 1	This changes the barrier form to the chuck barrier type 1. (*1)
Chuck type 2	This changes the barrier form to the chuck barrier type 2. (*1)
T-stock type 1	This changes the barrier form to the tailstock barrier type 1. (*2)
T-stock type 2	This changes the barrier form to the tailstock barrier type 2. (*2)

(*1) This menu can be selected when the parameter "#8315 BARRIER TYPE (L)" or "#8316 BARRIER TYPE (R)" is "1".

(*2) This menu can be selected when the parameter "#8315 BARRIER TYPE (L)" or "#8316 BARRIER TYPE (R)" is "2".

Setting the barrier position with length (length between P points)

- | | | |
|---|---|---|
| (1) Press the menu [Enter length]. | ➔ | The mode is switched to the length input mode. The highlight of the menu [Enter coordin] is canceled and the [Enter length] is highlighted.
The cursor is displayed at CX, and the length data can be set. |
| (2) Select whether the barrier to be set is right side or left side with the menu.
(Example) Press the menu [Left barrier]. | ➔ | The display is switched to the menu of the barrier form. |
| (3) Select the chuck type with the menu.
(Example) Press the menu [Chuck type 2]. | ➔ | The drawing is switched to the chuck barrier type 2 guide drawing. |
| (4) Input the value to CX.
20.000 [INPUT]
The setting can be performed also by pressing the menu [=Input] or [+Input] instead of the [INPUT] key. When the menu [+Input] is pressed, the value obtained by adding the input value to the original value is set. | ➔ | The value "20.000" is set to the cursor position (CX), and the coordinates value is also updated.
The cursor moves to CZ.
Consistency check is performed for respective setting data, and an error message is displayed when an illegality is detected. |
| (5) Input the values to CZ to W3 in the same way. | | |

Setting the barrier position with coordinates value (distance from the work center coordinates (barrier P0))

- | | | |
|---|---|--|
| (1) Press the menu [Enter coordin]. | ➔ | The mode is switched to the coordinates input mode. The highlight of the menu [Enter length] is cancelled and the menu [Enter coordin] is highlighted.
The cursor is displayed at P1 X, and the coordinates data can be set. |
| (2) Select whether the barrier to be set is right side or left side with the menu.
(Example) Press the menu [Right barrier]. | ➔ | The display is switched to the menu of the barrier form. |
| (3) Select the tailstock type with the menu.
(Example) Press the menu [T-stock type 1]. | ➔ | The drawing is switched to the tailstock barrier type 1 guide drawing. |
| (4) Input the value to P1 X.
30.000 [INPUT]
The setting can be performed also by pressing the menu [=Input] or [+Input] instead of the [INPUT] key. When the menu [+Input] is pressed, the value obtained by adding the input value to the original value is set. | ➔ | The value "30.000" is set to the cursor position (P1 X), and the length is also updated.
The cursor moves to P1 Z.
Consistency check is performed for respective setting data, and an error message is displayed when an illegality is detected. |
| (5) Input the values to P1 Z to P3 Z in the same way. | | |

Precautions

- (1) When the parameter "#8310 Barrier ON" is set to "0", the chuck and tailstock barriers settings are disabled.
- (2) The parameter "#8300 P0" and "#8311 P7" to "#8314 P10" cannot be set on this screen. Set the parameters with the menu [Barrier data] on the parameter screen.
- (3) When the parameters "#8315" and "#8316" are both "0", the barrier data is handled as left barrier and chuck type 1. The chuck type cannot be changed.
- (4) When the parameter for chuck or tailstock is set to both right and left barriers, an error message appears.
- (5) When multiple errors are occurred, an error concerning the X axis is preferentially displayed.

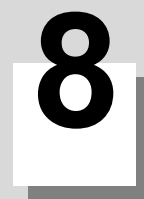

Other Setups

8.1 Integrated Time

8.1.1 Integrated Time Display



The integrated time (date, time, power ON time, automatic operation time, automatic start time, external integrated time 1, external integrated time 2, cycle time) controlled by the NC can be set and displayed.

Note that the cycle time cannot be set.

The integrated times displayed in cycle time display area on the Monitor screen can be set.

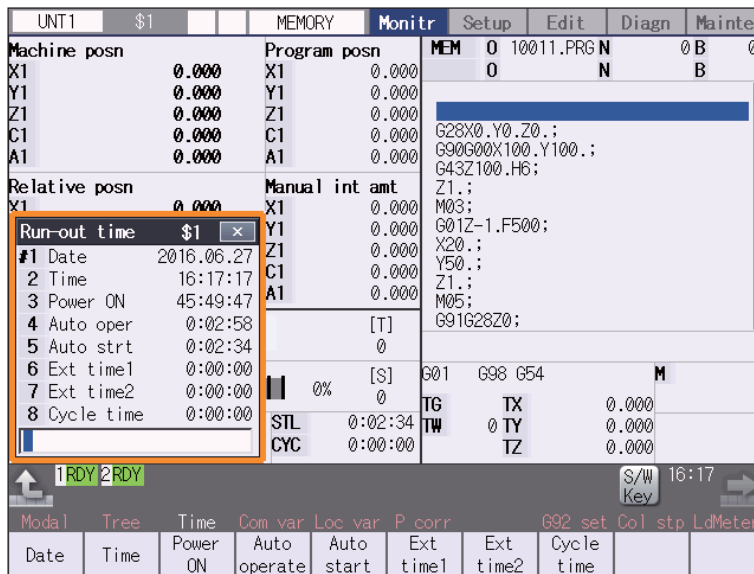

Display items

Display items	Details
#1 Date	The current date set in the NC is displayed. Year: 4 digits, Month: 2 digit, Date: 2 digit (YYYY.MM.DD)
2 Time	The current time set in the NC is displayed using the 24-hour system. (HH:MM:SS)
3 Power ON	This displays the total integrated time of the time from NC power ON to OFF. (HHHH:MM:SS)
4 Auto oper	This displays the total integrated time of the work time from automatic start button pressing in the memory mode or MDI to M02/M30 or reset button pressing. (HHHH:MM:SS)
5 Auto strt	This displays the total integrated time during automatic starting from automatic start button pressing in the memory mode or MDI to feed hold stop, block stop, or reset button pressing. (HHHH:MM:SS)
6 Ext time 1	This content differs depending on MTB specification. (HHHH:MM:SS)
7 Ext time 2	This content differs depending on MTB specification. (HHHH:MM:SS)
8 Cycle time	This displays the time that automatic operation is started from when the automatic start button is pressed in the memory mode or MDI to when feed hold stop or block stop is applied or the reset button is pressed.
Input section	This displays details of the key input.



Note

- (1) When the #3 Power ON to #8 Cycle time displays reach the maximum value (9999:59:59), the count stops, and the maximum value remains displayed.

Menus	
Menus	Details
Time setting	This sets the integrated time.
Time select1	The time that is displayed in upper line on cycle time display area is selected.
Time select2	The time that is displayed in bottom line on cycle time display area is selected.
Close	This closes the pop-up window and quits this function.

8.1.2 Setting the Integrated Time

Operation method

- (1) Press the menu [Time setting].  The mode changes to the time setting mode. The cursor appears at the "#1 Date" position in the integrated time display.
- (2) Input today's date.
(Example) 2015/4/1 [INPUT]  "2015.04.01" appears at "#1 Date", and the cursor moves to "#2 Time".
- (3) Set the data for each item, and press the [INPUT] key.  When "#7 External integrated time 2" has been set, the cursor disappears, and the time setting menu highlight is turned OFF.
If the item does not need to be set, press the [↓] key and move the cursor.
Note that #8 Cycle time cannot be set, so the cursor will not move.

Note

- (1) The data delimiters are as shown below:

Item	Valid delimiters during setting	Delimiters in display
#1 Date	". " or " / "	" : "
#2 Time to #7 Ext time2	". " or " / "	" : "
#8 Cycle time		" : "

- (2) If the [Time setting menu] or  key is pressed again during the time setting mode, the time setting mode will be canceled.

Setting range

Display items	Range
#1 Date	1980.1.1 to 2069.12.31
2 Time	00:00:00 to 23:59:59
3 Power ON	00:00:00 to 59999:59:59
4 Auto oper	
5 Auto strt	
6 Ext time 1	
7 Ext time 2	

8.1.3 Setting the Time Display Selection

The displayed time is set on cycle time display area.

Operation method	
(1) Press the menu "Time select1".	→ The time selection mode is activated.
(2) Press the time type for the mode to display. (Example) [Auto oper]	→ The automatic operation time is displayed in upper line on cycle time display area. The menu display returns to integrated time sub-menu.
(3) Press the menu "Time select2".	→ The time selection mode is activated.
(4) Press the time type for the mode to display. (Example) [Power ON]	→ The automatic operation time is displayed in bottom line on cycle time display area. The menu display returns to integrated time sub-menu.

Note

- (1) The displayed time is held even after the power is turned OFF and ON.
- (2) The displayed time is common for part systems.

8.2 Counter Setting

Monitr — Cnt set

Setup — Cnt set

An arbitrary value can be set in the relative position counter which opens as a pop-up window. The counter cannot be set for an axis of auxiliary axis state. It also can be set on the setup (Setup) screen.

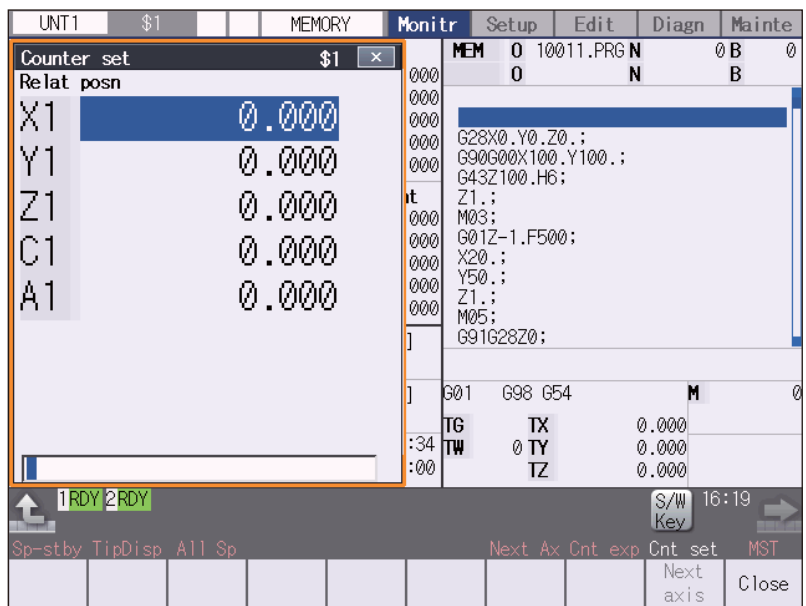

Menus

Menus	Details
Close	This closes the pop-up window and quits this function.
Next axis	<p>This switches the axis to be displayed on the counter.</p> <p><Note></p> <ul style="list-style-type: none"> • This menu is grayed out and non-selectable in the following cases: <ul style="list-style-type: none"> - The number of enabled axes is 8 or less. - The number of enabled axes is 9 or more, however, the number of displayed axes is 8 or less according to the parameter "#1069 no_dsp Axis with no counter display" setting.

Operation method

- (1) Press the main menu [Counter set].



The relative position counter opens as a pop-up window. The cursor appears at the 1st axis of the relative position counter.

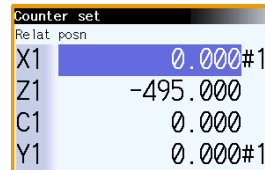

Instead of the operation above, the axis name address key can be pressed to set the counter. (Example) [Z]



The relative position counter opens as a pop-up window. The cursor appears at the designated axis (Z axis).

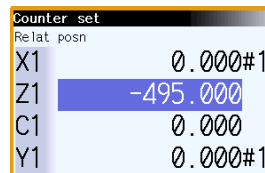

- (2) Using the [↑], [↓], or the axis name address key, move the cursor to the axis to be set.



The cursor moves.

<Note>

- ◆ If two axes or more of the same name exist such as mixed control (cross axis control), the cursor moves to the axis corresponding to the address key to the axis name input first.

- (3) Input a numeric value. (Example) 100.000 [INPUT]
If the [INPUT] key is pressed without inputting a value, zero (0) will be set.



The set value "100.000" appears at the cursor position. The cursor moves to the next axis.

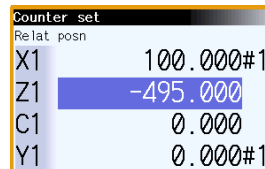

- (4) Repeat step (3) for each axis. For axes that are not to be operated, press the [↓] key and move the cursor.



The pop-up window closes when the counter has been set for the last axis.

Note

- (1) When an address such as "S", "M", "T" or "B" is used for the first character of axis name of the parameter "#1022 ax-name2", not the MSTB window but the Counter set window is displayed for address key input.

8.3 Origin Set, Origin Cancel



Origin set and origin cancel can be executed.

Origin set and origin cancel cannot be executed for an axis of auxiliary axis state.

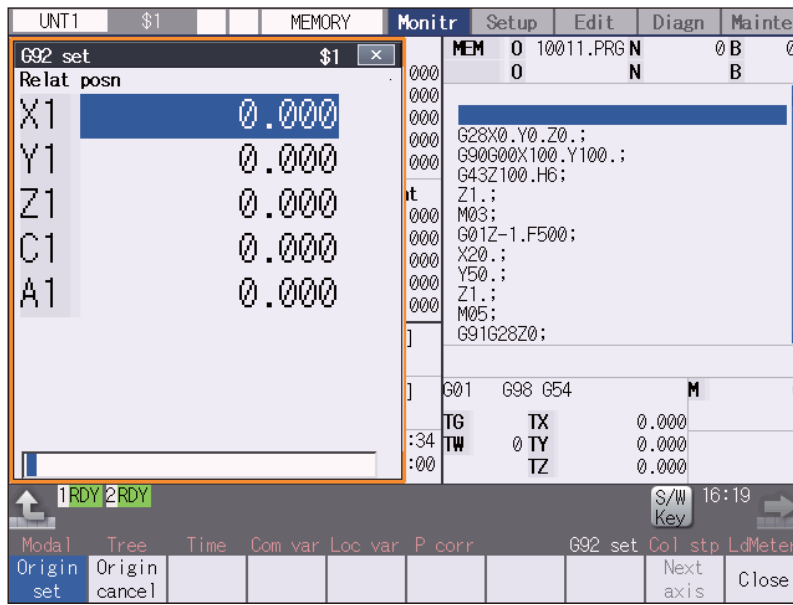

Menus

Menus	Details
Origin set	The origin is set. When main menu [G92 set] is pressed, the menu [Origin set] is highlighted and the origin set mode is activated.
Origin cancel	The origin is canceled. The origin cancel mode is activated when this menu is pressed.
Next axis	This switches the axis to be displayed on the counter. <Note> <ul style="list-style-type: none"> ◆ This menu is grayed out and non-selectable in the following cases: <ul style="list-style-type: none"> - The number of enabled axes is 8 or less. - The number of enabled axes is 9 or more, however, the number of displayed axes is 8 or less according to the parameter "#1069 no_dsp Axis with no counter display" setting.
Close	This closes the pop-up window and quits this function.

Differences between origin set and origin cancel

	Origin set	Origin cancel
Function	The coordinate system is shifted so the current position becomes the designated position of the workpiece coordinate system. This is equivalent to "G92 X0". (When X is the target axis.)	The coordinate system is shifted so the zero point of the workpiece coordinate system matches the zero point of the basic machine coordinate system. This is equivalent to "G92 G53 X0". (When X is the target axis.)
Changes in the counter value	The relative position counter and workpiece coordinate counters become "0".	The relative position counter matches the machine coordinate counter.
Offset	The G92 shift amount is updated.	The G92 shift amount and the G52 shift amount for the G54 to G59 coordinate system becomes "0".

Operation method (Setting the origin)

- (1) Press the main menu [G92 set]. ➔ The relative position counter opens as a pop-up window. The menu [Origin set] is highlighted. The cursor appears at the 1st axis of the relative position counter.

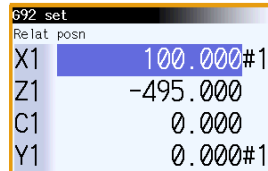

- (2) Using the [↑], [↓], or the axis name address key, move the cursor to the axis to be set. ➔ The cursor moves.
- <Note>
- If two axes or more of the same name exist such as mixed control (cross axis control), the cursor moves to the axis corresponding to the address key to the axis name input first.

- (3) Input 0, and then press the [INPUT] key. If the [INPUT] key is pressed without inputting a value, zero (0) will be set. (Origin zero) ➔ "0.000" appears at the cursor position. The cursor moves to the next axis.

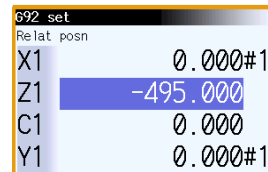



- (4) Repeat step (3) for each axis. For axes that are not to be operated, press the [↓] key and move the cursor. ➔ The pop-up window closes when the origin has been set for the last axis.

Note

- (1) An error will occur if a value other than 0 is set.

Operation method (Canceling the origin)

- (1) Press the main menu [G92 set], and then press the menu [Origin cancel].  The relative position counter opens as a pop-up window. The menu [Origin cancel] is highlighted. The cursor appears at the 1st axis of the relative position counter.
- (2) Press the [INPUT] key.  The same value as the machine position appears at the cursor position. The cursor moves to the next axis.
- (3) Repeat step (2) for each axis. For axes that are not to be operated, press the [↓] key and move the cursor.  The pop-up window closes when the origin has been canceled for the last axis.

8.4 Manual Numerical Value Command

Monitr — MST

Setup — MST

The spindle function (S), miscellaneous function (M), tool function (T) and 2nd miscellaneous function (B) commands can be executed.

The manual numerical value command can be executed by inputting an address such as S, M, T or B, as well.

It also can be commanded on the setup (Setup) screen.

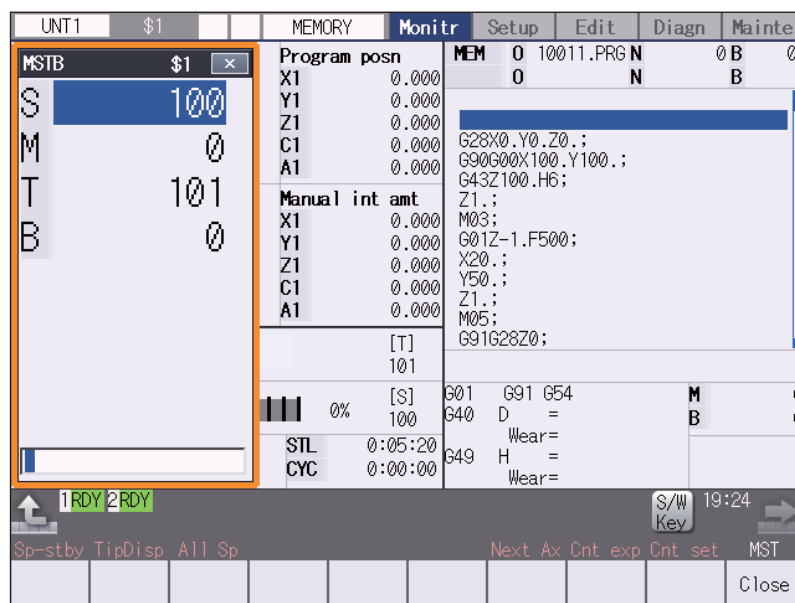

Display items

Display items	Details
S (spindle function) command value	The command value of S (spindle rotation command value) is displayed. The number of displays varies depending on the value of the parameter "#1039 spinno" (Number of spindles). However, if the value of the parameter "#1300 ext36/bit0" (Multiple-spindle control) is set to "1" (Multiple-spindle control II), the number of displays is set to "1" regardless of the value of the parameter "#1039 spinno" (Number of spindles).
M (miscellaneous function) command value	The command value of M (miscellaneous function command value) is displayed. The number of displays is set to "1" regardless of the value of the parameter "#12005 Mfig" (M count).
T (Tool function) command value	The command value of T (Tool function command value) is displayed. The number of displays is set to "1" regardless of the value of the parameter "#12009 Tfig" (T count). Only the tool number is displayed regardless of the value of the parameter "#11038 T disp type".
B (second (2nd) miscellaneous function) command value	The command value of B (second (2nd) miscellaneous function command value) is displayed. The number of displays is set to "1" regardless of the value of the parameter "#12011 Bfig" (B count). However, the value is displayed or hidden depending on the value of the parameter ("#1170 M2name" (2nd miscellaneous code)).

Note

(1) If the number of spindles is 5 or less, the scroll bar is not displayed.

Menus

Menus	Details
Close	This closes the pop-up window and quits this function.

Operation method (Executing T31 with a manual numerical value command)

(1) Press the main menu [MST]. → The S, M, T, B display opens as a pop-up window.

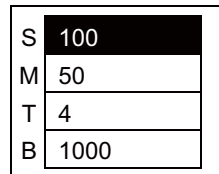

Using the [↑] or [↓] key, move the cursor to the setting position. → The cursor moves.

(2) The manual numerical value command can also be issued by using the address keys instead of the operation above. (Example) [T] → The S, M, T, B display opens as a pop-up window. The cursor appears at T.

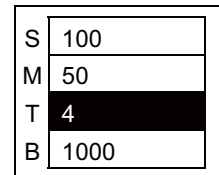

(3) Input a numeric value. 31 [INPUT] → The input value is set.

Note

(1) The cursor moves to the first line when the part system is changed while displaying the manual numeric command window.

Operation method (Canceling the manual numerical value command)

The manual numerical value command mode is canceled by carrying out one of the following operations before pressing the [INPUT] key.

- ♦ Press the menu [Close].
- ♦ Press the  key.
- ♦ Change the screen.

Setting/output range of manual numerical value command

For each S, M, T, G and B command, the data type to output to PLC program is designated by parameters "#12006 Mbin" (M binary), "#12008 Sbin" (S binary), "#12010 Tbin" (T binary) and "#12012 Bbin" (B binary). The output data type and the manual numerical value command setting/output range are shown below:

		BCD	No-signed binary	Signed binary
Output range	S	-99999999 to 99999999 (*1)	0 to 99999999	-99999999 to 99999999
	M	0 to 99999999		
	T			
	B			
Setting range	S	-99999999 to 99999999 (*2)		
	M			
	T			
	B			

(*1) Even if the parameter "#12008 Sbin" (S binary) is set to "0" (BCD), the signed binary output is applied to S. BCD output is not applied.

(*2) If a negative value is set when the data type is "BCD type" or "No-signed binary type", a value converted into positive value is output to PLC program.

Note

- (1) Add a "-" sign before the value to set a negative value. The display will be a positive value.
- (2) A value larger than the limit rotation speed (parameters "#3001 slimt1" to "#3004 slimt4") or the maximum rotation speed (parameters "#3005 smax1" to "#3008 smax4") cannot be output for S. Select a gear with "Spindle gear selection input" of Y device.

8.5 MDI Program Editing



Press the main menu [MDI] to display the contents of the MDI program in a pop-up window.
 When the parameter "#1144 mdlkof" is "0" (MDI setting impossible), switch to the MDI mode once to press the menu [MDI].
 For details on editing of MDI program, refer to "3.6 Editing Operations" and the following descriptions.

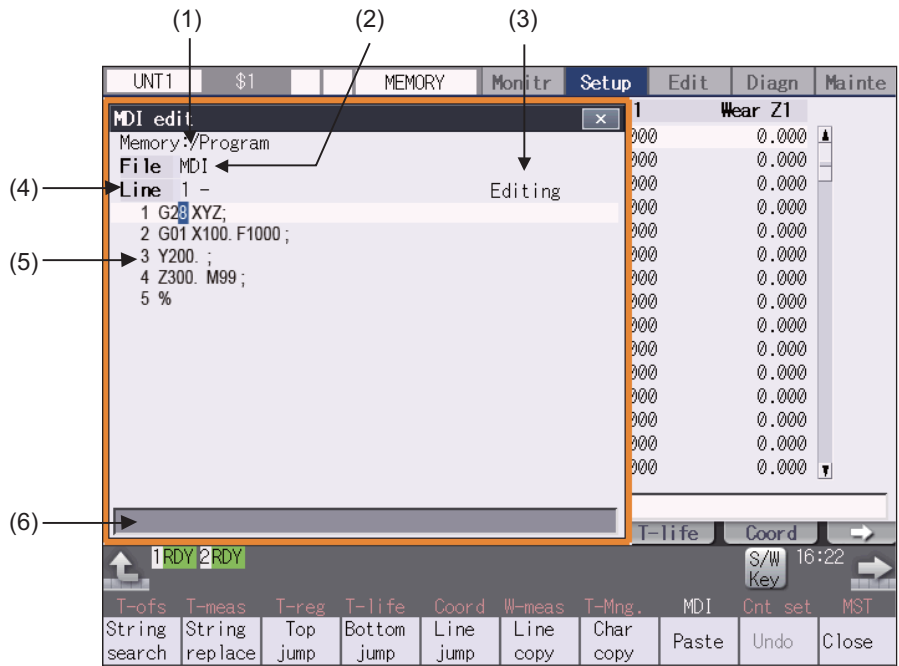

Display items

Display items	Details
(1) Path display	The path of the currently opened program file (memory:/program) is displayed.
(2) File name display	This displays the file name of the program currently being edited (MDI).
(3) Status	<Current edit display "Editing"> Displayed when the program is edited after it was displayed. < Insert mode display > "INS" appears when the mode is switched to overwrite mode by pressing the [INSERT] key.
(4) Top line of the displayed program	The No. of the top line of the program is displayed.
(5) Line number	<Line number> This displays the last 3 digits of the program line number. When over two or more lines are displayed on the screen because one line is long, the line No. does not attach to the beginning of the next line.
Program display	<Program display> This displays the contents of the MDI program currently being edited.
(6) Input section	This displays details of the key input.

Menus

Menus	Details
String search	When the character string is designated and the [INPUT] key is pressed, that character string is searched for.
String replace	If the character string to be searched for and the character string to be replaced are separated with a "/" and designated, when the [INPUT] key is pressed, the character string is replaced.
Top jump	The program data from the top line is displayed on the screen. The cursor moves to the left side of the top line.
Bottom jump	The program data from the last line is displayed on the screen. The cursor moves to the left side of the last line.
Line jump	When the line number is set and the [INPUT] key is pressed, the program data for the set number and later is displayed on the screen. The cursor moves to the No. of designated line.
Line copy	This copies the designated line (multiple lines can be copied.)
Char copy	This copies the character string designated by the cursor (multiple lines can be copied.)
Paste	This inserts the most recently copied contents to the line before the cursor or the position before the cursor.
Undo	This menu cannot be selected when parameter "#8910 Edit undo" is set to "0". <Note> ♦When the parameter "#8939 Undo confirm msg" is set to "1", the menu is highlighted while the confirmation message is displayed.
Close	This closes the pop-up window and quits this function.
Line clear	This erases the designated line (multiple lines can be erased).

8.6 Thread Recutting Function



This function stores the thread groove position to enable thread re-machining.

Using this function allows the tool to pass through the machined thread groove by storing the lead axis machine position and the spindle angle to fit the groove position of the re-chucked workpiece.

This function is an additional specification.

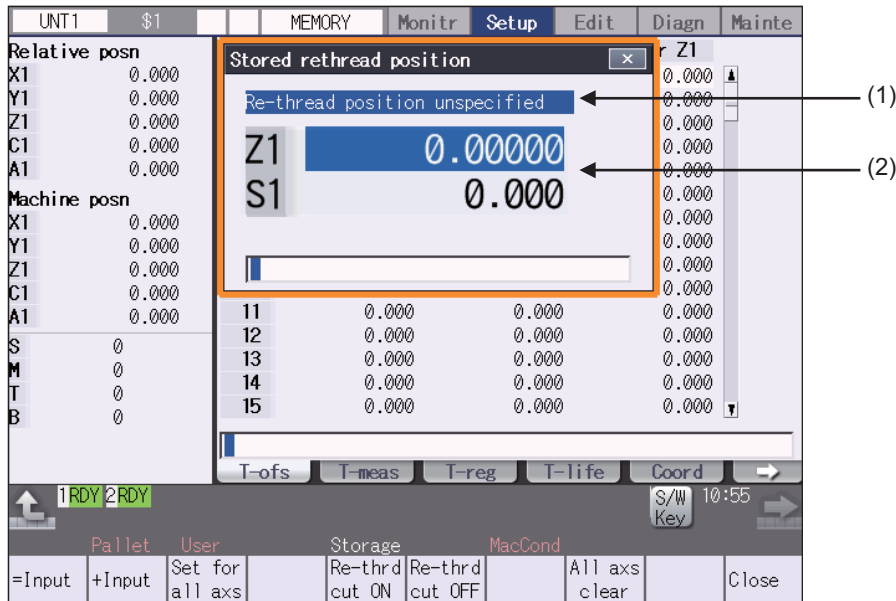

Display items

Display items	Details								
(1) Thread recutting status	<p>Displays the status to suit the thread recutting machining status.</p> <table border="1"> <thead> <tr> <th>Status</th> <th>Details</th> </tr> </thead> <tbody> <tr> <td>Thread recutting pos unspecified</td> <td>Displays the status in which the thread recutting position is not stored. When the menu [Thrdrecut ON] is pressed in this status, thread recutting is not enabled.</td> </tr> <tr> <td>Thread recutting pos specified</td> <td>Displays the status in which the thread recutting position is stored. When the menu [Thrdrecut ON] is pressed under this status, thread recutting is enabled. If thread cutting is commanded before the menu [Thrdrecut ON] is pressed, thread recutting is not carried out.</td> </tr> <tr> <td>In thread recutting</td> <td>Displays the status in which thread recutting is possible. When thread cutting is commanded under this status, thread recutting is carried out.</td> </tr> </tbody> </table>	Status	Details	Thread recutting pos unspecified	Displays the status in which the thread recutting position is not stored. When the menu [Thrdrecut ON] is pressed in this status, thread recutting is not enabled.	Thread recutting pos specified	Displays the status in which the thread recutting position is stored. When the menu [Thrdrecut ON] is pressed under this status, thread recutting is enabled. If thread cutting is commanded before the menu [Thrdrecut ON] is pressed, thread recutting is not carried out.	In thread recutting	Displays the status in which thread recutting is possible. When thread cutting is commanded under this status, thread recutting is carried out.
Status	Details								
Thread recutting pos unspecified	Displays the status in which the thread recutting position is not stored. When the menu [Thrdrecut ON] is pressed in this status, thread recutting is not enabled.								
Thread recutting pos specified	Displays the status in which the thread recutting position is stored. When the menu [Thrdrecut ON] is pressed under this status, thread recutting is enabled. If thread cutting is commanded before the menu [Thrdrecut ON] is pressed, thread recutting is not carried out.								
In thread recutting	Displays the status in which thread recutting is possible. When thread cutting is commanded under this status, thread recutting is carried out.								
(2) Stored thread groove position	<p>Displays the currently stored thread groove position. When the power is turned ON, "0" is displayed. Once the thread groove position is stored, it is held until the power is turned OFF or data is cleared.</p> <table border="1"> <tbody> <tr> <td>Z1</td> <td>Lead axis machine position The target axis follows the setting of the parameter "#8714 Thrdrecut lead ax".</td> </tr> <tr> <td>S1</td> <td>Spindle angle The target spindle follows the setting of the parameter "#8715 Thread recut SP#".</td> </tr> </tbody> </table>	Z1	Lead axis machine position The target axis follows the setting of the parameter "#8714 Thrdrecut lead ax".	S1	Spindle angle The target spindle follows the setting of the parameter "#8715 Thread recut SP#".				
Z1	Lead axis machine position The target axis follows the setting of the parameter "#8714 Thrdrecut lead ax".								
S1	Spindle angle The target spindle follows the setting of the parameter "#8715 Thread recut SP#".								

Menus

Menus	Details
=Input	This executes an absolute input.
+Input	This executes an incremental input.
Set for all axs	Press this menu to automatically input the lead machine position or spindle angle in the stored rethread position window and store data.
Thrdrec ut ON	This changes the status to "In thread recutting", enabling thread recutting using the stored data. If this menu is not pressed, thread recutting is not carried out. If this menu is pressed while thread recutting is disabled, the message "Thread recut position is unspecified" is displayed.
Thrdrec ut OFF	This changes the thread recutting status from "In thread recutting" to "Re-thread position specified", disabling thread recutting.
All axs clear	This erases all data of the stored positions.
Close	This closes the pop-up window.

8.6.1 Storing the Thread Groove Position

Operation method

Two methods are available to store the thread groove position: manual input and automatic input.

<Storing the thread groove position via manual input>

(1) Using the [↑] or [↓] key, switch the lead axis machine position (Z1) and the spindle angle (S1). → The cursor appears at the lead axis machine position (Z1) or the spindle angle (S1).

(2) Input the value in the item indicated by the cursor. → The input value is displayed in the input area.
 Z1: Lead axis machine position
 S1: Spindle angle

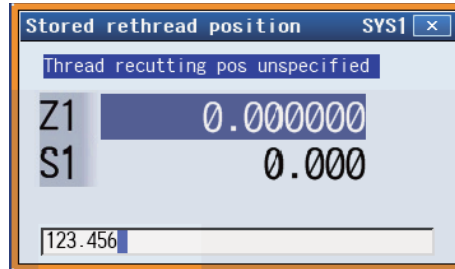

(3) Press the [INPUT] key or the menu [=Input].

<Note>

- It is possible to perform incremental input by pressing the menu [+Input] key instead of the [INPUT] key or the menu [=Input].
 (Example) If the original data is 200:
 $250 + [+Input] \rightarrow 200 + 250 = 450$

The input value is displayed in the input area. The value is stored at the position indicated by the cursor, and the cursor then moves down. However, if the cursor is at the spindle angle (S1), press the [INPUT] key to move the cursor to the lead axis machine position (Z1).

<Storing the thread groove position via automatic input>

(1) Manually move the nose of the thread cutting tool to the thread recutting groove.

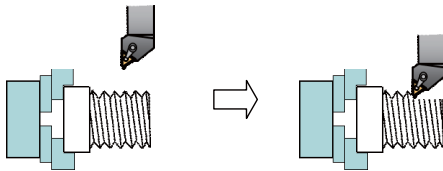

(2) Press the menu [Set for all axs].

→ The thread cutting status is changed to "Thread recutting pos specified", and the current lead axis machine position (Z1) and spindle angle (S1) are stored collectively.

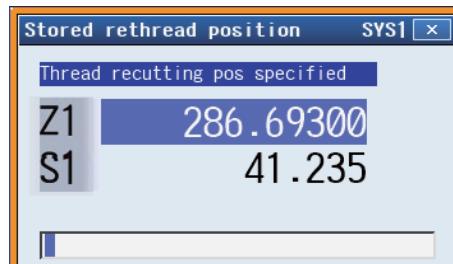

8.6.2 Switching the Stored Thread Groove ON/OFF

Operation method

- (1) Press the menu [Thrdrecut ON] in the state "Thread recutting pos specified". → The thread cutting status is changed to "In thread recutting". In this state, retract the tool and start the thread recutting program to enable the same thread machining as that carried out for the original thread.

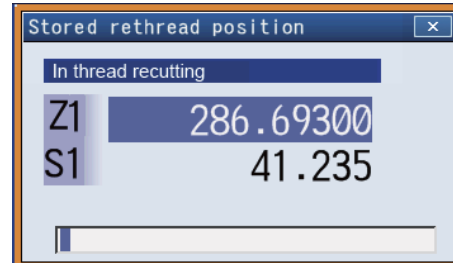

- (2) Press the menu [Thrdrecut OFF] in the state "In thread recutting". → The thread recutting status returns to the "Thread recutting pos specified" status, and thread recutting is disabled.

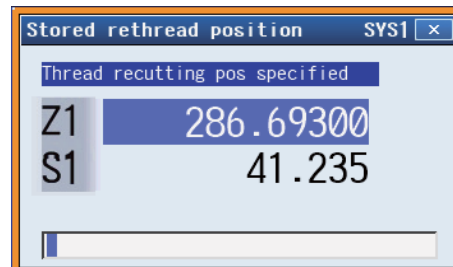

8.6.3 Erasing the Stored Thread Groove Position

Operation method

- (1) Press the menu [All axis clear]. → The menu [All axis clear] is highlighted. A message displays confirming whether it is okay to erase the data.
- (2) Press the [Y] or [INPUT] key. → The lead axis machine position (Z1) or the spindle angle (S1) is cleared to "0".

Machining a Workpiece

This chapter mainly describes the functions set on the monitor (Monitr) screen.

9.1 Operation Search



On this screen, the program can be called from the program storage site, such as a memory, by designating the program (program No.) to be automatically run and the program start position (sequence No., block No.).

When the multi-part system program management is valid (#1285 ext21/bit0 =1, ext21/bit1 =1) and [Memory] is selected as a device, the program search is executed across all part systems in batch.

The device [Memory card] and [USB Memory] are not selectable with this function.

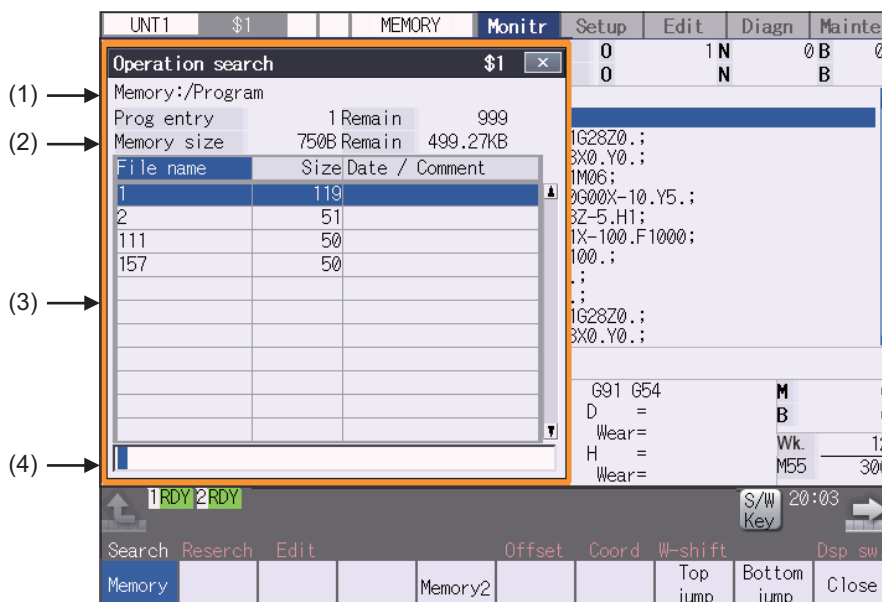





Display items

Display items	Details
(1) Device name, directory display	This displays the device and directory where the searched machining program is located.
(2) Capacity display	This displays the capacity of the device displayed in (1).
(3) List of directories and files	<p>This displays a list of the contents contained in the device or directory displayed in (1). Use and to scroll the displayed list.</p> <p>The comment of the machining program is displayed in the <Date/Comment> column. Whether to show or hide the comment field can be selected by pressing the menu [Comment switch]. When the comment field is hidden, the file name field will be enlarged. (Up to 13 characters can be displayed in the file name field when the comment is shown, and 32 when the comment is hidden.)</p> <p>If the file name exceeds the maximum number of characters, "" will appear at the last character.</p>
(4) Input section	This displays details of the key input.

Menus	
Menus	Details
Memory	This selects the device for searching for the program.
Memory2	<p><Note></p> <ul style="list-style-type: none"> •The menu [Memory2] is grayed out and non-selectable, when the specification of program memory capacity 1000kB[2560m] or 2000kB[5120m] is invalid.
Top jump	Display starts from the first page of the directory/list of files. The cursor moves to the top line.
Bottom jump	The last page of the directory/list of files is displayed. The cursor moves to the bottom line.
Comment switch	<p>Pressing this menu switches display/non-display status and the display contents of the "Date/Comment" column of the program list as follows:</p> <p>Program comment -> the last updated date/time of the file (*1) -> not displayed</p>
List update	This updates the list contents. (The latest contents of the currently selected device and directory are listed.)
Sort change	This changes the method of sorting the list.
Close	This closes the pop-up window and quits this function.

(*1) When the multi-part system program management is enabled (#1285 ext21/bit0 = 1) for the device [Memory], the last updated date/time of the file is not displayed.

9.1.1 Executing an Operation Search

Operation method	
(1) Press the  to select the part system to run.	➔ The selected part system appears on the upper left of the screen.
(2) Press the main menu [Search].	➔ The sub-menu is displayed. The list appears as a pop-up window.
(3) Select the device.	➔ The selected device name and root directory (memory:/) are displayed in the device name and directory display fields.
(4) Press the [↑], [↓],  or  key to move the cursor to the directory containing the file to be set.	➔ Moves into the directory.
(5) Press the [INPUT] key. If the list contents differ from the actual device or directory, press the menu [List Update].	
(6) Press [↑], [↓],  or  key to move the cursor to the machining program to be edited.	
(7) Press the [INPUT] key.	➔ The search starts. When the search is completed, the searched device and program position appear in the display area for the machining program currently being executed.

When designating the sequence number and block number and searching for the program, input the search conditions in the input area.

The program No. is categorized according to the presence of an extension.

Input details	(Program No.)	Sequence number	Block No.
1001/1/2	O1001	N1	B2
1001.PRG/1/2	O1001.PRG	N1	B2
/1/2	(Currently searched O No.)	N1	B2
1001/2	O1001	N0	B2
1001/1	O1001	N1	B0
1001	O1001	N0	B0
/1	(Currently searched O No.)	N1	B0
//2	(Currently searched O No.)	N0	B2

Note

- (1) The maximum number of digits is eight for the sequence No. and five for the block No.
- (2) Program after operation search
 - (a) Operation search is canceled if the following operations are carried out on the edit screen after operation search. Execute restart search in this case.
 - If the searched program is erased.
 - If the searched sequence No. is erased.
 - If the block corresponding to the searched block No. is erased.
 - (b) Operation search cannot be executed in another mode during MDI operation even if the block is stopped. Wait for MDI operation to end or reset the NC before searching.

- (3) A program with 33 or more file name characters cannot be searched.
- (4) Searched program No. is memorized in NC even after the power is turned OFF. When NC starts up after the power is turned ON again, the program which has the previously searched program No. will be operated.

9.1.2 Changing Whether to Show or Hide the Comment Field

You can switch to show or hide the "Date/Comment" column by pressing the menu [Comment switch].

(Example) When the file name is "123456789A123456789B123456789C12"

- When the comment field is displayed: The file name display is omitted and "*" is attached.

File name	Size	Date / Comment
123456789A12*	126	COLOR_CHK_01

- When the comment field is hidden: The file name is displayed up to 32 alphanumeric characters and symbols.

File name	Size
123456789A123456789B123456789C12	126

Note

- (1) The set status is held even if the NC power is turned OFF.
- (2) The set status is common for list view of operation screen, restart search screen, etc.
- (3) The cursor moves to the head when display/non-display in the comment field is switched.

9.1.3 Changing the Sorting Method

- ♦Sorting method changes to 1 -> 2 -> 3 -> 4 -> 5 -> 1.....every time the menu [Sort change] is pressed.
- ♦When the sorting method 1, 2, or 3 is selected, "File name" column is highlighted. The sorting method 4 or 5 is selected, "Date/Comment" column is highlighted. ("1. File name No. ascending order" is selected by default setting.)
- ♦The method is common for all the devices.
- ♦You can sort up to the sortable number of files (the total number of files and directories, including current directory "." and one directory above "..") within a directory.
- ♦"List updating" is displayed in flickering during sorting.
- ♦If it exceeds the sortable number of files, the menu [Sort change] is grayed out and changing the sorting method is impossible. Program is displayed with "1. File name No. ascending order". In this case, "File name" column is highlighted.

Sortable number of files: 64 files

Sorting method

No.	Sorting method	Priority
1	File name No. ascending order	1. "." for current directory, ".." for one directory above 2. Numerical value (excluding the case where "0" is put at the beginning) ascending order 3. Character code ascending order
2	File name character code ascending order	1. "." for current directory, ".." for one directory above 2. Character code ascending order
3	File name character code descending order	1. Character code descending order 2. "." for current directory, ".." for one directory above
4	Comment ascending order	"Date/comment" character code ascending order
5	Comment descending order	"Date/comment" character code descending order

Note

- (1) The selected sorting method is held even after the power is turned OFF.
- (2) The selected sorting method is common for list view of the Monitor screen, Restart search screen, etc.
- (3) The character code ascending (descending) order is the method in which file names are compared one by one using the ASCII code.
(Example) If the ascending order is applied, the appropriate order would be 1 to A because "1" equals to "0x31" and "A" equals to "0x41".
- (4) When the device is "Memory", display for "current directory" and "one directory above" is not available.
- (5) When comments are the same, sorting is carried out by the file name character code ascending (descending) order.

9.2 Checking the Movement under Machining (Monitor Screen)

Monitr

Various information related to operation, such as the axis counter, speed display and MSTB command are displayed on the Monitor screen. In addition, you can perform various monitoring operations, as shown below.

- (1) Search
- (2) Research
- (3) Editing the searched machining program
- (4) Correction of operating program's buffer
- (5) Counter set
- (6) Manual numerical value command, etc.

9.2.1 Screen Layout

The screen layout varies depending on whether the 2-part system simultaneous display (#11019 2-system display) is valid or invalid, operation mode, and the number of NC axes. Refer to the table below for details.

Screen		Number of counter display axes	Select display	Reference
1-part system display	Normal view	Up to 5 axes	Hidden	Screen 1
			Display	Screen 2
		6 axes or more	Hidden	Screen 3
			Display	-
	Simple view	Up to 5 axes	Display not possible	Screen 4
		6 axes or more	Display not possible	Screen 5
2-part system simultaneous display	Counter1 (expand)	Up to 4 axes	Display not possible	Screen 6
	Dual counter	Up to 4 axes	Display not possible	Screen 7
		5 axes or more	Display not possible	Screen 8
	Quad counter	Up to 4 axes	Display not possible	Screen 9

[1-part system display] (Parameter "#11019 2-systm display" = 0)

There are two types of screen displays: "Monitor screen (Normal view)" and "Monitor screen (Simple view)". This display can be switched using the menu [Dsp sw.]. However, the content of the display varies depending on the specification of NC axes.

<Screen 1: Monitor screen (Normal view) (Up to 5 axes)>

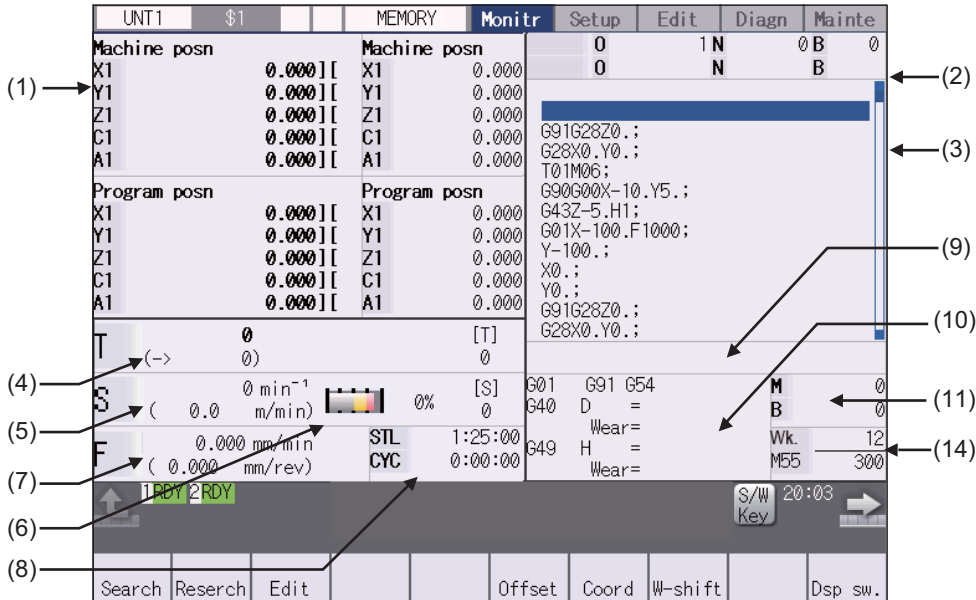

<Screen 2: Selectable display is valid>

When displaying monitor screen (normal view), display item on the bottom right of the screen can be changed, such as common variable, work coordinate system offset or tool compensation amount. To change the display, the parameter settings for "#8940 Selectable display" and "#8973 Set select display" are required.

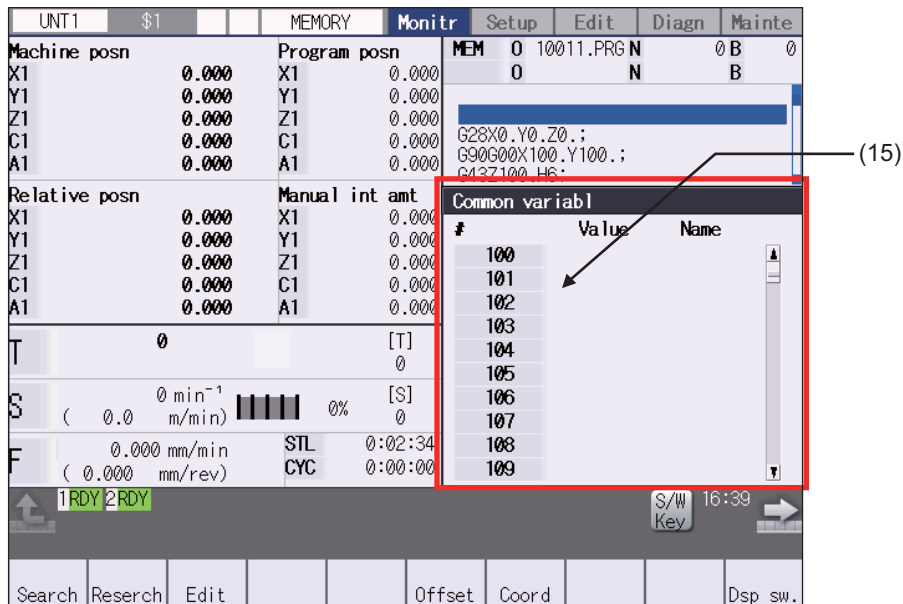

<Screen 3: Monitor screen (Normal view) (6 axes or more)>

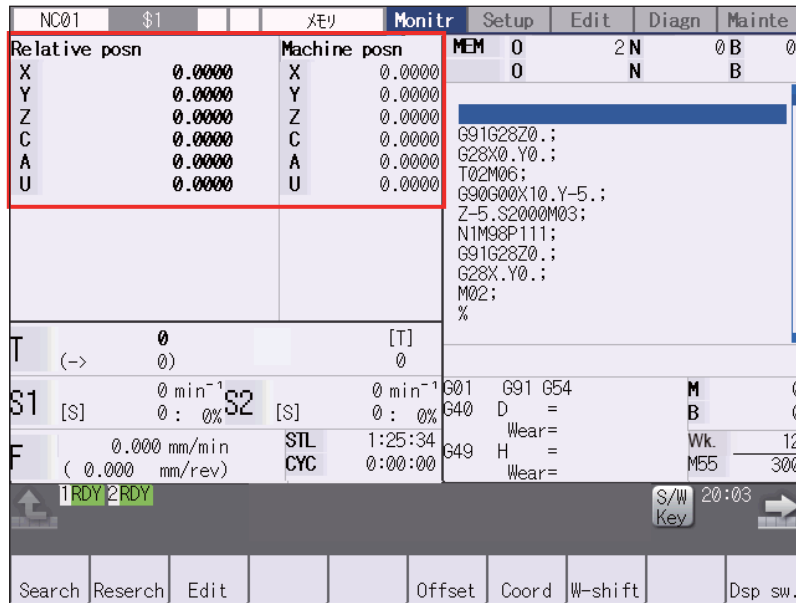

Note

- (1) The maximum number of axes that can be displayed is 10 axes. Press the menu [Next axis] to switch display to display the subsequent axes.

<Screen 4: Monitor screen (Simple view) (Up to 5 axes)>

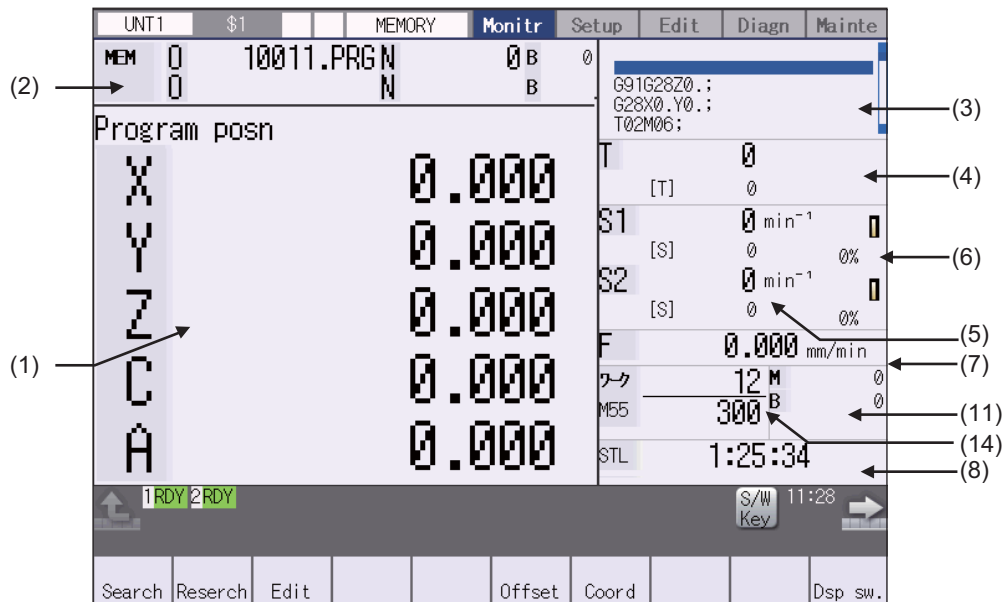

<Screen 5: Monitor screen (Simple view) (6 axes or more)>

UNT1	\$1	MEMORY	Monitr	Setup	Edit	Diagn	Mainte
MEM	0	2N	0B	0			
	0	N	B				
Program posn				G91G28Z0.; G28X0.Y0.; T02M06;			
X		0.0000	T	0			
Y		0.0000	[T]	0			
Z		0.0000	S1	0 min ⁻¹			
C		0.0000	[S]	0 0%			
A		0.0000	S2	0 min ⁻¹			
U		0.0000	[S]	0 0%			
			F	0.000 mm/min			
			Wk.	12 M			
			M55	300 B			
			STL	1:25:34			
1RDY 2RDY				S/W 16:55 Key			
Search	Reserch	Edit		Offset	Coord		Dsp sw.

Note

- (1) When the number of axes is 6 or more or the input unit is a maximum 0.01 μm in any one of the part systems, the screen display will change to the example shown above for all part systems. In this case the maximum number of axes that can be displayed are 8 axes.

[2-part system simultaneous display] (Parameter "#11019 2-systm display" = 1, 2)

■Counter1 (expand)

In "Counter1" (expand) display, single counter, MSTB display and currently executing program, etc. are displayed for each part system.

<Screen 6: Counter1 (expand) display>

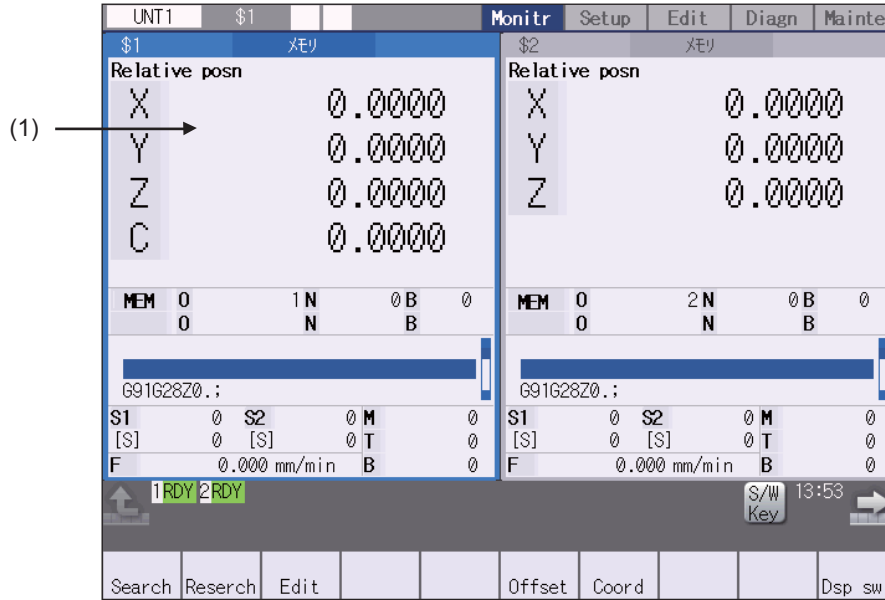

Note

(1) The maximum number of axes that can be displayed is 4 axes. Press the menu [Next axis] to switch display to display the subsequent axes.

■Dual counter display





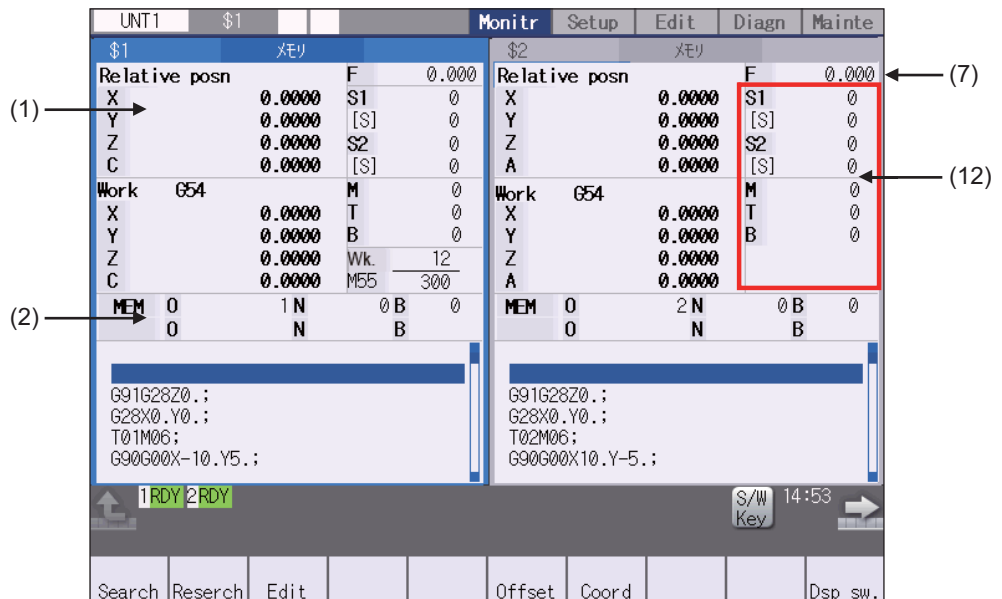



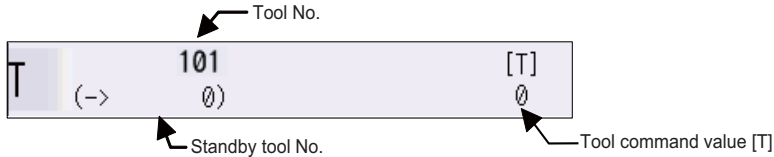
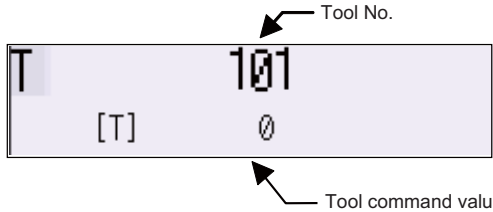
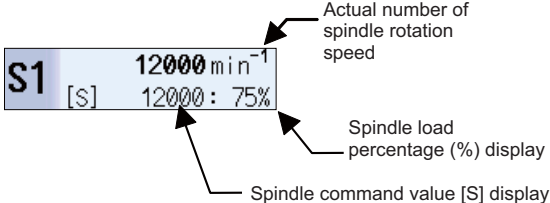
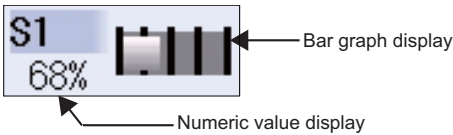

In "Dual counter" display, two counters, MSTB display and currently executing program, etc. are displayed for each part system.

<Screen 7: Dual counter display (up to 4 axes)>





Display items

Display items	Details				
(1) Counter display	<p>This area displays the counter of the relative position or workpiece coordinate position. If each axis is at a specific position or in a specific status, the following status abbreviations are displayed.</p> <p>#1 to #8: 1st to 8th reference position</p> <ul style="list-style-type: none"> •J]: Servo OFF state •MR: Mirror image •><: Axis removed state •CT: Auxiliary axis state <p>(Displayed when an axis that can be switched between the NC axis and auxiliary axis is set to the auxiliary axis state.)</p> <p>You can designate whether to consider the tool length compensation or tool radius compensation depending on the value of the parameter "#1287 ext23/bit4".</p> <p>The axis counter can be displayed or hidden depending on the value of the parameter "#1069 no_dsp".</p> <p>Also, if the axis is set to the diameter axis or uncontrol axis, the following symbol is displayed on the right of the axis name.</p> <ul style="list-style-type: none"> *: Uncontrol axis (axis where any part system does not have control rights) φ: Diameter axis <p>(When the target axis is equivalent to both the uncontrol axis and diameter axis, the symbol of the uncontrol axis is displayed.)</p>				
(2) Currently executed machining program (*1)	<table border="1" style="width: 100%; border-collapse: collapse;"> <tr> <td data-bbox="248 1021 475 1084" style="width: 20%;">Main O10...</td> <td data-bbox="475 1021 1450 1084">Displays the currently executed program number, sequence number, and block number.</td> </tr> <tr> <td data-bbox="248 1084 475 1151">Sub O1234...</td> <td data-bbox="475 1084 1450 1151">While a subprogram is executed, its program number, sequence number, and block number are displayed.</td> </tr> </table>	Main O10...	Displays the currently executed program number, sequence number, and block number.	Sub O1234...	While a subprogram is executed, its program number, sequence number, and block number are displayed.
Main O10...	Displays the currently executed program number, sequence number, and block number.				
Sub O1234...	While a subprogram is executed, its program number, sequence number, and block number are displayed.				
(3) Buffer display	<p>This displays the contents of the machining program currently being executed. The block being executed is highlighted.</p> <p>When the parameter "#1122 pglk_c" is enabled, the contents of the program are not displayed. Only "%" is displayed.</p> <p><Note></p> <ul style="list-style-type: none"> •If the program comment includes the double-byte width character for one character code, the program may not be displayed correctly. 				

Display items	Details						
<p>(4) Tool No. display</p>	<p>This area displays the tool number, standby tool number and T command value of the currently selected tool.</p> <p><Monitor screen (Normal view)></p>  <p><Monitor screen (Simple view)></p>  <p>Tool No.: Displays the tool number of the currently selected tool. Standby tool No.: Displayed only when standby tool 1 is designated. This is not displayed on the monitor screen (simple view). Tool command value [T]: Displays the T command value that is commanded last. In the L system, when "#11038 T disp typ" is set to "1", the diameter is displayed, including the compensation number.</p>						
<p>(5) Spindle rotation speed display</p>	<p>This area displays the actual number of spindle rotation speed as well as the spindle command value.</p>  <p>On the prototype or mass production screen, the values above vary depending on the value of the parameter "#1039 spinno".</p>						
<p>(6) Load meter display</p>	<p>This area displays the spindle load value (%) with a bar graph and numeric values. The simple view shows the load meter of up to two spindles.</p>  <p>The graph display color varies depending on the spindle load value. This item blinks when a warning occurs. The caution and warning thresholds conform to the parameters #3192 to #3194.</p> <p><Display example></p> <table border="0" style="width: 100%; text-align: center;"> <tr> <td>80% (Normal)</td> <td>130% (Caution)</td> <td>175% (Warning)</td> </tr> <tr> <td></td> <td></td> <td></td> </tr> </table>	80% (Normal)	130% (Caution)	175% (Warning)			
80% (Normal)	130% (Caution)	175% (Warning)					
							

Display items	Details
(7) Speed display	<p>Interpolation feeding: Displays the vector-direction speed (FA), dwell time, etc. of the axis currently being moved.</p> <p>Each axis independent feeding: Displays the speed of the axis with the highest speed designated.</p> <p>In the L system, the surface speed is displayed.</p> <p>When the parameter "#1125 real_f" is set to "1", the actual machine feedrate is displayed.</p>
(8) Cycle time display	<p>This area displays the automatic operation time and cycle time.</p> <p>The display item can be switched in the integrated time window.</p> <ul style="list-style-type: none"> ♦DAT: Date ♦TIM: Time ♦PON: Power ON ♦OP: Automatic operation ♦STL: Automatic start ♦EX1: Ext time1 ♦EX2: Ext time2 ♦CYC: Cycle time
(9) Control mode display	<p>This area displays the NC control mode.</p> <ul style="list-style-type: none"> ♦HTP: High-speed synchronous tapping ♦MOR: Manual arbitrary reverse run mode ♦SSS: SSS control ♦CSC: Corner smooth control ♦VAC: Variable-acceleration pre-interpolation acceleration/deceleration ♦EAC: Allowable acceleration for each axis (*3) ♦SFR: Smooth fairing ♦FRG: Fairing <p>Up to six control modes are displayed beginning at the top.</p>
(10) G modal simple display	<p>This area displays the following modal status.</p> <ul style="list-style-type: none"> ♦G command modal status of G code group 1 ♦G command modal status of G code group 3 ♦Currently selected workpiece coordinate system offset ♦Tool radius compensation modal, compensation number, tool shape amount, and tool radius wear ♦Tool length compensation modal, compensation axis name, compensation number, tool shape amount, and tool length wear
(11) M and B commands	<p>This area displays the command value for each of the M (miscellaneous function command value) and B (2nd miscellaneous function command value) functions.</p> <p><In 1-part system display></p> <p>The M (miscellaneous function command value) and B (2nd miscellaneous function command value) displays vary depending on the values of the parameters "#12005 Mfig" and "#1170 M2name".</p>
(12) M, S, T, and B commands (2-part system simultaneous display)	<p>Using the menu [MST Chg] allows you to switch the MSTB display in the area to be operated. (For details, refer to "Changing MSTB display" in "9.2.5 Operation of 2-part System Simultaneous Display".)</p>
(13) Spindle rotation speed display (2-part system simultaneous display)	<p>This area displays the spindle rotation speed and the spindle command value that are designated in the parameters "#8925 to #8928" ("SP on 1st part sys" to "SP on 4th part sys") and "#8958 to 8960" ("SP on 5th part sys" to "SP on 7th part sys").</p>
(14) Workpiece machining count display	<p>This area displays the current number of workpiece machining.</p> <p>The display varies depending on the setting of the parameter #8001 to #8003.</p> <p>However, when the parameter "#8001 WRK COUNT M" is set to "0", the number of workpiece machining is not counted, and it is not displayed on the screen.</p> <p>The setting value of the parameter "#8001 WRK COUNT M" is displayed up to high-order two digits.</p>

Display items	Details
(15) Selective display area	<p>This area displays NC data that is selected in the parameter "#8940 Set select display".</p> <p>Depending on the selected NC data, you can press the , , [↑], [↓], [←], [→], [→], or [←] key to scroll pages.</p> <p>Pressing the [INPUT] key displays the window that allows you to operate NC data displayed in the selective display area.</p> <p>The selective display area is displayed on the monitor screen. The monitor screen can be switched when the parameter "#8973 Selective display" is set to "1".</p>

(*1) If the program number (program name) exceeds the number of digits that can be displayed, the last digit is indicated by an asterisk (*).

The device name displays the device name detected by operation search.





If the sequence number exceeds six digits, only the low-order six digits are displayed.

(*2) If the data of the designated tool number has not been registered on the tool management screen, the tool icon is not displayed.

(*3) When the variable-acceleration pre-interpolation acceleration/deceleration is enabled, the allowable acceleration speed for each axis is always enabled, and "EAC" is not displayed while the control mode "VAC" is being displayed.

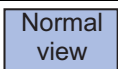
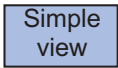
Sub-menus displayed by pressing the menu [Dsp sw.]

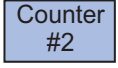
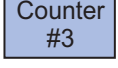
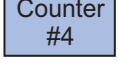
Sub-menu displayed by pressing the menu [Dsp sw.], when 2-part system simultaneous view is valid (#11019=0).

Menus	Details
	Switches the display format to the normal view.
	Switches the display format to the simple view.
	Switches counter type 1. (*1)
	Switches counter type 2. (*1) (*2)
	Switches counter type 3. (*1)
	Switches counter type 4. (*1) (*2)
	Switches counter type 5. (*3)

(*1) This menu cannot be operated in simple view mode.

(*2) This menu cannot be operated in normal view mode (6 axes or more).

(*3) This menu cannot be operated in normal view mode.

Note

(1) The selected display format is also held when the power is turned on again.

Sub-menus displayed by pressing the menu [Dsp sw.], when 2-part system simultaneous display is valid (#11019 = 1)

Menus	Details
Counter expand	Switches the counter display format to counter1 (expand).
Dual counter	Switches the counter display format to dual counter.
Quad counter	Switches the counter display format to quad counter.
MSTB view	Switches the MSTB display for the area to be operated.
Counter #1	Switches counter type 1.
Counter #2	Switches counter type 2. (*1) (*2)
Counter #3	Switches counter type 3. (*1) (*3)
Counter #4	Switches counter type 4. (*1) (*3)

(*1) This menu cannot be operated in single counter mode.

(*2) This menu cannot be operated in dual counter mode (5 axes or more).

(*3) This menu cannot be operated in dual counter mode.

Note

(1) The selected display format is also held when the power is turned on again.

9.2.2 Switching the Display Format



The monitor screen display format can be switched using the menu [Dsp sw.]. The switchable display format varies depending on the value of the parameter "#11019 2-system display".

- (1) In the 1-part system display (#11019 = 0), switch the display format between the normal view and simple view or among single counter, dual counter, and quad counter.
- (2) In the 2-part system simultaneous display (#11019 = 1), switch the display format among the counter1 (expand), dual counter and quad counter.

Switching the normal view and simple view

When the parameter "#11019 2-system display" (2-part system simultaneous display) is disabled, you can press the sub menu [Normal view] or [Simple view] in the [Dsp sw.] to switch the screen to the normal view or simple view.

Switching the Counter Display Format

When the parameter "#11019" (2-part system simultaneous display) is enabled, the counter display format can be switched to the following three modes.

- Counter1 (expand): Displays one counter (Counter type 1) for each part system.
- Dual counter: Displays two counters (Counter types 1 and 2) for each part system.
- Quad counter: Displays four counters (Counter types 1 to 4) for each part system.

Note

- (1) For details on the screen image, refer to Screens 6 to 9 in "9.2.1 Screen Layout".
You can press the sub-menu [Counterexpand], [Dual counter], or [Quad counter] in the menu [Dsp sw.] to switch the display format.

9.2.3 Switching the Counter Types



The counter mode on the monitor screen (monitor screen (normal view), monitor screen (simple view), and 2-part system simultaneous display screen) can be switched using the parameter or the menu [Counter].

- (1) Switching the counter type in the parameter setting
- (2) Switching the counter type in the menu [Counter]

Switching in the parameter setting

The type of the counter to be displayed on the monitor screen can be switched using each of the counter type parameters "#8901" to "#8905". The figure below shows the relationship between counters and parameters using arrows.

<Monitor screen (Normal view)>

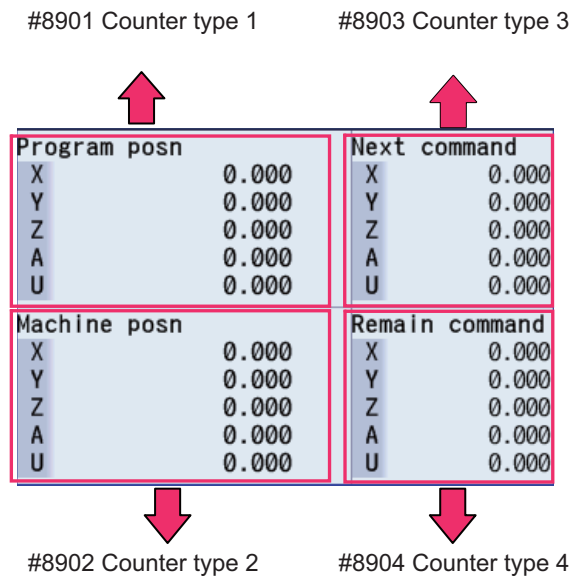

<Monitor screen (Simple view)>

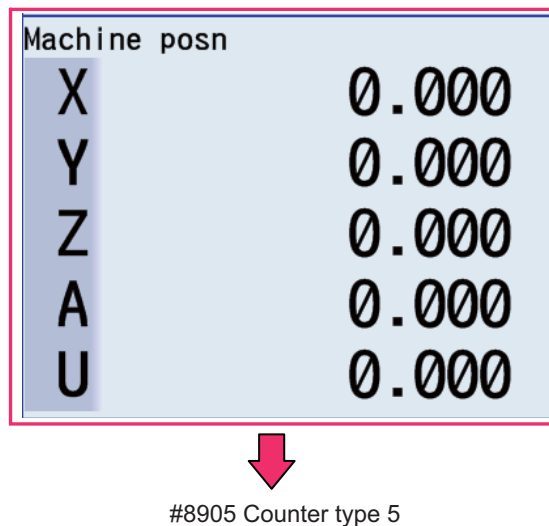

<Monitor screen (2-part system simultaneous display)>

The following counter type is displayed in the target operation area on the left.
Also, the same counter type is displayed in the target operation area on the right.

■[Counterexpand]

#8901
Counter type 1 →

M001		SYS1		MEMORY	
SYS1		MEMORY			
Machine posn					
X	∅	0.00000			
Z		0.00000			
C		0.00000			
A		0.00000			

■[Dual counter]

#8901
Counter type 1 →

#8902
Counter type 2 →

M001		SYS1		MEMORY			
SYS1		MEMORY					
Machine posn				F	0.000		
X	∅	0.00000		S	0		
Z		0.00000		[S]	0		
C		0.00000			0%		
A		0.00000					
Relative posn				M	0		
X	∅	0.00000		T	0		
Z		0.00000		B	0		
C		0.00000					
A		0.00000					

■[Quad counter]

#8901
Counter type 1 →

#8902
Counter type 2 →

#8903
Counter type 3 ←

#8904
Counter type 4 ←

M001		\$1		MEMORY			
\$1		MEMORY					
Machine posn				Pulse			
X		0.000		X		0.000	
Y		0.000		Y		0.000	
Z		0.000		Z		0.000	
A		0.000		A		0.000	
Tip wk G54				Tip Mach posn			
X		0.000		X		0.000	
Y		0.000		Y		0.000	
Z		0.000		Z		0.000	
A		0.000		A		0.000	

Switching the counter type using the menu

The type of the counter to be displayed on the monitor screen can be changed using the sub-menu [Counter] under the menu [Dsp sw.]. If the counter type is switched using the menus [Counter #1] to [Counter #5], the values of the parameters "#8901 Counter type 1" to "#8905 Counter type 5" are rewritten.

However, when data protection is valid, the displayed counter type can be switched using the menu, but the value of each parameter cannot be rewritten. In this case, if the display returns to the monitor screen after switching to another screen while the displayed counter type is different from the parameter value, the displayed counter is set to the counter type that matches the parameter value.

The figure below shows the counter types that can be displayed using the menu [Counter] as well as the switching order.

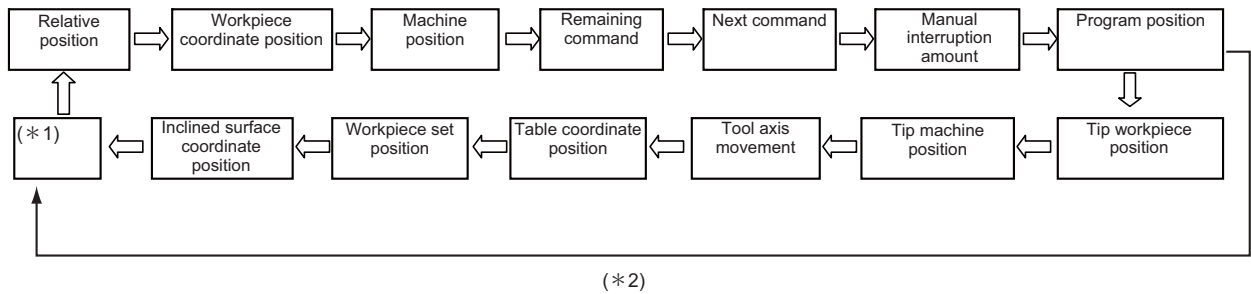

(*1) If a counter other than the 13 types of counters above ("Relative position" to "Inclined surface coordinate position") is set to the parameter ("#8901 Counter type 1" to "#8905 Counter type 5") before the counter type is switched using the menu [Counter], the counter type is switched among 14 types of counters, including that counter. When the counter type is switched to a counter type other than the 13 counter types above, it is held until the power is turned OFF. Furthermore, if the 13 counter types above are designated in parameters before the counter type is switched using the menu, the counter type is switched among these 13 counter types.

(*2) "Tip workpiece position", "Tip machine position", "Tool axis movement", "Table coordinate position", "Workpiece set position" and "Inclined surface coordinate position" counters can be switched when any of the following specifications is valid.

- ◆ Tool center point control
- ◆ Tool length compensation along the tool axis
- ◆ Tool handle feed & interruption
- ◆ Inclined surface machining command
- ◆ 3-dimensional tool radius compensation (tool's vertical-direction compensation)
- ◆ 3-dimensional manual feed

9.2.4 Switching the Spindle No. to be Displayed on Counter



The number of counter axes that can be displayed on the monitor screen is as follows. To refer to the subsequent axes, select the menu [Next axis].



- Monitor screen in 1-part system view (normal view): Up to 10 axes
- Monitor screen in 1-part system view (simple view): Up to 5 axes
- 2-part system simultaneous view (Counter1 (expand)): Up to 4 axes
- 2-part system simultaneous view (Dual counter): Up to 8 axes
- 2-part system simultaneous view (Quad counter): Up to 4 axes

Note

- (1) When the mixed control (cross axis control) function is enabled, the menu [Next axis] is displayed even if there is no axis to be switched.

9.2.5 Operation of 2-part System Simultaneous Display

Switching the area to be operated (right/left)

The area to be operated (right/left) can be switched by touching in the area using the tab key ( ) or on the touchscreen.

When the area to be operated is switched, the part system name to be operated is displayed on the selection bar. At NC startup, the left side is set as the area to be operated.

Note

- (1) The area to be operated cannot be switched while the pop-up window is being displayed.
- (2) The area to be operated can be switched while the software keyboard is being displayed.

Switching the display part system No.

The part system is switched for the area to be operated (right/left).

When the part system displayed in the non-target area is designated by incrementing displayed part systems by one each time you press the  key, the area to be operated is switched.

If the available number of displayed part systems is reached, the first part system is displayed.

Note

- (1) The same operation is also applied when you click a part system name in the selection bar on the touchscreen.
- (2) If the base common parameter "#11035 Sys. change limit" is set to "1", it disables part systems from being switched using the  key or on the touchscreen.

Changing MSTB display

On the monitor screen in 2-part system simultaneous view, you can press the [MST Chg] main menu to change the MSTB display for the area to be operated.

The MSTB display type is held for each part system when the screen is switched or the power is turned ON again.

<2-part system simultaneous view: Counter1 (expand) / Quad counter>

There are the following two types of MSTB displays, which are toggled each time the menu [MST Chg] is pressed.

- MSTB display type (*1) (*2) (*3)

- MSTB + Workpiece machining count display type (*1) (*2)

(*1) The S command is used to designate the spindle to be displayed for each part system using parameters (#8925 to #8928 ("SP on 1st part sys" to "SP on 4th part sys") and #8958 to #8960 ("SP on 5th part sys" to "SP on 7th part sys")). Up to two spindles can be designated in each part system. The M (miscellaneous function command value), T (tool command value), and B (2nd miscellaneous function command value) functions are displayed one by one regardless of the value of the parameter "#12005 Mfig" (M count), "#12009 Tfig" (T count), or "#12011 Bfig" (B count). However, the B (2nd miscellaneous function command value) function is displayed or hidden depending on the value of the parameter "#1170 M2name" (2nd miscellaneous code).

(*2) The menu [MST Chg] is not available in the following cases:

- The parameter "#8001 WRK COUNT M" is set to "0".

- "F" is set to the low-order byte of parameters #8925 to #8928 ("SP on 1st part sys" to "SP on 4th part sys") and #8958 to #8960 ("SP on 5th part sys" to "SP on 7th part sys"), or the parameter "#1039 spinno" is set to "1".

(*3) When the number of spindles is set to "1" or only one spindle is displayed depending on the operation parameters (#8925 to #8928 ("SP on 1st part sys" to "SP on 4th part sys") and #8958 to #8960 ("SP on 5th part sys" to "SP on 7th part sys")), the load meter of the target spindle is displayed at the position at which the second spindle is to be displayed.

<2-part system simultaneous view: Dual counter>

There are the following six types of MSTB displays, which are toggled each time the menu [MST Chg] is pressed.

- MSTB display type (*1)

- S display type 1

- S display type 2

- MTB display type

- MTB + Workpiece machining count display type

- MSTB + Workpiece machining count display type (*1)

(*1) When the number of spindles is set to "1" or only one spindle is displayed depending on the operation parameters (#8925 to #8928 ("SP on 1st part sys" to "SP on 4th part sys") and #8958 to #8960 ("SP on 5th part sys" to "SP on 7th part sys")), the load meter of the target spindle is displayed at the position at which the second spindle is to be displayed.

Customizing the screen display (Select display area (parameter "#8973 Selective display" = "1"))

A part of the monitor screen (normal view) can be customized to suit user's need (to display data which a user always needs to refer to). The select display area shows the screen that is selected using the parameter "#8940 Set select display".

9.2.6 Counter All-axis Display



A counter for all axes opens as a pop-up display.
The type of displayed counter can be selected with the menu.

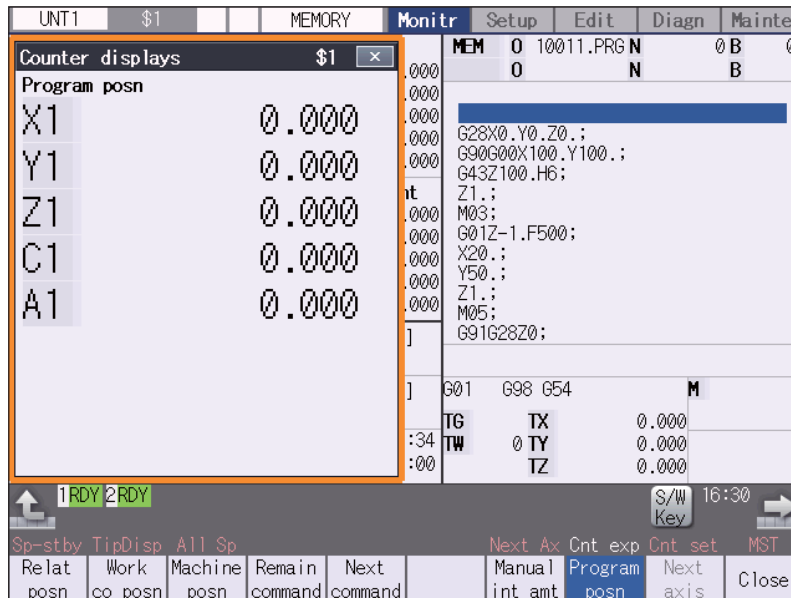

Menus

Menus	Details
Relat posn	This displays the currently executed position.
Work co posn	This displays the G54 to G59 workpiece coordinate system modal No. and the workpiece coordinate position in that workpiece coordinate system.
Machine posn	This displays the coordinate position of each axis in the basic machine coordinate system having a characteristic position, specified by the machine, as a zero point.
Remain command	This displays the remaining distance of the movement command being executed during automatic start or automatic halt. (The remaining distance is the incremental distance from the current position to the end point of that block.)
Next command	This displays the details of the command in the block executed after the block currently being executed.
Manual int amt	This displays the amount moved with the manual mode while the manual absolute switch was OFF. When the parameter "# 8173 Hold intr amount" is set to "0", interrupt amount is cleared by pressing the reset button.
Program posn	This displays the value obtained by subtracting the tool compensation amount compensated for that axis from the position actually being executed for each axis. When the parameter "# 8173 Hold intr amount" is set to "0", interrupt amount is cleared by pressing the reset button.
Close	This closes the pop-up window and quits this function.
Tip wk posn	This displays the position of the tool center from the workpiece coordinate reference position in the selected workpiece coordinate system.

Menus	Details
Tip machine	This displays the position of the tool center from the machine coordinate system reference position in the machine coordinate system.
Pulse	This displays the amount moved in the selected axis direction using the manual pulse generator in the hypothetical machine coordinate system. Basically this is updated only when manual ABS is OFF. If "#7905 NO_ABS" is set to "1", this will be updated regardless of the manual ABS ON/OFF.
Table co posn	This displays the table coordinate.
Incline co posn	This displays the inclined surface coordinate.
Next axis	This switches the axis to be displayed on the counter. This switches the axes to be displayed on the counter between "1st axis to 12th axis" and "13th axis or after".

Note

- (1) The type of counter displayed first when the pop-up display appears is the relative position. However, when any of the targeted specifications (*1) is valid, "Tip workpiece position" is displayed. The counter which appears next is the type selected previously.
- (2) The menus [Tip wk posn], [Tip machine], [Pulse] and [Table co posn] appear when any of the targeted specifications (*1) is valid.
- (3) The menu [Incline co posn] is displayed when the additional specification of the inclined surface machining command is valid.

(*1) Targeted specifications

- ◆ Tool center point control
- ◆ Tool length compensation along the tool axis
- ◆ Tool handle feed & interruption
- ◆ Inclined surface machining command
- ◆ 3-dimensional tool radius compensation (tool's vertical-direction compensation)
- ◆ 3-dimensional manual feed

9.2.7 Modal Display



The state of each modal during automatic operation is displayed.
 The displayed details differ for the M system and L system.

<M system>

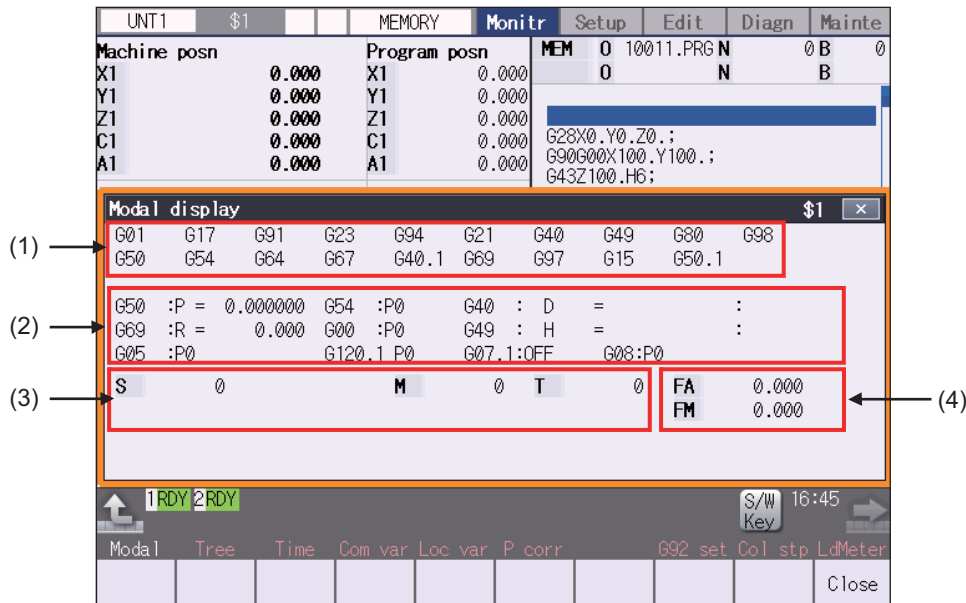

Even if operating area is switched in the 2-part system simultaneous display, the position of the pop-up window will not change. It is always displayed at the bottom of the screen.

Display items

Display items	Details
(1) G modal list	<p>The list below shows the G command modal status of the currently executed groups 1 to 20.</p> <p>Each item displays the following information.</p> <p>G00: Displays the G command modal status of the currently executed group 1. G17: Displays the G command modal status of the currently executed group 2. : Displays the G command modal status of each group in sequence. G50.1: Displays the G command modal status of the currently executed group 19.</p>

Display items	Details
(2) Details of G modal	This item displays detailed information of the G command modal status of the currently executed group. Each item displays the following information.
G50 :P= 0.000000	Scaling factor
G54.1:P1	Workpiece coordinate system offset No.
G42 : D 10= 0.000000: 0.000000 G42: D10: = 0.000000: 0.000000	Tool radius compensation modal Offset num Shape compensation amount of tool radius Tool radius wear amount
G69 :R = 0.000	Coordinate rotation angle (Displayed in the range of $\pm 360^\circ$.)
G43 :ZH 50= 0.000000: 0.000000 G43: Z H50 = 0.000000: 0.000000	Tool length compensation modal Compensation axis name Offset num Offset Tool length wear amount
G43 :ZH 50= 0.000000: 0.000000 G43: Z H50 = 0.000000: 0.000000	Tool length compensation modal Compensation axis name Offset num Offset Tool length wear amount
G05.1:P1000 (Display example) G05 :P0 G05.1: Q1 G05.1: Q2 G05 :P10000 G05 :P1 G05 :P2	High-speed machining mode High-speed high-accuracy control I Spline interpolation High-speed high-accuracy control II (SSS control OFF) High-speed machining mode I High-speed machining mode II
VAC CSC SFR SSS (*1)	Variable-acceleration pre-interpolation acceleration/ deceleration enabled Corner smooth control enabled Smooth fairing ON SSS enabled
G120.1 P1 Q1 (Display example) G120.1 P0 G120.1 P1 Q2 (*2)	Machining Condition Selection I Reference parameter selected Each machining condition parameter selected Pn: (n=1 to 3) Machining purpose Qm: (m=1 to 3) Condition
G07.1: ON G07.1: OFF	Cylindrical interpolation modal (Fixed to G07.1) Cylindrical interpolation mode (ON/OFF)
G08: P0 G08: P1	High-accuracy control mode OFF High-accuracy control mode ON

Display items	Details
(3) MSTB display area	<p>This area displays the program command modal value for each of the currently executed commands.</p> <p>Each item displays the following information.</p> <ul style="list-style-type: none"> ♦S command ♦M command ♦T command ♦2nd miscellaneous function (B) command <p>The number of S displays varies depending on the value of the parameter "#1039 spinno" (Number of spindles).</p> <p>The number of M displays varies depending on the value of the parameter "#12005 Mfig" (M count).</p> <p>The number of T or B displays is set to "1" regardless of the value of the parameters "#12009 Tfig" (T count) and "#12011 Bfig" (B count). However, for the B display, the value is displayed or hidden depending on the value of the parameter (#1170 M2name 2nd miscellaneous code).</p> <p>For the T display, only the tool number is displayed regardless of the value of the parameter "#11038 T disp type".</p>
(4) F modal display area	<p>This area displays the F modal value and manual feedrate.</p> <p>FA: Displays the program command F modal value of the currently executed command.</p> <p>FM: Displays the manual feedrate.</p>

(*1) Displays the current control mode. When multiple control modes are enabled simultaneously, one of them is displayed in the order in which the priority is higher. (The priority is higher beginning at the top.)

(*2) G121 command: Machining Condition Selection I Cancel

Changes to the machining condition selection command that is selected in [Setup] - [MacCond] screen.

<L system>

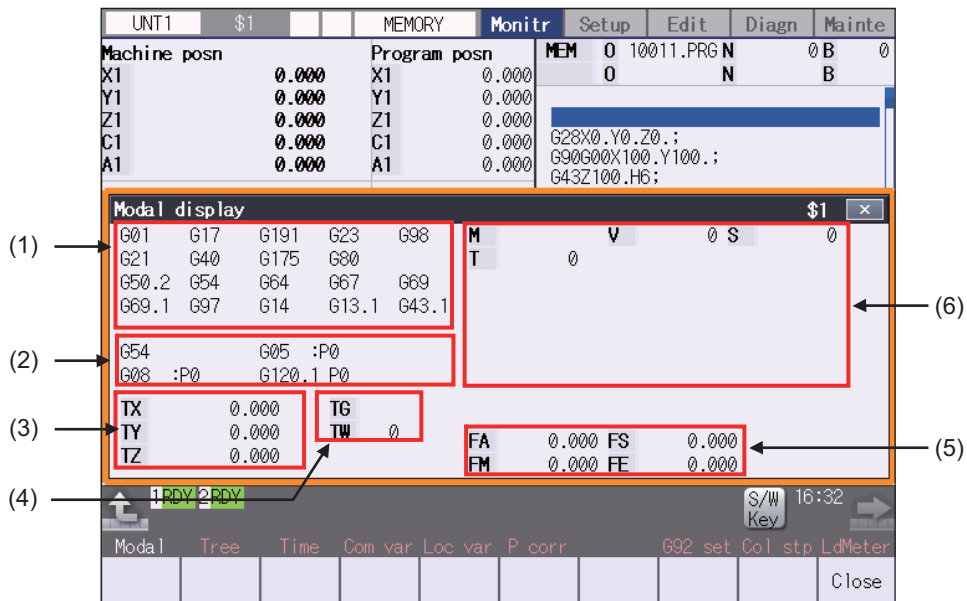

Even if operating area is switched in the 2-part system simultaneous display, the position of the pop-up window will not change. It is always displayed at the bottom of the screen.

Display items

Display items	Details
(1) G modal list	<p>The list below shows the G command modal status of the currently executed groups 1 to 20.</p> <p>Each item displays the following information.</p> <p>G00: Displays the G command modal status of the currently executed group 1. G17: Displays the G command modal status of the currently executed group 2. : Displays the G command modal status of each group in sequence. G43.1: Displays the G command modal status of the currently executed group 19.</p>

Display items	Details																																						
(2) Details of G modal	<p>This item displays detailed information of the G command modal status of the currently executed group. Each item displays the following information.</p> <table border="1" data-bbox="481 338 1398 371"> <tr> <td>G54.1:P10</td> <td>Workpiece coordinate system offset No.</td> </tr> </table> <p>The data format of the workpiece coordinate system offset number is as follows:</p> <table border="1" data-bbox="481 416 1398 689"> <tr> <td>G5x :P (x = 4 to 9)</td> <td>G54 Workpiece coordinate system selection 1 G55 Workpiece coordinate system selection 2 G56 Workpiece coordinate system selection 3 G57 Workpiece coordinate system selection 4 G58 Workpiece coordinate system selection 5 G59 Workpiece coordinate system selection 6</td> </tr> <tr> <td>G54.1: Pyy (yy = 1 to 96)</td> <td>G54.1 Workpiece coordinate system selection The number of extension sets is assigned to 0, 48, or 96 sets depending on the additional specifications.</td> </tr> </table> <p>When the high-speed machining mode, high-speed high-accuracy control, or direct command mode specification is enabled, the status of the high-speed machining mode, high-speed high-accuracy control, or direct command mode is displayed.</p> <table border="1" data-bbox="481 790 1398 1043"> <tr> <td>G05 :P0</td> <td>OFF</td> </tr> <tr> <td>G05 :P1</td> <td>High-speed machining mode I ON</td> </tr> <tr> <td>G05 :P2</td> <td>High-speed machining mode II ON</td> </tr> <tr> <td>G05.1: Q0</td> <td>High-speed high-accuracy control I OFF</td> </tr> <tr> <td>G05.1: Q1</td> <td>High-speed high-accuracy control I ON</td> </tr> <tr> <td>G05 :P10000</td> <td>High-speed high-accuracy control II ON</td> </tr> <tr> <td>G05 P4</td> <td>Direct command mode ON</td> </tr> </table> <p>Displays the current control mode. When multiple control modes are enabled simultaneously, one of them is displayed in the order in which the priority is higher. (The priority is higher beginning at the top.)</p> <table border="1" data-bbox="481 1171 1398 1346"> <tr> <td>VAC</td> <td>Variable-acceleration pre-interpolation acceleration/deceleration enabled</td> </tr> <tr> <td>CSC</td> <td>Corner smooth control enabled</td> </tr> <tr> <td>SFR</td> <td>Smooth fairing ON</td> </tr> <tr> <td>SSS</td> <td>SSS enabled</td> </tr> </table> <p>When the high-accuracy control specification is enabled, the status of the high-accuracy control mode is displayed.</p> <table border="1" data-bbox="481 1417 1398 1485"> <tr> <td>G08:P0</td> <td>High-accuracy control mode OFF</td> </tr> <tr> <td>G08:P1</td> <td>High-accuracy control mode ON</td> </tr> </table> <p>Displays the currently selected machining condition parameter group. * If the reference parameter is selected, "G120.1 P0" is displayed.</p> <table border="1" data-bbox="481 1559 1398 1765"> <tr> <td>G120.1 P1 Q2 (Display example)</td> <td>Machining Condition Selection I</td> </tr> <tr> <td>G120.1 P0</td> <td>Reference parameter selected</td> </tr> <tr> <td>G120.1 P1 Q1 (*1)</td> <td>Each machining condition parameter selected Pn: (n=1 to 3) Machining purpose Qm: (m=1 to 3) Condition</td> </tr> </table>	G54.1:P10	Workpiece coordinate system offset No.	G5x :P (x = 4 to 9)	G54 Workpiece coordinate system selection 1 G55 Workpiece coordinate system selection 2 G56 Workpiece coordinate system selection 3 G57 Workpiece coordinate system selection 4 G58 Workpiece coordinate system selection 5 G59 Workpiece coordinate system selection 6	G54.1: Pyy (yy = 1 to 96)	G54.1 Workpiece coordinate system selection The number of extension sets is assigned to 0, 48, or 96 sets depending on the additional specifications.	G05 :P0	OFF	G05 :P1	High-speed machining mode I ON	G05 :P2	High-speed machining mode II ON	G05.1: Q0	High-speed high-accuracy control I OFF	G05.1: Q1	High-speed high-accuracy control I ON	G05 :P10000	High-speed high-accuracy control II ON	G05 P4	Direct command mode ON	VAC	Variable-acceleration pre-interpolation acceleration/deceleration enabled	CSC	Corner smooth control enabled	SFR	Smooth fairing ON	SSS	SSS enabled	G08:P0	High-accuracy control mode OFF	G08:P1	High-accuracy control mode ON	G120.1 P1 Q2 (Display example)	Machining Condition Selection I	G120.1 P0	Reference parameter selected	G120.1 P1 Q1 (*1)	Each machining condition parameter selected Pn: (n=1 to 3) Machining purpose Qm: (m=1 to 3) Condition
G54.1:P10	Workpiece coordinate system offset No.																																						
G5x :P (x = 4 to 9)	G54 Workpiece coordinate system selection 1 G55 Workpiece coordinate system selection 2 G56 Workpiece coordinate system selection 3 G57 Workpiece coordinate system selection 4 G58 Workpiece coordinate system selection 5 G59 Workpiece coordinate system selection 6																																						
G54.1: Pyy (yy = 1 to 96)	G54.1 Workpiece coordinate system selection The number of extension sets is assigned to 0, 48, or 96 sets depending on the additional specifications.																																						
G05 :P0	OFF																																						
G05 :P1	High-speed machining mode I ON																																						
G05 :P2	High-speed machining mode II ON																																						
G05.1: Q0	High-speed high-accuracy control I OFF																																						
G05.1: Q1	High-speed high-accuracy control I ON																																						
G05 :P10000	High-speed high-accuracy control II ON																																						
G05 P4	Direct command mode ON																																						
VAC	Variable-acceleration pre-interpolation acceleration/deceleration enabled																																						
CSC	Corner smooth control enabled																																						
SFR	Smooth fairing ON																																						
SSS	SSS enabled																																						
G08:P0	High-accuracy control mode OFF																																						
G08:P1	High-accuracy control mode ON																																						
G120.1 P1 Q2 (Display example)	Machining Condition Selection I																																						
G120.1 P0	Reference parameter selected																																						
G120.1 P1 Q1 (*1)	Each machining condition parameter selected Pn: (n=1 to 3) Machining purpose Qm: (m=1 to 3) Condition																																						
(3) Tool length and wear compensation amount display area	<p>This area displays the tool length and wear compensation amount. TX: Displays the sum of the tool length and wear compensation amount of the first axis for the tool in use. (*2) TZ: Displays the sum of the tool length and wear compensation amount of the second axis for the tool in use. (*2) TY: Displays the sum of the tool length and wear compensation amount of the additional axis for the tool in use. (*3)</p>																																						
(4) Compensation number display area	<p>This area displays the compensation number. TG: Displays the tool length compensation number. TW: Displays the wear compensation number.</p>																																						

Display items	Details
(5) F modal area	This area displays the F modal value and manual feedrate. FA: Displays the program command asynchronous feedrate modal value of the currently executed command. FM: Displays the manual feedrate. FS: Displays the program command synchronous feedrate modal value of the currently executed command. FE: Displays the thread lead command synchronous feedrate modal value of the currently executed command.
(6) MSTB area and constant surface speed control (constant surface speed S) area	<MSTB area> This area displays the program command modal value for each of the currently executed commands. Each item displays the following information: ♦S command ♦M command ♦T command ♦2nd miscellaneous function (B) command The number of S displays varies depending on the value of the parameter "#1039 spin-no" (Number of spindles). The number of M displays varies depending on the value of the parameter "#12005 Mfig" (M count). The number of T or B displays is set to "1" regardless of the value of the parameter "#12009 Tfig" (T count) and "#12011 Bfig" (B count). However, for the B display, the value is displayed or hidden depending on the value of the parameter (#1170 M2name 2nd miscellaneous code). For the T display, only the tool number is displayed regardless of the value of the parameter "#11038 T disp type".

(*1) G121 command: Machining Condition Selection I Cancel

Changes to the machining condition selection command that is selected in [Setup] - [MacCond] screen.

(*2) Displays the axis name that is set to the first and second axes in the part system for the base axis specification parameter "#1013 axname". (If no axis name is set to "#1013 axname", the axis name item is blank.)

(*3) When the parameter "#1281 ext17 bit1" (tool offset additional axis selection) is set to "0", the display will change as follows by the parameter "#1520 Tch34" (additional axis tool) setting.

#1520 Tch34 = 0: Displays the axis name configured as the third axis in the part system by the parameter "1013 axname".

#1520 Tch34 = 1: Displays the axis name configured as the 4th axis in the part system.

(If no axis name is set to "#1013 axname", the axis name item is blank.)

When the parameter "#1281 ext17 bit1" (tool offset additional axis selection) is set to "1", the name of the axis designated by the parameter "#1027 base_J" (basic axis J) is displayed. (If the axis name designated in "#1027 base_J" is not set to "#1013 axname", the axis name item is blank.)

In the two-axis configuration system, the third row is not displayed.

Menus

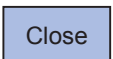
Menus	Details
	This closes the pop-up window and quits this function.

Note

(1) The menu is common for the M system and L system.

9.2.8 Program Tree Display



This displays the main program, subprogram, MDI interrupt and user macro call nesting structure.

This also displays the execution position of the main program and the subprogram (the lowest level of the nest only) as a percentage during the automatic operation.

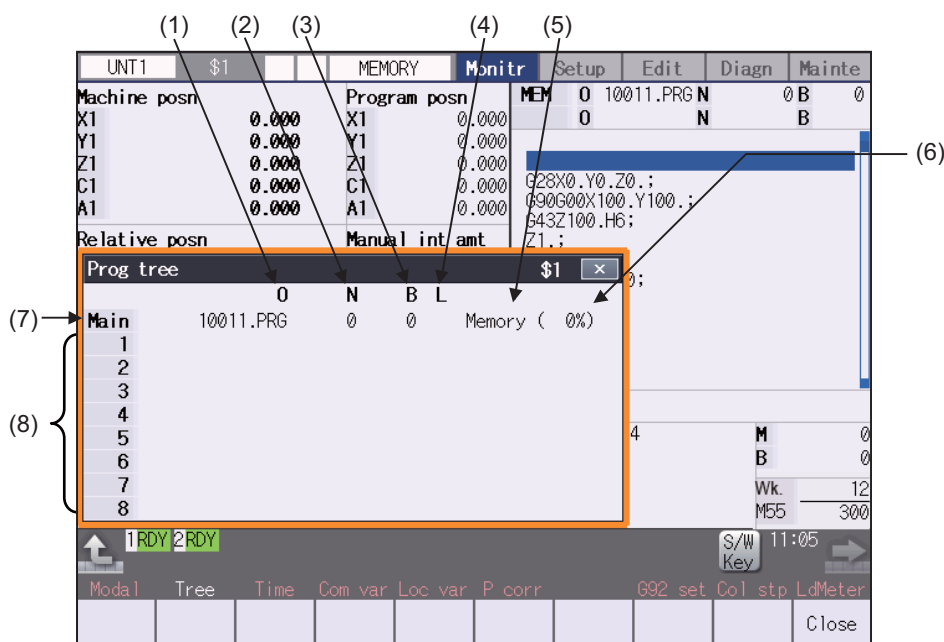

Display items

Display items	Details
(1) O	Program No. (0 to 15 characters) If the program No. (program name) exceeds 15 characters, "*" will appear at the 15th character.
(2) N	Sequence No. (0 to 99999999)
(3) B	Block No. (0 to 99999)
(4) L	Remaining number of subprogram repetitions (0 to 99)
(5) Devices	Operation device (0 to 7 characters) Displays the program storage device and MDI interruption. Memory Memory2 MDI (MDI interruption)
(6) (%)	Program execution rate display Assuming the whole machining program size as 100%, the execution position during an automatic operation is displayed in % (percentage). When the automatic operation is not executed, 0% is displayed for the main program's percentage display. The subprogram's percentage is displayed only for the lowest level of the nest and other subprograms will display blank.
(7) Main	Main program
(8) 1 to 8	Called subprogram, user macro call and MDI interrupt

Menus

Menus	Details
Close	This closes the pop-up window and quits this function.

9.2.9 Integrated Time Display



For details, refer to "8.1.1 Integrated Time Display".

9.2.10 Load Meter Display



The spindle load and Z axis load, etc., are displayed.

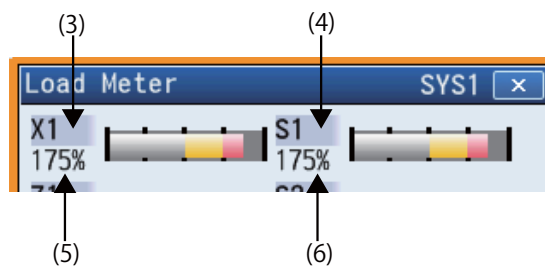
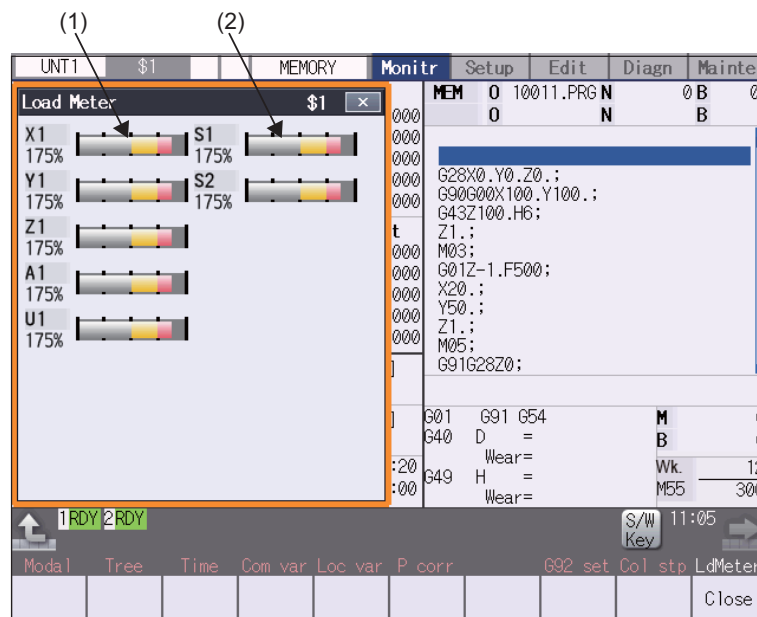

Display items

Display items	Details
(1) NC axis load meter	Up to eight NC axes loads (%) are displayed. The display color of graph is switched in accordance with the NC axis load. The threshold values of cautions (yellow) and warning (red) are determined according to the parameters (#2643 to #2645).
(2) Spindle load meter	Up to eight spindles loads (%) are displayed. The graph display color varies depending on the spindle load value. The threshold values of cautions (yellow) and warning (red) are determined according to the parameters (#3192 to #3194).
(3) NC axis name	This displays the axis name set with the parameter "#1022 axname2".
(4) Spindle name	This displays "S" + "Spindle No.".

Display items	Details
(5) Load current (%)	This displays the NC axis load current.
(6) Load(%)	This displays the spindle motor load.

Menus

Menus	Details
Close	This closes the pop-up window and quits this function.

Note

(1) Due to the specifications issued by MTB, pressing the menu [LdMeter] without setting ON load meter display causes an error.

9.2.11 Spindle, Standby Display



The current spindle tool No. and the standby tool No. (a maximum of 4 tools) are displayed.

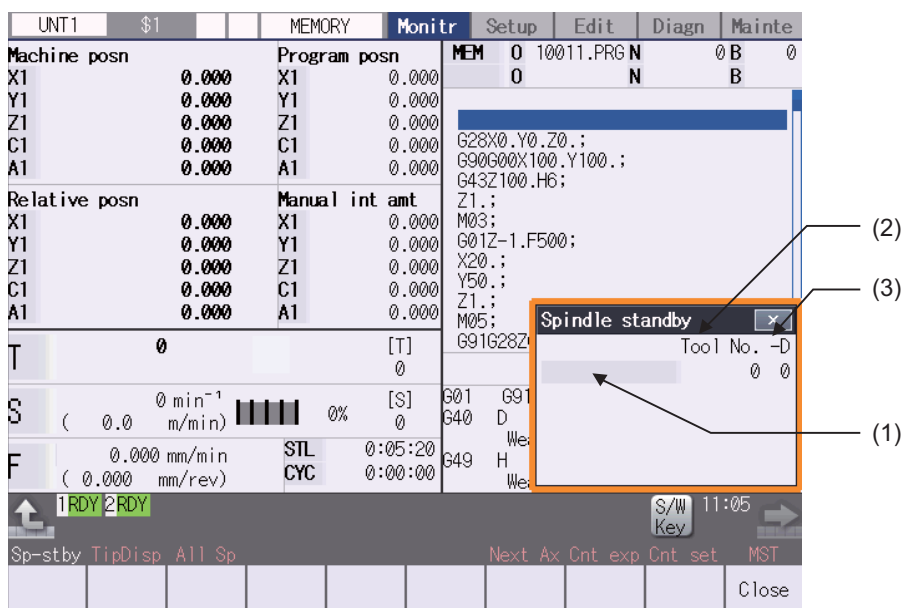

Display items

Display items	Details
(1) Spindle standby	This item is not displayed.
(2) Tool No.	This displays No. of the tool that is attached to the spindle or standby position in the magazine 1.
(3) -D	For D data function and purpose, refer to the instruction manual issued by the MTB.

Menus

Menus	Details
Close	This closes the pop-up window and quits this function.

9.2.12 Tool Center Coordinate Display



The tool center coordinates, handle interrupt amount (tool axis movement) and tool center point speed are displayed by the following functions: the tool center point control function, the tool length compensation along tool axis function and the tool handle feed & interrupt function (handle feed along the tool axis, tool handle interrupt, tool diameter direction handle feed, nose center rotation handlefeed)

This function is an additional specification. Any of the following specifications is required.

- Tool center point control
- Tool length compensation along the tool axis
- Tool handle feed & interruption
- Inclined surface machining command
- 3-dimensional tool radius compensation (tool's vertical-direction compensation)
- 3-dimensional manual feed

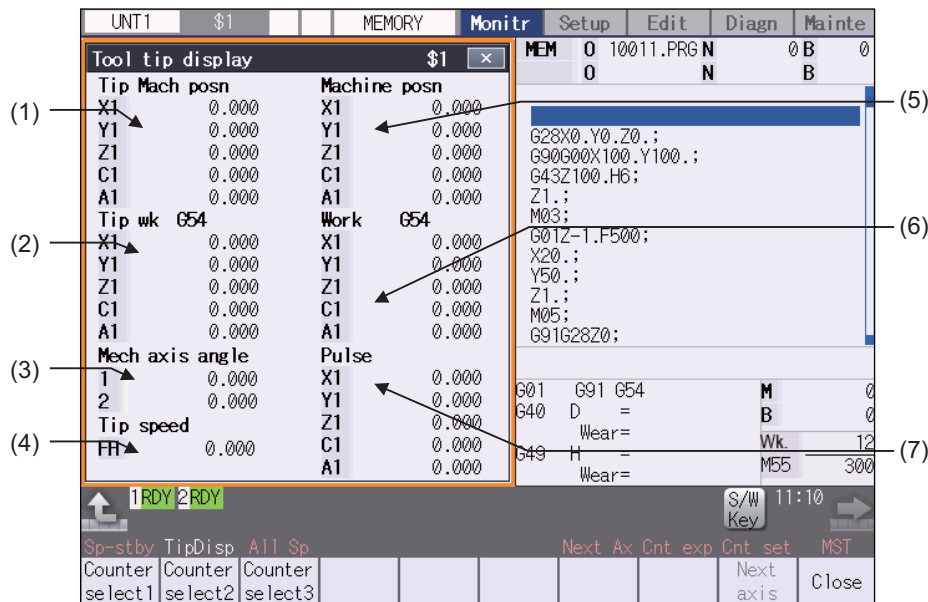

Display items

Display items	Details
(1) Tip Mach posn	This displays the position of the tool center from the machine coordinate system reference position in the machine coordinate system.
(2) Tip wk G54	This displays the position of the tool center from the workpiece coordinate reference position in the selected workpiece coordinate system.
(3) Mech axis angle	This displays the rotation angle when using the mechanical axis. 1st rotary axis angle: R2628 (L)/R2629 (H) 2nd rotary axis angle: R2630 (L)/R2631 (H)
(4) Tip speed	This displays the movement speed of tool center. By the parameter "#1125 real_f", actual feedrate and command speed can be switched.
(5) Counter display1	The counter type can be selected from the menu.
(6) Counter display2	The following counters are displayed by default.
(7) Counter display3	Counter display 1: Machine position counter Counter display 2: Workpiece position counter Counter display 3: Tool axis movement counter

Note

- (1) Status abbreviations are displayed only in "Tip Mach posn" counter area. They are not displayed in other counter area.
- (2) The data for 5 axes can be displayed in each counter. In case the number of valid axis is 6 or more, and you want to display the 6th and subsequent axes, press the menu [Next axis] to switch display.

Menus

Menus	Details
Counter select1	Select the counter type to display on "the counter display 1 to 3". It is valid after the power is turned ON again.
Counter select2	The counters shown below can be selected. ♦Machine position counter ♦Workpiece coordinate position counter
Counter select3	♦Inclined surface (*1) ♦Tool axis movement
Next axis	This changes the displayed axes each counter.
Close	This closes the pop-up window and quits this function.

(*1) It cannot be selected when the inclined surface machining command is not valid.

9.2.13 All Spindles' Rotation Speed Display



The command rotation speed and actual rotation of all spindles are displayed.
 This function only displays the value. It is not possible to operate here.

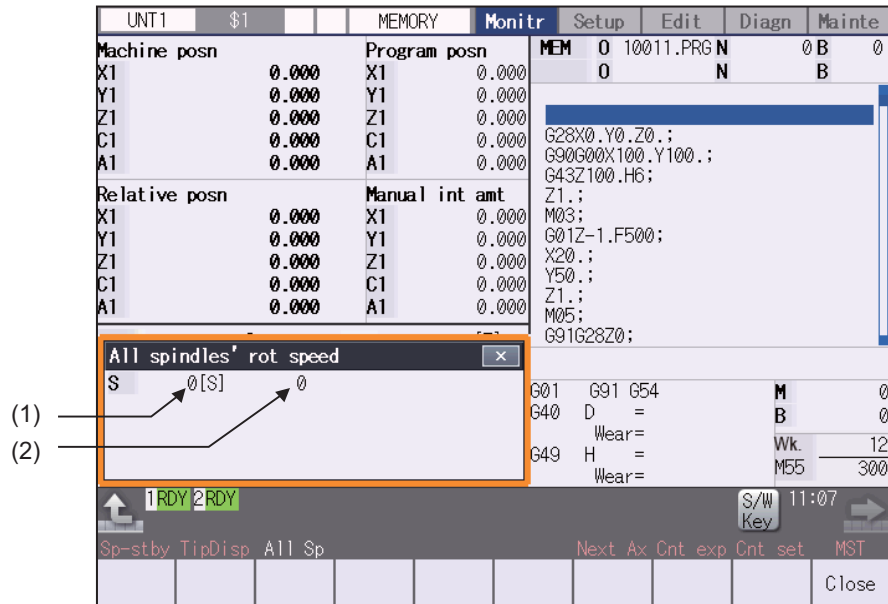

Display items

Display items	Details
(1) Spindles' command rotation speed	This displays the spindles' command rotation speed (S command value).
(2) Spindles' actual rotation speed	This displays the spindles' actual rotation speed (r/min).

Menus

Menus	Details
Close	This closes the pop-up window and quits this function.

9.3 Restart Search

Monitr

—

Reserch

With this function, the program search can be executed while updating the coordinate values and the modal information in the same manner as an actual program operation.

Therefore, this function enables machining from a block in the middle of the program as if the actual machining was carried out from the beginning.

This function is used to restart machining when a machining program is to be resumed after it has been suspended midway due to tool damage or for some other reason.

The device [Memory card] and [USB Memory] are not selectable with this function.

There are two types of restart, type 1 and type 2.

Restart method	Details	
Restart type 1	<p>After machining is reset due to a tool breakage, etc., machining is restarted from the designated sequence number and/or block number.</p> <p>Only the program which had been executed just before can be restarted.</p> <p>Even after the power is turned ON again, the program can be restarted if the program has been executed before the power supply is turned OFF.</p> <p><Note></p> <ul style="list-style-type: none"> ♦In case that NC has been reset or the power supply has been turned OFF while fixed cycle, custom fixed cycle, MTB macro, or macro interruption is executed, the search with no input to the setting will be performed for each source program. ♦When the user macro is executed, the user macro execution position is searched. 	
Restart type 2	<p>If a machining program different from the machining program to be restarted was run before starting restart search, specify the sequence No. and block No. before restarting the machining.</p>	
	Automatic top search OFF	<p>A top search must be executed from the screen. Then, command a sequence No. and block No., and restart a program.</p>
	Automatic top search ON	<p>A top search may not be executed from the screen. A top search is automatically executed, so it is not necessary to execute a top search from the screen. Command a sequence No. and block No., and restart a machining.</p> <p>An arbitrary program can be restarted by designating the program No. When a program No. is omitted, the program currently searched is restarted.</p>

The validity of the automatic top search can be changed with control parameter "#8914 Auto Top search".

Screen transition

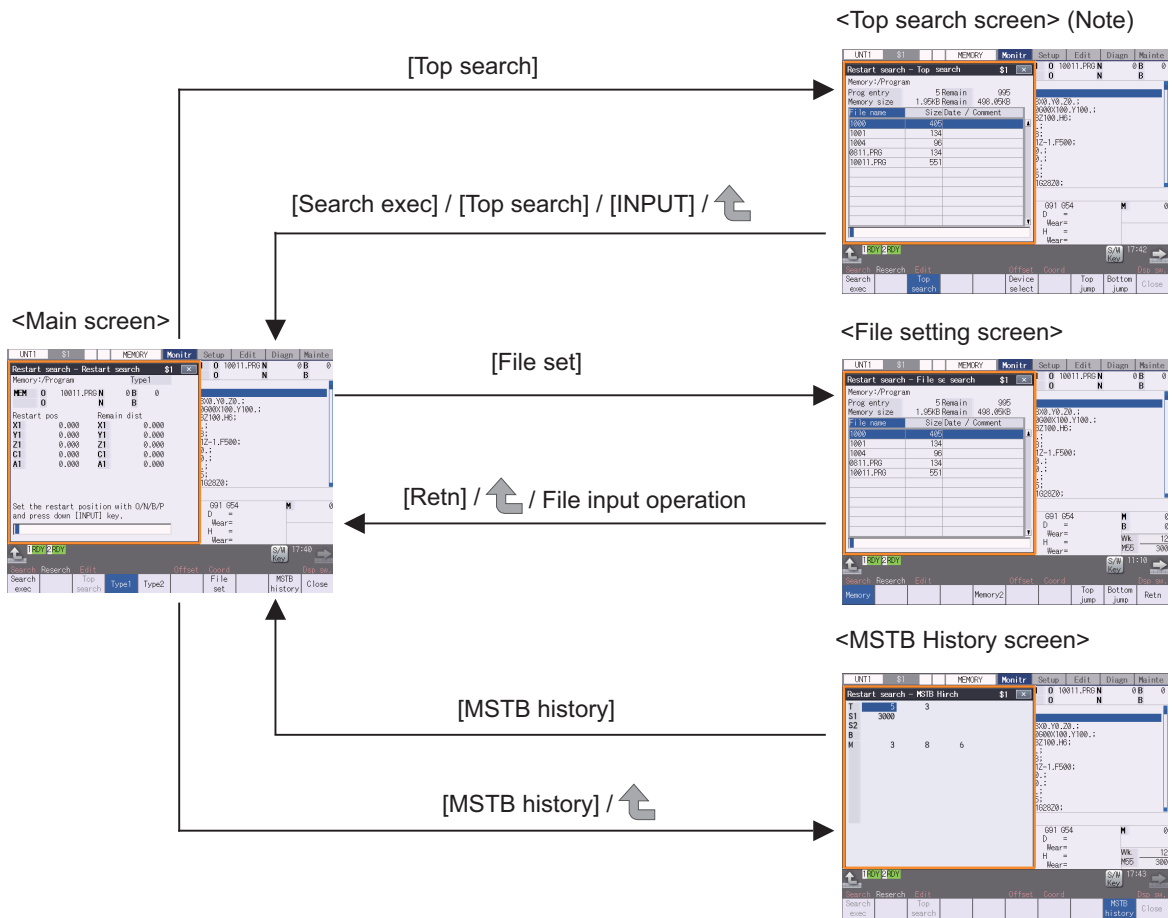

Note

- (1) In the following cases, the screen cannot be switched to top search screen.
- Restart type 1
 - The parameter "#8914 Auto Top search" is "1" (automatic top search)

Precautions

- (1) Set the tool offset amounts and parameters before proceeding the program restart search. If they are not set beforehand, the axes will not return to the proper machining start position.
- (2) The axes will not return to the proper machining start position if a program using the user macro external signal input, machine coordinate readout or external mirror image command executes the restart search.
- (3) If an attempt was made to shift the coordinate systems by manual or MDI interrupt the last time the machining program was being executed, the axes will not return to the proper machining position.
- (4) When using the type 1, a top search for the head of the program is not available. Restart search of the type 1 searches from the previous operation start block and locates the designated block as it memorizes the operation start block previously operated.
- (5) When "#8914 Auto Top search" is set to "0" for the type 2, an error message "Top search not completed" appears if the search is attempted directly with the type 2 without executing the top search. Conduct the top search first.
- (6) The macro statement blocks cannot be searched for both type 1 and type 2. It is possible to execute the restart search if the control parameter "#8101 MACRO SINGLE" is set to ON. However, note that the tool path may change because of the radius compensation, the corner R/C, and geometric read ahead blocks.
- (7) In a multi-part system, perform restart search operation in each part system.
- (8) When the linear-type rotary axis returns to the restart position, control returns to the workpiece coordinate position.
- (9) A program restart search is not available at the head of the program. Restart search settings are possible, but control may not return to the correct position when the head of the program is searched.
- (10) If the parameter "#1151 rstini" is set to "0" (No reset initial) in the program without the sequence number, a restart search (type 1) may not function properly after reset 1 has been executed. Therefore, assign a sequence number to each program.
- (11) If INPUT/search is carried out without designating any value in the input area, a restart search is performed using the previously executed ONB number (type 1 only). If a reset is executed during MDI interruption processing, a restart search is performed using the previous ONB number for MDI interruption.
- (12) If INPUT/search is carried out without designating any value in the input area, the position of the ONB number that first matches the designated condition is searched at restart, regardless of the number of repetitions.
- (13) When the operation mode is set to the MDI mode, a restart search is not available. If an attempt is made to carry out a restart search, the operation message "Can't search in MDI mode" is displayed.
- (14) Restart search is available for a program that has a file name consisting of up to 32 characters. Restart search is not available for a program that has a file name consisting 33 or more characters.
- (15) A search error will occur if an intended ONB is not found even M99 block is detected in the main program.
- (16) A error will occur if the M99 block in the main program is searched.
- (17) When "#1122 pglk_c" (Program display lock C) is set to "2", the restart search cannot be executed as "Program display lock C" is applied.
- (18) If both N and B are omitted, it will be assumed as the head of the program and the number of repetitions is considered as "1" even the P number is designated.
- (19) When either N or B is omitted, the omitted one is assumed as "0".
- (20) Restart search cannot be carried out for a block executing 3-dimensional circular interpolation, cylindrical interpolation, polar coordinate interpolation, milling interpolation or tool center point control. A program error (P49) will occur.
- (21) When you execute the restart search to a block in synchronous tapping cycle modal, issue the S code for a tapping spindle from MSTB history menu. If it is not issued, the tapping spindle execute the synchronous tapping with current gear step without changing the gear.
- (22) The number of program repetitions, "P", can be designated up to the total value of the same number of sub-program repetitions, "L", described on the program.
- (23) When "#8129 Subpro No. select" is set to "1" or "2", it triggers a restart search on a sub-program with the O number. Therefore, to designate the program number, it must be prefixed by an "O".

Precautions (For multi-part system)

- (1) If any ONBP is designated, restart search is only carried out in the displayed part system. (This operation is available when this function is invalid.)
- (2) The type 2 restart search cannot be carried out without ONBP designation; therefore, only the type 1 restart search becomes available for all part systems in batch.
- (3) The top search and type 2 restart search are carried out only in the displayed part system.
- (4) If an error occurs during a restart search for all part systems in batch, the numbers of all the part systems that are judged to be abnormal are displayed in the format "\$ + part system number" following the "Search error" message.
- (5) If the O number of the currently searched machining program is inconsistent in all part systems during the restart search for all part systems in batch, a restart search is carried out in the displayed part systems (a restart search in individual part systems).
When the restart search is completed, the number of the searched part system is displayed in the format "\$ + part system number" following the "Search completed" message.
- (6) When "#1285 ext21/bit1" is set to OFF (search by part system), restart search is only carried out in the displayed part systems even if search conditions (the O numbers of the machining programs in the NC memory and of the searched machining program are consistent in all the part systems with type 1 and no ONBP designation) are satisfied in all part systems.
- (7) When "#1285 ext21/bit1" is ON, the message "Executing automatic operation", "Program restarting", or "Program checking" is displayed while any part system is under automatic operation, program restarting, or program checking.
- (8) When "#1285 ext21/bit1" is OFF, the message "Executing automatic operation" or "Program restarting" is displayed while the displayed part system is under automatic operation or program restarting.
- (9) In multi-part system, carry out restart search for the queued blocks. If a restart search is carried out in a block other than the queued blocks, the block execution timing is off between the 1st part system and 2nd part system, and the machine is in danger of collision.

9.3.1 Main Screen

The type 1 and type 2 restart search can be executed from the main screen.

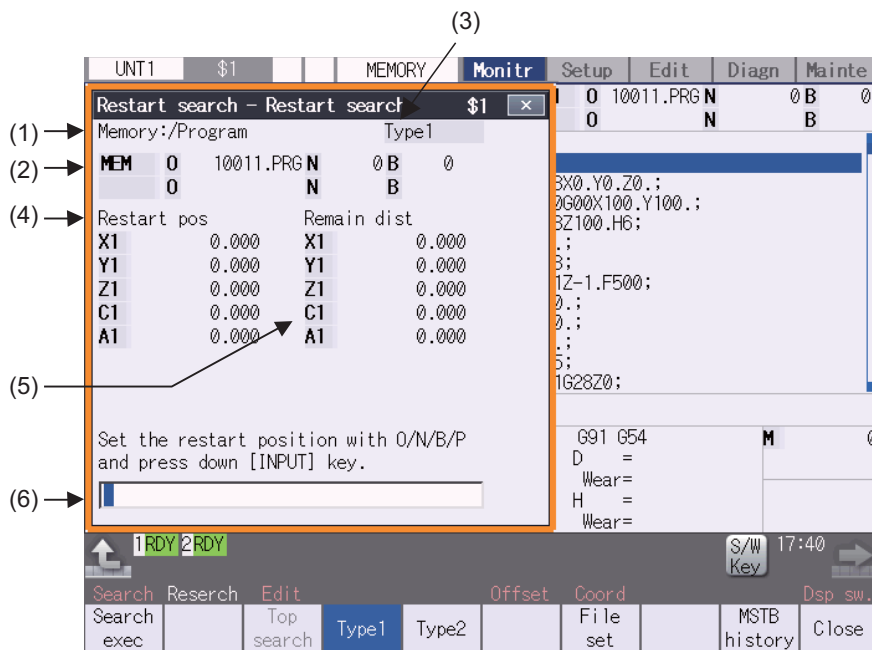

Display items

Display items	Details
(1) Device name, directory display	This displays the device and directory where the searched machining program is located.
(2) Research position	This displays the researched main program position (program No., sequence No.(*1), repeat count, block No.).
(3) Restart type	This displays the restart search type.
(4) Position when restart search is completed	This displays the position on the local coordinate system when the restart search is completed.
(5) Remaining distance when restart search is completed	This displays the remaining distance when the restart search is completed.
(6) Input section	This displays details of the key input.

(*1) If the sequence number exceeds six digits, only the low-order six digits are displayed.

Menus	
Menus	Details
Search exec	This starts the restart search based on the designated device, directory, program number (O), sequence number (N), block number (B) and number of block execution times (P).
Top search	This changes to the pop-up window for executing top search, and enables top search. When the type 1 is selected or the parameter "#8914 Auto Top search" is set to "1", this menu cannot be selected.
Type1	This selects the restart search type. Restart search is executed with the highlighted restart type. The type 1 or type 2 menu is always highlighted. When restart search is executed, the selected restart type is displayed at the display item (3) "Restart type".
Type2	
File set	This changes to the pop-up window for setting the file, and enables the file to be selected.
Next axis	This switches the axis to be displayed on the counter. (*1)
MSTB history	This opens the MSTB history screen as a pop-up window. The M, S, T and B command used in the machining program are listed on the MSTB history screen. If the cursor is moved to the listed M, S, T or B command and the [INPUT] key is pressed, that command will be executed.
Close	This closes the pop-up window and quits this function.

(*1) The menu will be grayed out and cannot be selected when the number of valid axes is six or less.

9.3.2 Top Search Screen

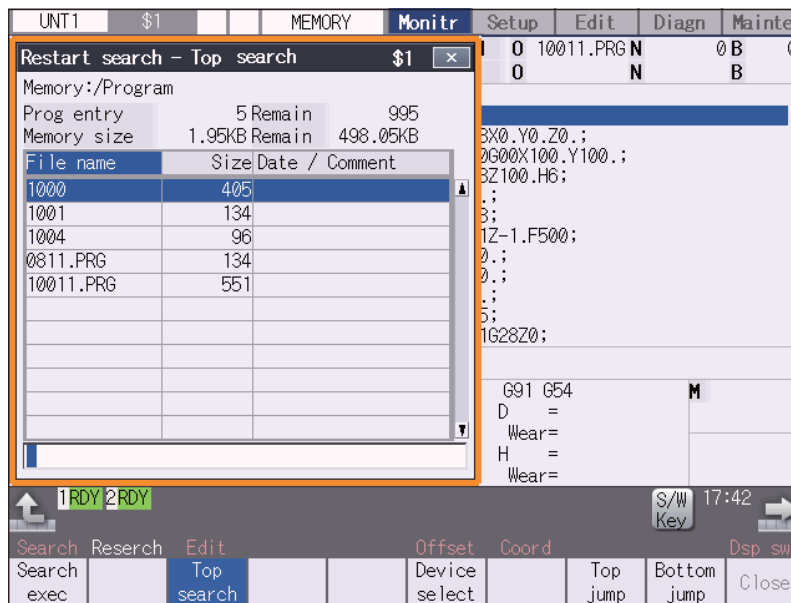

Display items

Same as "Operation Search".

Menus

Menus	Details
Search exec	This starts the top search based on the designated device, directory, program number (O), sequence number (N), block number (B) and number of block execution times (P).
Top search	When the menu is highlighted, it indicates that the top search pop-up window is open. If pressed again when highlighted, the top search pop-up window closes, and the main pop-up window opens.
Device select	This displays the device menu. Select which device program to search for from this menu. When a device with directory is selected, the route is selected first.
Top jump	Display starts from the first page of the directory/list of files. The cursor moves to the top line.
Bottom jump	The last page of the directory/list of files is displayed. The cursor moves to the bottom line.
Comment switch	Pressing this menu switches display/non-display status and the display contents of the "Date/Comment" column of the program list as follows: Program comment -> the last updated date/time of the file (*1) -> not displayed
List update	This updates the list contents. (The latest contents of the currently selected device and directory are listed.)
Sort change	This changes the method of sorting the list.

(*1) When the multi-part system program management is enabled (#1285 ext21/bit0 = 1) for the device [Memory], the last updated date/time of the file is not displayed.

9.3.3 File Setting Screen

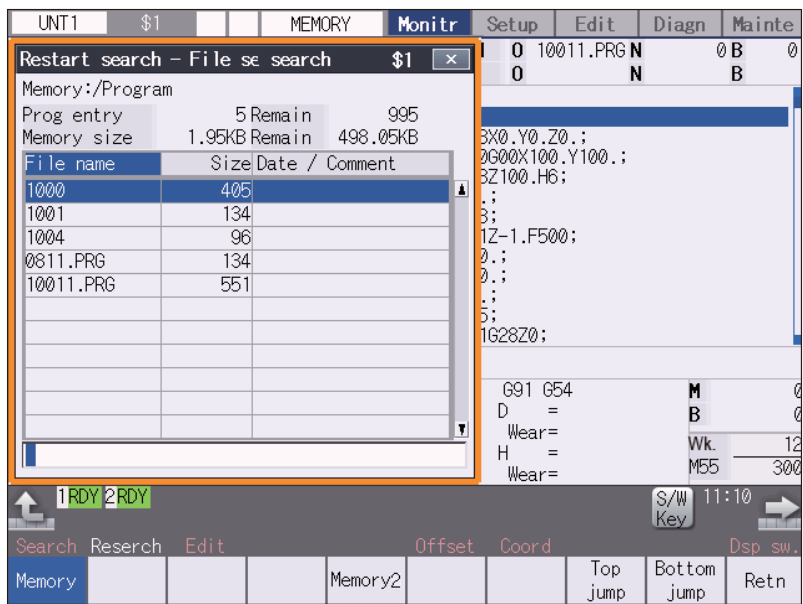

Display items

Same as "Operation Search".

Menus

Menus	Details
Memory	This selects the device for searching for the program.
Memory2	<Note> •The menu [Memory2] is grayed out and non-selectable, when the specification of program memory capacity 1000kB[2560m] or 2000kB[5120m] is invalid.
Top jump	Display starts from the first page of the directory/list of files. The cursor moves to the top line.
Bottom jump	The last page of the directory/list of files is displayed. The cursor moves to the bottom line.
Retn	This returns the main menu.
Comment switch	Pressing this menu switches display/non-display status and the display contents of the "Date/Comment" column of the program list as follows: Program comment -> the last updated date/time of the file (*1) -> not displayed
List update	This updates the list contents. (The latest contents of the currently selected device and directory are listed.)
Sort change	This changes the method of sorting the list.

(*1) When the multi-part system program management is enabled (#1285 ext21/bit0 = 1) for the device [Memory], the last updated date/time of the file is not displayed.

9.3.4 MSTB History Screen

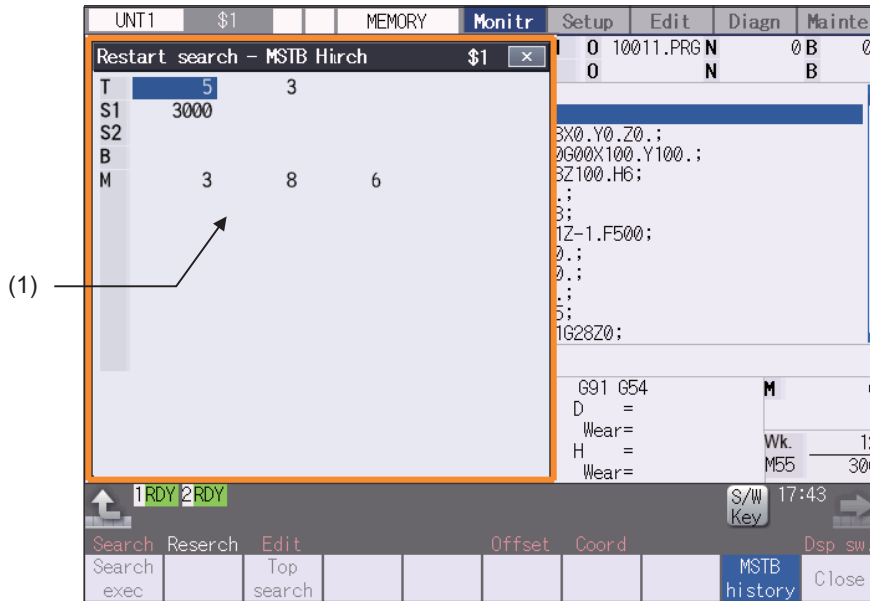

Display items

Display items	Details
(1) MSTB history	<p>The MSTB codes used for the machining are listed after the restart search is completed.</p> <p>The displayed value can be set (manual numerical value command) as the current modal value until the reset or starting is applied. The character color is changed for the value which is once set.</p> <p>The number of displayed codes is as follows: M: up to 35, S1 to S8: 3 each, T: 3, B:3. If the number of codes used for the machining exceeds the displayable number of codes, the codes which have been used in the beginning is not displayed.</p> <p>Address T will display only the tool number regardless of the parameter (#11038 T disp type).</p>

Menus

Menus	Details
MSTB history	<p>When this is highlighted, it indicates that the MSTB history pop-up window is open. If the menu is pressed when this menu is highlighted, the system will close the MSTB history pop-up window, and the main pop-up window opens.</p>

9.3.5 Operation Sequence for Program Restart

There are two types of restart, type 1 and type 2.

Restart type 1

When feed hold has been applied and reset because the tool has broken, etc., restart with restart type 1.

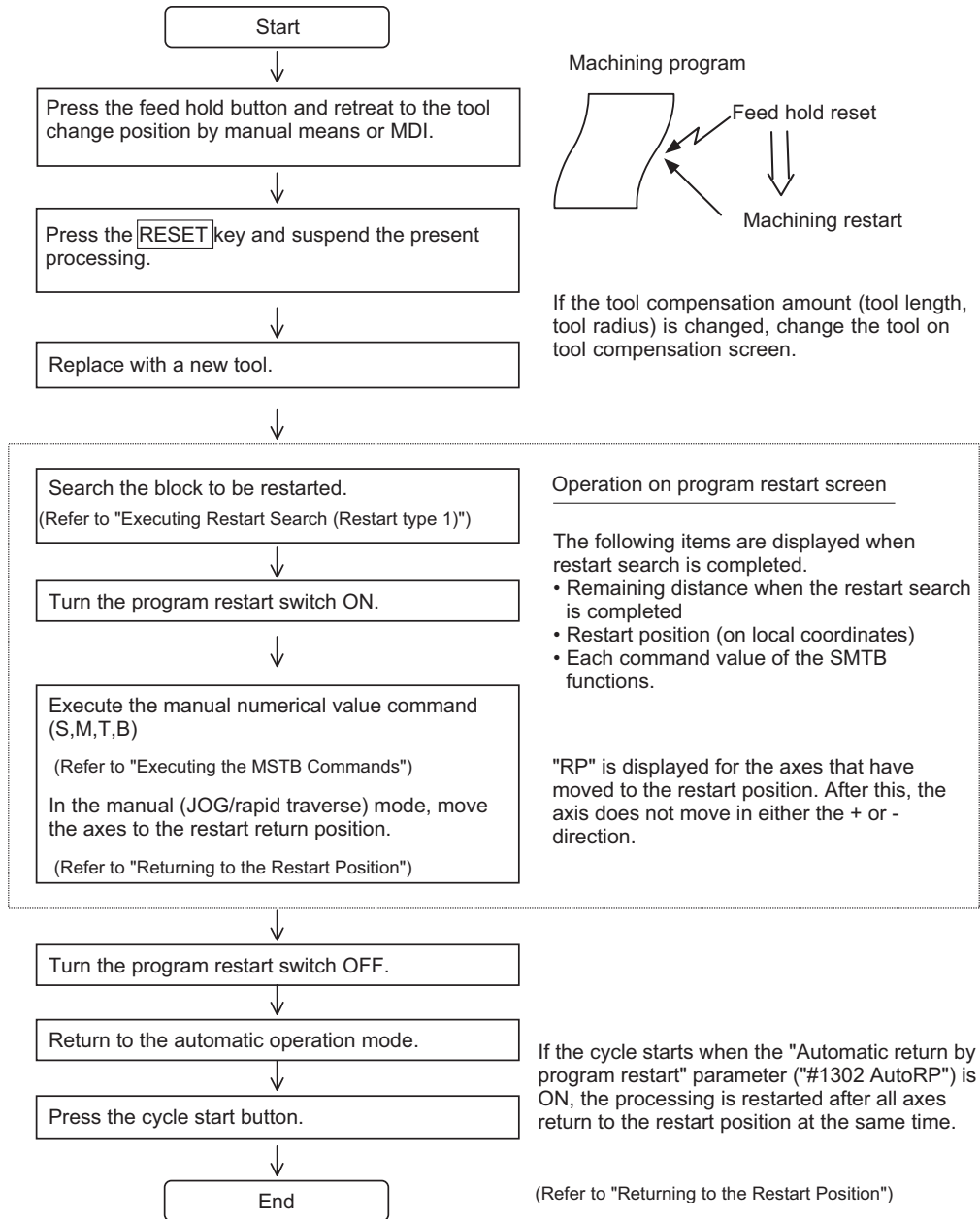

Note

- (1) When single block signal is OFF, the machining is restarted without stopping temporarily after the axes return to the restart position. (The cycle starts when the automatic return by program restart is valid.)
- (2) Execute "reset & rewind" for resetting.
- (3) Restart search is not available for a program that has a file name consisting 33 or more characters.

Restart type 2

If a machining program differing from the machining program to be restarted was run before starting restart search, restart with restart type 2.

When the coordinate system of the automatic operation last time and the coordinate system of the machining restart are changed, it is possible to restart.

Note

(1) The necessary matters for starting the machining program, such as setting the coordinate system, must be completed before starting restart search.

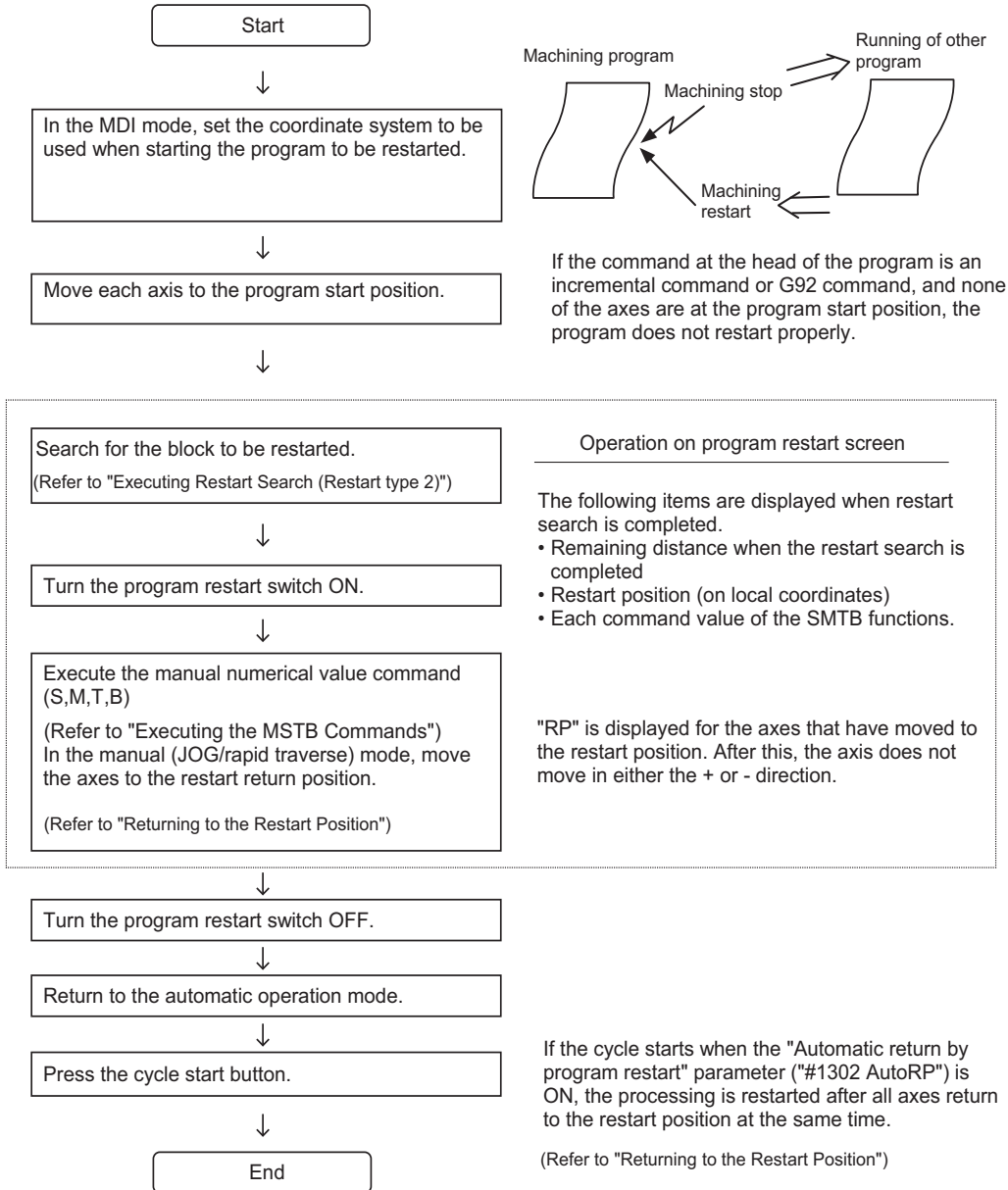

Machining program

Running of other program

Machining restart

If the command at the head of the program is an incremental command or G92 command, and none of the axes are at the program start position, the program does not restart properly.

Operation on program restart screen

The following items are displayed when restart search is completed.

- Remaining distance when the restart search is completed
- Restart position (on local coordinates)
- Each command value of the SMTB functions.

"RP" is displayed for the axes that have moved to the restart position. After this, the axis does not move in either the + or - direction.

If the cycle starts when the "Automatic return by program restart" parameter ("#1302 AutoRP") is ON, the processing is restarted after all axes return to the restart position at the same time.
(Refer to "Returning to the Restart Position")

Note

- (1) When single block signal is OFF, the machining is restarted without stopping temporarily after the axes return to the restart position. (The cycle starts when the automatic return by program restart is valid.)
- (2) Restart search is not available for a program that has a file name consisting 33 or more characters.
- (3) When the searched program do not exist, the operation message "Search error" appears.

9.3.6 Executing Restart Search (Restart Type 1)



When feed hold has been applied and reset because the tool has broken, etc., restart with Restart type 1.

When the following conditions are met, the program search is executed across all part systems in batch.

- The parameter "#1285 ext21/bit0" (Multi-part system program management) is set to "1".
- The parameter "#1285 ext21/bit1" (Program search type switch) is set to "1".
- The machining program is stored in the device [Memory].
- ONBP is not used.

Operation method

(Example) When tool breakage during execution of O1000 N7 occurred, and restarting from the O1000 N6 block

- (1) Press the feed hold button and retreat to the tool change position by manual means or MDI. Press the reset key and suspend the present processing.
- (2) Replace with a new tool.
- (3) Press the main menu [Reserch].  The sub-menu is displayed.
The main screen for restart search appears as a pop-up window.
- (4) Press the [Type 1].
Set the position to restart search in the setting area.  Delimit the ONB number in the setting area using /.
<When O No. was attached>
The main or sub program is targeted.
(Example) 1000/6/0
<When O No. was not attached>
The program currently searched is targeted.
(Example) /6/0
<Note>
•When the [INPUT] key is pressed without entering data in the input area, restart search will be carried out for the last executed block.
- (5) Press the [INPUT] key or the menu [Search exec].  Restart search is executed. (*1)
The message "Executing restart search" appears during the search process, and the message "Restart search is completed" appears when completed.
Each axis' restart position and the restart remaining distance are displayed.
When the menu [MSTB history] is pressed, the MSTB history screen will open as a pop-up window, and the M, S, T, B command used in the machining program will be listed.

(*1) The maximum number of digits is eight for the sequence No. and five for the block No.

Note

- (1) When the sorting of tool data is in progress, the operation message "Sorting of tool data is in progress" appears, and the search cannot be executed.

9.3.7 Executing Restart Search (Restart Type 2)









If a machining program differing from the machining program to be restarted was run before starting restart search, restart the respective machining program with restart type 2.

The restart type 2 operation sequence is the same as restart type 1, but necessary matters for starting the machining program, such as setting the coordinate system, must be completed before starting restart search.

When the parameter "#8914 Auto Top search" is "0", execute the top search for the machining program.

Operation method (When the parameter "#8914 Auto Top search" is "0")

(Example) When restarting from subprogram O123 N6 B2 called from main program O1000

- (1) Turn the power ON, and return all axes to the reference position.
- (2) In the MDI mode, set the coordinate system to be used when starting the program to be restarted.
- (3) Move each axis to the program restart position.
- (4) Press the main menu [Reserch].  The sub-menu is displayed.
The main screen for restart search appears as a pop-up window.
- (5) Press the [Type 2].
- (6) Press the sub-menu [Top search].  The window for top search appears as a pop-up window.
- (7) Press the sub-menu [Device select].
Select a device and press the menu key.
- (8) Press the [↑], [↓],  or  key to move the cursor to the directory to which the file to be set belongs.
Press the [INPUT] key.
- (9) Press [↑], [↓],  or  key to move the cursor to the machining program to be edited.  Set the cursor to 1000.
- (10) Press the [INPUT] key.  The top search starts.
The search can be executed by pressing the menu [Search exec] instead of the [INPUT] key. When the top search is completed, the operation message "Top search completed" appears.
The top search pop-up window closes, and the main screen for restart search appears as a pop-up window.

- (11) Set the position to restart search in the setting area. ➡
- Delimit the ONBP number in the setting area using /.
 - <When O No. was attached>
 - The restart search is executed at designated position by NBP No. with the set O No. at the head.
 - (Example) 123.PRG/6/2/1
 - <When O No. was not attached>
 - The program currently searched is targeted.
 - (Example) /6/2/1

Set the number of times which the block to be searched appears in "P".

For example, if a block in a subprogram is searched, and the subprogram is called out several times, the block to be searched is also executed several times. Thus, which execution block to be searched must be set. (If "0" is set, it is handled in the same manner as "1".)

To search the first execution block, or to search for a block executed only once, this item does not need to be set.

- (12) Press the [INPUT] key or the menu [Search exec]. ➡
- Restart search is executed. (*1)
 - The message "Executing restart search" appears during the search process, and the message "Restart search is completed" appears when completed.
 - Each axis' restart position and the restart remaining distance are displayed.
 - When the menu [MSTB history] is pressed, the MSTB history screen will open as a pop-up window, and the M, S, T, B command used in the machining program will be listed.











(*1) The maximum number of digits is eight for the sequence No. and five for the block No.

Note

- (1) When the sorting of tool data is in progress, the operation message "Sorting of tool data is in progress" appears, and the search cannot be executed.

Operation method (When the parameter "#8914 Auto Top search" is "1")

(Example) When restarting from subprogram O123 N6 B2 called from main program O1000

- (1) Turn the power ON, and return all axes to the reference position.
- (2) In the MDI mode, set the coordinate system to be used when starting the program to be restarted.
- (3) Move each axis to the program restart position.
- (4) Press the main menu [Restart].  The sub-menu is displayed.
The main screen for restart search appears as a pop-up window.
- (5) Press the [Type 2].
- (6) Press the sub-menu [File set].  The window for file set appears as a pop-up window.
- (7) Select a device and press the menu key.
- (8) Press the [↑], [↓],  or  key to move the cursor to the directory to which the file to be set belongs. Press the [INPUT] key.
- (9) Press [↑], [↓],  or  key to move the cursor to the machining program to be edited.  Set the cursor to 1000.
- (10) Press the [INPUT] key.  The screen for restart search appears as a pop-up window.
- (11) Set the position to restart search in the setting area.  Delimit the ONBP number in the setting area using /.
<When O No. was attached>
The restart search is executed at designated position by NBP No. with the set O No. at the head.
(Example) 123.PRG/6/2/1
<When O No. was not attached>
The program currently searched is targeted.
(Example) /6/2/1
- (12) Press the [INPUT] key or the menu [Search exec].  Restart search is executed. The message "Executing restart search" appears during the search process, and the message "Restart search is completed" appears when completed.
Each axis' restart position and the restart remaining distance are displayed.
When the menu [MSTB history] is pressed, the MSTB history screen will open as a pop-up window, and the M, S, T, B command used in the machining program will be listed.

9.3.8 Returning to the Restart Position

The axis is returned to the restart position after restart search is completed.

The method for returning to the restart position (manual/automatic) can be selected with the parameters "#1302 AutoRP".

0: Manual restart position return

1: Automatic restart position return

Operation method (manual restart position return)

- (1) Turn the restart switch ON.
- (2) Enter the manual (JOG/rapid traverse) mode.
- (3) Move the axis in the restart return direction.



The restart position and "RP" appear sequentially from the axes that have been returned. The Restart remaining distance is "0".

Restart pos		Remain dist	
X1	40.000	X1	40.000
Y1	150.100	Y1	150.100
Z1	-70.000	Z1	-25.000
C1	0.000RP	C1	0.000

- (4) When all axes have been returned, turn the restart switch OFF.

Note

- (1) When the restart switch is ON, move the axis in the same direction as the restart direction. If moved in the reverse direction, the operation error "M01 R-pnt direction illegal" occurs. If the tool needs to be retracted once, such as if the tool is interfering with the workpiece, turn the restart switch OFF and retract the axis manually.
- (2) After restart position return is completed, the axis cannot be moved if the restart switch is ON. If the axis is moved, the operation error "M01 restart switch ON" occurs.
- (3) If even one axis has not completed return to the restart position at cycle start, the error "M01 Restart pos. return incomplete" occurs. Note that if the axis has been returned to the restart position once and is not at the restart position during cycle start, the alarm does not occur.
- (4) If the axis to be returned to the restart position is a machine lock axis, the operation error "M01 program restart machine lock" occurs. Release the machine lock before returning to the restart position.
- (5) If the restart switch is turned to ON after the axis is returned to the restart position with the restart switch OFF, "PR" may not be displayed. Return to the restart position after the restart switch is turned ON.
- (6) After restart search had been completed, if the movement command is issued by MDI before automatic restart position return has been started, the program error (P48) occurs. Perform the operation again after reset.
- (7) After restart search had been completed, if the T command different from the program is issued by MDI before the searched program has been started, the program error (P48) may occur. Perform the operation again after reset. T commands which result in errors are shown below. (Only L system)
 - When "#1100 Tmove" = "0"
T command that selects a tool with different tool length/wear amount than the tool selected by the program.
 - When "#1100 Tmove" = "1"
A program error (P48) will not occur by T command.
 - When "#1100 Tmove" = "2"
T command that selects a tool with different wear amount than the tool selected by the program.
- (8) After restart search had been completed, if the handle interruption is performed before the searched program has been started, always the same operation as manual absolute ON is executed regardless of "Manual absolute" signal.

Automatic restart position return

If the parameter "#1302 AutoRP" is set to "1", each axis returns to the restart position with dry run at cycle start. Machining restarts after returning. The order that the axes return follows parameter "#2082 a_rstax".

Note

- (1) Manually move the axis to a position where the tool does not interfere with the workpiece before starting the cycle.
- (2) Even if the parameter "#1302 AutoRP" is to "1", the axes can be returned manually to the restart position by turning the restart switch ON. In this case, move the axes in the order of manual restart position return -> automatic restart position return. After completing automatic restart position return, if the operation is stopped temporarily and the restart switch is turned ON, the operation error "M01 restart switch ON" occurs.
- (3) Once the axis has been manually returned to the restart position, if it is moved from the restart position, it will not return to the restart position even if automatic restart position return is executed.
- (4) The axis for which parameter "#2082 a_rstax" is set to "0" does not return to the restart position. Note that if "0" is set for all axes, all axes simultaneously return to the restart position. Designate the axes in part system units. If the axis for which parameter "#2082 a_rstax" is set to "0" has not completed manual restart position return when automatic restart position return is started, an error occurs. The error "M01 Restart pos. return incomplete" is displayed.
- (5) After automatic restart position return had been started, if the automatic start is executed during MDI mode before not all axes have yet to complete automatic restart position return, the error "M01 Restart pos. return incomplete" occurs.
- (6) After restart search had been completed, if the movement command is issued by MDI before automatic restart position return has been started, the program error (P48) occurs. Perform the operation again after reset.
- (7) After restart search had been completed, if the T command different from the program is issued by MDI before the searched program has been started, the program error (P48) may occur. Perform the operation again after reset.
T commands which result in errors are shown below. (Only L system)
 - When "#1100 Tmove" = "0"
T command that selects a tool with different tool length/wear amount than the tool selected by the program.
 - When "#1100 Tmove" = "1"
A program error (P48) will not occur by T command.
 - When "#1100 Tmove" = "2"
T command that selects a tool with different wear amount than the tool selected by the program
- (8) After restart search had been completed, if the handle interruption is performed before the searched program has been started, always the same operation as manual absolute ON is executed regardless of "Manual absolute" signal. When manual interruption is executed to the automatic restart position return completed axis, the axis never returns the automatic restart position again.
- (9) When an axis moved to return is operated manually, the axis cannot return to correct position.



9.3.9 Executing the MSTB Commands

If the menu [MTB history] is pressed after restart search is completed, the MSTB commands used for machining program appear. If the cursor is moved to the listed M, S, T or B command and the [INPUT] key is pressed, that command will be executed.

Up to 35 M commands, 3 commands each for S1 to S8, 3 T commands and 3 B commands are displayed.

If many MSTB commands are used for machining, the MSTB commands used at first will not appear.

Operation method

- | | | |
|---|--|---|
| (1) Press the sub-menu [MSTB history]. |  | The pop-up window changes to the MSTB history window. The MSTB commands used for machining program are listed. |
| (2) Using the [↑], [↓], [→] or [←] key, move the cursor to the position of the data to set. | | |
| (3) Press the [INPUT] key. |  | The designated command is executed. A value, which has been commanded once, is grayed out. The cursor will move to the next item. |
| (4) Repeat steps (2) and (3). | | |
| (5) When completed with all settings, press the menu [Close] or [MSTB history]. |  | The MSTB history pop-up window closes and the restart search main window appears as a pop-up window. |

9.4 Collation and Stop



The machining program operation can be block stopped at a registered collation and stop position. The registered collation and stop position can be canceled.

When the specified block appears, NC status will change single block stop after the execution of the block.

The device [Memory card] and [USB Memory] are not selectable with this function.

■When collation and stop is registered

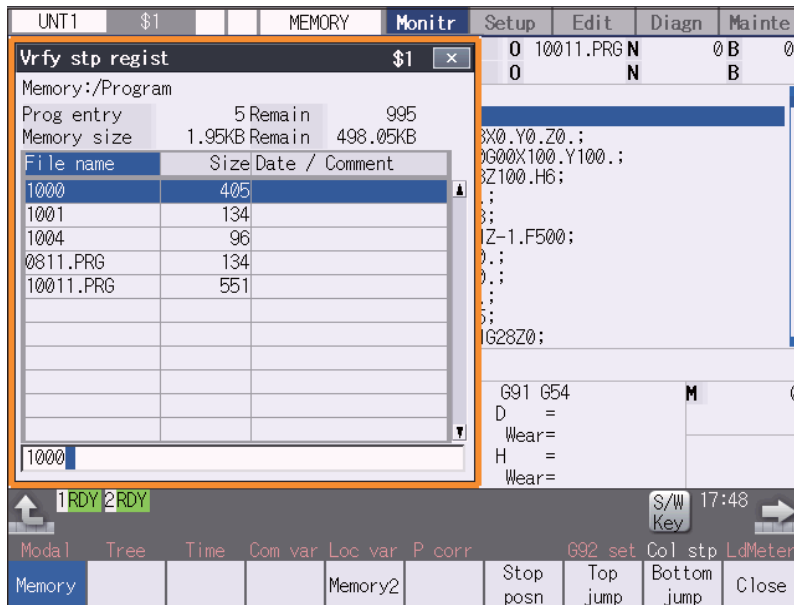

■When collation and stop position is displayed

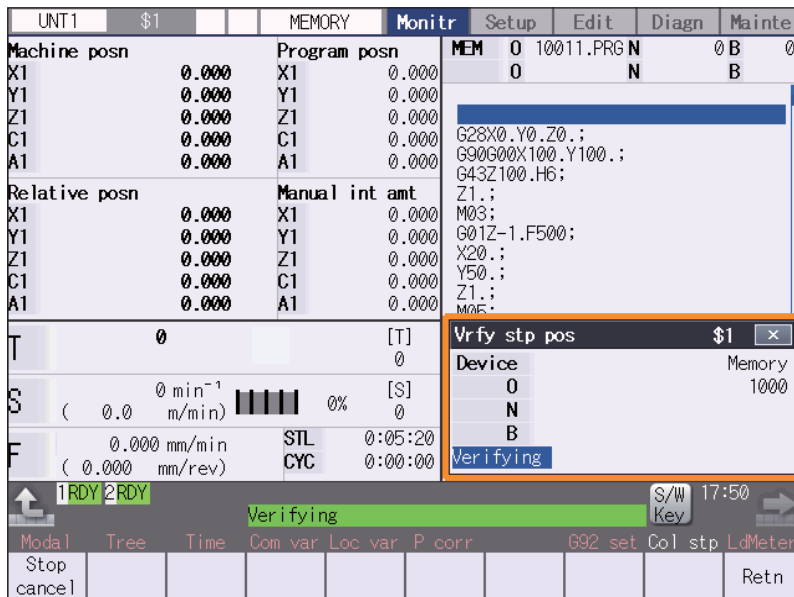

Display items

Display items	Details
(1) Collation and stop device name	This is the name of the device to be stopped for collation.
(2) Collation and stop position	This is the position of the program where collation and stop is to be executed. This display is cleared when program stop is completed, or NC is reset or canceled. If the program No. (program name) exceeds 24 characters, "*" will appear as the 24th character.
(3) Display during collation	This is displayed during collation.

Menus (When collation and stop is registered)



Menus	Details
Memory	This selects the device to be stopped for collation.
Memory2	<Note> ♦The menu [Memory2] is grayed out and non-selectable, when the specification of program memory capacity 1000kB[2560m] or 2000kB[5120m] is invalid.
Stop posn	This opens the collation and stop position display window as a pop-up window.
Top jump	Display starts from the first page of the directory/list of files. The cursor moves to the top line.
Bottom jump	The last page of the directory/list of files is displayed. The cursor moves to the bottom line.
Comment switch	Pressing this menu switches display/non-display status and the display contents of the "Date/Comment" column of the program list as follows: Program comment -> the last updated date/time of the file (*1) -> not displayed
List update	This updates the list contents. (The latest contents of the currently selected device and directory are listed.)
Sort change	This changes the method of sorting the list.
Close	This closes the pop-up window and quits this function.

(*1) When the multi-part system program management is enabled (#1285 ext21/bit0 = 1) for the device [Memory], the last updated date/time of the file is not displayed.

Menus (When collation and stop position is displayed)

Menus	Details
Stop cancel	This cancels the collation and stop setting. Note that automatic operation is not reset.
Retn	This returns the list when collation and stop is registered.

Operation method (Registering the collation and stop)

- (1) Press the  key to select the part system to be stopped for collation. → The currently selected part system is displayed at the upper left of the screen.
- (2) Press the main menu [Col stp]. → The mode changes to the buffer correction mode.
- (3) Select the device. → The selected device name and root directory (memory:/) are displayed in the device name and directory display fields.
The menu [Memory] is highlighted.
- (4) Press the [↑], [↓], , or  key to move the cursor to the directory containing the file to be set.

If the list contents differ from the actual device or directory, press the menu [List update].
- (5) Press the [INPUT] key. → Moves into the directory.
- (6) Input the program No., sequence No. and block No. using / as a delimiter.
(Example) 1001/1/2 [INPUT]
When carrying out collation and stop of MDI program, set "0" as the program No.
If pointing the cursor to a file name, the file name is echoed back to the input area.
→ The collation and stop position is displayed, and the program No. ("MDI" for MDI mode), sequence No., block No. and "Verifying" appear.

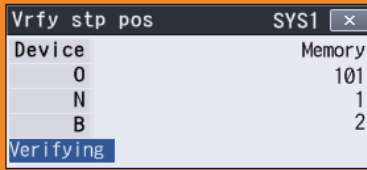

Device	Memory
0	101
N	1
B	2

Verifying

- (7) Start the automatic operation. → When the collation and stop is completed, a message indicating the end appears.
The stop position displayed on the screen is cleared, and the "Verifying" display is erased.

Press the menu [Stop cancel] to cancel the collation and stop.

Note

- (1) The maximum number of digits is eight for the sequence No. and five for the block No.
- (2) Collation and stop can be canceled during automatic operation.

Precautions

- (1) When registering the stop position (O, N, B values), confirm that the block exists in the searched program. Collation and stop will not be executed if the corresponding block is not found at the registered stop position.
- (2) Always set one of the O, N or B numbers. If nothing is set, a setting error will occur.
- (3) If the O No. is not set, the O No. used during operation search will be used.
- (4) If the N and B numbers are not set, the block will be searched using the O No.
- (5) If there are several sequences and blocks with the same number in one program, collation and stop will be executed after executing the first block that matches in the execution order.
- (6) The settings are canceled when collation and stop is executed.
- (7) The settings are canceled when reset is executed.
- (8) If only the program number is set, collation and stop will take place at the head of the program only when there is a program number at the first line.
- (9) Collation and stop cannot be performed or canceled for blocks being executed or blocks already read into the pre-read buffer.
- (10) Collation and stop is not performed in the tapping mode.
- (11) Collation and stop is possible in a subprogram, but is not possible in a MTB macro program.
- (12) If collation and stop is set for a fixed cycle block, it will be executed after the positioning block is completed.
- (13) Collation and stop is possible even when editing is locked.
- (14) Collation and stop is executed after executing the block set for the collation and stop position. If the position is set in a program call (M98) block, collation and stop will be executed before the subprogram is called.
- (15) If the set block is set to be skipped, collation and stop will not be executed.
- (16) The collation and stop position can be registered for each part system.
- (17) The stop position cannot be registered during verification.
- (18) Registration of collation and stop position is not possible for a program with 33 or more file name characters.

9.5 Correcting the Machining Program



9.5.1 Program Editing

If you press the [Edit] main menu or set the edit/search signal ON, the program editing window appears to enable you to edit a program. However, if the target program is not found (displays "O0"), the editing window does not appear. The program is opened on the unselected side for the 2-part system simultaneous display.

When the program is edited, the key input data is directly written into the program display area. All data is overwritten from the cursor position. "Editing" appears on the right side of the file name display once input is started.

When the [INPUT] key is pressed, the program is saved in the NC memory and the "Editing" message disappears.

A program to be edited can be switched to the other part system's program with $\$ \leftrightarrow \$$ key when a parameter "#8952 Edit-win \$ switch" is set to "1".

For information on editing operations, refer to "3.2 Creating and Editing a Machining Program".

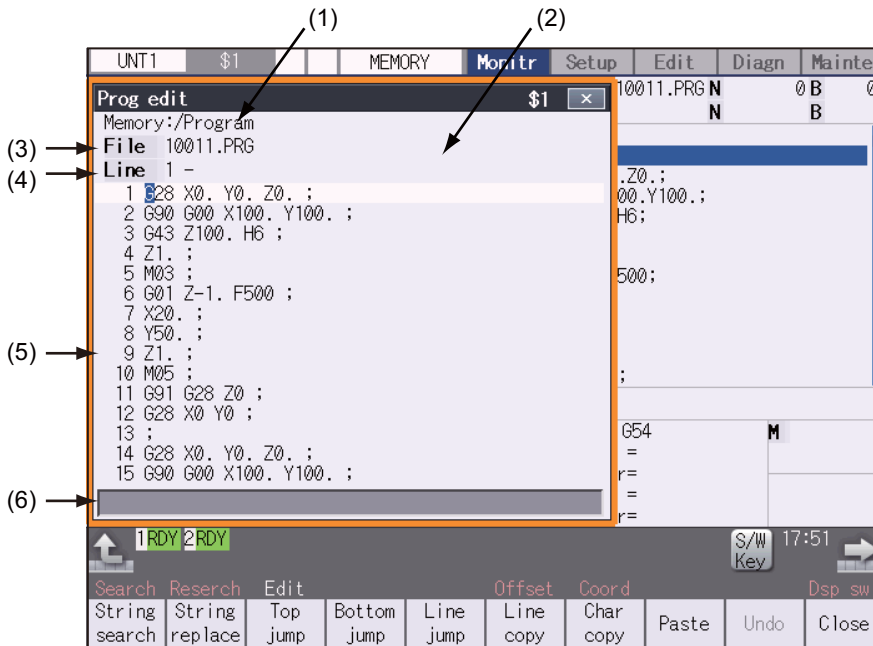

Display items

Display items	Details
(1) Path display	The path of the currently opened program file is displayed. (If the path is too long, the portion exceeding single-byte 49 characters is not displayed.) (Example) Memory: /Program
(2) Current edit display "Editing" Insert mode display	Displayed when the program is edited after it was displayed. The overwrite mode and insert mode are switched by pressing the [INSERT] key. During insert mode: "INS" appears. During overwrite mode: Nothing appears.
(3) File name display	This displays the file name of the program currently being edited. "MDI" appears when the MDI program is edited.
(4) Top line of the displayed program	The top line of the program to be displayed is displayed.
(5) Line number Program display	Each line of the program is numbered, and only the last three digits are displayed. If a line is wrapped because a line is too long, no number is assigned to the top of the next line. This displays the contents of the program (machining program, MDI program) currently being edited. The line that the cursor is on is highlighted. If the value of the parameter "#8952 Edit-win \$ switch" is set to "1" and a part system is switched while the window is displayed, the display is changed to the program of the part system. Machining program editing: Switch the mode selection switch to other than "MDI mode" and press the [Edit] main menu. However, to edit data, designate the machining program to execute a search. MDI program editing: Switch the mode selection switch to "MDI mode" and press the main menu [Edit].
(6) Input section	This displays details of the key input.

A selection part system operation search can be carried out using the block with the cursor as the top.
There are 2 ways to search cursor position, "INPUT search" and "Edit/search signal search".

INPUT search

By pressing [INPUT] key when it is in the normal status (not being in status such as editing or character searching, etc.), operation search of the selected part system is carried out starting from the block that has the cursor.

This is enabled when "1" is set to the parameter "#11031 Cursor pos search".

- (1) Carry out the operation search to find the program to carry out the cursor position search.

- (2) Press the menu [Edit].  The program edit window appears. The program is displayed starting from the block currently searched. (During automatic operation, the program is displayed from its top.)

- (3) Move the cursor to the block to be carried out the cursor operation search.

- (4) Press the [INPUT] key.  Operation search is carried out starting from the block that the cursor is positioned. During the search "Searing" will display blinking. When the search is completed, "Search completed" is displayed.

Note

- (1) When operating character string search, string replace, cursor on input unit, or editing it will not start cursor position search by pressing [INPUT] key.
- (2) A selection part system operation search can be carried out using the block with the cursor as the top.
- (3) Operating search program will be the program that was searched when program edit window was open.
- (4) Cursor position search is disabled during automatic operation or restart search. However, it is enabled when the parameter "#11039 Cusr pos srch type" is 1 even if the operation is under single block stop. For details, refer to "Search during single block stop" in "9.5.1 Program Editing".
- (5) When MDI program is displayed, the block with the cursor will be set for MDI by pressing [INPUT] key.
- (6) If the [INPUT] key is pressed when the data protection is valid, the cursor position search will be executed without displaying the message "Data protect", and the message "Search completed" will appear upon completion.
- (7) If the INPUT key is pressed during automatic operation or restart search while the program currently being displayed is not in a selected part system, message "Executing automatic operation" or "Program restarting" is not displayed. The cursor position search is carried out, and message "Search completed" is displayed.
- (8) If the N number of the block to be searched exceeds the maximum value or is set to "0", it causes a search error in all blocks that belong to the N number.
- (9) If characters other than digits follow "N" of the block to be searched, "N**" of the program is handled as a normal block, not a sequence number. Therefore, if the target block is searched, it is handled as a block that belongs to the previously searched N number.

Edit/search signal search

This is enabled when "2" or "3" is set to the parameter "#11031 Cursor pos search".

- (1) Carry out the operation search to find the program to carry out the cursor position search.

- (2) Turn ON the edit/search signal.



The "Edit/Search" window is displayed.
The program is displayed starting from the block currently searched.

(During automatic operation, the program is displayed from its top.)

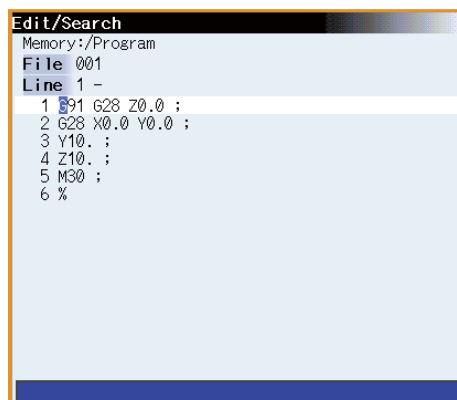

- (3) Move the cursor to the block to be carried out the cursor operation search.

- (4) Turn OFF the edit/search signal.



The "Edit/Search" window is closed, and the operation search is carried out starting from the block that has the cursor.

When the search is completed, "Search completed" is displayed.

(Also in the case where the screen is changed with a function key, etc. and the "Edit/Search" window is closed, the operation search is carried out.)

Note

- (1) If the "edit/search signal" is set to ON on a screen other than the monitor screen, the "Edit/Search" window is not displayed. To display the "Edit/Search" window, switch to the monitor screen. Switching to the monitor screen automatically displays the "Edit/Search" window.
- (2) If a window (operation search window, menu list, guidance, etc.) other than the program edit window is displayed while the monitor screen is being displayed, the "Edit/Search" window is not displayed even if the edit/search signal is set to ON. To display the "Edit/Search" window, close the currently displayed window. When the currently displayed window is closed, the "Edit/Search" window is displayed automatically.
- (3) If the edit/search signal is set ON during display of the program edit window on the monitor screen, the display changes to the "Edit/Search" window while the editing contents, cursor position, and menu etc. remain unchanged.
- (4) If the "Edit/Search" window is attempted to be closed during editing, a message to confirm whether to save the data will appear.
When it appears, if save is carried out by pressing the [Y] or [INPUT] key, the operation search will be carried out starting from the block that has the cursor.
If save is not carried out, the edited data will be aborted, and the operation search will not be carried out.
- (5) If the "Edit/Search" window is closed while the cursor is positioned in the input area during string searching or string replacement, the operation is canceled, and the cursor returns to the editing area. After this, an operation search is carried out with the block located by the cursor at the top. However, during editing, the cursor returns to the editing area, and the same operation as that described in (3) is performed.

- (6) If the "Edit/Search" window is displayed while the automatic operation or restart search is in process in the selected part system, message "Executing automatic operation" or "Program restarting" is displayed. However, when "#11039 Cusr pos srch type" is set to "1", cursor position search is possible even in the single block stop state. For details, refer to "Search during single block stop" in "9.5.1 Program Editing".
- (7) If the "Edit/Search" window is closed during automatic operation or restart search in the selected part system, message "Executing automatic operation" or "Program restarting" is displayed, but an operation search is not carried out. However, when "#11039 Cusr pos srch type" is set to "1", cursor position search is possible even in the single block stop state. For details, refer to "Search during single block stop" in "9.5.1 Program Editing".
- (8) If the "Edit/Search" window is opened while the operation mode is set to the MDI mode, the MDI program is displayed in the "Edit/Search" window. In this state, if the "Edit/Search" window is closed, the MDI setting at the cursor position is executed.
- (9) The part system that is selected when the "Edit/Search" window is opened is to be searched when the "Edit/Search" window is closed.
- (10) The program that is searched when the "Edit/Search" window is opened is to be searched when the "Edit/Search" window is closed.
- (11) In the following cases, edit/search is not available with the "Edit/Search" window. After an error is displayed, a blank "Edit/Search" window is displayed.
 - Edit lock B, C is enabled
 - Operation search is not carried out
 - Edit file size exceeded
- (12) If the edit/search signal is set ON at power ON, the "Edit/Search" window is displayed.
- (13) The "Edit/Search" window cannot be closed with the cancel key. To open another window of the monitor screen, either turn OFF the edit/search signal or use the direct screen selection in the menu list.
- (14) If you switch to the monitor screen to edit using the direct screen selection while the "Edit/Search" window is displayed, the "Edit/Search" window is closed once, a search is carried out, and then the "Edit/Search" window is displayed again.
- (15) If the N number of the block to be searched exceeds the maximum value or is set to "0", it causes a search error in all blocks that belong to the N number.
- (16) If characters other than digits follow "N" of the block to be searched, "N**" of the program is handled as a normal block, not a sequence number. Therefore, if the target block is searched, it is handled as a block that belongs to the previously searched N number.

Search during single block stop

Cursor position search can be operated during single block stop when "1" is set to the parameter "#11039 Cusr pos srch type". By pressing menu [Edit] during single block stop, single block stop position becomes top of the program display.

- (1) Pause automatic operation with single block stop.
- (2) Press the menu [Edit].
 - ➔ The program edit window appears.
The block where the operation is stopped due to single block stop is displayed on the top.
If the operation has been stopped in a subprogram, that subprogram is displayed.
- (3) Move the cursor to the block to be carried out the cursor operation search.
- (4) Press the [INPUT] key.
 - ➔ The search will operate by single block stop position with top.
During the search "Searing" will display blinking.
When the search is completed, "Search completed" is displayed.

Note

- (1) Blocks lower than the point of the single block stop only are eligible for cursor position search designation during single block stop. "Search error" will display and the search will fail when cursor position search is attempted at an already executed block.
- (2) The blocks between single block stop position and search position block will be ignored when cycle start is operated after cursor position search is operated during single block stop.
- (3) While the part system with a cursor position search to be performed is in block stop state in arbitrary reverse run mode (including a case in which the reverse run control mode signal is set ON), message "search error" is displayed, and a cursor position search cannot be carried out.
- (4) If the part system with a cursor position search to be performed is placed in block stop state due to a program error, message "During automatic operation" is displayed, and an operation search is not carried out.
- (5) If cursor position search is commanded at a block that causes a program error, the block of the single block stop, instead of the cursor position search target block, will appear on the top of program buffer display upon automatic start up.
- (6) If cursor position search is commanded at a block that comes later than a fixed cycle while stopped with single block stop in the midst of the fixed cycle, the cursor position search target block will appear on the top of the program buffer display. However, automatic operation will start from the top of the remaining of the fixed program, and after finishing the fixed cycle, will move on to executing the cursor search target program.
- (7) If a cursor position search is carried out for blocks after the MTB macro program while the MTB macro program is interrupted by a single block stop, a program buffer is displayed from a search block. However, when the system is started automatically, the MTB macro program is executed continuously, and the block detected by a cursor position search is processed after the MTB macro program has been completed.

9.5.2 Buffer Correction



The next command can be corrected and changed by block stop during the automatic operation in the memory mode or the operation in the MDI mode.

When a program error occurs, the block in which the error occurred can be corrected without resetting the NC, and operation can be continued.

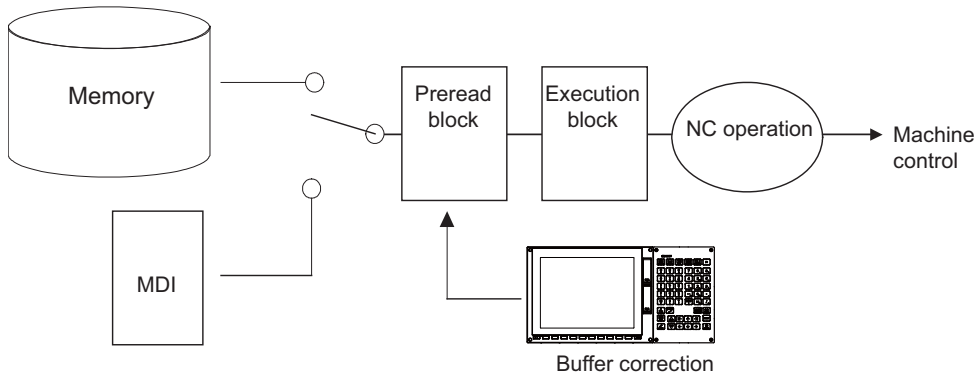
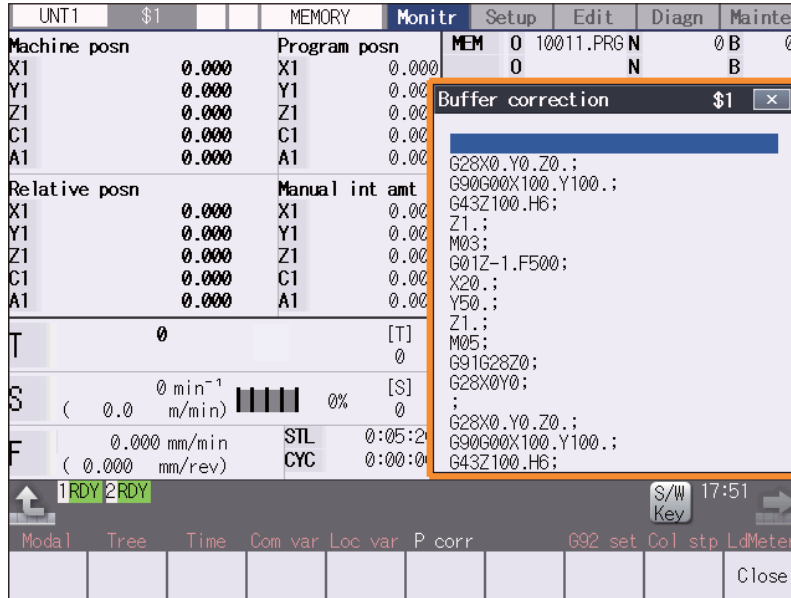

- (1) The next command can be corrected in the following two cases.
 - When single block stop is applied, and there is a command block to be corrected in the next command.
 - When there is an error (program error) in the next command and automatic operation is stopped.
- (2) Not only the displayed buffer data but also the contents in the device are corrected with the buffer corrections. (The corrected data is reflected.)
- (3) Several blocks following the next command can be corrected simultaneously.

Menus	
Menus	Details
Close	This closes the pop-up window and quits this function.

Operation method

During a single block stop or when a program error stop occurs, the buffer can be corrected with the following operations, and operation can be continued.

The normally executed program appears in the buffer correction area.

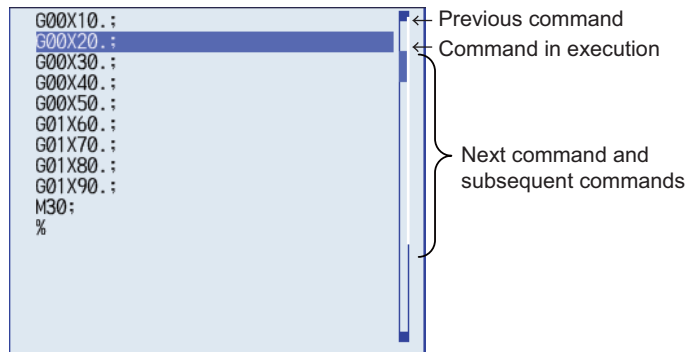

(1) Press the main menu [Prg correct].



The mode changes to the buffer correction mode.

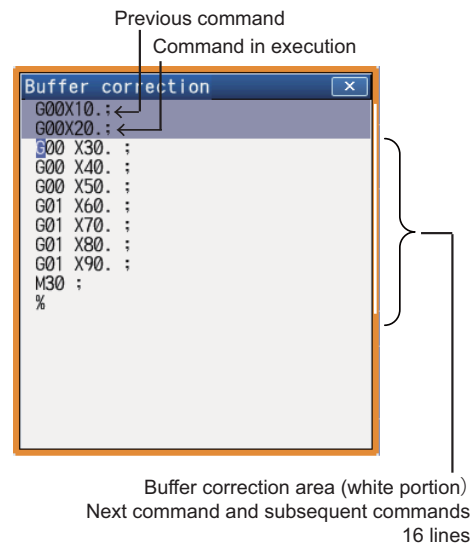

The display changes so that the next command is at the head of the area. The buffer correction area becomes the valid area, and the keys can be input or the cursor moved.

The cursor can be moved freely within the buffer correction area using the cursor keys.

(2) Correct the program with the same method as a normal program editing.

(3) Press the [INPUT] key.



The buffer correction mode ends, and the corrected data is written into program.

If a program error has occurred, the error display is erased.

(4) Confirm that the corrected data is correct, and then restart.



The program execution resumes from the currently stopped position.

Precautions

■ Buffer correction mode will not be applied in the following cases:

- (1) Machining program for buffer corrections is in edit lock or program display lock state.
- (2) When the data protection is valid.
- (3) Machining program for the device in write-protection state
- (4) Machining program in read-only state
- (5) During the compound type fixed cycle, the tool center point control or executing the MTB macro program

■ Starting and ending buffer corrections

- (1) If automatic operation is started or there is no next command data, the buffer correction mode is not entered even if the menu key is pressed.
- (2) To stop or to cancel the buffer corrections, press the menu [Close] again, or press the  key.
- (3) If another menu key, etc., is pressed before pressing the [INPUT] key, the corrected buffer contents return to the original data.
- (4) If changing to another screen or resetting the NC during buffer correction or changing system, the buffer correction is canceled. In this case, the corrected contents are not saved, and the buffer correction mode ends.

■ Display data during buffer correction

- (1) The key operations used for corrections in the buffer correction mode are the same as the operations when editing a program. Up to 16 blocks can be displayed. Even when a block is displayed over several lines, all 16 blocks can be displayed by scrolling the buffer correction area.
- (2) Number of characters in one block is max. 256 (including ";" (EOB)). If exceeds 256 characters, the block will be split into two.
- (3) Up to 4096 characters can be edited with buffer corrections.

■ Operations during buffer correction

- (1) If there is no ";" (EOB) at the data in the last block corrected when the [INPUT] key is pressed, it is added automatically.
- (2) When the buffer correction mode is set, the last block displayed in the buffer correction area may not fit in if the block is long, etc.
To correct this type of block, take care to the following points.
 - If a ";" (EOB) is added to the end of the displayed data, the section following the incomplete display becomes another block. If ";" (EOB) is not added, the following section stays the same, and is handled as the continuation of the displayed section.
 - If one block is deleted by pressing the [C.B] key, the block is deleted up to the section following the incomplete display (up to the ";").
- (3) Operation cannot be started during buffer correction. An alarm occurs.
- (4) If NC is reset during buffer correction, buffer correction mode will be canceled, although buffer correction window is left opened. At this time, editing operation is not possible. Close the correction window.
- (5) Buffer correction writing is not interrupted by NC reset.
- (6) The operation message "Can't write into file" appears at any attempt of the buffer mode correction to write into the program being operated, which had stopped when the buffer correction mode started.

■ For multi-part system

- (1) When a machining program under buffer correction is called by another part system, a file input/output error occurs to the caller-side part system, and restart of the operation will be disabled.
- (2) Note that if the same program is executed in another part system after a buffer correction, there may be some changes in paths, etc.
- (3) The program which has searched for the sequence No. while operating in another part system cannot be buffer correction. The operation message "Buffer correct not possible" appears.

■ Previous command and command in execution

- (1) When the buffer is corrected following the operation mode change at single block stop, nothing will be displayed in previous command and command in execution.
- (2) When there is no block after sub program call or user macro call, a program error occurs at the last block of the destination program. If a buffer correction is made in this state, the destination program will be displayed in the buffer correction window, but the actual correction result will be reflected on the source program.
- (3) The buffer cannot be corrected when the block where the buffer is corrected is in the forward side from the block called at another nest level. The operation message "Buffer correct not possible" appears.
The buffer can be corrected when the block where the buffer is corrected is in the rear side from the block called at another nest level.

- (a) : The buffer can be corrected.
- (b)(d) : The buffer can be corrected because the block is in the rear side from (a).
- (c) : The buffer cannot be corrected because the block is in the forward side from (b).

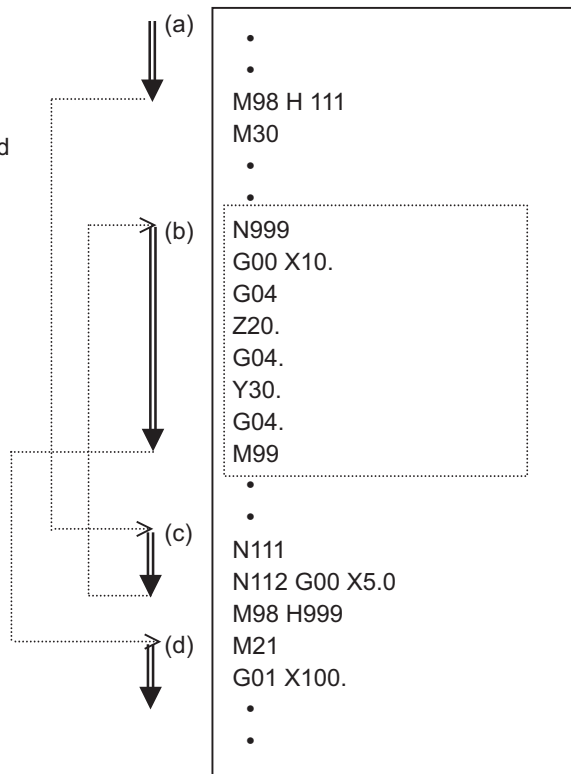

Troubleshooting

This chapter explains remedies when any alarm message is displayed, and how to check the NC status. The operations are mainly performed on the diagnosis (Diagn) or maintenance (Mainte) screen.

10.1 Confirming the NC Message (Alarm Screen)



A list of currently occurring alarms or messages can be displayed on this screen. The displayed messages include the NC alarms, stop codes, alarm messages, operator messages, etc. A history of alarm information can be displayed also.

■ NC message

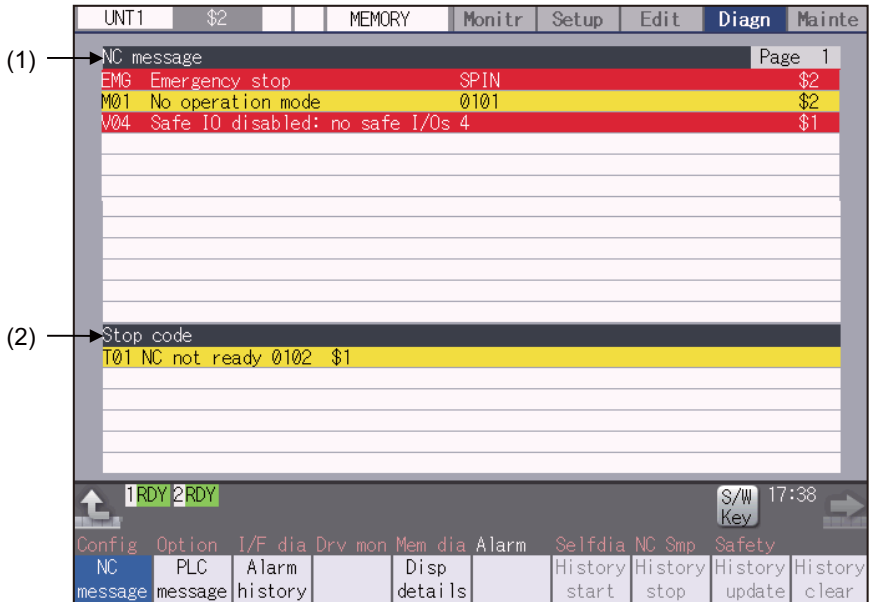

■ PLC message

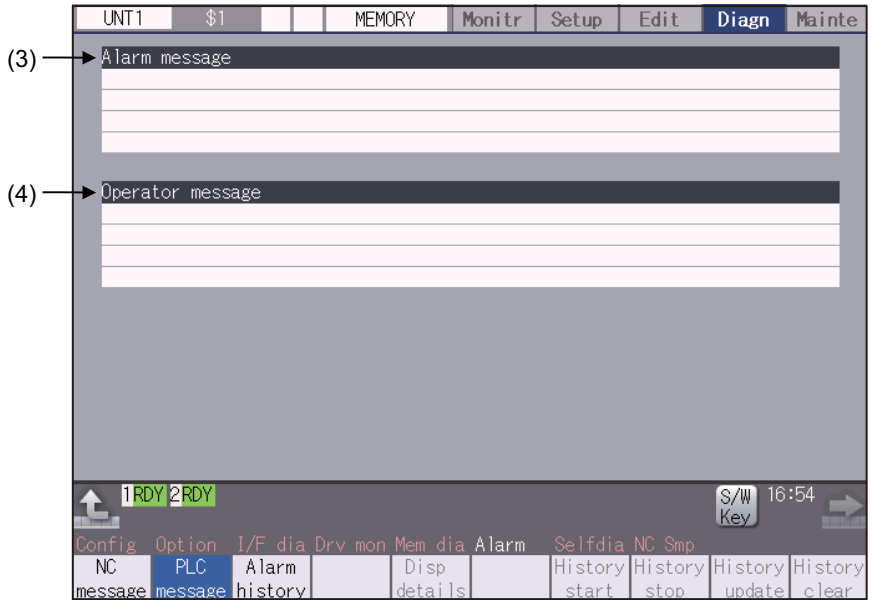

Display items

Display items	Details
(1) NC message	This displays the operation alarms, program errors, MCP alarms, servo alarms, system alarms, etc. Up to 10 messages are displayed in order of priority.
(2) Stop code	This displays the automatic operation status or stop status during automatic operation. Up to 4 messages are displayed in order of priority.
(3) Alarm message	The alarm messages for PLC are not displayed.
(4) Operator message	The macro alarm messages are displayed. Up to 4 messages are displayed.

Message display colors

The messages are color-coded in the following manner:

Message type	Character color	Background color
NC message	Alarm	White
	Warning	Black
Stop code	Black	Yellow
Operator message	Black	Yellow

Axis name display

The axis name is displayed in messages for each axis. The axis name is displayed as shown below according to the axis type.



Axis type	Axis name display	Display example	Remarks
NC axis	Control axis name (Name of axis in part system)	XYZ	If the same message occurs for each part system, several NC axes are displayed together.
Spindle	'S' + spindle No.	S1S2	If the same message occurs, several spindles are displayed together.
PLC axis	'P' + PLC axis No.	P1P2	If the same message occurs, several PLC axes are displayed together.

If the same message occurs for different axis types, they will appear as separate messages.

Part system display

The part system name is also displayed if the message is output for each part system. The part system name set in "#1169 system name" is displayed. The part system name does not appear for the 1-part system.

Menus

Menus	Details
Alarm history	This displays the first page of the alarm history. The history sequentially displays 16 alarms per page from the latest alarm. If there are two or more NC alarms of same day and time, the alarms are sequentially displayed from the alarm and warning of the 1st part system. To display the old history, press the  key. To display the new history, press the  key.
History start	The data collection of the alarm history is started (restarted). The operation message "The collection begin?(Y/N)" appears. When the [Y] or [INPUT] key is pressed, the data collection is started after the operation message "The collection begin" appears. Press the [N] or other than [INPUT] key when the data collection will be not started/restarted.
History stop	The data collection of the alarm history is stopped. The operation message "The collection stop?(Y/N)" appears. When the [Y] or [INPUT] key is pressed, the data collection is stopped after the operation message "The collection stop" appears. Press the [N] or other than [INPUT] key when the data collection will be not stopped.
History update	The alarm information of history is updated. When the history is updated, the page with latest alarm information (first page) is displayed. The history is updated even if changing to another screen, and returning to the alarm history screen.
History clear	The alarm information of history is cleared. The operation message "Execute the collection data clear?(Y/N)" appears. When the [Y] or [INPUT] key is pressed, the alarm information of history is cleared after the operation message "Data clear complete" appears. The first page is displayed when the history is cleared.

Note

- (1) The menus [History start], [History stop], [History update] and [History clear] are valid when the alarm history function is valid and the menu [Alarm history] is selected.
- (2) When the alarm history function is used for the first time, clear the alarm history contents by pressing the menu [History clear]. Unnecessary data may be recorded in the alarm history.

Precautions

- (1) If the recording of the alarms is stopped with the menu [History stop] in the alarm history screen, alarms are not recorded in the history even after the NC power is turned OFF and ON. In this case, the recording of the alarms must be started with the menu [History start] in the alarm history screen.
- (2) If the time and date are changed, the change is not reflected to the time and date of the history data recorded before the change. Therefore, if the time and date are changed, clear the history with the menu [History clear].
- (3) If an alarm occurs while the alarm history is displayed, the display is not updated. Update the history by switching the screen with the menu [History update].
- (4) Depending on the part system setting of "Sampling spec" in the maintenance diagnostic data collection setting, the part systems to be recorded in the alarm history vary. If "0" is set, alarms of all part systems are recorded.
- (5) The alarm history data collection start/stop operation is switched using the menu [Start] or [Stop] of data collection regardless of whether "Alarm history" is set to "0" or "1" in "Collecting data select" in the maintenance diagnostic data collection setting.

10.2 Checking Machine Status

10.2.1 System Configuration Screen



Select the menu [Config] on the diagnosis (Diagn) screen to display the hardware configuration (card name and sub-number), software configuration (software number and sub-number), and PLC program configuration (file name, file label, and execution type).



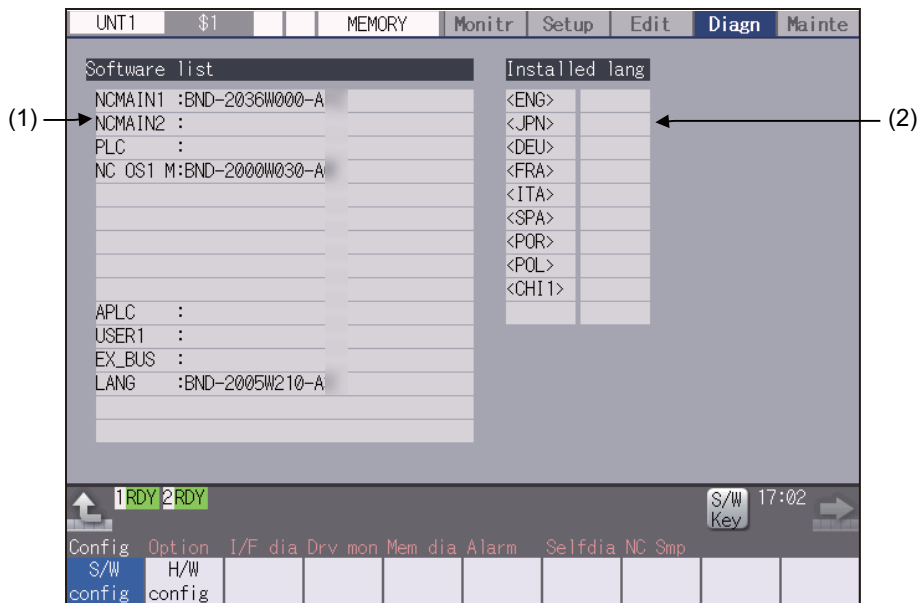

■Software configuration





■Hardware configuration



Display items

Display items	Details	Remarks
(1) Software list	This displays a list of the software being used. Use  /  keys to change the pages and refer it.	
(2) Installed lang	This displays a list of installed languages. <ENG>: English <SWE>: Swedish <JPN>: Japanese <HUN>: Hungarian <DEU>: German <POL>: Polish <FRA>: French <CHI1>: Simplified Chinese <ITA>: Italian <RUS>: Russian <SPA>: Spanish <TUR>: Turkish <CHI2>: Traditional Chinese <CZE>: Czech <KOR>: Korean <POR>: Portuguese <DUT>: Dutch	
(3) NC serial No.	This displays the NC model name, serial No, system type, and unit type.	
	NC TYPE:	NC type
	MODEL NAME:	System type name
	SERIAL NO.:	Serial No.
	UNIT NAME:	Unit type
(4) Hardware list	The hardware names are displayed. Use  /  keys to change the pages and refer it.	
	CNC	This displays the CPU model name.
	ATT CARD	Not displayed.
	EXT	Not displayed.
	DISPLAY	Not displayed.
	KEYBOARD	Not displayed.

Menus

Menus	Details
	This displays the software list.
	This displays the hardware list.

10.2.2 Option Display Screen

 — 

Select the menu [Option] on the diagnosis (Diagn) screen to display the contents of the additional specifications registered in the NC.

The additional specification items are displayed by name. If all of the additional specifications cannot be seen in one screen, the rest of items can be displayed by pressing the page up/down keys.

Display items

Display items	Details
(1) Option items	The list of currently usable additional specifications is displayed. As for the currently usable items, the background color is displayed in blue. The items set when the power supply was turned ON can be currently used.

10.2.3 Drive Monitor Screen (Servo Unit)



The various data related to the servo axis (NC axis, PLC axis) can be monitored by selecting the menus [Drv mon] -> [Servo unit] on the diagnosis (Diagn) screen.

Change the display item with or .

UNT1	\$1	MEMORY	Monitr	Setup	Edit	Diagn	Mainte
		X1	Y1	Z1	C1		
Gain (1/s)		0	0	0	0		
Droop (i)		0	0	0	0		
Speed (r/min)		0	0	0	0		
Feedrate (mm/s)		0	0	0	0		
Load current (%)		0	0	0	0		
Max current 1 (%)		0	0	0	0		
Max current 2 (%)		0	0	0	0		
Max current 3 (%)		0	0	0	0		
Over load (%)		0	0	0	0		
Regen load (%)		0	0	0	0		
Est disturb torq(%)		0	0	0	0		
Max disturb torq(%)		0	0	0	0		
Load inertia R. (%)		0	0	0	0		
AFLT frequency (Hz)		0	0	0	0		
AFLT gain (dB)		0	0	0	0		
Gain mag. (%)		100	100	100	100		
LED display		00	00	00	00		

1RDY 2RDY S/W 17:03 Key

Config Option I/F dia Drv mon Mem dia Alarm Selfdia NC Smp

Servo unit Spindle unit Power unit Synchro error Alarm his clr Next axis

The axis name set in the base axis specification parameter "#1022 axname2" appears at the axis name.

Display items

Display items	Details
Gain (1/s)	This displays the position loop gain. The position loop gain is obtained by the following formula: $\frac{\text{Feedrate (mm/s)}}{\text{Tracking delay error (mm)}}$
Droop (i)	The error of the actual machine position to the command position is called droop. This error is proportional to command speed value. This follows the setting and display unit (#1003 iunit).
Speed (r/min)	This displays the actual rotation speed of motor.
Feedrate (mm/s)	This displays the feedrate on the machine side.
Load current (%)	This displays the FB value of the motor current in terms of continuous current during stalling.
Max current 1 (%)	This displays the motor current command in terms of continuous current during stalling. An absolute value of the current command peak value sampled after the power ON is displayed.
Max current 2 (%)	This displays the motor current command in terms of continuous current during stalling. An absolute value of the current command peak value sampled in most recent 2 seconds is displayed.

Display items	Details
Max current 3 (%)	This displays the FB value of the motor current in terms of continuous current during stalling. An absolute value of the current FB peak value sampled in most recent 2 seconds is displayed.
Overload(%)	This is the data used to monitor the overload of motor and drive unit.
Regen load (%)	This is the data used to monitor the resistance overload state when the resistance regenerative power supply is connected.
Est disturb torq (%)	This displays the estimated disturbance torque in terms of stall rated torque when the disturbance observer is valid.
Max disturb torq (%)	This displays the estimated disturbance torque in terms of stall rated torque when the collision detection function is adjusted. An absolute value of the estimated disturbance torque peak value sampled in most recent 2 seconds is displayed.
Load inertia R. (%)	This displays the estimated load inertia ratio when the collision detection function is adjusted.
AFLT frequency (Hz)	This displays the current operation frequency of the adaptive filter.
AFLT gain (dB)	This displays the current filter depth of the adaptive filter.
Gain mag. (%)	While Real-time tuning 1 is valid, the currently applied speed control gain is displayed with the magnification for the setting value of speed loop gain 1 (parameter "#2205 SP005 VGN1").
LED display	This displays the 7-segment LED of the driver.
Alarm	This displays the alarms and warnings other than the LED display (displayed on drive unit side).
Cycle counter (p)	This displays the position within one rotation of the encoder detector. The position is displayed within one rotation in the range of "0" to "RNG (movement units) × 1000" using the grid point value as "0".
Grid space	This displays the grid space for the reference position return. (Command unit)
Grid amnt	This displays the distance from the dog-off point to the grid point when the dog-type reference position return is displayed. The grid mask amount is not included. (Command unit)
Machine position	This displays the NC basic machine coordinate system position. (Command unit)
Motor end FB	This displays the feedback value of the motor side position detector. (Command unit)
Machine end FB	This displays the feedback position of the machine side position detector. (Command unit)
FB error (i)	This displays the error of the motor side FB and machine side FB. This follows the setting and display unit (#1003 iunit).
DFB compen amnt (i)	This displays the compensation pulse amount during dual feedback control. This follows the setting and display unit (#1003 iunit).
Remain command	The remaining movement distance of one block is displayed. (Command unit)
Curmt posn (2)	The value of the tool compensation amount subtracted from the current position is displayed. (Command unit)
Man int amt	The amount of interrupt movement in the manual absolute OFF state is displayed. (Command unit)
Abs pos command	The absolute position that does not include the machine error compensation amount is displayed. (Command unit)
Superimp syn er (mm)	This displays the current value of the synchronous error between the reference axis and the synchronized axis during control axis synchronization between part systems, control axis superimposition, or arbitrary axis superimposition.
Superimp err +P (mm)	This displays the maximum value of the distance in which the synchronized axis advances beyond the reference axis during control axis synchronization between part systems, control axis superimposition, or arbitrary axis superimposition.
Superimp err -P (mm)	This displays the maximum value of the distance in which the synchronized axis lags behind the reference axis during control axis synchronization between part systems, control axis superimposition, or arbitrary axis superimposition.
Superimp errP-P (mm)	This displays the synchronous error width between the reference axis and the synchronized axis during control axis synchronization between part systems, control axis superimposition, or arbitrary axis superimposition.

Display items	Details
Motor temp. (°C)	This displays the motor temperature.
Power cycles (p)	This displays the power cycle counter. (Number of times)
Insul resist. (MOhm)	The insulation degradation status is displayed.
FAN1 rot. state (%)	The detected rotation speed of the unit cooling fan is displayed by converting it into percentage format (converted with the rated speed of the fan as 100%).
FAN2 rot. state (%)	The detected rotation speed of the unit cooling fan is displayed by converting it into percentage format (converted with the rated speed of the fan as 100%).
Battery voltage (V)	This displays the voltage of the connected battery.
AUX current sta No. (*1)	This displays the current station No.
AUX current posn (*1)	This displays the current coordinates position.
AUX inst station No. (*1)	This displays the command station No. of automatic operation or the nearest station No. to stop by manual operation etc.
AUX inst posn (*1)	This displays the coordinates position corresponding to target station No.
Mach err comp val	This displays the machine error compensation amount. (Command unit)
Control input 1L	This indicates the control signal input from NC to servo. (bit0 to bit7) Bit0: READY ON command Bit1: Servo ON command Bit4: Position loop gain changeover command Bit6: Excessive error detection width changeover command Bit7: Alarm reset command
Control input 1H	This indicates the control signal input from NC to servo. (bit8 to bitF) Bit8: Current limit selection command
Control input 2L	This indicates the control signal input from NC to servo. (bit0 to bit7)
Control input 2H	This indicates the control signal input from NC to servo. (bit8 to bitF) Bit9: Speed monitor command valid BitA: In door closed (controller) BitB: In door closed (all drive units)
Control input 3L	This indicates the control signal input from NC to servo. (bit0 to bit7) Bit0: Control axis detachment command
Control input 3H	This indicates the control signal input from NC to servo. (bit8 to bitF)
Control input 4L	This indicates the control signal input from NC to servo. (bit0 to bit7)
Control input 4H	This indicates the control signal input from NC to servo. (bit8 to bitF)
Control input 5L	This indicates the control signal input from NC to servo. (bit0 to bit7)
Control input 5H	This indicates the control signal input from NC to servo. (bit8 to bitF)
Control input 6L	This indicates the control signal input from NC to servo. (bit0 to bit7) Bit0: OMR-FF control request
Control input 6H	This indicates the control signal input from NC to servo. (bit8 to bitF) Bit8: Drivers communication control request
Control output 1L	This indicates the control signal output from servo to NC. (bit0 to bit7) Bit0: In READY ON Bit1: In Servo ON Bit4: In position loop gain changeover Bit6: In excessive error detection width changeover Bit7: In alarm
Control output 1H	This indicates the control signal output from servo to NC. (bit8 to bitF) Bit8: In current limit selection BitC: In-position BitD: In current limit BitE: In absolute position data loss BitF: In warning
Control output 2L	This indicates the control signal output from servo to NC. (bit0 to bit7) Bit0: Z-phase passed Bit3: In zero speed Bit7: In external emergency stop

Display items	Details
Control output 2H	This indicates the control signal output from servo to NC. (bit8 to bitF) Bit9: In speed monitor BitA: In door closed (controller) BitB: In door closed (self drive unit)
Control output 3L	This indicates the control signal output from servo to NC. (bit0 to bit7) Bit0: In control axis detachment
Control output 3H	This indicates the control signal output from servo to NC. (bit8 to bitF)
Control output 4L	This indicates the control signal output from servo to NC. (bit0 to bit7)
Control output 4H	This indicates the control signal output from servo to NC. (bit8 to bitF)
Control output 5L	This indicates the control signal output from servo to NC. (bit0 to bit7)
Control output 5H	This indicates the control signal output from servo to NC. (bit8 to bitF)
Control output 6L	This indicates the control signal output from servo to NC. (bit0 to bit7) Bit0: In OMR-FF control
Control output 6H	This indicates the control signal output from servo to NC. (bit8 to bitF) Bit8: In drivers communication control
Detection system	This displays the detector type symbol of the absolute position detection system. ES: Semi-closed encoder EC: Ball screw side encoder LS: Linear scale MP: MP scale ESS: Semi-closed high-speed serial encoder ECS: Ball screw side high-speed serial encoder INC: Incremental
Power OFF posn	This displays the coordinate at NC power OFF in the basic machine coordinate system. (Command unit)
Power ON posn	This displays the coordinate at NC power ON in the basic machine coordinate system. (Command unit)
Current posn	This displays the current coordinate in the basic machine coordinate system. (Command unit)
R0	This displays the multi-rotation counter value of the detector stored in the memory during basic point setting.
P0	This displays the position within one rotation of the detector stored in the memory during basic point setting.
E0	This displays the absolute position error stored in the memory during basic point setting.
Rn	This displays the multi-rotation counter value of the current detector.
Pn	This displays the position within one rotation of the detector.
En	This displays the absolute position error during NC power OFF.
ABS0	This displays the absolute position reference counter.
ABSn	This displays the current absolute position.
MPOS	This displays the offset amount of the MP scale when the power is turned ON.
Unit type	This displays the servo driver type.
Unit serial No.	This displays the servo driver serial No.
Software version	This displays the servo side software version.
Control method	SEMI: Semi-closed loop CLOSED: Closed loop DUAL: Dual feedback
Motor end detector	This displays the motor side detector type.
Motor end detect No.	This displays the motor side detector serial No.
Machine end detector	This displays the machine side detector type. The type is displayed when the control method is CLOSED or DUAL. * is displayed when the method is SEMI.
Mach. end detect No	This displays the machine side detector serial No.
Motor	This displays the motor type.
Work time	This displays the READY ON work time. (Units: 1 hr)

Display items	Details
Alarm history 1: Time 1: Alarm } 8: Time 8: Alarm	This displays servo alarms that occurred in latest order with the following formats. Time: Work time when the alarm occurred Alarm No.: Number of the servo alarms that occurred
Maint hist 1 } Maint hist 4	This displays the maintenance dates. Year: One digit Month: 1 to 9, X (Oct.), Y (Nov.), Z (Dec.)
Maint status	This displays the maintenance status.

(*1) Data (station No./current position/command position) is displayed for axes of auxiliary axis state.

"-" is displayed for axes of non-auxiliary axis state (NC axis or during PLC axis control).

10.2.4 Drive Monitor Screen (Spindle Unit)



The various data related to the spindle can be monitored by selecting the menus [Drv mon] -> [Spindle unit] on the diagnosis (Diagn) screen.

Change the display item with or .

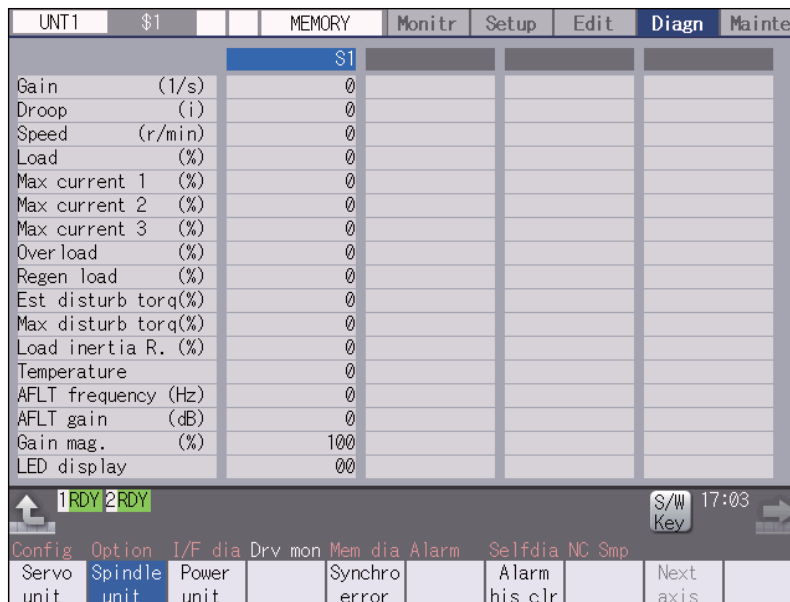

Display items

Display items	Details
Gain (1/s)	This displays the position loop gain. The position loop gain is obtained by the following formula: $\frac{\text{Feedrate (mm/s)}}{\text{Tracking delay error (mm)}}$
Droop (i)	The error of the actual machine position to the command position is called droop. This error is proportional to command speed value. (*1)
Speed (r/min)	This displays the actual rotation speed of motor.
Load (%)	This displays the motor load.
Max current 1 (%)	This displays the motor current command in terms of continuous current during stalling. An absolute value of the current command peak value sampled after the power ON is displayed.
Max current 2 (%)	This displays the motor current command in terms of continuous current during stalling. An absolute value of the current command peak value sampled in most recent 2 seconds is displayed.
Max current 3 (%)	This displays the FB value of the motor current in terms of continuous current during stalling. An absolute value of the current FB peak value sampled in most recent 2 seconds is displayed.
Overload(%)	This is the data used to monitor the overload of drive unit.
Regen load (%)	This is the data used to monitor the resistance overload state when the resistance regenerative power supply is connected.
Est disturb torq (%)	This displays the estimated disturbance torque in terms of stall rated torque when the disturbance observer is valid.

Display items	Details
Max disturb torq (%)	This displays the estimated disturbance torque in terms of stall rated torque when the collision detection function is adjusted. An absolute value of the estimated disturbance torque peak value sampled in most recent 2 seconds is displayed.
Load inertia R. (%)	This displays the estimated load inertia ratio when the collision detection function is adjusted. The ratio is displayed according to the parameter setting of "#1251 set23/bit0".
Temperature (°C)	This displays the thermistor temperature.
AFLT frequency (Hz)	This displays the current operation frequency of the adaptive filter.
AFLT gain (dB)	This displays the current filter depth of the adaptive filter.
Gain mag. (%)	While Real-time tuning 1 is valid, the currently applied speed control gain is displayed with the magnification for the setting value of speed loop gain 1 (parameter "#13005 SP005 VGN1").
LED display	This displays the 7-segment LED of the driver.
Alarm	This displays the alarms and warnings other than the LED display (displayed on drive unit side).
Cycle counter (p)	This displays the position within one rotation of the encoder detector. The position is displayed within one rotation in the range of "0" to "RNG (movement units) × 1000" using the grid point value as "0".
Grid space	This displays the grid space for the reference position return. (Command unit) (*1)
Grid amnt	This displays the distance from the dog-off point to the grid point when the dog-type reference position return is displayed. The grid mask amount is not included. (Command unit) (*1)
Machine position	This displays the NC basic machine coordinate system position. (Command unit) (*1)
Motor end FB	This displays the feedback value of the motor side position detector (Command unit) (*1)
FB error (i)	This displays the error of the motor side FB and machine side FB. (*1)
DFB compen amnt (i)	This displays the compensation pulse amount during dual feedback control. (*1)
Tap error (mm) (*2)	This displays the current value of the synchronous error between the tapping spindle and the drilling axis during synchronous tapping. (When the parameter "#1041 Initial inch" is set to "1", "Tap error (inch)" is displayed.) (*1)
Tap error +P (mm) (*2)	This displays the maximum value of the distance in which the drilling axis advances beyond the tapping spindle during synchronous tapping. (When the parameter "#1041 Initial inch" is set to "1", "Tap error +P (inch)" is displayed.) (*1)
Tap error -P (mm) (*2)	This displays the maximum value of the distance in which the drilling axis lags behind the tapping spindle during synchronous tapping. (When the parameter "#1041 Initial inch" is set to "1", "Tap error -P (inch)" is displayed.) (*1)
Tap error P-P (mm) (*2)	This displays the synchronous error width between the spindle and the drilling axis during the synchronous tapping. (When the parameter "#1041 Initial inch" is set to "1", "Tap error -P (inch)" is displayed.) (*1)
Tap error (deg) (*2)	This displays the current value of the synchronous error angle between the tapping spindle and the drilling axis during synchronous tapping. (±99999.999 deg) (*1)
Tap error +P (deg) (*2)	This displays the maximum value of the angle at which the tapping spindle advances beyond the drilling axis during synchronous tapping. (±99999.999 deg) (*1)
Tap error -P (deg) (*2)	This displays the maximum value of the angle at which the tapping spindle lags behind the drilling axis during synchronous tapping. (±99999.999 deg) (*1)
Tap error P-P (deg) (*2)	This displays the synchronous error angle between the spindle and the drilling axis during the synchronous tapping. (deg) (*1)
SP sync error (deg)	This displays the current value of the synchronous error between the reference spindle and the synchronized spindle during spindle synchronization I, tool spindle synchronization IA/IB, or tool spindle synchronization II. (±99999.999 deg)
SP sync err +P (deg)	This displays the maximum value of the angle at which the synchronized spindle advances beyond the reference spindle during spindle synchronization I, tool spindle synchronization IA/IB, or tool spindle synchronization II. (±99999.999 deg)

Display items	Details
SP sync err -P (deg)	This displays the maximum value of the angle at which the synchronized spindle lags behind the reference spindle during spindle synchronization I, tool spindle synchronization IA/IB, or tool spindle synchronization II. (± 99999.999 deg)
SP syn err P-P (deg)	This displays the synchronous error width between the reference spindle and the synchronized spindle during spindle synchronization I, tool spindle synchronization IA/IB, or tool spindle synchronization II. (± 99999.999 deg)
SP syn phas er (deg)	This displays the phase difference stored in the memory by calculating the phase shift value. (± 99999.999 deg)
SP sync ph1 FB (deg)	This displays the current value of the feedback phase difference that includes the phase difference stored in the memory by calculating the phase shift value during spindle synchronization I, tool spindle synchronization IA/IB, or tool spindle synchronization II. (± 99999.999 deg)
SP sync ph2 FB (deg)	This displays the current value of the feedback phase difference that does not include the phase difference stored in the memory by calculating the phase shift value during spindle synchronization I, tool spindle synchronization IA/IB, or tool spindle synchronization II. (± 99999.999 deg)
SP syn er comp (deg)	This displays the error compensation amount during spindle synchronization I, tool spindle synchronization IA/IB, or tool spindle synchronization II. (± 99999.999 deg)
GB sync error (deg)	This displays the current value of the synchronous error between the reference spindle and the guide bushing spindle during guide bushing spindle synchronization. (± 99999.999 deg)
GB sync err +P (deg)	This displays the maximum value of the distance in which the guide bushing spindle advances beyond the reference spindle during guide bushing spindle synchronization. (± 99999.999 deg)
GB sync err -P (deg)	This displays the maximum value of the distance in which the guide bushing spindle lags behind the reference spindle during guide bushing spindle synchronization. (± 99999.999 deg)
GB sync err P-P (deg)	This displays the synchronous error width between the reference spindle and the guide bushing spindle during guide bushing spindle synchronization. (± 99999.999 deg)
Motor temp. (°C)	This displays the motor temperature.
Power cycles (p)	This displays the power cycle counter. (Number of times)
Insul degrade (%)	The insulation degradation status is displayed.
FAN1 rot. state (%)	The detected rotation speed of the unit cooling fan is displayed by converting it into percentage format (converted with the rated speed of the fan as 100%).
FAN2 rot. state (%)	The detected rotation speed of the unit cooling fan is displayed by converting it into percentage format (converted with the rated speed of the fan as 100%).
Battery voltage (V)	This displays the battery voltage.
Control input 1L	This indicates the control signal input from NC to spindle. (bit0 to bit7) Bit0: READY ON command Bit1: Servo ON command Bit7: Alarm reset command
Control input 1H	This indicates the control signal input from NC to spindle. (bit8 to bitF) Bit8 to BitA: Torque limit selection command
Control input 2L	This indicates the control signal input from NC to spindle. (bit0 to bit7)
Control input 2H	This indicates the control signal input from NC to spindle. (bit8 to bitF) Bit9: Speed monitor command valid BitA: In door closed (controller) BitB: In door closed (all drive unit)
Control input 3L	This indicates the control signal input from NC to spindle. (bit0 to bit7)
Control input 3H	This indicates the control signal input from NC to spindle. (bit8 to bitF)
Control input 4L	This indicates the control signal input from NC to spindle. (bit0 to bit7) Bit0 to Bit2: Spindle control mode selection command Bit4: In gear changeover command Bit5 to Bit6: Gear selection command

Display items	Details
Control input 4H	This indicates the control signal input from NC to spindle. (bit8 to bitF) BitC: M coil selection command BitD: L coil selection command BitE: Sub-motor selection command
Control input 5L	This indicates the control signal input from NC to spindle. (bit0 to bit7)
Control input 5H	This indicates the control signal input from NC to spindle. (bit8 to bitF) BitB: Minimum excitation 2 changeover request BitC: Speed gain set 2 changeover request BitD: Zero point re-detection request BitE: Increase holding power of spindle
Control input 6L	This indicates the control signal input from NC to spindle. (bit0 to bit7) Bit0: OMR-FF control request
Control input 6H	This indicates the control signal input from NC to spindle. (bit8 to bitF) Bit8: Drivers communication control request
Control output 1L	This indicates the control signal input from spindle to NC. (bit0 to bit7) Bit0: In READY ON Bit1: In Servo ON Bit7: In alarm
Control output 1H	This indicates the control signal input from spindle to NC. (bit8 to bitF) Bit8 to BitA: In torque limit selection BitC: In-position BitD: In torque limit BitF: In warning
Control output 2L	This indicates the control signal input from spindle to NC. (bit0 to bit7) Bit0: Z phase passed Bit3: In zero speed Bit7: In external emergency stop
Control output 2H	This indicates the control signal input from spindle to NC. (bit8 to bitF) Bit9: In speed monitor BitA: In door closed (controller) BitB: In door closed (self drive unit)
Control output 3L	This indicates the control signal input from spindle to NC. (bit0 to bit7)
Control output 3H	This indicates the control signal input from spindle to NC. (bit8 to bitF)
Control output 4L	This indicates the control signal input from spindle to NC. (bit0 to bit7) Bit0 to Bit2: In spindle control mode selection Bit4: In gear changeover command Bit5 to Bit6: In gear selection Bit7: Magnetic pole position not set
Control output 4H	This indicates the control signal input from spindle to NC. (bit8 to bitF) BitD: In L coil selection
Control output 5L	This indicates the control signal input from spindle to NC. (bit0 to bit7) Bit0: Current detection Bit1: Speed detection Bit6: In coil changeover
Control output 5H	This indicates the control signal input from spindle to NC. (bit8 to bitF) Bit9: 2nd speed detection BitB: In minimum excitation rate 2 selection BitC: In speed gain set 2 selection BitD: Zero point re-detection complete BitF: In 2nd in-position
Control output 6L	This indicates the control signal input from spindle to NC. (bit0 to bit7) Bit0: In OMR-FF control
Control output 6H	This indicates the control signal input from spindle to NC. (bit8 to bitF) Bit8: In drivers communication control
Unit type	This displays the spindle type.
Unit serial No.	This displays the spindle serial No.
Software version	This displays the software No. and version on the spindle side.

Display items	Details
Motor end detect No	This displays the motor side detector serial No.
Mach. end detect No	This displays the machine side detector serial No.
Motor	It displays the motor type which is set for the spindle specification parameter "#3138 motor_type". The maximum of 26 words are displayed with 2 lines and left aligned.
Work time	This displays the READY ON work time. (Units: 1 hr)
Alarm history 1: Time 1: Alarm } 8: Time 8: Alarm	This displays servo alarms that occurred in latest order with the following formats. Time: Work time when the alarm occurred Alarm No.: Number of the servo alarms that occurred
Maint hist 1 } 4	This displays the maintenance dates. Year: One digit Month: 1 to 9, X (Oct.), Y (Nov.), Z (Dec.)
Maint status	This displays the maintenance status.

(*1) These follow the setting and display unit (#1003 iunit) of the 1st part system.

(*2) Synchronous tapping error

This displays the maximum values of the synchronous tapping error that occur during the synchronous tapping.

The synchronous tapping error means the motor tracking delay for the commanded positions of the spindle and the tapping axis.

The positive synchronous tapping error means that the tapping axis is delayed responding to the spindle, and the negative synchronous tapping error means that the spindle is delayed responding to the tapping axis.

Data name	Details
Synchronous tapping error width (Max value)	<ul style="list-style-type: none"> ♦This outputs the data of which absolute value is the largest among the synchronous tapping error width (-99999.999 to 99999.999 mm) during the synchronous tapping modal. ♦This data will be initialized to "0" when entering the synchronous tapping modal or restoring the power. Other than that, the data continues to display the maximum value.
Synchronous tapping error angle (Max value)	<ul style="list-style-type: none"> ♦This outputs the data of which absolute value is the largest among the synchronous tapping error angle (-99999.999 to 99999.999°) during the synchronous tapping modal. ♦This data will be initialized to "0" when entering the synchronous tapping modal or restoring the power. Other than that, the data continues to display the maximum value.

10.2.5 Drive Monitor Screen (Power Supply Unit)



The various data related to the power supply can be monitored by selecting the menus [Drv mon] -> [Power unit] on the diagnosis (Diagn) screen.

Change the display item with or .

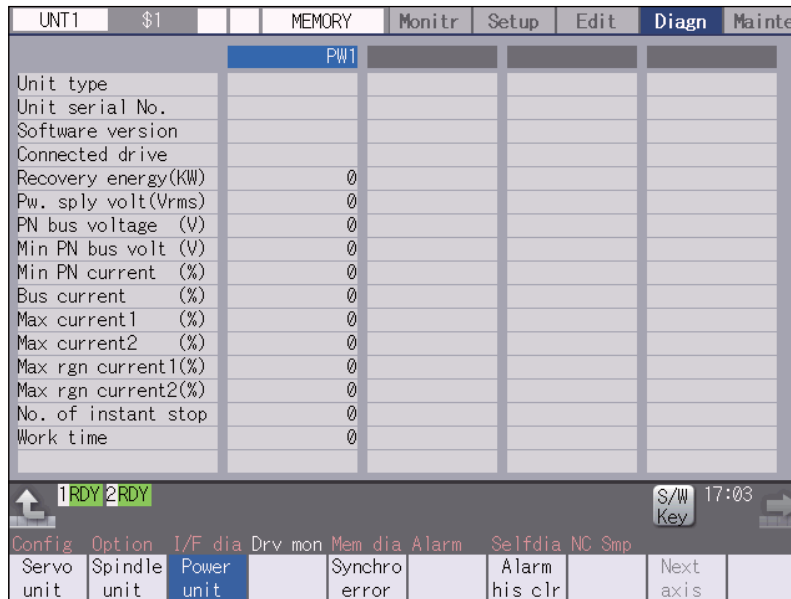

Display items

Display items	Details
Unit type	This displays the power supply unit type.
Unit serial No.	This displays the serial No. of the power supply unit.
Software version	This displays the software version.
Connected drive	This displays the I/F channel No. (mcp_no, smcp_no) of the drive unit connected to each power supply unit.
Recovery energy (KW)	This displays the regenerative power every two seconds. (0 to 999 kW)
Pw. sply volt (Vrms)	This displays the effective value of the power supply voltage. (0 to 999 Vrms)
PN bus voltage (V)	This displays PN bus voltage. (0 to 999V)
Min PN bus volt (V)	This displays the minimum PN bus voltage after the NC power ON. (0 to 999V)
Min PN current (%)	This displays the bus current when PN bus voltage is at minimum. (driving: +, regenerative: -) (0 to 999%)
Bus current (%)	This displays the bus current. (driving: +, regenerative: -) (0 to 999%)
Max current1 (%)	This displays the maximum driving current after the NC power ON. (0 to 999%)
Max current2 (%)	This displays the maximum driving current in most recent 2 seconds. (0 to 999%)
Max rgn current1 (%)	This displays the maximum regenerative current after the NC power ON. (0 to 999%)
Max rgn current2 (%)	This displays the maximum regenerative current in most recent 2 seconds. (0 to 999%)
No. of instant stop	This displays the number of instantaneous power interruption exceeding 1 cycle of the power. (0 to 9999 times)
Work time	This displays the READY ON work time. (Units: 1 hr)
Power-run pwr (kW)	The power-run power is calculated and displayed. (0.01 kW)
Regenerate pwr (kW)	The regenerated power is calculated and displayed. (0.01 kW)

Display items	Details
Consumed power (kW)	The power consumption is calculated and its integrated value is displayed. (0.01 kWh)
Pwr. distortion (V)	The amount of power distortion (harmonic voltage value) is calculated and displayed. (V)
Supplied power (kW)	The supplied power is calculated and displayed. (kW)
Accum. power (kWh)	The accumulated power is calculated and displayed. (kWh)
Harmonic volt. (V)	The power line harmonic voltage is displayed. (V)
CV margin (%)	The CV margin is calculated and displayed. (%)
FAN1 rot. state (%)	The detected rotation speed of the unit cooling fan is displayed by converting it into percentage format (converted with the rated speed of the fan as 100%).
FAN2 rot. state (%)	The detected rotation speed of the unit cooling fan is displayed by converting it into percentage format (converted with the rated speed of the fan as 100%).
Alarm history 1: Time 1: Alarm } 8: Time 8: Alarm	This displays servo alarms that occurred in latest order with the following formats. Time: Work time when the alarm occurred Alarm No.: Number of the servo alarms that occurred
Maint hist 1 } 4	This displays the maintenance dates. Year: One digit Month: 1 to 9, X (Oct.), Y (Nov.), Z (Dec.)
Maint status	This displays the maintenance status.

10.2.6 Drive Monitor Screen (Synchronous Error)



The "Synchronous error" appears only when the synchronous control axis specification is valid.

The various data related to the synchronous error can be monitored by selecting the menus [Drv mon] -> [Synchro error] on the diagnosis (Diagn) screen.







Display items

Display items	Details
Slave axis	This displays the slave axis name which is controlled following the master axis. The axis name corresponding to the axis No. set in the axis specification parameter "#1068 slavno" (slave axis No.) is displayed. The name set in the base axis specification parameter "#1022 axname2" (2nd axis name) is displayed for the slave axis.
Command error	This is the deviation of the slave axis machine position in respect to the master axis. The error of the commanded position to the servo control section before pitch error compensation, relative position compensation and backlash compensation is displayed. If this error occurs, the parameters that should be the same for the synchronous axes are different. Command error = Command s - command m - Δ Command s: Slave axis commanded position Command m: Master axis commanded position Δ: Command s - command m at start of synchronous control
FB error	This is the deviation of the slave axis feedback position in respect to the feedback position from the master axis servomotor. The actual error of the machine position is displayed. The synchronous error check is carried out on this error. FB error = FBs - FBm - Δ FBs: Slave axis feedback position FBm: Master axis feedback position Δ: FBs - FBm at start of synchronous control
FB error MAX1	This displays the maximum FB error after the start of the synchronous control.
FB error MAX2	This displays the maximum FB error approx. every 30 seconds after the start of the synchronous control.
Machine position	This displays the commanded machine position for the master axis.

10.2.7 Clearing the Alarm History on Drive Monitor Screen

**Operation method**

- (1) Press the menu [Servo unit], [Spindle unit] or [Power unit].
- (2) Using the menu [Next axis], tab keys  and , select the axis (device) from which to clear the alarm history.
- (3) Press the menu [Alarm his clr].
 The menu is highlighted, and a message appears to confirm the erasing.
The alarm history1: Time appears at the head.
- (4) Press the [Y] key.
 All alarm history data for the selected axis (device) are cleared to "0".

10.3 Diagnosis Screens

10.3.1 Self Diagnosis Screen



The hardware state and NC operation state can be confirmed by selecting the menu [Selfdia] on the diagnosis (Diagn) screen.

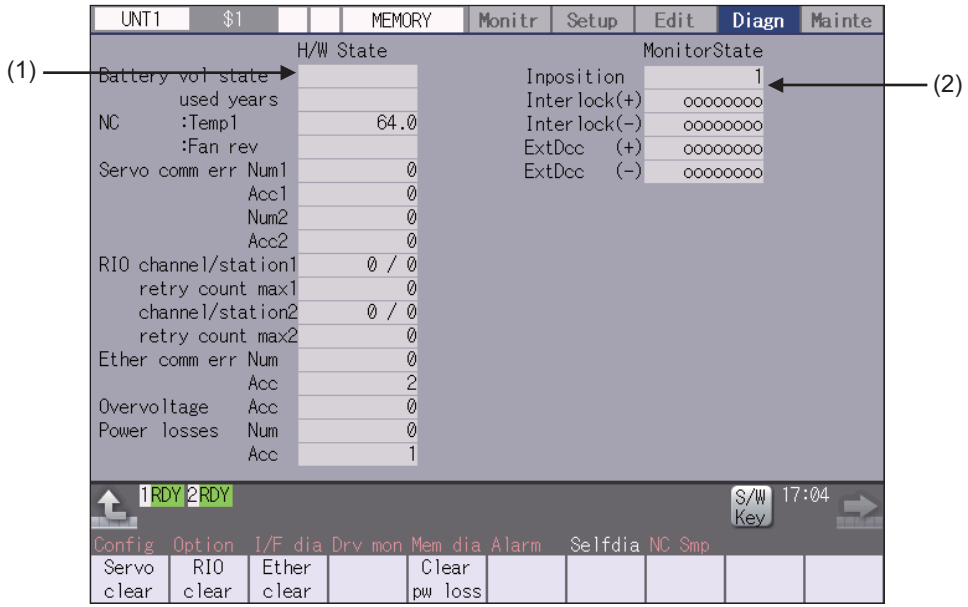

Display items

Display items	Details
(1) H/W state (common for part systems)	This displays the hardware state of the NC unit and display unit. (*1)
(2) Operation state (Depends on part system)	This displays the state when the operation seems to be stopped in spite that the alarm does not occur. (*2)

(*1) As for the NC unit, the contents are as follows depending on the condition:

NC

Item	Details	
Battery vol state	CPU module does not use the battery. This item is not displayed.	
Battery used years	The PLC CPU and the servo drive unit use batteries, but the states of these batteries are not displayed in the screen.	
NC : Temp. 1 (°C)	This displays the current temperature of the control unit.	
	Condition	Class
	94.5°C < Control unit temp. <= 96.5°C	Caution (gray)
	96.5°C < Control unit temp.	Warning (yellow)
NC :Fan rev	The fan is not mounted. This item is not displayed.	

Communication between NC unit and display unit

Item	Details
Servo comm err Num1	This displays the count of occurrence for "Y51 SV commu er: Recv frame No. xx04" after the power ON.
Servo comm err Acc1	This displays the cumulated count of occurrence for " Y51 SV commu er: Recv frame xx04". Press the menu [Servo clear] to clear the cumulated count to "0".
Servo comm err Num2	This displays the count of occurrence for "Y51 SV commu er: Data ID error xx03" after the power ON.
Servo comm err Acc2	This displays the cumulated count of occurrence for "Y51 SV commu er: Data ID error xx03". Press the menu [Servo clear] to clear the cumulated count to "0".
RIO channel/station1	This displays the Channel No./Station No. of occurrence for continuous error after the power ON. (*)
RIO retry count max 1	This displays the maximum value of the continuous error after the power ON. (*)
RIO channel/station 2	This displays the Channel No./Station No. held even if the power OFF. Press the menu [RIO clear] to clear the Channel No./Station No. to "0/0". (*)
RIO retry count max 2	This displays the count held even if the power OFF. (*) Press the menu [RIO clear] to clear the count to "0".
Ether comm err Num	This displays the number of Ethernet communication error after PLC program is executed once.
Ether comm err Acc	This displays the cumulated count of occurrence for Ethernet communication error. Press the menu [Ether clear] to clear the cumulated count to "0".
Overvoltage Acc	This displays the cumulated count of detection frequency of overvoltage after the power ON.
Power losses Num	This displays the count of detection frequency of instantaneous power interruption after the power ON.
Power losses Acc	This displays the cumulated count of detection frequency of instantaneous power interruption after the power ON. Press the menu [Clear pw loss] to clear the cumulated count to "0".

(*) The remote I/O communication error of the safety signal unit is the target. When the error occurs, the channel No. is fixed to "1".

(*2) The following state can be confirmed.

State	Details
In-position	This displays "1" (in-position state) when the following conditions are satisfied for even one axis. •There is a control axis whose acceleration/deceleration is not zero. •There is a control axis whose servo error exceeds the range designated with the parameter.
Interlock (+)	When the auto interlock +n-th axis signal or the manual interlock +n-th axis signal is OFF, "1" appears for the n-th axis. (Explanation of the display) o o o o o 1 o ↑ ↑ 8th axis ... 1st axis In the above case, the 2nd axis is interlocked. Even when the number of usable axes is less than 8 in 1 part system, this displays 8 axes fixed.
Interlock (-)	When the auto interlock -n-th axis signal or the manual interlock -n-th axis signal is OFF, "1" appears for the n-th axis. The explanation of the display is same as for the "Interlock (+)".
ExtDcc (+)	When the control axis is moving in (+) direction, "1" appears for the axis if the external deceleration speed is valid, and the feedrate is clamped, exceeding the set value of the external deceleration speed. (Explanation of the display) o o o o o 1 o 1 ↑ ↑ 8th axis ... 1st axis In the above case, the 1st axis and the 3rd axis are in external deceleration speed. Even when the number of usable axes is less than 8 in 1 part system, this displays 8 axes fixed.
ExtDcc (-)	When the control axis is moving in (-) direction, "1" appears for the axis if the external deceleration speed is valid, and the feedrate is clamped, exceeding the set value of the external deceleration speed. The explanation of the display is same as for the "ExtDcc(+)".

Menus

Menus	Details
Servo clear	This clears the cumulated count of the servo communication error 1 and 2 to "0".
RIO clear	This clears the cumulated count of the RIO communication error to "0".
Ether clear	This clears the cumulated count of the Ether communication error to "0".
Clear pw loss	This clears the accumulated number of instantaneous power interruption detection times to "0".

Clearing the cumulated counter to zero

(Example) Clearing the cumulated count of the servo communication error

- (1) Press the menu [Servo clear]. ➡ An operation message appears.

- (2) Press the [Y] or [INPUT] key. ➡ The cumulated count of the servo communication error 1 and 2 will be cleared to "0".
When other keys are pressed, it will not clear to "0".

This also applies to menus [RIO clear], [Ether clear], [Battery clear] and [Clear pw loss].

10.3.2 Checking Alarms of Drive Unit



You can confirm the following information on the servo diagnosis screen by pressing [Mainte] -> [Servo diagn] on the diagnosis (Diagn) screen:

- The number of alarms of servo/spindle drive unit
- DA output information
- PLG diagnosis (spindle)
- The maintenance diagnosis information of servo/spindle unit such as alarm cause counter

This operation is protected according to the operation level.

■ Servo unit

UNT1	\$1	MEMORY	Monitr	Setup	Edit	Diagn	Mainte
			X1	Y1	Z1	C1	
(1) {	Alarm times	31					
	Alarm times	32					
(2) {	34 AL cause cnt	accu	0	0	0	0	0
		freq	0	0	0	0	0
(2) {	36 AL cause cnt	accu	0	0	0	0	0
		freq	0	0	0	0	0
(2) {	38 AL cause cnt	accu	0	0	0	0	0
		freq	0	0	0	0	0
(2) {	39 AL cause cnt	accu	0	0	0	0	0
		freq	0	0	0	0	0
(3) {	DA Address	1					
	DA output	1					
	DA Address	2					
	DA output	2					
			1 RDY 2 RDY S/W 17:10 Key				
Mainte	Param	I/O	PLG	All	Alarm	All	Next
Servo	Spindle		diagn	num	num	cnt	axis
unit	unit			clr	clr	clr	

■ Spindle unit

(1) Display of the DA output data

UNT1	\$1	MEMORY	Monitr	Setup	Edit	Diagn	Mainte
			S1				
(1) {	Alarm times	31					
	Alarm times	32					
(2) {	34 AL cause cnt	accu	0				
		freq	0				
(2) {	36 AL cause cnt	accu	0				
		freq	0				
(2) {	38 AL cause cnt	accu	0				
		freq	0				
(2) {	39 AL cause cnt	accu	0				
		freq	0				
(3) {	DA Address	1					
	DA output	1					
	DA Address	2					
	DA output	2					
			1 RDY 2 RDY S/W 17:10 Key				
Mainte	Param	I/O	PLG	All	Alarm	All	Next
Servo	Spindle		diagn	num	num	cnt	axis
unit	unit			clr	clr	clr	

(2) Display of the spindle PLG diagnosis information

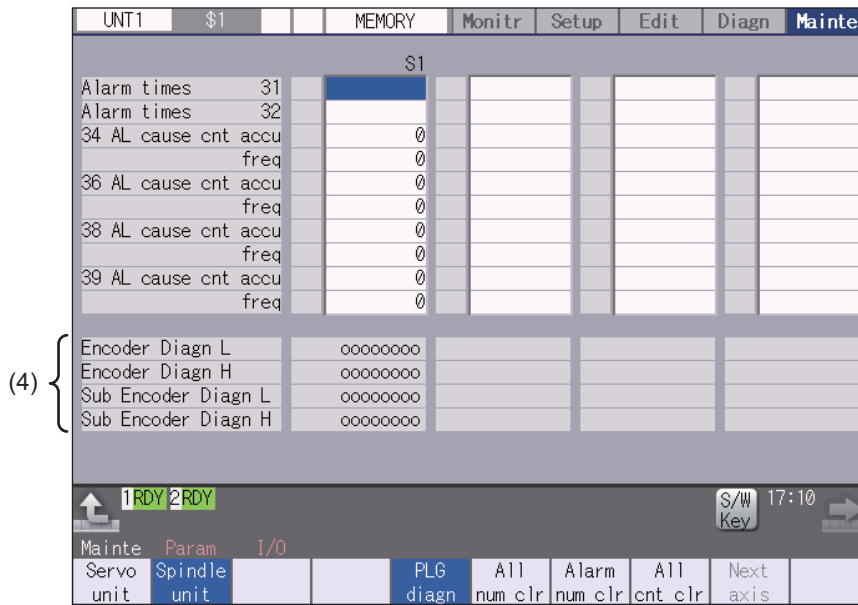

Display items

Display items	Details
(1) Alarm times	<p>This displays the data for each axis or unit. There are Alarm times 1 to 32, and there are switched with the page up/down keys. The number of times can be cleared for each axis or each column.</p> <p>Alarm No: Servo alarm No. (unit: ASCII) No. of times: The number of times of meeting the servo alarm condition after the servo drive unit ON. (Units: Number of times)</p>
(2) Alarm cause counter	<p>An alarm occurs when the specified number of conditions are met. This counter displays the number of times in which the alarm occurrence condition is met since the drive unit power was turned ON. The number of times can be cleared for each axis with [All cnt clr].</p> <p>accu: Displays the number of times in which the alarm occurrence condition was met since the drive unit power was turned ON. freq: Displays the peak hold value when the alarm occurrence condition is met per constant cycle.</p>
(3) DA output	<p>This displays the data for each axis or unit.</p> <p>DA Address 1: Servo parameter sv061 set value (address) (unit: ASCII) DA output 1: Servo parameter sv061 set address data (unit: pulse) DA Address 2: Servo parameter sv062 set value (address) (unit: ASCII) DA output 2: Servo parameter sv062 set address data (unit: pulse)</p>
(4) Spindle PLG diagnosis information (Spindle drive unit only)	<p>Displays the data for each axis</p> <p>Encoder Diagn L: Displays the output signal (Low) of the motor side PLG Encoder Diagn H: Displays the output signal (High) of the motor side PLG Sub Encoder Diagn L: Displays the output signal (Low) of the machine side PLG Sub Encoder Diagn H: Displays the output signal (High) of the machine side PLG</p>

Note

(1) PLG (pulse generator) detects the pulse signal and it is used to detect the rotation state of the motor.

Menus	
Menus	Details
Servo unit	Displays the servo unit diagnosis information in the data display area.
Spindle unit	Displays the spindle unit diagnosis information in the data display area. <Note> •When the parameter "#1039 spinno" is set to "0", this menu is not displayed.
PLG diagn	Switches the display between the DA output and the spindle PLG diagnosis information. Pressing this button again after this menu is highlighted, the display switches to the DA output. <Note> •When the parameter "#1039 spinno" is set to "0", this menu is not displayed. •Even when the parameter "#1039 spinno" is set to other than "0", this menu will be grayed out and non-selectable. while displaying the servo unit diagnosis information.
All num clr	This clears the number of alarms of the axis at the cursor position to "0".
Alarm num clr	This clears the number of alarms at the cursor position to "0". <Note> •When the cursor is on "AL cause cnt accu" or "freq", this menu is grayed out and non-selectable.
All cnt clr	Clears the all values of "AL cause cnt accu" and "freq" of the axis where the cursor is placed to 0.
Next axis	Displays the data of four axes from the next axis. This menu is displayed only when there are five or more servo axes or spindle.

Display items		Details
(2)	Sampling specifications	Specify the part system, spindle, and servo axes where sampling data is to be collected.
	System	Specify the part systems where sampling data is not to be collected. Specify the part system in HEX. When "0" is set, sampling is carried out for all part systems. This setting is ignored if a non-existent part system is specified.
	Spindle	Specify the spindle where sampling data is not to be collected. Specify the part system in HEX. When "0" is set, sampling is carried out for all spindles. This setting is ignored if a non-existent spindle is specified.
	Servo	Specify the servo axes where sampling data is not to be collected. Specify the part system in HEX. This setting is not system-specific. When "0" is set, sampling is carried out for all axes. This setting is ignored if a non-existent servo axis is specified.
(3)	Collecting data select	This selects the diagnosis data to be collected. 0: Collected. 1: Not collected.
	Key history	This selects whether or not key history data is collected.
	Alarm history	This selects whether or not alarm history data is collected.
	PLC I/O history	This selects whether or not PLC input/output signal history data is collected.
	AC alarm history	This selects whether or not AC power ON/OFF history data is collected.
	Touch history	This selects whether or not touchscreen history data is collected.
	Pert program history	This selects whether or not the data of the machining program No. and the PLC No. is collected.

Menus

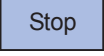
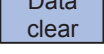
Menus	Details
	This begins collecting sampling data and history data.
	This stops the sampling data and history data collection operation.
	This stops the sampling data and history data collection operation, and clears the collected data. This is not displayed when "#1263 bit1" is ON.

Note

- (1) The alarm history data collection start/stop operation is switched using the menu [Start] or [Stop] of data collection regardless of whether "Alarm history" is set to "0" or "1".

Operation method (Start of data collection)

- (1) Press the menu [Start].
- (2) Press the [Y] or [INPUT] key.

Note

- (1) Data collection starts even if "Alarm history" is set to "1" (not collected).

Operation method (Stop of data collection)

- (1) Press the menu [Stop].
- (2) Press the [Y] or [INPUT] key.

Note

- (1) Data collection stops even if "Alarm history" is set to "1" (not collected).

Operation method (Clear of collected data)

- (1) Press the menu [Data clear].
- (2) Press the [Y] or [INPUT] key.

10.4 Advanced Diagnosis

Be sure to perform the operations in this section under the MTB instructions.

10.4.1 Displaying and Setting the PLC Device Data (I/F Diagnosis Screen)



The various input/output signals for the PLC (Programmable Logic Controller) control can be displayed and set in this screen.

These signals can be used in confirmation of the machine sequence operation during PLC development, and in confirmation and forced output, etc., of the input/output data between the NC and PLC.

Note

(1) Pay close attention to the sequence operation when using these functions during machine operation.

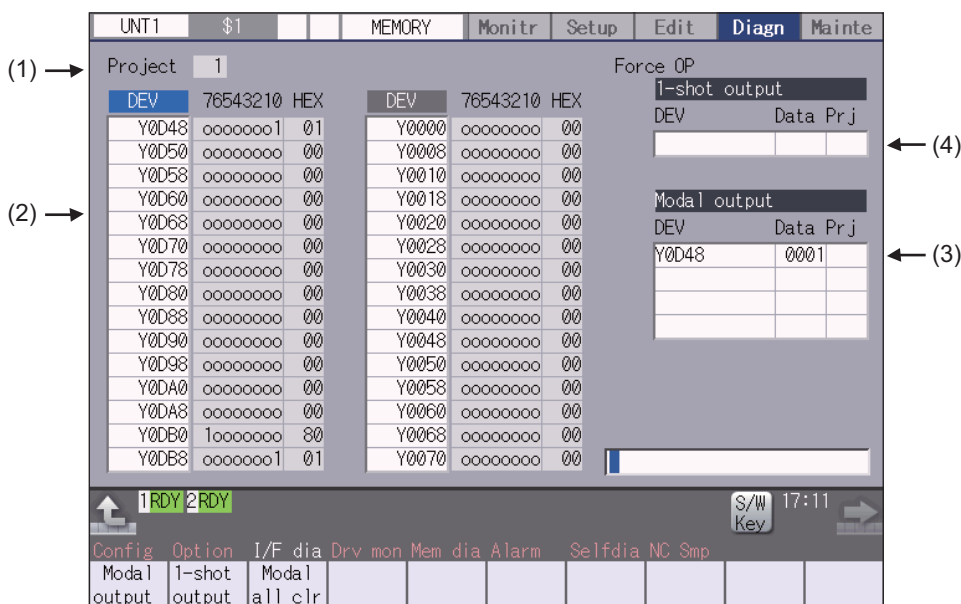

Display items

Display items	Details
(1) Project	This displays the currently displayed project.
(2) Device No. and input/output signal value (binary/hexadecimal display)	This displays the data from the device Nos. designated in the setting area in numerical order. The data is displayed as binary (bit units) and hexadecimal values. Individual device Nos. can be displayed separately in the left area and right area. Select the display area with the and key when operations such as display changeover and data setting are carried out. Target device: X, Y, M, L, F, SB, B, SM, V, SW, SD, TI, TO, TS, TA, STI, STO, STS, STA, CI, CO, CS, CA, D, R, ZR, W The common devices for each project are X, Y, R, and ZR.
(3) Modal output	This displays the data and device to carry out modal output. The details to be defined are set here when carrying out the modal type forced output of PLC interface signals. For details, refer to "Carrying Out Modal Output".

Display items	Details
(4) 1-shot output	This displays the data and device to carry out one-shot output. The details to be defined are set here when carrying out the one-shot type forced output of PLC interface signals. For details, refer to "Carrying Out One-shot Output".

Menus

Menus	Details
Modal output	This changes the setting area to an input standby status. The signal is forcibly output (modal).
1-shot output	This changes the setting area to an input standby status. The signal is forcibly output (one-shot).
Modal all clr	A confirmation message appears, and the machine turns into standby status. The force OP (one-shot output) of all I/O signals are canceled. (*1)

(*1) These menus are grayed out ordinarily, and cannot be operated.

How to read the device No. and display data

A device is an address for classifying a signal handled in the PLC. A device No. is a series of numbers attached to that device.

Device No. (bit-type)

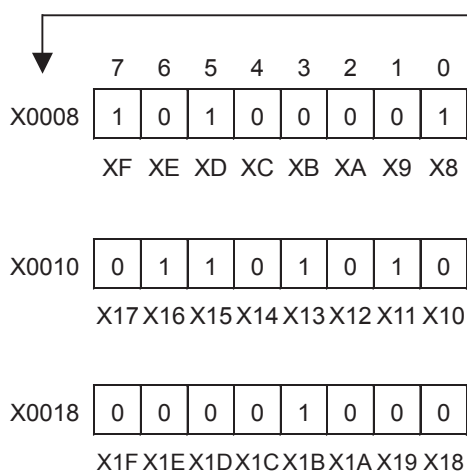

DEV	76543210	HEX	DEV	76543210	HEX
X0000	00000000	00	Y0000	00000000	00
X0008	10100001	A1	Y0008	00000000	00
X0010	01101010	6A	Y0010	10100000	A0
X0018	00001000	08	Y0018	00000001	01
X0020	01111100	7C	Y0020	00000000	00
X0028	00001111	0F	Y0028	00000000	00
X0030	00000010	02	Y0030	00000000	00

Signal status display corresponding to each device No. (I/O)

Device No. (word-type)

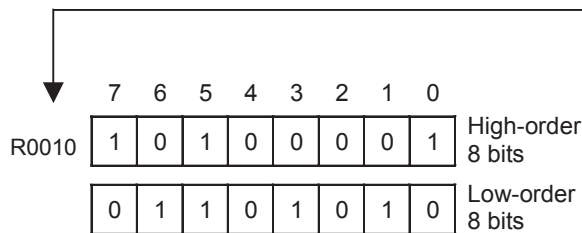

DEV	76543210	HEX
R00010	10100001	A1
	01101010	6A
R00011	00001001	09
	00000101	05
R00012	00010010	12
	00000110	06
R00013	00001010	0A
	00010101	15

10.4.1.1 Displaying the PLC Device Data



The various status signals and register data used in the PLC can be monitored and displayed.

When this screen is first selected, the respective 16-byte amounts of input/output data are displayed from device "X0000" on the left display area, and from device "Y0000" on the right side.

This screen constantly monitors and displays the PLC signal statuses. Consequently, when signals are changed in the PLC, the display is changed according to the changes.

Note that because time differences occur between the PLC signal change and the signal display, there may be a delay in the display. The machine may also not be able to correspond to extremely brief signal changes.

Displaying the data of an arbitrary device No. "X0020"

(1) Press the menu tab key  / , and select the area to display the data.

(2) Set the device No. (X0020), and press the [INPUT] key. 



The device "X0020" appears at the head of the valid display area.

DEV	76543210	HEX	DEV	76543210	HEX
X0020	11111111	FF	Y0000	00000000	00
X0028	01000000	40	Y0008	00000001	01
X0030	00001110	0E	Y0010	00000000	00
X0038	00000000	00	Y0018	00000000	00

Note

- (1) When setting the device No., an error will occur if a number exceeding the specifications or an illegal address is set.
- (2) The input/output signals of X, Y, R, and ZR are the same for all projects.

Changing the display with the page keys

The valid area device Nos. change in page units when  /  is pressed. Changing of the pages stops within the range of device numbers of which the device has.

(1) Press the  key.

 The data is displayed from the next number currently displayed.

DEV	76543210	HEX	DEV	76543210	HEX
X0000	10000001	81	Y0000	00000000	00
X0008	00000010	02	Y0008	00000001	01
X0010	00001111	0F	Y0010	00000000	00
X0018	10011111	9F	Y0018	00000000	00



DEV	76543210	HEX	DEV	76543210	HEX
X0080	11111111	FF	Y0000	00000000	00
X0088	01000000	40	Y0008	00000001	01
X0090	00001111	0F	Y0010	00000000	00
X0098	00000000	00	Y0018	00000000	00

10.4.1.2 Carrying Out Modal Output

Modal type forced output of PLC interface signals is carried out. Once set, this data is held until cancelled, the power is turned ON/OFF, or other data is overwritten. There are four sets of devices that modally output. If this number is exceeded, the previously existing data is overwritten.

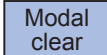

Menus used in modal output

Menus	Details
	This releases the modal output for the device at the cursor position in the modal output area. The released data is erased from this area.

Modally outputting data "1" to device "X0048"

- (1) Press the menu [Modal output].  The mode changes to the modal output mode, and the cursor appears at the modal output area.

- (2) Using the [↑] and [↓] keys, move the cursor to the setting position.

- (3) Set the device and data, and press the [INPUT] key.  Modal output is executed, and the cursor disappears. The data that was in the cursor position is overwritten by the input data, and is invalidated. The modal output mode is canceled by pressing the  key.



Note

- (1) The data of the modally output device is displayed in order in the selected area. This modal output is held until the output is canceled or the power is turned OFF.
- (2) When no data is set (Example: "X0048/", "X0048"), the operation message "Setting Data not found" is displayed.
- (3) The X, Y, R, and ZR devices are modally output for all projects.
- (4) The devices other than X, Y, R, and ZR are modally output for the currently displayed project.

Releasing the modal output

- (1) Press the menu [Modal output].  The mode changes to the modal output mode, and the cursor appears at the modal output area.

- (2) Using the [↑] and [↓] keys, move the cursor to the data to be released.

- (3) Press the menu [Modal clear].  The data that was in the cursor position is released from modal output. The "DEV" and "Data" columns become blank. The modal output mode is canceled by pressing the  key.



CAUTION

Pay close attention to the sequence operation when carrying out forced data setting (forced output) in the I/F diagnosis screen during machine operation.

10.4.1.3 Carrying Out One-shot Output

The one-shot type PLC interface signal forced output is forcibly output only once during the screen operations. Thus, it may not be possible to confirm the PLC interface signals updated with the PLC on the screen.

One-shot outputting data "1" to device "X0042"

- (1) Press the menu [1-shot output].
- (2) Set the device and data, and press the [INPUT] key.  X0042/1 [INPUT]
 - The input data is overwritten in the one-shot output area, and is one-shot output.
 - The cursor in the one-shot output area disappears.
 - The data of the one-shot output device is displayed in order in the selected area.
 - The one-shot output mode is canceled by pressing the  key.

Note

- (1) Because the input signal (X, etc.) to the PLC is updated at the head of each PLC cycle, the machine immediately returns to the normal state, even if one-shot type forced output is carried out.
- (2) When no data is set (Example: "X0048/", "X0048"), the operation message "Setting Data not found" is displayed.
- (3) The X, Y, R, and ZR devices are one-shot output for all projects.
- (4) The devices other than X, Y, R, and ZR are one-shot output for the currently displayed project.



CAUTION

Pay close attention to the sequence operation when carrying out forced data setting (forced output) in the I/F diagnosis screen during machine operation.

10.4.2 Writing and Reading the Data Using the NC Data Designation (NC Memory Diagnosis Screen)



The NC internal data can be displayed and rewritten on the NC memory diagnosis (Mem dia) screen of the diagnosis (Diagn) screen. The custom API library's NC data read/write interface is used to display and rewrite the NC's internal data. The contents of the NC data can be displayed by designating the part system No., section No., sub-section No. and axis No. on this screen.

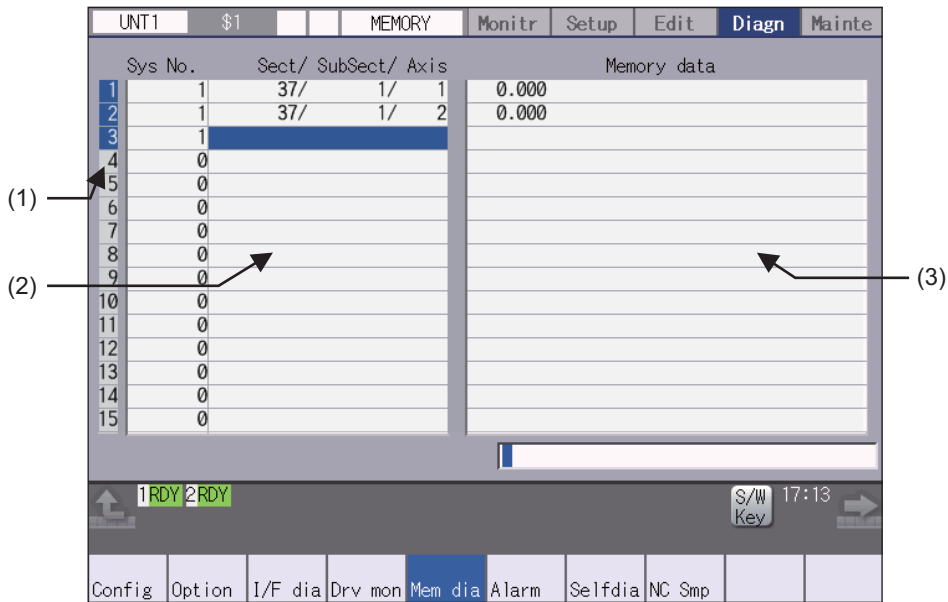

Display items

Display items	Details
(1) Index No.	This displays the registration No. of the NC memory data. When one of the "2. Data contents" is set, the number is highlighted indicating that the normal display of the data contents has stopped.
(2) Data contents	Part system No. Designate the part system No. (1: 1st part system). Designate "0" to designate the data common for the part systems. Section/sub-section/axis: Designate the section No., sub-section No. and axis No. of the data to be set and displayed. The setting format is, section No./sub-section No./axis No. <Note> •The axis No. "1" is handled as the first axis. Designate "0" for the data which does not require an axis designation.
(3) Memory data	This displays the contents of the data.

Menus	
Menus	Details
Line clear	This erases the information in the line where the cursor is. (One entire line becomes blank.) The cursor does not move at this time.
Data read	The contents of the set address data (Part system No, Section/sub-section/axis) for all the lines are constantly displayed. The Index No. highlight (indicating data is being set) is released. The cursor appears in "Part system No" of that line.
Data write	This writes the data in the setting area to the NC memory indicated by address data at the cursor position. (*1) The Data No. highlight (indicating data is being set) is released, and constant display is started. After writing, the cursor moves to "Part system No" of the next line.
Subsect continu	Based on the data of the address data where the cursor is, this displays the continuous data to which the sub-section No. has been added to the address data from the line where the cursor is. The cursor moves to "Part system No " of that line.
Axis continu	Based on the data of the address data where the cursor is, this displays the continuous data to which the axis No. has been added to the address data from the line where the cursor is. The cursor moves to "Part system No " of that line.

(*1) Decimal, hexadecimal, floating point data and character string data writing is possible. Note that hexadecimal, floating point data and character strings may not be settable depending on the data.

Decimal: Integers without decimal points (Example) -1234

Hexadecimal: An "H" is necessary at the end (Example) 1234H

Floating point data: Data with a decimal point (Example) -12.3

Character string data: Character string (Example) X

10.4.3 Collecting the NC Data (Data Sampling Screen)



Sampling start/stop, sampling state display, setting the sampling parameters necessary for sampling are performed in the data sampling screen. The NC internal data (speed output from NC to the drive unit, or feedback data from the drive unit, etc.) can be sampled.

Also, the sampling data can be output externally on the I/O screen on the maintenance (Mainte) screen.

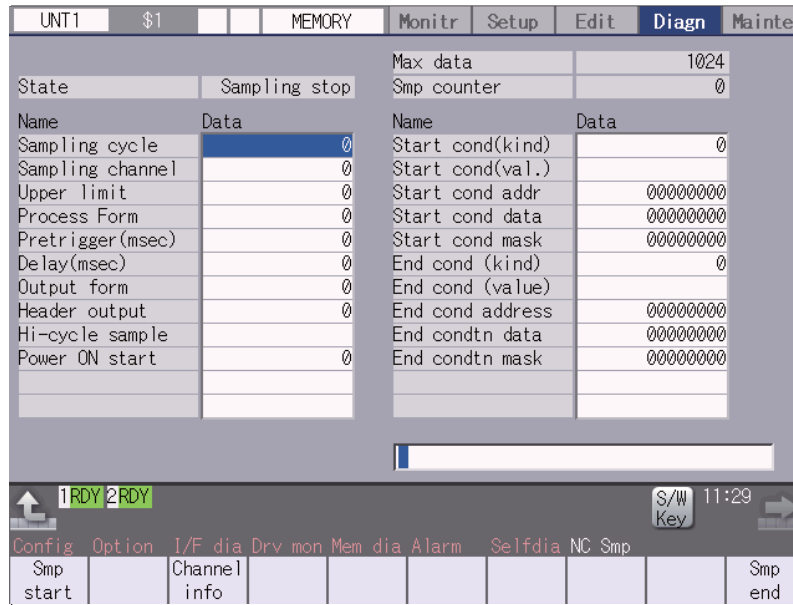

For the details, refer to "C80 Series Data Sampling Specification Manual (BNP-C3077-034)".

10.5 Safety Observation

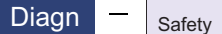

The configuration, signal status, drive status and version in use of the smart safety observation function are displayed on the safety observation screen.

10.5.1 Safety Observation Screen (Configuration Diagnosis)

The available/unavailable states of the smart safety observation function are displayed on the configuration diagnosis screen.

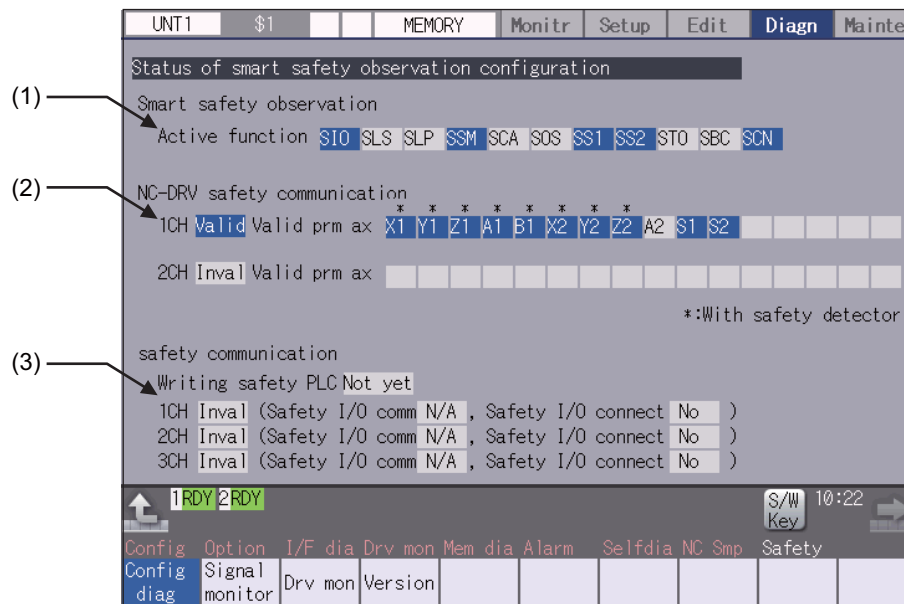

Display items

Display items	Details
(1) Active function	The drive safety functions which are enabled with the parameters are highlighted. SIO: Safety-related I/O observation, emergency stop observation SLS: Safety-limited speed observation SLP: Safety-limited position observation SSM: Safe speed monitor SCA: Safe cam SOS: Safe operating stop observation SS1: Safe stop 1 SS2: Safe stop 2 STO: Safe torque OFF SBC: Safe brake control SCN: Safety communication network
(2) NC-DRV safety communication	This displays the safety communication status of the drive unit. To perform the safety drive communication, the smart safety observation target axis needs to be set by the parameter, and the connected channel with the drive unit needs to be optical communication and configured only with drive units MDS-E Series. Valid prm ax: Out of the axes connected to each channel, the axes that the parameter "#51101 SF_Disable" (Disable smart safety observation) is OFF are highlighted. For the axis with safety encoder, "*" appears at the top of the axis name.

Display items	Details
(3) NC-I/O safety communication	<p>This displays the communication status of the safety I/O communication. To perform the safety I/O communication, at least one of remote I/O channels needs to be configured with the safety I/O devices (safety remote I/O unit, operation panel equipped with safety I/Os) and RIO2.0 unit alone.</p> <p>Writing safety PLC: This displays the status (Done/Not yet) whether the PLC ladder for safety is written.</p> <p>Safety I/O comm: "OK" is displayed when the channel is configured only with RIO2.0 units.</p> <p>Safety I/O connect: "Yes" is displayed when connected to the safety I/O devices (safety RIO unit, operation panel equipped with safety I/O).</p>

Menus

Menus	Details
Config diag	This switches the screen to the configuration diagnosis display of the smart safety observation.
Signal monitor	This switches the screen to the signal monitor display of the smart safety observation.
Drive monitor	This switches the screen to the drive monitor display of the smart safety observation.
Version	This switches the screen to the version display of the smart safety observation.
Servo unit	This switches the drive monitor diagnosis information to the servo unit information. Only when the drive monitor is displayed, the menu appears, and the operation can be performed.
Spindle unit	This switches the drive monitor diagnosis information to the spindle unit information. Only when the drive monitor is displayed, the menu appears, and the operation can be performed.
Next axis	This switches the axis to be displayed on the drive monitor. Only when the number of axes is five or more on the drive monitor screen, the menu appears, and the operation can be performed.

10.5.2 Safety Observation Screen (Signal Monitor)

The signal monitor screen displays the safety PLC signal status. The safety PLC signal displays both of the duplex PLC signals to identify the incongruous state. With the initial display, the input/output signal status from the device "X0000" is displayed on the left side and the input/output signals from the device "Y0000" is displayed on the right side.

Note that because time differences occur between the PLC signal change and the signal display, there may be a delay in the display. The machine may also not be able to correspond to extremely brief signal changes.

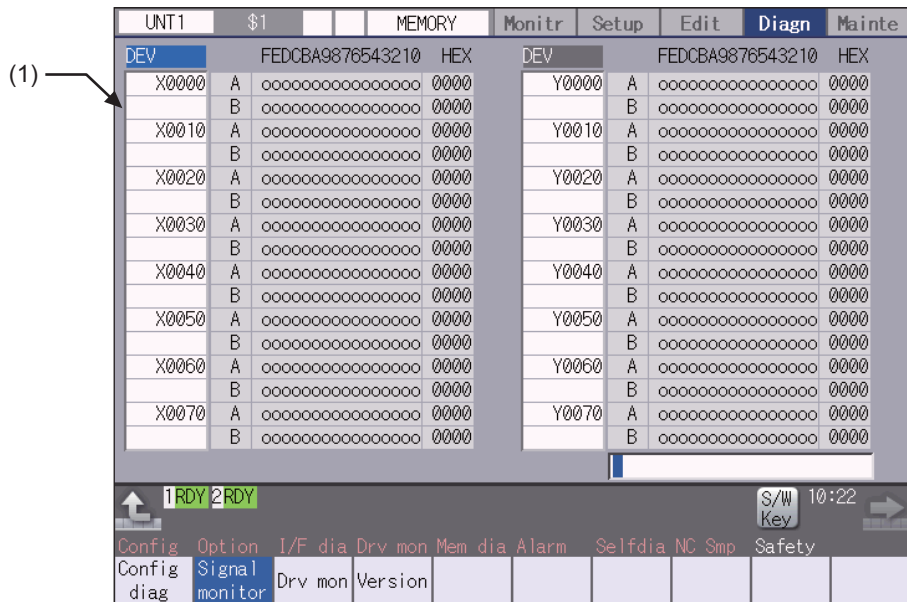

Display items

Display items	Details
(1) Device No. and input/output signal value (binary/hexadecimal display)	<p>This displays the duplex safety PLC signals (A, B) from the designated device No. in order.</p> <p>The input/output signal is displayed in binary and hexadecimal (bitwise).</p> <p>The device to be displayed can be switched individually for the left area and right area. The operation target (right or left) can be switched with the <input type="button" value="←"/> and <input type="button" value="→"/> keys. The head device and the operation target area are held until the power OFF.</p> <p>The displayable devices are X, Y, and ZR.</p> <p>If there is a comparison error with duplex safety PLC signals, the background color becomes yellow.</p>



List of displayable PLC devices

Devices	Device No.	No. of points	Units	Details
X	X0 to X1FF	512	1-bit	Input signals to PLC, machine input, etc.
Y	Y0 to Y1FF	512	1-bit	Output signals from PLC, machine output, etc.
ZR	ZR0 to ZR3071	3072	16-bit	File register, CNC word I/F

Displaying the PLC device input/output signal

To refer the arbitrary input/output signal status, enter the target device No. to the input area, and the display will be switched.

(Example) For displaying the input/output signal of the arbitrary device No. "X0020"

- (1) Press the tab key  or  to select the area where the data is displayed.
- (2) Set the device No. (X0020), and then press the [INPUT] key.

Note

- (1) Setting a device No. which exceeds the specification or setting an illegal address causes a setting error.

Changing the display with the page keys

The operation target device Nos. change in page unit when  /  is pressed. Changing of the pages stops within the range of device numbers of which the device has.

10.5.3 Safety Observation Screen (Drive Monitor)

The safety communication state with servo drive (NC axis, PLC axis) and spindle drive can be monitored. Only the safety drive communication parameter enabled axes are displayed on this screen.

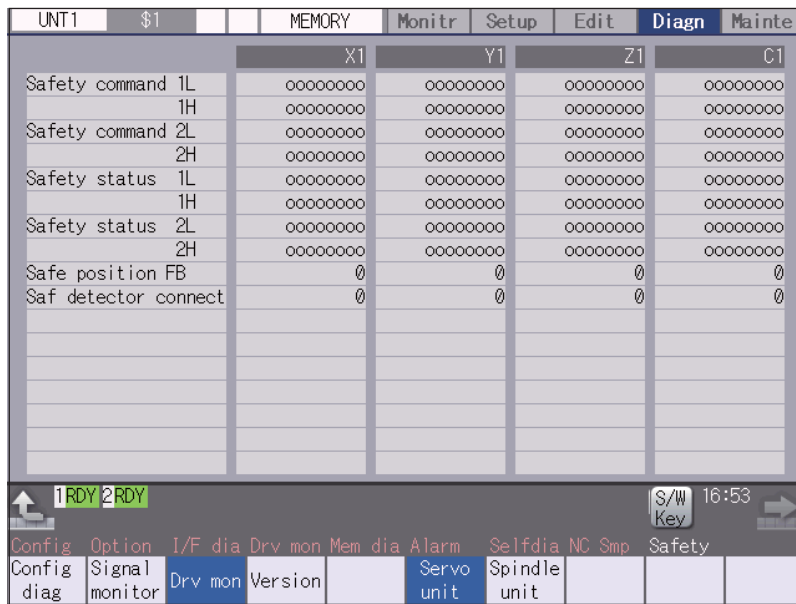

Display items

Display items	Details																																					
Safety command 1L	This displays the data sent to the drive. <table border="1"> <thead> <tr> <th></th> <th>Bit</th> <th>Details</th> </tr> </thead> <tbody> <tr> <td rowspan="7">1L</td> <td>0</td> <td>STO command (0: No command, 1: With command)</td> </tr> <tr> <td>1</td> <td></td> </tr> <tr> <td>2</td> <td></td> </tr> <tr> <td>3</td> <td></td> </tr> <tr> <td>4</td> <td></td> </tr> <tr> <td>5</td> <td></td> </tr> <tr> <td>6</td> <td></td> </tr> <tr> <td rowspan="9">1H</td> <td>7</td> <td></td> </tr> <tr> <td>8</td> <td></td> </tr> <tr> <td>9</td> <td></td> </tr> <tr> <td>A</td> <td></td> </tr> <tr> <td>B</td> <td></td> </tr> <tr> <td>C</td> <td></td> </tr> <tr> <td>D</td> <td></td> </tr> <tr> <td>E</td> <td></td> </tr> <tr> <td>F</td> <td></td> </tr> </tbody> </table>		Bit	Details	1L	0	STO command (0: No command, 1: With command)	1		2		3		4		5		6		1H	7		8		9		A		B		C		D		E		F	
		Bit	Details																																			
1L		0	STO command (0: No command, 1: With command)																																			
		1																																				
		2																																				
		3																																				
		4																																				
		5																																				
		6																																				
1H		7																																				
		8																																				
		9																																				
		A																																				
		B																																				
		C																																				
		D																																				
	E																																					
	F																																					
Safety command 1H																																						

Display items	Details																																								
Safety command 2L	<p>This displays the data sent to the drive.</p> <table border="1" data-bbox="515 277 1361 969"> <thead> <tr> <th></th> <th>Bit</th> <th>Details</th> </tr> </thead> <tbody> <tr> <td rowspan="5">2L</td> <td>0</td> <td></td> </tr> <tr> <td>1</td> <td></td> </tr> <tr> <td>2</td> <td>SBC command (0: No command, 1: With command)</td> </tr> <tr> <td>3</td> <td>SBC command for SBT (1CH side) (0: No command, 1: With command)</td> </tr> <tr> <td>4</td> <td>SBC command for SBT (2CH side) (0: No command, 1: With command)</td> </tr> <tr> <td></td> <td>5</td> <td></td> </tr> <tr> <td></td> <td>6</td> <td></td> </tr> <tr> <td></td> <td>7</td> <td></td> </tr> <tr> <td rowspan="8">2H</td> <td>8</td> <td></td> </tr> <tr> <td>9</td> <td></td> </tr> <tr> <td>A</td> <td></td> </tr> <tr> <td>B</td> <td></td> </tr> <tr> <td>C</td> <td></td> </tr> <tr> <td>D</td> <td></td> </tr> <tr> <td>E</td> <td></td> </tr> <tr> <td>F</td> <td></td> </tr> </tbody> </table>		Bit	Details	2L	0		1		2	SBC command (0: No command, 1: With command)	3	SBC command for SBT (1CH side) (0: No command, 1: With command)	4	SBC command for SBT (2CH side) (0: No command, 1: With command)		5			6			7		2H	8		9		A		B		C		D		E		F	
		Bit	Details																																						
2L	0																																								
	1																																								
	2	SBC command (0: No command, 1: With command)																																							
	3	SBC command for SBT (1CH side) (0: No command, 1: With command)																																							
	4	SBC command for SBT (2CH side) (0: No command, 1: With command)																																							
	5																																								
	6																																								
	7																																								
2H	8																																								
	9																																								
	A																																								
	B																																								
	C																																								
	D																																								
	E																																								
	F																																								
Safety command 2H																																									
Safety status 1L	<p>This displays the data received from the drive.</p> <table border="1" data-bbox="515 1043 1361 1680"> <thead> <tr> <th></th> <th>Bit</th> <th>Details</th> </tr> </thead> <tbody> <tr> <td rowspan="7">1L</td> <td>0</td> <td>STO status (0: No operation, 1: In operation)</td> </tr> <tr> <td>1</td> <td></td> </tr> <tr> <td>2</td> <td></td> </tr> <tr> <td>3</td> <td></td> </tr> <tr> <td>4</td> <td></td> </tr> <tr> <td>5</td> <td></td> </tr> <tr> <td>6</td> <td></td> </tr> <tr> <td></td> <td>7</td> <td></td> </tr> <tr> <td rowspan="7">1H</td> <td>8</td> <td></td> </tr> <tr> <td>9</td> <td></td> </tr> <tr> <td>A</td> <td></td> </tr> <tr> <td>B</td> <td></td> </tr> <tr> <td>C</td> <td></td> </tr> <tr> <td>D</td> <td></td> </tr> <tr> <td>E</td> <td></td> </tr> <tr> <td>F</td> <td></td> </tr> </tbody> </table>		Bit	Details	1L	0	STO status (0: No operation, 1: In operation)	1		2		3		4		5		6			7		1H	8		9		A		B		C		D		E		F			
		Bit	Details																																						
1L	0	STO status (0: No operation, 1: In operation)																																							
	1																																								
	2																																								
	3																																								
	4																																								
	5																																								
	6																																								
	7																																								
1H	8																																								
	9																																								
	A																																								
	B																																								
	C																																								
	D																																								
	E																																								
F																																									
Safety status 1H																																									



Display items	Details																																					
Safety status 2L	<p>This displays the data received from the drive.</p> <table border="1" data-bbox="555 277 1398 967"> <thead> <tr> <th></th> <th>Bit</th> <th>Details</th> </tr> </thead> <tbody> <tr> <td rowspan="6">2L</td> <td>0</td> <td></td> </tr> <tr> <td>1</td> <td></td> </tr> <tr> <td>2</td> <td>SBC status (0: No operation, 1: In operation)</td> </tr> <tr> <td>3</td> <td>SBC status for SBT (1CH side) (0: No operation, 1: In operation)</td> </tr> <tr> <td>4</td> <td>SBC status for SBT (2CH side) (0: No operation, 1: In operation)</td> </tr> <tr> <td>5</td> <td></td> </tr> <tr> <td rowspan="12">2H</td> <td>6</td> <td></td> </tr> <tr> <td>7</td> <td></td> </tr> <tr> <td>8</td> <td></td> </tr> <tr> <td>9</td> <td></td> </tr> <tr> <td>A</td> <td></td> </tr> <tr> <td>B</td> <td></td> </tr> <tr> <td>C</td> <td></td> </tr> <tr> <td>D</td> <td></td> </tr> <tr> <td>E</td> <td></td> </tr> <tr> <td>F</td> <td></td> </tr> </tbody> </table>		Bit	Details	2L	0		1		2	SBC status (0: No operation, 1: In operation)	3	SBC status for SBT (1CH side) (0: No operation, 1: In operation)	4	SBC status for SBT (2CH side) (0: No operation, 1: In operation)	5		2H	6		7		8		9		A		B		C		D		E		F	
	Bit	Details																																				
2L	0																																					
	1																																					
	2	SBC status (0: No operation, 1: In operation)																																				
	3	SBC status for SBT (1CH side) (0: No operation, 1: In operation)																																				
	4	SBC status for SBT (2CH side) (0: No operation, 1: In operation)																																				
	5																																					
2H	6																																					
	7																																					
	8																																					
	9																																					
	A																																					
	B																																					
	C																																					
	D																																					
	E																																					
	F																																					
	Safety status 2H																																					
	Safe position FB	This displays the encoder position information from the drive to NC.																																				
Saf detector connect	This displays the safety encoder connection status. 0: No connection 1: With connection																																					
Safety status 2L	This displays the data received from the drive.																																					

10.5.4 Safety Observation Screen (Version Display)

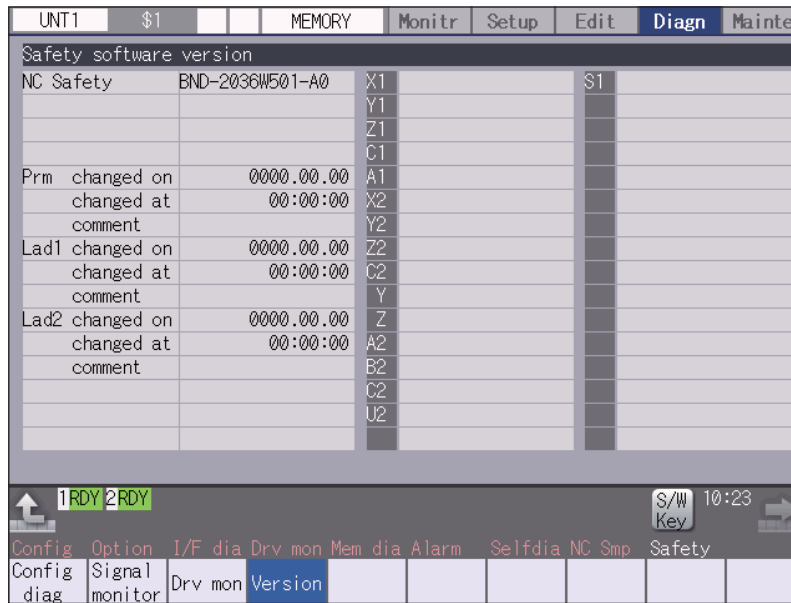
Software version about smart safety observation is displayed on the version display screen.



Display items

Display items	Details
NC Safety	This displays the smart safety observation software version of the NC system.
Parameters	This displays the safety parameter changed date and time, and comment.
Lad 1, 2	This displays the safety PLC ladder 1, 2 changed date and time, and comment.
Servo axis (up to 32 axes)	This displays the safety software version of servo axis. The version only for axis of the safety servo unit is displayed. Change the display item with  or  .
Spindle (up to 8 spindles)	This displays the safety software version of spindle. The version only for spindle of the safety spindle unit is displayed.

Performing a Backup Operation



The Input/Output screen of the maintenance (Mainte) screen is used to carry out NC data input/output between the NC internal memory and the external input/output devices.

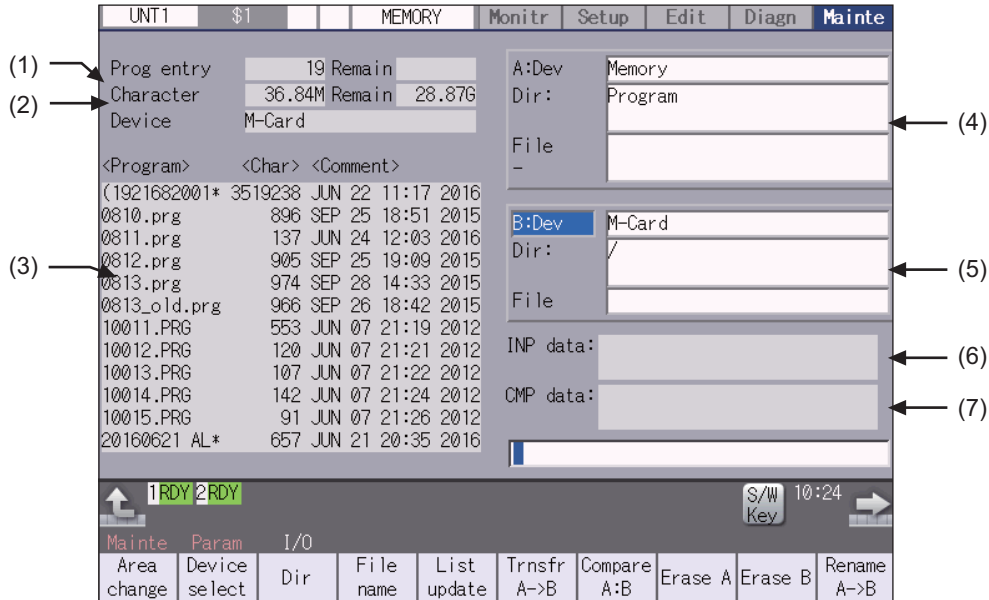

Display items

Display items	Details
(1) Number of programs registered and remainder (*1)	This displays the registration information of machining program of the selected device. Number of programs registered : This displays the number of programs previously registered as user machining programs. Remain: This displays the remaining number of programs that can be registered. When memory is selected as the device, the total of the number of programs registered and the remainder is the maximum number of registrations set in the specifications.
(2) Number of memory characters and remainder (*1)	This displays the number of characters of the machining program of the selected device. Number of memory characters: This displays the number of characters previously registered as user machining programs. Remain: This displays the remaining number of characters that can be registered. The total of the number of memory characters and the remainder is the maximum number of memory characters set in the specifications.

Display items	Details
(3) List	<p>This displays a contents list (directory and file name) of the directory in the setting column (file setting column A or B) where the cursor is currently located.</p> <p>Program: When "Memory" is selected for the device, this displays the file name (program No.) of the machining programs already registered.</p> <p>The file names are displayed in order from the smallest number, from 1 to 99999999.</p> <p>When a device other than memory is selected, this displays the file name and directory to be included in the directory that is set in the current setting column.</p> <p>When they exceed the displayable number of characters (12 characters), the excess is abbreviated and displayed (*).</p> <p>Character: The size of each file (when memory is selected for the device, the number of characters in the machining program).</p> <p>When directory is selected, this displays "DIR".</p> <p>Comment: This displays the comment (up to 17 alphanumeric characters and symbols) of each file.</p> <p>The date which the file is updated is displayed for the memory card or USB memory.</p> <p>When the number of characters exceeds 17, the excess is not displayed.</p>
(4) File setting column A	This sets the device, directory, and file name for which the transmission, compare, and erase functions are used.
(5) File setting column B	<p>When transferring, the file name of the transfer origin file is set. When renaming, the file name before renaming is set. When erasing, the erasing range is set.</p> <p>When the number of characters exceeds 28, the excess is not displayed.</p> <p>As for the device and directory, the setting values are retained even when the power is turned OFF. (*2)</p>
(6) Input data	This displays the data being transferred.
(7) Comparison data	This displays the data being compared. If an error occurs while comparing data, the block for which the error occurred is displayed.

(*1) Some items may not be displayed depending on the device.

○ : Displayed × : Not displayed

Display item/Device	Memory	Memory2	Memory card	USB memory
Number of programs registered	○	○	○	○
Remain	○	○	×	×
Number of memory characters	○	○	○	○
Remain	○	○	○	○
List	○	○	○	○

(*2) When the number of characters in the directory path (full path) from the root directory exceeds 100, the directory path is not retained, but a previously set directory path containing 100 characters or less retained.

When the device is "Memory", the initial directory display is "Program".

Menus	
Menus	Details
Area change	This changes the setting area to file setting column A (transfer origin) or file setting column B (transfer destination). The display of the valid area (A or B) is highlighted.
Device select	This displays the sub-menu of the machining program storage area. When the sub-menu is selected, the device is confirmed, and if a directory exists it is set in the root. The memory is selected as the default.
Dir	This menu sets the directory that carries out input/ output operations, and is on standby for input. Note that when memory is selected for the device, the directory can be selected from the sub-menu.
File name	This menu sets the file name that carries out input/ output operations, and is on standby for input. When memory is selected for the device, setting is not necessary if the directory is not the program.
List update	This updates the list. The list of the directly selected in the currently valid file setting column (A/B) is updated.
Trnsfr A->B	This copies the file in file setting column A (transfer origin) to the file setting column B (transfer destination). (The transfer origin file is not changed.) A message appears during transfer and when the transfer is completed.
Compare A:B	This compares the files in file setting column A (transfer origin) and file setting column B (transfer destination).
Erase A	This erases the file in file setting column A. <Note> •NC memory files other than the program cannot be erased.
Erase B	This erases the file in file setting column B. <Note> •NC memory files other than the program cannot be erased.
Rename A->B	This changes the name of the file in file setting column A (transfer origin) to the name of the file in file setting column B (transfer destination). <Note> •The same device must be selected for A and B. NC memory files other than the program cannot be renamed.
Comment switch	Pressing this menu switches display/non-display status and the display contents of the "Comment" column of the program list as follows: Program comment (*1) -> the last updated date/time of the file (*2) -> not displayed
Dir create	This creates a new directory in the directory of the currently valid file setting column (A/B). The directory can be created when the memory card or the USB memory is selected for the device.
Merge A->B	This adds the contents of the file in file setting column B to that of in file setting column A. (The file in file setting column B is not changed.) <Note> •NC memory files other than the program cannot be merged.
Stop	This interrupts the process (transfer, compare, etc.) during its execution.

(*1) When the selected device is [Memory card] or [USB Memory], the program comment is not displayed.

(*2) When the multi-part system program management is enabled (#1285 ext21/bit0 = 1) for the device [Memory], the last updated date/time of the file is not displayed.

When setting the file setting field A or B device, directory and file name on this screen, the area containing these must be valid.

The display area can be changed by pressing the menu key ([Area change]) or the cursor key [↑] and [↓].

After changing, the data setting operation is valid in that area.

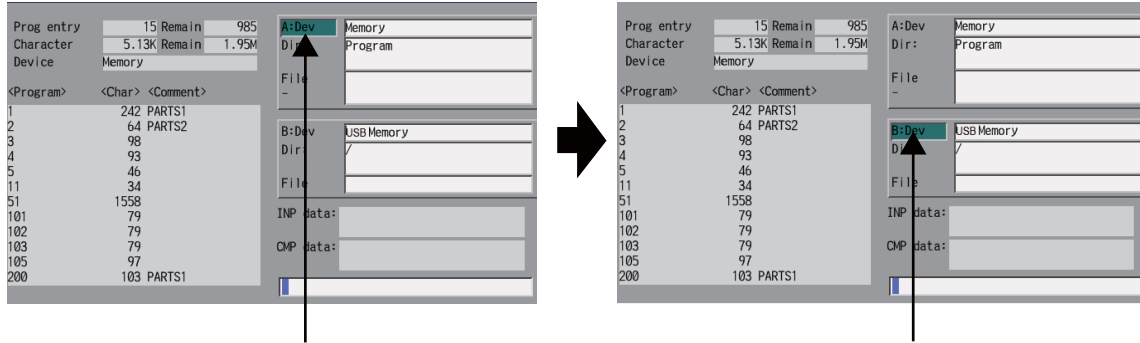

File setting column A is valid.

File setting column B is valid.

Changing the valid file setting field

When file setting column A (top) is valid

- (1) Press the menu [Area change].



The file setting column B (bottom) is validated.

This can also be changed with the cursor key [↓].

11.1 Selecting a Device, Directory and File



File selection sequence

Designate the device where the target file is located. → Select from the sub menu.





Designate the directory with a full path. → Input the full path or select from the list.



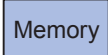
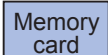

Designate the file name. → Input the file name or select from the list.

Menus

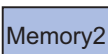
Sub-menus of [Device select]

Menus	Details
	This selects the NC memory (program, parameter, PLC program, NC data).
	This selects the back-side SD card of the GOT.
	This selects USB memory.
	This select the expanded area of NC memory. This menu is grayed out and non-selectable, when the specification of program memory capacity 1000kB[2560m] or 2000kB[5120m] is invalid.

Sub-menus of [Dir] (other than memory) and [File name]

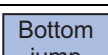
Menus	Details
	The cursor appears in the list display. The list contents can be selected with the [INPUT] key. When a directory is selected, the contents of the selected directory are displayed in the list. Continued selection is possible. When a file name is selected, the file name is temporarily displayed in the input area. When the [INPUT] key is pressed again, it is fixed.
	[In normal mode] The contents of the first page in the list are displayed. [When importing data from the list] The contents of the first page in the list are displayed, and the cursor moves to the top row.
	[In normal mode] The contents of the last page in the list are displayed. [When importing data from the list] The contents of the last page in the list are displayed, and the cursor moves to the bottom row.

Sub-menus of [Dir] (memory)

Menus	Details
Program	"Program" appears in the directory. The "File" column is blank.
Program all	"Program all" is displayed in the "Dir" column. The "File" column is blank.
Tool offset	"Tool offset" is displayed in the "Dir" column. "TOOL.OFS" is displayed in the "File" column.
Variabl	"Variable" is displayed in the Dir column. "COMMON.VAR" is displayed in the "File" column.
Coord offset	"Workpiece offset" is displayed in the "Dir" column. "WORK.OFS" is displayed in the "File" column.
All T data	"All tool data" is displayed in the "Dir" column. "TOOLALL.DAT" is displayed in the "File" column.
Param	"Parameter" is displayed in the "Dir" column. "ALL.PRM" is displayed in the "File" column.
System config	"System config" is displayed in the "Dir" column. "ASSEMBLY.INF" is displayed in the "File" column.
Safety param	"Safety parameter" is displayed in the "Dir" column. "SAFE PARA.BIN" is displayed in the "File" column.
Smp data	"Smp data" is displayed in the "Dir" column. "NCSAMP.CSV" is displayed in the "File" column.
System param	"System parameter" is displayed in the "Dir" column. "SYSTEM.PRM" is displayed in the "File" column.
Option	"Option" is displayed in the "Dir" column. "OPTION" is displayed in the "File" column.

The device can be selected from the sub-menu. (The devices that can be used will differ depending on the specifications.)
One of the following methods can be used to designate the directory (for devices other than the NC memory) and file name.

- Designate the directory path (full path) or file name in the input area and press the [INPUT] key.
- Press sub-menu [From list] of the menu [Dir] or [File name]. Move the cursor to the target directory or file name, and press the [INPUT] key.

A wildcard (*) can be used when selecting a file name.

Notes when selecting a file

- (1) During directory and file name setting, the designated directory, path or file name will be set, even if it does not actually exist. This will not cause an error. Note that the previously set directory is overwritten.
- (2) When a file in the NC memory other than a machining program is designated, it is not necessary to set the file name. (The file name is fixed.)
- (3) When a file name is selected from the menu, it first is displayed in the input area. However, at this time the file name has not yet been fixed. Press the [INPUT] key again to fix the file name.
- (4) If you press the  key when setting a file name, the file name in the input area is erased.
- (5) When selecting a fixed cycle program, it is necessary to set the basic common parameter "#1166 fixpro". Furthermore, select "Memory" for the device, and "Program" for the directory.

Selecting a NC memory program

- (1) Press the menu [Device select].
- (2) Press the menu [Memory].
- (3) Press the menu [File name].

- (4) Input the file name.
 <When inputting the file name from the input area>
 Input the file name.
 10013 [INPUT]

The selected file name appears.

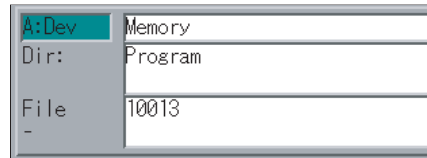

- <When selecting the file name from the list>
 Press the menu [From list].

The cursor appears in the list.

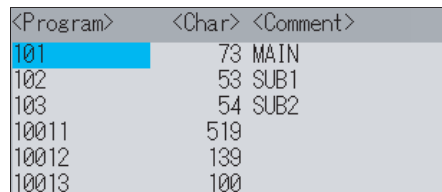

- (5) Move the cursor to the file name to be selected, and set.
 [↑], [↓] [INPUT]

Selected file name is displayed in the input area.



- (6) Press the [INPUT] key.

The selected file name appears.

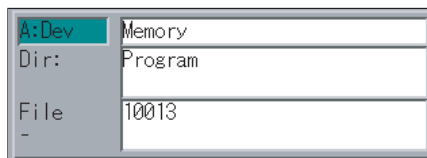

Designating multiple files

<Designating multiple serial files>

Multiple serial files can be transferred, compared and erased in the file setting column A. Set as follows in this case.

File name:
 (Upper row) First file name
 (Lower row) Last file name



A:Dev	Memory
Dir:	Program
File	10013
-	10050

<Using a wildcard>

A wildcard (*) can be used for the file name.

File: *
 -



All files will be selected.

A:Dev	Memory
Dir:	Program
File	*
-	

Selecting a file other than a program in NC memory

- (1) Press the menu [Device select].
- (2) Press the menu [Memory].
- (3) Select the menu [Dir].
- (4) Press the menu [Tool offset].



The directory and file name appear.

A:Dev	Memory
Dir:	Tool offset
File	TOOL.OFS
-	

Note

- (1) The file name for each directory is fixed. For the file name, refer to "11.8.2 List of File Names".
- (2) When the menu [Program] or [Program all] is selected, the setting of "File name" column is cleared.

Selecting a device file other than the NC memory (When separately selecting the directory and file name.)

- (1) Press the menu [Device select].
- (2) Select the device.
- (3) Select the menu [Dir].
- (4) Select a file.
 <When inputting the directory from the input area>
 Input the directory path as a full path.
 /PRG/PRECU T [INPUT]

<When selecting the directory from the list>
 Press the menu [From list].

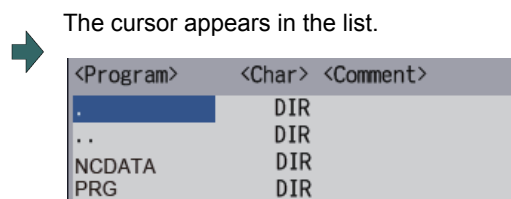

- (5) Move the cursor to the directory to be selected and set.
 [↑], [↓] [INPUT]
 Repeat this operation until the cursor arrives at the target directory.

 When the target directory is reached, press the key and quit the mode for inputting the directory.

→ The selected directory appears in the data setting column.
 The contents of the selected directory appear in the list.

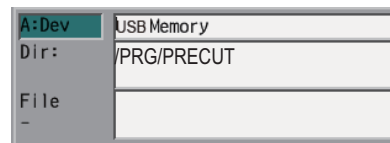

Note

- (1) Refer to next section "Selecting a device file other than the NC memory (When simultaneously selecting the directory and file name.)" procedure (3) or later for method of file designation.

Selecting a device file other than the NC memory (When simultaneously selecting the directory and file name.)

(1) Press the menu [Device select].

(2) Select the device.

(3) Press the menu [File name].

(4) Select a file.

<When inputting the file name from the input area>

Input the file name.

10013 [INPUT]



The selected file name appears.

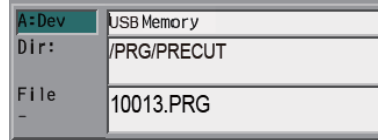

<When selecting the file name from the list>

Press the menu [From list].



The cursor appears in the list.

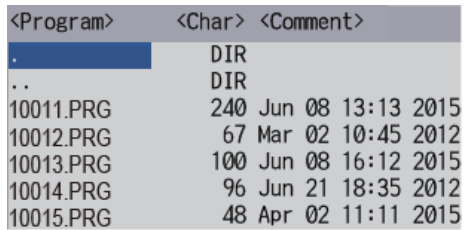

(5) Move the cursor to directory and file name to be selected, and set.

[↑], [↓] [INPUT]

This operation is repeated until the cursor reaches the file. When only the directory is selected and key is pressed, select the file name separately.

(6) Press the [INPUT] key.



The selected file name appears.

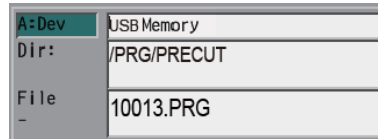

Canceling the input mode

(1) Press the [Device Select], [Dir] or [File name].

(2) Press the  key.

11.2 Transferring a File

Mainte

—

I/O

Operation method

- (1) Press the menu [Area change] to select file setting column A.
- (2) Designate the transfer source device, directory and file name.

➔ The designated file appears.
Multiple files can be designated in the file setting column A. Designate the first and last file name of the target range. A wildcard "*" can be designated for the file name.
- (3) Press the menu [Area change] to select file setting column B.
- (4) Designate the transfer destination device, directory and file name.
- (5) Press the menu [Trnsfr A->B].
- (6) Press the [Y] or [INPUT] key.



CAUTION



" ; ", "EOB", "%", and "EOR" are symbols used for explanation. The actual codes for ISO are "CR, LF" ("LF") and "%". "%", "EOB", and "EOR" are represented by "%" in ISO. The programs created on the edit screen are stored in the NC memory in a "CR, LF" format, however, the programs created with external devices may be stored in an "LF" format. The actual codes for EIA are "EOB (End of Block)" and "EOR (End of Record)".



To prevent influence from data omission and data transformation in the communication circuit, always verify the data after inputting and outputting machining programs.

Precautions

■Notes related to transferring in general

- (1) Depending on the type of file, some data cannot be transferred during automatic operation. Do not transfer during automatic operation.
- (2) When the capacity of the transfer destination is reached during file transfer, only the data transferred up to that point is registered as a file, and an error will occur.
- (3) During input to the NC memory or comparison, if the file format size on the NC memory side differs from the other side file format size (when the maximum number of registrations differs between the NC memory and the other side), processing is carried out matched to the smaller size.
(Example 1) If a format size of 200 files is input for a format size of 1000 NC files, 200 files are registered.
(Example 2) If 1000 files are input to the NC that formatted for 200 files, the files up to the 200th file can be registered and an error message appears. (The remaining files are not registered.)
- (4) Do not perform any file operation on the transfer source and destination files during the file transfer. The file may be damaged with the file operation.

■Notes when transferring machining program files

- (1) The transfer speed is slower if there are many registrations.
- (2) The size of one block of the machining program should be 250 characters or less.
- (3) The characters that can be used for the file name and directory path are 1-byte number, 1-byte capital alphabetical letters, and 1-byte symbols recognized by the system.
Note that the following characters cannot be used.
, /, :, ", " (comma), *, ?, ", <, >, a to z (small letters), space
Up to 32 characters are allowed for the file name to create in or transfer to NC memory.
- (4) If the file whose name includes lower case alphabet is transferred to NC memory, the lower case letter will be converted into the capital letter.
- (5) When the MTB macro and fixed cycle program are input to NC memory, change the program type with the parameter "#1166 fixpro". Also, set in the Input/Output screen as follows:
Device: Memory, Directory: Program
- (6) With machining program created before the MELDAS500 Series, "EOB" is registered as "LF". However, "EOB" will be converted to "CR LF", and the number of characters will increase in this Series. Thus, when all of the machining programs output from an MELDAS500 Series or earlier NC, having the same specifications as the maximum memory capacity, are stored in this Series, the memory capacity may be exceeded.
- (7) If the file to be transferred (input) is running or in "program restarting" mode, the operation message "Executing automatic operation" or "Program restarting" is displayed, and the file will not be transferred (input).
- (8) When the parameter "#8936 Delete leading 0" is set to "1", the file consisting only of numerical figures will be transferred with the "0" at the head deleted. For details, refer to "4.8.6 Leading Zero".
- (9) When the multi-part system program management is valid (#1285 ext21/bit0 =1) and "#1285 ext21/bit2" (Multi-part system program generation and operation) is set to "1", the file transfer to the device [Memory] from the other device is executed with the machining programs in only displayed part system. In other cases, the machining programs are transferred across all part systems in batch.
- (10) When the multi-part system program management is valid (#1285 ext21/bit0 =1) and "#1286 ext22/bit5" (Selection of multi-part system program input/output method) is set to "1", the file transfer from the device [Memory] to the other device is executed with the machining programs in only displayed part system. In other cases, the machining programs are transferred across all part systems in batch.
- (11) The transfer range from the external device to NC memory will change depending on the value set in the parameter "#19006 EOR Disable".
<When the parameter "#19006 EOR disable" is set to "0">
The head line will not be transferred.
Up to "%" in the second line onward will be transferred, and data after "%" will not be transferred.
If there is no "%", all data will be transferred.
<When the parameter "#19006 EOR disable" is set to "1">
All file contents will be transferred.

- (12) If the file to be transferred (input) is targeted for edit lock (edit lock B: 8000 to 9999 or edit lock C: 9000 to 9999), the message "Edit lock B" or "Edit lock C" is displayed, causing a transfer failure.
If the program name is input with only numbers when the parameter "#8936 Delete leading 0" is set to "1", the program is checked with the leading zero deleted. (Example: If the file name to be transferred (input) is designated by "008000" while edit lock B is enabled, the message "Edit lock B" is displayed, causing a transfer failure.)
- (13) Multiple successive files or wildcard (*), if designated, is transferred, excluding the programs to be edit-locked, to suit the status of edit lock B or C.
- (14) If the device shown below and the directory are designated for the destination to transfer a file, the following operation is performed depending on conditions.
- ◆When an existing file is designated: The file is transferred with a temporary file name, and changed to the designated file name after transfer processing has been completed.
 - ◆When a new file is designated: A new file is transferred with a temporary file name, and changed to the designated file name after transfer processing has been completed.
- (1) [B:Dev]: Memory, Memory2
Directory: Machining program
- (2) [B:Dev]: Memory card, USB memory
- A temporary file is designated by the file name that consists of 11 digits, beginning with the symbol "~".
- After transfer is terminated properly, the temporary file is changed to the designated file name.
- A temporary file remains in the cases below, but can be deleted in the same way as for a normal file.
- ◆When the transfer has terminated abnormally, for example, because the destination's capacity became full.
 - ◆When the transfer has been interrupted.

■Notes when transferring tool offset data files

- (1) If an error occurs during offset data transfer, an error message appears on the screen, and the transfer operation is interrupted.

■Notes when transferring parameter files

- (1) In the same manner as when setting in the Parameter screen, there are parameters validated immediately after input, and parameters validated after a restart. Restart when a parameter file has been transferred to the NC memory.
- (2) When a parameter file is transferred to the NC memory, the setting value of the input/output parameters is also changed. Before transferring next time, set the parameters again.

■Notes when transferring common variable data files

- (1) If the variable value is 10000 or more or less than 0.0001 when transferring common variable data, it is expressed with an exponential expression.

■Notes when transferring all tool data files

- (1) When tool life data is output from the NC memory, the tool information data, tool compensation data, and custom data allocation information are output per section.
- Tool information data section: [TOOLINF_L1] (Tool life management I), [TOOLINF_L2] (Tool life management II), [TOOLINF_M] (Tool life management M system)
- Tool compensation data section: [TOOLOFS]
- Custom data allocation section: [CUSTOM]

■Notes when transferring sampling data file

- (1) When the output form is set as 8-digit hexadecimal number and the parameter "#1004 ctrlunit" is set to "E (1nm)", accurate data can be output just within 1 m. When the output data length exceeds 1 m, lower 32 bits of the sampling data will be output.
- (2) Sampling data file can be transferred from NC memory to an external device (output) but cannot be transferred from an external device to NC memory (input).

11.3 Comparing Files (Compare)

Mainte

—

I/O

Operation method

- (1) Press the menu [Area change] to select file setting column A.
- (2) Designate the device, directory and file name to be compared.
- (3) Press the menu [Area change] to select file setting column B.
- (4) Designate the other device, directory and file name to be compared.
- (5) Press the menu [Compare A:B].



The file comparison starts.

The verifying data is displayed.

A message appears when the comparison is completed. If a comparison error occurs, the block with the error is displayed in the comparison data display column on the screen.

```
INP data: (MAIN);G28XYZ;G00X10.;N1X20.  
;X30.;X40.;N2X50.;M98P102H1;  
CMP data: (MAIN);G28XYZ;G00X10.;N1X20.  
;X30.;X40.;N2X50.;M98P103H1;
```

Note

- (1) Files that can be compared are text files only. Correct outcome will not be obtained through binary file comparison.
- (2) "0" at the head of the file name will not be deleted when checking the individual file which consists of one program in one file even the parameter "#8936 Delete leading 0" is set to "1". Designating the file name is required.
- (3) When multiple successive files or wildcard (*) are/is designated as the transfer source, the comparison is executed excluding the programs which are subject to the edit lock according to the status of Edit lock B and C.
- (4) If you attempt the file comparison during the tool data sorting, the operation message "Can't open file for dev A (or B)" appears, which disables the comparison.

11.4 Erasing a File

Mainte

—

I/O

Operation method (Erasing a file in file setting column A)

- (1) Press the menu [Area change] to select file setting column A.
- (2) Designate the device, directory and file name to be erased.
- (3) Press the menu [Erase A].
- (4) Press the [Y] or [INPUT] key.



The file is erased.

A message appears when the erasing is completed. The number of programs registered, number of memory characters and remainder reappear. Press the menu [List update] to update the list.

Note

- (1) If the file to be erased is running or in "program restarting" mode, the operation message "Executing automatic operation" or "Program restarting" is displayed, and the file will not be erased.
- (2) When a wildcard "*" is designated for the file to be erased, the erasing is executed excluding the programs which are subject to the edit lock according to the status of Edit lock B and C.

Operation method (Erasing a file in file setting column B)

The operations are the same as method "Erasing a file [Erase A] " above. Designate the target device, directory and file name in the file setting column B, and press the menu [Erase B].

11.5 Changing a File Name (Rename)

Mainte

—

I/O

Operation method

- (1) Press the menu [Area change] to select file setting column A.
- (2) Designate the original device, directory and file name.
- (3) Press the menu [Area change] to select file setting column B.
- (4) Designate the new device, directory and file name.
- (5) Press the menu [Rename A->B].
- (6) Press the [Y] or [INPUT] key.

Note

- (1) Make sure the original and new devices are the same.
- (2) If the file to be renamed is running or in "program restarting" mode, the operation message "Executing automatic operation" or "Program restarting" is displayed, and the name will not be changed.
- (3) If a file that does not exist is designated for the original file, or if an existing file name is designated for the new file selection, an error occurs, and the name is not changed.

11.6 Creating a Directory

Mainte

—

I/O

Operation method

- (1) Press the menu [Area change] to select the file setting column A.
- (2) Designate the device.
- (3) Designate the directory where the new directory is to be created.
- (4) Set the new directory in the file setting column A.
- (5) Press the menu [Dir create].



The designated details appear.

The devices that can create a directory are memory card and USB memory.

The directory can also be created in file setting column B.

11.7 Restrictions

- (1) When multiple files are transferred to NC memory, a file in edit lock mode is not transferred, and other files are transferred.

11.7.1 Device Definition

- (1) If a USB memory device formatted over FAT32 is used, it may cause a file reading and writing failure.
Use a USB memory device that is formatted with FAT32.
- (2) If a USB memory device is removed or inserted while data is being transferred to it, data integrity cannot be guaranteed.
While message "Now, transferring data" or "Now, formatting data" is being displayed, do not remove or insert the USB memory device.
After message "Transfer completed" or "Formatting completed" has been displayed, remove or insert the USB memory device.

11.7.2 List Display

- (1) If the number of full path characters exceeds 128 when the directory is being moved, it results in a movement failure.
- (2) In the NC memory, you cannot use the cursor movement key or [INPUT] key to move the directory.
- (3) The directory name must be designated using less than 100 characters. If the directory name is designated using 100 or more characters, it will not be recognized as the directory name.
- (4) If a directory that contains a double-byte code file name such as a Japanese file name is displayed in list view, such a double-byte code file name is not displayed correctly. In addition, the number of file characters, comments, and number of stored characters is not displayed correctly.

11.7.3 Program Name

The following restrictions are applied to the file name that can be created and transferred in NC memory.

- (1) The file name must be designated using up to 32 characters, including an extension.
- (2) Single-byte digits, single-byte uppercase alphabet characters, and Windows-recognizable single-byte symbols are available for the file name or directory name. Therefore, a double-byte code file name such as a Japanese file name cannot be used.
- (3) Edit lock B, edit lock C, and program display lock are available only for files that have the file name designated only by single-byte digits in the NC memory.

Example: When edit lock B (8000 to 9999) is enabled:

File name	Feature	Change
8000	Single-byte digits only	Disabled
8000.PRG	With extension	Enabled
08000	Single-byte digits only, beginning with "0"	Enabled
8000A	With characters other than digits	Enabled

- (4) The following names cannot be used as file names.
 - ♦File name with extension "\$\$\$", "\$\$0", "\$\$1", "\$\$2", "\$\$3", "\$\$4", "\$\$5", "\$\$6", "\$\$7", "\$\$8", or "\$\$9"
 - ♦"0" (File named "single-byte zero")

11.8 Other Functions

11.8.1 Merging a File



Operation method

- (1) Press the menu [Area change] to select file setting column A.
- (2) Designate the merge destination device, directory, and file name.
- (3) Press the menu [Area change] to select file setting column B.
- (4) Designate the merge source device, directory, and file name.
- (5) Press the menu [Merg B->A].
- (6) Press the [Y] or [INPUT] key.

➔ A message appears when the merge is completed. The details of the file in file setting column A will be as follows when the merge is completed.

```
(FILE A)
G28 XYZ
G90 F800
G00 X100. Y100.;
(FILE B)
G91 G28 XYZ
F1000;
G01 X200. Y200.;
M02;
%
```

Details of file in file setting column A before merge.

Details of file in file setting column B before merge.

The details of the file in file setting column B do not change.

Note

- (1) If the merge destination file (file in file setting column A) is running or in "program restarting" mode, the operation message "Executing automatic operation" or "Program restarting" is displayed, and the files will not be merged.
- (2) When the parameter "#19006 EOR Disable" is set to "1", a file is merged as it is. But the terminal character of the merge destination file (file in file setting column A) is "%", a line feed code is added and then merged.
- (3) Do not perform the file operation on the merge source and destination files during the merge. The file may be damaged with the file operation.

11.8.2 List of File Names

There is a directory for each type of data in the device [Memory].

Each directory and file name (fixed) in the device is shown below.

Do not change the extensions (.XXX) when storing in a device other than [Memory].

Data type	NC memory directory path	Fixed file name
Machining program	/PRG/USER	(Program No.)
Fixed cycle program	/PRG/FIX	(Program No.)
MTB macro	/PRG/MMACRO	(Program No.)
MDI	/PRG/MDI	(Program No.)
Parameters Parameters [User, machine] (Text format) System parameter Safety parameter file	/PRM	ALL.PRM SYSTEM.PRM SAFEPARA.BIN
User PLC Safety ladder 1 Safety ladder 2	/LAD	SAFEPLC1.LAD SAFEPLC2.LAD
NC data Tool compensation amount data All tool data Common variable data SRAM data Workpiece offset data	/DAT	TOOL.OFS TOOLALL.DAT COMMON.VAR SRAM.BIN WORK.OFS
System configuration data	/DGN	ASSEMBLY.INF
APLC data	/APLC	APLC.BIN
Sampling data (binary) History data All history Key history Alarm history Touch history	/LOG	NCSAMP.CSV NCSAMP.BIN ALLLOG.LOG KEYLOG.LOG ALMLOG.LOG TOUCHLOG.LOG

11.8.3 Edit Lock B and C

This function prohibits editing, erasing, etc., of the machining programs B and C, and protects the machining programs in the device [Memory].

Machining program	Edit Lock B	Edit Lock C
A 1 to 7999 10000 to 99999999	---	---
B (user standard program) 8000 to 8999	Editing prohibited	---
C (MTB custom) 9000 to 9999	Editing prohibited	Editing prohibited

The operations below in the Edit MDI and the Input/Output screens are influenced by the edit lock setting.

An error will occur if operations that are not possible are attempted.

When the edit lock is valid, processing is executed (except the edit lock target program) by the input/output function.

○: Operation possible ×: Operation not possible

Screen	Operation	Edit Lock B			Edit Lock C		
		Machining program			Machining program		
		A	B	C	A	B	C
Edit	Search	○	○	×	○	○	×
	Edit	○	×	×	○	○	×
	MDI registration	○	×	×	○	○	×
Input/Output	Transfer	○	×	×	○	○	×
	Compare	○	×	×	○	○	×
	Copy	○	×	×	○	○	×
	Merge	○	×	×	○	○	×
	Rename	○	×	×	○	○	×
	Erase	○	×	×	○	○	×
Monitor	Buffer correction	○	×	×	○	○	×

Note

- (1) When the multiple part system specification is valid, the machining programs of all the part systems are protected by edit lock B and C.
- (2) When multiple serial files or a wildcard (*) is designated for input/output function, programs except subject to edit lock will be processed.
- (3) When a multiple programs are input to the memory without designating the file name like program batch input, the message "Edit lock B" or "Edit lock C" will be displayed and the input will be interrupted if the program which is subject to edit lock is detected.

11.8.4 Data Protection Keys

Data protection key prevents various data from being set or erased.

The key name differs according to the MTB. Refer to the instruction manual issued by the MTB for details.

The following data can be protected with the data protection key:

- All tool data and the coordinate system preset data using the origin set
- User parameters and common variables
- Machining programs

The data protection key is enabled to prohibit the setting, erasing, etc. while the PLC signal is OFF (B contact). Data protection key has higher protection level than that of Data protection by user's level.

11.8.5 The Batch Input/Output the Machining Program of NC Memory



One file which consists of two or more machining program can be transferred to NC memory by dividing the file. The machining programs united with one file can be transferred to the external device.

The targets are the machining programs of the user.

Batch input and verify to NC memory

Example of "the external device -> NC memory" of machining program batch transfer

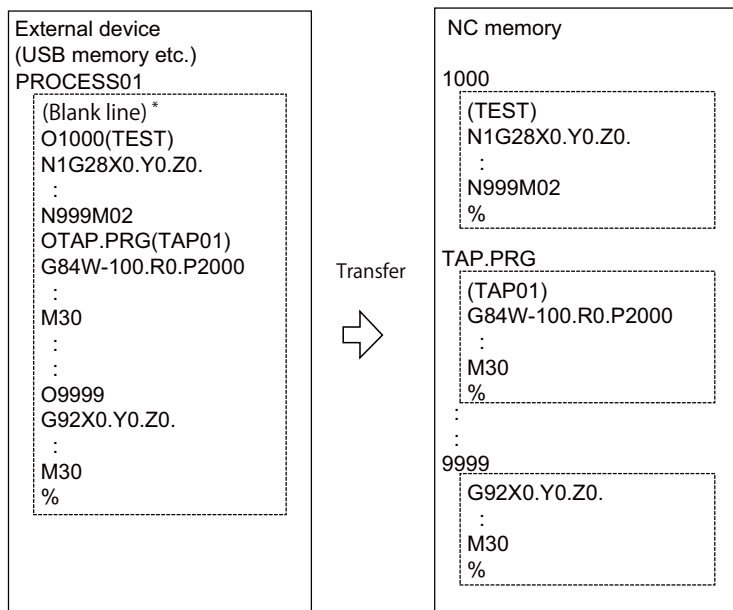

When the transfer direction file name is designated, the top program name of transfer source can be omitted. ("O1000" can be omitted in above example.)

- (1) Press the menu [Area change] to select file setting column A.
- (2) Designate the transfer source device and directory.
- (3) Designate the file which consists of two or more machining programs.
- (4) Press the menu [Area change] to select file setting column B.
- (5) Designate the transfer direction device (memory).
- (6) Press the menu [Dir] - [Program all].
When the file name is designated, only the top program of transfer source is stored in the designated file.
For example of "Example of "the external device -> NC memory" of machining program batch transfer", when "TEST-CUT" is designated as the transfer direction file name, the top program is transferred as not "1000" but "TESTCUT".
- (7) Press the menu [Trnsfr A->B].
- (8) Press the [Y] or [INPUT] key.
When the same machining program already exists in transfer direction device, the operation message "Overwrite this file?(Y/N)" appears.
The transferring the following program is continued by selecting [Y] or [N] key.
- (9) Press the menu [Compare A:B].

Note

- (1) When programs are input in a batch to NC memory, always specify "Program batch" to NC memory directory as transfer direction. If "Program batch" is not specified, one file is transferred (No batch).
- (2) When the program which is subject to edit lock exists in transfer source, the message "Edit lock B" or "Edit lock C" appears, and transfer is interrupted. When the program which is not subject to edit lock is transferred, delete the program which is subject to edit lock in transfer source. (Refer to "11.8.3 Edit Lock B and C".)
- (3) When the protection of the machining program is valid, the program cannot be transferred/verified. (Refer to "11.8.4 Data Protection Keys".)
- (4) During the automatic operation, the program in program restart cannot be overwritten. The operation message "Executing automatic operation" or "Program restarting" appears, and transfer is interrupted.
- (5) The first line of the transfer source file is ignored.

Batch output and verify from NC memory

Example of "NC memory -> the external device" of machining program batch transfer

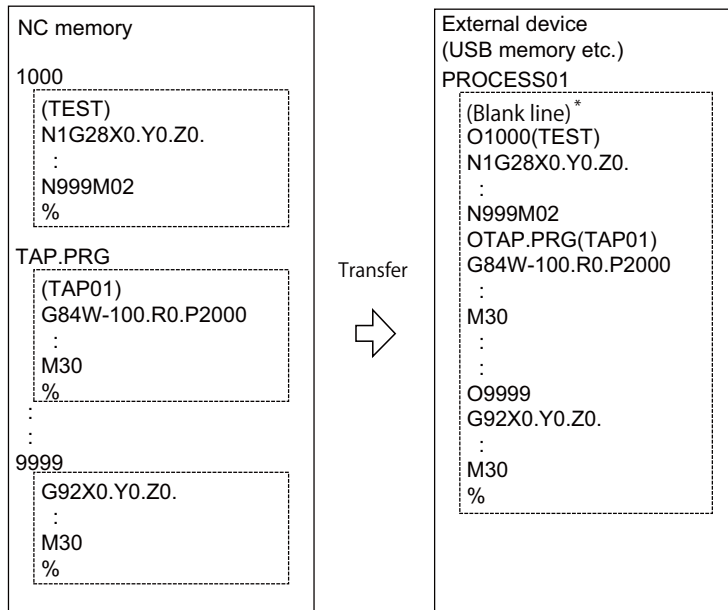

- (1) Press the menu [Area change] to select file setting column A.
- (2) Designate the transfer source device (memory).
- (3) Press the menu [Dir] - [Program all].
Do not specify the file name. If the name is specified, an error will occur.
- (4) Press the menu [Area change] to select file setting column B.
- (5) Designate the transfer direction device and directory.
- (6) Designate the transfer direction file to input multiple machining programs.
When the file name is not designated, output to the file "ALL.PRG" of the designated directory.
- (7) Press the menu [Trnsfr A->B].
- (8) Press the [Y] or [INPUT] key.
When the same machining program already exists in transfer direction device, the operation message "Overwrite this file?(Y/N)" appears.
The transferring the following program is continued by selecting [Y] or [N] key.
- (9) Press the menu [Compare A:B].

Note

- (1) When programs are output in a batch from NC memory, always specify "Program batch" to NC memory directory as transfer source. If "Program batch" is not specified, the program is transferred by one program per one file.
- (2) When the programs which are subject to edit lock exists in NC memory, those file is not transferred. (The files are transferred excluding those files.) The verification is executed excluding the programs which are subject to edit lock. (Refer to "11.8.3 Edit Lock B and C".)
- (3) When the protection of the machining program is valid, the program cannot be transferred/verified. (Refer to "11.8.4 Data Protection Keys".)

Precautions

- (1) When the machining program batch input/output function of NC memory is used, "(" cannot be used for the machining program name. It is recognized that the inside of "(" is a comment.
- (2) The file name of file which consists of two or more machining program can have up to 32 characters, including the extension as well as the machining program.
- (3) When the "Program batch" is designated to NC memory directory, it is not possible to delete, rename and merge files. When the files are deleted in a batch, use "Program" for directory, and a wildcard (*) for file name.
- (4) For other precautions, refer to "11.2 Transferring a File".

11.9 Performing Backups of NC Memory Data

Using the backup/restoration function of the GOT, the data of the NC memory can be backed up in the external device. Also, the data can be restored from the external device to the NC memory. This section explains the procedures to backup/restore the data using the front-side USB drive of the GOT.

The target data for the backup/restoration are as follows:

○: Targeted

×: Not targeted

Data outline	File name	Backup	Restoration
System file	SYSPRM.BIN	○	○
Parameters	ALL.PRM	○	○
Machining program	ALL.PRG	○	○
	ALL2.PRG (*2)	○	○
MTB macro program	MACROALL.BIN	○	○
MDI program	MDIALL.PRG	○	○
Tool offset data	TOOL.OFS	○	×
Tool all data files	TOOLALL.DAT	○	○
Workpiece offset data	WORK.OFS	○	○
Common variable	COMMON.VAR	○	○
Safety parameters (*1)	SAFEPARA.BIN	○	○
Safety ladders (*1)	SAFEPLC1.LAD	○	○
	SAFEPLC2.LAD		
APLC load module	APLC.BIN	○	○
System data	SRAM.BIN	○	×

(*1) When the parameter "#1481 Enable S-safety" (Enable smart safety observation) is set to "1", and when restoring the safety parameters and the safety ladders, release the safety password with the parameter "#51013 SF_PSWD". If the safety password is not released, these files will not be restored (the restoration will be skipped). When the safety password of the CNC does not match that of the target file for the restoration, an error will occur during the restoration even though the safety password has been released.

(*2) This file is valid when the specification of program memory capacity is 1000kB[2560m] or 2000kB[5120m].

Note

- (1) Make sure to complete the editing of the machining program or the data setting operation before performing the backup/restoration.
- (2) When the parameter "#1391 User level protect" (Enable Data protection by user's level) is set to "1", release the protection before operating the backup/restoration.

Operation method for backup

- (1) Insert a USB memory in the front-side USB drive of the GOT.
- (2) Press the screen at the top left to open the utility screen.
- (3) Press [Data mng.] tab -  (Backup restoration).

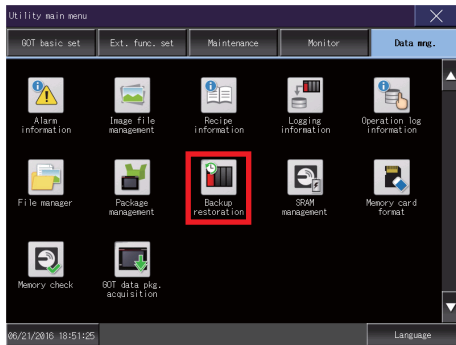

- (4) Press  (Backup function).
When the confirmation message appears, press [OK] to start the backup.

➔ CPU modules are selected and displayed automatically. The backup files will be created. The file names will be displayed automatically.

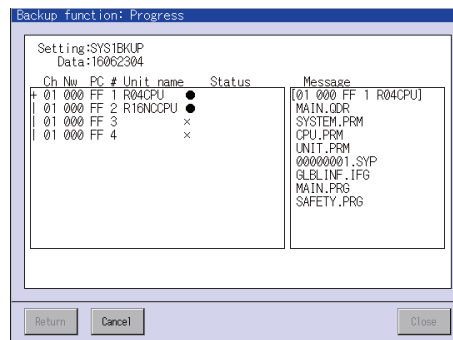
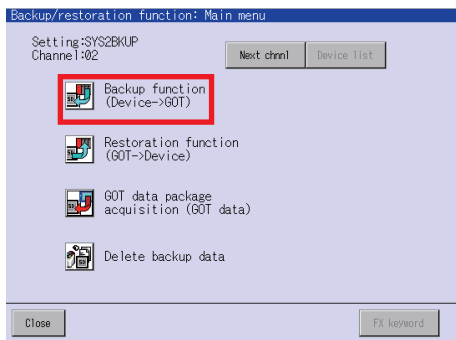



- (5) When the completion window appears, press [OK].
- (6) Remove the USB memory from the front-side USB drive of the GOT.

Operation method for restoring

- (1) Insert a USB memory with the backup data in the front-side USB drive of the GOT.
- (2) Press the screen at the top left to open the utility screen.

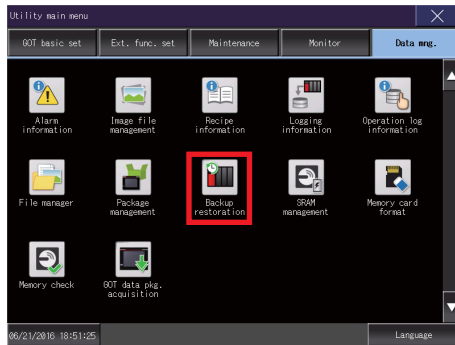
- (3) Press [Data mng.] tab -  (Backup restoration).



- (4) Press  (Restoration function).

When the device selection screen appears, select the restoration target device.



The files in the USB memory are displayed in "Data list".

<Note>

- Data name displayed in the "Date list" column indicates the date of backup and the number of backups.
 (Example) The data backed up on 2016/04/05 is displayed as follows.
 16040500 (1st backup)
 16040501 (2nd backup)

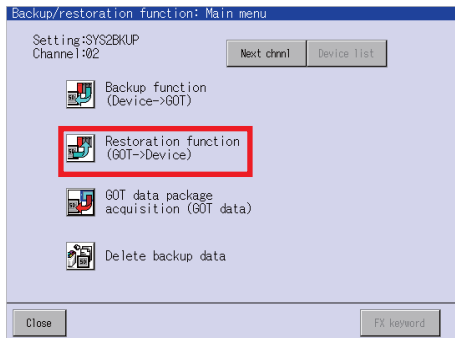

- (5) Select the data to restore and the device and then press [Execute].

When the confirmation message appears, press [OK] to start the restoration.

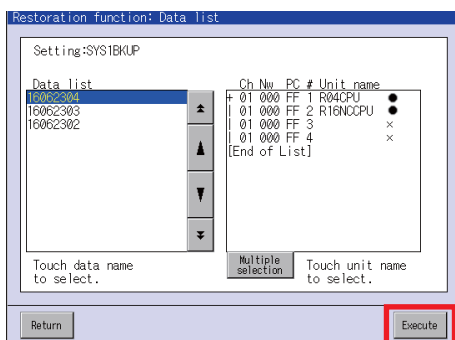

- (6) When the completion window appears, press [OK].

- (7) Remove the USB memory from the front-side USB drive of the GOT.

Appendix 1: List of Function Codes

Function code ISO	Control unit recognition	PARITY V	Screen display	Setting and display unit	In memory	Punch-output	Internal NC system function
		V count		Key-in	Store	ISO	
0 to 9	Yes	Counted	Displayed	Key-in	Stored	0 to 9	Numerical data
A to Z	Yes	Counted	Displayed	Key-in	Stored	A to Z	Addresses
+	Yes	Counted	Displayed	Key-in	Stored	+	Sign, variable operator (+)
-	Yes	Counted	Displayed	Key-in	Stored	-	Sign, variable operator (-)
.	Yes	Counted	Displayed	Key-in	Stored	.	Decimal point
,	Yes	Counted	Displayed	Key-in	Stored	,	
/	Yes	Counted	Displayed	Key-in	Stored	/	Block delete (optional block skip) Variable operator (÷)
%	Yes	Counted	Displayed (%)	No Key-in (automatically inserted)	Stored	%	End of record
LF/NL	Yes	Counted	Displayed (;)	Key-in ;/EOB	Stored	LF	End of block
(Yes	Counted	Displayed	Key-in ;/EOB	Stored	(Control out (comment start)
)	Yes	Counted	Displayed	Key-in ;/EOB	Stored)	Control in (comment end)
:	Yes	Counted	Displayed	No Key-in	Stored	:	Program number address (instead of O.)
#	Yes	Counted	Displayed	Key-in	Stored	#	Variable number
*	Yes	Counted	Displayed	Key-in	Stored	*	Variable operator (X)
=	Yes	Counted	Displayed	Key-in	Stored	=	Variable definition
[Yes	Counted	Displayed	Key-in	Stored	[Variable operator
]	Yes	Counted	Displayed	Key-in	Stored]	Variable operator
BS	No		Not displayed	No Key-in	Stored		
HT	No		Not displayed	No Key-in	Stored		
SP	No		Not displayed	Key-in	Stored	SP (T-V) Automatic adjustment	
CR	No		Not displayed	No Key-in	Stored		
DEL	No	Not Counted	Not displayed	No Key-in	Not Stored		
NULL	No	Not Counted	Not displayed	No Key-in	Not Stored		
Any other than the above	No	Counted	(*1)	No Key-in	Stored		

(*1) This denotes characters (including blanks) which are stored inside and which correspond to the command codes. "@" is not displayed.

Appendix 2: Other Functions for Reference

13.1 F1-digit Feed

The feedrate registered by parameter can be assigned by designating a single digit following address F.

There are six F codes: F0 and F1 to F5. The rapid traverse rate is applied when F0 is issued which is the same as the G00 command.

When one of the codes from F1 to F5 is issued, the cutting feedrate set to support the code serves as the valid rate command.

If F6 or larger value is command, the value is regarded as the cutting feedrate which has been directly commanded with numerical values.

When "F1-digit speed change valid" signal is valid when F1-digit feed is issued, a feedrate which is set by a parameter can be increased or decreased by operating the manual handle.

Refer to "Programming Manual" for more details on F1-digit feed.

Validate the F1-digit feedrate

To validate the F1-digit feed, the parameter "#1079 f1digit" or "#8145 Validate F1 digit" must be ON.

When the F1-digit feed is valid, the feedrate of each command is as follows:

F0: Rapid traverse rate

F1 to F5: The feedrate configured by the corresponding parameter "#1185 spd_F1" to "#1185 spd_F5"(F1 digit feedrate F1 to F5)

Enabling conditions of the speed change with the handle

When the F1-digit command is valid, the feedrate can be increased/decreased by operating the first manual handle. (The feedrate cannot be changed by the 2nd and 3rd handles.)

Changing the feedrate by the handle is available satisfying the following conditions:

- (1) The operation must be in automatic start.
- (2) The operation must be in cutting feed, and F1-digit feedrate command must be issued.
- (3) The F1-digit feed parameter must be ON.
- (4) The F1-digit feed switch must be ON.
- (5) The operation must not be in handle mode.
- (6) The operation must not be in dry run.
- (7) Upper limit of F1-digit feedrate ("#1506 F1_FM") and F1-digit feedrate change constant("#1507 F1_K F1") are not zero.

Conversion of the F1-digit feedrate changing with handle operation

Once the F1-digit feedrate is changed with manual handle, the changed feedrate is valid until parameter is changed or the power is turned OFF. Changed feedrate can be checked only during the operation. Note that if the parameter "#1246 set18(bit16)" (switch over of the F1-digit feedrate changing method) is set to "1", even after the power is turned OFF, operation is kept at the changed feedrate because the parameter of F1-digit feedrate has been changed. In this case, if the screen is not switched, the changed parameter values are not reflected to the display.

The increase/decrease amount per handle gradient is expressed with the following equation.

$$\Delta F = \Delta P \times \frac{FM}{K}$$

ΔP : Handle pulse (\pm)
 FM : Upper limit of F1-digit feedrate (#1506 F1_FM)
 K : F1-digit feedrate change constant (#1507 F1_K)

(Example) When the handle scale unit is to be made ± 10 mm/min.

If FM is made 3600mm/min, feedrate change constant (K) must be set to "360" according to the following formula.

$$\Delta F = 10 = 1 \times \frac{3600}{K}$$

Note

- (1) If F1-digit feedrate changing valid signal is turned ON when F1-digit feed is commanded and changing feedrate with the manual handle is valid, it is clamped at the upper limit of F1-digit feedrate if the F1-digit feedrate is greater than the upper limit of F1-digit feedrate.
- (2) When the F1-digit feedrate is 0 with the handle operation during the F1-digit feedrate command, the alarm "M01 F1-digit feedrate zero 0104" will occur. This alarm can be eliminated when the F1-digit feedrate is set in larger value than 0 with the handle operation.
- (3) When K is 0, the speed is not changed.

Precautions

- (1) The number of manual handle pulses is 1 pulse per scale unit regardless of the scaling factor.
- (2) During a F1-digit feed command, the F1-digit feed number and F1-digit feed command signal are output as the PLC signals.
- (3) When F1. to F5. (with decimal point) are assigned, the 1mm/min to 5mm/min (direct numerical value command) are established instead of the F1-digit feed command.
- (4) When the commands are used with inch command, one-tenth of the feedrate set correspond to F1 to F5 serves at the assigned speed inch/min.
- (5) When the commands are used with the millimeter or degree units, the feedrate set to correspond to F1 to F5 serves as the assigned speed mm ($^{\circ}$)/mm.
- (6) When both the F1-digit feedrate changing and the manual speed command are present, the manual speed command will have the priority.
- (7) In the synchronous tapping command, the speed cannot be changed with the handle.

Appendix 3: Daily Inspection of GOT

The GOT does not have consumable components that shorten its life. However, the battery and liquid crystal display have limited life. Periodical replacement of the battery is recommended. For replacing the liquid crystal display, consult the MTB.

Daily inspection items

Inspection item	Inspection method	Criterion	Corrective action
Dirt on the protective sheet	Visual check	Not outstanding	Replace the sheet with a new sheet.
Foreign material adherence	Visual check	No foreign material adherence	Remove the foreign material. Clean the screen.

■Cleaning the liquid crystal display

Use the GOT always in a clean condition.

To clean the GOT, wipe the dirty part with a soft cloth using neutral detergent or ethanol.

Revision History

Date of revision	Manual No.	Revision details
Oct. 2016	IB(NA)1501453-A	First edition created.
Aug. 2017	IB(NA)1501453-B	<p>Added or modified the following contents corresponding to the A2 version of the system software.</p> <p>Added the following contents:</p> <ul style="list-style-type: none"> - 2.6.3 Operating the Screen by Touch Gestures - 5.4.5 Undoing Change of Tool Compensation Data - 8.6 Thread Recutting Function <p>Changed the following contents:</p> <ul style="list-style-type: none"> - 1 Outline of Menu Items - 3.2 Creating and Editing a Machining Program - 3.6.1 Changing the Display - 3.8.1 Multi-part System Simultaneous Program Editing - 4.8.5 Data Protection Keys - 5.4.1 Setting the Tool Compensation Data - 5.4.3 Erasing the Tool Compensation Data - 5.4.4 Copying and Pasting the Tool Compensation Data - 5.5 Setting the Tool Management Data (Tool Management Screen) - 10.4.1 Displaying and Setting the PLC Device Data (I/F Diagnosis Screen) - 11.8.4 Data Protection Keys <p>Moved the following contents:</p> <ul style="list-style-type: none"> - 2.8 Changing the Operation Level (Protect Setting Screen) - 13.1 F1-digit Feed <p>Deleted the following contents:</p> <ul style="list-style-type: none"> - 9.7 Other Functions - 10.4.2.1 Writing/Reading the Data Using the NC Data Designation - Appx.2: Table of Command Value Ranges - Appx.3: Circular Cutting Radius Error <p>Also, corrected wrong indications.</p>

Date of revision	Manual No.	Revision details
Aug. 2018	IB(NA)1501453-C	<p>The descriptions were revised corresponding to S/W version B0 of Mitsubishi Electric CNC C80 Series.</p> <p>Changed the following contents:</p> <ul style="list-style-type: none"> - 2.1.3 Messages - 2.2.3 Operation Mode/MDI Status - 2.6.2 Software Keyboard - 2.6.3 Operating the Screen by Touch Gestures - 3.2 Creating and Editing a Machining Program - 3.8 Editing a Multi-part System Program - 3.9.1 Common Variables - 4.1 Inputting and Outputting a Program - 4.3 Transferring a File - 4.9 The Batch Input/Output the Machining Program of NC Memory - 5.3.2 Tool Measurement (L System) - 6.2 Selecting High-accuracy Control Parameters (Machining Cond I Screen) - 9.1 Operation Search - 9.2.8 Program Tree Display - 9.3.3 File Setting Screen - 9.3.6 Executing Restart Search (Restart Type 1) - 9.4 Collation and Stop - 11 Performing a Backup Operation - 11.1 Selecting a Device, Directory and File - 11.2 Transferring a File - 11.8.2 List of File Names - 11.9 Performing Backups of NC Memory Data <p>Changed the titles of the following contents:</p> <ul style="list-style-type: none"> - 10.2.3 Drive Monitor Screen (Servo Unit) - 10.2.4 Drive Monitor Screen (Spindle Unit) - 10.2.5 Drive Monitor Screen (Power Supply Unit) - 10.2.6 Drive Monitor Screen (Synchronous Error) - 10.2.7 Clearing the Alarm History on Drive Monitor Screen <p>Moved the following contents and changed their titles:</p> <ul style="list-style-type: none"> - 10.5 Safety Observation - 10.5.1 Safety Observation Screen (Configuration Diagnosis) - 10.5.2 Safety Observation Screen (Signal Monitor) - 10.5.3 Safety Observation Screen (Drive Monitor) - 10.5.4 Safety Observation Screen (Version Display) <p>Also, corrected wrong indications.</p>

Date of revision	Manual No.	Revision details
Dec. 2019	IB(NA)1501453-D	<p>The descriptions were revised corresponding to S/W version B5 of Mitsubishi Electric CNC C80 Series.</p> <p>Changed the following contents:</p> <ul style="list-style-type: none"> - 2.1.2 Explanations of the Screens - 2.6.2 Software Keyboard - 3.2 Creating and Editing a Machining Program - 3.4 Registering and Editing the Fixed Cycle Program - 3.9.1 Common Variables - 4.1 Inputting and Outputting a Program - 5.3.2 Tool Measurement (L System) - 5.7.2 Workpiece Measurement (L System) - 5.9 Setting Workpiece Coordinate System Shift - 5.9.2 Automatically Setting the Workpiece Coordinate System Shift Value - 6.1.5 Echoback - 8.5 MDI Program Editing - 9.1 Operation Search - 9.1.2 Changing Whether to Show or Hide the Comment Field - 9.3.2 Top Search Screen - 9.3.3 File Setting Screen - 9.4 Collation and Stop - 10.2.3 Drive Monitor Screen (Servo Unit) - 10.2.4 Drive Monitor Screen (Spindle Unit) - 10.3.2 Checking Alarms of Drive Unit - 10.5.1 Safety Observation Screen (Configuration Diagnosis) - 11. Performing a Backup Operation <p>Also, corrected wrong indications.</p>

Global Service Network

AMERICA

MITSUBISHI ELECTRIC AUTOMATION INC. (AMERICA FA CENTER)

Central Region Service Center (Chicago)
500 CORPORATE WOODS PARKWAY, VERNON HILLS, ILLINOIS 60061, U.S.A.
TEL: +1-847-478-2500 / FAX: +1-847-478-2650

Minneapolis, MN Service Satellite
Detroit, MI Service Satellite
Grand Rapids, MI Service Satellite
Lima, OH Service Satellite
Cleveland, OH Service Satellite
Indianapolis, IN Service Satellite
St. Louis, MO Service Satellite

South/East Region Service Center (Georgia)

1845 SATELLITE BOULEVARD STE. 450, DULUTH, GEORGIA 30097, U.S.A.
TEL: +1-678-258-4529 / FAX: +1-678-258-4519

Charleston, SC Service Satellite
Charlotte, NC Service Satellite
Raleigh, NC Service Satellite
Dallas, TX Service Satellite
Houston, TX Service Satellite
Hartford, CT Service Satellite
Knoxville, TN Service Satellite
Nashville, TN Service Satellite
Baltimore, MD Service Satellite
Pittsburg, PA Service Satellite
Newark, NJ Service Satellite
Syracuse, NY Service Satellite
Ft. Lauderdale, FL Service Satellite
Lafayette, LA Service Satellite

Western Region Service Center (California)

5900-B KATELLA AVE. - 5900-A KATELLA AVE. CYPRESS, CALIFORNIA 90630, U.S.A.
TEL: +1-714-699-2625 / FAX: +1-847-478-2650

San Francisco, CA Service Satellite
Seattle, WA Service Satellite
Denver, CO Service Satellite

Canada Region Service Center (Tronto)

4299 14TH AVENUE MARKHAM, ONTARIO L3R 0J2, CANADA
TEL: +1-905-754-3805 / FAX: +1-905-475-7935

Edmonton, AB Service Satellite
Montreal, QC Service Satellite

Mexico Region Service Center (Queretaro)

Parque Tecnológico Innovación Querétaro, Lateral Carretera Estatal 431, Km 2+200, Lote 91 Modulos 1 y 2
Hacienda la Machorra, CP 76246, El Marqués, Querétaro, México
TEL: +52-442-153 4250

Monterrey, NL Service Satellite
Mexico City, DF Service Satellite
Aguascalientes, AGS, Service Satellite

BRAZIL

MITSUBISHI ELECTRIC DO BRASIL COMÉRCIO E SERVIÇOS LTDA.

Votorantim Office
AV. GISELE CONSTANTINO,1578, PARQUE BELA VISTA, VOTORANTIM-SP, BRAZIL CEP:18.110-650
TEL: +55-15-3023-9000

Blumenau Santa Catarina office
MAQSERVICE – Canoas, RS Service Satellite

EUROPE

MITSUBISHI ELECTRIC EUROPE B.V.

European Service Headquarters (Dusseldorf, GERMANY)
Mitsubishi-Electric-Platz 1 40882 RATINGEN, GERMANY
TEL: +49-2102-486-5000 / FAX: +49-2102-486-5910

South Germany Service Center (Stuttgart)

SCHELMENWASENSTRASSE 16-20, 70567 STUTTGART, GERMANY
TEL: +49-711-770598-123 / FAX: +49-711-770598-141

France Service Center (Paris)

25, BOULEVARD DES BOUVETS, 92741 NANTERRE CEDEX FRANCE
TEL: +33-1-41-02-83-13 / FAX: +33-1-49-01-07-25

France Service Satellite (Lyon)

120, ALLEE JACQUES MONOD 69800 SAINT PRIEST FRANCE
TEL: +33-1-41-02-83-13 / FAX: +33-1-49-01-07-25

Italy Service Center (Milan)

PALAZZO SIRIO INGRESSO 1, VIA COLLEONI, 7, 20864 AGRATE BRIANZA(MI), ITALY
TEL: +39-039-6053-342 / FAX: +39-039-6053-206

Italy Service Satellite (Padova)

VIA G. SAVELLI, 24 - 35129 PADOVA, ITALY
TEL: +39-039-6053-342 / FAX: +39-039-6053-206

U.K. Service Center

TRAVELLERS LANE, HATFIELD, HERTFORDSHIRE, AL10 8XB, U.K.
TEL: +49-2102-486-5000 / FAX: +49-2102-486-5910

Spain Service Center

CTRA. RUBI, 76-80 8174 SAINT CUGAT DEL VALLES, BARCELONA SPAIN
TEL: +34-935-65-2236 / FAX: +34-935-89-1579

Poland Service Center

UL.KRAKOWSKA 50, 32-083 BALICE, POLAND
TEL: +48-12-347-6500 / FAX: +48-12-630-4701

Hungary Service Center

MADARASZ IRODAPARK, MADARASZ VIKTOR UT 47-49, 1138 BUDAPEST, HUNGARY
TEL: +48-12-347-6500 / FAX: +48-12-630-4701

Turkey Service Center

MITSUBISHI ELECTRIC TURKEY A.Ş
SERIFALI MAHALLESİ NUTUK SOKAK. NO.41 34775
UMRANIYE, ISTANBUL, TURKEY
TEL: +90-216-969-2500 / FAX: +90-216-526-3995

Czech Republic Service Center

AutoCont Control Systems s.r.o (Service Partner)
KAFKOVA 1853/3, 702 00 OSTRAVA 2, CZECH REPUBLIC
TEL: +420-59-5691-185 / FAX: +420-59-5691-199

Russia Service Center

MITSUBISHI ELECTRIC RUSSIA LLC
LETNIKOVSKAYA STREET 2, BLD.1, 5TH 115114 MOSCOW, RUSSIA
TEL: +7-495-721-2070 / FAX: +7-495-721-2071

Sweden Service Center

HAMMARBACKEN 14, P.O.BOX 750 SE-19127, SOLLENTUNA, SWEDEN
TEL: +46-8-6251000 / FAX: +46-8-966877

Bulgaria Service Center

AKHNATON Ltd. (Service Partner)
4 ANDREJ LJAPCHEV BLVD. POB 21, BG-1756 SOFIA, BULGARIA
TEL: +359-2-8176009 / FAX: +359-2-9744061

Ukraine Service Center (Kiev)

CSC Automation Ltd. (Service Partner)
4 B. YEVHENA SVERTYUKA STR., 02002 KIEV, UKRAINE
TEL: +380-44-494-3344 / FAX: +380-44-494-3366

Belarus Service Center

TECHNIKON Ltd. (Service Partner)
NEZAVISIMOSTI PR.177, 220125 MINSK, BELARUS
TEL: +375-17-393-1177 / FAX: +375-17-393-0081

South Africa Service Center

MOTIONTRONIX (Service Partner)
P.O. BOX 9234, EDLEEN, KEMPTON PARK GAUTENG, 1625, SOUTH AFRICA
TEL: +27-11-394-8512 / FAX: +27-11-394-8513

ASEAN**MITSUBISHI ELECTRIC ASIA PTE. LTD. (ASEAN FA CENTER)**

Singapore Service Center
307 ALEXANDRA ROAD #05-01/02 MITSUBISHI ELECTRIC BUILDING SINGAPORE 159943
TEL: +65-6473-2308 / FAX: +65-6476-7439

Philippines Service Center
Flexible Automation system corporation (Service Partner)
UNIT NO.411, ALABAMG CORPORATE CENTER KM 25. WEST SERVICE ROAD
SOUTH SUPERHIGHWAY, ALABAMG MUNTINLUPA METRO MANILA, PHILIPPINES 1771
TEL: +63-2-807-2416 / FAX: +63-2-807-2417

VIETNAM**MITSUBISHI ELECTRIC VIETNAM CO.,LTD.**

Vietnam Ho Chi Minh Service Center
UNIT 01-04, 10TH FLOOR, VINCOM CENTER 72 LE THANH TON STREET, DISTRICT1,
HO CHI MINH CITY, VIETNAM
TEL: +84-28-3910 5945 / FAX: +84-28-3910 5947

Vietnam Hanoi Service Center
24TH FLOOR, HANDICO TOWER, PHAM HUNG ROAD, ME TRI HA, ME TRI WARD,
NAM TU LIEM DISTRICT, HA NOI CITY, VIETNAM
TEL: +84-24-3937-8075 / FAX: +84-24-3937-8076

INDONESIA**PT. MITSUBISHI ELECTRIC INDONESIA**

Indonesia Service Center (Cikarang)
JL. KENARI RAYA BLOK G2-07A, DELTA SILICON 5, LIPPO CIKARANG - BEKASI 17550, INDONESIA
TEL: +62-21-2961-7797 / FAX: +62-21-2961-7794

MALAYSIA**MITSUBISHI ELECTRIC SALES MALAYSIA SDN. BHD.**

Malaysia Service Center (Kuala Lumpur Service Center)
LOT 11, JALAN 219, P.O BOX 1036, 46860 PETALING JAYA, SELANGOR DARUL EHSAN. MALAYSIA
TEL: +60-3-7960-2628 / FAX: +60-3-7960-2629
Johor Bahru Service Satellite

THAILAND**MITSUBISHI ELECTRIC FACTORY AUTOMATION (THAILAND) CO.,LTD.**

Thailand Service Center (Bangkok)
101 TRUE DIGITAL PARK OFFICE, 5TH FLOOR, SUKHUMVIT ROAD, BANGKOK 10260, THAILAND
TRUE DIGITAL PARK SUKHUMVIT 101
TEL: +66-2-092-8600 / FAX: +66-2-043-1231-33
Bowin Service Center (Chonburi)
Korat Service Center

INDIA**MITSUBISHI ELECTRIC INDIA PVT., LTD.**

CNC Technical Center (Bangalore)
PLOT NO. 56, 4TH MAIN ROAD, PEENYA PHASE 3,
PEENYA INDUSTRIAL AREA, BANGALORE 560058, KARNATAKA, INDIA
TEL : +91-80-4655-2121 / FAX : +91-80-4655-2147
Chennai Service Satellite
Coimbatore Service Satellite
Hyderabad Service Satellite

North India Service Center (Gurgaon)
2ND FLOOR, TOWER A&B, DLF CYBER GREENS, DLF CYBER CITY,
DLF PHASE-III, GURGAON- 122 002, HARYANA, INDIA
TEL : +91-124-4630 300 / FAX : +91-124-4630 399
Ludhiana Service Satellite
Panth Nagar Service Satellite
Delhi Service Satellite
Jamshedpur Service Satellite
Manesar Service Satellite

West India Service Center (Pune)
ICC-Devi GAURAV TECHNOLOGY PARK, UNIT NO.402, FOURTH FLOOR, NORTH WING,
SURVEY NUMBER 191-192 (P), NEXT TO INDIAN CARD CLOTHING COMPANY Ltd,
OPP. VALLABH NAGAR, PIMPRI, PUNE- 411 018, MAHARASHTRA, INDIA
TEL : +91-20-6819 2274 / FAX : +91-20-4624 2100
Kolhapur Service Satellite
Aurangabad Service Satellite
Mumbai Service Satellite

West India Service Center (Ahmedabad)
204-209, 2ND FLOOR, 31FIVE, CORPORATE ROAD PRAHLADNAGAR,
AHMEDABAD -380015, GUJARAT, INDIA
TEL : + 91-79-6777 7888
Rajkot Service Satellite

CHINA**MITSUBISHI ELECTRIC AUTOMATION (CHINA) LTD. (CHINA FA CENTER)**

China Shanghai Service Center
1-3,5-10,18-23/F, NO.1386 HONG QIAO ROAD, CHANG NING QU,
SHANGHAI 200336, CHINA
TEL: +86-21-2322-3030 / FAX: +86-21-2322-3000*8422

China Qingdao Service Center
China Suzhou Service Center
China Wuhan Service Center
China Ningbo Service Center
China Ningbo Service Partner
China Jinan Service Partner
China Hangzhou Service Partner
China Suzhou Service Partner

China Beijing Service Center
5/F, ONE INDIGO, 20 JIUXIANQIAO ROAD CHAOYANG DISTRICT,
BEIJING 100005, CHINA
TEL: +86-10-6518-8830 / FAX: +86-10-6518-2938
China Beijing Service Partner

China Tianjin Service Center
UNIT 2003, TIANJIN CITY TOWER, NO 35 YOUYI ROAD, HEXI DISTRICT,
TIANJIN 300061, CHINA
TEL: +86-22-2813-1015 / FAX: +86-22-2813-1017

China Xian Service Center
China Changchun Service Partner

China Chengdu Service Center
5/F, ONE INDIGO, 20 JIUXIANQIAO ROAD CHAOYANG DISTRICT,
BEIJING 100005, CHINA
TEL: +86-28-8446-8030 / FAX: +86-28-8446-8630

China Shenzhen Service Center
LEVEL8, GALAXY WORLD TOWER B, 1 YABAO ROAD, LONGGANG DISTRICT,
SHENZHEN 518129, CHINA
TEL: +86-755-2399-8272 / FAX: +86-755-8229-3686

China Dongguan Service Center
China Dongguan Service Partner
China Xiamen Service Partner

China Dalian Service Center
DONGBEI 3-5, DALIAN ECONOMIC & TECHNICAL DEVELOPMENTZONE, LIAONING PROVINCE,
116600, CHINA
TEL: +86-411-8765-5951 / FAX: +86-411-8765-5952

KOREA**MITSUBISHI ELECTRIC AUTOMATION KOREA CO., LTD. (KOREA FA CENTER)**

Korea Service Center
8F GANGSEO HANGANG XI-TOWER A, 401 YANGCHEON-RO, GANGSEO-GU,
SEOUL 07528 KOREA
TEL: +82-2-3660-9609 / FAX: +82-2-3664-8668
Korea Daegu Service Satellite

TAIWAN**MITSUBISHI ELECTRIC TAIWAN CO., LTD. (TAIWAN FA CENTER)**

Taiwan Taichung Service Center
NO.8-1, INDUSTRIAL 16TH RD., TAICHUNG INDUSTRIAL PARK, SITUN DIST.,
TAICHUNG CITY 40768, TAIWAN
TEL: +886-4-2359-0688 / FAX: +886-4-2359-0689

Taiwan Taipei Service Center
10F, NO.88, SEC.6, CHUNG-SHAN N. RD., SHI LIN DIST., TAIPEI CITY 11155, TAIWAN
TEL: +886-2-2833-5430 / FAX: +886-2-2833-5433

Taiwan Tainan Service Center
11F-1., NO.30, ZHONGZHENG S. ROAD, YONGKANG DISTRICT, TAINAN CITY 71067, TAIWAN
TEL: +886-6-252-5030 / FAX: +886-6-252-5031

OCEANIA**MITSUBISHI ELECTRIC AUSTRALIA PTY. LTD.**

Oceania Service Center
348 VICTORIA ROAD, RYDALMERE, N.S.W. 2116 AUSTRALIA
TEL: +61-2-9684-7269/ FAX: +61-2-9684-7245

Notice

Every effort has been made to keep up with software and hardware revisions in the contents described in this manual. However, please understand that in some unavoidable cases simultaneous revision is not possible.

Please contact your Mitsubishi Electric dealer with any questions or comments regarding the use of this product.

Duplication Prohibited

This manual may not be reproduced in any form, in part or in whole, without written permission from Mitsubishi Electric Corporation.

COPYRIGHT 2016-2019 MITSUBISHI ELECTRIC CORPORATION
ALL RIGHTS RESERVED

MITSUBISHI ELECTRIC CORPORATION

HEAD OFFICE : TOKYO BLDG.,2-7-3 MARUNOUCHI,CHIYODA-KU,TOKYO 100-8310,JAPAN

MODEL	C80 Series
MODEL CODE	100-564
Manual No.	IB-1501453