

Numerical Control (CNC)

Specifications Manual (Function)
M800/M80/E80/C80 Series

Introduction

This manual describes the specifications of Mitsubishi Electric CNC.

Supported models are as follows:

Supported models	Abbreviations in this manual
M800W Series	M850W, M830W
M800S Series	M850S, M830S
M80W Series	M80W
M80 Series	M80 TypeA, M80 TypeB
E80 Series	E80 TypeA, E80 TypeB
C80 Series	C80

Abbreviations in this manual are as follows:

Abbreviations	Supported models
M800, M800 Series	M800W Series/M800S Series
M80, M80 Series	M80W Series/M80 Series
M800/M80, M800/M80 Series	M800W Series/M800S Series/M80W Series/M80 Series
M8, M8 Series	M800W Series/M800S Series/M80W Series/M80 Series/E80 Series

To safely use this CNC unit, thoroughly study the "Precautions for Safety" on the next page before use.

Be sure to keep this manual always at hand.

At the beginning of each item, a table indicating it's specification according to the model.

M : Machining center system

L : Lathe system

○: Standard





△: Optional

□: Selection

In this manual, the following abbreviations might be used.

MTB: Machine tool builder

CAUTION

-  **The items that are not described in this manual must be interpreted as "not possible".**
-  **This manual is written on the assumption that all the applicable functions are included. Some of them, however, may not be available for your NC system.
Refer to the specifications issued by the machine tool builder before use.**
-  **Some screens and functions may differ depending on each NC system (or version), and some functions may not be possible. Please confirm the specifications before starting to use.**
-  **To protect the availability, integrity and confidentiality of the NC system against cyber-attacks including unauthorized access, denial-of-service (DoS) (*1) attack, and computer virus from external sources via a network, take security measures such as firewall, VPN, and anti-virus software.
(*1) Denial-of-service (DoS): refers to a type of cyber-attack that disrupts services by overloading the system or by exploiting a vulnerability of the system.**
-  **Mitsubishi Electric assumes no responsibility for any problems caused to the NC system by any type of cyber-attacks including DoS attack, unauthorized access and computer virus.**

General precautions

- (1) When the contents of this manual is updated, the version (A, B, ...) on the cover will be incremented.

Also refer to the manuals on "Manual List" as necessary.

Manual List

Manuals related to M800/M80/E80/C80 Series are listed as follows.

These manuals are written on the assumption that all optional functions are added to the targeted model.

Some functions or screens may not be available depending on the machine or specifications set by MTB. (Confirm the specifications before use.)

The manuals issued by MTB take precedence over these manuals.

Manual	IB No.	Purpose and Contents
M800/M80/E80 Series Instruction Manual	IB-1501274	<ul style="list-style-type: none"> ♦ Operation guide for NC ♦ Explanation for screen operation, etc.
C80 Series Instruction Manual	IB-1501453	<ul style="list-style-type: none"> ♦ Operation guide for NC ♦ Explanation for screen operation, etc.
M800/M80/E80/C80 Series Programming Manual (Lathe System) (1/2)	IB-1501275	<ul style="list-style-type: none"> ♦ G code programming for lathe system ♦ Basic functions, etc.
M800/M80/E80/C80 Series Programming Manual (Lathe System) (2/2)	IB-1501276	<ul style="list-style-type: none"> ♦ G code programming for lathe system ♦ Functions for multi-part system, high-accuracy function, etc.
M800/M80/E80/C80 Series Programming Manual (Machining Center System) (1/2)	IB-1501277	<ul style="list-style-type: none"> ♦ G code programming for machining center system ♦ Basic functions, etc.
M800/M80/E80/C80 Series Programming Manual (Machining Center System) (2/2)	IB-1501278	<ul style="list-style-type: none"> ♦ G code programming for machining center system ♦ Functions for multi-part system, high-accuracy function, etc.
M800/M80/E80 Series Alarm/Parameter Manual	IB-1501279	<ul style="list-style-type: none"> ♦ Alarms ♦ Parameters
C80 Series Alarm/Parameter Manual	IB-1501560	<ul style="list-style-type: none"> ♦ Alarms ♦ Parameters

Manuals for MTBs (NC)

Manual	IB No.	Purpose and Contents
M800/M80/E80/C80 Series Specifications Manual (Function)	IB-1501505	<ul style="list-style-type: none"> ♦ Model selection ♦ Outline of various functions
M800/M80/E80/C80 Series Specifications Manual (Hardware)	IB-1501506	<ul style="list-style-type: none"> ♦ Model selection ♦ Specifications of hardware unit
M800W/M80W Series Connection and Setup Manual	IB-1501268	<ul style="list-style-type: none"> ♦ Detailed specifications of hardware unit ♦ Installation, connection, wiring, setup (startup/adjustment)
M800S/M80/E80 Series Connection and Setup Manual	IB-1501269	<ul style="list-style-type: none"> ♦ Detailed specifications of hardware unit ♦ Installation, connection, wiring, setup (startup/adjustment)
C80 Series Connection and Setup Manual	IB-1501452	<ul style="list-style-type: none"> ♦ Detailed specifications of hardware unit ♦ Installation, connection, wiring, setup (startup/adjustment)
M800/M80/E80 Series PLC Development Manual	IB-1501270	<ul style="list-style-type: none"> ♦ Electrical design ♦ I/O relation (assignment, setting, connection), field network ♦ Development environment (PLC on-board, peripheral development environment), etc.
M800/M80/E80 Series PLC Programming Manual	IB-1501271	<ul style="list-style-type: none"> ♦ Electrical design ♦ Sequence programming ♦ PLC support functions, etc.
M800/M80/E80/C80 Series PLC Interface Manual	IB-1501272	<ul style="list-style-type: none"> ♦ Electrical design ♦ Interface signals between NC and PLC
M800/M80/E80 Series Maintenance Manual	IB-1501273	<ul style="list-style-type: none"> ♦ Cleaning and replacement for each unit ♦ Other items related to maintenance
C80 Series Maintenance Manual	IB-1501454	<ul style="list-style-type: none"> ♦ Cleaning and replacement for each unit ♦ Other items related to maintenance

Manuals for MTBs (drive section)

Manual	IB No.	Contents
MDS-E/EH Series Specifications Manual	IB-1501226	<ul style="list-style-type: none"> ♦ Specifications for power supply regeneration type
MDS-E/EH Series Instruction Manual	IB-1501229	<ul style="list-style-type: none"> ♦ Instruction for power supply regeneration type
MDS-EJ/EJH Series Specifications Manual	IB-1501232	<ul style="list-style-type: none"> ♦ Specifications for regenerative resistor type
MDS-EJ/EJH Series Instruction Manual	IB-1501235	<ul style="list-style-type: none"> ♦ Instruction for regenerative resistor type
MDS-EM/EMH Series Specifications Manual	IB-1501238	<ul style="list-style-type: none"> ♦ Specifications for multi-hybrid, power supply regeneration type
MDS-EM/EMH Series Instruction Manual	IB-1501241	<ul style="list-style-type: none"> ♦ Instruction for multi-hybrid, power supply regeneration type
DATA BOOK	IB-1501252	<ul style="list-style-type: none"> ♦ Specifications of servo drive unit, spindle drive unit, motor, etc.

Manuals for MTBs (Others)

Manual	No.	Purpose and Contents
GOT2000 Series User's Manual (Hardware)	SH-081194ENG	♦ Outline of hardware such as part names, external dimensions, installation, wiring, maintenance, etc. of GOTs
GOT2000 Series User's Manual (Utility)	SH-081195ENG	♦ Outline of utilities such as screen display setting, operation method, etc. of GOTs
GOT2000 Series User's Manual (Monitor)	SH-081196ENG	♦ Outline of each monitor function of GOTs
GOT2000 Series Connection Manual (Mitsubishi Electric Products)	SH-081197ENG	♦ Outline of connection types and connection method between GOT and Mitsubishi Electric connection devices
GT Designer3 (GOT2000) Screen Design Manual	SH-081220ENG	♦ Outline of screen design method using screen creation software GT Designer3

■ For M800/M80/E80 Series

Manual	No.	Purpose and Contents
GOT2000 Series Connection Manual (Non-Mitsubishi Electric Products 1)	SH-081198ENG	♦ Explanation for connection types and connection method between GOT and other company's devices
GOT2000 Series Connection Manual (Non-Mitsubishi Electric Products 2)	SH-081199ENG	
GOT2000 Series Connection Manual (Microcomputers, MODBUS/Fieldbus Products, Peripherals)	SH-081200ENG	♦ Explanation for connection types and connection method between GOT and microcomputers, MODBUS/fieldbus products, peripherals
GT SoftGOT2000 Version1 Operating Manual	SH-081201ENG	♦ Explanation for system configuration, screen configuration and operation method of monitoring software GT SoftGOT2000
GOT2000/GOT1000 Series CC-Link Communication Unit User's Manual	IB-0800351	♦ Explanation for handling CC-Link communication unit (for GOT2000 series/GOT1000 series)
GX Developer Version 8 Operating Manual (Startup)	SH-080372E	♦ Explanation for system configuration, installation, etc. of PLC development tool GX Developer
GX Developer Version 8 Operating Manual	SH-080373E	♦ Explanation for operations using PLC development tool GX Developer
GX Converter Version 1 Operating Manual	IB-0800004	♦ Explanation for operations using data conversion tool GX Converter
GX Works2 Installation Instructions	BCN-P5999-0944	♦ Explanation for the operating environment and installation method of GX Works2
GX Works2 Version 1 Operating Manual (Common)	SH-080779ENG	♦ Explanation for the system configuration of GX Works2 and the functions common to Simple project and Structured project such as parameter setting, operation method for the online function
GX Works2 Version 1 Operating Manual (Simple Project)	SH-080780ENG	♦ Explanation for methods for such as creating and monitoring programs in Simple project of GX Works2
GX Works2 Version 1 Operating Manual (Simple Project, Function Block)	SH-080984ENG	♦ Explanation for methods for such as creating function blocks, pasting function blocks to sequence programs, and operating FB library in Simple project of GX Works2
GX Works2 Version 1 Operating Manual (Structured Project)	SH-080781ENG	♦ Explanation for methods for such as creating and monitoring programs in Structured project of GX Works2
GX Works3 Installation Instructions	BCN-P5999-0391	♦ Explanation for the operating environment and installation method of GX Works3
MELSEC-Q CC-Link System Master/Local Module User's Manual	SH-080394E	♦ Explanation for system configuration, installation, wiring, etc. of master/local modules for CC-Link system

■ For C80 Series



Manual	No.	Purpose and Contents
MELSEC iQ-R Module Configuration Manual	SH-081262	♦ Outline of system configuration, specifications, installation, wiring, maintenance, etc.
MELSEC iQ-R CPU Module User's Manual (Startup)	SH-081263	♦ Outline of specifications, procedures before operation, troubleshooting, etc. for CPU module
MELSEC iQ-R CPU Module User's Manual (Application)	SH-081264	♦ Outline of memory, functions, devices, parameters, etc. for CPU module
MELSEC iQ-R CC-Link IE Field Network User's Manual (Application)	SH-081259	♦ Explanation for functions, parameter settings, programming, troubleshooting, etc. of the CC-Link IE Field Network function
QCPU User's Manual (Hardware Design, Maintenance and Inspection)	SH-080483	♦ Outline of specifications, necessary knowledge to configure the system and maintenance-related descriptions for Q series CPU module, etc.
GX Works3 Operating Manual	SH-081215	♦ Outline of functions, programming, etc.

Reference Manual for MTBs

Manual	No.	Purpose and Contents
M800/M80 Series Smart safety observation Specification manual	BNP-C3072-022	♦ Explanation for smart safety observation function
C80 Series Smart safety observation Specification manual	BNP-C3077-022	
M800/M80 Series Interactive cycle insertion (Customization) Specification manual	BNP-C3072-121-0003	♦ Explanation for interactive cycle insertion
M800/M80 Series Synchronous Control Specifications manual	BNP-C3072-074	♦ Explanation for synchronous control
M800/M80 Series Multiple-Axis Synchronization Control Specifications manual	BNP-C3072-339	♦ Explanation for multiple-axis synchronization control
M800/M80 Series GOT Connection Specifications manual	BNP-C3072-314	♦ Explanation for GOT connection
M800/M80 Series PROFIBUS-DP Specification manual	BNP-C3072-118	♦ Explanation for PROFIBUS-DP communication function
M800/M80 Series EtherNet/IP Specifications manual	BNP-C3072-263	♦ Explanation for EtherNet/IP
M800/M80 Series FL-net Specifications manual	BNP-C3072-368	♦ Explanation for FL-net
M800/M80 Series CC-Link (Master/Local) Specification manual	BNP-C3072-089	♦ Explanation for CC-Link
M800/M80 Series CC-Link IE Field (Master/local) Specifications manual	BNP-C3072-283	♦ Explanation for CC-Link IE Field
M800/M80 Series CC-Link IE Field Basic Specifications manual	BNP-C3072-337	♦ Explanation for CC-Link IE Field Basic





Precautions for Safety

Always read this manual, related manuals and attached documents before installation, operation, programming, maintenance or inspection to ensure correct use. Understand all the conditions described in this manual before using the unit. We rank the safety precautions into "DANGER", "WARNING" and "CAUTION" for the manuals issued by Mitsubishi, including this manual.











<p> DANGER</p> <p>When there is a great risk that the user could be subject to fatalities or serious injuries if handling is mistaken.</p>
<p> WARNING</p> <p>When the user could be subject to fatalities or serious injuries if handling is mistaken.</p>
<p> CAUTION</p> <p>When the user could be subject to injuries or when physical damage could occur if handling is mistaken.</p>

Note that even items ranked as "  CAUTION", may lead to major results depending on the situation. In any case, important information that must always be observed is described.

The following signs indicate prohibition and compulsory.

	<p>This sign indicates prohibited behavior (must not do).</p> <p>For example,  indicates "Keep fire away".</p>
	<p>This sign indicated a thing that is pompously (must do).</p> <p>For example,  indicates "it must be grounded".</p>

The meaning of each pictorial sign is as follows.

 CAUTION	 CAUTION rotated object	 CAUTION HOT	 Danger Electric shock risk	 Danger explosive
 Prohibited	 Disassembly is prohibited	 KEEP FIRE AWAY	 General instruction	 Earth ground

 **DANGER**





Not applicable in this manual.

 **WARNING**





Not applicable in this manual.

 **CAUTION**

1. Items related to product and manual

-  The items that are not described in this manual must be interpreted as "not possible".
-  This manual is written on the assumption that all the applicable functions are included. Some of them, however, may not be available for your NC system.
Refer to the specifications issued by the machine tool builder before use.
-  Some screens and functions may differ depending on the NC system (or its version), and some functions may not be possible. Please confirm the specifications before use.
-  To protect the availability, integrity and confidentiality of the NC system against cyber-attacks including unauthorized access, denial-of-service (DoS) (*1) attack, and computer virus from external sources via a network, take security measures such as firewall, VPN, and anti-virus software.
(*1) Denial-of-service (DoS): refers to a type of cyber-attack that disrupts services by overloading the system or by exploiting a vulnerability of the system.
-  Mitsubishi Electric assumes no responsibility for any problems caused to the NC system by any type of cyber-attacks including DoS attack, unauthorized access and computer virus.

2. Items related to start up and maintenance

-  Follow the power specifications (input voltage range, frequency range, momentary power failure time range) described in this manual.
-  Follow the environment conditions (ambient temperature, humidity, vibration, atmosphere) described in this manual.
-  Follow the remote type machine contact input/output interface described in this manual. (Connect a diode in parallel with the inductive load or connect a protective resistor in serial with the capacitive load, etc.)
-  If the parameter is used to set the temperature rise detection function to invalid, overheating may occur, thereby disabling control and possibly resulting in the axes running out of control, which in turn may result in machine damage and/or bodily injury or destruction of the unit. It is for this reason that the detection function is normally left "valid" for operation. The parameter for the temperature rise detection function will be validated forcibly when the NC unit is turned ON.

Treatment of waste

The following two laws will apply when disposing of this product. Considerations must be made to each law. The following laws are in effect in Japan. Thus, when using this product overseas, the local laws will have a priority. If necessary, indicate or notify these laws to the final user of the product.

- (1) Requirements for "Law for Promotion of Effective Utilization of Resources"
 - (a) Recycle as much of this product as possible when finished with use.
 - (b) When recycling, often parts are sorted into steel scraps and electric parts, etc., and sold to scrap contractors. Mitsubishi Electric recommends sorting the product and selling the members to appropriate contractors.

- (2) Requirements for "Law for Treatment of Waste and Cleaning"
 - (a) Mitsubishi Electric recommends recycling and selling the product when no longer needed according to item (1) above. The user should make an effort to reduce waste in this manner.
 - (b) When disposing a product that cannot be resold, it shall be treated as a waste product.
 - (c) The treatment of industrial waste must be commissioned to a licensed industrial waste treatment contractor, and appropriate measures, including a manifest control, must be taken.
 - (d) Batteries correspond to "primary batteries", and must be disposed of according to local disposal laws.

Disposal



(Note) This symbol mark is for EU countries only.
This symbol mark is according to the directive 2006/66/EC Article 20 Information for end-users and Annex II.

Your MITSUBISHI ELECTRIC product is designed and manufactured with high quality materials and components which can be recycled and/or reused.

This symbol means that batteries and accumulators, at their end-of-life, should be disposed of separately from your household waste.

If a chemical symbol is printed beneath the symbol shown above, this chemical symbol means that the battery or accumulator contains a heavy metal at a certain concentration. This will be indicated as follows:

Hg: mercury (0.0005%), Cd: cadmium (0.002%), Pb: lead (0.004%)

In the European Union there are separate collection systems for used batteries and accumulators.

Please, dispose of batteries and accumulators correctly at your local community waste collection/recycling centre.

Please, help us to conserve the environment we live in!

Trademarks

MELDAS, MELSEC, EZSocket, EZMotion, iQ Platform, MELSEC iQ-R, MELSOFT, GOT, CC-Link, CC-Link/LT, CC-Link IE, CC-Link IE/field, EcoMonitorLight and SLMP are either trademarks or registered trademarks of Mitsubishi Electric Corporation in Japan and/or other countries.

Ethernet is a registered trademark of Xerox Corporation in the United States and/or other countries.

Microsoft®, Windows®, SQL Server® and Access® are either trademarks or registered trademarks of Microsoft Corporation in the United States and/or other countries.

SD logo and SDHC logo are either registered trademarks or trademarks of LLC.

UNIX is a registered trademark of The Open Group in the United States and/or other countries.

Intel® and Pentium® are either trademarks or registered trademarks of Intel Corporation in the United States and/or other countries.

MODBUS® is either a trademark or a registered trademark of Schneider Electric USA, Inc. or the affiliated companies in Japan and/or other countries.

EtherNet/IP is a trademark of Open DeviceNet Vendor Association, Inc.

PROFIBUS-DP and PROFINET are either trademarks or registered trademarks of PROFIBUS User Organization.

Oracle® is a registered trademark of Oracle Corporation, the subsidiaries, or the affiliated companies in the United States and /or other countries.

VNC is a registered trademark of RealVNC Ltd. in the United States and other countries.

Punchtap is licensed by EMUGE.

BiSS is a registered trademark of iC-Haus GmbH.

Other company and product names that appear in this manual are trademarks or registered trademarks of the respective companies.

本製品の取扱いについて

(日本語 /Japanese)

本製品は工業用 (クラス A) 電磁環境適合機器です。販売者あるいは使用者はこの点に注意し、住商業環境以外での使用をお願いいたします。

Handling of our product

(English)

This is a class A product. In a domestic environment this product may cause radio interference in which case the user may be required to take adequate measures.

본 제품의 취급에 대해서

(한국어 /Korean)

이 기기는 업무용 (A 급) 전자파적합기기로서 판매자 또는 사용자는 이 점을 주의하시기 바라며 가정외의 지역에서 사용하는 것을 목적으로 합니다 .

WARRANTY

Please confirm the following product warranty details before using Mitsubishi Electric CNC.

1. Warranty Period and Coverage

Should any fault or defect (hereafter called "failure") for which we are liable occur in this product during the warranty period, repair services shall be provided at no cost through the distributor from which the product was purchased or through a Mitsubishi Electric service provider. Note, however, that this does not apply if the customer was informed prior to purchasing the product that the product is not covered under warranty. Also note that we are not responsible for any on-site readjustment and/or trial run that may be required after a defective unit is replaced.

[Warranty Term]

The term of warranty for this product shall be twenty-four (24) months from the date of delivery of the product to the end user, provided the product purchased from Mitsubishi Electric or a distributor in Japan is installed in Japan (but in no event longer than thirty (30) months, including distribution time after shipment from Mitsubishi Electric or a distributor).

Note that, in the case where the product purchased from Mitsubishi Electric or a distributor in or outside Japan is exported and installed in any country other than where it was purchased, please refer to "2. Service in Overseas Countries" below.

[Limitations]

- (1) The machine tool builder is requested to conduct an initial failure diagnosis, as a general rule. The diagnosis may also be carried out by Mitsubishi Electric or our service provider for a fee at the machine tool builder's request.
- (2) This warranty applies only when the conditions, method, environment, etc., of use are in compliance with the terms, conditions and instructions that are set forth in the instruction manual, user's manual, and the caution label affixed to the product, etc.
- (3) Even during the term of warranty, repair costs will be charged to the customer in the following cases:
 - (a) a failure caused by improper storage or handling, carelessness or negligence, etc., or a failure caused by a problem with the customer's hardware or software
 - (b) a failure caused by any alteration, etc., to the product made by the customer without Mitsubishi Electric's approval
 - (c) a failure which may be regarded as avoidable, if the customer's equipment in which this product is incorporated is equipped with a safety device required by applicable laws or has any function or structure considered to be indispensable in the light of common sense in the industry
 - (d) a failure which could have been avoided if consumable parts designated in the instruction manual, etc. had been duly maintained and replaced
 - (e) any replacement of consumable parts (including the battery, relay and fuse)
 - (f) a failure caused by external factors such as inevitable accidents, including without limitation fire and abnormal fluctuation of voltage, and acts of God, including without limitation earthquakes, lightning, and natural disasters
 - (g) a failure which could not have been foreseen under technologies available at the time of shipment of this product from Mitsubishi Electric
 - (h) any other failures which are not attributable to Mitsubishi Electric or which the customer acknowledges are not attributable to Mitsubishi Electric

2. Service in Overseas Countries

If the customer installs a product purchased from Mitsubishi Electric in a machine or equipment and exports it to any country other than where it was purchased, the customer may sign a paid warranty contract with our local FA center.

This applies in the case where the product purchased from us in or outside Japan is exported and installed in any country other than where it was purchased.

For details please contact the distributor from which the product was purchased.

3. Exclusion of Responsibility for Compensation against Loss of Opportunity, Secondary Loss, etc.

Regardless of the gratis warranty term, Mitsubishi Electric shall not be liable for compensation for:

- (1) Damage arising from any cause found not to be the responsibility of Mitsubishi Electric.
- (2) Lost opportunity or lost profit incurred by the user due to a failure of a Mitsubishi Electric product.
- (3) Special damage or secondary damage, whether foreseeable or not, compensation for accidents, and compensation for damages to products other than Mitsubishi Electric products.
- (4) Replacement by the user, maintenance of on-site equipment, start-up test run and other tasks.

4. Changes in Product Specifications

Specifications shown in our catalogs, manuals or technical documents are subject to change without notice.

5. Product Application

- (1) For use of this product, applications should be those that will not result in a serious damage even if a failure or malfunction occurs in the product, and a backup or failsafe function should operate on an external system when any failure or malfunction occurs to the product.
- (2) Mitsubishi Electric CNC is designed and manufactured solely for applications to machine tools for industrial purposes. Do not use this product in applications other than those specified above, especially those which have substantial influence on public interest or which are expected to have significant influence on human lives or properties.

CONTENTS

Mitsubishi Electric CNC M800W/M800S/M80W Series Specifications List [L system]

○: Standard △: Option □: Selection

Class	Lathe system					Page
	M850W	M830W	M850S	M830S	M80W	
1 Control Axes						1
1.1 Control Axes						2
1.1.1 Number of Basic Control Axes (NC Axes)	○ 2	○ 2	○ 2	○ 2	○ 2	2
1.1.2 Max. Number of Axes (NC Axes + Spindles + PLC Axes)	○16 △32	○16 △32	○16 △32	○16 △32	12	2
1.1.2.1 Max. Number of NC Axes (In Total for All the Part Systems)	○16 △32	○16 △32	○16 △32	○16 △32	10	2
1.1.2.2 Max. Number of Spindles	8	8	8	8	4+G/B (*2)	2
1.1.2.3 Max. Number of PLC Axes	8	8	8	8	6	2
1.1.4 Max. Number of PLC Indexing Axes	8	8	8	8	4	3
1.1.5 Number of Simultaneous Contouring Control Axes	8	4	8	4	4	3
1.1.6 Max. Number of NC Axes in a Part System	○8 △12	○8 △12	○8 △12	○8 △12	8	3
1.1.7 Axis Name Extension	○	○	○	○	○	3
1.2 Control Part System						4
1.2.1 Standard Number of Part Systems	1	1	1	1	1	4
1.2.2 Max. Number of Part Systems (Main + Sub)	○4 △8	○4 △8	○4 △8	○4 △8	○4	4
1.2.2.1 Max. Number of Main Part Systems	○4 △8	○4 △8	○4 △8	○4 △8	○2	4
1.2.2.2 Max. Number of Sub Part Systems	○4 △8	○4 △8	○4 △8	○4 △8	○2	4
1.3 Control Axes and Operation Modes						5
1.3.1 Tape (RS-232C Input) Mode	○	○	○	○	○	5
1.3.2 Memory Mode	○	○	○	○	○	5
1.3.3 MDI Mode	○	○	○	○	○	5
1.3.4 High-Speed Program Server Mode						6
1.3.4.1 Control Unit-side High-speed Program Server Mode	△	△	—	—	○	6
1.3.4.2 Display Unit-side High-speed Program Server Mode	△ / —	△ / —	△	△	○ / —	6
1.3.4.3 FTP High-speed Program Server Mode	—	—	—	—	—	6
1.3.5 Front-side SD Card Mode	○	○	○	○	○	7
1.3.6 Front-side USB Memory Mode	○	○	○	○	○	7
2 Input Command						9
2.1 Data Increment						10
2.1.1 Least Command Increment						10
Least command increment 1μm	○	○	○	○	○	10
Least command increment 0.1μm	○	○	○	○	○	10
Least command increment 0.01μm(10nm)	△	△	△	△	—	10
Least command increment 0.001μm(1nm)	△	△	△	△	—	10
2.1.2 Least Control Increment						12
Least control increment 0.01μm(10nm)	○	○	○	○	○	12
Least control increment 0.001μm(1nm)	○	○	○	○	○	12

○: Standard △: Option □: Selection

Class	Lathe system					Page
	M850W	M830W	M850S	M830S	M80W	
2.1.3 Indexing Increment	○	○	○	○	○	12
2.2 Unit System						13
2.2.1 Inch/Metric Changeover	○	○	○	○	○	13
2.2.2 Input Command Increment Tenfold	—	—	—	—	—	13
2.3 Program Format						14
2.3.1 Program Format						14
2.3.1.1 Format 1 for Lathe (G Code List 2, 3)	○	○	○	○	○	14
2.3.1.2 Format 2 for Lathe (G Code List 4, 5)	○	○	○	○	○	14
2.3.1.3 Special Format for Lathe (G Code List 6, 7)	○	○	○	○	○	14
2.3.1.4 Format 1 for Machining Center	—	—	—	—	—	14
2.3.1.5 Format 2 for Machining Center (M2 Format)	—	—	—	—	—	14
2.3.1.6 MITSUBISHI CNC Special Format	○	○	○	○	○	14
2.3.2 Program Format Switch	△	△	△	△	—	15
2.4 Command Value						17
2.4.1 Decimal Point Input I, II	○	○	○	○	○	17
2.4.2 Absolute/Incremental Command	○	○	○	○	○	18
2.4.3 Diameter/Radius Designation	○	○	○	○	○	19
2.4.4 Diameter/Radius Designation Switch	○	○	○	○	○	20
3 Positioning/Interpolation						21
3.1 Positioning						22
3.1.1 Positioning	○	○	○	○	○	22
3.1.2 Unidirectional Positioning	—	—	—	—	—	23
3.2 Linear/Circular Interpolation						24
3.2.1 Linear Interpolation	○	○	○	○	○	24
3.2.2 Circular Interpolation (Center/Radius Designation)	○	○	○	○	○	25
3.2.3 Helical Interpolation	○	○	○	○	○	27
3.2.4 Spiral/Conical Interpolation	—	—	—	—	—	30
3.2.5 Cylindrical Interpolation	△	△	△	△	○	32
3.2.6 Polar Coordinate Interpolation	△	△	△	△	○	33
3.2.7 Milling Interpolation	△	△	△	△	○	34
3.2.8 Hypothetical Axis Interpolation	—	—	—	—	—	35
3.3 Curve Interpolation						36
3.3.1 Involute Interpolation	—	—	—	—	—	36
3.3.2 Exponential Interpolation	△	△	△	△	—	38
3.3.3 Spline Interpolation (G05.1Q2/G61.2)	—	—	—	—	—	39
3.3.4 NURBS Interpolation	—	—	—	—	—	40
3.3.5 3-Dimensional Circular Interpolation	—	—	—	—	—	41
3.3.6 Spline Interpolation2 (G61.4)	—	—	—	—	—	42
4 Feed						45
4.1 Feedrate						46
4.1.1 Rapid Traverse Rate (m/min)	1000	1000	1000	1000	1000	46
4.1.2 Cutting Feedrate (m/min)	1000	1000	1000	1000	1000	47
4.1.3 Manual Feedrate (m/min)	1000	1000	1000	1000	1000	48

○: Standard △: Option □: Selection

Class	Lathe system					Page
	M850W	M830W	M850S	M830S	M80W	
4.1.4 Rotary Axis Command Speed Tenfold	○	○	○	○	○	48
4.2 Feedrate Input Methods						49
4.2.1 Feed per Minute (Asynchronous Feed)	○	○	○	○	○	49
4.2.2 Feed per Revolution (Synchronous Feed)	○	○	○	○	○	51
4.2.3 Inverse Time Feed	—	—	—	—	—	53
4.2.4 F 1-digit Feed	○	○	○	○	○	54
4.2.5 Manual Speed Command	△	△	△	△	○	55
4.2.7 G00 Feedrate Designation (, F Command)	△	△	△	△	○	55
4.2.8 Selection of Axis (Axes) for Feedrate Command	—	—	—	—	—	57
4.3 Override						58
4.3.1 Rapid Traverse Override	○	○	○	○	○	58
4.3.2 Cutting Feed Override	○	○	○	○	○	58
4.3.3 2nd Cutting Feed Override	○	○	○	○	○	58
4.3.4 Override Cancel	○	○	○	○	○	59
4.4 Acceleration/Deceleration						60
4.4.1 Automatic Acceleration/Deceleration after Interpolation	○	○	○	○	○	60
4.4.2 Rapid Traverse Constant-gradient Acceleration/Deceleration	○	○	○	○	○	62
4.4.3 Rapid Traverse Constant-gradient Multi-step Acceleration/Deceleration	—	—	—	—	—	63
4.5 Thread Cutting						64
4.5.1 Thread Cutting (Lead/Thread Number Designation)	○	○	○	○	○	64
4.5.2 Variable Lead Thread Cutting	○	○	○	○	○	67
4.5.3 Synchronous Tapping						68
4.5.3.1 Synchronous Tapping Cycle	○	○	○	○	○	68
4.5.3.2 Pecking Tapping Cycle	△	△	△	△	○	70
4.5.3.3 Deep-hole Tapping Cycle	△	△	△	△	○	72
4.5.3.4 Synchronous Tapping with Multiple Spindles	—	—	—	—	—	74
4.5.3.5 Synchronous Tapping with Analog I/F Spindle	○	○	○	○	○	74
4.5.4 Chamfering	○	○	○	○	○	74
4.5.6 Circular Thread Cutting	△	△	△	△	○	75
4.5.8 High-speed Synchronous Tapping (OMR-DD)	○	○	○	○	○	76
4.5.10 Thread Recutting	△	△	△	△	○	77
4.5.11 Thread Cutting Override	△	△	△	△	○	78
4.5.12 Variable Feed Thread Cutting	△	△	△	△	○	78
4.5.13 Thread Cutting Time Constant Switch	○	○	○	○	○	79
4.6 Manual Feed						80
4.6.1 Manual Rapid Traverse	○	○	○	○	○	80
4.6.2 Jog Feed	○	○	○	○	○	80
4.6.3 Incremental Feed	○	○	○	○	○	81
4.6.4 Handle Feed	○	○	○	○	○	81
4.6.5 Manual Feedrate B	○	○	○	○	○	82
4.6.6 Manual Feedrate B Surface Speed Control	—	—	—	—	—	83
4.6.8 Manual Speed Clamp	○	○	○	○	○	84

○: Standard △: Option □: Selection

Class	Lathe system					Page
	M850W	M830W	M850S	M830S	M80W	
4.7 Dwell						85
4.7.1 Dwell (Time-based Designation)	○	○	○	○	○	85
4.7.2 Dwell (Revolution-based Designation)	○	○	○	○	○	86
5 Program Memory/Editing						87
5.1 Memory Capacity						88
5.1.1 Memory Capacity (Number of Programs Stored)						88
230kB[600m] (400 programs)	—	—	—	—	—	88
500kB[1280m] (1000 programs)	○	○	○	○	○	88
1000kB[2560m] (1000 programs)	△	△	△	△	—	88
2000kB[5120m] (1000 programs)	△	△	△	△	—	88
5.2 Editing						89
5.2.1 Program Editing	○	○	○	○	○	89
5.2.2 Background Editing	○	○	○	○	○	90
5.2.3 Buffer Correction	○	○	○	○	○	91
5.2.5 Multi-part System Simultaneous Program Editing	○	○	○	○	○	92
5.2.6 Special Program Editing Display for Synchronization between Part Systems	△	△	△	△	○	92
5.2.7 Finish Shape View Programming	△	△	△	△	○	93
6 Operation and Display						95
6.1 Structure of Operation/Display Panel						96
6.1.1 Color Display (8.4-type LCD TFT)	—	—	—	—	—	96
6.1.2 Color Touchscreen Display (10.4-type LCD TFT)	—	—	□	□	—	96
6.1.3 Color Touchscreen Display (15-type LCD TFT)	—	—	□	□	—	96
6.1.4 Separated-type Color Display (8.4-type LCD TFT)	—	—	—	—	□	96
6.1.5 Separated-type Color Touchscreen Display (10.4-type LCD TFT)	□	□	—	—	□	96
6.1.6 Separated-type Color Touchscreen Display (15-type LCD TFT)	□	□	—	—	□	96
6.1.7 Separated-type Color Touchscreen Display (15-type LCD TFT/Windows8)	□	□	—	—	□	96
6.1.8 Separated-type Color Touchscreen Display (19-type LCD TFT/Windows8)	□	□	—	—	□	97
6.1.9 Separated-type Color Touchscreen Display (19-type Horizontal LCD TFT/Windows8)	□	□	—	—	□	97
6.1.11 GOT (GOT2000 Series GT27/GT25 12.1/10.4/8.4/5.7)	—	—	—	—	—	97
6.2 Operation Methods and Functions						98
6.2.1 Operation Input	○	○	○	○	○	98
6.2.2 Absolute/Incremental Setting	○	○	○	○	○	98
6.2.3 Multiple Display Connection	—	—	—	—	—	99
6.2.4 Common Display to Multiple NCs	—	—	—	—	—	99
6.2.5 Displayed Part System Switch	○	○	○	○	○	99
6.2.6 Menu List	○	○	○	○	○	100
6.2.7 Display Switch by Operation Mode	○	○	○	○	○	100
6.2.8 External Signal Display Switch	○	○	○	○	○	100

○: Standard △: Option □: Selection

Class	Lathe system					Page
	M850W	M830W	M850S	M830S	M80W	
6.2.9 Screen Saver	○	○	○	○	○	100
6.2.10 Parameter Guidance	○	○	○	○	○	100
6.2.11 Alarm Guidance	○	○	○	○	○	101
6.2.12 Machining Program Input Mistake Check Warning	△	△	△	△	—	101
6.2.14 Screenshot Capture	— / ○	— / ○	○	○	— / ○	101
6.2.15 User Selectable Menu Configuration	○	○	○	○	○	101
6.2.16 PC-NC Network Automatic Connection	○ / —	○ / —	—	—	○ / —	102
6.2.17 Device Open Parameter	○	○	○	○	○	102
6.2.18 SRAM Open Parameter	○	○	○	○	○	102
6.2.19 MTB Selectable Menu Configuration	○	○	○	○	○	102
6.2.20 Remote Desktop Connection	— / ○	— / ○	△	△	— / ○	103
6.2.21 VNC Server	— / △	— / △	△	△	— / ○	104
6.3 Display Methods and Contents						105
6.3.1 Status Display	○	○	○	○	○	105
6.3.2 Clock Display	○	○	○	○	○	105
6.3.3 Monitor Screen Display	○	○	○	○	○	106
6.3.4 Setup Screen Display	○	○	○	○	○	107
6.3.5 Edit Screen Display	○	○	○	○	○	107
6.3.6 Diagnosis Screen Display	○	○	○	○	○	107
6.3.7 Maintenance Screen Display	○	○	○	○	○	108
6.3.8 Home Application	○ / —	○ / —	—	—	○ / —	108
6.3.9 Home Screen	○	○	○	○	○	109
6.3.10 Additional Languages						110
6.3.10.1 Japanese	○	○	○	○	○	110
6.3.10.2 English	○	○	○	○	○	110
6.3.10.3 German	○	○	○	○	○	110
6.3.10.4 Italian	○	○	○	○	○	110
6.3.10.5 French	○	○	○	○	○	110
6.3.10.6 Spanish	○	○	○	○	○	110
6.3.10.7 Chinese						110
6.3.10.7.1 Chinese (Traditional Chinese Characters)	○	○	○	○	○	110
6.3.10.7.2 Chinese (Simplified Chinese Characters)	○	○	○	○	○	110
6.3.10.8 Korean	○	○	○	○	○	111
6.3.10.9 Portuguese	○	○	○	○	○	111
6.3.10.10 Hungarian	○	○	○	○	○	111
6.3.10.11 Dutch	○	○	○	○	○	111
6.3.10.12 Swedish	○	○	○	○	○	111
6.3.10.13 Turkish	○	○	○	○	○	111
6.3.10.14 Polish	○	○	○	○	○	111
6.3.10.15 Russian	○	○	○	○	○	111
6.3.10.16 Czech	○	○	○	○	○	111
6.3.10.17 Indonesian	○	○	○	○	○	112
6.3.10.18 Vietnamese	○	○	○	○	○	112

○: Standard △: Option □: Selection

Class	Lathe system					Page
	M850W	M830W	M850S	M830S	M80W	
7 Input/Output Functions and Devices						113
7.1 Input/Output Data						114
7.1.1 Machining Program Input/Output	○	○	○	○	○	114
7.1.2 Tool Offset Data Input/Output	○	○	○	○	○	114
7.1.3 Common Variable Input/Output	○	○	○	○	○	114
7.1.4 Parameter Input/Output	○	○	○	○	○	114
7.1.5 History Data Output	○	○	○	○	○	114
7.1.7 System Configuration Data Output	○	○	○	○	○	114
7.2 Input/Output I/F						115
7.2.1 RS-232C I/F	○	○	○	○	○	115
7.2.2 SD Card I/F						115
7.2.2.1 Control Unit-side SD Card I/F [Up to 32GB]	○	○	—	—	○	115
7.2.2.2 Front-side SD Card I/F [Up to 32GB]	○/—	○/—	○	○	○/—	115
7.2.3 Ethernet I/F	○	○	○	○	○	115
7.2.4 Display Unit-side Data Server I/F	○	○	○	○	○	116
7.2.5 Front-side USB Memory I/F [Up to 32GB]	○	○	○	○	○	116
7.2.6 USB I/F (GOT Front-side USB I/F)	—	—	—	—	—	116
7.2.7 SD I/F (GOT Back-side SD Card I/F)	—	—	—	—	—	116
7.3 Computer Link						117
7.3.1 Computer Link B	△	△	△	△	○	117
7.4 Others						118
7.4.1 Handy Terminal Connection	○	○	○	○	○	118
7.4.3 IP Filter Setting	○	○	○	○	○	119
8 Spindle, Tool and Miscellaneous Functions						121
8.1 Spindle Functions (S)						122
8.1.1 Spindle Control Functions						122
8.1.1.1 Spindle Digital I/F	○	○	○	○	○	123
8.1.1.2 Spindle Analog I/F	○	○	○	○	○	123
8.1.1.3 Coil Switch	○	○	○	○	○	123
8.1.1.4 Automatic Coil Switch	○	○	○	○	○	123
8.1.1.5 Encoder Input I/F	□	□	○	○	□	124
8.1.1.6 Spindle-mode Servo Motor Control	△	△	△	△	○	125
8.1.1.7 Spindle-mode Rotary Axis Control	—	—	—	—	—	126
8.1.1.8 Turret Gear Change Control	△	△	△	△	○	127
8.1.1.9 Spindle Control with Pulse Train Output	—	—	—	—	—	128
8.1.2 S Code Output	○	○	○	○	○	129
8.1.3 Constant Surface Speed Control	○	○	○	○	○	130
8.1.4 Spindle Override	○	○	○	○	○	132
8.1.5 Multiple-spindle Control						132
8.1.5.1 Multiple-spindle Control I	○	○	○	○	○	133
8.1.5.2 Multiple-spindle Control II	○	○	○	○	○	134
8.1.6 Spindle Orientation	○	○	○	○	○	135

○: Standard △: Option □: Selection

Class	Lathe system					Page
	M850W	M830W	M850S	M830S	M80W	
8.1.7 Spindle Position Control (Spindle/C Axis Control)						136
8.1.7.1 Spindle Position Control (Spindle/C Axis Control)	○	○	○	○	○	136
8.1.7.2 C Axis Control during Spindle Synchronization	△	△	△	△	○	137
8.1.8 Spindle Synchronization						138
8.1.8.1 Spindle Synchronization I	○	○	○	○	○	138
8.1.8.2 Spindle Synchronization II	○	○	○	○	○	139
8.1.8.3 Guide Bushing Spindle Synchronization	△	△	△	△	○	139
8.1.9 Tool Spindle Synchronization I (Polygon)						140
8.1.9.1 Tool Spindle Synchronization IA (Spindle-Spindle, Polygon)	△	△	△	△	○	140
8.1.9.2 Tool Spindle Synchronization IB (Spindle-Spindle, Polygon)	△	△	△	△	○	141
8.1.9.3 Tool Spindle Synchronization IC (Spindle-NC Axis, Polygon)	△	△	△	△	○	142
8.1.10 Tool Spindle Synchronization II (Hobbing)	△	△	△	△	○	143
8.1.11 Spindle Speed Clamp	○	○	○	○	○	144
8.1.13 Spindle Oscillation	△	△	△	△	—	144
8.1.14 Spindle Superimposition Control	△	△	△	△	○	145
8.1.15 Multiple Spindle Synchronization Set Control	○	○	○	○	○	147
8.1.16 Spindle Speed Fluctuation Detection	△	△	△	△	○	150
8.1.17 Spindle Motor Temperature Output to PLC	○	○	○	○	○	151
8.2 Tool Functions (T)						152
8.2.1 Tool Functions (T Command)	○	○	○	○	○	152
8.3 Miscellaneous Functions (M)						153
8.3.1 Miscellaneous Functions	○	○	○	○	○	153
8.3.2 Multiple M Codes in 1 Block	○	○	○	○	○	153
8.3.3 M Code Independent Output	○	○	○	○	○	154
8.3.4 Miscellaneous Function Finish	○	○	○	○	○	155
8.3.5 M Code Output during Axis Traveling	○	○	○	○	○	156
8.3.6 Miscellaneous Function Command High-speed Output	○	○	○	○	○	157
8.4 2nd Miscellaneous Functions (B)						159
8.4.1 2nd Miscellaneous Functions	○	○	○	○	○	159
8.4.2 2nd Miscellaneous Function Name Extension	○	○	○	○	○	159
9 Tool Compensation						161
9.1 Tool Length/Tool Position						162
9.1.1 Tool Length Offset	○	○	○	○	○	162
9.1.2 Tool Position Offset	—	—	—	—	—	165
9.1.3 Tool Compensation for Additional Axes	○	○	○	○	○	165
9.1.4 Tool Position Compensation (G43.7)	—	—	—	—	—	166
9.2 Tool Radius						167
9.2.1 Tool Radius Compensation	—	—	—	—	—	167

○: Standard △: Option □: Selection

Class	Lathe system					Page
	M850W	M830W	M850S	M830S	M80W	
9.2.2 3-dimensional Tool Radius Compensation	△(*3)	△(*3)	—	—	—	169
9.2.3 Tool Nose Radius Compensation (G40/41/42)	○	○	○	○	○	170
9.2.4 Automatic Decision of Nose Radius Compensation Direction (G46/40)	○	○	○	○	○	171
9.2.5 Tool Radius Compensation Diameter Designation	—	—	—	—	—	171
9.3 Tool Offset Amount						172
9.3.1 Number of Tool Offset Sets						172
99 sets	—	—	—	—	—	172
128 sets	○	○	○	○	—	172
200 sets	—	—	—	—	—	172
256 sets	—	—	—	—	○	172
400 sets	△	△	△	△	—	172
999 sets	△	△	△	△	—	172
9.3.2 Offset Memory						173
9.3.2.1 Tool Shape/Wear Offset Amount	○	○	○	○	○	173
9.3.2.2 Compensation Type Selection by Parameter	—	—	—	—	—	176
9.3.3 Number of Tool Offset Sets Allocation to Part Systems	○	○	○	○	○	177
10 Coordinate System						179
10.1 Coordinate System Type and Setting						180
10.1.1 Machine Coordinate System	○	○	○	○	○	181
10.1.2 Coordinate System Setting	○	○	○	○	○	182
10.1.3 Automatic Coordinate System Setting	○	○	○	○	○	183
10.1.4 Workpiece Coordinate System Selection						184
10.1.4.1 Workpiece Coordinate System Selection (6 Sets)	○	○	○	○	○	184
10.1.4.2 Extended Workpiece Coordinate System Selection (48 Sets) G54.1P1 to P48	△	△	△	△	○	186
10.1.4.3 Extended Workpiece Coordinate System Selection (96 Sets) G54.1P1 to P96	—	—	—	—	—	186
10.1.4.4 Extended Workpiece Coordinate System Selection (300 Sets) G54.1P1 to P300	—	—	—	—	—	186
10.1.5 External Workpiece Coordinate Offset	○	○	○	○	○	187
10.1.6 Workpiece Coordinate System Preset (G92.1)	○	○	○	○	○	188
10.1.7 Local Coordinate System	○	○	○	○	○	189
10.1.8 Coordinate System for Rotary Axis	○	○	○	○	○	190
10.1.9 Plane Selection	○	○	○	○	○	191
10.1.10 Origin Set/Origin Cancel	○	○	○	○	○	192
10.1.11 Counter Set	○	○	○	○	○	193
10.1.12 Workpiece Position Offset for Rotary Axis	—	—	—	—	—	194
10.1.13 Workpiece Coordinate System Shift	○	○	○	○	○	196
10.2 Return						197
10.2.1 Manual Reference Position Return	○	○	○	○	○	197

○: Standard △: Option □: Selection

Class	Lathe system					Page
	M850W	M830W	M850S	M830S	M80W	
10.2.2 Automatic 1st Reference Position Return	○	○	○	○	○	198
10.2.3 2nd, 3rd, 4th Reference Position Return	○	○	○	○	○	200
10.2.4 Reference Position Check	○	○	○	○	○	201
10.2.5 Absolute Position Detection	○	○	○	○	○	202
10.2.6 Tool Exchange Position Return	○	○	○	○	○	203
11 Operation Support Functions						205
11.1 Program Control						206
11.1.1 Optional Block Skip	○	○	○	○	○	206
11.1.2 Optional Block Skip Addition	○	○	○	○	○	206
11.1.3 Single Block	○	○	○	○	○	207
11.2 Program Test						208
11.2.1 Dry Run	○	○	○	○	○	208
11.2.2 Machine Lock	○	○	○	○	○	208
11.2.3 Miscellaneous Function Lock	○	○	○	○	○	208
11.2.4 Graphic Check						209
11.2.4.1 Graphic Check	○	○	○	○	○	209
11.2.4.2 3D Solid Program Check	○	○	○	○	○	209
11.2.4.3 Graphic Check Rotary Axis Drawing	△	△	△	△	○	210
11.2.5 Graphic Trace						211
11.2.5.1 Graphic Trace	○	○	○	○	○	211
11.2.5.2 Graphic Trace Rotary Axis Drawing	△	△	△	△	○	212
11.2.6 Machining Time Computation	○	○	○	○	○	212
11.2.7 Manual Arbitrary Reverse Run (Program Check Operation)	△	△	△	△	○	213
11.2.8 High-speed Simple Program Check	○	○	○	○	○	214
11.3 Program Search/Start/Stop						215
11.3.1 Program Search	○	○	○	○	○	215
11.3.2 Sequence Number Search	○	○	○	○	○	215
11.3.3 Collation and Stop	○	○	○	○	○	216
11.3.4 Program Restart	○	○	○	○	○	217
11.3.5 Automatic Operation Start	○	○	○	○	○	218
11.3.6 NC Reset	○	○	○	○	○	218
11.3.7 Feed Hold	○	○	○	○	○	219
11.3.8 Search & Start	○	○	○	○	○	219
11.3.10 Auto-restart	○	○	○	○	○	219
11.4 Interrupt Operation						220
11.4.1 Manual Interruption	○	○	○	○	○	220
11.4.2 Automatic Operation Handle Interruption	○	○	○	○	○	220
11.4.3 Manual Absolute Switch	○	○	○	○	○	221
11.4.4 Thread Cutting Cycle Retract	○	○	○	○	○	222
11.4.5 Tapping Retract	○	○	○	○	○	223
11.4.6 Manual Numerical Value Command	○	○	○	○	○	224
11.4.7 Arbitrary Reverse Run	—	—	—	—	—	225
11.4.8 MDI Interruption	○	○	○	○	○	226

○: Standard △: Option □: Selection

Class	Lathe system					Page
	M850W	M830W	M850S	M830S	M80W	
11.4.9 Simultaneous Operation of Manual and Automatic Modes	○	○	○	○	○	226
11.4.10 Simultaneous Operation of JOG and Handle Modes	○	○	○	○	○	226
11.4.11 Reference Position Retract	○	○	○	○	○	227
11.4.12 Tool Retract and Return	△	△	△	△	○	228
11.4.13 Skip Retract	—	—	—	—	—	229
11.4.14 PLC Interruption	○	○	○	○	○	229
11.4.16 Machining Interruption	—	—	—	—	—	230
12 Program Support Functions						231
12.1 Machining Method Support Functions						232
12.1.1 Program						232
12.1.1.1 Subprogram Control [Layers]	○10	○10	○10	○10	○10	232
12.1.1.2 Figure Rotation	—	—	—	—	—	235
12.1.1.3 Scaling	—	—	—	—	—	237
12.1.1.4 Axis Name Switch	○	○	○	○	○	238
12.1.2 Macro Program						239
12.1.2.1 User Macro [Layers]	○4	○4	○4	○4	○4	239
12.1.2.2 Machine Tool Builder Macro	○	○	○	○	○	242
12.1.2.3 Macro Interruption	○	○	○	○	○	244
12.1.2.4 Variable Command						245
200 sets	—	—	—	—	—	245
600 sets	—	—	—	—	—	245
700 sets	○	○	○	○	○	245
8000 sets	△	△	△	△	○	245
(600+100×number of part systems) sets	○	○	○	○	○	245
(7900+100×number of part systems) sets	△	△	△	△	○	245
12.1.3 Fixed Cycle						247
12.1.3.1 Fixed Cycle for Drilling	○	○	○	○	○	248
12.1.3.2 Fixed Cycle for Drilling (Type II)	○	○	○	○	○	253
12.1.3.3 Special Fixed Cycle	—	—	—	—	—	254
12.1.3.4 Fixed Cycle for Turning Machining	○	○	○	○	○	257
12.1.3.5 Compound Type Fixed Cycle for Turning Machining	△	△	△	△	○	262
12.1.3.6 Compound Type Fixed Cycle for Turning Machining (Type II)	△	△	△	△	○	267
12.1.3.7 Small-diameter Deep-hole Drilling Cycle	△	△	△	△	—	271
12.1.4 Mirror Image						271
12.1.4.1 Mirror Image by Parameter Setting	○	○	○	○	○	271
12.1.4.2 Mirror Image by External Input	○	○	○	○	○	271
12.1.4.3 Mirror Image by G Code	—	—	—	—	—	272
12.1.4.4 Mirror Image for Facing Tool Posts	○	○	○	○	○	273
12.1.4.5 T Code Mirror Image for Facing Tool Posts	○	○	○	○	○	273
12.1.5 Coordinate System Operation						274
12.1.5.1 Coordinate Rotation by Program	△	△	△	△	○	274
12.1.5.2 Coordinate Rotation by Parameter	—	—	—	—	—	276

○: Standard △: Option □: Selection

Class	Lathe system					Page
	M850W	M830W	M850S	M830S	M80W	
12.1.5.3 3-dimensional Coordinate Conversion	△	△	△	△	○	277
12.1.6 Dimension Input						279
12.1.6.1 Corner Chamfering/Corner R	△	△	△	△	○	279
12.1.6.2 Linear Angle Command	△	△	△	△	○	286
12.1.6.3 Geometric Command	○	○	○	○	○	287
12.1.6.4 Polar Coordinate Command	—	—	—	—	—	288
12.1.7 Axis Control						289
12.1.7.1 Chopping						289
12.1.7.1.1 Chopping	△	△	△	△	○	289
12.1.7.2 Normal Line Control	—	—	—	—	—	290
12.1.7.3 Circular Cutting	—	—	—	—	—	291
12.1.7.4 Vibration Cutting Control	□	□	□	□	□	292
12.1.8 Multi-part System Control						293
12.1.8.1 Timing Synchronization between Part Systems	○	○	○	○	○	293
12.1.8.2 Start Point Designation Timing Synchronization	○	○	○	○	○	294
12.1.8.3 Mixed Control						297
12.1.8.3.1 Mixed Control (Cross Axis Control)	△	△	△	△	○	297
12.1.8.3.2 Arbitrary Axis Exchange Control	△	△	△	△	○	298
12.1.8.4 Control Axis Superimposition						300
12.1.8.4.1 Control Axis Superimposition	△	△	△	△	○	300
12.1.8.4.2 Arbitrary Axis Superimposition Control	△	△	△	△	—	302
12.1.8.5 Control Axis Synchronization between Part Systems	△	△	△	△	○	302
12.1.8.6 Balance Cut	○	○	○	○	○	304
12.1.8.7 Common Memory for Part Systems	○	○	○	○	○	306
12.1.8.8 Multi-part System Simultaneous Thread Cutting						306
12.1.8.8.1 Two-part System Simultaneous Thread Cutting	△	△	△	△	○	307
12.1.8.8.2 Multi-part System Simultaneous Thread Cutting	△	△	△	△	○	309
12.1.8.9 Multi-part System Program Management	○	○	○	○	○	310
12.1.8.10 Synchronization between Part Systems						311
12.1.8.10.1 Single Block between Part Systems	△	△	△	△	○	311
12.1.8.10.2 Dwell/Miscellaneous Function Time Override	△	△	△	△	○	312
12.1.8.10.3 Synchronization between Part Systems OFF	△	△	△	△	○	313
12.1.8.11 Sub Part System Control I	△	△	△	△	○	314
12.1.8.12 Sub Part System Control II	△	△	△	△	○	316
12.1.8.13 Loader Control Part System	—	—	—	—	—	318

○: Standard △: Option □: Selection

Class	Lathe system					Page
	M850W	M830W	M850S	M830S	M80W	
12.1.9 Data Input/Output by Program						319
12.1.9.1 Parameter Input by Program	○	○	○	○	○	319
12.1.9.2 Compensation Data Input by Program	○	○	○	○	○	320
12.1.9.3 Tool/Material Shape Input by Program	○	○	○	○	○	324
12.1.9.5 API Section and Sub-section Nos. Input/Output by Program	○	○	○	○	○	326
12.1.9.6 R-Navi Data Input by Program	—	—	—	—	—	326
12.1.10 Machining Modal						327
12.1.10.1 Tapping Mode	○	○	○	○	○	327
12.1.10.2 Cutting Mode	○	○	○	○	○	327
12.1.11 High-speed Parts Machining						328
12.1.11.1 Rapid Traverse Block Overlap	△	△	△	△	○	328
12.2 Machining Accuracy Support Functions						330
12.2.1 Automatic Corner Override	○	○	○	○	○	330
12.2.2 Deceleration Check						331
12.2.2.1 Exact Stop Check Mode	○	○	○	○	○	333
12.2.2.2 Exact Stop Check	○	○	○	○	○	333
12.2.2.3 Error Detection	○	○	○	○	○	333
12.2.2.4 Programmable In-position Check	○	○	○	○	○	334
12.2.2.5 Automatic Error Detection	△	△	△	△	—	334
12.3 High-speed and High-accuracy Functions [kBPM: k Block per Minute]						335
12.3.1 High-speed Machining Mode						335
12.3.1.1 High-speed Machining Mode I (G05P1) Maximum [kBPM]	△33.7	△33.7	△33.7	△33.7	○33.7	335
12.3.1.2 High-speed Machining Mode II (G05P2) Maximum [kBPM]	△168	△168	△168	△168	○67.5	336
12.3.2 High-accuracy Control						337
12.3.2.1 High-accuracy Control (G61.1/G08)	△	△	△	△	○	337
12.3.2.2 Multi-part System Simultaneous High-accuracy Control	△	△	△	△	—	341
12.3.2.3 SSS Control	△	△	△	△	○	342
12.3.2.4 Tolerance Control	△	△	△	△	○	343
12.3.2.5 Variable-acceleration Pre-interpolation Acceleration/Deceleration	—	—	—	—	—	344
12.3.2.6 High-accuracy Acceleration/Deceleration Time Constant Extension	—	—	—	—	—	344
12.3.2.7 Axis-specific Acceleration Tolerance Control	△	△	△	△	—	345
12.3.3 High-speed High-accuracy Control						346
12.3.3.1 High-speed High-accuracy Control I (G05.1Q1) Maximum [kBPM]	△67.5	△67.5	△67.5	△67.5	○33.7	346
12.3.3.2 High-speed High-accuracy Control II (G05P10000) Maximum [kBPM]	△168	△168	△168	△168	○67.5	347
12.3.3.3 High-speed High-accuracy Control III (G05P20000) Maximum [kBPM]	—	—	—	—	—	350
12.3.3.4 Smooth Fairing	—	—	—	—	—	352
12.3.4 Machining Condition Selection I	○	○	○	○	○	353

○: Standard △: Option □: Selection

Class	Lathe system					Page
	M850W	M830W	M850S	M830S	M80W	
12.3.5 Direct Command Mode	△	△	△	△	—	353
12.4 Programming Support Functions						354
12.4.1 Playback	△	△	△	△	—	354
12.4.3 Interactive Cycle Insertion	△	△	△	△	○	355
12.4.4 Simple Programming (NAVI MILL/LATHE)	△	△	△	△	○	358
12.4.5 G code Guidance	○	○	○	○	○	358
12.4.7 DXF Data Input	△	△	△	△	○	359
13 Machine Accuracy Compensation						361
13.1 Static Accuracy Compensation						362
13.1.1 Backlash Compensation	○	○	○	○	○	362
13.1.2 Memory-type Pitch Error Compensation [sets]	○32	○32	○32	○32	○16	363
13.1.3 Memory-type Relative Position Error Compensation	○	○	○	○	○	364
13.1.4 External Machine Coordinate System Compensation	△	△	△	△	○	365
13.1.5 Circular Radius Error Compensation	△	△	△	△	○	365
13.1.6 Ball Screw Thermal Expansion Compensation	△	△	△	△	○	366
13.1.7 Rotation Center Error Compensation	△	△	△	△	—	367
13.1.8 Position-dependent Gradually Increasing-type Backlash Compensation	△	△	△	△	○	369
13.1.9 Bidirectional Pitch Error Compensation	△	△	△	△	○	370
13.1.10 Cyclic Error Compensation	△	△	△	△	○	370
13.1.11 Spatial Error Compensation	—	—	—	—	—	371
13.1.12 Backlash Compensation II	—	—	—	—	—	372
13.2 Dynamic Accuracy Compensation						373
13.2.1 Smooth High-gain (SHG) Control	○	○	○	○	○	373
13.2.2 Dual Feedback	○	○	○	○	○	374
13.2.3 Lost Motion Compensation	○	○	○	○	○	374
13.2.4 OMR II (Backlash with Filter)	△	△	△	△	○	375
13.2.6 OMR-FF	△	△	△	△	○	376
13.2.7 Distance-coded Reference Position Detection	△	△	△	△	○	377
13.2.9 Variable Torsion Compensation	—	—	—	—	—	378
13.2.10 Cogging Torque Compensation	△	△	△	△	○	379
14 Automation Support Functions						381
14.1 Measurement						382
14.1.1 Skip						382
14.1.1.1 Skip	○	○	○	○	○	382
14.1.1.2 Multiple-step Skip	○	○	○	○	○	384
14.1.1.4 PLC Skip	△	△	△	△	○	385
14.1.1.5 Speed Change Skip	△	△	△	△	—	385
14.1.1.6 Torque Limitation Skip	△	△	△	△	○	386
14.1.2 Automatic Tool Length Measurement	○	○	○	○	○	387
14.1.3 Manual Tool Length Measurement 1	○	○	○	○	○	390
14.1.4 Manual Tool Length Measurement 2	○	○	○	○	○	393
14.1.5 Workpiece Coordinate Offset Measurement	○	○	○	○	○	394

○: Standard △: Option □: Selection

Class	Lathe system					Page
	M850W	M830W	M850S	M830S	M80W	
14.1.6 Workpiece Position Measurement	—	—	—	—	—	395
14.1.7 Rotation Measurement	—	—	—	—	—	397
14.1.8 Rotation Center Error Measurement	—	—	—	—	—	398
14.1.9 Workpiece Installation Error Measurement	—	—	—	—	—	399
14.2 Tool Life Management						400
14.2.1 Tool Life Management						400
14.2.1.1 Tool Life Management I	○	○	○	○	○	400
14.2.1.2 Tool Life Management II	○	○	○	○	○	401
14.2.1.3 Tool Life Management III	—	—	—	—	—	401
14.2.2 Number of Tool Life Management Sets						402
99 sets	—	—	—	—	—	402
128 sets	○	○	○	○	—	402
200 sets	—	—	—	—	—	402
256 sets	—	—	—	—	○	402
400 sets	△	△	△	△	—	402
999 sets	△	△	△	△	—	402
14.2.3 Tool Life Management Set Allocation to Part Systems	○	○	○	○	○	404
14.3 Others						406
14.3.1 Programmable Current Limitation	○	○	○	○	○	406
14.3.2 Auto Power OFF	○	○	○	○	○	406
14.3.4 Load Monitoring I	△	△	△	△	○	407
14.3.5 Power ON/OFF Sequence	○ / —	○ / —	—	—	○ / —	407
14.3.6 PLC Axis Current Limit	—	—	—	—	—	407
14.3.7 Direct Robot Control	□	□	□	□	□	408
15 Safety and Maintenance						409
15.1 Safety Switches						410
15.1.1 Emergency Stop	○	○	○	○	○	410
15.1.2 Data Protection Key	○	○	○	○	○	410
15.2 Display for Ensuring Safety						411
15.2.1 NC Warning	○	○	○	○	○	411
15.2.2 NC Alarm	○	○	○	○	○	411
15.2.3 Operation Stop Cause	○	○	○	○	○	412
15.2.4 Emergency Stop Cause	○	○	○	○	○	412
15.2.5 Thermal Detection	○	○	○	○	○	412
15.2.6 Battery Alarm/Warning	○	○	○	○	○	413
15.3 Protection						414
15.3.1 Stroke End (Over Travel)	○	○	○	○	○	414
15.3.2 Stored Stroke Limit						414
15.3.2.1 Stored Stroke Limit I/II	○	○	○	○	○	415
15.3.2.2 Stored Stroke Limit IB	△	△	△	△	○	417
15.3.2.3 Stored Stroke Limit IIB	△	△	△	△	○	417
15.3.2.4 Stored Stroke Limit IC	△	△	△	△	○	418
15.3.3 Stroke Check before Travel	△	△	△	△	○	419
15.3.4 Chuck/Tailstock Barrier Check	○	○	○	○	○	421

○: Standard △: Option □: Selection

Class	Lathe system					Page
	M850W	M830W	M850S	M830S	M80W	
15.3.5 Interlock	○	○	○	○	○	422
15.3.6 External Deceleration	○	○	○	○	○	422
15.3.7 Interference Check III	△	△	△	△	—	423
15.3.8 3D Machine Interference Check	—	—	—	—	—	425
15.3.9 Door Interlock						426
15.3.9.1 Door Interlock I	○	○	○	○	○	426
15.3.9.2 Door Interlock II	○	○	○	○	○	428
15.3.10 Parameter Lock	○	○	○	○	○	430
15.3.11 Program Protection (Edit Lock B, C)	○	○	○	○	○	430
15.3.12 Program Display Lock	○	○	○	○	○	430
15.3.13 Data Protection by User's Level	△	△	△	△	○	430
15.3.15 Vertical Axis Pull-up	○	○	○	○	○	431
15.3.16 Machine Group-based Alarm Stop	△	△	△	△	○	431
15.3.17 Interference Check Between Part Systems	○	○	○	○	○	433
15.3.18 Spindle Protection	○	○	○	○	○	434
15.4 Maintenance and Troubleshooting						435
15.4.1 Operation History	○	○	○	○	○	435
15.4.2 Data Sampling	○	○	○	○	○	436
15.4.3 NC Data Backup	○	○	○	○	○	436
15.4.4 Servo Tuning Support						437
15.4.4.1 NC Analyzer2	○	○	○	○	○	437
15.4.5 Automatic Backup	○	○	○	○	○	439
15.4.8 Application Error Detection	○ / —	○ / —	—	—	○ / —	439
15.4.9 Email Notification to Operator	△	△	△	△	○	440
15.4.10 NC Configurator2	○	○	○	○	○	441
15.4.11 Diagnosis Data Output	○	○	○	○	○	441
15.4.12 Backup/Restore	—	—	—	—	—	441
15.4.14 Field Network Diagnostics	□	□	□	□	□	442
15.4.15 Remote service iQ Care Remote4U						443
15.4.15.1 Connection with RGU	□	□	□	□	□	443
15.5 Functional Safety						444
15.5.1 Safety Observation	△	△	△	△	○	444
15.5.2 Smart Safety Observation						445
15.5.2.1 Safety-related I/O Observation	△	△	△	△	○	445
15.5.2.2 Emergency Stop Observation	△	△	△	△	○	445
15.5.2.3 Drive Safety Function						446
15.5.2.3.1 SLS (Safely-Limited Speed)	△	△	△	△	○	446
15.5.2.3.2 SLP (Safely-Limited Position)	△	△	△	△	○	446
15.5.2.3.3 SOS (Safe Operating Stop)	△	△	△	△	○	446
15.5.2.3.4 SSM (Safe Speed Monitor)	△	△	△	△	○	446
15.5.2.3.5 SBC/SBT (Safe Brake Control/Safe Brake Test)	△	△	△	△	○	447

○: Standard △: Option □: Selection

Class	Lathe system					Page
	M850W	M830W	M850S	M830S	M80W	
15.5.2.3.6 SCA (Safe Cam)	△	△	△	△	○	447
15.5.2.3.7 SS1/SS2 (Safe Stop)	△	△	△	△	○	447
15.5.2.3.8 STO (Safe Torque Off)	△	△	△	△	○	447
15.5.2.3.9 SCN (Safety Communication Network)	—	—	—	—	—	448
16 Drive System						449
16.1 Servo/Spindle						450
Feed axis						—
MDS-E-Vx	□	□	□	□	□	—
MDS-EH-Vx	□	□	□	□	□	—
MDS-EJ-Vx	□	□	□	□	□	—
MDS-EJH-Vx	□	□	□	□	□	—
MDS-EM-SPVx	□	□	□	□	□	—
MDS-EMH-SPVx	□	□	□	□	□	—
Spindle						—
MDS-E-SPx	□	□	□	□	□	—
MDS-EH-SPx	□	□	□	□	□	—
MDS-EJ-SPx	□	□	□	□	□	—
MDS-EM-SPVx	□	□	□	□	□	—
MDS-EMH-SPVx	□	□	□	□	□	—
Power supply						—
MDS-E-CV	□	□	□	□	□	—
MDS-EH-CV	□	□	□	□	□	—
MDS-EX-CVP	□	□	□	□	□	—
17 Machine Support Functions						451
17.1 PLC						452
17.1.1 Built-in PLC Processing Mode	○	○	○	○	○	452
17.1.2 PLC Functions						452
17.1.2.1 Built-in PLC Basic Function	○	○	○	○	○	452
17.1.2.1.1 Index Modification	○	○	○	○	○	455
17.1.2.1.2 Multi-program [Number of Programs]	○120	○120	○120	○120	○60	455
17.1.2.1.3 Multi-project [Number of Projects Stored]						456
Number of PLC projects: 2	○	○	○	○	—	456
Number of PLC projects: 3	△	△	△	△	○	456
Number of PLC projects: 6	△	△	△	△	—	456
17.1.2.1.4 Function Block (FB)	○	○	○	○	○	456
17.1.2.1.5 Label Programming	○	○	○	○	○	456
17.1.2.2 PLC Exclusive Instruction	○	○	○	○	○	457
17.1.2.3 Enhanced PLC Security Mode	○	○	○	○	○	459
17.1.3 PLC Support Functions						460
17.1.3.1 Alarm Message Display	○	○	○	○	○	460

○: Standard △: Option □: Selection

Class	Lathe system					Page
	M850W	M830W	M850S	M830S	M80W	
17.1.3.2 Operator Message Display	○	○	○	○	○	460
17.1.3.3 Memory Switch (PLC Switch)						461
17.1.3.3.1 Memory Switch (PLC Switch) 32 Points	○	○	○	○	—	461
17.1.3.3.2 Memory Switch (PLC Switch) 64 Points	△	△	△	△	○	461
17.1.3.3.3 Memory Switch (PLC Switch) 96 points	△	△	△	△	—	461
17.1.3.4 Load Meter Display	○	○	○	○	○	462
17.1.3.5 User PLC Version Display	○	○	○	○	○	462
17.1.3.6 Ladder Program Writing during RUN	○	○	○	○	○	462
17.1.3.7 PLC Program Protection	○	○	○	○	○	462
17.1.4 Built-in PLC Capacity						463
17.1.4.1 Standard PLC Capacity [Number of Steps]	○128K	○128K	○128K	○128K	○64K	463
17.1.4.2 Large PLC Capacity: 256 Ksteps	△	△	△	△	—	463
17.1.4.3 Large PLC Capacity: 512 Ksteps	△	△	△	△	—	463
17.1.5 Machine Contact Input/Output I/F	○	○	○	○	○	463
17.1.6 Ladder Monitor	○	○	○	○	○	464
17.1.7 PLC Development						465
17.1.7.1 On-board Development	○	○	○	○	○	465
17.1.7.2 MELSEC Development Tool (GX Developer)	○	○	○	○	○	465
17.1.7.3 MELSEC Development Tool (GX Works2)	○	○	○	○	○	465
17.1.7.4 MELSEC Development Tool (GX Works3)	—	—	—	—	—	466
17.1.8 PLC Parameter						466
17.1.8.1 PLC Constant (150 Points)	○	○	○	○	○	466
17.1.8.2 PLC Constant Extension (Up to 750 Points)	○	○	○	○	○	466
17.1.9 GOT Connection						467
17.1.9.1 Ethernet Connection	○	○	○	○	○	467
17.1.9.2 CC-Link Connection	○	○	○	○	○	467
17.1.9.3 CC-Link IE Field Connection	—	—	—	—	—	467
17.1.10 Pallet Program Registration	—	—	—	—	—	468
17.2 Machine Construction						469
17.2.1 Servo OFF	○	○	○	○	○	469
17.2.2 Axis Detachment	○	○	○	○	○	470
17.2.3 Synchronous Control	△	△	△	△	○	471
17.2.4 Inclined Axis Control	△	△	△	△	○	475
17.2.5 Position Switch	○24	○24	○24	○24	○24	476
17.2.7 Index Table Indexing	○	○	○	○	○	477
17.2.8 Tool Length Compensation along the Tool Axis	△(*3)	△(*3)	△(*3)	△(*3)	—	479
17.2.9 Tool Handle Feed & Interruption	—	—	—	—	—	480

○: Standard △: Option □: Selection

Class	Lathe system					Page
	M850W	M830W	M850S	M830S	M80W	
17.2.10 Tool Center Coordinate Display	—	—	—	—	—	480
17.2.11 Tool Center Point Control						481
17.2.11.1 Tool Center Point Control (G43.4/G43.5)	—	—	—	—	—	481
17.2.12 Inclined Surface Machining Command	△	△	△	△	○	484
17.2.13 Simple Inclined Surface Machining Command	△	△	△	△	○	486
17.2.14 3-dimensional Tool Radius Compensation (Tool's Vertical-direction Compensation)	△(*3)	△(*3)	△(*3)	△(*3)	—	488
17.2.15 Workpiece Installation Error Compensation	△(*3)	—	△(*3)	—	—	489
17.2.16 3-dimensional Manual Feed	△	△	△	△	○	490
17.2.17 R-Navi	—	—	—	—	—	491
17.2.18 Simple Synchronous Control	—	—	—	—	—	493
17.2.20 Real-time Tuning						494
17.2.20.1 Real-time Tuning 1 (Speed Gain)	△	△	△	△	○	494
17.2.20.2 Real-time Tuning 2 (Rapid Traverse Time Constant)	△	△	△	△	○	495
17.2.21 Constant Torque Control	△	△	△	△	○	496
17.2.22 External Encoder Position Output I/F	○	○	○	○	○	497
17.2.23 Multiple-axis Synchronization Control	—	—	—	—	—	498
17.2.24 Hypothetical Linear Axis Control	—	—	—	—	—	499
17.2.25 BiSS Encoder I/F	—	—	○	○	—	500
17.2.26 Tool Head Hot Swapping	—	—	—	—	—	501
17.3 PLC Operation						502
17.3.1 Arbitrary Feed in Manual Mode	○	○	○	○	○	502
17.3.2 Circular Feed in Manual Mode	△	△	△	△	○	503
17.3.3 PLC Axis Control	○	○	○	○	○	505
17.3.5 PLC Axis Indexing	○	○	○	○	○	506
17.3.6 NC Axis/PLC Axis Switchover	△	△	△	△	○	508
17.4 PLC Interface						509
17.4.1 CNC Control Signal	○	○	○	○	○	509
17.4.2 CNC Status Signal	○	○	○	○	○	510
17.4.3 PLC Window	○	○	○	○	○	512
17.4.4 External Search	○	○	○	○	○	513
17.4.5 Direct Screen Selection	○	○	○	○	○	513
17.4.6 Buzzer Sound Control	○	○	○	○	○	514
17.5 Machine Contact I/O						515
17.5.1 Operation Panel I/O						515
17.5.1.1 DI:64/DO:64	□ / —	□ / —	—	—	□ / —	515
17.5.1.2 DI:64/DO:64 + SDI:8	□ / —	□ / —	—	—	□ / —	515
17.5.1.3 DI:96/DO:64	— / □	— / □	□	□	— / □	515
17.5.1.5 DI:64/DO:48/AO:1	— / □	— / □	□	□	— / □	515
17.5.2 Remote I/O						516
17.5.2.1 DI:32/DO:32	□	□	□	□	□	516
17.5.2.2 DI:64/DO:48	□	□	□	□	□	516
17.5.2.3 DI:64/DO:48 + AO:1	□	□	□	□	□	516

○: Standard △: Option □: Selection

Class	Lathe system					Page
	M850W	M830W	M850S	M830S	M80W	
17.5.2.5 DI:16/DO:8	□	□	□	□	□	516
17.5.2.6 DI:32/DO:32 + SDI:8/SDO:4	□	□	□	□	□	516
17.5.2.7 SDI:8/SDO:4	□	□	□	□	□	516
17.6 External PLC Link						517
17.6.1 CC-Link (Master/Local)	□	□	□	□	□	517
17.6.2 PROFIBUS-DP (Master)	□	□	□	□	□	523
17.6.3 CC-Link IE Field (Master/Local)	□	□	□	□	□	524
17.6.4 PROFINET	—	—	—	—	—	525
17.6.5 EtherNet/IP	□	□	□	□	□	526
17.6.8 FL-net	□	□	□	□	□	527
17.6.9 DeviceNet (Master)	—	—	—	—	—	527
17.6.10 CC-Link IE Field Basic	○	○	○	○	○	528
17.7 Installing S/W for Machine Tools						530
17.7.1 Customization (NC Designer2)	△	△	△	△	○	530
17.7.1.1 Customization Data Storage Capacity [MB]	□	□	6	6	□	532
17.7.1.2 Customization Working Memory Size [MB]	6	6	6	6	3	532
17.7.2 User-defined Key	○	○	○	○	○	532
17.7.3 EZSocket I/F	○	○	○	○	○	532
17.7.4 APLC Release	△	△	△	△	○	533
17.7.5 Custom API Library	○	○	○	○	○	534
17.7.6 MES Interface Library	△	△	△	△	○	534
17.7.7 SLMP Server	○	○	○	○	○	535
17.7.8 Numerical Control (CNC) Communication Software FCSB1224W000	○	○	○	○	○	536
17.7.10 GOT2000 Screen Design Tool GT Works3	—	—	—	—	—	536
17.8 Others						537
17.8.1 System Lock	△	△	△	△	○	537
17.8.2 CNC Remote Operation Tool						537
17.8.2.1 NC Monitor2	○	○	○	○	○	537
17.8.2.2 NC Explorer	○	○	○	○	○	537
17.8.3 Automatic Operation Lock	○	○	○	○	○	537
17.8.4 Power Consumption Computation	○	○	○	○	○	538
17.8.5 EcoMonitorLight Connection	○	○	○	○	○	538
17.8.6 GOT Window	—	—	—	—	—	539
17.8.7 Log Viewer	—	—	—	—	—	540

(*2) G/B: Guide Bush

(*3) This function is available during program format switch

CONTENTS

Mitsubishi Electric CNC M800W/M800S/M80W Series Specifications List [M system]

○: Standard △: Option □: Selection

Class	Machining center system					Page
	M850W	M830W	M850S	M830S	M80W	
1 Control Axes						1
1.1 Control Axes						2
1.1.1 Number of Basic Control Axes (NC Axes)	○ 3	○ 3	○ 3	○ 3	○ 3	2
1.1.2 Max. Number of Axes (NC Axes + Spindles + PLC Axes)	○16 △32	○16 △32	○16 △32	○16 △32	11	2
1.1.2.1 Max. Number of NC Axes (In Total for All the Part Systems)	○16	○16	○16	○16	8	2
1.1.2.2 Max. Number of Spindles	4	4	4	4	2	2
1.1.2.3 Max. Number of PLC Axes	8	8	8	8	6	2
1.1.4 Max. Number of PLC Indexing Axes	8	8	8	8	4	3
1.1.5 Number of Simultaneous Contouring Control Axes	8	4	8	4	4	3
1.1.6 Max. Number of NC Axes in a Part System	○8 △12	○8 △12	○8 △12	○8 △12	8	3
1.1.7 Axis Name Extension	○	○	○	○	○	3
1.2 Control Part System						4
1.2.1 Standard Number of Part Systems	1	1	1	1	1	4
1.2.2 Max. Number of Part Systems (Main + Sub)	○2 △3(*9)	○2 △3(*9)	○2 △3(*9)	○2 △3(*9)	○2	4
1.2.2.1 Max. Number of Main Part Systems	○2	○2	○2	○2	○2	4
1.2.2.2 Max. Number of Sub Part Systems	○2	○2	○2	○2	—	4
1.3 Control Axes and Operation Modes						5
1.3.1 Tape (RS-232C Input) Mode	○	○	○	○	○	5
1.3.2 Memory Mode	○	○	○	○	○	5
1.3.3 MDI Mode	○	○	○	○	○	5
1.3.4 High-Speed Program Server Mode						6
1.3.4.1 Control Unit-side High-speed Program Server Mode	△	△	—	—	○	6
1.3.4.2 Display Unit-side High-speed Program Server Mode	△ / —	△ / —	△	△	○ / —	6
1.3.4.3 FTP High-speed Program Server Mode	—	—	—	—	—	6
1.3.5 Front-side SD Card Mode	○	○	○	○	○	7
1.3.6 Front-side USB Memory Mode	○	○	○	○	○	7
2 Input Command						9
2.1 Data Increment						10
2.1.1 Least Command Increment						10
Least command increment 1μm	○	○	○	○	○	10
Least command increment 0.1μm	○	○	○	○	○	10
Least command increment 0.01μm(10nm)	△	△	△	△	—	10
Least command increment 0.001μm(1nm)	△	△	△	△	—	10
2.1.2 Least Control Increment						12
Least control increment 0.01μm(10nm)	○	○	○	○	○	12
Least control increment 0.001μm(1nm)	○	○	○	○	○	12

○: Standard △: Option □: Selection

Class	Machining center system					Page
	M850W	M830W	M850S	M830S	M80W	
2.1.3 Indexing Increment	○	○	○	○	○	12
2.2 Unit System						13
2.2.1 Inch/Metric Changeover	○	○	○	○	○	13
2.2.2 Input Command Increment Tenfold	○	○	○	○	○	13
2.3 Program Format						14
2.3.1 Program Format						14
2.3.1.1 Format 1 for Lathe (G Code List 2, 3)	—	—	—	—	—	14
2.3.1.2 Format 2 for Lathe (G Code List 4, 5)	—	—	—	—	—	14
2.3.1.3 Special Format for Lathe (G Code List 6, 7)	—	—	—	—	—	14
2.3.1.4 Format 1 for Machining Center	○	○	○	○	○	14
2.3.1.5 Format 2 for Machining Center (M2 Format)	○	○	○	○	○	14
2.3.1.6 MITSUBISHI CNC Special Format	—	—	—	—	—	14
2.3.2 Program Format Switch	—	—	—	—	—	15
2.4 Command Value						17
2.4.1 Decimal Point Input I, II	○	○	○	○	○	17
2.4.2 Absolute/Incremental Command	○	○	○	○	○	18
2.4.3 Diameter/Radius Designation	—	—	—	—	—	19
2.4.4 Diameter/Radius Designation Switch	○	○	○	○	—	20
3 Positioning/Interpolation						21
3.1 Positioning						22
3.1.1 Positioning	○	○	○	○	○	22
3.1.2 Unidirectional Positioning	△	△	△	△	○	23
3.2 Linear/Circular Interpolation						24
3.2.1 Linear Interpolation	○	○	○	○	○	24
3.2.2 Circular Interpolation (Center/Radius Designation)	○	○	○	○	○	25
3.2.3 Helical Interpolation	○	○	○	○	○	27
3.2.4 Spiral/Conical Interpolation	△	△	△	△	○	30
3.2.5 Cylindrical Interpolation	△	△	△	△	○	32
3.2.6 Polar Coordinate Interpolation	△	△	△	△	—	33
3.2.7 Milling Interpolation	—	—	—	—	—	34
3.2.8 Hypothetical Axis Interpolation	△	△	△	△	—	35
3.3 Curve Interpolation						36
3.3.1 Involute Interpolation	△	△	△	△	○	36
3.3.2 Exponential Interpolation	△	△	△	△	—	38
3.3.3 Spline Interpolation (G05.1Q2/G61.2)	△	△	△	△	○	39
3.3.4 NURBS Interpolation	△	△	△	△	—	40
3.3.5 3-Dimensional Circular Interpolation	△	△	△	△	○	41
3.3.6 Spline Interpolation2 (G61.4)	△	△	△	△	○	42
4 Feed						45
4.1 Feedrate						46
4.1.1 Rapid Traverse Rate (m/min)	1000	1000	1000	1000	1000	46
4.1.2 Cutting Feedrate (m/min)	1000	1000	1000	1000	1000	47
4.1.3 Manual Feedrate (m/min)	1000	1000	1000	1000	1000	48

○: Standard △: Option □: Selection

Class	Machining center system					Page
	M850W	M830W	M850S	M830S	M80W	
4.1.4 Rotary Axis Command Speed Tenfold	○	○	○	○	○	48
4.2 Feedrate Input Methods						49
4.2.1 Feed per Minute (Asynchronous Feed)	○	○	○	○	○	49
4.2.2 Feed per Revolution (Synchronous Feed)	△	△	△	△	○	51
4.2.3 Inverse Time Feed	△	△	△	△	○	53
4.2.4 F 1-digit Feed	○	○	○	○	○	54
4.2.5 Manual Speed Command	△	△	△	△	○	55
4.2.7 G00 Feedrate Designation (, F Command)	△	△	△	△	○	55
4.2.8 Selection of Axis (Axes) for Feedrate Command	△	△	△	△	—	57
4.3 Override						58
4.3.1 Rapid Traverse Override	○	○	○	○	○	58
4.3.2 Cutting Feed Override	○	○	○	○	○	58
4.3.3 2nd Cutting Feed Override	○	○	○	○	○	58
4.3.4 Override Cancel	○	○	○	○	○	59
4.4 Acceleration/Deceleration						60
4.4.1 Automatic Acceleration/Deceleration after Interpolation	○	○	○	○	○	60
4.4.2 Rapid Traverse Constant-gradient Acceleration/Deceleration	○	○	○	○	○	62
4.4.3 Rapid Traverse Constant-gradient Multi-step Acceleration/Deceleration	△	△	△	△	○	63
4.5 Thread Cutting						64
4.5.1 Thread Cutting (Lead/Thread Number Designation)	△	△	△	△	○	64
4.5.2 Variable Lead Thread Cutting	—	—	—	—	—	67
4.5.3 Synchronous Tapping						68
4.5.3.1 Synchronous Tapping Cycle	○	○	○	○	○	68
4.5.3.2 Pecking Tapping Cycle	△	△	△	△	○	70
4.5.3.3 Deep-hole Tapping Cycle	△	△	△	△	○	72
4.5.3.4 Synchronous Tapping with Multiple Spindles	—	—	—	—	—	74
4.5.3.5 Synchronous Tapping with Analog I/F Spindle	○	○	○	○	○	74
4.5.4 Chamfering	—	—	—	—	—	74
4.5.6 Circular Thread Cutting	—	—	—	—	—	75
4.5.8 High-speed Synchronous Tapping (OMR-DD)	○	○	○	○	○	76
4.5.10 Thread Recutting	—	—	—	—	—	77
4.5.11 Thread Cutting Override	—	—	—	—	—	78
4.5.12 Variable Feed Thread Cutting	—	—	—	—	—	78
4.5.13 Thread Cutting Time Constant Switch	○	○	○	○	○	79
4.6 Manual Feed						80
4.6.1 Manual Rapid Traverse	○	○	○	○	○	80
4.6.2 Jog Feed	○	○	○	○	○	80
4.6.3 Incremental Feed	○	○	○	○	○	81
4.6.4 Handle Feed	○	○	○	○	○	81
4.6.5 Manual Feedrate B	○	○	○	○	○	82
4.6.6 Manual Feedrate B Surface Speed Control	△	△	△	△	—	83
4.6.8 Manual Speed Clamp	○	○	○	○	○	84

○: Standard △: Option □: Selection

Class	Machining center system					Page
	M850W	M830W	M850S	M830S	M80W	
4.7 Dwell						85
4.7.1 Dwell (Time-based Designation)	○	○	○	○	○	85
4.7.2 Dwell (Revolution-based Designation)	—	—	—	—	—	86
5 Program Memory/Editing						87
5.1 Memory Capacity						88
5.1.1 Memory Capacity (Number of Programs Stored)						88
230kB[600m] (400 programs)	—	—	—	—	—	88
500kB[1280m] (1000 programs)	○	○	○	○	○	88
1000kB[2560m] (1000 programs)	△	△	△	△	—	88
2000kB[5120m] (1000 programs)	△	△	△	△	—	88
5.2 Editing						89
5.2.1 Program Editing	○	○	○	○	○	89
5.2.2 Background Editing	○	○	○	○	○	90
5.2.3 Buffer Correction	○	○	○	○	○	91
5.2.5 Multi-part System Simultaneous Program Editing	○	○	○	○	—	92
5.2.6 Special Program Editing Display for Synchronization between Part Systems	△	△	△	△	○	92
5.2.7 Finish Shape View Programming	△	△	△	△	○	93
6 Operation and Display						95
6.1 Structure of Operation/Display Panel						96
6.1.1 Color Display (8.4-type LCD TFT)	—	—	—	—	—	96
6.1.2 Color Touchscreen Display (10.4-type LCD TFT)	—	—	□	□	—	96
6.1.3 Color Touchscreen Display (15-type LCD TFT)	—	—	□	□	—	96
6.1.4 Separated-type Color Display (8.4-type LCD TFT)	—	—	—	—	□	96
6.1.5 Separated-type Color Touchscreen Display (10.4-type LCD TFT)	□	□	—	—	□	96
6.1.6 Separated-type Color Touchscreen Display (15-type LCD TFT)	□	□	—	—	□	96
6.1.7 Separated-type Color Touchscreen Display (15-type LCD TFT/Windows8)	□	□	—	—	□	96
6.1.8 Separated-type Color Touchscreen Display (19-type LCD TFT/Windows8)	□	□	—	—	□	97
6.1.9 Separated-type Color Touchscreen Display (19-type Horizontal LCD TFT/Windows8)	□	□	—	—	□	97
6.1.11 GOT (GOT2000 Series GT27/GT25 12.1/10.4/8.4/5.7)	—	—	—	—	—	97
6.2 Operation Methods and Functions						98
6.2.1 Operation Input	○	○	○	○	○	98
6.2.2 Absolute/Incremental Setting	○	○	○	○	○	98
6.2.3 Multiple Display Connection	—	—	—	—	—	99
6.2.4 Common Display to Multiple NCs	—	—	—	—	—	99
6.2.5 Displayed Part System Switch	○	○	○	○	○	99
6.2.6 Menu List	○	○	○	○	○	100
6.2.7 Display Switch by Operation Mode	○	○	○	○	○	100
6.2.8 External Signal Display Switch	○	○	○	○	○	100

○: Standard △: Option □: Selection

Class	Machining center system					Page
	M850W	M830W	M850S	M830S	M80W	
6.2.9 Screen Saver	○	○	○	○	○	100
6.2.10 Parameter Guidance	○	○	○	○	○	100
6.2.11 Alarm Guidance	○	○	○	○	○	101
6.2.12 Machining Program Input Mistake Check Warning	△	△	△	△	—	101
6.2.14 Screenshot Capture	— / ○	— / ○	○	○	— / ○	101
6.2.15 User Selectable Menu Configuration	○	○	○	○	○	101
6.2.16 PC-NC Network Automatic Connection	○ / —	○ / —	—	—	○ / —	102
6.2.17 Device Open Parameter	○	○	○	○	○	102
6.2.18 SRAM Open Parameter	○	○	○	○	○	102
6.2.19 MTB Selectable Menu Configuration	○	○	○	○	○	102
6.2.20 Remote Desktop Connection	— / ○	— / ○	△	△	— / ○	103
6.2.21 VNC Server	— / △	— / △	△	△	— / ○	104
6.3 Display Methods and Contents						105
6.3.1 Status Display	○	○	○	○	○	105
6.3.2 Clock Display	○	○	○	○	○	105
6.3.3 Monitor Screen Display	○	○	○	○	○	106
6.3.4 Setup Screen Display	○	○	○	○	○	107
6.3.5 Edit Screen Display	○	○	○	○	○	107
6.3.6 Diagnosis Screen Display	○	○	○	○	○	107
6.3.7 Maintenance Screen Display	○	○	○	○	○	108
6.3.8 Home Application	○ / —	○ / —	—	—	○ / —	108
6.3.9 Home Screen	○	○	○	○	○	109
6.3.10 Additional Languages						110
6.3.10.1 Japanese	○	○	○	○	○	110
6.3.10.2 English	○	○	○	○	○	110
6.3.10.3 German	○	○	○	○	○	110
6.3.10.4 Italian	○	○	○	○	○	110
6.3.10.5 French	○	○	○	○	○	110
6.3.10.6 Spanish	○	○	○	○	○	110
6.3.10.7 Chinese						110
6.3.10.7.1 Chinese (Traditional Chinese Characters)	○	○	○	○	○	110
6.3.10.7.2 Chinese (Simplified Chinese Characters)	○	○	○	○	○	110
6.3.10.8 Korean	○	○	○	○	○	111
6.3.10.9 Portuguese	○	○	○	○	○	111
6.3.10.10 Hungarian	○	○	○	○	○	111
6.3.10.11 Dutch	○	○	○	○	○	111
6.3.10.12 Swedish	○	○	○	○	○	111
6.3.10.13 Turkish	○	○	○	○	○	111
6.3.10.14 Polish	○	○	○	○	○	111
6.3.10.15 Russian	○	○	○	○	○	111
6.3.10.16 Czech	○	○	○	○	○	111
6.3.10.17 Indonesian	○	○	○	○	○	112
6.3.10.18 Vietnamese	○	○	○	○	○	112

○: Standard △: Option □: Selection

Class	Machining center system					Page
	M850W	M830W	M850S	M830S	M80W	
7 Input/Output Functions and Devices						113
7.1 Input/Output Data						114
7.1.1 Machining Program Input/Output	○	○	○	○	○	114
7.1.2 Tool Offset Data Input/Output	○	○	○	○	○	114
7.1.3 Common Variable Input/Output	○	○	○	○	○	114
7.1.4 Parameter Input/Output	○	○	○	○	○	114
7.1.5 History Data Output	○	○	○	○	○	114
7.1.7 System Configuration Data Output	○	○	○	○	○	114
7.2 Input/Output I/F						115
7.2.1 RS-232C I/F	○	○	○	○	○	115
7.2.2 SD Card I/F						115
7.2.2.1 Control Unit-side SD Card I/F [Up to 32GB]	○	○	—	—	○	115
7.2.2.2 Front-side SD Card I/F [Up to 32GB]	○/—	○/—	○	○	○/—	115
7.2.3 Ethernet I/F	○	○	○	○	○	115
7.2.4 Display Unit-side Data Server I/F	○	○	○	○	○	116
7.2.5 Front-side USB Memory I/F [Up to 32GB]	○	○	○	○	○	116
7.2.6 USB I/F (GOT Front-side USB I/F)	—	—	—	—	—	116
7.2.7 SD I/F (GOT Back-side SD Card I/F)	—	—	—	—	—	116
7.3 Computer Link						117
7.3.1 Computer Link B	△	△	△	△	○	117
7.4 Others						118
7.4.1 Handy Terminal Connection	○	○	○	○	○	118
7.4.3 IP Filter Setting	○	○	○	○	○	119
8 Spindle, Tool and Miscellaneous Functions						121
8.1 Spindle Functions (S)						122
8.1.1 Spindle Control Functions						122
8.1.1.1 Spindle Digital I/F	○	○	○	○	○	123
8.1.1.2 Spindle Analog I/F	○	○	○	○	○	123
8.1.1.3 Coil Switch	○	○	○	○	○	123
8.1.1.4 Automatic Coil Switch	○	○	○	○	○	123
8.1.1.5 Encoder Input I/F	□	□	○	○	□	124
8.1.1.6 Spindle-mode Servo Motor Control	△	△	△	△	○	125
8.1.1.7 Spindle-mode Rotary Axis Control	△	△	△	△	○	126
8.1.1.8 Turret Gear Change Control	—	—	—	—	—	127
8.1.1.9 Spindle Control with Pulse Train Output	—	—	—	—	—	128
8.1.2 S Code Output	○	○	○	○	○	129
8.1.3 Constant Surface Speed Control	○	○	○	○	○	130
8.1.4 Spindle Override	○	○	○	○	○	132
8.1.5 Multiple-spindle Control						132
8.1.5.1 Multiple-spindle Control I	—	—	—	—	—	133
8.1.5.2 Multiple-spindle Control II	○	○	○	○	○	134
8.1.6 Spindle Orientation	○	○	○	○	○	135

○: Standard △: Option □: Selection

Class	Machining center system					Page
	M850W	M830W	M850S	M830S	M80W	
8.1.7 Spindle Position Control (Spindle/C Axis Control)						136
8.1.7.1 Spindle Position Control (Spindle/C Axis Control)	○	○	○	○	○	136
8.1.7.2 C Axis Control during Spindle Synchronization	△	△	△	△	—	137
8.1.8 Spindle Synchronization						138
8.1.8.1 Spindle Synchronization I	○	○	○	○	○	138
8.1.8.2 Spindle Synchronization II	○	○	○	○	○	139
8.1.8.3 Guide Bushing Spindle Synchronization	—	—	—	—	—	139
8.1.9 Tool Spindle Synchronization I (Polygon)						140
8.1.9.1 Tool Spindle Synchronization IA (Spindle-Spindle, Polygon)	△	△	△	△	○	140
8.1.9.2 Tool Spindle Synchronization IB (Spindle-Spindle, Polygon)	△	△	△	△	○	141
8.1.9.3 Tool Spindle Synchronization IC (Spindle-NC Axis, Polygon)	△	△	△	△	○	142
8.1.10 Tool Spindle Synchronization II (Hobbing)	△	△	△	△	○	143
8.1.11 Spindle Speed Clamp	○	○	○	○	○	144
8.1.13 Spindle Oscillation	△	△	△	△	—	144
8.1.14 Spindle Superimposition Control	—	—	—	—	—	145
8.1.15 Multiple Spindle Synchronization Set Control	—	—	—	—	—	147
8.1.16 Spindle Speed Fluctuation Detection	△	△	△	△	○	150
8.1.17 Spindle Motor Temperature Output to PLC	○	○	○	○	○	151
8.2 Tool Functions (T)						152
8.2.1 Tool Functions (T Command)	○	○	○	○	○	152
8.3 Miscellaneous Functions (M)						153
8.3.1 Miscellaneous Functions	○	○	○	○	○	153
8.3.2 Multiple M Codes in 1 Block	○	○	○	○	○	153
8.3.3 M Code Independent Output	○	○	○	○	○	154
8.3.4 Miscellaneous Function Finish	○	○	○	○	○	155
8.3.5 M Code Output during Axis Traveling	—	—	—	—	—	156
8.3.6 Miscellaneous Function Command High-speed Output	○	○	○	○	○	157
8.4 2nd Miscellaneous Functions (B)						159
8.4.1 2nd Miscellaneous Functions	○	○	○	○	○	159
8.4.2 2nd Miscellaneous Function Name Extension	○	○	○	○	○	159
9 Tool Compensation						161
9.1 Tool Length/Tool Position						162
9.1.1 Tool Length Offset	○	○	○	○	○	162
9.1.2 Tool Position Offset	○	○	○	○	○	165
9.1.3 Tool Compensation for Additional Axes	—	—	—	—	—	165
9.1.4 Tool Position Compensation (G43.7)	△	△	△	△	—	166
9.2 Tool Radius						167
9.2.1 Tool Radius Compensation	○	○	○	○	○	167

○: Standard △: Option □: Selection

Class	Machining center system					Page
	M850W	M830W	M850S	M830S	M80W	
9.2.2 3-dimensional Tool Radius Compensation	△	△	△	△	—	169
9.2.3 Tool Nose Radius Compensation (G40/41/42)	△	△	△	△	—	170
9.2.4 Automatic Decision of Nose Radius Compensation Direction (G46/40)	—	—	—	—	—	171
9.2.5 Tool Radius Compensation Diameter Designation	○	○	○	○	○	171
9.3 Tool Offset Amount						172
9.3.1 Number of Tool Offset Sets						172
99 sets	—	—	—	—	—	172
128 sets	—	—	—	—	—	172
200 sets	○	○	○	○	—	172
256 sets	—	—	—	—	—	172
400 sets	△	△	△	△	○	172
999 sets	△	△	△	△	—	172
9.3.2 Offset Memory						173
9.3.2.1 Tool Shape/Wear Offset Amount	○	○	○	○	○	173
9.3.2.2 Compensation Type Selection by Parameter	○	○	○	○	○	176
9.3.3 Number of Tool Offset Sets Allocation to Part Systems	○	○	○	○	—	177
10 Coordinate System						179
10.1 Coordinate System Type and Setting						180
10.1.1 Machine Coordinate System	○	○	○	○	○	181
10.1.2 Coordinate System Setting	○	○	○	○	○	182
10.1.3 Automatic Coordinate System Setting	○	○	○	○	○	183
10.1.4 Workpiece Coordinate System Selection						184
10.1.4.1 Workpiece Coordinate System Selection (6 Sets)	○	○	○	○	○	184
10.1.4.2 Extended Workpiece Coordinate System Selection (48 Sets) G54.1P1 to P48	△	△	△	△	○	186
10.1.4.3 Extended Workpiece Coordinate System Selection (96 Sets) G54.1P1 to P96	△	△	△	△	—	186
10.1.4.4 Extended Workpiece Coordinate System Selection (300 Sets) G54.1P1 to P300	△	△	△	△	—	186
10.1.5 External Workpiece Coordinate Offset	○	○	○	○	○	187
10.1.6 Workpiece Coordinate System Preset (G92.1)	△	△	△	△	—	188
10.1.7 Local Coordinate System	○	○	○	○	○	189
10.1.8 Coordinate System for Rotary Axis	○	○	○	○	○	190
10.1.9 Plane Selection	○	○	○	○	○	191
10.1.10 Origin Set/Origin Cancel	○	○	○	○	○	192
10.1.11 Counter Set	○	○	○	○	○	193
10.1.12 Workpiece Position Offset for Rotary Axis	△	△	△	△	○	194
10.1.13 Workpiece Coordinate System Shift	—	—	—	—	—	196
10.2 Return						197
10.2.1 Manual Reference Position Return	○	○	○	○	○	197

○: Standard △: Option □: Selection

Class	Machining center system					Page
	M850W	M830W	M850S	M830S	M80W	
10.2.2 Automatic 1st Reference Position Return	○	○	○	○	○	198
10.2.3 2nd, 3rd, 4th Reference Position Return	○	○	○	○	○	200
10.2.4 Reference Position Check	○	○	○	○	○	201
10.2.5 Absolute Position Detection	○	○	○	○	○	202
10.2.6 Tool Exchange Position Return	○	○	○	○	○	203
11 Operation Support Functions						205
11.1 Program Control						206
11.1.1 Optional Block Skip	○	○	○	○	○	206
11.1.2 Optional Block Skip Addition	○	○	○	○	○	206
11.1.3 Single Block	○	○	○	○	○	207
11.2 Program Test						208
11.2.1 Dry Run	○	○	○	○	○	208
11.2.2 Machine Lock	○	○	○	○	○	208
11.2.3 Miscellaneous Function Lock	○	○	○	○	○	208
11.2.4 Graphic Check						209
11.2.4.1 Graphic Check	○	○	○	○	○	209
11.2.4.2 3D Solid Program Check	○	○	○	○	○	209
11.2.4.3 Graphic Check Rotary Axis Drawing	—	—	—	—	—	210
11.2.5 Graphic Trace						211
11.2.5.1 Graphic Trace	○	○	○	○	○	211
11.2.5.2 Graphic Trace Rotary Axis Drawing	—	—	—	—	—	212
11.2.6 Machining Time Computation	○	○	○	○	○	212
11.2.7 Manual Arbitrary Reverse Run (Program Check Operation)	△	△	△	△	○	213
11.2.8 High-speed Simple Program Check	○	○	○	○	○	214
11.3 Program Search/Start/Stop						215
11.3.1 Program Search	○	○	○	○	○	215
11.3.2 Sequence Number Search	○	○	○	○	○	215
11.3.3 Collation and Stop	○	○	○	○	○	216
11.3.4 Program Restart	○	○	○	○	○	217
11.3.5 Automatic Operation Start	○	○	○	○	○	218
11.3.6 NC Reset	○	○	○	○	○	218
11.3.7 Feed Hold	○	○	○	○	○	219
11.3.8 Search & Start	○	○	○	○	○	219
11.3.10 Auto-restart	○	○	○	○	○	219
11.4 Interrupt Operation						220
11.4.1 Manual Interruption	○	○	○	○	○	220
11.4.2 Automatic Operation Handle Interruption	○	○	○	○	○	220
11.4.3 Manual Absolute Switch	○	○	○	○	○	221
11.4.4 Thread Cutting Cycle Retract	○	○	○	○	○	222
11.4.5 Tapping Retract	○	○	○	○	○	223
11.4.6 Manual Numerical Value Command	○	○	○	○	○	224
11.4.7 Arbitrary Reverse Run	○	○	○	○	○	225
11.4.8 MDI Interruption	○	○	○	○	○	226

○: Standard △: Option □: Selection

Class	Machining center system					Page
	M850W	M830W	M850S	M830S	M80W	
11.4.9 Simultaneous Operation of Manual and Automatic Modes	○	○	○	○	○	226
11.4.10 Simultaneous Operation of JOG and Handle Modes	○	○	○	○	○	226
11.4.11 Reference Position Retract	○	○	○	○	○	227
11.4.12 Tool Retract and Return	△	△	△	△	○	228
11.4.13 Skip Retract	○	○	○	○	○	229
11.4.14 PLC Interruption	○	○	○	○	○	229
11.4.16 Machining Interruption	—	—	—	—	—	230
12 Program Support Functions						231
12.1 Machining Method Support Functions						232
12.1.1 Program						232
12.1.1.1 Subprogram Control [Layers]	○10	○10	○10	○10	○10	232
12.1.1.2 Figure Rotation	△	△	△	△	—	235
12.1.1.3 Scaling	△	△	△	△	○	237
12.1.1.4 Axis Name Switch	—	—	—	—	—	238
12.1.2 Macro Program						239
12.1.2.1 User Macro [Layers]	○4	○4	○4	○4	○4	239
12.1.2.2 Machine Tool Builder Macro	○	○	○	○	○	242
12.1.2.3 Macro Interruption	○	○	○	○	○	244
12.1.2.4 Variable Command						245
200 sets	—	—	—	—	—	245
600 sets	—	—	—	—	—	245
700 sets	○	○	○	○	○	245
8000 sets	△	△	△	△	○	245
(600+100×number of part systems) sets	○	○	○	○	○	245
(7900+100×number of part systems) sets	△	△	△	△	○	245
12.1.3 Fixed Cycle						247
12.1.3.1 Fixed Cycle for Drilling	○	○	○	○	○	248
12.1.3.2 Fixed Cycle for Drilling (Type II)	—	—	—	—	—	253
12.1.3.3 Special Fixed Cycle	△	△	△	△	○	254
12.1.3.4 Fixed Cycle for Turning Machining	○	○	○	○	○	257
12.1.3.5 Compound Type Fixed Cycle for Turning Machining	—	—	—	—	—	262
12.1.3.6 Compound Type Fixed Cycle for Turning Machining (Type II)	—	—	—	—	—	267
12.1.3.7 Small-diameter Deep-hole Drilling Cycle	○	○	○	○	○	271
12.1.4 Mirror Image						271
12.1.4.1 Mirror Image by Parameter Setting	○	○	○	○	○	271
12.1.4.2 Mirror Image by External Input	○	○	○	○	○	271
12.1.4.3 Mirror Image by G Code	○	○	○	○	○	272
12.1.4.4 Mirror Image for Facing Tool Posts	—	—	—	—	—	273
12.1.4.5 T Code Mirror Image for Facing Tool Posts	—	—	—	—	—	273
12.1.5 Coordinate System Operation						274
12.1.5.1 Coordinate Rotation by Program	△	△	△	△	○	274
12.1.5.2 Coordinate Rotation by Parameter	△	△	△	△	—	276

○: Standard △: Option □: Selection

Class	Machining center system					Page
	M850W	M830W	M850S	M830S	M80W	
12.1.5.3 3-dimensional Coordinate Conversion	△	△	△	△	○	277
12.1.6 Dimension Input						279
12.1.6.1 Corner Chamfering/Corner R	△	△	△	△	○	279
12.1.6.2 Linear Angle Command	△	△	△	△	○	286
12.1.6.3 Geometric Command	△	△	△	△	○	287
12.1.6.4 Polar Coordinate Command	△	△	△	△	○	288
12.1.7 Axis Control						289
12.1.7.1 Chopping						289
12.1.7.1.1 Chopping	△	△	△	△	○	289
12.1.7.2 Normal Line Control	○	○	○	○	○	290
12.1.7.3 Circular Cutting	○	○	○	○	○	291
12.1.7.4 Vibration Cutting Control	□	□	□	□	□	292
12.1.8 Multi-part System Control						293
12.1.8.1 Timing Synchronization between Part Systems	○	○	○	○	○	293
12.1.8.2 Start Point Designation Timing Synchronization	○	○	○	○	○	294
12.1.8.3 Mixed Control						297
12.1.8.3.1 Mixed Control (Cross Axis Control)	—	—	—	—	—	297
12.1.8.3.2 Arbitrary Axis Exchange Control	△	△	△	△	○	298
12.1.8.4 Control Axis Superimposition						300
12.1.8.4.1 Control Axis Superimposition	—	—	—	—	—	300
12.1.8.4.2 Arbitrary Axis Superimposition Control	—	—	—	—	—	302
12.1.8.5 Control Axis Synchronization between Part Systems	—	—	—	—	—	302
12.1.8.6 Balance Cut	—	—	—	—	—	304
12.1.8.7 Common Memory for Part Systems	—	—	—	—	—	306
12.1.8.8 Multi-part System Simultaneous Thread Cutting						306
12.1.8.8.1 Two-part System Simultaneous Thread Cutting	—	—	—	—	—	307
12.1.8.8.2 Multi-part System Simultaneous Thread Cutting	—	—	—	—	—	309
12.1.8.9 Multi-part System Program Management	○	○	○	○	○	310
12.1.8.10 Synchronization between Part Systems						311
12.1.8.10.1 Single Block between Part Systems	—	—	—	—	—	311
12.1.8.10.2 Dwell/Miscellaneous Function Time Override	—	—	—	—	—	312
12.1.8.10.3 Synchronization between Part Systems OFF	—	—	—	—	—	313
12.1.8.11 Sub Part System Control I	△	△	△	△	—	314
12.1.8.12 Sub Part System Control II	—	—	—	—	—	316
12.1.8.13 Loader Control Part System	○	○	○	○	—	318

○: Standard △: Option □: Selection

Class	Machining center system					Page
	M850W	M830W	M850S	M830S	M80W	
12.1.9 Data Input/Output by Program						319
12.1.9.1 Parameter Input by Program	○	○	○	○	○	319
12.1.9.2 Compensation Data Input by Program	○	○	○	○	○	320
12.1.9.3 Tool/Material Shape Input by Program	○	○	○	○	○	324
12.1.9.5 API Section and Sub-section Nos. Input/Output by Program	○	○	○	○	○	326
12.1.9.6 R-Navi Data Input by Program	△	△	△	△	○	326
12.1.10 Machining Modal						327
12.1.10.1 Tapping Mode	○	○	○	○	○	327
12.1.10.2 Cutting Mode	○	○	○	○	○	327
12.1.11 High-speed Parts Machining						328
12.1.11.1 Rapid Traverse Block Overlap	△	△	△	△	○	328
12.2 Machining Accuracy Support Functions						330
12.2.1 Automatic Corner Override	○	○	○	○	○	330
12.2.2 Deceleration Check						331
12.2.2.1 Exact Stop Check Mode	○	○	○	○	○	333
12.2.2.2 Exact Stop Check	○	○	○	○	○	333
12.2.2.3 Error Detection	○	○	○	○	○	333
12.2.2.4 Programmable In-position Check	○	○	○	○	○	334
12.2.2.5 Automatic Error Detection	—	—	—	—	—	334
12.3 High-speed and High-accuracy Functions [kBPM: k Block per Minute]						335
12.3.1 High-speed Machining Mode						335
12.3.1.1 High-speed Machining Mode I (G05P1) Maximum [kBPM]	△33.7	△33.7	△33.7	△33.7	○33.7	335
12.3.1.2 High-speed Machining Mode II (G05P2) Maximum [kBPM]	△168	△168	△168	△168	○67.5	336
12.3.2 High-accuracy Control						337
12.3.2.1 High-accuracy Control (G61.1/G08)	△	△	△	△	○	337
12.3.2.2 Multi-part System Simultaneous High-accuracy Control	△	△	△	△	○	341
12.3.2.3 SSS Control	△	△	△	△	○	342
12.3.2.4 Tolerance Control	△	△	△	△	○	343
12.3.2.5 Variable-acceleration Pre-interpolation Acceleration/Deceleration	△	△	△	△	—	344
12.3.2.6 High-accuracy Acceleration/Deceleration Time Constant Extension	△	△	△	△	—	344
12.3.2.7 Axis-specific Acceleration Tolerance Control	△	△	△	△	—	345
12.3.3 High-speed High-accuracy Control						346
12.3.3.1 High-speed High-accuracy Control I (G05.1Q1) Maximum [kBPM]	△67.5	△67.5	△67.5	△67.5	○33.7	346
12.3.3.2 High-speed High-accuracy Control II (G05P10000) Maximum [kBPM]	△168	△168	△168	△168	○67.5	347
12.3.3.3 High-speed High-accuracy Control III (G05P20000) Maximum [kBPM]	△270	△270	△270	△270	○135	350
12.3.3.4 Smooth Fairing	△	△	△	△	○	352
12.3.4 Machining Condition Selection I	○	○	○	○	○	353

○: Standard △: Option □: Selection

Class	Machining center system					Page
	M850W	M830W	M850S	M830S	M80W	
12.3.5 Direct Command Mode	—	—	—	—	—	353
12.4 Programming Support Functions						354
12.4.1 Playback	○	○	○	○	○	354
12.4.3 Interactive Cycle Insertion	△	△	△	△	○	355
12.4.4 Simple Programming (NAVI MILL/LATHE)	△	△	△	△	○	358
12.4.5 G code Guidance	○	○	○	○	○	358
12.4.7 DXF Data Input	△	△	△	△	○	359
13 Machine Accuracy Compensation						361
13.1 Static Accuracy Compensation						362
13.1.1 Backlash Compensation	○	○	○	○	○	362
13.1.2 Memory-type Pitch Error Compensation [sets]	○32	○32	○32	○32	○16	363
13.1.3 Memory-type Relative Position Error Compensation	○	○	○	○	○	364
13.1.4 External Machine Coordinate System Compensation	△	△	△	△	○	365
13.1.5 Circular Radius Error Compensation	△	△	△	△	○	365
13.1.6 Ball Screw Thermal Expansion Compensation	△	△	△	△	○	366
13.1.7 Rotation Center Error Compensation	△	△	△	△	—	367
13.1.8 Position-dependent Gradually Increasing-type Backlash Compensation	△	△	△	△	○	369
13.1.9 Bidirectional Pitch Error Compensation	△	△	△	△	○	370
13.1.10 Cyclic Error Compensation	△	△	△	△	○	370
13.1.11 Spatial Error Compensation	△	△	△	△	—	371
13.1.12 Backlash Compensation II	△	△	△	△	○	372
13.2 Dynamic Accuracy Compensation						373
13.2.1 Smooth High-gain (SHG) Control	○	○	○	○	○	373
13.2.2 Dual Feedback	○	○	○	○	○	374
13.2.3 Lost Motion Compensation	○	○	○	○	○	374
13.2.4 OMR II (Backlash with Filter)	△	△	△	△	○	375
13.2.6 OMR-FF	△	△	△	△	○	376
13.2.7 Distance-coded Reference Position Detection	△	△	△	△	○	377
13.2.9 Variable Torsion Compensation	△	△	△	△	○	378
13.2.10 Cogging Torque Compensation	△	△	△	△	○	379
14 Automation Support Functions						381
14.1 Measurement						382
14.1.1 Skip						382
14.1.1.1 Skip	○	○	○	○	○	382
14.1.1.2 Multiple-step Skip	○	○	○	○	○	384
14.1.1.4 PLC Skip	△	△	△	△	○	385
14.1.1.5 Speed Change Skip	△	△	△	△	—	385
14.1.1.6 Torque Limitation Skip	△	△	△	△	○	386
14.1.2 Automatic Tool Length Measurement	○	○	○	○	○	387
14.1.3 Manual Tool Length Measurement 1	○	○	○	○	○	390
14.1.4 Manual Tool Length Measurement 2	○	○	○	○	○	393
14.1.5 Workpiece Coordinate Offset Measurement	—	—	—	—	—	394

○: Standard △: Option □: Selection

Class	Machining center system					Page
	M850W	M830W	M850S	M830S	M80W	
14.1.6 Workpiece Position Measurement	○	○	○	○	○	395
14.1.7 Rotation Measurement	○	○	○	○	○	397
14.1.8 Rotation Center Error Measurement	△	△	△	△	—	398
14.1.9 Workpiece Installation Error Measurement	△	—	△	—	—	399
14.2 Tool Life Management						400
14.2.1 Tool Life Management						400
14.2.1.1 Tool Life Management I	○	○	○	○	○	400
14.2.1.2 Tool Life Management II	○	○	○	○	○	401
14.2.1.3 Tool Life Management III	○	○	○	○	○	401
14.2.2 Number of Tool Life Management Sets						402
99 sets	—	—	—	—	—	402
128 sets	—	—	—	—	—	402
200 sets	○	○	○	○	○	402
256 sets	—	—	—	—	—	402
400 sets	△	△	△	△	—	402
999 sets	△	△	△	△	—	402
14.2.3 Tool Life Management Set Allocation to Part Systems	○	○	○	○	—	404
14.3 Others						406
14.3.1 Programmable Current Limitation	○	○	○	○	○	406
14.3.2 Auto Power OFF	○	○	○	○	○	406
14.3.4 Load Monitoring I	△	△	△	△	○	407
14.3.5 Power ON/OFF Sequence	○ / —	○ / —	—	—	○ / —	407
14.3.6 PLC Axis Current Limit	—	—	—	—	—	407
14.3.7 Direct Robot Control	□	□	□	□	□	408
15 Safety and Maintenance						409
15.1 Safety Switches						410
15.1.1 Emergency Stop	○	○	○	○	○	410
15.1.2 Data Protection Key	○	○	○	○	○	410
15.2 Display for Ensuring Safety						411
15.2.1 NC Warning	○	○	○	○	○	411
15.2.2 NC Alarm	○	○	○	○	○	411
15.2.3 Operation Stop Cause	○	○	○	○	○	412
15.2.4 Emergency Stop Cause	○	○	○	○	○	412
15.2.5 Thermal Detection	○	○	○	○	○	412
15.2.6 Battery Alarm/Warning	○	○	○	○	○	413
15.3 Protection						414
15.3.1 Stroke End (Over Travel)	○	○	○	○	○	414
15.3.2 Stored Stroke Limit						414
15.3.2.1 Stored Stroke Limit I/II	○	○	○	○	○	415
15.3.2.2 Stored Stroke Limit IB	△	△	△	△	○	417
15.3.2.3 Stored Stroke Limit IIB	△	△	△	△	○	417
15.3.2.4 Stored Stroke Limit IC	△	△	△	△	○	418
15.3.3 Stroke Check before Travel	△	△	△	△	○	419
15.3.4 Chuck/Tailstock Barrier Check	—	—	—	—	—	421

○: Standard △: Option □: Selection

Class	Machining center system					Page
	M850W	M830W	M850S	M830S	M80W	
15.3.5 Interlock	○	○	○	○	○	422
15.3.6 External Deceleration	○	○	○	○	○	422
15.3.7 Interference Check III	△	△	△	△	—	423
15.3.8 3D Machine Interference Check	△	△	—	—	—	425
15.3.9 Door Interlock						426
15.3.9.1 Door Interlock I	○	○	○	○	○	426
15.3.9.2 Door Interlock II	○	○	○	○	○	428
15.3.10 Parameter Lock	○	○	○	○	○	430
15.3.11 Program Protection (Edit Lock B, C)	○	○	○	○	○	430
15.3.12 Program Display Lock	○	○	○	○	○	430
15.3.13 Data Protection by User's Level	△	△	△	△	○	430
15.3.15 Vertical Axis Pull-up	○	○	○	○	○	431
15.3.16 Machine Group-based Alarm Stop	△	△	△	△	○	431
15.3.17 Interference Check Between Part Systems	—	—	—	—	—	433
15.3.18 Spindle Protection	○	○	○	○	○	434
15.4 Maintenance and Troubleshooting						435
15.4.1 Operation History	○	○	○	○	○	435
15.4.2 Data Sampling	○	○	○	○	○	436
15.4.3 NC Data Backup	○	○	○	○	○	436
15.4.4 Servo Tuning Support						437
15.4.4.1 NC Analyzer2	○	○	○	○	○	437
15.4.5 Automatic Backup	○	○	○	○	○	439
15.4.8 Application Error Detection	○ / —	○ / —	—	—	○ / —	439
15.4.9 Email Notification to Operator	△	△	△	△	○	440
15.4.10 NC Configurator2	○	○	○	○	○	441
15.4.11 Diagnosis Data Output	○	○	○	○	○	441
15.4.12 Backup/Restore	—	—	—	—	—	441
15.4.14 Field Network Diagnostics	□	□	□	□	□	442
15.4.15 Remote service iQ Care Remote4U						443
15.4.15.1 Connection with RGU	□	□	□	□	□	443
15.5 Functional Safety						444
15.5.1 Safety Observation	△	△	△	△	○	444
15.5.2 Smart Safety Observation						445
15.5.2.1 Safety-related I/O Observation	△	△	△	△	○	445
15.5.2.2 Emergency Stop Observation	△	△	△	△	○	445
15.5.2.3 Drive Safety Function						446
15.5.2.3.1 SLS (Safely-Limited Speed)	△	△	△	△	○	446
15.5.2.3.2 SLP (Safely-Limited Position)	△	△	△	△	○	446
15.5.2.3.3 SOS (Safe Operating Stop)	△	△	△	△	○	446
15.5.2.3.4 SSM (Safe Speed Monitor)	△	△	△	△	○	446
15.5.2.3.5 SBC/SBT (Safe Brake Control/Safe Brake Test)	△	△	△	△	○	447

○: Standard △: Option □: Selection

Class	Machining center system					Page
	M850W	M830W	M850S	M830S	M80W	
15.5.2.3.6 SCA (Safe Cam)	△	△	△	△	○	447
15.5.2.3.7 SS1/SS2 (Safe Stop)	△	△	△	△	○	447
15.5.2.3.8 STO (Safe Torque Off)	△	△	△	△	○	447
15.5.2.3.9 SCN (Safety Communication Network)	—	—	—	—	—	448
16 Drive System						449
16.1 Servo/Spindle						450
Feed axis						—
MDS-E-Vx	□	□	□	□	□	—
MDS-EH-Vx	□	□	□	□	□	—
MDS-EJ-Vx	□	□	□	□	□	—
MDS-EJH-Vx	□	□	□	□	□	—
MDS-EM-SPVx	□	□	□	□	□	—
MDS-EMH-SPVx	□	□	□	□	□	—
Spindle						—
MDS-E-SPx	□	□	□	□	□	—
MDS-EH-SPx	□	□	□	□	□	—
MDS-EJ-SPx	□	□	□	□	□	—
MDS-EM-SPVx	□	□	□	□	□	—
MDS-EMH-SPVx	□	□	□	□	□	—
Power supply						—
MDS-E-CV	□	□	□	□	□	—
MDS-EH-CV	□	□	□	□	□	—
MDS-EX-CVP	□	□	□	□	□	—
17 Machine Support Functions						451
17.1 PLC						452
17.1.1 Built-in PLC Processing Mode	○	○	○	○	○	452
17.1.2 PLC Functions						452
17.1.2.1 Built-in PLC Basic Function	○	○	○	○	○	452
17.1.2.1.1 Index Modification	○	○	○	○	○	455
17.1.2.1.2 Multi-program [Number of Programs]	○120	○120	○120	○120	○60	455
17.1.2.1.3 Multi-project [Number of Projects Stored]						456
Number of PLC projects: 2	○	○	○	○	—	456
Number of PLC projects: 3	△	△	△	△	○	456
Number of PLC projects: 6	△	△	△	△	—	456
17.1.2.1.4 Function Block (FB)	○	○	○	○	○	456
17.1.2.1.5 Label Programming	○	○	○	○	○	456
17.1.2.2 PLC Exclusive Instruction	○	○	○	○	○	457
17.1.2.3 Enhanced PLC Security Mode	○	○	○	○	○	459
17.1.3 PLC Support Functions						460
17.1.3.1 Alarm Message Display	○	○	○	○	○	460

○: Standard △: Option □: Selection

Class	Machining center system					Page
	M850W	M830W	M850S	M830S	M80W	
17.1.3.2 Operator Message Display	○	○	○	○	○	460
17.1.3.3 Memory Switch (PLC Switch)						461
17.1.3.3.1 Memory Switch (PLC Switch) 32 Points	○	○	○	○	—	461
17.1.3.3.2 Memory Switch (PLC Switch) 64 Points	△	△	△	△	○	461
17.1.3.3.3 Memory Switch (PLC Switch) 96 points	△	△	△	△	—	461
17.1.3.4 Load Meter Display	○	○	○	○	○	462
17.1.3.5 User PLC Version Display	○	○	○	○	○	462
17.1.3.6 Ladder Program Writing during RUN	○	○	○	○	○	462
17.1.3.7 PLC Program Protection	○	○	○	○	○	462
17.1.4 Built-in PLC Capacity						463
17.1.4.1 Standard PLC Capacity [Number of Steps]	○128K	○128K	○128K	○128K	○64K	463
17.1.4.2 Large PLC Capacity: 256 Ksteps	△	△	△	△	—	463
17.1.4.3 Large PLC Capacity: 512 Ksteps	△	△	△	△	—	463
17.1.5 Machine Contact Input/Output I/F	○	○	○	○	○	463
17.1.6 Ladder Monitor	○	○	○	○	○	464
17.1.7 PLC Development						465
17.1.7.1 On-board Development	○	○	○	○	○	465
17.1.7.2 MELSEC Development Tool (GX Developer)	○	○	○	○	○	465
17.1.7.3 MELSEC Development Tool (GX Works2)	○	○	○	○	○	465
17.1.7.4 MELSEC Development Tool (GX Works3)	—	—	—	—	—	466
17.1.8 PLC Parameter						466
17.1.8.1 PLC Constant (150 Points)	○	○	○	○	○	466
17.1.8.2 PLC Constant Extension (Up to 750 Points)	○	○	○	○	○	466
17.1.9 GOT Connection						467
17.1.9.1 Ethernet Connection	○	○	○	○	○	467
17.1.9.2 CC-Link Connection	○	○	○	○	○	467
17.1.9.3 CC-Link IE Field Connection	—	—	—	—	—	467
17.1.10 Pallet Program Registration	△	△	△	△	—	468
17.2 Machine Construction						469
17.2.1 Servo OFF	○	○	○	○	○	469
17.2.2 Axis Detachment	○	○	○	○	○	470
17.2.3 Synchronous Control	△	△	△	△	○	471
17.2.4 Inclined Axis Control	△	△	△	△	○	475
17.2.5 Position Switch	○24	○24	○24	○24	○24	476
17.2.7 Index Table Indexing	○	○	○	○	○	477
17.2.8 Tool Length Compensation along the Tool Axis	△	△	△	△	—	479
17.2.9 Tool Handle Feed & Interruption	△	△	△	△	—	480

○: Standard △: Option □: Selection

Class	Machining center system					Page
	M850W	M830W	M850S	M830S	M80W	
17.2.10 Tool Center Coordinate Display	△	△	△	△	—	480
17.2.11 Tool Center Point Control						481
17.2.11.1 Tool Center Point Control (G43.4/G43.5)	△	△(*7)	△	△(*7)	○(*7)	481
17.2.12 Inclined Surface Machining Command	△	△	△	△	○	484
17.2.13 Simple Inclined Surface Machining Command	—	—	—	—	—	486
17.2.14 3-dimensional Tool Radius Compensation (Tool's Vertical-direction Compensation)	△	△	△	△	—	488
17.2.15 Workpiece Installation Error Compensation	△	—	△	—	—	489
17.2.16 3-dimensional Manual Feed	△	△	△	△	○	490
17.2.17 R-Navi	△	△	△	△	○	491
17.2.18 Simple Synchronous Control	△	△	△	△	○	493
17.2.20 Real-time Tuning						494
17.2.20.1 Real-time Tuning 1 (Speed Gain)	△	△	△	△	○	494
17.2.20.2 Real-time Tuning 2 (Rapid Traverse Time Constant)	△	△	△	△	○	495
17.2.21 Constant Torque Control	△	△	△	△	○	496
17.2.22 External Encoder Position Output I/F	○	○	○	○	○	497
17.2.23 Multiple-axis Synchronization Control	△	△	△	△	○	498
17.2.24 Hypothetical Linear Axis Control	—	—	—	—	—	499
17.2.25 BiSS Encoder I/F	—	—	○	○	—	500
17.2.26 Tool Head Hot Swapping	△	△	△	△	—	501
17.3 PLC Operation						502
17.3.1 Arbitrary Feed in Manual Mode	○	○	○	○	○	502
17.3.2 Circular Feed in Manual Mode	△	△	△	△	○	503
17.3.3 PLC Axis Control	○	○	○	○	○	505
17.3.5 PLC Axis Indexing	○	○	○	○	○	506
17.3.6 NC Axis/PLC Axis Switchover	△	△	△	△	○	508
17.4 PLC Interface						509
17.4.1 CNC Control Signal	○	○	○	○	○	509
17.4.2 CNC Status Signal	○	○	○	○	○	510
17.4.3 PLC Window	○	○	○	○	○	512
17.4.4 External Search	○	○	○	○	○	513
17.4.5 Direct Screen Selection	○	○	○	○	○	513
17.4.6 Buzzer Sound Control	○	○	○	○	○	514
17.5 Machine Contact I/O						515
17.5.1 Operation Panel I/O						515
17.5.1.1 DI:64/DO:64	□ / —	□ / —	—	—	□ / —	515
17.5.1.2 DI:64/DO:64 + SDI:8	□ / —	□ / —	—	—	□ / —	515
17.5.1.3 DI:96/DO:64	— / □	— / □	□	□	— / □	515
17.5.1.5 DI:64/DO:48/AO:1	— / □	— / □	□	□	— / □	515
17.5.2 Remote I/O						516
17.5.2.1 DI:32/DO:32	□	□	□	□	□	516
17.5.2.2 DI:64/DO:48	□	□	□	□	□	516
17.5.2.3 DI:64/DO:48 + AO:1	□	□	□	□	□	516

○: Standard △: Option □: Selection

Class	Machining center system					Page
	M850W	M830W	M850S	M830S	M80W	
17.5.2.5 DI:16/DO:8	□	□	□	□	□	516
17.5.2.6 DI:32/DO:32 + SDI:8/SDO:4	□	□	□	□	□	516
17.5.2.7 SDI:8/SDO:4	□	□	□	□	□	516
17.6 External PLC Link						517
17.6.1 CC-Link (Master/Local)	□	□	□	□	□	517
17.6.2 PROFIBUS-DP (Master)	□	□	□	□	□	523
17.6.3 CC-Link IE Field (Master/Local)	□	□	□	□	□	524
17.6.4 PROFINET	—	—	—	—	—	525
17.6.5 EtherNet/IP	□	□	□	□	□	526
17.6.8 FL-net	□	□	□	□	□	527
17.6.9 DeviceNet (Master)	—	—	—	—	—	527
17.6.10 CC-Link IE Field Basic	○	○	○	○	○	528
17.7 Installing S/W for Machine Tools						530
17.7.1 Customization (NC Designer2)	△	△	△	△	○	530
17.7.1.1 Customization Data Storage Capacity [MB]	□	□	6	6	□	532
17.7.1.2 Customization Working Memory Size [MB]	6	6	6	6	3	532
17.7.2 User-defined Key	○	○	○	○	○	532
17.7.3 EZSocket I/F	○	○	○	○	○	532
17.7.4 APLC Release	△	△	△	△	○	533
17.7.5 Custom API Library	○	○	○	○	○	534
17.7.6 MES Interface Library	△	△	△	△	○	534
17.7.7 SLMP Server	○	○	○	○	○	535
17.7.8 Numerical Control (CNC) Communication Software FCSB1224W000	○	○	○	○	○	536
17.7.10 GOT2000 Screen Design Tool GT Works3	—	—	—	—	—	536
17.8 Others						537
17.8.1 System Lock	△	△	△	△	○	537
17.8.2 CNC Remote Operation Tool						537
17.8.2.1 NC Monitor2	○	○	○	○	○	537
17.8.2.2 NC Explorer	○	○	○	○	○	537
17.8.3 Automatic Operation Lock	○	○	○	○	○	537
17.8.4 Power Consumption Computation	○	○	○	○	○	538
17.8.5 EcoMonitorLight Connection	○	○	○	○	○	538
17.8.6 GOT Window	—	—	—	—	—	539
17.8.7 Log Viewer	—	—	—	—	—	540

(*7)Restrained to 4-axis

simultaneous contouring

(*9)The 3rd part system is only for the loader part system.

CONTENTS

Mitsubishi Electric CNC M80/E80/C80 Series Specifications List [L system]

○: Standard △: Option □: Selection

Class	Lathe system					Page
	M80 TypeA	M80 TypeB	E80 TypeA	E80 TypeB	C80	
1 Control Axes						1
1.1 Control Axes						2
1.1.1 Number of Basic Control Axes (NC Axes)	○ 2	○ 2	○ 2	○ 2	○ 2	2
1.1.2 Max. Number of Axes (NC Axes + Spindles + PLC Axes)	12	9	8	6	16	2
1.1.2.1 Max. Number of NC Axes (In Total for All the Part Systems)	10	7	5	4	16	2
1.1.2.2 Max. Number of Spindles	5	4	3	3	7	2
1.1.2.3 Max. Number of PLC Axes	6	6	3	3	8	2
1.1.4 Max. Number of PLC Indexing Axes	4	4	1	1	8	3
1.1.5 Number of Simultaneous Contouring Control Axes	4	4	4	4	4	3
1.1.6 Max. Number of NC Axes in a Part System	8	5	5	4	8	3
1.1.7 Axis Name Extension	○	○	—	—	○	3
1.2 Control Part System						4
1.2.1 Standard Number of Part Systems	1	1	1	1	1	4
1.2.2 Max. Number of Part Systems (Main + Sub)	○4	○2	○1	○1	○7	4
1.2.2.1 Max. Number of Main Part Systems	○2	○2	○1	○1	○7	4
1.2.2.2 Max. Number of Sub Part Systems	○2	○1	—	—	○2	4
1.3 Control Axes and Operation Modes						5
1.3.1 Tape (RS-232C Input) Mode	○	○	○	○	—	5
1.3.2 Memory Mode	○	○	○	○	○	5
1.3.3 MDI Mode	○	○	○	○	○	5
1.3.4 High-Speed Program Server Mode						6
1.3.4.1 Control Unit-side High-speed Program Server Mode	—	—	—	—	—	6
1.3.4.2 Display Unit-side High-speed Program Server Mode	○	○	○	○	—	6
1.3.4.3 FTP High-speed Program Server Mode	—	—	—	—	△	6
1.3.5 Front-side SD Card Mode	○	○	○	○	—	7
1.3.6 Front-side USB Memory Mode	○	○	○	○	—	7
2 Input Command						9
2.1 Data Increment						10
2.1.1 Least Command Increment						10
Least command increment 1 μ m	○	○	○	○	○	10
Least command increment 0.1 μ m	○	○	○	○	○	10
Least command increment 0.01 μ m(10nm)	—	—	—	—	—	10
Least command increment 0.001 μ m(1nm)	—	—	—	—	—	10
2.1.2 Least Control Increment						12
Least control increment 0.01 μ m(10nm)	○	○	○	○	○	12
Least control increment 0.001 μ m(1nm)	○	○	○	○	○	12

○: Standard △: Option □: Selection

Class	Lathe system					Page
	M80 TypeA	M80 TypeB	E80 TypeA	E80 TypeB	C80	
2.1.3 Indexing Increment	○	○	○	○	○	12
2.2 Unit System						13
2.2.1 Inch/Metric Changeover	○	○	○	○	○	13
2.2.2 Input Command Increment Tenfold	—	—	—	—	—	13
2.3 Program Format						14
2.3.1 Program Format						14
2.3.1.1 Format 1 for Lathe (G Code List 2, 3)	○	○	○	○	○	14
2.3.1.2 Format 2 for Lathe (G Code List 4, 5)	○	○	○	○	○	14
2.3.1.3 Special Format for Lathe (G Code List 6, 7)	○	○	○	○	○	14
2.3.1.4 Format 1 for Machining Center	—	—	—	—	—	14
2.3.1.5 Format 2 for Machining Center (M2 Format)	—	—	—	—	—	14
2.3.1.6 MITSUBISHI CNC Special Format	○	○	○	○	○	14
2.3.2 Program Format Switch	—	—	—	—	—	15
2.4 Command Value						17
2.4.1 Decimal Point Input I, II	○	○	○	○	○	17
2.4.2 Absolute/Incremental Command	○	○	○	○	○	18
2.4.3 Diameter/Radius Designation	○	○	○	○	○	19
2.4.4 Diameter/Radius Designation Switch	○	○	○	○	—	20
3 Positioning/Interpolation						21
3.1 Positioning						22
3.1.1 Positioning	○	○	○	○	○	22
3.1.2 Unidirectional Positioning	—	—	—	—	—	23
3.2 Linear/Circular Interpolation						24
3.2.1 Linear Interpolation	○	○	○	○	○	24
3.2.2 Circular Interpolation (Center/Radius Designation)	○	○	○	○	○	25
3.2.3 Helical Interpolation	○	○	○	○	○	27
3.2.4 Spiral/Conical Interpolation	—	—	—	—	—	30
3.2.5 Cylindrical Interpolation	○	○	○	○	△	32
3.2.6 Polar Coordinate Interpolation	○	○	○	○	△	33
3.2.7 Milling Interpolation	○	○	○	○	△	34
3.2.8 Hypothetical Axis Interpolation	—	—	—	—	—	35
3.3 Curve Interpolation						36
3.3.1 Involute Interpolation	—	—	—	—	—	36
3.3.2 Exponential Interpolation	—	—	—	—	—	38
3.3.3 Spline Interpolation (G05.1Q2/G61.2)	—	—	—	—	—	39
3.3.4 NURBS Interpolation	—	—	—	—	—	40
3.3.5 3-Dimensional Circular Interpolation	—	—	—	—	—	41
3.3.6 Spline Interpolation2 (G61.4)	—	—	—	—	—	42
4 Feed						45
4.1 Feedrate						46
4.1.1 Rapid Traverse Rate (m/min)	1000	1000	1000	1000	1000	46
4.1.2 Cutting Feedrate (m/min)	1000	1000	1000	1000	1000	47
4.1.3 Manual Feedrate (m/min)	1000	1000	1000	1000	1000	48

○: Standard △: Option □: Selection

Class	Lathe system					Page
	M80 TypeA	M80 TypeB	E80 TypeA	E80 TypeB	C80	
4.1.4 Rotary Axis Command Speed Tenfold	○	○	○	○	○	48
4.2 Feedrate Input Methods						49
4.2.1 Feed per Minute (Asynchronous Feed)	○	○	○	○	○	49
4.2.2 Feed per Revolution (Synchronous Feed)	○	○	○	○	○	51
4.2.3 Inverse Time Feed	—	—	—	—	—	53
4.2.4 F 1-digit Feed	○	○	○	○	○	54
4.2.5 Manual Speed Command	○	○	○	○	△	55
4.2.7 G00 Feedrate Designation (, F Command)	○	—	—	—	△	55
4.2.8 Selection of Axis (Axes) for Feedrate Command	—	—	—	—	—	57
4.3 Override						58
4.3.1 Rapid Traverse Override	○	○	○	○	○	58
4.3.2 Cutting Feed Override	○	○	○	○	○	58
4.3.3 2nd Cutting Feed Override	○	○	○	○	○	58
4.3.4 Override Cancel	○	○	○	○	○	59
4.4 Acceleration/Deceleration						60
4.4.1 Automatic Acceleration/Deceleration after Interpolation	○	○	○	○	○	60
4.4.2 Rapid Traverse Constant-gradient Acceleration/Deceleration	○	○	○	○	○	62
4.4.3 Rapid Traverse Constant-gradient Multi-step Acceleration/Deceleration	—	—	—	—	—	63
4.5 Thread Cutting						64
4.5.1 Thread Cutting (Lead/Thread Number Designation)	○	○	○	○	○	64
4.5.2 Variable Lead Thread Cutting	○	○	○	○	○	67
4.5.3 Synchronous Tapping						68
4.5.3.1 Synchronous Tapping Cycle	○	○	○	○	○	68
4.5.3.2 Pecking Tapping Cycle	○	○	○	○	△	70
4.5.3.3 Deep-hole Tapping Cycle	○	○	○	○	△	72
4.5.3.4 Synchronous Tapping with Multiple Spindles	—	—	—	—	△	74
4.5.3.5 Synchronous Tapping with Analog I/F Spindle	○	○	○	○	—	74
4.5.4 Chamfering	○	○	○	○	○	74
4.5.6 Circular Thread Cutting	○	—	—	—	—	75
4.5.8 High-speed Synchronous Tapping (OMR-DD)	○	○	—	—	○	76
4.5.10 Thread Recutting	○	—	—	—	△	77
4.5.11 Thread Cutting Override	○	—	—	—	△	78
4.5.12 Variable Feed Thread Cutting	○	—	—	—	△	78
4.5.13 Thread Cutting Time Constant Switch	○	○	○	○	—	79
4.6 Manual Feed						80
4.6.1 Manual Rapid Traverse	○	○	○	○	○	80
4.6.2 Jog Feed	○	○	○	○	○	80
4.6.3 Incremental Feed	○	○	○	○	○	81
4.6.4 Handle Feed	○	○	○	○	○	81
4.6.5 Manual Feedrate B	○	○	○	○	○	82
4.6.6 Manual Feedrate B Surface Speed Control	—	—	—	—	—	83
4.6.8 Manual Speed Clamp	○	○	○	○	○	84

○: Standard △: Option □: Selection

Class	Lathe system					Page
	M80 TypeA	M80 TypeB	E80 TypeA	E80 TypeB	C80	
4.7 Dwell						85
4.7.1 Dwell (Time-based Designation)	○	○	○	○	○	85
4.7.2 Dwell (Revolution-based Designation)	○	○	○	○	○	86
5 Program Memory/Editing						87
5.1 Memory Capacity						88
5.1.1 Memory Capacity (Number of Programs Stored)						88
230kB[600m] (400 programs)	—	—	○	○	—	88
500kB[1280m] (1000 programs)	○	○	—	—	○	88
1000kB[2560m] (1000 programs)	—	—	—	—	△(*8)	88
2000kB[5120m] (1000 programs)	—	—	—	—	△(*8)	88
5.2 Editing						89
5.2.1 Program Editing	○	○	○	○	○	89
5.2.2 Background Editing	○	○	○	○	○	90
5.2.3 Buffer Correction	○	○	○	○	○	91
5.2.5 Multi-part System Simultaneous Program Editing	○	○	—	—	○	92
5.2.6 Special Program Editing Display for Synchronization between Part Systems	○	○	—	—	△	92
5.2.7 Finish Shape View Programming	○	○	○	○	—	93
6 Operation and Display						95
6.1 Structure of Operation/Display Panel						96
6.1.1 Color Display (8.4-type LCD TFT)	□	□	○	○	—	96
6.1.2 Color Touchscreen Display (10.4-type LCD TFT)	□	□	—	—	—	96
6.1.3 Color Touchscreen Display (15-type LCD TFT)	□	□	—	—	—	96
6.1.4 Separated-type Color Display (8.4-type LCD TFT)	—	—	—	—	—	96
6.1.5 Separated-type Color Touchscreen Display (10.4-type LCD TFT)	—	—	—	—	—	96
6.1.6 Separated-type Color Touchscreen Display (15-type LCD TFT)	—	—	—	—	—	96
6.1.7 Separated-type Color Touchscreen Display (15-type LCD TFT/Windows8)	—	—	—	—	—	96
6.1.8 Separated-type Color Touchscreen Display (19-type LCD TFT/Windows8)	—	—	—	—	—	97
6.1.9 Separated-type Color Touchscreen Display (19-type Horizontal LCD TFT/Windows8)	—	—	—	—	—	97
6.1.11 GOT (GOT2000 Series GT27/GT25 12.1/10.4/8.4/5.7)	—	—	—	—	○	97
6.2 Operation Methods and Functions						98
6.2.1 Operation Input	○	○	○	○	○	98
6.2.2 Absolute/Incremental Setting	○	○	○	○	○	98
6.2.3 Multiple Display Connection	—	—	—	—	○(GOT)	99
6.2.4 Common Display to Multiple NCs	—	—	—	—	○(GOT)	99
6.2.5 Displayed Part System Switch	○	○	—	—	○	99
6.2.6 Menu List	○	○	○	○	○	100
6.2.7 Display Switch by Operation Mode	○	○	○	○	○	100
6.2.8 External Signal Display Switch	○	—	—	—	○	100

○: Standard △: Option □: Selection

Class	Lathe system					Page
	M80 TypeA	M80 TypeB	E80 TypeA	E80 TypeB	C80	
6.2.9 Screen Saver	○	○	○	○	○ (GOT)	100
6.2.10 Parameter Guidance	○	○	○	○	○	100
6.2.11 Alarm Guidance	○	○	○	○	○	101
6.2.12 Machining Program Input Mistake Check Warning	—	—	—	—	—	101
6.2.14 Screenshot Capture	○	○	○	○	○ (GOT)	101
6.2.15 User Selectable Menu Configuration	○	○	○	○	○	101
6.2.16 PC-NC Network Automatic Connection	—	—	—	—	—	102
6.2.17 Device Open Parameter	○	○	○	○	—	102
6.2.18 SRAM Open Parameter	○	○	○	○	—	102
6.2.19 MTB Selectable Menu Configuration	○	○	○	○	○	102
6.2.20 Remote Desktop Connection	○	○	—	—	—	103
6.2.21 VNC Server	○	○	—	—	—	104
6.3 Display Methods and Contents						105
6.3.1 Status Display	○	○	○	○	○	105
6.3.2 Clock Display	○	○	○	○	○	105
6.3.3 Monitor Screen Display	○	○	○	○	○	106
6.3.4 Setup Screen Display	○	○	○	○	○	107
6.3.5 Edit Screen Display	○	○	○	○	○	107
6.3.6 Diagnosis Screen Display	○	○	○	○	○	107
6.3.7 Maintenance Screen Display	○	○	○	○	○	108
6.3.8 Home Application	—	—	—	—	—	108
6.3.9 Home Screen	○	○	○	○	—	109
6.3.10 Additional Languages						110
6.3.10.1 Japanese	○	○	○	○	○	110
6.3.10.2 English	○	○	○	○	○	110
6.3.10.3 German	○	○	○	○	○	110
6.3.10.4 Italian	○	○	○	○	○	110
6.3.10.5 French	○	○	○	○	○	110
6.3.10.6 Spanish	○	○	○	○	○	110
6.3.10.7 Chinese						110
6.3.10.7.1 Chinese (Traditional Chinese Characters)	○	○	○	○	○	110
6.3.10.7.2 Chinese (Simplified Chinese Characters)	○	○	○	○	○	110
6.3.10.8 Korean	○	○	○	○	○	111
6.3.10.9 Portuguese	○	○	○	○	○	111
6.3.10.10 Hungarian	○	○	○	○	○	111
6.3.10.11 Dutch	○	○	○	○	○	111
6.3.10.12 Swedish	○	○	○	○	○	111
6.3.10.13 Turkish	○	○	○	○	○	111
6.3.10.14 Polish	○	○	○	○	○	111
6.3.10.15 Russian	○	○	○	○	○	111
6.3.10.16 Czech	○	○	○	○	○	111
6.3.10.17 Indonesian	○	○	○	○	—	112
6.3.10.18 Vietnamese	○	○	○	○	—	112

○: Standard △: Option □: Selection

Class	Lathe system					Page
	M80 TypeA	M80 TypeB	E80 TypeA	E80 TypeB	C80	
7 Input/Output Functions and Devices						113
7.1 Input/Output Data						114
7.1.1 Machining Program Input/Output	○	○	○	○	○	114
7.1.2 Tool Offset Data Input/Output	○	○	○	○	○	114
7.1.3 Common Variable Input/Output	○	○	○	○	○	114
7.1.4 Parameter Input/Output	○	○	○	○	○	114
7.1.5 History Data Output	○	○	○	○	○	114
7.1.7 System Configuration Data Output	○	○	○	○	○	114
7.2 Input/Output I/F						115
7.2.1 RS-232C I/F	○	○	○	○	—	115
7.2.2 SD Card I/F						115
7.2.2.1 Control Unit-side SD Card I/F [Up to 32GB]	—	—	—	—	—	115
7.2.2.2 Front-side SD Card I/F [Up to 32GB]	○	○	○	○	—	115
7.2.3 Ethernet I/F	○	○	○	○	○ (GOT)	115
7.2.4 Display Unit-side Data Server I/F	○	○	○	○	—	116
7.2.5 Front-side USB Memory I/F [Up to 32GB]	○	○	○	○	—	116
7.2.6 USB I/F (GOT Front-side USB I/F)	—	—	—	—	○	116
7.2.7 SD I/F (GOT Back-side SD Card I/F)	—	—	—	—	○	116
7.3 Computer Link						117
7.3.1 Computer Link B	○	○	—	—	—	117
7.4 Others						118
7.4.1 Handy Terminal Connection	○	○	—	—	—	118
7.4.3 IP Filter Setting	○	○	○	○	—	119
8 Spindle, Tool and Miscellaneous Functions						121
8.1 Spindle Functions (S)						122
8.1.1 Spindle Control Functions						122
8.1.1.1 Spindle Digital I/F	○	○	○	○	○	123
8.1.1.2 Spindle Analog I/F	○	○	○	○	△ (MELSEC)	123
8.1.1.3 Coil Switch	○	○	○	○	○	123
8.1.1.4 Automatic Coil Switch	○	○	○	○	○	123
8.1.1.5 Encoder Input I/F	○	○	○	○	—	124
8.1.1.6 Spindle-mode Servo Motor Control	○	○	○	○	△	125
8.1.1.7 Spindle-mode Rotary Axis Control	—	—	—	—	—	126
8.1.1.8 Turret Gear Change Control	○	○	○	—	—	127
8.1.1.9 Spindle Control with Pulse Train Output	○	○	○	○	—	128
8.1.2 S Code Output	○	○	○	○	○	129
8.1.3 Constant Surface Speed Control	○	○	○	○	○	130
8.1.4 Spindle Override	○	○	○	○	○	132
8.1.5 Multiple-spindle Control						132
8.1.5.1 Multiple-spindle Control I	○	○	○	○	○	133
8.1.5.2 Multiple-spindle Control II	○	○	○	○	○	134
8.1.6 Spindle Orientation	○	○	○	○	○	135

○: Standard △: Option □: Selection

Class	Lathe system					Page
	M80 TypeA	M80 TypeB	E80 TypeA	E80 TypeB	C80	
8.1.7 Spindle Position Control (Spindle/C Axis Control)						136
8.1.7.1 Spindle Position Control (Spindle/C Axis Control)	○	○	○	○	○	136
8.1.7.2 C Axis Control during Spindle Synchronization	○	○	—	—	△	137
8.1.8 Spindle Synchronization						138
8.1.8.1 Spindle Synchronization I	○	○	○	○	○	138
8.1.8.2 Spindle Synchronization II	○	○	○	○	○	139
8.1.8.3 Guide Bushing Spindle Synchronization	○	—	—	—	—	139
8.1.9 Tool Spindle Synchronization I (Polygon)						140
8.1.9.1 Tool Spindle Synchronization IA (Spindle-Spindle, Polygon)	○	○	○	○	△	140
8.1.9.2 Tool Spindle Synchronization IB (Spindle-Spindle, Polygon)	○	○	○	○	△	141
8.1.9.3 Tool Spindle Synchronization IC (Spindle-NC Axis, Polygon)	○	—	—	—	△	142
8.1.10 Tool Spindle Synchronization II (Hobbing)	○	—	—	—	△	143
8.1.11 Spindle Speed Clamp	○	○	○	○	○	144
8.1.13 Spindle Oscillation	—	—	—	—	—	144
8.1.14 Spindle Superimposition Control	○	—	—	—	△	145
8.1.15 Multiple Spindle Synchronization Set Control	○	○	—	—	○	147
8.1.16 Spindle Speed Fluctuation Detection	○	○	—	—	—	150
8.1.17 Spindle Motor Temperature Output to PLC	○	○	○	○	—	151
8.2 Tool Functions (T)						152
8.2.1 Tool Functions (T Command)	○	○	○	○	○	152
8.3 Miscellaneous Functions (M)						153
8.3.1 Miscellaneous Functions	○	○	○	○	○	153
8.3.2 Multiple M Codes in 1 Block	○	○	○	○	○	153
8.3.3 M Code Independent Output	○	○	○	○	○	154
8.3.4 Miscellaneous Function Finish	○	○	○	○	○	155
8.3.5 M Code Output during Axis Traveling	○	—	—	—	○	156
8.3.6 Miscellaneous Function Command High-speed Output	○	○	○	○	○	157
8.4 2nd Miscellaneous Functions (B)						159
8.4.1 2nd Miscellaneous Functions	○	○	○	○	○	159
8.4.2 2nd Miscellaneous Function Name Extension	○	○	○	○	○	159
9 Tool Compensation						161
9.1 Tool Length/Tool Position						162
9.1.1 Tool Length Offset	○	○	○	○	○	162
9.1.2 Tool Position Offset	—	—	—	—	—	165
9.1.3 Tool Compensation for Additional Axes	○	○	○	○	○	165
9.1.4 Tool Position Compensation (G43.7)	—	—	—	—	—	166
9.2 Tool Radius						167
9.2.1 Tool Radius Compensation	—	—	—	—	—	167

○: Standard △: Option □: Selection

Class	Lathe system					Page
	M80 TypeA	M80 TypeB	E80 TypeA	E80 TypeB	C80	
9.2.2 3-dimensional Tool Radius Compensation	—	—	—	—	—	169
9.2.3 Tool Nose Radius Compensation (G40/41/42)	○	○	○	○	○	170
9.2.4 Automatic Decision of Nose Radius Compensation Direction (G46/40)	○	○	○	○	○	171
9.2.5 Tool Radius Compensation Diameter Designation	—	—	—	—	—	171
9.3 Tool Offset Amount						172
9.3.1 Number of Tool Offset Sets						172
99 sets	—	○	○	○	—	172
128 sets	—	—	—	—	○	172
200 sets	—	—	—	—	—	172
256 sets	○	—	—	—	△	172
400 sets	—	—	—	—	—	172
999 sets	—	—	—	—	—	172
9.3.2 Offset Memory						173
9.3.2.1 Tool Shape/Wear Offset Amount	○	○	○	○	○	173
9.3.2.2 Compensation Type Selection by Parameter	—	—	—	—	—	176
9.3.3 Number of Tool Offset Sets Allocation to Part Systems	○	○	—	—	—	177
10 Coordinate System						179
10.1 Coordinate System Type and Setting						180
10.1.1 Machine Coordinate System	○	○	○	○	○	181
10.1.2 Coordinate System Setting	○	○	○	○	○	182
10.1.3 Automatic Coordinate System Setting	○	○	○	○	○	183
10.1.4 Workpiece Coordinate System Selection						184
10.1.4.1 Workpiece Coordinate System Selection (6 Sets)	○	○	○	○	○	184
10.1.4.2 Extended Workpiece Coordinate System Selection (48 Sets) G54.1P1 to P48	○	○	○	○	△	186
10.1.4.3 Extended Workpiece Coordinate System Selection (96 Sets) G54.1P1 to P96	—	—	—	—	—	186
10.1.4.4 Extended Workpiece Coordinate System Selection (300 Sets) G54.1P1 to P300	—	—	—	—	—	186
10.1.5 External Workpiece Coordinate Offset	○	○	○	○	○	187
10.1.6 Workpiece Coordinate System Preset (G92.1)	○	○	○	○	○	188
10.1.7 Local Coordinate System	○	○	○	○	○	189
10.1.8 Coordinate System for Rotary Axis	○	○	○	○	○	190
10.1.9 Plane Selection	○	○	○	○	○	191
10.1.10 Origin Set/Origin Cancel	○	○	○	○	○	192
10.1.11 Counter Set	○	○	○	○	○	193
10.1.12 Workpiece Position Offset for Rotary Axis	—	—	—	—	—	194
10.1.13 Workpiece Coordinate System Shift	○	○	○	○	○	196
10.2 Return						197
10.2.1 Manual Reference Position Return	○	○	○	○	○	197

○: Standard △: Option □: Selection

Class	Lathe system					Page
	M80 TypeA	M80 TypeB	E80 TypeA	E80 TypeB	C80	
10.2.2 Automatic 1st Reference Position Return	○	○	○	○	○	198
10.2.3 2nd, 3rd, 4th Reference Position Return	○	○	○	○	○	200
10.2.4 Reference Position Check	○	○	○	○	○	201
10.2.5 Absolute Position Detection	○	○	○	○	○	202
10.2.6 Tool Exchange Position Return	○	○	○	○	○	203
11 Operation Support Functions						205
11.1 Program Control						206
11.1.1 Optional Block Skip	○	○	○	○	○	206
11.1.2 Optional Block Skip Addition	○	○	—	—	○	206
11.1.3 Single Block	○	○	○	○	○	207
11.2 Program Test						208
11.2.1 Dry Run	○	○	○	○	○	208
11.2.2 Machine Lock	○	○	○	○	○	208
11.2.3 Miscellaneous Function Lock	○	○	○	○	○	208
11.2.4 Graphic Check						209
11.2.4.1 Graphic Check	○	○	○	○	—	209
11.2.4.2 3D Solid Program Check	○	○	○	○	—	209
11.2.4.3 Graphic Check Rotary Axis Drawing	○	○	○	○	—	210
11.2.5 Graphic Trace						211
11.2.5.1 Graphic Trace	○	○	○	○	—	211
11.2.5.2 Graphic Trace Rotary Axis Drawing	○	○	○	○	—	212
11.2.6 Machining Time Computation	○	○	○	○	—	212
11.2.7 Manual Arbitrary Reverse Run (Program Check Operation)	○	○	○	○	△	213
11.2.8 High-speed Simple Program Check	○	○	○	○	○	214
11.3 Program Search/Start/Stop						215
11.3.1 Program Search	○	○	○	○	○	215
11.3.2 Sequence Number Search	○	○	○	○	○	215
11.3.3 Collation and Stop	○	○	—	—	○	216
11.3.4 Program Restart	○	○	○	○	○	217
11.3.5 Automatic Operation Start	○	○	○	○	○	218
11.3.6 NC Reset	○	○	○	○	○	218
11.3.7 Feed Hold	○	○	○	○	○	219
11.3.8 Search & Start	○	○	○	○	○	219
11.3.10 Auto-restart	○	○	○	○	○	219
11.4 Interrupt Operation						220
11.4.1 Manual Interruption	○	○	○	○	○	220
11.4.2 Automatic Operation Handle Interruption	○	○	○	○	○	220
11.4.3 Manual Absolute Switch	○	○	○	○	○	221
11.4.4 Thread Cutting Cycle Retract	○	○	—	—	○	222
11.4.5 Tapping Retract	○	○	○	○	○	223
11.4.6 Manual Numerical Value Command	○	○	○	○	○	224
11.4.7 Arbitrary Reverse Run	—	—	—	—	—	225
11.4.8 MDI Interruption	○	○	○	○	○	226

○: Standard △: Option □: Selection

Class	Lathe system					Page
	M80 TypeA	M80 TypeB	E80 TypeA	E80 TypeB	C80	
11.4.9 Simultaneous Operation of Manual and Automatic Modes	○	○	○	○	○	226
11.4.10 Simultaneous Operation of JOG and Handle Modes	○	○	○	○	○	226
11.4.11 Reference Position Retract	○	○	○	○	○	227
11.4.12 Tool Retract and Return	○	○	—	—	—	228
11.4.13 Skip Retract	—	—	—	—	—	229
11.4.14 PLC Interruption	○	○	○	○	○	229
11.4.16 Machining Interruption	—	—	—	—	△	230
12 Program Support Functions						231
12.1 Machining Method Support Functions						232
12.1.1 Program						232
12.1.1.1 Subprogram Control [Layers]	○10	○10	○10	○10	○10	232
12.1.1.2 Figure Rotation	—	—	—	—	—	235
12.1.1.3 Scaling	—	—	—	—	—	237
12.1.1.4 Axis Name Switch	○	○	○	○	○	238
12.1.2 Macro Program						239
12.1.2.1 User Macro [Layers]	○4	○4	○4	○4	○4	239
12.1.2.2 Machine Tool Builder Macro	○	○	○	○	○	242
12.1.2.3 Macro Interruption	○	○	○	○	○	244
12.1.2.4 Variable Command						245
200 sets	—	—	—	○	—	245
600 sets	—	○	○	—	—	245
700 sets	○	—	—	—	○	245
8000 sets	○	—	—	—	—	245
(600+100×number of part systems) sets	○	—	—	—	○	245
(7900+100×number of part systems) sets	○	—	—	—	—	245
12.1.3 Fixed Cycle						247
12.1.3.1 Fixed Cycle for Drilling	○	○	○	○	○	248
12.1.3.2 Fixed Cycle for Drilling (Type II)	○	○	○	○	○	253
12.1.3.3 Special Fixed Cycle	—	—	—	—	—	254
12.1.3.4 Fixed Cycle for Turning Machining	○	○	○	○	○	257
12.1.3.5 Compound Type Fixed Cycle for Turning Machining	○	○	○	○	○	262
12.1.3.6 Compound Type Fixed Cycle for Turning Machining (Type II)	○	○	○	○	△	267
12.1.3.7 Small-diameter Deep-hole Drilling Cycle	—	—	—	—	—	271
12.1.4 Mirror Image						271
12.1.4.1 Mirror Image by Parameter Setting	○	○	○	○	○	271
12.1.4.2 Mirror Image by External Input	○	○	○	○	○	271
12.1.4.3 Mirror Image by G Code	—	—	—	—	—	272
12.1.4.4 Mirror Image for Facing Tool Posts	○	○	—	—	○	273
12.1.4.5 T Code Mirror Image for Facing Tool Posts	○	○	—	—	○	273
12.1.5 Coordinate System Operation						274
12.1.5.1 Coordinate Rotation by Program	○	—	—	—	△	274
12.1.5.2 Coordinate Rotation by Parameter	—	—	—	—	—	276

○: Standard △: Option □: Selection

Class	Lathe system					Page
	M80 TypeA	M80 TypeB	E80 TypeA	E80 TypeB	C80	
12.1.5.3 3-dimensional Coordinate Conversion	○	—	—	—	—	277
12.1.6 Dimension Input						279
12.1.6.1 Corner Chamfering/Corner R	○	○	○	○	△	279
12.1.6.2 Linear Angle Command	○	○	○	○	△	286
12.1.6.3 Geometric Command	○	○	○	○	○	287
12.1.6.4 Polar Coordinate Command	—	—	—	—	—	288
12.1.7 Axis Control						289
12.1.7.1 Chopping						289
12.1.7.1.1 Chopping	○	○	—	—	△	289
12.1.7.2 Normal Line Control	—	—	—	—	—	290
12.1.7.3 Circular Cutting	—	—	—	—	—	291
12.1.7.4 Vibration Cutting Control	□	□	—	—	—	292
12.1.8 Multi-part System Control						293
12.1.8.1 Timing Synchronization between Part Systems	○	○	—	—	○	293
12.1.8.2 Start Point Designation Timing Synchronization	○	○	—	—	○	294
12.1.8.3 Mixed Control						297
12.1.8.3.1 Mixed Control (Cross Axis Control)	○	—	—	—	△	297
12.1.8.3.2 Arbitrary Axis Exchange Control	○	—	—	—	△	298
12.1.8.4 Control Axis Superimposition						300
12.1.8.4.1 Control Axis Superimposition	○	—	—	—	—	300
12.1.8.4.2 Arbitrary Axis Superimposition Control	—	—	—	—	—	302
12.1.8.5 Control Axis Synchronization between Part Systems	○	○	—	—	△	302
12.1.8.6 Balance Cut	○	—	—	—	○	304
12.1.8.7 Common Memory for Part Systems	○	—	—	—	○	306
12.1.8.8 Multi-part System Simultaneous Thread Cutting						306
12.1.8.8.1 Two-part System Simultaneous Thread Cutting	○	—	—	—	○	307
12.1.8.8.2 Multi-part System Simultaneous Thread Cutting	○	—	—	—	—	309
12.1.8.9 Multi-part System Program Management	○	○	—	—	○	310
12.1.8.10 Synchronization between Part Systems						311
12.1.8.10.1 Single Block between Part Systems	○	○	—	—	△	311
12.1.8.10.2 Dwell/Miscellaneous Function Time Override	○	○	—	—	△	312
12.1.8.10.3 Synchronization between Part Systems OFF	○	○	—	—	△	313
12.1.8.11 Sub Part System Control I	○	○	—	—	△	314
12.1.8.12 Sub Part System Control II	○	—	—	—	△	316
12.1.8.13 Loader Control Part System	—	—	—	—	—	318

○: Standard △: Option □: Selection

Class	Lathe system					Page
	M80 TypeA	M80 TypeB	E80 TypeA	E80 TypeB	C80	
12.1.9 Data Input/Output by Program						319
12.1.9.1 Parameter Input by Program	○	○	○	○	○	319
12.1.9.2 Compensation Data Input by Program	○	○	○	○	○	320
12.1.9.3 Tool/Material Shape Input by Program	○	○	○	○	○	324
12.1.9.5 API Section and Sub-section Nos. Input/Output by Program	○	○	○	○	—	326
12.1.9.6 R-Navi Data Input by Program	—	—	—	—	—	326
12.1.10 Machining Modal						327
12.1.10.1 Tapping Mode	○	○	○	○	○	327
12.1.10.2 Cutting Mode	○	○	○	○	○	327
12.1.11 High-speed Parts Machining						328
12.1.11.1 Rapid Traverse Block Overlap	○	○	—	—	△	328
12.2 Machining Accuracy Support Functions						330
12.2.1 Automatic Corner Override	○	○	○	○	○	330
12.2.2 Deceleration Check						331
12.2.2.1 Exact Stop Check Mode	○	○	○	○	○	333
12.2.2.2 Exact Stop Check	○	○	○	○	○	333
12.2.2.3 Error Detection	○	○	○	○	○	333
12.2.2.4 Programmable In-position Check	○	○	○	○	○	334
12.2.2.5 Automatic Error Detection	—	—	—	—	—	334
12.3 High-speed and High-accuracy Functions [kBPM: k Block per Minute]						335
12.3.1 High-speed Machining Mode						335
12.3.1.1 High-speed Machining Mode I (G05P1) Maximum [kBPM]	○33.7	—	—	—	△33.7	335
12.3.1.2 High-speed Machining Mode II (G05P2) Maximum [kBPM]	○67.5	—	—	—	△67.5	336
12.3.2 High-accuracy Control						337
12.3.2.1 High-accuracy Control (G61.1/G08)	○	○	○	○	△	337
12.3.2.2 Multi-part System Simultaneous High-accuracy Control	—	—	—	—	—	341
12.3.2.3 SSS Control	○	○	— (*4)	— (*4)	—	342
12.3.2.4 Tolerance Control	○	○	○	○	—	343
12.3.2.5 Variable-acceleration Pre-interpolation Acceleration/Deceleration	—	—	—	—	—	344
12.3.2.6 High-accuracy Acceleration/Deceleration Time Constant Extension	—	—	—	—	—	344
12.3.2.7 Axis-specific Acceleration Tolerance Control	—	—	—	—	—	345
12.3.3 High-speed High-accuracy Control						346
12.3.3.1 High-speed High-accuracy Control I (G05.1Q1) Maximum [kBPM]	○33.7	—	—	—	△33.7	346
12.3.3.2 High-speed High-accuracy Control II (G05P10000) Maximum [kBPM]	○67.5	—	—	—	△67.5	347
12.3.3.3 High-speed High-accuracy Control III (G05P20000) Maximum [kBPM]	—	—	—	—	—	350
12.3.3.4 Smooth Fairing	—	—	—	—	—	352
12.3.4 Machining Condition Selection I	○	—	—	—	○	353

○: Standard △: Option □: Selection

Class	Lathe system					Page
	M80 TypeA	M80 TypeB	E80 TypeA	E80 TypeB	C80	
12.3.5 Direct Command Mode	—	—	—	—	—	353
12.4 Programming Support Functions						354
12.4.1 Playback	—	—	—	—	—	354
12.4.3 Interactive Cycle Insertion	○	○	○	○	—	355
12.4.4 Simple Programming (NAVI MILL/LATHE)	○	○	○	○	—	358
12.4.5 G code Guidance	○	○	○	○	○	358
12.4.7 DXF Data Input	○	—	—	—	—	359
13 Machine Accuracy Compensation						361
13.1 Static Accuracy Compensation						362
13.1.1 Backlash Compensation	○	○	○	○	○	362
13.1.2 Memory-type Pitch Error Compensation [sets]	○16	○16	○16	○16	○10	363
13.1.3 Memory-type Relative Position Error Compensation	○	○	○	○	○	364
13.1.4 External Machine Coordinate System Compensation	○	○	○	○	△	365
13.1.5 Circular Radius Error Compensation	○	○	—	—	△	365
13.1.6 Ball Screw Thermal Expansion Compensation	○	○	○	○	△	366
13.1.7 Rotation Center Error Compensation	—	—	—	—	—	367
13.1.8 Position-dependent Gradually Increasing-type Backlash Compensation	○	○	—	—	△	369
13.1.9 Bidirectional Pitch Error Compensation	○	○	—	—	△	370
13.1.10 Cyclic Error Compensation	○	○	—	—	—	370
13.1.11 Spatial Error Compensation	—	—	—	—	—	371
13.1.12 Backlash Compensation II	—	—	—	—	—	372
13.2 Dynamic Accuracy Compensation						373
13.2.1 Smooth High-gain (SHG) Control	○	○	○	○	○	373
13.2.2 Dual Feedback	○	○	○	○	○	374
13.2.3 Lost Motion Compensation	○	○	○	○	○	374
13.2.4 OMR II (Backlash with Filter)	○	○	—	—	△	375
13.2.6 OMR-FF	○	○	○	○	△	376
13.2.7 Distance-coded Reference Position Detection	○	○	—	—	—	377
13.2.9 Variable Torsion Compensation	—	—	—	—	—	378
13.2.10 Cogging Torque Compensation	○	○	—	—	—	379
14 Automation Support Functions						381
14.1 Measurement						382
14.1.1 Skip						382
14.1.1.1 Skip	○	○	○	○	○	382
14.1.1.2 Multiple-step Skip	○	○	○	○	○	384
14.1.1.4 PLC Skip	○	○	○	○	△	385
14.1.1.5 Speed Change Skip	—	—	—	—	—	385
14.1.1.6 Torque Limitation Skip	○	○	○	○	△	386
14.1.2 Automatic Tool Length Measurement	○	○	○	○	○	387
14.1.3 Manual Tool Length Measurement 1	○	○	○	○	○	390
14.1.4 Manual Tool Length Measurement 2	○	○	○	○	○	393
14.1.5 Workpiece Coordinate Offset Measurement	○	○	○	○	○	394

○: Standard △: Option □: Selection

Class	Lathe system					Page
	M80 TypeA	M80 TypeB	E80 TypeA	E80 TypeB	C80	
14.1.6 Workpiece Position Measurement	—	—	—	—	—	395
14.1.7 Rotation Measurement	—	—	—	—	—	397
14.1.8 Rotation Center Error Measurement	—	—	—	—	—	398
14.1.9 Workpiece Installation Error Measurement	—	—	—	—	—	399
14.2 Tool Life Management						400
14.2.1 Tool Life Management						400
14.2.1.1 Tool Life Management I	○	○	○	○	○	400
14.2.1.2 Tool Life Management II	○	○	○	○	○	401
14.2.1.3 Tool Life Management III	—	—	—	—	—	401
14.2.2 Number of Tool Life Management Sets						402
99 sets	—	○	○	○	—	402
128 sets	—	—	—	—	○	402
200 sets	—	—	—	—	—	402
256 sets	○	—	—	—	△	402
400 sets	—	—	—	—	—	402
999 sets	—	—	—	—	—	402
14.2.3 Tool Life Management Set Allocation to Part Systems	○	○	—	—	○	404
14.3 Others						406
14.3.1 Programmable Current Limitation	○	○	○	○	○	406
14.3.2 Auto Power OFF	○	○	○	○	—	406
14.3.4 Load Monitoring I	○	—	—	—	—	407
14.3.5 Power ON/OFF Sequence	—	—	—	—	—	407
14.3.6 PLC Axis Current Limit	—	—	—	—	○	407
14.3.7 Direct Robot Control	□	□	□	□	—	408
15 Safety and Maintenance						409
15.1 Safety Switches						410
15.1.1 Emergency Stop	○	○	○	○	○	410
15.1.2 Data Protection Key	○	○	○	○	○	410
15.2 Display for Ensuring Safety						411
15.2.1 NC Warning	○	○	○	○	○	411
15.2.2 NC Alarm	○	○	○	○	○	411
15.2.3 Operation Stop Cause	○	○	○	○	○	412
15.2.4 Emergency Stop Cause	○	○	○	○	○	412
15.2.5 Thermal Detection	○	○	○	○	○	412
15.2.6 Battery Alarm/Warning	○	○	○	○	○	413
15.3 Protection						414
15.3.1 Stroke End (Over Travel)	○	○	○	○	○	414
15.3.2 Stored Stroke Limit						414
15.3.2.1 Stored Stroke Limit I/II	○	○	○	○	○	415
15.3.2.2 Stored Stroke Limit IB	○	○	—	—	△	417
15.3.2.3 Stored Stroke Limit IIB	○	○	—	—	△	417
15.3.2.4 Stored Stroke Limit IC	○	○	—	—	△	418
15.3.3 Stroke Check before Travel	○	○	—	—	—	419
15.3.4 Chuck/Tailstock Barrier Check	○	○	○	○	○	421

○: Standard △: Option □: Selection

Class	Lathe system					Page
	M80 TypeA	M80 TypeB	E80 TypeA	E80 TypeB	C80	
15.3.5 Interlock	○	○	○	○	○	422
15.3.6 External Deceleration	○	○	○	○	○	422
15.3.7 Interference Check III	—	—	—	—	—	423
15.3.8 3D Machine Interference Check	—	—	—	—	—	425
15.3.9 Door Interlock						426
15.3.9.1 Door Interlock I	○	○	○	○	○	426
15.3.9.2 Door Interlock II	○	○	○	○	○	428
15.3.10 Parameter Lock	○	○	○	○	○	430
15.3.11 Program Protection (Edit Lock B, C)	○	○	○	○	○	430
15.3.12 Program Display Lock	○	○	○	○	○	430
15.3.13 Data Protection by User's Level	○	○	○	○	△	430
15.3.15 Vertical Axis Pull-up	○	○	○	○	○	431
15.3.16 Machine Group-based Alarm Stop	○	○	—	—	△	431
15.3.17 Interference Check Between Part Systems	○	—	—	—	—	433
15.3.18 Spindle Protection	○	○	—	—	—	434
15.4 Maintenance and Troubleshooting						435
15.4.1 Operation History	○	○	○	○	○	435
15.4.2 Data Sampling	○	○	○	○	○	436
15.4.3 NC Data Backup	○	○	○	○	○	436
15.4.4 Servo Tuning Support						437
15.4.4.1 NC Analyzer2	○	○	○	○	○	437
15.4.5 Automatic Backup	○	○	○	○	○ (GOT)	439
15.4.8 Application Error Detection	—	—	—	—	—	439
15.4.9 Email Notification to Operator	○	○	○	○	—	440
15.4.10 NC Configurator2	○	○	○	○	○	441
15.4.11 Diagnosis Data Output	○	○	○	○	○	441
15.4.12 Backup/Restore	—	—	—	—	○	441
15.4.14 Field Network Diagnostics	□	□	□	□	—	442
15.4.15 Remote service iQ Care Remote4U						443
15.4.15.1 Connection with RGU	□	□	□	□	—	443
15.5 Functional Safety						444
15.5.1 Safety Observation	○	○	○	○	—	444
15.5.2 Smart Safety Observation						445
15.5.2.1 Safety-related I/O Observation	□	□	—	—	△	445
15.5.2.2 Emergency Stop Observation	□	□	—	—	△	445
15.5.2.3 Drive Safety Function						446
15.5.2.3.1 SLS (Safely-Limited Speed)	□	□	—	—	△	446
15.5.2.3.2 SLP (Safely-Limited Position)	□	□	—	—	△	446
15.5.2.3.3 SOS (Safe Operating Stop)	□	□	—	—	△	446
15.5.2.3.4 SSM (Safe Speed Monitor)	□	□	—	—	△	446
15.5.2.3.5 SBC/SBT (Safe Brake Control/Safe Brake Test)	□	□	—	—	△	447

○: Standard △: Option □: Selection

Class	Lathe system					Page
	M80 TypeA	M80 TypeB	E80 TypeA	E80 TypeB	C80	
15.5.2.3.6 SCA (Safe Cam)	□	□	—	—	△	447
15.5.2.3.7 SS1/SS2 (Safe Stop)	□	□	—	—	△	447
15.5.2.3.8 STO (Safe Torque Off)	□	□	—	—	△	447
15.5.2.3.9 SCN (Safety Communication Network)	—	—	—	—	△	448
16 Drive System						449
16.1 Servo/Spindle						450
Feed axis						—
MDS-E-Vx	□	□	□	□	□	—
MDS-EH-Vx	□	□	□	□	□	—
MDS-EJ-Vx	□	□	□	□	□	—
MDS-EJH-Vx	□	□	□	□	□	—
MDS-EM-SPVx	□	□	□	□	□	—
MDS-EMH-SPVx	□	□	□	□	□	—
Spindle						—
MDS-E-SPx	□	□	□	□	□	—
MDS-EH-SPx	□	□	□	□	□	—
MDS-EJ-SPx	□	□	□	□	□	—
MDS-EM-SPVx	□	□	□	□	□	—
MDS-EMH-SPVx	□	□	□	□	□	—
Power supply						—
MDS-E-CV	□	□	□	□	□	—
MDS-EH-CV	□	□	□	□	□	—
MDS-EX-CVP	□	□	□	□	□	—
17 Machine Support Functions						451
17.1 PLC						452
17.1.1 Built-in PLC Processing Mode	○	○	○	○	—	452
17.1.2 PLC Functions						452
17.1.2.1 Built-in PLC Basic Function	○	○	○	○	△ (MELSEC)	452
17.1.2.1.1 Index Modification	○	○	○	○	△ (MELSEC)	455
17.1.2.1.2 Multi-program [Number of Programs]	○60	○60	○60	○60	△ (MELSEC)	455
17.1.2.1.3 Multi-project [Number of Projects Stored]						456
Number of PLC projects: 2	—	○	○	○	—	456
Number of PLC projects: 3	○	—	—	—	—	456
Number of PLC projects: 6	—	—	—	—	—	456
17.1.2.1.4 Function Block (FB)	○	○	○	○	△ (MELSEC)	456
17.1.2.1.5 Label Programming	○	○	○	○	△ (MELSEC)	456
17.1.2.2 PLC Exclusive Instruction	○	○	—	—	△ (MELSEC)	457
17.1.2.3 Enhanced PLC Security Mode	○	○	○	○	—	459
17.1.3 PLC Support Functions						460
17.1.3.1 Alarm Message Display	○	○	○	○	—	460

○: Standard △: Option □: Selection

Class	Lathe system					Page
	M80 TypeA	M80 TypeB	E80 TypeA	E80 TypeB	C80	
17.1.3.2 Operator Message Display	○	○	○	○	○(*5)	460
17.1.3.3 Memory Switch (PLC Switch)						461
17.1.3.3.1 Memory Switch (PLC Switch) 32 Points	—	—	○	○	—	461
17.1.3.3.2 Memory Switch (PLC Switch) 64 Points	○	○	—	—	—	461
17.1.3.3.3 Memory Switch (PLC Switch) 96 points	—	—	—	—	—	461
17.1.3.4 Load Meter Display	○	○	○	○	○	462
17.1.3.5 User PLC Version Display	○	○	○	○	○	462
17.1.3.6 Ladder Program Writing during RUN	○	○	○	○	△ (MELSEC)	462
17.1.3.7 PLC Program Protection	○	○	○	○	△ (MELSEC)	462
17.1.4 Built-in PLC Capacity						463
17.1.4.1 Standard PLC Capacity [Number of Steps]	○64K	○32K	○20K	○20K	△ (MELSEC)	463
17.1.4.2 Large PLC Capacity: 256 Ksteps	—	—	—	—	—	463
17.1.4.3 Large PLC Capacity: 512 Ksteps	—	—	—	—	—	463
17.1.5 Machine Contact Input/Output I/F	○	○	○	○	△ (MELSEC)	463
17.1.6 Ladder Monitor	○	○	○	○	○(GOT)	464
17.1.7 PLC Development						465
17.1.7.1 On-board Development	○	○	○	○	○(GOT)	465
17.1.7.2 MELSEC Development Tool (GX Developer)	○	○	○	○	—	465
17.1.7.3 MELSEC Development Tool (GX Works2)	○	○	○	○	—	465
17.1.7.4 MELSEC Development Tool (GX Works3)	—	—	—	—	○	466
17.1.8 PLC Parameter						466
17.1.8.1 PLC Constant (150 Points)	○	○	○	○	○	466
17.1.8.2 PLC Constant Extension (Up to 750 Points)	○	○	—	—	—	466
17.1.9 GOT Connection						467
17.1.9.1 Ethernet Connection	○	○	○	○	○	467
17.1.9.2 CC-Link Connection	○	○	○	○	△ (MELSEC)	467
17.1.9.3 CC-Link IE Field Connection	—	—	—	—	△ (MELSEC)	467
17.1.10 Pallet Program Registration	—	—	—	—	—	468
17.2 Machine Construction						469
17.2.1 Servo OFF	○	○	○	○	○	469
17.2.2 Axis Detachment	○	○	○	○	○	470
17.2.3 Synchronous Control	○	○	—	—	△	471
17.2.4 Inclined Axis Control	○	○	○	○	△	475
17.2.5 Position Switch	○24	○24	○24	○24	○(*6)	476
17.2.7 Index Table Indexing	○	○	○	○	○	477
17.2.8 Tool Length Compensation along the Tool Axis	—	—	—	—	—	479
17.2.9 Tool Handle Feed & Interruption	—	—	—	—	—	480

○: Standard △: Option □: Selection

Class	Lathe system					Page
	M80 TypeA	M80 TypeB	E80 TypeA	E80 TypeB	C80	
17.2.10 Tool Center Coordinate Display	—	—	—	—	—	480
17.2.11 Tool Center Point Control						481
17.2.11.1 Tool Center Point Control (G43.4/G43.5)	—	—	—	—	—	481
17.2.12 Inclined Surface Machining Command	○	—	—	—	—	484
17.2.13 Simple Inclined Surface Machining Command	○	○	○	—	—	486
17.2.14 3-dimensional Tool Radius Compensation (Tool's Vertical-direction Compensation)	—	—	—	—	—	488
17.2.15 Workpiece Installation Error Compensation	—	—	—	—	—	489
17.2.16 3-dimensional Manual Feed	○	—	—	—	—	490
17.2.17 R-Navi	—	—	—	—	—	491
17.2.18 Simple Synchronous Control	—	—	—	—	—	493
17.2.20 Real-time Tuning						494
17.2.20.1 Real-time Tuning 1 (Speed Gain)	○	—	—	—	—	494
17.2.20.2 Real-time Tuning 2 (Rapid Traverse Time Constant)	○	—	—	—	—	495
17.2.21 Constant Torque Control	○	○	○	○	—	496
17.2.22 External Encoder Position Output I/F	○	○	○	○	—	497
17.2.23 Multiple-axis Synchronization Control	—	—	—	—	—	498
17.2.24 Hypothetical Linear Axis Control	—	—	—	—	—	499
17.2.25 BiSS Encoder I/F	○	○	○	○	—	500
17.2.26 Tool Head Hot Swapping	—	—	—	—	—	501
17.3 PLC Operation						502
17.3.1 Arbitrary Feed in Manual Mode	○	○	○	○	○	502
17.3.2 Circular Feed in Manual Mode	○	○	—	—	—	503
17.3.3 PLC Axis Control	○	○	○	○	○	505
17.3.5 PLC Axis Indexing	○	○	○	○	○	506
17.3.6 NC Axis/PLC Axis Switchover	○	○	—	—	△	508
17.4 PLC Interface						509
17.4.1 CNC Control Signal	○	○	○	○	○	509
17.4.2 CNC Status Signal	○	○	○	○	○	510
17.4.3 PLC Window	○	○	○	○	○	512
17.4.4 External Search	○	○	○	○	○	513
17.4.5 Direct Screen Selection	○	○	○	○	○	513
17.4.6 Buzzer Sound Control	○	○	○	○	—	514
17.5 Machine Contact I/O						515
17.5.1 Operation Panel I/O						515
17.5.1.1 DI:64/DO:64	—	—	□	□	—	515
17.5.1.2 DI:64/DO:64 + SDI:8	—	—	□	□	—	515
17.5.1.3 DI:96/DO:64	□	□	□	□	—	515
17.5.1.5 DI:64/DO:48/AO:1	□	□	□	□	—	515
17.5.2 Remote I/O						516
17.5.2.1 DI:32/DO:32	□	□	□	□	—	516
17.5.2.2 DI:64/DO:48	□	□	□	□	—	516
17.5.2.3 DI:64/DO:48 + AO:1	□	□	□	□	—	516

○: Standard △: Option □: Selection

Class	Lathe system					Page
	M80 TypeA	M80 TypeB	E80 TypeA	E80 TypeB	C80	
17.5.2.5 DI:16/DO:8	□	□	□	□	—	516
17.5.2.6 DI:32/DO:32 + SDI:8/SDO:4	□	□	□	□	—	516
17.5.2.7 SDI:8/SDO:4	□	□	□	□	—	516
17.6 External PLC Link						517
17.6.1 CC-Link (Master/Local)	□	□	□	□	△ (MELSEC)	517
17.6.2 PROFIBUS-DP (Master)	□	□	□	□	△ (MELSEC)	523
17.6.3 CC-Link IE Field (Master/Local)	□	□	□	□	△ (MELSEC)	524
17.6.4 PROFINET	—	—	—	—	△ (MELSEC)	525
17.6.5 EtherNet/IP	□	□	□	□	△ (MELSEC)	526
17.6.8 FL-net	□	□	□	□	△ (MELSEC)	527
17.6.9 DeviceNet (Master)	—	—	—	—	△ (MELSEC)	527
17.6.10 CC-Link IE Field Basic	○	○	○	○	—	528
17.7 Installing S/W for Machine Tools						530
17.7.1 Customization (NC Designer2)	○	○	○	○	—	530
17.7.1.1 Customization Data Storage Capacity [MB]	6	6	1	1	—	532
17.7.1.2 Customization Working Memory Size [MB]	3	3	1	1	—	532
17.7.2 User-defined Key	○	○	○	○	—	532
17.7.3 EZSocket I/F	○	○	○	○	—	532
17.7.4 APLC Release	○	○	○	○	△	533
17.7.5 Custom API Library	○	○	○	○	—	534
17.7.6 MES Interface Library	○	○	○	○	—	534
17.7.7 SLMP Server	○	○	○	○	—	535
17.7.8 Numerical Control (CNC) Communication Software FCSB1224W000	○	○	○	○	—	536
17.7.10 GOT2000 Screen Design Tool GT Works3	—	—	—	—	○	536
17.8 Others						537
17.8.1 System Lock	○	○	○	○	—	537
17.8.2 CNC Remote Operation Tool						537
17.8.2.1 NC Monitor2	○	○	○	○	○	537
17.8.2.2 NC Explorer	○	○	○	○	○	537
17.8.3 Automatic Operation Lock	○	○	○	○	○	537
17.8.4 Power Consumption Computation	○	○	○	○	○	538
17.8.5 EcoMonitorLight Connection	○	○	○	○	—	538
17.8.6 GOT Window	—	—	—	—	○	539
17.8.7 Log Viewer	—	—	—	—	○	540

(*2) G/B: Guide Bush

(*4) eSSS

(*5) Only the macro alarm message can be displayed.

(*6) 24 points for each part system and 32 points for the whole PLC axes.

(*8) Up to 2000 programs for C80

CONTENTS

Mitsubishi Electric CNC M80/E80/C80 Series Specifications List [M system]

○: Standard △: Option □: Selection

Class	Machining center system					Page
	M80 TypeA	M80 TypeB	E80 TypeA	E80 TypeB	C80	
1 Control Axes						1
1.1 Control Axes						2
1.1.1 Number of Basic Control Axes (NC Axes)	○ 3	○ 3	○ 3	○ 3	○ 3	2
1.1.2 Max. Number of Axes (NC Axes + Spindles + PLC Axes)	11	9	6	4	16	2
1.1.2.1 Max. Number of NC Axes (In Total for All the Part Systems)	8	5	5(*1)	3	16	2
1.1.2.2 Max. Number of Spindles	2	2	1	1	7	2
1.1.2.3 Max. Number of PLC Axes	6	6	2	0	8	2
1.1.4 Max. Number of PLC Indexing Axes	4	4	1	0	8	3
1.1.5 Number of Simultaneous Contouring Control Axes	4	4	4	3	4	3
1.1.6 Max. Number of NC Axes in a Part System	8	5	5(*1)	3	8	3
1.1.7 Axis Name Extension	○	○	—	—	○	3
1.2 Control Part System						4
1.2.1 Standard Number of Part Systems	1	1	1	1	1	4
1.2.2 Max. Number of Part Systems (Main + Sub)	○2	○1	○1	○1	○7	4
1.2.2.1 Max. Number of Main Part Systems	○2	○1	○1	○1	○7	4
1.2.2.2 Max. Number of Sub Part Systems	—	—	—	—	—	4
1.3 Control Axes and Operation Modes						5
1.3.1 Tape (RS-232C Input) Mode	○	○	○	○	—	5
1.3.2 Memory Mode	○	○	○	○	○	5
1.3.3 MDI Mode	○	○	○	○	○	5
1.3.4 High-Speed Program Server Mode						6
1.3.4.1 Control Unit-side High-speed Program Server Mode	—	—	—	—	—	6
1.3.4.2 Display Unit-side High-speed Program Server Mode	○	○	○	○	—	6
1.3.4.3 FTP High-speed Program Server Mode	—	—	—	—	△	6
1.3.5 Front-side SD Card Mode	○	○	○	○	—	7
1.3.6 Front-side USB Memory Mode	○	○	○	○	—	7
2 Input Command						9
2.1 Data Increment						10
2.1.1 Least Command Increment						10
Least command increment 1μm	○	○	○	○	○	10
Least command increment 0.1μm	○	○	○	—	○	10
Least command increment 0.01μm(10nm)	—	—	—	—	—	10
Least command increment 0.001μm(1nm)	—	—	—	—	—	10
2.1.2 Least Control Increment						12
Least control increment 0.01μm(10nm)	○	○	○	○	○	12
Least control increment 0.001μm(1nm)	○	○	○	○	○	12

○: Standard △: Option □: Selection

Class	Machining center system					Page
	M80 TypeA	M80 TypeB	E80 TypeA	E80 TypeB	C80	
2.1.3 Indexing Increment	○	○	○	○	○	12
2.2 Unit System						13
2.2.1 Inch/Metric Changeover	○	○	○	○	○	13
2.2.2 Input Command Increment Tenfold	○	○	○	○	○	13
2.3 Program Format						14
2.3.1 Program Format						14
2.3.1.1 Format 1 for Lathe (G Code List 2, 3)	—	—	—	—	—	14
2.3.1.2 Format 2 for Lathe (G Code List 4, 5)	—	—	—	—	—	14
2.3.1.3 Special Format for Lathe (G Code List 6, 7)	—	—	—	—	—	14
2.3.1.4 Format 1 for Machining Center	○	○	○	○	○	14
2.3.1.5 Format 2 for Machining Center (M2 Format)	○	○	—	—	○	14
2.3.1.6 MITSUBISHI CNC Special Format	—	—	—	—	—	14
2.3.2 Program Format Switch	—	—	—	—	—	15
2.4 Command Value						17
2.4.1 Decimal Point Input I, II	○	○	○	○	○	17
2.4.2 Absolute/Incremental Command	○	○	○	○	○	18
2.4.3 Diameter/Radius Designation	—	—	—	—	—	19
2.4.4 Diameter/Radius Designation Switch	—	—	—	—	—	20
3 Positioning/Interpolation						21
3.1 Positioning						22
3.1.1 Positioning	○	○	○	○	○	22
3.1.2 Unidirectional Positioning	○	○	○	○	△	23
3.2 Linear/Circular Interpolation						24
3.2.1 Linear Interpolation	○	○	○	○	○	24
3.2.2 Circular Interpolation (Center/Radius Designation)	○	○	○	○	○	25
3.2.3 Helical Interpolation	○	○	○	○	○	27
3.2.4 Spiral/Conical Interpolation	○	—	—	—	△	30
3.2.5 Cylindrical Interpolation	○	○	—	—	△	32
3.2.6 Polar Coordinate Interpolation	—	—	—	—	△	33
3.2.7 Milling Interpolation	—	—	—	—	—	34
3.2.8 Hypothetical Axis Interpolation	—	—	—	—	—	35
3.3 Curve Interpolation						36
3.3.1 Involute Interpolation	○	—	—	—	—	36
3.3.2 Exponential Interpolation	—	—	—	—	—	38
3.3.3 Spline Interpolation (G05.1Q2/G61.2)	○	—	—	—	△	39
3.3.4 NURBS Interpolation	—	—	—	—	—	40
3.3.5 3-Dimensional Circular Interpolation	—	—	—	—	—	41
3.3.6 Spline Interpolation2 (G61.4)	○	—	—	—	△	42
4 Feed						45
4.1 Feedrate						46
4.1.1 Rapid Traverse Rate (m/min)	1000	1000	1000	1000	1000	46
4.1.2 Cutting Feedrate (m/min)	1000	1000	1000	1000	1000	47
4.1.3 Manual Feedrate (m/min)	1000	1000	1000	1000	1000	48

○: Standard △: Option □: Selection

Class	Machining center system					Page
	M80 TypeA	M80 TypeB	E80 TypeA	E80 TypeB	C80	
4.1.4 Rotary Axis Command Speed Tenfold	○	○	○	○	○	48
4.2 Feedrate Input Methods						49
4.2.1 Feed per Minute (Asynchronous Feed)	○	○	○	○	○	49
4.2.2 Feed per Revolution (Synchronous Feed)	○	○	○	○	△	51
4.2.3 Inverse Time Feed	○	—	—	—	△	53
4.2.4 F 1-digit Feed	○	○	○	○	○	54
4.2.5 Manual Speed Command	○	○	○	—	△	55
4.2.7 G00 Feedrate Designation (, F Command)	○	—	—	—	△	55
4.2.8 Selection of Axis (Axes) for Feedrate Command	—	—	—	—	—	57
4.3 Override						58
4.3.1 Rapid Traverse Override	○	○	○	○	○	58
4.3.2 Cutting Feed Override	○	○	○	○	○	58
4.3.3 2nd Cutting Feed Override	○	○	○	○	○	58
4.3.4 Override Cancel	○	○	○	○	○	59
4.4 Acceleration/Deceleration						60
4.4.1 Automatic Acceleration/Deceleration after Interpolation	○	○	○	○	○	60
4.4.2 Rapid Traverse Constant-gradient Acceleration/Deceleration	○	○	○	○	○	62
4.4.3 Rapid Traverse Constant-gradient Multi-step Acceleration/Deceleration	○	○	—	—	△	63
4.5 Thread Cutting						64
4.5.1 Thread Cutting (Lead/Thread Number Designation)	○	○	○	○	△	64
4.5.2 Variable Lead Thread Cutting	—	—	—	—	—	67
4.5.3 Synchronous Tapping						68
4.5.3.1 Synchronous Tapping Cycle	○	○	○	○	○	68
4.5.3.2 Pecking Tapping Cycle	○	○	○	○	△	70
4.5.3.3 Deep-hole Tapping Cycle	○	○	○	○	△	72
4.5.3.4 Synchronous Tapping with Multiple Spindles	—	—	—	—	△	74
4.5.3.5 Synchronous Tapping with Analog I/F Spindle	○	○	○	○	—	74
4.5.4 Chamfering	—	—	—	—	—	74
4.5.6 Circular Thread Cutting	—	—	—	—	—	75
4.5.8 High-speed Synchronous Tapping (OMR-DD)	○	○	—	—	○	76
4.5.10 Thread Recutting	—	—	—	—	—	77
4.5.11 Thread Cutting Override	—	—	—	—	—	78
4.5.12 Variable Feed Thread Cutting	—	—	—	—	—	78
4.5.13 Thread Cutting Time Constant Switch	○	○	○	○	—	79
4.6 Manual Feed						80
4.6.1 Manual Rapid Traverse	○	○	○	○	○	80
4.6.2 Jog Feed	○	○	○	○	○	80
4.6.3 Incremental Feed	○	○	○	○	○	81
4.6.4 Handle Feed	○	○	○	○	○	81
4.6.5 Manual Feedrate B	○	○	○	○	○	82
4.6.6 Manual Feedrate B Surface Speed Control	—	—	—	—	—	83
4.6.8 Manual Speed Clamp	○	○	○	○	○	84

○: Standard △: Option □: Selection

Class	Machining center system					Page
	M80 TypeA	M80 TypeB	E80 TypeA	E80 TypeB	C80	
4.7 Dwell						85
4.7.1 Dwell (Time-based Designation)	○	○	○	○	○	85
4.7.2 Dwell (Revolution-based Designation)	—	—	—	—	—	86
5 Program Memory/Editing						87
5.1 Memory Capacity						88
5.1.1 Memory Capacity (Number of Programs Stored)						88
230kB[600m] (400 programs)	—	—	—	—	—	88
500kB[1280m] (1000 programs)	○	○	○	○	○	88
1000kB[2560m] (1000 programs)	—	—	—	—	△(*8)	88
2000kB[5120m] (1000 programs)	—	—	—	—	△(*8)	88
5.2 Editing						89
5.2.1 Program Editing	○	○	○	○	○	89
5.2.2 Background Editing	○	○	○	○	○	90
5.2.3 Buffer Correction	○	○	○	○	○	91
5.2.5 Multi-part System Simultaneous Program Editing	—	—	—	—	—	92
5.2.6 Special Program Editing Display for Synchronization between Part Systems	○	—	—	—	—	92
5.2.7 Finish Shape View Programming	○	○	—	—	—	93
6 Operation and Display						95
6.1 Structure of Operation/Display Panel						96
6.1.1 Color Display (8.4-type LCD TFT)	□	□	○	○	—	96
6.1.2 Color Touchscreen Display (10.4-type LCD TFT)	□	□	—	—	—	96
6.1.3 Color Touchscreen Display (15-type LCD TFT)	□	□	—	—	—	96
6.1.4 Separated-type Color Display (8.4-type LCD TFT)	—	—	—	—	—	96
6.1.5 Separated-type Color Touchscreen Display (10.4-type LCD TFT)	—	—	—	—	—	96
6.1.6 Separated-type Color Touchscreen Display (15-type LCD TFT)	—	—	—	—	—	96
6.1.7 Separated-type Color Touchscreen Display (15-type LCD TFT/Windows8)	—	—	—	—	—	96
6.1.8 Separated-type Color Touchscreen Display (19-type LCD TFT/Windows8)	—	—	—	—	—	97
6.1.9 Separated-type Color Touchscreen Display (19-type Horizontal LCD TFT/Windows8)	—	—	—	—	—	97
6.1.11 GOT (GOT2000 Series GT27/GT25 12.1/10.4/8.4/5.7)	—	—	—	—	○	97
6.2 Operation Methods and Functions						98
6.2.1 Operation Input	○	○	○	○	○	98
6.2.2 Absolute/Incremental Setting	○	○	○	○	○	98
6.2.3 Multiple Display Connection	—	—	—	—	○(GOT)	99
6.2.4 Common Display to Multiple NCs	—	—	—	—	○(GOT)	99
6.2.5 Displayed Part System Switch	○	—	—	—	○	99
6.2.6 Menu List	○	○	○	○	○	100
6.2.7 Display Switch by Operation Mode	○	○	○	○	○	100
6.2.8 External Signal Display Switch	○	—	—	—	○	100

○: Standard △: Option □: Selection

Class	Machining center system					Page
	M80 TypeA	M80 TypeB	E80 TypeA	E80 TypeB	C80	
6.2.9 Screen Saver	○	○	○	○	○ (GOT)	100
6.2.10 Parameter Guidance	○	○	○	○	○	100
6.2.11 Alarm Guidance	○	○	○	○	○	101
6.2.12 Machining Program Input Mistake Check Warning	—	—	—	—	—	101
6.2.14 Screenshot Capture	○	○	○	○	○ (GOT)	101
6.2.15 User Selectable Menu Configuration	○	○	○	○	○	101
6.2.16 PC-NC Network Automatic Connection	—	—	—	—	—	102
6.2.17 Device Open Parameter	○	○	○	○	—	102
6.2.18 SRAM Open Parameter	○	○	○	○	—	102
6.2.19 MTB Selectable Menu Configuration	○	○	○	○	○	102
6.2.20 Remote Desktop Connection	○	○	—	—	—	103
6.2.21 VNC Server	○	○	—	—	—	104
6.3 Display Methods and Contents						105
6.3.1 Status Display	○	○	○	○	○	105
6.3.2 Clock Display	○	○	○	○	○	105
6.3.3 Monitor Screen Display	○	○	○	○	○	106
6.3.4 Setup Screen Display	○	○	○	○	○	107
6.3.5 Edit Screen Display	○	○	○	○	○	107
6.3.6 Diagnosis Screen Display	○	○	○	○	○	107
6.3.7 Maintenance Screen Display	○	○	○	○	○	108
6.3.8 Home Application	—	—	—	—	—	108
6.3.9 Home Screen	○	○	○	○	—	109
6.3.10 Additional Languages						110
6.3.10.1 Japanese	○	○	○	○	○	110
6.3.10.2 English	○	○	○	○	○	110
6.3.10.3 German	○	○	○	○	○	110
6.3.10.4 Italian	○	○	○	○	○	110
6.3.10.5 French	○	○	○	○	○	110
6.3.10.6 Spanish	○	○	○	○	○	110
6.3.10.7 Chinese						110
6.3.10.7.1 Chinese (Traditional Chinese Characters)	○	○	○	○	○	110
6.3.10.7.2 Chinese (Simplified Chinese Characters)	○	○	○	○	○	110
6.3.10.8 Korean	○	○	○	○	○	111
6.3.10.9 Portuguese	○	○	○	○	○	111
6.3.10.10 Hungarian	○	○	○	○	○	111
6.3.10.11 Dutch	○	○	○	○	○	111
6.3.10.12 Swedish	○	○	○	○	○	111
6.3.10.13 Turkish	○	○	○	○	○	111
6.3.10.14 Polish	○	○	○	○	○	111
6.3.10.15 Russian	○	○	○	○	○	111
6.3.10.16 Czech	○	○	○	○	○	111
6.3.10.17 Indonesian	○	○	○	○	—	112
6.3.10.18 Vietnamese	○	○	○	○	—	112

○: Standard △: Option □: Selection

Class	Machining center system					Page
	M80 TypeA	M80 TypeB	E80 TypeA	E80 TypeB	C80	
7 Input/Output Functions and Devices						113
7.1 Input/Output Data						114
7.1.1 Machining Program Input/Output	○	○	○	○	○	114
7.1.2 Tool Offset Data Input/Output	○	○	○	○	○	114
7.1.3 Common Variable Input/Output	○	○	○	○	○	114
7.1.4 Parameter Input/Output	○	○	○	○	○	114
7.1.5 History Data Output	○	○	○	○	○	114
7.1.7 System Configuration Data Output	○	○	○	○	○	114
7.2 Input/Output I/F						115
7.2.1 RS-232C I/F	○	○	○	○	—	115
7.2.2 SD Card I/F						115
7.2.2.1 Control Unit-side SD Card I/F [Up to 32GB]	—	—	—	—	—	115
7.2.2.2 Front-side SD Card I/F [Up to 32GB]	○	○	○	○	—	115
7.2.3 Ethernet I/F	○	○	○	○	○(GOT)	115
7.2.4 Display Unit-side Data Server I/F	○	○	○	○	—	116
7.2.5 Front-side USB Memory I/F [Up to 32GB]	○	○	○	○	—	116
7.2.6 USB I/F (GOT Front-side USB I/F)	—	—	—	—	○	116
7.2.7 SD I/F (GOT Back-side SD Card I/F)	—	—	—	—	○	116
7.3 Computer Link						117
7.3.1 Computer Link B	○	○	—	—	—	117
7.4 Others						118
7.4.1 Handy Terminal Connection	○	○	—	—	—	118
7.4.3 IP Filter Setting	○	○	○	○	—	119
8 Spindle, Tool and Miscellaneous Functions						121
8.1 Spindle Functions (S)						122
8.1.1 Spindle Control Functions						122
8.1.1.1 Spindle Digital I/F	○	○	○	○	○	123
8.1.1.2 Spindle Analog I/F	○	○	○	○	△ (MELSEC)	123
8.1.1.3 Coil Switch	○	○	○	○	○	123
8.1.1.4 Automatic Coil Switch	○	○	○	○	○	123
8.1.1.5 Encoder Input I/F	○	○	○	○	—	124
8.1.1.6 Spindle-mode Servo Motor Control	○	○	—	—	△	125
8.1.1.7 Spindle-mode Rotary Axis Control	○	—	—	—	—	126
8.1.1.8 Turret Gear Change Control	—	—	—	—	—	127
8.1.1.9 Spindle Control with Pulse Train Output	○	○	○	○	—	128
8.1.2 S Code Output	○	○	○	○	○	129
8.1.3 Constant Surface Speed Control	○	○	○	○	○	130
8.1.4 Spindle Override	○	○	○	○	○	132
8.1.5 Multiple-spindle Control						132
8.1.5.1 Multiple-spindle Control I	—	—	—	—	—	133
8.1.5.2 Multiple-spindle Control II	○	○	—	—	○	134
8.1.6 Spindle Orientation	○	○	○	○	○	135

○: Standard △: Option □: Selection

Class	Machining center system					Page
	M80 TypeA	M80 TypeB	E80 TypeA	E80 TypeB	C80	
8.1.7 Spindle Position Control (Spindle/C Axis Control)						136
8.1.7.1 Spindle Position Control (Spindle/C Axis Control)	○	○	○	—	○	136
8.1.7.2 C Axis Control during Spindle Synchronization	—	—	—	—	△	137
8.1.8 Spindle Synchronization						138
8.1.8.1 Spindle Synchronization I	○	○	—	—	○	138
8.1.8.2 Spindle Synchronization II	○	○	—	—	○	139
8.1.8.3 Guide Bushing Spindle Synchronization	—	—	—	—	—	139
8.1.9 Tool Spindle Synchronization I (Polygon)						140
8.1.9.1 Tool Spindle Synchronization IA (Spindle-Spindle, Polygon)	○	○	—	—	—	140
8.1.9.2 Tool Spindle Synchronization IB (Spindle-Spindle, Polygon)	○	○	—	—	—	141
8.1.9.3 Tool Spindle Synchronization IC (Spindle-NC Axis, Polygon)	○	—	—	—	—	142
8.1.10 Tool Spindle Synchronization II (Hobbing)	○	—	—	—	—	143
8.1.11 Spindle Speed Clamp	○	○	○	○	○	144
8.1.13 Spindle Oscillation	—	—	—	—	—	144
8.1.14 Spindle Superimposition Control	—	—	—	—	—	145
8.1.15 Multiple Spindle Synchronization Set Control	—	—	—	—	○	147
8.1.16 Spindle Speed Fluctuation Detection	○	○	—	—	—	150
8.1.17 Spindle Motor Temperature Output to PLC	○	○	○	○	—	151
8.2 Tool Functions (T)						152
8.2.1 Tool Functions (T Command)	○	○	○	○	○	152
8.3 Miscellaneous Functions (M)						153
8.3.1 Miscellaneous Functions	○	○	○	○	○	153
8.3.2 Multiple M Codes in 1 Block	○	○	○	○	○	153
8.3.3 M Code Independent Output	○	○	○	○	○	154
8.3.4 Miscellaneous Function Finish	○	○	○	○	○	155
8.3.5 M Code Output during Axis Traveling	—	—	—	—	—	156
8.3.6 Miscellaneous Function Command High-speed Output	○	○	○	○	○	157
8.4 2nd Miscellaneous Functions (B)						159
8.4.1 2nd Miscellaneous Functions	○	○	○	○	○	159
8.4.2 2nd Miscellaneous Function Name Extension	○	○	○	○	○	159
9 Tool Compensation						161
9.1 Tool Length/Tool Position						162
9.1.1 Tool Length Offset	○	○	○	○	○	162
9.1.2 Tool Position Offset	○	○	○	○	○	165
9.1.3 Tool Compensation for Additional Axes	—	—	—	—	—	165
9.1.4 Tool Position Compensation (G43.7)	—	—	—	—	—	166
9.2 Tool Radius						167
9.2.1 Tool Radius Compensation	○	○	○	○	○	167

○: Standard △: Option □: Selection

Class	Machining center system					Page
	M80 TypeA	M80 TypeB	E80 TypeA	E80 TypeB	C80	
9.2.2 3-dimensional Tool Radius Compensation	—	—	—	—	—	169
9.2.3 Tool Nose Radius Compensation (G40/41/42)	—	—	—	—	—	170
9.2.4 Automatic Decision of Nose Radius Compensation Direction (G46/40)	—	—	—	—	—	171
9.2.5 Tool Radius Compensation Diameter Designation	○	○	○	○	○	171
9.3 Tool Offset Amount						172
9.3.1 Number of Tool Offset Sets						172
99 sets	—	—	—	○	—	172
128 sets	—	—	—	—	—	172
200 sets	—	—	○	—	○	172
256 sets	—	—	—	—	—	172
400 sets	○	○	—	—	△	172
999 sets	—	—	—	—	—	172
9.3.2 Offset Memory						173
9.3.2.1 Tool Shape/Wear Offset Amount	○	○	○	○	○	173
9.3.2.2 Compensation Type Selection by Parameter	○	○	—	—	—	176
9.3.3 Number of Tool Offset Sets Allocation to Part Systems	—	—	—	—	—	177
10 Coordinate System						179
10.1 Coordinate System Type and Setting						180
10.1.1 Machine Coordinate System	○	○	○	○	○	181
10.1.2 Coordinate System Setting	○	○	○	○	○	182
10.1.3 Automatic Coordinate System Setting	○	○	○	○	○	183
10.1.4 Workpiece Coordinate System Selection						184
10.1.4.1 Workpiece Coordinate System Selection (6 Sets)	○	○	○	○	○	184
10.1.4.2 Extended Workpiece Coordinate System Selection (48 Sets) G54.1P1 to P48	○	○	○	—	△	186
10.1.4.3 Extended Workpiece Coordinate System Selection (96 Sets) G54.1P1 to P96	—	—	—	—	—	186
10.1.4.4 Extended Workpiece Coordinate System Selection (300 Sets) G54.1P1 to P300	—	—	—	—	—	186
10.1.5 External Workpiece Coordinate Offset	○	○	○	○	○	187
10.1.6 Workpiece Coordinate System Preset (G92.1)	—	—	—	—	—	188
10.1.7 Local Coordinate System	○	○	○	○	○	189
10.1.8 Coordinate System for Rotary Axis	○	○	○	○	○	190
10.1.9 Plane Selection	○	○	○	○	○	191
10.1.10 Origin Set/Origin Cancel	○	○	○	○	○	192
10.1.11 Counter Set	○	○	○	○	○	193
10.1.12 Workpiece Position Offset for Rotary Axis	○	—	—	—	—	194
10.1.13 Workpiece Coordinate System Shift	—	—	—	—	—	196
10.2 Return						197
10.2.1 Manual Reference Position Return	○	○	○	○	○	197

○: Standard △: Option □: Selection

Class	Machining center system					Page
	M80 TypeA	M80 TypeB	E80 TypeA	E80 TypeB	C80	
10.2.2 Automatic 1st Reference Position Return	○	○	○	○	○	198
10.2.3 2nd, 3rd, 4th Reference Position Return	○	○	○	○	○	200
10.2.4 Reference Position Check	○	○	○	○	○	201
10.2.5 Absolute Position Detection	○	○	○	○	○	202
10.2.6 Tool Exchange Position Return	○	○	○	○	○	203
11 Operation Support Functions						205
11.1 Program Control						206
11.1.1 Optional Block Skip	○	○	○	○	○	206
11.1.2 Optional Block Skip Addition	○	○	—	—	○	206
11.1.3 Single Block	○	○	○	○	○	207
11.2 Program Test						208
11.2.1 Dry Run	○	○	○	○	○	208
11.2.2 Machine Lock	○	○	○	○	○	208
11.2.3 Miscellaneous Function Lock	○	○	○	○	○	208
11.2.4 Graphic Check						209
11.2.4.1 Graphic Check	○	○	○	○	—	209
11.2.4.2 3D Solid Program Check	○	○	○	○	—	209
11.2.4.3 Graphic Check Rotary Axis Drawing	—	—	—	—	—	210
11.2.5 Graphic Trace						211
11.2.5.1 Graphic Trace	○	○	○	○	—	211
11.2.5.2 Graphic Trace Rotary Axis Drawing	—	—	—	—	—	212
11.2.6 Machining Time Computation	○	○	○	○	—	212
11.2.7 Manual Arbitrary Reverse Run (Program Check Operation)	○	○	—	—	△	213
11.2.8 High-speed Simple Program Check	○	○	○	○	○	214
11.3 Program Search/Start/Stop						215
11.3.1 Program Search	○	○	○	○	○	215
11.3.2 Sequence Number Search	○	○	○	○	○	215
11.3.3 Collation and Stop	○	○	—	—	○	216
11.3.4 Program Restart	○	○	○	○	○	217
11.3.5 Automatic Operation Start	○	○	○	○	○	218
11.3.6 NC Reset	○	○	○	○	○	218
11.3.7 Feed Hold	○	○	○	○	○	219
11.3.8 Search & Start	○	○	○	○	○	219
11.3.10 Auto-restart	○	○	○	○	○	219
11.4 Interrupt Operation						220
11.4.1 Manual Interruption	○	○	○	○	○	220
11.4.2 Automatic Operation Handle Interruption	○	○	○	○	○	220
11.4.3 Manual Absolute Switch	○	○	○	○	○	221
11.4.4 Thread Cutting Cycle Retract	○	—	—	—	—	222
11.4.5 Tapping Retract	○	○	○	○	○	223
11.4.6 Manual Numerical Value Command	○	○	○	○	○	224
11.4.7 Arbitrary Reverse Run	○	—	—	—	—	225
11.4.8 MDI Interruption	○	○	○	○	○	226

○: Standard △: Option □: Selection

Class	Machining center system					Page
	M80 TypeA	M80 TypeB	E80 TypeA	E80 TypeB	C80	
11.4.9 Simultaneous Operation of Manual and Automatic Modes	○	○	○	○	○	226
11.4.10 Simultaneous Operation of JOG and Handle Modes	○	○	○	○	○	226
11.4.11 Reference Position Retract	○	○	○	○	○	227
11.4.12 Tool Retract and Return	○	○	—	—	—	228
11.4.13 Skip Retract	○	○	—	—	○	229
11.4.14 PLC Interruption	○	○	○	○	○	229
11.4.16 Machining Interruption	—	—	—	—	△	230
12 Program Support Functions						231
12.1 Machining Method Support Functions						232
12.1.1 Program						232
12.1.1.1 Subprogram Control [Layers]	○10	○10	○10	○10	○10	232
12.1.1.2 Figure Rotation	—	—	—	—	—	235
12.1.1.3 Scaling	○	○	○	—	△	237
12.1.1.4 Axis Name Switch	—	—	—	—	—	238
12.1.2 Macro Program						239
12.1.2.1 User Macro [Layers]	○4	○4	○4	○4	○4	239
12.1.2.2 Machine Tool Builder Macro	○	○	○	○	○	242
12.1.2.3 Macro Interruption	○	○	○	○	○	244
12.1.2.4 Variable Command						245
200 sets	—	—	—	○	—	245
600 sets	—	—	○	—	—	245
700 sets	○	○	—	—	○	245
8000 sets	○	—	—	—	—	245
(600+100×number of part systems) sets	○	—	—	—	○	245
(7900+100×number of part systems) sets	○	—	—	—	—	245
12.1.3 Fixed Cycle						247
12.1.3.1 Fixed Cycle for Drilling	○	○	○	○	○	248
12.1.3.2 Fixed Cycle for Drilling (Type II)	—	—	—	—	—	253
12.1.3.3 Special Fixed Cycle	○	○	○	○	△	254
12.1.3.4 Fixed Cycle for Turning Machining	○	—	—	—	—	257
12.1.3.5 Compound Type Fixed Cycle for Turning Machining	—	—	—	—	—	262
12.1.3.6 Compound Type Fixed Cycle for Turning Machining (Type II)	—	—	—	—	—	267
12.1.3.7 Small-diameter Deep-hole Drilling Cycle	○	○	—	—	—	271
12.1.4 Mirror Image						271
12.1.4.1 Mirror Image by Parameter Setting	○	○	○	○	○	271
12.1.4.2 Mirror Image by External Input	○	○	○	○	○	271
12.1.4.3 Mirror Image by G Code	○	○	○	○	○	272
12.1.4.4 Mirror Image for Facing Tool Posts	—	—	—	—	—	273
12.1.4.5 T Code Mirror Image for Facing Tool Posts	—	—	—	—	—	273
12.1.5 Coordinate System Operation						274
12.1.5.1 Coordinate Rotation by Program	○	○	○	○	△	274
12.1.5.2 Coordinate Rotation by Parameter	—	—	—	—	—	276

○: Standard △: Option □: Selection

Class	Machining center system					Page
	M80 TypeA	M80 TypeB	E80 TypeA	E80 TypeB	C80	
12.1.5.3 3-dimensional Coordinate Conversion	○	—	—	—	△	277
12.1.6 Dimension Input						279
12.1.6.1 Corner Chamfering/Corner R	○	○	○	○	△	279
12.1.6.2 Linear Angle Command	○	○	○	—	△	286
12.1.6.3 Geometric Command	○	○	○	—	—	287
12.1.6.4 Polar Coordinate Command	○	○	—	—	△	288
12.1.7 Axis Control						289
12.1.7.1 Chopping						289
12.1.7.1.1 Chopping	○	○	—	—	△	289
12.1.7.2 Normal Line Control	○	—	—	—	○	290
12.1.7.3 Circular Cutting	○	○	○	○	○	291
12.1.7.4 Vibration Cutting Control	□	□	—	—	—	292
12.1.8 Multi-part System Control						293
12.1.8.1 Timing Synchronization between Part Systems	○	—	—	—	○	293
12.1.8.2 Start Point Designation Timing Synchronization	○	—	—	—	○	294
12.1.8.3 Mixed Control						297
12.1.8.3.1 Mixed Control (Cross Axis Control)	—	—	—	—	—	297
12.1.8.3.2 Arbitrary Axis Exchange Control	○	—	—	—	△	298
12.1.8.4 Control Axis Superimposition						300
12.1.8.4.1 Control Axis Superimposition	—	—	—	—	—	300
12.1.8.4.2 Arbitrary Axis Superimposition Control	—	—	—	—	—	302
12.1.8.5 Control Axis Synchronization between Part Systems	—	—	—	—	—	302
12.1.8.6 Balance Cut	—	—	—	—	—	304
12.1.8.7 Common Memory for Part Systems	—	—	—	—	—	306
12.1.8.8 Multi-part System Simultaneous Thread Cutting						306
12.1.8.8.1 Two-part System Simultaneous Thread Cutting	—	—	—	—	—	307
12.1.8.8.2 Multi-part System Simultaneous Thread Cutting	—	—	—	—	—	309
12.1.8.9 Multi-part System Program Management	○	—	—	—	○	310
12.1.8.10 Synchronization between Part Systems						311
12.1.8.10.1 Single Block between Part Systems	—	—	—	—	—	311
12.1.8.10.2 Dwell/Miscellaneous Function Time Override	—	—	—	—	—	312
12.1.8.10.3 Synchronization between Part Systems OFF	—	—	—	—	—	313
12.1.8.11 Sub Part System Control I	—	—	—	—	—	314
12.1.8.12 Sub Part System Control II	—	—	—	—	—	316
12.1.8.13 Loader Control Part System	—	—	—	—	—	318

○: Standard △: Option □: Selection

Class	Machining center system					Page
	M80 TypeA	M80 TypeB	E80 TypeA	E80 TypeB	C80	
12.1.9 Data Input/Output by Program						319
12.1.9.1 Parameter Input by Program	○	○	○	○	○	319
12.1.9.2 Compensation Data Input by Program	○	○	○	○	○	320
12.1.9.3 Tool/Material Shape Input by Program	○	○	○	○	○	324
12.1.9.5 API Section and Sub-section Nos. Input/Output by Program	○	○	○	○	—	326
12.1.9.6 R-Navi Data Input by Program	○	—	—	—	—	326
12.1.10 Machining Modal						327
12.1.10.1 Tapping Mode	○	○	○	○	○	327
12.1.10.2 Cutting Mode	○	○	○	○	○	327
12.1.11 High-speed Parts Machining						328
12.1.11.1 Rapid Traverse Block Overlap	○	○	—	—	△	328
12.2 Machining Accuracy Support Functions						330
12.2.1 Automatic Corner Override	○	○	○	○	○	330
12.2.2 Deceleration Check						331
12.2.2.1 Exact Stop Check Mode	○	○	○	○	○	333
12.2.2.2 Exact Stop Check	○	○	○	○	○	333
12.2.2.3 Error Detection	○	○	○	○	○	333
12.2.2.4 Programmable In-position Check	○	○	○	○	○	334
12.2.2.5 Automatic Error Detection	—	—	—	—	—	334
12.3 High-speed and High-accuracy Functions [kBPM: k Block per Minute]						335
12.3.1 High-speed Machining Mode						335
12.3.1.1 High-speed Machining Mode I (G05P1) Maximum [kBPM]	○33.7	○16.8	—	—	△33.7	335
12.3.1.2 High-speed Machining Mode II (G05P2) Maximum [kBPM]	○67.5	○67.5	—	—	△67.5	336
12.3.2 High-accuracy Control						337
12.3.2.1 High-accuracy Control (G61.1/G08)	○	○	○	—	△	337
12.3.2.2 Multi-part System Simultaneous High-accuracy Control	○	—	—	—	△	341
12.3.2.3 SSS Control	○	○	— (*4)	—	△	342
12.3.2.4 Tolerance Control	○	○	○	—	△	343
12.3.2.5 Variable-acceleration Pre-interpolation Acceleration/Deceleration	—	—	—	—	—	344
12.3.2.6 High-accuracy Acceleration/Deceleration Time Constant Extension	—	—	—	—	—	344
12.3.2.7 Axis-specific Acceleration Tolerance Control	—	—	—	—	—	345
12.3.3 High-speed High-accuracy Control						346
12.3.3.1 High-speed High-accuracy Control I (G05.1Q1) Maximum [kBPM]	○33.7	○33.7	—	—	△33.7	346
12.3.3.2 High-speed High-accuracy Control II (G05P10000) Maximum [kBPM]	○67.5	○67.5	—	—	△67.5	347
12.3.3.3 High-speed High-accuracy Control III (G05P20000) Maximum [kBPM]	○135	—	—	—	△135	350
12.3.3.4 Smooth Fairing	○	—	—	—	△	352
12.3.4 Machining Condition Selection I	○	○	○	—	○	353

○: Standard △: Option □: Selection

Class	Machining center system					Page
	M80 TypeA	M80 TypeB	E80 TypeA	E80 TypeB	C80	
12.3.5 Direct Command Mode	—	—	—	—	—	353
12.4 Programming Support Functions						354
12.4.1 Playback	○	○	○	—	○	354
12.4.3 Interactive Cycle Insertion	○	○	○	○	—	355
12.4.4 Simple Programming (NAVI MILL/LATHE)	○	○	○	○	—	358
12.4.5 G code Guidance	○	○	○	○	○	358
12.4.7 DXF Data Input	○	—	—	—	—	359
13 Machine Accuracy Compensation						361
13.1 Static Accuracy Compensation						362
13.1.1 Backlash Compensation	○	○	○	○	○	362
13.1.2 Memory-type Pitch Error Compensation [sets]	○16	○16	○16	○16	○10	363
13.1.3 Memory-type Relative Position Error Compensation	○	○	○	○	○	364
13.1.4 External Machine Coordinate System Compensation	○	○	○	○	△	365
13.1.5 Circular Radius Error Compensation	○	○	—	—	△	365
13.1.6 Ball Screw Thermal Expansion Compensation	○	○	○	○	△	366
13.1.7 Rotation Center Error Compensation	—	—	—	—	—	367
13.1.8 Position-dependent Gradually Increasing-type Backlash Compensation	○	○	○	○	△	369
13.1.9 Bidirectional Pitch Error Compensation	○	○	—	—	△	370
13.1.10 Cyclic Error Compensation	○	○	—	—	—	370
13.1.11 Spatial Error Compensation	—	—	—	—	—	371
13.1.12 Backlash Compensation II	○	○	○	○	—	372
13.2 Dynamic Accuracy Compensation						373
13.2.1 Smooth High-gain (SHG) Control	○	○	○	○	○	373
13.2.2 Dual Feedback	○	○	○	○	○	374
13.2.3 Lost Motion Compensation	○	○	○	○	○	374
13.2.4 OMR II (Backlash with Filter)	○	○	○	○	△	375
13.2.6 OMR-FF	○	○	○	○	△	376
13.2.7 Distance-coded Reference Position Detection	○	○	—	—	—	377
13.2.9 Variable Torsion Compensation	○	—	—	—	—	378
13.2.10 Cogging Torque Compensation	○	○	—	—	—	379
14 Automation Support Functions						381
14.1 Measurement						382
14.1.1 Skip						382
14.1.1.1 Skip	○	○	○	○	○	382
14.1.1.2 Multiple-step Skip	○	○	○	○	○	384
14.1.1.4 PLC Skip	○	○	○	○	△	385
14.1.1.5 Speed Change Skip	—	—	—	—	—	385
14.1.1.6 Torque Limitation Skip	○	○	○	○	—	386
14.1.2 Automatic Tool Length Measurement	○	○	○	○	○	387
14.1.3 Manual Tool Length Measurement 1	○	○	○	○	○	390
14.1.4 Manual Tool Length Measurement 2	○	○	○	○	○	393
14.1.5 Workpiece Coordinate Offset Measurement	—	—	—	—	—	394

○: Standard △: Option □: Selection

Class	Machining center system					Page
	M80 TypeA	M80 TypeB	E80 TypeA	E80 TypeB	C80	
14.1.6 Workpiece Position Measurement	○	○	○	○	○	395
14.1.7 Rotation Measurement	○	○	—	—	○	397
14.1.8 Rotation Center Error Measurement	—	—	—	—	—	398
14.1.9 Workpiece Installation Error Measurement	—	—	—	—	—	399
14.2 Tool Life Management						400
14.2.1 Tool Life Management						400
14.2.1.1 Tool Life Management I	○	○	○	○	○	400
14.2.1.2 Tool Life Management II	○	○	○	○	○	401
14.2.1.3 Tool Life Management III	○	○	○	○	○	401
14.2.2 Number of Tool Life Management Sets						402
99 sets	—	—	—	—	—	402
128 sets	—	—	—	—	—	402
200 sets	○	○	○	○	○	402
256 sets	—	—	—	—	—	402
400 sets	—	—	—	—	—	402
999 sets	—	—	—	—	—	402
14.2.3 Tool Life Management Set Allocation to Part Systems	—	—	—	—	—	404
14.3 Others						406
14.3.1 Programmable Current Limitation	○	○	○	○	○	406
14.3.2 Auto Power OFF	○	○	○	○	—	406
14.3.4 Load Monitoring I	○	—	—	—	—	407
14.3.5 Power ON/OFF Sequence	—	—	—	—	—	407
14.3.6 PLC Axis Current Limit	—	—	—	—	○	407
14.3.7 Direct Robot Control	□	□	□	□	—	408
15 Safety and Maintenance						409
15.1 Safety Switches						410
15.1.1 Emergency Stop	○	○	○	○	○	410
15.1.2 Data Protection Key	○	○	○	○	○	410
15.2 Display for Ensuring Safety						411
15.2.1 NC Warning	○	○	○	○	○	411
15.2.2 NC Alarm	○	○	○	○	○	411
15.2.3 Operation Stop Cause	○	○	○	○	○	412
15.2.4 Emergency Stop Cause	○	○	○	○	○	412
15.2.5 Thermal Detection	○	○	○	○	○	412
15.2.6 Battery Alarm/Warning	○	○	○	○	○	413
15.3 Protection						414
15.3.1 Stroke End (Over Travel)	○	○	○	○	○	414
15.3.2 Stored Stroke Limit						414
15.3.2.1 Stored Stroke Limit I/II	○	○	○	○	○	415
15.3.2.2 Stored Stroke Limit IB	○	○	—	—	△	417
15.3.2.3 Stored Stroke Limit IIB	○	○	—	—	△	417
15.3.2.4 Stored Stroke Limit IC	○	○	—	—	△	418
15.3.3 Stroke Check before Travel	○	○	—	—	△	419
15.3.4 Chuck/Tailstock Barrier Check	—	—	—	—	—	421

○: Standard △: Option □: Selection

Class	Machining center system					Page
	M80 TypeA	M80 TypeB	E80 TypeA	E80 TypeB	C80	
15.3.5 Interlock	○	○	○	○	○	422
15.3.6 External Deceleration	○	○	○	○	○	422
15.3.7 Interference Check III	—	—	—	—	—	423
15.3.8 3D Machine Interference Check	—	—	—	—	—	425
15.3.9 Door Interlock						426
15.3.9.1 Door Interlock I	○	○	○	○	○	426
15.3.9.2 Door Interlock II	○	○	○	○	○	428
15.3.10 Parameter Lock	○	○	○	○	○	430
15.3.11 Program Protection (Edit Lock B, C)	○	○	○	○	○	430
15.3.12 Program Display Lock	○	○	○	○	○	430
15.3.13 Data Protection by User's Level	○	○	○	○	△	430
15.3.15 Vertical Axis Pull-up	○	○	○	○	○	431
15.3.16 Machine Group-based Alarm Stop	○	○	—	—	△	431
15.3.17 Interference Check Between Part Systems	—	—	—	—	—	433
15.3.18 Spindle Protection	○	○	—	—	—	434
15.4 Maintenance and Troubleshooting						435
15.4.1 Operation History	○	○	○	○	○	435
15.4.2 Data Sampling	○	○	○	○	○	436
15.4.3 NC Data Backup	○	○	○	○	○	436
15.4.4 Servo Tuning Support						437
15.4.4.1 NC Analyzer2	○	○	○	○	○	437
15.4.5 Automatic Backup	○	○	○	○	○ (GOT)	439
15.4.8 Application Error Detection	—	—	—	—	—	439
15.4.9 Email Notification to Operator	○	○	○	○	—	440
15.4.10 NC Configurator2	○	○	○	○	○	441
15.4.11 Diagnosis Data Output	○	○	○	○	○	441
15.4.12 Backup/Restore	—	—	—	—	○	441
15.4.14 Field Network Diagnostics	□	□	□	□	—	442
15.4.15 Remote service iQ Care Remote4U						443
15.4.15.1 Connection with RGU	□	□	□	□	—	443
15.5 Functional Safety						444
15.5.1 Safety Observation	○	○	○	○	—	444
15.5.2 Smart Safety Observation						445
15.5.2.1 Safety-related I/O Observation	□	□	—	—	△	445
15.5.2.2 Emergency Stop Observation	□	□	—	—	△	445
15.5.2.3 Drive Safety Function						446
15.5.2.3.1 SLS (Safely-Limited Speed)	□	□	—	—	△	446
15.5.2.3.2 SLP (Safely-Limited Position)	□	□	—	—	△	446
15.5.2.3.3 SOS (Safe Operating Stop)	□	□	—	—	△	446
15.5.2.3.4 SSM (Safe Speed Monitor)	□	□	—	—	△	446
15.5.2.3.5 SBC/SBT (Safe Brake Control/Safe Brake Test)	□	□	—	—	△	447

○: Standard △: Option □: Selection

Class	Machining center system					Page
	M80 TypeA	M80 TypeB	E80 TypeA	E80 TypeB	C80	
15.5.2.3.6 SCA (Safe Cam)	□	□	—	—	△	447
15.5.2.3.7 SS1/SS2 (Safe Stop)	□	□	—	—	△	447
15.5.2.3.8 STO (Safe Torque Off)	□	□	—	—	△	447
15.5.2.3.9 SCN (Safety Communication Network)	—	—	—	—	△	448
16 Drive System						449
16.1 Servo/Spindle						450
Feed axis						—
MDS-E-Vx	□	□	□	□	□	—
MDS-EH-Vx	□	□	□	□	□	—
MDS-EJ-Vx	□	□	□	□	□	—
MDS-EJH-Vx	□	□	□	□	□	—
MDS-EM-SPVx	□	□	□	□	□	—
MDS-EMH-SPVx	□	□	□	□	□	—
Spindle						—
MDS-E-SPx	□	□	□	□	□	—
MDS-EH-SPx	□	□	□	□	□	—
MDS-EJ-SPx	□	□	□	□	□	—
MDS-EM-SPVx	□	□	□	□	□	—
MDS-EMH-SPVx	□	□	□	□	□	—
Power supply						—
MDS-E-CV	□	□	□	□	□	—
MDS-EH-CV	□	□	□	□	□	—
MDS-EX-CVP	□	□	□	□	□	—
17 Machine Support Functions						451
17.1 PLC						452
17.1.1 Built-in PLC Processing Mode	○	○	○	○	—	452
17.1.2 PLC Functions						452
17.1.2.1 Built-in PLC Basic Function	○	○	○	○	△ (MELSEC)	452
17.1.2.1.1 Index Modification	○	○	○	○	△ (MELSEC)	455
17.1.2.1.2 Multi-program [Number of Programs]	○60	○60	○60	○60	△ (MELSEC)	455
17.1.2.1.3 Multi-project [Number of Projects Stored]						456
Number of PLC projects: 2	—	○	○	○	—	456
Number of PLC projects: 3	○	—	—	—	—	456
Number of PLC projects: 6	—	—	—	—	—	456
17.1.2.1.4 Function Block (FB)	○	○	○	○	△ (MELSEC)	456
17.1.2.1.5 Label Programming	○	○	○	○	△ (MELSEC)	456
17.1.2.2 PLC Exclusive Instruction	○	○	—	—	△ (MELSEC)	457
17.1.2.3 Enhanced PLC Security Mode	○	○	○	○	—	459
17.1.3 PLC Support Functions						460
17.1.3.1 Alarm Message Display	○	○	○	○	—	460

○: Standard △: Option □: Selection

Class	Machining center system					Page
	M80 TypeA	M80 TypeB	E80 TypeA	E80 TypeB	C80	
17.1.3.2 Operator Message Display	○	○	○	○	○(*5)	460
17.1.3.3 Memory Switch (PLC Switch)						461
17.1.3.3.1 Memory Switch (PLC Switch) 32 Points	—	—	○	○	—	461
17.1.3.3.2 Memory Switch (PLC Switch) 64 Points	○	○	—	—	—	461
17.1.3.3.3 Memory Switch (PLC Switch) 96 points	—	—	—	—	—	461
17.1.3.4 Load Meter Display	○	○	○	○	○	462
17.1.3.5 User PLC Version Display	○	○	○	○	○	462
17.1.3.6 Ladder Program Writing during RUN	○	○	○	○	△ (MELSEC)	462
17.1.3.7 PLC Program Protection	○	○	○	○	△ (MELSEC)	462
17.1.4 Built-in PLC Capacity						463
17.1.4.1 Standard PLC Capacity [Number of Steps]	○64K	○32K	○20K	○20K	△ (MELSEC)	463
17.1.4.2 Large PLC Capacity: 256 Ksteps	—	—	—	—	—	463
17.1.4.3 Large PLC Capacity: 512 Ksteps	—	—	—	—	—	463
17.1.5 Machine Contact Input/Output I/F	○	○	○	○	△ (MELSEC)	463
17.1.6 Ladder Monitor	○	○	○	○	○(GOT)	464
17.1.7 PLC Development						465
17.1.7.1 On-board Development	○	○	○	○	○(GOT)	465
17.1.7.2 MELSEC Development Tool (GX Developer)	○	○	○	○	—	465
17.1.7.3 MELSEC Development Tool (GX Works2)	○	○	○	○	—	465
17.1.7.4 MELSEC Development Tool (GX Works3)	—	—	—	—	○	466
17.1.8 PLC Parameter						466
17.1.8.1 PLC Constant (150 Points)	○	○	○	○	○	466
17.1.8.2 PLC Constant Extension (Up to 750 Points)	○	○	—	—	—	466
17.1.9 GOT Connection						467
17.1.9.1 Ethernet Connection	○	○	○	○	○	467
17.1.9.2 CC-Link Connection	○	○	○	○	△ (MELSEC)	467
17.1.9.3 CC-Link IE Field Connection	—	—	—	—	△ (MELSEC)	467
17.1.10 Pallet Program Registration	—	—	—	—	—	468
17.2 Machine Construction						469
17.2.1 Servo OFF	○	○	○	○	○	469
17.2.2 Axis Detachment	○	○	○	○	○	470
17.2.3 Synchronous Control	○	○	—	—	△	471
17.2.4 Inclined Axis Control	○	○	—	—	—	475
17.2.5 Position Switch	○24	○24	○24	○24	○(*6)	476
17.2.7 Index Table Indexing	○	○	○	○	○	477
17.2.8 Tool Length Compensation along the Tool Axis	—	—	—	—	—	479
17.2.9 Tool Handle Feed & Interruption	—	—	—	—	—	480

○: Standard △: Option □: Selection

Class	Machining center system					Page
	M80 TypeA	M80 TypeB	E80 TypeA	E80 TypeB	C80	
17.2.10 Tool Center Coordinate Display	—	—	—	—	—	480
17.2.11 Tool Center Point Control						481
17.2.11.1 Tool Center Point Control (G43.4/G43.5)	○(*7)	—	—	—	—	481
17.2.12 Inclined Surface Machining Command	○	—	—	—	△	484
17.2.13 Simple Inclined Surface Machining Command	—	—	—	—	—	486
17.2.14 3-dimensional Tool Radius Compensation (Tool's Vertical-direction Compensation)	—	—	—	—	—	488
17.2.15 Workpiece Installation Error Compensation	—	—	—	—	—	489
17.2.16 3-dimensional Manual Feed	○	—	—	—	△	490
17.2.17 R-Navi	○	—	—	—	—	491
17.2.18 Simple Synchronous Control	○	—	—	—	—	493
17.2.20 Real-time Tuning						494
17.2.20.1 Real-time Tuning 1 (Speed Gain)	○	—	—	—	—	494
17.2.20.2 Real-time Tuning 2 (Rapid Traverse Time Constant)	○	—	—	—	—	495
17.2.21 Constant Torque Control	○	○	○	○	—	496
17.2.22 External Encoder Position Output I/F	○	○	○	○	—	497
17.2.23 Multiple-axis Synchronization Control	○	○	○	—	—	498
17.2.24 Hypothetical Linear Axis Control	—	—	—	—	△	499
17.2.25 BiSS Encoder I/F	○	○	○	○	—	500
17.2.26 Tool Head Hot Swapping	—	—	—	—	—	501
17.3 PLC Operation						502
17.3.1 Arbitrary Feed in Manual Mode	○	○	○	○	○	502
17.3.2 Circular Feed in Manual Mode	○	○	—	—	—	503
17.3.3 PLC Axis Control	○	○	○	—	○	505
17.3.5 PLC Axis Indexing	○	○	○	—	○	506
17.3.6 NC Axis/PLC Axis Switchover	○	○	—	—	△	508
17.4 PLC Interface						509
17.4.1 CNC Control Signal	○	○	○	○	○	509
17.4.2 CNC Status Signal	○	○	○	○	○	510
17.4.3 PLC Window	○	○	○	○	○	512
17.4.4 External Search	○	○	○	○	○	513
17.4.5 Direct Screen Selection	○	○	○	○	○	513
17.4.6 Buzzer Sound Control	○	○	○	○	—	514
17.5 Machine Contact I/O						515
17.5.1 Operation Panel I/O						515
17.5.1.1 DI:64/DO:64	—	—	□	□	—	515
17.5.1.2 DI:64/DO:64 + SDI:8	—	—	□	□	—	515
17.5.1.3 DI:96/DO:64	□	□	□	□	—	515
17.5.1.5 DI:64/DO:48/AO:1	□	□	□	□	—	515
17.5.2 Remote I/O						516
17.5.2.1 DI:32/DO:32	□	□	□	□	—	516
17.5.2.2 DI:64/DO:48	□	□	□	□	—	516
17.5.2.3 DI:64/DO:48 + AO:1	□	□	□	□	—	516

○: Standard △: Option □: Selection

Class	Machining center system					Page
	M80 TypeA	M80 TypeB	E80 TypeA	E80 TypeB	C80	
17.5.2.5 DI:16/DO:8	□	□	□	□	—	516
17.5.2.6 DI:32/DO:32 + SDI:8/SDO:4	□	□	□	□	—	516
17.5.2.7 SDI:8/SDO:4	□	□	□	□	—	516
17.6 External PLC Link						517
17.6.1 CC-Link (Master/Local)	□	□	□	□	△ (MELSEC)	517
17.6.2 PROFIBUS-DP (Master)	□	□	□	□	△ (MELSEC)	523
17.6.3 CC-Link IE Field (Master/Local)	□	□	□	□	△ (MELSEC)	524
17.6.4 PROFINET	—	—	—	—	△ (MELSEC)	525
17.6.5 EtherNet/IP	□	□	□	□	△ (MELSEC)	526
17.6.8 FL-net	□	□	□	□	△ (MELSEC)	527
17.6.9 DeviceNet (Master)	—	—	—	—	△ (MELSEC)	527
17.6.10 CC-Link IE Field Basic	○	○	○	○	—	528
17.7 Installing S/W for Machine Tools						530
17.7.1 Customization (NC Designer2)	○	○	○	○	—	530
17.7.1.1 Customization Data Storage Capacity [MB]	6	6	1	1	—	532
17.7.1.2 Customization Working Memory Size [MB]	3	3	1	1	—	532
17.7.2 User-defined Key	○	○	○	○	—	532
17.7.3 EZSocket I/F	○	○	○	○	—	532
17.7.4 APLC Release	○	○	○	○	△	533
17.7.5 Custom API Library	○	○	○	○	—	534
17.7.6 MES Interface Library	○	○	○	○	—	534
17.7.7 SLMP Server	○	○	○	○	—	535
17.7.8 Numerical Control (CNC) Communication Software FCSB1224W000	○	○	○	○	—	536
17.7.10 GOT2000 Screen Design Tool GT Works3	—	—	—	—	○	536
17.8 Others						537
17.8.1 System Lock	○	○	○	○	—	537
17.8.2 CNC Remote Operation Tool						537
17.8.2.1 NC Monitor2	○	○	○	○	○	537
17.8.2.2 NC Explorer	○	○	○	○	○	537
17.8.3 Automatic Operation Lock	○	○	○	○	○	537
17.8.4 Power Consumption Computation	○	○	○	○	○	538
17.8.5 EcoMonitorLight Connection	○	○	○	○	—	538
17.8.6 GOT Window	—	—	—	—	○	539
17.8.7 Log Viewer	—	—	—	—	○	540

(*1)Up to one rotary axis.

(*4) eSSS

(*5) Only the macro alarm message can be displayed.

(*6) 24 points for each part system and 32 points for the whole PLC axes.

(*7) Restrained to 4-axis simultaneous contouring

(*8) Up to 2000 programs for C80



Control Axes

1.1 Control Axes

The NC axis, spindle, PLC axis and auxiliary axis are generically called the control axis.

The NC axis is an axis that can be manually operated, or automatically operated with the machining program. X, Y, Z, U, V, W, A, B and C axis can be used.

The PLC axis is an axis that can be controlled from the PLC ladder.

1.1.1 Number of Basic Control Axes (NC Axes)

	M850W	M830W	M850S	M830S	M80W	M80 TypeA	M80 TypeB	E80 TypeA	E80 TypeB	C80
M	○ 3	○ 3	○ 3	○ 3	○ 3	○ 3	○ 3	○ 3	○ 3	○ 3
L	○ 2	○ 2	○ 2	○ 2	○ 2	○ 2	○ 2	○ 2	○ 2	○ 2

1.1.2 Max. Number of Axes (NC Axes + Spindles + PLC Axes)

	M850W	M830W	M850S	M830S	M80W	M80 TypeA	M80 TypeB	E80 TypeA	E80 TypeB	C80
M	○ 16 △ 32	○ 16 △ 32	○ 16 △ 32	○ 16 △ 32	11	11	9	6	4	16
L	○ 16 △ 32	○ 16 △ 32	○ 16 △ 32	○ 16 △ 32	12	12	9	8	6	16

A number of axes that are within the maximum number of axes, and that does not exceed the maximum number given for the NC axis, spindle and PLC axis can be used.

Connection specifications of NC axis, PLC axis and spindle:

NC axes, PLC axes and spindles (except for analog spindles) are connected to the high-speed optical servo communication (OPTH).

Refer to the Connection and Setup Manual for details.

1.1.2.1 Max. Number of NC Axes (In Total for All the Part Systems)

	M850W	M830W	M850S	M830S	M80W	M80 TypeA	M80 TypeB	E80 TypeA	E80 TypeB	C80
M	○ 16	○ 16	○ 16	○ 16	8	8	6	5 (*1)	3	16
L	○ 16 △ 32	○ 16 △ 32	○ 16 △ 32	○ 16 △ 32	10	10	7	5	4	16

(*1) Up to one rotary axis.

1.1.2.2 Max. Number of Spindles

	M850W	M830W	M850S	M830S	M80W	M80 TypeA	M80 TypeB	E80 TypeA	E80 TypeB	C80
M	4	4	4	4	2	2	2	1	1	7
L	8	8	8	8	4+G/B (*1)	5	4	3	3	7

(*1) G/B : Guide Bush

Includes analog spindles.

1.1.2.3 Max. Number of PLC Axes

	M850W	M830W	M850S	M830S	M80W	M80 TypeA	M80 TypeB	E80 TypeA	E80 TypeB	C80
M	8	8	8	8	6	6	6	2	0	8
L	8	8	8	8	6	6	6	3	3	8

1.1.4 Max. Number of PLC Indexing Axes

	M850W	M830W	M850S	M830S	M80W	M80 TypeA	M80 TypeB	E80 TypeA	E80 TypeB	C80
M	8	8	8	8	4	4	4	1	0	8
L	8	8	8	8	4	4	4	1	1	8

PLC axis indexing function: This function is used to move the PLC axis to the positioning destination or an arbitrary coordinate position.

1.1.5 Number of Simultaneous Contouring Control Axes

	M850W	M830W	M850S	M830S	M80W	M80 TypeA	M80 TypeB	E80 TypeA	E80 TypeB	C80
M	8	4	8	4	4	4	4	4	3	4
L	8	4	8	4	4	4	4	4	4	4

Simultaneous control of all axes is possible as a principle in the same part system. However, for actual use, the machine tool builder specification will apply.

1.1.6 Max. Number of NC Axes in a Part System

	M850W	M830W	M850S	M830S	M80W	M80 TypeA	M80 TypeB	E80 TypeA	E80 TypeB	C80
M	○ 8 △ 12	○ 8 △ 12	○ 8 △ 12	○ 8 △ 12	8	8	5	5 (*1)	3	8
L	○ 8 △ 12	○ 8 △ 12	○ 8 △ 12	○ 8 △ 12	8	8	5	5	4	8

(*1) Up to one rotary axis.

Listed are the maximum number of axes which can be controlled in a part system. Follow the specifications by each machine tool builder for actual use.

1.1.7 Axis Name Extension

	M850W	M830W	M850S	M830S	M80W	M80 TypeA	M80 TypeB	E80 TypeA	E80 TypeB	C80
M	○	○	○	○	○	○	○	—	—	—
L	○	○	○	○	○	○	○	—	—	—

The axis name (command axis name) to perform the absolute/incremental command to NC control axis can be expanded to two letters. Because the command axis name while this function is invalid is set with one letter from A, B, C, U, V, W, X, Y or Z, when the incremental command axis name is used (two letters of the alphabet are used per one axis), the number of axes is limited. The incremental command axis name can be used to all axes by this function. The name extension axis cannot be designated to the parameter which sets the command axis name such as axes configuring plane I, J or K. Thus, apply this function to miscellaneous axis which is not used for machining (cutting).

1.2 Control Part System

1.2.1 Standard Number of Part Systems

	M850W	M830W	M850S	M830S	M80W	M80 TypeA	M80 TypeB	E80 TypeA	E80 TypeB	C80
M	1	1	1	1	1	1	1	1	1	1
L	1	1	1	1	1	1	1	1	1	1

1.2.2 Max. Number of Part Systems (Main + Sub)

	M850W	M830W	M850S	M830S	M80W	M80 TypeA	M80 TypeB	E80 TypeA	E80 TypeB	C80
M	○ 2 △ 3 (*1)	○ 2 △ 3 (*1)	○ 2 △ 3 (*1)	○ 2 △ 3 (*1)	○ 2	○ 2	○ 1	○ 1	○ 1	○ 7
L	○ 4 △ 8	○ 4 △ 8	○ 4 △ 8	○ 4 △ 8	○ 4	○ 4	○ 2	○ 1	○ 1	○ 7

(*1) The 3rd part system is only for the loader part system.

For actual use, the machine tool builder specification will apply.

1.2.2.1 Max. Number of Main Part Systems

	M850W	M830W	M850S	M830S	M80W	M80 TypeA	M80 TypeB	E80 TypeA	E80 TypeB	C80
M	○ 2	○ 2	○ 2	○ 2	○ 2	○ 2	○ 1	○ 1	○ 1	○ 7
L	○ 4 △ 8	○ 4 △ 8	○ 4 △ 8	○ 4 △ 8	○ 2	○ 2	○ 2	○ 1	○ 1	○ 7

1.2.2.2 Max. Number of Sub Part Systems

	M850W	M830W	M850S	M830S	M80W	M80 TypeA	M80 TypeB	E80 TypeA	E80 TypeB	C80
M	○ 2	○ 2	○ 2	○ 2	—	—	—	—	—	—
L	○ 4 △ 8	○ 4 △ 8	○ 4 △ 8	○ 4 △ 8	○ 2	○ 2	○ 1	—	—	○ 2

1.3 Control Axes and Operation Modes

1.3.1 Tape (RS-232C Input) Mode

	M850W	M830W	M850S	M830S	M80W	M80 TypeA	M80 TypeB	E80 TypeA	E80 TypeB	C80
M	○	○	○	○	○	○	○	○	○	—
L	○	○	○	○	○	○	○	○	○	—

In this mode, operation is performed using the machining program data from the RS-232C interface built in the CNC unit. A paper tape reader must be provided if machining programs on paper tape are to be run.

1.3.2 Memory Mode

	M850W	M830W	M850S	M830S	M80W	M80 TypeA	M80 TypeB	E80 TypeA	E80 TypeB	C80
M	○	○	○	○	○	○	○	○	○	○
L	○	○	○	○	○	○	○	○	○	○

The machining programs stored in the memory of the CNC unit are run.

1.3.3 MDI Mode

	M850W	M830W	M850S	M830S	M80W	M80 TypeA	M80 TypeB	E80 TypeA	E80 TypeB	C80
M	○	○	○	○	○	○	○	○	○	○
L	○	○	○	○	○	○	○	○	○	○

The MDI data stored in the memory of the CNC unit is executed. Once executed, the MDI data is set to the "setting incomplete" status, and the data will not be executed unless the "setting completed" status is established by screen operations.

1.3.4 High-Speed Program Server Mode

1.3.4.1 Control Unit-side High-speed Program Server Mode

	M850W	M830W	M850S	M830S	M80W	M80 TypeA	M80 TypeB	E80 TypeA	E80 TypeB	C80
M	△	△	—	—	○	—	—	—	—	—
L	△	△	—	—	○	—	—	—	—	—

The machining program stored in SD card can be operated by installing a SD card in the control unit SD card interface. From this, mass capacity and multi-process machining can be done.

Machining programs can be copied to SD card with the front SD card or Ethernet on the input/output screen.

When a machining program stored in SD card is searched while "DS" (Data server) is selected for device during operation search, the machining program in SD card can be operated as a main program. ("Memory mode" is used as the operation mode.)

Also, when "M198 Pp;" is commanded in the main program, the machining program in SD card can be called and operated as a sub program.

Macros such as WHILE, IF and GOTO can be used. Also, calling the sub program and macro program stored in memory or SD card is possible.

1.3.4.2 Display Unit-side High-speed Program Server Mode

	M850W	M830W	M850S	M830S	M80W	M80 TypeA	M80 TypeB	E80 TypeA	E80 TypeB	C80
M	△ /—	△ /—	△	△	○ /—	○	○	○	○	—
L	△ /—	△ /—	△	△	○ /—	○	○	○	○	—

* Specifications of separated-type display are classified with "Windows-based" and "non-Windows-based"

The machining program stored in the built-in disk of the display unit can be operated.

The built-in disk of the display unit is mounted in the personal computer for M800W/M80W.

For M800S/M80/E80, the SD card inserted into SD card I/F on the back of the display unit is equivalent to the built-in disk of the display unit.

When a machining program stored in the built-in disk of the display unit is searched while "HD" (M800W/M80W) or "DS" (M800S/M80/E80) is selected for device during operation search, the machining program in the built-in disk of the display unit can be operated as a main program. ("Memory mode" is used as the operation mode.)

Also, when "M98 Pp ,Dd;" ("d" for designating a unit) is commanded in the main program, the machining program in the built-in disk of the display unit can be called and operated as a sub program.

Macros such as WHILE, IF and GOTO can be used. Also, calling the sub program and macro program stored in memory or the built-in disk of the display unit is possible.

1.3.4.3 FTP High-speed Program Server Mode

	M850W	M830W	M850S	M830S	M80W	M80 TypeA	M80 TypeB	E80 TypeA	E80 TypeB	C80
M	—	—	—	—	—	—	—	—	—	△
L	—	—	—	—	—	—	—	—	—	△

This function allows high-speed transfer of machining programs from the FTP server to the large-capacity buffer memory in CNC CPU via Ethernet to execute the program.

The buffer memory has 20 MB of data capacity; however, the memory does not retain machining programs when the power is turned OFF.

If the FTP server function of GOT is used, programs stored in such as a USB memory of GOT can be transferred and operated. ("Tape mode" is used as the operation mode.)

1.3.5 Front-side SD Card Mode

	M850W	M830W	M850S	M830S	M80W	M80 TypeA	M80 TypeB	E80 TypeA	E80 TypeB	C80
M	○	○	○	○	○	○	○	○	○	—
L	○	○	○	○	○	○	○	○	○	—

The machining program stored in a SD card can be operated. This SD card is installed to the front-side SD card I/F.

When a machining program stored in SD card is searched while "Memory Card" is selected for device during operation search, the machining program in SD card can be operated as a main program. ("Memory mode" is used as the operation mode.)

Also, when "M98 Pp ,Dd;" ("d" for designating a unit) is commanded in the main program, the machining program in SD card can be called and operated as a sub program.

Macros such as WHILE, IF and GOTO can be used. Also, calling the sub program and macro program stored in memory or SD card is possible.

1.3.6 Front-side USB Memory Mode

	M850W	M830W	M850S	M830S	M80W	M80 TypeA	M80 TypeB	E80 TypeA	E80 TypeB	C80
M	○	○	○	○	○	○	○	○	○	—
L	○	○	○	○	○	○	○	○	○	—

The control is able to run a machining program stored in a USB memory when it is inserted into the front USB port of the display unit.

USB memory may be pulled off due to the machine vibration depending on the environment. Use this function at your own risk.

USB memory mode enables you to handle the same programs as for memory mode. In addition you can handle the greater number of large-capacity programs.

When a machining program stored in the USB memory is searched while USB is selected for device during operation search, the machining program in the USB memory can be operated as a main program. ("Memory mode" is used as the operation mode.)

Also, when "M98 Pp ,Dd;" ("d" for designating a unit) is commanded in the main program, the machining program in the USB memory can be called and operated as a sub program.

Display unit

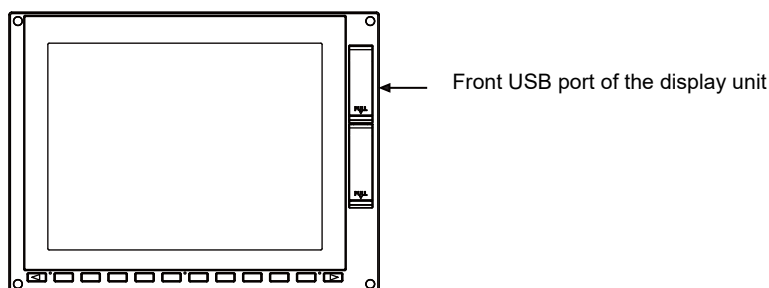

2

Input Command

2.1 Data Increment

2.1.1 Least Command Increment

[M system]

Least command increment (input setting increment)	M850W	M830W	M850S	M830S	M80W	M80 TypeA	M80 TypeB	E80 TypeA	E80 TypeB	C80
1 μ m (1 μ m)	○	○	○	○	○	○	○	○	○	○
0.1 μ m (0.1 μ m)	○	○	○	○	○	○	○	○	—	○
0.01 μ m (10nm)	△	△	△	△	—	—	—	—	—	—
0.001 μ m (1nm)	△	△	△	△	—	—	—	—	—	—

[L system]

Least command increment (input setting increment)	M850W	M830W	M850S	M830S	M80W	M80 TypeA	M80 TypeB	E80 TypeA	E80 TypeB	C80
1 μ m (1 μ m)	○	○	○	○	○	○	○	○	○	○
0.1 μ m (0.1 μ m)	○	○	○	○	○	○	○	○	○	○
0.01 μ m (10nm)	△	△	△	△	—	—	—	—	—	—
0.001 μ m (1nm)	△	△	△	△	—	—	—	—	—	—

The data increment handled in the controller includes the input setting increment, PLC increment and machine error compensation increment. Each type is set with parameters.

(1) Input setting increment

The input setting increment applies to the data entered from or displayed in the Monitor or other screens, the travel distance per pulse of manual pulse generator, machining programs, and maintenance data. (Excluding PLC increment and machine error compensation increment mentioned below.) This increment is applied per part system (1st to the maximum part system within the specification, PLC axis).

Input setting increment (parameter)	Metric unit system		Inch unit system	
	Linear axis (Unit = mm)	Rotary axis (Unit = °)	Linear axis (Unit = inch)	Rotary axis (Unit = °)
1 μ m (B)	0.001	0.001	0.0001	0.001
0.1 μ m (C)	0.0001	0.0001	0.00001	0.0001
10nm (D)	0.00001	0.00001	0.000001	0.00001
1nm (E)	0.000001	0.000001	0.0000001	0.000001

(Note) The inch and metric systems cannot be used together.

(2) PLC increment

PLC increment is used for setting and display of PLC interface. Input-output to ladder is handled with this increment. (excluding machine error compensation increment) This increment is applied per part system.

(Example)

When writing to 90 degree for A axis and 180 degree for C axis on the A-C axis configuration with using a rotary axis angle designation (*).

- When PLC increment is 1 μ m(B).

	Angle		1/1000°	=	System unit	
<A axis>	90	×	1000	=	90000	┆┆┆[DMOV K90000 R2628]┆┆┆
<C axis>	180	×	1000	=	180000	┆┆┆[DMOV K180000 R2630]┆┆┆

- When PLC increment is 1nm(E).

	Angle		1/1000000°	=	System unit	
<A axis>	90	×	1000000	=	90000000	┆┆┆[DMOV K90000000 R2628]┆┆┆
<C axis>	180	×	1000000	=	180000000	┆┆┆[DMOV K180000000 R2630]┆┆┆

(*) Rotary axis angle designation

R2628-2629: part system1, 1st rotary axis of the mechanical axis angle 0 to $\pm 720000(1^\circ/1000)$ (When PLC increment is 1 μ m(B))

R2630-2631: part system1, 2nd rotary axis of the mechanical axis angle 0 to $\pm 720000(1^\circ/1000)$ (When PLC increment is 1 μ m(B))

(3) Machine error compensation increment

Machine error compensation increment is used for setting and display of machine error compensation amount. This increment is applied per part system.

This increment is applied for following parameters and PLC interface.

(a) Backlash compensation (parameter)

This function compensates for the error (backlash) produced when the direction is reversed.

(b) Pitch error compensation (parameter)

This function compensates for the errors in pitch intervals of ball screws.

(c) Machine rotation center error compensation (parameter)

This function compensates for the errors difference between the center of the actual rotary axis and the center of programmed rotary axis.

(d) External machine coordinate system compensation (PLC interface)

This function shifts the coordinate system by PLC.

(e) Ball screw thermal displacement compensation (PLC interface)

This function compensates for axis feed error caused by the ball screw thermal expansion, etc.

2.1.2 Least Control Increment

[M system]

Least control increment	M850W	M830W	M850S	M830S	M80W	M80 TypeA	M80 TypeB	E80 TypeA	E80 TypeB	C80
0.01 μ m (10nm)	○	○	○	○	○	○	○	○	○	○
0.001 μ m (1nm)	○	○	○	○	○	○	○	○	○	○

[L system]

Least control increment	M850W	M830W	M850S	M830S	M80W	M80 TypeA	M80 TypeB	E80 TypeA	E80 TypeB	C80
0.01 μ m (10nm)	○	○	○	○	○	○	○	○	○	○
0.001 μ m (1nm)	○	○	○	○	○	○	○	○	○	○

The least control increment determines the CNC's internal operation accuracy.

The control increment (the unit of the NC internal position data) and output increment (the unit of the data communicated to the drive unit) can be set individually.

2.1.3 Indexing Increment

	M850W	M830W	M850S	M830S	M80W	M80 TypeA	M80 TypeB	E80 TypeA	E80 TypeB	C80
M	○	○	○	○	○	○	○	○	○	○
L	○	○	○	○	○	○	○	○	○	○

This function limits the command value for the rotary axis.

This can be used for indexing the rotary table, etc. It is possible to cause a program error with a program command other than an indexing increment (parameter setting value).

(Example)When the indexing increment setting value is 2 degrees, only command with the 2-degree increment are possible.

G90 G01 C102.000 ; ... Moves to the 102 degree angle.

G90 G01 C101.000 ; ... Program error

G90 G01 C102 ; ... Moves to the 102 degree angle. (Decimal point type II)

2.2 Unit System

2.2.1 Inch/Metric Changeover

	M850W	M830W	M850S	M830S	M80W	M80 TypeA	M80 TypeB	E80 TypeA	E80 TypeB	C80
M	○	○	○	○	○	○	○	○	○	○
L	○	○	○	○	○	○	○	○	○	○

The unit systems of the data handled in the controller include the metric unit system and inch unit system. The unit (inch/mm) for the setting and display, as well as for the handle/incremental feed can be switched with either the parameters or machining program (G20/G21 command).

An additional specification is required when the unit is switched with the machining program command.

Unit system	Length data	Meaning
Metric unit system	1.0	1.0mm
Inch unit system	1.0	1.0inch

(Note) For the angle data, 1.0 means 1 degree (°) regardless of the unit system.

Parameter	Data					
	Machining program		Screen data (Compensation amount, user parameter, counter, etc.) / Feedrate of handle, etc.	Machine parameter / PLC interface machine position, etc.		
A	0	G20	Inch unit system	Metric unit system	Not affected	
		G21	Metric unit system			
	1	G20	Inch unit system			Inch unit system
		G21	Metric unit system			
B	0	Not affected		Not affected	Metric unit system	
	1	Not affected			Inch unit system	

(Note 1) The parameter changeover is valid after the power is turned ON again.

(Note 2) The unit system for the PLC axis can be switched with a parameter different from the one used with the NC axis.

The PLC axis unit system cannot be switched with the machining program (G20/G21 command).

(Note 3) When the power is turned ON or resetting is performed, the command increment depends on the parameter setting.

2.2.2 Input Command Increment Tenfold

	M850W	M830W	M850S	M830S	M80W	M80 TypeA	M80 TypeB	E80 TypeA	E80 TypeB	C80
M	○	○	○	○	○	○	○	○	○	○
L	—	—	—	—	—	—	—	—	—	—

The program's command increment can be multiplied by an arbitrary scale with the parameter designation.

This function is valid when a decimal point is not used for the command increment.

For example, this function allows a CNC unit, for which the command increment is set to 1 μ m, to run a machining program, which has been created with a 10 μ m input command increment, as same as before.

The scale is set with the parameters.

(Note 1) This function cannot be used for the dwell function G04_X_(P_);.

(Note 2) This function cannot be used for the compensation amount of the tool offset input.

(Note 3) This function can be used when decimal point type I is valid, but cannot be used when decimal point type II is valid.

(Note 4) This function cannot be used for a tool shape setting command (in G10L100 format).

2.3 Program Format

2.3.1 Program Format

This is G code (program) format.

The G-code of lathe system is selected by parameter.

This manual explains the G function with G-code list 3 as standard.

2.3.1.1 Format 1 for Lathe (G Code List 2, 3)

	M850W	M830W	M850S	M830S	M80W	M80 TypeA	M80 TypeB	E80 TypeA	E80 TypeB	C80
M	—	—	—	—	—	—	—	—	—	—
L	○	○	○	○	○	○	○	○	○	○

2.3.1.2 Format 2 for Lathe (G Code List 4, 5)

	M850W	M830W	M850S	M830S	M80W	M80 TypeA	M80 TypeB	E80 TypeA	E80 TypeB	C80
M	—	—	—	—	—	—	—	—	—	—
L	○	○	○	○	○	○	○	○	○	○

2.3.1.3 Special Format for Lathe (G Code List 6, 7)

	M850W	M830W	M850S	M830S	M80W	M80 TypeA	M80 TypeB	E80 TypeA	E80 TypeB	C80
M	—	—	—	—	—	—	—	—	—	—
L	○	○	○	○	○	○	○	○	○	○

2.3.1.4 Format 1 for Machining Center

	M850W	M830W	M850S	M830S	M80W	M80 TypeA	M80 TypeB	E80 TypeA	E80 TypeB	C80
M	○	○	○	○	○	○	○	○	○	○
L	—	—	—	—	—	—	—	—	—	—

2.3.1.5 Format 2 for Machining Center (M2 Format)

	M850W	M830W	M850S	M830S	M80W	M80 TypeA	M80 TypeB	E80 TypeA	E80 TypeB	C80
M	○	○	○	○	○	○	○	—	—	○
L	—	—	—	—	—	—	—	—	—	—

2.3.1.6 MITSUBISHI CNC Special Format

	M850W	M830W	M850S	M830S	M80W	M80 TypeA	M80 TypeB	E80 TypeA	E80 TypeB	C80
M	—	—	—	—	—	—	—	—	—	—
L	○	○	○	○	○	○	○	○	○	○

The formats of the turning fixed cycles (G77 to G79), compound type fixed cycle for turning machining (G71 to G76) and the fixed cycle for drilling (G80 to G89) can be switched to the MITSUBISHI CNC special formats.

(Note) There is a specification (zigzag thread cutting) for specific machine tool builder.

2.3.2 Program Format Switch

	M850W	M830W	M850S	M830S	M80W	M80 TypeA	M80 TypeB	E80 TypeA	E80 TypeB	C80
M	—	—	—	—	—	—	—	—	—	—
L	Δ	Δ	Δ	Δ	—	—	—	—	—	—

Program format switch is a function designed to switch the program format (G code list) using G codes or PLC signal. While the switch is active, the control runs a program based on the switched G code list. When you run a lathe-based multi-tasking machine, and if you change to the G code list of Machining center system, you can use a free-curved surface machining program made with CAM without modifying the program.

[Switchover using G codes (G code method)]

Command format

Program format switch ON

When G188 is given, the control switches the L-system program format to M-system (G code list 1 (Command type II)). The control runs the next and subsequent program blocks based on the M-system G code list.

G188 ; Change to M-system G code list (G code list 1 (Command type II))
--

Program format switch cancel

When G189 is given, the control switches the M-system program format back to L-system (a system selected by command type parameter). The control runs the next and subsequent program blocks based on the L-system G code list.

G189 ; Change back to L-system G code list (G code list determined by command type parameter)
--

Program example

[For G code list 2]

O1 :	L-system (G code list 2 (Command type III))
G188;	Enable "Program format switch"
G90 G00 X20. Z200.; G91 G01 X30. Z180. F100; :	M-system (G code list 1 (Command type II))
G189;	Disable "Program format switch"
:	L-system (G code list 2 (Command type III))

[Switchover using PLC signal (PLC I/F method)]

PFCHR ON; Change to M-system G code list (G code list 1 (Command type II))
PFCHR OFF; Change back to L-system G code list (G code list determined by command type parameter)

(Note) A switchover using the PLC I/F method is unavailable during automatic operation.

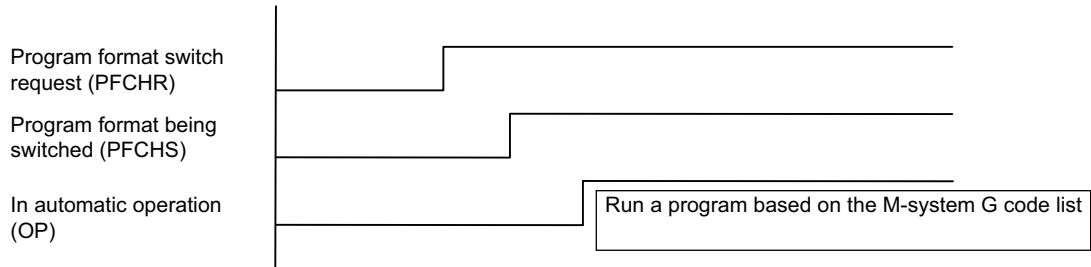

G code method and PLC I/F method are distinguished in the following points:

G code method	This switches by G188/G189 commands in cycle operation. (e.g. to switch the format dynamically for some machining processes)
PLC I/F method	This switches by PLC signal not in cycle operation. (e.g. to enable the switched state at the time of power up)

2.4 Command Value

2.4.1 Decimal Point Input I, II

	M850W	M830W	M850S	M830S	M80W	M80 TypeA	M80 TypeB	E80 TypeA	E80 TypeB	C80
M	○	○	○	○	○	○	○	○	○	○
L	○	○	○	○	○	○	○	○	○	○

There are two types of the decimal point input commands and they can be selected by parameter.

(1) Decimal point input type I

When axis coordinates and other data are issued in machining program commands, the assignment of the program data can be simplified by using a decimal point. The minimum digit of a command not using a decimal point is the same as the least command increment.

The decimal point can be applied not only to axis coordinate position but also to speed commands and dwell commands.

The decimal point position serves as the millimeter unit in the metric mode, as the inch unit in the inch mode and as the second unit in a time designation of dwell command.

(2) Decimal point input type II

As opposed to type I, the minimum digit of a command without a decimal point serves as the millimeter unit in the metric mode, as the inch unit in the inch mode and as the second unit in the time designation.

The "." (point) must be added when commands below the decimal point are required.

	Unit interpretation (for metric system)	
	Type I	Type II
G00 X100. Y-200.5	X100mm, Y-200.5mm	<-
G1 X100 F20.	X100μm, F20mm/min	X100mm, F20mm/min
G1 Y200 F100 (*1)	Y200μm, F100mm/min	Y200mm, F100mm/min
G4 X1.5	Dwell 1.5s	<-
G4 X2	Dwell 2ms	Dwell 2s

(*1) The F unit is mm/min for either type (inch system : inch/min).

2.4.2 Absolute/Incremental Command

	M850W	M830W	M850S	M830S	M80W	M80 TypeA	M80 TypeB	E80 TypeA	E80 TypeB	C80
M	○	○	○	○	○	○	○	○	○	○
L	○	○	○	○	○	○	○	○	○	○

(1) M system

When axis coordinate data is issued in a machining program command, either the incremental command method (G91) that commands a relative distance from the current position or the absolute command method (G90) that moves to a designated position in a predetermined coordinate system can be selected.

The absolute and incremental commands can be both used in one block, and are switched with G90 or G91.

However, the arc radius designation (R) and arc center designation (I, J, K) always use incremental designations.

The absolute and incremental commands are switched with G190 and G191 depending on G code list.

G90, G190 ... Absolute command

G91, G191 ... Incremental command

These G codes can be commanded multiple times in one block.

(2) L system

When axis coordinate data is issued in a machining program command, either the incremental command method that commands a relative distance from the current position or the absolute command method that moves to a designated position in a predetermined coordinate system can be selected.

When issuing an incremental command, register the axis address to be commanded as the incremental axis name in the parameter. However, the arc radius designation (R) and arc center designation (I, J, K) always use incremental designations.

Absolute command ... X, Z

Incremental command ... U, W

(Note) Absolute command and incremental command can be switched by the parameter. In addition to the command method using the axis addresses as indicated above, a command method using G code (G90/G91 or G190/G191) may be selected.

2.4.3 Diameter/Radius Designation

	M850W	M830W	M850S	M830S	M80W	M80 TypeA	M80 TypeB	E80 TypeA	E80 TypeB	C80
M	—	—	—	—	—	—	—	—	—	—
L	○	○	○	○	○	○	○	○	○	○

For axis command value, the radius designation or diameter designation can be changed over with parameters.

When the diameter designation is selected, the scale of the length of the selected axis is doubled.

(Only the half (1/2) of the commanded amount moves.)

This function is used when programming the workpiece dimensions on a lathe as diameters.

Changing over from the diameter designation to the radius designation or vice versa can be set separately for each axis.

When the tool is to be moved from point P1 to point P2

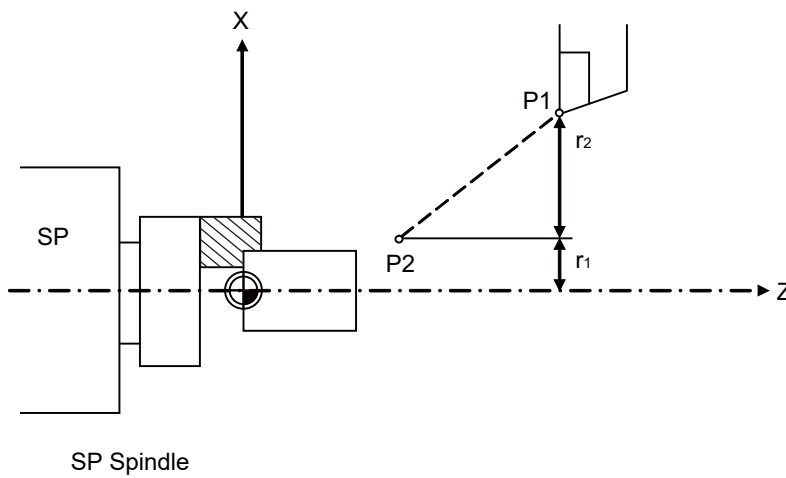

Radius and diameter commands

X command		U command		Remarks
Radius	Diameter	Radius	Diameter	
$X = r_1$	$X = 2r_1$	$U = r_2$	$U = 2r_2$	Even when a diameter command has been selected, only the U command can be made a radius command by parameter.

2.4.4 Diameter/Radius Designation Switch

	M850W	M830W	M850S	M830S	M80W	M80 TypeA	M80 TypeB	E80 TypeA	E80 TypeB	C80
M	○	○	○	○	—	—	—	—	—	—
L	○	○	○	○	○	○	○	○	○	—

The method of commanding a travel distance (command with a diameter dimension/command with a radius dimension (as-is distance)) in a program is defined individually for each axis using the parameter. Diameter/Radius designation switch function; however, enables you to switch the diameter/radius designation of each axis using a G code at your desired timing. When you use the function to switch diameter/radius designation, it helps you create a program more flexibly, from turning to milling, according to each machining situation.

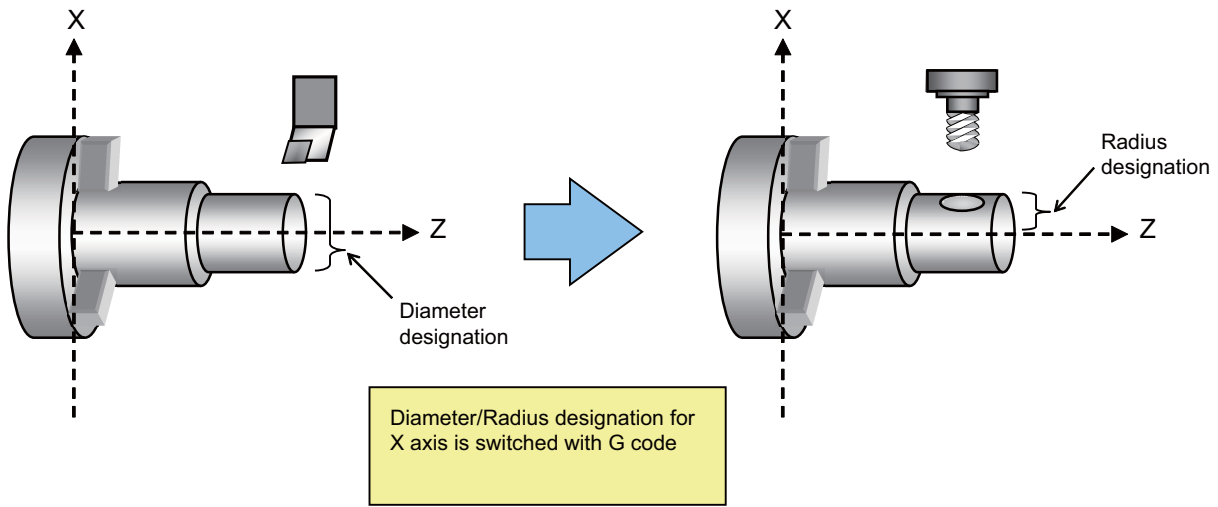

Command format

Diameter/Radius designation switch

Diameter/Radius designation switch enables you to select any desired NC axis, excluding rotary axes, and switch the diameter/radius designation of the axis.

```
G10.9 Axis address 1__ Axis address 2__ ... Axis address n__ ;
Axis address n : Axis address for which diameter/radius designation is switched
                Select radius or diameter designation with a value that follows the axis address.
                0: Radius designation
                1: Diameter designation
```

If you select no axis address, the diameter/radius designation statuses of all the axes of the part system are returned to the initial power-on state.

Positioning/Interpolation

3.1 Positioning

3.1.1 Positioning

	M850W	M830W	M850S	M830S	M80W	M80 TypeA	M80 TypeB	E80 TypeA	E80 TypeB	C80
M	○	○	○	○	○	○	○	○	○	○
L	○	○	○	○	○	○	○	○	○	○

This function carries out high-speed positioning following the movement command given in a program.

```
G00 Xx1 Yy1 Zz1 ;(Also possible for additional axes A, B, C, U, V, W simultaneously)
```

```
Xx1, Yy1, Zz1 :Position data
```

The above command positions the tool with rapid traverse rate. The tool path takes the shortest distance to the end point in the form of a straight line.

For details on the rapid traverse feed rate of the NC, refer to the section entitled "Rapid Traverse Rate".

Since the actual rapid traverse feed rate depends on the machine, refer to the specifications of the machine concerned.

- (1) The rapid traverse feed rate can be set for each axis with parameters.
- (2) The number of axes which can be commanded simultaneously depends on the specifications (number of simultaneously controlled axes). The axes can be used in any combination within this range.
- (3) The feed rate is controlled within the range that it does not exceed the rapid traverse rate of each axis and so that the shortest time is taken. (Linear type)
Parameter setting enables movement at the rapid traverse rates of the respective axes independently for each axis. In this case, the tool path does not take the form of a straight line to the end point. (Non-Linear type)
- (4) The tool is always accelerated at the start of the program command block and decelerated at the end of the block.

3.1.2 Unidirectional Positioning

	M850W	M830W	M850S	M830S	M80W	M80 TypeA	M80 TypeB	E80 TypeA	E80 TypeB	C80
M	△	△	△	△	○	○	○	○	○	△
L	—	—	—	—	—	—	—	—	—	—

The G60 command always moves the tool to the final position in a direction determined with parameters.

The tool can be positioned without backlash.

The parameter setting enables G60 to switch between G code group 0 (unmodal) and G code group 01 (modal).

```
G60 X__ Y__ Z__ ;(Also possible for additional axes A/B/C/U/V/W simultaneously)
X/Y/Z      :Position data
```

With the above command, the tool is first moved to a position distanced from the end point by an amount equivalent to the creep distance (parameter setting) with rapid traverse and then moved to its final position.

For details on the rapid traverse feed rate of the NC, refer to the section entitled "Rapid Traverse Rate".

Since the actual rapid traverse feed rate depends on the machine, refer to the specifications of the machine concerned.

Positioning to the final point is shown below (when this positioning is in the "+" direction.)

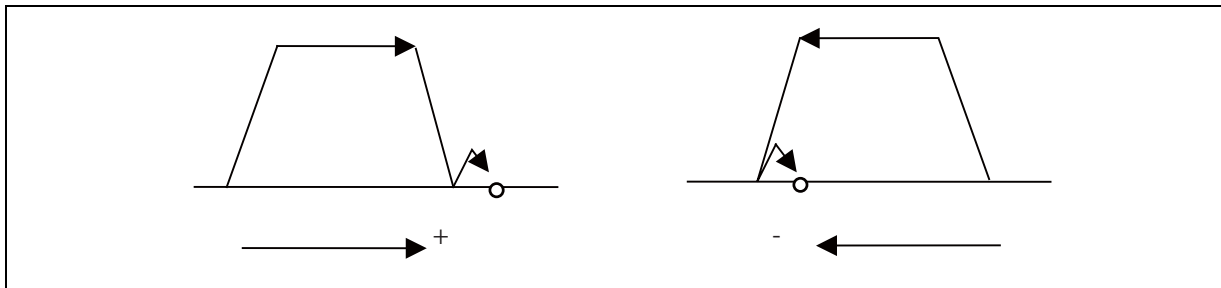

(Note 1) The processing of the above pattern will be followed even for the machine lock and Z-axis command cancel.

(Note 2) On the creep distance, the tool is moved with rapid traverse.

(Note 3) G60 is valid even for positioning in drilling in the fixed cycle.

(Note 4) When the mirror image function is on, the tool will be moved in the reverse direction by mirror image as far as the interim position, but operation over the creep distance with the final advance will not be affected by the mirror image.

3.2 Linear/Circular Interpolation

3.2.1 Linear Interpolation

	M850W	M830W	M850S	M830S	M80W	M80 TypeA	M80 TypeB	E80 TypeA	E80 TypeB	C80
M	○	○	○	○	○	○	○	○	○	○
L	○	○	○	○	○	○	○	○	○	○

Linear interpolation is a function that moves a tool linearly by the movement command value supplied in the program at the cutting feed rate designated by the F code.

G01 Xx1 Yy1 Zz1 Ff1 ; (Also possible for additional axes A, B, C, U, V, W simultaneously)

Xx1,Yy1,z1 :Position data

Ff1 :Feed rate data

Linear interpolation is executed by the above command at the f1 feed rate. The tool path takes the shortest distance to the end point in the form of a straight line.

For details on the f1 command values for NC, refer to the section entitled "Cutting Feedrate".

Since the actual cutting feed rate depends on the machine, refer to the specifications of the machine concerned.

- (1) The number of axes which can be commanded simultaneously depends on the specifications (number of simultaneously controlled axes). The axes can be used in any combination within this range.
- (2) The feed rate is controlled so that it does not exceed the cutting feed rate clamp of each axis.
- (3) When a rotary axis has been commanded in the same block, it is treated as a linear axis in degree(°) units (1° = 1mm), and linear interpolation is performed.

3.2.2 Circular Interpolation (Center/Radius Designation)

	M850W	M830W	M850S	M830S	M80W	M80 TypeA	M80 TypeB	E80 TypeA	E80 TypeB	C80
M	○	○	○	○	○	○	○	○	○	○
L	○	○	○	○	○	○	○	○	○	○

(1) Circular interpolation with I, J, K commands

This function moves a tool along a circular arc on the plane selected by the plane selection G code with movement command supplied in the program.

```
G02(G03) Xx1 Yy1 Ii1 Jj1 Ff1 ; (Also possible for additional axes A, B, C, U, V, W)
G02,G03 : Arc rotation direction
Xx1,Yy1 : End point coordinate
Ii1,Jj1 : Arc center
Ff1 : Feed rate
```

The above commands move the tool along the circular arc at the f1 feed rate. The tool moves along a circular path, whose center is the position from the start point designated by distance "i1" in the X-axis direction and distance "j1" in the Y-axis direction, toward the end point.

The direction of the arc rotation is specified by G02 or G03.

G02: Clockwise (CW)

G03: Counterclockwise (CCW)

The plane is selected by G17, G18 or G19.

G17: XY plane

G18: ZX plane

G19: YZ plane

(Example) See below for examples of circular commands.

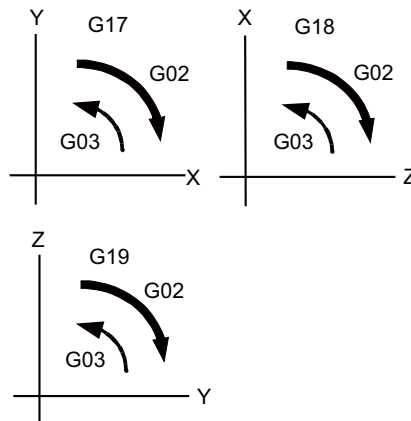
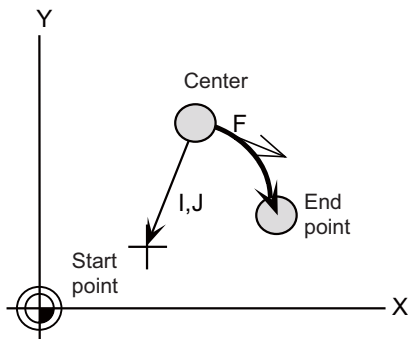

- (a) The axes that can be commanded simultaneously are the two axes for the selected plane.
- (b) The feed rate is controlled so that the tool always moves at a speed along the circumference of the circle.
- (c) Circular interpolation can be commanded within a range extending from 0° to 360° .
- (d) The max. value of the radius can be set up to six digits above the decimal point.

(Note 1) The arc plane is always based on the G17, G18 or G19 command. If a command is issued with two addresses which do not match the plane, an alarm will occur.

(Note 2) The axes configuring a plane can be designated by parameters. Refer to the section entitled "Plane Selection".

(2) R-specified circular interpolation

Besides the designation of the arc center coordinates using the above-mentioned I, J and K commands, arc commands can also be issued by designating the arc radius directly.

G02(G03) Xx1 Yy1 Rr1 Ff1 ; (Also possible for additional axes A, B, C, U, V, W)	
---	--

G02,G03	: Arc rotation direction
---------	--------------------------

Xx1,Yy1	: End point coordinate
---------	------------------------

Rr1	: Arc radius
-----	--------------

Ff1	: Feed rate
-----	-------------

G02 or G03 is used to designate the direction of the arc rotation.

The arc plane is designated by G17, G18 or G19.

The arc center is on the bisector which orthogonally intersects the segment connecting the start and end points, and the point of intersection with the circle, whose radius has been designated with the start point serving as the center, is the center coordinate of the arc command.

When the sign of the value of R in the command program is positive, the command will be for an arc of 180° or less; when it is negative, it will be for an arc exceeding 180°.

(Note 1) The arc plane is always based on the G17, G18 or G19 command. If a command is issued with two addresses which do not match the plane, an alarm will occur.

3.2.3 Helical Interpolation

	M850W	M830W	M850S	M830S	M80W	M80 TypeA	M80 TypeB	E80 TypeA	E80 TypeB	C80
M	○	○	○	○	○	○	○	○	○	○
L	○	○	○	○	○	○	○	○	○	○

With this function, any two of three axes intersecting orthogonally are made to perform circular interpolation while the third axis performs linear interpolation in synchronization with the arc rotation. This simultaneous 3-axis control can move helically to machine and be exercised to machine large-diameter screws or 3-dimensional cams.

This is commanded by combining a height axis to the circular interpolation command.

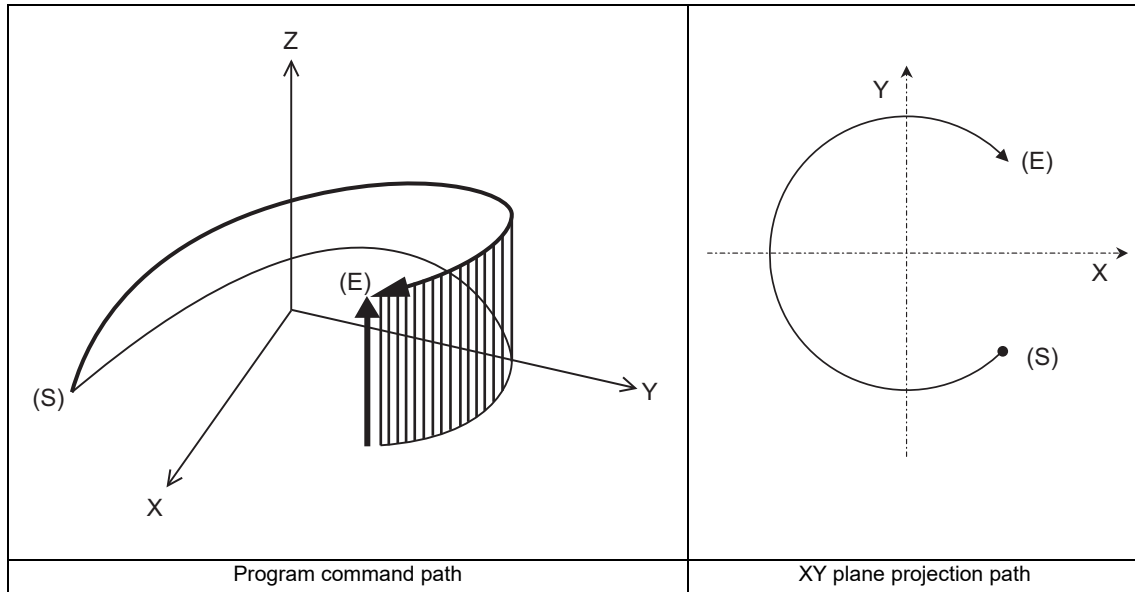

- (S) Start point
- (E) End point
- Program command path
- Circular interpolation components
- Linear interpolation components

3 Positioning/Interpolation

Command format

[M system]

G17 G02/G03 X__Y__Z__I__J__P__F__ ;	Helical interpolation command (Specify arc center)
G17 G02/G03 X__Y__Z__R__F__ ;	Helical interpolation command (Specify arc radius "R")
G17/G18/G19	: Arc plane (G17: XY plane, G18: ZX plane, G19: YZ plane)
G02/G03	: Arc rotation direction (G02: clockwise, G03: counterclockwise)
X,Y	: End point coordinate values for arc
Z	: End point coordinate values of linear axis
I,J	: Arc center coordinate values
R	: Arc radius
P	: Number of pitches
F	: Feed rate

The arc center coordinate values and arc radius are commanded by the input increment. Pay attention to the case of the helical interpolation command of the axis which has a different input command increment.

To prevent confusion, command with a decimal point.

Absolute and incremental commands can be used for the arc end point coordinates and the end point coordinates of the linear axis, but incremental commands must be used for the arc center coordinates.

When executing the pitch command with ",P" address, the program error occurs.

[L system]

G17 G02/G03 X/U__Y/V__Z/W__I__J__P/,P__F__ ;	
G17 G02/G03 X/U__Y/V__Z/W__R__F__ ;	
G17/G18/G19	: Arc plane (G17: XY plane, G18: ZX plane, G19: YZ plane)
G02/G03	: Arc rotation direction (G02: clockwise, G03: counterclockwise)
X/U, Y/V	: End point coordinate values for arc
Z/W	: End point coordinate values of linear axis
I,J	: Arc center coordinate values
R	: Arc radius
P/,P	: Number of pitches
F	: Feed rate

(Note 1) Indicates as I axis: X, J axis: Y, and K axis: Z.

(Note 2) When commanding "P" and ",P" for the number of pitches together, the command value ",P" is prioritized.

- (1) The arc plane is designated by G17, G18 or G19.
- (2) G02 or G03 is used to designate the direction of the arc rotation.
- (3) Absolute and incremental commands can be used for the arc end point coordinates and the end point coordinates of the linear axis, but incremental commands must be used for the arc center coordinates.
- (4) The linear interpolation axis is the other axis which is not included in the plane selection.
- (5) Command the speed in the component direction that represents all the axes combined for the feed rate. Pitch L is obtained by the formula below.

$$L = \frac{Z}{(2\pi \cdot P + \theta) / 2\pi}$$

$$\theta = \theta_e - \theta_s = \tan^{-1} \frac{y_e}{x_e} - \tan^{-1} \frac{y_s}{x_s} \quad (0 \leq \theta < 2\pi)$$

Where xs, ys are the start point coordinates (0 ≤ θ < 2π)

xe, ye are the end point coordinates

The combination of the axes which can be commanded simultaneously depends on the specifications. The axes can be used in any combination under the specifications.

The feed rate is controlled so that the tool always moves at a speed along the circumference of the circle.

(Note 1) Helical shapes are machined by assigning linear commands for one axis which is not a circular interpolation axis using an orthogonal coordinate system. It is also possible to assign these commands to two or more axes which are not circular interpolation axes.

When a simultaneous 4-axis command is used with the V axis as the axis parallel to the Y axis, helical interpolation will be carried out for a cylinder which is inclined as illustrated below. In other words, linear interpolation of the Z and V axes is carried out in synchronization with the circular interpolation on the XY plane.

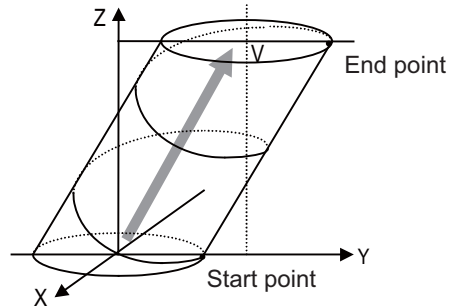

3.2.4 Spiral/Conical Interpolation

	M850W	M830W	M850S	M830S	M80W	M80 TypeA	M80 TypeB	E80 TypeA	E80 TypeB	C80
M	△	△	△	△	○	○	—	—	—	△
L	—	—	—	—	—	—	—	—	—	—

This function interpolates arcs where the start point and end point are not on the circumference of the same circle into spiral shapes.

Conical interpolation is performed by commanding end point in height direction.

There are two types of command formats which can be changed with the parameters.

(1) For command format type 1

(a) Spiral interpolation

```
G02.1(G03.1) Xx1 Yy1 Ii1 Jj1 Pp1 Ff1 ;
G02.1,G03.1 : Arc rotation direction
Xx1,Yy1      : End point coordinate
Ii1,Jj1      : Arc center
Pp1          : Number of pitches
Ff1          : Feed rate
```

The circular interpolation operation is performed at the feed rate f1 by the commands listed above. The tool draws a spiral arc path whose center is at the position from the start point which is designated by distance i1 for the X-axis direction and distance j1 for the Y-axis direction as the tool moves toward the end point.

The arc plane is designated by G17, G18 or G19.

G17.....XY plane

G18.....ZX plane

G19.....YZ plane

The direction of the arc rotation is designated by G02.1 or G03.1.

G02.1.....Clockwise (CW)

G03.1.....Counterclockwise (CCW)

The number of pitches (number of rotations) is designated by p1.

By assigning zero to p1, the pitch designation can be omitted in this case, the interpolation is obtained as a spiral rotation of less than one full turn. Assigning 1 to p1 yields a spiral rotation of more than one full turn but less than two full turns.

(b) Conical interpolation

When an axis other than the ones for the spiral interpolation plane has been designated at the same time, the other axis will also be interpolated in synchronization with the spiral interpolation.

```
G17 G91 G02.1 X100. Z150. I150.
P3 F500;
```

In the example given above, truncated cone interpolation is performed.

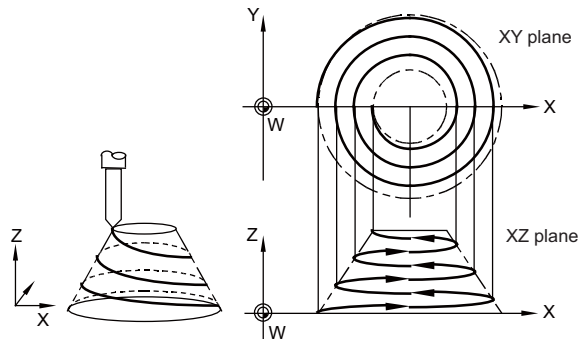

(2) For command format type 2

(a) Spiral interpolation

G02(G03) Xx1 Yy1 Ii1 Jj1 Qq1/Ll1 Ff1 ;	
G02,G03	: Arc rotation direction
Xx1,Yy1	: End point coordinate
Ii1,Jj1	: Arc center
Qq1	: Incremental/decremental amount of radius per spiral rotation
Ll1	: Number of pitches
Ff1	: Feed rate

- The number of spiral rotations when the increment/decrement amount of radius is specified can be calculated with the following expression.

Number of rotations =

$\frac{|\text{arc end point radius} - \text{arc start point radius}|}{|\text{increment or decrement amount of radius}|}$

- Q takes precedence if both Q and L have been designated at the same time.

(b) Conical interpolation

G02(G03) Xx1 Yy1 Zz1 Ii1 Jj1 Kk1 /Qq /Ll1 Ff1 ;	
G02,G03	: Arc rotation direction
Zz1	: End point coordinate in height direction
Ii1,Jj1	: Arc center
Kk1	: Amount by which height is incremented or decremented per spiral rotation
Qq1	: Amount by which radius is incremented or decremented per spiral rotation
Ll1	: Number of pitches
Ff1	: Feed rate

- The number of rotations when the height increment or decrement amount is specified can be calculated with the following expression.
Number of rotations = $\frac{|\text{Height}|}{|\text{Amount by which height is incremented or decremented (I,J,K)}|}$
- Q takes precedence over K which in turn takes precedence over L if Q, K and L have been designated at the same time.
- The tolerable error range (absolute position) for when the commanded end point position is deviated from the end point position obtained from the number of pitches and increment/decrement amount is set with the parameters.

(3) Common cautions for type 1 and 2

- This function cannot be used in combination with a tool radius compensation command (G41, G42).
- The arc plane is always based on the G17, G18 or G19 command. Arc control is performed on a plane by the G17, G18 or G19 command even when two addresses which are not on the selected plane are designated.

3.2.5 Cylindrical Interpolation

	M850W	M830W	M850S	M830S	M80W	M80 TypeA	M80 TypeB	E80 TypeA	E80 TypeB	C80
M	△	△	△	△	○	○	○	—	—	△
L	△	△	△	△	○	○	○	○	○	△

This function transfers the shape that is on the cylinder's side surface (shape yielded by the cylindrical coordinate system) onto a plane, and when the transferred shape is designated in the program in the form of plane coordinates, the shape is converted into a movement along the linear and rotary axes of the original cylinder coordinates, and the contours are controlled by means of the CNC unit during machining.

Since the programming can be performed for the shapes produced by transferring the side surfaces of the cylinders, this function is useful when it comes to machining cylindrical cams and other such parts.

The command is programmed with the rotary axis and its orthogonal axis, which are different between the lathe and the machining center systems, to machine grooves and other shapes on the side of the cylinder.

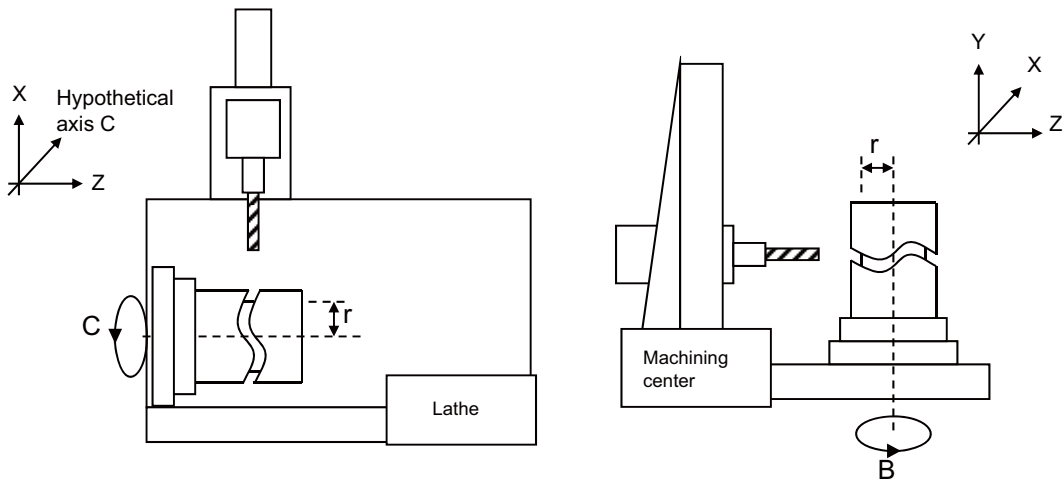

Command format

Cylindrical interpolation mode start

G07.1 Name of rotary axis Cylinder radius;	
or G107 Name of rotary axis Cylinder radius;	
Name of rotary axis	: Axis name set to the rotary axis
Cylinder radius	: Radius value ≠ 0: Cylindrical interpolation mode start Command a value other than "0".

Cylindrical interpolation mode cancel

G07.1 Name of rotary axis 0 ;	
or G107 Name of rotary axis 0 ;	

3.2.6 Polar Coordinate Interpolation

	M850W	M830W	M850S	M830S	M80W	M80 TypeA	M80 TypeB	E80 TypeA	E80 TypeB	C80
M	△	△	△	△	—	—	—	—	—	△
L	△	△	△	△	○	○	○	○	○	△

This function converts the commands programmed by the orthogonal coordinate axes into linear axis movements (tool movements) and rotary axis movements (workpiece rotation) to control the contours. It is useful for cutting linear cutouts on the outside diameter of the workpiece, grinding cam shafts, etc.

This function can be used only with the G code list 6 or 7.

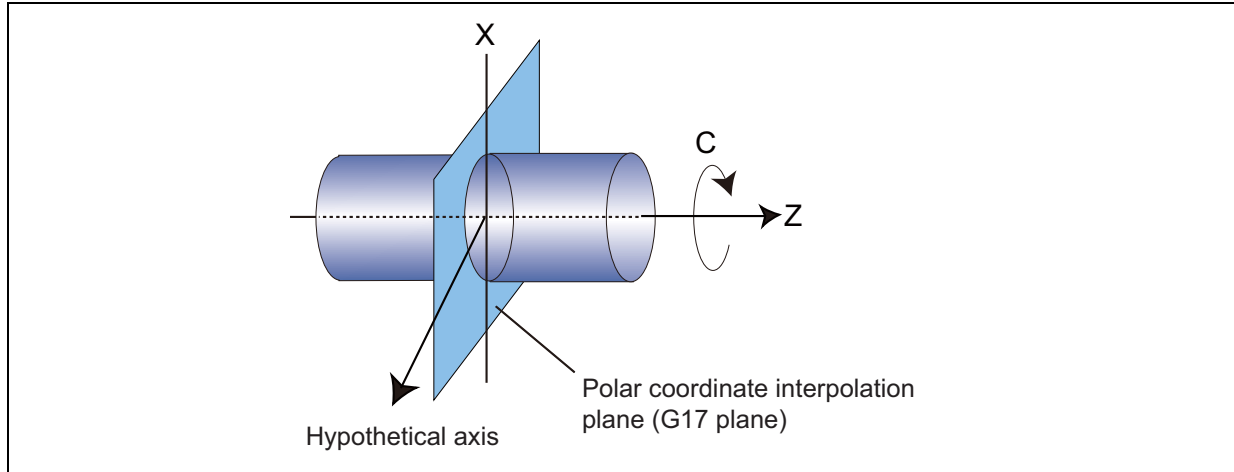

(1) Polar coordinate interpolation mode

(G12.1)

The polar coordinate interpolation mode is established by designating the G12.1 command.

Polar coordinate interpolation plane consists of a linear axis and a hypothetical axis, which are at right angles to each other.

Polar coordinate interpolation is performed on this plane.

- (a) Linear interpolation and circular interpolation can be designated in the polar coordinate interpolation mode.
- (b) Either absolute command or incremental command can be issued.
- (c) Tool radius compensation can be applied to the program commands. Polar coordinate interpolation is performed for the path after tool radius compensation.
- (d) For the feed rate, designate a tangential rate on the polar coordinate interpolation plane (orthogonal coordinate system) using the F command.

The F rate is in either mm/min or inch/mm units.

(2) Polar coordinate interpolation cancel mode

(G13.1)

The polar coordinate interpolation cancel mode is established by designating the G13.1 command.

3.2.7 Milling Interpolation

	M850W	M830W	M850S	M830S	M80W	M80 TypeA	M80 TypeB	E80 TypeA	E80 TypeB	C80
M	—	—	—	—	—	—	—	—	—	—
L	△	△	△	△	○	○	○	○	○	△

When a lathe with linear axes (X, Z axes) and rotary axis (C axis) serving as the control axes is to perform milling at a workpiece end face or in the longitudinal direction of the workpiece, this function uses the hypothetical axis Y which is at right angles to both the X and Z axes to enables the milling shape to be programmed as the X, Y and Z orthogonal coordinate system commands.

With this function, the workpiece can be treated as a cylinder with radius X, and commands can be designated on the plane formed by transferring the cylinder side surface instead.

With milling interpolation, the commands programmed by the orthogonal coordinate system are converted into linear axis and rotary axis movements (workpiece rotation) to control the contours.

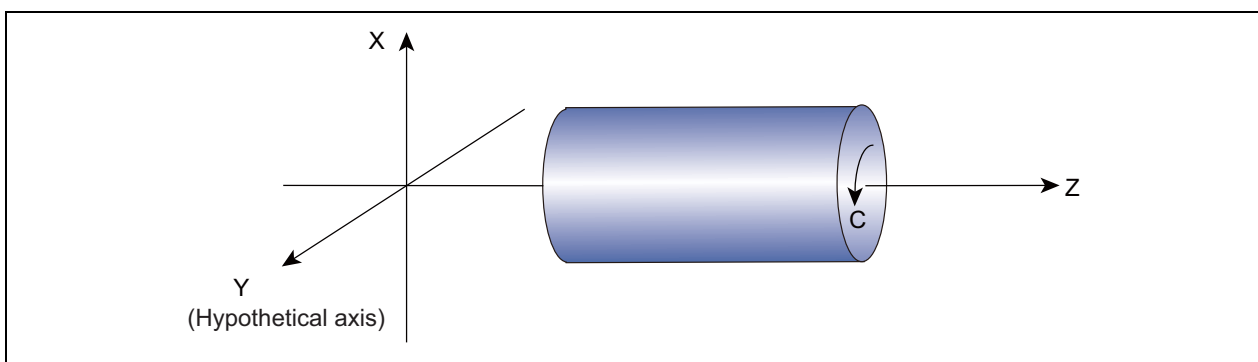

G12.1 ; Milling mode ON
 G13.1 ; Milling mode OFF (Turning mode)

G16(Y-Z cylindrical plane)	G17(X-Y plane)	G19(Y-Z plane)
Plane on which radius X cylinder is developed. Select this to machine the cylindrical plane of a workpiece.	X-Y plane in XYZ orthogonal coordinate system. Select this to machine the workpiece end face.	Y-Z plane in XYZ orthogonal coordinate system. Select this to machine a plane of a cylinder cut in the longitudinal direction.

3.2.8 Hypothetical Axis Interpolation

	M850W	M830W	M850S	M830S	M80W	M80 TypeA	M80 TypeB	E80 TypeA	E80 TypeB	C80
M	△	△	△	△	—	—	—	—	—	—
L	—	—	—	—	—	—	—	—	—	—

Take one of the axes of the helical interpolation or spiral interpolation, including a linear axis, as a hypothetical axis (axis with no actual movement) and perform pulse distribution. With this procedure, an interpolation equivalent to the helical interpolation or spiral interpolation looked from the side (hypothetical axis), or SIN or COS interpolation, will be possible. The setting of this hypothetical axis is commanded with G07.

G07 Y0 ;	(X axis command cancel ON)
G07 Y1 ;	(X axis command cancel OFF)
	:Hypothetical axis interpolation command
G07	:Designate the axis for which hypothetical axis interpolation is performed
Y	Designation of the axis for which axis command cancellation is performed applies for all the NC axes.
	(0: Cancel (normal), 1: Handle as hypothetical axis)

- (1) Interpolation functions that are used for hypothetical interpolation are helical interpolation and spiral interpolation.
- (2) During G07 α 0; to G07 α 1;, α axis will be the hypothetical axis. Thus, when α axis is commanded independently during this time, dwell mode will be held until finishing the pulse distribution to the hypothetical axis.

(Note) In order to perform hypothetical axis interpolation, helical interpolation must be added.

3.3 Curve Interpolation

3.3.1 Involute Interpolation

	M850W	M830W	M850S	M830S	M80W	M80 TypeA	M80 TypeB	E80 TypeA	E80 TypeB	C80
M	△	△	△	△	○	○	—	—	—	—
L	—	—	—	—	—	—	—	—	—	—

Involute interpolation moves a tool along an involute curve. This function can also move a tool helically (spirally) while moving the tool along the involute curve. This can be used for scroll machining of involute gears or compressors. The interpolation can eliminate a path step that is generated at a micro segment command, as well as acceleration/ deceleration that is caused due to differences of segment length, leading to smooth accurate machining. Using the automatic speed control function, including "involute interpolation override" and "acceleration clamping during involute interpolation", further improves the machining accuracy.

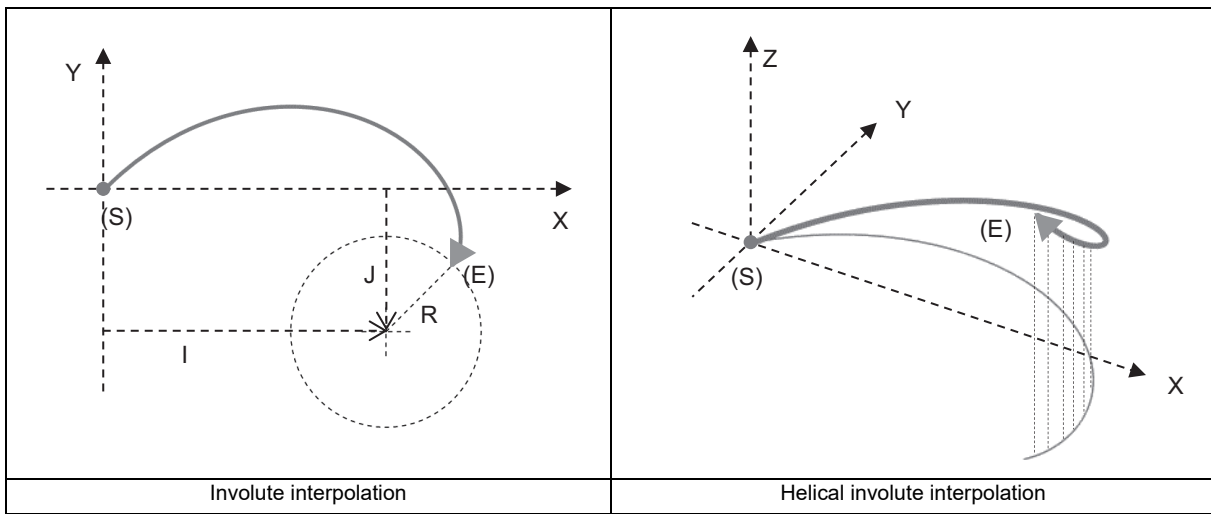

- (S) Start point
- (E) End point
- Program command path
- Projected trajectory of XY plane of command program

Involute curve is obtained with the following expression:
 $X(\theta) = R\{\cos(\theta + \theta_0) + \theta \times \sin(\theta + \theta_0)\} + X_0$
 $Y(\theta) = R\{\sin(\theta + \theta_0) - \theta \times \cos(\theta + \theta_0)\} + Y_0$
 Circle in the right figure is the base circle.

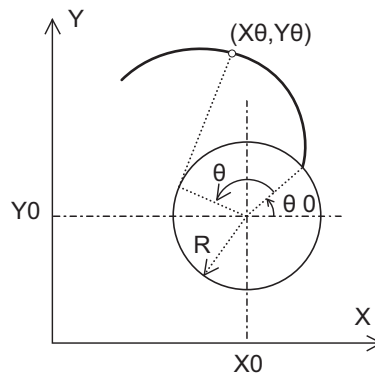

Command format

Involute interpolation

G02.2 (G03.2) X__Y__I__J__R__F__ ; G17 plane
G02.2 (G03.2) Z__X__K__I__R__F__ ; G18 plane
G02.2 (G03.2) Y__Z__J__K__R__F__ ; G19 plane
 G02.2 (G03.2) : Involute curve rotation direction (G02.2: clockwise; G03.2: counterclockwise)
 X : End point of involute interpolation (X axis)
 Y : End point of involute interpolation (Y axis)
 Z : End point of involute interpolation (Z axis)
 I : Incremental value from the start point to the center of base circle (X axis)
 J : Incremental value from the start point to the center of base circle (Y axis)
 K : Incremental value from the start point to the center of base circle (Z axis)
 R : Base circle radius
 F : Feedrate (in involute curve tangent direction)

The range of command value follows the input range of coordinate position data.

Helical involute interpolation

G02.2 (G03.2) X__Y__α__I__J__R__F__ ; G17 plane
G02.2 (G03.2) Z__X__α__K__I__R__F__ ; G18 plane
G02.2 (G03.2) Y__Z__α__J__K__R__F__ ; G19 plane
 G02.2 (G03.2) : Involute curve rotation direction (G02.2: clockwise; G03.2: counterclockwise)
 X : End point of involute interpolation (X axis)
 Y : End point of involute interpolation (Y axis)
 Z : End point of involute interpolation (Z axis)
 α : End point of linear axis (α: the name of the linear axis)
 When a rotary axis is designated, a program error occurs.
 Multiple linear axes can be designated.
 I : Incremental value from the start point to the center of base circle (X axis)
 J : Incremental value from the start point to the center of base circle (Y axis)
 K : Incremental value from the start point to the center of base circle (Z axis)
 R : Base circle radius
 F : Feedrate (in involute curve tangent direction)

The range of command value follows the input range of coordinate position data.

3.3.2 Exponential Interpolation

	M850W	M830W	M850S	M830S	M80W	M80 TypeA	M80 TypeB	E80 TypeA	E80 TypeB	C80
M	△	△	△	△	—	—	—	—	—	—
L	△	△	△	△	—	—	—	—	—	—

With this function, the rotary axis movement is changed into exponential functions vis-a-vis the linear axis movements. When exponential function interpolation is performed, linear interpolation is performed between the other axes and the linear axis. This makes it possible to machine tapered grooves (regular helix machining of tapered shapes) whose helix angle is always constant.

The function can be used for slotting and grinding end mills and other tools.

[Regular helix machining of tapered shapes]

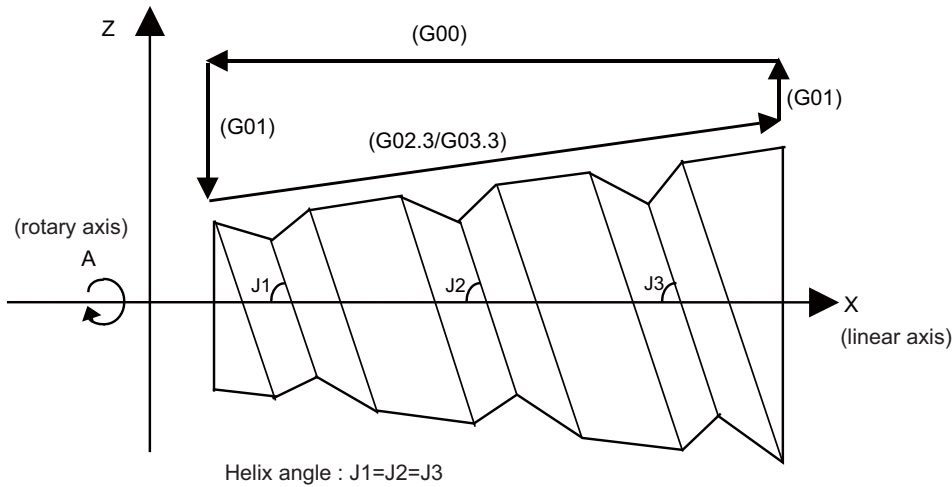

[Relationship between linear and rotary axes]

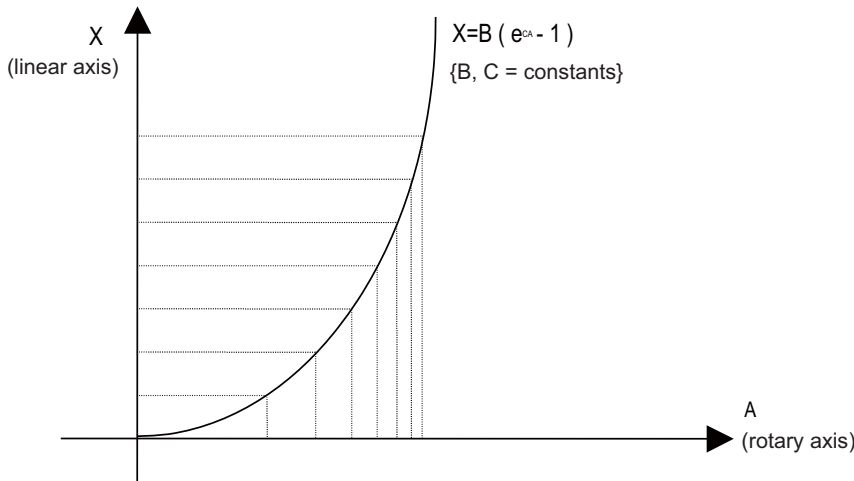

3.3.3 Spline Interpolation (G05.1Q2/G61.2)

	M850W	M830W	M850S	M830S	M80W	M80 TypeA	M80 TypeB	E80 TypeA	E80 TypeB	C80
M	△	△	△	△	○	○	—	—	—	△
L	—	—	—	—	—	—	—	—	—	—

This function automatically generates spline curves that smoothly pass through rows of dots designated by a fine-segment machining program, and performs interpolation for the paths along the curves. This enables high-speed and high-accuracy machining to be achieved.

There are two types of the spline interpolation command format: G61.2 and G05.1Q2.

The high-speed high-accuracy control II/III is required for G05.1Q2 command. Command G05.1Q2 for the high-speed and smooth machining in the high-speed high-accuracy control II/III mode.

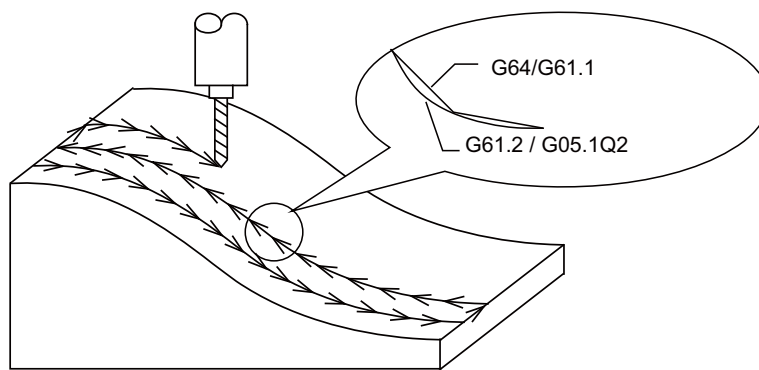

(Note) While the spline interpolation is valid, the high-speed high-accuracy control III operates as high-speed high-accuracy control II.

Command format

G61.2 command

G61.2 X__Y__Z__F__ ;	Spline interpolation mode ON
or	
G61.2 ;	

G64 ;	Spline interpolation mode OFF
-------	-------------------------------

G05.1Q2 command

G05.1 Q2 X0 Y0 Z0 ;	Spline interpolation mode ON
---------------------	------------------------------

G05.1 Q0 ;	Spline interpolation mode OFF
------------	-------------------------------

3.3.4 NURBS Interpolation

	M850W	M830W	M850S	M830S	M80W	M80 TypeA	M80 TypeB	E80 TypeA	E80 TypeB	C80
M	△	△	△	△	—	—	—	—	—	—
L	—	—	—	—	—	—	—	—	—	—

This function realizes NURBS curve machining by commanding NURBS curve parameters (number of stages, weight, knot, control point). The path does not need to be replaced with fine segments.

This function operates only in the high-speed high-accuracy control II/III mode, so the high-speed high-accuracy control II/III function is required.

During NURBS interpolation, interpolation takes place at the commanded speed. However, if the curvature is large, the speed is clamped so that the machine's tolerable acceleration rate is not exceeded.

NURBS interpolation cannot be used during graphic check (continuous/step check).

Linear interpolation that connects the control points is used during graphic check.

The multi-part system simultaneous high-accuracy function is required when the NURBS interpolation is commanded to 2nd part system or higher.

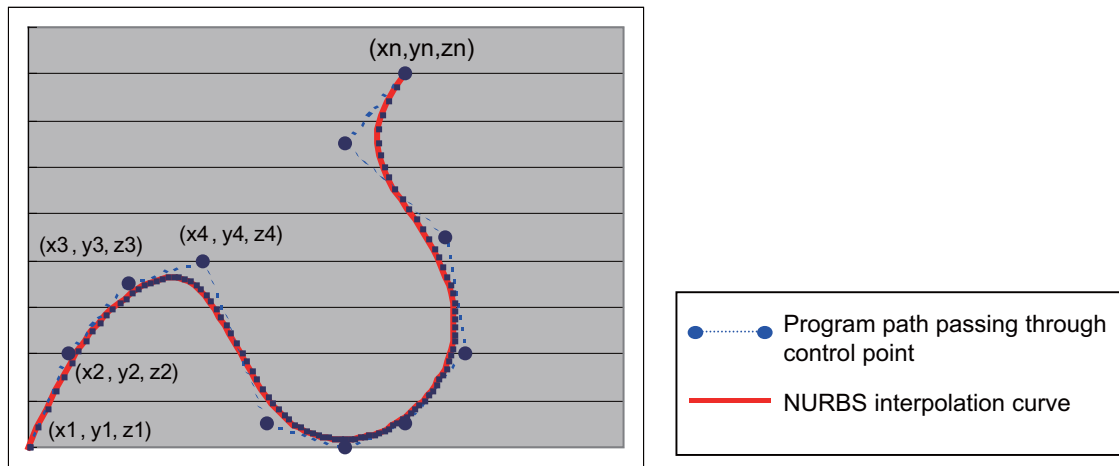

(Note) While the NURBS interpolation is valid, the high-speed high-accuracy control III operates as high-speed high-accuracy control II.

3.3.5 3-Dimensional Circular Interpolation

	M850W	M830W	M850S	M830S	M80W	M80 TypeA	M80 TypeB	E80 TypeA	E80 TypeB	C80
M	△	△	△	△	○	—	—	—	—	—
L	—	—	—	—	—	—	—	—	—	—

To issue a circular command over a three-dimensional space, an arbitrary point (intermediate point) must be designated on the arc in addition to the start point (current position) and end point. Using the 3-dimensional circular interpolation command, an arc shape determined by the three points (start point, intermediate point, end point) designated on the three-dimensional space can be machined.

The speed command during 3-dimensional circular interpolation is the tangential velocity on the arc.

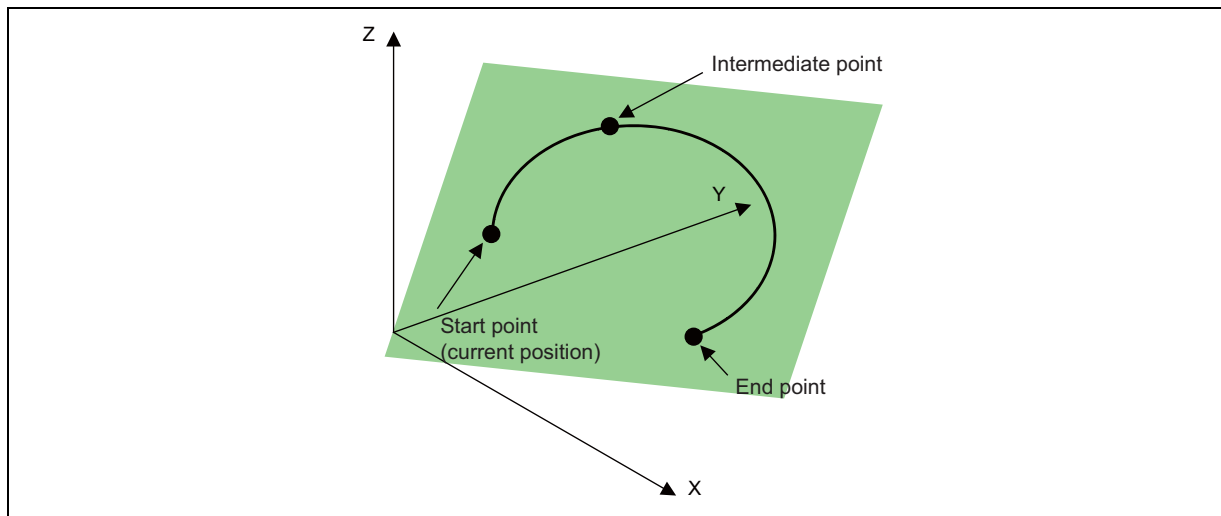

The command format is shown below.

G02.4(G03.4) Xx1 Yy1 Zz1 αα1 ... ;	Intermediate point designation (1st block)
Xx2 Yy2 Zz2 αα2 ... ;	End point designation (2nd block)
G02.4(G03.4)	: 3-dimensional circular interpolation command
Xx1, Yy1, Zz1	: Intermediate point coordinates
Xx2, Yy2, Zz2	: End point coordinates
αα1	: Arbitrary axis other than axis used as the reference in 3-dimensional circular interpolation (May be omitted)

- The operation is the same for G02.4 and G03.4. (The rotation direction cannot be designated.)
- The axes used as the reference in 3-dimensional circular interpolation are the three basic axes set with the parameters.
- The X, Y, Z address in the block may be omitted. The intermediate point coordinates omitted in the 1st block become the start point coordinates, and the end point coordinates omitted in the 2nd block become the intermediate point coordinates.
- When using the 3-dimensional circular interpolation command, an arbitrary axis can be commanded in addition to the orthogonal coordinate system (X, Y, Z) used as the reference. The arbitrary axis designated in the intermediate point designating block (1st block) will interpolate to the command point when moving from the start point to intermediate point movement. The arbitrary axis designated in the end point command block (2nd block) will interpolate to the command point when moving from the intermediate point to the end point. The number of arbitrary axes that can be commanded differs according to the number of simultaneous contour control axes. The total of the basic three axes used as the reference of the 3-dimensional circular interpolation and the arbitrary axes commanded simultaneously must be less than the number of simultaneous contour control axes.
- To command 3-dimensional circular interpolation when the incremental command is enabled, specify as follows.
Intermediate point coordinates: The position of the intermediate point relative to the start point
End point coordinates: The position of the end point relative to the intermediate point

3.3.6 Spline Interpolation2 (G61.4)

	M850W	M830W	M850S	M830S	M80W	M80 TypeA	M80 TypeB	E80 TypeA	E80 TypeB	C80
M	△	△	△	△	○	○	—	—	—	△
L	—	—	—	—	—	—	—	—	—	—

This function automatically generates a curve that smoothly passes through within the tolerable error range. The tool is able to move along the curve, providing smooth machining.

This function allows the machine to operate with the optimum tool path and speed, simply by specifying the tolerance size, so an operator can easily attain high quality machining.

This function is enabled under the tolerance control, so the specification of the tolerance control is required, too.

The tolerance size is the allowable error value between the path commanded by machining program and the path output with NC.

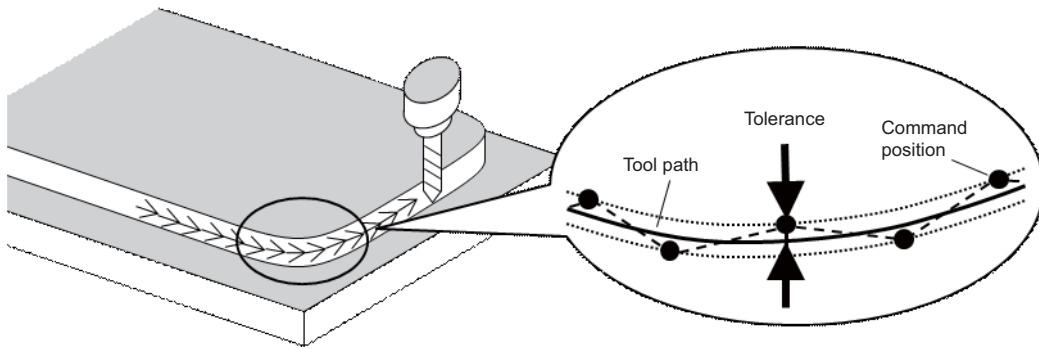

When spline interpolation 2 is used in combination with tool center point (TCP) control, spline interpolation 2 is performed with 5 axes. It generates a curve that passes through the TCP points smoothly within the tolerance, with the rotary axis angle also within the tolerance. The tool moves along the curve.

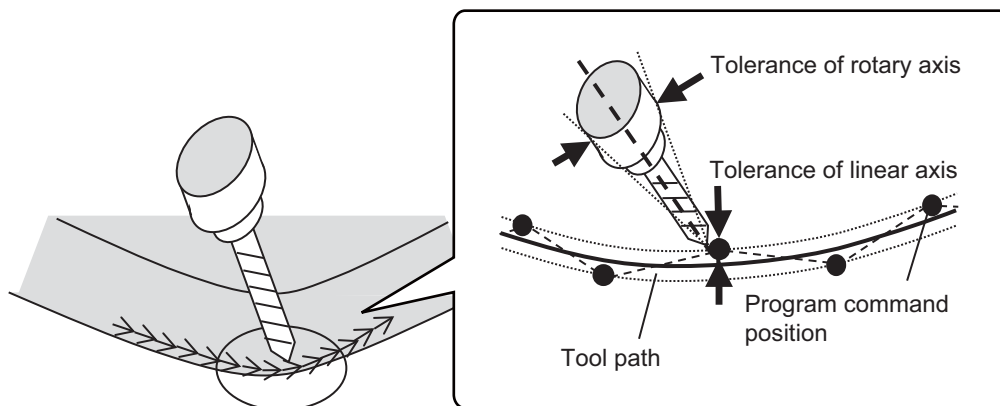

Command format

G61.4 (,K__) (,R__) ;	Spline interpolation 2 mode ON
,K	: Tolerance size (mm) linear axis
,R	: Tolerance size (deg) rotary axis

Spline interpolation 2 mode with command G61.4 will be cancelled by designating any one of G code group 13.

- G61 (Exact stop check mode)
- G61.1 (High-accuracy control mode)
- G61.2 (Spline interpolation command)
- G62 (Automatic corner override)
- G63 (Tapping mode)
- G64 (Cutting mode)
- G08P1 (High-accuracy control mode start)
- G08P0 (High-accuracy control mode end)

4

Feed

4.1 Feedrate

4.1.1 Rapid Traverse Rate (m/min)

	M850W	M830W	M850S	M830S	M80W	M80 TypeA	M80 TypeB	E80 TypeA	E80 TypeB	C80
M	1000	1000	1000	1000	1000	1000	1000	1000	1000	1000
L	1000	1000	1000	1000	1000	1000	1000	1000	1000	1000

The rapid traverse rate is set in the parameters for each axis.

During high-accuracy control mode, the dedicated rapid traverse rate (parameter) is applied.

Override can be applied to the rapid traverse rate using the external signal supplied.

The rapid traverse rate is effective for the following commands.

M system: G00, G27, G28, G29, G30, G60

L system: G00, G27, G28, G29, G30

The high-accuracy control mode rapid traverse rate is effective for the following commands.

M system: High-accuracy control, high-speed high-accuracy control I/II/III, SSS control, high-accuracy spline control

L system: High-accuracy control, high-speed high-accuracy control I/II, SSS control

Rapid traverse rate and high-accuracy control mode rapid traverse rate setting

Least command increment	B	C	D	E
Metric input (mm/min, °/min)	1 to 1000000	1 to 1000000	1 to 1000000	1 to 1000000
Inch input (inch/min)	1 to 100000	1 to 100000	1 to 100000	1 to 100000

Least command increment B : 0.001mm (0.0001inch)

Least command increment C : 0.0001mm (0.00001inch)

Least command increment D : 0.00001mm (0.000001inch)

Least command increment E : 0.000001mm (0.0000001inch)

4.1.2 Cutting Feedrate (m/min)

	M850W	M830W	M850S	M830S	M80W	M80 TypeA	M80 TypeB	E80 TypeA	E80 TypeB	C80
M	1000	1000	1000	1000	1000	1000	1000	1000	1000	1000
L	1000	1000	1000	1000	1000	1000	1000	1000	1000	1000

[M system]

This function specifies the feedrate of the cutting commands, and a feed amount per spindle rotation or feed amount per minute is commanded.

Once commanded, it is stored in the memory as a modal value. The feedrate modal value is cleared to zero only when the power is turned ON.

The maximum cutting feedrate is clamped by the cutting feedrate clamp parameter (whose setting range is the same as that for the cutting feedrate).

If the high-accuracy control mode's cutting clamp speed is set, the cutting feedrate will be clamped at that speed during high-accuracy control, high-speed high-accuracy control, high-accuracy spline control or SSS control.

- If the value set for high-accuracy control mode cutting clamp speed is 0, the axis will be clamped at the cutting feed clamp speed.

- High-accuracy control mode cutting clamp speed is set with the parameters.

Cutting feedrate setting range

Least command increment	B	C	D	E
Metric input (mm/min, °/min)	0.001 to 1000000	0.0001 to 1000000	0.00001 to 1000000	0.000001 to 1000000
Inch input (inch/min)	0.0001 to 100000	0.00001 to 100000	0.000001 to 100000	0.0000001 to 100000

Least command increment B : 0.001mm (0.0001inch)

Least command increment C : 0.0001mm (0.00001inch)

Least command increment D : 0.00001mm (0.000001inch)

Least command increment E : 0.000001mm (0.0000001inch)

- G code command for which the cutting feedrate is effective

For others such as G01,G02,G03,G02.1,G03.1,G33, etc., refer to the interpolation specifications.

[L system]

This function specifies the feedrate of the cutting commands, and a feed amount per spindle rotation or feed amount per minute is commanded.

Once commanded, it is stored in the memory as a modal value. The feedrate modal is cleared to zero only when the power is turned ON.

The maximum cutting feedrate is clamped by the cutting feedrate clamp parameter (whose setting range is the same as that for the cutting feedrate).

Cutting feedrate setting range

Least command increment	B	C	D	E
Metric input (mm/min, °/min)	0.001 to 1000000	0.0001 to 1000000	0.00001 to 1000000	0.000001 to 1000000
Inch input (inch/min)	0.0001 to 100000	0.00001 to 100000	0.000001 to 100000	0.0000001 to 100000

Least command increment B : 0.001mm (0.0001inch)

Least command increment C : 0.0001mm (0.00001inch)

Least command increment D : 0.00001mm (0.000001inch)

Least command increment E : 0.000001mm (0.0000001inch)

- G code command for which the cutting feedrate is effective

For others such as G01,G02,G03,G02.1,G03.1,G33, etc., refer to the interpolation specifications.

4.1.3 Manual Feedrate (m/min)

	M850W	M830W	M850S	M830S	M80W	M80 TypeA	M80 TypeB	E80 TypeA	E80 TypeB	C80
M	1000	1000	1000	1000	1000	1000	1000	1000	1000	1000
L	1000	1000	1000	1000	1000	1000	1000	1000	1000	1000

The manual feedrate are designated as the feedrate in the jog mode or incremental feed mode for manual operation and the feedrate during dry run ON for automatic operation. The manual feedrate are set with external signals.

The manual feedrate signals from the PLC include two methods, the code method and value setting method.

Which method to be applied is determined with a signal common to the entire system. The signals used by these methods are common to all axes.

- Setting range under the code method

Metric input 0.00 to 14000.00 mm/min (31 steps)

Inch input 0.000 to 551.000 inch/min (31 steps)

- Setting range under the value setting method

Metric input 0 to 1000000.00 mm/min in 0.01 mm/min increments

Inch input 0 to 39370 inch/min in 0.001 inch/min increments

Multiplication factor PCF1 and PCF2 are available with the value setting method.

4.1.4 Rotary Axis Command Speed Tenfold

	M850W	M830W	M850S	M830S	M80W	M80 TypeA	M80 TypeB	E80 TypeA	E80 TypeB	C80
M	○	○	○	○	○	○	○	○	○	○
L	○	○	○	○	○	○	○	○	○	○

This function multiplies the rotary axis' command speed by 10 during initial inching.

The commanded speeds are as follow.

Automatic operation	Cutting feedrate	For the inch system, the rotary axis command speed is multiplied by 10. For example, if the B axis is the rotary axis in the inch system and the following type of machining program is executed, the rotary axis command speed will be multiplied by 10, and the rotary axis will move at 1000 deg./min. N1 G1 B100. F100.;
	Rapid traverse rate	The rapid traverse rate is not multiplied by 10, and is the speed set in the parameters.
Manual operation		The command speeds related to manual operation, such as JOG feed, are not multiplied by 10. The display speed unit also remains as "deg./min".

4.2 Feedrate Input Methods

4.2.1 Feed per Minute (Asynchronous Feed)

	M850W	M830W	M850S	M830S	M80W	M80 TypeA	M80 TypeB	E80 TypeA	E80 TypeB	C80
M	○	○	○	○	○	○	○	○	○	○
L	○	○	○	○	○	○	○	○	○	○

[M system]

By issuing the G94 command, the commands from that block are issued directly by the numerical value following F as the feedrate per minute (mm/min, inch/min).

Metric input

Input Setting unit	B(0.001mm)	C(0.0001mm)	D(0.00001mm)	E(0.000001mm)
Command Mode	Feed per minute	Feed per minute	Feed per minute	Feed per minute
Command Address	F(mm/min)	F(mm/min)	F(mm/min)	F(mm/min)
Minimum command unit	1 (= 1.000) (1. = 1.000)	1 (= 1.0000) (1. = 1.0000)	1 (= 1.00000) (1. = 1.00000)	1 (= 1.000000) (1. = 1.000000)
Command range	0.001 - 1000000.0000	0.0001 - 1000000.0000	0.00001 - 1000000.00000	0.000001 - 1000000.000000

Inch input

Input setting unit	B(0.0001inch)	C(0.00001inch)	D(0.000001inch)	E(0.0000001inch)
Command Mode	Feed per minute	Feed per minute	Feed per minute	Feed per minute
Command Address	F(inch/min)	F(inch/min)	F(inch/min)	F(inch/min)
Minimum command unit	1 (= 1.0000) (1. = 1.0000)	1 (= 1.00000) (1. = 1.00000)	1 (= 1.000000) (1. = 1.000000)	1 (= 1.0000000) (1. = 1.0000000)
Command range	0.0001 - 100000.0000	0.00001 - 100000.00000	0.000001 - 100000.000000	0.0000001 - 100000.0000000

[L system]

By issuing the G94 command, the commands from that block are issued directly by the numerical value following F as the feedrate per minute (mm/min, inch/min).

Metric input

Input Setting unit	B(0.001mm)	C(0.0001mm)	D(0.00001mm)	E(0.000001mm)
Command Mode	Feed per minute	Feed per minute	Feed per minute	Feed per minute
Command Address	F(mm/min)	F(mm/min)	F(mm/min)	F(mm/min)
Minimum command unit	1(=1.000) (1.=1.000)	1(=1.0000) (1.=1.0000)	1(=1.00000) (1.=1.00000)	1(=1.000000) (1.=1.000000)
Command range	0.001 - 1000000.000	0.0001 - 1000000.0000	0.00001 - 1000000.00000	0.000001 - 1000000.000000

Inch input

Input setting unit	B(0.0001inch)	C(0.00001inch)	D(0.000001inch)	E(0.0000001inch)
Command Mode	Feed per minute	Feed per minute	Feed per minute	Feed per minute
Command Address	F(inch/min)	F(inch/min)	F(inch/min)	F(inch/min)
Minimum command unit	1(=0.0100) (1.=1.0000)	1(=0.01000) (1.=1.00000)	1(=0.010000) (1.=1.000000)	1(=0.0100000) (1.=1.0000000)
Command range	0.0001 - 100000.0000	0.00001 - 100000.00000	0.000001 - 100000.000000	0.0000001 - 100000.0000000

4.2.2 Feed per Revolution (Synchronous Feed)

	M850W	M830W	M850S	M830S	M80W	M80 TypeA	M80 TypeB	E80 TypeA	E80 TypeB	C80
M	△	△	△	△	○	○	○	○	○	△
L	○	○	○	○	○	○	○	○	○	○

By issuing the G95 command, the commands from that block are issued directly by the numerical value following F as the feedrate per spindle revolution (mm/revolution or inch/revolution).

The least command increment and command range of the feedrate designation F are as follows.

[M system]

Metric input

Input Setting unit	B(0.001mm)	C(0.0001mm)	D(0.00001mm)	E(0.000001mm)
Command Mode	Feed per revolution	Feed per revolution	Feed per revolution	Feed per revolution
Command Address	F(mm/rev)	F(mm/rev)	F(mm/rev)	F(mm/rev)
Minimum command unit	1 (= 0.001) (1. = 1.000)	1 (= 0.0001) (1. = 1.0000)	1 (= 0.00001) (1. = 1.00000)	1 (= 0.000001) (1. = 1.000000)
Command range	0.001 - 999.999	0.0001 - 999.9999	0.00001 - 999.99999	0.000001 - 999.999999

Inch input

Input setting unit	B(0.0001inch)	C(0.00001inch)	D(0.000001inch)	E(0.0000001inch)
Command Mode	Feed per revolution	Feed per revolution	Feed per revolution	Feed per revolution
Command Address	F(inch/rev)	F(inch/rev)	F(inch/rev)	F(inch/rev)
Minimum command unit	1 (= 0.0001) (1. = 1.0000)	1 (= 0.00001) (1. = 1.00000)	1 (= 0.000001) (1. = 1.000000)	1 (= 0.0000001) (1. = 1.0000000)
Command range	0.0001 - 999.9999	0.00001 - 999.99999	0.000001 - 999.999999	0.0000001 - 999.9999999

[L system]

Metric input

Input Setting unit	B(0.001mm)	C(0.0001mm)	D(0.00001mm)	E(0.000001mm)
Command Mode	Feed per revolution	Feed per revolution	Feed per revolution	Feed per revolution
Command Address	F(mm/rev)	F(mm/rev)	F(mm/rev)	F(mm/rev)
Minimum command unit	1(=0.0001) (1.=1.00)	1(=0.00001) (1.=1.00)	1(=0.000001) (1.=1.00)	1(=0.0000001) (1.=1.00)
Command range	0.0001 - 999.9999	0.00001 - 999.99999	0.000001 - 999.999999	0.0000001 - 999.9999999

Inch input

Input setting unit	B(0.0001inch)	C(0.00001inch)	D(0.000001inch)	E(0.0000001inch)
Command Mode	Feed per revolution	Feed per revolution	Feed per revolution	Feed per revolution
Command Address	F(inch/rev)	F(inch/rev)	F(inch/rev)	F(inch/rev)
Minimum command unit	1(=0.000001) (1.=1.000)	1(=0.0000001) (1.=1.000)	1(=0.00000001) (1.=1.000)	1(=0.000000001) (1.=1.000)
Command range	0.00001 - 99.99999	0.000001 - 99.999999	0.0000001 - 99.9999999	0.00000001 - 99.99999999

4.2.3 Inverse Time Feed

	M850W	M830W	M850S	M830S	M80W	M80 TypeA	M80 TypeB	E80 TypeA	E80 TypeB	C80
M	△	△	△	△	○	○	—	—	—	△
L	—	—	—	—	—	—	—	—	—	—

During inside cutting when machining curved shapes with tool radius compensation applied, the machining speed on the cutting surface becomes faster than the tool center feedrate. Therefore, problems such as reduced accuracy on the cutting surface may occur.

This reduced accuracy can be prevented with inverse time feed. This function can, in place of normal feed commands, issue one block of machining time (inverse) in F commands. The machining speed on the cutting surface is constantly controlled, even if radius compensation is applied to the machining program that expresses the free curve surface with fine segment lines.

Note that when the calculated machining time exceeds the cutting feed clamp speed, the F command value in the inverse time feed follows the cutting feed clamp speed.

Regular F command

Inverse time feed

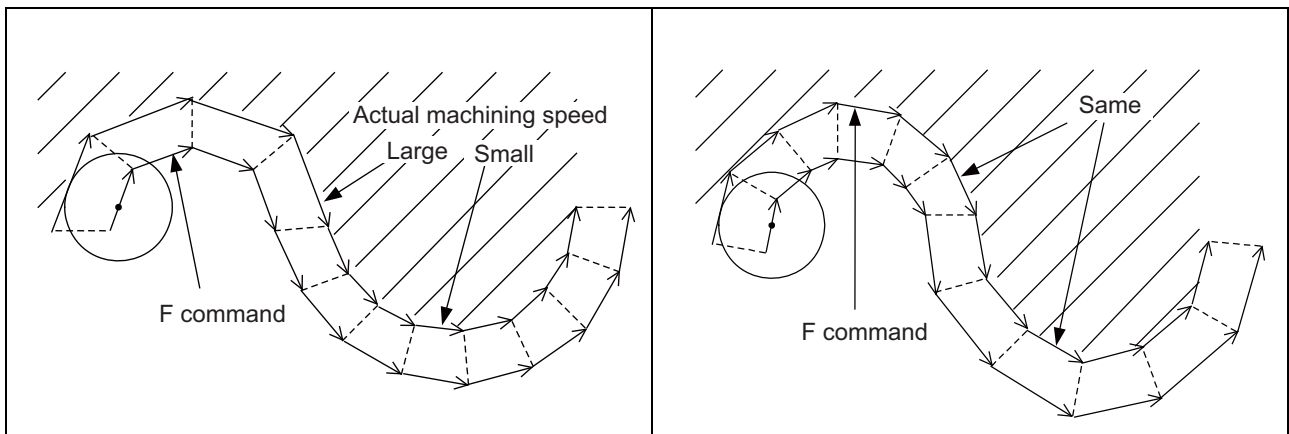

Command format is as shown below.

G93 ;	Inverse time feed
--------------	--------------------------

Inverse time feed (G93) is a modal command and is valid until feed per minute (G94) or feed per revolution (G95) is commanded.

G00 Xx1 Yy1 ;	
G93 ;	→ Inverse time feed mode ON
G01 Xx2 Yy2 Ff2 ;	→ In inverse time feed mode
G02 Xx3 Yy3 Ii3 Jj3 Ff3 ;	:
G94(G95) ;	→ Inverse time feed mode OFF

In movement blocks, since processing time is commanded to a line segment, command the feedrate "F" each time.

4.2.4 F 1-digit Feed

	M850W	M830W	M850S	M830S	M80W	M80 TypeA	M80 TypeB	E80 TypeA	E80 TypeB	C80
M	○	○	○	○	○	○	○	○	○	○
L	○	○	○	○	○	○	○	○	○	○

The feedrate registered by parameter can be assigned by designating a single digit following address F.

There are six F codes: F0 and F1 to F5. The rapid traverse rate is applied when F0 is issued which is the same as the G00 command.

When one of the codes F1 to F5 is issued, the cutting feedrate set to support the code serves as the valid rate command. If F6 or larger value is command, the value is regarded as the cutting feedrate which has been directly commanded with numerical values.

When an F 1-digit command has been issued, the external output signal is output.

When the programmed feedrate has been issued as an F 1-digit command, the feedrate can be increased or reduced by turning the manual handle.

The feedrate cannot be changed by the 2nd and 3rd handles.

(1) Amount by which speed is varied by manual handle

Speed variation amount ΔF is expressed by the equation below:

$$\Delta F = \Delta P \times \frac{FM}{K}$$

ΔP : Handle pulses (\pm)

FM : F1 to F5 upper limit (parameter setting)

K : Speed variation constant (parameter setting)

(Example) When the feedrate is to be increased or reduced by 10 mm/min per manual handle scale increment
If FM is 3600 mm/min, then:

$$\Delta F = 10 = 1 \times \frac{3600}{K} \quad \text{Therefore, } K = 360.$$

(2) Conditions under which F1-digit feed is valid

- Cycle start must be underway.
- Cutting feed must be underway, and the F 1-digit feedrate must be designated.
- The F 1-digit valid parameter must be ON
- The F 1-digit feedrate change valid signal must be ON.
- The handle mode must not be selected.
- A dry run must not be in progress.
- Machine lock must not be activated.
- The parameter settings (the F 1-digit feedrate upper limit and F 1-digit feedrate change constant) must not be "0".

4.2.5 Manual Speed Command

	M850W	M830W	M850S	M830S	M80W	M80 TypeA	M80 TypeB	E80 TypeA	E80 TypeB	C80
M	△	△	△	△	○	○	○	○	—	△
L	△	△	△	△	○	○	○	○	○	△

In the memory or MDI mode, validate the manual speed command and select either handle feed or jog (manual) feed so that the automatic operation is carried out at the feedrate.

With a command in the (-) direction, the program path can be reversed. Note that, however, program path can be reversed only within the currently executing block and not beyond the block.

Whether or not to execute reverse run with a command in the (-) direction is set with the PLC interface.

Furthermore, by setting the parameter, handle, jog and manual feed speed can be executed at the feed speed according to the ratio of program command speed of running block when issuing the manual speed command in multiple systems.

4.2.7 G00 Feedrate Designation (,F Command)

	M850W	M830W	M850S	M830S	M80W	M80 TypeA	M80 TypeB	E80 TypeA	E80 TypeB	C80
M	△	△	△	△	○	○	—	—	—	△
L	△	△	△	△	○	○	—	—	—	△

Feedrates can be specified for G00 (positioning command).

The speed of tool exchange, axis movement of gantry, etc. can be specified with the machining program so that the mechanical vibration can be suppressed.

Operations other than the feedrate follows the G00 specification.

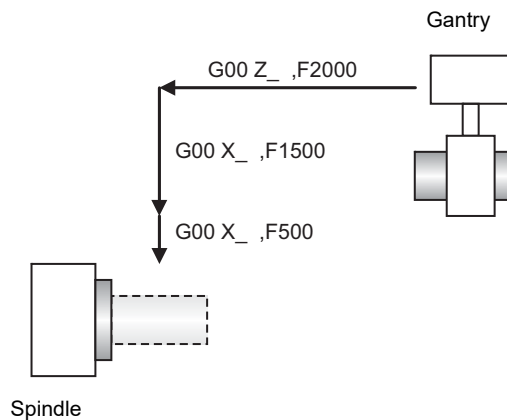

Command format

The feedrates of the movement in the G00,G00 mode and the movement during the fixed cycle for drilling are commanded with ",F".

Feedrate designation in G00 block

```
G00 X__ Z__ ,F1000 ;
```

Feedrate designation for movement command in G00 mode

```
G00 ;
X__ Z__ ,F1000 ;
```

(Note) ", F" command is ignored in the G01 mode.

Feedrate designation for movement command during drilling cycle

```
G8 □ (G7 □ ) X/Z__ ..... ,F1000;
X/Z__ ..... ,F500;
:
:
G80
:
```

L system G83/G87: Deep-hole drilling, G84/G88: Tapping, G85/G89: Boring

M system G81: Drilling/Spot drilling, G82: Drilling/Counter boring, G83: Deep-hole drilling, G84: Tapping, G85/G86: Boring, G87: Back boring, G88/G89: Boring, G73: Step, G74: Reverse tapping, G75: Circular cutting, G76: Fine boring

",F" command range

- The range is equal to the range of the feed per minute F command (mm/min, inch/min) in the G01 mode.
- Commands that exceed the command range cause the error "P67: F value is exceeding the limit".
- Switching inch/mm is invalid for rotary axes.

4.2.8 Selection of Axis (Axes) for Feedrate Command

	M850W	M830W	M850S	M830S	M80W	M80 TypeA	M80 TypeB	E80 TypeA	E80 TypeB	C80
M	△	△	△	△	—	—	—	—	—	—
L	—	—	—	—	—	—	—	—	—	—

This function enables designation of the feedrate of a specific axis (with the command F).

When the feedrate of a specific axis fluctuates wildly, desired surface finish may fail to be attained. The fluctuation can be suppressed with this function, resulting in improved surface quality.

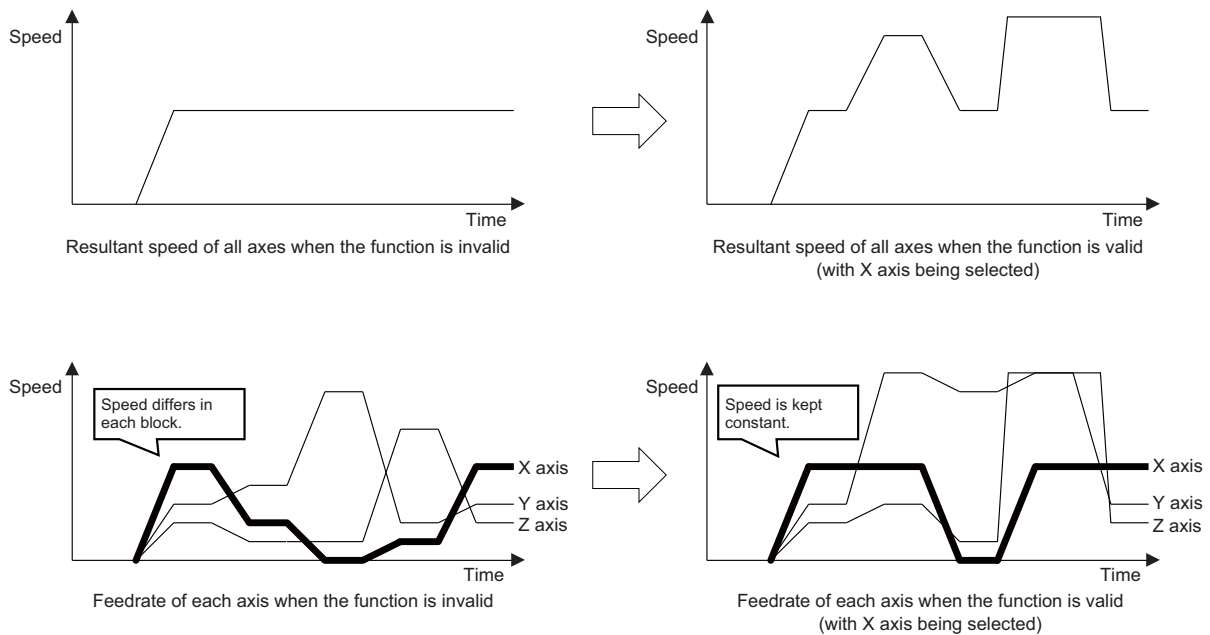

Command format

Selection of axis (axes) for feedrate command

```
G130 Axis name 1 Axis name 2 ... Axis name n ;
Axis name n : Axis (axes) for feedrate command as axis address
```

Selection of axis (axes) for feedrate command cancel

```
G130 ;
```

- (1) G130 is a non-modal command of group 0.
- (2) G130 must be commanded alone in a block. A program error occurs when another G code is commanded in the same block.
- (3) Designate the axis name "n" using an axis address set in the parameter. If the designated axis does not exist, a program error occurs.
- (4) When an axis address enabled with the axis name extension function is specified for the axis name "n", a program error occurs.
- (5) The selection of axis (axes) for feedrate command is canceled with reset 1, reset 2, Reset & rewind, or emergency stop.

4.3 Override

4.3.1 Rapid Traverse Override

	M850W	M830W	M850S	M830S	M80W	M80 TypeA	M80 TypeB	E80 TypeA	E80 TypeB	C80
M	○	○	○	○	○	○	○	○	○	○
L	○	○	○	○	○	○	○	○	○	○

(1) Type 1 (code method)

Four levels of override (1%, 25%, 50% and 100%) can be applied to manual or automatic rapid traverse using the external input signal supplied.

(2) Type 2 (value setting method)

Override can be applied in 1% steps from 0% to 100% to manual or automatic rapid traverse using the external input signal supplied.

(Note 1) Type 1 and type 2 can be selected by PLC processing.

(Note 2) This function requires a built-in PLC for type 2.

4.3.2 Cutting Feed Override

	M850W	M830W	M850S	M830S	M80W	M80 TypeA	M80 TypeB	E80 TypeA	E80 TypeB	C80
M	○	○	○	○	○	○	○	○	○	○
L	○	○	○	○	○	○	○	○	○	○

(1) Type 1 (code method)

Override can be applied in 10% steps from 0% to 300% to the feed rate command designated in the machining program using the external input signal supplied.

(2) Type 2 (value setting method)

Override can be applied in 1% steps from 0% to 327% to the feed rate command designated in the machining program using the external input signal supplied.

(Note 1) This function requires a built-in PLC for type 2.

4.3.3 2nd Cutting Feed Override

	M850W	M830W	M850S	M830S	M80W	M80 TypeA	M80 TypeB	E80 TypeA	E80 TypeB	C80
M	○	○	○	○	○	○	○	○	○	○
L	○	○	○	○	○	○	○	○	○	○

Override can be further applied in 0.01% steps from 0% to 327.67% as a second stage override to the feed rate after the cutting feed override has been applied.

(Note 1) This function requires a built-in PLC.

4.3.4 Override Cancel

	M850W	M830W	M850S	M830S	M80W	M80 TypeA	M80 TypeB	E80 TypeA	E80 TypeB	C80
M	○	○	○	○	○	○	○	○	○	○
L	○	○	○	○	○	○	○	○	○	○

By turning on the override cancel external signal, the override is automatically set to 100% for the cutting feed during an automatic operation mode (tape, memory and MDI).

(Note 1) The override cancel signal is not valid for manual operation.

(Note 2) When the cutting feed override or second cutting feed override is 0%, the 0% override takes precedence and the override is not canceled.

(Note 3) The override cancel signal is not valid for rapid traverse.

4.4 Acceleration/Deceleration

4.4.1 Automatic Acceleration/Deceleration after Interpolation

	M850W	M830W	M850S	M830S	M80W	M80 TypeA	M80 TypeB	E80 TypeA	E80 TypeB	C80
M	○	○	○	○	○	○	○	○	○	○
L	○	○	○	○	○	○	○	○	○	○

Acceleration/deceleration is applied to all commands automatically. The acceleration/deceleration patterns are linear acceleration/deceleration, soft acceleration/deceleration, exponent function acceleration/ deceleration, exponent function acceleration/linear deceleration and any of which can be selected by using a parameter.

For rapid traverse feed or manual feed, acceleration/deceleration is always made for each block, and the time constant can be set for each axis separately.

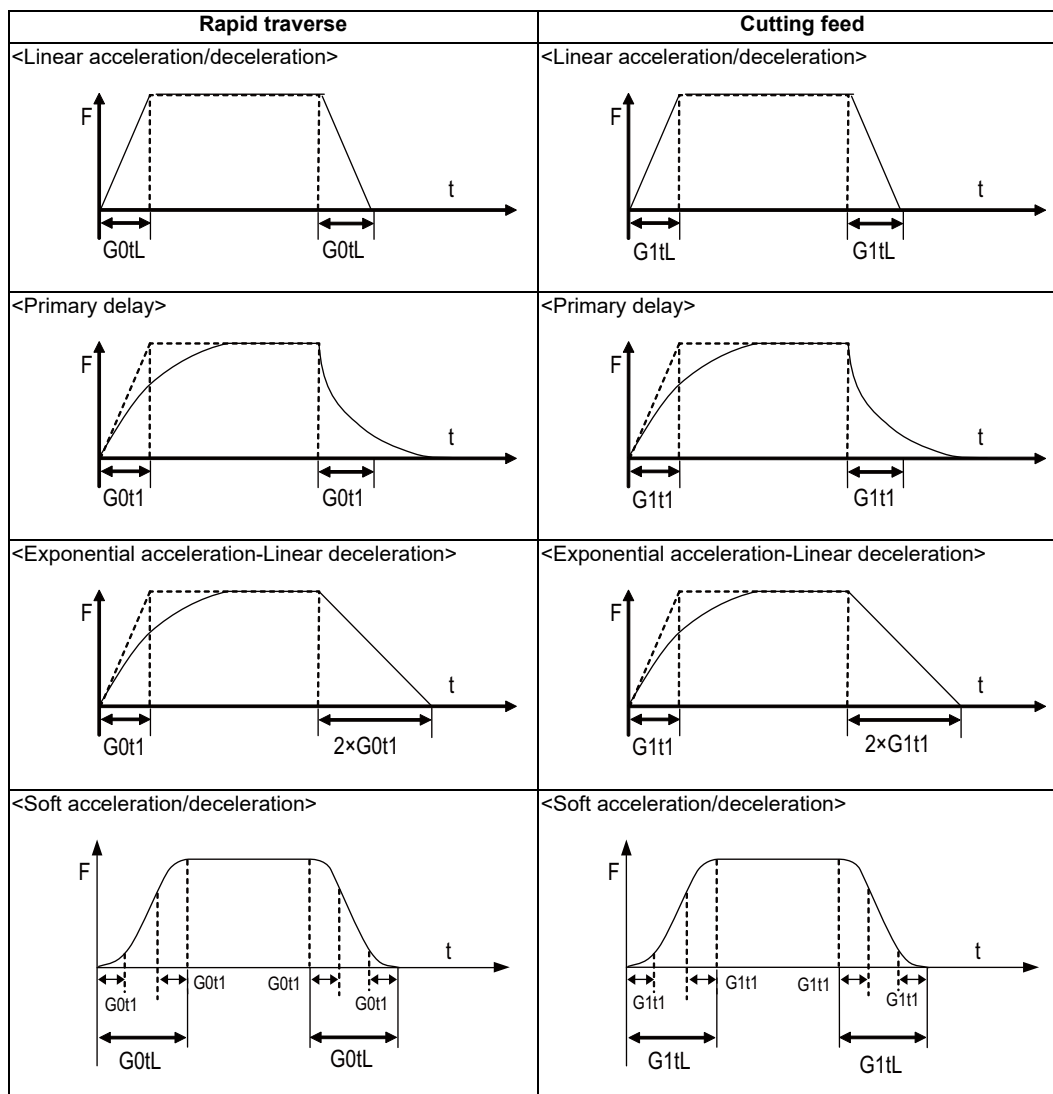

G0tL:G0 time constant(linear)

G0t1:G0 time constant(primary delay)/The 2nd step time constant of the soft acceleration/deceleration

G1tL:G1 time constant(linear)

G1t1:G1 time constant(primary delay)/The 2nd step time constant of the soft acceleration/deceleration

- (Note 1) The rapid traverse feed acceleration/deceleration patterns are effective for the following:
G00, G27, G28, G29, G30, rapid traverse feed in manual run, JOG feed, incremental feed, return to reference position.
It is invalid to G31 and handle feed.
- (Note 2) Acceleration/deceleration in handle feed mode is usually performed according to the acceleration/deceleration pattern for cutting feed. However, a parameter can be specified to select a pattern with no acceleration/deceleration (step).
- (Note 3) Acceleration/deceleration time of soft acceleration/deceleration can be changed by parameter as follows.

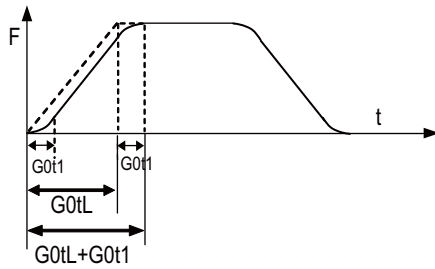

Total accelerating time: $G0tL + G0t1$
 S-pattern part time: $G0t1$
 Linear part time: $G0tL - G0t1$

A rapid traverse time constant can be switched by rapid traverse time constant changeover request signal.

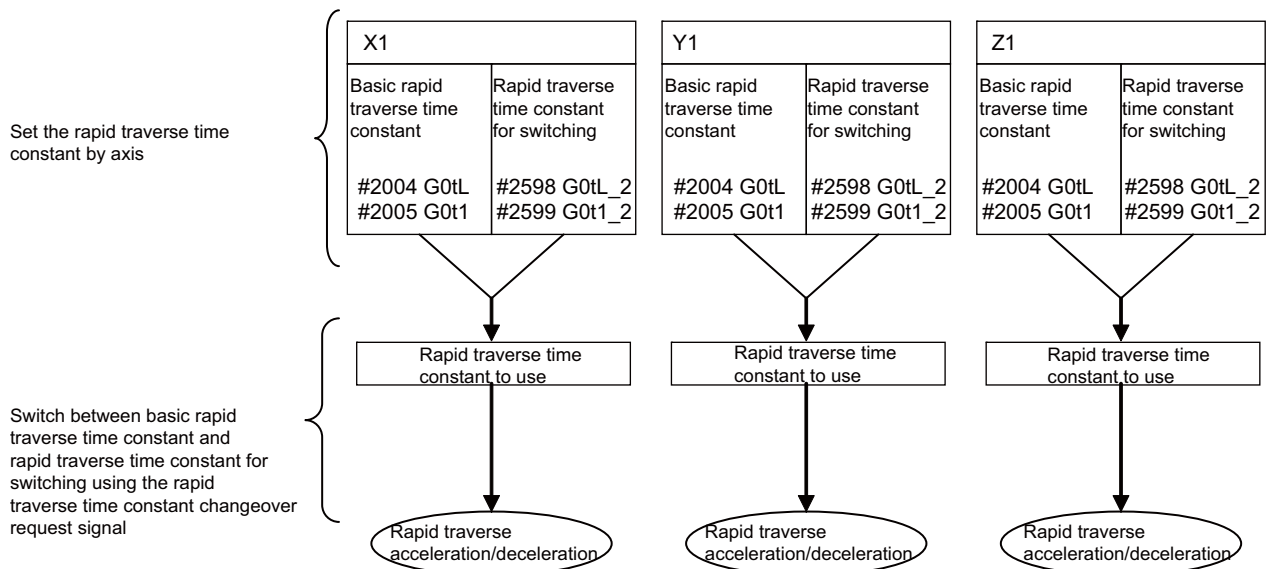

4.4.2 Rapid Traverse Constant-gradient Acceleration/Deceleration

	M850W	M830W	M850S	M830S	M80W	M80 TypeA	M80 TypeB	E80 TypeA	E80 TypeB	C80
M	○	○	○	○	○	○	○	○	○	○
L	○	○	○	○	○	○	○	○	○	○

This function performs acceleration and deceleration at a constant-gradient during linear acceleration/deceleration by the rapid traverse command or the linear interpolation command. Compared to the method of acceleration/deceleration after interpolation, the constant-gradient acceleration/deceleration method makes for improved cycle time.

This function is valid for the rapid traverse (G00) command and the linear interpolation (G01) command only when the acceleration/deceleration mode is set to linear acceleration/deceleration or soft acceleration/deceleration.

(Example) When the interpolation distance is so short that the rapid traverse rate is not achieved

For acceleration/deceleration with fixed time constant, the gradient is determined by the rapid traverse rate; however, the cycle time is determined by the time constant, and the reaching speed is slower than constant-gradient acceleration/deceleration.

For constant-gradient acceleration/deceleration, the gradient is determined by the rapid traverse rate and the time constant. The reaching time is determined by interpolation distance; therefore, the cycle time is shorter than acceleration/deceleration with fixed time constant.

In case of acceleration/deceleration with fixed time constant:

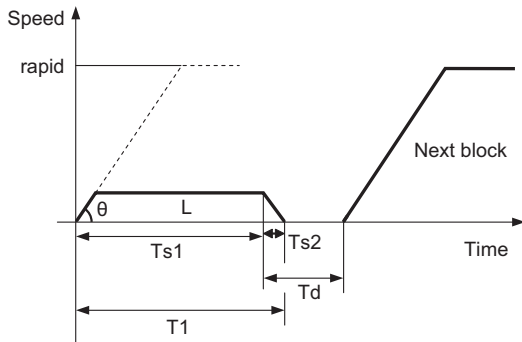

In case of constant-gradient acceleration/deceleration:

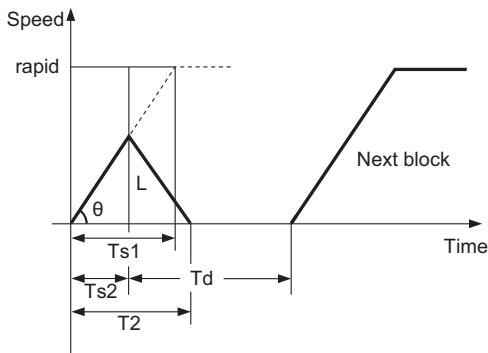

$$T1 = Ts1 + Ts2$$

$$T2 = 2 \times \sqrt{Ts1 \times L / \text{rapid}}$$

$$Td = Ts2 + (0 \text{ to } 14 \text{ ms})$$

$$\theta = \tan^{-1} \left(\frac{\text{rapid}}{Ts1} \right)$$

- rapid: Rapid traverse rate
- Ts1: Acceleration/deceleration time
- Ts2: Acceleration/deceleration time to reach the maximum speed
- Td: Command deceleration check time
- θ: Acceleration/deceleration gradient
- T1: Interpolation time (Acceleration/deceleration with fixed time constant)
- T2: Interpolation time (Constant-gradient acceleration/deceleration)
- L: Interpolation distance

4.4.3 Rapid Traverse Constant-gradient Multi-step Acceleration/Deceleration

	M850W	M830W	M850S	M830S	M80W	M80 TypeA	M80 TypeB	E80 TypeA	E80 TypeB	C80
M	△	△	△	△	○	○	○	—	—	△
L	—	—	—	—	—	—	—	—	—	—

This function carries out the acceleration/deceleration according to the torque characteristic of the motor in the rapid traverse mode during automatic operation. (This function is not available in manual operation.) The rapid traverse constant-gradient multi-step acceleration/deceleration method makes for improved cycle time because the positioning time is shortened by using the motor ability to its maximum.

In general, the servomotor has the characteristic that the torque falls in the high-speed rotation range.

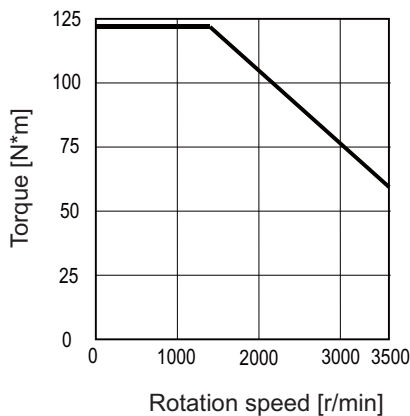

(Note) This characteristic is data at input voltage 380VAC.

In the rapid traverse constant-gradient acceleration/deceleration method, the acceleration has been treated constantly because this torque characteristic is not considered. So, it is necessary to use a minimum acceleration within the used speed range. Therefore, the margin of acceleration must be had in a low-speed range. Or if the acceleration is used to its maximum, the upper limit of the rotation speed must be slowed.

Then, to use the servomotor ability to its maximum, acceleration/deceleration to which the torque characteristic is considered is carried out by the rapid traverse constant-gradient multi-step acceleration/deceleration method.

The acceleration/deceleration patterns in the case where rapid traverse constant-gradient multi-step acceleration/deceleration are performed are as follows.

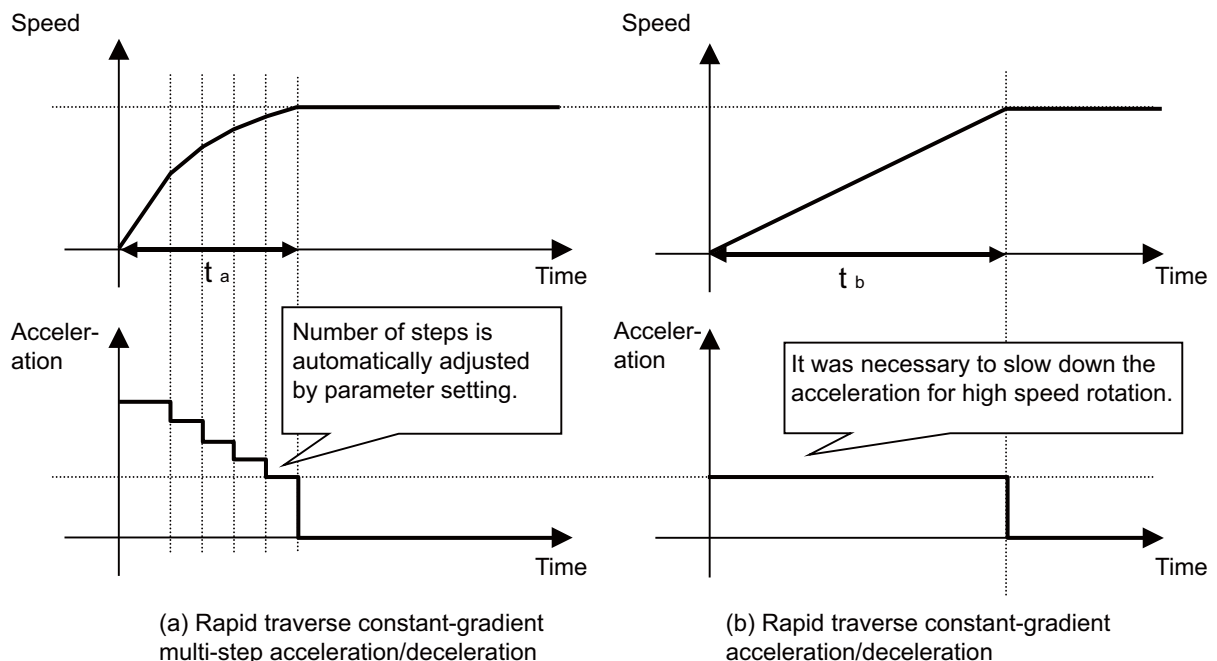

4.5 Thread Cutting

4.5.1 Thread Cutting (Lead/Thread Number Designation)

	M850W	M830W	M850S	M830S	M80W	M80 TypeA	M80 TypeB	E80 TypeA	E80 TypeB	C80
M	△	△	△	△	○	○	○	○	○	△
L	○	○	○	○	○	○	○	○	○	○

Thread cutting with designated lead can be performed. Designate the number of threads per inch with the E address to cut inch threads.

(1) Lead designation

The thread cutting with designated lead is performed based on the synchronization signals from the spindle encoder.

G33 Zz1/Ww1 Xx1/Uu1 Qq1 Ff1/Ee1 ;

G33 : Thread cutting command
 Zz1/Ww1,Xx1/Uu1 : Thread end point coordinates
 Qq1 : Shift angle at start of thread cutting (0.000 to 360.000°)
 Ff1 : Thread lead (normal lead threads)
 Ee1 : Thread lead (precise lead threads)

The thread cutting with designated lead can be performed. Inch threads are cut by designating the number of threads per inch with the E address.

(2) Thread number designation

Inch threads are cut by designating the number of threads per inch with the E address.

Whether the E command is a thread number designation or lead designation is selected with the parameters.

G33 Zz1/Ww1 Xx1/Uu1 Qq1 Ee1 ;

G33 : Thread cutting command
 Zz1/Ww1,Xx1/Uu1 : Thread end point coordinates
 Qq1 : Shift angle at start of thread cutting (0.000 to 360.000°)
 Ee1 : Thread number per inch

[M system]

Thread cutting metric input

Input setting unit	B (0.001mm)			C (0.0001mm)		
	F (mm/rev)	E (mm/rev)	E (ridges/inch)	F (mm/rev)	E (mm/rev)	E (ridges/inch)
Least Command Increments	1(=0.001) (1.=1.000)	1(=0.0001) (1.=1.0000)	1(=1.00) (1.=1.00)	1(=0.0001) (1.=1.0000)	1(=0.00001) (1.=1.00000)	1(=1.000) (1.=1.000)
Command range	0.001 - 999.999	0.0001 - 999.9999	0.03 - 999.99	0.0001 - 999.9999	0.00001 - 999.99999	0.026 - 222807.017

Input setting unit	D (0.00001mm)			E (0.000001mm)		
	F (mm/rev)	E (mm/rev)	E (ridges/inch)	F (mm/rev)	E (mm/rev)	E (ridges/inch)
Least Command Increments	1(=0.00001) (1.=1.00000)	1(=0.000001) (1.=1.000000)	1(=1.0000) (1.=1.0000)	1(=0.000001) (1.=1.000000)	1(=0.0000001) (1.=1.0000000)	1(=1.00000) (1.=1.00000)
Command range	0.00001 - 999.99999	0.000001 - 999.999999	0.0255 - 224580.0000	0.000001 - 999.999999	0.0000001 - 999.9999999	0.02541 - 224719.00000

Thread cutting inch input

Input setting unit	B (0.0001inch)			C (0.00001inch)		
Command address	F (inch/rev)	E (inch/rev)	E (ridges/inch)	F (inch/rev)	E (inch/rev)	E (ridges/inch)
Least Command Increments	1(=0.0001) (1.=1.0000)	1(=0.00001) (1.=1.00000)	1(=1.000) (1.=1.000)	1(=0.00001) (1.=1.00000)	1(=0.000001) (1.=1.000000)	1(=1.0000) (1.=1.0000)
Command range	0.0001 - 39.3700	0.00001 - 39.37007	0.025 - 9999.999	0.00001 - 39.37007	0.000001 - 39.370078	0.0255 - 9999.9999

Input setting unit	D (0.000001inch)			E (0.0000001inch)		
Command address	F (inch/rev)	E (inch/rev)	E (ridges/inch)	F (inch/rev)	E (inch/rev)	E (ridges/inch)
Least Command Increments	1(=0.000001) (1.=1.000000)	1(=0.0000001) (1.=1.0000000)	1(=1.00000) (1.=1.00000)	1(=0.0000001) (1.=1.0000000)	1(=0.00000001) (1.=1.00000000)	1(=1.000000) (1.=1.000000)
Command range	0.000001 - 39.370078	0.0000001 - 39.3700787	0.02541 - 9999.99999	0.0000001 - 39.3700787	0.00000001 - 39.37007873	0.025401 - 9999.999999

(Note 1) It is not possible to assign a lead that causes the feedrate converted into the feed per minute value to exceed the maximum cutting feedrate.

[L system]

Thread cutting metric input

Input setting unit	B (0.001mm)			C (0.0001mm)		
Command address	F (mm/rev)	E (mm/rev)	E (ridges/inch)	F (mm/rev)	E (mm/rev)	E (ridges/inch)
Least Command Increments	1(=0.0001) (1.=1.0000)	1(=0.00001) (1.=1.00000)	1(=1.00) (1.=1.00)	1(=0.00001) (1.=1.00000)	1(=0.000001) (1.=1.000000)	1(=1.000) (1.=1.000)
Command range	0.0001 - 999.9999	0.00001 - 999.99999	0.03 - 999.99	0.00001 - 999.99999	0.000001 - 999.999999	0.026 - 222807.017

Input setting unit	D (0.00001mm)			E (0.000001mm)		
Command address	F (mm/rev)	E (mm/rev)	E (ridges/inch)	F (mm/rev)	E (mm/rev)	E (ridges/inch)
Least Command Increments	1(=0.000001) (1.=1.000000)	1(=0.0000001) (1.=1.0000000)	1(=1.0000) (1.=1.0000)	1(=0.0000001) (1.=1.0000000)	1(=0.00000001) (1.=1.00000000)	1(=1.00000) (1.=1.00000)
Command range	0.000001 - 999.999999	0.0000001 - 999.9999999	0.0255 - 224580.0000	0.0000001 - 999.9999999	0.00000001 - 999.99999999	0.02540 - 224719.00000

Thread cutting inch input

Input setting unit	B (0.0001inch)			C (0.00001inch)		
	Command address	F (inch/rev)	E (inch/rev)	E (ridges/inch)	F (inch/rev)	E (inch/rev)
Least Command Increments	1(=0.00001) (1.=1.00000)	1(=0.000001) (1.=1.000000)	1(=1.000) (1.=1.000)	1(=0.000001) (1.=1.000000)	1(=0.0000001) (1.=1.0000000)	1(=1.0000) (1.=1.0000)
Command range	0.00001 - 39.37007	0.000001 - 39.370078	0.025 - 9999.999	0.000001 - 39.370078	0.0000001 - 39.3700787	0.0254 - 9999.9999

Input setting unit	D (0.000001inch)			E (0.0000001inch)		
	Command address	F (inch/rev)	E (inch/rev)	E (ridges/inch)	F (inch/rev)	E (inch/rev)
Least Command Increments	1(=0.0000001) (1.=1.0000000)	1(=0.00000001) (1.=1.00000000)	1(=1.00000) (1.=1.00000)	1(=0.00000001) (1.=1.00000000)	1(=0.000000001) (1.=1.000000000)	1(=1.000000) (1.=1.000000)
Command range	0.0000001 - 39.3700787	0.00000001 - 39.37007873	0.02540 - 9999.99999	0.00000001 - 39.37007873	0.000000001 - 39.370078736	0.025400 - 9999.999999

(Note 1) It is not possible to assign a lead that causes the feedrate converted into the feed per minute value to exceed the maximum cutting feedrate.

4.5.2 Variable Lead Thread Cutting

	M850W	M830W	M850S	M830S	M80W	M80 TypeA	M80 TypeB	E80 TypeA	E80 TypeB	C80
M	—	—	—	—	—	—	—	—	—	—
L	○	○	○	○	○	○	○	○	○	○

By commanding the lead increment/decrement amount per thread rotation, variable lead thread cutting can be done. The machining program is commanded in the following manner.

```
G34 Xx1/Uu1 Zz1/Ww1 Ff1/Ee1 Kk1 ;
G34          : Variable lead thread cutting command
Xx1/Uu1      : Thread end point X coordinate
Zz1/Ww1      : Thread end point Z coordinate
Ff1/Ee1      : Thread's basic lead
Kk1          : Lead increment/decrement amount per thread rotation
```

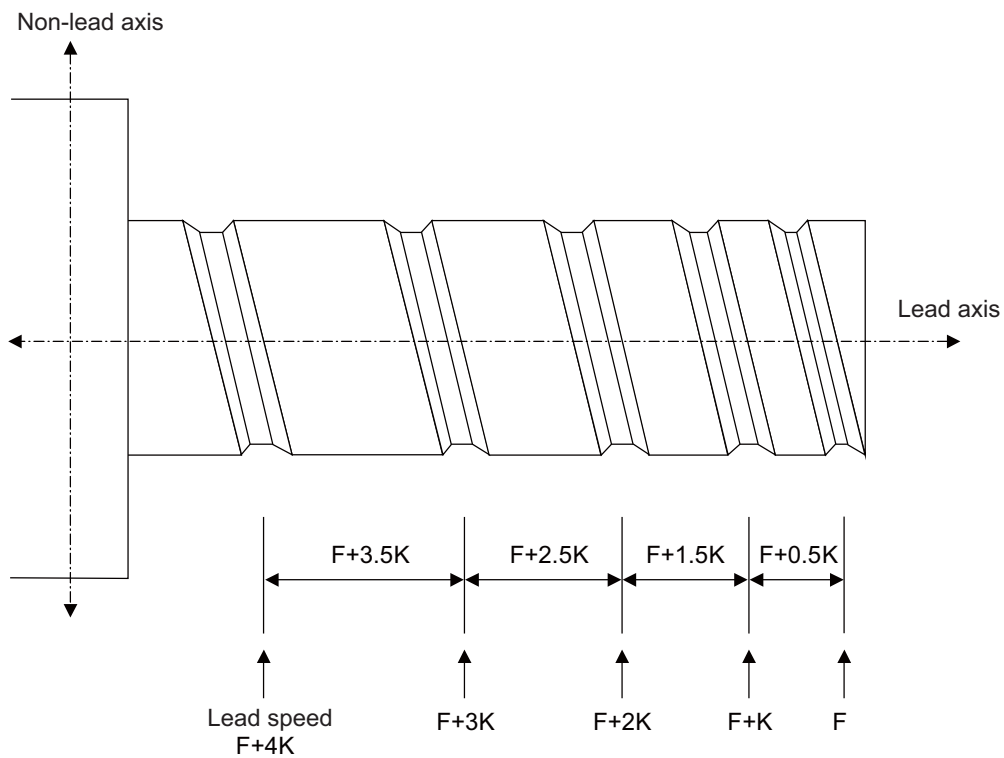

4.5.3 Synchronous Tapping

(Note) With digital I/F spindle

4.5.3.1 Synchronous Tapping Cycle

	M850W	M830W	M850S	M830S	M80W	M80 TypeA	M80 TypeB	E80 TypeA	E80 TypeB	C80
M	○	○	○	○	○	○	○	○	○	○
L	○	○	○	○	○	○	○	○	○	○

This function performs tapping through the synchronized control of the digital spindle and servo axis. This eliminates the need for floating taps and enables tapping to be conducted at a highly precise tap depth.

(1) Tapping pitch assignment

G84(G74) Xx1 Yy1 Zz1 Rr1 Dd1 Pp1 Ff1 Kk1 Ss1 ,Ss2 ,Rr2 ,li1 ,Jj1 Mm1 ;	
G84	: Mode, forward tapping
G74	: Mode, reverse tapping
Xx1,Yy1	: Hole position data, hole drilling position
Zz1	: Hole machining data, hole bottom position
Rr1	: Hole machining data, point R position
Dd1	: Tool spindle number (d is 1 to number of spindles) Depending on the parameter setting, command as "-d1" to carry out reverse tapping.
Pp1	: Hole machining data, dwell time at hole bottom
Ff1	: Z-axis feed amount (tapping pitch) per spindle rotation
Kk1	: Number of repetitions
Ss1	: Spindle speed
,Ss2	: Rotation speed of spindle during retract
,Rr2	: Synchronization method selection (r2=1 Synchronous, r2=0 Asynchronous)
,li1,Jj1	: In-position width of positioning axis/hole drilling axis
Mm1	: M function designation

(2) Tapping thread number assignment

G84(G74) Xx1 Yy1 Zz1 Rr1 Dd1 Pp1 Ee1 Kk1 Ss1 ,Ss2 ,Rr2 ,li1 ,Jj1 Mm1 ;	
G84	: Mode, forward tapping
G74	: Mode, reverse tapping
Xx1,Yy1	: Hole position data, hole drilling position
Zz1	: Hole machining data, hole bottom position
Rr1	: Hole machining data, point R position
Dd1	: Tool spindle number (d is 1 to number of spindles) Depending on the parameter setting, command as "-d1" to carry out reverse tapping.
Pp1	: Hole machining data, dwell time at hole bottom
Ee1	: Tap thread number per 1-inch feed of Z axis
Kk1	: Number of repetitions
Ss1	: Spindle speed
,Ss2	: Rotation speed of spindle during retract
,Rr2	: Synchronization method selection (r2=1 synchronous, r2=0 asynchronous)
,li1,Jj1	: In-position width of positioning axis/hole drilling axis
Mm1	: M function designation

(Note) The synchronous tapping cycle can be used for axes other than the Z axis with the plane selection. Furthermore, in-position checks can be performed at the hole bottom or point R, etc. using the parameters. The figure below shows the correlation between the in-position width and the movement of the tapping axis of the synchronous tapping in-position check.

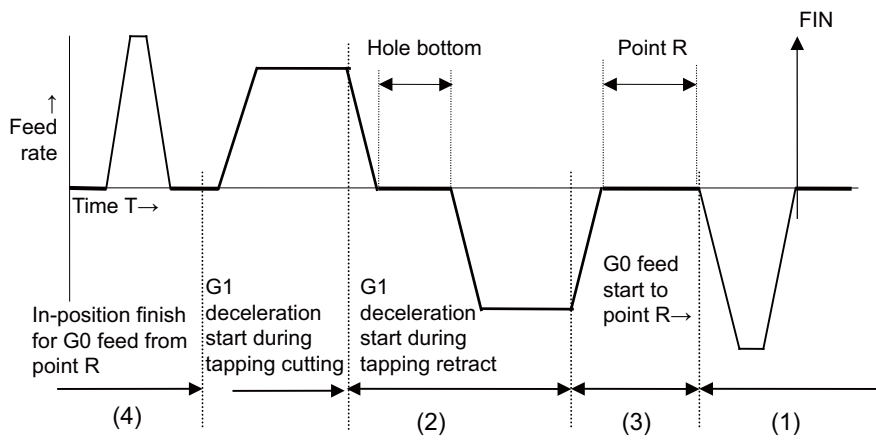

- (1) Section where in-position check is performed using servo in-position width
- (2) Section where in-position check is performed using in-position width for tapping
- (3) Section where in-position check is performed using in-position width for cutting feed (G1, G2, G3)
- (4) Section where in-position check is performed using in-position width for rapid traverse (G0)

4.5.3.2 Pecking Tapping Cycle

	M850W	M830W	M850S	M830S	M80W	M80 TypeA	M80 TypeB	E80 TypeA	E80 TypeB	C80
M	△	△	△	△	○	○	○	○	○	△
L	△	△	△	△	○	○	○	○	○	△

The load applied to the tool can be reduced by designating the depth of cut per pass and cutting the workpiece to the hole bottom for a multiple number of passes.

The amount retracted from the hole bottom is set to the parameters.

Select either the pecking tapping cycle or the deep-hole tapping cycle by parameter.

When the pecking tapping cycle is executed in the synchronous tapping mode, the synchronous tapping cycle function and pecking tapping cycle function are required.

When "depth of cut per pass Q" is designated in the block containing the G84 or G74 command in the state where the pecking tapping cycle is selected by parameter, the pecking tapping cycle is executed.

In the following cases, the normal tapping cycle is established.

When Q is not designated

When the command value of Q is zero

When there is no Pecking tapping cycle function

(1) M system

G84(G74) Xx1 Yy1 Zz1 Rr1 Qq1 Ff1(Ee1) Pp1 Ss1 ,Ss2 ,li1 ,Jj1 ,Rr2 L11 ;	
G84	: G84 forward tapping cycle
G74	: G74 reverse tapping cycle
Xx1,Yy1	: Hole drilling position
Zz1	: Hole bottom position
Rr1	: Point R position
Qq1	: Depth of cut per pass (designated as an incremental position)
Ff1	: During synchronous tapping: Designation of drilling axis feed amount (tapping pitch) per spindle revolution (modal) During asynchronous tapping: Designation of the feedrate for cutting feed (modal)
Ee1	: Tap thread number per 1-inch feed of Z axis
Pp1	: Dwell time at hole bottom position
Ss1	: Rotation speed of spindle
,Ss2	: Rotation speed of spindle during retract
,li2	: In-position width of positioning axis
,Jj2	: In-position width of hole drilling axis
,Rr2	: Synchronization method selection (r2=1 synchronous, r2=0 asynchronous)
L11	: Number of repetitions

(2) L system

G84(G88, G84.1, G88.1) Xx1 Cc1 Zz1 Rr1 Qq1 Ff1(Ee1) Pp1 Ss1 ,Ss2 ,li ,Jj ,Rr2 Dd1 LI1 Mm1 ;	
G84	: G84 Face forward tapping cycle
G88	: G88 Side forward tapping cycle
G84.1	: G84.1 Face reverse tapping cycle (It can be commanded by setting of parameter)
G88.1	: G88.1 Side reverse tapping cycle (It can be commanded by setting of parameter)
Xx1,Cc1,Zz1	: Hole position data and : hole bottom position
Rr1	: Point R position
Qq1	: Depth of cut per pass (designated as an incremental position)
Ff1	: During synchronous tapping: Designation of drilling axis feed amount (tapping pitch) per spindle revolution (modal) During asynchronous tapping: Designation of the feedrate for cutting feed (modal)
Ee1	: Tap thread number per 1-inch feed of Z axis
Pp1	: Dwell time at hole bottom position
Ss1	: Rotation speed of spindle
,Ss2	: Rotation speed of spindle
,li2	: In-position width of positioning axis
,Jj2	: In-position width of hole drilling axis
,Rr2	: Synchronization method selection (r2=1:synchronous、r2=0:asynchronous)
Dd1	: Tapping spindle number assignment (By minus command, reverse tapping can be commanded by setting of parameter. It can be commanded when it is multiple-spindle control I . Program error occurs when multiple-spindle control II is commanded by D command.)
LI1	: Number of repetitions
Mm1	: C axis clamp M code

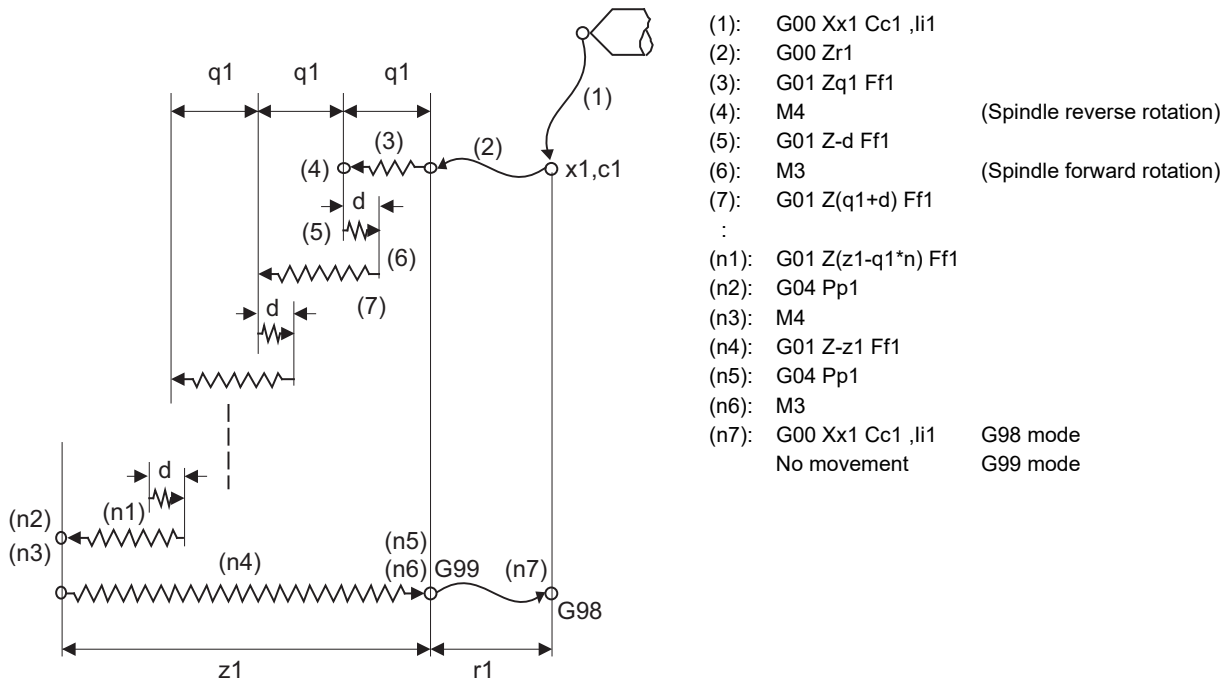

d : Retract amount (parameter)

(Note) This program is for the G84 command. The spindle forward rotation (M3) and reverse rotation (M4) are reversed with the G74 command.

4.5.3.3 Deep-hole Tapping Cycle

	M850W	M830W	M850S	M830S	M80W	M80 TypeA	M80 TypeB	E80 TypeA	E80 TypeB	C80
M	△	△	△	△	○	○	○	○	○	△
L	△	△	△	△	○	○	○	○	○	△

In the deep-hole tapping, the load applied to the tool can be reduced by designating the depth of cut per pass and cutting the workpiece to the hole bottom for a multiple number of passes.

Adding this function, the pecking tapping cycle function is also added.

Under the deep-hole tapping cycle, the tool is retracted to the R-point every time.

Select either the pecking tapping cycle or the deep-hole tapping cycle by parameter.

When the deep-hole tapping cycle is executed in the synchronous tapping mode, the synchronous tapping cycle function and deep-hole tapping cycle function are required.

When "depth of cut per pass Q" is designated in the block containing the G84 or G74 command in the state where the deep-hole tapping cycle is selected by parameter, the deep-hole tapping cycle is executed.

In the following cases, the normal tapping cycle is established.

When Q is not designated

When the command value of Q is zero

When there is no deep tapping cycle function

(1) M system

G84(G74) Xx1 Yy1 Zz1 Rr1 Qq1 Ff1(Ee1) Pp1 Ss1 ,Ss2 ,li ,Jj ,Rr2 Ll1 (Kk1) ;	
G84	: G84 forward tapping cycle
G74	: G74 reverse tapping cycle
Xx1,Yy1	: Hole drilling position
Zz1	: Hole bottom position
Rr1	: Point R position
Qq1	: Depth of cut per pass (designated as an incremental position)
Ff1	: During synchronous tapping: Designation of drilling axis feed amount (tapping pitch) per spindle revolution (modal) During asynchronous tapping: Designation of the feedrate for cutting feed (modal)
Ee1	: Tap thread number per 1-inch feed of Z axis
Pp1	: Dwell time at hole bottom and point R return
Ss1	: Rotation speed of spindle
,Ss2	: Rotation speed of spindle during retract
,li2	: In-position width of positioning axis
,Jj2	: In-position width of hole drilling axis
,Rr2	: Synchronization method selection (r2=1 synchronous, r2=0 asynchronous)
Ll1	: Number of repetitions
Kk1	: Number of repetitions (It commanded by parameter)

(2) L system

G84(G88, G84.1, G88.1) Xx1 Cc1 Zz1 Rr1 Qq1 Ff1(Ee1) Pp1 Ss1 ,Ss2 ,li ,Jj ,Rr2 Dd1 LI1 Mm1 ;	
G84	: G84 Face forward tapping cycle
G88	: G88 Side forward tapping cycle
G84.1	: G84.1 Face reverse tapping cycle (It can be commanded by setting of parameter)
G88.1	: G88.1 Side reverse tapping cycle (It can be commanded by setting of parameter)
Xx1,Cc1,Zz1	: Hole position data and : hole bottom position
Rr1	: Point R position
Qq1	: Depth of cut per pass (designated as an incremental position)
Ff1	: During synchronous tapping: Designation of drilling axis feed amount (tapping pitch) per spindle revolution (modal) During asynchronous tapping: Designation of the feedrate for cutting feed (modal)
Ee1	: Tap thread number per 1-inch feed of Z axis
Pp1	: Dwell time at hole bottom position
Ss1	: Rotation speed of spindle
,Ss2	: Rotation speed of spindle
,li2	: In-position width of positioning axis
,Jj2	: In-position width of hole drilling axis
,Rr2	: Synchronization method selection (r2=1:synchronous、r2=0:asynchronous)
Dd1	: Tapping spindle number assignment (By minus command, reverse tapping can be commanded by setting of parameter. It can be commanded when it is multiple-spindle control I . Program error occurs when multiple-spindle control II is commanded by D command.)
LI1	: Number of repetitions
Mm1	: C axis clamp M code

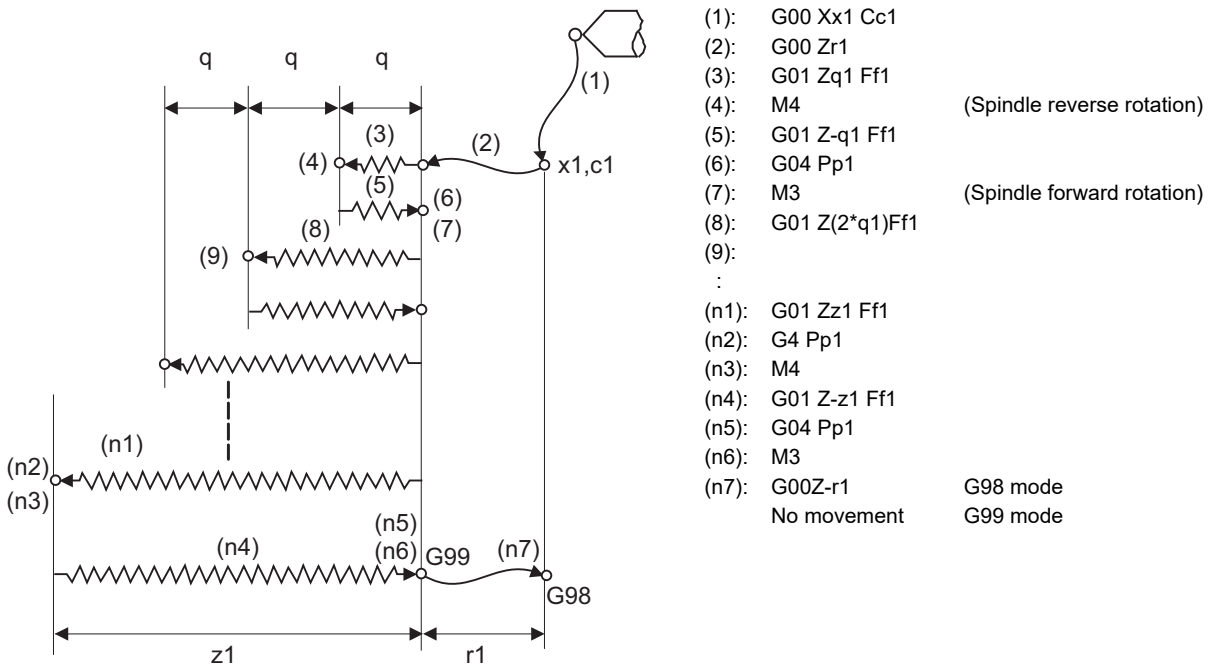

(Note) This program is for the G84 command. The spindle forward rotation (M3) and reverse rotation (M4) are reversed with the G74 command.

4.5.3.4 Synchronous Tapping with Multiple Spindles

	M850W	M830W	M850S	M830S	M80W	M80 TypeA	M80 TypeB	E80 TypeA	E80 TypeB	C80
M	—	—	—	—	—	—	—	—	—	△
L	—	—	—	—	—	—	—	—	—	△

This can perform synchronous tapping with multiple spindles simultaneously, and can improve efficiency of the tapping. You can designate all spindles to constitute.

The command format is the same as the command for normal synchronous tapping.

The multiple spindles to execute the synchronous tapping are designated from the sequence I/F.

4.5.3.5 Synchronous Tapping with Analog I/F Spindle

	M850W	M830W	M850S	M830S	M80W	M80 TypeA	M80 TypeB	E80 TypeA	E80 TypeB	C80
M	○	○	○	○	○	○	○	○	○	—
L	○	○	○	○	○	○	○	○	○	—

This function performs tapping using the analog-connected spindle. The functions in the table below can be used using the spindle analog-connected by inverter, etc. The operation of synchronous tapping cycle other than this function follows the specification in the table below.

When this function is used, the analog spindle with the function to control the spindle position needs to be connected. Also, the parameter needs to be turned ON.

The voltage value to be output to the analog spindle is between -10V and 10V, which is determined by the ratio of the spindle rotation speed corresponding to the command to analog spindle and the setting value of the parameter.

	Function name	G code
M system	Tapping cycle	G84
	Reverse tapping cycle	G74
L system	Face tapping cycle	G84
	Face reverse tapping cycle	G84.1
	Longitudinal tapping cycle	G88
	Longitudinal reverse tapping cycle	G88.1
	Synchronous tapping cycle	G84.2

4.5.4 Chamfering

	M850W	M830W	M850S	M830S	M80W	M80 TypeA	M80 TypeB	E80 TypeA	E80 TypeB	C80
M	—	—	—	—	—	—	—	—	—	—
L	○	○	○	○	○	○	○	○	○	○

Chamfering can be validated during the thread cutting cycle by using external signals.

The chamfer amount and angle are designated with parameters.

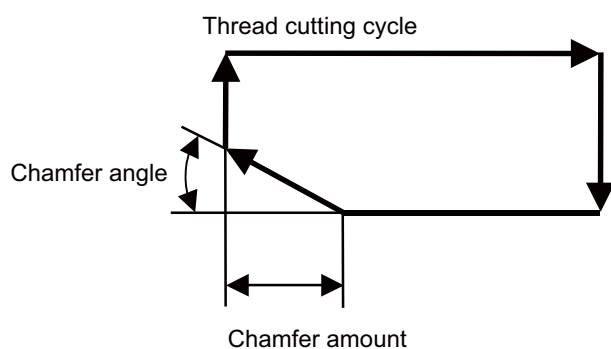

4.5.6 Circular Thread Cutting

	M850W	M830W	M850S	M830S	M80W	M80 TypeA	M80 TypeB	E80 TypeA	E80 TypeB	C80
M	—	—	—	—	—	—	—	—	—	—
L	△	△	△	△	○	○	—	—	—	—

Circular thread in which the lead is in longitudinal direction can be cut.
 This function can be used with the G code list 6 or 7.

Command format

```

G35(G36) Xx/Uu Zz/Ww { li Kk } Ff/Ee Qq ;
        Rr
    
```

G35 : Clockwise (CW)
(G36) : Counterclockwise (CCW)
Xx/Uu : X-axis arc end point coordinate
Zz/Ww : Z-axis arc end point coordinate
li : X-axis arc center (incremental value from start point to arc center)
Kk : Z-axis arc center (incremental value from start point to arc center)
Rr : Arc radius
Ff/Ee : Longitudinal axis (axis with most travel) direction lead
 (Ff: normal lead thread cutting, Ee: precise lead threads or inch threads)
Qq : Thread cutting start shift angle (0.000 to 360.000°)

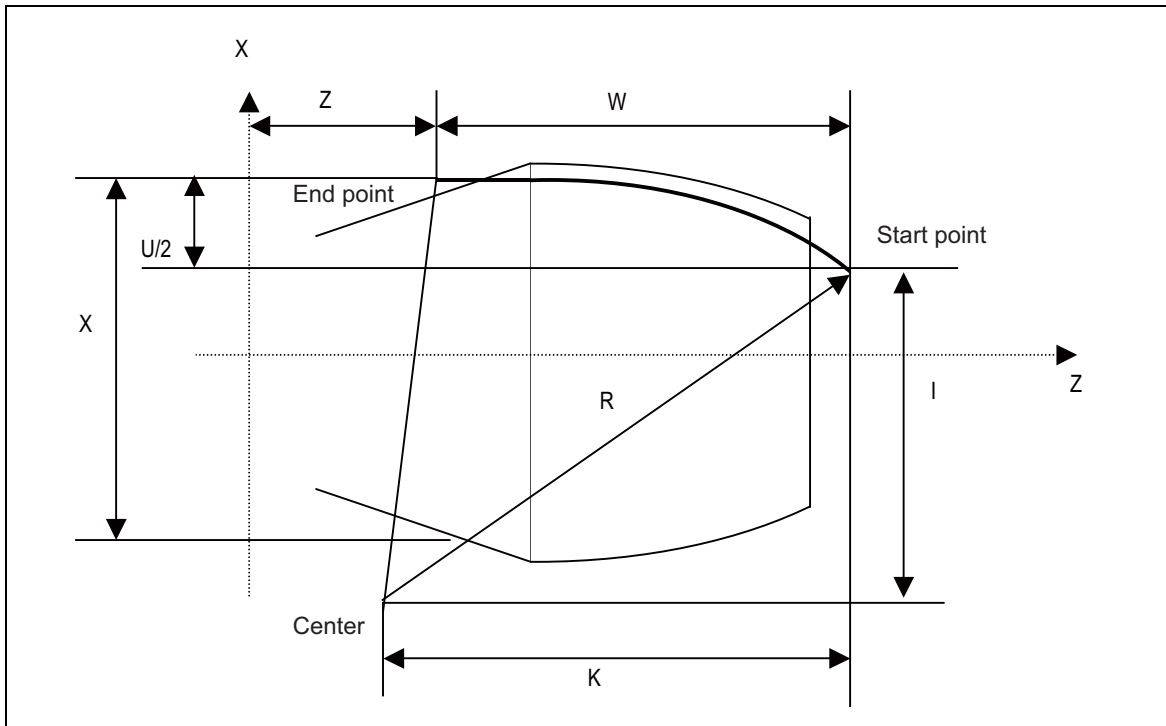

4.5.8 High-speed Synchronous Tapping (OMR-DD)

	M850W	M830W	M850S	M830S	M80W	M80 TypeA	M80 TypeB	E80 TypeA	E80 TypeB	C80
M	○	○	○	○	○	○	○	—	—	○
L	○	○	○	○	○	○	○	—	—	○

The servo axis directly detects and compensates of the spindle's delay in tracking by using the communication between drive unit over the high-speed optical servo network. By minimizing the synchronization error, the accuracy of the synchronous tapping is increased.

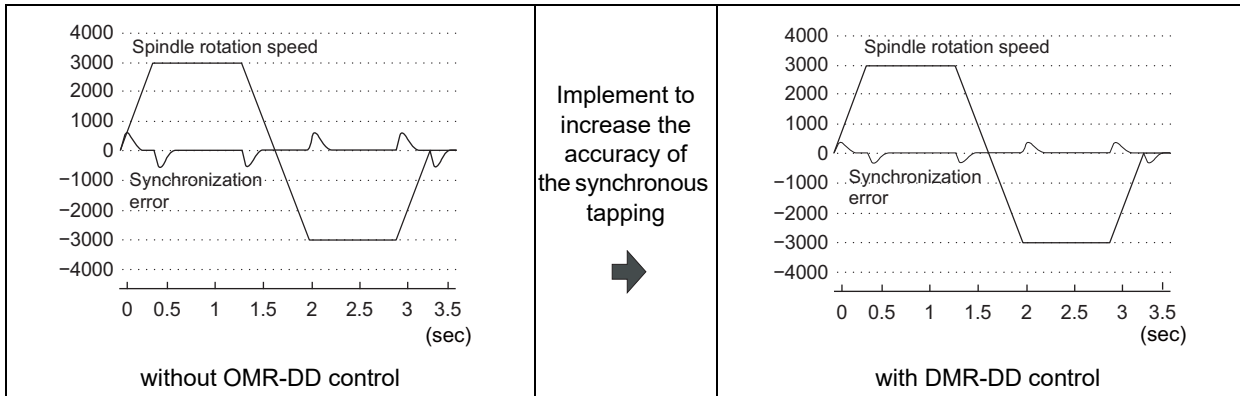

4.5.10 Thread Recutting

	M850W	M830W	M850S	M830S	M80W	M80 TypeA	M80 TypeB	E80 TypeA	E80 TypeB	C80
M	—	—	—	—	—	—	—	—	—	—
L	△	△	△	△	○	○	—	—	—	△

The function stores a thread groove position and compensates a start position of spindle thread cutting automatically so that the tool can pass along the memorized position of the thread groove at the thread cutting execution. Thread machined workpieces which have problems such as the thread number shortage, striped groove, etc., can be re-chucked and thread recut.

(1) Re-chucking of thread machined workpiece

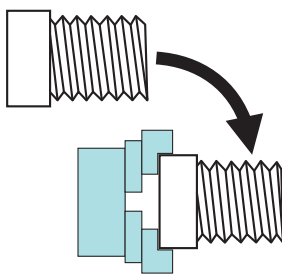

(2) Memorizing thread groove position (memorizing lead axis and spindle position)

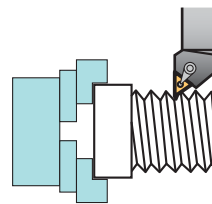

(3) Moving to start position after tool retract

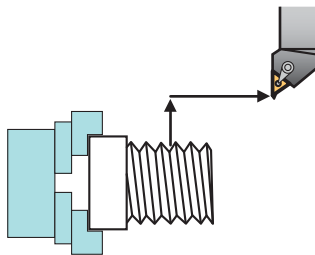

(4) Thread recutting ON and program operation start

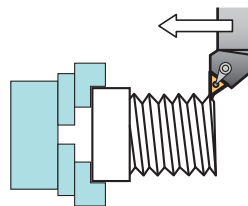

The start position of spindle thread cutting is automatically compensated with the memorized position of the lead axis and spindle.

Thread recutting correspondence table

Thread cutting command	Z direction feed thread	X direction feed thread
	Right-handed/Left-handed thread	Scroll thread
Thread cutting	○	○
Continuous thread	△ (Note 1)	△ (Note 1)
Variable lead thread	△ (Note 2)	△ (Note 2)
Fixed cycle for turning machining	○	○
Compound type fixed cycle for turning machining	△ (Note 3)	△ (Note 3)

○: Machinable △: Machinable with conditions ×: Impossible

Machinable with conditions (△)

- (Note 1) Continuous thread: Conduct a memorizing of thread recutting position at the groove on the first block of continuous thread.
- (Note 2) Variable lead thread: thread recutting is disable during an automatic operation with thread recutting enabled when the first thread cutting command is the variable lead thread cutting.
- (Note 3) Compound type fixed cycle: Thread re-cutting can be performed only for the workpiece which has been cut its finishing allowance.

4.5.11 Thread Cutting Override

	M850W	M830W	M850S	M830S	M80W	M80 TypeA	M80 TypeB	E80 TypeA	E80 TypeB	C80
M	—	—	—	—	—	—	—	—	—	—
L	△	△	△	△	○	○	—	—	—	△

The thread cutting feedrate can be changed by changing the spindle override depending on rough cutting, finish machining, etc.

The spindle speed during thread cutting is determined with the spindle override at the start of thread cutting.

4.5.12 Variable Feed Thread Cutting

	M850W	M830W	M850S	M830S	M80W	M80 TypeA	M80 TypeB	E80 TypeA	E80 TypeB	C80
M	—	—	—	—	—	—	—	—	—	—
L	△	△	△	△	○	○	—	—	—	△

This function changes the cutting feedrate by the spindle override at the time of the thread cutting. The machining condition during thread cutting can be changed.

4.5.13 Thread Cutting Time Constant Switch

	M850W	M830W	M850S	M830S	M80W	M80 TypeA	M80 TypeB	E80 TypeA	E80 TypeB	C80
M	○	○	○	○	○	○	○	○	○	—
L	○	○	○	○	○	○	○	○	○	—

"Thread cutting time constant" can be applied to the acceleration/deceleration time constant of the NC control axis during the thread cutting. Usually, incorrect lead parts occur at the start and the end of thread cutting due to the acceleration/deceleration of the NC control axis. However, the acceleration/deceleration time, which causes incorrect lead parts, can be reduced by applying the thread cutting time constant to the NC control axis during the thread cutting so that the incorrect thread parts can be reduced. Additionally, the machining time can be reduced as much as the acceleration/deceleration time reduction of thread cutting.

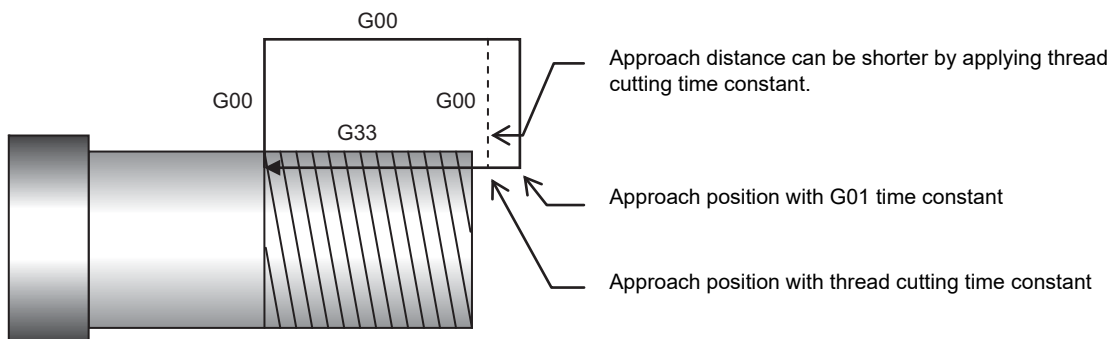
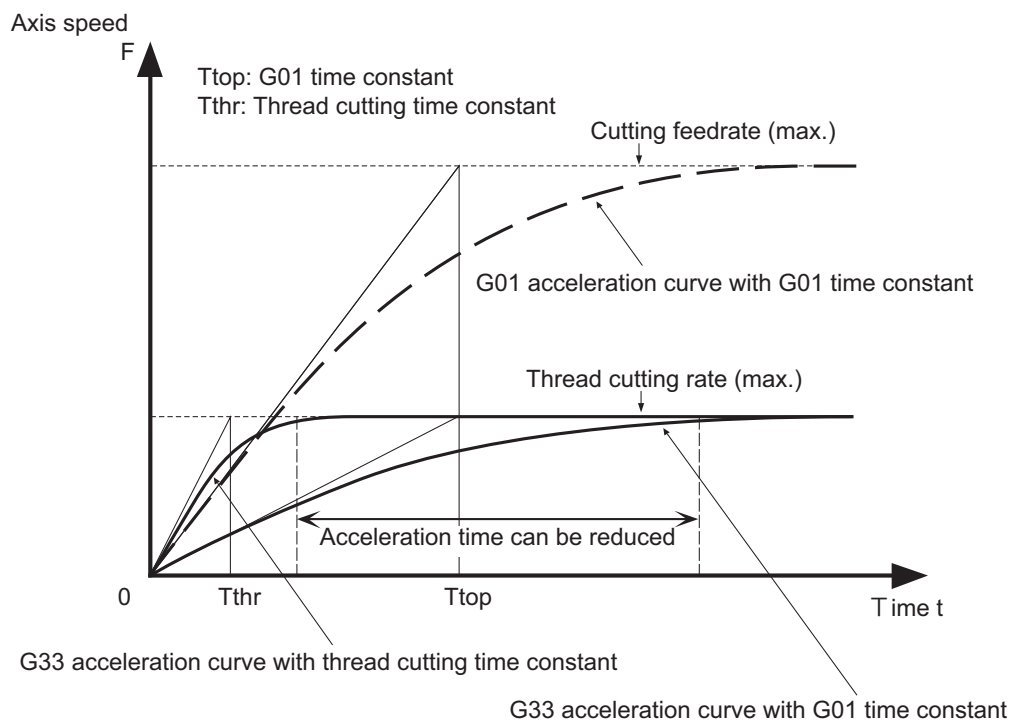

4.6 Manual Feed

4.6.1 Manual Rapid Traverse

	M850W	M830W	M850S	M830S	M80W	M80 TypeA	M80 TypeB	E80 TypeA	E80 TypeB	C80
M	○	○	○	○	○	○	○	○	○	○
L	○	○	○	○	○	○	○	○	○	○

When the manual rapid traverse mode is selected, the tool can be moved at the rapid traverse rate for each axis separately. Override can also be applied to the rapid traverse rate by means of the rapid traverse override function. Rapid traverse override can be set for each part system respectively.

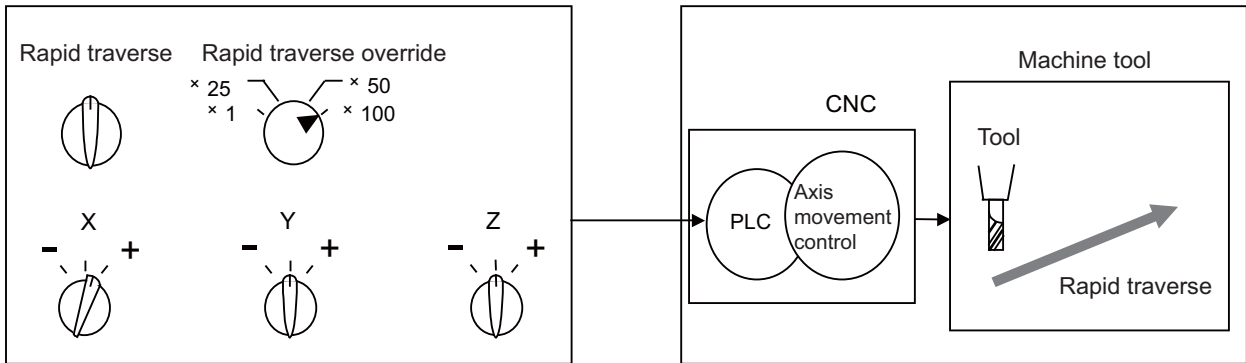

4.6.2 Jog Feed

	M850W	M830W	M850S	M830S	M80W	M80 TypeA	M80 TypeB	E80 TypeA	E80 TypeB	C80
M	○	○	○	○	○	○	○	○	○	○
L	○	○	○	○	○	○	○	○	○	○

When the jog feed mode is selected, the tool can be moved in the axis direction (+ or -) in which the machine is to be moved at the per-minute feed.

The jog feedrate can be set for each axis with the parameters.

If the jog feedrate is not set with the parameters, the jog feedrate is set with the PLC signal.

There are two methods for PLC signal which sets the jog feed rate: the code method and the value setting method.

The method to be used is selected by PLC signal for each part system. The signals of code and value setting methods are set for each part system.

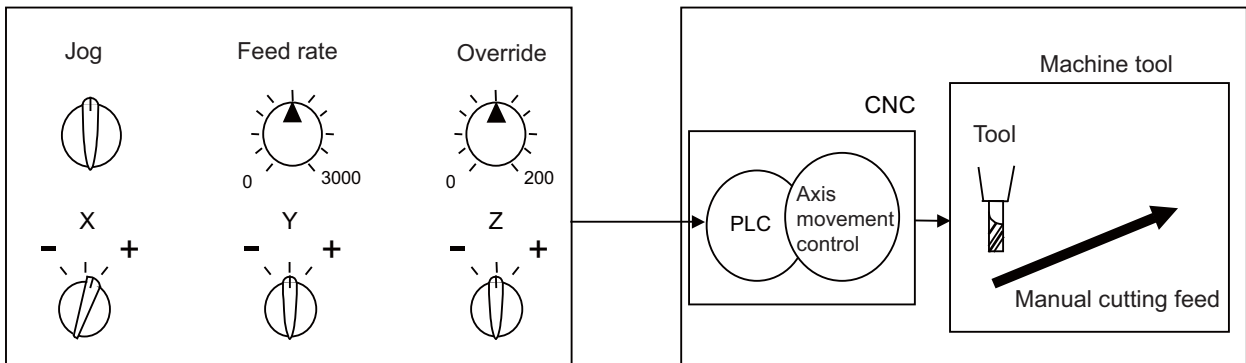

4.6.3 Incremental Feed

	M850W	M830W	M850S	M830S	M80W	M80 TypeA	M80 TypeB	E80 TypeA	E80 TypeB	C80
M	○	○	○	○	○	○	○	○	○	○
L	○	○	○	○	○	○	○	○	○	○

When the incremental feed mode is selected, the tool can be operated by an amount equivalent to the designated amount (incremental amount) in the axis direction each time the jog switch is pressed. The incremental feed amount is the amount obtained by multiplying the least command increment that was set with the parameter by the incremental feed magnification rate.

The incremental feed amount parameter and its magnification rate can be set for each part system respectively.

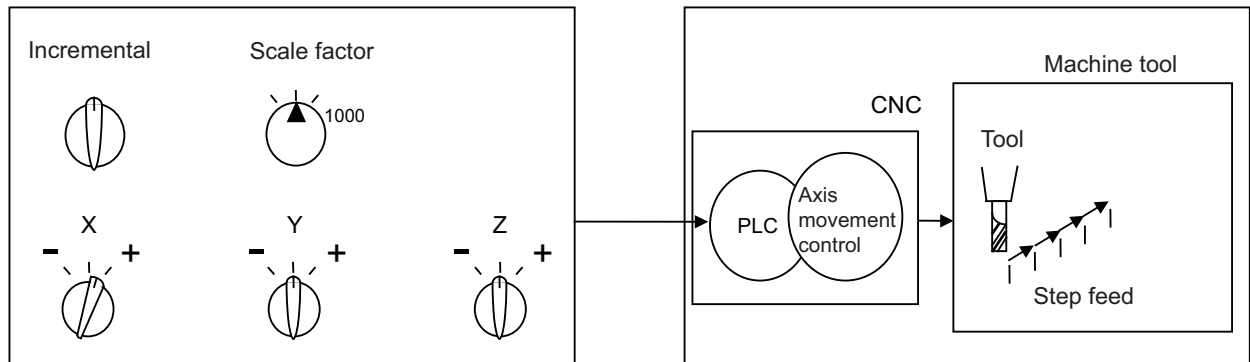

4.6.4 Handle Feed

	M850W	M830W	M850S	M830S	M80W	M80 TypeA	M80 TypeB	E80 TypeA	E80 TypeB	C80
M	○	○	○	○	○	○	○	○	○	○
L	○	○	○	○	○	○	○	○	○	○

In the handle feed mode, the machine can be moved in very small amounts by rotating the manual pulse generator. The scale can be selected from x1, x10, x100, x1000 or arbitrary value.

If the least command increment is 10nm or 1nm, the scale can be selected from x5000, x10000, x50000 or x100000, as well.

Individual axes can be moved in very small amounts separately by rotating the manual pulse generators installed on each of the axes.

(Note 1) The actual movement amount and scale may not match if the manual pulse generator is rotated quickly.

Up to three handles (manual pulse generators) can be used with the MITSUBISHI CNC.

The handles can be connected to the control unit and remote I/O unit. If the operation panel I/O unit is connected, the handle can also be connected to the operation panel I/O unit.

4.6.5 Manual Feedrate B

	M850W	M830W	M850S	M830S	M80W	M80 TypeA	M80 TypeB	E80 TypeA	E80 TypeB	C80
M	○	○	○	○	○	○	○	○	○	○
L	○	○	○	○	○	○	○	○	○	○

"Manual feedrate B" is a function that sets an arbitrary axis feedrate from the user PLC separately from the "manual feedrate". The "manual feedrate B" feedrate setting can be selected from the feedrate common for all axes and the feedrate independent of reach axis.

By combining the "manual feedrate B" function with the manual/automatic simultaneous function, an arbitrary axis can be moved at the "manual feedrate B" independently of the machining program operation even during automatic operation. Similarly, if the jog mode and other manual operation mode are set simultaneously, an arbitrary axis can be moved at a speed independent from the "manual feedrate" even during the manual operation mode.

The "manual feedrate B" function can move an axis at a speed different from the "manual feedrate". This is not affected by dry run, or by manual or cutting override, so an arbitrary axis can be moved independently even in operations during automatic operation or override during manual axis movement.

The relation of the "manual feedrate B" and "manual feedrate" is shown below.

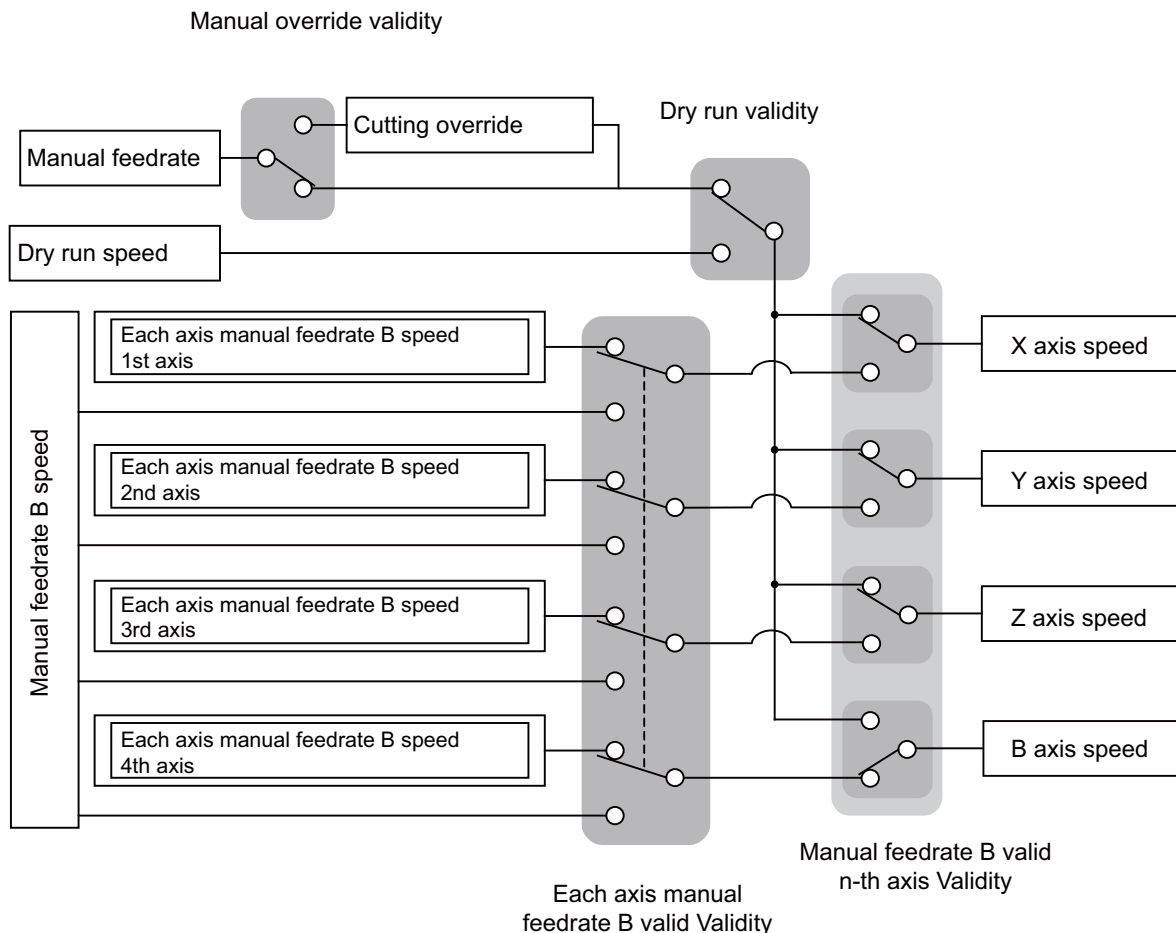

(Note) For the axis to which manual feedrate B is applied, the feedrate is not displayed on the screen.

4.6.6 Manual Feedrate B Surface Speed Control

	M850W	M830W	M850S	M830S	M80W	M80 TypeA	M80 TypeB	E80 TypeA	E80 TypeB	C80
M	△	△	△	△	—	—	—	—	—	—
L	—	—	—	—	—	—	—	—	—	—

When using the manual feedrate B function and machining by moving the orthogonal axis while rotating the rotary table, the tool nose and workpiece's relative speed will drop as the tool nears the rotation center if the table rotation speed remains under the set conditions. This function controls the table rotation speed according to the distance from the rotation center.

As shown below, the distance (radius) from the rotation center at two points and the rotary axis speed at each point is set in the parameters. When the "manual feedrate B constant surface speed control valid" signal is turned ON, the rotary axis speed will be automatically calculated according to the current radius R.

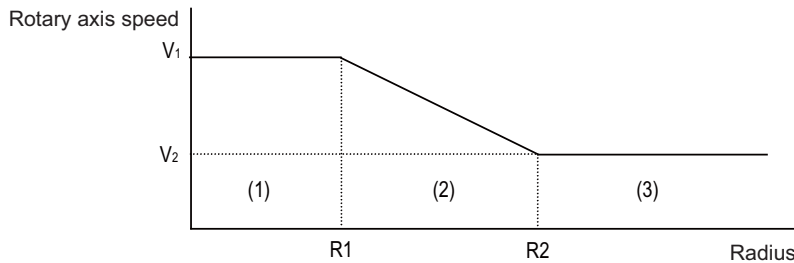

- (1) If $R \leq R1$, then $V1$ will be applied.
- (2) If $R1 < R < R2$, the speed V is calculated with the following expression.

$$V = \frac{(V_2 - V_1)}{(R_2 - R_1)} * (R - R_1) + V_1$$

- (3) If $R_2 \leq R$, then $V2$ will be applied.

Override can be applied in the range of 0 to 200% in respect to the rotary axis's speed for which the manual feedrate B surface speed control is valid.

This function can be used with a rotary axis for which the manual feedrate B function is valid.

The manual feedrate B speed and each axis' manual feedrate B speed which are issued from the user PLC is ignored for an axis for which this function is valid.

4.6.8 Manual Speed Clamp

	M850W	M830W	M850S	M830S	M80W	M80 TypeA	M80 TypeB	E80 TypeA	E80 TypeB	C80
M	○	○	○	○	○	○	○	○	○	○
L	○	○	○	○	○	○	○	○	○	○

The maximum speed for manual feed can be switched to the rapid traverse rate or the manual feed clamp speed. This function is usable, for instance, when the axis speed needs to be clamped at an arbitrary rate for performing a manual feed with a cutting cover opened.

The clamp speed is switched with the parameter or PLC signal.

The manual feed clamp speed can be set to an arbitrary speed with the parameter.

The manual feedrate can be applied for operation modes as follows:

- Jog mode
- Handle mode
- Incremental mode
- Manual reference position return (high-speed) mode

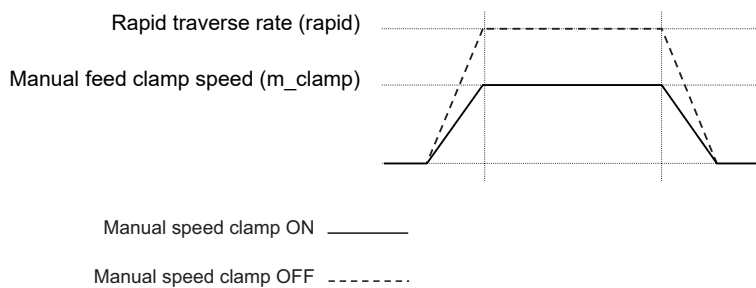

4.7 Dwell

With this function, the program command temporarily stops the machine movement and puts the machine into standby status so that the starting time of the next block can be delayed.

4.7.1 Dwell (Time-based Designation)

	M850W	M830W	M850S	M830S	M80W	M80 TypeA	M80 TypeB	E80 TypeA	E80 TypeB	C80
M	○	○	○	○	○	○	○	○	○	○
L	○	○	○	○	○	○	○	○	○	○

When G04 is commanded in the asynchronous feed mode (G94), the machine waits for the specified amount of time before executing the next block.

Command format

G94 G04 X/U__ ; or G94 G04 P__ ; X/P/U : Dwell time

- (1) G94 is not necessary in the asynchronous feed mode (G94).
- (2) The decimal point command is valid for dwell time designated with the address "X" or "U".
- (3) The decimal point command is valid for dwell time designated with the address "P", depending on the parameter setting. When the decimal point command is set to be invalid by the parameter, the number below the decimal point of the P command value is ignored.
- (4) When the decimal point command is valid or invalid, the dwell time command range for each status is as follows.

Command range when the decimal point command is valid	Command range when the decimal point command is invalid
0 to 99999.999 (s)	0 to 99999999 (ms)

- (5) When the dwell is commanded with no decimal point, the setting unit for dwell time can be changed by setting the parameter. (M8 Series)

4.7.2 Dwell (Revolution-based Designation)

	M850W	M830W	M850S	M830S	M80W	M80 TypeA	M80 TypeB	E80 TypeA	E80 TypeB	C80
M	—	—	—	—	—	—	—	—	—	—
L	○	○	○	○	○	○	○	○	○	○

When G04 is commanded in the synchronous feed mode (G95), the machine waits for the spindle to rotate for the number of the revolutions designated.

Command format

G95 G04 X/U __ D __ ; or G95 G04 P __ D __ ;	
X/P/U	: Number of revolutions for dwell
D	: Dwell target spindle (For command using the spindle number, the spindle number should be within the number of spindles for specifications. For command using the spindle name, the number from 1 to 9 is valid for the spindle name.)

- (1) G95 is not necessary when the D command is assigned in the same block as G04.
- (2) G95 is not necessary in the synchronous feed mode (G95).
- (3) The decimal point command is valid for the number of revolutions for dwell designated with the address "X" or "U".
- (4) The decimal point command is valid for the number of revolutions for dwell designated with the address "P", depending on the parameter setting. When the decimal point command is set to be invalid by the parameter, the number below the decimal point of the P command value is ignored.
- (5) When the decimal point command is valid or invalid, the command range of number of revolution for dwell is as follows for each status.

Command range when the decimal point command is valid	Command range when the decimal point command is invalid
0 to 99999.999 (rev)	0 to 99999999 (0.001rev)

- (6) When the dwell is commanded with no decimal point, the setting unit for the number of revolution can be changed by setting the parameter. (M8 Series)

5

Program Memory/Editing

5.1 Memory Capacity

Machining programs are stored in the NC memory, DS, and external memory device (front SD card, built-in disk of display unit, etc.).

When using devices such as the built-in disk (HD) of the display unit, DS and memory card, mass-editing, which is carried out on those devices, is possible.

The data size that can be handled in the mass-editing differs depending on the devices.

5.1.1 Memory Capacity (Number of Programs Stored)

[M system]

Memory capacity (number of programs stored)	M850W	M830W	M850S	M830S	M80W	M80 TypeA	M80 TypeB	E80 TypeA	E80 TypeB	C80
230 KB [600m] (400 programs)	—	—	—	—	—	—	—	—	—	—
500 KB [1280m] (1000 programs)	○	○	○	○	○	○	○	○	○	○
1000 KB [2560m] (1000 programs)	△	△	△	△	—	—	—	—	—	△ (*1)
2000 KB [5120m] (1000 programs)	△	△	△	△	—	—	—	—	—	△ (*1)

[L system]

Memory capacity (number of programs stored)	M850W	M830W	M850S	M830S	M80W	M80 TypeA	M80 TypeB	E80 TypeA	E80 TypeB	C80
230 KB [600m] (400 programs)	—	—	—	—	—	—	—	○	○	—
500 KB [1280m] (1000 programs)	○	○	○	○	○	○	○	—	—	○
1000 KB [2560m] (1000 programs)	△	△	△	△	—	—	—	—	—	△ (*1)
2000 KB [5120m] (1000 programs)	△	△	△	△	—	—	—	—	—	△ (*1)

(*1) Up to 2000 programs for C80

(Note) The tape length for the multi-part system specifications is the total for all part systems.

5.2 Editing

5.2.1 Program Editing

	M850W	M830W	M850S	M830S	M80W	M80 TypeA	M80 TypeB	E80 TypeA	E80 TypeB	C80
M	○	○	○	○	○	○	○	○	○	○
L	○	○	○	○	○	○	○	○	○	○

The following editing functions are possible.

(1) Program erasing

- (a) Machining programs can be erased individually or totally.

(2) Program filing

- (a) This function displays a list of the machining programs stored (registered) in the controller memory.
 (b) The programs are displayed in ascending order.
 (c) Comments can be added to corresponding program numbers.

(3) Program copying

- (a) Machining programs stored in the controller memory can be copied, condensed or merged.
 (b) The program No. of the machining programs in the memory can be changed.

(4) Program editing

- (a) Overwriting, inserting and erasing can be done per character.

(5) Mass editing (M8 series)

There are regular editing and mass-editing for program editing. The specification and restrictions are different between the regular editing and mass-editing.

Refer to the table below for conditions to be mass-editing and its maximum editing size.

Series	Conditions to be mass-editing	Maximum editing size
M800 Series M80W Series	- The storage destination for the machining program to be opened is either the built-in disk (HD) of the display unit, USB memory, memory card or DS. - A file size is 1.0 MB or larger. (The size could be 2.0 MB or larger, depending on the parameter settings.)	1 GB
M80 Series E80 Series	- The storage destination for the machining program to be opened is either memory card, USB memory or DS. - A file size is 0.5 MB or larger.	

5.2.2 Background Editing

	M850W	M830W	M850S	M830S	M80W	M80 TypeA	M80 TypeB	E80 TypeA	E80 TypeB	C80
M	○	○	○	○	○	○	○	○	○	○
L	○	○	○	○	○	○	○	○	○	○

This function enables one machining program to be created or editing while another program is being run.

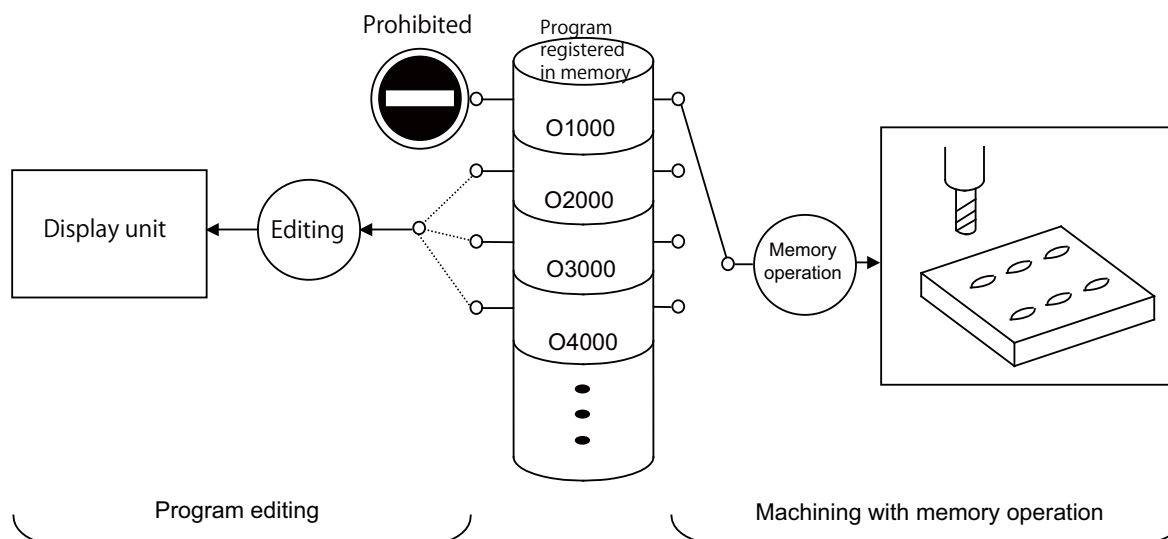

- (1) The data of the machining programs being used in memory operation can be displayed and scrolled on the setting and display unit, but data cannot be added, revised or deleted.
- (2) The editing functions mentioned in the preceding section can be used at any time for machining programs which are not being used for memory operation.
This makes it possible to prepare and edit the next program for machining, and so the machining preparations can be made more efficiently.
- (3) The machining program will not be searched as the operation target even when searched in the edit screen.

5.2.3 Buffer Correction

	M850W	M830W	M850S	M830S	M80W	M80 TypeA	M80 TypeB	E80 TypeA	E80 TypeB	C80
M	○	○	○	○	○	○	○	○	○	○
L	○	○	○	○	○	○	○	○	○	○

During automatic operation (including memory, SD card, USB memory or DS operation) or MDI operation, this function initiates single block stop and enables the next command to be corrected or changed.

Only memory or DS operation allows the changes with buffer corrections to be updated in the machining program.

When a program error has occurred, the function enables the block in which the error occurred to be corrected and operation to be resumed without having to perform NC resetting.

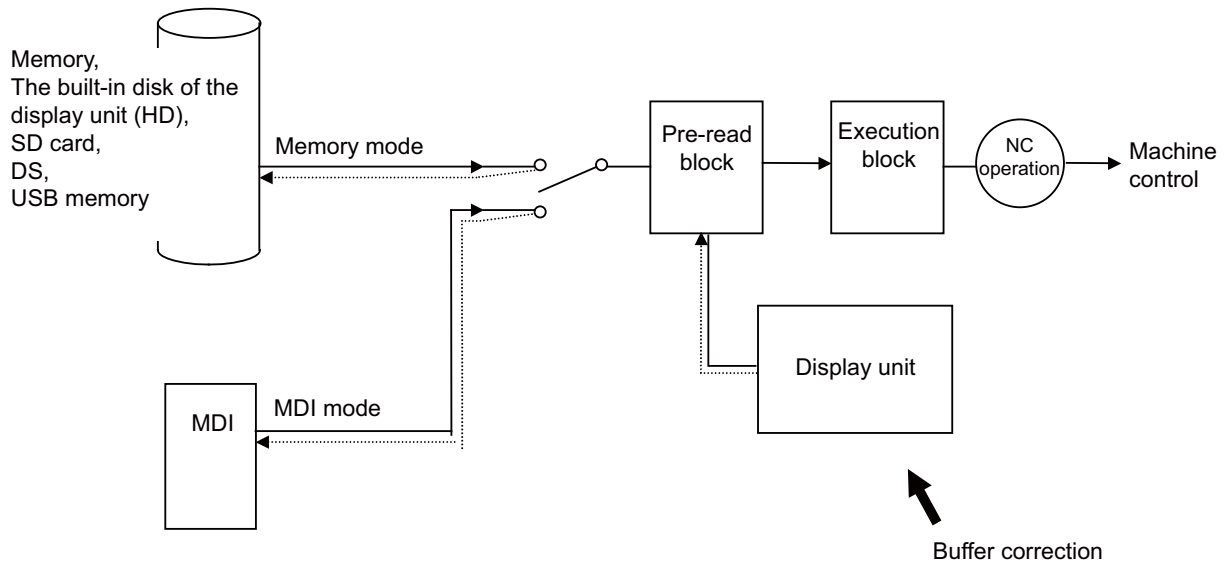

5.2.5 Multi-part System Simultaneous Program Editing

	M850W	M830W	M850S	M830S	M80W	M80 TypeA	M80 TypeB	E80 TypeA	E80 TypeB	C80
M	○	○	○	○	—	—	—	—	—	—
L	○	○	○	○	○	○	○	—	—	○

When an operation to open a machining program in the NC memory is performed on the edit screen, machining programs are opened in the right and left areas at the same time; the specified machining program of the displayed part system in the edit area being selected and the machining program of another part system with the same name in the unselected edit area.

5.2.6 Special Program Editing Display for Synchronization between Part Systems

	M850W	M830W	M850S	M830S	M80W	M80 TypeA	M80 TypeB	E80 TypeA	E80 TypeB	C80
M	△	△	△	△	○	○	—	—	—	—
L	△	△	△	△	○	○	○	—	—	△

Pressing the [Synchro view] menu enables synchronized display of the left- and right-side programs aligned using the timing synchronization symbols, when all the following conditions are met:

- Multi-part system program management is ON
- Multi-program display type is selected
- The left and right edit areas are displaying the same named programs of different part systems stored on the NC memory

5.2.7 Finish Shape View Programming

	M850W	M830W	M850S	M830S	M80W	M80 TypeA	M80 TypeB	E80 TypeA	E80 TypeB	C80
M	△	△	△	△	○	○	○	—	—	—
L	△	△	△	△	○	○	○	○	○	—

This function shows the machining shape according to the command at the time the machining program is input, and is intended to eliminate mistakes in programming.

Therefore, the machining shape can be confirmed easily without performing the automatic operation or the graphic check.

(Example) For a new program file, confirm the finish shape by inputting the machining program.

The input machining program will be reflected in the shape.
 * In this example, as the cutting is not performed with G54, the shape will not be changed.

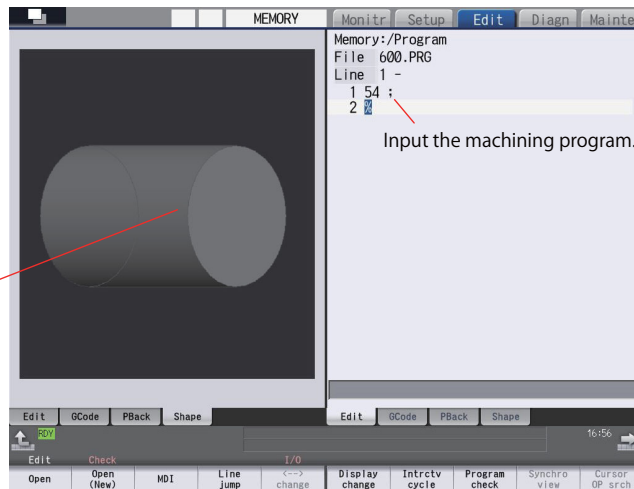

When inputting the machining program continuously ...

The input machining program will be reflected in the shape.

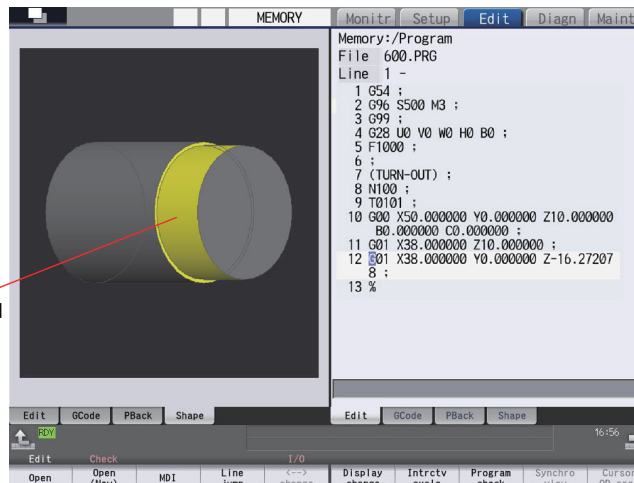

6

Operation and Display

6.1 Structure of Operation/Display Panel

Setting display unit consists of the display and keyboard unit.

Refer to "Specifications Manual (Hardware)" for details.

(Note) For Separated-type color touchscreen display (19-type LCD TFT/Windows8), only software keyboard is available and there is no hardware keyboard.

6.1.1 Color Display (8.4-type LCD TFT)

	M850W	M830W	M850S	M830S	M80W	M80 TypeA	M80 TypeB	E80 TypeA	E80 TypeB	C80
M	—	—	—	—	—	□	□	○	○	—
L	—	—	—	—	—	□	□	○	○	—

6.1.2 Color Touchscreen Display (10.4-type LCD TFT)

	M850W	M830W	M850S	M830S	M80W	M80 TypeA	M80 TypeB	E80 TypeA	E80 TypeB	C80
M	—	—	□	□	—	□	□	—	—	—
L	—	—	□	□	—	□	□	—	—	—

6.1.3 Color Touchscreen Display (15-type LCD TFT)

	M850W	M830W	M850S	M830S	M80W	M80 TypeA	M80 TypeB	E80 TypeA	E80 TypeB	C80
M	—	—	□	□	—	□	□	—	—	—
L	—	—	□	□	—	□	□	—	—	—

6.1.4 Separated-type Color Display (8.4-type LCD TFT)

	M850W	M830W	M850S	M830S	M80W	M80 TypeA	M80 TypeB	E80 TypeA	E80 TypeB	C80
M	—	—	—	—	□	—	—	—	—	—
L	—	—	—	—	□	—	—	—	—	—

6.1.5 Separated-type Color Touchscreen Display (10.4-type LCD TFT)

	M850W	M830W	M850S	M830S	M80W	M80 TypeA	M80 TypeB	E80 TypeA	E80 TypeB	C80
M	□	□	—	—	□	—	—	—	—	—
L	□	□	—	—	□	—	—	—	—	—

6.1.6 Separated-type Color Touchscreen Display (15-type LCD TFT)

	M850W	M830W	M850S	M830S	M80W	M80 TypeA	M80 TypeB	E80 TypeA	E80 TypeB	C80
M	□	□	—	—	□	—	—	—	—	—
L	□	□	—	—	□	—	—	—	—	—

6.1.7 Separated-type Color Touchscreen Display (15-type LCD TFT/Windows8)

	M850W	M830W	M850S	M830S	M80W	M80 TypeA	M80 TypeB	E80 TypeA	E80 TypeB	C80
M	□	□	—	—	□	—	—	—	—	—
L	□	□	—	—	□	—	—	—	—	—

6.1.8 Separated-type Color Touchscreen Display (19-type LCD TFT/Windows8)

	M850W	M830W	M850S	M830S	M80W	M80 TypeA	M80 TypeB	E80 TypeA	E80 TypeB	C80
M	□	□	—	—	□	—	—	—	—	—
L	□	□	—	—	□	—	—	—	—	—

6.1.9 Separated-type Color Touchscreen Display (19-type Horizontal LCD TFT/Windows8)

	M850W	M830W	M850S	M830S	M80W	M80 TypeA	M80 TypeB	E80 TypeA	E80 TypeB	C80
M	□	□	—	—	□	—	—	—	—	—
L	□	□	—	—	□	—	—	—	—	—

6.1.11 GOT (GOT2000 Series GT27/GT25 12.1/10.4/8.4/5.7)

	M850W	M830W	M850S	M830S	M80W	M80 TypeA	M80 TypeB	E80 TypeA	E80 TypeB	C80
M	—	—	—	—	—	—	—	—	—	○
L	—	—	—	—	—	—	—	—	—	○

6.2 Operation Methods and Functions

6.2.1 Operation Input

	M850W	M830W	M850S	M830S	M80W	M80 TypeA	M80 TypeB	E80 TypeA	E80 TypeB	C80
M	<input type="radio"/>	<input type="radio"/>	<input type="radio"/>	<input type="radio"/>	<input type="radio"/>	<input type="radio"/>	<input type="radio"/>	<input type="radio"/>	<input type="radio"/>	<input type="radio"/>
L	<input type="radio"/>	<input type="radio"/>	<input type="radio"/>	<input type="radio"/>	<input type="radio"/>	<input type="radio"/>	<input type="radio"/>	<input type="radio"/>	<input type="radio"/>	<input type="radio"/>

In addition to the method of directly inputting numeric data, a method to input the operation results using four rules operators and function symbols can be used for specific data settings.

Numeric values, function symbols, operators and parentheses () are combined and set in the data setting area. The operation results appear when the INPUT key is pressed. If the INPUT key is pressed again, the data is processed and displayed on the screen. The contents in the data setting area are erased.

Examples of operator settings and results			Function symbols, setting examples and results			
Operation	Setting example	Operation results	Function	Function symbol	Setting example	Operation results
Addition	= 100+50	150.000	Absolute value	ABS	= ABS(50-60)	10
Subtraction	= 100-50	50.000	Square root	SQRT	= SQRT(3)	1.732
Multiplication	= 12.3*4	49.200	Sine	SIN	= SIN(30)	0.5
Division	= 100/3	33.333	Cosine	COS	= COS(15)	0.966
Function	= 1.2*(2.5+SQRT(4))	5.4	Tangent	TAN	= TAN(45)	1
			Arc tangent	ATAN	= ATAN(1.3)	52.431

6.2.2 Absolute/Incremental Setting

	M850W	M830W	M850S	M830S	M80W	M80 TypeA	M80 TypeB	E80 TypeA	E80 TypeB	C80
M	<input type="radio"/>	<input type="radio"/>	<input type="radio"/>	<input type="radio"/>	<input type="radio"/>	<input type="radio"/>	<input type="radio"/>	<input type="radio"/>	<input type="radio"/>	<input type="radio"/>
L	<input type="radio"/>	<input type="radio"/>	<input type="radio"/>	<input type="radio"/>	<input type="radio"/>	<input type="radio"/>	<input type="radio"/>	<input type="radio"/>	<input type="radio"/>	<input type="radio"/>

When setting the data, the absolute/incremental setting can be selected from the menu.

The absolute/incremental settings can be selected on the following screens.

- Common variable screen
- Tool compensation amount screen
- Coordinate system offset screen

6.2.3 Multiple Display Connection

	M850W	M830W	M850S	M830S	M80W	M80 TypeA	M80 TypeB	E80 TypeA	E80 TypeB	C80
M	—	—	—	—	—	—	—	—	—	○ (GOT)
L	—	—	—	—	—	—	—	—	—	○ (GOT)

By attaching an Ethernet hub, one CNC can be switched to display up to 8 setting display units (CNC monitor2 for GOT or NC Monitor2) at a time. (However, depending on the specification of machine operation panel, there might be the limitation of the maximum number of the connectable units.)

6.2.4 Common Display to Multiple NCs

	M850W	M830W	M850S	M830S	M80W	M80 TypeA	M80 TypeB	E80 TypeA	E80 TypeB	C80
M	—	—	—	—	—	—	—	—	—	○ (GOT)
L	—	—	—	—	—	—	—	—	—	○ (GOT)

By attaching an Ethernet hub, one setting display unit can be switched to display up to 64 CNCs. (However, depending on the specification of machine operation panel, there might be the limitation of the maximum number of the connectable units.)

6.2.5 Displayed Part System Switch

	M850W	M830W	M850S	M830S	M80W	M80 TypeA	M80 TypeB	E80 TypeA	E80 TypeB	C80
M	○	○	○	○	○	○	—	—	—	○
L	○	○	○	○	○	○	○	—	—	○

The part system displayed on the screen can be changed with the [←→] keys.

The number of displayed part systems is counted by one each time the [←→] keys are pressed. The screen corresponding to that part system opens.

If the number of displayed part systems exceeds the valid number of part systems, the number of displayed part systems will return to 1.

6.2.6 Menu List

	M850W	M830W	M850S	M830S	M80W	M80 TypeA	M80 TypeB	E80 TypeA	E80 TypeB	C80
M	○	○	○	○	○	○	○	○	○	○
L	○	○	○	○	○	○	○	○	○	○

The menu list function displays the menu configuration of each screen as a list making it possible to directly select the menu for other screens.

When the cursor is moved to the menu, the outline of that menu's functions will also appear. The menu can be selected while checking the details of the menu.

6.2.7 Display Switch by Operation Mode

	M850W	M830W	M850S	M830S	M80W	M80 TypeA	M80 TypeB	E80 TypeA	E80 TypeB	C80
M	○	○	○	○	○	○	○	○	○	○
L	○	○	○	○	○	○	○	○	○	○

The screen display changes when the screen mode selection switch is changed.

The details corresponding to the operation mode are displayed.

6.2.8 External Signal Display Switch

	M850W	M830W	M850S	M830S	M80W	M80 TypeA	M80 TypeB	E80 TypeA	E80 TypeB	C80
M	○	○	○	○	○	○	—	—	—	○
L	○	○	○	○	○	○	—	—	—	○

The screen display changes with the signal from PLC.

6.2.9 Screen Saver

	M850W	M830W	M850S	M830S	M80W	M80 TypeA	M80 TypeB	E80 TypeA	E80 TypeB	C80
M	○	○	○	○	○	○	○	○	○	○ (GOT)
L	○	○	○	○	○	○	○	○	○	○ (GOT)

The screen saver function protects the screen display unit by turning the backlight OFF after the time set in the parameters has elapsed. The backlight is turned OFF after a certain period of time (automatic change function) or after the key operations (manual change function).

The screen is displayed again by pressing any key, or by touching anywhere on the screen if the display unit carries a touch-sensitive screen.

6.2.10 Parameter Guidance

	M850W	M830W	M850S	M830S	M80W	M80 TypeA	M80 TypeB	E80 TypeA	E80 TypeB	C80
M	○	○	○	○	○	○	○	○	○	○
L	○	○	○	○	○	○	○	○	○	○

The parameter guidance function displays the details of the parameters according to the state of the screen currently being displayed.

If the ? key is pressed on any screen, the parameter guidance window will open. If a pop-up window other than the parameter guidance window is opened, the parameter guidance window will open over the currently opened pop-up window.

For the display unit with a touch-sensitive screen, if you hold down the parameter data area (tap the target and keep your finger down for a while), the guidance of that parameter is displayed.

6.2.11 Alarm Guidance

	M850W	M830W	M850S	M830S	M80W	M80 TypeA	M80 TypeB	E80 TypeA	E80 TypeB	C80
M	○	○	○	○	○	○	○	○	○	○
L	○	○	○	○	○	○	○	○	○	○

The alarm guidance displays the alarm message, details and remedy for the alarm currently issued.

By utilizing the guidance information, identify the cause from possible factors and determine the countermeasures.

When a multiple number of alarms are issued at the same time, guidance will be displayed for all the alarm issued.

6.2.12 Machining Program Input Mistake Check Warning

	M850W	M830W	M850S	M830S	M80W	M80 TypeA	M80 TypeB	E80 TypeA	E80 TypeB	C80
M	△	△	△	△	—	—	—	—	—	—
L	△	△	△	△	—	—	—	—	—	—

If an illegal input is found in the decimal point after the current cursor position, the cursor will move to that position, and a warning message will appear.

If this function is ON when editing the program, the decimal point will be checked for the block each time an edit key (alphabet, number, symbol, Delete, etc.) is pressed. The block is not checked when the cursor keys or page feed keys are pressed.

The warning for illegal machining program can also be issued while editing an MDI program.

The comment block is also subject to the warning for illegal machining program.

A warning does not appear in the following cases.

- (1) When the data in the address subject to the illegal decimal point input is "0", a warning will not be issued regardless of whether there is a decimal point or not. (Example: A warning is not issued for "X0".)
- (2) When the data in the address subject to the illegal decimal point input is omitted, a warning will not be issued. (Example: A warning is not issued for "G28XYZ".)
- (3) Blocks containing "[" or "]" are not subject to the warning for illegal machining program.

6.2.14 Screenshot Capture

	M850W	M830W	M850S	M830S	M80W	M80 TypeA	M80 TypeB	E80 TypeA	E80 TypeB	C80
M	—/○	—/○	○	○	—/○	○	○	○	○	○ (GOT)
L	—/○	—/○	○	○	—/○	○	○	○	○	○ (GOT)

* Specifications of separated-type display are classified with "Windows-based" and "non-Windows-based"

This function allows to output a bitmap file of a screen displayed on the setting and display unit to USB memory or SD card.

6.2.15 User Selectable Menu Configuration

	M850W	M830W	M850S	M830S	M80W	M80 TypeA	M80 TypeB	E80 TypeA	E80 TypeB	C80
M	○	○	○	○	○	○	○	○	○	○
L	○	○	○	○	○	○	○	○	○	○

This function allows to change the display order of operations, procedure and edit screen, and to change display/non-display selection.

6.2.16 PC-NC Network Automatic Connection

	M850W	M830W	M850S	M830S	M80W	M80 TypeA	M80 TypeB	E80 TypeA	E80 TypeB	C80
M	○/—	○/—	—	—	○/—	—	—	—	—	—
L	○/—	○/—	—	—	○/—	—	—	—	—	—

* Specifications of separated-type display are classified with "Windows-based" and "non-Windows-based"

This function supports to restore the connection when the network connection cannot be created between the display unit and the control unit.

When the connection is not established even after the time out has expired, the connectable control unit IP address list appears. From the IP address list, the network connection can be re-established and restored when the IP address, which is to be connected with the control unit, is selected.

6.2.17 Device Open Parameter

	M850W	M830W	M850S	M830S	M80W	M80 TypeA	M80 TypeB	E80 TypeA	E80 TypeB	C80
M	○	○	○	○	○	○	○	○	○	—
L	○	○	○	○	○	○	○	○	○	—

This function can set or change the user backed up area of the PLC device from the NC screen.

The following settings are available from the NC screen.

- Divide the device area accordance with the specifications of the machine maker and set and display for each divided area.
- Switch the display format or data type for each divided area.

6.2.18 SRAM Open Parameter

	M850W	M830W	M850S	M830S	M80W	M80 TypeA	M80 TypeB	E80 TypeA	E80 TypeB	C80
M	○	○	○	○	○	○	○	○	○	—
L	○	○	○	○	○	○	○	○	○	—

This function can set or change the SRAM open area for the machine maker from the NC screen.

The following settings are available from the NC screen.

- Divide the SRAM area accordance with the specifications of the machine maker and set and display for each divided area.
- Switch the display format or data type for each divided area.

6.2.19 MTB Selectable Menu Configuration

	M850W	M830W	M850S	M830S	M80W	M80 TypeA	M80 TypeB	E80 TypeA	E80 TypeB	C80
M	○	○	○	○	○	○	○	○	○	○
L	○	○	○	○	○	○	○	○	○	○

Menu items on the "Monitor", "Setup", and "Edit" screens (of MITSUBISHI standard format) can be moved within a screen or hidden as desired. The custom screen menu items added by machine tool builders, to the contrary, cannot be moved or hidden.

6.2.20 Remote Desktop Connection

	M850W	M830W	M850S	M830S	M80W	M80 TypeA	M80 TypeB	E80 TypeA	E80 TypeB	C80
M	—/○	—/○	△	△	—/○	○	○	—	—	—
L	—/○	—/○	△	△	—/○	○	○	—	—	—

* Specifications of separated-type display are classified with "Windows-based" and "non-Windows-based"

Remote desktop connection enables you to operate an external personal computer through the NC screen when UltraVNC server is installed in the PC.

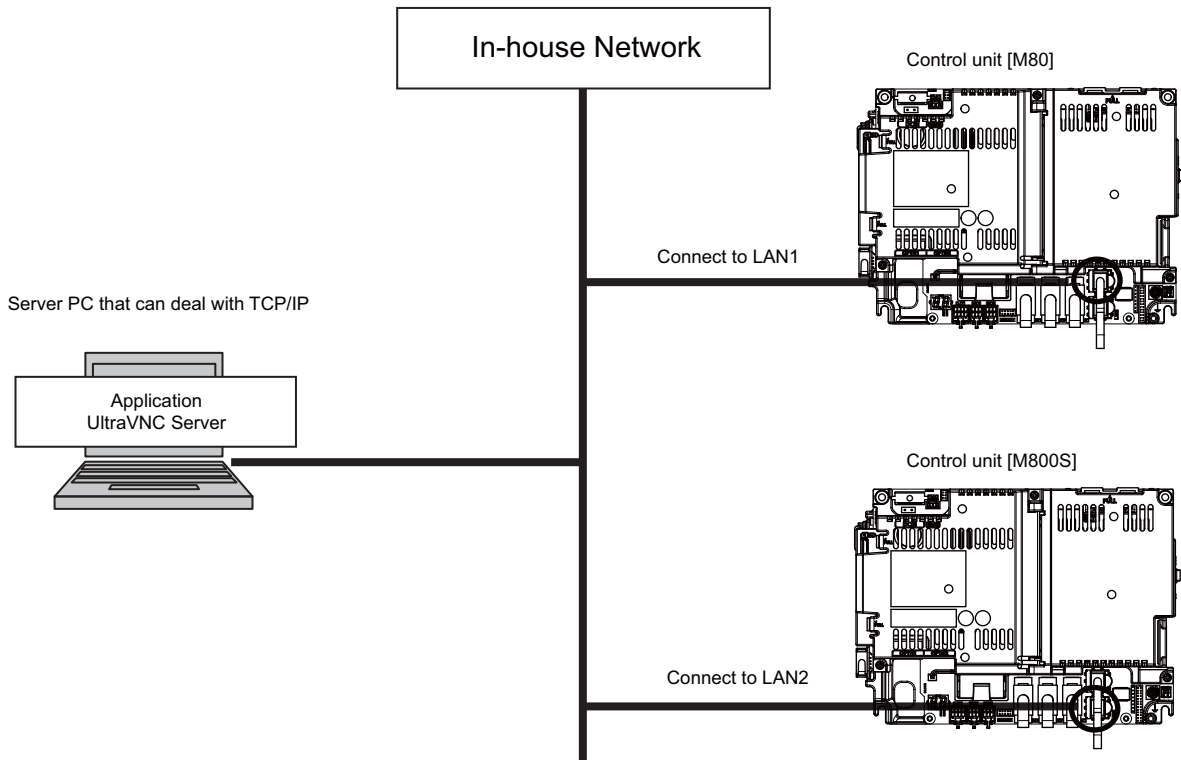

6.2.21 VNC Server

	M850W	M830W	M850S	M830S	M80W	M80 TypeA	M80 TypeB	E80 TypeA	E80 TypeB	C80
M	- / Δ	- / Δ	Δ	Δ	- / O	O	O	-	-	-
L	- / Δ	- / Δ	Δ	Δ	- / O	O	O	-	-	-

* Specifications of separated-type display are classified with "Windows-based" and "non-Windows-based"

This function enables status confirmation and remote operation by displaying the NC screen display on the external computer or tablet PC.

This function can be valid by setting the parameter.

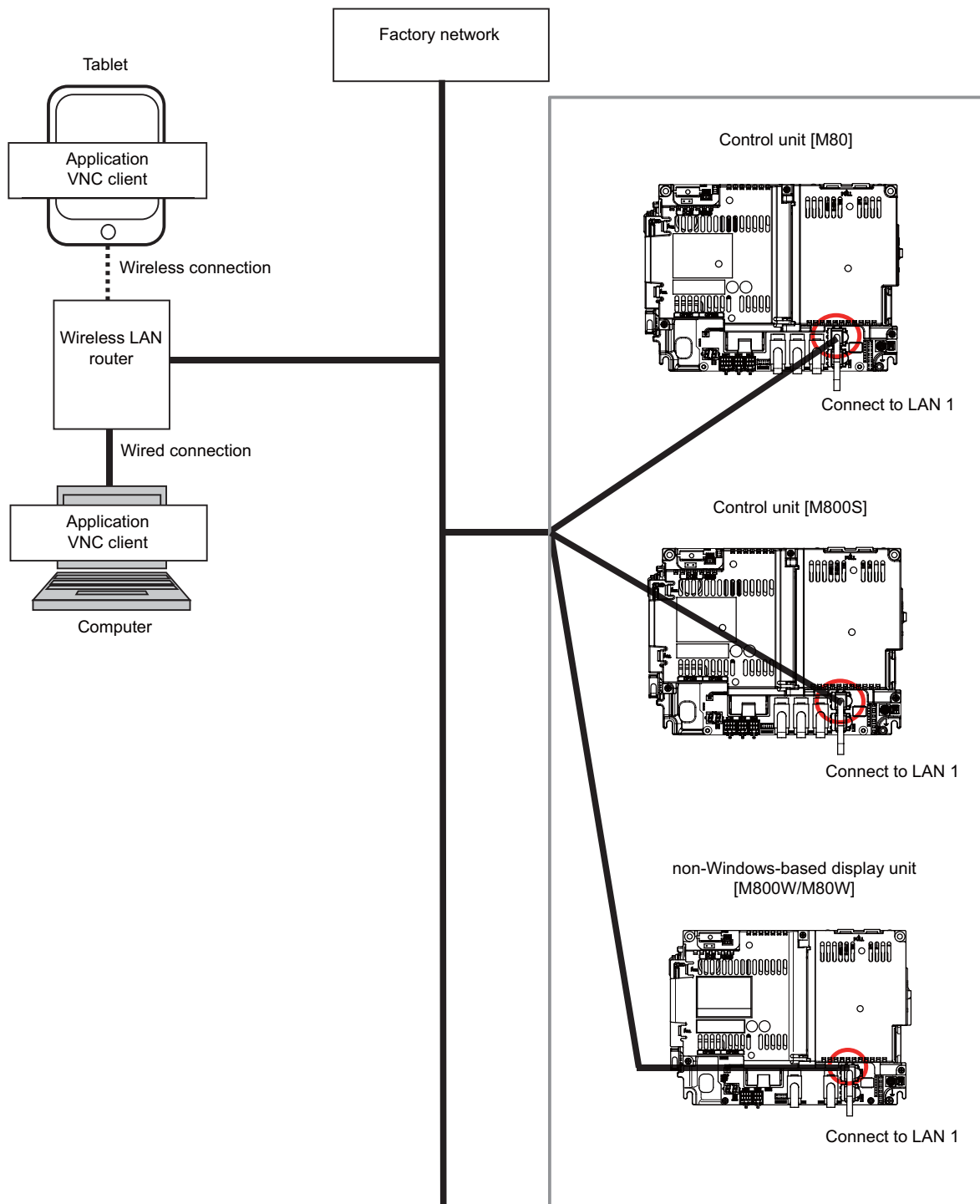

6.3 Display Methods and Contents

6.3.1 Status Display

	M850W	M830W	M850S	M830S	M80W	M80 TypeA	M80 TypeB	E80 TypeA	E80 TypeB	C80
M	○	○	○	○	○	○	○	○	○	○
L	○	○	○	○	○	○	○	○	○	○

The status of the program now being executed is indicated.

- (1) Display of G, S, T, M commands and 2nd miscellaneous command modal values
- (2) Feed rate display
- (3) Tool compensation No. and compensation amount display
- (4) Real speed display (*)

(*) The feed rate of each axis is converted from the final speed output to the drive unit, and is displayed. However, during follow up, the speed is converted and displayed with the signals from the detector installed on the servomotor.

6.3.2 Clock Display

	M850W	M830W	M850S	M830S	M80W	M80 TypeA	M80 TypeB	E80 TypeA	E80 TypeB	C80
M	○	○	○	○	○	○	○	○	○	○
L	○	○	○	○	○	○	○	○	○	○

The clock is built-in, and the date (year, month, date) and time (hour, minute, second) are displayed.

Once the time is set, it can be seen as a clock on the screen.

6.3.3 Monitor Screen Display

	M850W	M830W	M850S	M830S	M80W	M80 TypeA	M80 TypeB	E80 TypeA	E80 TypeB	C80
M	○	○	○	○	○	○	○	○	○	○
L	○	○	○	○	○	○	○	○	○	○

A variety of information related to operation, such as the axis counter, speed display and MSTB command is displayed. The display can be switched according to the machining application (prototype or mass production).

The following operations regarding operation can be executed:

- Operation search
- Restart search
- Editing of searched machining program
- Trace (Display of machine movement path)
- Check (Display of NC program's tool movement path)
- Correction of running program's buffer
- Counter set
- Manual numeric command, etc.

(1) Simple monitor screen

The information displayed on the simple monitor screen is limited. Therefore, the size of the text is larger and it is readable from a distance.

(2) Selective display

A part of monitor screen can be customized to suit user's need (to display data which a user always needs to refer to). The following can be displayed on the selective display area by selecting with the parameter:

- Tool offset
- Common variable
- Workpiece offset, etc.

(Note) The display is not selective on the simple monitor screen.

6.3.4 Setup Screen Display

	M850W	M830W	M850S	M830S	M80W	M80 TypeA	M80 TypeB	E80 TypeA	E80 TypeB	C80
M	<input type="radio"/>	<input type="radio"/>	<input type="radio"/>	<input type="radio"/>	<input type="radio"/>	<input type="radio"/>	<input type="radio"/>	<input type="radio"/>	<input type="radio"/>	<input type="radio"/>
L	<input type="radio"/>	<input type="radio"/>	<input type="radio"/>	<input type="radio"/>	<input type="radio"/>	<input type="radio"/>	<input type="radio"/>	<input type="radio"/>	<input type="radio"/>	<input type="radio"/>

Tool/workpiece related settings, user parameter settings, MDI editing, counter setting, manual numeric command issuing, etc., can be carried out.

When the data of the selected workpiece offset has been changed, the timing when the change is reflected in each counter can be selected by the parameter. (M8 Series)

6.3.5 Edit Screen Display

	M850W	M830W	M850S	M830S	M80W	M80 TypeA	M80 TypeB	E80 TypeA	E80 TypeB	C80
M	<input type="radio"/>	<input type="radio"/>	<input type="radio"/>	<input type="radio"/>	<input type="radio"/>	<input type="radio"/>	<input type="radio"/>	<input type="radio"/>	<input type="radio"/>	<input type="radio"/>
L	<input type="radio"/>	<input type="radio"/>	<input type="radio"/>	<input type="radio"/>	<input type="radio"/>	<input type="radio"/>	<input type="radio"/>	<input type="radio"/>	<input type="radio"/>	<input type="radio"/>

Machining program editing (addition, deletion, change), program check, simple programming, playback and file input/output can be carried out.

The specified character string can be searched even during the mass-editing.

6.3.6 Diagnosis Screen Display

	M850W	M830W	M850S	M830S	M80W	M80 TypeA	M80 TypeB	E80 TypeA	E80 TypeB	C80
M	<input type="radio"/>	<input type="radio"/>	<input type="radio"/>	<input type="radio"/>	<input type="radio"/>	<input type="radio"/>	<input type="radio"/>	<input type="radio"/>	<input type="radio"/>	<input type="radio"/>
L	<input type="radio"/>	<input type="radio"/>	<input type="radio"/>	<input type="radio"/>	<input type="radio"/>	<input type="radio"/>	<input type="radio"/>	<input type="radio"/>	<input type="radio"/>	<input type="radio"/>

The data related CNC diagnosis can be set and displayed as follows:

- Display of hardware and software configuration
- Display of CNC options
- Diagnosis of PLC interface
- Display of drive unit information
- Display of CNC internal data
- Display of alarm message / alarm history list etc.
- Display of H/W and Operation stop status
- Setting of sampling parameter and sampling of NC internal data
- Diagnosis for functional safety

6.3.7 Maintenance Screen Display

	M850W	M830W	M850S	M830S	M80W	M80 TypeA	M80 TypeB	E80 TypeA	E80 TypeB	C80
M	○	○	○	○	○	○	○	○	○	○
L	○	○	○	○	○	○	○	○	○	○

Parameter setting and display, NC data input/output, NC memory format, etc., can be carried out on the Maintenance screen.

Important operations are protected with a password.

6.3.8 Home Application

	M850W	M830W	M850S	M830S	M80W	M80 TypeA	M80 TypeB	E80 TypeA	E80 TypeB	C80
M	○/—	○/—	—	—	○/—	—	—	—	—	—
L	○/—	○/—	—	—	○/—	—	—	—	—	—

* Specifications of separated-type display are classified with "Windows-based" and "non-Windows-based"

19-type vertical display unit has the expansion applications that display the machine status, software keyboard, etc. in the lower half of the screen in no linkage with the upper half.

The following expansion applications are provided as standard MITSUBISHI CNC specifications:

- Home screen (machine state display)
- Software keyboard
- Software operation panel
- Manual
- Notepad

MTB unique applications can also be added.

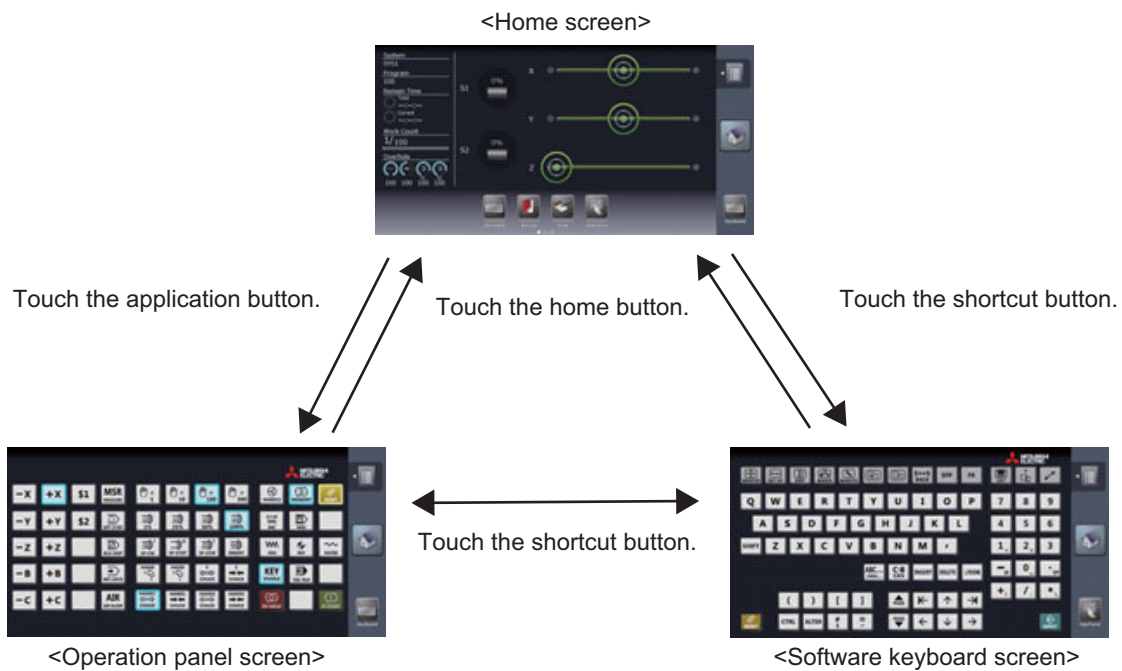

6.3.9 Home Screen

	M850W	M830W	M850S	M830S	M80W	M80 TypeA	M80 TypeB	E80 TypeA	E80 TypeB	C80
M	○	○	○	○	○	○	○	○	○	—
L	○	○	○	○	○	○	○	○	○	—

Home screen is able to display the machine status (including spindle loads and positions of linear and rotary axes) which can be monitored by an operator. Also, each application can be called by pressing the application button on the home screen. Registered applications differ depending on MTB. It can be selected by the parameter as to whether to hide, display (display at power ON) or display (not display at power ON) the home screen.

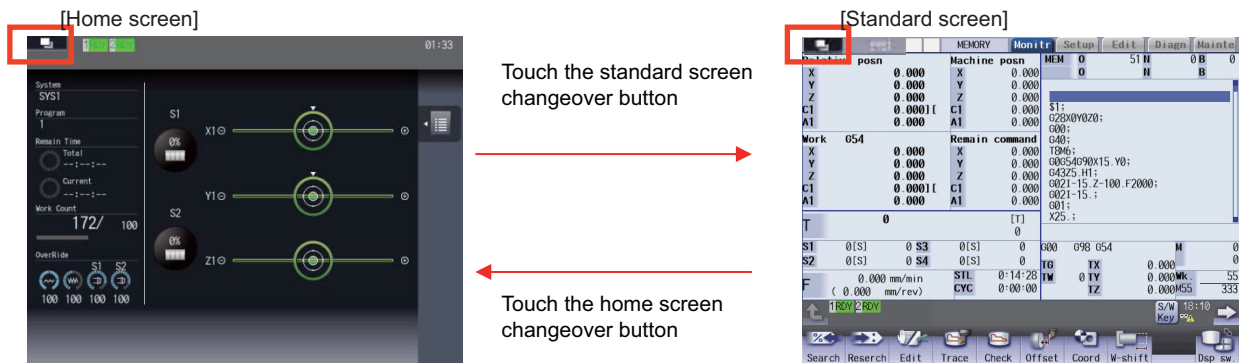

* The screen can also be changed between [Home screen] and [Standard screen] by pressing the window display key ().

(Example) When calling the manual display application with the application button

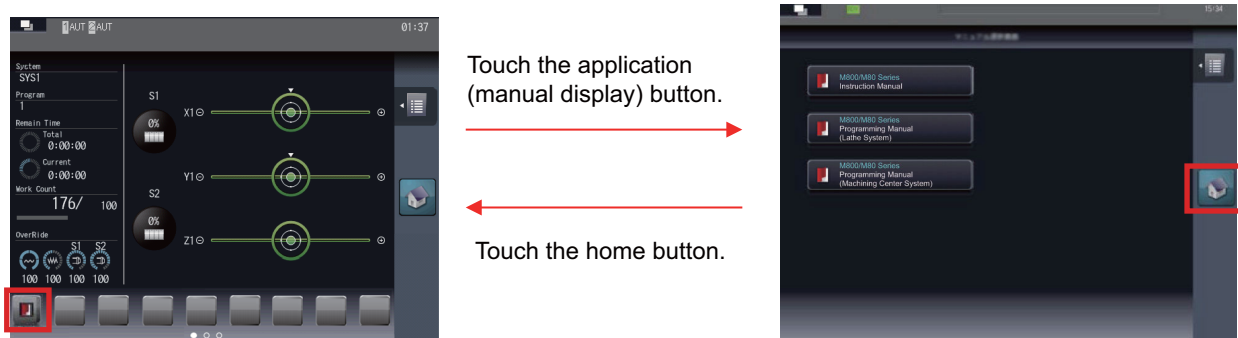

When the manual to be displayed is touched on the manual selection screen, the selected manual is displayed. The manuals which can be displayed differ depending on MTB.

6.3.10 Additional Languages

A language of choice can be selected by parameter setting.

6.3.10.1 Japanese

	M850W	M830W	M850S	M830S	M80W	M80 TypeA	M80 TypeB	E80 TypeA	E80 TypeB	C80
M	<input type="radio"/>	<input type="radio"/>	<input type="radio"/>	<input type="radio"/>	<input type="radio"/>	<input type="radio"/>	<input type="radio"/>	<input type="radio"/>	<input type="radio"/>	<input type="radio"/>
L	<input type="radio"/>	<input type="radio"/>	<input type="radio"/>	<input type="radio"/>	<input type="radio"/>	<input type="radio"/>	<input type="radio"/>	<input type="radio"/>	<input type="radio"/>	<input type="radio"/>

6.3.10.2 English

	M850W	M830W	M850S	M830S	M80W	M80 TypeA	M80 TypeB	E80 TypeA	E80 TypeB	C80
M	<input type="radio"/>	<input type="radio"/>	<input type="radio"/>	<input type="radio"/>	<input type="radio"/>	<input type="radio"/>	<input type="radio"/>	<input type="radio"/>	<input type="radio"/>	<input type="radio"/>
L	<input type="radio"/>	<input type="radio"/>	<input type="radio"/>	<input type="radio"/>	<input type="radio"/>	<input type="radio"/>	<input type="radio"/>	<input type="radio"/>	<input type="radio"/>	<input type="radio"/>

6.3.10.3 German

	M850W	M830W	M850S	M830S	M80W	M80 TypeA	M80 TypeB	E80 TypeA	E80 TypeB	C80
M	<input type="radio"/>	<input type="radio"/>	<input type="radio"/>	<input type="radio"/>	<input type="radio"/>	<input type="radio"/>	<input type="radio"/>	<input type="radio"/>	<input type="radio"/>	<input type="radio"/>
L	<input type="radio"/>	<input type="radio"/>	<input type="radio"/>	<input type="radio"/>	<input type="radio"/>	<input type="radio"/>	<input type="radio"/>	<input type="radio"/>	<input type="radio"/>	<input type="radio"/>

6.3.10.4 Italian

	M850W	M830W	M850S	M830S	M80W	M80 TypeA	M80 TypeB	E80 TypeA	E80 TypeB	C80
M	<input type="radio"/>	<input type="radio"/>	<input type="radio"/>	<input type="radio"/>	<input type="radio"/>	<input type="radio"/>	<input type="radio"/>	<input type="radio"/>	<input type="radio"/>	<input type="radio"/>
L	<input type="radio"/>	<input type="radio"/>	<input type="radio"/>	<input type="radio"/>	<input type="radio"/>	<input type="radio"/>	<input type="radio"/>	<input type="radio"/>	<input type="radio"/>	<input type="radio"/>

6.3.10.5 French

	M850W	M830W	M850S	M830S	M80W	M80 TypeA	M80 TypeB	E80 TypeA	E80 TypeB	C80
M	<input type="radio"/>	<input type="radio"/>	<input type="radio"/>	<input type="radio"/>	<input type="radio"/>	<input type="radio"/>	<input type="radio"/>	<input type="radio"/>	<input type="radio"/>	<input type="radio"/>
L	<input type="radio"/>	<input type="radio"/>	<input type="radio"/>	<input type="radio"/>	<input type="radio"/>	<input type="radio"/>	<input type="radio"/>	<input type="radio"/>	<input type="radio"/>	<input type="radio"/>

6.3.10.6 Spanish

	M850W	M830W	M850S	M830S	M80W	M80 TypeA	M80 TypeB	E80 TypeA	E80 TypeB	C80
M	<input type="radio"/>	<input type="radio"/>	<input type="radio"/>	<input type="radio"/>	<input type="radio"/>	<input type="radio"/>	<input type="radio"/>	<input type="radio"/>	<input type="radio"/>	<input type="radio"/>
L	<input type="radio"/>	<input type="radio"/>	<input type="radio"/>	<input type="radio"/>	<input type="radio"/>	<input type="radio"/>	<input type="radio"/>	<input type="radio"/>	<input type="radio"/>	<input type="radio"/>

6.3.10.7 Chinese

6.3.10.7.1 Chinese (Traditional Chinese Characters)

	M850W	M830W	M850S	M830S	M80W	M80 TypeA	M80 TypeB	E80 TypeA	E80 TypeB	C80
M	<input type="radio"/>	<input type="radio"/>	<input type="radio"/>	<input type="radio"/>	<input type="radio"/>	<input type="radio"/>	<input type="radio"/>	<input type="radio"/>	<input type="radio"/>	<input type="radio"/>
L	<input type="radio"/>	<input type="radio"/>	<input type="radio"/>	<input type="radio"/>	<input type="radio"/>	<input type="radio"/>	<input type="radio"/>	<input type="radio"/>	<input type="radio"/>	<input type="radio"/>

6.3.10.7.2 Chinese (Simplified Chinese Characters)

	M850W	M830W	M850S	M830S	M80W	M80 TypeA	M80 TypeB	E80 TypeA	E80 TypeB	C80
M	<input type="radio"/>	<input type="radio"/>	<input type="radio"/>	<input type="radio"/>	<input type="radio"/>	<input type="radio"/>	<input type="radio"/>	<input type="radio"/>	<input type="radio"/>	<input type="radio"/>
L	<input type="radio"/>	<input type="radio"/>	<input type="radio"/>	<input type="radio"/>	<input type="radio"/>	<input type="radio"/>	<input type="radio"/>	<input type="radio"/>	<input type="radio"/>	<input type="radio"/>

6.3.10.8 Korean

	M850W	M830W	M850S	M830S	M80W	M80 TypeA	M80 TypeB	E80 TypeA	E80 TypeB	C80
M	○	○	○	○	○	○	○	○	○	○
L	○	○	○	○	○	○	○	○	○	○

6.3.10.9 Portuguese

	M850W	M830W	M850S	M830S	M80W	M80 TypeA	M80 TypeB	E80 TypeA	E80 TypeB	C80
M	○	○	○	○	○	○	○	○	○	○
L	○	○	○	○	○	○	○	○	○	○

6.3.10.10 Hungarian

	M850W	M830W	M850S	M830S	M80W	M80 TypeA	M80 TypeB	E80 TypeA	E80 TypeB	C80
M	○	○	○	○	○	○	○	○	○	○
L	○	○	○	○	○	○	○	○	○	○

6.3.10.11 Dutch

	M850W	M830W	M850S	M830S	M80W	M80 TypeA	M80 TypeB	E80 TypeA	E80 TypeB	C80
M	○	○	○	○	○	○	○	○	○	○
L	○	○	○	○	○	○	○	○	○	○

6.3.10.12 Swedish

	M850W	M830W	M850S	M830S	M80W	M80 TypeA	M80 TypeB	E80 TypeA	E80 TypeB	C80
M	○	○	○	○	○	○	○	○	○	○
L	○	○	○	○	○	○	○	○	○	○

6.3.10.13 Turkish

	M850W	M830W	M850S	M830S	M80W	M80 TypeA	M80 TypeB	E80 TypeA	E80 TypeB	C80
M	○	○	○	○	○	○	○	○	○	○
L	○	○	○	○	○	○	○	○	○	○

6.3.10.14 Polish

	M850W	M830W	M850S	M830S	M80W	M80 TypeA	M80 TypeB	E80 TypeA	E80 TypeB	C80
M	○	○	○	○	○	○	○	○	○	○
L	○	○	○	○	○	○	○	○	○	○

6.3.10.15 Russian

	M850W	M830W	M850S	M830S	M80W	M80 TypeA	M80 TypeB	E80 TypeA	E80 TypeB	C80
M	○	○	○	○	○	○	○	○	○	○
L	○	○	○	○	○	○	○	○	○	○

6.3.10.16 Czech

	M850W	M830W	M850S	M830S	M80W	M80 TypeA	M80 TypeB	E80 TypeA	E80 TypeB	C80
M	○	○	○	○	○	○	○	○	○	○
L	○	○	○	○	○	○	○	○	○	○

6.3.10.17 Indonesian

	M850W	M830W	M850S	M830S	M80W	M80 TypeA	M80 TypeB	E80 TypeA	E80 TypeB	C80
M	○	○	○	○	○	○	○	○	○	—
L	○	○	○	○	○	○	○	○	○	—

6.3.10.18 Vietnamese

	M850W	M830W	M850S	M830S	M80W	M80 TypeA	M80 TypeB	E80 TypeA	E80 TypeB	C80
M	○	○	○	○	○	○	○	○	○	—
L	○	○	○	○	○	○	○	○	○	—

7

Input/Output Functions and Devices

7.1 Input/Output Data

Certain kinds of data handled by the NC system can be input and output between the NC system's memory and external devices.

7.1.1 Machining Program Input/Output

	M850W	M830W	M850S	M830S	M80W	M80 TypeA	M80 TypeB	E80 TypeA	E80 TypeB	C80
M	○	○	○	○	○	○	○	○	○	○
L	○	○	○	○	○	○	○	○	○	○

User Macros and Fixed Cycle Macros are included.

7.1.2 Tool Offset Data Input/Output

	M850W	M830W	M850S	M830S	M80W	M80 TypeA	M80 TypeB	E80 TypeA	E80 TypeB	C80
M	○	○	○	○	○	○	○	○	○	○
L	○	○	○	○	○	○	○	○	○	○

7.1.3 Common Variable Input/Output

	M850W	M830W	M850S	M830S	M80W	M80 TypeA	M80 TypeB	E80 TypeA	E80 TypeB	C80
M	○	○	○	○	○	○	○	○	○	○
L	○	○	○	○	○	○	○	○	○	○

7.1.4 Parameter Input/Output

	M850W	M830W	M850S	M830S	M80W	M80 TypeA	M80 TypeB	E80 TypeA	E80 TypeB	C80
M	○	○	○	○	○	○	○	○	○	○
L	○	○	○	○	○	○	○	○	○	○

7.1.5 History Data Output

	M850W	M830W	M850S	M830S	M80W	M80 TypeA	M80 TypeB	E80 TypeA	E80 TypeB	C80
M	○	○	○	○	○	○	○	○	○	○
L	○	○	○	○	○	○	○	○	○	○

7.1.7 System Configuration Data Output

	M850W	M830W	M850S	M830S	M80W	M80 TypeA	M80 TypeB	E80 TypeA	E80 TypeB	C80
M	○	○	○	○	○	○	○	○	○	○
L	○	○	○	○	○	○	○	○	○	○

7.2 Input/Output I/F

7.2.1 RS-232C I/F

	M850W	M830W	M850S	M830S	M80W	M80 TypeA	M80 TypeB	E80 TypeA	E80 TypeB	C80
M	○	○	○	○	○	○	○	○	○	—
L	○	○	○	○	○	○	○	○	○	—

Two ports (port 1 and port 2) can be used for control unit and graphic control unit of the RS-232C interface.

	Control unit	Graphic control unit (*)
Port	Port 1, Port 2	Port 1, Port 2
Baudrate	Up to 19.2kbps	
Handshake method	DC code method, RTS/CTS method possible	

(*) Only for non-Windows-based display unit

RS-232C devices can be used by connecting to each of the ports.

7.2.2 SD Card I/F

7.2.2.1 Control Unit-side SD Card I/F [Up to 32GB]

	M850W	M830W	M850S	M830S	M80W	M80 TypeA	M80 TypeB	E80 TypeA	E80 TypeB	C80
M	○	○	—	—	○	—	—	—	—	—
L	○	○	—	—	○	—	—	—	—	—

An SD card can be inserted into the slot inside the control unit and used.

7.2.2.2 Front-side SD Card I/F [Up to 32GB]

	M850W	M830W	M850S	M830S	M80W	M80 TypeA	M80 TypeB	E80 TypeA	E80 TypeB	C80
M	○/—	○/—	○	○	○/—	○	○	○	○	—
L	○/—	○/—	○	○	○/—	○	○	○	○	—

* Specifications of separated-type display are classified with "Windows-based" and "non-Windows-based"

An SD card can be inserted into the slot in front of the display unit and used.

7.2.3 Ethernet I/F

	M850W	M830W	M850S	M830S	M80W	M80 TypeA	M80 TypeB	E80 TypeA	E80 TypeB	C80
M	○	○	○	○	○	○	○	○	○	○ (GOT)
L	○	○	○	○	○	○	○	○	○	○ (GOT)

The NC unit can be connected to Ethernet and used.

7.2.4 Display Unit-side Data Server I/F

	M850W	M830W	M850S	M830S	M80W	M80 TypeA	M80 TypeB	E80 TypeA	E80 TypeB	C80
M	○	○	○	○	○	○	○	○	○	—
L	○	○	○	○	○	○	○	○	○	—

A built-in disk (HD) of display unit can be used.

7.2.5 Front-side USB Memory I/F [Up to 32GB]

	M850W	M830W	M850S	M830S	M80W	M80 TypeA	M80 TypeB	E80 TypeA	E80 TypeB	C80
M	○	○	○	○	○	○	○	○	○	—
L	○	○	○	○	○	○	○	○	○	—

A USB memory can be mounted.

7.2.6 USB I/F (GOT Front-side USB I/F)

	M850W	M830W	M850S	M830S	M80W	M80 TypeA	M80 TypeB	E80 TypeA	E80 TypeB	C80
M	—	—	—	—	—	—	—	—	—	○
L	—	—	—	—	—	—	—	—	—	○

A USB memory can be mounted.

7.2.7 SD I/F (GOT Back-side SD Card I/F)

	M850W	M830W	M850S	M830S	M80W	M80 TypeA	M80 TypeB	E80 TypeA	E80 TypeB	C80
M	—	—	—	—	—	—	—	—	—	○
L	—	—	—	—	—	—	—	—	—	○

An SD card can be mounted on the back side of GOT.

7.3 Computer Link

7.3.1 Computer Link B

	M850W	M830W	M850S	M830S	M80W	M80 TypeA	M80 TypeB	E80 TypeA	E80 TypeB	C80
M	△	△	△	△	○	○	○	—	—	—
L	△	△	△	△	○	○	○	—	—	—

Computer link B is a function that passes the data between host computer (hereafter abbreviated to "HOST") and CNC. This function sends [DC1] to the HOST at the CNC cycle start, and it enables operation to be performed while the machining programs are received from the HOST.

The computer link has a reception buffer so that operation will be less susceptible to the effects of the data transfer status at the HOST end.

The high-speed machining mode function is required for high-speed fine-segment machining.

This function cannot be operated in the 2nd and following part systems.

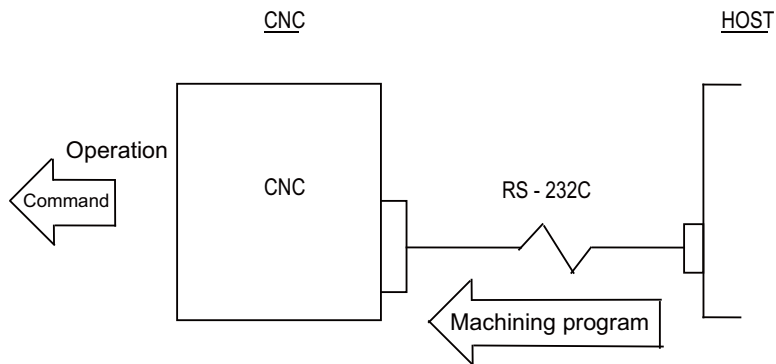

7.4 Others

7.4.1 Handy Terminal Connection

	M850W	M830W	M850S	M830S	M80W	M80 TypeA	M80 TypeB	E80 TypeA	E80 TypeB	C80
M	○	○	○	○	○	○	○	—	—	—
L	○	○	○	○	○	○	○	—	—	—

This function controls the serial communication (RS232C) of CNC and handy terminal.

Handy terminal is a downsized machine operation panel which enables you to operate the machine including setup at hand. Consequently, machine interference can be detected at hand and the usability and safety can be improved.

CNC receives data from the handy terminal and outputs them to PLC interface. CNC also sends the transmission data which PLC set in PLC interface to the handy terminal.

Each MTB needs to create PLC program corresponding to the handy terminal.

The handy terminal needs to be customized such as the configuration of the display area, key input and communication conditions with CNC.

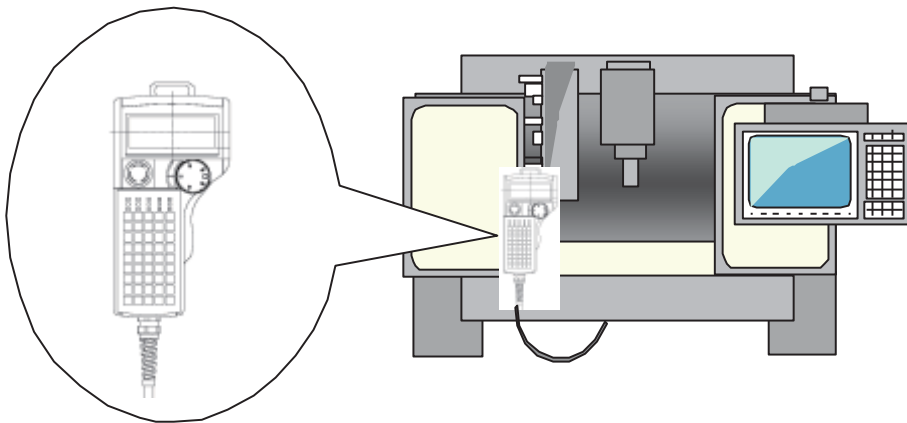

7.4.3 IP Filter Setting

	M850W	M830W	M850S	M830S	M80W	M80 TypeA	M80 TypeB	E80 TypeA	E80 TypeB	C80
M	○	○	○	○	○	○	○	○	○	—
L	○	○	○	○	○	○	○	○	○	—

This function prevents unauthorized access from external devices by filtering the IP address of the access source when the NC is being connected to Ethernet. By setting the IP addresses to be passed or rejected, access from external devices can be restricted.

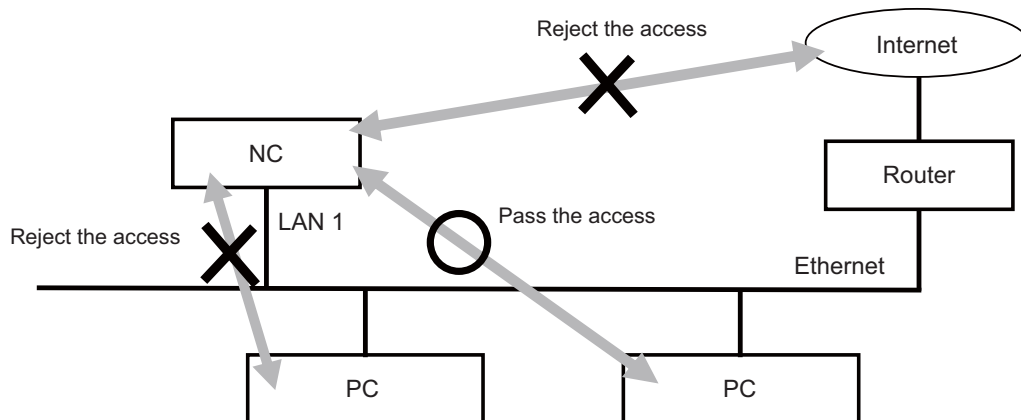

Access to the NC is limited with one of the following two methods. The method is specified by the parameter.

- (1) Pass
When the range of IP addresses from which access to the NC should be allowed is set, access from an IP address within the range is permitted. Access from the other IP addresses is restricted.
- (2) Reject
When the range of IP addresses to block is set, access from an IP address within the range is blocked. Access from the other IP addresses is permitted.

Spindle, Tool and Miscellaneous Functions

8.1 Spindle Functions (S)

8.1.1 Spindle Control Functions

The spindle rotation speed is determined in consideration of the override and gear ratio for the S command commanded in automatic operation or with manual numerical commands, and the spindle is rotated. The following diagram shows an outline of the spindle control.

When an 8-digit number following address S (S0 to S±99999999) is commanded, a signed 32-bit binary data and start signal, or a non-signed 32-bit binary data and start signal will be output to the PLC.

Up to 1 set of S commands can be commanded in one block.

Processing and complete sequences must be incorporated on the PLC side for all S commands.

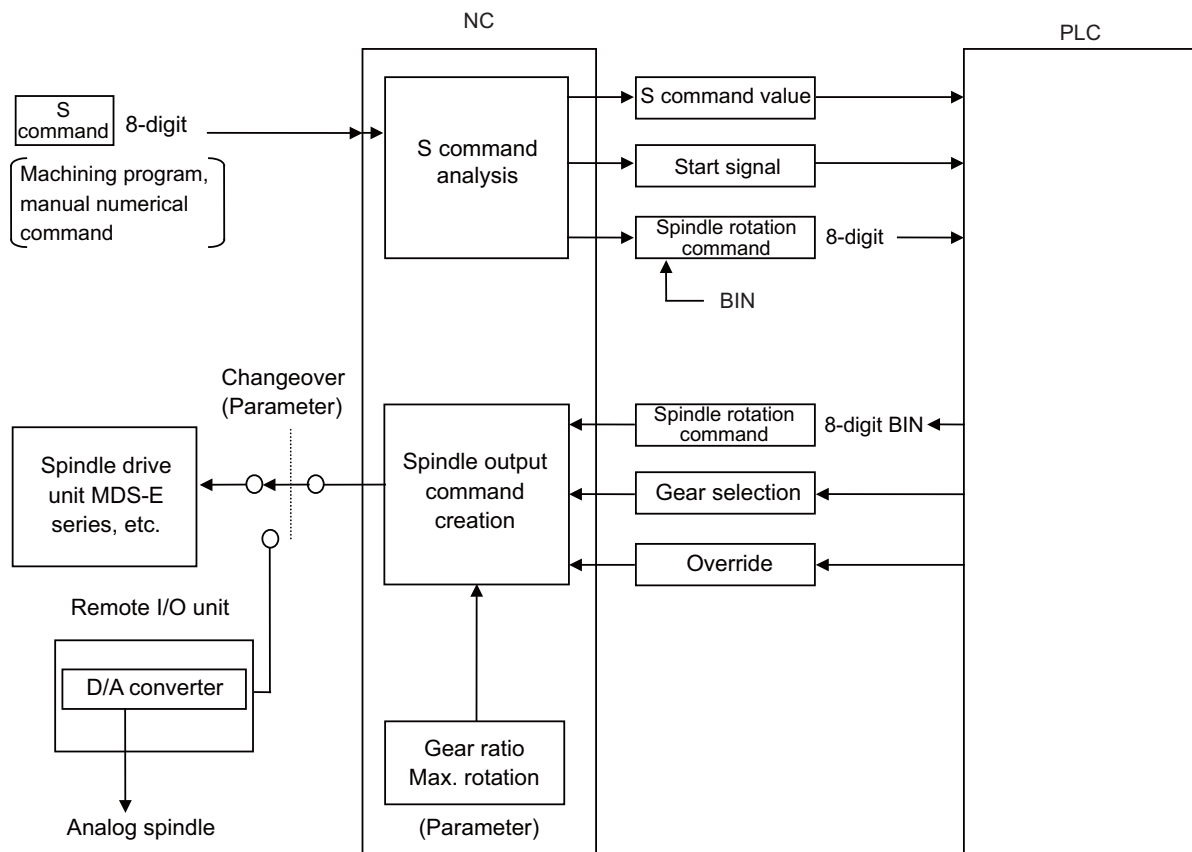

- (1) The override can be designated as 50% to 120% in 10% increments or 0% to 200% in 1% increments (with built-in PLC specifications).
The override is not changed while the spindle stop input is ON, during the tapping mode, or during the thread cutting mode.
- (2) The number of gear steps can be commanded up to four steps.
- (3) The max. spindle rotation speed can be set for each gear.

(Note) The spindle functions can work on serially connected spindles.
Check the specifications of your machine.

8.1.1.1 Spindle Digital I/F

	M850W	M830W	M850S	M830S	M80W	M80 TypeA	M80 TypeB	E80 TypeA	E80 TypeB	C80
M	○	○	○	○	○	○	○	○	○	○
L	○	○	○	○	○	○	○	○	○	○

This interface is used to connect the digital spindle (AC spindle motor and spindle driver).

8.1.1.2 Spindle Analog I/F

	M850W	M830W	M850S	M830S	M80W	M80 TypeA	M80 TypeB	E80 TypeA	E80 TypeB	C80
M	○	○	○	○	○	○	○	○	○	△ (*1)
L	○	○	○	○	○	○	○	○	○	△ (*1)

(*1) MELSEC

Spindle control can be executed using an analog spindle instead of the digital spindle.

8.1.1.3 Coil Switch

	M850W	M830W	M850S	M830S	M80W	M80 TypeA	M80 TypeB	E80 TypeA	E80 TypeB	C80
M	○	○	○	○	○	○	○	○	○	○
L	○	○	○	○	○	○	○	○	○	○

Constant output characteristics can be achieved across a broad spectrum down to the low-speed range by switching the spindle motor connections.

This is a system under which commands are assigned from the PLC.

8.1.1.4 Automatic Coil Switch

	M850W	M830W	M850S	M830S	M80W	M80 TypeA	M80 TypeB	E80 TypeA	E80 TypeB	C80
M	○	○	○	○	○	○	○	○	○	○
L	○	○	○	○	○	○	○	○	○	○

Constant output characteristics can be achieved across a broad spectrum down to the low-speed range by switching the spindle motor connections.

This is a system under which the NC unit switches the coils automatically in accordance with the motor speed.

8.1.1.5 Encoder Input I/F

	M850W	M830W	M850S	M830S	M80W	M80 TypeA	M80 TypeB	E80 TypeA	E80 TypeB	C80
M	□	□	○	○	□	○	○	○	○	—
L	□	□	○	○	□	○	○	○	○	—

* Encoder I/F expansion unit is required for M800W/M80W

Arbitrary pulse can be input by parameters set in R register.

The maximum number of input pulse is 76800. Synchronous feed function can be activated with the arbitrary pulse if the number of pulse to be used is set in R register and the external signal is turned ON.

When the arbitrary pulse is invalid, the input pulse is fixed to 1024 pulses.

Encoder arbitrary pulse input

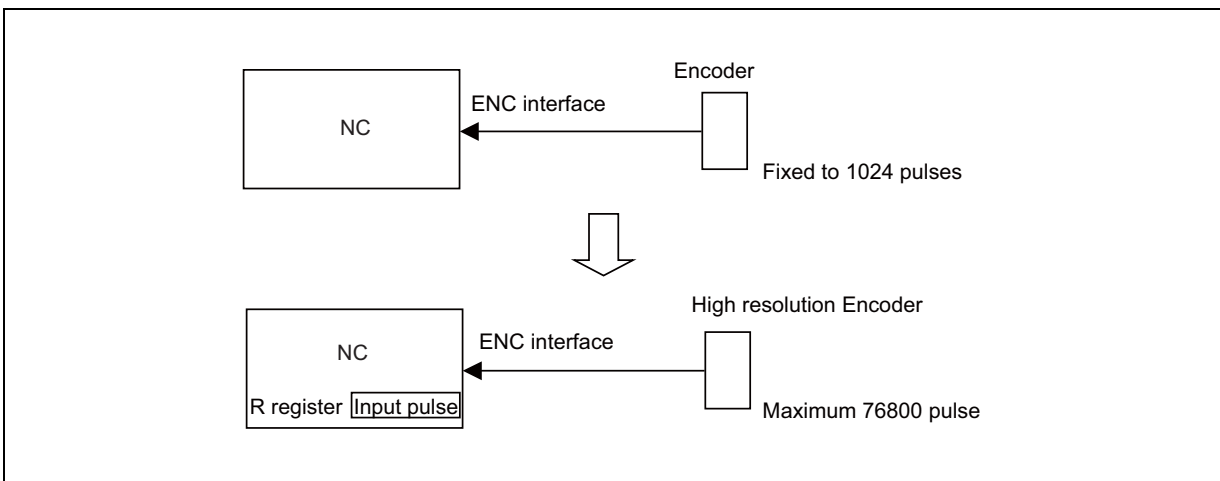

Two kinds of encoders can be switched over and connected. Encoder switch-over is possible, using PLC device.

Encoder changeover pulse input

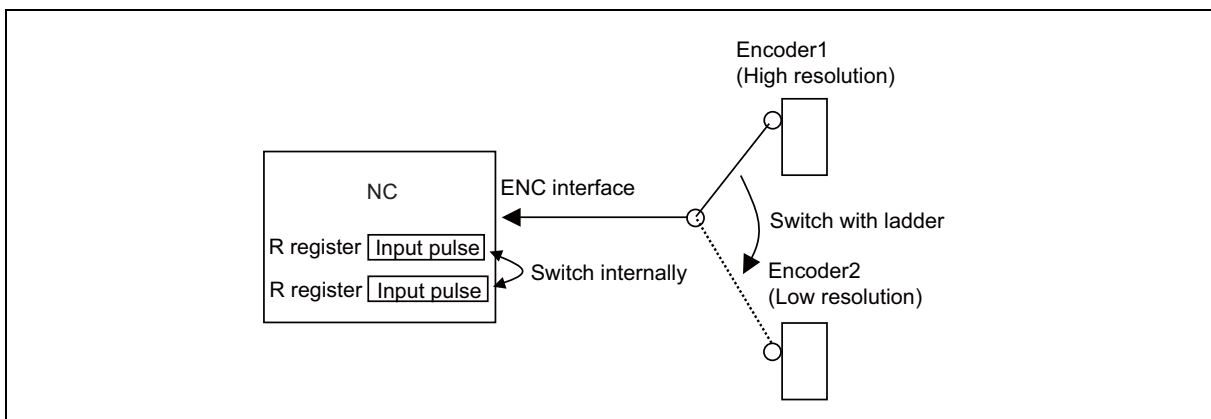

8.1.1.6 Spindle-mode Servo Motor Control

	M850W	M830W	M850S	M830S	M80W	M80 TypeA	M80 TypeB	E80 TypeA	E80 TypeB	C80
M	△	△	△	△	○	○	○	—	—	△
L	△	△	△	△	○	○	○	○	○	△

This function controls a spindle using the combination of servo motor and servo drive unit (MDS-E Series) which controls NC axis.

The maximum rotation speed of servo motor is low compared with a spindle motor. However, if the rated output is the same, the machine components can be downsized by using a servo motor to drive tool spindle, etc., because the servo motor is smaller than the spindle motor.

Note that some spindle functions can not be used under the spindle-mode servo motor control.

The figure below is the example of the application.

Normally, the components "spindle drive unit + spindle motor" are needed when cutting, drilling or milling is performed on a lathe with turret type tool selection mechanism, which means two pairs of "spindle drive unit + spindle motor" are needed; one for a main spindle and one for a turret.

However, downsizing of the turret, space-saving of the lathe and cost reduction can be achieved by replacing the turret side spindle drive with a servo motor and using spindle-mode servo motor control.

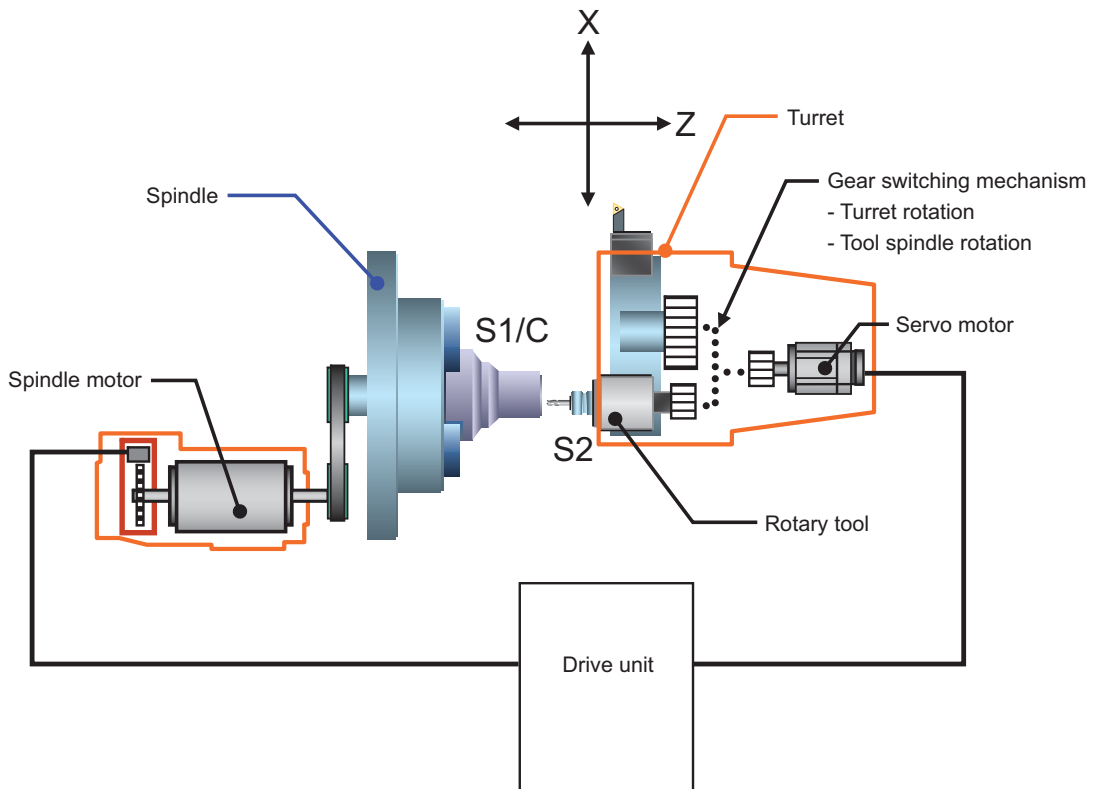

8.1.1.7 Spindle-mode Rotary Axis Control

	M850W	M830W	M850S	M830S	M80W	M80 TypeA	M80 TypeB	E80 TypeA	E80 TypeB	C80
M	△	△	△	△	○	○	—	—	—	—
L	—	—	—	—	—	—	—	—	—	—

This function enables a rotary axis driven by a servo motor to be controlled as a spindle. When the spindle-mode rotary axis control command signal is turned ON, the rotary axis is controlled as a spindle. This enables lathe-turning machining, including synchronous feed and thread cutting, to be performed in synchronization with the feedback speed of the rotary axis (spindle-mode rotary axis mode). When the signal is turned OFF, positioning and interpolation commands can be given to the rotary axis (servo axis mode).

The following is the example of the application.

Add S2 as B axis spindle. B axis can be controlled as S2 spindle by setting "2" to B axis parameter "#1020 sp_ax" and setting the same value as the B axis (servo axis) drive unit I/F number to S2 axis parameter "#3031 smcp_no". B axis can be controlled as S2 spindle by turning the spindle-mode rotary axis control command signal ON after being used as B axis for indexing the machining surface. This enables turning machining, including thread cutting.

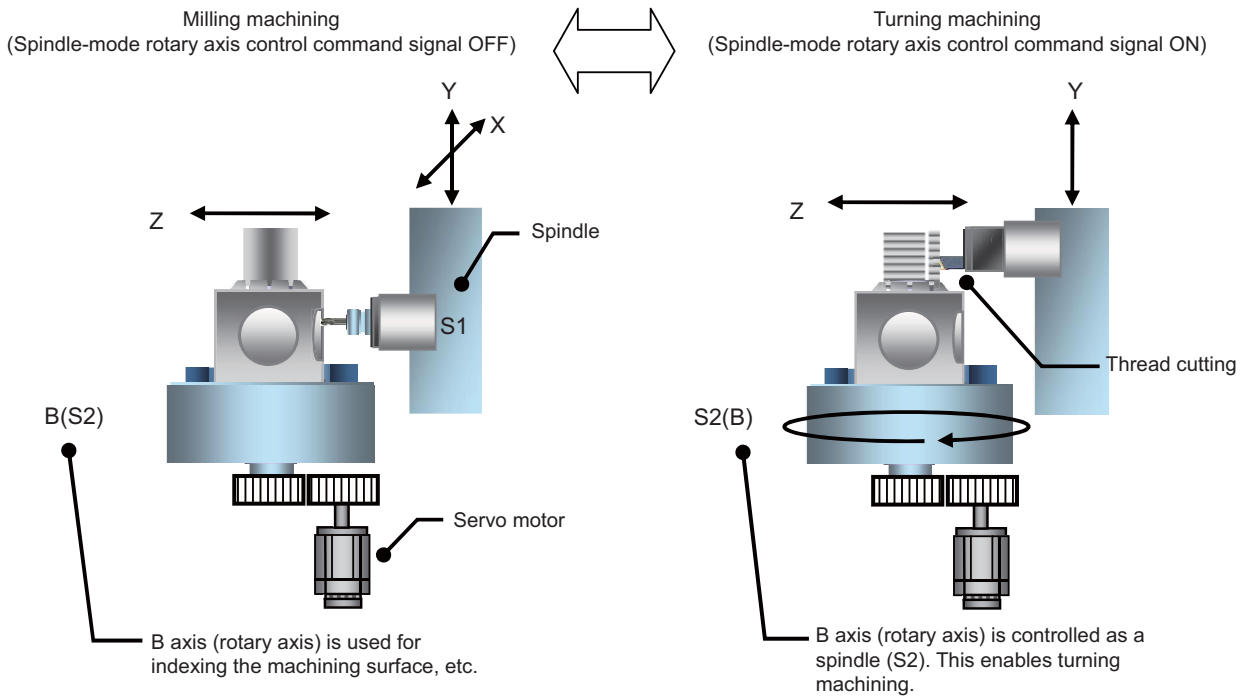

8.1.1.8 Turret Gear Change Control

	M850W	M830W	M850S	M830S	M80W	M80 TypeA	M80 TypeB	E80 TypeA	E80 TypeB	C80
M	—	—	—	—	—	—	—	—	—	—
L	△	△	△	△	○	○	○	○	—	—

This function enables axes in the semi-closed system to select four types of gear ratios which are set to the spindle specification parameters according to the control input from the PLC.

There are differences from normal gear change as follows:

- (1) Positioning can be made at the predefined motor side position regardless of the selected gear step during spindle orientation or change to spindle position control (C axis control).
- (2) Gears can be changed during the rotation.

Example of application

- (1) Gear change between turret swiveling and tool spindle rotation in turret type tool post

For gear change on a turret where the turret swiveling and tool rotation are switched by physical gear using one servo or spindle motor as illustrated below, the positioning to motor side Z-phase position (orientation) can be made regardless of the selected gear steps by using this function. Consequently, the gears for the physical gear change are engaged and the physical gears can be changed.

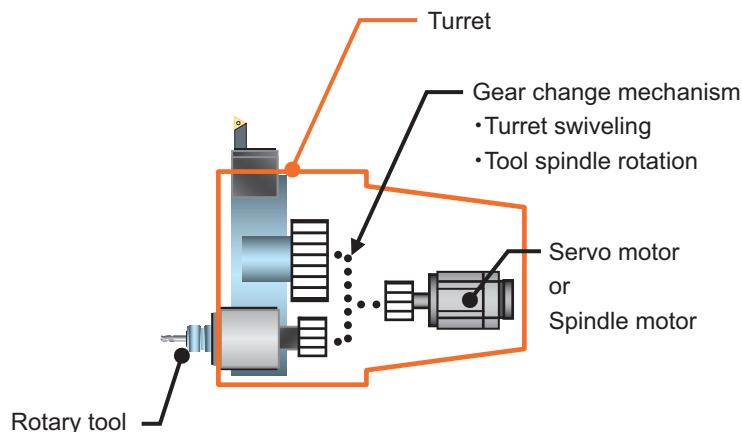

- (2) Gear change during rotation

For example, the tool for polygon has a tool system in which the reduction gear is for starting torque (cutter + tool folder). If this tool is installed in a tool post that has mechanism which rotates multiple tools by one motor, the gear change is needed when selecting the polygon tool. However, the gear change can be performed during the tool rotation without temporary stop so that the tool change time can be reduced.

- (3) Gear change during spindle-mode servo motor control

This function is used when gear change is needed in the spindle-mode servo motor control which controls a servo motor as spindle using the combination of servo drive unit and servo motor.

8.1.1.9 Spindle Control with Pulse Train Output

	M850W	M830W	M850S	M830S	M80W	M80 TypeA	M80 TypeB	E80 TypeA	E80 TypeB	C80
M	—	—	—	—	—	○	○	○	○	—
L	—	—	—	—	—	○	○	○	○	—

This function controls a spindle using pulse trains output from the NC. You can control a spindle which is connected mainly to an inverter by outputting pulse trains.

Using this function requires an inverter which is capable of controlling spindle operation through pulse train input.

When this function is used, RIO port 1 and 2 are exclusively used for outputting pulse trains.

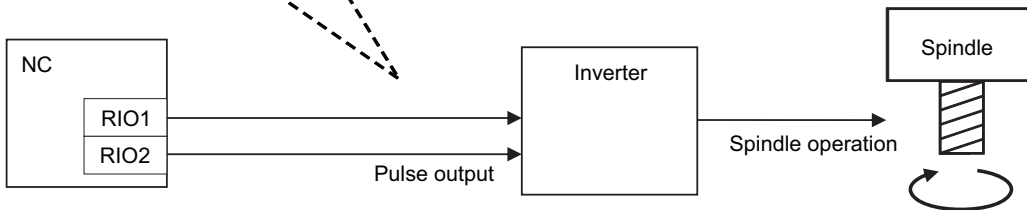
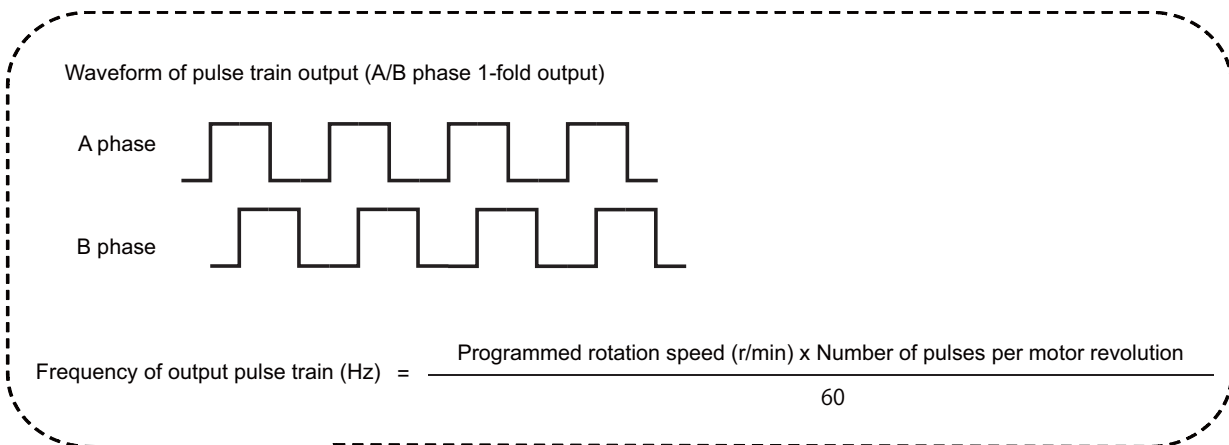

8.1.2 S Code Output

	M850W	M830W	M850S	M830S	M80W	M80 TypeA	M80 TypeB	E80 TypeA	E80 TypeB	C80
M	○	○	○	○	○	○	○	○	○	○
L	○	○	○	○	○	○	○	○	○	○

When an 8-digit number following address S (S0 to S±99999999) is commanded, a signed 32-bit binary data and start signal, or a non-signed 32-bit binary data and start signal will be output to the PLC.

One set of S commands can be issued in one block.

Processing and complete sequences must be incorporated on the PLC side for all S commands.

S function can be designated with any other kind of commands. In the case where a movement command is in the same block, two different command sequences are available. Depending on user PLC specifications, either one of the following two will be applied.

- (1) S function is executed after the movement is completed.
- (2) S function is executed at the same time as when the movement command is issued.

8.1.3 Constant Surface Speed Control

	M850W	M830W	M850S	M830S	M80W	M80 TypeA	M80 TypeB	E80 TypeA	E80 TypeB	C80
M	○	○	○	○	○	○	○	○	○	○
L	○	○	○	○	○	○	○	○	○	○

This function enables the spindle rotation speed to be adjusted (constant surface speed control) in accordance with the movement of tool nose point so that the cutting point always remains at the constant speed (constant surface speed). Using this function for processes such as a cutting-off process is effective for a machining time and tool life, etc. Note that when the tool nose point is moving to the workpiece zero point, the rotation may be at the maximum rotation speed of the machine specification and this is dangerous.

Command format

Constant surface speed ON

G96 S__ P__ ;

S : Surface speed designation (-99999999 to 99999999 (m/min), (feet/min))

P : Constant surface speed control axis designation (0 to the maximum number of the controllable axes in G96 part system.)

Constant surface speed cancel

G97 S__ ;

S : Spindle rotation speed (-99999999 to 99999999 (r/min))

The surface speed is commanded with an S code. For the metric designation, the speed is commanded with an m/min unit, and for the inch designation, the speed is commanded with a feet/min unit.

In the constant surface speed cancel mode, the S code is a spindle rotation speed command.

The axis for which constant surface speed is controlled is generally the X axis. However, this can be changed with the parameter settings or with address P in the G96 block.

Select with the parameter whether to enable the spindle rotation command from other part systems to the spindle which is in the constant surface speed control.

(Note 1) Under the constant surface speed control (during G96 modal), if the axis targeted for the constant surface speed control moves toward the spindle center, the spindle rotation speed will increase and may exceed the allowable speed of the workpiece or chuck, etc. In this case, the workpiece, etc. may jump out during machining, which may result in breakage of tools or machine or may cause damage to the operators. Thus make sure to use this control while the "spindle speed clamp" is enabled. When the constant surface speed control is commanded, keep enough distance from the program zero point.

(Note 2) If there is only one spindle, the spindle will not operate normally if the constant surface speed control command, S command or spindle related M command is commanded randomly from each part system. These commands must be commanded from only one certain part system, or commanded simultaneously with timing synchronization function.

The controller will execute the following control for the constant surface speed control and S commands. The part system from which an S command was issued last will have the spindle control rights. That part system will judge whether the constant surface speed command mode is valid or canceled, and will execute spindle control.

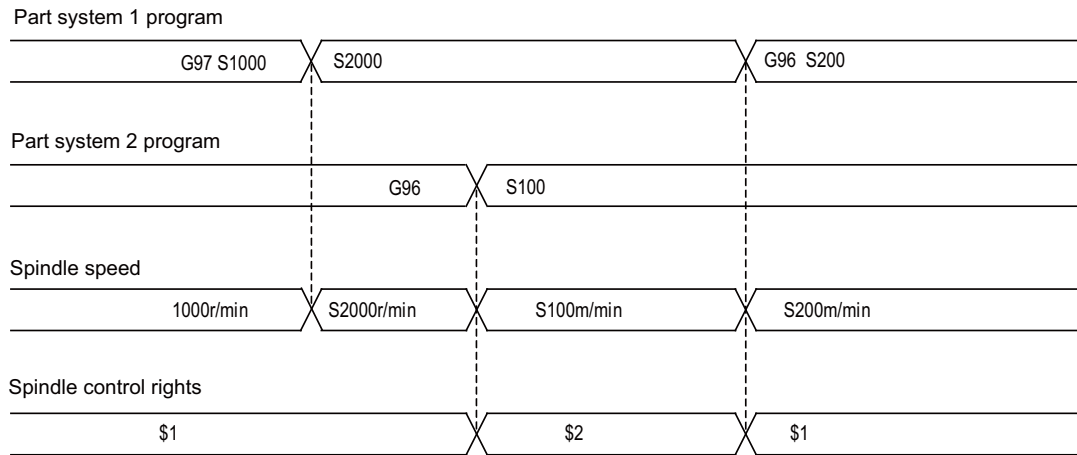

\$1: Part system 1

\$2: Part system 2

8.1.4 Spindle Override

	M850W	M830W	M850S	M830S	M80W	M80 TypeA	M80 TypeB	E80 TypeA	E80 TypeB	C80
M	○	○	○	○	○	○	○	○	○	○
L	○	○	○	○	○	○	○	○	○	○

This function applies override to the rotation speed of a spindle or mill spindle assigned by the machining program command during automatic operation or by manual operation. There are two types of override.

(1) Type 1 (code method)

Using an external signal, override can be applied to the commanded rotation speed of a spindle or mill spindle in 10% increments from 50% to 120%.

(2) Type 2 (value setting method)

Using an external signal, override can be applied to the commanded rotation speed of a spindle or mill spindle in 1% increments from 0% to 200%.

(Note 1) Selection between type 1 and type 2 can be designated by user PLC processing.

8.1.5 Multiple-spindle Control

Multiple-spindle control is a function that controls second and following spindles in addition to the first spindle in a machine tool equipped with multiple spindles.

Multiple-spindle control I can be switched to multiple-spindle control II or vice versa using a parameter and, by so doing, the spindle control method changes.

Multiple-spindle control I (L system only) Control based on a spindle selection command (such as G43.1) and spindle control command ([S*****;] or [SO=*****;]), etc.

Multiple-spindle control II Control based on a PLC signal (spindle command selection signal, spindle selection signal) and spindle control command ([S*****;] only), etc.
Spindle selection command and control command of [SO=*****;] cannot be used.

The figure below shows an example of the configuration for a machine which is equipped with second and third spindles.

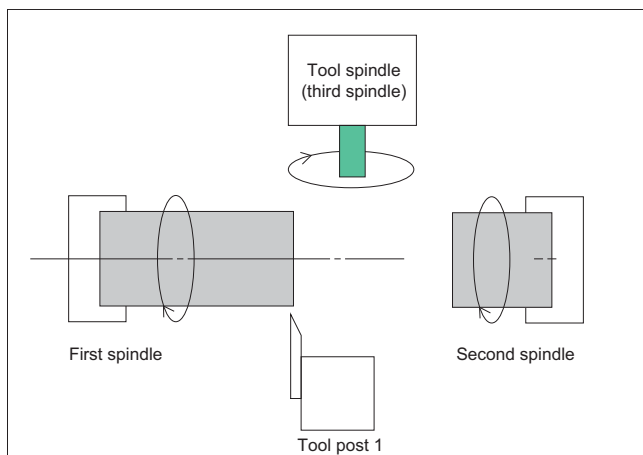

8.1.5.1 Multiple-spindle Control I

	M850W	M830W	M850S	M830S	M80W	M80 TypeA	M80 TypeB	E80 TypeA	E80 TypeB	C80
M	—	—	—	—	—	—	—	—	—	—
L	○	○	○	○	○	○	○	○	○	○

(1) Spindle selection command

In a machine with two or more spindles, this function makes it possible to select the spindle to apply the S commands or feed per revolution.

Spindle selection command (G43.1/G44.1/G44.1 D_) makes it possible to select the spindle.

Using the 1st spindle control command (G43.1) and the 2nd spindle control command (G44.1), the commands can be given to the spindle designated with the parameter.

Using the arbitrary spindle control command (G44.1 D_), an arbitrary spindle can be selected with address D.

Using all spindles simultaneous control command (G47.1), all spindles are selected.

Use this function when cutting the back of workpiece by shifting it to the second spindle from the first spindle, cutting multiple workpieces with the respective spindles or on the respective tool posts, etc.

When selecting G43.1 = 1st spindle, G44.1 = 2nd spindle

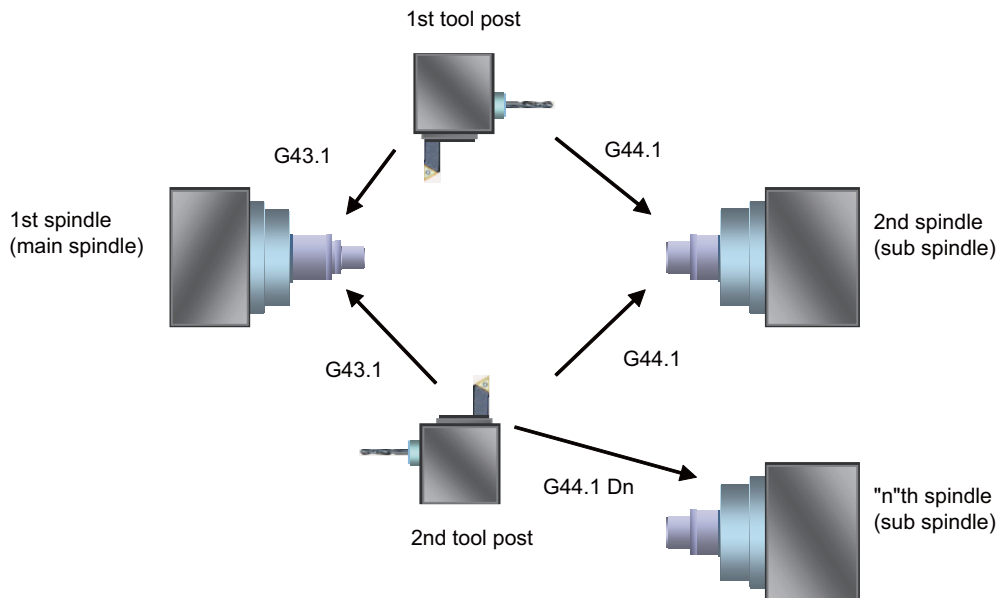

Command format

G43.1 ; First spindle control mode ON (The spindle to be used is set using the parameter.)
G44.1 ; Second spindle control mode ON (The spindle to be used is set using the parameter.)
G44.1 D_ ; Arbitrary spindle control mode ON (The spindle to be used is set using address D.)
G47.1 ; All spindles simultaneous control mode ON (Encoder of the 1st spindle is used)
D : Designate the spindle. (For a spindle number command, the range is from 1 to the number of available spindles, or from 1 to 9 for a spindle name command.)

(2) Spindle control command (Using extended word address (S =****))

In addition to using the "S****" S commands, it is also possible to assign commands which differentiate each spindle by using the S =****.

Command format

S ○ =**** ;
○ : Number assigned as the spindle number (1: first spindle; 2:second spindle; ...; n: "n"th spindle (n = maximum number of spindles for the specification)); variables can be designated.
**** : Rotational speed or surface speed value assigned by command; variables can be designated.

8.1.5.2 Multiple-spindle Control II

	M850W	M830W	M850S	M830S	M80W	M80 TypeA	M80 TypeB	E80 TypeA	E80 TypeB	C80
M	○	○	○	○	○	○	○	—	—	○
L	○	○	○	○	○	○	○	○	○	○

This function selects which spindle to perform spindle function (S) command or feed per revolution (synchronous feed) on a machine equipped with 2 or more spindles.

Command to spindles is issued with one spindle function (S) command, and you can select the target spindle with a PLC signal (spindle selection or spindle command selection).

A parameter is used to switch the control to multiple-spindle control I.

There are two types of spindle rotation speed control: common to part systems (which validates the S function command issued last to each spindle), and separated by each part system (which validates the S function command issued last in the part system to which the selected spindle belongs).

8.1.6 Spindle Orientation

	M850W	M830W	M850S	M830S	M80W	M80 TypeA	M80 TypeB	E80 TypeA	E80 TypeB	C80
M	○	○	○	○	○	○	○	○	○	○
L	○	○	○	○	○	○	○	○	○	○

This function stops the spindle at a specified position.

The spindle zero position is determined to be the Z-phase position at the encoder method spindle orientation (PLG and external encoder). At the proximity switch method spindle orientation, the spindle zero position is determined to be the position of the proximity switch attached at the spindle end.

On a lathe, this function can be used for the workpiece positioning to align the attaching/removing direction and the turret turn positioning for the tool exchanges.

When Z-phase has not yet been passed, pass Z-phase twice (excluding reciprocations within one rotation), and then position to the orientation position.

When Z-phase has been passed already, immediately position to the orientation position.

The rotation direction of the spindle orientation is determined by the spindle zero point return specification parameter.

The spindle does not rotate if Z-phase has been passed and the orientation position is already established when orientation command is issued.

When the spindle has been rotating in the direction opposite from that of orientation rotation when the orientation command is issued, orientation operation will be executed after decelerating to stop. By using the parameter, the orientation operation can be executed with the spindle revolution direction as it is, without having to decelerate and stop.

(a) Orientation

This function stops the spindle rotation at a certain position when using the digital spindle.

When the orientation command is used, the spindle will rotate several times and then stop at the orientation point.

The orientation position differs depending on the detector.

- When the orientation (PLG and external encoder) is used:
...At the Z-phase position
- When the proximity switch method orientation is used:
...At the proximity switch installation position

(b) Multi-point orientation

This function performs orientation to a position other than the Z-phase position by inputting a shift amount with the parameter or PLC. The shift amount is -35999 to 35999. (Unit: $360^\circ/36000=0.01^\circ$)

(Note 1) Multi-point orientation cannot be executed when using the proximity switch.

(Note 2) Orientation is possible only when the gear ratio is 1:1 for the PLG orientation.

(The orientation is completed at the PLG encoder's Z-phase, so when using reduction gears, the orientation points will be generated at several points during one spindle rotation.)

(c) Orientation in-position advance output

This function turns the spindle in-position signal ON as soon as the spindle reaches within the second in-position width. Then, the spindle 2nd in-position signal is turned ON as soon as the spindle reaches within the in-position width.

Since orientation completion can be predicted using this function, it is possible to eliminate the sequence delay time, etc. for tool changes and other such operations, thereby achieving a faster takt time.

(d) Proximity switch method orientation

Proximity switch method orientation enables the spindle positioning by providing the proximity switch position installed on the spindle side as the spindle position zero point.

When the spindle motor and the spindle are connected with V-belt, the spindle position zero point calculated from the spindle motor position varies due to belt slipping, etc. Thus, the spindle position zero point must be detected from the proximity switch signal every time orientation or zero point return is carried out.

In the conventional spindle position zero point detection method, the spindle position zero point is calculated from the spindle drive unit and transmitted to NC when the position detector detects the one-time rotation signal (Z-phase) for the first time after the system has been turned ON, and the zero point will not be changed thereafter.

In the case of proximity switch signal orientation, NC updates the spindle position zero point every time orientation or zero point return is carried out.

8.1.7 Spindle Position Control (Spindle/C Axis Control)

8.1.7.1 Spindle Position Control (Spindle/C Axis Control)

	M850W	M830W	M850S	M830S	M80W	M80 TypeA	M80 TypeB	E80 TypeA	E80 TypeB	C80
M	○	○	○	○	○	○	○	○	—	○
L	○	○	○	○	○	○	○	○	○	○

A spindle can be controlled as the rotary axis. After switching the spindle to the rotary axis, the positioning and the interpolation between the spindle and other NC axes can be operated in the same way as the NC axis by executing the position command (the movement command).

The NC axis for controlling the spindle as the rotary axis or the machinery for switching the spindle and NC axis (such as a gear switching machinery) had been necessary for controlling a spindle readily as the rotary axis, but they are not necessary with this function.

There are two method for switching a spindle and a rotary axis: PLC signal method and program command method. The method can be selected with the parameter.

(1) PLC signal method

The spindle mode and the C axis mode can be switched with the servo OFF signal (*SVFn) ON/OFF with PLC ladder.

The interpolation operation is enabled by executing the movement command to the C axis in the C axis mode same as NC axis.

(a) Switching spindle mode to C axis mode

Change the servo OFF signal (*SVFn) OFF to ON.

(b) Switching C axis mode to spindle mode

Change the servo OFF signal (*SVFn) ON to OFF.

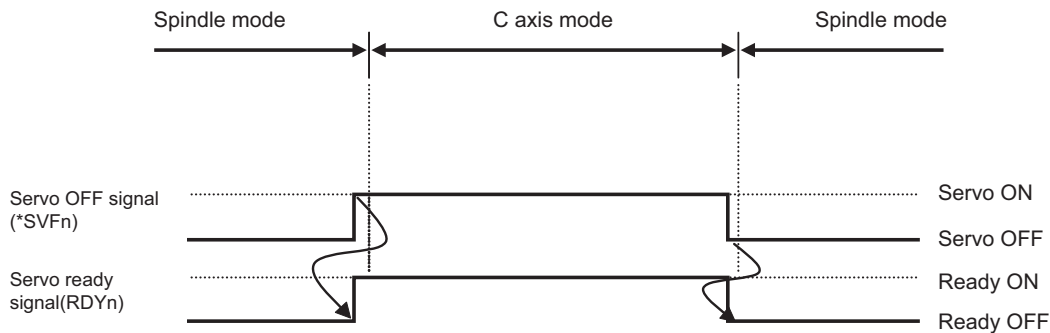

(2) Program command method

In the machining program, the program switches to the C axis mode with G00 command, and to the spindle mode with S command. The C axis servo OFF signal (*SVFn) must be kept ON while the program command method is selected.

(a) Switching spindle mode to C axis mode

Command [G00 C__] in the NC program during the spindle mode. The axis is positioned directly to the specified position.

The non-interpolation positioning for each axes is performed by specifying [G00 X__ Z__ C__] regardless of the parameter setting, and C axis is switched to the C axis mode.

(b) Switching C axis mode to spindle mode

- The switching is performed with the spindle forward run signal (SRN) ON or the spindle reverse run signal (SRI) ON and the S command.
- The switching is performed with the rising edge of the spindle forward run signal (SRN) or the spindle reverse run signal (SRI).

8.1.7.2 C Axis Control during Spindle Synchronization

	M850W	M830W	M850S	M830S	M80W	M80 TypeA	M80 TypeB	E80 TypeA	E80 TypeB	C80
M	△	△	△	△	—	—	—	—	—	△
L	△	△	△	△	○	○	○	—	—	△

This control enables C axis positioning while a long workpiece is controlled by front and rear spindles that are in synchronization with each other. Under this control, the machine can perform milling at the center of workpiece.

8.1.8 Spindle Synchronization

In a machine with two or more spindles, this function controls the rotation speed and phase of one selected spindle (synchronized spindle) in synchronization with the rotation of the other selected spindle (reference spindle). This function can be assigned by G code or by PLC.

It is used in cases where, for instance, workpiece clamped to the reference spindle is to be clamped to the synchronized spindle instead or where the spindle rotation speed is to be changed while one workpiece remains clamped to both spindles.

8.1.8.1 Spindle Synchronization I

	M850W	M830W	M850S	M830S	M80W	M80 TypeA	M80 TypeB	E80 TypeA	E80 TypeB	C80
M	○	○	○	○	○	○	○	—	—	○
L	○	○	○	○	○	○	○	○	○	○

The synchronized spindle is designated and the start/end of the synchronization are commanded with the G command in the machining program.

This function cannot be combined with the following spindle synchronization functions while it is active. An operation error occurs.

- Spindle synchronization I
- Spindle synchronization II
- Tool spindle synchronization IA
- Tool spindle synchronization IB (IC)
- Tool Spindle Synchronization II
- Spindle superimposition control

However, if multiple spindle synchronization set control is enabled, multiple spindle synchronization functions can be commanded. For details on the multiple spindle synchronization set control, refer to "8.1.15 Multiple Spindle Synchronization Set Control".

Command format

Spindle synchronization control ON (G114.1)

This command is used to designate the reference spindle and the spindle to be synchronized with the reference spindle, and it places the two designated spindles in the synchronized state.

By designating the synchronized spindle phase shift amount, the phases of the reference spindle and synchronized spindle can be aligned.

G114.1 H__D__R__A__;

H	: Designate the reference spindle.
D	: Designate the spindle to be synchronized with the reference spindle.
R	: Designates the synchronized spindle phase shift amount.
A	: Designates the spindle synchronization acceleration/deceleration time constant.

Spindle synchronization control cancel (G113 or G113.1)

This command releases the state of synchronization between two spindles whose rotation has been synchronized by the spindle synchronization command.

G113 ; (Lathe system)

G113.1 ; (Lathe system/Machining center system)

[Only for C80 Series]

This command can change the phase shift amount of the synchronized spindle of two spindles which have already synchronized by spindle synchronization command.

8.1.8.2 Spindle Synchronization II

	M850W	M830W	M850S	M830S	M80W	M80 TypeA	M80 TypeB	E80 TypeA	E80 TypeB	C80
M	○	○	○	○	○	○	○	—	—	○
L	○	○	○	○	○	○	○	○	○	○

The selection of the spindles to be synchronized, the start of the synchronization and other settings are all designated from the PLC.

The spindle synchronization control mode is established by inputting the spindle synchronization control signal. While this mode is established, the synchronized spindle is controlled in synchronization with the rotation speed assigned for the reference spindle.

This function cannot be combined with the following spindle synchronization functions while it is active. An operation error occurs.

- Spindle synchronization I
- Spindle synchronization II
- Tool spindle synchronization IA
- Tool spindle synchronization IB (IC)
- Tool Spindle Synchronization II
- Spindle superimposition control

[Only for C80 Series]

If multiple spindle synchronization set control is enabled, multiple spindle synchronization functions can be commanded. For details on the multiple spindle synchronization set control, refer to "8.1.15 Multiple Spindle Synchronization Set Control".

8.1.8.3 Guide Bushing Spindle Synchronization

	M850W	M830W	M850S	M830S	M80W	M80 TypeA	M80 TypeB	E80 TypeA	E80 TypeB	C80
M	—	—	—	—	—	—	—	—	—	—
L	△	△	△	△	○	○	—	—	—	—

This function is for a machine with a spindle motor to rotate a guide bushing: This function allows the guide bushing spindle motor (G/B spindle) to synchronize with a reference spindle motor (Reference spindle).

The position error compensation function reduces the spindle's vibration due to the workpiece's torsion, and the motor's overload.

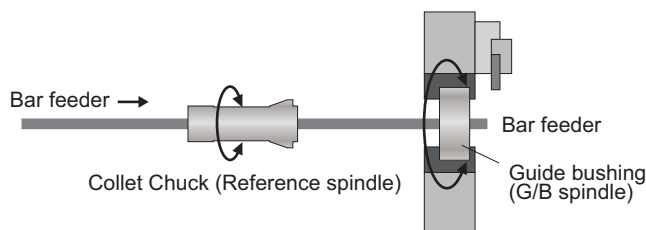

8.1.9 Tool Spindle Synchronization I (Polygon)

8.1.9.1 Tool Spindle Synchronization IA (Spindle-Spindle, Polygon)

	M850W	M830W	M850S	M830S	M80W	M80 TypeA	M80 TypeB	E80 TypeA	E80 TypeB	C80
M	△	△	△	△	○	○	○	—	—	—
L	△	△	△	△	○	○	○	○	○	△

In a machine containing a rotary tool axis and that has a spindle controlled as the workpiece axis, spindle-spindle polygon machining can be carried out by controlling the workpiece axis rotation in synchronization with the rotation of the rotary tool axis.

This function can be used with the G code list 1 to 5.

This function cannot be combined with the following spindle synchronization functions while it is active. An operation error occurs.

- Spindle synchronization I
- Spindle synchronization II
- Tool spindle synchronization IA
- Tool spindle synchronization IB (IC)
- Tool Spindle Synchronization II
- Spindle superimposition control

However, if multiple spindle synchronization set control is enabled, multiple spindle synchronization functions can be commanded.

Command format

Tool spindle synchronization IA mode command (G114.2)

This command establishes the spindle-spindle polygon machining mode (IA) in which two spindles are rotated in synchronization at two different speeds. It is required to designate the rotary tool spindle, workpiece spindle and the rotational ratios (number of rotary tool teeth and number of work angles) of the two designated spindles.

G114.2 H _ D _ E _ L _ R _ ;

H	: Selects the rotary tool spindle.
D	: Selects the workpiece spindle.
E	: Designates the rotary tool spindle rotational ratio.
L	: Designates the workpiece spindle rotational ratio.
R	: Synchronized spindle phase shift amount

Tool spindle synchronization IA mode cancel command (G113/G113.1)

This command releases the state of synchronization between two spindles whose rotation has been synchronized by the spindle synchronization command.

G113 ; (L system)

G113.1 ; (L system/M system)

(Note) An axis that involves any travel cannot be put in the same block as Tool spindle synchronization IA mode cancel command. If the axis address is included in the block, a program error occurs upon the cancel command, causing the automatic operation to stop.

8.1.9.2 Tool Spindle Synchronization IB (Spindle-Spindle, Polygon)

	M850W	M830W	M850S	M830S	M80W	M80 TypeA	M80 TypeB	E80 TypeA	E80 TypeB	C80
M	△	△	△	△	○	○	○	—	—	—
L	△	△	△	△	○	○	○	○	○	△

In a machine containing a workpiece axis and that has a spindle controlled as the rotary tool axis, spindle-spindle polygon machining can be carried out by controlling the rotary tool axis rotation in synchronization with the rotation of the workpiece axis.

A parameter is used to switch from Tool spindle synchronization IB to Tool spindle synchronization IC or vice versa.

This function can be used with the G code list 1,6 and 7.

This function cannot be combined with the following spindle synchronization functions while it is active. An operation error occurs.

- Spindle synchronization I
- Spindle synchronization II
- Tool spindle synchronization IA
- Tool spindle synchronization IB (IC)
- Tool Spindle Synchronization II
- Spindle superimposition control

However, if multiple spindle synchronization set control is enabled, multiple spindle synchronization functions can be commanded.

Command format

Tool spindle synchronization IB mode ON (G51.2 or G251)

This command establishes the spindle-spindle polygon machining mode in which two spindles are rotated in synchronization at two different speeds. It is required to designate the rotary tool spindle, workpiece spindle and the rotational ratios (number of work angles and number of rotary tool teeth) of the two designated spindles.

G51.2 H__D__P__Q__R__;

H : Selects the workpiece spindle (spindle).
D : Selects the rotary tool spindle (spindle).
P : Designates the workpiece spindle rotational ratio.
Q : Designates the rotary tool spindle rotational ratio.
R : Synchronized spindle phase shift amount

Tool spindle synchronization IB mode cancel command (G50.2 or G250)

G50.2 ;

(Note) An axis that involves any travel cannot be put in the same block as Tool spindle synchronization IB mode cancel command. If the axis address is included in the block, a program error occurs upon the cancel command, causing the automatic operation to stop.

8.1.9.3 Tool Spindle Synchronization IC (Spindle-NC Axis, Polygon)

	M850W	M830W	M850S	M830S	M80W	M80 TypeA	M80 TypeB	E80 TypeA	E80 TypeB	C80
M	△	△	△	△	○	○	—	—	—	—
L	△	△	△	△	○	○	—	—	—	△

This function controls so that the workpiece (spindle) and tool (NC axis) synchronously rotate at the commanded ratio and allows polygon machining. By changing the rotational ratio of workpieces and tools and the number of tool blades mounted, polygons such as rectangles and hexagons can be machined.

Tool spindle synchronization IB and Tool spindle synchronization IC can be switched by the parameter.

This function can be used with the G code list 1,6 and 7.

Command format

Tool spindle synchronization IC mode ON (G51.2 or G251)

G51.2 P__ Q__ ; Spindle synchronization start (Tool spindle synchronization IC mode start)

P : Spindle rotational ratio
 Q : Rotary tool axis rotational ratio
 Rotation direction is specified with a sign.
 +: Forward run / -: Reverse run

Tool spindle synchronization IC mode OFF (G50.2 or G250)

G50.2 ;

8.1.10 Tool Spindle Synchronization II (Hobbing)

	M850W	M830W	M850S	M830S	M80W	M80 TypeA	M80 TypeB	E80 TypeA	E80 TypeB	C80
M	△	△	△	△	○	○	—	—	—	—
L	△	△	△	△	○	○	—	—	—	△

This function is to cut the gear with hob (hob cutter).

A spur gear can be machined by synchronizing and rotating the hob axis and the workpiece axis in a constant ratio.

A helical gear can be machined by compensating the workpiece axis according to the gear torsion angle for the Z axis movement.

Different command format is used for G code list 1 to 5 and G code list 6 or 7.

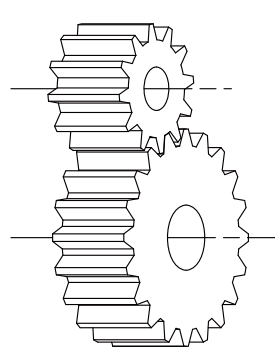

Spur gears

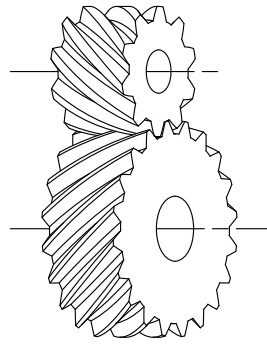

Helical gears

By synchronizing and rotating the hob axis and the workpiece axis in a constant rotation ratio, a gear is machined so that the cutter is engaged with gear.

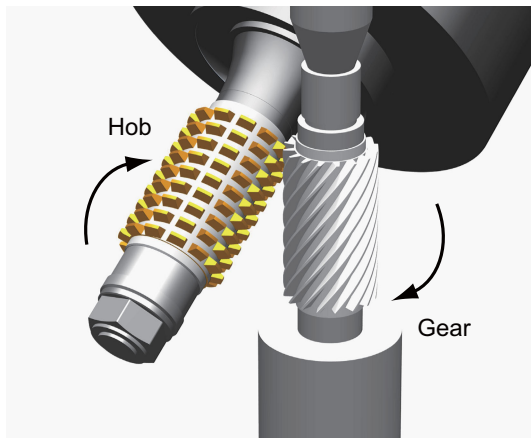

Hob axis : Rotary tool axis on which a hob is mounted.

Workpiece axis : Rotary axis on which a workpiece is mounted.

This function cannot be combined with the following spindle synchronization functions while it is active. An operation error occurs.

- Spindle synchronization I
- Spindle synchronization II
- Tool spindle synchronization IA
- Tool spindle synchronization IB (IC)
- Tool Spindle Synchronization II
- Spindle superimposition control

However, if multiple spindle synchronization set control is enabled, multiple spindle synchronization functions can be commanded.

8.1.11 Spindle Speed Clamp

	M850W	M830W	M850S	M830S	M80W	M80 TypeA	M80 TypeB	E80 TypeA	E80 TypeB	C80
M	○	○	○	○	○	○	○	○	○	○
L	○	○	○	○	○	○	○	○	○	○

This function is to limit the spindle rotation speed to the ranges between the maximum rotation speed and the minimum rotation speed.

This function can be set by a parameter or a program.

G92 S_ Q_ ;	Spindle clamp speed setting
S	: Maximum clamp rotation speed
Q	: Minimum clamp rotation speed

An alarm will occur if the constant surface speed control is conducted without issuing the spindle clamp speed command (G92).

8.1.13 Spindle Oscillation

	M850W	M830W	M850S	M830S	M80W	M80 TypeA	M80 TypeB	E80 TypeA	E80 TypeB	C80
M	△	△	△	△	—	—	—	—	—	—
L	△	△	△	△	—	—	—	—	—	—

This function reciprocates (oscillates) the spindles with designated amplitude and frequency.

8.1.14 Spindle Superimposition Control

	M850W	M830W	M850S	M830S	M80W	M80 TypeA	M80 TypeB	E80 TypeA	E80 TypeB	C80
M	—	—	—	—	—	—	—	—	—	—
L	△	△	△	△	○	○	—	—	—	△

Spindles are controlled by superimposing the rotation speed of one spindle on the rotary speed of other spindle. Use this function when the tool spindle needs to be rotated with the superimposed speed on the spindle rotation speed. If this function is used when tapping is performed to the center of a workpiece clamped to a spindle during its rotation, for instance, the tapping to the center of the workpiece (shown in Figure (b) below) can be performed during the turning machining (shown in Figure (a) below) so that the cycle time can be reduced.

This function cannot be combined with the following spindle synchronization functions while it is active. An operation error occurs.

- Spindle synchronization I
- Spindle synchronization II
- Tool spindle synchronization IA
- Tool spindle synchronization IB (IC)
- Tool Spindle Synchronization II
- Spindle superimposition control

However, if multiple spindle synchronization set control is enabled, multiple spindle synchronization functions can be commanded.

(1) Conventional method

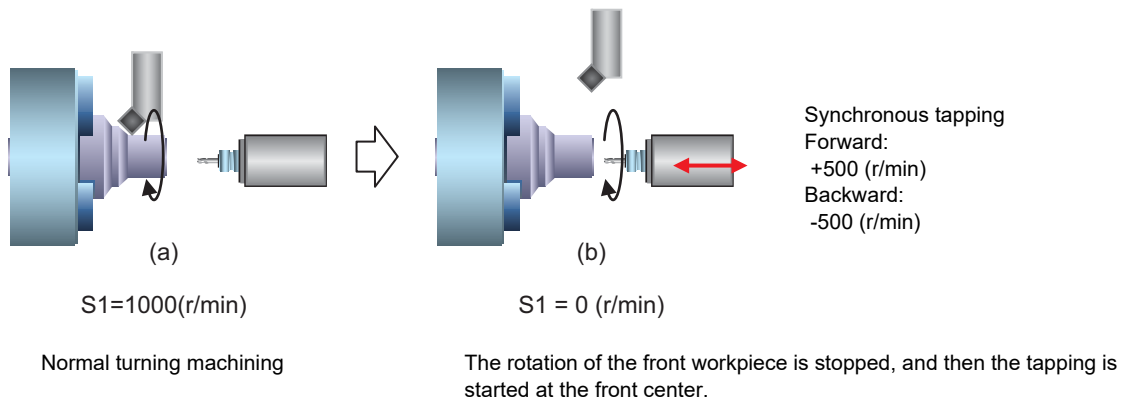

(2) Using the spindle superimposition control

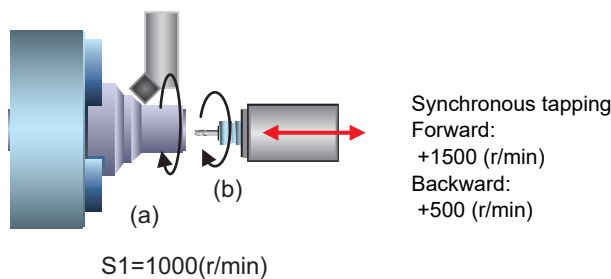

Turning (a) and tapping at the front center (b) are performed simultaneously.

Command format

Spindle superimposition control valid command

G164 command specifies the reference spindle and superimposed spindle and makes the two spindles to be superimposed.

G164 H__ D__ ;

H	: Select the reference spindle (For command using the spindle number, the spindle number should be within the number of spindles for specifications. For command using the spindle name, the name is valid from 1 to 9.)
D	: Select the superimposed spindle (For command using the spindle number, the spindle number should be within the number of spindles for specifications. For command using the spindle name, the number from 1 to 9 or from -1 to -9 is valid for the spindle name.)

Command with the spindle name if all spindle names are set to the spindle name parameter. For others, command with the spindle number.

Spindle superimposition control cancel command

G113 command cancels the superimposition of two spindles which are rotating by the differential velocity rotation tool command.

The superimposition can be cancelled also with "Spindle synchronization cancel" signal ON.

G113 ;**G113.1 ;**

For G code list 6 and 7, only G113.1 is available for the cancel command.

(Note) An axis that involves any travel cannot be put in the same block as the spindle superimposition control cancel command. If the axis address is included in the block, a program error occurs upon the cancel command, causing the automatic operation to stop.

8.1.15 Multiple Spindle Synchronization Set Control

	M850W	M830W	M850S	M830S	M80W	M80 TypeA	M80 TypeB	E80 TypeA	E80 TypeB	C80
M	—	—	—	—	—	—	—	—	—	○
L	○	○	○	○	○	○	○	—	—	○

This function enables users to combine the following spindle control functions and control them simultaneously.

(*1) The same function can be combined.

When a certain pair of spindles has been designated for one spindle control function, a different pair of spindles can be used for another spindle control function.

- Spindle synchronization I
- Tool Spindle Synchronization IA (Spindle-Spindle, Polygon)
- Tool Spindle Synchronization IB (Spindle-Spindle, Polygon)
- Tool Spindle Synchronization II (Hobbing)
- Spindle superimposition control
- Spindle synchronization II [Only for C80 Series]

The same reference spindle can be used when the following spindle control functions are combined.

- Spindle synchronization I
- Tool Spindle Synchronization IA
- Spindle synchronization II [Only for C80 Series]

(Note 1) For C80, spindle synchronization II can also be commanded. However, in case of machining center systems, only spindle synchronization I and spindle synchronization II can be used among spindle synchronization functions.

(Note 2) The guide bushing spindle synchronization is not included in the number of multiple spindle synchronization sets.

This function enables the following machining.

[Example for Lathe systems]

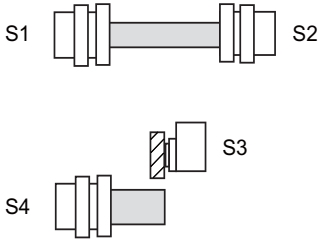
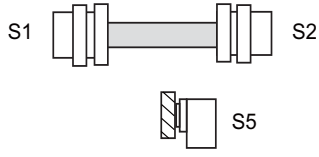
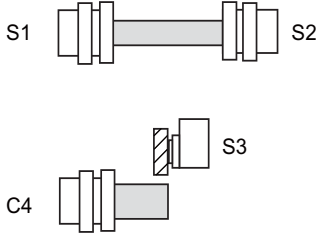
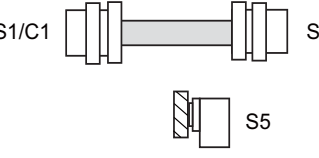
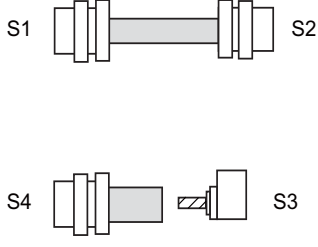
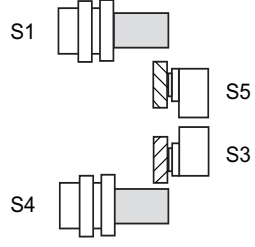
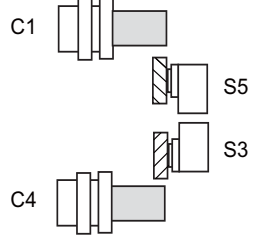
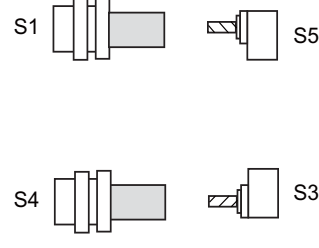
<p>Spindle synchronization I command (S1-S2) + Tool spindle synchronization IA command (S3-S4)</p> 	<p>Spindle synchronization I command (S1-S2) + Tool spindle synchronization IA command (S1-S5)</p> 
<p>Spindle synchronization I command (S1-S2) + Tool spindle synchronization II command (S3-C4)</p> 	<p>Spindle/C axis synchronization control command (S1/C1-S2) + Tool spindle synchronization II command (S5-C1)</p> 
<p>Spindle synchronization I command (S1-S2) + Spindle superimposition control command (S4-S3)</p> 	<p>Tool spindle synchronization IA command (S5-S1) + Tool spindle synchronization II command (S3-S4)</p> 
<p>Tool spindle synchronization II command (S5-C1) + Tool spindle synchronization II command (S3-C4)</p> 	<p>Spindle superimposition control command (S1-S5) + Spindle superimposition control command (S4-S3)</p> 

Command format

For details on the command format which starts each function, refer to the respective chapters.

Spindle synchronization control cancel

- (1) Command to cancel all synchronization modes

Cancels all the synchronized sets. The format varies depending on the parameter settings.

G113 H0 ; Cancels all the active tool spindle synchronization II (hobbing) commands.
G113 D0 ; Cancels all the active spindle synchronization I, tool spindle synchronization IA (spindle-spindle, polygon), and spindle superimposition commands.

G113 ;

- (2) Spindle synchronization I, tool spindle synchronization IA (spindle-spindle, polygon), or spindle superimposition control cancel command

G113 D_ ;
 D : Synchronized or superimposed spindle to cancel (For a spindle number command, the range is from 1 to the number of available spindles, or from 1 to 9 for a spindle name command.)

- (3) Tool spindle synchronization II (hobbing) cancel command (when the G code list of the program is 2, 3, 4, or 5)

G113 H_ ;
 H : Reference spindle to cancel (For a spindle number command, the range is from 1 to the number of available spindles, or from 1 to 9 for a spindle name command.)

- (4) Tool spindle synchronization II (hobbing) cancel command (when the G code list of the program is 6 or 7)
 Cancel tool spindle synchronization II (hobbing) of the specified part system.

G80.4 ;

- (5) Tool spindle synchronization IB (spindle-spindle, polygon) cancel command

Cancel tool spindle synchronization IB (spindle-spindle, polygon) of the specified part system.

G50.2 ;

8.1.16 Spindle Speed Fluctuation Detection

	M850W	M830W	M850S	M830S	M80W	M80 TypeA	M80 TypeB	E80 TypeA	E80 TypeB	C80
M	△	△	△	△	○	○	○	—	—	—
L	△	△	△	△	○	○	○	—	—	—

When this function is valid and the spindle actual speed fluctuates for the commanded speed by the program due to external factors such as load fluctuation, the NC outputs the signal (Spindle speed out of setting range) to PLC and the operation error occurs.

PLC can take the necessary measure for the fluctuation of the spindle speed using the output signal (Spindle speed out of setting range) from the NC.

The operation error output from the NC does not stop the automatic operation or the spindle.

A parameter is used to switch whether or not to output the operation error during spindle speed fluctuation detection (G162).

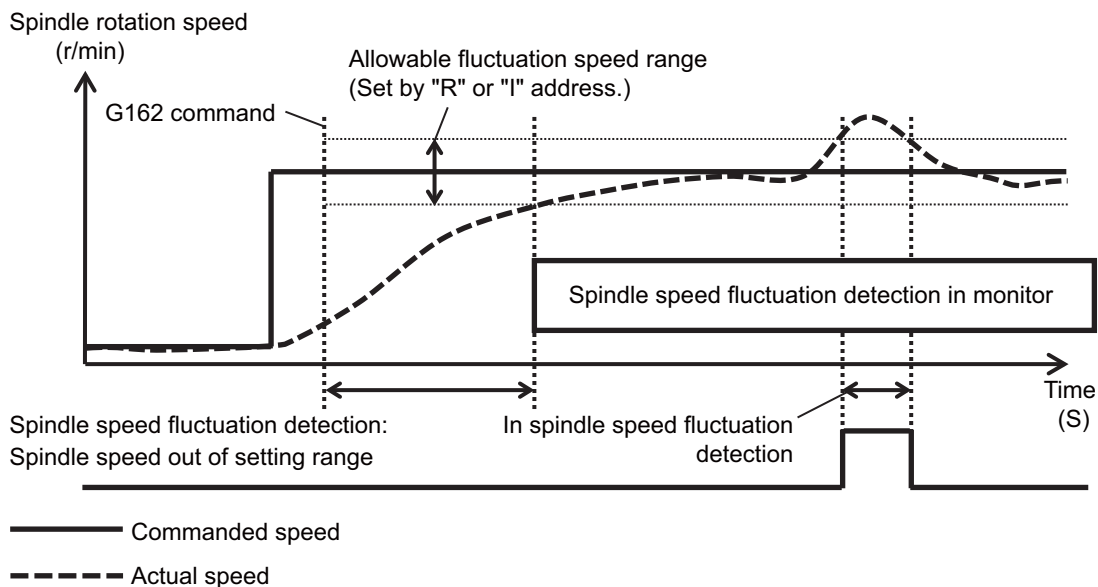

Command format

Starting the spindle speed fluctuation detection

The spindle speed fluctuation detection is started by commanding G162.

G162 S_ P_ Q_ R_ I_ ;

S : Detection target spindle name (1 to 9)
P : Delay time for starting spindle speed fluctuation detection (0 to 99.999 (s))
Q : Spindle speed attainment detection range (1 to 100 (%))
R : Spindle speed fluctuation allowance rate (1 to 100 (%))
I : Allowable fluctuation range in spindle speed (0 to 999999 (r/min))

Canceling the spindle speed fluctuation detection

The spindle speed fluctuation detection is canceled by commanding G163.

G163 S_ ;

S : Detection target spindle name (1 to 9)

8.1.17 Spindle Motor Temperature Output to PLC

	M850W	M830W	M850S	M830S	M80W	M80 TypeA	M80 TypeB	E80 TypeA	E80 TypeB	C80
M	○	○	○	○	○	○	○	○	○	—
L	○	○	○	○	○	○	○	○	○	—

This function outputs spindle motor temperature information to R registers.

Spindle motor temperature can be monitored by this function. The function makes it possible, for instance, to add MTB-original custom spindle control based on the spindle motor temperature, and to notify external equipment of temperature information.

8.2 Tool Functions (T)

8.2.1 Tool Functions (T Command)

	M850W	M830W	M850S	M830S	M80W	M80 TypeA	M80 TypeB	E80 TypeA	E80 TypeB	C80
M	○	○	○	○	○	○	○	○	○	○
L	○	○	○	○	○	○	○	○	○	○

The command is issued with an 8-digit number following address T (T0 - T99999999). The tool function is used to command the tool No. In the lathe specification controller, the tool compensation (tool length compensation, tool nose wear compensation) Nos. are also indicated.

(1) M system

Tool function, or T function, is used to designate the tool No. and tool compensation No.

This can be designated with an 8-digit number following address T (0 to 99999999). Up to four sets of T commands can be issued in one block. Note that the number of T commands to be issued within the same block is determined by parameter.

BCD output or binary output can be selected by parameter.

Output signal is 8-digit BCD code and start signal, signed 32-bit binary data and start signal, or non-signed 32-bit binary data and start signal.

T function can be designated with any other kind of commands. In the case where a movement command is in the same block, two different command sequences are available. Depending on machine specifications, either one of the following two will be applied.

(a) T function is executed after the movement is completed.

(b) T function is executed at the same time as when the movement command is issued.

Processing and completion sequences are required for all the T commands.

(Note 1) In some setting and display units, there may be screens that cannot display all eight digits.

(2) L system

The command is issued with an 8-digit number following address T (T0 to T99999999). The high-order digits are designated as the tool No., and the low-order digit(s) are designated as the offset No. Each number of high/low-order digits depends on the specifications of MTB (the parameter setting).

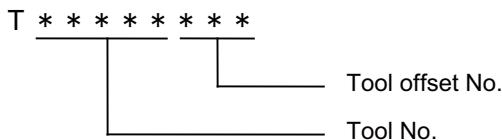
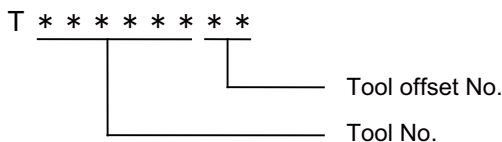
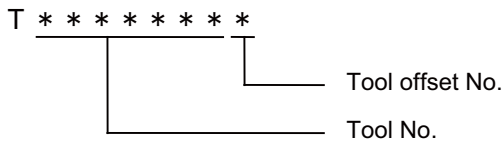

The tool No. code data and start signal will be output to the PLC.

All the other details are the same as in M system.

8.3 Miscellaneous Functions (M)

8.3.1 Miscellaneous Functions

	M850W	M830W	M850S	M830S	M80W	M80 TypeA	M80 TypeB	E80 TypeA	E80 TypeB	C80
M	○	○	○	○	○	○	○	○	○	○
L	○	○	○	○	○	○	○	○	○	○

Miscellaneous function, or M function, is used to command auxiliary functions for NC, such as rotating the spindle forward/backward or stopping it, as well as turning the cooling oil ON/OFF.

These functions are designated by an 8-digit number (0 to 99999999) following the address M, and multiple commands can be issued in a single block. The number of M commands that can be issued within the same block depends on the parameter setting. ([M8] maximum 4 sets, [C80] maximum 6 sets)

BCD output or binary output can be selected by parameter.

Output signal is 8-digit BCD code and start signal, signed 32-bit binary data and start signal, or non-signed 32-bit binary data and start signal.

(Example) G00 Xx1 Mm1 Mm2 Mm3 Mm4 ;

- (1) When the number of M commands in a single block is greater than the setting value of the parameter, the commands issued later are valid.
M00, M01, M02, M30, M96, M97, M98 and M99 are used only for some specific purposes and cannot be assigned as regular M functions.
- (2) Processing and completion sequences are required for all M functions except M96, M97, M98 and M99. Refer to user PLC specification for the relationship between values and functions.
As for M00, M01, M02 and M30, next block is not read into pre-reading buffer due to ban on pre-reading processing.
- (3) Although M00, M01, M02, and M30 output an independent signal for each, the independent output of M00, M01, M02 and M30 will be reset upon pressing a reset key.
- (4) M command can be designated with other commands within the same block. In the case where a movement command is in the same block, two different command sequences are available. Depending on user PLC specifications, either one of the following two will be applied.
 - (a) M function is executed after the movement is completed.
 - (b) M function is executed at the same time as when the movement command is issued.
 Processing and completion sequences are required for all the M commands except M96, M97, M98 and M99.

(Note 1) In some setting and display units, there may be screens that cannot display all eight digits.

8.3.2 Multiple M Codes in 1 Block

	M850W	M830W	M850S	M830S	M80W	M80 TypeA	M80 TypeB	E80 TypeA	E80 TypeB	C80
M	○	○	○	○	○	○	○	○	○	○
L	○	○	○	○	○	○	○	○	○	○

Multiple sets of M commands can be issued in a block. ([M8] maximum 4 sets, [C80] maximum 6 sets)

Respective processing and completion sequences are required for all M commands included in a block (except M96, M97, M98 and M99).

(Note 1) This function requires a built-in PLC. In this case, the code data and start signals of all the M commands in the same block are transferred simultaneously from the controller to the PLC, and so high-speed machine control can be done by the PLC processing sequence.

8.3.3 M Code Independent Output

	M850W	M830W	M850S	M830S	M80W	M80 TypeA	M80 TypeB	E80 TypeA	E80 TypeB	C80
M	○	○	○	○	○	○	○	○	○	○
L	○	○	○	○	○	○	○	○	○	○

When the M00, M01, M02 or M30 command is assigned during an automatic operation (tape, memory, MDI) or by a manual numerical command, the signal of this function is output. It is turned OFF after the miscellaneous function finishes or by the reset & rewind signal.

Machining program	M code independent output	Response to controller
M00	M00	Fin1 or Fin2
M01	M01	Fin1 or Fin2
M02	M02	Reset & rewind
M30	M30	Reset & rewind

If movement or dwell command exists in the same block as these M commands, this signal is output upon completion of the movement or dwell command.

8.3.4 Miscellaneous Function Finish

	M850W	M830W	M850S	M830S	M80W	M80 TypeA	M80 TypeB	E80 TypeA	E80 TypeB	C80
M	○	○	○	○	○	○	○	○	○	○
L	○	○	○	○	○	○	○	○	○	○

These signals inform the CNC system that a miscellaneous function (M), spindle function (S), tool function (T) or 2nd miscellaneous function (A, B, C) has been assigned and that the PLC which has received it has completed the required operation. They include miscellaneous function finish signal 1 (FIN1) and miscellaneous function finish signal 2 (FIN2).

Miscellaneous function finish signal 1 (FIN1)

When the controller checks that FIN1 is ON, it sets the function strobes OFF. Furthermore, when the PLC checks that the function strobes are OFF, it sets FIN1 OFF. The controller checks that FIN1 is OFF and advances to the next block. Below is an example of a time chart applying when a miscellaneous function has been assigned.

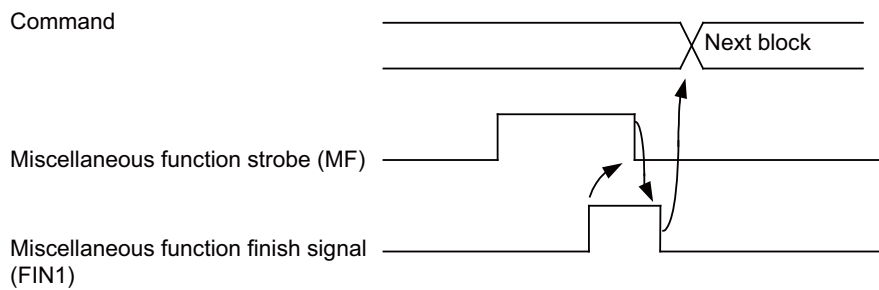

Miscellaneous function finish signal 2 (FIN2)

When the controller checks that FIN2 is ON, it sets the function strobes OFF and simultaneously advances to the next block. The PLC checks that the strobe signals are OFF and sets FIN2 OFF. Below is an example of a time chart applying when a miscellaneous function has been assigned.

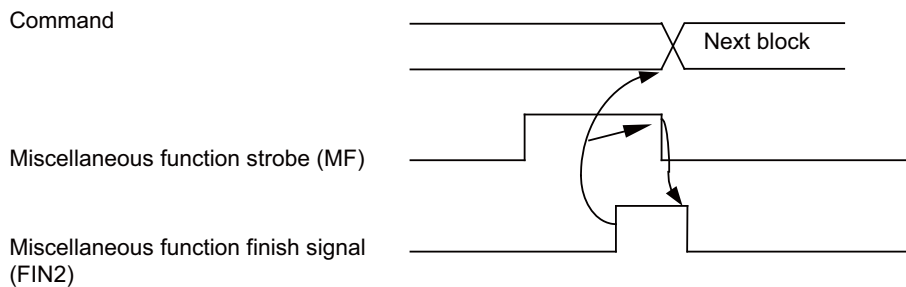

8.3.5 M Code Output during Axis Traveling

	M850W	M830W	M850S	M830S	M80W	M80 TypeA	M80 TypeB	E80 TypeA	E80 TypeB	C80
M	—	—	—	—	—	—	—	—	—	—
L	○	○	○	○	○	○	—	—	—	○

This function controls the timing at which miscellaneous functions are output, and it outputs a miscellaneous function when axis reaches at the designated position movement.

The command format is as follows.

```
G117 Xx1 Zz1 Cc1 □ □ □ □ ;
G117          : Command of M code output during axis traveling
Xx1,Zz1,Cc1   : Movement start points
□ □ □ □      : Miscellaneous function
```

- (1) This command is issued independently immediately before the block with the movement command that activates the miscellaneous function.
- (2) Single block stop does not apply to this command.
- (3) The maximum number of groups to which the miscellaneous functions in the G117 block can be issued is as follows:

M commands	4 sets
S commands	2 sets
T commands	1 set
2nd miscellaneous function	1 set

- (4) This command can be issued in up to two consecutive blocks. When issued in three or more consecutive blocks, the last two blocks will be valid.

(Example) G117 Xx₁ Zz₁ Mm₁ Mm₂ Mm₃ Mm₄ ;

G117 Xx₂ Zz₂ Mm₅ Mm₆ Mm₇ Mm₈ ;

G01 X200 Z200 ;

:

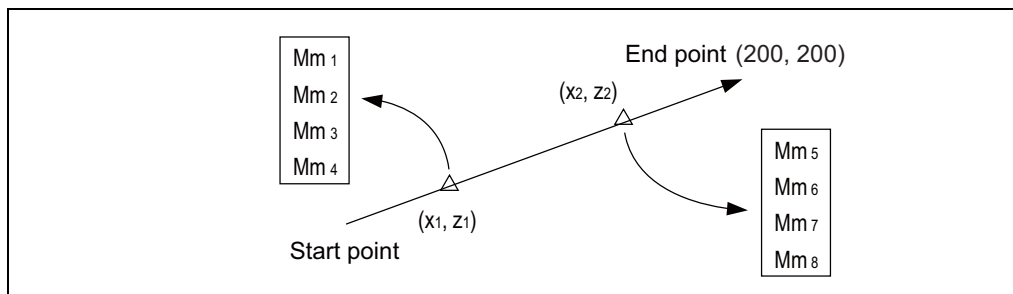

8.3.6 Miscellaneous Function Command High-speed Output

	M850W	M830W	M850S	M830S	M80W	M80 TypeA	M80 TypeB	E80 TypeA	E80 TypeB	C80
M	○	○	○	○	○	○	○	○	○	○
L	○	○	○	○	○	○	○	○	○	○

The miscellaneous command high-speed output shortens a processing time per miscellaneous function. There are two functions that can be selected individually.

(1) Change miscellaneous command completion method

Select one of the following methods by the parameter.

High-speed method:

The controller inverts a strobe signal logically at the time of outputting a miscellaneous command. The PLC performs the designated operation and logically inverts the high-speed miscellaneous function finish signal.

The controller completes the miscellaneous function when the strobe signal and the high-speed miscellaneous function finish signal become the same logic level.

Normal method:

Conventional method (Refer to "8.3.4 Miscellaneous Function Finish" for details.)

(2) Selecting miscellaneous command completion method

Select whether or not to wait for a finish signal from the PLC using the parameter.

It can be selected for M, S, T or B individually.

- High-speed method that waits for a finish signal from the PLC

The miscellaneous function completes by matching the logic level of the finish signal with that of the strobe signal.

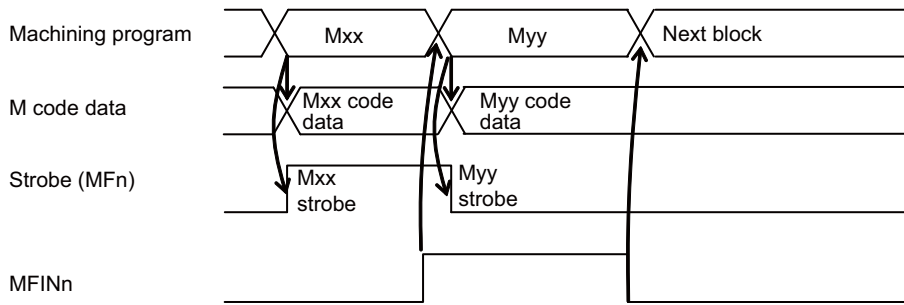

- High-speed method that does not wait for a finish signal from the PLC

When a series of miscellaneous commands is issued, the completion of the previous miscellaneous command is waited.

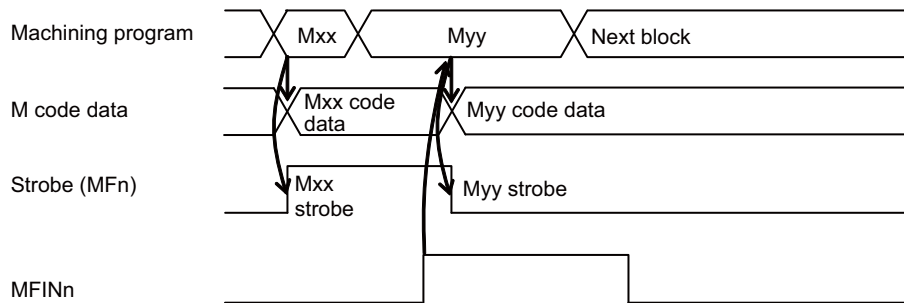

- Normal method that waits for a finish signal from the PLC

Conventional method.

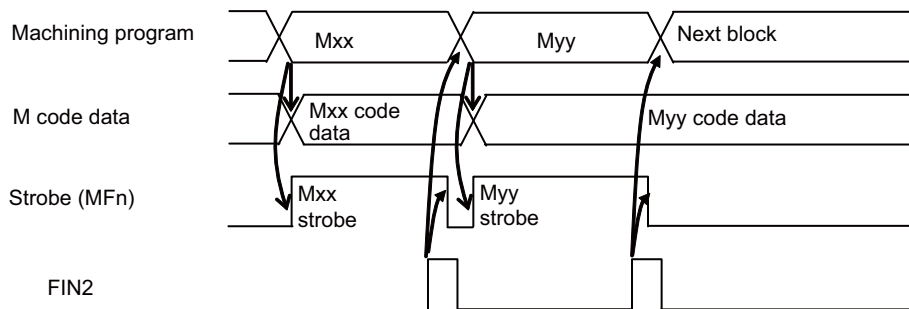

- Normal method that does not wait for a finish signal from the PLC

When a series of miscellaneous commands is issued, the completion of the previous miscellaneous command is waited.

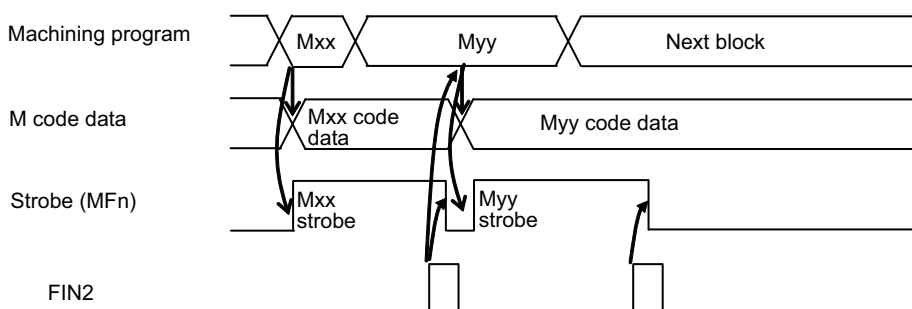

8.4 2nd Miscellaneous Functions (B)

8.4.1 2nd Miscellaneous Functions

	M850W	M830W	M850S	M830S	M80W	M80 TypeA	M80 TypeB	E80 TypeA	E80 TypeB	C80
M	○	○	○	○	○	○	○	○	○	○
L	○	○	○	○	○	○	○	○	○	○

The code data and start signals are output when an 8-digit number is assigned following the address code A, B or C - whichever does not duplicate the axis name being used.

Processing and complete sequences must be incorporated on the PLC side for all 2nd miscellaneous commands.

(Note 1) This function requires a built-in PLC.

(Note 2) There are some screens in the setting and display unit that cannot display all eight digits.

8.4.2 2nd Miscellaneous Function Name Extension

	M850W	M830W	M850S	M830S	M80W	M80 TypeA	M80 TypeB	E80 TypeA	E80 TypeB	C80
M	○	○	○	○	○	○	○	○	○	○
L	○	○	○	○	○	○	○	○	○	○

The 2nd miscellaneous function name same as the additional axes (A, B, C) can be used by specifying the command address of the 2nd miscellaneous function with two characters.

Whether the command address has one character or two characters can be set by the parameter.

The operation of the 2nd miscellaneous function is same as the operation with the one character address method.

Tool Compensation

9.1 Tool Length/Tool Position

9.1.1 Tool Length Offset

	M850W	M830W	M850S	M830S	M80W	M80 TypeA	M80 TypeB	E80 TypeA	E80 TypeB	C80
M	○	○	○	○	○	○	○	○	○	○
L	○	○	○	○	○	○	○	○	○	○

These commands make it possible to control the axis movement by compensating the position of the end point of the movement command by a compensation amount set on the tool compensation screen.

Using this function, it is possible to compensate the difference in distance between the actual position of the machine's tool nose and the program coordinate position made by the tool length and to enhance both the programming and operational efficiency.

(1) M system

G43 Zz1 Hh1 ;	
G44 Zz1 Hh1 ;	
G43	: Tool length compensation command + direction (z1+h1)
G44	: Tool length compensation command + direction (z1-h1)
Zz1	: Compensation axis. Tool length compensation can be provided not only for the Z axis but for all the other axes (X, Y, etc.) which can be controlled in the system.
Hh1	: Compensation No.

Compensation can be canceled by the following G commands.

G49 ;
G43 H0 ;
G44 H0 ;

(Note) When the tool length compensation axis is returned to the reference position, the compensation of that axis is canceled.

(2) L system

(a) Shape compensation

Tool length is compensated in reference to the programmed base position. The programmed base position is usually the center of the tool rest or the nose position of the base tool.

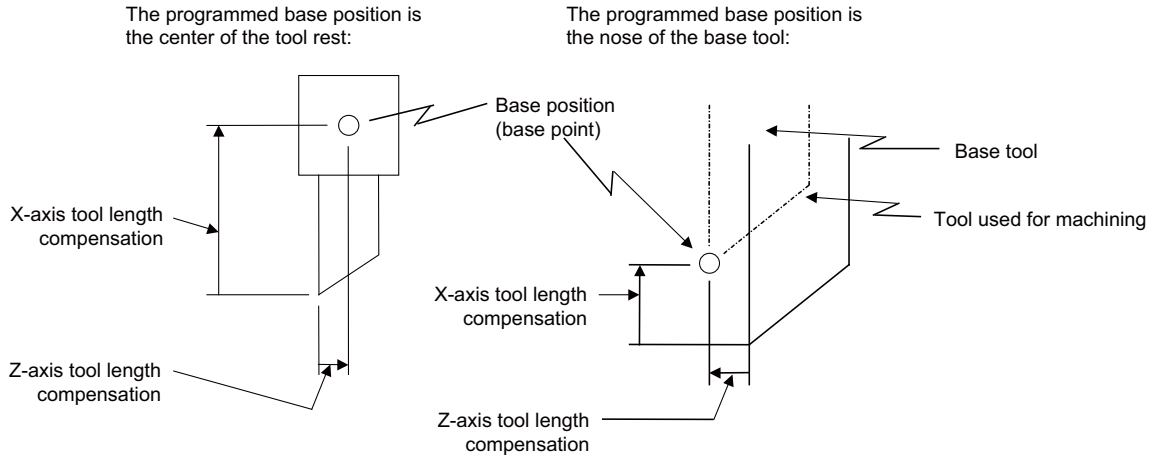

(b) Wear compensation

The wear of a tool nose can be compensated.

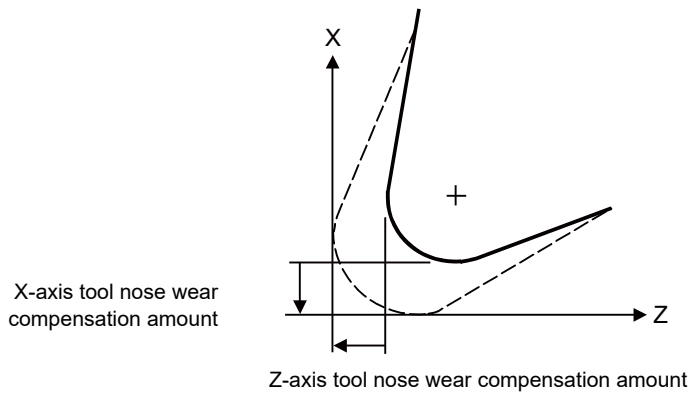

(c) Command format

Tool compensation is performed by a T command. It is specified in eight digits following address T. Tool compensation is divided into two types: tool length compensation and tool nose wear compensation. It depends on the machine specifications as to which digit of T command denotes the tool No., tool length compensation No. or tool nose wear compensation No. (specified by parameters).

(i) Specifying tool length and wear compensation Nos. together using low-order digits of the T command

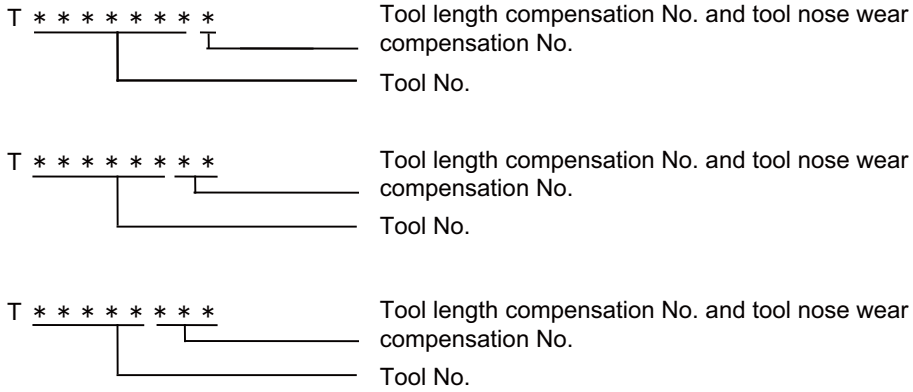

(ii) Specifying tool length and wear compensation Nos. separately

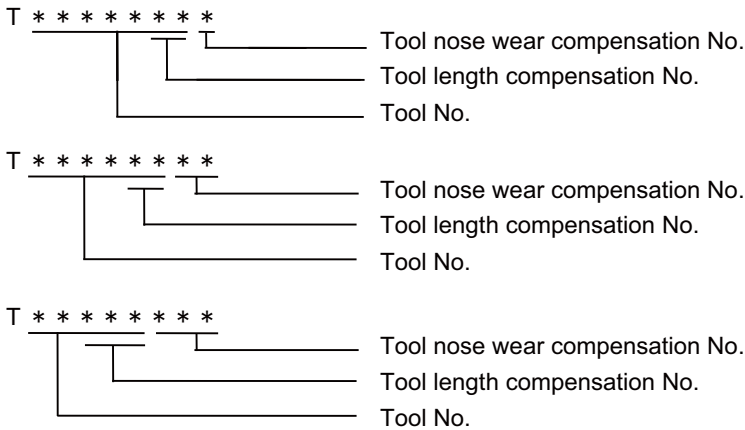

The tool compensation for the lathe is valid only for the X and Z axes. If an additional axis (Y axis) and the second additional axis are added, the tool compensation will be validated for each additional axis. It supports 4 axes in total.

The additional axis is the third or fourth axis which is selected using a parameter.

9.1.2 Tool Position Offset

	M850W	M830W	M850S	M830S	M80W	M80 TypeA	M80 TypeB	E80 TypeA	E80 TypeB	C80
M	○	○	○	○	○	○	○	○	○	○
L	—	—	—	—	—	—	—	—	—	—

This function uses commands to control the movement by changing the positions of the end points of the movement commands to positions which have been extended or reduced by an amount equivalent to the tool compensation amount.

This function can be used to compensate for the difference in distance between the position where the tool on the machine is actually mounted and the programmed coordinate position based on the tool position and thereby improve the efficiency of both machining and operation.

```
G45 G00 Xx1 Yy1 Dd1 ;
G45          : Tool position offset command
Xx1,Yy1     : Movement axes
Dd1         : Offset No.
```

With tool position offset, the offset operation is performed only for blocks containing a G45 to G48 command.

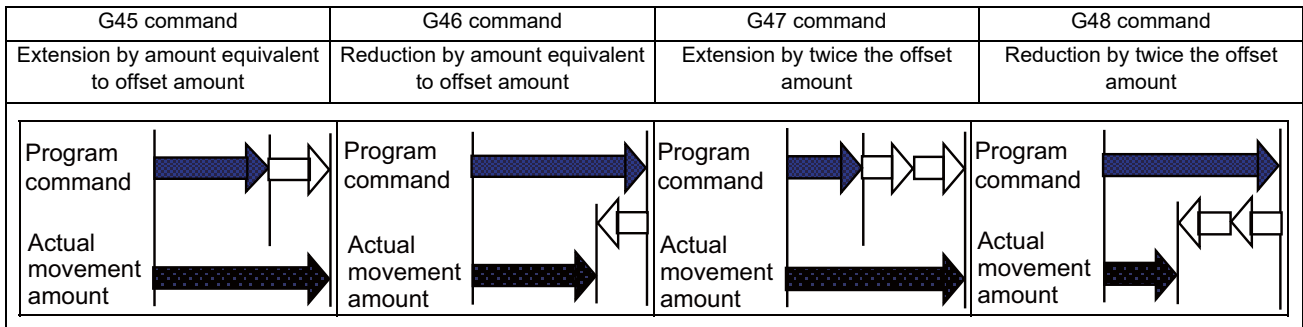

- (1) If the start and end points are on an axis, the radius can be extended or reduced only for one-quarter, one-half and three-quarter arcs.
- (2) In the case of absolute commands, the position is extended or reduced in each axial direction from the end point of the previous block along the line of the movement toward the position commanded in the block containing the G45 (or G46, G47 or G48) command.
- (3) In the case of simultaneous n axes command, the same amount of offset is applied to all the axes that have the command within the range of the number of the axes which can be simultaneously controlled. Tool position offset is also valid for additional axes.

9.1.3 Tool Compensation for Additional Axes

	M850W	M830W	M850S	M830S	M80W	M80 TypeA	M80 TypeB	E80 TypeA	E80 TypeB	C80
M	—	—	—	—	—	—	—	—	—	—
L	○	○	○	○	○	○	○	○	○	○

The tool compensation for the lathe is valid for the first axis (normally X axis) and the second axis (normally Z axis). If additional or second additional axes are added as the third and subsequent axes, the tool compensation is also valid for each additional axes.

The additional axes to which the tool compensation is executed are determined according to the parameter setting.

9.1.4 Tool Position Compensation (G43.7)

	M850W	M830W	M850S	M830S	M80W	M80 TypeA	M80 TypeB	E80 TypeA	E80 TypeB	C80
M	△	△	△	△	—	—	—	—	—	—
L	—	—	—	—	—	—	—	—	—	—

The position compensation of a turning tool is executed when turning is performed in a machine of machining center system. Use of the tool position compensation enables the three base axes (X, Y and Z axes) to be compensated from the tool base position (base point).

Before setting the compensations of the three base axes, set the parameter to switch the tool compensation display type to type III.

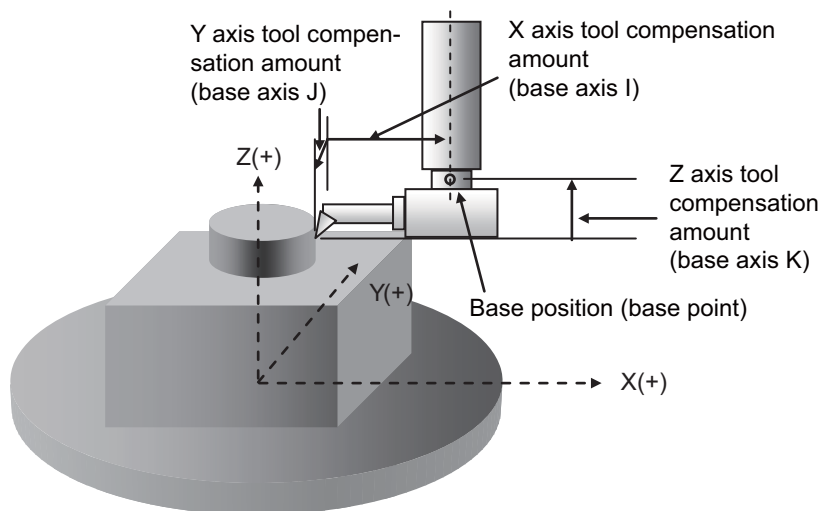

Command format

G43.7 H_{__}; Tool position compensation start

G49; Tool position compensation cancel

H : Compensation No. (H0 cancels tool position compensation.)

9.2 Tool Radius

9.2.1 Tool Radius Compensation

	M850W	M830W	M850S	M830S	M80W	M80 TypeA	M80 TypeB	E80 TypeA	E80 TypeB	C80
M	○	○	○	○	○	○	○	○	○	○
L	—	—	—	—	—	—	—	—	—	—

These commands function to provide tool radius compensation. Through a combination with the G command and D address assignment, they compensate for the actual tool center path either inside or outside the programmed path by an amount equivalent to the tool radius.

The tool path is calculated by the intersection point arithmetic system and, as a result, excessive cut amounts on the inside of corners are avoided.

G code	Function
G38	Vector designation during tool radius compensation
G39	Corner arc during tool radius compensation
G40	Tool radius compensation cancel
G41	Tool radius compensation left command
G42	Tool radius compensation right command

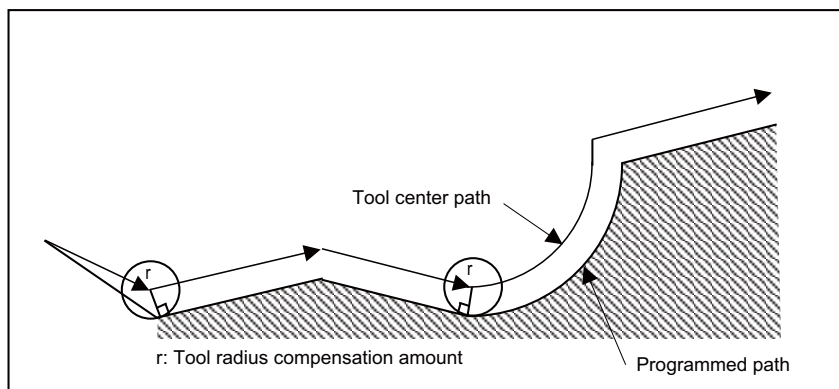

The tool radius compensation command controls the compensation from that block in which G41 or G42 is commanded. At start of the compensation, regardless of continuous operation or single block operation, three blocks of movement commands are always pre-read consecutively before execution. If there are fewer than three blocks of movement commands, up to five blocks are pre-read.

Similarly, during the compensation mode, up to five blocks are read for compensation calculation.

In the compensation mode, the program is read in up to five blocks ahead including blocks with no movement, and interference check using tool radius is conducted in up to three blocks of movement commands ahead.

The maximum number of blocks pre-read at start of the compensation and during the compensation mode can be changed by the parameter.

```
G17 G01 G41 Xx1 Yy1 Dd1 ;
G17          : Compensation plane
G01          : Cutting command
G41          : Tool radius compensation left command
Xx1,Yy1     : Movement axis
Dd1         : Compensation No.
```

The compensation plane, movement axes and next advance direction vector are based on the plane selection command designated by G17 to G19.

G17: XY plane, X, Y, I, J
 G18: ZX plane, Z, X, K, I
 G19: YZ plane, Y, Z, J, K

9 Tool Compensation

An arc is inserted at the corner by the following command during tool radius compensation.

```
G39 Xx1 Yy1 ;
G39           : Corner arc during tool radius compensation
Xx1,Yy1      : Movement amount
```

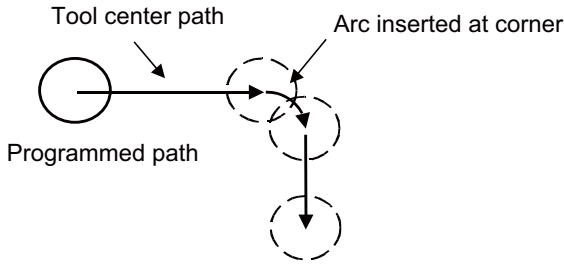

The compensation vector can be changed in following two ways.

```
G38 Xx1 Yy1 ;
G38           : Vector designation for tool radius compensation
Xx1,Yy1      : Movement amount
```

The tool radius compensation vector amount and direction are retained.

```
G38 Xx1 Yy1 Ii1 Jj1 Dd1 ;
G38           : Vector designation for tool radius compensation
Xx1,Yy1      : Movement amount
Ii1,Jj1      : Compensation vector direction
Dd1          : Compensation vector length
```

The tool radius compensation vector direction is updated by I and J.

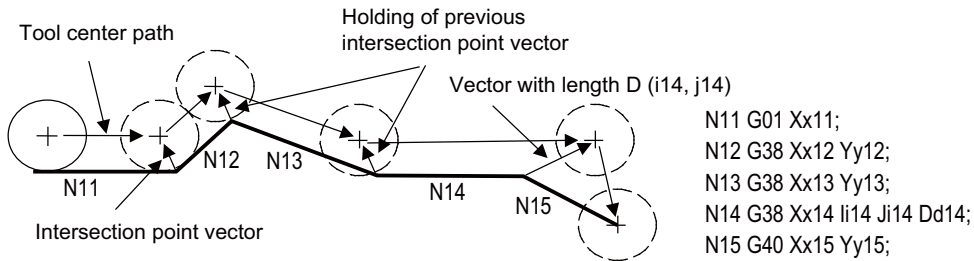

The tool radius compensation is canceled by the following command.

```
G40 Xx1 Yy1 Ii1 Jj1 ;
G40           : Tool radius compensation cancel
Xx1,Yy1      : Movement amount
Ii1,Jj1      : Compensation vector direction
```

The vector prior to canceling is prepared by calculating the intersection point with the I and J direction.

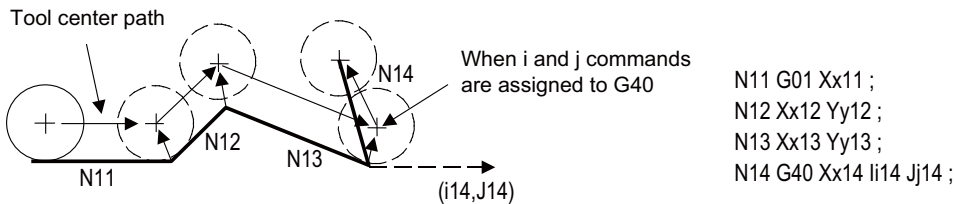

9.2.2 3-dimensional Tool Radius Compensation

	M850W	M830W	M850S	M830S	M80W	M80 TypeA	M80 TypeB	E80 TypeA	E80 TypeB	C80
M	△	△	△	△	—	—	—	—	—	—
L	△ (*1)	△ (*1)	—	—	—	—	—	—	—	—

(*1) This function is available during program format switch.

This command serves the function of compensating for the spherical radius of ball end mills. It compensates for the actual tool center path to be either more outside or inside the programmed path by an amount equivalent to the tool radius amount in accordance with the 3-dimensional vectors.

G code	Function
G40	Tool radius compensation cancel
G41	Tool radius compensation left command (compensation in the direction toward IJK)
G42	Tool radius compensation right command (compensation in the direction away from IJK)

With 3-dimensional tool radius compensation, the compensation is controlled from the block in which the block containing the G41 or G42 command has been designated.

```
G01 G41 Xx1 Yy1 Zz1 Ii1 Jj1 Kk1 Dd1 ;
G01          : Cutting
G41          : Tool radius compensation left command
Xx1,Yy1,Zz1  : Movement axis
Ii1,Jj1,Kk1  : Tool sphere center vectors
Dd1          : Compensation No.
```

The radius from the tool spherical center to the end nose serves as the compensation amount that corresponds to the tool compensation No. designated by d1. The compensation Nos. that can be used are limited by the "number of tool compensation sets." (Refer to the section "9.3.1 Number of Tool Offset Sets".)

If the compensation vectors (tool spherical center vectors) are to be changed, the G41 and I, J and K commands must be assigned.

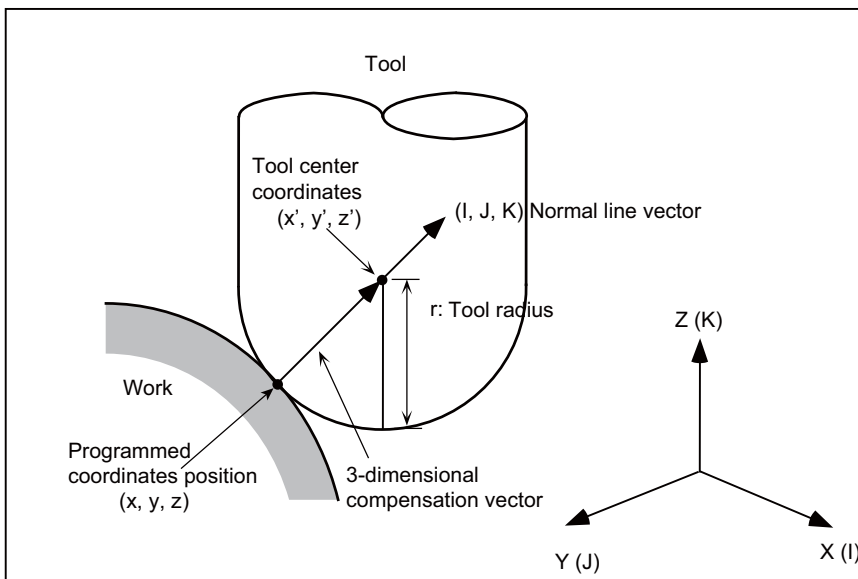

9.2.3 Tool Nose Radius Compensation (G40/41/42)

	M850W	M830W	M850S	M830S	M80W	M80 TypeA	M80 TypeB	E80 TypeA	E80 TypeB	C80
M	△	△	△	△	—	—	—	—	—	—
L	○	○	○	○	○	○	○	○	○	○

Because a tool nose is generally rounded, a hypothetical tool nose point is used for creating programming. As a result, due to this roundness of the tool nose, there will be a gap between the programmed shape and the actual cutting shape during taper cutting or circular cutting. Nose radius compensation is a function to automatically calculate and offset this error by setting the tool nose radius value.

"Nose radius compensation" is a type of compensation that is available when turning is performed on a lathe.

"Nose radius compensation for machining center system" is a function which enables the nose radius compensation when turning is performed on a machining center. The basic operation follows the specifications of "Tool Nose Radius Compensation".

G code	Function
G40	Nose R compensation cancel
G41	Nose R compensation left command
G42	Nose R compensation right command

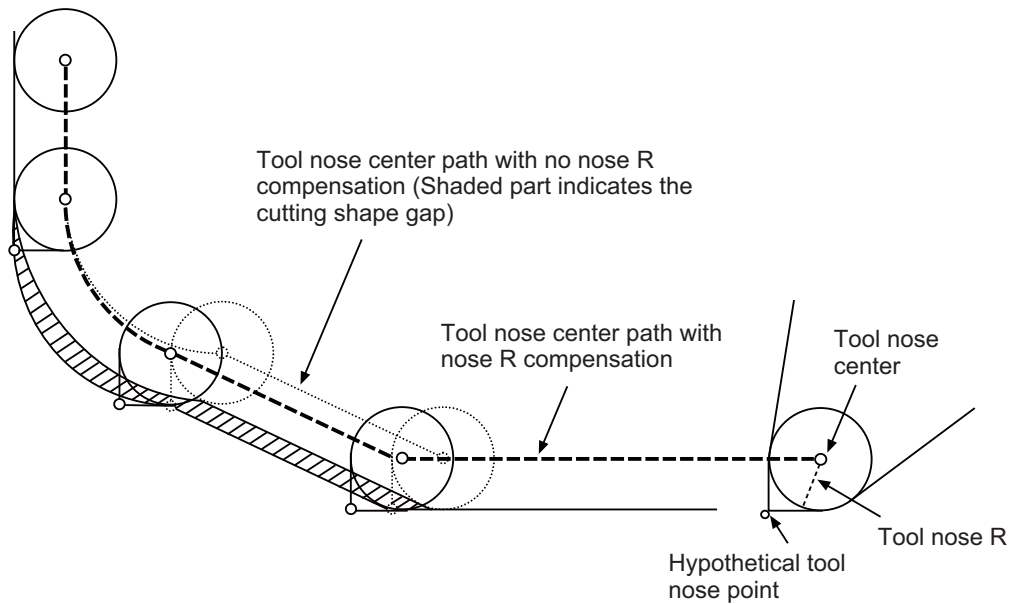

At start of the compensation, regardless of continuous operation or single block operation, two to five blocks are always read for intersection point calculation before execution. (Two blocks of movement commands are pre-read. If there are fewer than two blocks of movement commands, up to five blocks are pre-read.)

Similarly, during the compensation mode, up to five blocks are pre-read for compensation calculation.

The maximum number of blocks pre-read at start of the compensation and during the compensation mode can be changed by the parameter.

Nose R interference check

In the nose radius compensation mode, the program is read in up to five blocks ahead including blocks with no movement, and an interference check using the nose radius is conducted in up to three blocks of movement commands ahead.

9.2.4 Automatic Decision of Nose Radius Compensation Direction (G46/40)

	M850W	M830W	M850S	M830S	M80W	M80 TypeA	M80 TypeB	E80 TypeA	E80 TypeB	C80
M	—	—	—	—	—	—	—	—	—	—
L	○	○	○	○	○	○	○	○	○	○

The nose radius compensation direction is automatically determined from the tool nose point and the specified movement vector.

G code	Function
G40	Nose radius compensation cancel
G46	Nose radius compensation ON (Automatic decision of compensation direction)

The compensation directions based on the movement vectors at the tool nose points are as follows:

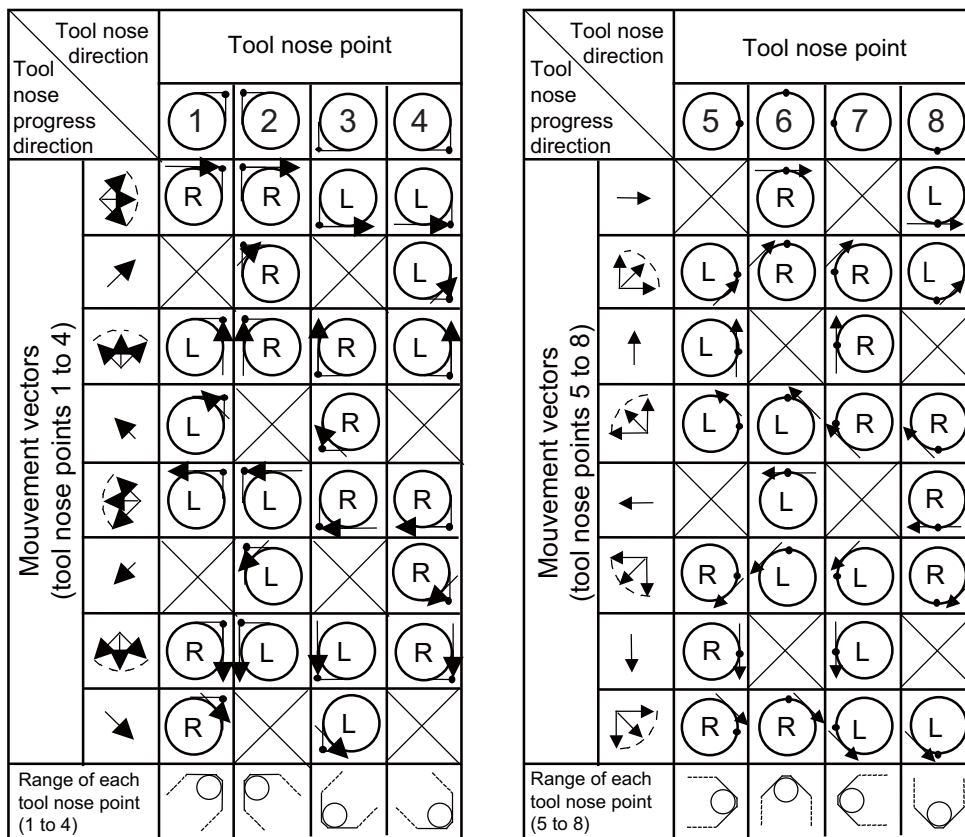

9.2.5 Tool Radius Compensation Diameter Designation

	M850W	M830W	M850S	M830S	M80W	M80 TypeA	M80 TypeB	E80 TypeA	E80 TypeB	C80
M	○	○	○	○	○	○	○	○	○	○
L	—	—	—	—	—	—	—	—	—	—

Tool diameter designation handles the compensation amount as diameter value and compensates the amount set in the tool compensation amount screen when tool radius compensation (G41/G42 command) is commanded. Whether compensation amount is handled in radius value or diameter value is switched by the parameter.

9.3 Tool Offset Amount

9.3.1 Number of Tool Offset Sets

[M system]

Number of tool compensation sets	M850W	M830W	M850S	M830S	M80W	M80 TypeA	M80 TypeB	E80 TypeA	E80 TypeB	C80
Number of tool offset sets (99 sets)	—	—	—	—	—	—	—	—	○	—
Number of tool offset sets (128 sets)	—	—	—	—	—	—	—	—	—	—
Number of tool offset sets (200 sets)	○	○	○	○	—	—	—	○	—	○
Number of tool offset sets (256 sets)	—	—	—	—	—	—	—	—	—	—
Number of tool offset sets (400 sets)	△	△	△	△	○	○	○	—	—	△
Number of tool offset sets (999 sets)	△	△	△	△	—	—	—	—	—	—

[L system]

Number of tool compensation sets	M850W	M830W	M850S	M830S	M80W	M80 TypeA	M80 TypeB	E80 TypeA	E80 TypeB	C80
Number of tool offset sets (99 sets)	—	—	—	—	—	—	○	○	○	—
Number of tool offset sets (128 sets)	○	○	○	○	—	—	—	—	—	○
Number of tool offset sets (200 sets)	—	—	—	—	—	—	—	—	—	—
Number of tool offset sets (256 sets)	—	—	—	—	○	○	—	—	—	△
Number of tool offset sets (400 sets)	△	△	△	△	—	—	—	—	—	—
Number of tool offset sets (999 sets)	△	△	△	△	—	—	—	—	—	—

The number of tool compensation sets (the number of tool offset sets) for the fixed allocation is shown in the following tables. Refer to "9.3.3 Number of Tool Offset Sets Allocation to Part Systems" for the arbitrary allocation.

<M system>

Function name	Common for part systems or 1-part system specification	Independent for part systems and multi-part system specification
Number of tool offset sets (200 sets)	200 sets	Divide the number of tool offset sets by the number to obtain the number of sets per part system. (If there is the remainder, the remainder goes to the 1st part system.)
Number of tool offset sets (400 sets)	400 sets	
Number of tool offset sets (999 sets)	999 sets	

<L system>

Function name	Common for part systems or 1-part system specification	Independent for part systems and multi-part system specification
Number of tool offset sets (99 sets)	99 sets	Divide the number of tool offset sets by the number to obtain the number of sets per part system. (If there is the remainder, the remainder goes to the 1st part system.)
Number of tool offset sets (128 sets)	128 sets	
Number of tool offset sets (256 sets)	256 sets	
Number of tool offset sets (400 sets)	400 sets	
Number of tool offset sets (999 sets)	999 sets	

(Note) Whether the tool compensation memory is provided commonly for the part systems or independently for the part systems depends on the parameter settings.

9.3.2 Offset Memory

9.3.2.1 Tool Shape/Wear Offset Amount

	M850W	M830W	M850S	M830S	M80W	M80 TypeA	M80 TypeB	E80 TypeA	E80 TypeB	C80
M	○	○	○	○	○	○	○	○	○	○
L	○	○	○	○	○	○	○	○	○	○

This function registers the tool shape compensation and wear compensation amounts. Compensation may encompass two or more axes.

Tool compensation types I, II and III are available for M system, which can be selected by the parameter. For L system, tool compensation type III is always used.

(1) Shape compensation amount

The tool length compensation amount, tool radius compensation amount, nose radius compensation amount, nose radius imaginary tool tip point or tool width can be set as the shape compensation amount.

The compensation amount that can be set and used differs depending on whether compensation amount setting type I, II or III is used.

(2) Wear compensation amount

When the tip of the tool used has become worn, the wear compensation amount is used to compensate this wear. Types of wear compensation amounts include the tool length wear compensation amount, tool radius wear compensation amount, and nose radius wear compensation amount.

The wear compensation amount can be used with compensation amount setting types II and III, and it is added to the shape compensation amount for compensation.

(a) Type I: 1-axis compensation amount [M system]

This is the value that is used by rotary tools.

As the tool length compensation amount, among the compensation amounts for the position of the tool moving in the direction parallel to the control axis, the compensation amount in the longitudinal direction of the rotary tool is registered. The tool length compensation amount is set as a minus value.

As the tool radius compensation amount, among the compensation amounts for the position of the tool moving in the direction parallel to the control axis, the compensation amount in the radial direction of the rotary tool is registered. The tool radius compensation amount is set as a plus value.

One compensation amount data is registered in one compensation No., and the compensation Nos. are assigned using the address D or H commands. When a No. is assigned by a D address command, compensation is provided in the form of the tool radius; when it is assigned by an H address command, it is provided in the form of the tool length.

(b) Type II: 1-axis compensation amounts/with wear compensation [M system]

As with type I, type II is for the compensation amounts used by rotary tools.

With type II, four kinds of compensation amount data are registered in one compensation No.: the tool length compensation amount, tool length wear compensation amount, tool radius compensation amount, and tool radius wear compensation amount.

When a compensation No. is assigned by address D as the compensation amount, the tool radius is compensated using the amount obtained by adding the shape compensation amount and tool radius wear compensation amount. Further, the tool length is compensated using the amount obtained by adding the shape compensation amount and tool length wear compensation amount.

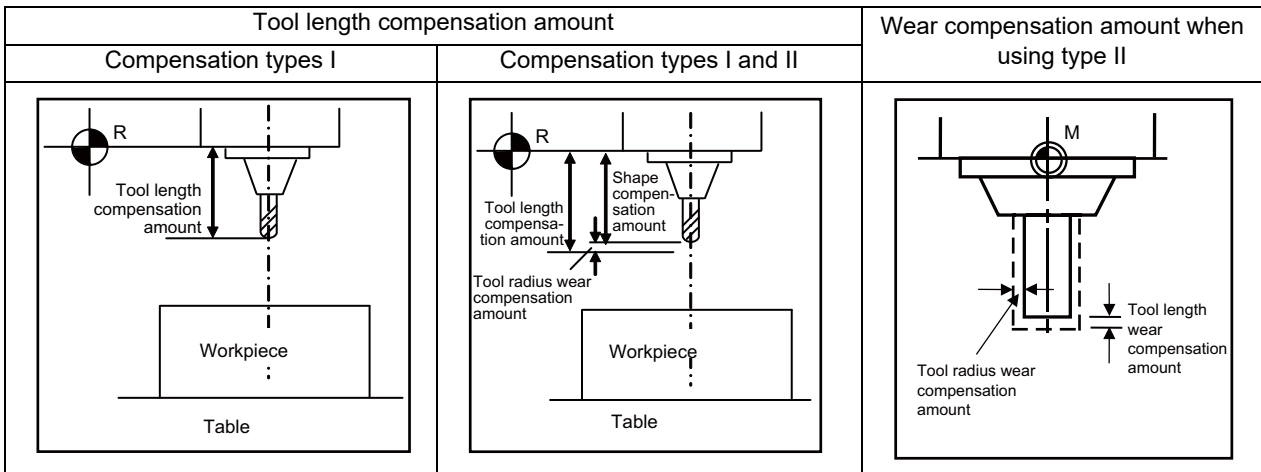

(c) Type III: 2-axis compensation amounts [M system][L system]

Type III is for the compensation amounts used by non-rotary tools.

As the compensation amounts, the tool length along the X, Y and Z axes and the wear amount along each of these axes, the nose radius and nose radius wear amount, tool tip point P and tool width can be registered.

Compensation is carried out in the directions of the X, Y and Z axes from the base position in the program. Generally, the center of the tool rest or the tip of the base tool is used as the programmed base position.

1. The programmed base position is the center of the tool rest:
2. The programmed base position is the tip of the base tool:

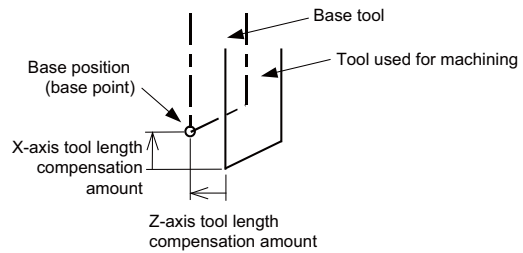
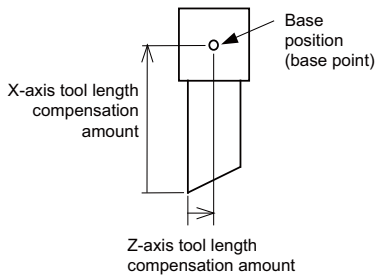

The tool tip contour arc radius (nose radius) of a non-rotary tool with an arc (nose radius) at its tip is registered as the nose radius compensation amount.

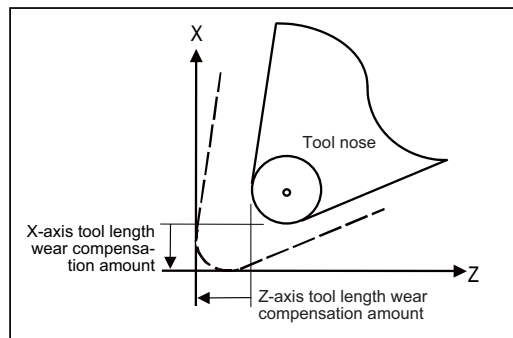
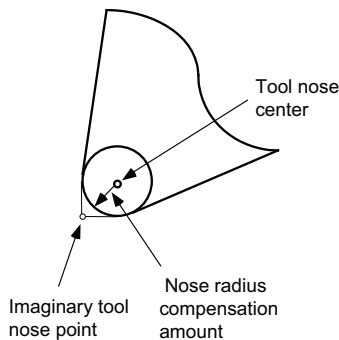

The X-axis tool length compensation amount, Z-axis tool length compensation amount and nose radius compensation amount are set as plus amounts.

9.3.2.2 Compensation Type Selection by Parameter

	M850W	M830W	M850S	M830S	M80W	M80 TypeA	M80 TypeB	E80 TypeA	E80 TypeB	C80
M	○	○	○	○	○	○	○	—	—	—
L	—	—	—	—	—	—	—	—	—	—

This function switches the tool compensation type with the parameter.

The type is switched to the tool compensation type III by setting the parameter, regardless of #1037 cmdtyp.

This function enables tool compensation for a turning tool by registering the tool compensation amount of the base axes IJK and tool tip point for a machining center system.

(1) Machining center system

Tool compensation type I and II are used for machining center system. However, use of this function switches the type to tool compensation type III.

[Correspondence of the registered data between the compensation types]

(a) Tool compensation type I -> Tool compensation type III

The tool compensation amount of tool compensation type I is handled as tool length Z of tool compensation type III.

(b) Tool compensation type II -> Tool compensation type III

The table below shows the relationship between the registered items.

Tool compensation type II	Tool compensation type III
Length	Length Z
L wear	Wear Z
Radius	Nose R
R wear	R-wear

(2) Lathe system

The tool compensation type is not switched by using this function.

9.3.3 Number of Tool Offset Sets Allocation to Part Systems

	M850W	M830W	M850S	M830S	M80W	M80 TypeA	M80 TypeB	E80 TypeA	E80 TypeB	C80
M	○	○	○	○	—	—	—	—	—	—
L	○	○	○	○	○	○	○	—	—	—

* Variable number of per-part-system tool offset sets

The number of tool offset sets can be set per part system.

There are two types of the allocation: "Arbitrary allocation" which allocates the number of tool offset sets to each part system arbitrarily and "Fixed allocation" which automatically allocates the number of tool offset sets to each part system equally, and the type can be selected using the parameter.

The arbitrary allocation enables the efficient allocation because when a certain part system needs only a small number of offset sets, the rest can be allocated to another part system. If an auxiliary-axis part system does not need the tool offset set at all, the number of tool offset sets can be set 0 in the auxiliary-axis part system.

"Number of tool offset sets in system" is the total number of tool offset sets of all part systems.

(1) Arbitrary allocation

(a) When the number of tool offset sets is increased in the 1st part system of 4-part system

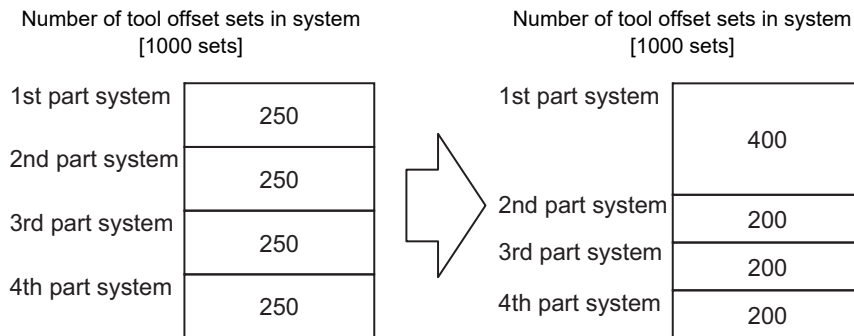

(b) When the number of offset sets is set "0" to the 3rd part system of 3-part system for use of the 3rd part system as auxiliary-axis part system

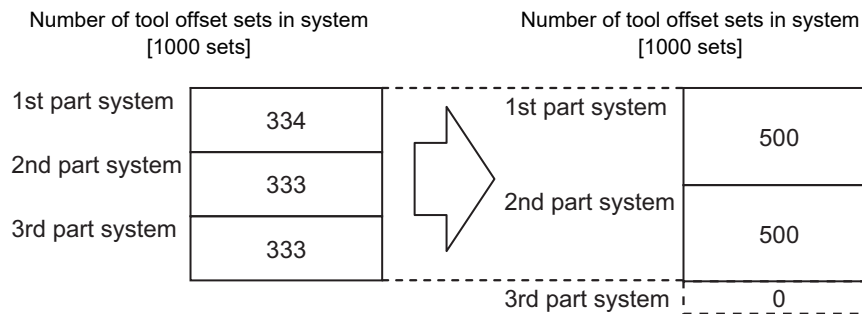

(2) Fixed allocation

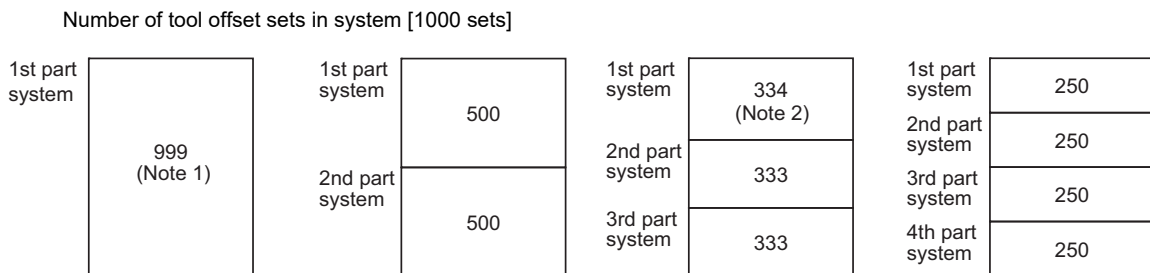

(Note 1) The maximum number of tool offset sets per part system is 999.

(Note 2) If there is any remainder, the remainder is allocated to the 1st part system.

10

Coordinate System

10.1 Coordinate System Type and Setting

The coordinate system handled by the NC is shown below.

The points that can be commanded with the movement command are points on the local coordinate system or machine coordinate system.

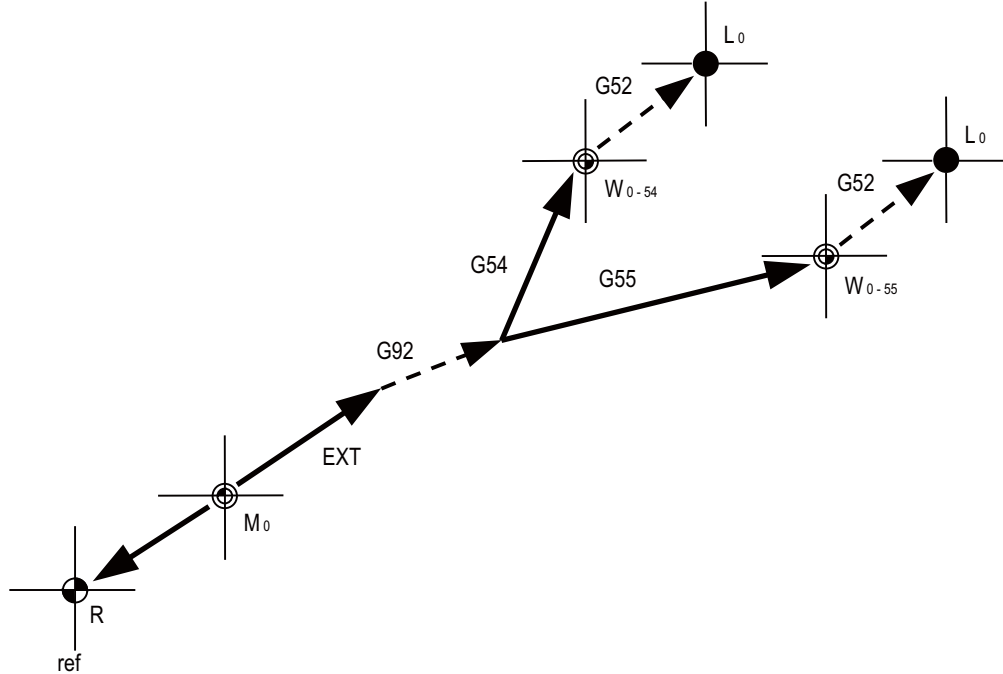

- L0 Local coordinate system zero point
- G52 Local coordinate system offset (*1)
- W0-54 Workpiece coordinate system zero point (G54)
- W0-55 Workpiece coordinate system zero point (G55)
- G54 Workpiece coordinate system (G54) offset (*1)
- G55 Workpiece coordinate system (G55) offset
- G92 G92 coordinate system shift
- EXT External workpiece coordinate offset
- M0 Machine coordinate system zero point
- ref Reference position

- Offset set with parameters
- Offset set with program (0 when power is turned ON)

(*1) The G52 offset is available independently for G54 to G59.

10.1.1 Machine Coordinate System

	M850W	M830W	M850S	M830S	M80W	M80 TypeA	M80 TypeB	E80 TypeA	E80 TypeB	C80
M	○	○	○	○	○	○	○	○	○	○
L	○	○	○	○	○	○	○	○	○	○

The machine coordinate system is used to express the prescribed positions (such as the tool exchange and stroke end positions) that are specific to each machine.

The G53 command followed by coordinates moves the tool to the command position in the machine coordinate system.

If a coordinate command is included in the same block as G53, it is treated as a command not in the workpiece coordinate system but in the machine coordinate system.

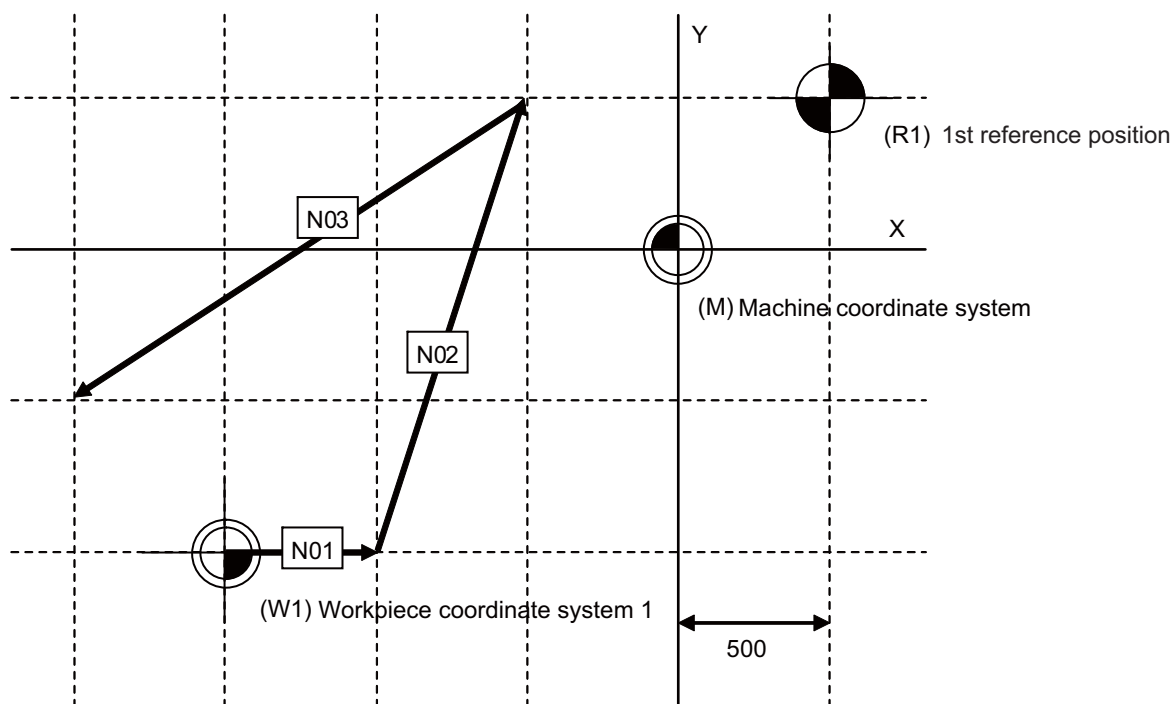

When the initial position of workpiece coordinate is (0,0) with absolute command.

N01 G01 X500. Y0. F1000

N02 G53 X-500. Y500.

N03 X-500. Y500.

Command format

```
G53 X_ (U_) Y_ (V_) Z_ (W_) α_ β_ ;
X/U/Y/V/Z/W/α/β : Axis address (range of coordinate position command (mm, inch))
```

If the incremental or absolute commands and movement mode have been omitted, operation complies with the modal command that prevails at the time.

G53 (movement on machine coordinate system) is an unmodal command which is effective only in the block where it is assigned. The workpiece coordinate system being selected is not changed by this command.

10.1.3 Automatic Coordinate System Setting

	M850W	M830W	M850S	M830S	M80W	M80 TypeA	M80 TypeB	E80 TypeA	E80 TypeB	C80
M	○	○	○	○	○	○	○	○	○	○
L	○	○	○	○	○	○	○	○	○	○

After the power is turned ON, the basic machine coordinate system and the workpiece coordinate system are automatically set without executing the zero point return.

The coordinate systems created are given below.

- (1) Machine coordinate system corresponding to G53
- (2) G54 to G59 workpiece coordinate system
- (3) Local coordinate systems created under G54 to G59 workpiece coordinate systems

The distances from the zero point of G53 machine coordinate system are set to the controller coordinate related parameters.

10.1.4 Workpiece Coordinate System Selection

The workpiece coordinate systems facilitate the programming on the workpiece, serving the reference position of the machining workpiece as the zero point.

These commands enable the tool to move to the positions in the workpiece coordinate system. There are extended workpiece coordinate systems (G54.1) in addition to 6 workpiece coordinate systems, which are used by the programmer for programming (G54 to G59). The number of the extended workpiece coordinate systems varies depending on the MTB specifications.

Among the workpiece coordinate systems currently selected by these commands, any workpiece coordinate system with coordinates that have been commanded by the current position of the tool is reset. (The "current position of the tool" includes the compensation amounts for tool radius, tool length and tool position.)

A hypothetical machine coordinate system with coordinates that have been commanded by the current position of the tool is set by these commands. (The "current position of the tool" includes the compensation amounts for tool radius, tool length and tool position.) (G54, G92)

10.1.4.1 Workpiece Coordinate System Selection (6 Sets)

	M850W	M830W	M850S	M830S	M80W	M80 TypeA	M80 TypeB	E80 TypeA	E80 TypeB	C80
M	○	○	○	○	○	○	○	○	○	○
L	○	○	○	○	○	○	○	○	○	○

Up to 6 workpiece coordinate systems can be selected.

The G54 workpiece coordinate system is selected when the power is turned ON.

G code	Function
G54	Workpiece coordinate system 1 (W1)
G55	Workpiece coordinate system 2 (W2)
G56	Workpiece coordinate system 3 (W3)
G57	Workpiece coordinate system 4 (W4)
G58	Workpiece coordinate system 5 (W5)
G59	Workpiece coordinate system 6 (W6)

Command format

Workpiece coordinate system selection

(G90) G54 to G59 ;

Workpiece coordinate system setting

(G54 to G59)G92 X__ Y__ Z__ a__ ;
 X,Y,Z : Coordinate position of end point
 a : Additional axis

The workpiece coordinate zero points are provided as distances from the zero point of the machine coordinate system.

Settings can be performed in one of the following two ways:

- (1) Setting using the setting and display unit
- (2) Setting using commands assigned from the machining program

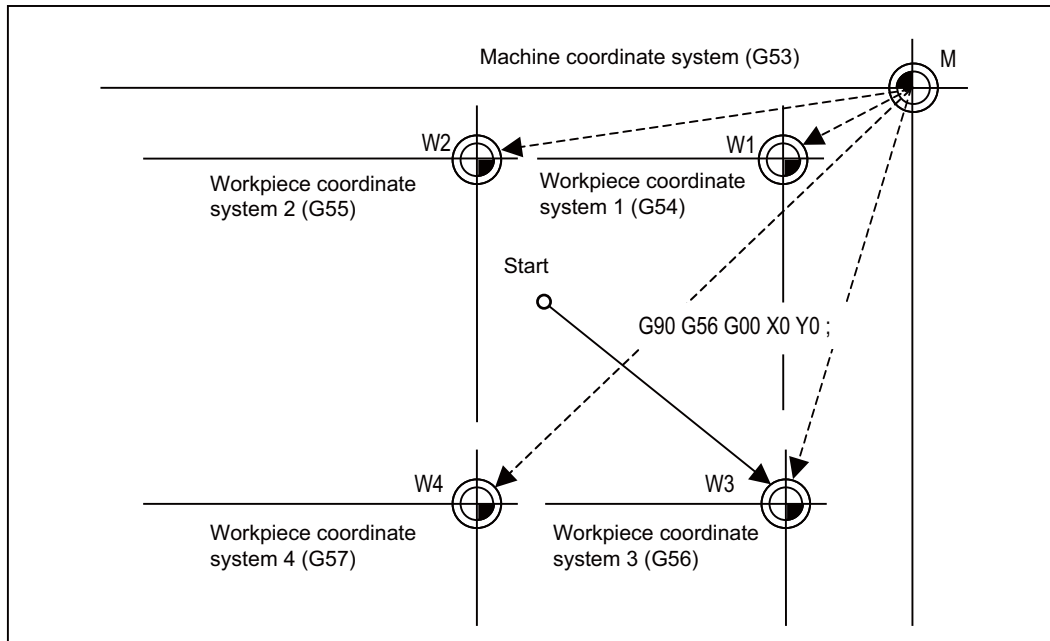

10.1.4.2 Extended Workpiece Coordinate System Selection (48 Sets) G54.1P1 to P48

	M850W	M830W	M850S	M830S	M80W	M80 TypeA	M80 TypeB	E80 TypeA	E80 TypeB	C80
M	△	△	△	△	○	○	○	○	—	△
L	△	△	△	△	○	○	○	○	○	△

In addition to the six workpiece coordinate systems G54 to G59, 48 workpiece coordinate systems can be used by assigning G54.1Pn command.

The command format to select the workpiece coordinate system using the G54.1Pn command and to move on the workpiece coordinate system are given below.

Workpiece coordinate system selection

```
(G90) G54.1Pn ;
```

The numerical value n of P following G54.1 indicates each workpiece coordinate system. Specify a value between 1 and 48.

The workpiece coordinate zero points are provided as distances from the zero point of the machine coordinate system.

Settings can be performed in one of the following two ways:

- (a) Setting using the setting and display unit
- (b) Setting using commands assigned from the machining program

G54Pn can be used as the extended workpiece coordinate system selection command by setting the parameter.

10.1.4.3 Extended Workpiece Coordinate System Selection (96 Sets) G54.1P1 to P96

	M850W	M830W	M850S	M830S	M80W	M80 TypeA	M80 TypeB	E80 TypeA	E80 TypeB	C80
M	△	△	△	△	—	—	—	—	—	—
L	—	—	—	—	—	—	—	—	—	—

In addition to the six workpiece coordinate systems (G54 to G59), 96 workpiece coordinate systems can be used by assigning G54.1Pn command. Refer to "Extended workpiece coordinate system selection (48 sets) G54.1P1 to P48" for details.

10.1.4.4 Extended Workpiece Coordinate System Selection (300 Sets) G54.1P1 to P300

	M850W	M830W	M850S	M830S	M80W	M80 TypeA	M80 TypeB	E80 TypeA	E80 TypeB	C80
M	△	△	△	△	—	—	—	—	—	—
L	—	—	—	—	—	—	—	—	—	—

In addition to the six workpiece coordinate systems (G54 to G59), 300 workpiece coordinate systems can be used by assigning G54.1Pm command. Refer to "Extended Workpiece Coordinate System Selection (48 sets) G54.1P1 to P48" for details.

10.1.5 External Workpiece Coordinate Offset

	M850W	M830W	M850S	M830S	M80W	M80 TypeA	M80 TypeB	E80 TypeA	E80 TypeB	C80
M	○	○	○	○	○	○	○	○	○	○
L	○	○	○	○	○	○	○	○	○	○

External workpiece coordinate offset that serves as the reference for all the workpiece coordinate systems is available outside the workpiece coordinates.

By setting the external workpiece coordinate offset, the external workpiece coordinate system can be shifted from the machine coordinate system, and all the workpiece coordinate systems can be simultaneously shifted by an amount equivalent to the offset.

When the external workpiece coordinate offset is zero, the external workpiece coordinate systems coincide with the machine coordinate system.

It is not possible to assign movement commands with the external workpiece coordinate selected.

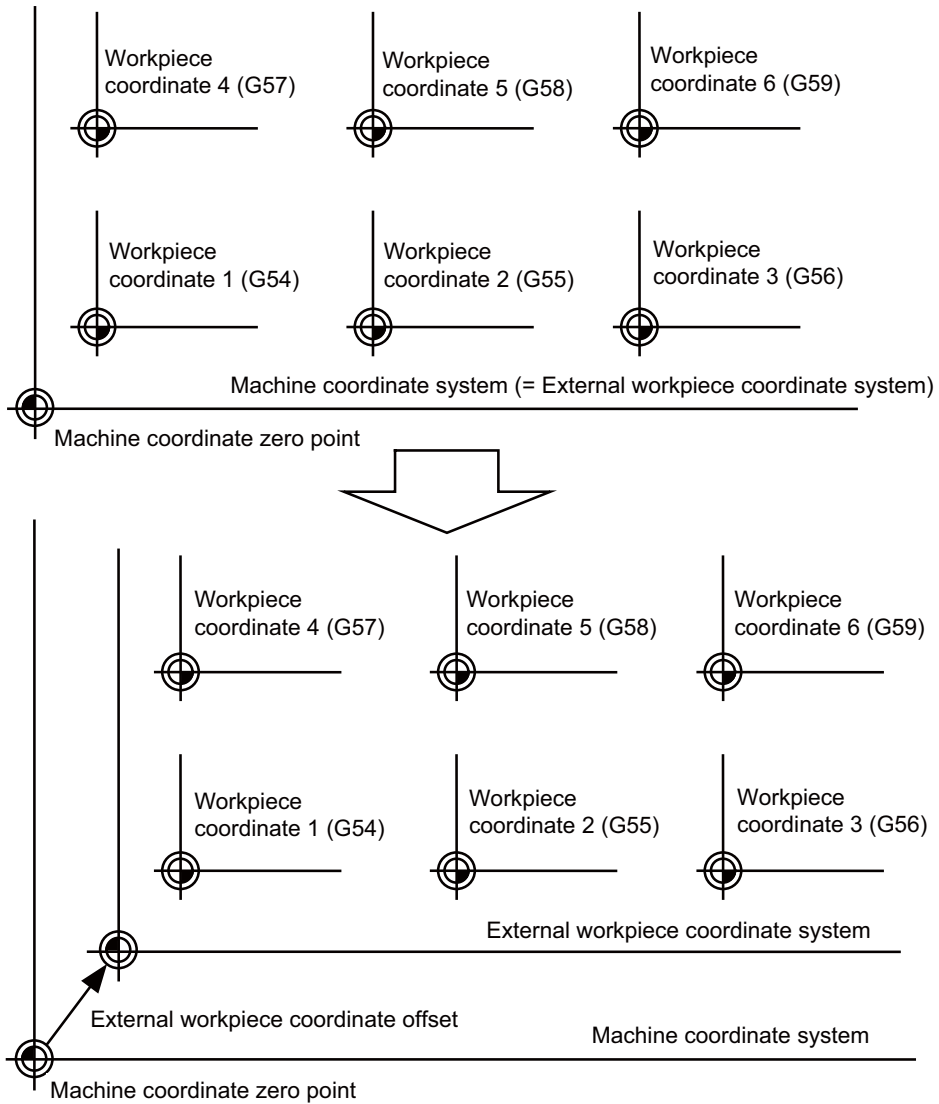

10.1.6 Workpiece Coordinate System Preset (G92.1)

	M850W	M830W	M850S	M830S	M80W	M80 TypeA	M80 TypeB	E80 TypeA	E80 TypeB	C80
M	△	△	△	△	—	—	—	—	—	—
L	○	○	○	○	○	○	○	○	○	○

This function presets the workpiece coordinate system, which has been shifted by the programmed command or the manual operation, as the workpiece coordinate system which has been offset by the programmed command (G92.1) from the machine zero point by an amount equivalent to the workpiece coordinate offset amount.

The workpiece coordinate system is shifted from the machine coordinate system when the such operations or the programmed commands as below have been performed.

- When manual intervention has occurred in the manual absolute OFF status
- When a movement command was performed in the machine lock status
- When movement was initiated by handle interrupt
- When a movement command was performed in the mirror image mode
- When a local coordinate system was set using the G52 command
- When a workpiece coordinate system was shifted using the G92 command

Just as when manual reference position return has been performed, this function presets the workpiece coordinate system which has been shifted once to the workpiece coordinate system which has been offset from the machine zero point by an amount equivalent to the workpiece coordinate offset amount.

Furthermore, whether to preset relative coordinates as well is selected with a parameter.

Command format

G92.1 (G50.3) X0 Y0 Z0 α0 ; (where α is an additional axis)
--

Designate the addresses of the axes to be preset.

Axes whose addresses have not designated will not be preset.

Depending on the command type, G50.3 command is used in stead.

A program error results when a value other than 0 is commanded.

10.1.7 Local Coordinate System

	M850W	M830W	M850S	M830S	M80W	M80 TypeA	M80 TypeB	E80 TypeA	E80 TypeB	C80
M	○	○	○	○	○	○	○	○	○	○
L	○	○	○	○	○	○	○	○	○	○

This function is for assigning a coordinate system on the workpiece coordinate system now being selected. This enables the workpiece coordinate system to be changed temporarily.

The local coordinate system can be selected independently on each workpiece coordinate system G54 to G59.

G code	Function
G54 G52	Local coordinate system on the workpiece coordinate system 1
G55 G52	Local coordinate system on the workpiece coordinate system 2
G56 G52	Local coordinate system on the workpiece coordinate system 3
G57 G52	Local coordinate system on the workpiece coordinate system 4
G58 G52	Local coordinate system on the workpiece coordinate system 5
G59 G52	Local coordinate system on the workpiece coordinate system 6

The command format of the local coordinate system is given below.

```
(G54) G52 Xx1 Yy1 Zz1 ;
(G54)           : Workpiece coordinate system selection
G52            : Local coordinate system setting
Xx1,Yy1,Zz1    : Local coordinate offset amount
```

The local coordinate zero points are provided as distances from the zero point of the designated workpiece coordinate system (local coordinate offset).

In the incremental command mode, the position obtained by adding the local coordinate offset amount to the previously specified offset amount serves as the new local coordinate zero point.

If no workpiece coordinates are designated, the local coordinates will be created on the currently selected workpiece coordinates.

This command is unmodal but the local coordinate system created by G52 is valid until the next G52 command is issued.

The local coordinate system is canceled by the input of the reset signal or by manual or automatic dog-type reference position return.

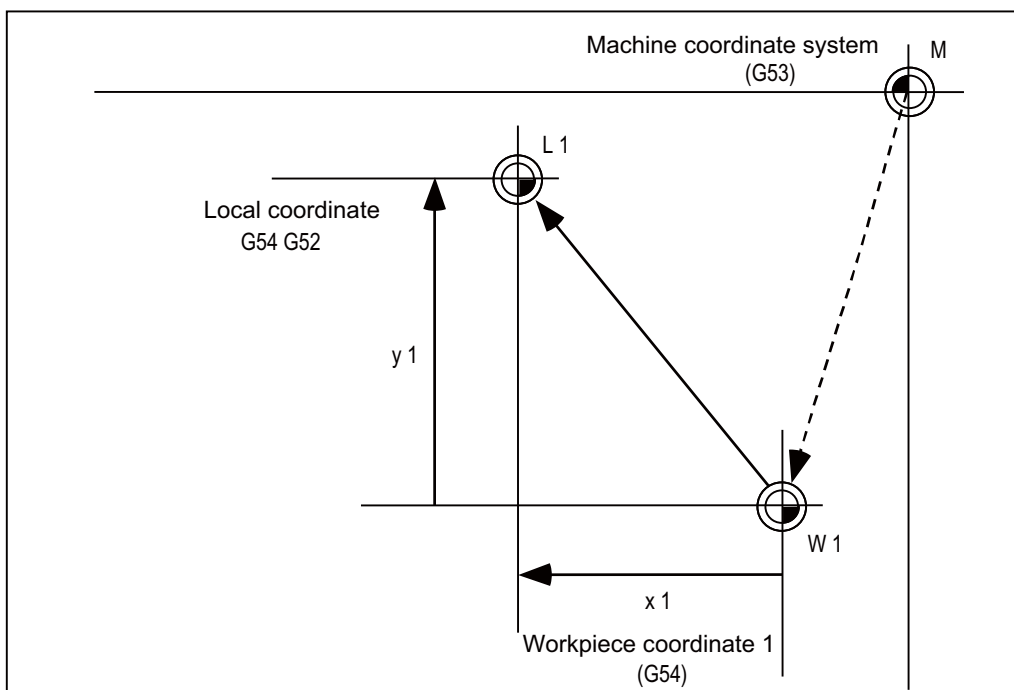

10.1.8 Coordinate System for Rotary Axis

	M850W	M830W	M850S	M830S	M80W	M80 TypeA	M80 TypeB	E80 TypeA	E80 TypeB	C80
M	○	○	○	○	○	○	○	○	○	○
L	○	○	○	○	○	○	○	○	○	○

The axis designated as the rotary axis with the parameters is controlled with the rotary axis' coordinate system.

The rotary axis includes the rotating type (short-cut valid/invalid) and linear type (workpiece coordinate position linear type, all coordinate position linear type).

The workpiece coordinate position range is 0 to 359.999° for the rotating type, and 0 to 99999.999° for the linear type.

The machine position and relative position differ according to the parameters.

The rotary axis is commanded with a degree (°) unit regardless of the inch or metric designation.

The rotary axis type can be set with the parameters for each axis.

	Rotary axis				Linear axis
	Rotating type rotary axis		Linear type rotary axis		
	Short-cut invalid	Short-cut valid	Workpiece coordinate position linear type	All coordinate position linear type	
Workpiece coordinate position	Displayed in the range of 0° to 359.999°.		Displayed in the range of 0° to 99999.999°.		
Machine position/ relative position	Displayed in the range of 0° to 359.999°.		Displayed in the range of 0° to 99999.999°.		
ABS command	The incremental amount from the end point to the current position is divided by 360, and the axis moves by the remainder amount according to the sign.	Moves with a short-cut to the end point.	In the same manner as the normal linear axis, moves according to the sign by the amount obtained by subtracting the current position from the end point (without rounding up to 360 degrees.).		
INC command	Moves in the direction of the commanded sign by the commanded incremental amount starting at the current position.				
Reference position return	Follows the absolute/incremental command for a movement to the interim position.				
	Returns to the reference position from the interim position within a 360 degree movement.		Moves and returns in the reference position direction for the difference from the current position to the reference position.		

10.1.9 Plane Selection

	M850W	M830W	M850S	M830S	M80W	M80 TypeA	M80 TypeB	E80 TypeA	E80 TypeB	C80
M	○	○	○	○	○	○	○	○	○	○
L	○	○	○	○	○	○	○	○	○	○

G17, G18, and G19 are for specifying the planes for the arc, tool radius compensation, coordinate rotation and other such commands.

G17;	Xp-Yp plane designation
G18;	Zp-Xp plane designation
G19;	Yp-Zp plane designation

- (1) A parameter can be used to set either the X, Y or Z axis to which the additional axis is to be parallel.
- (2) A parameter can be used to set the initialization status (when the power has been turned ON or when the reset status has been entered) to G17, G18 or G19.
- (3) The movement commands have no connection with the plane selection.

(Example)

G19 X100. ;	With these program commands, X100. is the axis which does not exist on the G19 (Yp, Zp) plane, Yp-Zp plane is selected by G19 and the X axis moves by 100. mm separately from the plane selection.
G17 X100 . R50. ;	With these program commands, the Xp-Yp plane is selected by G17 and the arc command is controlled on the X-Y plane by this command.

10.1.10 Origin Set/Origin Cancel

	M850W	M830W	M850S	M830S	M80W	M80 TypeA	M80 TypeB	E80 TypeA	E80 TypeB	C80
M	○	○	○	○	○	○	○	○	○	○
L	○	○	○	○	○	○	○	○	○	○

(1) Origin set

Origin set is a function that shifts the coordinate system so that the current position is the zero point on the workpiece coordinate system containing the workpiece coordinate system's offset value.

The relative position counter and workpiece coordinate counter are set to "0" with this operation. In other words, this is the same as the coordinate system setting command "G92 X0;". (For target axis: X)

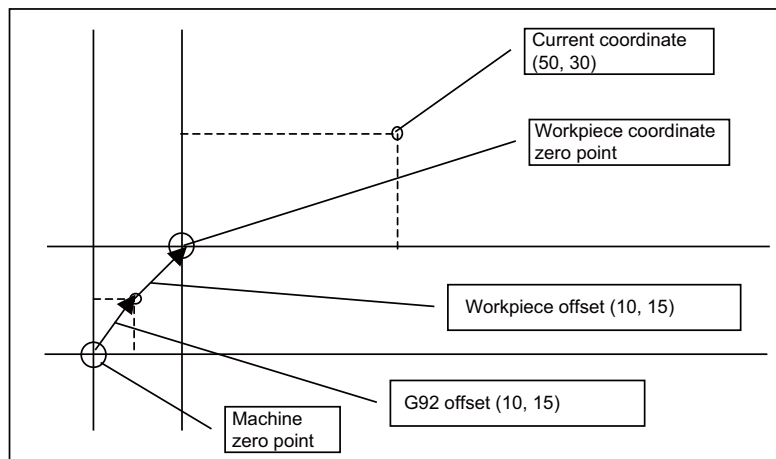

Execution of origin set

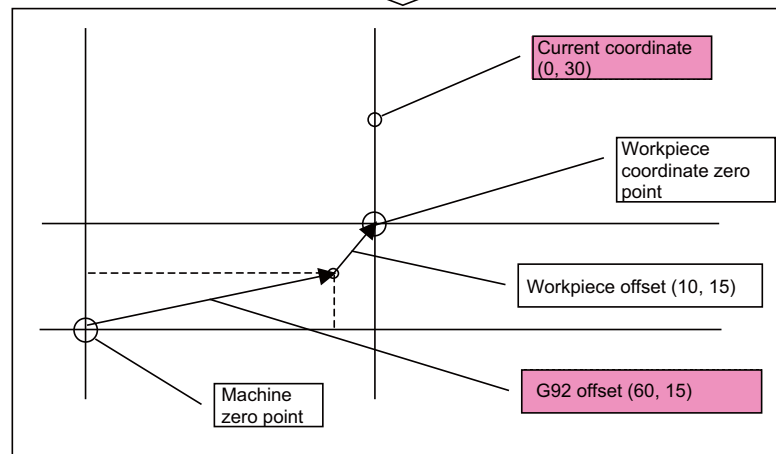

Items updated by origin set

(2) Origin cancel

Origin cancel is a function that manually cancels all deviated amounts, and shifts to the designated zero point with the workpiece offset.

The relative position counter and machine position counter are set to "0" with this operation. In other words, this is the same "G92 G53 X0 ;". (For target axis: X)

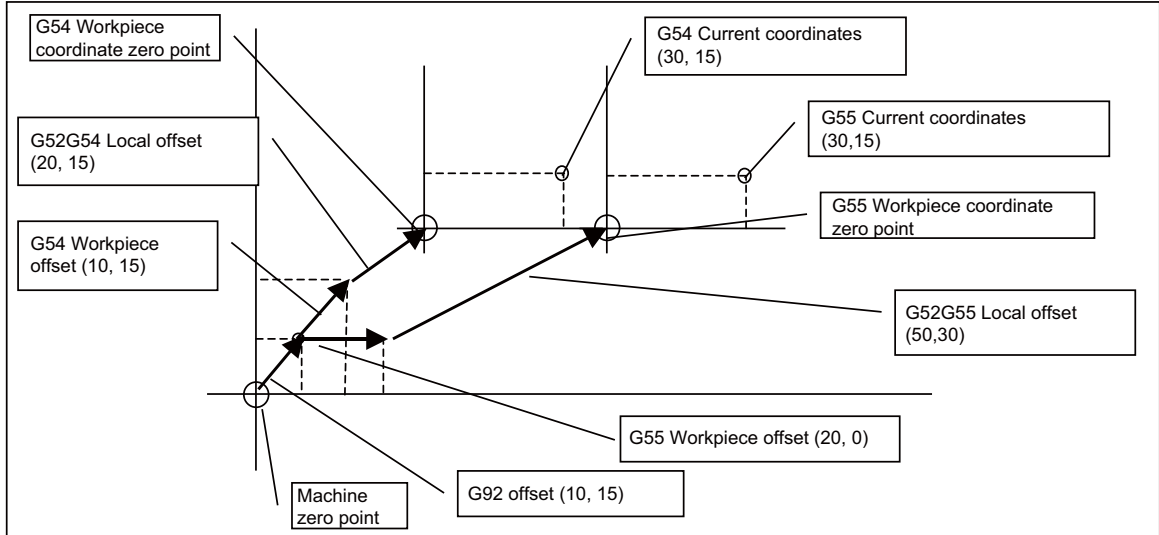

Execution of origin cancel

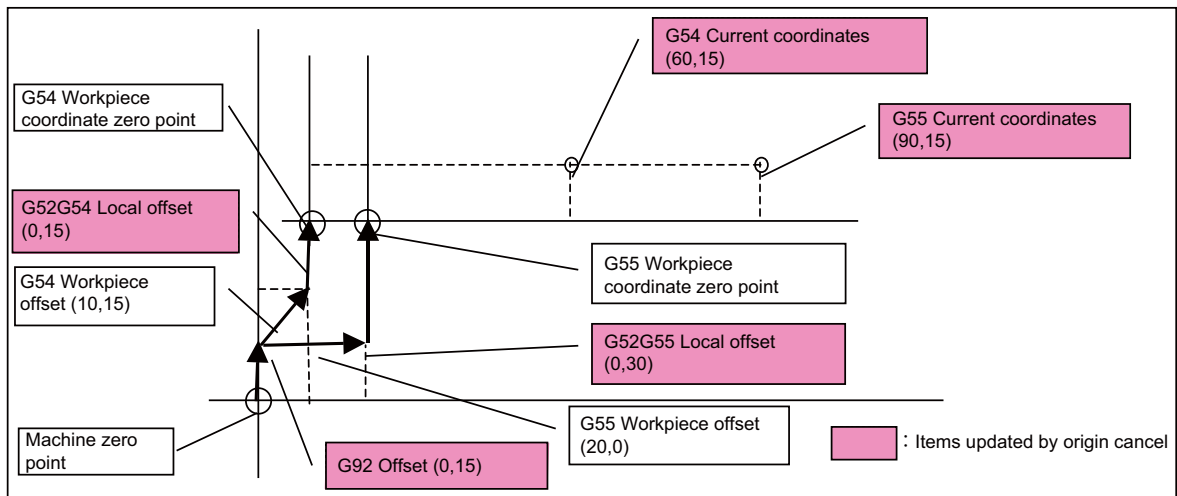

10.1.11 Counter Set

	M850W	M830W	M850S	M830S	M80W	M80 TypeA	M80 TypeB	E80 TypeA	E80 TypeB	C80
M	○	○	○	○	○	○	○	○	○	○
L	○	○	○	○	○	○	○	○	○	○

The relative position counter can be set to an arbitrary value by operating the setting and display unit screens.

Select the axis and then input a value. Finally, press the key.

Only the [Relative Position] display field will change to the set value. The other coordinate positions displayed will not change.

Up to 9 digits can be input in the integer section. The number of digits after the decimal point depends on the parameter setting.

10.1.12 Workpiece Position Offset for Rotary Axis

	M850W	M830W	M850S	M830S	M80W	M80 TypeA	M80 TypeB	E80 TypeA	E80 TypeB	C80
M	△	△	△	△	○	○	—	—	—	—
L	—	—	—	—	—	—	—	—	—	—

For a machine equipped with a table rotary axis, this function corrects installation errors between workpiece coordinate zero point and workpiece reference position.

When a workpiece set on a rotary table is machined, if there is a difference between the workpiece coordinate zero point and the workpiece reference position, an error occurs in a machined shape. Setting the installation error between the workpiece coordinate zero point and the workpiece reference position (workpiece position offset amount for rotary axis) corrects in accordance with the table rotation angle for each block. This makes it possible to reduce the shape error at the time of machining, which enables machining with high accuracy.

This function is available only in the 1st part system. When this function is used in other than the 1st part system, an program error occurs.

The error is compensated for the axis set to be valid by the relevant parameter.

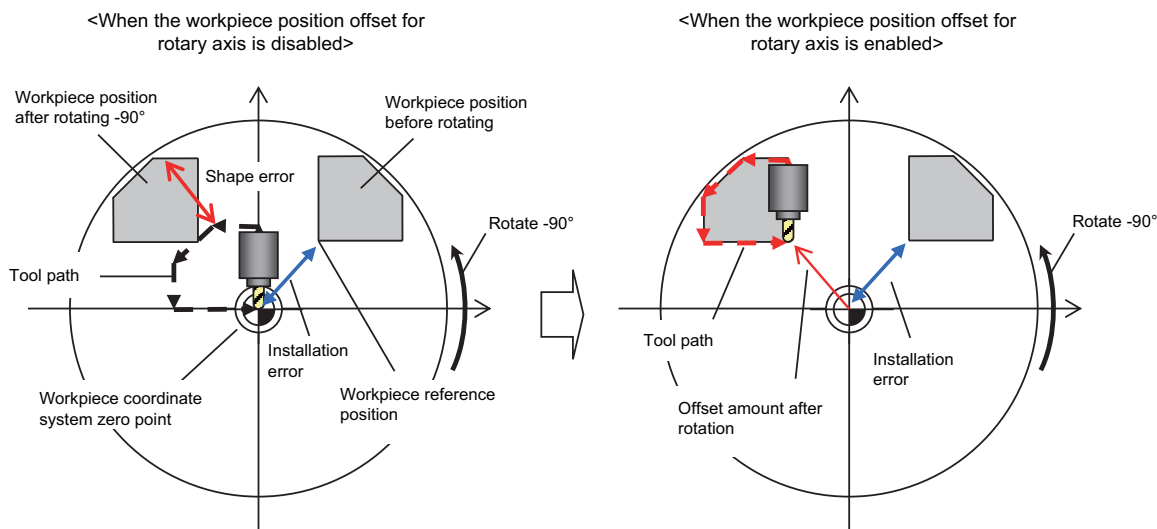

Workpiece position offset for rotary axis is valid in a machine configuration of the right-hand orthogonal coordinate system defined in ISO standard.

Workpiece position offset for rotary axis is applicable to the following three types of machine configuration:

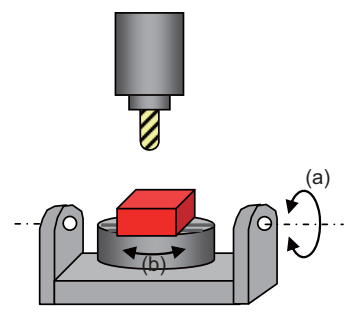
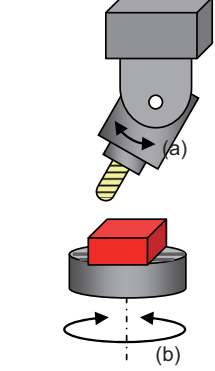
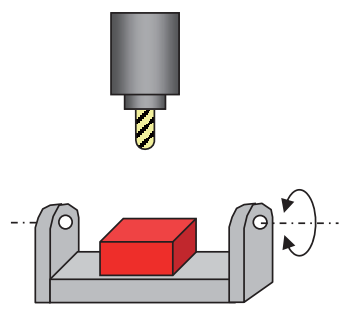
Type	Table tilt type	Combined type	4-axis machine
Description	2 rotary axes on table side	A rotary axis each on tool head side and table side	3 orthogonal axes and 1 rotary axis
Example of machines			
Primary rotary axis (a)	The 1st rotary axis on the table side	Rotary axis on the tool side	Not applicable
Secondary rotary axis (b)	The 2nd rotary axis on the table side	Rotary axis on the table side	Not applicable

(Note 1) This function cannot be applied to a machine whose tool direction from the tool tip to the base is not parallel to the Z axis (Z axis positive direction) when machine position of all the rotary axes is 0 degree.

(Note2) This function cannot be applied to a machine whose rotation center axis of rotary axis is not parallel to any of the orthogonal coordinate axes.

Command format

Workpiece position offset for rotary axis

G54.2 P__ ;
P : Set No. of workpiece position offset for rotary axis (n = 0 to 8)

- (1) Make sure to command G54.2 independently. When it is commanded in the same block with other G codes, travel commands and miscellaneous commands, an program error occurs.
- (2) When address P is not commanded, an alarm occurs. Also, commanding values other than "0" to "8" to the address P causes an alarm.
- (3) If P is given in a block that contains no G54.2 command, the address P is not regarded as a command for specifying the workpiece position offset No. for rotary axis.
- (4) G54.2 is a modal command of the G group 23.
- (5) When "G54.2 Pm" is given during "G54.2 Pn", offset is applied with the offset set No. "m".
- (6) Set the compensation amount of the group specified with address P to system variables. Refer to the "Programing Manual" for system variables for setting compensation amount.

10.1.13 Workpiece Coordinate System Shift

	M850W	M830W	M850S	M830S	M80W	M80 TypeA	M80 TypeB	E80 TypeA	E80 TypeB	C80
M	—	—	—	—	—	—	—	—	—	—
L	○	○	○	○	○	○	○	○	○	○

This function can shift the workpiece coordinate system.

When a workpiece coordinate system which is considered at programming is misaligned with an actual set workpiece coordinate or a workpiece coordinate set by automatic coordinate system setting, the measured workpiece coordinate system can be shifted to the workpiece coordinate system at the program creation so that the machining can be performed without modification of the machining program. This function also eliminates the need to change the machining program even when the workpiece shape is changed.

Setting the shift amount to O' -O to the shift amount of the workpiece coordinate system

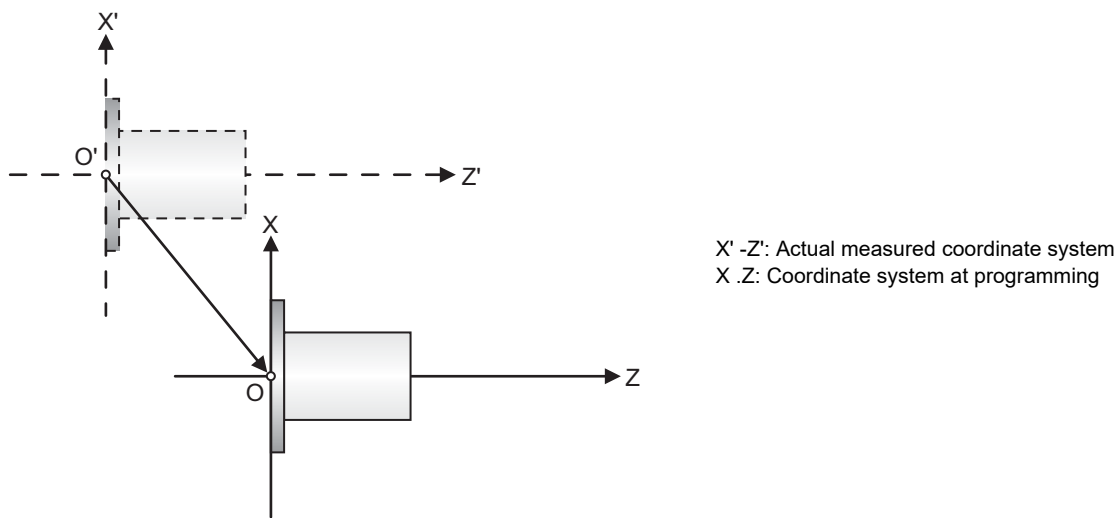

Setting the change amount of the workpiece shape to the shift amount of the workpiece coordinate system

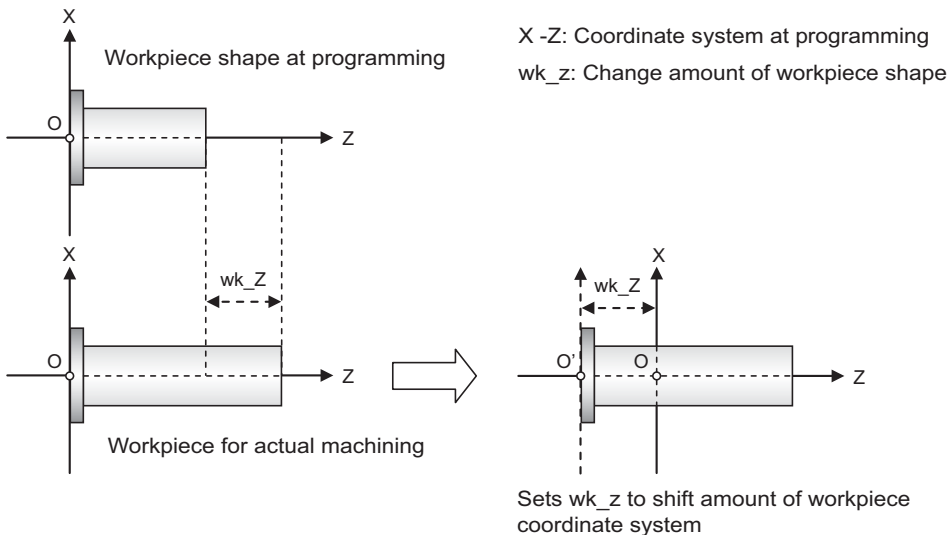

The methods for the setting are as follows:

- Setting on screen
- Setting with machining program (G code command)
- Setting by automatic measurement
- Setting and acquiring with system variables

10.2 Return

10.2.1 Manual Reference Position Return

	M850W	M830W	M850S	M830S	M80W	M80 TypeA	M80 TypeB	E80 TypeA	E80 TypeB	C80
M	○	○	○	○	○	○	○	○	○	○
L	○	○	○	○	○	○	○	○	○	○

This function enables the tool to be returned manually to the position (reference position) which is characteristic to the machine.

(1) Return pattern to reference position

[Dog type]

When starting in same direction as final advance direction

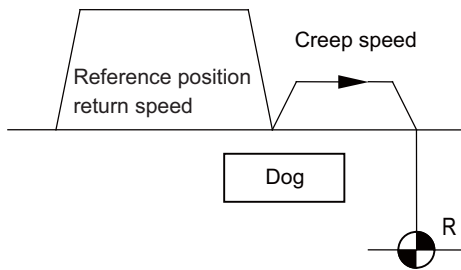

When starting in opposite direction as final advance direction

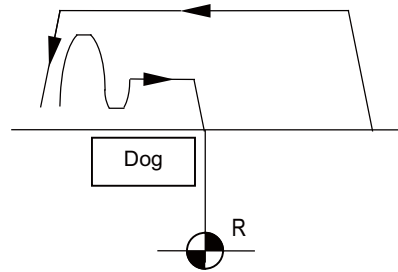

[High-speed type]

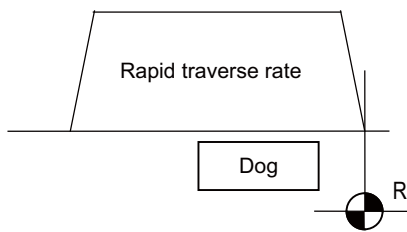

(2) Differences according to detection method

	First return after power ON	Second return and following
Incremental position detection method	Dog-type	High-speed type
Absolute position detection method	High-speed type	High-speed type

10.2.2 Automatic 1st Reference Position Return

	M850W	M830W	M850S	M830S	M80W	M80 TypeA	M80 TypeB	E80 TypeA	E80 TypeB	C80
M	○	○	○	○	○	○	○	○	○	○
L	○	○	○	○	○	○	○	○	○	○

The machine can be returned to the first reference position by assigning the G28 command during automatic operation. If the interim point is commanded, the machine is moved up to that point by rapid traverse so that it is positioned and then returned separately for each axis to the first reference position.

Alternatively, by assigning the G29 command, the machine can be first positioned separately for each axis at the G28 or G30 interim point, and then positioned at the assigned position.

G code	Function
G28	Automatic 1st reference position return
G29	Start position return (The tool first returns to the interim position from the 1st reference position, and then is positioned at the position assigned in the program.)

The G28 programming format is given below.

```
G28 Xx1 Yy1 Zz1 ;
G28           : Return command
Xx1,Yy1,Zz1   : Return control axes (coordinate of interim point)
```

Tool is first positioned by rapid traverse to the assigned position (interim point) and then is returned to the 1st reference position for each axis independently.

The G29 programming format is given below.

```
G29 Xx1 Yy1 Zz1 ;
G29           : Return command
Xx1,Yy1,Zz1   : Return control axes (coordinate of assigned position)
```

The tool is first moved by rapid traverse for each axis to the interim position which is passed through with G28 or G30, and is then positioned by rapid traverse at the position assigned by the program.

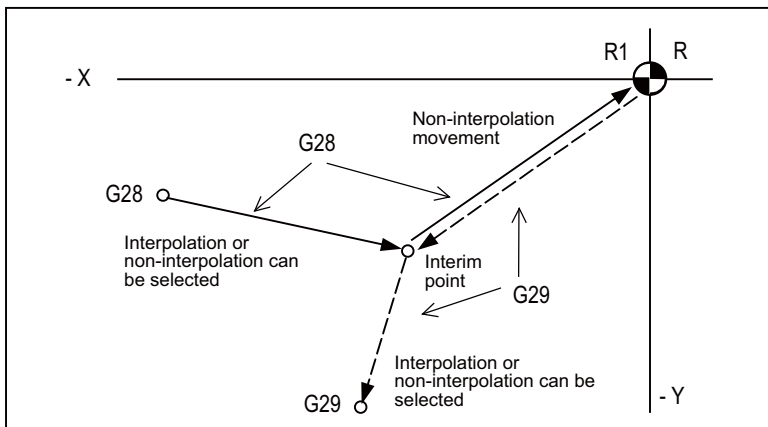

R1 1st reference position

If the position detector is for the incremental detection system, the first reference position return for the first time after the NC power has been turned ON will be the dog-type. However, whether the second and subsequent returns are to be the dog type or the high-speed type can be selected by designating a parameter.

The high-speed type is always used when the position detector is for the absolute position detection system.

- (Note 1) The automatic 1st reference position return pattern is the same as for manual reference position return.
- (Note 2) The number of axes for which reference position return can be performed simultaneously depends on the number of simultaneously controlled axes.
- (Note 3) If, at the time of the first reference position return, the tool radius compensation or nose radius compensation has not been canceled, it will be temporarily canceled during the movement to the interim point. The compensation is restored at the next movement after the return.
- (Note 4) If, at the time of the reference position return, the tool length compensation has not been canceled, it will be canceled and the compensation amount also cleared upon completion of reference position return. The tool length compensation can also be canceled temporarily using a parameter. In this case, however, the tool compensation is restored by the next movement command.
- (Note 5) Interpolation or non-interpolation can be selected using a parameter for the movement up to the G28 interim point or for the movement from the G29 interim point to the command point. Non-interpolation applies for movement from the G28 interim point to the reference position and movement up to the G29 interim point.
- (Note 6) When a single block operation is selected, it can be chosen by parameter setting whether or not to enable interim point stop.

10.2.3 2nd, 3rd, 4th Reference Position Return

	M850W	M830W	M850S	M830S	M80W	M80 TypeA	M80 TypeB	E80 TypeA	E80 TypeB	C80
M	○	○	○	○	○	○	○	○	○	○
L	○	○	○	○	○	○	○	○	○	○

As with automatic 1st reference position return, commanding G30Pn during automatic operation enables the tool to be returned to the set points (2nd, 3rd or 4th reference positions) characteristic to the machine. The 2nd, 3rd and 4th reference positions can be set by parameters.

G code	Function
G30 P2	2nd reference position return
G30 P3	3rd reference position return
G30 P4	4th reference position return

The G30 programming format is given below.

G30 Xx1 Yy1 Zz1 Pp1 ;	
G30	: Return command
Xx1,Yy1,Zz1	: Return control axes (coordinate of interim point)
Pp1	: Return position No.

The tool is first positioned by rapid traverse to the assigned interim point and then is returned to the reference position for each axis independently.

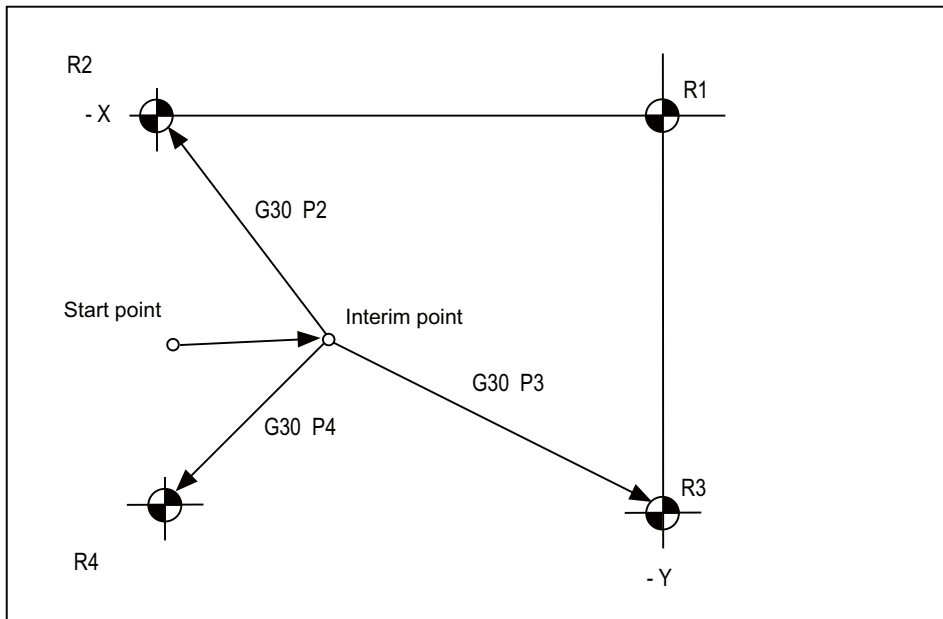

- R1: 1st reference position
- R2: 2nd reference position
- R3: 3rd reference position
- R4: 4th reference position

- (Note 1) The second reference position return is performed if the P address is omitted.
- (Note 2) The number of axes for which reference position return can be performed simultaneously depends on the number of simultaneously controlled axes.
- (Note 3) If, at the time of the reference position return, the tool radius compensation or nose R compensation has not been canceled, it will be temporarily canceled during the movement up to the interim point. The compensation is restored at the next movement command after the return.
- (Note 4) If, at the time of the reference position return, the tool length compensation has not been canceled, it will be canceled and the compensation amount also cleared upon completion of reference position return. The tool length compensation can also be canceled temporarily using a parameter. In this case, however, the tool compensation is restored by the next movement command.
- (Note 5) Whether interpolation or non-interpolation is to apply to the movement up to the interim point can be selected using a parameter. Non-interpolation applies for movement from the interim point to each of the reference positions.
- (Note 6) When a single block operation is selected, it can be chosen by parameter setting whether or not to enable interim point stop.

10.2.4 Reference Position Check

	M850W	M830W	M850S	M830S	M80W	M80 TypeA	M80 TypeB	E80 TypeA	E80 TypeB	C80
M	○	○	○	○	○	○	○	○	○	○
L	○	○	○	○	○	○	○	○	○	○

By commanding G27, a machining program, which has been prepared so that the tool starts off from the reference position and returns to the reference position, can be checked to see whether the tool will return properly to the reference position.

Command format

```
G27 Xx1 Yy1 Zz1 Pp1 ;
G27          : Check command
Xx1,Yy1,Zz1 : Return control axes
Pp1         : Check No.
            P1: 1st reference position check
            P2: 2
            P3: 3
            P4: 4
```

The tool is first positioned by rapid traverse to the assigned position and then, if this is the reference position, the reference position arrival signal is output.

When the address P is omitted, the first reference position check will be applied.

- (Note 1) The number of axes for which reference position check can be performed simultaneously depends on the number of simultaneously controlled axes.
- (Note 2) An alarm results unless the tool is positioned at the reference position upon completion of the command.
- (Note 3) Whether interpolation or non-interpolation is to apply to the movement can be selected using a parameter.

10.2.5 Absolute Position Detection

	M850W	M830W	M850S	M830S	M80W	M80 TypeA	M80 TypeB	E80 TypeA	E80 TypeB	C80
M	○	○	○	○	○	○	○	○	○	○
L	○	○	○	○	○	○	○	○	○	○

The absolute position detection function holds the position data of the actual machine position and the machine coordinates in the controller even after the power is turned OFF. When the power is turned ON again, a position command can be executed in automatic operation immediately without executing reference position return. (High-speed return is always used for the reference position return command.)

There are two types of absolute position detection method: dog type and dog-less type, which use different reference position establishment methods.

The type is selected with the parameter.

Method		Details	Establishment of zero point	Adjustment of zero point position
Dog-less type	Machine end stopper method	The zero point is established by pressing the machine against a set point on the machine.	The zero point is established when a torque limit is applied on the servo and the torque limit is reached by pressing against the machine stopper.	Input a value equivalent to the shift amount on the absolute position setting screen.
	Basic position alignment method	Method I	The zero point is established by inputting it through the absolute position setting screen.	Input a value equivalent to the shift amount on the absolute position setting screen.
		Method II		
	Grid-on method [Only for C80 Series]	The axis is positioned to the nearest grid point.	The axis is activated in reference position return mode.	Set a value in the parameter.
Dog-type		Same method as incremental detection dog-type.	The zero point is established with dog-type reference position return completion.	Set a value in the parameter.

(Note) This function is valid for the NC axis and the PLC axis. This function cannot be used for the spindle and the auxiliary axis.

10.2.6 Tool Exchange Position Return

	M850W	M830W	M850S	M830S	M80W	M80 TypeA	M80 TypeB	E80 TypeA	E80 TypeB	C80
M	○	○	○	○	○	○	○	○	○	○
L	○	○	○	○	○	○	○	○	○	○

By specifying the tool change position in a parameter and also assigning a tool change position return command in a machining program, the tool can be changed at the most appropriate position.

The axes for which returning to the tool change position is performed and the order in which the axes begin to return can be changed by commands.

G30.n ;
n = 1 to 6 : Specify the axes that return to the tool change position and the order in which they return. (For L system, n = 1 to 5)

Command and return order

[M system]

Command	Return order
G30. 1	Z axis → X axis / Y axis (→ additional axis)
G30. 2	Z axis → X axis → Y axis (→ additional axis)
G30. 3	Z axis → Y axis → X axis (→ additional axis)
G30. 4	X axis → Y axis / Z axis (→ additional axis)
G30. 5	Y axis → X axis / Z axis (→ additional axis)
G30. 6	X axis / Y axis / Z axis (→ additional axis)

[L system]

Command	Return order
G30. 1	X axis only (→ additional axis)
G30. 2	Z axis only (→ additional axis)
G30. 3	X axis → Z axis (→ additional axis)
G30. 4	Z axis → X axis (→ additional axis)
G30. 5	X axis / Z axis (→ additional axis)

(Note 1) An arrow (→) indicates the order of axes that begin to return. A period (/) indicates that the axes begin to return simultaneously.

Example : "Z axis → X axis" indicate that the Z axis returns to the tool change position, then the X axis does.

(Note 2) G30.6 is only for the M system.

The tool change position return ON/OFF for the additional axis can be set with parameter for the additional axis.

For the order to return to the tool change position, the axes return after the standard axis completes the return to the tool change position (refer to above table).

The additional axis cannot return to the tool change position alone.

Operation Support Functions

11.1 Program Control

11.1.1 Optional Block Skip

	M850W	M830W	M850S	M830S	M80W	M80 TypeA	M80 TypeB	E80 TypeA	E80 TypeB	C80
M	○	○	○	○	○	○	○	○	○	○
L	○	○	○	○	○	○	○	○	○	○

It is possible to command to selectively ignore a part, from a "/" (slash) code to the end of the block, of a machining program. When the optional block skip input signal from the external source is turned ON for automatic operation, the block with the "/" code is skipped. If the optional block skip signal is turned OFF, the block with the "/" code will be executed without being skipped.

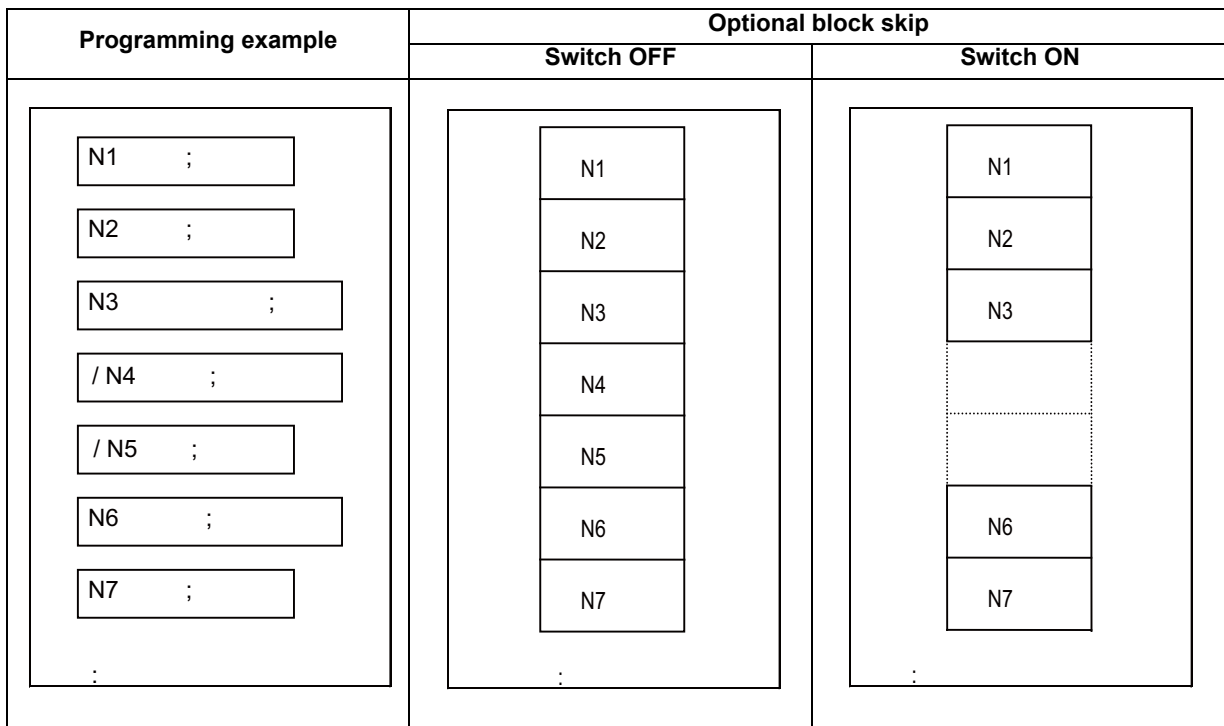

Skipping from a "/" in the middle of a program to the end of the program can also be enabled by parameter setting.

11.1.2 Optional Block Skip Addition

	M850W	M830W	M850S	M830S	M80W	M80 TypeA	M80 TypeB	E80 TypeA	E80 TypeB	C80
M	○	○	○	○	○	○	○	—	—	○
L	○	○	○	○	○	○	○	—	—	○

When "/n (n:1 to 9)" (slant code) is programmed at the head of a block, and the optional block skip n input signal from the external source is turned ON for automatic operation, the block with the "/n" code is skipped.

If the optional block skip n signal is turned OFF, the block with the "/n" code will be executed without being skipped.

11.1.3 Single Block

	M850W	M830W	M850S	M830S	M80W	M80 TypeA	M80 TypeB	E80 TypeA	E80 TypeB	C80
M	○	○	○	○	○	○	○	○	○	○
L	○	○	○	○	○	○	○	○	○	○

The commands for automatic operation can be executed one block at a time (block stop) by turning ON the single block input signal. When the single block input signal is turned ON temporarily during continuous operation, the machine will stop after that block has been executed.

Even when operation is switched to another automatic operation mode (for example, memory operation mode to MDI operation mode) during continuous operation, the machine will stop after that block has been executed.

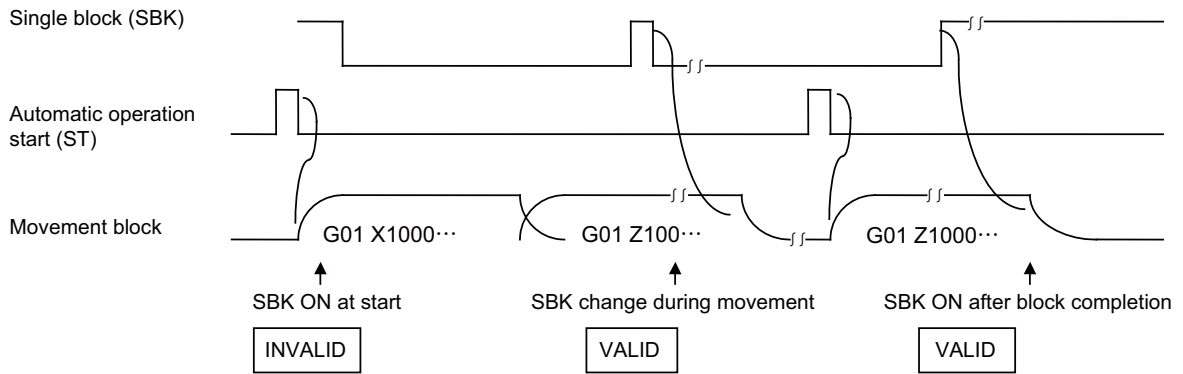

As with the multi-part system specification, the following function can be selected instead.

Multi-part system single block (L system)

This function is for executing single block operation while maintaining the synchronization between the part systems when two or more part systems are operated. When one part system has been stopped by single block stop, the other part systems are stopped by feed hold.

11.2 Program Test

11.2.1 Dry Run

	M850W	M830W	M850S	M830S	M80W	M80 TypeA	M80 TypeB	E80 TypeA	E80 TypeB	C80
M	○	○	○	○	○	○	○	○	○	○
L	○	○	○	○	○	○	○	○	○	○

F code feed commands for automatic operation can be switched to the manual feed rate data of the machine operation board by turning ON the dry run input signal.

Command	Dry run switch ON	
	Rapid traverse selection switch OFF	Rapid traverse selection switch ON
G00,G27,G28,G29,G30,G60	Manual feed rate	Rapid traverse rate
G01,G02,G03	Manual feed rate	Cutting clamp speed

11.2.2 Machine Lock

	M850W	M830W	M850S	M830S	M80W	M80 TypeA	M80 TypeB	E80 TypeA	E80 TypeB	C80
M	○	○	○	○	○	○	○	○	○	○
L	○	○	○	○	○	○	○	○	○	○

When the machine lock input signal is set to ON, the NC operations can be executed without assigning commands to the NC axes.

The feed rate in the machine lock status is the command speed.

The M, S, T and B commands are executed as usual and operation is completed by returning the FIN signal.

- (1) Reference position return (manual, G28, G29, G30) is controlled as far as the interim point in the machine lock status but the block is completed when the interim point is reached.
- (2) Machine lock is effective in the signal status applying when the axis has stopped.
- (3) Block stop will be applied if the machine lock signal is turned ON to OFF or OFF to ON during automatic operation.

11.2.3 Miscellaneous Function Lock

	M850W	M830W	M850S	M830S	M80W	M80 TypeA	M80 TypeB	E80 TypeA	E80 TypeB	C80
M	○	○	○	○	○	○	○	○	○	○
L	○	○	○	○	○	○	○	○	○	○

The M, S, T and B (2nd miscellaneous function) output signals are not output to the machine or PLC when the miscellaneous function lock signal of external input is turned ON. This function can be used when checking only the movement commands in a program check.

The start signals of the M command are output for the M00, M01, M02 and M30 commands, and so a completion signal must be returned.

- (1) Fixed cycle spindle functions containing an S code and any M, S, T or B function assigned by a manual numerical command or in automatic operation will not be executed. The code data and strobe (MF, SF, TF, BF) outputs are stopped.
- (2) If this signal is set ON after the code data has already been output, the output is executed as it would normally be executed until the end (until FIN1 or FIN2 is received and the strobe is turned OFF).
- (3) Even when this signal is ON, the M00, M01, M02 and M30 commands among the miscellaneous functions are executed, and the decode signal, code data and strobe signals are also output as they would be normally.
- (4) Any miscellaneous functions which are executed only inside the controller and not output (M96, M97, M98, M99) are executed as they would be normally even if this signal is ON.

11.2.4 Graphic Check

11.2.4.1 Graphic Check

	M850W	M830W	M850S	M830S	M80W	M80 TypeA	M80 TypeB	E80 TypeA	E80 TypeB	C80
M	○	○	○	○	○	○	○	○	○	—
L	○	○	○	○	○	○	○	○	○	—

The machining program movement path can be confirmed with the graphic drawing without executing automatic operation. Therefore, the machining program can be checked while drawing the figure accurately at a high speed.

There are two description method for the graphic check function: 2D check and 3D check.

The drawing's viewpoint can be moved, enlarged and reduced while drawing. The three axes displayed are set with the parameters.

(Note) Automatic operation is disabled during graphic check for M80/E80.

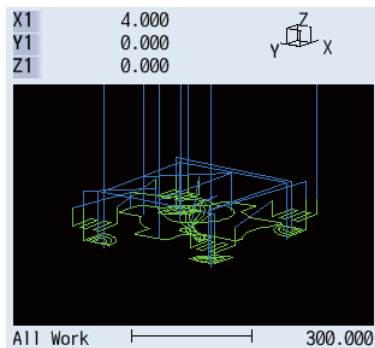

11.2.4.2 3D Solid Program Check

	M850W	M830W	M850S	M830S	M80W	M80 TypeA	M80 TypeB	E80 TypeA	E80 TypeB	C80
M	○	○	○	○	○	○	○	○	○	—
L	○	○	○	○	○	○	○	○	○	—

The machining program movement path can be confirmed with the graphic drawing without executing automatic operation. Therefore, the machining program can be checked while drawing the figure accurately at a high speed.

There are two types of check methods for the 3D check: Check method I and Check method II. The Check method I simplifies the machining result of machining program and simulates at a high speed. The check method II simulates the machining result of machining program at a higher accuracy than the Check method I.

The workpiece shape's viewpoint can be moved, enlarged and reduced while drawing. The three axes displayed are set with the parameters.

The workpiece shape and tool shape used are set on this screen.

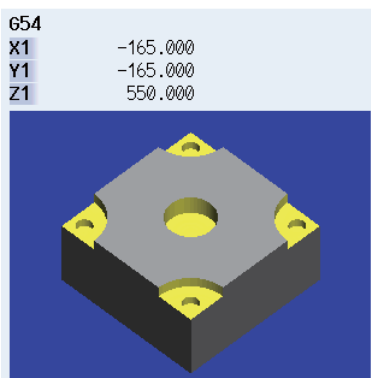

11.2.4.3 Graphic Check Rotary Axis Drawing

	M850W	M830W	M850S	M830S	M80W	M80 TypeA	M80 TypeB	E80 TypeA	E80 TypeB	C80
M	—	—	—	—	—	—	—	—	—	—
L	△	△	△	△	○	○	○	○	○	—

When the rotary axis (C axis) is designated with the parameter in program check (2D), the path is drawn depending on the rotary axis. The rotary axis can be set for each part system.

Refer to "11.2.4.1 Graphic Check" for details on the graphic check.

(Note 1) When the control axis address other than C axis is designated with the parameter, the path corresponding to the rotary axis is not drawn.

(Note 2) The workpiece coordinate system must be set so that the center of the rotary axis becomes the coordinate system zero point.

Image of actual tool and workpiece

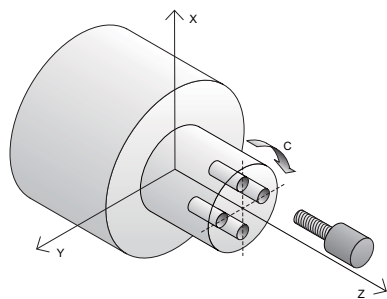

Example of machining program

```
G83Z-20.R-5.Q5000F300 ;
G0C90. ;
G83Z-20.R-5.Q5000F300 ;
G0C180. ;
G83Z-20.R-5.Q5000F300 ;
G0C270. ;
G83Z-20.R-5.Q5000F300 ;
G80 ;
```

Drawing image when the rotary axis drawing is invalid

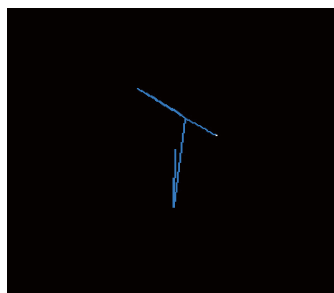

Drawing image when the rotary axis drawing is valid



11.2.5 Graphic Trace

11.2.5.1 Graphic Trace

	M850W	M830W	M850S	M830S	M80W	M80 TypeA	M80 TypeB	E80 TypeA	E80 TypeB	C80
M	○	○	○	○	○	○	○	○	○	—
L	○	○	○	○	○	○	○	○	○	—

This function draws the machine tool's machine position. The movement path following the actual automatic operation or manual operation, or the tool tip movement path can be drawn, and the machine operation during machining can be monitored.

For the display mode, 1-plane, 2-plane and 3-dimensional display are provided. In the 3-dimensional display mode, cubic shapes can be rotated and tracing of the figure seen from the desired direction can be assigned.

One of the following functions is required for the trace of tool path:

- Tool center point control
- Tool length compensation along the tool axis
- Tool handles feed & interruption, workpiece installation error compensation
- Workpiece installation error compensation
- Inclined surface machining command
- Simple inclined surface machining command
- 3-dimensional tool radius compensation (tool's vertical-direction compensation)
- 3-dimensional manual feed
- R-Navi

11.2.5.2 Graphic Trace Rotary Axis Drawing

	M850W	M830W	M850S	M830S	M80W	M80 TypeA	M80 TypeB	E80 TypeA	E80 TypeB	C80
M	—	—	—	—	—	—	—	—	—	—
L	△	△	△	△	○	○	○	○	○	—

When the rotary axis (C axis) is designated with the parameter in program trace, the path is drawn depending on the rotary axis. The rotary axis can be set for each part system.

Refer to "11.2.5.1 Graphic Trace" for details on the graphic trace.

(Note 1) When the control axis address other than C axis is designated with the parameter, the path corresponding to the rotary axis is not drawn.

(Note 2) The workpiece coordinate system must be set so that the center of the rotary axis becomes the coordinate system zero point.

Image of actual tool and workpiece

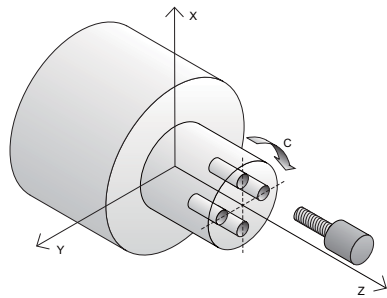

Example of machining program

```
G83Z-20.R-5.Q5000F300 ;
G0C90. ;
G83Z-20.R-5.Q5000F300 ;
G0C180. ;
G83Z-20.R-5.Q5000F300 ;
G0C270. ;
G83Z-20.R-5.Q5000F300 ;
G80 ;
```

Drawing image when the rotary axis drawing is invalid

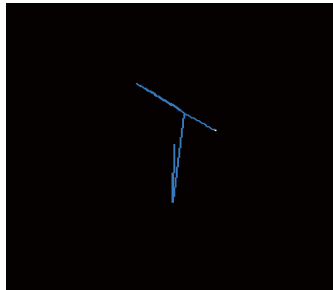

Drawing image when the rotary axis drawing is valid

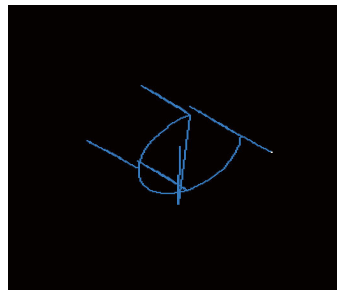

11.2.6 Machining Time Computation

	M850W	M830W	M850S	M830S	M80W	M80 TypeA	M80 TypeB	E80 TypeA	E80 TypeB	C80
M	○	○	○	○	○	○	○	○	○	—
L	○	○	○	○	○	○	○	○	○	—

This function analyzes the machining program without moving the axis and calculates the approximate time required for machining.

Machining time is calculated by accumulating the following times:

- Rapid traverse time
- Cutting feed time
- Dwell time
- MSTB time

The machining time is displayed as "hour: minute: second".

11.2.7 Manual Arbitrary Reverse Run (Program Check Operation)

	M850W	M830W	M850S	M830S	M80W	M80 TypeA	M80 TypeB	E80 TypeA	E80 TypeB	C80
M	△	△	△	△	○	○	○	—	—	△
L	△	△	△	△	○	○	○	○	○	△

The manual arbitrary reverse run can be performed by controlling the feedrate being in the automatic operation in the memory or MDI mode in proportion to the manual feedrate by jog or the rotation speed by manual handle. This function allows a program to run the executed blocks backward (reverse run) after the block stop in the automatic operation. The buffer correction of the program can be performed after reverse run to a desired point and the corrected program can be run.

Example of machining operation

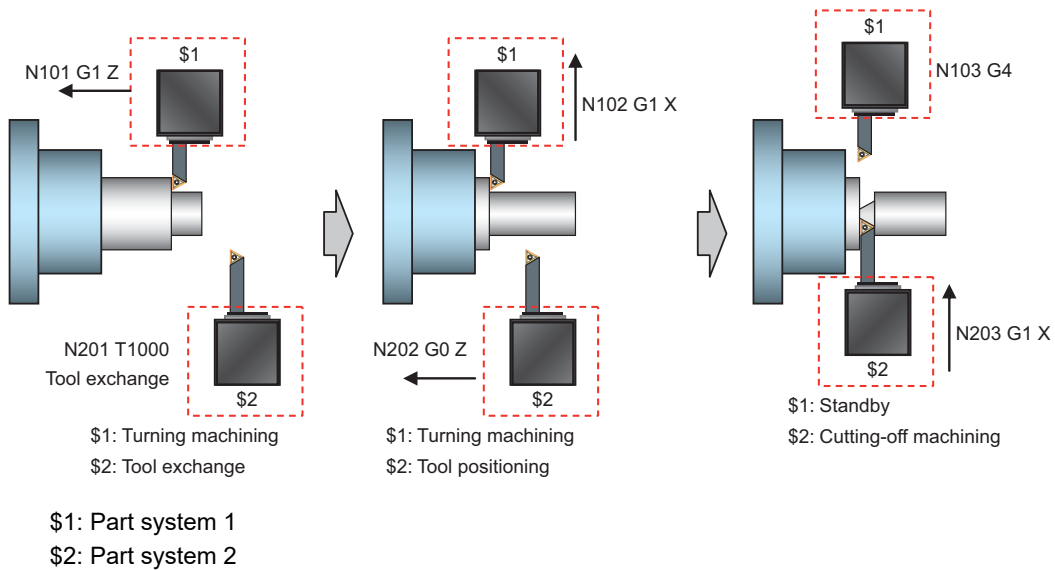

Timing diagram in override 100%

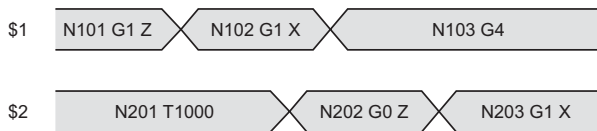

Timing diagram in manual arbitrary reverse run

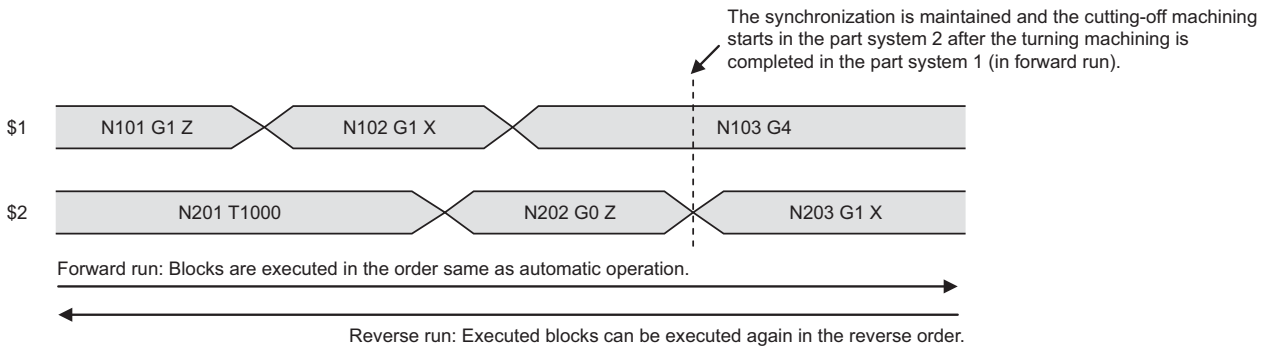

The total operation time is increased in the timing diagram for the manual arbitrary reverse run, however the synchronization between part systems can be maintained and the cutting-off machining starts after the turning machining is completed in forward run. The synchronization between part systems is maintained in both forward and reverse run.

11.2.8 High-speed Simple Program Check

	M850W	M830W	M850S	M830S	M80W	M80 TypeA	M80 TypeB	E80 TypeA	E80 TypeB	C80
M	○	○	○	○	○	○	○	○	○	○
L	○	○	○	○	○	○	○	○	○	○

This function checks whether a program error occurs by operating the machining program without the axes movements. The estimated machining time can be checked in time shorter than the actual execution time of the machining program. This function is valid with the "High-speed simple program check" signal ON .

The machining program is operated in the reduced time according to the coefficient which is set to the time reduce coefficient.

The estimated machining time of the machining program is output to time measurement output.

The miscellaneous command code which outputs strobes can be allocated arbitrarily with the parameter during the high-speed simple program check.

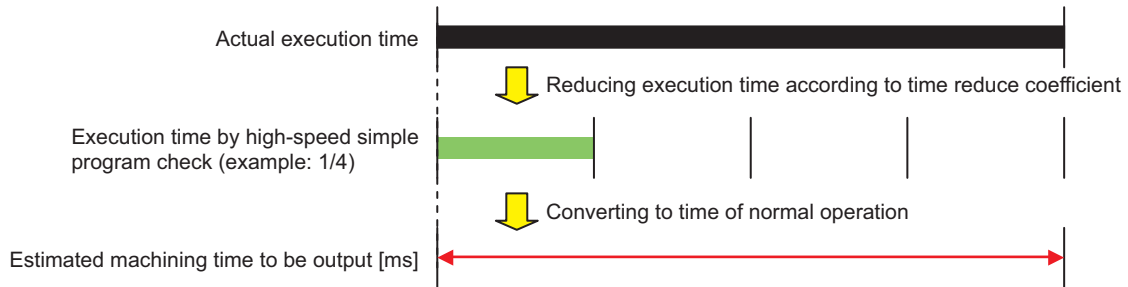

11.3 Program Search/Start/Stop

11.3.1 Program Search

	M850W	M830W	M850S	M830S	M80W	M80 TypeA	M80 TypeB	E80 TypeA	E80 TypeB	C80
M	○	○	○	○	○	○	○	○	○	○
L	○	○	○	○	○	○	○	○	○	○

The program No. of the program to be operated automatically can be designated and called. Upon completion of search, the head of the program searched is displayed.

Machining programs are stored in the memory inside the NC system.

11.3.2 Sequence Number Search

	M850W	M830W	M850S	M830S	M80W	M80 TypeA	M80 TypeB	E80 TypeA	E80 TypeB	C80
M	○	○	○	○	○	○	○	○	○	○
L	○	○	○	○	○	○	○	○	○	○

Blocks can be indexed by setting the program No., sequence No. and block No. of the program to be operated automatically.

The searched program is displayed upon completion of the search.

Machining programs are stored in the memory inside the NC system.

11.3.3 Collation and Stop

	M850W	M830W	M850S	M830S	M80W	M80 TypeA	M80 TypeB	E80 TypeA	E80 TypeB	C80
M	○	○	○	○	○	○	○	—	—	○
L	○	○	○	○	○	○	○	—	—	○

This function enables the single block stop status to be established at any block without having to set the SINGLE BLOCK switch to ON.

It can be used to readily check the machining shape up to the designated block and resume machining.

```

G91 ;
:
G00 Z-150. ;
N100 G81 X-100. Z-100. R-50. F100 ;
N101 X-100. ;
→ N102 X-100. ;
N103 Y100. ;
N104 X100. ;
N105 X-100. ;
:

```

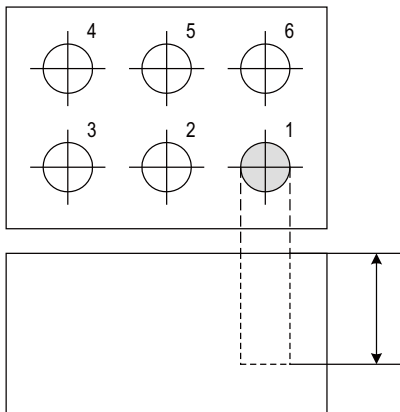

Collation and stop is executed when drilling of one hole is completed (N100 block is completed) as shown on the left. The hole depth is measured to confirm that the dimensions are correct. If the dimensions are not correct, the tool compensation amount is changed.

If machining is started from the head of the program, accurate hole drilling can be carried out.

11.3.4 Program Restart

	M850W	M830W	M850S	M830S	M80W	M80 TypeA	M80 TypeB	E80 TypeA	E80 TypeB	C80
M	○	○	○	○	○	○	○	○	○	○
L	○	○	○	○	○	○	○	○	○	○

With this function, the program search can be executed while updating the coordinate values and the modal information in the same manner as an actual program operation.

Therefore, this function enables machining from a block in the middle of the program as if the actual machining was carried out from the beginning.

This function is used to restart machining when a machining program is to be resumed after it has been suspended midway due to tool damage or for some other reason.

The machine will not move during the search.

When the search is completed, the distance from the current position of the machine (workpiece coordinates) to the restart position (start point of the searched block) is displayed as restart remaining distance on the screen.

After the program restart, positioning to the restart position is carried out at the cycle start, and automatic operation is performed for the searched and subsequent blocks.

Positioning to the restart position can also be manually performed.

After the program restart, an arbitrary M, S, T or B command can be executed by the manual numerical value command before the cycle start.

There are two search methods by the program restart.

Restart method	Details	
Restart search type 1	After machining is reset due to a tool breakage, etc., machining is restarted from the designated sequence number and/or block number. Only the program which had been executed just before can be restarted. Even after the power is turned ON again, the program can be restarted if the program has been executed before the power supply is turned OFF.	
Restart search type 2	If a machining program different from the machining program to be restarted was run before starting restart search, specify the sequence No. and block No. before restarting the machining.	
	Automatic top search OFF	A top search must be executed from the screen. Then, command a sequence No. and block No., and restart a program.
	Automatic top search ON	A top search may not be executed from the screen. A top search is automatically executed, so it is not necessary to execute a top search from the screen. Command a sequence No. and block No., and restart a machining. An arbitrary program can be restarted by designating the program No. When a program No. is omitted, the program currently searched is restarted.

The validity of the automatic top search can be changed with control parameter.

11.3.5 Automatic Operation Start

	M850W	M830W	M850S	M830S	M80W	M80 TypeA	M80 TypeB	E80 TypeA	E80 TypeB	C80
M	○	○	○	○	○	○	○	○	○	○
L	○	○	○	○	○	○	○	○	○	○

With the input of the automatic operation start signal (change from ON to OFF), the automatic operation of the program that has been operation searched is started by the controller (or the halted program is restarted).

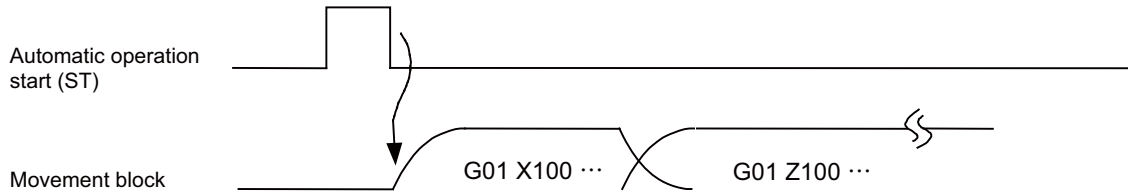

Automatic operation startup is performed on a part system by part system basis.

[C80 Series]

Trigger edge for a cycle start (ST) can be selected by the parameter.

- Enabled at the falling edge (the automatic operation start signal is turned ON to OFF)
- Enabled at the rising edge (the automatic operation start signal is turned OFF to ON)

11.3.6 NC Reset

	M850W	M830W	M850S	M830S	M80W	M80 TypeA	M80 TypeB	E80 TypeA	E80 TypeB	C80
M	○	○	○	○	○	○	○	○	○	○
L	○	○	○	○	○	○	○	○	○	○

This function enables the controller to be reset.

		Reset 1	Reset 2	Reset & Rewind
1	G command modals	Retained	Initialized	Initialized
2	Tool compensation data	Retained	Canceled (no operations)	Canceled
3	Memory indexing	Executed	Not executed	Executed
4	Errors/alarms	Reset	Reset	Reset
5	M, S and T code outputs	Retained	Retained	Retained
6	M code independent output	OFF	OFF	OFF
7	Control axis moving	Decelerated and stopped	Decelerated and stopped	Decelerated and stopped
8	Output signals	"In reset" signal	"In reset" signal	"In reset" signal "In rewind" signal

11.3.7 Feed Hold

	M850W	M830W	M850S	M830S	M80W	M80 TypeA	M80 TypeB	E80 TypeA	E80 TypeB	C80
M	○	○	○	○	○	○	○	○	○	○
L	○	○	○	○	○	○	○	○	○	○

When the feed hold signal is set ON during automatic operation, the machine feed is immediately decelerated and stopped. The machine is started again by the "Automatic operation start (cycle start)" signal.

- (1) When the feed hold mode is entered during cycle start, the machine feed is stopped immediately, but the M, S, T and B commands in the same block are still executed as programmed.
- (2) When the mode is switched during automatic operation to manual operation (such as jog feed, handle feed or incremental feed), the feed hold stop mode is entered.
- (3) An interrupt operation based on manual operation (such as jog feed, handle feed or incremental feed) can be executed during feed hold.

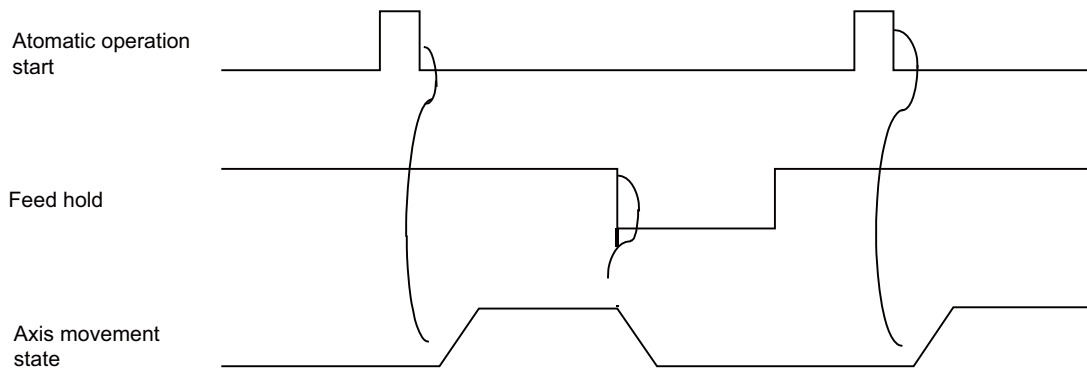

11.3.8 Search & Start

	M850W	M830W	M850S	M830S	M80W	M80 TypeA	M80 TypeB	E80 TypeA	E80 TypeB	C80
M	○	○	○	○	○	○	○	○	○	○
L	○	○	○	○	○	○	○	○	○	○

If the search & start signal is input in a status where the memory mode is selected, the designated machining program is searched and executed from its head.

If the search & start signal has been input during automatic operation in the memory mode, search & start is executed after resetting.

11.3.10 Auto-restart

	M850W	M830W	M850S	M830S	M80W	M80 TypeA	M80 TypeB	E80 TypeA	E80 TypeB	C80
M	○	○	○	○	○	○	○	○	○	○
L	○	○	○	○	○	○	○	○	○	○

A machining program is restarted automatically at the completion of the machining program execution.

11.4 Interrupt Operation

11.4.1 Manual Interruption

	M850W	M830W	M850S	M830S	M80W	M80 TypeA	M80 TypeB	E80 TypeA	E80 TypeB	C80
M	○	○	○	○	○	○	○	○	○	○
L	○	○	○	○	○	○	○	○	○	○

Manual interrupt is a function that enables manual operations to be performed during automatic operation.

The methods to select the operation mode are as follows:

- Initiates the interrupt by switching from the automatic mode to manual mode
- Initiates the interrupt by selecting the manual mode at the same time as the automatic mode (Refer to "11.4.9 Simultaneous Operation of Manual and Automatic Modes".)

Whether the manual interrupt amount is to be retained and automatic operation is to be continued is determined by setting manual absolute mode ON or OFF (refer to "11.4.3 Manual Absolute Switch").

11.4.2 Automatic Operation Handle Interruption

	M850W	M830W	M850S	M830S	M80W	M80 TypeA	M80 TypeB	E80 TypeA	E80 TypeB	C80
M	○	○	○	○	○	○	○	○	○	○
L	○	○	○	○	○	○	○	○	○	○

The handle command can interrupt and be superimposed onto a command without suspending automatic operation and the machine can be moved by rotating the manual pulse generator during automatic operation.

If the spindle load is greatly exceeded when cutting a workpiece as per the machining program due to a high rough cutting amount in face machining, for instance, automatic handle interrupt makes it possible to raise the Z surface and reduce the load easily without suspending feed in the automatic operation mode.

Automatic handle interrupt is conducted by setting the "automatic handle interrupt" valid switch which is provided separately from the "manual operation mode". The axis selection, pulse scale factor and operation are conducted as for manual handle feed.

Whether, after an interrupt, to return to the path of the machining program by automatic operation or remain offset by the amount equivalent to the interrupt amount is determined using a parameter.

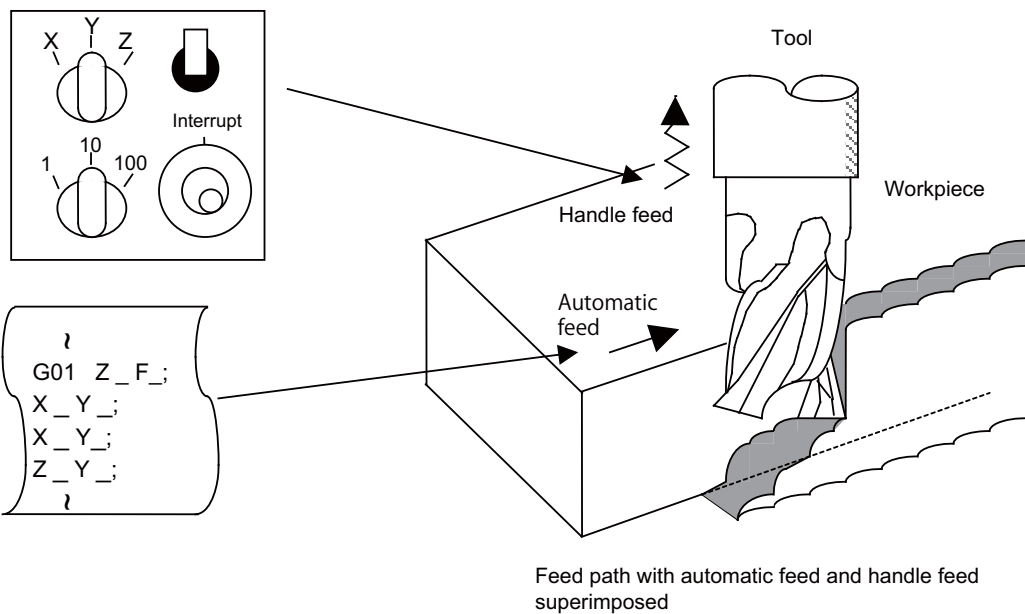

11.4.3 Manual Absolute Switch

	M850W	M830W	M850S	M830S	M80W	M80 TypeA	M80 TypeB	E80 TypeA	E80 TypeB	C80
M	○	○	○	○	○	○	○	○	○	○
L	○	○	○	○	○	○	○	○	○	○

The program absolute positions are updated by an amount equivalent to the distance by which the tool is moved by hand when the manual absolute switch signal is turned ON.

In other words, the coordinate system based on the original program will not shift even if the tool (machine) is moved by hand. Thus, if automatic operation is started in this case, the tool will return to the path before manual movement.

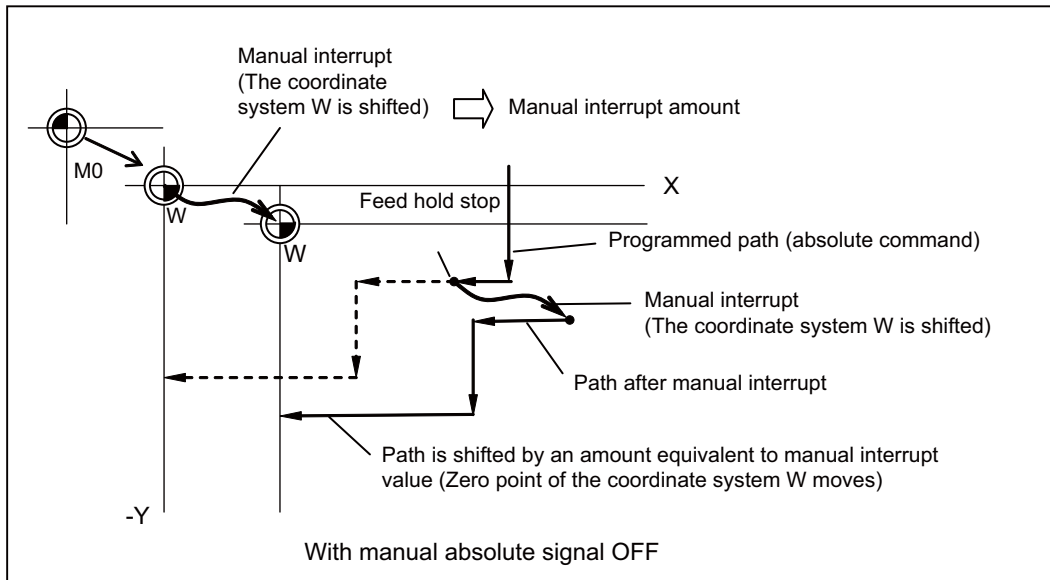
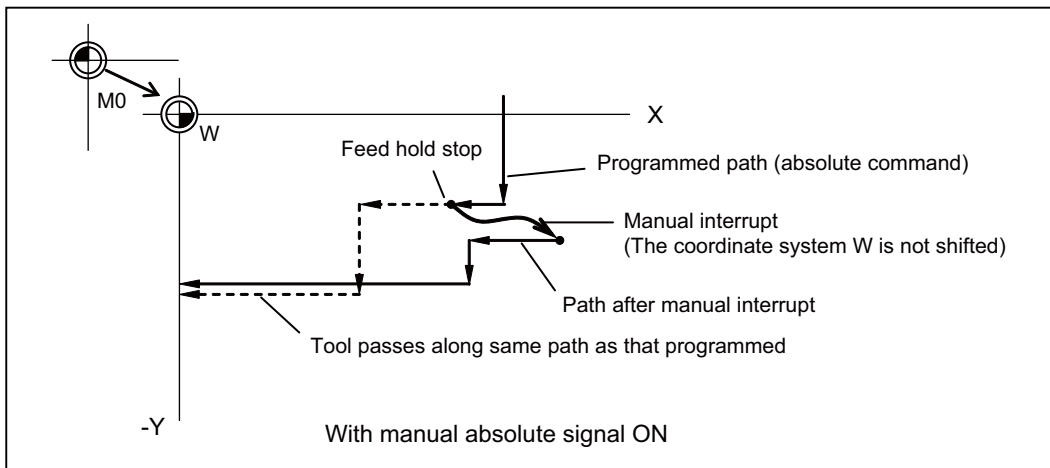

The manual absolute ON state will be entered when the power is turned ON.

11.4.4 Thread Cutting Cycle Retract

	M850W	M830W	M850S	M830S	M80W	M80 TypeA	M80 TypeB	E80 TypeA	E80 TypeB	C80
M	○	○	○	○	○	○	—	—	—	—
L	○	○	○	○	○	○	○	—	—	○

This function suspends the thread cutting cycle if a feed hold signal has been input during thread cutting in a thread cutting cycle.

If a feed hold signal is input during chamfering or thread cutting without chamfering, operation stops at the position where the block following the thread cutting is completed.

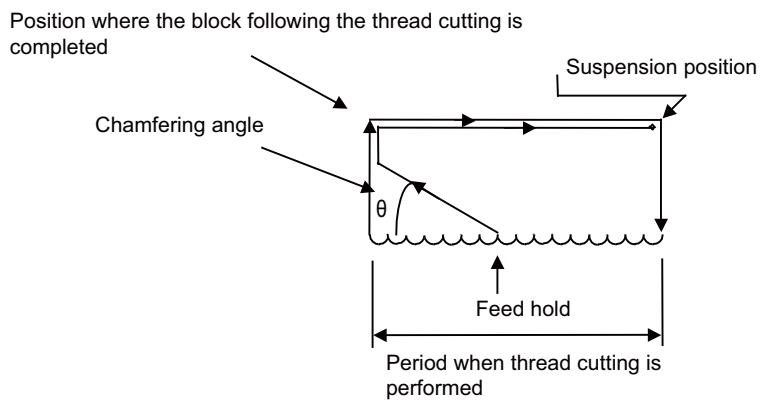

11.4.5 Tapping Retract

	M850W	M830W	M850S	M830S	M80W	M80 TypeA	M80 TypeB	E80 TypeA	E80 TypeB	C80
M	○	○	○	○	○	○	○	○	○	○
L	○	○	○	○	○	○	○	○	○	○

If tapping is interrupted by a reset or emergency stop signal that is input during tapping and the tap is left engaged inside the workpiece, the tap tool engaged inside the workpiece can be rotated in the reverse direction so that it will be disengaged by inputting the tap retract signal.

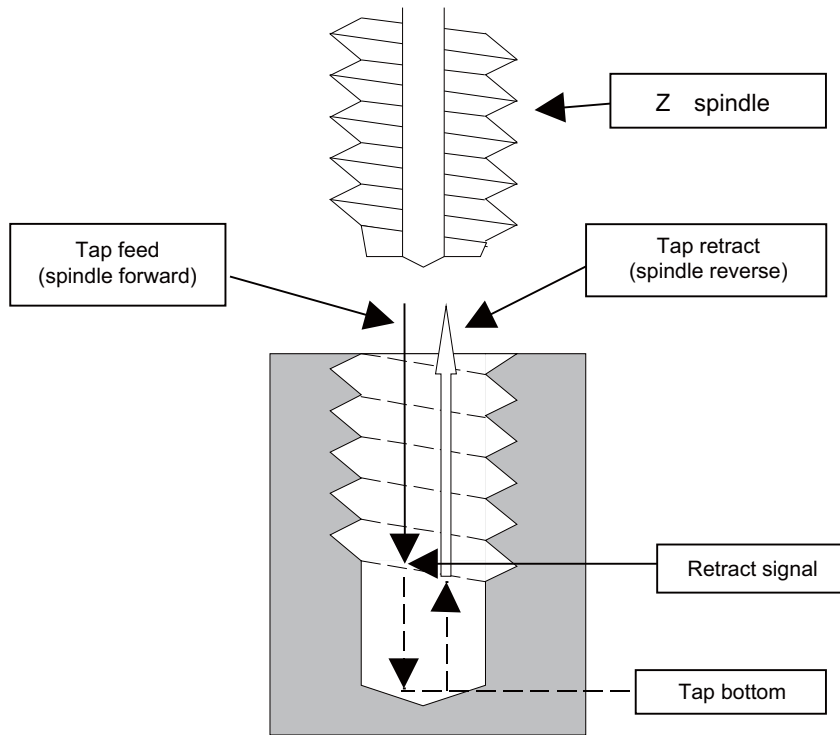

This function can be used when the machining was interrupted upon reset, emergency stop or power OFF during tapping cycle.

(Note that "power OFF" is applied only when the absolute position detection system is valid.)

A return is made to the initial point by tap retract.

11.4.6 Manual Numerical Value Command

	M850W	M830W	M850S	M830S	M80W	M80 TypeA	M80 TypeB	E80 TypeA	E80 TypeB	C80
M	○	○	○	○	○	○	○	○	○	○
L	○	○	○	○	○	○	○	○	○	○

Commands of spindle function (S), miscellaneous function (M), tool function (T) and 2nd miscellaneous function (B) can be executed through the Monitor screen or Setup screen.

This enables operations such as spindle speed changing, starting, stopping, calling and selecting assigned tools and replacing of the spindle tools to be done easily without having to prepare or revise the machining program.

The corresponding macro program can be executed from the manual numerical value command.

Miscellaneous command macro call	Calls and executes the macro program registered as an M code macro (*1) from the M command. Calls and executes the macro program registered as an M code macro (*1) from the M command.
T command macro call	Calls and executes the T code macro program registered exclusively for manual numerical value command from the T command.

(*1) The M code macros that can be used for manual numerical value command are limited to those with a call type of M98.

11.4.7 Arbitrary Reverse Run

	M850W	M830W	M850S	M830S	M80W	M80 TypeA	M80 TypeB	E80 TypeA	E80 TypeB	C80
M	○	○	○	○	○	○	—	—	—	—
L	—	—	—	—	—	—	—	—	—	—

This function allows a program to run the executed blocks backward (hereinafter called "reverse run") after the block stop in the automatic operation.

The following steps are available:

- Execute the reverse run to the point to go back,
- Run the reversed blocks again following the program (hereinafter called "forward run") and
- Continue the remaining blocks from the point of the interruption.

Maximum 200 blocks can be executed in the reverse run.

Only the 1st to 3rd axes of each part system can be used for this function.

(Example 1) Reverse run

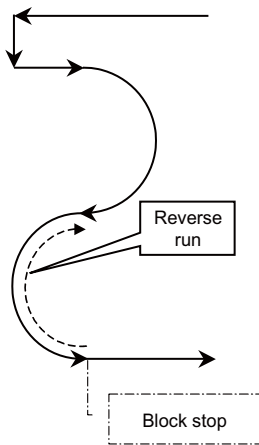

(Example 2) Forward run after the reverse run

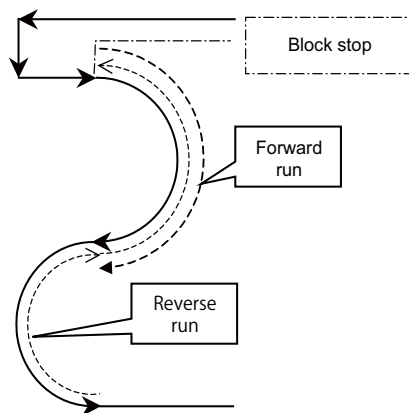

11.4.8 MDI Interruption

	M850W	M830W	M850S	M830S	M80W	M80 TypeA	M80 TypeB	E80 TypeA	E80 TypeB	C80
M	○	○	○	○	○	○	○	○	○	○
L	○	○	○	○	○	○	○	○	○	○

This function enables MDI programs to be executed during automatic operation in the single block stop status. When the modal status is changed in the MDI program, the modal status in the automatic operation mode is also changed.

11.4.9 Simultaneous Operation of Manual and Automatic Modes

	M850W	M830W	M850S	M830S	M80W	M80 TypeA	M80 TypeB	E80 TypeA	E80 TypeB	C80
M	○	○	○	○	○	○	○	○	○	○
L	○	○	○	○	○	○	○	○	○	○

This function enables manual operations to be performed during automatic operation by selecting an automatic operation mode (tape, MDI or memory) and manual mode (handle, step, jog or manual reference position return) simultaneously.

(Arbitrary feed based on the PLC is also possible.)

The feed rates for the axes subject to automatic commands and the feed rates for axes subject to manual command are set separately. The acceleration/deceleration modes (rapid traverse, cutting feed) are also set separately. Rapid traverse override, cutting feed override and second cutting feed override are valid both for axes subject to automatic commands and manual commands. Override cancel is valid for axes subject to automatic commands.

Manual interlock is applied to axes subject to manual commands; automatic interlock is applied to axes subject to automatic commands.

11.4.10 Simultaneous Operation of JOG and Handle Modes

	M850W	M830W	M850S	M830S	M80W	M80 TypeA	M80 TypeB	E80 TypeA	E80 TypeB	C80
M	○	○	○	○	○	○	○	○	○	○
L	○	○	○	○	○	○	○	○	○	○

When executing the jog feed and handle feed, both these feeds are available without changing the mode each time by inputting the jog mode signal and simultaneous operation of jog and handle modes signal to the control unit. However, while axis is moving in one of the two modes, the feed in the other mode is not valid.

11.4.11 Reference Position Retract

	M850W	M830W	M850S	M830S	M80W	M80 TypeA	M80 TypeB	E80 TypeA	E80 TypeB	C80
M	○	○	○	○	○	○	○	○	○	○
L	○	○	○	○	○	○	○	○	○	○

When the retract signal is turned ON during the automatic and manual operation, this function can retract the tool immediately to a set reference position.

The reference position to be retracted to can be selected from the 1st reference position to 4th reference position with 2-bit input signal.

Set the retracting order of axes with parameter.

(1) Other operations

- (a) When the retract signal is turned ON, the control unit is reset, the operation is interrupted, and the machining program is indexed.
- (b) When the rapid traverse input signal is input, the rapid traverse rate is applied. When the rapid traverse input signal is not input, the manual feed rate is applied.
- (c) If the retract signal is input during execution of a tapping cycle, the operation will be the tapping retract, and the normal reference position retract will be executed from the end point of tapping retract operation.
- (d) Even if the retract signal is input during the thread cutting cycle, it will be invalid. However, if the retract signal is input in a block other than the thread cutting block, the retracting operation will be executed.
- (e) If the retract signal is turned OFF midway during retracting, the operation will decelerate and stop. However, since the machining program is indexed, the block can not be resumed.
- (f) The retract signal is invalid if the coordinate system is not established. An operation error will occur when the retract signal is input in such case.

11.4.12 Tool Retract and Return

	M850W	M830W	M850S	M830S	M80W	M80 TypeA	M80 TypeB	E80 TypeA	E80 TypeB	C80
M	△	△	△	△	○	○	○	—	—	—
L	△	△	△	△	○	○	○	—	—	—

Even if the machining program's operation is halted and the tool is escaped to change the tool or check the workpiece, etc., the tool can be returned to the halted point (machining halted point) and machining resumed.

The two main functions are as follow.

- After the machining program is halted, the halt point is designated, and the tool is escaped manually.

The transit points for returning are designated when escaping.

- The tool returns automatically.

When returning, the tool passes through the transit points designated when escaping and returns to the halt point. Then, machining restarts.

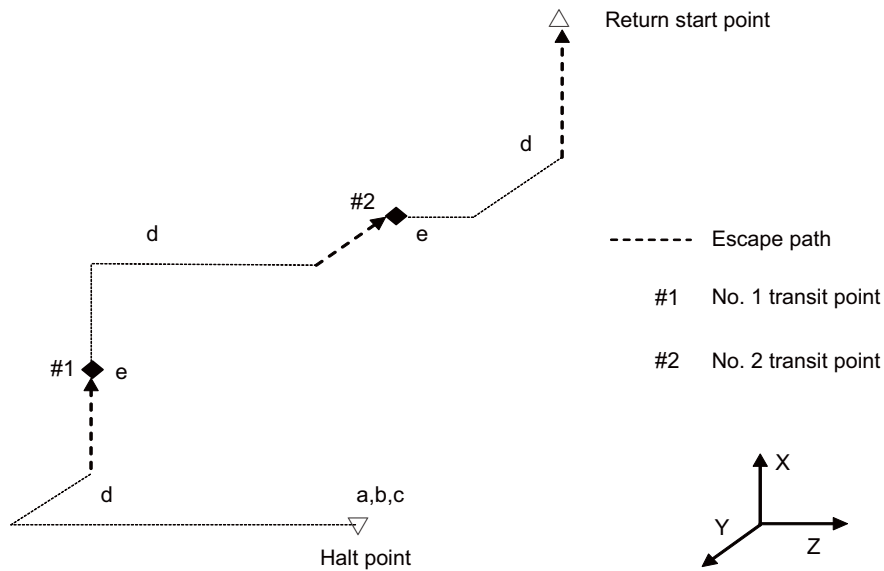

- a. Machining program halt
- b. Halt point designation
- c. Operation mode changeover
- d. Tool retract
- e. Transit point designation

11.4.13 Skip Retract

	M850W	M830W	M850S	M830S	M80W	M80 TypeA	M80 TypeB	E80 TypeA	E80 TypeB	C80
M	○	○	○	○	○	○	○	—	—	○
L	—	—	—	—	—	—	—	—	—	—

This function is used to return to the opposite advance direction when the skip signal is input during G31 command.

11.4.14 PLC Interruption

	M850W	M830W	M850S	M830S	M80W	M80 TypeA	M80 TypeB	E80 TypeA	E80 TypeB	C80
M	○	○	○	○	○	○	○	○	○	○
L	○	○	○	○	○	○	○	○	○	○

The interrupt program set with the R register is executed with the signals from the PLC during single block stop in program operation or during the manual mode.

11.4.16 Machining Interruption

	M850W	M830W	M850S	M830S	M80W	M80 TypeA	M80 TypeB	E80 TypeA	E80 TypeB	C80
M	—	—	—	—	—	—	—	—	—	△
L	—	—	—	—	—	—	—	—	—	△

Machining interruption is a function which enables interrupt operations in the table below while a program is normally executed.

Interruption programs (called "retract programs") need to be prepared in advance to validate various interruption operations.

This function is available only during memory mode operation, but not during MDI operation.

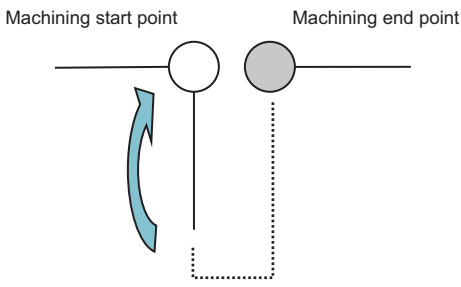
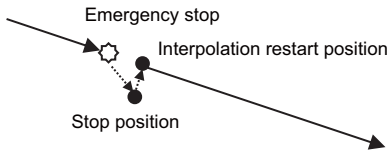
Interrupt operation	Details of operation	Purpose
Program-based retraction	<p>When the retract button is pressed, the program immediately branches to the predetermined retraction program. A safe tool-path that avoids interference can be programmed in the retraction program. On returning from the retraction program, the tool returns to the programmed position called "machining start point", from which the operation can be restarted.</p>  <p>Returns to the machining start point from the status of machining in progress</p>	e.g. when machining is temporarily suspended due to such as tool breakage, and then restarted after the issue is solved.
Emergency stop	<p>When an emergency stop occurs during program execution, machining stops in a feed hold status. When the NC is restarted after the cancellation of emergency stop, a tool returns from the stop position (caused by emergency stop) to the interpolation restart position, and then operation restarts along the original program path.</p>  <p>Returns to the interpolation interrupted position from the emergency stop position, then the interpolation restarts</p>	e.g. when machining is temporary suspended due to such as the emergency stop

Program Support Functions

12.1 Machining Method Support Functions

12.1.1 Program

12.1.1.1 Subprogram Control [Layers]

	M850W	M830W	M850S	M830S	M80W	M80 TypeA	M80 TypeB	E80 TypeA	E80 TypeB	C80
M	○ 10	○ 10	○ 10	○ 10	○ 10	○ 10	○ 10	○ 10	○ 10	○ 10
L	○ 10	○ 10	○ 10	○ 10	○ 10	○ 10	○ 10	○ 10	○ 10	○ 10

When the same pattern is repeated during machining, the machining pattern can be registered as one subprogram and the subprogram can be called from the main program as required, thereby realizing the same machining easily. Efficient use of program can be made. The subprogram is called with the program No. and sequence No. or the file name and sequence No.

(1) Calling the subprogram with M98 command

M98 P__H__L__,D__ ; or, M98 <File name> H__L__,D__ ;	
M98	: Subprogram call command
P	: Program No. in subprogram to be called. (Own program if omitted.) Note that P can be omitted only during memory operation MDI operation, high-speed program server operation, SD card operation and hard disk operation. (Max. 8-digit value) A four-digit or eight-digit program No. starting with O No. can be called by the parameter. However, the commanded subprogram is called when the number of digits of the command value is larger than the one set in the parameter.
<File name>	: A file name can be designated instead of the program No. In this case, enclose the file name with brackets <>. (The file name can have up to 32 characters, including the extension.) (Example) M98 <PARTS-12.RAF>;
H	: Sequence No. in subprogram to be called (Head block if omitted)
L	: Number of subprogram repetitions (If omitted, this is handled as L1. When L0 is set, the subprogram is not called.) (1 to 9999 times)
,D	: Device No. where subprogram is stored. The setting of ",D" depends on the model.

Subprograms can be nested up to 10 levels deep.

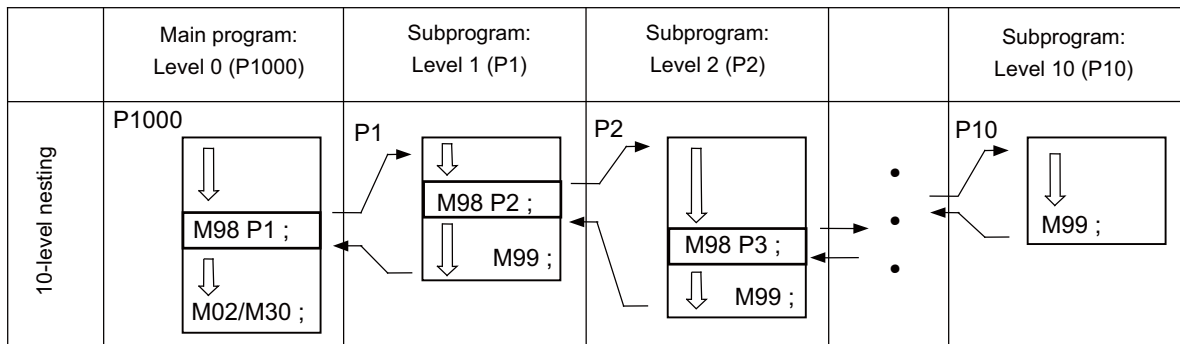

A subprogram branch destination or repetition of a subprogram can be specified.

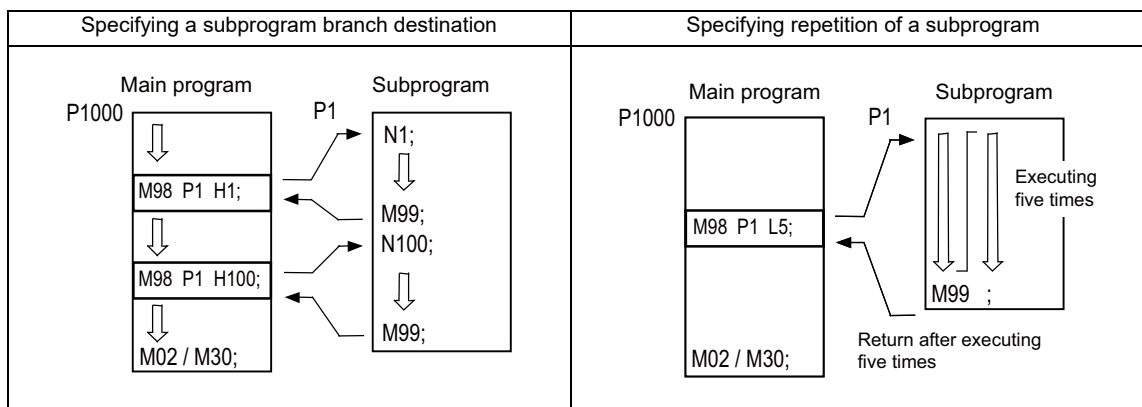

(2) Returning to main program from the subprogram with M99 command

```
M99 P__ ;
```

P : Sequence No. of return destination (returned to block that follows the calling block)

(3) Calling the subprogram with M198 command (only for M8 series)

A program registered in the data server (SD card in control unit) or Front SD card can be called out as a subprogram.

To call a program in the SD card as the subprogram, command as shown below in the main program.

```
M198 P__ L__ ;
```

```
or, M198 <File name> L__ ;
```

M198 : Call command

P : Program No. in SD card to be called as subprogram (Max. 8 digits)

A four-digit or eight-digit program No. starting with O No. can be called by the parameter.

However, the commanded subprogram is called when the number of digits of the command value is larger than the one set by the parameter.

<File name> : A file name can be designated instead of the program No. In this case, enclose the file name with brackets <>.

(The file name can have up to 32 characters, including the extension.)

L : Number of subprogram repetitions (Max. 4 digits)

This can be omitted. (If omitted, this is handled as L1.)

When L0 is set, the subprogram is not called.

(Note 1) Sequence No. call (M198 H****) is not possible.

(Note 2) The device that can be used for M198 subprogram call differs depending on the NC models.

The device is the front-side SD card for M800S/M80/E80, or the SD card in the control unit for M800W/M80W.

(Note 3) Calling of the subprogram with the M198 command is limited to once in the subprogram nest.

The subprogram can be called only from the memory or MDI program.

(Note 4) The data from the head of the program to the first LF (line feed code. 0x0A as hexadecimal) is invalid, and cannot be run or displayed. Note that if the head starts from an O number (program No.), the program is valid from the head.

(Note 5) A program registered in an SD card can be executed from only one part system. A program error will occur if an attempt is made to execute the programs in the SD card simultaneously by two or more part systems. If all the part system is reset when the error occurred, programs will be displayed as only "%" except for the first part system.

(Note 6) Refer to "(1) Calling the subprogram with M98 command" for <File name> and calling the subprogram with O No.

(4) Returning to main program from the subprogram with M99 command (only for M8 series)

```
M99 ;
```

(5) Subprogram calling/return block operation switching (only for C80 series)

The subprogram call command M98 (including the macro call command G65) is usually treated as an executable statement; however, it can also be treated in the same manner as a macro statement depending on the parameter setting. When it is treated as a macro statement, it can be processed in batch with the commands in the call destination, the movement commands before and after subprogram call can be processed continuously, and continuous movement is enabled without speed fluctuation.

12.1.1.2 Figure Rotation

	M850W	M830W	M850S	M830S	M80W	M80 TypeA	M80 TypeB	E80 TypeA	E80 TypeB	C80
M	△	△	△	△	—	—	—	—	—	—
L	—	—	—	—	—	—	—	—	—	—

If the same pattern is used repeatedly on a concentric circle, one of the rotating machining patterns can be registered as a subprogram. When the subprogram is called from the main program, if the rotation center is designated, a path similar to the rotary phase can be easily created on the concentric circle. This simplifies creation of the program.

The program format is shown below.

```

M98 li1 Jj1 (Kk1) Pp1 Hh1 LI1 ,Dd1;
or, M98 li1 Jj1 (Kk1) <File name> Hh1 LI1 ,Dd1 ;
M98           : Subprogram call command
li1 Jj1 (Kk1) : Rotation center coordinates
Pp1           : Program No. in subprogram to be called. (Own program if omitted.)
               Note that P can be omitted only during memory operation and MDI operation.
               (Max. 8-digit value)
               A four-digit or eight-digit program No. starting with O No. can be called by the parameter.
<File name>  : A file name can be designated instead of the program No. In this case, enclosed the file name with
               brackets <>.
               (The file name can have up to 32 characters, including the extension.)
               (Example) M98 <PARTS-12.RAF>;
Hh1           : Sequence No. in subprogram to be called (Head block if omitted)
LI1           : Number of subprogram repetitions
               (If omitted, this is handled as L1. When L0 is set, the subprogram is not called.)
               (1 to 9999 times)
,Dd1         : Subprogram device No. (0 to 4)
               The subprogram in the memory can be used when ,D is omitted.
               The device No. is set with the machining parameters.
    
```

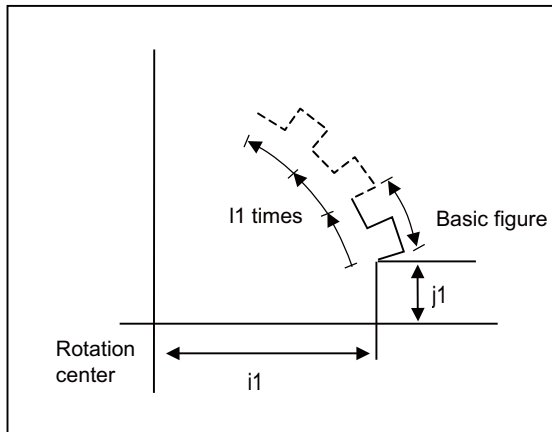

- (1) The first subprogram called out with subprogram call is executed at a 0° rotation angle. The path is created as commanded.
- (2) If the number of repetitions is set to two or more, the rotation angle is obtained from the called subprogram's start point, end point and rotation center coordinate. The path of the first subprogram is used as a basic figure and is rotated and arranged for the designated number of call repetitions, using the rotation center coordinates as a reference.
- (3) During figure rotation, all blocks in the subprogram are treated as to be rotated.
- (4) If the subprogram start point and end point are not on the same circle having the commanded figure rotation center coordinates as the center, the axis will interpolate using the subprogram's end point as the start point, and the end point in the first movement command block in the rotated subprogram as the end point.
- (5) The figure is rotated on the workpiece coordinate system, and can be shifted with the G92, G52, G54 to G59 (workpiece coordinate system shift) command.
- (6) Functions (reference position return, uni-direction positioning, etc.) on the machine coordinate system for the rotary plane axis cannot be used while the figure is rotated. However, the machine coordinate system functions can be used for axes other than the rotation plane.
- (7) A program error will occur if figure rotation is commanded during figure rotation.
- (8) Figure rotation and coordinate rotation by program cannot be commanded simultaneously.

12.1.1.3 Scaling

	M850W	M830W	M850S	M830S	M80W	M80 TypeA	M80 TypeB	E80 TypeA	E80 TypeB	C80
M	△	△	△	△	○	○	○	○	—	△
L	—	—	—	—	—	—	—	—	—	—

The shape commanded by the program can be extended or reduced to the desired size by applying a scale factor to the movement axis command position.

Gcode	Function
G50	Scaling cancel
G51	Scaling ON

The program format is given below.

```
G51 Xx1 Yy1 Zz1 Pp1 ;
G51          : Call command
Xx1,Yy1,Zz1 : Scaling center coordinate position
Pp1         : Scale factor
```

The scale factor ranges from 0.000001 to 99.999999 times.

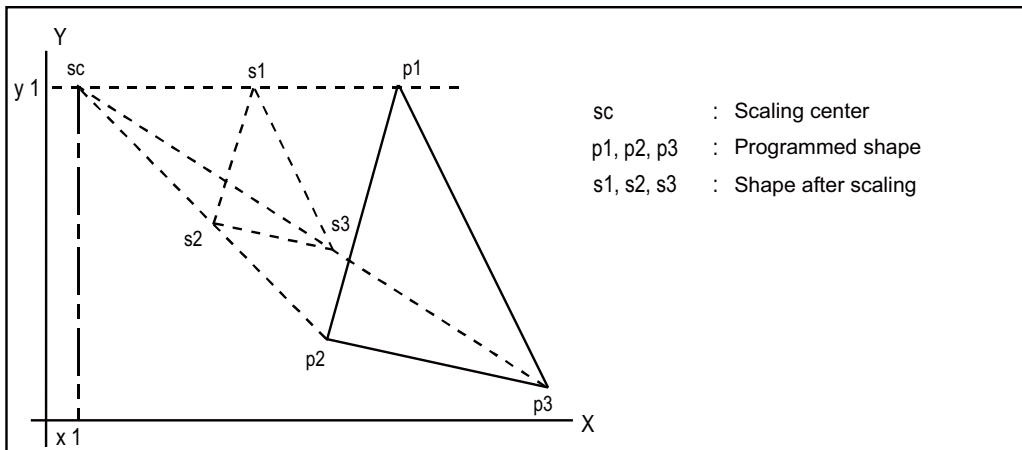

(Note 1) Scaling cannot be applied to compensation amount for tool radius compensation, tool position offset, or tool length compensation, etc. (The compensation and offset are calculated for the scaled shape.)

(Note 2) Scaling applies only to the axes commanded with G51 block; it does not apply to axes which have not been commanded.

When the scale factor is not assigned, the parameter setting applies instead.

12.1.1.4 Axis Name Switch

	M850W	M830W	M850S	M830S	M80W	M80 TypeA	M80 TypeB	E80 TypeA	E80 TypeB	C80
M	—	—	—	—	—	—	—	—	—	—
L	○	○	○	○	○	○	○	○	○	○

The axis name switch function switches the name of command axis and control axis.

G111 Axis name1 Axis name2 ;

G111 : Axis name switch command

Axis name 1,2 : Axes to be performed the name switch command

When the axis name switch command is canceled, assign only "G111;" command.

When switching the name of X-axis and Y-axis by axis name switch command, the machine performs as follow.

<Before axis name switch>			<After axis name switch>	
Command axis name	Control axis		Command axis name	Control axis
X	Xaxis	->	X	Yaxis
Y	Yaxis		Y	Xaxis

(Example)

G111 X Y ;

G01 X100. ; (Y axis moves to 100.mm)

G01 Y100. ; (X axis moves to 100.mm)

12.1.2 Macro Program

12.1.2.1 User Macro [Layers]

	M850W	M830W	M850S	M830S	M80W	M80 TypeA	M80 TypeB	E80 TypeA	E80 TypeB	C80
M	○ 4	○ 4	○ 4	○ 4	○ 4	○ 4	○ 4	○ 4	○ 4	○ 4
L	○ 4	○ 4	○ 4	○ 4	○ 4	○ 4	○ 4	○ 4	○ 4	○ 4

(1) Macro commands 1 ; G65 to G67

In order to carry through one integrated function, a group of control and arithmetic instructions can be used and registered as a macro program. Furthermore, subprograms with a high degree of expandability can be configured by setting these macro programs as types which are capable of conducting control and arithmetic operations using variable commands.

G code	Function
G65	Macro call (Sample call)
G66	Macro modal call A
G66.1	Macro modal call B
G67	Macro modal call cancel

The program formats are given below

G65 P__ L__ --Argument--;or,G65 <File name> L__ --Argument--;	
G65	: Call command
P	: Program No. A four-digit or eight-digit program No. starting with 0 No. can be called by the parameter.
<File name>	: File name When designating the file name, enclose the file name with brackets < >.
L	: Number of repetitions
Argument	: Variable data assignment

The macro program is called immediately by this command

G66 P__ L__ --Argument--;or,G66 <File name> L__ --Argument--;	
G66	: Call command
P	: Program No. A four-digit or eight-digit program No. starting with 0 No. can be called by the parameter.
<File name>	: File name When designating the file name, enclose the file name with brackets < >.
L	: Number of repetitions
Argument	: Variable data assignment

The macro program is executed from the block with the axis command following this command.

G66.1 P__ L__ --Argument--;or, G66.1 <File name> L__ --Argument--;	
G66.1	: Call command
P	: Program No. A four-digit or eight-digit program No. starting with 0 No. can be called by the parameter.
<File name>	: File name When designating the file name, enclose the file name with brackets < >.
L	: Number of repetitions
Argument	: Variable data assignment

The macro program is executed with the word data of each block as the argument.

The following macro command functions are available.

Arithmetic commands	#1=<Expression> ; Various arithmetic operations can be conducted between variables by the above. "<Expression>" is a combination of constants, variables, functions and operators.	
Assignment of priority of arithmetic operations	The portion in which the operator is to be given priority can be enclosed in []. Up to five pairs of square parentheses [] including the function [] can be used. The normal priority of operation is functions and multiplication/division followed by addition/subtraction.	
Control commands	(1) IF[<Conditional expression>]GOTO n ; (2) WHILE[<Conditional expression>]Do m ; --- END m ;	The flow of the program can be controlled by these commands. "n" denotes the sequence numbers of the branching destination. "m" is an identification number, and 1 to 127 can be used. Note that only 27 nestings can be used.

(Note 1) The variable commands are provided under the optional specifications independently of the user macros. If they are to be used, specify the optional specifications separately.

(2) Macro commands 2

Specific G commands and the miscellaneous commands (M, S, T, B) can be used for macro call.

(a) Macro call using G codes

Simply by assigning a G code, it is possible to call user macro programs with the prescribed program number.

Format

G** P__ L__ Argument;	
G**	: G code for performing macro call
P	: Argument (When macro argument L/P valid function is enabled. Disabled when it is invalid.)
L	: Argument (When macro argument L/P valid function is enabled. Disabled when it is invalid.)
Argument	: Variable data designation

The correspondence between the G** code which performs macro call and the program number for the macro to be called is set by a parameter.

[M8 Series]

G codes and G codes with decimal points can be used for this function. Consecutive G code macros can be set all at once by designating the first G code, the first No. of the program, consecutive number of G codes, and macro call type.

Maximum of 538 G codes can be used.

- In the range of G1 to G9999, 10 codes can be set individually, and 255 codes can be set all at once.
- In the range of G0.1 to G999.9, 10 codes can be set individually, and 255 codes can be set all at once.
- 8 codes are set by parameters (G200, G300, G400, G500, G600, G700, G800 and G900)

[C80 Series]

Up to 10 codes from G100 to G999 can be used for this command.

(Note 1) The G codes that are used in the system also can be made available for this use by parameter setting.

(Note 2) G101 to G110 and G200 to G202 are user macro I codes. However, if a parameter is set for the G code call code, the G code call will have the priority, and these cannot be used as the user macro I.

- (b) Macro call using miscellaneous commands (M, S, T, B code macro call)
Simply by designating an M (or S, T, B) code, it is possible to call user macro programs with the prescribed program number. (Entered M codes and all S, T and B codes can be used.)

Format

M** (or S**, T**, B**); P__ L__ Argument;	
M** (S**, T**, B**)	: M (or S, T, B) code for performing macro call
P	: Argument (When macro argument L/P valid function is enabled. Disabled when it is invalid.)
L	: Argument (When macro argument L/P valid function is enabled. Disabled when it is invalid.)

The correspondence between the M** code which performs macro call and the program number for the macro to be called is set by a parameter. Up to 10 M codes from M00 to M9999, M198 can be entered. Select codes to be entered other than the codes basically required by the machine and M codes of M0, M1, M2, M30 and M96 through M99.

- (Note 1) G commands in G code macro programs are not subject to macro calls but normal G commands. M commands in M code macro programs are not subject to macro calls but normal M commands. (The same applies to S, T and B codes.)
- (Note 2) The registration of the program number used for calling the G code macro or M (or S, T, B) code macro can be done independently for each part system.

(3) Macro argument L/P valid

This function allows the addresses L (number of subprogram repetitions) and P (calling program No.) used as commands in user macro to be used as arguments. This function is enabled by a parameter.

Followings can be used by user macro.

- G65 Macro call (Sample call)
- G66 Macro modal call A
- G66.1 Macro modal call B
- Macro call using G codes
- Macro call using miscellaneous commands
- ASCII macro

(4) Common variables protection

This function protects the common variables used for machine tool builder macro from being changed by user operation.

The common variables in the range designated with the parameter cannot be changed by user operation, such as through a machining program, screen operation or file input.

The range of common variables to be protected can be designated individually for each part system.

12.1.2.2 Machine Tool Builder Macro

	M850W	M830W	M850S	M830S	M80W	M80 TypeA	M80 TypeB	E80 TypeA	E80 TypeB	C80
M	○	○	○	○	○	○	○	○	○	○
L	○	○	○	○	○	○	○	○	○	○

This function enables dedicated macro programs made by MTB to be registered in the CNC. By registering the macro as a program numbered in the 100010000s, the macro program display, editing and input/output can be protected with a password and the macro program confidentiality can be kept.

Machine tool builder macro programs are stored in a dedicated area which means that the user program registration area is not reduced in the process.

When registering a machine tool builder macro, secure its space by formatting.

Macro program memory capacity

Model	When the simple programming is in use (Note 1)		When the simple programming is not in use	
	Memory capacity (KB)	Max. registrable number of programs (programs)	Memory capacity (KB)	Max. registrable number of programs (programs)
M800W	128	500	256	600
M800S				
M80	80	100	208	200
M80W				
E80				
C80	-	-	208	200

(Note 1) "When the simple programming is in use" means that the simple programming (NAVI MILL/NAVI Lathe) is being used and the macro is stored in the machine tool builder macro area.

(Note 2) The memory capacity and the maximum registrable number of programs vary depending on the simple programming macro when the simple programming macro is registered in the machine tool builder macro area.

The macro program registered as a machine tool builder macro is called out as "G65 command" or "G code macro equivalent to G65". The macro program is described in the same manner as a conventional machining program. Variables for the machine tool builder macros can be used within the machine tool builder macros. These variables can be used commonly within the machine tool builder macro programs.

Command format

User macro call (G65)

G65 P__ L__ Argument ;	
P	: Machine tool builder macro program No.(100010000 to 199999998)
L	: Number of repetitions (0 to 9999)
Argument	: Variable data designation

(Note) The machine tool builder macro program cannot be called with G66, G66.1 or M98. Note that a machine tool builder macro program can be called from a machine tool builder macro program using M98.

Macro call with G code (G***)

G*** Argument;	
***	: G code defined in macro definition program or G command macro parameter
Argument	: Variable data designation Argument is used when a local variable must be delivered to the macro program. Designate a real value after the address.

Miscellaneous command macro call (M or T code macro call)

M*** Argument; (or T***)	
***	: M (or T) code defined in macro definition program
Argument	: Variable data designation Use this argument when a local variable needs to be passed on to the macro program. Designate a real value after the address.

(Note) If M96, M97, M98, M99, M198 or the M code for G83 S Mode (for M system only) is commanded, machine tool builder macro will not be called and the said M code will be handled as a normal miscellaneous command.

Miscellaneous command macro call (S code, 2nd miscellaneous command macro call) [only for C80 series]

S*** Argument; (or B***)	
***	: S code and 2nd miscellaneous command code which are defined in macro list parameter
Argument	: Variable data designation Use this argument when a local variable needs to be passed on to the macro program. Designate a real value after the address.

(Note) S command and 2nd miscellaneous command cannot be defined in macro definition program. They are ignored.

12.1.2.3 Macro Interruption

	M850W	M830W	M850S	M830S	M80W	M80 TypeA	M80 TypeB	E80 TypeA	E80 TypeB	C80
M	○	○	○	○	○	○	○	○	○	○
L	○	○	○	○	○	○	○	○	○	○

This function inputs from the machine to interrupt the program currently being executed, and instead calls and executes another program.

The program can be operated flexibly enough to meet varying conditions.

There are two types of interrupts, type 1 and type 2, as described below, and they are selected using a parameter.

[Interrupt type 1] The block being executed is immediately interrupted, and the interrupt program is run immediately.

[Interrupt type 2] After the block being executed is complete, the interrupt program is executed.

The command format is given below.

M96 P__ H__ ; or, M96 <File name> H__ ; User macro interrupt valid	
M96	: Interrupt valid command
P	: Interrupt program number
<File name>	: A four-digit or eight-digit program No. starting with O No. can be called by the parameter.
	: File name
H	: When designating a file name, enclose the file name in brackets <>.
	: Interrupt sequence No.

M97 ; User macro interrupt invalid	
M97	: User macro interrupt end command

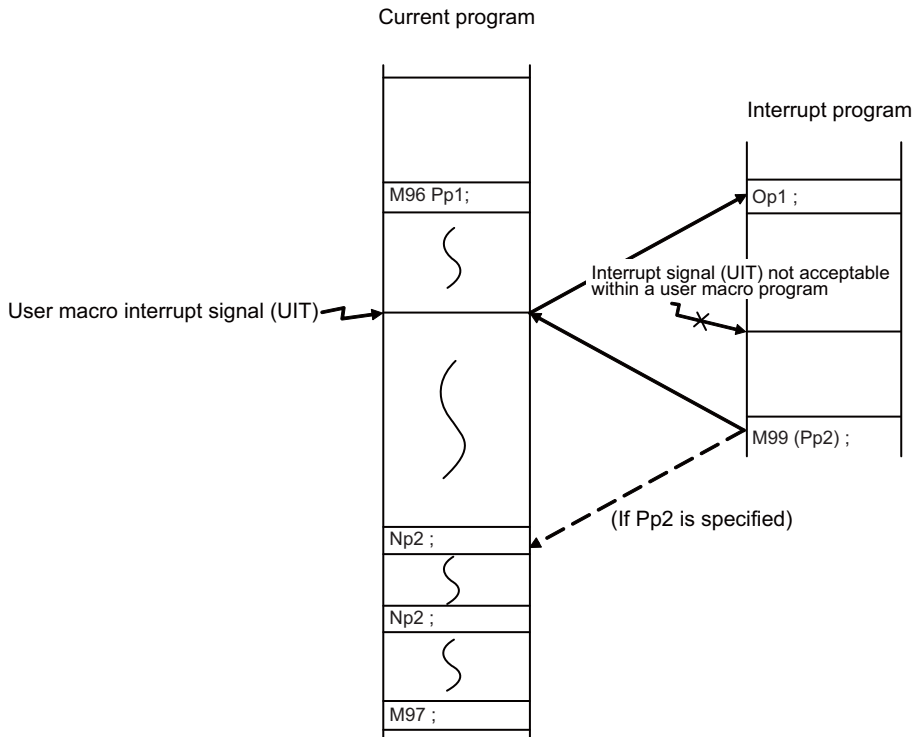

12.1.2.4 Variable Command

[M system]

Variable sets	M850W	M830W	M850S	M830S	M80W	M80 TypeA	M80 TypeB	E80 TypeA	E80 TypeB	C80
200 sets	—	—	—	—	—	—	—	—	○	—
600 sets	—	—	—	—	—	—	—	○	—	—
700 sets	○	○	○	○	○	○	○	—	—	○
8000 sets	△	△	△	△	○	○	—	—	—	—
(600 + 100 × number of part systems) sets	○	○	○	○	○	○	—	—	—	○
(7900 + 100 × number of part systems) sets	△	△	△	△	○	○	—	—	—	—

[L system]

Variable sets	M850W	M830W	M850S	M830S	M80W	M80 TypeA	M80 TypeB	E80 TypeA	E80 TypeB	C80
200 sets	—	—	—	—	—	—	—	—	○	—
600 sets	—	—	—	—	—	—	○	○	—	—
700 sets	○	○	○	○	○	○	—	—	—	○
8000 sets	△	△	△	△	○	○	—	—	—	—
(600 + 100 × number of part systems) sets	○	○	○	○	○	○	—	—	—	○
(7900 + 100 × number of part systems) sets	△	△	△	△	○	○	—	—	—	—

Programming can be given flexible and general-purpose capabilities by designating variables instead of directly assigning numbers for addresses in programs and by supplying the values of those variables as required when running the programs.

Arithmetic operations (adding, subtracting, multiplying and dividing) can also be conducted for the variables.

Number of variable sets specifications

Type		Number		Function
Common variables		Common variables 1	Common variables 2	Can be used commonly for main, sub and each macro program. When using the common variables across multiple part systems, Some MTB specifications allow you to designate the number of common variables that are common to part systems.
For 1-part system specifications	200 sets	500 to 999	100 to 199	
	600 sets	500 to 999 100100 to 800199(Note 6)	100 to 199	
	700 sets	400 to 999 100100 to 800199(Note 6)	100 to 199	
	8000 sets	400 to 999 100100 to 800199(Note 6) 900000 to 907399	100 to 199	
For multi-part system specifications	600+100 sets	400 to 999 100100 to 800199(Note 6)	100 to 199×number of part systems	
	7900+100 sets	400 to 999 100100 to 800199(Note 6) 900000 to 907399	100 to 199×number of part systems	
Local variables		1 to 33		Can be used as local in macro program.
ZR device access variables (only for C80 series)		50000 to 50749 51000 to 51749 52000 to 52749		Can be read and written by the PLC or GOT.
System variables		1000 to		Application is fixed in system.
Fixed cycle variables		1 to 32		Local variables in fixed cycle program.

12 Program Support Functions

- (Note 1) All common variables are held even when the power is turned OFF.
- (Note 2) The common variables can be emptied by resetting or turning the power OFF when the parameters are set accordingly.
- (Note 3) The common variables are divided into the following two types.
 Common variable 1: Variables that can be used commonly through the part systems.
 Common variable 2: Variables that can be used commonly within that part system's program.
- (Note 4) The variable names can be set for some common variables.
- (Note 5) The common variables used for machine tool builder macro can be protected from being changed by user operation.
- (Note 6) The part system common variable which can be used is shown in the table below.

Variable sets		Common variables 1
Variable sets specification	600 sets	#100100 to #100199 (Equivalent to # 100 to #199 in 1st part system) #200100 to #200199 (Equivalent to # 100 to #199 in 2nd part system) #300100 to #300199 (Equivalent to # 100 to #199 in 3rd part system)
	700 sets(600+100)	#400100 to #400199 (Equivalent to # 100 to #199 in 4th part system) #500100 to #500199 (Equivalent to # 100 to #199 in 5th part system) #600100 to #600199 (Equivalent to # 100 to #199 in 6th part system)
	8000 sets(7900 + 100)	#700100 to #700199 (Equivalent to # 100 to #199 in 7th part system) #800100 to #800199 (Equivalent to # 100 to #199 in 8th part system)

Variable expressions

Variable : #Numerical value #100

(Numerical value: 1,2,3,)

: # [Expression] #100

Expression : Numerical value

: Variable

: Expression Operator Expression #100 + #101

: - (minus) Expression -#120

: [Expression] [#110]

: Function [Expression] SIN [#110]

Variable definition

Variable = expression

- (Note 1) Variables cannot be used with addresses "O" and "N".

12.1.3 Fixed Cycle

List of fixed cycles

Type of fixed cycle	M system	L system						Remarks
	Gcode list 1	Gcode list 2	Gcode list 3	Gcode list 4	Gcode list 5	Gcode list 6	Gcode list 7	
Fixed cycle for drilling	G73	G80	G80	G80	G80	G80	G80	Refer to 12.1.3.1. Refer to 12.1.3.2 (Type II). Refer to 4.5.3.
	:	:	:	:	:	:	:	
	G89	G89	G89	G89	G89	G89	G89	
		G79	G83.2	G79	G83.2	G79	G83.2	
	G98	G98	G98	G98	G98	G98	G98	
	G99	G99	G99	G99	G99	G99	G99	
	G187	G187	G187	G187	G187	G187	G187	
Special fixed cycles	G34							Refer to 12.1.3.3.
	G35	-	-	-	-	-	-	
	G36							
Fixed cycles for turning machining	G174	G90	G77	G90	G77	G90	G77	Refer to 12.1.3.4.
	G175	G92	G78	G92	G78	G92	G78	
	G176	G94	G79	G94	G79	G94	G79	
Compound-type fixed cycles for turning machining		G70	G70	G70	G70	G70	G70	Refer to 12.1.3.5. Refer to 12.1.3.6 (Type II). Refer to 12.1.8.8.
	:	:	:	:	:	:	:	
	-	G76	G76	G76	G76	G76	G76	
		G76.1	G76.1	G76.1	G76.1	G76.1	G76.1	
	G76.2	G76.2	G76.2	G76.2	G76.2	G76.2	G76.2	
Small-diameter deep-hole drilling cycle	G83	-	-	-	-	-	-	Refer to 12.1.3.7.

12.1.3.1 Fixed Cycle for Drilling

	M850W	M830W	M850S	M830S	M80W	M80 TypeA	M80 TypeB	E80 TypeA	E80 TypeB	C80
M	○	○	○	○	○	○	○	○	○	○
L	○	○	○	○	○	○	○	○	○	○

(1) M system

These functions enable drilling, tapping and other hole machining cycles to be assigned in a simple 1-block program.

Gcode	Function
G73	Step cycle
G74	Reverse tapping cycle
G75	Circular cutting cycle
G76	Fine boring cycle
G80	Fixed cycle cancel
G81	Drilling, spot drilling cycle
G82	Drilling, counterboring cycle
G83	Deep hole drilling cycle
G84	Tapping cycle
G85	Boring cycle
G86	Boring cycle
G87	Backboring cycle
G88	Boring cycle
G89	Boring cycle
G187	Thread milling cycle
G84.5, G84.6, G84.8	Punch Tap cycle (*1)
G74.5, G74.6, G74.8	Reverse Punch Tap cycle (*1)

(*1) The Punch Tap cycle is a function that uses a Punch Tap-exclusive tool to synchronously control the spindle and the servo axis to cut in the workpiece and execute the tapping.

There are two levels of hole machining axis return which apply upon completion of the fixed cycle machining operation.

Gcode	Function
G98	Initial point level return
G99	R point level return

The basic program format for the fixed cycle commands is shown below.

G8*(G7*)	X_Y_Z_R_Q_P_F_L_S_,S_,I_,J_;
G8*(G7*)	X_Y_Z_R_Q_P_F_L_S_,R_,I_,J_;
G8*(G7*)	: Hole drilling mode
X/Y	: Hole position data
Z/R/Q/P/F	: Hole machining data
L	: Number of repeats
S	: Spindle rotation speed
,S	: Spindle rotation speed during return
,R	: Synchronization switch
,I	: Positioning axis in-position width
,J	: Drilling axis in-position width

For details on the synchronous tapping cycle (including pecking tapping cycle and deep-hole tapping cycle), refer to the section "4.5.3 Synchronous Tapping".

<p>G73 Step cycle</p> <p>Initial point R point q q Z point G98 mode G99 mode</p>	<p>G74 Reverse tapping cycle</p> <p>Initial point R point Z point G98 mode M04 M03 G99 mode</p>	<p>G75 Perfect circle cutting cycle</p> <p>Initial point R point Z point G98 mode G99 mode</p>	<p>G76 Fine boring cycle</p> <p>Initial point R point Z point G98 mode q q M19 Shift G99 mode</p>
<p>G81 Drilling, spot drilling cycle</p> <p>Initial point R point Z point G98 mode G99 mode</p>	<p>G82 Drilling, counterboring cycle</p> <p>Initial point R point Z point G98 mode G99 mode Dwell</p>	<p>G83 Deep hole drilling cycle</p> <p>Initial point R point Z point G98 mode q n G99 mode</p>	<p>G84 Tapping cycle</p> <p>Initial point R point Z point G98 mode M03 M04 G99 mode</p>
<p>G85 Boring cycle</p> <p>Initial point R point Z point G98 mode</p>	<p>G86 Boring cycle</p> <p>Initial point R point Z point G98 mode M03 M03 M05</p>	<p>G87 Back boring cycle</p> <p>Initial point R point Z point M19 M03</p>	<p>G88 Boring cycle</p> <p>Initial point R point Z point M03 M03 M05 G98 mode Dwell</p>
<p>G89 Boring cycle</p> <p>Initial point R point Z point G98 mode Dwell</p>	<p>G187 Thread milling cycle</p> <p>Movement (approach) Dwell Helical interpolation Tool pull-out Movement X Y Z</p>	<p>G84.5 (G84.6, G84.8) Punch Tap cycle</p> <p>Dotted line: Tool edge path at conventional tapping Solid line: Tool edge path at executing Punch Tap (1) Helical grooving (2) Tapping (3) Retract</p>	

(2) L system

These functions enable drilling, tapping and other hole machining cycles to be assigned in a simple 1-block program.

Gcode	Drilling axis	Drilling work start	Motion at hole bottom	Retract motion	Use
G80					Cancel
G83	Z	Cutting feed Intermittent feed	In-position check Dwell	Rapid traverse feed	Deep-hole drilling cycle1
G84 (G84.1)	Z	Cutting feed	In-position check Dwell Spindle CCW	Cutting feed	Tapping cycle (Reverse tapping cycle) Pecking tapping cycle Deep tapping cycle
G85	Z	Cutting feed	In-position check Dwell	Cutting feed	Boring cycle
G87	X	Cutting feed Intermittent feed	In-position check Dwell	Rapid traverse feed	Deep-hole drilling cycle1
G88 (G88.1)	X	Cutting feed	In-position check Dwell Spindle CCW	Cutting feed	Tapping cycle (Reverse tapping cycle) Pecking tapping cycle Deep tapping cycle
G89	X	Cutting feed	In-position check Dwell	Cutting feed	Boring cycle
G83.2	Z/X	Cutting feed Intermittent feed	In-position check Dwell	Rapid traverse feed	Deep-hole drilling cycle2
G185	X	Circular interpolation	-	Rapid traverse feed	Hole edge chamfering cycle
G187	X/Y/Z	Cutting feed	-	Rapid traverse feed	Thread milling cycle

The fixed cycle mode is canceled when G80 or some G command of the G01 group is issued. Data is also cleared to zero simultaneously.

Command format

End-face drilling

G8* X/U_ C/H_ Z/W_ R_ Q_ P_ F_ K_ D_ S_ ,S_ M_ ;	
G8*	: Hole machining mode (G83, G84, G85)
X/U/C/H	: Hole position data
Z/W/R/Q/P/F	: Hole machining data
K	: Number of repetitions
D	: Tool spindle number
S	: Spindle rotation speed
,S	: Spindle rotation speed during return
M	: Miscellaneous command

Longitudinal hole drilling

G8* Z/W_ C/H_ X/U_ R_ Q_ P_ F_ K_ D_ S_ ,S_ M_ ;	
G8*	: Hole machining mode (G87, G88, G89)
Z/W/C/H	: Hole position data
X/U/R/Q/P/F	: Hole machining data
K	: Number of repetitions
D	: Tool spindle number
S	: Spindle rotation speed
,S	: Spindle rotation speed during return
M	: Miscellaneous command

Cancel

G80 ;

The drilling cycle motions generally are classified into the following seven.

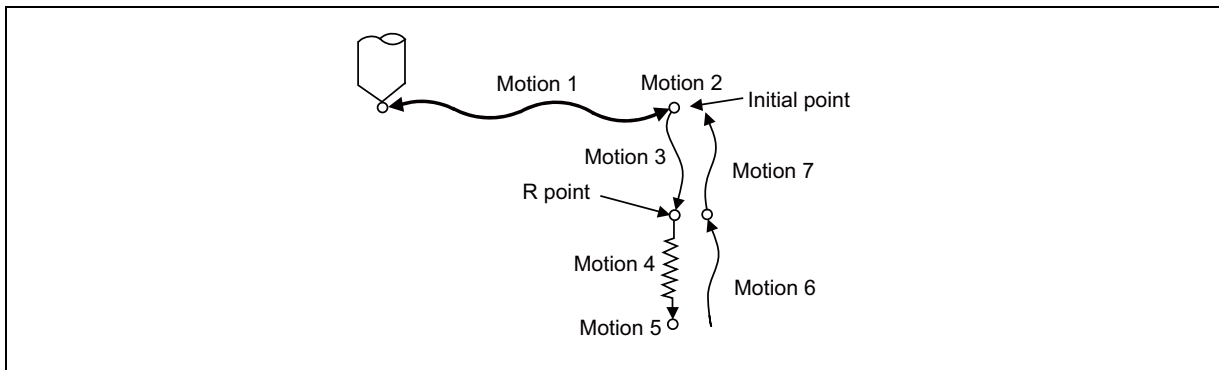

Motion 1: Rapid positioning up to the initial point of X (Z) and C axes.

If the "positioning axis in-position width" is designated, the in-position check is conducted upon completion of the block.

Motion 2: Output if the C axis clamp M code is given.

Motion 3: Rapid positioning up to the R point.

Motion 4: Hole machining at cutting feed.

If the "drilling axis in-position width" is designated, the in-position check is conducted upon completion of the block. However, in the case of deep-hole drilling cycles 1 and 2, the in-position check is not conducted with the drilling of any holes except the last one. The in-position check is conducted at the commanded hole bottom position (last hole drilling).

Motion 5: Motion at the hole bottom position. It varies depending on the fixed cycle mode.

Spindle CCW (M04), spindle CW (M03), dwell, etc., are included.

Motion 6: Return to the R point.

Motion 7: Return to the initial point at rapid traverse feed.

(Motions 6 and 7 may be conducted as a single motion depending on the fixed cycle mode.)

(Note) With a synchronous tap command, the in-position check is conducted in accordance with the parameters.

Whether the fixed cycle is complete with motion 6 or 7 can be specified by using either of the following G commands:

G98 : Initial level return

G99 : R point level return

These commands are modal. For example, once G98 is given, the G98 mode is entered until G99 is given. The G98 mode is entered in the initial state when the controller is ready.

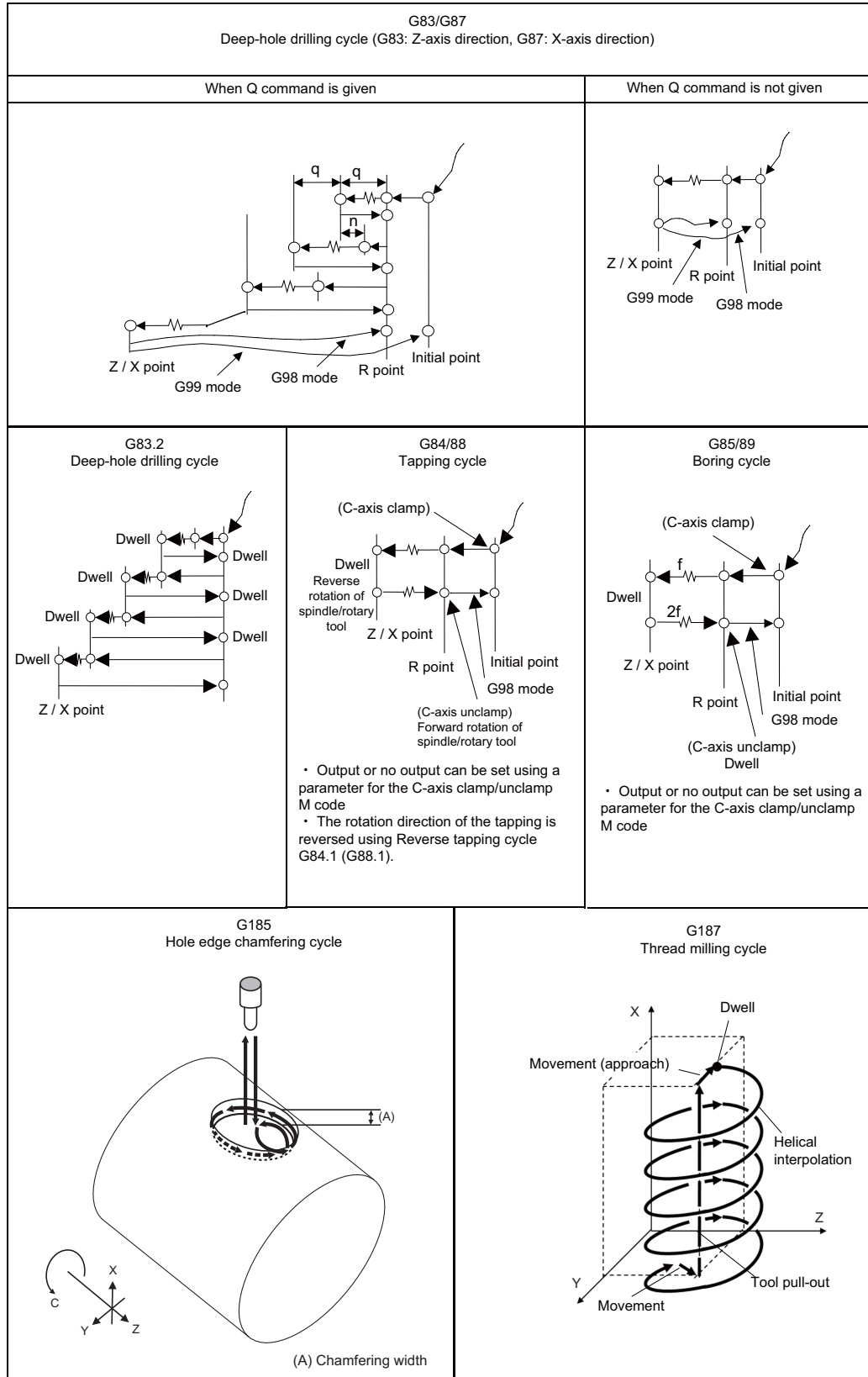

There are two levels of hole machining axis return which apply upon completion of the fixed cycle machining operation.

Gcode	Function
G98	Initial point level return
G99	R point level return

12.1.3.2 Fixed Cycle for Drilling (Type II)

	M850W	M830W	M850S	M830S	M80W	M80 TypeA	M80 TypeB	E80 TypeA	E80 TypeB	C80
M	—	—	—	—	—	—	—	—	—	—
L	○	○	○	○	○	○	○	○	○	○

In the longitudinal hole drilling fixed cycle, the X axis is designated as the hole drilling axis. However, in the longitudinal hole drilling fixed cycle (type II), the Y axis can be designated as the hole drilling axis with the longitudinal hole drilling axis selection function.

The relationship between the longitudinal hole drilling axis selection signal's ON/OFF state and the hole drilling axis of the fixed cycle for drilling is shown below.

Gcode	Details	Y axis cross tap function selection signal state	Hole drilling axis
G80	Cancel	-	-
G83	Deep hole drilling cycle 1	ON	Z
		OFF	
G84 (G84.1)	Tapping cycle	ON	Z
		OFF	
G85	Boring cycle	ON	Z
		OFF	
G87	Deep hole drilling cycle 1	ON	Y
		OFF	X
G88 (G88.1)	Tapping cycle	ON	Y
		OFF	X
G89	Boring cycle	ON	Y
		OFF	X
G83.2	Deep hole drilling cycle 2	ON	Z/X
		OFF	

12.1.3.3 Special Fixed Cycle

	M850W	M830W	M850S	M830S	M80W	M80 TypeA	M80 TypeB	E80 TypeA	E80 TypeB	C80
M	△	△	△	△	○	○	○	○	○	△
L	—	—	—	—	—	—	—	—	—	—

These functions enable drilling, tapping and other hole machining cycles to be assigned in a simple 1-block program. Special fixed cycles must always be used in combination with fixed cycles.

The special fixed cycles are as follows:

Gcode	Function
G34	Bolt hole circle
G35	Line at angle
G36	Arc
G37.1	Grid

(1) Bolt hole circle (G34)

The tool starts at the point forming angle θ with the X axis on the circumference of a circle with radius R whose center is the coordinates designated by X and Y, and it drills "n" number of holes at "n" equal intervals along the circumference of that circle. The drilling data for the standard fixed cycle of the G81 or other such command is retained for the drilling operation at each hole position.

All movements between the hole positions are conducted in the G00 mode. The data is not retained upon completion of the G34 command.

G34 Xx Yy Ir Jθ Kn ;

Xx,Yy : Center position of bolt hole circle; this is affected by the G90/G91 commands.
 Ir : Radius "r" of circle; it is based on the least command increment and is provided using a positive number.
 Jθ : Angle θ at point to be drilled initially; the counterclockwise direction is taken to be positive.
 Kn : Number "n" of holes to be drilled; any number of holes from 1 through 9999 can be designated; 0 cannot be assigned.
 When 0 has been designated, the alarm will occur. A positive number provides positioning in the counterclockwise direction;
 a negative number provides positioning in the clockwise direction.

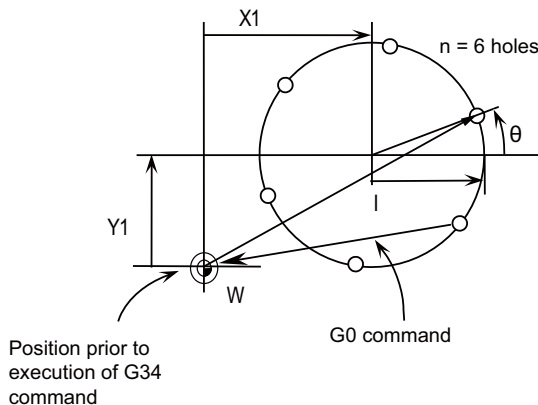

As shown in the figure, the tool is positioned above the final hole upon completion of the G34 command. This means that when it is to be moved to the next position, if the command is issued with incremental position, it will be necessary to calculate the coordinate position. Thus, it is convenient to issue the command with absolute position.

(2) Line at angle (G35)

With the starting point at the position designated by X and Y, the tool drills "n" number of holes each at interval "d" in the direction forming angle θ with the X axis. A standard fixed cycle applies for the drilling operation at each of the hole positions and so there is a need to retain beforehand the drilling data (drilling mode and drilling data). All movements between the hole positions are conducted in the G00 mode. The data is not retained upon completion of the G35 command.

G35 Xx Yy Id J θ Kn ;

Xx,Yy : The starting point coordinates; they are affected by the G90/G91 commands.

Id : Interval "d"; it is based on the least command increment and when "d" is negative, drilling proceeds in the point symmetrical direction centered on the starting point.

J θ : Angle θ ; the counterclockwise direction is taken to be positive.

Kn : Number "n" of holes to be drilled including the starting point; any number of holes from 1 through 9999 can be assigned.

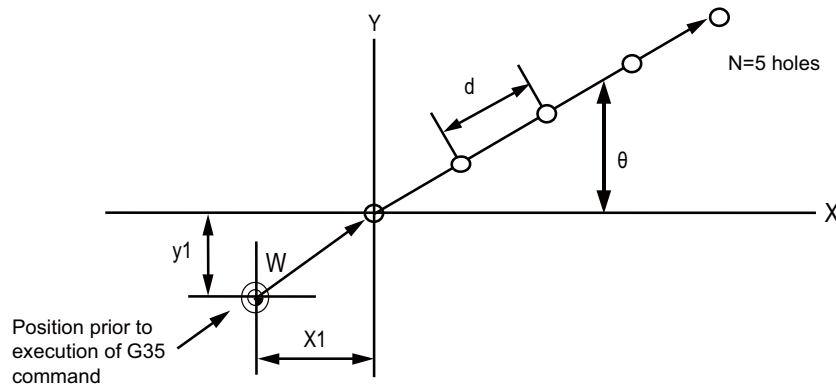
**(3) Arc (G36)**

The tool starts at the point forming angle θ with the X axis on the circumference of a circle with radius "r" whose center is the coordinates designated by X and Y, and it drills "n" number of holes aligned at angle interval $\Delta\theta$. As with the bolt hole circle function, the drilling operation at each of the hole positions is based on a hold drilling fixed cycle and so there is a need to retain the drilling data beforehand.

All movements between the hole positions are conducted in the G00 mode. The data is not retained upon completion of the G36 command.

G36 Xx Yy Ir J θ P $\Delta\theta$ Kn ;

Xx,Yy : Center coordinates of arc; they are affected by the G90/G91 commands.

Ir : Radius "r" of arc; it is based on the least command increment and is provided with a positive number.

J θ : Angle θ at the point to be drilled initially; the counterclockwise direction is taken to be positive.

P $\Delta\theta$: Angle interval $\Delta\theta$; when it is positive, the tool drills in the counterclockwise direction and when it is negative, it drills in the clockwise direction.

Kn : Number "n" of holes to be drilled; any number of holes from 1 through 9999 can be assigned.

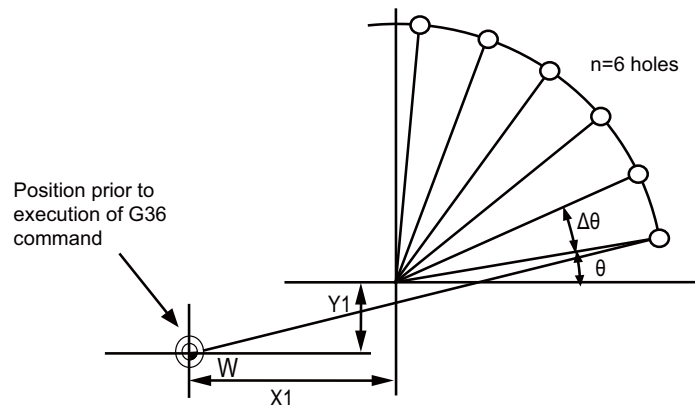

(4) Grid (G37.1)

With the starting point at on the position designated by X and Y, this function enables the tool to drill the holes on the lattice with "nx" number of holes at parallel intervals of Δx to the X axis. Drilling proceeds in the X-axis direction. The drilling operation at each of the hole positions is based on a standard fixed cycle and so there is a need to command the drilling data (drilling mode and drilling data) beforehand. All movements between the hole positions are conducted in the G00 mode. The data is not retained upon completion of the G37.1 command.

G37.1 Xx Yy IΔx Pnx JΔy Kny ;
 Xx,Yy : The starting point coordinates; they are affected by the G90/G91 commands.
 IΔx : X-axis interval Δx ; it is based on the least command increment; when Δx is positive, the intervals are provided in the positive direction as seen from the starting point and when it is negative, they are provided in the negative direction.
 Pnx : Number of holes "nx" in the X-axis direction; any number of holes from 1 through 9999 can be assigned.
 JΔy : Y-axis interval Δy ; it is based on the least command increment; when Δy is positive, the intervals are provided in the positive direction as seen from the starting point and when it is negative, they are provided in the negative direction.
 Kny : Number of holes "ny" in the Y-axis direction; any number of holes from 1 through 9999 can be assigned.

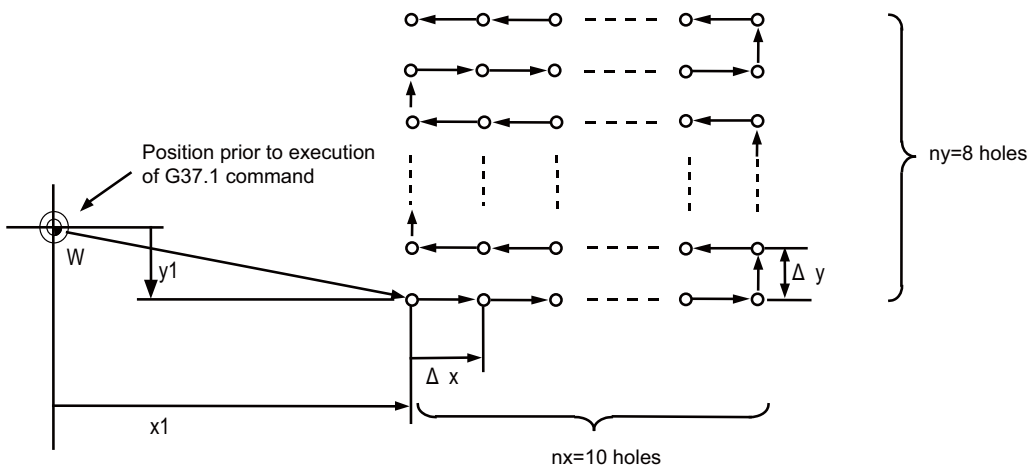

12.1.3.4 Fixed Cycle for Turning Machining

	M850W	M830W	M850S	M830S	M80W	M80 TypeA	M80 TypeB	E80 TypeA	E80 TypeB	C80
M	○	○	○	○	○	○	—	—	—	—
L	○	○	○	○	○	○	○	○	○	○

By using this function, the shape normally programmed in several blocks for rough cutting, etc., in the turning machining can be commanded in one block.

By editing the standard fixed cycle subprograms, the fixed cycle sequences can be changed by the user. The user can also register and edit an original fixed cycle program.

G code [L system]	G code [M system]	Function
G77	G174	Longitudinal cutting fixed cycle
G78	G175	Thread cutting fixed cycle
G79	G176	Face cutting fixed cycle

(1) Longitudinal cutting fixed cycle (G77/G174)

(a) Straight cutting

Straight cutting in the longitudinal direction can be performed consecutively by the following block:

```
G77 X/U__ Z/W__ F__ ; [L system]
G174 X__ Z__ F__ ; [M system]
X/U   : X axis end point coordinate
Z/W   : Z axis end point coordinate
F     : Feedrate
```

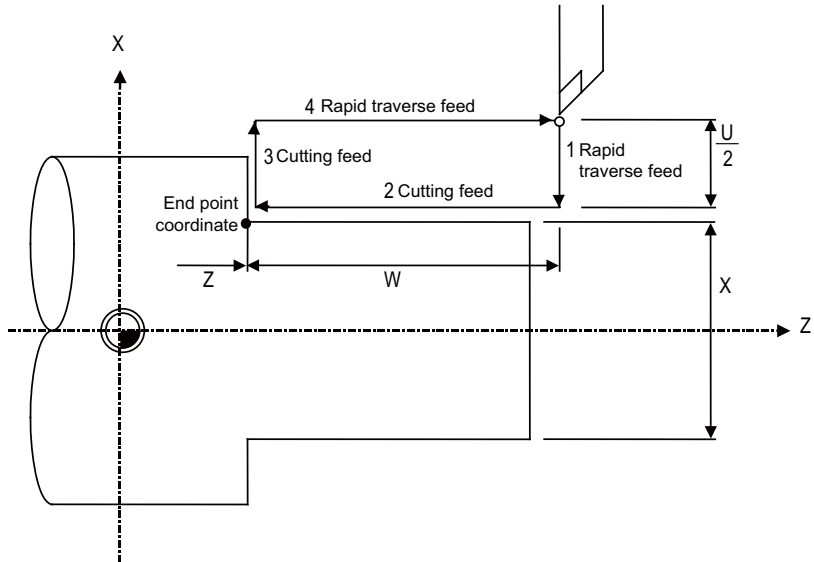

(b) Taper cutting

Taper cutting in the longitudinal direction can be performed consecutively by the following block:

```
G77 X/U__ Z/W__ R__ F__ ; [L system]
G174 X__ Z__ R__ F__ ; [M system]
X/U   : X axis end point coordinate
Z/W   : Z axis end point coordinate
R     : Taper part depth (radius designation, incremental position, sign is required)
F     : Feedrate
```

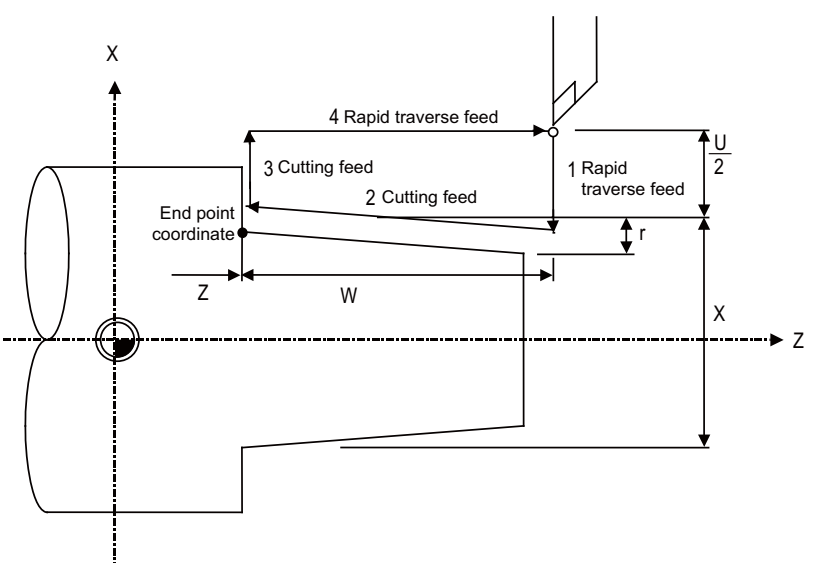

r: Taper part depth (radius designation, incremental position, sign is required)

(2) Thread cutting fixed cycle (G78/G175)

(a) Straight thread cutting

Straight thread cutting can be performed by the following block:

G78	X/U__ Z/W__ F/E__ Q__ ; [L system]
G175	X__ Z__ F/E__ Q__ ; [M system]
X/U	: X axis end point coordinate
Z/W	: Z axis end point coordinate
F/E	: Lead of Longitudinal axis (axis which moves most) direction
Q	: Thread cutting start shift angle

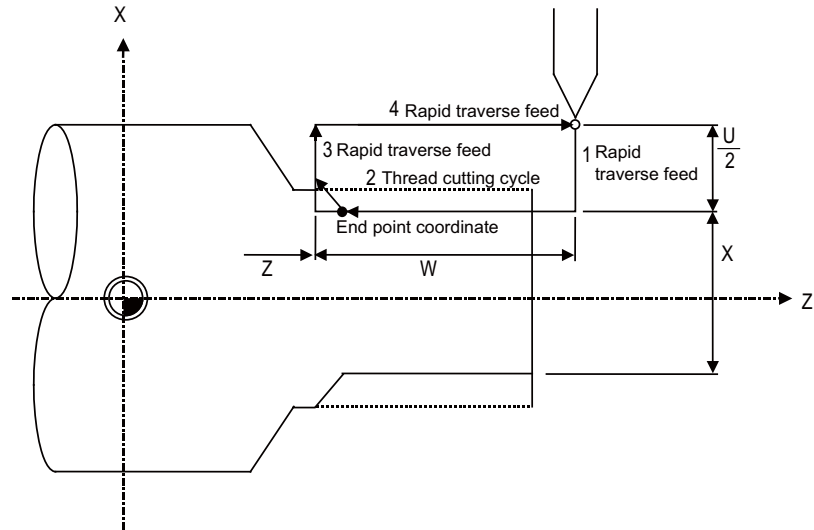

(b) Taper thread cutting

Taper thread cutting can be performed by the following block:

G78	X/U__ Z/W__ R__ F/E__ Q__ ; [L system]
G175	X__ Z__ R__ F/E__ Q__ ; [M system]
X/U	: X axis end point coordinate
Z/W	: Z axis end point coordinate
R	: Taper part depth (radius designation, incremental position, sign is required)
F/E	: Lead of Longitudinal axis (axis which moves most) direction
Q	: Thread cutting start shift angle

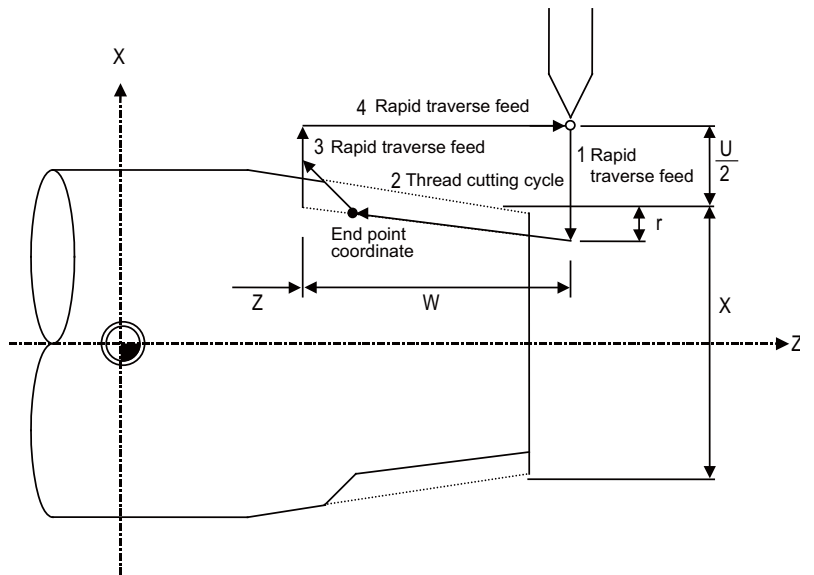

r : Taper part depth (radius designation, incremental position, sign is required)

Chamfering

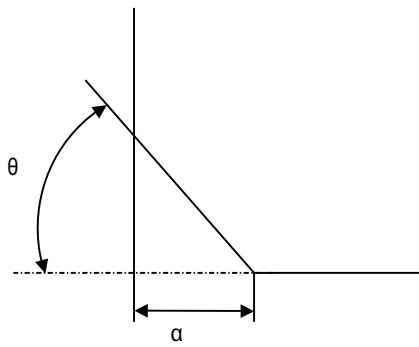

α : Thread chamfering amount

Set the chamfer amount with the parameters.

The setting range is 0 to 12.7L with increments of 0.1L.

θ : Thread chamfering angle

The thread chamfering angle can be set in a given parameter in 1° steps in the range of 0 to 89°

(3) Face cutting fixed cycle (G79/G176)

(a) Straight cutting

Straight cutting in the end face direction can be performed consecutively by the following block:

```
G79 X/U__ Z/W__ F__ ; [L system]
G176 X__ Z__ F__ ; [M system]
X/U   : X axis end point coordinate
Z/W   : Z axis end point coordinate
F     : Feedrate
```

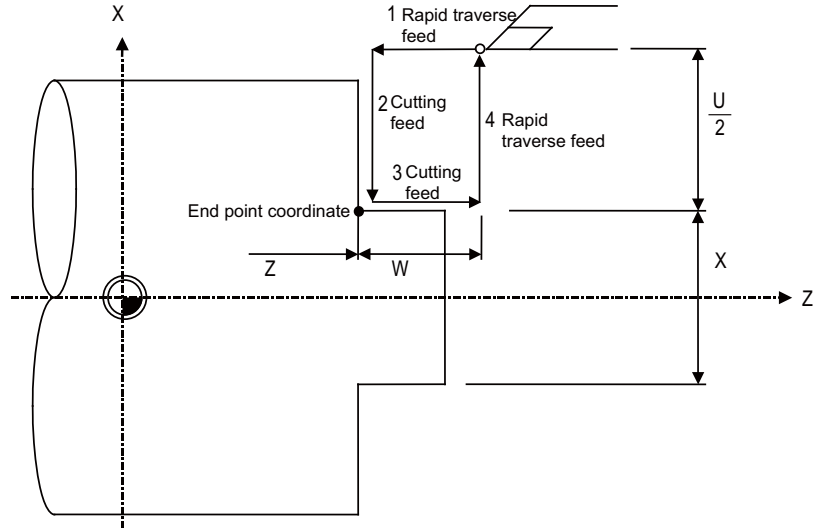

(b) Taper cutting

Taper cutting in the end face direction can be performed consecutively by the following block:

```
G79 X/U__ Z/W__ R__ F__ ; [L system]
G176 X__ Z__ R__ F__ ; [M system]
X/U   : X axis end point coordinate
Z/W   : Z axis end point coordinate
R     : Taper part depth (radius designation, incremental position, sign is required)
F     : Feedrate
```

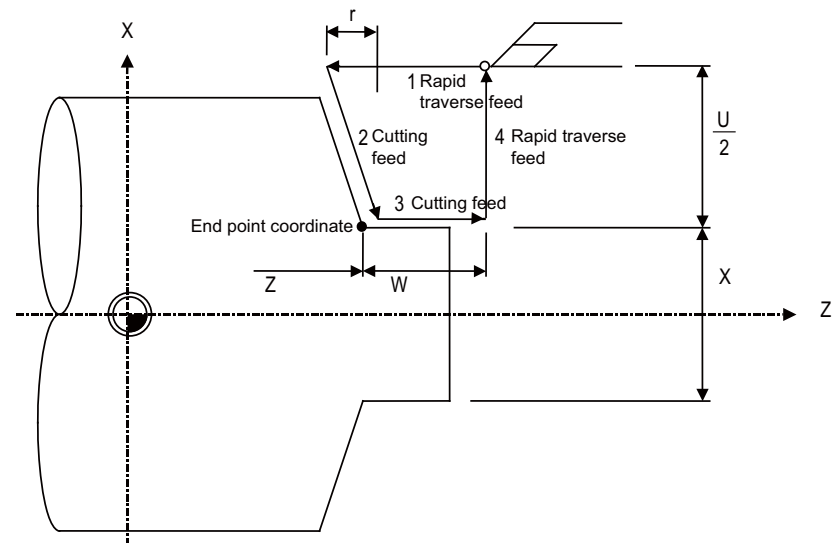

r: Taper part depth (radius designation, incremental position, sign is required)

12.1.3.5 Compound Type Fixed Cycle for Turning Machining

	M850W	M830W	M850S	M830S	M80W	M80 TypeA	M80 TypeB	E80 TypeA	E80 TypeB	C80
M	—	—	—	—	—	—	—	—	—	—
L	△	△	△	△	○	○	○	○	○	○

The shape normally programmed in several blocks for rough cutting, etc., in the turning machining can be commanded in one block. This function is useful for machining program simplification.

Compound type fixed cycle for turning machining are as follows:

G code	Function	
G71	Longitudinal rough cutting cycle	Compound type fixed cycle for turning machining I
G72	Face rough cutting cycle	
G73	Molding material in rough cutting cycle	
G70	Finish cycle	
G74	Face cutting-off cycle	Compound type fixed cycle for turning machining II
G75	Longitudinal cutting-off cycle	
G76	Compound type thread cutting cycle	

(1) Longitudinal rough cutting cycle (G71)

The finish shape program is called, and straight rough cutting is performed while intermediate path is being calculated automatically.

G71 Ud Re Hh ;	
G71 Aa Pp Qq Uu Ww Ff Ss Tt ;	
Ud	: Cut depth (modal) Can also be set with the Reversible parameter. Increment: μm or 1/10000 inch (Radius value command)
Re	: Retract amount (modal) ... Can also be set with the Reversible parameter. Increment: μm or 1/10000 inch (Radius value command)
Hh	: Pocket machining (modal) Can also be set with the Reversible parameter. 0: No pocket machining 1: Pocket machining
Aa	: Finished shape program No. (Program being executed when omitted) A four-digit or eight-digit program No. starting with O No. can specify the finish shape program by the parameter.
Pp	: Finished shape start sequence No. (program head when omitted)
Qq	: Finished shape end sequence No. (To the end of the program when omitted) However, if M99 precedes the Q command, up to M99.
Uu	: Finishing allowance in X axis direction (If omitted, finishing allowance in X axis direction is handled as "0".) Increment: μm or 1/10000 inch (Whether diameter value or radius value is commanded depends on the parameter setting.)
Ww	: Finishing allowance in Z axis direction (If omitted, finishing allowance in Z axis direction is handled as "0".) Increment: μm or 1/10000 inch (Radius value command)
Ff	: Cutting feedrate (If omitted, cutting feedrate (modal) before G71 is applied.)
Ss, Tt	: Spindle command, tool command

Example of a finished shape without pocket	Example of a finished shape with pocket
<p>G71 Ud Re H0; G71 Pp Qq . . ;</p>	<p>G71 Ud Re H1; G71 Pp Qq . . ;</p>
<p>With the beginning of the pockets, the tool is pulled up in the 45-degree direction with each cycle, and finally roughing along finishing shape is performed. By setting parameters, the tool can be moved to the cycle command point at rapid traverse without roughing along finishing shape.</p>	<p>A method that traces the finished shape with each cycle is used for the beginning of the pockets. Roughing along finishing shape can be executed by setting parameters.</p>
<p>S: Cycle command point A: Rough cutting start point (R) Rapid traverse (f) Cutting feed</p>	

The path to the cycle command point and whether or not to retract a tool after roughing along finishing shape can be selected by parameters.

(2) Face rough cutting cycle (G72)

The finish shape program is called, and rough cutting is performed in the end face direction while intermediate path is being calculated automatically.

G72 Wd Re Hh ;	
G72 Aa Pp Qq Uu Ww Ff Ss Tt ;	
Wd	: Cut depth (modal) Can also be set with the Reversible parameter. Unit: $\mu\text{m}/1/10000$ inch (Radius value command)
Re	: Retract amount (modal) ... Can also be set with the Reversible parameter. Unit: $\mu\text{m}/1/10000$ inch (Radius value command)
Hh	: Pocket machining (modal) Can also be set with the Reversible parameter. 0: No pocket machining 1: Pocket machining
Aa	: Finished shape program No. (Program being executed when omitted) A four-digit or eight-digit program No. starting with O No. can specify the finish shape program by the parameter.
Pp	: Finished shape start sequence No. (program head when omitted)
Qq	: Finished shape end sequence No. (To the end of the program when omitted) However, if M99 precedes the Q command, up to M99.
Uu	: Finishing allowance in X axis direction (If omitted, finishing allowance in X axis direction is handled as "0".) Increment: μm or $1/10000$ inch (Whether diameter value or radius value is commanded depends on the parameter setting.)
Ww	: Finishing allowance in Z axis direction (If omitted, finishing allowance in Z axis direction is handled as "0".) Increment: μm or $1/10000$ inch (Radius value command)
Ff	: Cutting feedrate (If omitted, cutting feedrate (modal) before G72 is applied.)
Ss, Tt	: Spindle command, tool command

Example of a finished shape without pocket	Example of a finished shape with pocket
<p>G72 Wd Re H0; G72 Pp Qq . . ;</p>	<p>G72 Wd Re H1; G72 Pp Qq . . ;</p>
<p>With the beginning of the pockets, the tool is pulled up in the 45-degree direction with each cycle, and finally roughing along finishing shape is performed. By setting parameters, the tool can be moved to the cycle command point at rapid traverse without roughing along finishing shape.</p>	<p>A method that traces the finished shape with each cycle is used for the beginning of the pockets. Roughing along finishing shape can be executed by setting parameters.</p>
<p>S: Cycle command point A: Rough cutting start point (R) Rapid traverse (f) Cutting feed</p>	

The path to the cycle command point and whether or not to retract a tool after roughing along finishing shape can be selected by parameters.

(3) Molding material in rough cutting cycle (G73)

The finish shape program is called. Intermediate path is automatically calculated and rough cutting is performed conforming to the finish shape.

G73 Ui Wk Rd ;		
G73 Aa Pp Qq Uu Ww Ff Ss Tt ;		
Ui	:Cutting allowance in the X axis direction i	- Cutting allowance when P, Q command is not given.
Wk	:Cutting allowance in the Z axis direction k	- Modal data
Rd	:Split count d	- Sign is ignored.
		- Cutting allowance is given with a radius designation.
		(If it is omitted, the present program is assumed to be designated.)
Aa	:Finish shape program No.	A file name can be designated instead of address A by enclosing the file name in brackets <>. (The file name can have up to 32 characters, including the extension.)
		(If it is omitted, the program top is assumed to be designated.)
Pp	:Finish shape start sequence No.	(If it is omitted, the program end is assumed to be designated.)
Qq	:Finish shape end sequence No.	However, if M99 precedes the Q command, up to M99.
		- Finishing allowance for the finish shape commanded by the address P or Q.
Uu	:Finishing allowance in the X axis direction u	- Sign is ignored.
Ww	:Finishing allowance in the Z axis direction w	- Diameter or radius is designated according to the parameter.
		- The shift direction is determined by the shape
Ff	:Cutting feed rate (F function)	The F, S, and T commands in the finish shape program are ignored, and the value in the rough cutting command or the preceding value becomes effective.
Ss	:Spindle speed (S function)	
Tt	:Tool selection (T function)	

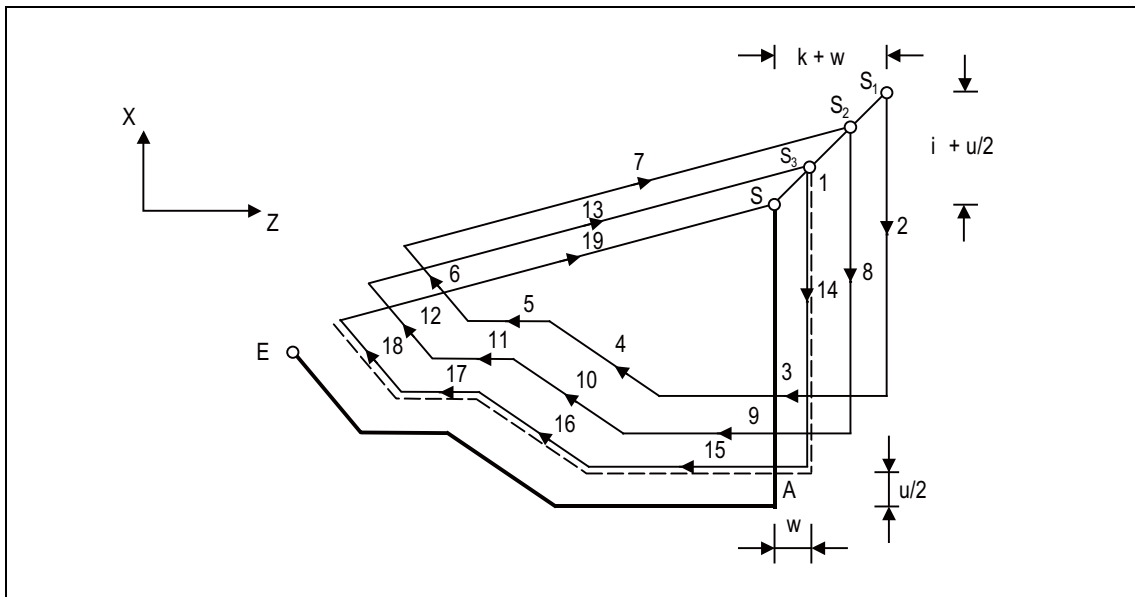

(4) Finish cycle (G70)

After rough cutting is performed by using G71 to G73, finish cutting can be performed by using the G70 command.

G70 Aa Pp Qq Hh;	
Aa	: Finish shape program No. (If it is omitted, the program being executed is assumed to be designated.) A file name can be designated instead of address A by enclosing the file name in brackets <>. (The file name can have up to 32 characters, including the extension.)
Pp	: Finish shape start sequence No. (If it is omitted, the program top is assumed to be designated.)
Qq	: Finish shape end sequence No. (If it is omitted, the program end is assumed to be designated.) However, if M99 precedes the Q command, up to M99.
Hh	: Tool feed directions when the cutting-edge angle is compensated 0: Not compensate the cutting-edge angle 1: Compensate the cutting-edge angle in the longitudinal direction (same tool feed direction as G71/G73 command) 2: Compensate the cutting-edge angle in the end face direction (same tool feed direction as G72 command) When H address is omitted, the cutting-edge is not compensated. When the tool shape compensation for turning is disabled, H address is ignored.

- (a) The F, S, and T commands in the rough cutting cycle command G71 to G73 blocks are ignored, and the F, S, and T commands in the finish shape program become effective.
- (b) The memory address of the finish shape program executed by G71 to G72 is not stored. Whenever G70 is executed, a program search is made.
- (c) When the G70 cycle terminates, the tool returns to the start point at the rapid traverse feed rate and the next block is read.

(Example1) Sequence No. designation

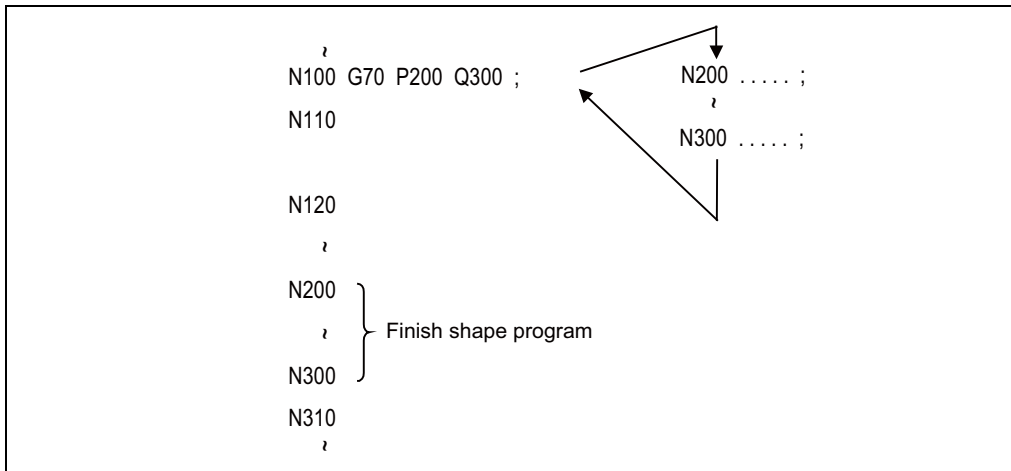

(Example2) Program No. designation

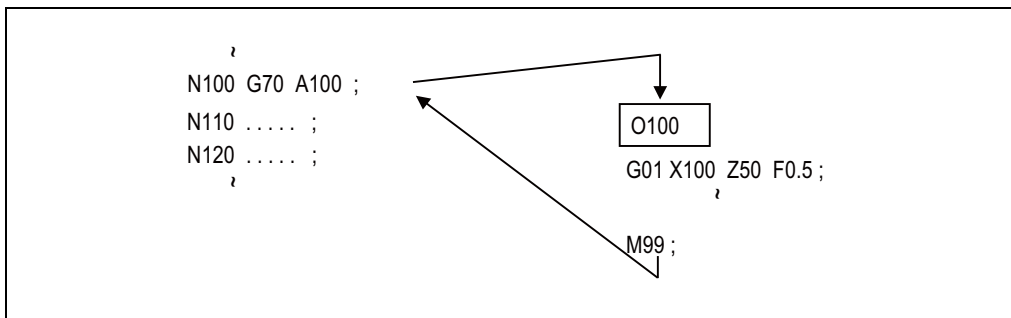

In either example 1 or 2, after the N100 cycle is executed, the N110 block is executed.

(3) Compound type thread cutting cycle (G76)

When the thread cutting start and end points are commanded, cut at any desired angle can be made by automatic cutting so that the cut section area (cutting torque) per time becomes constant in the G76 fixed cycle.

Various longitudinal threads can be cut by considering the thread cutting end point coordinate and taper height constituent command value.

Command Format

G76 Pmra Q Δ dmin Rd ;

G76 Xx1/Uu1 Zz1/Ww1 Ri Pk Q Δ d FI ;

m : Cut count at finishing 01 to 99 (modal)

r : Chamfering amount 00 to 99 (modal). Set in 0.1-lead increments.

a : Nose angle (included angle of thread) 00 to 99 (modal) Set in 1-degree increments.

Δ dmin : Least cut depth

When the calculated cut depth becomes smaller than Δ dmin, the cut depth is clamped at Δ dmin.

d : Finishing allowance (modal)

Xx1/Uu1 : X axis end point coordinate of thread part. --- Absolute/Incremental position

Zz1/Ww1 : Z axis end point coordinate of thread part. --- Absolute/Incremental position

Ri : Taper height constituent in thread part (radius value). When i = 0 is set, straight screw is made.

Pk : Thread height. Designate the thread height in a positive radius value.

Q Δ d : Cut depth. Designate the first cut depth in a positive radius value.

FI : Thread lead

12.1.3.7 Small-diameter Deep-hole Drilling Cycle

	M850W	M830W	M850S	M830S	M80W	M80 TypeA	M80 TypeB	E80 TypeA	E80 TypeB	C80
M	○	○	○	○	○	○	○	—	—	—
L	△	△	△	△	—	—	—	—	—	—

In deep hole drilling, cutting and retract are repeated and the workpiece is machined multiple times. In addition, when PLC signals are input during cutting, the cutting for the time concerned is skipped. In this way, this cycle reduces the load applied to the tool.

Command format

The small-diameter deep-hole drilling cycle mode is established by designating the M code command which was set in the parameter.

If the G83 command is designated in this mode, the small-diameter deep-hole drilling cycle is executed.

The mode is canceled by the following conditions.

- Designation of a fixed cycle cancel command (G80, G commands in Group 1)
- Resetting

The signal is not output in respect to the M command which changes the mode to the small-diameter deep-hole drilling mode.

G83 Xx1 Yy1 Zz1 Rr1 Qq1 Ff1 Ii1 Pp1 ;

Xx1, Yy1 : Hole drilling position
 Zz1 : Hole bottom position
 Rr1 : R point position
 Qq1 : Depth of cut in each pass (designated with incremental position)
 Ff1 : Cutting feed rate
 Ii1 : Feedrate from R point to the cutting start position, the speed for returning from hole bottom
 Pp1 : Dwell time at hole bottom position

12.1.4 Mirror Image

12.1.4.1 Mirror Image by Parameter Setting

	M850W	M830W	M850S	M830S	M80W	M80 TypeA	M80 TypeB	E80 TypeA	E80 TypeB	C80
M	○	○	○	○	○	○	○	○	○	○
L	○	○	○	○	○	○	○	○	○	○

A parameter is used to designate the axis for which the mirror image function is to be executed before the machining program is run.

When mirror image is set to ON by the parameter, an operation which is symmetrical on the left and right or at the top or bottom is performed.

Each axis has its own parameter.

12.1.4.2 Mirror Image by External Input

	M850W	M830W	M850S	M830S	M80W	M80 TypeA	M80 TypeB	E80 TypeA	E80 TypeB	C80
M	○	○	○	○	○	○	○	○	○	○
L	○	○	○	○	○	○	○	○	○	○

Signals from an external device (PLC) to request the mirror image operation either while a machining program is running or before it is run.

When ON has been set for mirror image from an external device, an operation which is symmetrical on the left and right or at the top or bottom is performed.

Each axis has its own request signal.

12.1.4.3 Mirror Image by G Code

	M850W	M830W	M850S	M830S	M80W	M80 TypeA	M80 TypeB	E80 TypeA	E80 TypeB	C80
M	○	○	○	○	○	○	○	○	○	○
L	—	—	—	—	—	—	—	—	—	—

Using a program for the left or right side of a shape, this function can machine the other side of the shape when a left/right symmetrical shape is to be cut.

Mirror image can be applied directly by a G code when preparing a machining program.

Gcode	Function
G50.1	G code mirror image cancel
G51.1	G code mirror image ON

The program format for the G code mirror image is shown below.

```
G51.1 Xx1 Yy1 Zz1 ;
G51.1           : Mirror image on
Xx1,Yy1,Zz1    : Command axes and command positions
```

With the local coordinate system, the mirror image is applied with the mirror positioned respectively at x1, y1 and z1.

The program format for the G code mirror image cancel is shown below.

```
G50.1 Xx1 Yy1 Zz1 ;
G50.1           : Mirror image cancel
Xx1,Yy1,Zz1    : Command axes
```

The x1, y1 and z1 indicate the axes for which the mirror image function is to be canceled and the coordinate position is ignored.

In the case of G51.1 Xx1 ;

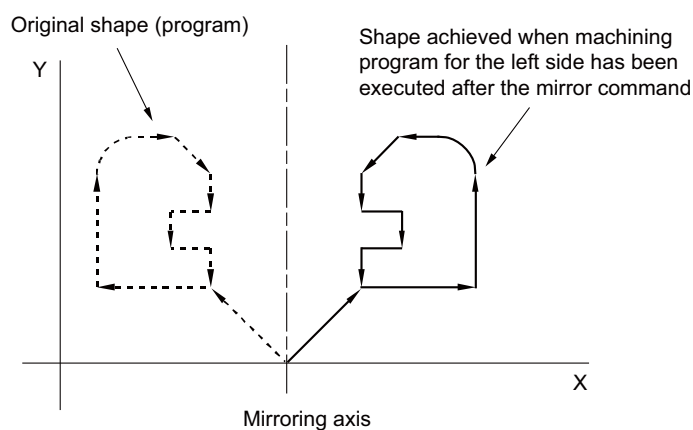

12.1.4.4 Mirror Image for Facing Tool Posts

	M850W	M830W	M850S	M830S	M80W	M80 TypeA	M80 TypeB	E80 TypeA	E80 TypeB	C80
M	—	—	—	—	—	—	—	—	—	—
L	○	○	○	○	○	○	○	—	—	○

With machines in which the base tool post and facing tool post are integrated, this function enables the programs prepared for cutting at the base side to be executed by the tools on the facing side.

The distance between the two posts is set beforehand with the parameter.

The command format is given below.

Gcode	Function
G68	Facing tool post mirror image ON
G69	Facing tool post mirror image OFF

When the G68 command is issued, the subsequent program coordinate systems are shifted to the facing side and the movement direction of the X axis is made the opposite of that commanded by the program.

When the G69 command is issued, the subsequent program coordinate systems are returned to the base side.

The facing tool post mirror image function can be set to ON or OFF automatically by means of T (tool) commands without assigning the G68 command.

A parameter is used to set ON or OFF for the facing tool post mirror image function corresponding to the T commands.

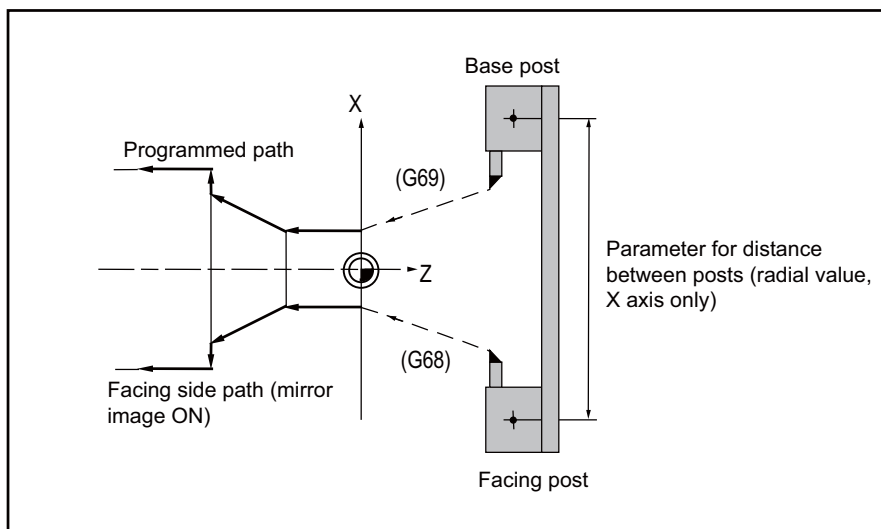

12.1.4.5 T Code Mirror Image for Facing Tool Posts

	M850W	M830W	M850S	M830S	M80W	M80 TypeA	M80 TypeB	E80 TypeA	E80 TypeB	C80
M	—	—	—	—	—	—	—	—	—	—
L	○	○	○	○	○	○	○	—	—	○

If, when tools that correspond to tool Nos. 1 to 64 are selected (T commands), these are tool Nos. for which the facing tool post mirror image function has already been designated with a parameter, the status equivalent to G68 (facing tool post mirror image ON) is established. When the commands apply to tool Nos. for which the facing tool post mirror image function is not designated, the status equivalent to G69 (facing tool post mirror image OFF) is established.

12.1.5 Coordinate System Operation

12.1.5.1 Coordinate Rotation by Program

	M850W	M830W	M850S	M830S	M80W	M80 TypeA	M80 TypeB	E80 TypeA	E80 TypeB	C80
M	△	△	△	△	○	○	○	○	○	△
L	△	△	△	△	○	○	—	—	—	△

Coordinate rotation by program is used to rotate the programmed shape by the specified angle and to machine it. Even complex shapes can be easily machined in the rotated position.

The program format for the coordinate rotation command is given below.

(1) M system

G68 X__Y__R__;	Coordinate rotation ON
G69 ;	Coordinate rotation cancel
X,Y	: Rotation center coordinates
R	: Angle of rotation

(Example)

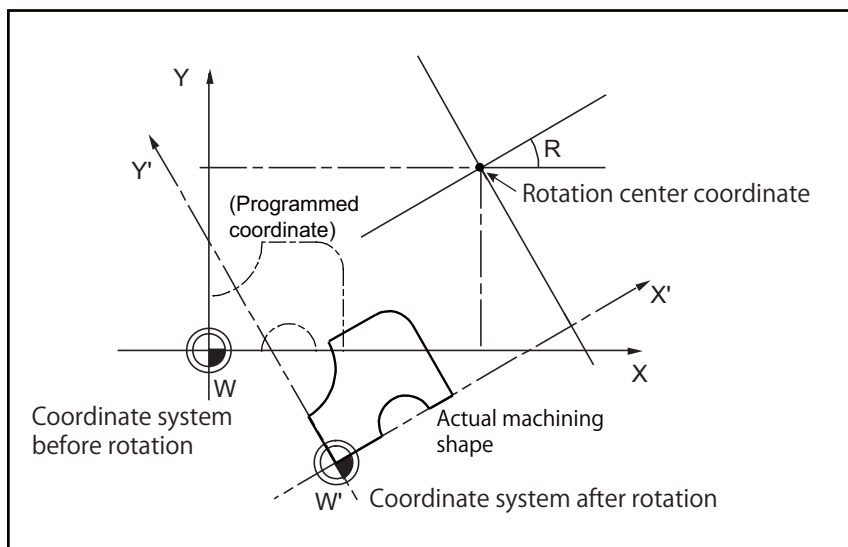

(2) L system

G68.1 X__Z__R__;	Coordinate rotation ON
G69.1 ;	Coordinate rotation cancel
X,Z	: Rotation center coordinates
R	: Angle of rotation

(Note) This function rotates the coordinate system and realizes mainly drilling and tapping.

(Example)

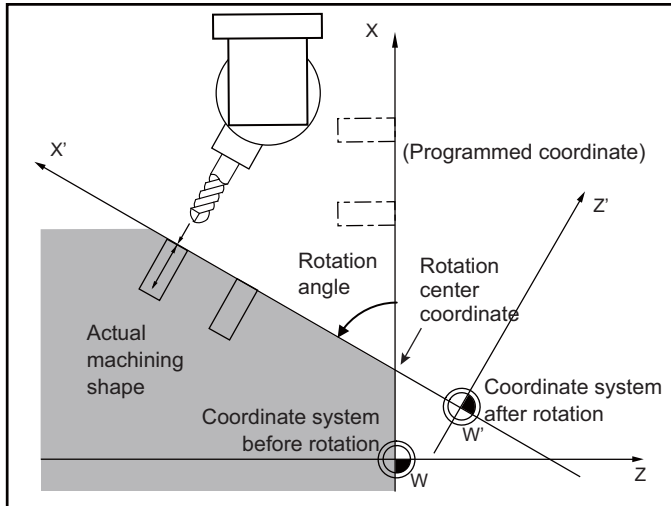

12.1.5.2 Coordinate Rotation by Parameter

	M850W	M830W	M850S	M830S	M80W	M80 TypeA	M80 TypeB	E80 TypeA	E80 TypeB	C80
M	△	△	△	△	—	—	—	—	—	—
L	—	—	—	—	—	—	—	—	—	—

If a deviation occurs between the workpiece alignment line and machine coordinate system's coordinate axis when the workpiece is mounted, the machine can be controlled to rotate the machining program coordinates according to the workpiece alignment line deviation. The coordinate rotation amount and the rotation center are set with the parameters. The coordinate rotation amount can also be set with the G10 command.

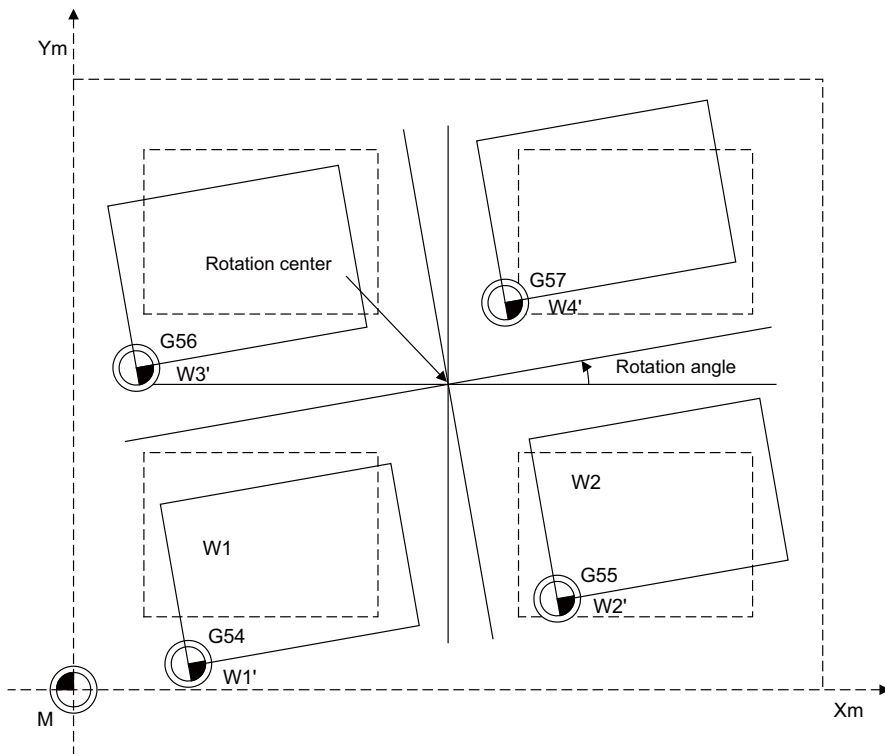

- (1) As for the rotation center coordinate position, designate the position on the machine coordinate system.
- (2) All workpiece coordinate systems from G54 to G59, G54.1 rotate with the rotation command. The machine coordinate system does not rotate.
- (3) If the setting is made on the parameter screen, the setting value will be valid at the timing of the followings:
 Automatic operation:
 After setting the parameters, the setting value will be valid from the next block.
 Manual operation:
 After setting the parameters, the setting value will be valid when the PLC signal (Coordinate rotation by parameter: Coordinate switch for manual feed) is ON.

12.1.5.3 3-dimensional Coordinate Conversion

	M850W	M830W	M850S	M830S	M80W	M80 TypeA	M80 TypeB	E80 TypeA	E80 TypeB	C80
M	△	△	△	△	○	○	—	—	—	△
L	△	△	△	△	○	○	—	—	—	—

With the 3-dimensional coordinate conversion function, a new coordinate system can be defined by rotating and moving in parallel the zero point in respect to the X, Y and Z axes of the currently set workpiece coordinate system. By using this function, an arbitrary spatial plane can be defined, and machining on that plane can be carried out with normal program commands.

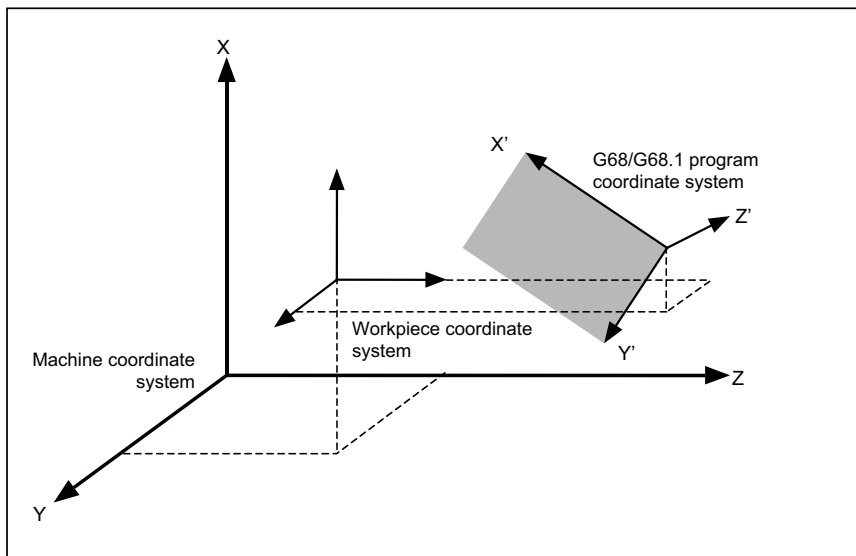

When the G68 (M system) /G68.1 (L system) command is issued, the zero point is shifted by the command value (x, y, z) in respect to the current local coordinate system. A new G68/G68.1 program coordinate system rotated by the designated rotation angle r in respect to the commanded rotation center direction (i, j, k) is created. The local coordinate system is the same as the workpiece coordinate system when the local coordinate system offset is not ON.

The program format is as follows.

(1) M system

G68 X_ Y_ Z_ I_ J_ K_ R_ ;

G68 : 3-dimensional coordinate conversion mode command

X,Y,Z : Rotation center coordinates

I,J,K : Rotation center axis direction

R : Rotation angle

G69 ;

G69 : 3-dimensional coordinate conversion mode cancel command

(2) L system

G68.1 X_ Y_ Z_ I_ J_ K_ R_ ,E_ ;

G68.1 : 3-dimensional coordinate conversion mode command

X,Y,Z : Rotation center coordinates

I,J,K : Rotation center axis direction

R : Rotation angle

,E : Command coordinate system selection

G69.1 ;

G69.1 : 3-dimensional coordinate conversion mode cancel command

12.1.6 Dimension Input

12.1.6.1 Corner Chamfering/Corner R

	M850W	M830W	M850S	M830S	M80W	M80 TypeA	M80 TypeB	E80 TypeA	E80 TypeB	C80
M	△	△	△	△	○	○	○	○	○	△
L	△	△	△	△	○	○	○	○	○	△

This function executes corner processing by automatically inserting a straight line or an arc by the commanded amount between two consecutive movement blocks (G01/G02/G03).

The corner command is executed by assigning the ",C" or ",R" command for the block at whose end point the corner is inserted.

(1) Corner chamfering I/ Corner R I

When ",C" or ",R" is commanded for linear interpolation, corner chamfering or corner R can be inserted between linear blocks.

Corner chamfering I

Example:

```
N1 G01 Xx1 Zz1 ,Cc1 ;
```

```
N2 Zz2 ;
```

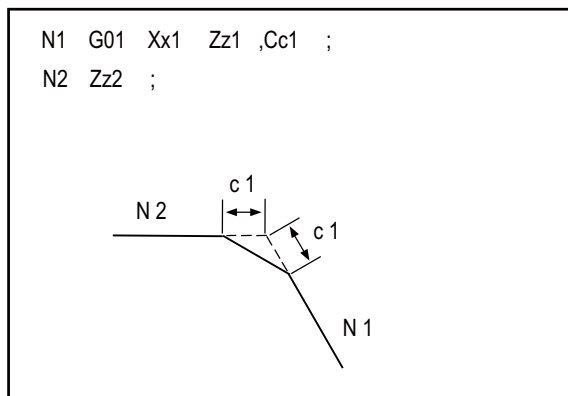

Corner R I

Example:

```
N1 G01 Xx1 Zz1 ,Rr1 ;
```

```
N2 Zz2 ;
```

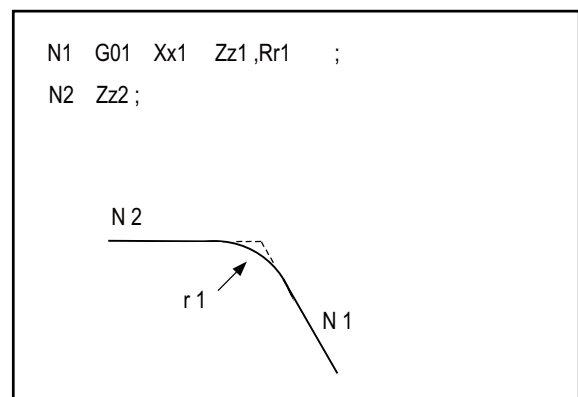

(Note 1) If a corner chamfering or corner R command is issued specifying a length longer than the N1 or N2 block, a program error occurs.

(2) Corner chamfering II/ corner R II

When ",C" or ",R" is commanded in a program between linear-circular, corner chamfering or corner R can be inserted between blocks.

When the parameters are set, "I_", "K_", "C_" can be used to command chamfering instead of ",C", and "R_" can be used to command rounding instead of ",R_". (L system only)

(a) Corner chamfering II (Linear - circular)

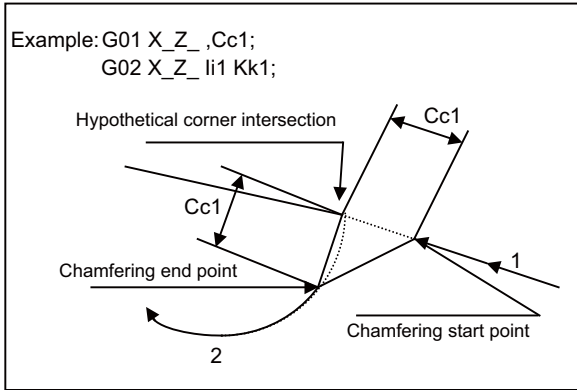

(b) Corner chamfering II (Circular - linear)

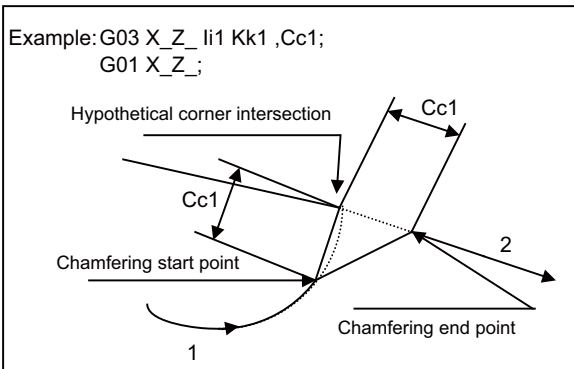

(c) Corner chamfering II (Circular - circular)

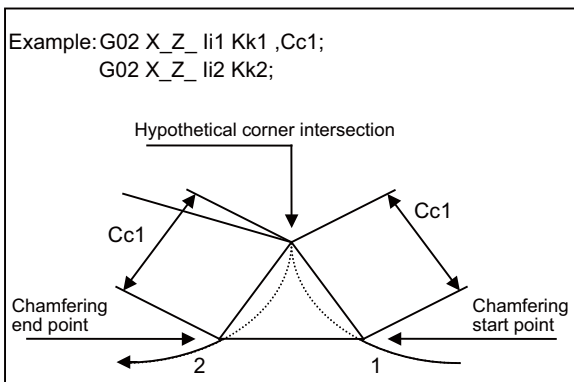

(d) Corner R II (Linear - circular)

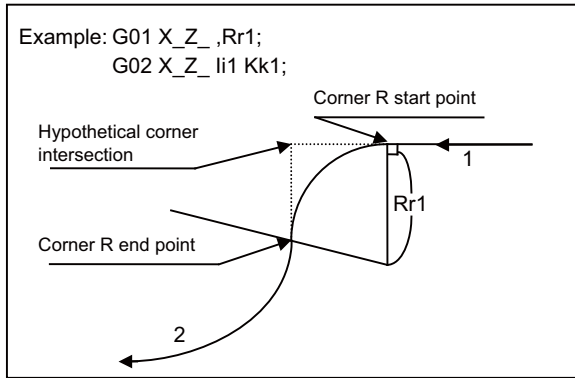

(e) Corner R II (Circular - linear)

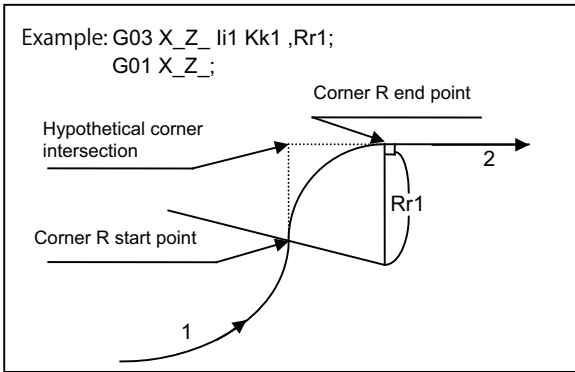

(f) Corner R II (Circular - circular)

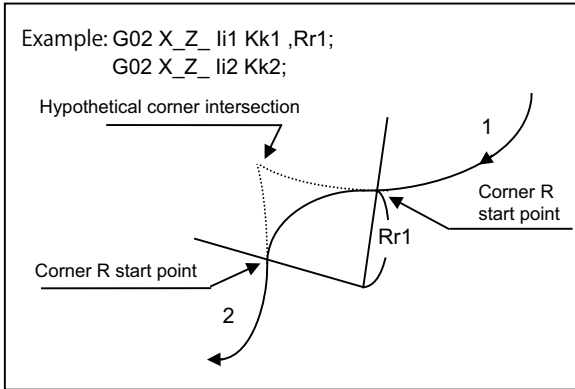

(3) Specification of corner chamfering Expansion/ corner R Expansion

An E address can be used to specify the speed for corner chamfering or corner R. This enables a corner to be cut to a correct shape.

(Example)

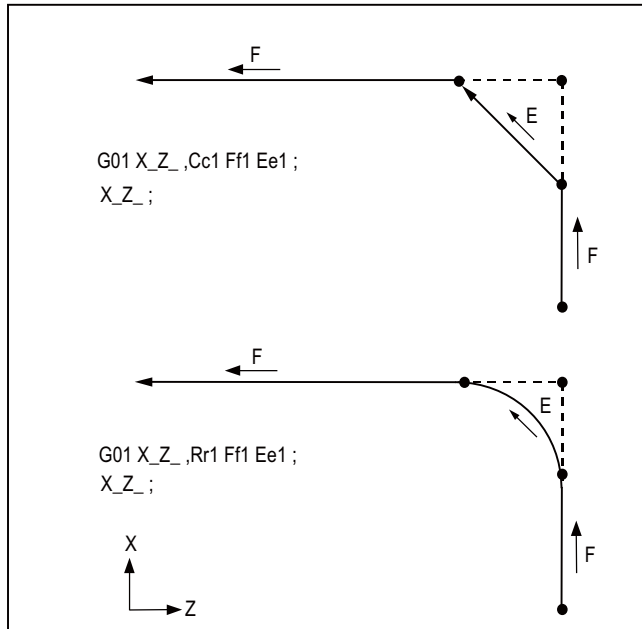

An E address is a modal and remains effective for feeding in next corner chamfering or corner R.

An E address has two separate modals: synchronous and asynchronous feed rate modals. The effective feed rate is determined by synchronous (G95) or asynchronous (G94) mode.

If an E address is specified in 0 or no E command has been specified, the feed rate specified by an F command is assumed as the feed rate for corner chamfering or corner R.

An E address modal is not cleared even if the reset button is pressed.

It is cleared when the power is turned OFF. (In the same manner as F commands.)

(4) Corner chamfering / corner R (I, K designation) (L system only)

With this command format, by means of parameter settings, corners are chamfered using the "I", "K" or "C" address without a comma, and corners are rounded using the "R" address.

The ",C" and ",R" addresses with commas can also be used.

(a) Corner chamfering (I, K designation)

Corners are chamfered using the "I_", "K_" or "C_" address with no comma.

Corners can be chamfered to any angle.

Signs, if they are provided for the corner chamfering commands, are ignored.

Command format

```
N100 Xx1/Uu1 Zz1/Ww1 Ii1/Kk1/Cc1 ;
```

```
N200 Xx1/Uu1 Zz1/Ww1 ;
```

Xx1/Uu1 : X-axis end point coordinate

Zz1/Ww1 : Z-axis end point coordinate

Ii1/Kk1/Cc1 : The length from the hypothetical corner intersection to the chamfering start point or chamfering end point is designated using the I, K or C address.

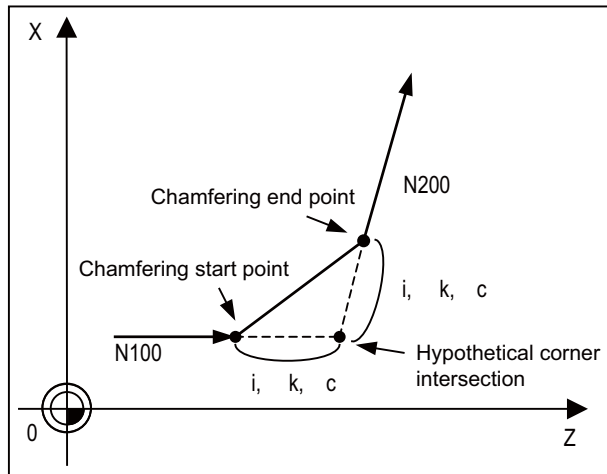

- If multiple "I", "K" or "C" addresses or duplicated addresses have been designated in the same block, the last address will take effect.
- If both corner chamfering and corner R commands are present in the same block, the last command will take effect.
- If "C" is used as the name of an axis, corner chamfering commands cannot be designated using the "C" address.
- If "C" is used as a 2nd miscellaneous function, corner chamfering commands cannot be designated using the "C" address.
- Corner chamfering commands using the "I" or "K" address cannot be designated in an arc command block. "I" and "K" are the arc center commands.

(b) Corner R (I, K designation)

Corners are rounded using the "R_" address with no comma.

Corners can be rounded to any angle.

Signs, if they are provided for the corner R commands, are ignored.

Command format

N100 Xx1/Uu1 Zz1/Ww1 Rr1 ;

N200 Xx1/Uu1 Zz1/Ww1 ;

Xx1/Uu1 : X-axis end point coordinate

Zz1/Ww1 : Z-axis end point coordinate

Rr1 : Radius of corner R arc

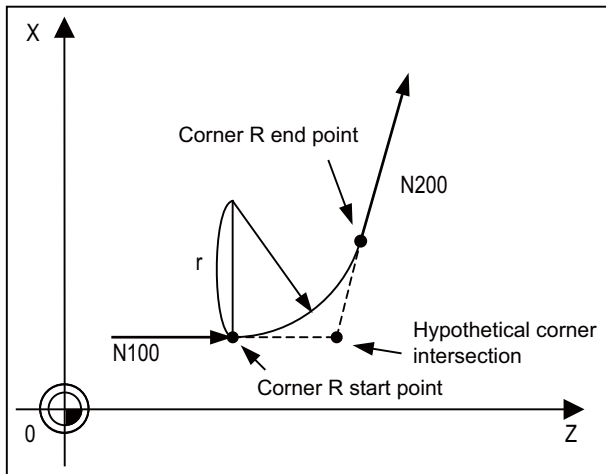

- If both corner chamfering and corner R commands are present in the same block, the last address will take effect.
- Corner R commands using the "R" address cannot be designated in an arc command block. "R" is regarded as the arc radius command in such a block.

(5) Interrupt during corner chamfering / Interrupt during corner R

Shown below are the operations of manual interruption during corner chamfering or corner R.

(a) With an absolute command and manual absolute switch ON:

```
N1 G28 XZ;
N2 G00 X40. Z120.;
N3 G03 X140.Z70. K-50. ,R20. F100 ;
N4 G01 X40. Z20. ;
:
```

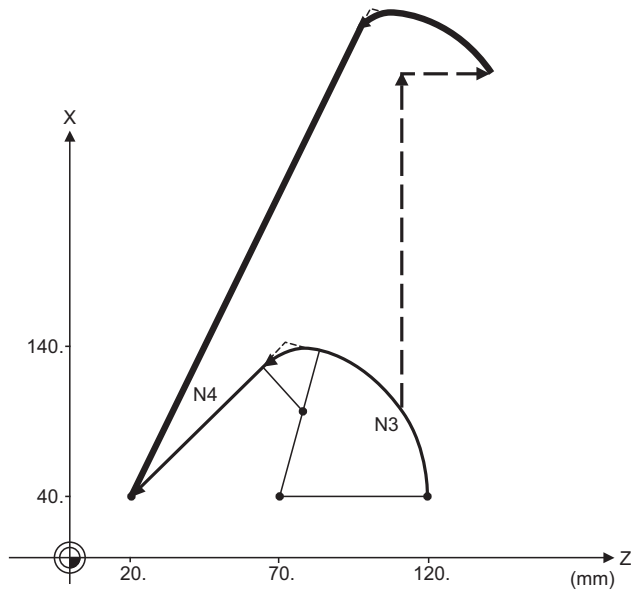

- Amount of interruption
- Path with interruption
- Path without interruption

(b) With an incremental command or manual absolute switch OFF:

```
N1 G28 XZ;
N2 G00 U40. W120.;
N3 G03 U100. W-50. K-50. ,R20.
F100 ;
N4 G01 U-100.W-50. ;
:
```

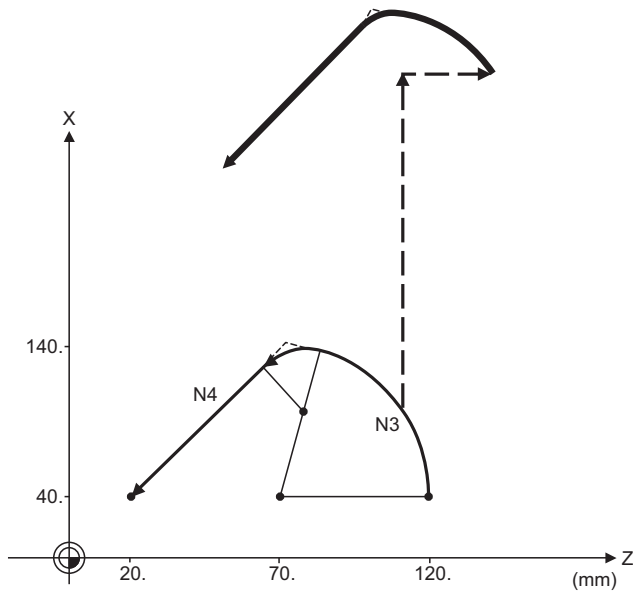

- Amount of interruption
- Path with interruption
- Path without interruption

12.1.6.2 Linear Angle Command

	M850W	M830W	M850S	M830S	M80W	M80 TypeA	M80 TypeB	E80 TypeA	E80 TypeB	C80
M	△	△	△	△	○	○	○	○	—	△
L	△	△	△	△	○	○	○	○	○	△

The end point coordinates are automatically calculated by assigning one element (one component of the selected plane) of the end point coordinates and the linear angle.

G17 Xx1 Aa1 ; or G17 Yy1 Aa1 ;
 G17 : Plane selection
 Xx1,Yy1 : 1 element of the end point coordinate
 Aa1 : Angle

Example

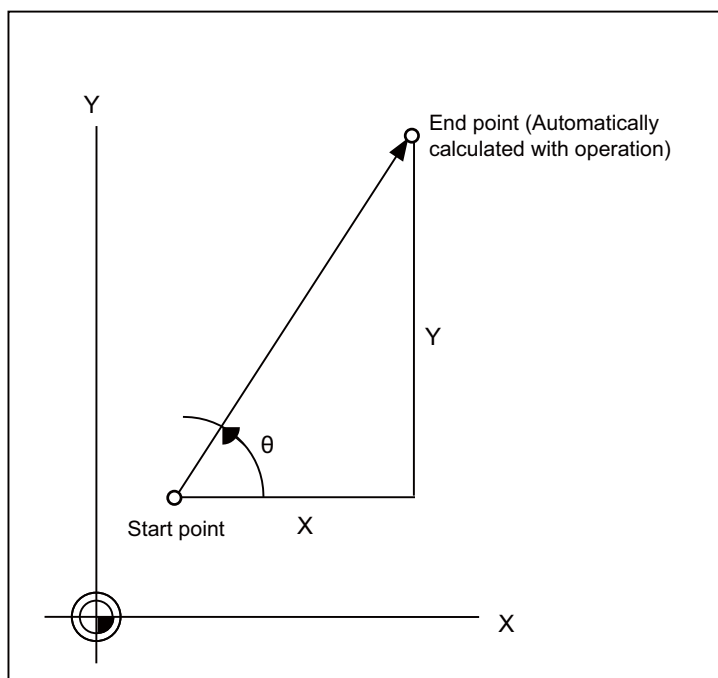

(Note 1) If the axis "A" or 2nd miscellaneous function "A" is used, address "A" is treated as the axis "A" command or the 2nd miscellaneous function, respectively.

12.1.6.3 Geometric Command

	M850W	M830W	M850S	M830S	M80W	M80 TypeA	M80 TypeB	E80 TypeA	E80 TypeB	C80
M	△	△	△	△	○	○	○	○	—	—
L	○	○	○	○	○	○	○	○	○	○

(1) Geometric I

When it is difficult to calculate the intersection point of two straight lines in a continuous linear interpolation command, the end point of the first straight line will be automatically calculated inside the CNC and the movement command will be controlled, provided that the slope of the first straight line as well as the end point coordinates and slope of the second straight line are commanded.

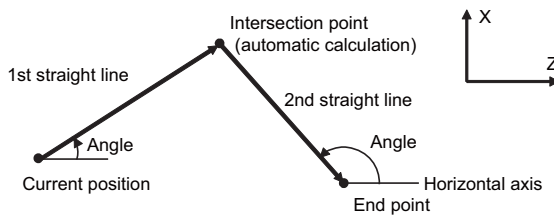

(2) Geometric IB

With the geometric IB function, the contact and intersection are calculated by commanding an arc center point or linear angle in the movement commands of two continuous blocks (only blocks with arc commands), instead of commanding the first block end point.

(a) Two-arc contact

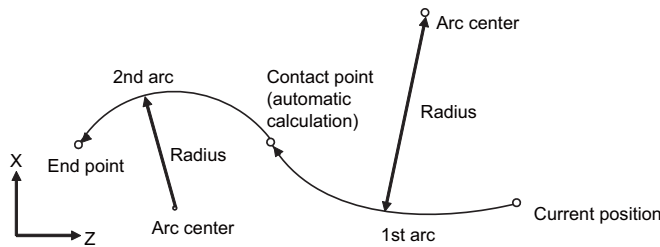

(b) Linear-arc (arc-linear) intersection

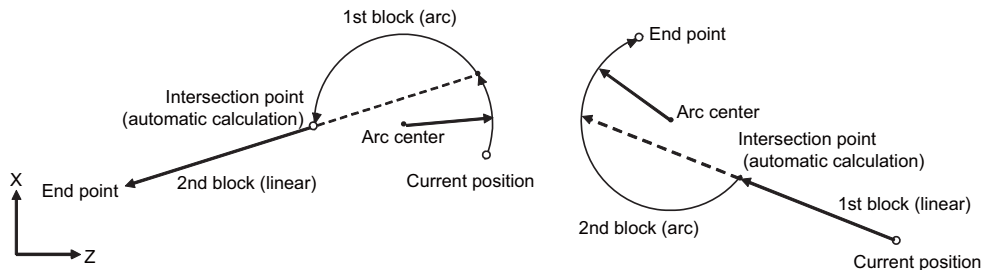

(c) Linear-arc (arc-linear) contact

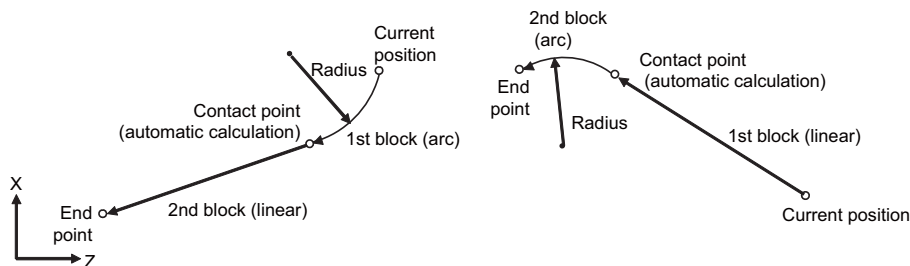

12.1.6.4 Polar Coordinate Command

	M850W	M830W	M850S	M830S	M80W	M80 TypeA	M80 TypeB	E80 TypeA	E80 TypeB	C80
M	△	△	△	△	○	○	○	—	—	△
L	—	—	—	—	—	—	—	—	—	—

With this function, the end point position is commanded with the radius and angle.

Command format

G16 ; Polar coordinate command mode ON

G15 ; Polar coordinate command mode OFF

Example of program

<p>G1x ; G16 ; G9x G01 Xx1 Yy1 F2000 ; : G15 ;</p>	<p>Plane selection for polar coordinate command (G17/G18/G19) Polar coordinate command mode ON Polar coordinate command G9x : Center selection for polar coordinate command (G90/G91) G90...The workpiece coordinate system zero point is the polar coordinate center. G91...The present position is the polar coordinate center. x1 : 1st axis for the plane...The radius commanded y1 : 2nd axis for the plane...The angle commanded</p> <div style="text-align: center;"> <p>For G90/G17(X-Y plane)</p> </div> <p>Polar coordinate command mode OFF</p>
--	--

12.1.7 Axis Control

12.1.7.1 Chopping

12.1.7.1.1 Chopping

	M850W	M830W	M850S	M830S	M80W	M80 TypeA	M80 TypeB	E80 TypeA	E80 TypeB	C80
M	△	△	△	△	○	○	○	—	—	△
L	△	△	△	△	○	○	○	—	—	△

This function continuously raises and lowers the chopping axis independently of the program operation when workpiece contours are to be cut. It can be used for grinding operations using machining centers, for instance.

Which of the axes is to serve as the chopping axis is set by a parameter beforehand.

(1) Chopping action

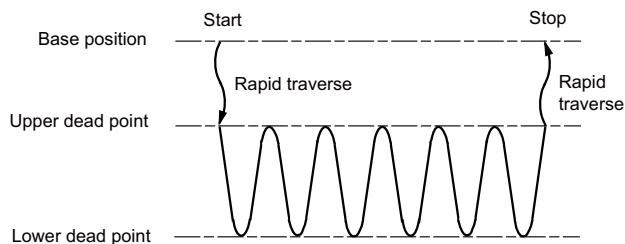
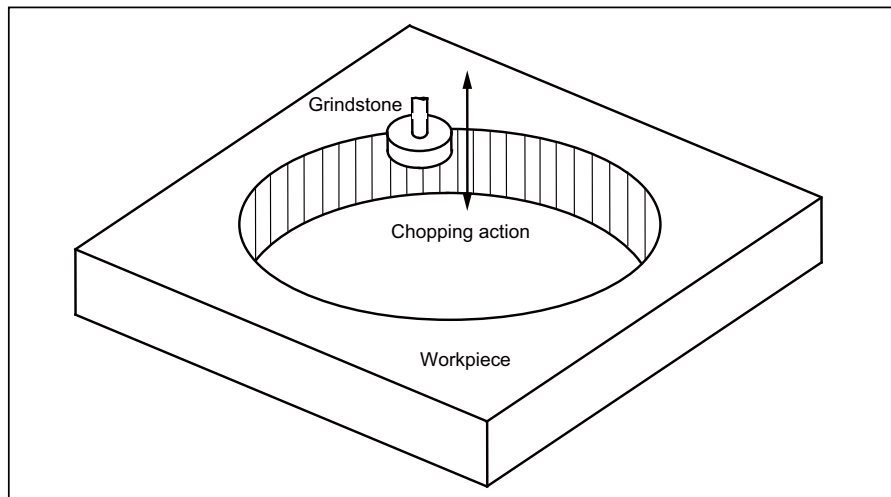

The chopping operation is initiated by setting the upper dead point position, lower dead point position and number of cycles (number of up/down movements per minute) and pressing the chopping start switch.

(Note 1) The upper dead point position, lower dead point position and number of cycles are set and the start and stop commands are designated by input signals from the user PLC.

(Note 2) The setting for the number of cycles differs according to the motor, inertia and other factors.

The chopping operation is performed as follows.

- The axis moves from the base position to the upper dead point by rapid traverse.
- Next, the axis moves repeatedly from the upper dead point to the lower dead point and then from the lower dead point to the upper dead point. (Sinusoidal waveforms)

The feed rate is tailored to achieve the number of cycles set for the up/down motion.

Chopping override

Override in 1% increments from 0% to 100% can be applied to the chopping operation.

(Note) Bear in mind that the override increment differs according to the machine specifications.

12.1.7.2 Normal Line Control

	M850W	M830W	M850S	M830S	M80W	M80 TypeA	M80 TypeB	E80 TypeA	E80 TypeB	C80
M	○	○	○	○	○	○	—	—	—	○
L	—	—	—	—	—	—	—	—	—	—

This function controls the swiveling of the C axis (rotary axis) so that the tool is always pointing in the normal line direction for the X and Y axes movement commands during program operation. It can be used for machining hole, for sewing operations involving sewing machines, carpets, etc. It is valid for only one C axis (rotary axis). At the block seams, the C axis turning is controlled so that the tool faces the normal line direction at the next block's start point.

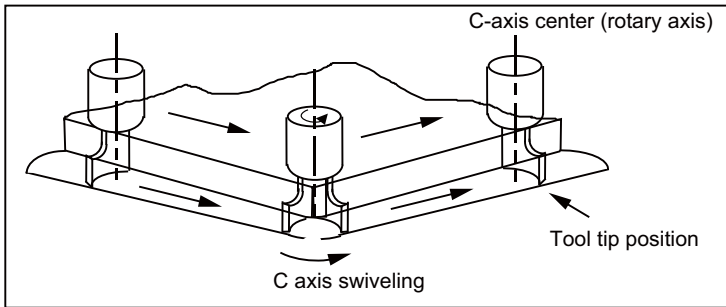

During arc interpolation, the C axis turning is controlled in synchronization with the operation of arc interpolation.

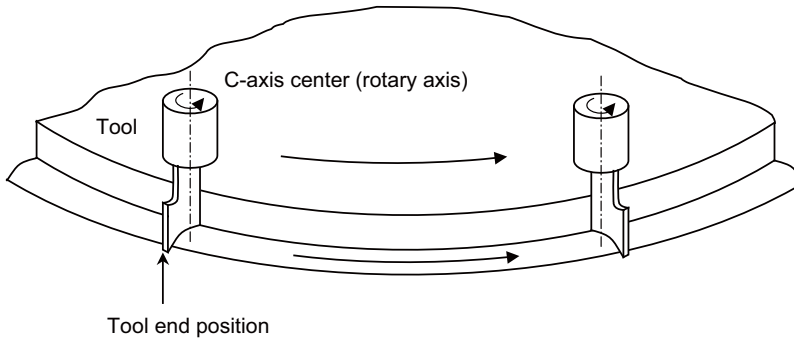

Gcode	Function
G40.1	Normal line direction control cancel
G41.1	Normal line direction control left ON
G42.1	Normal line direction control right ON

12.1.7.3 Circular Cutting

	M850W	M830W	M850S	M830S	M80W	M80 TypeA	M80 TypeB	E80 TypeA	E80 TypeB	C80
M	○	○	○	○	○	○	○	○	○	○
L	—	—	—	—	—	—	—	—	—	—

In circular cutting, a system of cutting steps are performed: first, the tool departs from the center of the circle, and by cutting along the inside circumference of the circle, it draws a complete circle, then it returns to the center of the circle. The position at which G12 or G13 has been programmed serves as the center of the circle.

The program format is given below.

```
G12(G13) li Dd Ff ;
G12      : Circular cutting command CW (clockwise)
G13      : Circular cutting command CCW (counter clockwise)
li        : Radius of complete circle
Dd        : Compensation No.
Ff        : Feed rate
```

When the G12 command is used (path of tool center)

0→1→2→3→4→5→6→7→0

When the G13 command is used (path of tool center)

0→7→6→5→4→3→2→1→0

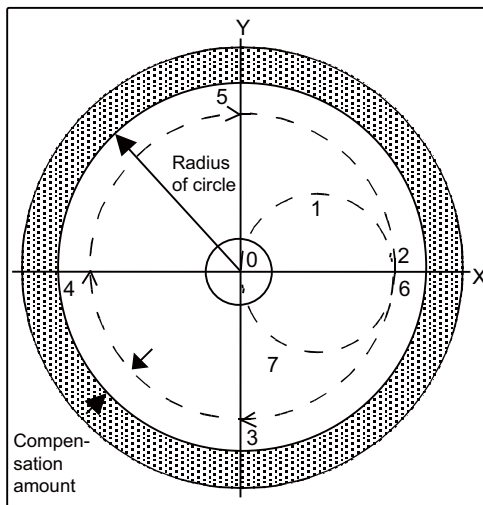

(Note 1) Circular cutting is carried out on the plane which has been currently selected (G17, G18 or G19).

(Note 2) The (+) and (-) signs for the compensation amount denote reduction and expansion respectively.

12.1.7.4 Vibration Cutting Control

	M850W	M830W	M850S	M830S	M80W	M80 TypeA	M80 TypeB	E80 TypeA	E80 TypeB	C80
M	□	□	□	□	□	□	□	—	—	—
L	□	□	□	□	□	□	□	—	—	—

While cutting machining is performed, the chips can be dispersed by applying vibration in synchronization with the spindle rotation to the feed axis so that an air-cutting zone is made. Difficult-to-cut workpieces such as stainless steel can be machined easily and at high speed. In addition, this function can reduce the heat generated by machining and extend tool life.

- (Note 1) The vibration cutting extension unit is required.
- (Note 2) The vibration axis is the only one in the commanded part system. (Only the specified single axis vibrates even for the cutting command of two or more axes such as a taper.)
- (Note 3) This function may affect the surface quality of the workpiece as the axis vibration. Use it for the machining such as rough machining.

[Lathe system]

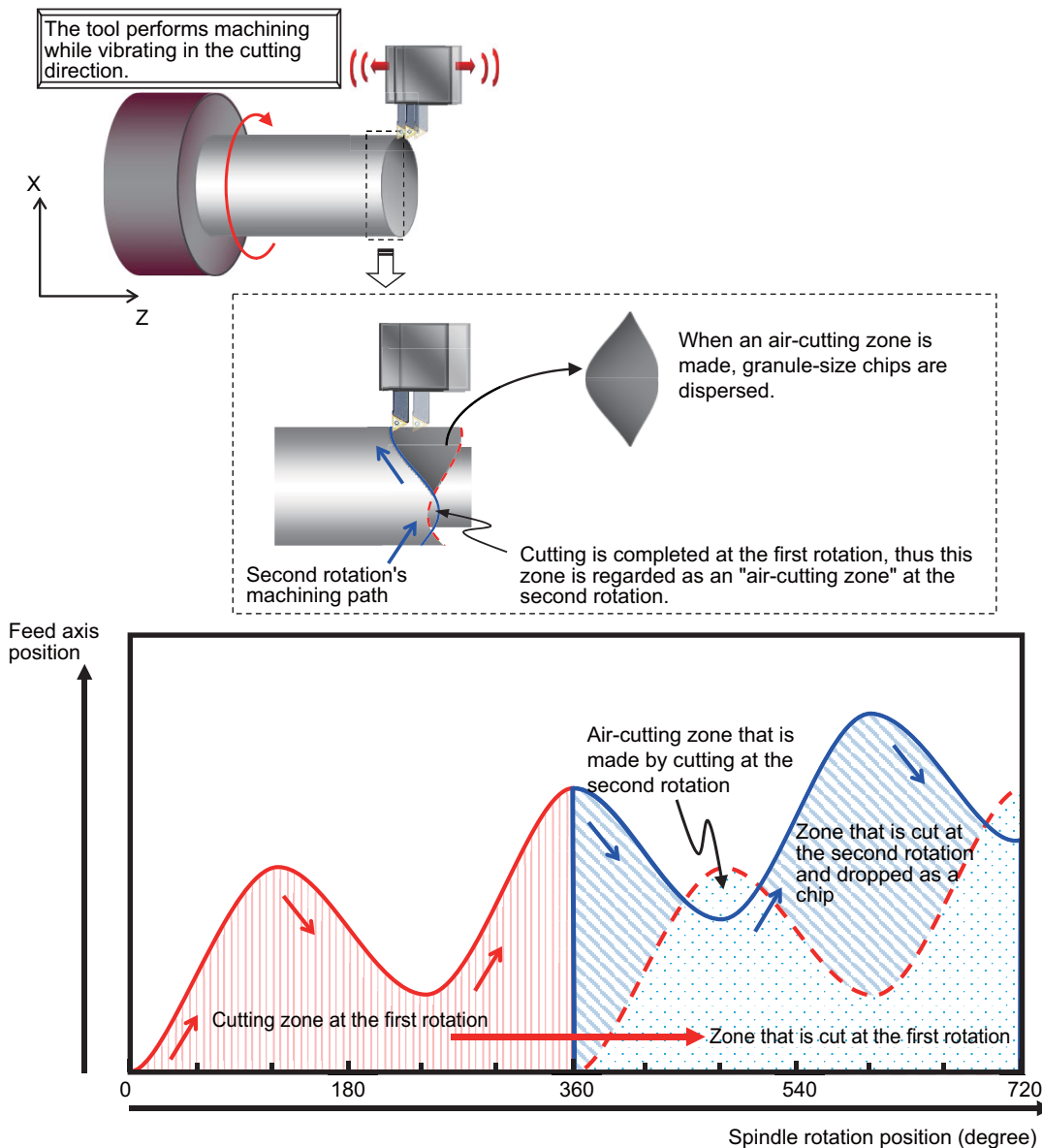

12.1.8 Multi-part System Control

12.1.8.1 Timing Synchronization between Part Systems

	M850W	M830W	M850S	M830S	M80W	M80 TypeA	M80 TypeB	E80 TypeA	E80 TypeB	C80
M	○	○	○	○	○	○	—	—	—	○
L	○	○	○	○	○	○	○	—	—	○

Multiple machining programs can be operated independently at same time for multi-axis and multi-part system mixed control CNC. This function enables the timing synchronization between part systems or the operation of only one part system while the machining programs are being operated independently for each part system.

Command format

Timing synchronization with ! code

```
!n (!m...) L __ ;
!n !m : Part system number for timing synchronization (Multiple command can be performed.)
        Follows the parameter if part system number is omitted.
L      : Timing synchronization number (0 to 9999)
```

Timing synchronization with ! code is also valid among three part systems and more.

Timing synchronization with M code

```
M*** ;
***   : M code for timing synchronization
```

The range of M code for the timing synchronization is determined with the minimum and maximum values set with the parameter beforehand.

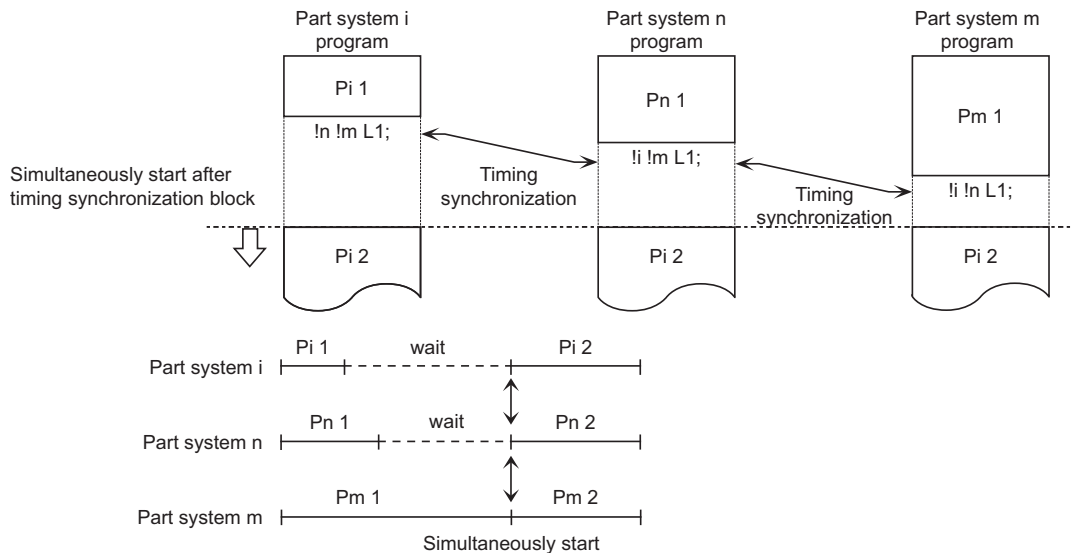

(Note 1) The timing synchronization can be disvalued with the parameter setting and "Timing synchronization between part systems ignored" signal. When a part system to be waited for a simultaneous operation is not operating, the currently operating part system will move on to the next block without executing timing synchronization. This function is useful when conducting a program check on each part system.

(Note 2) The timing synchronization command is normally assigned as a separate command. However, if a movement command and M, S or T command have been assigned in the same block, a parameter is set to decide whether timing synchronization is executed upon executing of the movement command and M, S or T command, or the movement command and M, S or T command are executed upon completion of timing synchronization.

12.1.8.2 Start Point Designation Timing Synchronization

	M850W	M830W	M850S	M830S	M80W	M80 TypeA	M80 TypeB	E80 TypeA	E80 TypeB	C80
M	○	○	○	○	○	○	—	—	—	○
L	○	○	○	○	○	○	○	—	—	○

Multiple machining programs can be operated independently at same time for multi-axis and multi-part system mixed control CNC. This function enables the timing synchronization with the position in the movement block while the machining programs are being operated independently for each part system.

When a workpiece is being delivered from part system 1 to part system 2, the movement operation in part system 2 can be started in the middle of the part system 1 tool post movement with this function so that the machining time can be reduced.

A part system for start point designation timing synchronization can be designated by adding ! code on the command block G115 and G116.

(1) Start point designation timing synchronization Type 1 (G115)

Command format

In L __ G115 X __ Z __ C __ ;	
In	: Part system number for timing synchronization
L	: Timing synchronization number (0 to 9999)
G115	: G command
X Z C	: Start point (Designate an axis which checks the timing synchronization and workpiece coordinate value in other part system)

- (a) The other part system starts first when timing synchronization is executed.
- (b) The own part system waits for the other part system to move and reach the designated start point, and then starts.

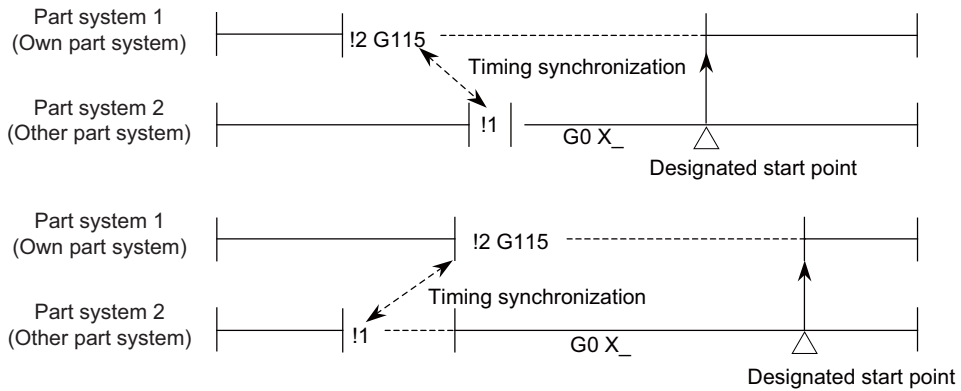

- (c) When the start point designated by G115 is not on the next block movement path of the other part system, the own part system starts once the other part system has reached each start point axis coordinate position.

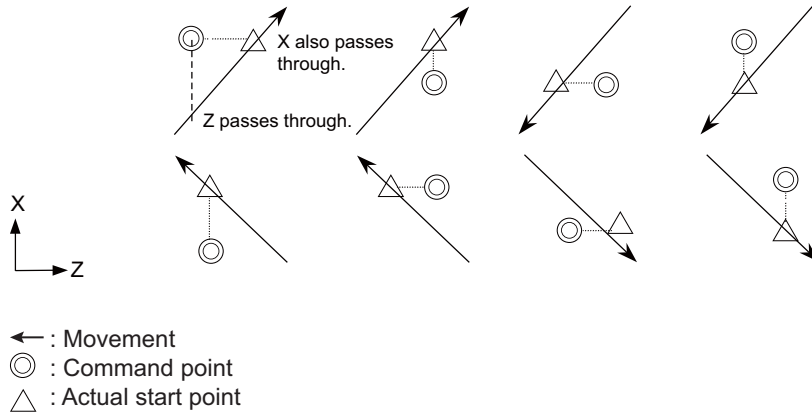

(2) Start point designation timing synchronization Type 2 (G116)

Command format

In L __ G116 X __ Z __ C __ ;	
In	: Part system number for timing synchronization
L	: Timing synchronization number (0 to 9999)
G116	: G command
X Z C	: Start point (Designate an axis which checks the timing synchronization and workpiece coordinate value in own part system)

- (a) The own part system starts first when timing synchronization is executed.
- (b) The other part system waits for the own part system to move and reach the designated start point, and then starts.

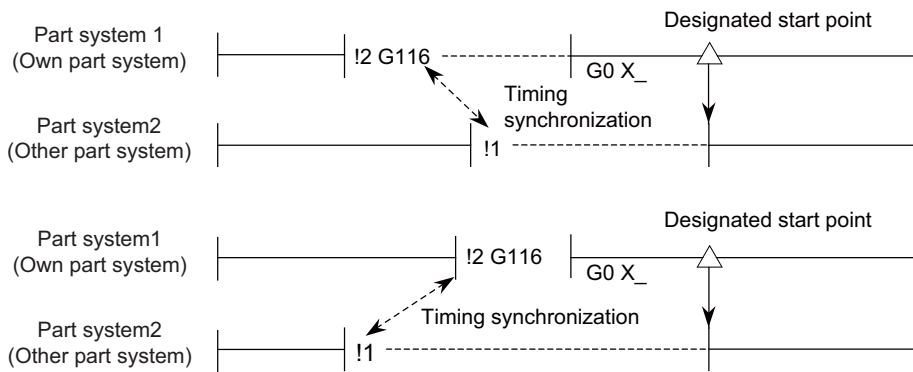

- (c) When the start point designated by G116 is not on the next block movement path of the own part system, the other part system starts once the own part system has reached each start point coordinate position.

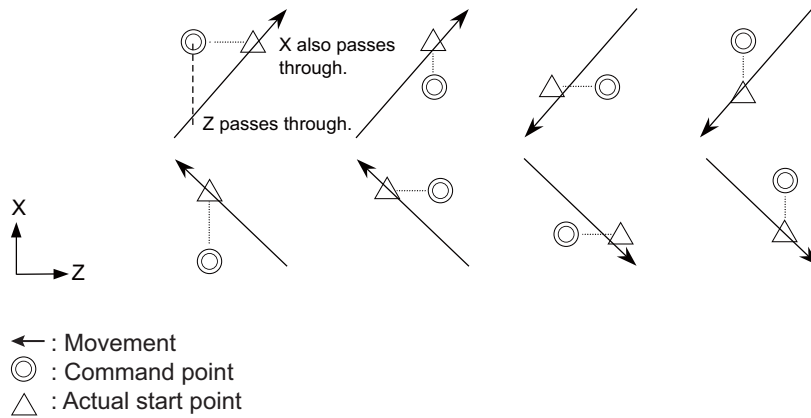

12.1.8.3 Mixed Control

12.1.8.3.1 Mixed Control (Cross Axis Control)

	M850W	M830W	M850S	M830S	M80W	M80 TypeA	M80 TypeB	E80 TypeA	E80 TypeB	C80
M	—	—	—	—	—	—	—	—	—	—
L	△	△	△	△	○	○	—	—	—	△

Performs the mixed control (cross axis control) by G command or PLC signal.

Any axis to be replaced by another axis between part systems.

This makes it possible to perform operations which are not possible with regular axis configurations; for instance, tools which are provided only on part system 1 can be used for machining on part system 2.

This function cannot be used with arbitrary axis exchange control.

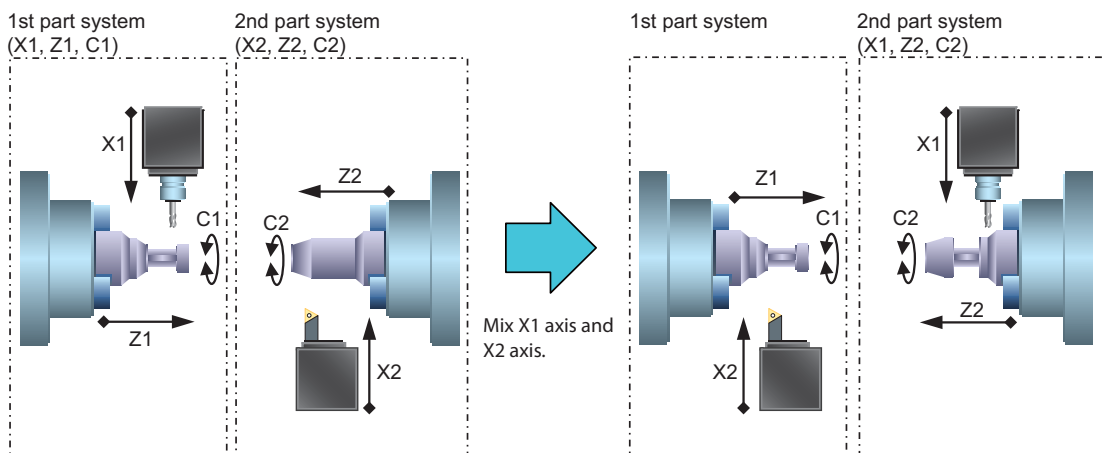

12.1.8.3.2 Arbitrary Axis Exchange Control

	M850W	M830W	M850S	M830S	M80W	M80 TypeA	M80 TypeB	E80 TypeA	E80 TypeB	C80
M	△	△	△	△	○	○	—	—	—	△
L	△	△	△	△	○	○	—	—	—	△

An arbitrary axis can be exchanged freely between part systems in the multiple part systems.

The machining can be freer in the multiple part systems by exchanging an axis which can be commanded for machining programs in each part system.

This makes it possible to perform operations which are not possible with regular axis configurations; for instance, tools which are provided only on the 1st part system can be used for machining on the 2nd part system.

This function cannot be used with the mixed control (cross control).

(Example) Using X1 axis in part system 2

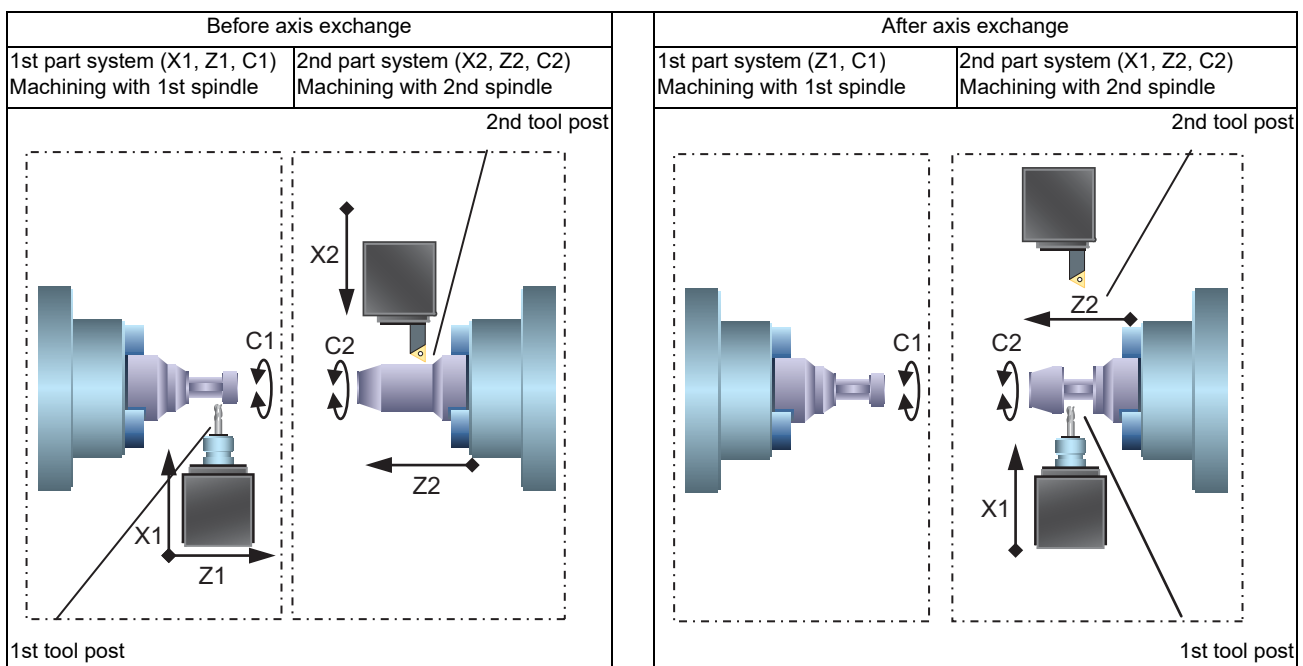

Command format

Arbitrary axis exchange command

Commands the arbitrary axis exchange by G140.

G140 command address = axis address command address = axis address...;

Command address : Designate the command address used in commands such as the movement command with one alphabetical character set to the parameter after the arbitrary axis exchange command (G140).

Axis address : Designate the axis name for arbitrary axis exchange with two alphanumeric characters set to the parameter.

Arbitrary axis exchange return command

Returns the control right of the axis, exchanged by the previous arbitrary axis exchange command (G140) in the commanded part system, to the state before the axis exchange.

G141 ;

Reference axis arrange return command

Returns the control right of the axis, exchanged by the arbitrary axis exchange command (G140) in the commanded part system, to the power-on state.

G142 ;

(Note) For G code list 6 and 7, replace G140, G141 and G142 with G165, G166 and G167.

12.1.8.4 Control Axis Superimposition

12.1.8.4.1 Control Axis Superimposition

	M850W	M830W	M850S	M830S	M80W	M80 TypeA	M80 TypeB	E80 TypeA	E80 TypeB	C80
M	—	—	—	—	—	—	—	—	—	—
L	△	△	△	△	○	○	—	—	—	—

In the multi-part system, an axis in a part system can be superimposed on an axis in another part system and can be controlled.

This is effective when machining by the 1st part system (X1, Z1) and the 2nd part system (X2, Z2) are executed simultaneously for the machine configuration where a workpiece moves by a movement command to the Z axis direction. The machining of the reference axis part system (the 1st part system) and the superimposed axis (the 2nd part system) can be operated simultaneously with no need to fix the workpiece position for machining in the superimposed part system (the 2nd part system).

- Reference axis: The basic in the control axis superimposition function (moves only by its own axis command)
- Superimposed axis: The axis which moves including the reference axis movement in the control axis superimposition function (moves by reference axis or/and own axis command).

The control axis superimposition can be commanded with G code or PLC signal.

Command format

Superimposition start command

G126 Superimposed axis name = Reference axis name,P__ ;	
Superimposed axis name	: Specify the superimposed axis name for the superimposition control with 2 alphanumeric characters set to the parameter.
Reference axis name	: Specify the reference axis name for the superimposition control with 2 alphanumeric characters set to the parameter. Put the symbol "-" at the beginning of the reference axis name for synchronizing the superimposed axis with the reference axis in the reverse direction.
, (comma)	: Specify as delimiter when the address is needed to be assigned after "superimposed axis name = reference name".
P	: Superimposed axis workpiece coordinate system designation (The command range of the coordinate value is mm/inch. The decimal point command is valid.)

Superimposition end command

G126 Superimposed axis name;	
Superimposed axis name	: Specify the name of the superimposed axis which is working for the superimposition control with 2 alphanumeric characters set to the parameter.

While using the control axis superimposition function, the workpiece zero point of the superimposed axis moves according to the movement amount of the reference axis. Because the superimposed axis tries to maintain the position in the workpiece coordinate system, it moves as much as the movement amount of the reference axis.

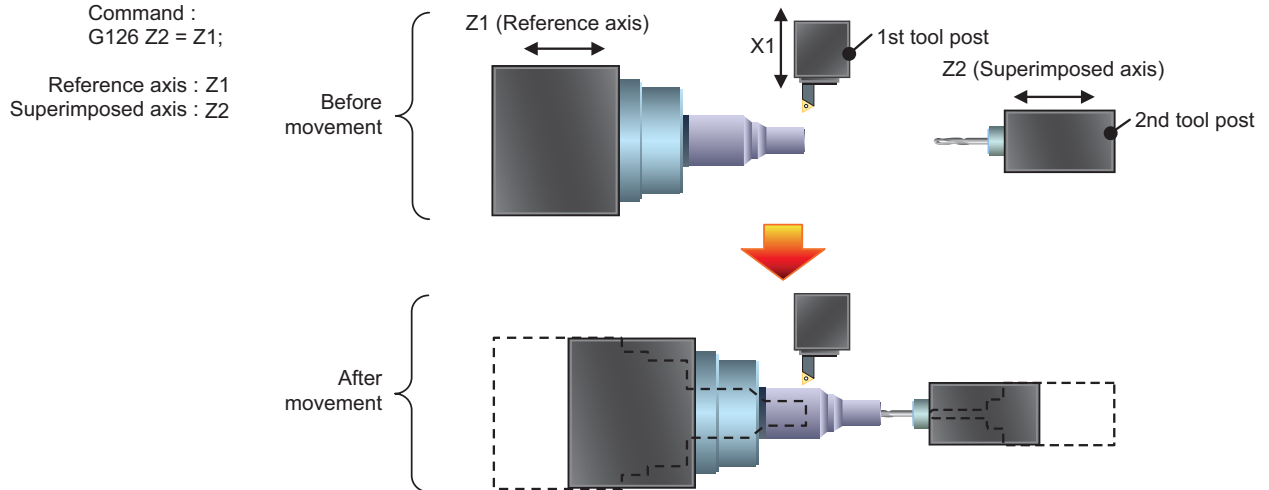

Superimposition control among 3 axes

Superimposition can be controlled among 3 axes.

3 axes tandem superimposition is the condition that an axis is the superimposed axis and becomes the reference axis for another superimposed axis at same time. The first superimposed axis is "1st superimposed axis" and the other axis is "2nd superimposed axis" for 3 axes tandem superimposition.

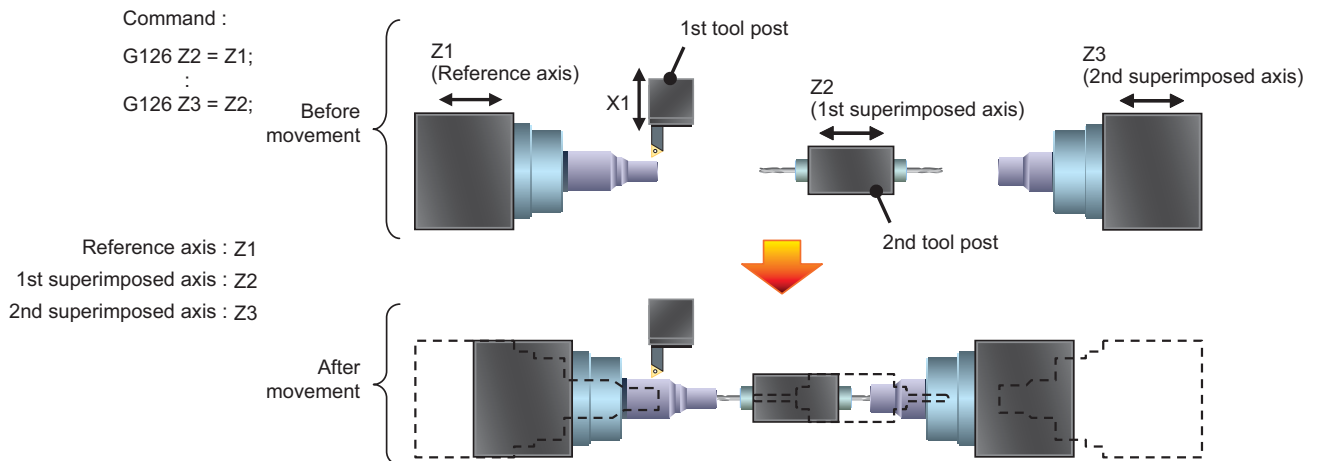

12.1.8.4.2 Arbitrary Axis Superimposition Control

	M850W	M830W	M850S	M830S	M80W	M80 TypeA	M80 TypeB	E80 TypeA	E80 TypeB	C80
M	—	—	—	—	—	—	—	—	—	—
L	△	△	△	△	—	—	—	—	—	—

The arbitrary control axis in other part system can be moved by superimposing on the movement command for the arbitrary control axis in own part system.

12.1.8.5 Control Axis Synchronization between Part Systems

	M850W	M830W	M850S	M830S	M80W	M80 TypeA	M80 TypeB	E80 TypeA	E80 TypeB	C80
M	—	—	—	—	—	—	—	—	—	—
L	△	△	△	△	○	○	○	—	—	△

Synchronization control enables an arbitrary control axis in the other part system to move in synchronization with the movement command assigned to an arbitrary control axis.

The direction in which the axis is to move synchronously can also be reversed using a parameter.

Example of processing with Z1 axis synchronized with Z2 axis in the first part system (X1, Z1) and the second part system (Z2)

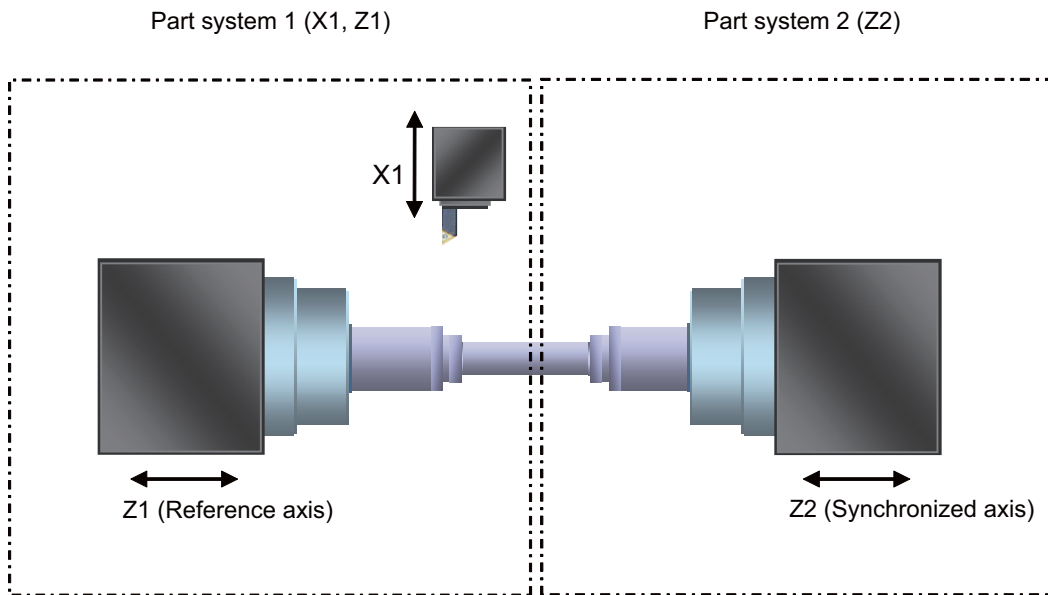

During synchronization, as the synchronized axis moves in synchronization with the reference axis regardless of automatic operation or manual operation, the movement command cannot be issued to the synchronized axis.

There are two types of control axis synchronization between part systems depending on the command method: Control axis synchronization between part systems I (G command) and control axis synchronization between part systems II (PLC signal). The method is chosen depending on the parameter setting.

Command format (Control axis synchronization between part systems I)

Synchronization start command

G125 Synchronized axis name = Reference axis name ;

Synchronized axis name : Command the axis name to be operated as synchronized axis under the control axis synchronization between part systems with two alphanumeric characters set to the parameter.

Reference axis name : Command the axis name to be operated as reference axis under the control axis synchronization between part systems with two alphanumeric characters set to the parameter.

Synchronization end command

G125 Synchronized axis name ;

Synchronized axis name : Command the axis name to be operated as synchronized axis under the control axis synchronization between part systems with two alphanumeric characters set to the parameter.

12.1.8.6 Balance Cut

	M850W	M830W	M850S	M830S	M80W	M80 TypeA	M80 TypeB	E80 TypeA	E80 TypeB	C80
M	—	—	—	—	—	—	—	—	—	—
L	○	○	○	○	○	○	—	—	—	○

Multiple machining programs can be operated independently at same time for multi-axis and multi-part system mixed control CNC. This function enables the operation start timing synchronization between tool posts of two part systems. When workpiece that is relatively long and thin is machined on a lathe, deflection may result, making it impossible for the workpiece to be machined with any accuracy. In cases like this, the deflection can be minimized by holding tools simultaneously from both sides of the workpiece and using them in synchronization to machine the workpiece (balance cutting). This method has an additional advantage: since the workpiece is machined by two tools, the machining time is reduced.

This function enables the movements belonging to two different part systems to be synchronized so that this kind of machining can easily be accomplished.

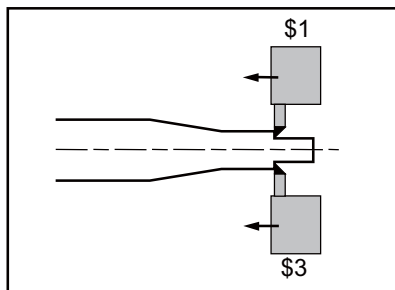

Command format

Balance cut command ON (modal)

```
In L_ G15 ;
In      : Part system number for balance cut
          Follows the parameter if the part system number is omitted.
L       : Timing synchronization number (0 to 9999)
```

* !n LI can be omitted.

Balance cut command OFF (modal)

```
G14 ;
```

(Note) The G code varies depending on the G code list.

	G code list other than 6/7	G code list 6, 7
Balance cut command ON	G15	G68
Balance cut command OFF	G14	G69

G14 and G15 are modal commands. When the G15 command is assigned, the timing synchronization is being executed in all of the cutting feed command blocks until the G14 command is assigned or until the modal information is cleared by the reset signal. The timing synchronization is possible in all blocks by the parameter.

Part system 1 program

```
T 0 1 0 1;  
G00 X_ Z_;  
!3G15;  
G01 Z_ F0.4;  
  
:  
:
```

Part system 3 program

```
T 0 1 0 2;  
G00 X_ Z_;  
!1G15  
G01 Z_ F0.4;  
  
:  
:
```

Whereas synchronization is possible only with the next block when using the code "!" of timing synchronization between part systems, the balance cutting function provides synchronization (at the block start timing) with multiple consecutive blocks.

12.1.8.7 Common Memory for Part Systems

	M850W	M830W	M850S	M830S	M80W	M80 TypeA	M80 TypeB	E80 TypeA	E80 TypeB	C80
M	—	—	—	—	—	—	—	—	—	—
L	○	○	○	○	○	○	—	—	—	○

For a machine with multiple part systems, the common variables and tool compensation memory which exist for each part system can be made common for all part systems by setting the parameters.

(1) Common variables

In the multi-part system, normally the common variables #100 to #199 are used for each part system, and variables #500 to #999 are common for the part systems. When this function is valid, the common variables #500 to #999 also become variables for each part system.

To use part or all of the common variables #100 to #199 and #500 to #999 commonly for all part systems, set the number of parameters to be used commonly for the part systems in variables #100 to #199 and #500 to #999.

As for the variables designated to be common to part systems, the data for part system 1 is used.

(2) Tool compensation memory

When this specification is valid, the tool compensation memory used for operation in the 2nd or following part system changes to be used with the part system 1 data. Thus, the 2nd part system and following data is not used when the common data is used for the part systems.

This function is only for the lathe system and supported up to 2 part systems.

(Note) The setting (such as number of axes and axis names) for the tool compensation amount of part system 1 and part system 2 must be the same.

If the settings differ, the setting of part system 1 will be applied.

12.1.8.8 Multi-part System Simultaneous Thread Cutting

Multi-part system simultaneous thread cutting allows different part systems to perform thread cutting simultaneously on one spindle.

Multi-part system simultaneous thread cutting has two commands; the command (G76.1) for simultaneously cutting threads in multiple places, which is known as "multi-part system simultaneous thread cutting cycle I", and the command (G76.2) for simultaneously cutting a thread by two part systems, which is known as "two-part system simultaneous thread cutting cycle II".

Chamfering is available for multi-part system simultaneous thread cutting cycle I and two-part system simultaneous thread cutting cycle II.

Multi-part system simultaneous thread cutting cycle I (G76.1)

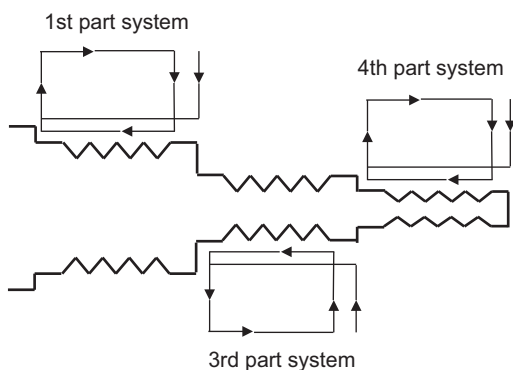

Two-part system simultaneous thread cutting cycle II (G76.2)

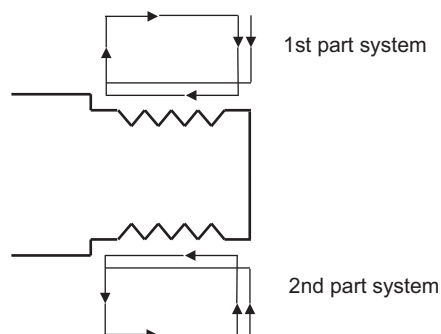

12.1.8.8.1 Two-part System Simultaneous Thread Cutting

	M850W	M830W	M850S	M830S	M80W	M80 TypeA	M80 TypeB	E80 TypeA	E80 TypeB	C80
M	—	—	—	—	—	—	—	—	—	—
L	△	△	△	△	○	○	—	—	—	○

When G76.2 is issued in the 1st and 2nd part systems, waiting is done until G76.2 is issued in each part system.

The thread cutting cycle starts when the commands are aligned properly.

G76.2 assumes the same thread cutting, and deeply cuts in with the cutting amount using 1st part system and 2nd part system alternately.

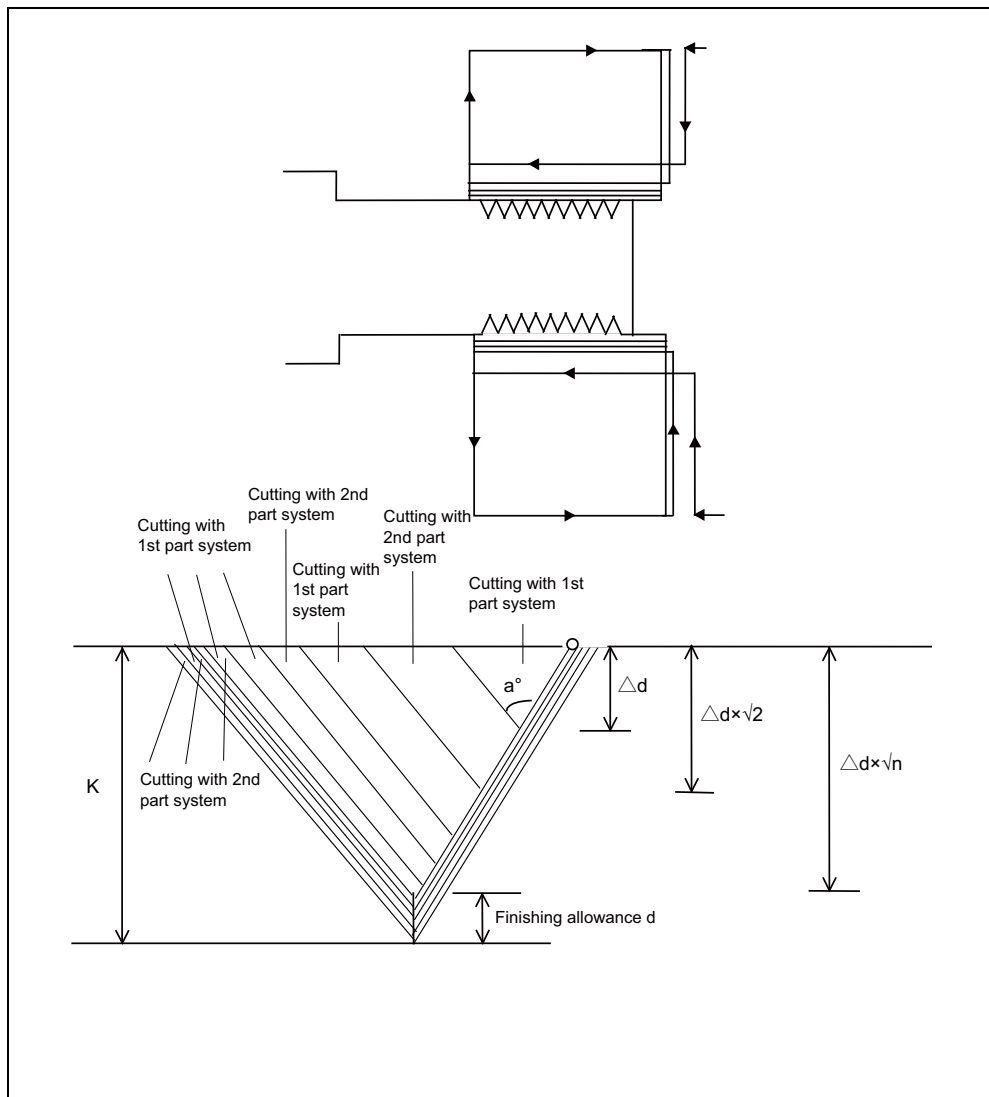
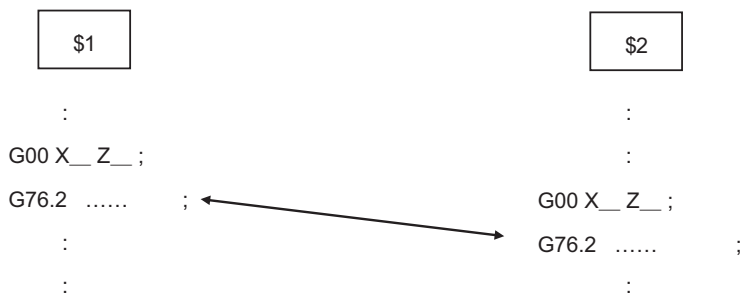

Command format

G76.2 X/U_ Z/W_ R_ P_ Q_ A_ F_ ;	
X/U	: X-axis end point coordinates of thread section
Z/W	: Z-axis end point coordinates of thread section
R	: Taper height component at thread section
P	: Thread height
Q	: Cut amount
A	: Thread cutting start shift angle
F	: Thread lead

(Note) Two-part system simultaneous thread cutting cycle II (G76.2) can be commanded in part system 1 or 2 only. A program error will occur when issuing the command in the other part systems.

12.1.8.8.2 Multi-part System Simultaneous Thread Cutting

	M850W	M830W	M850S	M830S	M80W	M80 TypeA	M80 TypeB	E80 TypeA	E80 TypeB	C80
M	—	—	—	—	—	—	—	—	—	—
L	△	△	△	△	○	○	—	—	—	—

If G76.1 is given to multiple part systems, each part system waits for G76.1 to be commanded. The thread cutting cycle starts when the G76.1 commands are aligned properly.

When "J134" is commanded in \$1, \$3 and \$4

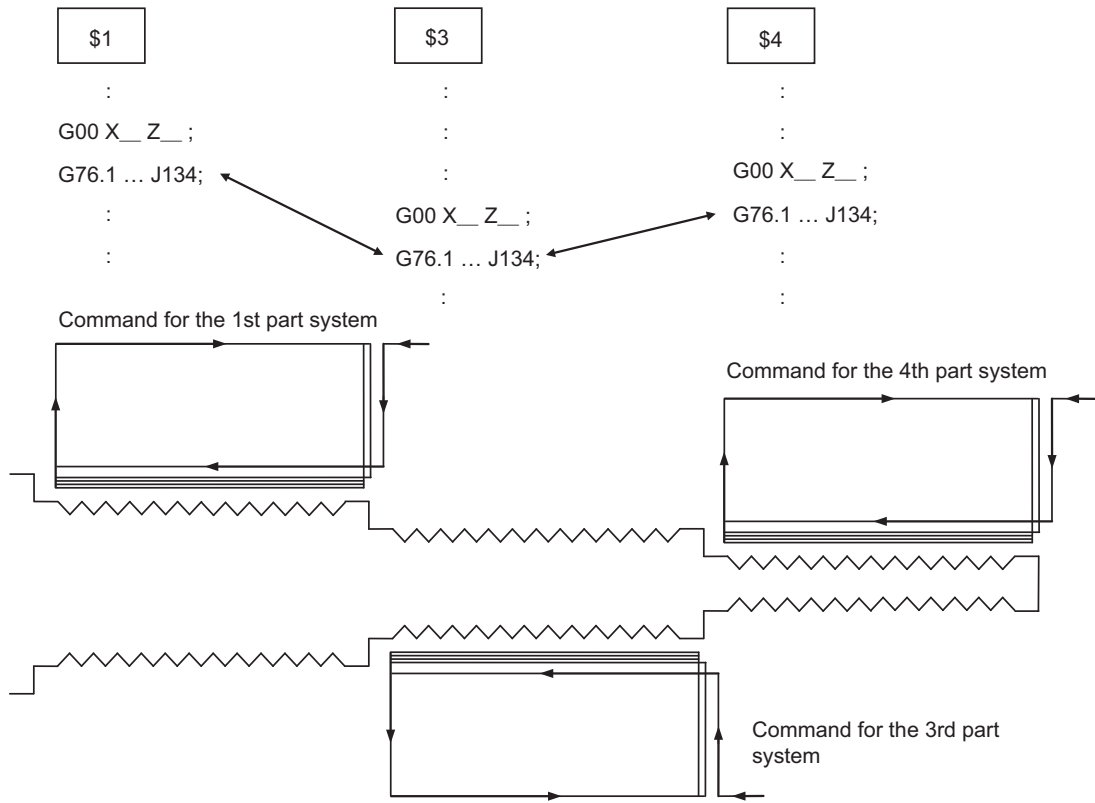

Thread cutting will start simultaneously after waiting for the 1st, 3rd and 4th part systems.

Command format

G76.1 X/U__ Z/W__ R__ P__ Q__ J__ F__ ;	
X/U	: X axis end point coordinate of thread part
Z/W	: Z axis end point coordinate of thread part
R	: Taper height constituent in thread part
P	: Thread height
Q	: Cut depth
J	: Part system for simultaneous thread cutting
	Ones digit: Part system number for the 1st set
	Tens digit: Part system number for the 2nd set
	:
	Ten-millions digit: Part system number for the 8th set
F	: Thread lead

12.1.8.9 Multi-part System Program Management

	M850W	M830W	M850S	M830S	M80W	M80 TypeA	M80 TypeB	E80 TypeA	E80 TypeB	C80
M	○	○	○	○	○	○	—	—	—	○
L	○	○	○	○	○	○	○	—	—	○

In a system composed of multiple part systems, this function manages the program storage method, program search method and program input/output.

- This facilitates the management of such machining programs that run simultaneously in multiple part systems.
- This enables separate programs that run simultaneously in multiple part systems to be handled under one common name.
- The parameter enables or disables this function.
- NC memory (*1) is the only device compatible with this function.

(*1) MDI and machine tool builder's macro are included.

<Multi-part system program management INVALID>

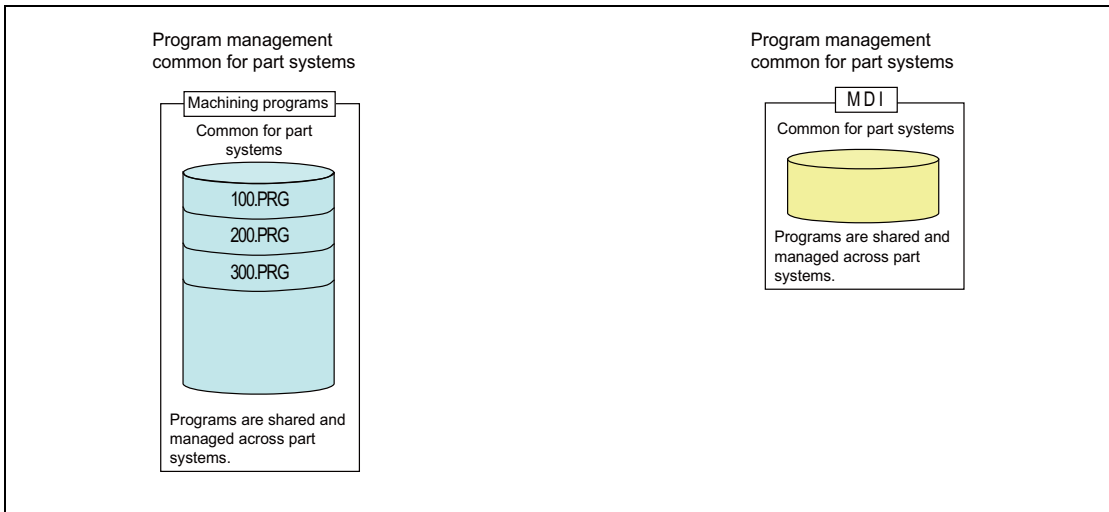

<Multi-part system program management VALID>

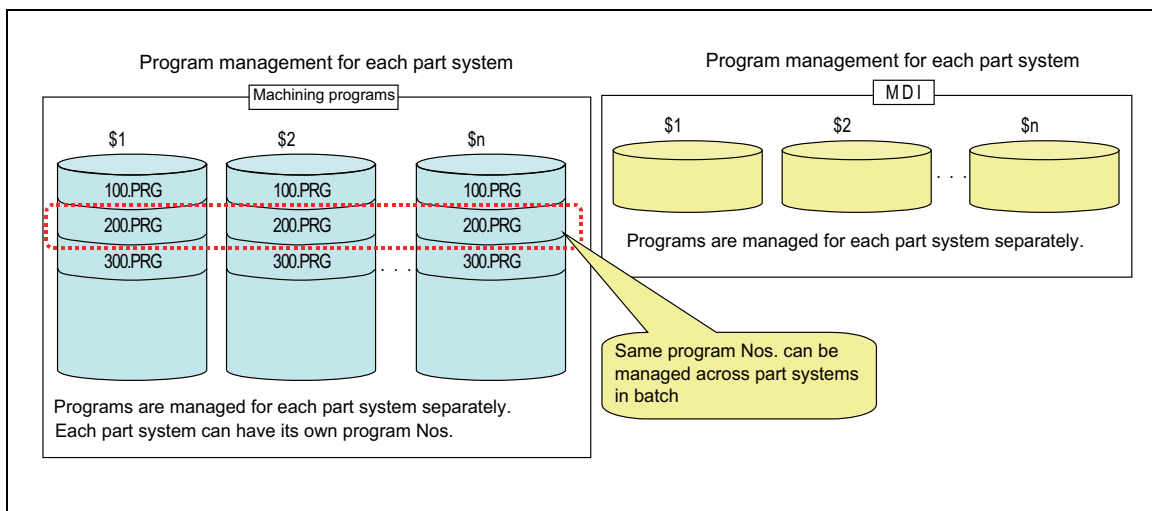

- \$1: Part system 1
- \$2: Part system 2
- \$n: Part system n

12.1.8.10 Synchronization between Part Systems

12.1.8.10.1 Single Block between Part Systems

	M850W	M830W	M850S	M830S	M80W	M80 TypeA	M80 TypeB	E80 TypeA	E80 TypeB	C80
M	—	—	—	—	—	—	—	—	—	—
L	△	△	△	△	○	○	○	—	—	△

Single block between part systems is the function for executing single block operation while maintaining the synchronization between the part systems when two or more part systems are operated in the multi-part system. When one part system has been stopped by single block stop, the other part systems pause in the cycle operation. In the normal single block, the synchronization between the part systems differs from the synchronization during the continuous operation because the other part systems continue the operation without stop even a part system is stopped by single block stop, and the tool interference could occur in some cases. The synchronization between part systems can be maintained the same as the continuous operation by the single block operation with part systems synchronized. Valid/invalid can be switched with the PLC signal.

(Example) 3 part systems lathe

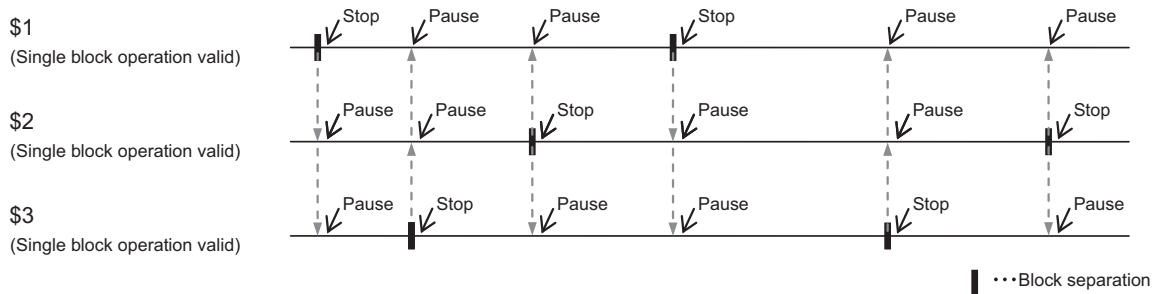

- Stop: Single block stop
- Pause: Cycle operation pause
- \$1: Part system 1
- \$2: Part system 2
- \$3: Part system 3

12.1.8.10.2 Dwell/Miscellaneous Function Time Override

	M850W	M830W	M850S	M830S	M80W	M80 TypeA	M80 TypeB	E80 TypeA	E80 TypeB	C80
M	—	—	—	—	—	—	—	—	—	—
L	Δ	Δ	Δ	Δ	○	○	○	—	—	Δ

Override can be applied to dwell time and miscellaneous function finish wait time of all part systems. The synchronization between part systems can be maintained when the multiple machining programs are operated with override in the multi-axis and multi-part system mixed control CNC.

If a machining program that performs cutting-off machining in part system 2 (\$2) after the completion of turning machining in part system 1 (\$1) is executed with override when this function is invalid, part system 1 and part system 2 will be out of synchronization and the machining may not be operated properly.

The differences on the start timing for each command are shown in (1) to (3) when executing the machining with the part system 1 (\$1) and part system 2 (\$2) as shown in the figure below.

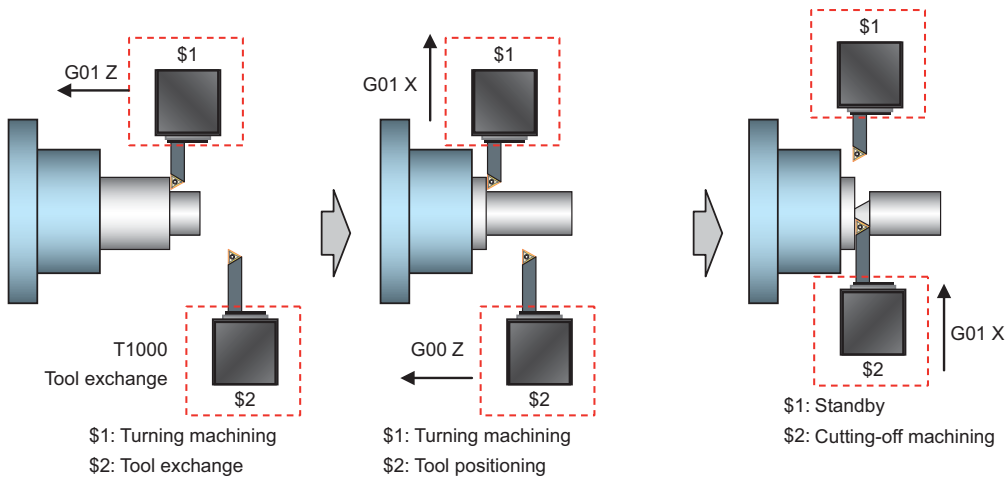

(1) Override 100%

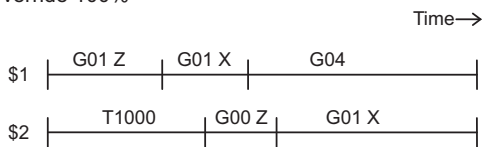

(2) When this function is invalid
Override 50%

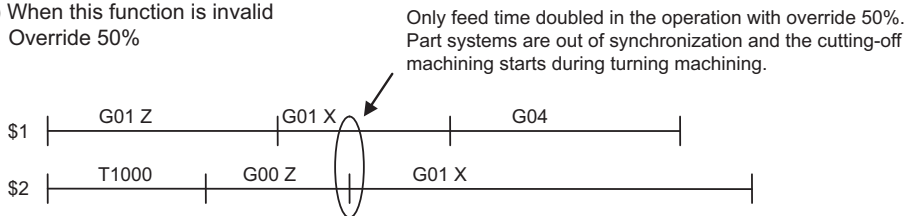

(3) When this function is valid
Override 50%

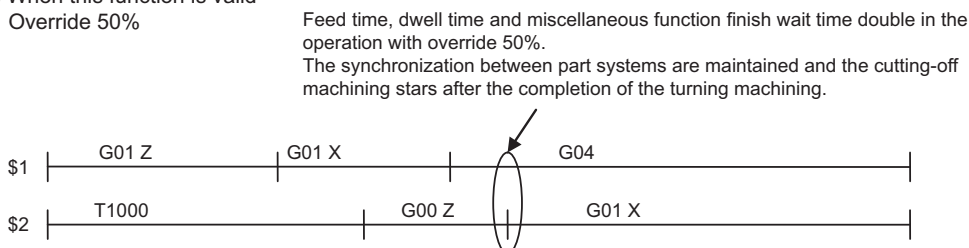

12.1.8.10.3 Synchronization between Part Systems OFF

	M850W	M830W	M850S	M830S	M80W	M80 TypeA	M80 TypeB	E80 TypeA	E80 TypeB	C80
M	—	—	—	—	—	—	—	—	—	—
L	Δ	Δ	Δ	Δ	○	○	○	—	—	Δ

Synchronization between part systems and feedrate change are turned OFF in a part of a machining program to eliminate a synchronization relation between part systems by single block operation with part systems synchronized or variation of a machining program feedrate by dry run. This function is effective mainly in blocking the cycle operation pause or feedrate variation in only some of part systems when the sub part system control II function is being used. When loader control and ATC control which are operated independently of machining are performed with a sub program or sub part system control, this function enables a operation with synchronization between part systems in machining part systems and an independent operation in sub part systems.

ON/OFF can be switched with the system variable or the PLC signal.

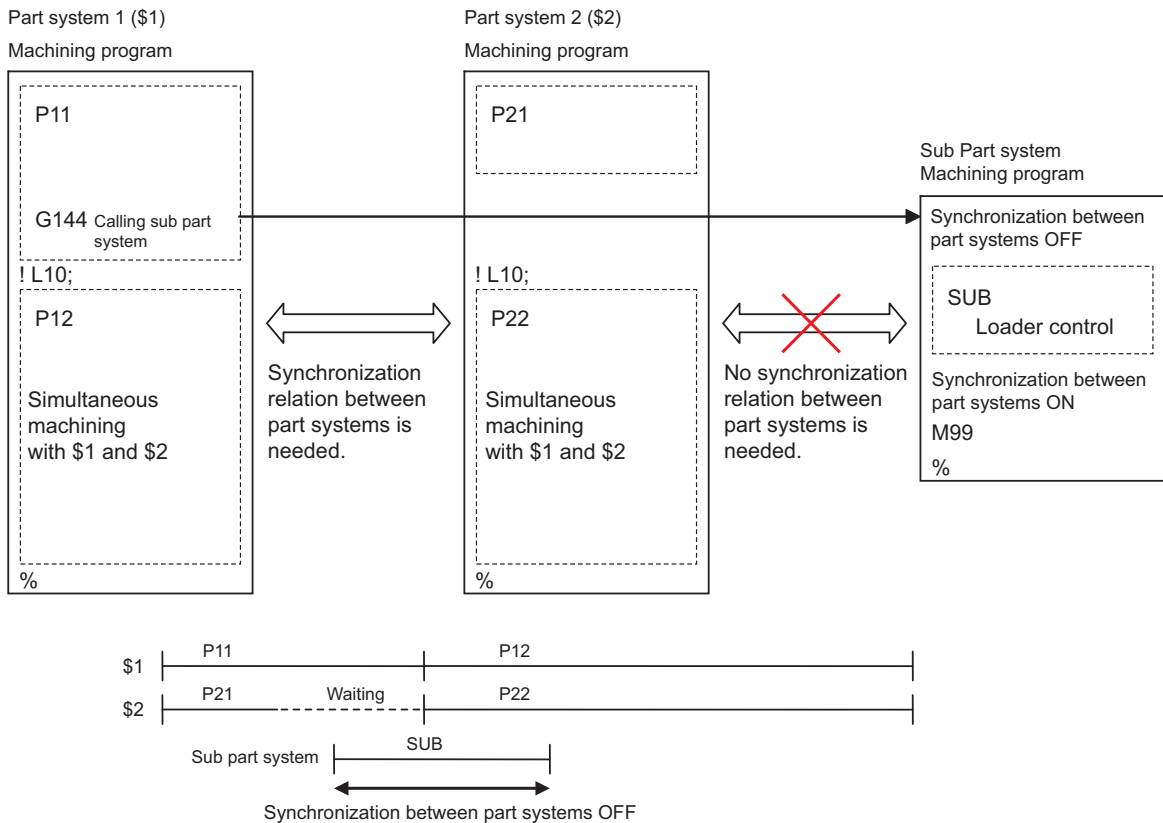

The behaviors with synchronization between part systems OFF is as follows:

Single block between part systems	- The pause is not made from other part systems. - The other part systems do not pause with block stop.
Dwell/miscellaneous function time override	- Override is invalid.

12.1.8.11 Sub Part System Control I

	M850W	M830W	M850S	M830S	M80W	M80 TypeA	M80 TypeB	E80 TypeA	E80 TypeB	C80
M	△	△	△	△	—	—	—	—	—	—
L	△	△	△	△	○	○	○	—	—	△

This function activates and operates any non-operating part system (sub part system) in the multi-part system.

Sub part system control I can be used in the same manner as calling subprogram in a non-operating part system. An auxiliary axis machining program can be controlled in the sub part system by commanding Sub part system control I (G122) from the main part system.

In the usage example below, the tool positioning starts to the machining start point at the same time (time T1) as the start of gantry retract by using Sub part system control I (G122) in the flow from feeding the workpiece to moving to cut start position in order to reduce the cycle time.

Select whether main part system or sub part system for each part system in Sub part system control I. When using a part system as sub part system, by setting the operation mode to "Sub part system I operation mode" with the PLC signal and commanding Sub part system control I (G122) from an operating part system, it is possible to activate the part system in the sub part system I operation mode as sub part system.

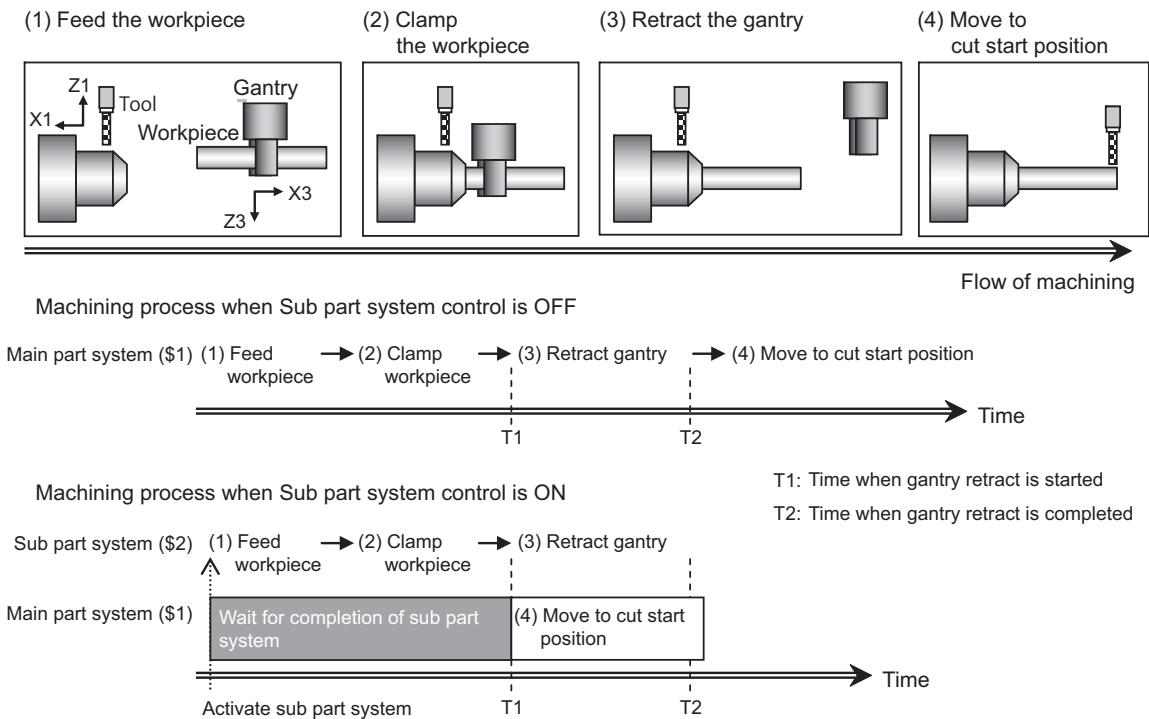

Command format

Activate sub part system

Command an activation of sub part systems by Sub part system control I with G122.

G122 A__P__Q__K__D__B__H__ Argument;	
Or, G122 <File name> P__Q__K__D__B__H__ Argument;	
A	: Program No. (1 to 99999999 or 100010000 to 199999998)
<File name>	: File name of program (up to 32 characters)
P	: Start sequence number (Head of program if omitted.)
Q	: End sequence number (To end of program (M99) if omitted.)
K	: Number of repetitions (1 to 9999)
D	: Synchronization control (0/1)
B	: Sub part system identification number (1 to 7)
H	: Sub part system reset type (0/1)
Argument	: Argument of sub part system local variable (Setting range of local variable (decimal point command is valid))

Complete sub part system

Command M99 in sub part system to complete an operation of sub part system.

M99 ;

Cancel the standby status for completion of sub part system

When a sub part system is activated in the completion wait method (D0 command), it is possible to cancel the standby status for completion of sub part system in a calling part system by commanding G145 in the sub part system program. G145 is ignored in a sub part system activated in the parallel control method (D1 command).

G145 ;

(Note) For G code list 6 and 7, replace G122 with G153 and G145 with G155.

12.1.8.12 Sub Part System Control II

	M850W	M830W	M850S	M830S	M80W	M80 TypeA	M80 TypeB	E80 TypeA	E80 TypeB	C80
M	—	—	—	—	—	—	—	—	—	—
L	Δ	Δ	Δ	Δ	○	○	—	—	—	Δ

This function activates and operates any non-operating part system (sub part system) in the multi-part system. Using sub part systems enables parallel operation between an operating program in main part system and a program called with Sub part system control II (G144).

Sub part systems does not have any controllable axes soon after the activation. When an axis is needed to be controlled in sub part system, command the arbitrary axis exchange control (G140) to give sub part system authorization to control the axis.

In the machine configuration below, when performing the back drill machining (machining (a)) and the cutting by tool (machining (b)), machining (a) and (b) are operated in order only with main part system, however machining (a) and (b) can be operated simultaneously by using the sub part system in addition to the main part system, resulting in a shorter cycle time. In the usage example below, T2 (time when machining (b) is completed) is shorter.

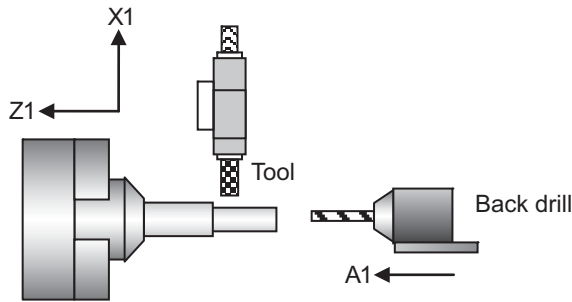

Machining process when Sub part system control is OFF

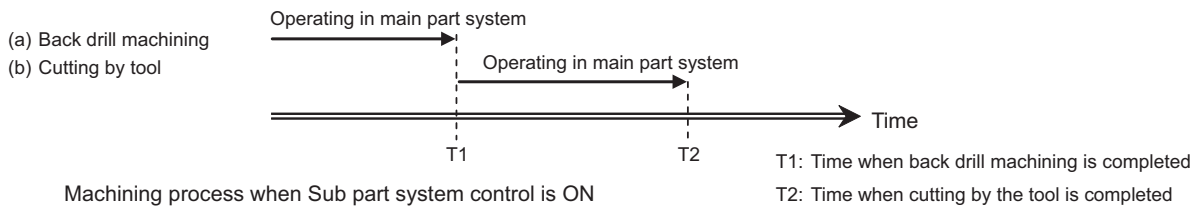

Machining process when Sub part system control is ON

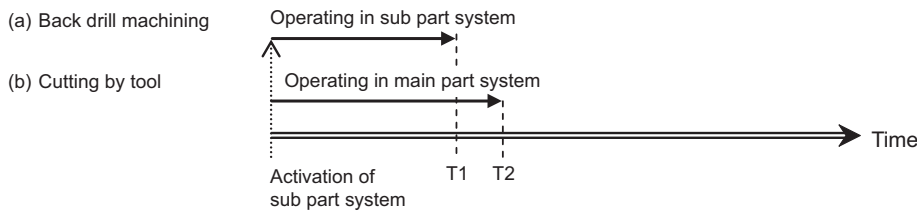

Command format

Activate sub part system

Command an activation of sub part systems by Sub part system control II with G144.

G144 A__P__Q__K__D__B__H__ Argument;	
Or, G144 <File name> P__Q__K__D__B__H__ Argument;	
A	: Program No. (1 to 99999999 or 100010000 to 199999998)
<File name>	: File name of program (up to 32 characters)
P	: Start sequence number (Head of program if omitted.)
Q	: End sequence number (To end of program (M99) if omitted.)
K	: Number of repetitions (1 to 9999)
D	: Synchronization control (0/1)
B	: Sub part system identification number (1 to 9999)
H	: Sub part system designation (1 to number of part system that can be used)
Argument	: Argument of sub part system local variable (Setting rage of local variable (decimal point command is valid))

Complete sub part system

Command M99 in sub part system to complete an operation of sub part system.

M99 ;

Cancel the standby status for completion of sub part system

When a sub part system is activated in the completion wait method (D0 command), it is possible to cancel the standby status for completion of sub part system in a calling part system by commanding G145 in the sub part system program. G145 is ignored in a sub part system activated in the parallel control method (D1 command).

G145 ;

(Note) For G code list 6 and 7, replace G144 with G154 and G145 with G155.

12.1.8.13 Loader Control Part System

	M850W	M830W	M850S	M830S	M80W	M80 TypeA	M80 TypeB	E80 TypeA	E80 TypeB	C80
M	○	○	○	○	—	—	—	—	—	—
L	—	—	—	—	—	—	—	—	—	—

This function operates a part system which is dedicated to a carrier loader (hereinafter referred to as "loader") in the machining center system. This function can be used to isolate the loader system from other controls, allowing your machine to operate in automatic operation with CNC machining program.

Compared to when a loader is operated in a workpiece machining part system, the cycle time can be improved because the loader-specific process (such as placing the next workpiece and carrying the machined workpiece) is performed independently while a workpiece is being machined.

12.1.9 Data Input/Output by Program

12.1.9.1 Parameter Input by Program

	M850W	M830W	M850S	M830S	M80W	M80 TypeA	M80 TypeB	E80 TypeA	E80 TypeB	C80
M	○	○	○	○	○	○	○	○	○	○
L	○	○	○	○	○	○	○	○	○	○

The parameters set from the setting and display unit can be changed in the machining programs.
Command format is as follows.

G10 L70 ; Data setting start command	
Pparameter No. Spart system No. Aaxis No. H □ data ;	Bit parameter;
Pparameter No. Spart system No. Aaxis No. Ddata ;	Numerical value parameter
Pparameter No. Spart system No. Aaxis No. <character string> ; ...	Character string parameter
G11 Data setting end command	

- (Note 1) The sequence of addresses in a block must be as shown above.
When an address is commanded two or more times, the last command will be valid.
- (Note 2) The part system No. is set in the following manner: "1" for 1st part system, "2" for 2nd part system, and so forth.
If the address S is omitted, the part system of the executing program will be applied.
As for the parameters common to part systems, the command of part system No. will be ignored.
- (Note 3) The axis No. is set in the following manner: "1" for 1st axis, "2" for 2nd axis, and so forth.
If the address A is omitted, the 1st axis will be applied.
As for the parameters common to axes, the command of axis No. will be ignored.
- (Note 4) Address H is commanded with the combination of setting data (0 or 1) and the bit designation (□) (0 to 7).
- (Note 5) Only the decimal number can be commanded with the address D.
The value that is smaller than the input setting increment (#1003 iunit) will be round off to the nearest increment.
- (Note 6) The character string must be put in angled brackets "<" and ">".
If these brackets are not provided, the program error (P33) will occur.
Up to 63 characters can be set.
- (Note 7) G10L70 or G11 must be commanded alone in a block. A program error (P33, P421) will occur if it is not commanded alone in a block.
- (Note 8) The following data cannot be changed with the G10 L70 command:
Tool compensation data, workpiece coordinate data, PLC switch, and PLC axis parameter.
- (Note 9) The settings of the parameters with (PR) in the parameter list will be enable after the power is turned OFF and ON. Refer to the parameter list in your manual.

12.1.9.2 Compensation Data Input by Program

	M850W	M830W	M850S	M830S	M80W	M80 TypeA	M80 TypeB	E80 TypeA	E80 TypeB	C80
M	○	○	○	○	○	○	○	○	○	○
L	○	○	○	○	○	○	○	○	○	○

The value of the workpiece coordinate systems selected can be set or changed by program commands.
 The tool offset amounts, which have been set from the setting and display unit, can be input by program commands.

(1) Workpiece coordinate system offset input

[M system]

The position of the workpiece coordinate systems selected by the G54 to G59 commands can be set or changed by program commands.

During the absolute command (G90) mode, the commanded offset amount serves as the new offset, whereas during the incremental command (G91) mode, the currently set offset plus the commanded offset serves as the new offset.

Gcode	Function
G10 L2 P0	External workpiece coordinate system setting
G10 L2 P1	Workpiece coordinate system 1 setting (G54)
G10 L2 P2	Workpiece coordinate system 2 setting (G55)
G10 L2 P3	Workpiece coordinate system 3 setting (G56)
G10 L2 P4	Workpiece coordinate system 4 setting (G57)
G10 L2 P5	Workpiece coordinate system 5 setting (G58)
G10 L2 P6	Workpiece coordinate system 6 setting (G59)
G10 L20 Pn (n=1 to 300)	Extended workpiece coordinate system setting (G54.1 P1 to P300)

Command format

G10 L2(L20) P__ X__ Y__ Z__ ;	
G10 L2(L20)	: Workpiece coordinate system setting command
P	: Workpiece coordinate system No.
X,Y,Z	: Setting values

(Note 1) L2 can be omitted. If the command P is omitted, the specified offset is treated as that of the currently selected workpiece coordinate system.

(Note 2) L20 is used to designate the extended workpiece coordinate system.

[L system]

When the command is given with absolute positions (X, Z and R), the offset is updated with the values. On the other hand, when the command is given with incremental positions (U, W and C), the currently set offset plus the commanded offset serves as the new offset.

Gcode	Function
G10 L2 P0	External workpiece coordinate system setting
G10 L2 P1	Workpiece coordinate system 1 setting (G54)
G10 L2 P2	Workpiece coordinate system 2 setting (G55)
G10 L2 P3	Workpiece coordinate system 3 setting (G56)
G10 L2 P4	Workpiece coordinate system 4 setting (G57)
G10 L2 P5	Workpiece coordinate system 5 setting (G58)
G10 L2 P6	Workpiece coordinate system 6 setting (G59)
G10 L20 Pn (n=1 to 48)	Extended workpiece coordinate system setting (G54.1 P1 to P48)

Command format

G10 L2(L20) P__ X__ (U__) Z__ (W__) ;	
G10 L2(L20)	: Workpiece coordinate system setting command
P	: Compensation No.
X,Z	: Compensation amount for each axis(absolute)
U,W	: Compensation amount for each axis(incremental)

(Note 1) L2 can be omitted. If the command P is omitted, the specified offset is treated as that of the currently selected workpiece coordinate system.

(Note 2) L20 is used to designate the extended workpiece coordinate system.

(2) Tool compensation input

The tool compensation amounts, which have been set from the setting and display unit, can be input by program commands.

The command format differs between the [M system] and the [L system].

[M system]

Type I

G code	Function
G10 L10	Tool compensation amounts

TypeII

Gcode	Function
G10 L10	Tool length shape compensation amount
G10 L11	Tool length wear compensation amount
G10 L12	Tool radius shape compensation amount
G10 L13	Tool radius wear compensation amount

Command format

G10 L_ P_ R_ ;	
G10 L	: Command for setting compensation amount
P	: Compensation No.
R	: Compensation amount

[L system]

Gcode	Function
G10 L10	Tool length compensation amount
G10 L11	Tool wear compensation amount

Command format

G10 L10(L11) P_ X_ (U_) Z_ (W_) [Additional axis]_ [2nd additional axis]_ R_ (C_) Q_ ;	
G10 L10(L11)	: Command for setting compensation amount
P	: Compensation No.
X,Z	: Compensation amount for each axis (absolute)
U,W	: Compensation amount for each axis (incremental)
Additional axis	: Additional axis compensation amount (absolute)
2nd additional axis	: 2nd additional axis compensation amount (absolute)
R	: Nose R compensation amount (absolute)
C	: Nose R compensation amount (incremental)
Q	: Hypothetical tool nose point

(Note 1) L11 can be omitted.

(3) M system turning tool compensation input

By setting the parameter in M system, the compensation amount, Nose R compensation amount and tool nose point for three basic axes can be written with the following G10 format. In the absolute command (G90) mode, the commanded compensation amount is new compensation amount. In the incremental command (G91) mode, new compensation amount is obtained by adding the commanded compensation amount to the currently set compensation amount.

Command format

Shape compensation

G10 L12 P__X__Y__Z__R__Q__ ;	
P	: Tool shape compensation number (1 to the number of tool offset sets)
X	: X axis compensation amount
Y	: Y axis compensation amount
Z	: Z axis compensation amount
R	: Tool nose radius compensation amount
Q	: Hypothetical tool nose point number

Wear compensation

G10 L13 P__X__Y__Z__R__Q__ ;	
P	: Wear compensation number (1 to the number of tool offset sets)
X	: X axis compensation amount
Y	: Y axis compensation amount
Z	: Z axis compensation amount
R	: Tool nose radius compensation amount
Q	: Hypothetical tool nose point number

(4) Cancelling the compensation input

Command format

G11 ;

12.1.9.3 Tool/Material Shape Input by Program

	M850W	M830W	M850S	M830S	M80W	M80 TypeA	M80 TypeB	E80 TypeA	E80 TypeB	C80
M	○	○	○	○	○	○	○	○	○	○
L	○	○	○	○	○	○	○	○	○	○

Tool shape data on the tool management screen (M system) and workpiece shape data (L system) of the 3D solid program check (hereinafter referred to as 3D check) can be set with the machining program. There is no need to input the tool/workpiece shape on the screen for 3D check.

(1) L100 command format

Tool shape data on the tool management screen can be set by the machining program with this function.

G10 L100 ; Data setting start command	
P__T__K__D__H__I__J__C__ ; Data setting command	
G11 ; Data setting end command	
P	: Data number (The maximum number varies depending on the number of tool management data sets.)
T	: Tool number (0 to 99999999)
K	: Type
D	: Shape data 1 (decimal point allowed)
H	: Shape data 2 (decimal point allowed)
I	: Shape data 3 (decimal point allowed)
J	: Shape data 4 (decimal point allowed)
C	: Tool color

(Note 1) Omitted addresses cannot be set.

(Note 2) Omitting address P or T causes the program error.

(Note 3) On graphic check of M800 series or M80W, only drawing is reflected to the graphic check. Tool shape data will not be rewritten.

(Note 4) On graphic check of M80/E80 series, tool shape data will be rewritten.

(Note 5) This function can be used only with the M system.

(2) L101 command format

Workpiece shape data can be set by the machining program for 3D solid program check with this function.

G10 L101 ; Data setting start command

C__R__D__E__L__A__K__W__F__P__H__I__J__ ; Data setting command

G11 ; Data setting end command

C	: Workpiece shape
R	: Number of angles (3 to 99)
D	: Outside diameter of workpiece (0.001 to 99999.999 mm, 0.0001 to 9999.9999 inch)
E	: Inside diameter of workpiece (0.001 to 99999.999 mm, 0.0001 to 9999.9999 inch)
L	: Workpiece length (0.001 to 99999.999 mm, 0.0001 to 9999.9999 inch)
A	: Installation angle (0.000 to 359.999°)
K	: Front face workpiece zero point position Z (-1 or 0.000 to 99999.999 mm, -1 or 0.0000 to 9999.9999 inch)
W	: Back face workpiece zero point position Z (-1 or 0.000 to 99999.999 mm, -1 or 0.0000 to 9999.9999 inch)
F	: Workpiece color
P	: Machining surface color
H	: Tapping/Thread machining surface color
I	: Interference surface color
J	: Cross-section color

(Note 1) Omitted addresses cannot be set.

(Note 2) Omitting address C causes the program error.

(Note 3) On graphic check of M800 series or M80W, only drawing is reflected to the graphic check. Workpiece shape data will not be rewritten.

(Note 4) On graphic check of M80/E80 series, workpiece shape data will be rewritten.

(Note 5) This function can be used only with the L system.

12.1.9.5 API Section and Sub-section Nos. Input/Output by Program

	M850W	M830W	M850S	M830S	M80W	M80 TypeA	M80 TypeB	E80 TypeA	E80 TypeB	C80
M	○	○	○	○	○	○	○	○	○	—
L	○	○	○	○	○	○	○	○	○	—

NC internal data can be read/written by specifying the section number, sub-section number, part system number and axis number using system variables.

12.1.9.6 R-Navi Data Input by Program

	M850W	M830W	M850S	M830S	M80W	M80 TypeA	M80 TypeB	E80 TypeA	E80 TypeB	C80
M	△	△	△	△	○	○	—	—	—	—
L	—	—	—	—	—	—	—	—	—	—

This function enables the R-Navi setup parameters to be configured from a machining program.

After the parameters have been configured from the program, you can check the values or select the machining surface from the setup screen.

Command format

G10 L110 ;	Workpiece data setting
G10 L111 ;	Machining surface data setting

Refer to "17.2.17 R-Navi" for details.

12.1.10 Machining Modal

12.1.10.1 Tapping Mode

	M850W	M830W	M850S	M830S	M80W	M80 TypeA	M80 TypeB	E80 TypeA	E80 TypeB	C80
M	○	○	○	○	○	○	○	○	○	○
L	○	○	○	○	○	○	○	○	○	○

When tapping mode commands are issued, the NC system is set to the following internal control modes required for tapping.

1. Cutting override is fixed at 100%.
2. Deceleration commands at joints between blocks are invalid.
3. Feed hold is invalid.
4. Single block is invalid.
5. "In tapping mode" signal is output.

G code	Function
G63	Tapping mode ON

The tapping mode command will be canceled with the following commands:

- Exact stop check mode (G61)
- Automatic corner override (G62)
- Cutting mode (G64)
- High-accuracy control mode command (G61.1/G08P1) [M system]

The machine is in the cutting mode status when its power is turned ON.

12.1.10.2 Cutting Mode

	M850W	M830W	M850S	M830S	M80W	M80 TypeA	M80 TypeB	E80 TypeA	E80 TypeB	C80
M	○	○	○	○	○	○	○	○	○	○
L	○	○	○	○	○	○	○	○	○	○

When a cutting mode command is issued, the NC system is set to the cutting mode that enables smooth cutting surface to be achieved. In this mode, the next block is executed continuously without the machine having to decelerate and stop between the cutting feed blocks: this is the opposite of what happens in the exact stop check mode (G61).

G code	Function
G64	Cutting mode ON

The cutting mode command will be canceled with the following commands:

- Exact stop check mode (G61)
- Automatic corner override (G62)
- Tapping mode (G63)
- High-accuracy control mode command (G61.1) [M system]

The machine is in the cutting mode status when its power is turned ON.

12.1.11 High-speed Parts Machining

12.1.11.1 Rapid Traverse Block Overlap

	M850W	M830W	M850S	M830S	M80W	M80 TypeA	M80 TypeB	E80 TypeA	E80 TypeB	C80
M	△	△	△	△	○	○	○	—	—	△
L	△	△	△	△	○	○	○	—	—	△

This function enables the next block to start (overlap) without waiting for positioning (G00) or reference position return (G28/G30). Consequently, cycle time of machining including operation of positioning (G00) or reference position return (G28/G30) can be reduced.

Adjust the overlap amount with command by machining program or with the parameter, and specify it as in-position width for rapid traverse block overlap.

Also, the operation does not decelerate between blocks if the movement command continues in same direction.

The overlap is also valid when the block after G00 is G01 instead of G00 or G28/G30 and it is invalid when G00 or G28/G30 is commanded after G28 continuously.

This function has two modes. The modes can be selected with the parameter.

Mode 1: The cycle time can be reduced in normal acceleration/deceleration control.

Mode 2: It is also effective to reduce the cycle time in pre-interpolation acceleration/deceleration control.

(Recommended)

Example of application of rapid traverse block overlap in tool exchange operation

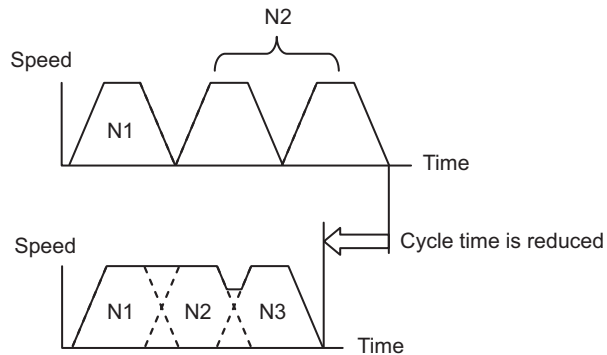
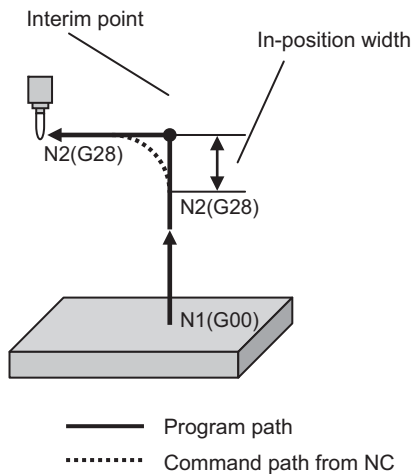

Example of application of rapid traverse block overlap in continuous drilling operation

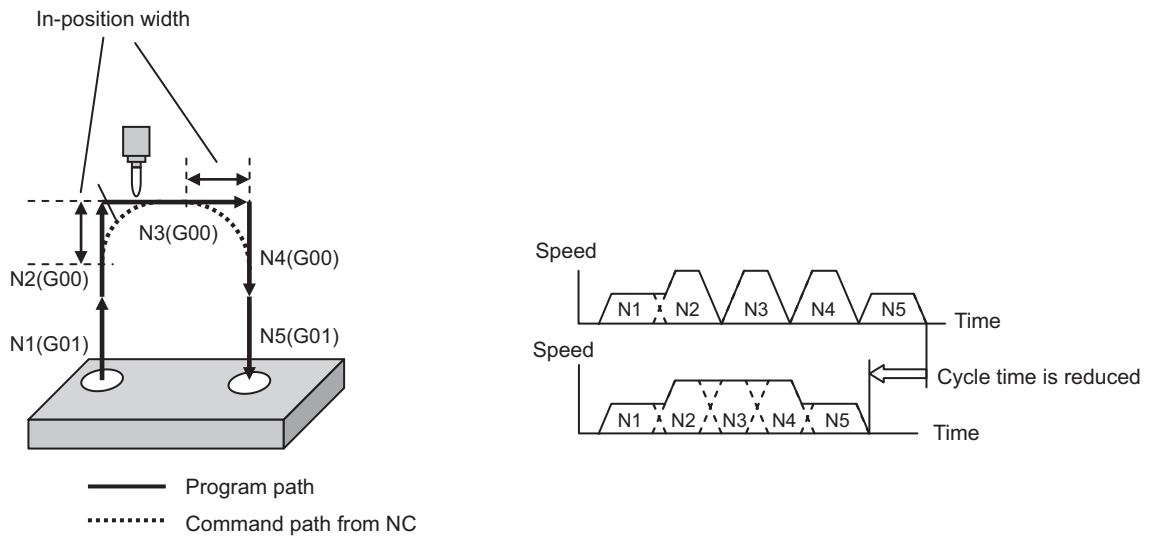

Command format

The command format to switch the rapid traverse block overlap function for G00 to valid/invalid is as follows:

```
G0.5 P1 J__ K__ ; Rapid traverse block overlap function for G00 ON

J          : Liner axis in-position width (0.000 to 1000.000 (mm))
K          : Rotary axis in-position width (0.000 to 1000.000 (°))

G0.5 P1 J__ K__ ; Rapid traverse block overlap function for G00 OFF
```

12.2 Machining Accuracy Support Functions

12.2.1 Automatic Corner Override

	M850W	M830W	M850S	M830S	M80W	M80 TypeA	M80 TypeB	E80 TypeA	E80 TypeB	C80
M	○	○	○	○	○	○	○	○	○	○
L	○	○	○	○	○	○	○	○	○	○

When cutting with tool radius compensation, this function applies feedrate override automatically to decrease cutting load at the inside corner cutting or the inside cutting of corner R.

There are automatic corner override (G62) and inside arc override as the automatic corner override.

Automatic corner override (G62) is valid until the tool radius compensation cancel (G40), exact stop check mode (G61), high-accuracy control mode (G61.1), tapping mode (G63), or cutting mode (G64) command is issued.

Inside arc override is valid without automatic corner override (G62) during tool radius compensation mode (G41/G42).

This can also be enabled with the parameter setting when the tool radius compensation mode (G41/G42) and the automatic corner override mode (G62) are active.

Automatic corner override (G62) inside corner

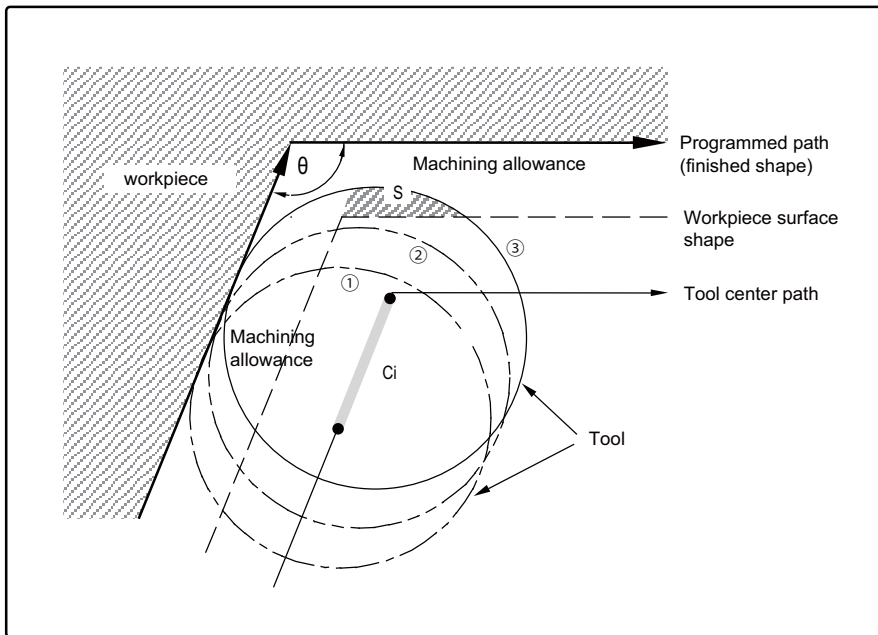

θ : Max. angle at inside corner

Ci : Deceleration range (IN)

Operation

(a) When G62 command is not given :

When the tool moves in the order of (1) -> (2) -> (3) in the figure above, the machining allowance at (3) is larger than that at (2) by an amount equivalent to the area of shaded section S and so the tool load increases.

(b) When G62 command is given :

When the inside corner angle θ in the figure above is less than the angle set in the parameter, the override set into the parameter is automatically applied in the deceleration range Ci.

Command format

G62; Automatic corner override

12.2.2 Deceleration Check

This function leads the machine to decelerate and stop at the join between axis movement blocks before executing the next block. This is effective to alleviate the machine shock and prevent the corner rounding when the feed rate of the control axis changes suddenly.

There are three methods for deceleration check: command deceleration check method, smoothing check method and in-position check method.

Without deceleration check

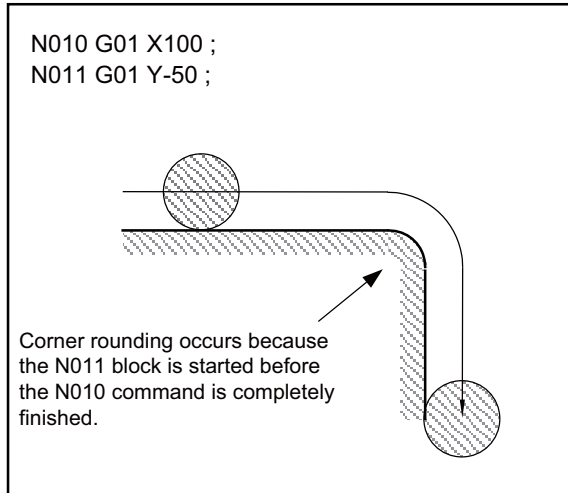

With deceleration check

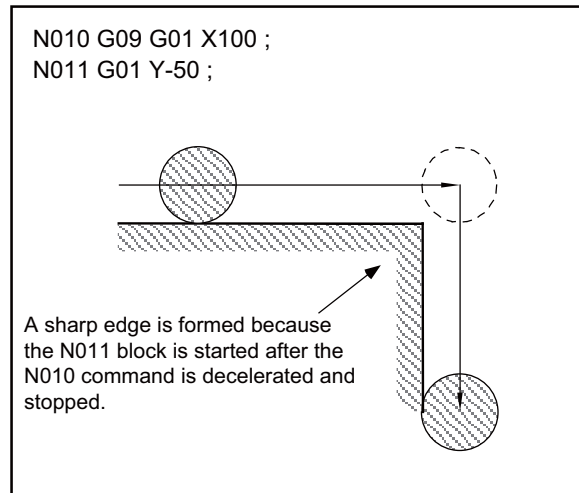

The conditions for executing deceleration check are described below.

(1) Deceleration check in the rapid traverse mode

In the rapid traverse mode, the deceleration check is always performed when block movement is completed before executing the next block.

(2) Deceleration check in the cutting feed mode

In the cutting feed mode, the deceleration check is performed at the end of block when any of the conditions below is applicable before executing the next block.

- (a) When G61 (exact stop check mode) is selected.
- (b) When the G09 (exact stop check) is issued in the same block.
- (c) When the error detect switch (PLC signal) is ON.

The following deceleration check methods can be selected with the parameter to each feed command during rapid traverse command and cutting feed command.

(1) Command deceleration check method

The deceleration is completed after the deceleration check time (Note) has passed after the interpolation.

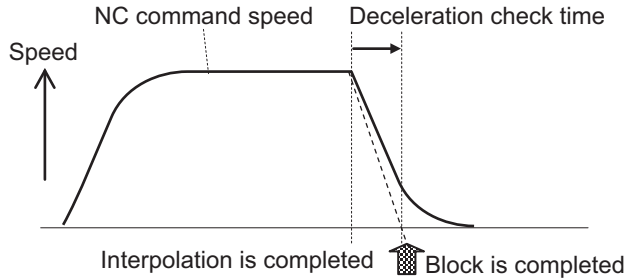

(2) Smoothing check method

The deceleration is completed after the deceleration check time (Note) has passed after the interpolation and all axes smoothing has become zero.

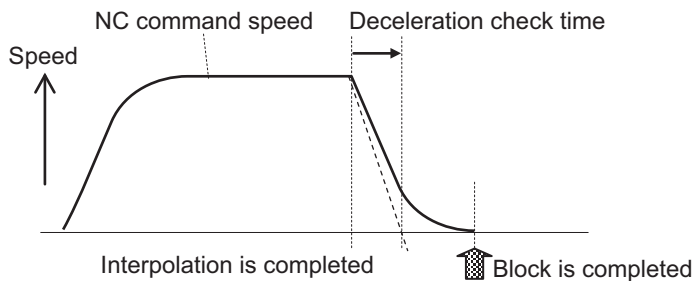

(3) In-position check method

The deceleration is completed after the deceleration check time (Note) had passed after the interpolation, all axes smoothing has become zero and all axes have become in-position.

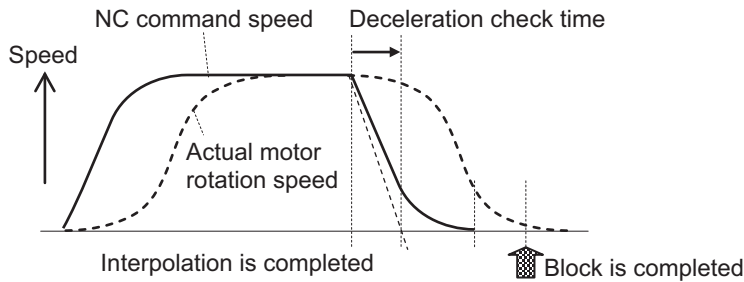

(Note) Deceleration check time: automatically calculated from the acceleration/deceleration mode and time constant.

12.2.2.1 Exact Stop Check Mode

	M850W	M830W	M850S	M830S	M80W	M80 TypeA	M80 TypeB	E80 TypeA	E80 TypeB	C80
M	○	○	○	○	○	○	○	○	○	○
L	○	○	○	○	○	○	○	○	○	○

A deceleration check is performed when the G61 (exact stop check mode) command has been selected.

G61 is a modal command. The deceleration is applied at the end points of each block to all the cutting commands (G01 to G03) subsequent to G61 and the in-position status is checked.

Refer to "12.2.2 Deceleration Check" for details on the deceleration check.

12.2.2.2 Exact Stop Check

	M850W	M830W	M850S	M830S	M80W	M80 TypeA	M80 TypeB	E80 TypeA	E80 TypeB	C80
M	○	○	○	○	○	○	○	○	○	○
L	○	○	○	○	○	○	○	○	○	○

A deceleration check is performed when the G09 (exact stop check) command has been designated in the same block.

The G09 command should be issued in the same block as the cutting command. It is an unmodal command.

Refer to "12.2.2 Deceleration Check" for details on the deceleration check.

12.2.2.3 Error Detection

	M850W	M830W	M850S	M830S	M80W	M80 TypeA	M80 TypeB	E80 TypeA	E80 TypeB	C80
M	○	○	○	○	○	○	○	○	○	○
L	○	○	○	○	○	○	○	○	○	○

To prevent rounding of a corner during cutting feed, the operation can be changed by turning an external signal switch ON so that the axis decelerates and stops once at the end of the block and then the next block is executed.

The deceleration stop at the end of the cutting feed block can also be commanded with a G code.

Refer to "12.2.2 Deceleration Check" for details on the deceleration check.

12.2.2.4 Programmable In-position Check

	M850W	M830W	M850S	M830S	M80W	M80 TypeA	M80 TypeB	E80 TypeA	E80 TypeB	C80
M	○	○	○	○	○	○	○	○	○	○
L	○	○	○	○	○	○	○	○	○	○

"," address is used to designate the in-position width for a linear interpolation command from the machining program. The in-position width designated with a linear interpolation command is valid only in cases when the deceleration check is performed, such as:

- When the error detect switch is ON.
- When the G09 (exact stop check) command has been designated in the same block.
- When the G61 (exact stop check mode) command has been selected.

G01 Xx1 Zz1 Ff1 ,li1 ;
 Xx1, Zz1 : Linear interpolation coordinate position of each axis
 Ff1 : Feed rate
 ,li1 : In-position width

As with linear interpolation, "," address is used to designate the in-position width for a positioning command from the machining program.

G00 Xx1 Zz1 ,li1 ;
 Xx1, Zz1 : Positioning coordinate position of each axis
 ,li1 : In-position width

In-position check operation

As for G01, after it is verified that the position error of the block in which the deceleration check is performed by the linear interpolation command (G01) is less than the in-position width of this command, the execution of the next block is commenced.

As for G00, after it is verified that the position error of the positioning command (G00: rapid traverse) is less than the in-position width of this command, the execution of the next block is commenced.

12.2.2.5 Automatic Error Detection

	M850W	M830W	M850S	M830S	M80W	M80 TypeA	M80 TypeB	E80 TypeA	E80 TypeB	C80
M	—	—	—	—	—	—	—	—	—	—
L	△	△	△	△	—	—	—	—	—	—

This function is effective to reduce the extension of cycle time for the cutting at the corner and realize the high edge accurate machining.

12.3 High-speed and High-accuracy Functions [kBPM: k Block per Minute]

12.3.1 High-speed Machining Mode

12.3.1.1 High-speed Machining Mode I (G05P1) Maximum [kBPM]

	M850W	M830W	M850S	M830S	M80W	M80 TypeA	M80 TypeB	E80 TypeA	E80 TypeB	C80
M	△ 33.7	△ 33.7	△ 33.7	△ 33.7	○ 33.7	○ 33.7	○ 16.8	—	—	△ 33.7
L	△ 33.7	△ 33.7	△ 33.7	△ 33.7	○ 33.7	○ 33.7	—	—	—	△ 33.7

This function runs a machining program that approximates a free curve with fine segments at a high speed. This is effective in increasing the speed of machining dies with a free curve. The command format is as follows.

G05 P1	: High-speed machining mode I start
G05 P0	: High-speed machining mode I cancel

In addition to the G05P0 command, the high-speed machining mode I is canceled with the following commands.

- High-speed machining mode II (G05P2)
- High-speed high-accuracy control I (G05.1Q1)
- High-speed high-accuracy control II (G05P10000)

Fine segment capacity

G1 block fine segment capacity (unit: kBPM)

Mode	Command	Maximum feed rate when G1 block is executed
High-speed machining mode I	G05 P1	33.7 (M800W/M800S/M80W/M80 TypeA/C80) 16.8 (M80 TypeB)

The above performance applies under the following conditions.

- 6-axis system (including spindle) or less
- 1-part system
- 3 axes or less commanded simultaneously in G01
- Block containing only axis name and movement amount (Does not contain macro or variable command)
- During G61.1 high-accuracy control mode or during cutting mode (G64)

It may not be possible to attain the specified feed rate if deviated from the above conditions.

- (1) During the high-speed machining mode I, the blocks are pre-read. If the length of the block is sufficiently short in respect to the command speed, and enough to be completed with one interpolation calculation, several blocks may be combined and converted into a block length that can be completed with one interpolation.

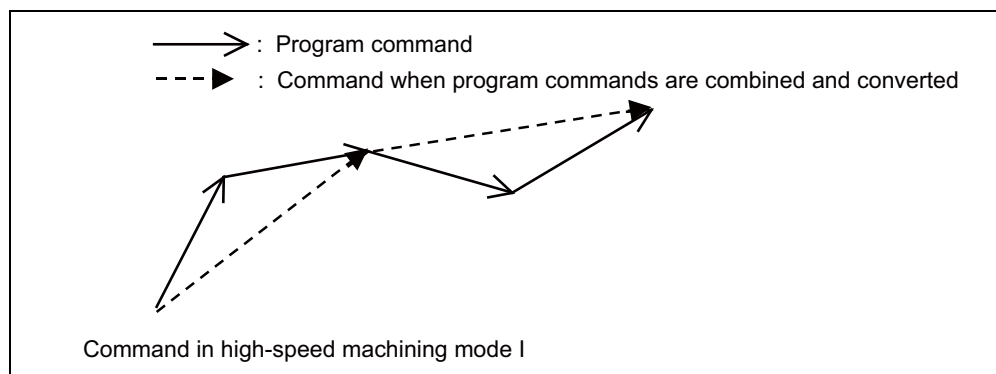

- (2) Override, maximum cutting speed clamp, single block operation, dry run, manual interruption, graphic trace and high-accuracy control mode are valid even during the high-speed machining mode I.

12.3.1.2 High-speed Machining Mode II (G05P2) Maximum [kBPM]

	M850W	M830W	M850S	M830S	M80W	M80 TypeA	M80 TypeB	E80 TypeA	E80 TypeB	C80
M	△ 168	△ 168	△ 168	△ 168	○ 67.5	○ 67.5	○ 67.5	—	—	△ 67.5
L	△ 168	△ 168	△ 168	△ 168	○ 67.5	○ 67.5	—	—	—	△ 67.5

This function runs a machining program that approximates a free curve with fine segments at a high speed.

Higher fine segment processing capacity can make the cutting speed faster, resulting in reducing the cycle time and improving the quality of the machining surface.

This function can be used simultaneously in up to two part systems.

Command format

G05 P2	: High-speed machining mode II start
G05 P0	: High-speed machining mode II cancel

In addition to the G05P0 command, the high-speed machining mode II is canceled with the following commands.

- High-speed machining mode I (G05P1)
- High-speed high-accuracy control I (G05.1Q1)
- High-speed high-accuracy control II (G05P10000)
- High-speed high-accuracy control III (G05P20000)

Fine segment capacity

The following is the fine segment capacity while high-speed machining mode II is valid.

Fine segment processing capacity (unit: kBPM)

M: Machining center system

L: Lathe system

Number of part systems/ Number of axes	Number of high-speed high-accuracy control- enabled part systems	M850/M830		M80W/M80 TypeA		M80 TypeB	
		M	L	M	L	M	L
1-part system	1-part system	168	168	67.5	67.5	67.5	— (*2)
2-part system	1-part system	100	100	67.5	67.5	67.5	— (*2)
	2-part system	67.5	67.5	33.7	33.7	33.7	— (*2)
4-part system Less than 16 axes	1-part system	— (*1)	33.7	— (*1)	— (*1)	— (*1)	— (*2)
	2-part system	— (*1)	33.7	— (*1)	— (*1)	— (*1)	— (*2)
5-part system or more or 17 axes or more	1-part system	— (*1)	16.8	— (*1)	— (*1)	— (*1)	— (*2)
	2-part system	— (*1)	16.8	— (*1)	— (*1)	— (*1)	— (*2)

(*1) The maximum number of part systems is 2

(*2) There is no specifications for high-speed machining mode II.

(Note) The above performance applies under the following conditions.

- 3 axes or less commanded simultaneously in G01
- Block containing only axis name and movement amount (Does not contain macro or variable command)
- During tool radius compensation OFF (G40)

It may not be possible to attain the specified feed rate if deviated from the above conditions.

12.3.2 High-accuracy Control

12.3.2.1 High-accuracy Control (G61.1/G08)

	M850W	M830W	M850S	M830S	M80W	M80 TypeA	M80 TypeB	E80 TypeA	E80 TypeB	C80
M	△	△	△	△	○	○	○	○	—	△
L	△	△	△	△	○	○	○	○	○	△

Machining errors caused by delays in control systems can be inhibited. This function is useful for machining which needs to make an edge at a corner or reduce an error from an inner route of curved shape. In high-accuracy control, acceleration/deceleration is performed not to cause machining error by pre-reading blocks and acceleration/deceleration is automatically performed according to a machining shape so that the machining error is inhibited with minimizing an extension of machining time.

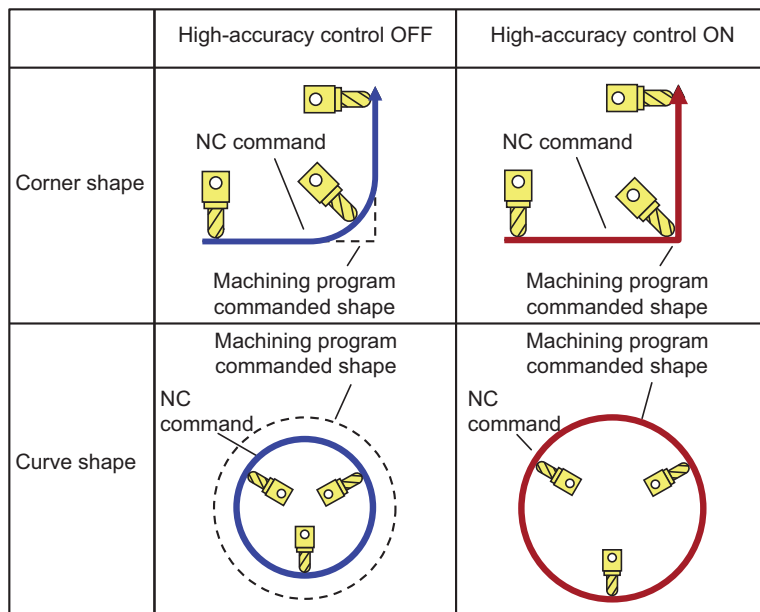

High-accuracy control is valid in High-accuracy control command (G08P1/G61.1), High-speed high-accuracy control I command (G05.1Q1), High-speed high-accuracy control II command (G05P10000), High-speed high-accuracy control III command (G05P20000) and Spline interpolation command (G61.2).

One or more of the functions in the table below must be ON. Program error occurs if the high-accuracy control is commanded with all of functions OFF status.

Function name	Details
High-accuracy control	This function enables High-accuracy control.
High-speed high-accuracy control I	This function enables High-speed high-accuracy control I.
High-speed high-accuracy control II	This function enables High-speed high-accuracy control II.
High-speed high-accuracy control III	This function enables High-speed high-accuracy control III.
Spline interpolation	This function enables Spline interpolation.

Command format

High-accuracy control ON

```
G61.1 ;
or, G08 P1;
```

High-accuracy control OFF

```
G08 PO ;
or, G command in G code group 13 expect G61.1
```

High-accuracy control can be cancelled with either command regardless of enabled high-accuracy control.

High-accuracy control inhibits machining errors with minimizing an extension of machining time using the following functions.

- (1) Acceleration/deceleration before interpolation
- (2) Optimum speed control
- (3) Vector accuracy interpolation
- (4) Feed forward control
- (5) S-pattern filter control

(1) Acceleration/deceleration before interpolation

Velocity waveform is smoothed by performing acceleration/deceleration control on movement commands to inhibit shocks caused by rapid acceleration at the machine movement start/stop. However, if the high-accuracy control is OFF, a corner rounding may occur at the joint between blocks or a path error may occur for the commanded shape which has been described in machining program because the acceleration/deceleration process is performed after the interpolation.

If the high-accuracy control is ON, the acceleration/deceleration process is performed before the interpolation to solve the problems mentioned above. This acceleration/deceleration before interpolation enables machining with a faithful path to the commanded shape of machining program. Furthermore, the acceleration/deceleration time can be reduced because the constant-gradient acceleration/deceleration is performed for the acceleration/deceleration before interpolation.

(2) Optimum speed control

When the moving direction is changed on the corner, arc, etc., acceleration corresponding to the amount of change and the feedrate is generated. When the acceleration is large, there is a possibility of machine vibration and it may remain stripes on the machining surface.

In the high-accuracy control mode, the deceleration control (optimum speed control) is performed to keep the generated acceleration under the allowance which has been designed with the parameter so that the problem mentioned above can be solved. The optimum speed control suppresses the machine vibration and enables highly accurate machining while minimizing the extension of cycle time.

(3) Vector accuracy interpolation

When a fine segment is commanded and the angle between the blocks is extremely small (when not using corner deceleration), interpolation can be carried out more smoothly using the vector accuracy interpolation.

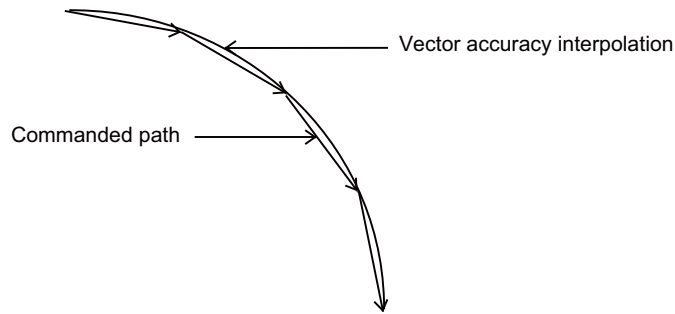

(4) Feed forward control

This function reduces path errors caused by delay of servo systems. Path errors caused by acceleration/ deceleration of NC can be eliminated by acceleration/deceleration before interpolation, however errors caused by delay of servo systems cannot be eliminated by acceleration/deceleration before interpolation. Therefore, when the arc shape of radius R (mm) is machined at speed F (mm/min) as the figure (a) below, for instance, the lag time occurs between the NC commanded speed and the actual tool speed in amount of the servo system time constant and the path error ΔR (mm) occurs. Feed forward control generates the command value taking the delay of servo systems as shown in figure (b) below so that the path error caused by delay of servo systems can be inhibited.

(a) NC command and actual tool movement during Feed forward control OFF

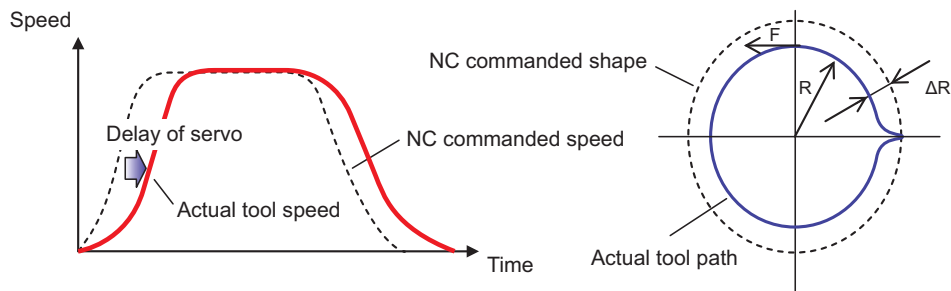

(b) NC command and actual tool movement during Feed forward control ON

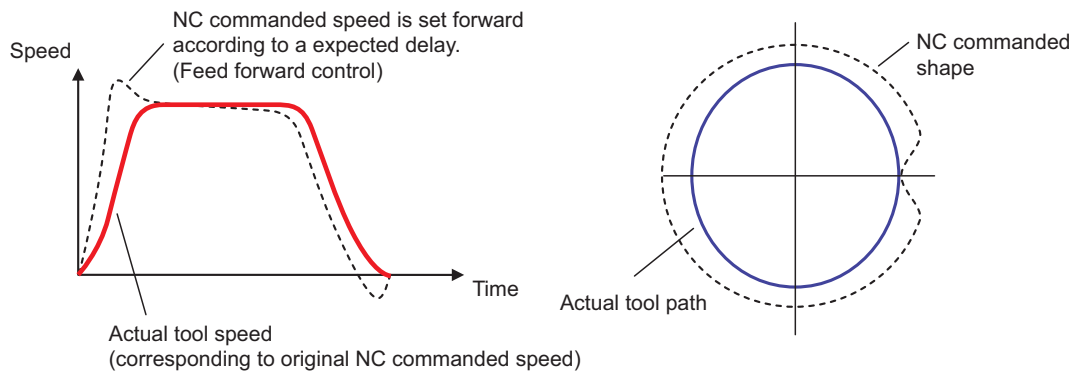

(5) S-pattern filter control

S-pattern filter (soft acceleration/deceleration filter) is the function that inhibits the machine vibration by smoothing a velocity waveform. There are types of filters as follows:

- G1/G0 S-pattern filter
- Jerk filter
- S-pattern filter 2

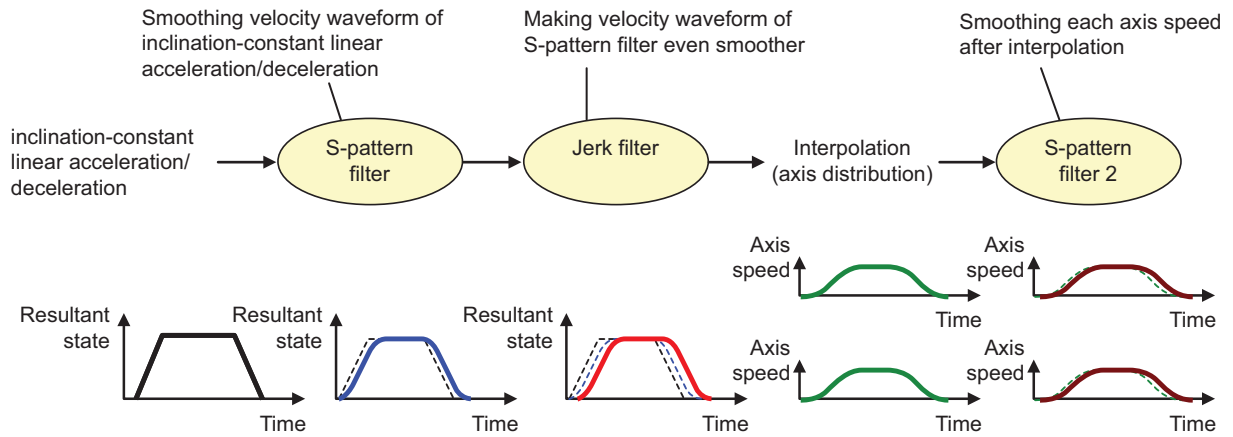

12.3.2.2 Multi-part System Simultaneous High-accuracy Control

	M850W	M830W	M850S	M830S	M80W	M80 TypeA	M80 TypeB	E80 TypeA	E80 TypeB	C80
M	△	△	△	△	○	○	—	—	—	△
L	△	△	△	△	—	—	—	—	—	—

* Up to two part systems.

High-accuracy control and high-speed machining mode are available respectively in all part systems, however, the simultaneous usage of high-accuracy control and high-speed machining mode (including High-speed high-accuracy control I/II/III) are available only in part systems which are limited by the parameter "High-speed high-accuracy enabled part system". The high-accuracy control and high-speed machining mode can be used simultaneously in the part system which is set to "1" for "High-speed high-accuracy enabled part system". The program error (P129) occurs when the high-accuracy control and high-speed machining mode are used simultaneously in the part system which is set to "0" for "High-speed high-accuracy enabled part system".

Note that up to 2 part systems can be set to "1" for "High-speed high-accuracy enabled part system". If 3 or more part systems are set to "1", MCP alarm (Y51) occurs. If all part systems are set to "0" for "High-speed high-accuracy enabled part system", only the first part system is handled as the one with the parameter set to "1".

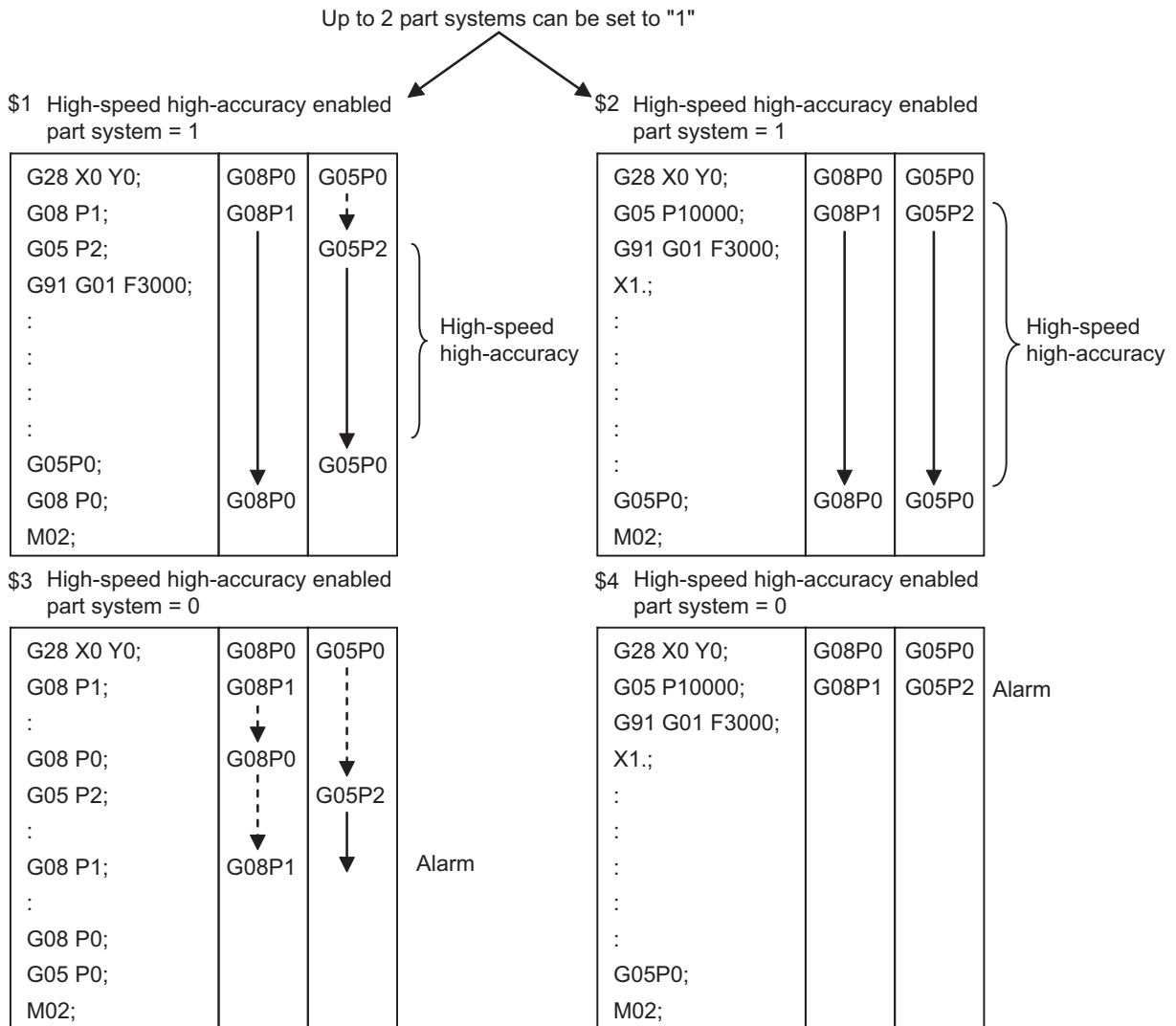

(Note) It is limited also in G61.1 command.

12.3.2.3 SSS Control

	M850W	M830W	M850S	M830S	M80W	M80 TypeA	M80 TypeB	E80 TypeA	E80 TypeB	C80
M	△	△	△	△	○	○	○	— (*1)	—	△
L	△	△	△	△	○	○	○	— (*1)	— (*1)	—

(*1) eSSS

Machining programs that approximate a freely curved surface with fine segments are run at high speed and with high accuracy. This function enables machining with less scratches and streaks on the cutting surface compared to the conventional high-accuracy control function.

When the speed control with reference to the angle between two blocks, such as the conventional high-accuracy control "Optimum corner deceleration", is applied, the acceleration and deceleration may be frequently repeated for local steps and errors, resulting in scratches and streaks on the cutting surface.

The SSS (Super Smooth Surface) control uses the global paths information in addition to the angle information between two blocks. Thus, optimum speed control that is not adversely affected by minute steps or waviness is possible. This reduces the parts which get scratch like marks and streaks on the cutting surface.

Multiple part systems simultaneous high-accuracy function is required to conduct the SSS control in the second or following part systems.

[Features of SSS control]

- (1) This is valid for machining a mold with a smooth shape using a fine segment program.
- (2) This speed control is not easily affected by the error found in the path.
- (3) Even if corner deceleration is not required, the speed is clamped if the predicted acceleration is high.
(The clamp speed can be adjusted with the parameter "Clamp speed coefficient".)

The length of the path direction recognized with SSS control can be adjusted with the parameter. The range is increased as the setting value increases, and the effect of the error is reduced.

(Note 1) When using this function, one of the following SSS-controlled high-accuracy control functions is required, as well.

- High-accuracy control (G61.1)
- High-accuracy control (G08P1)
- High-speed high-accuracy control I (G05.1Q1)
- High-speed high-accuracy control II (G05P10000)
- High-speed high-accuracy control III (G05P20000)

(Note 2) The performance of fine-segment execution during SSS control differs depending on the type of high-accuracy control mode and machine model to be combined.

12.3.2.4 Tolerance Control

	M850W	M830W	M850S	M830S	M80W	M80 TypeA	M80 TypeB	E80 TypeA	E80 TypeB	C80
M	△	△	△	△	○	○	○	○	—	△
L	△	△	△	△	○	○	○	○	○	—

This function obtains the optimum clamp speed for corners or curves based on the designated tolerance to perform operations. It also ensures smooth passing in corner sections within the tolerance range, which suppresses machine vibrations.

This function allows the machine to operate with the optimum tool path and speed, simply by specifying the tolerance, so an operator can easily carry out high quality machining.

The tolerance refers to the allowable error amount between the path commanded in the machining program and the path output by NC.

This function requires the SSS control specifications because it can only be used under SSS control.

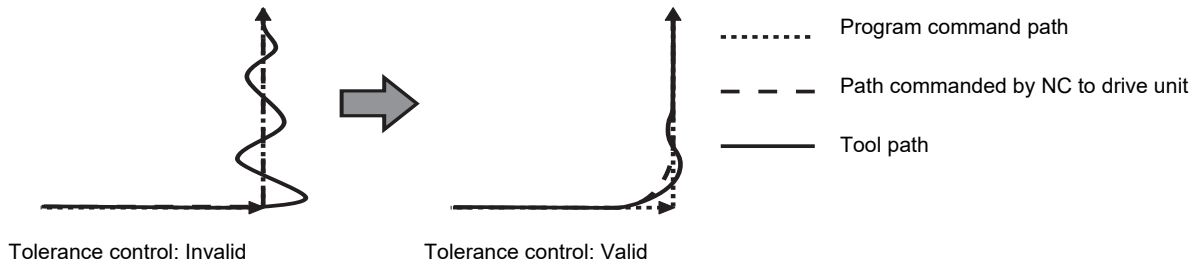

12.3.2.5 Variable-acceleration Pre-interpolation Acceleration/Deceleration

	M850W	M830W	M850S	M830S	M80W	M80 TypeA	M80 TypeB	E80 TypeA	E80 TypeB	C80
M	△	△	△	△	—	—	—	—	—	—
L	—	—	—	—	—	—	—	—	—	—

This function is useful when each axis differs in the characteristics (responsiveness) during SSS control (4-axis/5-axis machine, etc.).

The normal acceleration/deceleration before interpolation performs the acceleration/deceleration by setting acceleration common to all axes. Therefore, if the high responsiveness and low responsiveness coexist in axes, the acceleration needs to be set to suit the axis with low responsiveness.

On the other hand, the variable-acceleration pre-interpolation acceleration/deceleration can perform the acceleration/deceleration by setting diverse acceleration to each axis. This means that it is possible to set a higher acceleration for axes with high responsiveness than before. Therefore, the cycle time can be reduced especially in the indexing machining.

Shortening indexing machining time (when responsiveness of linear axis is higher than responsiveness of rotary axis)

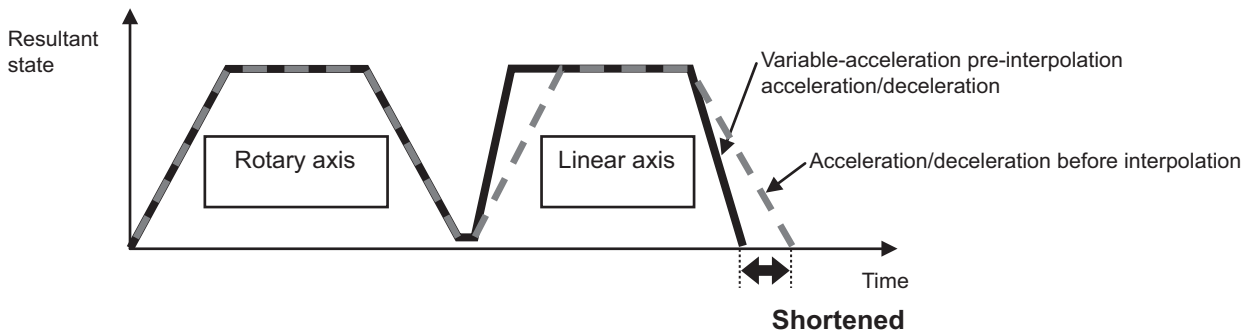

12.3.2.6 High-accuracy Acceleration/Deceleration Time Constant Extension

	M850W	M830W	M850S	M830S	M80W	M80 TypeA	M80 TypeB	E80 TypeA	E80 TypeB	C80
M	△	△	△	△	—	—	—	—	—	—
L	—	—	—	—	—	—	—	—	—	—

* 1st part system only.

This extends the upper limit of cutting feed time constant from 5,000[ms] to 30,000[ms] for acceleration/ deceleration before interpolation.

In the multi-part system, this function cannot be used together as an alarm will occur.

12.3.2.7 Axis-specific Acceleration Tolerance Control

	M850W	M830W	M850S	M830S	M80W	M80 TypeA	M80 TypeB	E80 TypeA	E80 TypeB	C80
M	△	△	△	△	—	—	—	—	—	—
L	△	△	△	△	—	—	—	—	—	—

* The first part system only.

The acceleration to be generated at a seam between blocks is evaluated for each axis to control deceleration so that the seam is passed at the optimum speed. This enables highly accurate edge machining. The optimum deceleration speed is calculated so that the acceleration of each axis to be generated at the seam is equal to or less than the tolerable acceleration for each axis, which is determined by maximum speed for each axis, time constant for each axis, and the accuracy coefficient. The machine decelerates to the speed in advance, and then accelerates back to the command speed after passing the corner.

This control enables deceleration at an appropriate speed for the characteristics of each axis even when machine vibrations may easily occur due to a low tolerable acceleration for a specific axis (rotary axis). This means that the deceleration speed can be raised at a corner where acceleration is generated only for an axis with a high tolerable acceleration, leading to a reduced cycle time.

12.3.3 High-speed High-accuracy Control

A machining program that approximates a free curve with fine segments can be run at a high speed and with a high accuracy. This function is effective in decreasing the cycle time of machining dies with free curves. This function is also useful in machining which needs to make an edge at a corner or reduce a path error from inner route of curved shape because the high-accuracy control mode is turned ON automatically.

12.3.3.1 High-speed High-accuracy Control I (G05.1Q1) Maximum [kBPM]

	M850W	M830W	M850S	M830S	M80W	M80 TypeA	M80 TypeB	E80 TypeA	E80 TypeB	C80
M	△ 67.5	△ 67.5	△ 67.5	△ 67.5	○ 33.7	○ 33.7	○ 33.7	—	—	△ 67.5
L	△ 67.5	△ 67.5	△ 67.5	△ 67.5	○ 33.7	○ 33.7	—	—	—	△ 67.5

Command format

G05.1 Q1 ; High-speed high-accuracy control I ON
G05.1 Q0 ; High-speed high-accuracy control I OFF

Fine segment capacity

The following is the fine segment capacity while high-speed high-accuracy control I is valid.

Fine segment processing capacity (unit: kBPM)

M: Machining center system

L: Lathe system

Number of part systems/ Number of axes	Number of high-speed high-accuracy control- enabled part systems	M850/M830		M80W/M80 TypeA		M80 TypeB	
		M	L	M	L	M	L
1-part system (*3)	1-part system	67.5	67.5	33.7	33.7	33.7	— (*2)
2-part system	1-part system	67.5	67.5	33.7	33.7	— (*4)	— (*2)
	2-part system	33.7	33.7	16.8	16.8	— (*4)	— (*2)
3-part system	1-part system	33.7	33.7	— (*1)	— (*1)	— (*4)	— (*2)
	2-part system	33.7	33.7	— (*1)	— (*1)	— (*4)	— (*2)
4-part system Less than 16 axes	1-part system	— (*1)	33.7	— (*1)	— (*1)	— (*4)	— (*2)
	2-part system	— (*1)	33.7	— (*1)	— (*1)	— (*4)	— (*2)
5-part system or more or 17 axes or more	1-part system	— (*1)	16.8	— (*1)	— (*1)	— (*4)	— (*2)
	2-part system	— (*1)	16.8	— (*1)	— (*1)	— (*4)	— (*2)

(*1) The maximum number of part systems is 2

(*2) There is no specifications for high-speed high-accuracy control I.

(*3) When the number of NC axes is nine or more, the micro segment processing capability is equivalent to that of two part systems.

(*4) The maximum number of part systems is 1.

(Note) The above performance applies under the following conditions.

- 3 axes or less commanded simultaneously in G01

- Block containing only axis name and movement amount (Does not contain macro or variable command)

- During tool radius compensation OFF (G40)

It may not be possible to attain the specified feed rate if deviated from the above conditions.

12.3.3.2 High-speed High-accuracy Control II (G05P10000) Maximum [kBPM]

	M850W	M830W	M850S	M830S	M80W	M80 TypeA	M80 TypeB	E80 TypeA	E80 TypeB	C80
M	△ 168	△ 168	△ 168	△ 168	○ 67.5	○ 67.5	○ 67.5	—	—	△ 67.5
L	△ 168	△ 168	△ 168	△ 168	○ 67.5	○ 67.5	—	—	—	△ 67.5

Command format

G05 P10000 ; High-speed high-accuracy control II ON G05 P0 ; High-speed high-accuracy control II OFF

Fine segment capacity

The following is the fine segment capacity while high-speed high-accuracy control II is valid.

Fine segment processing capacity (unit: kBPM)

M: Machining center system

L: Lathe system

Number of part systems/ Number of axes	Number of high-speed high-accuracy control- enabled part systems	M850/M830		M80W/M80 TypeA		M80 TypeB	
		M	L	M	L	M	L
1-part system (*4)	1-part system	168 (*3)	168 (*3)	67.5	67.5	67.5	— (*2)
2-part system	1-part system	100	100	67.5	67.5	— (*5)	— (*2)
	2-part system	67.5	67.5	33.7	33.7	— (*5)	— (*2)
3-part system	1-part system	33.7	33.7	— (*1)	— (*1)	— (*5)	— (*2)
	2-part system	33.7	33.7	— (*1)	— (*1)	— (*5)	— (*2)
4-part system Less than 16 axes	1-part system	— (*1)	33.7	— (*1)	— (*1)	— (*5)	— (*2)
	2-part system	— (*1)	33.7	— (*1)	— (*1)	— (*5)	— (*2)
5-part system or more or 17 axes or more	1-part system	— (*1)	16.8	— (*1)	— (*1)	— (*5)	— (*2)
	2-part system	— (*1)	16.8	— (*1)	— (*1)	— (*5)	— (*2)

(*1) The maximum number of part systems is 2

(*2) There is no specifications for high-speed high-accuracy control II.

(*3) 100 kBPM for a time constant expansion system, or while the following modes.

- Tool center point control is in progress.
- Inclined surface machining is in progress.
- Workpiece installation error compensation mode is active.
- Tolerance control is in progress.

(Time constant expansion system can be used in a system configured with a single part system when the specification is valid.)

(*4) When the number of NC axes is nine or more, the micro segment processing capability is equivalent to that of two part systems.

(*5) The maximum number of part systems is 1.

(Note) The above performance applies under the following conditions.

- 3 axes or less commanded simultaneously in G01
- Block containing only axis name and movement amount (Does not contain macro or variable command)
- During tool radius compensation OFF (G40)

It may not be possible to attain the specified feed rate if deviated from the above conditions.

Additional functions when high-speed high-accuracy control II/III mode is ON

(1) Fairing

If the protruding path (zigzagging path) is shorter than the parameter setting values in the machining program generated with a CAM, etc., this function can be used to eliminate the protruding paths smaller than the setting value so that the front and back paths are smoothly connected.

This function is valid only for continuous linear commands (G1).

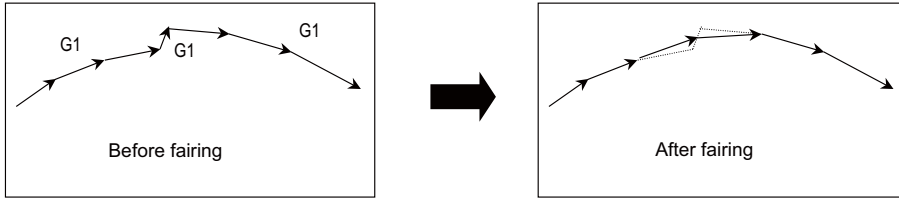

If there is any protruding path after fairing, fairing is repeated.

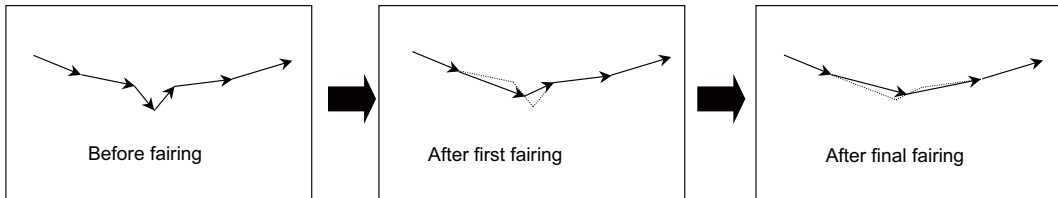

There is the smooth fairing function in addition to the fairing function.

When a minute step exists on a commanded path, for instance, the path after compensation differs between fairing and smooth fairing as follows:

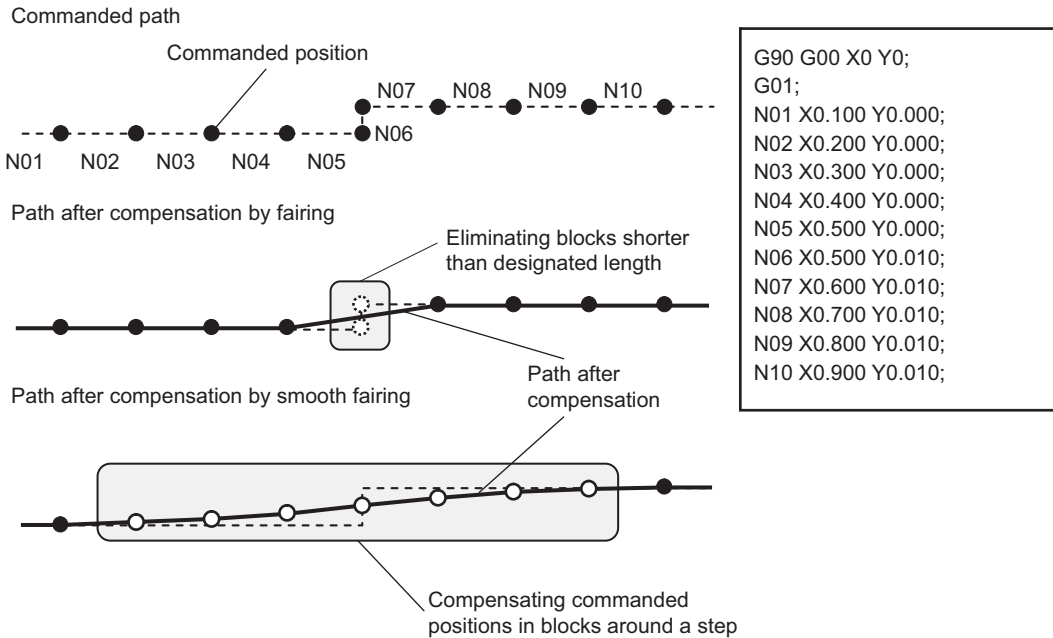

(2) Smooth fairing

This function interpolates the command position of machining program so that the movement path becomes smooth. This is used in cases of executing a fine-segment machining program at low speed for smooth machining and executing a long-segment rough machining program for smooth machining.

Refer to "12.3.3.4 Smooth Fairing" for details.

(3) Acceleration clamp speed

With the cutting feed clamp speed during the high-speed high-accuracy control II mode, when the parameter is set, the speed is clamped so that the acceleration generated by each block movement does not exceed the tolerable value. This function clamps the speed optimally even at a section where "angle change at each block is small but entire curvature is large" such as shown below. The tolerable acceleration value is calculated from the parameter setting values.

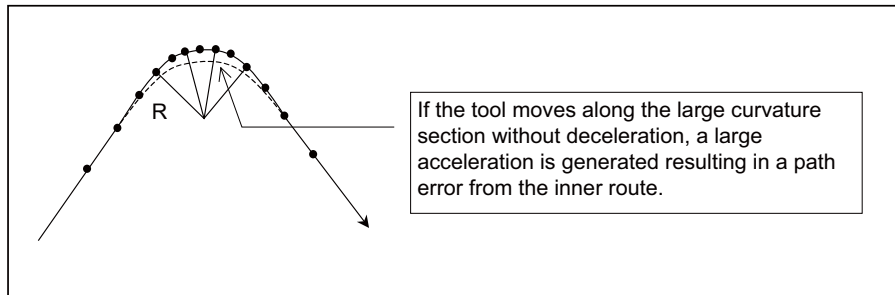
**(4) High-speed mode corner deceleration**

Conventionally during high-accuracy control, if the angle is large between the adjacent blocks in the machining program, this function automatically decelerates so that the acceleration generated when passing through the corner is within the tolerable value.

If a small block is inserted at the corner section with the machining program generated with the CAM, etc., the corner passing speed will not match the periphery. This can affect the machining surface.

If this type of small block is inserted when using high-speed mode corner deceleration, the corner will be largely judged by the parameter settings.

The small block is excluded when the angle is judged, but it not excluded from the actual movement command.

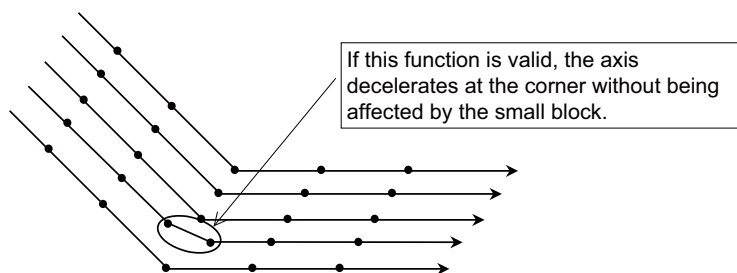

12.3.3.3 High-speed High-accuracy Control III (G05P20000) Maximum [kBPM]

	M850W	M830W	M850S	M830S	M80W	M80 TypeA	M80 TypeB	E80 TypeA	E80 TypeB	C80
M	△ 270	△ 270	△ 270	△ 270	○ 135	○ 135	—	—	—	△ 135
L	—	—	—	—	—	—	—	—	—	—

Command format

(1) Setting to enable the function by G code

High-speed high-accuracy control III can be enabled by the following G code command. If the following G code is commanded, the high-speed high-accuracy control III mode will be ON even the parameter "High speed/accu 3" is OFF.

G05 P20000 ;	High-speed high-accuracy control III ON
G05 P0 ;	High-speed high-accuracy control III OFF

(2) Setting to enable the function by parameter

The high-speed high-accuracy control II command can be treated as the high-speed high-accuracy control III command by enabling the parameter "High speed/accu 3".

G05 P10000 ;	High-speed high-accuracy control III ON
G05 P0 ;	High-speed high-accuracy control III OFF

G05P2 command in high-accuracy control mode can also be treated as the high-speed high-accuracy control III command.

Fine segment capacity

The following is the fine segment capacity while high-speed high-accuracy control III is valid.

Fine segment processing capacity (unit: kBPM)

M: Machining center system

L: Lathe system

Number of part systems/ Number of axes	Number of high-speed high-accuracy control- enabled part systems	M850/M830		M80W/M80 TypeA		M80 TypeB	
		M	L	M	L	M	L
1-part system (*5)	1-part system	270 (*3)	— (*2)	135 (*4)	— (*2)	— (*2)	— (*2)
2-part system	1-part system	168 (*3)	— (*2)	135 (*4)	— (*2)	— (*2)	— (*2)
	2-part system	100	— (*2)	67.5	— (*2)	— (*2)	— (*2)
3-part system	1-part system	33.7	— (*2)	— (*2)	— (*2)	— (*2)	— (*2)
	2-part system	33.7	— (*2)	— (*2)	— (*2)	— (*2)	— (*2)
4-part system Less than 16 axes	1-part system	— (*1)	— (*2)	— (*1)	— (*2)	— (*2)	— (*2)
	2-part system	— (*1)	— (*2)	— (*1)	— (*2)	— (*2)	— (*2)
5-part system or more or 17 axes or more	1-part system	— (*1)	— (*2)	— (*1)	— (*2)	— (*2)	— (*2)
	2-part system	— (*1)	— (*2)	— (*1)	— (*2)	— (*2)	— (*2)

(*1) The maximum number of part systems is 2

(*2) There is no specifications for high-speed high-accuracy control III.

(*3) 100 kBPM for a time constant expansion system, or during tool center point control, inclined surface machining or workpiece installation error compensation.

(*4) 67.5 kBPM for a time constant expansion system, or during tool center point control, inclined surface machining or workpiece installation error compensation.

(Time constant expansion system can be used in a system configured with a single part system when the specification is valid.)

(*5) When the number of NC axes is nine or more, the micro segment processing capability is equivalent to that of two part systems.

(Note) The above performance applies under the following conditions.

- 3 axes or less commanded simultaneously in G01

- Block containing only axis name and movement amount (Does not contain macro or variable command)

- During tool radius compensation OFF (G40)

It may not be possible to attain the specified feed rate if deviated from the above conditions.

12.3.3.4 Smooth Fairing

	M850W	M830W	M850S	M830S	M80W	M80 TypeA	M80 TypeB	E80 TypeA	E80 TypeB	C80
M	△	△	△	△	○	○	—	—	—	△
L	—	—	—	—	—	—	—	—	—	—

A path can be smoothen by compensating commanded positions of a machining program. This function is useful when executing a fine segment program to machine smoothly at low speed or a rough machining program with long segment to machine smoothly.

This function is enabled while high-speed high-accuracy control II is ON or while high-accuracy control is ON in high-speed machining mode II/III, and performs compensation in consecutive G01 command during the time.

Refer to "12.3.3.2 High-speed High-accuracy Control II (G05P10000) Maximum [kBPM]" for the differences between fairing and smooth fairing.

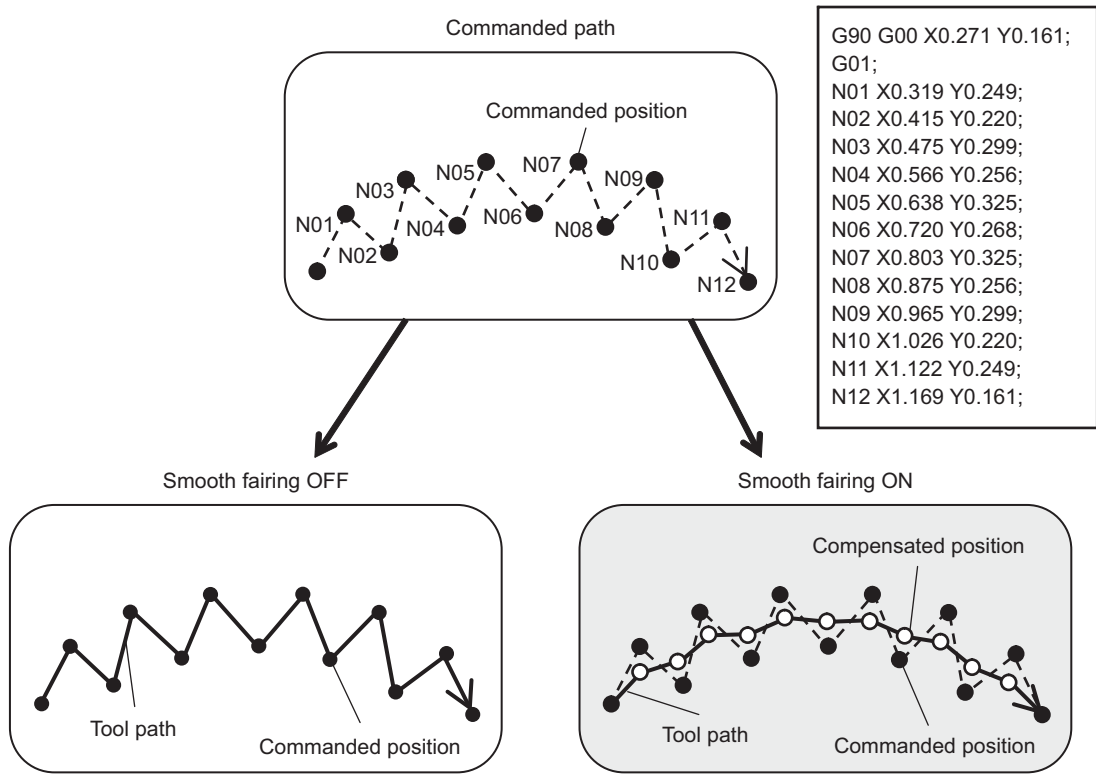

(Note) While smooth fairing is valid, the high-speed high-accuracy control III operates as high-speed high-accuracy control II.

12.3.4 Machining Condition Selection I

	M850W	M830W	M850S	M830S	M80W	M80 TypeA	M80 TypeB	E80 TypeA	E80 TypeB	C80
M	○	○	○	○	○	○	○	○	—	○
L	○	○	○	○	○	○	—	—	—	○

The machining condition parameter set which consists of parameters related to the high-accuracy control can be configured in advance for each machining application (such as part machining or die machining) or machining process (such as rough or finishing), and it can be switched according to the purpose.

This can easily perform the machining which meets the conditions for the intended machining.

Multiple part systems simultaneous high-accuracy function is required to apply the machining conditions to the second or following part systems.

The machine condition commanded by G code command will reflect only to commanded part system.

12.3.5 Direct Command Mode

	M850W	M830W	M850S	M830S	M80W	M80 TypeA	M80 TypeB	E80 TypeA	E80 TypeB	C80
M	—	—	—	—	—	—	—	—	—	—
L	△	△	△	△	—	—	—	—	—	—

This function reduces the loads of NC machining program analysis and interpolations as much as possible so that machining programs composed of fine segments are executed at high-speed with a processing speed.

Compared to normal machining modes, this function is effective for accelerating 3-dimensional machining of curved surface such as variable cam machining.

12.4 Programming Support Functions

12.4.1 Playback

	M850W	M830W	M850S	M830S	M80W	M80 TypeA	M80 TypeB	E80 TypeA	E80 TypeB	C80
M	○	○	○	○	○	○	○	○	—	○
L	△	△	△	△	—	—	—	—	—	—

This function enables creation of a program while proceeding with sample machining by manual (handle or job) feed or mechanical handle feed. A machining program can be edited by using the playback movement amount obtained by manual operation as the program command values.

Playback edit is disabled for the machining program in the mass-editing mode.

12.4.3 Interactive Cycle Insertion

	M850W	M830W	M850S	M830S	M80W	M80 TypeA	M80 TypeB	E80 TypeA	E80 TypeB	C80
M	△	△	△	△	○	○	○	○	○	—
L	△	△	△	△	○	○	○	○	○	—

This function enables to interactively insert a cycle to assist in the machining and setup for the program opening on the edit screen.

The programming time can be reduced by using this function.

The cycle can easily be inserted by editing data in an interactive window.

[Operation image to insert a cycle]

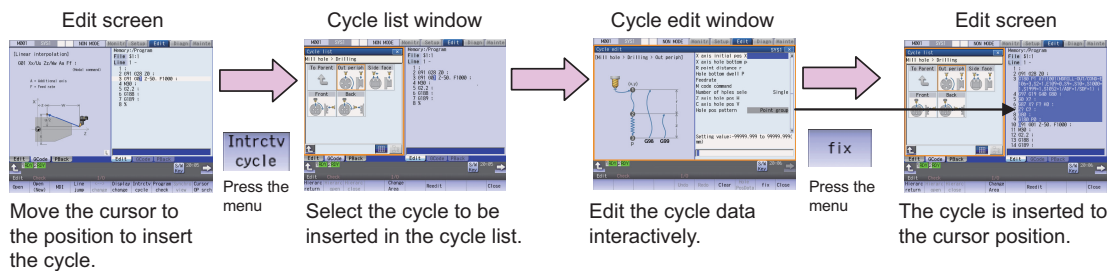

The program of the cycle block inserted once can directly be edited on the edit screen, and can be re-edited in the cycle edit window if the cycle format is not changed.

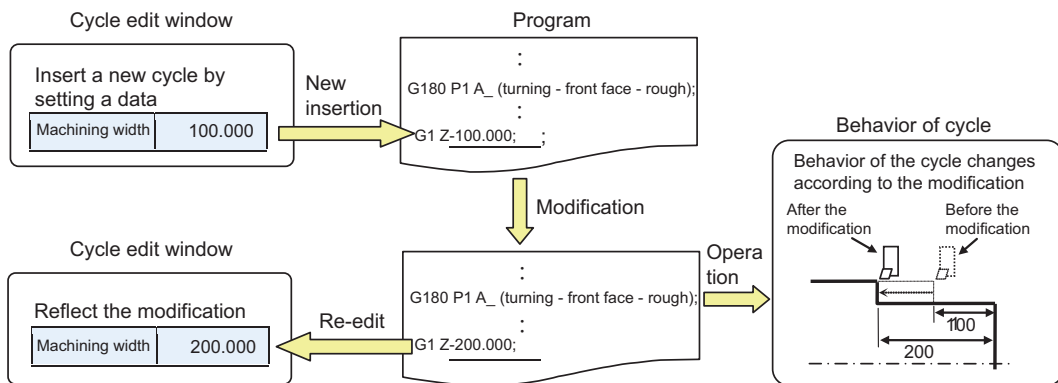

12 Program Support Functions

[Types of Cycle]

Machining cycle can be inserted.

In accordance with the NC system set by the parameter, either cycle for lathe or cycle for machining center can be selected.

For cycle types, there are "Standard type" and "Extend type" of MITSUBISHI cycle and arbitrary cycle type "Custom type" prepared by MTB.

For "Standard type", there are normal format and special format, which is set with the parameter.

Press the menu [Standard type], [Extend type] or [Custom type] to be selected on the interactive cycle screen. Select a cycle type to be changed on the displayed cycle list window to switch the cycle.

Cycle for Lathe system

○ : Cycle insertion available - : No specification

Hierarchy 1	Hierarchy 2	Hierarchy 3	Standard type	Extend type
Cycle type	Machining cycle	Machining portion		
Turning hole	Drilling	Front	○	○
	Deep-hole drilling	Back	○	○
	Tapping		○	○
	Deep-hole tapping		○	○
	Reaming		-	○
	Boring		○	○
Turning	Turning	Outer diameter	○	○
	Turning (compound)	Inner diameter	○	○
	Copying	Front	○	○
	Grooving	Back	○	○
	Cutting-off		○	○
	Thread cutting	Outer diameter	○	○
	Thread cutting (compound)	Inner diameter	○	○
	Thread recutting		○	○
	Thread recutting (compound)		○	○
	Milling hole	Drilling	Periphery	○
Deep-hole drilling		Side	○	○
Step drilling		Front	○	○
Tapping		Back	○	○
Deep-hole tapping			○	○
Reaming			-	○
Boring			○	○
Milling		Pocketing	Side	-
	Grooving	Front Back	-	○

(Note 1) For standard type, there are conventional format and MITSUBISHI CNC special format. Which format to be used depends on the setting of the parameter.

(Note 2) Fixed cycle is used for "Tapping" and "Deep-hole tapping" of "Extend type". The format to be used is the same as "Standard type", which depends on the setting of the parameter.

Cycle for Machining center system

○ : Cycle insertion available - : No specification

Hierarchy 1	Hierarchy 2	Standard type	Extend type
Cycle type	Machining cycle		
Hole	Drilling	○	○
	Deep-hole drilling	○	○
	Step drilling	○	○
	Tapping	○	○
	Deep-hole tapping	○	○
	Reaming	-	○
	Boring	○	○
Milling	Plane	-	○
	Pocketing	-	○
	Grooving	-	○
	Contour	-	○

(Note) Fixed cycle is used for "Tapping" and "Deep-hole tapping" of "Extend type".

Display of cycle list window

The cycle list window is displayed in the area opposite to the editing area. There are two display types for cycle list window, "image display type" and "tree display type", which can be switched Change list button.

Image display type

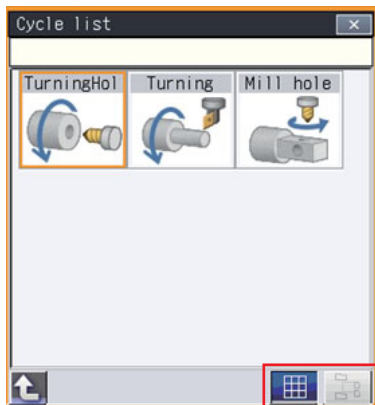

Tree display type

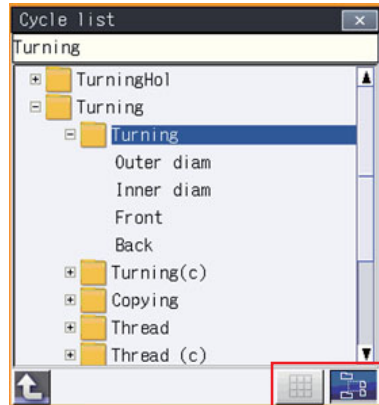

Change list button

12.4.4 Simple Programming (NAVI MILL/LATHE)

	M850W	M830W	M850S	M830S	M80W	M80 TypeA	M80 TypeB	E80 TypeA	E80 TypeB	C80
M	△	△	△	△	○	○	○	○	○	—
L	△	△	△	△	○	○	○	○	○	—

Create a part program by using NAVI MILL (for machining center system) or NAVI LATHE (for lathe system).

- (1) The following machining processes can be edited.

M system	L system
- Hole drilling (Drilling, deep hole drilling, step, boring, tapping) - Surface cutting (Circle, square) - Contour cutting (Circle, square, arbitrary shape) - Pocket machining (Circle, square, L pattern, U pattern) - EIA	<Turning machining> - Turning (Outside dia., inside dia., front face) - Copying (Outside dia., inside dia., front face) - Threading (Outside dia., inside dia., front face) - Grooving (Outside dia., inside dia., front face) - Trapezoid grooving (Outside dia., inside dia., front face) - Hole drilling (Drilling, deep hole drilling, step, tapping) - EIA - Cutting-off <Milling machining> - Milling hole machining (Drilling, deep hole drilling, boring, tapping) [Hole pattern] - Random (Front face, outer periphery, side face) - Line (Front face, outer periphery, side face) - Arc (Front face, side face) - Circle (Front face, side face) - Square (Front face, side face) - Lattice (Front face, side face) - Key groove (Front face, outer periphery, side face) - Contour machining (Front face, outer periphery, side face) <Auxiliary operation> - Delivery <Balance cut> - Turning balance cut - Copying balance cut - Two-part system simultaneous thread cutting

- (2) Cutting conditions are automatically determined from tool management data and cutting condition file.
- (3) The operation screen consists of the list view area and the operation view area. In the list view area, the entire part program can be seen at all time. In the operation view area, there are guide drawings related to each input item, which allows an easy data input.
- (4) Program Checker enables the tool paths of a part program to be graphically traced. With this function, an input error can be detected at an earlier stage.
- (5) Guidance function provides an operator with error recovery information.
- (6) Part program is a macro-program-based NC program. Process commands can be added in the edit screen.
- (7) The macro program above can be customized by the machine tool builder.

12.4.5 G code Guidance

	M850W	M830W	M850S	M830S	M80W	M80 TypeA	M80 TypeB	E80 TypeA	E80 TypeB	C80
M	○	○	○	○	○	○	○	○	○	○
L	○	○	○	○	○	○	○	○	○	○

G code guidance is a function to display illustration of the contents or movements of the commanded format for the G code currently under editing. This is used when creating or editing a machining program.

With this function, the G code contents under the editing process can be checked on the spot.

12.4.7 DXF Data Input

	M850W	M830W	M850S	M830S	M80W	M80 TypeA	M80 TypeB	E80 TypeA	E80 TypeB	C80
M	△	△	△	△	○	○	—	—	—	—
L	△	△	△	△	○	○	—	—	—	—

This function is a support for the interactive cycle insert function.

This function allows you to import a DXF drawing file from an external I/O device through DXF data input window, extract the figure element data from the drawing, and add them as arbitrary shape data or as hole position data to the cycle being edited using the interactive cycle insertion function.

DXF data input function requires FCU8-MU542 or -MA542 for M800S, or FCU8-MU512 for M80.

The supported devices are as follows:

- HD
- Memory card (front-side SD card)
- DS (back-side SD card)
- USB memory

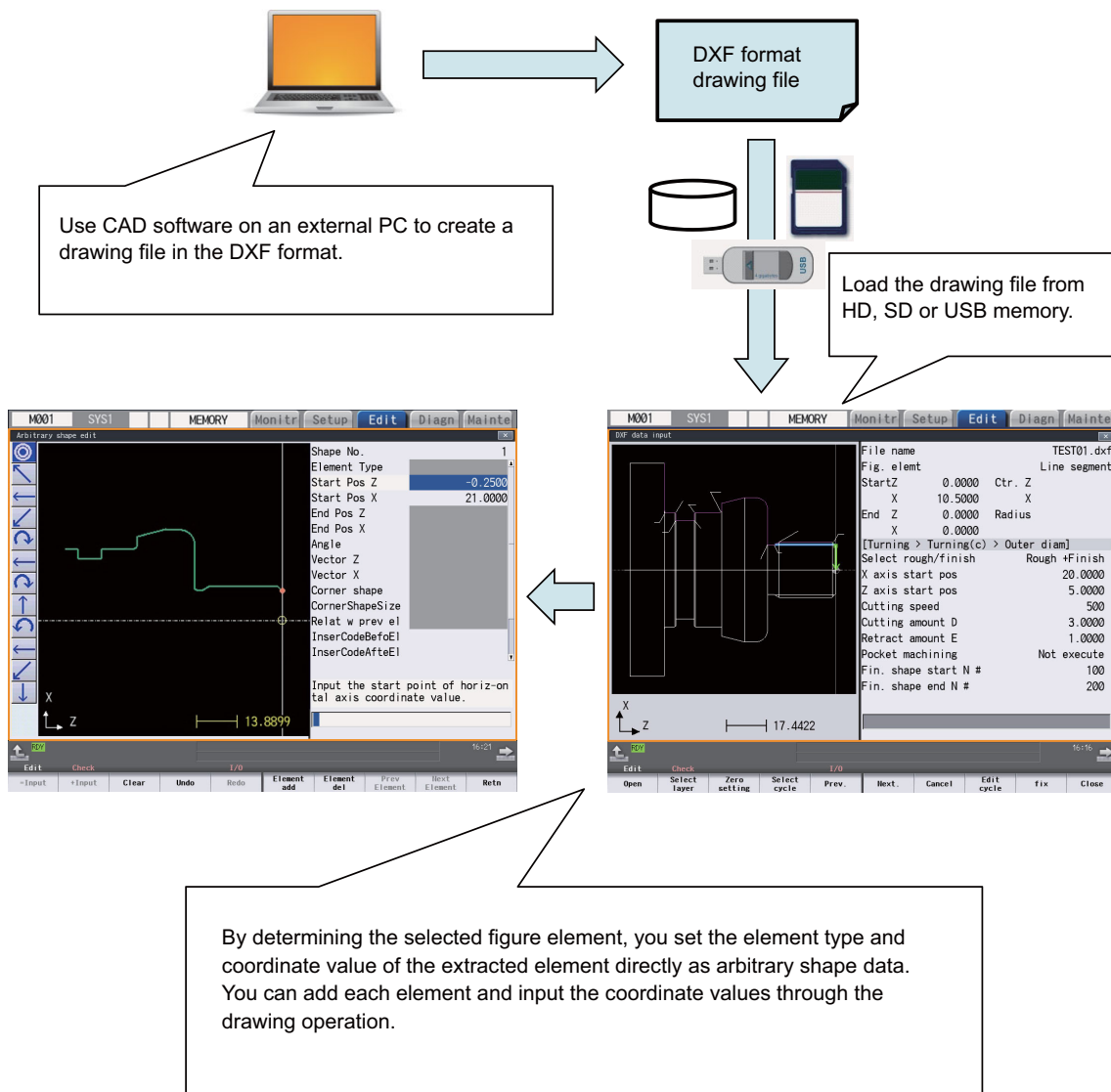

Machine Accuracy Compensation

13.1 Static Accuracy Compensation

13.1.1 Backlash Compensation

	M850W	M830W	M850S	M830S	M80W	M80 TypeA	M80 TypeB	E80 TypeA	E80 TypeB	C80
M	○	○	○	○	○	○	○	○	○	○
L	○	○	○	○	○	○	○	○	○	○

This function compensates for the error (backlash) produced when the direction of the machine system is reversed. The backlash compensation can be set in the cutting feed mode or rapid traverse mode.

The amount of backlash compensation can be set separately for each axis. It is set using a number of pulses in increments of one-half of the least command increments. The output follows the output unit system. The "output unit system" is the unit system of the machine system (ball screw unit system).

13.1.2 Memory-type Pitch Error Compensation [sets]

	M850W	M830W	M850S	M830S	M80W	M80 TypeA	M80 TypeB	E80 TypeA	E80 TypeB	C80
M	○ 32	○ 32	○ 32	○ 32	○ 16	○ 16	○ 16	○ 16	○ 16	○ 10
L	○ 32	○ 32	○ 32	○ 32	○ 16	○ 16	○ 16	○ 16	○ 16	○ 10

With the reference position defined as the base, set the compensation amount in the division points obtained by equally dividing the machine coordinates.

According to the specified parameters, this method compensates an axis feed error caused by a ball screw pitch error, etc.

The compensation amount can be set by either the absolute or incremental system. Select the desired method with the parameter.

Machine position between division points n and $n+1$ is smoothly compensated by the linear approximation of the compensation amount.

Up to 32 sets of axes can be set for the compensation for M800 Series, or up to 16 sets of axes for M80/E80 Series.

Up to 1899 points can be set for the compensation for M800 and M80/E80 Series.

PLC axes and PLC indexing axes can be also compensated.

[Relationship between the compensation amount and machine position]

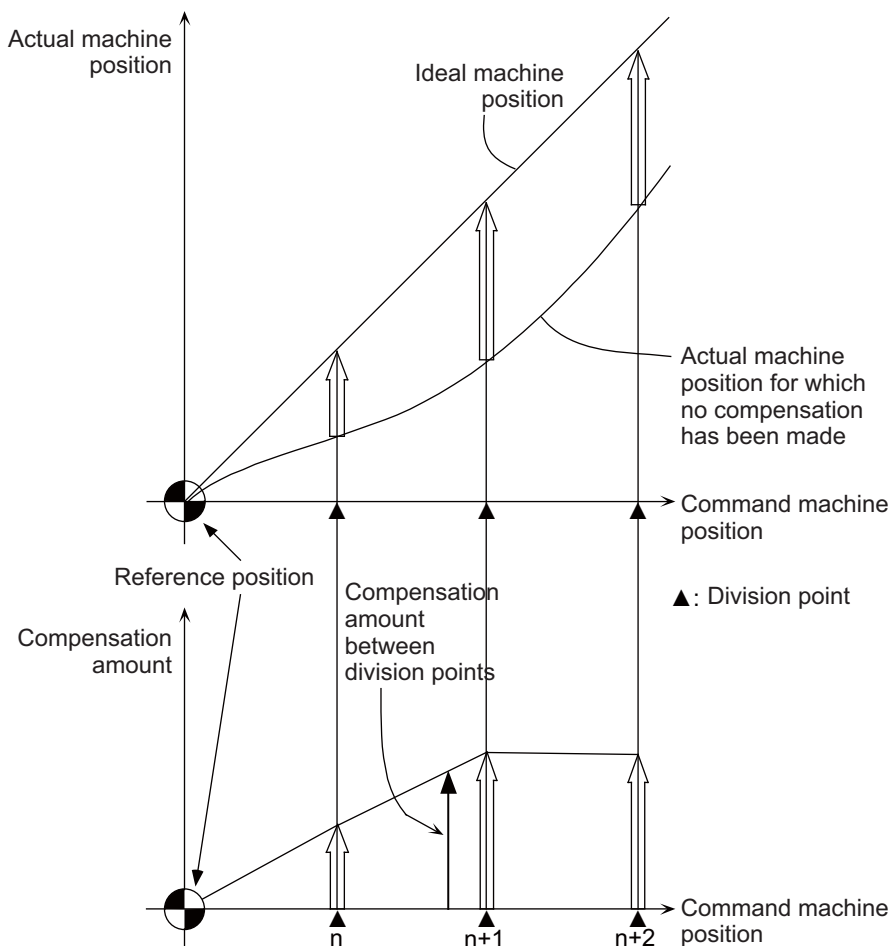

(Note 1) Compensation points 1899 is a total including the points for memory-type relative position error compensation.

(Note 2) A scale of 0 to 99-fold is applied on the compensation amount.

13.1.3 Memory-type Relative Position Error Compensation

	M850W	M830W	M850S	M830S	M80W	M80 TypeA	M80 TypeB	E80 TypeA	E80 TypeB	C80
M	○	○	○	○	○	○	○	○	○	○
L	○	○	○	○	○	○	○	○	○	○

This method, according to the parameters specified in advance, compensates the relative position error between two orthogonal axes caused by deflection of the moving stand.

Specify the compensation amount in the compensation axis direction in the division points obtained by equally dividing the machine coordinates of the base axis.

The base axis is one of the two orthogonal axes to which relative position compensation applies. This axis is used as the criterion for relative-error measurement. The compensation axis is the coordinate axis that is orthogonal to the base axis. The compensation is actually made for this coordinate axis.

Machine position between division points n and n+1 is smoothly compensated by the linear approximation of the compensation amount.

Up to 32 sets of axes can be set for the compensation for M800 Series, or up to 16 sets of axes for M80/E80 Series.

Up to 1899 points can be set for the compensation for M800 and M80/E80 Series.

PLC axes and PLC indexing axes can be also compensated.

[Relationship between the compensation amount and machine position]

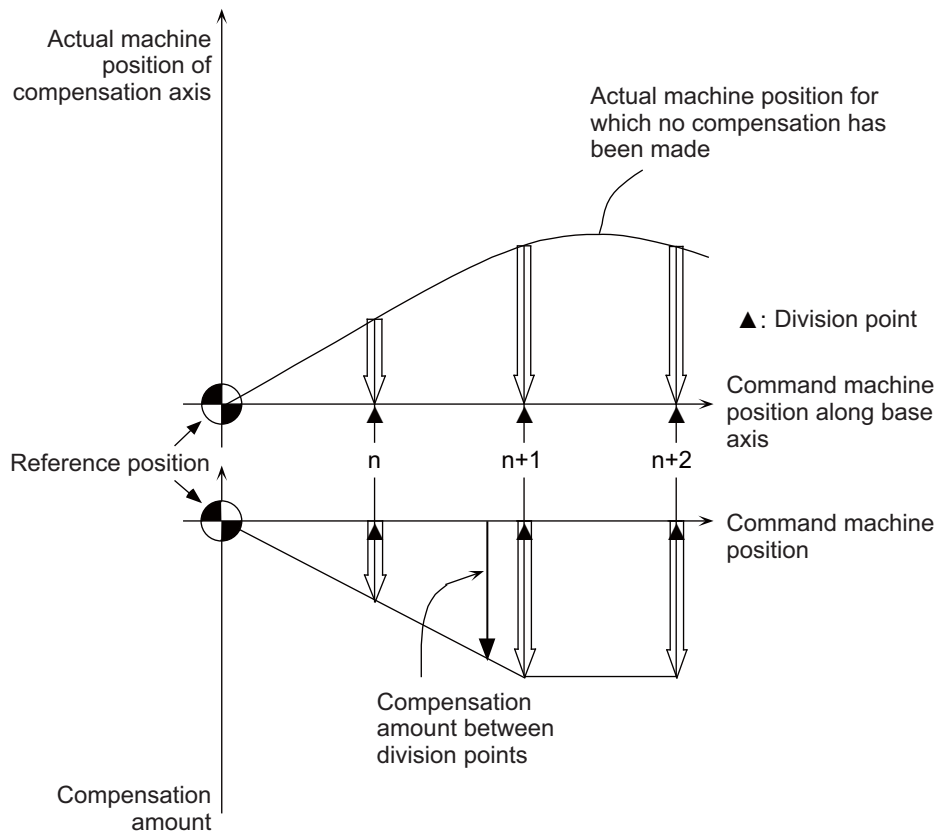

(Note 1) Compensation points 1899 is a total including the points for memory-type pitch error compensation.

(Note 2) A scale of 0 to 99-fold is applied on the compensation amount.

13.1.4 External Machine Coordinate System Compensation

	M850W	M830W	M850S	M830S	M80W	M80 TypeA	M80 TypeB	E80 TypeA	E80 TypeB	C80
M	△	△	△	△	○	○	○	○	○	△
L	△	△	△	△	○	○	○	○	○	△

The coordinate system can be shifted by inputting a compensation amount from the PLC. This compensation amount will not appear on the counter (all counters including machine position). If the machine's displacement value caused by heat is input for example, this can be used for thermal displacement compensation.

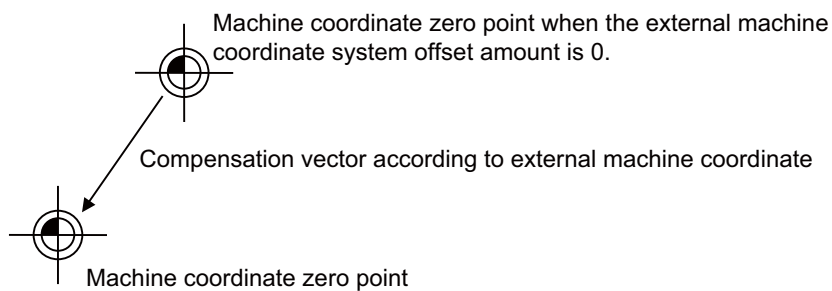

13.1.5 Circular Radius Error Compensation

	M850W	M830W	M850S	M830S	M80W	M80 TypeA	M80 TypeB	E80 TypeA	E80 TypeB	C80
M	△	△	△	△	○	○	○	—	—	△
L	△	△	△	△	○	○	○	—	—	△

With commands designated during arc cutting, this function compensates for movement toward the inside of the arcs caused by a factor such as servo delay.

13.1.6 Ball Screw Thermal Expansion Compensation

	M850W	M830W	M850S	M830S	M80W	M80 TypeA	M80 TypeB	E80 TypeA	E80 TypeB	C80
M	△	△	△	△	○	○	○	○	○	△
L	△	△	△	△	○	○	○	○	○	△

This compensates the axis feed error caused by the ball screw thermal expansion, etc. using the values set in the R register's thermal displacement compensation parameter.

The compensation amount at the end of the machine error compensation range (mdvno to pdvno) is set. The compensation line is obtained from the set compensation amount, and is linearly distributed in the machine error compensation range to attain smooth compensation. A compensation amount that changes during operation can also be compensated.

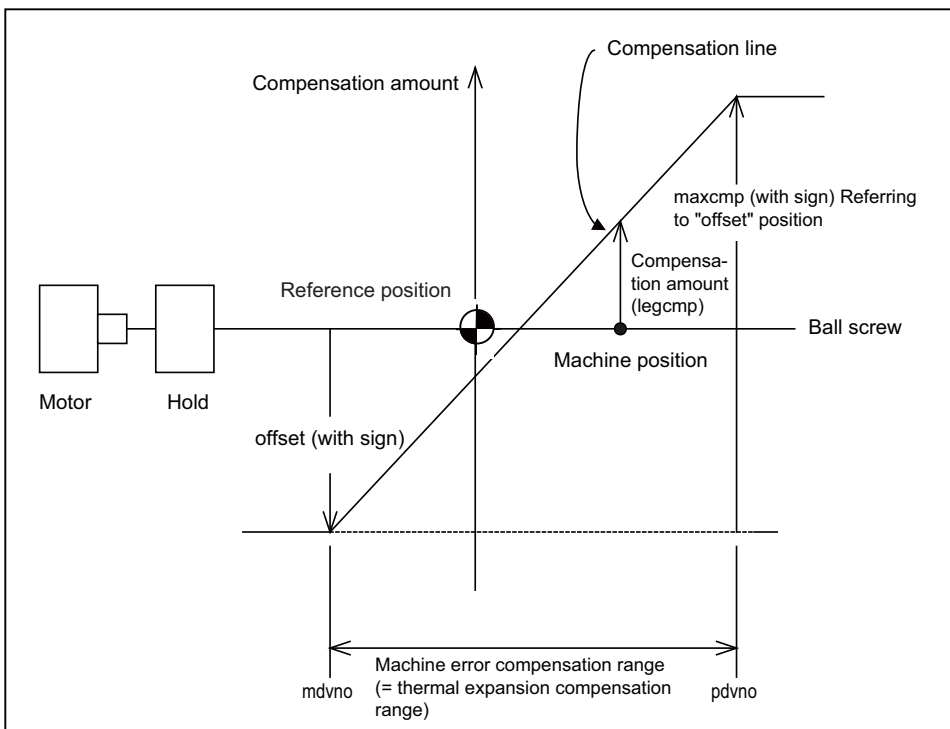

(1) Conditions under which thermal displacement compensation is valid

- When function is valid.
- When axis No. and parameter (offset, maxcmp) is set in R register.
- When pitch error compensation parameter is set correctly.

(2) Compensation operation

- The machine error compensation range is compensated with the thermal displacement compensation amount (absolute position compensation amount) obtained with the compensation line.
- The compensation amount is immediately calculated when thermal displacement compensation is validated.
- When the compensation amount is changed, the new compensation line is immediately obtained, and the range is compensated again with that compensation amount.
- Thermal displacement compensation can be used with machine error compensation. In this case, the sum of the machine error compensation amount and the thermal displacement compensation amount is added to the machine position and issued as the NC command.

13.1.7 Rotation Center Error Compensation

	M850W	M830W	M850S	M830S	M80W	M80 TypeA	M80 TypeB	E80 TypeA	E80 TypeB	C80
M	△	△	△	△	—	—	—	—	—	—
L	△	△	△	△	—	—	—	—	—	—

In the machine having a rotary axis, the rotation center deviates due to the assembly error of the rotary axis. Thus, if a machining is carried out with the rotary axis, the machining accuracy is impaired because an error is caused in the relative position between the tool and workpiece.

There are two types of rotation center deviation. One is "position deviation", in which the rotation center is shifted in the planar direction, and the other is "angle deviation", in which the rotation center inclines.

Higher-accuracy machining is realized by compensating for these two types of deviation.

[Position deviation and angle deviation]

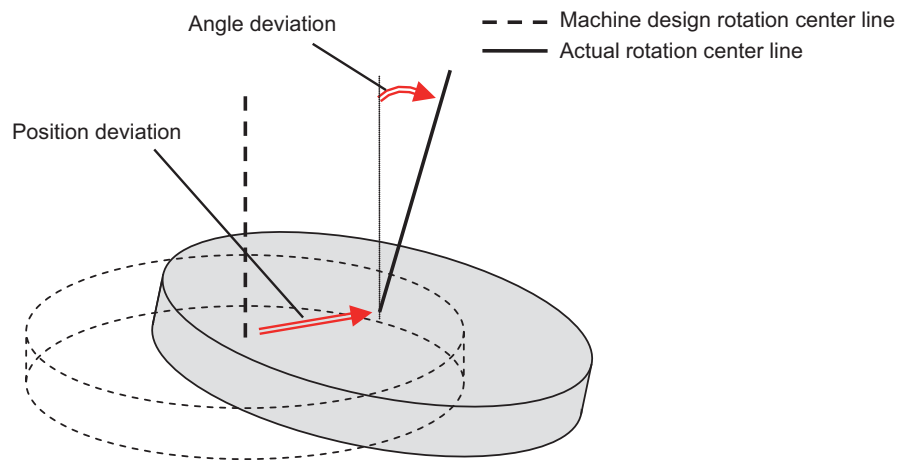

[Compensation for the deviation of the rotation center]

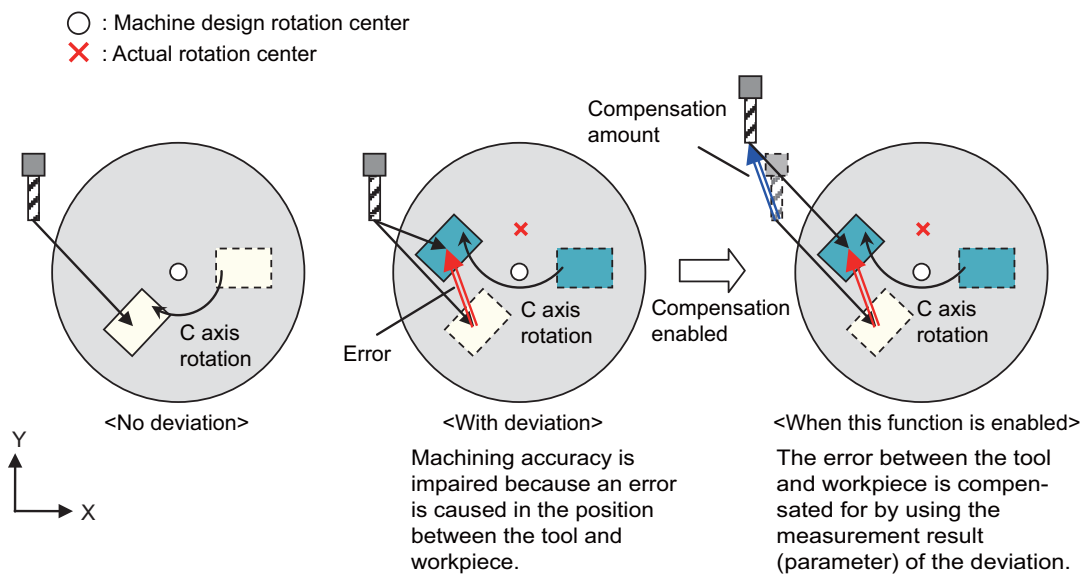

13 Machine Accuracy Compensation

This function can be used on the machine whose rotary axis is installed with ISO polarity and the machine whose axis is installed with non-ISO polarity. However, the orthogonal axis needs to be installed with ISO polarity. (*1)

(*1) In the machine coordinate system (right-hand orthogonal coordinate system) defined in ISO standard, the rotation turning to the right-handed screw is handled as ISO polarity and the one turning to the left-handed screw is handled as non-ISO polarity.

This function is compatible with the following axis configurations of the machines.

Machine		Machine type	Axis configuration
M system	4-axis machine	Table tilt	Configured in right-handed orthogonal coordinate system + 1 rotary axis
		Tool tilt	
	5-axis machine	Table tilt	Configured in right-handed orthogonal coordinate system + 2 rotary axes
		Combined Tool tilt	
L system	4-axis machine	Table tilt	Configured in right-handed orthogonal coordinate system + 1 rotary axis
		Tool tilt	
	5-axis machine	Combined	Configured in right-handed orthogonal coordinate system + 2 rotary axes
		Tool tilt	

13.1.8 Position-dependent Gradually Increasing-type Backlash Compensation

	M850W	M830W	M850S	M830S	M80W	M80 TypeA	M80 TypeB	E80 TypeA	E80 TypeB	C80
M	△	△	△	△	○	○	○	○	○	△
L	△	△	△	△	○	○	○	—	—	△

Usually, minute bumps are generated when the machine movement direction is reversed. (Lost motion) However, due to various mechanical system factors, there may be cases where the bumps do not change in steps but gradually change after the direction reversal. (Gradually increasing-type lost motion)

Depending on the mechanical structure, the gradually increasing-type lost motion includes the type where the bump amount depends on "duration of time" from when the machine movement direction is reversed and the type where the bump amount depends on "distance". When the bump amount depends on "duration of time", compensation is possible with the OMR-II function. (13.2.4 OMR II(Backlash with Filter)).

With this function, the gradually increasing-type lost motion which depends on the distance from the point where the machine movement direction is reversed can be compensated by controlling the variation of backlash compensation amount according to the distance from the direction reversal point.

<When the bump amount changes according to speed>

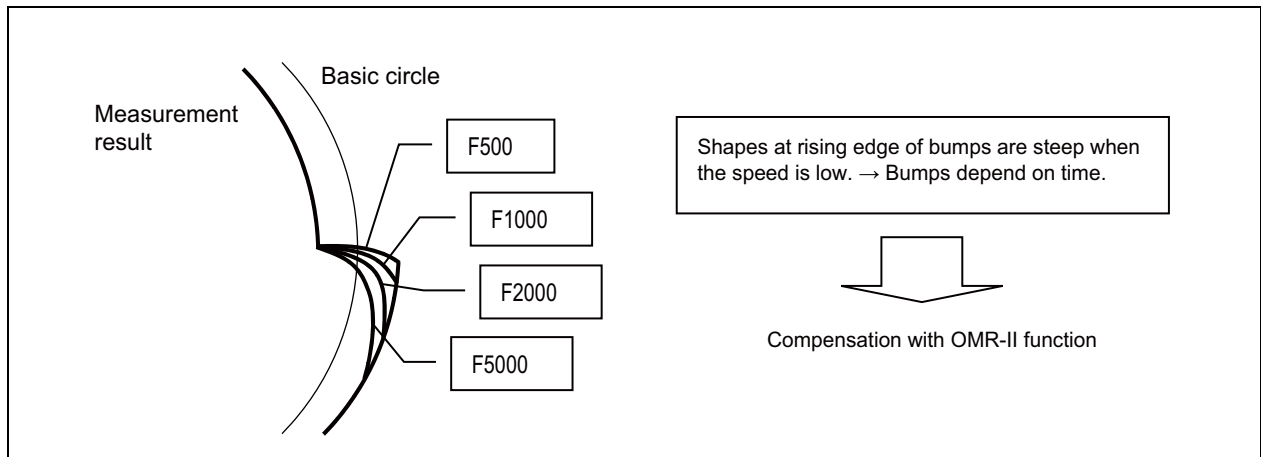

<When the bump amount does not change according to speed>

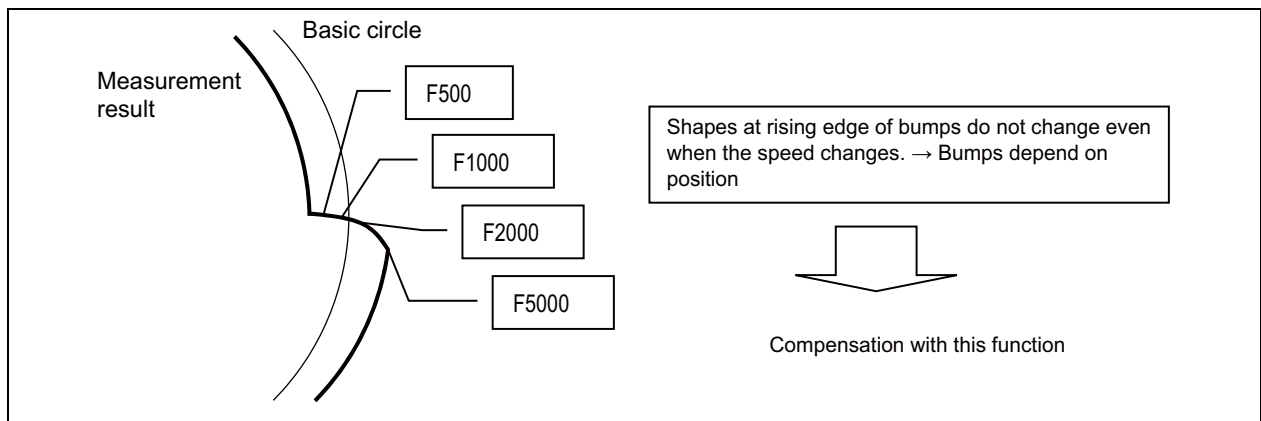

13.1.9 Bidirectional Pitch Error Compensation

	M850W	M830W	M850S	M830S	M80W	M80 TypeA	M80 TypeB	E80 TypeA	E80 TypeB	C80
M	△	△	△	△	○	○	○	—	—	△
L	△	△	△	△	○	○	○	—	—	△

Bidirectional pitch error compensation function is used to compensate the pitch error in each direction by setting the pitch error compensation amount when moving in the positive and negative direction.

This function reduces the difference of tool path between the positive and negative direction.

13.1.10 Cyclic Error Compensation

	M850W	M830W	M850S	M830S	M80W	M80 TypeA	M80 TypeB	E80 TypeA	E80 TypeB	C80
M	△	△	△	△	○	○	○	—	—	—
L	△	△	△	△	○	○	○	—	—	—

When the machine operation induces certain cyclic errors, this function compensates a series of cyclic errors by setting the compensation amount for a single cycle.

Short-pitched compensation is possible for the errors occurring due to the tooth shape of the encoder.

You can set the period of the error cycle, the number of steps in the cycle, and the compensation amount at each step by the parameter.

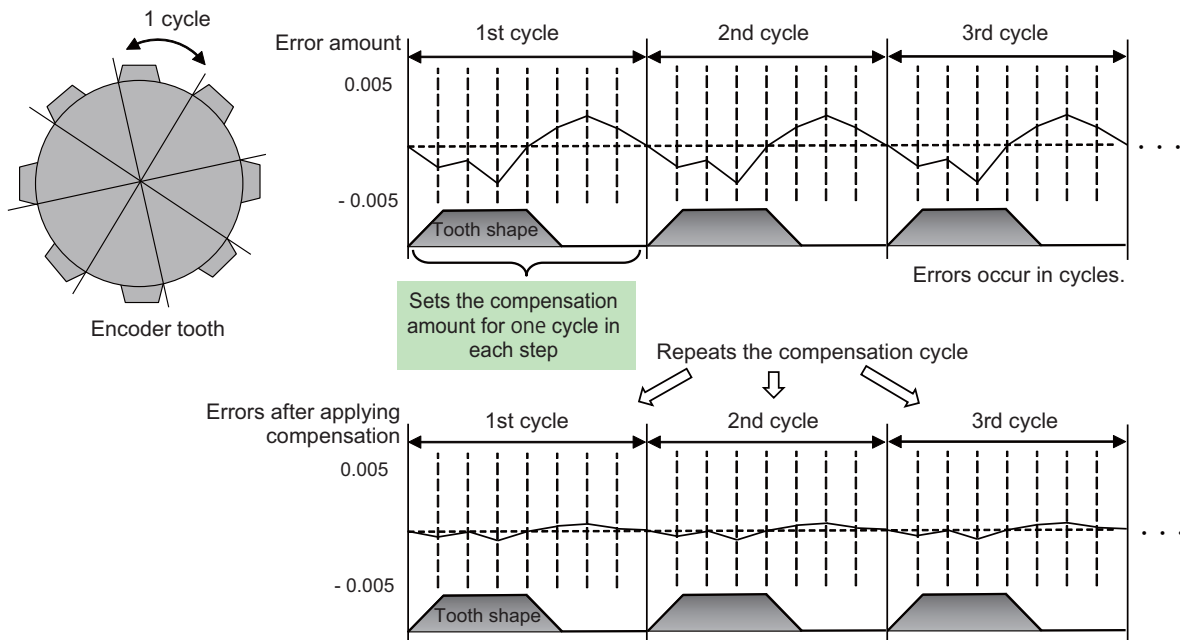

13.1.11 Spatial Error Compensation

	M850W	M830W	M850S	M830S	M80W	M80 TypeA	M80 TypeB	E80 TypeA	E80 TypeB	C80
M	△	△	△	△	—	—	—	—	—	—
L	—	—	—	—	—	—	—	—	—	—

This function can compensate for three-dimensional errors of a machine tool due to its linear and rotary axes. This measures the spatial errors caused by the linear and rotary axes with a measuring device, and inputs the measurement results to the NC to make an error data file. The function calculates the compensation amount based on the error data file and adds the calculated compensation amount of the linear and rotary axes to the drive command position to perform the compensation. The function can reduce deterioration of machining accuracy due to mechanical errors, which will lead to high-accuracy machining.

This function is enabled for a machine where three linear axes form a right-handed orthogonal coordinate system.

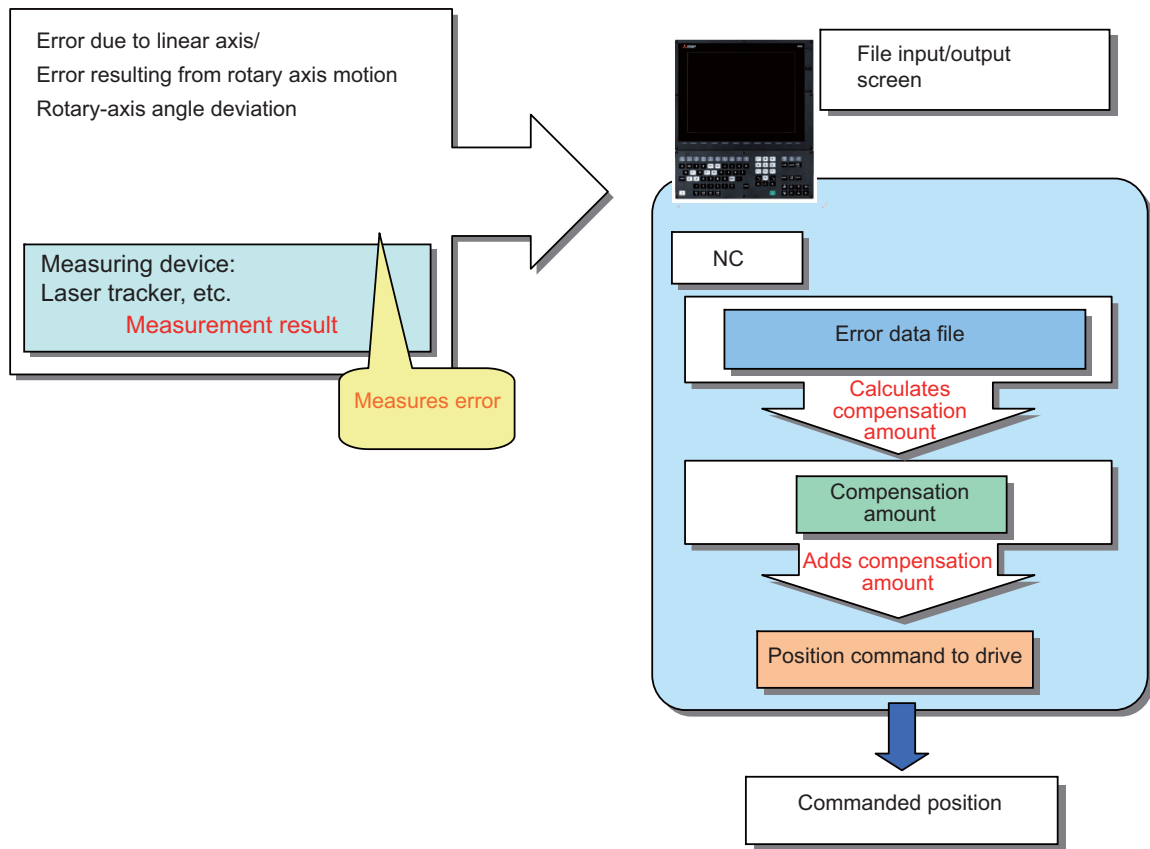

This function is compatible with the following axis configurations of the machines.

Machine	Machine type	Axis configuration
3-axis machine	3 orthogonal axes	Configured in right-handed orthogonal coordinate system
4-axis machine	Table tilt	Configured in right-handed orthogonal coordinate system + 1 rotary axis
	Tool tilt	
5-axis machine	Table tilt	Configured in right-handed orthogonal coordinate system + 2 rotary axes
	Combined	
	Tool tilt	

13.1.12 Backlash Compensation II

	M850W	M830W	M850S	M830S	M80W	M80 TypeA	M80 TypeB	E80 TypeA	E80 TypeB	C80
M	△	△	△	△	○	○	○	○	○	—
L	—	—	—	—	—	—	—	—	—	—

This function reduces quadrant error caused by the backlash when the traversing direction is reversed in machines where semi-closed loop control is implemented.

Compensation based on the acceleration rate at a direction reversal improves machining accuracy. For the range between the acceleration rates defined in parameters, the error is compensated using the compensation amount obtained through linear interpolation.

Backlash compensation II allows up to four compensation amounts for different acceleration rates to be set for each axis.

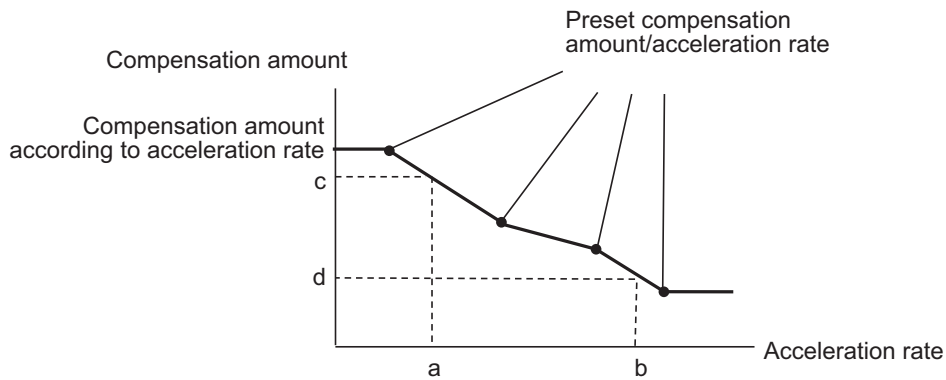

[Before the compensation]

[After the compensation]

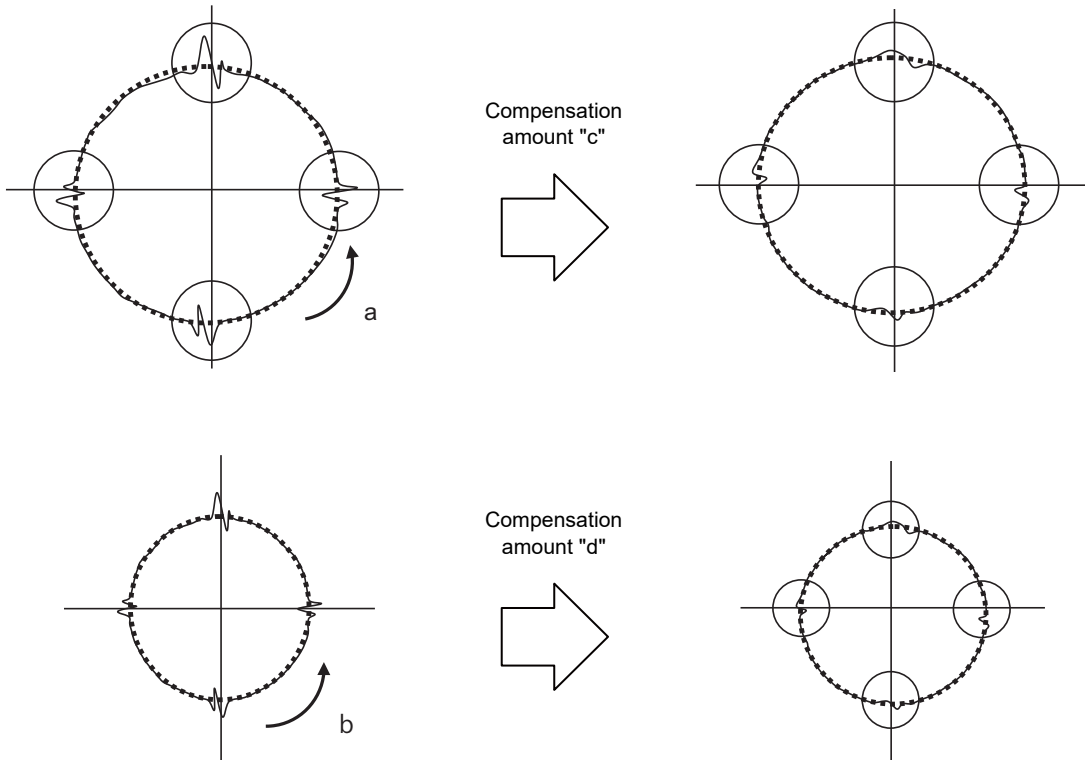

13.2 Dynamic Accuracy Compensation

13.2.1 Smooth High-gain (SHG) Control

	M850W	M830W	M850S	M830S	M80W	M80 TypeA	M80 TypeB	E80 TypeA	E80 TypeB	C80
M	○	○	○	○	○	○	○	○	○	○
L	○	○	○	○	○	○	○	○	○	○

This is a high-response and stable position control method using the servo system. This SHG control achieves an approximately three-fold position loop gain equally compared to the conventional control method.

The features of the SHG control are as follows.

- (1) The acceleration/deceleration becomes smoother, and the mechanical vibration can be suppressed (approx. 1/2) during acceleration/deceleration. (In other words, the acceleration/deceleration time constant can be shortened.)

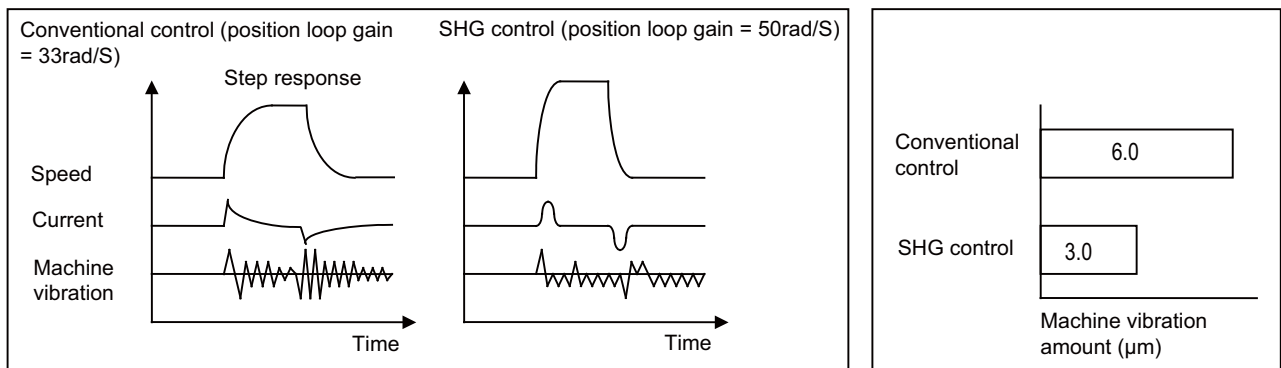

- (2) The shape error is approx. 1/9 of the conventional control.

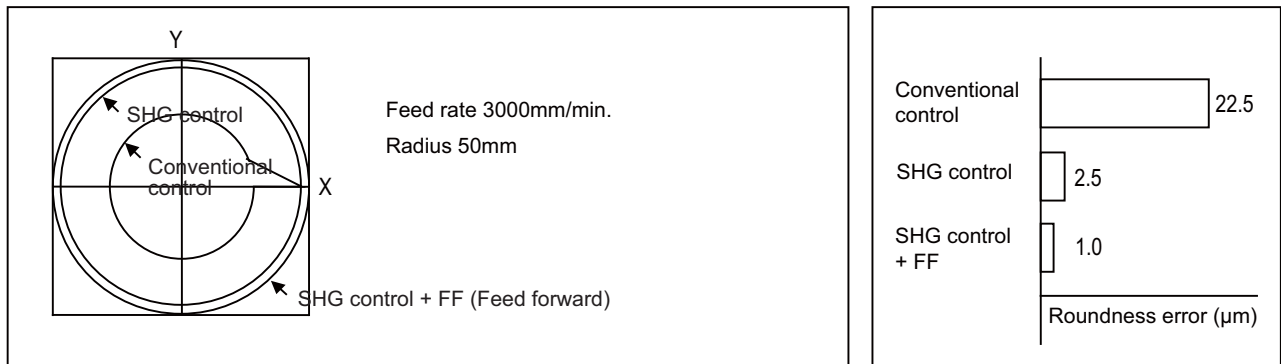

- (3) The positioning time is approx. 1/3 of the conventional control.

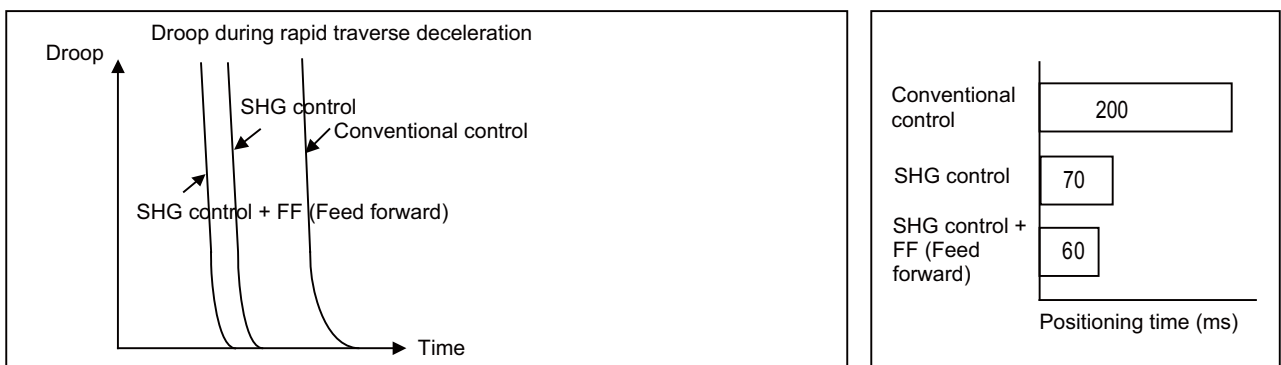

13.2.2 Dual Feedback

	M850W	M830W	M850S	M830S	M80W	M80 TypeA	M80 TypeB	E80 TypeA	E80 TypeB	C80
M	○	○	○	○	○	○	○	○	○	○
L	○	○	○	○	○	○	○	○	○	○

If the motor and machine coupling or machine system's rigidity is low (ex. large machine, etc.) when using a closed loop system, the response during acceleration/deceleration will vibrate and cause overshooting. This can cause the position loop gain from increasing. The dual feedback function is effective in this case.

To validate the dual feedback function, use position feedback with a motor side detector in ranges with high acceleration to enable stable control. In ranges with low acceleration, use position feedback with the machine side detector (scale).

This will make it possible to increase the position loop gain.

The machine side detector (scale) is required separately.

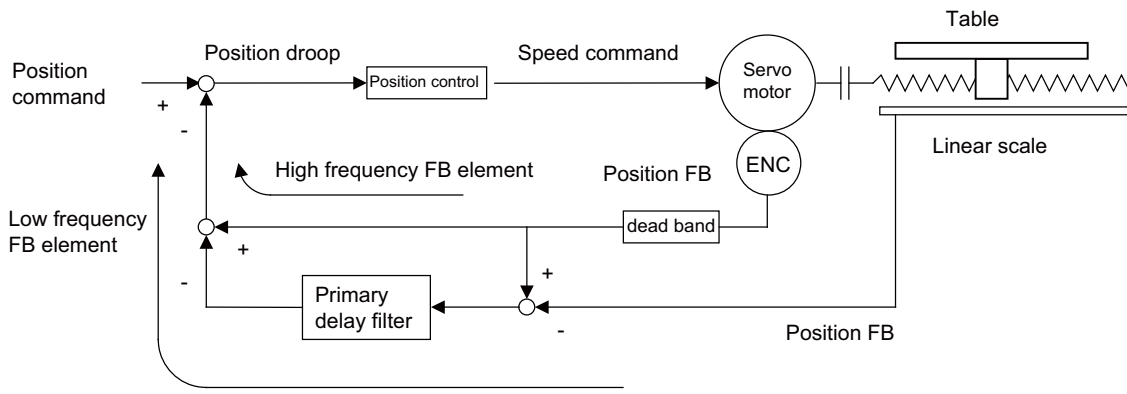

Dual feedback control

The state will approach the semi-closed loop system as the primary delay filter's time constant increases, so the position loop gain limit will increase. Note that the limit of the position loop gain increased with the dual feedback function is the same as the position loop gain limit for a semi-closed system that does not use a machine side detector (scale, etc.). In addition, the positioning time will increase as the primary delay filter time constant increases.

13.2.3 Lost Motion Compensation

	M850W	M830W	M850S	M830S	M80W	M80 TypeA	M80 TypeB	E80 TypeA	E80 TypeB	C80
M	○	○	○	○	○	○	○	○	○	○
L	○	○	○	○	○	○	○	○	○	○

This function compensates the error in the protrusion shape caused by lost motion at the arc quadrant changeover section during circular cutting.

13.2.4 OMR II (Backlash with Filter)

	M850W	M830W	M850S	M830S	M80W	M80 TypeA	M80 TypeB	E80 TypeA	E80 TypeB	C80
M	△	△	△	△	○	○	○	○	○	△
L	△	△	△	△	○	○	○	—	—	△

The OMR (Optimal Machine Response) control function estimates the machine or motor model (moment of inertia, clone friction, viscosity coefficient, etc.) that can cause a path error (error in actual tool path in respect to the path commanded with the program). High-accuracy machining is achieved by carrying out feed forward control based on that model. This allows error caused by quadrant protrusions during circular interpolation or quadrants on the inner side of the path to be greatly reduced.

OMR-II is a function that focuses on the quadrant protrusions, and improves the path error with this. Quadrant path compensation is included in OMR-II.

The quadrant protrusion compensation function improves quadrant protrusions by issuing compensation to the backlash compensation amount to compensate the error when the machine system direction is reversed.

By adding the compensated backlash compensation amount to the position command and sending it to the servo, the gradually increasing-type lost motion which occurs at quadrant changeover can be compensated.

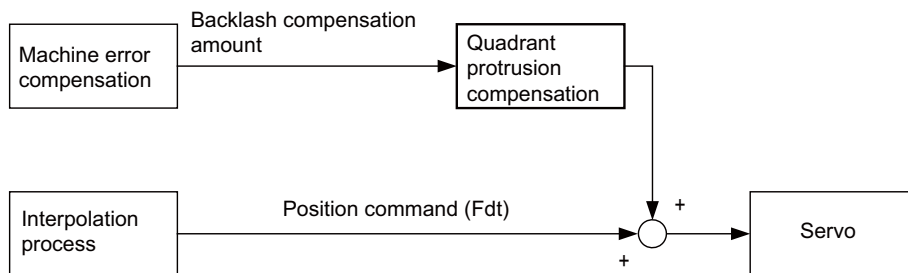

13.2.6 OMR-FF

	M850W	M830W	M850S	M830S	M80W	M80 TypeA	M80 TypeB	E80 TypeA	E80 TypeB	C80
M	△	△	△	△	○	○	○	○	○	△
L	△	△	△	△	○	○	○	○	○	△

The OMR (Optimal Machine Response) control estimates the causes (moment of inertia, clone friction, viscosity coefficient, etc.) of the path error (error in actual tool path in respect to the path commanded with the program) by making a model of the control target. Feed forward control is carried out based on that model.

With the OMR-FF control method, highly accurate machining can be achieved by using the command filter function to suppress vibration in addition to the reverse model feed forward function.

The reverse model feed forward function estimates the control target's vibration characteristics using a reverse model. The feed forward command for the appropriate position, speed and current can be obtained from this estimation. This allows the machine position to be tracked to the commanded position without causing vibration when using machine tools with low rigidity.

When the command filter function is also used, the high-range vibration elements in the command can also be suppressed.

New control method to bring out the full potential of a high-speed high-acceleration machine

- High tracking ability for the command (Smaller path error)
- Suppression of the machine vibration (Suppress low-range vibration without losing tracking ability)

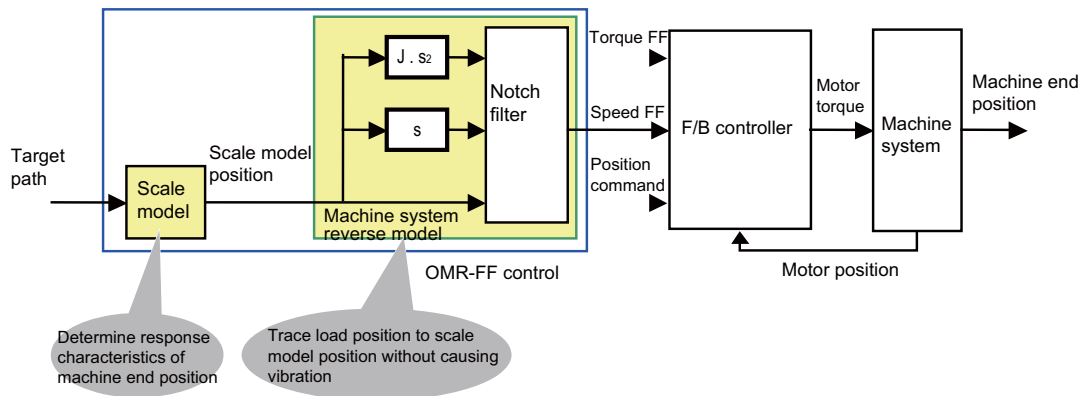

Set parameters:

- (1) Scale model time constant
- (2) Machine system resonance frequency ω_p , anti-resonance frequency ω_z , attenuation rate ζ , inertia J

13.2.7 Distance-coded Reference Position Detection

	M850W	M830W	M850S	M830S	M80W	M80 TypeA	M80 TypeB	E80 TypeA	E80 TypeB	C80
M	△	△	△	△	○	○	○	—	—	—
L	△	△	△	△	○	○	○	—	—	—

This is the function where the scale with absolute address reference mark is used to establish the reference point in the relative position detection system.

When the reference point has not been established, it is necessary to move the axis to the reference point. On the other hand, with this function, the reference point is established by moving the axis only for several reference marks, resulting in a significant reduction of the axis movement amount.

No dog is used as the position is calculated using reference marks.

<Reference point establishment process>

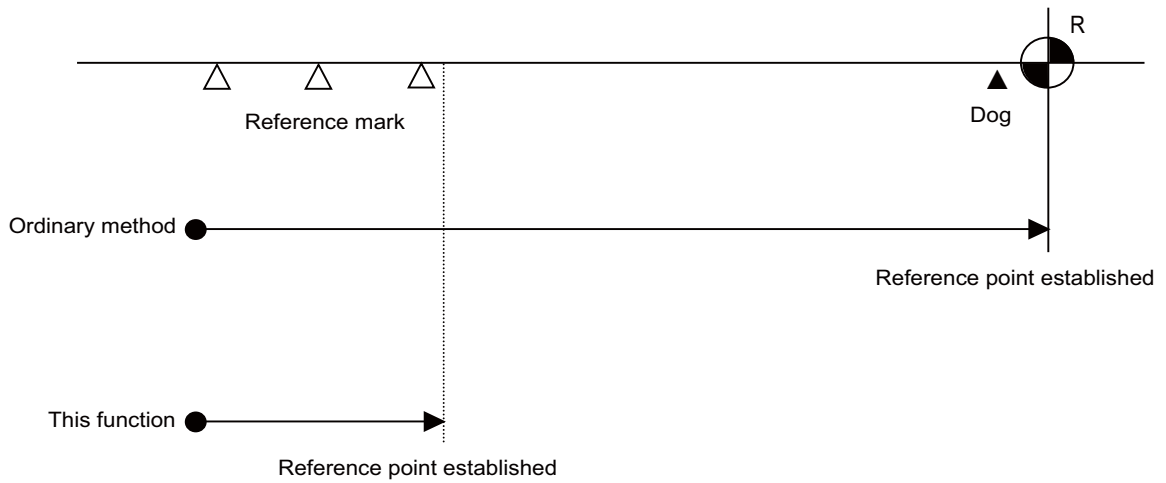

13.2.9 Variable Torsion Compensation

	M850W	M830W	M850S	M830S	M80W	M80 TypeA	M80 TypeB	E80 TypeA	E80 TypeB	C80
M	△	△	△	△	○	○	—	—	—	—
L	—	—	—	—	—	—	—	—	—	—

When the direction of the machine movement is reversed, a response delay (*1) causes protrusion on the path.
 (*1) The response delay occurs due to dead band, such as friction, torsion, and backlash.

The lost motion compensation and OMR-II provide a certain compensation using the set compensation parameters regardless of the acceleration rate at the direction reversal to suppress the protrusion. However, the characteristics of the response delay at the reversal differs depending on the acceleration rate at the reversal; therefore, when the arc radius or command speed is changed, the compensation cannot be performed sufficiently.
 The variable torsion compensation enables compensation based on the acceleration rate at the reversal and machining with high accuracy by setting the compensation parameters for each acceleration rate at the reversal.

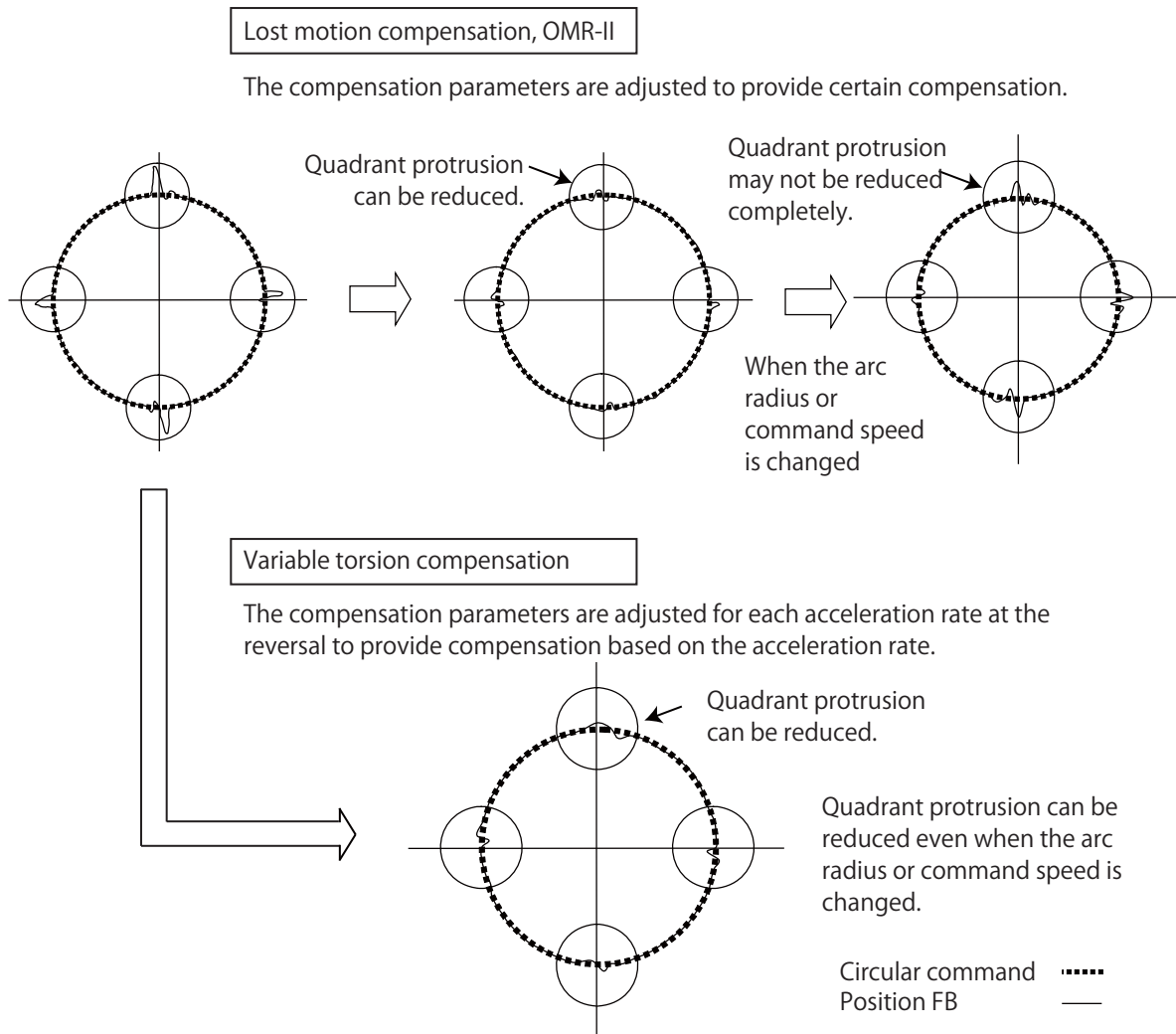

13.2.10 Cogging Torque Compensation

	M850W	M830W	M850S	M830S	M80W	M80 TypeA	M80 TypeB	E80 TypeA	E80 TypeB	C80
M	△	△	△	△	○	○	○	—	—	—
L	△	△	△	△	○	○	○	—	—	—

This function compensates the torque ripple (cogging torque).

Ensure to adjust this function before adjusting the machine.

As cogging torque varies with the characteristics of the motors used, machines need to be adjusted individually.

This function is designed for servo motors, and cannot be used for spindle motors.

This function is valid for the axes in the rotary axis spindle mode during spindle-mode rotary axis control.

This function is invalid for the axes under spindle-mode servo motor control.

Automation Support Functions

14.1 Measurement

14.1.1 Skip

14.1.1.1 Skip

	M850W	M830W	M850S	M830S	M80W	M80 TypeA	M80 TypeB	E80 TypeA	E80 TypeB	C80
M	○	○	○	○	○	○	○	○	○	○
L	○	○	○	○	○	○	○	○	○	○

When the external skip signal is input during linear interpolation with the G31 command, the machine feed is stopped immediately, the remaining distance is discarded and the commands in the next block are executed.

[M system]

G31 X__Y__Z__α__R__F__ ; (α is the additional axis.)	
X,Y,Z,α	: Coordinate values of each axis. Use absolute or incremental command.
R	: Acceleration/deceleration command
F	: Feed rate (mm/min)

[L system]

G31 X/U__Z/W__R__F__ ;	
X,Z,U,W	: Command values
R	: Acceleration/deceleration command
F	: Feed rate (mm/min)

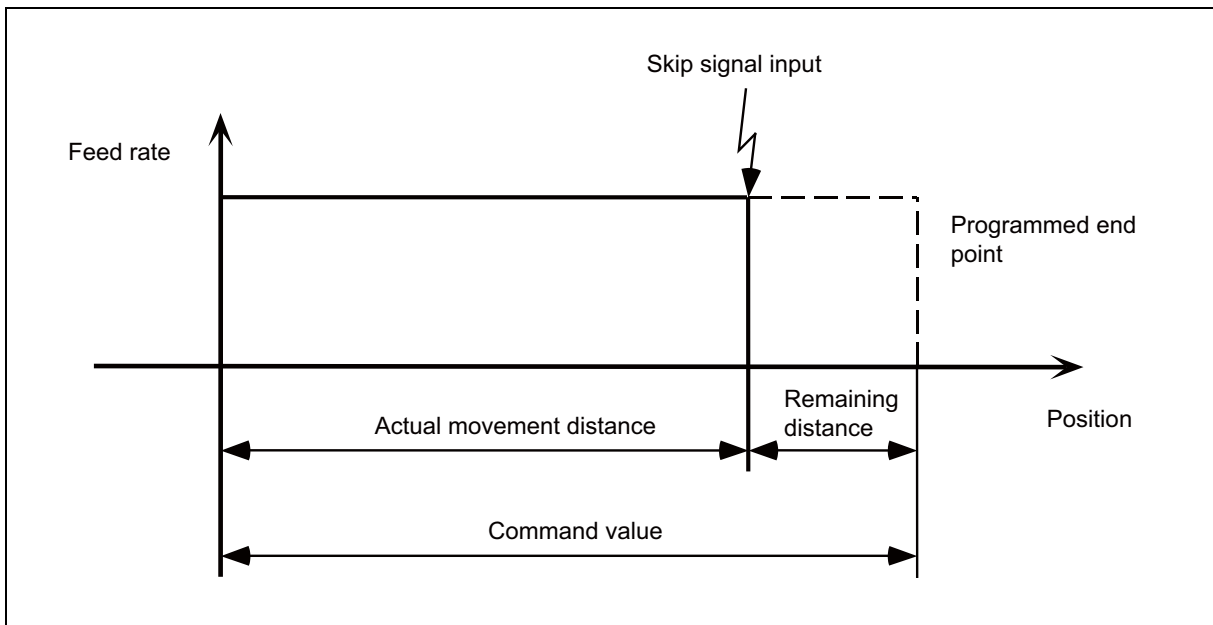

- (1) The cutting feed override and dry run are enabled or disabled by the respective parameters.
- (2) The feedrate switches as follows according to the parameter setting.
 - The value of address F given in the G31 block, or if F is not commanded, the value set by the parameter.
 - The F modal value commanded in the program.

- (3) Command by G31 command basis for acceleration/deceleration command (R0/R1).

When R0 command is issued or R command is omitted, automatic acceleration/deceleration is not performed but step acceleration/deceleration is performed after interpolation in G31 block.

If R1 command is issued, automatic acceleration/deceleration is performed after interpolation even when skip signal is input.

A command is not issued or a command other than R0/R1 is issued, it will be the operation of acceleration/deceleration time constant=0(R0) and automatic acceleration/deceleration is not performed after interpolation.

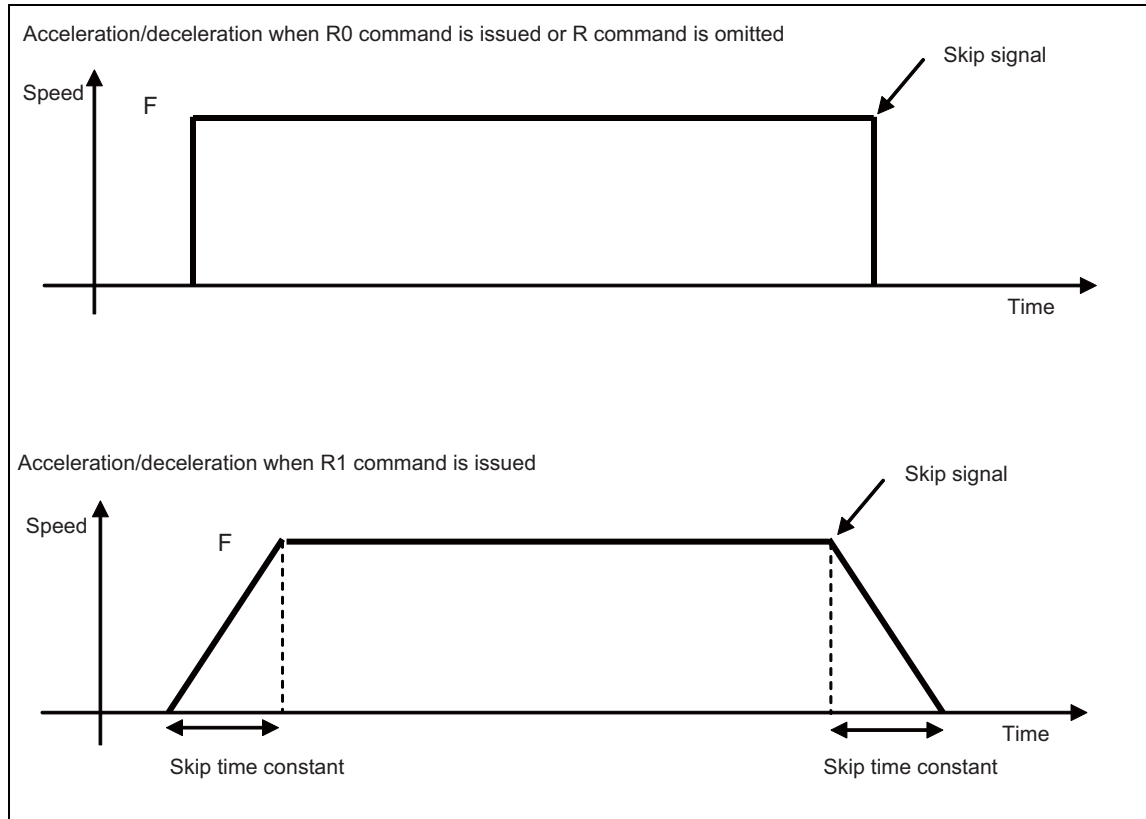

Changeover of acceleration/deceleration type with R command

- (4) The approximate coasting distance up to feed stop based on the detection delay in the skip signal input is calculated as below.

$$\begin{aligned}\delta_0 &= \frac{F}{60} \times T_p + \frac{F}{60} \times (t_1 \pm t_2) \\ &= \underbrace{\frac{F}{60} \times (T_p + t_1)}_{\delta_1} \pm \underbrace{\frac{F}{60} \times t_2}_{\delta_2}\end{aligned}$$

δ : Coasting distance (mm)

F : G31 rate (mm/min)

T_p : Position loop time constant (s) = (position loop gain)⁻¹

t_1 : Response delay time (s) = (A period of time from when the skip signal is detected until it reaches the control device.)

t_2 : Response error time 0.001 (s)

(Note 1) Skipping during machine lock is not valid.

14.1.1.2 Multiple-step Skip

	M850W	M830W	M850S	M830S	M80W	M80 TypeA	M80 TypeB	E80 TypeA	E80 TypeB	C80
M	○	○	○	○	○	○	○	○	○	○
L	○	○	○	○	○	○	○	○	○	○

This function realizes skipping by designating a combination of skip signals for each skip command.

(1) G31.n method

This function carries out skipping by designating a combination of skip signals for each skip command (G31.1, G31.2, G31.3).

The combination of the skip signals are designated with parameters for each G code (G31.1, 31.2, 31.3), and the skip operation is executed when all signals in the combination are input.

```
G31.n Xx1 Yy1 Zz1 Ff1 ;
G31.n          : Skip command (n=1, 2, 3)
Xx1,Yy1,Zz1   : Axis address and target position
Ff1           : Feedrate (mm/min)
```

(2) G31Pn method

As with the G31.n method, the valid skip signal is designated and skip is executed. However, the method of designating the valid skip signal differs.

The skip signals that can be used are 1 to 8. Which is to be used is designated with P in the program. Refer to Table 1 for the relation of the P values and valid signals.

Skip can be executed on dwell, allowing the remaining dwell time to be canceled during the dwell command (G04) and the next block executed under the skip conditions (to distinguish external skip signals 1 to 8) set with the parameters.

```
G31 Xx1 Yy1 Zz1 Pp Ff1 ;
G31          : Skip command
Xx1,Yy1,Zz1  : Axis address and target position
Pp           : Skip signal command
Ff1          : Feedrate (mm/min)
```

- (a) Specify the skip rate in command feedrate F. However, F modal is not updated.
- (b) Specify skip signal command in skip signal command P. Specify the P value in the range of 1 to 255. If it exceeds the specified range, a program error occurs.
- (c) When the skip signals are commanded in combination, the skip operation takes place with OR result of those signals.

Table 1 Valid skip signals

Skip signal command P	Valid skip signal							
	8	7	6	5	4	3	2	1
1								○
2							○	
3							○	○
4						○		
5						○		○
:	:	:	:	:	:	:	:	:
253	○	○	○	○	○	○		○
254	○	○	○	○	○	○	○	
255	○	○	○	○	○	○	○	○

14.1.1.4 PLC Skip

	M850W	M830W	M850S	M830S	M80W	M80 TypeA	M80 TypeB	E80 TypeA	E80 TypeB	C80
M	△	△	△	△	○	○	○	○	○	△
L	△	△	△	△	○	○	○	○	○	△

This function enables skip operations to be performed by signals which are input from the user PLC.

14.1.1.5 Speed Change Skip

	M850W	M830W	M850S	M830S	M80W	M80 TypeA	M80 TypeB	E80 TypeA	E80 TypeB	C80
M	△	△	△	△	—	—	—	—	—	—
L	△	△	△	△	—	—	—	—	—	—

This function is used to change the feed rate or to stop the movement by inputting the skip signal during the linear interpolation.

After stopping the movement with skipping, the remaining movement command is canceled and the next block is executed.

In addition to the speed change skip function, the high-speed skip option and multiple-step skip function are required to use this function.

G31 Xx Yy Zz Ff F1 = f1 ... Fn = fn ; (n is the skip signal 1 to 8.)
 G31 : Skip command
 Xx, Yy, Zz : Command position
 Ff : Feed rate when starting the cutting feed (mm/min)
 fn : Feed rate after detecting the skip signal (mm/min)
 fn = 0 : Movement stop
 fn ≠ 0 : Changing the feed rate to fn
 F1 = Feed rate after inputting the skip signal 1
 :
 F8 = Feed rate after inputting the skip signal 8

Operation example

G31 X100. Ff F1 = 0 F2 = f2 F3 = f3 F4 = f4 ;

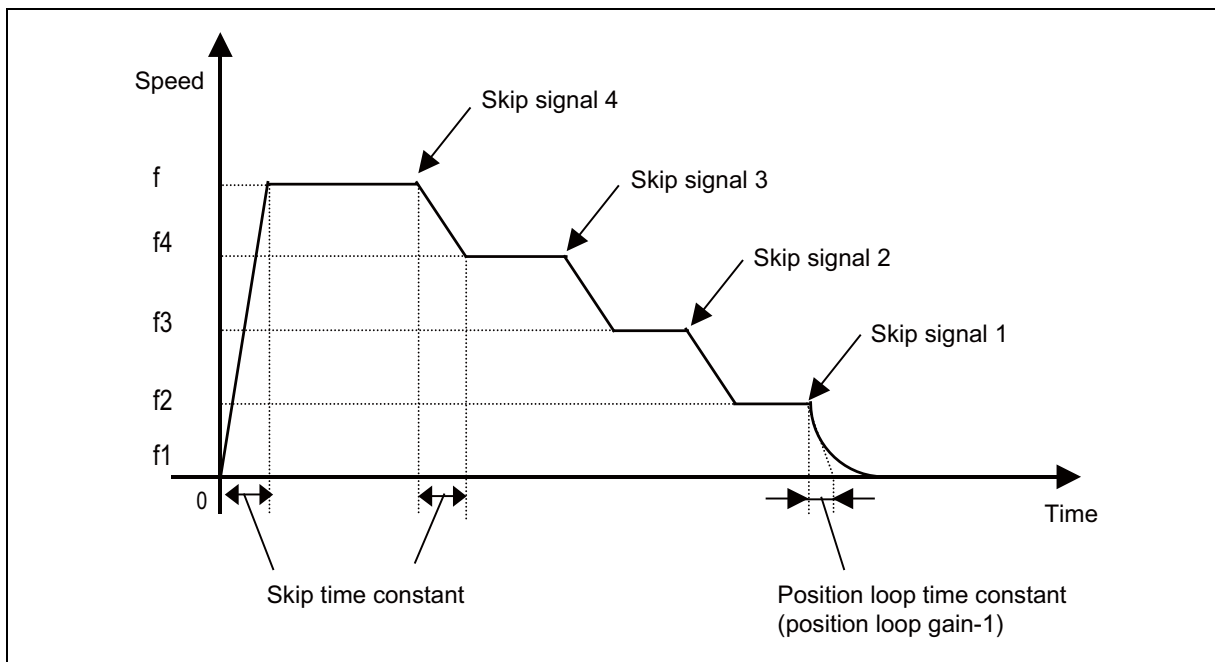

14.1.1.6 Torque Limitation Skip

	M850W	M830W	M850S	M830S	M80W	M80 TypeA	M80 TypeB	E80 TypeA	E80 TypeB	C80
M	△	△	△	△	○	○	○	○	○	—
L	△	△	△	△	○	○	○	○	○	△

Axis movement is performed in the torque limited status, and the axis movement command is suspended to proceed to the next block when the current command value reaches the designated torque skip value and the torque skip turns ON. In addition to the torque, the droop value can be add to the condition of the skip ON. (Droop skip)
 This function enables measurement without a sensor.

Workpiece radius measurement tool

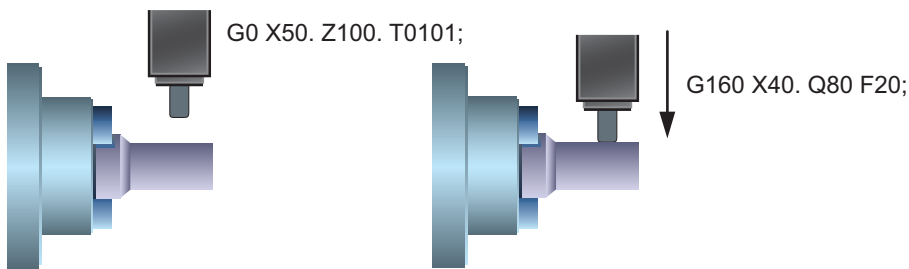

```

:
G0 X50. Z100. T0101;      Tool selection for measurement
G160 X40. Q80 F20;       Torque skip command
#100=#5061; :           Coordinate position (workpiece value) read
:
    
```

Command format

G160 X/U/Z/W/α Q D F ;	
X/U/Z/W/α	: Axis address (range of coordinate position command (mm, inch), decimal point command is possible)
Q	: Torque skip value (0 to 500 (%))
D	: Droop skip value (0 to 99999.999 (mm, inch))
F	: Skip speed (range of feedrate (mm/min, inch/min, mm/rev, inch/rev))

14.1.2 Automatic Tool Length Measurement

	M850W	M830W	M850S	M830S	M80W	M80 TypeA	M80 TypeB	E80 TypeA	E80 TypeB	C80
M	○	○	○	○	○	○	○	○	○	○
L	○	○	○	○	○	○	○	○	○	○

This function moves the tool in the direction of the tool measurement position by assigning a distance between the measurement start position to the measurement position. The machine stops when the tool reaches the sensor and automatically calculates the difference between the coordinate position where the tool stopped and measurement position. It registers this difference as the tool length compensation amount for that tool.

(1) Automatic Tool Length Measurement (M system)

This function moves the tool in the direction of the tool measurement position by commanding a distance between the measurement start position to the measurement position, it stops the tool as soon as it contacts the sensor and calculates the difference between the coordinate position when the tool has stopped and commanded coordinate position. It registers this difference as the tool length compensation amount for that tool.

If compensation has already been applied to the tool, it is moved in the direction of the measurement position with the compensation still applied, and when the measurement and calculation results are such that a further compensation amount is to be provided, the current compensation amount is further corrected.

If the compensation amount at this time is one type, the compensation amount is automatically corrected; if there is a distinction between the tool length compensation amount and wear compensation amount, the wear amount is automatically corrected.

G37 Zz1 Rr1 Dd1 Ff1 ;

G37 ; : Measurement command
 Zz1 : Measurement axis address and measurement position X, Y, Z, α (α = optional axis)
 Rr1 : The distance between the point at which tool movement is to start at the measurement speed and the measurement position
 Dd1 : The range in which the tool is to stop
 Ff1 : The measurement rate

When Rr1_, Dd1_ and Ff1_ have been omitted, the values set in the parameters are used.

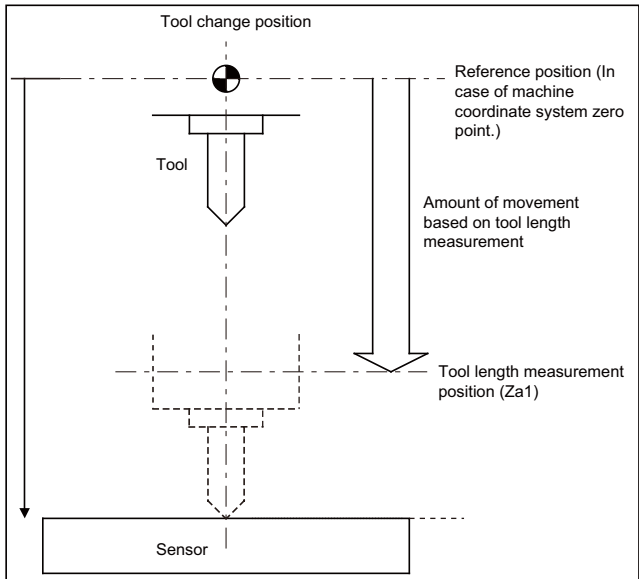

At this time, the tool length compensation amount has a minus ("-") value.

Example of program
 G28 Z0 ;
 T01 ;
 M06 T02 ;
 G43 G00 Z0 H01 ;
 G37 Z-300. R10. D2. F10 ;
 ;

In this case, the distance (H01 = Za1 - z0) from the tool T01 tip to the top of the measurement sensor is calculated as the tool length compensation amount which is then registered in the tool compensation table.

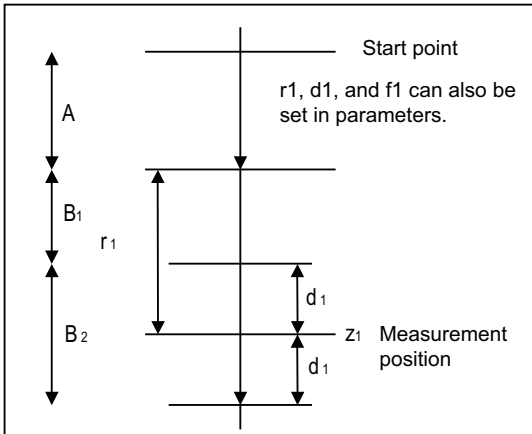

Area A : Moves with rapid traverse feed rate.
 Areas B₁, B₂ : Moves with the measurement speed (f1 or parameter setting)

If a sensor signal is input in area B₁, an error will occur.
 If a sensor signal is not input in the area B₂, an error will occur.

(2) Automatic tool length measurement (L series)

This function moves the tool in the direction of the tool measurement position by commanding a distance between the measurement start position to the measurement position, it stops the tool as soon as it contacts the sensor and calculates the difference between the coordinate position when the tool has stopped and commanded coordinate position. It registers this difference as the tool length compensation amount for that tool.

If compensation has already been applied to the tool, it is moved in the direction of the measurement position with the compensation still applied, and when the measurement and calculation results are such that a further compensation amount is to be provided, the current wear compensation amount is further corrected.

G37 $\alpha\alpha 1$ Rr1 Dd1 Ff1 ;

G37 : Measurement command

$\alpha\alpha 1$: Measurement axis address and measurement position coordinate ... X,Z

Rr1 : The distance between the point at which tool movement is to start at the measurement speed and the measurement position (Radial value fixed / incremental position)

Dd1 : The range in which the tool is to stop (Radial value fixed: incremental position)

Ff1 : The measurement rate

When Rr1_, Dd1_ and Ff1_ have been omitted, the values set in the parameters are used.

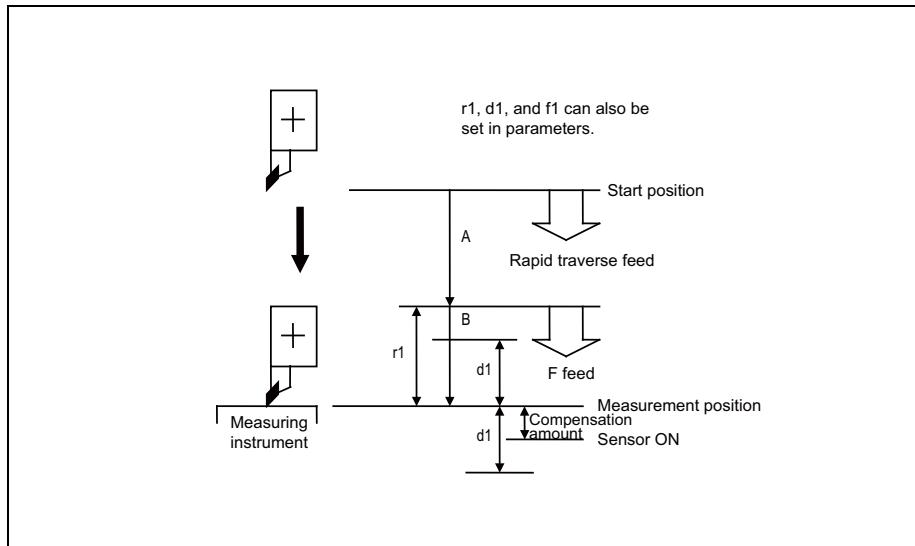

When the tool moves from the measurement start position to the measurement position specified in G37 x1 (z1), it passes through the A area at rapid traverse. Then, it moves at the measurement rate set in F command or parameter from the position specified in r1. If the measurement position arrival signal (sensor signal) turns ON during the tool is moving in the B area, an error occurs. If the measurement position arrival signal (sensor signal) does not turn ON although the tool passes through the measurement position x1 (z1) and moves by d1, an error occurs.

14.1.3 Manual Tool Length Measurement 1

	M850W	M830W	M850S	M830S	M80W	M80 TypeA	M80 TypeB	E80 TypeA	E80 TypeB	C80
M	○	○	○	○	○	○	○	○	○	○
L	○	○	○	○	○	○	○	○	○	○

Simple measurement of the tool length is done without a sensor.

(1) Manual tool length measurement I [M system]

When the tool is at the reference position, this function enables the distance from the tool tip to the measurement position (top of workpiece) to be measured and registered as the tool length compensation amount.

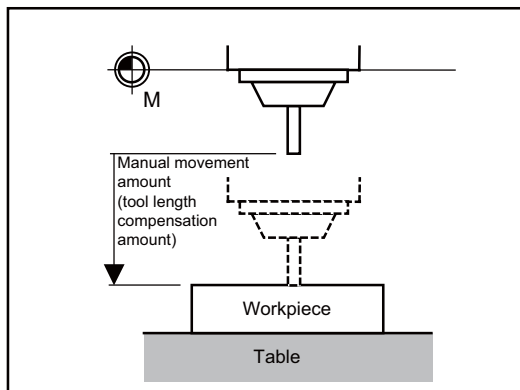

(2) Manual tool length measurement I [L system]

This is the function to calculate the tool length compensation amount automatically by moving the tool to the measurement point with manual feed. There are two types of measurement methods in manual tool length measurement I: the basic point method and the measurement value input method. The method is selected by setting parameter. For key operation there are normal operation mode/simple operation mode.

(a) Basic point method

Obtain the tool length with the tool nose placed on the measurement point.

To carry out the basic point method, a point to place the tool nose on (measurement point) is required.

When measurement position is set to parameter or workpiece coordinate offset (modal).

<Parameter designation method>

The tool length is automatically calculated using the following formula.

$$\text{Tool length} = \text{Machine coordinates} - \text{Measurement point (\#2015 tml-)}$$

(Note) Always set the measurement point with a radius value, regardless of the diameter/radius command.

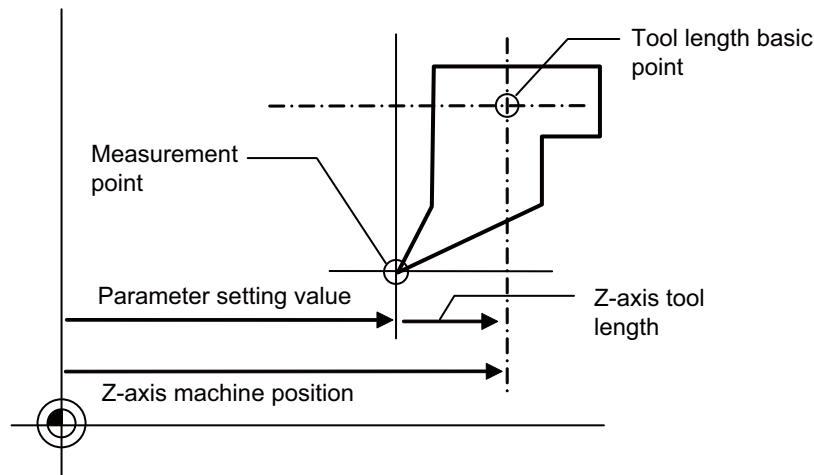
**<Workpiece coordinate offset designation method>**

Tool length is the coordinate value on the workpiece coordinate system.

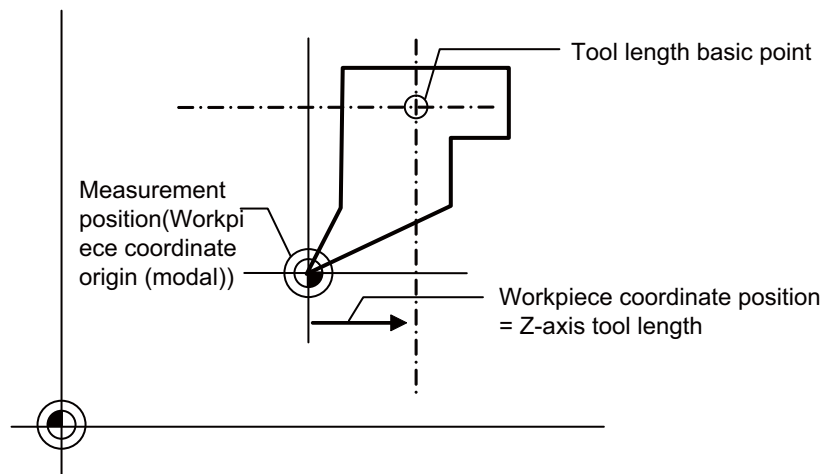

(b) Measurement value input method

Actually cut the workpiece. Measure its dimensions, and obtain the tool length from the measured values. The measurement basic point is characteristic for each machine (the center of the chuck face, etc. designated by parameter), or workpiece coordinate offset (modal).

<Parameter designation method>

The tool length is automatically calculated by the equation below.

$$\text{Tool length} = \text{Machine coordinate values} - \text{Measurement basic point (\#2015 tml-)} - \text{Measured value}$$

(Note) Always set the measurement point with a radius value, regardless of the diameter/radius command.

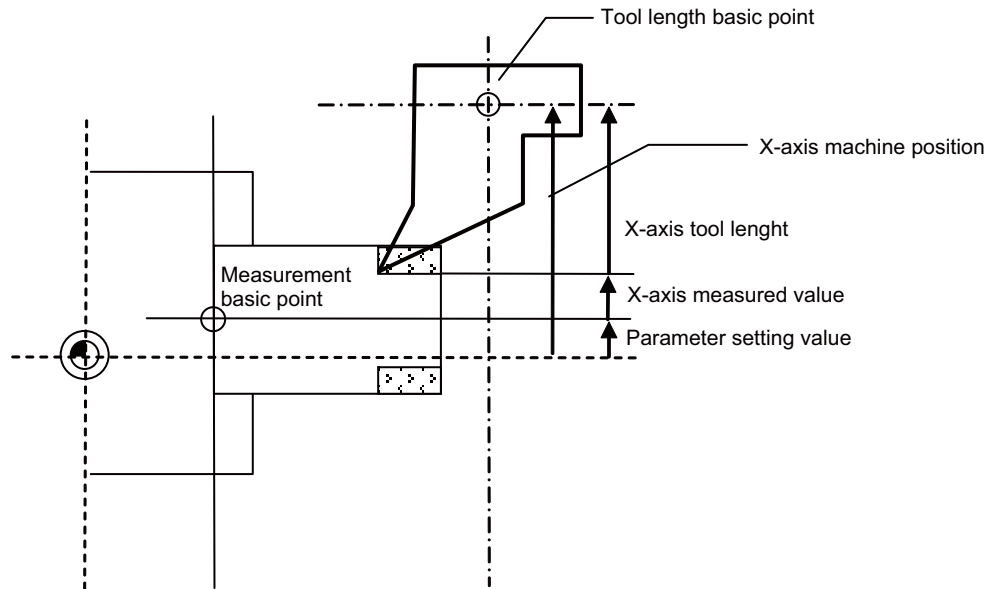

<Workpiece coordinate offset designation method>

The tool length is automatically calculated by the equation below.

$$\text{Tool length} = \text{Workpiece coordinate position} \cdot \text{Measured value}$$

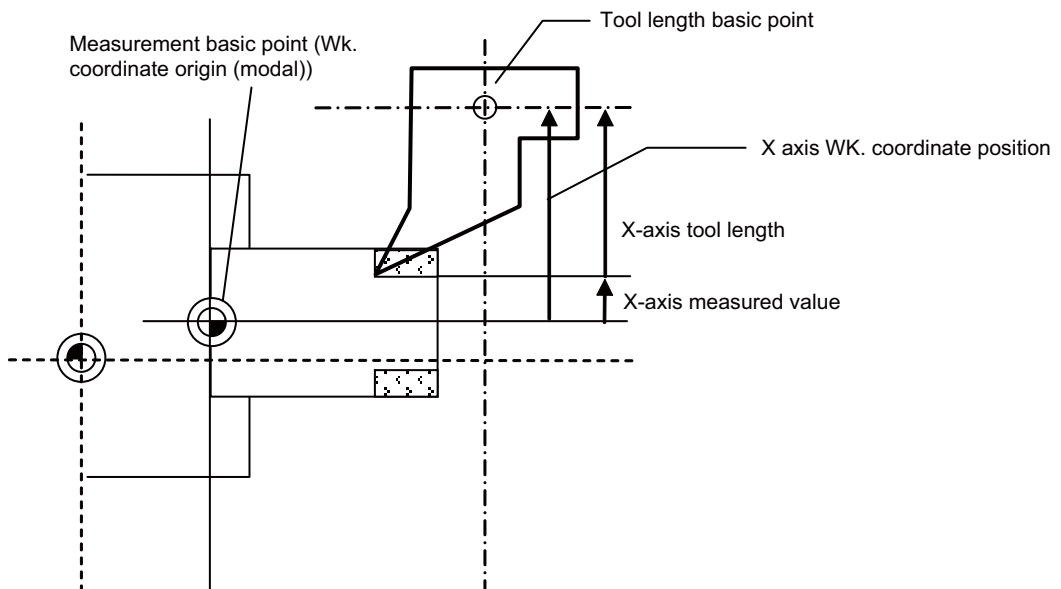

14.1.4 Manual Tool Length Measurement 2

	M850W	M830W	M850S	M830S	M80W	M80 TypeA	M80 TypeB	E80 TypeA	E80 TypeB	C80
M	○	○	○	○	○	○	○	○	○	○
L	○	○	○	○	○	○	○	○	○	○

(1) Manual tool length measurement II [M system]

When the tool is positioned at the reference position, this function enables the distance from the reference position to the tool tip to be measured and registered as the tool length compensation amount. In this case, the position of the gauge block used as a reference must be set as the basic height.

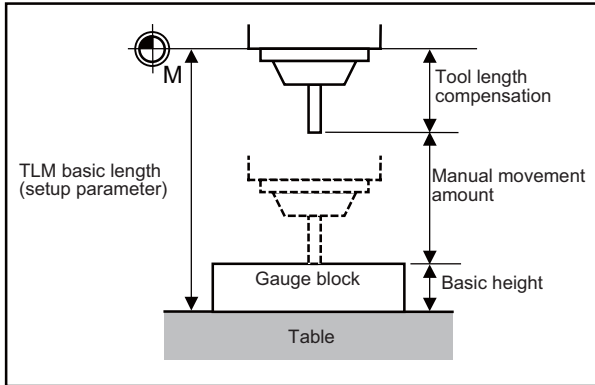

If the height axis designation parameter is ON, the axis designated for plane selection basic axis K is the axis targeted for measurement as the height axis.

Furthermore, if the tool length measurement check parameter is ON, an input OK/cancel confirmation message appears after input key has been pressed.

(2) Manual tool length measurement II [L system]

A device in which a touch probe is built is used. Simply by causing the tool nose to touch the touch probe in manual feed, the tool compensation amount can be calculated and stored in tool length compensation amount memory. If you set the tool compensation values of each tool, cut the workpiece end face manually, and then input the workpiece measurement signal, you can set the external workpiece coordinate offset data of Z axis. Preset the machine coordinate position of the touch probe touch face in parameter as the measurement basic position.

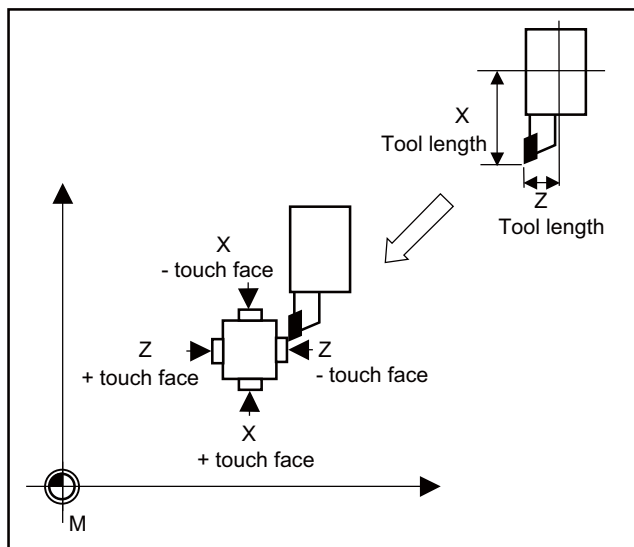

14.1.5 Workpiece Coordinate Offset Measurement

	M850W	M830W	M850S	M830S	M80W	M80 TypeA	M80 TypeB	E80 TypeA	E80 TypeB	C80
M	—	—	—	—	—	—	—	—	—	—
L	○	○	○	○	○	○	○	○	○	○

The external workpiece coordinate offset data for the Z axis can be set by cutting the workpiece face by means of manual operations and inputting the workpiece measurement signal.

By pressing the menu key, data can be set in the Z axis of an arbitrary coordinate offset.

Coordinate offset setting for the Z axis (2nd axis) of the part system 1 to 4 is possible.

Note that the workpiece coordinate offsets for multiple part systems cannot be measured at the same time.

(Note) Measurement is disabled for the part system with one-axis structure.

Example of measurement of external workpiece coordinate offset data for Z axis

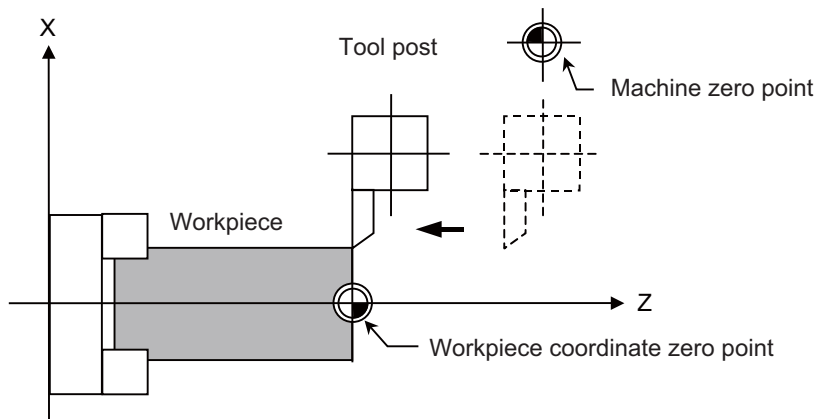

- (1) Measurement method with workpiece measurement signal
 - (a) Select the tool, and cut the workpiece face.
 - (b) When the workpiece measurement signal is input, the external workpiece coordinate offset data for the Z axis is calculated from the machine coordinate position, length of the tool used and tool nose wear compensation amount, and stored in the memory.

- (2) Measurement method with "MeasVal take in" menu
 - (a) Select a tool, and cut the workpiece face.
 - (b) When the "MeasVal take in" menu is pressed, workpiece coordinate offset data is calculated from the machine coordinate position, tool length and tool nose wear compensation amount of a used tool, and external workpiece coordinate offset. The workpiece coordinate offset data is stored in the Z-axis of the selected coordinate system offset.

14.1.6 Workpiece Position Measurement

	M850W	M830W	M850S	M830S	M80W	M80 TypeA	M80 TypeB	E80 TypeA	E80 TypeB	C80
M	○	○	○	○	○	○	○	○	○	○
L	—	—	—	—	—	—	—	—	—	—

The workpiece position measurement function is used to measure each axis' coordinate point by installing a sensor on the spindle and the sensor contacting the workpiece with the manual feed or handle feed.

The surface, hole center and width center coordinates are calculated from the measured coordinates, and those calculated results are set in the workpiece coordinate offset.

The axis to be measured is designated with parameter.

The workpiece position measurement is available for all the part systems.

Here the measurement axes are explained as "X", "Y" and "Z".

(1) Surface workpiece offset measurement

The workpiece position measurement coordinates are calculated from the skip machine position of the X, Y and Z axes.

Measurement position coordinate X = X axis' skip machine position + sensor diameter/2 ± center compensation amount (horizontal) ± skip flow amount (horizontal)

Measurement position coordinate Y = Y axis' skip machine position + sensor diameter/2 ± center compensation amount (vertical) ± skip flow amount (vertical)

Measurement position coordinate Z = Z axis' skip machine position - sensor length

The sensor diameter/2 and skip flow amount change between +/- with the tool movement direction during the measurement.

The X and Y axes use the sensor diameter, center compensation amount (horizontal/vertical) and skip flow amount (horizontal/vertical).

The Z axis uses the sensor length.

The measurement position coordinate of the X axis, Y axis or Z axis is set in the specified workpiece coordinate offset.

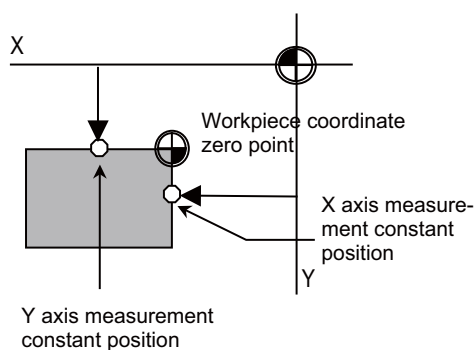

To set the workpiece coordinate offset, the X axis is measured and the X axis' offset coordinate is set. Then, the Y axis' offset is measured and set. Finally, the Z axis' offset is measured and set.

(2) Hole center workpiece offset measurement

The measurement position coordinates of two axes (X, Y) are measured at three points, and the hole center is calculated. The calculated result is set in the specified workpiece coordinate offset.

The workpiece position measurement coordinates are calculated from the skip machine position of the X and Y axes.

Measurement position coordinate X = X axis' skip machine position + center compensation amount (horizontal) ± skip flow amount (horizontal)

Measurement position coordinate Y = Y axis' skip machine position + center compensation amount (vertical) ± skip flow amount (vertical)

The +/- of the skip flow amount changes according to the tool movement amount during measurement.

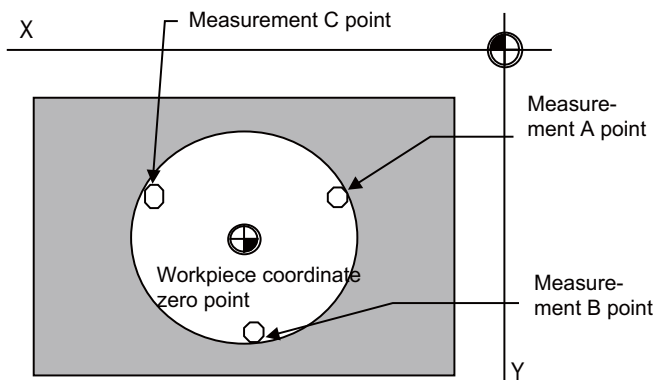

To set the workpiece coordinate offset, the position X and Y of the measurement A point are measured, and the measured values are set in the measurement A point. In the same manner as the measurement A point, the measurement B point and then C point are measured and set. The hole center coordinate is calculated by setting the workpiece coordinate system after setting three points, and the calculated result is set in the workpiece coordinate offset.

(3) Width center workpiece offset measurement

The two points among the measurement position coordinate of the X axis, Y axis or Z axis are measured, and each axis' groove center is calculated. The calculated result is set in the specified workpiece coordinate offset. The workpiece position measurement coordinates are calculated from the skip machine position of the X, Y and Z axes.

Measurement position coordinate X = X axis' skip machine position + center compensation amount (horizontal) ± skip flow amount (horizontal)

Measurement position coordinate Y = Y axis' skip machine position + center compensation amount (vertical) ± skip flow amount (vertical)

Measurement position coordinate Z = Z axis' skip machine position - Sensor length

The +/- of the skip flow amount changes according to the tool movement amount during measurement

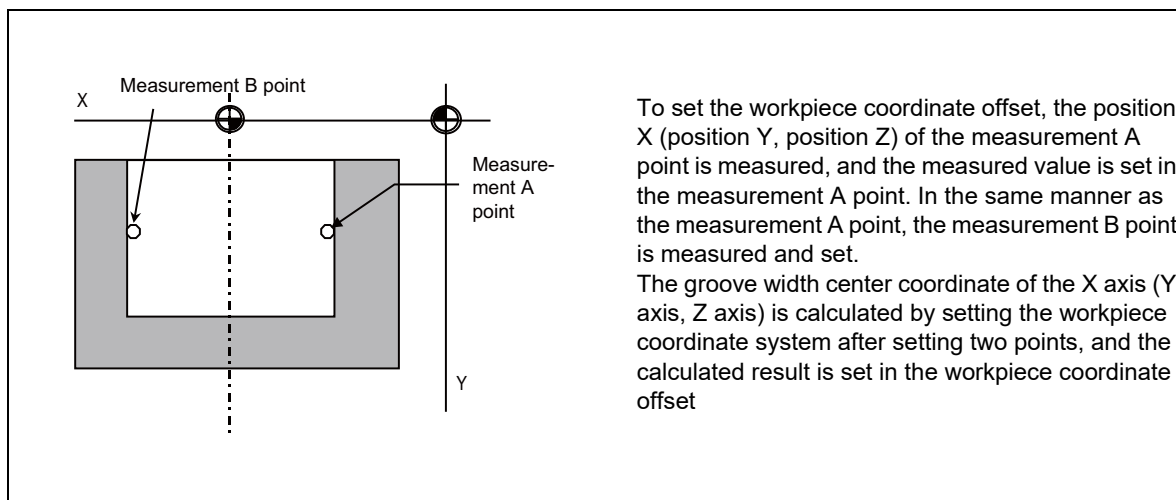

To set the workpiece coordinate offset, the position X (position Y, position Z) of the measurement A point is measured, and the measured value is set in the measurement A point. In the same manner as the measurement A point, the measurement B point is measured and set.

The groove width center coordinate of the X axis (Y axis, Z axis) is calculated by setting the workpiece coordinate system after setting two points, and the calculated result is set in the workpiece coordinate offset

14.1.7 Rotation Measurement

	M850W	M830W	M850S	M830S	M80W	M80 TypeA	M80 TypeB	E80 TypeA	E80 TypeB	C80
M	○	○	○	○	○	○	○	—	—	○
L	—	—	—	—	—	—	—	—	—	—

The offset (rotation center and rotation angle) of the rotary coordinate system is measured, and the results are set to the workpiece coordinate system offset (rotation center) and the parameters.

<Measurement using touch probe>

Measurement counter X = X axis skip position (Machine position)

Measurement counter Y = Y axis skip position (Machine position)

<Simple measurement (measurement without using touch probe)>

Measurement counter X = X axis machine position + center compensation (H) + skip past amount (Horizontal axis)

(Note)

Measurement counter Y = Y axis machine position + center compensation (V) + skip past amount (Vertical axis) (Note)

(Note) The skip past amount is added for only the axis that moved last.

The sign (+ or -) of the skip past amount depends on the movement direction of the axis.

14.1.8 Rotation Center Error Measurement

	M850W	M830W	M850S	M830S	M80W	M80 TypeA	M80 TypeB	E80 TypeA	E80 TypeB	C80
M	△	△	△	△	—	—	—	—	—	—
L	—	—	—	—	—	—	—	—	—	—

This function executes automatic measurement with the touch probe on the reference sphere to calculate the rotation center error compensation amount.

As the movement of the touch probe, the rotation of the axis, the reading of the coordinate and the calculation of the error are performed automatically, the rotation center error compensation amount can be easily calculated. The calculated error compensation amount can be confirmed on the rotation center error measurement screen and set to the parameter.

In order to perform the rotation center error measurement, you need to execute the rotation center error macro initialization in advance and input the rotation center error measurement macro program to the memory.

This function supports the following machine configurations only:

- AC table tilt
- BC table tilt

If the rotation center error measurement is attempted with the configuration which is not subject, the alarm occurs when the automatic start button is pressed.

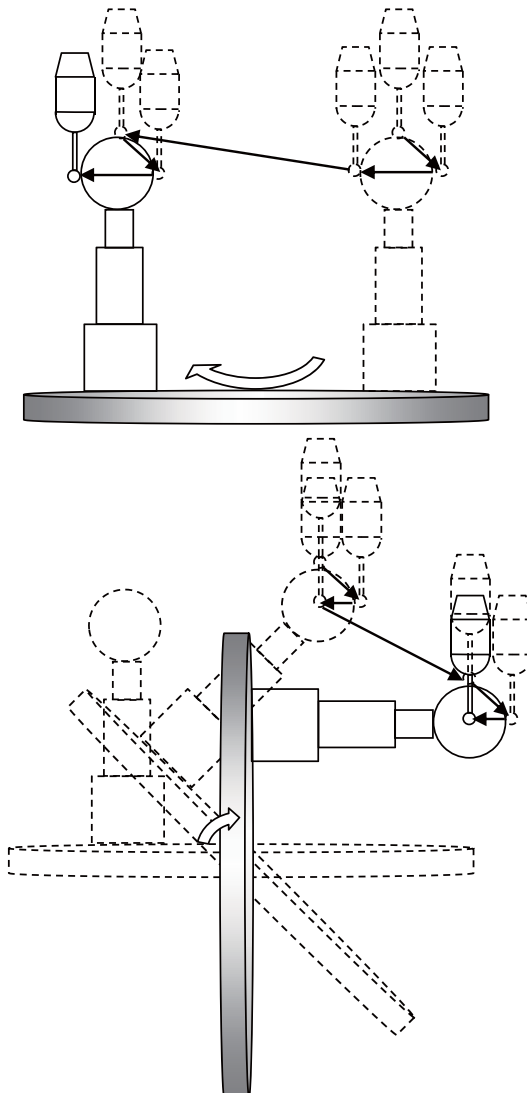

14.1.9 Workpiece Installation Error Measurement

	M850W	M830W	M850S	M830S	M80W	M80 TypeA	M80 TypeB	E80 TypeA	E80 TypeB	C80
M	△	—	△	—	—	—	—	—	—	—
L	—	—	—	—	—	—	—	—	—	—

This function executes automatic measurement with the touch probe to calculate the workpiece installation error compensation amount.

As the movement of the touch probe, the reading of the coordinate and the calculation of the error are performed automatically, the workpiece installation error compensation amount can be easily calculated. The calculated error compensation amount can be confirmed on the workpiece installation error measurement screen and set to the error compensation amount.

In order to perform the workpiece installation error measurement, you need to execute the workpiece installation error measurement macro initialization in advance and input the workpiece installation error measurement macro program to the memory.

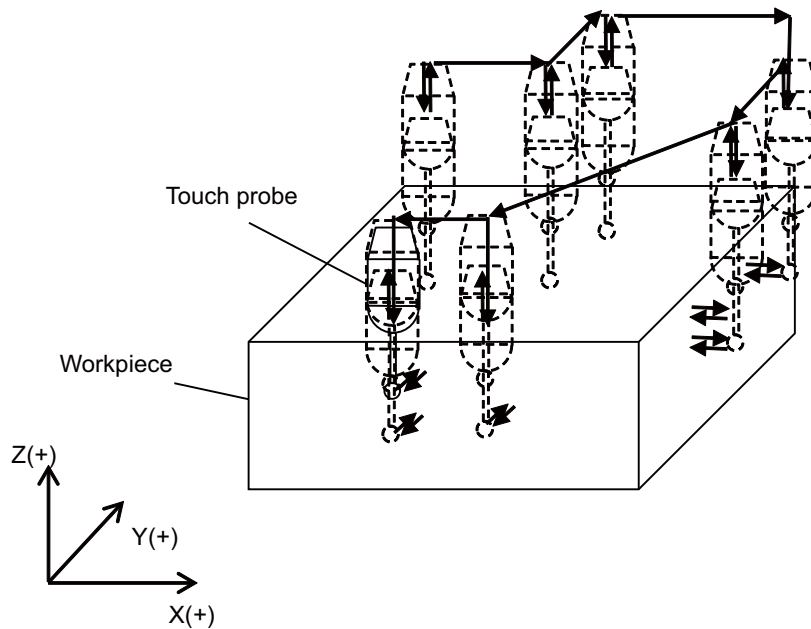

14.2 Tool Life Management

14.2.1 Tool Life Management

Tool life management is a function to monitor the usage of the programmed tool based on the cumulative cutting hours or the cumulative number of cuttings.

The function enables appropriate exchange of tools, which leads to consistent quality of machining.

For multi-part system, the number of tools for tool life management can be set individually for each part system.

14.2.1.1 Tool Life Management I

	M850W	M830W	M850S	M830S	M80W	M80 TypeA	M80 TypeB	E80 TypeA	E80 TypeB	C80
M	○	○	○	○	○	○	○	○	○	○
L	○	○	○	○	○	○	○	○	○	○

The following two method can be selected.

- Management by the cutting hours

The cutting time (such as G01, G02, or G33) after tool selection (T) command is added to the cumulative cutting hours for the specified tool.

- Management by the number of cuttings

The cumulative number of cuttings of the specified tool is incremented each time a tool selection (T) command is issued for the tool.

(1) M system

The "Tool life over" signal will turn ON when the cumulative tool usage data has reached the end of tool life.

(2) L system

The "Tool life over" signal will turn ON when a T command is issued after the cumulative tool usage data has reached the end of tool life.

14.2.1.2 Tool Life Management II

	M850W	M830W	M850S	M830S	M80W	M80 TypeA	M80 TypeB	E80 TypeA	E80 TypeB	C80
M	○	○	○	○	○	○	○	○	○	○
L	○	○	○	○	○	○	○	○	○	○

(1) M system

A spare tool change function is added to tool life management I. This function selects a usable tool out of the spare tools of the group determined by the value specified by the user PLC, then outputs data of such usable spare tool. The spare tool can be selected in two ways: the tools are selected in order they were registered in the group, or the tool whose remaining period of the tool life is the longest of all in the group is selected.

(2) L system

The tool life of each tool (cutting hours or number of cuttings) is controlled, and when the usage data has reached the end of tool life, a spare tool of the same type is selected from the group where the tool belongs to. By setting the remaining tool life value prediction value (hours or the number of times) in advance, when the remaining tool life of the tool in use is below the set value, the "Tool life prediction" signal can be output. (Tool life prediction function) (M8 series)

14.2.1.3 Tool Life Management III

	M850W	M830W	M850S	M830S	M80W	M80 TypeA	M80 TypeB	E80 TypeA	E80 TypeB	C80
M	○	○	○	○	○	○	○	○	○	○
L	—	—	—	—	—	—	—	—	—	—

For the tools designated by user PLC, tools' cumulative cutting hours (0 to 4000 minutes) or cumulative number of cuttings (0 to 65000 times) is accumulated, and the tool usage state is monitored. The tool life data for up to 1000 tools can be managed.

This function does not support the management by the group No.

14.2.2 Number of Tool Life Management Sets

[M system]

Number of tool life management tools	M850W	M830W	M850S	M830S	M80W	M80 TypeA	M80 TypeB	E80 TypeA	E80 TypeB	C80
Number of tool life management tools (99 sets)	—	—	—	—	—	—	—	—	—	—
Number of tool life management tools (128 sets)	—	—	—	—	—	—	—	—	—	—
Number of tool life management tools (200 sets)	○	○	○	○	○	○	○	○	○	○
Number of tool life management tools (256 sets)	—	—	—	—	—	—	—	—	—	—
Number of tool life management tools (400 sets)	△	△	△	△	—	—	—	—	—	—
Number of tool life management tools (999 sets)	△	△	△	△	—	—	—	—	—	—

[L system]

Number of tool life management tools	M850W	M830W	M850S	M830S	M80W	M80 TypeA	M80 TypeB	E80 TypeA	E80 TypeB	C80
Number of tool life management tools (99 sets)	—	—	—	—	—	—	○	○	○	—
Number of tool life management tools (128 sets)	○	○	○	○	—	—	—	—	—	○
Number of tool life management tools (200 sets)	—	—	—	—	—	—	—	—	—	—
Number of tool life management tools (256 sets)	—	—	—	—	○	○	—	—	—	△
Number of tool life management tools (400 sets)	△	△	△	△	—	—	—	—	—	—
Number of tool life management tools (999 sets)	△	△	△	△	—	—	—	—	—	—

The number of tools that can be managed for their lives in the case of fixed allocation are shown below. Refer to "14.2.3 Tool Life Management Set Allocation to Part Systems" for details on the arbitrary allocation.

[M system]

Function name	Common for part systems or 1-part system	Independent for systems and multi-part system
Number of tool life management tools (200 sets)	200 tools	Divide the number of tools in the system by the number of part systems to calculate the number of tools in each part system (If there is the remainder, the remainder is allocated to the first part system.)
Number of tool life management tools (400 sets)	400 tools	
Number of tool life management tools (999 sets)	999 tools	

[L system]

Function name	Common for part systems or 1-part system	Independent for systems and multi-part system
Number of tool life management tools (99 sets)	99 tools	Divide the number of tools in the system by the number of part systems to calculate the number of tools in each part system (If there is the remainder, the remainder is allocated to the first part system.)
Number of tool life management tools (128 sets)	128 tools	
Number of tool life management tools (256 sets)	256 tools	
Number of tool life management tools (400 sets)	400 tools	
Number of tool life management tools (999 sets)	999 tools	

14.2.3 Tool Life Management Set Allocation to Part Systems

	M850W	M830W	M850S	M830S	M80W	M80 TypeA	M80 TypeB	E80 TypeA	E80 TypeB	C80
M	○	○	○	○	—	—	—	—	—	—
L	○	○	○	○	○	○	○	—	—	○

* Variable number of management tools

The number of tool life management tools can be set per part system.

There are two types of the allocation: "Arbitrary allocation" which allocates the number of tool life management tools to each part system arbitrarily and "Fixed allocation" which automatically allocates the number of tool life management tools to each part system equally, and the type can be selected using the parameter.

The arbitrary allocation enables the efficient allocation because when a certain part system needs only a small number of tool life management tools, the rest can be allocated to another part system. If an auxiliary-axis part system does not need the tool life management at all, the number of tool life management tools can be set 0 in the auxiliary-axis part system.

"Number of tool life management tools in system" is the total number of tool life management tools of all part systems.

(1) Arbitrary allocation

- (a) When the number of tool life management tools is increased in the 1st part system of 4-part system

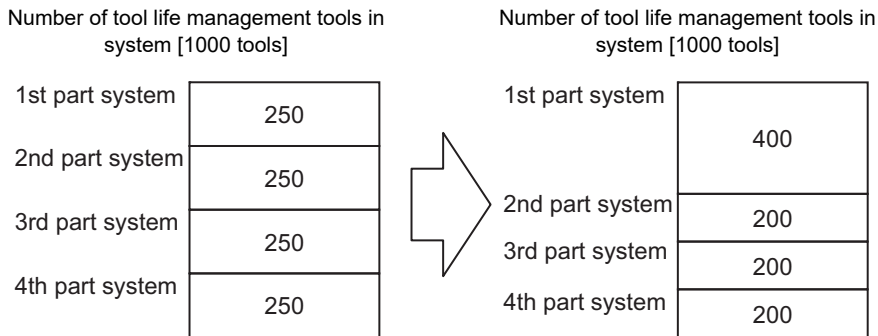

- (b) When the number of tool life management tools is set "0" to the 3rd part system of 3-part system for use of the 3rd part system as auxiliary-axis part system

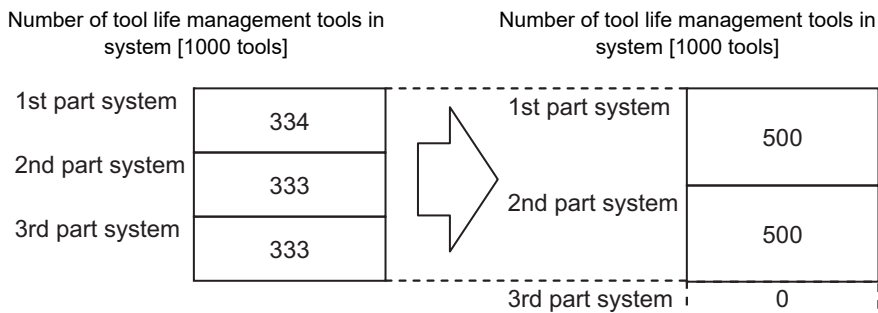

(2) Fixed allocation

Number of tool life management tools in system [1000 tools]

	1-part system	2-part system	3-part system	4-part system
1st part system	999 (Note 1)	1st part system 500	1st part system 334 (Note 2)	1st part system 250
		2nd part system 500	2nd part system 333	2nd part system 250
			3rd part system 333	3rd part system 250
				4th part system 250

(Note 1) The maximum number of tool life management tools per part system is 999.

(Note 2) If there is any remainder, the remainder is allocated to the 1st part system.

14.3 Others

14.3.1 Programmable Current Limitation

	M850W	M830W	M850S	M830S	M80W	M80 TypeA	M80 TypeB	E80 TypeA	E80 TypeB	C80
M	○	○	○	○	○	○	○	○	○	○
L	○	○	○	○	○	○	○	○	○	○

This function allows the current limit value of the NC axis to be changed to a desired value in the program, and is used for the workpiece stopper, etc.

The commanded current limit value is designated with a ratio of the limit current to the rated current. The current limit value can also be set from the setting and display unit.

The validity of the current limit can be selected with the external signal input.

However, the current limit value of the PLC axis cannot be rewritten.

G10 L14 X dn ;

G10	: Current limit input command
L14	: Current limit value setting (+ side/- side)
X	: Axis address
dn	: Current limit value 1% to 999%

- (1) If the current limit is reached when the current limit is valid, the current limit reached signal is output.
- (2) The following two modes can be used with external signals as the operation after the current limit is reached.
 - Normal mode
The movement command is executed in the current state.
During automatic operation, the movement command is executed to the end, and then the next block is moved to with the droops still accumulated.
 - Interlock mode
The movement command is blocked (internal interlock).
During automatic operation, the operation stops at the corresponding block, and the next block is not moved to.
During manual operation, the following same direction commands are ignored.
- (3) During the current limit, the droop generated by the current limit can be canceled with external signals.
(Note that the axis must not be moving.)
- (4) The setting range of the current limit value is 1% to 999%. Commands that exceed this range will cause a program error.
- (5) If a decimal point is designated with the G10 command, only the integer will be valid.
(Example) G10 L14 X10.123 ; The current limit value will be set to 10%.
- (6) For the axis name "C", the current limit value cannot be set from the program (G10 command). To set from the program, set the axis address with an incremental axis name, or set the axis name to one other than "C".

14.3.2 Auto Power OFF

	M850W	M830W	M850S	M830S	M80W	M80 TypeA	M80 TypeB	E80 TypeA	E80 TypeB	C80
M	○	○	○	○	○	○	○	○	○	—
L	○	○	○	○	○	○	○	○	○	—

This can notify that the control unit's power can be turned OFF after shutting the display unit down (Do not turn the power OFF.) by entering "automatic power OFF request" signal from user PLC to NC.

(Note) The Mitsubishi Electric-supplied display unit is required.

14.3.4 Load Monitoring I

	M850W	M830W	M850S	M830S	M80W	M80 TypeA	M80 TypeB	E80 TypeA	E80 TypeB	C80
M	△	△	△	△	○	○	—	—	—	—
L	△	△	△	△	○	○	—	—	—	—

This function aims at detecting tool wear or degradation by detecting and monitoring the actual load (current value) on spindle and NC axes on a real time basis.

The effective torques and estimated disturbance torques on the spindle and NC axes are output to the predetermined R registers in real time. Sampling of the estimated disturbance torque can be performed with this function.

Up to 8 servo axes in each part system (maximum 4 part systems) are supported with this function.

14.3.5 Power ON/OFF Sequence

	M850W	M830W	M850S	M830S	M80W	M80 TypeA	M80 TypeB	E80 TypeA	E80 TypeB	C80
M	○/—	○/—	—	—	○/—	—	—	—	—	—
L	○/—	○/—	—	—	○/—	—	—	—	—	—

* Specifications of separated-type display are classified with "Windows-based" and "non-Windows-based"

This function turns the power supply ON/OFF, synchronizing the NC control unit and the HMI screen. This enables the following:

- The relay which synchronizes the control unit and the personal computer unit when the power supply is turned ON becomes unnecessary.
- The control unit and the personal computer unit are configured with the same power supply and can be started up at optimum timing even when they are turned ON at the same time.
- By using the power ON/OFF button of the operation panel side, both the control unit and the personal computer unit can be started up and their power supply can be turned ON again.
- When the automatic power OFF is performed, NC starts the end processing right after the end processing of the personal computer unit is completed to reduce the wasteful standby time.

14.3.6 PLC Axis Current Limit

	M850W	M830W	M850S	M830S	M80W	M80 TypeA	M80 TypeB	E80 TypeA	E80 TypeB	C80
M	—	—	—	—	—	—	—	—	—	○
L	—	—	—	—	—	—	—	—	—	○

This function can set a current limit to the PLC axis as with NC axis. This can be used for the stopper control, etc.

14.3.7 Direct Robot Control

	M850W	M830W	M850S	M830S	M80W	M80 TypeA	M80 TypeB	E80 TypeA	E80 TypeB	C80
M	<input type="checkbox"/>	<input type="checkbox"/>	<input type="checkbox"/>	<input type="checkbox"/>	<input type="checkbox"/>	<input type="checkbox"/>	<input type="checkbox"/>	<input type="checkbox"/>	<input type="checkbox"/>	—
L	<input type="checkbox"/>	<input type="checkbox"/>	<input type="checkbox"/>	<input type="checkbox"/>	<input type="checkbox"/>	<input type="checkbox"/>	<input type="checkbox"/>	<input type="checkbox"/>	<input type="checkbox"/>	—

This function enables a robot to be connected to and directly operated by an NC.

A robot-dedicated screen is provided to display the status of the robot on the NC screen. Some of the possible operations are as follows:

- Automatic operation using robot-dedicated G code commands in NC machining programs
- Manual operation of the robot using a handle on the NC
- Digital I/O control to open and close the robot hand

As in the following example, this function enables the NC to control the machining of workpieces with the robot loading and unloading workpieces in coordination with the machining, as well as deburring through the robot concurrent with the machining of workpieces.

<Example of system configuration>

1st part system (\$1) : X, Z

2nd part system (\$2) : - (The part system has no axes because only a robot is controlled.)

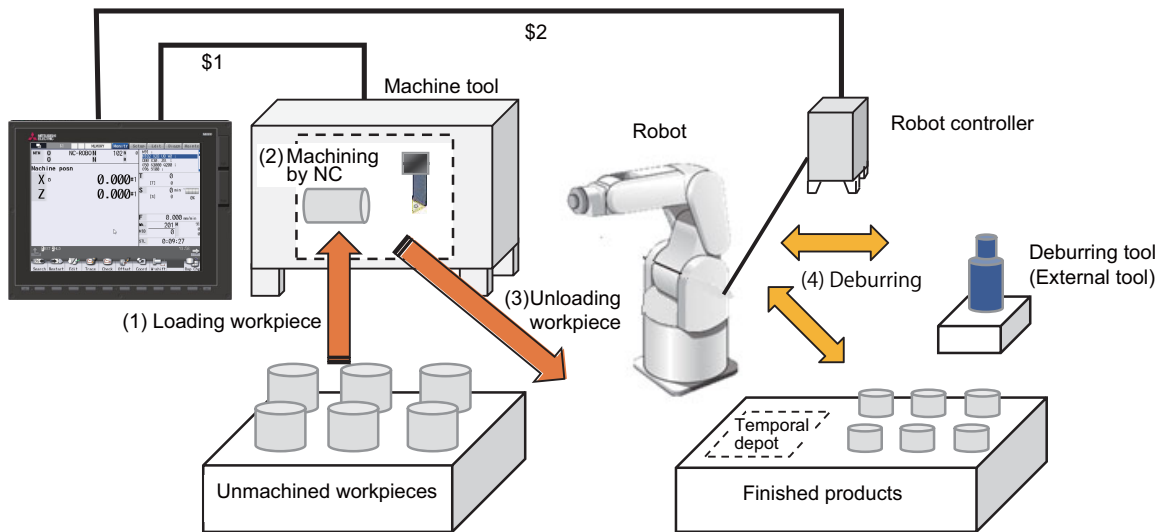

A part system to be used exclusively for robot operation (robot-dedicated part system) can be set. Even when the robot-dedicated part system is not used, robot operation is possible; however, when the robot-dedicated part system is used, robot operation is possible with the same command (program) as the NC axis control.

Safety and Maintenance

15.1 Safety Switches

15.1.1 Emergency Stop

	M850W	M830W	M850S	M830S	M80W	M80 TypeA	M80 TypeB	E80 TypeA	E80 TypeB	C80
M	○	○	○	○	○	○	○	○	○	○
L	○	○	○	○	○	○	○	○	○	○

All operations are stopped by the emergency stop signal input and, at the same time, the drive section is stopped and the movement of the machine is stopped.

At this time, the READY lamp on the setting and display unit goes OFF and the servo ready signal is turned OFF.

When the emergency stop is cancelled, the reset will be performed. The reset type can be selected in the parameter.

15.1.2 Data Protection Key

	M850W	M830W	M850S	M830S	M80W	M80 TypeA	M80 TypeB	E80 TypeA	E80 TypeB	C80
M	○	○	○	○	○	○	○	○	○	○
L	○	○	○	○	○	○	○	○	○	○

The editing functions such as setting and deleting of data can be prohibited by the data protection key. There are 5 types of data protection keys, and each data protection key and the data to be protected are as follows:

Data protection key type	Description
Data protection key 1	For protecting the overall tool data and the coordinate system presettings as based on origin setting.
Data protection key 2	For protecting the user parameters and common variables.
Data protection key 3	For protecting the machining programs of NC memory.
Data protection key (memory card)	For protecting the data on the front-side SD (memory card).
Data protection key (DS)	For protecting the data on the back-side SD (DS).

The data protection keys prohibit the editing functions such as setting and deleting when the keys are OFF (0).

15.2 Display for Ensuring Safety

15.2.1 NC Warning

	M850W	M830W	M850S	M830S	M80W	M80 TypeA	M80 TypeB	E80 TypeA	E80 TypeB	C80
M	○	○	○	○	○	○	○	○	○	○
L	○	○	○	○	○	○	○	○	○	○

The warnings which are output by the NC system are listed below. When one of these warnings has occurred, a warning number is output to the PLC and a description of the warning appears on the screen. Operation can be continued without taking further action.

Type of warning	Description
Servo warning	The servo warning is displayed.
Spindle warning	The spindle warning is displayed.
System warning	The system warning is displayed. (State such as temperature rise, battery voltage low, etc.)
Absolute position warning	A warning in the absolute position detection system is displayed.
Auxiliary axis warning	The auxiliary axis warning is displayed.

15.2.2 NC Alarm

	M850W	M830W	M850S	M830S	M80W	M80 TypeA	M80 TypeB	E80 TypeA	E80 TypeB	C80
M	○	○	○	○	○	○	○	○	○	○
L	○	○	○	○	○	○	○	○	○	○

When an alarm has occurred, an alarm number is output to the PLC, and a description of the alarm appears on the screen. Operation cannot be continued without taking remedial action.

For NC alarm display and alarm signals, refer to "Alarm/Parameter Manual" and "PLC Interface Manual" for details. In addition, the NC alarm has the following functions.

(1) Display delay function of an operation alarm

This function can be used to postpone only alarm display (including alarm signal ON and alarm history record) when an operation error has occurred.

By removing the causes of the operation error while alarm display is being postponed, unnecessary alarm display is not displayed and also unnecessary alarm history is not recorded.

(2) 7-segment LED alarm/status display

The 7-segment LED mounted on the operation board I/O can display NC status.

When alarms occur, an alarm with the highest priority within each part system is displayed.

(3) Alarm/warning on PLC output of servo/spindle drive unit

When an alarm or a warning has occurred in the servo drive unit or spindle drive unit, alarm No. and warning No. of each drive unit is output to the R register.

When a warning has occurred in the servo drive unit or spindle drive unit, the signal is output to indicate that a warning has occurred.

(4) Multiple keys cannot be input (M8 Series only)

This function is used to display an operation error when multiple keys are input with the keyboard or the menu buttons on the display unit.

15.2.3 Operation Stop Cause

	M850W	M830W	M850S	M830S	M80W	M80 TypeA	M80 TypeB	E80 TypeA	E80 TypeB	C80
M	○	○	○	○	○	○	○	○	○	○
L	○	○	○	○	○	○	○	○	○	○

The stop cause of automatic operation is displayed on the setting and display unit.

15.2.4 Emergency Stop Cause

	M850W	M830W	M850S	M830S	M80W	M80 TypeA	M80 TypeB	E80 TypeA	E80 TypeB	C80
M	○	○	○	○	○	○	○	○	○	○
L	○	○	○	○	○	○	○	○	○	○

When "EMG" (emergency stop) message is displayed in the operation status display area of the setting and display unit, the emergency stop cause can be confirmed.

15.2.5 Thermal Detection

	M850W	M830W	M850S	M830S	M80W	M80 TypeA	M80 TypeB	E80 TypeA	E80 TypeB	C80
M	○	○	○	○	○	○	○	○	○	○
L	○	○	○	○	○	○	○	○	○	○

When overheating is detected in the control unit, an overheat signal is output at the same time as the alarm is displayed. If the system is in automatic run at the time, run is continued, but it cannot be started after reset or completion by M02/M30. (It can be started after block stop or feed hold.)

When the temperature falls below the specified temperature, the alarm is released and the overheat signal is turned OFF.

The overheat alarm occurs at 80 C or more in the control unit.

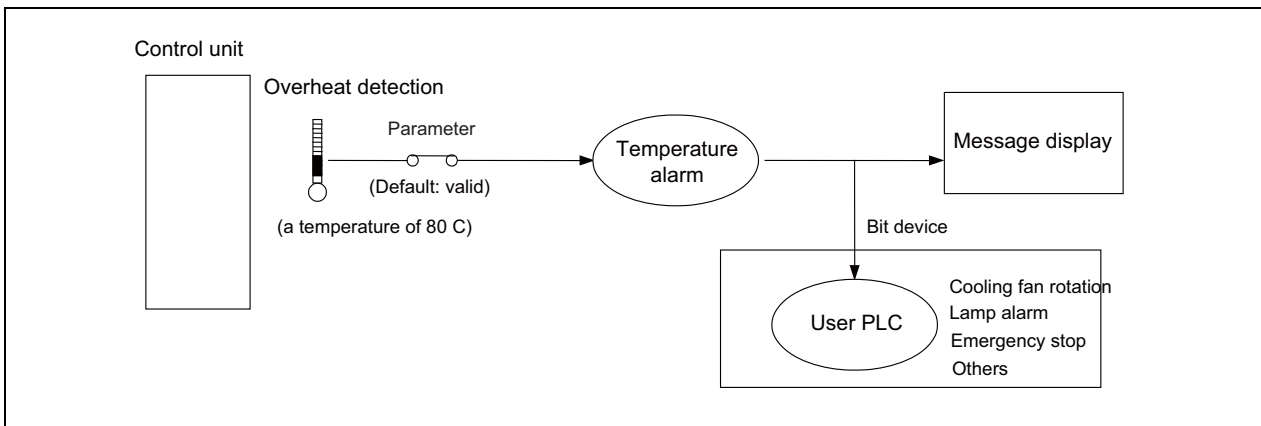

(Note 1) If the parameter is used to set the temperature rise detection function to invalid, overheating may occur, thereby disabling control and possibly resulting in the axes running out of control, which in turn may result in machine damage and/or bodily injury or destruction of the unit. It is for this reason that the detection function is normally left "valid" for operation.

15.2.6 Battery Alarm/Warning

	M850W	M830W	M850S	M830S	M80W	M80 TypeA	M80 TypeB	E80 TypeA	E80 TypeB	C80
M	○	○	○	○	○	○	○	○	○	○
L	○	○	○	○	○	○	○	○	○	○

When it is time for changing batteries, alarm or warning is displayed.

When a warning is displayed, immediately backup all the necessary data and change batteries.

When an alarm is displayed, there is a possibility that memory has been lost.

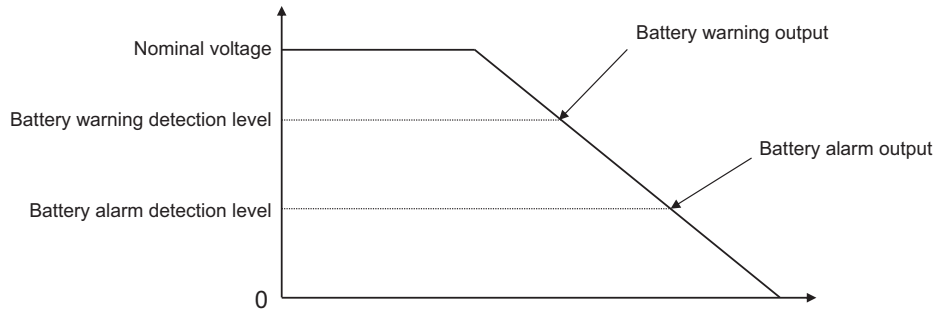

15.3 Protection

15.3.1 Stroke End (Over Travel)

	M850W	M830W	M850S	M830S	M80W	M80 TypeA	M80 TypeB	E80 TypeA	E80 TypeB	C80
M	○	○	○	○	○	○	○	○	○	○
L	○	○	○	○	○	○	○	○	○	○

When limit switches and dogs have been attached to the machine and a limit switch has kicked a dog, the movement of the machine is stopped by the signal input from the limit switch.

At the same time, the alarm output is sent to the machine.

The stroke end state is maintained and the alarm state is released by feeding the machine in the reverse direction in the manual mode to disengage the dog.

15.3.2 Stored Stroke Limit

The areas where tool entry is prohibited can be set with parameters or program commands.

The maximum value and the minimum value of the prohibited area are set for each axis with coordinate value (radius value) on the basic machine coordinate system.

This function is enabled only for the axis whose reference position has been established. (*1)

When the tool entered the prohibited area, an operation error occurs and the machine stops moving.

The alarm can be reset by moving the erroneous axis in the opposite direction.

During automatic operation, if an alarm occurs with even one axis, all axes will decelerate to a stop.

During manual operation, only the axis that caused the alarm will decelerate to a stop. The axis will always stop at a position before the prohibited area.

The distance between the prohibited area and stop position will depend on the feedrate.

(*1) For the absolute position detection system, if the zero point initial setting has already completed, this function is enabled immediately after the power is turned ON.

The stored stroke limits I, II, IIB, IB and IC are handled as follows.

Type	Prohibited area	Explanation
I	Outside	- Set by the machine tool builder. - When used with II, the narrow range designated by the two types becomes the movable area.
II	Outside	- Set by the user. - By using the program command, the parameter can be changed and the function can be switched to ON/OFF.
IIB	Inside	- Select II or IIB with the parameters.
IB	Inside	- Set by the machine tool builder.
IC	Outside	- Set by the machine tool builder.

When the same data is set for the maximum value and the minimum value of prohibited area of the stored stroke limit, note the following points:

[Stored stroke limit I and II]

- When "0" is set for both the maximum value and the minimum value, the entire area will be the prohibited area.

- When the same data other than "0" is set for both the maximum value and the minimum value, the entire area will be the movable area.

[Stored stroke limit IB and IC]

- When the same data is set for the maximum value and the minimum value, the entire area will be the movable area.

15.3.2.1 Stored Stroke Limit I/II

	M850W	M830W	M850S	M830S	M80W	M80 TypeA	M80 TypeB	E80 TypeA	E80 TypeB	C80
M	○	○	○	○	○	○	○	○	○	○
L	○	○	○	○	○	○	○	○	○	○

(1) Stored Stroke Limit I

This is the stroke limit function used by the machine tool builder, and the outside of the boundary is defined as the entrance prohibited area.

The maximum and minimum values for each axis can be set by parameters. The function itself is used together with the stored stroke limit II function described in the following section, and the tolerable area of both functions is the movable area.

The setting range is -99999.999 to +99999.999 mm.

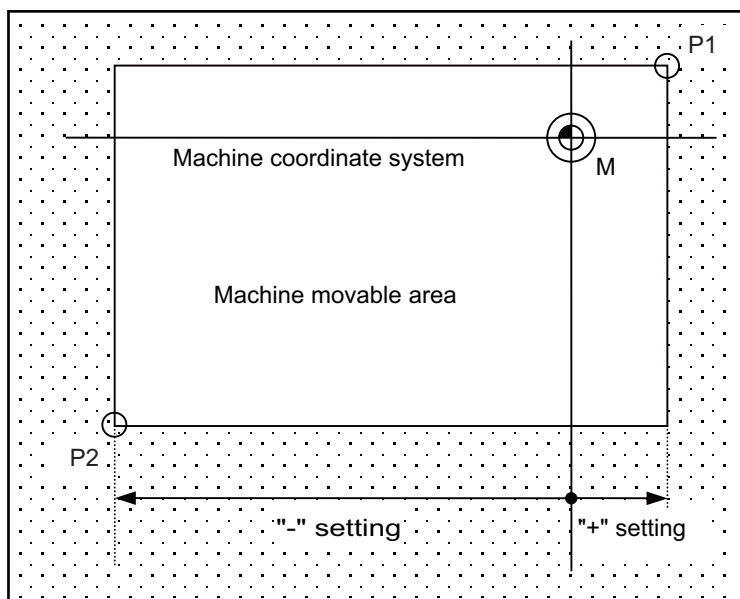

The position of points 1 and 2 are set using the machine coordinate.

 : Prohibited area

The range of the stored stroke limit I can be changed to the value set to R register for each axis. When "Stored stroke limit I change request" signal is turned ON, the area of stored stroke limit changes. Changing the area for the stored stroke limit I is also possible during automatic operation. Also, the current settings for the stored stroke limit I can be checked by with the R register values.

This feature allows an operator to switch the area of the stored stroke limit I during axis movement for the purpose of tool exchange, for example.

(2) Stored Stroke Limit II

This is the stroke limit function which can be set by the user, and the area outside the set limits is the prohibited area.



The maximum and minimum values for each axis can be set by parameters. The function itself is used together with the stored stroke limit I function described in the foregoing section, and the tolerable area of both functions is the movable area.

The setting range is -99999.999 to +99999.999 mm.

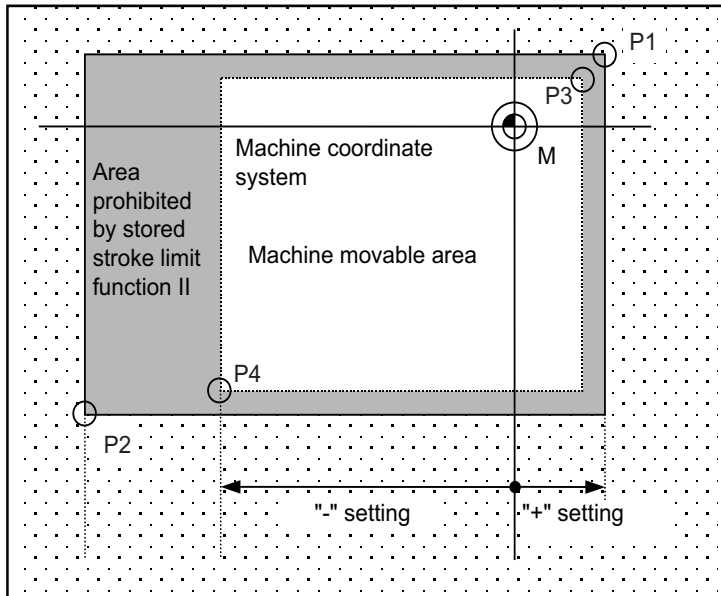
The stored stroke limit II function can also be invalidated with the parameter settings.



The position of points 3 and 4 are set with the machine coordinate. The area determined by points 1 and 2 is the prohibited area set with stored stroke limit I.

  : Prohibited area

15.3.2.2 Stored Stroke Limit IB

	M850W	M830W	M850S	M830S	M80W	M80 TypeA	M80 TypeB	E80 TypeA	E80 TypeB	C80
M	△	△	△	△	○	○	○	—	—	△
L	△	△	△	△	○	○	○	—	—	△

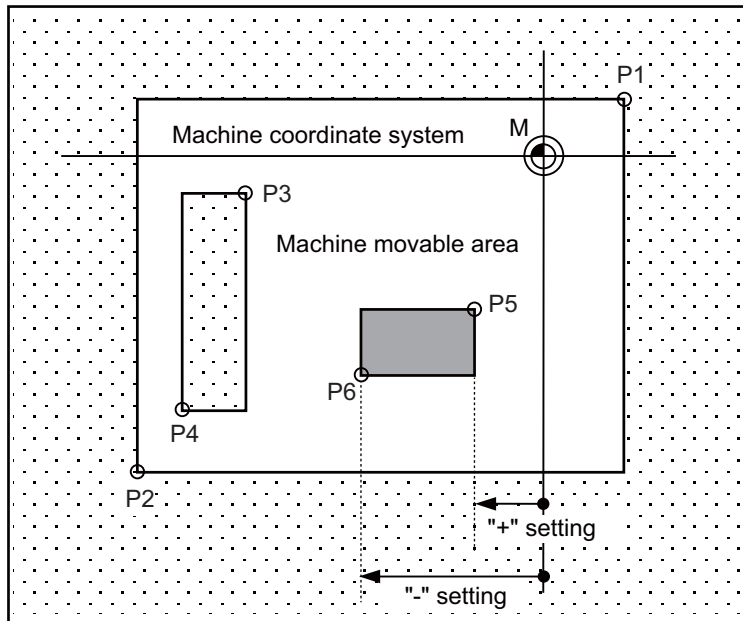

The boundary is set for each axis with parameters. The inside of the set boundary is defined as the prohibited area. Three areas where tool entry is prohibited can be set using the stored stroke limit I, stored stroke limit II, IIB and stored stroke limit IB functions.



The area determined by points 5 and 6 is the prohibited area set with stored stroke limit IB.

The area determined by points 1 and 2 is the prohibited area set with stored stroke limit I.

The area determined by points 3 and 4 is the prohibited area set with stored stroke limit IIB.

  : Prohibited area

When an attempt is made to move the tool beyond the set range, an alarm is displayed, and the tool decelerates and stops.

If the tool has entered into the prohibited area and an alarm has occurred, it is possible to move the tool only in the opposite direction to the direction in which the tool has just moved.

15.3.2.3 Stored Stroke Limit IIB

	M850W	M830W	M850S	M830S	M80W	M80 TypeA	M80 TypeB	E80 TypeA	E80 TypeB	C80
M	△	△	△	△	○	○	○	—	—	△
L	△	△	△	△	○	○	○	—	—	△

A parameter is used to switch between this function and stored stroke limit II. With stored stroke limit IIB, the inside of the set boundary is defined as the prohibited area.

An area other than the area specified with stored stroke limit I is set as the movement prohibited area.

15.3.2.4 Stored Stroke Limit IC

	M850W	M830W	M850S	M830S	M80W	M80 TypeA	M80 TypeB	E80 TypeA	E80 TypeB	C80
M	△	△	△	△	○	○	○	—	—	△
L	△	△	△	△	○	○	○	—	—	△

The boundary is set for each axis with the parameters. The inside of the set boundary is the additional movement range. This cannot be used with stored stroke limit IB.

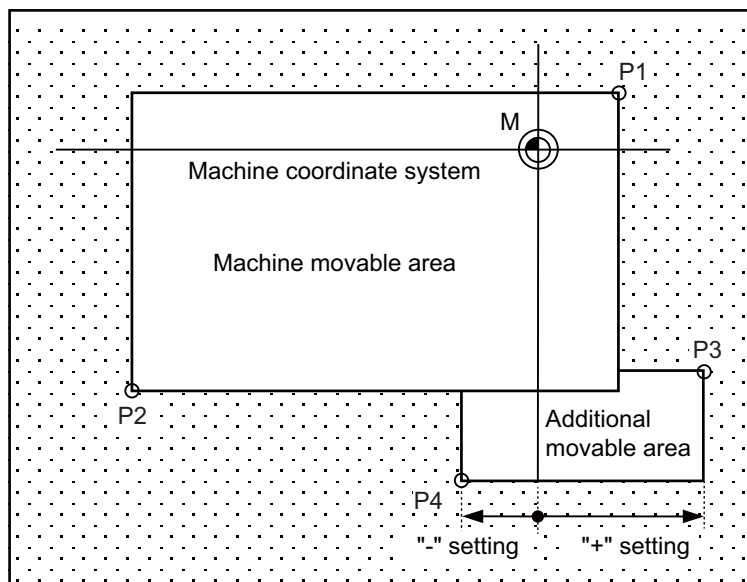

The position of points 3 and 4 are set with the machine coordinate. The area determined by points 1 and 2 is the prohibited area set with stored stroke limit I.

 : Prohibited area

15.3.3 Stroke Check before Travel

	M850W	M830W	M850S	M830S	M80W	M80 TypeA	M80 TypeB	E80 TypeA	E80 TypeB	C80
M	△	△	△	△	○	○	○	—	—	△
L	△	△	△	△	○	○	○	—	—	—

This function detects an error of the program command which causes the machine to enter the prohibited area where machine entry is prohibited.

Whereas normal stored stroke limit stops the machine just before the set prohibited area, this function causes the program error to occur in a block where the said command is given, and stops the machine before movement. This facilitates review of program paths as well as continuous operation.

There are two methods for stroke check before travel, which can be selected with a parameter.

(1) Stroke check before travel (G22/G23)

G22 allows you to set the entry prohibited area (X, Y and Z) and enable the stroke check before travel.

The program error occurs in a command block whose start or end point of travel, or linear or circular path enters the prohibited area.

G23 turns OFF the check function.

This method can be used for machining center specification only.

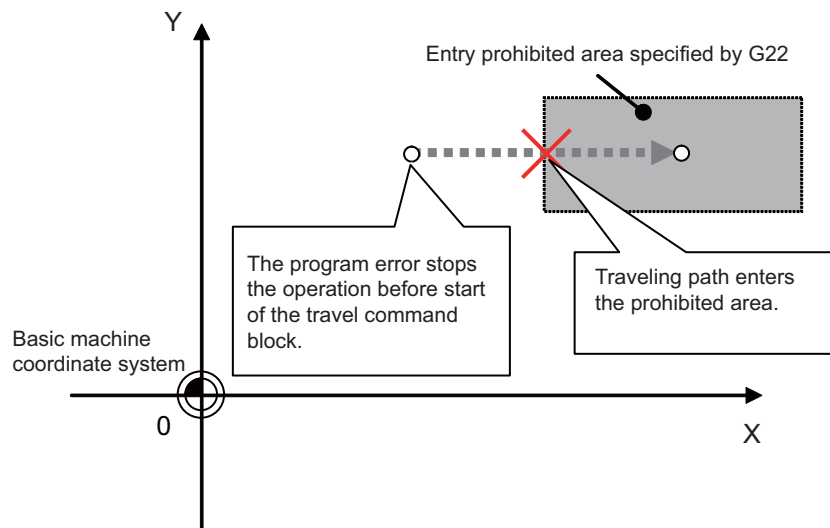

Command format

Stroke check before travel ON

G22 X_ Y_ Z_ I_ J_ K_ ;

X,Y,Z (*1) : Coordinates of upper point (basic axis name and its coordinate position)

I,J,K : Coordinates of lower point (I,J,K address and its coordinate position)

(*1) In the command format, the basic axes are X, Y and Z. Command the basic axis set in the parameter.

Stroke check before travel cancel

G23 ;

(2) Stroke check before travel in the stored stroke limit area

The block in which the end point of the movement command enters the entrance prohibited area set with the stored stroke limit I, IB, IC II or IIB function becomes a program error.

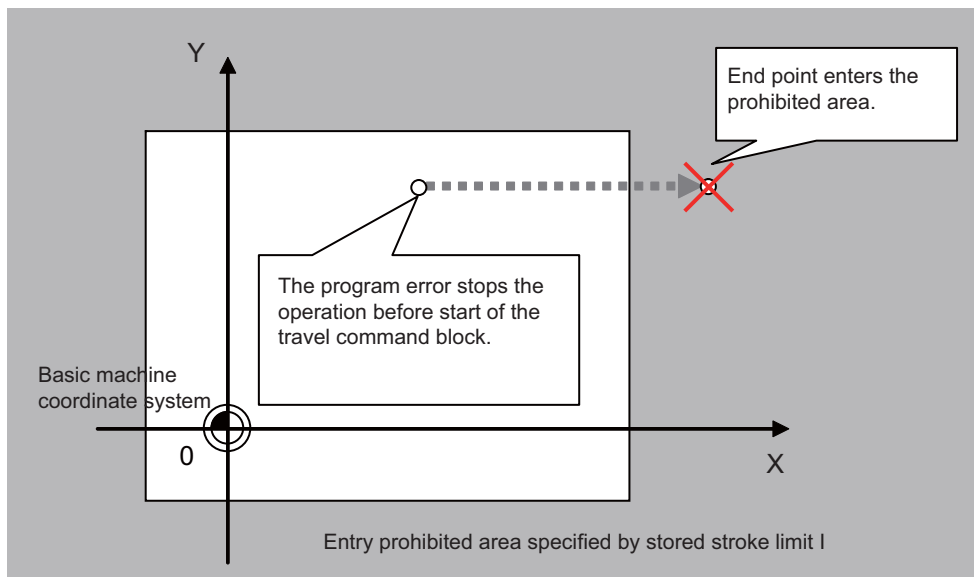

15.3.4 Chuck/Tailstock Barrier Check

	M850W	M830W	M850S	M830S	M80W	M80 TypeA	M80 TypeB	E80 TypeA	E80 TypeB	C80
M	—	—	—	—	—	—	—	—	—	—
L	○	○	○	○	○	○	○	○	○	○

By limiting the tool nose point move range, this function prevents the tool from colliding with the chuck or tailstock because of a programming error. When a move command exceeding the area set in a given parameter is programmed, the tool is stopped at the barrier boundaries.

Program format

G22 ; Barrier ON G23 ; Barrier OFF (cancel)
--

- (1) When the machine is about to exceed the area, the machine is stopped and an alarm is displayed. To cancel the alarm, execute reset.
- (2) The function is also effective when the machine is locked.
- (3) This function is valid when all axes for which a barrier has been set have completed reference position return.
- (4) The chuck barrier/tailstock barrier can be set per each part system.
- (5) Chuck barrier/tailstock barrier setting.

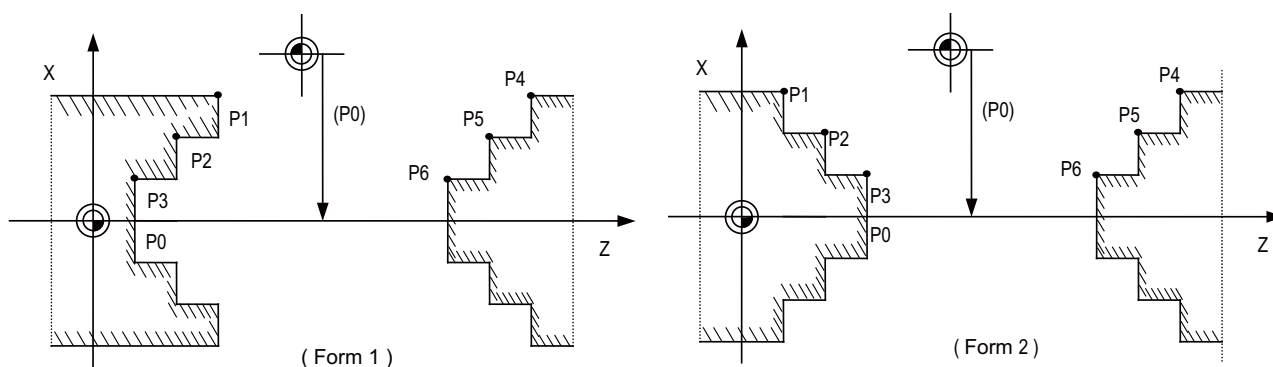

The chuck barrier and tailstock barrier are both set with the machine coordinate by inputting one set of three-point data in the parameter. Points P1, P2 and P3 are the chuck barrier, and points P4, P5 and P6 are the tailstock barrier. The X axis is set with the coordinate position (radius value) from the workpiece center, and the Z axis is set with the basic machine coordinate system coordinate.

Point P0 is the chuck barrier and tailstock barrier's basic X coordinates, and the workpiece center coordinate in the basic machine coordinate system is set.

The barrier area is assumed to be symmetrical for the Z axis, and if the X axis coordinate of barrier point P_i is minus, the sign is inverted to plus and the coordinate is converted for a check.

Set the absolute positions of the X axis coordinates of the barrier points as shown below:

$P1 \geq P2 \geq P3, P4 \geq P5 \geq P6$

(However, this need not apply to the Z axis coordinates.)

15.3.5 Interlock

	M850W	M830W	M850S	M830S	M80W	M80 TypeA	M80 TypeB	E80 TypeA	E80 TypeB	C80
M	○	○	○	○	○	○	○	○	○	○
L	○	○	○	○	○	○	○	○	○	○

The machine movement will decelerate and stop as soon as the interlock signal, serving as the external input, is turned ON.

When the interlock signal is turned OFF, the machine starts moving again.

- (1) In the manual mode, only that axis for which the interlock signal is input will stop.
- (2) In the automatic mode, all axes will stop when the interlock signal is input to even one axis which coincides with the moving axis.
- (3) Block start interlock

While the block start interlock signal (*BSL) is OFF (valid), the execution of the next block during automatic operation will not be started. The block whose execution has already commenced is executed until its end.

Automatic operation is not suspended. The commands in the next block are placed on standby, and their execution is started as soon as the signal is turned ON.

(Note 1) This signal is valid for all blocks including internal operation blocks such as fixed cycles.

(Note 2) This signal (*BSL) is set ON (invalid) when the power is turned ON. If it is not used, there is no need to make a program with the PLC.

- (4) Cutting start interlock

While the cutting start interlock signal (*CSL) is OFF (valid), the execution of all movement command blocks except positioning during automatic operation will not be started. The block whose execution has already commenced is executed until its end. Automatic operation is not suspended. The commands in the next block are placed on standby, and their execution is started as soon as the signal is turned ON.

(Note 1) The signal is valid for all blocks including internal operation block such as fixed cycles.

(Note 2) This signal (*CSL) is set ON (invalid) when the power is turned ON. If it is not used, there is no need to make a program with the PLC.

15.3.6 External Deceleration

	M850W	M830W	M850S	M830S	M80W	M80 TypeA	M80 TypeB	E80 TypeA	E80 TypeB	C80
M	○	○	○	○	○	○	○	○	○	○
L	○	○	○	○	○	○	○	○	○	○

This function reduces the feed rate to the deceleration speed set by the parameter when the external deceleration input signal, which is the external input from the user PLC, has been set to ON. External deceleration input signals are provided for each axis and for each movement direction ("+" and "-"), and a signal is valid when the signal in the direction coinciding with the direction of the current movement has been input. When an axis is to be returned in the opposite direction, its speed is returned immediately to the regular speed assigned by the command.

When non-interpolation positioning is performed during manual operation or automatic operation, only the axis for which the signal that coincides with the direction of the current movement has been input will decelerate.

However, with interpolation during automatic operation, the feed rate of the axis will be reduced to the deceleration rate if there is even one axis for which the signal that coincides with the direction of current movement has been input.

The external deceleration input signal can be canceled using a parameter for the cutting feed only.

15.3.7 Interference Check III

	M850W	M830W	M850S	M830S	M80W	M80 TypeA	M80 TypeB	E80 TypeA	E80 TypeB	C80
M	△	△	△	△	—	—	—	—	—	—
L	△	△	△	△	—	—	—	—	—	—

By checking the relative relation between interference objects, the interference can be prevented from occurring.

One interference object is defined by one to sixteen tridimensional objects.

The maximum definable number is 128 for the interference objects and is 256 for the tridimensional objects.

Solids/interference objects	Number
Solid interference objects	256
Number of defined interference objects	128
Number of solids which can be used for one interference object	16

Up to 16 interference objects out of 128 can be selected for the interference check. The number of solids which can be used in the selected interference object is 42 in total.

Solids/interference objects to be checked	Number
Number of interference objects which can be checked	16
The total of solids which can be used in the interference object to be checked	42

Select 16 interference objects to be checked by the R register or the system variable.

For the solids, two kinds of shapes, cuboids and cylinders, can be defined.
 It is also possible to define the rotated solid for one of the I J K axes of the solid.
 For the interfering object, up to 2 axes can be defined as rotary axes.
 You are able to define more than one interfering object with one-rotary axis, and one interfering object with two-rotary axis within 16 interfering objects to perform the interference check.
 You are not able to define the interfering object with one-rotary axis and interfering object with two-rotary axis at the same time.
 2 kinds of areas can be defined for an interference area defined as the interfering object: an area where interference must be avoided surely (interference alarm area) and an area where interference should be mitigated (interference warning area)

The schematic view of interfering object definition

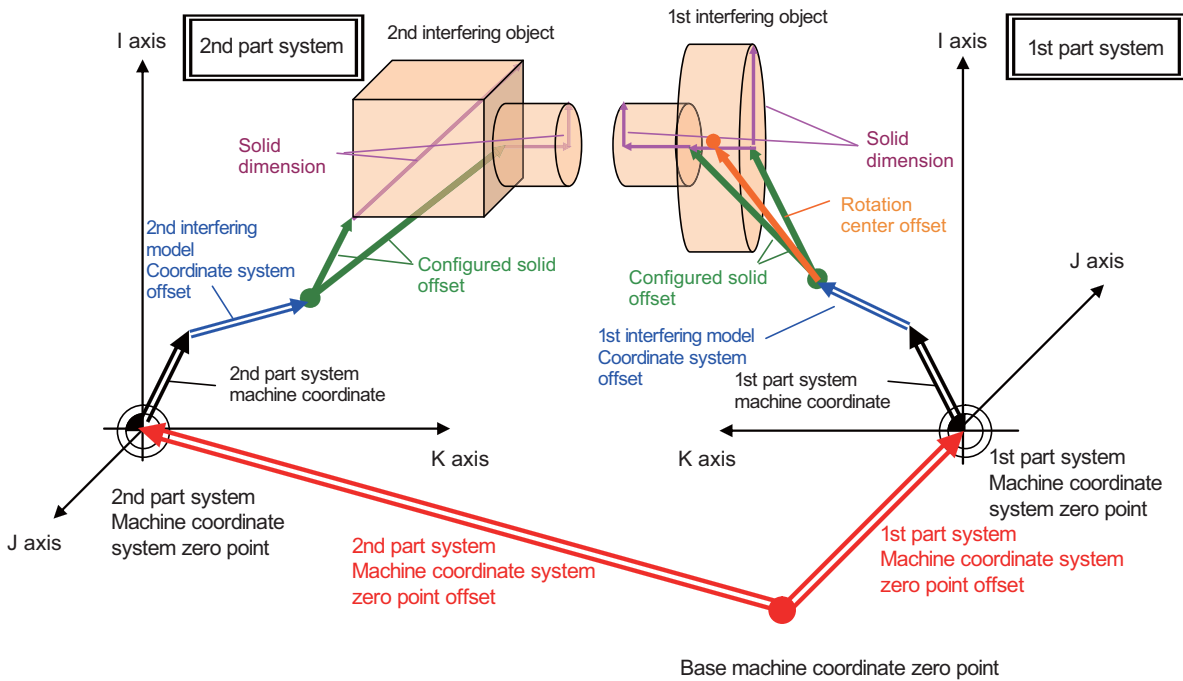

15.3.8 3D Machine Interference Check

	M850W	M830W	M850S	M830S	M80W	M80 TypeA	M80 TypeB	E80 TypeA	E80 TypeB	C80
M	△	△	—	—	—	—	—	—	—	—
L	—	—	—	—	—	—	—	—	—	—

The machine pre-reads the position to be moved during the operation to check the interference by the 3D model (machine, tool and jig) registered in advance. When an interference is predicted, the an alarm will be shown immediately and all the axes will be decelerated to stop.

The actual positional relation between the tool position and the interference check position

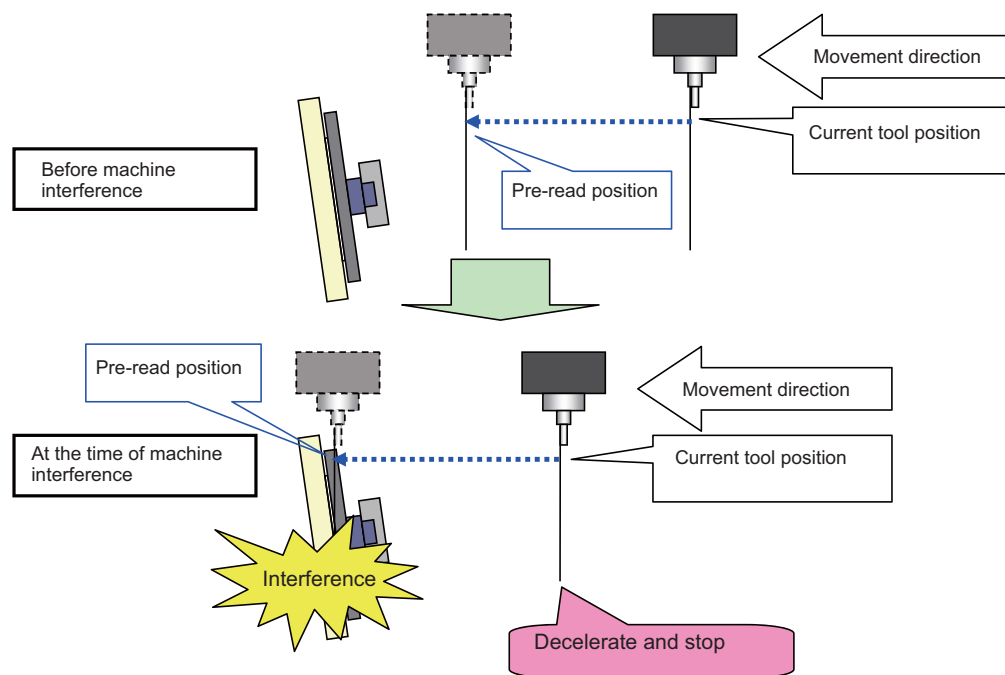

Also, since the 3D model is shown on the 3D monitor screen in real time, the actual positional relation of the machine can be figured out. When the interference occurs, the interference part in the 3D model will be shown in yellow or red. The interference check is performed between the following:

- machine and machine
- machine and tool
- machine and jig
- tool and jig

The interference check is not performed between the machine and the workpiece. This function is dedicated to the machining center in single part system.

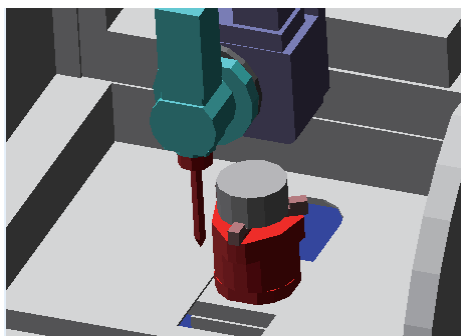

(Note) The software sold separately is required to create the 3D model.

15.3.9 Door Interlock

15.3.9.1 Door Interlock I

	M850W	M830W	M850S	M830S	M80W	M80 TypeA	M80 TypeB	E80 TypeA	E80 TypeB	C80
M	○	○	○	○	○	○	○	○	○	○
L	○	○	○	○	○	○	○	○	○	○

(Outline of function)

Under the CE marking scheme of the European safety standards (machine directive), the opening of any protection doors while a machine is actually moving is prohibited.

When the door open signal is input from the PLC, this function first decelerates and stops all the control axes, establishes the ready OFF status, and then shuts off the drive power inside the servo drive unit so that the motors are no longer driven.

When the door open signal has been input during automatic operation, the suspended machining can be resumed by first closing the door concerned and then initiating cycle start again.

(Description of operation)

When a door is open

The NC system operates as follows when the door open signal is input:

- (1) It stops operations.
 - (a) When automatic operation was underway
The machine is set to the feed hold mode, and all the axes decelerate and stop.
The spindle also stops.
 - (b) When manual operation was underway
All the axes decelerate and stop immediately.
The spindle also stops.
- (2) The complete standby status is established.
- (3) After all the NC axes and the spindle have stopped, the ready OFF status is established.
- (4) The door open enable signal is output.
Release the door lock using this signals at the PLC.

When a door is closed

After the PLC has confirmed that the door has been closed and locked, the NC system operates as follows when the door open signal is set to OFF.

- (5) All the axes are set to ready ON.
- (6) The door open enable signal is set to OFF.

Resuming operation

- (7) When automatic operation was underway
Press the cycle start button.
Operation now resumes from the block in which machining was suspended when the door open signal was input.
- (8) When manual operation was underway
Axis movement is commenced when the axis movement signals are input again.
- (9) Spindle rotation
Restore the spindle rotation by inputting the forward rotation or reverse rotation signal again: this can be done either by operations performed by the operator or by using the user PLC.
- (10) Chopping operation
Input the chopping signal again after returning the chopping axis to the basic point.
If the axis is not returned to the basic point, chopping operation will be resumed from the position where the chopping signal is input again.
- (11) When the spindle/C axis exists
If the switching method of the spindle/C axis is PLC signal method and the "Door open signal" is input in the C axis mode, the mode shifts to the spindle mode. Operations when the "Door open signal" is set to OFF differ depending on the parameter setting value.

15.3.9.2 Door Interlock II

	M850W	M830W	M850S	M830S	M80W	M80 TypeA	M80 TypeB	E80 TypeA	E80 TypeB	C80
M	○	○	○	○	○	○	○	○	○	○
L	○	○	○	○	○	○	○	○	○	○

(Outline of function)

Under the CE marking scheme of the European safety standards (machine directive), the opening of any protection doors while a machine is actually moving is prohibited.

When the door open signal is input from the PLC, this function first decelerates and stops all the control axes, establishes the ready OFF status, and then shuts off the drive power inside the servo amplifiers so that the motors are no longer driven.

With the door interlock function established by the door open II signal, cycle start can be enabled even when the door open signal has been input. However, the axes will be set to the interlock status.

(Description of operation)

When a door is open

The NC system operates as follows when the door open II signal is input:

- (1) It stops operations.
All the axes decelerate and stop.
The spindle also stops.
- (2) The complete standby status is established.
- (3) After all the NC axes and the spindle have stopped, the ready OFF status is established.
However, the servo ready finish signal (SA) is not set to OFF.

When a door is closed

After the PLC has confirmed that the door has been closed and locked, the NC system operates as follows when the door open signal is set to OFF.

- (4) All the axes are set to ready ON.
- (5) The door open enable signal is set to OFF.

Resuming operation

- (6) When automatic operation was underway
The door open signal is set to OFF, and after the ready ON status has been established for all the axes, operation is resumed.
- (7) When manual operation was underway
Axis movement is commenced when the axis movement signals are input again.
- (8) Spindle rotation
Restore the spindle rotation by inputting the forward rotation or reverse rotation signal again: this can be done either by operations performed by the operator or by using the user PLC.

(Note) Concerning the handling of an analog spindle

The signals described in this section are valid in a system with bus connections for the NC control unit and drive units. When an analog spindle is connected, the NC system cannot verify that the spindle has come to a complete stop. This means that the door should be opened after the PLC has verified that the spindle has come to a complete stop. Since the spindle may resume its rotation immediately after the door has been closed, set the forward and reverse rotation signals to OFF when opening the door so as to ensure safety.

- (9) Chopping operation
The door open signal is turned OFF, and after the ready ON status has been established, operation is resumed.
The basic point when resuming the operation is the same as where the chopping signal is turned ON.
- (10) When the spindle/C axis exists

If the switching method of the Spindle/C axis is PLC signal method and the "Door open II signal" is input in the C axis mode, the mode shifts to the spindle mode. Operations when the "Door open II signal" is set to OFF differ depending on the parameter setting value.

- (Note) When emergency stop occurs with the spindle forward run start signal or spindle reverse run start signal ON, the spindle rotation does not restart even if the emergency stop is cancelled.
- Note, however, that if you turn ON the door open II signal during emergency stop (or if emergency stop occurs with the door open II signal ON), and then you cancel the emergency stop before turning OFF the said signal, the spindle rotation restarts. (When the door open II signal is turned OFF first, the rotation does not restart.)

Differences from door interlock I

- (1) The method used to stop the machine during automatic operation is the same as with the axis interlock function.
- (2) The servo ready finish signal (SE) is not set to OFF.
- (3) Cycle start is valid during door interlock. However, the interlock takes effect for the axis movements.
- (4) When the door interlock function (door open signal ON) is initiated during axis movement, the axes decelerate and stop.
- (5) When the door interlock function (door open signal) is set to OFF, the axis movement resumes.
- (6) When the door interlock function (door open signal) is set to ON and OFF in the chopping operation, the chopping operation resumes.

15.3.10 Parameter Lock

	M850W	M830W	M850S	M830S	M80W	M80 TypeA	M80 TypeB	E80 TypeA	E80 TypeB	C80
M	○	○	○	○	○	○	○	○	○	○
L	○	○	○	○	○	○	○	○	○	○

This function is used to prohibit changing the machine parameter.

15.3.11 Program Protection (Edit Lock B, C)

	M850W	M830W	M850S	M830S	M80W	M80 TypeA	M80 TypeB	E80 TypeA	E80 TypeB	C80
M	○	○	○	○	○	○	○	○	○	○
L	○	○	○	○	○	○	○	○	○	○

The edit lock function B or C inhibits machining program B or C (group with machining program numbers) from being edited or erased when these programs require to be protected.

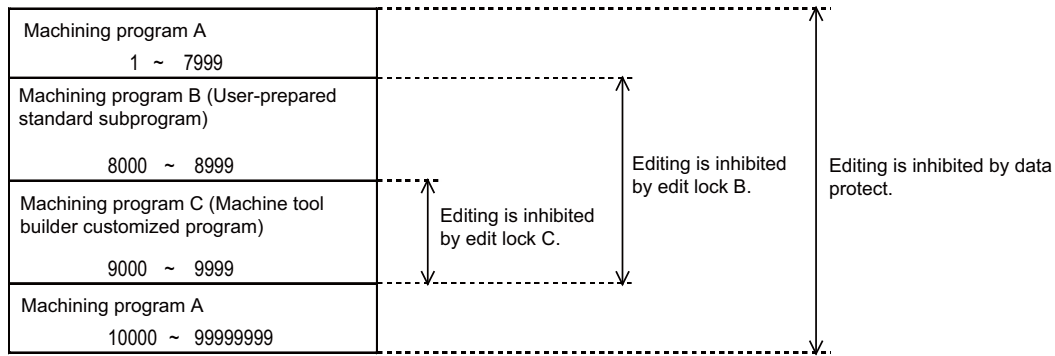

15.3.12 Program Display Lock

	M850W	M830W	M850S	M830S	M80W	M80 TypeA	M80 TypeB	E80 TypeA	E80 TypeB	C80
M	○	○	○	○	○	○	○	○	○	○
L	○	○	○	○	○	○	○	○	○	○

This function allows the display of only a target program (label address 9000) to be invalidated for the program display in the monitor screen, etc.

The operation search of a target program can also be invalidated.

The validity of the display is selected with the parameters. The setting will be handled as follows according to the value.

- 0: Display and search are possible.
- 1: Display of the program details is prohibited.
- 2: Display and operation search of the program details are prohibited.

15.3.13 Data Protection by User's Level

	M850W	M830W	M850S	M830S	M80W	M80 TypeA	M80 TypeB	E80 TypeA	E80 TypeB	C80
M	△	△	△	△	○	○	○	○	○	△
L	△	△	△	△	○	○	○	○	○	△

Up to 8 levels of access permission helps to prevent you from dispatching defective works.

On the protection setting screen, the current operation level can be displayed and changed, and the password for the operation level and the protection level for each data can be changed.

15.3.15 Vertical Axis Pull-up

	M850W	M830W	M850S	M830S	M80W	M80 TypeA	M80 TypeB	E80 TypeA	E80 TypeB	C80
M	○	○	○	○	○	○	○	○	○	○
L	○	○	○	○	○	○	○	○	○	○

When emergency stop or power interruption occurs, motor brake and vertical axis drop prevention function is supposed to work to prevent vertical axis (such as Z axis of vertical machining center) from dropping. However, there might be a case that the vertical axis drops by several μm because of decrepitude of motor brake.

Therefore, emergency stop or the power interruption during finish machining at low speed might cause damage to the cutting tool in operation.

Vertical axis pull-up function prevents the tool from breakage, through pulling up the cutting tool during emergency stop or instantaneous power interruption at low cutting speed.

15.3.16 Machine Group-based Alarm Stop

	M850W	M830W	M850S	M830S	M80W	M80 TypeA	M80 TypeB	E80 TypeA	E80 TypeB	C80
M	△	△	△	△	○	○	○	—	—	△
L	△	△	△	△	○	○	○	—	—	△

When an alarm occurs for an axis, this function performs an alarm stop only for the axes in a machine group to which the axis belongs. When this function is used in a lathe system, even though an alarm occurs for the loader axis, the operation can be continued if the servo axis and the spindle have been set in a different machine group from the loader axis as illustrated below. Without this function, the alarm stop is performed for all the axes when an alarm occurs.

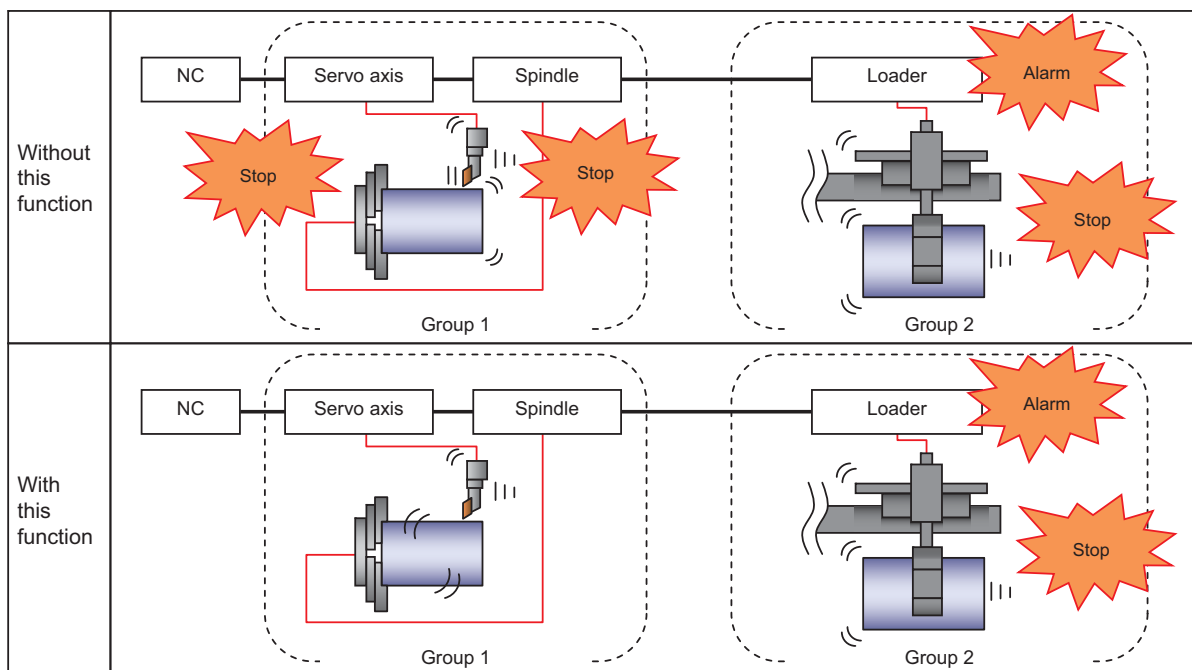

Likewise, when this function is used in a machining center system, the axes belonging to a different machine group from the axis for which an alarm has occurred can continue the operation as illustrated below. Without this function, the alarm stop is performed for all the axes when an alarm occurs.

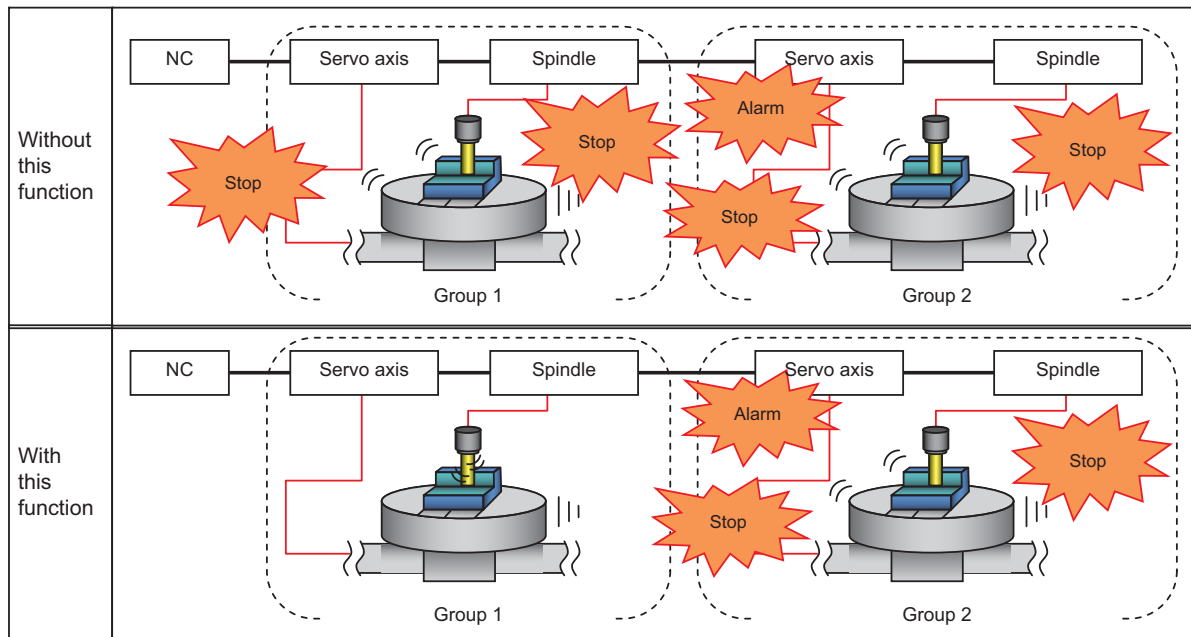

(Note) The machining group number can be set for each servo axis and spindle in this function, and incorrect setting may lead to accidents. Set the machine group number with enough care.

15.3.17 Interference Check Between Part Systems

	M850W	M830W	M850S	M830S	M80W	M80 TypeA	M80 TypeB	E80 TypeA	E80 TypeB	C80
M	—	—	—	—	—	—	—	—	—	—
L	○	○	○	○	○	○	—	—	—	—

* Maximum 4 part systems

This function checks the relative position of up to six cuboids (referred to as interfering objects) all the time, and if a command which causes the interfering objects to collide with each other is issued, the function stops the axis movement to prevent the interference in advance.

Such interference can be prevented by covering the tool post, etc. with cuboids. Because the check is performed for axis movement of all part systems, interference between tool posts which are positioned in different part systems can be prevented.

This is valid for the L-system configured with two or more part systems.

<Interference check between part systems OFF>

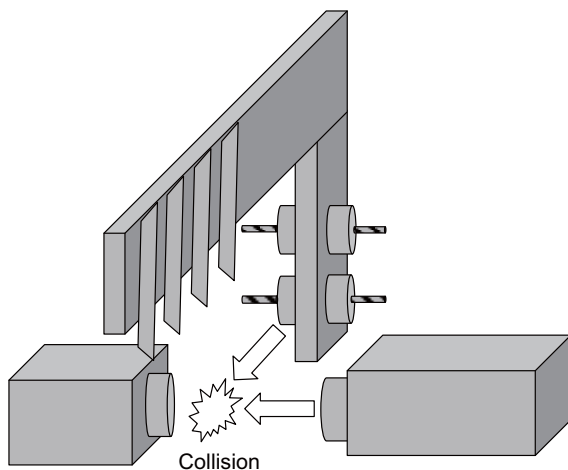

<Interference check between part systems ON>

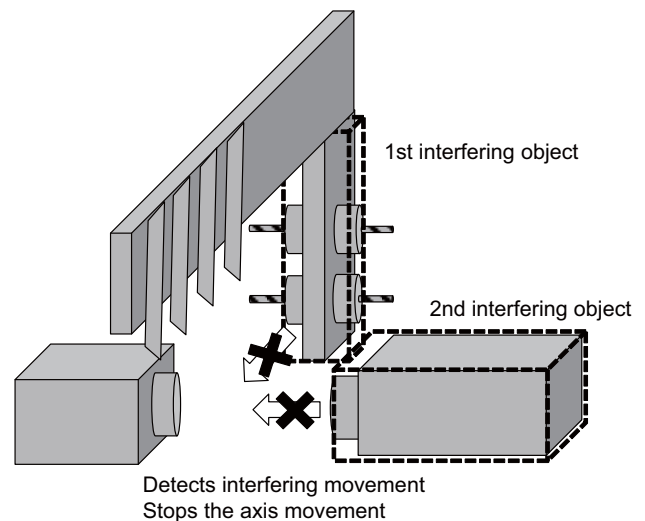

15.3.18 Spindle Protection

	M850W	M830W	M850S	M830S	M80W	M80 TypeA	M80 TypeB	E80 TypeA	E80 TypeB	C80
M	○	○	○	○	○	○	○	—	—	—
L	○	○	○	○	○	○	○	—	—	—

By setting the temperature to start/cancel the spindle protection, acceleration/deceleration time constant of the spindle is changed automatically when the spindle is overloaded and the operation is continued while suppressing overheating of the spindle.

This is effective in protecting the spindle when the spindle is overloaded by repeated acceleration/deceleration of the spindle.

Protection state of the spindle is output to the "Spindle protection is active" signal (for each spindle). When acceleration/deceleration time constant of the spindle has been changed to protect the spindle, this signal can be used to notify users that the spindle is protected.

The equivalent load ratio of spindle motor is determined by calculating the average output of spindle motor from the start of cycle operation to the next cycle operation and showing the average output as a percentage of the continuous rated output. The ratio is output to the ZR register and the drive monitor (item name: Duty value).

The equivalent load ratio and temperature of spindle motor can be output to a log file.

The log file can be used to analyze the operating environment of spindle motor and to detect a decrease in cooling capacity caused by dirt or clogging of spindle motor cooling fan.

While the same machining program is operated continuously, if the equivalent load ratio of last operation exceeds the threshold at the start of cycle operation, a warning is displayed.

15.4 Maintenance and Troubleshooting

15.4.1 Operation History

	M850W	M830W	M850S	M830S	M80W	M80 TypeA	M80 TypeB	E80 TypeA	E80 TypeB	C80
M	○	○	○	○	○	○	○	○	○	○
L	○	○	○	○	○	○	○	○	○	○

This is a maintenance function which is useful for tracing down the history and NC operation information and analyzing trouble, etc. This information is saved in the history data file, and can be displayed on the screen and output to a file. The machine tool builder password is required to use this function.

The following of history data files are used.

The following contents can be viewed on the edit screen.

- All history:

The key history, touchscreen history, alarm/warning history, PLC signal history, tool offset change history (M8 Series), workpiece offset change history (M8 Series), program No. history (C80 Series), sequence No. history (C80 Series) and AC input power OFF history is recorded in date/time order.

- Key history:

Only the key history is recorded in date/time order.

- Touchscreen history:

Only the touchscreen history is recorded in date/time order.

- Detailed alarm history information:

Separately from the existing alarm history, the alarm information, modal information and coordinate information at the time of the alarm occurrence are recorded in date/time order.

The data sorting order of the all history data files can be changed by the parameter.

- In chronologically ascending order for each log type

- In chronologically ascending order for all the log types

(Note) If the date and time are the same, the history will be displayed in the following order. Key history

- Key history
- Touchscreen history
- Alarm history
- PLC signal history
- Tool offset change history (M8 Series)
- Workpiece offset change history (M8 Series)
- Program No. history (C80 Series)
- Sequence No. history (C80 Series)
- AC input power OFF history

When a servo alarm or a spindle alarm occurs, all history is backed up for three times at most. (M8 Series)

15.4.2 Data Sampling

	M850W	M830W	M850S	M830S	M80W	M80 TypeA	M80 TypeB	E80 TypeA	E80 TypeB	C80
M	○	○	○	○	○	○	○	○	○	○
L	○	○	○	○	○	○	○	○	○	○

The NC internal data (speed output from NC to drive unit, feedback data from the drive unit, etc.) can be sampled and the data can be output as text data.

The type of sampling NC internal data and sampling conditions are input on the screen as the sampling parameter. The sampling parameter can be input/output with the sampling data as the header information of the sampling data. The parameter can be used to set whether the sampling starts when the power is turned ON.

[M8 Series]

Sampling data can be displayed in waveform by channel. (This function requires FCU8-MU542 or FCU8-MA542 for M800S, or FCU8-MU511 or FCU8-MU512 for M80.)

[C80 Series]

During the sampling, the sampling data can be output to the inter-CPU communication area on a real time basis, and sequential data can be monitored with the sequencer CPU.

Item	Specifications	
Sampling cycle	M8 Series	1.777 ms × setting value
	C80 Series	0.888 ms (For three or more part systems, 1.777 ms) 1.777 ms × setting value (For three or more part systems, 3.555 ms × setting value)
Number of sampled axes	NC axis: The maximum number of axes usable for specifications Spindle: The maximum number of spindles usable for specifications	
Number of sampled channels	1 to 16 points 1 to 8 points for displayed in waveform [M8]	
Sampling data size	M800W、M800S	Maximum 2,620,416 points
	M80W、M80、E80	Maximum 655,360 points
	C80	Maximum 1,310,720 points
(Note 1) This is the entire data size. The data size per channel will decrease when the number of sampled channels increases.		
Output to inter-CPU communication area [C80]	Sampling data of 16 times × 16 channels	

15.4.3 NC Data Backup

	M850W	M830W	M850S	M830S	M80W	M80 TypeA	M80 TypeB	E80 TypeA	E80 TypeB	C80
M	○	○	○	○	○	○	○	○	○	○
L	○	○	○	○	○	○	○	○	○	○

The NC data back up function backs up the NC parameters, etc., on a built-in disk of display (HD) unit or SD card. The data can also be restored.

15.4.4 Servo Tuning Support

15.4.4.1 NC Analyzer2

	M850W	M830W	M850S	M830S	M80W	M80 TypeA	M80 TypeB	E80 TypeA	E80 TypeB	C80
M	○	○	○	○	○	○	○	○	○	○
L	○	○	○	○	○	○	○	○	○	○

(Note) The software sold separately is necessary.

Servo parameters can be automatically adjusted by measuring/analyzing the machine characteristics. The measurement/analysis is conducted by activating the motor using machining programs for adjustment or vibration signals. Various data can be sampled.

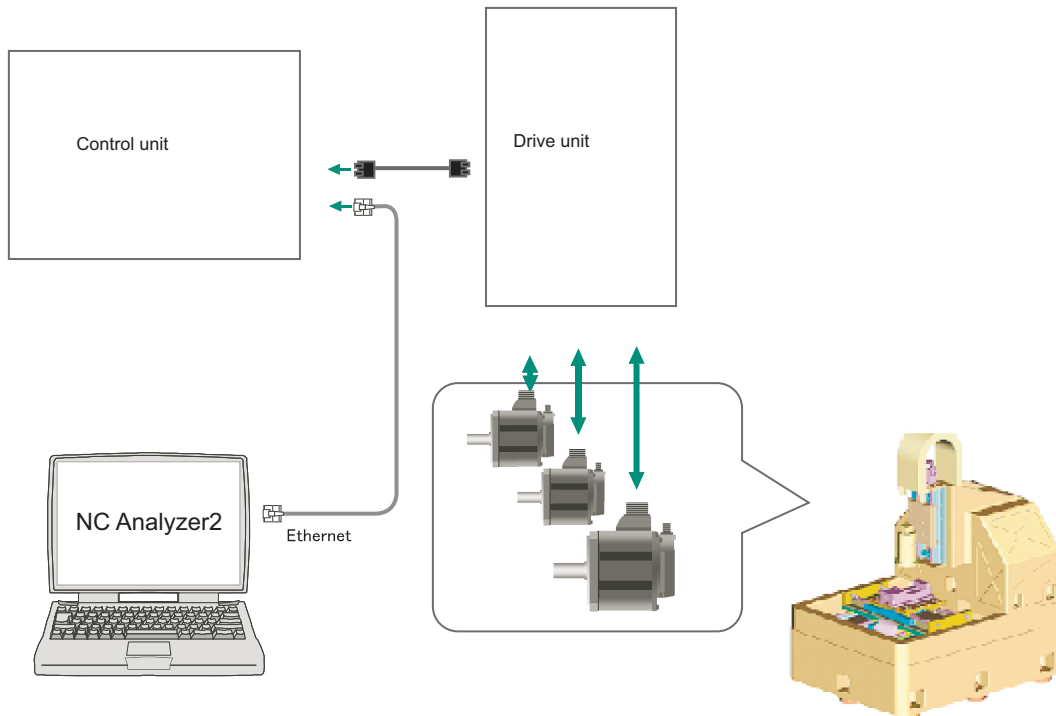

<Functions>

Adjustment wizard	Description
Velocity loop gain adjustment	Automatically adjusts velocity loop gain and resonance filters.
Lost motion adjustment	Adjusts the lost motion automatically for the delay in response caused when the direction of the machine rotates is reversed.

Measurement and adjustment	Description
Frequency response measurement	Measures the frequency response of speed loop for the designated axis. The result will be output as frequency response waveform.
Reciprocation acceleration/deceleration measurement	Measures the reciprocation acceleration/deceleration for the designated axis. The result will be output as time-series waveform. (*1)
Roundness measurement	Measures the roundness for the designated axis. The result will be output as roundness waveform. (*1)
Synch tap error measurement	Measures the synchronous tap error for the designated axis. The result will be output as time-series waveform. (*1)
Spindle acceleration/deceleration measurement	Measures the spindle acceleration/deceleration for the designated axis. The result will be output as time-series waveform. (*1)
Spindle orientation measurement	Measures the spindle orientation for the designated axis. The result will be output as time-series waveform. (*1)
Spindle C-axis measurement	Executes the reciprocation acceleration/deceleration measurement of spindle C axis with specified axis. The result will be output as time-series waveform. (*1)
Spindle synchronization measurement	Executes an arbitrary machining program with specified axis, and measures spindle synchronization by using that data. The result will be output as time-series waveform.
PLC axis acceleration/deceleration measurement	Executes an arbitrary machining program with specified axis, and measures PLC axis acceleration/deceleration by using that data. The result will be output as time-series waveform.
Arbitrary path measurement (*2)	Executes an arbitrary machining program with specified two axes. The result will be output as arbitrary path measurement waveform. (*1)

(*1) For the measurement, create a program by the program creation function or use an arbitrary machining program.

(*2) Two or more NC axes in the same system are needed.

15.4.5 Automatic Backup

	M850W	M830W	M850S	M830S	M80W	M80 TypeA	M80 TypeB	E80 TypeA	E80 TypeB	C80
M	○	○	○	○	○	○	○	○	○	○ (GOT)
L	○	○	○	○	○	○	○	○	○	○ (GOT)

With this function, system data, ladder program and custom software can be automatically backed up in case of system failure. Up to the three most recent backup data can be stored.

The backup execution timing can be set with parameters.

15.4.8 Application Error Detection

	M850W	M830W	M850S	M830S	M80W	M80 TypeA	M80 TypeB	E80 TypeA	E80 TypeB	C80
M	○/—	○/—	—	—	○/—	—	—	—	—	—
L	○/—	○/—	—	—	○/—	—	—	—	—	—

* Specifications of separated-type display are classified with "Windows-based" and "non-Windows-based"

Application error detection function observes applications such as MITSUBISHI standard screen or custom screen. When an error such as screen lock is detected, this function saves information and data in the log to investigate the causes easily.

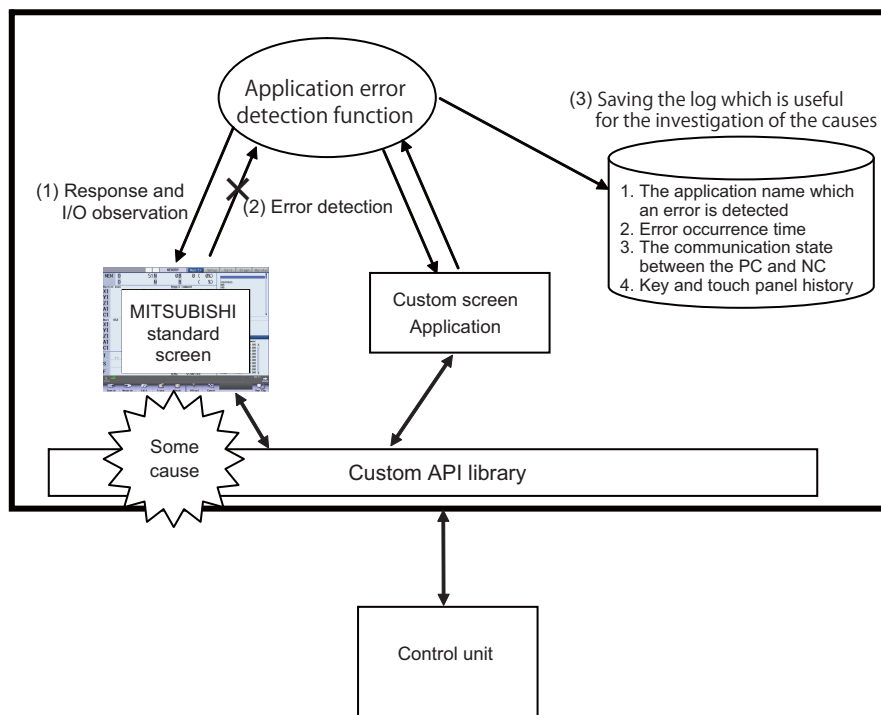

- (1) Response from the application and a change of I/O is observed on a periodical basis.
- (2) When an application with no response and no change of I/O for a certain period is detected, it is determined that there is an error.
- (3) When an error is detected, the log which is useful for the investigation of the causes will be saved.

15.4.9 Email Notification to Operator

	M850W	M830W	M850S	M830S	M80W	M80 TypeA	M80 TypeB	E80 TypeA	E80 TypeB	C80
M	△	△	△	△	○	○	○	○	○	—
L	△	△	△	△	○	○	○	○	○	—

This function enables NC to transmit emails to network-connected email servers (SMTP servers). The transmitted emails can be received by means of email software in PC or mobile phone via email servers. With this function, the NC can send emails to PCs and mobile terminals away from machines. You are able to know machining conditions (such as machining completion, stop and failure) even if you are in remote places.

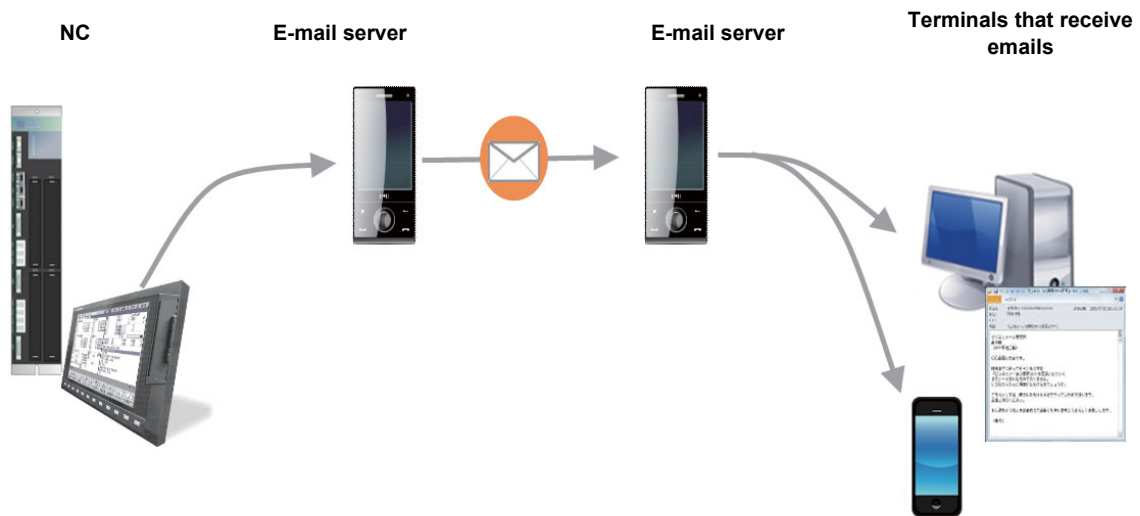

15.4.10 NC Configurator2

	M850W	M830W	M850S	M830S	M80W	M80 TypeA	M80 TypeB	E80 TypeA	E80 TypeB	C80
M	○	○	○	○	○	○	○	○	○	○
L	○	○	○	○	○	○	○	○	○	○

NC Configurator2 achieves the following functions for the multiple NCs connected to the network, or a file in the SD card or the local disk. Data from up to 8 machines can be handled at a time.

- (1) NC Data: Transmit, display, edit and control the data related to the NC machine and parameters for NC control module side, and transmit, display the machining programs, tools and work.
- (2) Function parameter: Support Parameter settings for individual NC function for the users.
- (3) RS232C communication function: Offer various functions using the tape mode and serial communication.

Please contact us to purchase a full function version. A limited function version is also available free of charge.

15.4.11 Diagnosis Data Output

	M850W	M830W	M850S	M830S	M80W	M80 TypeA	M80 TypeB	E80 TypeA	E80 TypeB	C80
M	○	○	○	○	○	○	○	○	○	○
L	○	○	○	○	○	○	○	○	○	○

With this function, the information indicating the replacement cycle of the service parts used in NC, drive or motor can be output to the ZR registers. This information can be used for the preventive maintenance including life prediction.

15.4.12 Backup/Restore

	M850W	M830W	M850S	M830S	M80W	M80 TypeA	M80 TypeB	E80 TypeA	E80 TypeB	C80
M	—	—	—	—	—	—	—	—	—	○
L	—	—	—	—	—	—	—	—	—	○

This function stores the setting information (sequence programs, parameters and the setting values, etc.) of a connected device to the installed data storage in GOT, and restores those data to the device as needed.

15.4.14 Field Network Diagnostics

	M850W	M830W	M850S	M830S	M80W	M80 TypeA	M80 TypeB	E80 TypeA	E80 TypeB	C80
M	<input type="checkbox"/>	<input type="checkbox"/>	<input type="checkbox"/>	<input type="checkbox"/>	<input type="checkbox"/>	<input type="checkbox"/>	<input type="checkbox"/>	<input type="checkbox"/>	<input type="checkbox"/>	—
L	<input type="checkbox"/>	<input type="checkbox"/>	<input type="checkbox"/>	<input type="checkbox"/>	<input type="checkbox"/>	<input type="checkbox"/>	<input type="checkbox"/>	<input type="checkbox"/>	<input type="checkbox"/>	—

This function displays the statistical information of packet transmission and reception (transmission/reception frequency, number of errors, etc.), which is necessary when the communication status of the communication function expansion unit (the field network expansion unit) is diagnosed.

The function is useful to figure out the causes, for example, in the following cases.

- Communication is disconnected
- Communication is not carried out properly

The communication function expansion units in the table below are available with this function.

Unit No.	Protocol
FCU8-EX564	CC-Link IE Field
FCU8-EX565	EtherNet/IP
FCU8-EX568	FL-net

The statistical information of communication packets can be checked on the I/F diagnostic screen of NC.

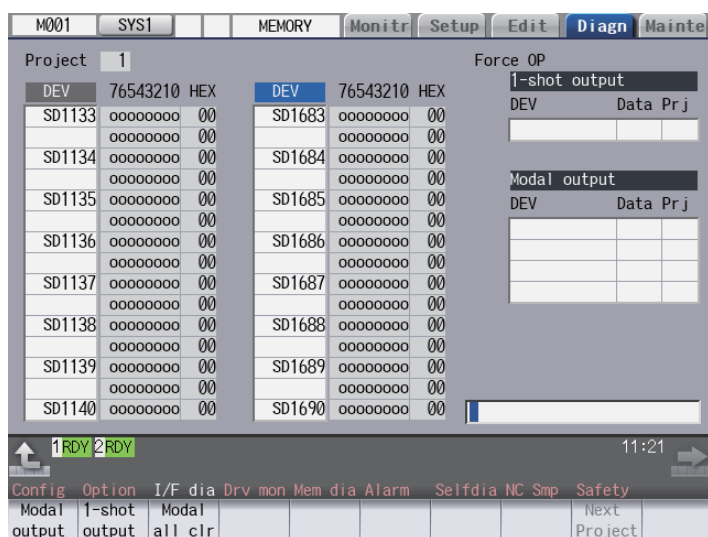

15.4.15 Remote service iQ Care Remote4U

This function is a remote service to support remote maintenance of machine tools using IoT technology. Operation monitoring of machine tools and remote diagnostics of CNC are available.

(Note 1) The license agreement is required.

(Note 2) Remote service gateway unit is required for connection with RGU.

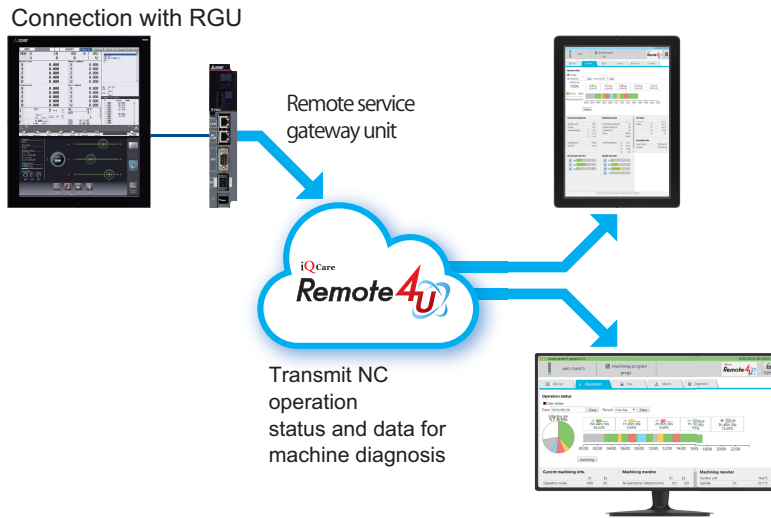

15.4.15.1 Connection with RGU

	M850W	M830W	M850S	M830S	M80W	M80 TypeA	M80 TypeB	E80 TypeA	E80 TypeB	C80
M	<input type="checkbox"/>	<input type="checkbox"/>	<input type="checkbox"/>	<input type="checkbox"/>	<input type="checkbox"/>	<input type="checkbox"/>	<input type="checkbox"/>	<input type="checkbox"/>	<input type="checkbox"/>	—
L	<input type="checkbox"/>	<input type="checkbox"/>	<input type="checkbox"/>	<input type="checkbox"/>	<input type="checkbox"/>	<input type="checkbox"/>	<input type="checkbox"/>	<input type="checkbox"/>	<input type="checkbox"/>	—

15.5 Functional Safety

15.5.1 Safety Observation

	M850W	M830W	M850S	M830S	M80W	M80 TypeA	M80 TypeB	E80 TypeA	E80 TypeB	C80
M	△	△	△	△	○	○	○	○	○	—
L	△	△	△	△	○	○	○	○	○	—

This function can be available in the system consisting of the NC control unit and drive unit, and various communication cables, sensors and contactors.

The followings are available.

- Opens the door without shutting off the drive power of motor.
- Operates at safety speed or lower while the door is opened.

Function	Description
Dual emergency stop	The NC control unit and the drive unit separately observe the input of emergency stop. In case of an emergency stop, both the NC control unit and the drive unit (power supply unit) will independently control the contactors to shut the drive power OFF.
Speed monitor	The NC control unit and the drive unit (servo/spindle drive unit) separately observe the following. When an error is detected during observation, the main power for the drive will be shut OFF. (1) That the command speed should not exceed the speed set by the parameter (the "safety speed"). (2) That the motor rotation speed should not exceed the rotation speed set by the parameter (the "safety rotation speed").
Door state signal monitor	This observes the door state signal (open or closed) detected with different circuit.

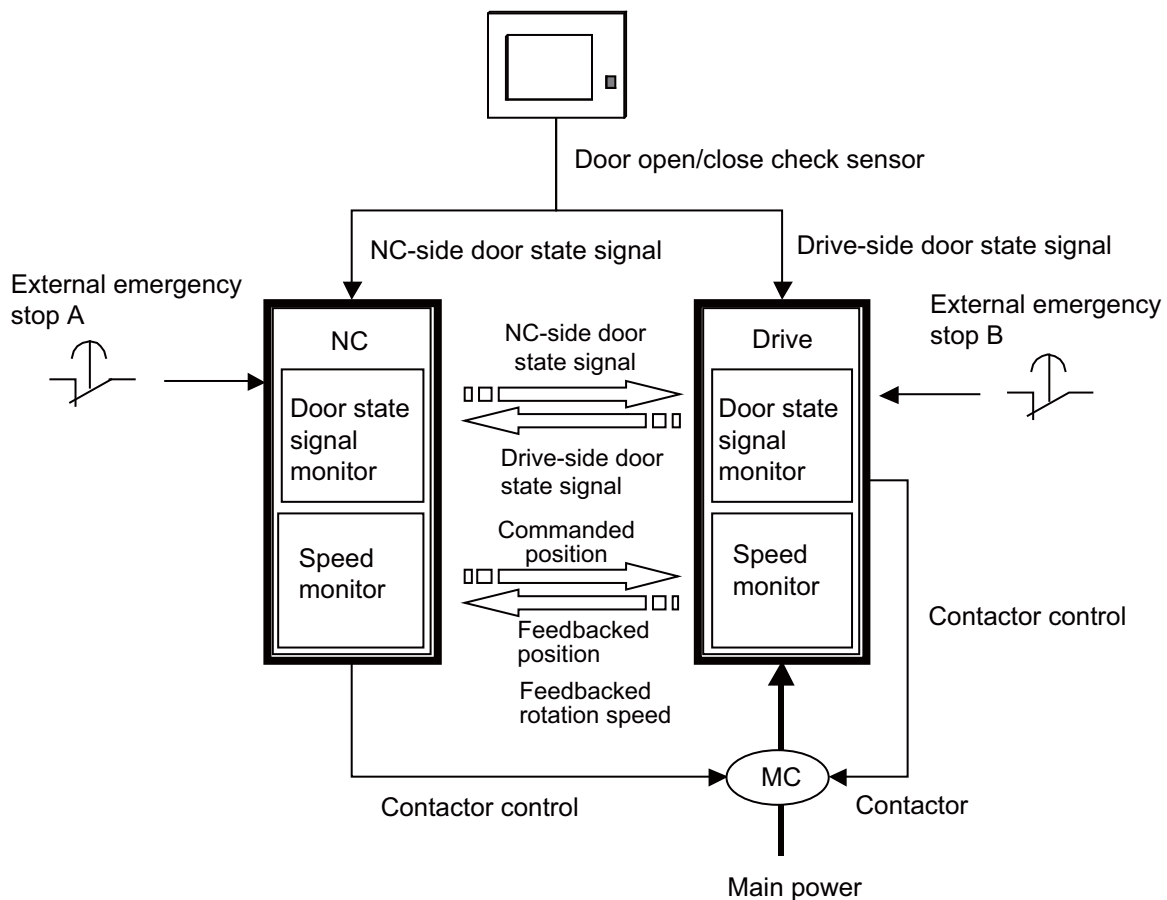

15.5.2 Smart Safety Observation

The smart safety observation function achieves smart and high safety with the following features.

- (1) The redundant observation is enabled not only for the door signal but for various signals that require the safety.
- (2) Eight new functions including the position observation are added.
- (3) Signal wiring is simplified by having redundant PLC signal. (With the conventional safety observation, the signal wiring is needed for NC and drive units.)
- (4) Redundant safety ladder eliminates the need for MTB to prepare the safety unit. (M800/M80 Series)
- (5) It is possible to make only one ladder of the redundant safety ladder when they serve as the equivalent role. (It is also possible to make two ladders to have different roles.)
- (6) The I/O board equipped with safety signal input terminal is available, which is mounted on the back of the operation panel. This eliminates the need to mount the safety I/O unit additionally in the operation panel. (M800/M80 Series)

(Note 1) Safety I/O devices (safety RIO unit, operation panel with safety I/O) are required for inputting/outputting safety signals. Of the I/O device connection channels on NC unit, the channels which input/output safety signals need to be composed only of safety I/O devices and RIO2.0 units. (RIO1.0 units cannot be connected to I/O channels which input/output safety signals.) (M800/M80 Series)

(Note 2) In order to input/output the safety signals, the safety signal unit needs to be used. The NC unit and the safety signal unit need to be connected with the RIO cable. (C80 Series)

(Note 3) For user safety sequence, machine tool builders need to create safety signal process logic and write it to NC unit.

(Note 4) Of connection channels for each drive unit in NC unit, channels with axes which use "Safety function S" need to be composed only of drive units of MSD-E Series.

15.5.2.1 Safety-related I/O Observation

	M850W	M830W	M850S	M830S	M80W	M80 TypeA	M80 TypeB	E80 TypeA	E80 TypeB	C80
M	△	△	△	△	○	□	□	—	—	△
L	△	△	△	△	○	□	□	—	—	△

* Functional safety expansion unit is required for M80

Using the dual circuits for processing signals input/output to/from the machine (safety signal compare sequence) and dual execution of safety signal process logic made by users (safety PLC), if one circuit has broken down, the other circuit can detect errors, which improves the safety of signal process.

15.5.2.2 Emergency Stop Observation

	M850W	M830W	M850S	M830S	M80W	M80 TypeA	M80 TypeB	E80 TypeA	E80 TypeB	C80
M	△	△	△	△	○	□	□	—	—	△
L	△	△	△	△	○	□	□	—	—	△

* Functional safety expansion unit is required for M80

Emergency stop signal is doubled and observed to see whether there is any error. When one emergency stop signal is in open state, the whole system can be set in emergency stop condition.

15.5.2.3 Drive Safety Function

15.5.2.3.1 SLS (Safely-Limited Speed)

	M850W	M830W	M850S	M830S	M80W	M80 TypeA	M80 TypeB	E80 TypeA	E80 TypeB	C80
M	△	△	△	△	○	□	□	—	—	△
L	△	△	△	△	○	□	□	—	—	△

* Functional safety expansion unit is required for M80

Axis speed (command speed, FB speed) is observed doubly to see whether the speed exceeds the safe speed. Four steps of safe speed and 16 steps of override can be selected. (64 ways of safe speed can be created in total.)

15.5.2.3.2 SLP (Safely-Limited Position)

	M850W	M830W	M850S	M830S	M80W	M80 TypeA	M80 TypeB	E80 TypeA	E80 TypeB	C80
M	△	△	△	△	○	□	□	—	—	△
L	△	△	△	△	○	□	□	—	—	△

* Functional safety expansion unit is required for M80

Axis absolute position (command position, FB position) is observed doubly to see whether the position exceeds the safe position range. Safe position range can be selected from 4 levels.

15.5.2.3.3 SOS (Safe Operating Stop)

	M850W	M830W	M850S	M830S	M80W	M80 TypeA	M80 TypeB	E80 TypeA	E80 TypeB	C80
M	△	△	△	△	○	□	□	—	—	△
L	△	△	△	△	○	□	□	—	—	△

* Functional safety expansion unit is required for M80

SOS is made by performing the following operations simultaneously.

- (1) Axis stop speed (command speed, FB speed) is observed doubly whether the speed exceeds the safe stop speed.
- (2) Axis stop position (command position, FB position) is observed doubly whether the position exceeds the safe stop position range.
- (3) Axis stop position deviation (difference between command position and FB position) is observed doubly to make sure that the deviation does not exceed the safe stop position deviation.

15.5.2.3.4 SSM (Safe Speed Monitor)

	M850W	M830W	M850S	M830S	M80W	M80 TypeA	M80 TypeB	E80 TypeA	E80 TypeB	C80
M	△	△	△	△	○	□	□	—	—	△
L	△	△	△	△	○	□	□	—	—	△

* Functional safety expansion unit is required for M80

This function uses the safety signals to inform that the axis speed (command speed, FB speed) is equal to or below the safe speed. Up to 4 safe speeds can be set.

15.5.2.3.5 SBC/SBT (Safe Brake Control/Safe Brake Test)

	M850W	M830W	M850S	M830S	M80W	M80 TypeA	M80 TypeB	E80 TypeA	E80 TypeB	C80
M	△	△	△	△	○	□	□	—	—	△
L	△	△	△	△	○	□	□	—	—	△

* Functional safety expansion unit is required for M80

The brakes connected to motors are activated by this function. Because there are two circuits for activating the brakes, one circuit can activate the brakes even when the other circuit is broken down. Furthermore, Safe Brake Test (SBT) can diagnose the circuits for activating the breaks and the effectiveness of the brakes (deterioration due to abrasion, etc.).

15.5.2.3.6 SCA (Safe Cam)

	M850W	M830W	M850S	M830S	M80W	M80 TypeA	M80 TypeB	E80 TypeA	E80 TypeB	C80
M	△	△	△	△	○	□	□	—	—	△
L	△	△	△	△	○	□	□	—	—	△

* Functional safety expansion unit is required for M80

This function uses the safety signals to inform that the axis absolute position (command position, FB position) is within the range of safe position. Up to 16 sets (16 each for pulse side and minus side) can be set for the safe position range.

15.5.2.3.7 SS1/SS2 (Safe Stop)

	M850W	M830W	M850S	M830S	M80W	M80 TypeA	M80 TypeB	E80 TypeA	E80 TypeB	C80
M	△	△	△	△	○	□	□	—	—	△
L	△	△	△	△	○	□	□	—	—	△

* Functional safety expansion unit is required for M80

(1) Safe stop 1 (SS1)

STO function is activated after an axis is decelerated and the speed (command speed, FB speed) becomes equal to or below the safe stop speed. STO function is also activated when the speed does not reach the safe stop speed within a specified time from the start of deceleration.

(2) Safe stop 2 (SS2)

SOS function is activated after an axis is decelerated and the speed (command speed, FB speed) becomes equal to or below the safe stop speed. SOS function is also activated when the speed does not reach the safe stop speed within a specified time from the start of deceleration.

15.5.2.3.8 STO (Safe Torque Off)

	M850W	M830W	M850S	M830S	M80W	M80 TypeA	M80 TypeB	E80 TypeA	E80 TypeB	C80
M	△	△	△	△	○	□	□	—	—	△
L	△	△	△	△	○	□	□	—	—	△

* Functional safety expansion unit is required for M80

This function shuts OFF power supply to axes. Because there are two power shutoff circuits, one circuit can shut OFF the power supply even when the other circuit is broken down. STO also performs fault diagnosis of the shutoff circuits.

15.5.2.3.9 SCN (Safety Communication Network)

	M850W	M830W	M850S	M830S	M80W	M80 TypeA	M80 TypeB	E80 TypeA	E80 TypeB	C80
M	—	—	—	—	—	—	—	—	—	△
L	—	—	—	—	—	—	—	—	—	△

This function performs safety communication between master station and local station using CC-Link IE field network. The safety communication transfers and receives 32-bit safety data between the safety CPU and the NC CPU.

Drive System

16.1 Servo/Spindle

Refer to "Mitsubishi Electric CNC M800W/M800S/M80W Series Specifications List" "Mitsubishi Electric CNC M80/E80/C80 Series Specifications List".

Refer to the following manuals for details on the servo and spindle system.

DRIVE SYSTEM DATA BOOK (IB-1501252(ENG))

MDS-E/EH Series Specifications Manual (IB-1501226(ENG))

MDS-EJ/EJH Series Specifications Manual (IB-1501232(ENG))

MDS-EM/EMH Series Specifications Manual (IB-1501238(ENG))

Machine Support Functions

17.1 PLC

17.1.1 Built-in PLC Processing Mode

	M850W	M830W	M850S	M830S	M80W	M80 TypeA	M80 TypeB	E80 TypeA	E80 TypeB	C80
M	○	○	○	○	○	○	○	○	○	—
L	○	○	○	○	○	○	○	○	○	—

An exclusive sequence program that controls the various signals between the controller and machine to realize operation applicable to each machine can be created and built in.

The sequence execution modes include high-speed processing and main processing.

(1) High-speed processing

This mode provides repeated execution at constant cycles. It is used to process signals requiring high speeds. The max. number of program steps for high-speed processing (1 period) is 1000 steps when using basic instructions.

(2) Main processing

This mode provides normal sequence processing. The processing cycle depends on the number of sequence steps.

17.1.2 PLC Functions

17.1.2.1 Built-in PLC Basic Function

	M850W	M830W	M850S	M830S	M80W	M80 TypeA	M80 TypeB	E80 TypeA	E80 TypeB	C80
M	○	○	○	○	○	○	○	○	○	Δ (*1)
L	○	○	○	○	○	○	○	○	○	Δ (*1)

(*1) MELSEC

[M8 series]

(1) Ladder instructions

Basic instructions (bit processing instructions)

LD, LDI, OR, ORI, AND, ANI, OUT, PLS, etc.

Function instructions

Data transfer, 4 basic arithmetic operations, logic arithmetic operations, large/small identification, binary/BCD conversion, branching, conditional branching, decoding, encoding, etc.

(2) Devices

The device range in the following table is the default number of device points set in the project 1 when the multi-project setting or the setting of the number of device points is not performed.

Device	Device No.	Unit	Details
X*	X0 ~ X1FFF (8192 points)	1 bit	Input signal to PLC: Machine input, etc.
Y*	Y0 ~ Y1FFF (8192 points)	1 bit	Output signal from PLC: Machine output, etc.
M	M0 ~ M61439 (61440 points)	1 bit	Temporary memory
F	F0 ~ F2047 (2048 points)	1 bit	Temporary memory. Alarm message interface
L	L0 ~ L1023 (1024 points)	1 bit	Latch relay (back up memory)
SM	SM0 ~ SM2047 (2048 points)	1 bit	Special relay
V	V0 ~ V511 (512 points)	1 bit	Edge relay
SB	SB0 ~ SB3FF (1024 points)	1 bit	Special relay
B	B0 ~ BDFFF (57344 points)	1 bit	Link relay
SW	SW0 ~ SW3FF (1024 points)	1 bit	Special register
SD	SD0 ~ SD204 (2048 points)	16 bit	Special register
T	T0 ~ T2047 (2048 points)	1 bit/ 16 bit	Timer (The variable/fixed boundary is set with a parameter.) (Note 2)
ST	ST0 ~ ST127 (128 points)	1 bit/ 16 bit	Integrated timer (100ms unit)
C	C0 ~ C511 (512 points)	1 bit/ 16 bit	Counter (The variable/fixed boundary is set with a parameter.)
D	D0 ~ D4095 (4096 points)	16 bit/ 32 bit	Data register. Register for calculation
R*	R0 ~ R32767 (32768 points)	16 bit/ 32 bit	File register. CNC word interface
ZR*	ZR0 ~ ZR13311 (13312 points)	16 bit/ 32 bit	File register, input/output signals with the PLC, machine input/output, etc.
W	W0 ~ W2FFF (12288 points)	16 bit/ 32 bit	Link register
Z	Z0 ~ Z13 (14 points)	16 bit	Address index
N	N0 ~ N7 (8 points)		Master controller nesting level
P*	P0 ~ P4095 (4096 points)		Label for conditional jump, subroutine call command
K	K-32768 ~ K32767		Decimal constant for 16-bit command
	K-2147483648 ~ K2147483647		Decimal constant for 32-bit command
H	H0 ~ HFFFF		Hexadecimal constant for 16-bit command
	H0 ~ HFFFFFFFF		Hexadecimal constant for 32-bit command

(Note 1) Devices marked with * in the device column have designated applications. Do not use devices other than those corresponding to the input/output signals with the machine side (input/output signals of the remote I/O unit), even if it is an undefined vacant device.

(Note 2) Distinction of 10ms timer and 100ms timer is performed by command. (10ms timer is performed by OUTH command, 100ms timer is performed by OUT command.)

(3) Timer / counter setting display**(a) PLC timer**

The setting value of the timer used by the built-in PLC can be set from the screen on the setting and display unit.

The timer types include the 10ms, 100ms and 100ms integral types.

Whether to validate the timer in the PLC program or to validate the setting value from the screen can be selected with the parameters.

Whether to hold the integral timer when the power is turned OFF can also be selected.

(b) PLC counter

The setting value of the counter used by the built-in PLC can be set from this screen.

Whether to validate the constants in the PLC program or to validate the setting value from the screen can be selected with the parameters.

Whether to hold the counter value when the power is turned OFF can also be selected.

(4) External key input

By inputting the key data from the built-in PLC, the same operation as when the operator operates the operation board can be done.

(5) Real spindle speed output

The real spindle speed is converted by the signals of the encoder installed on the spindle and is output to the PLC. The output increment is 0.001r/min.

(6) High speed input/output signal

There are signals that can be input and output at a 3.5ms cycle for high-speed processing.

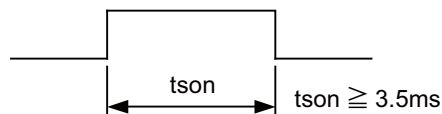
(a) Input signal ON time

(b) After the signal output is set in the interface, it can be output to the machine side with a max. 3.5ms delay. The input also appears on the interface with a 3.5ms delay.

(c) The signals used for high-speed processing are assigned with the parameters. Assignment is possible in a continuous 16-point unit.

(7) PLC analog voltage control

(a) Analog output

When the specified data is put in the file register, the corresponding analog voltage is output from the analog output external connector.

<Relation of file register details and analog output voltage>

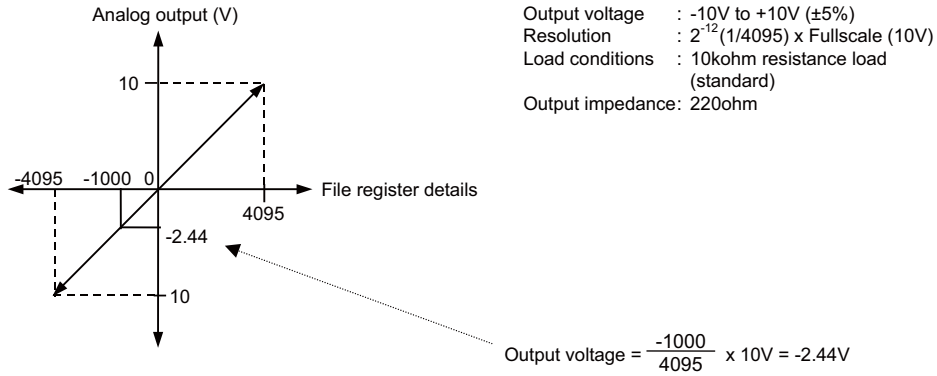

(Note) For analog output, the hardware corresponding to analog output is required.

Refer to the PLC Programming Manual for details.

[C80 series]

For the details of C80 series, refer to the manual of MITSUBISHI Programmable Controller "MELSEC iQ-R Series".

17.1.2.1.1 Index Modification

	M850W	M830W	M850S	M830S	M80W	M80 TypeA	M80 TypeB	E80 TypeA	E80 TypeB	C80
M	○	○	○	○	○	○	○	○	○	△ (*1)
L	○	○	○	○	○	○	○	○	○	△ (*1)

(*1) MELSEC

17.1.2.1.2 Multi-program [Number of Programs]

	M850W	M830W	M850S	M830S	M80W	M80 TypeA	M80 TypeB	E80 TypeA	E80 TypeB	C80
M	○ 120	○ 120	○ 120	○ 120	○ 60	○ 60	○ 60	○ 60	○ 60	△ (*1)
L	○ 120	○ 120	○ 120	○ 120	○ 60	○ 60	○ 60	○ 60	○ 60	△ (*1)

(*1) MELSEC

17.1.2.1.3 Multi-project [Number of Projects Stored]

[M system]

PLC project	M850W	M830W	M850S	M830S	M80W	M80 TypeA	M80 TypeB	E80 TypeA	E80 TypeB	C80
Number of PLC projects: 2	○	○	○	○	—	—	○	○	○	—
Number of PLC projects: 3	△	△	△	△	○	○	—	—	—	—
Number of PLC projects: 6	△	△	△	△	—	—	—	—	—	—

[L system]

PLC project	M850W	M830W	M850S	M830S	M80W	M80 TypeA	M80 TypeB	E80 TypeA	E80 TypeB	C80
Number of PLC projects: 2	○	○	○	○	—	—	○	○	○	—
Number of PLC projects: 3	△	△	△	△	○	○	—	—	—	—
Number of PLC projects: 6	△	△	△	△	—	—	—	—	—	—

17.1.2.1.4 Function Block (FB)

	M850W	M830W	M850S	M830S	M80W	M80 TypeA	M80 TypeB	E80 TypeA	E80 TypeB	C80
M	○	○	○	○	○	○	○	○	○	△ (*1)
L	○	○	○	○	○	○	○	○	○	△ (*1)

(*1) MELSEC

17.1.2.1.5 Label Programming

	M850W	M830W	M850S	M830S	M80W	M80 TypeA	M80 TypeB	E80 TypeA	E80 TypeB	C80
M	○	○	○	○	○	○	○	○	○	△ (*1)
L	○	○	○	○	○	○	○	○	○	△ (*1)

(*1) MELSEC

17.1.2.2 PLC Exclusive Instruction

	M850W	M830W	M850S	M830S	M80W	M80 TypeA	M80 TypeB	E80 TypeA	E80 TypeB	C80
M	○	○	○	○	○	○	○	—	—	△ (*1)
L	○	○	○	○	○	○	○	—	—	△ (*1)

(*1) MELSEC

PLC exclusive instruction is provided for certain limited applications, enabling a complex machining process, which is difficult to carry out only by the basic instructions and function instructions.

[M800/M80 series]

PLC exclusive instructions include:

(1) ATC exclusive instruction (ATC)

This is an instruction to function ATC, or magazine index control, tool exchange with arm, etc.

ATC exclusive instructions are as follows.

- Tool No. search
- Tool change
- Tool table forward/reverse run
- Pointer (which indicates magazine index position) forward/reverse run
- Tool data read/write

(2) Rotary body control instruction (ROT)

This is an instruction to determine the rotary body's target position or rotation direction, or to function as a ring counter.

This is used when calculating the rotation direction or number of index steps of the magazine or turret based on the output data figured from ATC exclusive instruction tool No. search processing, or when controlling the rotary body position.

Using the ATC and ROT instructions

The order for using the ATC and ROT instructions when T is commanded or tool exchange is commanded is shown below.

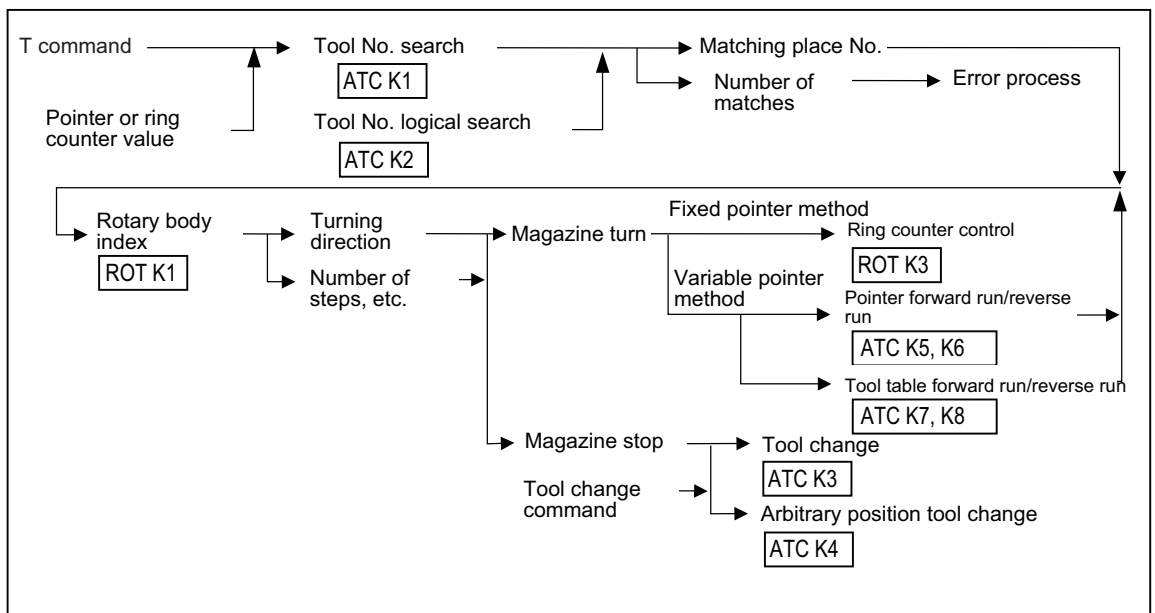

[C80 series]

PLC exclusive instructions include:

(1) Other device write instruction (DDWR)

This is an instruction to write the data to the device in other machine from the PLC CPU.

(2) Other device read instruction (DDRD)

This is an instruction to read the device data in other machine to the PLC CPU.

PLC exclusive instructions enable to access the device data of NC CPU from the PLC CPU.

PLC exclusive instructions are transferred via the exclusive instruction transmission between CPUs area provided in the system area on the CPU multi-buffer memory (fixed period communication area).

Also, "D (P)." or "M (P)." can be added before each instruction.

Periodic instruction, D (P).	The setting needs to be changed to use the periodic connection function on GX Works3, but since the periodic instruction is compatible with the old models, it can use the program of the old models.
Non-periodic instruction, M (P).	This can be used regardless of the setting of the periodic connection function, but since non-periodic instruction is not compatible, the correction needs to be done in order to use the program of the old model.

The non-periodic instruction "M (P)." is recommended as it can be used regardless of the setting.

For the details of C80 series, refer to the manual of MITSUBISHI Programmable Controller "MELSEC iQ-R Series".

17.1.2.3 Enhanced PLC Security Mode

	M850W	M830W	M850S	M830S	M80W	M80 TypeA	M80 TypeB	E80 TypeA	E80 TypeB	C80
M	○	○	○	○	○	○	○	○	○	—
L	○	○	○	○	○	○	○	○	○	—

This function restricts connections to the built-in PLC from applications such as PLC on-board and GX Developer/GX Works2. This function helps to protect the assets in the built-in PLC.

Two modes are available in this function:

- (1) PLC write protect mode (inhibits only write operations by applications)
 PLC write protect mode prevents users from accidentally overwriting sequence programs and modifying device values when a sequence program is monitored.
- (2) PLC read/write protect mode (inhibits write and monitoring operations by applications)
 PLC read/write protect mode protects sequence programs from being overwritten or read out by an unauthorized user.

While this function is used, one of the multi projects is available as the "end user project". (End user mode (or E/U mode))

Using this project, the end users can create sequence programs to add a new jig and sensor. Restrictions are imposed on the other projects; therefore, there is no risk of modifying or deleting sequence programs created by the machine tool builder.

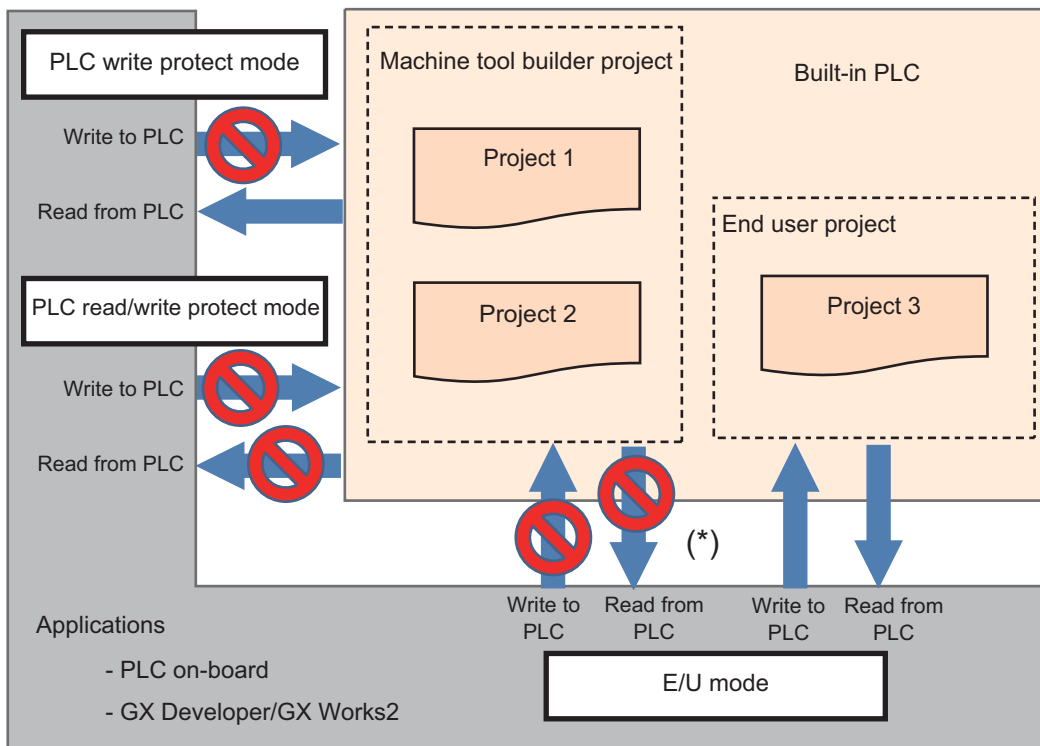

(*) Read/write operations between the application and the machine tool builder project depend on the enhanced PLC security mode settings.

17.1.3 PLC Support Functions

17.1.3.1 Alarm Message Display

	M850W	M830W	M850S	M830S	M80W	M80 TypeA	M80 TypeB	E80 TypeA	E80 TypeB	C80
M	○	○	○	○	○	○	○	○	○	—
L	○	○	○	○	○	○	○	○	○	—

The contents of the alarms which have occurred during sequence (user PLC) processing can be displayed on the setting and display unit.

Up to four alarm message displays can be displayed simultaneously on the alarm diagnosis screen. The maximum length of one message is 46 characters.

17.1.3.2 Operator Message Display

	M850W	M830W	M850S	M830S	M80W	M80 TypeA	M80 TypeB	E80 TypeA	E80 TypeB	C80
M	○	○	○	○	○	○	○	○	○	○ (*1)
L	○	○	○	○	○	○	○	○	○	○ (*1)

(*1) Only macro alarm messages are displayed.

When a condition has arisen in which a message is to be relayed to the operator, an operator message can be displayed separately from the alarm message.

The maximum length of an operator message on PLC message screen is 60 characters. The maximum number of characters per line is 55, and the message more than 56 characters is displayed on two lines. The number of messages displayed at the same time are up to four.

17.1.3.3 Memory Switch (PLC Switch)

The function equivalent to the machine operation switches can be implemented by using the setting display unit of controller. Switches can be turned ON/OFF from PLC switch screen and user PLC. Each switch can be named arbitrarily.

By the PLC switch for reverse, the valid switches by the additional specifications will be reversed.

Even when turning on the PLC switch for reverse, the invalid switches without the additional specification will not be reversed.

17.1.3.3.1 Memory Switch (PLC Switch) 32 Points

	M850W	M830W	M850S	M830S	M80W	M80 TypeA	M80 TypeB	E80 TypeA	E80 TypeB	C80
M	○	○	○	○	—	—	—	○	○	—
L	○	○	○	○	—	—	—	○	○	—

32 points of PLC switches can be set on the setting and display unit screen, and the ON/OFF control executed.

17.1.3.3.2 Memory Switch (PLC Switch) 64 Points

	M850W	M830W	M850S	M830S	M80W	M80 TypeA	M80 TypeB	E80 TypeA	E80 TypeB	C80
M	△	△	△	△	○	○	○	—	—	—
L	△	△	△	△	○	○	○	—	—	—

64 points of PLC switches can be set on the setting and display unit screen, and the ON/OFF control executed.

17.1.3.3.3 Memory Switch (PLC Switch) 96 points

	M850W	M830W	M850S	M830S	M80W	M80 TypeA	M80 TypeB	E80 TypeA	E80 TypeB	C80
M	△	△	△	△	—	—	—	—	—	—
L	△	△	△	△	—	—	—	—	—	—

96 points of PLC switches can be set on the setting and display unit screen, and the ON/OFF control executed.

17.1.3.4 Load Meter Display

	M850W	M830W	M850S	M830S	M80W	M80 TypeA	M80 TypeB	E80 TypeA	E80 TypeB	C80
M	○	○	○	○	○	○	○	○	○	○
L	○	○	○	○	○	○	○	○	○	○

A load meter can be displayed on the setting and display unit.

Up to two axes designated with the built-in PLC such as the spindle load and Z axis load can be displayed as bar graphs on the screen.

17.1.3.5 User PLC Version Display

	M850W	M830W	M850S	M830S	M80W	M80 TypeA	M80 TypeB	E80 TypeA	E80 TypeB	C80
M	○	○	○	○	○	○	○	○	○	○
L	○	○	○	○	○	○	○	○	○	○

The user PLC version can be displayed in the software list on the Software Configuration screen.

17.1.3.6 Ladder Program Writing during RUN

	M850W	M830W	M850S	M830S	M80W	M80 TypeA	M80 TypeB	E80 TypeA	E80 TypeB	C80
M	○	○	○	○	○	○	○	○	○	△ (*1)
L	○	○	○	○	○	○	○	○	○	△ (*1)

(*1) MELSEC

Ladder program can be edited while PLC is running. This function is available, either by GX Developer or PLC onboard edit. (Only M8)

17.1.3.7 PLC Program Protection

	M850W	M830W	M850S	M830S	M80W	M80 TypeA	M80 TypeB	E80 TypeA	E80 TypeB	C80
M	○ (*1)	○ (*1)	○ (*1)	○ (*1)	○ (*1)	○ (*1)	○ (*1)	○ (*1)	○ (*1)	△ (*2)
L	○ (*1)	○ (*1)	○ (*1)	○ (*1)	○ (*1)	○ (*1)	○ (*1)	○ (*1)	○ (*1)	△ (*2)

(*1) Each file

(*2) MELSEC

[M8 series]

For PLC data protection, the file password can be set to each file of PLC data.

The file password of the PLC data stored in NC can be released temporarily with PLC on-board.

(Note 1) The file password registration/change or cancellation can not be made with PLC on-board. Use GX Developer/GX Works2 for these operation.

The file password has the writing attribute (write protection/permission) and the reading attribute (read protection/permission), and the following operation is prohibited for these attributes.

Write protection: PLC data overwrite and deletion, conversion after editing the ladder

Read/write protection: PLC data overwrite, deletion, read and verification, conversion after editing the ladder

[C80 series]

For the details of C80 series, refer to the manual of MITSUBISHI Programmable Controller "MELSEC iQ-R Series".

17.1.4 Built-in PLC Capacity

17.1.4.1 Standard PLC Capacity [Number of Steps]

	M850W	M830W	M850S	M830S	M80W	M80 TypeA	M80 TypeB	E80 TypeA	E80 TypeB	C80
M	○ 128K	○ 128K	○ 128K	○ 128K	○ 64K	○ 64K	○ 32K	○ 20K	○ 20K	△ (*1)
L	○ 128K	○ 128K	○ 128K	○ 128K	○ 64K	○ 64K	○ 32K	○ 20K	○ 20K	△ (*1)

(*1) MELSEC

For the details of C80 series, refer to the manual of MITSUBISHI Programmable Controller "MELSEC iQ-R Series".

17.1.4.2 Large PLC Capacity: 256 Ksteps

	M850W	M830W	M850S	M830S	M80W	M80 TypeA	M80 TypeB	E80 TypeA	E80 TypeB	C80
M	△	△	△	△	—	—	—	—	—	—
L	△	△	△	△	—	—	—	—	—	—

17.1.4.3 Large PLC Capacity: 512 Ksteps

	M850W	M830W	M850S	M830S	M80W	M80 TypeA	M80 TypeB	E80 TypeA	E80 TypeB	C80
M	△	△	△	△	—	—	—	—	—	—
L	△	△	△	△	—	—	—	—	—	—

17.1.5 Machine Contact Input/Output I/F

	M850W	M830W	M850S	M830S	M80W	M80 TypeA	M80 TypeB	E80 TypeA	E80 TypeB	C80
M	○	○	○	○	○	○	○	○	○	△ (*1)
L	○	○	○	○	○	○	○	○	○	△ (*1)

(*1) MELSEC

[M8 series]

CAUTION

 Follow the remote type machine contact input/output interface described in this manual. (Connect a diode in parallel with the inductive load or connect a protective resistor in serial with the capacitive load, etc.)

Refer to the "Specifications Manual (Hardware)" for details.

[C80 series]

Selecting from within the input/output unit of MITSUBISHI Programmable Controller "MELSEC iQ-R Series". Refer to the manual of input/output unit for details.

17.1.6 Ladder Monitor

	M850W	M830W	M850S	M830S	M80W	M80 TypeA	M80 TypeB	E80 TypeA	E80 TypeB	C80
M	○	○	○	○	○	○	○	○	○	○ (GOT)
L	○	○	○	○	○	○	○	○	○	○ (GOT)

[M8 series]

This function enables the operating status of the sequence circuit to be checked on the controller's setting and display unit.

The ladder monitor functions include the following.

- (1) Circuit monitoring
- (2) Screen stop by monitor stop trigger point
- (3) Entry monitoring
- (4) Decimal-hexadecimal conversion present value monitoring

[C80 series]

The operation state of sequence circuit can be confirmed on the screen of Mitsubishi Graphic Operation Terminal (GOT).

The ladder monitor functions include the following.

- (1) Sequence program monitoring (circuit)
- (2) Sequence program monitoring (R circuit)
- (3) Sequence program monitoring (SFC)

Refer to the manual of Mitsubishi Graphic Operation Terminal (GOT) for details.

17.1.7 PLC Development

17.1.7.1 On-board Development

	M850W	M830W	M850S	M830S	M80W	M80 TypeA	M80 TypeB	E80 TypeA	E80 TypeB	C80
M	○	○	○	○	○	○	○	○	○	○ (GOT)
L	○	○	○	○	○	○	○	○	○	○ (GOT)

[M8 series]

On-board refers generically to the PLC related operations carried out with the CNC unit.

This is the easy-to-use on-board with the enhanced ladder monitoring functions and improved ladder edit usability by enhancing the linkage with the MELSEC series sequencer development tool (GX Developer/GX Works2).

When this function is started on the NC system version D1 or later where "smart safety observation function" is enabled, the user safety sequence "SafePLC1" and "SafePLC2" are displayed in the project list on the main screen. Select the project or the user safety sequence to switch the operation target.

Refer to "15.5.2 Smart Safety Observation" for details on the smart safety observation function.

[C80 series]

The sequence program can be monitored and edited by the sequence program monitoring of Mitsubishi Graphic Operation Terminal (GOT).

Refer to the manual of Graphic Operation Terminal (GOT) for details.

17.1.7.2 MELSEC Development Tool (GX Developer)

	M850W	M830W	M850S	M830S	M80W	M80 TypeA	M80 TypeB	E80 TypeA	E80 TypeB	C80
M	○	○	○	○	○	○	○	○	○	—
L	○	○	○	○	○	○	○	○	○	—

This CNC supports the user PLC development environment which uses the Mitsubishi Electric FA engineering software MELSOFT Series (GX Developer), which is the PLC development tool for the Mitsubishi PLC MELSEC Series.

This is used to create the machine sequence and user safety sequence of MITSUBISHI CNC.

Machine sequence: Control circuit created to control the machine tools (ladder circuit)

User safety sequence: Control circuit of the safety-related I/O observation created with the smart safety observation function (ladder circuit)

For the smart safety observation function, refer to "M800/M80 Series Smart safety observation Specification manual".

17.1.7.3 MELSEC Development Tool (GX Works2)

	M850W	M830W	M850S	M830S	M80W	M80 TypeA	M80 TypeB	E80 TypeA	E80 TypeB	C80
M	○	○	○	○	○	○	○	○	○	—
L	○	○	○	○	○	○	○	○	○	—

This CNC supports the user PLC development environment using the Mitsubishi Electric FA engineering software MELSOFT Series (GX Works2) which is the PLC development tool for MITSUBISHI PLC MELSEC Series.

GX Works2 is a programming software package (model name:SW1DND-GXW2) for Mitsubishi Electric programmable controller MELSEC series. It enables sequence programs for MITSUBISHI CNC series to be developed using similar operations to those for MELSEC series. Some of the functions are exclusively for MELSEC series and cannot be used in developing sequence programs for CNC.

GX Works2 Version 1.570U or newer version is recommended for developing sequence programs for MITSUBISHI CNC series. For details of the functions, refer to each of GX Works2 Operating Manuals.

(Note) The software sold separately is necessary.

17.1.7.4 MELSEC Development Tool (GX Works3)

	M850W	M830W	M850S	M830S	M80W	M80 TypeA	M80 TypeB	E80 TypeA	E80 TypeB	C80
M	—	—	—	—	—	—	—	—	—	○
L	—	—	—	—	—	—	—	—	—	○

Using GX Works3, the sequence programs of the MELSEC CPU can be developed and debugged.

(Note) The software sold separately is necessary.

17.1.8 PLC Parameter

The PLC constants set with the data type and the bit selection parameters set with bit types can be set from the screen as parameters used by the built-in PLC.

17.1.8.1 PLC Constant (150 Points)

	M850W	M830W	M850S	M830S	M80W	M80 TypeA	M80 TypeB	E80 TypeA	E80 TypeB	C80
M	○	○	○	○	○	○	○	○	○	○
L	○	○	○	○	○	○	○	○	○	○

17.1.8.2 PLC Constant Extension (Up to 750 Points)

	M850W	M830W	M850S	M830S	M80W	M80 TypeA	M80 TypeB	E80 TypeA	E80 TypeB	C80
M	○	○	○	○	○	○	○	—	—	—
L	○	○	○	○	○	○	○	—	—	—

There are PLC constants that can be set with data types as parameters used by the built-in PLC. The set data is set in the R register of the PLC and backed up. If data is set in the R register corresponding to the PLC constant with sequence program MOV commands, etc., the data will be backed up in the PLC constant parameter. However, the display will not change, so enter another screen, and then select this screen again.

The number of PLC constants is 150 points in the basic area and 750 points at the maximum in the extended area.

17.1.9 GOT Connection

This function connects and communicates between Mitsubishi Graphic Operation Terminal (GOT) and MITSUBISHI CNC.

Only GOT2000 series can be connected. Soft GOT 2000 can be connected, too.

There are two connection methods for GOT connection, Ethernet connection and CC-Link connection.

For details, refer to each manual of GOT.

[M8 series]

Operation and monitoring from GOT to PLC device of the NC can be performed, and GOT can be used as a sub monitor of peripheral operation panel or NC operation panel.

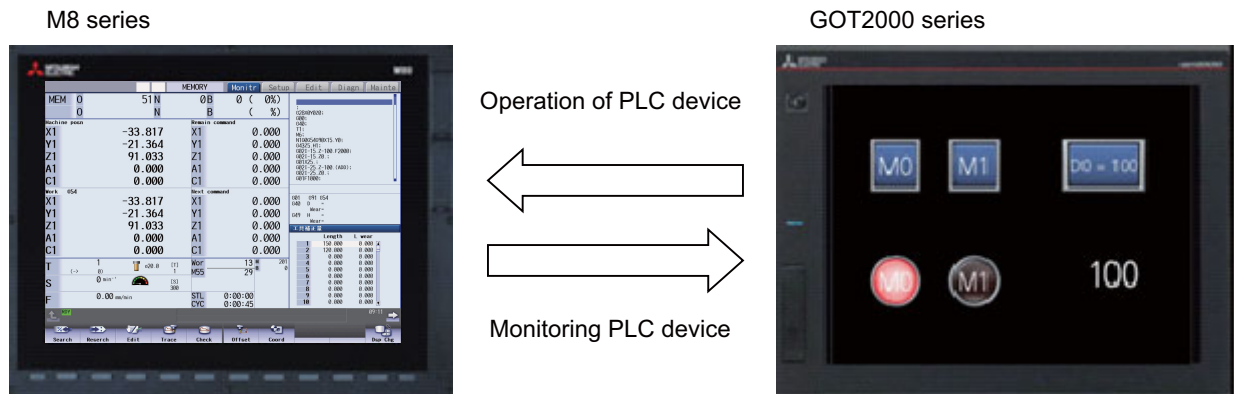

[C80 series]

To display the dedicated screen for CNC (CNC monitor2 function), connect the DISPLAY interface of NC CPU.

In addition, the size of GTO supports SVGA and VGA.

17.1.9.1 Ethernet Connection

	M850W	M830W	M850S	M830S	M80W	M80 TypeA	M80 TypeB	E80 TypeA	E80 TypeB	C80
M	○	○	○	○	○	○	○	○	○	○
L	○	○	○	○	○	○	○	○	○	○

17.1.9.2 CC-Link Connection

	M850W	M830W	M850S	M830S	M80W	M80 TypeA	M80 TypeB	E80 TypeA	E80 TypeB	C80
M	○	○	○	○	○	○	○	○	○	△ (*1)
L	○	○	○	○	○	○	○	○	○	△ (*1)

(*1) MELSEC

17.1.9.3 CC-Link IE Field Connection

	M850W	M830W	M850S	M830S	M80W	M80 TypeA	M80 TypeB	E80 TypeA	E80 TypeB	C80
M	—	—	—	—	—	—	—	—	—	△ (*1)
L	—	—	—	—	—	—	—	—	—	△ (*1)

(*1) MELSEC

17.1.10 Pallet Program Registration

	M850W	M830W	M850S	M830S	M80W	M80 TypeA	M80 TypeB	E80 TypeA	E80 TypeB	C80
M	△	△	△	△	—	—	—	—	—	—
L	—	—	—	—	—	—	—	—	—	—

Pallet program function allows machining program to be registered for each pallet of the auto pallet changer (hereinafter referred to as APC) and assists in the machining setups.

Operation search for the registered program will be executed by PLC using the external search function.

Machining program for each pallet is registered at "Pallet program registration" screen in the setup screen group. Registered program is output to PLC device.

If necessary, execute an external search on PLC ladder by referring to the program No. registered for each pallet.

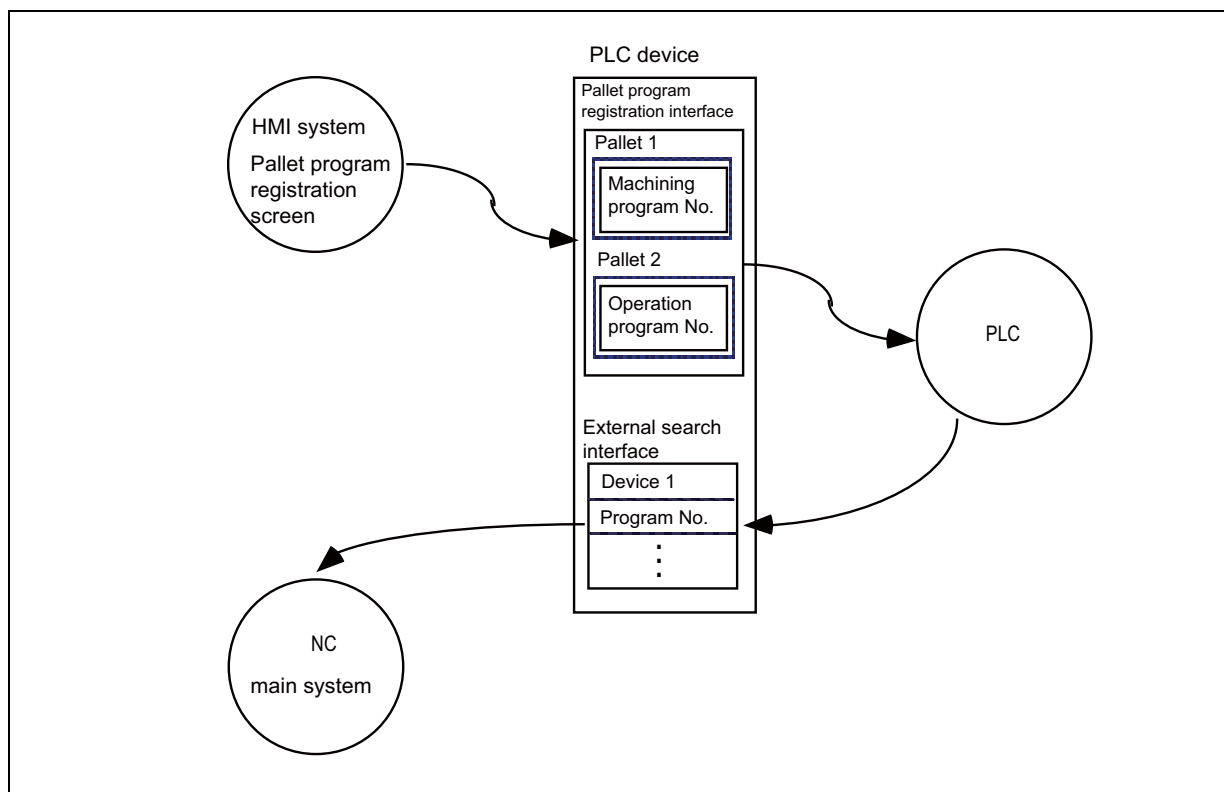

17.2 Machine Construction

17.2.1 Servo OFF

	M850W	M830W	M850S	M830S	M80W	M80 TypeA	M80 TypeB	E80 TypeA	E80 TypeB	C80
M	○	○	○	○	○	○	○	○	○	○
L	○	○	○	○	○	○	○	○	○	○

When the servo OFF signal (per axis) is input, the corresponding axis is set in the servo OFF state.

When the moving axis is mechanically clamped, this function is designed to prevent the servomotor from being overloaded by the clamping force.

Even if the motor shaft should move because of some reason in the servo OFF state, the movement amount will be compensated in the next servo ON state by one of the following two methods. (You can select the compensation method using a parameter.)

- (1) The counter is corrected according to the movement amount (follow up function).
- (2) The motor is moved according to the counter and compensated.

When follow up function is designated, the movement amount will be compensated even in the emergency stop state. The axis is simultaneously set to servo OFF state and the interlock state.

Mechanical handle

Even if the servo OFF axis is moved with the mechanical handle with the application of the servo OFF function and follow up function, the position data can be constantly read in and the machine position updated. Thus, even if the axis is moved with the mechanical handle, the coordinate position display will not deviate.

17.2.2 Axis Detachment

	M850W	M830W	M850S	M830S	M80W	M80 TypeA	M80 TypeB	E80 TypeA	E80 TypeB	C80
M	○	○	○	○	○	○	○	○	○	○
L	○	○	○	○	○	○	○	○	○	○

This function enables the control axis to be freed from control. Conversely, an axis which has been freed from control can be returned to the control status.

This function enables the rotary table or attachments to be removed and replaced. Automatic operation is disabled until the axis for which the axis detachment command has been released completes its dog-type reference position return.

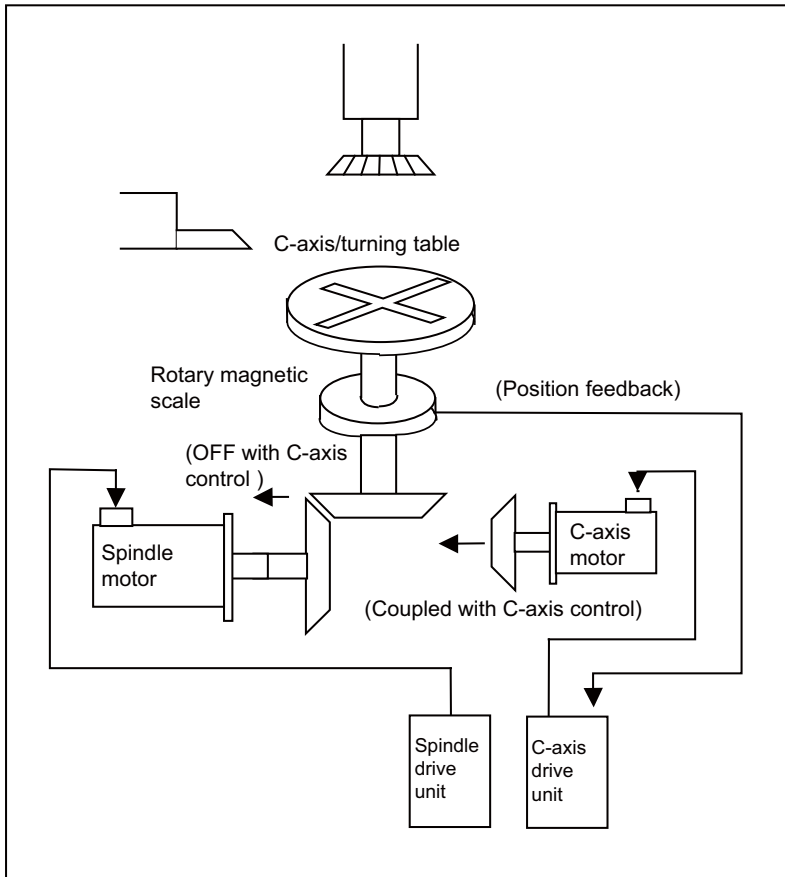

This shows the configuration of a machine for which switching between the C axis and turning table is performed. When the spindle motor is connected, the C axis is placed in the detached status. As a result, the position feedback of the detector is ignored.

<p>POSITION X 123.456 Z 0.000#1 C 345.678><</p>	<p>The detached status > < is indicated on the right of the POSITION display on the POSITION screen and at the same time the servo ready for the controller output signal is set to OFF. The POSITION counter retains the value applying when detach was assigned.</p>
---	--

(Note) Axis detachment can be executed even for the absolute position detection specifications axis, but when the axis is reinstalled, the zero point must be set.

17.2.3 Synchronous Control

	M850W	M830W	M850S	M830S	M80W	M80 TypeA	M80 TypeB	E80 TypeA	E80 TypeB	C80
M	△	△	△	△	○	○	○	—	—	△
L	△	△	△	△	○	○	○	—	—	△

The synchronous control is a control method that both master and slave axes are controlled with the same movement command by designating the movement command for the master axis also to the slave axis. This function is assumed to be used in the large machine tool, etc. which drives one axis with two servo motors.

The axis for the base of the synchronization is called the master axis, and the axis according to the master axis is called the slave axis.

(Note 1) The axis detachment function cannot be added to the axes used in the synchronous control.

(Note 2) The control axis synchronization between part systems and the synchronous control cannot be used simultaneously. (L system)

- The slave axis is controlled with the movement command for the master axis.
- One slave axis can be set to one master axis.
- Up to the following sets of the master axes/slave axes can be set for all the part systems in total.
8 sets for M800 Series, 3 sets for M80/C80 Series

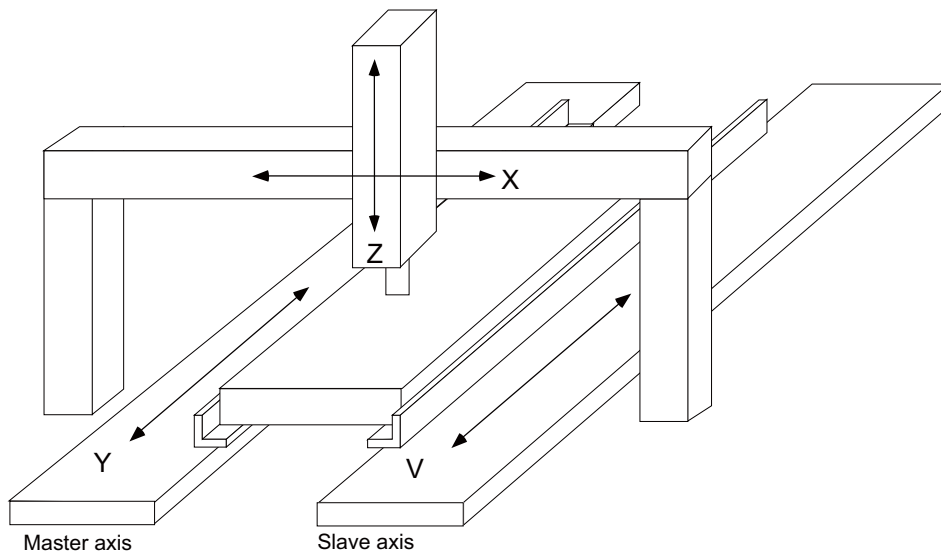

There are 3 types of synchronous control as follows:

(1) Position command synchronous control

This is used when the machine's rigidity is low.

This conforms the position command of the master axis to that of the slave axis using the synchronous control function of NC and drive those axes in parallel.

This can be used only by changing the NC setting, without changing the settings in the servo drive unit.

Position command synchronous control diagram

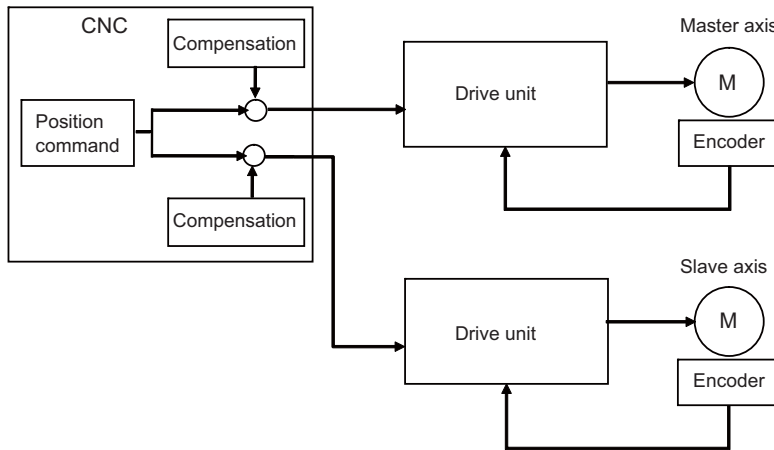

The position command synchronous control has the following configuration:

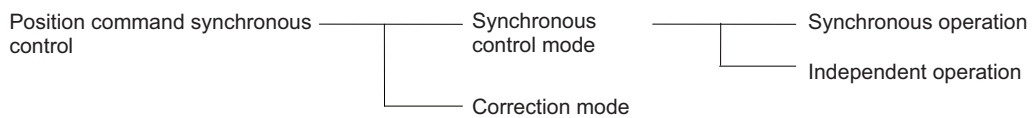

(2) Speed command synchronous control

This is used when reducing the scale of the full-closed system or when the machine's rigidity, etc. cause the mutual interference to the axes positions.

This drives the master axis and the slave axis in parallel using the common position feedback. Since the feedrate of each axis is controlled by the speed feedback of each axis, the stable control is available.

This can be used when the settings of the NC and the servo drive unit are changed.

Speed command synchronous control diagram

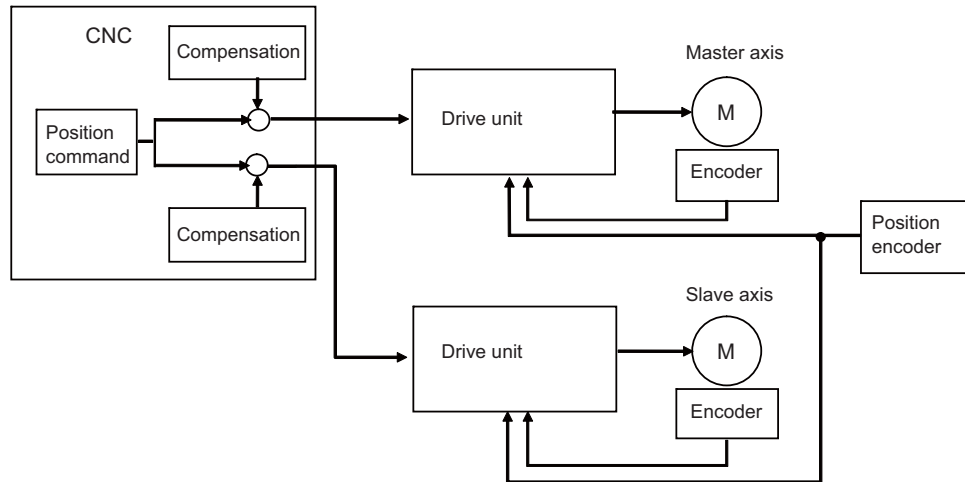
**(3) Current command synchronous control**

This drives the master and slave axes in parallel by reference to the speed feedback from the encoder onto the master axis side on the slave axis. Since that speed feedback is not the slave axis's itself, the slave axis easily vibrates.

Also, as the slave axis is easily influenced by the disturbance, this is not appropriate for the machine tools which need the positioning accuracy or the interpolation accuracy.

This can be used when the setting of the NC and the servo drive unit are changed.

Current command synchronous control diagram

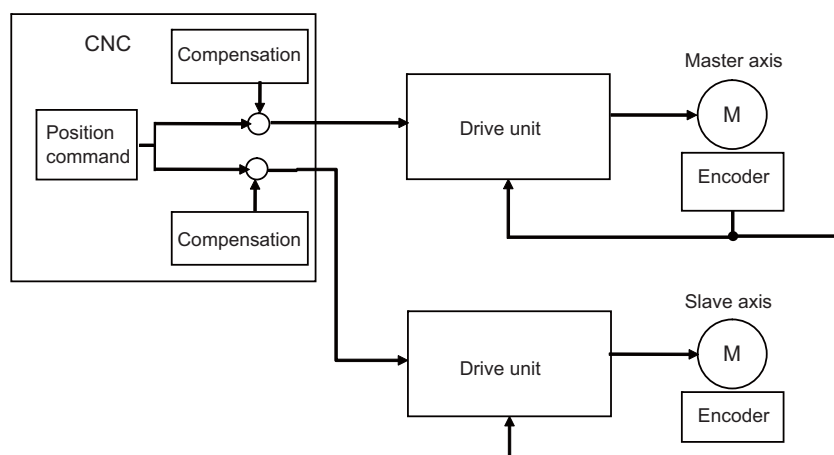

The "compensation" in the (1), (2) and (3) diagrams indicates the pitch error compensation, the thermal expansion compensation, the backlash compensation and the external machine coordinate compensation.

The axes which can set the compensation during the synchronous control differ according to the synchronous control type.

There are 2 types of modes as follows:

(1) Synchronous control mode

The following two operation methods are available in the synchronous control mode.

(a) Synchronous operation

This is a method that both master and slave axes are moved simultaneously with the movement command for the master axis.

(b) Independent operation

This is a method that either the master or slave axis is moved with the movement command for the master axis.

(2) Correction mode

The synchronization is temporarily canceled to adjust the balance of the master and slave axes during the synchronous control mode in the machine adjustment. Each axis can be moved separately with the manual handle feed or the arbitrary feed in manual mode. If the operation mode other than the manual handle feed and arbitrary feed in manual mode is applied during the correction mode, the operation error will occur.

17.2.4 Inclined Axis Control

	M850W	M830W	M850S	M830S	M80W	M80 TypeA	M80 TypeB	E80 TypeA	E80 TypeB	C80
M	△	△	△	△	○	○	○	—	—	—
L	△	△	△	△	○	○	○	○	○	△

Even when the control axes configuring that machine are mounted at an angle other than 90 degrees, this function enables it to be controlled by the same program as that for an orthogonal axis.

The inclination angle is set using a parameter, and axes are controlled using the movement amounts of the axes which are obtained through conversion and compensation using this angle.

<Example of use> When the X axis serves as the basic axis and the Y axis serves as the inclined axis

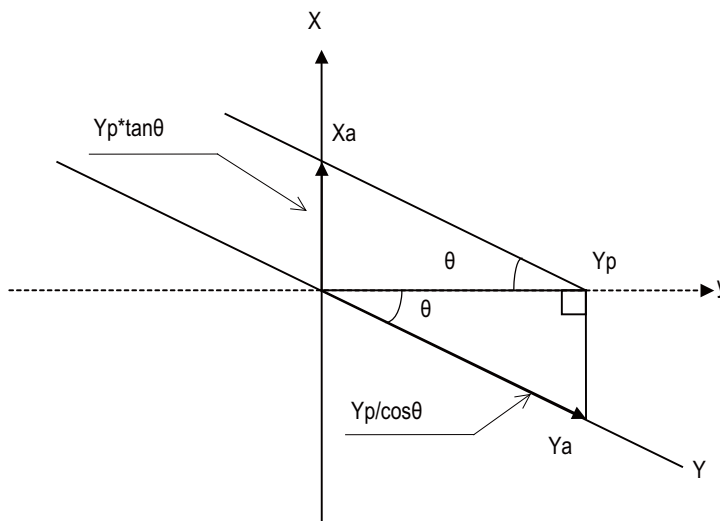

X: Actual X axis
 Y: Actual Y axis
 y: Programmed Y axis
 θ : Inclination angle

Y_p , the Y-axis position on the programmed coordinates (on the orthogonal coordinates), is the position of X_a and Y_a which are produced by synthesis of X axis and Y axis.

Therefore, the Y-axis (inclined axis) movement amount is expressed by the following formula:

$$Y_a = Y_p / \cos\theta \quad \dots (1)$$

The X-axis (basic axis) movement amount is compensated by the inclined movement of the Y axis, and it is expressed as follows:

$$X_a = X_p - Y_p \tan\theta \quad \dots (2)$$

The Y-axis (inclined axis) speed is as follows:

$$F_a = F_p / \cos\theta$$

X_a , Y_a and F_a are the actual movement amounts and speed.
 X_p , Y_p and F_p are the movement amounts and speed on the program coordinates.

17.2.5 Position Switch

	M850W	M830W	M850S	M830S	M80W	M80 TypeA	M80 TypeB	E80 TypeA	E80 TypeB	C80
M	○ 24	○ 24	○ 24	○ 24	○ 24	○ 24	○ 24	○ 24	○ 24	○ (*1)
L	○ 24	○ 24	○ 24	○ 24	○ 24	○ 24	○ 24	○ 24	○ 24	○ (*1)

(*1) 24 points for each part system and 32 points for the whole PLC axes.

The position switch (PSW) function provides hypothetical dog switches in place of the dog switches provided on the machine axes by setting the axis names and coordinate positions indicating the hypothetical dog positions (dog1, dog2) as parameters beforehand so that signals are output to the PLC interface when the machine has reached these hypothetical dog range. The hypothetical dog switches are known as position switches (PSW). 24 points of the position switches can be set to the NC axis for each part system.

Position switch area checking can be performed at high-speed by parameter setting. In high-speed checking, the parameter determines which is used between the command type machine position or detector feedback position for area checking by each position switch.

Example of dog1, dog2 settings and execution

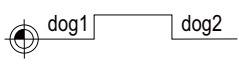
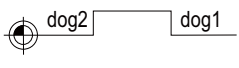
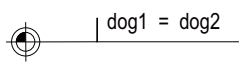
dog1, dog2 settings	dog1, dog2 positions	Description
dog1 < dog2		Signal is output between dog1 and dog2
dog1 > dog2		Signal is output between dog2 and dog1
dog1 = dog2		Signal is output at the dog1 (dog2) position

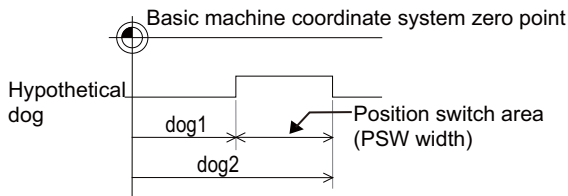

[Only for C80 series]

32 points of the position switches (PSW) in total can be set to the PLC axis. Also, the position switch interlock function is in the axis interlock state outside of the position switch (PSW) by PLC signal, and prohibits the movement of the PSW target axis. This function can be set only to the NC axis, cannot be set to the PLC axis.

The PLC axis position switch cannot be set to the axis which is used for either NC axis or PLC axis indexing.

17.2.7 Index Table Indexing

	M850W	M830W	M850S	M830S	M80W	M80 TypeA	M80 TypeB	E80 TypeA	E80 TypeB	C80
M	○	○	○	○	○	○	○	○	○	○
L	○	○	○	○	○	○	○	○	○	○

The indexing of the index table can be performed by setting the index axes.

Programming is facilitated because, in terms of the index commands, only the indexing angle need to be designated using the address of the programmed axis serving as the index setting axis, and there is no need to designate special M codes for clamping and unclamping the table.

Clamp operation is performed by setting the unclamp command signal to OFF (type A) or is performed with the clamp signal (type B).

(1) Type A

- Designate the movement commands (absolute or incremental) for the selected axis using a program.
- The unclamp command signal is now output prior to the axis movement.
- When the axes are unclamped, set the unclamp finish signal to ON with the PLC. (Set the signal to ON after performing required process such as servo ON or the unclamp process.)
- After checking the unclamp finish signal, the designated axis starts moving.
- Upon completion of the movement, the unclamp command signal is set to OFF.
- Clamp the axes and set the unclamp finish signal to OFF with the PLC. (Set the signal to OFF after performing required process such as in-position check, servo OFF or the clamp process.)
- After checking that the unclamp finish signal is OFF, processing of the next block is initiated.

[Operation timing chart for type A]

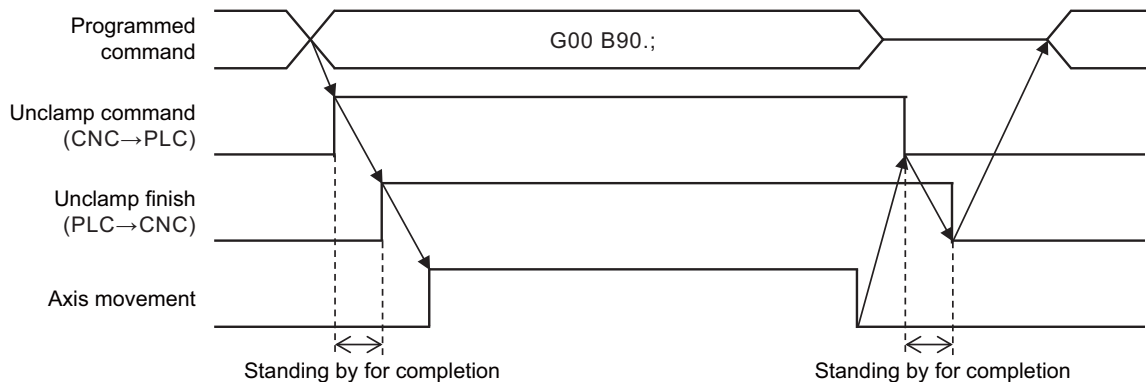

(2) Type B

- (a) Designate the movement commands (absolute or incremental) for the selected axis using a program.
- (b) The unclamp command signal is now output prior to the axis movement.
- (c) When the axes are unclamped, set the unclamp finish signal to ON with the PLC.
(Set the signal to ON after performing required process such as servo ON or the unclamp process.)
- (d) After checking the unclamp finish signal, set the unclamp command signal to OFF and the designated axis starts moving.
- (e) Set the unclamp finish signal to OFF with the PLC.
- (f) Upon completion of the movement, the clamp command signal is set to ON.
- (g) Clamp the axes and set the clamp finish signal to ON with the PLC.
(Set the signal to ON after performing required process such as in-position check, servo OFF or the clamp process.)
- (h) After checking that the clamp finish signal is ON, set the clamp command signal to OFF and processing of the next block is initiated.
- (i) Set the clamp finish signal to OFF with the PLC.

[Operation timing chart for type B]

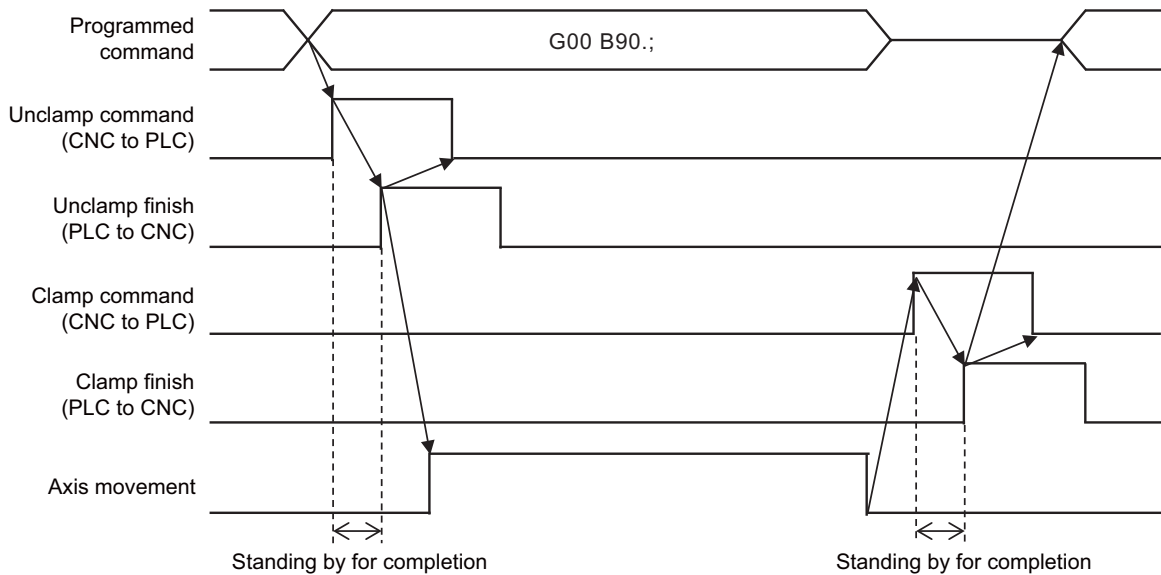

17.2.8 Tool Length Compensation along the Tool Axis

	M850W	M830W	M850S	M830S	M80W	M80 TypeA	M80 TypeB	E80 TypeA	E80 TypeB	C80
M	△	△	△	△	—	—	—	—	—	—
L	△ (*1)	△ (*1)	△ (*1)	△ (*1)	—	—	—	—	—	—

(*1) This function is available during program format switch.

(1) Changing the tool length compensation in tool axis direction and compensation amount

Even if the tool axis direction is not the Z axis direction because the rotary axis is rotated, the tool can be compensated in the tool axis direction. By setting the deviation of the tool length value set when the program was created and the actual tool length as a compensation amount, the program can be made more flexible.

This is especially effective for programs with many rotary axis movement commands.

The tool length compensation amount in the tool axis direction can be changed by rotating the manual pulse generator when the tool length compensation along tool axis mode and tool length compensation amount along the tool axis change mode are valid.

(2) Machine configuration

The tool length compensation in tool axis direction is carried out in respect to the direction of the tool nose axis (rotary axis).

The axis which determines the compensation direction is designated with the parameters as a combination of the Z-axis rotation C axis (spindle) and X-axis rotation A axis or Y-axis rotation B axis.

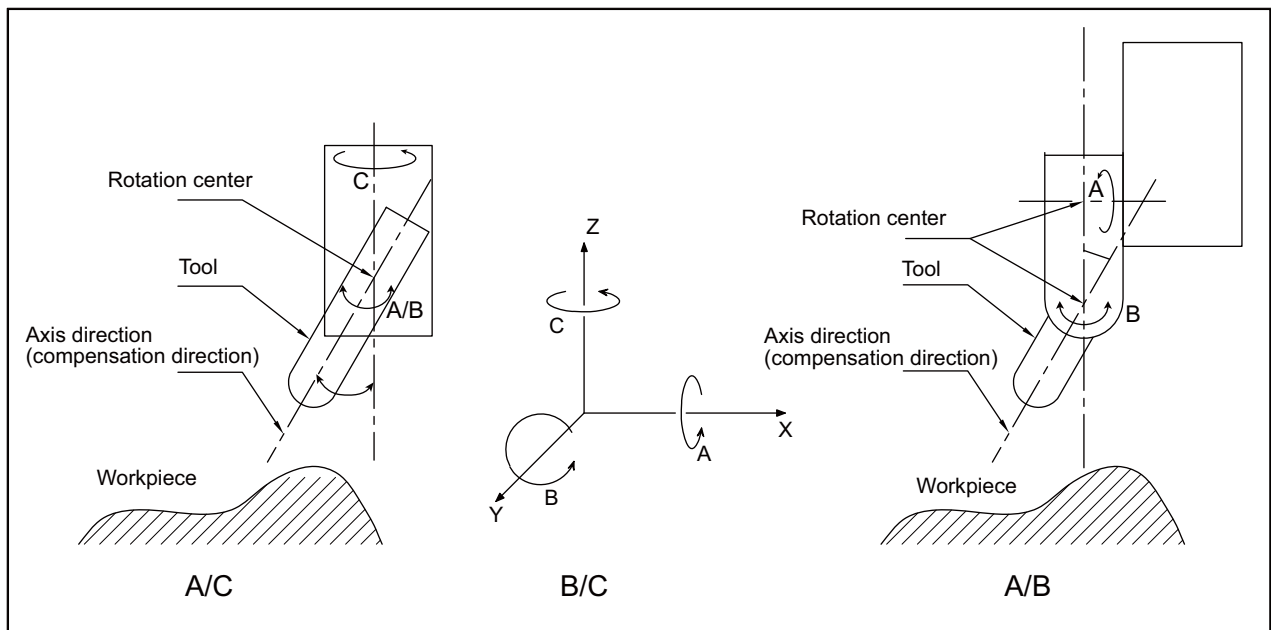

17.2.9 Tool Handle Feed & Interruption

	M850W	M830W	M850S	M830S	M80W	M80 TypeA	M80 TypeB	E80 TypeA	E80 TypeB	C80
M	Δ	Δ	Δ	Δ	—	—	—	—	—	—
L	—	—	—	—	—	—	—	—	—	—

The tool handle feed & interrupt function makes it possible to move the axis with the manual pulse generator in the tool axis direction, tool diameter direction X and tool diameter direction Y within the hypothetical coordinate system over the tool axis.

Normal handle feed and interrupt is applied when this function is not provided.

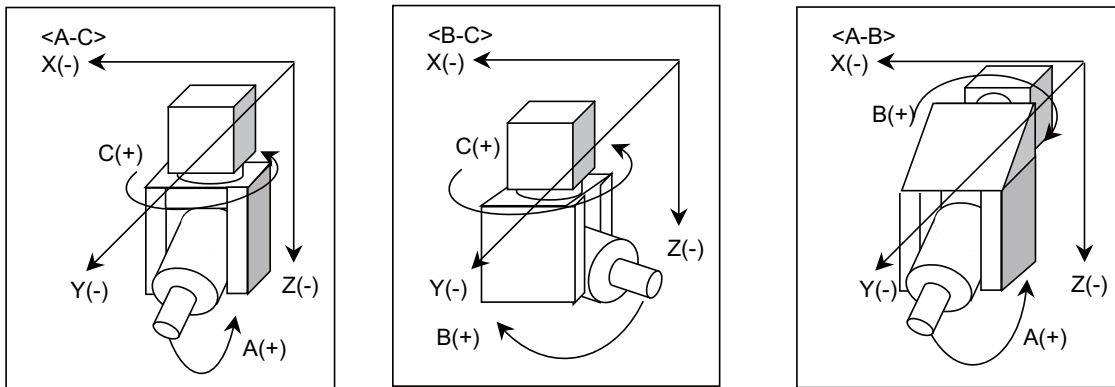

This is also effective for a machine configuration having the tool tilt 1 axis and table tilt 1 axis.

17.2.10 Tool Center Coordinate Display

	M850W	M830W	M850S	M830S	M80W	M80 TypeA	M80 TypeB	E80 TypeA	E80 TypeB	C80
M	Δ	Δ	Δ	Δ	—	—	—	—	—	—
L	—	—	—	—	—	—	—	—	—	—

The tool center coordinates, handle interrupt amount (tool axis movement), table/workpiece installation, machine position coordinates in the inclined surface coordinate system, mechanical axis angle and tool center point speed are displayed during the tool center point control function, tool length compensation along tool axis function, and tool handle feed & interrupt function (tool axis direction handle feed, tool handle interrupt, tool diameter direction handle feed, nose center rotation handle feed).

The path using the tool center coordinate position is drawn on the Graphic Trace screen.

One of the functions below is required to validate this function.

- Tool length compensation along tool axis
- Tool handle feed & interrupt
- Tool center point control
- Workpiece installation error compensation
- Inclined surface machining command
- Simple inclined surface machining command
- 3-dimensional tool radius compensation (tool's vertical-direction compensation)
- 3-dimensional manual feed
- R-Navi

17.2.11 Tool Center Point Control

17.2.11.1 Tool Center Point Control (G43.4/G43.5)

	M850W	M830W	M850S	M830S	M80W	M80 TypeA	M80 TypeB	E80 TypeA	E80 TypeB	C80
M	△	△ (*1)	△	△ (*1)	○ (*1)	○ (*1)	—	—	—	—
L	—	—	—	—	—	—	—	—	—	—

(*1) Restrained to 4-axis simultaneous contouring

The tool center point control function controls so that the position command in the machining program is at the tool center point on the coordinate system (table coordinate system) which rotates together with the workpiece. This function can be applied with the machine including the tool tilt type with two rotary axes on the head (1), the table title type with two rotary axes on the table (2), and the combined type with rotary axes on the tool and table (3).

(1) Tool tilt type

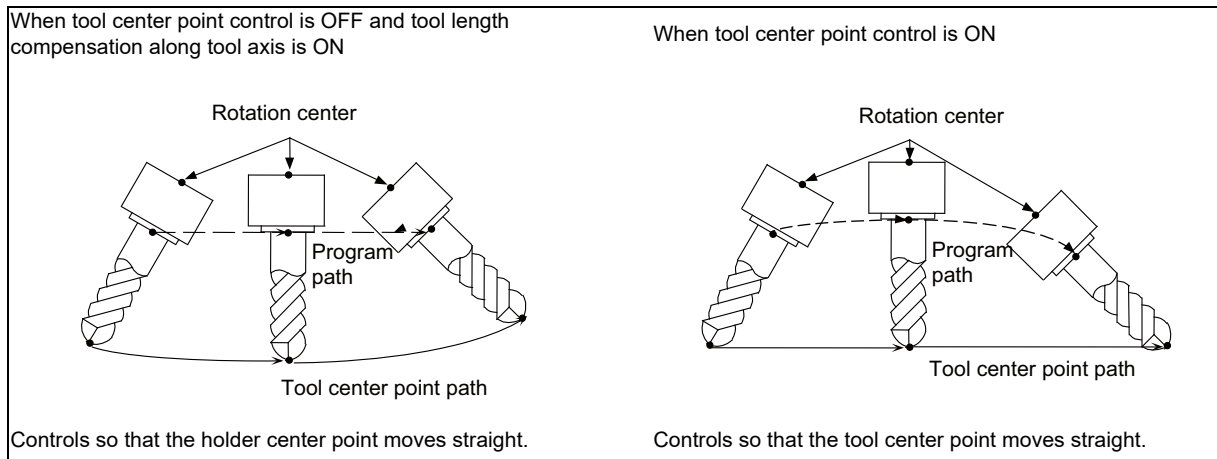

(2) Table tilt type

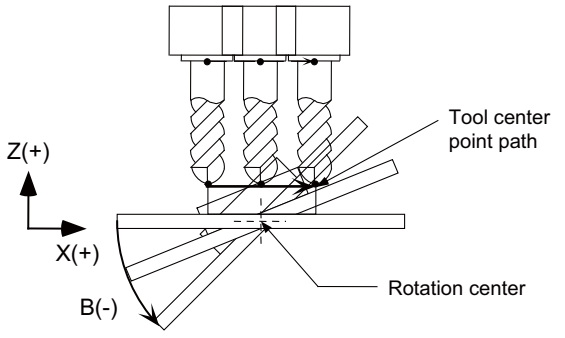
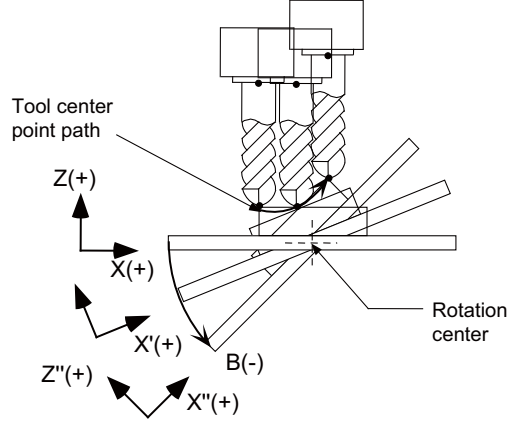
<p>When tool center point control is OFF and tool length compensation along tool axis is ON</p>  <p>Controls so that the holder center point is at the workpiece coordinate system's position</p>	<p>When tool center point control is ON</p>  <p>Controls so that the tool center point is at the table coordinate system's position.</p>
--	--

(3) Combined type

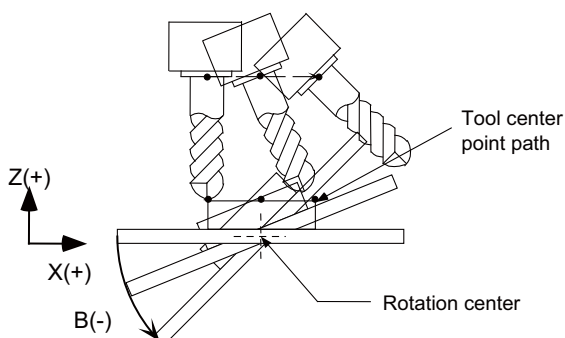
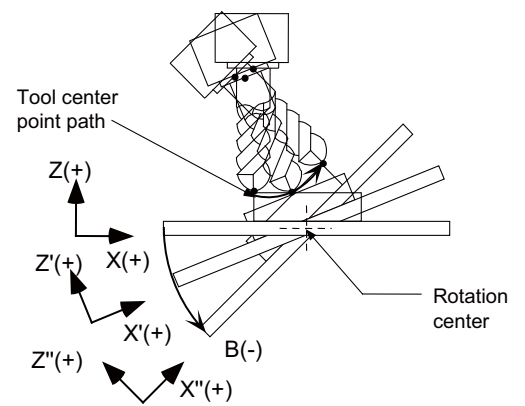
<p>When tool center point control is OFF and tool length compensation along tool axis is ON</p>  <p>Controls so that the holder center point is at the workpiece coordinate system's position.</p>	<p>When tool center point control is ON</p>  <p>Controls so that the tool center point is at the table coordinate system's position.</p>
---	--

[Axis configuration of applicable machines]

This function can be used on the machine whose rotary axis is installed with ISO polarity and the machine whose axis is installed with non-ISO polarity. However, the orthogonal axis needs to be installed with ISO polarity. (*1)

Note that this function can be also used on the machine with a tilted rotary axis.

(*1) In the machine coordinate system (right-hand orthogonal coordinate system) defined in ISO standard, the rotation turning to the right-handed screw is handled as ISO polarity and the one turning to the left-handed screw is handles as non-ISO polarity.

This function is not applicable to machines as in the table below:

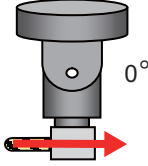
Description	Example of machines
<p>A machine whose direction of the tool axis (from the tool tip to the tool base) is not parallel to Z axis (Z axis positive direction) when machine positions of the rotary axes are all 0° (The arrow shown in the figure at the right indicates the direction of the tool axis.)</p>	

17.2.12 Inclined Surface Machining Command

	M850W	M830W	M850S	M830S	M80W	M80 TypeA	M80 TypeB	E80 TypeA	E80 TypeB	C80
M	△	△	△	△	○	○	—	—	—	△
L	△	△	△	△	○	○	—	—	—	—

This function is to define the new coordinate system (called the "feature coordinate system") which was created by rotation and reference position translation of the X, Y, Z axes of the original one (before the inclined surface machining command was applied). By using this function, an arbitrary spatial plane can be defined, and machining on that plane can be carried out with normal program commands.

Also, the tool axis can automatically be controlled to the + Z direction of the newly defined feature coordinate system. Since the feature coordinate system will be re-created in accordance with the tool axis direction, machining programs can be developed without the need to consider the direction of the feature coordinate system and rotation of the tool axis.

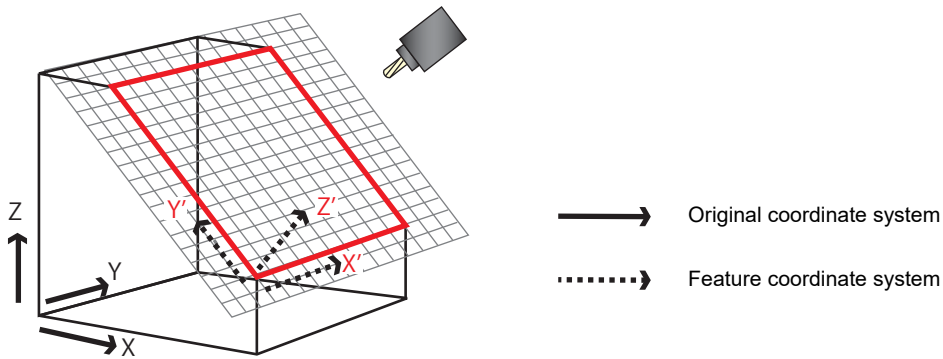

The feature coordinate system is defined in the following method.

- Designation with Euler angle.
- Designation with the roll angle, pitch and yaw angle.
- Designation with the three points on the plane.
- Designation with two vectors.
- Designation with a projection angle.
- Designation with the registered machining surface selection
- Designation with the tool axis direction.

The orthogonal axes must be installed with ISO polarity, while the rotary axes can be installed with either ISO polarity or non-ISO polarity.

This function is compatible with the following types of machine.

Type	Tool tilt type	Table tilt type	Combined type
Description	Two rotary axes on the tool side	Two rotary axes on the table side	One rotary axis on each of the tool side and table side
Example of machine	<p>The 1st rotary axis on the tool side</p> <p>The 2nd rotary axis on the tool side</p>	<p>The 1st rotary axis on the table side</p> <p>The 2nd rotary axis on the table side</p>	<p>Rotary axis on the tool side</p> <p>Rotary axis on the table side</p>
Primary rotary axis	The 2nd rotary axis on the tool side	The 1st rotary axis on the table side	Rotary axis on the tool side

(Note 1) This function is not applicable to machine configuration of the following types:

- A machine whose direction from the tool tip to the tool base is not parallel to Z axis (Z axis positive direction) when machine positions of the rotary axes are all 0°

(Note 2) Only one rotary axis can be tilted. When you attempt to tilt two or more rotary axes, an operation error occurs.

(Note 3) The inclined surface machining cannot be performed on a machine where the primary rotary axis rotates around the K axis or where the primary and secondary rotary axes rotate around the same axis. A program error occurs when the command is issued.

17.2.13 Simple Inclined Surface Machining Command

	M850W	M830W	M850S	M830S	M80W	M80 TypeA	M80 TypeB	E80 TypeA	E80 TypeB	C80
M	—	—	—	—	—	—	—	—	—	—
L	△	△	△	△	○	○	○	○	—	—

In a lathe with three orthogonal axes and one rotary axis on the tool side, this function enables simultaneous 4-axis control milling on an inclined surface along workpiece end face.

To facilitate machining on an inclined surface, this function uses three commands: simple inclined surface control (G176), simple tool center point control (G174), and tool axis direction control (G53.1) as follows. The tool axis direction can be turned at right angles to the inclined surface by issuing the tool axis direction control command (G53.1) after the simple inclined surface control command (G176). When G174 is given after G176, the direction of tool length is compensated in accordance with the tool angle.

For a machine configured with a turret, this function allows you to use any tool on the turret to carry out simple inclined surface machining.

(1) Simple inclined surface control (G176)

G176 enables a new coordinate system (called "feature coordinate system") to be defined. Feature coordinate system is obtained by rotating and parallel translating a plane using the X, Y and Z axes configuring the workpiece coordinate system as a rotary axis. Consequently, there is no need to calculate the coordinate position in accordance with the inclined surface angle. This simplifies creation of a machining program.

(2) Simple tool center point control (G174)

G174 allows a tool length offset in the tool axis direction even when the tool axis direction is not parallel to the orthogonal coordinate system after rotation of the rotary axis. Consequently, the nose of the tool mounted on the rotary axis can be kept in the programmed position at all times. This simplifies creation of a complicated-shape machining program.

(3) Tool axis direction control (G53.1)

G53.1 aligns the tool with the + Z direction of the feature coordinate system. This eliminates the need for you to mind the feature coordinate system's direction or tool axis' rotation direction, resulting in greater ease of programming.

Feature coordinate system

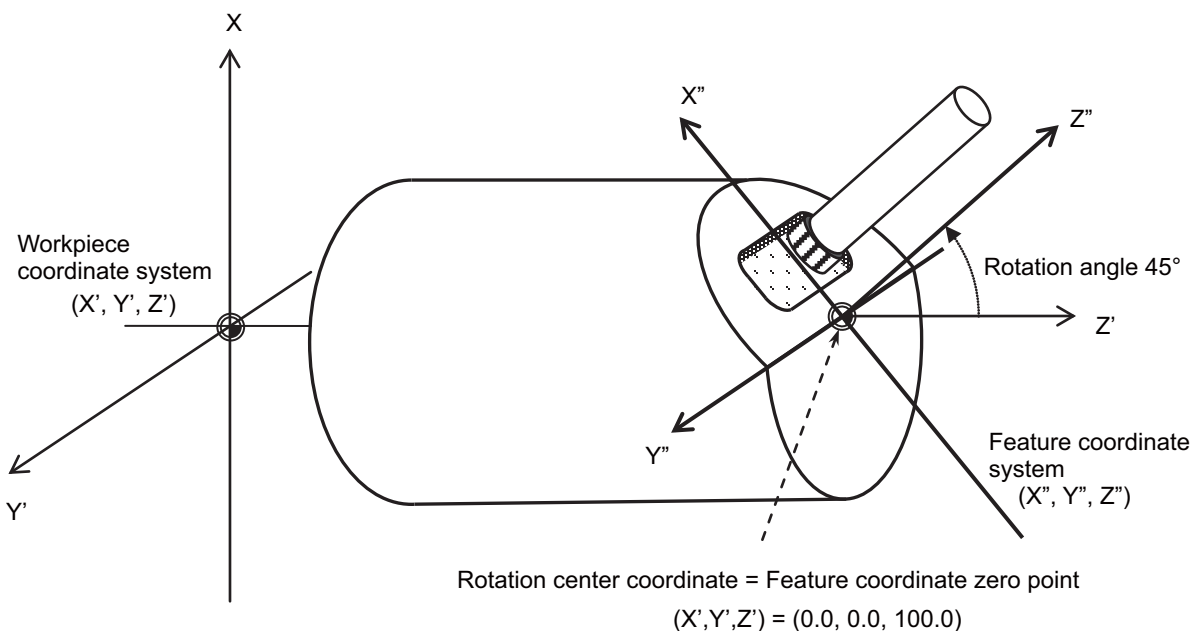

Command format

Simple inclined surface control start

G176 X__Z__D__	;	When rotating K-I plane about the axis parallel to the J axis
G176 X__Y__D__	;	When rotating I-J plane about the axis parallel to the K axis
G176 Y__Z__D__	;	When rotating J-K plane about the axis parallel to the I axis
X,Y,Z	:	Feature coordinate system zero point (Rotation center position) (-99999.999 to 99999.999 (mm)) (-9999.9999 to 9999.9999 (inch))
D	:	Rotation angle (-359.999 to 359.999 (°))

Simple inclined surface control cancel

G69.1;

Tool axis direction control

G53.1 R__ ;		
R	:	Tool axis rotation angle compensation amount (-359.999 to 359.999 (°))

Simple tool center point control start

G174 R__ ;		
R	:	Tool axis rotation angle compensation amount (-359.999 to 359.999 (°))

G174 (X__Y__Z__B__) ;	The axis movement command in () can be omitted.
------------------------------	---

Simple tool center point control cancel command

G175;

17.2.14 3-dimensional Tool Radius Compensation (Tool's Vertical-direction Compensation)

	M850W	M830W	M850S	M830S	M80W	M80 TypeA	M80 TypeB	E80 TypeA	E80 TypeB	C80
M	△	△	△	△	—	—	—	—	—	—
L	△ (*1)	△ (*1)	△ (*1)	△ (*1)	—	—	—	—	—	—

(*1) This function is available during program format switch.

This function is to compensate the tool radius of the machine with two rotary axes, in accordance with the change of the workpiece direction and inclination of the tool due to the movement of the rotary axis. The 3-dimensional tool radius compensation was realized by searching the tool path on the workpiece by the program command and calculating the compensation vector on the plane (compensation plane) which is vertical to the path in the tool direction.

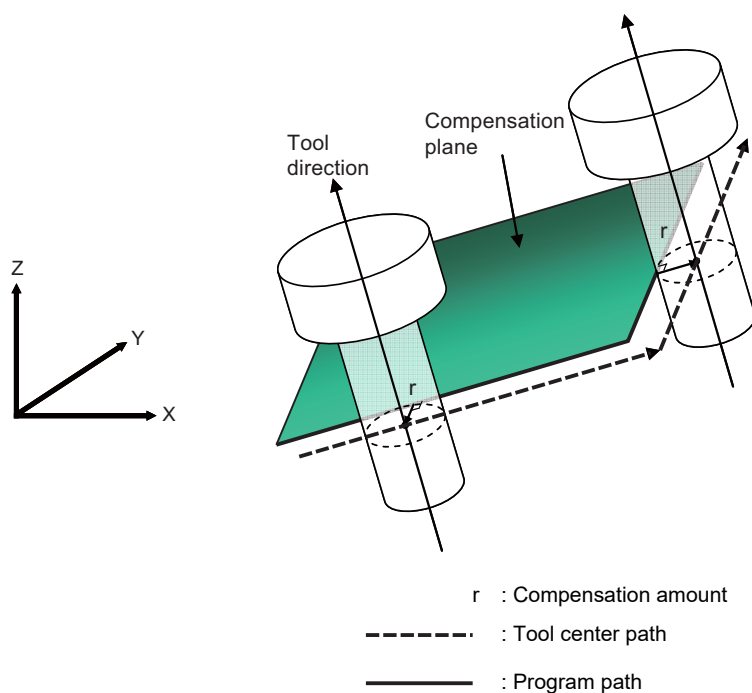

When the 3-dimensional tool radius compensation (tool's vertical-direction compensation) is commanded while the specification is not added, an alarm will occur.

17.2.15 Workpiece Installation Error Compensation

	M850W	M830W	M850S	M830S	M80W	M80 TypeA	M80 TypeB	E80 TypeA	E80 TypeB	C80
M	△	—	△	—	—	—	—	—	—	—
L	△ (*1)	—	△ (*1)	—	—	—	—	—	—	—

(*1) This function is available during program format switch.

This function is for the 5-axis machine. This compensates the error when a workpiece is placed off the workpiece coordinate system to enable machining according to the program. In this function, a new coordinate system with the workpiece as its reference position will be defined (called "workpiece installation coordinate system") and the program will be executed in this new coordinate system.

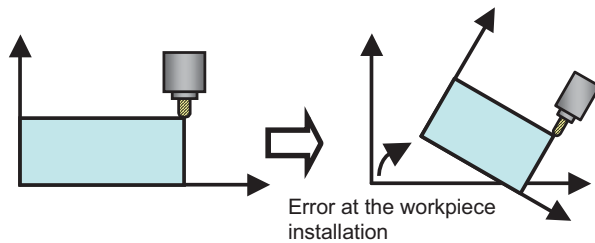

This function is compatible with the same types of machine as listed in the inclined surface machining command.

17.2.16 3-dimensional Manual Feed

	M850W	M830W	M850S	M830S	M80W	M80 TypeA	M80 TypeB	E80 TypeA	E80 TypeB	C80
M	△	△	△	△	○	○	—	—	—	△
L	△	△	△	△	○	○	—	—	—	—

By selecting the hypothetical coordinate system to be machined, axis can be moved with manual feed (JOG, HANDLE or INCREMENTAL) in the coordinate system with this function.

If a movement command on the hypothetical coordinate is issued, it can be easy to setup because multiple axes is moved by NC according to the tool angle or the inclination of the table.

This function consists of the hypothetical coordinate feed and tool center point rotation.

Movement command for the linear axis operates as the hypothetical coordinate feed and manual feed will be carried out on the hypothetical coordinate.

Movement command for the rotary axis operates as the tool center point rotation and manual feed will be carried out with the rotary axis and 3 linear axes which are issued a movement command to keep position relations of the workpiece and tool tip.

This function can be used on the machine whose rotary axis is installed with ISO polarity and the machine whose axis is installed with non-ISO polarity. However, the orthogonal axis needs to be installed with ISO polarity.*1

Note that this function can be also used on the machine with a tilted rotary axis.

(*1) In the machine coordinate system (right-hand orthogonal coordinate system) defined in ISO standard, the rotation turning to the right-handed screw is handled as ISO polarity and the one turning to the left-handed screw is handles as non-ISO polarity.

Standard manual feed is applied when this function is not provided.

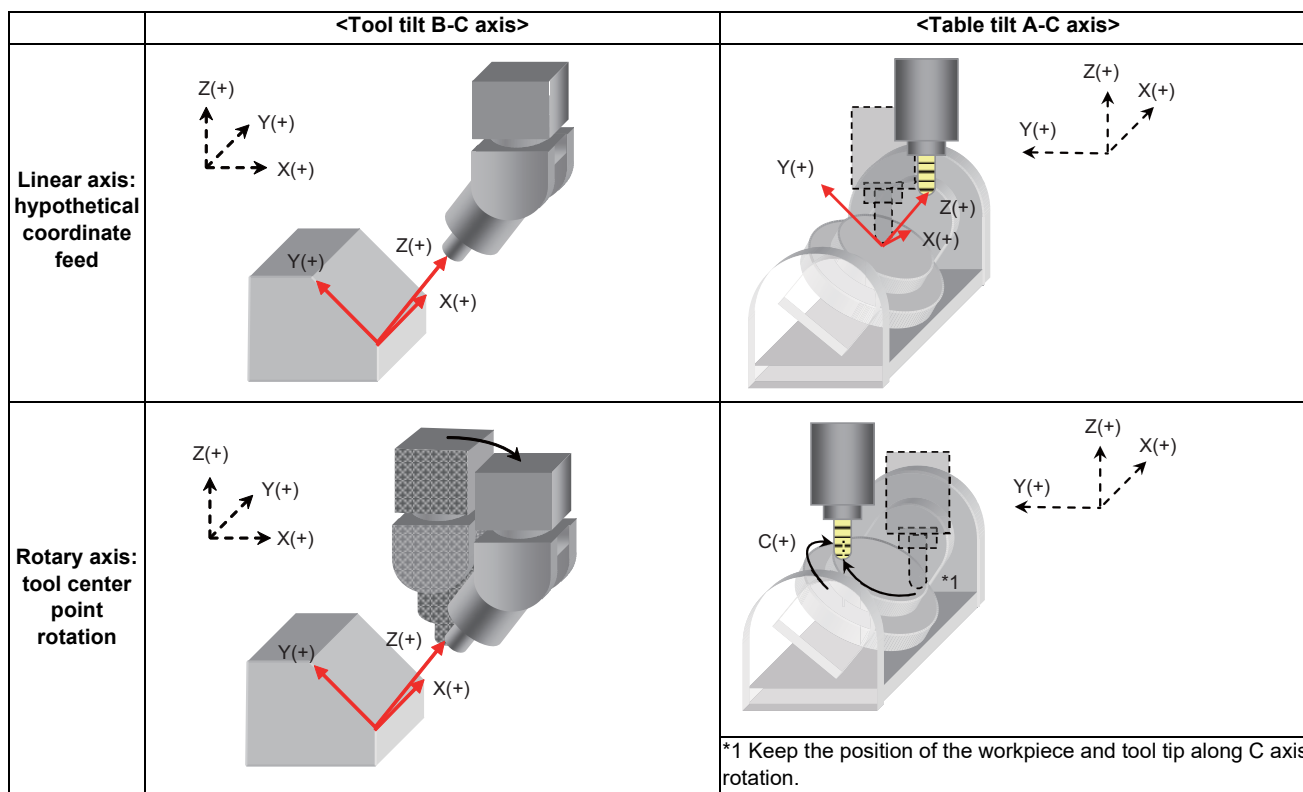

.....➔ Original coordinate system

➔ Hypothetical coordinate system

17.2.17 R-Navi

	M850W	M830W	M850S	M830S	M80W	M80 TypeA	M80 TypeB	E80 TypeA	E80 TypeB	C80
M	△	△	△	△	○	○	—	—	—	—
L	—	—	—	—	—	—	—	—	—	—

This function allows you to perform index machining (including inclined surface and multiple-surface machining) simply and smoothly using a rotary axis.

To enable index machining, register a feature coordinate system (coordinate origin and coordinate axial direction) along the machining surface in advance, and select the registered surface from the operation screen. Then the tool is able to move along the coordinate system to perform index machining.

As shown below, the machining surface selected from the screen is not affected by whether the surface indexing is complete or not.

The function is effective for the machine configuration with the right-hand orthogonal coordinate system defined in ISO standard.

The R-Navi function enables you to use "Inclined machining surface" and "3-dimensional manual feed".

Features of this function are as follows;

- (1) Various and simple machining surface registration (Feature coordinate system registration)
 - Possible to register multiple surfaces (Up to 16 surfaces per workpiece, and up to 10 workpieces)
 - Guide drawing which helps to set the coordinate system along the machining surface
 - Feature coordinate system setting without dependence on the workpiece installation position.
 - 3D workpiece graphics which enables a visual check of the registered surface.
- (2) Easy-to-understand machining surface selection
 - An operator is able to select a surface while observing the 3D workpiece graphics.
- (3) Automatic indexing and manual indexing of the selected machining surface
 - R-Navi automatically executes surface indexing to set the tool to be perpendicular to the selected surface.
 - Manual indexing is also available.
 - The coordinate system is linked with rotation of the rotary axis (no need to calculate the coordinate origin after the rotation).
- (4) A program for 3-axis machining can be used without modification (G68.2 command-less inclined surface machining).
 - Able to work on the coordinate system defined along the selected surface (by automatic or manual operation)
 - The coordinate system is held even when NC reset is input (no need to re-define the coordinate system).

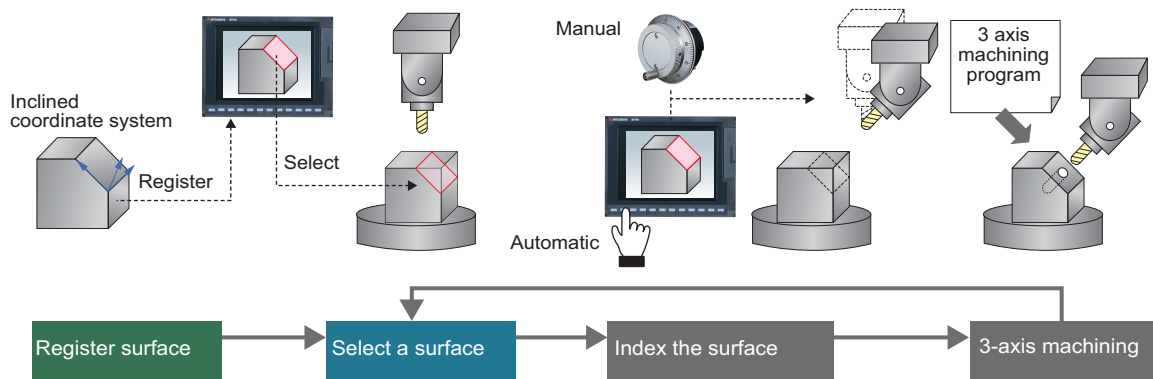

Command format

The R-Navi setup parameters can be configured from a machining program.

(1) Workpiece registration and setting

G69 ;	Cancel the selected machining surface
G10 L110 ;	Start setting workpiece data
Q_ <_> F_ C_ R_ X_ Y_ Z_ I_ J_ K_ ;	Data setting
G11 ;	End data setting
Q	: Workpiece registration No. (1 to 10)
< >	: Workpiece name (max. 20 characters)
F	: Workpiece shape
C	: Basic coordinate system
R	: Basic No. (0 to 8)
X/Y/Z	: Workpiece size (0.000 to 99999.999)
I/J/K	: Workpiece shift (-99999.999 to 99999.999)

(2) Machining surface registration and setting

G69 ;	Cancel the selected machining surface
G10 L111 ;	Start setting machining surface data
P0 Q_ D_ <_> X_ Y_ Z_ A_ ;	Machining surface setting
P1 M_ B_ C_ E_ F_ H_ I_ ;	Designate coordinate axial direction for 1st axis
P2 M_ B_ C_ E_ F_ H_ I_ ;	Designate coordinate axial direction for 2nd axis
G11 ;	End data setting
G68.2 P10 Q_ D_ ;	Select the registered machining surface

Command address of machining surface registration

P	: Machining surface registration
Q	: Workpiece registration No. (1 to 10)
D	: Machining surface registration No. (2 to 17)
< >	: Machining surface name (max. 15 characters)
X/Y/Z	: Feature coordinate origin (-99999.999 to 99999.999)
A	: Coordinate axis selection

Command address of coordinate axial direction designation

P	: Coordinate axial direction axis designation
M	: Coordinate axial direction designation method
B/C/E/F/H/I	: Coordinate axial direction setting (-99999.999 to 99999.999)

17.2.18 Simple Synchronous Control

	M850W	M830W	M850S	M830S	M80W	M80 TypeA	M80 TypeB	E80 TypeA	E80 TypeB	C80
M	△	△	△	△	○	○	—	—	—	—
L	—	—	—	—	—	—	—	—	—	—

This function is an extension of the synchronous control function. This function enables an axis to be synchronized with the axis previously defined as master axis for the synchronous control, and another axis to be synchronized with the slave axis. Backlash can be restrained by distributing load torque imposed on one axis to two servo motors. When the synchronous control and the simple synchronous control are combined, one axis can be driven with four servo motors. An axis to be synchronized with is referred to as a "main axis" and an axis which follows the main axis is referred to as a "sub axis".

This is a control method in which the main axis and the sub axis are controlled in the same position by executing a position command for the main axis to the sub axis as well. The main points of the method are as follows:

- The sub axes can be set only for the master axis and the slave axis for the synchronous control.
- The sub axis is controlled with the movement command for the main axis.
- Only one sub axis can be set for the main axis.
- The main axis and the sub axis are controlled at the same position. Therefore, the main axis and the sub axis can only be used together, while either of the axes can be used singly for single operation and correction mode for the synchronous control.
- For simple synchronous control, synchronization error between the main axis and the sub axis is not monitored.
- For the main axis and the sub axis, specify the speed command synchronous control or the current command synchronous control.

(Example) Example of use of the simple synchronous control

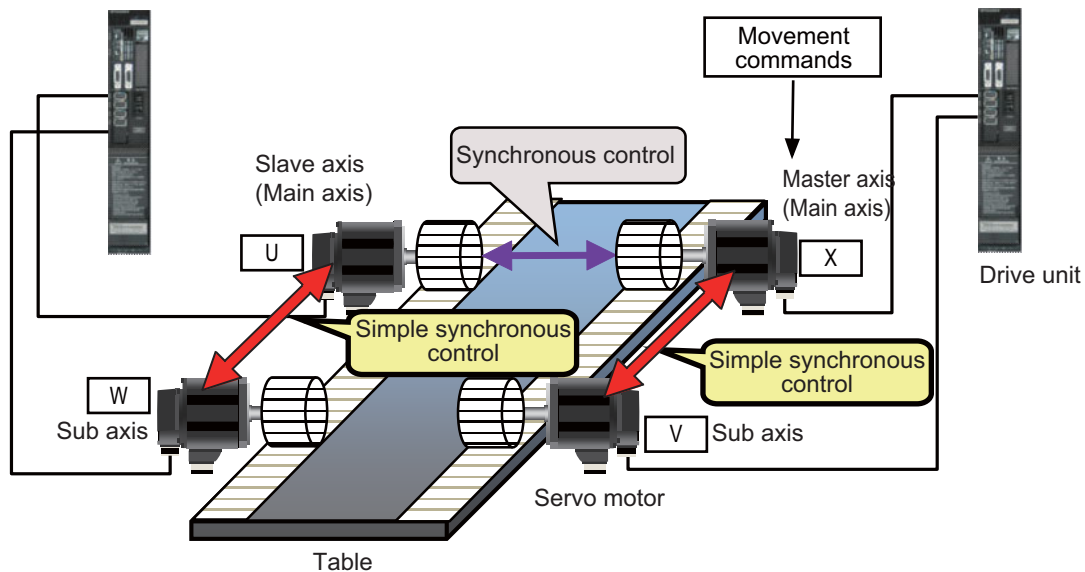

17.2.20 Real-time Tuning

17.2.20.1 Real-time Tuning 1 (Speed Gain)

	M850W	M830W	M850S	M830S	M80W	M80 TypeA	M80 TypeB	E80 TypeA	E80 TypeB	C80
M	△	△	△	△	○	○	—	—	—	—
L	△	△	△	△	○	○	—	—	—	—

This function estimates the inertia (or workpiece weight) of mechanical system and changes the speed control gain automatically according to the estimation results to suppress mechanical vibration.

For example, this suppresses vibration caused when a large workpiece becomes smaller in turning machining as illustrated in Example 1 below. This function also suppresses vibration caused when a workpiece that is relatively small for the table is replaced by a larger one as illustrated in Example 2 below.

Using this function, users can expect suppression of vibration caused by inertia fluctuation, as well as reduction of machining time through adaptation of appropriate speed control gain.

This function also commands a stop of speed control gain change and displays the estimated inertia ratio and magnification of speed control gain (ratio of the changed speed control gain to the initially set gain).

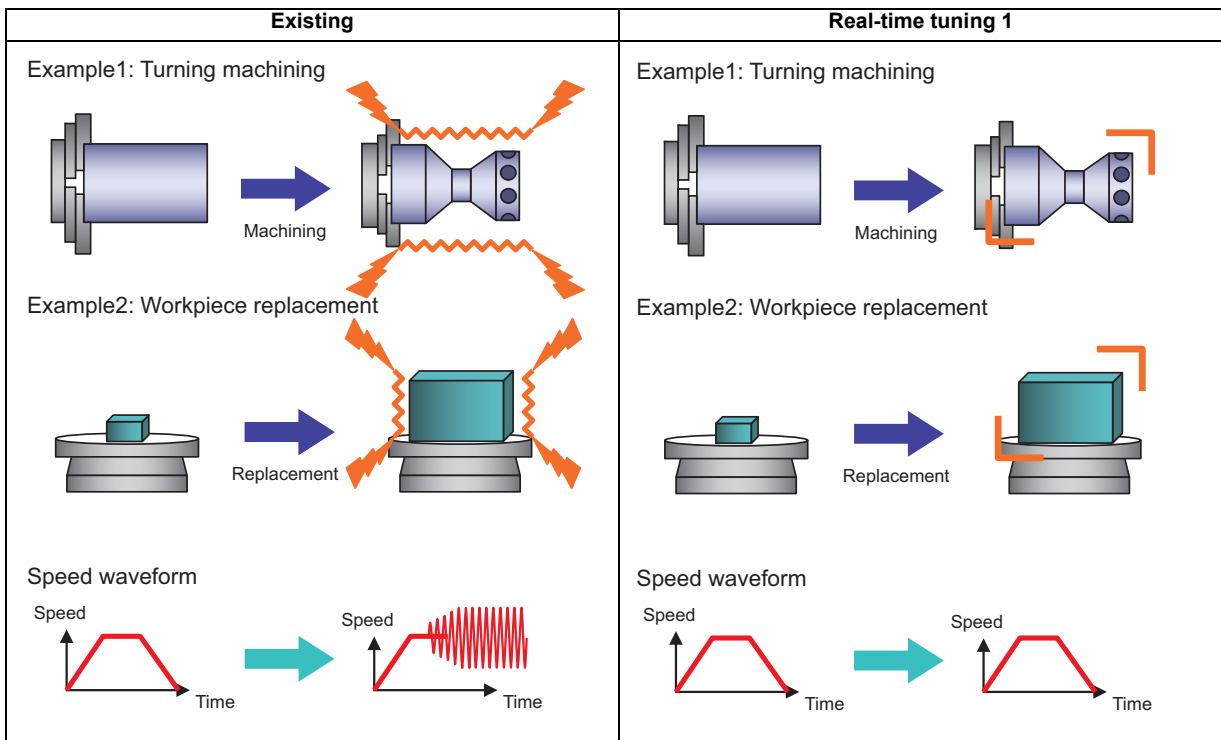

17.2.20.2 Real-time Tuning 2 (Rapid Traverse Time Constant)

	M850W	M830W	M850S	M830S	M80W	M80 TypeA	M80 TypeB	E80 TypeA	E80 TypeB	C80
M	△	△	△	△	○	○	—	—	—	—
L	△	△	△	△	○	○	—	—	—	—

This function estimates the inertia of workpiece and optimizes the operation acceleration/deceleration time constant automatically according to the estimation results.

This allows the cycle time to be reduced when the inertia of workpiece fluctuates considerably.

This function is useful when the inertia of workpiece fluctuates considerably during machining as illustrated in Example 1: Indexing machining and Example 2: Workpiece replacement on the rotary table below.

In Example 1, the inertia of workpiece is reduced gradually as machining progresses. In Example 2, the inertia of workpiece on the rotary table is reduced by workpiece replacement. When the inertia of workpiece is large in Example 1 or Example 2, the machine tool is required to be operated at a low acceleration to suppress the vibration for the workpiece and overload for the motor. On the other hand, when the inertia of workpiece is smaller, the operation at a higher acceleration is available. In other words, acceleration/deceleration time constant can be reduced when the inertia of workpiece is smaller.

In the existing specifications, the operation acceleration/deceleration time constant is fixed regardless of the inertia of workpiece, which wastes time because a large time constant is applied even if the inertia of workpiece is small. On the other hand, this function enables the operation with optimum acceleration/deceleration time constant according to the inertia of the workpiece. Therefore, machining is performed while reducing the acceleration/deceleration time constant in Example 1 or Example 2, which leads to a shorter tact time.

Furthermore, the large inertia workpiece is not machined with small acceleration/deceleration time constant since the optimum time constant is adjusted automatically. This enables suppression of vibration and overload.

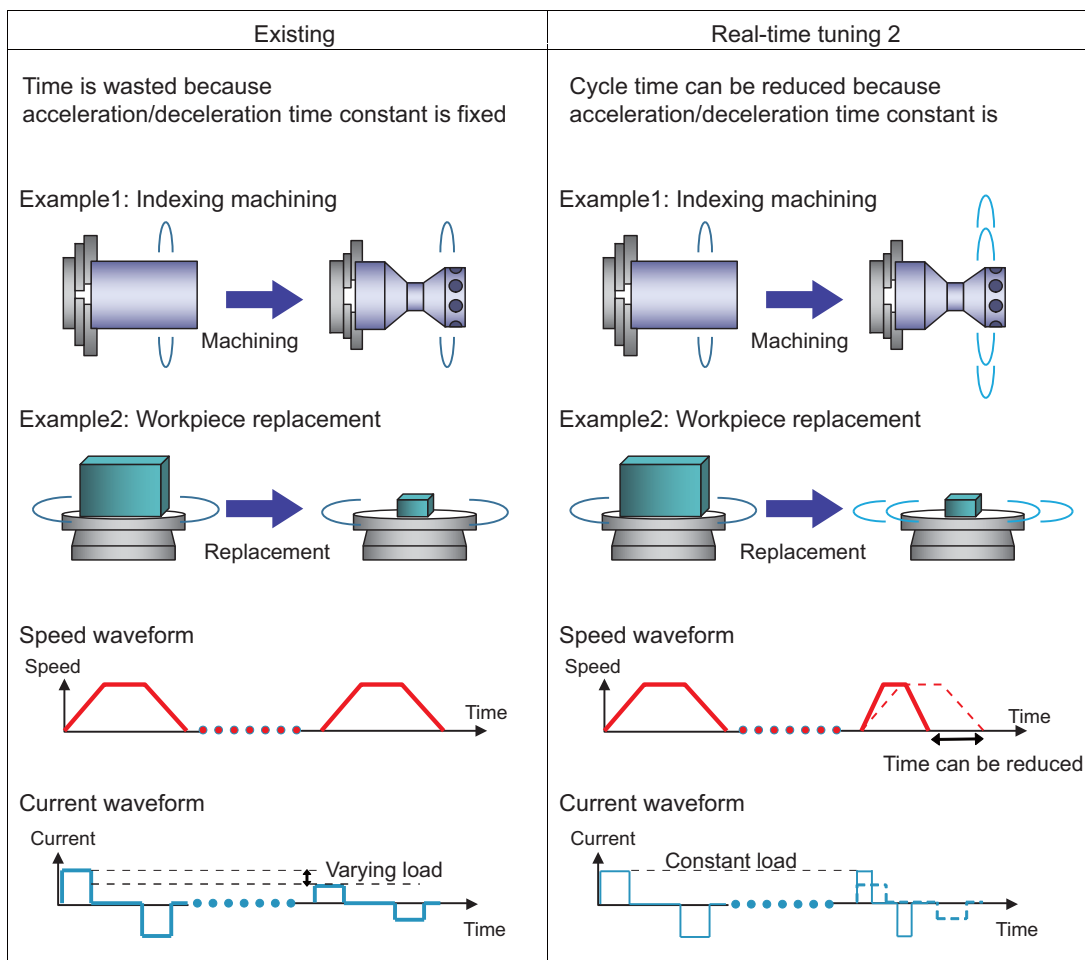

17.2.21 Constant Torque Control

	M850W	M830W	M850S	M830S	M80W	M80 TypeA	M80 TypeB	E80 TypeA	E80 TypeB	C80
M	△	△	△	△	○	○	○	○	○	—
L	△	△	△	△	○	○	○	○	○	—

(1) Constant torque control

By setting "Constant torque control request axis" signal to ON from PLC, the servo motor of the designated axis outputs torque set by the parameter in a constant direction. By using this function for a servo motor which drives a bar feeder, the bar feeder can press the workpiece with constant torque regardless of whether it is during movement, stop, or acceleration/deceleration.

By setting "Proportional torque stopper control request axis" signal to ON from PLC, proportional torque stopper control enables a servo motor of the designated axis to generate torque set by the parameter in the stopper direction. When position droop is generated, the motor generates torque in proportion to the position droop in the stopper direction to keep the stopper position.

(Note) Do not cancel the constant torque control or the proportional torque stopper control for an axis moving under manual or automatic operation. Otherwise the fixed workpiece, fixed turret, etc., may get loose, and it is dangerous.

Example of constant torque control

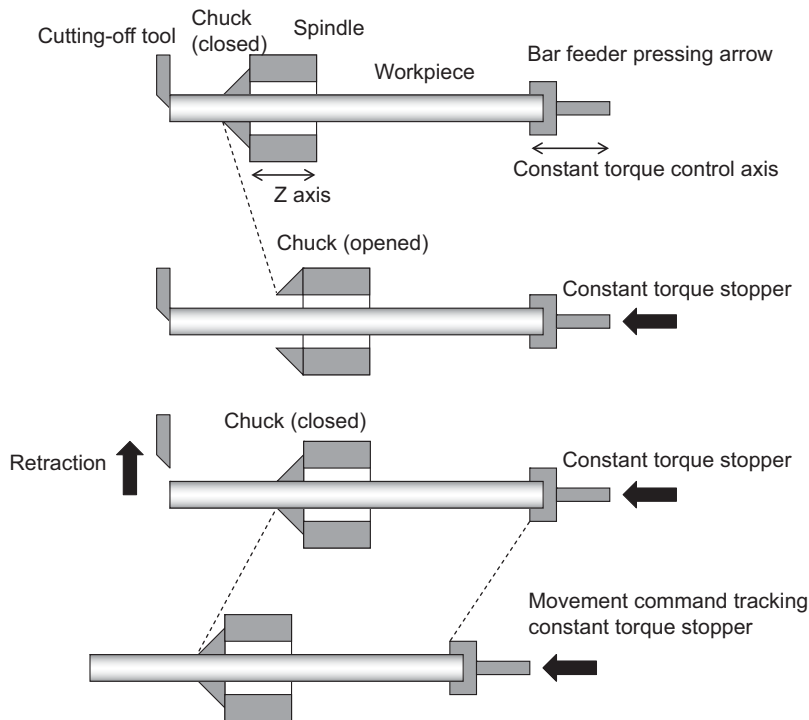

(2) Droop cancel under constant torque control

Droop cancel under constant torque control cancels the position droop generated during constant torque control without moving an axis.

Note that the droop cancel under constant torque control must be commanded while the axis is pressed against the workpiece, etc.

(3) Proportional constant torque control

Proportional torque stopper control generates constant torque in the stopper direction according to the value designated to the parameter. When position droop is generated, the motor generates torque in proportion to the position droop in the stopper direction and to keep the stopper position.

17.2.22 External Encoder Position Output I/F

	M850W	M830W	M850S	M830S	M80W	M80 TypeA	M80 TypeB	E80 TypeA	E80 TypeB	C80
M	○	○	○	○	○	○	○	○	○	—
L	○	○	○	○	○	○	○	○	○	—

* Encoder I/F expansion unit is required for M800W/M80W

This function outputs the position (angle) of external encoder to PLC device based on the input pulses from the encoder. This function can be used to monitor the position of angular head which the external encoder is connected to. The position to output to PLC device can be cleared to 0 with PLC signal.

M800W/M80W connection diagram

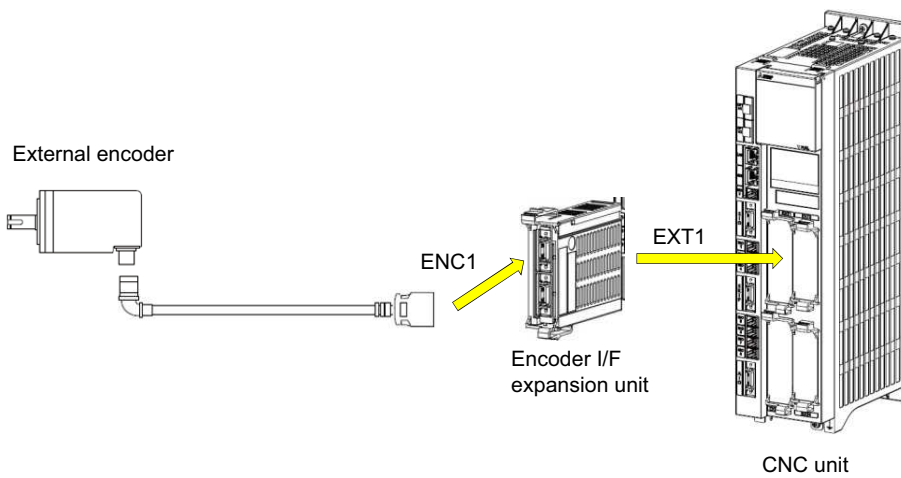

(Note) Encoder I/F expansion unit can be used for ENC1 only.

M800S/M80/E80 connection diagram

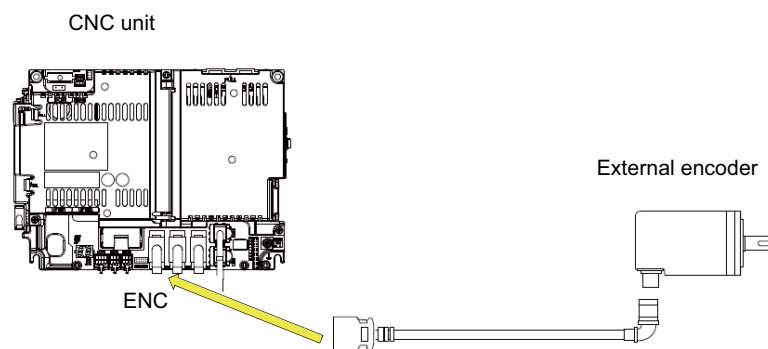

17.2.23 Multiple-axis Synchronization Control

	M850W	M830W	M850S	M830S	M80W	M80 TypeA	M80 TypeB	E80 TypeA	E80 TypeB	C80
M	△	△	△	△	○	○	○	○	—	—
L	—	—	—	—	—	—	—	—	—	—

Multiple-axis synchronization control is the function that enables multiple slave axes to be synchronized with commands to the master axis. This function can be used, for example, in multi-head machine configurations.

The axis that serves as the reference of synchronization is called "master axis", whereas the axis that follows the master axis is called "slave axis".

- The synchronized axes are controlled with travel commands to the master axis.
- For one master axis, two or more slave axes can be set.
- Up to three combinations of master axis and slave axes can be set for all the part systems.

Configuration example of multiple-axis synchronization control

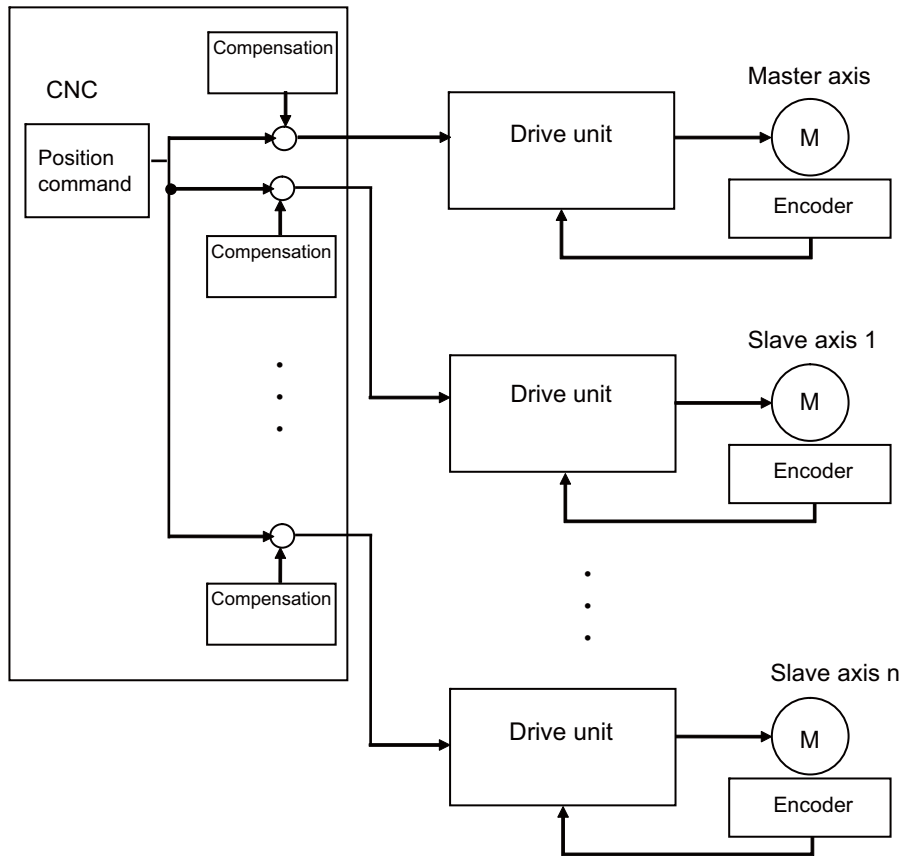

The "compensation" in the figure indicates the pitch error compensation, the thermal expansion compensation, the backlash compensation and the external machine coordinate compensation. Even under the multiple-axis synchronization control, the compensation is performed independently for each axis.

17.2.24 Hypothetical Linear Axis Control

	M850W	M830W	M850S	M830S	M80W	M80 TypeA	M80 TypeB	E80 TypeA	E80 TypeB	C80
M	—	—	—	—	—	—	—	—	—	△
L	—	—	—	—	—	—	—	—	—	—

Using one linear axis and one rotary axis, this function composes a hypothetical linear axis which orthogonally intersects the real linear axis. 3-dimensional positioning and interpolation operation can be executed by configuring two linear axes and one rotary axis.

This function reduces actual linear axes, so the machine configuration can be simplified. In the figure below, the movement mechanism of X axis direction which intersects with V axis is not required. However, a linear movement is performed by the rotary axis and linear axis; therefore, the machining accuracy may not be as high as when movement is performed by the actual axis.

Although a hypothetical linear axis is a linear axis (hypothetical axis) without an actual axis, it needs setting as CNC control axis. There are three actual axes and two hypothetical axes, so total of five CNC control axes are required for the figure below. A mode to control a hypothetical linear axis is called hypothetical axis command mode and a mode to control actual axis is called actual axis command mode. Each mode can be switched with a control signal from PLC I/F.

This function is valid in both automatic operation and manual feed.

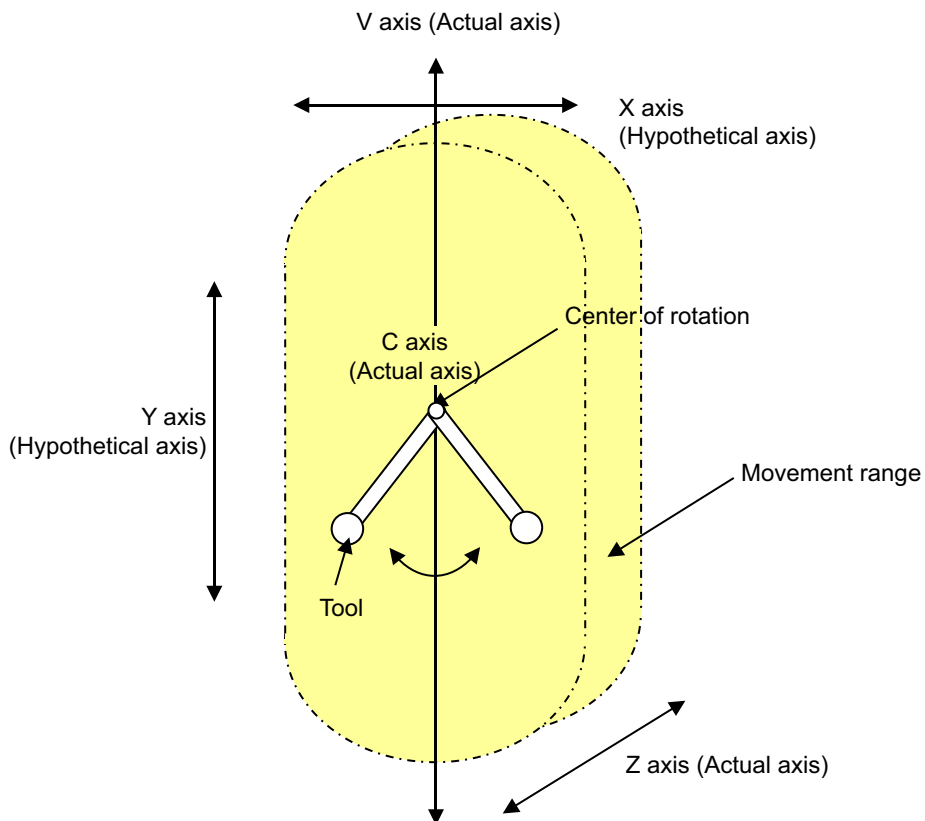

17.2.25 BiSS Encoder I/F

	M850W	M830W	M850S	M830S	M80W	M80 TypeA	M80 TypeB	E80 TypeA	E80 TypeB	C80
M	—	—	○	○	—	○	○	○	○	—
L	—	—	○	○	—	○	○	○	○	—

This function outputs input data from the encoder compatible with BiSS-C (hereinafter referred to BiSS encoder) to the PLC device (ZR register).

This function can be used to monitor the position of the turret rotary axis by connecting the BiSS encoder.

Data length and data bit arrangement of the BiSS encoder differ depending on the encoder specifications.

Create a sequence program according to the specifications of the data sent from the encoder to calculate the encoder angle. The figure below is an example of connection structure for 3-axis tapping center.

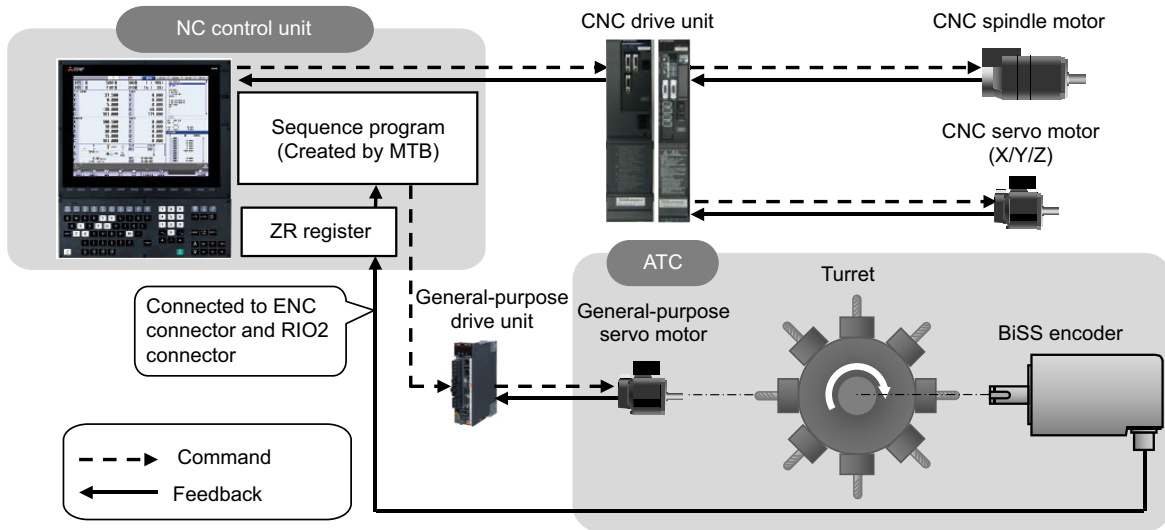

(Note) This function supports both BiSS-C and BiSS-C (unidirectional), but does not support access to the register in the device on the slave side of the BiSS-C.

17.2.26 Tool Head Hot Swapping

	M850W	M830W	M850S	M830S	M80W	M80 TypeA	M80 TypeB	E80 TypeA	E80 TypeB	C80
M	△	△	△	△	—	—	—	—	—	—
L	—	—	—	—	—	—	—	—	—	—

This is a function to perform machining by detaching the tool head connected to the machine temporarily and attaching another tool head.

When the tool head side includes the drive sections of the rotary axis and the spindle, the tool head can be changed without turning off the NC and the drive units. In that case, the servo parameter of the rotary axis and the spindle parameter of the spindle can be changed according to the tool head to be used. When the rotary axis configuration differs depending on the tool head, the rotary axis configuration parameter can be changed.

This function is used by commanding a combination of the following three types of PLC signals. The combination of the signals needs to be selected according to the specifications of the machine head.

- NC axis switch
- Spindle switch
- Rotary axis configuration parameter switch (available only for the first part system)

[Image of tool head change including two rotary axes and spindle]

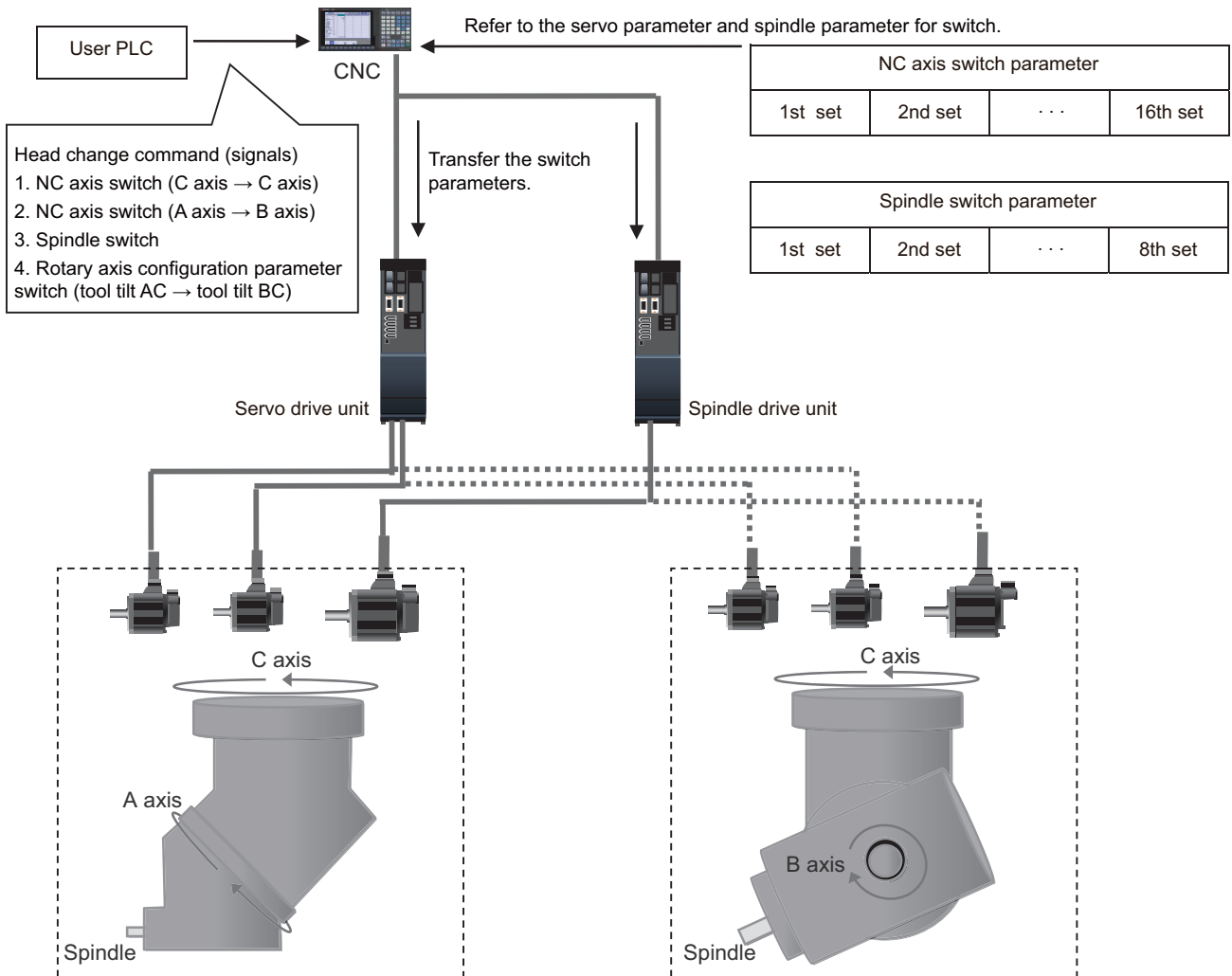

17.3 PLC Operation

17.3.1 Arbitrary Feed in Manual Mode

	M850W	M830W	M850S	M830S	M80W	M80 TypeA	M80 TypeB	E80 TypeA	E80 TypeB	C80
M	○	○	○	○	○	○	○	○	○	○
L	○	○	○	○	○	○	○	○	○	○

This is a function to control the NC control axis with command from the PLC in addition to the normal automatic operation command on the NC.

This function can be primarily used for axis control for ATC. This function enables positioning of the axes from the PLC.

17.3.2 Circular Feed in Manual Mode

	M850W	M830W	M850S	M830S	M80W	M80 TypeA	M80 TypeB	E80 TypeA	E80 TypeB	C80
M	△	△	△	△	○	○	○	—	—	—
L	△	△	△	△	○	○	○	—	—	—

By specifying a hypothetical coordinate on the machine coordinate system from the user PLC, oblique linear interpolation or circular interpolation is executed with jog feed, handle feed, manual rapid traverse or incremental feed of the two axes designated by plane selection.

This function is valid only in the jog mode, handle mode, manual rapid traverse mode or incremental mode. This function cannot be used in the other manual modes and automatic operation modes.

This function operates for the horizontal axis (H axis) and vertical axes (V axis) determined by the parameters and PLC device settings. This function cannot be used for the other NC axes and PLC axis. When this function is valid, all the axes other than H axis and V axis move as usual.

(1) Oblique linear interpolation

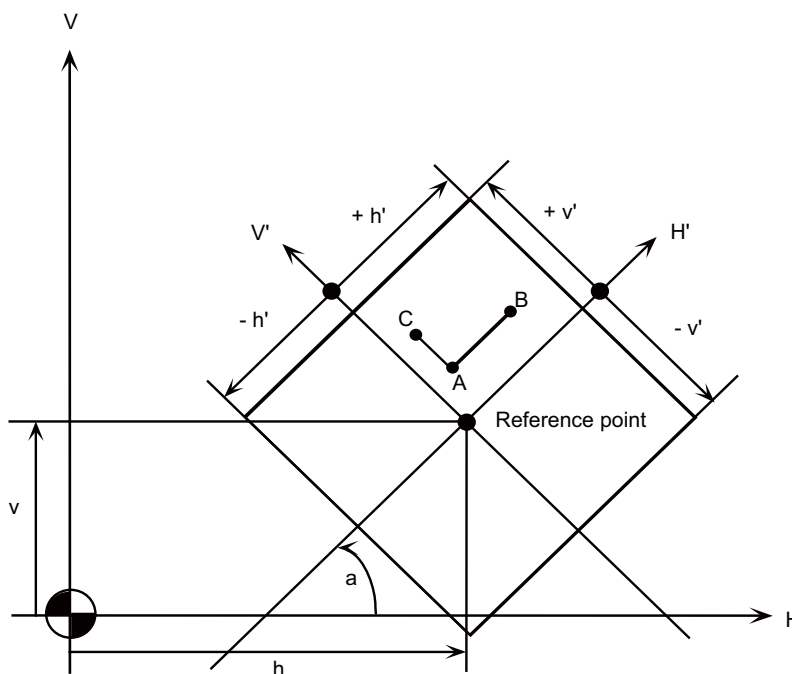

When the circular feed in manual mode (oblique linear interpolation) is valid:

- Jog/handle feed of H axis results in the movement in parallel with H' axis (see above).
- Jog/handle feed of V axis results in the movement in parallel with V' axis (see above).

Operation example:

- Handle feed of the H axis in the "+" direction at the current position (point "A") results in the movement to the point "B". Then handle feed of the H axis in the "-" direction at the current position (point "B") results in the movement to the point "A".
- Handle feed of the V axis in the "+" direction at the current position (point "A") results in the movement to the point "C". Then handle feed of the V axis in the "-" direction at the current position (point "C") results in the movement to the point "A".

These are set in the R registers.

a : Gradient angle

h,v : Basic point coordinate

$\pm h'$: H' travel range

$\pm v'$: V' travel range

(2) Circular interpolation

By specifying a hypothetical coordinate on the machine coordinate as shown in the figure below, jog/handle feed can be executed on the hypothetical coordinate.

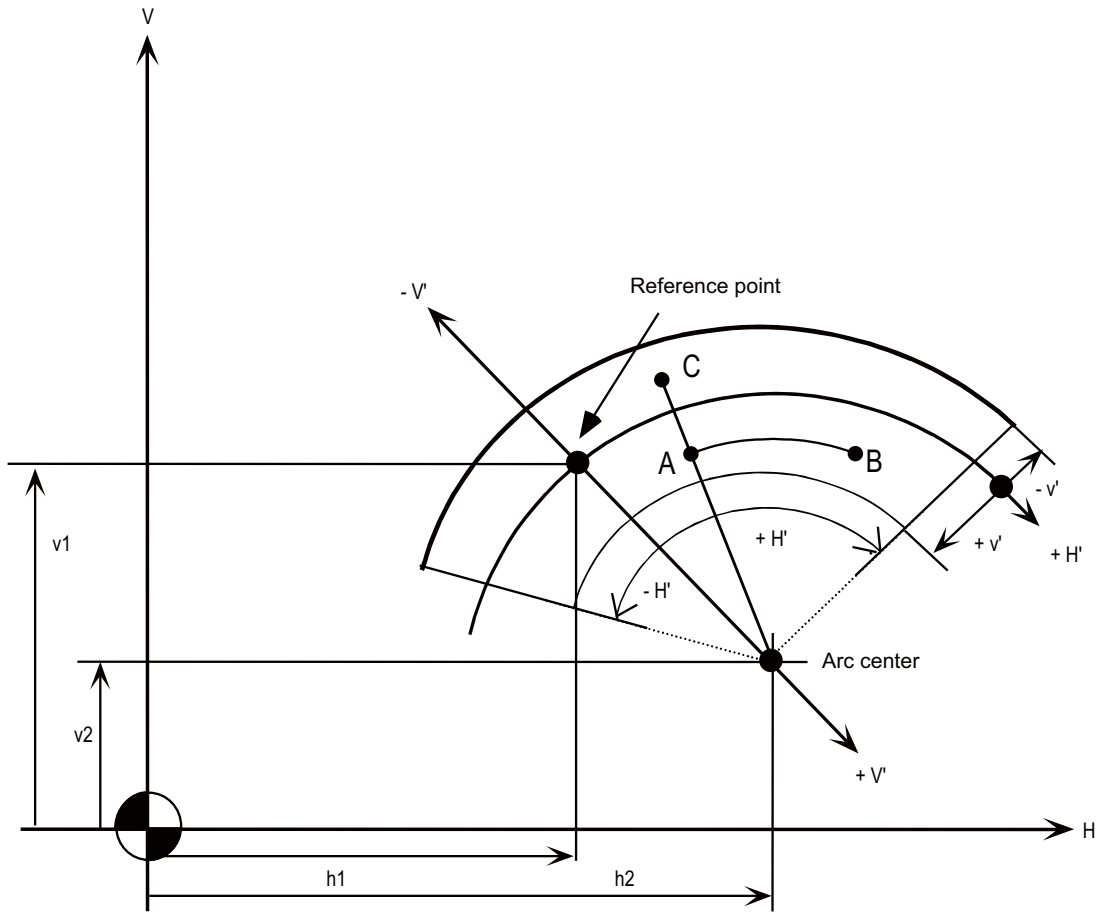

When the circular feed in manual mode (circular interpolation) is valid:

- Jog/handle feed of H axis results in the movement along the arc whose radius is the distance from the arc center to the current position.
- Jog/handle feed of V axis results in the movement on the line connecting the current position and the arc center.

Operation example:

- Handle feed of the H axis in the "+" direction at the current position (point "A") results in the movement to the point "B". Then handle feed of the H axis in the "-" direction at the current position (point "B") results in the movement to the point "A". The movement is done along the circumference of the arc whose radius is the distance from the arc center to the current position (point "A").
- Handle feed of the V axis in the "+" direction at the current position (point "A") results in the movement to the point "C". Then handle feed of the V axis in the "-" direction at the current position (point "C") results in the movement to the point "A".

These are set in the R registers.

h1, v1 : Basic point coordinate

h2, v2 : Arc center coordinate

$\pm h'$: H' travel range

$\pm v'$: V' travel range

17.3.3 PLC Axis Control

	M850W	M830W	M850S	M830S	M80W	M80 TypeA	M80 TypeB	E80 TypeA	E80 TypeB	C80
M	○	○	○	○	○	○	○	○	—	○
L	○	○	○	○	○	○	○	○	○	○

Over and above the NC control axes, this function enables axes to be controlled independently by commands based on the PLC.

Specifications

Item	Description
Number of control axes	Refer to "Max. Number of PLC Axes"
Simultaneously controlled axes	PLC control axis is controlled independently from NC control axes. A multiple number of PLC axes can be started simultaneously.
Command increment	Least command increment 0.001 mm (0.0001 inch) 0.0001 mm (0.00001 inch) 0.00001 mm (0.000001 inch) 0.000001 mm (0.0000001 inch) (The command increment depends on the parameter setting.)
Feed rate	0 to 1000000mm/min (0 to 100000 inch/min) (Speed is fixed regardless of the unit system.)
Movement commands	Incremental commands from current position Absolute commands for machine coordinate system 0 to ±99999999 (The command increment depends on the parameter setting.)
Operation modes	Rapid traverse, cutting feed, jog feed (+) (-), reference position return feed (+) (-), handle feed, Automatic initial setting (C80 series)
Backlash compensation	Available
Stroke end	Device arbitrary allocation is available
Soft limit	Available
Rotary axis command	Available For absolute commands.....amount within 1 rotation (rotation by amount remaining after division into the division number of rotary axis) For incremental commands.....rotation by assigned amount
Inch/mm changeover	None Set to the command that corresponds to the feedback unit.
Position detector	Encoder (Absolute position can also be detected.)

17.3.5 PLC Axis Indexing

	M850W	M830W	M850S	M830S	M80W	M80 TypeA	M80 TypeB	E80 TypeA	E80 TypeB	C80
M	○	○	○	○	○	○	○	○	—	○
L	○	○	○	○	○	○	○	○	○	○

PLC axis indexing allows a PLC axis to function as an auxiliary axis with no need for changing the user ladder used conventionally for an auxiliary axis. (The position of R register will be changed.)

(1) Command methods

Station method (for rotary axis) : One rotation (360°) of the rotary axis is equally divided to determine the stations (positioning destinations). The maximum number of divisions is 360.

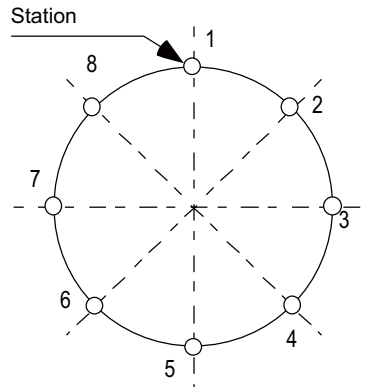

Setting 8 stations (8 divisions)

Station method (for linear axis) : A valid stroke is equally divided to determine the stations (positioning destinations). The maximum number of stations is 360.

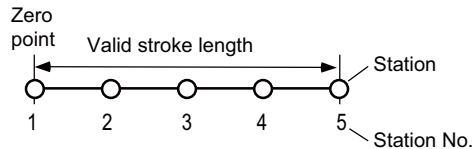

Setting 5 stations

The zero point is station 1, and the final end of the valid stroke is station 5. When using a linear axis, the No. of equal divisions is "number of stations - 1".

Unequal station method : When the positioning stations are not at equal intervals, this method allows you to set up to 20 coordinate points arbitrarily to determine the station coordinates. This method is available for a rotary or linear axis.

Arbitrary coordinate designation method : This method allows you to transfer arbitrary coordinates (the absolute coordinates based on the zero point) from PLC to perform positioning.

(2) Feed functions

Feed rate selection : Four different feeds per minute are set in the unit of "°/min" (rotary axis) or "mm/min" (linear axis). Which of the four is used is switched by the PLC I/F.

Acceleration/deceleration method : The constant-gradient acceleration/deceleration is automatically controlled. The linear or soft acceleration/deceleration is selectable.

Acceleration/deceleration pattern designation method : Four different acceleration/deceleration patterns are set to be selected by switching with PLC I/F.

Short-cut control : A least movement distance is automatically judged when a rotary axis is rotated. Also the rotation direction can be designated by the command.

(3) Operation functions

The following operation modes are available. Send a command from PLC to change the operation mode.

- Automatic mode : The axis is positioned at the station No. designated by the start signal. When the start signal has turned OFF before the positioning is completed, the axis is positioned at the nearest station position.
The arbitrary position command operation is also available: the positioning can be carried out to any position other than a station by directly commanding the positioning coordinates from the PLC.
- Manual mode : While the start signal is ON, the axis is rotated at a constant speed in the designated direction. When the start signal has turned OFF, the axis is positioned at the nearest station position.
- JOG mode : While the start signal is ON, the axis is rotated at a constant speed in the designated direction.
- Incremental feed mode : This mode is to feed the axis by the designated distance at each activation.
- Manual handle mode : The axis is moved by using a pulse generator.
- Reference position return mode : This mode is to position at the reference position. The reference position return by the dog switch is not available.

(4) Operation support function

- Position switch : A signal is output to the PLC interface when the machine has reached within the specified range.

17.3.6 NC Axis/PLC Axis Switchover

	M850W	M830W	M850S	M830S	M80W	M80 TypeA	M80 TypeB	E80 TypeA	E80 TypeB	C80
M	△	△	△	△	○	○	○	—	—	△
L	△	△	△	△	○	○	○	—	—	△

This function is to use one drive unit by switching the control from the NC or the PLC dynamically.

The function of the NC axis can be used during the NC axis control and the function of the PLC axis can be used during the PLC axis control respectively.

A part of function or signal of the NC axis can also be used during the PLC axis control.

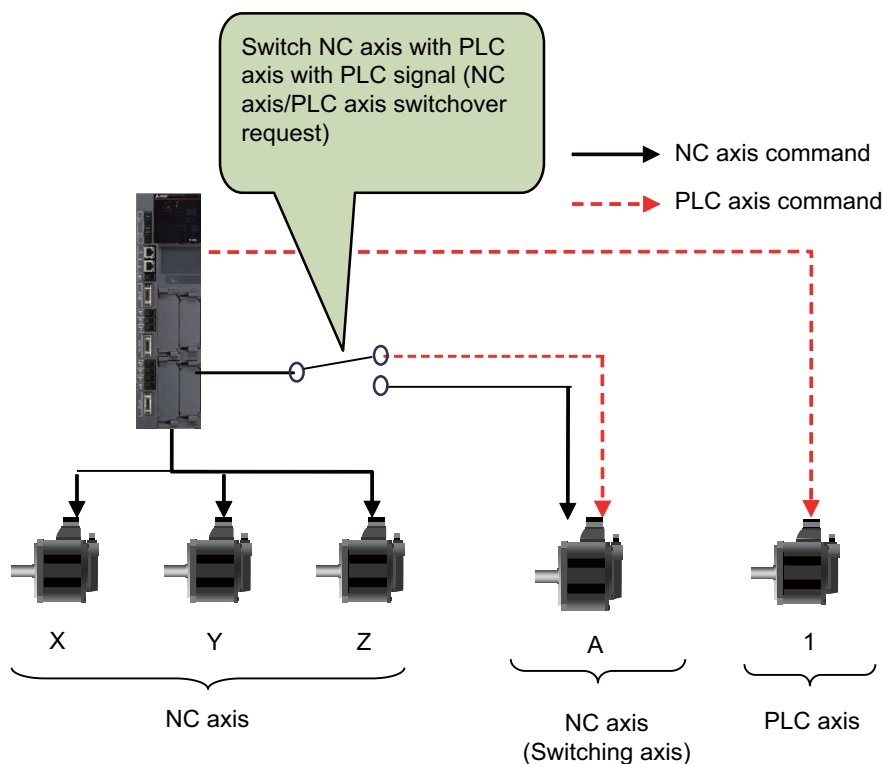

17.4 PLC Interface

17.4.1 CNC Control Signal

	M850W	M830W	M850S	M830S	M80W	M80 TypeA	M80 TypeB	E80 TypeA	E80 TypeB	C80
M	○	○	○	○	○	○	○	○	○	○
L	○	○	○	○	○	○	○	○	○	○

Control commands to the CNC system are assigned from the PLC. Input signals with an A/D conversion function and skip inputs that respond at high speed can also be used.

(1) Control signals

- Control signals for operations in automatic operation mode
- Control signals for operations in manual operation mode
- Control signals for program execution
- Control signals for interrupt operations
- Control signals for servo
- Control signals for spindle
- Control signals for mode selection
- Control signals for axis selection
- Control signals for feed rates

(2) Analog voltage control [M system]

When an analog voltage is input to an external connector used to connect CNC analog inputs, the data corresponding to the input voltage can be read out in the prescribed file register. This data can be used for load meter displays, thermal deformation compensation, etc. (Maximum 4 points)

(3) Skip signals

When signals are input to the skip input interface, they are processed by interrupt processing. This enables functions requiring a high response speed to be implemented. (Maximum 8 points)

For further details, refer to the PLC Interface Manual.

17.4.2 CNC Status Signal

	M850W	M830W	M850S	M830S	M80W	M80 TypeA	M80 TypeB	E80 TypeA	E80 TypeB	C80
M	○	○	○	○	○	○	○	○	○	○
L	○	○	○	○	○	○	○	○	○	○

The status signals are output from the CNC system. They can be utilized by referencing them from the PLC. These signals can also be output as analog data by setting the data from the PLC in the R register.

Status output functions

(1) Controller operation ready

When the controller power is turned ON and the controller enters the operation ready status, the "Ready" signal is output to the machine.

Refer to the PLC Interface Manual for details of the sequences from when the controller power is supplied to when the controller ready status is entered.

(2) Servo operation ready

When the controller power is turned ON and the servo system enters the operation ready status, the "Servo ready" signal is output to the machine.

Refer to the PLC Interface Manual for details of the sequences from when the power is supplied to when the "Servo ready" signal is turned ON.

(3) In automatic operation

Generally, if the "cycle start" switch is turned ON in the automatic operation mode (memory, MDI), this signal is output until the reset state or emergency stop state is entered by the M02, M30 execution or the reset & rewind input to the controller using the reset button.

(4) In cycle start

The signal that denotes that the controller is operating in the automatic mode is output from the time when the cycle start button is pressed in the memory or MDI mode and the cycle start status has been entered until the time when the automatic operation is terminated in the automatic operation pause status entered by the "feed hold" function, block completion stop entered by the block stop function or resetting.

(5) In automatic pause

An automatic operation pause occurs and this signal is output during automatic operation from when the automatic pause switch is pressed ON until the cycle start switch is pressed ON, or during automatic operation when the mode select switch is changed from the automatic mode to the manual mode.

(6) In rapid traverse

The "In rapid traverse" signal is output when the command now being executed is moving an axis by rapid traverse during automatic operation.

(7) In cutting feed

The "In cutting feed" signal is output when the command now being executed is moving an axis by cutting feed during automatic operation.

(8) In tapping

The "In tapping" signal is output when the command now being executed is in a tapping modal which means that one of the statuses below is entered during automatic operation.

- (a) G84, G88 (fixed cycle: tapping cycle)
- (b) G84.1, G88.1 (fixed cycle: reverse tapping cycle)
- (c) G63 (tapping mode)

(9) In thread cutting

The "In thread cutting" signal is output when the command now being executed is moving an axis by thread cutting feed during automatic operation.

(10) In rewinding

The "In rewinding" signal is output when the reset & rewind signal is input by M02/M30, etc., during memory operation and the program currently being executed is being indexed.

The rewinding time is short, so there may be cases when it cannot be confirmed with the sequence program (ladder).

(11) Axis selection output

The "Axis selection output" signal for each axis is output to the machine during machine axis movement.

(a) Automatic mode

The signal is output in the movement command of each axis. It is output until the machine stops during stop based on feed hold or block stop.

(b) Manual mode (including incremental feed)

The signal is output while the axis is moving from the time when the jog feed signal is turned ON until the time when it is turned OFF and the machine feed stops.

(c) Handle feed mode

The signal is output at all times when the axis selection input is on.

(12) Axis movement direction

This output signal denotes the direction of the axis now moving, and for each axis a "+" (plus) signal and a "-" (minus) signal are output respectively.

(13) Alarm

This signal indicates the various alarm statuses that arise during controller operation. It is divided into the following types and output.

(a) System errors**(b) Servo alarms****(c) Program errors****(d) Operation errors****(14) In resetting**

The "Reset" signal is output during the reset process when the reset & rewind command is input to the controller with the "reset" button on the setting and display unit is pressed or when the "Reset" signal is input from the machine operation panel, etc.

This signal will also be output when the controller READY status is OFF, when the Emergency stop signal is input or when a servo alarm is occurring, etc.

(15) Movement command finish

In the memory or MDI automatic operation, the "Movement command finish" signal is output when the command block in the machining program features a movement command and when that block command has been completed.

When the movement command and M, S, T or B command have been assigned in the same block, then the movement command signal can be used as a sync signal for either executing the processing of the M, S, T or B command at the same time as the command or executing it upon completion of the movement command.

17.4.3 PLC Window

	M850W	M830W	M850S	M830S	M80W	M80 TypeA	M80 TypeB	E80 TypeA	E80 TypeB	C80
M	○	○	○	○	○	○	○	○	○	○
L	○	○	○	○	○	○	○	○	○	○

[M8 series]

Using the "read window" or "write window" that are arbitrarily allocated to the R register's user area, it is possible to read and write the CNC operation status, axis information, parameters and tool data etc.

The area used for the "read window" and "write window" has 1500 points for the backup area and 100 points for the non-backup area.

Up to three window areas can be specified simultaneously for both "read window" area and "write window" area. 16 R registers (18 R registers when an extended interface is used) are used for one read window or write window.

The read window is further divided into the "read control window" and "read data window". The write window is also divided into the "write control window" and "write data window".

Up to four data items can be successively read or written from the data designated in one read window or write window.

[C80 series]

The operation status of NC CPU, the axis information, the parameters, and the tool data, etc. can be read and written by using "Read control window" or the "write control window".

The "read control window" and "write control window" are available by 50 sets each.

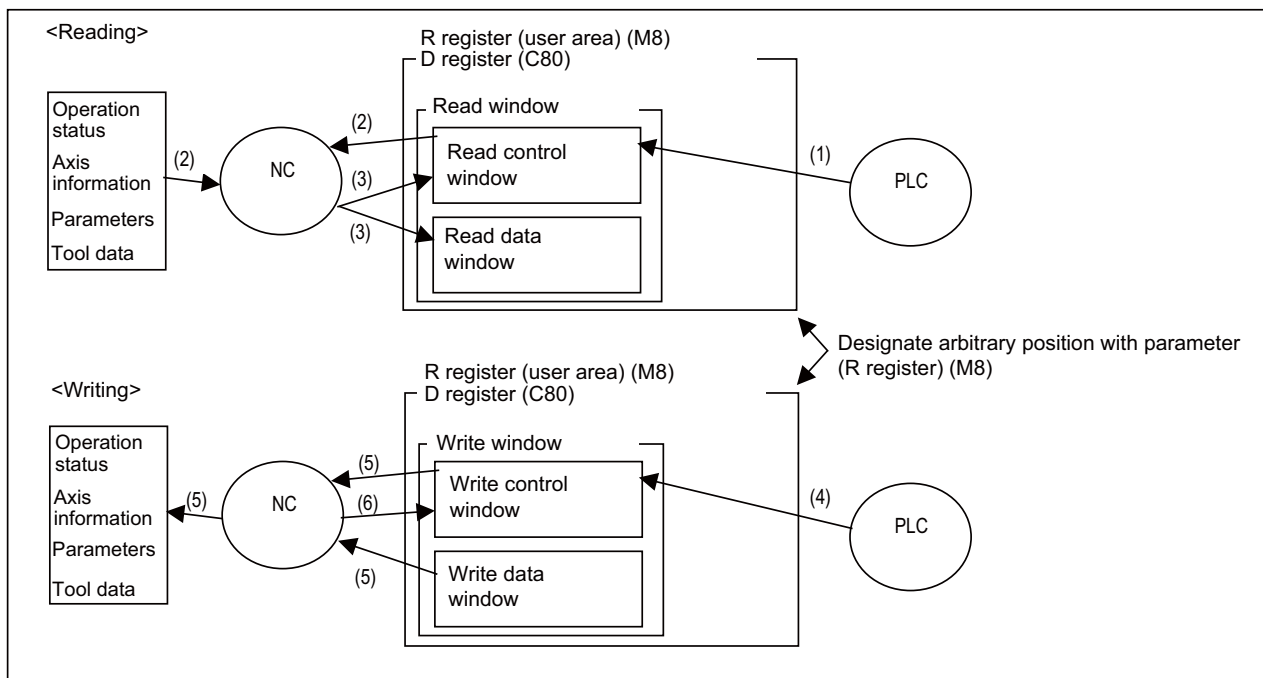

- (1) PLC turns control signal ON.
- (2) NC receives control signal, and reads designated data in control window.
- (3) Results of NC read are set in read control window and read data window.
- (4) PLC turns control signal ON.
- (5) NC receives control signal, and writes contents of write data window corresponding to designated data in control window.
- (6) Results of NC write are set in write control window.

17.4.4 External Search

	M850W	M830W	M850S	M830S	M80W	M80 TypeA	M80 TypeB	E80 TypeA	E80 TypeB	C80
M	○	○	○	○	○	○	○	○	○	○
L	○	○	○	○	○	○	○	○	○	○

Machining program can be searched from user PLC by specifying the storage device of machining program, program No., sequence No. or block No.

17.4.5 Direct Screen Selection

	M850W	M830W	M850S	M830S	M80W	M80 TypeA	M80 TypeB	E80 TypeA	E80 TypeB	C80
M	○	○	○	○	○	○	○	○	○	○
L	○	○	○	○	○	○	○	○	○	○

This function enables automatic transition to an arbitrary screen by setting the screen selection information to the file registers from user PLC.

The screens that can be selected as the transition destination are Monitr, Setup, Edit, Diagn, Mainte and custom release screens.

This function is used to move to the custom screen being set by the MTB.

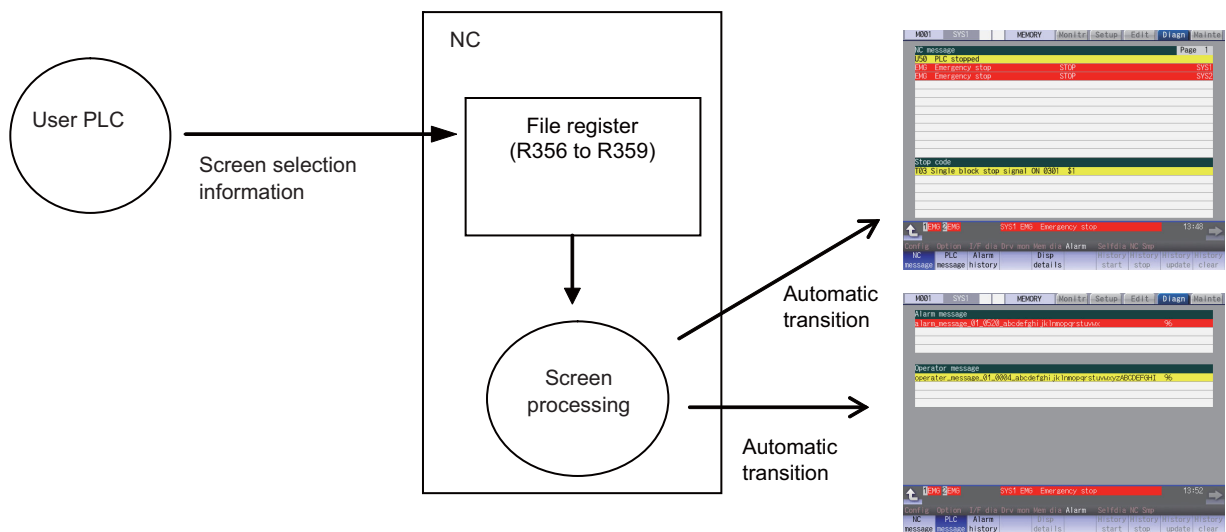

17.4.6 Buzzer Sound Control

	M850W	M830W	M850S	M830S	M80W	M80 TypeA	M80 TypeB	E80 TypeA	E80 TypeB	C80
M	○	○	○	○	○	○	○	○	○	—
L	○	○	○	○	○	○	○	○	○	—

This function gives a buzzer mounted on the NC keyboard by operating the PLC device.

The buzzer will be activated when the PLC device is turned ON, and be deactivated when the PLC device is turned OFF. This is effective in applications of sounding a buzzer such as during the alarm occurrence, or for the program operation end notification.

This function also gives a buzzer when the operation sound disable has set.

This can be used when the NC keyboard is mounted.

The buzzer sound image by the buzzer ON operation:

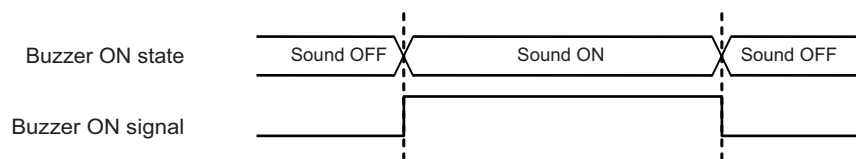

17.5 Machine Contact I/O

17.5.1 Operation Panel I/O

17.5.1.1 DI:64/DO:64

	M850W	M830W	M850S	M830S	M80W	M80 TypeA	M80 TypeB	E80 TypeA	E80 TypeB	C80
M	□ /—	□ /—	—	—	□ /—	—	—	□	□	—
L	□ /—	□ /—	—	—	□ /—	—	—	□	□	—

* Specifications of separated-type display are classified with "Windows-based" and "non-Windows-based"

17.5.1.2 DI:64/DO:64 + SDI:8

	M850W	M830W	M850S	M830S	M80W	M80 TypeA	M80 TypeB	E80 TypeA	E80 TypeB	C80
M	□ /—	□ /—	—	—	□ /—	—	—	□	□	—
L	□ /—	□ /—	—	—	□ /—	—	—	□	□	—

* Specifications of separated-type display are classified with "Windows-based" and "non-Windows-based"

17.5.1.3 DI:96/DO:64

	M850W	M830W	M850S	M830S	M80W	M80 TypeA	M80 TypeB	E80 TypeA	E80 TypeB	C80
M	—/□	—/□	□	□	—/□	□	□	□	□	—
L	—/□	—/□	□	□	—/□	□	□	□	□	—

* Specifications of separated-type display are classified with "Windows-based" and "non-Windows-based"

17.5.1.5 DI:64/DO:48/AO:1

	M850W	M830W	M850S	M830S	M80W	M80 TypeA	M80 TypeB	E80 TypeA	E80 TypeB	C80
M	—/□	—/□	□	□	—/□	□	□	□	□	—
L	—/□	—/□	□	□	—/□	□	□	□	□	—

* Specifications of separated-type display are classified with "Windows-based" and "non-Windows-based"

17.5.2 Remote I/O

17.5.2.1 DI:32/DO:32

	M850W	M830W	M850S	M830S	M80W	M80 TypeA	M80 TypeB	E80 TypeA	E80 TypeB	C80
M	<input type="checkbox"/>	<input type="checkbox"/>	<input type="checkbox"/>	<input type="checkbox"/>	<input type="checkbox"/>	<input type="checkbox"/>	<input type="checkbox"/>	<input type="checkbox"/>	<input type="checkbox"/>	—
L	<input type="checkbox"/>	<input type="checkbox"/>	<input type="checkbox"/>	<input type="checkbox"/>	<input type="checkbox"/>	<input type="checkbox"/>	<input type="checkbox"/>	<input type="checkbox"/>	<input type="checkbox"/>	—

17.5.2.2 DI:64/DO:48

	M850W	M830W	M850S	M830S	M80W	M80 TypeA	M80 TypeB	E80 TypeA	E80 TypeB	C80
M	<input type="checkbox"/>	<input type="checkbox"/>	<input type="checkbox"/>	<input type="checkbox"/>	<input type="checkbox"/>	<input type="checkbox"/>	<input type="checkbox"/>	<input type="checkbox"/>	<input type="checkbox"/>	—
L	<input type="checkbox"/>	<input type="checkbox"/>	<input type="checkbox"/>	<input type="checkbox"/>	<input type="checkbox"/>	<input type="checkbox"/>	<input type="checkbox"/>	<input type="checkbox"/>	<input type="checkbox"/>	—

17.5.2.3 DI:64/DO:48 + AO:1

	M850W	M830W	M850S	M830S	M80W	M80 TypeA	M80 TypeB	E80 TypeA	E80 TypeB	C80
M	<input type="checkbox"/>	<input type="checkbox"/>	<input type="checkbox"/>	<input type="checkbox"/>	<input type="checkbox"/>	<input type="checkbox"/>	<input type="checkbox"/>	<input type="checkbox"/>	<input type="checkbox"/>	—
L	<input type="checkbox"/>	<input type="checkbox"/>	<input type="checkbox"/>	<input type="checkbox"/>	<input type="checkbox"/>	<input type="checkbox"/>	<input type="checkbox"/>	<input type="checkbox"/>	<input type="checkbox"/>	—

17.5.2.5 DI:16/DO:8

	M850W	M830W	M850S	M830S	M80W	M80 TypeA	M80 TypeB	E80 TypeA	E80 TypeB	C80
M	<input type="checkbox"/>	<input type="checkbox"/>	<input type="checkbox"/>	<input type="checkbox"/>	<input type="checkbox"/>	<input type="checkbox"/>	<input type="checkbox"/>	<input type="checkbox"/>	<input type="checkbox"/>	—
L	<input type="checkbox"/>	<input type="checkbox"/>	<input type="checkbox"/>	<input type="checkbox"/>	<input type="checkbox"/>	<input type="checkbox"/>	<input type="checkbox"/>	<input type="checkbox"/>	<input type="checkbox"/>	—

17.5.2.6 DI:32/DO:32 + SDI:8/SDO:4

	M850W	M830W	M850S	M830S	M80W	M80 TypeA	M80 TypeB	E80 TypeA	E80 TypeB	C80
M	<input type="checkbox"/>	<input type="checkbox"/>	<input type="checkbox"/>	<input type="checkbox"/>	<input type="checkbox"/>	<input type="checkbox"/>	<input type="checkbox"/>	<input type="checkbox"/>	<input type="checkbox"/>	—
L	<input type="checkbox"/>	<input type="checkbox"/>	<input type="checkbox"/>	<input type="checkbox"/>	<input type="checkbox"/>	<input type="checkbox"/>	<input type="checkbox"/>	<input type="checkbox"/>	<input type="checkbox"/>	—

* Functional safety expansion unit is required for M80

17.5.2.7 SDI:8/SDO:4

	M850W	M830W	M850S	M830S	M80W	M80 TypeA	M80 TypeB	E80 TypeA	E80 TypeB	C80
M	<input type="checkbox"/>	<input type="checkbox"/>	<input type="checkbox"/>	<input type="checkbox"/>	<input type="checkbox"/>	<input type="checkbox"/>	<input type="checkbox"/>	<input type="checkbox"/>	<input type="checkbox"/>	—
L	<input type="checkbox"/>	<input type="checkbox"/>	<input type="checkbox"/>	<input type="checkbox"/>	<input type="checkbox"/>	<input type="checkbox"/>	<input type="checkbox"/>	<input type="checkbox"/>	<input type="checkbox"/>	—

* Functional safety expansion unit is required for M80

17.6 External PLC Link

17.6.1 CC-Link (Master/Local)

	M850W	M830W	M850S	M830S	M80W	M80 TypeA	M80 TypeB	E80 TypeA	E80 TypeB	C80
M	□	□	□	□	□	□	□	□	□	△ (*1)
L	□	□	□	□	□	□	□	□	□	△ (*1)

(*1) MELSEC

[M8 series]

NC unit can be directly connected to the network to serve as the master/local station of the MELSEC CC-Link.

CC-Link unit is required for this connection.

(1) Outline of CC-Link

- Distributing and installing each unit to the equipments such as conveyor line and mechanical device can simplify the wiring of the whole system.
- The ON/OFF data and numerical data such as input/output treated by each unit can be communicated easily and at high speed.
- The simple distribution system can be established by connecting several PLC CPUs or NCs.
- Connecting the device equipments made by the partner manufacturer can flexibly support various systems.

(2) Outline drawing (M800W Series)

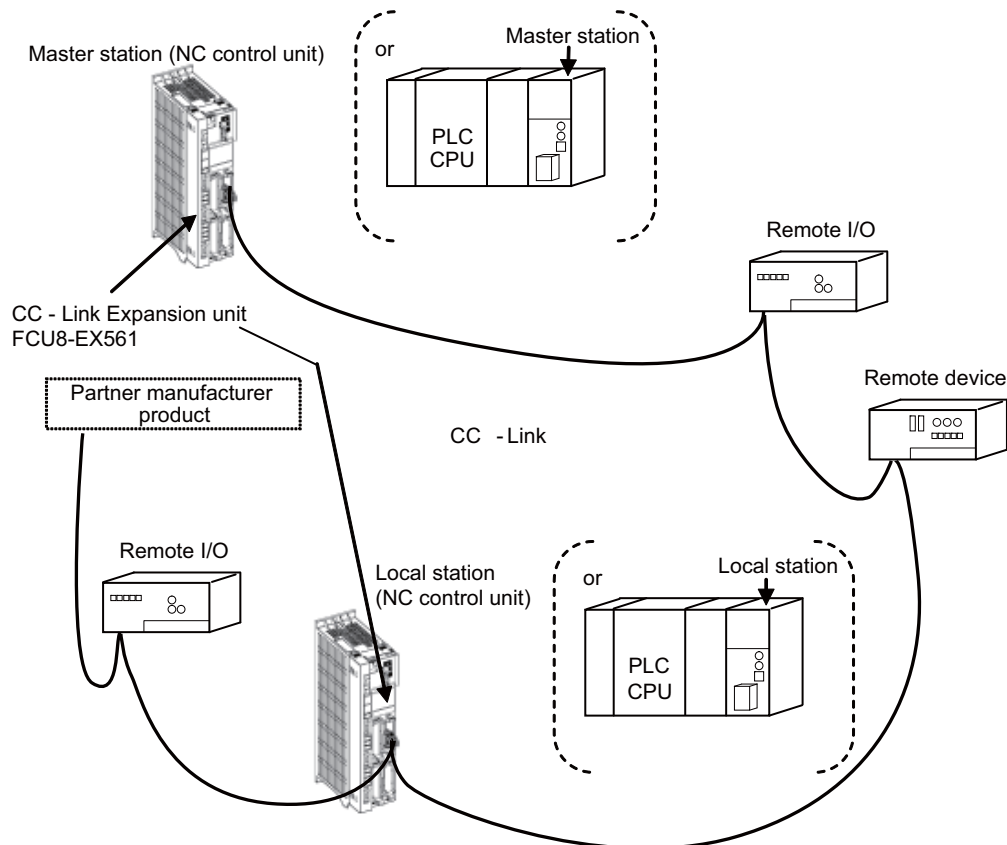

Master station	This station controls the remote station and local station. One master station is required for one system.
Local station	This station contains the CPU and can communicate with the master and the other local stations.
Remote I/O station	Remote station that handles only bit information.
Remote device station	Remote station that handles bit information and word information.
Intelligent device station	This station allows the transient transmission. (Including local station)

(3) Performance specifications

mitsubishi CNC M8 Series is compliant with CC-Link Ver.2.00.

<CC-Link Ver.2.00 specification>

Item		CC-Link master/local unit				
Max. number of link points per one system (Note 1)		Remote input/output (RX,RY)	8192 points each			
		Remote register (RWw) (Master St. → Remote/Local St.)	2048 points			
		Remote register (RWr) (Remote/Local St. → Master St.)	2048 points			
Extended cyclic setting			1 time setting	2 times setting	4 times setting	8 times setting
Number of link points per one remote/local station	1 station occupied	Remote input/output (RX,RY)	32 points each	32 points each	64 points each	128 points each
		Remote register (RWw) (Master St. → Remote/Local St.)	4 words	8 words	16 words	32 words
		Remote register (RWr) (Remote/Local St. → Master St.)	4 words	8 words	16 words	32 words
	2 stations occupied	Remote input/output (RX,RY)	64 points each	96 points each	192 points each	384 points each
		Remote register (RWw) (Master St. → Remote/Local St.)	8 words	16 words	32 words	64 words
		Remote register (RWr) (Remote/Local St. → Master St.)	8 words	16 words	32 words	64 words
	3 stations occupied	Remote input/output (RX,RY)	96 points each	160 points each	320 points each	640 points each
		Remote register (RWw) (Master St. → Remote/Local St.)	12 words	24 words	48 words	96 words
		Remote register (RWr) (Remote/Local St. → Master St.)	12 words	24 words	48 words	96 words
	4 stations occupied	Remote input/output (RX,RY)	128 points each	224 points each	448 points each	896 points each
		Remote register (RWw) (Master St. → Remote/Local St.)	16 words	32 words	64 words	128 words
		Remote register (RWr) (Remote/Local St. → Master St.)	16 words	32 words	64 words	128 words
Number of occupied stations (Number of local stations)		Station 1 to station 4 (The station No. can be switched with parameters.)				
Baud rates		156kbps / 625kbps / 2.5Mbps / 5Mbps / 10Mbps can be selected. (Baud rate can be selected with parameters.)				
Communication method		Polling method				
Synchronization method		Flame synchronization method				
Encode method		NRZI method				
Transmission path method		Bus (EIA RS485 compliant)				
Transmission format		HDLC compliant				
Illegal control method		CRC($X^{16} + X^{12} + X^5 + 1$)				

(4) Usable functions

Of all the CC-Link functions, the following functions can be used with the NC.

(○: Available ×: Not available - : Not relevant)

	Function item	MELSEC		NC unit	
		Master station	Local station	Master station	Local station
Method	Ver.1.00	○	○	○	○
	Ver.2.00	○	○	○	○
Master function	Communication between master station and remote I/O station	○	-	○	-
	Communication between master station and remote device station	○	-	○	-
	Communication between master station and local station	○	○	○	○
	Mixed system communication	○	○	○	○
	Reserved station function	○	-	○	-
	Error cancel station function	○	-	○	-
	Setting of data link status when trouble occurs in CPU of master station	○	○	○	○
	Registration of parameters in E ² PROM	○	-	○ (Note 2)	-
	Setting of input data status from data link trouble station	○	○	○	○
	Unit resetting by sequence program	○	○	○	○
	Data link stop/restart	○	○	○	○
	Parameter registration function	○	○	○ (Note 2)	○ (Note 2)
	Automatic refresh function	○	○	○	○
	Scan synchronization function	Synchronous mode	○	-	○
Asynchronous mode		○	○	○	○
Setting & display function	LED diagnosis status	16-point display (A1SJ61QBT11)		16-point display	
	Station number setting	Unit front panel switches		Parameters (Note 2)	
	Baud rate setting				
	Mode setting switch				
	Condition setting			H/W switches	
RAS function	Automatic link refresh function	○	○	○	○
	Sub-station isolation function	○	-	○	-
	Data link status check (SB/SW)	○	○	○	○
	Off-line test	○	○	○	○
	On-line test	○	○	○	○
	Monitor diagnosis	○	○	×	×
	Standby master function (Note 3)	○	-	○	-
	Temporary error cancel station designation function	○	-	○	-
exclusive instruction ⁿ	READ instruction / SREAD instruction (Note 1)	○	○	○	○
	WRITE instruction / SWRITE instruction (Note 1)	○	○	○	○
	RIRD instruction / RIWT instruction (Note 1)	○	○	×	×

(Note 1) The transient instruction cannot be used.

(Note 2) The parameter for the CC-Link is set with the GX Developer.

(Note 3) With this function, when an error occurs in the master station, switch to the standby master station so that data link can be continued.

(5) Communication data flow
 The flow of data communicated by the CC-Link's link scan is as follows.
 (The master station and local station of MELSEC CPU can be also mixed.)

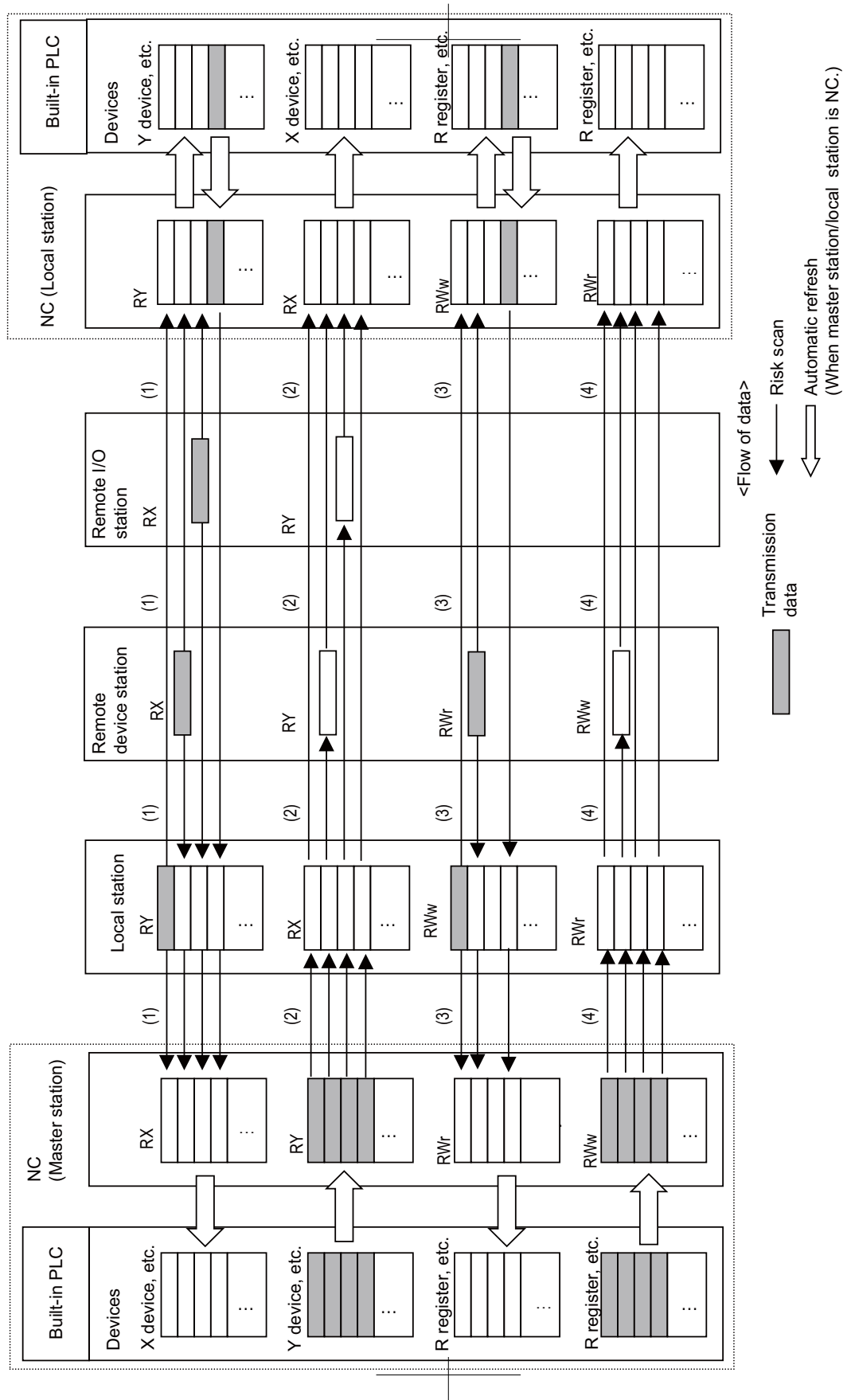

- (1) By executing a link scan, data in the remote I/O station and remote device station's remote input (RX) and in the local station's remote output (RY) is transmitted to the master station's remote input (RX) and the local station's remote output (RY).
- (2) By executing a link scan, data in the master station's remote output (RY) is transmitted to the remote I/O station and remote device station's remote output (RY) and the local station's remote input (RX).
- (3) By executing a link scan, data in the remote device station's remote register (RW_r) and the local station's remote register (RW_w) is transmitted to the master station's remote register (RW_r) and the local station's remote register (RW_w).
- (4) By executing a link scan, data in the master station's remote register (RW_w) is transmitted to the remote device station's remote register (RW_w) and the local station's remote register (RW_r).

[C80 series]

For the details of C80 series, refer to the manual of each unit of MITSUBISHI PLC "MELSEC iQ-R series".

17.6.2 PROFIBUS-DP (Master)

	M850W	M830W	M850S	M830S	M80W	M80 TypeA	M80 TypeB	E80 TypeA	E80 TypeB	C80
M	□	□	□	□	□	□	□	□	□	△ (*1)
L	□	□	□	□	□	□	□	□	□	△ (*1)

(*1) MELSEC

On MITSUBISHI CNC M8 Series, by mounting the PROFIBUS-DP master unit on the expansion slot or option relay unit and by connecting the unit with the slave stations compatible with PROFIBUS-DP communication, NC can input/output the devices to/from the slave stations as the master station for PROFIBUS-DP communication. CNC can be connected to up to 125 slave stations.

For the I/O data communication function (Cyclic communication), the maximum number of device I/O points is 8192 each. The CNC handles all the devices input/output to/from the PLC as bit device data. At this time, the maximum number of device I/O points of CNC's remote I/O is 768 each.

Using the aperiodic data communication function (Acyclic communication) with the slave station, data exchange can be performed to the slave station via PLC word device. Aperiodic data communication function can be performed with the I/O data communication function simultaneously.

Also, an error that occurred in the slave station can be acquired or responded via PLC word device as diagnosis data or alarm information.

There are two types of PLC I/O device assignment method for PROFIBUS-DP, fixed or arbitrary assignment, which you can select with the parameter. According to the assignment method, the number of available device points differs as follows:

	Fixed device assignment	Arbitrary device assignment
Maximum number of input device points	512 bits	8192 bits
Maximum number of output device points	512 bits	8192 bits

Hilscher's Fieldbus communication control circuit (COMX module) is mounted on PROFIBUS-DP master unit and the parameter setting is carried out using Hilscher's configurator "SYCON.net".

However, two PROFIBUS-DP master units cannot be mounted at a time. If these are mounted at the same time, both units stop their operations and the error occurs.

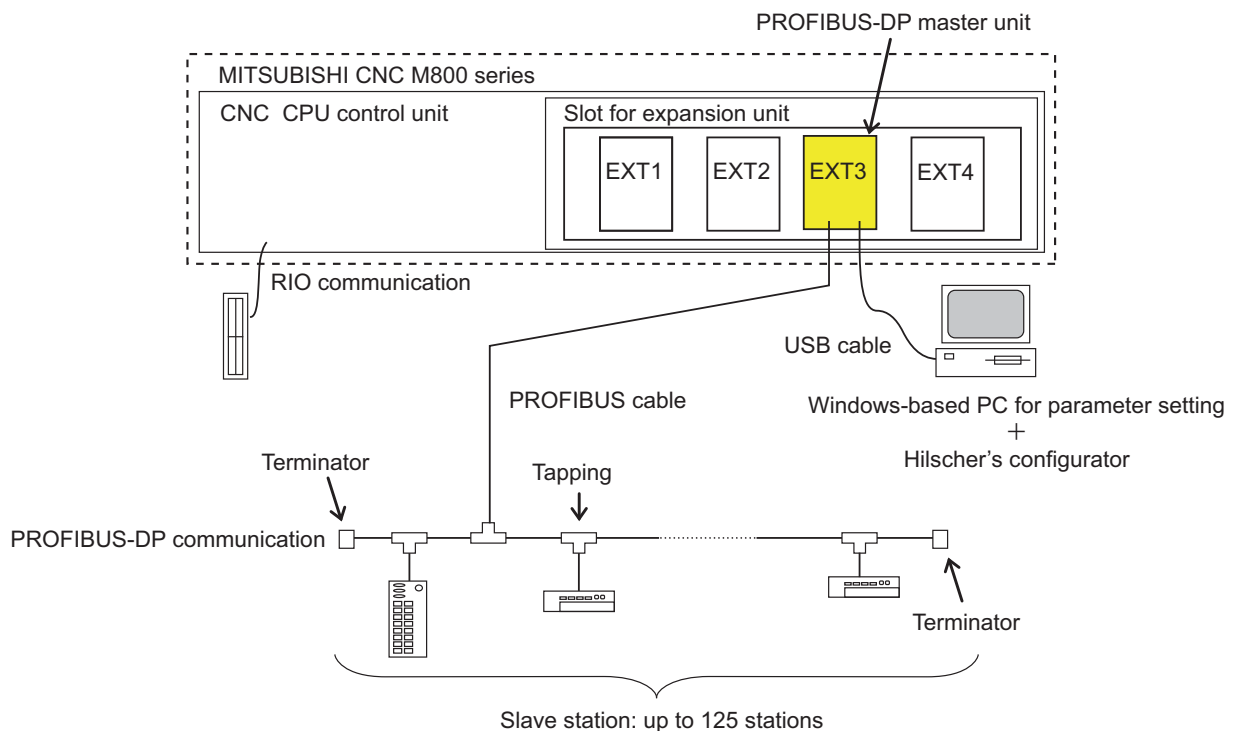

17.6.3 CC-Link IE Field (Master/Local)

	M850W	M830W	M850S	M830S	M80W	M80 TypeA	M80 TypeB	E80 TypeA	E80 TypeB	C80
M	□	□	□	□	□	□	□	□	□	△ (*1)
L	□	□	□	□	□	□	□	□	□	△ (*1)

(*1) MELSEC

[M8 series]

CC-Link IE Field is high-speed and large capacity open field network using Ethernet (1000BASE-T).

By mounting CC-Link IE Field expansion unit on the expansion slot of NC control unit, NC can be operated as master or local station of CC-Link IE Field. By connecting CC-Link IE Field expansion unit with CC-Link IE Field unit, data communication with the connected unit can be performed.

NC can be set as master or local station, but cannot be set as sub master station.

When CC-Link IE Field expansion unit is not mounted on the expansion slot, CC-Link IE Field cannot be used. CC-Link IE Field related parameter screen is not displayed on NC screen, either.

(1) Data communication

High-speed and large-capacity data communication is available between a master station and device stations on CC-Link IE Field Network.

The network supports cyclic transmission (periodic communication) and transient transmission (non-periodic communication).

(a) Cyclic transmission (periodic communication)

Data are periodically transmitted between stations on the same network.

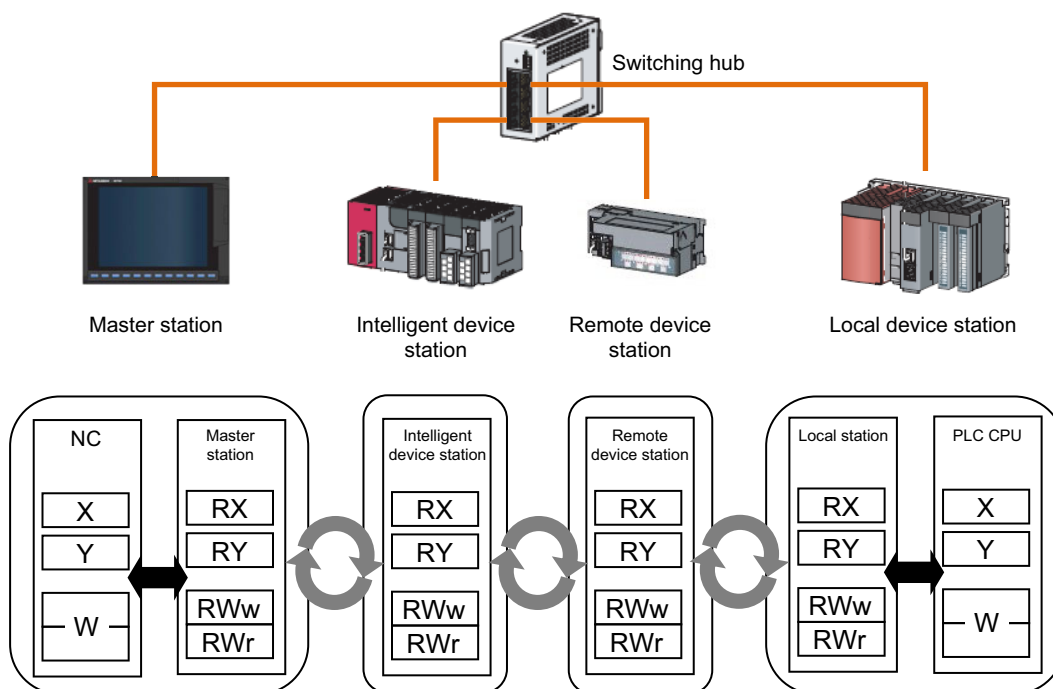

(b) Transient transmission (non-periodic communication)

Data are transmitted upon request.

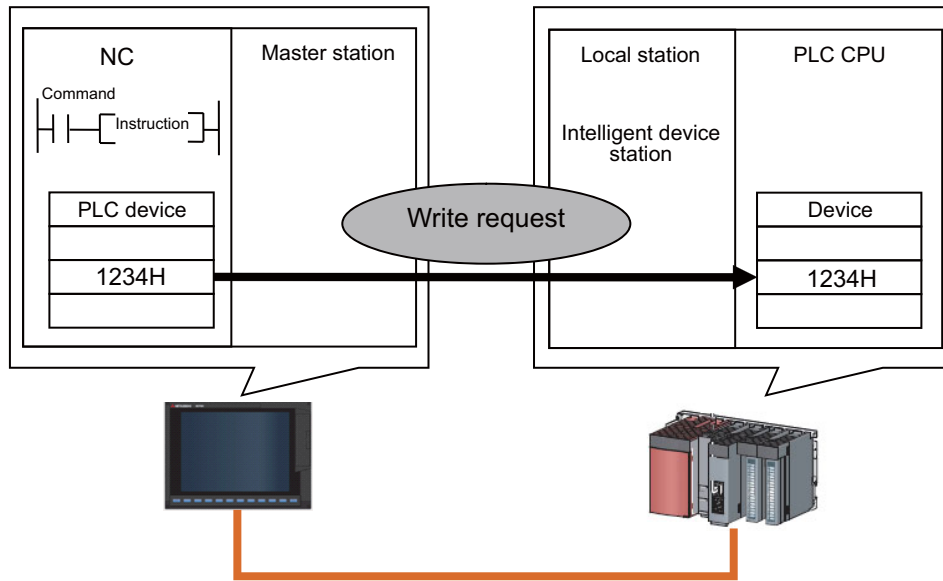

(2) 1Gbps communication speed

1Gbps communication speed allows high-speed communication.

(3) Use of Ethernet cable

A 1000BASE-T-compliant Ethernet is used for the connection interface.

The wiring cost can be reduced because 1000BASE-T-compliant Ethernet cables are commercially available.

(4) Flexible wiring for system arrangements

The network can be wired into star topology, line topology and ring topology.

For star topology, a 1000BASE-T-compliant switching hub can be used.

Wiring is highly flexible because a network can consist of a combination of star and line topologies.

For example, the machine tools can be connected through a line topology whereas star and line topologies can be used within each machine.

[C80 series]

For the details of C80 series, refer to the manual of each unit of MITSUBISHI Programmable Controller "MELSEC iQ-R Series".

17.6.4 PROFINET

	M850W	M830W	M850S	M830S	M80W	M80 TypeA	M80 TypeB	E80 TypeA	E80 TypeB	C80
M	—	—	—	—	—	—	—	—	—	Δ (*1)
L	—	—	—	—	—	—	—	—	—	Δ (*1)

(*1) MELSEC

17.6.5 EtherNet/IP

	M850W	M830W	M850S	M830S	M80W	M80 TypeA	M80 TypeB	E80 TypeA	E80 TypeB	C80
M	□	□	□	□	□	□	□	□	□	△ (*1)
L	□	□	□	□	□	□	□	□	□	△ (*1)

(*1) MELSEC

EtherNet/IP is the Ethernet for industry which ODVA (Open DeviceNet Vendor Association) suggests. It communicates using TCP/IP which is the standard Ethernet technology and the communication protocol which is called CIP (Common Industrial Protocol). EtherNet/IP can be used as not only field network but also the network between controllers. Also, as the standard Ethernet technology is used as lower protocol at the same time, it can be used mixing various general purpose Ethernet devices.

By mounting EtherNet/IP scanner/adaptor unit on the expansion slot or option relay unit of NC control unit to connect EtherNet/IP-compatible equipment, PLC devices can be input/output using NC control unit as a scanner or an adapter for EtherNet/IP communication.

When EtherNet/IP scanner/adaptor unit is not mounted on the expansion slot or option relay unit, EtherNet/IP cannot be used. Ethernet/IP related parameter screen is not displayed, either.

Two EtherNet/IP scanner/adaptor units cannot be mounted on the expansion slot or option relay unit. When two of them are mounted at the same time, both units stop operating and an alarm is output.

EtherNet/IP has two communication functions: Implicit message communication which communicates at regular intervals and Explicit message communication which communicates at arbitrary timing.

Message type	Outline
Explicit Message	Communication based on TCP/IP. Communication method which sends and receives data at 1:1 at arbitrary timing. (Example) Parameter communication, reading diagnostic data, etc.
Implicit Message	Communication based on UDP/IP. Communication method which sends and receives data at regular intervals (Cyclic). (Example) Transferring periodic data

Connection Diagram

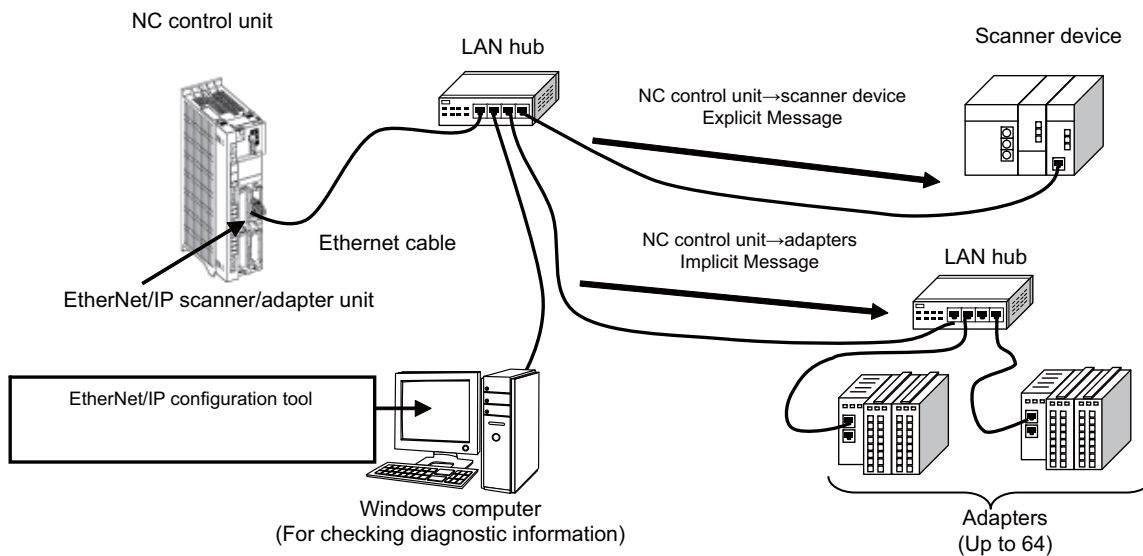

17.6.8 FL-net

	M850W	M830W	M850S	M830S	M80W	M80 TypeA	M80 TypeB	E80 TypeA	E80 TypeB	C80
M	□	□	□	□	□	□	□	□	□	△ (*1)
L	□	□	□	□	□	□	□	□	□	△ (*1)

(*1) MELSEC

FL-net is a network capable of interconnecting various FA controllers such as the programmable controllers (PLC) and the CNC from many manufacturers, and personal computers for control and monitoring. FL-net communication is made available by mounting an FL-net expansion unit on the expansion slot or option relay unit of NC control unit.

FL-net expansion unit of the NC control unit supports the following FL-net (OPCN-2) version.

FL-net version	Class
FL-net Version 3.01	Class 1 (*) Controller level network (Version 2.00 of FL-net) is available.

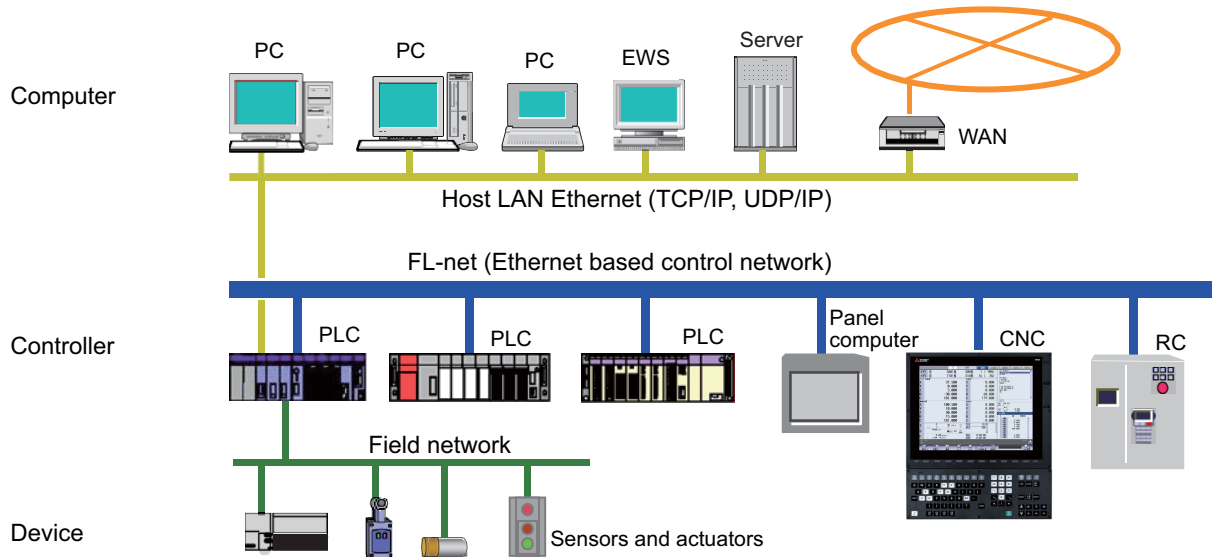

17.6.9 DeviceNet (Master)

	M850W	M830W	M850S	M830S	M80W	M80 TypeA	M80 TypeB	E80 TypeA	E80 TypeB	C80
M	—	—	—	—	—	—	—	—	—	△ (*1)
L	—	—	—	—	—	—	—	—	—	△ (*1)

(*1) MELSEC

17.6.10 CC-Link IE Field Basic

	M850W	M830W	M850S	M830S	M80W	M80 TypeA	M80 TypeB	E80 TypeA	E80 TypeB	C80
M	○	○	○	○	○	○	○	○	○	—
L	○	○	○	○	○	○	○	○	○	—

CC-Link IE field network Basic is an FA network taking advantage of general Ethernet. This function is used to perform cyclic transmission between the master station and remote station using link devices.

The MITSUBISHI CNC M8 Series enables periodic (cyclic transmission) data communication between the master station and remote station by connecting the machine to the device conforming to CC-Link IE field network Basic communication through the built-in Ethernet port. The data communicated is assigned to built-in PLC devices and can be referred to from the ladder program.

The M8 CNC can function as a master station or as a remote station of CC-Link IE field network Basic communication. The two functions cannot be used concurrently. Whether to use the CNC as the master station or as the remote station is determined by NC parameters.

The parameters are used to set CC-Link IE field network Basic communication, to specify the communication device, and to assign the link refresh devices.

The advantages of using CC-Link field network Basic are described below.

(1) Cyclic transmission (periodic communication)

Data communications can be made periodically between stations of the same network.

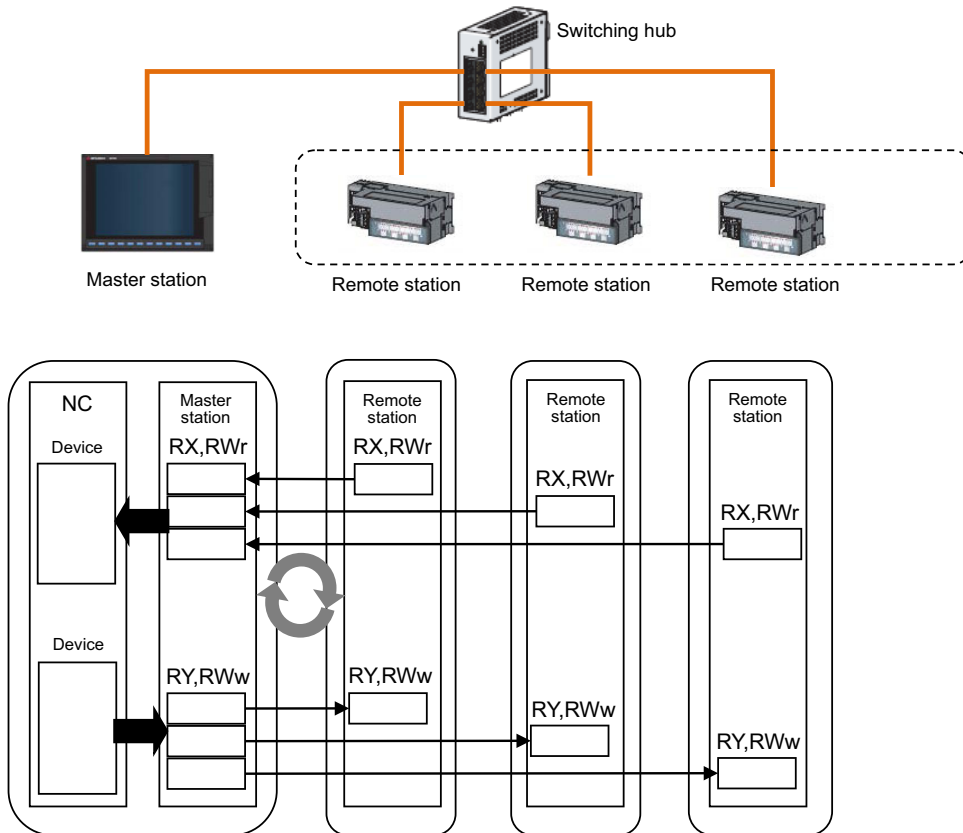

(2) Reduction in system costs

The NC communicates through its built-in Ethernet port. This eliminates the need for a dedicated network unit, and therefore contributes to reduction in system costs.

(3) Mixture of protocols

CC-Link IE field network Basic can be used concurrently with other general Ethernet protocols. Therefore, the network can be configured using FTP, HTTP, SLMP, etc. However, a link scan time for cyclic transmission may increase due to those Ethernet protocols.

(4) Easy-to-configure system

All the settings of CC-Link IE field network Basic are made on the master station. Cyclic transmission is enabled by setting the IP address and the subnet mask on the remote station. There is no need for setting the information of the master station on the remote station.

In addition, there is no restriction on the connection order nor connecting locations of the devices as they are connected via a star network. It is therefore easy to connect an additional remote device.

17.7 Installing S/W for Machine Tools

17.7.1 Customization (NC Designer2)

	M850W	M830W	M850S	M830S	M80W	M80 TypeA	M80 TypeB	E80 TypeA	E80 TypeB	C80
M	△	△	△	△	○	○	○	○	○	—
L	△	△	△	△	○	○	○	○	○	—

"Customization" is a function which allows to display a user-created screen or user-created window as an HMI screen or as a screen of another application.

(Note) The software sold separately is necessary.

"Customization" function has four types of assignment, "F0 assignment", "Menu assignment", "Partial-screen customization" and "Selectable-screen customization". Each customized screen can be created and registered with "NC Designer2 interpreter method", "NC Designer2 compilation method" or "EXE file registration method".

F0 assignment:

Customized screen (Note 1) can be assigned to the function keys (F0, SFP, window display or window selection). When the function key is pressed, the customized screen assigned is displayed.

Menu assignment:

Customized window (Note 2) can be assigned to a main menu of the monitor screen, setup screen, edit screen, diagnosis screen, or maintenance screen.

For the monitor screen, setup screen, edit screen, diagnosis screen, or maintenance screen, the display order of main menus can be changed.

When the registered menu is pressed, the customized window is displayed.

Also, display/non-display of the customized menu can be changed depending on the conditions.

Partial-screen customization:

Customized window created with "NC Designer2 interpreter method" or "NC Designer2 compilation method" can be displayed as a part of the standard screen.

Selectable-screen customization:

Customized window created with "NC Designer2 interpreter method" or "NC Designer2 compilation method" can be displayed in the selectable display area on the monitor screen. Designated customized window (menu assignment) opens by pressing the INPUT key in the same manner as the selectable display of the standard screen.

G-code guidance open, M-code guidance open:

In the G code guidance display area of the edit screen, the guidance of the original G code (G code macro) and M code (M code macro) created by the MTB can be displayed. By creating a guidance file for G code macro (or M code macro) in HTML format and storing it in a custom folder by the MTB, the corresponding G code (or M code) guidance can be displayed. If there is both a standard G code guidance file and a G code guidance file created by the MTB, the G code guidance created by the MTB is displayed with priority.

(Note 1) A user-created HMI screen with NC Designer2 or an executable file prepared by a user.

(Note that the executable file cannot be used with M800S/M80/E80.)

(Note 2) A user-created HMI window with NC Designer2 or an executable file prepared by a user.

(Note that the executable file cannot be used with M800S/M80/E80.)

(Note 3) "EXE file registration method" can not be used with M800S/M80/E80.

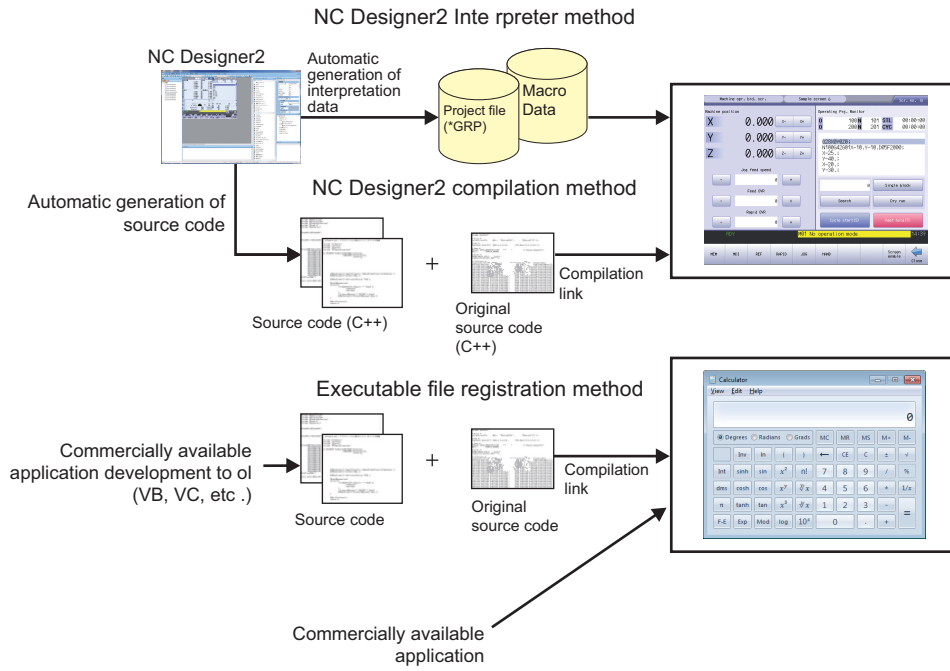

17.7.1.1 Customization Data Storage Capacity [MB]

	M850W	M830W	M850S	M830S	M80W	M80 TypeA	M80 TypeB	E80 TypeA	E80 TypeB	C80
M	□ (*1)	□ (*1)	6	6	□ (*1)	6	6	1	1	—
L	□ (*1)	□ (*1)	6	6	□ (*1)	6	6	1	1	—

(*1) Depending on display unit-side memory space. The number indicates the maximum size of the custom screen module (.o).

17.7.1.2 Customization Working Memory Size [MB]

	M850W	M830W	M850S	M830S	M80W	M80 TypeA	M80 TypeB	E80 TypeA	E80 TypeB	C80
M	6	6	6	6	3	3	3	1	1	—
L	6	6	6	6	3	3	3	1	1	—

17.7.2 User-defined Key

	M850W	M830W	M850S	M830S	M80W	M80 TypeA	M80 TypeB	E80 TypeA	E80 TypeB	C80
M	○	○	○	○	○	○	○	○	○	—
L	○	○	○	○	○	○	○	○	○	—

This function allows an arbitrary character string to be assigned to one key and makes it easy to input the fixed phrases. Register correspondences between SHIFT keys and character strings in a configuration file (keydef.txt).

The maximum number of registerable key types is 8 for ABC layout and 10 for QWERTY layout.

The maximum number of characters used per definition is 256. The definition is disregarded when it is set exceeding the number.

In the configuration file (Keydef.txt), a character string should be defined as follows:

```
n [character string] ;
n(Registration No.) : 0 to 7 (SHIFT+A to SHIFT+H (ABC layout))
                   : 0 to 9 (SHIFT+Q to SHIFT+G (QWERTY layout))
```

Example:

0[G28X0Y0]; ←When SHIFT+A and a key is input, a character string "G28X0Y0" is input.

1[G28Z0]; ←When SHIFT+B and a key is input, a character string "G28Z0" is input.

17.7.3 EZSocket I/F

	M850W	M830W	M850S	M830S	M80W	M80 TypeA	M80 TypeB	E80 TypeA	E80 TypeB	C80
M	○	○	○	○	○	○	○	○	○	—
L	○	○	○	○	○	○	○	○	○	—

(Note) The software sold separately is necessary.

This middleware makes it easy to develop applications having a Windows interface.

The various functions of the NC unit can be used from a Windows application using VC++ language, VB language and VBA macro language.

17.7.4 APLC Release

	M850W	M830W	M850S	M830S	M80W	M80 TypeA	M80 TypeB	E80 TypeA	E80 TypeB	C80
M	△	△	△	△	○	○	○	○	○	△
L	△	△	△	△	○	○	○	○	○	△

(Note) The software sold separately is necessary.

APLC (Advanced Programmable Logic Controller) release is a function that allows the user-generated C language module to be called from NC.

Control operations that are difficult to express in ladder language can be created with C language.

PLC ladder can easily be customized by converting a part of PLC ladder that has grown complex and bulky into C language module.

There are three methods where APLC is executed. It is possible to use the three in combination.

- Type 1 : By registering the start address of the module to be processed asynchronously with PLC, C language module will be executed in a constant frequency.

- Type 2 (M8 series) : By registering the start address of the module to be processed synchronously with PLC, C language module will be started synchronizing with PLC. Note that C language will not be called if PLC is incorrect, even if the process has been registered.

- Type 3 (M8 series) : By registering the start address of the module to be called from the sequence program and processed, C language module will be started from the sequence program upon S.CALL instruction.

(Note) C language module needs to be generated by NC compiler2.

[Hardware configuration]

This function is activated by installing the C language module into the following memory devices.

- SD memory card (Only for M8 Series)
- Built-in memory of the control unit

When the module is to be installed into an SD memory card, insert the card into the control unit-side SD card I/F for M800W/M80W Series, or do so into the front-side SD card I/F of the display unit for M800S/M80/E80 Series.

Up to 120KB data can be stored in built-in memory.

When the C language module is installed into an SD memory card, C language inside the SD memory card is executed. (The module inside the built-in memory is not executed.)

[Software configuration]

The names of directory, file and initialize function, where C language modules are stored, are fixed.

(Note) Incorrect hardware or software configuration disables operations.

17.7.5 Custom API Library

	M850W	M830W	M850S	M830S	M80W	M80 TypeA	M80 TypeB	E80 TypeA	E80 TypeB	C80
M	○	○	○	○	○	○	○	○	○	—
L	○	○	○	○	○	○	○	○	○	—

This function is designed to interface an NC with an application developed by a user.

You can set and refer the data for NC using this function.

Please contact us for details.

17.7.6 MES Interface Library

	M850W	M830W	M850S	M830S	M80W	M80 TypeA	M80 TypeB	E80 TypeA	E80 TypeB	C80
M	△	△	△	△	○	○	○	○	○	—
L	△	△	△	△	○	○	○	○	○	—

[M8 series]

This function enables to link the CNC internal data and the database of information system (manufacturing execution system). Production control and traceability can be ensured with the registered information by registering at machining completion, alarm occurrence, or user's arbitrary timing as needed. The data registered in the database can also be operated with CNC.

Conventionally, data was obtained by constantly monitoring CNC from an external computer (information system).

However, by using MES interface library function, it is possible to connect without a communication gateway and it allows the communication between CNC and the database at a necessary timing.

This function is supported on CNC and the function range is from obtaining the information at the time of machining completion, alarm occurrence, and user's arbitrary timing to transmitting to the database. Screen application of database and external computer must be prepared by user side.

[C80 series]

For the details of C80 series, refer to the manual of MITSUBISHI Programmable Controller "MELSEC iQ-R Series".

17.7.7 SLMP Server

	M850W	M830W	M850S	M830S	M80W	M80 TypeA	M80 TypeB	E80 TypeA	E80 TypeB	C80
M	○	○	○	○	○	○	○	○	○	—
L	○	○	○	○	○	○	○	○	○	—

SLMP server is a function that transfers data using the SLMP between an NC and an external device. SLMP (Seamless Message Protocol) is a general-purpose protocol to transfer information between the NC and an SLMP-compatible external device through the Ethernet cable and the SLMP is applied to many external devices because it can be easily utilized only by applying S/W. This function enables easy connection with external devices and read/write NC data through the Ethernet cable, improving productivity by utilizing external devices and meeting broad automation needs.

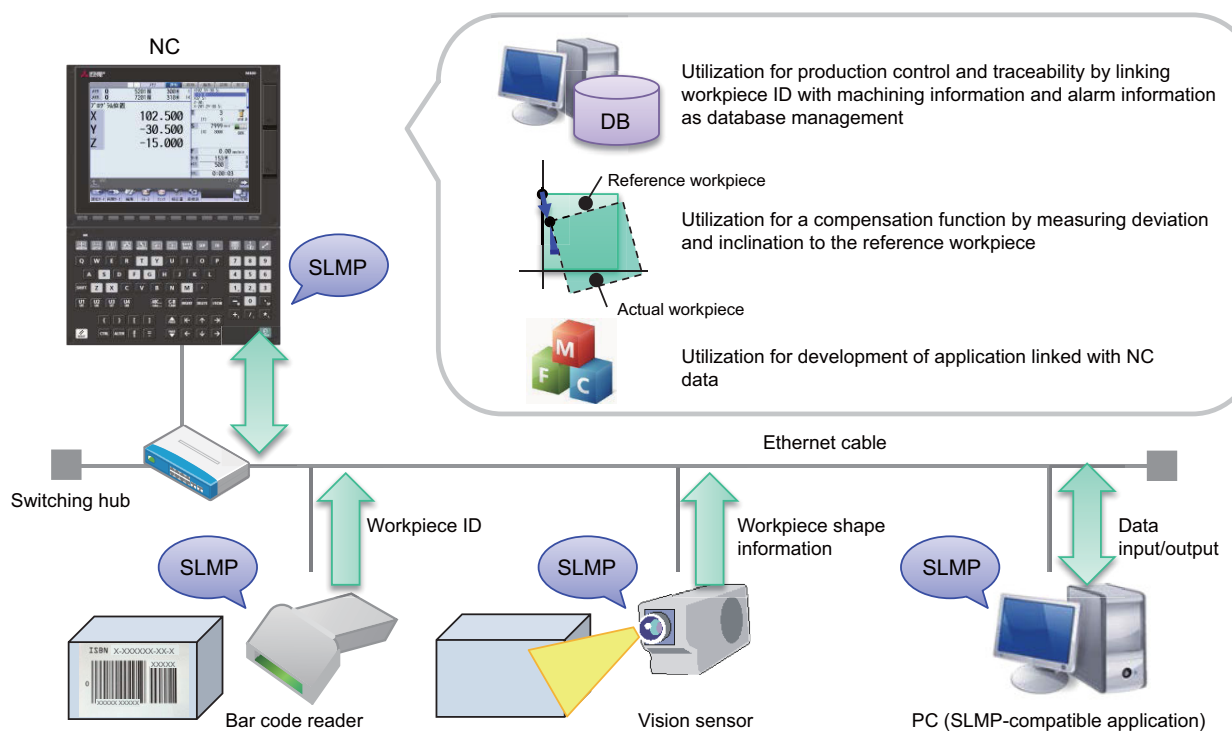

The specifications of SLMP transmitted by an external device are shown below.

Item	Specification
Supported protocols	TCP/IP (UDP is not supported.)
SLMP data code	Binary code (ASCII code is not supported.)
TCP/IP connection waiting port number	30000
Number of TCP/IP connections (Number of external devices connected at the same time)	Up to 4 connections (When multiple connections are made from a single external device, each one is counted as one connection in the total number of connections.)

17.7.8 Numerical Control (CNC) Communication Software FCSB1224W000

	M850W	M830W	M850S	M830S	M80W	M80 TypeA	M80 TypeB	E80 TypeA	E80 TypeB	C80
M	○	○	○	○	○	○	○	○	○	—
L	○	○	○	○	○	○	○	○	○	—

(Note) The software sold separately is required.

The Numerical Control (CNC) communication software FCSB1224W000 is designed to help development of an application with Windows interface for Mitsubishi Electric computerized numerical controller.

The product can accelerate development by using OLE interface common to computerized numerical controller without knowing internal processing of the machine.

17.7.10 GOT2000 Screen Design Tool GT Works3

	M850W	M830W	M850S	M830S	M80W	M80 TypeA	M80 TypeB	E80 TypeA	E80 TypeB	C80
M	—	—	—	—	—	—	—	—	—	○
L	—	—	—	—	—	—	—	—	—	○

(Note) The software sold separately is necessary.

This software provides comprehensive support for the screen design of a display unit.

17.8 Others

17.8.1 System Lock

	M850W	M830W	M850S	M830S	M80W	M80 TypeA	M80 TypeB	E80 TypeA	E80 TypeB	C80
M	△	△	△	△	○	○	○	○	○	—
L	△	△	△	△	○	○	○	○	○	—

System lock is a function that allows machine tool builders to set the expiration date for use of their machines.

If the cancel code is not entered by the specified deadline, the system forcibly turns OFF the Servo ready completion signal to place the machine in an inoperable status.

(Note) We do not compensate for any detriment that may be caused when the lock is cancelled illegally.

17.8.2 CNC Remote Operation Tool

17.8.2.1 NC Monitor2

	M850W	M830W	M850S	M830S	M80W	M80 TypeA	M80 TypeB	E80 TypeA	E80 TypeB	C80
M	○	○	○	○	○	○	○	○	○	○
L	○	○	○	○	○	○	○	○	○	○

(Note) The software sold separately is necessary.

NC Monitor2 is the software tool that monitors the condition of NC remotely with a personal computer using a intranet of a plant. Multiple NCs can be connected and their conditions can be monitored simultaneously.

17.8.2.2 NC Explorer

	M850W	M830W	M850S	M830S	M80W	M80 TypeA	M80 TypeB	E80 TypeA	E80 TypeB	C80
M	○	○	○	○	○	○	○	○	○	○
L	○	○	○	○	○	○	○	○	○	○

(Note) This tool is free of charge. Please contact us.

NC Explorer is a software tool to operate the machining data files of each NC unit connected with a host personal computer by Ethernet connection from the Explorer on the host personal computer.

17.8.3 Automatic Operation Lock

	M850W	M830W	M850S	M830S	M80W	M80 TypeA	M80 TypeB	E80 TypeA	E80 TypeB	C80
M	○	○	○	○	○	○	○	○	○	○
L	○	○	○	○	○	○	○	○	○	○

Automatic operation lock function prevents the falsification of APLC(C language module: herein after called APLC) by a third party.

Automatic operation will be prohibited when illegal APLC is installed by authenticating APLC with the password for APLC authentication which is registered to NC unit beforehand using this function.

Refer to "17.7.4 APLC Release" for details on the APLC.

17.8.4 Power Consumption Computation

	M850W	M830W	M850S	M830S	M80W	M80 TypeA	M80 TypeB	E80 TypeA	E80 TypeB	C80
M	○	○	○	○	○	○	○	○	○	○
L	○	○	○	○	○	○	○	○	○	○

Present power consumption, accumulated power consumption, and accumulated power consumption history can be acquired with this function.

The total amount of the drive section power consumption (power consumed by the operation of the spindles and servo axes) and the non-drive section power consumption (power consumed by the electrical equipment of the machine tool) is informed to the PLC device.

The instantaneous power consumption is informed as "present power consumption". The integrated value of the present power consumption is informed as "accumulated power consumption".

The "accumulated power consumption" can be recorded at the specified time, and the history data "accumulated power consumption history" can be extracted.

17.8.5 EcoMonitorLight Connection

	M850W	M830W	M850S	M830S	M80W	M80 TypeA	M80 TypeB	E80 TypeA	E80 TypeB	C80
M	○	○	○	○	○	○	○	○	○	—
L	○	○	○	○	○	○	○	○	○	—

(Note) EcoMonitorLight sold separately is required.

NC system can collect and manage the electric power of the machine tool which is measured by the energy measuring unit "EcoMonitorLight".

The electric power (mainly consumed and regenerated power) of entire machine tool and peripheral devices can be measured by connecting EcoMonitorLight to the main breaker of the machine tool or the breaker of the peripheral devices (motor, coolant, etc.) which configure the machine tool.

By establishing serial communication (Modbus) between the NC unit and EcoMonitorLight using a serial cable, the NC system can collect the power values of the entire machine tool and peripheral devices measured by EcoMonitorLight. Consequently, the electric power in the machine tool can be finely managed, which enables energy-saving operation.

17.8.6 GOT Window

	M850W	M830W	M850S	M830S	M80W	M80 TypeA	M80 TypeB	E80 TypeA	E80 TypeB	C80
M	—	—	—	—	—	—	—	—	—	○
L	—	—	—	—	—	—	—	—	—	○

This is the interface to display the variety of NC data on GOT connected to the CNC CPU.

This reads out the running machining program No., the running machining program and the coordinate values, etc. by the device read command.

Setting the command from the GOT or sequence program for the CNC CPU, then the CNC CPU generates the data corresponding to the command.

Because there are up to ten command areas, you can designate up to 10 kinds of commands at the same time.

Additionally, there is also an interface which can refer the often used commands without the sequence programs by automatically setting them up at the time of power ON.

Examples of a screen display and used commands

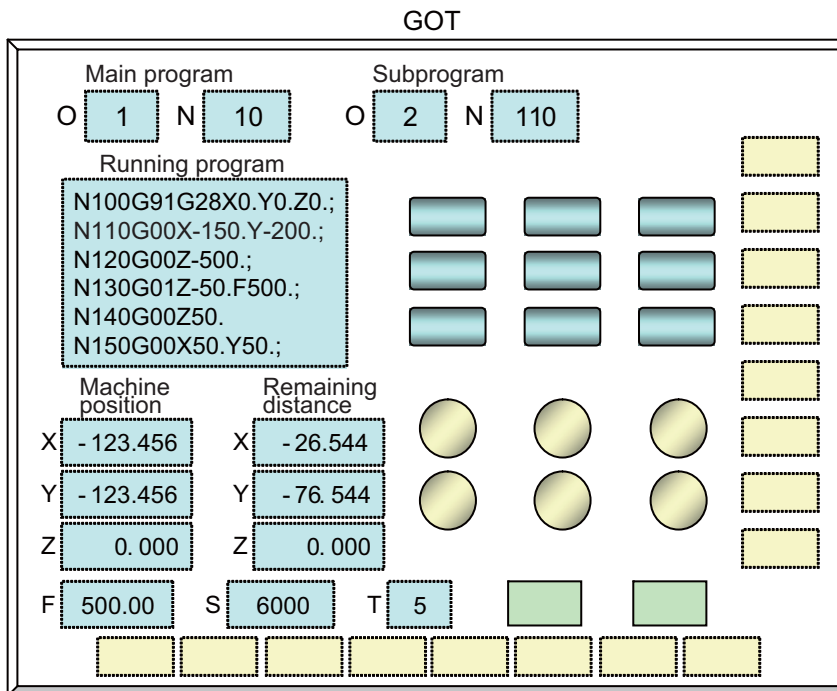

17.8.7 Log Viewer

	M850W	M830W	M850S	M830S	M80W	M80 TypeA	M80 TypeB	E80 TypeA	E80 TypeB	C80
M	—	—	—	—	—	—	—	—	—	○
L	—	—	—	—	—	—	—	—	—	○

This function enables the recorded data by the data sampling function of the NC to display with a graph on the GOT, and to store the data as a file.

The data acquired by the GOT can be stored in an external memory, and also can be read to display with the peripheral tool "GX LogViewer".

This function uses the "Data Sampling function" of NC, and the "Log viewer function" of GOT for displaying and controlling the logging data.

The connectable log viewer to one NC is one GOT only . The second or subsequent units cannot connect the log viewer.

The NC and the GOT are connected through the Ethernet, and the logging data sampled with the NC is displayed on the GOT.

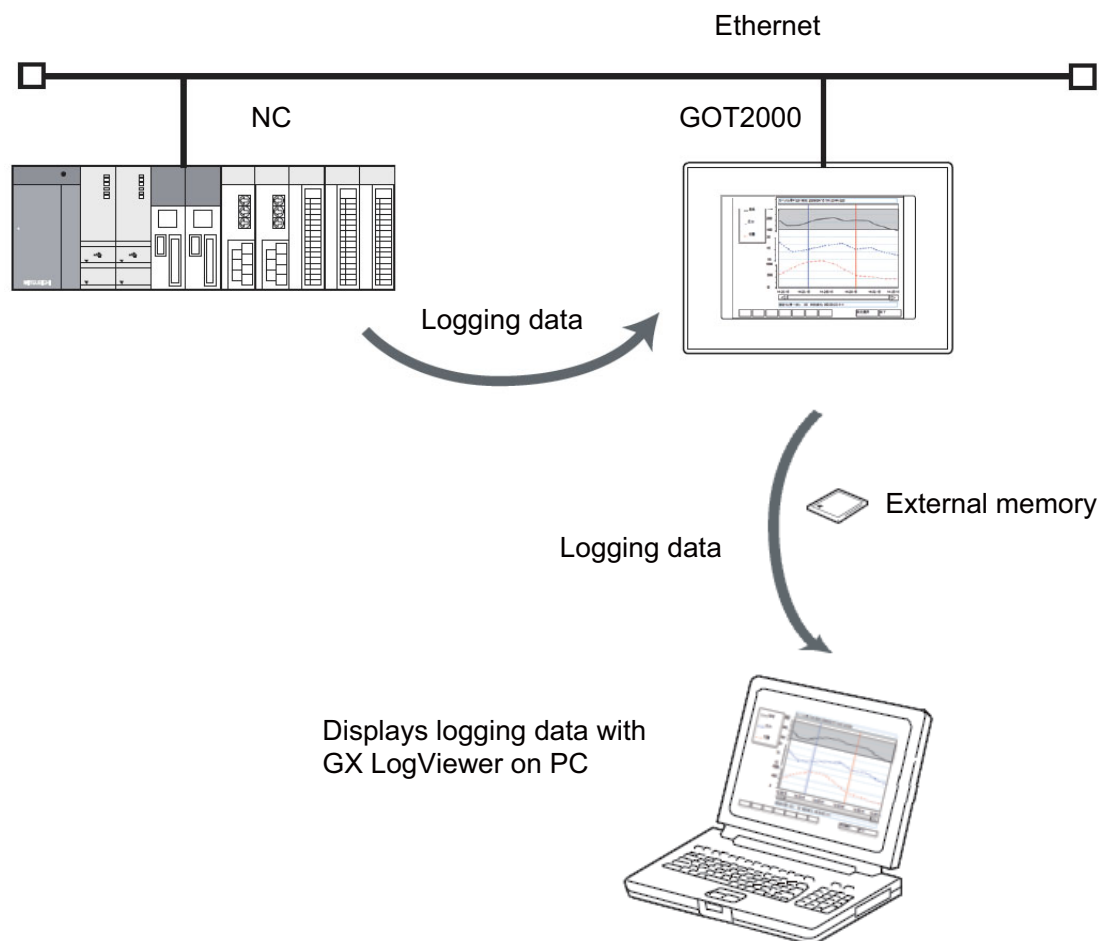

Revision History

Date of revision	Manual No.	Revision details
Aug. 2017	IB(NA)1501505-A	<p>The first edition was created excerpting from functional specifications pages in "M800/M80/C80 Series Specifications Manual" (IB-1501267(ENG)-G).</p> <p>The descriptions of C80 Series were revised in response to S/W version A2.</p> <p>The following chapter numbers and chapter titles were changed.</p> <ul style="list-style-type: none"> - 15.4.12 Backup/Restore - 17.3.6 NC Axis/PLC Axis Switchover <p>The following chapter numbers were changed.</p> <ul style="list-style-type: none"> - 4.5.3.4 Multiple Spindle Synchronous Tapping - 6.1.11 GOT (GOT2000 Series GT27/GT25 12.1/10.4/8.4/5.7) - 7.2.6 USB I/F (GOT Front-side USB I/F) - 7.2.7 SD I/F (GOT Back-side SD Card I/F) - 14.3.6 PLC Axis Current Limit - 17.7.10 GOT2000 Screen Design Tool GT Works3 - 17.8.6 GOT Window - 17.8.7 Log Viewer <p>The following chapter titles were changed.</p> <ul style="list-style-type: none"> - 17.1.9.1 Ethernet Connection - 17.1.9.2 CC-Link Connection <p>Other contents were added/revised/deleted according to specification.</p>
Dec. 2017	IB(NA)1501505-B	<p>The descriptions of M800 Series/M80 Series were revised in response to S/W version C7.</p> <p>The following chapters were added.</p> <ul style="list-style-type: none"> - 2.4.4 Diameter/Radius Designation Switch - 6.2.21 VNC Server - 12.3.2.7 Axis-specific Acceleration Tolerance Control - 12.4.7 DXF Data Input - 14.1.8 Rotation Center Error Measurement - 14.1.9 Workpiece Installation Error Measurement <p>Other contents were added/revised/deleted according to the specifications.</p>
Mar. 2018	IB(NA)1501505-C	<p>The descriptions were revised corresponding to Mitsubishi CNC E80 series.</p> <p>The following chapters were added.</p> <ul style="list-style-type: none"> - 4.5.3.5 Synchronous Tapping with Analog I/F Spindle - 17.2.23 Multiple-axis Synchronization Control - 17.5.1.5 DI:64/DO:48/AO:1 - 17.6.5 EtherNet/IP <p>Other contents were added/revised/deleted according to the specifications.</p>
Aug. 2018	IB(NA)1501505-D	<p>The descriptions of M800 Series/M80 Series were revised in response to S/W version D1.</p> <p>The descriptions of C80 Series were revised in response to S/W version B0.</p> <p>The following chapters were added.</p> <ul style="list-style-type: none"> - 1.3.4.3 FTP High-speed Program Server Mode - 11.4.16 Machining interruption <p>Other contents were added/revised/deleted according to the specifications.</p>

Date of revision	Manual No.	Revision details
Mar. 2019	IB(NA)1501505-E	<p>The descriptions of M800 Series/M80 Series/E80 Series were revised in response to S/W version E0.</p> <p>The following chapters were added.</p> <ul style="list-style-type: none"> - 4.2.8 Selection of Axis (Axes) for Feedrate Command - 7.4.3 IP Filter Setting - 10.1.12 Workpiece Position Offset for Rotary Axis - 13.2.10 Cogging Torque Compensation - 14.3.7 Direct Robot Control - 15.4.14 Field Network Diagnostics - 15.5.2.3.9 SCN (Safety Communication Network) - 17.1.7.3 MELSEC Development Tool (GX Works2) - 17.6.10 CC-Link IE Field (Master/Local) <p>Other contents were added/revised/deleted according to the specifications.</p>
Aug. 2019	IB(NA)1501505-F	<p>The descriptions of M800 Series/M80 Series/E80 Series were revised in response to S/W version E1.</p> <p>The following chapters were added.</p> <ul style="list-style-type: none"> - 6.3.10.17 Indonesian - 8.1.1.9 Spindle Control with Pulse Train Output - 8.1.17 Spindle Motor Temperature Output to PLC - 13.1.12 Backlash Compensation II - 17.1.2.3 Enhanced PLC Security Mode - 17.2.18 Simple Synchronous Control - 17.6.8 FL-net <p>Other contents were added/revised/deleted according to the specifications.</p>
Feb. 2020	IB(NA)1501505-G	<p>The descriptions were revised in response to S/W version F0 of Mitsubishi Electric CNC M800/M80/E80 Series.</p> <p>The descriptions were revised in response to S/W version B5 of Mitsubishi Electric CNC C80 Series.</p> <p>The following chapter was added.</p> <ul style="list-style-type: none"> - 13.1.10 Cyclic Error Compensation <p>Other contents were added/revised/deleted according to the specifications.</p>
Jun. 2020	IB(NA)1501505-H	<p>The descriptions were revised in response to S/W version F1 of Mitsubishi Electric CNC M800/M80/E80 Series.</p> <p>The following chapter titles were changed.</p> <ul style="list-style-type: none"> - 17.1.4.2 Large PLC Capacity: 256 Ksteps - 17.1.4.3 Large PLC Capacity: 512 Ksteps <p>Other contents were added/revised/deleted according to the specifications.</p>
Mar. 2021	IB(NA)1501505-J	<p>The descriptions were revised in response to S/W version F4 of Mitsubishi Electric CNC M800/M80/E80 Series.</p> <p>The descriptions were revised in response to S/W version B8 of Mitsubishi Electric CNC C80 Series.</p> <p>The following chapters were added.</p> <ul style="list-style-type: none"> - 6.3.10.18 Vietnamese - 12.1.7.4 Vibration Cutting Control - 17.6.4 PROFINET - 17.6.9 DeviceNet (Master) <p>Other contents were added/revised/deleted according to the specifications.</p>

Date of revision	Manual No.	Revision details
Jul. 2022	IB(NA)1501505-K	<p>The descriptions were revised in response to S/W version F8 of Mitsubishi Electric CNC M800/M80/E80 Series.</p> <p>The descriptions were revised in response to S/W version BB of Mitsubishi Electric CNC C80 Series.</p> <p>The following chapters were added.</p> <ul style="list-style-type: none"> - 12.1.8.13 Loader Control Part System - 13.2.9 Variable Torsion Compensation - 15.4.15 Remote service iQ Care Remote4U - 15.4.15.1 Connection with RGU - 17.2.24 Hypothetical Linear Axis Control - 17.2.25 BiSS Encoder I/F <p>Other contents were added/revised/deleted according to the specifications.</p>
Aug. 2023	IB(NA)1501505-L	<p>The descriptions were revised in response to S/W version FB of Mitsubishi Electric CNC M800/M80/E80 Series.</p> <p>The descriptions were revised in response to S/W version BE of Mitsubishi Electric CNC C80 Series.</p> <p>The following chapter was added.</p> <ul style="list-style-type: none"> - 17.2.6 Tool Head Hot Swapping <p>Other contents were added/revised/deleted according to the specifications.</p>
Jan. 2024	IB(NA)1501505-M	<p>The descriptions were revised in response to S/W version FC of Mitsubishi Electric CNC M800/M80/E80 Series.</p> <p>The following chapters were changed.</p> <ul style="list-style-type: none"> - 9.2.1 Tool Radius Compensation - 9.2.3 Tool Nose Radius Compensation (G40/41/42) - 12.1.7.4 Vibration Cutting Control - 12.3.3.1 High-speed High-accuracy Control I (G05.1Q1) Maximum [kBPM] - 12.3.3.2 High-speed High-accuracy Control II (G05P10000) Maximum [kBPM] - 12.3.3.3 High-speed High-accuracy Control III (G05P20000) Maximum [kBPM] - 17.6.2 PROFIBUS-DP (Master) - 17.6.5 EtherNet/IP <p>Other contents were added/revised/deleted according to the specifications.</p>

Global Service Network

AMERICA

MITSUBISHI ELECTRIC AUTOMATION INC. (AMERICA FA CENTER)

HQ and Central Region Service Center (Chicago)
500 CORPORATE WOODS PARKWAY, VERNON HILLS, ILLINOIS 60061, U.S.A.
TEL: +1-847-478-2500 / FAX: +1-847-478-2650
Minneapolis, MN Service Satellite
Detroit, MI Service Satellite
Grand Rapids, MI Service Satellite
Cleveland, OH Service Satellite
St. Louis, MO Service Satellite
Indianapolis, IN Service Satellite

South/East Region Service Center (Georgia)

1845 SATELLITE BOULEVARD STE. 450, DULUTH, GEORGIA 30097, U.S.A.
TEL: +1-678-258-4529 / FAX: +1-678-258-4519
Charleston, SC Service Satellite
Charlotte, NC Service Satellite
Raleigh, NC Service Satellite
Dallas, TX Service Satellite
Houston, TX Service Satellite
Hartford, CT Service Satellite
Knoxville, TN Service Satellite
Nashville, TN Service Satellite
Huntsville, AL Satellite
Pittsburg, PA Service Satellite
Tampa, FL Service Satellite
Miami, FL Satellite
Lafayette, LA Service Satellite
Allentown, PA Satellite

Western Region Service Center (California)

5900-B KATELLA AVE. - 5900-A KATELLA AVE. CYPRESS, CALIFORNIA 90630, U.S.A.
TEL: +1-714-699-2625 / FAX: +1-847-478-2650
San Francisco, CA Satellite
Seattle, WA Service Satellite
Denver, CO Service Satellite

Canada Region Service Center (Toronto)

4299 14TH AVENUE MARKHAM, ONTARIO L3R 0J2, CANADA
TEL: +1-905-475-7728 / FAX: +1-905-475-7935
Edmonton, AB Service Satellite
Montreal, QC Service Satellite

Mexico Region Service Center (Querétaro)

Parque Tecnológico Innovación Querétaro, Lateral Carretera Estatal 431, Km 2+200, Lote 91 Modulos 1 y 2
Hacienda la Machorra, CP 76246, El Marqués, Querétaro, México
TEL: +52-442-153-6050
Monterrey, NL Service Satellite
Mexico City, DF Service Satellite

BRAZIL

MITSUBISHI ELECTRIC DO BRASIL COMÉRCIO E SERVIÇOS LTDA.

Votorantim Office
AV. GISELE CONSTANTINO, 1578, PARQUE BELA VISTA, VOTORANTIM-SP, BRAZIL CEP:18.110-650
TEL: +55-15-3023-9000
Blumenau, Santa Catarina Office

EUROPE

MITSUBISHI ELECTRIC EUROPE B.V.

European Service Headquarters (Dusseldorf, GERMANY)
Mitsubishi-Electric-Platz 1 40882 RATINGEN, GERMANY
TEL: +49-2102-486-5000 / FAX: +49-2102-486-5910

South Germany Service Center (Stuttgart)

SCHELMENWASENSTRASSE 16-20, 70567 STUTTGART, GERMANY
TEL: +49-711-770598-123 / FAX: +49-711-770598-141

France Service Center (Paris)

2 RUE DE L'UNION, 92565 RUEIL-MALMAISON CEDEX, FRANCE
TEL: +33-1-41-02-83-13 / FAX: +33-1-49-01-07-25

France Service Satellite (Lyon)

240, ALLEE JACQUES MONOD 69800 SAINT PRIEST FRANCE
TEL: +33-1-41-02-83-13 / FAX: +33-1-49-01-07-25

Italy Service Center (Milan)

VIA ENERGY PARK 14, VIMERCATE 20871 (MB) ITALY
TEL: +39-039-6053-342 / FAX: +39-039-6053-206

Italy Service Satellite (Padova)

VIA G. SAVELLI, 24 - 35129 PADOVA, ITALY
TEL: +39-039-6053-342 / FAX: +39-039-6053-206

U.K. Service Center

TRAVELLERS LANE, HATFIELD, HERTFORDSHIRE, AL10 8XB, U.K.
TEL: +44-1707-288-780 / FAX: +44-1707-278-695

Spain Service Center

CTRA. RUBI, 76-80 8174 SAINT CUGAT DEL VALLES, BARCELONA, SPAIN
TEL: +34-935-65-2236 / FAX: +34-935-89-1579

Poland Service Center

UL.KRAKOWSKA 50, 32-083 BALICE, POLAND
TEL: +48-12-347-6500 / FAX: +48-12-630-4701

Hungary Service Center

MITSUBISHI ELECTRIC EUROPE B.V. HUNGARIAN BRANCH
BUDAÖRS OFFICE PARK, SZABADSÁG ÚT 117., 2040 BUDAÖRS, HUNGARY
TEL: +36-70-433-2263

Turkey Service Center

MITSUBISHI ELECTRIC TURKEY ELEKTRİK ÜRÜNLERİ A.Ş
SERIFALI MAHALLESİ KALE SOKAK. NO.41 34775
UMRANIYE, ISTANBUL, TURKEY
TEL: +90-216-969-2500 / FAX: +90-216-661-44-47

Czech Republic Service Center

MITSUBISHI ELECTRIC EUROPE B.V. PRAGUE OFFICE
Pekařská 621/7, 155 00 PRAHA 5, CZECH REPUBLIC
TEL: +420-734-402-587

Sweden Service Center

HAMMARBACKEN 14, P.O.BOX 750 SE-19127, SOLLENTUNA, SWEDEN
TEL: +46-8-6251200 / FAX: +46-8-6251014

Bulgaria Service Center

AKHNATON Ltd. (Service Partner)
4 ANDREJ LJAPCHEV BLVD. POB 21, BG-1756 SOFIA, BULGARIA
TEL: +359-2-8176009 / FAX: +359-2-9744061

Ukraine Service Center (Kiev)

CSC Automation Ltd. (Service Partner)
4 B. YEVHENA SVERSTYUKA STR., 02002 KIEV, UKRAINE
TEL: +380-44-494-3344 / FAX: +380-44-494-3366

South Africa Service Center

Adroit Technologies (Service Partner)
20 WATERFORD OFFICE PARK, WATERFORD DRIVE, CNR OF WITKOPPEN ROAD,
FOURWAYS JOHANNESBURG SOUTH AFRICA
TEL: +27-11-658-8100 / FAX: +27-11-658-8101

ASEAN**MITSUBISHI ELECTRIC ASIA PTE. LTD. (ASEAN FA CENTER)**

Singapore Service Center
307 ALEXANDRA ROAD MITSUBISHI ELECTRIC BUILDING SINGAPORE 159943
TEL: +65-6473-2308 / FAX: +65-6476-7439

PHILIPPINES**MELCO FACTORY AUTOMATION PHILIPPINES INC.**

Head Office
128 LOPEZ RIZAL STREET, BRGY., HIGHWAY HILLS, MANDALUYONG CITY, MM PHILIPPINES 1550
TEL: +63-2-8256-8042 / FAX: +63-2-8637-2294

Philippines Service Center

KM.23 WEST SERVICE ROAD SSH, CUPANG, MUNTINLUPA CITY, PHILIPPINES
TEL: +63-2-8807-0420 / FAX: +63-2-8842-5202

VIETNAM**MITSUBISHI ELECTRIC VIETNAM CO., LTD.**

Vietnam Ho Chi Minh Service Center
11TH & 12TH FLOOR, VIETTEL TOWER B, 285 CACH MANG THANG 8 STREET, WARD 12, DISTRICT 10, HO CHI MINH CITY, VIETNAM
TEL: +84-28-3910-5945 / FAX: +84-28-3910-5947

Vietnam Hanoi Service Center

14TH FLOOR, CAPITAL TOWER, 109 TRAN HUNG DAO STREET, CUA NAM WARD, HOAN KIEM DISTRICT, HA NOI CITY, VIETNAM
TEL: +84-24-3937-8075 / FAX: +84-24-3937-8076

INDONESIA**PT. MITSUBISHI ELECTRIC INDONESIA**

Indonesia Service Center (Cikarang)
JL. KENARI RAYA BLOK G2-07A, DELTA SILICON 5, LIPPO CIKARANG - BEKASI 17550, INDONESIA
TEL: +62-21-2961-7797 / FAX: +62-21-2961-7794

MALAYSIA**MITSUBISHI ELECTRIC SALES MALAYSIA SDN. BHD.**

Malaysia Service Center (Kuala Lumpur Service Center)
LOT 11, JALAN 219, P.O BOX 1036, 46880 PETALING JAYA, SELANGOR DARUL EHSAN, MALAYSIA
TEL: +60-3-7626-5032

Johor Bahru Service Center

9, Jalan Perjiranan 4/6, Bandar Dato Onn, 81100 Johor.
TEL: 07-3642250 / 2256

Pulau Pinang Service Center

25-G, Pusat Perniagaan Perdana Jaya, Jalan Permatang Rawa, 14000 Bukit Mertajam, Pulau Pinang
TEL: +60-4-510-1838 / Fax: +60-4-510-1835

THAILAND**MITSUBISHI ELECTRIC FACTORY AUTOMATION (THAILAND) CO., LTD.**

Thailand Service Center (Bangkok)
101, TRUE DIGITAL PARK OFFICE, 5TH FLOOR, SUKHUMVIT ROAD, BANGCHAK, PHRA KHANONG, BANGKOK, 10260 THAILAND
TEL: +66-2-092-8600 / FAX: +66-2-043-1231-33

INDIA**MITSUBISHI ELECTRIC INDIA PVT., LTD.**

Service Head office and South India Service Center (Bangalore)
CNC eXPerience Park, PLOT NO. 57/A, PEENYA PHASE 3, PEENYA INDUSTRIAL AREA, BANGALORE 560058, KARNATAKA, INDIA
TEL: +91-80-4655-2121
Chennai Service Satellite
Coimbatore Service Satellite
Hyderabad Service Satellite

North India Service Center (Gurgaon)

PLOT 517, GROUND FLOOR, UDYOG VIHAR PHASE-III, GURUGRAM 122008, HARYANA, INDIA
TEL: +91-124-463-0300
Ludhiana Service Satellite
Panthenagar Service Satellite
Delhi Service Satellite
Jamshedpur Service Satellite
Manesar Service Satellite

West India Service Center (Pune)

ICC-Devi GAURAV TECHNOLOGY PARK, UNIT NO.402, FOURTH FLOOR, NORTH WING, SURVEY NUMBER 191-192 (P), NEXT to INDIAN CARD CLOTHING COMPANY Ltd, OPP. VALLABH NAGAR, PIMPRI, PUNE- 411 018, MAHARASHTRA, INDIA
TEL: +91-20-6819-2274
Kolhapur Service Satellite
Aurangabad Service Satellite
Mumbai Service Satellite

West India Service Center (Ahmedabad)

204-209, 2ND FLOOR, 31FIVE, CORPORATE ROAD PRAHLADNAGAR, AHMEDABAD -380015, GUJARAT, INDIA
TEL: + 91-79-6777-7888
Rajkot Service Satellite

CHINA**MITSUBISHI ELECTRIC AUTOMATION (CHINA) LTD. (CHINA FA CENTER)**

CNC Call Center
TEL: +86-400-921-5130

Shanghai Service Center

NO.1386 HONG QIAO ROAD, CHANG NING QU, SHANGHAI 200336, CHINA
TEL: +86-21-2322-3030 / FAX: +86-21-2322-3000*8422

Qingdao Service Center**Suzhou Service Center****Wuhan Service Center****Ningbo Service Center****Hefei Service Center****Beijing Service Center****Tianjin Service Center****Xian Service Center****Dalian Service Center****Chengdu Service Center****Shenzhen Service Center**

LEVEL 8, GALAXY WORLD TOWER B, 1 YABAO ROAD, LONGGANG DISTRICT, SHENZHEN 518129, CHINA
TEL: +86-755-2399-8272 / FAX: +86-755-8229-3686

Dongguan Service Center**Xiamen Service Center****KOREA****MITSUBISHI ELECTRIC AUTOMATION KOREA CO., LTD. (KOREA FA CENTER)**

Korea Seoul Service Center
8F GANGSEO HANGANG XI-TOWER A, 401 YANGCHEON-RO, GANGSEO-GU, SEOUL 07528 KOREA
TEL: +82-2-3660-9631 / FAX: +82-2-3664-8668

Korea Daegu Service Center

2F KT BLDG. 8, HOGUK-RO, BUK-GU, DAEGU 41518, KOREA
TEL: +82-53-382-7401 / FAX: +82-53-382-7412

Korea Changwon Technical Center

#205, 888, CHANGWON-DAERO, SEONGSAN-GU, CHANGWON-SI, GYEONGSANGNAM-DO, 51532, KOREA
TEL: +82-55-261-5559 / FAX: +82-55-261-5558

TAIWAN**MITSUBISHI ELECTRIC TAIWAN CO., LTD. (TAIWAN FA CENTER)**

Taiwan Taichung Service Center
NO. 8-1, GONGYEQU 16TH RD., XITUN DIST., TAICHUNG CITY 40768, TAIWAN
TEL: +886-4-2359-0688 / FAX: +886-4-2359-0689

Taiwan Taipei Service Center

11F, NO.88, SEC.6, ZHONGSHAN N. RD., SHILIN DIST., TAIPEI CITY 11155, TAIWAN
TEL: +886-2-2833-5430 / FAX: +886-2-2833-5433

Taiwan Tainan Service Center

11F-1, NO.30, ZHONGZHENG S. RD., YONGKANG DIST., TAINAN CITY 71067, TAIWAN
TEL: +886-6-252-5030 / FAX: +886-6-252-5031

OCEANIA**MITSUBISHI ELECTRIC AUSTRALIA PTY. LTD.**

Oceania Service Center
348 VICTORIA ROAD, RYDALMERE, N.S.W. 2116 AUSTRALIA
TEL: +61-2-9684-7269 / FAX: +61-2-9684-7245

Notice

Every effort has been made to keep up with software and hardware revisions in the contents described in this manual. However, please understand that in some unavoidable cases simultaneous revision is not possible. Please contact your Mitsubishi Electric dealer with any questions or comments regarding the use of this product.

Duplication Prohibited

This manual may not be reproduced in any form, in part or in whole, without written permission from Mitsubishi Electric Corporation.

COPYRIGHT 2017-2024 MITSUBISHI ELECTRIC CORPORATION
ALL RIGHTS RESERVED

MITSUBISHI ELECTRIC CORPORATION

HEAD OFFICE : TOKYO BLDG.,2-7-3 MARUNOUCHI,CHIYODA-KU,TOKYO 100-8310,JAPAN

MODEL	M800/M80/E80/C80 Series
MODEL CODE	100-623
Manual No.	IB-1501505