

# MITSUBISHI

## GT16

### General Description

GT1695M-XTBA  
GT1695M-XTBD  
GT1685M-STBA  
GT1685M-STBD  
GT1675M-STBA  
GT1675M-STBD  
GT1675M-VTBA  
GT1675M-VTBD  
GT1675-VNBA  
GT1675-VNBD  
GT1672-VNBA  
GT1672-VNBD

GT1665M-STBA  
GT1665M-STBD  
GT1665M-VTBA  
GT1665M-VTBD  
GT1662-VNBA  
GT1662-VNBD  
GT1655-VTBD

Thank you for purchasing the GOT1000 Series.

Prior to use, please read both this manual and detailed manual thoroughly to fully understand the product.

MODEL	GT16-U(HW)
MODEL CODE	1D7M79
IB(NA)-0800434-N(1312)MEE	

GRAPHIC OPERATION TERMINAL

# GOT1000

## ● SAFETY PRECAUTIONS ●

(Always read these precautions before using this equipment.)

Before using this product, please read this manual and the relevant manuals introduced in this manual carefully and pay full attention to safety to handle the product correctly.

The precautions given in this manual are concerned with this product.

In this manual, the safety precautions are ranked as "WARNING" and "CAUTION".



### WARNING

Indicates that incorrect handling may cause hazardous conditions, resulting in death or severe injury.



### CAUTION

Indicates that incorrect handling may cause hazardous conditions, resulting in medium or slight personal injury or physical damage.

Note that the  caution level may lead to a serious accident according to the circumstances. Always follow the instructions of both levels because they are important to personal safety.

Please save this manual to make it accessible when required and always forward it to the end user.

## [DESIGN PRECAUTIONS]



### WARNING

- Some failures of the GOT, communication unit or cable may keep the outputs on or off. Some failures of a touch panel may cause malfunction of the input objects such as a touch switch. An external monitoring circuit should be provided to check for output signals which may lead to a serious accident. Not doing so can cause an accident due to false output or malfunction.
- If a communication fault (including cable disconnection) occurs during monitoring on the GOT, communication between the GOT and PLC CPU is suspended and the GOT becomes inoperative. For bus connection : The CPU becomes faulty and the GOT becomes inoperative. For other than bus connection : The GOT becomes inoperative. A system where the GOT is used should be configured to perform any significant operation to the system by using the switches of a device other than the GOT on the assumption that a GOT communication fault will occur. Not doing so can cause an accident due to false output or malfunction.
- Do not use the GOT as the warning device that may cause a serious accident. An independent and redundant hardware or mechanical interlock is required to configure the device that displays and outputs serious warning. Failure to observe this instruction may result in an accident due to incorrect output or malfunction.
- Incorrect operation of the touch switch(s) may lead to a serious accident if the GOT backlight is gone out. When the GOT backlight goes out, although the POWER LED blinks (green/orange) and the display section dims, the input of the touch switch(s) remains active. This may confuse an operator in thinking that the GOT is in "screensaver" mode, who then tries to release the GOT from this mode by touching the display section, which may cause a touch switch to operate. Note that the following occurs on the GOT when the backlight goes out.
  - GT1655-V: The POWER LED blinks (green/orange) and the monitor screen appears blank.
  - Models other than GT1655-V: The POWER LED blinks (green/orange) and the monitor screen appears dimmed.
- The display section of the GT16 is an analog-resistive type touch panel. If you touch the display section simultaneously in 2 points or more, the switch that is located around the center of the touched point, if any, may operate. Do not touch the display section in 2 points or more simultaneously. Doing so may cause an accident due to incorrect output or malfunction.
- When programs or parameters of the controller (such as a PLC) that is monitored by the GOT are changed, be sure to reset the GOT or shut off the power of the GOT at the same time. Not doing so can cause an accident due to false output or malfunction.

## [DESIGN PRECAUTIONS]

### CAUTION

- Do not bundle the control and communication cables with main-circuit, power or other wiring. Run the above cables separately from such wiring and keep them a minimum of 100mm apart. Not doing so noise can cause a malfunction.
- Do not press the GOT display section with a pointed material as a pen or driver. Doing so can result in a damage or failure of the display section.
- When the GOT is connected to the Ethernet network, the available IP address is restricted according to the system configuration.
  - When multiple GOTs are connected to the Ethernet network:  
Do not set the IP address (192.168.0.18) for the GOTs and the controllers in the network.
  - When a single GOT is connected to the Ethernet network:  
Do not set the IP address (192.168.0.18) for the controllers except the GOT in the network.  
Doing so can cause the IP address duplication. The duplication can negatively affect the communication of the device with the IP address (192.168.0.18).  
The operation at the IP address duplication depends on the devices and the system.
- Turn on the controllers and the network devices to be ready for communication before they communicate with the GOT.  
Failure to do so can cause a communication error on the GOT.

## [MOUNTING PRECAUTIONS]

### WARNING

- Be sure to shut off all phases of the external power supply used by the system before mounting or removing the GOT main unit to/from the panel.  
Not doing so can cause the unit to fail or malfunction.
- Be sure to shut off all phases of the external power supply used by the system before mounting or removing the communication unit, option function board onto/from the GOT.  
Not doing so can cause the unit to fail or malfunction.
- When installing the option function board, wear an earth band etc. to avoid the static electricity.  
Not doing so can cause a unit corruption.

### CAUTION

- Use the GOT in the environment that satisfies the general specifications described in this manual.  
Not doing so can cause an electric shock, fire, malfunction or product damage or deterioration.
- When mounting the GOT to the control panel, tighten the mounting screws in the specified torque range (0.36 to 0.48 N·m) with a Phillips-head screwdriver No.2.  
Undertightening can cause the GOT to drop, short circuit or malfunction.  
Overtightening can cause a drop, short circuit or malfunction due to the damage of the screws or the GOT.
- When loading the communication unit to the GOT, fit it to the connection interface of the GOT and tighten the mounting screws in the specified torque range (0.36 to 0.48 N·m) with a Phillips-head screwdriver No.2.  
Under tightening can cause the GOT to drop, short circuit or malfunction.  
Overtightening can cause a drop, failure or malfunction due to the damage of the screws or unit.
- When mounting the option function board onto the GOT, connect it to the corresponding connector securely and tighten the mounting screws within the specified torque range (0.25 to 0.35 N·m) with a Phillips-head screwdriver No.1.  
Undertightening can cause malfunction due to poor contact.  
Overtightening can cause malfunction due to screw or unit damage.
- When inserting a CF card into the GOT, push it into the insertion slot until the CF card eject button will pop out.  
If not properly inserted, a bad connection may cause a malfunction.
- When inserting/removing a CF card into/from the GOT, turn the CF card access switch off in advance.  
Failure to do so may corrupt data within the CF card.
- When removing a CF card from the GOT, make sure to support the CF card by hand, as it may pop out.  
Failure to do so may cause the CF card to drop from the GOT and break.

## [MOUNTING PRECAUTIONS]

### CAUTION

- When installing a USB memory to the GOT, make sure to install the USB memory to the USB interface firmly. Failure to do so may cause a malfunction due to poor contact.
- Before removing the USB memory from the GOT, operate the utility screen for removal. After the successful completion dialog box is displayed, remove the memory by hand carefully. Failure to do so may cause the USB memory to drop, resulting in a damage or failure of the memory.
- For closing the USB environmental protection cover, fix the cover by pushing the  $\Delta$  mark on the latch firmly to comply with the protective structure.
- Remove the protective film of the GOT.  
When the user continues using the GOT with the protective film, the film may not be removed.
- Operate and store the GOT in environments without direct sunlight, high temperature, dust, humidity, and vibrations.
- When using the GOT in the environment of oil or chemicals, use the protective cover for oil.  
Failure to do so may cause failure or malfunction due to the oil or chemical entering into the GOT.

## [WIRING PRECAUTIONS]

### WARNING

- Be sure to shut off all phases of the external power supply used by the system before wiring.  
Failure to do so may result in an electric shock, product damage or malfunctions.

### CAUTION

- Always ground the FG terminal, LG terminal, and Functional ground terminal of the GOT power to the protective ground conductors dedicated to the GOT.  
Not doing so may cause an electric shock or malfunction.
- When tightening the terminal screws, use a Phillips-head screwdriver No.2.
- Terminal screws which are not to be used must be tightened always at torque 0.5 to 0.8 N·m.  
Otherwise there will be a danger of short circuit against the solderless terminals.
- Use applicable solderless terminals and tighten them with the specified torque.  
If any solderless spade terminal is used, it may be disconnected when the terminal screw comes loose, resulting in failure.
- Correctly wire the GOT power supply section after confirming the rated voltage and terminal arrangement of the product.  
Not doing so can cause a fire or failure.
- Tighten the terminal screws of the GOT power supply section in the specified torque range (0.5 to 0.8 N·m).  
Undertightening can cause a short circuit or malfunction.  
Overtightening can cause a short circuit or malfunction due to the damage of the screws or the GOT.
- Exercise care to avoid foreign matter such as chips and wire offcuts entering the GOT. Not doing so can cause a fire, failure or malfunction.
- The module has an ingress prevention label on its top to prevent foreign matter, such as wire offcuts, from entering the module during wiring.  
Do not peel this label during wiring.  
Before starting system operation, be sure to peel this label because of heat dissipation.
- Plug the communication cable into the connector of the connected unit and tighten the mounting and terminal screws in the specified torque range.  
Undertightening can cause a short circuit or malfunction.  
Overtightening can cause a short circuit or malfunction due to the damage of the screws or unit.
- Plug the QnA/ACPU/Motion controller(A series) bus connection cable by inserting it into the connector of the connected unit until it "clicks".  
After plugging, check that it has been inserted snugly.  
Not doing so can cause a malfunction due to a contact fault.

## [TEST OPERATION PRECAUTIONS]

### **WARNING**

- Before performing the test operations of the user creation monitor screen (such as turning ON or OFF bit device, changing the word device current value, changing the settings or current values of the timer or counter, and changing the buffer memory current value), read through the manual carefully and make yourself familiar with the operation method.  
During test operation, never change the data of the devices which are used to perform significant operation for the system.  
False output or malfunction can cause an accident.

## [STARTUP/MAINTENANCE PRECAUTIONS]

### **WARNING**

- When power is on, do not touch the terminals.  
Doing so can cause an electric shock or malfunction.
- Correctly connect the battery connector.  
Do not perform the following actions to the battery.
  - Charging, disassembling, heating, short-circuiting, or soldering the battery, or throwing it into the fire  
Doing so will cause the battery to produce heat, explode, or ignite, resulting in injury and fire.
- Before starting cleaning or terminal screw retightening, always switch off the power externally in all phases.  
Not switching the power off in all phases can cause a unit failure or malfunction.  
Undertightening can cause a short circuit or malfunction.  
Overtightening can cause a short circuit or malfunction due to the damage of the screws or unit.

### **CAUTION**

- Do not disassemble or modify the unit.  
Doing so can cause a failure, malfunction, injury or fire.
- Do not touch the conductive and electronic parts of the unit directly.  
Doing so can cause a unit malfunction or failure.
- The cables connected to the unit must be run in ducts or clamped.  
Not doing so can cause the unit or cable to be damaged due to the dangling, motion or accidental pulling of the cables or can cause a malfunction due to a cable connection fault.
- When unplugging the cable connected to the unit, do not hold and pull the cable portion.  
Doing so can cause the unit or cable to be damaged or can cause a malfunction due to a cable connection fault.
- Do not drop the module or subject it to strong shock. A module damage may result.
- Do not drop or give an impact to the battery mounted to the unit.  
Doing so may damage the battery, causing the battery fluid to leak inside the battery.  
If the battery is dropped or given an impact, dispose of it without using.
- Before touching the unit, always touch grounded metals, etc. to discharge static electricity from human body, etc.  
Not doing so can cause the unit to fail or malfunction.
- Replace battery with GT15-BAT or GT11-50BAT by Mitsubishi electric Co. only.  
Use of another battery may present a risk of fire or explosion.
- Dispose of used battery promptly.  
Keep away from children. Do not disassemble and do not dispose of in fire.

## [TOUCH PANEL PRECAUTIONS]

### CAUTION

- For the analog-resistive film type touch panels, normally the adjustment is not required. However, the difference between a touched position and the object position may occur as the period of use elapses. When any difference between a touched position and the object position occurs, execute the touch panel calibration.
- When any difference between a touched position and the object position occurs, other object may be activated. This may cause an unexpected operation due to incorrect output or malfunction.

## [BACKLIGHT CHANGING PRECAUTIONS]

### WARNING

- Before changing the backlight, always switch off the GOT power externally in all phases (when the GOT is connected to the bus, the PLC CPU power must also be switched off externally in all phases) and remove the GOT from the control panel.  
Not switching the power off in all phases may cause an electric shock.  
Not removing the unit from the control panel can cause injury due to a drop.

### CAUTION

- When replacing the backlight, use the gloves.  
Otherwise, it may cause you to be injured.
- Start changing the backlight more than 5 minutes after switching the GOT power off.  
Not doing so can cause a burn due to the heat of the backlight.

## [DISPOSAL PRECAUTIONS]

### CAUTION

- When disposing of this product, treat it as industrial waste.  
When disposing of batteries, separate them from other wastes according to the local regulations.  
(Refer to GT16 User's Manual for details of the battery directive in the EU member states.)

## [TRANSPORTATION PRECAUTIONS]

### CAUTION

- When transporting lithium batteries, make sure to treat them based on the transport regulations.  
(Refer to GT16 User's Manual for details of the regulated models.)
- Make sure to transport the GOT main unit and/or relevant unit(s) in the manner they will not be exposed to the impact exceeding the impact resistance described in the general specifications of the GT16 User's Manual, as they are precision devices.  
Failure to do so may cause the unit to fail.  
Check if the unit operates correctly after transportation.

# REVISIONS

\* The manual number is noted at the lower right of the top cover.

Print Date	*Manual Number	Revision
Aug., 2008	IB(NA)-0800434-A	First edition
Jan., 2009	IB(NA)-0800434-C	Partial corrections SAFETY PRECAUTIONS, Section 2.1 Partial additions Packing List, Section 3.2
Jun., 2009	IB(NA)-0800434-D	Additions Chapter 4.
Oct., 2009	IB(NA)-0800434-E	Partial corrections SAFETY PRECAUTIONS, Manuals
Nov., 2009	IB(NA)-0800434-F	Partial additions SAFETY PRECAUTIONS Section 4.1.1, Section 4.3, Section 4.4
Apr., 2010	IB(NA)-0800434-G	Partial corrections Section 1, Section 2.1, Section 3.1 Partial additions SAFETY PRECAUTIONS, Section 1, Section 3.2.1, Section 3.2.2, Section 3.3, Section 4.3.1, Section 5.2, Section 5.3
Jan., 2011	IB(NA)-0800434-H	Partial corrections Section 1, Section 2.1, Section 4.4.2, Section 4.4.3, Section 5.3 Partial additions Packing List, Section 2.1, Section 3.2.2, Section 4.3.1, Section 4.4.1, Section 5.2 Additions Chapter 3.3
Apr., 2011	IB(NA)-0800434-I	Partial corrections Section 2.1 Partial additions SAFETY PRECAUTIONS, Compliance with the Radio Waves Act (South Korea), Section 4.3.3, Section 4.4.2, Section 5.3
Aug., 2011	IB(NA)-0800434-J	Partial corrections SAFETY PRECAUTIONS, Compliance with the Radio Waves Act (South Korea)
Jan., 2012	IB(NA)-0800434-K	Partial corrections SAFETY PRECAUTIONS, Section 3.1, 5.3
Sep., 2012	IB(NA)-0800434-L	Partial corrections SAFETY PRECAUTIONS
Apr., 2013	IB(NA)-0800434-M	Partial corrections SAFETY PRECAUTIONS
Dec., 2013	IB(NA)-0800434-N	Partial additions Descriptions in French are added for compliance with the cUL standards. Partial corrections Change of the protective ground to the functional ground, Change of the functional ground symbol

This manual confers no industrial property rights or any rights of any other kind, nor does it confer any patent licenses. Mitsubishi Electric Corporation cannot be held responsible for any problems involving industrial property rights which may occur as a result of using the contents noted in this manual.

---

---

## CONTENTS

---

---

1. FEATURES .....	1
2. PART NAMES .....	2
2.1 Part Names and Settings of the GT16 .....	2
3. SPECIFICATIONS .....	3
3.1 General Specifications .....	3
3.2 Power Supply Specifications .....	4
3.2.1 For GOTs powered from the 100 to 240VAC power supply .....	4
3.2.2 For GOTs powered from the 24VDC power supply .....	4
3.3 External Dimensions .....	5
4. EMC AND LOW VOLTAGE DIRECTIVE .....	6
4.1 Requirements to Meet EMC Directive .....	6
4.1.1 EMC directive .....	6
4.1.2 Control panel .....	7
4.1.3 Noise filter (power supply line filter) .....	8
4.2 Requirements for Compliance with the Low Voltage Directive .....	8
4.2.1 Standard subject to GOT .....	8
4.2.2 Power supply .....	8
4.2.3 Control panel .....	9
4.2.4 Grounding .....	9
4.2.5 External wiring .....	9
4.3 EMC Directive-Compliant System Configuration .....	9
4.3.1 GOT .....	10
4.3.2 When the option unit is used .....	10
4.3.3 Cables .....	11
4.4 Precautions for Wiring/Connecting the EMC Directive-Compliant Product .....	11
4.4.1 Power and ground wires wiring method .....	11
4.4.2 Processing connection cables .....	12
4.4.3 Grounding the cable .....	16
5. INSTALLATION.....	17
5.1 Control Panel Inside Dimensions for Mounting GOT .....	17
5.2 Panel Cutting Dimensions .....	17
5.3 Mounting Position .....	17
5. <i>INSTALLATION.....</i>	19
5.1 <i>Dimensions intérieures du tableau de commande pour le montage du GOT .....</i>	19
5.2 <i>Cotes de découpe du panneau .....</i>	19
5.3 <i>Position de montage .....</i>	19



## Manuals

The following shows manuals relevant to this product.

Detailed Manual

Manual name	Manual Number (Model code)
GT16 User's Manual (Hardware) (Sold separately)	SH-080928ENG (1D7MD3)
GT16 User's Manual (Basic Utility) (Sold separately)	SH-080929ENG (1D7MD4)

Relevant Manual

For relevant manuals, refer to the PDF manuals stored in the CD-ROM for the drawing software used.

- \* Before using the GOT, connect the connector of the GOT to the battery connector.
- \* For details on GT16 specifications, installing procedure, EMC Directive, wiring, maintenance and inspection, or checking method for the version and the compatible standard, refer to GT16 User's Manual.

## Packing List

The GOT product package includes the following:

Model name	Product	Quantity
GT1695M-X	GOT	1
	Battery (GT15-BAT)	1
	Installation fitting	8
	GT16 General Discription	1
GT1685M-S GT1675M-S GT1675M-V GT1675-VN GT1672-VN GT1665M-S GT1665M-V GT1662-VN	GOT	1
	Battery (GT15-BAT)	1
	Installation fitting	4
	GT16 General Discription	1
GT1655-V	GOT	1
	Battery (GT11-50BAT)	1
	Installation fitting	4
	GT16 General Discription	1

## Compliance with the Radio Waves Act (South Korea)

The GOT with the rating plate labeled with the KC mark complies with the Radio Waves Act (South Korea). Note the following when using the product in South Korea.

이 기기는 업무용 (A 급) 전자파적합기기로서 판매자 또는 사용자는 이 점을 주의하시기 바라며, 가정외의 지역에서 사용하는 것을 목적으로 합니다.  
(The product is for business use (Class A) and meets the electromagnetic compatibility requirements. The seller and the user must note the above point, and use the product in a place except for home.)

---

---

## 1. FEATURES

---

---

- (1) Improved monitoring performance and connectivity to FA devices
  - GT1695M-X, GT1685M-S, GT1675M-S, GT1675M-V, GT1665M-S, GT1665M-V, GT1655-V: The TFT color liquid crystal display (high intensity, wide angle view, and high definition type) provides clear full-color display and displays small characters clearly. (Displays digital images of BMP and other formats in 65536 colors.)  
GT1675-VN, GT1672-VN, GT1662-VN: The TFT color liquid crystal display provides 4096 or 16 colors to offer a wide range of models that meet user requirements.
  - Provides multi-language display function based on Unicode2.1 True Type font and high-speed drawing of beautiful text.
  - High speed monitoring through high speed communication at maximum of 115.2kbps.
  - High speed display and high speed touch switch response.
  - The operation performance is improved by the analog touch panel.
  - GT1695M-X, GT1685M-S, GT1675M-S, GT1675M-V, GT1665M-S, GT1665M-V: Applicable to a video/RGB unit and a multimedia unit
- (2) More efficient GOT operations including screen design, startup, adjustment, management and maintenance works
  - GT1695M-X, GT1685M-S, GT1675M-S, GT1675M-V, GT1665M-S, GT1665M-V, GT1655-V: 15MB user memory is included as standard.  
GT1675-VN, GT1672-VN, GT1662-VN: 11MB user memory is included as standard.
  - Interfaces are included as standard. (Ethernet, RS-232, RS-422/485, CF card, and USB)
  - Font installation is available to increase the system fonts.
  - Combined use of 4 types of alarms (system alarm, user alarm, alarm history, alarm popup display) realizes more efficient alarm notification.
  - Maintenance timing report function is available that measures the backlight energization time and notifies of maintenance time.
  - The USB interface is positioned on the GOT front. This enables the system startup to be performed more efficiently using FA device startup tool, and eliminates the necessity of indirect works (opening and closing the control panel, cable replacement, cable rewiring) in order to improve the working efficiency.
  - The blown backlight bulb can be confirmed even during screen saving, with the blinked POWER LED at backlight shutoff detection.
- (3) Enhanced support of FA device setup tools
  - Transferring and monitoring sequence programs with the personal computer connected to the GOT can be executed when connecting to a PLC CPU with the direct CPU connection or bus connection. (FA transparent function)

## 2. PART NAMES

### 2.1 Part Names and Settings of the GT16

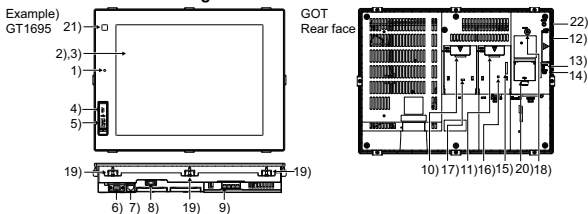

No.	Name	Description
1)	POWER LED	Lit in green : Power is correctly supplied , Lit in orange : Screen saving Blinks in orange/green : Blown back light bulb , Not lit : Power is not supplied
2)	Display screen	Displays the Utility and the user creation screen.
3)	Touch key	For operating touch switches in the Utility and the user creation screen
4)	USB interface (Device)	For connecting a personal computer (Connector type: Mini-B)
5)	USB interface (Host)	For USB mouse/keyboard ,data transfer and storage (Connector type: TYPE-A)
6)	RS-232 interface	For communicating with a controller or connecting a personal computer (Connector type: D sub 9-pin)
7)	Ethernet interface	For communicating with a controller or using the gateway function (Connector type: RJ-45 (modular jack))
8)	RS-422/485 interface	For communicating with a controller (Connector type: 14-pin (female))
9)	Power terminal <sup>8</sup>	Power input terminal, LG terminal <sup>7</sup> , FG terminal
10)	Extension interface1	For installing an extension unit (I/F-1)
11)	Extension interface2 <sup>3</sup>	For installing an extension unit (I/F-2)
12)	CF card interface	For installing a CF card
13)	CF card access LED	Lit : CF card accessed , Not lit : CF card not accessed
14)	CF card access switch	Used for accepting or stopping the access to the CF card before removing the CF card from the GOT ON :CF card being accessed (CF card removal prohibited) OFF :CF card not accessed (CF card removal possible)
15)	Video/RGB interface <sup>*1</sup>	For mounting the video input unit, RGB input unit, video/RGB input unit, RGB output unit, or multimedia unit
16)	Terminating resistor setting switch	For switching on and off of the terminating resistor for the RS-422/485 communication port
17)	Optional function board interface <sup>*4</sup>	For installing the optional function board
18)	Reset switch	Hardware reset switch (Inoperative in the bus connection or with the bus connection unit installed)
19)	Hole for unit installation fitting	Hole for inserting the unit installation fitting
20)	Battery cover <sup>*2*5</sup>	Houses the battery
21)	Human sensor <sup>*6</sup>	Sensor that detects human movement
22)	Installation switch	Used for OS installations at the GOT startup

\*1 No video/RGB interface on the GT1675-VN, GT1672-VN, GT1662-VN, and GT1655-V.

\*2 Battery holder for the GT1665 and GT1662.

\*3 No extension interface 2 on the GT1655.

\*4 Located on the extension interface 2 on the GT1655.

\*5 Integral with the CF card interface cover for the GT1655.

\*6 No human sensor on the GT1675, GT1672, GT1665, GT1662, and GT1655.

\*7 No LG terminal on the GT1655.

\*8 On the rear face of the GT1655, the functional ground terminal is located on the left side of the FG terminal.

## 3. SPECIFICATIONS

### 3.1 General Specifications

Item		Specifications				
Operating ambient temperature*1 <i>Température ambiante de fonctionnement*1</i>	Display section <i>Zone d'affichage</i>	0 to 50°C 0 à 50°C				
	Other than the display section <i>Autre que la zone d'affichage</i>	0 to 55°C 0 à 55°C				
Storage ambient temperature		-20 to 60°C				
Operating ambient humidity		10 to 90% RH, non-condensing				
Storage ambient humidity		10 to 90% RH, non-condensing				
Vibration resistance	Compliant with JIS B3502 and IEC61131-2	Under intermittent vibration	Frequency	Acceleration	Half-amplitude	Sweep count
			5 to 8.4Hz	-	3.5mm	
		Under continuous vibration	8.4 to 150Hz	9.8m/s <sup>2</sup>	-	10 times each in X, Y and Z directions
			5 to 8.4Hz	-	1.75mm	-
8.4 to 150Hz	4.9m/s <sup>2</sup>	-				
Shock resistance		Compliant with JIS B3502 and IEC61131-2 (147 m/s <sup>2</sup> , 3 times each in X, Y and Z directions)				
Operating atmosphere		No greasy fumes, corrosive gas, flammable gas, excessive conductive dust, and direct sunlight(Same as storage atmosphere)				
Operating altitude*2		2000 m (6562 ft) max.				
Installation location		Inside control panel				
Overvoltage category*3		II or less				
Pollution degree*4		2 or less				
Cooling method		Self-cooling				
Grounding		Grounding with a resistance of 100Ω or less				

\*1 When mounting a multimedia unit (GT16M-MMR), MELSECNET/H communication unit (GT15-J71LP23-25, GT15-J71BR13), or CC-Link communication unit (GT15-J61BT13), the operating ambient temperature must be reduced 5 °C against the maximum values described in general specifications.

*Lors du montage d'un module multimédia (GT16M-MMR), du module de communication MELSECNET/H (GT15-J71LP23-25, GT15-J71BR13) ou du module de communication CC-Link (GT15-J61BT13), la température ambiante de fonctionnement doit être réduite de 5°C par rapport aux valeurs maximales décrites dans les spécifications générales.*

\*2 Do not use or store the GOT under pressure higher than the atmospheric pressure of altitude 0m (0ft.). Failure to observe this instruction may cause a malfunction.

When an air purge is made inside the control panel by adding pressure, there may be a clearance between the surface sheet and the screen making it difficult to use the touch panel, or the sheet may come off.

\*3 This indicates the section of the power supply to which the equipment is assumed to be connected between the public electrical power distribution network and the machinery within the premises.

Category II applies to equipment for which electrical power is supplied from fixed facilities. The surge voltage withstand level for up to the rated voltage of 300 V is 2500 V.

\*4 This index indicates the degree to which conductive material is generated in the environment where the equipment is used.

In pollution degree 2, only non-conductive pollution occurs but temporary conductivity may be produced due to condensation.

Point	
Refer to GT16 User's Manual for details of the performance specifications of each GOT.	

### 3.2 Power Supply Specifications

The following describes the power supply specifications for the GT16.

- 3.2.1 For GOTs powered from the 100 to 240VAC power supply
- 3.2.2 For GOTs powered from the 24VDC power supply

Remark

#### Operation at momentary failure

- If an instantaneous power failure occurs in the power supply and continues for more than the permissible period, the GOT will be reset.
- Make sure to power on the unit more than 5 seconds after power-off.

#### 3.2.1 For GOTs powered from the 100 to 240VAC power supply

Item	Specifications		
	GT1695M-XTBA	GT1685M-STBA	GT1675M-STBA GT1675M-VTBA GT1675-VNBA GT1672-VNBA GT1665M-STBA GT1665M-VTBA GT1662-VNBA
Input power supply voltage	100 to 240VAC (+10% -15%)		
Input frequency	50/60Hz±5%		
Input max. apparent power	150VA (maximum load)	110VA (maximum load)	100VA (maximum load)
Power consumption	64W or less	46W or less	39W or less
At backlight off	38W or less	32W or less	30W or less
Inrush current	28A or less (4ms) (maximum load)		
Allowable momentary power failure time	20ms or less (100VAC or more)		
Noise immunity	1,500Vp-p noise voltage, 1 μs noise width (when measuring with a noise simulator under 25 to 60Hz noise frequency)		
Dielectric withstand voltage	1500VAC for 1 minute across power terminals and earth		
Insulation resistance	10MΩ or more across power terminals and earth by a 500V DC insulation resistance tester		
Applicable wire size	0.75 to 2 [mm <sup>2</sup> ]		
Applicable solderless terminal	Solderless terminal for M3 screw RAV1.25-3, V2-S3.3, V2-N3A, FV2-N3A		
Applicable tightening torque (Terminal block terminal screw)	0.5 to 0.8 [N·m]		

#### 3.2.2 For GOTs powered from the 24VDC power supply

Item	Specifications			
	GT1695M-XTBD	GT1685M-STBD	GT1675M-STBD GT1675M-VTBD GT1675-VNBD GT1672-VNBD GT1665M-STBD GT1665M-VTBD GT1662-VNBD	GT1655-VTBD
Input power supply voltage	DC24V (+25%, -20%)			
Power consumption	60W or less	40W or less	38W or less	16W or less
At backlight off	30W or less	26W or less	27W or less	14W or less
Inrush current	12A or less (75ms) (maximum load)	12A or less (55ms) (maximum load)		67A or less (1ms) (maximum load)
Allowable momentary power failure time	10 ms or less			
Noise immunity	500Vp-p noise voltage, 1 μs noise width (when measuring with a noise simulator under 25 to 60Hz noise frequency)			
Dielectric withstand voltage	500VDC for 1 minute across power terminals and earth			
Insulation resistance	10MΩ or more across power terminals and earth by a 500V DC insulation resistance tester			
Applicable wire size	0.75 to 2 [mm <sup>2</sup> ]			
Applicable solderless terminal	Solderless terminal for M3 screw RAV1.25-3, V2-S3.3, V2-N3A, FV2-N3A			
Applicable tightening torque (Terminal block terminal screw)	0.5 to 0.8 [N·m]			

### 3.3 External Dimensions

The following shows the external dimensions of each model.

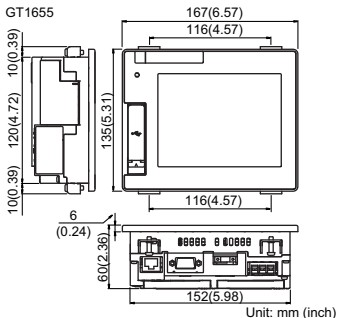
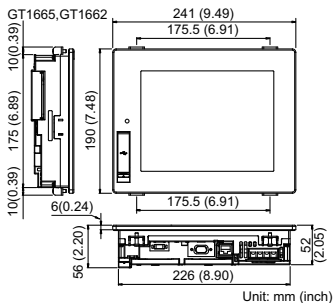
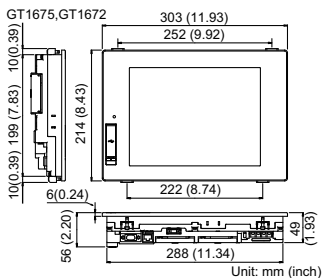
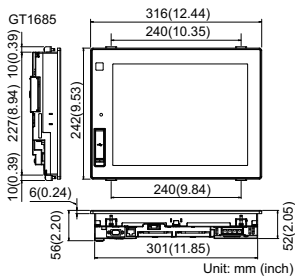
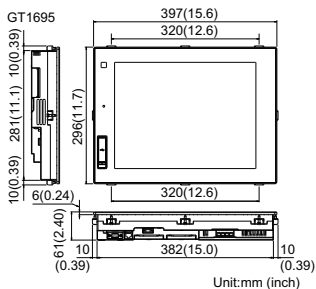

## 4. EMC AND LOW VOLTAGE DIRECTIVE

For the products sold in European countries, the conformance to the EMC Directive, which is one of the European Directives, has been a legal obligation since 1996. Also, conformance to the Low Voltage

Directive, another European Directives, has been a legal obligation since 1997.

Manufacturers who recognize their products must conform to the EMC and Low Voltage Directive are required to declare that their products conform to these Directives and put a "CE mark" on their products.

- Authorized representative in Europe  
Authorized representative in Europe is shown below.  
Name :Mitsubishi Electric Europe BV  
Address :Gothaer strasse 8, 40880 Ratingen, Germany

### 4.1 Requirements to Meet EMC Directive

EMC Directives are those which require "any strong electromagnetic force is not output to the external.:Emission (electromagnetic interference)" and "It is not influenced by the electromagnetic wave from the external.: Immunity (electromagnetic sensitivity)".

Items 4.1.1 thru 4.1.3 summarize the precautions to use GOT and configure the mechanical unit in order to match the EMC directives.

Though the data described herein are produced with our best on the basis of the requirement items and standards of the restrictions gathered by Mitsubishi, they do not completely guaranteed that all mechanical unit manufactured according to the data do not always match the above directives. The manufacturer itself which manufactures the mechanical unit must finally judge the method and others to match the EMC directives.

#### 4.1.1 EMC directive

The standards of the EMC Directive are shown below.

Applied standard	Test standard	Test details	Standard value
EN61131-2 : 2007	EN55011 Radiated noise <sup>*1</sup>	Electromagnetic emissions from the product are measured.	30M-230MHz QP: 30dB $\mu$ V/m (30m in measurement range) <sup>2, *3</sup> 230M-1000MHz QP: 37dB $\mu$ V/m(30m in measurement range) <sup>2, *3</sup>
	EN55011 Conducted noise <sup>*1</sup>	Electromagnetic emissions from the product to the power line is measured.	150k-500kHz QP:79dB, Mean: 66dB <sup>2</sup> 500k-30MHz QP:73dB, Mean: 60dB <sup>2</sup>
	EN61000-4-2 Electrostatic immunity <sup>*1</sup>	Immunity test in which static electricity is applied to the cabinet of the equipment.	$\pm$ 4kV Contact discharge $\pm$ 8kV Aerial discharge
	EN61000-4-3 Radiated field AM modulation <sup>*1</sup>	Immunity test in which field is irradiated to the product.	80-1000MHz:10V/m 1.4-2GHz:3V/m 2.0-2.7GHz:1V/m 80%AM modulation@1kHz
	EN61000-4-4 Fast transient burst noise <sup>*1</sup>	Immunity test in which burst noise is applied to the power line and signal lines.	Power line:2kV Digital I/O(24V or higher): 1kV (Digital I/O(24V or less))> 250V (Analog I/O, signal lines)> 250V
	EN61000-4-5 Surge immunity <sup>*1</sup>	Immunity test in which lightning surge is applied to the product.	AC power type Power line (between line and ground) : $\pm$ 2kV Power line (between lines) : $\pm$ 1kV Data communication port : $\pm$ 1kV DC power type Power line (between line and ground) : $\pm$ 0.5kV Power line (between lines) : $\pm$ 0.5kV Data communication port : $\pm$ 1kV
	EN61000-4-6 Conducted RF immunity <sup>*1</sup>	Immunity test in which a noise induced on the power and signal lines is applied.	Power line: 10V Data communication port: 10V

(continue to next page)

Applied standard	Test standard	Test details	Standard value
EN61131-2 : 2007	EN61000-4-8 Power supply frequency magnetic field immunity	Test for checking normal operations under the circumstance exposed to the ferromagnetic field noise of the power supply frequency (50/60Hz).	30 A/m
	EN61000-4-11 EN61000-4-29 Instantaneous power failure and voltage dips immunity	Test for checking normal operations at instantaneous power failure.	AC power type 0.5 cycle 0% (interval 1 to 10s) 250/300 cycle 0% 10/12 cycle 40% 25/30 cycle 70% DC power type 10ms (interval 1 to 10s)

- \*1 The GOT is an open type device (device installed to another device) and must be installed in a conductive control panel.  
The above test items are conducted in the condition where the GOT is installed on the conductive control panel and combined with the Mitsubishi PLC.
- \*2 QP: Quasi-peak value, Mean : Average value
- \*3 The above test items are conducted in the following conditions.  
30M-230MHz QP : 40dB $\mu$ V/m (10m in measurement range)  
230M-1000MHz QP : 47dB $\mu$ V/m (10m in measurement range)

#### 4.1.2 Control panel

The GOT is an open type device (device installed to another device) and must be installed in a conductive control panel.

It not only assure the safety but also has a large effect to shut down the noise generated from GOT, on the control panel.

- (1) Control panel
- The control panel must be conductive.
  - When fixing a top or bottom plate of the control panel with bolts, do not coat the plate and bolt surfaces so that they will come into contact.  
And connect the door and box using a thick grounding cable in order to ensure the low impedance under high frequency.
  - When using an inner plate to ensure electric conductivity with the control panel, do not coat the fixing bolt area of the inner plate and control panel to ensure conductivity in the largest area as possible.
  - Ground the control panel using a thick grounding cable in order to ensure the low impedance under high frequency.
  - The diameter of cable holes in the control panel must be 10cm (3.94in.). In order to reduce the chance of radio waves leaking out, ensure that the space between the control panel and its door is small as possible.  
Paste the following EMI gasket directly on the painted surface to seal the space so that the leak of electric wave can be suppressed.

Manufacturer	Series model name
KITAGAWA INDUSTRIES CO., LTD.	UC series (Recommended Product)

Our test has been carried out on a panel having the damping characteristics of 37dB max. and 30dB mean (measured by 3m method with 30 to 300MHz).

- (2) Connection of power and ground wires  
Ground and power supply wires for the GOT must be connected as described below.
- Provide a grounding point near the GOT. Short-circuit the LG and FG terminals of the GOT (LG: line ground, FG: frame ground) and ground them with the thickest and shortest wire possible (The wire length must be 30cm (11.81in.) or shorter.)  
The LG and FG terminals function is to pass the noise generated in the PC system to the ground, so an impedance that is as low as possible must be ensured. As the wires are used to relieve the noise, the wire itself carries a large noise content and thus short wiring means that the wire is prevented from acting as an antenna.  
Note) A long conductor will become a more efficient antenna at high frequency.



- (b) The earth wire led from the earthing point must be twisted with the power supply wires.  
By twisting with the earthing wire, noise flowing from the power supply wires can be relieved to the earthing. However, if a filter is installed on the power supply wires, the wires and the earthing wire may not need to be twisted.

#### 4.1.3 Noise filter (power supply line filter)

The noise filter (power supply line filter) is a device effective to reduce conducted noise. Except some models, installation of a noise filter onto the power supply lines is not necessary. However conducted noise can be reduced if it is installed. (The noise filter is generally effective for reducing conducted noise in the band of 10MHz or less.) Usage of the following filters is recommended.

Model name	FN343-3/01	FN660-6/06	ZHC2203-11
Manufacturer	SCHAFFNER	SCHAFFNER	TDK
Rated current	3A	6A	3A
Rated voltage	250V		

The precautions required when installing a noise filter are described below.

- (1) Do not install the input and output cables of the noise filter together to prevent the output side noise will be inducted into the input side cable where noise has been eliminated by the noise filter

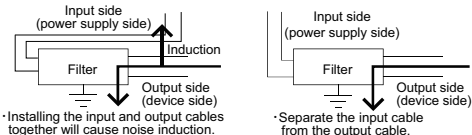

- (2) Connect the noise filter's ground terminal to the control panel with the shortest cable as possible (approx. 10cm (3.94 in.) or less).

## 4.2 Requirements for Compliance with the Low Voltage Directive

The Low Voltage Directive requires each device which operates with power supply ranging from 50VAC to 1000V and 75VDC to 1500V to satisfy necessary safety items.

In the Sections from 4.2.1 to 4.2.5, cautions on installation and wiring of the GOT to conform to the Low Voltage Directive requires are described.

We have put the maximum effort to develop this material based on the requirements and standards of the Directive that we have collected.

However, compatibility of the devices which are fabricated according to the contents of this manual to the above Directive is not guaranteed. Each manufacturer who fabricates such device should make the final judgement about the application method of the Low Voltage Directive and the product compatibility.

### 4.2.1 Standard subject to GOT

Standard applied to GOT : EEN61131-2 Programmable controllers - Equipment requirements and tests  
EN60950-1 Safety of Information Technology Equipment

### 4.2.2 Power supply

The insulation specification of the GOT was designed assuming installation category II. Be sure to use the installation category II power supply to the GOT.

The installation category indicates the durability level against surge voltage generated by lightning strike. Category I has the lowest durability; category IV has the highest durability.

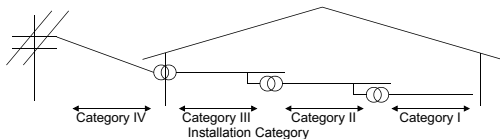

Category II indicates a power supply whose voltage has been reduced by two or more levels of isolating transformers from the public power distribution.

#### 4.2.3 Control panel

Because the GOT is open type equipment (device designed to be stored within another device), be sure to use it only when installed in a control panel.

(1) Shock protection

In order to prevent those who are unfamiliar with power facility, e.g., an operator, from getting a shock, make sure to take the following measures on the control panel.

- (a) Store the GOT within the control panel locked, and allow only those who are familiar with power facility to unlock the panel.
- (b) Build the structure in order that the power supply will be shut off when the control panel is opened.

(2) Dustproof and waterproof features

The control panel also provides protection from dust, water and other substances. Insufficient ingress protection may lower the insulation withstand voltage, resulting in insulation destruction. The insulation in the GOT is designed to cope with the pollution level 2, so use in an environment with pollution level 2 or better.

Pollution level1 : An environment where the air is dry and conductive dust does not exist.

Pollution level2 : An environment where conductive dust does not usually exist, but occasional temporary conductivity occurs due to the accumulated dust.  
Generally, this is the level for inside the control panel equivalent a control room or on the floor of a typical factory.

Pollution level3 : An environment where conductive dust exists and conductivity may be generated due to the accumulated dust.  
An environment for a typical factory floor.

Pollution level4 : Continuous conductivity may occur due to rain, snow, etc. An outdoor environment.

#### 4.2.4 Grounding

The following are applicable ground terminals. Use them in the grounded state.

Be sure to ground the GOT for ensuring the safety and complying with the EMC Directive.

Functional grounding  : Improves the noise resistance.

#### 4.2.5 External wiring

(1) External devices

When a device with a hazardous voltage circuit is externally connected to the GOT, select a model which complies with the Low Voltage Directive's requirements for isolation between the primary and secondary circuits.

(2) Insulation requirements

Dielectric withstand voltages are shown in the following table.

Reinforced Insulation Withstand Voltage  
(Installation Category II, source : IEC664)

Rated voltage of hazardous voltage area	Surge withstand voltage (1.2/50 $\mu$ s)
150 VAC or below	2500V
300 VAC or below	4000V

### 4.3 EMC Directive-Compliant System Configuration

You can also check the EMC Directive compliance status of the GOT1000 series at the Mitsubishi Electric Factory Automation Global Website.

For the latest information, go to the Mitsubishi Electric Factory Automation Global Website.

<http://www.mitsubishielectric.co.jp/fa/>

### 4.3.1 GOT

Use any of the following GOTs with which CE mark logo is printed on the rating plate.

Item	Model	Hardware version of the GOT(Production year and month)
GT1695	GT1695M-XTBA	Version J or later (Feb., 2009)
		Version R or later (Oct., 2009) <sup>*1</sup>
	GT1695M-XTBD	Version H or later (Feb., 2009)
		Version Q or later (Oct., 2009) <sup>*1</sup>
GT1685	GT1685M-STBA	Version G or later (Feb., 2009)
	GT1685M-STBD	Version F or later (Feb., 2009)
GT1675	GT1675M-STBA	Version F or later (Oct., 2009)
	GT1675M-STBD	Version E or later (Oct., 2009)
	GT1675M-VTBA	Version F or later (Oct., 2009)
	GT1675M-VTBD	Version E or later (Oct., 2009)
	GT1675-VNBA	Version A or later (Apr., 2010)
	GT1675-VNBD	Version A or later (Apr., 2010)
GT1672	GT1672-VNBA	Version A or later (Apr., 2010)
	GT1672-VNBD	Version A or later (Apr., 2010)
GT1665	GT1665M-STBA	Version G or later (Oct., 2009)
	GT1665M-STBD	Version E or later (Oct., 2009)
	GT1665M-VTBA	Version J or later (Oct., 2009)
	GT1665M-VTBD	Version H or later (Oct., 2009)
GT1662	GT1662-VNBA	Version A or later (Apr., 2010)
	GT1662-VNBD	Version A or later (Apr., 2010)
GT1655	GT1655-VTBD	Version A or later (Jan., 2011)

\*1: To comply with the EMC Directive, use the hardware version of a GOT shown above or later when the GT16M-V4, GT16M-R2, GT16M-V4R1, GT16M-ROUT, or GT16M-MMR is mounted on the GOT.

When the hardware version of a GOT is earlier than the version shown above, the GOT does not comply with the EMC Directive.

### 4.3.2 When the option unit is used

To meet the EMC Directive, use the following option units. When an option unit other than below is used, it does not meet the EMC Directive.

Product name	Model name	Hardware version of option unit (Production year and month)
Video input unit	GT16M-V4	Version B or later (Jan., 2009)
		Version E or later (Oct., 2009) <sup>*2</sup>
RGB input unit	GT16M-R2	Version B or later (Jan., 2009)
		Version E or later (Oct., 2009) <sup>*2</sup>
Video/RGB input unit	GT16M-V4R1	Version B or later (Jan., 2009)
		Version E or later (Oct., 2009) <sup>*2</sup>
RGB output unit	GT16M-ROUT	Version B or later (Jan., 2009)
Multimedia unit	GT16M-MMR	Version B or later (Jan., 2009)
		Version G or later (Oct., 2009) <sup>*2</sup>
Printer unit <sup>*1</sup>	GT15-PRN	Version B or later (Feb.,2006)
CF card unit	GT15-CFCD	Version C or later (Jul.,2007)
CF card extension unit	GT15-CFEX-C08SET	Version B or later (Jul.,2007)
External I/O unit	GT15-DIO	Version B or later (May,2007)
	GT15-DIOR	Version A or later (Jul.,2008)
Sound output unit	GT15-SOUT	Version B or later (May,2007)

- \*1: For the printer to be connected, configure the system in accordance with the EMC Directive specifications for the printer as requested by the printer manufacturer.
- \*2: To comply with the EMC Directive, use the hardware version of an option unit shown above or later when the option unit is mounted on the GT1695, GT1675 or GT1665.  
When the hardware version of an option unit is earlier than the version shown above, the GOT does not comply with the EMC Directive.

### 4.3.3 Cables

(1) Cables used

- (a) For the MELSECNET/H connection (coaxial cable) and video connection, use double shield coaxial cables.

The 5C-2V connector plug is applicable to double-shielded coaxial cable.

Connect the 5C-2V connector plug to the coaxial cable inside a double-shielded coaxial cable.

Ground the shielded part outside a double-shielded coaxial cable as shown in the following figure.

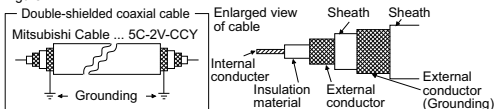

- (b) For the CC-Link IE Field Network connection, use the following cable dedicated to the CC-Link IE Field Network.

Manufacturer	Model name
Mitsubishi Electric System & Service Co., Ltd.	SC-E5EW-S□□M

- (c) For details of the cables used for connections other than the above, refer to the GOT1000 Series Connection Manual.

(2) Adjusting a cable for the EMC Directive compliance

Modify the cables (including user-produced cable) to ensure compliance with the EMC Directive.

For details, refer to Section 4.4.2.

## 4.4 Precautions for Wiring/Connecting the EMC Directive-Compliant Product

Wire and connect GOT1000 series equipments as instructed below. If the GOT1000 series equipments are configured in a way different from the following instructions, the system may not comply with EMC directives.

### 4.4.1 Power and ground wires wiring method

(1) Power and ground wires wiring method

Connect the power wire and connection cable as shown in the illustration, and be sure to attach a ferrite core (TDK Corporation type ZCAT3035-1330) within the range shown below.

Lead the power wire and ground wire as shown in Section 4.1.2 (2).

Be sure to ground the LG cable, FG cable, and functional ground cable.

- (a) 100-240VAC GOT power section

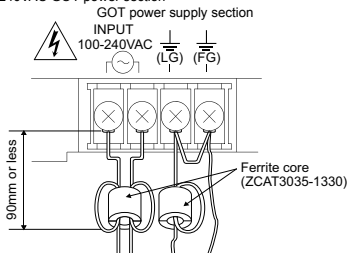

(b) 24VDC GOT power section  
GOT power supply section

For other than GT1655

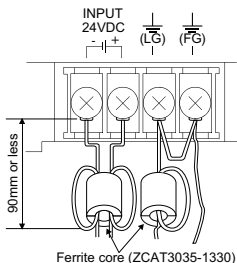

For GT1655

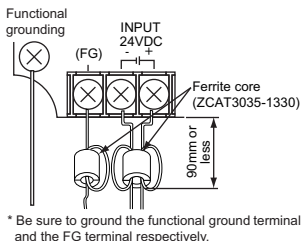

- When CC-Link IE Controller Network communication unit is mounted on GT1655

#### 4.4.2 Processing connection cables

Process the cable used with the GOT with the following method.

When processing the cable, ferrite core, cable clamp and shielding material are required.

The cable clamp used by Mitsubishi Electric for the EMC specification compatibility test is shown below.

- TDK corporation brand ZCAT3035-1330 Ferrite Core
- Mitsubishi Electric Model AD75CK cable clamp
- Japan Zipper Tubing Co., Ltd. Zipper tube SHNJ type

(1) BUS connection cable

(a) For GT15-QC□B, GT15-QC□BS

- Peel the sheath (with the length shown below) at both ends of the cable, and expose the shield braided wire for grounding. (For grounding with cable clamps. (refer to Section 4.4.3.))

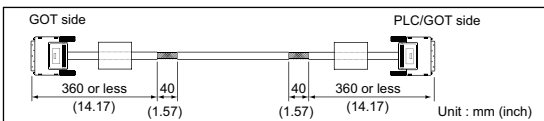

(b) For GT15-C□BS

- Cut the connection wire protruding from both ends of the cable to the lengths shown below.
- Attach the ferrite core to the cable in the position as illustrated below and insert the ground wire into the ferrite core.
- Peel the sheath (with the length shown below) at both ends of the cable, and expose the shield braided wire for grounding. (For grounding with cable clamps. (refer to Section 4.4.3.))

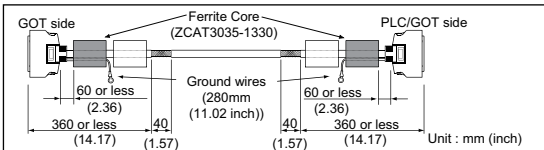

(c) For other bus connection cables

- Wind cable shield material around the cable, and pull out the grounding braided wire of the cable shield material with the length shown below.
- Attach the ferrite core to the cable in the position as illustrated below and insert the braided wire for grounding into the ferrite core.

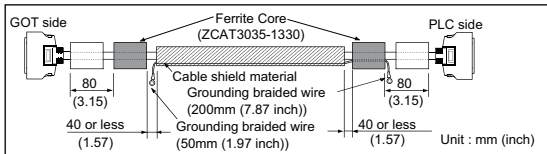

(2) CPU direct connection and computer link connection

- Attach the ferrite core to the cable in the position as illustrated below.

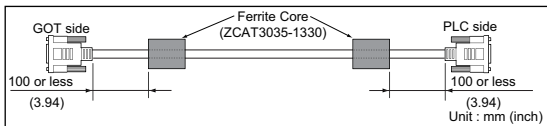

(3) For MELSECNET/H connection (PLC to PLC network)

(a) For coaxial cable

- Strip the outer insulation layer at both ends of the cable by the length shown below to expose the outer braided shield for grounding. (For grounding with cable clamps (refer to Section 4.4.3.))
- Attach ferrite cores to the cable in the positions as illustrated below.

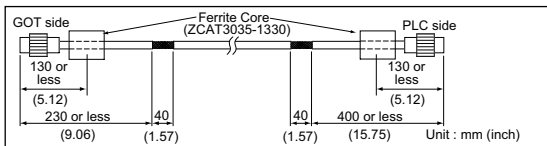

(b) For optical fiber cable

- Processing of the cable is not required.

(4) CC-Link connection (Intelligent device station)

- Strip the outer insulation layer at both ends of the cable by the length shown below to expose the braided shield for grounding. (For grounding with cable clamps (refer to Section 4.4.3.))
- Attach ferrite cores to the cable in the positions as illustrated below.

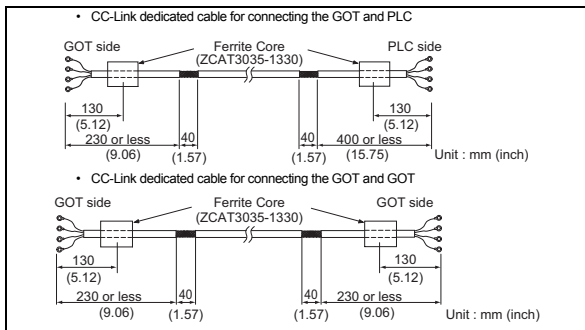

(5) CC-Link IE Field Network connection

- Strip the outer insulation layer at both ends of the cable by the length shown below to expose the braided shield for grounding. (For grounding with cable clamps (refer to Section 4.4.3.))
- Attach ferrite cores to the cable in the positions as illustrated below.

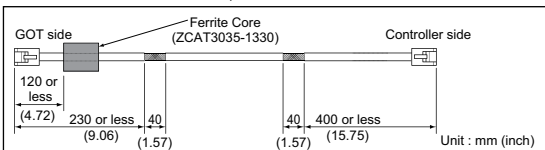

(6) Ethernet connection

- Strip the outer insulation layer at both ends of the cable by the length shown below to expose the braided shield for grounding - (For grounding with cable clamps. (refer to Section 4.4.3.))
- Attach the ferrite core to the cable in the position as illustrated below.

(a) Ethernet interface of GOT

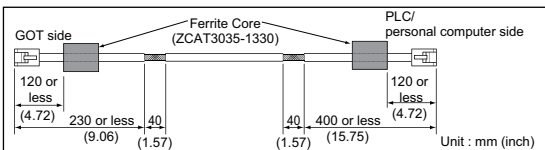

(b) Multi media unit (GT16M-MMR)

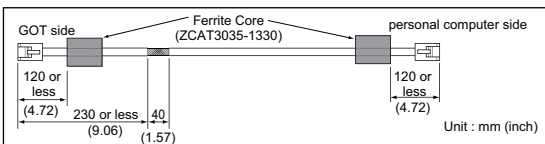

(7) External I/O device connection

- Strip the outer insulation layer at both ends of the cable by the length shown below to expose the braided shield for grounding. (For grounding with cable clamps (Refer to Section 4.4.2.))
- Connect the braided shield to the connector with the connector cover.
- Twist power cables. Attach the ferrite core to the cable in the position as illustrated below.

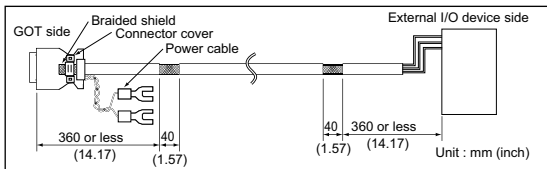

(8) Video/RGB connection

(a) Video input

- Peel the sheath (with the length shown below) at both ends of the cable, and expose the shield braided wire for grounding. (For grounding with cable clamps. (refer to Section 4.4.2.))
- Attach the ferrite core to the cable in the position as illustrated below.

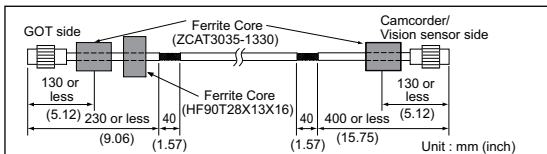

(b) RGB input

- Wind cable shield material around the cable, and pull out the grounding braided wire of the cable shield material with the length shown below.
- Attach the ferrite core to the cable in the position as illustrated below.

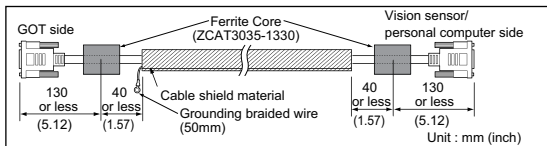

(c) RGB output

- Wind cable shield material around the cable, and pull out the grounding braided wire of the cable shield material with the length shown below.
- Attach the ferrite core to the cable in the position as illustrated below.

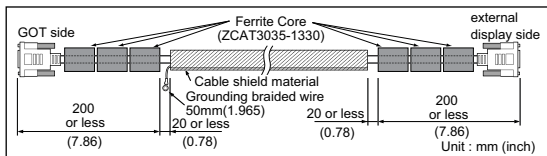



- (9) PLC (manufactured by other company), microcomputer, temperature controller, inverter, servo amplifier, CNC, MODBUS(R)/RTU or MODBUS(R)/TCP connection  
Produce the cable (RS-232 cable, RS-422 / 485 cable) for connecting the GOT to a controller with reference to the GOT1000 Series Connection Manual.

POINT
<p>Configure the system to meet the EMC Directive specifications for the connected device when connecting the GOT to a controller.</p> <p>The following gives the instructions to ensure the machinery comply with the EMC Directive. However, the manufacturer of the machinery must finally determine how to make it comply with the EMC Directives: if it is actually compliant with the EMC Directives.</p>

(a) For RS-422 / 485 cable

- Each signal wire (excluding SG and FG) should be made into a two power wires and connected, then twisted.

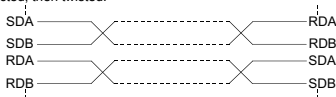

- Make the SG wire more than two wires and connect.

(b) For RS-232 cable

- Use a twisted pair style for each signal wire (except SG, FG) with SG.

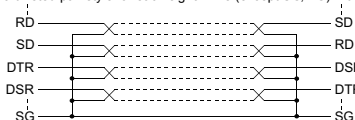

- Attach the ferrite core to the cable in the position as illustrated below.

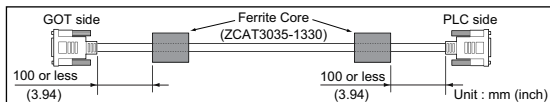

#### 4.4.3 Grounding the cable

Ground the cable and grounding wire to the control panel where the GOT and base unit are installed.

- Ground the braided shield portion of the cable to the control panel with the cable clamp (AD75CK).

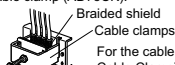
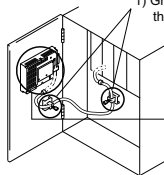

For the cable clamp attaching details refer to AD75CK-type Cable Clamping Instruction Manual <IB-68682>.

- For GT15-C□EXSS-1 and GT15-C□BS Ground the ground wire to the FG terminal of the GOT power supply section.

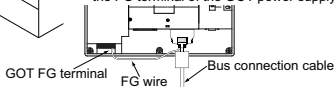

- For other bus connection cables

Ground the braided wire for grounding to the control panel by tightening a screw.

- Do not arrange the cable clamp adjacent to other cables which do not clamp. Noise from the control panel may access the GOT from the cable clamp and cause adverse effects.

## 5. INSTALLATION

### 5.1 Control Panel Inside Dimensions for Mounting GOT

Install the GOT on the control panel out of the way for the equipment inside the control panel. Do not install the GOT and the unit in prohibited areas for the installation.

Point

#### Applicable cable

Some cables may need to be longer than the specified dimensions when connecting to the GOT. Therefore, consider the connector dimensions and bending radius of the cable as well for installation.

### 5.2 Panel Cutting Dimensions

Make an installation hole on the control panel with the dimensions shown below. Make space of 10mm above and below the hole respectively for the installation fittings.

\* Panel thickness: 2 to 4 mm or less

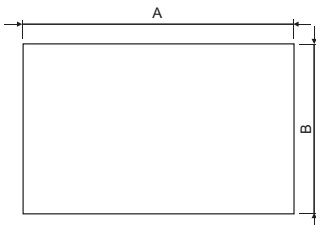

GOT	A [mm] (inch)	B [mm] (inch)
GT1695M-X	383.5(15.10) (+2(0.08), 0(0))	282.5(11.12) (+2(0.08), 0(0))
GT1685M-S	302(11.89) (+2(0.08), 0(0))	228(8.98) (+2(0.08), 0(0))
GT1675M-S GT1675M-V GT1675-VN GT1672-VN	289(11.38) (+2(0.08), 0(0))	200(7.87) (+2(0.08), 0(0))
GT1665M-S GT1665M-V GT1662-VN	227(8.94) (+2(0.08), 0(0))	176(6.93) (+2(0.08), 0(0))
GT1655-V	153(6.02) (+2(0.08), 0(0))	121(4.76) (+2(0.08), 0(0))

### 5.3 Mounting Position

When mounting the GOT, the following clearances must be left from the other device. Depending on the units and cables connected to the GOT, clearances more than the described dimensions can be required.

Therefore, consider the connector dimensions and bending radius of the cable as well for installation.

For the lead-in allowance for cables at the bottom of the GOT, refer to the following.

 GT16 User's Manual (Hardware)

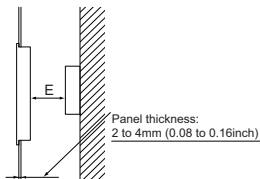
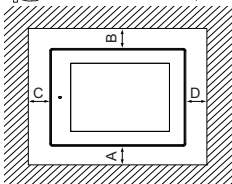

According to the dimensions in the following table, leave clearances between the GOT and the other devices. The values enclosed in square brackets apply to the case where no other equipment generating radiated noise (such as a contactor) or heat is installed near the GOT. However, keep the ambient temperature of the GOT to 55°C or lower.

Item	GT1695M-X	GT1685M-S	GT1675M-S GT1675M-V GT1675-VN GT1672-VN	GT1665M-S GT1665M-V GT1662-VN	GT1655-V
GOT only					61(2.40) or more
Bus connection unit is fitted	50(1.97) or more [20(0.79) or more]		50(1.97) or more [26(1.02) or more]	50(1.97) or more [36(1.42) or more]	50(1.97) or more
Serial communication unit fitted					49(1.93) or more
RS-422 Conversion unit is fitted	50(1.97) or more	51(2.01) or more	63(2.48) or more	73(2.87) or more	-
CC-Link communication unit (GT15-J61BT13) fitted	50(1.97) or more [20(0.79) or more]				50(1.97) or more [24(0.94) or more]
MELSECNET/H communication unit (coaxial) fitted	50(1.97) or more [20(0.79) or more]	50(1.97) or more [24(0.94) or more]	50(1.97) or more [33(1.30) or more]	50(1.97) or more	64(2.52) or more
MELSECNET/H communication unit (optical) fitted	50(1.97) or more [20(0.79) or more] <sup>1</sup>				79(3.11) or more
CC-Link IE Controller Network communication unit fitted	50(1.97) or more [20(0.79) or more]				57(2.24) or more
CC-Link IE Field Network communication unit fitted					
Video input unit fitted <sup>4</sup>	50(1.97) or more [20(0.79) or more] <sup>2</sup>				-
RGB input unit fitted <sup>4</sup>	50(1.97) or more [20(0.79) or more] <sup>3</sup>				-
Video/RGB input unit fitted <sup>4</sup>	50(1.97) or more [20(0.79) or more] <sup>2,3</sup>				-
RGB output unit fitted <sup>4</sup>	50(1.97) or more [20(0.79) or more] <sup>3</sup>				-
Multimedia unit fitted <sup>4</sup>	50(1.97) or more [20(0.79) or more] <sup>2</sup>				-
Printer unit fitted	50(1.97) or more [20(0.79) or more]		50(1.97) or more [26(1.02) or more]	50(1.97) or more [36(1.42) or more]	50(1.97) or more [29(1.14) or more]
CF card unit					50(1.97) or more [20(0.79) or more]
CF card extension unit					50(1.97) or more
External I/O unit					
Sound output unit					
B	80 (3.15) or more [20 (0.79) or more]				
C	(When the CF card is not used)	50(1.97) or more [20(0.79) or more]			50(1.97) or more [20(0.79) or more] <sup>5</sup>
	(When the CF card is used)	100(3.94) or more			
D	50(1.97) or more [20(0.79) or more]				
E	100(3.94) or more [20 (0.79) or more]				

Unit: mm (inch)

\*1 This value differs depending on the cable used.

Please contact your local Mitsubishi Electric System & Service Co., Ltd.  
The value indicated in the table is a reference value.

\*2 This value is for use of the coaxial cable 3C-2V (JIS C 3501).  
For specifications of the cable, refer to the following manual.

 GOT1000 Series Connection Manual for GT Works3 and a controller used  
GOT1000 Series Connection Manual for GT Designer2/GT Works2

\*3 This value differs depending on the cable used.

If the bending radius of the cable used is greater than the value specified above, apply the value of the cable used.

\*4 The unit cannot be used for the GT1675-V, GT1672-V, GT1662-V, and GT1655-V.

\*5 Dimension when no battery is used.

If a battery is used, the dimension when a CF card is used is required.

## 5. INSTALLATION

### 5.1 Dimensions intérieures du tableau de commande pour le montage du GOT

Installez le GOT sur le tableau de commande en laissant de l'espace pour le dispositif à l'intérieur du tableau de commande. N'installez pas le GOT et le module dans des zones où l'installation est interdite.

Point
<b>Câble applicable</b> Certains câbles peuvent être plus longs que les dimensions spécifiées lors de la connexion au GOT. Par conséquent, prenez également en compte les dimensions du connecteur et le rayon de courbure du câble pour l'installation.

### 5.2 Cotes de découpe du panneau

Faites un trou d'installation sur le tableau de commande avec les dimensions indiquées ci-dessous. Laissez un espace de 10mm au-dessus et sous le trou respectivement pour les attaches de montage.

\* Épaisseur du panneau : 2 à 4mm ou moins



GOT	A [mm] (pouce)	B [mm] (pouce)
GT1695M-X	383,5(15,10) (+2(0,08), 0(0))	282,5(11,12) (+2(0,08), 0(0))
GT1685M-S	302(11,89) (+2(0,08), 0(0))	228(8,98) (+2(0,08), 0(0))
GT1675M-S GT1675M-V GT1675-VN GT1672-VN	289(11,38) (+2(0,08), 0(0))	200(7,87) (+2(0,08), 0(0))
GT1665M-S GT1665M-V GT1662-VN	227(8,94) (+2(0,08), 0(0))	176(6,93) (+2(0,08), 0(0))
GT1655-V	153(6,02) (+2(0,08), 0(0))	121(4,76) (+2(0,08), 0(0))

### 5.3 Position de montage

Lors du montage du GOT, laissez les espaces suivants pour les autres dispositifs.

En fonction des modules et des câbles connectés au GOT, il peut être nécessaire de laisser des espaces plus importants que les dimensions indiquées.

Par conséquent, prenez également en compte les dimensions du connecteur et le rayon de courbure du câble pour l'installation.

Pour connaître l'espace à laisser pour les câbles sous le GOT, référez-vous à ce qui suit.

 GT16 User's Manual (Hardware)

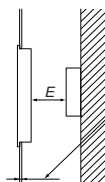
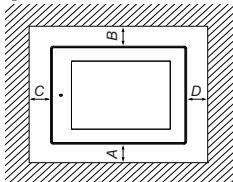

Épaisseur du panneau :  
2 à 4mm (0,08 à 0,16 pouce)

Laissez les espaces entre le GOT et les autres dispositifs en fonction des dimensions contenues dans le tableau suivant. Les valeurs entre parenthèses s'appliquent au cas où aucun dispositif générant des émissions sonores (comme un contacteur) ou de la chaleur n'est installé près du GOT. Toutefois, maintenez la température ambiante du GOT à 55°C ou moins.

Article	GT1695M-X	GT1685M-S	GT1675M-S GT1675M-V GT1675-VN GT1672-VN	GT1665M-S GT1665M-V GT1662-VN	GT1655-V
GOT uniquement					61 (2,40) ou plus
Unité de connexion de bus encastrée	50 (1,97) ou plus [20 (0,79) ou plus]		50 (1,97) ou plus [26 (1,02) ou plus]	50 (1,97) ou plus [36 (1,42) ou plus]	50 (1,97) ou plus
Module de communication série encastré					49 (1,93) ou plus
Unité de conversion RS-422 encastrée	50 (1,97) ou plus	51 (2,01) ou plus	63 (2,48) ou plus	73 (2,87) ou plus	-
Module de communication CC-Link (GT15-J61BT13) encastré	50 (1,97) ou plus [20 (0,79) ou plus]				50 (1,97) ou plus [24 (0,94) ou plus]
Module de communication MELSECNET/H (coaxial) encastré	50 (1,97) ou plus [20 (0,79) ou plus]	50 (1,97) ou plus [24 (0,94) ou plus]	50 (1,97) ou plus [33 (1,30) ou plus]	50 (1,97) ou plus	64 (2,52) ou plus
Module de communication MELSECNET/H (optique) encastré	50 (1,97) ou plus [20 (0,79) ou plus] <sup>*1</sup>				79 (3,11) ou plus
Module de communication réseau de contrôleur CC-Link IE encastré	50 (1,97) ou plus [20 (0,79) ou plus]				57 (2,24) ou plus
Module de communication réseau de champ CC-Link IE encastré	50 (1,97) ou plus [20 (0,79) ou plus] <sup>*2</sup>				-
Module d'entrée vidéo encastré <sup>*4</sup>	50 (1,97) ou plus [20 (0,79) ou plus] <sup>*3</sup>				-
Module d'entrée RGB encastré <sup>*4</sup>	50 (1,97) ou plus [20 (0,79) ou plus] <sup>*2-3</sup>				-
Module de sortie RGB encastré <sup>*4</sup>	50 (1,97) ou plus [20 (0,79) ou plus] <sup>*3</sup>				-
Module multimédia encastré <sup>*4</sup>	50 (1,97) ou plus [20 (0,79) ou plus] <sup>*2</sup>				-
Imprimante encastrée	50 (1,97) ou plus [20 (0,79) ou plus]		50 (1,97) ou plus [26 (1,02) ou plus]	50 (1,97) ou plus [36 (1,42) ou plus]	50 (1,97) ou plus [29 (1,14) ou plus]
Module de carte CF	50 (1,97) ou plus [20 (0,79) ou plus]		50 (1,97) ou plus [26 (1,02) ou plus]	50 (1,97) ou plus [36 (1,42) ou plus]	50 (1,97) ou plus [20 (0,79) ou plus]
Module d'extension de carte CF	50 (1,97) ou plus [20 (0,79) ou plus]		50 (1,97) ou plus [26 (1,02) ou plus]	50 (1,97) ou plus [36 (1,42) ou plus]	50 (1,97) ou plus
Module d'E/S externe	50 (1,97) ou plus [20 (0,79) ou plus]		50 (1,97) ou plus [26 (1,02) ou plus]	50 (1,97) ou plus [36 (1,42) ou plus]	50 (1,97) ou plus
Module de sortie acoustique	50 (1,97) ou plus [20 (0,79) ou plus]		50 (1,97) ou plus [26 (1,02) ou plus]	50 (1,97) ou plus [36 (1,42) ou plus]	50 (1,97) ou plus
B	80 (3,15) ou plus [20 (0,79) ou plus]				
C	(Quand la carte CF n'est pas utilisée)				50 (1,97) ou plus [20 (0,79) ou plus] <sup>5</sup>
	(Quand la carte CF est utilisée)				100 (3,94) ou plus
D	50 (1,97) ou plus [20 (0,79) ou plus]				
E	100 (3,94) ou plus [20 (0,79) ou plus]				

Unité : mm (pouce)

\*1 Cette valeur diffère selon le câble utilisé.

Contactez le bureau local Mitsubishi Electric System & Service Co., Ltd.  
La valeur indiquée dans le tableau est une référence.

\*2 Cette valeur est utilisée pour le câble coaxial 3C-2V (JIS C 3501).  
Pour connaître les spécifications du câble, référez-vous au manuel suivant.

 GOT1000 Series Connection Manual for GT Works3 and a controller used  
GOT1000 Series Connection Manual for GT Designer2/GT Works2

\*3 Cette valeur diffère selon le câble utilisé.

Si le rayon de courbure du câble utilisé est supérieur à la valeur spécifiée ci-dessus, appliquez la valeur du câble utilisé.

\*4 Le module ne peut pas être utilisé pour les modèles GT1675-V, GT1672-V, GT1662-V et GT1655-V.

\*5 Dimension quand aucune batterie n'est utilisée.

Si une batterie est utilisée, il est nécessaire d'utiliser la dimension quand une carte CF est utilisée.

## Warranty

Mitsubishi will not be held liable for damage caused by factors found not to be the cause of Mitsubishi; machine damage or lost profits caused by faults in the Mitsubishi products; damage, secondary damage, accident compensation caused by special factors unpredictable by Mitsubishi; damages to products other than Mitsubishi products; and to other duties.

### For safe use

- This product has been manufactured as a general-purpose part for general industries, and has not been designed or manufactured to be incorporated in a device or system used in purposes related to human life.
- Before using the product for special purposes such as nuclear power, electric power, aerospace, medicine or passenger movement vehicles, consult with Mitsubishi.
- This product has been manufactured under strict quality control. However, when installing the product where major accidents or losses could occur if the product fails, install appropriate backup or failsafe functions in the system.

Country/Region	Sales office/Tel	Country/Region	Sales office/Tel
U.S.A	Mitsubishi Electric Automation Inc. 500 Corporate Woods Parkway Vernon Hills, IL 60061, U.S.A. Tel : +1-847-478-2100	Hong Kong	Mitsubishi Electric Automation (Hong Kong) Ltd. 10th Floor, Manulife Tower, 169 Electric Road, North Point, Hong Kong Tel : +852-2887-8870
Brazil	MELCO-TEC Rep. Com.e Assessoria Tecnica Ltda. Rua Correia Dias, 184, Edificio Paraiso Trade Center-8 andar Paraiso, Sao Paulo, SP Brazil Tel : +55-11-5908-8331	China	Mitsubishi Electric Automation (China) Ltd. 4/F Zhi Fu Plaza, No.80 Xin Chang Road, Shanghai 200003, China Tel : +86-21-6120-0808
Germany	Mitsubishi Electric Europe B.V. German Branch Gothaer Strasse 8 D-40880 Ratingen, GERMANY Tel : +49-2102-486-0	Taiwan	Setsuyo Enterprise Co., Ltd. 6F No.105 Wu-Kung 3rd.Rd, Wu-Ku Hsiang, Taipei Hsine, Taiwan Tel : +886-2-2299-2499
U.K	Mitsubishi Electric Europe B.V. UK Branch Travellers Lane, Hatfield, Hertfordshire., AL10 8XB, U.K. Tel : +44-1707-276100	Korea	Mitsubishi Electric Automation Korea Co., Ltd. 1480-6, Gayang-dong, Gangseo-ku Seoul 157-200, Korea Tel : +82-2-3660-9552
Italy	Mitsubishi Electric Europe B.V. Italian Branch Centro Dir. Colleoni, Pal. Perseo-Ingr.2 Via Paracelso 12, I-20041 Agrate Brianza., Milano, Italy Tel : +39-039-60531	Singapore	Mitsubishi Electric Asia Pte, Ltd. 307 Alexandra Road #05-01/02, Mitsubishi Electric Building, Singapore 159943 Tel : +65-6470-2460
Spain	Mitsubishi Electric Europe B.V. Spanish Branch Carretera de Rubi 76-80, E-08190 Sant Cugat del Valles, Barcelona, Spain Tel : +34-93-565-3131	Thailand	Mitsubishi Electric Automation (Thailand) Co., Ltd. Bang-Chan Industrial Estate No.11 Moo 4, Serithai Rd, T.Kannayao, A.Kannayao, Bangkok 10230 Thailand Tel : +66-2-517-1326
France	Mitsubishi Electric Europe B.V. French Branch 25, Boulevard des Bouvets, F-92741 Nanterre Cedex, France Tel : +33-1-5568-5568	Indonesia	P.T. Autoteknindo Sumber Makmur Muara Karang Selatan, Block A/Utara No.1 Kav. No.11 Kawasan Industri Pergudangan Jakarta - Utara 14440, P.O.Box 5045 Jakarta, 11050 Indonesia Tel : +62-21-6630833
South Africa	Circuit Breaker Industries Ltd. Private Bag 2016, ZA-1600 Isando, South Africa Tel : +27-11-928-2000	India	Messung Systems Pvt. Ltd. Electronic Sadan NO:III Unit No15, M.I.D.C Bhosari, Pune-411026, India Tel : +91-20-2712-3130
		Australia	Mitsubishi Electric Australia Pty. Ltd. 348 Victoria Road, Rydalmere, N.S.W 2116, Australia Tel : +61-2-9684-7777

## MITSUBISHI ELECTRIC CORPORATION

HEAD OFFICE : TOKYO BUILDING, 2-7-3 MARUNOUCHI, CHYODA-KU, TOKYO 100-8310, JAPAN  
NAGOYA WORKS : 1-14, YADA-MINAMI 5-CHOME, HIGASHI-KU, NAGOYA, JAPAN

When exported from Japan, this manual does not require application to the Ministry of Economy, Trade and Industry for service transaction permission.

Specifications subject to change without notice.  
Printed in Japan, December 2013.