



GRAPHIC OPERATION TERMINAL

GOT1000

GT11 User's Manual



● SAFETY PRECAUTIONS ●

(Always read these precautions before using this equipment.)

Before using this product, please read this manual and the relevant manuals introduced in this manual carefully and pay full attention to safety to handle the product correctly.

The precautions given in this manual are concerned with this product.

In this manual, the safety precautions are ranked as "WARNING" and "CAUTION".



WARNING

Indicates that incorrect handling may cause hazardous conditions, resulting in death or severe injury.



CAUTION

Indicates that incorrect handling may cause hazardous conditions, resulting in medium or slight personal injury or physical damage.

Note that the  caution level may lead to a serious accident according to the circumstances. Always follow the instructions of both levels because they are important to personal safety.

Please save this manual to make it accessible when required and always forward it to the end user.

[DESIGN PRECAUTIONS]



WARNING

- Some failures of the GOT or cable may keep the outputs on or off.
Some failures of a touch panel may cause malfunction of the input objects such as a touch switch.
An external monitoring circuit should be provided to check for output signals which may lead to a serious accident.
Not doing so can cause an accident due to false output or malfunction.
- If a communication error (including cable disconnection) occurs while monitoring on the GOT, communication between the GOT and PLC CPU is suspended, and the GOT becomes inoperative as described below:
 - (1) GT1155-QSBD, GT1150-QLBD: Become inoperative
 - (2) PLC CPU shuts down and the GOT becomes inoperative.For the system configuration with GOT, assuming communication error occurs in the GOT, the switches for critical operation to the system should be set in the device other than GOT. False output or malfunction may occur.
- Do not use the GOT as the warning device that may cause a serious accident.
An independent and redundant hardware or mechanical interlock is required to configure the device that displays and outputs serious warning.
Failure to observe this instruction may result in an accident due to incorrect output or malfunction.

[DESIGN PRECAUTIONS]

WARNING

- Incorrect operation of the touch switch(s) may lead to a serious accident if the GOT backlight is gone out.

When the GOT backlight goes out, the POWER LED flickers (green/orange) and the display section turns black and causes the monitor screen to appear blank, while the input of the touch switch(s) remains active.

This may confuse an operator in thinking that the GOT is in "screensaver" mode, who then tries to release the GOT from this mode by touching the display section, which may cause a touch switch to operate.

Note that the following occurs on the GOT when the backlight goes out.

- The POWER LED flickers (green/orange) and the monitor screen appears blank

CAUTION

- Do not bundle the control and communication cables with main-circuit, power or other wiring. Run the above cables separately from such wiring and keep them a minimum of 100mm (3.94in.) apart. Not doing so noise can cause a malfunction.
- Do not press the GOT display section with a pointed material as a pen or driver. Doing so can result in a damage or failure of the display section.

[MOUNTING PRECAUTIONS]

WARNING

- Be sure to shut off all phases of the external power supply used by the system before mounting or removing the GOT to/from the panel. Not doing so can cause the unit to fail or malfunction.
- Be sure to shut off all phases of the external power supply used by the system before mounting or removing the option function board on to/from the GOT. Not doing so can cause the unit to fail or malfunction.
- When installing the option function board or battery, or operating the reset switch, wear an earth band etc. to avoid the static electricity. The static electricity can cause the unit to fail or malfunction.

[MOUNTING PRECAUTIONS]

CAUTION

- Use the GOT in the environment that satisfies the general specifications described in this manual. Not doing so can cause an electric shock, fire, malfunction or product damage or deterioration.
- When mounting the GOT to the control panel, tighten the mounting screws in the specified torque range.
Undertightening can cause the GOT to drop, short circuit or malfunction.
Overtightening can cause a drop, short circuit or malfunction due to the damage of the screws or the GOT.
- Securely connect the option function board to the connector provided for the board.
- When inserting/removing a CF card into/from the GOT, turn the CF card access switch off in advance.
Failure to do so may corrupt data within the CF card.
- When inserting a CF card into the GOT, push it into the insertion slot until the CF card eject button will pop out.
Failure to do so may cause a malfunction due to poor contact.
- When removing a CF card from the GOT, make sure to support the CF card by hand, as it may pop out.
Failure to do so may cause the CF card to drop from the GOT and break.
- When using the GOT in the environment of oil or chemicals, use the protective cover for oil.
Failure to do so may cause failure or malfunction due to the oil or chemical entering into the GOT.

[WIRING PRECAUTIONS]

WARNING

- Be sure to shut off all phases of the external power supply used by the system before wiring.
Failure to do so may result in an electric shock, product damage or malfunctions.
- Please make sure to ground FG terminal of the GOT power supply section by applying 100Ω or less which is used exclusively for the GOT.
Not doing so may cause an electric shock or malfunction.
- Correctly wire the GOT power supply section after confirming the rated voltage and terminal arrangement of the product.
Not doing so can cause a fire or failure.
- Tighten the terminal screws of the GOT power supply section in the specified torque range.
Undertightening can cause a short circuit or malfunction.
Overtightening can cause a short circuit or malfunction due to the damage of the screws or the GOT.
- Exercise care to avoid foreign matter such as chips and wire offcuts entering the GOT.
Not doing so can cause a fire, failure or malfunction.

[WIRING PRECAUTIONS]

CAUTION

- Plug the communication cable into the connector of the connected unit and tighten the mounting and terminal screws in the specified torque range.
Undertightening can cause a short circuit or malfunction.
Overtightening can cause a short circuit or malfunction due to the damage of the screws or unit.
- Insert the bus cables for QnA, ACPU, and motion controller (A series) into the GOT's bus interface connectors until they click into the place.
Check for proper insertion to avoid malfunctions.

[TEST OPERATION PRECAUTIONS]

WARNING

- Before performing the test operations of the user creation monitor screen (such as turning ON or OFF bit device, changing the word device current value, changing the settings or current values of the timer or counter, and changing the buffer memory current value), read through the manual carefully and make yourself familiar with the operation method.
During test operation, never change the data of the devices which are used to perform significant operation for the system.
False output or malfunction can cause an accident.

[STARTUP/MAINTENANCE PRECAUTIONS]

WARNING

- When power is on, do not touch the terminals.
Doing so can cause an electric shock or malfunction.
- Connect the battery correctly.
Do not discharge, disassemble, heat, short, solder or throw the battery into the fire.
Incorrect handling may cause the battery to generate heat, burst or take fire, resulting in injuries or fires.
- Before starting cleaning or terminal screw retightening, always switch off the power externally in all phases.
Not switching the power off in all phases can cause a unit failure or malfunction.
Undertightening can cause a short circuit or malfunction.
Overtightening can cause a short circuit or malfunction due to the damage of the screws or unit.

[STARTUP/MAINTENANCE PRECAUTIONS]

CAUTION

- Do not disassemble or modify the unit.
Doing so can cause a failure, malfunction, injury or fire.
- Do not touch the conductive and electronic parts of the unit directly.
Doing so can cause a unit malfunction or failure.
- The cables connected to the unit must be run in ducts or clamped.
Not doing so can cause the unit or cable to be damaged due to the dangling, motion or accidental pulling of the cables or can cause a malfunction due to a cable connection fault.
- When unplugging the cable connected to the unit, do not hold and pull the cable portion.
Doing so can cause the unit or cable to be damaged or can cause a malfunction due to a cable connection fault.
- Do not drop or apply any impact to the battery.
If any impact has been applied, discard the battery and never use it.
The battery may be damaged by the drop or impact.
- Before touching the unit, always touch grounded metal, etc. to discharge static electricity from human body, etc.
Not doing so can cause the unit to fail or malfunction.
- Replace battery with GT11-50BAT by Mitsubishi electric Co. only.
Use of another battery may present a risk of fire or explosion.
- Dispose of used battery promptly.
Keep away from children. Do not disassemble and do not dispose of in fire.

[DISPOSAL PRECAUTIONS]

CAUTION

- When disposing of the product, handle it as industrial waste.
When disposing of batteries, separate them from other wastes according to the local regulations.
(For details of the battery directive in EU member states, refer to 17.4 .)

[TRANSPORTATION PRECAUTIONS]

CAUTION

- When transporting lithium batteries, make sure to treat them based on the transport regulations.
(Refer to Appendix 3 for details of the regulated units.)
- Before transporting the GOT, turn the GOT power on and check that the battery voltage status is normal on the Time setting & display screen (utilities screen). In addition, confirm that the adequate battery life remains on the rating plate.
Transporting the GOT with the low battery voltage or the battery the reached battery life may unstabilize the backup data unstable during transportation.
- Make sure to transport the GOT main unit and/or relevant unit(s) in the manner they will not be exposed to the impact exceeding the impact resistance described in the general specifications of this manual, as they are precision devices.
Failure to do so may cause the unit to fail.
Check if the unit operates correctly after transportation.

REVISIONS

The manual number is given on the bottom left of the back cover.

Print Date	Manual Number	Ver.	Revision
Mar. 2005	JY997D17501	A	First edition
Oct. 2005	JY997D17501	B	<p>Partial correcting</p> <p>ABOUT MANUALS, ABBREVIATIONS AND GENERIC TERMS IN THIS MANUAL, Chapter 1, Section 2.2, 3.1, 3.2, 4.2, Chapter 6, 7, Section 8.1, 8.4, 8.5, 9.2, 9.3, Chapter 10, 11, 12, 13, Section 14.1, 14.3, 16.2, 16.3, 17.4, Chapter 18, Appendix2, Appendix 4</p> <p>Additions</p> <p>Section 13.6, 16.4</p>
Nov. 2006	JY997D17501	C	<p>Partial correcting</p> <p>ABOUT MANUALS, ABBREVIATIONS AND GENERIC TERMS IN THIS MANUAL, Section 2.2, 7.1, 9.2, 9.3, 10.1, Chapter 11, Section 13.1, Chapter 14, Section 16.3, 16.4, Appendix1, Appendix2, Appendix 4</p> <p>Additions</p> <p>Section 7.2, 13.7, 14.8, 14.9</p>
May 2007	JY997D17501	D	<p>Partial revisions</p> <p>ABBREVIATIONS AND GENERIC TERMS IN THIS MANUAL, ABOUT MANUALS, Section 4.1, Appendix 4</p> <p>Additions</p> <p>Section 1.1, 2.2, 2.2.1, 2.2.2, 3.2, 3.3, 3.4, 4.2, Chapter 5, Section 6.1, 6.5, 7.1, 8.1.2, 8.3, 10.1.3, 11.2.1, 13.1.3, 16.4, 18.3, Appendix 1, Appendix 2</p>
Nov. 2007	JY997D17501	E	<p>Partial revisions</p> <p>ABBREVIATIONS AND GENERIC TERMS IN THIS MANUAL, ABOUT MANUALS, Appendix 4</p> <p>Additions</p> <p>Section 2.2, Chapter 3, Section 4.2, Chapter 5, Section 6.1, 6.5, 7.1, 8.1, 8.3, 8.4, 10.1, 11.2.1, 13.1, 14.7, 16.4, Appendix 1</p>
Jan. 2008	JY997D17501	F	<p>Partial revisions</p> <p>ABBREVIATIONS AND GENERIC TERMS IN THIS MANUAL, ABOUT MANUALS, Section 8.3, 14.9, Appendix 4</p> <p>Additions</p> <p>Chapter 2, Section 3.3, 4.2, Chapter 5, Section 6.1, 7.1, 10.1</p>

The manual number is given on the bottom left of the back cover.

Print Date	Manual Number	Ver.	Revision
Oct. 2008	JY997D17501	G	<p>Partial revisions</p> <p>ABBREVIATIONS AND GENERIC TERMS IN THIS MANUAL, ABOUT MANUALS, Section 3.1, 3.2, 3.3, 8.8, 10.2, Appendix 4</p>
Mar. 2009	JY997D17501	H	<p>Partial revisions</p> <p>SAFETY PRECAUTIONS, ABBREVIATIONS AND GENERIC TERMS, HOW TO READ THIS MANUAL, Chapter 2, 3, Section 4.2, 8.4, 17.4, Appendix 1, Appendix 4</p> <p>Additions</p> <p>Section 8.9, 8.10</p>
Jul. 2009	JY997D17501	J	<p>Partial revisions</p> <p>Section 2.1, 3.3, 4.2, Chapter 5, Section 8.9, 8.10</p>
Oct. 2009	JY997D17501	K	<p>Partial revisions</p> <p>ABBREVIATIONS AND GENERIC TERMS, HOW TO READ THIS MANUAL, Chapter 1, Section 2.2, 3.2, 4.1, 8.3, 8.9, Chapter 9, 10, 11, 12, 13, 14, 16, 17, 18, Appendix 2</p> <p>Additions</p> <p>Section 14.2, 14.3, 14.4</p>
Apr. 2010	JY997D17501	L	<p>Partial revisions</p> <p>SAFETY PRECAUTIONS, ABBREVIATIONS AND GENERIC TERMS, Chapter 1, 2, 3, 5, 8, 14, 16, 17, Index</p>
Oct. 2010	JY997D17501	M	<p>Partial revisions</p> <p>ABBREVIATIONS AND GENERIC TERMS, HOW TO READ THIS MANUAL, Chapter 2, Section 3.2, Chapter 5, Section 7.1, Chapter 8, Section 9.3, Section 11.3.3, Chapter 13, Section 16.4, Appendix 4</p>
Jan. 2011	JY997D17501	N	<p>Partial revisions</p> <p>ABBREVIATIONS AND GENERIC TERMS, HOW TO READ THIS MANUAL, Section 4.2, 6.5, 9.3.1, 11.5.3</p>
Apr. 2011	JY997D17501	P	<p>Partial revisions</p> <p>HOW TO READ THIS MANUAL, Section 5.2, 8.3</p> <p>Partial additions</p> <p>ABBREVIATIONS AND GENERIC TERMS, Section 3.2, 6.2, 6.5, 11.2</p>
Jun. 2013	JY997D17501	Q	<p>Partial revisions</p> <p>Section 3.2, Chapter 5, Section 14.4</p>
Apr. 2015	JY997D17501	R	<p>Partial revisions</p> <p>A part of the cover design is changed.</p>
Jun. 2020	JY997D17501	S	Some corrections
Oct. 2022	JY997D17501	T	Some corrections

This manual confers no industrial property rights or any rights of any other kind, nor does it confer any patent licenses. Mitsubishi Electric Corporation cannot be held responsible for any problems involving industrial property rights which may occur as a result of using the contents noted in this manual.

INTRODUCTION

Thank you for choosing the Mitsubishi Electric Graphic Operation Terminal.

Before using the equipment, please read this manual carefully to use the equipment to its optimum.

OUTLINE PRECAUTIONS

- This manual provides information for the use of the graphic operation terminal. The manual has been written to be used by trained and competent personnel. The definition of such a person or persons is as follows;
 - 1) Any engineer who is responsible for the planning, design and construction of automatic equipment using the product associated with this manual should be of a competent nature, trained and qualified to the local and national standards required to fulfill that role. These engineers should be fully aware of all aspects of safety with regards to automated equipment.
 - 2) Any commissioning or service engineer must be of a competent nature, trained and qualified to the local and national standards required to fulfill that job. These engineers should also be trained in the use and maintenance of the completed product. This includes being completely familiar with all associated documentation for the said product. All maintenance should be carried out in accordance with established safety practices.
 - 3) All operators of the completed equipment should be trained to use that product in a safe and coordinated manner in compliance to established safety practices. The operators should also be familiar with documentation which is connected with the actual operation of the completed equipment.
- Note: the term 'completed equipment' refers to a third party constructed device which contains or uses the product associated with this manual.
- This product has been manufactured as a general-purpose part for general industries, and has not been designed or manufactured to be incorporated in a device or system used in purposes related to human life.
- Before using the product for special purposes such as nuclear power, electric power, aerospace, medicine or passenger movement vehicles, consult with Mitsubishi Electric.
- This product has been manufactured under strict quality control. However when installing the product where major accidents or losses could occur if the product fails, install appropriate backup or failsafe functions in the system.
- When using this product combining other products, please confirm the standard and the code, or regulation which a user should suit. Moreover, please confirm the compatibility of this product to the system, machine, and apparatus with which a user is used for user itself.
- If in doubt at any stage of the installation of the product always consult a professional electrical engineer who is qualified and trained to the local and national standards. If in doubt about the operation or use, please consult the nearest Mitsubishi Electric distributor.
- Since the example indicated by this manual, technical bulletin, the catalog, etc. is reference, please use it after confirming the function and safety of equipment and system when employing. Mitsubishi Electric will accept no responsibility for actual use of the product based on these illustrative examples.
- About this manual content, specification etc. may be changed without a notice for improvement.
- The information in this manual has been carefully checked and is believed to be accurate; however, you have noticed a doubtful point, a doubtful error, etc., please contact the nearest Mitsubishi Electric distributor.

CONTENTS

SAFETY PRECAUTIONS	A-1
REVISIONS.....	A-6
INTRODUCTION.....	A-8
OUTLINE PRECAUTIONS.....	A-8
CONTENTS	A-9
ABBREVIATIONS AND GENERIC TERMS.....	A-17
HOW TO READ THIS MANUAL	A-22
1. OVERVIEW	1-1 to 1-5
1.1 Features	1-4
1.2 Rough Pre-operation Procedure	1-5
2. SYSTEM CONFIGURATION	2-1 to 2-13
2.1 Overall Configuration	2-1
2.2 Component List	2-2
2.2.1 GOT (GT11).....	2-4
2.2.2 Option (Optional components for GT11).....	2-5
3. SPECIFICATIONS	3-1 to 3-9
3.1 General Specifications	3-1
3.2 Performance Specifications	3-2
3.3 Built-in Interface Specifications	3-6
3.4 Power Supply Specifications.....	3-8
4. PART NAME.....	4-1 to 4-4
4.1 Front Panel.....	4-1
4.2 Back Panel	4-2
5. UL, cUL STANDARDS AND EMC DIRECTIVE	
.....	5-1 to 5-8
5.1 UL, cUL Standards.....	5-1
5.2 EMC DIRECTIVE	5-1
5.2.1 Requirements for Conformance to EMC Directive.....	5-1
5.2.2 System Configuration when EMC Directive is Applicable.....	5-4
5.2.3 Wiring Precautions the Part which Matches the EMC Directives.....	5-5
6. INSTALLATION.....	6-1 to 6-7
6.1 Control Panel Inside Dimensions for Mounting GOT	6-2
6.2 Panel Cutting Dimensions.....	6-4
6.3 Mounting Position.....	6-4
6.4 Control Panel Temperature and Mounting Angle.....	6-5
6.5 Installation Procedure	6-6

7. WIRING	7-1 to 7-8
7.1 Power Supply Wiring	7-2
7.1.1 Wiring example	7-2
7.1.2 The cause of malfunctions related wiring/Remedy	7-4
7.2 Wiring inside and outside the panel.....	7-6
7.2.1 Wiring inside	7-6
7.2.2 Outside the panel.....	7-6
7.2.3 Attaching surge killers to control equipment	7-7
7.2.4 Wiring the FG wire of the BUS cable	7-8
8. OPTION	8-1 to 8-19
8.1 CF Card	8-1
8.1.1 Applicable CF card.....	8-1
8.1.2 Installing and removing procedures of the CF card	8-2
8.2 Memory Card Adaptor	8-4
8.2.1 Applicable memory card adaptor	8-4
8.2.2 Installing procedure of the CF card into a memory card adaptor.....	8-4
8.3 Option Function Board.....	8-5
8.3.1 Applicable option function board	8-5
8.3.2 Part names.....	8-5
8.3.3 How to install or remove the option function board	8-6
8.4 Battery	8-7
8.4.1 Applicable battery	8-7
8.4.2 Battery specifications	8-7
8.4.3 Battery replacement procedure.....	8-7
8.5 Protective Sheet	8-10
8.5.1 Applicable protective sheet	8-10
8.5.2 Installing procedure.....	8-10
8.6 USB Environmental Protection Cover	8-11
8.6.1 Applicable USB environmental protection cover	8-11
8.6.2 Installing procedure.....	8-11
8.7 Stand	8-12
8.7.1 Applicable stand.....	8-12
8.7.2 Installing procedure.....	8-12
8.8 Protective cover for oil	8-13
8.8.1 Applicable protective cover for oil	8-13
8.8.2 Installation procedure.....	8-13
8.9 Serial Multi-Drop Connection Unit	8-16
8.9.1 Serial multi-drop connection unit.....	8-16
8.9.2 Applicable serial multi-drop connection unit.....	8-17
8.9.3 Part name	8-17
8.9.4 Installation.....	8-18
8.9.5 Caution for compliance with EMC Directive.....	8-18
8.10 Connector Conversion Adapter	8-19
8.10.1 Applicable connector conversion adapter	8-19
8.10.2 Installing procedure.....	8-19

9. UTILITY FUNCTION	9-1 to 9-11
9.1 Utility Execution.....	9-1
9.2 Utility Function List	9-2
9.3 Utility Display.....	9-4
9.3.1 Display operation of main menu	9-6
9.3.2 Utility basic configuration	9-9
9.3.3 Basic operation of settings change.....	9-10
10. COMMUNICATION INTERFACE SETTING (COMMUNICATION SETTING).....	10-1 to 10-15
10.1 Communication Setting	10-1
10.1.1 Communication setting functions	10-1
10.1.2 Communication setting display operation	10-1
10.1.3 Description of communication setting screen	10-2
10.1.4 Operation of communication setting	10-5
10.2 Communication Detail Settings	10-8
10.2.1 Communication detail settings functions.....	10-8
10.2.2 Communication detail settings display operation.....	10-8
10.2.3 Display contents of communication detail settings	10-9
11. DISPLAY AND OPERATION SETTINGS (GOT SET UP)	11-1 to 11-18
11.1 Display Settings	11-1
11.1.1 Display setting functions	11-1
11.1.2 Display operation of display setting	11-3
11.1.3 Display setting operations.....	11-4
11.2 Brightness, Contrast Adjustment.....	11-8
11.2.1 Brightness, contrast adjustment function	11-8
11.2.2 Display operation of brightness, contrast.....	11-8
11.2.3 Brightness adjustment operation	11-9
11.3 Operation Settings	11-10
11.3.1 Operation setting functions	11-10
11.3.2 Display operation of operation setting.....	11-11
11.3.3 Setting operation of operation.....	11-12
11.4 Security Level Change	11-14
11.4.1 Security level change functions	11-14
11.4.2 Security change display operation	11-14
11.4.3 Security level change operation.....	11-15
11.5 Utility Call Key Setting	11-16
11.5.1 Utility call key setting function	11-16
11.5.2 Utility call key display operation	11-16
11.5.3 Utility call key setting operation.....	11-17

12. CLOCK SETTINGS AND BATTERY STATUS DISPLAY (TIME SETTING AND DISPLAY)12-1 to 12-5

12.1 Time Setting and Display.....	12-1
12.1.1 Time setting and display functions.....	12-1
12.1.2 Display operation of clock display and setting	12-1
12.1.3 Clock setting operations.....	12-2

13. FILE DISPLAY AND COPY (PROGRAM/DATA CONTROL) 13-1 to 13-36

13.1 Data Storage Location.....	13-1
13.1.1 Drive name allocation	13-1
13.1.2 Data type and storage location	13-1
13.1.3 OS version confirmation.....	13-3
13.1.4 Display file.....	13-5
13.2 OS Information	13-6
13.2.1 Function of OS information	13-6
13.2.2 Display operation of OS information screen	13-6
13.2.3 Display example of OS information	13-7
13.2.4 Operation of OS information	13-8
13.3 Project Information	13-13
13.3.1 Function of project information.....	13-13
13.3.2 Display operation of project information.....	13-13
13.3.3 Display example of project information	13-14
13.3.4 Operation of project information.....	13-15
13.4 Alarm Information	13-23
13.4.1 Function of alarm information	13-23
13.4.2 The display operation of alarm information.....	13-23
13.4.3 The display example of alarm information	13-24
13.4.4 Alarm information operation.....	13-25
13.5 Memory Card Format	13-29
13.5.1 Format function of memory card.....	13-29
13.5.2 Display operation of memory card format.....	13-29
13.5.3 Format operation of memory card.....	13-30
13.6 Memory Information.....	13-31
13.6.1 Memory information function.....	13-31
13.6.2 Memory information display operation	13-31
13.6.3 Display example of memory information.....	13-32
13.7 GOT data package acquisition	13-33
13.7.1 The function of GOT data package acquisition.....	13-33
13.7.2 Operating the GOT data package acquisition function	13-33
13.7.3 Display example of GOT data package acquisition	13-34
13.7.4 GOT data package acquisition operation.....	13-35

14. GOT SELF CHECK (DEBUG & SELF CHECK) 14-1 to 14-131

14.1 Debug.....	14-1
14.1.1 Debug functions	14-1
14.1.2 Display operation of debug	14-1

14.2 System Monitor	14-2
14.2.1 Specifications	14-5
14.2.2 Display	14-13
14.2.3 Operation procedure common to the system monitor screens	14-14
14.2.4 Functional change menu screen	14-14
14.2.5 Entering monitor devices (specifying monitor stations and devices)	14-15
14.2.6 Key window setting columns and operation procedure	14-18
14.2.7 Switching the display format (DEC/HEX) and comment/no-comment display	14-19
14.2.8 Quick test operation of monitor devices	14-21
14.2.9 Changing screens (common operation)	14-25
14.2.10 Entry monitor	14-26
14.2.11 Information displayed on the entry monitor screen and key functions	14-26
14.2.12 Procedure for entry monitor basic operation	14-28
14.2.13 Deleting entry devices	14-29
14.2.14 Batch monitor	14-30
14.2.15 Information displayed on the Batch Monitor screen and key functions	14-30
14.2.16 Procedure for batch monitor basic operation	14-33
14.2.17 TC Monitor (Monitoring Timers and Counters)	14-34
14.2.18 Information displayed on the TC Monitor screen and key functions	14-34
14.2.19 Procedure for TC monitor basic operation	14-36
14.2.20 Procedure for canceling TC monitor keywords	14-37
14.2.21 BM monitor (monitoring buffer memory)	14-38
14.2.22 Information displayed on the BM Monitor screen and key functions	14-38
14.2.23 Procedure for BM monitor basic operation	14-40
14.2.24 Test operation	14-41
14.2.25 Procedure for displaying the test menu screen and the setting key window screen	14-41
14.2.26 Information displayed on the test menu screen and key functions	14-42
14.2.27 Information and set items displayed on each setting key window screen	14-43
14.2.28 Test operation procedure	14-45
14.2.29 Test operation basic procedure	14-47
14.2.30 Error messages and corrective actions	14-48
14.3 MELSEC-A List Editor	14-49
14.3.1 Specifications	14-50
14.3.2 Access range	14-51
14.3.3 Precautions	14-51
14.3.4 Display	14-52
14.3.5 Operation of keyword input	14-53
14.3.6 Operation methods	14-55
14.3.7 Display format of the display area	14-57
14.3.8 Switching valid keys (upper/lower functions)	14-60
14.3.9 Selection and operation of modes	14-60
14.3.10 Command input procedures	14-61
14.3.11 Action if an incorrect key is input	14-64
14.3.12 List of functions	14-65
14.3.13 Basic Operation	14-66
14.3.14 Reading sequence programs	14-66
14.3.15 Changing (Overwriting) commands	14-67
14.3.16 Adding (Inserting) commands	14-68
14.3.17 Deleting commands	14-69
14.3.18 Using the help function	14-70
14.3.19 PLC memory all clear	14-72
14.3.20 List of operation procedures	14-73
14.3.21 Common operation	14-73
14.3.22 Operation in write mode (W)	14-74
14.3.23 Operation in read mode (R)	14-74
14.3.24 Operation in insert mode (I)	14-75
14.3.25 Operation in delete mode (D)	14-75
14.3.26 Operation in parameter mode (P)	14-76
14.3.27 Operation in other mode (O)	14-77
14.3.28 Error messages and corrective actions	14-78

14.4 MELSEC-FX List Editor	14-84
14.4.1 Specifications	14-85
14.4.2 Access range	14-86
14.4.3 Precautions	14-87
14.4.4 Display	14-88
14.4.5 Operation procedures	14-90
14.4.6 Selection and operation of modes	14-92
14.4.7 Sequence program display	14-93
14.4.8 Searching commands and devices	14-95
14.4.9 Writing commands	14-97
14.4.10 Changing operands, set values	14-100
14.4.11 Deleting commands	14-101
14.4.12 Sequence program all clear	14-102
14.4.13 PLC diagnostics	14-103
14.4.14 Parameter setting.....	14-105
14.4.15 Keywords	14-107
14.4.16 List monitor	14-109
14.4.17 Action for an incorrect key input.....	14-111
14.4.18 Error messages and corrective actions.....	14-111
14.5 Self Check	14-112
14.5.1 Self check function	14-112
14.6 Memory Check	14-113
14.6.1 Memory check function	14-113
14.6.2 Display operation of memory check	14-113
14.6.3 Memory check operation.....	14-114
14.7 Drawing Check	14-117
14.7.1 Drawing check function.....	14-117
14.7.2 Display operation of drawing check	14-117
14.7.3 Display and operation of drawing check	14-118
14.8 Font Check	14-121
14.8.1 Font check function.....	14-121
14.8.2 Display operation of font check.....	14-121
14.8.3 Font check operation	14-122
14.9 Touch Panel Check	14-123
14.9.1 Touch panel check function	14-123
14.9.2 Display operation of touch panel check	14-123
14.9.3 Touch panel check operations	14-124
14.10 I/O Check.....	14-125
14.10.1 I/O check function	14-125
14.10.2 Display operation of I/O check	14-125
14.10.3 I/O check operation.....	14-126
14.11 System Alarm Display	14-128
14.11.1 System alarm display function	14-128
14.11.2 Displaying the system alarm display.....	14-128
14.11.3 Operating the system alarm display.....	14-129
14.12 GOT Start Time	14-130
14.12.1 GOT start time function.....	14-130
14.12.2 Display operation of GOT start time.....	14-130
14.12.3 Display of GOT start time.....	14-131

15. CLEANING OF DISPLAY SECTION(CLEAN) 15-1

15.1 Clean.....	15-1
15.1.1 Display operation of clean.....	15-1
15.1.2 Operation of clean.....	15-1

16. INSTALLATION OF CoreOS, BOOTOS AND STANDARD MONITOR OS 16-1 to 16-13

16.1 BootOS and Standard Monitor OS Required for Installation.....	16-2
16.2 Prior Preparations for Installing BootOS and Standard Monitor OS	16-3
16.3 BootOS and Standard Monitor OS Installation Using CF Card.....	16-4
16.3.1 Installation method when the GOT is turned on.....	16-5
16.3.2 Installation method using the program/data control function (Utility)	16-6
16.4 When Installing the Different Version of BootOS, Standard Monitor OS	16-8
16.5 CoreOS	16-11
16.5.1 Installation method of CoreOS.....	16-11
16.5.2 When CoreOS cannot be installed.....	16-13

17. MAINTENANCE AND INSPECTION..... 17-1 to 17-7

17.1 Daily Inspection.....	17-2
17.2 Periodic Inspection.....	17-2
17.3 Cleaning Method.....	17-3
17.4 Battery Voltage Low Detection and Battery Replacement	17-4
17.5 Backlight Shutoff Detection	17-7
17.5.1 Backlight shutoff detection and external alarm	17-7

18. ERROR MESSAGE AND SYSTEM ALARM 18-1 to 18-11

18.1 Error Contents Display.....	18-1
18.2 List of Error Message/System Alarm.....	18-3
18.3 Troubleshooting in Bus Connection	18-7
18.3.1 Locating error positions.....	18-7
18.3.2 Further locating error positions	18-8
18.3.3 Specific example of troubleshooting	18-9
18.4 Troubleshooting for Monitoring	18-10
18.5 Starting GOT	18-11
18.5.1 Power-Off.....	18-11
18.5.2 Communication from drawing software to the GOT.....	18-11

APPENDICES..... App-1 to App-17

Appendix 1 External Dimensions	App- 1
Appendix 2 Usage Condition of Utility Function.....	App- 10

Appendix 3 Transportation Precautions App- 16
Appendix 3.1 Relevant models..... App- 16
Appendix 3.2 Transport guidelines..... App- 16
Appendix 4 List of Functions Added by GT Designer2 Version Upgrade
(For GOT1000 Series) App- 17

INDEXIndex-1 to Index-2

ABBREVIATIONS AND GENERIC TERMS

■ GOT

Abbreviations and generic terms		Description
GT1695	GT1695M-X	Abbreviation of GT1695M-XTBA, GT1695M-XTBD
GT1685	GT1685M-S	Abbreviation of GT1685M-STBA, GT1685M-STBD
GT1675	GT1675M-S	Abbreviation of GT1675M-STBA, GT1675M-STBD
	GT1675M-V	Abbreviation of GT1675M-VTBA, GT1675M-VTBD
	GT1675-VN	Abbreviation of GT1675-VNBA, GT1675-VNBD
GT1672	GT1672-VN	Abbreviation of GT1672-VNBA, GT1672-VNBD
GT1665	GT1665M-S	Abbreviation of GT1665M-STBA, GT1665M-STBD
	GT1665M-V	Abbreviation of GT1665M-VTBA, GT1665M-VTBD
GT1662	GT1662-VN	Abbreviation of GT1662-VNBA, GT1662-VNBD
GT1655	GT1655-V	Abbreviation of GT1655-VTBD
GT16		Abbreviation of GT1695, GT1685, GT1675, GT1672, GT1665, GT1662, GT1655, GT16 Handy GOT
GT1595	GT1595-X	Abbreviation of GT1595-XTBA, GT1595-XTBD
GT1585	GT1585V-S	Abbreviation of GT1585V-STBA, GT1585V-STBD
	GT1585-S	Abbreviation of GT1585-STBA, GT1585-STBD
GT157□	GT1575V-S	Abbreviation of GT1575V-STBA, GT1575V-STBD
	GT1575-S	Abbreviation of GT1575-STBA, GT1575-STBD
	GT1575-V	Abbreviation of GT1575-VTBA, GT1575-VTBD
	GT1575-VN	Abbreviation of GT1575-VNBA, GT1575-VNBD
	GT1572-VN	Abbreviation of GT1572-VNBA, GT1572-VNBD
GT156□	GT1565-V	Abbreviation of GT1565-VTBA, GT1565-VTBD
	GT1562-VN	Abbreviation of GT1562-VNBA, GT1562-VNBD
GT155□	GT1555-V	Abbreviation of GT1555-VTBD
	GT1555-Q	Abbreviation of GT1555-QTBD, GT1555-QSBD
	GT1550-Q	Abbreviation of GT1550-QLBD
GT15		Abbreviation of GT1595, GT1585, GT157□, GT156□, GT155□
GT145□	GT1455-Q	Abbreviation of GT1455-QTBDE, GT1455-QTBD
	GT1450-Q	Abbreviation of GT1450-QLBDE, GT1450-QLBD
GT14		Abbreviation of GT1455-Q, GT1450-Q
GT1275	GT1275-V	Abbreviation of GT1275-VNBA, GT1275-VNBD
GT1265	GT1265-V	Abbreviation of GT1265-VNBA, GT1265-VNBD
GT12		Abbreviation of GT1275, GT1265
GT115□	GT1155-Q	Abbreviation of GT1155-QTBDQ, GT1155-QSBDQ, GT1155-QTBDA, GT1155-QSBDA, GT1155-QTBD, GT1155-QSBD
	GT1150-Q	Abbreviation of GT1150-QLBDQ, GT1150-QLBDA, GT1150-QLBD
GT11		Abbreviation of GT115□, GT11 Handy GOT,
GT105□	GT1055-Q	Abbreviation of GT1055-QSBD
	GT1050-Q	Abbreviation of GT1050-QBBD
GT104□	GT1045-Q	Abbreviation of GT1045-QSBD
	GT1040-Q	Abbreviation of GT1040-QBBD
GT1030		Abbreviation of GT1030-LBD, GT1030-LBD2, GT1030-LBL, GT1030-LBDW, GT1030-LBDW2, GT1030-LBLW, GT1030-LWD, GT1030-LWD2, GT1030-LWL, GT1030-LWDW, GT1030-LWDW2, GT1030-LWLW, GT1030-HBD, GT1030-HBD2, GT1030-HBL, GT1030-HBDW, GT1030-HBDW2, GT1030-HBLW, GT1030-HWD, GT1030-HWD2, GT1030-HWL, GT1030-HWDW, GT1030-HWDW2, GT1030-HWLW
GT1020		Abbreviation of GT1020-LBD, GT1020-LBD2, GT1020-LBL, GT1020-LBDW, GT1020-LBDW2, GT1020-LBLW, GT1020-LWD, GT1020LWD2, GT1020-LWL, GT1020-LWDW, GT1020-LWDW2, GT1020-LWLW
GT10		Abbreviation of GT105□, GT104□, GT1030, GT1020

GOT1000
Series

Abbreviations and generic terms				Description
GOT1000 Series	Handy GOT	GT16 Handy GOT	GT1665HS-V	Abbreviation of GT1665HS-VTBD
		GT11 Handy GOT	GT1155HS-Q	Abbreviation of GT1155HS-QSBD
			GT1150HS-Q	Abbreviation of GT1150HS-QLBD
	GT SoftGOT1000			Abbreviation of GT SoftGOT1000
GOT900 Series				Abbreviation of GOT-A900 series, GOT-F900 series
GOT800 Series				Abbreviation of GOT-800 series

■ Communication unit

Abbreviations and generic terms	Description
Bus connection unit	GT15-QBUS, GT15-QBUS2, GT15-ABUS, GT15-ABUS2, GT15-75QBUSL, GT15-75QBUS2L, GT15-75ABUSL, GT15-75ABUS2L
Serial communication unit	GT15-RS2-9P, GT15-RS4-9S, GT15-RS4-TE
RS-422 conversion unit	GT15-RS2T4-9P, GT15-RS2T4-25P
Ethernet communication unit	GT15-J71E71-100
MELSECNET/H communication unit	GT15-J71LP23-25, GT15-J71BR13
MELSECNET/10 communication unit	GT15-75J71LP23-Z ^{*1} , GT15-75J71BR13-Z ^{*2}
CC-Link IE Controller Network communication unit	GT15-J71GP23-SX
CC-Link IE Field Network communication unit	GT15-J71GF13-T2
CC-Link communication unit	GT15-J61BT13, GT15-75J61BT13-Z ^{*3}
Interface converter unit	GT15-75IF900
Serial multi-drop connection unit	GT01-RS4-M
Connection Conversion Adapter	GT10-9PT5S
RS-232/485 signal conversion adapter	GT14-RS2T4-9P

*1 A9GT-QJ71LP23 + GT15-75IF900 set

*2 A9GT-QJ71BR13 + GT15-75IF900 set

*3 A8GT-J61BT13 + GT15-75IF900 set

■ Option unit

Abbreviations and generic terms	Description	
Printer unit	GT15-PRN	
Video/RGB unit	Video input unit	GT16M-V4, GT15V-75V4
	RGB input unit	GT16M-R2, GT15V-75R1
	Video/RGB input unit	GT16M-V4R1, GT15V-75V4R1
	RGB output unit	GT16M-ROUT, GT15V-75ROUT
Multimedia unit	GT16M-MMR	
CF card unit	GT15-CFCD	
CF card extension unit ^{*1}	GT15-CFEX-C08SET	
External I/O unit	GT15-DIO, GT15-DIOR	
Sound output unit	GT15-SOUT	

*1 GT15-CFEX + GT15-CFEXIF + GT15-C08CF set.

Option

Abbreviations and generic terms		Description
Memory card	CF card	GT05-MEM-16MC, GT05-MEM-32MC, GT05-MEM-64MC, GT05-MEM-128MC, GT05-MEM-256MC, GT05-MEM-512MC, GT05-MEM-1GC, GT05-MEM-2GC, GT05-MEM-4GC, GT05-MEM-8GC, GT05-MEM-16GC
	SD card	L1MEM-2GBSD, L1MEM-4GBSD
Memory card adaptor		GT05-MEM-ADPC
Option function board		GT16-MESB, GT15-FNB, GT15-QFNB, GT15-QFNB16M, GT15-QFNB32M, GT15-QFNB48M, GT11-50FNB, GT15-MESB48M
Battery		GT15-BAT, GT11-50BAT
Protective Sheet	For GT16	GT16-90PSCB, GT16-90PSGB, GT16-90PSCW, GT16-90PSGW, GT16-80PSCB, GT16-80PSGB, GT16-80PSCW, GT16-80PSGW, GT16-70PSCB, GT16-70PSGB, GT16-70PSCW, GT16-70PSGW, GT16-60PSCB, GT16-60PSGB, GT16-60PSCW, GT16-60PSGW, GT16-50PSCB, GT16-50PSGB, GT16-50PSCW, GT16-50PSGW, GT16-90PSCB-012, GT16-80PSCB-012, GT16-70PSCB-012, GT16-60PSCB-012, GT16-50PSCB-012, GT16H-60PSC
	For GT15	GT15-90PSCB, GT15-90PSGB, GT15-90PSCW, GT15-90PSGW, GT15-80PSCB, GT15-80PSGB, GT15-80PSCW, GT15-80PSGW, GT15-70PSCB, GT15-70PSGB, GT15-70PSCW, GT15-70PSGW, GT15-60PSCB, GT15-60PSGB, GT15-60PSCW, GT15-60PSGW, GT15-50PSCB, GT15-50PSGB, GT15-50PSCW, GT15-50PSGW
	For GT14	GT14-50PSCB, GT14-50PSGB, GT14-50PSCW, GT14-50PSGW
	For GT12	GT11-70PSCB, GT11-65PSCB
	For GT11	GT11-50PSCB, GT11-50PSGB, GT11-50PSCW, GT11-50PSGW, GT11H-50PSC
	For GT10	GT10-50PSCB, GT10-50PSGB, GT10-50PSCW, GT10-50PSGW, GT10-40PSCB, GT10-40PSGB, GT10-40PSCW, GT10-40PSGW, GT10-30PSCB, GT10-30PSGB, GT10-30PSCW, GT10-30PSGW, GT10-20PSCB, GT10-20PSGB, GT10-20PSCW, GT10-20PSGW
Protective cover for oil		GT05-90PCO, GT05-80PCO, GT05-70PCO, GT05-60PCO, GT05-50PCO, GT16-50PCO, GT10-40PCO, GT10-30PCO, GT10-20PCO
USB environmental protection cover		GT16-UCOV, GT16-50UCOV, GT15-UCOV, GT14-50UCOV, GT11-50UCOV
Stand		GT15-90STAND, GT15-80STAND, GT15-70STAND, A9GT-50STAND, GT05-50STAND
Attachment		GT15-70ATT-98, GT15-70ATT-87, GT15-60ATT-97, GT15-60ATT-96, GT15-60ATT-87, GT15-60ATT-77, GT15-50ATT-95W, GT15-50ATT-85
Backlight		GT16-90XLTT, GT16-80SLTT, GT16-70SLTT, GT16-70VLTT, GT16-70VLTTA, GT16-70VLTN, GT16-60SLTT, GT16-60VLTT, GT16-60VLTN, GT15-90XLTT, GT15-80SLTT, GT15-70SLTT, GT15-70VLTT, GT15-70VLTN, GT15-60VLTT, GT15-60VLTN
Multi-color display board		GT15-XHNB, GT15-VHNB
Connector conversion box		GT11H-CNB-37S, GT16H-CNB-42S
Emergency stop sw guard cover		GT11H-50ESCOV, GT16H-60ESCOV
Memory loader		GT10-LDR
Memory board		GT10-50FMB
Panel-mounted USB port extension		GT14-C10EXUSB-4S, GT10-C10EXUSB-5S

■ Software

Abbreviations and generic terms	Description
GT Works3	Abbreviation of the SW □ DNC-GTWK3-E and SW □ DNC-GTWK3-EA
GT Designer3	Abbreviation of screen drawing software GT Designer3 for GOT1000 series
GT Simulator3	Abbreviation of screen simulator GT Simulator3 for GOT1000/GOT900 series
GT SoftGOT1000	Abbreviation of monitoring software GT SoftGOT1000
GT Converter2	Abbreviation of data conversion software GT Converter2 for GOT1000/GOT900 series
GT Designer2 Classic	Abbreviation of screen drawing software GT Designer2 Classic for GOT900 series
GT Designer2	Abbreviation of screen drawing software GT Designer2 for GOT1000/GOT900 series
iQ Works	Abbreviation of iQ Platform compatible engineering environment MELSOFT iQ Works
MELSOFT Navigator	Generic term for integrated development environment software included in the SW □ DNC-IQWK (iQ Platform compatible engineering environment MELSOFT iQ Works)
GX Works2	Abbreviation of SW □ DNC-GXW2-E and SW □ DNC-GXW2-EA type programmable controller engineering software
GX Simulator2	Abbreviation of GX Works2 with the simulation function
GX Simulator	Abbreviation of SW □ D5C-LLT-E(-EV) type ladder logic test tool function software packages (SW5D5C-LLT (-EV) or later versions)
GX Developer	Abbreviation of SW □ D5C-GPPW-E(-EV)/SW D5F-GPPW-E type software package
GX LogViewer	Abbreviation of SW □ DNN-VIEWER-E type software package
PX Developer	Abbreviation of SW □ D5C-FBDQ-E type FBD software package for process control
MT Works2	Abbreviation of motion controller engineering environment MELSOFT MT Works2 (SW □ DNC-MTW2-E)
MT Developer	Abbreviation of SW □ RNC-GSV type integrated start-up support software for motion controller Q series
MR Configurator2	Abbreviation of SW □ DNC-MRC2-E type Servo Configuration Software
MR Configurator	Abbreviation of MRZJW □ -SETUP □ E type Servo Configuration Software
FR Configurator	Abbreviation of Inverter Setup Software (FR-SW □ -SETUP-WE)
NC Configurator	Abbreviation of CNC parameter setting support tool NC Configurator
FX Configurator-FP	Abbreviation of parameter setting, monitoring, and testing software packages for FX3U-20SSC-H (SW □ D5C-FXSSC-E)
FX3U-ENET-L Configuration tool	Abbreviation of FX3U-ENET-L type Ethernet module setting software (SW1D5-FXENETL-E)
RT ToolBox2	Abbreviation of robot program creation software (3D-11C-WINE)
MX Component	Abbreviation of MX Component Version □ (SW □ D5C-ACT-E, SW □ D5C-ACT-EA)
MX Sheet	Abbreviation of MX Sheet Version □ (SW □ D5C-SHEET-E, SW □ D5C-SHEET-EA)
QnUDVCPU & LCPULogging Configuration Tool	Abbreviation of QnUDVCPU & LCPULogging Configuration Tool (SW1DNN-LLUTL-E)

■ License key (for GT SoftGOT1000)

Abbreviations and generic terms	Description
License	GT15-SGTKEY-U, GT15-SGTKEY-P

Others

Abbreviations and generic terms	Description
IAI	Abbreviation of IAI Corporation
AZBIL	Abbreviation of Azbil Corporation (former Yamatake Corporation)
OMRON	Abbreviation of OMRON Corporation
KEYENCE	Abbreviation of KEYENCE CORPORATION
KOYO EI	Abbreviation of KOYO ELECTRONICS INDUSTRIES CO., LTD.
SHARP	Abbreviation of Sharp Manufacturing Systems Corporation
JTEKT	Abbreviation of JTEKT Corporation
SHINKO	Abbreviation of Shinko Technos Co., Ltd.
CHINO	Abbreviation of CHINO CORPORATION
TOSHIBA	Abbreviation of TOSHIBA CORPORATION
TOSHIBA MACHINE	Abbreviation of TOSHIBA MACHINE CO., LTD.
HITACHI IES	Abbreviation of Hitachi Industrial Equipment Systems Co., Ltd.
HITACHI	Abbreviation of Hitachi, Ltd.
FUJI	Abbreviation of FUJI ELECTRIC CO., LTD.
PANASONIC	Abbreviation of Panasonic Corporation
PANASONIC INDUSTRIAL DEVICES SUNX	Abbreviation of Panasonic Industrial Devices SUNX Co., Ltd.
YASKAWA	Abbreviation of YASKAWA Electric Corporation
YOKOGAWA	Abbreviation of Yokogawa Electric Corporation
ALLEN-BRADLEY	Abbreviation of Allen-Bradley products manufactured by Rockwell Automation, Inc.
GE	Abbreviation of GE Intelligent Platforms
LS IS	Abbreviation of LS Industrial Systems Co., Ltd.
SCHNEIDER	Abbreviation of Schneider Electric SA
SICK	Abbreviation of SICK AG
SIEMENS	Abbreviation of Siemens AG
RKC	Abbreviation of RKC INSTRUMENT INC.
HIRATA	Abbreviation of Hirata Corporation
MURATEC	Abbreviation of Muratec products manufactured by Muratec Automation Co., Ltd.
PLC	Abbreviation of programmable controller
Control equipment	Generic term for control equipment manufactured by each corporation
Temperature controller	Generic term for temperature controller manufactured by each corporation
Indicating controller	Generic term for indicating controller manufactured by each corporation
CHINO controller	Abbreviation of indicating controller manufactured by CHINO CORPORATION
PC CPU module	Abbreviation of PC CPU Unit manufactured by CONTEC CO., LTD
GOT (server)	Abbreviation of GOTs that use the server function
GOT (client)	Abbreviation of GOTs that use the client function
Windows® font	Abbreviation of TrueType font and OpenType font available for Windows® (Differs from the True Type fonts settable with GT Designer3)
Intelligent function module	Indicates the modules other than the PLC CPU, power supply module and I/O module that are mounted to the base unit
MODBUS® /RTU	Generic term for the protocol designed to use MODBUS® protocol messages on a serial communication
MODBUS® /TCP	Generic term for the protocol designed to use MODBUS® protocol messages on a TCP/IP network

HOW TO READ THIS MANUAL

1 Functions

This manual describes functions available for the GT Designer2 Version 2.96A, GT Designer3 Version 1.28E.

For the added functions by the product version upgrade, refer to the list of functions added by GT Designer2 version upgrade in Appendices.

2 Symbols

Following symbols are used in this manual.

13.3.3 Memory check operation

Carries out write/read check of memory.

Point When drive is not displayed
When the drive (memory) to check is not displayed, confirm the mounting procedure or memory type with reference to the following.

- CF card inserting/removing method (Section 7.1 CF Card)

When no faults are found in mounting, etc, a memory failure may be arisen. Replace the CF card or Flash memory.
For details of Flash memory, contact your nearest sales office or FA Center.

The following example explains about Memory Check using Flash memory.
For the CF card memory check, install the CF card before carrying out the same key operations as built-in flash memory.

Internal Flash memory area write/read check

Execute now?

Debug/self check: Memory check

Please input password.

XXXXXXXXXX

7	8	9	A	B
4	5	6	C	D
1	2	3	E	F
0	AC	Del	Enter	

Point Refers to the information required.

Remark Refers to the supplementary explanations for reference.

Indicates the items in which the detailed explanation is described (manual, chapter, section, item of the manual).

1 → 2 → 3 Indicates the operation steps.

Menu and items are differentiated with parentheses.

[] : refers to the menu of GOT utility.

: refers to the button in the dialog box of GOT utility.

13 - 4 13.3 Memory Check
 13.3.3 Memory check operation

1. OVERVIEW

1 About GOT

A GOT is installed on the panel surface of a control panel or operating panel and connects to the PLC within the control panel. The GOT carries out switch operation, lamp display, data display, message display, etc.

For the display screen, two kinds of screens are available : user screen and utility screen.

(1) User screen

The user screen is a screen drawn by drawing software.

The objects [Touch switch], [Lamp display], [Comment display], and [Numeric display] can be arbitrarily arranged on the display.

A "horizontal format" or "vertical format" may be selected for displaying a user's project.

Moreover, multiple screens created within drawing software can be individually selected or overlapped for the display.

For details, refer to the following.

- ☞ GT Designer2 Version□ Basic Operation/Data Transfer Manual
- ☞ GT Designer2 Version□ Screen Design Manual
- ☞ GT Designer3 Version1 Screen Design Manual

(2) Utility Screen

The utility screen is a factory drawn horizontal screen that cannot be edited.

Installing the BootOS or Standard monitor OS in the GOT from drawing software, the utility screen is displayed.

The utility screen has options for [Brightness/contrast], [Memory check], etc, and the format is horizontal only.

For details, refer to the following.

- ☞ Chapter 9 to Chapter 15

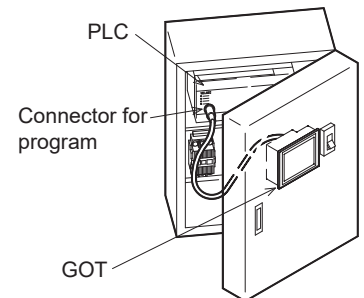











2 About Manual

The following manuals related to GOT 1000 series are available. Refer to each manual in accordance with the intended use.











(1) Installation of the software programs → Drawing → Data transfer

For operations from creating project data to transferring data to GOT, refer to the following manuals.

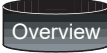
		
Purpose	GT Designer2 Version <input type="checkbox"/> Basic Operation/Data Transfer Manual* ¹ GT Designer3 Version1 Screen Design Manual (Fundamentals)* ¹	GT Designer2 Version <input type="checkbox"/> Screen Design Manual* ¹ GT Designer3 Version1 Screen Design Manual (Functions)* ¹
Installing product on PC	 Detailed	
Creating projects	 Detailed	
Creating screens	 Detailed	
Drawing figures	 Detailed	
Making Common Settings	 Overview	 Detailed
Placing/Setting objects	 Overview	 Detailed
Transferring data to GOT	 Detailed	

*1 Stored in the GT Works 2/GT Designer2/GT Works 3/GT Designer3 in PDF format.

- (2) Installing a GOT → connection to a PLC
 For the operations from installing a GOT to communicating with a PLC CPU, refer to the following manuals.

	 (Included)		
Purpose	GT15 General Description GT11 General Description	GT15 User's Manual GT11 User's Manual	GOT1000 Series Connection Manual* ¹
Confirming part names and specifications of the GOT			
Confirming the GOT installation method			
Confirming the mounting method for communication units or option devices			
Confirming the PLC connection method			
Confirming the utility operation method			
Confirming error codes (system alarm) displayed on the GOT			

*1 Stored in the GT Works2/GT Designer2/GT Works 3/GT Designer3 in PDF format.

- (3) Other manuals
 The following manuals are also available.
 The following manuals are stored in the GT Works2/GT Designer2/GT Works3/GT Designer3 in PDF format.
- (a) GOT1000 Series Gateway Functions Manual
 Describes how to use the gateway function.
 - (b) GT Simulator 2 Version□ Operation Manual
 Describes how to simulate the created project data with GT Simulator2.
 - (c) GT Converter2 Version□ Operating Manual
 Describes how to use the GT Converter2.

1.1 Features

- (1) Improved monitoring performance and connectivity to FA devices
 - Multiple languages are displayed using the Unicode2.1-compatible fonts and beautiful characters are drawn using the TrueType and high quality fonts.
 - Two types of display modes are provided: 256-color display and monochrome display. In the monochrome display, 16 scales are used to improve the display.
 - High-speed monitoring through high-speed serial communication at maximum rate of 115.2 kbps or through bus connection with the PLC.
 - High speed display and high speed touch switch response.
- (2) More efficient GOT operations including screen design, startup, adjustment, management and maintenance works
 - The 3MB user memory is included as standard.
 - CF card interface is included as standard.
 - The USB connector is positioned on the GOT front. This enables the system startup to be performed more efficiently using FA device setup tool, and eliminates the indirect works (opening and closing the control panel, cable replacement, cable rewiring) in order to improve the working efficiency.
- (3) Enhanced support of FA setup tools
 - PLC program transfer and monitoring are possible via the personal computer that is connected to the GOT if connected directly to the A, QnA, L, Q, or FX series of the PLC CPU (FA transparent function).

1.2 Rough Pre-operation Procedure

The outline procedure before operating GOT is shown.

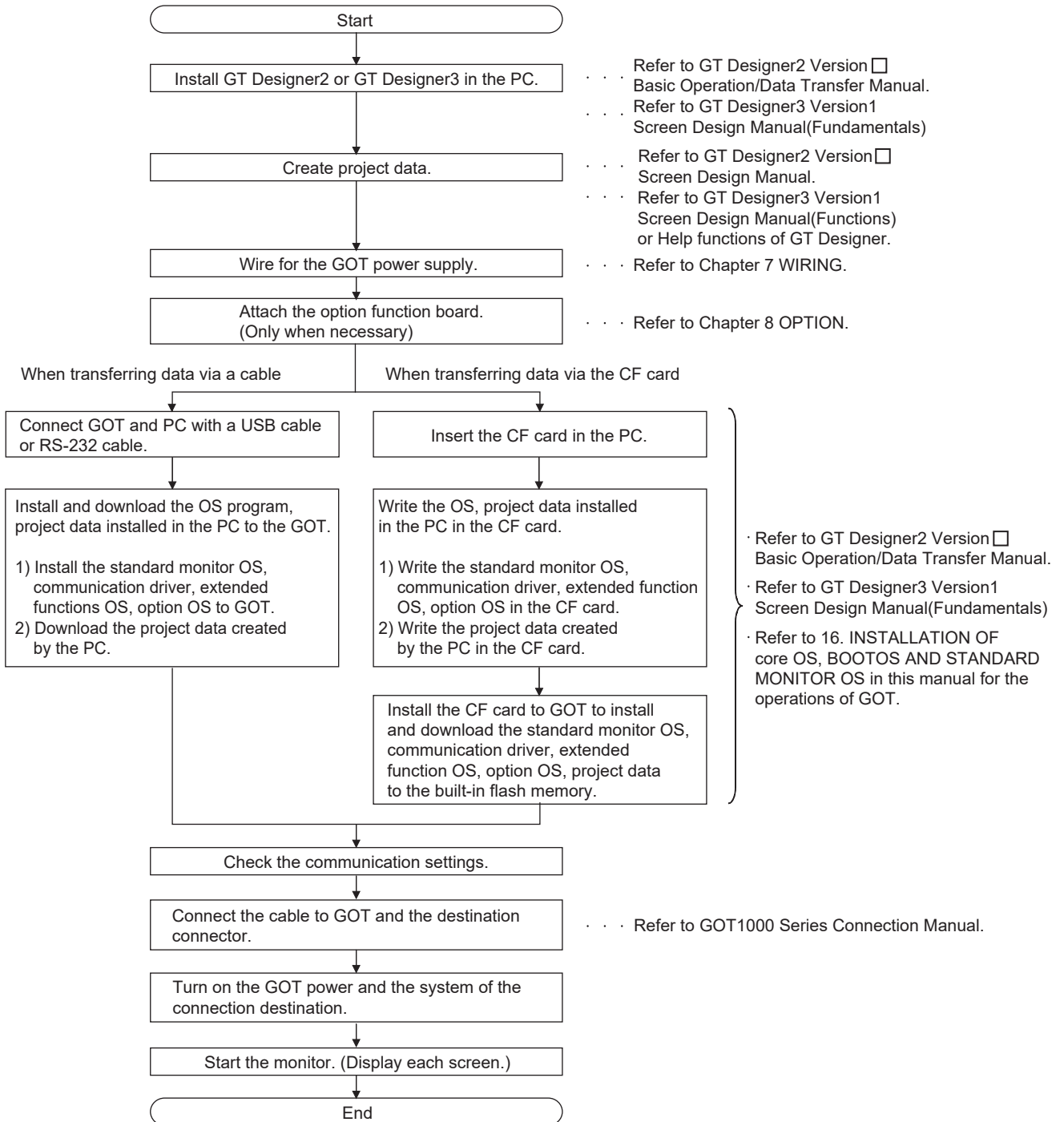

1	OVERVIEW
2	SYSTEM CONFIGURATION
3	SPECIFICATIONS
4	PART NAME
5	UL, cUL STANDARDS AND EMC DIRECTIVE
6	INSTALLATION
7	WIRING
8	OPTION

2. SYSTEM CONFIGURATION

2.1 Overall Configuration

The overall configuration of GOT is as follows.

For the connection methods applicable to GOT1000 series and cable, refer to the following.

 GOT1000 Series Connection Manual

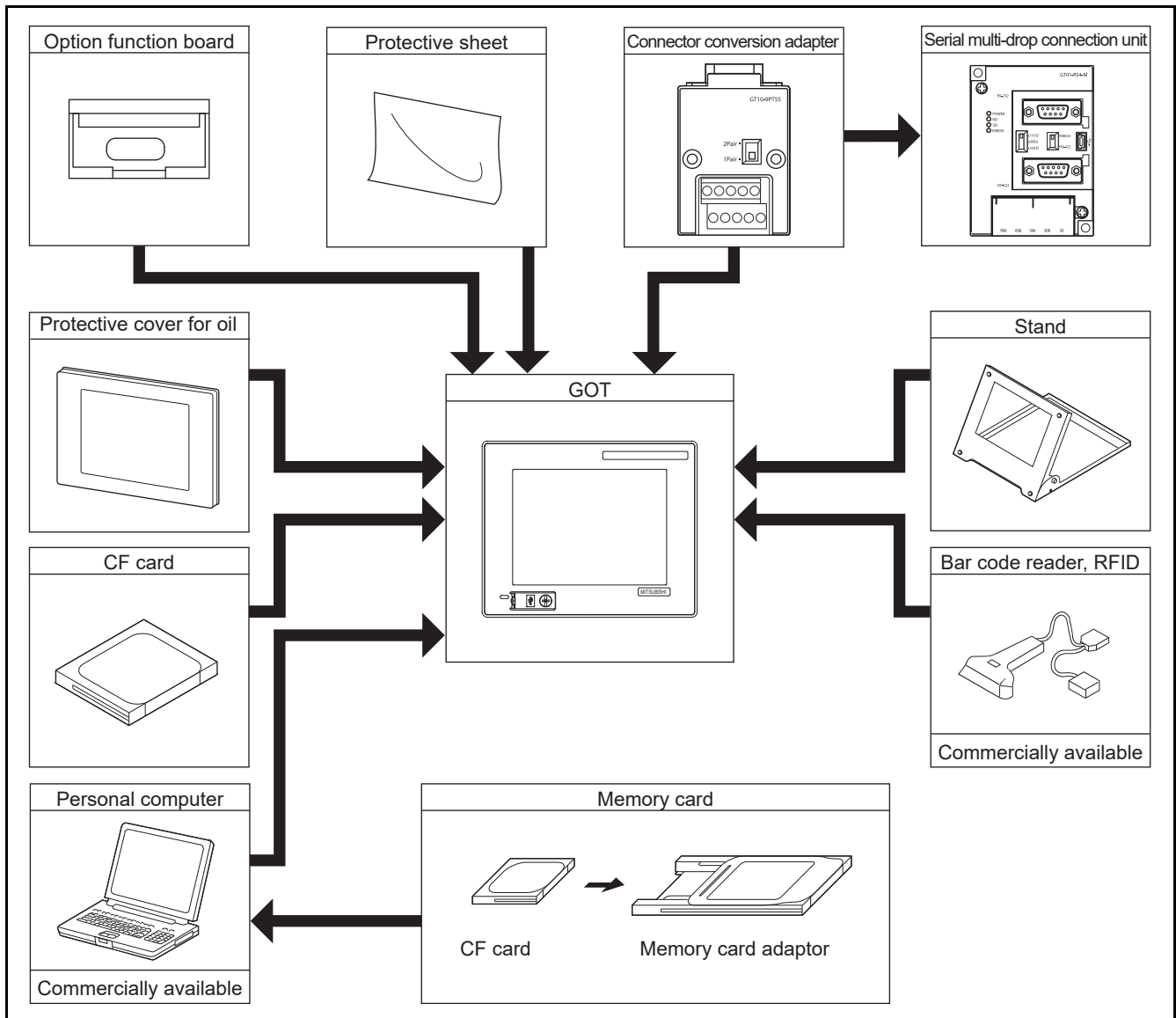

• GT11□□ does not connect a printer.

2.2 Component List

(1) Explanation of the GOT model name

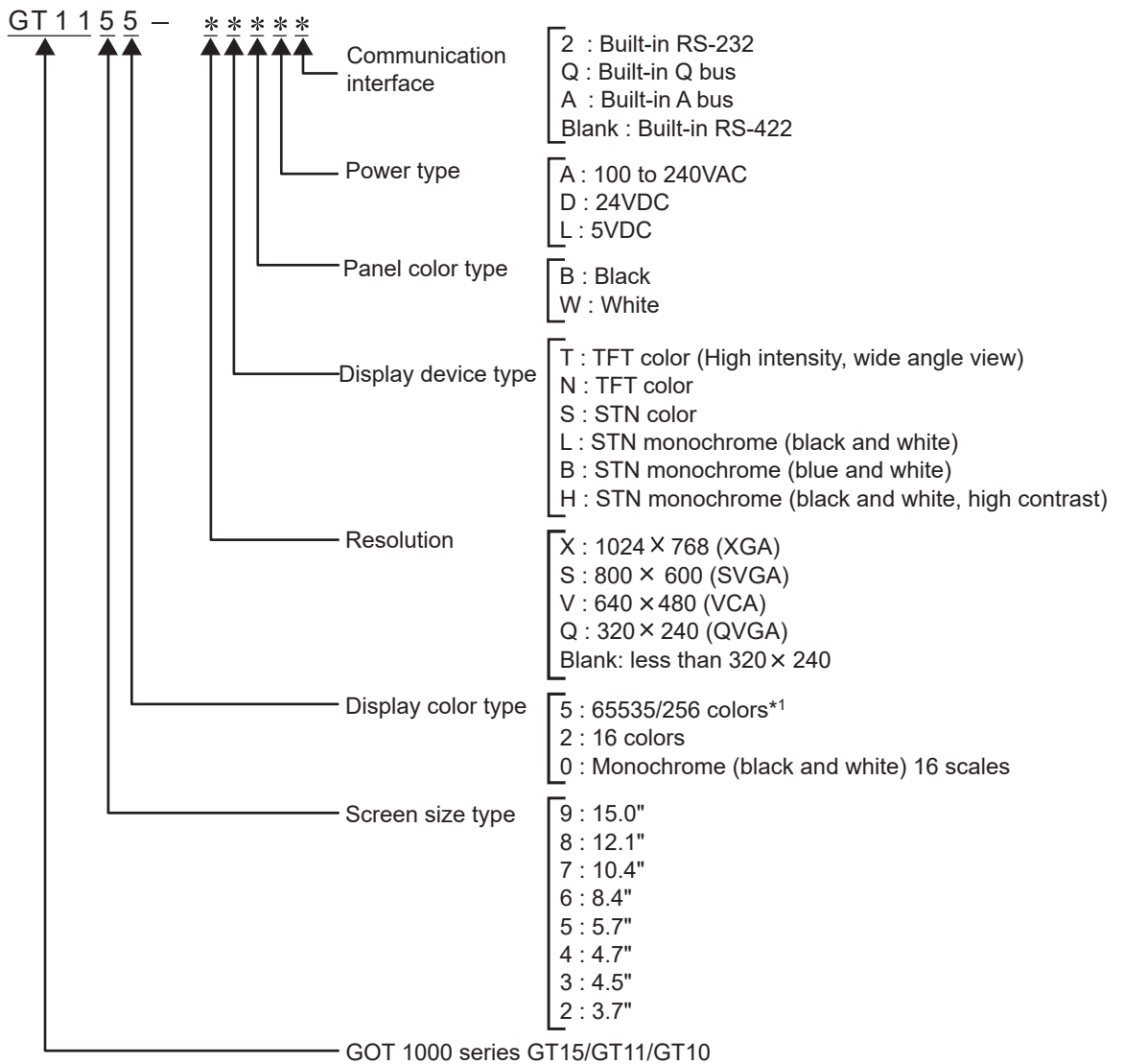

*1: For GT15 that can display 65536 colors, refer to following.

GT15 User's Manual

(2) Explanation of the option model name

GT ** - ** ****

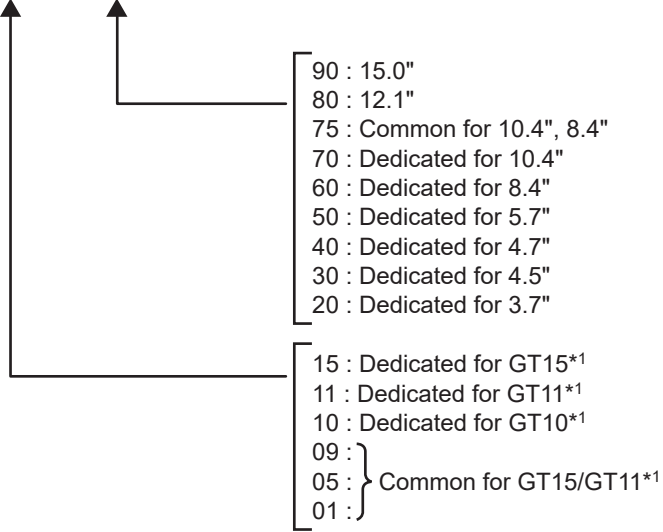

*1: There are optional components common for GT15, GT11 and GT10.

2.2.1 GOT (GT11)

1 Models with a built-in serial interface

GOT	GT1155-QTBD	5.7" [320 x 240 dots], TFT color liquid crystal, 256 colors, 24VDC, memory size 3MB, built-in battery, built-in serial interface
	GT1155-QSBD	5.7" [320 x 240 dots], STN color liquid crystal, 256 colors, 24VDC, memory size 3MB, built-in battery, built-in serial interface
	GT1150-QLBD	5.7" [320 x 240 dots], STN monochrome liquid crystal, monochrome (black/white), 16 scales, 24VDC, memory size 3MB, built-in battery, built-in serial interface

2 Models with a built-in bus interface

GOT	GT1155-QTBDQ	5.7" [320 x 240 dots], TFT color liquid crystal, 256 colors, 24VDC, memory size 3MB, built-in battery, built-in Q bus/serial interface
	GT1155-QTBDA	5.7" [320 x 240 dots], TFT color liquid crystal, 256 colors, 24VDC, memory size 3MB, built-in battery, built-in A bus/serial interface
	GT1155-QSBDQ	5.7" [320 x 240 dots], STN color liquid crystal, 256 colors, 24VDC, memory size 3MB, built-in battery, built-in Q bus/serial interface
	GT1155-QSBDA	5.7" [320 x 240 dots], STN color liquid crystal, 256 colors, 24VDC, memory size 3MB, built-in battery, built-in A bus/serial interface
	GT1150-QLBDQ	5.7" [320 x 240 dots], STN monochrome liquid crystal, monochrome (black/white), 16 scales, 24VDC, memory size 3MB, built-in battery, built-in Q bus/serial interface
	GT1150-QLBDA	5.7" [320 x 240 dots], STN monochrome liquid crystal, monochrome (black/white), 16 scales, 24VDC, memory size 3MB, built-in battery, built-in A bus/serial interface

1

OVERVIEW

2

SYSTEM
CONFIGURATION

3

SPECIFICATIONS

4

PART NAME

5

UL, cUL
STANDARDS AND
EMC DIRECTIVE

6

INSTALLATION

7

WIRING

8

OPTION

2.2.2 Option (Optional components for GT11)

PLC connection cable (Sold separately)

Product name		Model name	Cable length	Contents
RS-422 Cable	FXCPU direct connection cable FX expansion board connection cable	GT01-C10R4-8P	1m	For connecting FXCPU (MINI DIN 8 pins) and GOT. For connecting FXCPU expansion board (MINI DIN 8 pins) and GOT.
		GT01-C30R4-8P	3m	
		GT01-C100R4-8P	10m	
		GT01-C200R4-8P	20m	
		GT01-C300R4-8P	30m	
	QnA/A/ FXCPU direct connection cable computer link connection cable	GT01-C30R4-25P	3m	For connecting QnA/ACPU/Motion controller CPU (A series) FXCPU (D-sub 25 pins) and GOT. For connecting FA-CNV □ CBL and GOT For connecting serial communication unit (AJ71QC24(N)-R4) and GOT
		GT01-C100R4-25P	10m	
		GT01-C200R4-25P	20m	
		GT01-C300R4-25P	30m	
	Computer link connection cable	GT09-C30R4-6C	3m	For connecting computer link unit/serial communication unit and GOT
		GT09-C100R4-6C	10m	
		GT09-C200R4-6C	20m	
GT09-C300R4-6C		30m		
RS-232 Cable	QCPU direct connection cable	GT01-C30R2-6P	3m	For connecting QCPU/Motion controller CPU (Q series) and GOT
	FX expansion board connection, FX special adaptor connection, data transfer cable	GT01-C30R2-9S	3m	For connecting FXCPU expansion board (D-sub 9pins), special adaptor (D-sub 9 pins) and GOT. For connecting personal computer (GT Designer2) (D-sub 9 pins: female) ^{*1} and GOT (D-sub 9 pins: female) ^{*1}
	FX special adaptor connection	GT01-C30R2-25P	3m	For connecting FXCPU special adaptor (D-sub 25 pins) and GOT.
	Computer link connection cable	GT09-C30R2-9P	3m	For connecting computer link unit/serial communication unit and GOT
		GT09-C30R2-25P	3m	

*1: Description in parentheses indicates the cable side connector shape.

Bus cable for connection to QCPU (Q mode) (Sold separately)

Product name	Model name	Cable length	Description
Q add-on cable Inter-GOT connection cable	GT15-QC06B	0.6m	For connecting QCPU and GOT For interconnecting GOTs
	GT15-QC12B	1.2m	
	GT15-QC30B	3m	
	GT15-QC50B	5m	
	GT15-QC100B	10m	
Long Q connection cable Long inter-GOT connection cable	GT15-QC150BS	15m	For connecting QCPU and GOT over a distance of 13.2 m or farther (Requires A9GT-QCNB)
	GT15-QC200BS	20m	
	GT15-QC250BS	25m	For interconnecting GOTs over a distance of 13.2 m or farther
	GT15-QC300BS	30m	
	GT15-QC350BS	35m	

Bus cable for connection to QnA/ACPU/motion controller (A series) (sold separately)

Product name	Model name	Cable length	Description	
Small-CPU connection cable Inter-GOT connection cable	GT15-A1SC07B	0.7m	For connecting QnAS/AnSCPU/motion controller CPU (A series) and GOT	
	GT15-A1SC12B	1.2m		
	GT15-A1SC30B	3m		
	Large-CPU connection cable	GT15-A1SC50B	5m	For connecting QnAS/AnSCPU and GOT
		GT15-A1SC05NB	0.45m	For connecting QnAS/AnSCPU/motion controller CPU (A series) and A7GT-CNB
		GT15-A1SC07NB	0.7m	
		GT15-A1SC30NB	3m	
		GT15-A1SC50NB	5m	For connecting QnAS/AnSCPU and A7GT-CNB
Large-CPU connection cable	GT15-C12NB	1.2m	For connecting QnA/ACPU/motion controller CPU (A series/expanded base) and GOT	
	GT15-C30NB	3m		
	GT15-C50NB	5m		
	GT15-AC06B	0.6m	For connecting QnA/ACPU/motion controller CPU (A series/expanded base) and A7GT-CNB	
	GT15-AC12B	1.2m		
	GT15-AC30B	3m		
	GT15-AC50B	5m		
	Small-CPU long connection cable	GT15-A370C12B-S1	1.2m	For connecting motion controller CPU (A series/basic base) and GOT
		GT15-A370C25B-S1	2.5m	
		GT15-A370C12B	1.2m	For connecting motion controller CPU (A series/basic base) and A7GT-CNB
GT15-A370C25B		2.5m		
Small-CPU long connection cable	GT15-C100EXSS-1	10.6m	For QnAS/AnSCPU/motion controller CPU (A series) to GOT long distance connection	
	GT15-C200EXSS-1	20.6m	For A7GT-CNB to GOT long distance connection	
	GT15-C300EXSS-1	30.6m	Combination of GT15-FXCNB and GT15-C□BS	

1	OVERVIEW
2	SYSTEM CONFIGURATION
3	SPECIFICATIONS
4	PART NAME
5	STANDARDS AND EMC DIRECTIVE
6	INSTALLATION
7	WIRING
8	OPTION

Product name	Model name	Cable length	Description
Long inter-GOT connection cable	GT15-C07BS	0.7m	For interconnecting GOTs
	GT15-C12BS	1.2m	
	GT15-C30BS	3m	
	GT15-C50BS	5m	
	GT15-C100BS	10m	
	GT15-C200BS	20m	
	GT15-C300BS	30m	
A0J2HCPU connection cable	GT15-J2C10B	1m	For connecting the power supply unit (A0J2-PW) to GOT
Buffer circuit cable	GT15-EXCNB	0.5m	Can be used as a GT15-C□EXSS-1 when used in combination with GT15-C□BS

Connection cables for OMRON PLCs (Sold separately)

Product name	Model name	Cable length	Description	
RS-422 cable	GT09-C30R40101-9P	3m	For connecting GOT to OMRON PLC, serial communication module, serial communication board	
	GT09-C100R40101-9P	10m		
	GT09-C200R40101-9P	20m		
	GT09-C300R40101-9P	30m		
	RS-422 cable	GT09-C30R40102-9P	3m	For connecting GOT to OMRON rack type host link unit, communication board
		GT09-C100R40102-9P	10m	
		GT09-C200R40102-9P	20m	
		GT09-C300R40102-9P	30m	
	RS-422 cable	GT09-C30R40103-5T	3m	For connecting GOT to serial communication board
		GT09-C100R40103-5T	10m	
		GT09-C200R40103-5T	20m	
		GT09-C300R40103-5T	30m	
RS-232 cable	GT09-C30R20101-9P	3m	For connecting GOT to OMRON PLC, serial communication module, communication board, serial communication board	
	GT09-C30R20102-25P	3m	For connecting GOT to OMRON connection cable	
	GT09-C30R20103-25P	3m	For connecting GOT to OMRON rack type host link unit	

Connection cables for KEYENCE PLCs (Sold separately)

Product name	Model name	Cable length	Description
RS-422 cable	GT09-C30R41101-5T	3m	For connecting GOT to KEYENCE multi-communication unit
	GT09-C100R41101-5T	10m	
	GT09-C200R41101-5T	20m	
	GT09-C300R41101-5T	30m	
RS-232 cable	GT09-C30R21101-6P	3m	For connecting GOT to KEYENCE PLC
	GT09-C30R21102-9S	3m	For connecting GOT to KEYENCE multi-communication unit
	GT09-C30R21103-3T	3m	For connecting GOT to KEYENCE multi-communication unit

Connection cables for JTEKT PLCs (Sold separately)

Product name	Model name	Cable length	Description
RS-422 cable	GT09-C30R41201-6C	3 m	For connecting GOT to JTEKT PLC
	GT09-C100R41201-6C	10 m	
	GT09-C200R41201-6C	20 m	
	GT09-C300R41201-6C	30 m	
RS-232 cable	GT09-C30R21201-25P	3 m	For connecting GOT to JTEKT PLC

Connection cables for SHARP PLCs (Sold separately)

Product name	Model name	Cable length	Description
RS-422 cable	GT09-C30R40601-15P	3m	For connecting GOT to SHARP PLC
	GT09-C100R40601-15P	10m	
	GT09-C200R40601-15P	20m	
	GT09-C300R40601-15P	30m	
	For connecting GOT to SHARP PLC	GT09-C30R40602-15P	3m
		GT09-C100R40602-15P	10m
		GT09-C200R40602-15P	20m
		GT09-C300R40602-15P	30m
	For connecting GOT to SHARP link unit	GT09-C30R40603-6T	3m
		GT09-C100R40603-6T	10m
		GT09-C200R40603-6T	20m
		GT09-C300R40603-6T	30m
RS-232 cable	GT09-C30R20601-15P	3m	For connecting GOT to SHARP PLC
	GT09-C30R20602-15P	3m	For connecting GOT to SHARP PLC

Connection cables for TOSHIBA PLCs (Sold separately)

Product name	Model name	Cable length	Description
RS-422 cable	GT09-C30R40501-15P	3m	For connecting GOT to TOSHIBA PLC
	GT09-C100R40501-15P	10m	
	GT09-C200R40501-15P	20m	
	GT09-C300R40501-15P	30m	
	For connecting GOT to TOSHIBA PLC	GT09-C30R40502-6C	3m
		GT09-C100R40502-6C	10m
		GT09-C200R40502-6C	20m
		GT09-C300R40502-6C	30m
	For connecting GOT to TOSHIBA PLC	GT09-C30R40503-15P	3m
		GT09-C100R40503-15P	10m
		GT09-C200R40503-15P	20m
		GT09-C300R40503-15P	30m
RS-232 cable	GT09-C30R20501-9P	3m	For connecting GOT to TOSHIBA PLC
	GT09-C30R20502-15P	3m	For connecting GOT to TOSHIBA PLC

1	OVERVIEW
2	SYSTEM CONFIGURATION
3	SPECIFICATIONS
4	PART NAME
5	STANDARDS AND EMC DIRECTIVE
6	INSTALLATION
7	WIRING
8	OPTION

UL, cUL
STANDARDS AND
EMC DIRECTIVE

Connection cables for HITACHI PLCs (Sold separately)

Product name	Model name	Cable length	Description
RS-422 cable	GT09-C30R40401-7T	3m	For connecting GOT to HITACHI intelligent serial port module
	GT09-C100R40401-7T	10m	
	GT09-C200R40401-7T	20m	
	GT09-C300R40401-7T	30m	
RS-232 cable	GT09-C30R21101-6P	3m	For connecting GOT to HITACHI PLC, intelligent serial port module
	GT09-C30R21103-3T	3m	For connecting GOT to HITACHI PLC

Connection cables for HITACHI PLCs (Sold separately)

Product name	Model name	Cable length	Description
RS-422 cable	GT09-C30R41301-9S	3m	For connecting Connector Conversion Box to HITACHI PLC
	GT09-C100R41301-9S	10m	
	GT09-C200R41301-9S	20m	
	GT09-C300R41301-9S	30m	
RS-232 cable	GT09-C30R21301-9S	3m	For connecting Connector Conversion Box to HITACHI communication module

Connection cables for FUJI FA PLCs (Sold separately)

Product name	Model name	Cable length	Description
RS-422 cable	GT09-C30R41001-9S	3m	For connecting Connector Conversion Box to FUJI FA RS-232C interface card, RS-232C/485 interface capsule, general-purpose interface module
	GT09-C100R41001-9S	10m	
	GT09-C200R41001-9S	20m	
	GT09-C300R41001-9S	30m	
RS-232 cable	GT09-C30R21003-25P	3m	

Connection cables for Panasonic Electric Works PLCs (Sold separately)

Product name	Model name	Cable length	Description
RS-232 cable	GT09-C30R20901-25P	3m	For connecting GOT to Panasonic Electric Works RS422/232C conversion adapter
	GT09-C30R20902-9P	3m	For connecting GOT to the tool port or RS232C port of Panasonic Electric Works PLC, computer communication unit
	GT09-C30R20903-9P	3m	For connecting GOT to the RS232C port of Panasonic Electric Works PLC
	GT09-C30R20904-3C	3m	For connecting GOT to the RS232C port of Panasonic Electric Works PLC

Connection cables for YASKAWA PLCs (Sold separately)

Product name	Model name	Cable length	Description	
RS-422 cable	GT09-C30R40201-9P	3m	For connecting GOT to YASKAWA MEMOBUS module	
	GT09-C100R40201-9P	10m		
	GT09-C200R40201-9P	20m		
	GT09-C300R40201-9P	30m		
	RS-232 cable	GT09-C30R40202-14P	3m	For connecting GOT to YASKAWA PLC
		GT09-C100R40202-14P	10m	
		GT09-C200R40202-14P	20m	
		GT09-C300R40202-14P	30m	
RS-232 cable	GT09-C30R20201-9P	3m	For connecting GOT to YASKAWA PLC	
	GT09-C30R20202-15P	3m		
	GT09-C30R20203-9P	3m		
	GT09-C30R20204-14P	3m		
	GT09-C30R20205-25P	3m	For connecting GOT to YASKAWA MEMOBUS module	

Connection cables for YOKOGAWA PLCs (Sold separately)

Product name	Model name	Cable length	Description	
RS-422 cable	GT09-C30R40301-6T	3m	For connecting GOT to YOKOGAWA PC link module	
	GT09-C100R40301-6T	10m		
	GT09-C200R40301-6T	20m		
	GT09-C300R40301-6T	30m		
	GT09-C30R40302-6T	3m		
	GT09-C100R40302-6T	10m		
	GT09-C200R40302-6T	20m		
	RS-232 cable	GT09-C30R40303-6T	3m	For connecting Connector Conversion Box to YOKOGAWA temperature controller
		GT09-C100R40303-6T	10m	
		GT09-C200R40303-6T	20m	
		GT09-C300R40303-6T	30m	
		GT09-C30R40304-6T	3m	
		GT09-C100R40304-6T	10m	
		GT09-C200R40304-6T	20m	
RS-232 cable	GT09-C30R20301-9P	3m	For connecting GOT to YOKOGAWA CPU port/D-Sub 9-pin conversion cable	
	GT09-C30R20302-9P	3m	For connecting GOT to YOKOGAWA PC link module	
	GT09-C30R20304-9S	3m	For connecting Connector Conversion Box to YOKOGAWA converter	

1	OVERVIEW
2	SYSTEM CONFIGURATION
3	SPECIFICATIONS
4	PART NAME
5	UL, cUL STANDARDS AND EMC DIRECTIVE
6	INSTALLATION
7	WIRING
8	OPTION

Connection cables for Allen-Bradley PLCs (Sold separately)

Product name	Model name	Cable length	Description
RS-232 cable	GT09-C30R20701-9S	3m	For connecting GOT to Allen-Bradley PLC

Connection cables for SIEMENS PLCs (Sold separately)

Product name	Model name	Cable length	Description
RS-232 cable	GT09-C30R20801-9S	3m	For connecting GOT to SIEMENS HMI Adapter

Connection cables for SHINKO indicating controller PLCs (Sold separately)

Product name	Model name	Cable length	Description
RS-232 cable	GT09-C30R21401-4T	3m	For connecting Connector Conversion Box to SHINKO indicating controller

CF card (Sold separately)

Product name	Model name	Contents
CF card	GT05-MEM-128MC	Flash ROM 128MB
	GT05-MEM-256MC	Flash ROM 256MB
	GT05-MEM-512MC	Flash ROM 512MB
	GT05-MEM-1GC	Flash ROM 1GB
	GT05-MEM-2GC	Flash ROM 2GB
	-	Commercially-available CF card *2

*2: Some models with the operations checked by our company are usable.
For the operation-checked models, refer to "List of valid devices applicable for GOT1000 series" (T10-0039) separately available, or contact your local distributor.

Memory card adaptor (Sold separately)

Product name	Model name	Contents
Memory card adaptor	GT05-MEM-ADPC	CF card to memory card (Type II) conversion adaptor

Option function board (Sold separately)

Product name	Model name	Contents
Option function board	GT11-50FNB	Option function board*3

*3: Necessity of mounting the option function board may offer depending on the hardware version. Refer to the following for details.

 Section 8.3 Option Function Board

Stand (Sold separately)

Product name	Model name	Contents
Stand	GT05-50STAND	Stand for 5.7"
	A9GT-50STAND	Stand for 5.7" (Common to A95□GOT)

Battery (Sold separately)

Product name	Model name	Contents
Battery*4	GT11-50BAT	For storing clock data, alarm history, recipe data and time action setting value

*4: At GOT purchase, it is installed in the main unit.

Bus extension connector box (sold separately)

Product name	Model name	Contents
Bus extension connector box	A9GT-QCNB	Used for QCPU (Q mode)/motion controller CPU (Q series) bus connection when the cable is longer than 13.2 m

Bus connector adapter box (sold separately)

Product name	Model name	Contents
Bus connector adapter box	A7GT-CNB	Used for QnA/ACPU/motion controller CPU (A series) bus connection when the cable is longer than 13.2 m (For changing a large connector to a small connector.)

Protective sheet (Sold separately)

Product name	Model name	Contents	
Protective sheet	GT11-50PSCB	5.7" protective sheet	Clear 5 sheets
	GT11-50PSGB		Antiglare 5 sheets
	GT11-50PSCW		Clear (Frame: white) 5 sheets
	GT11-50PSGW		Antiglare (Frame: white) 5 sheets

USB environmental protection cover (Sold separately)

Product name	Model name	Contents
USB environmental protection cover*5	GT11-50UCOV	Replacement environmental protection cover for USB interface on the GOT main unit front side (For complying IP67)

*5: At GOT purchase, it is installed in the main unit.

Protective cover for oil (Sold separately)

Product name	Model name	Contents
Protective cover for oil	GT05-50PCO	5.7" protective cover for oil

Drawing software (Sold separately)

Product name	Model name	Contents
GT Designer2	SW □ D5C-GTD2-E (□ indicates the version) ^{*6}	Drawing software for GOT1000/GOT900 series
GT Designer3	SW □ DNC-GTD3-E (□ indicates the version)	Drawing software for GOT1000 series

* 6: The □ is assigned with an integer 2 or more.

PC connection cable (Sold separately)

Product name	Model name	Cable length	Description
Project data transfer cable	GT01-C30R2-9S	3m	For connecting GOT (D sub 9-pin female) and PC (D sub 9-pin female) ^{*7}
	GT01-C30R2-25P	3m	For connecting GOT (D sub 9-pin female) and PC (D sub 25-pin male) ^{*7}
	GT01-C20USB-5P	2m	For connecting GOT (USB mini) ^{*7} and PC (USB)
	GT09-C30USB-5P	3m	

* 7: Connector shape on the cable is shown in ().

Bar code reader (Sold separately)

Product name	Model name	Contents
Bar code reader	-	Commercially-available bar code reader ^{*8}

*8: Some models with the operations checked by our company are usable.
For the operation-checked models, refer to "List of valid devices applicable for GOT1000 series" (T10-0039) separately available, or contact your local distributor.

RFID controller (Sold separately)

Product name	Model name	Contents
RFID controller	-	Commercially-available RFID controller ^{*9}

*9: For connectable RFID controllers and system equipment, refer to the following Technical bulletin.

 List of valid devices applicable for GOT 1000 series (T10-0039)

Serial multi-drop connection unit (Sold separately)

Product name	Model name	Contents
Serial multi-drop connection unit	GT01-RS4-M	For GOT multi-drop connection

Connector conversion adapter (Sold separately)

Product name	Model name	Contents
Connector conversion adapter	GT10-9PT5S	For GOT multi-drop connection

3. SPECIFICATIONS

3.1 General Specifications

Item		Specifications					
Operating ambient temperature	Display section	0 to 50°C					
	Other than display section	0 to 55°C*5 (when horizontally installed), 0 to 50°C (when vertically installed)					
Storage ambient temperature		-20 to 60°C					
Operating ambient humidity*1		10 to 90% RH, non-condensing					
Storage ambient humidity*1		10 to 90% RH, non-condensing					
Vibration resistance		Compliant with JIS B3502 and IEC61131-2		Frequency	Acceleration	Half-amplitude	Sweep Count
			Under intermittent vibration	5 to 9Hz	-	3.5mm	10 times each in X, Y and Z directions
				9 to 150Hz	9.8m/s ²	-	
			Under continuous vibration	5 to 9Hz	-	1.75mm	
9 to 150Hz	4.9m/s ²	-					
Shock resistance		Compliant with JIS B3502, IEC 61131-2 (147 m/s ² , 3 times each in X, Y and Z directions)					
Operating atmosphere		Must be free of lamp black, corrosive gas, flammable gas, or excessive amount of electro conductive dust particles and must be no direct sunlight. (Same as for saving)					
Operating altitude*2		2000 m (6562 ft) max.					
Installation location		Inside control panel					
Overvoltage category*3		II or less					
Pollution degree*4		2 or less					
Cooling method		Self-cooling					
Grounding		Class D grounding (100Ω or less), To be connected to the panel when grounding is not possible					

*1 : STN liquid crystal type to be stored at or below 39°C WBT.

*2 : Do not use or store the GOT under pressures higher than the atmospheric pressure of altitude 0m (0ft.). Failure to observe this instruction may cause a malfunction.

When the air inside the control panel is purged by pressurization, the surface sheet may be lifted by high pressure. As a result, the touch panel may be difficult to press, and the sheet may be peeled off.

*3 : This indicates the section of the power supply to which the equipment is assumed to be connected between the public electrical power distribution network and the machinery within the premises.

Category II applies to equipment for which electrical power is supplied from fixed facilities.

The surge voltage withstand level for up to the rated voltage of 300 V is 2500 V.

*4 : This index indicates the degree to which conductive pollution is generated in the environment where the equipment is used.

In pollution degree 2, only non-conductive pollution occurs but temporary conductivity may be produced due to condensation.



*5 : When a protective cover for oil is mounted on the GOT, the maximum operating ambient temperature must be 5°C lower than the one described above.

3.2 Performance Specifications

- GT1155-QTBD, GT1155-QSBD, GT1150-QLBD

Item	Specifications			
	GT1155-QTBD	GT1155-QSBD	GT1150-QLBD	
Display section*1	Type	TFT color liquid crystal	STN color liquid crystal	STN monochrome (white/black) liquid crystal
	Screen size	5.7"		
	Resolution	320 × 240 dots		
	Display size	W115(4.53) × H86(3.39)[mm](inch) (Horizontal format)		
	Display character	16-dot standard font: 20 characters × 15 lines (Horizontal format), 12-dot standard font: 26 characters × 20 lines (Horizontal format)		
	Display color	256 colors		Monochrome (white/black), 16 scales
	Display angle	Left/Right: 70 degrees, Top: 70 degrees, Bottom: 50 degrees (Horizontal format)	<ul style="list-style-type: none"> • Left/Right: 50 degrees, Top: 50 degrees, Bottom: 60 degrees (Horizontal format) (Hardware version A, B) • Left/Right: 55 degrees, Top: 65 degrees, Bottom: 70 degrees (Horizontal format) (Hardware version C to K) • Left/Right: 50 degrees, Top: 50 degrees, Bottom: 70 degrees (Horizontal format) (Hardware version L or earlier) 	Left/Right: 45 degrees, Top: 20 degrees, Bottom: 40 degrees (Horizontal format)
	Contrast adjustment	-	16-level adjustment	
	Intensity of LCD only	400[cd/m ²] (Adjustable in 8 levels)	<ul style="list-style-type: none"> • 350[cd/m²] (Adjustable in 8 levels) (Hardware version A, B) • 380[cd/m²] (Adjustable in 8 levels) (Hardware version C or later) 	220[cd/m ²] (Adjustable in 8 levels)
	Intensity adjustment	8-level adjustment		
Life	Approx. 50,000h. (Time for display intensity to become 1/5 at operating ambient temperature of 25°C)			
Backlight	Cold cathode fluorescent tube (irreplaceable by a user) backlight shutoff detection function is included. Backlight off/screen saving time can be set.			
	Life*2	Approx. 75,000h or longer. (Time for display intensity reaches 50% at the operating ambient temperature of 25°C)	Approx. 54,000h or longer. (Time for display intensity reaches 50% at the operating ambient temperature of 25°C)	
Touch panel	Number of touch keys	300 keys/screen (Matrix structure of 15 lines × 20 columns)		
	Key size	Minimum 16 × 16 dots (per key)		
	Number of points touched simultaneously	Maximum of 2 points		
	Life	1 million times or more (operating force 0.98N max.)		
Memory	C drive*3	Flash memory (Internal), for storing project data (3Mbytes) and OS		
	Life (Number of write times)	100,000 times		
	D drive	SRAM (Internal), 512kbytes (battery backup)		
Battery		GT11-50BAT lithium battery		
	Backup target	Clock data, alarm history, recipe data and time action setting value		
	Life	Approx. 5 years (Operating ambient temperature of 25°C)		
Buzzer output	Single tone (tone length adjustable)			
Environmental protective structure*4	Equivalent to IP67 (JEM1030) (front section) when the USB environmental protective cover is attached			
External dimensions	W164(6.46) × H135(5.32) × D56(2.21)[mm](inch) (Excluding USB environmental protective cover) (Horizontal format)			
Panel cutting dimensions	W153 (6.03) × H121(4.77)[mm] (inch) (Horizontal format)			

Item	Specifications		
	GT1155-QTBD	GT1155-QSBD	GT1150-QLBD
Weight	0.7kg (Excluding mounting fixtures)		
Compatible software package	GT Designer2 Version2.73B or later/ GT Designer3 Version1 or later	GT Designer2 Version2 or later/GT Designer3 Version1 or later	

- *1:
- Bright dots (always lit) and dark dots (unlit) may appear on a liquid crystal display panel. It is impossible to completely avoid this symptom, as the liquid crystal display comprises of a great number of display elements. Flickers may be observed depending on the display color. Please note that these dots appear due to its characteristic and are not caused by product defect.
 - Flickers and partial discoloration may be generated on the liquid crystal display panel due to the display contents or the contrast adjustment. However, please note that these phenomena appear due to its characteristic and are not caused by product defect.
 - There is a difference in the display brightness and the color tones between liquid crystal display panels. When using multiple liquid crystal display panels, please note that there is an individual difference between them.
 - A crosstalk (shadow as an extension of the display) may appear on the liquid crystal display panel. Please note that it appears due to its characteristic.
 - When the display section is seen from the outside of the display angle, the display color seems like it has changed. Please note that it is due to its characteristic.
Please note that the response time, brightness and color of the liquid crystal display panel may vary depending on the usage environmental temperature.
 - When the same screen is displayed for a long time, an incidental color or partial discoloration is generated on the screen due to heat damage, and it may not disappear.
To prevent the heat damage, the screen saver function is effective.
For details on the screen saver function, refer to the following.
 Chapter 11 DISPLAY AND OPERATION SETTINGS (GOT SET UP)
- *2: Using the GOT Backlight OFF function can prolong the life of the backlight.
For details on the Backlight OFF function, refer to the following.
 Chapter 11 DISPLAY AND OPERATION SETTINGS (GOT SET UP)
- *3: ROM in which new data can be written without deleting the written data.
- *4: Compliant with IP67 when the USB environmental protection cover is attached. Not compliant when a USB cable is connected. Note that this does not guarantee all user's operation environment.
In addition, the product may not be used in environments under exposition of oil or chemicals for a long period of time, or in environments filled with oil-mist.

1

OVERVIEW

2

SYSTEM CONFIGURATION

3

SPECIFICATIONS

4

PART NAME

5

UL, cUL STANDARDS AND EMC DIRECTIVE

6

INSTALLATION

7

WIRING



8

OPTION

- GT1155-QTBDQ, GT1155-QSBDQ, GT1150-QLBDQ, GT1155-QTBDA, GT1155-QSBDA, GT1150-QLBDA

Item		Specifications		
		GT1155-QTBDQ GT1155-QTBDA	GT1155-QSBDQ GT1155-QSBDA	GT1150-QLBDQ GT1150-QLBDA
Display section *1	Type	TFT color liquid crystal	Color liquid crystal	STN monochrome (black/white) liquid crystal
	Screen size	5.7"		
	Resolution	320 × 240 dots		
	Display size	W115(4.53) × H86 (3.39)[mm](inch) (Horizontal format)		
	Display character	16-dot standard font: 20 characters × 15 lines, 12-dot standard font: 26 characters × 20 lines (Horizontal format)		
	Display color	256 colors		Monochrome (black/white), 16 scales
	Display angle	Left/right: 70 degrees, Top: 70 degrees, Bottom: 50 degrees (Horizontal format)	Left/right: 55 degrees, Top: 65 degrees, Bottom: 70 degrees (Horizontal format)	Left/right: 45 degrees, Top: 20 degrees, Bottom: 40 degrees (Horizontal format)
	Contrast adjustment	-	16-level adjustment	
	Intensity of LCD only	400[cd/m ²] (Adjustable in 8 levels)	380[cd/m ²] (Adjustable in 8 levels)	220[cd/m ²] (Adjustable in 8 levels)
	Intensity adjustment	8-level adjustment		
Life	Approx. 50,000 h (at operating ambient temperature of 25°C)			
Backlight	Cold cathode fluorescent tube (irreplaceable by the user) backlight detection function is included Backlight/screen saving time can be set.			
	Life *2	Approx. 75,000 hours or longer. (The time takes to reduce to 50% of the backlight luminance at the operating ambient temperature of 25°C)		Approx. 54,000 hours or longer. (The time takes to reduce to 50% of the backlight luminance at the operating ambient temperature of 25°C)
Touch panel	Number of touch keys	300 keys/screen (Matrix of 15 lines × 20 columns)		
	Key size	Minimum 16 × 16 dots (per key)		
	Maximum simultaneous key presses	Maximum of 2 points		
	Life	1 million times or more (operating force 0.98N max.)		
Memory	C drive*3	Flash memory (Internal), for storing project data (3Mbytes) and OS		
	Life (Number of write times)	100,000 times		
	D drive	SRAM (internal), 512kbytes (battery backup)		
Battery	GT11-50BAT lithium battery			
	Backup target	Clock data, alarm history, recipe data and time action setting value		
	Life	Approx. 5 years (Operating ambient temperature of 25°C)		
Buzzer output	Single tone (tone length adjustable)			
Environmental protective structure*4	Equivalent to IP67f (JEM1030) (front section) when the USB environmental protective cover is attached (Horizontal format)			
External dimensions	W167(6.58) × H135(5.32) × D65(2.56)[mm](inch)(Excluding USB environmental protective cover) (Horizontal format)			
Panel cutting dimensions	W153 (6.03) × H121(4.77)[mm] (inch)(Horizontal format)			

Item	Specifications		
	GT1155-QTBDQ GT1155-QTBDA	GT1155-QSBDQ GT1155-QSBDA	GT1150-QLBDQ GT1150-QLBDA
Weight	0.9kg(Excluding mounting fixtures)		
Compatible software package	GT Designer2 Version2.58L or later/ GT Designer3 Version1 or later	GT Designer2 Version2 or later/GT Designer3 Version1 or later	

- *1:
- Bright dots (always lit) and dark dots (unlit) may appear on a liquid crystal display panel. It is impossible to completely avoid this symptom, as the liquid crystal display comprises of a great number of display elements. Flickers may be observed depending on the display color. Please note that these dots appear due to its characteristic and are not caused by product defect.
 - Flickers and partial discoloration may be generated on the liquid crystal display panel due to the display contents or the contrast adjustment. However, please note that these phenomena appear due to its characteristic and are not caused by product defect.
 - There is a difference in the display brightness and the color tones between liquid crystal display panels. When using multiple liquid crystal display panels, please note that there is an individual difference between them.
 - A crosstalk (shadow as an extension of the display) may appear on the liquid crystal display panel. Please note that it appears due to its characteristic.
 - When the display section is seen from the outside of the display angle, the display color seems like it has changed. Please note that it is due to its characteristic.
Please note that the response time, brightness and color of the liquid crystal display panel may vary depending on the usage environmental temperature.
 - When the same screen is displayed for a long time, an incidental color or partial discoloration is generated on the screen due to heat damage, and it may not disappear.
To prevent the heat damage, the screen saver function is effective.
For details on the screen saver function, refer to the following.
 Chapter 11 DISPLAY AND OPERATION SETTINGS (GOT SET UP)
- *2: Using the GOT Backlight OFF function can prolong the life of the backlight.
For details on the Backlight OFF function, refer to the following.
 Chapter 11 DISPLAY AND OPERATION SETTINGS (GOT SET UP)
- *3: ROM in which new data can be written without deleting the written data.
- *4: Compliant with IP67 when the USB environmental protection cover is attached. Not compliant when a USB cable is connected. Note that this does not guarantee all user's operation environment.
In addition, the product may not be used in environments under exposition of oil or chemicals for a long period of time, or in environments filled with oil-mist.

1

OVERVIEW

2

SYSTEM
CONFIGURATION

3

SPECIFICATIONS

4

PART NAME

5

UL, cUL
STANDARDS AND
EMC DIRECTIVE

6

INSTALLATION

7

WIRING

8

OPTION

3.3 Built-in Interface Specifications

- GT1155-QTBD, GT1155-QSBD, GT1150-QLBD

Item	Specifications	
	GT1155-QTBD	GT1155-QSBD GT1150-QLBD
Built-in Interface	RS-422	<ul style="list-style-type: none"> • RS422, 1ch Transmission speed :115,200/57,600/ 38,400/19,200/ 9,600/4,800bps Connector type : D-sub 9-pin (female) Use : PLC communication <ul style="list-style-type: none"> • RS422/485, 1ch Transmission speed :115,200/57,600/ 38,400/19,200/ 9,600/4,800bps Connector type : D-sub 9-pin (female) Use : PLC communication Terminating resistor* ² : Open/110Ω/330Ω (Switched by terminating resistor selector switch) (At factory shipment: 330Ω) (Compatibility with the serial multi-drop connection: Hardware version C or later)
	RS-232	RS232, 1ch Transmission speed : 115,200/57,600/38,400/19,200/9,600/4,800bps Connector type : D-sub 9-pin (male) Use : PLC communication, barcode reader, RFID connection, PC communication (project data upload/download, OS installation, transparent function)
	USB	USB (Full Speed 12Mbps), device, 1ch Connector type : Mini-B Use : PC communication (project data upload/download, OS installation, transparent function)
	CF card	PCMCIA, compact flash slot, 1ch Connector type : For TYPE I only Use : Data transmission and storage
	Option function board* ¹	For mounting the option function board 1ch

*1: Necessity of mounting the option function board may offer depending on the hardware version. Refer to the following for details.

 Section 8.3 Option Function Board

*2: Set the terminating resistor selector switch of the GOT in accordance with the connection type when adopting GOT multidrop connection. For details of GOT multidrop connection, refer to the following.

 Section 8.9 Serial Multi-Drop Connection Unit

- GT1155-QTBDQ, GT1155-QSBDQ, GT1150-QLBDQ, GT1155-QTBDA, GT1155-QSBDA, GT1150-QLBDA

Item	Specifications		
	GT1155-QTBDQ GT1155-QSBDQ GT1150-QLBDQ	GT1155-QTBDA GT1155-QSBDA GT1150-QLBDA	
Built-in Interface	Bus	QCPU (Q mode)/motion controller CPU (Q series), 1ch Use : PLC communication	-
		-	QnA/ACPU/motion controller CPU (A series), 1ch Use : PLC communication
	RS-232	RS232, 1ch Transmission speed : 115,200/57,600/38,400/19,200/9,600/4,800bps Connector type : D-sub 9-pin (male) Use : Barcode reader, RFID connection, PC communication (project data upload/download, OS installation, transparent function)	
	USB	USB (Full Speed 12Mbps), device, 1ch Connector type : Mini-B Use : PC communication (project data upload/download, OS installation, transparent function)	
	CF card	PCMCIA, compact flash slot, 1ch Connector type : For TYPE I only Use : Data transmission and storage	

1

OVERVIEW

2

SYSTEM CONFIGURATION

3

SPECIFICATIONS

4

PART NAME

5

UL, cUL STANDARDS AND EMC DIRECTIVE

6

INSTALLATION

7

WIRING

8

OPTION

3.4 Power Supply Specifications

- GT1155-QTBD, GT1155-QSBD, GT1150-QLBD

Item	Specifications		
	GT1155-QTBD	GT1155-QSBD	GT1150-QLBD
Input power supply voltage	24VDC (+10% -15%), ripple voltage 200mV or less		
Fuse (built-in, not exchangeable)	1.0A		
Power consumption	9.84W (410mA/24VDC) or less	9.36W (390mA/24VDC) or less	
At backlight off	4.32W (180mA/24VDC) or less		
Inrush current	15A or less (26.4V) 2ms		
Permissible instantaneous power failure time	Within 5ms		
Noise immunity	Noise voltage: 1000Vp-p, Noise width: 1 μ s (by noise simulator of 30 to 100Hz noise frequency)		
Dielectric withstand voltage	500VAC for 1 minute (across power supply terminals and earth)		
Insulation resistance	10M Ω or larger by insulation resistance tester (across power supply terminals and earth)		
Applicable wire size	0.75 to 2[mm ²]		
Applicable solderless terminal	Solderless terminal for M3 screw RAV1.25-3, V2-N3A, FV2-N3A		
Applicable tightening torque (Terminal block terminal screw)	0.5 to 0.8[N•m]		

- GT1155-QTBDQ, GT1155-QSBDQ, GT1150-QLBDQ, GT1155-QTBDA, GT1155-QSBDA, GT1150-QLBDA

Item	Specifications		
	GT1155-QTBDQ GT1155-QTBDA	GT1155-QSBDQ GT1155-QSBDA	GT1150-QLBDQ GT1150-QLBDA
Input power supply voltage	DC24V(+10% -15%)ripple voltage 200mV or less		
Fuse (built-in, irreplaceable)	1.0A		
Power consumption	11.16W (465mA/24VDC) or less	9.72W (405mA/24VDC) or less	7.92W (330mA/24VDC) or less
With backlight off	5.04W (210mA/24VDC) or less		
Inrush current	26A or less (26.4V) 4ms		
Permissible instantaneous power failure time	Within 10ms		
Noise immunity	Noise voltage: 500Vp-p, Noise width: 1 μ s (by noise simulator of 25 to 60 Hz noise frequency)		
Dielectric withstand voltage	500VAC for 1 minute (across power supply terminals and earth)		
Insulation resistance	10M Ω or larger as measured with the 500 VDC insulation resistance tester (across power supply terminals and earth)		
Applicable wire size	0.75 to 2[mm ²]		
Applicable solderless terminal	Solderless terminal for M3 screw RAV1.25-3, V2-N3A, FV2-N3A		
Applicable tightening torque (Terminal block terminal screw)	0.5 to 0.8[N•m]		

Remark

Operation at momentary power failure

The GOT continues to operate even when the instantaneous power failure occurs within the permissible instantaneous power failure time.

The GOT stops operating if there is extended power failure or voltage drop, while it automatically resumes operation as soon as the power is restored.

1	OVERVIEW
2	SYSTEM CONFIGURATION
3	SPECIFICATIONS
4	PART NAME
5	UL, cUL STANDARDS AND EMC DIRECTIVE
6	INSTALLATION
7	WIRING
8	OPTION

4. PART NAME

4.1 Front Panel

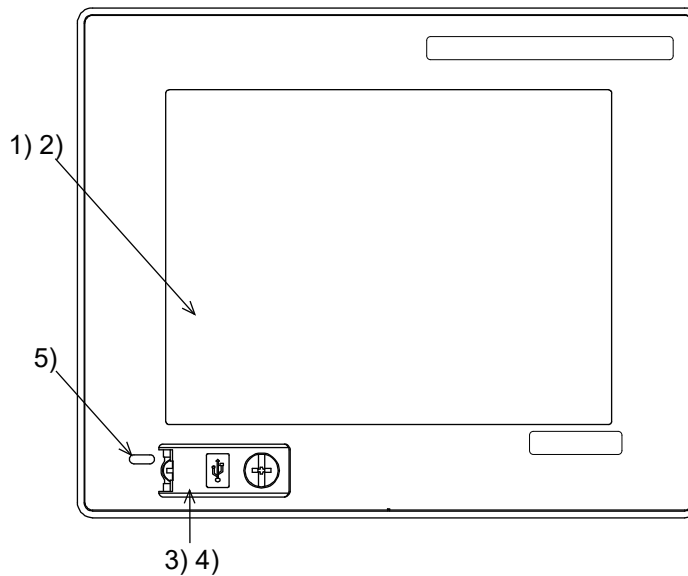

No	Name	Specifications
1)	Display screen	Displays the utility screen and the user creation screen.
2)	Touch key	For operating the touch switches in the utility screen and the user creation screen
3)	USB interface	USB interface for connecting a personal computer (OS installation, project data download, transparent)
4)	USB environmental protection cover	Opens/Closes when the USB interface is used.
5)	POWER LED	Lit in green : Power is correctly supplied Lit in orange : Screen saving Blinking in orange/green : Blown backlight bulb Not lit : Power is not supplied

For the PC connection, refer to the following.

 GT Designer2 Version□ Basic Operation/Data Transfer Manual
 GT Designer3 Version1 Screen Design Manual (Fundamentals)

4.2 Back Panel

Remark

Connecting the back panel

For the connection to the controller (PLC, microcomputer board, bar code reader, RFID, etc) or PC, refer to the following.

☞ GOT 1000 Series Connection Manual

1 GT1155-QTBD, GT1155-QSBD, GT1150-QLBD

- Hardware version
 GT1155-QTBD : A
 GT1155-QSBD : A to D
 GT1150-QLBD : A to C

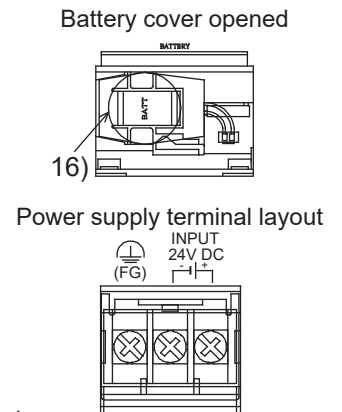
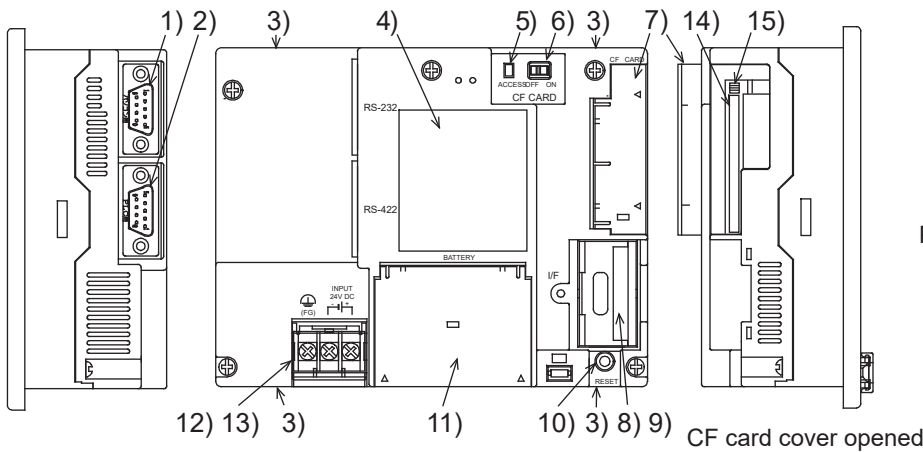

- Compatibility with the serial multi-drop connection
 GT1155-QTBD : C
 GT1155-QSBD : F
 GT1150-QLBD : F

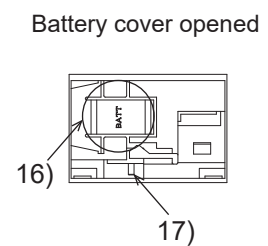
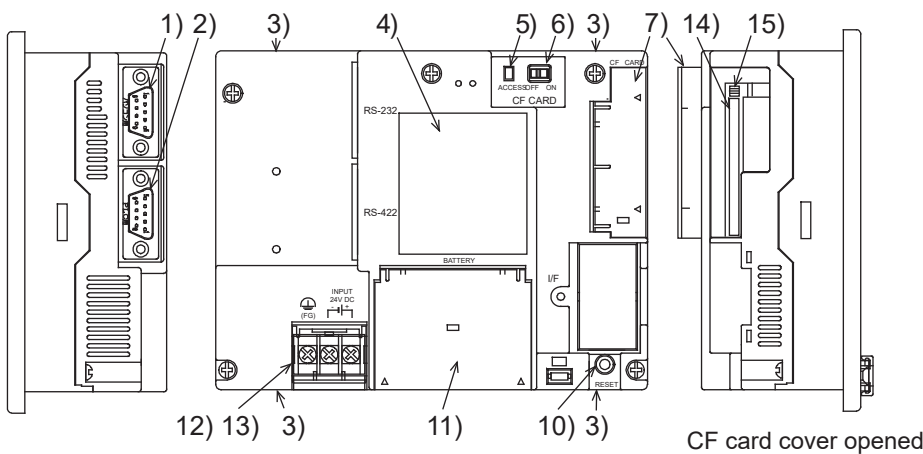

1	OVERVIEW
2	SYSTEM CONFIGURATION
3	SPECIFICATIONS
4	PART NAME
5	UL, cUL STANDARDS AND EMC DIRECTIVE
6	INSTALLATION
7	WIRING
8	OPTION

No.	Name	Specifications
1)	RS-232 interface	For communicating with controller (PLC, microcomputer board, bar code reader, RFID, etc) or personal computer (OS installation, project data download, transparent) (D-sub 9-pin male)
2)	RS-422 interface	For communicating with controller (PLC, microcomputer board, etc) (D-sub 9-pin female)
3)	Hole for unit installation fitting	Hole for the inserting installation fittings (accessory) during the GOT installation to the panel (4 holes at top and bottom)
4)	Rating plate (nameplate)	-
5)	CF card access LED	Lit: CF card accessed Not lit: CF card not accessed
6)	CF card access switch	Switch for prohibiting access to CF card before removing the CF card from the GOT ON : CF card being accessed (CF card removal prohibited) OFF : No access to CF card (CF card removal possible)
7)	CF card cover	Open or close when inserting or removing the CF card.
8)	Option function board (option)	Connect when using optional functions.
9)	Option function board cover	Remove when using the option function board.
10)	Reset switch	Hardware reset switch (Use an isolated rod to operate.)
11)	Battery cover	Open or close when replacing the battery.
12)	Power terminal	Power terminal and FG terminal (for power supply (24VDC) to GOT and grounding)
13)	Power terminal cover	Open or close when connecting a power terminal. (Color: transparent)
14)	CF card interface	Interface for installing the CF card to GOT
15)	CF card eject button	Button for removing the CF card
16)	Battery	GT11-50BAT battery for storing clock data, alarm history, recipe data and time action setting value (The project data is stored in the built-in flash memory.)
17)	Terminating resistor selector switch	Terminating resistor selector of RS422/485 (330Ω/OPEN/110Ω) (At factory shipment: 330Ω)

2 GT1155-QTBDQ, GT1155-QSBDQ, GT1150-QLBDQ, GT1155-QTBDA, GT1155-QSBDA, GT1150-QLBDA

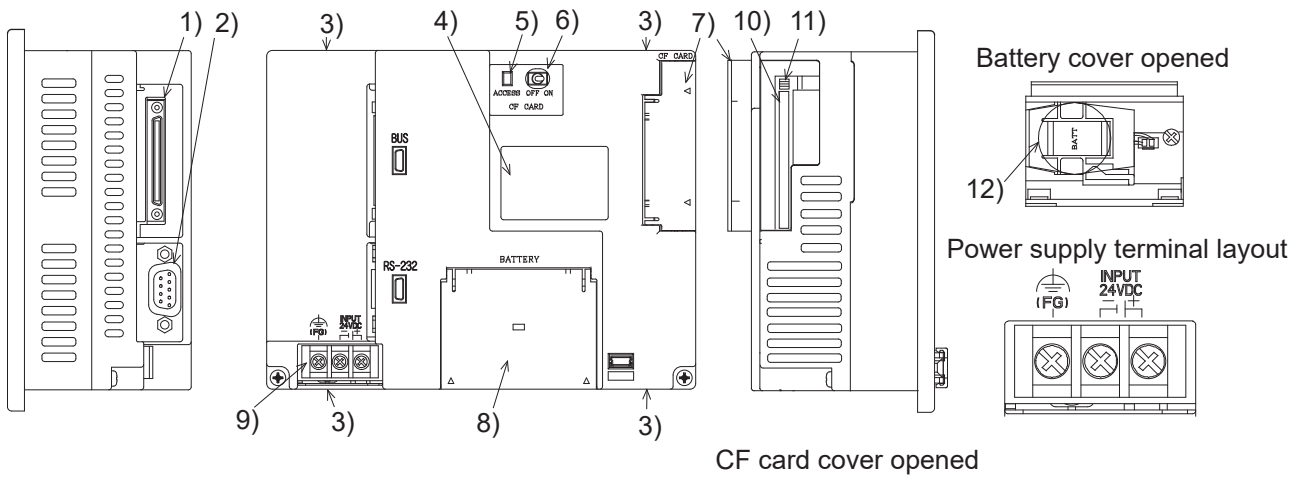

No.	Name	Specifications
1)	Bus interface	Compatible GOT : GT1155-QTBDQ, GT1155-QSBDQ, GT1150-QLBDQ Use : For connection to QCPU (Q mode)/motion controller CPU (Q series)
		Compatible GOT : GT1155-QTBDA, GT1155-QSBDA, GT1150-QLBDA Use : For connection to QnA/ACPU/motion controller CPU (A series)
2)	RS-232 interface	For communicating with controller (bar code reader, RFID) or personal computer (OS installation, project data download, transparent) (D-sub 9-pin male)
3)	Hole for unit installation fitting	Hole for the inserting installation fittings (accessory) during the GOT installation to the panel (4 holes at top and bottom)
4)	Rating plate (nameplate)	-
5)	CF card access LED	Lit: CF card accessed Not lit: CF card not accessed
6)	CF card access switch	Switch for prohibiting access to CF card before removing the CF card from the GOT ON : CF card being accessed (CF card removal prohibited) OFF : No access to CF card (CF card removal possible)
7)	CF card cover	Open or close when inserting or removing the CF card.
8)	Battery cover	Open or close when replacing the battery.
9)	Power terminal	Power terminal and FG terminal (for power supply (24VDC) to GOT and grounding)
10)	CF card interface	Interface for installing the CF card to GOT
11)	CF card eject button	Button for removing the CF card
12)	Battery	GT11-50BAT battery for storing clock data, alarm history, recipe data and time action setting value (The project data is stored in the built-in flash memory.)

5. UL, cUL STANDARDS AND EMC DIRECTIVE

5.1 UL, cUL Standards

■ Using GOT

GOT is for use on a Flat Surface of a Type 1 Enclosure.

5.2 EMC DIRECTIVE

For the products sold in European countries, the conformance to the EMC Directive, which is one of the European Directives, has been a legal obligation since 1996. Also, conformance to the Low Voltage Directive, another European Directives, has been a legal obligation since 1997. Manufacturers who recognize their products must conform to the EMC and Low Voltage Directives required to declare that their products conform to these Directives and put a "CE mark" on their products. Products that the EMC Directive applies to are marked with the CE mark logo.



Authorized representative in Europe

- This product is designed for use in industrial applications.
- Authorized Representative in the European Community: Mitsubishi Electric Europe B.V.
Gothaer Str. 8, 40880 Ratingen, Germany

5.2.1 Requirements for Conformance to EMC Directive

The EMC Directive specifies that products placed on the market must "be so constructed that they do not cause excessive electromagnetic interference (emissions) and are not unduly affected by electromagnetic interference (immunity)".

The applicable products are requested to meet these requirements.

The paragraphs **1** through **3** summarize the precautions on conformance to the EMC Directive of the machinery constructed using the GOT.

The details of these precautions has been prepared based on the requirements and the applicable standards control. However, we will not assure that the overall machinery manufactured according to these details conforms to the above-mentioned directives. The method of conformance to the EMC Directive and the judgment on whether or not the machinery conforms to the EMC Directive must be determined finally by the manufacturer of the machinery.

1 Standards applicable to the EMC Directive

The following products have shown compliance through direct testing (to the identified standards) and design analysis (forming a technical construction file) to the European Directive for Electromagnetic Compatibility (2004/108/EC) when used as directed by the appropriate documentation

Type : Programmable Controller (Open Type Equipment)

Standard		Remark
EN61131-2 : 2007 Programmable controllers - Equipment, requirement and tests	EMI	Compliance with all relevant aspects of the standard. (Radiated Emissions)
	EMS	Compliance with all relevant aspects of the standard. (ESD,RF electromagnetic field, EFTB, Surge, RF conducted disturbances and Power frequency magnetic field)

Models : MELSEC GOT series products, identified here, manufactured from April 1st, 2005
GT1155-QSBD, GT1150-QLBD (For this product see note under and over the page).
Models : MELSEC GOT series products, identified here, manufactured from October 1st, 2007
GT1155-QTBD (For this product see note under and over the page).

Standard		Remark
EN61131-2 : 2007 Programmable controllers - Equipment, requirement and tests	EMI	Compliance with all relevant aspects of the standard. (Radiated Emissions)
	EMS	Compliance with all relevant aspects of the standard. (ESD,RF electromagnetic field, EFTB, Surge, RF conducted disturbances and Power frequency magnetic field)

Models : MELSEC GOT series products, identified here, manufactured from January 7th, 2008
GT1155-QTBDQ, GT1155-QTBDA, GT1155-QSBDQ, GT1155-QSBDA,
GT1150-QLBDQ, GT1150-QLBDA (For this product see note under and over the page).

2 Control cabinet

The GOT is an open type device (device installed to another device) and must be installed in a conductive control panel or cabinet.

It not only assure the safety but also has a large effect to shut down the noise generated from GOT, on the control panel.

- (1) Control cabinet
 - (a) Use a conductive control cabinet.
 - (b) When attaching the control cabinet's top plate or base plate, mask painting and weld so that good surface contact can be made between the cabinet and plate.
 - (c) To ensure good electrical contact with the control cabinet, mask the paint on the installation bolts of the inner plate in the control cabinet so that contact between surfaces can be ensured over the widest possible area.
 - (d) Earth the control cabinet with a thick wire so that a low impedance connection to ground can be ensured even at high frequencies. (22mm 2 wire or thicker is recommended.)
 - (e) Holes made in the control cabinet must be 10 cm (3.94inch) diameter or less. If the holes are 10cm (3.94inch) or larger, radio frequency noise may be emitted.
In addition, because radio waves leak through a clearance between the control panel door and the main unit, reduce the clearance as much as practicable. The leakage of radio waves can be suppressed by the direct application of an EMI gasket on the paint surface.

(2) Connection of power and ground wires

Ground and power supply wires for the GOT must be connected as described below.

- (a) Provide an earthing point near the GOT. Earth the power supply's FG terminal (FG: Frame Ground) with the thickest and shortest wire possible. (The wire length must be 30cm (11.18inch) or shorter.)

The FG terminal function is to pass the noise generated in the GOT to the ground, so an impedance that is as low as possible must be ensured. As the wires are used to relieve the noise, the wire itself carries a large noise content and thus short wiring means that the wire is prevented from acting as an antenna.

Note) A long conductor will become a more efficient antenna at high frequency.

(3) Electrical shock prevention

In order to such as the operators from electric shocks, the control box must have the following functions :

- (a) The control cabinet must be equipped with a lock so that only skilled or qualified personnel.
(b) The control cabinet must be fitted with advice which automatically stops the power supply when the cabinet is opened.

(4) Dustproof and waterproof features

The control box also has the dustproof and waterproof functions. Insufficient dustproof and waterproof features lower the insulation withstand voltage, resulting in insulation destruction.

The insulation in our GOT is designed to cope with the pollution level 2, so use in an environment with pollution level 2 or better.

Pollution level 1: An environment where the air is dry and conductive dust does not exist.

Pollution level 2: An environment where conductive dust does not usually exist, but occasional temporary conductivity occurs due to the accumulated dust.

Generally, this is the level for inside the control box equivalent a control room or on the floor of a typical factory.

Pollution level 3: An environment where conductive dust exists and conductivity may be generated due to the accumulated dust.

An environment for a typical factory floor.

Pollution level 4: Continuous conductivity may occur due to rain, snow, etc.

An outdoor environment.

3 Grounding

It is necessary to use the GOT grounding terminal only when it is in the grounded condition.

Be sure to ground the grounding for the safety reasons and EMC Directives.

Functional grounding : Improves the noise resistance.

5.2.2 System Configuration when EMC Directive is Applicable

Connection conditions and models where the EMC Directive is applicable are shown below. (Available April, 2005)

1 About models applicable to the EMC Directive

The following table lists the modules compliant with the EMC Directive.

○ : Compliant with EMC Directive × : Not compliant with EMC Directive

Item	EMC Directive	Hardware version
GT1155-QTBD	○	A
GT1155-QSBD, GT1150-QLBD	○	B
GT1155-QTBDQ, GT1155-QTBDA, GT1155-QSBDQ, GT1155-QSBDA, GT1150-QLBDQ, GT1150-QLBDA	○	D



Please use the GOT whose hardware version is later than that described. Confirm the hardware version with the products rating plate. (Products that the EMC Directive applies to are marked with the CE mark logo.)

- (1) GT1155-QTBD, GT1155-QSBD, GT1150-QLBD

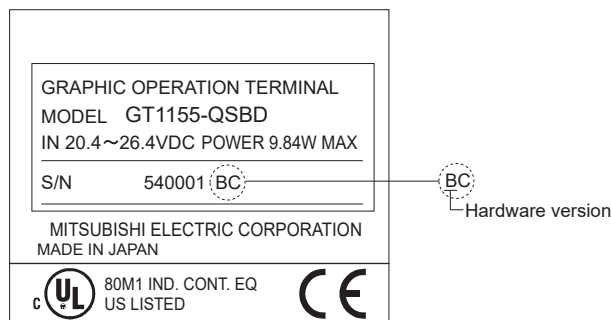

- (2) GT1155-QTBDQ, GT1155-QTBDA, GT1155-QSBDQ, GT1155-QSBDA, GT1150-QLBDQ, GT1150-QLBDA

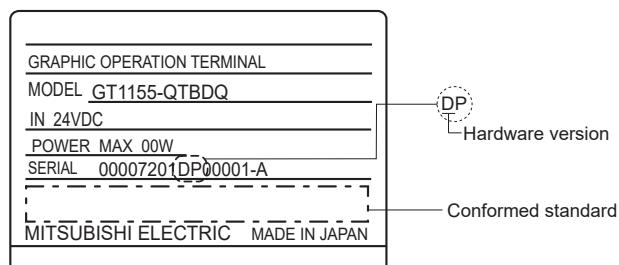

2 Connection format

Connection conditions where the GT11 is applicable to the EMC Directive are shown below.

- (1) GT1155-QTBD, GT1155-QSBD, GT1150-QLBD
 Connection format: CPU direct connection (RS-422)



If connecting to a PLC not from this company (MELSEC-FX2N series), refer to the manual of the connected device (PLC, microcomputer) for information about the applicability of the EMC Directive.

- (2) GT1155-QTBDQ, GT1155-QTBDA, GT1155-QSBDQ,
 GT1155-QSBDA, GT1150-QLBDQ, GT1150-QLBDA
 Connection format: Bus connection

5.2.3 Wiring Precautions the Part which Matches the EMC Directives

Connect and wire GOT equipment as instructed below.

If the GOT equipment is configured in a way that differs from the following instructions then the system will not comply with EMC directives.

1 About the cable used

- (1) Serial connection cable

Any device which utilizes a data communication function is susceptible to the wider effects of local EMC noise. Therefore, when installing any communication cables care should always be taken with the routing and location of those cables. The GOT units identified on the previous page are compliant with the EMC requirement when the following communication cables are used.

GOT Unit	Existing Cables	User Made Cables
GT1155-QTBD GT1155-QSBD GT1150-QLBD	GT01-C30R4-8P modified as shown in EX.1	Those cables need to be independently tested by the user to demonstrate EMC compatibility when they are used with Mitsubishi GOT unit and FX2N Programmable Controllers.

EX.1

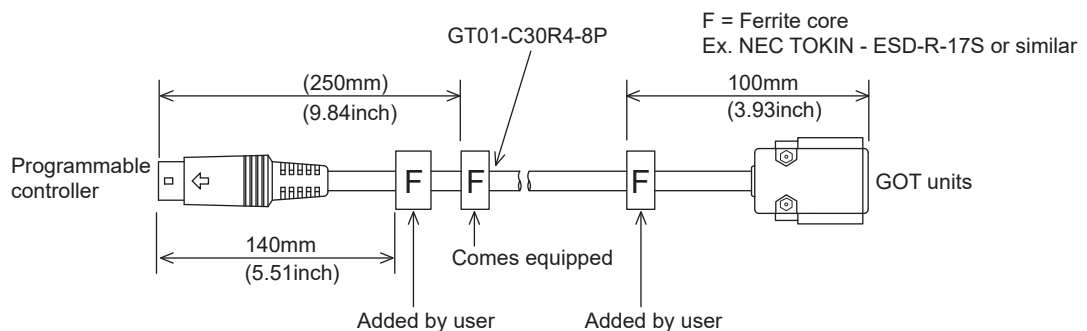

(2) Bus connection cable

The following products are used in the EMC specification compatibility test conducted by Mitsubishi Electric Corporation.

- ZCAT3035-1330 ferrite core manufactured by TDK corporation
- AD75CK-type cable clamp manufactured by MITSUBISHI
- Zipper tube SHNJ type manufactured by Zippertubing(Japan),Ltd.

GOT Unit	Existing Cables	User Made Cables
GT1155-QTBDQ GT1155-QSBDQ GT1150-QLBDQ	GT15-QC□ B, GT15-QC□ BS modified as shown in EX.2. Peel the sheath at both ends of the cable, and expose the shield braided wire for grounding. (For grounding with clamps. (refer to 3 Grounding the cable.))	The cable need to be independently tested by the user to demonstrate EMC compatibility when they are used with the GOT, the PLC of MELSEC-Q series, MELSEC-QnA series, and MELSEC-A series.
GT1155-QTBDA GT1155-QSBDA GT1150-QLBDA	GT15-C□ BS, GT15-C□ EXSS-S1 modified as shown in EX.3. Peel the sheath at both ends of the cable, and expose the shield braided wire for grounding. (For grounding with clamps. (refer to 3 Grounding the cable.))	
	Other bus connection cables modified as shown in EX.4. Wind cable shield material around the cable, and pull out the grounding braided wire of the cable shield material. Attach the ferrite core to the cable in the specified position and insert the braided wire for grounding into the ferrite core.	

EX.2

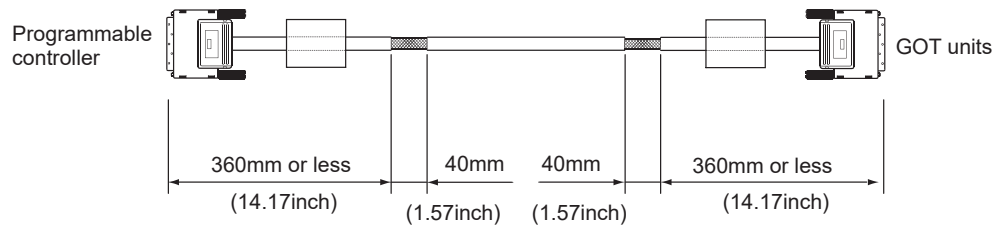

EX.3

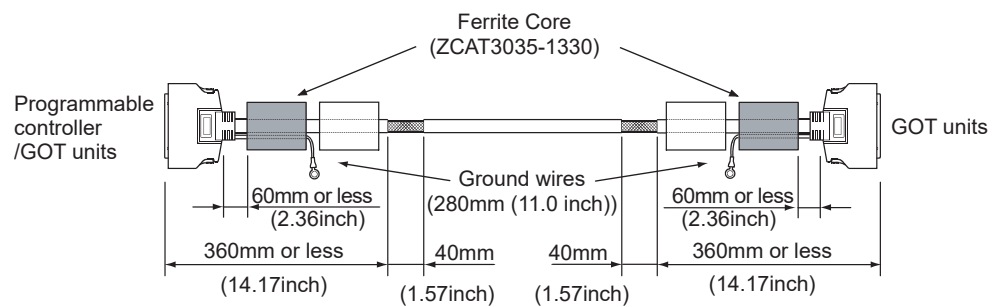

EX.4

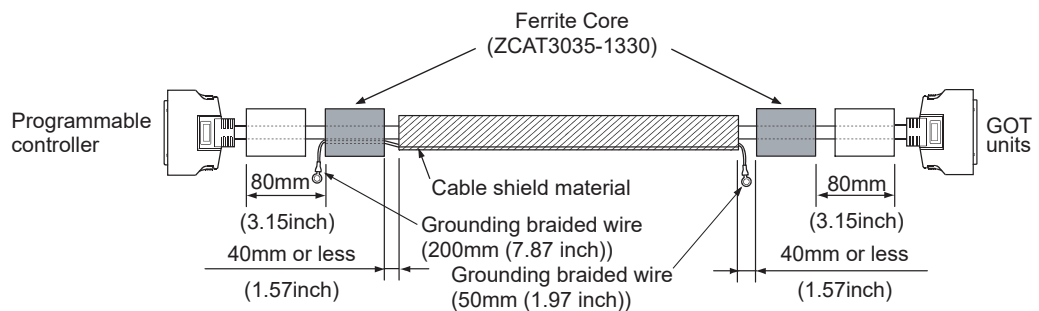

2 Method to connect the power wire and ground wire

(1) GT1155-QTBD, GT1155-QSBD, GT1150-QLBD

The GT1155-QTBD, GT1155-QSBD and GT1150-QLBD unit requires an additional ferrite filter to be attached to the 24V DC power supply cables. The filter should be attached in a similar manner as shown in the figure opposite, i.e. the power cables are wrapped around the filter. However, as with all EMC situations the more correctly applied precautions the better the systems Electro-magnetic Compatibility. The ferrite recommended is a TDK ZCAT3035-1330 or similar. The ferrite should be placed as near to the 24V DC terminals of the GT1155-QTBD, GT1155-QSBD and GT1150-QLBD as possible (which should be within 75mm of the GOT terminal).

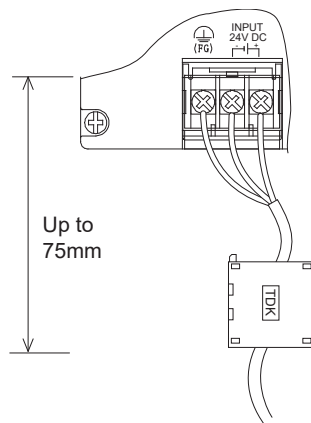

(2) GT1155-QTBDQ, GT1155-QTBDA, GT1155-QSBDQ, GT1155-QSBDA, GT1150-QLBDQ, GT1150-QLBDA

Twist the 24VDC cables to connect to the GT1155-QTBDQ, GT1155-QTBDA, GT1155-QSBDQ, GT1155-QSBDA, GT1150-QLBDQ, and GT1150-QLBDA.

The ferrite filter is required for the 24VDC cables. The filter should be attached in a similar manner as shown in the figure opposite, i.e. the power cables are wrapped around the filter.

However, as with all EMC situations the more correctly applied precautions the better the systems Electro-magnetic Compatibility. The ferrite recommended is a TDK ZCAT3035-1330 or similar. The ferrite should be placed as near to the 24V DC terminals of the GT1155-QTBDQ, GT1155-QTBDA, GT1155-QSBDQ, GT1155-QSBDA, GT1150-QLBDQ and GT1150-QLBDA as possible (which should be within 75mm of the GOT terminal).

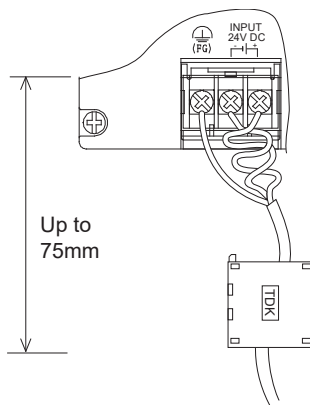

3 Grounding the cable

Use the bus connection cable to ground the cable and grounding wire to the control panel where the GOT and base unit are installed.

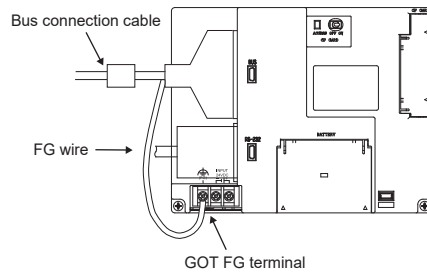
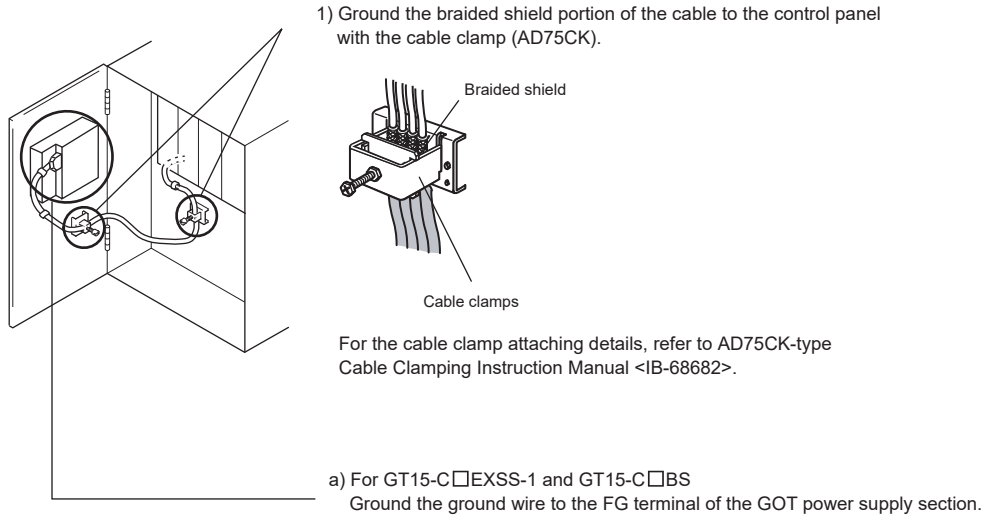

- b) For other bus connection cables Ground the braided wire for grounding to the control panel by tightening a screw.

6. INSTALLATION

MOUNTING PRECAUTIONS

WARNING

- Be sure to shut off all phases of the external power supply used by the system before mounting or removing the GOT to/from the panel.
Not doing so can cause the unit to fail or malfunction.
- Be sure to shut off all phases of the external power supply used by the system before mounting or removing the option function board on to/from the GOT.
Not doing so can cause the unit to fail or malfunction.
- When installing the option function board or battery, or operating the reset switch, wear an earth band etc. to avoid the static electricity.
The static electricity can cause the unit to fail or malfunction.

MOUNTING PRECAUTIONS

CAUTION

- Use the GOT in the environment that satisfies the general specifications described in this manual.
Not doing so can cause an electric shock, fire, malfunction or product damage or deterioration.
- When mounting the GOT to the control panel, tighten the mounting screws in the specified torque range.
Undertightening can cause the GOT to drop, short circuit or malfunction.
Overtightening can cause a drop, short circuit or malfunction due to the damage of the screws or the GOT.
- Securely connect the option function board to the connector provided for the board.
- When inserting/removing a CF card into/from the GOT, turn the CF card access switch off in advance.
Failure to do so may corrupt data within the CF card.
- When inserting a CF card into the GOT, push it into the insertion slot until the CF card eject button will pop out.
Failure to do so may cause a malfunction due to poor contact.
- When removing a CF card from the GOT, make sure to support the CF card by hand, as it may pop out.
Failure to do so may cause the CF card to drop from the GOT and break.

6.1 Control Panel Inside Dimensions for Mounting GOT

Mount the GOT onto the control panel while considering the following control panel inside dimensions. Vertical installation of the GOT requires a space with the same dimensions as the horizontal installation turned 90 degrees clockwise (seen from the display side).



Applicable cable

Some cables may need to be longer than the specified dimensions when connecting to the GOT.

Therefore, consider the connector dimensions and bending radius of the cable as well for installation.

1 GT1155-QTBD, GT1155-QSBD, GT1150-QLBD

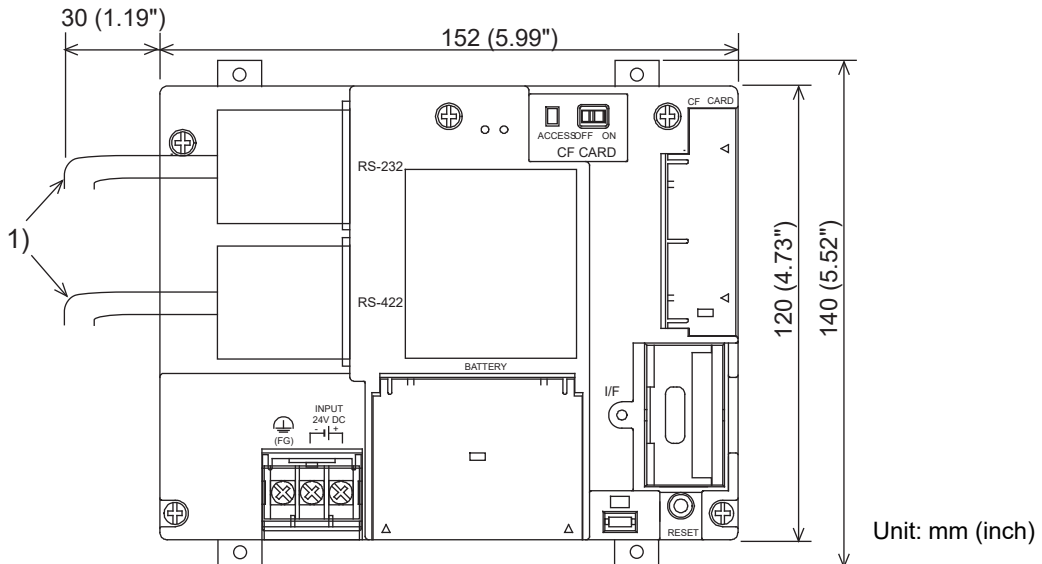

No	Name
1)	PLC connection cable/PC connection cable

2 GT1155-QTBDQ, GT1155-QSBDQ, GT1155-QLBDQ,
GT1155-QTBDA, GT1155-QSBDA, GT1155-QLBDA

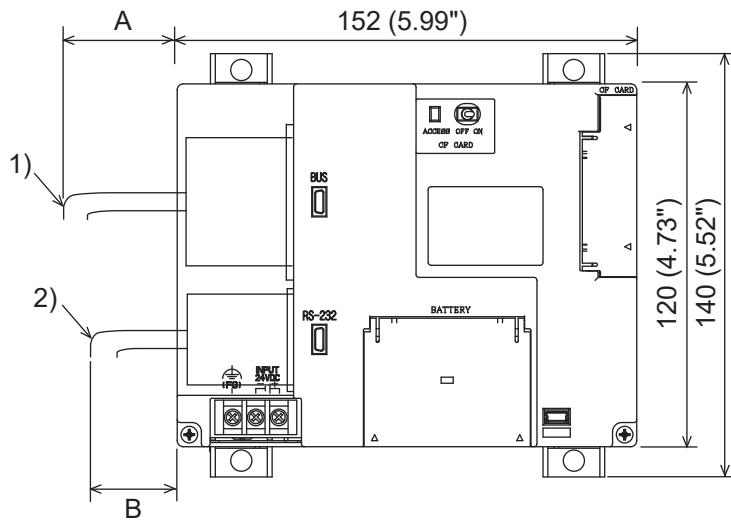

Type	A	B
GT1155-QTBDQ		
GT1155-QSBDQ	56(2.20")	40(1.57")
GT1155-QLBDQ		
GT1155-QTBDA		
GT1155-QSBDA	38(1.50")	40(1.57")
GT1155-QLBDA		

Unit: mm(inch)

No	Name
1)	Bus cable
2)	PC cable/barcode cable/RFID cable

6.2 Panel Cutting Dimensions

Make holes in the panel according to the dimensions list below.
 Also, ensure 10mm of space in upper and lower parts of the panel for mounting fixtures.
 Horizontal format (If the vertical format is selected, the dimension must be rotated 90 degrees.)

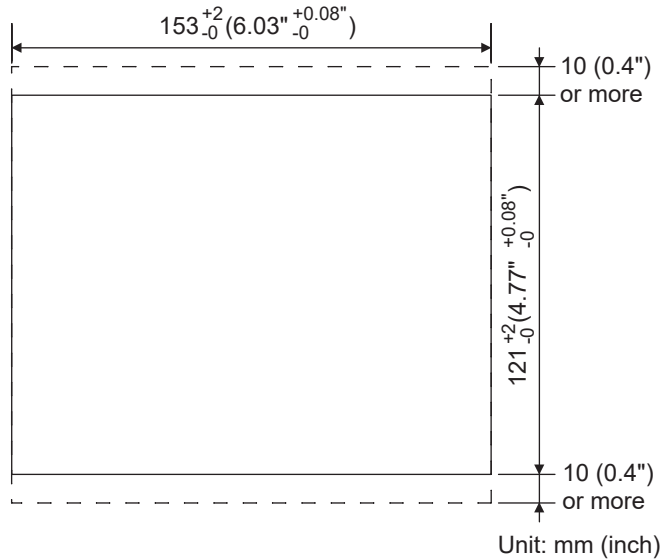

Type	Panel thickness [mm] (inch)
GT1155-QTBD	Within 2 (0.08") to 4 (0.16")
GT1155-QSBD	
GT1150-QLBD	
GT1155-QTBDDQ	
GT1155-QSBDQ	
GT1150-QLBDQ	
GT1155-QTBDA	
GT1155-QSBDA	
GT1150-QLBDA	

6.3 Mounting Position

When mounting the GOT, the following clearances must be maintained from other structures and devices.
 The below diagram represents a horizontal installation. (The same clearances must be maintained when rotating the GOT 90 degrees clockwise for a vertical installation.)

Installation Environment	A,D	B	C		E
			When the CF card is not used	When the CF card is used	
In the presence of radiated-noise or heat-generating equipment nearby	50 mm (1.97") or more	80 mm (3.14") or more ^{*1}	50 mm (1.97") or more ^{*2}	100 mm (3.93") or more	100 mm (3.93") or more
In the absence of radiated-noise or heat-generating equipment nearby	20 mm (0.79") or more	20 mm (0.79") or more	20 mm (0.79") or more	or more	20 mm (0.79") or more

*1 Vertical Format...50 mm (1.97") or more

*2 Vertical Format...80 mm (3.14") or more

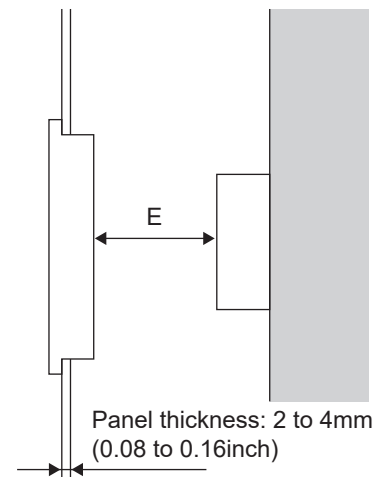
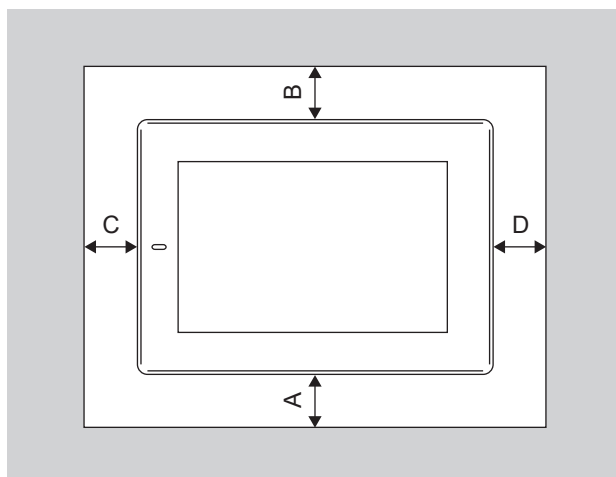

6.4 Control Panel Temperature and Mounting Angle

When mounting the main unit to a control panel or similar fixture, set the GOT display section as shown below.

1 Horizontal installation

When the temperature inside the control panel is 40 to 55°C, the mounting angle should be in the range from 60 to 105 degrees.

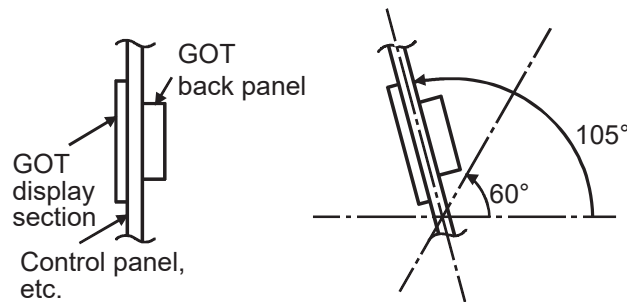

- The GOT will have a longer lifetime if used within the mounting angles shown above. Ideally, the temperature inside the control panel should not exceed 0 to 40°C

2 Vertical installation

When the temperature inside the control panel is 40 to 50°C, the mounting angle should be in the range from 60 to 105 degrees.

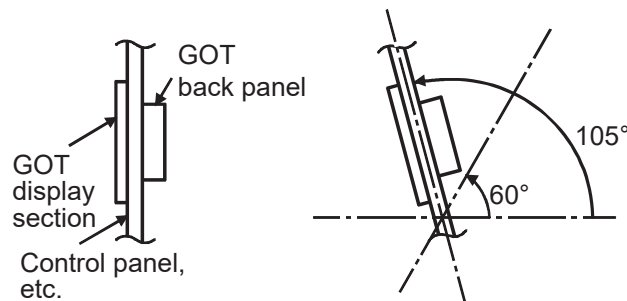

- The GOT will have a longer lifetime if used within the mounting angles shown above. Ideally, the temperature inside the control panel should not exceed 0 to 40°C.

6.5 Installation Procedure

The GOT is designed to be embedded into a panel.
Mount the GOT by following the procedure below.

Point

Cautions on the installation panel

Refer to "Section 6.2 Panel Cutting Dimensions" for the panel cutting dimensions and panel thickness.

Make sure that the panel surface is free from warpage, flaws and irregularities. Warpage, flaws and irregularities may disable the waterproof effect. Select proper panel thickness under consideration of the panel strength. (For example, the panel strength may be insufficient depending on the panel material and dimensions even if the panel thickness is acceptable. Insufficient panel strength may cause warpage depending on the installation positions of the GOT and other equipment.)

1 Installing the packing

- (1) GT1155-QTBD, GT1155-QSBD and GT1150-QLBD
Install packing to the packing installation groove on the back panel of the GOT.

While referring to the cross sectional view of the packing shown right, push the thinner side into the packing groove.

(Right drawing is the example of lateral format.)

- (2) GT1155-QTBDQ, GT1155-QSBDQ, GT1150-QLBDQ, GT1155-QTBDA, GT1155-QSBDA, and GT1150-QLBDA

Units are shipped with the packing attached.

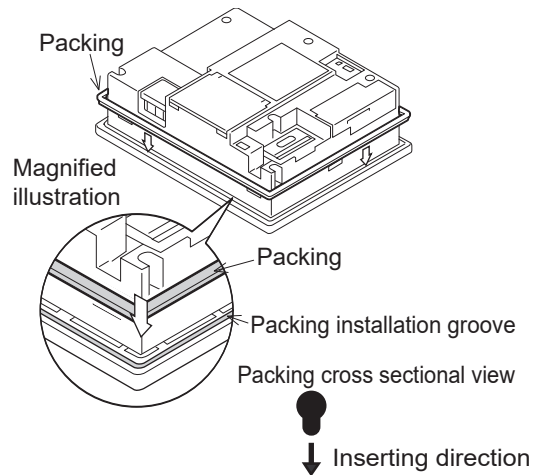

2 Inserting into the panel face

Insert the GOT from the front side of the panel.

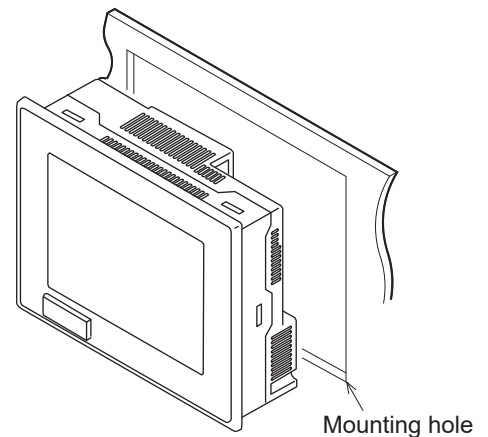

1	OVERVIEW
2	SYSTEM CONFIGURATION
3	SPECIFICATIONS
4	PART NAME
5	UL, cUL STANDARDS AND EMC DIRECTIVE
6	INSTALLATION
7	WIRING
8	OPTION

3 Fixing the GOT

Engage the hook of the mounting fitting (accessory) to the unit fixing hole of the GOT and tighten the screw until the GOT is fixed with the mounting bolt (accessory).

The GOT will be fixed in 4 upper/lower parts.

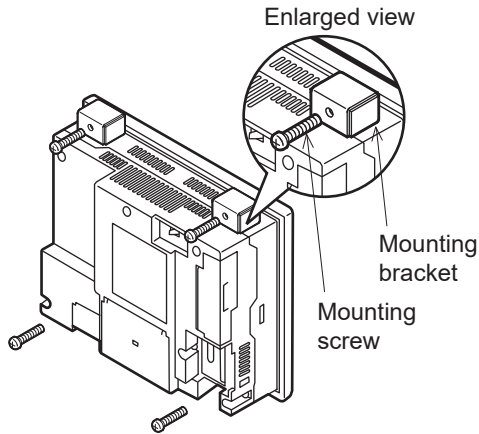

GT1155-QTBD, GT1155-QSBD,
GT1150-QLBD

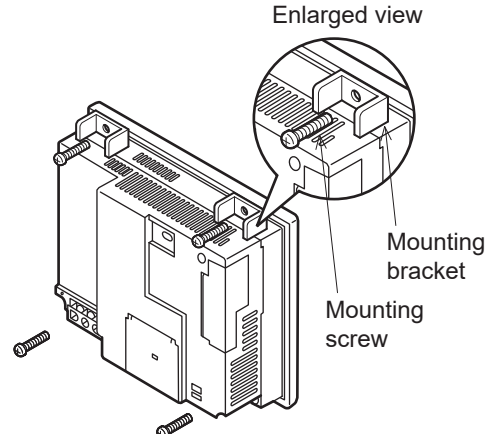

GT1155-QTBDQ, GT1155-QTBDA,
GT1155-QSBDQ, GT1155-QSBDA,
GT1150-QLBDQ, GT1150-QLBDA

Point

Cautions on installation

Tighten the mounting screw with the specified torque.

Failure to do so may damage the unit, or distort the panel and make a surface waviness on the display area, leading to deterioration of the visibility or incorrect input from the touch panel.

GOT	GT1155-QTBD, GT1155-QSBD GT1150-QLBD	GT1155-QTBDQ, GT1155-QTBDA GT1155-QSBDQ, GT1155-QSBDA GT1150-QLBDQ, GT1150-QLBDA
Tightening torque	0.3 to 0.5N•m	0.36 to 0.48N•m

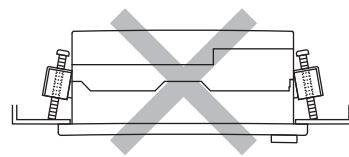
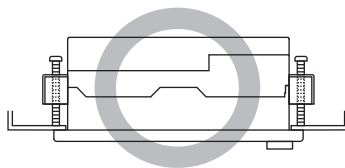

4 A protection film is attached on the display section of GOT prior to shipment.

Remove the film when the installation is completed.

7. WIRING

WIRING PRECAUTIONS	 WARNING
<ul style="list-style-type: none">● Be sure to shut off all phases of the external power supply used by the system before wiring. Failure to do so may result in an electric shock, product damage or malfunctions.● Please make sure to ground FG terminal of the GOT power supply section by applying 100Ω or less which is used exclusively for the GOT. Not doing so may cause an electric shock or malfunction.● Correctly wire the GOT power supply section after confirming the rated voltage and terminal arrangement of the product. Not doing so can cause a fire or failure.● Tighten the terminal screws of the GOT power supply section in the specified torque range. Undertightening can cause a short circuit or malfunction. Overtightening can cause a short circuit or malfunction due to the damage of the screws or the GOT.● Exercise care to avoid foreign matter such as chips and wire offcuts entering the GOT. Not doing so can cause a fire, failure or malfunction.	

WIRING PRECAUTIONS	 CAUTION
<ul style="list-style-type: none">● Plug the communication cable into the connector of the connected unit and tighten the mounting and terminal screws in the specified torque range. Undertightening can cause a short circuit or malfunction. Overtightening can cause a short circuit or malfunction due to the damage of the screws or unit.	

This chapter describes the wiring to the GOT power supply section.

- (1) For the connection with a PLC, refer to the following.

 GOT1000 Series Connection Manual

- (2) For the dimensional drawing of connection cables, refer to the following.

 Appendix 1 External Dimensions

Remark

General preventive measures against noise

There are two kinds of noises: Radiated noise that is transmitted into the air and Conductive noise that is directly transmitted along connected lines. Countermeasures must be taken considering both kinds of noises and referring to the following 3 points.

- (1) Protecting against noise
 - (a) Keep signal lines away from noise sources such as a power cable or a high-power drive circuit.
 - (b) Shield the signal lines.
- (2) Reducing generated noise
 - (a) Use a noise filter, etc. to reduce the level of the noise generated due to a source such as a high-power motor drive circuit.
 - (b) Attach surge killers to the terminals on the No Fuse Breaker (NFB), electromagnetic contactors, relays, solenoid valves, and generators to suppress noise interference.
- (3) Releasing noise to the ground
 - (a) Make sure to connect the ground cable to the ground.
 - (b) Use a short and thick cable to lower its impedance.
 - (c) Ground the power system and the control system separately.

7.1 Power Supply Wiring

7.1.1 Wiring example

Connect the power supply to the power terminals on the back panel of the GOT.

Use 0.75mm² or thicker cables to avoid voltage drop and tighten the terminal screw with the specified torque securely.

1 GT1155-QTBD, GT1155-QSBD, GT1155-QLBD

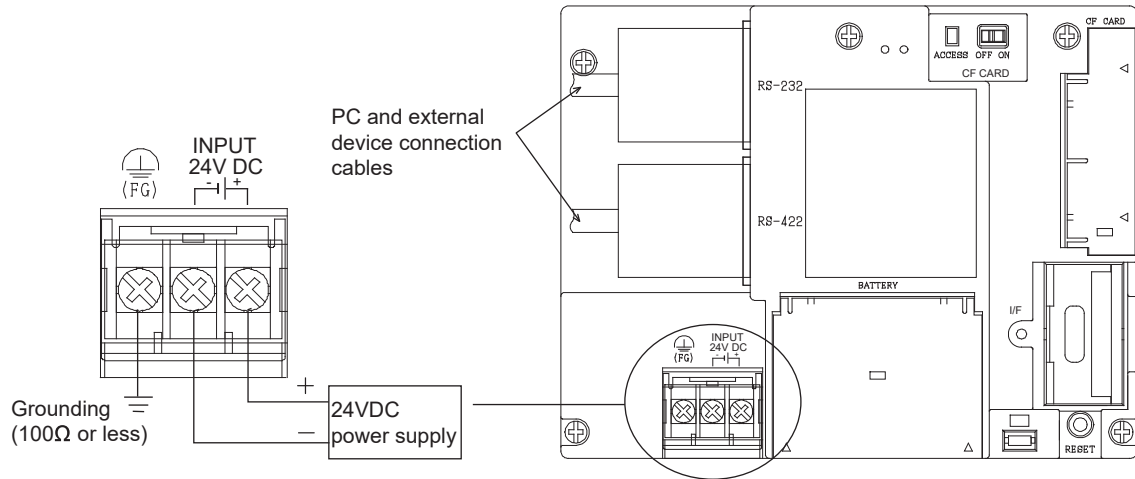

2 GT1155-QTBDQ, GT1155-QSBDQ, GT1155-QLBDQ, GT1155-QTBDA, GT1155-QSBDA, GT1155-QLBDA

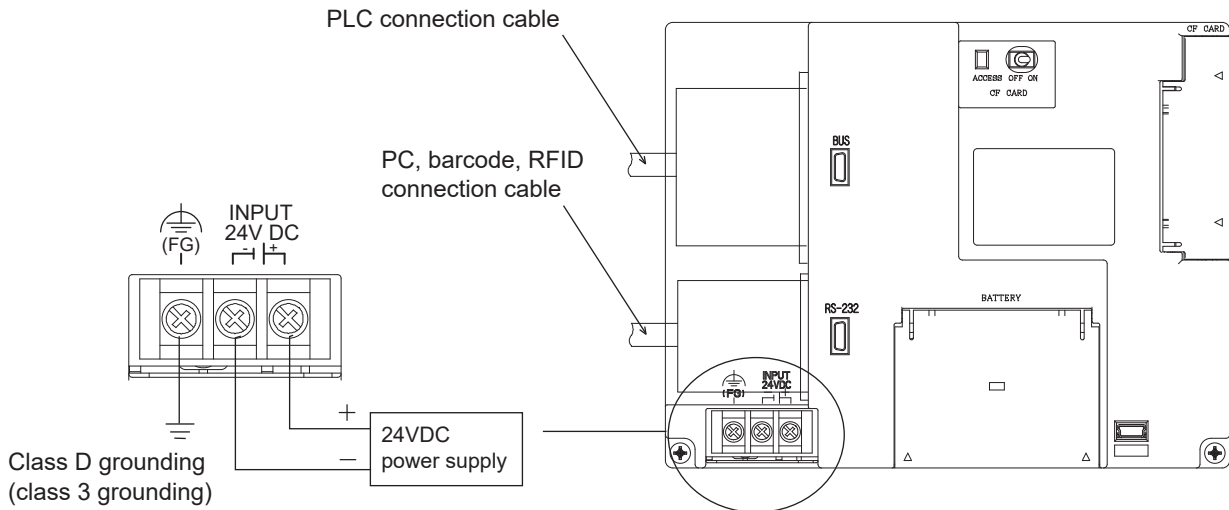

Make sure to carry out the followings for grounding.

- Carry out the independent grounding if possible.
- If the independent grounding is impossible, carry out the shared grounding as shown in fig.2) below.

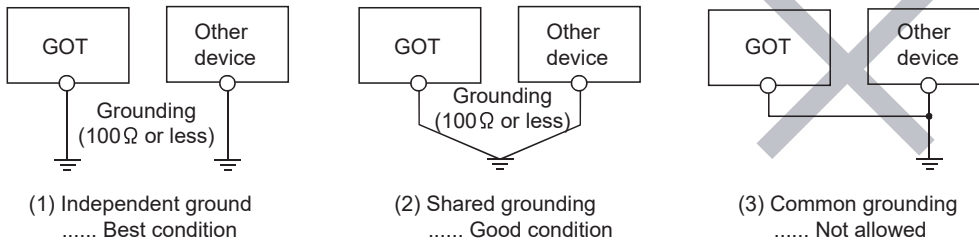

- Use the cable of 2mm² or more for grounding.
Set the grounding point closer to the GOT to make the grounding cable short as possible.

Recommended terminal shape

- Terminal screws should be tightened to between 0.5 to 0.8 N·m.
Terminal screws must be secured to prevent a loose connection thus avoiding a malfunction.
Failure to do so may cause equipment failures or malfunctions.

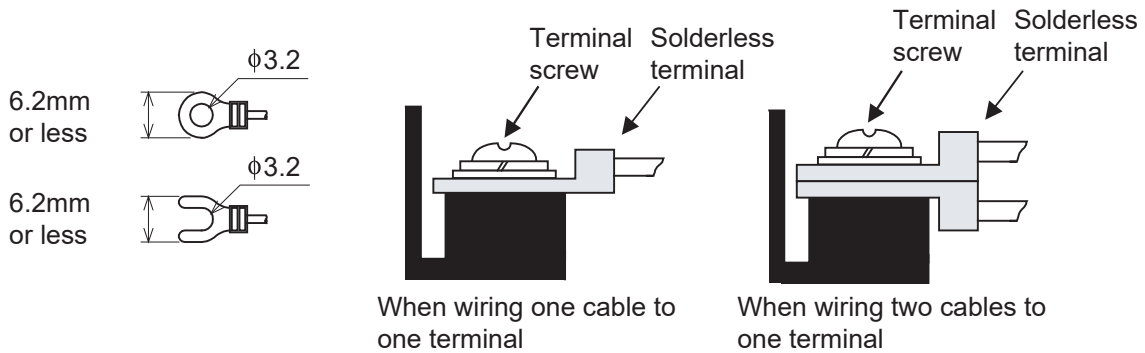

Cable size	For power supply: 0.75mm ² min. For grounding: 2mm ² min.
Solderless terminal	M3 solderless terminal (applicable solderless terminal: RAV 1.25-3, V2-N3A and FV2-N3A)
Tightening torque	0.5 to 0.8N·m

7.1.2 The cause of malfunctions related wiring/Remedy

Grounding of the GOT may cause electric potential difference and noise interference, which may result in GOT malfunctions.

These problems may be resolved by taking the following measures.

1 Wiring path of the GOT's ground cable and power line

Bundling the GOT's ground cable and power line together can cause interference noise, which may result in malfunctions.

Keeping the GOT's ground cable and power line away from each other will help minimize noise interference.

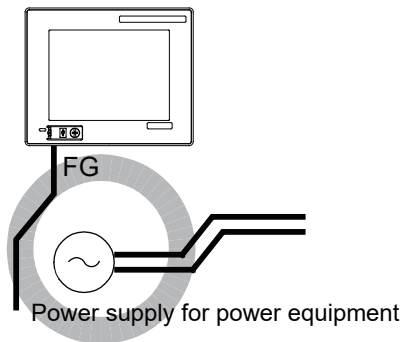

Good : Wiring the ground cable away from the power cable

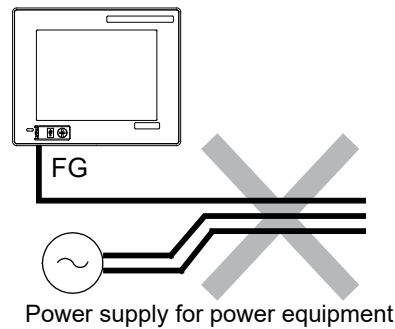

Bad : Bundling the ground cable and the power cable

2 Connecting the ground cable from the panel that houses control equipment to the panel to which the GOT is grounded

When running a single ground cable from the panel that houses such piece of control equipment as a sequencer to the panel to which the GOT is grounded, the ground cable may have to be directly connected to the terminal on the GOT.

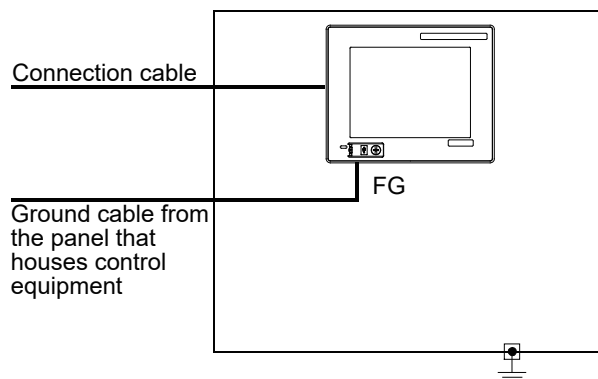

If electric potential difference between the ground points created by it causes malfunctions, lowering the voltage as shown in Remedy 1 below may solve the problem.

- Remedy 1 (Refer to the figures Remedy 1-1 and 1-2 below.)
 If the electric potential difference between the ground cable and the panel that houses the GOT is creating problems, connect the ground cable to the panel also.
 If the wiring method as shown in Remedy 1-1 is not feasible, follow Remedy 1-2.

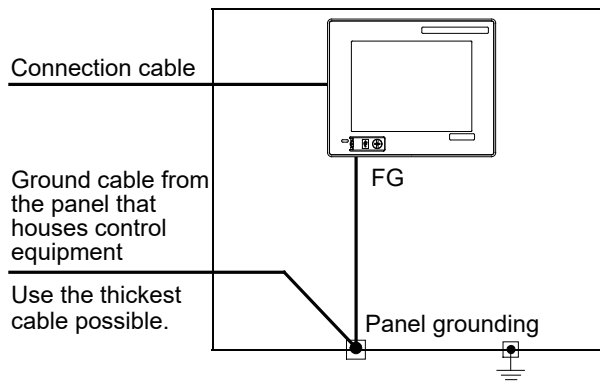

Remedy 1-1

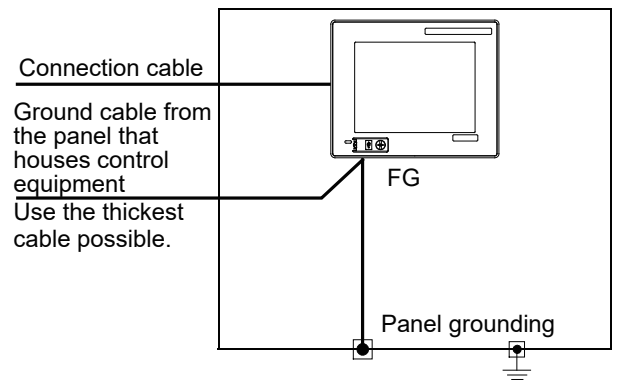

Remedy 1-2

If taking Remedy 1 worsens noise interference, taking Remedy 2 may alleviate it.

- Remedy 2 (Refer to the figures Remedy 2-1 and 2-2 below.)
 Attach a ferrite core to the cable if noise from the GOT panel has adverse effects on the GOT when Remedy 1 is taken.
 Wind the wire around the ferrite core several times (approx. 3 times), if a ferrite core is used.
 If the wiring method as shown in Remedy 2-1 is not feasible, follow Remedy 2-2.

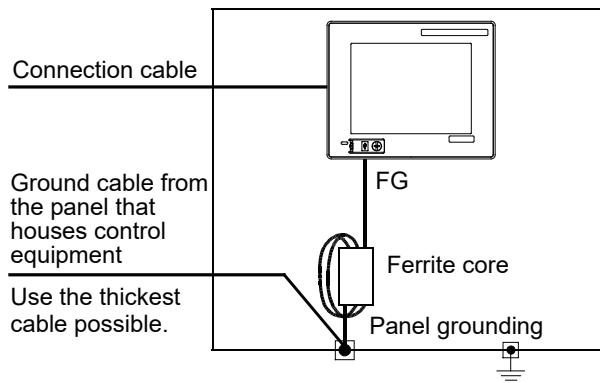

Remedy 2-1

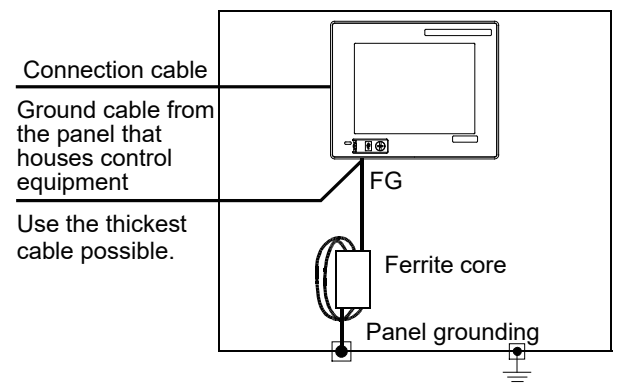

Remedy 2-2

7.2 Wiring inside and outside the panel

7.2.1 Wiring inside

Run power lines, servo amplifier drive wires, and communication cables so that they do not cross each other. Noise interference that is generated by cables that cross each other may cause malfunctions. Surge suppressors are an effective way to filter out surge noise that is generated from no fuse breakers (NFB), electromagnetic contactors (MC), relays (RA), solenoid valves, and induction motors. Refer to the section to follow for surge killers.

7.2.3 Attaching surge killers to control equipment

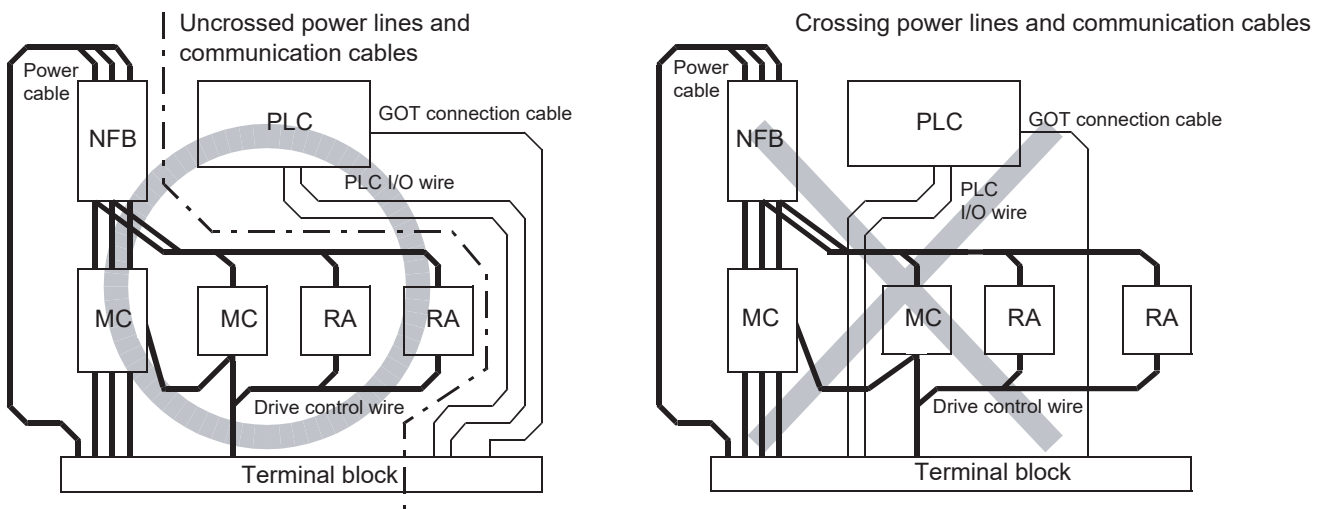

7.2.2 Outside the panel

To pull the power line and communication cable out of the panel, make two pullout holes away from each other and pull the cables through.

Putting both cables through the same pullout hole will increase noise interference.

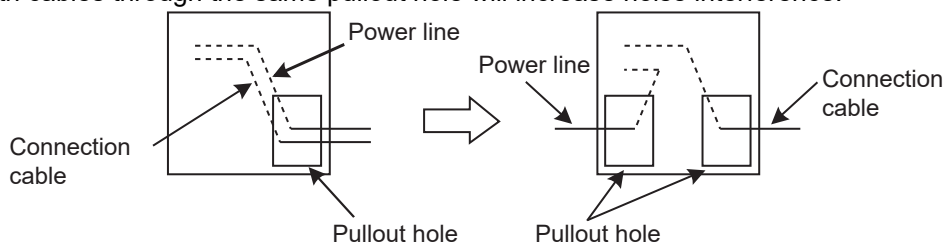

Keep the power line and communication cable inside the duct at least 100 mm away from each other. If that is not possible, the use of a metal separator inside the duct can reduce noise interference.

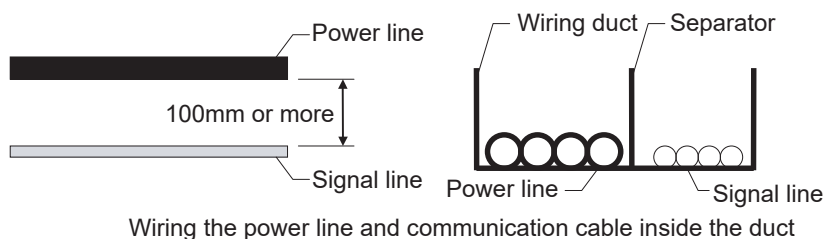

7.2.3 Attaching surge killers to control equipment

If communication errors happen in synch with the on/off signals from certain control equipment (referred to as "load" hereafter) such as no fuse breakers, electromagnetic contactors, relays, solenoid valves, and induction motors, surge noise interference is suspected.

If this problem happens, keep the ground cable and communication cable away from the load.

If that is not possible, an installation of a surge killer will help reduce noise interference.

Place the surge killer as close to the load as possible.

Remedy for AC inductive load

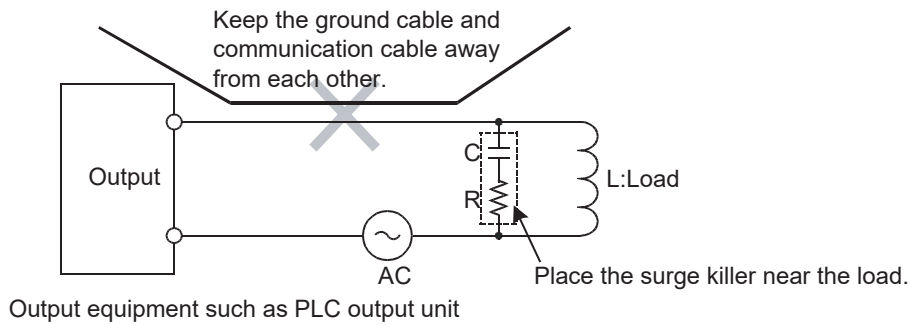

Remedy for DC inductive load

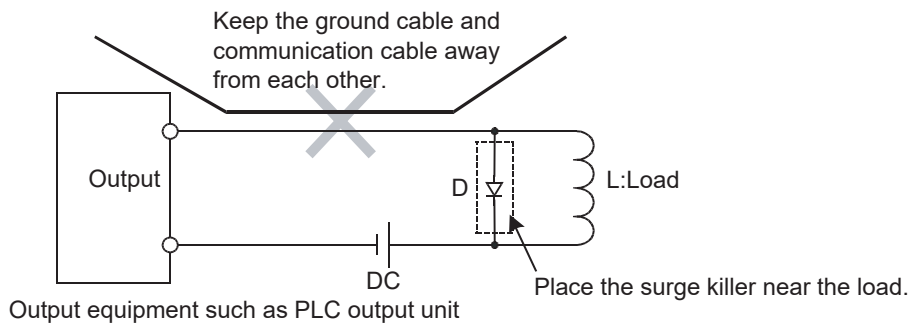

1

OVERVIEW

2

SYSTEM CONFIGURATION

3

SPECIFICATIONS

4

PART NAME

5

UL, cUL STANDARDS AND EMC DIRECTIVE

6

INSTALLATION

7

WIRING

8

OPTION

7.2.4 Wiring the FG wire of the BUS cable

1 To connect the QCPU, motion controller CPU (Q series) and GOT

The cable for connection to the QCPU, motion controller CPU (Q series) does not have a FG wire that needs to be grounded.

2 To connect QnACPU, ACPUCPU, motion controller CPU (A series) and GOT

When using GT15-C□EXSS-1 or GT15-C□BS, ground the FC wires as shown in the figure below.

(1) GT15-C□EXSS-1

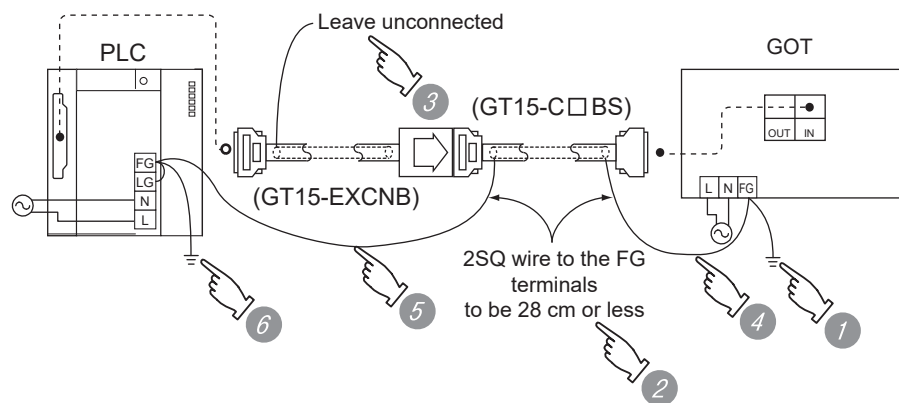

- 1 Ground the FG terminal of the power supply terminal block on the GOT.
- 2 FG wires on GT15-C□BS must be 28 cm or less.
- 3 Leave the FG ground wire on GT15-EXCNB unconnected.
- 4 Connect the FG wire on GT15-C□BS on the GOT side to the FG terminal of the power supply terminal block on the GOT.
- 5 Connect the FG wire on GT15-C□BS on the PLC side to the FG terminal of the power supply terminal block on the PLC.
- 6 Connect the LG and FG terminals on the terminal block, and provide a single grounding point for them.

(2) GT15-C□BS

For both GOTs, provide the same grounding as described in the section (1) above to both GOTs.

8. OPTION

8.1 CF Card

The CF card is used to transmit the OS or project data and to save the data of the alarm history function. Refer to the following for details.

 Chapter 13 FILE DISPLAY AND COPY (PROGRAM/DATA CONTROL)

8.1.1 Applicable CF card

The following CF cards are applicable for GT11□□.

Model	Description
GT05-MEM-128MC	Flash ROM 128MB
GT05-MEM-256MC	Flash ROM 256MB
GT05-MEM-512MC	Flash ROM 512MB
GT05-MEM-1GC	Flash ROM 1GB
GT05-MEM-2GC	Flash ROM 2GB
--	Commercially-available CF card *1

*1 Some models with the operations checked by our company are usable.
For the operation-checked models, refer to "List of valid devices applicable for GOT 1000 series" (T10-0039) separately available.



The flash PC card of the GOT-A900 series

In the GT11□□, the flash PC card for GOT-A900 series cannot be used.

Use the CF card which is described in the above.

8.1.2 Installing and removing procedures of the CF card

Install/remove the CF card with the power supply of GOT is OFF or CF card access switch is "OFF".

1 Installing

- 1 Set the CF card access switch of the GOT to "OFF", and make sure that the CF card access LED turns off. (When the CF card access LED turns off, the CF card can be installed even during the GOT power on.)

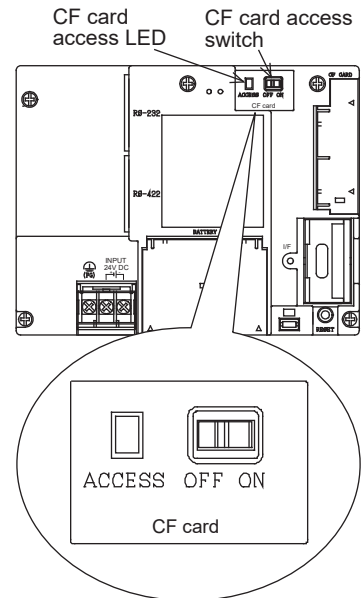

GT1155-QTBD, GT1155-QSBD,
GT1150-QLBD

- 2 To install the CF card to the GOT, insert the CF card into the CF card interface with its front side outside. Push-in the CF card until the CF card eject button snaps.

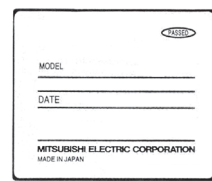
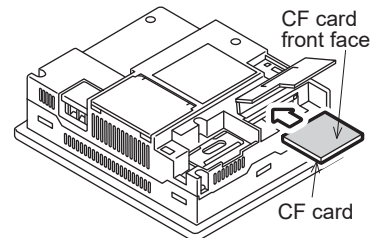

CF card front face

- 3 Turn the CF card access switch on. After the CF card access switch is turned on, the CF card can be used.

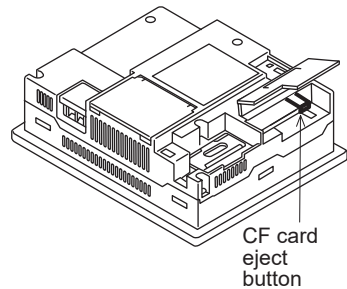

2 Removing

- 1 Set the CF card access switch of the GOT to "OFF."
Make sure that the CF card access LED turns off.
When the CF card access LED turns off, the CF card can be installed or removed even during the GOT power on.

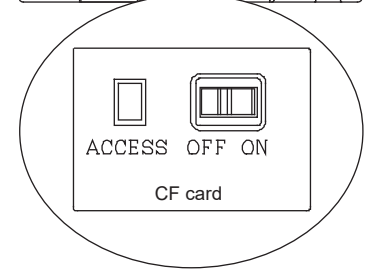
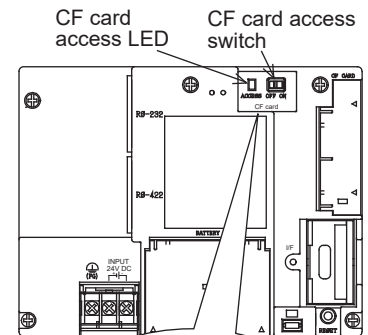

GT1155-QTBD, GT1155-QSBD,
GT1150-QLBD

- 2 Push-in the CF card eject button of the GOT to eject the CF card, and then remove the CF card.

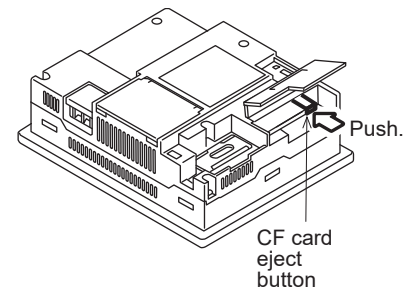

Point

Precautions for removing the CF card

- (1) While the CF card access LED is on, do not install/remove the CF card or power off the GOT.
To do so may cause data corruption or malfunction.
- (2) When ejecting the CF card, support it by hand since it may pop out.
Failure to do so may cause a fall of the CF card leading to failure or damage of the card.

8.2 Memory Card Adaptor

The memory card adaptor is used to convert the CF card into the memory card (Type II). Install the memory card adaptor to a PC equipped with a PCMCIA interface, to write the OS or project data on the CF card from the PC or load alarm history data from the CF card to the PC. Refer to the following for the details related to CF card.

 Section 8.1 CF Card

8.2.1 Applicable memory card adaptor

The following memory card adaptor is applicable.

Model	Contents
GT05-MEM-ADPC	Adaptor converting from CF card to memory card (Type II)

8.2.2 Installing procedure of the CF card into a memory card adaptor

Fit the CF card in the memory card adaptor.

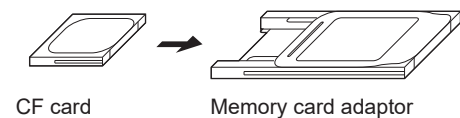

8.3 Option Function Board

1 GT1155-QSBD, GT1150-QLBD

To use the optional functions, the option function board is necessary.

For GT11 with hardware version C or later, option function can be used without mounting the option function board.

Refer to the following for the functions requiring the option function board.

 GT Designer2 Version□ Screen Design Manual
GT Designer3 Version1 Screen Design Manual

Point 

Checking method of hardware version

Confirm the hardware version with the products rating plate.

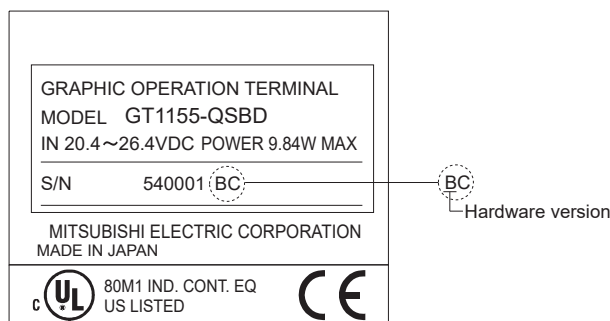

2 GT1155-QTBD, GT1155-QTBDQ, GT1155-QTBDA, GT1155-QSBDQ, GT1155-QSBDA, GT1150-QLBDQ, GT1150-QLBDA

The above models of GOTs have built-in option functions and do not require the option function board.

8.3.1 Applicable option function board

The table below shows the type of option function board that can be used with GT1155-QSBD and GT1150-QLBD.

Model	Contents
GT11-50FNB	Option function board

8.3.2 Part names

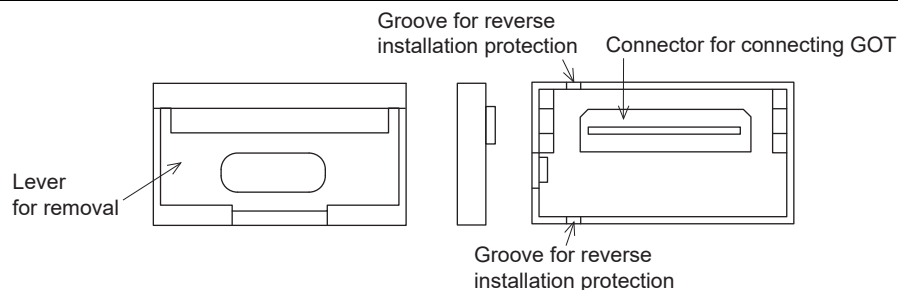

8.3.3 How to install or remove the option function board

1 Installing

- 1 Turn the GOT power off.
- 2 Rise the lever on the dummy cover with a fingernail as shown in the figure on the right.
- 3 Pinch the lever with fingers and pull-up it vertically to remove the dummy cover.
- 4 Install the option function board to the option function board connector on the back panel of the GOT. Push-down the option function board by approximately 0.5mm with fingers along the groove for reverse installation protection.

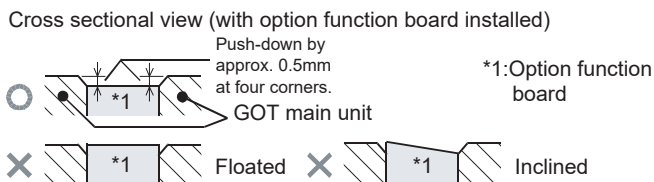
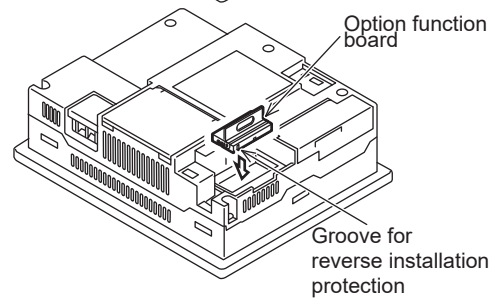
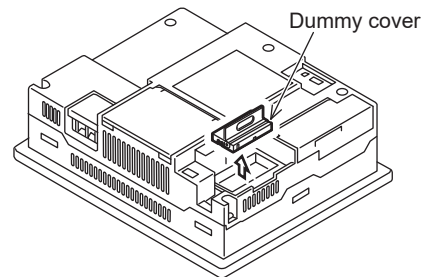
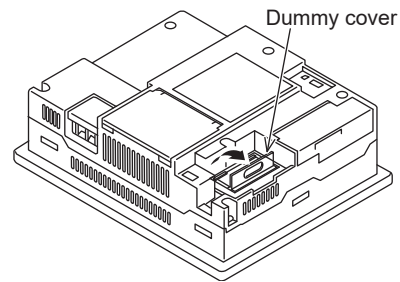

Do not keep the option function board in a floated or inclined status.

Do not touch the circuit board in the GOT main unit during the option function board installation.

2 Removing

- 1 Turn the GOT power off.
- 2 Rise the lever for removing the option function board with a fingernail as shown in the figure on the right.
- 3 Pinch the lever with fingers and pull-up it vertically to remove the option function board.

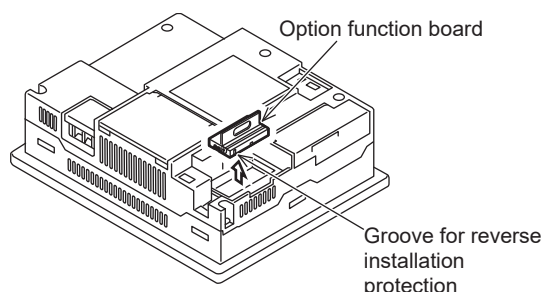
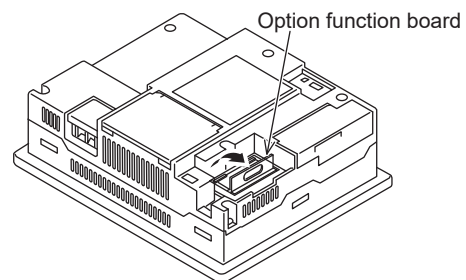

Precautions for installing/removing the option function board

- (1) Do not twist the lever when removing the option function board. Otherwise the lever may be broken.
- (2) Install the dummy cover when not using the option function board.

8.4 Battery

The battery backs up clock data, alarm history and recipe data.
A battery is installed to GT11□□ when the GT11 is shipped from the factory.

8.4.1 Applicable battery

The following battery is applicable for GT11□□.

Model	Contents
GT11-50BAT	Battery for backup of clock data, alarm history, recipe data and time action setting value

8.4.2 Battery specifications

Item	Specifications
Type	Magnesium manganese dioxide lithium primary battery
Initial voltage	3.0V
Storage life	Approx. 5 years (Operating ambient temperature of 25°C)
Application	For backup of clock data, alarm history, recipe data and time action setting value



Remark

For the battery directive in EU member states, refer to 17.4 **2** Handling of Batteries and Devices with Built-in Batteries in EU Member States.

8.4.3 Battery replacement procedure

Replace battery periodically at intervals of 4 to 5 years as reference.

- 1 Turn the GOT power off.
- 2 Open the back cover of the GOT.
- 3 Remove the old battery from the holder.
- 4 Disconnect the old battery connector and insert the new battery connector within 30s.
- 5 Insert the new battery into the holder and close the back cover.
- 6 Turn the GOT power on.
- 7 Check if the battery condition is normal with the utility.
Refer to the following for the details of battery status display.



Chapter 12 CLOCK SETTINGS AND BATTERY STATUS DISPLAY (TIME SETTING AND DISPLAY)

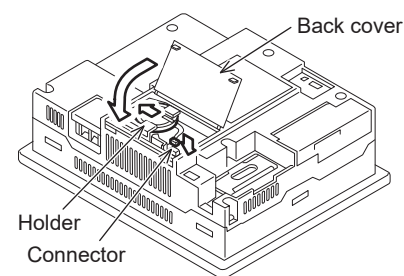
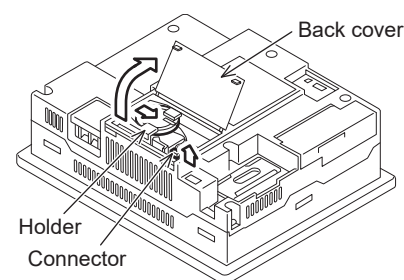



(1) Battery life

The battery life is approximately 5 years.

The production date of the optional replacement battery can be confirmed by the lot No. marked on the nameplate (label) affixed on the battery.

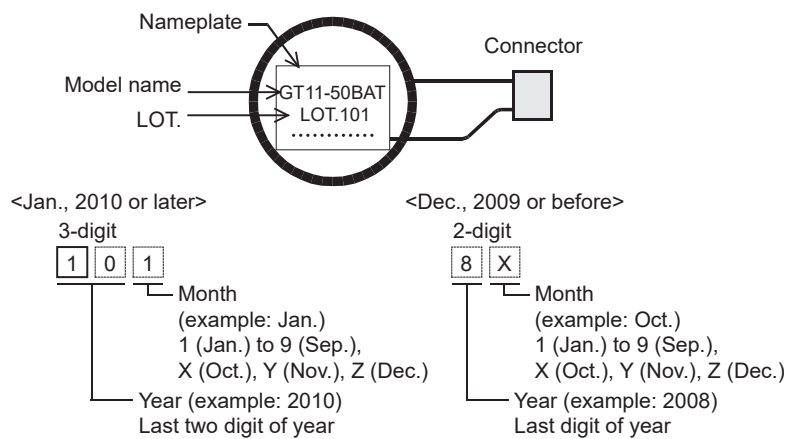

The production date of the battery built in the purchased GOT can be confirmed by the production No. (S/N) marked on the GOT main unit.

(a) GT1155-QTBD, GT1155-QSBD, GT1150-QLBD.

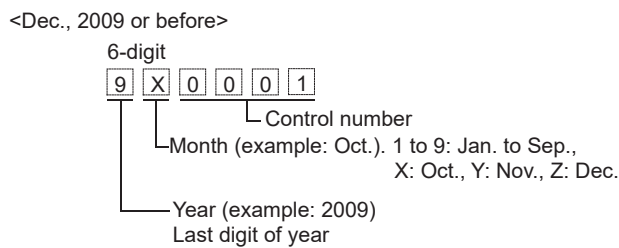
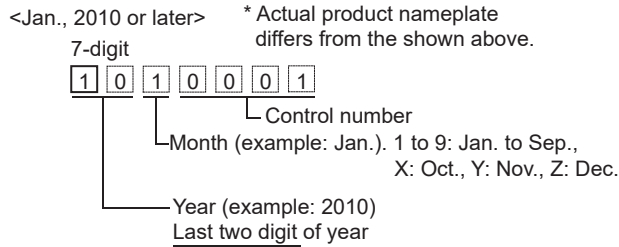
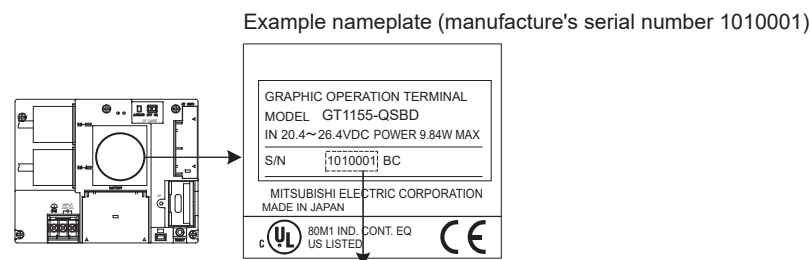

- (b) GT1155-QTBDQ, GT1155-QTBDA, GT1155-QSBDQ,
GT1155-QSBDA, GT1150-QLBDQ, GT1150-QLBDA

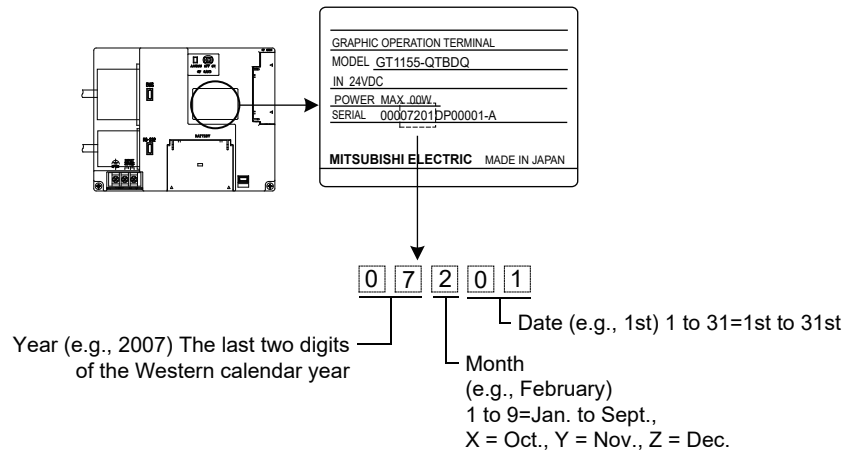

(2) Battery procurement

The battery is susceptible to natural discharge. Order one when necessary.

8.5 Protective Sheet

The protective sheet is used to protect the operation surface from damage or dirt when the touch key of GOT display section is operated.

8.5.1 Applicable protective sheet

The following protective sheets are applicable for GT11□□.

Product name	Model	Contents	
Protective sheet	GT11-50PSCB	Protective sheet for 5.7"	Clear 5 sheets
	GT11-50PSGB		Antiglare 5 sheets
	GT11-50PSCW		Clear (Frame: White) 5 sheets
	GT11-50PSGW		Antiglare (Frame: White) 5 sheets

8.5.2 Installing procedure

- 1 If the protective sheet has been already attached to the GOT, remove the old one from the GOT display section holding the lower right corner.
If the protective sheet for transportation is attached to the GOT, remove it too.
- 2 Peel the release paper from the back of the new protective sheet, and attach its adhesive side to the GOT display section.
When attaching the protective sheet, make sure to fit it on the display section closely without leaving any clearance between them.

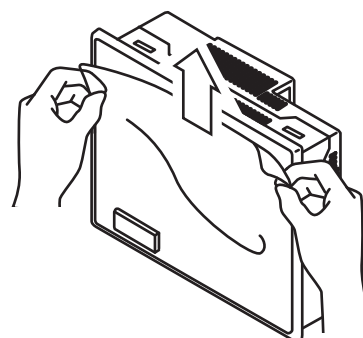
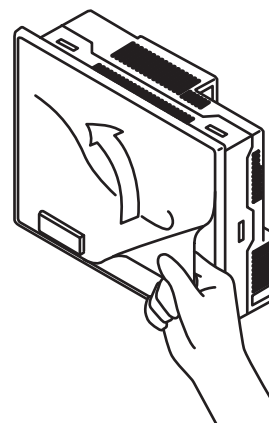

Remark

Replacement time of protective sheet

Check the status of the protection sheet visually by to the daily inspection.
The visibility becomes worse when there is too much dirt and cracks, causing malfunction. Proceeds replacement promptly.

8.6 USB Environmental Protection Cover

The USB environmental protection cover protects the USB connector on the front face of GOT from dust, water, and oil.

The GOT is installed with the USB environmental protection cover at factory shipment.
 Replace when damage and deterioration are caused.

8.6.1 Applicable USB environmental protection cover

The following USB environmental protection cover is applicable for GT11□□.

Product name	Model	Contents
USB environmental protection cover	GT11-50UCOV	Environmental protection cover for USB interface on the main unit front panel (conforming to IP67)

8.6.2 Installing procedure

- 1 Turn the GOT power off.
- 2 Disconnect the USB cable from the GOT if one is connected.
- 3 Open the USB environmental protection cover equipped with the GOT and remove the mounting screws.
- 4 Remove the old USB environmental protection cover from the GOT to replace it with the new USB environmental protection cover.
- 5 Fix the new USB environmental protection cover while fitting its projection to the hole in the GOT, and mount the cover to the GOT, using the mounting screws.

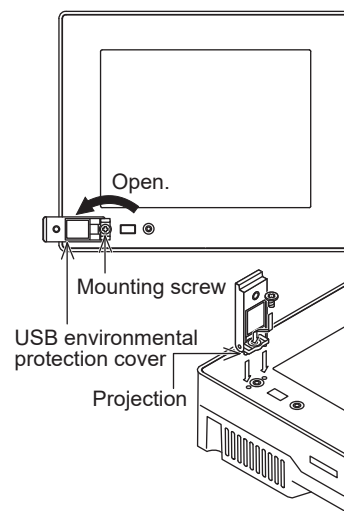

Tightening torque	0.36 to 0.48N•m for both mounting screws A and B
-------------------	--

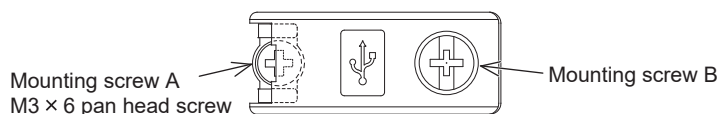

Precautions when the USB environmental protection cover is opened

Environmental protective structure of USB interface is "IP2X" when the USB environmental protection cover is opened.

1	OVERVIEW
2	SYSTEM CONFIGURATION
3	SPECIFICATIONS
4	PART NAME
5	UL, cUL STANDARDS AND EMC DIRECTIVE
6	INSTALLATION
7	WIRING
8	OPTION

8.7 Stand

Stand is used to fix the GOT to standing status in order to debug the monitor screen data easily.

8.7.1 Applicable stand

The following stand is applicable for GT11□□.

Product name	Model	Contents
Stand	GT05-50STAND	Stand for 5.7"
	A9GT-50STAND	Stand for 5.7"

8.7.2 Installing procedure

- 1 Adjust the mounting angle of GOT with the angle adjusting fitting of the stand.

Adjust to
45°, 55°, 65° or 75°.

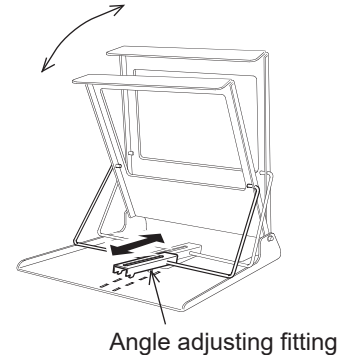

- 2 Put the GOT into the stand from the stand front side and fix it using the fixtures.

For how to mount the GOT, refer to the following.

☞ Section 6.5 Installation Procedure

For details of the stand, refer to the following.

GT05-50STAND

☞ GOT1000 series User's Manual

A9GT-50STAND

☞ A9GT-50STAND User's Manual

GOT
mounting face

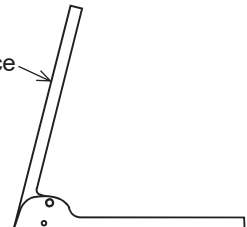

8.8 Protective cover for oil

Use of the protective cover for oil improves waterproof property, oil resistance, and chemical resistance of the GOT.

8.8.1 Applicable protective cover for oil

The following protective covers for oil are applicable to the GT11□□.

Product name	Model	Contents
Protective cover for oil	GT05-50PCO	For 5.7" GOT

8.8.2 Installation procedure



Before attaching protective cover for oil

A protective film is attached on the display area when the GOT is shipped. Make sure to remove the protective film before attaching the protective cover for oil.

For attaching the protective cover for oil to the GOT already mounted on the control panel, follow the procedures as below.

- Remove the GOT from the control panel. Make sure to externally shut off all phases of the power supply and remove all cables from the GOT in advance.
- Clean dirt off surfaces of the GOT and control panel.

- 1 When the USB environmental protection cover is installed on the GOT, remove the cover.
- 2 After removing the cover, put the USB connector protective sticker on the USB connector.
- 3 Position the POWER LED frame of the cover to the POWER LED on the GOT front face, and the direction of the cover is decided.

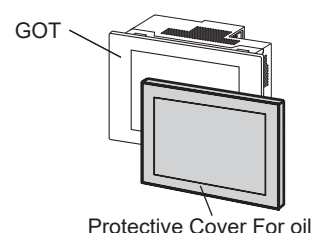
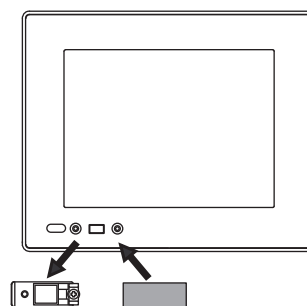

- 4 One corner of the cover is pulled outside, and it hangs it on the corner of the front panel of GOT.

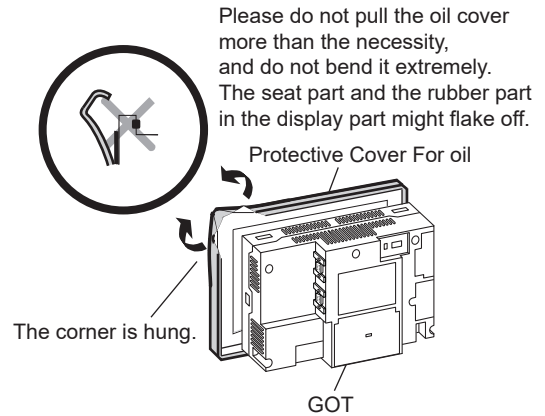

- 5 The oil cover was hung and the edge of the oil cover is sequentially obtained and obtain the oil cover to cover rubber packing parts in the back of GOT of the front panel.
(It is the order of the arrow from A side to D side.)

The corner on the left is hung and the oil cover is hung from A side to D side on the starting point sequentially.

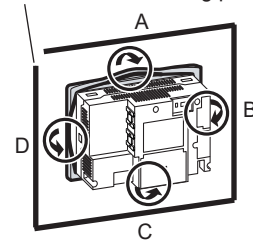

Please confirm all surroundings.
Check whether the rubber packing is fitted correctly into the groove on the under side of the GOT front panel, and then whether the protective cover for oil securely covers the rubber packing part to prevent invasion of liquids into the board.

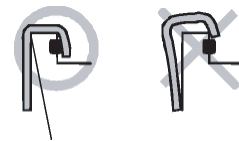

Make sure that corners of protective cover for oil match those of GOT front.

- 6 Mount the GOT onto the control panel.
When the control panel is dirty, clean the control panel.
The panel cutting dimensions and mounting screw tightening torque with the protective cover for oil are the same as those without the cover.

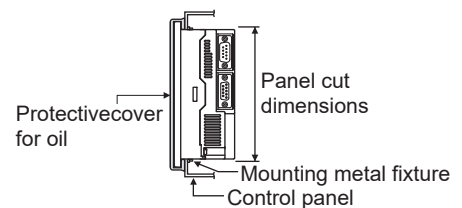



Precautions for protective cover for oil

- The protective cover for oil is a consumable product.
Check the cover for scratch, damage or dirt at regular intervals, and replace with new one if necessary.
- Do not push the protective cover for oil with pointed tools, including mechanical pencils and screwdrivers.
Doing so causes scratches and damages of the cover.
- Do not clean the protective cover for oil with bleaches, thinners, organic solvents, corrosive chemicals, and others. Doing so causes changes in shape and color of the cover.
- When the protective cover for oil is attached to the GOT, do not stretch and bend the cover too much.
Doing so may cause a separation between the sheet and rubber.
- Do not place or use the protective cover for oil in direct sunshine.
- When the protective cover for oil gets dusts, wipe the dusts off with a damp cloth.
- When the protective cover for oil is used, the USB connector on the GOT front face cannot be used.
- When the protective cover for oil is used, the human sensor does not correctly operate.
- Do not do a frequent detaching the protective cover for oil. It causes deterioration in the waterproof function, the oil performance, and the medicine performance.
- It is not the one to guarantee all customer's environments. Moreover, it is not likely to be able to use it in the environment to which oil splashes for a long time and the environment with which Oilmist is filled.

1

OVERVIEW

2

SYSTEM
CONFIGURATION

3

SPECIFICATIONS

4

PART NAME

5

UL, cUL
STANDARDS AND
EMC DIRECTIVE

6

INSTALLATION

7

WIRING

8

OPTION

8.9 Serial Multi-Drop Connection Unit

8.9.1 Serial multi-drop connection unit

GOT multi-drop connection is a communication method for 1:N communication by connecting multiple GOTs to one PLC, using the GT01-RS4-M serial multi-drop connection module.

For details of GOT multidrop connection, refer to the following.

 GOT1000 Series Connection Manual

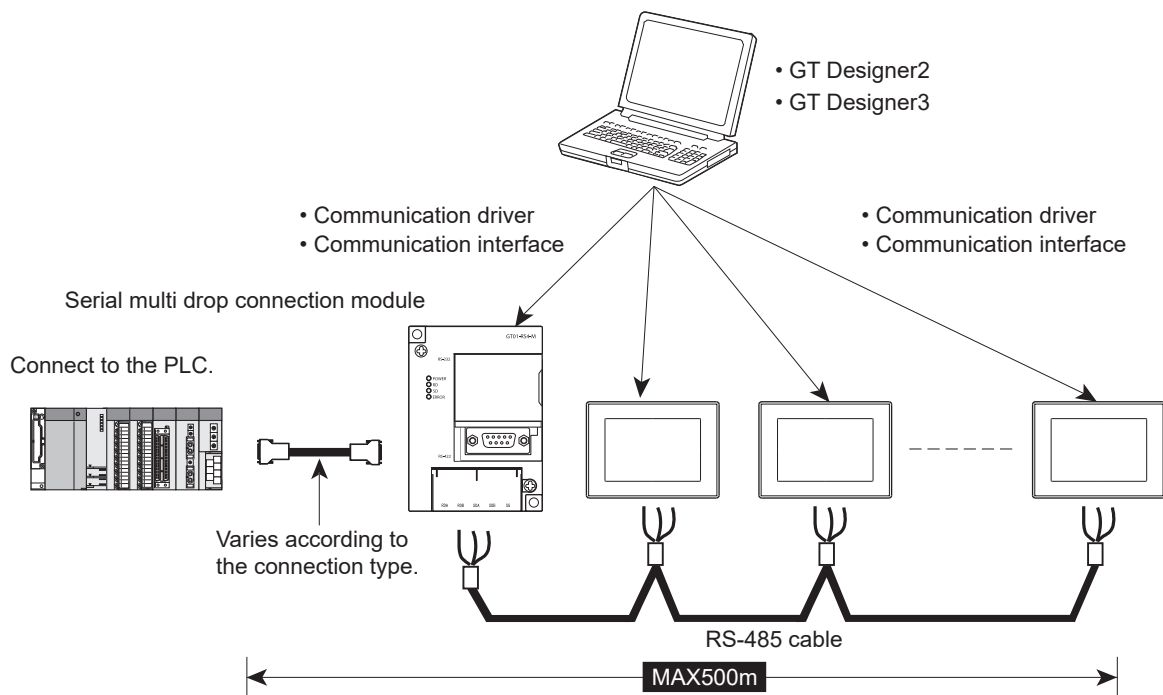

Point

- (1) GOTs supporting the GOT multi-drop connection
The followings are the GOTs compatible with the GOT multi-drop connection.

GOT	Hardware version
GT1155-QTBD	Hardware version C or later
GT1155-QSBD, GT1150-QLBD	Hardware version F or later

- (2) Checking method of hardware version
Confirm the hardware version with the products rating plate.

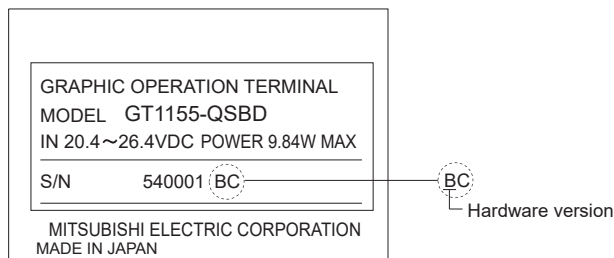

8.9.2 Applicable serial multi-drop connection unit

The following serial multi-drop connection unit is applicable.

Model	Contents
GT01-RS4-M	For GOT multi-drop connection

8.9.3 Part name

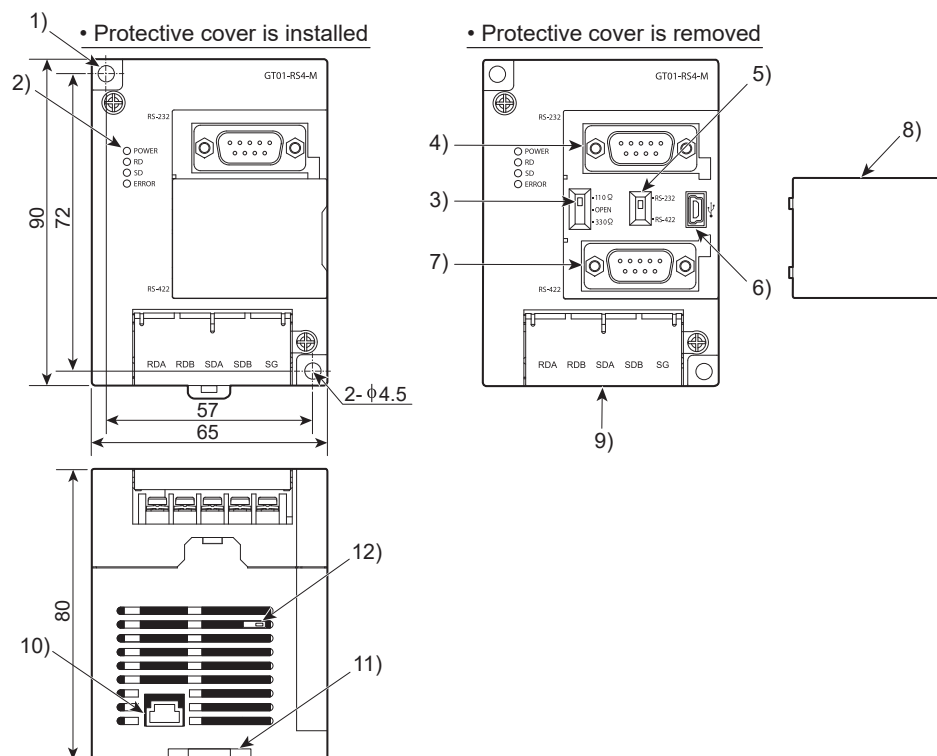

No.	Name	Specifications	
1)	Installation hole for the main unit	Installation hole	
2)	LED	POWER	Lit in green when the power is properly supplied.
		SD	Lit in green when the data is being sent to PLC.
		RD	Lit in green when the data is being received from PLC.
		ERROR	Lit or blinking depending on the status.
3)	Terminating resistor selector	Can be selected among 110Ω, OPEN and 330Ω (set to "OPEN" by default)	
4)	Connector for PLC communication	D-sub 9-pin (male) For RS-232 connection	
5)	Connector selection switch for PLC communication	Switch for selecting RS-422 or RS-232 (set to "RS-422" by default)	
6)	USB port	For connecting to a personal computer (for changing the communication driver)	
7)	Connector for PLC communication	D-sub 9-pin (female) For RS-422 connection	
8)	Protective cover	Protect unused D-sub connector, USB port and switches.	
9)	Terminal block for the serial multi-drop communication	Terminal block 5-pin (with a protective cover) M3 Tightening torque 0.5 to 0.6N•m	
10)	Power supply connector	24VDC power supply connector insertion point (A dedicated cable is included.)	
11)	Slider for installing the DIN rail	-	
12)	Mode selection switch (Slide switch)	Do not operate. (Set to right by default. When set to left, the module does not operate normally.)	

8.9.4 Installation

1 Installed with DIN rail

Install the multi-drop connection module with its hook (1 place) using the DIN rail.

- Applicable DIN rail DIN46277 (width: 35mm)

(Install the DIN rail with screws at intervals of 150mm.)

2 Directly installed to panel

Install the multi-drop connection module to the panel using $\phi 4.5$ mm holes (2 places).

8.9.5 Caution for compliance with EMC Directive

Programmable logic controllers are open-type devices that must be installed and used within conductive control boxes. Please use the Multi-Drop Connection Unit while installed in conductive shielded control boxes. Please secure the control box lid to the control box (for conduction). Installation within a control box greatly affects the safety of the system and aids in shielding noise from the Multi-Drop Connection Unit.

8.10 Connector Conversion Adapter

GT10-9PT5S type connector conversion adapter enables an easy crossover wiring for the multi-drop-connected GOTs.

For the wiring between the connector conversion adapter and the controller, refer to the following manual.

 GOT1000 Series Connection Manual

Point

- (1) GOTs supporting the connector conversion adapter

The followings are the GOTs compatible with the connector conversion adapter.

GOT	Hardware version
GT1155-QTBD	Hardware version C or later
GT1155-QSBD, GT1150-QLBD	Hardware version F or later

- (2) Checking method of hardware version

Confirm the hardware version with the products rating plate.

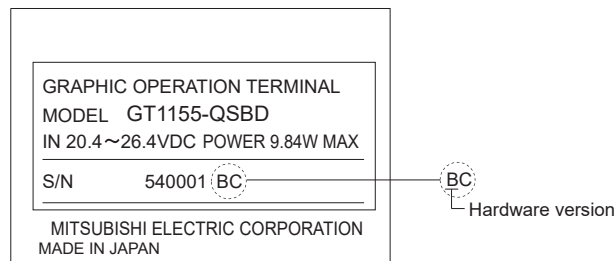

8.10.1 Applicable connector conversion adapter

The following connector conversion adapter is applicable.

Model	Contents
GT10-9PT5S	For GOT multi-drop connection

8.10.2 Installing procedure

- 1 Turn the GOT power off.
- 2 Connect the connection conversion adapter to the RS-422/485 interface on the GOT.

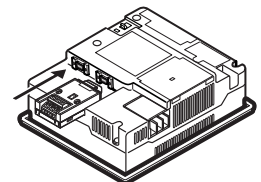

- 3 Fix the connection conversion adapter to the GOT using the provided M3 tapping screws.

Tightening torque: 0.3 to 0.6 N·m

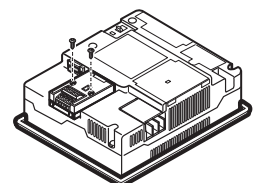

9. UTILITY FUNCTION

Utility is a function, which carries out connection of GOT and PLC, screen display and operation method settings, program/data control and self-check etc.

Refer to the following for the utility function list.

 Section 9.2 Utility Function List

9.1 Utility Execution

For utility execution, utility has to be displayed by installing BootOS and Standard monitor OS in the C drive (Flash memory).

There are following three types for the installing Standard monitor OS methods.

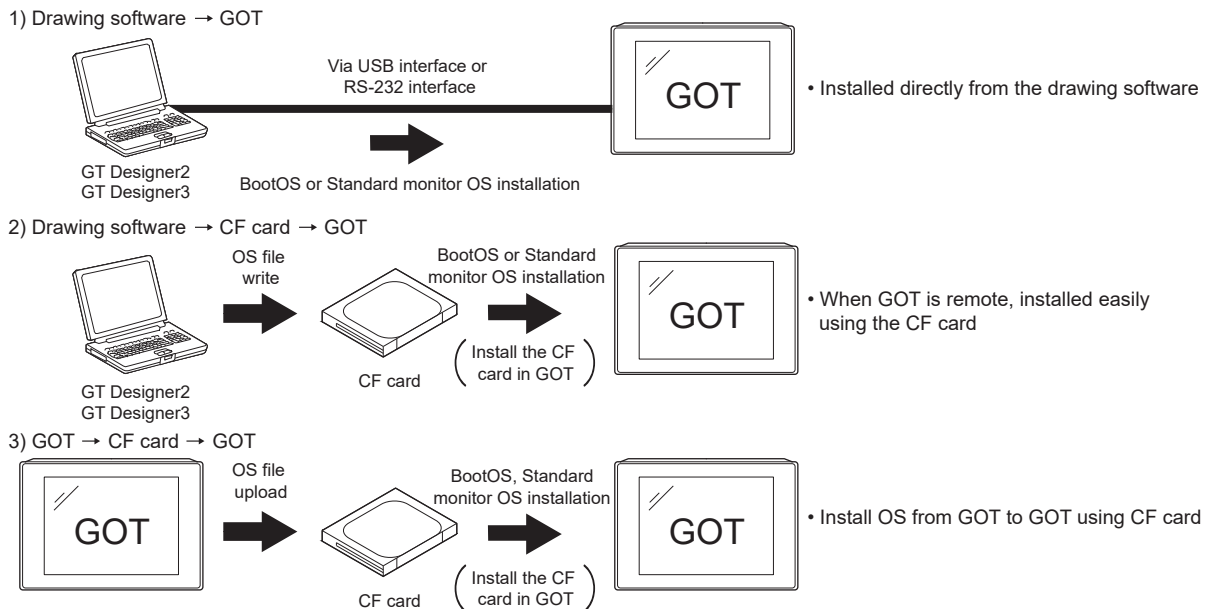

Refer to the following for the installation which uses drawing software.

 GT Designer2 Version□ Basic Operation/Data Transfer Manual
GT Designer3 Version1 Screen Design Manual (Fundamentals)

Refer to the following for the installation which uses GOT.

 Chapter 16 INSTALLATION OF CoreOS, BOOTOS AND STANDARD MONITOR OS

9.2 Utility Function List

The items in the following list can be set/operated on the utility screens.

Item		Functions overview	
Communication setting ^{*1}		Setting of channel number for the communication interface and assignment of communication driver	
	Detail settings	Setting of communication parameter.	
		Sequence program protection key word setting. (When FX series PLC is connected)	
		Sequence program protection key word deleting. (When FX series PLC is connected)	
		Sequence program protection status cancel. (When FX series PLC is connected)	
		Sequence program protection status reactivate. (When FX series PLC is connected)	
GOT setup	Display	Setting of opening screen time.	
		Setting of screen saving time.	
		Setting of screen saving back light ON/OFF.	
		Switching message language. (Japanese/English/Chinese (Simplified)/Korean/German) ²	
		Setting of battery alarm display ON/OFF	
		Setting of Invert colors ON/OFF	
	Brightness, contrast	Liquid crystal intensity setting.	
		Liquid crystal contrast setting	
	Operation		Setting of buzzer volume.
			Setting of window move buzzer volume.
		Security setting ^{*3}	Security level change. (security password input of each object)
		Utility call key	Setting of the menu call key.
Key sensitivity		Key sensitivity setting	
Key reaction speed		Display of key reaction speed	
Time setting & display		Selection of base clock.	
		Display current time of clock.	
		Set current time of clock.	
		Display of battery status.	



Item		Functions overview	
Program/data control	OS information	Installing OS.	
		Uploading OS.	
		Property display of OS. (Kind, version, and date)	
		Data check of system file. (OS)	
	Project Information	Downloading project file.	
		Uploading project file.	
		Project file deleting.	
		Copying project file. (A drive → A drive)	
		Property display of project file. (Date, version and screen title)	
		Data check of project file.	
Alarm information	Deleting alarm log file.		
	Copying alarm log file.		
Memory card format	Formatting of CF card and Internal SRAM		
Memory information	Display of free memory space in GOT		
GOT data package acquisition	Copies the OS and project data to the memory card		
Debug & Self check	Debug	System monitor	Device monitor of PLC, Test function, Present value change of the buffer memory monitor and the buffer memory of intelligent module
		A List editor	Sequence program and parameter change of ACPUCPU
		FX list editor	Sequence program and parameter change of FX PLC
	Self check	Memory check	A drive memory check (Standard CF card)
			C drive memory check (Built-in flash memory)
			D drive memory check (Internal SRAM)
		Drawing check	Missing bits, color, draw, display and overlap display check of liquid crystal
		Font check	Installed fonts check
		Touch panel checking	Touch panel operation check
	I/O check	Connected target confirmation	
		Self-loopback check ^{*4}	
	System alarm display	Displaying GOT errors, CPU errors, network errors	
		Resetting GOT errors	
	GOT start time	Displaying GOT start date and time, current time, accumulated operating hours	
	Clean	Clean	Display the screen to clean the display section.

- *1: Perform the following with the drawing software.
- Installing the communication driver
 - Downloading the project data with communication settings (channel number and communication driver assignment)
- *2: Selectable languages vary, depending on the standard fonts that are installed.
- *3: It is necessary to set the security level with drawing software.
- *4: It is necessary to install the RS-232 connector for test. (Section 14.10 I/O Check)

9.3 Utility Display

To display setting screens for each utility, the main menu must be displayed first.
(The utility screen is a factory installed horizontal format screen that cannot be edited.)

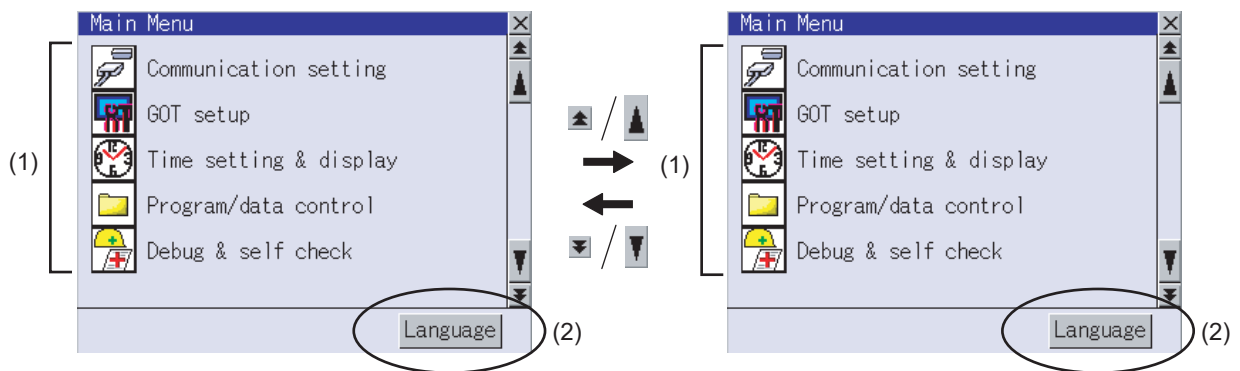

- (1) Main menu
The menu items that can be selected from the GOT utility are displayed.
Touching a menu item in the main menu will display the setting screen or following selection screen for the item.
- (2) System message switch button
This button switches the language used for the utility screen and system alarms.
When touching the Language button, the Select Language screen is displayed.



- 1 Touch the button of a language to be displayed and then OK button, and the language is selected. ^{*1}
(The ▶ mark moves.)
- 2 Touching the X button restarts the GOT and the language on the utility is switched to the selected one.

*1: Only selectable languages are displayed.

The selectable languages differ depending on the fonts installed in the GOT.
For details of the fonts, refer to the following manual.

GT Designer2 Version Screen Design Manual

GT Designer3 Version1 Screen Design Manual (Fundamentals)

Switching the display language of the utility

- (1) When starting the GOT without selecting any language or the selected language and the installed fonts are not matched.
The following screen will be displayed.
Touching the button of a desired language restarts the GOT and the language is switched to the selected one.



- (2) Switching the display language of the utility by devices
Any device can be used for switching the display language of the utility.
For details, refer to the following.

 GT Designer3 Version1 Screen Design Manual (Fundamentals)

When using devices to switch the display language of the utility, it does not change even if the display language is switched from the GOT utility screen.

9.3.1 Display operation of main menu

The following four types of operation can display the main menu.

(Display the main menu after installing the Standard monitor OS from drawing software to the GOT Flash memory (Internal).)

(1) When project data is undownloaded

After the GOT is turned on, a dialog box for notifying of absence of project data is displayed. After the dialog box is displayed, touch the **OK** button to display the main menu.

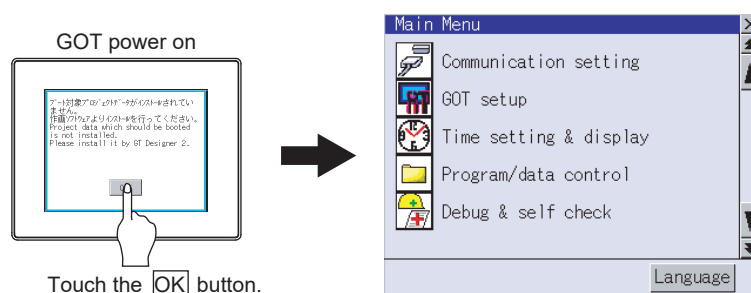

(2) When touching menu call key

If you touch the menu call key while user-created screen is displayed, the main menu is displayed. The menu call key can be set by the GOT utility or drawing software.

(At factory shipment, the GOT is set to "Simultaneous 2-point presses on GOT screen upper-right and upper-left corners".)

Menu call key Simultaneous 2-point touch

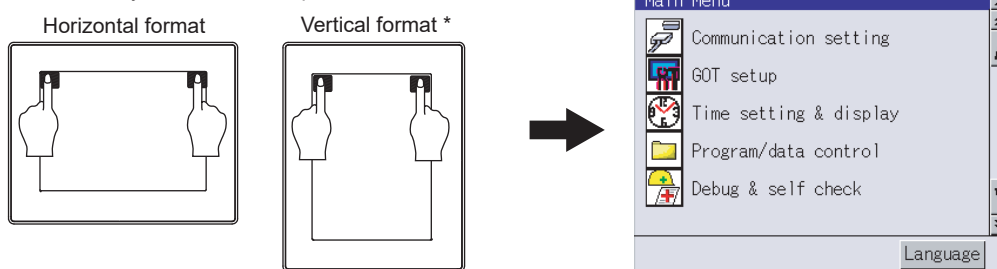

*: The utility screen is a factory installed horizontal format screen that cannot be edited.



When the utility call key is set to the zero point

Even when the utility call key is set to the zero point, you can display the main menu using either of the following two operations:

- Pressing the special function switch set on the user-created screen
- Powering ON the GOT while touching the upper left corner of the screen

(3) When touching special function switch (utility)

If you touch the special function switch (utility) while user-created screen is displayed, the main menu is displayed.

The special function switch (utility) can be set as a touch switch that is displayed on a user-created screen by drawing software.

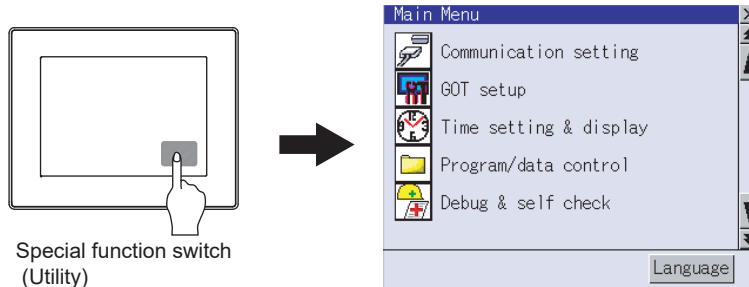

For the details of the special function switch, refer to the following.

- ☞ GT Designer2 Version□ Screen Design Manual
- GT Designer3 Version1 Screen Design Manual (Functions)

(4) When powering ON the system

If you power ON the GOT while touching the upper left corner of the screen, the main menu is displayed.

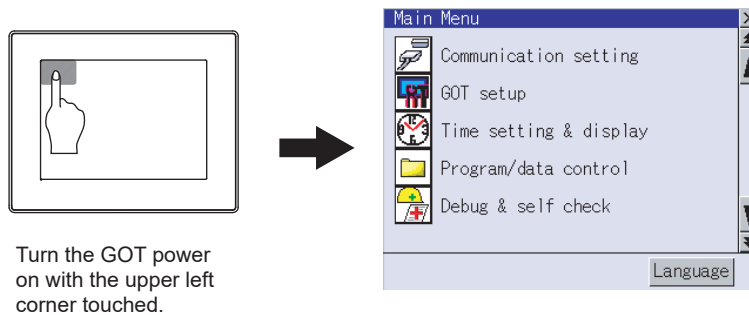

Turn the GOT power on with the upper left corner touched.

Remark

Lock the utility display by password.

When a password is set on the GOT using drawing software, a password dialog box is displayed when trying to access the main menu of the utility display.
(The password setting option in drawing software is located in the common menu.)

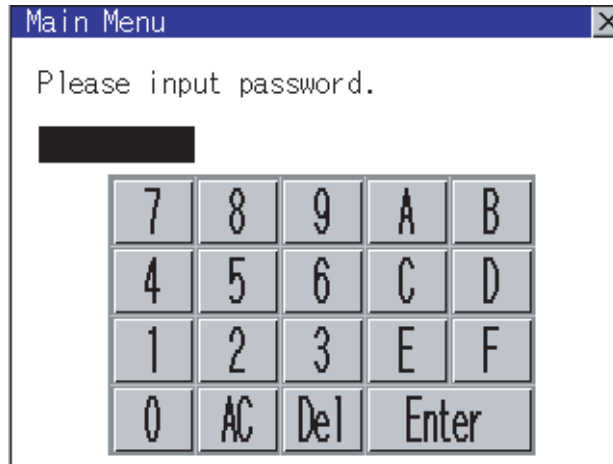

When the password is not matched, the following error message is displayed.



When touching , the screen returns to the monitor screen.

(1) Input operation of password

- 1) Input the password after touching to , to key.
- 2) Define the password by touching key, after inputting password.
- 3) To correct the input character, touch key to delete the correcting character and then reinput/retype the new character.

(2) Password input cancel operation

When button is touched, the screen returns to the monitor screen.

Refer to the following for details on setting passwords.

GT Designer2 Version□ Screen Design Manual

GT Designer3 Version1 Screen Design Manual (Fundamentals)

9.3.2 Utility basic configuration

The basic configuration of the screen is as follows.

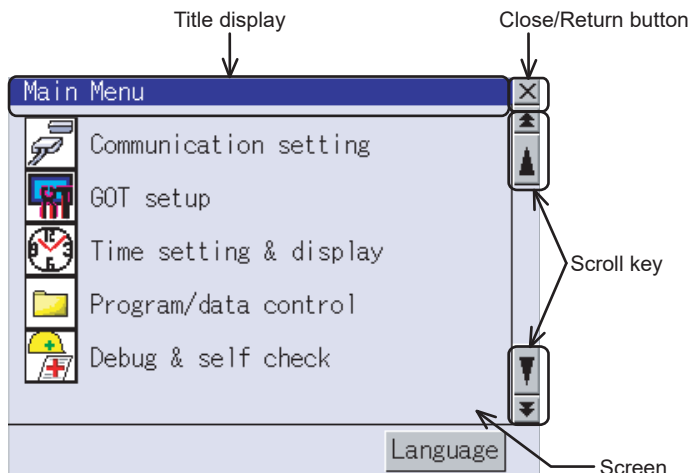

(1) Title display

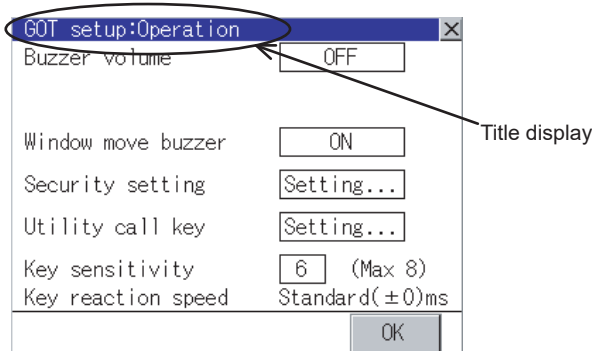

The screen title name is displayed in title display part.

As the screen is composed of multiple layers, the title including these layers is displayed.

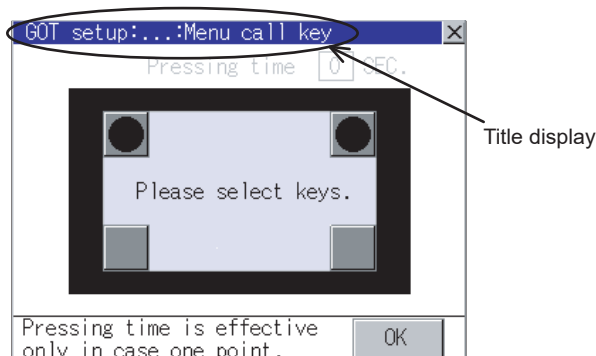

If the title overflows the title display area, the middle section is omitted and "..." is displayed at the section.

(2) Close/Return button

When a middle screen of the layers is displayed, if the  (Close/return) button in the right corner of screen is touched, returns to the previous screen.

If this button is touched when directly displayed from monitor screen, the screen is closed and returns to monitor screen.

(3) Scroll button

For screens in which the content does not fit on one screen page, there is a right or down scroll button on the screen.

 Scroll one line/column

 Scroll window

9.3.3 Basic operation of settings change

1 Change of setting value

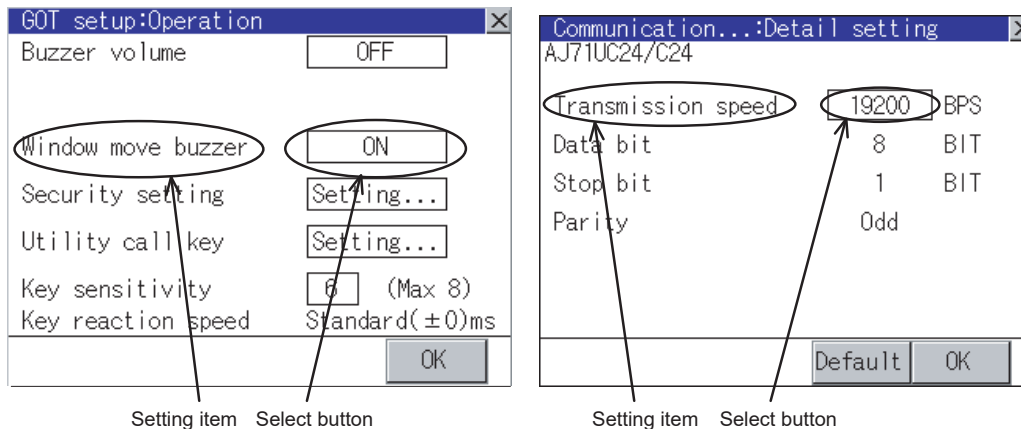

1 Touch the select button (setting point) on the screen.

- **OK** Key: It is a key for selecting the setting value. Repeats with each touch ON \leftrightarrow OFF .
- **Numerical** Key: It is a key for inputting the numerical value. It displays the keyboard on the bottom of the screen when touched.

In the above mentioned screen example, there is no setting item which displays the keyboard. For the operation of keyboard refer to the next page.

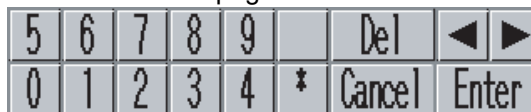

Touching **Enter** confirms the numerical input.

When the setting range exists it repeats the numerical without displaying keyboard.

Example: 4800bps \leftrightarrow 9600bps \leftrightarrow 19200bps

- **Setting...** Key: It shifts to the setting screen of each setting item when touched.

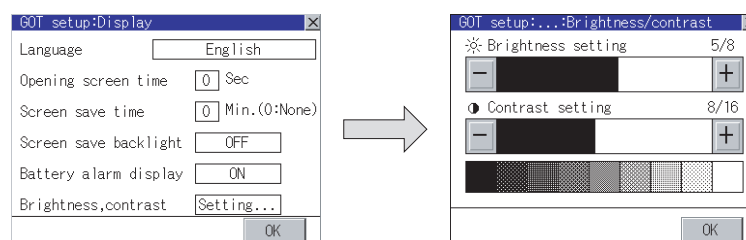

2 Setting contents are reflected if **OK** button is touched.

- 3 If **X** button is pressed without touching **OK** button, the dialogue below is displayed and the changes are canceled, then the dialog box is closed.

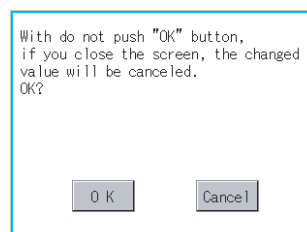

OK button: The changed value is canceled, and the screen is closed.

Cancel button: The operation setting screen is displayed.

2 Keyboard operation

- 1 Touch the numerical value to be changed.
- 2 Keyboard for numerical input is displayed and cursor is displayed simultaneously.
The key board display position changes by the position of numerical value touched.
(At the time of numerical input, displayed in the position which will not interrupt the inputting.)

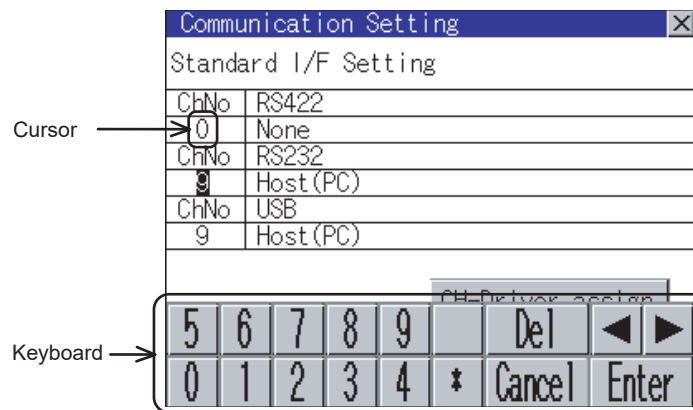

- 3 Input numeric with keyboard.
 - [0] to [9] Key : Input the numeric.
 - [Enter] Key : Touching the [Enter] key completes numeric input and closes the keyboard.
 - [Cancel] Key : Touching the [Cancel] key cancels numeric input and closes the keyboard.
 - [◀] [▶] Key : Moves the cursor left or right if there is an item that can be entered.
 - [Del] Key : [Del] key is used when canceling the input by 1 character.
 - [*] key and the key which is not mentioned do not function.
- 4 If [Enter] key is touched, numeric input is completed and keyboard is closed.

10. COMMUNICATION INTERFACE SETTING (COMMUNICATION SETTING)

In [Communication Setting], the communication interface names and the related communication channel, communication driver names display and channel numbers are set. Moreover, in [Communication Detail setting], the communication interface details are set. (Communication parameters setting)

10.1 Communication Setting

10.1.1 Communication setting functions

Function	Contents
Channel-Driver assign	Change the assignment of channel No. and communication driver name.
Channel no. (Ch No.) setting	Set the channel numbers of the communication interface.
Communication parameters setting	Set communication parameters of communication devices.

10.1.2 Communication setting display operation

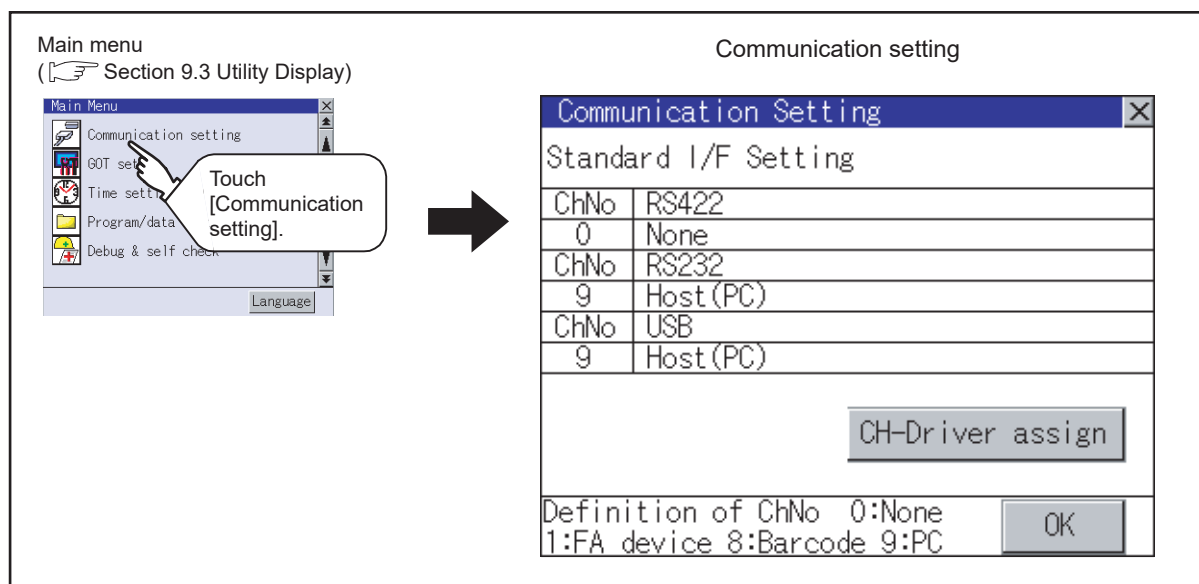

10.1.3 Description of communication setting screen

Name of setting item and display item columns for [Communication Setting]

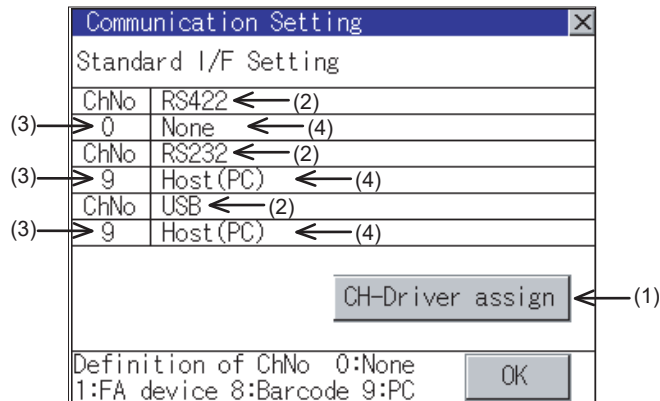

(1) Channel - Driver assign

(a) Assigning channel No.

Channel No.s can be assigned to each of the communication drivers installed in the GOT. Without setting [Communication Settings] in drawing software, communication with PLC CPU is only available after assigning a channel No. with this function.

(b) Changing communication driver

The communication driver assigned to the channel can be changed using the communication setting.

(To change the communication driver, it is required to pre-install the communication driver to be changed in the GOT.) Section 10.1.4 Operation of communication setting

(2) Standard interface display box: Communication interface included as standard in GT11□□

(a) GT1155-QTBD, GT1155-QSBD, GT1150-QLBD

The standard interface includes the following three types.

RS232For communication with PC (drawing software), PLC, microcomputer, bar code reader, RFID and other equipment

RS422For communication with PLC and microcomputer

USB.....For communication with PC (drawing software)

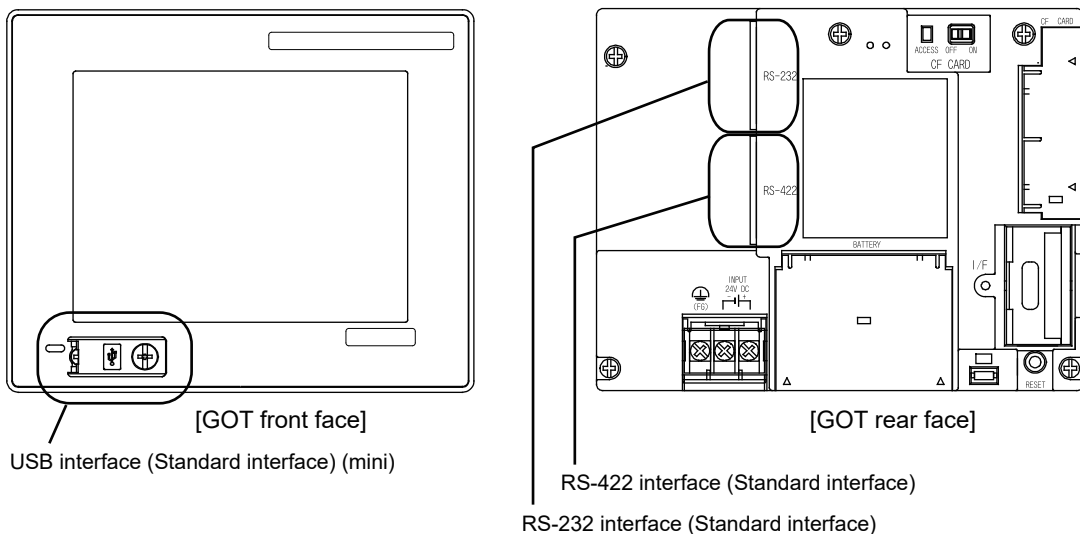

- (b) GT1155-QTBDQ, GT1155-QSBDQ, GT1150-QLBDQ, GT1155-QTBDA, GT1155-QSBDA, GT1150-QLBDA

Standard interfaces have the following three types

BUS..... For communication with PLC

RS232 For communication with PC (drawing software) and barcode reader, RFID

USB..... For communication with PC (drawing software)

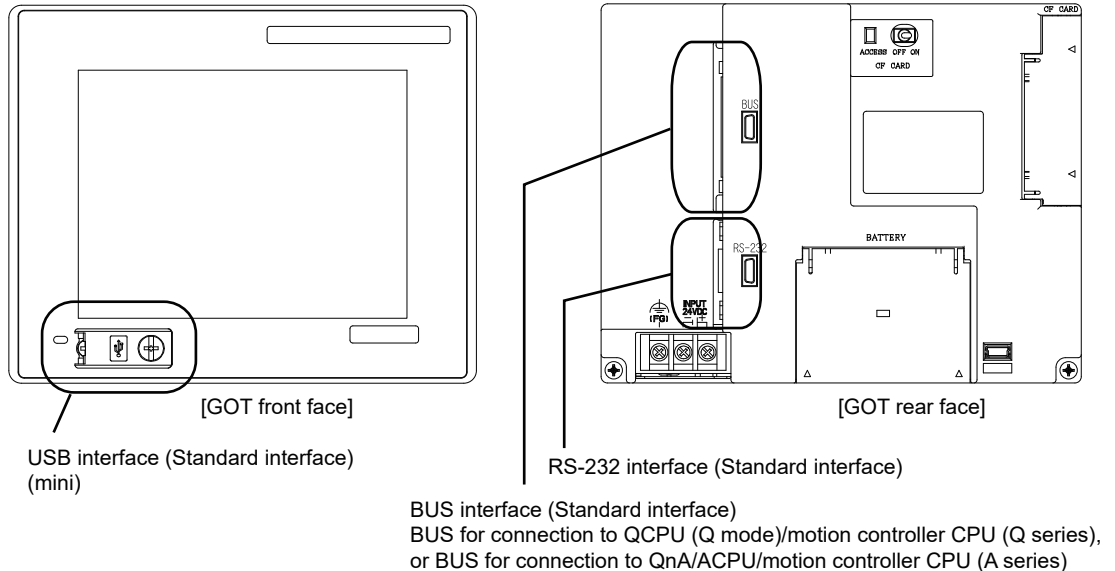

BUS interface (Standard interface)
 BUS for connection to QCPU (Q mode)/motion controller CPU (Q series),
 or BUS for connection to QnA/ACPU/motion controller CPU (A series)

(3) Channel number specification menu BOX

- 0: Set when the communication interface is not used.
 - 1: Set when connecting to PLC or microcomputer. (Only one can be set among arbitrary communication interfaces.)
 - 8: Set when connecting to a bar code reader, RFID.
 - 9: Set when connecting to PC (drawing software) or modem. (For USB and RS-232 interfaces, the simultaneous setting is possible. However, when either interface is communicating, the communication is not allowed for another interface.)
- Setting is not allowed for 2 to 7, *.
 - Fixed to 9 for the USB interface.
 - Fixed to 1 for the BUS interface.

(4) Driver display BOX

The name of the communication driver for which a channel number is assigned is displayed.

"None" is displayed in the driver display BOX in the following cases :

- The communication driver is not installed. (☞ Section 13.2 OS Information)
- "0" is set in the channel number specification menu BOX.

When setting the channel number to "9", the communication driver "Host (PC)" is automatically assigned.

When setting the channel number to "9" for the RS-232 interface, the communication driver [Host(PC)] or [Host(Modem)] can be selected.

When setting the channel number to "9" for the USB interface, the communication driver [Host(PC)] is automatically assigned.

Precautions for communication between GOT and connected devices

- (1) Installing [Communication driver] and downloading [Communication Settings]

To perform communication with the connected device, the following actions are necessary.

 - 1) Installing [Communication driver] (Up to 4, OS installation)
 - 2) Assigning channel number and communication driver to communication interface (Communication Setting)
 - 3) Downloading [Communication Settings] (project data) assigned in step 2)

Perform 1), 2) and 3) with drawing software.

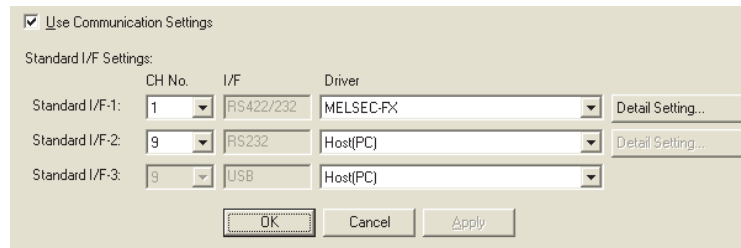

For [Communication Settings], refer to the following manual.

-  GT Designer 2 Version□ Screen Design Manual
- GT Designer 3 Version1 Screen Design Manual (Fundamentals)

For installation of [Communication driver] (OS) and download of project data, refer to the following manual.

-  GT Designer 2 Version□ Basic Operation/Data Transfer Manual
- GT Designer 3 Version1 Screen Design Manual (Fundamentals)

- (2) When [Communication Settings] has not been downloaded using drawing software

(GT1155-QTBD, GT1155-QSBD and GT1150-QLBD only)

When [Communication Settings] has not been downloaded, the GOT automatically assigns the installed communication driver as the RS422 interface. When multiple communication drivers are installed, the GOT automatically assigns the first-installed communication driver to the RS422 interface. To assign the communication driver to the RS-232 interface or to change the already assigned communication driver, change the settings in the [Communication Settings] of the utility screen or in the [Communication Settings] of drawing software.

On the unit that only allows a bus connection, the installed bus communication driver is assigned to the bus interface.

 - (a) After automatic assignment

If the button is clicked to store the settings in the GOT after automatic assignment, the automatic assignment will not be executed from the next startup.
 - (b) Priority of [Communication Settings] of drawing software

When [Communication Settings] is downloaded to the GOT from drawing software after automatic assignment, the GOT will operate according to the [Communication Settings] of drawing software.

10.1.4 Operation of communication setting

1 Channel and driver assignment operation

The operation method for the channel and communication driver assignment is described here. In this section, the case for changing the computer link connection (Communication driver: [AJ71QC24, MELDAS C6*]) to CPU direct connection (Communication driver: [A/QnA/QCPU, QJ71C24]) is described. (In the present example, [Communication Settings] is not downloaded.)

Point

Before starting operation

(1) Restarting the GOT

After Communication Setting is executed, the GOT automatically restarts.

If the project data is downloaded, GOT starts monitoring the communication device after restarting.

Before starting the operation, check for safe conditions.

(2) Setting retention

Once being established, [Channel-Driver assign] is retained until [Communication Settings] is updated.

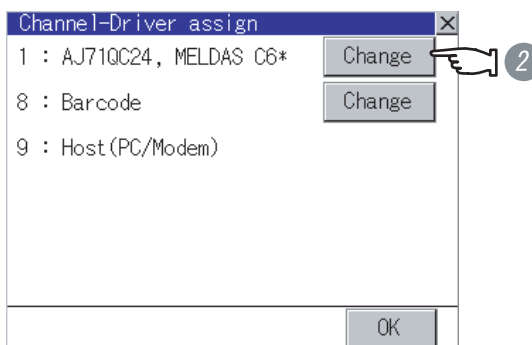
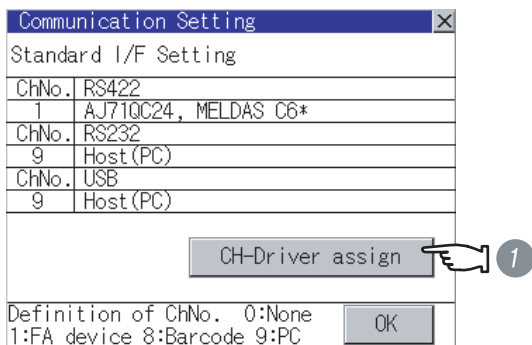

1 Install communication driver [A/QnA/QCPU, QJ71C24] to the GOT [Communication Settings] with AJ71QC24, MELDAS C6*. ([Communication Settings] is not downloaded from drawing software.) After installing the communication driver, touch the **CH-Driver assign** button in [Communication Settings].

2 The screen shown on the left is displayed. Touch the **Change** button.

3 Touch the communication driver installed to the GOT ([A/QnA/QCPU, QJ71C24]).

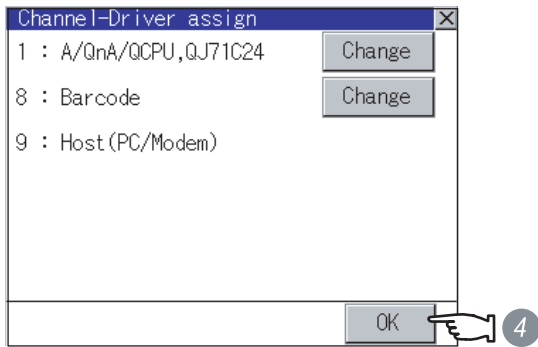

- 4 The [Channel-Driver assign] screen is displayed again.
Touch the button.
- 5 Touch the button to return to the [Communication Settings] screen.

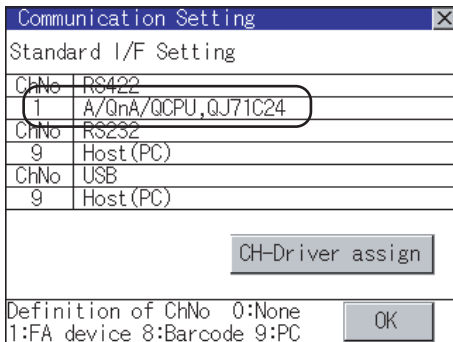

- 6 Check that the selected communication driver ([A/QnA/QCPU, QJ71C24]) is assigned.
- 7 After checking, touch the button.
- 8 Touch the button. The GOT restarts.

Point

Communication driver

- (1) Multi-channel function
GT11 can install up to 4 communication drivers.
However, multiple communication drivers cannot be used at the same time.
(Multi-channel function cannot be used.)
- (2) Display of communication driver
Communication drivers are displayed in the order of installation.
To change the assigned communication driver to one that is not listed, change the [Communication Settings] of drawing software and download to the GOT.

2 Channel number setting operation

- 1 Touch channel number specification menu BOX to be set.

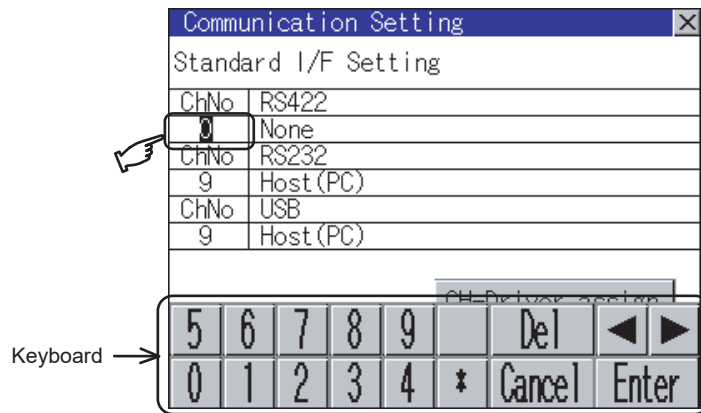

- 2 The cursor for the channel number specification menu BOX is displayed. Simultaneously the keyboard for a numerical input is displayed.
- 3 Enter the channel number from the keyboard and touch the **Enter** key to settle the entered value. Setting the channel number to "1" displays the name of the communication driver for which CH No.1 is assigned with drawing software in the driver display box.

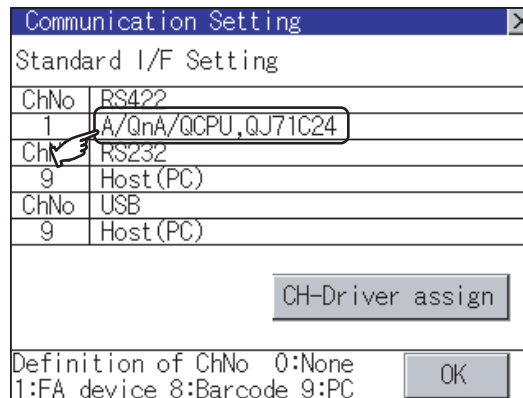

3 Communication detail settings switching operation

- 1 If you touch the driver display BOX, the screen switches to the [Detailed setting] screen of the related communication device.

(☞ Section 10.2 Communication Detail Settings)

10.2 Communication Detail Settings

10.2.1 Communication detail settings functions

Function	Contents
Communication parameters setting	Set various communication parameters of communication devices. The settable parameters differ according to the communication device.
Keyword Register	For the FX series PLCs, key word for protecting program in the PLC can be set.
Keyword Delete	For the FX series PLCs, key word for protecting program in the PLC can be deleted.
Keyword Clear	For the FX series PLCs, the program protection status in the PLC can be cancelled.
Keyword Protect	For the FX series PLCs with the 2nd keyword in use, the cancelled program protection in the PLC can be reactivated.

10.2.2 Communication detail settings display operation

- 1 Touch the driver display BOX of the communication parameter to be set in the [Communication setting] screen.

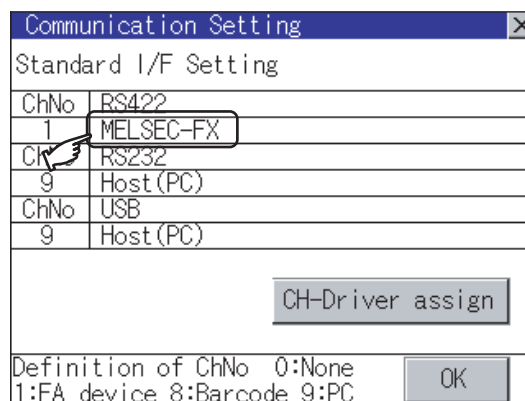

- 2 The screen switches to the [Communication Detail setting] screen.

Set communication parameters from this screen.

Refer to the following for the setting change operation.

☞ Section 9.3.3 Basic operation of settings change

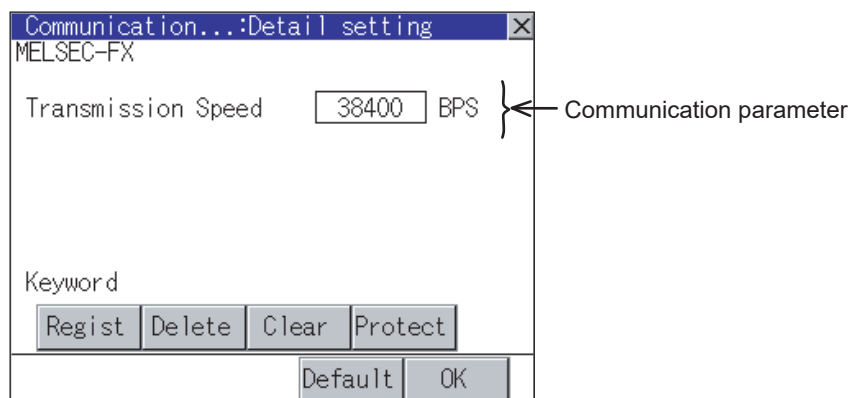

Communication parameter setting using drawing software

- (1) Select [System Environment] → [Communication Settings] from GT Designer2 to enter the communication parameters for each communication driver. When using GT Designer3, execute the settings at [Controller Setting...] of [Common].
To change the communication parameter setting after downloading project data, change the setting at [Communication Detail Setting] (described in this section). For [Communication Settings] using drawing software, refer to the following manual.

 GT Designer 2 Version□ Screen Design Manual
GT Designer 3 Version1 Screen Design Manual (Fundamentals)

10.2.3 Display contents of communication detail settings

Display items or setting items of communication detail settings depend on the type of communication driver installed in the GOT.

For the setting contents of each driver, refer to the following.

 GT Designer2 Version □ Screen Design Manual
GT Designer3 Version1 Screen Design Manual (Fundamentals)

This section describes the items that can be set using only the utility screen.

- (1) Detail setting of Host (Modem)
On the communication detail setting screen of the Host (Modem), communication settings between GOT and modem, and model operation can be executed.

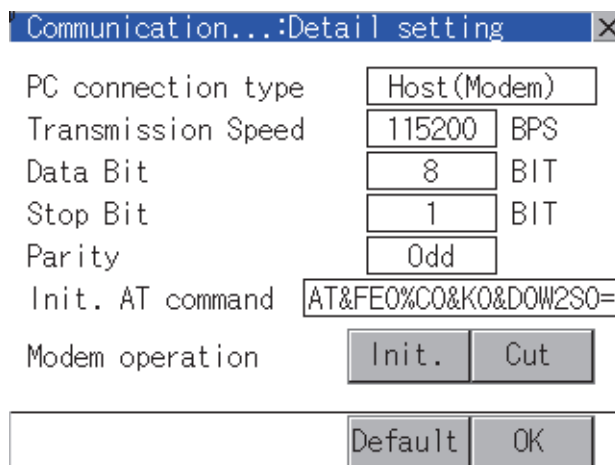

Item	Description	Setting range
PC connection type	Select the connection method to the personal computer.	Host (PC) / Host (Modem) <Default: Host (PC)>
Transmission Speed	Set the transmission speed when communicating.	9600/19200/38400/57600/115200 <Default: 115200>
Data Bit	Set the data bit when communicating.	7bit/8bit <Default: 8bit>
Stop Bit	Set the stop bit length when communicating.	1bit/2bit <Default: 1bit>
Parity	Set whether to execute or not the parity check during communication. When executing, set the type of the parity check.	Odd/Even/None <Default: Odd>
Init. AT command	Set the AT command for initialize the modem.	<Default: AT & FE0%C0 & K0 & D0W2S0=1>
Modem operation	Touch the [Init.] button to initialize the modem. Touch the [Cut] button to disconnect the line.	-

(2) Keyword settings of MELSEC-FX

On the communication detail setting screen of MELSEC-FX, registration, deletion, cancellation, or protection of the keyword for FX series PLC can be executed.

MELSEC FX

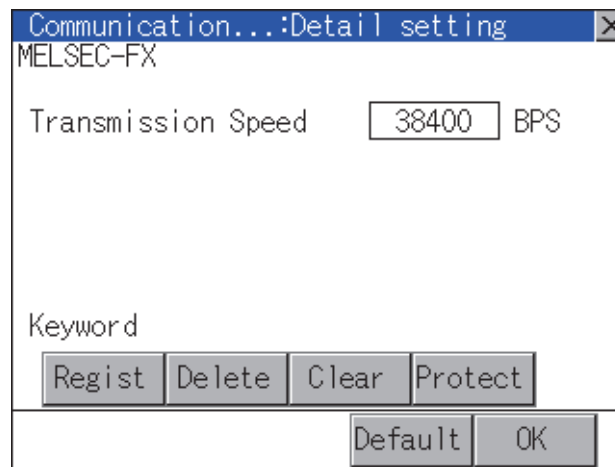

1 Regist

Keyword is registered.

- 1 Touching the Regist key displays the selection screen for the registration.

For a FX PLC*¹ that is not compatible with the customer keyword, the keyboard for the keyword input of 2 is displayed.

Select [Keyword] or [Keyword and Customer keyword].

When the key is touched, the selection is completed and the keyboard for the keyword input is displayed.

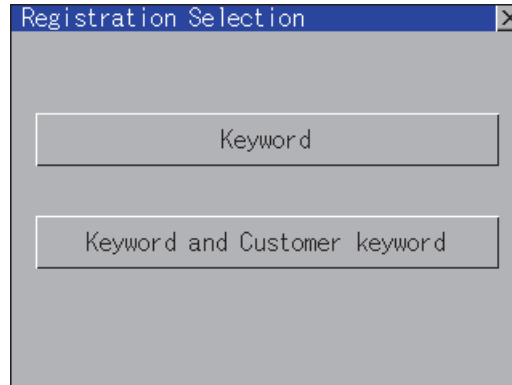

Selection	Details
When [Keyword] is selected	Only keyword can be registered.
When [Keyword and Customer Keyword] is selected	The Customer Keyword can be registered after registration of the keyword.

*1 For details on FX PLC compatible with customer keyword, refer to the following.

Point

The customer keyword allows the user to clear the protection set by a keyword. However, the protection cannot be deleted.

- 2 When the registration is selected or the Regist key is touched on a PLC not compatible with the customer keyword, the keyboard for the keyword input is displayed in a pop-up window.

When the keyword is input and the key is touched, registration is completed.

When [Keyword and Customer Keyword] is selected on the selection screen for the registration, the

Customer Keyword entry screen of 3 is displayed.

For the keyword, 8 digits from 0 to 9 or A to F must be set.



Target PLC	Settings	
	When keyword and 2nd keyword are registered	When only keyword is registered
FX PLC compatible with 2nd keyword ^{*1}	Registration options can be selected.	Registration options ^{*2} cannot be selected.
FX PLC not compatible with 2nd keyword ^{*1}	-	

*1: Refer to the manual for the PLC in use for the models that are compatible with the 2nd keyword.

*2: Registration options

Options can be selected among "Read/Write Protect", "Write Protect", or "All Protect".

For access restrictions of each setting, refer to the manual of the PLC to be used.

Point

(1) Selection of keyword protection level

For the devices which can perform the online operation of FX PLC, 3 levels of protection can be set.

When the monitoring or setting change by online devices is needed, set the keyword taking the following into consideration.

(a) When only keyword is registered

Protection level is selected by the head character of keyword.

All operation prohibition: Set the keyword starting with one of A, D to F, or 0 to 9.

Read/incorrect write protection: Set the keyword starting with B.

Erroneous write prohibition: Set the keyword starting with C.

(b) When keyword and 2nd keyword are registered

Protection level is selected by "Registration options".

(2) Applicability of monitoring for each keyword protection level

The applicability of monitoring for each protection level is as follows.

Setting items		When only keyword is registered			When keyword and 2nd keyword are registered			Keyword unregistered/ protection cancelled
		All operation prohibition	Read/incorrect write protection	Erroneous write prohibition	All Protect	Read/Write prohibition	Write Protect	
Device monitoring		○	○	○	×	○	○	○
Device change	T, C setting values and file register (from D1000)	× *1	× *1	× *1	×	○	○	○
	Other than the above	○	○	○	×	○	○	○

*1 When the T, C set values are specified indirectly, changing devices is available.

(3) Difference between "All Protect" and "All operation prohibition"

When "All Protect" is selected, both device display and input by the programming tool or GOT are prohibited.

When "All operation prohibition" is selected, device display and input are possible although operations by the programming tool are all prohibited.

- 3 When [Keyword and Customer Keyword] is selected on the selection screen for registration and the keyword input is completed, the Customer Keyword registration screen is displayed.

When the customer keyword is input and the key is touched, registration is completed.

To set the customer keyword, 8 digits from 0 to 9 or A to F must be used.

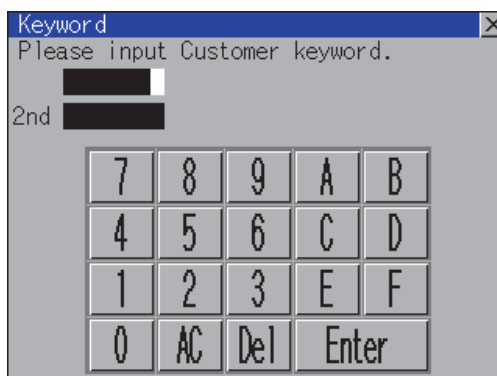

2 Delete

Registered keyword is deleted.

- 1 Touching the **Delete** key pops up a keyboard for keyword input.
- 2 When the correct keyword is input and the **Enter** key is touched, the keyword is deleted.



Target PLC	Settings
FX PLC compatible with 2nd keyword*1	Input a keyword to be deleted.
FX PLC not compatible with 2nd keyword*1	Input a keyword to be deleted only into "keyword". "2nd keyword" is ignored.

*1: Refer to the manual for the PLC in use for the models that are compatible with the 2nd keyword.

3 Clear

To access an FX PLC where a keyword has been registered, keyword protection is cancelled.

- 1 Touching the **Clear** key pops up a keyboard for keyword input.
- 2 When the correct keyword is input and the **Enter** key is touched, the protection is cancelled.



Target PLC	Settings
FX PLC compatible with 2nd keyword*1	Input a keyword or Customer Keyword to cancel the protection.
FX PLC not compatible with 2nd keyword*1	Input a keyword into "keyword" to cancel the protection. "2nd keyword" is ignored.

*1: For details on FX PLCs compatible with the 2nd keyword or customer keyword, refer to the following.

 [FX series PLCs Manual](#)

4 Protect

A keyword with cancelled protection is reactivated for protection.

Keyword protection function is valid when the 2nd keyword is registered.

- 1 Touching the **Protect** key activates keyword protection.

11. DISPLAY AND OPERATION SETTINGS (GOT SET UP)



Setting screen for display and setting screen for operation can be displayed from GOT setup. In the setting screen for display and the setting screen for operation, the following settings can be set.

Screen	Description	Reference page
Setting screen for display	Opening screen time, screen save time, screen save backlight, language, battery alarm display, invert colors	11-1
	Brightness, contrast	11-8
	Buzzer volume, window move buzzer, key sensitivity, key reaction speed	11-12
Setting screen for operation	Security setting	11-12
	Utility call key	11-12

11.1 Display Settings

11.1.1 Display setting functions

Setting regarding display is possible. The items which can be set are shown below.

Items	Contents	Setting range
Opening screen time	The title display period at the main unit boot can be set.	0 to 60 seconds ^{*1} <At factory shipment: 5 seconds >
Screen save time	The period from the user stops the touch panel operation till the screen save function starts can be set.	0 to 60 minutes <At factory shipment: 0 minutes> When set to 0, the function becomes invalid.
Screen save backlight	Whether turn ON or OFF the backlight simultaneously at the screen save function start can be specified.	ON/OFF <At factory shipment: OFF>
Language	Confirmation of the current language and switching language can be performed regarding with the language displayed by utility and dialogue.	<input type="button" value="日本語"/> Japanese <input type="button" value="English"/> English <input type="button" value="中文(简体)"/> Chinese (Simplified) <input type="button" value="한국어"/> Korean <input type="button" value="Deutsch"/> German Factory setting: User-selected language
Battery alarm display	Whether to display system alarm when the voltage of the GOT internal battery has dropped can be specified.	ON/OFF <At factory shipment: OFF>
Brightness, Contrast	The brightness or contrast can be adjusted.  Section 11.2 Brightness, Contrast Adjustment	—
Invert colors ^{*2} 	User creation screen and utility screen can be set to be highlighted or not.	ON/OFF <At factory shipment: OFF>

*1 If setting 0, the title screen is not hidden.

The title screen is always displayed for 4 seconds or longer (which changes depending on the project data contents).

*2 Applied to GT1150-QLBD only.(Standard monitor OS Ver.03.01.00 or later)
(BootOS Ver.03.01.**.M or later)



- (1) Display setting by drawing software
Set title display period, screen save time and screen save backlight at [GOT set up] in [System Environment] of GT Designer2.
When using GT Designer3, execute the settings at [GOT Setup...] of [GOT Environmental Setting].
When change a part of the setting after downloading the project data, change the setting by [Display] screen of the GOT.

 GT Designer2 Version □ Screen Design Manual
GT Designer3 Version1 Screen Design Manual (Fundamentals)

- (2) Screen save and screen save backlight OFF function
When using the screen save and screen save back light OFF function, select valid/invalid by the system information reading device in [System Environment] of GT Designer2.
When using GT Designer3, select valid/invalid by the reading device of [System Information...] in [GOT Environmental Setting].
For system information details, refer the following.

 GT Designer2 Version □ Screen Design Manual
GT Designer3 Version1 Screen Design Manual (Fundamentals)

11.1.2 Display operation of display setting

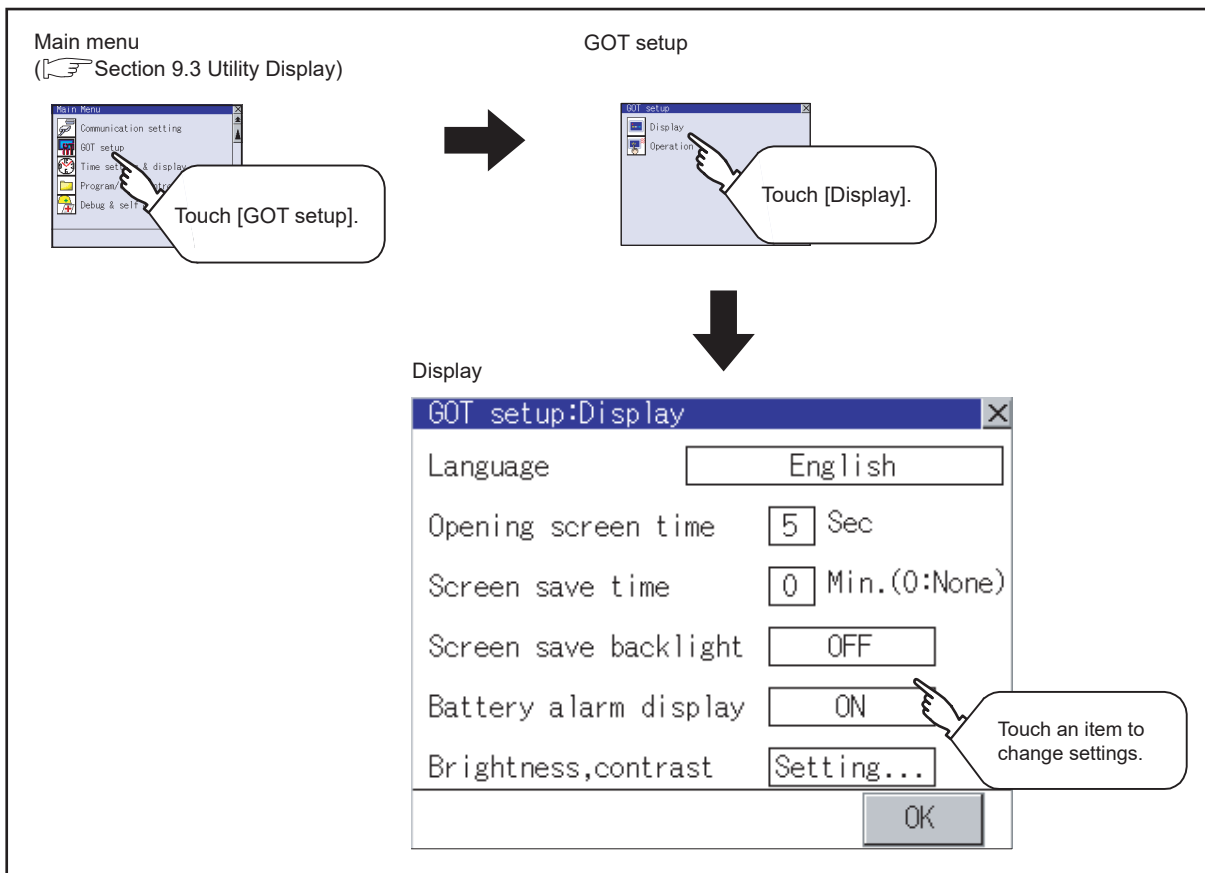

Point

Restart after setting change

If return the display to the GOT setup screen by touching the button after the setting of each item is changed and touch the button on the GOT setup screen, the GOT will restart.

After GOT restarts, it is displayed with the changed settings.

If restarted the GOT by powering OFF the GOT without the procedure above, the setting contents are canceled without reflected.

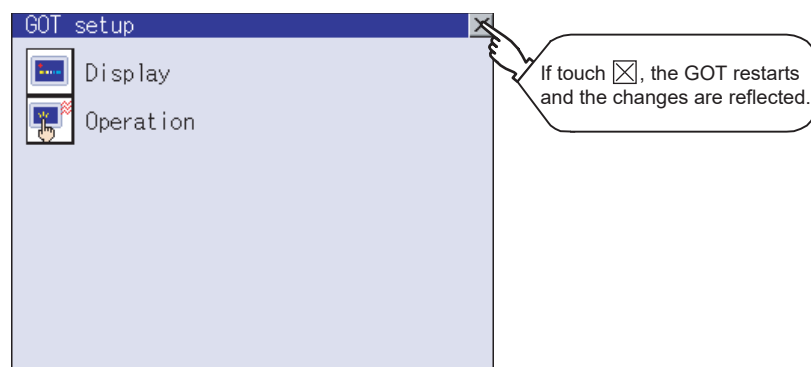

11.1.3 Display setting operations

1 Opening screen time, screen save time

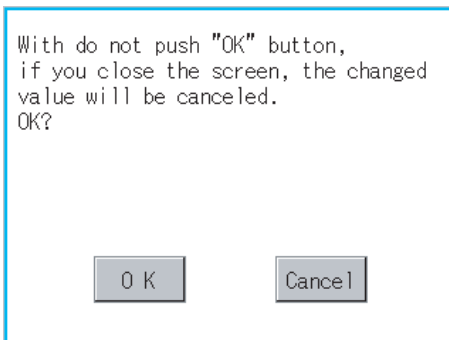
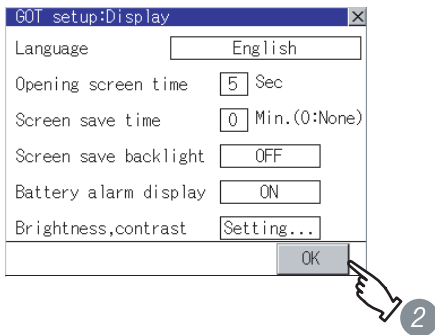
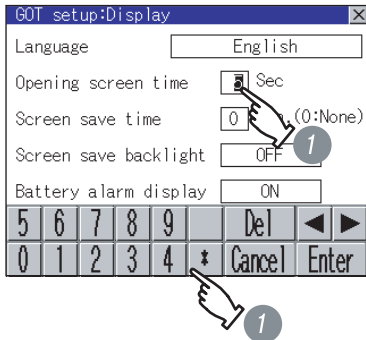

- 1 If touching the setting time (numerical), keyboard is displayed. Input numeric with the keyboard.

- 2 Setting contents are defined if button is touched.

- 3 If button is touched without touching button, the dialogue box shown on the left is displayed.

button: The changed value is canceled, and the screen is closed.

button: The display setting screen is displayed.

- 4 If close the display setting and GOT setup screens after completing the setting of all items to change with button, GOT restarts and reflects the setting contents.

2 Screen save backlight, Battery alarm display

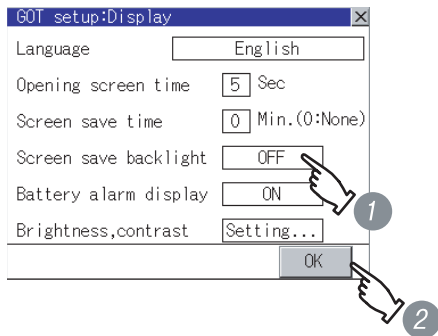

- 1 Setting item is changed if setting item is touched. (ON ↔ OFF)
- 2 Setting contents are defined if button is touched

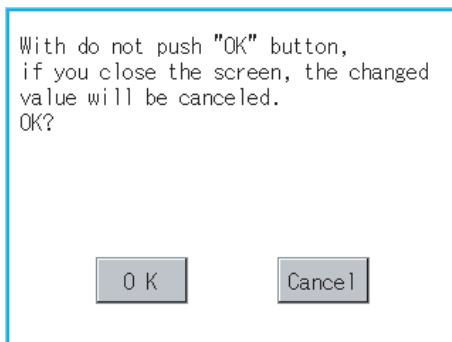

- 3 If button is touched without touching button, the dialogue mentioned left is displayed.

button: The change contents are canceled, and the screen is closed.

button: The display setting screen is displayed.

- 4 If close the display setting and GOT setup screens after completing the setting of all items to change with button, GOT restarts and reflects the setting contents.

3 Language

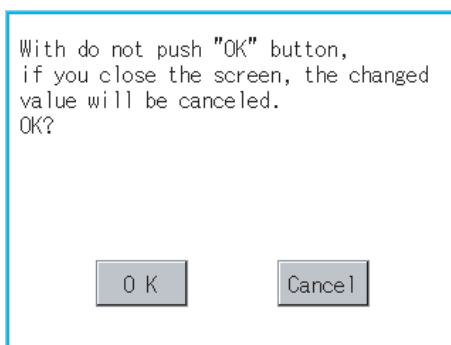
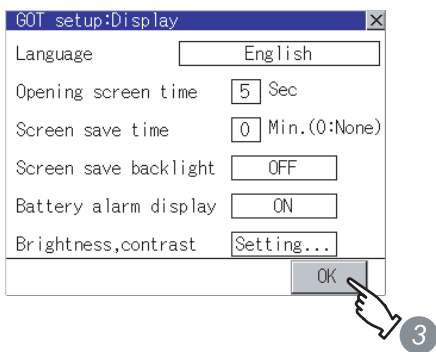
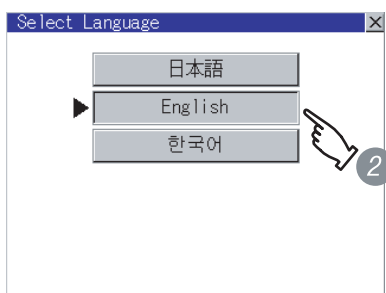
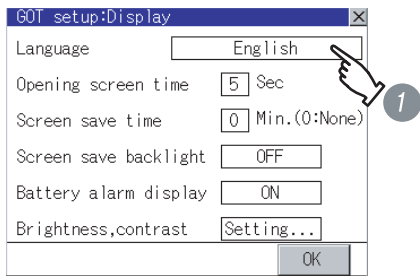

1 Touch the setting items to display the Select Language screen.

2 When touching the button of a desired language, the language is selected and the screen returns to the Display screen.

3 Setting contents are defined if button is touched. The language display does not change till 5 is carried out.

4 If button is touched without touching button, the dialogue box shown on the left is displayed.

button: The changed value is canceled, and the screen is closed.

button: The display setting screen is displayed.

5 If close the display setting and GOT setup screens after completing the setting of all items to change with button, GOT restarts and reflects the setting contents.

4 Brightness, Contrast

Refer to the following for brightness, contrast setting.

 Section 11.2 Brightness, Contrast Adjustment

5 Invert colors

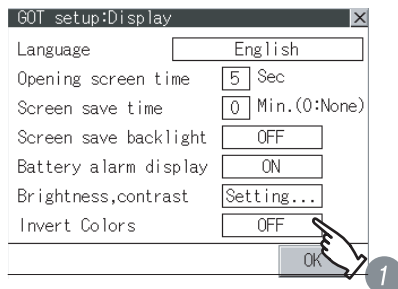

1 Setting item is changed if setting item is touched. (ON  OFF)

2 Setting contents are defined if button is touched

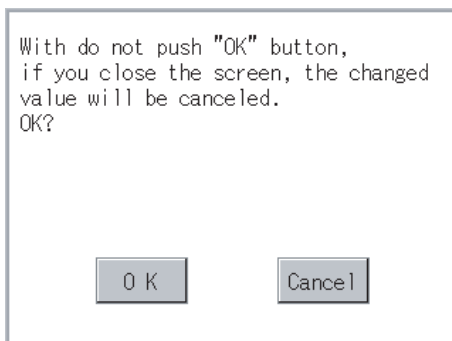

3 If button is touched without touching button, the dialogue mentioned left is displayed.

button: The change contents are canceled, and the screen is closed.

button: The display setting screen is displayed.

4 If close the display setting and GOT setup screens after completing the setting of all items to change with button, GOT restarts and reflects the setting contents.

11.2 Brightness, Contrast Adjustment

11.2.1 Brightness, contrast adjustment function

Brightness or contrast can be adjusted.

Function	Contents
Brightness setting	Brightness of display part can be adjusted by 8 levels.
Contrast setting	Contrast of display part can be adjusted by 16 levels. (GT1155-QTBQ, GT1155-QTBDQ and GT1155-QTBDA excluded)

11.2.2 Display operation of brightness, contrast

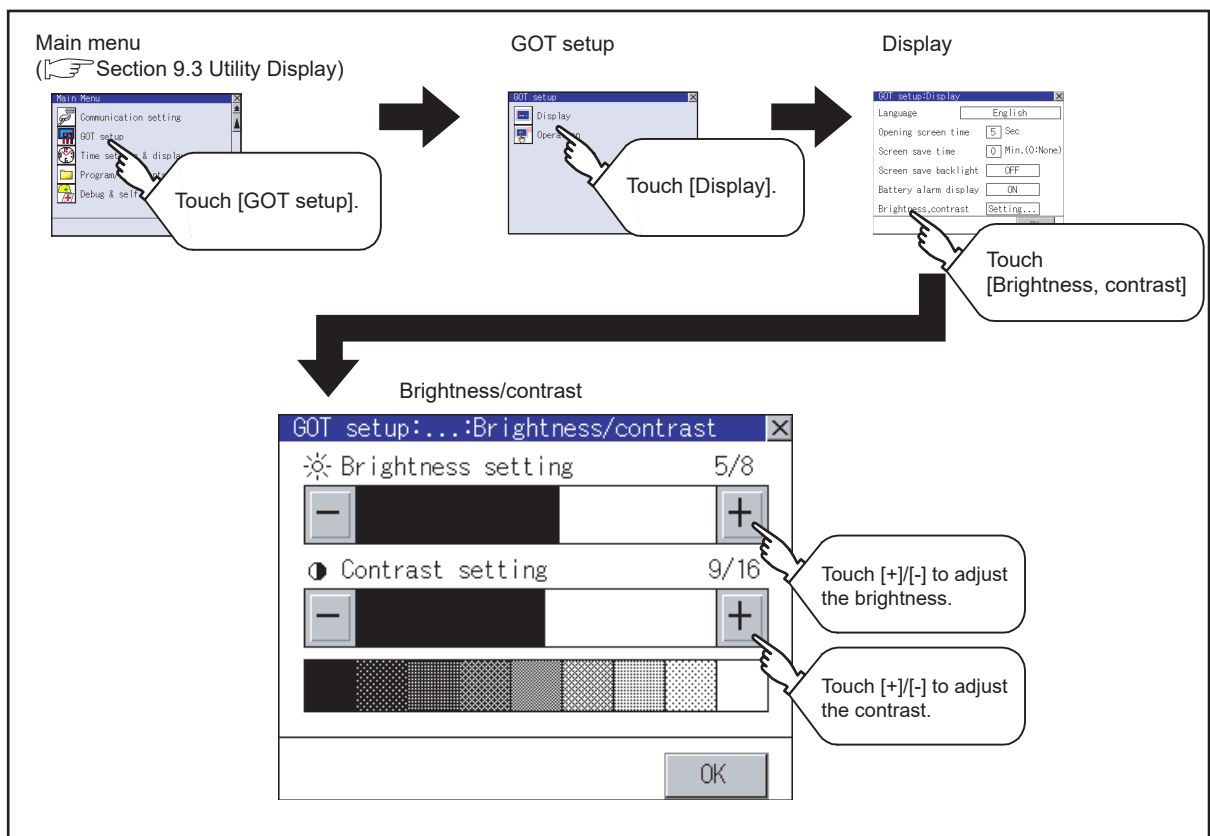

Remark

Display immediately after the power is turned ON

On the "Booting" window displayed immediately after the power is turned ON, the contrast set value set in the factory before shipment is displayed.
On the "Booting project data ..." window and later after that, the contrast set value set in the utility is reflected, and the value displayed immediately after the power is turned ON changes.

11.2.3 Brightness adjustment operation

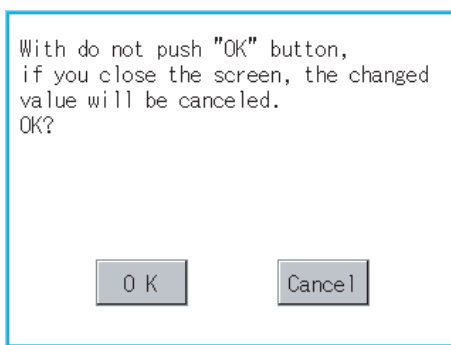
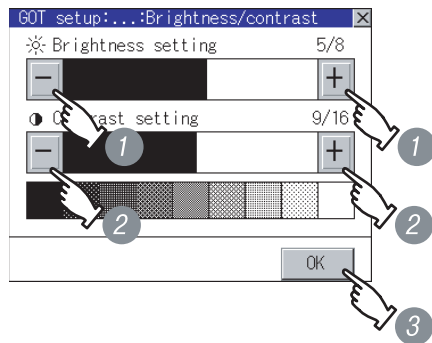



- 1 Brightness can be adjusted by touching , key of brightness adjustment.
- 2 Contrast can be adjusted by touching , key of contrast adjustment.
- 3 Setting contents are defined if button is touched
- 4 If button is touched without touching button, the dialogue box shown on the left displayed.
 button: The changed value is canceled, and the screen is closed.
 button: The brightness/contrast adjustment screen is displayed.

11.3 Operation Settings

11.3.1 Operation setting functions

Setting regarding GOT operation can be set.
The items which can be set are described below.

Function	Contents	Setting range
Buzzer volume setting	Buzzer volume setting can be changed.	OFF/SHORT/LONG <At factory shipment: SHORT>
Window move buzzer volume setting	Whether turn ON/OFF buzzer when move window can be selected.	ON/OFF <At factory shipment: ON>
Security setting screen change	Security level change screen can be displayed.  Section 11.4 Security Level Change	—
Utility call key screen change	Utility call key setting screen can be displayed.  Section 11.5 Utility Call Key Setting	—
Key sensitivity setting	The sensitivity of touch panel when GOT screen is touched can be set.	1 to 8 *1

*1 Relationship between the "key sensitivity" setting and the "key reaction speed"

The relationship between "key sensitivity" and "key reaction speed" is shown in the table below.

- Decreasing the "key sensitivity" value will speed up the key reaction speed.
- Increasing the "key sensitivity" value will slow down the key reaction speed.

"Key sensitivity" setting value	8	7	6	5	4	3	2	1
"Key reaction speed" [ms]	-20	-10	Standard(±0)	+10	+20	+40	+80	+120

When the GOT screen recognizes a single touch as two touches, decrease the "key sensitivity" (to slow down the key reaction speed).



Operation settings by drawing software

Set buzzer volume and window move buzzer volume by [GOT setup] in [System Environment] of GT Designer2.

When using GT Designer3, execute the settings at [GOT Setup...] of [GOT Environmental Setting].

When change a part of the setting, change the setting by the GOT display setting after downloading the project data.

 GT Designer2 Version □ Screen Design Manual
GT Designer3 Version1 Screen Design Manual (Fundamentals)

11.3.2 Display operation of operation setting

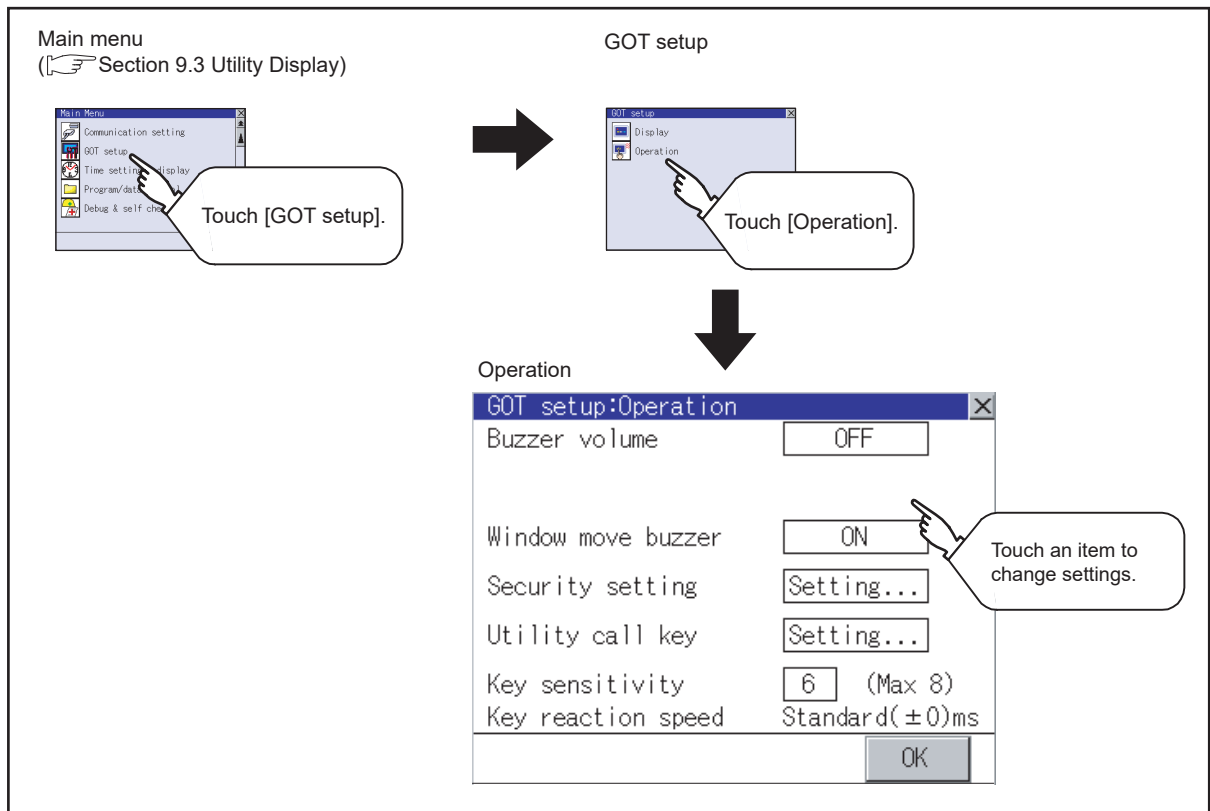

Point

Restart after setting change

If return the display to the GOT setup screen by touching the button after the setting of each item (excluding the security setting) is changed and touch the button on the GOT setup screen, the GOT will restart.

After GOT restarts, it is displayed with the changed settings.

If restarted the GOT by powering OFF the GOT without the procedure above, the setting contents are canceled without reflected.

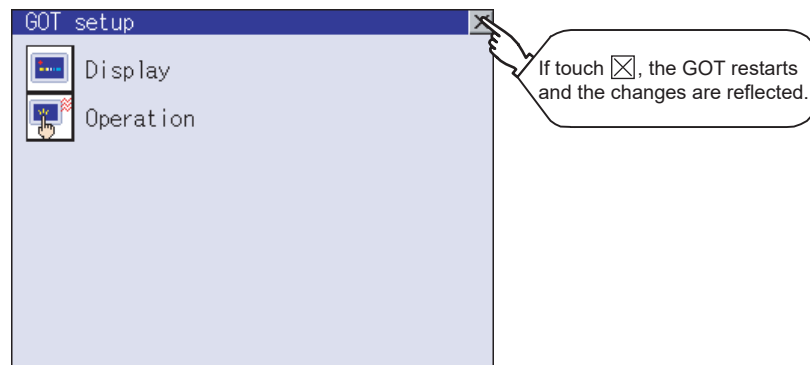

11.3.3 Setting operation of operation

1 Buzzer volume, window move buzzer

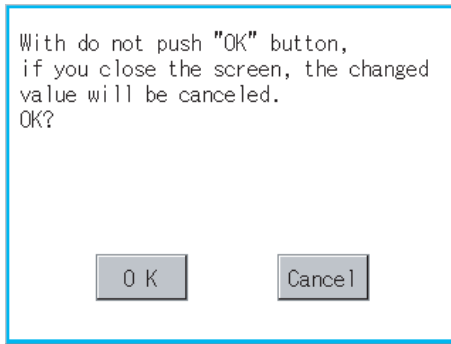
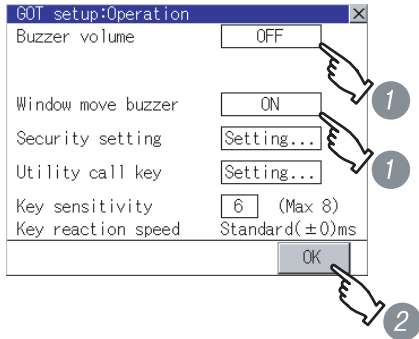

- 1 Setting items are changed if setting item is touched.

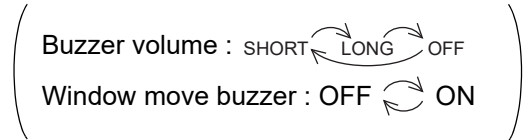

- 2 Setting contents are defined if OK button is touched.

- 3 If OK button is touched without touching button, the dialogue box shown on the left is displayed.

OK button: The changed value is canceled, and the screen is closed.

Cancel button: The operation setting screen is displayed.

- 4 If close the display setting and GOT setup screens with button after completing the setting of all items to change, GOT restarts and reflects the setting contents.

2 Security setting

Refer to the following for the security setting operation.

Section 11.4 Security Level Change

3 Utility call key

Refer to the following for the utility call key operation.

Section 11.5 Utility Call Key Setting

4 Key sensitivity setting

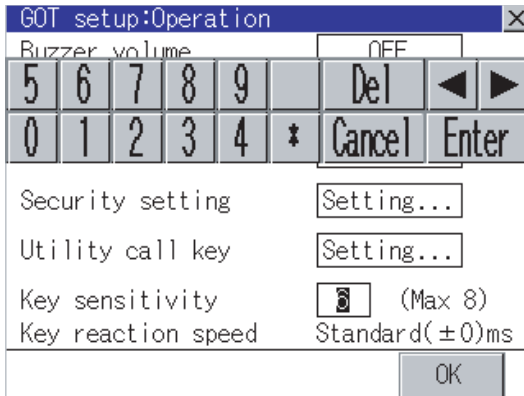



- 1 The keyboard is displayed if setting item is touched.
- 2 Enter the numerical value from the keyboard.
- 3 The key reaction speed according to the "key sensitivity" setting is displayed.
- 4 Setting contents are defined if button is touched.

11.4 Security Level Change

11.4.1 Security level change functions

Changes the security level to the same security level set by each object or screen switch.
To change the security level, input the password of the security level which is set in drawing software.

- Security level setting  GT Designer2 Version □ Screen Design Manual
GT Designer3 Version1 Screen Design Manual (Fundamentals)
- Password setting.....  GT Designer2 Version □ Screen Design Manual
GT Designer3 Version1 Screen Design Manual (Fundamentals)



Restrictions on screen display

The security level change screen cannot be displayed when project data do not exist in GOT. Change the security level after downloading the project data to GOT

11.4.2 Security change display operation

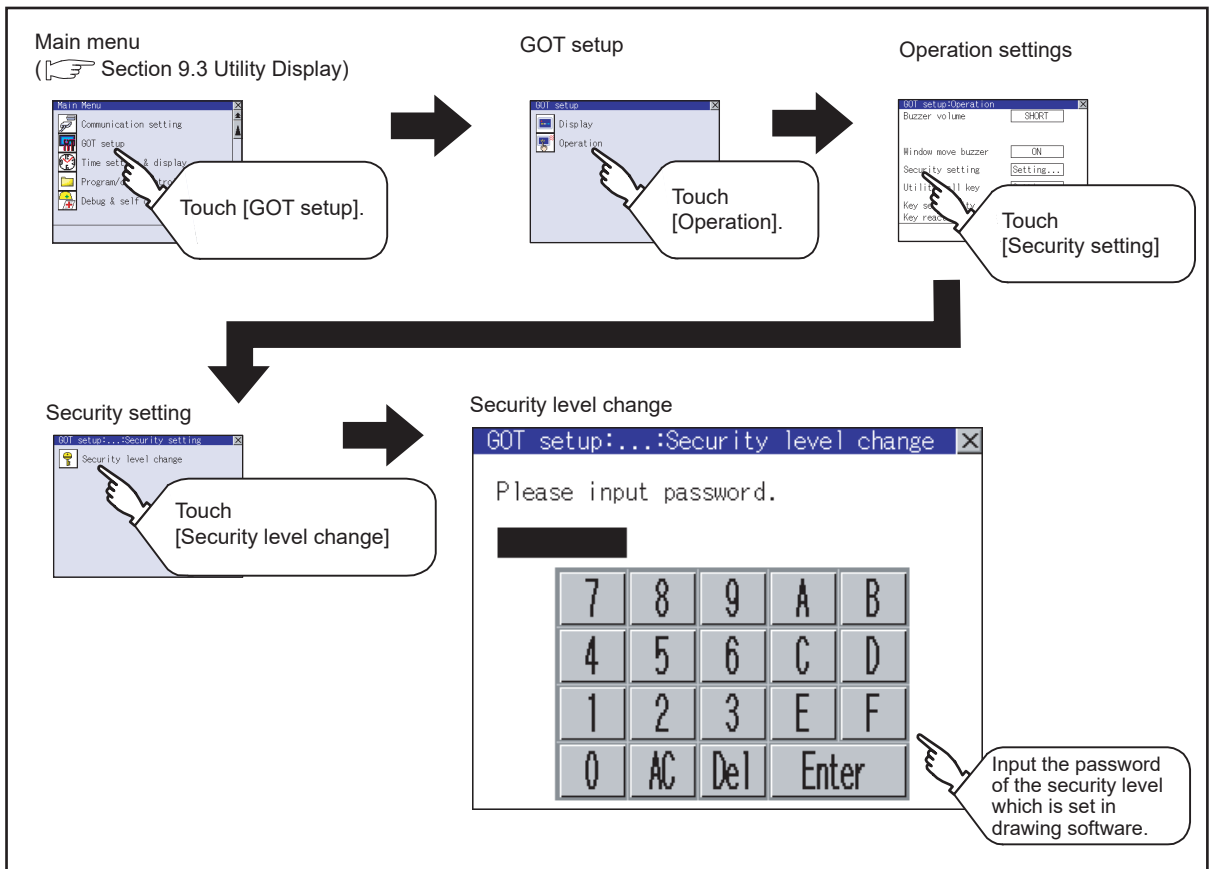

11.4.3 Security level change operation

1 Password input operation

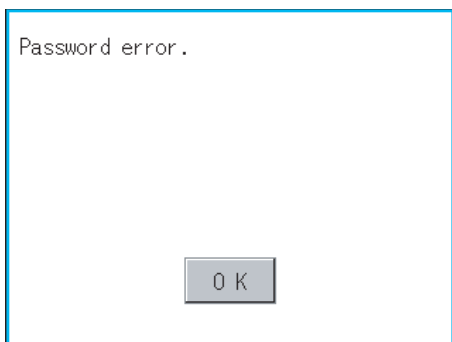
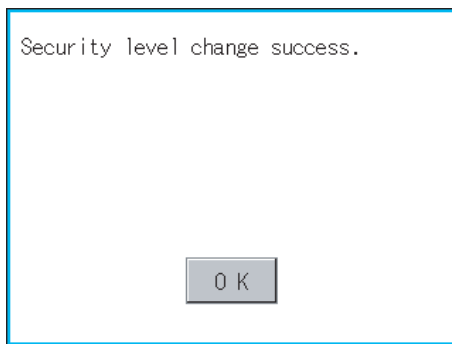
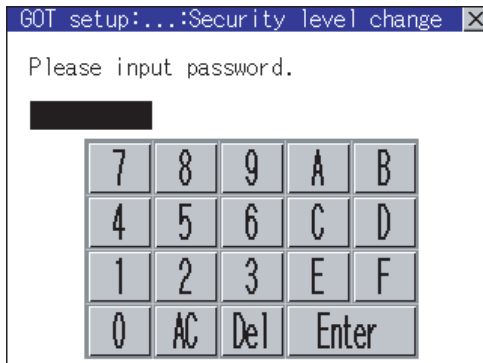

1 By touching to , to key, the password of the changed security level is input.

2 When correcting the input character, touch key to delete the correcting character and input the password again.

3 After inputting password, touch the key.

When the password matches, a message notifying successful change of the security level is displayed.

When the password does not match, an error message is displayed.

4 If button is touched it returns to the password input screen again.

5 If button is touched it returns to security setting screen.

Remark

About forgetting to return to the original level after changing security level temporarily
When use GOT after temporarily changing the security level, do not forget to return the security level to the original level.

11.5 Utility Call Key Setting

11.5.1 Utility call key setting function

The key position for calling the main menu of the utility can be specified.
The key position can be specified by one point or two points of 4 corners on the screen.
When the key position is specified by one point, the time to switch to the utility when the key position is kept pressing can be set.
For default setting, the upper left and upper right corners are specified.



Operation settings by drawing software

Set the utility call key at [GOT set up] in [System Environment] of GT Designer2.
When using GT Designer3, execute the settings at [GOT Setup...] of [GOT Environmental Setting].

When change a part of the setting after downloading the project data, change the setting by [Display] screen of the GOT.



GT Designer2 Version □ Screen Design Manual

GT Designer3 Version1 Screen Design Manual (Fundamentals)

11.5.2 Utility call key display operation

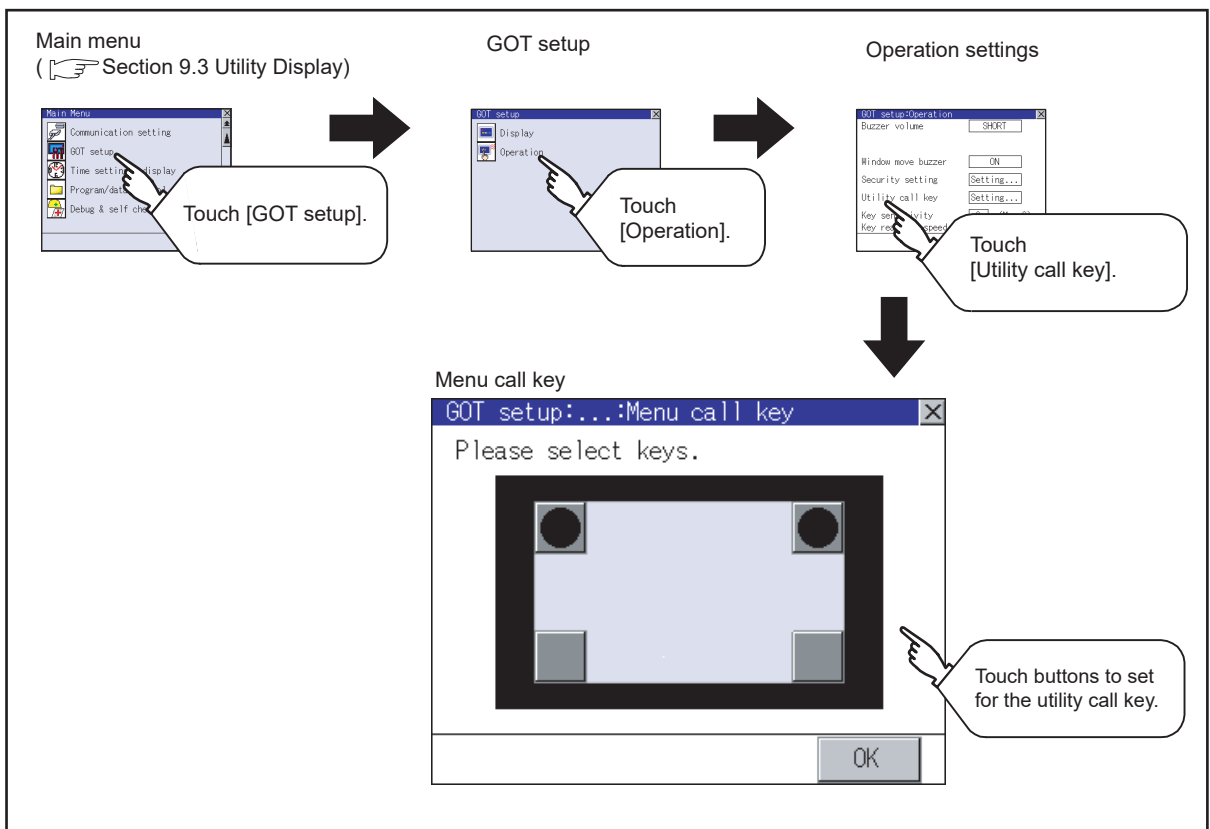

11.5.3 Utility call key setting operation

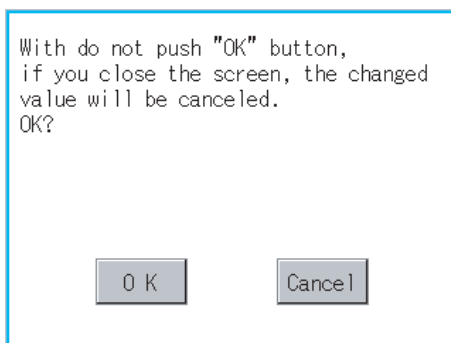

- 1 Touch or displayed on the four corners of the setting screen.
The button repeats  every time it is pressed.
Change the part to be set as a key position to .
- 2 When the key position is specified by one point, the time to switch to the utility when the key position is kept pressing can be set.
Touch the time area.
- 3 The keyboard is displayed if the input area is touched.
Input a setting time from the keyboard.
- 4 Setting contents are defined by touching button.
- 5 If button is touched without touching button, the dialogue box shown on the left is displayed.
 button: The changed value is canceled, and the screen is closed.
 button: The utility call key setting screen is displayed.
- 6 After finishing all the settings for items to be changed on the operation screen, closing "Operation" and "GOT setup" screens with button restarts GOT and reflects the setting contents.

(1) Setting another key position when there are two

Make the setting after changing either one of the key positions from to .

Three of cannot be set at the same time.

Example: When changing the two positions from the upper left and upper right corners to the upper left and lower left corners

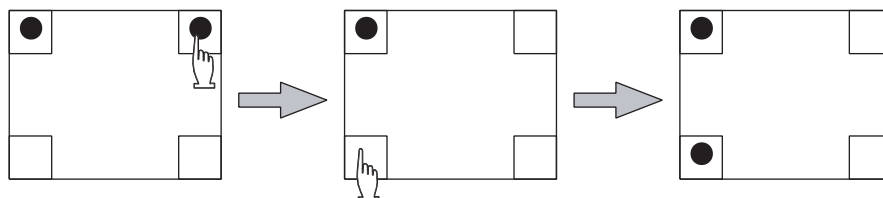

Change the upper right to . Change the lower left to .

(2) When the utility call key is set to the zero point

Refer to the following for the utility screen displaying method:

- Pressing the special function switch set on the user-created screen
- Powering ON the GOT while touching the upper left corner of the screen

 Section 9.3.1 Display operation of main menu

(3) When limiting the display and operation of the utility

When limiting the display and operating users, set a password to the GOT using the drawing software.

If a user tries to display the main menu of the utility, the password is displayed.

Refer to the following for details on setting passwords.

 GT Designer2 Version Screen Design Manual

GT Designer3 Version1 Screen Design Manual (Fundamentals)

12. CLOCK SETTINGS AND BATTERY STATUS DISPLAY (TIME SETTING AND DISPLAY)

The clock display setting items and the time when displayed the setting screen are displayed.
The voltage status of the built-in battery is also displayed.

12.1 Time Setting and Display

12.1.1 Time setting and display functions

Time settings and displaying of the status of GOT built-in battery are possible.

Function	Contents	Reference page
Clock setting	Setup the method to adjust the time between GOT clock data and clock data of PLC CPU connected with GOT.	12-2
Clock display	Carry out the display and setup of GOT clock data.	12-4
GOT internal battery voltage status	Displays GOT internal battery voltage status.	12-5



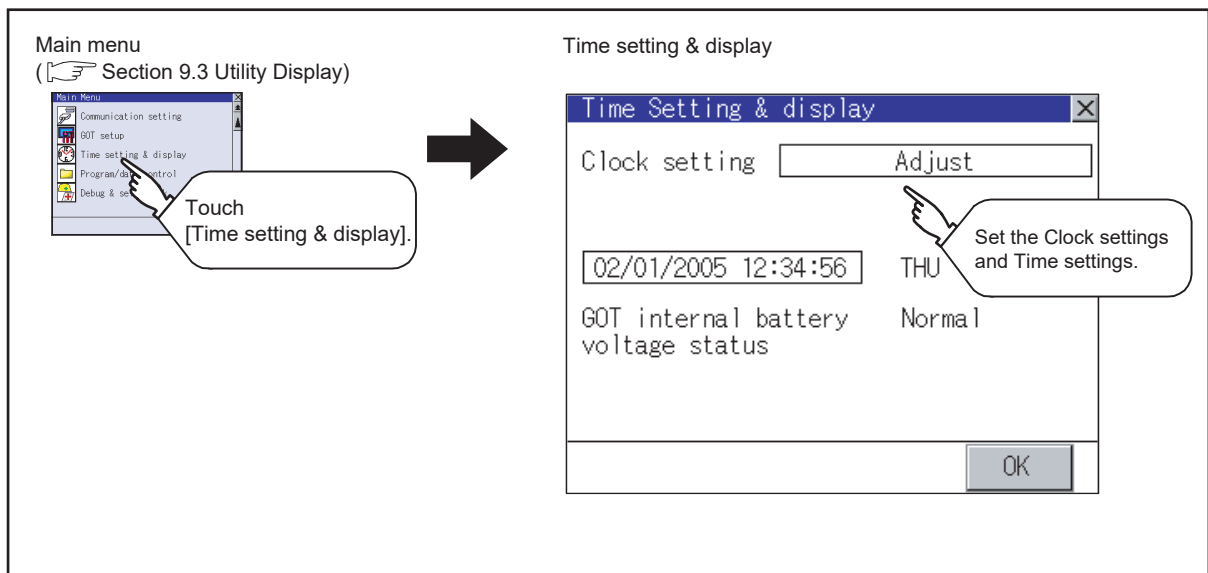



12.1.2 Display operation of clock display and setting

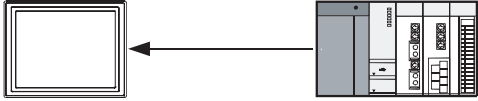

12.1.3 Clock setting operations

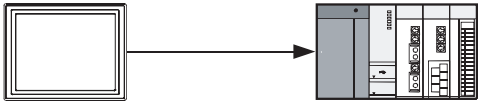
1 Clock setting

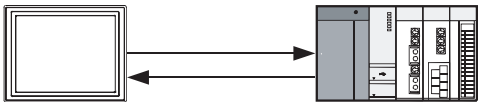
Setup the method to adjust the time between GOT data and the clock data of PLC CPU connected with GOT.

Setting	Contents
Adjust	<p>Adjust the time of GOT clock data to the clock data of PLC CPU.</p>  <p>Same as setting in [GOT setup] in [System Environment] of GT Designer2. Same as setting in [GOT Setup...] in [GOT Environmental Setting] of GT Designer3.</p> <p> GT Designer2 Version <input type="checkbox"/> Screen Design Manual GT Designer3 Version1 Screen Design Manual (Fundamentals)</p>
Broadcast	<p>Adjust the time of PLC CPU clock data to the clock data of GOT.</p>  <p>Same as setting in [GOT setup] in [System Environment] of GT Designer2. Same as setting in [GOT Setup...] in [GOT Environmental Setting] of GT Designer3.</p> <p> GT Designer2 Version <input type="checkbox"/> Screen Design Manual GT Designer3 Version1 Screen Design Manual (Fundamentals)</p>
Adjust/Broadcast	<p>Adjust and Broadcast can be used appropriately.</p>  <p>Same as setting in [GOT setup] in [System Environment] of GT Designer2. Same as setting in [GOT Setup...] in [GOT Environmental Setting] of GT Designer3.</p> <p> GT Designer2 Version <input type="checkbox"/> Screen Design Manual GT Designer3 Version1 Screen Design Manual (Fundamentals)</p>
None	No adjustment of clock data.

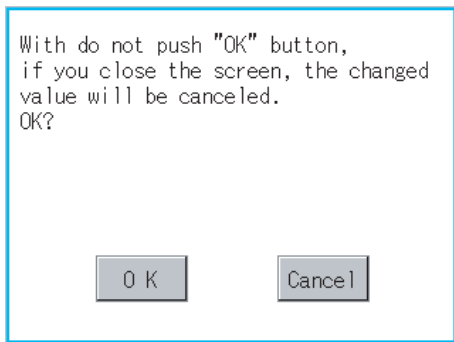
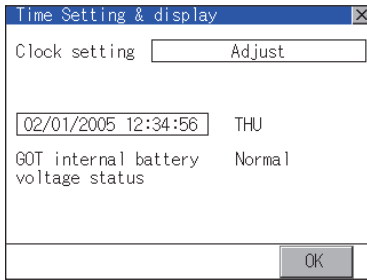

1 If touch the setup item, the setup contents is changed.

(Adjust → Broadcast → Adjust/Broadcast → None)

2 If touch button, the setup contents is reflected.

3 If touch button without touching button, the dialogue box shown on the left is displayed.

button: The changed value is canceled, and the screen is closed.

button: The time display and setting screen is displayed.

4 If touch button, GOT restarts. After restart, GOT operates with the changed settings.

Point

(1) When connecting with an external device which does not have clock function. If set to [Adjust] or [Broadcast] for [Clock setting] while the GOT is connected with external devices (PLC or microcomputers) which do not have clock function, the clock data will not be adjusted.

Refer to the following for the list of PLC installed with clock function.

 GT Designer2 Version Screen Design Manual
GOT1000 Series Connection Manual (for GT Works3)
(Mitsubishi Products), (Non-Mitsubishi Products1), (Non-Mitsubishi Products 2), (Microcomputer, MODBUS Products, Peripherals)

(2) Clock setting and battery

If [Broadcast] or [None] is selected for [Clock setting], the battery status of the GOT is required to be normal.

Refer to **3** "GOT internal battery voltage status" to check the battery status.

(3) Operation setting by drawing software

Carry out the setting of clock setting in [GOT set up] in [System Environment] of GT Designer2.

When using GT Designer3, execute the settings at [GOT Setup...] of [GOT Environmental Setting].

To change a part of the setting after downloading the project data, change the setting at the display setting of GOT.

 GT Designer2 Version Screen Design Manual
GT Designer3 Version1 Screen Design Manual (Fundamentals)

2 Clock display

Carry out the display and setting of GOT clock data.

When setting the clock data, change the clock data on the GOT and controller regardless of clock setting.

The setup methods of clock data are shown below.

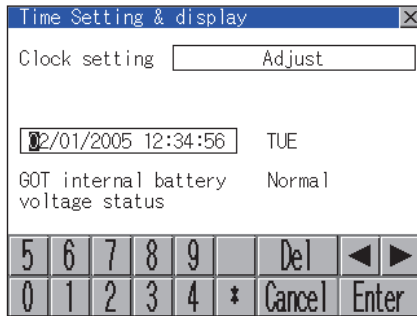

- 1 If touch the clock display section, the keyboard for input is displayed and the clock update stops.
- 2 Input time with the keyboard by referring to the table below. Input the scheduled time when the operation of 3 is to be carried out since the input time is reflected at the time of the operation of 3. The day of the week is displayed automatically according to the input date.

Key	Contents
[0] to [9] Key	Input numeric value in cursor position.
[←] / [→] Key	Move the cursor.
[Del] Key	Move the cursor to the left by one character when [Del] Key is touched while inputting year, month, day, time, minutes, seconds. Carry out nothing when touched other than when inputting the above.
[Enter] Key	Close the keyboard after the input time is displayed in clock display. The update of the clock display does not restart even if the keyboard is closed. The update of the clock display restarts with the operation of 3.
[Cancel] Key	Cancel the input time and returns the time of clock display to the time at which the keyboard was displayed and close the keyboard. The update of the clock display does not restart even if the keyboard is closed. The update of the clock display restarts with the operation of 3.

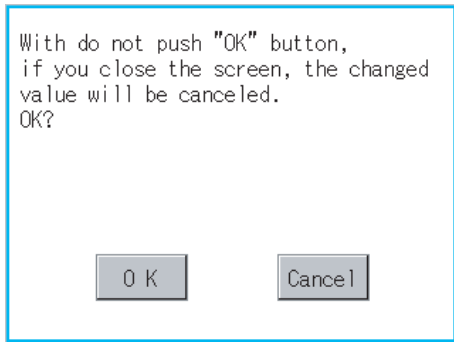

3 Touching the button reflects the settings and restarts updating the clock display.

Then, the settings are reflected to both clock data on the GOT and controller.

4 If touch button, the GOT restarts if the clock settings is changed, or the screen closes if clock settings is not changed. If touch button without touching button, the dialogue box shown on the left is displayed.

button: The changed value is canceled, and the screen is closed.

button: The time display and setting screen is displayed.

3 GOT internal battery voltage status

Displays battery voltage status.

Display	Status
Normal	Normal
Low/None	Low voltage

When the battery voltage is low, replace the battery immediately.

Refer to the following for battery replacement procedure.

 Section 8.4 Battery

13. FILE DISPLAY AND COPY (PROGRAM/DATA CONTROL)

The display of OS, project data or alarm data which is written in the GOT or CF card and the data transmission between GOT and CF card are possible.
The format of the CF card is also possible.

13.1 Data Storage Location

13.1.1 Drive name allocation

For the Built-in CF card, Flash Memory (Internal) or Internal SRAM, the following drive names (A drive, C drive and D drive) are allocated.

Drive name	Allocation
A drive	Built-in CF card
C drive	Flash Memory (Internal)
D drive	Internal SRAM

13.1.2 Data type and storage location

1 At system startup

The data storage location and transferring (write/read) route for each data type are shown below.

■ GOT main unit

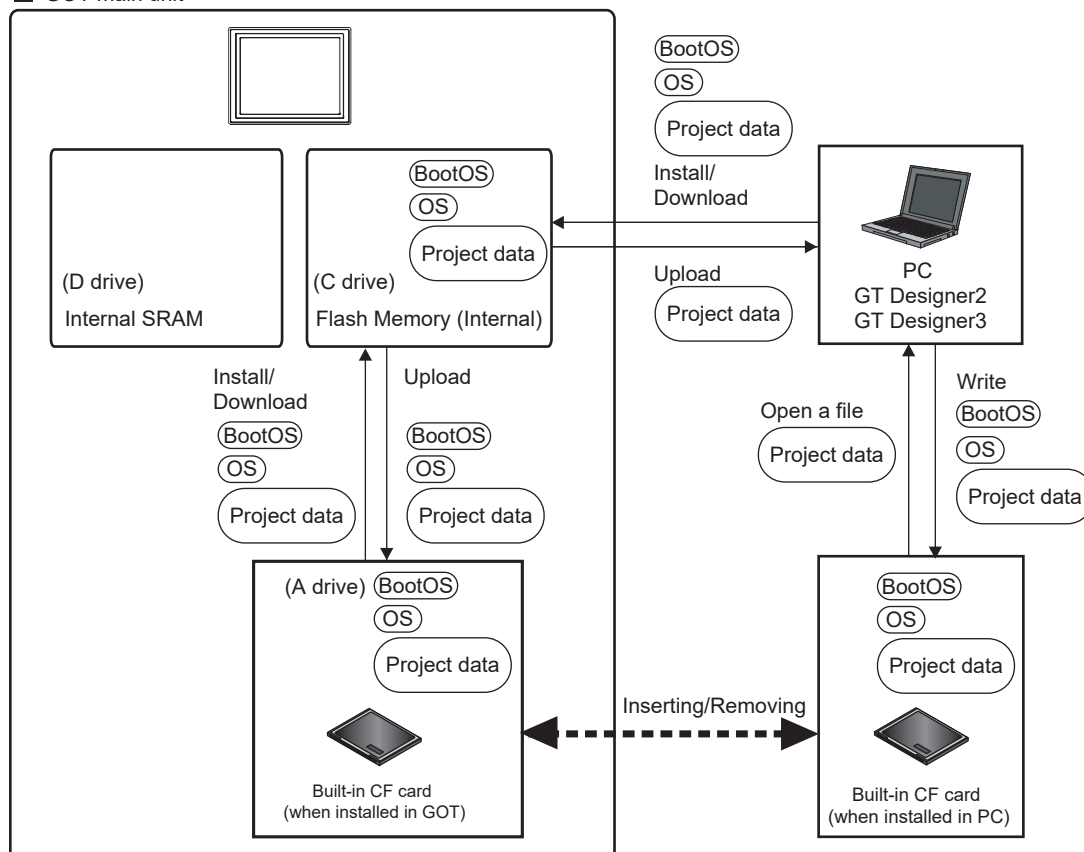

2 At maintenance

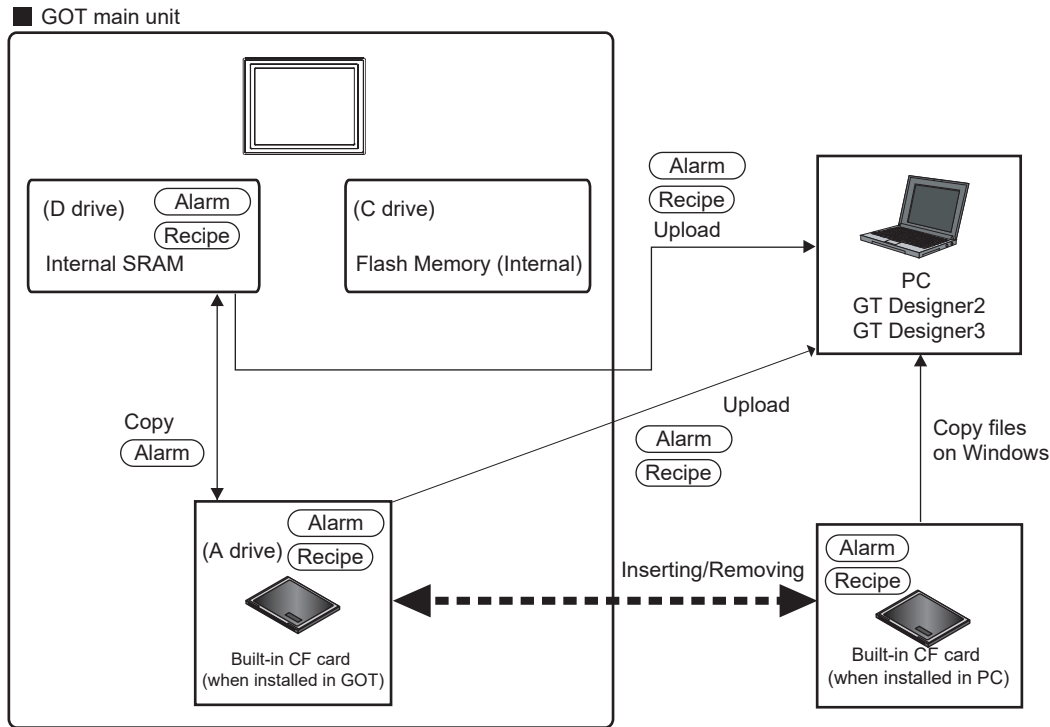

The data of the Flash Memory (Project data, etc.) can be saved even if the battery voltage becomes low.

	Data type	Storage location
(BootOS)	BootOS	Flash Memory (C drive)
(OS)	Standard monitor OS	
	Communication driver	
	Extended function OS	
	Option OS	
(Project data)	Project data (Including recipe setting, alarm conditions, time action, and GOT setup.)	Flash Memory (C drive) ^{*1}
(Alarm)	Alarm data (Alarm log file)	Internal SRAM (D drive)
(Recipe)	Recipe data	Built-in CF card (A drive)

*1 The project data can be started only from the flash memory (C drive).
It cannot be started from the built-in CF card (A drive).



Folder and file in memory card

Multiple folders and files will be created when OS or project data is transferred to the memory card.

Do not delete or edit these folders and files since the GOT uses them.

If the folders or files are deleted or edited, the GOT will not function normally.

13.1.3 OS version confirmation

Confirm the OS version carefully when install BootOS and Standard monitor OS.
When OS is installed, GOT checks and compares the OS version automatically.

- (1) When install BootOS
When the BootOS to be installed has the older major version, GOT displays the installation disapproving message to cancel the installation so that the older version may not be written. (Even when the version of the BootOS to be installed has the same or later version, the version information and the dialog for selecting continue/not continue will be displayed.)
When installing from the standard CF card, the dialog is displayed by the main unit.
When installing from drawing software via USB or RS-232, the dialog is displayed by the drawing software.
- (2) When install Standard monitor OS, communication driver, Option OS
When Standard monitor OS, communication driver, or Option OS has already been installed, the version information of the OS which has been installed and the dialog for selecting continue/not continue will be displayed.
Moreover, when the different versions will coexist among all OSs (Standard monitor OS, communication driver, and Option OS) by installing OS, the installation disapproving dialog will be displayed and the installation process is canceled.
- (3) When download project data
GOT automatically compares the version between the project data to be downloaded and the installed OS.
When the versions are different, the dialog confirming whether to install the OS together is displayed.
When downloading the project data from the CF card, storing the project data and OS beforehand is recommended.

The version of each OS can be confirmed by [Property] of [OS information] screen.

Program/Data control:...:Property				
Name	Kind	Version	Date	Time
G1OSMONT.OUT	Basic	01.02.01	02-01-05	12:40
G1F16STG.FON	Basic	01.02.01	02-01-05	12:40
G1F12STG.FON	Basic	01.02.01	02-01-05	12:41
G1OSMONT.G1D	Basic	01.02.01	02-01-05	12:41
G1OSMONT.G1	Basic	01.02.01	02-01-05	12:41
G1FTTNMG.FON	Basic	01.02.01	02-01-05	12:42

Explanation of OS version
01.00.00A
 └─ BootOS version
 └─ Appears only when the property of the BootOS is displayed.
 └─ Minor version
 └─ Major version

Refer to the following for details of the screen display operation.

 Section 13.2 OS Information



Version confirmation of BootOS by rating plate

Confirm the version of BootOS installed in the GOT at product shipment by rating plate of GOT rear face.

- (a) GT1155-QTBD, GT1155-QSBD, GT1150-QLBD

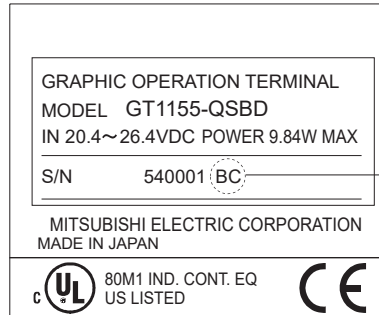

When the Boot OS version is 2 digits, only the lower digit is printed.

Example H/W version: H
Boot OS version: AD



Rating plate: HD

BC
BootOS version

- (b) GT1155-QTBDQ, GT1155-QTBDA, GT1155-QSBDQ, GT1155-QSBDA, GT1150-QLBDQ, GT1150-QLBDA

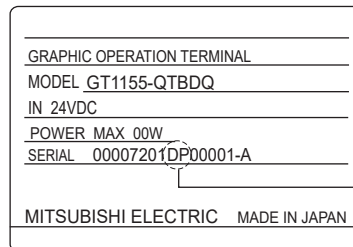

DP
BootOS version

13.1.4 Display file

The files that can be displayed in each screen are as follows.

Contents		Display screen	Storage location (Drive name/folder name)
BootOS			Built-in flash memory C:\G1BOOT ^{*3}
Standard monitor OS	Standard monitor OS system screen data	OS information screen	Built-in flash memory C:\G1SYS ^{*3}
	Standard monitor OS system screen management information file		
	Standard monitor OS (monitor function) ^{*1}		
	6 × 8-dot font (ASCII characters)		
	12-dot numerical HQ font		
	16-dot numerical HQ font		
	TrueType numerical font		
Extended function OS			
Option OS			
Communication driver			
Project data ^{*2}		Project information screen	Built-in flash memory C:\PROJECT1\ ^{*3*4}
User-created screen data			
Comment data			
12-dot HQ fonts (Mincho/Gothic)			
16-dot HQ fonts (Mincho/Gothic)			
TrueType (Mincho/Gothic)			
Resource data	Advanced alarm log file CSV file	Alarm information screen	Internal SRAM D:\ or Standard CF card A:\ With drawing software, any folder name or file name can be specified.

*1 The 6 × 8 dot font, 12-dot numerical HQ font, 16-dot numerical HQ font are displayed as Standard monitor OS.

*2 The user-created screen data, comment data, and font data are displayed as project data.

*3 Each folder is created automatically at installation, download and upload of each file.

*4 The folder name and file name can be set at [System Setting] in [System Environment] of GT Designer2. When using GT Designer3, execute the settings by [GOT Type Setting...] in [Common].



GT Designer2 Version □ Screen Design Manual

GT Designer3 Version1 Screen Design Manual (Fundamentals)

13.2 OS Information

13.2.1 Function of OS information

Each file name/folder name of BootOS and OS (Standard monitor OS, PC communication driver and Option OS) by which each drive (A: Built-in CF card, C: Flash memory) holds can be displayed in lists. Installation and uploading of the files are also possible.

Function	Contents	Reference page
Information display of files and folders	Displays the kind, name, data size, creation date and time of the file or folder.	13-7, 13-8
Install	All files written in the A drive (Built-in CF card) can be installed in the C drive (Flash memory).	13-9
Upload	All files in the C drive (Flash memory) can be uploaded to the A drive (Built-in CF card).	13-10
Property display	Displays the property (file name, data size, type, version and creation date) of the file.	13-11
Data check	Data check of files is possible.	13-12



Notes on installing OS

If the Boot OS or the Standard monitor OS is installed, such data on the GOT as the project data will be deleted.

After installing the Boot OS or the Standard monitor OS, reinstall/download necessary data.

13.2.2 Display operation of OS information screen

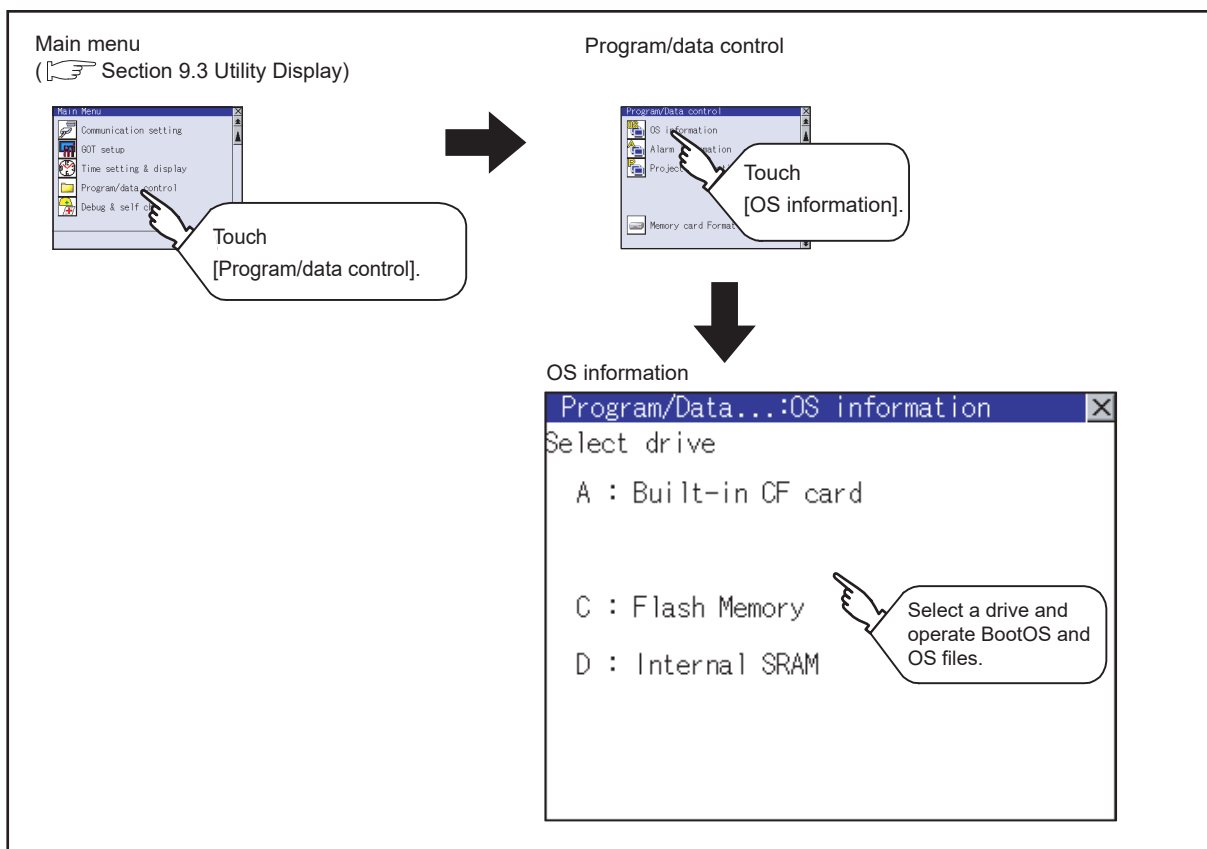

13.2.3 Display example of OS information

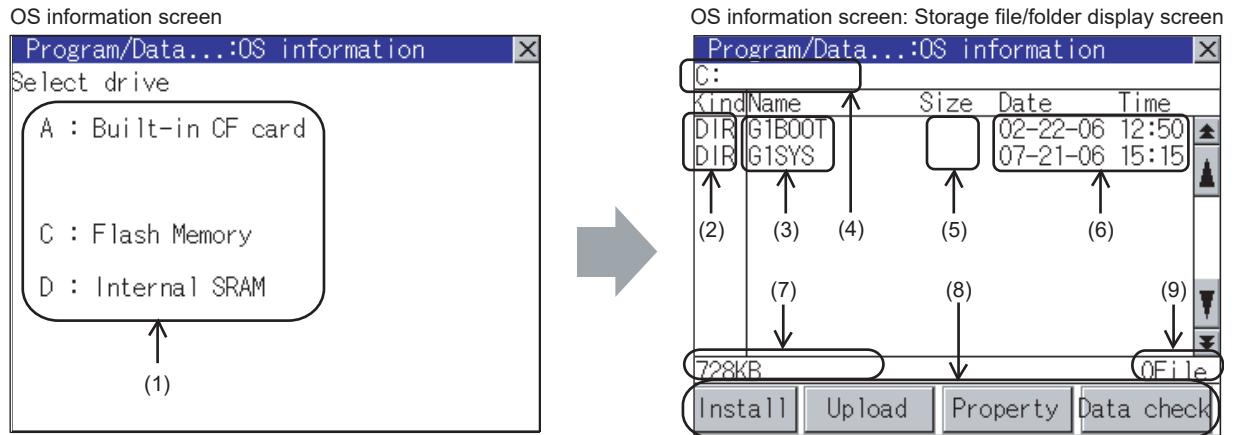

Number	Item	Contents
(1)	Select drive	The drive of which file or folder is displayed can be selected. When the CF card is not installed, [A: Built-in CF card] will not be displayed.
(2)	Kind	Indicates whether the displayed name is for file or folder. In case of file, displays the extension; in case of folder, displays "DIR".
(3)	Name	The file name or folder name which is stored in the selected drive or folder is displayed. When the file name or folder name exceeds 20 characters, the exceeding characters (the 21th character or after) are not displayed.
(4)	Path name	The path name of the currently displayed drive/folder is displayed.
(5)	Size	Displays the size of the file displayed in Name.
(6)	Date and time	The date and time when each file was installed are displayed.
(7)	The size of drive	Displays the size in use size of the drive which is selected by drive selection.
(8)	Operation switch	Execution switch of each function (install, upload, etc.) which can be executed on the OS information screen.
(9)	Number of files	Displays the total number of the displayed files.

Remark

Displayed folders and files

Refer to the following for the details of displayed folders and files.

☞ Section 13.1.4 Display file

13.2.4 Operation of OS information

1 Display operation of OS information

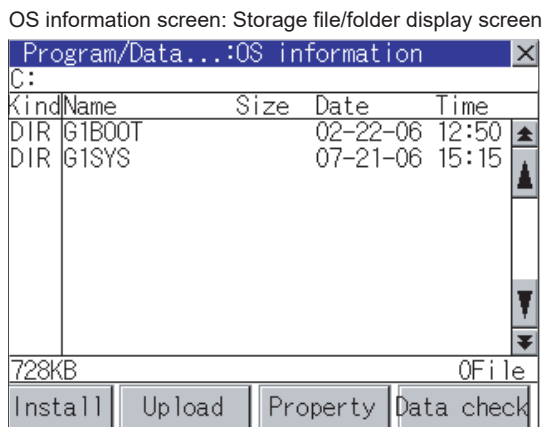
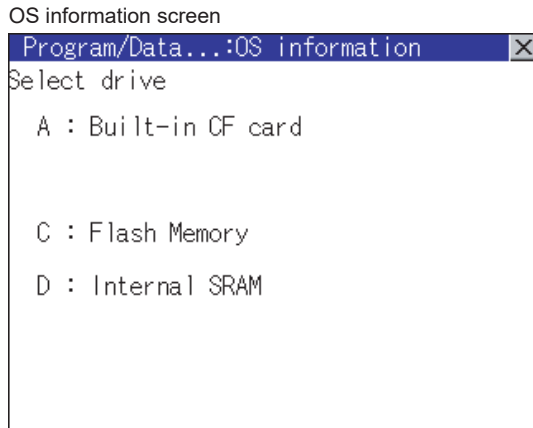

- 1 If touch a drive in [Select drive], the information of the first folder of the touched drive is displayed.
- 2 If touch a folder name, the information of the touched folder is displayed.
- 3 If touch a folder name of [. .], the information of the folder in one higher hierarchy is displayed.
- 4 If touch ▲▼ button of the scrollbar, the screen scrolls up/down by one line. If touch ▲▼ button, the screen scrolls up/down by one screen.
- 5 If touch a file name, the touched file name is selected and inverted.
- 6 Refer to the following for operation of installation, upload, property, data check.
 - Installation this section 2
 - Upload this section 3
 - Property this section 4
 - Data check this section 5
- 7 Touching ☒ button closes the screen.

2 Installation operation

BootOS and OS which are written in the A drive (Built-in CF card) can be installed in GOT.

- 1 Install the CF card to which the BootOS or OS to install is written to the GOT. Refer to the following for inserting/removing method of CF card.
 Section 8.1 CF Card
- 2 Touch [A: Built-in CF Card] for drive selection.
- 3 Touching button starts the install.

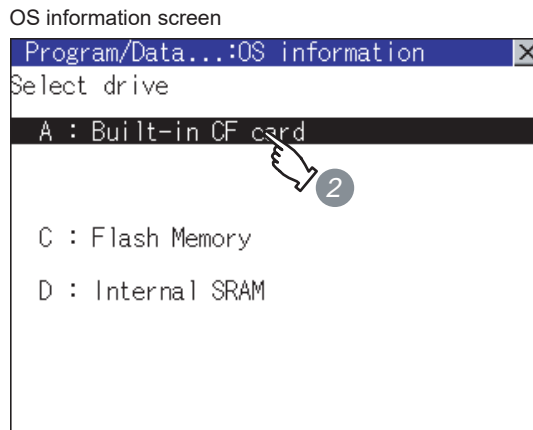

OS information screen: Storage file/folder display screen

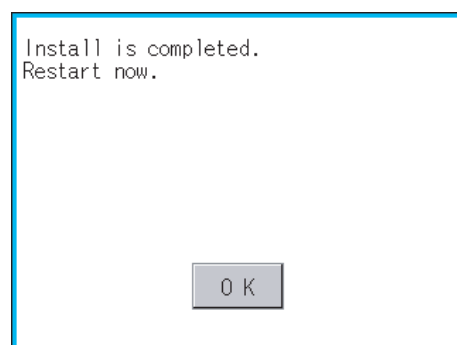
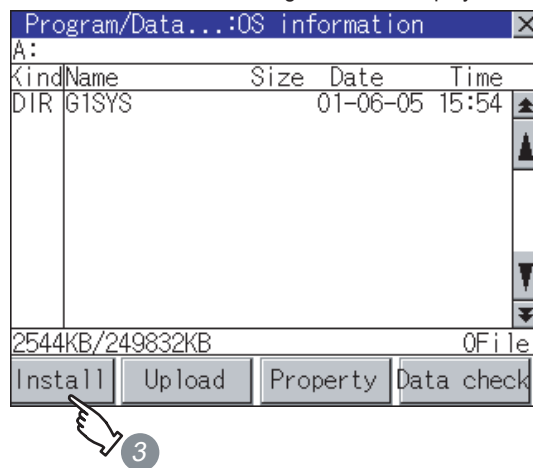

- 4 When the installation is completed, the dialog shown left is displayed. GOT restarts if touch button.

3 Upload operation

BootOS and OS in the C drive (Flash memory) can be uploaded to the A drive (Built-in CF card).

- 1 Install the CF card used as the uploading destination to GOT. Refer to the following for inserting/removing method of CF card.
☞ Section 8.1 CF Card
- 2 Touch [A: Built-in CF Card] of [Select drive].
- 3 Touching starts the uploading.

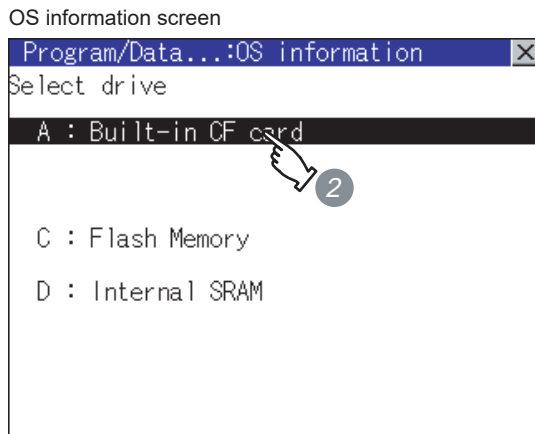

OS information screen: Storage file/folder display screen

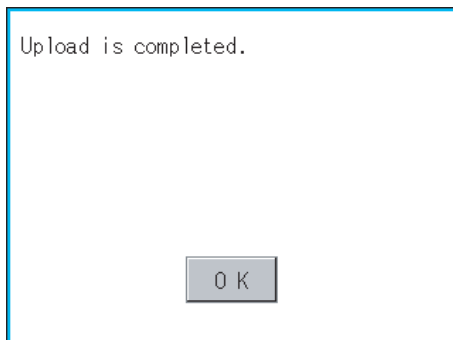
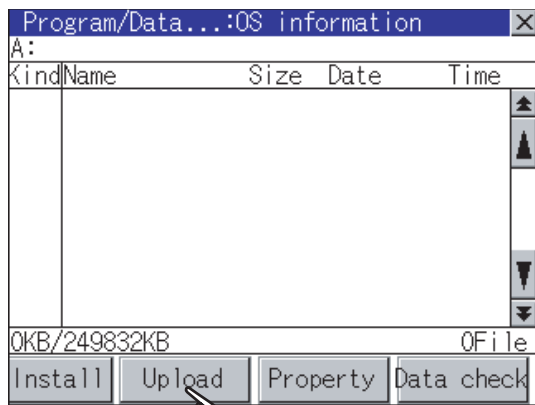

- 4 When the upload is completed, the dialog shown left is displayed. Touching closes the dialog.

4 Property display operation

Displays the property of the file stored in the selected folder.

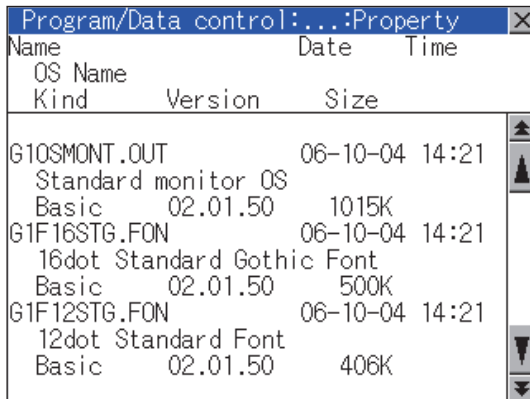

- 1 If touch **Property** button after selecting the property displaying target folder, the [Property] screen shown left is displayed. In the [Property] screen, the following information is displayed for each file selected by 1.

Item	Contents
Name	Displays the file name.
Kind	Displays the following items according to the file type. Boot : BootOS Standard : Standard monitor OS Communication : Communication driver Option : Option OS Extend : Extended function OS
Version	Displays the version of BootOS and OS.
Date, Time	Displays the date and time of the file creation.
Size	Displays the file size.

- 2 If touch **▲▼** button of the scrollbar, the screen scrolls up/down by one line. If touch **▲▼** button, the screen scrolls up/down by one screen.
- 3 Touching **⊗** button returns the screen to the previous screen display.

5 Data check operation

Carries out data check of the selected system file.

When data is normal.

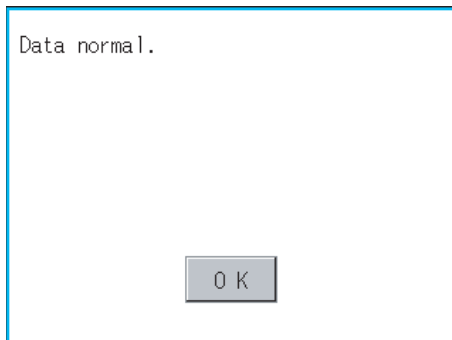

When data is erroneous.

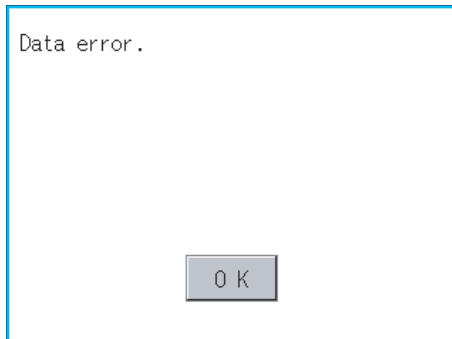

1 Touch **Data check** button after selecting a data check target file.
The dialog mentioned left will be displayed after executing data check.

2 Touching **OK** button closes the dialog.

3 If the data check fails, the target file may be broken.

Install the target file again.

For details of installation, refer to the following.

 Chapter 16 INSTALLATION OF CoreOS, BOOTOS AND STANDARD MONITOR OS

13.3 Project Information

13.3.1 Function of project information

The project data files stored in each drive (A: Built-in CF card, C: Flash memory) can be displayed by lists. In addition, the files can be downloaded, uploaded, deleted or copied, etc.

Function	Contents	Reference page
Information display of files and folders	Displays the kind, name, data size, the creation date and time of the file or folder.	13-14, 13-15
Delete	Deletes project data.	13-16
Copy	Copies project data. (Enabled to copy only from the A drive to the A drive)	13-17
Property display	Displays the project data creation date, author name and the version of drawing software.	13-18
Data check	Data check of the file can be executed.	13-19
Download	Downloads the project data written in the A drive (Built-in CF card) to C drive (Flash memory).	13-20
Upload	Uploads the project data written in the C drive (Flash memory) to the A drive (Built-in CF card).	13-22

13.3.2 Display operation of project information

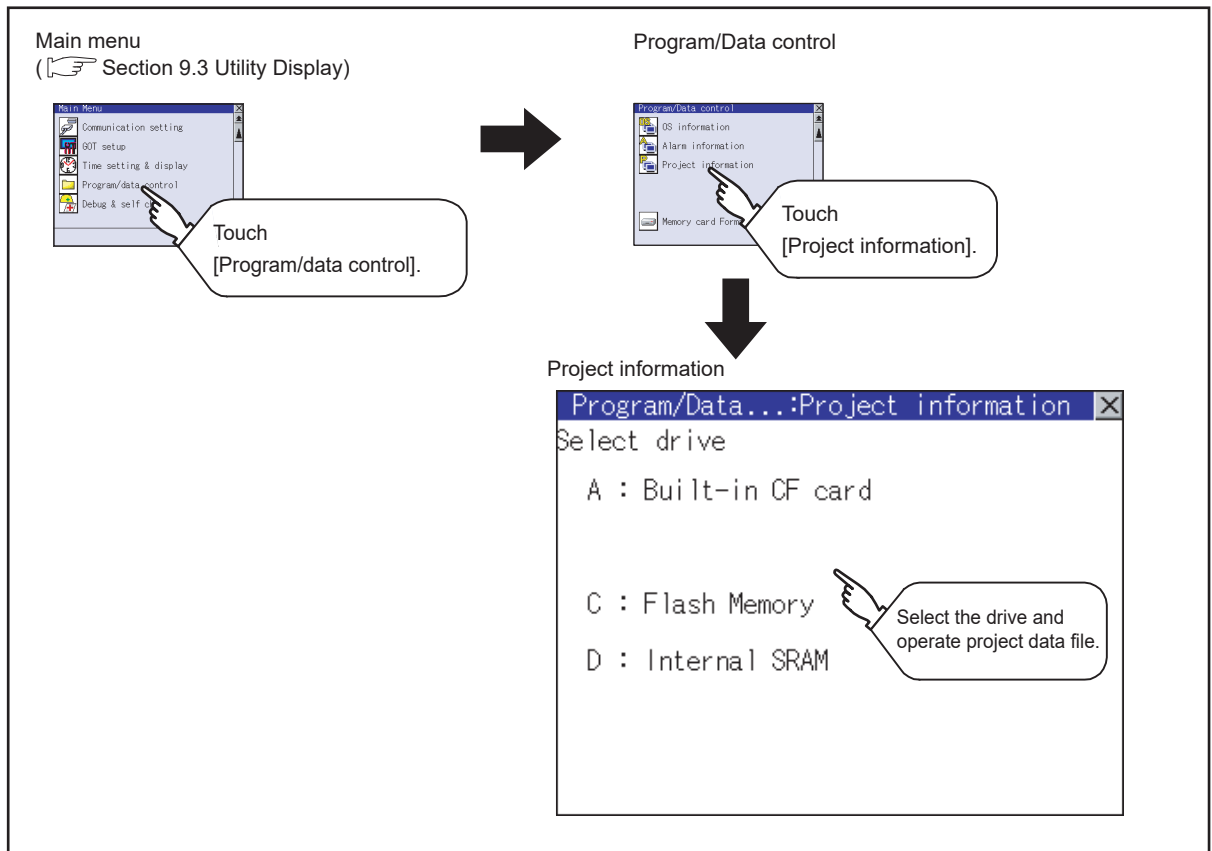

13.3.3 Display example of project information

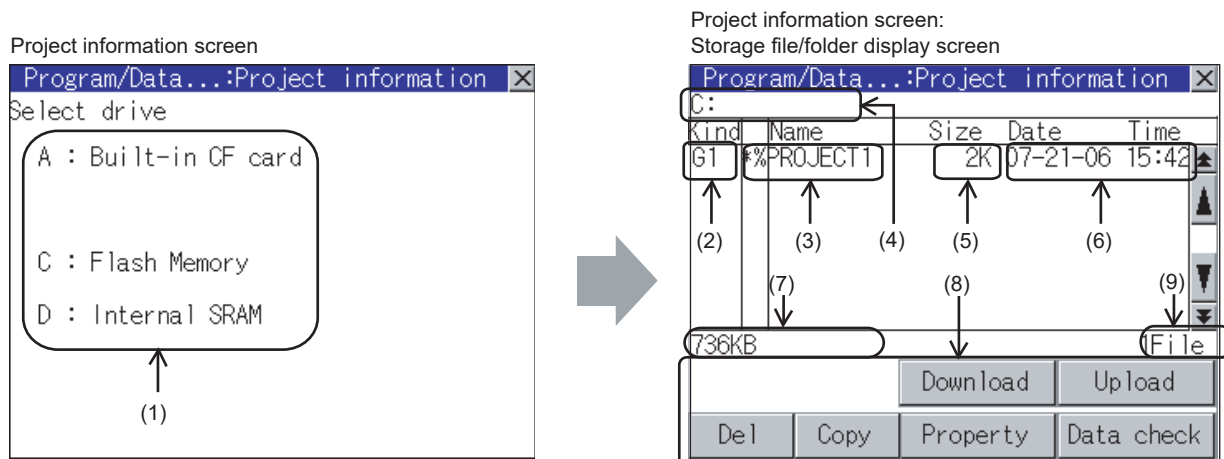

Number	Item	Contents
(1)	Select drive	The drive by which a file or folder is displayed can be selected. When the CF card is not connected, [A: Built-in CF card] is not displayed.
(2)	Kind	Indicates the type of the displayed name (file or folder). The file is indicated with an extension, while the folder is indicated with "DIR."
(3)	Name	Displays the name of file or folder saved in the selected drive or contained in the selected folder. When the file or folder name exceeds 18 characters, the 19th and later characters are not displayed. If the displayed project data is a GOT monitoring target file, "%" mark precedes the file name. If the displayed project data is currently selected to be displayed, asterisk "*" precedes the file name.
(4)	Path name	Displays the path name of drive/folder which is currently displayed.
(5)	Size	Displays the size of the file displayed in [Name].
(6)	Date and time	Displays the date and time when each file is installed.
(7)	Size of the drive	Displays the size in use size of the drive selected in [Select drive].
(8)	Operation switch	Displays the execution switch of functions (download, upload, etc.) which can be carried out in [Project information].
(9)	Number of files	Displays the total number of the displayed files.

Remark

Displayed folders and files

Refer to the following for the details of displayed folders and files.

☞ Section 13.1.4 Display file

13.3.4 Operation of project information

1 Display operation of project information

Project information screen

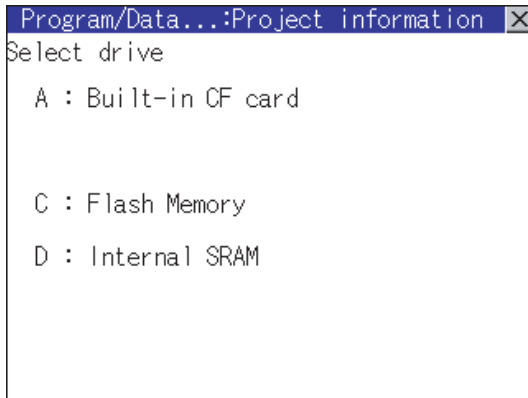

Project information screen: Storage file/folder display screen

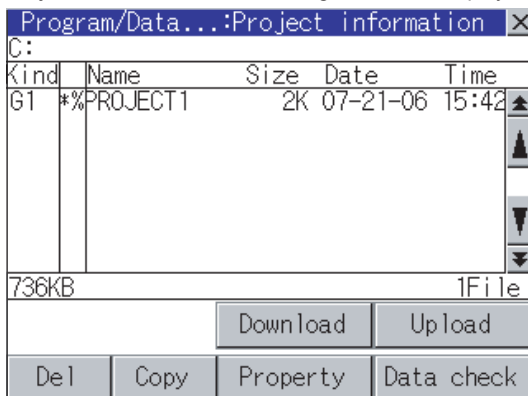

- 1 Touch a drive in [Select drive], and the data in the first folder contained in the touched drive is displayed.
- 2 If touch a folder name, the data contained in the touched folder is displayed.
- 3 If touch the folder with name [. .], the data in the one-higher hierarchy folder is displayed.
- 4 Touching the ▲▼ button in the scroll bar scrolls up or down by 1 line. Touching the ▲▼ button scrolls up or down by 1 screen.
- 5 If touch a file name, the file is selected and the file name is highlighted.
- 6 Refer to the following for operation of delete, copy, property, data check, download, upload.

Delete		this section	2
Copy		this section	3
Property		this section	4
Data check		this section	5
Download		this section	6
Upload		this section	7
- 7 Touching ☒ button closes the screen.

2 Delete operation

This operation deletes the selected file.

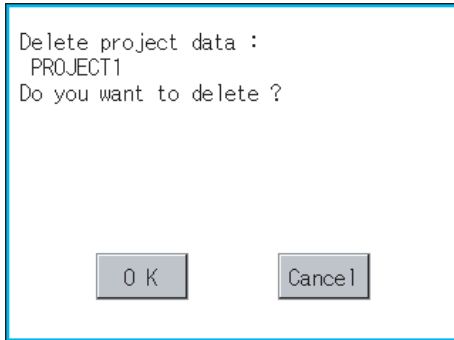

- 1 Touch and select the file to delete.
- 2 Screen mentioned left is displayed if button is touched.
Confirm the deletion targeted file is specified correctly.
If touch button, the file is deleted.
If touch button, the deletion is canceled.
- 3 When the deletion completes, the dialog box shown left is displayed.
If touch button, the dialog is closed.

3 Copy operation

The file in the A drive is copied to another directory of the A drive.
Copy to/from C drive or D drive is disabled.

Dialog for selecting a copy destination drive

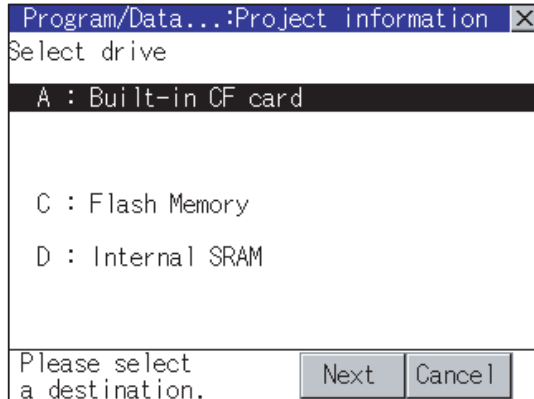

Dialog for selecting a copy destination folder

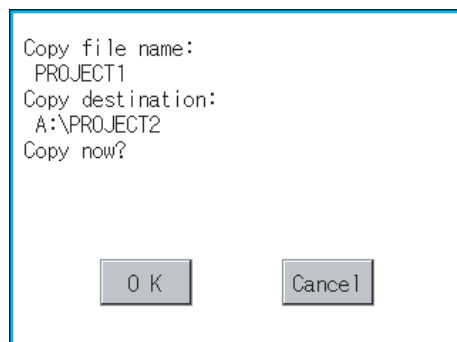
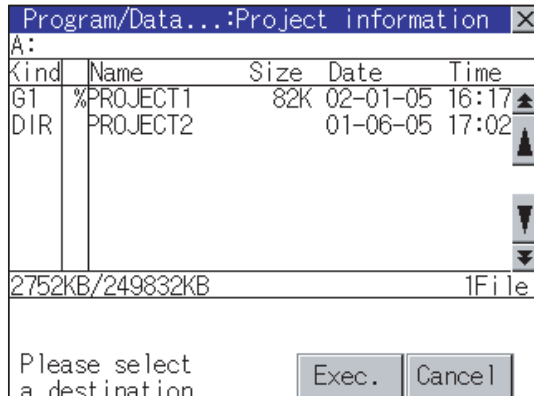

- 1 Install CF card in the PC, in which create a folder for the copy destination. Set the same character with [System Setting] of [System Environment] of GT Designer2 for the folder name. When using GT Designer3, set the same character with [GOT Type Setting...] in [Common].
 GT Designer2 Version□ Screen Design Manual
 GT Designer3 Version1 Screen Design Manual (Fundamentals)
- 2 Install the CF card mentioned above to GOT.
 Refer to the following for inserting/removing method of CF card.
 Section 8.1 CF Card
- 3 Open [Project information] and touch the drive of the file to be copied to select the drive, and then touch the **Next** button. The dialog for selecting a copy destination folder as shown left is displayed.
- 4 Touch the folder display area to select a folder, and then touch the **Exec.** button. The dialog shown left is displayed.

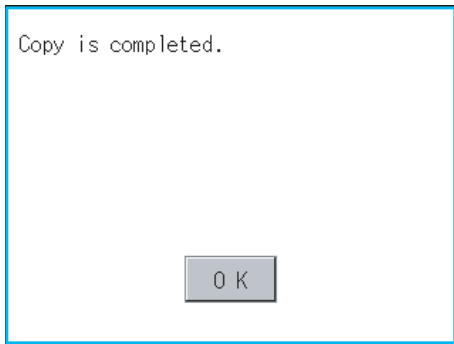
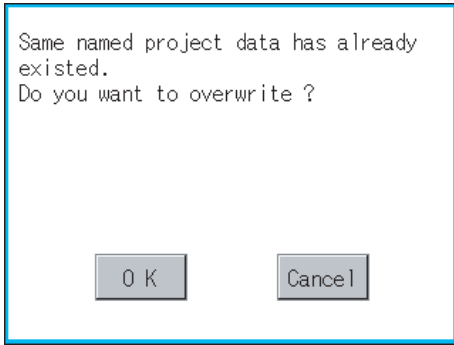

- 5 Touch button.
 If there is no file of the same name in the copy destination folder, starts to copy.
 When there is a file of the same name in the copy destination folder, the dialog mentioned left is displayed without starting the copy.
 If copy, in this case, the copied file is overwritten to the project data in the copy destination folder.
 If touch button, starts to copy.
 If touch button, cancels to copy.

- 6 When copying completes, the dialog of completion is displayed.
 If touch button, closes the dialog.

4 Property display operation

Displays the property of the project data in the selected folder.

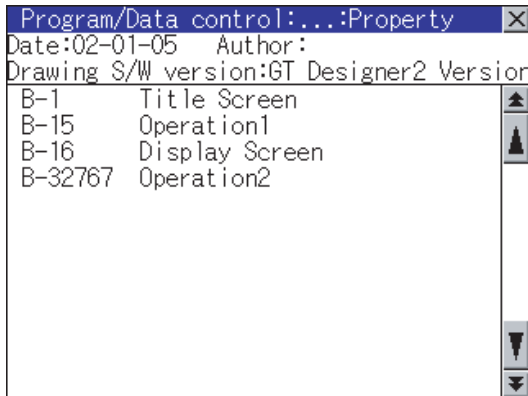

- 1 If touch button after selecting the project data to display the property, the property is displayed as shown left.
 In property display, the following information is displayed.

Item	Contents
Date	Displays the creation date of the file.
Author	Displays the author of the project data.
Drawing S/W version	Displays name and version of the drawing software by which the project data is created.

- 2 If touch button, the screen scrolls up/down line by line.
- 3 If touch button, the screen scrolls up/down by one screen.
- 4 If touch button, the property display is closed and returned to the previous screen.

5 Data check operation

Carries out data check of the selected project file.

When data is normal.

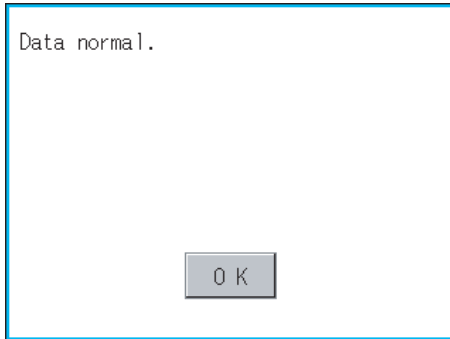

When data is erroneous.

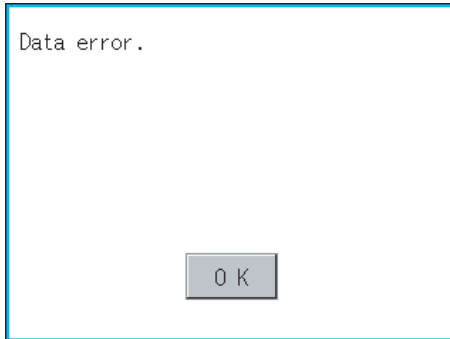

- 1 Touch the **Data check** button after selecting the file for data check. The data check is executed and the result is displayed by the dialog shown left.
- 2 If touch **OK** button, the dialog is closed.
- 3 If [Data error] is displayed, the target file may be broken. Download the target file again.

6 Download

Transfers the project data from the A drive (Built-in CF card) to the C drive (Flash Memory).

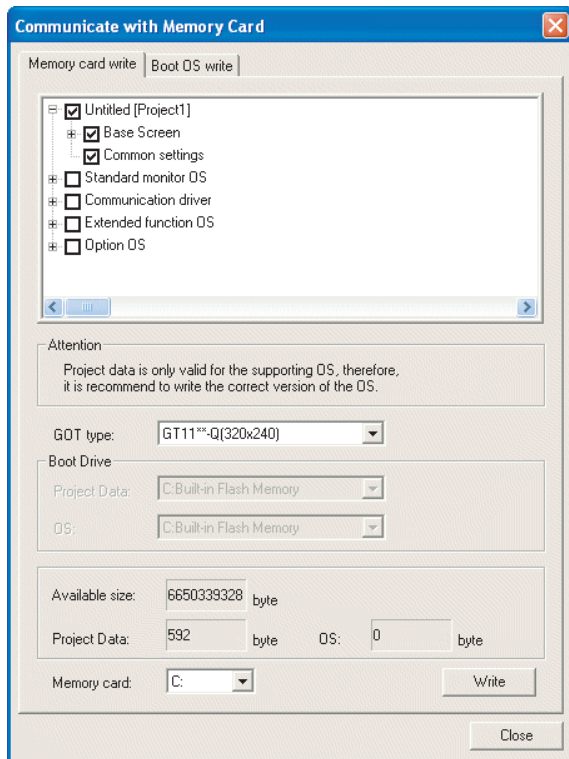

- 1 Transfer the project data to be downloaded to the GOT to the CF card, using drawing software or another GOT.

- 2 Install the CF card mentioned by 1 to GOT. Refer to the following for inserting/removing method of CF card.
☞ Section 8.1 CF Card
- 3 Touch [A: Built-in CF card] in [Select drive].
- 4 If touching **Download** button, the screen mentioned left is displayed.
If touching **OK** button, the download is executed.

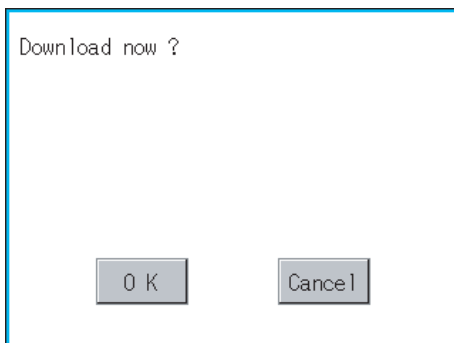

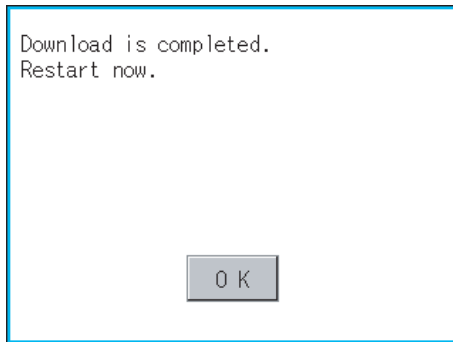
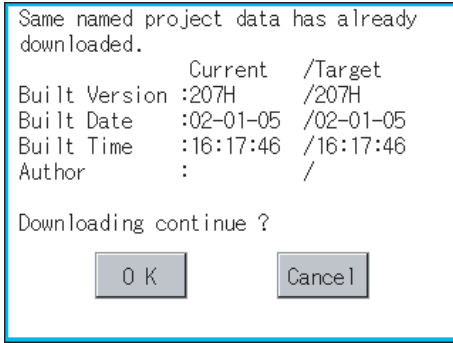



- 5 Touch button. If there is no project data of the same name in the C drive, starts the download.
If there is a project data of the same name in the C drive, the screen shown left is displayed without starting the download.
If touching button, an overwrite download is executed to a project data of the same name.
If touching button, cancels the downloading.
- 6 When the downloading is completed, the completion dialog mentioned left is displayed.
GOT is restarted if button is touched.

7 Upload

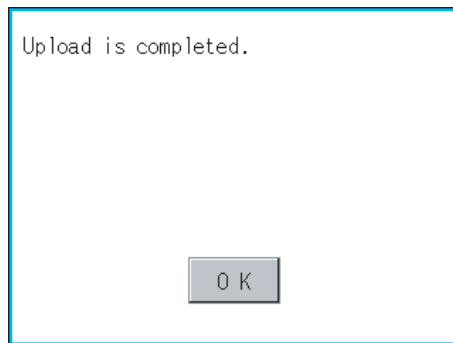
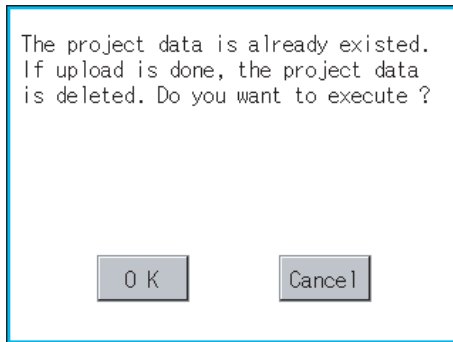
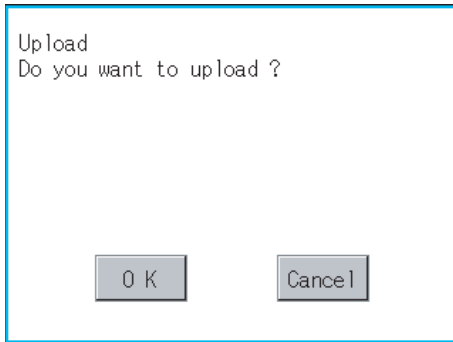
Transfers the project data from the C drive (Flash Memory) to the A drive (Built-in CF card).



- 1 Mount the CF card to GOT.
For the CF card installation/removal method, refer to the following.
 Section 8.1 CF Card
- 2 Touch "A: Standard CF card" in the drive selection.
- 3 If touching button, the screen shown on the left is displayed.
- 4 If touching button, the upload is executed.
- 5 If there is a project data of the same name in the A drive, the screen shown on the left is displayed without starting the upload.
If touching button, an overwrite upload is executed to the project data of the same name.
If touching button, the upload is canceled.
- 6 When the upload is completed, the dialogue box shown on the left is displayed.
If touching button, the dialogue box is closed.

13.4 Alarm Information

13.4.1 Function of alarm information

The alarm log file held by the D drive (Internal SRAM) is displayed.
The functions below can be carried out for files.

Function	Contents	Reference page
Information display of files and folders	Displays name, data size, creation date and time of file or folder.	13-24, 13-25
Deletion	Deletes file.	13-26
Copy	Copys file.	13-27

13.4.2 The display operation of alarm information

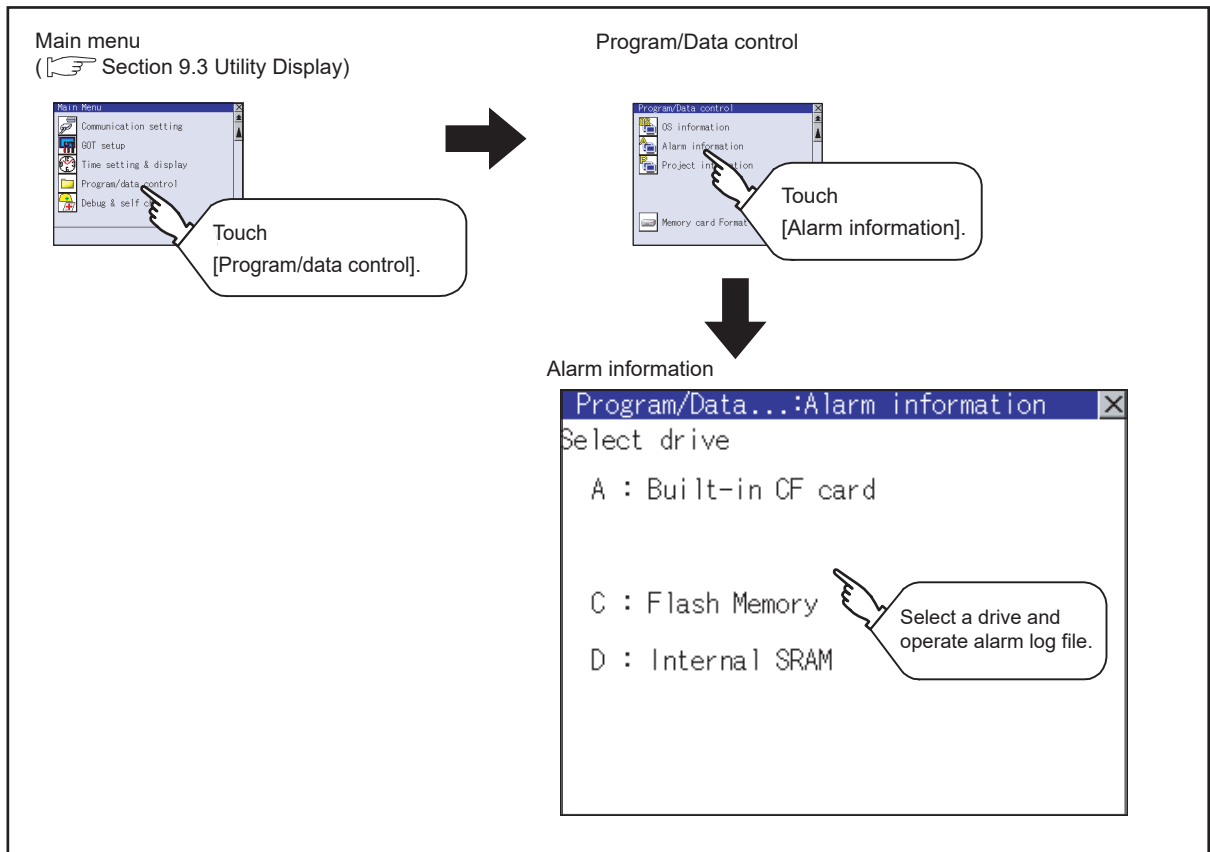

13.4.3 The display example of alarm information

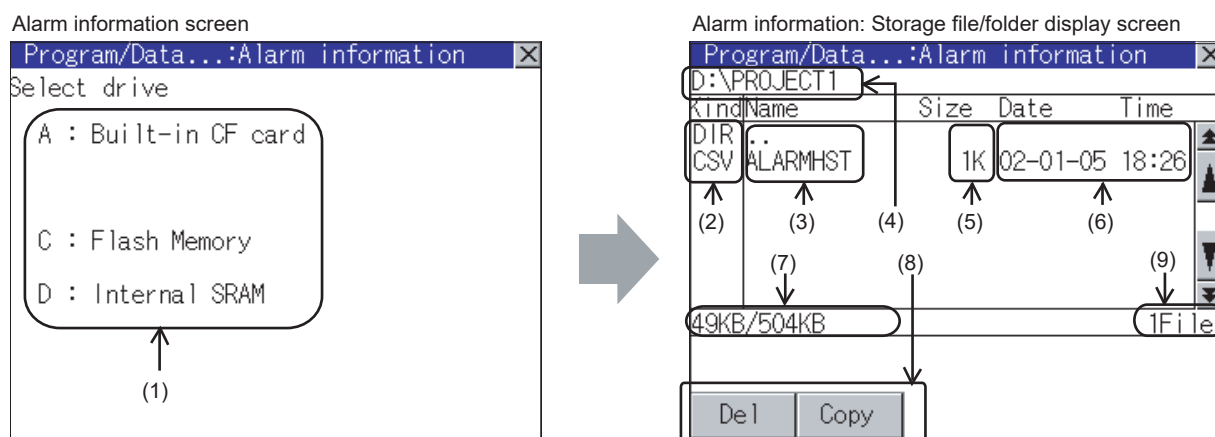

Number	Item	Contents
(1)	Select drive	The drive of which file or folder is displayed can be selected. When the CF card is not installed, [A: Built-in CF card] is not displayed.
(2)	Kind	Indicates whether the displayed name is file or folder. In case of file, displays the extension; in case of folder, displays "DIR".
(3)	Name	Displays the file name or folder name held by the selected drive or folder. When the file name or folder name exceeds 20 characters, the exceeding characters (the 21th character and after) are not displayed.
(4)	Path name	Displays the path name of drive/folder which is currently displayed.
(5)	Size	Displays the size of the file displayed in Name.
(6)	Date and time	Displays the date and time when each file has been created.
(7)	Drive size	Displays the size in use and the entire size of the drive selected by "Select drive".
(8)	Operation switch	Displays the execution switch of each function (Delete, copy) which can be executed on the alarm information screen.
(9)	Number of files	Displays the total number of the displayed files.

Point

Display of creation date and time

The creation date and time display is not updated even if a file is created or updated while displaying the alarm information display screen.

If close the screen currently displayed (moving the screen to the folder of the upper hierarchy, etc.) and display the screen again, the updated contents are displayed.

Remark

Folders and files displayed

Refer to the following for the details of folders and files displayed.

☞ Section 13.1.4 Display file

13.4.4 Alarm information operation

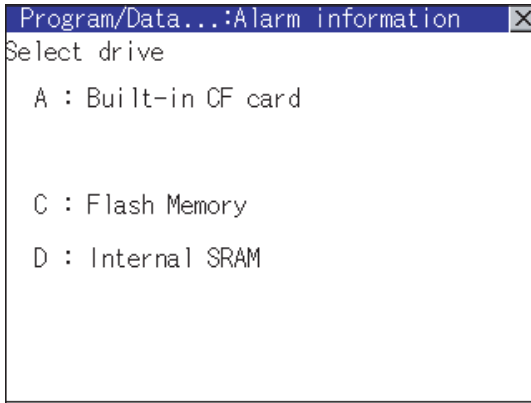

1 The display operation of alarm information

Alarm information screen

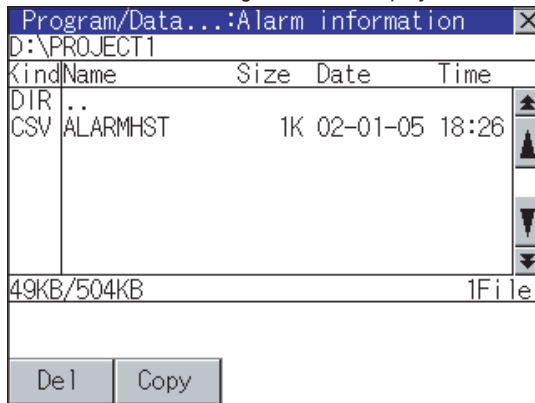

Alarm information: Storage file/folder display screen



- 1 If touch a drive of [Select drive], the information in the first folder of the touched drive is displayed.
- 2 If touch a folder name, the information of the touched folder is displayed.
- 3 If touch a folder of [. .], the information of the folder of the one upper hierarchy is displayed.
- 4 If touch ▲▼ button of the scrollbar, the screen scrolls up/down by one line. If touch ▲▼ button, the screen scrolls up/down by one screen.
- 5 If touch a file name, the touched file name is selected and inverted.
- 6 Refer to the following for delete, copy, operations.
Delete  this section 2
Copy  this section 3
- 7 If touch ☒ button, the screen is closed.

2 Deletion operation

Deletes selected files.

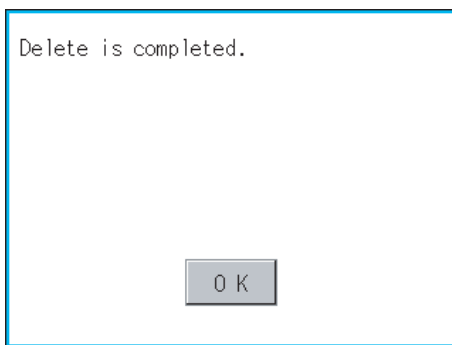

- 1 Touch and select the file to delete.
- 2 If touch button, the dialog mentioned left is displayed.
Confirm deletion targeted file is specified correctly.
If touch button, the file is deleted.
If touch button, the deletion is canceled.
- 3 When the deletion is completed, the completion dialog is displayed.
If touch button, the dialog is closed.

3 Copy operation

Copies the selected file.

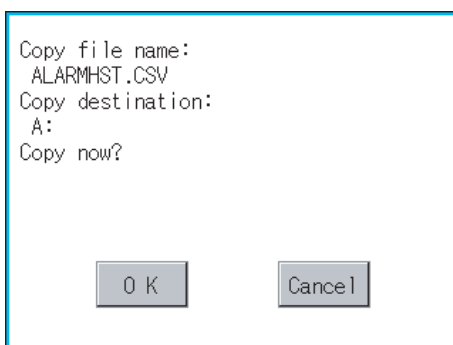
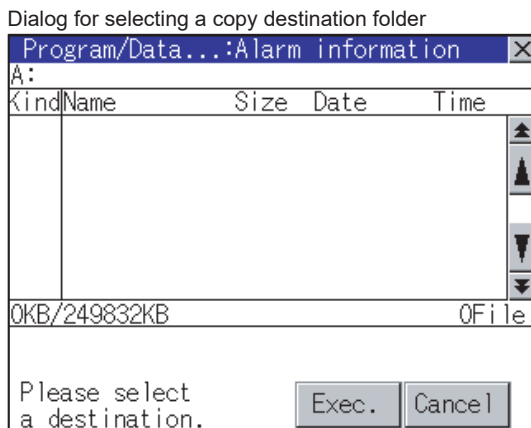
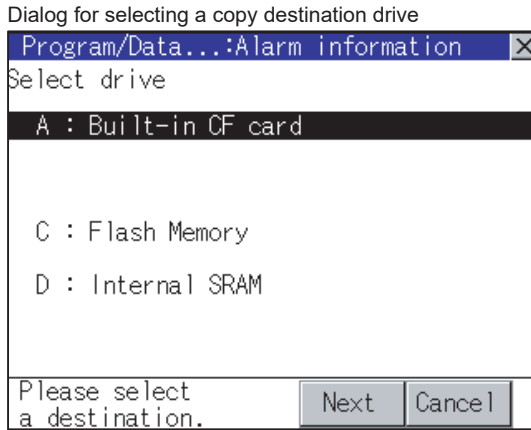

- 1 Touch and select the file to copy.
- 2 If touch **Copy** button, the message [Please select a destination.] is displayed in the left bottom of the screen.
- 3 Touch the drive name display area to select a drive, and then touch the **Next** button. The dialog for selecting a copy destination folder is displayed as shown left.

- 4 Touch the folder display area to select a folder, and then touch the **Exec.** button. The confirmation dialog shown left is displayed.

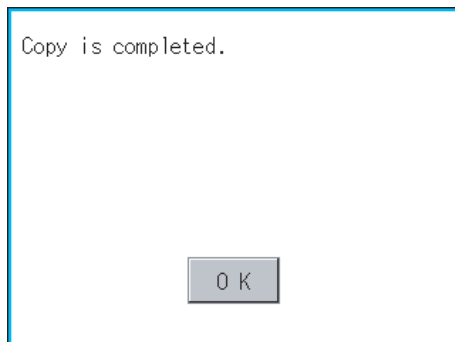
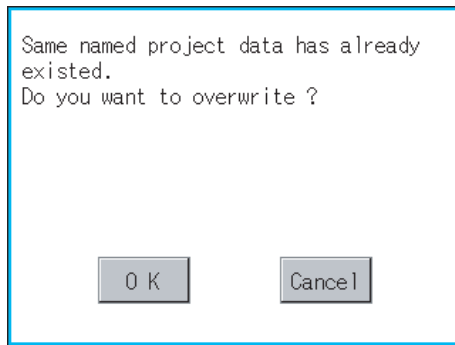

- 5 Touch button.
If there is no file of the same name in the copy destination folder, starts to copy.
If there is a file of the same name in the copy destination folder, the following dialog is displayed without starting the copy.
If copy, in this case, the copied file is overwritten to the project data in the copy destination folder.
If touch button, starts to copy.
If touch button, cancels to copy.
- 6 When the copy is completed, the dialog of completion is displayed.
If touch button, closes the dialog.

13.5 Memory Card Format

13.5.1 Format function of memory card

Formats the CF card or Internal SRAM.

13.5.2 Display operation of memory card format

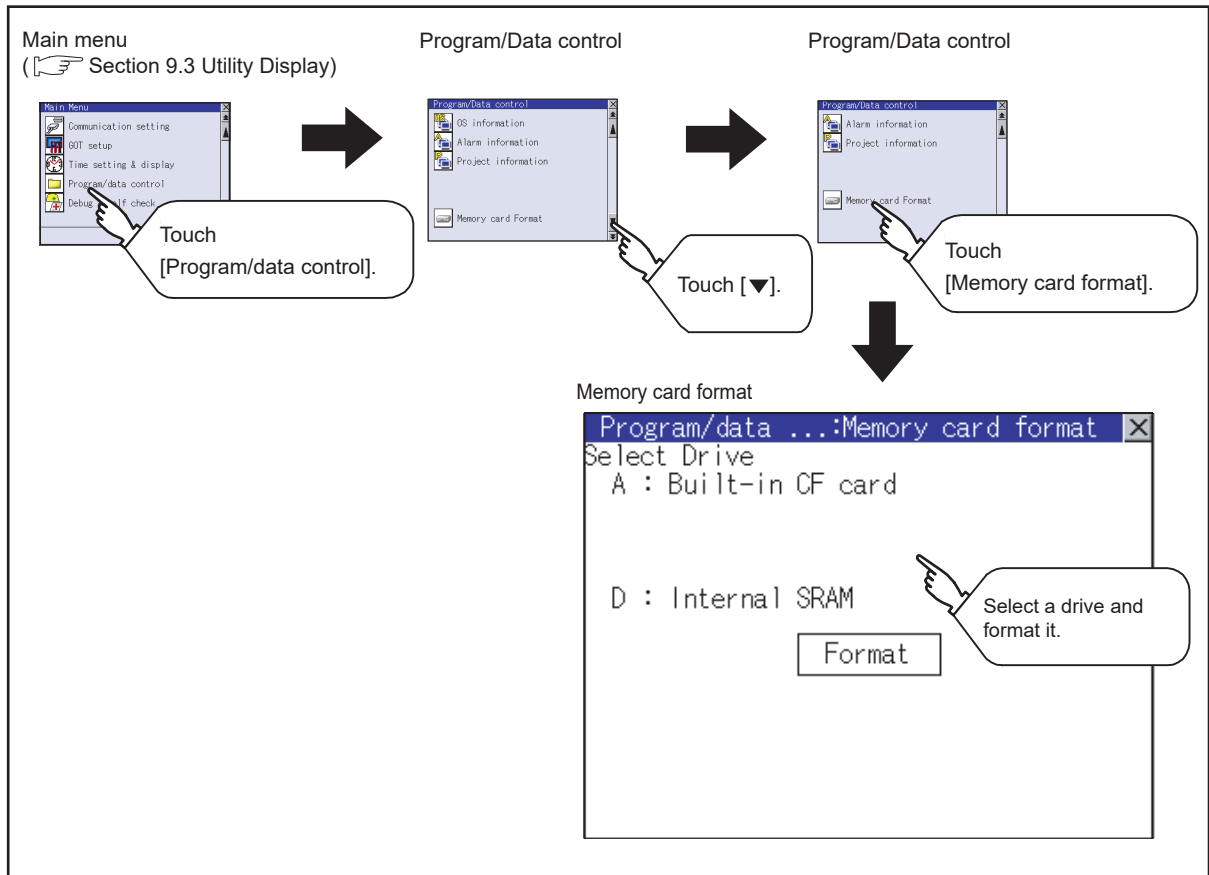

Formatting the D drive (Internal SRAM)

If the GOT is turned off and left in the status without a battery for 30s or longer, the data in the D drive (Internal SRAM) becomes indefinite, possibly disabling data writing. If the GOT is left in the status without a battery for 30s or longer, format the D drive (Internal SRAM).

13.5.3 Format operation of memory card

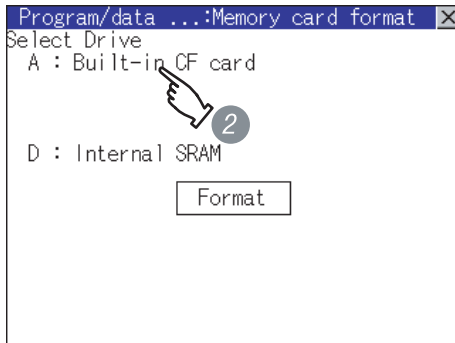

- 1 To format the CF card, install the CF card to the GOT first.

For the CF card installation/removal method, refer to the following.

Section 8.1 CF Card

- 2 Touch and select the drive to format by [Select Drive].

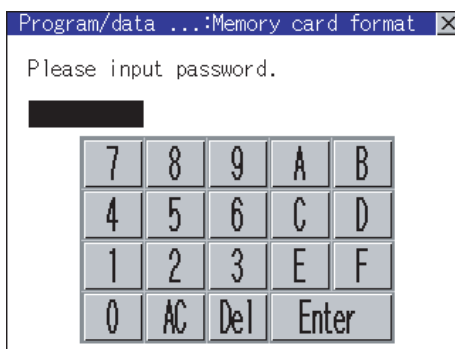

- 3 If touch button, the password input screen is displayed.

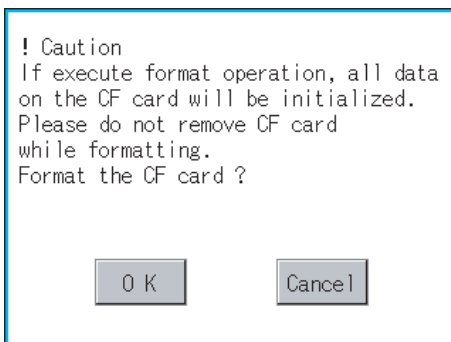

- 4 Type [1][1][1][1] and touch the key. The dialog box shown on the left will appear. (The password is fixed to 1111.) Confirm the contents of the dialog. When execute the CF card format, touch button. When cancel the CF card format, touch button.

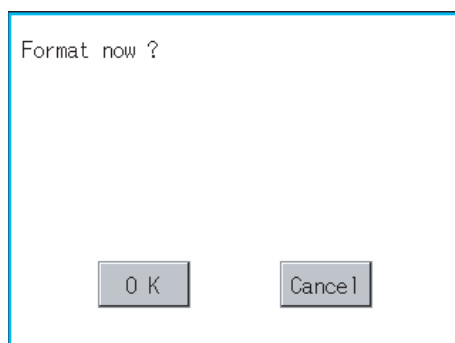

- 5 If touch button by 4, the dialog mentioned left is displayed for reconfirm.
- 6 Reconfirm whether to format the CF card. If touch button, starts formatting. If touch button, cancels formatting.

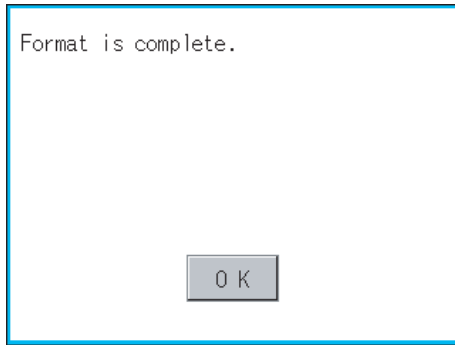

7 When the formatting is completed, the completion dialog mentioned left is displayed.

8 If touch button, closes the dialog.

Remark

Restrictions on formatting

- When use an unformatted CF card in GOT, format the CF card by PC. GOT cannot format the unformatted CF card.
- The formatting of GOT does not change the file system (Example: FAT16) of the CF card and inherits the file system before formatting.

13.6 Memory Information

13.6.1 Memory information function

The following shows the amount of the memory empty area size and boot Drive information empty area size which can be used by the user of each drive (A: Standard CF card, C: Built-in Flash Memory).

13.6.2 Memory information display operation

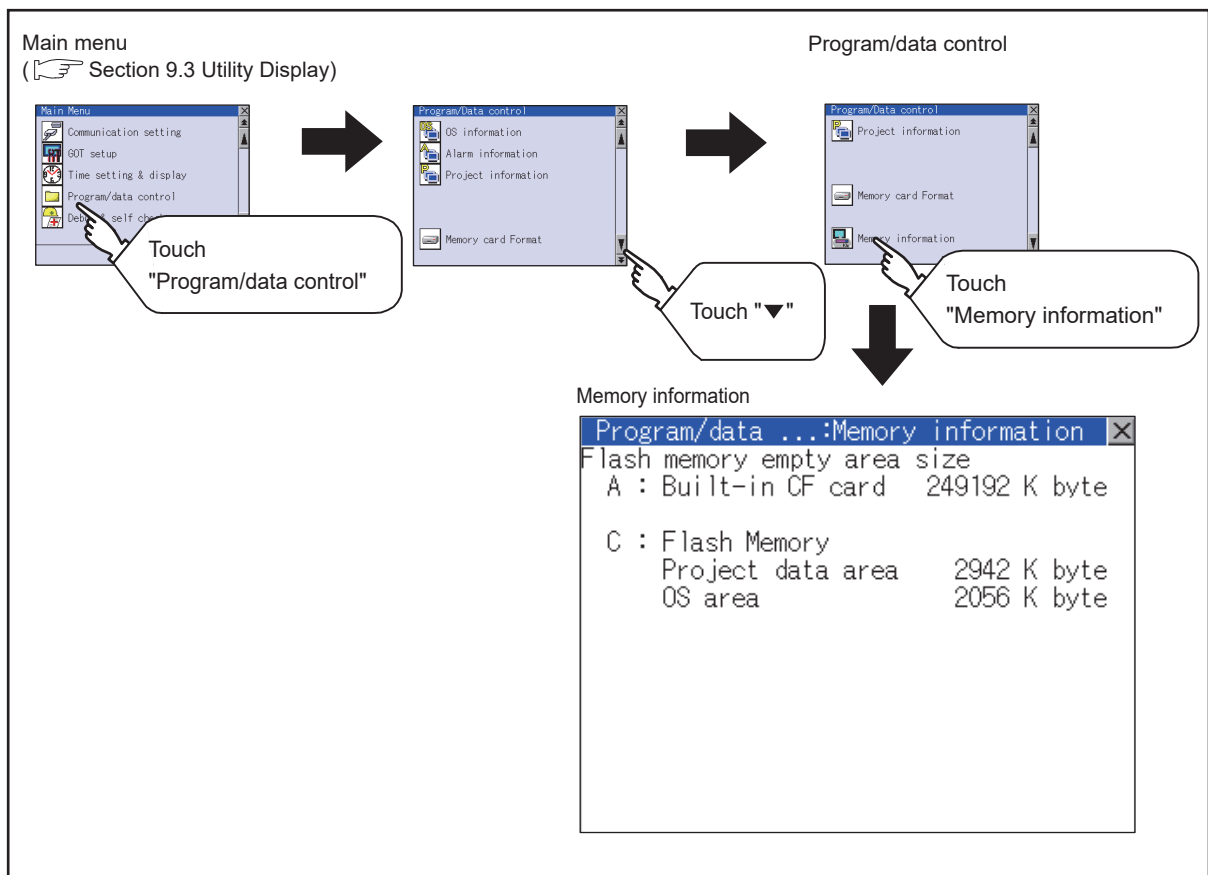

13.6.3 Display example of memory information

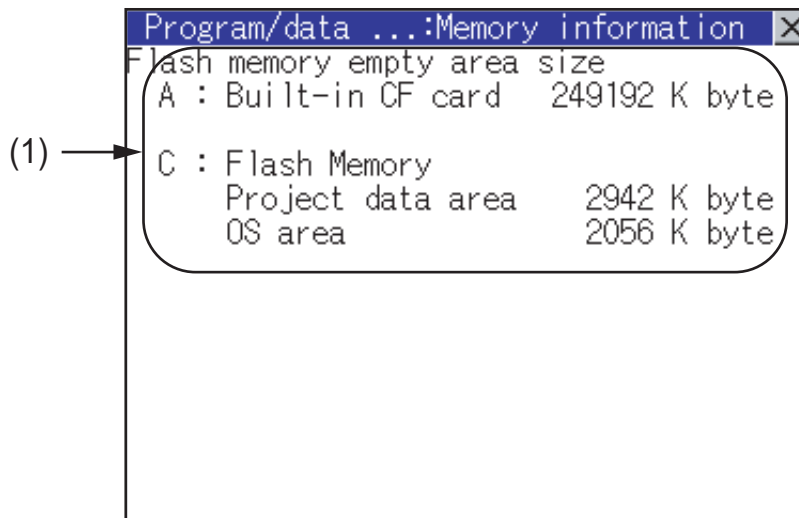

No.	Setting items	Description
(1)	Flash memory empty area size	Indicates the amount of memory empty area size for each drive in which a file or folder can be stored. If CF card is not mounted, "A: Standard CF card" is not displayed.

13.7 GOT data package acquisition

13.7.1 The function of GOT data package acquisition

This function copies the following OSs that are installed on the GOT and the data to the memory card.

- OS (Boot OS, Standard monitor OS, Communication driver, Extended function OS, Option OS)
- Project data

Copied data can be used as a backup, or they can be installed on another GOT to create a GOT that has the same configuration.

Refer to the following section for the Installation function of the GOT.

 Section 16.3 BootOS and Standard Monitor OS Installation Using CF Card

13.7.2 Operating the GOT data package acquisition function

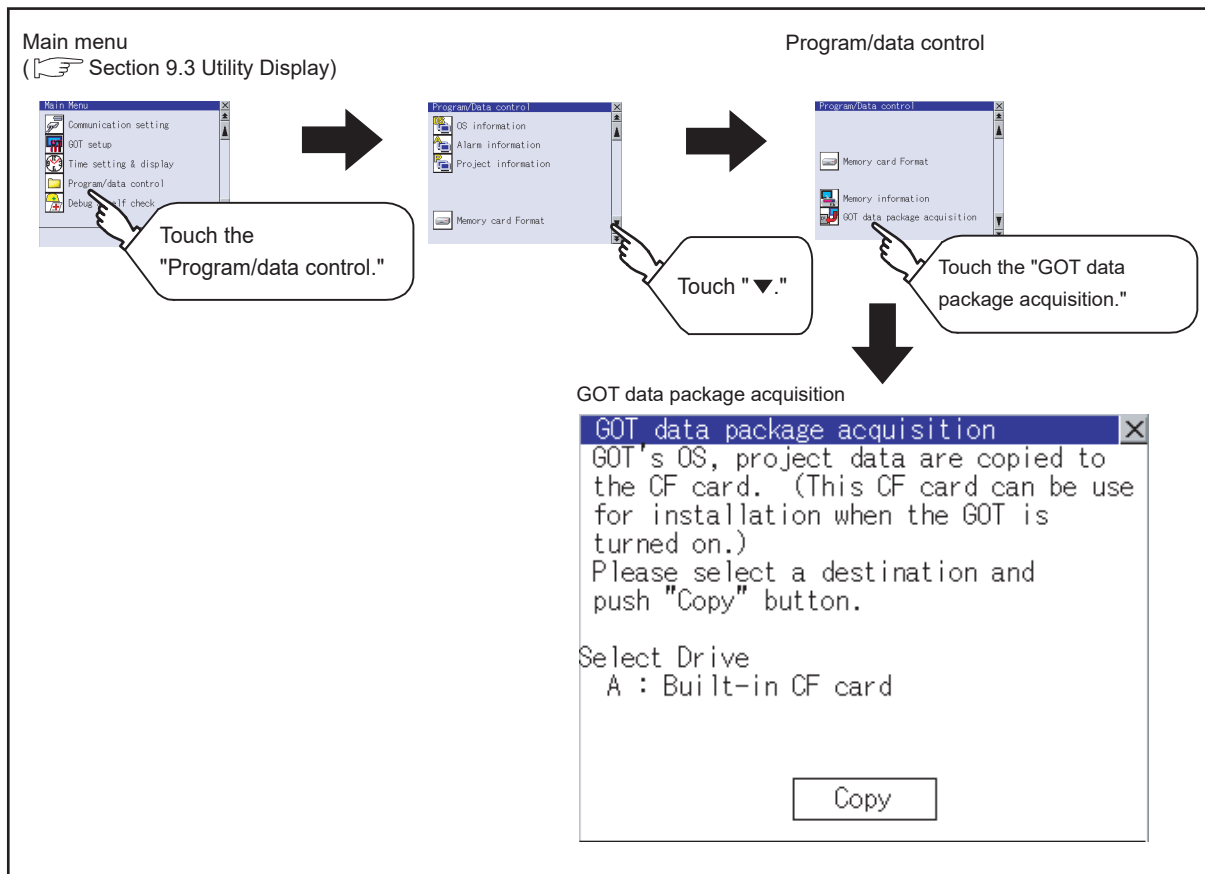

13.7.3 Display example of GOT data package acquisition

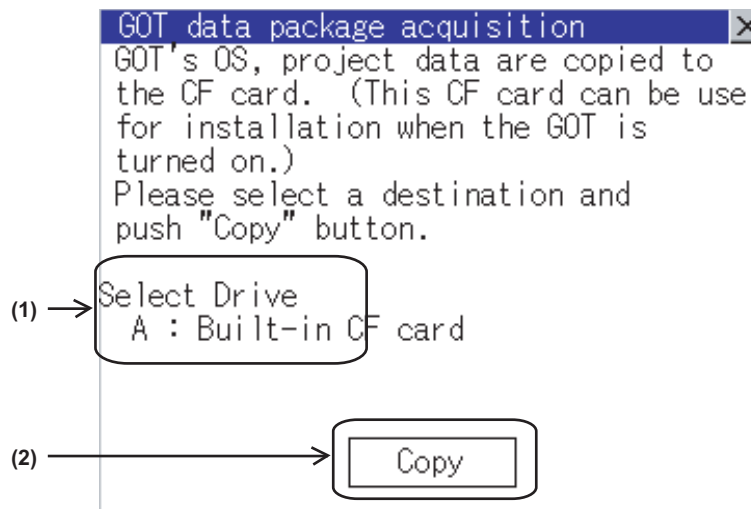

No.	Setting items	Description
(1)	Select Drive	Displays the drive to which the user can copy the OS and data. [A: Standard CF Card] will not appear if a CF card is not inserted.
(2)	Copy	Copying begins when [Copy] is touched.

13.7.4 GOT data package acquisition operation

1 GOT data package acquisition operation on the display

Copy the following OS that is installed on the GOT and data to the CF card.

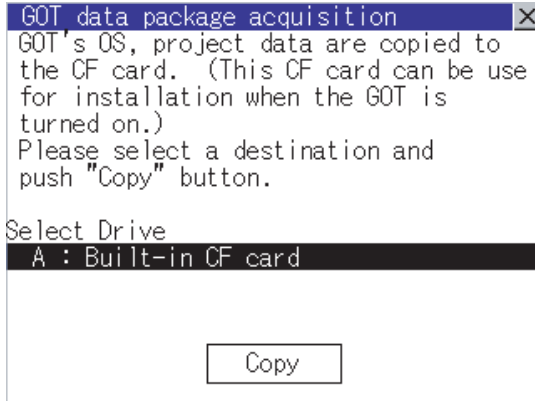

- 1 Touch [A: Standard CF Card] under Select drive to highlight it. Touch the **Copy** button to begin copying.

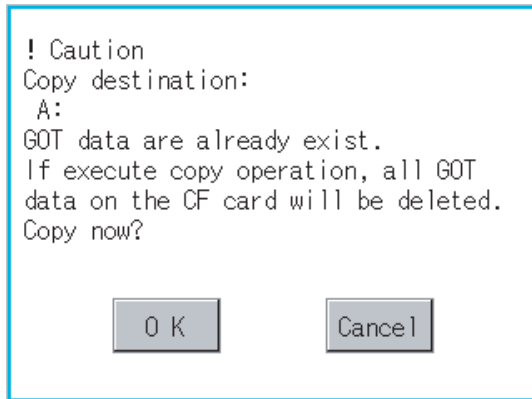

- 2 Different dialogs appear, depending on the status of the copying destination. Follow the dialog that appears.

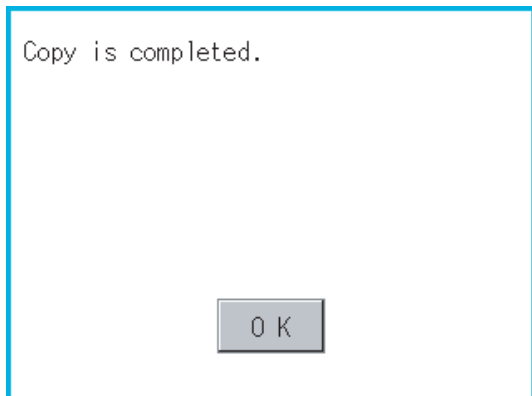

- 3 Upon completion of OS/Data copying, a dialog that indicates a completion of copying will appear. Touch the **OK** button to close the dialog window.

2 Notes on copying operations

(1) Copying the OS/Project data to the GOT

When the OS or project data are copied to the memory card using the GOT data package acquisition function and then to the GOT, the utility settings will also be copied.

After copying the OS and project data to the GOT, check the utility settings and reconfigure the settings as necessary.

(2) Storage of other data on the CF card

When using the GOT data package acquisition function, do not store any other data to the memory card.

Other data on the memory card will become unusable.

14. GOT SELF CHECK (DEBUG & SELF CHECK)

The GOT can display the screen for debugging or self-checking.
The following describes the functions available as the debugging and self-checking function.

Items	Contents	Reference page
Debug	System monitor, A list editor and FX list editor	14-1
Self check	Memory check, Drawing check, Font check, Touch panel check and I/O check	14-112
System alarm display	GOT errors, CPU errors	14-128
GOT start time	Time when the GOT was started	14-130

14.1 Debug

14.1.1 Debug functions

The debug function includes functions for the PLC system status check and those for increasing the efficiency in troubleshooting.

The following items can be realized with the debug function.

Items	Contents
System monitor	The device of PLC CPU or buffer memory of the intelligent function module can be monitored and tested.
A list editor	The sequence program of A CPU can be list edited.
FX list editor	The sequence program of FX PLC can be list edited.

14.1.2 Display operation of debug

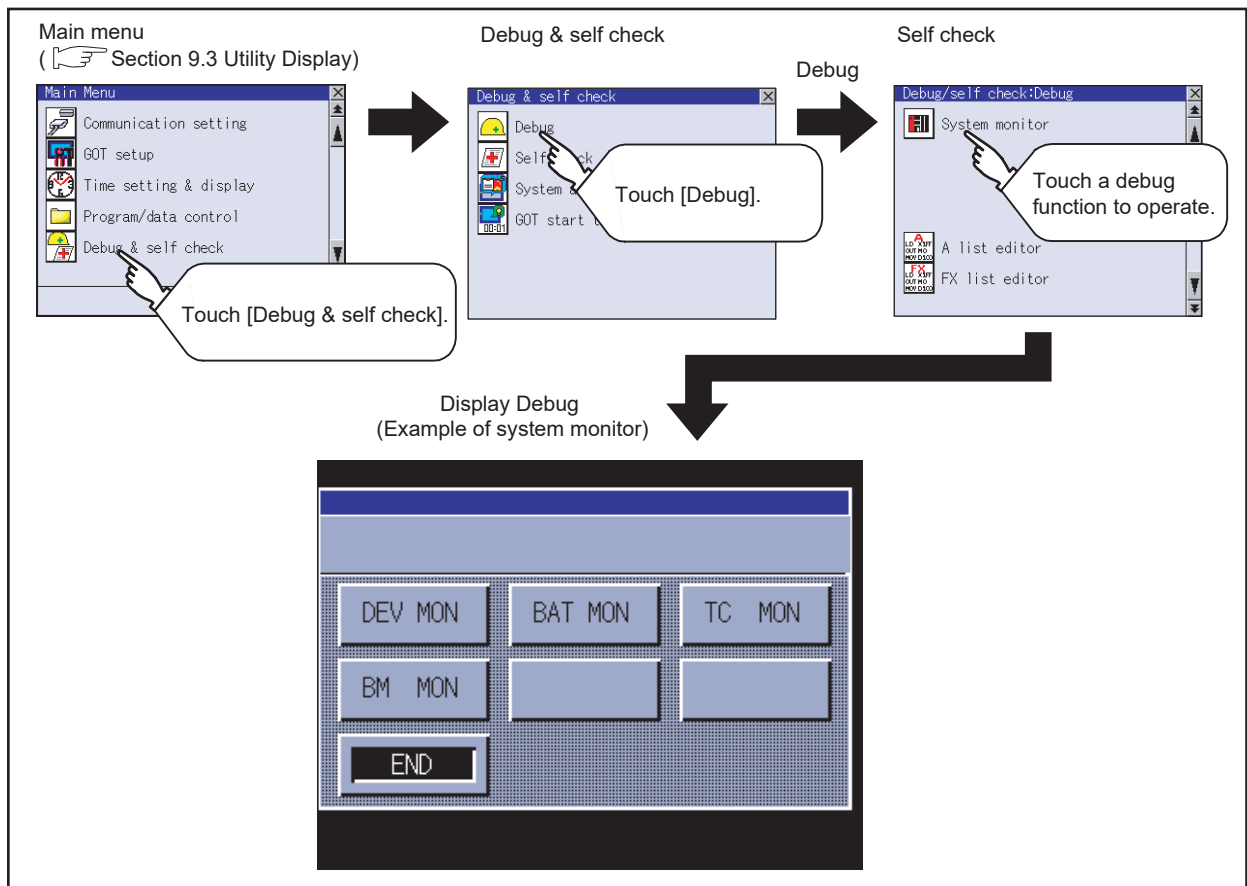

14.2 System Monitor

The system monitor function is capable of monitoring and changing the devices within a target controller. It is intended to troubleshoot the controller system and to streamline maintenance operations. By installing the system monitor, an extended function OS, from drawing software into the GOT, you can monitor and test the devices of the controller and the buffer memory of the intelligent function module.

1 Any device on four dedicated screens can be monitored

The system monitor function comprises four monitors - entry monitor, batch monitor, TC monitor, and BM monitor, and you can monitor any device according to the application.

Entry monitor

DEVICE MONITOR TEST MENU FORM SET					
NetNo. [0] ST [FF] CPUNo. [0]					
D	15	-2147483645	DW		
Z	1	-32767			
X	1	●			
M	25	○			
W	200	100			
R	50	68378428	DW		
D	0	3	DW		
B	10	○			

The entry monitor function monitors up to 8 controller devices entered by the user in a single window.

(☞ Subsection 14.2.10 Entry monitor)

Batch monitor

BATCH MONITOR TEST MENU FORM SET					
NetNo. [0] ST [FF] CPUNo. [0]					
D	10	32767	D	18	-500
D	11	0	D	19	3234
D	12	0	D	20	0
D	13	-1	D	21	0
D	14	0	D	22	0
D	15	3	D	23	-32768
D	16	3256	D	24	0
D	17	0	D	25	0

The batch monitor function monitors up to 16 controller devices from the device number specified by the user in a single window.

(☞ Subsection 14.2.14 Batch monitor)

TC monitor

TC MONITOR TEST MENU FORM SET					
NetNo. [0] ST [FF] CPUNo. [0]					
FILE NAME [MAIN .QPG]					
T	0	PV	0	SV	25
[Operation start]					
T	1	PV	30	SV	30
[Products Line A]					
T	2	PV	0	SV	
[Products Line B]					
T	3	PV	0	SV	
[Products Line C]					

The TC monitor function monitors the present value, set value, contact point, and coil of up to 8 controller timers (T)/counters (C) from the device number specified by the user in a single window.

(☞ Subsection 14.2.17 TC Monitor (Monitoring Timers and Counters))

BM monitor (monitoring Buffer memory)

BM MONITOR TEST MENU FORM SET					
NetNo. [0] ST [FF] CPUNo. [0]					
I/O NO [0]					
BM	1	0	BM	9	0
BM	2	0	BM	10	0
BM	3	0	BM	11	0
BM	4	0	BM	12	0
BM	5	0	BM	13	0
BM	6	0	BM	14	0
BM	7	0	BM	15	0
BM	8	0	BM	16	0

The BM monitor function monitors up to 16 devices from the initial device number in the buffer memory of the intelligent function module specified by the user in a single window.

(☞ Subsection 14.2.21 BM monitor (monitoring buffer memory))



Displaying the system monitor screen

The GOT can display one of the four monitor screens as a full screen.

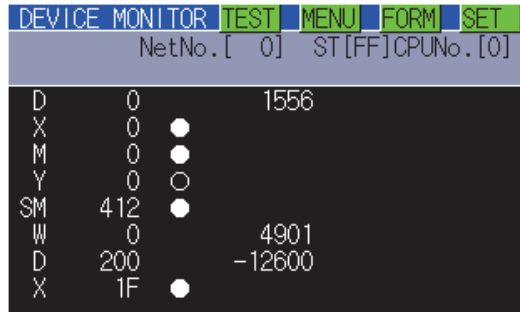

2 Data can be changed by test operation

For further information, see the following:



Subsection 14.2.24 Test operation

(Test example)

When turning ON MO



When changing the present value of DO



- (1) Testing a bit device
A device specified by the user is turned on and off.
- (2) Testing a word device
A specified value is written to a device specified by the user.
- (3) Testing a timer/counter
Specified values are written as the present and set values of a device specified by the user.
- (4) Testing buffer memory
A specified value is written to buffer memory specified by the user.

3 The display format and device comment/no-comment display can be switched

For further information, see the following:

 Subsection 14.2.7 Switching the display format (DEC/HEX) and comment/no-comment display

(Test example)

When the entry monitor is displayed
(comment display)

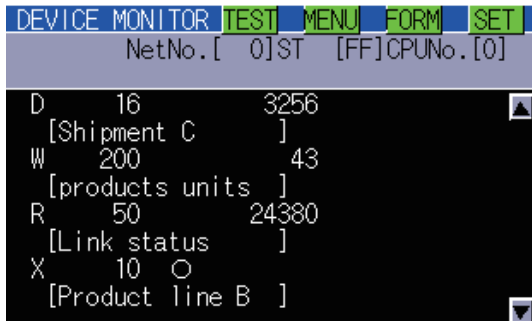

DEVICE	MONITOR	TEST	MENU	FORM	SET
NetNo. [0]ST [FF]CPUNo. [0]					
D	16		3256		
			[Shipment C]
W	200		43		
			[products units]
R	50		24380		
			[Link status]
X	10		○		
			[Product line B]

When the entry monitor is displayed
(hexadecimal display)

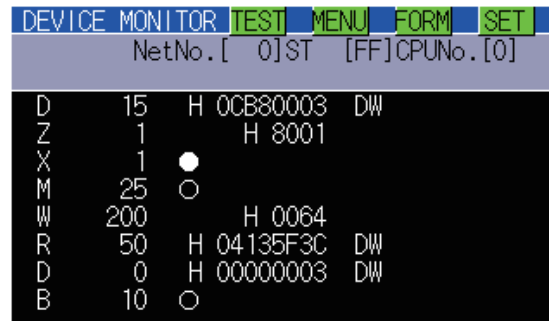

DEVICE	MONITOR	TEST	MENU	FORM	SET
NetNo. [0]ST [FF]CPUNo. [0]					
D	15	H	0CB80003	DW	
Z	1	H	8001		
X	1		●		
M	25		○		
W	200	H	0064		
R	50	H	04135F3C	DW	
D	0	H	00000003	DW	
B	10		○		

(1) Switching the display format

Word device values are displayed in decimal or hexadecimal numbers on the entry, batch, TC, and BM monitors.

(2) Device comment display

Comments written in the controller are displayed when a controller device is monitored.

4 Other stations can be monitored

You can monitor other stations in the data link system containing the GOT (or GOT-connected station), network system or CC-Link system.

For further information about the connection forms that can be monitored, see the following:

 Subsection 14.2.1 **1** System configuration

14.2.1 Specifications

1 System configuration

This subsection describes the controller names and the connection forms between the GOT and the controller that can be covered by the system monitor function.

For further information about communication units and cables for each connection form, see the following:

 GOT1000 Series Connection Manual

2 Target controller

Controller
QCPU (Q mode), Q series motion controller CPU
QSCPU* ¹
QnACPU
ACPU/QCPU (A mode), A series motion controller CPU
FXCPU
Remote I.O station (MELSECNET/H system)

*¹ The GOT cannot write data to devices in the QSCPU. (The test operation is not available.)

3 Connection type

(1) When the GOT is connected to a QCPU (Q mode), Q series motion controller CPU, or QSCPU

(○: Available, △: Partly restricted, ×: Unavailable)

Function		Connection type between GOT and controller					Reference
Name	Description	Bus connection *6	Direct CPU connection *6	Computer link connection *6	CC-Link connection	GOT multidrop connection	
					G4*4*6		
Entry monitor	Monitoring present values by entering devices to be monitored in advance	○	○	○	○		Subsection 14.2.10
Batch monitor	Monitoring the present value of n devices from a specified device						Subsection 14.2.14
TC monitor	Monitoring the present value, set value, contact point, and coil of m devices from a specified device	△*1	△*1	△*1	△*1		Subsection 14.2.17
BM monitor	Monitoring the present value of x devices in specified buffer memory of a specified intelligent function module						Subsection 14.2.21
Data change by test operation	Setting/Resetting bit devices	△*3	△*3	○	△*3	×	Subsection 14.2.24
	Changing the present value of word devices and buffer memory			△*2			
	Changing the present value of TC (possible during TC monitoring)						
	Changing the set value of TC (possible during TC monitoring)*5						
Quick test	Changing device values by performing a quick test			△*3			Subsection 14.2.8
Display switching	Displaying device comments						Subsection 14.2.7
	Displaying word device and buffer memory values in decimal or hexadecimal						

*1 These items cannot be monitored when a motion controller (Q series) is monitored.

*2 The present value of Z cannot be changed. None of the connection types supports V.

*3 When a motion controller (Q series) is connected, device comments cannot be displayed.

*4 Indicates CC-Link connection (via G4).

*5 When a QCPU redundant system is used, data of the set value cannot be changed.

*6 The QSCPU does not support the connection type.

(2) When the GOT is connected to a QnACPU

(○: Available, △: Partly restricted, x: Unavailable)

Function		Connection type between GOT and controller					Reference					
Name	Description	Bus connection	Direct CPU connection	Computer link connection	CC-Link connection	GOT multidrop connection						
					G4 ^{*3}							
Entry monitor	Monitoring present values by entering devices to be monitored in advance	△ ^{*2}	△ ^{*2}	○	x	x	Subsection 14.2.10					
Batch monitor	Monitoring the present value of n devices from a specified device						Subsection 14.2.14					
TC monitor	Monitoring the present value, set value, contact point, and coil of m devices from a specified device						Subsection 14.2.17					
BM monitor	Monitoring the present value of x devices in specified buffer memory of a specified intelligent function module						Subsection 14.2.21					
Data change by test operation	Setting/Resetting bit devices						△ ^{*2}	△ ^{*2}	△ ^{*1}	x	x	Subsection 14.2.24
	Changing the present value of word devices and buffer memory											
	Changing the present value of TC (possible during TC monitoring)											
Quick test	Changing the set value of TC (possible during TC monitoring)						△ ^{*2}	△ ^{*2}	△ ^{*2}	x	x	Subsection 14.2.8
	Changing device values by performing a quick test											Subsection 14.2.8
Display switching	Displaying device comments						△ ^{*2}	△ ^{*2}	△ ^{*2}	x	x	Subsection 14.2.7
	Displaying word device and buffer memory values in decimal or hexadecimal											

*1 The present value of Z cannot be changed. None of the connection forms supports V.

*2 When the GOT is connected to a QnACPU whose date shown on the rating plate is earlier than 9707B, device comments cannot be displayed.

*3 Indicates CC-Link connection (via G4).

(3) When the GOT is connected to a ACPU/QCPU (A mode) or A series motion controller CPU

(○: Available, △: Partly restricted, ×: Unavailable)

Function		Connection type between GOT and controller					Reference		
Name	Description	Bus connection	Direct CPU connection	Computer link connection	CC-Link connection	GOT multidrop connection			
					G4*3				
Entry monitor	Monitoring present values by entering devices to be monitored in advance	○	○	△*2	×	×	Subsection 14.2.10		
Batch monitor	Monitoring the present value of n devices from a specified device						Subsection 14.2.14		
TC monitor	Monitoring the present value, set value, contact point, and coil of m devices from a specified device						Subsection 14.2.17		
BM monitor	Monitoring the present value of x devices in specified buffer memory of a specified intelligent function module	△*1	△*1	△*1	×	×	Subsection 14.2.21		
Data change by test operation	Setting/Resetting bit devices	○	○	○			×	×	Subsection 14.2.24
	Changing the present value of word devices and buffer memory			△*2					
	Changing the present value of TC (possible during TC monitoring)			○					
	Changing the set value of TC (possible during TC monitoring)			○					
Quick test	Changing device values by performing a quick test	○	○	△*2			×	×	Subsection 14.2.8
Display switching	Displaying device comments			○	Subsection 14.2.7				
		Displaying word device and buffer memory values in decimal or hexadecimal							

*1 These items cannot be monitored when an A motion controller CPU is monitored.

*2 V, Z, and A cannot be monitored, or their present values cannot be changed.

*3 Indicates CC-Link connection (via G4).

(4) When the GOT is connected to an FXCPU

(○: Available, △: Partly restricted, ×: Unavailable)

Function		Connection type between GOT and controller		Reference
Name	Description	Direct CPU connection	GOT multidrop connection	
Entry monitor	Monitoring present values by entering devices to be monitored in advance	△ ^{*2*3}	×	Subsection 14.2.10
Batch monitor	Monitoring the present value of n devices from a specified device	△ ^{*1*3}		Subsection 14.2.14
TC monitor	Monitoring the present value, set value, contact point, and coil of m devices from a specified device	○		Subsection 14.2.17
BM monitor	Monitoring the present value of x devices in specified buffer memory of a specified intelligent function module	○		Subsection 14.2.21
Data change by test operation	Setting/Resetting bit devices	△ ^{*3}		Subsection 14.2.24
	Changing the present value of word devices and buffer memory	△ ^{*3}		
	Changing the present value of TC (possible during TC monitoring)	○		
	Changing the set value of TC (possible during TC monitoring)	○		
Quick test	Changing device values by performing a quick test	△ ^{*3}		Subsection 14.2.8
Display switching	Displaying device comments	×		Subsection 14.2.7
	Displaying word device and buffer memory values in decimal or hexadecimal	△ ^{*3}		

*1 Set value of T/C and contact coil cannot be monitored.

*2 Set value of T/C, contact coil, and actual value cannot be monitored. Use the TC monitor.

*3 V, Z, and A cannot be monitored, or their present values cannot be changed.

(5) When the GOT is connected to a remote I/O station of MELSECNET/H system

(○: Available, △: Partly restricted, ×: Unavailable)

Function		Connection type between GOT and controller					Reference					
Name	Description	Bus connection	Direct CPU connection	Computer link connection	CC-Link connection	GOT multidrop connection						
					G4*2							
Entry monitor	Monitoring present values by entering devices to be monitored in advance	×	○	○	○	×	×	Subsection 14.2.10				
Batch monitor	Monitoring the present value of n devices from a specified device							Subsection 14.2.14				
TC monitor	Monitoring the present value, set value, contact point, and coil of m devices from a specified device							Subsection 14.2.17				
BM monitor	Monitoring the present value of x devices in specified buffer memory of a specified intelligent function module							Subsection 14.2.21				
Data change by test operation	Setting/Resetting bit devices							△*1	×	×	×	Subsection 14.2.24
	Changing the present value of word devices and buffer memory											
	Changing the present value of TC (possible during TC monitoring)											
Quick test	Changing the set value of TC (possible during TC monitoring)*3							○	○	○	○	Subsection 14.2.8
	Changing device values by performing a quick test											
Display switching	Displaying device comments							○	○	○	○	○
	Displaying word device and buffer memory values in decimal or hexadecimal											

*1 The present value of V and Z cannot be changed.

*2 Indicates CC-Link connection (via G4).

*3 When a QCPU redundant system is used, data of the set value cannot be changed.

4 Required Extended function OS

- (1) The Extended function OS shown in the table below is required.

Extended function OS	OS memory space (user area)	Option function board
System monitor	0KB	Not required

- (2) Install the Extended function OS.
Install System monitor (Extended function OS) in the GOT.
For a detailed installation procedure, see the following:

 GT Designer2 Version □ Basic Operation/Data Transfer Manual
GT Designer3 Version1 Screen Design Manual (Fundamentals)

5 Devices that can be monitored

For further information about the monitor device names that can be monitored and the scope, see the following:

 GT Designer2 Version □ Screen Design Manual
GT Designer3 Version1 Screen Design Manual (Fundamentals)

6 Access range

When the GOT is connected to the remote I/O station in MELSECNET/H network system, only the master station can be monitored.

The access range other than above is the same as the access range when the GOT is connected to a controller.

Refer to the following manual for details of the access range.

 GT Designer2 Version □ Screen Design Manual
GOT1000 Series Connection Manual (Mitsubishi Products) for GT Works3

7 Precautions

(1) Monitoring and testing real number data

Real number data cannot be monitored and tested.

All word devices containing real number data are monitored in integer data (binary data).

(2) Monitoring devices in 32-bit (two-word) module

When monitoring word devices (T, C, D, W, etc.) in 32-bit (two-word) module, those with 32 bits of data remaining are monitored.

Devices with 16 bits (one-word) of data remaining are not monitored.

If an odd number is specified for the first monitor device number, the last device number of the specified controller will not be displayed.

(Example) When the data entry of the A2NCPU is monitored in units of 32 bits from odd numbers (D1, D3 ...)

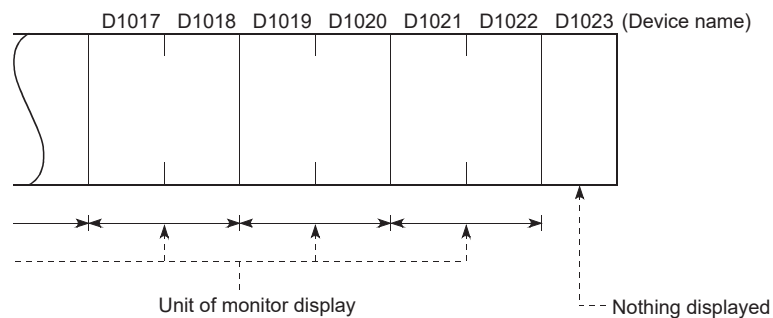

(3) Changing the T/C set values of large-size and small-size QnACPU and displaying device comments

The T/C set values of QnACPU whose date on the CPU rating plate is after [9707B] can be changed, and device comments can be displayed.

<Information on the rating plate>

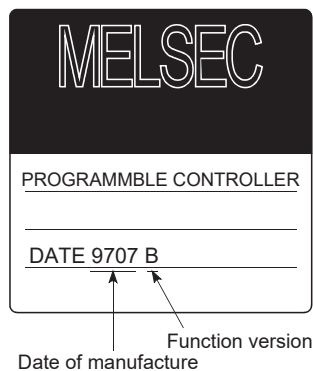

(4) Programs capable of changing timer/counter set values

- Only the main program can change the timer/counter set values of AnNCPUs, AnACPU, and AnUCPU.
- When executing multiple programs with the QCPU (Q mode) and QnACPU, setting values of timer/counter can be changed only to the program (scan execution type program set at the lowest number among them in parameter settings of GX Developer) whose file name is displayed on the TC Monitor screen.

Note that a file to be displayed cannot be changed on the GOT.

(5) Z0 of Q/QnACPU and Z0 and V0 of ACPU

- Z0 of Q/QnACPU and Z0 and V0 of ACPU are displayed as Z and V respectively.

14.2.2 Display

This section describes the operation procedure from turning on the power to the GOT to system monitor display.

1 Outline until starting the system monitor

This subsection describes the flow until the system monitor function screen is displayed after System monitor (Extended function OS) is installed in the GOT.

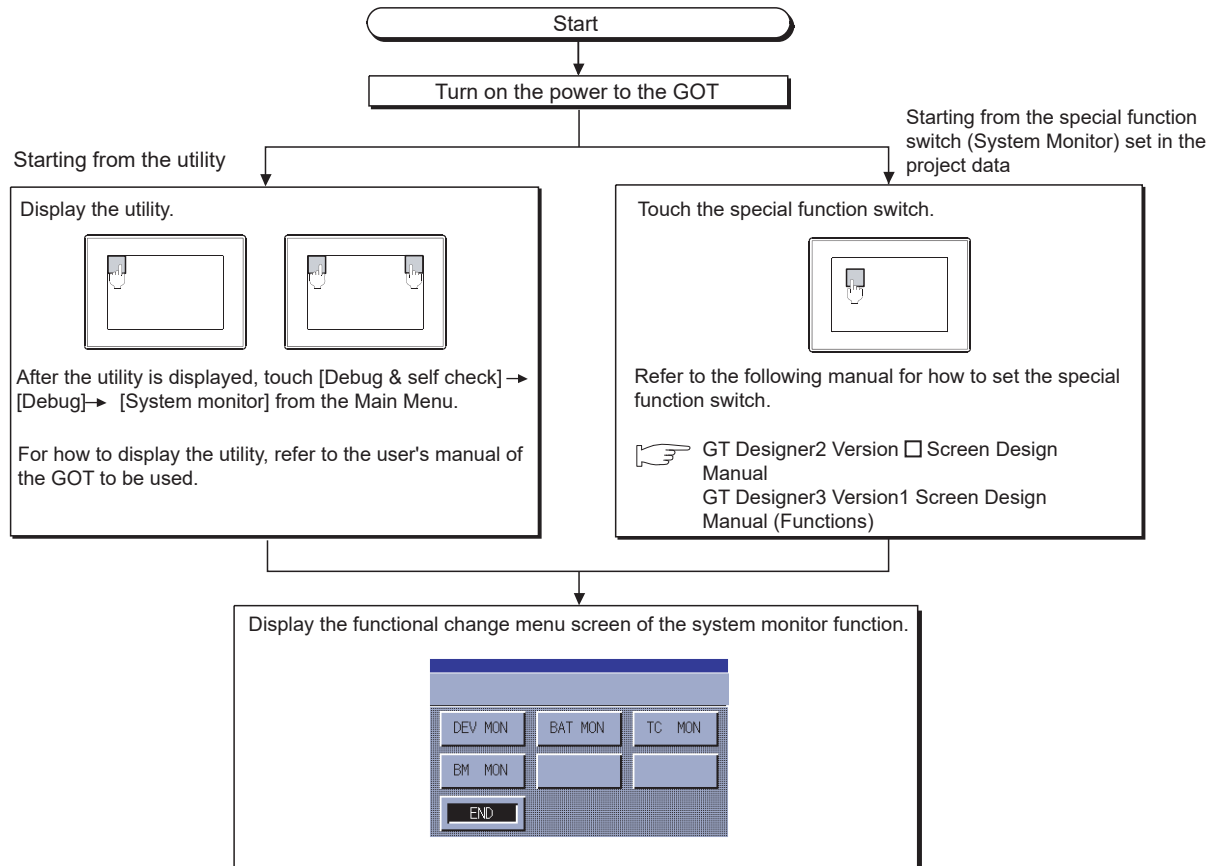

(1) How to display the utility

For how to display the utility, refer to the following.

Section 9.3 Utility Display

(2) If the project data has not been downloaded

The system monitor can be started from the utility even if the project data has not been downloaded to the GOT.

14.2.3 Operation procedure common to the system monitor screens

14.2.4 Functional change menu screen

This subsection describes the configuration of the functional change menu screen and the functions of the keys displayed on it.

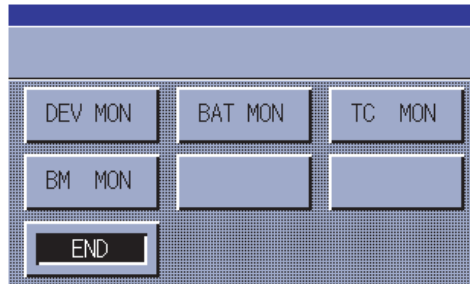

The table below describes the functions of the keys displayed on the functional change menu screen.

Key	Function
DEV MON	Performs entry monitoring in the Entry Monitor window. ☞ Subsection 14.2.10 Entry monitor
BAT MON	Performs batch monitoring in the Batch Monitor window. ☞ Subsection 14.2.14 Batch monitor
TC MON	Performs TC monitoring in the TC Monitor window. ☞ Subsection 14.2.17 TC Monitor (Monitoring Timers and Counters)
BM MON	Performs buffer memory monitoring in the BM Monitor window. ☞ Subsection 14.2.21 BM monitor (monitoring buffer memory)
END	The system monitor function is deactivated, and the screen returns to Main Menu of the utility. If the system is activated from the User screen, the screen returns to it.

14.2.5 Entering monitor devices (specifying monitor stations and devices)

This subsection describes how to specify network numbers, monitor stations, and monitor devices by taking the Entry Monitor window as an example.

The procedure for specifying network numbers, monitor stations, and monitor devices is the same even if other items than the "entry monitor."

(Example) Entering a monitor device when the entry monitor is used.

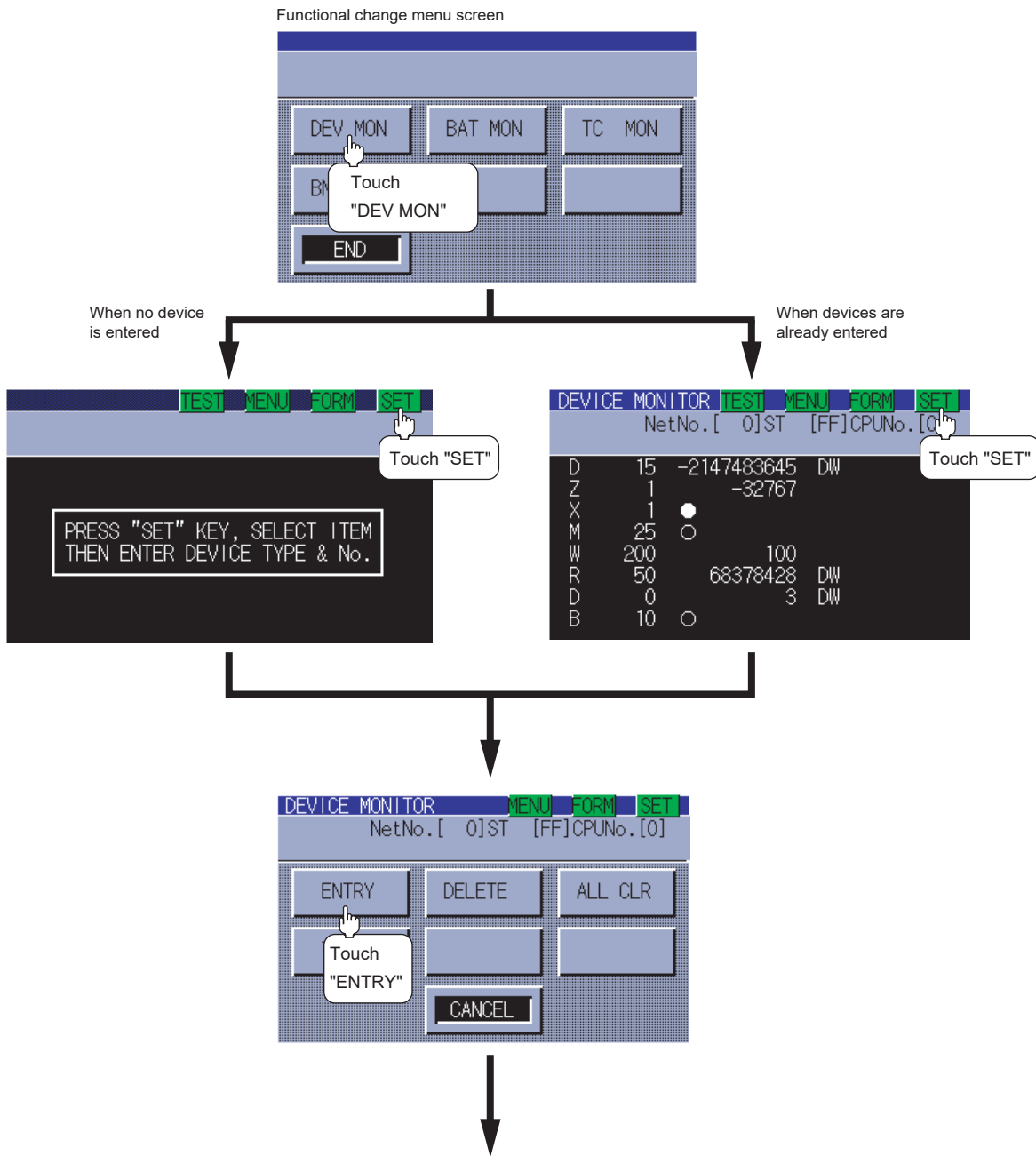

(Continued to next page)

(From previous page)

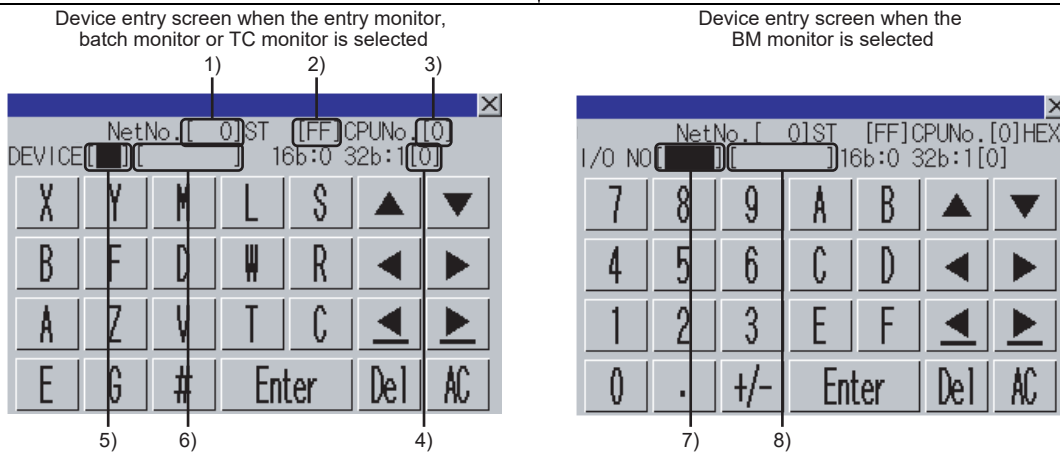

Set 1) to 8) as shown in the table below, and then touch the **Enter** key.
For the operation of key windows, see the following:

Subsection 14.2.6 Key window setting columns and operation procedure

No.	Item	Description of setting			
		Bus connection	Direct CPU connection	Computer link connection	CC-Link connection
					G4*2
1)	Network No.	0			
2)	Station No.	FF			FF: When the host station is selected 0: When the master station is selected 1 to 64: When a local station is selected
3)*3	CPU No.	0 to 4: This item must be set only when the system is connected to multiple QCPUs. It is not necessary when the system is connected to another CPU.			
4)	Data range	1: Indicates that the device value is a 32-bit (two-word) module. 0: Indicates that the device value is a 16-bit (one-word) module.			
5)	Device name	Set the name and number of the device to be monitored.			
6)*1	Device number				
7)*1	I/O number	When the initial I/O signal of module is displayed with three digits, specify the first two digits.			
8)*1	Initial device number	Set the initial device number of the buffer memory in decimal.			

*1 For devices that can be set, see the following:

GT Designer 2 Version □ Screen Design Manual
GT Designer 3 Version1 Screen Design Manual(Fundamentals)

*2 Indicates CC-Link connection (via G4).

*3 When the station No. is set to the host station (FF), set the network No. to 0.



Displaying the data range

The Entry Monitor, Batch Monitor, TC Monitor, and BM Monitor screens display the data range as shown below.

- DW : 32-bit (two-word) module
- Nothing displayed : 16-bit (one-word) module

(Continued to next page)

(From previous page)

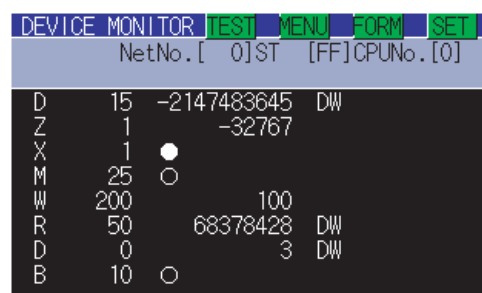
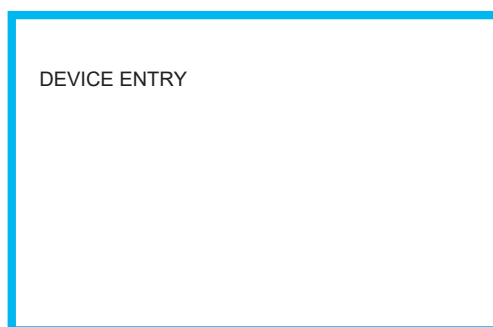

Point

(1) Retaining entered information

If the system monitor function is reactivated without turning off the power to the GOT, the last displayed information will be retained.

If the power to the GOT is turned on again and the system monitor function is reactivated, the last displayed information will be deleted.

(2) Entry unit of monitor devices

Each monitor device is entered in a combination of a network number and a CPU station number. If the CPU station number is changed, the entered monitor device will become invalid.

14.2.6 Key window setting columns and operation procedure

1 Operating the key window

- 1 Using the ◀ and ▶ keys, move the cursor to the item you want to set.

The displayed keyboard depends on the position of the cursor as shown below.

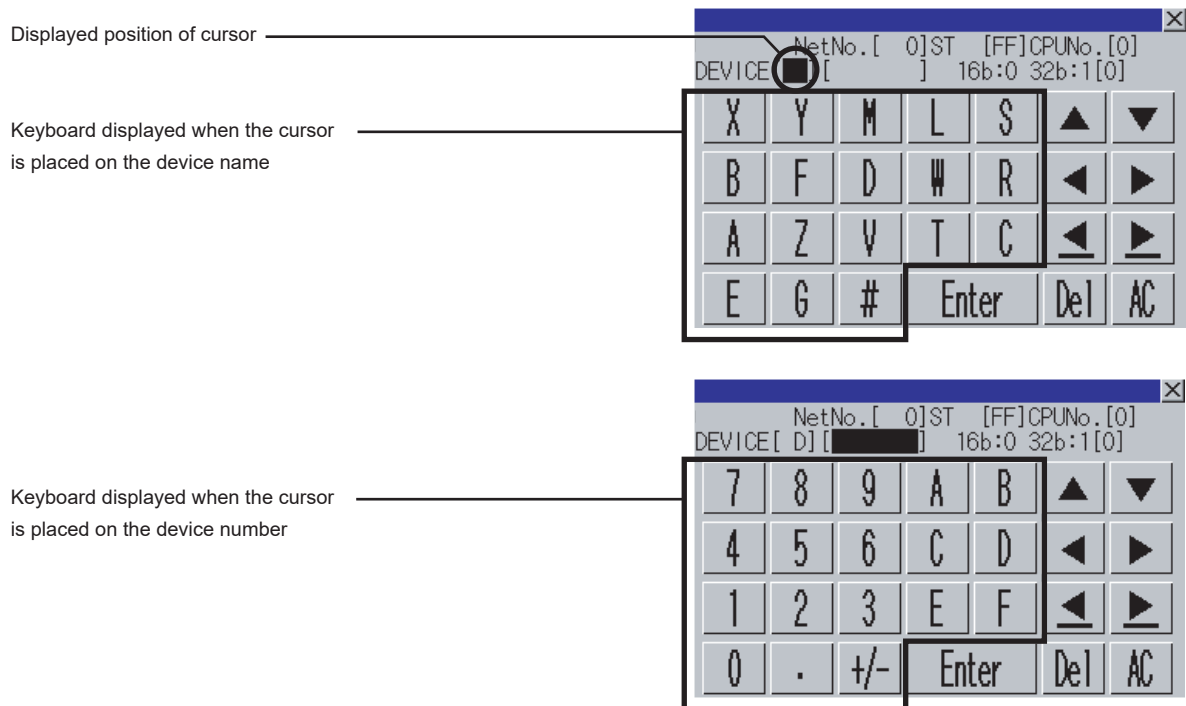

- 2 If necessary, enter numbers or characters from the keyboard.

- **Del** key: Used to delete a character of the entered information.
- **AC** key: Used to delete all characters under the cursor.
- The ▲/▼ keys without a description do not function.

- 3 Entry is completed by touching the **Enter** key.

The keyboard closes by touching the **×** key.

14.2.7 Switching the display format (DEC/HEX) and comment/no-comment display

This subsection describes how to switch the display format and comment/no-comment display. The Entry Monitor window is taken here as an example to describe the specification of a monitor station and a monitor device when the system monitor function is executed. The procedure for switching the display format (DEC/HEX) and comment display when another item is selected.

(Example of switching when the entry monitor is selected)

Switching the display format from DEC to HEX

Switching no-comment display to comment display

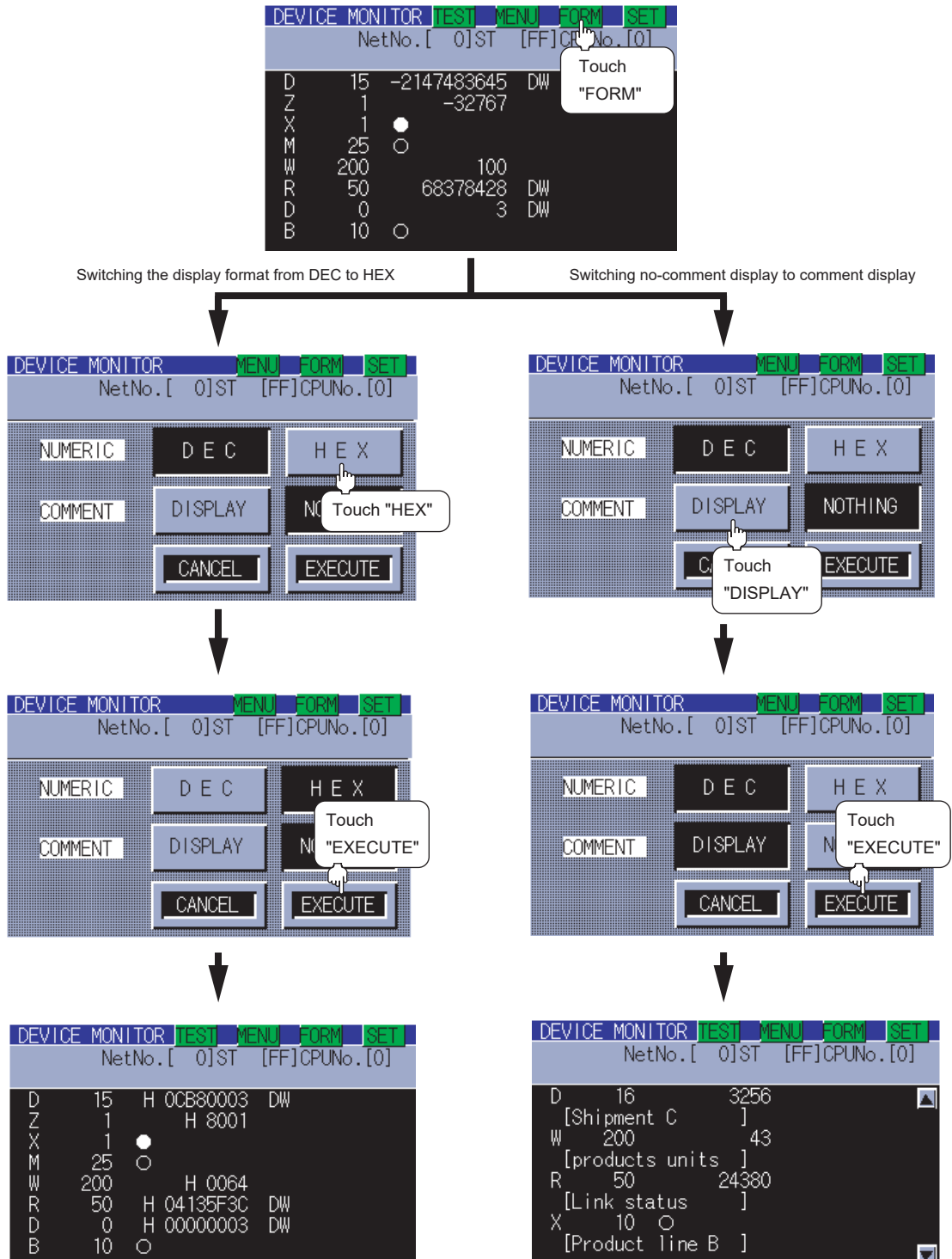

- (1) Changing the comment or comment capacity of the controller
If you change a comment or comment capacity of the controller after the system monitor function is activated, the comment may not be properly displayed on each monitor screen.
After a comment or comment capacity is changed, turn off the GOT and turn it on again.
- (2) Switching the display format (DEC/HEX)
The present value of word devices and the present value and set value of timers/counters will be displayed in decimal or hexadecimal numbers.
- (3) Switching comment/no-comment display
The comments written to the target controller will be displayed or not be displayed. (Priority of comment display: Extension comment > Comment)
- (4) Comment/No-comment display
 - (a) The BM monitor does not display comments.
 - (b) Comments will not be displayed when any of the CPUs listed below is monitored.
 - FXCPU
 - QnACPU or Q series motion controller CPU whose date on the rating plate is earlier than 9707B
 - (c) Comments will not be displayed when any of the devices listed below is monitored.
 - Internal device of the GOT (GB, GD, GS)
 - Host device (X,Y, WW, WR) when a CC-Link is connected
 - (d) Displaying the comments of QCPUs (Q02CPU, Q02HCPU, Q06HCPU, Q12HCPU, Q25HCPU, Q12PHCPU, Q25PHCPU, Q12PRHCPU, Q25PRHCPU, Q02UCPU, Q03UDCPU, Q04UDHCPU, Q06UDHCPU)
Comments will not be displayed when the following PLC parameters (PLC file settings) are set:
 - When the comment file is set to "Not used"
 - When the comment file is set to "Use the same file name as the program"
 - When a password is set to the comment file
 - When a comment file is stored in program memory
 - (e) Displaying the comments of QCPUs (Q00JCPU, Q00CPU, Q01CPU)
Comments will not be displayed when the following PLC parameter (PLC file setting) is set:
 - When the comment file "MAIN" does not exist in the program memory
 - (f) Displaying the comments of QnACPU
With a QnACPU whose date on the rating plate is earlier than 9707B, comments cannot be displayed.
Use a QnACPU whose date on the rating plate is 9707B or later.
Also, comments will not be displayed when the following settings are made to the PLC parameter (PLC file setting) is set.
 - When the comment file is not set "Not used"
 - When the comment file is set to "Use the same file name as the program"
 - When a keyword is entered for each memory

14.2.8 Quick test operation of monitor devices

! WARNING

- Before performing the quick test operations of the system monitor function (such as turning ON or OFF bit device, changing the word device current value, changing the settings or current values of the timer or counter, and changing the buffer memory current value), read through the manual carefully and make yourself familiar with the operation method. During quick test operation, never change the data of the devices which are used to perform significant operation for the system. False output or malfunction can cause an accident.

The quick test operation procedure for monitor devices is described below.

The Entry Monitor screen is taken as an example to describe quick test operation when the system monitor function is executed.

The operation procedure is the same even if the batch monitor, TC monitor or BM monitor is selected. (Example of quick test operation when the entry monitor is selected)

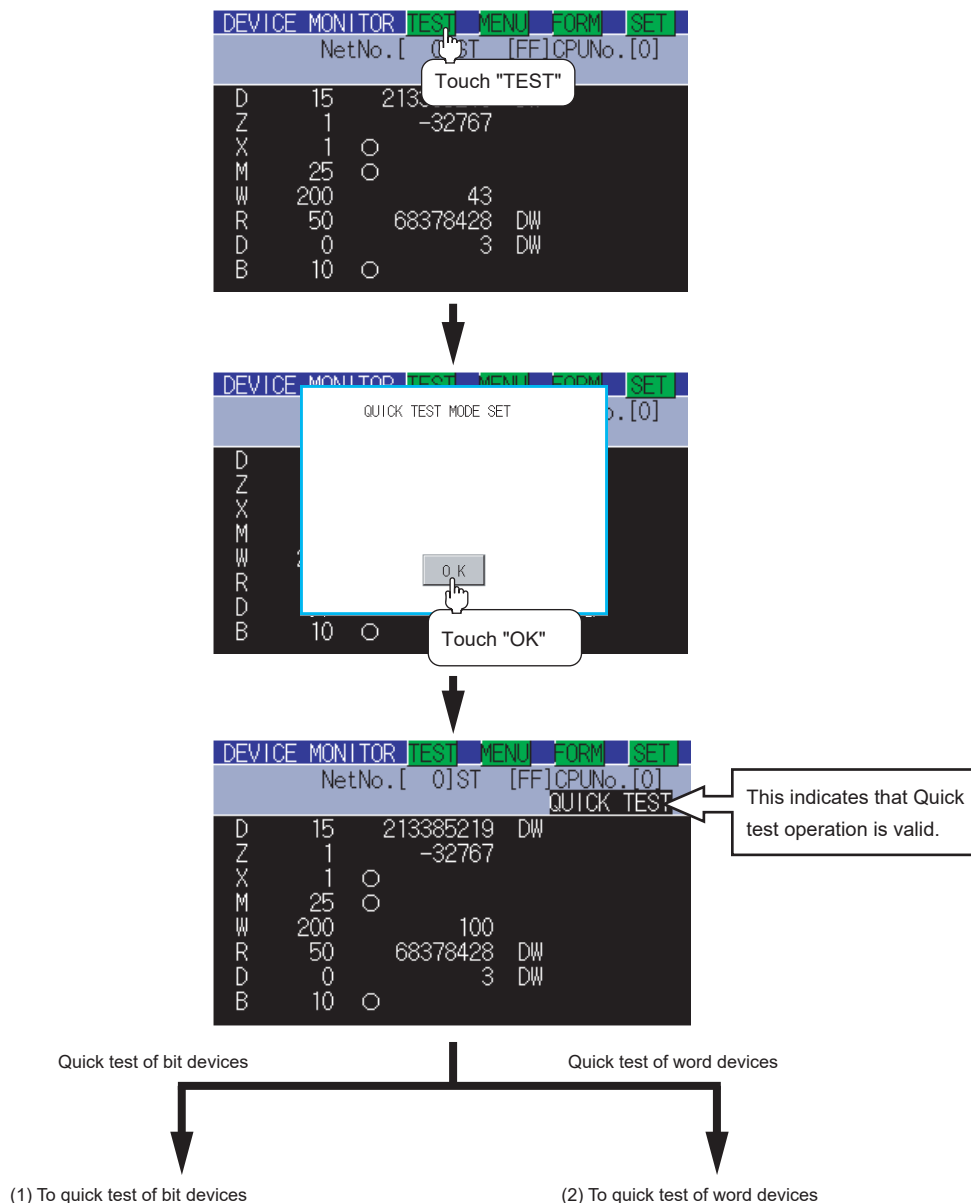

(1) Quick test of bit devices
 (Operation example)

Change the status of bit device X001 from off (○) to on (●).

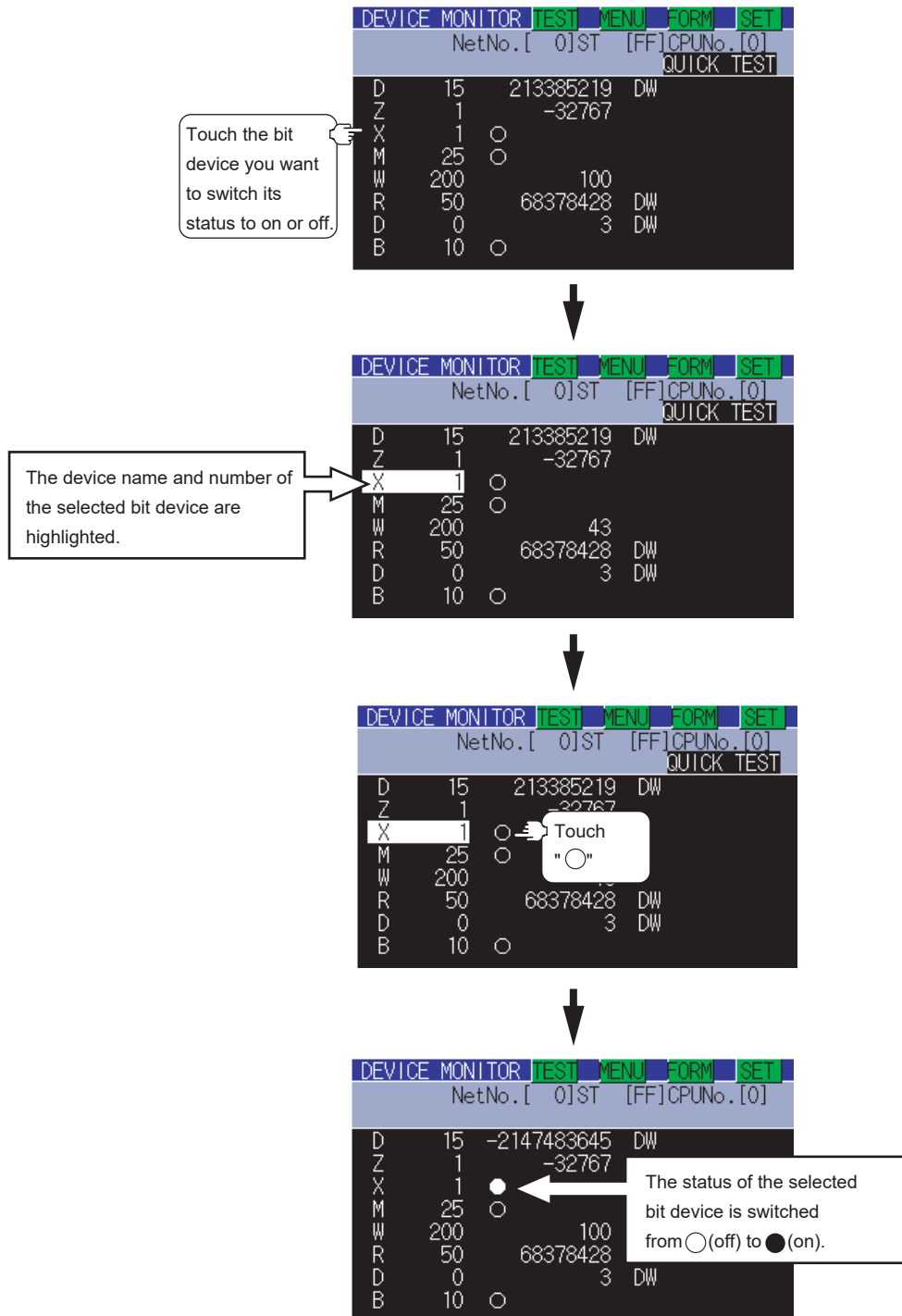

(2) Quick test of word devices
(Operation example)

Change the device value of word device W200 from 43 to 100.

Conditions: Data range: 16 bits, device value display format: decimal number

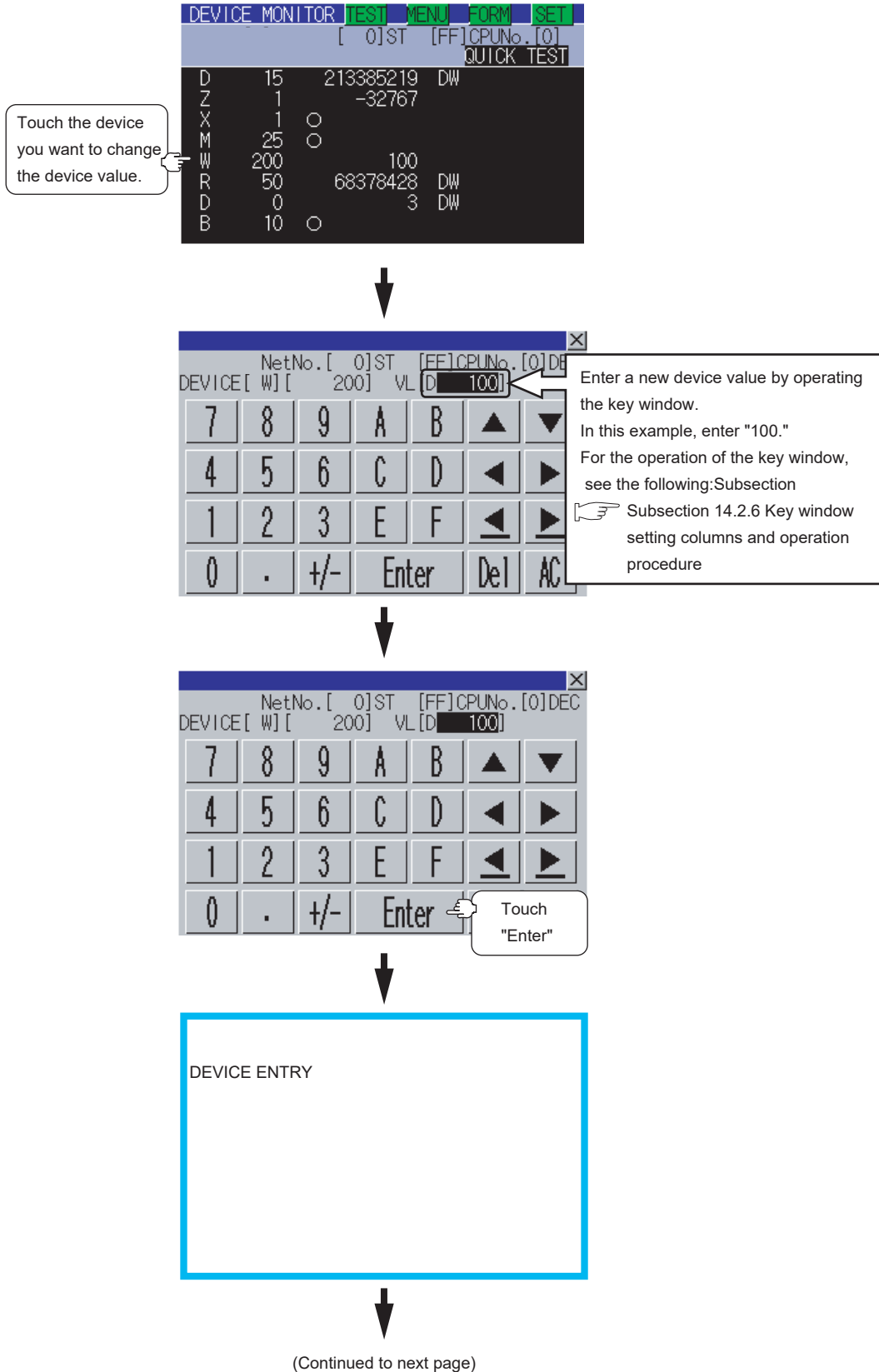

(From previous page)

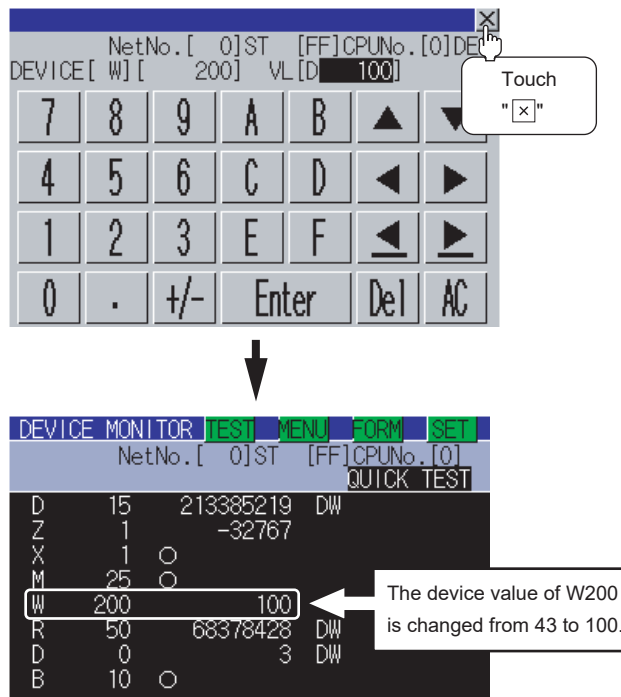

Point

Effective number of digits of device values that can be changed

If an entered value exceeds the corresponding number of digits specified below, the device value cannot be changed.

[Decimal number]

16-bit (one-word) module : Six digits (including a digit for a sign)

32-bit (two-word) module : Ten digits (including a digit for a sign)

[Hexadecimal number]

16-bit (one-word) module : Four digits

32-bit (two-word) module : Eight digits

14.2.9 Changing screens (common operation)

This subsection takes the entry monitor as an example to describe how to change screens.

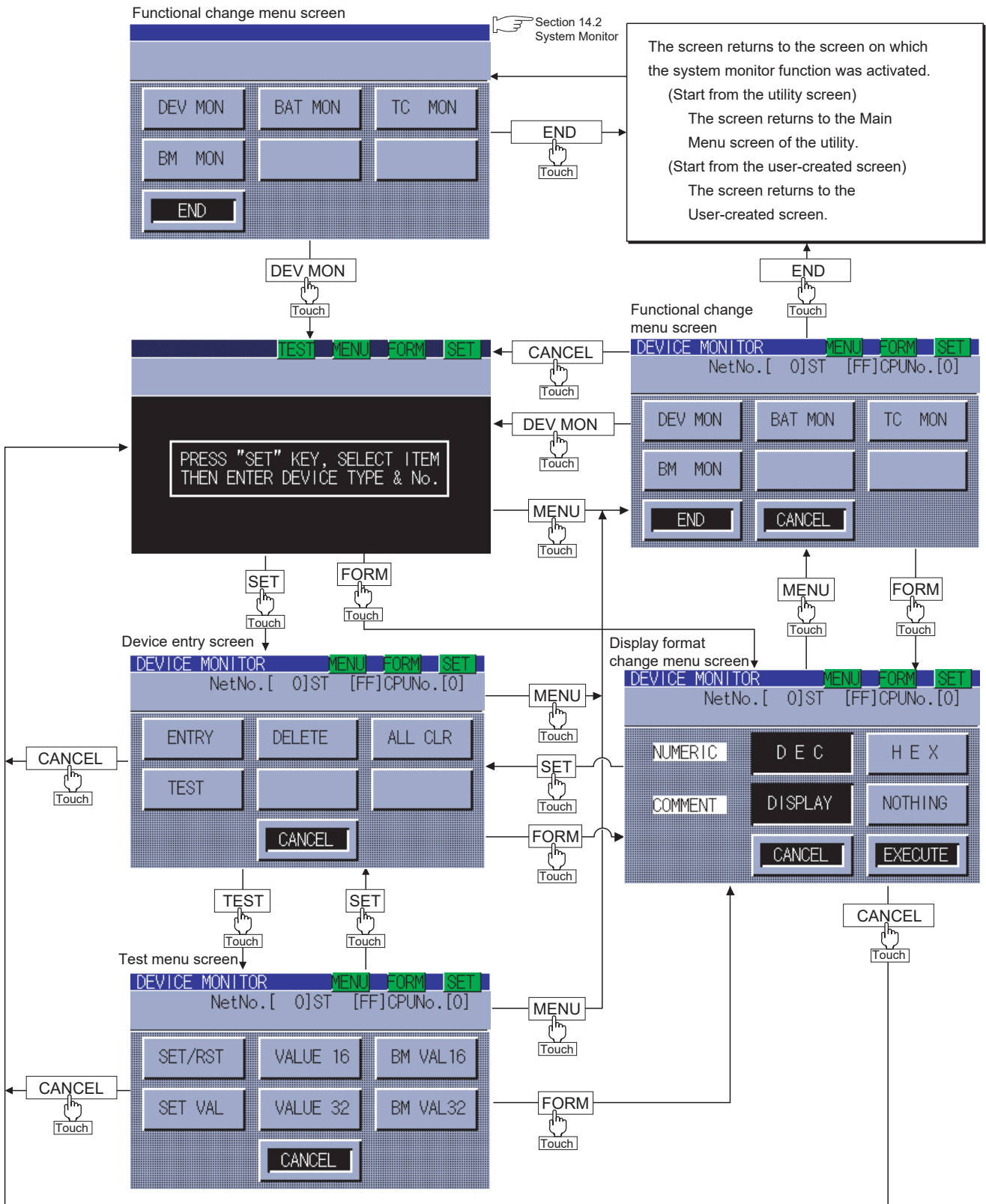

14.2.10 Entry monitor

The device monitor is a function to enter devices to be monitored in advance and monitor only entered devices.

This section describes how to activate the entry monitor when the system monitor function is executed.

14.2.11 Information displayed on the entry monitor screen and key functions

- (1) The information displayed on the Entry Monitor screen is described below.
For the key functions, see the page that follows.

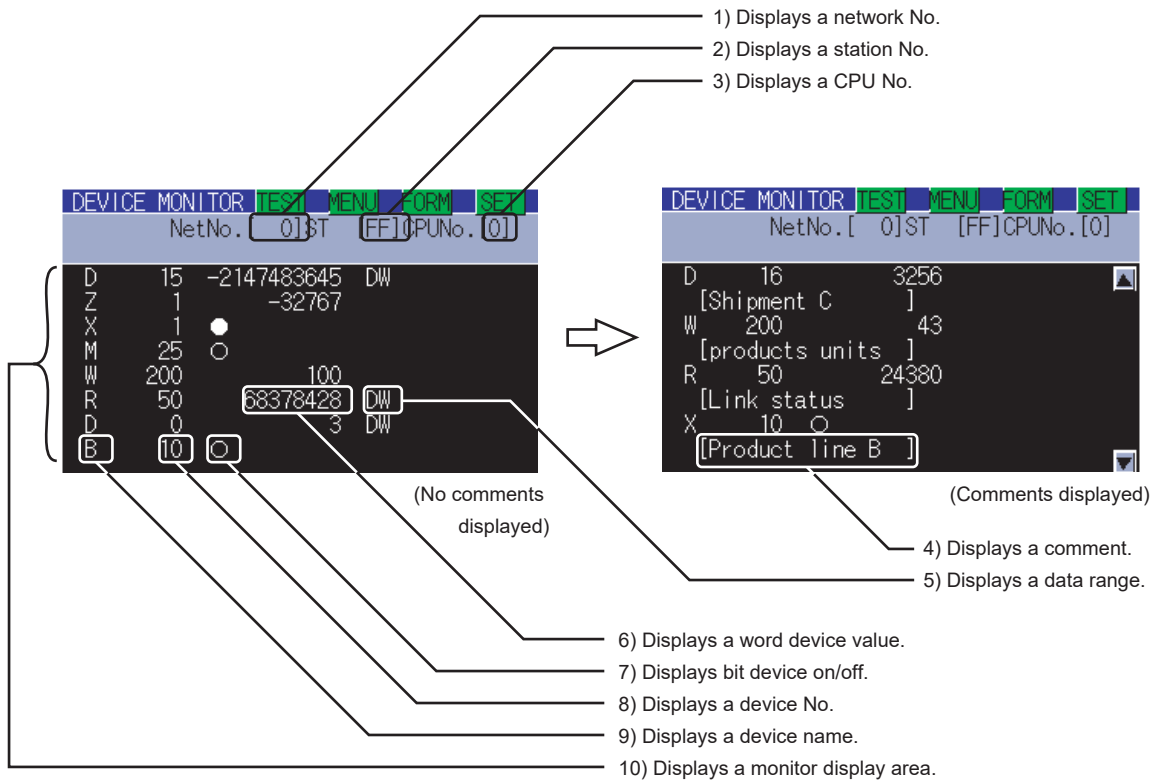

For further information about items 1) to 10) shown above, see the page that follows.

(2) The following table describes the key functions displayed on the Entry Monitor screen.

Key switch	Function
	Activates the Quick test operation. Subsection 14.2.8 Quick test operation of monitor devices
	Switches the screen to the functional change menu screen to activate another monitor function or terminate the system monitor function. Subsection 14.2.9 Changing screens (common operation)
	Switches the screen to the display format switching screen to change the value display format (DEC/HEX) on the Entry Monitor screen or comment/no-comment display. Subsection 14.2.7 Switching the display format (DEC/HEX) and comment/no-comment display
	Switches the screen to the Device entry screen to enter monitor devices or delete or test entry devices. <ul style="list-style-type: none"> · Entering monitor devices: Subsection 14.2.5 Entering monitor devices (specifying monitor stations and devices) · Deleting entry devices: Subsection 14.2.13 Deleting entry devices · Test operation: Subsection 14.2.24 Test operation
	Scroll displayed information upward or downward by a line to display the preceding or next monitor device that is not currently displayed. When five or more monitor devices are entered, these switches are available when their comments are displayed. : Scrolls information upward by a line. : Scrolls information downward by a line.

(3) The following table below describes the range of display of items 1) to 10) displayed

No.	Item	Description of setting			
		Bus connection	Direct CPU connection	Computer link connection	CC-Link connection
					G4 *1
1)	Network No.	0			
2)	Station No.	FF			F: When the host station is selected 0: When the master station is selected 1 to 64: When a local station is selected
3)	CPU No.	0 to 4: This item must be set only when the system is connected to multiple QCPUs. It is not necessary when the system is connected to another CPU.			
4)	Comment	Displays a comment (maximum number of characters: 16 one-byte characters) A comment is displayed when "DISPLAY" is selected for comment display on the display format switching screen.			
5)	Data range	DW: Indicates that the device value is a 32-bit (two-word) module. Nothing displayed: Indicates that the device value is a 16-bit (one-word) module.			
6)	Word device value	[Decimal number] 16-bit (one-word) module: Six digits (including a digit for a sign) are displayed. (Display example: -12345) 32-bit (two-word) module: Ten digits (including a digit for a sign) are displayed. (Display example: -123456789) [Hexadecimal number] 16-bit (one-word) module: Four digits are displayed. (Display example: H AB12) 32-bit (two-word) module: Eight digits are displayed. (Display example: H ABCDE123)			
7)	Bit device ON/OFF	●: ON ○: OFF			
8)	Device No.	Up to eight devices can be monitored with regard to each CPU station number.			
9)	Device name	For further information about device numbers and names that can be entered: GT Designer 2 Version <input type="checkbox"/> Screen Design Manual GT Designer 3 Version1 Screen Design Manual (Fundamentals)			
10)	Monitor display area	When no comments are displayed: Up to eight devices can be displayed. When comments are displayed : Up to four devices can be displayed.			

*1: Indicates CC-Link connection (via G4).

14.2.12 Procedure for entry monitor basic operation

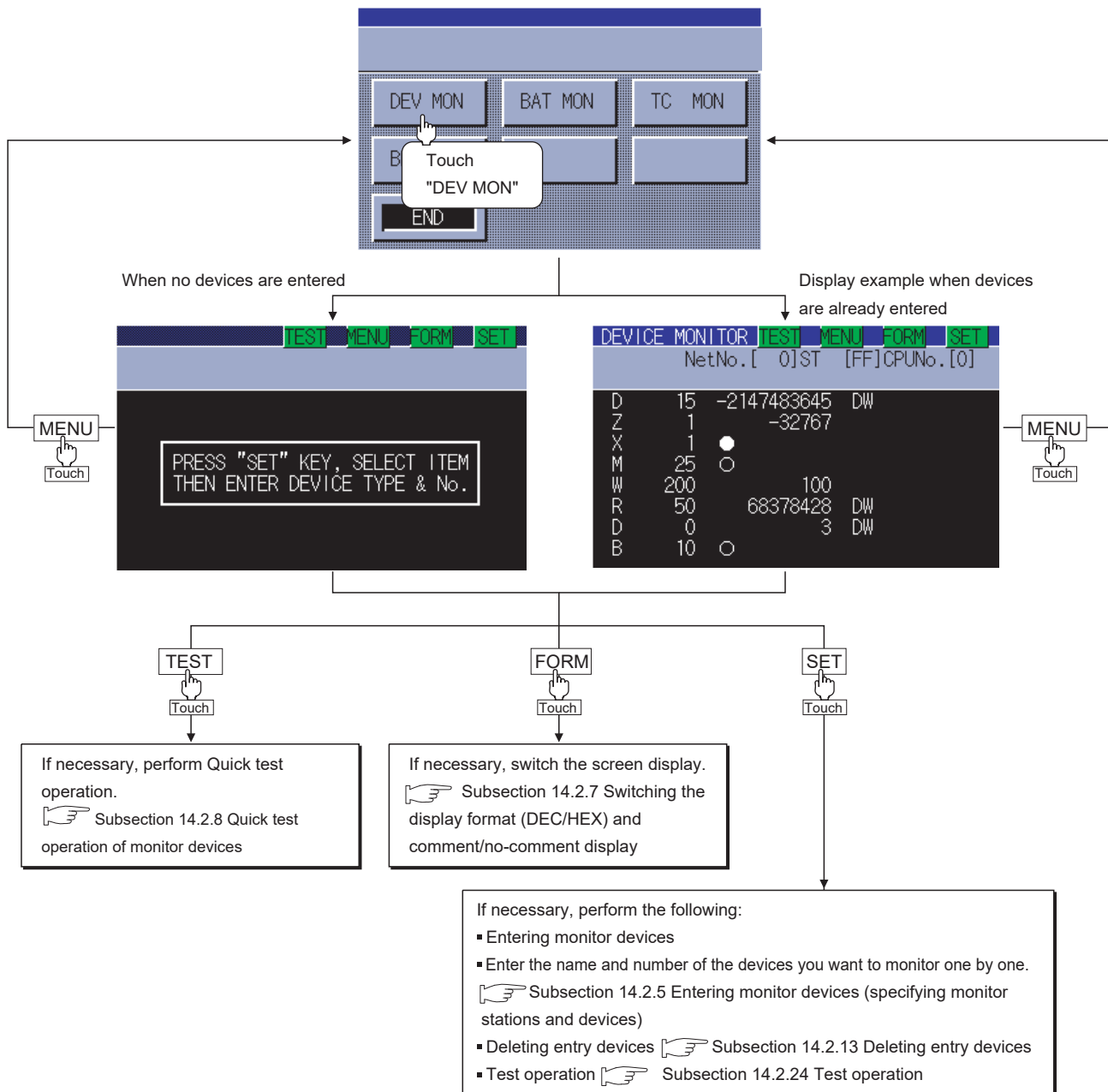

If more than eight devices are registered

You can register up to eight entry devices.

If more than eight devices are registered, the oldest ones will be deleted one by one, and the eight latest entry devices will be monitored.

If necessary, delete unnecessary entry devices and re-enter ones you want to monitor.

14.2.13 Deleting entry devices

This subsection describes how to delete entry devices.

Deleting entry devices with the system monitor function executed is described below.

When specifying the device name you want to delete

When deleting devices at a time

Touch "SET"

Touch "DELETE"

Touch "ALL CLR"

1 Enter the device name you want to delete in (1).

2 Enter the device number you want to delete in (2).

3 Touch the **Enter** key.

4 Touch the **X** key. The window closes.

For further information about key window operation, see Subsection 14.2.6 Key window setting columns and operation procedure.

PRESS "SET" KEY, SELECT ITEM THEN ENTER DEVICE TYPE & No.

14.2.14 Batch monitor

The batch monitor is a function to specify the head device of any device range to perform monitoring. This section describes how to operate the batch monitor when the system monitor function is executed.

14.2.15 Information displayed on the Batch Monitor screen and key functions

(1) The information displayed on the Batch Monitor screen is described below.

Display example of bit devices

1) Displays a network No.
2) Displays a station No.
3) Displays a CPU No.

(No comments displayed)

(Comments displayed)

4) Displays bit device on/off.

5) Displays a comment.

Display example of word devices (16-bit)

(No comments displayed)

(Comments displayed)

6) Displays a word device value.
7) Displays a device number.
8) Displays a device name.

Display example of word devices (32-bit)

BATCH MONITOR TEST MENU FORM SET			
NetNo. [0] ST [FF] CPUNo. [0]			
D	10	32767	DW
D	12	-65536	DW
D	14	196608	DW
D	16	3256	DW
D	18	212008460	DW
D	20	0	DW
D	22	-2147483648	DW
D	24	0	DW

(No comments displayed)

9) Displays a data range.
10) Monitor display area

→

BATCH MONITOR TEST MENU FORM SET			
NetNo. [0] ST [FF] CPUNo. [0]			
D	10	32767	DW
[Inventory units]			
D	12	-65536	DW
[Shipment A]			
D	14	196608	DW
[Shipment B]			
D	16	3256	DW
[Shipment C]			

(Comments displayed)

For further information about items 1) to 10) shown above, see the page that follows.

Point

Number of devices displayed on a single screen

The number of devices displayed on a single screen depends on the setting of the data range, as shown below.

Word devices (16-bit) : 16 devices (no comments displayed), eight devices (comments displayed)

Word devices (32-bit) : Eight devices (no comments displayed), four devices (comments displayed)













Bit devices : 16 devices (no comments displayed), eight devices (comments displayed)

For further information about the setting of the data range, see the following:

☞ Subsection 14.2.5 Entering monitor devices (specifying monitor stations and devices)

9	UTILITY FUNCTION
10	COMMUNICATION INTERFACE SETTING
11	DISPLAY AND OPERATION SETTINGS
12	CLOCK SETTINGS AND BATTERY STATUS DISPLAY
13	FILE DISPLAY AND COPY
14	GOT SELF CHECK
15	CLEANING OF DISPLAY SECTION
16	INSTALLATION OF CoreOS, BOOTOS AND STANDARD MONITOR OS

(2) The following table describes the key functions displayed on the Batch Monitor screen.

Key switch	Function
	Activates the Quick test operation.  Subsection 14.2.8 Quick test operation of monitor devices
	Switches the screen to the functional change menu screen to activate another monitor function or terminate the system monitor function.  Subsection 14.2.9 Changing screens (common operation)
	Switches the screen to the display format switching screen to change the value display format (DEC/HEX) on the Batch Monitor screen or comment/no-comment display.  Subsection 14.2.7 Switching the display format (DEC/HEX) and comment/no-comment display
	Switches the screen to the Device entry screen to enter or test monitor devices. <ul style="list-style-type: none"> · Entering monitor devices :  Subsection 14.2.5 Entering monitor devices (specifying monitor stations and devices) · Test operation :  Subsection 14.2.24 Test operation
 	Scroll displayed information upward or downward by a line to display the preceding or next monitor device that is not currently displayed. When five or more monitor devices are entered, these switches are available when their comments are displayed. <ul style="list-style-type: none">  : Scrolls information upward by a line.  : Scrolls information downward by a line.

(3) The following table below describes the range of display of items 1) to 10) displayed.

No.	Item	Description of setting			
		Bus connection	Direct CPU connection	Computer link connection	CC-Link connection
					G4*1
1)	Net No.	0			
2)	Station No.	FF			FF: When the host station is selected 0: When the master station is selected 1 to 64: When a local station is selected
3)	CPU No.	0 to 4: This item must be set only when the system is connected to multiple QCPUs. It is not necessary when the system is connected to another CPU.			
4)	Bit device ON/OFF	● : ON ○ : OFF			
5)	Comment	Displays a comment (maximum number of characters: 16 one-byte characters). A comment is displayed when "DISPLAY" is selected for comment display on the display format switching screen.			
6)	Word device value	[Decimal number] 16-bit (one-word) module: Six digits (including a digit for a sign) are displayed. (Display example: -12345) 32-bit (two-word) module: Ten digits (including a digit for a sign) are displayed. (Display example: -123456789) [Hexadecimal number] 16-bit (one-word) module: Four digits are displayed. (Display example: H AB12) 32-bit (two-word) module: Eight digits are displayed. (Display example: H ABCDE123)			
7)	Device No.	Up to 16 devices can be entered when the data range is word (16 bits). Up to eight devices can be entered when the data range is two-word (32 bits).			
8)	Device name	For further information about device numbers and names that can be entered:  GT Designer 2 Version <input type="checkbox"/> Screen Design Manual GT Designer 3 Version1 Screen Design Manual (Fundamentals)			
9)	Data range	DW: Indicates that the device value is a 32-bit (two-word) module. Nothing displayed: Indicates that the device value is a 16-bit (one-word) module.			
10)	Monitor display area	When no comments are displayed : Up to 16 devices can be displayed at a time (monitor module: one-word). Up to eight devices can be displayed at a time (monitor module: two-word). When comments are displayed : Up to eight devices can be displayed at a time (monitor module: one-word). Up to four devices can be displayed at a time (monitor module: two-word).			

*1: Indicates CC-Link connection (via G4).

14.2.16 Procedure for batch monitor basic operation

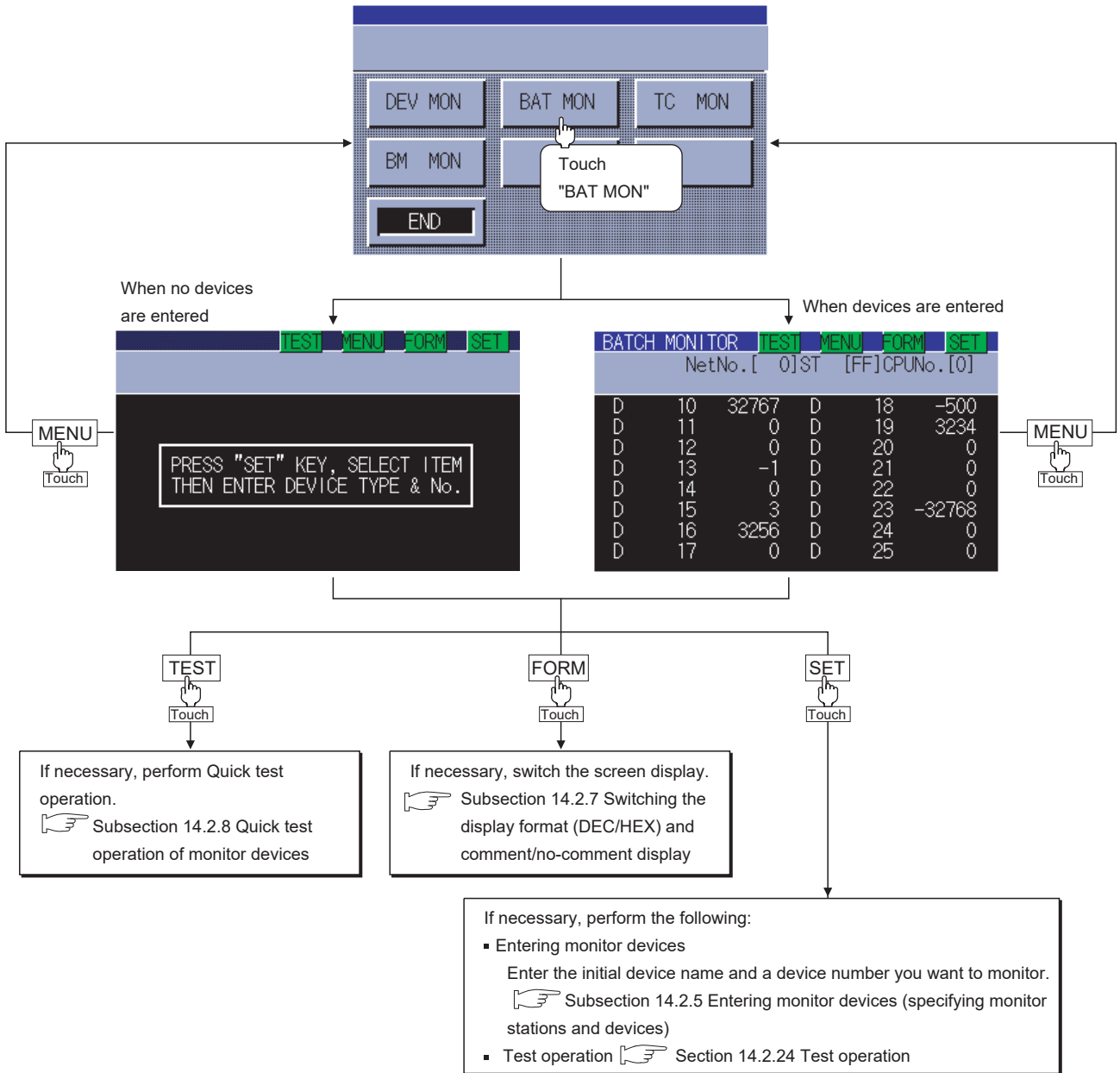

14.2.17 TC Monitor (Monitoring Timers and Counters)

The TC monitor is a function to monitor only timers (T) and counters (C).

This section describes how to operate the TC monitor when the system monitor function is executed.

14.2.18 Information displayed on the TC Monitor screen and key functions

(1) The information displayed on the TC Monitor screen is described below.

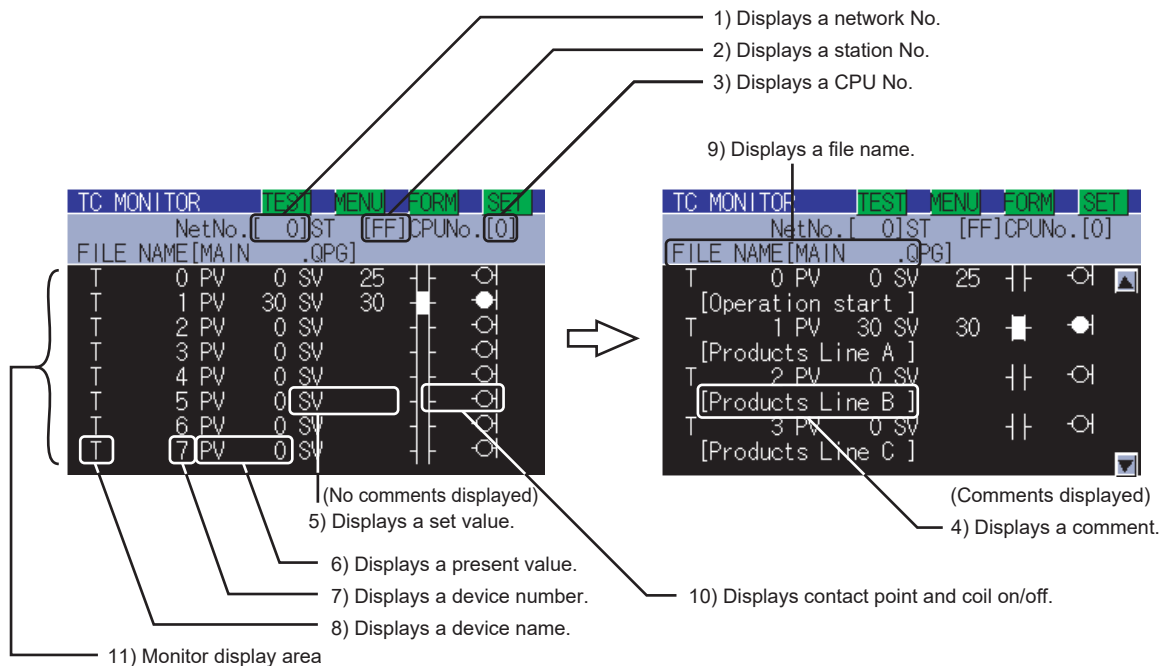

For further information about items 1) to 11) shown above, see the page that follows.

(2) The following table describes the key functions displayed on the TC Monitor screen.

Key switch	Function
TEST	Activates the Quick test operation. Subsection 14.2.8 Quick test operation of monitor devices
MENU	Switches the screen to the functional change menu screen to activate another monitor function or terminate the system monitor function. Subsection 14.2.9 Changing screens (common operation)
FORM	Switches the screen to the display format switching screen to change the value display format (DEC/HEX) on the TC Monitor screen or comment/no-comment display. Subsection 14.2.7 Switching the display format (DEC/HEX) and comment/no-comment display
SET	Switches the screen to the Device entry screen to enter or test monitor devices. <ul style="list-style-type: none"> Entering monitor devices: Subsection 14.2.5 Entering monitor devices (specifying monitor stations and devices) Test operation: Subsection 14.2.24 Test operation Canceling keywords: Subsection 14.2.20 Procedure for canceling TC monitor keywords
▲ ▼	Scroll displayed information upward or downward by a line to display the preceding or next monitor device that is not currently displayed. When five or more monitor devices are entered, these switches are available when their comments are displayed. <ul style="list-style-type: none"> ▲ : Scrolls information upward by a line. ▼ : Scrolls information downward by a line.

(3) The following table below describes the range of display of items 1) to 11) displayed.

No.	Item	Description of setting			
		Bus connection	Direct CPU connection	Computer link connection	CC-Link connection G4*1
1)	Network No.	0			
2)	Station No.	FF			FF: When the host station is selected 0: When the master station is selected 1 to 64: When a local station is selected
3)	CPU No.	0 to 4: This item must be set only when the system is connected to multiple QCPUs. It is not necessary when the system is connected to another CPU.			
4)	Comment	Displays a comment (maximum number of characters: 16 one-byte characters). A comment is displayed when "DISPLAY" is selected for comment display on the display format switching screen.			
5)	Set value	[Decimal number] Four digits are displayed. (Display example: 1234) [Hexadecimal number] Four digits are displayed. (Display example: H AB12)			
6)	Present value	[Decimal number] Four digits are displayed. (Display example: 1234) [Hexadecimal number] Four digits are displayed. (Display example: H AB12) (Present values cannot be monitored when the CPU is an FXCPU.)			
7)	Device No.	Up to eight devices can be entered.			
8)	Device name	For further information about device numbers and names that can be entered:  GT Designer 2 Version <input type="checkbox"/> Screen Design Manual GT Designer 3 Version1 Screen Design Manual (Fundamentals)			
9)	File name	When the CPU is a QnACPU or QCPU : A program name will be displayed. When there are plural program names, the initial file name to be executed will be displayed. When the CPU is an ACPU or FXCPU : "MAIN PROGRAM" will always be displayed.			
10)	Contact point and coil on/off	 : ON  : OFF (When the CPU is an FXCPU, contact points and coils cannot be monitored.)			
11)	Monitor display area	When no comments are displayed : Up to eight devices can be displayed at a time. When comments are displayed : Up to four devices can be displayed at a time.			

*1: Indicates CC-Link connection (via G4).

14.2.19 Procedure for TC monitor basic operation

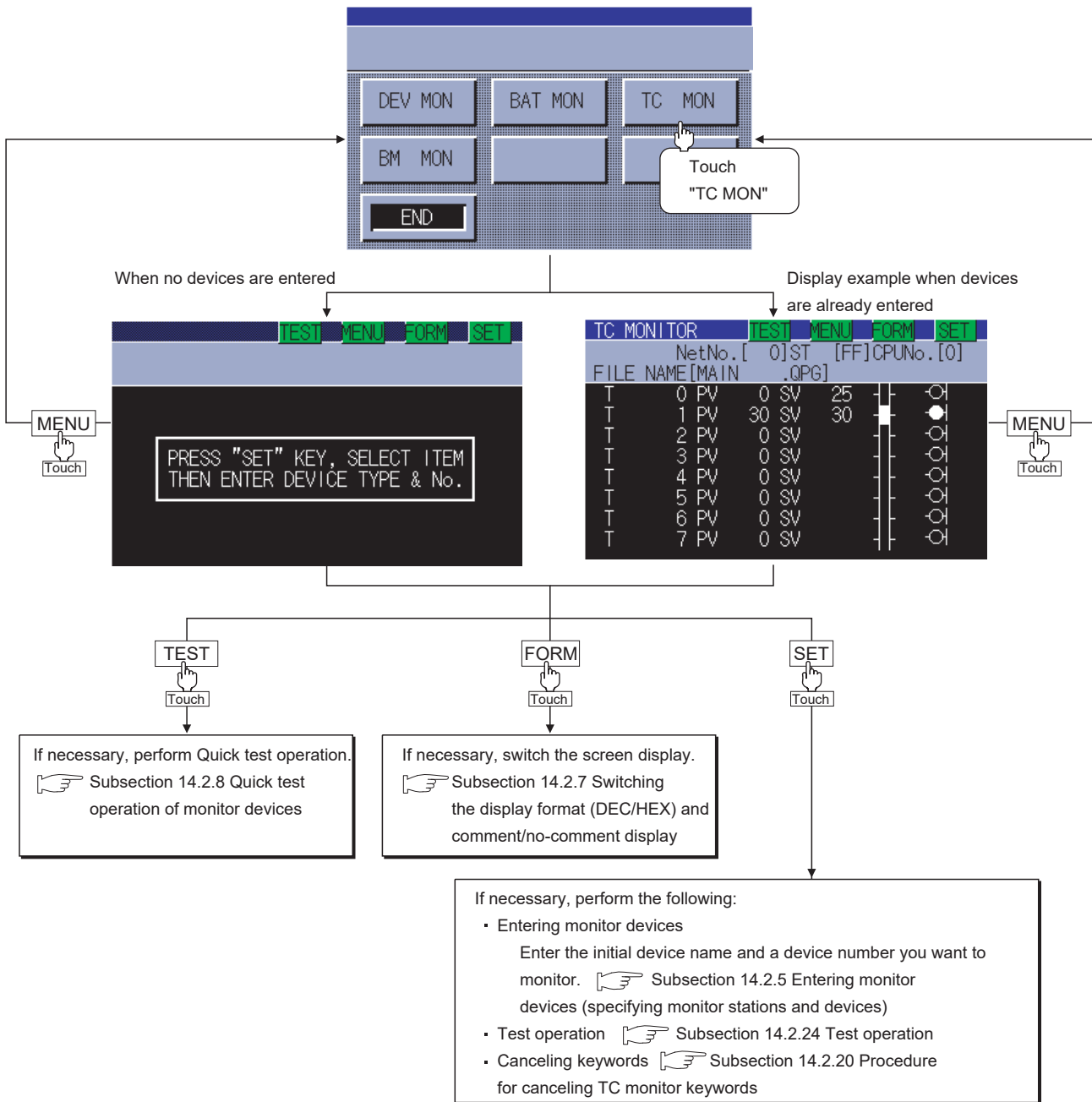

14.2.20 Procedure for canceling TC monitor keywords

When the target controller is a QCPU and a password is entered in the sequence program, the keyword must be canceled to display the set values of times and counters. The procedure for canceling keywords is described below.

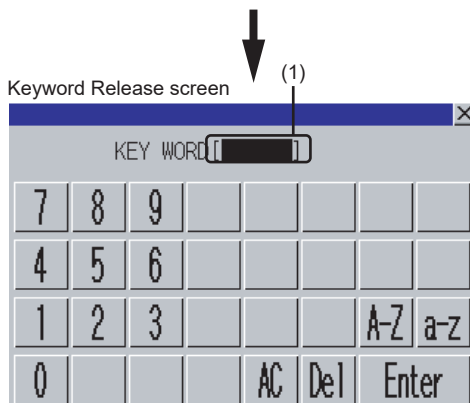
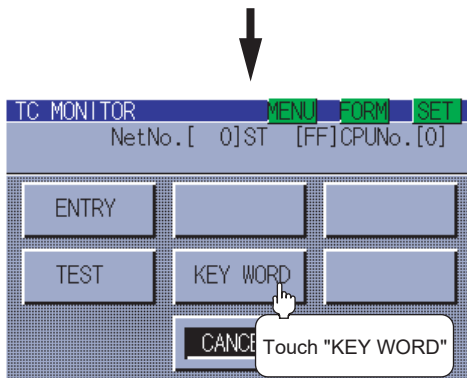
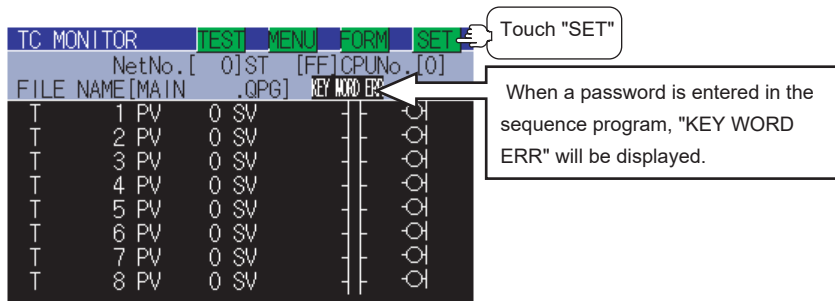

- 1 Enter the password entered in the sequence program at 1).
 - **A-Z** key : Touch this key to enter alphabetic characters A to Z (uppercase).
 - **a-z** key : Touch this key to enter alphabetic characters a to z (lowercase).
 - **0-9** key : Touch this key to enter numbers 1 to 9.
 - **Del** key : Use this key to delete an entered character.
 - **AC** key : Use this key to delete all characters under the cursor.
- 2 Entry is completed by touching the **Enter** key, and the keyboard closes.

14.2.21 BM monitor (monitoring buffer memory)

The BM monitor (buffer memory monitor) is a function to monitor the buffer memory of special function modules.

This section describes how to operate the BM monitor when the system monitor function is executed.

14.2.22 Information displayed on the BM Monitor screen and key functions

(1) The information displayed on the BM Monitor screen is described below.

The screenshot shows the BM Monitor screen with the following fields and data:

- NetNo. [0] ST [FF] CPU No. [0]
- I/O No. [0]
- BM 1 0 BM 9 0
- BM 2 0 BM 10 0
- BM 3 0 BM 11 0
- BM 4 0 BM 12 0
- BM 5 0 BM 13 0
- BM 6 0 BM 14 0
- BM 7 0 BM 15 0
- BM 8 0 BM 16 0

Callouts explain the fields:

- 1) Displays a network No.
- 2) Displays a station No.
- 3) Displays a CPU No.
- 4) Displays a word device value.
- 5) Displays a device No.
- 6) Displays a device name.
- 7) Displays the initial I/O signal of the module.

For further information about items 1) to 7) shown above, see the page that follows.

(2) The following table describes the key functions displayed on the BM Monitor screen.

Key switch	Function
	Activates the Quick test operation. Subsection 14.2.8 Quick test operation of monitor devices
	Switches the screen to the functional change menu screen to activate another monitor function or terminate the system monitor function. Subsection 14.2.9 Changing screens (common operation)
	Switches the screen to the display format switching screen to change the value display format (DEC/HEX) on the BM Monitor screen or comment/no-comment display. Subsection 14.2.7 Switching the display format (DEC/HEX) and comment/no-comment display
	Switches the screen to the Device entry screen to enter or test monitor devices. <ul style="list-style-type: none"> · Entering monitor devices: Subsection 14.2.5 Entering monitor devices (specifying monitor stations and devices) · Test operation: Subsection 14.2.24 Test operation
	Scroll displayed information upward or downward by a line to display the preceding or next monitor device that is not currently displayed. When five or more monitor devices are entered, these switches are available when their comments are displayed. : Scrolls information upward by a line. : Scrolls information downward by a line.

(3) The following table below describes the range of display of items 1) to 7) displayed.

No.	Item	Description of setting			
		Bus connection	Direct CPU connection	Computer link connection	CC-Link connection
1)	Network No.	0			
2)	Station No.	FF			FF: When the host station is selected 0: When the master station is selected 1 to 64: When a local station is selected
3)	CPU No.	0 to 4: This item must be set only when the system is connected to multiple QCPUs. It is not necessary when the system is connected to another CPU.			
4)	Word device value	[Decimal number] four digits (including a digit for a sign) are displayed. (Display example: 1234) [Hexadecimal number] four digits are displayed. (Display example: H AB12)			
5)	Device No.	Up to 16 devices can be entered. (When the CPU is an FXCPU, devices cannot be entered.) For further information about device numbers and names that can be entered:			
6)	Device name	GT Designer 2 Version <input type="checkbox"/> Screen Design Manual GT Designer 3 Version1 Screen Design Manual (Fundamentals)			
7)	Monitor display area	Up to 16 devices can be displayed at a time.			

*1: Indicates CC-Link connection (via G4).

14.2.23 Procedure for BM monitor basic operation

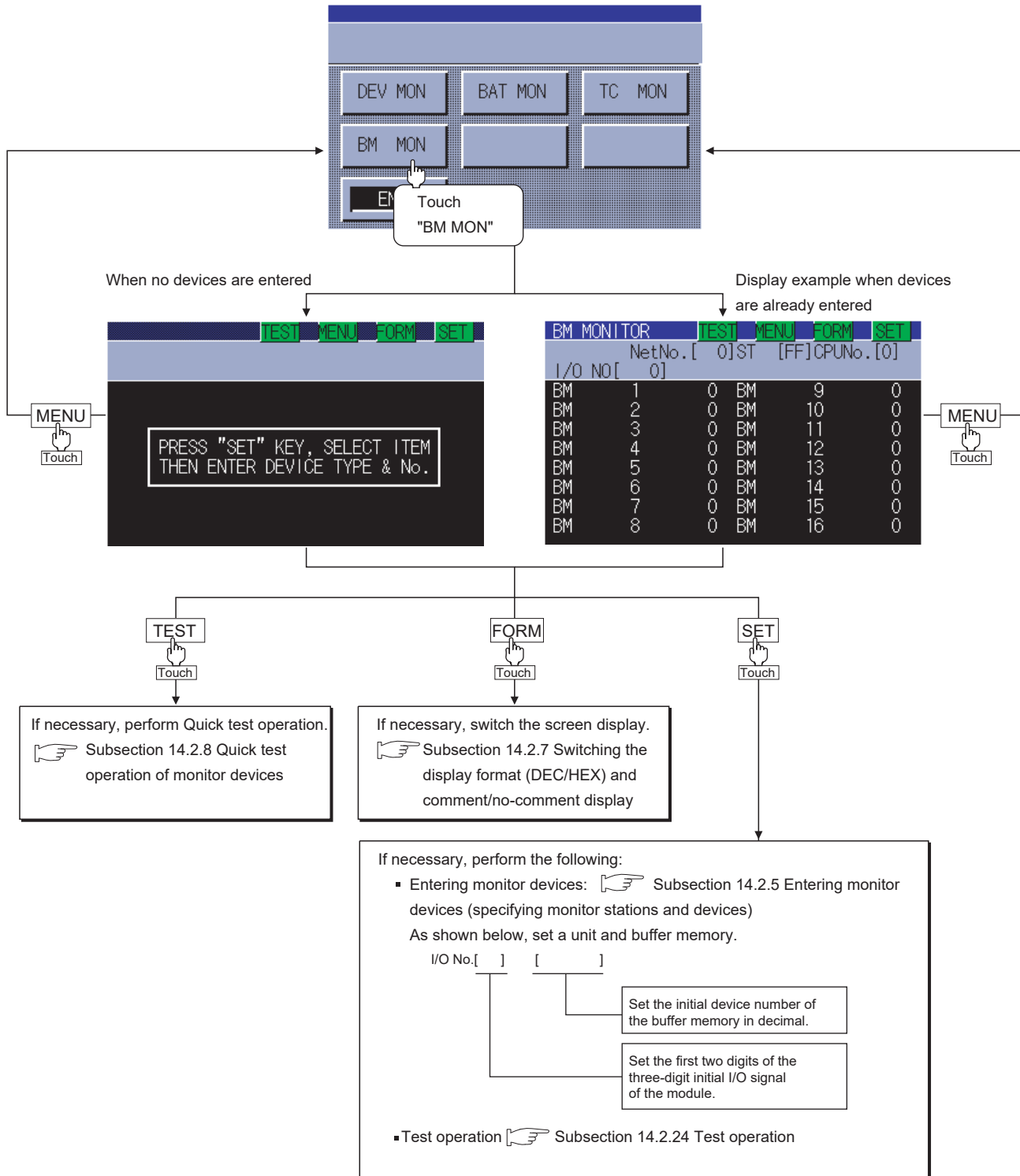

14.2.24 Test operation

! WARNING

- Before performing the quick test operations of the system monitor function (such as turning ON or OFF bit device, changing the word device current value, changing the settings or current values of the timer or counter, and changing the buffer memory current value), read through the manual carefully and make yourself familiar with the operation method.
During test operation, never change the data of the devices which are used to perform significant operation for the system.
False output or malfunction can cause an accident.

You can specify and test any station and device that can be monitored during monitoring by the system monitor function. This section describes how to test the bit or word devices of the controller or the buffer memory of the intelligent function unit.

14.2.25 Procedure for displaying the test menu screen and the setting key window screen

This subsection describes how to display the test menu screen and the setting key window screen.

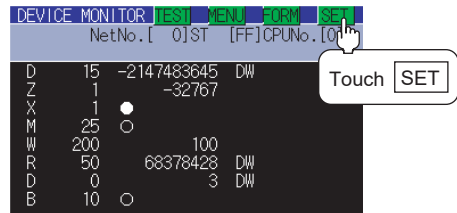

- 1 Touch **[SET]** .
(When performing test operation from the Entry Monitor screen)

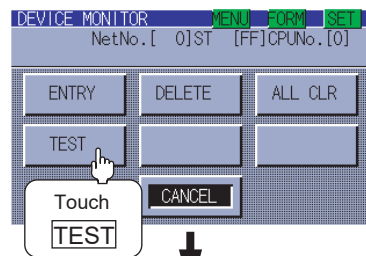

- 2 Touch **[TEST]** .

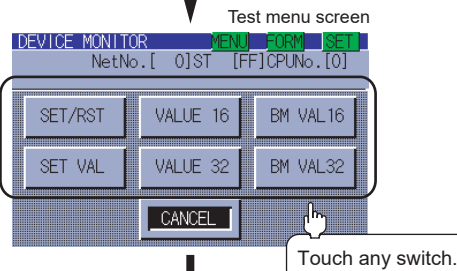

- 3 The test menu screen appears.
Touch **[SET/RST]** , **[SET VAL]** , **[VALUE 16]** , **[VALUE 32]** , **[BM VAL 16]** or **[BM VAL 32]**
Operation example: touch **[SET VAL]**
For a detailed description of each key function, see the following:
☞ Subsection 14.2.26 Information displayed on the test menu screen and key functions

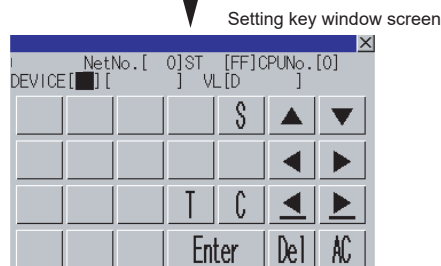

- 4 The setting key window screen appears.
Display example: set value operation screen of T (timer) and C (counter)
For further information about each setting key window, see the following:
☞ Subsection 14.2.27 Information and set items displayed on each setting key window screen
For further information about the test operation procedure, see the following:
☞ Subsection 14.2.28 Test operation procedure

14.2.26 Information displayed on the test menu screen and key functions

(1) Test menu screen

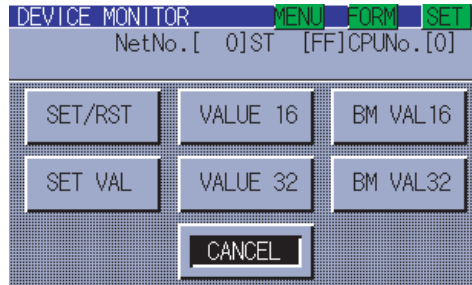

The table shown below describes the key functions.

Key	Function
MENU	Switches the screen to the functional change menu screen to activate another monitor function or terminate the system monitor function. Subsection 14.2.9 Changing screens (common operation)
FORM	Switches the screen to the display format switching screen to change the value display format (DEC/HEX) or comment/no-comment display. Subsection 14.2.7 Switching the display format (DEC/HEX) and comment/no-comment display
SET	Switches the screen to the Device entry screen.
SET/RST	Displays the screen for bit device on/off operation.
SET VAL	Displays the Set value operation screen for T (timers) and C (counters).
VALUE 16	Displays the Present value operation screen for word devices. Data range: 16-bit (one-word) module
VALUE 32	Displays the Present value operation screen for word devices. Data range: 32-bit (two-word) module
BM VAL 16	Displays the Present value operation screen for buffer memory. Data range: 16-bit (one-word) module
BM VAL 32	Displays the Present value operation screen for buffer memory. Data range: 32-bit (two-word) module
CANCEL	Terminates the test menu screen and displays each monitor screen.

14.2.27 Information and set items displayed on each setting key window screen

The information and set items on the setting key window screen to be used for each test are described below.

(1) Information displayed on each setting key window screen

SET/RST
Screen for bit device on/off operation

1) Displays a network No.
2) Displays a station No.
3) Displays a CPU No.
4) Sets on/off
5) Sets a device number.
6) Sets a device name.

SET VAL
Set value operation screen for timers and counters

7) Sets a T/C set value.
Displays whether decimal or hexadecimal is selected.
D: Decimal
H: Hexadecimal

VALUE 16 **VALUE 32**
Present value operation screen for word devices
(16-bit (one-word) module/32-bit (two-word) module)

8) Sets the present value of a word device.

BM VAL 16 **BM VAL 32**
Present value operation screen for buffer memory
(16-bit (one-word) module/32-bit (two-word) module)

9) Sets the initial I/O signal of a module.
10) Sets the initial device number of the buffer memory.

(2) Set items on the setting key window screen

The table shown below describes details of the set items mentioned on the preceding page.

No.	Item	Description of setting			
		Bus connection	Direct CPU connection	Computer link connection	CC-Link connection
					G4 *1
1)	Net No.	0			
2)	Station number	FF			FF: When the host station is selected 0: When the master station is selected 1 to 64: When a local station is selected
3)	CPU No.	0 to 4: This item must be set only when the system is connected to multiple QCPUs. It is not necessary when the system is connected to another CPU.			
4)	On/Off setting	Set "1": On, Set "0": Off			
5)	Device No.	For further information about device numbers and names that can be entered:			
6)	Device name	 GT Designer 2 Version <input type="checkbox"/> Screen Design Manual GT Designer 3 Version1 Screen Design Manual (Fundamentals)			
7)	T/C set value	[Decimal number] 16-bit (one-word) module: Six digits (including a digit for a sign) are set. (Entry example: -12345) 32-bit (two-word) module: Ten digits (including a digit for a sign) are set. (Entry example: -123456789) [D] displayed in the number entry box indicates that the entry is decimal. [Hexadecimal number] 16-bit (one-word) module: Four digits are set. (Entry example: H AB12) 32-bit (two-word) module: Eight digits are set. (Entry example: H ABCDE123) [H] displayed in the number entry box indicates that the entry is hexadecimal.			
8)	Word device present value	[Decimal number] 16-bit (one-word) module: Six digits (including a digit for a sign) are set. (Entry example: -12345) 32-bit (two-word) module: Ten digits (including a digit for a sign) are set. (Entry example: -123456789) [D] displayed in the number entry box indicates that the entry is decimal. [Hexadecimal number] 16-bit (one-word) module: Four digits are set. (Entry example: H AB12) 32-bit (two-word) module: Eight digits are set. (Entry example: H ABCDE123) [H] displayed in the number entry box indicates that the entry is hexadecimal.			
9)	Initial I/O signal of module	Set the first two digits of the three-digit initial I/O signal of the module.			
10)	Initial device number of buffer memory	Set the number in a decimal number.			

*1: Indicates CC-Link connection (via G4).

14.2.28 Test operation procedure

Test operation takes place by setting on the setting key window screen the name and number of a device, initial device number of the buffer memory, and the initial I/O of the module or entering change values. This subsection takes a change of set values as an example to describe the test operation procedure.

- 1 Touch the **SET VAL** key on the test menu screen.
The setting key window screen appears.

- 2 Using the **◀** and **▶** keys, move the cursor to the item you want to set.

The keyboard displayed depends on the position of the cursor, as shown below.

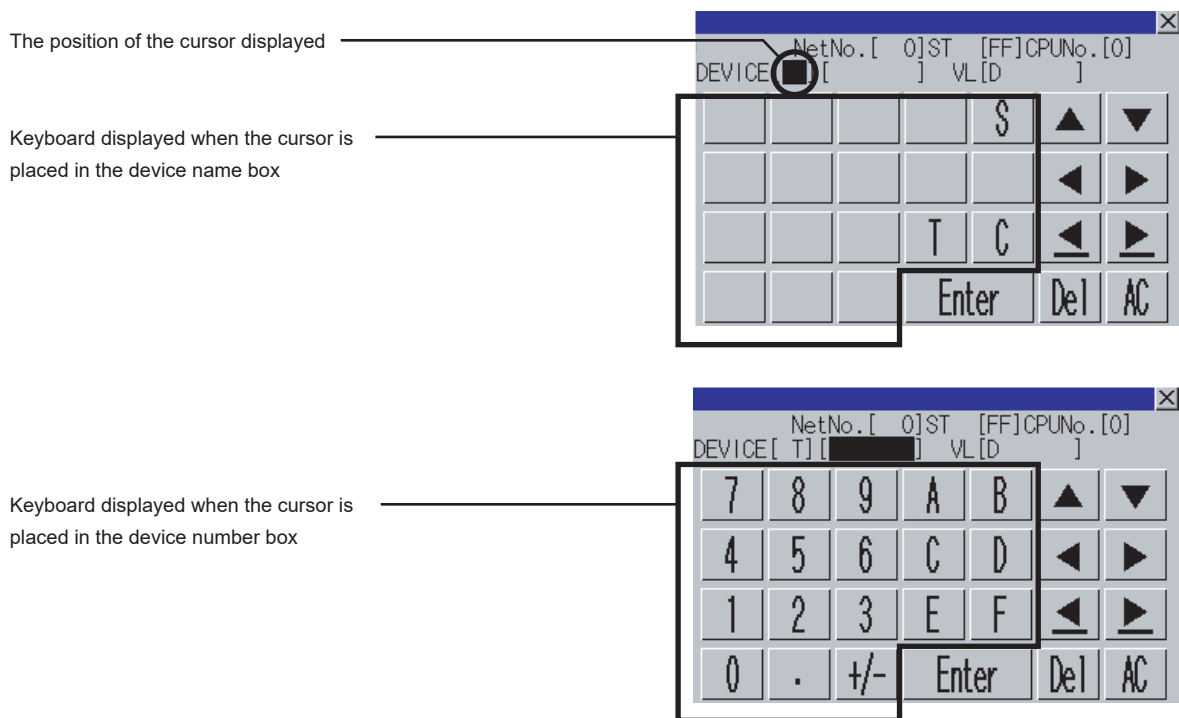

- 3 If necessary, enter numbers or characters on the keyboard.
 - **Del** key: Use the **Del** key to delete an entered character.
 - **AC** key: Use the **AC** key to delete all characters under the cursor.
 - The **▲/▼** and the keys on which nothing is displayed are not available.
 - For further information about the setting ranges, see the following:
 - ☞ Subsection 14.2.27 Information and set items displayed on each setting key window screen
- 4 Entry is completed by touching the **Enter** key.
- 5 The keyboard closes by touching the **✕** key.

Point

Operating the set values of timers and counters

(1) Time-up/Count-up status

Even if a set value or present value is changed after a timer or counter is up, the time-up or count-up status does not change. The present status is retained.

(2) Changing an index qualifier

Only the constant part of a T/C set value with a qualifier can be changed. The index qualifier cannot be changed.

(Example) Change the set value of T5 from 300 to 200.

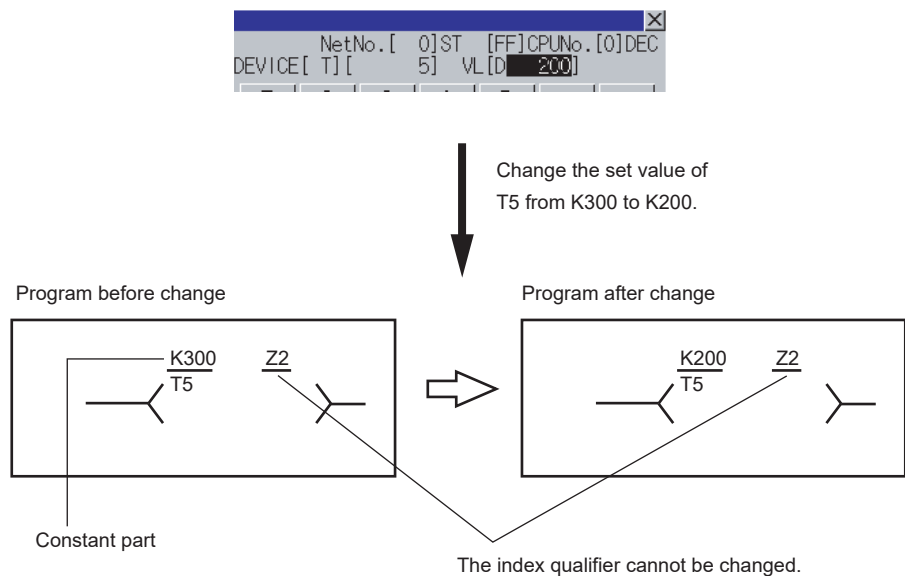

(3) Operation when a password is entered for the controller

When the target controller is a QCPU, the Keyword Release screen appears. Enter the password.



1) Enter the password entered in the sequence program at 1).

- **A-Z** key : Touch this key to enter alphabetic characters A to Z (uppercase).
- **a-z** key : Touch this key to enter alphabetic characters a to z (lowercase).
- **0-9** key : Touch this key to enter numbers 1 to 9.
- **Del** key : Use this key to delete an entered character.
- **AC** key : Use this key to delete all characters under the cursor.

2) Entry is completed by touching the **Enter** key, and the keyboard closes.

14.2.29 Test operation basic procedure

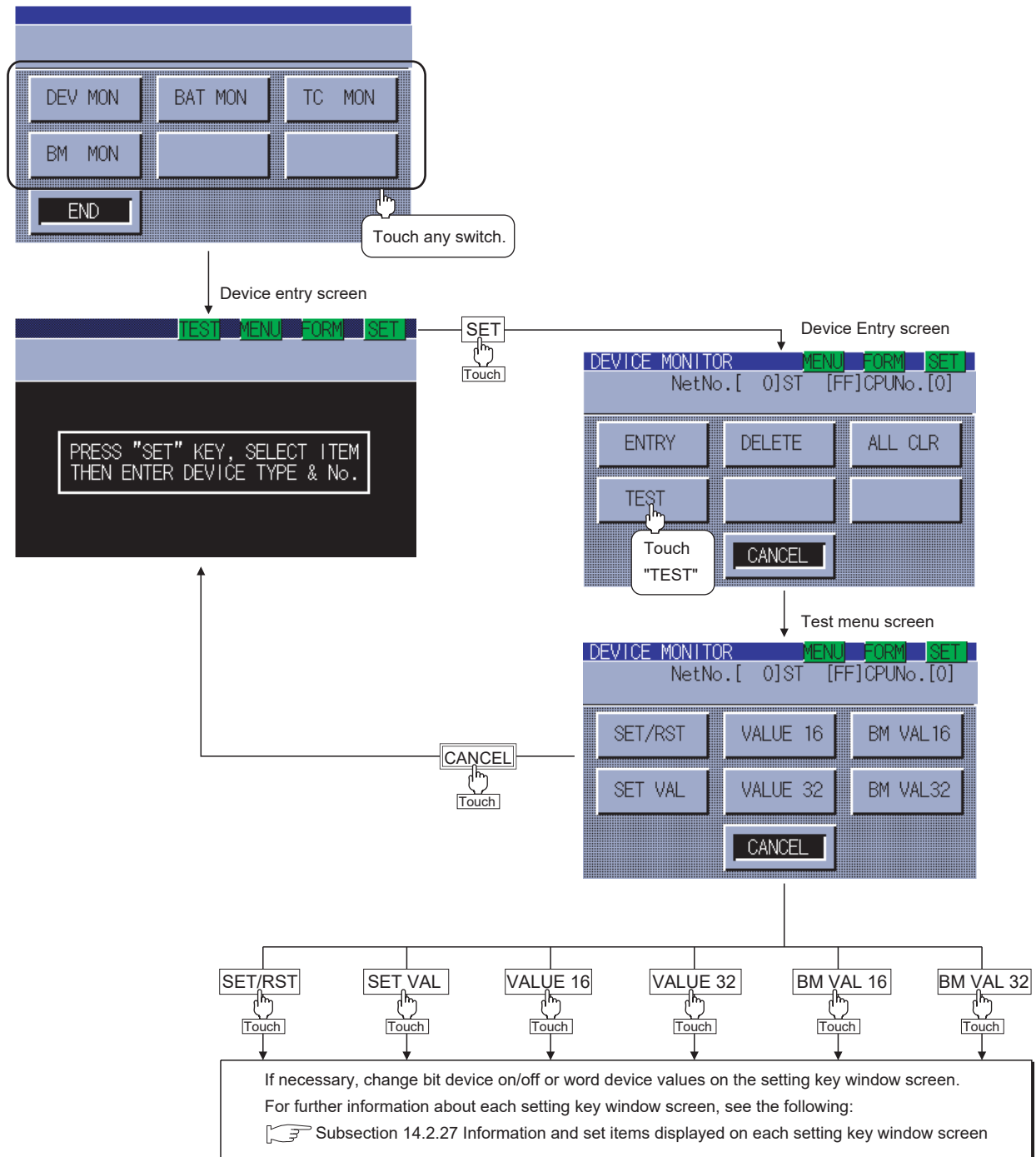

14.2.30 Error messages and corrective actions

This section describes the error messages displayed when the system monitor function is executed, and corrective action.

Error message	Description	Corrective action
PLC communications error	Communication could not be established with the PLC CPU.	<ul style="list-style-type: none">(1) Connections between the PLC CPU and the GOT. (disconnected or cut cables).(2) Has an error occurred in the PLC CPU.(3) Refer to the following manual for confirming whether the error has occurred in network.  GT11 User's Manual

14.3 MELSEC-A List Editor

The MELSEC-A list editor enables you to change the sequence program in the ACPU/QCPU (A mode). This function is intended to troubleshoot the PLC system and to streamline maintenance operations. By installing list editor for MELSEC-A, an Option OS, from drawing software into the GOT, you can edit the ACPU/QCPU (A mode) PLC program. The features of the MELSEC-A list editor are described below.

1 Parameters and sequence programs are easy to maintain

You can check or partly correct, change or add PLC CPU parameters and sequence programs simply by operating keys.

You can easily edit sequence programs without preparing any peripheral unit other than the GOT.

Example of changing sequence program commands

```
LD X0      Changed      LD X0
OUT Y20    ───────────> MOV D0 D1
LD X1      LD X1
```

2 Other stations are accessible

You can edit the sequence program for other stations in the data link system containing the GOT (or GOT-connected station), network system or CC-Link system.

3 Help function

A convenient help function is supported, which enables you to read, write, insert, and delete data as you select menus.

4 Comment for each device can be displayed

Comment of the device at the cursor position can be displayed.

```
W 9 OUT M50
^ 10 MOV
10▶ D1
   Current value
```

← Comment of D1 is displayed.

9 UTILITY FUNCTION

10 COMMUNICATION INTERFACE SETTING

11 DISPLAY AND OPERATION SETTINGS

12 CLOCK SETTINGS AND BATTERY STATUS DISPLAY

13 FILE DISPLAY AND COPY

14 GOT SELF CHECK

15 CLEANING OF DISPLAY SECTION

16 INSTALLATION OF CoreOS, BOOTOS AND STANDARD MONITOR OS

14.3.1 Specifications

1 System configuration

This subsection describes the PLC CPU series names and the connection forms between the GOT and the PLC for which the MELSEC-A list editor is available.

For further information about communication units and cables for each connection form, see the following:

 GOT1000 Series Connection Manual

2 Targeted PLC

PLC

ACPU/QCPU (A mode)^{*1*2}

*1 Motion controller CPUs cannot be connected. The message "MOTION CONTROLLER NOT SUPPORTED" will be displayed when the MELSEC-A list editor function is activated.

*2 When the PLC is A2USH-S1, it operates within the range of A3U; when the PLC is the A2SH-S1, A2SH, A1SH, or A1SJH, it operates within the range of A3N.

3 Connection forms

When the GOT is connected to an ACPUCPU (A mode)

(○: Available, ×: Unavailable)

Function name	Connection form between GOT and PLC				
	Bus connection ^{*1*3}	Direct CPU connection	Computer link connection	CC-Link connection ^{*1*2}	GOT multidrop connection
				G4 ^{*4}	
MELSEC-A list editor	○	○	×	×	×

*1 When the PLC is the A2SH-S1/A2SH/A1SH/A1SJH, use a CPU of version E or a later version.

Programs cannot be written to CPUs of version D or an earlier version.

*2 When the PLC is A3N, A2N-S1, A2N, or A1N, it can not be used.

*3 When the PLC is QCPU (A mode), it cannot be used.

*4 Indicates CC-Link connection (via G4).

4 Required option OS and option function board

The option OS and option function board shown below are required.

Option OS	OS memory space (user area)	Option function board
MELSEC-A list editor	0KB	GT11-50FNB

(1) Option OS

Install the option OS in the above table to the GOT.

Refer to the following manual for the procedure for installing the option OS.

 GT Designer2 Version □ Basic Operation/Data Transfer Manual
GT Designer3 Version1 Screen Design Manual (Fundamentals)

(2) OS memory space

The available memory space shown in the table above is required in the user area to install the option OS to the GOT.

Refer to the following manual for the procedure for checking the available memory space of the user area and information about the data using other user areas.

 GT Designer2 Version □ Basic Operation/Data Transfer Manual
GT Designer3 Version1 Screen Design Manual (Fundamentals)

(3) Option function board

Mount one of the option function boards in the above table on the GOT.

For how to mount an option function board on the GOT, refer to the following manual.

 Section 8.3 Option Function Board

14.3.2 Access range

The access range is the same as the access range when the GOT is connected to a controller. Refer to the following manual for details of the access range.

 GT Designer2 Version □ Screen Design Manual
GOT1000 Series Connection Manual (Mitsubishi Products) for GT Works3

14.3.3 Precautions

The points of precaution when using MELSEC-A list editor are described.

- (1) Reading the MELSEC-A list editor by specifying a command
The MELSEC-A list editor cannot be ready by specifying a dedicated command.
- (2) Executing the MELSEC-A list editor
Execute the MELSEC-A list editor when the target PLC is not running.
It cannot be executed when the PLC is running.
- (3) Changing sequence programs/parameters using another peripheral equipment
When using the MELSEC-A list editor, do not change programs or parameters in the PLC CPU from other peripheral equipment.
If you change programs or parameters, either reset the GOT main unit or set the PLC No. again.
If you carelessly change the program on one PLC from multiple units of peripheral equipment (including GOT), the contents of the program in the PLC CPU and the peripheral equipment may not be the same, resulting in an unintended operation of the PLC CPU.
- (4) Writing sequence programs
Sequence programs cannot be written when the target CPU is operating EEPROM.

14.3.4 Display

1 Outline until the start

This subsection describes an outline until the system monitor screen is displayed after List editor for MELSEC-A (Option OS) is installed in the GOT.

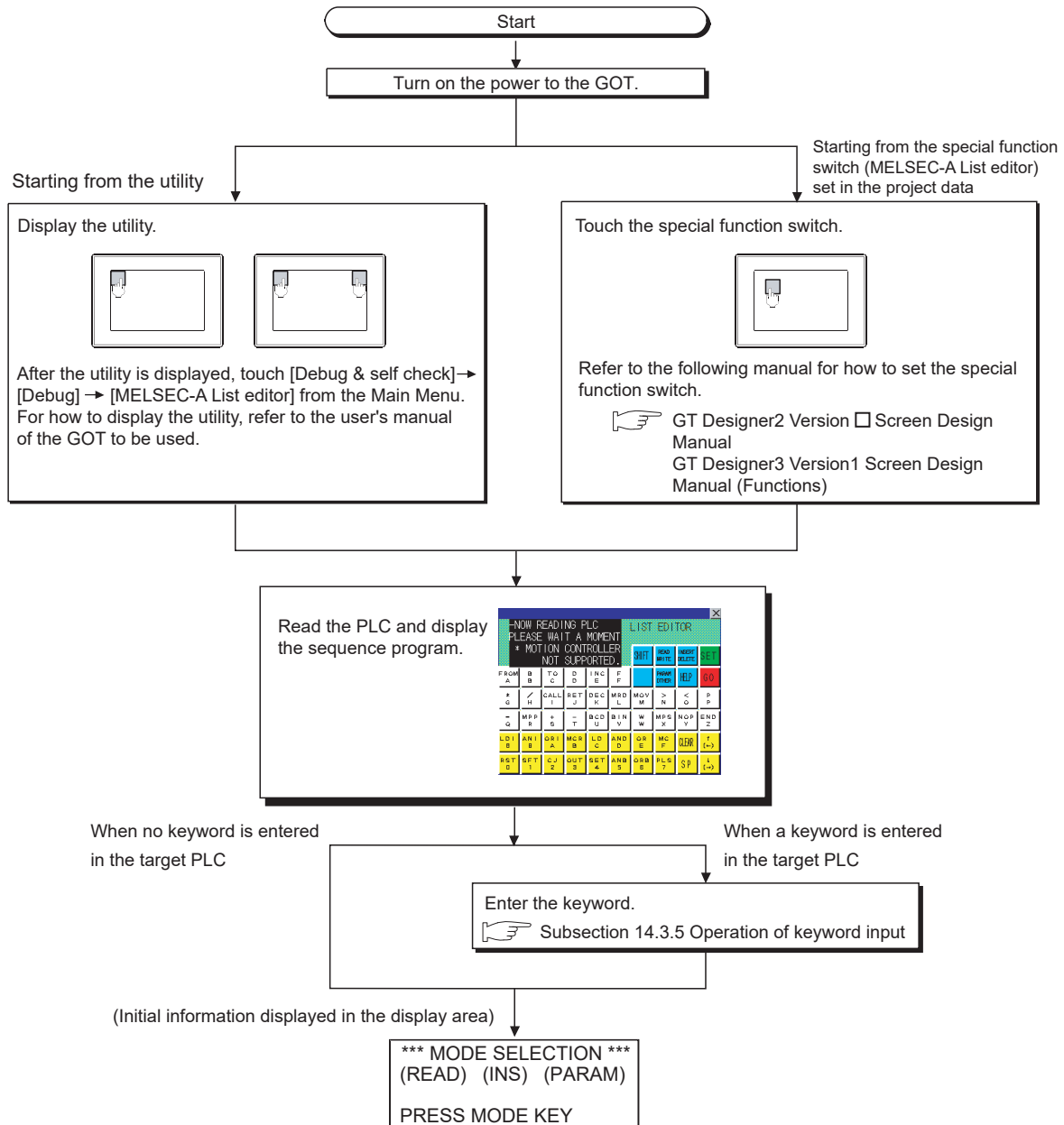

Point

- (1) How to display the utility

For how to display the utility, refer to the following.

☞ Section 9.3 Utility Display

- (2) If the project data has not been downloaded

The A list editor can be started from the utility even if the project data has not been downloaded to the GOT.

14.3.5 Operation of keyword input

If a keyword is registered in the ACPU when the connected ACPU or the ACPU PLC No. No. corresponding to the operation is changed, the GOT requests for input of the registered keyword. Input the keyword registered in the ACPU and press the **GO** key. If a keyword is not registered in the ACPU, this operation is not required.

Procedure for inputting the keyword for the MELSEC-A list editor

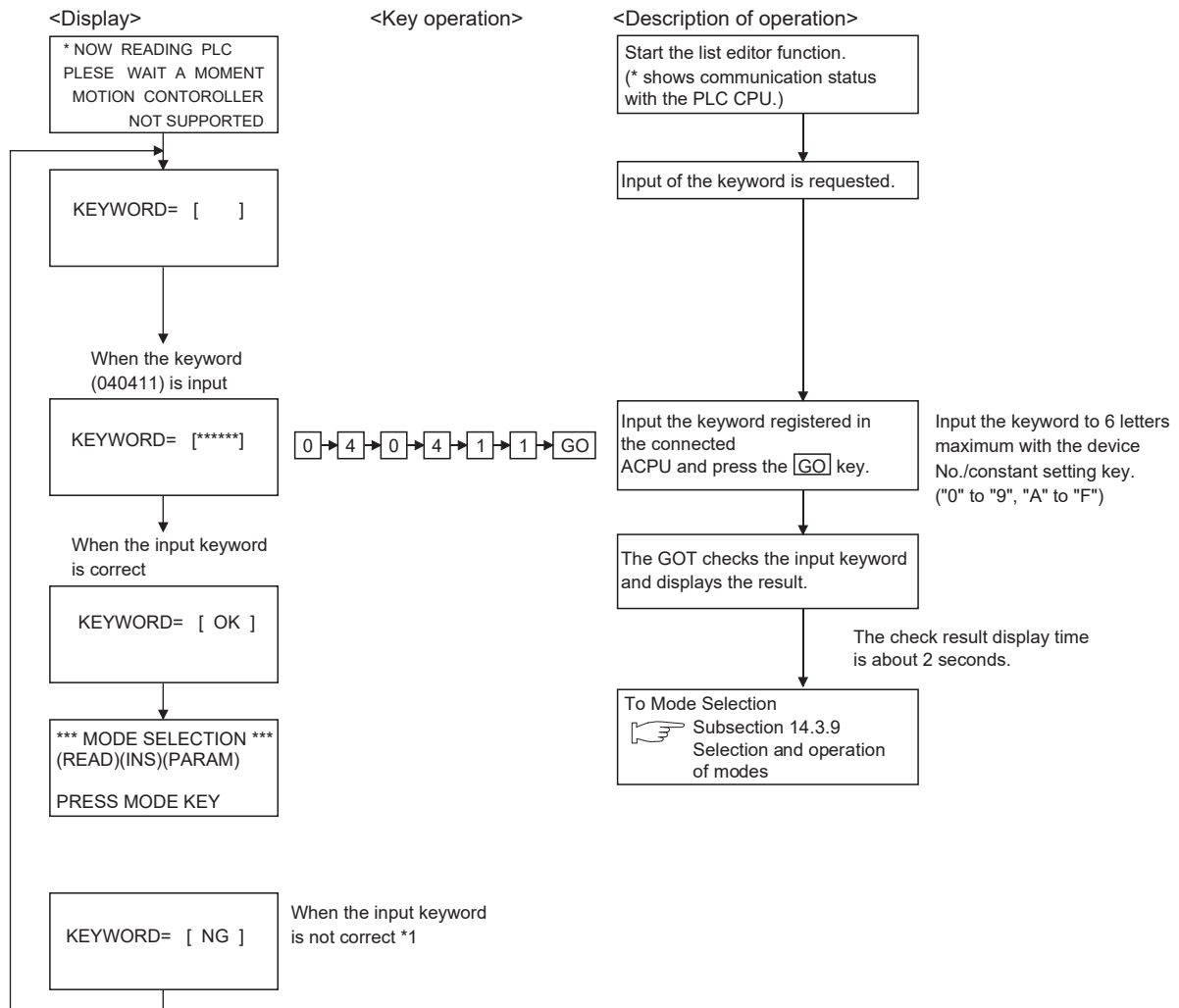

*1 When the input keyword does not match with the registered keyword, only the following operations in subsection 14.3.27 can be allowed.

- Other modes
- Error step reading
 - Buffer memory overall monitor
 - Time monitor
 - PLC No. setting
 - Main/sub switching



When you forgot the keyword entered in the ACPU

- Even if you are unsure of the keyword entered in the ACPU, you cannot delete it independently. If deleting user data, including sequence programs, does not cause any inconvenience to you, clear (delete) the entered keyword by <PLC memory all clear.>

Note that <PLC memory all clear> clears user data, including sequence programs, as well.

For further information about PLC memory all clear, see the following:



Subsection 14.3.19 PLC memory all clear

- When you know the keyword and want to change it or add a new keyword, see the following:



Subsection 14.3.21 Common operation

14.3.6 Operation methods

1 Key arrangement and a list of key functions

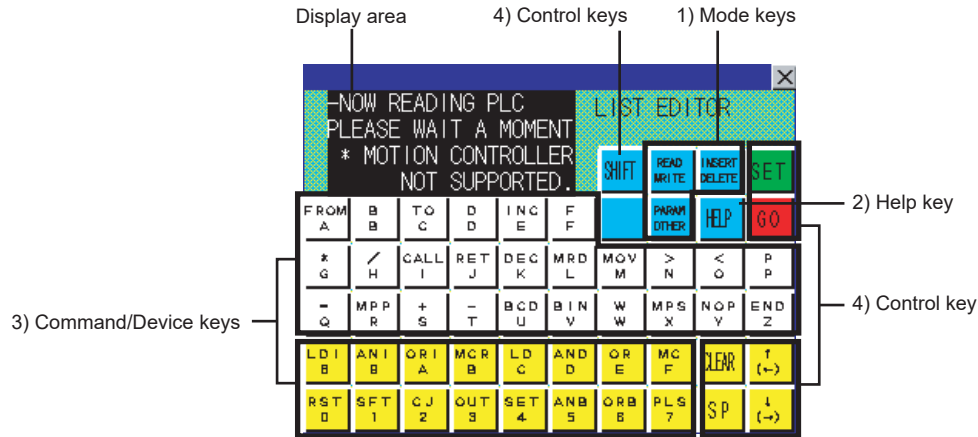

- (1) The arrangement and functions of the keys displayed on the MELSEC-A List Editor window are described below.





Key name	Summary of function	Reference
1) Mode key	The key that specifies read or write mode. Switch the valid key with [SHIFT] .	Subsection 14.3.9 Subsection 14.3.22 Subsection 14.3.23
	The key that specifies insert or delete mode. Switch the valid key with [SHIFT] .	Subsection 14.3.9 Subsection 14.3.24 Subsection 14.3.25
	The key that specifies parameter or other mode. Switch the upper and lower lines with [SHIFT] .	Subsection 14.3.9 Subsection 14.3.26 Subsection 14.3.27
2) Help key	The key that can operate the help function.	Subsection 14.3.18
3) Command/Device key	 Key that inputs K/H at the input of command, device name and constant input. Only when the valid key of upper/lower character needs to be switched, switching is allowed with input of the [SHIFT] and [SET] keys.	-
	 Key that inputs the command, device number and constant. Only when the valid key of upper/lower character needs to be switched, switching is allowed with input of the [SHIFT] and [SET] keys.	-
	Key that declares start of step number input or automatic scroll. Switch key that makes the lower character valid on each key with dual functions. Whether upper or lower character is valid can be checked on the display.	Subsection 14.3.9
4) Control key	Switch key that makes the upper character valid on each key with dual functions. Whether upper or lower character is valid can be checked on the display.	Subsection 14.3.9
	When the Help function is used, the screen returns to the display at the input of the [HELP] key. In the Parameter mode, the process is cancelled. After restarting, continue the operation.	-
	If the Clear key is pressed when the system is not in the Parameter mode, Other mode or Help function, the screen returns to the initial status of the mode selection. (The input commands or device numbers except for the mode are cleared.) This is used for repeating the procedure if incorrect keys are pressed. In the Other mode, the screen returns to the previous display.	Subsection 14.3.11
	Key that provides blank space at the command and at between device names.	-
	 Key that moves the cursor on the display (▶, ■) or determines scroll directions.	Subsection 14.3.8
	Press this key at the last of a series of key operations to execute the operation. Check the details of key operations on the display before pressing this key.	Subsection 14.3.10

(2) How to express keys and key operation descriptions





The keys for the MELSEC-A list editor and operation procedures are described in text in a simplified manner as shown below.

- (a) Some keys, such as  and , are available for two different purposes. Operate such keys with either the upper or lower function indicated on them valid according to the operation. In descriptions, only the necessary functions are indicated on keys. (Example of description)





When entering the character "M," the  key is indicated as  in the description.

Make upper or lower functions valid by using the  key or the  key. For further information about the procedure for making upper or lower functions valid, see the following:

 Subsection 14.3.8 Switching valid keys (upper/lower functions)

- (b) The expression  →  → ...  means touching keys from  to  in order.

(Example of description)

The example of description shown below indicates that  must be touched first,  second,  third, and  finally.



14.3.7 Display format of the display area

The following describes the position and content of each data field in the MELSEC-A list editor display area.

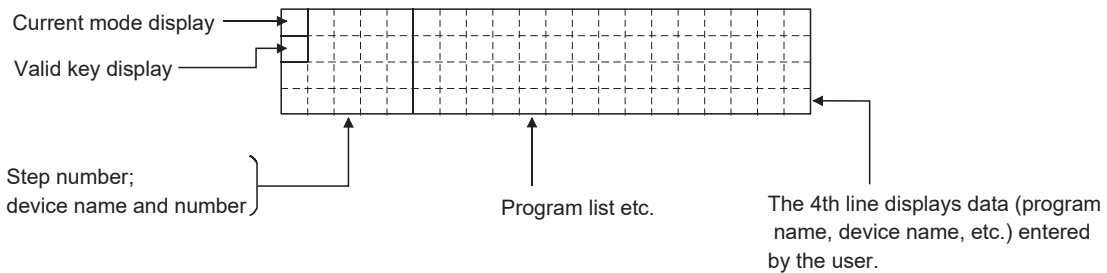

(1) Mode and valid key display

The following describes the mode and valid key display.

The mode display shows the MELSEC-A list editor mode selected by the user.

The valid key display shows which of the two functions assigned to each key is currently available: the function indicated at the upper part of the key or the function indicated at the lower part of the key.

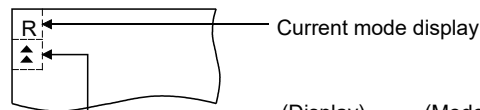

(Display)	(Mode)
R	Read mode
W	Write mode
I	Insert mode
D	Delete mode
P	Parameter mode
O	Other mode

Valid key display (This display is not always available.)

With regard to keys framed in dotted lines in the figure shown at the left, the valid key display indicates which of the two functions assigned to each key is valid:

- ▲ : Function indicated at the upper part of each key is available.
- ▼ : Function indicated at the lower part of each key is available.

Example: FROM key

- ▲ : Function indicated at the upper part of the key is available. FROM
- ▼ : Function indicated at the lower part of the key is available. A

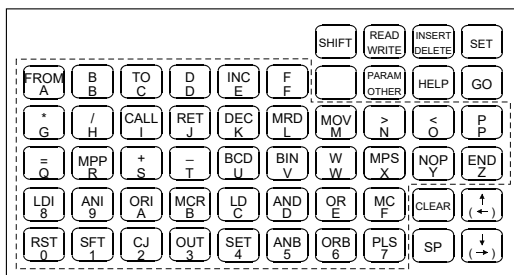

To switch between two functions of keys (functions indicated at upper and lower parts of the keys), press the **SHIFT** and **SET** keys.



Subsection 14.3.8 Switching valid keys (upper/lower functions)

- (2) The cursor appears

The cursor appears ■ and is highlighted during data input.

- (3) Indication of the selected line

When a program list is displayed, the line currently selected for editing is indicated by "▶" appearing immediately after the step number.

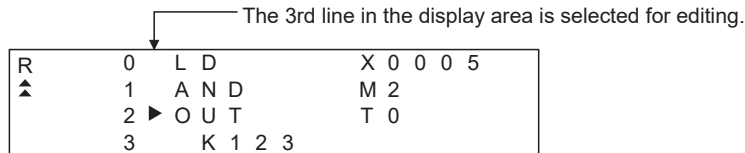

You can use the ↑ and ↓ keys to move "▶" up and down.

- (4) Step number display

A step number is displayed as a decimal number.

On the 1st and 2nd lines in the display area, significant digits in the lower four digits of a step number are displayed.

On the 3rd and 4th lines in the display area, up to five significant digits in a step number are displayed.

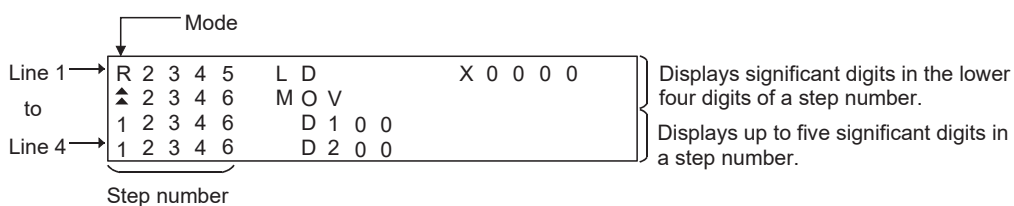

- (5) Device display

Two or more device specifications attached to a basic or application instruction are displayed using the same step number.

For information on the step numbers, see Paragraph (4) above.

- (6) Display of data input from the keys

Data input from the keys will appear at the cursor position. As more characters are input, the cursor moves to the right.

The cursor appears as "■".

Example: The user enters SET → 1 → 0

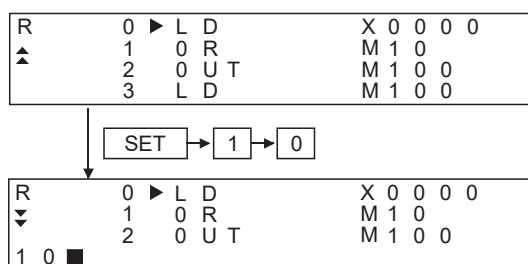

(7) Shifting of data to the left during the input of a program

When the user inputs a program, the codes entered before a touch on the **GO** key will appear on the 4th (bottom) line of the display area.

If the codes cannot appear on a single line, the display on the 4th line only will shift by a single character position to the left each time the user touches a key. (Each character that goes out of the display area by the left-shift operation is retained in the memory.)

W	1	1	5		M	5		X	0	0	0	5
▲	1	2	0		L	D		M	3			
	1	2	1	▶	N	O	P					
P	K	2	1	4	7	4	8	3	6	4	7	D 1 0 0 0 ■

↑ The user has entered "DMOVP K2147483647 D1000".

You can move " ■ " in the specified direction (right or left) with the **←** or **→** key.

(8) Display of an error message

An error message will appear on the 4th line of the display area.

An error message on the display is cleared when you press any key. Then the display resumes the state before the appearance of the error message.

When an error message is displayed, take action according to the procedure described in the following section:

 Subsection 14.3.28 Error messages and corrective actions

14.3.8 Switching valid keys (upper/lower functions)

Make valid the upper or lower function of keys available for two different purposes to operate the MELSEC-A list editor.

- (1) Switching the upper and lower functions of mode keys
In general, the upper functions of mode keys are valid.

To make the lower function of a mode key valid, touch the key and then the mode key. During switching of the upper and lower functions of mode keys, the mark on the valid keys remains ▲.

- (2) Switching the upper and lower functions of command/device keys
Switch the upper and lower functions of command/device keys using the keys shown below, if necessary.

:Makes the upper function valid.

:Makes the lower function valid.

* The keys shown below can be operated even if the lower function of a key is valid.

(You do not need to operate the key.)

- Comparison symbol keys at the input of comparison operation commands: , ,
- Minus key in command source data:

For further information about the display of valid keys, see the following:

 Subsection 14.3.7 Display format of the display area

- (3) Valid command/device keys after setting each mode
Valid command/device keys after setting each mode are shown below.
- (a) Valid keys after setting read, write, and insert modes.
The upper functions of the command/device keys are valid.
If necessary, switch the upper and lower functions of necessary keys for operation.
- (b) Valid keys after setting parameter, other, and help modes.
The lower functions of the command/device keys are valid.
If necessary, switch the upper and lower functions of necessary keys for operation.

14.3.9 Selection and operation of modes

Select appropriate modes of the MELSEC-A list editor for the operations described in Subsections 14.3.13 and 14.3.20.

You can change modes as you desire during any of the operations described in Subsections 14.3.13 and 14.3.20, so that you can continue operations while changing modes.

<input type="button" value="READ"/>	Read mode
<input type="button" value="WRITE"/>	Write mode
<input type="button" value="INSERT"/>	Insert mode
<input type="button" value="DELETE"/>	Delete mode
<input type="button" value="PARAM"/>	Parameter mode
<input type="button" value="OTHER"/>	Other mode



Mode key input is always valid.

Input of the mode key clears the input data except for the step numbers. The display returns to the initial status of the mode selection.

14.3.10 Command input procedures

Command input procedures can be classified as follows:

- 1) Input the command key to use the command on the key.
- 2) Input the alphanumeric keys corresponding to each character of command sequentially.
- 3) Select and input the command to be used from the Help function.

Command input procedures for 1) and 2) above are as follows.

For command input procedure 3) from the Help function, refer to Subsection 14.3.10 Command input procedures



When the command is input, the input details are displayed at the 4th line (the bottom line) on the display. In the following description, the input of **[SP]** key may be omitted when a blank space between the input command and the cursor position is automatically inserted. Refer to the example in each description.

- (1) For command code only

- (a) When the command available on the keyboard is input

[Command] → GO

- (Ex) When END is input

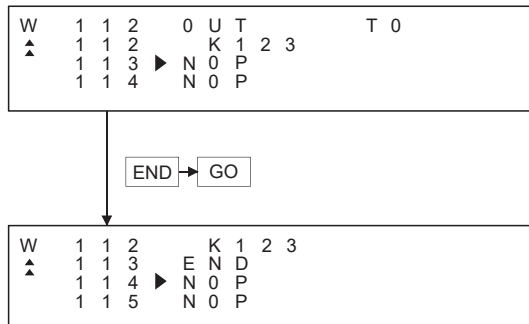

- (b) When the command not available on the keyboard is input

- (Ex) When FOR K5 is input

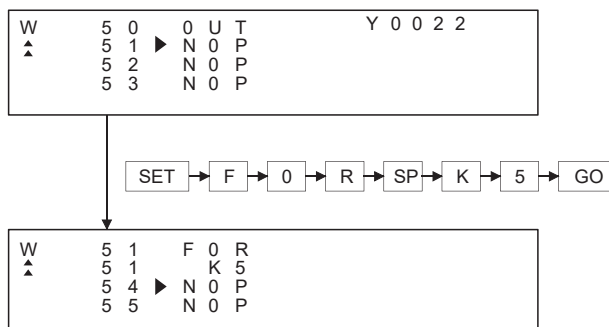

(2) For command code and device (1)

[Command] → [SP] → [DEVICE] → [DEVICE No.] → [GO]

(Ex) When LD X0 is input

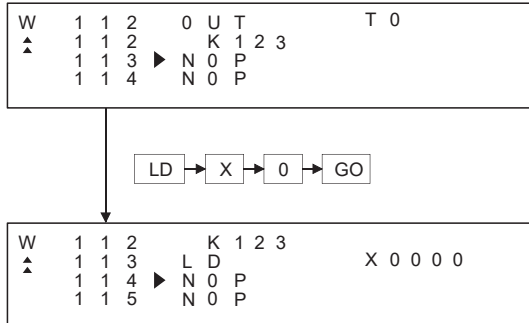

(3) For commands other than above

Input the [SP] key between the command and the device, the source data, and the destination data.

(Ex 1) When FMOV K2 D0 K5 is input

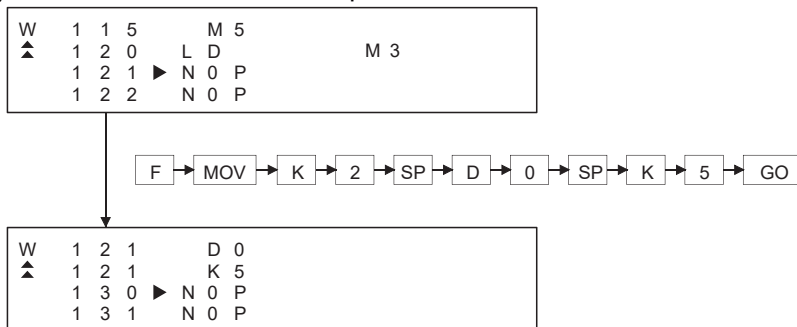

(Ex 2) When OUT T1 K10 is input

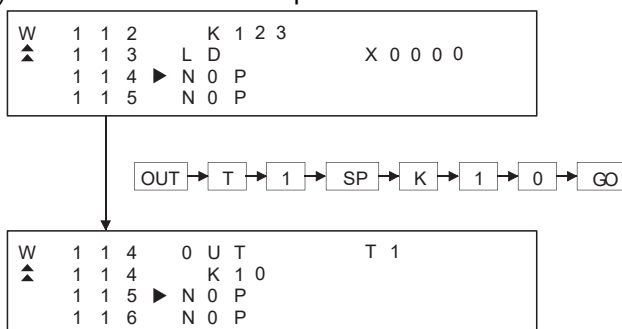

(Ex 3) When MC N3 M5 is input

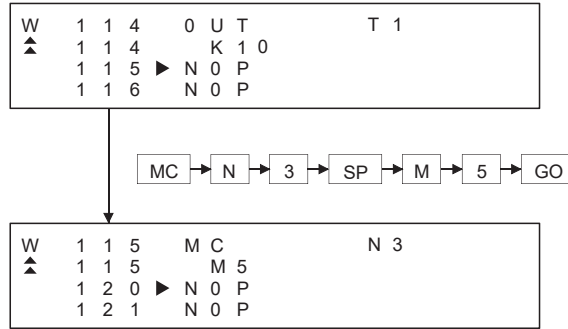

(Ex 4) When LD = K10 D10 is input

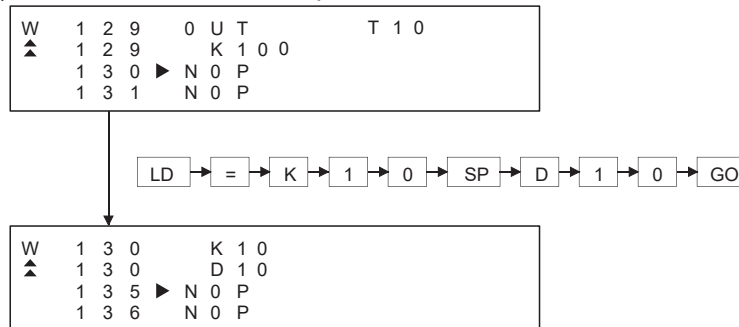

(Ex 5) When ANDD<=H7FFFF D20 is input

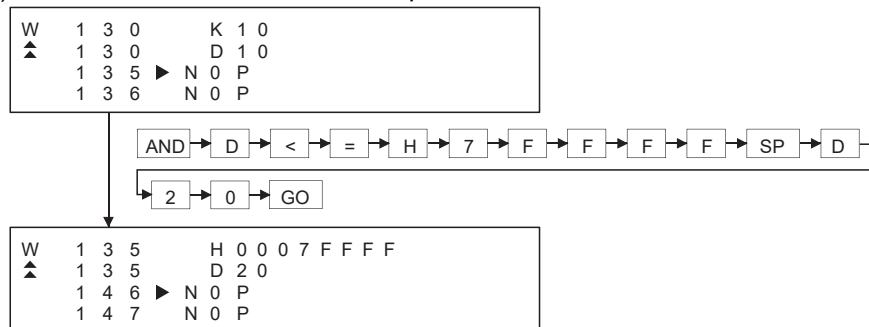

(4) Handling of devices M, L and S

Devices M, L and S in the Test, Monitor, Write and Insert modes change the display depending on the set parameters.

If LD L0 is input for the parameter setting of M0 to 999 and L1000 to L2047, the result is LD M0.

- (5) For extension timer/extension counter of AnA and AnUCPU
 When the extension timer (T256 to T2047) and the extension counter (C256 to C1023) are input as the first device of the command, input the first device and the device number.

(Ex) When OUT T256 D500 is input

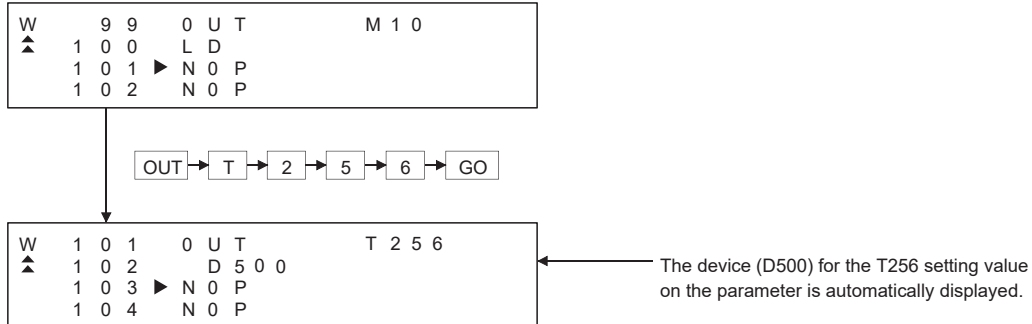

When the extension timer and the extension counter are used, be sure to set the 257 points or more and the setting value device (D, W, R) on the parameter for both the timer and the counter.

14.3.11 Action if an incorrect key is input

If an incorrect key is input, cancel the input contents.

1 Operation

- (1) Before touching the **GO** key (before reading/writing the input contents)
 Before touching the **GO** key, touch the **CLEAR** key.
- (2) After touching the **GO** key (after reading/writing the input contents)
 Write the command again. (👉 Subsection 14.4.9 Writing commands)
 Commands finalized by writing and inserting operations are revised (overwritten) with the program writing.



When the **CLEAR** key is input in the parameter mode, the GOT stops the process. To continue the operation, carry on the key input.

14.3.12 List of functions

The table below shows the functions available for each mode.

Mode (mode display)	Function
Write (W)	Writes, adds, or modifies a program.
	Changes a device used at the selected step in the program.
	Displays a list of instructions that start with the specified character and allows the user to choose from them.
	Reads a program after allowing the user to specify a step number.
	Declares the specified part of the program NOP.
	Displays a comment for the specified device.
Read (R)	Reads a program after allowing the user to specify a step number.
	Reads a program after allowing the user to specify an instruction used.
	Reads a program after allowing the user to specify a device used.
	Automatically scrolls the display of a program that has been read up to a specified step.
	Corresponds to program read and automatic scroll functions described above.
	Displays a comment for the specified device.
Insert (I)	Inserts a new program into the displayed program.
	Displays a list of instructions that start with the specified character and allows the user to choose from them.
	Reads a program after allowing the user to specify a step number.
	Moves the selected part of the program to a specified part of the program.
	Copies the selected part of the program to a specified part of the program.
	Displays a comment for the specified device.
Delete (D)	Deletes a program at the specified step.
	Deletes the specified block in the program.
	Deletes all NOP instructions found in program codes described before the END instruction. (NOPLF instructions will not be deleted.)
	Displays a comment for the specified device.
Parameter (P))	Clears all parameters in the ACPU only.
	Sets or changes various parameters like those for the memory capacity, timer/counter, and latching range.
	Sets or changes a keyword.
Others (O)	Changes values set to timer/counter devices.
	Displays details of an error in the ACPU and the associated step number.
	Checks duplex coils, instruction codes, and other elements in the program.
	With regard to a special function unit of the specified I/O number, monitors the contents of the buffer memory at the specified address.
	Monitors the ACPU clock (D9025 through D9027).
	Clears all contents of the ACPU memory and resets it to the initial state.
	Clears the program (Main/Sub) currently selected.
	Clears all device memories except for special-D, special-M, and R.
	Switches the target ACPU in GOT operations in each mode.
	Switches the target program (Main/Sub) in GOT operations in each mode.
Forcibly changes the ACPU running status between RUN and STOP.	
Performs a read or write operation to the ACPU memory in the machine language.	

14.3.13 Basic Operation

This section takes an easy operation example to describe the basic operation of the MELSEC-A list editor.

14.3.14 Reading sequence programs

[Operation example]

<p><Key operation></p> <p>① Select the "Read" mode. [READ]</p> <p>② Read the 0th step. [SET] → [0] → [GO]</p> <p>③ [GO]</p>	<p><Display></p> <table border="1"><tr><td>R</td><td>7</td><td>D20</td></tr><tr><td>▲</td><td>14</td><td>END</td></tr><tr><td></td><td>15</td><td>▶NOP</td></tr><tr><td></td><td>16</td><td>NOP</td></tr></table> <table border="1"><tr><td>R</td><td>0</td><td>▶LD</td><td>X0000</td></tr><tr><td>▲</td><td>1</td><td>OR</td><td>Y0010</td></tr><tr><td></td><td>2</td><td>ANI</td><td>X0001</td></tr><tr><td></td><td>3</td><td>OUT</td><td>Y0010</td></tr></table> <table border="1"><tr><td>R</td><td>3</td><td>OUT</td><td>Y0010</td></tr><tr><td>▲</td><td>4</td><td>▶OUT</td><td>T0</td></tr><tr><td></td><td>4</td><td>K10</td><td></td></tr><tr><td></td><td>5</td><td>LD</td><td>T0</td></tr></table> <p style="text-align: center;">↓</p> <p>Scroll the screen with the [GO] key.</p>	R	7	D20	▲	14	END		15	▶NOP		16	NOP	R	0	▶LD	X0000	▲	1	OR	Y0010		2	ANI	X0001		3	OUT	Y0010	R	3	OUT	Y0010	▲	4	▶OUT	T0		4	K10			5	LD	T0
R	7	D20																																											
▲	14	END																																											
	15	▶NOP																																											
	16	NOP																																											
R	0	▶LD	X0000																																										
▲	1	OR	Y0010																																										
	2	ANI	X0001																																										
	3	OUT	Y0010																																										
R	3	OUT	Y0010																																										
▲	4	▶OUT	T0																																										
	4	K10																																											
	5	LD	T0																																										

14.3.15 Changing (Overwriting) commands

The example shown below is used to describe how to change sequence program commands.

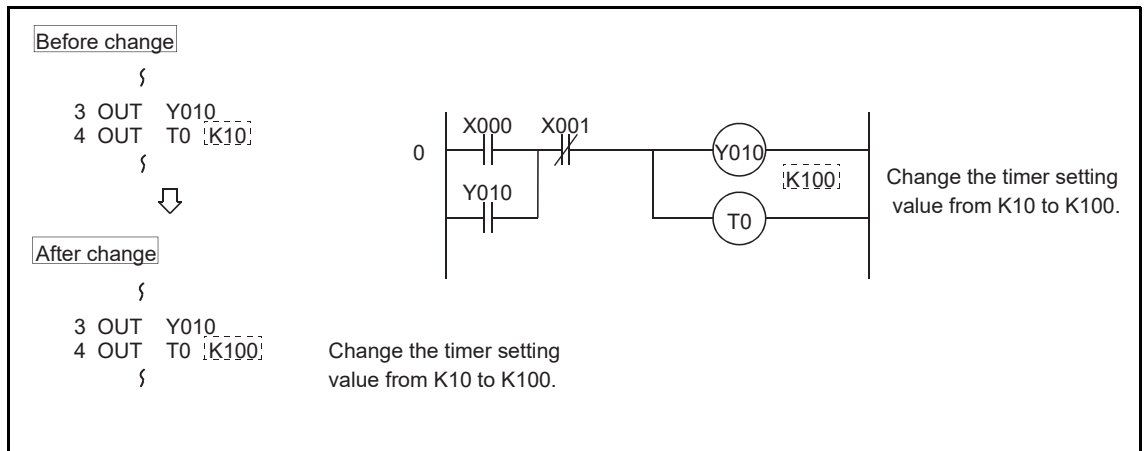

[Operation example]

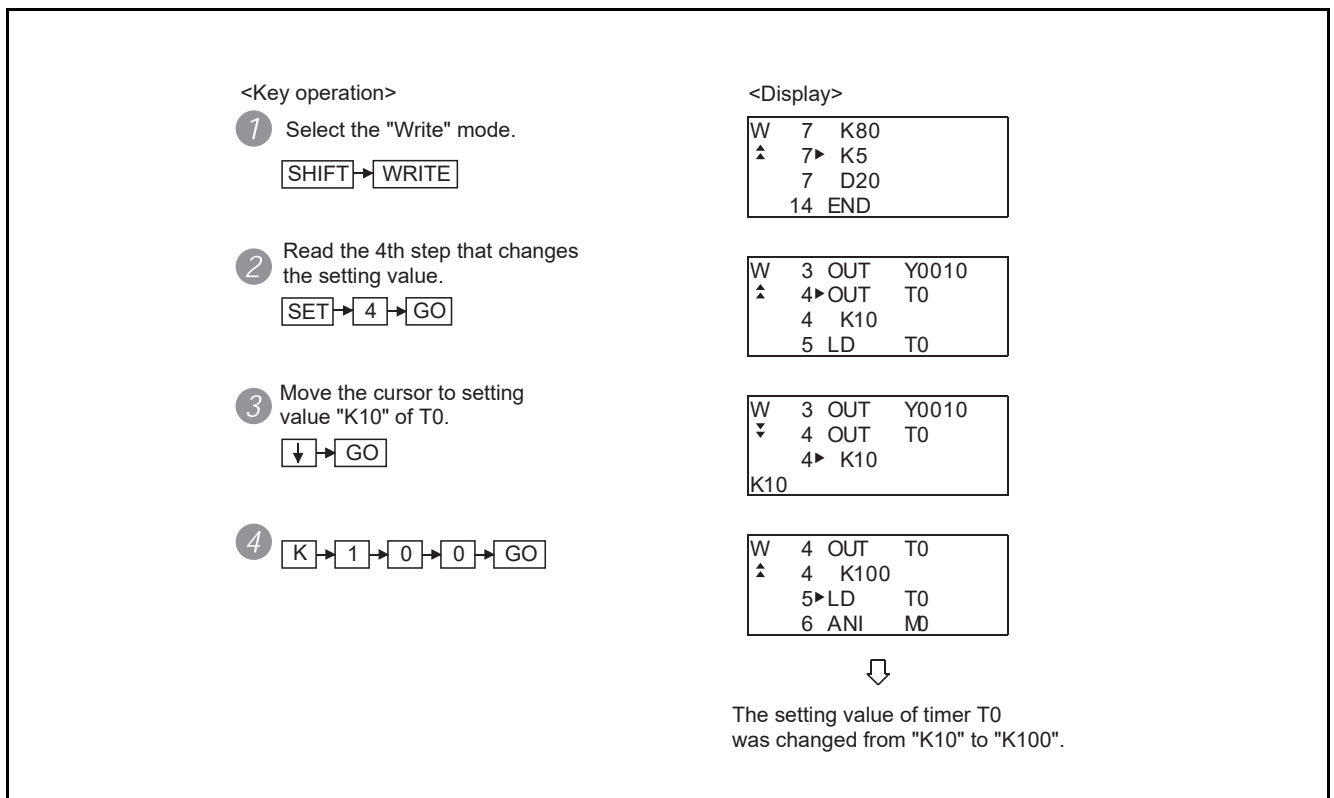

14.3.16 Adding (Inserting) commands

The example shown below is used to describe how to add sequence program commands.

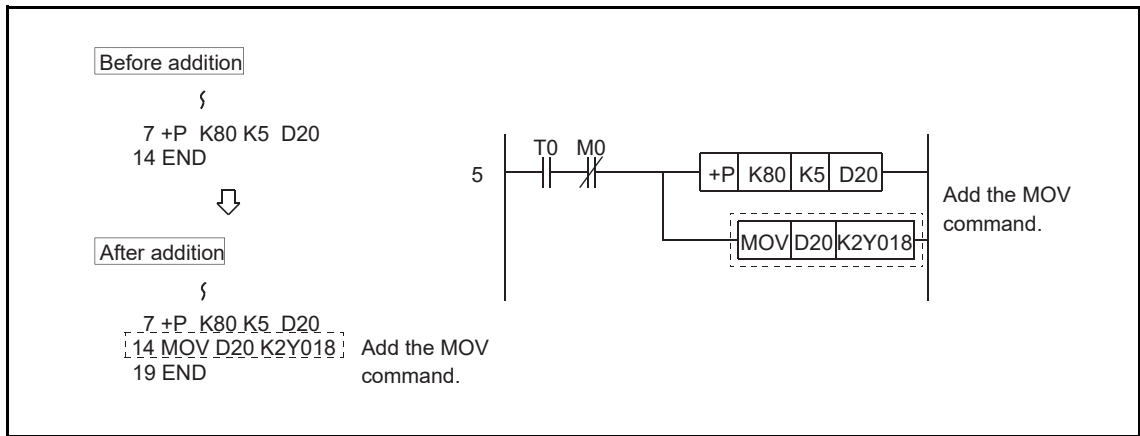

[Operation example]

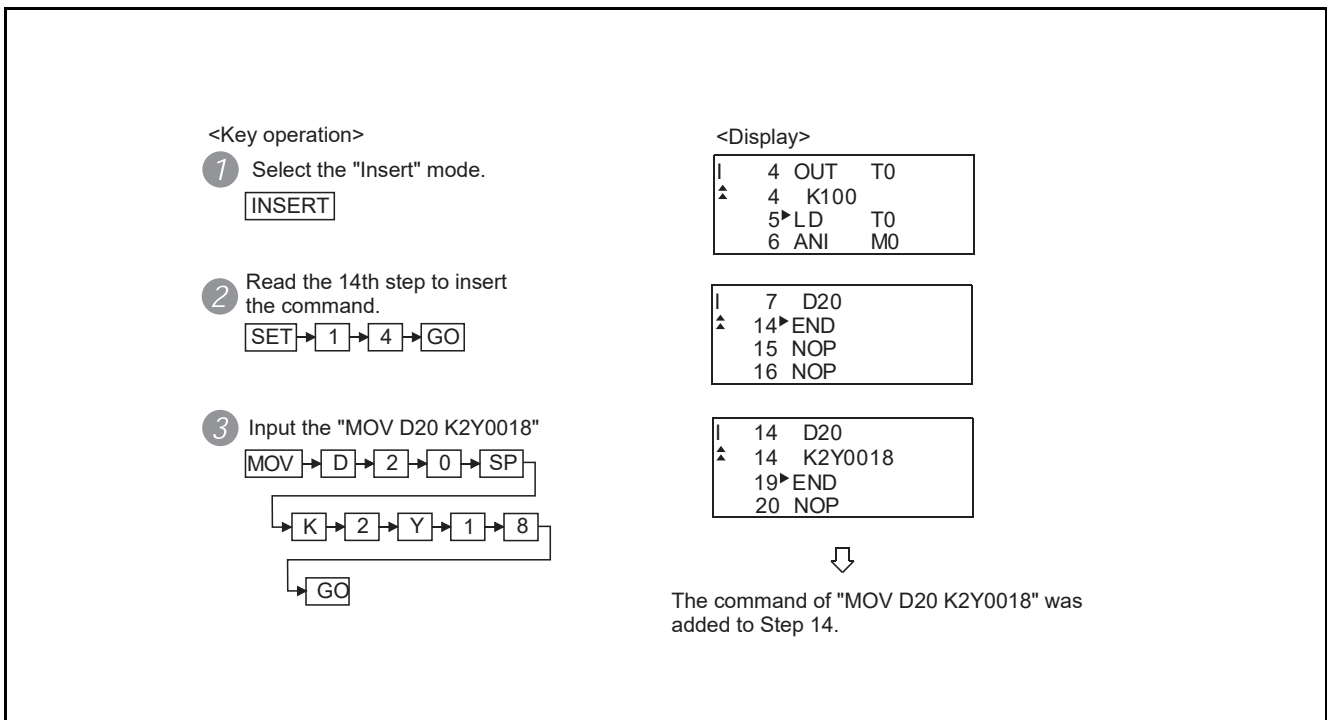

14.3.17 Deleting commands

The example shown below is used to describe how to delete sequence program commands.

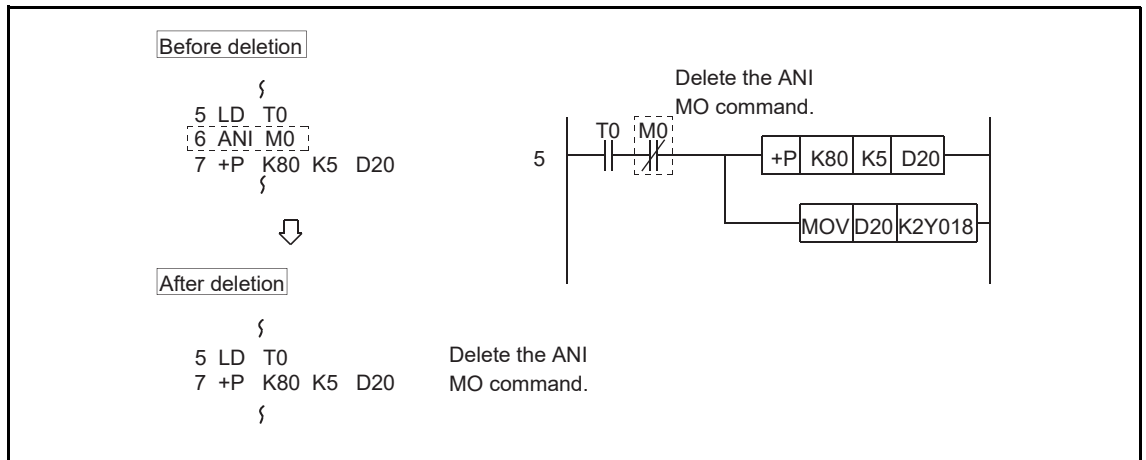

[Operation example]

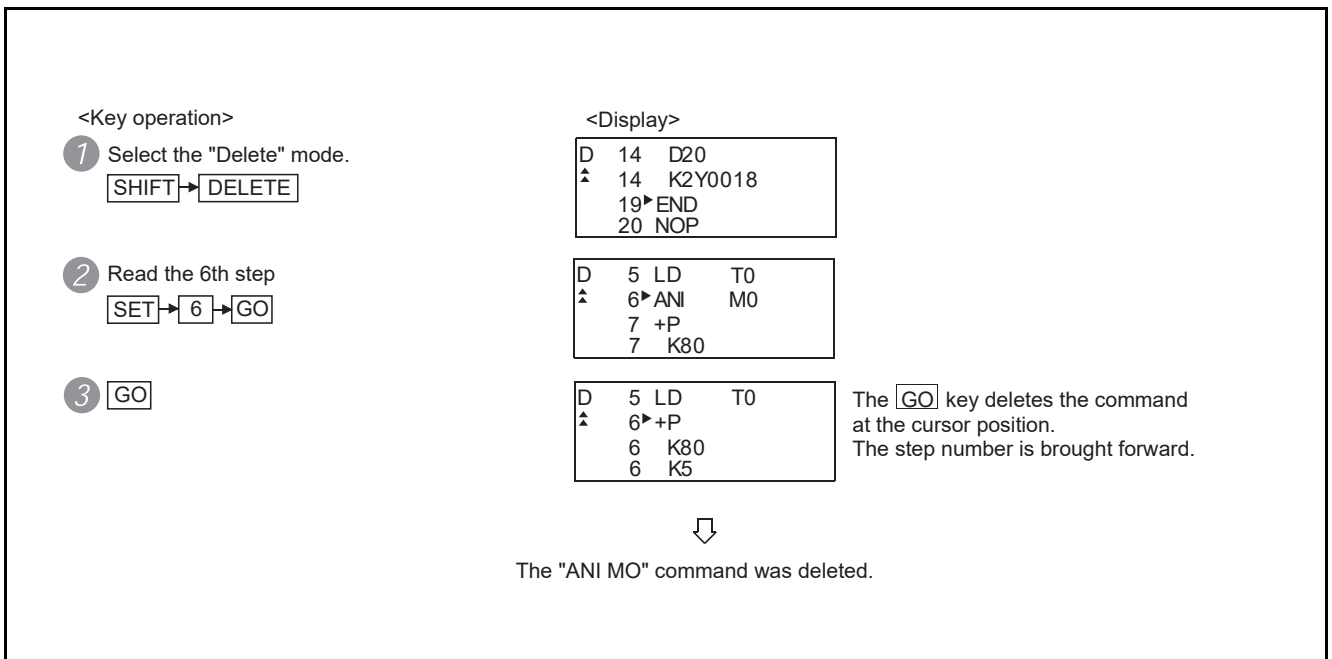

14.3.18 Using the help function

HELP is input to use the Help function.

Input of **HELP** displays the Help function menus in each mode. Select the corresponding item for execution.

- (1) Reading the command in the sequence program

Example of reading the area using the "MOV" command in the sequence program.

[Operation example]

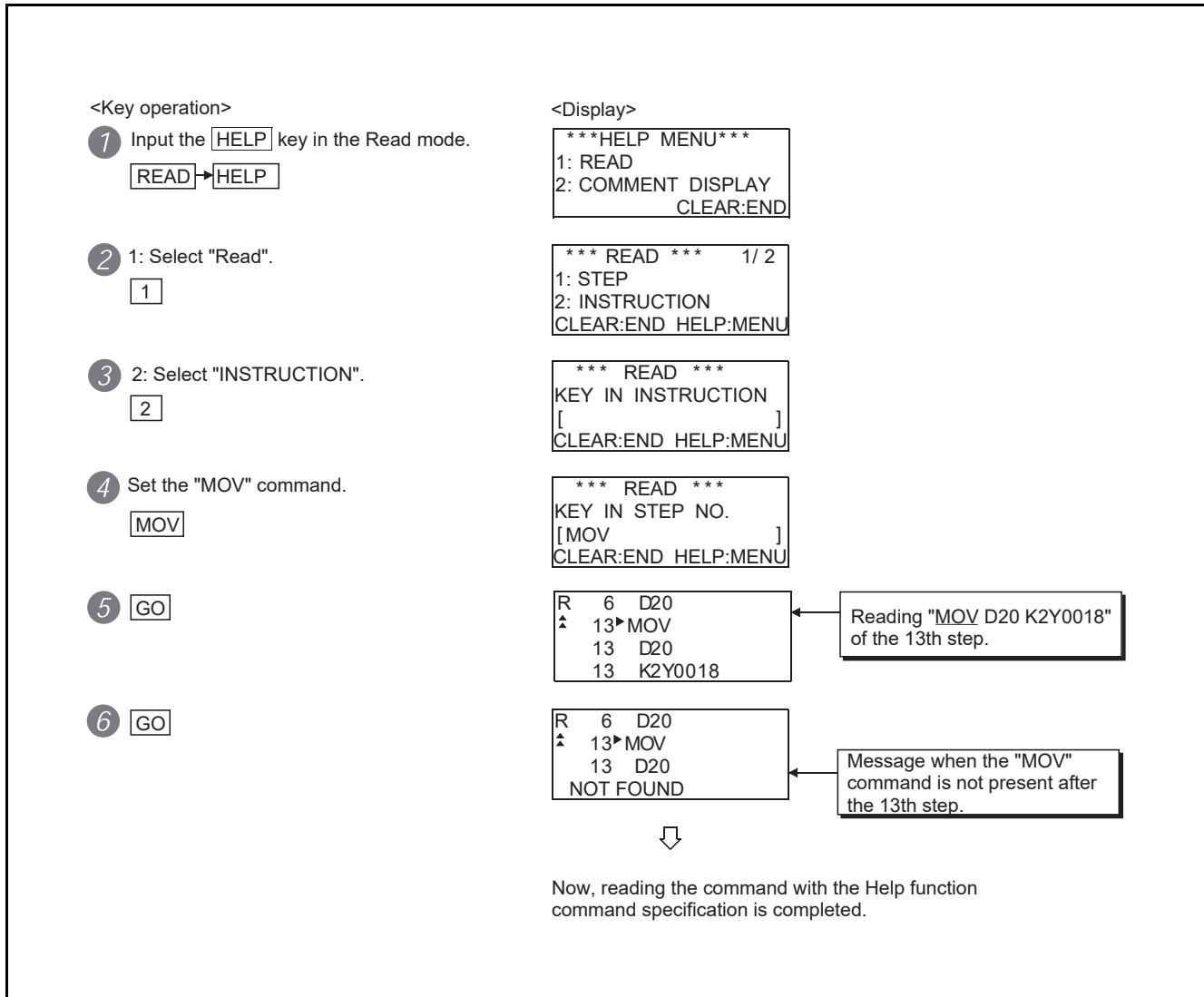

(2) Displaying comment

The following example shows the procedure of displaying the comment in the Read mode.
 [Operation example]

<Key operation>	<Display>
① Input the HELP key in the Read mode. HELP	<pre>***HELP MENU*** 1: READ 2: COMMENT DISPLAY CLEAR:END</pre>
② Select "2: COMMENT DISPLAY". 2	<pre>***COMMENT DISP.*** 1: YES 2: NO CLEAR:END HELP:MENU</pre>
③ Select "1: YES". 1	<pre>R 0▶LD X0000 ^ 1 OUT Y0020 2 LD X0000 Motor start limit</pre> <p>Display the comment of the device at the cursor position.</p>
④ Move the cursor to the following step. ↓	<pre>R 0 LD X0000 ^ 1▶OUT Y0020 2 LD X0000 Motor start check</pre>

14.3.19 PLC memory all clear

When input of a keyword is requested, all parameters and sequence programs can be cleared together with the keyword registered in the ACPU using the operation below.

[Operation example]

- 1 Display the keyword input request.

KEYWORD= []

- 2 Stop operation of ACPU
Set the target ACPU to the stop status.

- 3 Operation of PC memory all clear
Input "ALLCLR" and press the GO key.



- 4 Display of PC memory all clear process

When the GOT starts clearing the process, the display in the left appears. "*" column and the total number of bytes change sequentially.

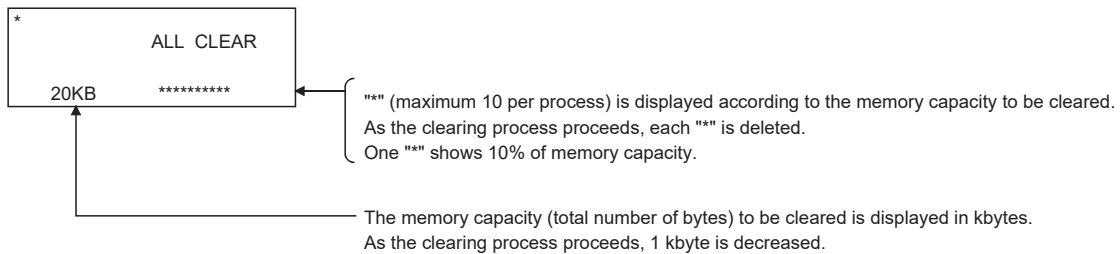

- 5 Completion of PC memory all clear process

When the GOT completes the clearing process, the screen in the left appears.
(status before the mode selection)

** MODE SELECTION **
(READ) (INS) (PARAM)

PRESS MODE KEY

- 6 If necessary, start the next operation.

14.3.20 List of operation procedures

14.3.21 Common operation

	Details	Purpose	Procedures (key input sequence)
Basic operation	Input of keyword at start-up	Input when the keyword is registered in the ACPU.	Keyword → GO
	Mode selection Switching of valid key	Select the mode.	Mode key (READ , INSERT , PARAM) SHIFT → Mode key (WRITE , DELETE , OTHERS)
	Switching of valid key	Switch the valid key (function indicated at the upper/lower part of the key) by a user.	SHIFT or SET
	Action for incorrect input	Perform the operation for incorrect key input.	CLEAR , Mode key or SHIFT → Mode key
	Operation of command help function	Perform operation with the Help function command specification.	Perform program display → HELP → 1 → 1 → 1 → Input the capital letter of the command.
	Display of Comment	Display the comment stored in the ACPU.	Perform program display operation → HELP → 2 → 1 / 2
Command input operation	Command code only	Input the command code only.	Command → GO
	Command code and 1 device	Input the command code and 1 device.	Command → SP → Device → Device No. → GO
	Other than above (command key input)	Input the command other than above with the command key.	Input the SP between the device, the source data and the destination.
	Other than above (device key input)	Input the command other than above without the command key.	Input the SP between the command, the device, the source data and the destination.

14.3.22 Operation in write mode (W)

Details	Purpose	Procedures (key input sequence)
Continuous write in NOP	Set the specified range in the program to NOP.	Program display → [HELP] → [1] → [2] in the Write mode [1] → Start step specification → [GO] → Final step specification → [GO] [2] → Start step specification → [GO]
Write/modify (change) of program	Write the new program/ modify (change)	[SHIFT] → [WRITE] → [SET] → Step number → [GO] → Com → [GO] ↑ ↓

14.3.23 Operation in read mode (R)

Details	Purpose	Procedures (key input sequence)
Command reading with the specified step number	Read the command of the specified step number in the program.	[READ] → [SET] → Step number → [GO] → [GO]
Read the command with the specified command.	Read the specified command in the program.	[READ] → Command → Device → Device number → [GO] [GO]
Read the command with the specified device.	Read the command with the specified device used in the program.	[READ] → [SET] → Device → Device number → [GO] [GO]
Automatic scroll	Display the program with automatic scroll.	Read operation above → [SET] → ↑ ↓ [SET] → Step number → ↑ ↓ [SET] → SP → ↑ ↓





14.3.24 Operation in insert mode (I)

Details	Purpose	Procedures (key input sequence)
Insert a command in the program.	Insert a command in the program.	
Move the program.	Move the whole program.	Display the program → [HELP] → [1] → [2] → Specify the movement start step. → [GO] → Specify the movement end step. → [GO] → Specify the movement destination step. → [GO]
Copy the program.	Copy the program.	Display the program → [HELP] → [1] → [3] → Specify the copy start step. → [GO] → Specify the copy end step. → [GO] → Specify the copy destination step. → [GO]

14.3.25 Operation in delete mode (D)

Details	Purpose	Procedures (key input sequence)
Delete a command from the program.	Delete a command from the program.	
Delete the specified range of the program.	Specify the range of the program for deletion.	Display the program → [HELP] → [1] → [1] → Specify the deletion start step. → [GO] → Specify the deletion end step. → [GO]
Delete the whole NOP.	Delete the whole NOP in the program.	Display the program → [HELP] → [1] → [2]

14.3.26 Operation in parameter mode (P)

Details	Purpose	Procedures (key input sequence)
Clearing all parameters	Return the parameters to the initial setting status.	PARAM → 1 → ↑ → GO → END → ↑ → GO
Parameter setting (for A0J2HCPU)	Set the parameters for the A0J2HCPU.	PARAM → 2 → 1)
Setting of latch range	Select the latch range from "No latch", "1/2 latch" and "All latch".	1) → 1 →  → GO → 2)
Setting of step relay	Set the availability (S1536 to 2047) of the step relay.	1) → 2 →  → GO → 2)
Completion of setting	When the parameter setting is complete, write the PLC CPU.	2) → CLEAR → END → ↑ → GO (End of writing is displayed.) Setting for multiple items is also available.
Parameter setting (other than A0J2HCPU)	Set the parameters other than A0J2HCPU.	PARAM → 2 → 1)
Setting of memory capacity	Set the main sequence program capacity and the file register capacity.	1) → 1 → Capacity → GO → END → 2) (For main, input unit: 1K step) 1) → 1 → ↓ → Capacity → GO → END → 2) (For sub, input unit: 1K step) 1) → 1 → ↓ → points → GO → END → 2) (For file register, input unit: 1K point)
M, L, S setting (other than AnA, AnUCPU)	Set the top device number used in the latch relay/step relay.	1) → 2 → Top number of L → GO → Top number of S → GO → 2)
M, L, S setting (AnA, AnUCPU only)	Set the top device number used in the latch relay/step relay/internal relay.	1) → 2 → Top number of L → GO → Top number of S → GO → Top number of M → GO → 2)
Timer setting (other than AnACPU)	Set the top device used in the low speed/high speed/retentive timers.	1) → 3 → Top number of timer → GO → 2)
Timer setting (AnACPU)	Set the number of timers used, the top device number that stores the setting value after T256, and the top device used in the low speed/highspeed/retentive timers.	1) → 3 → No. of timers → GO → Top device for storage of setting values → GO → Top number of timer → GO → 2)
Counter setting (AnACPU only)	Set the number of counters used, and the top device number that stores the setting value after C255.	1) → 4 → No. of counters → GO → Top device for storage of setting values → GO → 2)
Setting of latch range WDT setting	Set the range of the device for latch setting.	1) → 5 →  → Top number of latch → GO →  → End number of latch → GO → END → 2)
WDT setting (other than AnA, AnU)	Set the value of the watchdog timer in the unit of 10 ms.	1) → 6 → WDT value → GO → 2) (input unit: 10 ms)
Setting of I/O control system (only for A3HCPU and A3MCP)	Set the I/O control system.	1) → 7 →  → GO → 2)
Completion of setting (write)	When parameter setting is complete, write the PLC CPU.	2) → CLEAR → END → ↑ → GO (End of writing is displayed.) Setting for multiple items is also available.

14.3.27 Operation in other mode (O)

Details	Purpose	Procedures (key input sequence)
Error check	Operation that checks the error step number/error code for the current error in the ACPU. (other than AnA and AnUCPU)	<p>(Except AnA, AnUCPU) (AnA, AnUCPU)</p>
Program check	Check the program(double coil, command code, END command).	
Buffer memory batch monitoring	Monitor the buffer memory details of the special function unit.	
Clock monitor	Monitor the clock data of the ACPU.	
Clearing of all PC memories	Clear all memories in the ACPU.	
Clearing of all programs	Clear all sequence program, microcomputer program and T/C setting value areas.	
Clearing of all device memories	Clear all details of the bit device and the word device in the ACPU.	
PLC No. setting	Set the PLC No. of other stations for access on the MELSECNET II (/B) or MELSECNET/10.	
Main/sub-program switching	Select the main/sub- program displayed on the list edit screen.	
Remote run/stop	Operate the run/stop status of the ACPU from the GOT.	
Read/write of machine language	Specify the memory address (absolute address) of the ACPU. Read the memory details and write the machine language to the memory.	

14.3.28 Error messages and corrective actions

1 Error messages and corrective actions in direct CPU connection

If an error is detected with the MELSEC-A list editor during operation of each mode, an error message appears at the 4th line of the display.

Error messages, display conditions and corrective actions are displayed below.

If an error message appears, take the following actions to resume operation.

1 Check the error message.

2 Remove the cause of the error.

3 Input the corresponding key.

(The error message disappears. The screen returns to the status before error.)

(Example)

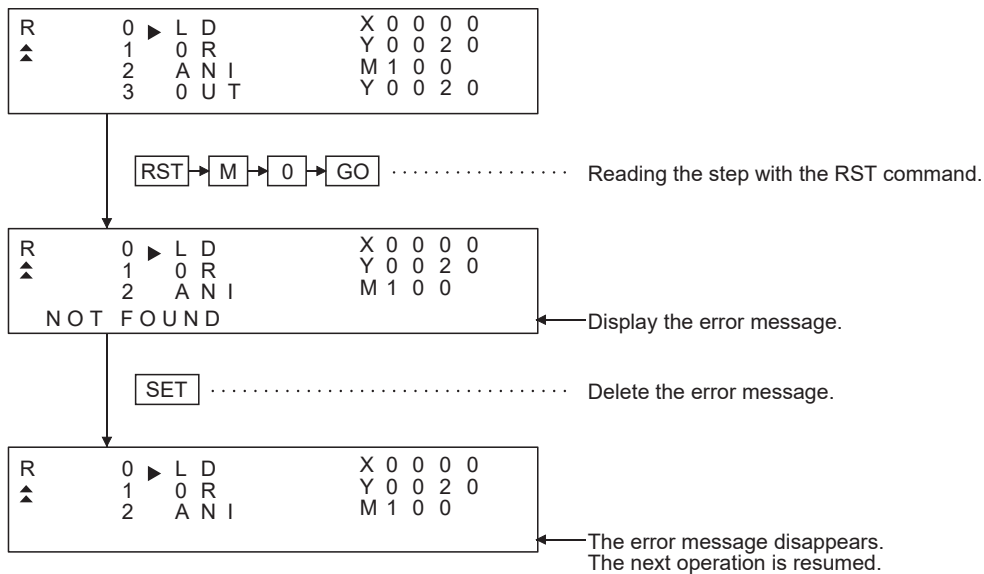

Error message	Description	Corrective action
Address error	In machine language writing, the address which was tried to be written was at the write-protect area.	Set the correct address.
No corresponding program	The specified command was not found.	Check the program.
Memory cassette check	In communication with the CPU for clearing the keyword or writing the parameter, the memory cassette is insufficient or not mounted.	(1) Mount the memory cassette properly. (2) Replace the memory cassette with a new one.
Step over error	The set step number is larger than the maximum step number.	Set the correct step number.
Setting error	Setting value is not correct.	Set the correct value.
Not selectable	The function which cannot be executed was selected.	Select other function.
Operation error	The set device symbol is incorrect.	Perform the correct key operation.
Device error	The specified command was not found. The device number exceeds the range.	(1) Set the correct device symbol. (2) Set the number within the range of CPU device.
Identical coil	The identical coil is found in the sequence program.	Proceed to the next operation if it does not affect the control. Correct the program if it affects the control.
Command error	When the program is read, it cannot be converted to the proper command.	When the CPU has detected the error, stop running of the operation. After resetting the CPU, check the command around the error. Write the correct command. (For check of the error step, refer to 14.3.27.)
Command setting error	The command set at the time of read, write or insert is not correct.	Set the correct command.
Memory protect	When writing in the Write or the Insert/Delete mode, the memory protect switch in the memory cassette is ON.	Turn OFF the memory protect switch in the memory cassette.
Capacity over	Memory assignment set in the parameter exceeded the capacity of the memory cassette.	Set the parameter within the capacity of the memory cassette.
No END command	There is no END command.	Write the END command at the last step of the program.
PLC communication error	When the list editor function is started, proper communication with the PLC is not made.	Restart the list editor function. If communication is not made properly, check the following: (1) GOT main unit (2) Connection of the cable (3) CPU main unit (if any error has occurred)
PLC COMM ERROR PLEASE CLOSE	When the editor for MELSEC-A is started, proper communication with the CPU is not made.	Close and restart the editor for MELSEC-A. If communication is not made properly, check the following: (1) GOT main unit (2) Connection of the cable (3) CPU main unit
PC write error	Correct writing was not made in the Write or Insert mode.	(1) Check the setting of RAM/ROM. (2) Check the RAM mounting. (3) Check the setting of the memory protect switch in the CPU.
PLC is running	Writing, insertion or deletion was attempted during running of the CPU.	Stop the CPU.
PC No. error	The PLC number is set to other station.	Change the PLC number and set the station for access to the host.

(Continued to next page)

Error message	Description	Corrective action
**KS over	The value exceeding the range of the program capacity by **K steps was attempted to be set.	Reduce the program capacity by **K steps for setting.
**KP over	The value exceeding the range of the file register capacity by **K points was attempted to be set.	The value exceeding the range of the file register capacity by **K points was attempted to be set.
Not available for QnACPU. Set the PLC No.	The CPU at the list edit destination is QnACPU.	Set the PLC number and change the station for access.
The keyword is not input. Set the PLC No.	The "GO" key was pressed without input of the keyword on the keyword input screen.	Set the PLC number and change the station for list edit. Or select the same station and input the keyword.
The PLC parameter was changed. Read the ladder monitor again.	The PLC parameter exceeding the file (R) register capacity was set.	Restart the GOT system if required.
The PLC parameter was changed. Restart the GOT system.	The capacity of the file (R) register was set.	Read the ladder monitor on the PLC again if required.
The PLC program was edited. Read the ladder monitor again.	Edit the PLC program.	Read the ladder monitor on the PLC again if required.

2 PLC CPU error messages and troubleshooting

When the error step read in other mode is performed, the error message and the error step of the current error in the ACPU are displayed.

Error messages, error details and corrective actions are displayed below.

If an error message appears, take the following actions to resume operation.

- 1 Check the error message.
- 2 If the error code is not displayed, check the error code of special register D9008 with the system monitor function (Refer to Section 14.2).
- 3 Remove the cause of the error.

(Display)

- (1) Example of display for an error in the CPU other than AnA and AnU

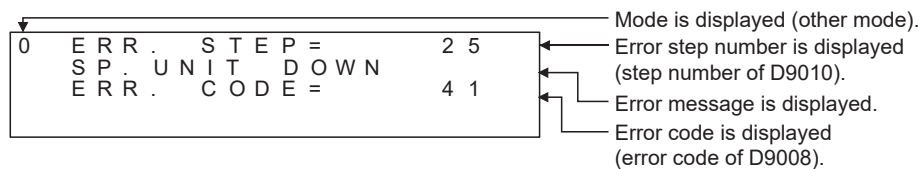

- (2) Example of display for an error in the AnA or AnUCPU

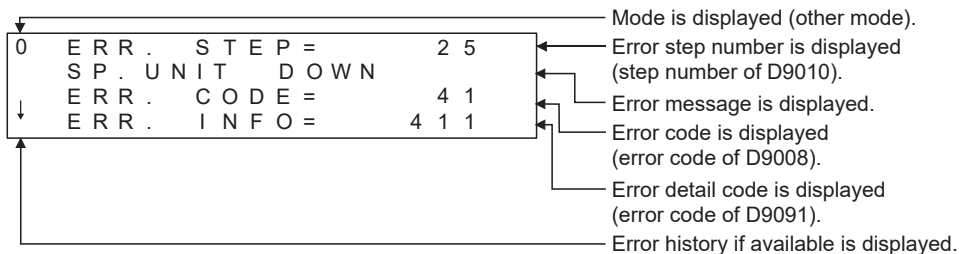

- (3) Example of next display for the display of "↓" above (error history is available)

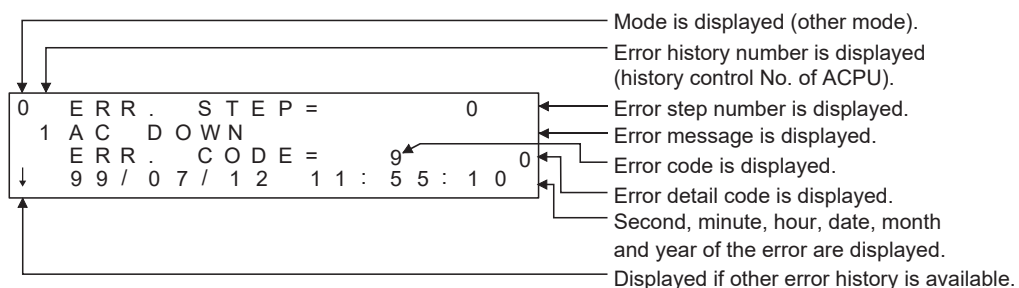

When an error message of the PLC CPU appears, refer to the ACPU programming manual (Common Command) and the user's manual for each CPU for corrective actions.

3 Error using list editor function on the link system

When the MELSEC-A list editor is used on the link system, the "PLC communication error (**)" may appear.

In this case, check the error details and the corrective actions.

Error No.	Error message	Corrective action
2	Time-out error: No response to the request	Check the cable wiring.
4	Process cancel: New process request was given to the list editor function while the CPU is processing.	Perform correct key operations on the GOT.
5	Sum check error: A sum check error from the link communication has occurred.	There may be noise interference. Check the system again.
16	PLC No. error: There is no station corresponding to the PLC number.	Check the PLC number setting. Set the correct number.
19	This error may occur when the ACPU is reset during monitoring.	Perform the monitor setting again.
24	Remote error: Although remote stop/pause is performed from the computer link unit, remote run/stop is additionally performed.	Perform the remote run/stop/pause from either unit.
25	Refer to the next page for error messages and actions. After confirming the device value explained at the next page with the system monitor function, take action.	
32	Link error: While the slave station is monitoring the master station, the master station is reset.	Perform the monitor setting again.
34	EEPROM failure: The EEPROM, cannot be written due to EEPROM failure.	Replace the EEPROM with a new one.

[Detailed description of error No. "25"]

If error number "25" appears, the following causes are possible. Check the details and the corrective actions.

(1) When connected to the master station

Device number	Description	Details	
M9210	Link card error (for master station)	OFF : Normal ON : Error	The control depends on whether there is an error at the hardware of the link card. The link card in the CPU link unit is judged at the CPU. Replace the link unit.
M9224	Link status	OFF : Online ON : Offline, station-to-station test, or self-loopback test	The control depends on whether the master station itself is online or offline, or in the station-to-station mode or the self-loopback mode. Check the mode switch.
M9227	Loop test status	OFF : Not executed ON : Forward loop test and reverse loop test are being executed.	The control depends on whether the master station itself is executing the forward loop test or the reverse loop test.

(2) When connected to the local station

Device number	Description	Details	
M9211	Link card error (for local station)	OFF : Normal ON : Error	The control depends on whether there is an error at the hardware of the link card. The link card in the CPU link unit is judged at the CPU. Replace the link unit.
M9240	Link status	OFF : Online ON : Offline, station-to-station test, or self-loopback test	The control depends on whether the local station itself is online or offline, or in the station-to-station mode or the self-loopback mode. Check the mode switch.
M9257	Loop test status	OFF : Not executed ON : Forward loop test and reverse loop test are being executed.	The control depends on whether the local station itself is executing the forward loop test or the reverse loop test.

If an error code not listed in the previous page is displayed, contact the nearest of our system service centers, agents, and branch offices.

14.4 MELSEC-FX List Editor

The MELSEC-FX list editor enables you to change the sequence program in the FX PLC. This function is intended to troubleshoot the PLC system and to streamline maintenance operations. By installing list editor for MELSEC-FX, an Option OS, from drawing software into the GOT, you can edit the FX PLC program.

The features of the MELSEC-FX list editor are described below.

1 Parameters and sequence programs are easy to maintain

You can check or partly correct, change or add FX PLC CPU parameters and sequence programs simply by operating keys.

You can easily edit sequence programs without preparing any peripheral unit other than the GOT.

(Example of changing sequence program commands)

	Changed	
LD X000	→	LD X000
OUT Y020		OUT Y030
LD X001		LD X001
}		}

2 Errors that occur during list editing can be checked easily

Error messages, error codes, and number of steps for errors that occur in the FX PLC can be checked. Details can be checked immediately even for errors that occur during list editing.

Error message	Detail	Step
I/O configuration error	1010	
PC/HPP communication error	6201	

3 Commands and devices can be searched and displayed

Commands and devices used in sequence programs can be searched.

The correction position can be searched for cases such as when you want to correct a specific device.

Searched device
M800

→

Displays the searched device.

14.4.1 Specifications

1 System configuration

This section describes the system configuration of the MELSEC-FX list editor. For further information about communication units and cables for each connection form, see the following.

 GOT1000 Series Connection Manual

2 Controllers that can be edited with the MELSEC-FX list editor

Target controller
FXCPU

3 Connection forms

(○: Available, x: Unavailable)

Function name		Connection form between GOT and PLC				
		Bus connection	Direct CPU connection	Computer link connection	CC-Link connection	GOT multidrop connection
Name	Description					
				G4*1		
MELSEC-FX list editor	Sequence program writing, parameter setting, PLC diagnostics and keyword registration, etc.	x	○	x	x	x

*1 Indicates CC-Link connection (via G4).

4 Required option OS and option function board

The option OS and option function board shown below are required.

Option OS	OS memory space (user area)	Option function board
MELSEC-FX list editor	0KB	GT11-50FNB

(1) Option OS

Install the option OS in the above table to the GOT.

Refer to the following manual for the procedure for installing the option OS.

 GT Designer2 Version □ Basic Operation/Data Transfer Manual
GT Designer3 Version1 Screen Design Manual (Fundamentals)

(2) OS memory space

The available memory space shown in the table above is required in the user area to install the option OS to the GOT.

Refer to the following manual for the procedure for checking the available memory space of the user area and information about the data using other user areas.

 GT Designer2 Version □ Basic Operation/Data Transfer Manual
GT Designer3 Version1 Screen Design Manual (Fundamentals)

(3) Option function board

For how to mount an option function board on the GOT, refer to the following manual.

 Section 8.3 Option Function Board

5 Functions list and monitor conditions

The following shows the memory that can be monitored by the MELSEC-FX list editor and the FX PLC status conditions.

(○ : Can be monitored △ : Can be monitored under certain conditions × : Cannot be monitored)

Function		Memory that can be monitored ^{*2}				FX PLC status	Reference
		Built-in memory	RAM memory cassette	EEPROM memory cassette, flash memory cassette	EPROM memory cassette		
Reading sequence programs	Displaying sequence programs	○	○	○	○	RUN/STOP	Subsection 14.4.7
	Searching commands/devices						Subsection 14.4.8
Writing sequence programs	Writing commands	○	○	○	○	For Stop only	Subsection 14.4.9
	Changing operands/set values						Subsection 14.4.10
Inserting commands		○	○	△ ^{*1}	×	For Stop only	Subsection 14.4.9
Deleting commands							Subsection 14.4.11
Sequence program all clear							Subsection 14.4.12
PLC diagnostics		○	○	○	○	RUN/STOP	Subsection 14.4.13
Parameter setting	Display						○
	Set	Subsection 14.4.14					
Keyword		○	○	○	○	RUN/STOP	Subsection 14.4.15

*1 The operation is available only when the protect switch is OFF.

*2 The available memory differs depending on the FX PLC being used.

For further information, see the following manual.

 The hardware manual of the FX PLC being used

14.4.2 Access range

The access range is the same as the access range when the GOT is connected to a controller. Refer to the following manual for details of the access range.

 GT Designer2 Version □ Screen Design Manual
GOT1000 Series Connection Manual (Mitsubishi Products) for GT Works3

14.4.3 Precautions

- (1) Using other peripheral equipment for sequence program/parameter change
When using the MELSEC-FX list editor, do not change programs or parameters in the PLC CPU from other peripheral equipment.
If you make a change, temporarily exit the MELSEC-FX list editor after the change is made, then start the MELSEC-FX list editor again.
If you carelessly change the program on one PLC from multiple units of peripheral equipment (including GOT), the contents of the program in the PLC CPU and the peripheral equipment may not be the same, resulting in an unintended operation of the PLC CPU.
- (2) Sequence program change
Stop the FX PLC before changing (writing, inserting, deleting) a sequence program or changing parameters.
Operation is not possible with the FX PLC running.
- (3) If you press the **GO** key but the system does not proceed to the next operation (for example, a search)
Check the input contents (applied instruction number, device value, etc.).
- (4) When using list monitor
Only devices to be used for basic instructions can be monitored.
The status of devices (word, bit) to be used for application instructions cannot be monitored.

14.4.4 Display

1 Outline until the start

This subsection describes an outline until the MELSEC-FX list editor screen is displayed after List editor for MELSEC-FX (Option OS) is installed in the GOT.

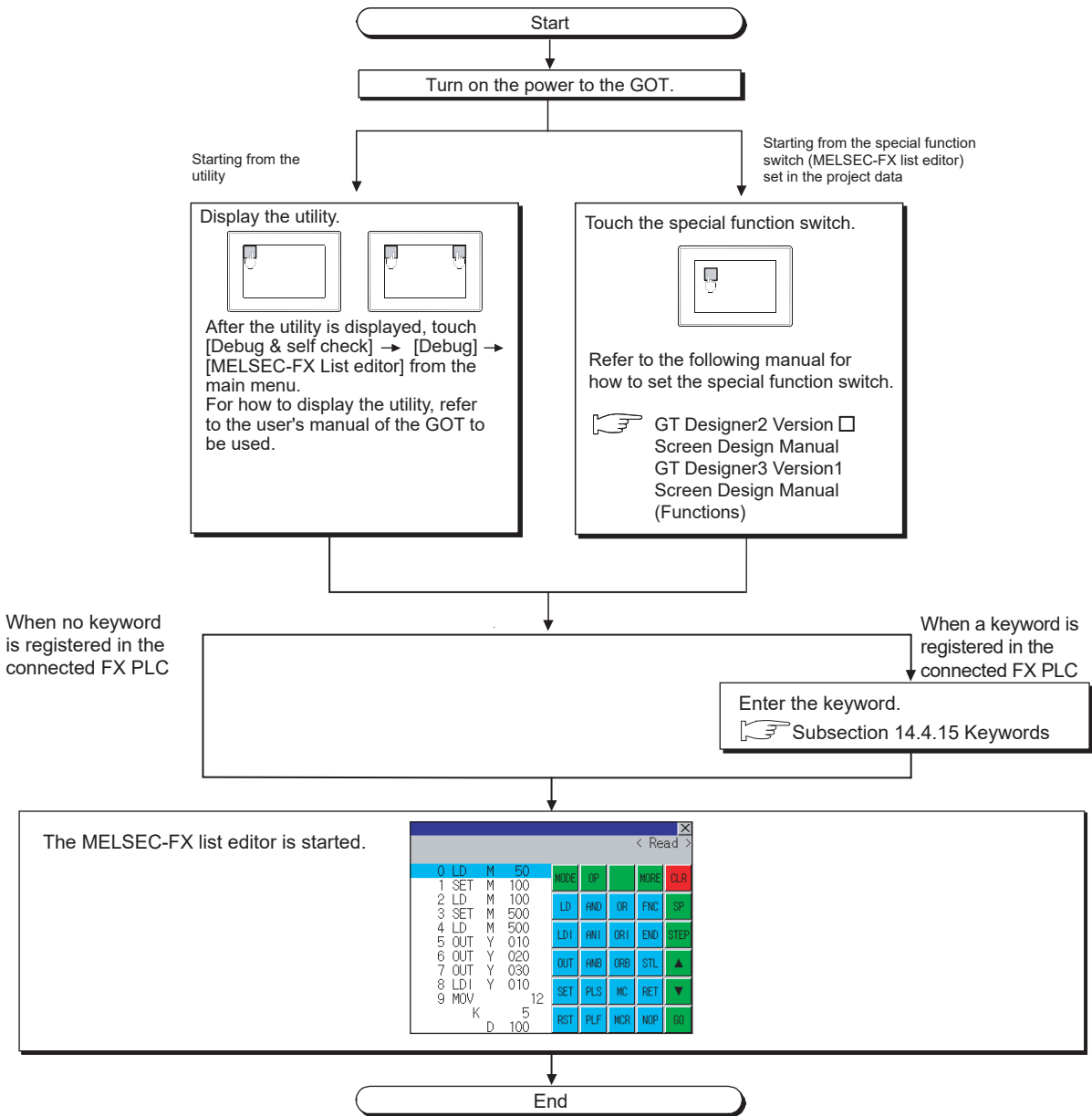

(1) How to display the utility

For how to display the utility, refer to the following.

☞ Section 9.3 Utility Display

(2) If the project data has not been downloaded

The MELSEC-FX list editor can be started from the utility even if the project data has not been downloaded to the GOT.

2 Change screens

This section describes how to change the screen.

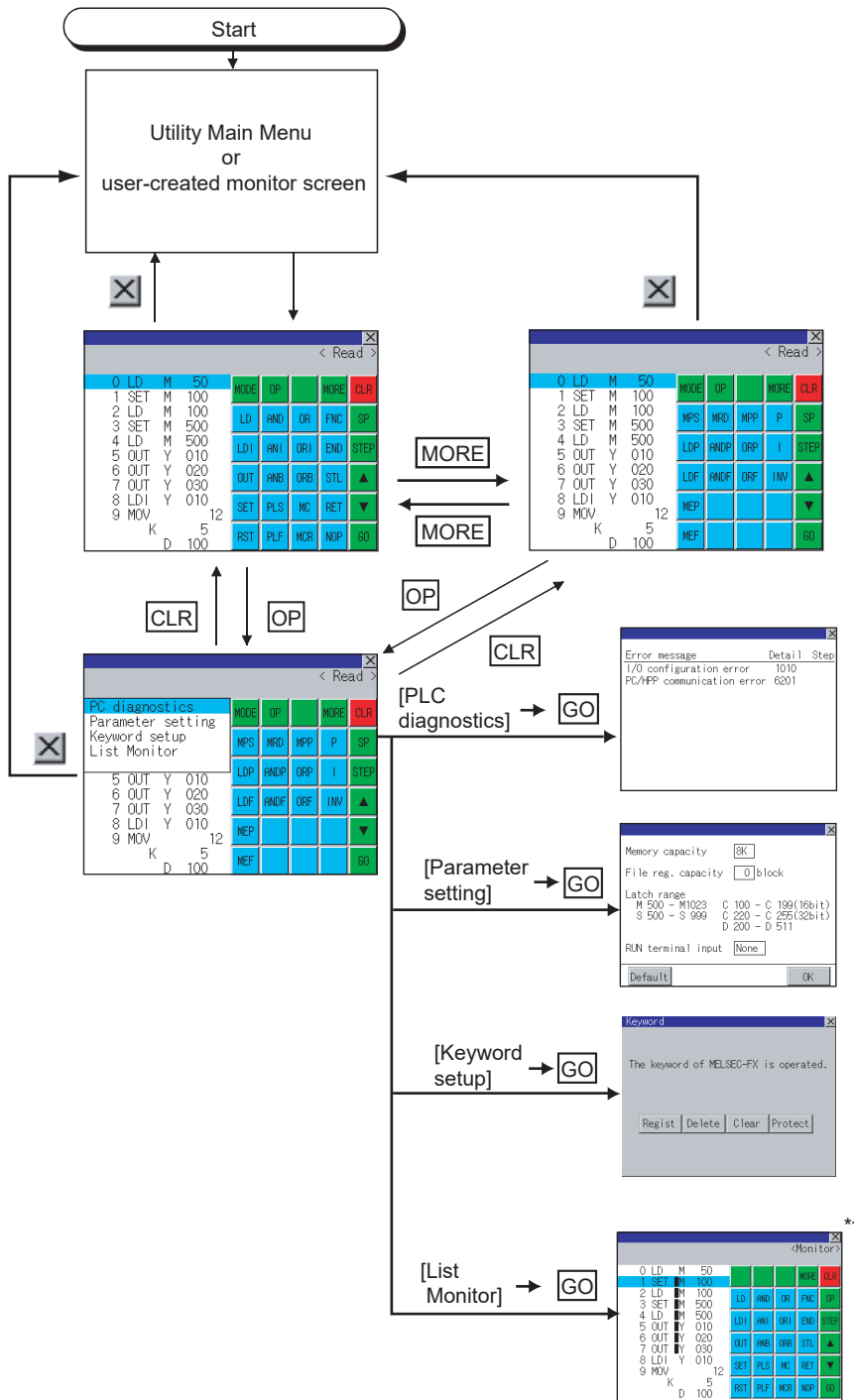

*1 With setting special function switches (FX list monitor), the list monitor can be started on the monitor screen. When the list monitor is started on the monitor screen, the list editor cannot be used. For how to set special function switches, refer to the following manual.

☞ GT Designer2 Version □ Screen Design Manual

GT Designer3 Version1 Screen Design Manual (Functions)

14.4.5 Operation procedures

This section describes the contents of the MELSEC-FX list editor and the key functions displayed on the screen.

1 Key arrangement and a list of key functions

The arrangement and functions of the keys displayed on the MELSEC-FX List Editor window are described below.

2 Displayed contents

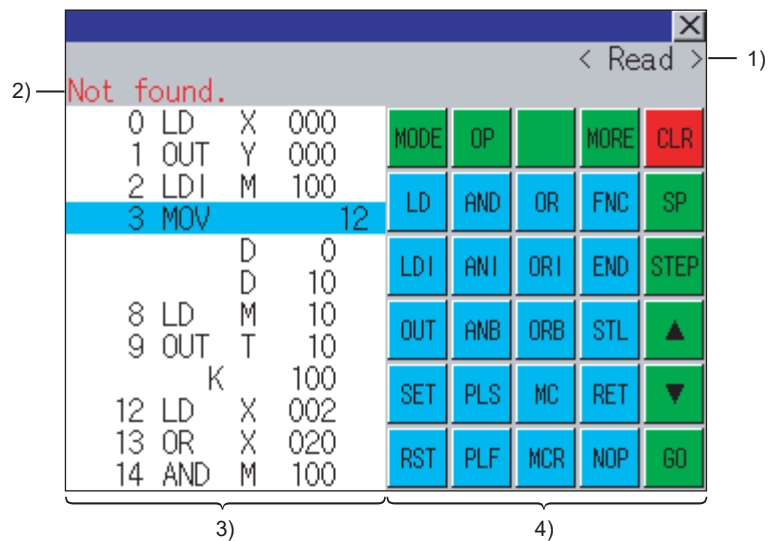

No.	Item	Description
1)	Mode	Displays a mode for MELSEC-FX list editor. (☞ Subsection 14.4.6 Selection and operation of modes) [Monitor] is displayed when the list monitor is executed. (☞ Subsection 14.4.16 List monitor)
2)	Error message	Displays the contents of errors that occur with the MELSEC-FX list editor. (☞ Subsection 14.4.18 Error messages and corrective actions)
3)	List display area	Displays the sequence program in list format (12 digits). The position (line) that can be edited is displayed with a bar.
4)	Key area	Displays the keys that can be used with the MELSEC-FX list editor.

3 Key functions

The table below shows the functions of the keys that are used for the operation on the MELSEC-FX list editor screen.

Key	Function
	Selects a mode for MELSEC-FX list editor. (☞ Subsection 14.4.6 Selection and operation of modes)
	Displays the PLC diagnostics, parameter setting, and keyword selection menu.
	Switches between command keyboard 1 and command keyboard 2. (☞ 4 "Keyboard switching" in this section)
	When inputting commands :Cancels the key input when only part of the command has been input. (☞ Subsection 14.4.17 Action for an incorrect key input) When option menu is displayed: Closes the option menu. Commands cannot be deleted with this key. (☞ Subsection 14.4.11 Deleting commands)
	Space key. This key is used when setting timers and counters, writing applied commands, etc.
	Displays the list from a specified step No. when the step No. is input.
	Moves the list display area bar up and down and switches the line being edited.
	Determines the key operation.
	Inputs commands, device names, etc. The key contents depend on the input contents. The commands that can be used differ depending on the target FX PLC. Refer to the manual for the FX PLC to be used.
	Exits the MELSEC-FX list editor.

4 Keyboard switching

Touching the **MORE** button switches the command keyboard 1 and command keyboard 2. When you touch the button for a keyboard function, the optimum keyboard for input for that function is displayed automatically.

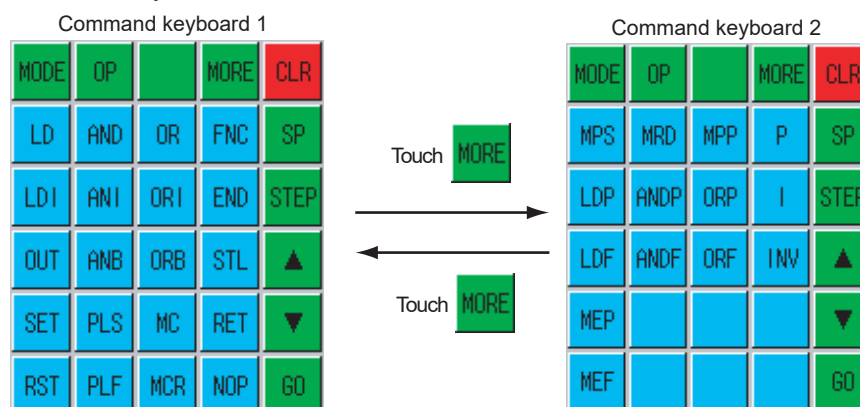

14.4.6 Selection and operation of modes

The MELSEC-FX list editor has four modes: READ, WRITE, INSERT, and DELETE.

Select an appropriate mode for the intended operation.

For more information on the mode to select, refer to the function operations from subsection 14.4.7 onward.

1 How to change modes

Touch the **MODE** button.

Each time you touch this button, the mode changes.

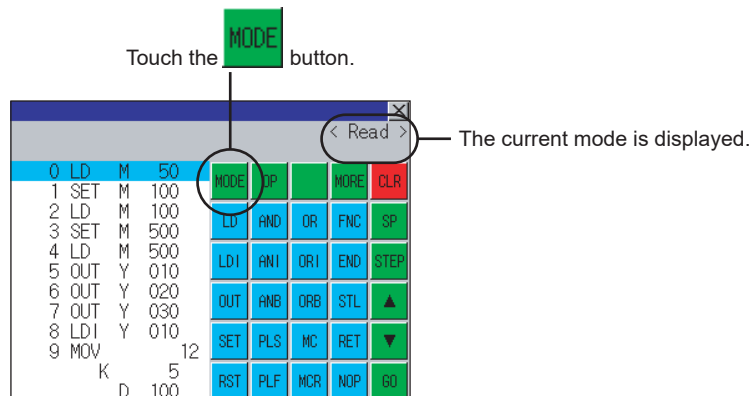

2 In the case the mode cannot be changed

In the following cases, only READ mode is allowed.

If you try to change to other than READ mode, an error message is displayed.

To change to other than READ mode, take the action below.

Error Message	Description	Corrective action
PLC is running	The FX PLC is in the RUN status.	Stop the FX PLC.
Can not write.	The protect switch of the EEPROM memory cassette is on.	Switch off the protect switch of the EEPROM memory cassette.
	The EPROM memory cassette is enabled.	Set a memory other than EPROM as the memory to write to.

14.4.7 Sequence program display

Sequence programs are read from the FX PLC to the GOT and displayed.
There are two displaying methods: specifying the step number, and scrolling one screen at a time.

1 Display using cursor keys

(1) Operation

Scroll with  or .

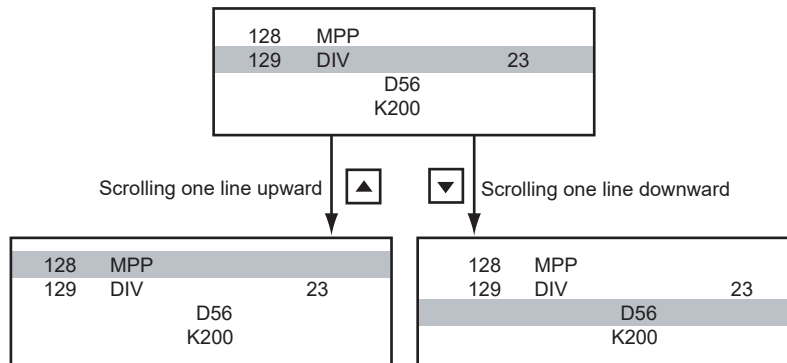

(2) Example

Scroll one line upward or downward.



2 Display specifying the step number

(1) Operation

 → → 

(2) Example

Displaying step number 123.

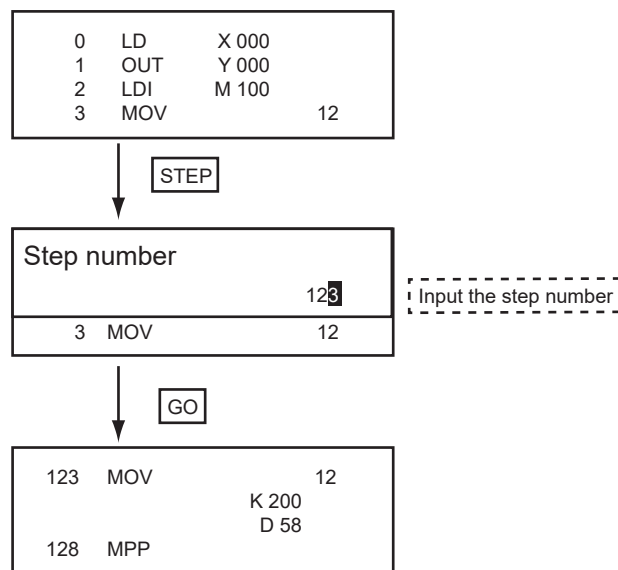

Hint!

When the specified step number is the operand of an applied instruction

If the specified step number is a timer (T) or counter (C) set value or the operand of an applied instruction, that command section is displayed at the head.

3 Display scrolling one screen at a time

(1) Operation

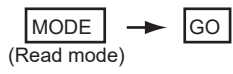

(2) Example

Displaying with scrolling one screen at a time.

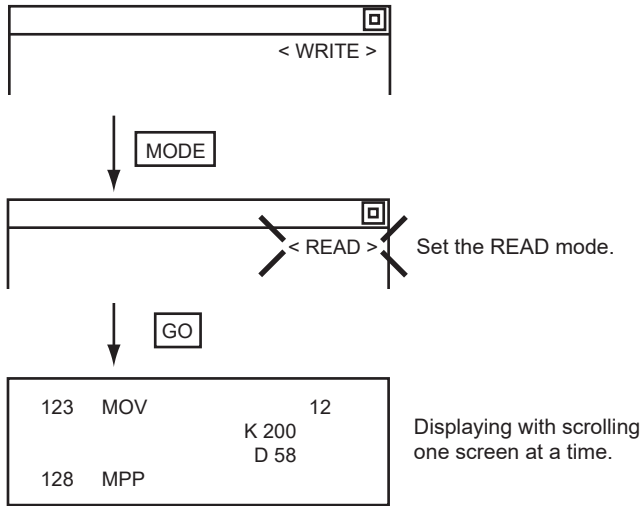

14.4.8 Searching commands and devices

Displays a command or device by searching it in sequence program from Step 0.

1 Command search

(1) Operation



*1 If the command you want to search for is not on the keyboard, touch the **[MORE]** key to switch to the other keyboard.
When searching for an applied instruction, touch the **[FNC]** key and input the applied instruction number.
When searching for a label, touch **[P]** or **[I]** and input the pointer number.

Subsection 14.4.9 **2** Writing applied instructions)

*2 Input only when searching for commands requiring a device name and device number.

*3 After the search results are displayed, you can continue searching with the same conditions by touching the **[GO]** key.
Touching any key other than the **[GO]** key ends the search.

(2) Example

Searching for LD M8000.

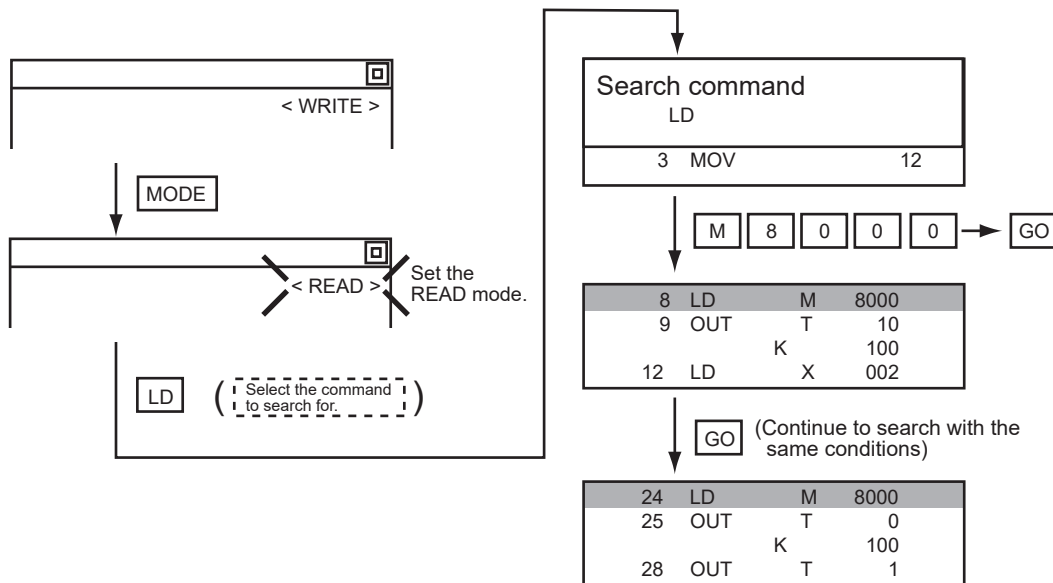

Pointer (P, I) searches

For pointer searches, only labels are searched.

Pointers specified as operands in applied instructions are not searched.

2 Device search

(1) Operation

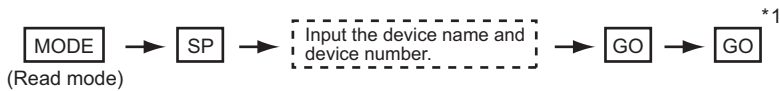

*1 After the search results are displayed, you can continue searching with the same conditions by touching the **GO** key. Touching any key other than the **GO** key ends the search.

(2) Example

Searching for LD M8000.

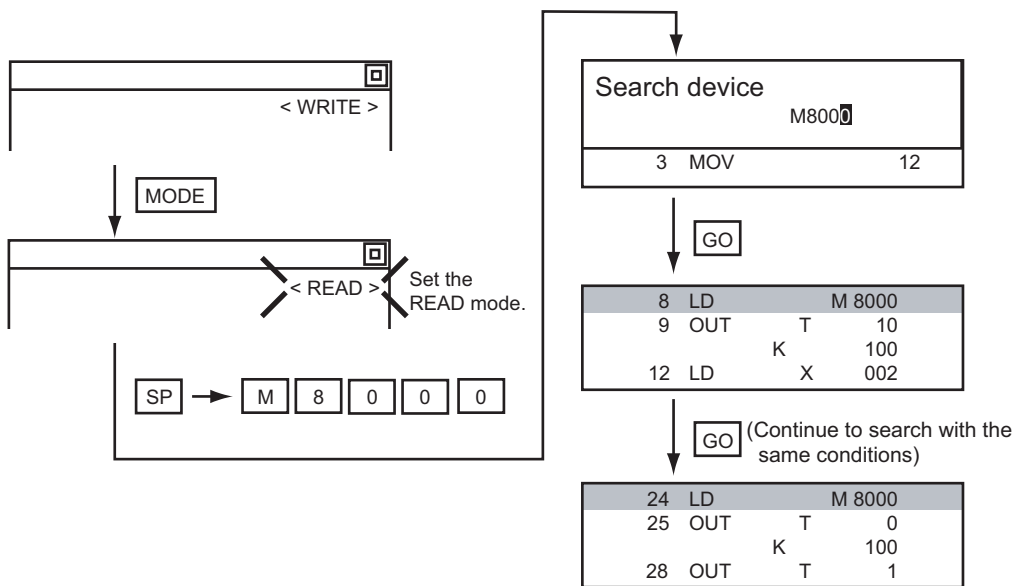

Point

Devices that cannot be searched

The following devices cannot be searched.

- Pointers, interrupt pointers
- Constant K, constant H, constant E
- Bit devices with specifying numbers only
- Special function unit/block buffer memory
- Devices specified with the operand of an applied instruction

Pointers and interrupt pointers can be searched for with command searches.

(**1** "Command search" in this section)

14.4.9 Writing commands

Writes a sequence program to the FX PLC. (Overwrite/Insert)

1 Writing basic commands

(1) Operations

(a) Inputting command only (Ex.: ANB, ORB command etc.)

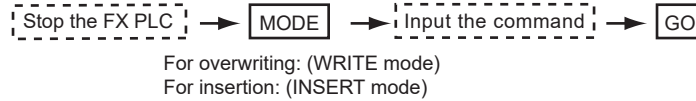

(b) Inputting command and device (LD, AND commands etc.)

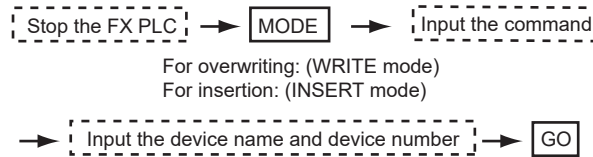

(c) Inputting command, No. 1 device, No. 2 device (MC, OUT (T, C) commands, etc.)

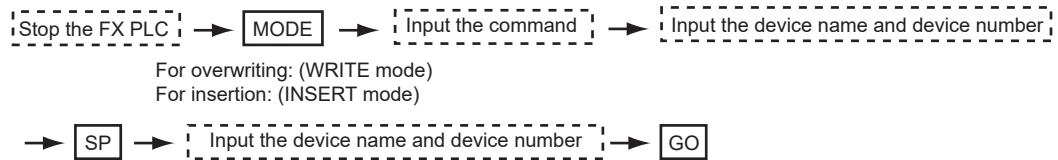

Point

Moving the cursor to the position to write the command

When starting to write a command, place the cursor on the command line (the line on which the step number is displayed).

You cannot write a command with the cursor on an operand or set value line.

2	LDI	M	100	} Command line (Place the cursor on this line.)
3	MOV		12	
		D	0	} Operand, set value line (Cannot operate on this line.)
		D	10	

(2) Example

(a) Writing ORB command

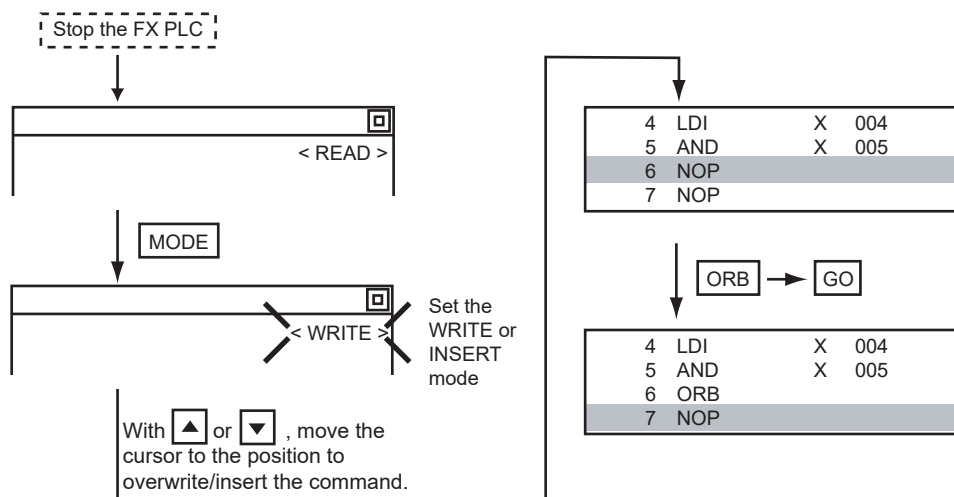

(b) Inputting LD X000

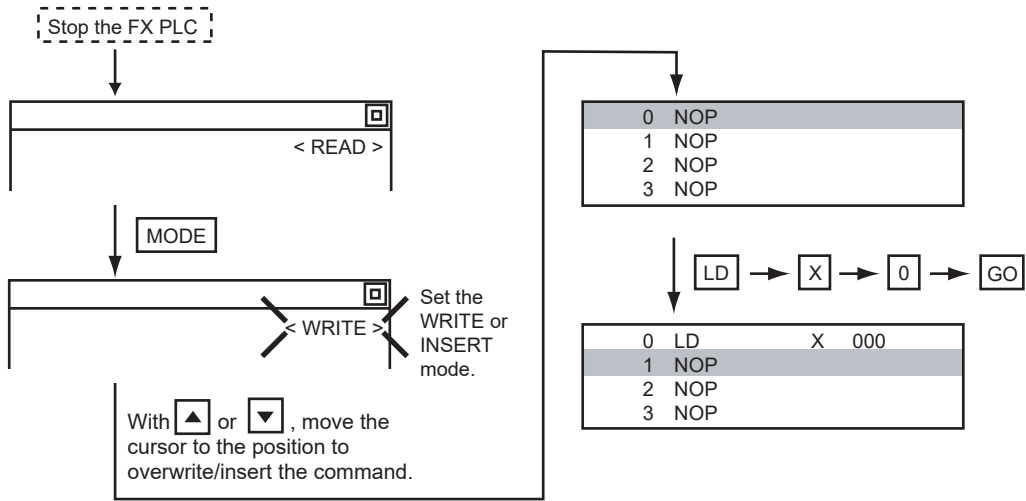

(c) Inputting OUT T100 K19

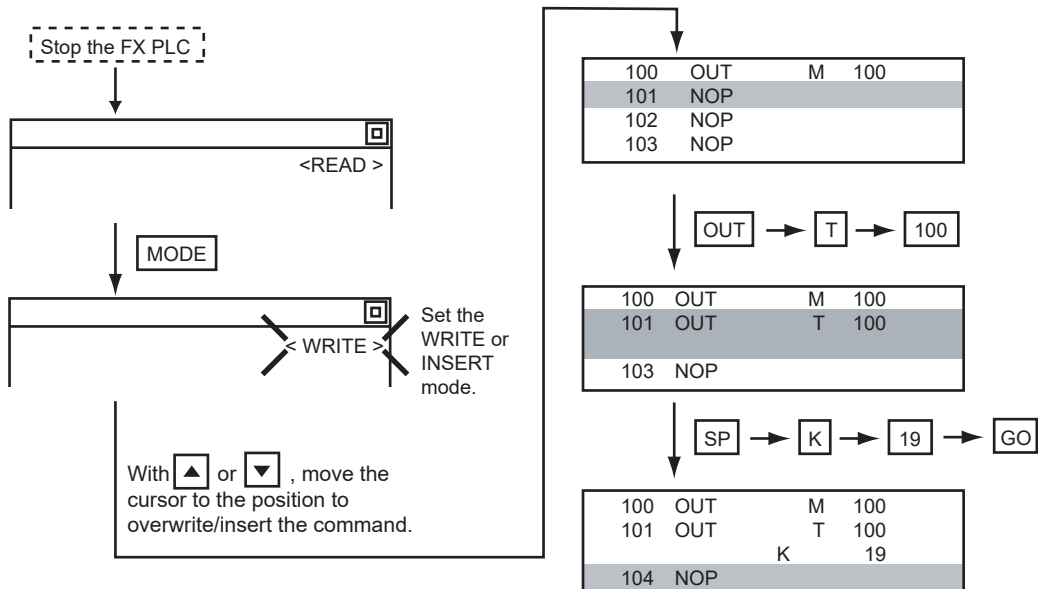

2 Writing applied instructions

(1) Operations

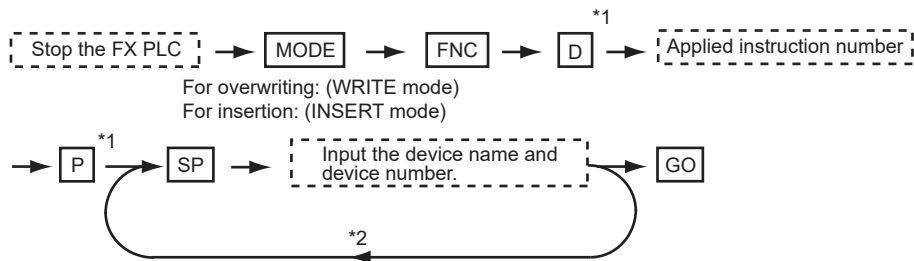

*1 **[D]** (double word command) and **[P]** (pulse execution format command) can also be input after the applied instruction number is input.

Inputting in the order **[P]** → **[D]** is also possible.

*2 When a command specifies multiple devices for operations, input the **[SP]** key followed by the device name and device number.

Point

(1) Moving the cursor to the position to write the command

When starting to write a command, place the cursor on the command line (the line on which the step number is displayed).

You cannot write a command with the cursor on any other line.

2	LDI	M	100	
3	MOV			12
		D	0	
		D	10	

Command line (Place the cursor on this line.)

Operand, set value line (Cannot operate on this line.)

(2) Commands using a text string constant for a command operand (such as ASC command)

With the MELSEC-FX list editor, text string constants cannot be written as operands. (such as ASC commands)

Use GX Developer for writing such commands.

(2) Example

Input "DMOV P D0 D2".

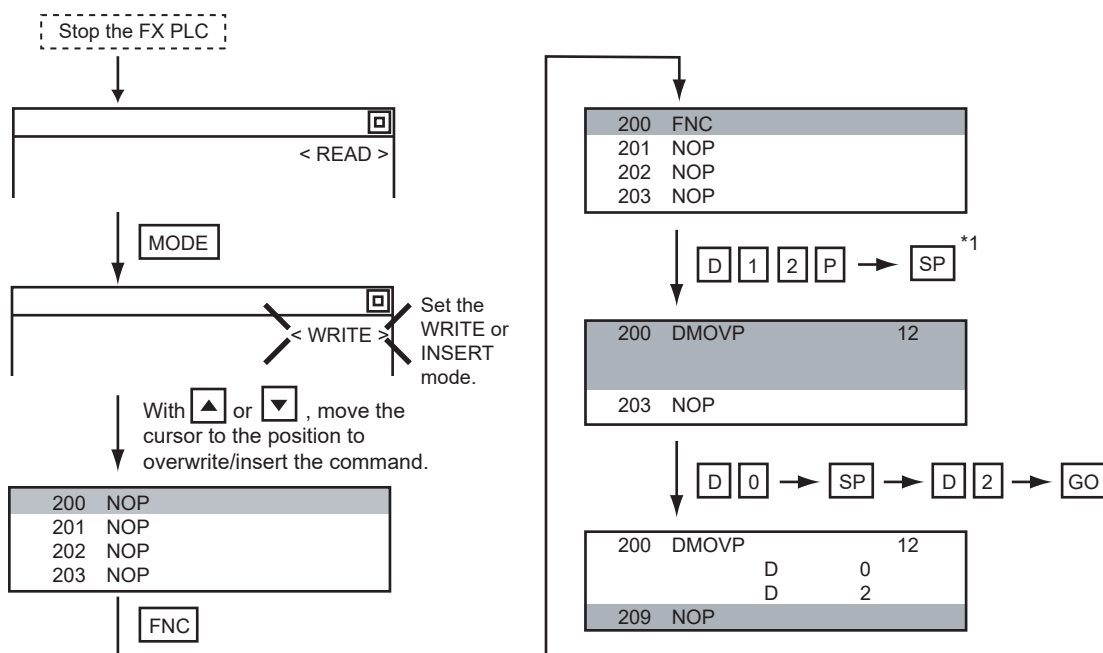

*1 The MOV command is FNC12.

14.4.10 Changing operands, set values

Changes the operand section of an applied instruction and OUT (T, C) command set value.

1 Operation

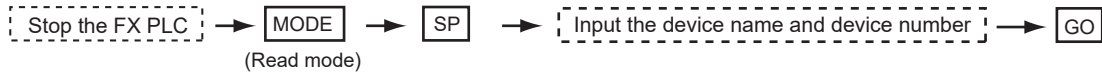

*1 For decimal numbers, input K, then the number.
For hexadecimal numbers, input H, then the number.

Point

Moving the cursor to the line on which the operand or set value is to be changed

When starting to change an operand or a set value, place the cursor on the line of the operand or set value to be changed (the line on which the step number is not displayed).

If you place the cursor on the command line, the input operation is not possible.

2	LDI	M	100	
3	MOV			12
		D	0	
		D	10	

Command line (Cannot operate on this line.)
Operand, set value line (Place the cursor on this line.)

2 Example

Changing "MOV D0 D10" to "MOV D0 D123".

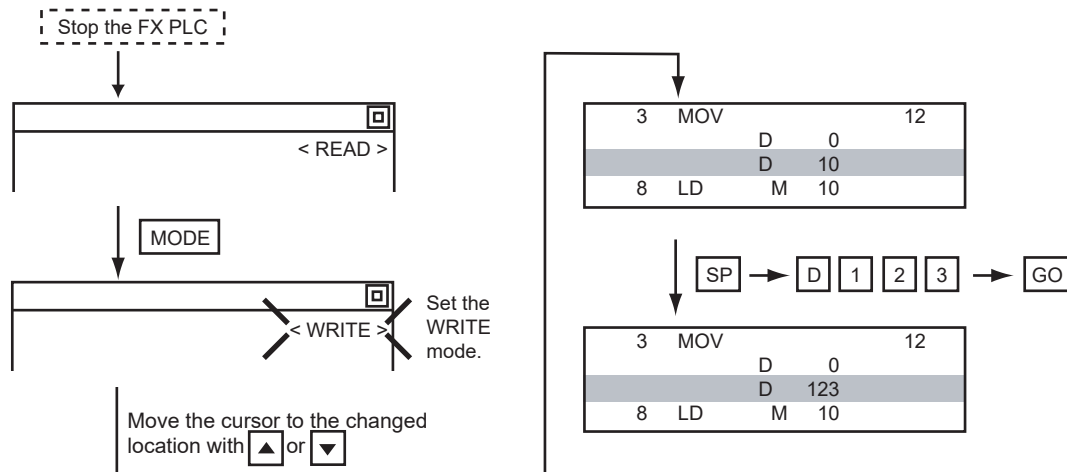

14.4.11 Deleting commands

Deletes one command at a time from a sequence program.

1 Operation

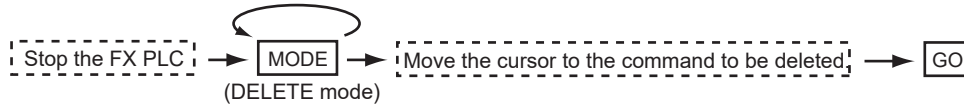

Point

When moving the cursor to the position where the command is to be deleted.

Place the cursor on the command line (the line on which the step number is displayed).

You cannot delete the command if the cursor is placed on the line of an operand or set value.

2	LDI	M	100	} Command line (Place the cursor on this line.)
3	MOV		12	
		D	0	} Operand, set value line (Cannot operate on this line.)
		D	10	

2 Example

Deleting "OUT T10 K100".

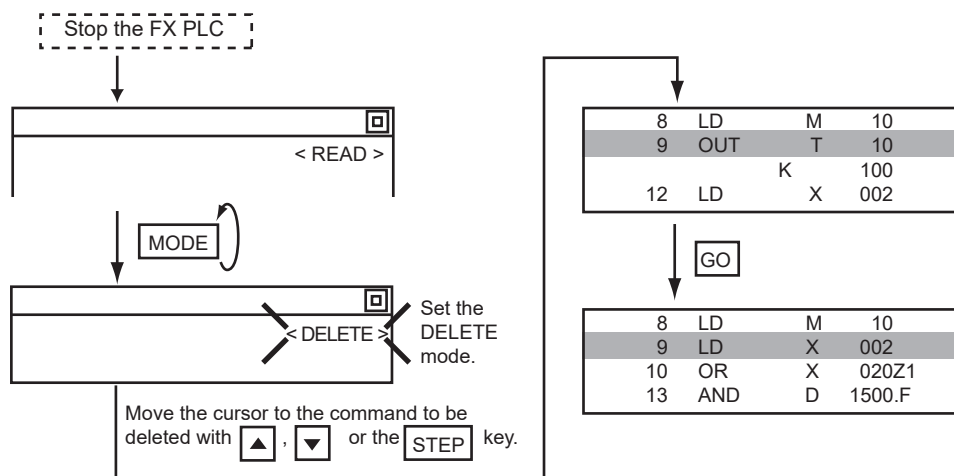

14.4.12 Sequence program all clear

Clears all the sequence programs.

1 Operation



2 Example

Clears all the sequence programs.

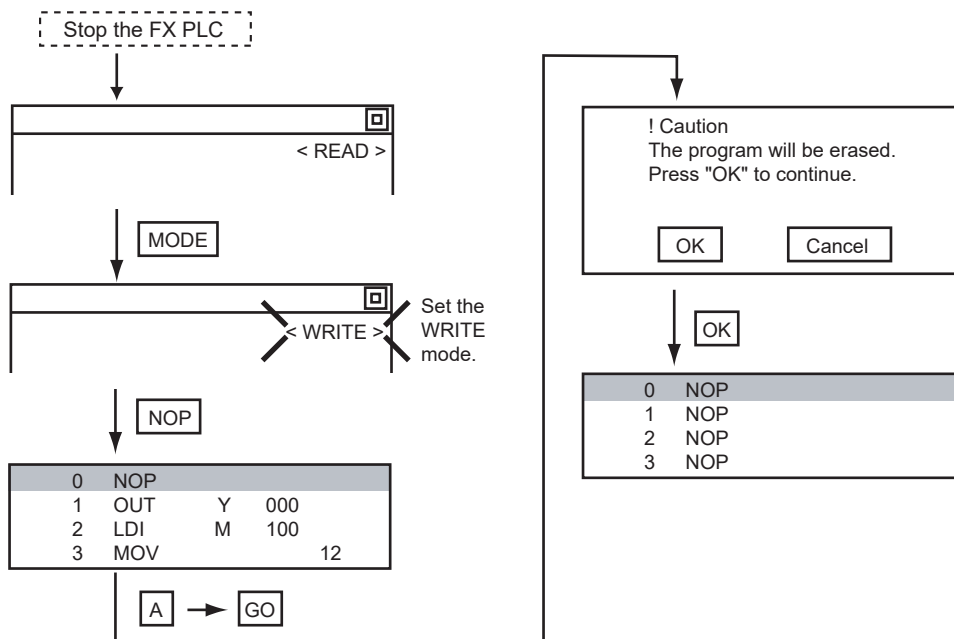

Point

Items cleared when All Clear for a sequence program is performed

When All Clear is executed, the parameters before program execution are initialized and Latch Clear is executed.

The memory space becomes the default value, the comment area a 0 block, the file register space a 0 block, and keywords unregistered.

After All Clear, set the above parameters etc. again.

Remark

Error details

For details on an FX PLC error, refer to the manual below.

 Programming manual for the FX CPU used

(2) Key functions

The table below shows the functions of the keys that are used for the operation on the PLC diagnostics screen.

Key	Function
	Exits the PLC diagnostics.

14.4.14 Parameter setting

Sets FX PLC parameters.

1 Parameters that can be changed and change targets

(1) Parameters that can be changed

The parameters that can be changed with the MELSEC-FX list editor and the target FX PLCs are as follows.

(○: Can be set/changed ×: Cannot be set/changed)

Item	Target CPU								
	FX0(S) /FX0N	FX1	FX2(C)	FX1S	FX1N(C)	FX2N(C)	FX3S	FX3G(C)	FX3U(C)
Memory space setting	×	○	○	×	×	○	○	○	○
File register space setting	○ ^{*1}	×	○	○	○	○	○	○	○
Latch range setting	×	○	○	×	×	○	×	×	○
RUN terminal setting	×	×	×	○	○	○	○	○	○
Initialization of parameters	○	○	○	○	○	○	○	○	○

*1 When connecting an FX0(S), set "0".

Setting other than "0" causes a parameter error.

*2 When the parameters are initialized, the display on the MELSEC-FX list editor is different from the FX PLC default values, but do not change the latch range. Changing the latch range causes an error.

(2) Change targets

When a memory cassette is mounted, the parameters in the memory cassette are targeted for changes.

2 Operation



Stop the FX PLC ^{*1}

OP → Select [Parameter setting] with **▲** or **▼**

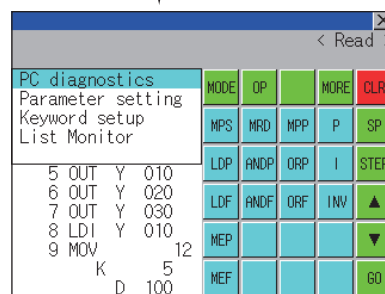

GO

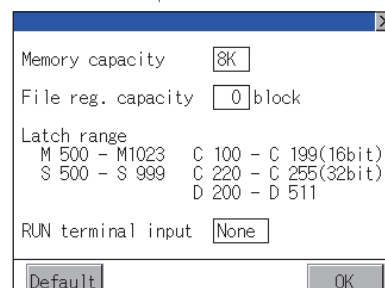

*1 When checking parameters (not changing), it is not necessary to stop the PLC.

3 Parameter setting screen

The following describes the contents displayed on the PLC diagnostics screen and the function of on-screen keys.

(1) Displayed contents

1) Memory capacity

2) File reg. capacity block

3) Latch range
M 500 - M1023 C 100 - C 199(16bit)
S 500 - S 999 C 220 - C 255(32bit)
D 200 - D 511

4) RUN terminal input

5)

No.	Item	Display contents
1)	Memory capacity	Sets the memory space (number of steps). If you touch the <input type="text" value="8K"/> section, you can change the memory space.
2)	File reg. capacity	Sets the memory space (number of blocks) allocated to the file register. Touch the <input type="text" value="0"/> section and input the number of blocks.
3)	Latch range	Sets the latch range (power failure hold area). Touch the number display section and input the value.
4)	RUN terminal input	Sets whether or not to use one of the FX PLC input terminals for RUN input. Touch the <input type="text" value="None"/> section and set the device to be set for the RUN terminal.
5)	Default	Initializes the parameters



Memory space for kana comments after changing memory space, file register space

If the memory space is set smaller than the total of the file register space and kana comment space, the kana comment space is automatically reduced.

(With the MELSEC-FX list editor, the kana comment space is not displayed.)

Note that if any setting as described below is made, the kana comment space is reduced.

(Settings that reduce kana comment space and the kana comment space after setting change)

Settings resulting in $Nm < Nf \times 500 + Nk \times 500 + 500$

$$\text{Kana comment space (steps) after setting change} = \frac{Nm - Nf \times 500 - 500}{500}$$

Nm: Memory space after change (steps)

Nf: File register space after change (blocks)

Nk: Comment space before change (blocks)



Settable range and default value



The settable range and the default value depend on the FX PLC type.

Refer to the following manual for details of the settable range and the default value.

Programming manual for the FX PLC used

(2) Key functions

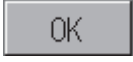
The table below shows the functions of the keys that are used for the operation on the parameter setting screen.

Key	Function
	Initializes the parameters
	Completes the changed setting contents.
	Ends parameter setting.

14.4.15 Keywords

Registers, deletes, releases protection for, and sets protection for the FX PLC keywords.

1 Function usability of the MELSEC-FX list editor for keyword protection levels

The functions that can be used with the MELSEC-FX list editor depend on the keyword protection level.

(○: Available, ×: Unavailable)

Function		Keyword protection level				Reference
		All operation protect (All on-line operation protect) *2	Read/Incorrect write protection (Read/write protect) *2	Incorrect write protect (Write protect) *2	Keyword not registered/keyword protection canceled	
Reading sequence programs	Displaying sequence programs	×	×	○	○	Subsection 14.4.7
	Searching commands/devices	×	×	○	○	Subsection 14.4.8
Writing sequence programs	Writing commands	×	×	×	○	Subsection 14.4.9
	Changing operands/set values	×	×	×	○	Subsection 14.4.10
Inserting commands		×	×	×	○	Subsection 14.4.9
Deleting commands		×	×	×	○	Subsection 14.4.11
Sequence program all clear		×	×	×	○	Subsection 14.4.12
PLC diagnostics		○*1	○	○	○	Subsection 14.4.13
Parameter setting		×	×	×	○	Subsection 14.4.14

*1 When the 2nd keyword is set to an FX PLC that supports 2nd keyword, it becomes "×" (cannot be used).

*2 The names within the parentheses () are for when a keyword + 2nd keyword is set.

2 Operation

OP → [Keyword setup] → GO

↓
OP → Select [Keyword setup] with ▲ or ▼.

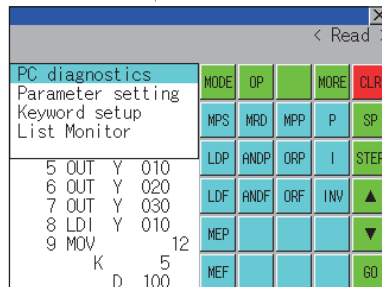

↓
GO

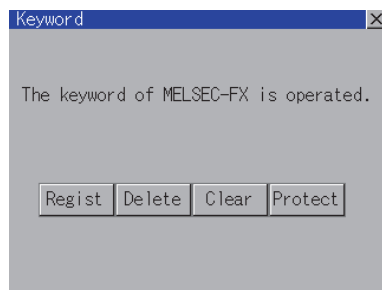

3 Keyword screen and protection level

When [Keyword setup] is selected with the MELSEC-FX list editor, the keyword screen is displayed. Refer to the following manual for the procedure for keyword operations.

☞ Subsection 10.2.3 Display contents of communication detail settings

Remark

Keywords

Refer to the following manual for details of keyword.

☞ Programming manual for the FX PLC used

14.4.16 List monitor

The status of contacts and coils in a sequence program is displayed.

1 Operation

OP → [List Monitor] → GO

↓

OP → Select [List Monitor] with ▲ or ▼.

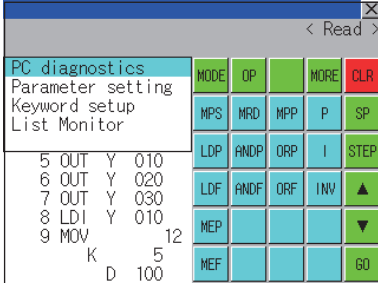

↓

GO

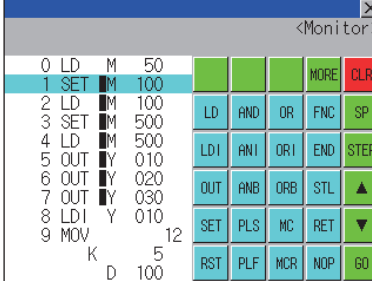

When the list monitor is started on the FX list editor screen, the step numbers displayed on the FX list editor screen is displayed on the list monitor screen.



Starting list monitor with special function switches (FX list monitor)

With setting special function switches (FX list monitor), the list monitor can be started on the monitor screen.

When the list monitor is started on the monitor screen, the list editor cannot be used.



For how to set special function switches, refer to the following manual.

- GT Designer2 Version Screen Design Manual
- GT Designer3 Version1 Screen Design Manual (Functions)

2 Displays and key functions

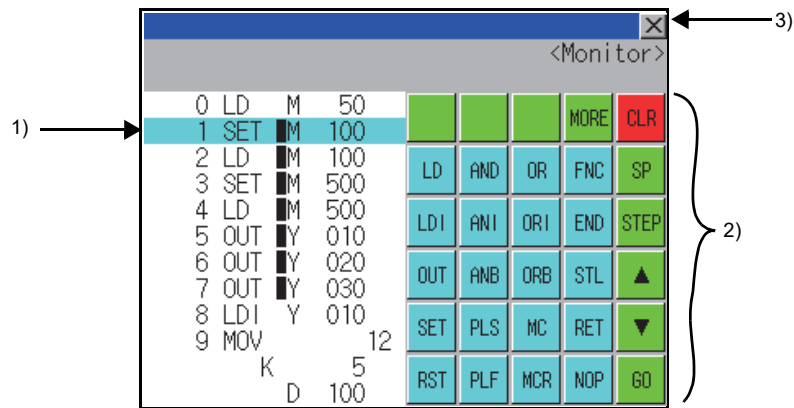
The following describes the displays for the list monitor.



No.	Item	Display contents
1)	List display area* ¹	The status of contacts and coils is displayed on the left of device displays.
2)	Keys	The same operations as in the READ mode of the FX list editor can be executed.  Subsection 14.4.7 Sequence program display
3)		Ends the list monitor. When the list monitor is executed on the FX list editor screen, the screen is switched to the FX list editor screen.

*1 The status of contacts and coils is displayed as below.

Type of instruction	Description	Status	
		■ Displayed	■ Not displayed
LD, AND, OR(Contact instruction (Normal open))	Contact	ON	OFF
LDI, ANI, ORI(Contact instruction (Normal close))	Contact	OFF	ON
OUT, SET	TC: Coil	ON	OFF
	Except TC: Contact	ON	OFF
RST	TC: Reset	ON	OFF
	Word device	Value: 0	Value: Except 0
	Except TC and word device: Contac	OFF	ON
MC, STL	Contact	ON	OFF
LDP, ANDP, ORP, LDF, ANDF, ORF (Rise or fall contact instruction)	Not monitored	Always ■ not displayed	

14.4.17 Action for an incorrect key input

If an incorrect key is input, cancel the input contents.

1 Operation

- (1) Before touching the **GO** key (before reading/writing the input contents)
Before touching the **GO** key, touch the **CLR** key.
- (2) After touching the **GO** key (after reading/writing the input contents)
Write the command again. (☞ Subsection 14.4.9 Writing commands)
Commands finalized by writing and inserting operations are revised (overwritten) with the program writing.

14.4.18 Error messages and corrective actions

This section describes the error messages displayed when the MELSEC-FX list editor is executed, and corrective action.

Error Message	Description	Corrective action
Can not display while protected.	The all-operation protect, anti-plagiarism, or incorrect write protect keyword is set.	<ul style="list-style-type: none"> · Check the protected operation. · Clear the keyword protection or delete the keyword. ☞ Subsection 14.4.15 Keywords
Can not operate while protected.		
PLC parameter error.	An FX PLC parameter is defective.	Set correct parameters in the FX PLC.
PLC communications error.	The communication with the FX PLC is defective.	<ul style="list-style-type: none"> · Check the FX PLC, cable, and GOT for abnormality. · Check whether the communication settings are correct or not.
PLC is running.	A writing operation etc. has been made while the FX PLC is running.	Stop the FX PLC.
Can not write.	<ul style="list-style-type: none"> · The memory to write to is EPROM. · The protect switch of the EEPROM is on. 	<ul style="list-style-type: none"> · Set other than EPROM for the memory to write to. · Switch off the protect switch of the EEPROM.
Step number is out of a range.	The specified step number exceeded the maximum number.	Specify a step number below the maximum value.
Not found.	The specified command cannot be found.	Proceed to the next operation.
Not found.	The specified device cannot be found.	Proceed to the next operation.
Step overflow.	The program may exceed the available space. (Writing is not executed.)	Check the program memory space and delete commands to keep it within the space. ☞ Subsection 14.4.11 Deleting commands
Command error.	An invalid command (non-existent command) was specified.	Input the correct command.



How to erase an error message

An error message is not erased even if the cause of the error is eliminated.
To erase an error message, touch a key on the MELSEC-FX list editor screen.

14.5 Self Check

14.5.1 Self check function

Carries out self-check for the GOT hardware or memory etc.
The items that can be self-checked are as follows.

Items	Contents	Reference page
Memory check	Carries out write/read check of the Built-in CF card, Flash memory, and Internal SRAM. Password: "5920" (fixed)	14-113
Drawing Check	Carries out missing bit check, color check and drawing check.	14-117
Font check	Displays the character data on the screen to check visually.	14-121
Touch panel Check	Checks whether there are no dead zone area in the Touch key minimum unit (16 dots x 16 dots).	14-123
I/O check	Carries out RS-422 and RS-232 connecting target confirmation (CPU communication check) and the RS-232 self-loopback check (hardware check of the RS-232 interface).	14-125

14.6 Memory Check

14.6.1 Memory check function

The memory check function carries out the write/read check of the Standard CF card, Flash memory, and Internal SRAM.

Function	Contents
A drive memory check	Checks whether the memory (Standard CF card) of the A drive can be read/written normally.
C drive memory check	Checks whether the memory (Flash memory) of the C drive can be read/written normally.
D drive memory check	Checks whether the memory (Internal SRAM) of the D drive can be read/written normally.

14.6.2 Display operation of memory check

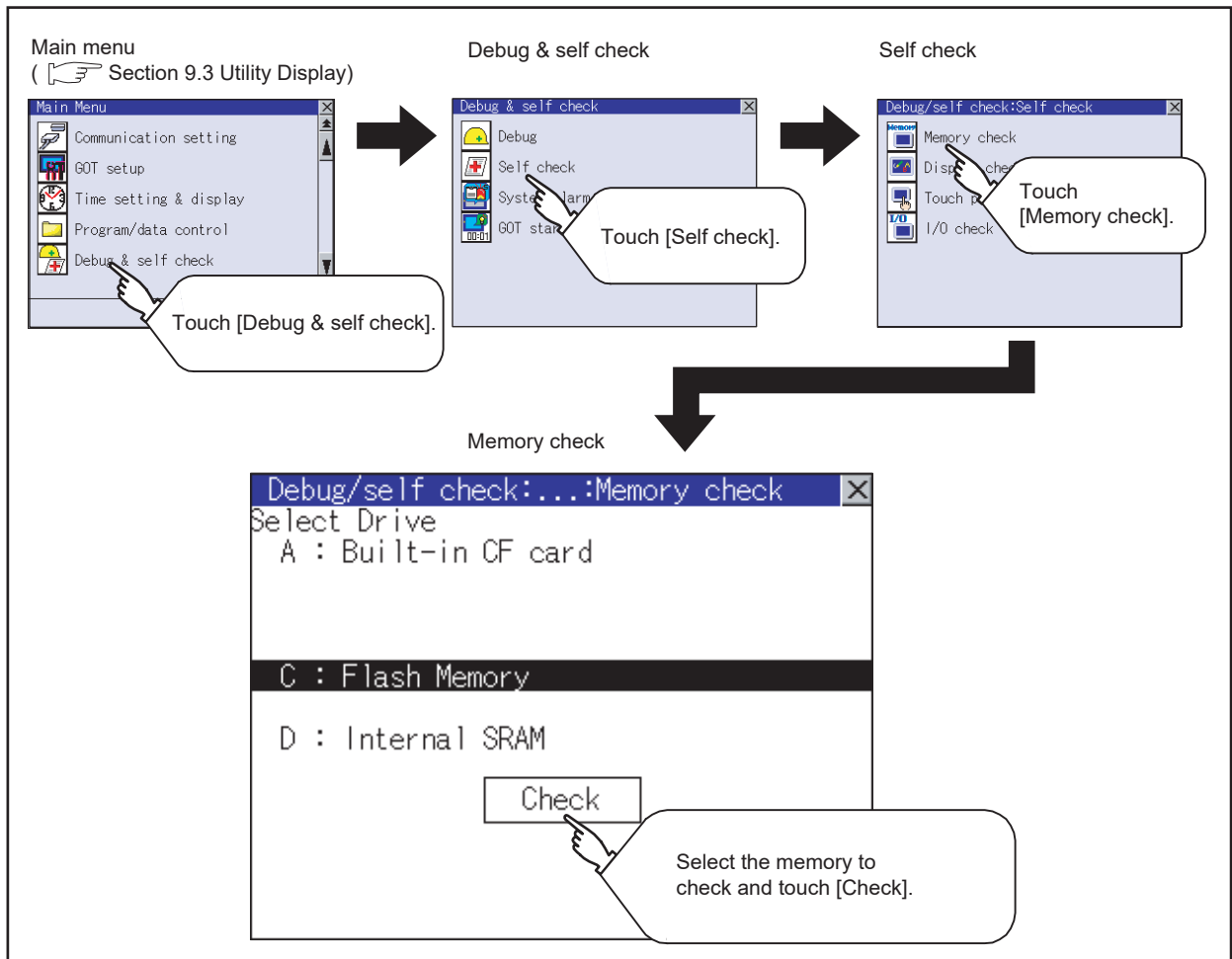

14.6.3 Memory check operation

Carries out write/read check of memory.



When drive is not displayed

When the drive (memory) to check is not displayed, confirm the mounting procedure or memory type with reference to the following.

- CF card inserting/removing method  Section 8.1 CF Card

When no faults are found in mounting, etc, a memory failure may be arisen.

Replace the CF card or Flash memory (C drive).

For details of Flash memory, contact your nearest sales office or FA Center.

The following example explains about Memory Check using Flash memory (C drive).

For the standard CF card (A drive) memory check, install the CF card before carrying out the same key operations as Flash memory.

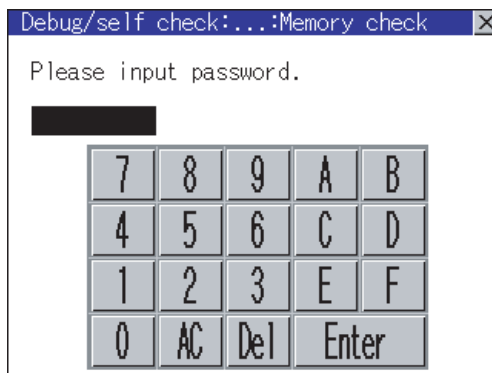
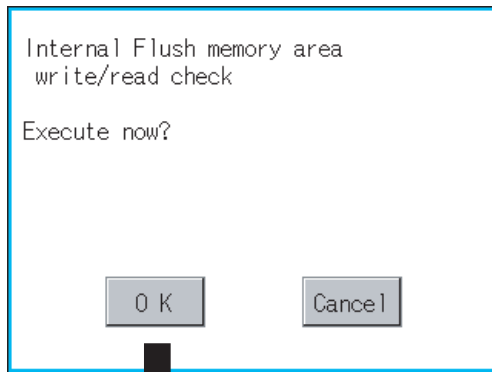

- 1 Select [Flash Memory] in the [Memory check] setting screen, and touch the button.

If select the button, the numeric keyboard window is displayed.

If select the button, the screen returns to the initial menu.

- 2 Touch and then .

(The password is fixed to 5920.)

Touching executes read/write check for the flash memory.

Internal Flush memory area
write/read check
Executing now...



Internal Flush memory area
write/read check
Normally completed.

OK

- 3 Touching the **OK** button returns to the [Memory check] screen.

Remark

Password change

The password cannot be changed.

When input password error, the cancel dialog is displayed.

Internal Flush memory area
write/read check
Password error.

OK

If touch **OK**, returns to the [Memory check] screen.

Point

When error is found in the memory

When error is found by memory check, the dialog indicating the area in which the error occurred is displayed.

If an error is found in the D drive [Internal SRAM], format the internal SRAM.

For details of the formatting of the D drive [Internal SRAM], refer to the following.

 Section 13.5 Memory Card Format

If an error is found in the C drive [Flash memory] or the D drive [Internal SRAM] right after formatting, contact your nearest sales office or FA Center.

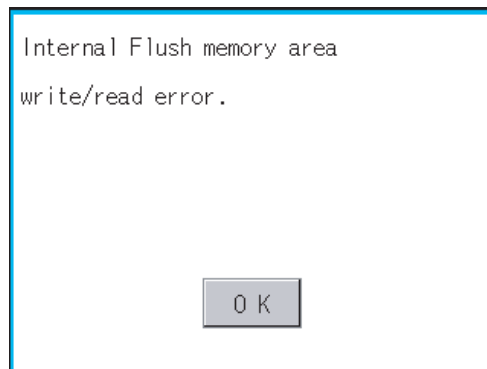

If touch , the screen returns to the [Memory check] screen.

14.7 Drawing Check

14.7.1 Drawing check function

The drawing check function carries out display checks as missing bit check, color check, basic figure display check, move check among screens.

14.7.2 Display operation of drawing check

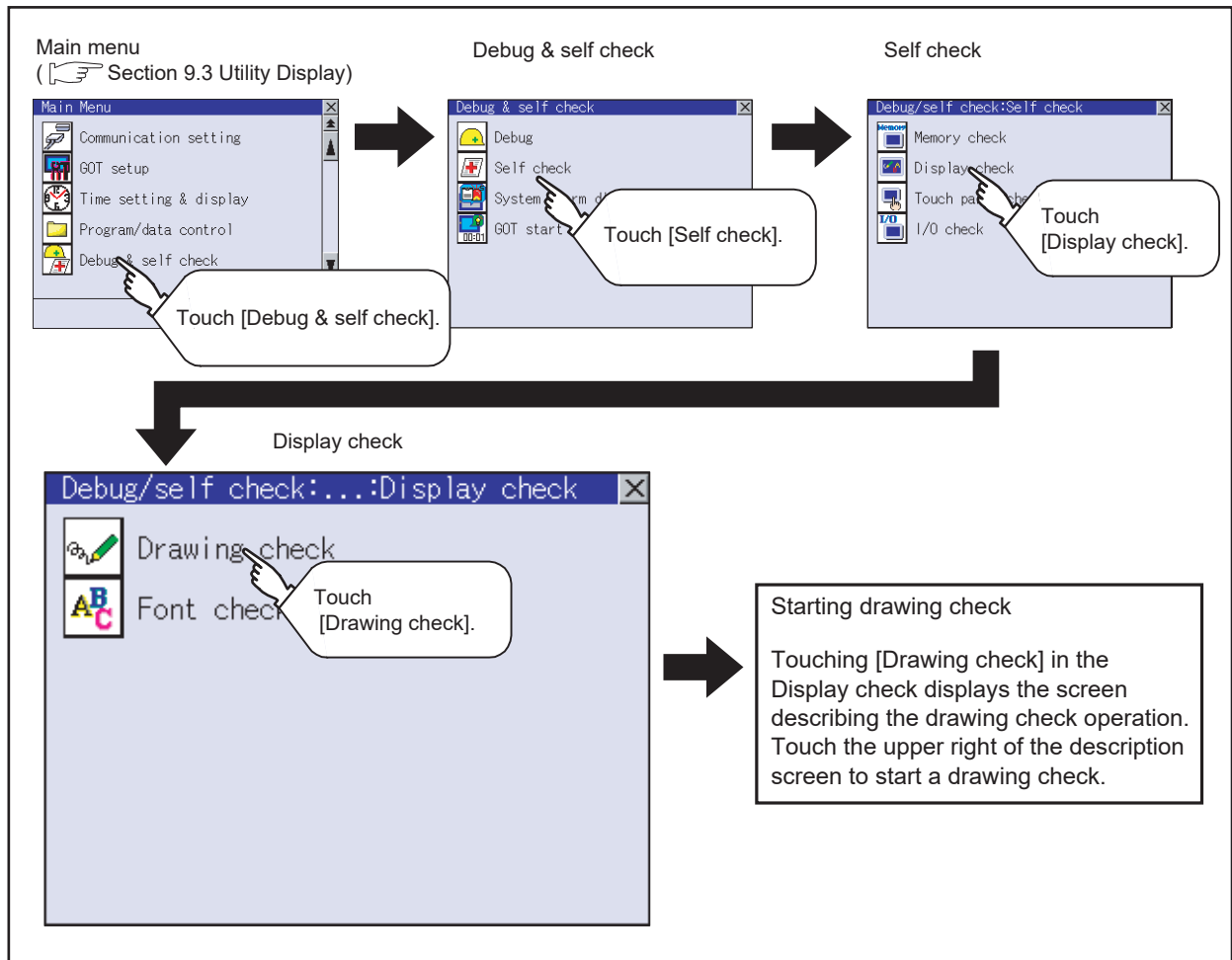

Notes on drawing check

Missing bits is occurred in the following cases.

1. There are parts drawn in different color with the filled color.
2. There are parts of basic figure and drawing patterns which are not drawn according to the layout and procedures described in "Section 14.7.3 Display and operation of drawing check".

When missing bits occurs, contact your nearest sales office or FA Center.

Bright dots (always lit) and dark dots (unlit) may appear on a liquid crystal display panel. It is impossible to completely avoid this symptom, as the liquid crystal display comprises of a great number of display elements.

A flicker may be caused in some display colors. This is a characteristic of the LCD panel; it is not due to a fault or failure of the product.

14.7.3 Display and operation of drawing check

Touching [Drawing check] in the [Display check] displays the screen describing the drawing check operation. Touch the upper right of the screen to start a drawing check.

1 Before execute drawing check

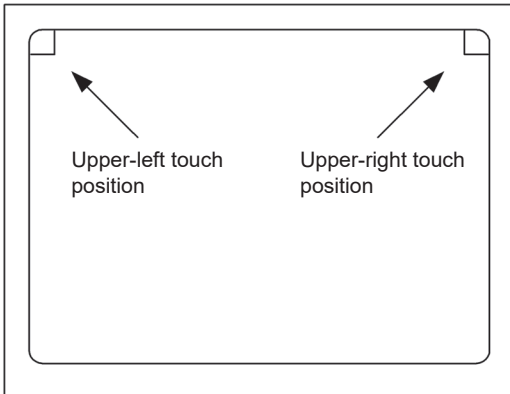

- (1) Touching the upper right part of the screen proceeds to the next check in each step during the drawing check. Touching the upper left part of the screen returns to the [Display check] screen.
- (2) For GT1155 (256 colors), color display (blue, black, red, purple, green, light blue, yellow and white) is available.
For GT1150 (monochrome 16 scales), the colors are reduced to the 16-scale monochrome.
This section describes with an example using GT1155 (256 colors).

1 Missing bit, Color Check

By touching the upper-right part of the screen, the entire screen color changes in the following order:
blue → black → red → purple → green → light blue → yellow → white.
Check missing bit and color visually.

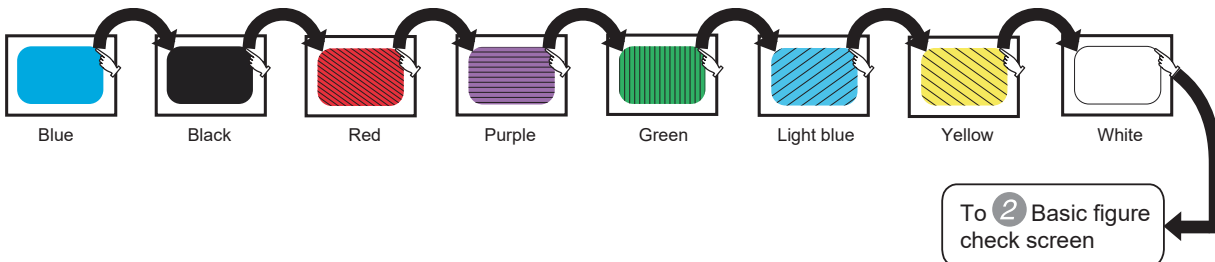

If touch the upper right part of the screen at the final color (white screen), the following 2 Basic figure check screen is displayed.

2 Basic figure check

Check whether there is no shape transformation of basic figure or display losses.
The basic figure drawn has 4 types: 1. Filled circle, 2. Line, 3. Rectangle, 4. Ellipse.

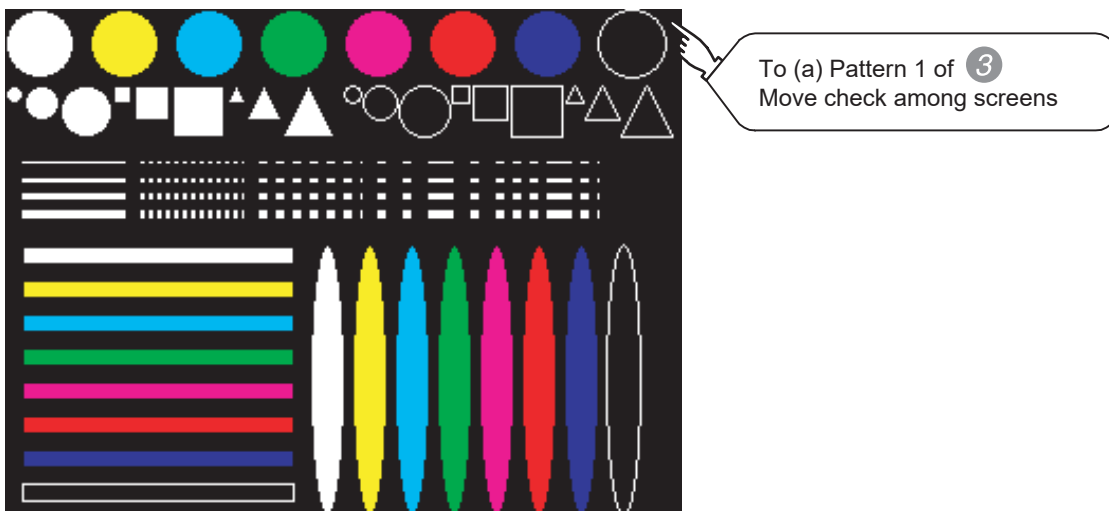

3 Move check among screens

(a) Pattern 1: Shape transformation, color check

The drawn figures are displayed in order and at regular intervals.

If the shape and color (white, yellow, light blue, green, purple, red, blue, black) are displayed visually in order, it is normal.

For GT1150 (monochrome 16 scales), each color is subtracted to monochrome 16-scale.

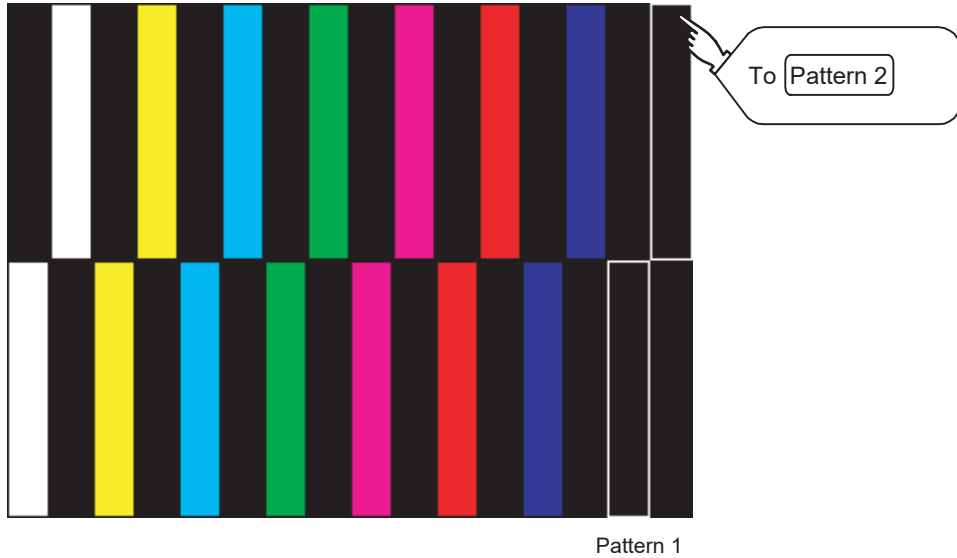

(b) Pattern 2: Shape transformation, color check

The drawn figures are displayed in order and at regular intervals.

If the shape and color (white, yellow, light blue, green, purple, red, blue, black) are displayed visually in order, it is normal.

For GT1150 (monochrome 16 scales), each color is subtracted to monochrome 16-scale.

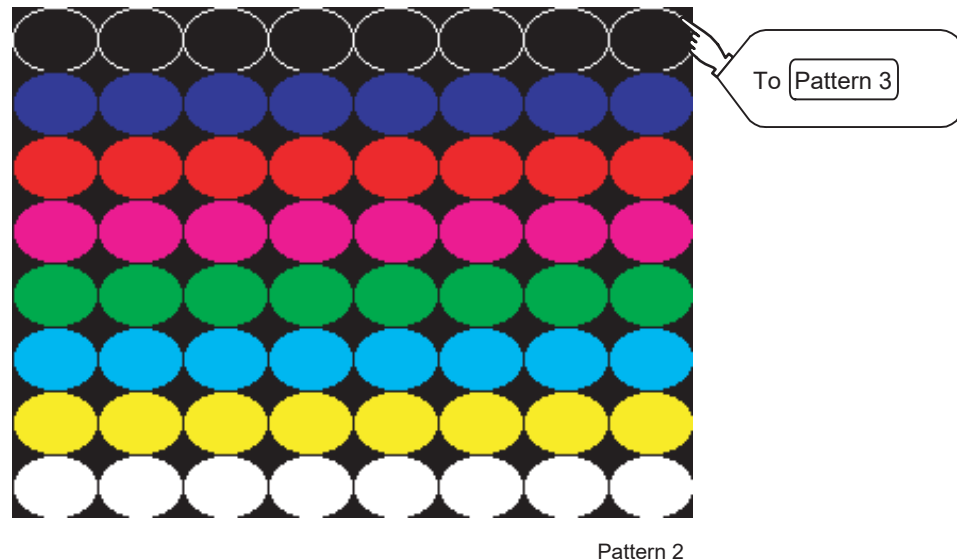

(c) Pattern 3: Shape transformation, color check

The overlapped shapes of pattern 1 and pattern 2 are displayed.

If the shape and color (white, yellow, light blue, green, purple, red, blue, black) are displayed visually in order, it is normal.

For GT1150 (monochrome 16 scales), each color is subtracted to monochrome 16-scale.

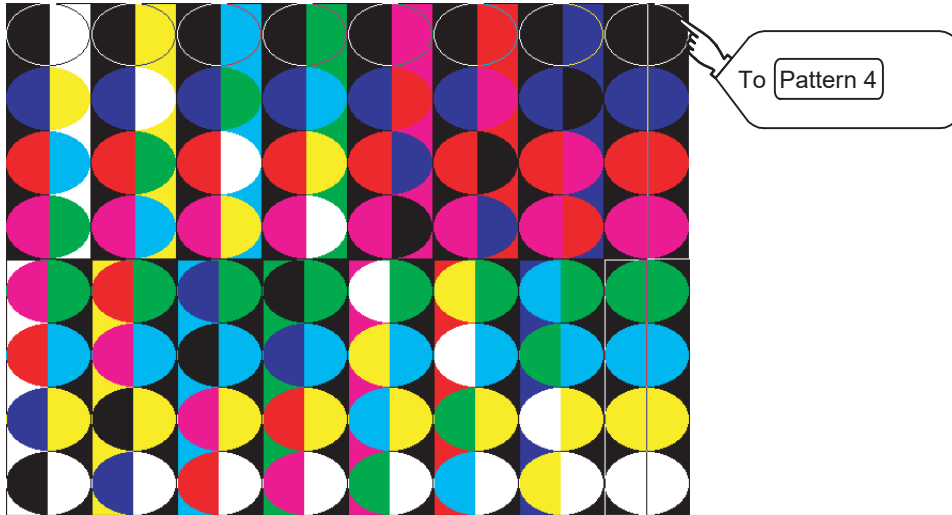

(d) Pattern 4: Shape Check

The drawn figures are displayed in order and at regular intervals.

If the shape and color are displayed visually in order, it is normal.

If touch the upper right part of the screen, returns to [Display check] screen.

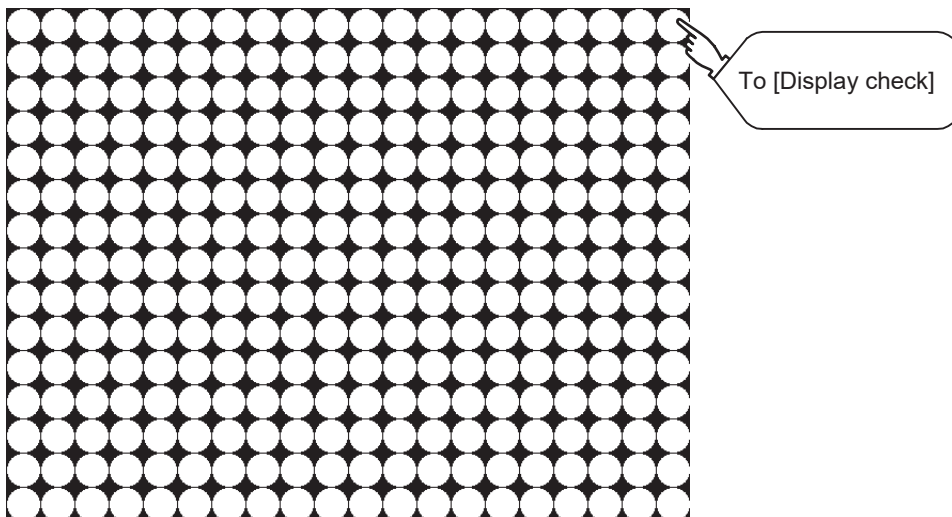

14.8 Font Check

14.8.1 Font check function

The font check is a function which confirms fonts installed in GOT. The character data of the font is displayed on the upper left part of the screen one by one.

14.8.2 Display operation of font check

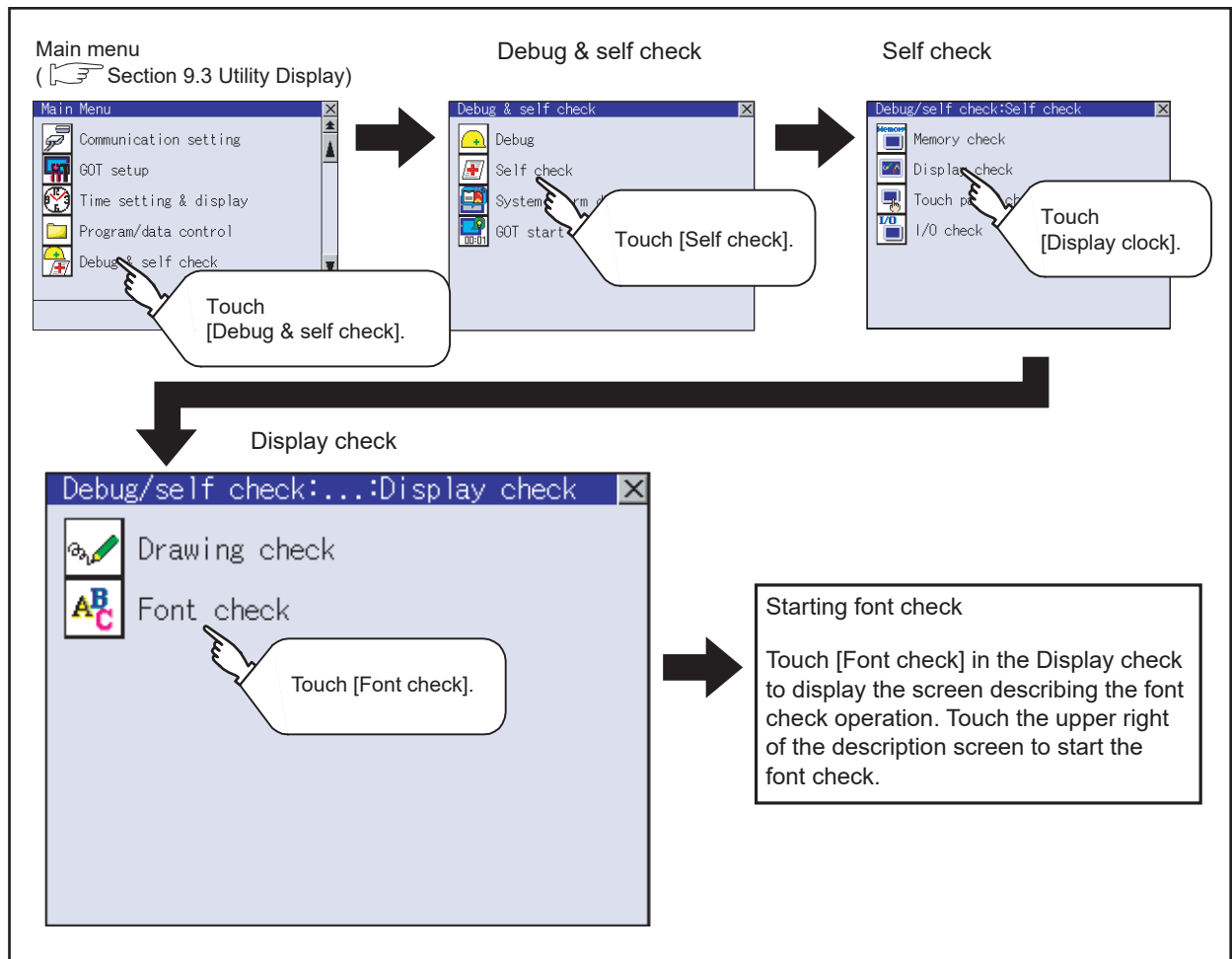

Notes on font check

- Judged as normal if the following characters are correctly displayed. (UNICODE)
- Alphabetic & etc. : 0 x 0000 to 0 x 04F9 (From basic Latin to Krill)
- Hangul : 0 x AC00 to 0 x D7A3 (Hangul / Hangul auxiliary)
- Chinese Characters : 0 x 4E00 to 0 x 9FA5 (CJK integrated Kanjis)

If the characters above are not displayed correctly, the fonts may not be normally installed.

Install the Standard monitor OS again.

14.8.3 Font check operation

Touching [Font check] in the [Display check] menu displays the screen describing the font check operation. Touching the upper right of the screen starts the font check. The character data of the installed font (stored in the flash memory) can be displayed on the screen one by one to confirm the font drawings visually.

1 Before execute font check

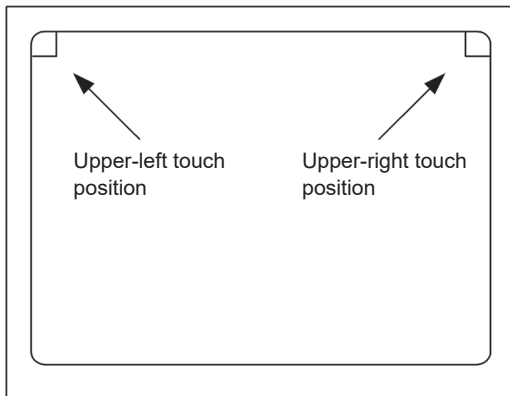

Touching the upper right part of the screen proceeds to the next check in each step during Font check.

Touching the upper left part of the screen returns to the [Display check] screen.

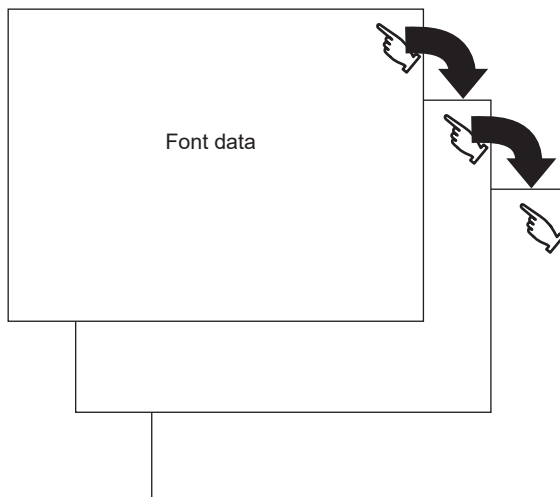

The installed font data is displayed by touching the upper right part of the screen.

14.9 Touch Panel Check

14.9.1 Touch panel check function

Touch panel check is a function which checks whether there is no dead zone area in touch key minimum unit (16 dots x 16 dots).

14.9.2 Display operation of touch panel check

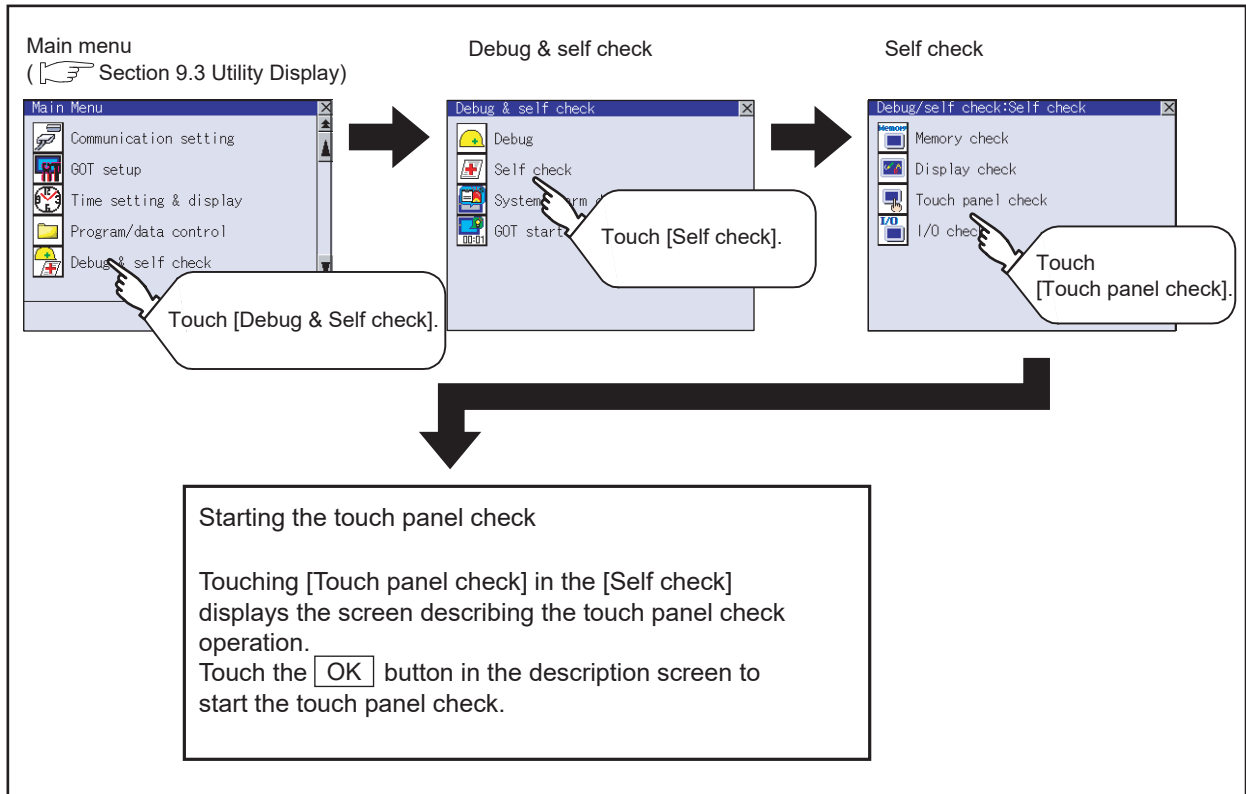

Notes on Touch panel check

If the touched part is not filled with yellow color, there are the following two possible causes.

1. Display part failure
2. Touch panel failure

In that case, contact your nearest sales office or FA Center.

14.9.3 Touch panel check operations

Touching [Touch panel check] of [Self check] displays the screen explaining the touch panel check operation. Touch the button to start the touch panel check.

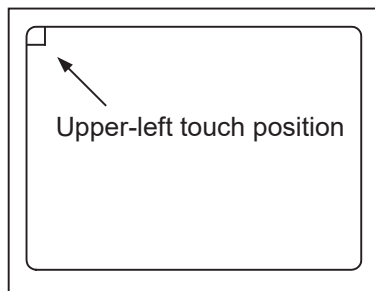
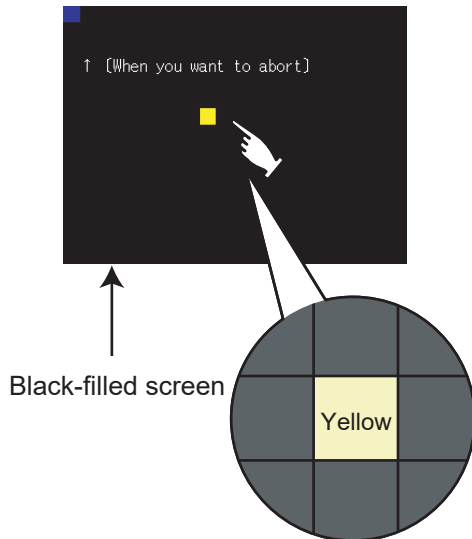

- 1 Touch a part of the screen.

The touched part becomes a yellow^{*1}-filled display.

If not displayed in yellow even when touched, the display part may be faulty. In this case, contact your nearest sales office or FA Center.

*1: For a monochrome 16-scale GOT, the part is displayed with a subtracted yellow color.

- 2 If touch the upper left part, returns to the [Self-check] screen.

Remark

Checking the upper left part of the screen

Only the upper left part of the screen cannot be filled with yellow.^{*1}

If returns to the [Self check] screen by touching the upper left part, judge that the upper left area operates normally.

*1: For a monochrome 16-scale GOT, the part is displayed with a subtracted yellow color.

14.10 I/O Check

14.10.1 I/O check function

The I/O check is a function which checks whether GOT and PLC can communicate with each other. If I/O check ends normally, the communication interface and the connection cable hardwares are normal. To execute I/O check, the PLC communication driver has to be installed in GOT in advance from drawing software.

Refer to the following for the details related to the installation of the PLC communication driver.

- GT Designer2 Version□ Basic Operation/Data Transfer Manual
- GT Designer3 Version1 Screen Design Manual (Fundamentals)



I/O check function

Controllers except MITSUBISHI PLC cannot be checked with the use of I/O check function.

When checking the communication between GOT and controller, follow "Preparatory Procedures for Monitoring" in "GOT 1000 Series Connection Manual".

- GOT 1000 Series Connection Manual.

14.10.2 Display operation of I/O check

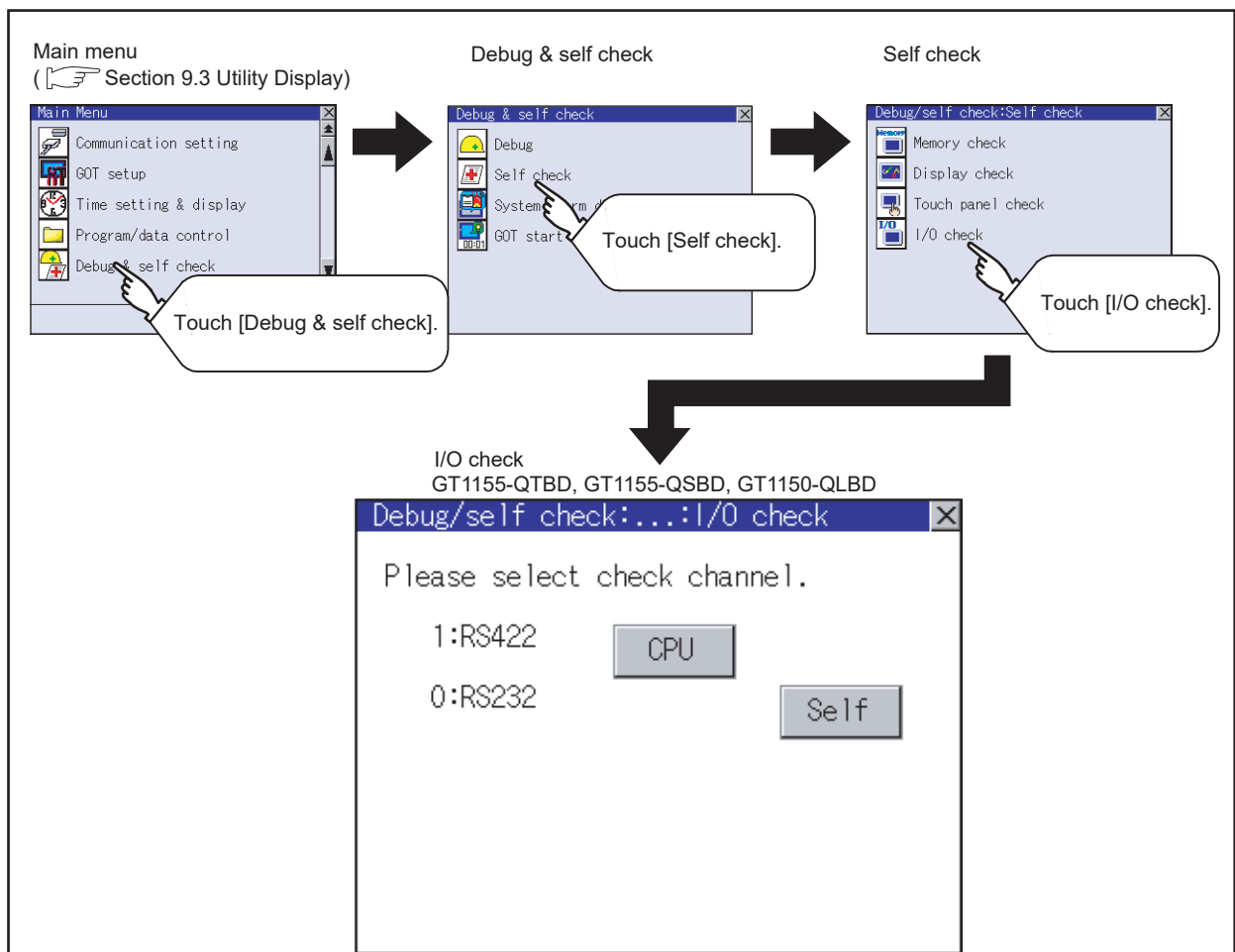

14.10.3 I/O check operation

1 Target confirmation

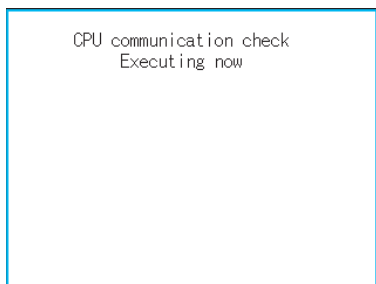
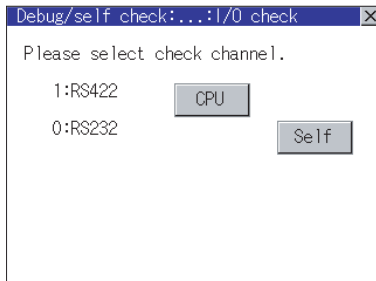

- 1 As a preparatory step for the CPU communication check, perform the following items.
 - Installing [Communication driver]: Use drawing software to install.
 - Setting [Communication settings]: Use drawing software to enter and download.
 - Connecting connection device: Connect a PLC to the communication interface for which the CPU communication check is applied in order to start the communication.
(Check for the power is on or if any error occurred.)
- 2 If touch the **CPU** button, the CPU communication check is carried out.
- 3 After the CPU communication starts normally, the dialog mentioned left notifying that it is on checking, until the CPU communication check ends normally.

- 4 When the CPU communication check ends, its result is notified by dialog.
If the CPU communication check ends normally, the dialog notifying of the normal termination mentioned left is displayed. If touch the button in the dialog after confirming the result, returns to I/O check.

If the dialog mentioned left is displayed after selecting **CPU** or during CPU communication check, confirm the following.

- No misconnection with CPU
(☞ GOT1000 Series Connection Manual)
- No hardware error
(☞ GOT1000 Series Connection Manual)
- No missettings of parameter
(☞ Section 10.2 Communication Detail Settings)

If touch the **OK** button in the dialog after confirming the result, returns to I/O check.

2 Self-loopback

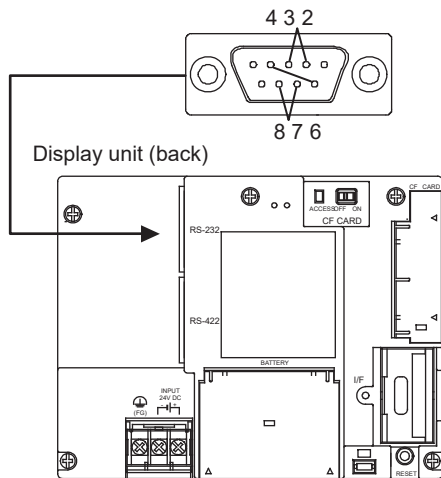

RS232 communication check
Error
The following cause:
Connection error H/W error
parameter setting error.
Restart

CPU communication check
Executing now

CPU communication check
No error
Restart

- 1 For preparation for the self-loopback communication check, insert the connector for self-loopback check (Customer purchased) shown in the diagram left in the RS-232 interface.
For this connector, short 2 and 3 pins, 7 and 8 pins, 4 and 6 pins, respectively.
Set the interface channel setting for the self-loopback check to none (ChNo. : 0) by using Communication Settings of the GOT main unit. Refer to the followings for the Communication Settings.
- 2 If touch the button, the hardware check for the RS-232 interface is carried out.
- 3 After selecting , the transferred data and received data are verified through the self-loopback connector. If data can not be received during data transmission, the dialog shown left is displayed, and the GOT restarts which notifies the self-loopback connector failure, self-loopback connector communication error or RS-232 interface hardware failure.
- 4 During check, the dialog shown left is displayed.
- 5 When all checks end normally, the dialog shown left is displayed, and the GOT restarts.



- 6 If an error occurs the dialog is displayed at that point, notifying the GOT has terminated abnormally and which byte the error occurred, and then the GOT restarts.

If a verification error occurs, the RS-232 interface hardware may be faulty.

14.11 System Alarm Display

14.11.1 System alarm display function

System alarm display is the function to display error code and error message when an error occurs in GOT, controller or network.

System alarms can be reset on the System alarm display screen.

For details of system alarm, refer to the following manual.

➔ GT Designer2 Version□ Screen Design Manual

GT Designer3 Version1 Screen Design Manual (Functions)

14.11.2 Displaying the system alarm display

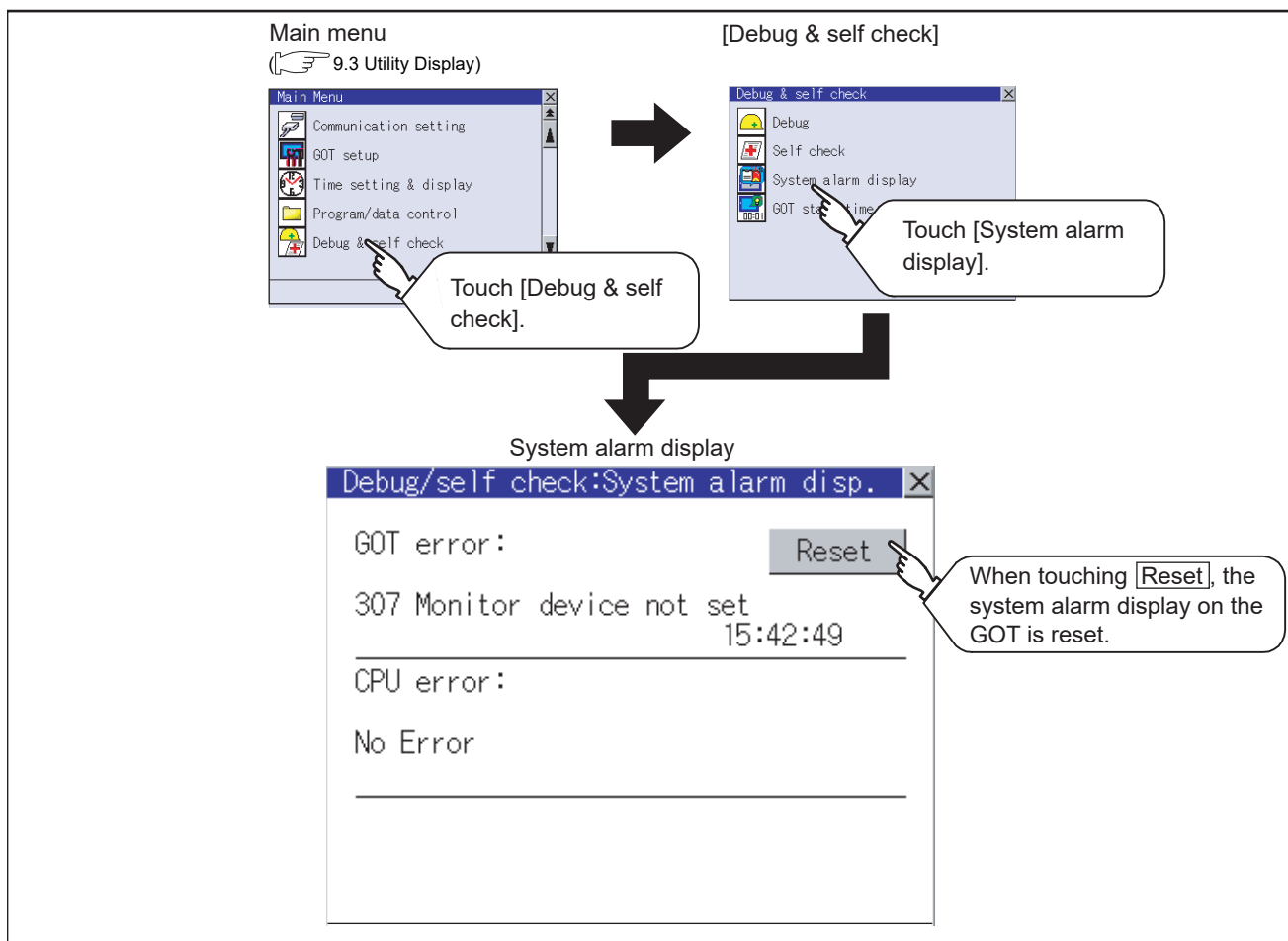

14.11.3 Operating the system alarm display

1 System Alarm display resetting

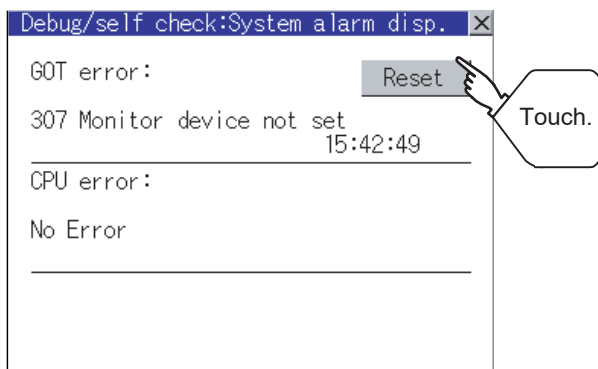
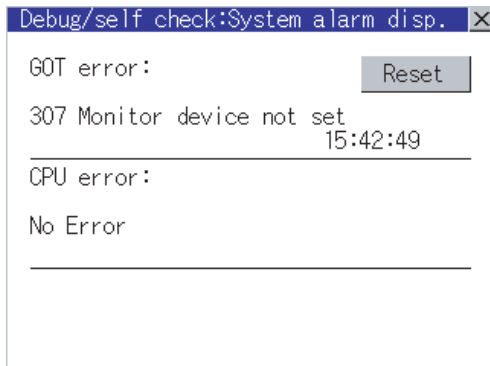

- 1 Eliminate each cause of the system alarm being occurred.
Error causes can be identified by the error code, error message and channel No. displayed on the System alarm display screen.
(☞ 18. ERROR MESSAGE AND SYSTEM ALARM)

- 2 Touch the Reset button to reset system alarms.

Point

- (1) Before resetting System Alarm display
Eliminate each cause before resetting system alarms.
Without eliminating causes, System Alarm display cannot be reset even when touching the [Reset] button.
- (2) Processings with reset operation
The following data in the system information are also reset.
 - GOT error code (Write device)
 - GOT error detection signal (System Signal 2-1.b13)

14.12 GOT Start Time

14.12.1 GOT start time function

GOT start time is the function to display the following date and time.

- Start time of GOT
- Current time of GOT
- Operating hours of GOT

14.12.2 Display operation of GOT start time

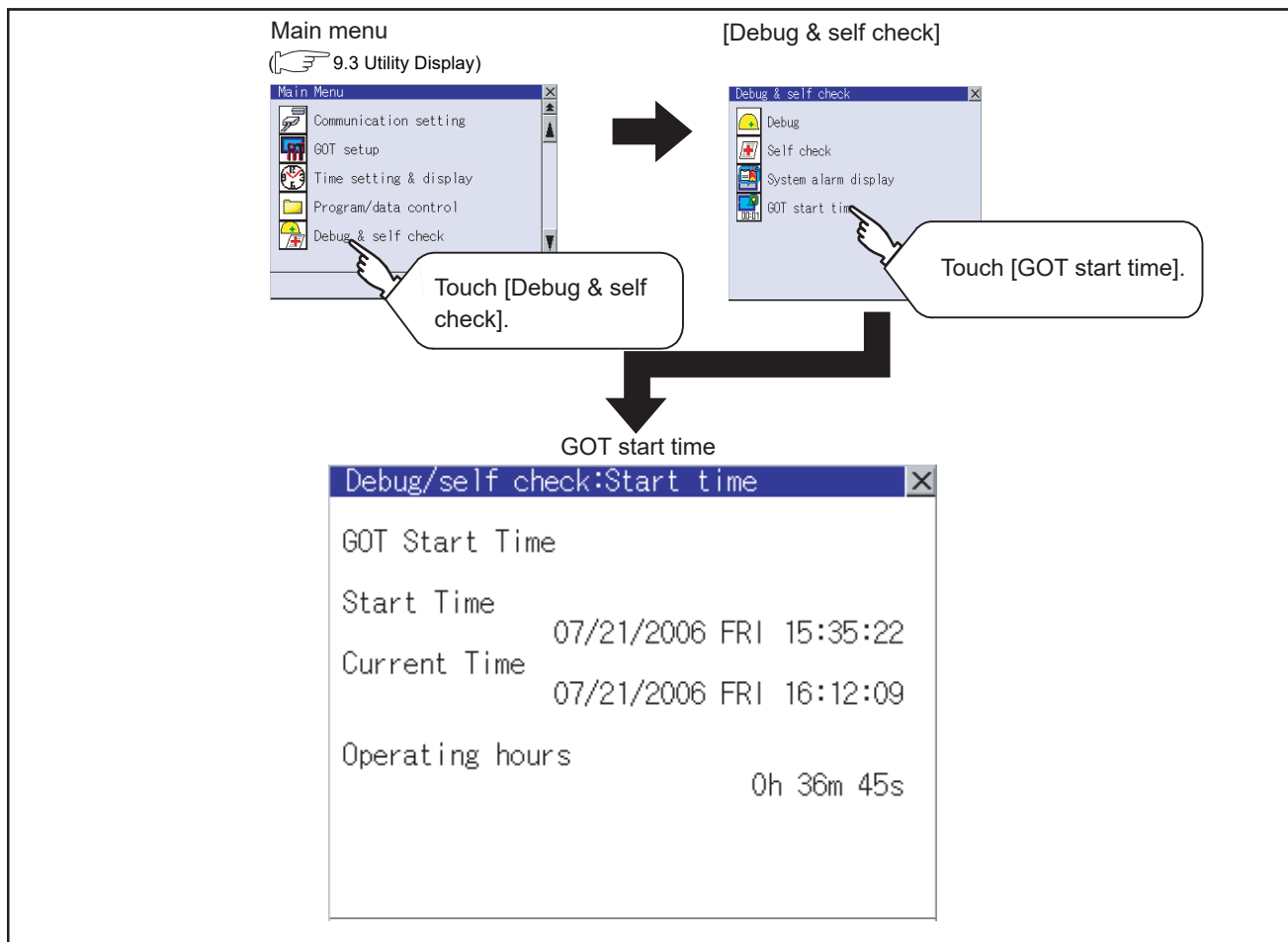

14.12.3 Display of GOT start time

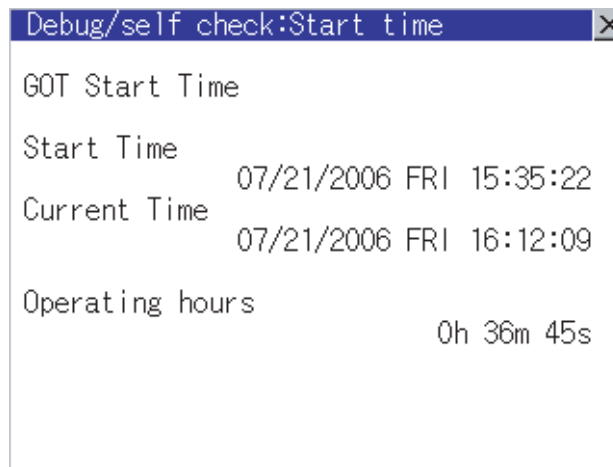

Item	Description
Start Time	Displays the time when the GOT was powered on or reset-restarted (OS installation, communication setting change).
Current Time	Displays the current time.
Operating hours	Displays operating hours of the GOT. The displayed operating hours is the accumulated time while GOT is powered on or reset-restarted (OS installation, communication setting change). When powering off or reset-restarting the GOT, the operating hours is cleared.

Point

To display correct time

Set the clock of GOT. (☞ Section 12.1 Time Setting and Display)
When the clock has not been set, the correct time is not displayed at [Start Time] and [Current Time].

Remark

Time displayed at [Operating hours]

[Operating hours] is displayed irrespective of [Start Time] and [Current Time].
When changing the clock of the GOT, [Operating hours] does not match with the difference between [Current Time] and [Start Time]. ([Operating hours] is not the time calculated from [Current Time] and [Start Time].)
The time displayed at [Operating hours] is a reference for the accumulated time while GOT is powered on or reset-restarted (OS installation, communication setting change).

15. CLEANING OF DISPLAY SECTION (CLEAN)

In utility, the screen can be set as not to be effected by touching the screen when clean with clothes.
For cleaning method, refer to "Section 17.3 Cleaning Method".

15.1 Clean

15.1.1 Display operation of clean

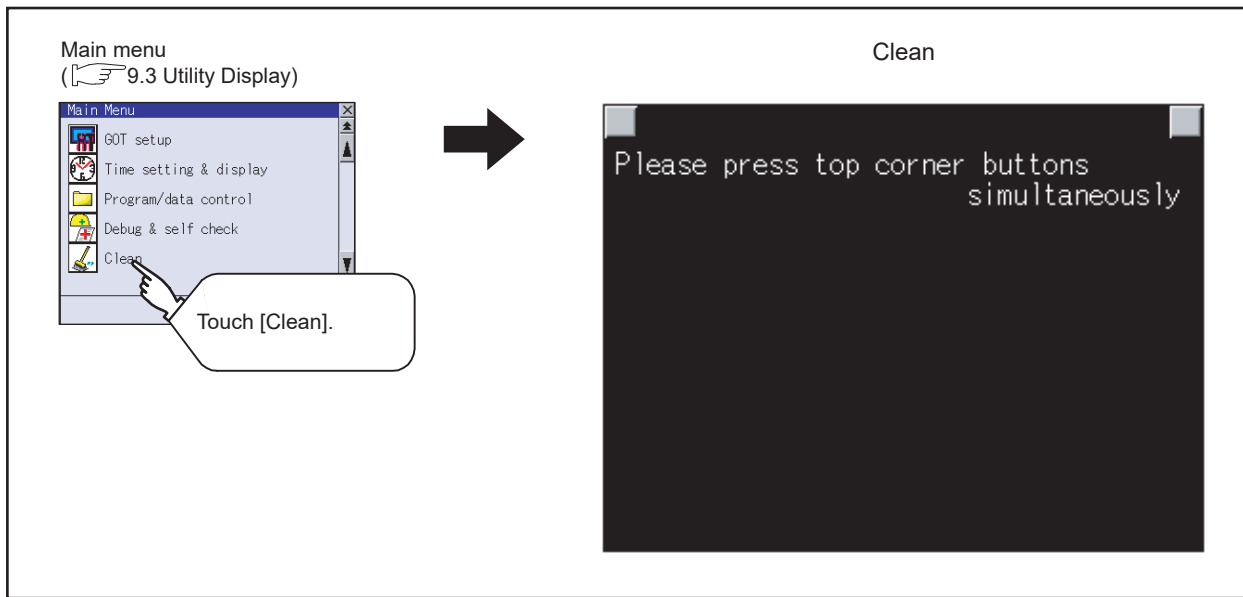

Even if touch points other than the upper left corner and upper right corner of the screen, the GOT does not operate.

15.1.2 Operation of clean

If touch the upper left and upper right corners of the screen at the same time, the screen returns to the previous screen display.

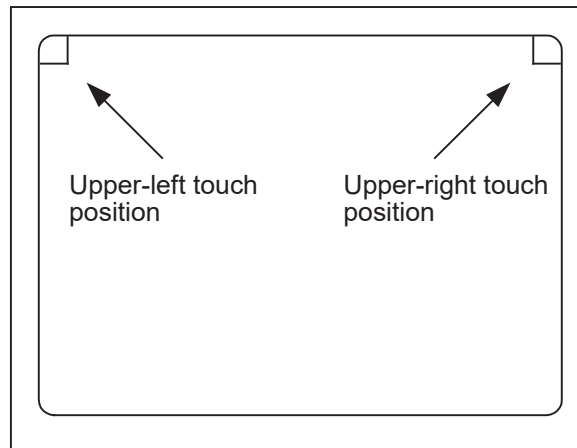

For details of cleaning method, refer to the following.

 Section 17.3 Cleaning Method

16. INSTALLATION OF CoreOS, BOOTOS AND STANDARD MONITOR OS

To execute the GOT utility, BootOS or Standard monitor OS has to be installed in the C drive (Flash memory).

This chapter explains the installation using GOT.

Drawing software → CF card → GOT

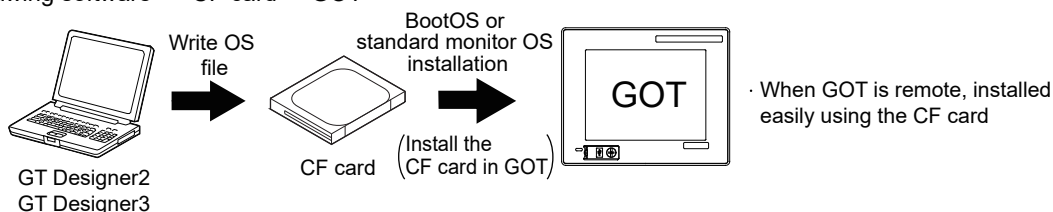

GOT → CF card → GOT

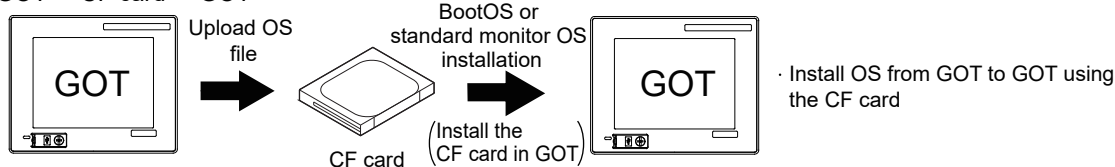

For details of the installation using drawing software, refer to the following.

- ☞ GT Designer2 Version □ Basic Operation/Data Transfer Manual
- ☞ GT Designer3 Version1 Screen Design Manual (Fundamentals)

Point

CoreOS

Section 16.1 to 16.4 of this chapter describes BootOS and Standard monitor OS only.

For CoreOS, refer to the following.

- ☞ Section 16.5 CoreOS

16.1 BootOS and Standard Monitor OS Required for Installation

Under-mentioned BootOS and Standard monitor OS are necessary to execute utility.

OS name	Function overview		Storage location
BootOS	Required for the control of GOT and the communication between PC and GOT. Installed at factory shipment. (BootOS can be installed from drawing software or the CF card. When installed from drawing software or the CF card, GOT is initialized to be the factory shipment status.)		Flash memory C: G1BOOT
Standard monitor OS	Standard monitor OS	Required for display and operation of the user-created screen and utility screen. Not installed in GOT at factory shipment. Install it from drawing software or the CF card. At installation, select Mincho or Gothic for the 16-dot standard font.	Flash memory C:G1SYS
	System Screen Data		
	System Screen Information		
	TrueType numerical font		
	12-dot Standard Font (Gothic)		
	16-dot Standard Font (Mincho)		
	16-dot Standard Font (Gothic)		

16.2 Prior Preparations for Installing BootOS and Standard Monitor OS

For the installation using GOT, the CF card storing BootOS or Standard monitor OS is required. For the method of writing BootOS and Standard monitor OS in the CF card, the following two methods are available.

- (1) [To Memory Card] from drawing software

☞ GT Designer2 Version □ Basic Operation/Data Transfer Manual
GT Designer3 Version1 Screen Design Manual (Fundamentals)

- (2) Uploading from other GOT (BootOS or Standard monitor OS has been installed)

☞ Chapter 13 FILE DISPLAY AND COPY (PROGRAM/DATA CONTROL)

Point

Precautions on writing BootOS, Standard monitor OS in CF card

When writing BootOS, Standard monitor OS, etc. in the CF card, be sure to execute by the utility of other GOT or drawing software.

The installation is not executed properly with the CF card to which uploaded from the utility of GOT or copied by softwares other than drawing software.

Note the available capacity of the CF card.

The available capacity of BootOS and Standard monitor OS can be confirmed by [To Memory Card] of drawing software.

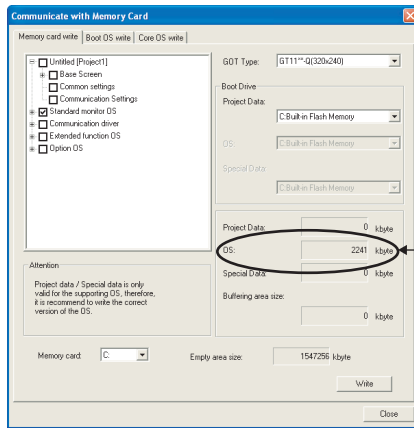

Capacity of data of OS to be transferred



16.3 BootOS and Standard Monitor OS Installation Using CF Card

There are the following two types for the BootOS, Standard monitor OS installation using CF card.

- (1) Installation method when the GOT is turned on
When the GOT is turned on, all the OS and project data stored in the memory card are transferred to the GOT.
This installation method is valid for the following cases.
 - When the utility of GOT cannot be displayed
 - When the standard monitor OS is not installed
 - To create a GOT with the same configuration as the copy source by using the GOT data package acquisition function
- (2) Installation method using the program/data control function (Utility)
By the operation of the utility, the OS and project data stored in the memory card are selected and transferred to GOT.

Point

Notes on installing the Boot OS and Standard monitor OS

- (1) Installing both the Boot OS and Standard monitor OS
Install the Boot OS first, and then install the Standard monitor OS.
When the Boot OS is installed, the built-in flash memory on the GOT becomes initialized to the factory setting. (All OSs and project data will be deleted.)
The Boot OS comes factory installed. Installation of the Boot OS is not necessary unless upgrading the Boot OS version.
- (2) Copying the project data using the CF card
Download the project data after installing the Boot OS, Standard monitor OS, and other OSs.
Make sure that the version of the Standard monitor OS on the GOT and that of the Standard monitor OS that created the project data match.
- (3) When the OS and project data are on the CF card (When drawing software is in use)
When the 2-point press installation function is used, project data will be installed at the completion of the OS installation.
When installing the system using the utility screen, install the OS and download the project data on their respective operation screens.
- (4) The installation cannot be interrupted.
The followings should not be performed during the installation of BootOS or standard monitor OS.
The installation may fail, and GOT may not operate.
 - Turning OFF the GOT power
 - Pressing the reset button of GOT
 - Turning OFF the CF card access switch
 - Removing the CF cardWhen GOT does not operate due to the failure of the installation, follow the procedures mentioned below.
 - When the installation of BootOS is failed:
Install CoreOS.
 Section 16.5.1 Installation method of CoreOS
 - When the installation of standard monitor OS is failed:
Install BootOS.
 Section 16.3.1 Installation method when the GOT is turned on

16.3.1 Installation method when the GOT is turned on

The displayed message is different depending on the installation condition of Standard monitor OS. When the screen requesting operation is displayed, operate the GOT according to the instructions on the screen.

1 Operation procedure

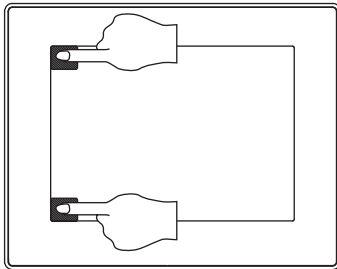

BootOSをインストール中です。
Now installing BootOS.

GOTを再起動します。
Reboot.

- 1 Power OFF GOT and CF card access switch. Insert the CF card in which BootOS, Standard monitor OS or project data is stored in the CF card interface of GOT.
- 2 Switch ON the CF card access switch of GOT.
- 3 Power ON the GOT touching the upper and lower left corners of the GOT screen.
- 4 BootOS and Standard monitor OS are installed in the built-in Flash memory.
- 5 The CF card access LED is lit during installation.
Do not pull out the CF card or power off the GOT while the CF card access LED is lit.
- 6 GOT restarts automatically after installation is completed.
(When Standard monitor OS is already installed, touch the button to reboot the GOT.)
- 7 After confirming that GOT restarted normally, switch OFF the CF card access switch of GOT.
- 8 Confirm the CF card access LED is extinguished, remove the CF card from the CF interface of GOT.

16.3.2 Installation method using the program/data control function (Utility)

For details of program/data control function, refer to the following.

☞ Chapter 13 FILE DISPLAY AND COPY (PROGRAM/DATA CONTROL)

Program/data control is a function to install OS files from the CF card to GOT by the Utility operation.

Point

Precautions on executing program/data control function

When execute program/data control function, Standard monitor OS has to be installed in GOT in advance. Thus, this function cannot be used for the initial installation of Standard monitor OS after purchasing GOT.

Install Standard monitor OS by the following two methods.

(1) Method using drawing software

☞ GT Designer2 Version□ Basic Operation/Data Transfer Manual
GT Designer3 Version1 Screen Design Manual (Fundamentals)

(2) Installation method when turning the GOT power on

☞ Section 16.3.1 Installation method when the GOT is turned on

1 Operation procedure

- 1 Power OFF the GOT. After CF card access LED is off, install the CF card in which BootOS, Standard monitor OS or project data is stored in the CF card interface of GOT.
- 2 Switch ON the CF card access switch of GOT.
- 3 Display the program/data control function screen (Utility) on the GOT, and install BootOS, Standard monitor OS from the CF card to GOT.

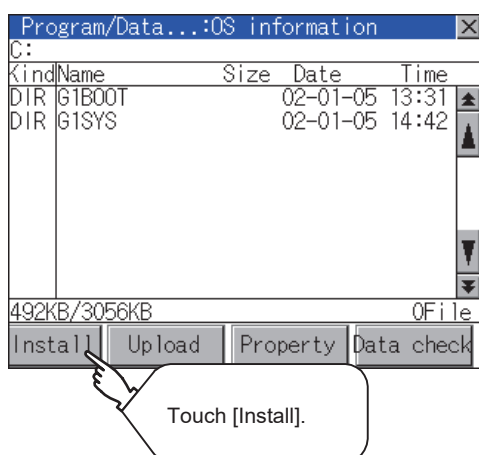

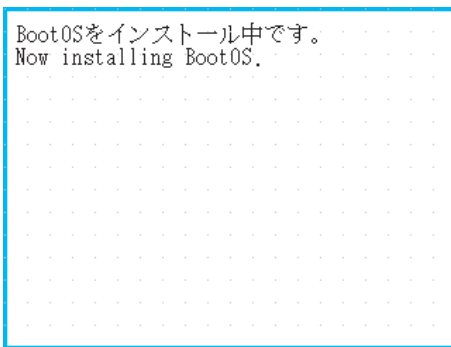

- ④ The CF card access LED is lit during install execution.
- ⑤ Do not pull out the CF card, power OFF, or reset the GOT while the CF card access card is lit.
- ⑥ After the installation is finished, the dialog box shown on the left is displayed.
- ⑦ Touch the button to reboot the GOT.
- ⑧ After confirming that GOT restarted normally, switch OFF the CF card access switch of GOT.
- ⑨ Confirm the CF card access LED is extinguished, remove the CF card from the CF card interface of GOT.

16.4 When Installing the Different Version of BootOS, Standard Monitor OS

(1) Boot OS installation

When the Boot OS is installed, the GOT compares the version of the current Boot OS and the version of the Boot OS to be installed.

When the major version of the Boot OS to be installed is older than that of the current Boot OS, the following warning dialogs will appear to prevent an accidental overwriting.

(When installing from drawing software, follow the messages that appear on the PC screen.)

(a) When only the Boot OS is stored on the CF card.

A message will appear to indicate that the installation cannot be proceeded.

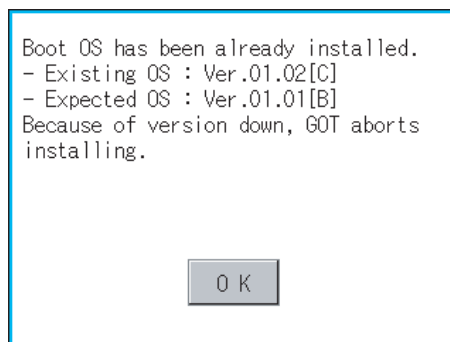

Touch the button to cancel the installation.

Restart the GOT.

(b) When the Boot OS, Standard monitor OS, and other OSs are stored on the CF card.

The installation of the Boot OS will be skipped, and an installation of the Standard monitor OS and other OSs will take place.

The following message will appear if the Standard monitor OS is already installed on the GOT.

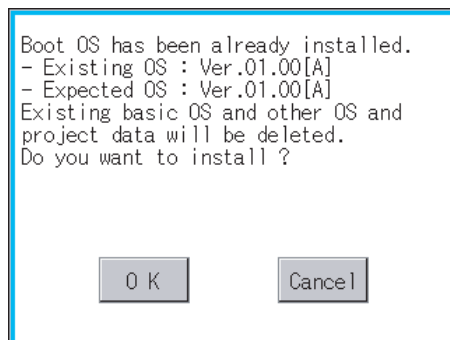

Touching the button will start the installation.

Touching the button will stop the installation.

Regardless of the types of data (as described in section (a) and (b) above) on the CF card, or whether the version of the OS to be installed is the same as the current one or newer, a window that has the version information and a message that asks whether to continue installation will appear.

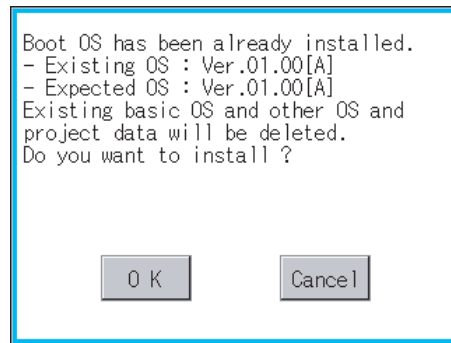

<The GOT screen that appears when the Boot OS was installed from the CF card>

Touching the **OK** button will start the installation.

Touching the **Cancel** button will stop the installation.

(2) Standard monitor OS installation

Match the version of each OS file when installing Standard monitor OS.

Standard monitor OS cannot be installed if the version of each OS file does not match.

	When the installation process is discontinued.		When the installation process is normally executed.
Standard monitor OS :	[1.] O. O		Standard monitor OS : 2. O. O
Communication driver :	[2.] O. O		Communication driver : 2. O. O
Option OS :	[2.] O. O		Option OS : 2. O. O

↑
Please match the number.



Checking method of BootOS, Standard monitor OS version

1. Check the version of BootOS or Standard monitor OS installed in GOT at [OS information] of the utility.

Refer to the following for details.

☞ Section 13.2 OS Information

2. Check the version of BootOS installed in GOT at product shipment on the rating plate on GOT rear face.

(a) GT1155-QTBD, GT1155-QSBD, GT1150-QLBD

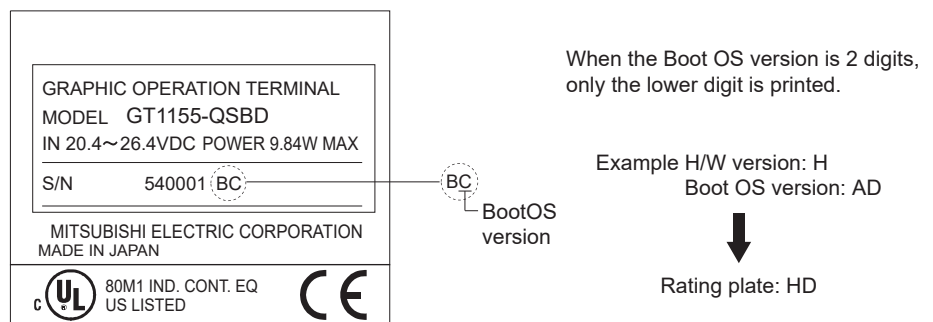

- (b) GT1155-QTBDQ, GT1155-QTBDA, GT1155-QSBDQ, GT1155-QSBDA,
GT1150-QLBDQ, GT1150-QLBDA

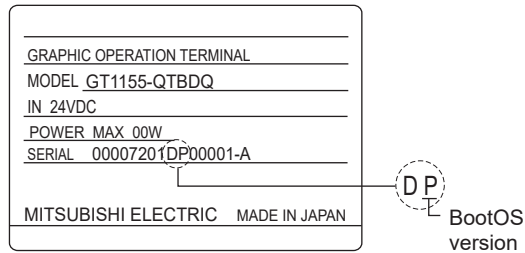

16.5 CoreOS

Install CoreOS only if the GOT is not in its factory-shipped condition, even if BootOS is installed. Normally, installation is not required.



Precautions when installing CoreOS.

The installation cannot be interrupted.

The followings should not be performed during the installation of CoreOS.

GOT may not operate.

- Turning OFF the GOT power
- Pressing the reset button of GOT
- Turning ON the CF card access switch
- Removing the CF card

If GOT does not operate, please consult your nearest sales office or FA Center.

If GOT does not recover after CoreOS is installed, there may be a hardware problem.

Please consult your nearest sales office or FA Center.

16.5.1 Installation method of CoreOS

1 Before installing CoreOS.

(1) Installation method

CoreOS can be installed only using the memory card.

The installation via USB, RS-232 or Ethernet is not available.

(2) CF card to be used

CF card of 32MB or more is required.

(3) BootOS

By installing CoreOS, BootOS is also installed with its latest version automatically.

(No operation is required to the user.)

2 Installation method of CoreOS

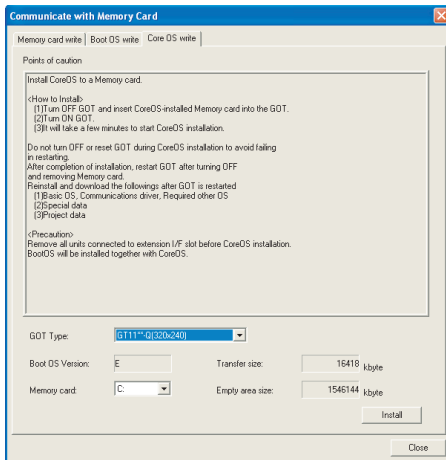

- 1 Write CoreOS from drawing software to the CF card

For details on the operation method of drawing software, refer to the following manual.

☞ GT Designer2 Version □ Basic Operation/Data Transfer Manual
 GT Designer3 Version1 Screen Design Manual (Fundamentals)

- 2 Check that the power of GOT main unit is OFF, and then mount the CF card to GOT. After mounting it, turn ON the CF card access switch.

- 3 Turn ON the GOT power
 After the power is turned on, CoreOS installation execution screen is automatically displayed after a brief interval.

- 4 After the CF card access switch is turned off, the installation of CoreOS is started.

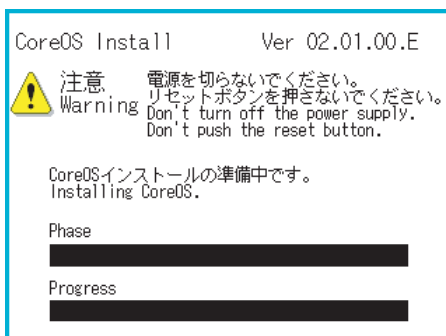
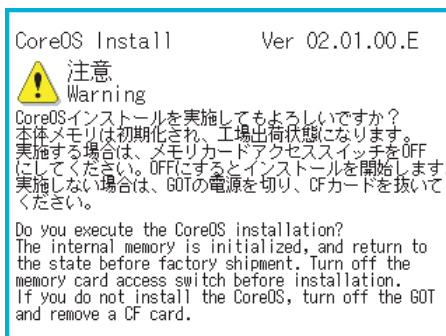



- 5 When the installation is completed, the dialogue box shown on the left is displayed. Check that the message is displayed, and turn the GOT power OFF. (When the installation is completed, the power LED blinks.)
- 6 Remove the CF card after turning the power OFF.
- 7 If the power is turned on again, the screen shown on the left is displayed. (The GOT goes into its factory shipped condition.) As necessary, install each OS (Standard monitor OS, communication driver, etc.) or download a project data. For the installation method of each OS or the download method of project data, refer to the following manual.

☞ GT Designer2 Version □ Basic Operation/Data Transfer Manual
 GT Designer3 Version1 Screen Design Manual (Fundamentals)

16.5.2 When CoreOS cannot be installed

When CoreOS cannot be installed, check the following contents.

When CoreOS cannot be installed even after the following contents are checked, there may be a hardware problem.

Please consult your nearest sales office or FA Center.

Description	Action
The installation of CoreOS is not executed after the CF card is inserted to GOT.	<ul style="list-style-type: none"> • Check that the CF card access switch of GOT is ON. If it is OFF, turn it ON. • Memory card write from drawing software may not be normally completed. Execute memory card write from drawing software again.
The following message is displayed on GOT. "GOT error. Contact your local sales office."	GOT main unit is breakdown. Please consult your nearest sales office or FA Center.
The following message is displayed on GOT. "CF card error. Installation will be canceled. Check whether the CF card can be used."	CF card is broken. <ul style="list-style-type: none"> • Format the CF card and execute the installation again. • Replace the CF card.
The following message is displayed on GOT. Wrong operation system.	Either the wrong type of GOT was selected for the [Core OS write] setting of the drawing software, or the data on the CF card are broken. Make sure that the correct type of GOT is selected, and execute [Core OS write] again.
The following message is displayed on GOT. The version of OS is not acceptable to this GOT. Installation will be canceled. Confirm the version of OS.	Install Core OS from the latest version of drawing software.

17. MAINTENANCE AND INSPECTION

STARTUP AND MAINTENANCE PRECAUTIONS

WARNING

- When power is on, do not touch the terminals.
Doing so can cause an electric shock or malfunction.
- Connect the battery correctly.
Do not discharge, disassemble, heat, short, solder or throw the battery into the fire.
Incorrect handling may cause the battery to generate heat, burst or take fire, resulting in injuries or fires.
- Before starting cleaning or terminal screw retightening, always switch off the power externally in all phases.
Not switching the power off in all phases can cause a unit failure or malfunction.
Undertightening can cause a short circuit or malfunction.
Overtightening can cause a short circuit or malfunction due to the damage of the screws or unit.

STARTUP AND MAINTENANCE PRECAUTIONS

CAUTION

- Do not disassemble or modify the unit.
Doing so can cause a failure, malfunction, injury or fire.
- Do not touch the conductive and electronic parts of the unit directly.
Doing so can cause a unit malfunction or failure.
- The cables connected to the unit must be run in ducts or clamped.
Not doing so can cause the unit or cable to be damaged due to the dangling, motion or accidental pulling of the cables or can cause a malfunction due to a cable connection fault.
- When unplugging the cable connected to the unit, do not hold and pull the cable portion.
Doing so can cause the unit or cable to be damaged or can cause a malfunction due to a cable connection fault.
- Do not drop or apply any impact to the battery.
If any impact has been applied, discard the battery and never use it.
The battery may be damaged by the drop or impact.
- Before touching the unit, always touch grounded metal, etc. to discharge static electricity from human body, etc.
Not doing so can cause the unit to fail or malfunction.

DISPOSAL PRECAUTIONS

CAUTION

- When disposing of the product, handle it as industrial waste.

The GOT does not include consumable components that will cause the shorten life.

However, the battery, liquid crystal screen and backlight have each life length.

It is recommended to replace the battery periodically.

(For the replacement of the liquid crystal screen and backlight, please consult your nearest sales office or FA center.)

For the battery life, refer to the following.

 Section 3.4 Power Supply Specifications

For the life of the LCD screen or backlight, refer to the following.

 Section 3.2 Performance Specifications

17.1 Daily Inspection

Daily inspection items

No.	Inspection Item		Inspection Method	Criterion	Action
1	GOT mounting status		Check for loose mounting screws.	Securely mounted	Retighten screws within the specified torque range
2	Connection status	Loose terminal screws	Retighten screws with screwdriver	Not loose	Retighten terminal screws
		Proximate solderless terminals	Visual check	Proper intervals	Correct
		Loose connectors	Visual check	Not loose	Retighten connector fixing screws
3	Usage status	Dirt on protection sheet	Visual check	Not outstanding	Replace with new one
		Foreign material attachment	Visual check	No foreign matter sticking	Remove clean

Refer to the following for the model names of the protection sheet or the replacement procedure.

 Section 8.5 Protective Sheet

17.2 Periodic Inspection

Yearly or half-yearly inspection items

The following inspection should also be performed when equipment has been moved or modified or the wiring changed.

No.	Inspection Item		Inspection Method	Criterion	Action	
1	Surrounding environment	Ambient temperature	Make measurement with thermometer or hygrometer Measure corrosive gas	Display section	0 to 50°C	For use in control panel, temperature inside control panel is ambient temperature
		Ambient humidity		Other portions	0 to 55°C	
		Atmosphere		10 to 90%RH		
		No corrosive gas				
2	Power supply voltage check		24VDC Measure voltage across terminals.	20.4 to 26.4VDC	Change supply power	
3	Mounting status	Looseness	Move module	Should be mounted firmly	Retighten screws	
		Dirt, foreign matter	Visual check	No dirt, foreign matter sticking	Remove, clean	
4	Connection status	Loose terminal screws	Retighten screws with screwdriver	Not loose	Retighten terminal screws	
		Proximate solderless terminals	Visual check	Proper intervals	Correct	
		Loose connectors	Visual check	Not loose	Retighten connector fixing screws	
5	Battery		Check the system alarm (error code: 500) report on the Alarm Information screen (Section 13.4 Alarm Information).	(Preventive maintenance)	Replace with new battery when the current battery has reached the specified life span, even if battery voltage is not displayed.	

17.3 Cleaning Method

Use the GOT always in a clean condition.

To clean the GOT, wipe the dirty part with a soft cloth using neutral detergent.

For the display operation of the [Clean] screen, refer to the following.

☞ Chapter 15 CLEANING OF DISPLAY SECTION (CLEAN)

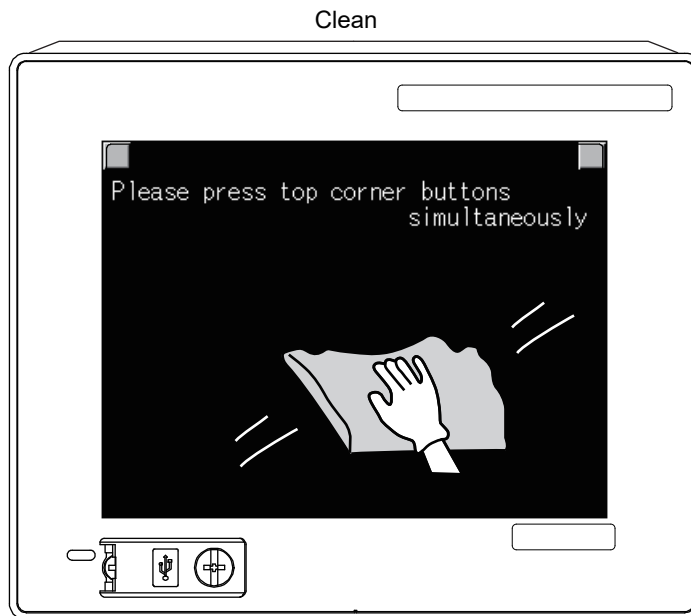

Point

Precautions for cleaning

Do not use chemicals such as thinner, organic solvents and strong acids, since they may cause the protective sheet to be deformed or the dissolvable paint on the surface to peel off.

In addition, do not use spray solvents since they may cause the electrical failure of the GOT and peripheral devices.

17.4 Battery Voltage Low Detection and Battery Replacement

1 Low battery voltage detection and replacement

The battery is used for backing up the clock data, alarm history or recipe data. It is recommended that you replace battery periodically. Refer to the following for the replacement procedure.

➡ Section 8.4 Battery

The battery voltage low detection can be confirmed by the utility screen and system alarm. Refer to the following for details of the battery status display by the utility screen.

➡ Chapter 12 CLOCK SETTINGS AND BATTERY STATUS DISPLAY (TIME SETTING AND DISPLAY)

By using system alarm, the message that notifies the battery voltage has decreased can be displayed at the battery voltage low on the screen of the GOT.

➡ Section 12.1.1 Time setting and display functions

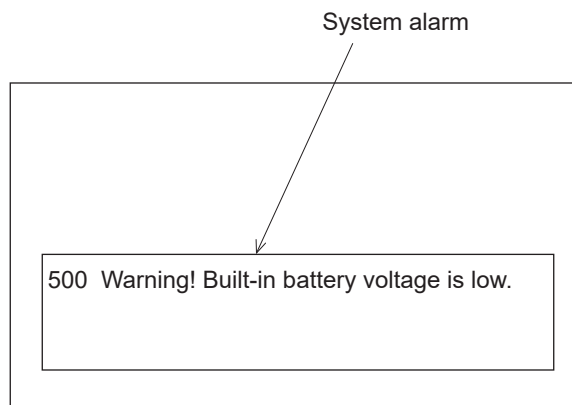

Refer to the following for details of the system alarm display.

➡ GT Designer2 Version□ Screen Design Manual
GT Designer3 Version1 Screen Design Manual (Functions)



Battery replacement timing

When detecting voltage low, replace the battery immediately. Data can be saved for approximately a month after the battery voltage low detection and cannot be saved after that. If it exceeds a month from the voltage low detection to battery replacement, the clock data or D-drive (Internal SRAM) data may become indefinite. Adjust the clock and format the D drive (Internal SRAM).



Example of alarm output to external device (lamp, buzzer, etc.)

The following describes an example of outputting the battery voltage low signal from a FX series PLC to an external device with system information.

Condition: The Write Device is "D20" and all data is used (the button is clicked on the setting screen of drawing software) for the system information assignment.

D36 b12: Battery voltage low (System Signal 2-2)

Turned on upon a battery voltage drop.

Used as shown below in the sequence program.

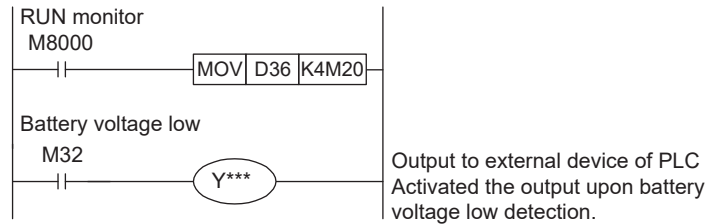

*** indicates the output number at which the external device is connected.

For details of system information, refer to the following.



GT Designer2 Version□ Screen Design Manual

GT Designer3 Version1 Screen Design Manual (Fundamentals)

2 Handling of Batteries and Devices with Built-in Batteries in EU Member States

This section describes the precautions for disposing of waste batteries in EU member states and exporting batteries and/or devices with built-in batteries to EU member states.

(1) Disposal precautions

In EU member states, there is a separate collection system for waste batteries. Dispose of batteries properly at the local community waste collection/recycling center.

The following symbol is printed on the batteries and packaging of batteries and devices with built-in batteries used for Mitsubishi Graphic Operation Terminal (GOT).



Symbol



This symbol is for EU member states only.

The symbol is specified in the new EU Battery Directive (2006/66/EC) Article 20 "Information for end-users" and Annex II.

The symbol indicates that batteries need to be disposed of separately from other wastes.

(2) Exportation precautions

The new EU Battery Directive (2006/66/EC) requires the following when marketing or exporting batteries and/or devices with built-in batteries to EU member states.

- To print the symbol on batteries, devices, or their packaging
- To explain the symbol in the manuals of the products

(a) Labelling

To market or export batteries and/or devices with built-in batteries, which have no symbol, to EU member states on September 26, 2008 or later, print the symbol shown in (1) on the GOT or their packaging.

(b) Explaining the symbol in the manuals

To export devices incorporating Mitsubishi Graphic Operation Terminal to EU member states on September 26, 2008 or later, provide the latest manuals that include the explanation of the symbol.

If no Mitsubishi manuals or any old manuals without the explanation of the symbol are provided, separately attach an explanatory note regarding the symbol to each manual of the devices.



Remark

The requirements apply to batteries and/or devices with built-in batteries manufactured before the enforcement date of the new EU Battery Directive(2006/66/EC).

17.5 Backlight Shutoff Detection

The backlight is built into GOT for the liquid crystal display.

When GOT detects backlight shutoff, the POWER LED blinks green/orange alternately.

The brightness of the backlight decreases with the lapse of usage period. When backlight shutoff is detected or the display becomes unclear, replace the backlight.

For replacement of the backlight, contact your nearest sales office or FA Center.

(1) Life of backlight

The usable duration of backlight can be extended by setting to "Screen saving backlight off" in the utility of GOT (GOT set up).

Refer to the following for details.

 Chapter 11 DISPLAY AND OPERATION SETTINGS (GOT SET UP)

17.5.1 Backlight shutoff detection and external alarm

When the GOT detects a backlight shutoff, the system information set with drawing software is turned on.

You can issue a backlight shutoff of the GOT from the PLC to external devices (such as the lamp or buzzer), using system information.

To avoid any screen touch operation by the user who misunderstands it is in screen saving mode, install an external alarm and interlock the loads that would cause danger.

For details of the system information, refer to the following.

 GT Designer2 Version□ Screen Design Manual

GT Designer3 Version1 Screen Design Manual (Fundamentals)



Hint!

Example of alarm output to external devices (such as lamp or buzzer)

The following provides an example of outputting the backlight shutoff detection signal from a FX Series PLC to an external device, using system information.

Condition: The Written Device is "D20" and all data is used (the button is clicked on the setting screen of drawing software) for the system information assignment.

D36 b14: D36b14: Backlight shutoff detection (System Signal 2-2)

Turned on upon a backlight shutoff.

Used as shown below in the sequence program.

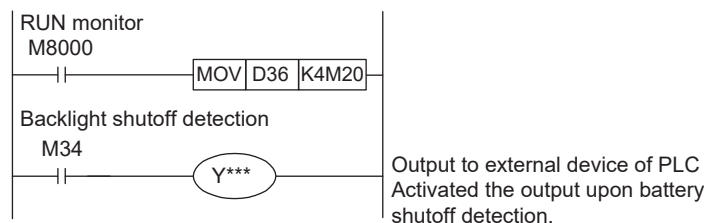

*** indicates the output number at which the external device is connected.



Precautions for the backlight shutoff status

In the backlight shutoff status, the touch key operates.

Early replacement of backlight is recommended.

18. ERROR MESSAGE AND SYSTEM ALARM

This chapter describes the error messages and system alarm displayed in the GOT.
As the error code and error message displaying functions when an error occurs at the GOT or Controller, the system alarm is available.
The error code can also be confirmed in the error code storage area of the system information.
For details of system alarm and system information, refer to the following.

- GT Designer2 Version□ Screen Design Manual
- GT Designer3 Version1 Screen Design Manual (Fundamentals)

18.1 Error Contents Display

This section describes how to identify the error code and system alarm displayed on the monitor screen by the system alarm display function and the reference material.

- (1) Displaying format on monitor screen ... Displayed in user setting position
The system alarm is displayed together with an error code, its error message and occurrence time.
The displayed error code and error message are registered to the GOT in advance and need not to be prepared by the user.

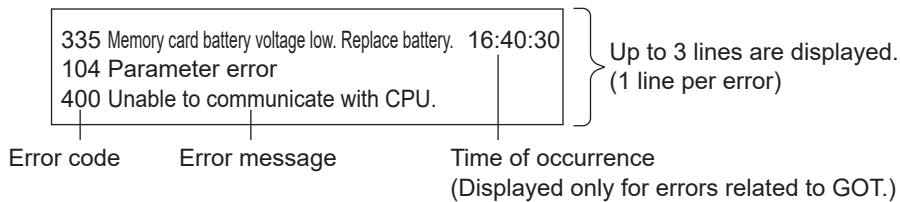

Display priority

The alarm is displayed in the following priority if the displaying range is one or two lines.

- (1) GOT error :The error in the GOT is displayed as an alarm.
- (2) CPU error :The error in the PLC CPU is displayed as an alarm.
- (3) Network error :The error in the network is displayed as an alarm.

Alarms with smaller priority cannot be displayed if system alarms overflow the displaying range.
As well, the error code, error message or time is not displayed if the displayed message overflows each line in the displaying range.

(2) Error code and reference manual

Error source	Error code	Contents	Reference
CPU	0 to 99 (Value of D9008)	Error code of CPU (for ACPU)	User's manual of the ACPU connected with GOT
	100 to 299	Error code of CPU <ul style="list-style-type: none"> • FX PLC^{*1} • Third party PLC • Temperature controller (OMRON temperature controller only) 	User's manual of the FXCPU to which GOT is connected If a third-party PLC is connected, take actions referring to the error message.  GOT1000 Series Connection Manual
GOT	300 to 399	Error code of the GOT main unit function	Section 18.2
	400 to 499	Error code of the GOT communication function	
	500 to 699	Error code of the GOT main unit function	
CPU	1000 to 10000 (Value of SD0)	Error code of CPU (for QCPU, QnACPU)	User's manual of the QCPU and QnACPU connected with GOT
Servo amplifier ^{*2}	20016 to 20237	Error code of servo amplifier	User's manual of the servo amplifier connected to GOT

*1 The assigned error code for FXPLC is 100 to 109, which displays the status of M8060 to M8069.
(Example) When the error code (100) error occurs, correct the error according to the M8060 description.

*2 The error code displayed on GOT is calculated by changing the error code displayed on the servo amplifier to a decimal number and adding "20000" to it.

For this reason, to refer to the manual of the servo amplifier based on the error code displayed upon a system alarm caused to the GOT, subtract the error code by "20000" and convert the lower three digits into a hexadecimal.

(Example: If the system alarm displayed at GOT is "20144," the error code of the servo amplifier is: 20144 - 20000 = 144 (BIN) = 90 (HEX).

18.2 List of Error Message/System Alarm

The system alarm detected with GOT is shown below.

Error code	Error message	Action
303	Set monitor points too large. Decrease setting points.	The number of objects of the screen to be displayed is too large and the system work area cannot be secured. Decrease the number of objects from the displayed screen. For the number of maximum objects for 1 screen, refer to the following.  GT Designer2 Version□ Screen Design Manual GT Designer3 Version1 Screen Design Manual (Fundamentals)
304	Set trigger points too large. Decrease setting points.	When cycle is / ON and when cycle is / OFF the number of objects used exceeds 100. Decrease the number of objects.
306	No project data. Download screen data.	The project data is not downloaded to the built-in flash memory. Download the project data to the built-in flash memory.
307	Monitor device not set	The monitor device of the object is not set. Set the monitor device of the object.
308	No comment data. Download comment.	The comment file does not exist. Create the comment file and download to GOT.
309	Device reading error. Correct device.	The error occurred when reading a continuous device. Correct the device.
310	Project data does not exist or out of range.	1. Specified base screen / window screen does not exist in the project data. 2. Specified base screen / window screen is out of the permissible area. Specify the existing base screen / window screen.
311	No. of alarm has exceeded upper limit. Delete restored alarm.	The number of alarm histories that can be observed by the alarm history display function has exceeded the maximum points (1024 points). Delete the restored history to decrease the number of alarm histories.
312	No. of sampling has exceeded upper limit. Delete collected data.	The collection frequency exceeded the upper limit when "Store Memory" and "Accumulate/Average" were set in the scatter graph. 1. Approve "Clear trigger" setup in the scatter graph. 2. Set the "Operation at frequency over time" and "initialize and continue" in scatter graph.
315	Device writing error. Correct device.	Error occurred while writing in the device. Correct the device.
316	Cannot display or input operation value. Review expression.	In indirect specification of comment/parts number, the data operation result exceeded the range in which device type can be expressed. Review the data operational expression, in order not exceeding the range in which the device type can be expressed.
320	Specified object does not exist or out of range.	The part file does not exist. Create the part file and download to GOT.
321	Station No. for monitor device is wrong	Check the monitor target station No. of the project data.

Error code	Error message	Action
322	Dedicated device is out of range. Confirm device range.	The monitored device No. is set out of the permissible range of the targeted PLC CPU, or the data length for a device dedicated to 32 bits is set other than 32 bits. 1. Set the device within the range that can be monitored by the monitored PLC CPU and parameter settings. 2. AB: L device/ S7-200: HC device/ OMPON temperature controller: Set the data length of C0, C1 and C3 devices to 32 bits.
330	Insufficient memory media capacity. Confirm M-card capacity.	Available memory of the memory card is insufficient. Check the available memory of the memory card on the Drive Information of drawing software.  GT Designer2 Version□ Basic Operation/Data Transfer Manual GT Designer3 Version1 Screen Design Manual (Fundamentals)
331	Memory card not installed or M-CARD switched OFF	The memory card is uninstalled or access switch is OFF in drive. 1. Install the memory card in the specified drive. 2. Turn ON the access switch.
332	Memory media is not formatted.	Memory card is not formatted or formatted incorrectly. Format the memory card.
334	Memory media error. Replace memory media.	Memory card is faulty. Replace the memory card.
345	BCD/BIN conversion error. Correct data	The BCD/BIN conversion disabled data is being displayed/input. 1. Change the device data to be displayed to the BCD value. 2. Correct the input value to the 4 digits integer.
351	Recipe file error. Confirm content of recipe file.	The contents of the recipe file are not normal. 1. Confirm the contents of the recipe files in the memory card. 2. Reboot the GOT after deleting the recipe file in the memory card (format).
352	Recipe file make error. Reboot GOT after inserting memory card.	Failed to generate recipe file. Reboot the GOT after installing the memory card.
353	Unable to write Recipe file. Confirm memory card is inserted.	Failed to write in the recipe file. 1. Confirm the contents of the memory card. 2. Do not pull out the memory card while recipe is operating.
354	Recipe file write error	Error occurred while writing in the recipe file. Do not unplug the memory card while recipe is operating.
355	Recipe file read error	Error occurred while writing in the recipe file. 1. Do not unplug the memory card while recipe is operating. 2. Confirm the contents (device value) of the recipe file in the memory card.
356	File system error occurred in PLC. Confirm file register.	Error occurred in the specified file register when executing the recipe function by specifying the file register name. 1. Execute the recipe function again after confirming the file register name. 2. Execute the recipe function again after formatting the PC memory in the specified PLC CPU drive with GX Developer.

Error code	Error message	Action
357	Error in specified PLC drive. Confirm PLC drive.	When executing the recipe function specifying the file register name, error occurred in PLC CPU drive. 1. Execute the recipe function again after confirming the specified PLC CPU drive. 2. Execute the recipe function again after formatting the PC memory in the specified PLC CPU drive with GX Developer.
358	PLC file access failure. Confirm PLC drive.	When the recipe function is executed specifying the file register name, PLC CPU file register could not be accessed. Execute the recipe function again after confirming the specified PLC CPU drive / file register name. (When you specify drive 0, execute the recipe function again after changing to other drives.)
359	Processing from another peripheral device. Execute it after.	When the recipe function is executed specifying the file register name, other peripherals carry out the process to the file register. Wait until the processing of other peripherals end, and execute the recipe function again.
360	0 divisor division error. Confirm operation expression.	Division 0 was generated by the data operational expression. Review the data operational expression so that the divisor should not become 0.
370	Upper and lower limit value error. Confirm value setting.	The setting of lower/upper limit value is [Upper limit ≤ Lower limit]. Correct the setting so as to be "Upper limit > Lower limit".
402	Communication timeout. Confirm communication pathway or modules.	The time-out error occurred during communication. 1. Confirm the cable omission and PLC status. 2. Put COM instruction when A, QnA or QCPU is connected and the PLC scanning is long.
403	SIO status error. Confirm communication pathway or modules.	Either of the overrun error, parity bit error or flaming error was generated when the RS-422 / RS-232 communication was received. Confirm the cable omission, status of the PLC, and the transmission speed of the computer link.
406	Specified station access is out of range. Confirm station no.	1. Station numbers other than master/local station are specified at the CC-Link connection (via G4). 2. Accessed PLC CPUs other than QCPU. Confirm the station number of the monitor screen data.
410	Cannot perform operation because of PLC run mode. stop the PLC.	The operation, which could not be performed during RUN of PLC CPU, was performed. Stop the PLC CPU.
411	Memory cassette is write-protected. Check the memory cassette.	The memory cassette installed in PLC CPU is in the state protected with EPROM or E ² PROM. Confirm the memory cassette installed in PLC CPU.
412	Cannot read/write device protected by keyword. Remove key word.	The key word is set in PLC CPU. Cancel the key word.
448	PLC cannot handle as requested. Correct devices.	The file register of QnACPU and the device beyond the outside range of buffer memory was specified. Correct the monitor device by setting file register of PLC CPU.

Error code	Error message	Action
480	Communication channel not set. Set channel number on Utility.	One or more channel for PLC and host (microcomputer) connection (Ch.1 to 5) is not allocated by drawing software or utility. Set the channel by drawing software or utility.
500	Warning! Built-in battery voltage is low.	The voltage of the GOT built-in battery is decreased. Replace the GOT built-in battery.
510	Clock data input out of range	The value that is input as clock data is out of the input enabled range. In this case, the input value is not accepted. Confirm the input range of the value to be input as clock data, and input the proper value again.
522	Unnecessary file deleted to create new file.	Cancelled the file of different contents and created a new file. Note that the old file is cancelled and the new file is created if the file of the same name with different contents exists when creating files.
524	Device writing error. Correct device.	When writing in the device, error occurred. Correct the device.
525	Unable to read/write alarm log files under different projects.	Unable to read the alarm log file saved by the different project. Confirm where to store the alarm log file and alarm log file.
535	Cannot open image file.	<ul style="list-style-type: none"> • No CF card is installed in the drive or the access switch is turned on. <ol style="list-style-type: none"> 1. Install a recording medium in the specified drive. 2. Turn the access switch on. • The specified file is not found in the card. <ol style="list-style-type: none"> 3. Add the image file or change the image file name to a correct one.
536	Image file error or invalid file format.	There is an error in the image file data or the image file format is not supported. Change to the correct image file.
550	Invalid key code	The key code input execution trigger was ON with the non-target key code set in the key code storage device. Confirm the key code supported by the object where error occurs.
570	Recipe device points too large.	The number of the set points of the recipe device exceeds the specified range. Put the number of the set points of the recipe device within the specified range.
571	Capacity shortage of user memory (RAM)	There is no empty area/space in D drive. If the alarm log file located in the D drive needs to be backed up, copy it to the CF card with the utility and then format the D drive. If the recipe function is used to read devices, format the D drive and then read again to create the recipe data.

18.3 Troubleshooting in Bus Connection

When connect GOT and PLC CPU with bus connection, and the cause is not clear in "18.2 List of Error Message/System Alarm", execute the following troubleshooting.
Refer to the following for details concerning the bus connection.

 GOT1000 Series Connection Manual

18.3.1 Locating error positions

Explanation regarding the method of specifying the error part.
(Please refer to User's Manual of used PLC CPU for details related to the PLC CPU error and special register.)

- (1) How to locate error positions:
 - (a) Use of peripheral devices
Using the peripheral devices such as GX Developer, check what type of the error occurs on the PLC CPU and, based on the error message on the PLC CPU, check each module and cable for installation and earthing statuses.

- (2) Error timing
Check the timing of errors.
 - 1) An error occurs when the power is turned on or immediately after the PLC is reset:
The error may be detected by the initial processing of the PLC CPU.
In this case, because the faulty module may not be identified, use only an END instruction for the sequence program and remove the modules one by one until the error does not occur.
When the error is eliminated after a specific module has been removed, the module may be causing the error.

 - 2) An error occurs after a specific operation or several seconds:
The error may occur in the sequence program. Check the error step where the error may occur and the sequence program in that step.
The sequence program can be diagnosed throughout by merely using an END instruction for the sequence program.

 - 3) An error occurs when a specific device operates:
The mis-operation may be caused by noise.
Check that any signal line such as bus cable is not laid out too close to the operating device.
If the line is too close to the device, separate the line 100 mm or more from the device.

- (a) Locating the module where an error occurs:
Based on the PLC CPU error codes and special register information, locate a specific module where an error occurs.

By the method stated above, correct the sequence program or replace the faulty module with a new one, and check whether the error occurs.

If the error continues to occur, it may have another cause.

Referring to 18.3.2 "Further locating error positions", locate the error position further.

18.3.2 Further locating error positions

If the function of the PLC cannot be recovered even when the module on which an error occurs is replaced with a new one, the error may be caused by the effect from another module.

Disconnect the extension cables and bus connection cables in order from the modules starting from the module located furthest from the operating position in the system, and check for the status of occurrence of the error each time the cables are disconnected until the error does not occur.

The module or extension cables/bus-connection cables disconnected immediately before the error does not occur are considered to cause the error.

Examples of the ways of further locating error positions are shown below. (When use the extension base unit QnASCPU)

Example 1:

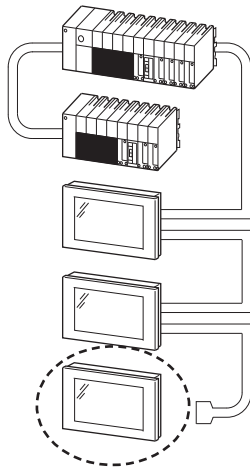
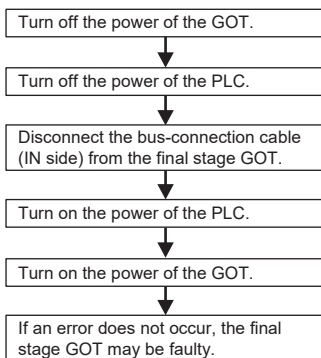

Example 2:

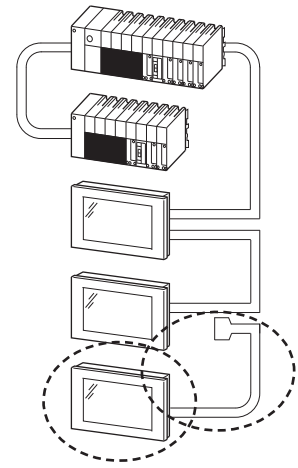
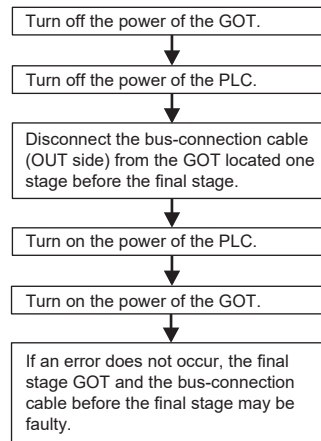

Repeat the examples 1 and 2 above to locate error positions.



Notes on narrowing the error part range

1. When disconnecting the extension base units in order, use only an END instruction for the sequence program, and any error resulting from the sequence program will not occur, and the status of occurrence of errors will be obtained easily.
2. When the frequency of occurrence of an error is low, check the error by taking a rather long time with the modules disconnected.

The checks stated above are effective to locate a noise invading route when the mis-operation is caused by noise.

18.3.3 Specific example of troubleshooting

Taking the following system as an example, troubleshooting is shown when PLC CPU error occurred. (When QnASCPU and the extension base unit are used)

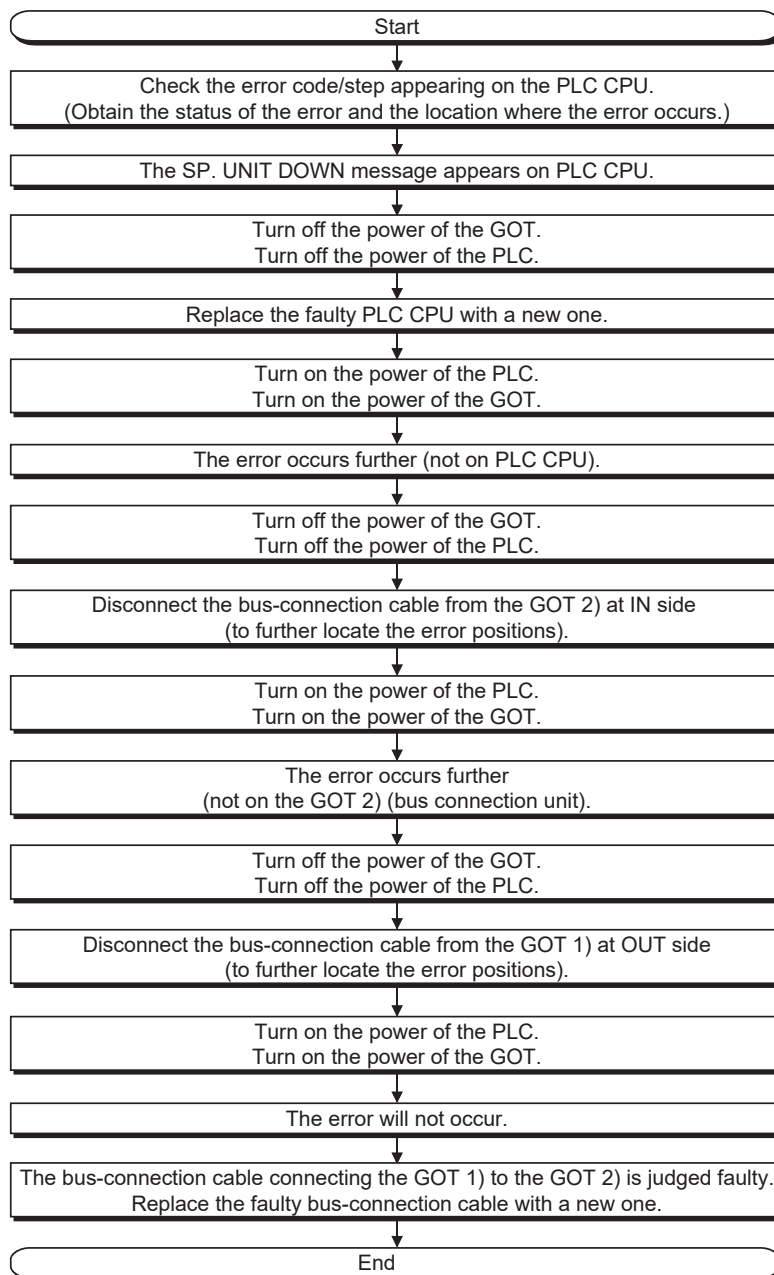
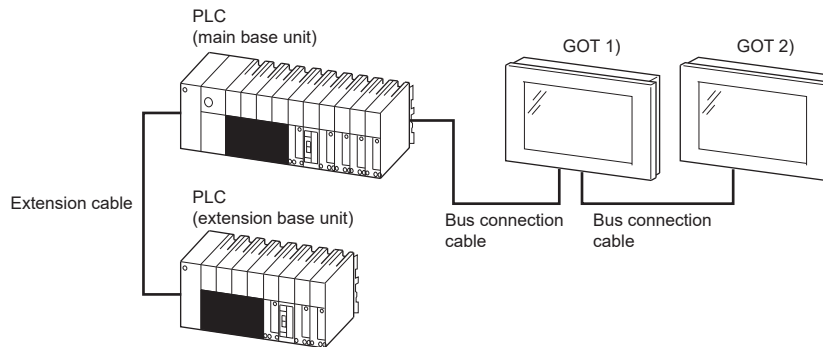

18.4 Troubleshooting for Monitoring

This section describes the countermeasures when GOT does not display the monitor screen.

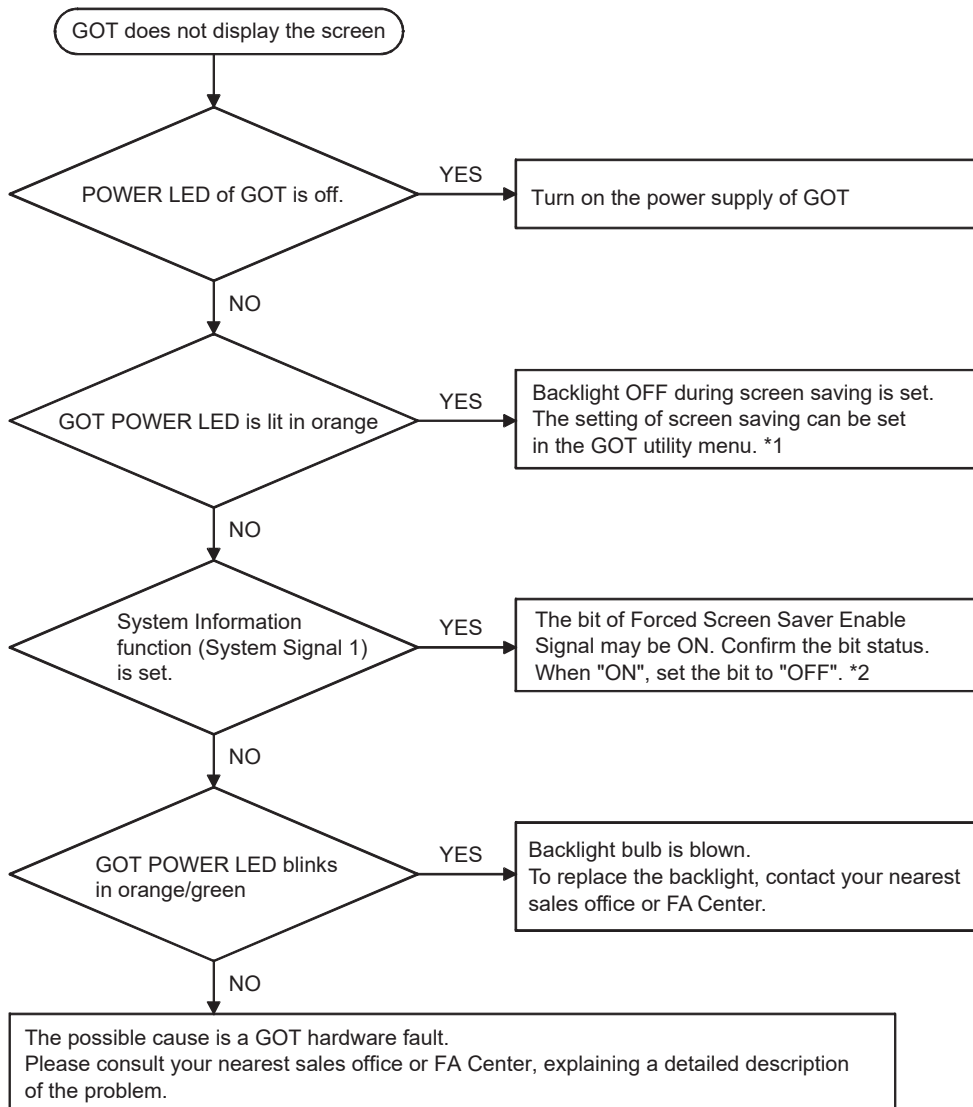

*1 For utility menu, refer to the following.

 Chapter 11 DISPLAY AND OPERATION SETTINGS (GOT SET UP)

*2 For the details of the forced screen saver enable signal, refer to the following.

 GT Designer2 Version□ Screen Design Manual

GT Designer3 Version1 Screen Design Manual (Fundamentals)

18.5 Starting GOT

18.5.1 Power-Off

Do not turn the GOT power OFF during the start-up right after turning the GOT power on or during the restart-up after transferring each OS or project data and changing the setting on the utility screen. "When "Booting" or "Booting project data" is displayed on the screen, GOT is in start-up mode or restart-up mode."

<When GOT standard monitor OS is V 01. 02. 01 or before>

When the GOT power is turned OFF, the setting may return to the factory-shipped default when the GOT power is turned on next time.

If the power is turned off due to power failure or others, install the OS or download the project data again.

<When GOT standard monitor OS is V 01. 02. 02 or later>

Even if the power is turned off during the start-up, GOT operates in the condition that the OS and project data before the power OFF are stored when turning the GOT power on.

18.5.2 Communication from drawing software to the GOT

Drawing software cannot communicate with the GOT while "Booting" is displayed on the GOT screen.

"Booting" is displayed on the GOT screen under the following conditions:

- Right after turning on the power to the GOT
- When rebooting after transferring OSs and project data
- When rebooting after changing the settings on the utility screen.

When the communication with GOT is attempted, communication errors will occur on drawing software. Carry out the communication after "Booting project data" is displayed on the GOT screen.

It may take time to start the communication between the GOT and the controller depending on the type of controllers.

GOT starts the communication with drawing software after the communication with the controller has been established.

APPENDICES

Appendix 1 External Dimensions

External dimensional diagrams of GT1155-QTBD, GT1155-QSBD and GT1155-QLBD

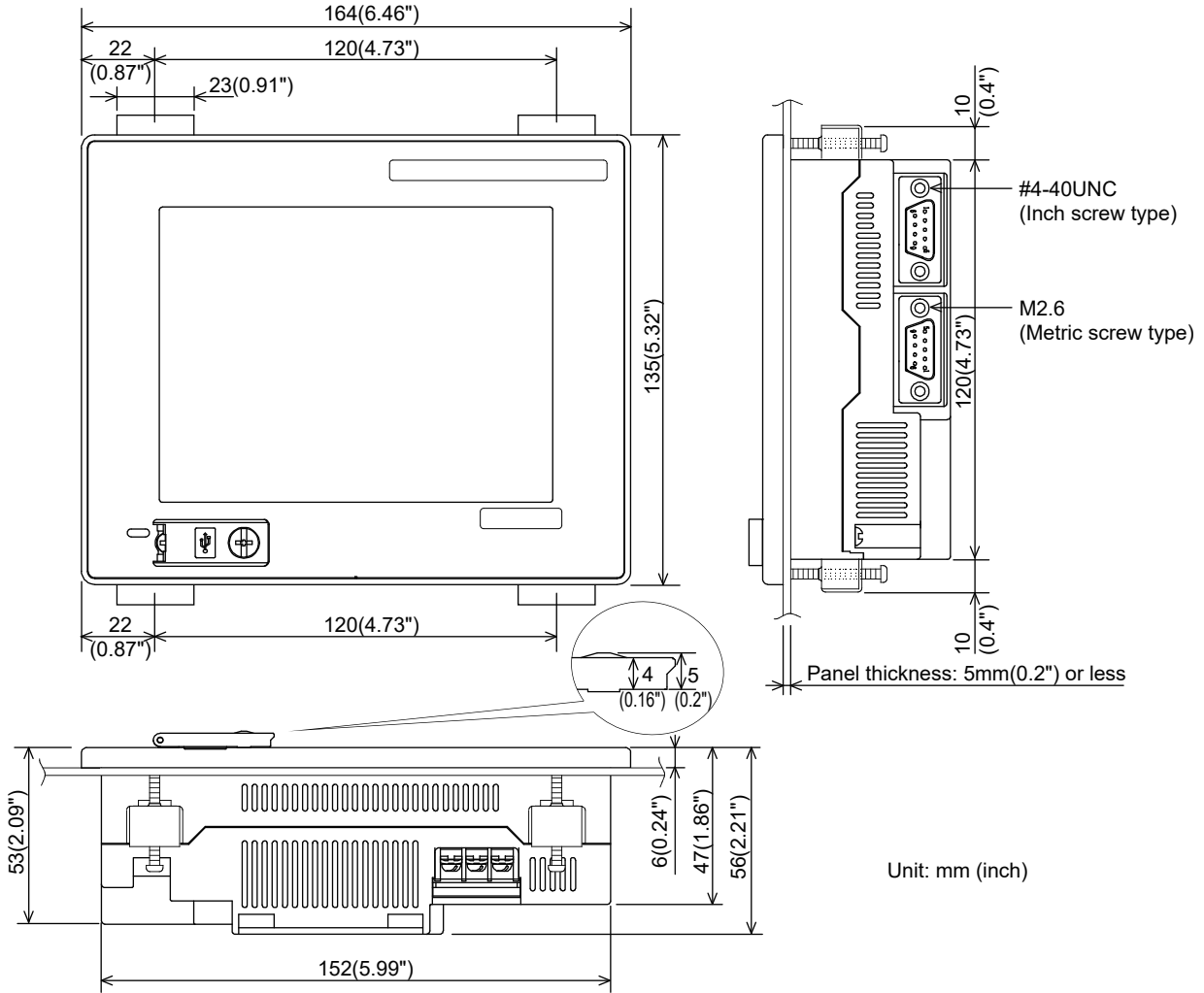

External dimensional diagrams of GT1155-QTBDQ, GT1155-QSBDQ and GT1150-QLBDQ

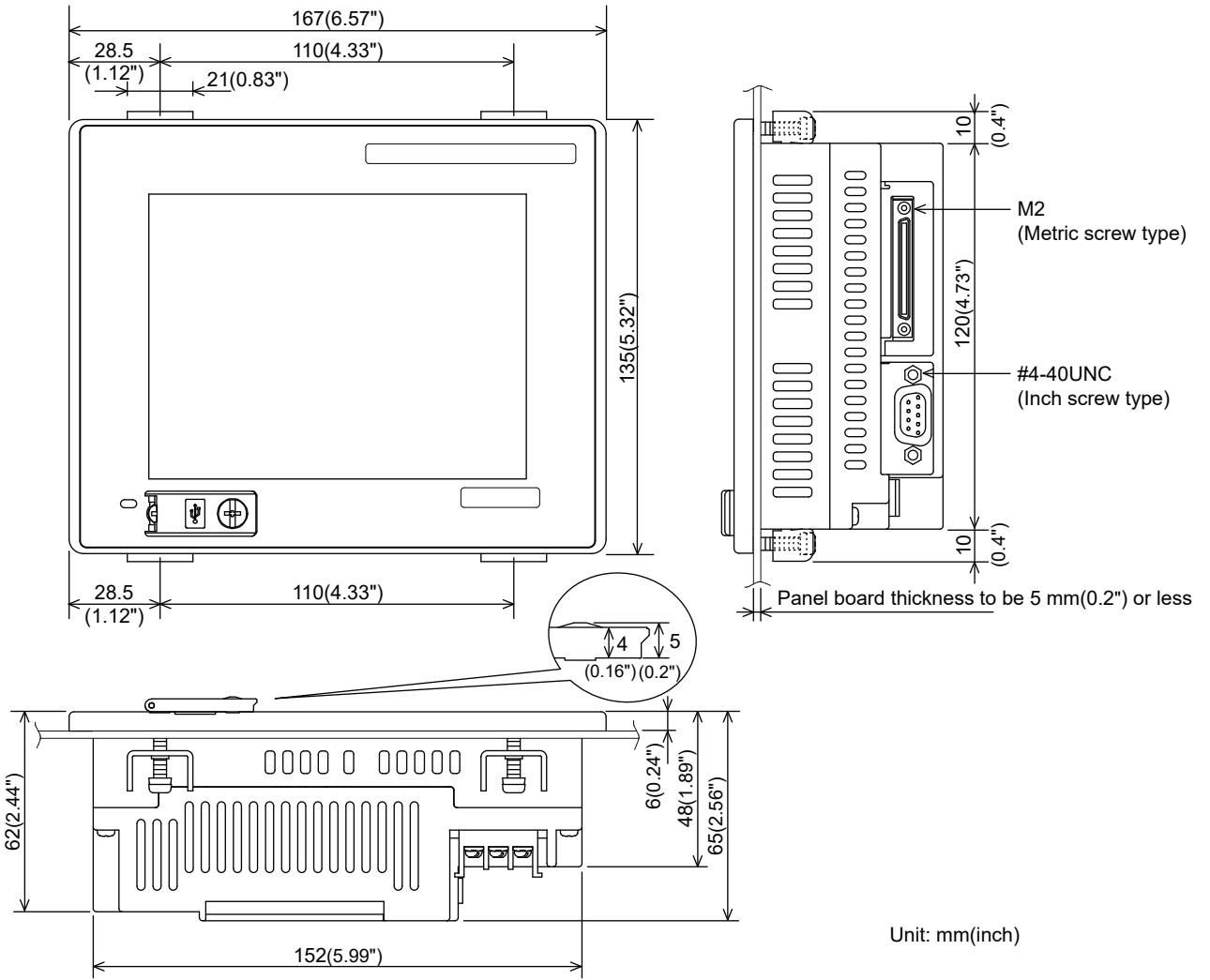

External dimensional diagrams of GT1155-QTBDA, GT1155-QSBDA and GT1150-QLBDA

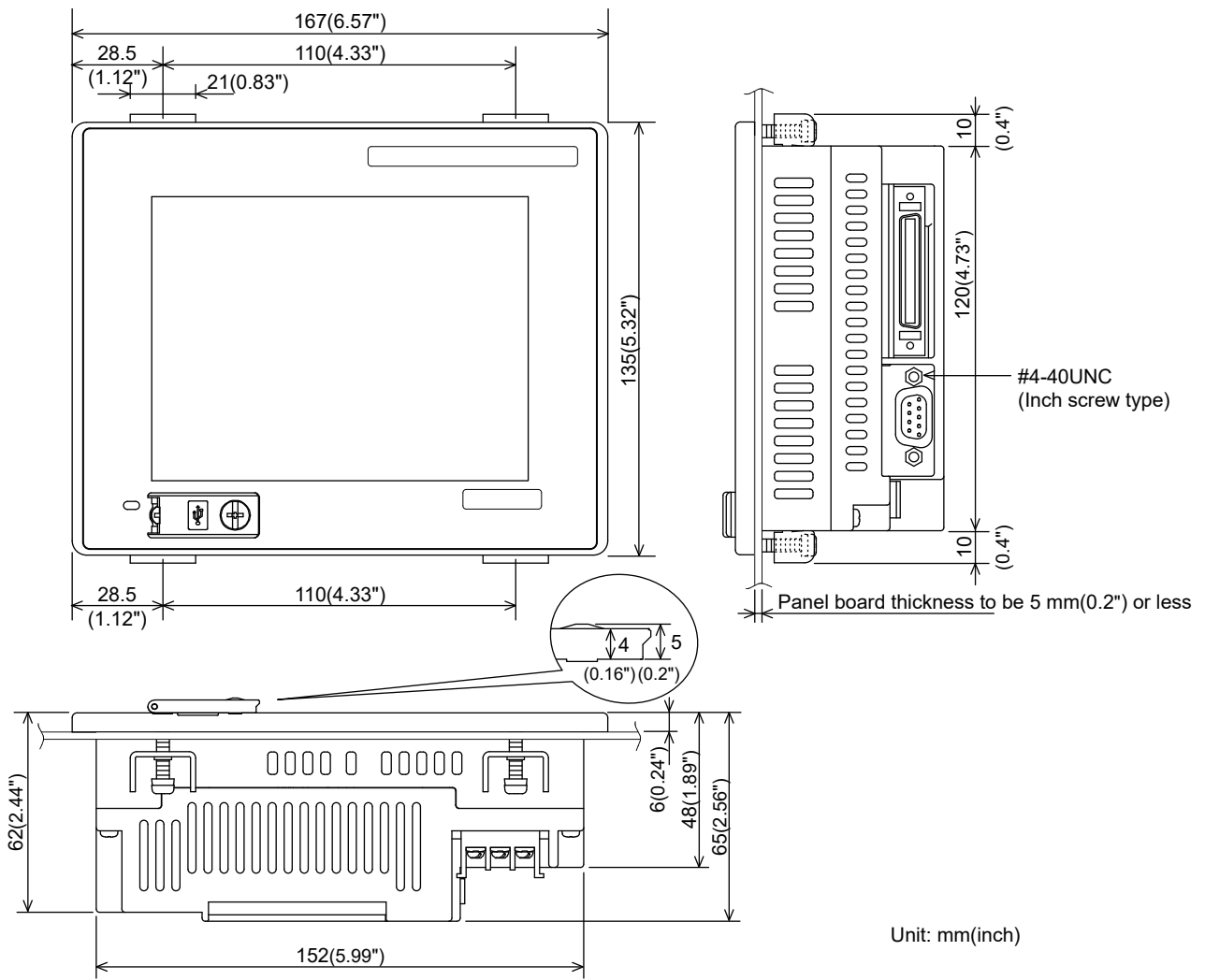

External dimensions of memory board

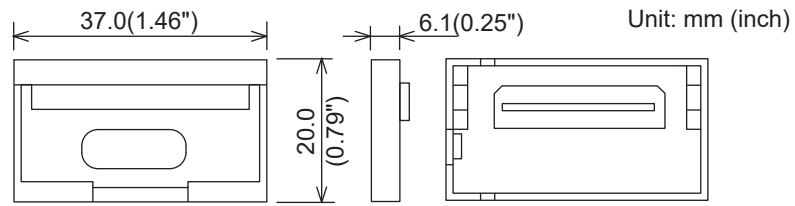

External dimensions of stand
GT05-50STAND

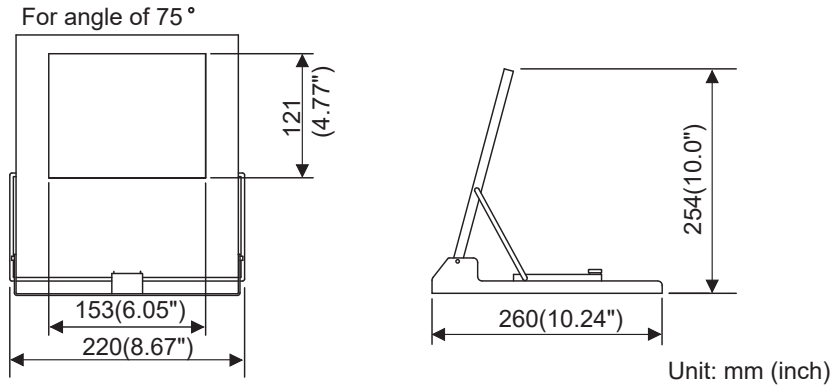

A9GT-50STAND

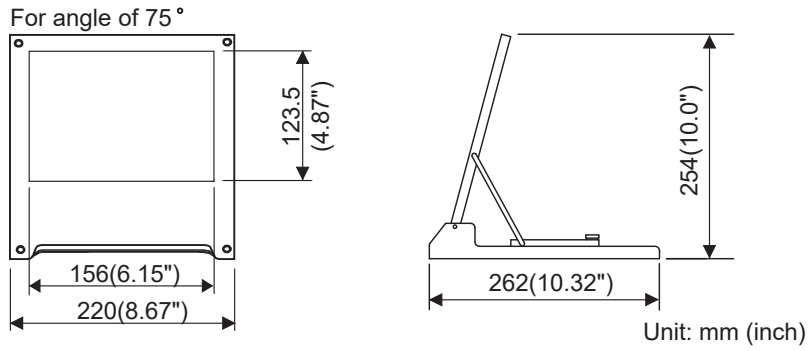

**External dimensions of serial multi-drop connection unit
GT01-RS4-M**

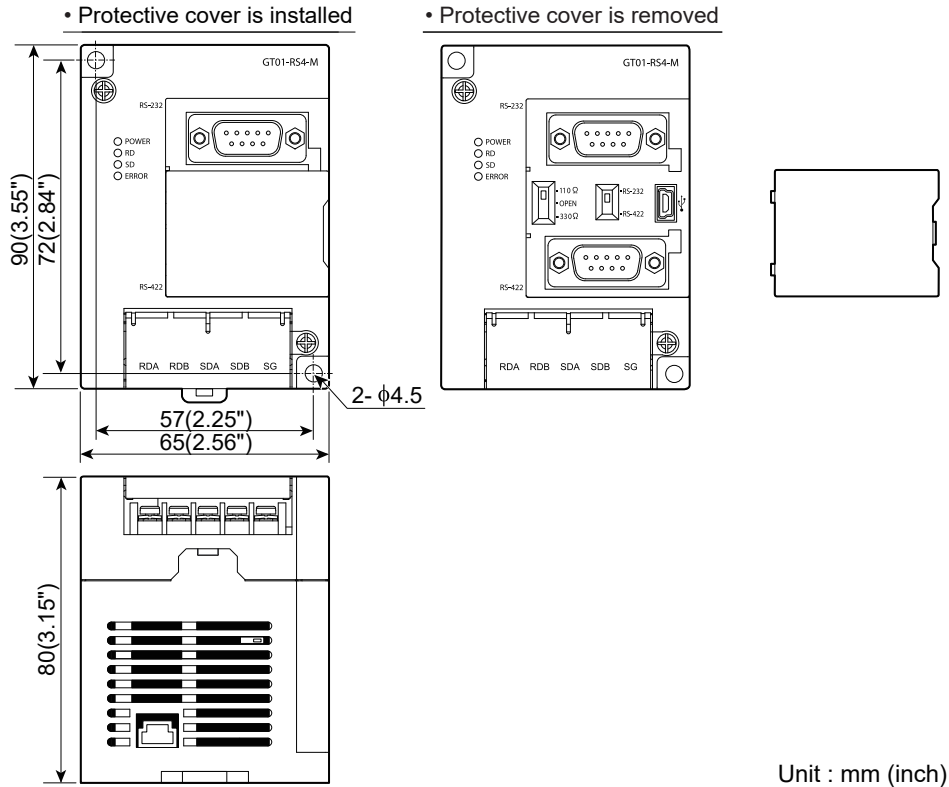

**External dimensions of connector conversion adapter
GT10-9PT5S**

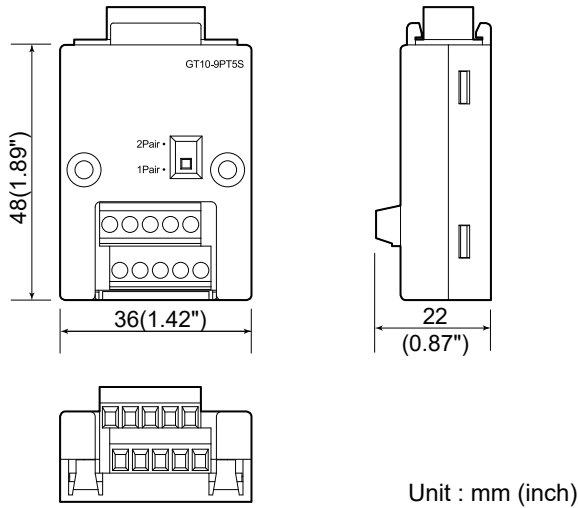

External dimensions of communication cable

GT01-C30R4-25P

Unit: mm (inch)

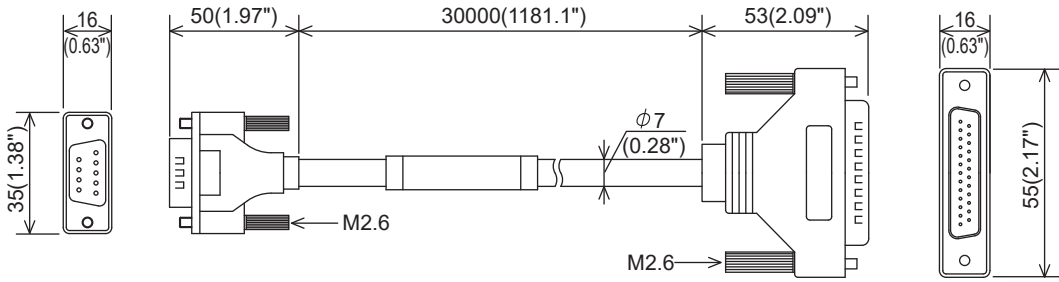

GT01-C □□□ R4-25P

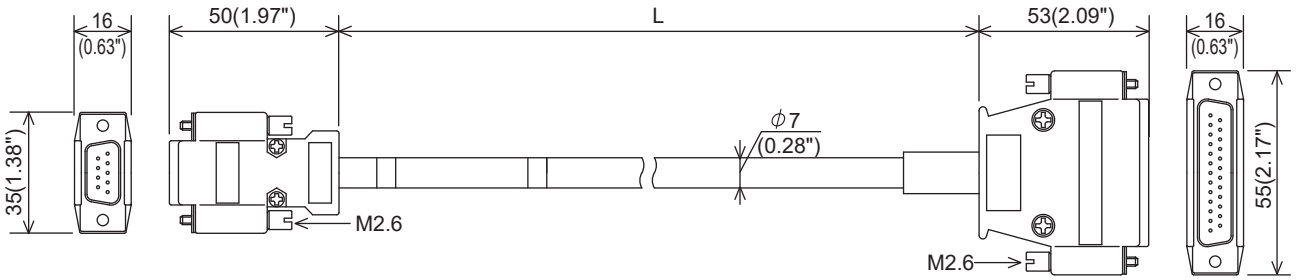

Value of □□□	Length L mm (inch)
100	10000 (393.7")
200	20000 (787.4")
300	30000 (1181.1")

GT01-C □□□ R4-8P

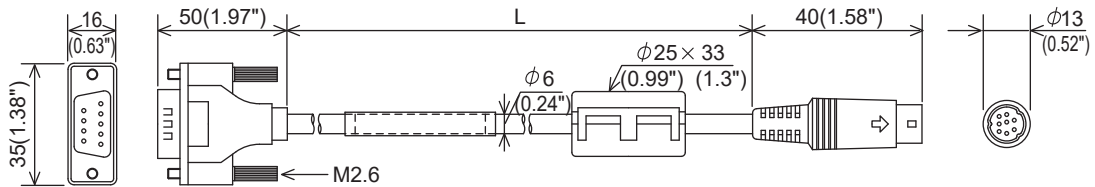

Value of □□□	Length L mm (inch)
10	1000 (39.37")
30	3000 (118.11")
100	10000 (393.7")
200	20000 (787.4")
300	30000 (1181.1")

GT01-C30R2-25P

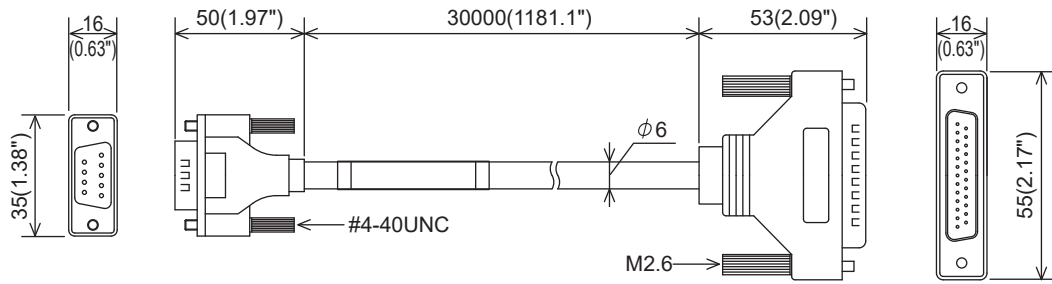

GT01-C30R2-9S

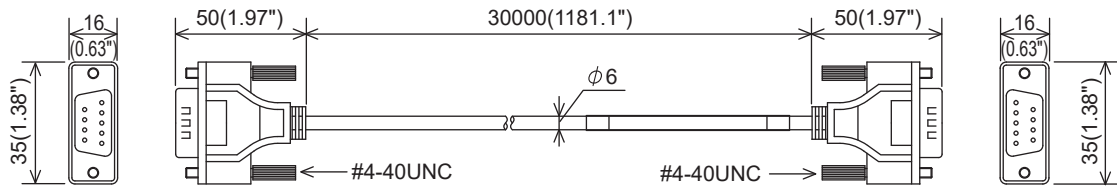

GT01-C30R2-6P

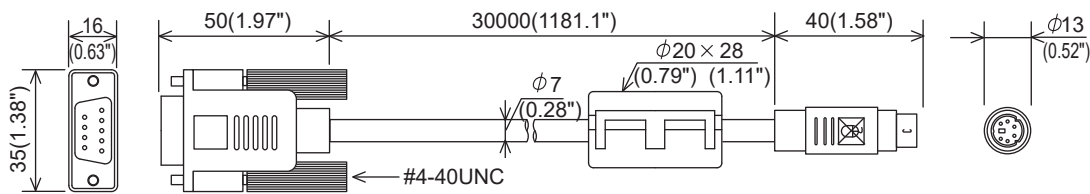

External dimensions of bus connection cable connector

Cable model	Cable length (m(ft.))	External dimensions
GT15-QC□B	0.6(2), 1.2(3.9), 3(10), 5(20), 10(33)	Fig. 1
GT15-QC□BS	15(49), 20(66), 25(82), 30(98), 35(120)	Fig. 1
GT15-C□NB	1.2(3.9), 3(10), 5(20)	Fig. 2
GT15-AC□B	0.6(2), 1.2(3.9), 3(10), 5(20)	Fig. 3
GT15-A370C□B-S1	1.2(3.9), 2.5(8)	Fig. 4
GT15-A370C□B	1.2(3.9), 2.5(8)	Fig. 5
GT15-A1SC□B	0.7(2), 1.2(3.9), 3(10), 5(20)	Fig. 6
GT15-A1SC□NB	0.45(1.5), 0.7(2), 3(10), 5(20)	Fig. 7
GT15-C□EXSS-1	10.6(34.8), 20.6(67.6), 30.6(100)	Fig. 8 + Fig. 9
GT15-EXCNB	0.5(2)	Fig. 8
GT15-C□BS	0.7(2), 1.2(3.9), 3(10), 5(20), 10(33), 20(66), 30(98)	Fig. 9
GT15-J2C□B	1(3)	Fig. 10

*1: The GT15-C□EXSS/GT15-C□BS cable has a grounding wire (1 m).

The GT15-C□BS cable has a grounding wire (For the cable length of 10m or more: 1m, for the cable length less than 10m: 0.5m).

Be sure to connect the wire to control panels.

*2: The GT15-C□EXSS-1 is the set product consisting of (GT15-EXCNB+GT15-C□BS). (Refer to Fig. A)

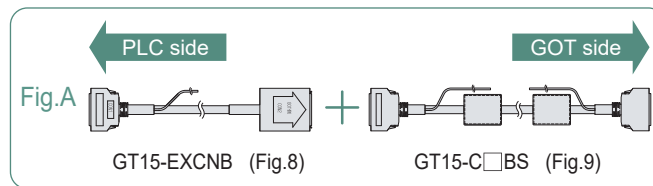

Unit : mm (inch)

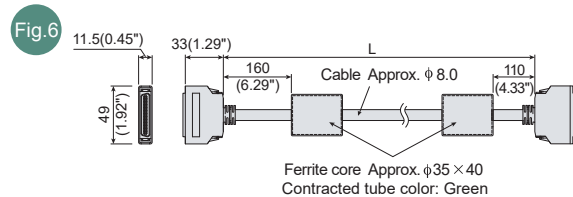
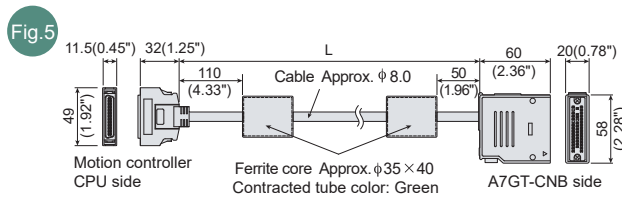
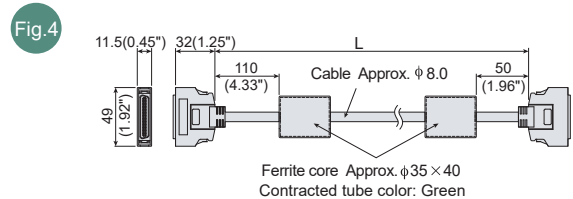
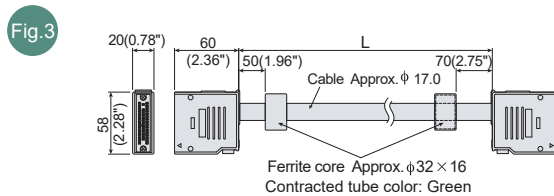
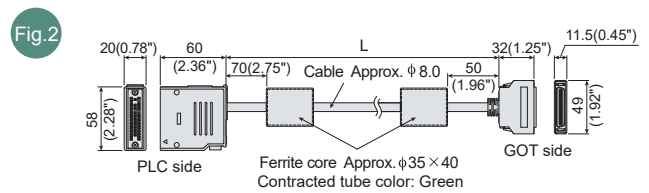
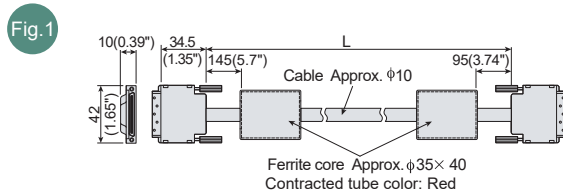

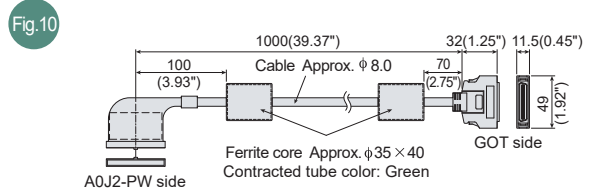
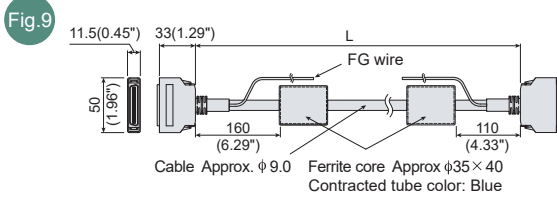
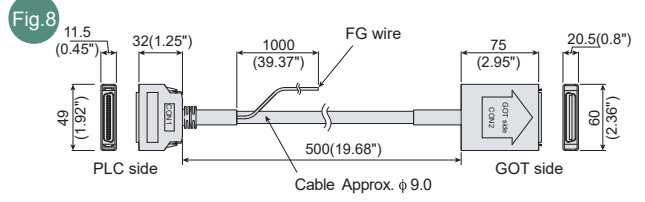
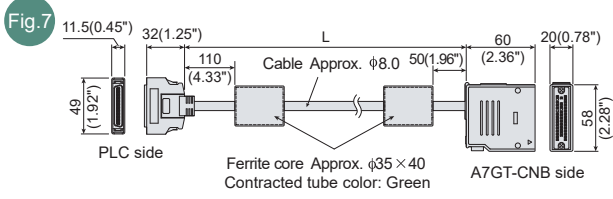

Appendix 2 Usage Condition of Utility Function

The function which can be used differs according to the GOT type.

Moreover, there are the function which can be set with drawing software and the function which cannot be set.

○ : Applicable × : Not Applicable - : Not required

Setting items	Function	GT15	GT Soft GOT 1000	GT11	Drawing Setting	
*1 Connection settings	Channel No. setting and communication driver assignment to communication interface	○	×	○	○	
	Connection detail settings	Communication parameter setting	○	×	○	○
		Sequence program protection key word setting (When connecting FX series PLC)	○	×	○	×
		Sequence program protection key word deleting (When connecting FX series PLC)	○	×	○	×
GOT Setup	Sequence program protection status cancel (When connecting FX series PLC)	○	×	○	×	
	Display settings	Opening screen time setting	○	○	○	○
		Screen save time setting	○	×	○	○
		Screen save backlight ON/OFF setting	○	-	○	○
		Message language switching (Japanese/English/Chinese (Simplified)/Chinese (Traditional)/Korean/German)	○	○	○*2	○
		Battery alarm display ON/OFF setting	○	-	○	○
		Screen saving human sensor enable/disable setting 	○	×	×	×
		Human sensor detect level setting 	○	×	×	×
		Display of human sensor detect time 	○	×	×	×
		Human sensor OFF delay setting 	○	×	×	×
Invert colors ON/OFF setting 		○	×	○	×	
Brightness /contrast adjustment	Liquid crystal brightness setting	○	×	○	×	
	Liquid crystal contrast setting	×	×	○	×	

(Continued to next page)

○ : Applicable × : Not Applicable - : Not required

Setting items		Function	GT15	GT Soft GOT 1000	GT11	Drawing Setting	
GOT Setup	Operation	Buzzer volume setting	○	○	○	○	
	Security setting *3	Security level change (Security password input for each object)	○	○	○	×	
	Utility call key	Utility call key setting	○	○	○	○	
	Key sensitivity	Key sensitivity setting	○	-	○	×	
	Key reaction speed	Displaying key response speed	○	-	○	×	
	Touch panel adjustment 	Correcting touch position reading error	○	-	×	×	
	Q/QnA ladder monitor setting	Setting of data holding destination for MELSEC-Q/QnA ladder monitor function	○	-	×	○	
	Transparent mode setting	Setting of communication target channel No. when using FA transparent function	○	-	×	○	
	Video/RGB Setting	Video Unit Settings	Setting of the video input signal and resolution	○	-	×	○
		Video Display Settings	Setting of the captive area size for each video channel, the color tone, contrast, brightness, and color intensity	○	-	×	○
RGB Display Settings		Setting of the RGB clock phase, horizontal screen position, and vertical screen position	○	-	×	○	
Time display and setting *4	Selecting base clock		○	-	○	○	
	Displaying the present time of the clock		○	-	○	×	
	Setting the present time of the clock		○	-	○	×	
	Displaying battery status		○	-	○	×	

○ : Applicable × : Not Applicable - : Not required

Setting items		Function	GT15	GT Soft GOT 1000	GT11	Drawing Setting	
Program/data control	OS information	Installing OS	○	×	○	×	
		Uploading OS	○	×	○	×	
		Displaying the properties of OS (Type, version, date)	○	×	○	×	
		System file (OS) data check	○	×	○	×	
	Project information	Downloading project file	○	×	○	×	
		Uploading project file	○	×	○	×	
		Deleting project file	○	×	○	×	
		Copying project file (A drive → A drive)	○	×	○	×	
		Displaying the properties of project file (Date, version, screen title)	○	×	○	×	
		Project file data check	○	×	○	×	
	Alarm information	Deleting alarm log file	○	×	○	×	
		Copying alarm log file	○	×	○	×	
		G1A → CSV conversion (Conversion of alarm file from G1A to CSV)	○	×	×	×	
		G1A → TXT conversion (Conversion of alarm file from G1A to TEXT)	○	×	×	×	
	Historical graph display	Historical graph display of alarm file	○	×	×	×	
		Total graph display	○	×	×	×	
	Advanced recipe information	Advanced recipe information	G1P → CSV conversion (Conversion of advanced recipe file from G1P to CSV)	○	×	×	×
			G1P → TXT conversion (Conversion of advanced recipe file from G1P to CSV)	○	×	×	×
			Deleting advanced recipe file or folder	○	×	×	×
			Copying advanced recipe file	○	×	×	×
			Moving advanced recipe file or folder	○	×	×	×
			Changing advanced recipe folder name	○	×	×	×
			Creating a new advanced recipe file or folder	○	×	×	×
		Advanced recipe record list	Loading record value	○	×	×	×
			Saving record value	○	×	×	×
			Matching record value	○	×	×	×
			Deleting device value	○	×	×	×

(Continued to next page)

○ : Applicable × : Not Applicable - : Not required

Setting items	Function	GT15	GT Soft GOT 1000	GT11	Drawing Setting	
Program/data control	Logging information	G1L → CSV conversion (Conversion of logging file from G1L to CSV)	○	×	×	×
		G1L → TXT conversion (Conversion of logging file from G1L to TXT)	○	×	×	×
		Deleting logging file or folder	○	×	×	×
		Copying logging file	○	×	×	×
		Moving logging file	○	×	×	×
		Changing logging file name	○	×	×	×
		Creating a new logging folder or file	○	×	×	×
	Operation log information	G1O CSV conversion (Conversion from G1L of operation log file to CSV)	○	○	×	○
		G1O TXT conversion (Conversion from G1O of logging file to TXT)	○	○	×	○
		Deletion of a operation log file or folder	○	○	×	×
		Copying of an operation log file	○	○	×	×
		Moving of an operation log file	○	○	×	×
		Changing of an operation log file name	○	○	×	×
		Creating of a new operation log folder	○	○	×	×
	Hard copy information	Deleting hard copy file	○	×	×	×
		Copying hard copy file	○	×	×	×
	Memory card format	Formatting memory card	○	×	○	×
	Memory information	Displaying the memory free space of GOT	○	×	○	×
	Special data information	Displaying the name, data size and creating date of file or folder	○	×	×	×
		Deleting special data file or folder	○	×	×	×
		Special data file check	○	×	×	×
		Downloading special data of A drive (Standard CF card) to C drive (Built-in flash memory)	○	×	×	×
	GOT data package acquisition	Copies OS, special data, and project data to the memory card	○	×	○	×

○ : Applicable × : Not Applicable - : Not required

Setting items		Function	GT15	GT Soft GOT 1000	GT11	Drawing Setting	
Debug/Self check	Debug	System monitor	Changing the present value of the device monitor of PLC, the buffer memory monitor of the test function and special memory, and the buffer memory	○	×	○	×
		Ladder monitor	Displaying ladder monitor and executing hard copy	○	×	×	×
		A list editor	Changing PLC program of ACPU and parameters	○	×	○	×
		FX list editor	List editing PLC program of FX PLC	○	×	○	×
		Intelligent module monitor	Executing the monitor and data change for the buffer memory of intelligent function module on the dedicated screen Or monitoring available to check the signal status of I/O module	○	×	×	×
		Network monitor	Monitoring the network status of MELSECNET/H, MELSECNET/10, MELSECNET(II) and MELSECNET/B	○	×	×	×
		Q motion monitor	Servo monitor and parameter settings of the motion controller CPU (Q series)	○	×	×	×
		Servo amplifier monitor	Executing each monitor function, parameter change, test operation and others of the servo amplifier	○	×	×	×
		CNC monitor	Executing the position display monitor equivalent to the display dedicated to MELDAS, the alarm diagnosis monitor, the tool offset/parameter, the program monitor, etc.	○	×	×	×

○ : Applicable × : Not Applicable - : Not required

Setting items		Function	GT15	GT Soft GOT 1000	GT11	Drawing Setting
Debug/Self check	Memory check	A drive memory check (Standard CF card)	○	×	○	×
		C drive memory check (Built-in flash memory)	○	×	○	×
		D drive memory check (Built-in SRAM)	×	×	○	×
	Drawing check	Missing bits, color, draw, display and overlap display check of liquid crystal	○	×	○	×
	Font check	Installed fonts check	○	×	○	×
	Touch panel check	Touch panel operation check	○	×	○	×
	I/O check	Connected target confirmation	○	×	○	×
		Self-loopback check *5	○	×	○	×
	NETWK unit status display	Monitoring of the LED status display of the MELSECNET/H communication unit and CC-Link communication unit (GT15-J61BT13)	○	-	×	×
	System alarm display	Displaying GOT errors, CPU errors, network errors	○	×	○*6	×
		Resetting GOT errors		×	○	
	GOT start time	Displaying GOT start date and time, current time, accumulated operating hours	○	×	○	×
Screen cleaning		Displaying the screen to clean the display section	○	×	○	×
Maintenance report	Maintenance report *7	Backlight maintenance notification time setting	○	-	×	×
		Display section maintenance notification time setting	○	-	×	×
		Touch key maintenance notification count setting	○	-	×	×
		Built-in flash memory maintenance notification count setting	○	-	×	×
Integrated value reset	Integrated value reset *7	Function to reset the values of backlight maintenance notification time counted for maintenance time report, display section maintenance notification time, touch key maintenance notification count and built-in flash memory maintenance notification count	○	-	×	×

- *1: It is necessary to perform the followings by drawing software.
• Installation of communication driver
• Assignment of channel No. and communication driver
- *2: The following display and operations are not allowed with the GT11.
• Chinese (Traditional) cannot be displayed.
• Japanese and Chinese (Simplified) cannot be selected on the GOT screen.
(Japanese and Chinese (Simplified) fonts cannot be installed at the same time.)
- *3: It is necessary to set the security level by drawing software.
- *4: Mount a battery as necessary.
- *5: It is necessary to mount a RS-232 connector for test. ( Section 14.10 I/O Check)
- *6: GT11 will display only the GOT error and CPU error.
- *7: It is necessary to mount the option function board and battery.

Appendix 3 Transportation Precautions

When transporting lithium batteries, make sure to treat them based on the transport regulations.

Appendix 3.1 Relevant models

The battery for the GOT1000 Series is classified as shown in the table below.

Product name	Model	Description	Handled as
Battery for GOT1000 Series	GT11-50BAT	Lithium coin battery	Non-dangerous goods

Appendix 3.2 Transport guidelines

Products are packed properly in compliance with the transportation regulations prior to shipment. When repacking any of the unpacked products to transport it to another location, make sure to observe the IATA Dangerous Goods Regulations, IMDG Code and other local transportation regulations. For details, please consult your transportation company.

Appendix 4 List of Functions Added by GT Designer2 Version Upgrade (For GOT1000 Series)

For the functions added by version upgrade of the GT Designer2, refer to the following.

 GT Designer2 Version2 Screen Design Manual

INDEX

- [A]
 - A list editor 14-49

- [B]
 - Backlight shutoff detection 17-7
 - Bar code 2-1,2-13
 - Battery 4-3,8-7,17-4
 - BootOS 9-1,13-2,16-2
 - Brightness/contrast adjustment 11-8
 - Brightness/contrast adjustment of display 11-8
 - Buzzer volume setting 11-10

- [C]
 - CF card (Compact Flash card)
..... 2-11,8-1,9-1,13-2,16-1
 - Clean 15-1
 - Cleaning of display 15-1,17-3
 - Clock settings 12-1
 - Communication settings screen 10-2
 - Component list 2-2
 - Connector conversion adapter 2-1,8-19

- [D]
 - Daily inspection 17-2
 - Debug & self check 14-1
 - Display 14-131
 - Display of OS information 13-6
 - Display of utility screen 9-6
 - Display settings 11-1
 - Displaying 14-128

- [E]
 - Error list 18-3
 - Error message and solution 18-3
 - External dimensions App-1

- [F]
 - Features 1-4
 - FX list editor 14-84

- [G]
 - General specifications 3-1
 - GOT data package acquisition 13-33
 - GOT set up 11-1
 - GOT Start Time 14-130

- [I]
 - Installation 6-1
 - Invert colors 11-7

- [L]
 - List of error code and error message 18-3

- [M]
 - Memory card adaptor 8-4
 - Message indicator 18-3

- [O]
 - Operation setting 11-11
 - Option 2-5,8-1
 - Option function board 2-1,8-5
 - OS file list 13-5,16-2
 - OS file storage location 13-1,16-2
 - OS installation 9-1,13-1,16-2
 - Overall configuration 2-1

- [P]
 - Panel cutting dimensions 6-4
 - Part name 4-1
 - Password 9-8
 - PC connection cable 2-13
 - Performance specifications 3-2
 - Periodic inspection 17-2
 - Power supply specifications 3-8
 - Program/data control 13-1
 - Project data storage location 13-1,13-5
 - Protective cover for oil 2-1,8-13
 - Protective sheet 2-1,8-10,17-2

- [R]
 - Required device 2-1
 - RFID 2-1,2-13
 - Rough pre-operation procedure 1-5

- [S]
 - Screen data transfer cable 2-13
 - Security level change 11-10,11-14
 - Self check 14-112
 - Serial multi-drop connection unit 2-1,8-16
 - Set up 11-1
 - Specifications 3-1
 - General specifications 3-1
 - Performance specifications 3-2
 - Power supply specifications 3-8
 - Stand 2-1,8-12
 - Standard monitor OS 9-1,13-2,16-2
 - System 14-128
 - System alarm 17-4,18-1
 - System Alarm Display 14-128
 - System configuration 2-1
 - System monitor 14-2

[T]

Third party PLC connection cable	2-3
Time setting and display	12-1
Troubleshooting	
Troubleshooting in bus connection	18-7

[U]

USB environmental protection cover	8-11
Utility function list	9-2

[W]

Wiring	7-1
--------------	-----

WARRANTY

Please confirm the following product warranty details before using this product.

1. Gratis Warranty Term and Gratis Warranty Range

If any faults or defects (hereinafter "Failure") found to be the responsibility of Mitsubishi occurs during use of the product within the gratis warranty term, the product shall be repaired at no cost via the sales representative or Mitsubishi Service Company. However, if repairs are required onsite at domestic or overseas location, expenses to send an engineer will be solely at the customer's discretion. Mitsubishi shall not be held responsible for any re-commissioning, maintenance, or testing on-site that involves replacement of the failed module.

[Gratis Warranty Term]

The gratis warranty term of the product shall be for one year after the date of purchase or delivery to a designated place. Note that after manufacture and shipment from Mitsubishi, the maximum distribution period shall be six (6) months, and the longest gratis warranty term after manufacturing shall be eighteen (18) months. The gratis warranty term of repair parts shall not exceed the gratis warranty term before repairs.

[Gratis Warranty Range]

- (1) The range shall be limited to normal use within the usage state, usage methods and usage environment, etc., which follow the conditions and precautions, etc., given in the instruction manual, user's manual and caution labels on the product.
- (2) Even within the gratis warranty term, repairs shall be charged for in the following cases.
 1. Failure occurring from inappropriate storage or handling, carelessness or negligence by the user. Failure caused by the user's hardware or software design.
 2. Failure caused by unapproved modifications, etc., to the product by the user.
 3. When the Mitsubishi product is assembled into a user's device, Failure that could have been avoided if functions or structures, judged as necessary in the legal safety measures the user's device is subject to or as necessary by industry standards, had been provided.
 4. Failure that could have been avoided if consumable parts (battery, backlight, fuse, etc.) designated in the instruction manual had been correctly serviced or replaced.
 5. Failure caused by external irresistible forces such as fires or abnormal voltages, and Failure caused by force majeure such as earthquakes, lightning, wind and water damage.
 6. Failure caused by reasons unpredictable by scientific technology standards at time of shipment from Mitsubishi.
 7. Any other failure found not to be the responsibility of Mitsubishi or that admitted not to be so by the user.

2. Onerous repair term after discontinuation of production

- (1) Mitsubishi shall accept onerous product repairs for seven (7) years after production of the product is discontinued. Discontinuation of production shall be notified with Mitsubishi Technical Bulletins, etc.
- (2) Product supply (including repair parts) is not available after production is discontinued.

3. Overseas service

Overseas, repairs shall be accepted by Mitsubishi's local overseas FA Center. Note that the repair conditions at each FA Center may differ.

4. Exclusion of loss in opportunity and secondary loss from warranty liability

Regardless of the gratis warranty term, Mitsubishi shall not be liable for compensation of damages caused by any cause found not to be the responsibility of Mitsubishi, loss in opportunity, lost profits incurred to the user or third person by Failures of Mitsubishi products, special damages and secondary damages whether foreseeable or not, compensation for accidents, and compensation for damages to products other than Mitsubishi products, replacement by the user, maintenance of on-site equipment, start-up test run and other tasks.

5. Changes in product specifications

The specifications given in the catalogs, manuals or technical documents are subject to change without prior notice.

6. Product application

- (1) In using the Mitsubishi graphic operation terminal, the usage conditions shall be that the application will not lead to a major accident even if any problem or fault should occur in the graphic operation terminal device, and that backup and fail-safe functions are systematically provided outside of the device for any problem or fault.
- (2) The Mitsubishi graphic operation terminal has been designed and manufactured for applications in general industries, etc. Thus, applications in which the public could be affected such as in nuclear power plants and other power plants operated by respective power companies, and applications in which a special quality assurance system is required, such as for Railway companies or Public service purposes shall be excluded from the graphic operation terminal applications. In addition, applications in which human life or property that could be greatly affected, such as in aircraft, medical applications, incineration and fuel devices, manned transportation, equipment for recreation and amusement, and safety devices, shall also be excluded from the graphic operation terminal range of applications. However, in certain cases, some applications may be possible, providing the user consults their local Mitsubishi representative outlining the special requirements of the project, and providing that all parties concerned agree to the special circumstances, solely at the users discretion.

GOT is a registered trademark of Mitsubishi Electric Corporation.

Microsoft, Windows, Windows NT, Windows Vista, Windows 7 are registered trademarks of Microsoft Corporation in the United States and other countries.

Adobe and Adobe Reader are registered trademarks of Adobe Systems Incorporated.

Pentium and Celeron are a registered trademarks of Intel Corporation in the United States and other countries.

Ethernet is a trademark of Xerox Co., Ltd. in the United States.

MODBUS is a trademark of Schneider Electric SA.

Other company and product names herein may be either trademarks or registered trademarks of their respective owners.

GRAPHIC OPERATION TERMINAL

GOT1000

GT11 User's Manual

MODEL	GT11-U-E
MODEL CODE	09R815
JY997D17501T	

MITSUBISHI ELECTRIC CORPORATION

HEAD OFFICE : TOKYO BUILDING, 2-7-3 MARUNOUCHI, CHIYODA-KU, TOKYO 100-8310, JAPAN

When exported from Japan, this manual does not require application to the Ministry of Economy, Trade and Industry for service transaction permission.

Effective October 2022

Specifications are subject to change without notice.