

GRAPHIC OPERATION TERMINAL

GOT1000 Series

User's Manual (Extended Functions, Option Functions) for GT Works3

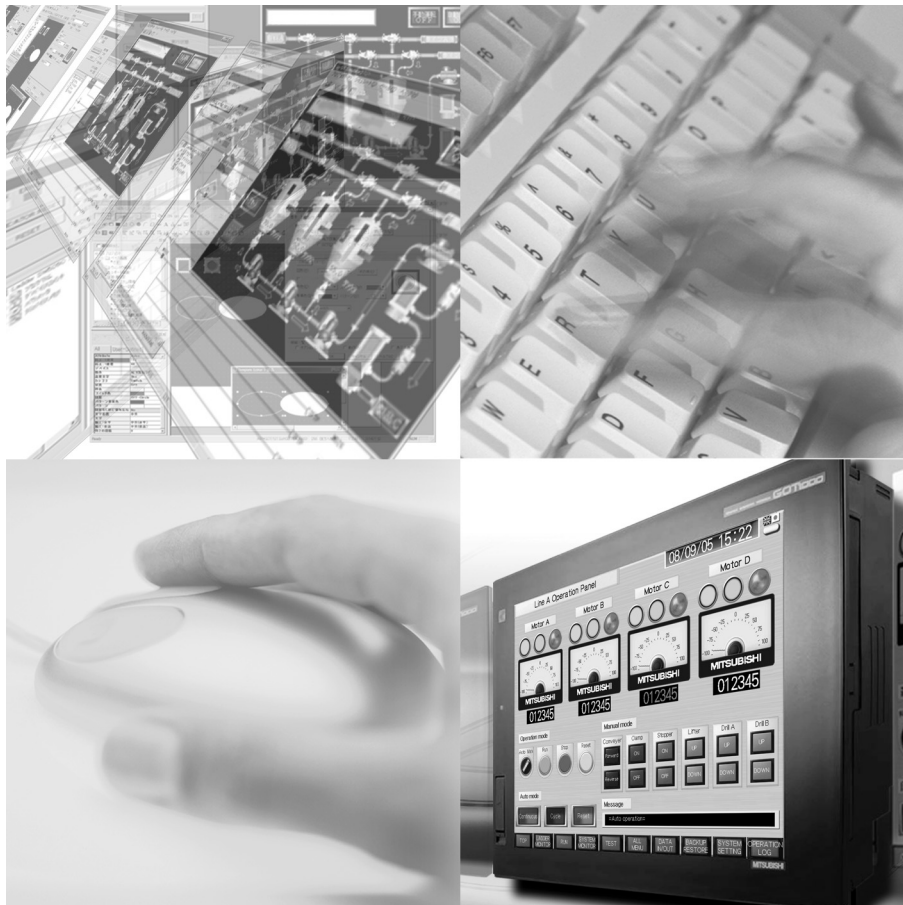

● SAFETY PRECAUTIONS ●

(Always read these precautions before using this equipment.)

Before using this product, please read this manual and the relevant manuals introduced in this manual carefully and pay full attention to safety to handle the product correctly.

The precautions given in this manual are concerned with this product.

In this manual, the safety precautions are ranked as "WARNING" and "CAUTION".



WARNING

Indicates that incorrect handling may cause hazardous conditions, resulting in death or severe injury.



CAUTION

Indicates that incorrect handling may cause hazardous conditions, resulting in medium or slight personal injury or physical damage.

Note that the  caution level may lead to a serious accident according to the circumstances. Always follow the instructions of both levels because they are important to personal safety.

Please save this manual to make it accessible when required and always forward it to the end user.

[DESIGN PRECAUTIONS]



WARNING

- Some failures of the GOT, communication unit or cable may keep the outputs on or off.
An external monitoring circuit should be provided to check for output signals which may lead to a serious accident.
Not doing so can cause an accident due to false output or malfunction.
- If a communication fault (including cable disconnection) occurs during monitoring on the GOT, communication between the GOT and PLC CPU is suspended and the GOT becomes inoperative.
For bus connection : The CPU becomes faulty and the GOT becomes inoperative.
For other than bus connection : The GOT becomes inoperative.
A system where the GOT is used should be configured to perform any significant operation to the system by using the switches of a device other than the GOT on the assumption that a GOT communication fault will occur.
Not doing so can cause an accident due to false output or malfunction.
- Do not use the GOT as the warning device that may cause a serious accident.
An independent and redundant hardware or mechanical interlock is required to configure the device that displays and outputs serious warning.
Failure to observe this instruction may result in an accident due to incorrect output or malfunction.

[DESIGN PRECAUTIONS]

WARNING

- Incorrect operation of the touch switch(s) may lead to a serious accident if the GOT backlight is gone out.

When the GOT backlight goes out, the display section dims, while the input of the touch switch(s) remains active.

This may confuse an operator in thinking that the GOT is in "screensaver" mode, who then tries to release the GOT from this mode by touching the display section, which may cause a touch switch to operate.

Note that the following occurs on the GOT when the backlight goes out.

- When using the GT1655-V, Handy GOT, GT15, GT14, GT12, GT11, or GT105□
The POWER LED blinks (green/orange) and the monitor screen appears blank.
 - When using the GT1695, GT1685, GT1675, GT1672, GT1665, or GT1662
The POWER LED blinks (green/orange) and the monitor screen appears dimmed.
 - When using the GT104□
The monitor screen appears blank.
 - When using the GT103□ or GT102□
The monitor screen appears dimmed.
- The display section of the GT16 is an analog-resistive type touch panel.
If you touch the display section simultaneously in 2 points or more, the switch that is located around the center of the touched point, if any, may operate.
Do not touch the display section in 2 points or more simultaneously.
Doing so may cause an accident due to incorrect output or malfunction.
- When programs or parameters of the controller (such as a PLC) that is monitored by the GOT are changed, be sure to reset the GOT or shut off the power of the GOT at the same time.
Not doing so can cause an accident due to false output or malfunction.
- When the GOT is connected to the Ethernet network, the available IP address is restricted according to the system configuration.
 - When multiple GOTs are connected to the Ethernet network:
Do not set the IP address (192.168.0.18) for the GOTs and the controllers in the network.
 - When a single GOT is connected to the Ethernet network:
Do not set the IP address (192.168.0.18) for the controllers except the GOT in the network.
Doing so can cause the IP address duplication. The duplication can negatively affect the communication of the device with the IP address (192.168.0.18).
The operation at the IP address duplication depends on the devices and the system.
 - Turn on the controllers and the network devices to be ready for communication before they communicate with the GOT.
Failure to do so can cause a communication error on the GOT.

[DESIGN PRECAUTIONS]

WARNING

- To maintain the security (confidentiality, integrity, and availability) of the GOT and the system against unauthorized access, DoS^{*1} attacks, computer viruses, and other cyberattacks from unreliable networks and devices via network, take appropriate measures such as firewalls, virtual private networks (VPNs), and antivirus solutions.
Mitsubishi Electric shall have no responsibility or liability for any problems involving GOT trouble and system trouble by unauthorized access, DoS attacks, computer viruses, and other cyberattacks.
^{*1} DoS: A denial-of-service (DoS) attack disrupts services by overloading systems or exploiting vulnerabilities, resulting in a denial-of-service (DoS) state.

CAUTION

- Do not bundle the control and communication cables with main-circuit, power or other wiring. Run the above cables separately from such wiring and keep them a minimum of 100mm apart. Not doing so noise can cause a malfunction.
- Do not press the GOT display section with a pointed material as a pen or driver. Doing so can result in a damage or failure of the display section.

[MOUNTING PRECAUTIONS]

WARNING

- Be sure to shut off all phases of the external power supply used by the system before mounting or removing the GOT to/from the panel.
Not doing so can cause the GOT to fail or malfunction.
- Be sure to shut off all phases of the external power supply used by the system before mounting or removing the communication unit, option function board or multi-color display board onto/from the GOT.
Not doing so can cause the unit to fail or malfunction.
- Before mounting an optional function board or Multi-color display board, wear a static discharge wrist strap to prevent the board from being damaged by static electricity.

CAUTION

- Use the GOT in the environment that satisfies the general specifications described in the User's Manual.
Not doing so can cause an electric shock, fire, malfunction or product damage or deterioration.
- When mounting the GOT to the control panel, tighten the mounting screws in the specified torque range.
Undertightening can cause the GOT to drop, short circuit or malfunction.
Overtightening can cause a drop, short circuit or malfunction due to the damage of the screws or the GOT.

[MOUNTING PRECAUTIONS]

CAUTION

- When loading the communication unit or option unit to the GOT (GT16, GT15), fit it to the extension interface of the GOT and tighten the mounting screws in the specified torque range.
Undertightening can cause the GOT to drop, short circuit or malfunction.
Overtightening can cause a drop, failure or malfunction due to the damage of the screws or unit.
- When mounting the multi-color display board onto the GOT (GT15), connect it to the corresponding connector securely and tighten the mounting screws within the specified torque range.
Loose tightening may cause the unit and/or GOT to malfunction due to poor contact.
Overtightening may damage the screws, unit and/or GOT; they might malfunction.
- When mounting the option function board onto the GOT (GT16), connect it to the corresponding connector securely and tighten the mounting screws within the specified torque range.
- When mounting an optional function board onto the GOT(GT15), fully connect it to the connector until you hear a click.
- When mounting an optional function board onto the GOT(GT11), fully connect it to the connector.
- When inserting a CF card into the GOT(GT16, GT15, GT11), push it into the CF card interface of GOT until the CF card eject button will pop out.
Failure to do so may cause a malfunction due to poor contact.
- When inserting/removing a CF card into/from the GOT(GT16, GT15, GT11), turn the CF card access switch off in advance.
Failure to do so may corrupt data within the CF card.
- When inserting/removing a SD card into/from the GOT(GT14), turn the SD card access switch off in advance.
Failure to do so may corrupt data within the SD card.
- When removing a CF card from the GOT, make sure to support the CF card by hand, as it may popout.
Failure to do so may cause the CF card to drop from the GOT and break.
- When removing a SD card from the GOT(GT14), make sure to support the SD card by hand, as it may pop out.
Failure to do so may cause the SD card to drop from the GOT and break.
- When installing a USB memory to the GOT(GT16, GT14), make sure to install the USB memory to the USB interface firmly.
Failure to do so may cause a malfunction due to poor contact.
- Before removing the USB memory from the GOT(GT16, GT14), operate the utility screen for removal.
After the successful completion dialog box is displayed, remove the memory by hand carefully.
Failure to do so may cause the USB memory to drop, resulting in a damage or failure of the memory.
- For closing the USB environmental protection cover, fix the cover by pushing the Δ mark on the latch firmly to comply with the protective structure.

[MOUNTING PRECAUTIONS]

CAUTION

- Remove the protective film of the GOT.
When the user continues using the GOT with the protective film, the film may not be removed.
- Operate and store the GOT in environments without direct sunlight, high temperature, dust, humidity, and vibrations.
- When using the GOT(GT16, GT15, GT11, GT10) in the environment of oil or chemicals, use the protective cover for oil.
Failure to do so may cause failure or malfunction due to the oil or chemical entering into the GOT.

[WIRING PRECAUTIONS]

WARNING

- Be sure to shut off all phases of the external power supply used by the system before wiring.
Failure to do so may result in an electric shock, product damage or malfunctions.

CAUTION

- Please make sure to ground FG terminal and LG terminal and protective ground terminal of the GOT power supply section by applying Class D Grounding (Class 3 Grounding Method) or higher which is used exclusively for the GOT.
Not doing so may cause an electric shock or malfunction.
- Be sure to tighten any unused terminal screws with a torque of 0.5 to 0.8N•m.
Failure to do so may cause a short circuit due to contact with a solderless terminal.
- Use applicable solderless terminals and tighten them with the specified torque.
If any solderless spade terminal is used, it may be disconnected when the terminal screw comes loose, resulting in failure.
- Correctly wire the GOT power supply section after confirming the rated voltage and terminal arrangement of the product.
Not doing so can cause a fire or failure.
- Tighten the terminal screws of the GOT power supply section in the specified torque range.
Undertightening can cause a short circuit or malfunction.
Overtightening can cause a short circuit or malfunction due to the damage of the screws or the GOT.
- Exercise care to avoid foreign matter such as chips and wire offcuts entering the GOT. Not doing so can cause a fire, failure or malfunction.
- The module has an ingress prevention label on its top to prevent foreign matter, such as wire offcuts, from entering the module during wiring.
Do not peel this label during wiring.
Before starting system operation, be sure to peel this label because of heat dissipation.

[WIRING PRECAUTIONS]

CAUTION

- Plug the bus connection cable by inserting it into the connector of the connected unit until it "clicks".
After plugging, check that it has been inserted snugly.
Not doing so can cause a malfunction due to a contact fault.
- Plug the communication cable into the connector of the connected unit and tighten the mounting and terminal screws in the specified torque range.
Undertightening can cause a short circuit or malfunction.
Overtightening can cause a short circuit or malfunction due to the damage of the screws or unit.
- Plug the QnA/ACPU/Motion controller (A series) bus connection cable by inserting it into the connector of the connected unit until it "clicks".
After plugging, check that it has been inserted snugly.
Not doing so can cause a malfunction due to a contact fault.

[TEST OPERATION PRECAUTIONS]

WARNING

- Before performing the test operations of the user creation monitor screen (such as turning ON or OFF bit device, changing the word device current value, changing the settings or current values of the timer or counter, and changing the buffer memory current value), read through the manual carefully and make yourself familiar with the operation method.
During test operation, never change the data of the devices which are used to perform significant operation for the system.
False output or malfunction can cause an accident.

[STARTUP/MAINTENANCE PRECAUTIONS]

WARNING

- When power is on, do not touch the terminals.
Doing so can cause an electric shock or malfunction.
- Correctly connect the battery connector.
Do not charge, disassemble, heat, short-circuit, solder, or throw the battery into the fire.
Doing so will cause the battery to produce heat, explode, or ignite, resulting in injury and fire.
- Before starting cleaning or terminal screw retightening, always switch off the power externally in all phases. Not switching the power off in all phases can cause a unit failure or malfunction.
Undertightening can cause a short circuit or malfunction.
Overtightening can cause a short circuit or malfunction due to the damage of the screws or unit.
- Do not disassemble or modify the unit.
Doing so can cause a failure, malfunction, injury or fire.

[STARTUP/MAINTENANCE PRECAUTIONS]

WARNING

- Do not touch the conductive and electronic parts of the unit directly.
Doing so can cause a unit malfunction or failure.

CAUTION

- The cables connected to the unit must be run in ducts or clamped.
Not doing so can cause the unit or cable to be damaged due to the dangling, motion or accidental pulling of the cables or can cause a malfunction due to a cable connection fault.
- When unplugging the cable connected to the unit, do not hold and pull the cable portion.
Doing so can cause the unit or cable to be damaged or can cause a malfunction due to a cable connection fault.
- Do not drop or apply strong impact to the unit.
Doing so may damage the unit.
- Do not drop or give an impact to the battery mounted to the unit.
Doing so may damage the battery, causing the battery fluid to leak inside the battery.
If the battery is dropped or given an impact, dispose of it without using.
- Before touching the unit, always touch grounded metal, etc. to discharge static electricity from human body, etc.
Not doing so can cause the unit to fail or malfunction.
- Replace battery with GT15-BAT(GT16, GT15) or GT11-50BAT(GT11, GT10) by Mitsubishi electric Co. only.
Use of another battery may present a risk of fire or explosion.
- Dispose of used battery promptly.
Keep away from children. Do not disassemble and do not dispose of in fire.

[TOUCH PANEL PRECAUTIONS]

CAUTION

- For the analog-resistive film type touch panels, normally the adjustment is not required.
However, the difference between a touched position and the object position may occur as the period of use elapses.
When any difference between a touched position and the object position occurs, execute the touch panel calibration.
- When any difference between a touched position and the object position occurs, other object may be activated.
This may cause an unexpected operation due to incorrect output or malfunction.

[BACKLIGHT REPLACEMENT PRECAUTIONS]

WARNING

- Be sure to shut off all phases of the external power supply of the GOT (and the PLC CPU in the case of a bus topology) and remove the GOT from the control panel before replacing the backlight (when using the GOT with the backlight replaceable by the user).
Not doing so can cause an electric shock.
Replacing a backlight without removing the GOT from the control panel can cause the backlight or control panel to drop, resulting in an injury.

CAUTION

- Wear gloves for the backlight replacement when using the GOT with the backlight replaceable by the user.
Not doing so can cause an injury.
- Before replacing a backlight, allow 5 minutes or more after turning off the GOT when using the GOT with the backlight replaceable by the user.
Not doing so can cause a burn from heat of the backlight.

[DISPOSAL PRECAUTIONS]

CAUTION

- When disposing of the product, handle it as industrial waste.
- When disposing of this product, treat it as industrial waste.
When disposing of batteries, separate them from other wastes according to the local regulations.
(For details of the battery directive in EU member states, refer to the User's Manual of the GOT to be used.)

[TRANSPORTATION PRECAUTIONS]

CAUTION

- When transporting lithium batteries, make sure to treat them based on the transport regulations.
(For details on models subject to restrictions, refer to the User's Manual for the GOT you are using.)
- Make sure to transport the GOT main unit and/or relevant unit(s) in the manner they will not be exposed to the impact exceeding the impact resistance described in the general specifications of the User's Manual, as they are precision devices.
Failure to do so may cause the unit to fail.
Check if the unit operates correctly after transportation.

INTRODUCTION

Thank you for choosing Mitsubishi Electric Graphic Operation Terminal (GOT).
Read this manual and make sure you understand the functions and performance of the GOT thoroughly in advance to ensure correct use.

CONTENTS

SAFETY PRECAUTIONS	A - 1
INTRODUCTION	A - 9
CONTENTS	A - 9
MANUALS.....	A - 19
QUICK REFERENCE	A - 21
ABBREVIATIONS AND GENERIC TERMS	A - 23
HOW TO READ THIS MANUAL	A - 28

1. OVERVIEW

1.1 Before Using Each Function	1 - 2
1.1.1 Each function and related manuals	1 - 2
1.1.2 Hardware and OS' required for each function	1 - 3
1.1.3 Outline of procedure to the operation of each function.....	1 - 11
1.1.4 Displayable languages for each function.....	1 - 13

2. SYSTEM MONITOR

2.1 Features.....	2 - 1
2.2 Specifications.....	2 - 5
2.2.1 System configuration	2 - 5
2.2.2 Devices that can be monitored	2 - 13
2.2.3 Access range.....	2 - 13
2.2.4 Precautions.....	2 - 14
2.3 Operation for Display	2 - 15
2.4 Operation Procedure Common to the System Monitor Screens.....	2 - 17
2.4.1 Functional change menu screen	2 - 17
2.4.2 Entering monitor devices (specifying monitor stations and devices)	2 - 18
2.4.3 Key window setting columns and operation procedure	2 - 21
2.4.4 Switching the display format (DEC/HEX) and comment/no-comment display.....	2 - 22
2.4.5 Quick test operation of monitor devices	2 - 24
2.4.6 Changing screens.....	2 - 28
2.5 Entry Monitor	2 - 29
2.5.1 Information displayed on the Entry Monitor screen and key functions	2 - 29
2.5.2 Procedure for entry monitor basic operation	2 - 32
2.5.3 Deleting entry devices	2 - 33
2.6 Batch Monitor.....	2 - 34
2.6.1 Information displayed on the Batch Monitor screen and key functions	2 - 34
2.6.2 Procedure for batch monitor basic operation.....	2 - 37
2.7 TC Monitor (Monitoring Timers and Counters)	2 - 38
2.7.1 Information displayed on the TC Monitor screen and key functions	2 - 38
2.7.2 Procedure for TC monitor basic operation.....	2 - 40

2.7.3	Procedure for canceling TC monitor keywords.....	2 - 41
2.8	BM Monitor (Monitoring Buffer Memory)	2 - 42
2.8.1	Information displayed on the BM Monitor screen and key functions	2 - 42
2.8.2	Procedure for BM monitor basic operation	2 - 44
2.9	Test Operation	2 - 45
2.9.1	Procedure for displaying the test menu screen and the setting key window screen	2 - 45
2.9.2	Information displayed on the test menu screen and key functions	2 - 46
2.9.3	Information and set items displayed on each setting key window screen	2 - 47
2.9.4	Test operation procedure.....	2 - 49
2.9.5	Test operation basic procedure	2 - 51
2.10	Error Messages and Corrective Action	2 - 52

3. LADDER MONITOR FUNCTION

3.1	Features.....	3 - 1
3.2	Specifications.....	3 - 4
3.2.1	System configuration	3 - 4
3.2.2	Devices and range that can be monitored	3 - 9
3.2.3	Access range	3 - 11
3.2.4	Precautions.....	3 - 11
3.3	Operation for Display	3 - 14
3.3.1	Setting and deleting media for saving ladder data.....	3 - 19
3.3.2	Display	3 - 20
3.3.3	Searching from the monitor screen.....	3 - 30
3.3.4	Reading comment files from CF cards	3 - 35
3.4	Operation Procedure Common.....	3 - 37
3.4.1	Information and key functions displayed on the screen.....	3 - 37
3.4.2	Hard copy output	3 - 44
3.5	Switching the Display Format	3 - 45
3.5.1	Display switching of 16-bit (one-word)/32-bit (two-word) modules	3 - 45
3.5.2	Display switching of decimal numbers/hexadecimal numbers.....	3 - 46
3.5.3	Switching comment/no-comment display	3 - 47
3.5.4	Displaying 32 characters of comments.....	3 - 48
3.5.5	Displaying notes	3 - 50
3.5.6	Displaying statements.....	3 - 51
3.5.7	Language switching of the sequence program (MELSEC-Q/L/QnA ladder monitor).....	3 - 52
3.6	Search Operation.....	3 - 54
3.6.1	Device search	3 - 55
3.6.2	Contact point search.....	3 - 57
3.6.3	Coil search.....	3 - 59
3.6.4	Step search.....	3 - 61
3.6.5	Ladder end search.....	3 - 62
3.6.6	Defect search.....	3 - 63
3.6.7	Touch search	3 - 67
3.7	Test Operation	3 - 69
3.7.1	Displaying the test menu screen.....	3 - 69
3.8	Local Device Monitor	3 - 70
3.8.1	Operation procedure for local device monitor.....	3 - 70
3.9	Error Messages and Corrective Action	3 - 73

4. MELSEC-A LIST EDITOR

4.1	Features.....	4 - 1
4.2	Specifications.....	4 - 3
4.2.1	System configuration	4 - 3
4.2.2	Access range.....	4 - 4
4.2.3	Precautions.....	4 - 4
4.3	Operations for Display	4 - 5
4.3.1	Operation of keyword input.....	4 - 7
4.4	Operation Methods	4 - 9
4.4.1	Key arrangement and a list of key functions.....	4 - 9
4.4.2	Display format of the display area	4 - 11
4.4.3	Switching valid keys (upper/lower functions).....	4 - 14
4.4.4	Selection and operation of modes	4 - 14
4.4.5	Command input procedures	4 - 15
4.4.6	Hard copy output	4 - 18
4.4.7	Action if an incorrect key is input.....	4 - 18
4.4.8	List of functions.....	4 - 19
4.5	Basic Operation	4 - 20
4.5.1	Reading sequence programs	4 - 20
4.5.2	Changing (Overwriting) commands	4 - 21
4.5.3	Adding (Inserting) commands.....	4 - 22
4.5.4	Deleting commands.....	4 - 23
4.5.5	Using the help function	4 - 24
4.5.6	PLC memory all clear	4 - 26
4.6	List of Operation Procedures	4 - 27
4.6.1	Common operation	4 - 27
4.6.2	Operation in write mode (W).....	4 - 28
4.6.3	Operation in read mode (R).....	4 - 28
4.6.4	Operation in insert mode (I).....	4 - 29
4.6.5	Operation in delete mode (D)	4 - 29
4.6.6	Operation in parameter mode (P).....	4 - 30
4.6.7	Operation in other mode (O).....	4 - 31
4.7	Error Messages and Corrective Actions	4 - 32
4.7.1	Error messages and corrective actions in direct CPU connection.....	4 - 32
4.7.2	PLC CPU error messages and troubleshooting	4 - 34
4.7.3	Error using list editor function on the link system	4 - 35

5. MELSEC-FX LIST EDITOR

5.1	Features.....	5 - 1
5.2	Specifications.....	5 - 3
5.2.1	System configuration	5 - 3
5.2.2	Access range.....	5 - 5
5.2.3	Precautions.....	5 - 5
5.3	Operations for Display	5 - 6
5.4	Operation Procedures.....	5 - 9
5.4.1	Key arrangement and a list of key functions.....	5 - 9
5.4.2	Selection and operation of modes	5 - 11
5.4.3	Sequence program display	5 - 12

5.4.4	Searching commands and devices	5 - 14
5.4.5	Writing commands	5 - 16
5.4.6	Changing operands, set values	5 - 19
5.4.7	Deleting commands	5 - 20
5.4.8	Sequence program all clear	5 - 21
5.4.9	PLC diagnostics	5 - 22
5.4.10	Parameter setting	5 - 24
5.4.11	Keywords	5 - 27
5.4.12	List monitor	5 - 29
5.4.13	Hard copy output	5 - 31
5.4.14	Action for an incorrect key input	5 - 31
5.5	Error Messages and Corrective Actions	5 - 32

6. INTELLIGENT MODULE MONITOR

6.1	Features	6 - 1
6.2	Specifications	6 - 3
6.2.1	System configuration	6 - 3
6.2.2	Access range	6 - 7
6.2.3	Precautions	6 - 9
6.3	Operations for Display	6 - 12
6.4	Operation of Each Intelligent Module Monitor Screen	6 - 16
6.4.1	Composition of the system configuration screen and key functions	6 - 16
6.4.2	Setting method for other station monitoring	6 - 18
6.4.3	Composition of PC Information monitor screen and key functions	6 - 20
6.4.4	Composition of the unit detail info screen and key functions	6 - 26
6.4.5	Composition of the intelligent module monitor screen and key functions	6 - 31
6.4.6	Specifying a module to monitor and selecting monitor menu	6 - 32
6.4.7	Testing of the intelligent function module	6 - 33
6.5	Intelligent Module Monitor Screens	6 - 35
6.5.1	A62DA-S1 module monitoring	6 - 35
6.5.2	A68AD module monitoring	6 - 36
6.5.3	A68ADN module monitoring	6 - 37
6.5.4	A68RD module monitoring	6 - 38
6.5.5	A84AD module monitoring	6 - 39
6.5.6	A616AD module monitoring	6 - 41
6.5.7	A616TD module monitoring	6 - 43
6.5.8	A616DAV, A616DAI module monitoring	6 - 46
6.5.9	A61LS module monitoring	6 - 47
6.5.10	A62LS module monitoring	6 - 48
6.5.11	AD61 module monitoring	6 - 49
6.5.12	AD70/A1SD70 module monitoring	6 - 50
6.5.13	AD70D module monitoring	6 - 52
6.5.14	AD71 module monitoring	6 - 54
6.5.15	AD72/A1SD71 module monitoring	6 - 57
6.5.16	AJ71PT32-S3/A1SJ71PT32-S3 module monitoring	6 - 60
6.5.17	A1SD61 module monitoring	6 - 62
6.5.18	A1S64AD module monitoring	6 - 63
6.5.19	A1S62DA module monitoring	6 - 64
6.5.20	A1S62RD module monitoring	6 - 65
6.5.21	A1S63ADA module monitoring	6 - 66

6.5.22	AD75P/A1SD75P module monitoring	6 - 67
6.5.23	AJ71ID1(ID2)-R4/A1SJ71ID1(ID2)-R4 module monitoring.....	6 - 73
6.5.24	A1S68DAV/A1S68DAI module monitoring	6 - 74
6.5.25	A1S68AD module monitoring	6 - 75
6.5.26	A1S64TCTT(BW)/A1S64TCRT(BW)-S1 monitoring.....	6 - 76
6.5.27	Q68ADV/Q68ADI/Q64AD module monitoring	6 - 78
6.5.28	Q62DA/Q64DA module monitoring	6 - 79
6.5.29	QD62D/QD62E/QD62 module monitoring.....	6 - 80
6.5.30	QD65PD2 module monitoring.....	6 - 81
6.5.31	QD73A1 module monitoring	6 - 87
6.5.32	QD75P [] (N)/QD75D [] (N) module monitoring	6 - 89
6.5.33	QD75M module monitoring.....	6 - 99
6.5.34	QD75MH module monitoring	6 - 112
6.5.35	QD77MS4, QD77MS2 module monitoring	6 - 125
6.5.36	QD77MS16 module monitoring	6 - 143
6.5.37	QD77GF16 module monitoring.....	6 - 174
6.5.38	L60AD4 module monitoring	6 - 195
6.5.39	L60DA4 module monitoring	6 - 197
6.5.40	LD62D/LD62 module monitoring	6 - 199
6.5.41	LD75P/LD75D module monitoring.....	6 - 200
6.5.42	LD77MH4 module monitoring.....	6 - 210
6.5.43	LD77MH16 module monitoring.....	6 - 223
6.5.44	LD77MS4 module monitoring	6 - 249
6.5.45	LD77MS16 module monitoring	6 - 267
6.6	Operating I/O Module Monitor Screen	6 - 298
6.6.1	Specifying the module to be monitored	6 - 298
6.6.2	Monitor screen configuration and key functions	6 - 299
6.7	Error Messages and Corrective Action	6 - 300

7. NETWORK MONITOR

7.1	Features.....	7 - 1
7.2	Specifications.....	7 - 3
7.2.1	System configuration	7 - 3
7.2.2	Network information that can be monitored.....	7 - 6
7.2.3	Access range.....	7 - 7
7.2.4	Precautions.....	7 - 8
7.3	Operations for display.....	7 - 10
7.4	Operation Procedures.....	7 - 13
7.4.1	Line monitor.....	7 - 13
7.4.2	Detailed monitor	7 - 16
7.4.3	Other station monitor	7 - 25
7.4.4	Other station communication status monitor	7 - 26
7.4.5	Other station data link status monitor	7 - 27
7.4.6	Other station parameter status monitor	7 - 28
7.4.7	Other station CPU operation status monitor.....	7 - 29
7.4.8	Other station CPU RUN status monitor	7 - 30
7.4.9	Other station loop status monitor.....	7 - 31
7.5	Error Message and Corrective Action.....	7 - 32

8. Q MOTION MONITOR

8.1	Features.....	8 - 1
8.2	Specifications.....	8 - 3
8.2.1	System configuration	8 - 3
8.2.2	Access range	8 - 10
8.2.3	Precautions.....	8 - 10
8.3	Operations for Display	8 - 11
8.4	Operation Procedures.....	8 - 14
8.4.1	System configuration screen layout.....	8 - 14
8.4.2	Setting method for other station monitoring.....	8 - 15
8.4.3	Monitor Menu screen	8 - 17
8.4.4	Present Value Monitor screen	8 - 18
8.4.5	SFC Error History screen.....	8 - 19
8.4.6	Error List screen	8 - 20
8.4.7	Error List Designated-Axis screen	8 - 22
8.4.8	Positioning Monitor screen	8 - 24
8.4.9	Servo Monitor screen.....	8 - 26
8.4.10	Present Value History Monitor screen	8 - 27
8.4.11	Parameter setting screen.....	8 - 29
8.4.12	Hard copy output	8 - 32
8.5	Error Messages and Corrective Action	8 - 33

9. SERVO AMPLIFIER MONITOR

9.1	Features.....	9 - 1
9.2	Specifications.....	9 - 3
9.2.1	System configuration	9 - 3
9.2.2	Access range	9 - 10
9.2.3	Precautions.....	9 - 11
9.3	Operations of Display	9 - 12
9.4	Operations of Servo Amplifier Monitor Screens.....	9 - 15
9.4.1	Servo amplifier monitor.....	9 - 15
9.4.2	Setup	9 - 16
9.4.3	Monitor functions	9 - 17
9.4.4	Alarm function.....	9 - 19
9.4.5	Diagnostics function.....	9 - 22
9.4.6	Parameter setting	9 - 29
9.4.7	Test operations	9 - 35
9.4.8	Hard copy output	9 - 43
9.5	Error Messages and Corrective Action	9 - 44

10. CNC MONITOR FUNCTIONS

10.1	Features.....	10 - 1
10.2	Specifications.....	10 - 2
10.2.1	System configuration	10 - 2
10.2.2	Access range	10 - 4
10.2.3	Precautions.....	10 - 4
10.3	Operations for Display	10 - 5

10.4	Operation Procedures.....	10 - 7
10.5	Error Messages and Corrective Action.....	10 - 9

11. BACKUP/RESTORE

11.1	Features.....	11 - 1
11.2	Specifications.....	11 - 3
11.2.1	System configuration.....	11 - 3
11.2.2	Access range.....	11 - 11
11.2.3	Precautions.....	11 - 11
11.3	Operations for Display.....	11 - 15
11.3.1	Setting storage location for backup data.....	11 - 18
11.3.2	Security and password.....	11 - 19
11.3.3	Trigger backup.....	11 - 25
11.3.4	Network batch backup/restore.....	11 - 32
11.4	Operation Procedures.....	11 - 36
11.4.1	Main menu.....	11 - 36
11.4.2	Progress screen (backup).....	11 - 37
11.4.3	Data list (restoration).....	11 - 38
11.4.4	Progress screen (restoration).....	11 - 39
11.4.5	Controller list screen.....	11 - 40
11.4.6	Controller selection screen (Restoration).....	11 - 41
11.5	Backup Data Conversion Tool.....	11 - 42
11.5.1	Operating environment.....	11 - 42
11.5.2	How to install and start Backup Data Conversion Tool.....	11 - 43
11.5.3	How to use Backup Data Conversion Tool.....	11 - 43
11.5.4	Precautions.....	11 - 45
11.6	Errors and Corrective Actions.....	11 - 46

12. CNC DATA I/O

12.1	Features.....	12 - 1
12.2	Specifications.....	12 - 1
12.2.1	System configuration.....	12 - 1
12.2.2	Access range.....	12 - 3
12.2.3	Precautions.....	12 - 3
12.3	Operations for Display.....	12 - 5
12.4	Operation Procedures.....	12 - 7
12.5	Error Messages and Corrective Actions.....	12 - 19

13. SFC MONITOR

13.1	Features.....	13 - 1
13.2	Specifications.....	13 - 4
13.2.1	System configuration.....	13 - 4
13.2.2	Devices and range that can be monitored.....	13 - 6
13.2.3	Access range.....	13 - 7
13.2.4	Precautions.....	13 - 7
13.3	Operations for Display.....	13 - 8
13.3.1	Setting SFC data storage location.....	13 - 11
13.3.2	Reading comment files from CF card.....	13 - 12

13.4	Setting Display Format	13 - 14
13.4.1	Switching languages of SFC programs	13 - 14
13.4.2	Setting display mode of SFC programs	13 - 14
13.4.3	Setting zoom comment display mode.....	13 - 14
13.4.4	Switching display formats between decimal and hexadecimal numbers	13 - 14
13.4.5	Setting automatic scroll mode.....	13 - 15
13.5	How to Operate PLC Read Screen.....	13 - 16
13.5.1	Displayed contents	13 - 16
13.5.2	Key functions	13 - 19
13.6	How to Operate Block List Screen.....	13 - 22
13.6.1	Displayed contents	13 - 22
13.6.2	Key functions	13 - 23
13.6.3	Menus.....	13 - 23
13.7	How to Operate SFC Diagram Monitor Screen	13 - 24
13.7.1	Displayed contents	13 - 24
13.7.2	Key functions	13 - 27
13.7.3	Menus.....	13 - 28
13.8	Test Operation	13 - 37
13.9	Error Messages and Corrective Action	13 - 39

14. LADDER EDITOR

14.1	Features.....	14 - 1
14.2	Specifications.....	14 - 4
14.2.1	System configuration	14 - 4
14.2.2	Devices and range that can be monitored	14 - 6
14.2.3	Access range	14 - 7
14.2.4	Precautions.....	14 - 7
14.3	Display Operation	14 - 9
14.3.1	Setting ladder data storage location	14 - 16
14.3.2	Reading comment files from CF card	14 - 17
14.3.3	Program update check.....	14 - 19
14.3.4	Setting the security	14 - 20
14.4	Setting Display Format	14 - 22
14.4.1	Switching languages of sequence programs	14 - 22
14.4.2	Switching comment display mode	14 - 22
14.4.3	Switching display formats between decimal and hexadecimal numbers	14 - 22
14.5	How to Operate PLC Read Screen.....	14 - 23
14.5.1	Displayed contents	14 - 23
14.5.2	Key functions	14 - 25
14.6	How to Operate Ladder Monitor Screen	14 - 28
14.6.1	Displayed contents	14 - 28
14.6.2	Key functions	14 - 29
14.6.3	Menus.....	14 - 29
14.7	How to Operate Ladder Editor Screen.....	14 - 34
14.7.1	Displayed contents	14 - 34
14.7.2	Key functions	14 - 42
14.7.3	Menus.....	14 - 42
14.8	Find/Replace Operation.....	14 - 53

14.8.1	Device/Contact/Coil search	14 - 53
14.8.2	Factor search.....	14 - 55
14.8.3	Replace device	14 - 57
14.8.4	Change open/close contact	14 - 58
14.9	Test Operation	14 - 59
14.10	Error Messages and Corrective Action	14 - 61

15. MELSEC-L TROUBLESHOOTING

15.1	Features.....	15 - 1
15.2	Specifications.....	15 - 2
15.2.1	System configuration	15 - 2
15.2.2	Access range.....	15 - 2
15.3	Operation for Display	15 - 3
15.4	Operation Procedures.....	15 - 5
15.5	Error Messages and Corrective Action	15 - 7

16. LOG VIEWER

16.1	Features.....	16 - 1
16.2	Specifications.....	16 - 2
16.2.1	System configuration	16 - 2
16.2.2	GOT Side Settings.....	16 - 3
16.2.3	Access range.....	16 - 3
16.2.4	Precautions.....	16 - 4
16.3	Operations for Display	16 - 6
16.3.1	Changing screens when view logged device is selected.....	16 - 7
16.3.2	Changing screens when manage log file is selected.....	16 - 8
16.4	How to Operate Various Selection Screens	16 - 9
16.4.1	How to operate target setting window	16 - 9
16.4.2	How to operate target selection screen	16 - 10
16.4.3	How to operate Main Menu screen.....	16 - 14
16.4.4	How to operate file selection screen.....	16 - 15
16.5	How to Operate Data Log Viewer	16 - 18
16.5.1	Data log viewer screen	16 - 18
16.5.2	Legend display	16 - 20
16.5.3	Upper and lower limit values setting.....	16 - 21
16.5.4	Cursor position information.....	16 - 22
16.5.5	Selecting data	16 - 23
16.5.6	Searching data	16 - 24
16.5.7	Help	16 - 25
16.6	Error Messages and Corrective Actions	16 - 26

17. MOTION SFC MONITOR

17.1	Features.....	17 - 1
17.2	Specifications.....	17 - 2
17.2.1	System configuration	17 - 2
17.2.2	Devices and range that can be monitored	17 - 3
17.2.3	Access range.....	17 - 3
17.2.4	Readable motion SFC programs	17 - 4

17.2.5	Displayable character codes.....	17 - 4
17.2.6	Precautions.....	17 - 4
17.3	Operations for Display	17 - 5
17.3.1	Setting motion SFC program storage location.....	17 - 8
17.4	Operation Procedures.....	17 - 9
17.4.1	SFC diagram monitor screen.....	17 - 9
17.4.2	Detailed program window	17 - 13
17.4.3	Step list window	17 - 15
17.4.4	Active step list window	17 - 16
17.4.5	Program batch monitor window	17 - 17
17.4.6	Communication setting window	17 - 18
17.4.7	Password input window	17 - 19

18. CNC MACHINING PROGRAM EDIT

18.1	Features.....	18 - 1
18.2	Specifications.....	18 - 1
18.2.1	System configuration	18 - 1
18.2.2	Access range.....	18 - 2
18.2.3	Recautions.....	18 - 2
18.3	Operations for Display	18 - 3
18.4	Operation Procedures.....	18 - 5
18.5	Error Messages and Corrective Actions	18 - 11

19. MOTION PROGRAM (SV43) EDITOR

19.1	Features.....	19 - 1
19.2	Specifications.....	19 - 1
19.3	Operations for Display	19 - 1
19.4	Operation Procedures.....	19 - 1
19.5	Error Messages and Corrective Actions	19 - 1

20. MOTION PROGRAM (SV43) I/O

20.1	Features.....	20 - 1
20.2	Specifications.....	20 - 1
20.3	Operations for Display	20 - 1
20.4	Operation Procedures.....	20 - 1
20.5	Error Messages and Corrective Actions	20 - 1

INDEX

REVISIONS

WARRANTY

Intellectual Property Rights

MANUALS

The following table lists the manual relevant to this product.
Refer to each manual for any purpose.

■ Screen creation software manuals

Manual Name	Delivery method	Manual Number
GT Works3 Version1 Installation Procedure Manual	Enclosed in product	-
GT Designer3 Version1 Screen Design Manual (Fundamentals) 1/2, 2/2	*1	SH-080866ENG
GT Designer3 Version1 Screen Design Manual (Functions) 1/2, 2/2	*1	SH-080867ENG
GT Simulator3 Version1 Operating Manual for GT Works3	*1	SH-080861ENG
GT Converter2 Version3 Operating Manual for GT Works3	*1	SH-080862ENG

*1 Contact your local distributor.

■ Connection manuals

Manual Name	Delivery method	Manual Number
GOT1000 Series Connection Manual (Mitsubishi Products) for GT Works3	*1	SH-080868ENG
GOT1000 Series Connection Manual (Non-Mitsubishi Products 1) for GT Works3	*1	SH-080869ENG
GOT1000 Series Connection Manual (Non-Mitsubishi Products 2) for GT Works3	*1	SH-080870ENG
GOT1000 Series Connection Manual (Microcomputer, MODBUS Products, Peripherals) for GT Works3	*1	SH-080871ENG
GOT1000 Series Connection Manual (α2 Connection) for GT Works3	*1	JY997D39201

*1 Contact your local distributor.

■ Extended and option function manuals

Manual Name	Delivery method	Manual Number
GOT1000 Series Gateway Functions Manual for GT Works3	*1	SH-080858ENG
GOT1000 Series MES Interface Function Manual for GT Works3	*1	SH-080859ENG
GOT1000 Series User's Manual (Extended Functions, Option Functions) for GT Works3	*1	SH-080863ENG

*1 Contact your local distributor.

■ GT SoftGOT1000 manuals

Manual Name	Delivery method	Manual Number
GT SoftGOT1000 Version3 Operating Manual for GT Works3	*1	SH-080860ENG

*1 Contact your local distributor.

■ GT16 manuals

Manual Name	Delivery method	Manual Number
GT16 User's Manual (Hardware)	*1	SH-080928ENG
GT16 User's Manual (Basic Utility)	*1	SH-080929ENG
GT16 Handy GOT User's Manual	*1	JY997D41201 JY997D41202

*1 Contact your local distributor.

■ GT15 manuals

Manual Name	Delivery method	Manual Number
GT15 User's Manual	*1	SH-080528ENG

*1 Contact your local distributor.

■ GT14 manuals

Manual Name	Delivery method	Manual Number
GT14 User's Manual	*1	JY997D44801

*1 Contact your local distributor.

■ GT12 manuals

Manual Name	Delivery method	Manual Number
GT12 User's Manual	*1	SH-080977ENG

*1 Contact your local distributor.

■ GT11 manuals

Manual Name	Delivery method	Manual Number
GT11 User's Manual	*1	JY997D17501
GT11 Handy GOT User's Manual	*1	JY997D20101 JY997D20102

*1 Contact your local distributor.

■ GT10 manuals

Manual Name	Delivery method	Manual Number
GT10 User's Manual	*1	JY997D24701

*1 Contact your local distributor.

QUICK REFERENCE

■ Creating a project

Obtaining the specifications and operation methods of GT Designer3	GT Designer3 Version1 Screen Design Manual (Fundamentals) 1/2, 2/2
Setting available functions on GT Designer3	
Creating a screen displayed on the GOT	
Obtaining useful functions to increase efficiency of drawing	
Setting details for figures and objects	GT Designer3 Version1 Screen Design Manual (Functions) 1/2, 2/2
Setting functions for the data collection or trigger action	
Setting functions to use peripheral devices	
Simulating a created project on a personal computer	GT Simulator3 Version1 Operating Manual for GT Works3

■ Connecting a controller to the GOT

Obtaining information of Mitsubishi products applicable to the GOT	GOT1000 Series Connection Manual (Mitsubishi Products) for GT Works3
Connecting Mitsubishi products to the GOT	
Connecting multiple controllers to one GOT (Multi-channel function)	
Establishing communication between a personal computer and a controller via the GOT (FA transparent function)	
Obtaining information of Non-Mitsubishi products applicable to the GOT	• GOT1000 Series Connection Manual (Non-Mitsubishi Products 1) for GT Works3 • GOT1000 Series Connection Manual (Non-Mitsubishi Products 2) for GT Works3
Connecting Non-Mitsubishi products to the GOT	
Obtaining information of peripheral devices applicable to the GOT	GOT1000 Series Connection Manual (Microcomputer, MODBUS Products, Peripherals) for GT Works3
Connecting peripheral devices including a barcode reader to the GOT	
Connecting α2 with GOT	GOT1000 Series Connection Manual (α2 Connection) for GT Works3

■ Transferring data to the GOT

Writing data to the GOT	GT Designer3 Version1 Screen Design Manual (Fundamentals) 1/2, 2/2
Reading data from the GOT	
Verifying a editing project to a GOT project	

■ Others

Obtaining specifications (including part names, external dimensions, and options) of each GOT	<ul style="list-style-type: none">• GT16 User's Manual (Hardware)• GT16 Handy GOT User's Manual• GT15 User's Manual• GT14 User's Manual• GT12 User's Manual• GT11 User's Manual• GT11 Handy GOT User's Manual• GT10 User's Manual
Installing the GOT	
Operating the utility	<ul style="list-style-type: none">• GT16 User's Manual (Basic Utility)• GT16 Handy GOT User's Manual• GT15 User's Manual• GT14 User's Manual• GT12 User's Manual• GT11 User's Manual• GT11 Handy GOT User's Manual• GT10 User's Manual
Configuring the gateway function	GOT1000 Series Gateway Functions Manual for GT Works3
Configuring the MES interface function	GOT1000 Series MES Interface Function Manual for GT Works3
Configuring the extended function and option function	GOT1000 Series User's Manual (Extended Functions, Option Functions) for GT Works3
Using a personal computer as the GOT	GT SoftGOT1000 Version3 Operating Manual for GT Works3

ABBREVIATIONS AND GENERIC TERMS

■ GOT

Abbreviations and generic terms		Description
GT1695	GT1695M-X	Abbreviation of GT1695M-XTBA, GT1695M-XTBD
GT1685	GT1685M-S	Abbreviation of GT1685M-STBA, GT1685M-STBD
GT1675	GT1675M-S	Abbreviation of GT1675M-STBA, GT1675M-STBD
	GT1675M-V	Abbreviation of GT1675M-VTBA, GT1675M-VTBD
	GT1675-VN	Abbreviation of GT1675-VNBA, GT1675-VNBD
GT1672	GT1672-VN	Abbreviation of GT1672-VNBA, GT1672-VNBD
GT1665	GT1665M-S	Abbreviation of GT1665M-STBA, GT1665M-STBD
	GT1665M-V	Abbreviation of GT1665M-VTBA, GT1665M-VTBD
GT1662	GT1662-VN	Abbreviation of GT1662-VNBA, GT1662-VNBD
GT1655	GT1655-V	Abbreviation of GT1655-VTBD
GT16		Abbreviation of GT1695, GT1685, GT1675, GT1672, GT1665, GT1662, GT1655, GT16 Handy GOT
GT1595	GT1595-X	Abbreviation of GT1595-XTBA, GT1595-XTBD
GT1585	GT1585V-S	Abbreviation of GT1585V-STBA, GT1585V-STBD
	GT1585-S	Abbreviation of GT1585-STBA, GT1585-STBD
GT157□	GT1575V-S	Abbreviation of GT1575V-STBA, GT1575V-STBD
	GT1575-S	Abbreviation of GT1575-STBA, GT1575-STBD
	GT1575-V	Abbreviation of GT1575-VTBA, GT1575-VTBD
	GT1575-VN	Abbreviation of GT1575-VNBA, GT1575-VNBD
	GT1572-VN	Abbreviation of GT1572-VNBA, GT1572-VNBD
GT156□	GT1565-V	Abbreviation of GT1565-VTBA, GT1565-VTBD
	GT1562-VN	Abbreviation of GT1562-VNBA, GT1562-VNBD
GT155□	GT1555-V	Abbreviation of GT1555-VTBD
	GT1555-Q	Abbreviation of GT1555-QTBD, GT1555-QSBD
	GT1550-Q	Abbreviation of GT1550-QLBD
GT15		Abbreviation of GT1595, GT1585, GT157□, GT156□, GT155□
GT145□	GT1455-Q	Abbreviation of GT1455-QTBDE, GT1455-QTBD
	GT1450-Q	Abbreviation of GT1450-QMBDE, GT1450-QMBD, GT1450-QLBDE, GT1450-QLBD
GT14		Abbreviation of GT1455-Q, GT1450-Q
GT1275	GT1275-V	Abbreviation of GT1275-VNBA, GT1275-VNBD
GT1265	GT1265-V	Abbreviation of GT1265-VNBA, GT1265-VNBD
GT12		Abbreviation of GT1275, GT1265
GT115□	GT1155-Q	Abbreviation of GT1155-QTBDQ, GT1155-QSBDQ, GT1155-QTBDA, GT1155-QSBDA, GT1155-QTBD, GT1155-QSBD
	GT1150-Q	Abbreviation of GT1150-QLBDQ, GT1150-QLBDA, GT1150-QLBD
GT11		Abbreviation of GT115□, GT11 Handy GOT,
GT105□	GT1055-Q	Abbreviation of GT1055-QSBD
	GT1050-Q	Abbreviation of GT1050-QBBD
GT104□	GT1045-Q	Abbreviation of GT1045-QSBD
	GT1040-Q	Abbreviation of GT1040-QBBD
GT1030		Abbreviation of GT1030-LBD, GT1030-LBD2, GT1030-LBL, GT1030-LBDW, GT1030-LBDW2, GT1030-LBLW, GT1030-LWD, GT1030-LWD2, GT1030-LWL, GT1030-LWDW, GT1030-LWDW2, GT1030-LWLW, GT1030-HBD, GT1030-HBD2, GT1030-HBL, GT1030-HBDW, GT1030-HBDW2, GT1030-HBLW, GT1030-HWD, GT1030-HWD2, GT1030-HWL, GT1030-HWDW, GT1030-HWDW2, GT1030-HWLW
GT1020		Abbreviation of GT1020-LBD, GT1020-LBD2, GT1020-LBL, GT1020-LBDW, GT1020-LBDW2, GT1020-LBLW, GT1020-LWD, GT1020LWD2, GT1020-LWL, GT1020-LWDW, GT1020-LWDW2, GT1020-LWLW
GT10		Abbreviation of GT105□, GT104□, GT1030, GT1020

GOT1000
Series

Abbreviations and generic terms				Description
GOT1000 Series	Handy GOT	GT16 Handy GOT	GT1665HS-V	Abbreviation of GT1665HS-VTBD
		GT11 Handy GOT	GT1155HS-Q	Abbreviation of GT1155HS-QSBD
			GT1150HS-Q	Abbreviation of GT1150HS-QLBD
	GT SoftGOT1000			Abbreviation of GT SoftGOT1000
GOT900 Series				Abbreviation of GOT-A900 series, GOT-F900 series
GOT800 Series				Abbreviation of GOT-800 series

■ Communication unit

Abbreviations and generic terms		Description
Bus connection unit		GT15-QBUS, GT15-QBUS2, GT15-ABUS, GT15-ABUS2, GT15-75QBUSL, GT15-75QBUS2L, GT15-75ABUSL, GT15-75ABUS2L
Serial communication unit		GT15-RS2-9P, GT15-RS4-9S, GT15-RS4-TE
RS-422 conversion unit		GT15-RS2T4-9P, GT15-RS2T4-25P
Ethernet communication unit		GT15-J71E71-100
MELSECNET/H communication unit		GT15-J71LP23-25, GT15-J71BR13
MELSECNET/10 communication unit		GT15-75J71LP23-Z ^{*1} , GT15-75J71BR13-Z ^{*2}
CC-Link IE Controller Network communication unit		GT15-J71GP23-SX
CC-Link IE Field Network communication unit		GT15-J71GF13-T2
CC-Link communication unit		GT15-J61BT13, GT15-75J61BT13-Z ^{*3}
Interface converter unit		GT15-75IF900
Serial multi-drop connection unit		GT01-RS4-M
Connection Conversion Adapter		GT10-9PT5S
RS-232/485 signal conversion adapter		GT14-RS2T4-9P

*1 A9GT-QJ71LP23 + GT15-75IF900 set

*2 A9GT-QJ71BR13 + GT15-75IF900 set

*3 A8GT-J61BT13 + GT15-75IF900 set

■ Option unit

Abbreviations and generic terms		Description
Printer unit		GT15-PRN
Video/RGB unit	Video input unit	GT16M-V4, GT15V-75V4
	RGB input unit	GT16M-R2, GT15V-75R1
	Video/RGB input unit	GT16M-V4R1, GT15V-75V4R1
	RGB output unit	GT16M-ROUT, GT15V-75ROUT
Multimedia unit		GT16M-MMR
CF card unit		GT15-CFCD
CF card extension unit ^{*1}		GT15-CFEX-C08SET
External I/O unit		GT15-DIO, GT15-DIOR
Sound output unit		GT15-SOUT

*1 GT15-CFEX + GT15-CFEXIF + GT15-C08CF set.

■ Option

Abbreviations and generic terms		Description
Memory card	CF card	GT05-MEM-16MC, GT05-MEM-32MC, GT05-MEM-64MC, GT05-MEM-128MC, GT05-MEM-256MC, GT05-MEM-512MC, GT05-MEM-1GC, GT05-MEM-2GC, GT05-MEM-4GC, GT05-MEM-8GC, GT05-MEM-16GC
	SD card	NZ1MEM-2GBSD, NZ1MEM-4GBSD, NZ1MEM-8GBSD, NZ1MEM-16GBSD, L1MEM-2GBSD, L1MEM-4GBSD
Memory card adaptor		GT05-MEM-ADPC
Option function board		GT16-MESB, GT15-FNB, GT15-QFNB, GT15-QFNB16M, GT15-QFNB32M, GT15-QFNB48M, GT11-50FNB, GT15-MESB48M
Battery		GT15-BAT, GT11-50BAT
Protective Sheet	For GT16	GT16-90PSCB, GT16-90PSGB, GT16-90PSCW, GT16-90PSGW, GT16-80PSCB, GT16-80PSGB, GT16-80PSCW, GT16-80PSGW, GT16-70PSCB, GT16-70PSGB, GT16-70PSCW, GT16-70PSGW, GT16-60PSCB, GT16-60PSGB, GT16-60PSCW, GT16-60PSGW, GT16-50PSCB, GT16-50PSGB, GT16-50PSCW, GT16-50PSGW, GT16-90PSCB-012, GT16-80PSCB-012, GT16-70PSCB-012, GT16-60PSCB-012, GT16-50PSCB-012, GT16H-60PSC
	For GT15	GT15-90PSCB, GT15-90PSGB, GT15-90PSCW, GT15-90PSGW, GT15-80PSCB, GT15-80PSGB, GT15-80PSCW, GT15-80PSGW, GT15-70PSCB, GT15-70PSGB, GT15-70PSCW, GT15-70PSGW, GT15-60PSCB, GT15-60PSGB, GT15-60PSCW, GT15-60PSGW, GT15-50PSCB, GT15-50PSGB, GT15-50PSCW, GT15-50PSGW
	For GT14	GT14-50PSCB, GT14-50PSGB, GT14-50PSCW, GT14-50PSGW
	For GT12	GT11-70PSCB, GT11-65PSCB
	For GT11	GT11-50PSCB, GT11-50PSGB, GT11-50PSCW, GT11-50PSGW, GT11H-50PSC
	For GT10	GT10-50PSCB, GT10-50PSGB, GT10-50PSCW, GT10-50PSGW, GT10-40PSCB, GT10-40PSGB, GT10-40PSCW, GT10-40PSGW, GT10-30PSCB, GT10-30PSGB, GT10-30PSCW, GT10-30PSGW, GT10-20PSCB, GT10-20PSGB, GT10-20PSCW, GT10-20PSGW
Protective cover for oil		GT05-90PCO, GT05-80PCO, GT05-70PCO, GT05-60PCO, GT05-50PCO, GT16-50PCO, GT10-40PCO, GT10-30PCO, GT10-20PCO
USB environmental protection cover		GT16-UCOV, GT16-50UCOV, GT15-UCOV, GT14-50UCOV, GT11-50UCOV
Stand		GT15-90STAND, GT15-80STAND, GT15-70STAND, A9GT-50STAND, GT05-50STAND
Attachment		GT15-70ATT-98, GT15-70ATT-87, GT15-60ATT-97, GT15-60ATT-96, GT15-60ATT-87, GT15-60ATT-77, GT15-50ATT-95W, GT15-50ATT-85
Backlight		GT16-90XLTT, GT16-80SLTT, GT16-70SLTT, GT16-70VLTT, GT16-70VLTTA, GT16-70VLTN, GT16-60SLTT, GT16-60VLTT, GT16-60VLTN, GT15-90XLTT, GT15-80SLTT, GT15-70SLTT, GT15-70VLTT, GT15-70VLTN, GT15-60VLTT, GT15-60VLTN
Multi-color display board		GT15-XHNB, GT15-VHNB
Connector conversion box		GT11H-CNB-37S, GT16H-CNB-42S
Emergency stop sw guard cover		GT11H-50ESCOV, GT16H-60ESCOV
Wall-hanging fitting		GT14H-50ATT
Memory loader		GT10-LDR
Memory board		GT10-50FMB
Panel-mounted USB port extension		GT14-C10EXUSB-4S, GT10-C10EXUSB-5S

■ Software

Abbreviations and generic terms		Description
GT Works3		Abbreviation of the SW□DND-GTWK3-E and SW□DND-GTWK3-EA
GT Designer3		Abbreviation of screen drawing software GT Designer3 for GOT1000 series
GT Simulator3		Abbreviation of screen simulator GT Simulator3 for GOT1000/GOT900 series
GT SoftGOT1000		Abbreviation of monitoring software GT SoftGOT1000
GT Converter2		Abbreviation of data conversion software GT Converter2 for GOT1000/GOT900 series
GT Designer2 Classic		Abbreviation of screen drawing software GT Designer2 Classic for GOT900 series
GT Designer2		Abbreviation of screen drawing software GT Designer2 for GOT1000/GOT900 series
iQ Works		Abbreviation of iQ Platform compatible engineering environment MELSOFT iQ Works
MELSOFT Navigator		Generic term for integrated development environment software included in the SW□DNC-IQWK (iQ Platform compatible engineering environment MELSOFT iQ Works)
MELSOFT iQ AppPortal		SW□DND-IQAPL-M type integrated application management software
GX Works3		Abbreviation of SW□DND-GXW3-E and SW□DND-GXW3-EA type programmable controller engineering software
GX Works2		Abbreviation of SW□DNC-GXW2-E and SW□DNC-GXW2-EA type programmable controller engineering software
Controller simulator	GX Simulator3	Abbreviation of GX Works3 with the simulation function
	GX Simulator2	Abbreviation of GX Works2 with the simulation function
	GX Simulator	Abbreviation of SW□D5C-LLT-E(-EV) type ladder logic test tool function software packages (SW5D5C-LLT (-EV) or later versions)
GX Developer		Abbreviation of SW□D5C-GPPW-E(-EV)/SW D5F-GPPW-E type software package
GX LogViewer		Abbreviation of SW□DNN-VIEWER-E type software package
PX Developer		Abbreviation of SW□D5C-FBDQ-E type FBD software package for process control
MT Works2		Abbreviation of motion controller engineering environment MELSOFT MT Works2(SW□DND-MTW2-E)
MT Developer		Abbreviation of SW□RNC-GSV type integrated start-up support software for motion controller Q series
MR Configurator2		Abbreviation of SW□DNC-MRC2-E type Servo Configuration Software
MR Configurator		Abbreviation of MRJW□-SETUP□E type Servo Configuration Software
FR Configurator		Abbreviation of Inverter Setup Software (FR-SW□-SETUP-WE)
NC Configurator		Abbreviation of CNC parameter setting support tool NC Configurator
FX Configurator-FP		Abbreviation of parameter setting, monitoring, and testing software packages for FX3U-20SSC-H (SW□D5C-FXSSC-E)
FX3U-ENET-L Configuration tool		Abbreviation of FX3U-ENET-L type Ethernet module setting software (SW1D5-FXENETL-E)
RT ToolBox2		Abbreviation of robot program creation software (3D-11C-WINE)
MX Component		Abbreviation of MX Component Version□ (SW□D5C-ACT-E, SW□D5C-ACT-EA)
MX Sheet		Abbreviation of MX Sheet Version□ (SW□D5C-SHEET-E, SW□D5C-SHEET-EA)
CPU Module Logging Configuration Tool		Abbreviation of CPU Module Logging Configuration Tool (SW1DNN-LLUTL-E)

■ License key (for GT SoftGOT1000)

Abbreviations and generic terms	Description
License	GT15-SGTKEY-U, GT15-SGTKEY-P

■ Others

Abbreviations and generic terms	Description
IAI	Abbreviation of IAI Corporation
AZBIL	Abbreviation of Azbil Corporation (former Yamatake Corporation)
OMRON	Abbreviation of OMRON Corporation
KEYENCE	Abbreviation of KEYENCE CORPORATION
KOYO EI	Abbreviation of KOYO ELECTRONICS INDUSTRIES CO., LTD.
SHARP	Abbreviation of Sharp Corporation
JTEKT	Abbreviation of JTEKT Corporation
SHINKO	Abbreviation of Shinko Technos Co., Ltd.
CHINO	Abbreviation of CHINO CORPORATION
TOSHIBA	Abbreviation of TOSHIBA CORPORATION
TOSHIBA MACHINE	Abbreviation of TOSHIBA MACHINE CO., LTD.
HITACHI IES	Abbreviation of Hitachi Industrial Equipment Systems Co., Ltd.
HITACHI	Abbreviation of Hitachi, Ltd.
FUJI	Abbreviation of FUJI ELECTRIC CO., LTD.
PANASONIC	Abbreviation of Panasonic Corporation
PANASONIC INDUSTRIAL DEVICES SUNX	Abbreviation of Panasonic Industrial Devices SUNX Co., Ltd.
YASKAWA	Abbreviation of YASKAWA Electric Corporation
YOKOGAWA	Abbreviation of Yokogawa Electric Corporation
ALLEN-BRADLEY	Abbreviation of Allen-Bradley products manufactured by Rockwell Automation, Inc.
GE	Abbreviation of GE Intelligent Platforms
LS IS	Abbreviation of LS Industrial Systems Co., Ltd.
MITSUBISHI INDIA	Mitsubishi Electric India Pvt. Ltd.
SCHNEIDER	Abbreviation of Schneider Electric SA
SICK	Abbreviation of SICK AG
SIEMENS	Abbreviation of Siemens AG
RKC	Abbreviation of RKC INSTRUMENT INC.
HIRATA	Abbreviation of Hirata Corporation
MURATEC	Abbreviation of Muratec products manufactured by Muratec Automation Co., Ltd.
PLC	Abbreviation of programmable controller
Temperature controller	Generic term for temperature controller manufactured by each corporation
Indicating controller	Generic term for indicating controller manufactured by each corporation
Control equipment	Generic term for control equipment manufactured by each corporation
CHINO controller	Abbreviation of indicating controller manufactured by CHINO CORPORATION
PC CPU module	Abbreviation of PC CPU Unit manufactured by CONTEC CO., LTD
GOT (server)	Abbreviation of GOTs that use the server function
GOT (client)	Abbreviation of GOTs that use the client function
Windows® font	Abbreviation of TrueType font and OpenType font available for Windows® (Differs from the True Type fonts settable with GT Designer3)
Intelligent function module	Indicates the modules other than the PLC CPU, power supply module and I/O module that are mounted to the base unit
MODBUS®/RTU	Generic term for the protocol designed to use MODBUS® protocol messages on a serial communication
MODBUS®/TCP	Generic term for the protocol designed to use MODBUS® protocol messages on a TCP/IP network

HOW TO READ THIS MANUAL

The following symbols are used in this manual.

3. LADDER MONITOR FUNCTION

GT16 GT15 GT14 GT12 GT11 GT10 GT SOFT GOT1000

3.1 Features

The ladder monitor enables you to monitor the sequence program within the target controller and change device values. It is intended to troubleshoot and maintain the PLC system efficiently. The features of the ladder monitor are shown below.

■ Start operation for the Ladder Monitor

(1) Normal operation
This subsection describes the flow until the ladder monitor operation screen is displayed after a ladder monitor (Option OS) is installed in the GOT.

Shows whether the GT16, GT15, GT14, GT12, GT11, GT10, and GT SoftGOT1000 are applicable.

- : Applicable
- × : Not applicable

[] : Shows the setting item displayed on the software screen or the GOT screen.

3.7 Test Operation

You can change device values and turn on and off bit devices on the screen when the ladder monitor is executed. This section describes how to display the test menu screen. For the procedure for changing device values and turning on and off bit devices, see the following.

POINT

Before test operation
With the MELSEC-Q/L/QnA ladder monitor function, the GOT cannot write data to the devices in the QSCPU.

3.7.1 Displaying the test menu screen

(1) Displaying the test menu screen
The procedure for displaying the test menu screen during ladder monitoring is described below.

Show the items including detailed explanation (manual and the chapter, section, item).

POINT Refers to the information required.

HINT Refers to the supplementary explanations for reference.

Shows the operation steps. Operate the steps from the step 1.

The above is different from the actual page, as it is provided for explanation only.

1. OVERVIEW

This manual describes the following functions available on a GOT system in which the standard monitor OS, an Extended function OS, an Option OS, and the Communication driver are installed.

- System monitor
- Ladder monitor
- A list editor
- FX list editor
- Intelligent module monitor
- Network monitor
- Q motion monitor
- Servo amplifier monitor
- CNC monitor
- Backup/restore
- CNC data I/O
- SFC monitor
- Ladder editor
- MELSEC-L Troubleshooting
- Log viewer
- Motion SFC monitor
- CNC machining program edit
- Motion program (SV43) editor
- Motion program (SV43) I/O

The monitor functions explained herein are intended to troubleshoot the PLC system and to streamline maintenance operations.

POINT

(1) Precautions for using each function

Some functions are not available depending on the GOT used, target CPU or connection form. For option function boards, functions available on each GOT, and restrictions on each target CPU and connection form, see the appropriate chapter.

(2) Display examples in this manual

In this manual, with a few special exceptions, explanations are given primarily using the GT1675M-V screens.

1.1 Before Using Each Function

1.1.1 Each function and related manuals

The difference between the extended and option functions of the GOT is shown below.

- Extended functions : Functions available by installing an Extended function OS.
- Option functions : Functions available by connecting an option function board (including a board with add-on memory).

Many of the option functions require an Option OS to be installed.

For a description of each function, see the appropriate manual listed below.

■ Manuals describing functions and how to set them

Category	Function name	Reference	
Extended functions	Stroke font	GT Designer 3 Version1 Screen Design Manual (Fundamentals)	
	Operator authentication		
	USB mouse/keyboard function		
	Device data transfer	GT Designer 3 Version1 Screen Design Manual (Functions)	
	Bar code		
	RFID		
	Remote personal computer operation(serial)		
	Remote personal computer operation(Ethernet)		
	VNC® server function		
	Video display		
	Multimedia		
	External I/O/operation panel		
	RGB display		
	Report	GOT1000 Series Gateway Functions Manual for GT Works3	
	Sound output		
	File transfer function (FTP client)		GT SoftGOT1000 Version3 Operating Manual for GT Works3
	SoftGOT-GOT link function		2. SYSTEM MONITOR
	System monitor		11. BACKUP/RESTORE
	Backup/restore		12. CNC DATA I/O
	CNC data I/O		15. MELSEC-L TROUBLESHOOTING
MELSEC-L Troubleshooting	16. LOG VIEWER		
Log viewer	18. CNC MACHINING PROGRAM EDIT		
CNC machining program edit	19. MOTION PROGRAM (SV43) EDITOR		
Motion program (SV43) editor	20. MOTION PROGRAM (SV43) I/O		
Motion program (SV43) I/O			
Option functions	KANJI regions	GT Designer 3 Version1 Screen Design Manual (Fundamentals)	
	Document display		
	Kana-kanji conversion	GT Designer 3 Version1 Screen Design Manual (Functions)	
	Kana-kanji conversion (enhanced version)		
	Historical data list display		
	Historical Trend Graph		
	Operation log		
	Logging		
	Recipe		
	Advanced Recipe		
	Object Script		
	Multi-channel		GOT1000 Series Connection Manual (Mitsubishi Products) for GT Works3
	Gateway	GOT1000 Series Gateway Functions Manual for GT Works3	
MES interface	GOT1000 Series MES Interface Function Manual for GT Works3		

(Continued to next page)

Category	Function name	Reference
Option OS	Ladder monitor	3. LADDER MONITOR FUNCTION
	A list editor	4. MELSEC-A LIST EDITOR
	FX list editor	5. MELSEC-FX LIST EDITOR
	Intelligent module monitor	6. INTELLIGENT MODULE MONITOR
	Network monitor	7. NETWORK MONITOR
	Q motion monitor	8. Q MOTION MONITOR
	Servo amplifier monitor	9. SERVO AMPLIFIER MONITOR
	CNC monitor	10. CNC MONITOR FUNCTIONS
	SFC monitor	13. SFC MONITOR
	Ladder editor	14. LADDER EDITOR
	Motion SFC monitor	17. MOTION SFC MONITOR
	Maintenance timing setting	User's Manual for the GOT used

■ Manuals describing how to connect an option function board

 User's Manual for the GOT used

■ Manuals describing how to install each OS

OS	Reference manual
Extended function OS	GT Designer 3 Version1 Screen Design Manual (Fundamentals)
Option OS	

1.1.2 Hardware and OS' required for each function

To use each function, extended function OS, or option OS and option function board is required.

For installing the extended function OS or option OS on the GOT, make sure that the user area of the specified drive has enough free space for the OS memory space shown on the next page.

For details of data transfer, refer to the following.

 GT Designer 3 Version1 Screen Design Manual (Fundamentals)

The following shows the option function boards applicable to each GOT.

GOT	Option function board
GT16	GT16-MESB
GT15	GT15-FNB, GT15-QFNB, GT15-QFNB16M, GT15-QFNB32M, GT15-QFNB48M, GT15-MESB48M
GT14	Not required
GT12	Not required
GT11	GT11-50FNB
GT10	Not required

An option function board (GT15-FNB or GT11-50FNB) is built in the following GOTs.

GOT	Model	Description*1
GT15	All models	Function version D or later
GT11	GT1155-QTBDQ, GT1155-QTBDA, GT1155-QSBDQ, GT1155-QSBDA, GT1150-QLBDQ, GT1150-QLBDA	
	GT1155-QTBD	Hardware Version A or later
	GT1155HS-QSBD, GT1150HS-QLBD	Hardware Version B or later
	GT1155-QSBD, GT1150-QLBD	Hardware Version C or later

*1 For how to confirm the function version or hardware version, refer to the following.

 User's Manual for the GOT used

When using the GOTs mentioned above, option functions operated with the GT15-FNB or GT11-50FNB can be used without installing an option function board.

For using functions operated with the GT16-MESB, GT15-QFNB (□ M), or GT15-MESB48M, and for adding more memory to the GT15, install an applicable option function board.

An additional option function board can be installed on the GOT with a built-in option function board.

(However, an option function board inapplicable to the GOT, such as a GT15 option function board to the GT16, cannot be used.)

■ For GT16

○: Required (Either one) ×: Unusable

Function name	Extended function OS / option OS name	OS memory space (user area) ^{*1}		Option function board
		Built-in flash memory (ROM)	User memory (RAM)	GT16-MESB
Stroke font ^{*2}	Stroke Font Support Data	300 KB	400 KB	Not required
	Stroke Standard Font (JPN)	2160KB	2160KB	Not required
	Stroke Standard Font (JPN)(supporting Hangul)	3175KB	3175KB	Not required
	Stroke Standard Font (China GB)	1474KB	1474KB	Not required
	Stroke Standard Font (China GB)(supporting Hangul)	2016KB	2016KB	Not required
Operator Authentication	Operator authentication	460KB	730KB	Not required
	Fingerprint Authentication	270KB	616KB	Not required
USB mouse/keyboard function	USB Mouse/Keyboard	80KB	200KB	Not required
Device data transfer	Device Data Transfer	50KB	100KB	Not required
Bar code	Bar code	50KB	84KB	Not required
RFID	RFID	50KB	166KB	Not required
Remote personal computer operation(serial) ^{*6*8}	Video/RGB	298KB	480KB	Not required
	PC Remote Operation (Serial)	50KB	84KB	Not required
Remote personal computer operation(Ethernet) ^{*6}	PC Remote Operation (Ethernet)	860KB	5130KB	Not required
Video display ^{*6*8}	Video/RGB	298KB	480KB	Not required
Multimedia ^{*6*8}	Multimedia	298KB	1074KB	Not required
External I/O / Operation Panel	External I/O / Operation Panel	70KB	100KB	Not required
RGB display ^{*6*8}	Video/RGB	298KB	480KB	Not required
Report	Report	150KB	235KB	Not required
	Printer (PictBridge)	552KB	1104KB	Not required
	Printer (serial)	80KB	200KB	Not required
Sound Output	Sound Output	100KB	200KB	Not required
System monitor	System monitor	450KB	692KB	Not required
Backup/restore ^{*9}	Backup/Restore	420KB	766KB	Not required
	Device name converter	400KB	800KB	Not required
CNC data I/O ^{*3*8}	CNC Data I/O	210KB	383KB	Not required
	GOT Platform Library	77KB	200KB	Not required
CNC machining program edit ^{*3*8}	CNC Machining Program Edit	220KB	738KB	Not required
	GOT Platform Library	77KB	200KB	Not required
MELSEC-L Troubleshooting	MELSEC-L Troubleshooting Function	340KB	770KB	Not required
SoftGOT-GOT link function	SoftGOT-GOT Link Function	100KB	200KB	Not required
Log viewer	Log viewer	1434KB	3882KB	Not required
VNC [®] server function	VNC server	512KB	8192KB	Not required
Motion program (SV43) editor	Motion program (SV43) editor	510KB	1010KB	Not required
Motion program (SV43) I/O	Motion program (SV43) I/O	210KB	383KB	Not required

(Continued to next page)

○: Required × : Unusable

Function name	Extended function OS / option OS name	OS memory space (user area)		Option function board
		Built-in flash memory (ROM)	User memory (RAM)	GT16-MESB
KANJI regions	Standard Font (China GB)	1280KB	1280KB	Not required
	Standard Font (China Big5)	1920KB	1920KB	Not required
	Standard Font (Japanese)	1280KB	1280KB	Not required
	Stroke Font (JPN)	1037KB	1037KB	Not required
	Stroke Font (China GB5)	1248KB	1248KB	Not required
	Stroke Font (China Big5)	1680KB	1680KB	Not required
Document display	Document Display	150KB	3072KB	Not required
Kana-kanji conversion (enhanced version)	KANA KANJI(JPN) (Enhanced Version)	1242KB	2774KB	Not required
Historical data list display	Not required	-	-	Not required
Historical Trend Graph	Not required	-	-	Not required
Operation log	Operation Log	384KB	1221KB	Not required
	Device name converter	400KB	800KB	Not required
Logging	Logging	380KB	710KB	Not required
Recipe	Recipe	70KB	100KB	Not required
Advanced Recipe	Advanced Recipe	310KB	1187KB	Not required
Object Script	Object Script	180KB	360KB	Not required
Multi-channel	Not required	-	-	Not required
Gateway	Gateway (Server, Client)	50KB	100KB	Not required
	Gateway (Mail)	50KB	100KB	Not required
	Gateway (FTP server)	50KB	84KB	Not required
	File transfer (FTP client)	300KB	1300KB	Not required
MES interface	MES Interface	1598KB	13461KB	○
Ladder monitor	Ladder monitor for MELSEC-A	342KB	674KB	Not required
	Ladder monitor for MELSEC-FX	342KB	674KB	Not required
	Ladder monitor for MELSEC-Q/L/QnA	590KB	4170KB	Not required
A list editor	List editor for MELSEC-A	542KB	1024KB	Not required
FX list editor	List editor for MELSEC-FX	542KB	1024KB	Not required
Intelligent module monitor	Intelligent module monitor	390KB	770KB	Not required
Network monitor	Network monitor	210KB	370KB	Not required
Q motion monitor	Q motion monitor	390KB	770KB	Not required
Servo amplifier monitor	Servo amplifier monitor	390KB	770KB	Not required
CNC monitor ^{*3*8}	CNC monitor	390KB	770KB	Not required
SFC monitor ^{*4}	GOT Platform Library	77KB	200KB	Not required
	SFC monitor	442KB	2108KB	Not required
	SFC monitor (enhanced) ^{*10}	442KB	2108KB	Not required
	GOT Function Expansion Library (enhanced) ^{*10}	9458KB	25840KB	Not required

(Continued to next page)

1	OVERVIEW
2	SYSTEM MONITOR
3	LADDER MONITOR FUNCTION
4	MELSEC-A LIST EDITOR
5	MELSEC-FX LIST EDITOR
6	INTELLIGENT MODULE MONITOR
7	NETWORK MONITOR
8	Q MOTION MONITOR

○ : Required × : Unusable

Function name	Extended function OS / option OS name	OS memory space (user area)		Option function board
		Built-in flash memory (ROM)	User memory (RAM)	GT16-MESB
Ladder editor*5*8	GOT Platform Library	77KB	200KB	Not required
	Ladder editor	2567KB	8192KB	Not required
	Ladder editor (enhanced)*10	2567KB	8192KB	Not required
	GOT Function Expansion Library	4729KB	19381KB	Not required
	GOT Function Expansion Library (enhanced)*10	9458KB	25840KB	Not required
Motion SFC monitor*7	GOT Platform Library	77KB	200KB	Not required
	Motion SFC monitor	1240KB	12522KB	Not required
Maintenance timing setting	Not required	-	-	Not required

- *1 The OS memory space differs between the built-in flash memory (ROM) and the user memory (RAM). When writing data, including the OS, communication drivers, and project data, from the built-in flash memory (ROM) to the user memory (RAM), the OS data size increases. Make sure that the total data size does not exceed the user memory (RAM) capacity.
- *2 For using fonts, install option fonts if necessary.
For how to use fonts and the setting method, refer to the following manual.
 GT Designer3 Version1 Screen Design Manual (Fundamentals)
- *3 Inapplicable to the GT1675M-V, GT1675-VN, GT1672-VN, GT1665M-V, and GT1662-VN.
- *4 For using the SFC monitor, install all the OSs of [GOT Platform Library], [SFC monitor], and [GOT Function Expansion Library] on the GOT.
- *5 For using the ladder editor, install all the OSs of [GOT Platform Library], [Ladder editor], and [GOT Function Expansion Library] on the GOT.
- *6 Inapplicable to the GT1675-VN, GT1672-VN, and GT1662-VN.
- *7 For using the motion SFC monitor, install all the OSs of [GOT Platform Library] and [Motion SFC monitor] on the GOT.
- *8 Inapplicable to GT1655.
- *9 For using the trigger backup, install the backup/restore function and the device name converter.
For not using the trigger backup, install only the backup/restore function.
- *10 For using the Q00UJCPU-S8, QnUDVCP, L06CPU, or L26CPU, install this function.

■ For GT15

For GOTs with built-in option function boards, refer to the following.

 1.1.2 Hardware and OS' required for each function

○ : Required (Either one) × : Unusable

Function name	Extended function OS / option OS name	OS memory space (user area)	Option function board		
			GT15-FNB	GT15-QFNB GT15-QFNB□M	GT15-MESB48M
Stroke font*1	Stroke Font Support Data	400 KB	Not required		
	Stroke Standard Font (JPN)	2160KB	Not required		
	Stroke Standard Font (JPN)(supporting Hangul)	3175KB	Not required		
	Stroke Standard Font (China GB)	1474KB	Not required		
	Stroke Standard Font (China GB)(supporting Hangul)	2016KB	Not required		
Operator Authentication	Operator authentication	784KB	Not required		
	Fingerprint Authentication	616KB	Not required		
Device data transfer	Device Data Transfer	100KB	Not required		
Bar code	Bar code	84KB	Not required		
RFID	RFID	166KB	Not required		
Remote personal computer operation*2	Video/RGB	512KB	Not required		
	PC Remote Operation	84KB	Not required		
Video display*2	Video/RGB	512KB	Not required		
External I/O / Operation Panel	External I/O / Operation Panel	100KB	Not required		

(Continued to next page)

○: Required × : Unusable

Function name	Extended function OS / option OS name	OS memory space (user area)	Option function board		
			GT15-FNB	GT15-QFNB GT15-QFNB□M	GT15-MESB48M
RGB display* ²	Video/RGB	512KB	Not required		
Report* ¹⁰	Report	235KB	Not required		
	Printer (PictBridge)	1104KB	Not required		
	Printer (serial)	200KB	Not required		
Sound Output	Sound Output	200KB	Not required		
System monitor	System monitor	746KB	Not required		
Backup/restore* ¹¹	Backup/Restore	820KB	Not required		
	Device name converter	800KB	Not required		
CNC data I/O* ³	CNC Data I/O	437KB	Not required		
	GOT Platform Library	100KB	Not required		
SoftGOT-GOT link function	SoftGOT-GOT Link Function	200KB	Not required		
KANJI regions	Standard Font (China GB)	1280KB	○	○	○
	Standard Font (China Big5)	1920KB	○	○	○
	Standard Font (Japanese)	1280KB	○	○	○
	Stroke Font (JPN)	1037KB	○	○	○
	Stroke Font (China GB5)	1248KB	○	○	○
	Stroke Font (China Big5)	1680KB	○	○	○
Document display	Document Display	2048KB	×	○	○
Kana-kanji conversion* ⁴	KANA KANJI(JPN)* ⁴	1223KB	○	○	○
Kana-kanji conversion (enhanced version)* ⁴	KANA KANJI(JPN) (Enhanced Version)* ⁴	2774KB	○	○	○
Historical data list display	Not required	-	○	○	○
Historical Trend Graph	Not required	-	○	○	○
Operation log	Operation Log	1218KB	○	○	○
	Device name converter	800KB	○	○	○
Logging	Logging	740KB	○	○	○
Recipe	Recipe	100KB	○	○	○
Advanced Recipe	Advanced Recipe	1241KB	○	○	○
Object Script	Object Script	360KB	○	○	○
Multi-channel	Not required	-	×	○	○
Gateway	Gateway (Server, Client)	100KB	○	○	○
	Gateway (Mail)	100KB	○	○	○
	Gateway (FTP server)	64KB	○	○	○
	File transfer (FTP client)	1300KB	Not required		
MES interface* ⁵	MES Interface	3196KB	×	×	○
Ladder monitor* ⁶	Ladder monitor for MELSEC-A	523KB	○	○	○
	Ladder monitor for MELSEC-FX	592KB	○	○	○
	Ladder monitor for MELSEC-Q/L/QnA	1082KB	×	○	○
A list editor	List editor for MELSEC-A	1058KB	○	○	○
FX list editor	List editor for MELSEC-FX	1058KB	○	○	○
Intelligent module monitor* ⁶	Intelligent module monitor	384KB	○	○	○
Network monitor	Network monitor	324KB	○	○	○
Q motion monitor	Q motion monitor	607KB	○	○	○
Servo amplifier monitor	Servo amplifier monitor	524KB	○	○	○

(Continued to next page)

1 OVERVIEW
2 SYSTEM MONITOR
3 LADDER MONITOR FUNCTION
4 MELSEC-A LIST EDITOR
5 MELSEC-FX LIST EDITOR
6 INTELLIGENT MODULE MONITOR
7 NETWORK MONITOR
8 Q MOTION MONITOR

○: Required (Either one) ×: Unusable

Function name	Extended function OS / option OS name	OS memory space (user area)	Option function board		
			GT15-FNB	GT15-QFNB GT15-QFNB□M	GT15-MESB48M
CNC monitor ^{*3}	CNC monitor	588KB	○	○	○
SFC monitor ^{*6*7}	GOT Platform Library	100KB	Not required		
	SFC monitor	1373KB	×	○	○
	SFC monitor (enhanced) ^{*12}	1373KB	×	○	○
	GOT Function Expansion Library	4729KB	×	○	○
	GOT Function Expansion Library (enhanced) ^{*12}	9458KB	×	○	○
Ladder editor ^{*6*8*9}	GOT Platform Library	100KB	Not required		
	Ladder editor	5121KB	×	○	○
	Ladder editor (enhanced) ^{*12}	5121KB	×	○	○
	GOT Function Expansion Library (enhanced) ^{*12}	9458KB	×	○	○
Motion SFC monitor ^{*6*10}	GOT Platform Library	100KB	Not required		
	Motion SFC monitor	2477KB	×	○	○
Maintenance timing setting	Not required	-	○	○	○

*1 For using fonts, install option fonts if necessary.

For how to use fonts and the setting method, refer to the following manual.

 GT Designer3 Version1 Screen Design Manual (Fundamentals)

*2 Applicable to the GT1585V-S and GT1575V-S only.

*3 Applicable to the GT1595-X, GT1585V-S, GT1585-S, GT1575V-S, and GT1575-S only.

*4 This function is dedicated to Japanese version.

*5 A capacity of 8218KB in the add-on memory (48MB) of the GT15-MESB48M is used for the MES interface function operation.

*6 Inapplicable to the GT1555-Q and GT1550-Q.

*7 For using the SFC monitor function, a capacity of 6202KB or more is required in the user area of the specified drive for installing the extended function OS and option OS. (For using the GOT with the built-in flash memory of 5MB, set the OS boot drive to [A: Standard CF Card].)

For operating GOT Function Expansion Library (option OS), a capacity of 12920KB is required in the user area of the GOT memory. (A total memory capacity of 14393KB is required for using the SFC monitor function.)

Therefore, the following settings are required depending on the GOT to be used.

GOT	Required setting
GT1575-VN, GT1572-VN, GT1562-VN	<ul style="list-style-type: none"> Setting the OS boot drive to [A: Standard CF Card] Memory expansion (Installing an option function board with add-on memory)
Other than the above	<ul style="list-style-type: none"> Memory expansion (Installing an option function board with add-on memory)

For setting the OS boot drive, refer to the following.

 GT Designer3 Version1 Screen Design Manual (Fundamentals)

*8 The GT1555-V does not support the function.

*9 For using the ladder editor function, a capacity of 9950KB or more is required in the user area of the specified drive for installing the extended function OS and option OS.

A total memory capacity of 21212KB is required for using the ladder editor function.

Therefore, to use the ladder editor function, set the OS boot drive to [A: Standard CF Card] and mount an option function board with 16MB or more memory on the GOT.

*10 For using the motion SFC monitor, install all the OSs of [GOT Platform Library] and [Motion SFC monitor] on the GOT.

For using the motion SFC monitor function, a capacity of 2577KB or more is required in the user area of the specified drive for installing the extended function OS and option OS.

A total memory capacity of 12622KB is required for using the motion SFC monitor function.

Therefore, to use the motion SFC monitor function, mount an option function board with 16MB or more memory on the GOT.

*11 For using the trigger backup, install the backup/restore function and the device name converter.

For not using the trigger backup, install only the backup/restore function.

*12 For using the Q00UJCPU-S8, QnUDVCPU, L06CPU, or L26CPU, install this function.

■ For GT14

Function name	Extended function OS / option OS name	OS memory space (user area) ^{*1}		Option function board
		Built-in flash memory (ROM)	User memory (RAM)	
Stroke font ^{*1}	Stroke Font Support Data	400KB	1300KB	Not required
	Stroke Standard Font (JPN)	2160KB	2160KB	Not required
	Stroke Standard Font (JPN)(supporting Hangul)	3175KB	3175KB	Not required
	Stroke Standard Font (China GB)	1474KB	1474KB	Not required
	Stroke Standard Font (China GB)(supporting Hangul)	2016KB	2016KB	Not required
Operation log	Operation Log	730KB	730KB	Not required
Bar code	Bar code	84KB	84KB	Not required
RFID	RFID	166KB	166KB	Not required
USB mouse/keyboard function	USB Mouse/Keyboard	200KB	200KB	Not required
Device data transfer	Device Data Transfer	100KB	100KB	Not required
System monitor	System monitor	692KB	692KB	Not required
Backup/restore ^{*2}	Backup/Restore	766KB	766KB	Not required
	Device name converter	800KB	800KB	Not required
VNC [®] server function	VNC server	512KB	2048KB	Not required
KANJI regions	Standard Font (China GB)	1280KB	1280KB	Not required
	Standard Font (China Big5)	1920KB	1920KB	Not required
	Standard Font (Japanese)	1280KB	1280KB	Not required
	Stroke Font (JPN)	1037KB	1037KB	Not required
	Stroke Font (China GB5)	1248KB	1248KB	Not required
	Stroke Font (China Big5)	1680KB	1680KB	Not required
Kana-kanji conversion (enhanced version)	KANA KANJI(JPN) (Enhanced Version)	1228KB	2048KB	Not required
Logging	Logging	710KB	710KB	Not required
Recipe	Recipe	100KB	100KB	Not required
Advanced Recipe	Advanced Recipe	1187KB	1187KB	Not required
Object Script	Object Script	360KB	360KB	Not required
Gateway ^{*3}	Gateway (Server, Client)	100KB	100KB	Not required
	Gateway (Mail)	100KB	100KB	Not required
	Gateway (FTP server)	84KB	84KB	Not required
	File transfer (FTP client)	1300KB	1300KB	Not required
A list editor	List editor for MELSEC-A	1024KB	1024KB	Not required
FX list editor	List editor for MELSEC-FX	1024KB	1024KB	Not required

*1 For using fonts, install option fonts if necessary.
For how to use fonts and the setting method, refer to the following manual.

 GT Designer3 Version1 Screen Design Manual (Fundamentals)

*2 For using the trigger backup, install the backup/restore function and the device name converter.
For not using the trigger backup, install only the backup/restore function.

*3 Can be used only with GT1455-QTBDE or GT1450-QLBDE.

■ For GT12

Function name	Extended function OS / option OS name	OS memory space (user area)	Option function board
		Built-in flash memory (ROM)	
Bar code	Bar code	50KB	Not required
RFID	RFID	50KB	
System monitor	System monitor	450KB	
Backup/restore *1	Backup/Restore	420KB	
	Device name converter	400KB	
Logging	Logging	380KB	
Recipe	Recipe	70KB	
Gateway	Gateway (FTP server)	50KB	
A list editor	List editor for MELSEC-A	542KB	
FX list editor	List editor for MELSEC-FX	542KB	

*1 For using the trigger backup, install the backup/restore function and the device name converter.
For not using the trigger backup, install only the backup/restore function.

■ For GT11

For GOTs with built-in option function boards, refer to the following.

 1.1.2 Hardware and OS' required for each function

○: Required - : Unusable

Function name	Extended function OS/ Option OS name	OS memory space (user area)	Option function board
			GT11-50FNB
Bar code	Bar code	0KB	Not required
RFID	RFID		Not required
System monitor	System monitor		Not required
Recipe	Recipe		○
A list editor*1	List editor for MELSEC-A		○
FX list editor*2	List editor for MELSEC-FX		○

*1 Inapplicable to the GT1155-QTBDQ, GT1155-QSBDQ, and GT1150-QLBDQ.

*2 Inapplicable to the GT1155-QTBDQ, GT1155-QTBDA, GT1155-QSBDQ, GT1155-QSBDA, GT1150-QLBDQ, and GT1150-QLBDA.

■ For GT10

Function name	Extended function OS/ Option OS name	OS memory capacity (user area)	Option function board
Bar code	Not required	-	Not required
Recipe	Not required	-	Not required
FX list editor *1	Not required	-	Not required

*1 Inapplicable to the GT1030 and GT1020.

1.1.3 Outline of procedure to the operation of each function

Before operating each function, download the required Extended function OS or Option OS into the GOT according to the procedure shown below, and connect required hardware to the GOT.

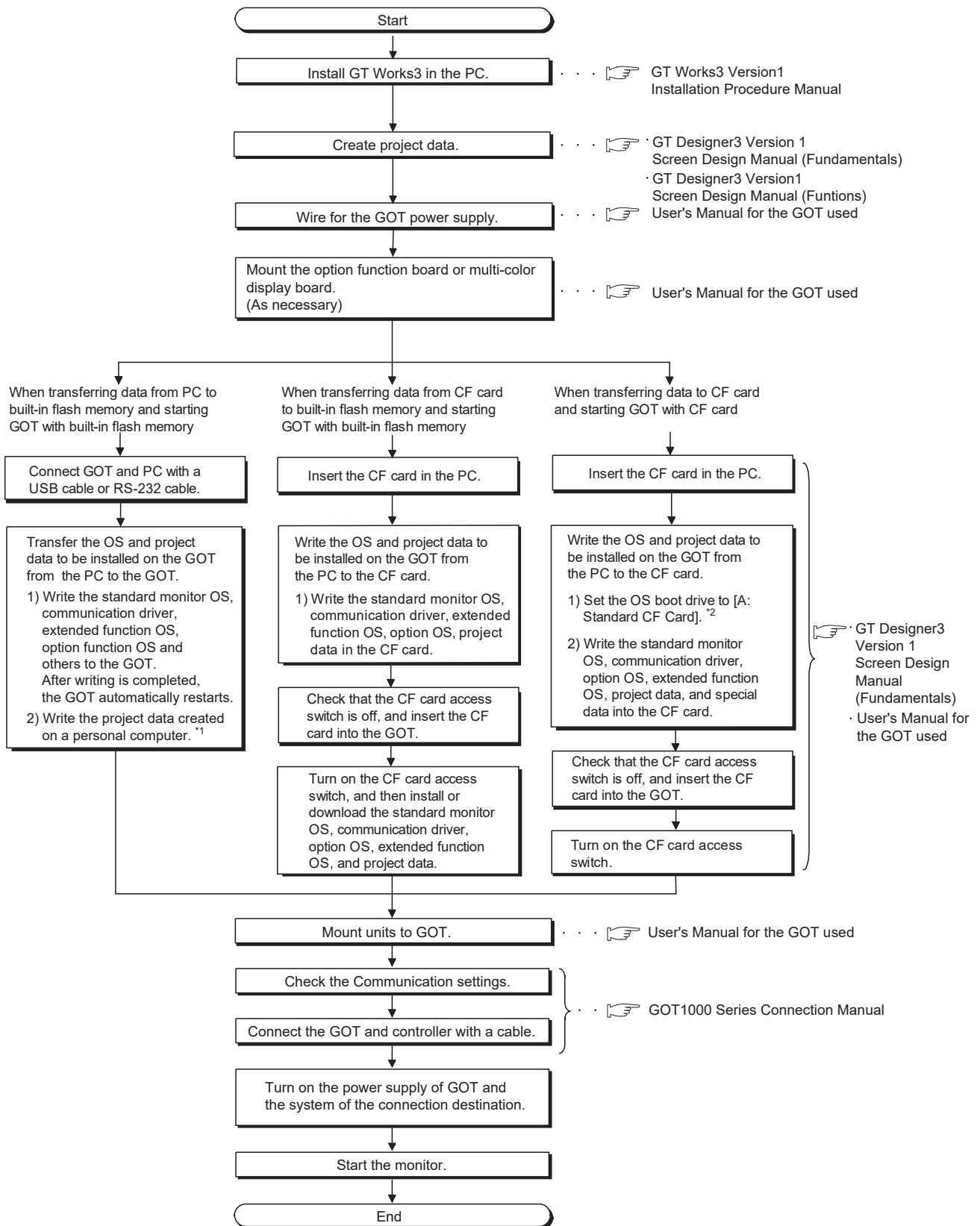

- * 1 Project data can be also downloaded/uploaded via Ethernet.
For download/upload of project data via Ethernet, BootOS and standard monitor OS should be installed in the GOT in advance so that the GOT and PC can communicate with each other via Ethernet by setting Communication Settings.
Refer to the following manual for details.
 GT Designer3 Version1 Screen Design Manual (Fundamentals)
- * 2 The B drive cannot be set as the OS boot drive.

POINT

Precautions for setting OS boot drive to [A: Standard CF Card]

(1) GOT startup time

When the OS boot drive is set to [A: Standard CF Card], the GOT startup time with the A drive takes longer than that with the C drive.

The GOT startup time with the A drive differs depending on the CF card type, the numbers of extended function OSs and option OSs, and project data size.

(2) Handling CF card during booting OS

Do not remove the CF card and do not turn off the CF card access switch during booting the OS. Doing so causes the boot to fail. As a result, the GOT does not start correctly.

(3) Corrective actions when OS cannot be booted

The OS cannot be booted in the following conditions.

Take the following corrective actions, and then boot the OS again.

Condition	Corrective action
The type of the GOT to be used differs from the GOT type data set with GT Designer2 stored in the CF card.	Select the same GOT type as the GOT to be used in the Communicate with Memory Card screen. Select OSs and project data to be downloaded, and then download the selected data to the CF card.
The OS boot drive has insufficient free space.	Mount an option function board with add-on memory on the GOT or delete unnecessary data.
The CF card access switch is off.	Turn on the CF card access switch.

1.1.4 Displayable languages for each function

Languages available for each function are shown in the following table.
For details of font data and displayable language, refer to the following.

 GT Designer3 Version1 Screen Design Manual (Fundamentals)

(○ : Displayed, × : Not displayed, Eng.: Displayed in English)

Function		Japanese	English	Chinese (Simplified)	Chinese (Traditional)	German	Korean
Utility function		○	○	○	○	○	○
System monitor		○	○	○	○	○	○
Ladder monitor							
• File name • Title • Comment • Note • Statement	Ladder monitor for MELSEC-A	○	○	×	×	×	×
	Ladder monitor for MELSEC-FX	○	○	×	×	×	×
	Ladder monitor for MELSEC-Q/L/QnA	○	○	○	×	×	○ ^{*1}
Other than the above	Ladder monitor for MELSEC-A	○	○	Eng.	Eng.	Eng.	Eng.
	Ladder monitor for MELSEC-FX	○	○	○	○	○	○
	Ladder monitor for MELSEC-Q/L/QnA	○	○	○	○	○	○
A list editor		○	○	Eng.	Eng.	Eng.	Eng.
FX list editor		○	○	○	○	○	○
Intelligent module monitor ^{*3}		○	○	Eng.	Eng.	Eng.	Eng.
Network monitor		○	○	○	○	○	○
Q motion monitor ^{*3}		○	○	Eng.	Eng.	Eng.	Eng.
Servo amplifier monitor ^{*3}		○	○	Eng.	Eng.	Eng.	Eng.
CNC monitor							
Monitor area		*2	*2	*2	*2	*2	*2
Other than the above		○	○	○	○	○	○
Backup/restore		○	○	○	○	○	○
CNC data I/O		○	○	○	Eng.	Eng.	Eng.
SFC monitor		○	○	○	○	○	○
Ladder editor		○	○	○	○	○	○
MELSEC-L Troubleshooting		○	○	○	○	○	○
Log viewer		○	○	○	○	○	○
Motion SFC monitor		○	○	○	○	○	○
CNC machining program edit		○	○	○	Eng.	Eng.	Eng.
Motion program (SV43) editor		○	○	○	○	○	○
Motion program (SV43) I/O		○	○	○	○	○	○

*1 For further information, see the following:

 3.5.7 Language switching of the sequence program (MELSEC-Q/L/QnA ladder monitor)

*2 The displayable language depends on the setting of the CNC side. (The language used on the monitor area is not linked to the language setting of [GOT setup].)

For the CNC settings, refer to the manual of CNC (C70, C6/C64) to be connected.

*3 Special data is displayed in the language selected in GT Designer3.

2. SYSTEM MONITOR



2.1 Features

The system monitor function is capable of monitoring and changing the devices within a target controller. It is intended to troubleshoot the controller system and to streamline maintenance operations.

By installing the system monitor, an extended function OS, from GT Designer 2 into the GOT, you can monitor and test the devices of the controller and the buffer memory of the intelligent function module.

■ Any device on four dedicated screens can be monitored.

The system monitor function comprises four monitors - entry monitor, batch monitor, TC monitor, and BM monitor, and you can monitor any device according to the application.

Entry monitor (On the GT15)

DEVICE MONITOR				TEST	MENU	FORM	SET
ChNo.	[1]	NetNo.	[0]	ST	[FF]	CPUNo.	[0]
D	15	-2147483645	DW				
Z	1	-32767					
X	1	●					
M	25	○					
W	200	100					
R	50	68378428	DW				
D	0	3	DW				
B	10	○					

The entry monitor function monitors up to 8 controller devices entered by the user in a single window.

2.5 Entry Monitor)

Batch monitor (On the GT15)

BATCH MONITOR						TEST	MENU	FORM	SET
ChNo.	[1]	NetNo.	[0]	ST	[FF]	CPUNo.	[0]		
D	10	32767	D	18	-500				
D	11	0	D	19	3234				
D	12	0	D	20	0				
D	13	-1	D	21	0				
D	14	0	D	22	0				
D	15	3	D	23	-32768				
D	16	3256	D	24	0				
D	17	0	D	25	0				

The batch monitor function monitors up to 16 controller devices from the device number specified by the user in a single window.

2.6 Batch Monitor)

TC monitor (On the GT15)

TC MONITOR							TEST	MENU	FORM	SET
ChNo.	[1]	NetNo.	[0]	ST	[FF]	CPUNo.	[0]			
FILE NAME [MAIN .QPG]										
T	0	PV	0	SV	25	+	-	○	▲	
[Operation start]										
T	1	PV	30	SV	30	+	-	○		
[Products Line A]										
T	2	PV	0	SV		+	-	○		
[Products Line B]										
T	3	PV	0	SV		+	-	○		
[Products Line C]										

The TC monitor function monitors the present value, set value, contact point, and coil of up to 8 controller timers (T)/counters (C) from the device number specified by the user in a single window.

2.7 TC Monitor (Monitoring Timers and Counters))

BM monitor (monitoring Buffer memory) (On the GT15)

BM MONITOR					TEST	MENU	FORM	SET
ChNo.	[1]	NetNo.	[0]	ST	[FF]	CPUNo.	[0]	
I/O NO [0]								
BM	1	0	BM	9	0			
BM	2	0	BM	10	0			
BM	3	0	BM	11	0			
BM	4	0	BM	12	0			
BM	5	0	BM	13	0			
BM	6	0	BM	14	0			
BM	7	0	BM	15	0			
BM	8	0	BM	16	0			

The BM monitor function monitors up to 16 devices from the initial device number in the buffer memory of the intelligent function module specified by the user in a single window.

2.8 BM Monitor (Monitoring Buffer Memory))

POINT

(1) System monitor screen display of GT16, GT15, and GT12

Display methods differ depending on the GOT.

For the GOT with VGA or higher resolution, the monitor screen is divided into four windows. The GOT can simultaneously display four different kinds of monitor screens.

For the GT1655-V and GT1555-V, the monitor screen can be switched between the full and quad modes with the button for switching the number of monitor screens.

For the GOT with QVGA resolution, the GOT can display one of the four monitor screens as a full screen.

DEVICE MONITOR				BATCH MONITOR					
ChNo.	[1]NetNo.	[0]ST	[FF]CPUNo.	ChNo.	[1]NetNo.	[0]ST	[FF]CPUNo.		
D	15	213385219	DW	D	10	32767	D	18	-500
Z	1	-32767		D	11	0	D	19	3234
X	1	○		D	12	0	D	20	0
M	25	○		D	13	-1	D	21	0
W	200	43		D	14	0	D	22	0
R	50	68378428	DW	D	15	3	D	23	-32768
D	0	3	DW	D	16	3256	D	24	0
B	10	○		D	17	0	D	25	0

TOP MONITOR				FORM MONITOR					
ChNo.	[1]NetNo.	[0]ST	[FF]CPUNo.	ChNo.	[1]NetNo.	[0]ST	[FF]CPUNo.		
FILE NAME[MAIN] (OPG)				I/O NO[0]					
T	0	0 SV	25	EM	1	0	EM	9	0
[Operation start]				EM	2	0	EM	10	0
T	1	0 SV	30	EM	3	0	EM	11	0
[Products Line A]				EM	4	0	EM	12	0
T	2	0 SV		EM	5	0	EM	13	0
[Products Line B]				EM	6	0	EM	14	0
T	3	0 SV		EM	7	0	EM	15	0
[Products Line C]				EM	8	0	EM	16	0

(GOT with VGA or higher resolution)

DEVICE MONITOR			
ChNo.	[1]NetNo.	[0]ST	[FF]CPUNo.
D	0	1556	
X	0	○	
M	0	○	
Y	0	○	
SM	412	4901	
D	0	-12600	
X	200		
X	IF		

(GOT with QVGA resolution)

• For GT1655-V and GT1555-V

(a) Full mode

When starting the system monitor, the GOT displays the monitor screen in the full mode.

The GOT displays one of the four monitor screens.

The screen display size differs depending on the monitor screen to be displayed.*1

(b) Quad mode

With the button for switching the number of monitor screens, the monitor screen is divided into four windows. The GOT can simultaneously display the four kinds of monitor screens.

DEVICE MONITOR			
ChNo.	[1]NetNo.	[0]ST	[FF]CPUNo.
D	15	-2147483645	DW
Z	1	-32767	
X	1	●	
M	25	○	
W	200	100	
R	50	68378428	DW
D	0	3122	
B	8	○	

Quad

(Full mode)

DEVICE MONITOR				BATCH MONITOR					
ChNo.	[1]NetNo.	[0]ST	[FF]CPUNo.	ChNo.	[1]NetNo.	[0]ST	[FF]CPUNo.		
D	15	-2147483645	DW	D	10	0	D	18	0
Z	1	-32767		D	11	0	D	19	0
X	1	○		D	12	0	D	20	0
M	25	○		D	13	0	D	21	0
W	200	100		D	14	0	D	22	0
R	50	68378428	DW	D	15	3	D	23	-32768
D	0	-17776		D	16	-32768	D	24	0
B	8	○		D	17	0	D	25	0

TOP MONITOR				FORM MONITOR					
ChNo.	[1]NetNo.	[0]ST	[FF]CPUNo.	ChNo.	[1]NetNo.	[0]ST	[FF]CPUNo.		
FILE NAME[MAIN] (OPG)				I/O NO[2]					
T	0	0 SV	6	EM	0	1	EM	8	0
[Products Line A]				EM	1	3	EM	9	0
T	1	0 SV		EM	2	1	EM	10	0
[Products Line B]				EM	3	0	EM	11	0
T	2	0 SV		EM	4	0	EM	12	0
[Products Line C]				EM	5	0	EM	13	0
T	3	0 SV		EM	6	0	EM	14	0
[Products Line D]				EM	7	0	EM	15	0

Full

(Quad mode)

*1 The monitor screen in the full mode is four times bigger than each monitor screen in the quad mode. For displaying screens commonly used in the system, including the key window, the monitor screen size in the full mode is the same as each monitor screen size in the quad mode.

For details of switching the number of the monitor screens, refer to the following.

☞ This subsection describes the flow until the system monitor function screen is displayed after System monitor (Extended function OS) is installed in the GOT.

(2) System monitor screen display of GT14 and GT11

The GOT can display one of the four monitor screens as a full screen.

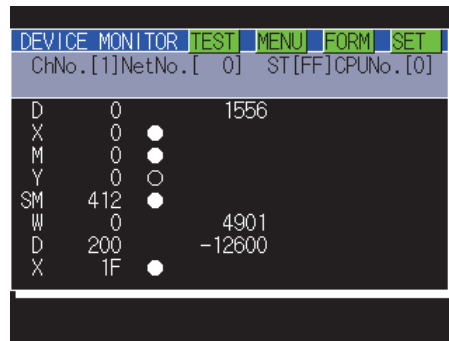

■ Data can be changed by test operation.

For further information, see the following:

2.9 Test Operation

(Test example)

When turning ON MO (On the GT15)



When changing the present value of DO (On the GT15)



(1) Testing a bit device

A device specified by the user is turned on and off.

(2) Testing a word device

A specified value is written to a device specified by the user.

(3) Testing a timer/counter

Specified values are written as the present and set values of a device specified by the user.

(4) Testing buffer memory

A specified value is written to buffer memory specified by the user.

■ **The display format and device comment/no-comment display can be switched.**

For further information, see the following:

☞ 2.4.4 Switching the display format (DEC/HEX) and comment/no-comment display

When the entry monitor is displayed
(comment display)

(On the GT15)

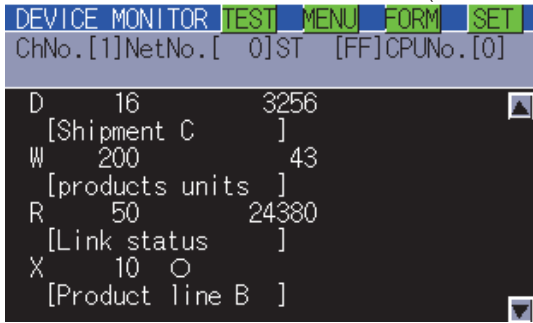

When the entry monitor is displayed
(hexadecimal display)

(On the GT15)

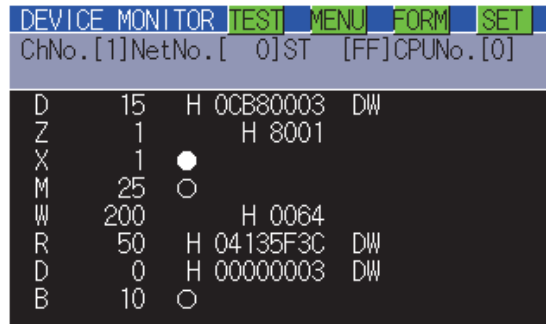

(1) **Switching the display format**

Word device values are displayed in decimal or hexadecimal numbers on the entry, batch, TC, and BM monitors.

(2) **Device comment display**

Comments written in the controller are displayed when a controller device is monitored.

■ **Other stations can be monitored.**

You can monitor other stations in the data link system containing the GOT (or GOT-connected station), network system or CC-Link system.

For further information about the connection forms that can be monitored, see the following:

☞ 2.2.1 System configuration

2.2 Specifications

2.2.1 System configuration

This subsection describes the controller names and the connection forms between the GOT and the controller that can be covered by the system monitor function.

For further information about communication units and cables for each connection form, see the following:

 GOT1000 Series Connection Manual (Mitsubishi Products) for GT Works3

■ Target controller

Controller
RCPU, motion controller CPU (MELSEC iQ-R Series)
QCPU (Q mode), Q series motion controller CPU
QSCPU*1
LCPU
QnACPU
ACPU/QCPU (A mode), A series motion controller CPU
FXCPU
Remote I.O station (MELSECNET/H system)
MELDAS C6/C64
Robot controller(CRnQ-700, CRnD-700)
CNC C70

*1 The GOT cannot write data to devices in the QSCPU. (The test operation is not available.)

■ Connection type

This function can be used in the following connection types.

(1) When GOT is connected to an RCP, MELSEC iQ-R series motion controller CPU

(○: Available, △: Partly restricted, ×: Unavailable)

Function		Connection type between GOT and controller										Reference section
Name	Description	Bus connection	Direct CPU connection	Computer link connection	Ethernet connection	MELSECNET/H connection, MELSECNET/10 connection	CC-Link IE controller connection ^{*2} , CC-Link IE field connection ^{*3}		CC-Link connection		Reference section	
							GT16	GT14	ID ^{*4}	G4		
		-	-	GT16 GT14	GT16 GT14	-	GT16	GT14	GT16	GT14	-	
Entry monitor	Monitoring present values by entering devices to be monitored in advance											2.5
Batch monitor	Monitoring the present value of n devices from a specified device											2.6
TC monitor	Monitoring the present value, set value, contact point, and coil of m devices from a specified device			○								2.7
BM monitor	Monitoring the present value of x devices in specified buffer memory of a specified intelligent function module											2.8
Data change by test operation	Setting/Resetting bit devices	×	×		○	×	○	×	○	×	×	2.9
	Changing the present value of word devices and buffer memory			△ ^{*1}								
	Changing the present value of TC (possible during TC monitoring)											
	Changing the set value of TC (possible during TC monitoring)											
Quick test	Changing device values by performing a quick test			○								2.4.5
Display switching	Displaying device comments											2.4.4
	Displaying word device and buffer memory values in decimal or hexadecimal											

*1 The present value of Z cannot be changed. None of the connection types supports V.

*2 Indicates the CC-Link IE controller network connection.

*3 Indicates CC-Link IE field network connection.

*4 Indicates CC-Link connection (Intelligent device station).

(2) When the GOT is connected to a QCPU (Q mode), Q series motion controller CPU, QSCPU, or LCPU

(○: Available, △: Partly restricted, ×: Unavailable)

Function		Connection type between GOT and controller													Reference section	
Name	Description	Bus connection *10*11		Direct CPU connection *10*12	Computer link connection *10	Ethernet connection		MELSECNET/H connection*11, MELSECNET/10 connection*11		CC-Link IE controller connection*5*11, CC-Link IE field connection *11*6*11		CC-Link connection				
		GT16 GT15 GT11	GT14 GT12	GT16 GT15 GT14 GT12 GT11	GT16 GT15 GT14 GT12 GT11	GT16 GT15 GT14 GT12	GT11	GT16 GT15	GT14 GT12 GT11	GT16 GT15	GT14 GT12 GT11	GT16 GT15	GT14 GT12 GT11	GT16 GT15 GT14 GT12 GT11		
Entry monitor	Monitoring present values by entering devices to be monitored in advance	○	×	○	○					△*2		○			○	2.5
Batch monitor	Monitoring the present value of n devices from a specified device	○	×	○	○										○	2.6
TC monitor	Monitoring the present value, set value, contact point, and coil of m devices from a specified device															2.7
BM monitor	Monitoring the present value of x devices in specified buffer memory of a specified intelligent function module	△*1	×	△*1	△*1					△*1 *2		△*1			△*1	2.8
Data change by test operation	Setting/Resetting bit devices				○		△*4	×		×		×	△*4	×		2.9
	Changing the present value of word devices and buffer memory				△*3											
	Changing the present value of TC (possible during TC monitoring)															
	Changing the set value of TC (possible during TC monitoring)*9	△*4	×	△*4					△*2*4		△*4			△*4		
Quick test	Changing device values by performing a quick test				△*4											2.4.5
Display switching	Displaying device comments															2.4.4
	Displaying word device and buffer memory values in decimal or hexadecimal															

- *1 These items cannot be monitored when a motion controller (Q series) is monitored.
- *2 When the GOT is connected to the MELSECNET/10, use a QCPU and a network module (QJ71LP21, QJ71LP21-25, QJ71LP21S-25, QJ71LP21G, QJ71BR11) of function version B or a later version.
- *3 The present value of Z cannot be changed. None of the connection types supports V.
- *4 When a motion controller (Q series) is connected, device comments cannot be displayed.
- *5 Indicates the CC-Link IE controller network connection.
- *6 Indicates CC-Link IE field network connection.
- *7 Indicates CC-Link connection (Intelligent device station).
- *8 Indicates CC-Link connection (via G4).
- *9 When a QCPU redundant system is used, data of the set value cannot be changed.
- *10 The QSCPU does not support the connection type.
- *11 The LCPU does not support the connection type.
- *12 When the GOT is connected to LCPU, use L6ADP-R2.

1 OVERVIEW
2 SYSTEM MONITOR
3 LADDER MONITOR
4 FUNCTION
5 MELSEC-A LIST EDITOR
6 MELSEC-FX LIST EDITOR
7 INTELLIGENT MODULE MONITOR
8 NETWORK MONITOR
9 Q MOTION MONITOR

(3) When the GOT is connected to a QnACPU

(○: Available, △: Partly restricted, ×: Unavailable)

Function		Connection form between GOT and controller											Reference section	
Name	Description	Bus connection		Direct CPU connection	Computer link connection	Ethernet connection		MELSEC NET/10 connection		CC-Link connection				
		GT16 GT15 GT11	GT14 GT12	GT16 GT15 GT14 GT12 GT11	GT16 GT15 GT14 GT12 GT11	GT16 GT15 GT14 GT12	GT11	GT16 GT15	GT14 GT12 GT11	ID*4		GT16 GT15 GT14 GT12 GT11		
										GT16 GT15	GT14 GT12 GT11			
Entry monitor	Monitoring present values by entering devices to be monitored in advance													2.5
Batch monitor	Monitoring the present value of n devices from a specified device													2.6
TC monitor	Monitoring the present value, set value, contact point, and coil of m devices from a specified device													2.7
BM monitor	Monitoring the present value of x devices in specified buffer memory of a specified intelligent function module													2.8
Data change by test operation	Setting/Resetting bit devices	△*3	×	△*3		△*3	×		×	△*3	×	×		2.9
	Changing the present value of word devices and buffer memory				△*2									
	Changing the present value of TC (possible during TC monitoring)													
Quick test	Changing the set value of TC (possible during TC monitoring)													2.4.5
	Changing device values by performing a quick test				△*3									
Display switching	Displaying device comments													2.4.4
	Displaying word device and buffer memory values in decimal or hexadecimal													

*1 When the GOT is connected to the MELSECNET/10, use a QCPU and a network module (QJ71LP21, QJ71LP21-25, QJ71LP21S-25, QJ71LP21G, QJ71BR11) of function version B or a later version.

*2 The present value of Z cannot be changed. None of the connection forms supports V.

*3 When the GOT is connected to a QnACPU whose date shown on the rating plate is earlier than 9707B, device comments cannot be displayed.

*4 Indicates CC-Link connection (Intelligent device station).

*5 Indicates CC-Link connection (via G4).

(4) When the GOT is connected to a ACPU/QCPU (A mode) or A series motion controller CPU

(○: Available, △: Partly restricted, ×: Unavailable)

Function		Connection form between GOT and controller											Reference section	
Name	Description	Bus connection		Direct CPU connection	Computer link connection	Ethernet connection		MELSEC NET/10 connection		CC-Link connection				
		GT16 GT15 GT11	GT14 GT12	GT16 GT15 GT14 GT12 GT11	GT16 GT15 GT14 GT12 GT11	GT16 GT15 GT14 GT12	GT11	GT16 GT15	GT14 GT12 GT11	ID*3		GT16 GT15 GT14 GT12 GT11		
										GT16 GT15	GT11			
Entry monitor	Monitoring present values by entering devices to be monitored in advance	○	×	○	△ ⁺²									2.5
Batch monitor	Monitoring the present value of n devices from a specified device	○	×	○	△ ⁺²									2.6
TC monitor	Monitoring the present value, set value, contact point, and coil of m devices from a specified device	△ ⁺¹	×	△ ⁺¹	△ ⁺¹									2.7
BM monitor	Monitoring the present value of x devices in specified buffer memory of a specified intelligent function module	△ ⁺¹	×	△ ⁺¹	△ ⁺¹									2.8
Data change by test operation	Setting/Resetting bit devices				○	○	×			×	○	×	×	2.9
	Changing the present value of word devices and buffer memory				△ ⁺²									
	Changing the present value of TC (possible during TC monitoring)				○									
	Changing the set value of TC (possible during TC monitoring)	○	×	○	○					○				
Quick test	Changing device values by performing a quick test				△ ⁺²									2.4.5
Display switching	Displaying device comments				○									2.4.4
	Displaying word device and buffer memory values in decimal or hexadecimal				○									

- *1 These items cannot be monitored when an A motion controller CPU is monitored.
- *2 V, Z, and A cannot be monitored, or their present values cannot be changed.
- *3 Indicates CC-Link connection (Intelligent device station).
- *4 Indicates CC-Link connection (via G4).

1	OVERVIEW
2	SYSTEM MONITOR
3	LADDER MONITOR
4	FUNCTION
5	MELSEC-A LIST EDITOR
6	MELSEC-FX LIST EDITOR
7	INTELLIGENT MODULE MONITOR
8	NETWORK MONITOR
9	Q MOTION MONITOR

(5) When the GOT is connected to an FXCPU

(○: Available, △: Partly restricted, ×: Unavailable)

Function		Connection form between GOT and controller			Reference section
Name	Description	Direct CPU connection	Ethernet connection		
		GT16 GT15 GT14 GT12 GT11	GT16 GT15 GT14 GT12	GT11	
Entry monitor	Monitoring present values by entering devices to be monitored in advance	△ ^{*1}	△ ^{*1}	×	2.5
Batch monitor	Monitoring the present value of n devices from a specified device	△ ^{*1}	△ ^{*1}	×	2.6
TC monitor	Monitoring the present value, set value, contact point, and coil of m devices from a specified device	○	○	×	2.7
BM monitor	Monitoring the present value of x devices in specified buffer memory of a specified special function unit/block	○	×	×	2.8
Data change by test operation	Setting/Resetting bit devices	○	○	×	2.9
	Changing the present value of word devices and buffer memory	△ ^{*1}	△ ^{*1+2}		
	Changing the present value of TC (possible during TC monitoring)	○	○		
	Changing the set value of TC (possible during TC monitoring)	○	○		
Quick test	Changing device values by performing a quick test	△ ^{*1}	△ ^{*1}	×	2.4.5
Display switching	Displaying device comments	×	×	×	2.4.4
	Displaying word device and buffer memory values in decimal or hexadecimal	△ ^{*1}	△ ^{*1+2}		

*1 The monitor and values of V and Z cannot be changed.

*2 Not compatible with buffer memory.

(6) When the GOT is connected to a remote I/O station of MELSECNET/H system

(○: Available, △: Partly restricted, ×: Unavailable)

Function		Connection form between GOT and controller							Reference section
Name	Description	Bus connection	Direct CPU connection	Computer link connection	Ethernet connection	MELSECNET/H connection, MELSEC NET/10 connection	CC-Link connection		
							ID*2	G4*3	
		GT16 GT15 GT14 GT12 GT11	GT16 GT15 GT14 GT12 GT11	GT16 GT15 GT14 GT12 GT11	GT16 GT15 GT14 GT12 GT11	GT16 GT15 GT14 GT12 GT11	GT16 GT15 GT14 GT12 GT11	GT16 GT15 GT14 GT12 GT11	
Entry monitor	Monitoring present values by entering devices to be monitored in advance								2.5
Batch monitor	Monitoring the present value of n devices from a specified device								2.6
TC monitor	Monitoring the present value, set value, contact point, and coil of m devices from a specified device			○					2.7
BM monitor	Monitoring the present value of x devices in specified buffer memory of a specified intelligent function module								2.8
Data change by test operation	Setting/Resetting bit devices	×	○		×	×	×	×	2.9
	Changing the present value of word devices and buffer memory			△*1					
	Changing the present value of TC (possible during TC monitoring)								
	Changing the set value of TC (possible during TC monitoring)*4								
Quick test	Changing device values by performing a quick test			○					2.4.5
Display switching	Displaying device comments								2.4.4
	Displaying word device and buffer memory values in decimal or hexadecimal								

- *1 The present value of V and Z cannot be changed.
- *2 Indicates CC-Link connection (Intelligent device station).
- *3 Indicates CC-Link connection (via G4).
- *4 When a QCPU redundant system is used, data of the set value cannot be changed.

1	OVERVIEW
2	SYSTEM MONITOR
3	LADDER MONITOR FUNCTION
4	MELSEC-A LIST EDITOR
5	MELSEC-FX LIST EDITOR
6	INTELLIGENT MODULE MONITOR
7	NETWORK MONITOR
8	Q MOTION MONITOR

(7) When the GOT is connected to a MELDAS C6/C64

(○: Available, △: Partly restricted, ×: Unavailable)

Function		Connection form between GOT and controller											Reference section	
Name	Description	Bus connection GT16 GT15 GT14 GT12 GT11	Direct CPU connection		Computer link connection GT16 GT15 GT14 GT12 GT11	Ethernet connection		MELSECNET/10 connection		CC-Link connection				
			GT16 GT15 GT14 GT12	GT11		GT16 GT15 GT14 GT12	GT11	GT16 GT15	GT14 GT12 GT11	ID*1		G4*2		
Entry monitor	Monitoring present values by entering devices to be monitored in advance													2.5
Batch monitor	Monitoring the present value of n devices from a specified device													2.6
TC monitor	Monitoring the present value, set value, contact point, and coil of m devices from a specified device													2.7
BM monitor	Monitoring the present value of x devices in specified buffer memory of a specified intelligent function module													2.8
Data change by test operation	Setting/Resetting bit devices	×		×	×		×		×	×		×	×	2.9
	Changing the present value of word devices and buffer memory													
	Changing the present value of TC (possible during TC monitoring)													
	Changing the set value of TC (possible during TC monitoring)													
Quick test	Changing device values by performing a quick test													2.4.5
Display switching	Displaying device comments													2.4.4
	Displaying word device and buffer memory values in decimal or hexadecimal													

*1 Indicates CC-Link connection (Intelligent device station).

*2 Indicates CC-Link connection (via G4).

■ Required Extended function OS

About the extended function OS and the option boards, see the following:

 1.1.2 Hardware and OS' required for each function

(1) Install the Extended function OS.

Install System monitor (Extended function OS) in the GOT.

For a detailed installation procedure, see the following:

 1.1.3 Outline of procedure to the operation of each function

Before transferring data from GT Designer 2 to the GOT (installing OS', downloading project data), it is necessary to confirm the free capacity of the user area in the specified drive and the size of the data to be transferred.

For further information, see the following:

 GT Designer3 Version1 Screen Design Manual (Fundamentals)

2.2.2 Devices that can be monitored

For further information about the monitor device names that can be monitored and the scope, see the following:

 GOT1000 Series Connection Manual (Mitsubishi Products) for GT Works3

2.2.3 Access range

With Universal model QCPU, the GOT can monitor up to 64 stations.

When the GOT is connected to the remote I/O station in MELSECNET/H network system, only the master station can be monitored.

For details of the access range, refer to the following.

 GOT1000 Series Connection Manual (Mitsubishi Products) for GT Works3

2.2.4 Precautions

(1) Monitoring and testing real number data

Real number data cannot be monitored and tested.

All word devices containing real number data are monitored in integer data (binary data).

(2) Monitoring devices in 32-bit (two-word) module

When monitoring word devices (T, C, D, W, etc.) in 32-bit (two-word) module, those with 32 bits of data remaining are monitored.

Devices with 16 bits (one-word) of data remaining are not monitored.

If an odd number is specified for the first monitor device number, the last device number of the specified controller will not be displayed.

(Example) When the data entry of the A2NCPU is monitored in units of 32 bits from odd numbers (D1, D3 ...)

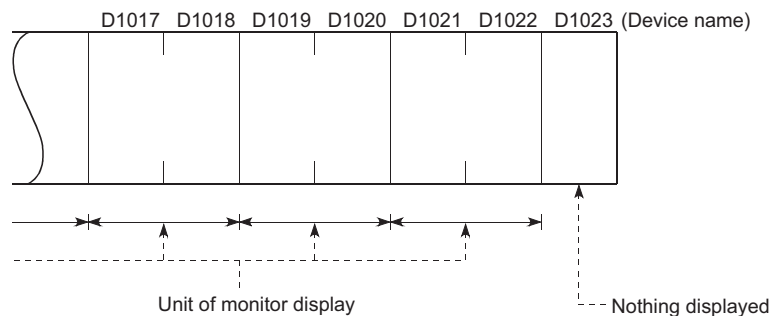

(3) Changing the T/C set values of large-size and small-size QnACPU and displaying device comments

The T/C set values of QnACPU whose date on the CPU rating plate is after [9707B] can be changed, and device comments can be displayed.

<Information on the rating plate>

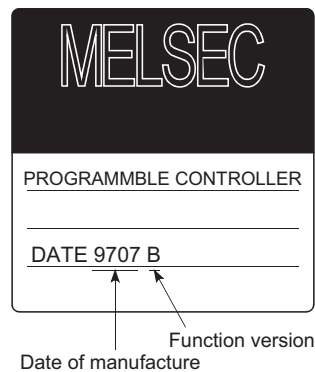

(4) Programs capable of changing timer/counter set values

- Only the main program can change the timer/counter set values of AnNCPUs, AnACPU, and AnUCPU.
- When executing multiple programs with the QCPU (Q mode) and QnACPU, setting values of timer/counter can be changed only to the program (scan execution type program set at the lowest number among them in parameter settings of GX Developer) whose file name is displayed on the TC Monitor screen.
Note that a file to be displayed cannot be changed on the GOT.

(5) Z0 of QCPUs and QnACPU and Z0 and V0 of ACPUs

- Z0 of QCPUs and QnACPU and Z0 and V0 of ACPUs are displayed as Z and V respectively.

2.3 Operation for Display

This subsection describes the flow until the system monitor function screen is displayed after System monitor (Extended function OS) is installed in the GOT.

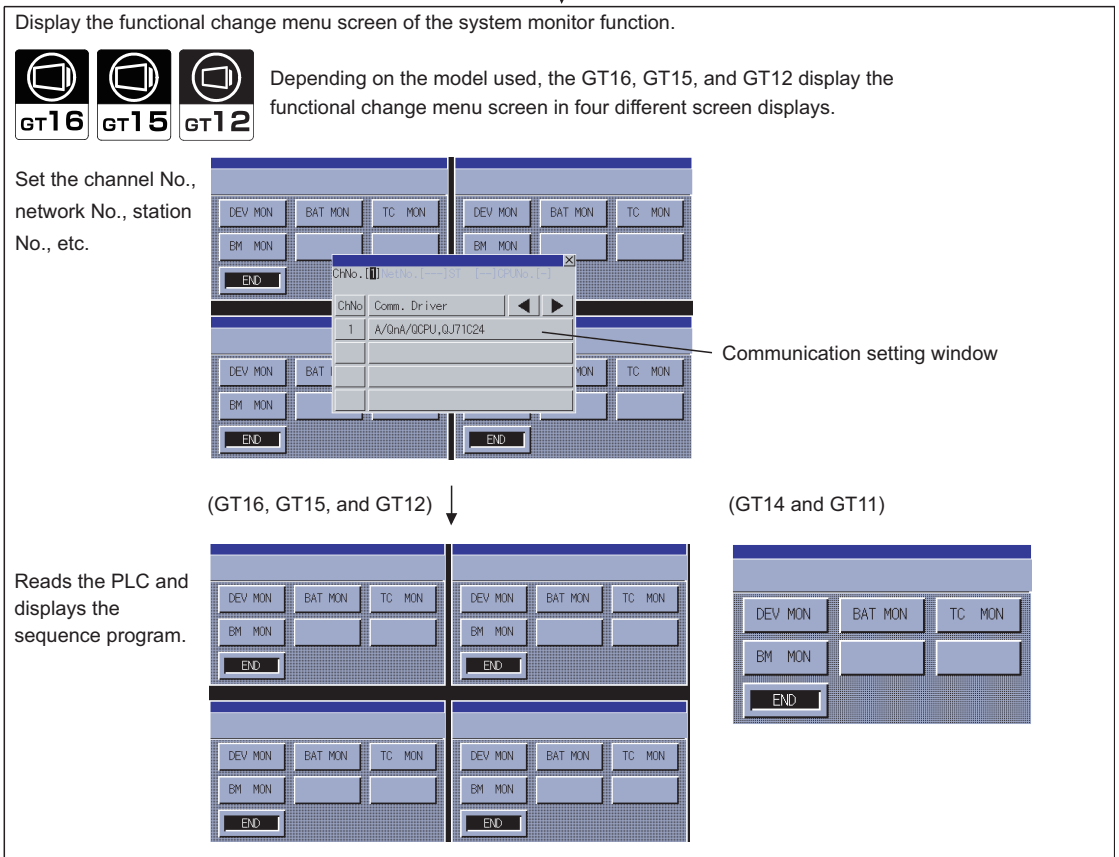
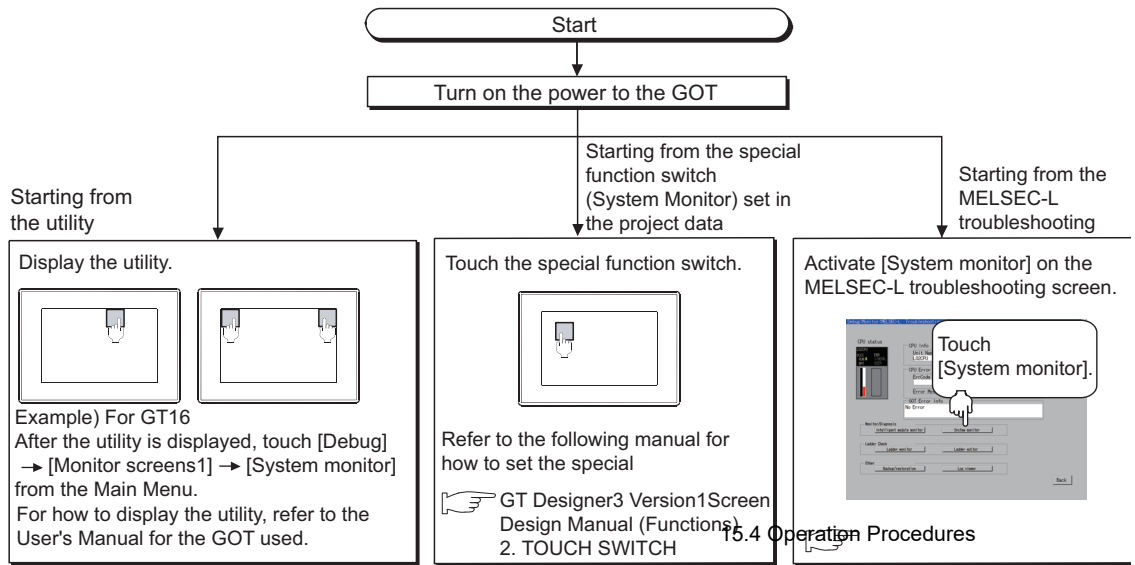

(Continued to next page)

From previous page

Changing monitor screen from full mode to quad mode (For GT1655-V and GT1555-V)

For the GT1655-V and GT1555-V, the monitor screen can be switched between the full and quad modes with the button for switching the number of monitor screens. When the monitor screen is switched to the full mode, the GOT displays a monitor screen displayed on the upper left in the quad mode in the full mode.*1

When starting the system monitor, the GOT displays the monitor screen in the full mode.

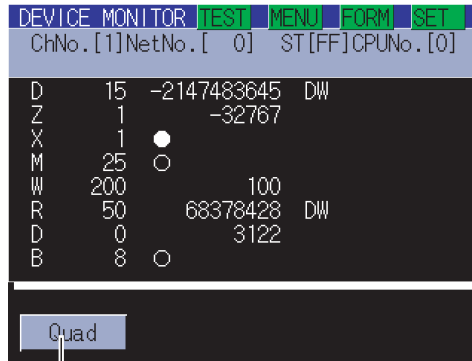

The button for switching the number of monitor screens

The monitor screen is switched between the full and quad modes with the button for switching the number of monitor screens.

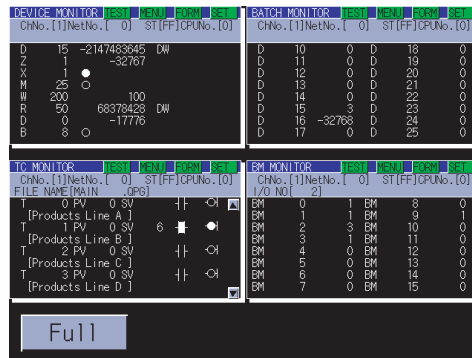

*1 The monitor screen in the full mode is four times bigger than each monitor screen in the quad mode. For displaying screens commonly used in the system, including the key window, the monitor screen size in the full mode is the same as each monitor screen size in the quad mode.

POINT

(1) How to display the utility

For how to display the utility, refer to the following.

User's Manual for the GOT used

(2) Displaying the start screen on the GT16, GT15, GT14, and GT12

If you reactivate the system monitor function without turning off the power to the GOT, the last displayed screen appears.

(3) Displaying communication setting window

After turning on the GOT, the communication setting window is displayed at the first startup of the system monitor only.

For displaying the communication setting window at the second or later startup, touch the **[ENTRY]** button on the system monitor screen.

(4) If the project data has not been downloaded

The system monitor can be started from the utility even if the project data has not been downloaded to the GOT.



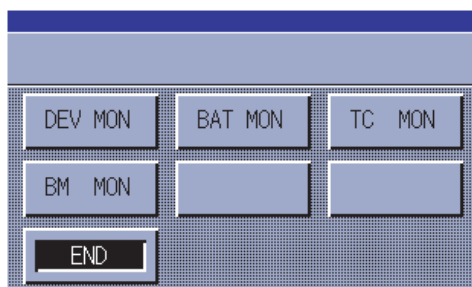

2.4 Operation Procedure Common to the System Monitor Screens

2.4.1 Functional change menu screen

This subsection describes the configuration of the functional change menu screen and the functions of the keys displayed on it.



The table below describes the functions of the keys displayed on the functional change menu screen.

Key	Function
DEV MON	Performs entry monitoring in the Entry Monitor window.  2.5 Entry Monitor
BAT MON	Performs batch monitoring in the Batch Monitor window.  2.6 Batch Monitor
TC MON	Performs TC monitoring in the TC Monitor window.  2.7 TC Monitor (Monitoring Timers and Counters)
BM MON	Performs buffer memory monitoring in the BM Monitor window.  2.8 BM Monitor (Monitoring Buffer Memory)
END	The system monitor function is deactivated, and the screen returns to Main Menu of the utility. If the system is activated from the User screen, the screen returns to it.

2.4.2 Entering monitor devices (specifying monitor stations and devices)

This subsection describes how to specify network numbers, monitor stations, and monitor devices by taking the Entry Monitor window as an example.

The procedure for specifying network numbers, monitor stations, and monitor devices is the same even if other items than the "entry monitor."

(Example) Entering a monitor device when the entry monitor is used

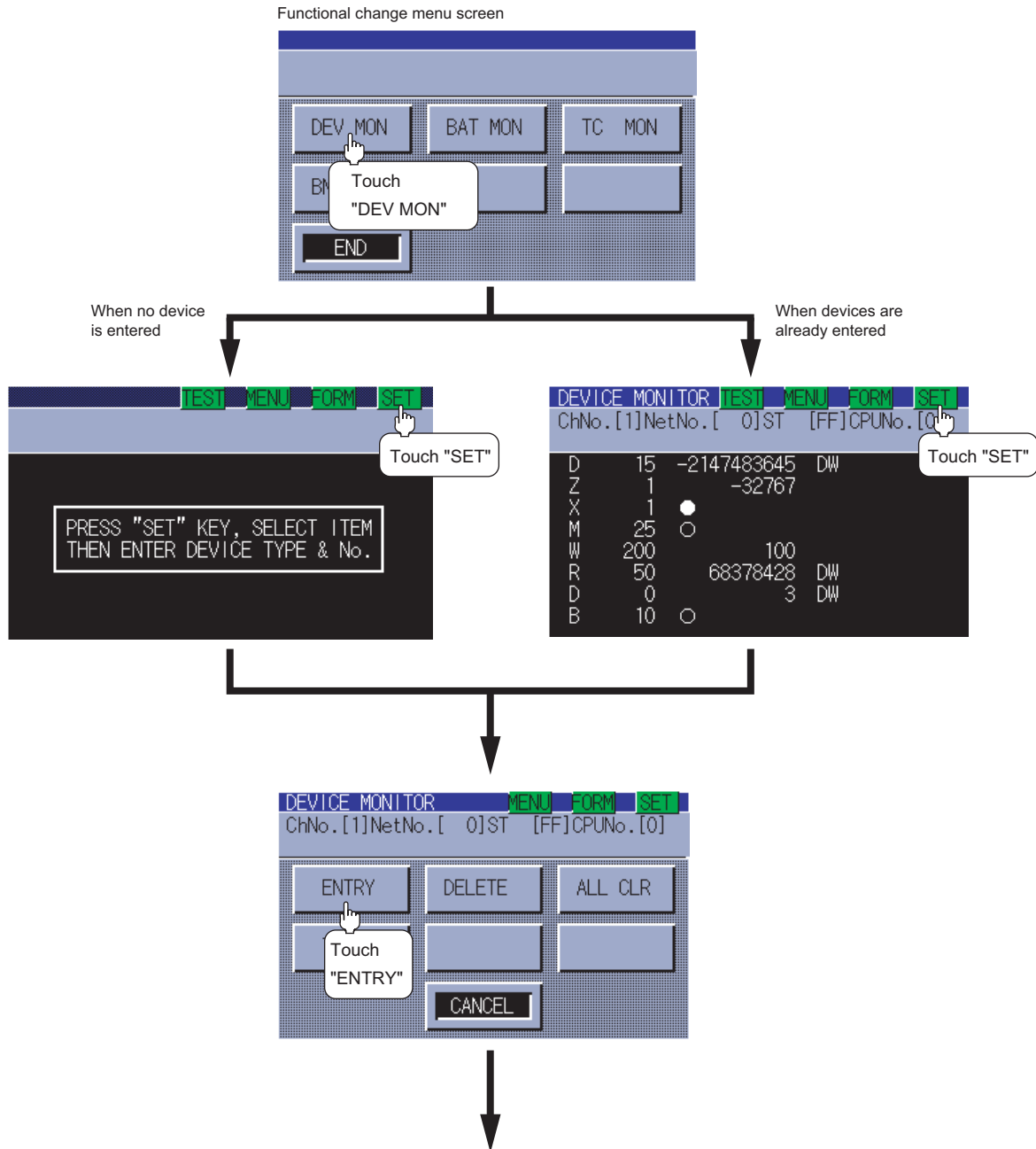

(From previous page)

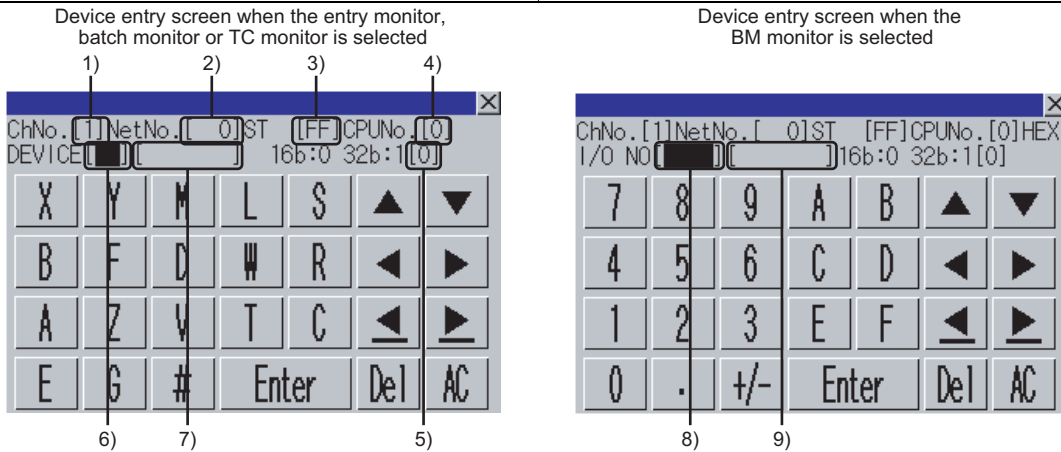

Set 1) to 9) as shown in the table below, and then touch the **Enter** key.
For the operation of key windows, see the following:

2.4.3 Key window setting columns and operation procedure

No.	Item	Description of setting						
		Bus connection	Direct CPU connection	Computer link connection	Ethernet connection	MELSECNET/H connection, MELSECNET/10 connection	CC-Link connection	
							ID*2	G4*3
1)*1	Channel No.	Sets the channel number of the controller targeted to the system monitor.						
2)	Network No.		0		1 to 239	0: Host loop 1 to 255: Specified loop		0
3)*4	Station No.		FF		1 to 64	FF: When the host station is selected 0: When the control station is selected 1 to 64: When a normal station is selected	FF: When the host station is selected 0: When the master station is selected 1 to 64: When a local station is selected	
4)	CPU No.	0 to 4: This item must be set only when the system is connected to multiple QCPUs. It is not necessary when the system is connected to another CPU.						
5)	Data range	1: Indicates that the device value is a 32-bit (two-word) module. 0: Indicates that the device value is a 16-bit (one-word) module.						
6)*1	Device name	Set the name and number of the device to be monitored.						
7)*1	Device number							
8)*1	I/O number	When the initial I/O signal of module is displayed with three digits, specify the first two digits.						
9)*1	Initial device number	Set the initial device number of the buffer memory in decimal.						

*1 For devices that can be set, see the following:

GT Designer 3 Version1 Screen Design Manual (Fundamentals)

*2 Indicates CC-Link connection (Intelligent device station).

*3 Indicates CC-Link connection (via G4).

*4 When the station No. is set to the host station (FF), set the network No. to 0.

POINT

Displaying the data range

The Entry Monitor, Batch Monitor, TC Monitor, and BM Monitor screens display the data range as shown below.

- DW: 32-bit (two-word) module
- Nothing displayed: 16-bit (one-word) module

(Continued to next page)

(From previous page)

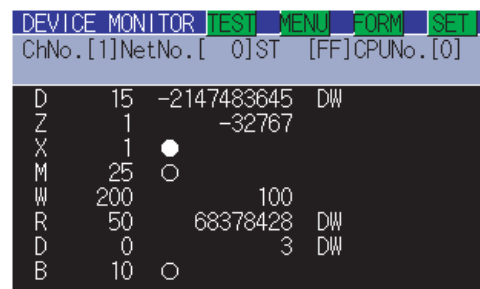
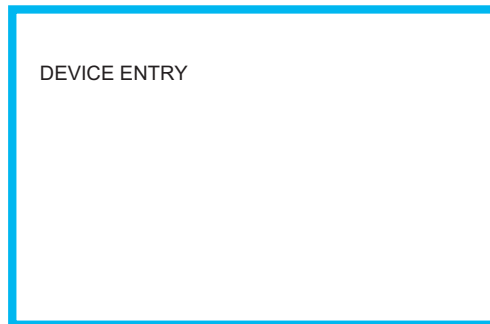

POINT

(1) Retaining entered information

If the system monitor function is reactivated without turning off the power to the GOT, the last displayed information will be retained.

If the power to the GOT is turned on again and the system monitor function is reactivated, the last displayed information will be deleted.

(2) Entry unit of monitor devices

Each monitor device is entered in a combination of a network number and a CPU station number. If the CPU station number is changed, the entered monitor device will become invalid.

2.4.3 Key window setting columns and operation procedure

■ Operating the key window

1. Using the ◀ and ▶ keys, move the cursor to the item you want to set.
The displayed keyboard depends on the position of the cursor as shown below.

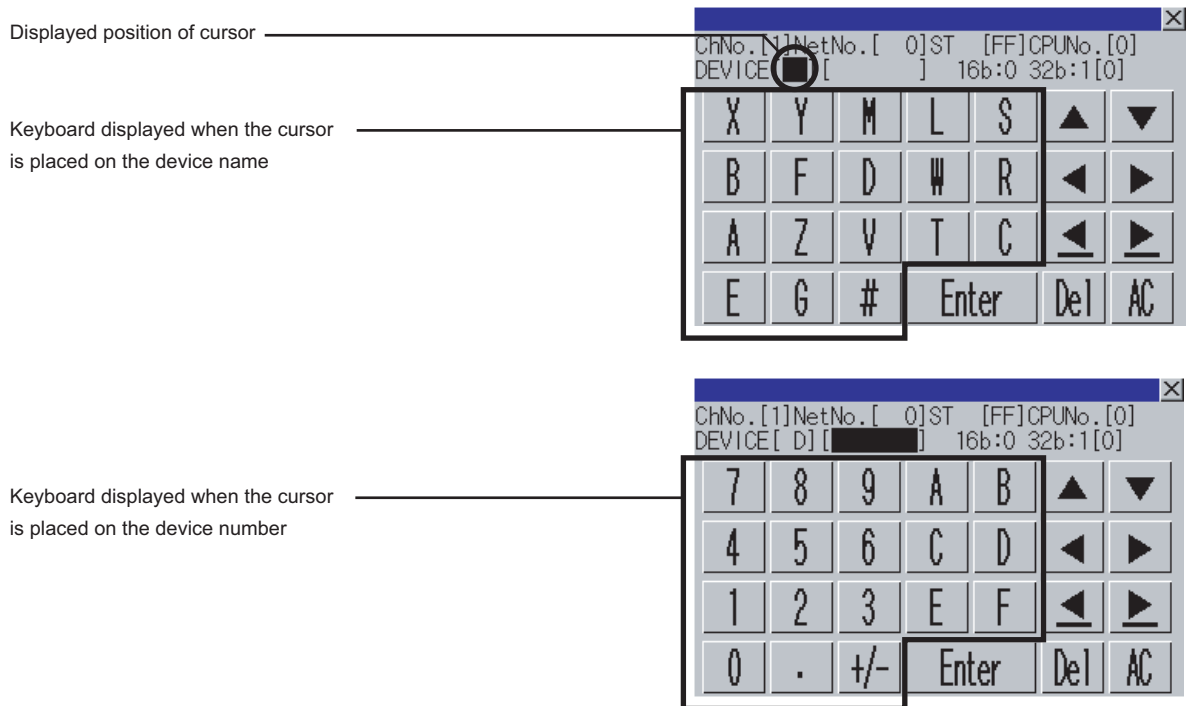

2. If necessary, enter numbers or characters from the keyboard.
 - **Del** key: Used to delete a character of the entered information.
 - **AC** key: Used to delete all characters under the cursor.
 - The ▲/▼ keys without a description do not function.
3. Entry is completed by touching the **Enter** key.
The keyboard closes by touching the **×** key.

2.4.4 Switching the display format (DEC/HEX) and comment/no-comment display

This subsection describes how to switch the display format and comment/no-comment display.

The Entry Monitor window is taken here as an example to describe the specification of a monitor station and a monitor device when the system monitor function is executed.

The procedure for switching the display format (DEC/HEX) and comment display when another item is selected. (Example of switching when the entry monitor is selected)

Switching the display format from DEC to HEX

Switching no-comment display to comment display

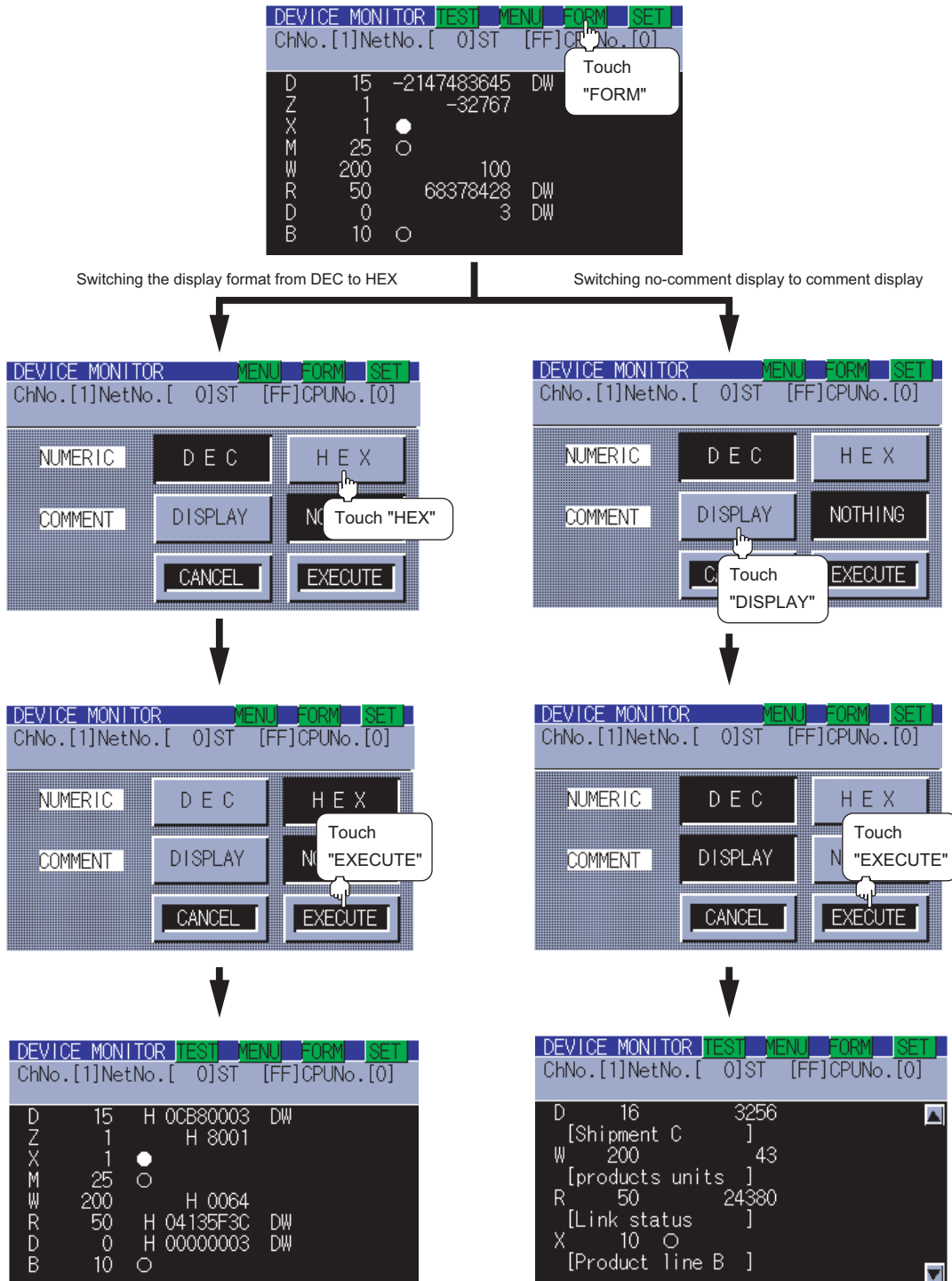

POINT

(1) Changing the comment or comment capacity of the controller

If you change a comment or comment capacity of the controller after the system monitor function is activated, the comment may not be properly displayed on each monitor screen.

After a comment or comment capacity is changed, turn off the GOT and turn it on again.

(2) Switching the display format (DEC/HEX)

The present value of word devices and the present value and set value of timers/counters will be displayed in decimal or hexadecimal numbers.

(3) Switching comment/no-comment display

The comments written to the target controller will be displayed or not be displayed.

(Priority of comment display: Extension comment > Comment)

(4) Comment/No-comment display

(a) The BM monitor does not display comments.

(b) Comments will not be displayed when any of the CPUs listed below is monitored.

- FXCPU
- QnACPU or Q series motion controller CPU whose date on the rating plate is earlier than 9707B

(c) Comments will not be displayed when any of the devices listed below is monitored.

- Internal device of the GOT (GB, GD, GS)
- Host device (B, W, SB, SW) when the MELSECNET/H or MELSECNET/10 is connected
- Host device (X,Y, WW, WR) when a CC-Link is connected

(d) Displaying the comments of QCPUs (Q02CPU, Q02HCPU, Q06HCPU, Q12HCPU, Q25HCPU, Q12PHCPU, Q25PHCPU, Q12PRHCPU, Q25PRHCPU, Q02UCPU, Q03UDCPU, Q04UDHCPU, Q06UDHCPU)

Comments will not be displayed when the following PLC parameters (PLC file settings) are set:

- When the comment file is set to "Not used"
- When the comment file is set to "Use the same file name as the program"
- When a password is set to the comment file
- When a comment file is stored in program memory

(e) Displaying the comments of QCPUs (Q00JCPU, Q00CPU, Q01CPU)

Comments will not be displayed when the following PLC parameter (PLC file setting) is set:

- When the comment file "MAIN" does not exist in the program memory

(f) Displaying the comments of QnACPU

With a QnACPU whose date on the rating plate is earlier than 9707B, comments cannot be displayed. Use a QnACPU whose date on the rating plate is 9707B or later.

Also, comments will not be displayed when the following settings are made to the PLC parameter (PLC file setting) is set.

- When the comment file is not set "Not used"
- When the comment file is set to "Use the same file name as the program"
- When a keyword is entered for each memory

2.4.5 Quick test operation of monitor devices

WARNING

- Before performing the quick test operations of the system monitor function (such as turning ON or OFF bit device, changing the word device current value, changing the settings or current values of the timer or counter, and changing the buffer memory current value), read through the manual carefully and make yourself familiar with the operation method.
During quick test operation, never change the data of the devices which are used to perform significant operation for the system.
False output or malfunction can cause an accident.

The quick test operation procedure for monitor devices is described below.

The Entry Monitor screen is taken as an example to describe quick test operation when the system monitor function is executed.

The operation procedure is the same even if the batch monitor, TC monitor or BM monitor is selected.

(Example of quick test operation when the entry monitor is selected)

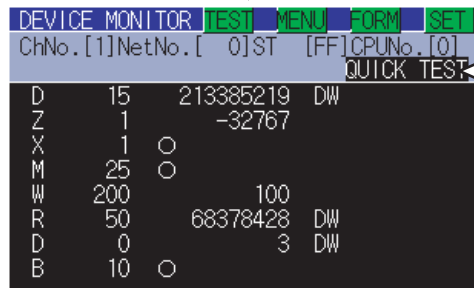
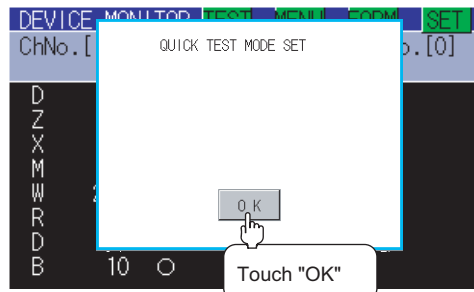
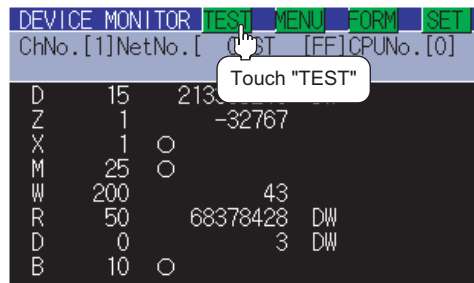

(1) Quick test of bit devices

(Operation example)

Change the status of bit device X001 from off (○) to on (●).

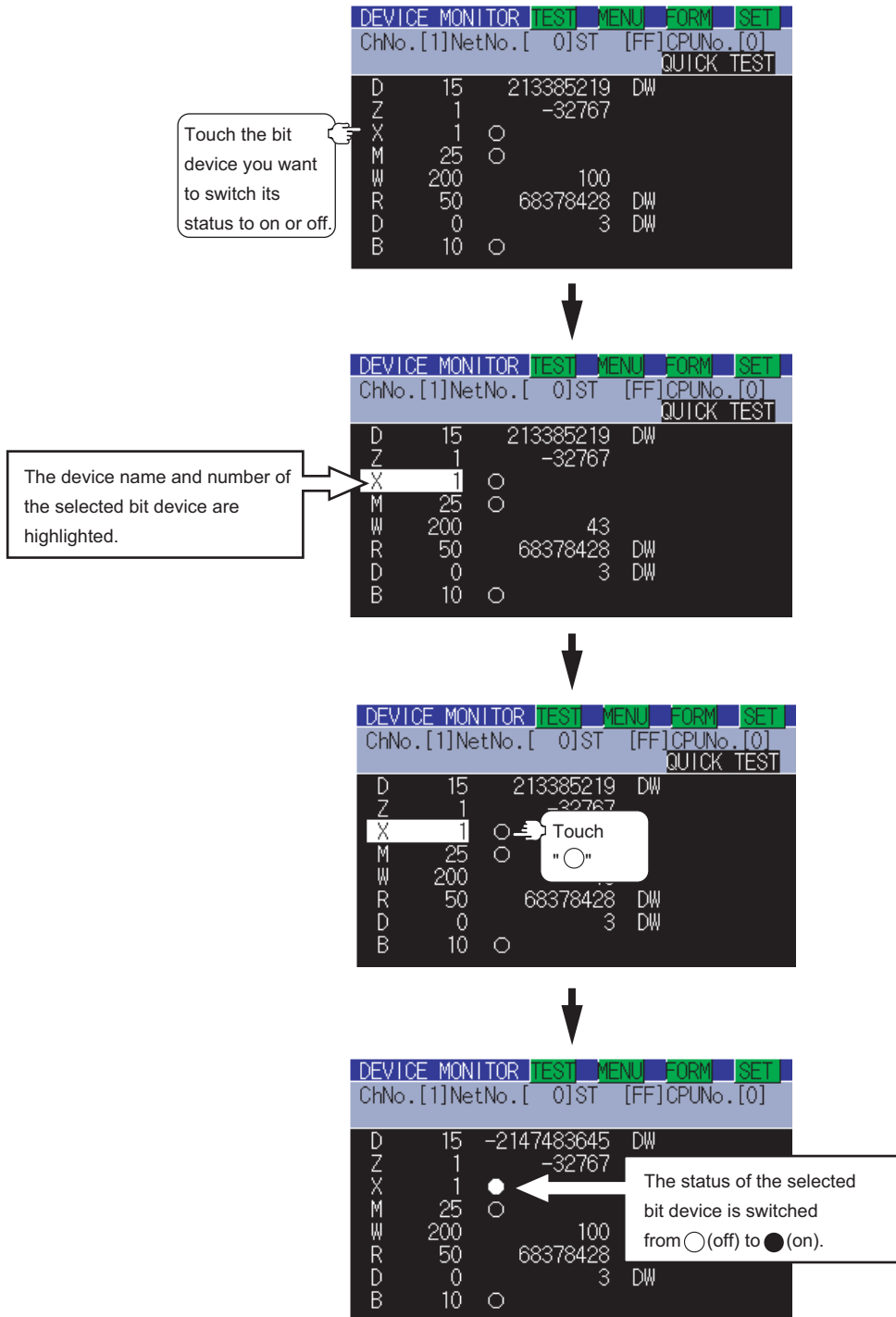

(2) Quick test of word devices

(Operation example)

Change the device value of word device W200 from 43 to 100.

Conditions: Data range: 16 bits, device value display format: decimal number

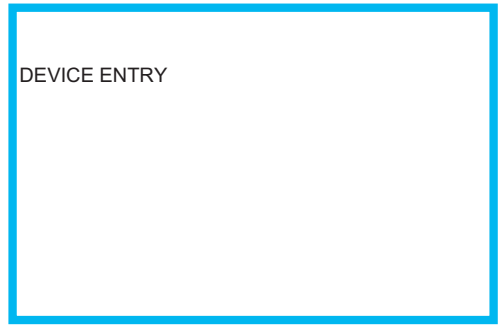
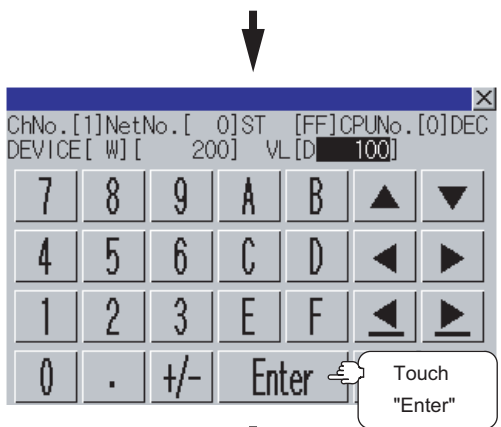
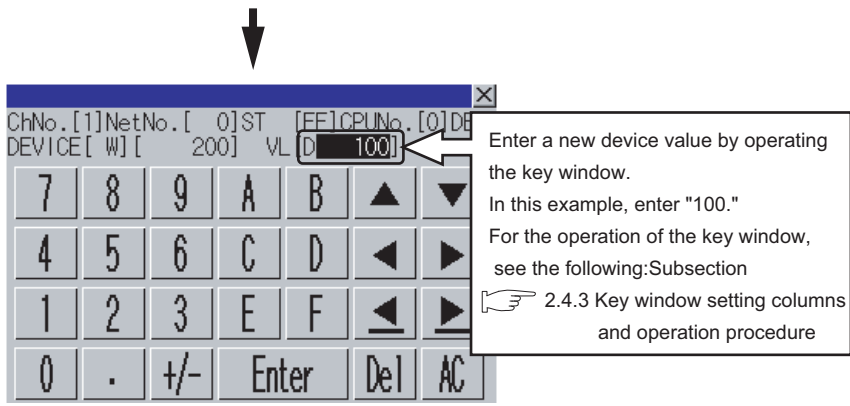

(Continued to next page)

(From previous page)

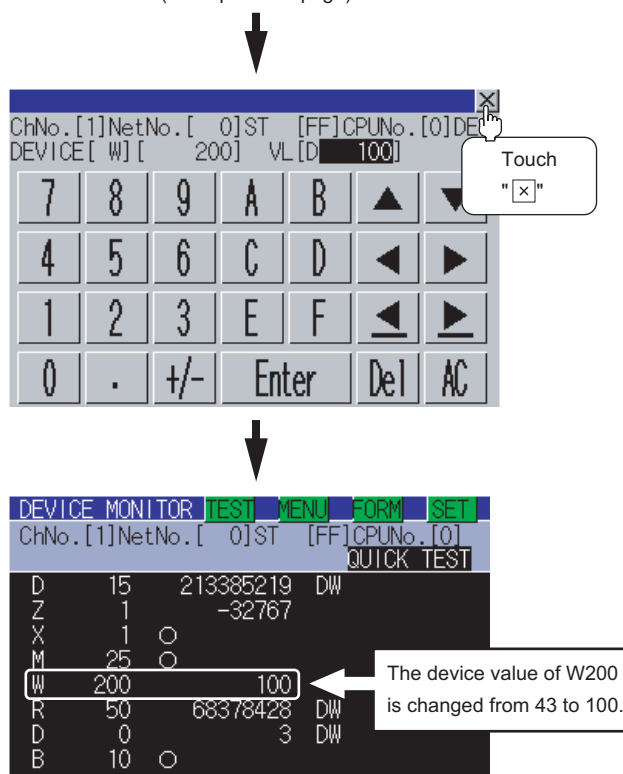

POINT

Effective number of digits of device values that can be changed

If an entered value exceeds the corresponding number of digits specified below, the device value cannot be changed.

[Decimal number]

16-bit (one-word) module : Six digits (including a digit for a sign)

32-bit (two-word) module : Ten digits (including a digit for a sign)

[Hexadecimal number]

16-bit (one-word) module : Four digits

32-bit (two-word) module : Eight digits

2.4.6 Changing screens

This subsection takes the entry monitor as an example to describe how to change screens.

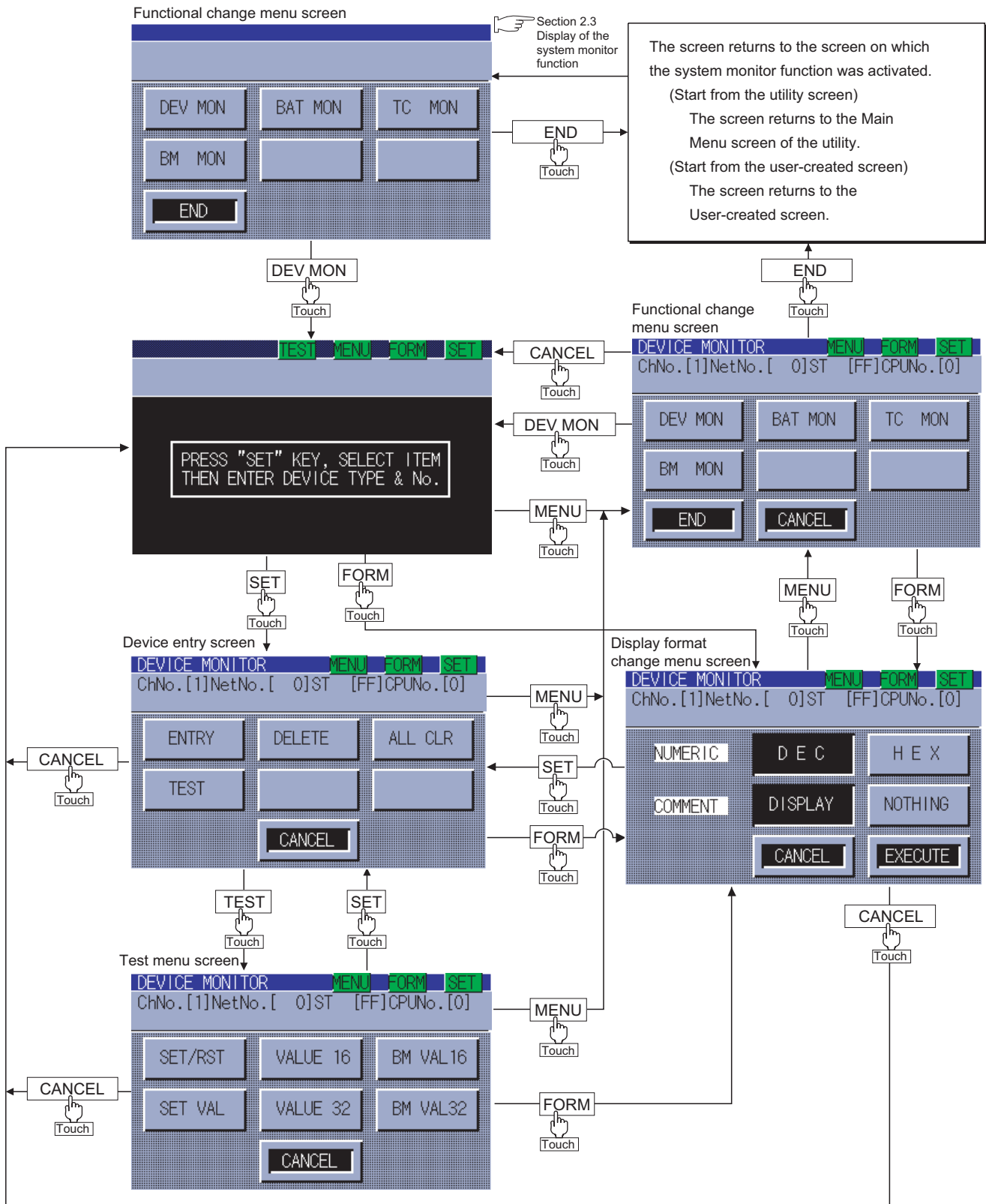

2.5 Entry Monitor

The device monitor is a function to enter devices to be monitored in advance and monitor only entered devices. This section describes how to activate the entry monitor when the system monitor function is executed.

2.5.1 Information displayed on the Entry Monitor screen and key functions





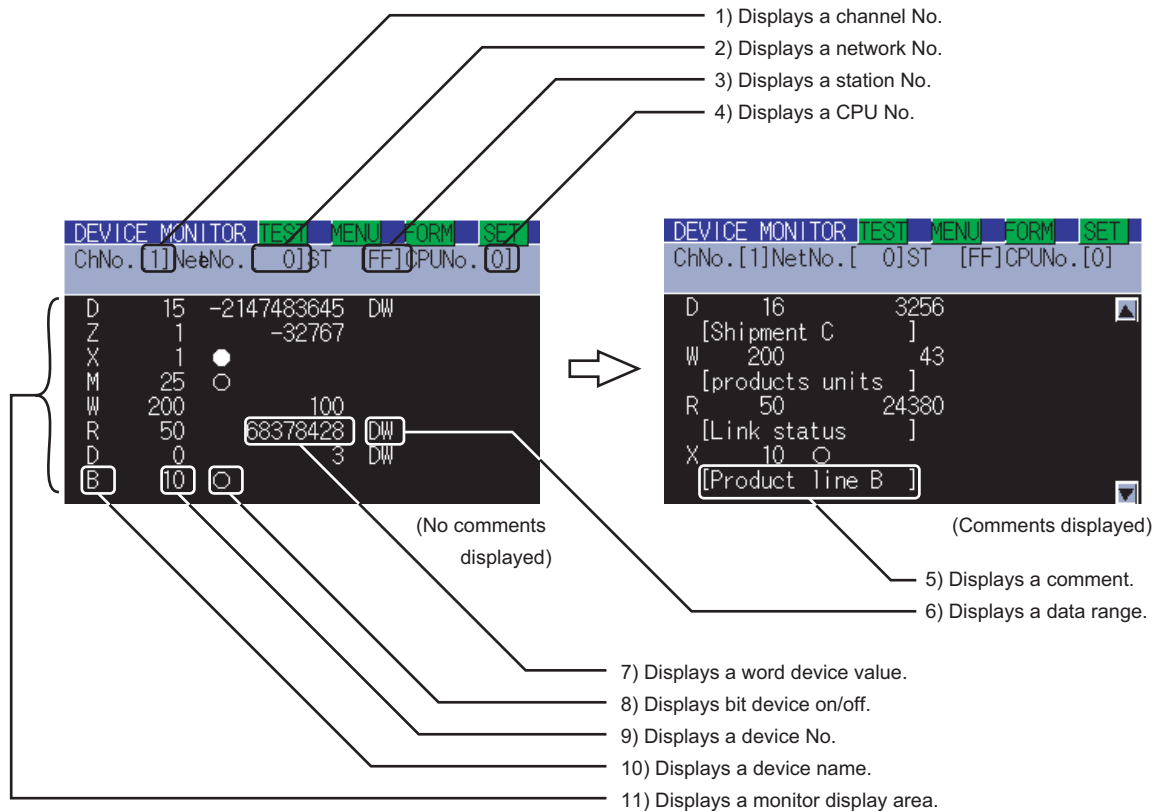









(1) The information displayed on the Entry Monitor screen is described below.

For the key functions, see the page that follows.



For further information about items 1) to 11) shown above, see the page that follows.

(2) The following table describes the key functions displayed on the Entry Monitor screen.

Key switch	Function
	Activates the Quick test operation.  2.4.5 Quick test operation of monitor devices
	Switches the screen to the functional change menu screen to activate another monitor function or terminate the system monitor function.  2.4.6 Changing screens
	Switches the screen to the display format switching screen to change the value display format (DEC/HEX) on the Entry Monitor screen or comment/no-comment display.  2.4.4 Switching the display format (DEC/HEX) and comment/no-comment display
	Switches the screen to the Device entry screen to enter monitor devices or delete or test entry devices. <ul style="list-style-type: none"> • Entering monitor devices :  2.4.2 Entering monitor devices (specifying monitor stations and devices) • Deleting entry devices :  2.5.3 Deleting entry devices • Test operation :  2.9 Test Operation
 	Scroll displayed information upward or downward by a line to display the preceding or next monitor device that is not currently displayed. When five or more monitor devices are entered, these switches are available when their comments are displayed. <ul style="list-style-type: none">  : Scrolls information upward by a line.  : Scrolls information downward by a line.

(3) The following table below describes the range of display of items 1) to 11) displayed

No.	Item	Description of setting						
		Bus connection	Direct CPU connection	Computer link connection	Ethernet connection	MELSECNET/H connection, MELSECNET/10 connection	CC-Link connection	
							ID*1	G4 *2
1)	Channel No.	Sets the channel number of the controller targeted to the entry monitor.						
2)	Network No.	0			1 to 239	0: Host loop 1 to 255: Specified loop	0	
3)	Station No.	FF			1 to 64	FF: When the host station is selected 0: When the control station is selected 1 to 64: When a normal station is selected	FF: When the host station is selected 0: When the master station is selected 1 to 64: When a local station is selected	
4)	CPU No.	0 to 4: This item must be set only when the system is connected to multiple QCPUs. It is not necessary when the system is connected to another CPU.						
5)	Comment	Displays a comment (maximum number of characters: 16 one-byte characters) A comment is displayed when "DISPLAY" is selected for comment display on the display format switching screen.						
6)	Data range	DW : Indicates that the device value is a 32-bit (two-word) module. Nothing displayed : Indicates that the device value is a 16-bit (one-word) module.						
7)	Word device value	[Decimal number] 16-bit (one-word) module : Six digits (including a digit for a sign) are displayed. (Display example: -12345) 32-bit (two-word) module : Ten digits (including a digit for a sign) are displayed. (Display example: -123456789) [Hexadecimal number] 16-bit (one-word) module : Four digits are displayed. (Display example: H AB12) 32-bit (two-word) module : Eight digits are displayed. (Display example: H ABCDE123)						
8)	Bit device ON/OFF	○ : ON ● : OFF						
9)	Device No.	Up to eight devices can be monitored with regard to each CPU station number. For further information about device numbers and names that can be entered:  GOT1000 Series Connection Manual (Mitsubishi Products) for GT Works3						
10)	Device name							
11)	Monitor display area	When no comments are displayed : Up to eight devices can be displayed. When comments are displayed : Up to four devices can be displayed.						

*1: Indicates CC-Link connection (Intelligent device station).

*2: Indicates CC-Link connection (via G4).

1 OVERVIEW
2 SYSTEM MONITOR
3 LADDER MONITOR FUNCTION
4 MELSEC-A LIST EDITOR
5 MELSEC-FX LIST EDITOR
6 INTELLIGENT MODULE MONITOR
7 NETWORK MONITOR
8 Q MOTION MONITOR

2.5.2 Procedure for entry monitor basic operation

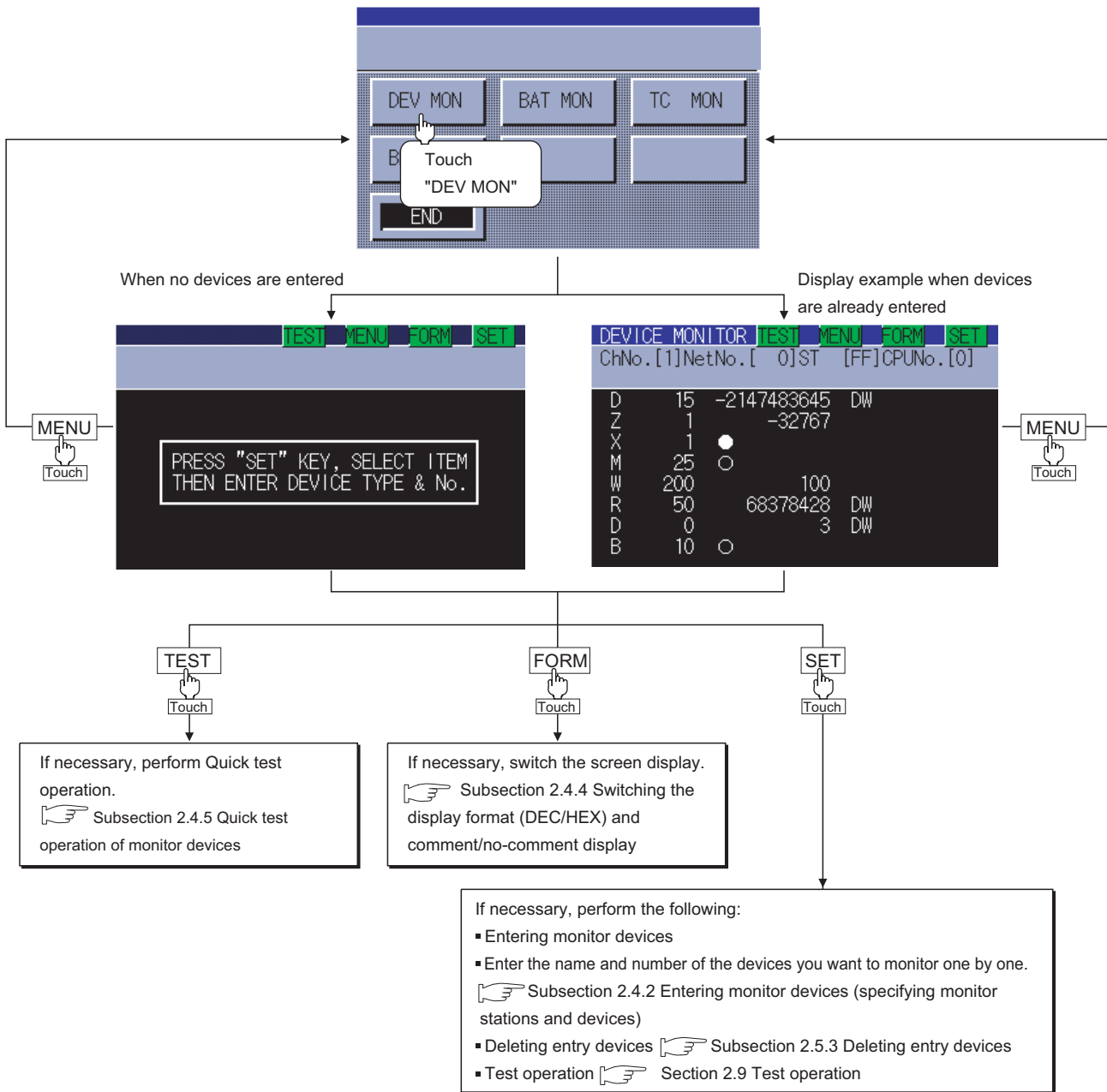

POINT

If more than eight devices are registered

You can register up to eight entry devices.

If more than eight devices are registered, the oldest ones will be deleted one by one, and the eight latest entry devices will be monitored.

If necessary, delete unnecessary entry devices and re-enter ones you want to monitor.

2.5.3 Deleting entry devices

This subsection describes how to delete entry devices.
Deleting entry devices with the system monitor function executed is described below.

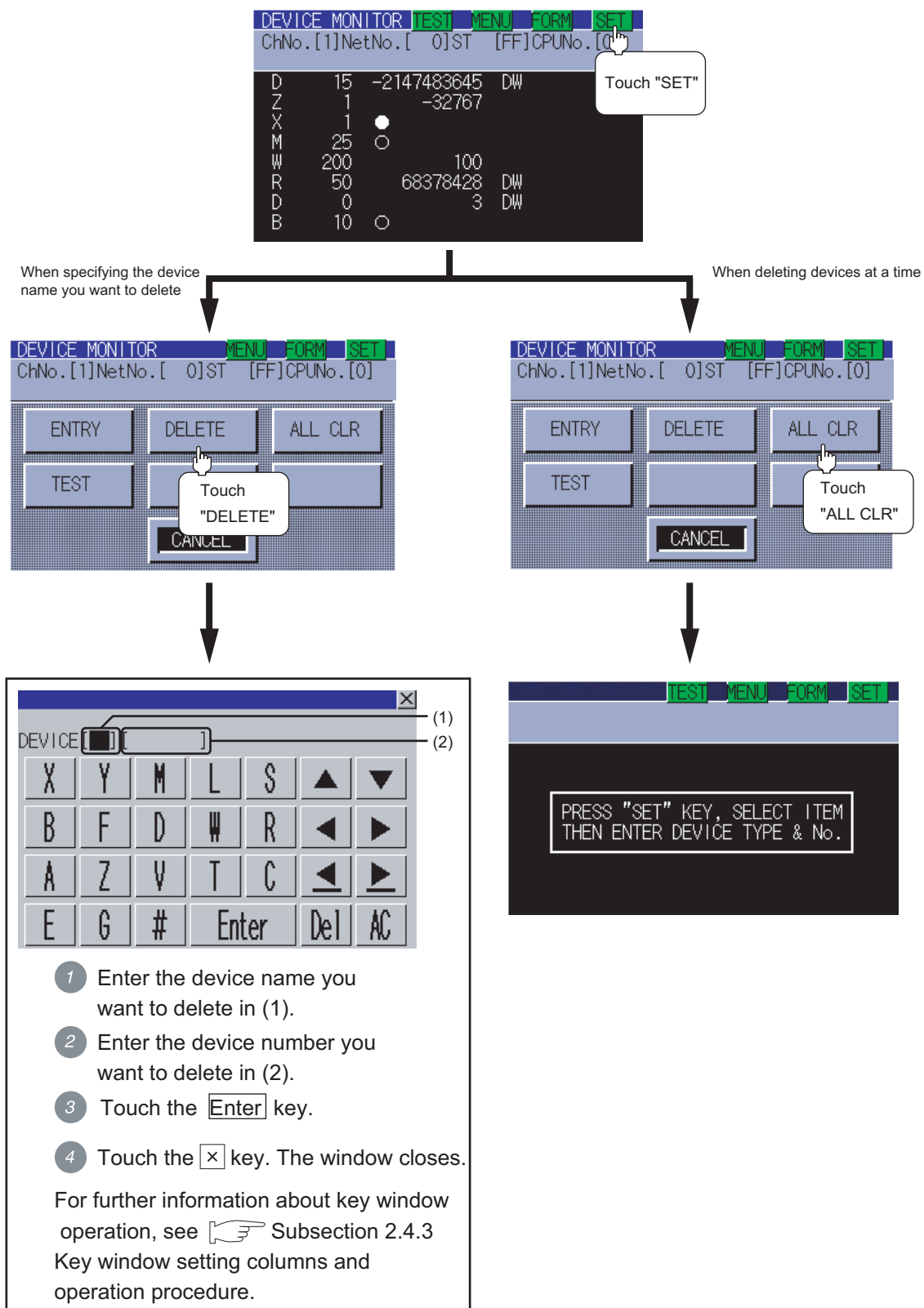

2.6 Batch Monitor

The batch monitor is a function to specify the head device of any device range to perform monitoring. This section describes how to operate the batch monitor when the system monitor function is executed.

2.6.1 Information displayed on the Batch Monitor screen and key functions

(1) The information displayed on the Batch Monitor screen is described below.

Display example of bit devices

ChNo.	NetNo.	ST	CPUNo.
[1]	[0]	[FF]	[0]

1) Displays a channel No.
 2) Displays a network No.
 3) Displays a station No.
 4) Displays a CPU No.

M	1	●	M	9	○
M	2	●	M	10	○
M	3	●	M	11	○
M	4	●	M	12	○
M	5	●	M	13	○
M	6	●	M	14	○
M	7	●	M	15	○
M	8	○	M	16	○

(No comments displayed)

5) Displays bit device on/off.

M	1	●	[Product A
M	2	●	[Product B
M	3	●	[Product C
M	4	●	[Resource A
M	5	●	[Resource B
M	6	●	[Resource C
M	7	●	[Cooling start
M	8	○	[Heating start

(Comments displayed)

6) Displays a comment.

Display example of word devices (16-bit)

ChNo.	NetNo.	ST	CPUNo.
[1]	[0]	[FF]	[0]

D	10	32767	D	18	-500
D	11	0	D	19	3234
D	12	0	D	20	0
D	13	-1	D	21	0
D	14	0	D	22	0
D	15	3	D	23	-32768
D	16	3256	D	24	0
D	17	0	D	25	0

(No comments displayed)

D	10	32767	[Inventory units
D	11	0	[
D	12	0	[Shipment A
D	13	-1	[
D	14	0	[Shipment B
D	15	3	[
D	16	3256	[Shipment C
D	17	0	[

(Comments displayed)

7) Displays a word device value.
 8) Displays a device number.
 9) Displays a device name.

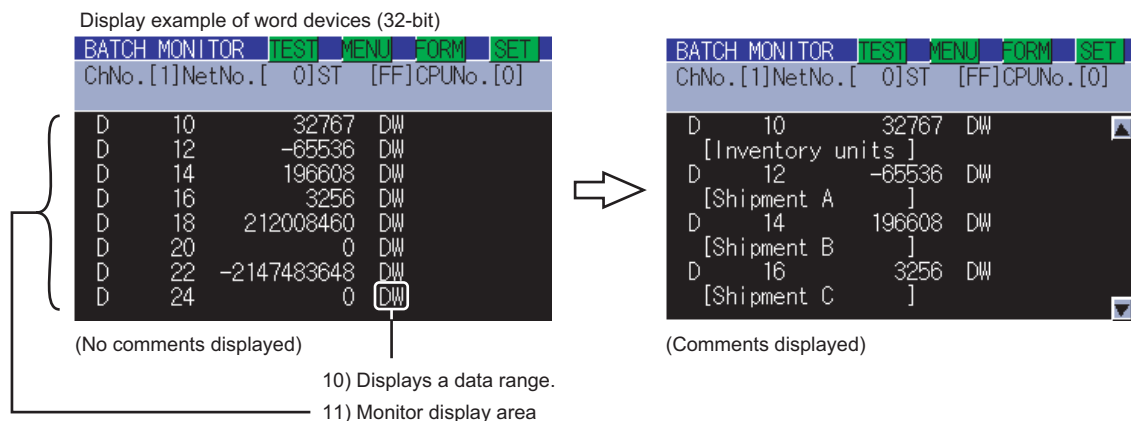

For further information about items 1) to 11) shown above, see the page that follows.

POINT

Number of devices displayed on a single screen

The number of devices displayed on a single screen depends on the setting of the data range, as shown below.

Word devices (16-bit) : 16 devices (no comments displayed), eight devices (comments displayed)

Word devices (32-bit) : Eight devices (no comments displayed), four devices (comments displayed)

Bit devices : 16 devices (no comments displayed), eight devices (comments displayed)

For further information about the setting of the data range, see the following:

2.4.2 Entering monitor devices (specifying monitor stations and devices)

(2) The following table describes the key functions displayed on the Batch Monitor screen.

Key switch	Function
	Activates the Quick test operation. 2.4.5 Quick test operation of monitor devices
	Switches the screen to the functional change menu screen to activate another monitor function or terminate the system monitor function. 2.4.6 Changing screens
	Switches the screen to the display format switching screen to change the value display format (DEC/HEX) on the Batch Monitor screen or comment/no-comment display. 2.4.4 Switching the display format (DEC/HEX) and comment/no-comment display
	Switches the screen to the Device entry screen to enter or test monitor devices. <ul style="list-style-type: none"> • Entering monitor devices : 2.4.2 Entering monitor devices (specifying monitor stations and devices) • Test operation : 2.9 Test Operation
	Scroll displayed information upward or downward by a line to display the preceding or next monitor device that is not currently displayed. When five or more monitor devices are entered, these switches are available when their comments are displayed. <ul style="list-style-type: none"> : Scrolls information upward by a line. : Scrolls information downward by a line.

(3) The following table below describes the range of display of items 1) to 11) displayed.

No.	Item	Description of setting						
		Bus connection	Direct CPU connection	Computer link connection	Ethernet connection	MELSECNET/H connection, MELSECNET/10 connection	CC-Link connection	
							ID*1	G4*2
1)	Channel No.	Sets the channel number of the controller targeted to the batch monitor.						
2)	Net No.	0			1 to 239	0: Host loop 1 to 255: Specified loop	0	
3)	Station No.	FF			1 to 64	FF: When the host station is selected 0: When the control station is selected 1 to 64: When a normal station is selected	FF: When the host station is selected 0: When the master station is selected 1 to 64: When a local station is selected	
4)	CPU No.	0 to 4: This item must be set only when the system is connected to multiple QCPUs. It is not necessary when the system is connected to another CPU.						
5)	Bit device ON/OFF	○ : ON ● : OFF						
6)	Comment	Displays a comment (maximum number of characters: 16 one-byte characters). A comment is displayed when "DISPLAY" is selected for comment display on the display format switching screen.						
7)	Word device value	[Decimal number] 16-bit (one-word) module : Six digits (including a digit for a sign) are displayed. (Display example: -12345) 32-bit (two-word) module : Ten digits (including a digit for a sign) are displayed. (Display example: -123456789) [Hexadecimal number] 16-bit (one-word) module : Four digits are displayed. (Display example: H AB12) 32-bit (two-word) module : Eight digits are displayed. (Display example: H ABCDE123)						
8)	Device No.	Up to 16 devices can be entered when the data range is word (16 bits). Up to eight devices can be entered when the data range is two-word (32 bits).						
9)	Device name	For further information about device numbers and names that can be entered:  GOT1000 Series Connection Manual						
10)	Data range	DW : Indicates that the device value is a 32-bit (two-word) module. Nothing displayed : Indicates that the device value is a 16-bit (one-word) module.						
11)	Monitor display area	When no comments are displayed : Up to 16 devices can be displayed at a time (monitor module: one-word). Up to eight devices can be displayed at a time (monitor module: two-word). When comments are displayed : Up to eight devices can be displayed at a time (monitor module: one-word). Up to four devices can be displayed at a time (monitor module: two-word).						

*1: Indicates CC-Link connection (Intelligent device station).

*2: Indicates CC-Link connection (via G4).

2.6.2 Procedure for batch monitor basic operation

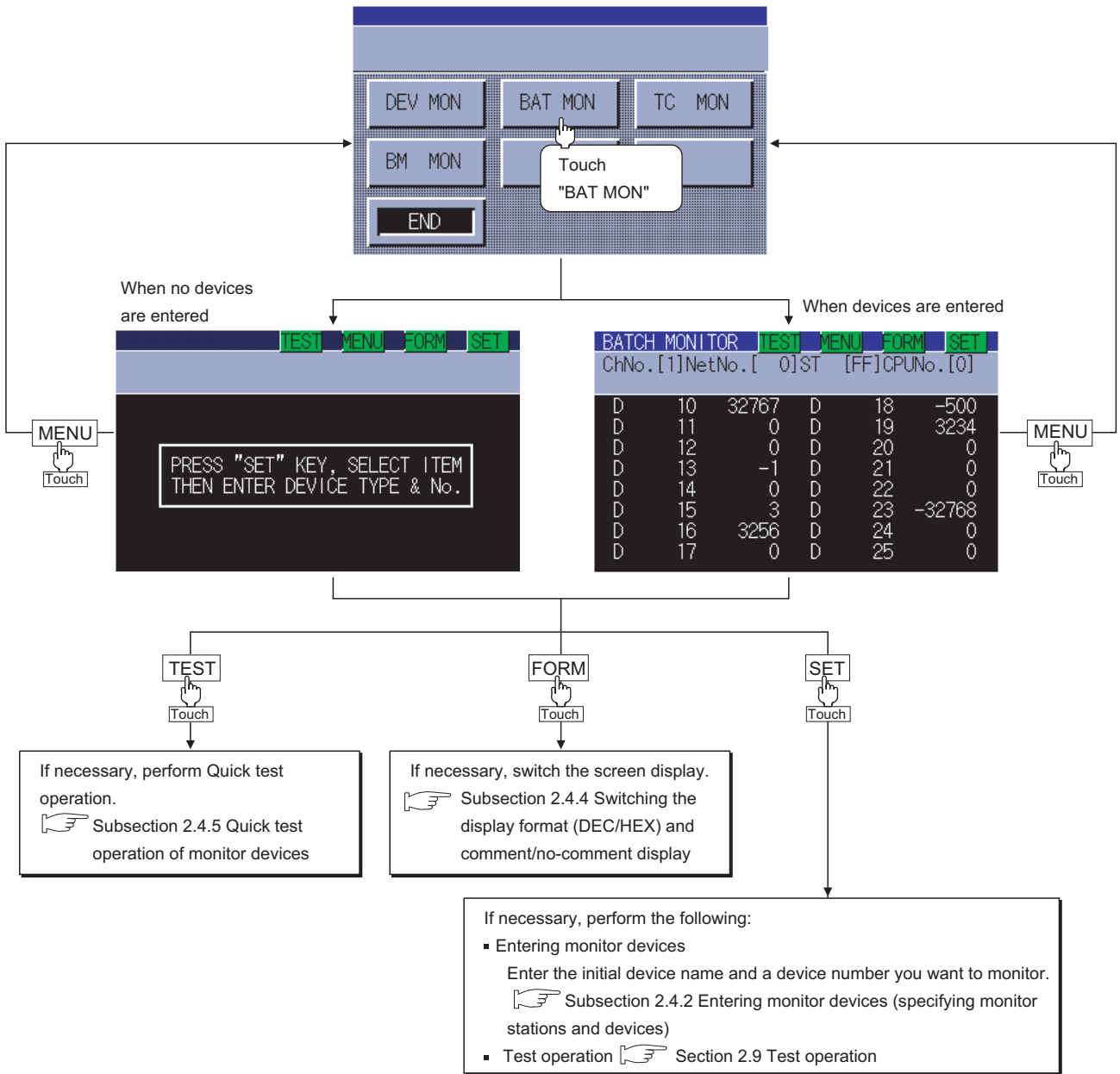

2.7 TC Monitor (Monitoring Timers and Counters)

The TC monitor is a function to monitor only timers (T) and counters (C). This section describes how to operate the TC monitor when the system monitor function is executed.

2.7.1 Information displayed on the TC Monitor screen and key functions

(1) The information displayed on the TC Monitor screen is described below.

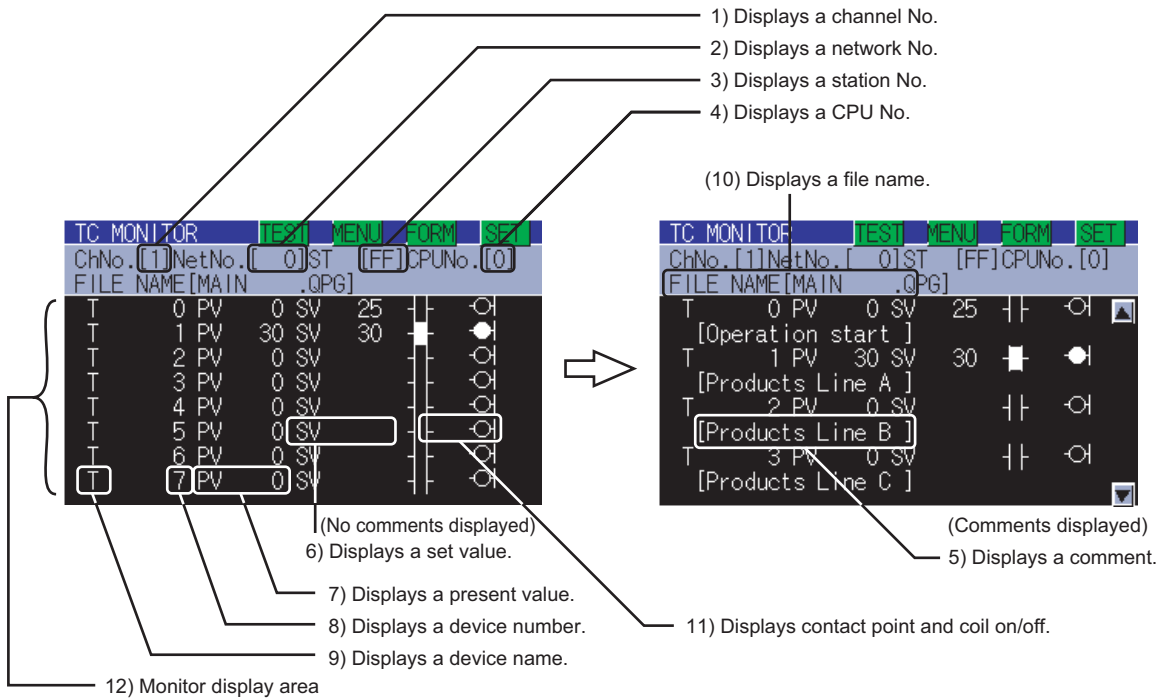



For further information about items 1) to 12) shown above, see the page that follows.

(2) The following table describes the key functions displayed on the TC Monitor screen.

Key switch	Function
TEST	Activates the Quick test operation. 2.4.5 Quick test operation of monitor devices
MENU	Switches the screen to the functional change menu screen to activate another monitor function or terminate the system monitor function. 2.4.6 Changing screens
FORM	Switches the screen to the display format switching screen to change the value display format (DEC/HEX) on the TC Monitor screen or comment/no-comment display. 2.4.4 Switching the display format (DEC/HEX) and comment/no-comment display
SET	Switches the screen to the Device entry screen to enter or test monitor devices. <ul style="list-style-type: none"> Entering monitor devices : 2.4.2 Entering monitor devices (specifying monitor stations and devices) Test operation : 2.9 Test Operation Canceling keywords : 2.7.3 Procedure for canceling TC monitor keywords
▲ ▼	Scroll displayed information upward or downward by a line to display the preceding or next monitor device that is not currently displayed. When five or more monitor devices are entered, these switches are available when their comments are displayed. <ul style="list-style-type: none"> ▲ : Scrolls information upward by a line. ▼ : Scrolls information downward by a line.

(3) The following table below describes the range of display of items 1) to 12) displayed.

No.	Item	Description of setting						
		Bus connection	Direct CPU connection	Computer link connection	Ethernet connection	MELSECNET/H connection, MELSECNET/10 connection	CC-Link connection	
							ID*1	G4*2
1)	Channel No.	Sets the channel number of the controller targeted to the TC monitor.						
2)	Network No.	0		1 to 239		0: Host loop 1 to 255: Specified loop		0
3)	Station No.	FF		1 to 64		FF: When the host station is selected 0: When the control station is selected 1 to 64: When a normal station is selected		FF: When the host station is selected 0: When the master station is selected 1 to 64: When a local station is selected
4)	CPU No.	0 to 4: This item must be set only when the system is connected to multiple QCPUs. It is not necessary when the system is connected to another CPU.						
5)	Comment	Displays a comment (maximum number of characters: 16 one-byte characters). A comment is displayed when "DISPLAY" is selected for comment display on the display format switching screen.						
6)	Set value	[Decimal number] Four digits are displayed. (Display example: 1234) [Hexadecimal number] Four digits are displayed. (Display example: H AB12)						
7)	Present value	[Decimal number] Four digits are displayed. (Display example: 1234) [Hexadecimal number] Four digits are displayed. (Display example: H AB12)						
8)	Device No.	Up to eight devices can be entered.						
9)	Device name	For further information about device numbers and names that can be entered:  GOT1000 Series Connection Manual (Mitsubishi Products) for GT Works3						
10)	File name	When the CPU is a QnACPU or QCPU : A program name will be displayed. When there are plural program names, the initial file name to be executed will be displayed. When the CPU is an ACPU or FXCPU : "MAIN PROGRAM" will always be displayed.						
11)	Contact point and coil on/off	 : On  : Off						
12)	Monitor display area	When no comments are displayed : Up to eight devices can be displayed at a time. When comments are displayed : Up to four devices can be displayed at a time.						

*1: Indicates CC-Link connection (Intelligent device station).

*2: Indicates CC-Link connection (via G4).

2.7.2 Procedure for TC monitor basic operation

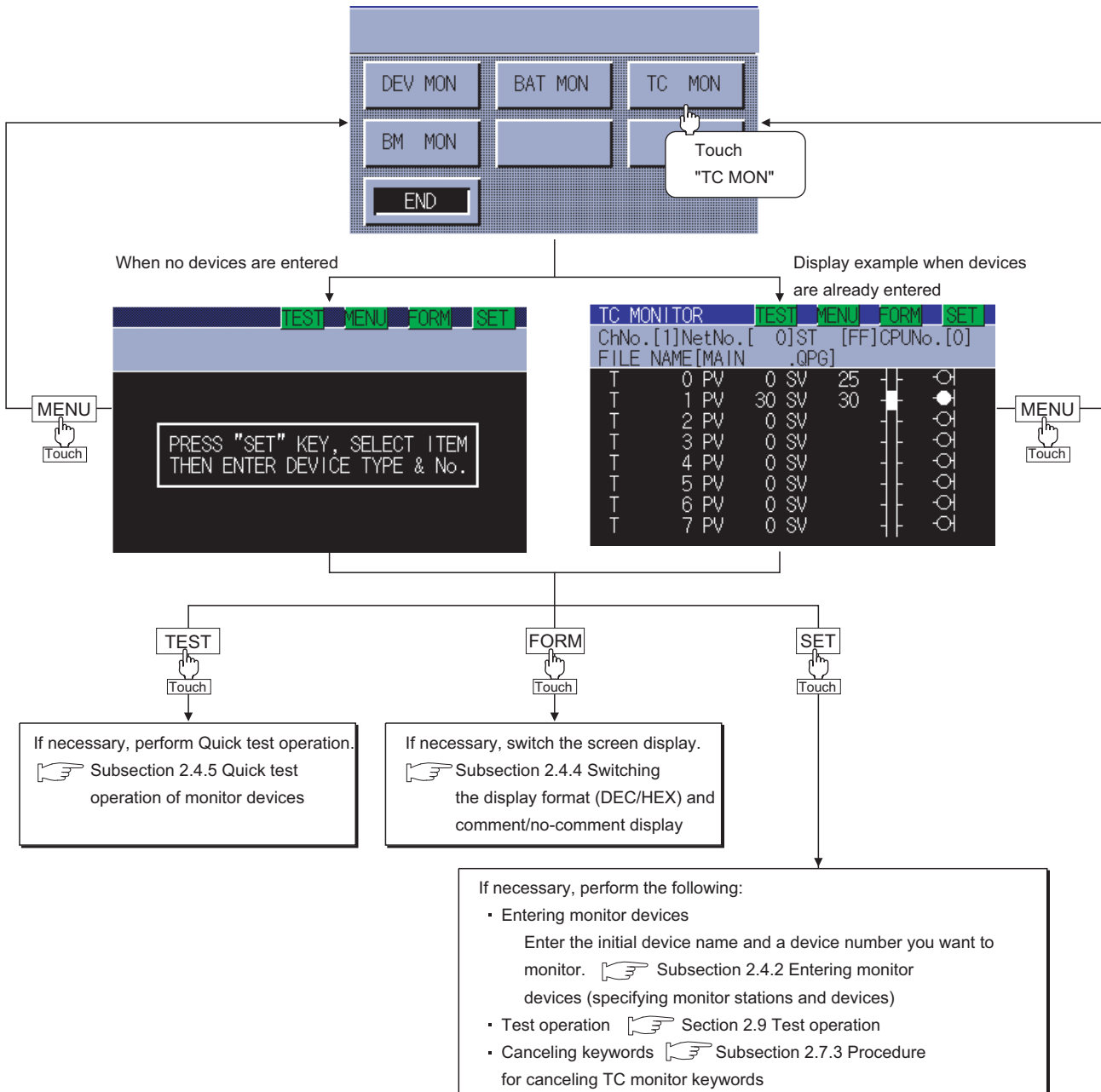

2.7.3 Procedure for canceling TC monitor keywords

When the target controller is a QCPU or FXCPU, and a keyword or password is entered in the sequence program, the monitoring and the change of the set value of T (timer) and C (counter) are limited. The monitoring and the change of the set value are enabled by canceling the keyword or password. The canceling operation of the keyword or password differs according to the controller.

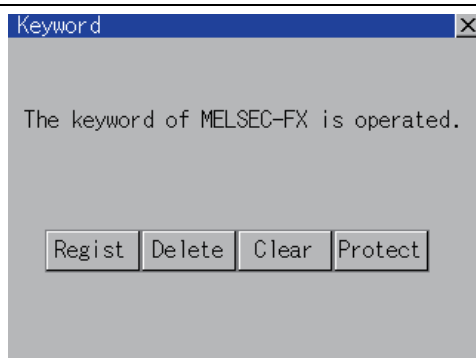
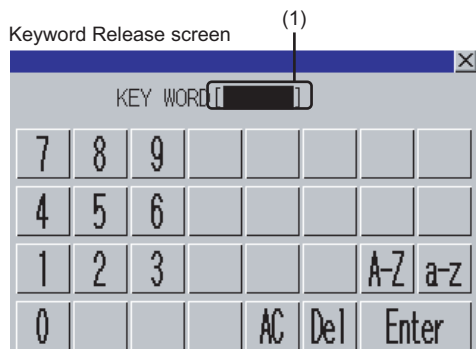
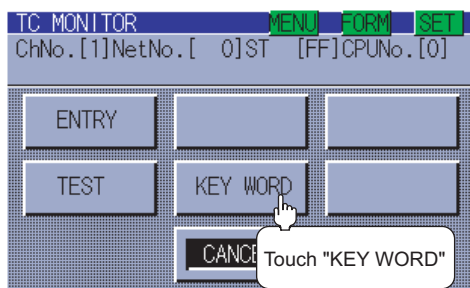
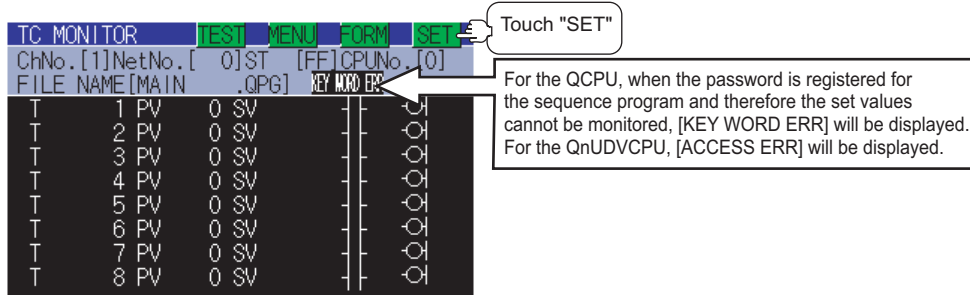

• QCPU

- Enter the password entered in the sequence program at 1).
 - A-Z** key : Touch this key to enter alphabetic characters A to Z (uppercase).
 - a-z** key : Touch this key to enter alphabetic characters a to z (lowercase).
 - 0-9** key : Touch this key to enter numbers 1 to 9.
 - Del** key : Use this key to delete an entered character.
 - AC** key : Use this key to delete all characters under the cursor.
- Entry is completed by touching the **Enter** key, and the keyboard closes.

• FXCPU

- The keyword window is displayed. For the keyword operation, refer to the following.

User's Manual for the GOT used

2.8 BM Monitor (Monitoring Buffer Memory)

The BM monitor (buffer memory monitor) is a function to monitor the buffer memory of special function modules. This section describes how to operate the BM monitor when the system monitor function is executed.

2.8.1 Information displayed on the BM Monitor screen and key functions

(1) Information on the screen

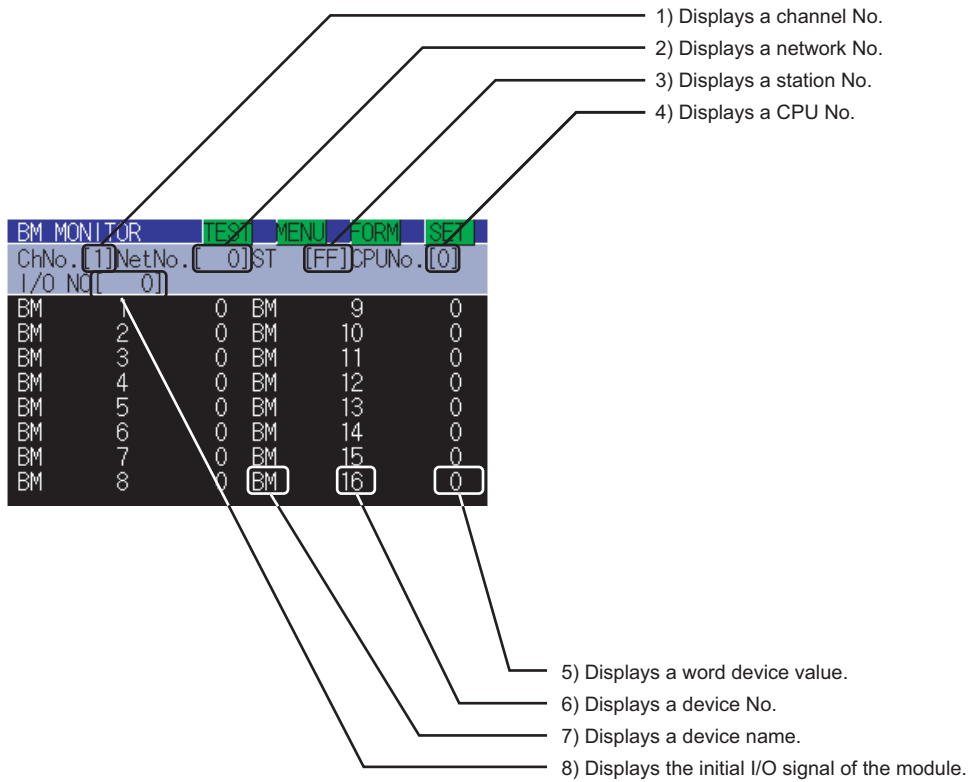

(2) Key functions

Key switch	Function
	Activates the Quick test operation. 2.4.5 Quick test operation of monitor devices
	Switches the screen to the functional change menu screen to activate another monitor function or terminate the system monitor function. 2.4.6 Changing screens
	Switches the screen to the display format switching screen to change the value display format (DEC/HEX) on the BM Monitor screen or comment/no-comment display. 2.4.4 Switching the display format (DEC/HEX) and comment/no-comment display
	Switches the screen to the Device entry screen to enter or test monitor devices. <ul style="list-style-type: none"> • Entering monitor devices : 2.4.2 Entering monitor devices (specifying monitor stations and devices) • Test operation : 2.9 Test Operation
	Scroll displayed information upward or downward by a line to display the preceding or next monitor device that is not currently displayed. When five or more monitor devices are entered, these switches are available when their comments are displayed. <ul style="list-style-type: none"> : Scrolls information upward by a line. : Scrolls information downward by a line.

(3) Display items

No.	Item	Description of setting							
		Bus connection	Direct CPU connection	Computer link connection	Ethernet connection	MELSECNET/H connection, MELSECNET/10 connection	CC-Link connection		
						ID*1	G4 *2		
1)	Channel No.	Sets the channel number of the controller targeted to the BM monitor.							
2)	Network No.	0			1 to 239	0: Host loop 1 to 255: Specified loop	0		
3)	Station No.	FF			1 to 64	FF: When the host station is selected 0: When the control station is selected 1 to 64: When a normal station is selected	FF: When the host station is selected 0: When the master station is selected 1 to 64: When a local station is selected		
4)	CPU No.	0 to 4: This item must be set only when the system is connected to multiple QCPUs. It is not necessary when the system is connected to another CPU.							
5)	Word device value	[Decimal number] four digits (including a digit for a sign) are displayed. (Display example: 1234) [Hexadecimal number] four digits are displayed. (Display example: H AB12)							
6)	Device No.	Up to 16 devices can be entered. (When the CPU is an FXCPU, devices cannot be entered.)							
7)	Device name	For further information about device numbers and names that can be entered: GOT1000 Series Connection Manual (Mitsubishi Products) for GT Works3							
8)	Start I/O number	Sets the start I/O number of the module. For the start I/O number, set the first two digits of the three digits. When monitoring FXCPU, set the module No. 0 to 7.							

*1: Indicates CC-Link connection (Intelligent device station).

*2: Indicates CC-Link connection (via G4).

2.8.2 Procedure for BM monitor basic operation

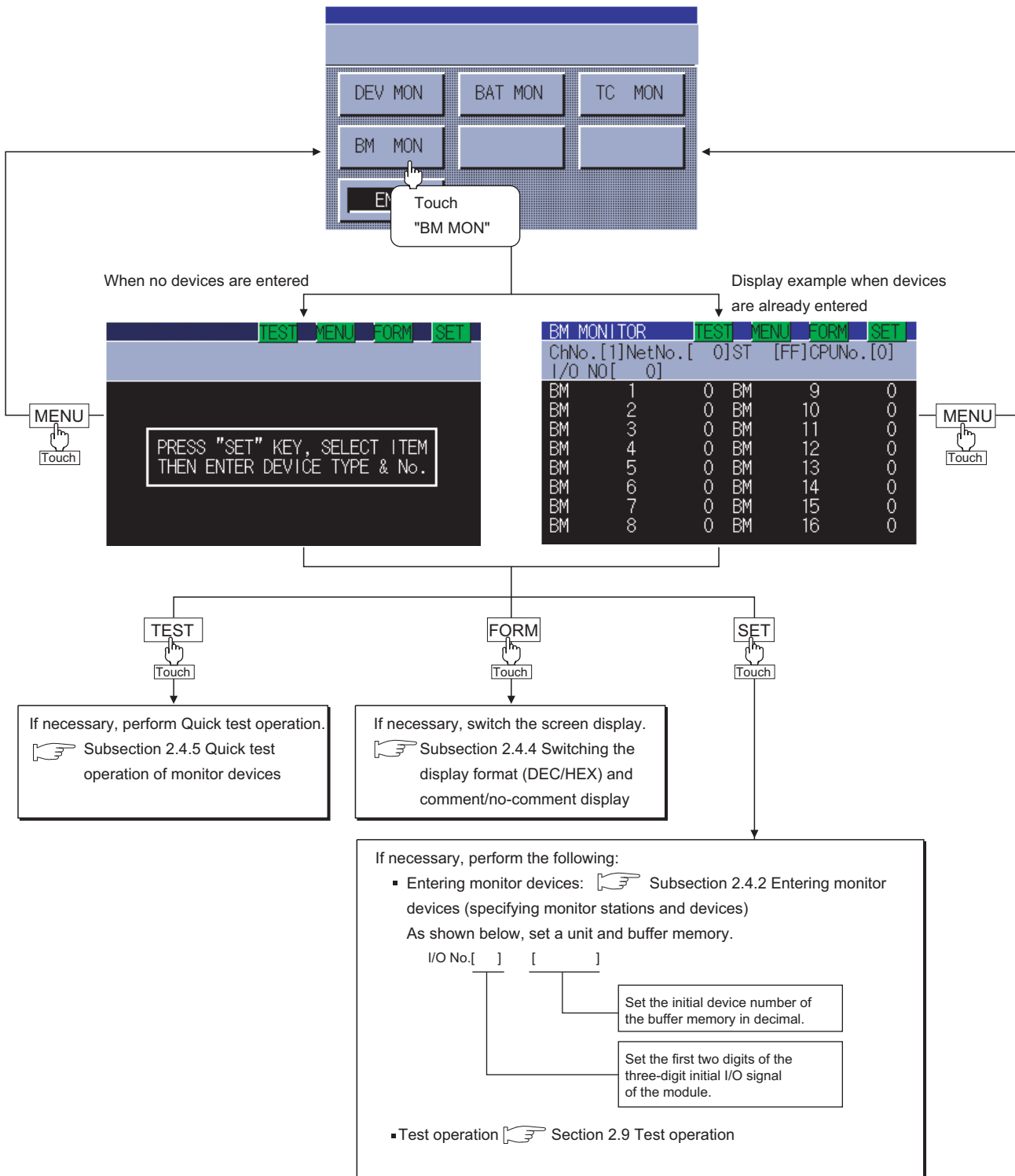

2.9 Test Operation

⚠ WARNING

- Before performing the quick test operations of the system monitor function (such as turning ON or OFF bit device, changing the word device current value, changing the settings or current values of the timer or counter, and changing the buffer memory current value), read through the manual carefully and make yourself familiar with the operation method.
During test operation, never change the data of the devices which are used to perform significant operation for the system. False output or malfunction can cause an accident.

You can specify and test any station and device that can be monitored during monitoring by the system monitor function. This section describes how to test the bit or word devices of the controller or the buffer memory of the intelligent function unit.

2.9.1 Procedure for displaying the test menu screen and the setting key window screen

This subsection describes how to display the test menu screen and the setting key window screen.

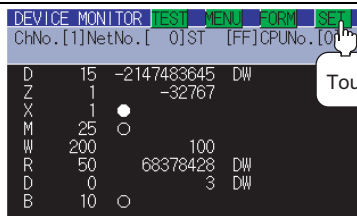

1. Touch **SET** .
(When performing test operation from the Entry Monitor screen)

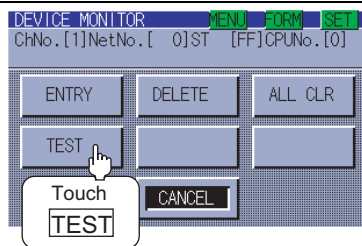

2. Touch **TEST** .

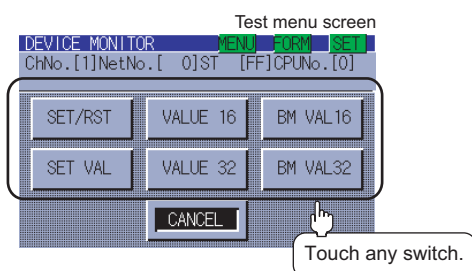

3. The test menu screen appears.
Touch **SET/RST** , **SET VAL** , **VALUE 16** , **VALUE 32** , **BM VAL 16** or **BM VAL 32** .
Operation example: touch **SET VAL** .
For a detailed description of each key function, see the following:
☞ 2.9.2 Information displayed on the test menu screen and key functions

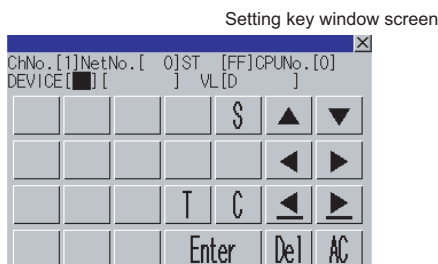

4. The setting key window screen appears.
Display example: set value operation screen of T (timer) and C (counter)
For further information about each setting key window, see the following:
☞ 2.9.3 Information and set items displayed on each setting key window screen
For further information about the test operation procedure, see the following:
☞ 2.9.4 Test operation procedure

2.9.2 Information displayed on the test menu screen and key functions

(1) Test menu screen

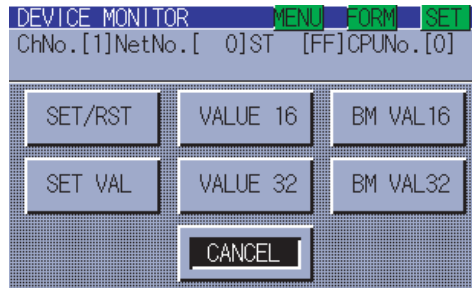

The table shown below describes the key functions.

Key	Function
MENU	Switches the screen to the functional change menu screen to activate another monitor function or terminate the system monitor function. ☞ 2.4.6 Changing screens
FORM	Switches the screen to the display format switching screen to change the value display format (DEC/HEX) or comment/no-comment display. ☞ 2.4.4 Switching the display format (DEC/HEX) and comment/no-comment display
SET	Switches the screen to the Device entry screen.
SET/RST	Displays the screen for bit device on/off operation.
SET VAL	Displays the Set value operation screen for T (timers) and C (counters).
VALUE 16	Displays the Present value operation screen for word devices. Data range: 16-bit (one-word) module
VALUE 32	Displays the Present value operation screen for word devices. Data range: 32-bit (two-word) module
BM VAL 16	Displays the Present value operation screen for buffer memory. Data range: 16-bit (one-word) module
BM VAL 32	Displays the Present value operation screen for buffer memory. Data range: 32-bit (two-word) module
CANCEL	Terminates the test menu screen and displays each monitor screen.

2.9.3 Information and set items displayed on each setting key window screen

The information and set items on the setting key window screen to be used for each test are described below.

(1) Information displayed on each setting key window screen

SET/RST

Screen for bit device on/off operation

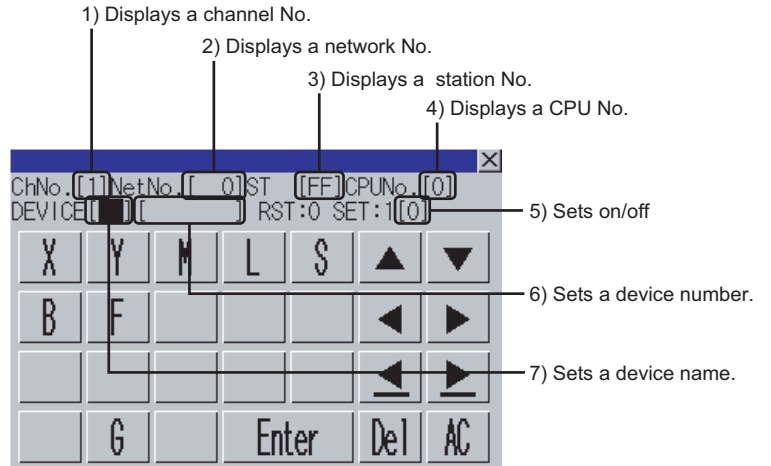

SET VAL

Set value operation screen for timers and counters

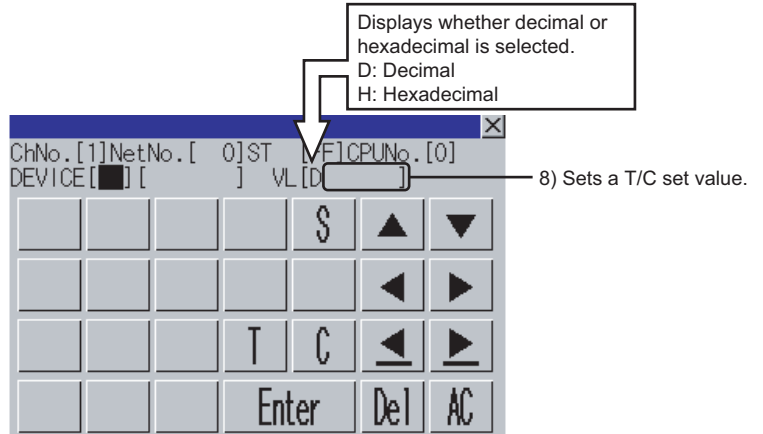

VALUE 16 VALUE 32

Present value operation screen for word devices
 (16-bit (one-word) module/32-bit (two-word) module)

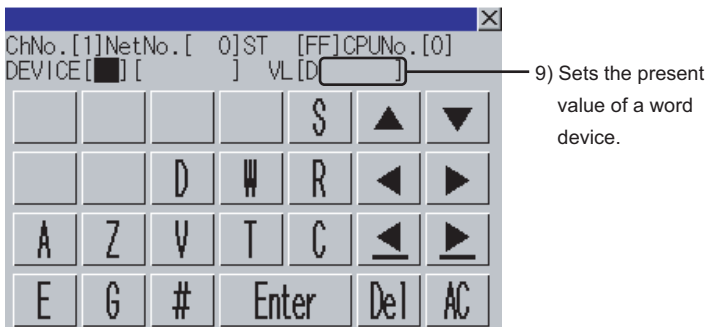

BM VAL 16 BM VAL 32

Present value operation screen for buffer memory
 (16-bit (one-word) module/32-bit (two-word) module)

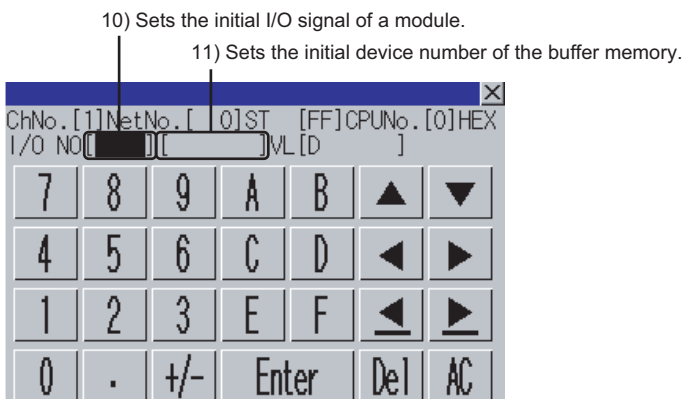

1 OVERVIEW
 2 SYSTEM MONITOR
 3 LADDER MONITOR FUNCTION
 4 MELSEC-A LIST EDITOR
 5 MELSEC-FX LIST EDITOR
 6 INTELLIGENT MODULE MONITOR
 7 NETWORK MONITOR
 8 Q MOTION MONITOR

(2) Set items on the setting key window screen

The table shown below describes details of the set items mentioned on the preceding page.

No.	Item	Description of setting						
		Bus connection	Direct CPU connection	Computer link connection	Ethernet connection	MELSECNET/H connection, MELSECNET/10 connection	CC-Link connection	
							ID *1	G4 *2
1)	Channel No.	Sets the channel number of the controller targeted to the test operation.						
2)	Net No.	0			1 to 239	0: Host loop 1 to 255: Specified loop	0	
3)	Station number	FF			1 to 64	FF: When the host station is selected 0: When the control station is selected 1 to 64: When a normal station is selected	FF: When the host station is selected 0: When the master station is selected 1 to 64: When a local station is selected	
4)	CPU No.	0 to 4: This item must be set only when the system is connected to multiple QCPUs. It is not necessary when the system is connected to another CPU.						
5)	On/Off setting	Set "1": On, Set "0": Off						
6)	Device No.	For further information about device numbers and names that can be entered:						
7)	Device name	 GOT1000 Series Connection Manual (Mitsubishi Products) for GT Works3						
8)	T/C set value	[Decimal number] 16-bit (one-word) module : Six digits (including a digit for a sign) are set. (Entry example: -12345) 32-bit (two-word) module : Ten digits (including a digit for a sign) are set. (Entry example: -123456789) [D] displayed in the number entry box indicates that the entry is decimal. [Hexadecimal number] 16-bit (one-word) module : Four digits are set. (Entry example: H AB12) 32-bit (two-word) module : Eight digits are set. (Entry example: H ABCDE123) [H] displayed in the number entry box indicates that the entry is hexadecimal.						
9)	Word device present value	[Decimal number] 16-bit (one-word) module : Six digits (including a digit for a sign) are set. (Entry example: -12345) 32-bit (two-word) module : Ten digits (including a digit for a sign) are set. (Entry example: -123456789) [D] displayed in the number entry box indicates that the entry is decimal. [Hexadecimal number] 16-bit (one-word) module : Four digits are set. (Entry example: H AB12) 32-bit (two-word) module : Eight digits are set. (Entry example: H ABCDE123) [H] displayed in the number entry box indicates that the entry is hexadecimal.						
10)	Initial I/O signal of module	Set the first two digits of the three-digit initial I/O signal of the module.						
11)	Initial device number of buffer memory	Set the number in a decimal number.						

*1: Indicates CC-Link connection (Intelligent device station).

*2: Indicates CC-Link connection (via G4).

2.9.4 Test operation procedure

Test operation takes place by setting on the setting key window screen the name and number of a device, initial device number of the buffer memory, and the initial I/O of the module or entering change values. This subsection takes a change of set values as an example to describe the test operation procedure.

1. Touch the **SET VAL** key on the test menu screen.
The setting key window screen appears.
2. Using the **◀** and **▶** keys, move the cursor to the item you want to set.
The keyboard displayed depends on the position of the cursor, as shown below.

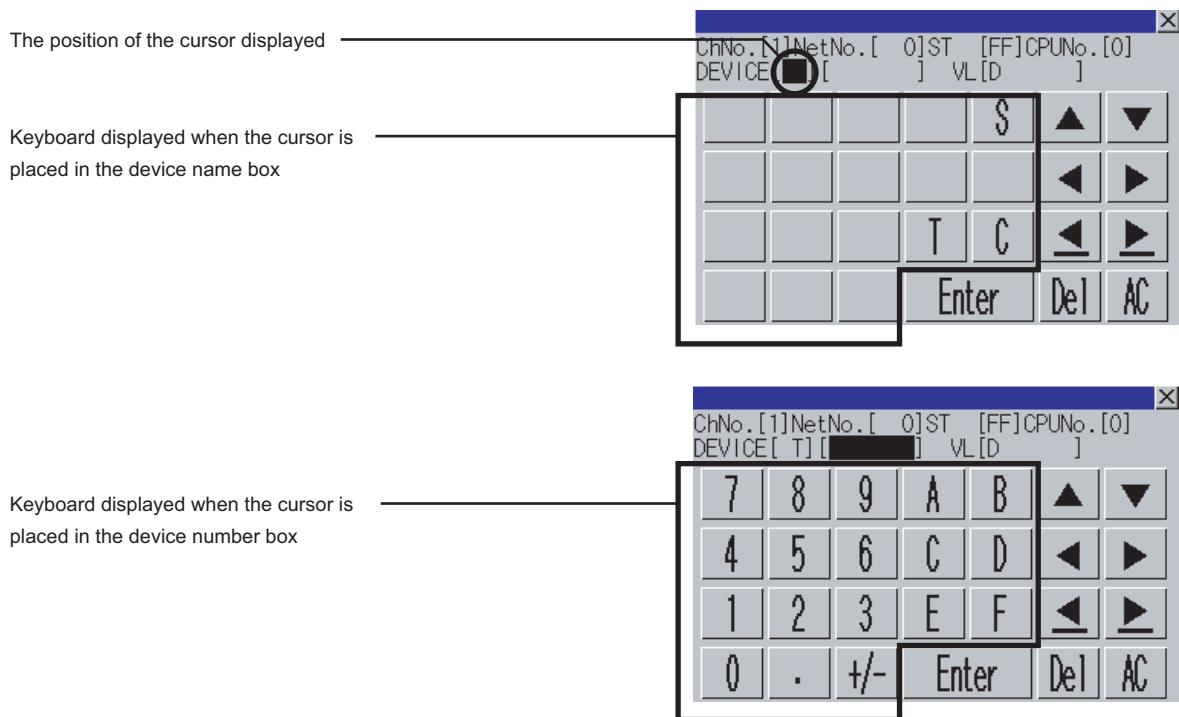

3. If necessary, enter numbers or characters on the keyboard.
 - **Del** key : Use the **Del** key to delete an entered character.
 - **AC** key : Use the **AC** key to delete all characters under the cursor.
 - The **▲/▼** and the keys on which nothing is displayed are not available.
 - For further information about the setting ranges, see the following:
☞ 2.9.3 Information and set items displayed on each setting key window screen
4. Entry is completed by touching the **Enter** key.
5. The keyboard closes by touching the **×** key.

POINT

Operating the set values of timers and counters

(1) Time-up/Count-up status

Even if a set value or present value is changed after a timer or counter is up, the time-up or count-up status does not change. The present status is retained.

(2) Changing an index qualifier

Only the constant part of a T/C set value with a qualifier can be changed. The index qualifier cannot be changed.

(Example) Change the set value of T5 from 300 to 200.

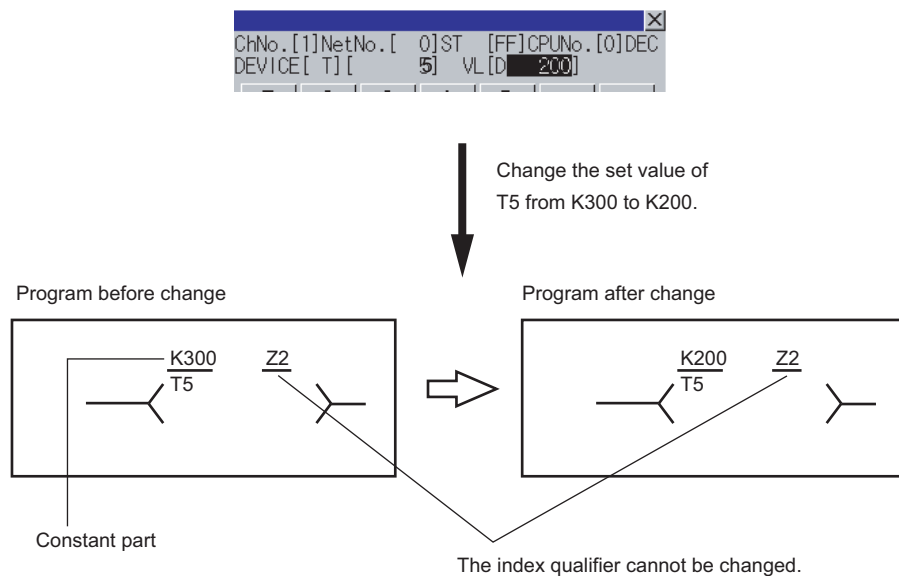

(3) Operation when a password is entered for the controller

When the target controller is a QCPU, the Keyword Release screen appears. Enter the password.



1. Enter the password entered in the sequence program at 1).
 - **A-Z** key : Touch this key to enter alphabetic characters A to Z (uppercase).
 - **a-z** key : Touch this key to enter alphabetic characters a to z (lowercase).
 - **0-9** key : Touch this key to enter numbers 1 to 9.
 - **Del** key : Use this key to delete an entered character.
 - **AC** key : Use this key to delete all characters under the cursor.
2. Entry is completed by touching the **Enter** key, and the keyboard closes.

2.9.5 Test operation basic procedure

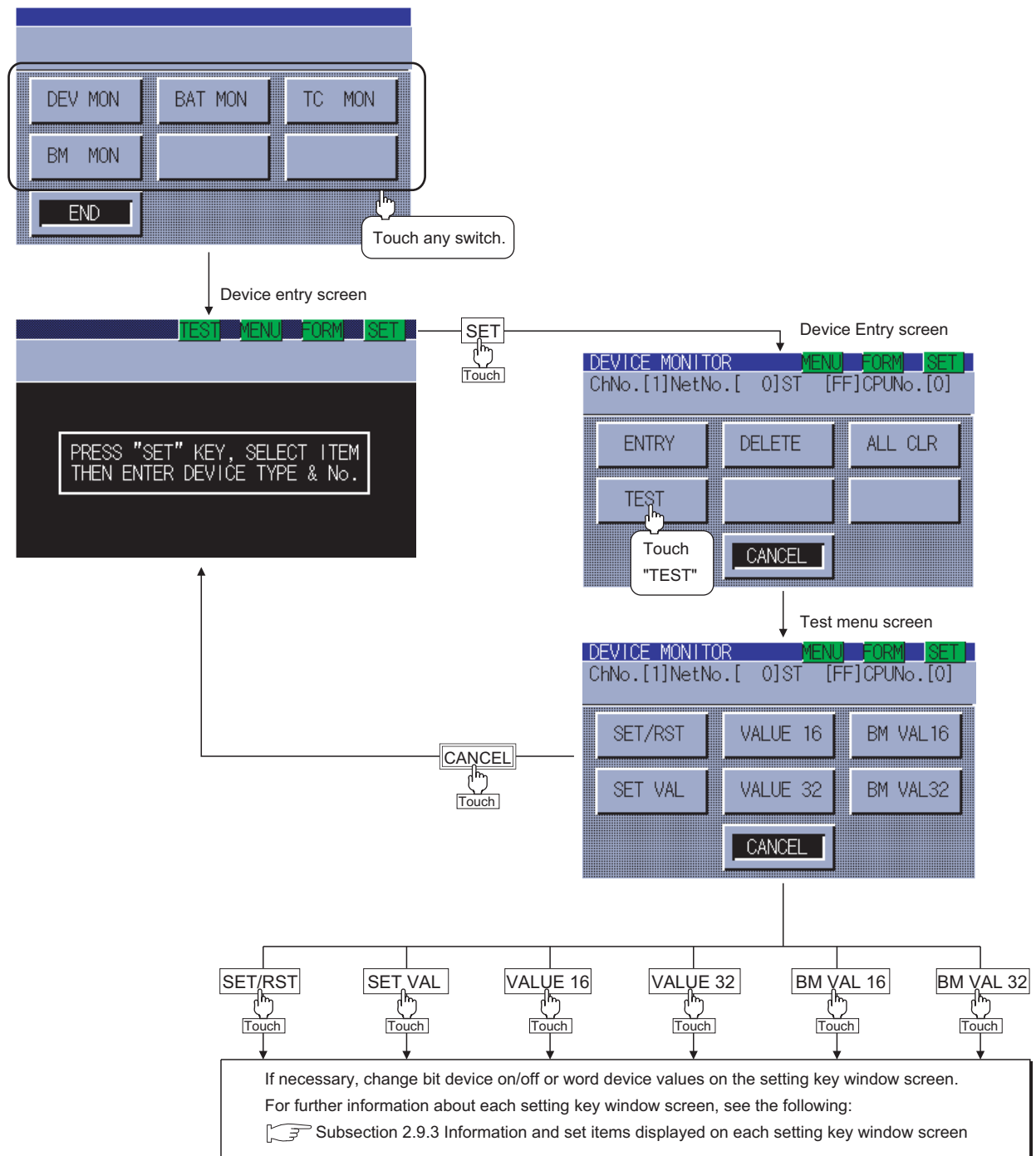

2.10 Error Messages and Corrective Action

This section describes the error messages displayed when the system monitor function is executed, and corrective action.

Error message	Description	Corrective action
PLC communications error	Communication could not be established with the PLC CPU.	<ul style="list-style-type: none">(1) Connections between the PLC CPU and the GOT(disconnected or cut cables).(2) Has an error occurred in the PLC CPU?(3) Refer to the following manual for confirming whether the error has occurred in network.  User's Manual for the GOT used

3. LADDER MONITOR FUNCTION



3.1 Features

The ladder monitor enables you to monitor the sequence program within the target controller and change device values. It is intended to troubleshoot and maintain the PLC system efficiently. The features of the ladder monitor are shown below.

■ The program with ladder symbols can be monitored

You can monitor PLC CPU programs in ladder diagram format and save displayed screens in BMP or JPEG format.

(☞ 3.4 Operation Procedure Common)

(Display example)

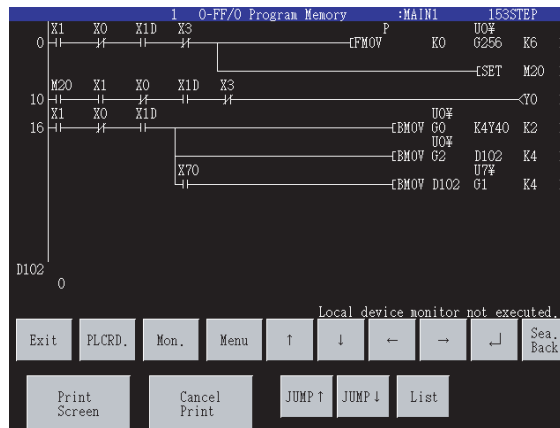

■ The display format, device comment display and language can be switched

The following can be switched. (☞ 3.5 Switching the Display Format)

- Display format of device values, timer and counter values
- Comment display/non-display of the target device
- Language used for items of the sequence program such as file name and comments

(Display example)

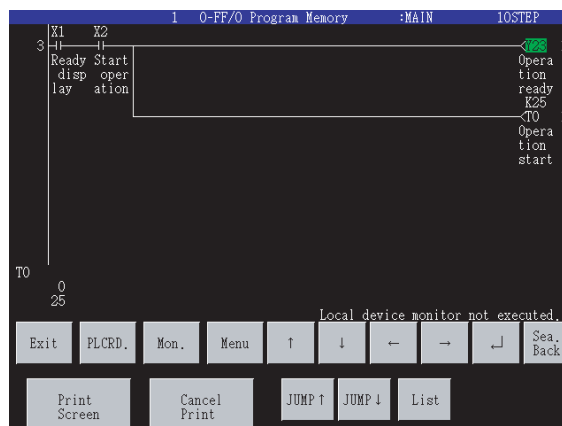

(1) Switching the display format

The present value of a word device is displayed in a decimal or hexadecimal number in the lower area of the screen.

 3.5.2 Display switching of decimal numbers/hexadecimal numbers

(2) Device comment display

Comments of the devices used in the sequence program (comments written in the controller) are displayed.

 3.5.3 Switching comment/no-comment display

Comment file data stored in a CF card can also be displayed when the MELSEC-Q/L/QnA ladder monitor is used.(3.3.4 Reading comment files from CF cards)

(3) Language switching (for MELSEC-Q/L/QnA ladder monitor only)

In the MELSEC-Q/L/QnA ladder monitor, language switching (Japanese/Korean/Simplified Chinese) is available for displaying the following items of a sequence program.

(To switch the language, register the following items with the language (Japanese/Korean/Simplified Chinese) used for the PLC READING DATA DISPLAY. To display Korean, for example, register the following items with Korean on GX Developer.)

- File name
- Title
- Comment
- Note
- Statement

Items other than the above (such as menu) are displayed with the system language.

 3.5.7 Language switching of the sequence program (MELSEC-Q/L/QnA ladder monitor)

■ Other stations can be monitored

You can use the ladder monitor on other station in the data link system containing the GOT (or GOT-connected station), network system or CC-Link system.

For further information about the connection forms available for the ladder monitor, see the following:

 3.2.1 System configuration

■ Enhanced interaction with objects (for the MELSEC-Q/L/QnA ladder monitor only)

(1) One-touch ladder jump function

Only by touching an object on a user-created screen, a target device can be searched and displayed.

In addition, in the case of the MELSEC-Q/L/QnA ladder monitor, searching is performed only when the monitor target of the sequence program that has been read and the monitor target that is set on the object match, enabling more accurate search.

Even a person who is not the operator familiar with the equipment inside can trace the source of the equipment error without fail by simple operations, reducing time to stop the error.

Example) Coil searching by touching a touch switch

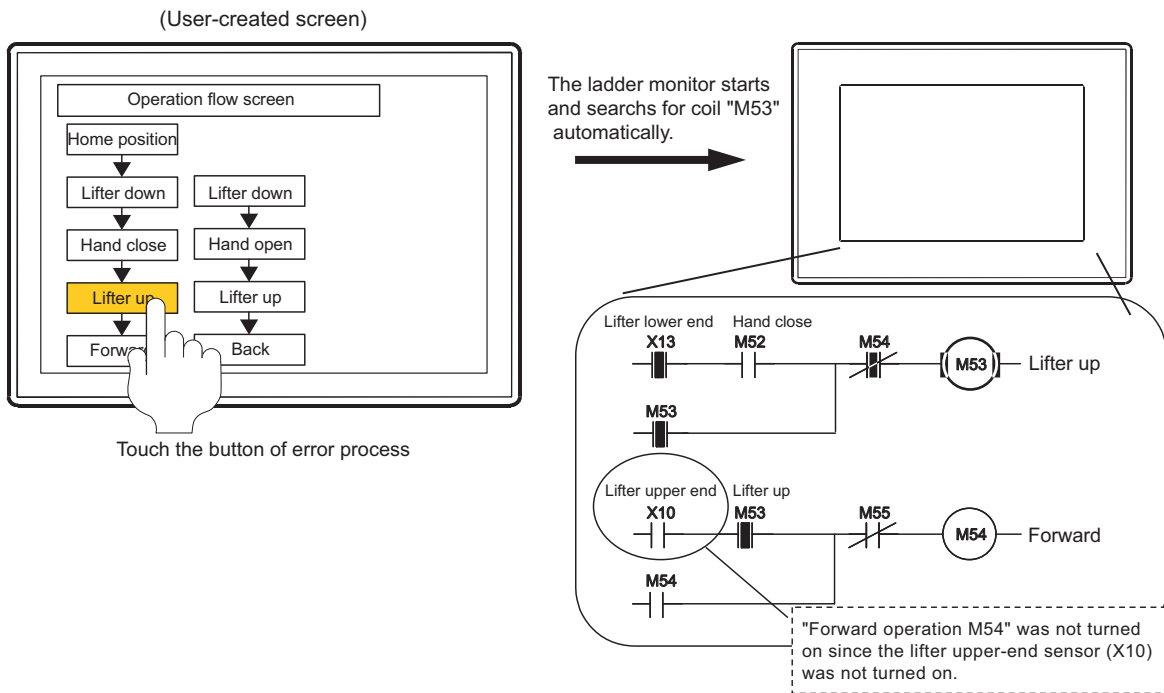

(2) Real-time program searching from advanced alarm display, touch switch

PLC data can be read automatically and programs to be read can be specified.

When a Japanese or English file name is specified, the corresponding program can be read.

Accordingly, the specified program can be read to be searched and the search result is displayed on the monitor screen by a simple operation as selecting a displayed alarm and then touch the key code switch.

Multiple files can be read

By reading multiple PLC CPU files in advance, reading of another program from the PLC CPU is not needed every time the program display is switched, and comment display can be switched automatically.

In addition, when ladder data of multiple destinations are stored in a CF card, they can be switched to be displayed without reading the data from PLC.

This enables more efficient ladder monitoring, reducing the operation time.

3.2 Specifications

3.2.1 System configuration

This section describes the system configuration of the ladder monitor.

For connection type settings and precautions regarding the communication unit/cable and connection type, refer to the following.

 GOT1000 Series Connection Manual (Mitsubishi Products) for GT Works3

■ Target controller

Controller
QCPU (Q mode) ^{*1*2} , motion controller (Q series) ^{*3}
QSCPU ^{*4}
LCPU
QnACPU
ACPU/QCPU (A mode), motion controller (A series)
FXCPU ^{*5}
CNC (C70, C6/C64) ^{*6}

- *1 When the GOT is connected to a QCPU set on a redundant type extension base unit, the ladder monitor function cannot be used.
- *2 When the GT15 is connected to QCPU(Q03UDVCP, Q04UDVCP, Q06UDVCP, Q13UDVCP, Q26UDVCP), the ladder monitor function cannot be used.
- *3 For the motion controller CPU (Q series), only the PLC CPU area (CPU No.1) in the Q170MCP and Q170MSCPU can be monitored.
- *4 The GOT cannot write data to devices in the QSCPU.
- *5 FX3U or FX3UC is connectable.
- *6 Use the function version A2 or later.

■ Connection type

This function can be used in the following connection types.

(1) When the GOT is connected to a QCPU (Q mode), a motion controller (Q series), a QSCPU, or a LCPU

(○: Available, △: Partly restricted, ✕: Unavailable)

Function		Connection type between GOT and controller							Reference section	
Name	Description	Bus connection ^{*7,8}	Direct CPU connection ^{*7,9,11}	Computer link connection ^{*7}	Ethernet connection ^{*10}	MELSECNET/H connection ^{*8} , MELSECNET/10 connection ^{*8}	CC-Link IE controller connection ^{*3,8} , CC-Link IE field connection ^{*4}	CC-Link connection		
								ID ^{*5,7}	G4 ^{*6,7}	
Search operation	Device search, defect search, etc.		○		○	△ ^{*1}	○	○	○	3.6
Display switching	Displaying word devices in DEC or HEX		○		○	△ ^{*1}	○	○	○	3.5
	Displaying device comments, etc.		○		○	△ ^{*1}	○	○	○	
Test operation	Changing device values, etc.		△ ^{*2}		○	△ ^{*1,2}	○	△ ^{*2}	○	3.7
Local device monitor	Monitoring local devices		○		○	△ ^{*1}	○	○	○	3.8
Hard copy	Storing ladder monitor screen in BMP/JPEG format or printing it with a printer		○		○	△ ^{*1}	○	○	○	3.4.2

*1 For the MELSECNET/10 connection, use a QCPU and network module (QJ71LP21, QJ71LP21-25, QJ71LP21S-25, and QJ71BR11) with the function version B or later.

*2 The present value of Z cannot be changed. V cannot be turned ON or OFF.

*3 Indicates the CC-Link IE controller network connection.

*4 Indicates CC-Link IE field network connection.

*5 Indicates CC-Link connection (Intelligent device station).

*6 Indicates CC-Link connection (via G4).

*7 The QSCPU does not support the connection type.

*8 The LCPU does not support the connection type.

*9 When the GOT is connected to the following CPUs, use L6ADP-R2.

L02CPU, L02CPU-P, L02CPU-CM, L06CPU, L06CPU-P, L26CPU, L26CPU-P, L26CPU-PBT, L26CPU, L26CPU-BT-CM

*10 Ladder monitor cannot be used when using CC-Link IE field network Ethernet adapter.

*11 When multiple CPUs are connected, the QnUDE(H)CPU and QnUDVCPU can be connected by using the serial port of the QCPU.

(2) When the GOT is connected to a QnACPU

(○: Available, △: Partly restricted, ✕: Unavailable)

Function		Connection form between GOT and controller						Reference section
Name	Description	Bus connection	Direct CPU connection	Computer link connection	Ethernet connection	MELSECNET/10 connection	CC-Link connection (intelligent device station)	
Search operation	Device search, defect search, etc.		○		○	○	○	3.6
Display switching	Displaying word devices in DEC or HEX		○		○	○	○	3.5
	Displaying device comments, etc.		○		○	○	○	
Test operation	Changing device values, etc.		△ ^{*1}		○	△ ^{*1}	△ ^{*1}	3.7
Local device monitor	Monitoring local devices		✕		✕	✕	✕	-
Hard copy	Storing ladder monitor screen in BMP/JPEG format or printing it with a printer		○		○	○	○	3.4.2

*1 The present value of Z cannot be changed. V cannot be turned on or off.

(3) When the GOT is connected to an ACPUCPU (A mode) and an A series motion controller CPU

(○: Available, △: Partly restricted, ✕: Unavailable)

Function		Connection form between GOT and controller						Reference section
Name	Description	Bus connection	Direct CPU connection	Computer link connection	Ethernet connection	MELSECNET/10 connection	CC-Link connection (intelligent device station)	
Search operation	Device search, defect search, etc.				○	○	○	3.6
Display switching ^{*1}	Displaying word devices in DEC or HEX	○		△ ^{*3}	○	○	○	3.5
	Displaying device comments, etc.				○	○	○	
Test operation	Changing device values, etc.		△ ^{*2}		○	△ ^{*2}	△ ^{*2}	3.7
Hard copy	Storing ladder monitor screen in BMP/JPEG format or printing it with a printer		○		○	○	○	3.4.2

*1 If the total capacity of parameters, sequence programs, T/C set values, comments, and extension comments is 144 Kbytes or over, comments cannot be correctly displayed.

*2 The present value of V and Z cannot be changed.

*3 Subprograms 2 and 3 of the A4UCPU (in computer link connection) cannot be ladder-monitored.

(4) When the GOT is connected to an FXCPU

(○: Available, △: Partly restricted, ✕: Unavailable)

Function		Connection form between GOT and controller		Reference section
Name	Description	Direct CPU connection	Ethernet connection	
Search operation	Device search, defect search, etc.	○	○	3.6
Display switching	Displaying word devices in DEC or HEX	○	○	3.5
	Displaying device comments, etc.	○	○	
Test operation	Changing device values, etc.	△ ^{*1*2}	△ ^{*1*2}	3.7
Hard copy	Storing ladder monitor screen in BMP/JPEG format or printing it with a printer	○	○	3.4.2

*1 The present value of V and Z cannot be changed.

*2 The set values of T and C cannot be changed.

(5) When the GOT is connected to a CNC

(a) When the GOT is connected to a CNC C70

Use CNC C70 of software version B1 or later (BND-1006W000-B1 or later).

(○: Available, △: Partly restricted, ✕: Unavailable)

Function		Connection form between GOT and controller							Reference section	
Name	Description	Bus connection	Direct CPU connection ^{*1}	Computer link connection	Ethernet connection ^{*6}	MELSECNET/H connection, MELSECNET/10 connection	CC-Link IE controller connection ^{*3*4} , CC-Link IE field connection ^{*5}	CC-Link connection		
								ID ^{*6*8}	G4 ^{*7*8}	
Search operation	Device search, defect search, etc.		○		○	△ ^{*2}	○	○	○	3.6
Display switching	Displaying word devices in DEC or HEX		○		○	△ ^{*2}	○	○	○	3.5
	Displaying device comments, etc.		○		✕	△ ^{*2}	○	○	○	
Test operation	Changing device values, etc.		△ ^{*3}		○	△ ^{*2*3}	○	△ ^{*3}	○	3.7
Hard copy	Storing ladder monitor screen in BMP/JPEG format or printing it with a printer		○		○	△ ^{*2}	○	○	○	3.4.2

*1 Available with the multiple CPU system including a QCPU (Q mode).

*2 For the MELSECNET/10 connection, use a QCPU and network module (QJ71LP21, QJ71LP21-25, QJ71LP21S-25, and QJ71BR11) with the function version B or later.

*3 The present value of Z cannot be changed. V cannot be turned ON or OFF.

*4 Indicates the CC-Link IE controller network connection.

*5 Indicates CC-Link IE field network connection.

*6 Available with the Display I/F connection only.

*7 Indicates the CC-Link IE controller network connection.

*8 Indicates CC-Link connection (Intelligent device station).

*9 Indicates CC-Link connection (via G4).

(b) When the GOT is connected to a MELDAS C6/C64

(○: Available, △: Partly restricted, ✕: Unavailable)

Function		Connection form between GOT and controller							Reference section
Name	Description	Bus connection	Direct CPU connection	Computer link connection	Ethernet connection	MELSECNET/10 connection	CC-Link connection		
							ID ^{*4}	G4 ^{*5}	
Search operation	Device search, defect search, etc.	✕	○	✕	○	○ ^{*1}	○	✕	3.6
Display switching ^{*1}	Displaying word devices in DEC or HEX	✕	○	✕	○	○ ^{*1}	○	✕	3.5
	Displaying device comments, etc.	✕	○	✕	○	○	○	✕	
Test operation	Changing device values, etc.	✕	△ ^{*2 *3}	✕	△ ^{*2 *3}	△ ^{*1 *2 *3}	△ ^{*2 *3}	✕	3.7
Hard copy	Storing ladder monitor screen in BMP/JPEG format or printing it with a printer	✕	○	✕	○	○ ^{*1}	○	✕	3.4.2

*1 For the MELSECNET/10 connection, use a QCPU and network module (QJ71LP21, QJ71LP21-25, QJ71LP21S-25, and QJ71BR11) with the function version B or later.

*2 The present value of Z cannot be changed. V cannot be turned ON or OFF.

*3 The set values of T and C cannot be changed.

*4 Indicates CC-Link connection (Intelligent device station).

*5 Indicates CC-Link connection (via G4).

Required option OS' and option function boards

The option function OS' and option function boards shown in the table below are required.

 1.1.2 Hardware and OS' required for each function

(1) Extended function OS and option OS

Install the option OS in the above table to the GOT.

When executing the test operation, install the system monitor (extended function OS) to the GOT.

For the installation procedure, refer to the following.

 GT Designer3 Version1 Screen Design Manual (Fundamentals) 8. COMMUNICATION WITH GOT

(2) OS memory space

For installing the extended function OS and option OS, the available space shown in the above table is required in the user area.

For the procedure for checking the available memory space of the user area and information about the data using other user areas, refer to the following.

 GT Designer3 Version1 Screen Design Manual (Fundamentals) 8. COMMUNICATION WITH GOT

(3) Option function board

(a) For GT16

No option function board is required.

(b) For GT15

Mount one of the option function boards in the above table on the GOT.

For the GOTs with a built-in option function board, refer to the following.

 1.1.2 Hardware and OS' required for each function

For how to mount an option function board on the GOT, refer to the following.

 User's Manual for the GOT used

Display screen for the ladder monitor

A sequence program of up to 8 lines (one line: up to 11 contacts (12 or more contacts will be looped back)) is displayed on a single screen.

In addition, the current values of up to 8 word devices (9 or more devices are displayed by switching the display with the arrow key) etc. are displayed.

For the GT1695M-X, GT1685M-S, GT1675M-S, GT1665M-S, GT1595-X, GT1585V-S, GT1585-S, GT1575V-S, or GT1575-S, the MELSEC-Q/QnA ladder monitor displays a sequence program of up to 15 lines (one line: up to 11 contacts (12 or more contacts will be looped back)) on a single screen.

3.2.2 Devices and range that can be monitored

(1) MELSEC-A ladder monitor

(○: Possible, ✕: Impossible)

Device	Device range	Ladder display	Device monitor display	Search operation
Input	X000 to XFFF (hexadecimal)	○	○	○
Output	Y000 to YFFF (hexadecimal)	○	○	○
Internal relay	M0 to M8191	○	○	○
Latch relay	L0 to L8191			
Step relay	S0 to S8191			
Special internet relay	M9000 to M9255	○	○	○
Link relay	B0000 to B1FFF (hexadecimal)	○	○	○
Timer	T0 to T2047	○	○	○
Counter	C0 to C1023	○	○	○
Data register	D0 to D8191	○	○	○
Special data register	D9000 to D9255	○	○	○
Link register	W0000 to W1FFF (hexadecimal)	○	○	○
Annunciator	F0 to F2047	○	○	○
File register	R0 to R8191	○	○	○
Accumulator	A0 to A1	○	○	○
Index register	V to V1 to V6	○	○	○
Index register	Z to Z1 to Z6	○	○	○
Nesting	N0 to N7	○	✕	✕
Pointer	P0 to P255	○	✕	✕
Interrupt pointer	I0 to I31	○	✕	✕

(2) MELSEC-FX ladder monitor

(○: Possible, ✕: Impossible)

Device	Device range	Ladder display	Device monitor display	Search operation
Input	X000 to X337 (octadecimial)	○	○	○
Output	Y000 to Y337 (octadecimial)	○	○	○
Auxiliary relay	M0 to M8511	○	○	○
State	S0 to S4095	○	○	○
Timer contact	T0 to T511	○	○	○
Counter contact	C0 to C255	○	○	○
Data register	D0 to D8511	○	○	○
Index register	V0 to V7	○	○	○
Index register	Z0 to Z7	○	○	○
Nesting	N0 to N7	○	✕	✕
Pointer	P0 to P4095	○	✕	✕
Interrupt pointer	I00* to I30* (four points) : Fx0 I00* to I50* (six points) : Fx1, Fx2 I6** to I8** (three points) : Fx1, Fx2 I010 to I060 (six points) : Fx1, Fx2	○	✕	✕
Extension register	R0 to R32767	○	○	○

(3) MELSEC-Q/L/QnA ladder monitor

(○: Possible, ✕: Impossible)

Device	Device range	Ladder display	Device monitor display	Search operation
Input	X0 to 1FFF, DX0 to 1FFF	○	○	○
Output	Y0 to 1FFF, DY0 to 1FFF	○	○	○
Internal relay	M0 to 32767	○	○	○
Latch relay	L0 to 8191	○	○	○
Link relay	B0 to 7FFF	○	○	○
Timer	T0 to 2047	○	○	○
Retentive timer	ST0 to 2047	○	○	○
Counter	C0 to 1023	○	○	○
Data register	D0 to 12287	○	○	○
Link register	W0 to 1FFF	○	○	○
Annunciator	F0 to 2047	○	○	○
Edge relay	V0 to 2047	○	✕	○
File register	R0 to 32767	○	○	○
	ZR0 to 32767	○	○	○
	ZR32768 to 4184063	○	○	✕
Extended data register	D0 to 32767	○	○	○ ^{*1}
Extended link register	W0 to 7FFF	○	○	○ ^{*1}
Link special relay	SB0 to 7FF	○	○	○
Link special register	SW0 to 7FF	○	○	○
Step relay	S0 to 8191	○	○	○
Index register	Z0 to 15	○	○	○
	Z16 to 19	○	○	○ ^{*1}
	ZZ0 to 18	○	✕	○ ^{*2}
Special relay	SM0 to 2047	○	○	○
Special data register	SD0 to 2047	○	○	○
Function input	FX0 to F	○	✕	○
Function output	FY0 to F	○	✕	○
Function register	FD0 to 4	○	✕	○
Link direct device	J □ □ ¥ □ □	○	✕	✕
Intelligent function module	U □ □ ¥ □ □	○	✕	✕
	U3En □ □ ¥ □ □			
Nesting	N0 to 14	○	✕	✕
Pointer	P0 to 4095	○	✕	✕
Interrupt pointer	I0 to 255	○	✕	✕
SFC block device	BL0 to 319	○	✕	○
SFC transition device	TR0 to 511	○	✕	○
Network No. device	J0 to 255	○	✕	✕
I/O No. device	U0 to FF	○	✕	✕
	3E0 to 3E3			
Macro registration device	VD0 to	○	✕	✕

*1 For searching devices with the menu for the ladder monitor, the device number cannot be specified.

*2 Search ZZ by specifying Z. (For searching ZZ0, specify Z0. For searching ZZ1, specify Z1.)
ZZ0 is not searched by specifying Z1.
When a sequence program has Z and ZZ, specifying Z searches both Z and ZZ.

3.2.3 Access range

For the FXCPU in Ethernet connection, the GOT can monitor only the host station. The access range other than the above is the same as the access range when the GOT is connected to a controller. For details of the access range, refer to the following.

 GOT1000 Series Connection Manual (Mitsubishi Products) for GT Works3

3.2.4 Precautions

(1) Inapplicable GOT

The ladder monitor cannot be used with the GOTs shown below.

GOT	Inapplicable GOT
GT15	GT1555-Q, GT1550-Q

(2) Precautions to be taken while the ladder monitor is activated

While the ladder monitor is activated, do not perform the following for the GOT.

Otherwise, the stored data may be deleted or the ladder monitor may not operate normally.

- Turning the CF card access switch (ON, OFF)
- Installing/removing the CF card

(3) Ladder display

Up to 24 lines can be displayed per ladder block.

If a sequence program is written in which 24 or more lines are used in a ladder block, the ladder cannot be correctly displayed. It is advisable to divide such programs.

(4) When the system is connected to an FXCPU

(a) During PLC reading, only the host station is read.

(b) An STL (step ladder) command, a dedicated command for the FXCPU, is displayed as shown below.

Ladder monitoring by GOT

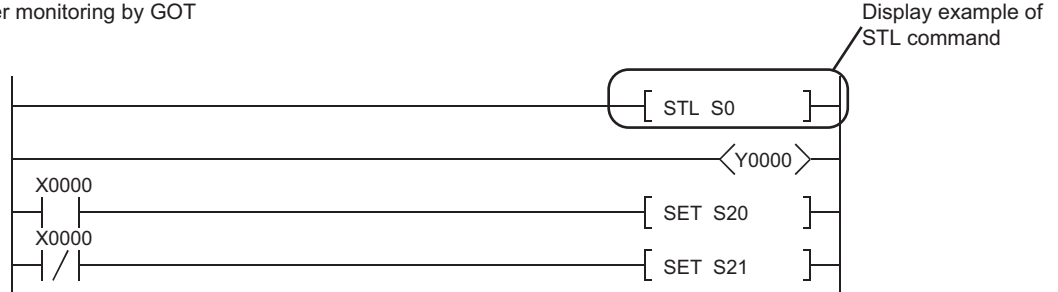

(c) How an INV command is displayed

Ladder monitoring by GOT

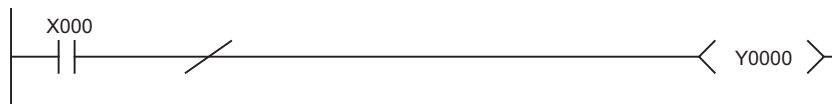

(d) When searching an STL command, use "S (state)" in a device search.

(e) The 32-bit counters are displayed in 32-bit fixed display in the device monitor.

(f) When using FX3U(C), if the memory capacity is set to 32,000 or higher with the GX Developer PLC parameters, sequence programs cannot be displayed.

When displaying a sequence program with the GOT, set the memory capacity to 16,000 or less.

(g) Changes to T/C set values are reflected on the ladder monitor display only when they are made with the system monitor or test function.

When a value is changed by numerical input or other object, the change is reflected on the display after the GOT is restarted.

(5) When reading multiple files

- (a) Continuous searching in multiple sequence programs is allowed only for device search, contact search, coil search, and touch search.
- (b) For searching in multiple sequence programs, the GOT can display search results of the previously searched program by touching the

Sea.
Back

 key.
The GOT cannot display search results of multiple programs on one screen.
When programs are switched, the currently displayed search results of the program disappear from the screen.
- (c) For returning to the search results of the previously searched program by touching the

Sea.
Back

 key during searching in multiple sequence programs, the touch operation is canceled when the previously searched program is deleted.
- (d) For defect search, when multiple sequence programs have been read, searching is performed continuously in the program that is searched and displayed first.
Continuous searching in multiple programs is not performed.
- (e) Automatical reading and searching of a specified sequence program is allowed only for the special function switch and advanced alarm display.
- (f) If the monitor target is changed to another PLC, all the files that have been stored in the drive of the GOT are deleted when data are read from the PLC.
- (g) Without changing the monitor target PLC CPU, files stored in the drive of the GOT will not be deleted by changing the read target drive.
When all files are read from the monitor target PLC CPU with the automatic PLC read setting made, therefore, the programs to be searched and the monitor target programs may not match.
In such a case, delete unnecessary files on the file list window.
- (h) Up to 512 files of ladder data including those displayed on the GOT (up to 3 files) can be stored in the storage destination drive.
When 511 files of ladder data are stored and another ladder data is displayed on the GOT, therefore, storing a new ladder data is not allowed.

(6) Reading comment files

- (a) Comment data can be read from a CF card only with the MELSEC-Q/L/QnA ladder monitor.
- (b) Only files with the file names (program names) with one-byte alphanumeric characters are applicable to the GOT.
When project data are created on GX Developer, use only one-byte alphanumeric characters for file names (program names).
- (c) When the data save location is set to [None], save only one comment file in a CF card.
Multiple comment files cannot be read.

(7) Monitoring local devices

- (a) When a sequence program stored in a PLC CPU is changed, be sure to read the program with the GOT.
When the sequence program in the PLC CPU is changed after reading the sequence program with the GOT, the GOT may not correctly monitor local devices.
- (b) For monitoring local devices, do not monitor the same local device in the same PLC CPU simultaneously with multiple GOTs and GX Developer.
- (c) When the same local device in the same PLC CPU is simultaneously monitored with multiple GOTs and GX Developer, the GOT cannot correctly monitor the devices.

(8) Changing set values of timer and counter when monitoring multiple programs

For monitoring multiple programs, set values of all the target programs can be changed by switching displayed programs when the test menu screen is opened from the ladder monitor screen.

POINT

Reflecting value changes in display of ladder monitor screen

For opening the test menu screen from the system monitor screen or user-created screen, even if the set values of the timer and counter are changed, the changed values are not reflected in the display of the ladder monitor screen.

For reflecting the changed values in the display of the ladder monitor screen, read the program again.

(9) Precautions for Universal model QCPU

Even though Universal model QCPU processes 64-bit data, the GOT cannot monitor the 64-bit data.

(10) Precautions for QSCPU

- (a) The GOT cannot write data to the devices in the QSCPU.
- (b) For a safety function block, only the FB definition name is displayed in the application instruction format. The program in the safety function block is not displayed.

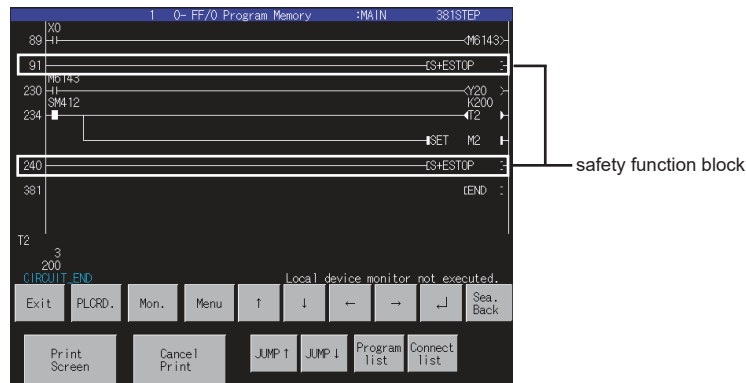

- (c) The following shows the GOT operation when the program in a safety function block has the target of the search operation.

Search operation	GOT operation
Device search Contact point search Coil search	The GOT adds and displays the ladder block that shows the FB definition name in the application instruction format in the last row. For the continuous search, when the program in the safety function block has multiple target devices, the ladder block is added to the last row only one time.
Step search	The GOT displays the ladder block that shows the FB definition name in the application instruction format corresponding to the searched step.
Defect search	The GOT adds and displays the ladder block that shows the FB definition name in the application instruction format in the last row and ends the defect search. (The operation is the same as that when all the defective devices are searched.)

3.3 Operation for Display

This section describes the operation procedure from turning on the power to the GOT to ladder monitor function display. For the ladder monitor start operation when using one-touch ladder jump function, refer to the following.

☞ ■Start operation when using the One-touch Ladder Jump function (for the MELSEC-Q/L/QnA ladder monitor only)

■ Start operation for the Ladder Monitor

(1) Normal operation

This subsection describes the flow until the ladder monitor operation screen is displayed after a ladder monitor (Option OS) is installed in the GOT.

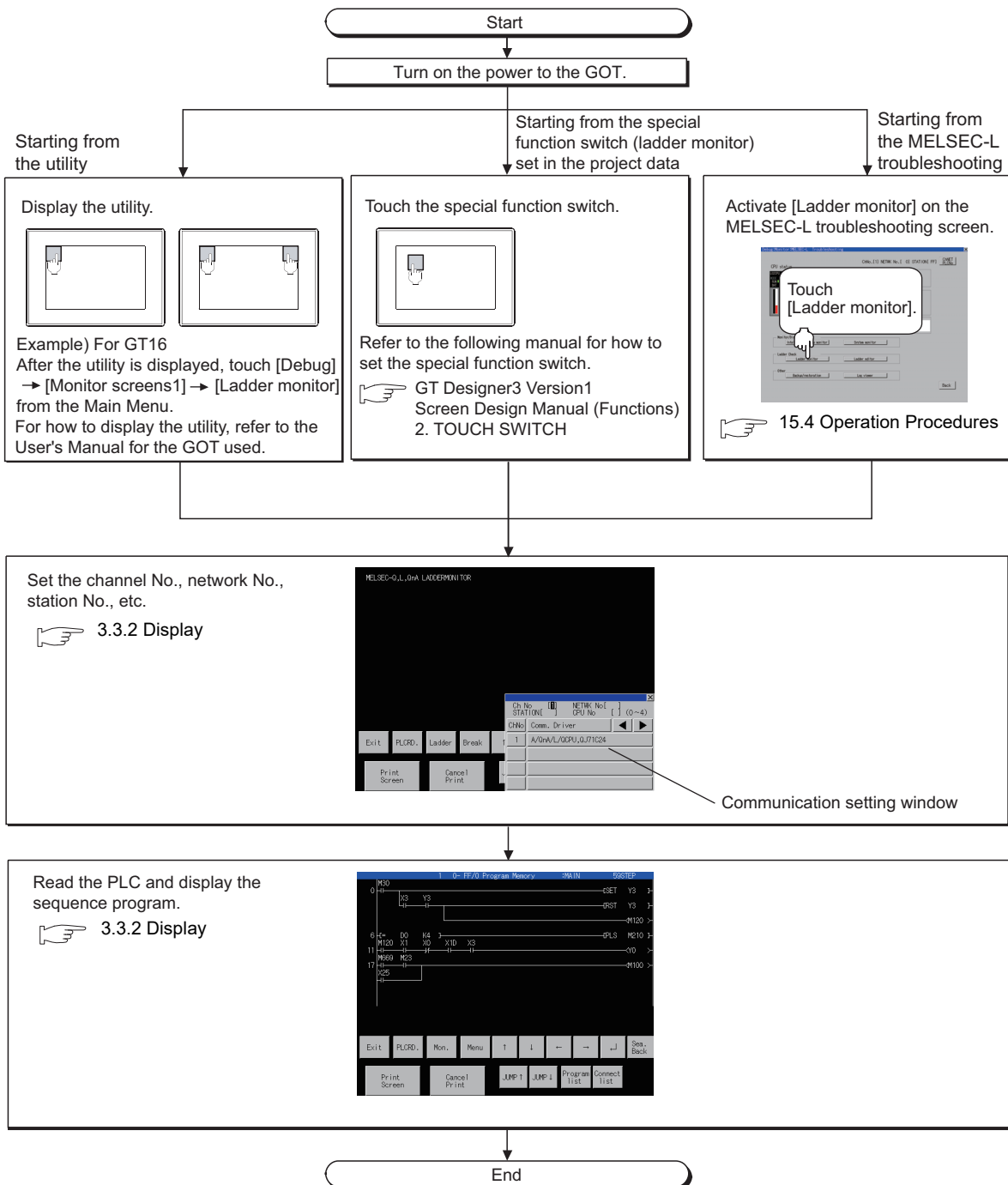

POINT

(1) How to display the utility

For how to display the utility, refer to the following.

 User's Manual for the GOT used

(2) How to make PLC reading unnecessary when turning the GOT power on again

With the MELSEC-Q/L/QnA ladder monitor, you can save ladder monitor data to a memory card or internal flash memory.

If you save the data beforehand, it is not necessary to read the PLC when switching the GOT power on again.

( 3.3.1 Setting and deleting media for saving ladder data)

(3) If the project data has not been downloaded

The ladder monitor can be started from the utility even if the project data has not been downloaded to the GOT.

■ Start operation when using the One-touch Ladder Jump function (for the MELSEC-Q/L/QnA ladder monitor only)

By using the special function switch, advanced user alarm display, or others, start the Ladder Monitor, and sequence program files can be read automatically and devices can be searched automatically.

The following shows objects which can use the One-touch Ladder Jump function.

Object
Special function switch, advanced user alarm display, alarm history display, user alarm display

POINT

Before executing the automatic PLC read

(1) Setting the automatic PLC read

When reading a sequence program file or a comment file from controllers, the automatic PLC read have to be set on GT Designer3 or in the utility.

For the setting of automatic PLC read, refer to the following.

 GT Designer3 Version1 Screen Design Manual (Fundamentals) 4.9 GOT Display and Operation Setting

User's Manual for the GOT used

(2) Specifying an automatic PLC read file

With the special function switch or advanced user alarm display, the target sequence program of automatic PLC read can be specified in each object setting.

However, the operation differs depending on the automatic PLC read setting on GT Designer3 or in the utility.

Automatic PLC read setting of GT Designer3/utility	File name specification in objects	Operation
Done	Done	The specified sequence program file is read automatically.
	None	All sequence program files are read automatically.
None	Done	No sequence program file is read. To search automatically, if a sequence program file of the specified file name among the sequence program files read in the GOT exists, it is executed.
	None	No sequence program file is read. To search automatically, if a sequence program file read in the GOT exists, it is executed to all files.

(2) Starting from the special function switch

Select [Ladder Monitor] in [Switch Action], and the [Use One-touch Ladder Jump] check box of the special function switch. By touching this switch, Ladder Monitor can be started.

Operation at start differs depending on the setting contents of the special function switch.

For the setting items for the special function switch, refer to the following.

GT Designer3 Version1 Screen Design Manual (Functions) 2. TOUCH SWITCH

(○: Set, x: Not set)

Setting		Operation for touching the special function switch
Search Method	Specify Search File	
Specify Search Device*1	○	(a)
	x	(b)
Specify Connected Station*2	○	(c)
	x	(d)

*1 When [Specify Search Device] is selected, set [Ladder Search Device] and [Ladder Search Mode].
The setting of PLC station number is included in the [Ladder Search Device] setting.

*2 When [Specify Connected Station] is selected, set [CH No.] and [Network].
If [Other] in [Network] is selected, also set [N/W No.], [PC Station No.] and [CPU Machine].

(a) Operations for searching a device with specifying the file name

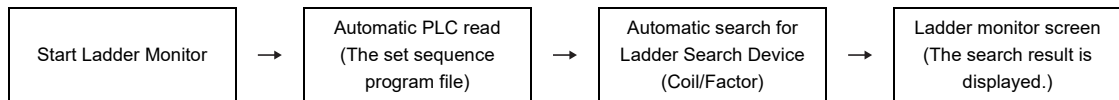

(b) Operations for searching a device without specifying the file name

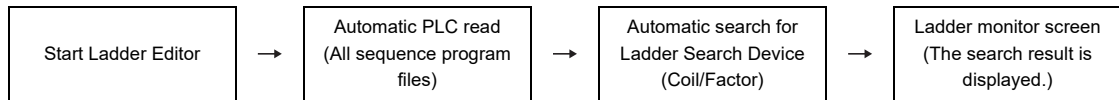

(c) Operations for searching a connected station with specifying the file name

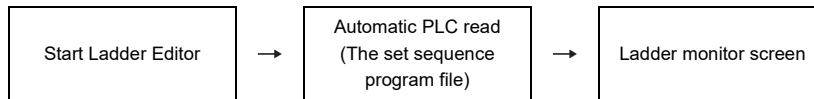

(d) Operations for setting a connected station without specifying the file name

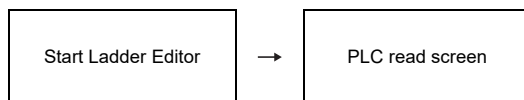

Operations for the special function switch when not using the One-touch Ladder Jump function

When the [Use One-touch Ladder Jump] is not selected, the operation for touching the special function switch is the same as when starting from the utility.

In this case, the automatic PLC read is not executed.



■Start operation for the Ladder Monitor

(3) Starting from the advanced user alarm display

By selecting an alarm in the advanced user alarm display and touching the key code switch (setting the key code of [Display Ladder]), the Ladder Monitor can be started and the device of alarm can be searched. Operation at start differs depending on the setting contents of the advanced user alarm observation. For the setting items for advanced user alarm observation, refer to the following.

 GT Designer3 Version1 Screen Design Manual (Functions) 11.3 Advanced User Alarm Display

(○: Set, ×: Not set)

Ladder search setting ^{*1}		Operation for touching the special function switch
Ladder Search Mode	Specify Search File	
○	○	 (a)
○	×	 (b)

*1 The setting of PLC station number is included in the target device.

(a) Operations for setting the Ladder Search Mode and file name

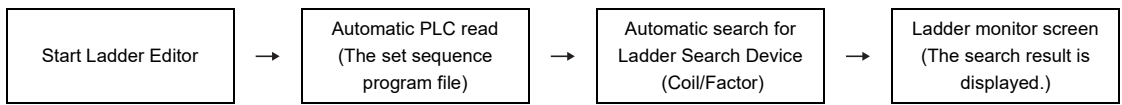

(b) Operations for setting the Ladder Search Mode

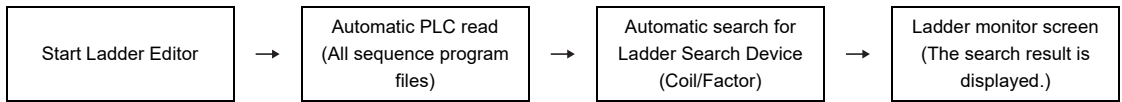

(4) Starting from the alarm history display or user alarm display

By selecting an alarm in the alarm history display or user alarm display and touching the key code switch (setting the key code of [Display Ladder]), the Ladder Monitor can be started and the device of alarm can be coil-searched.

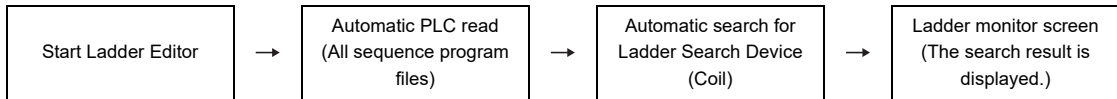

For the alarm history display, refer to the following.

 GT Designer3 Version1 Screen Design Manual (Functions) 11.5 Alarm History Display

For the user alarm display, refer to the following.

 GT Designer3 Version1 Screen Design Manual (Functions) 11.6 User Alarm Display

■ Changing screens

The following describes screen changes of (1) Normal operation using an example of the MELSEC-Q/L/QnA ladder monitor.

Screen changes of the A/FX ladder monitor is the same.

Start the ladder monitor.
For further information, refer to the following.
☞ "Operation for display"

<MELSEC-Q/L/QnA ladder monitor>
• When ladder data is stored on a memory card or in the built-in flash memory after the power to the GOT is turned on



<MELSEC-Q/L/QnA ladder monitor>
When no ladder data is stored after the GOT is started

<MELSEC-A/FX ladder monitor>
When performing the ladder monitor first after starting the GOT

<MELSEC-Q/L/QnA/A/FX ladder monitor>
When ladder data has already been read after the GOT was started

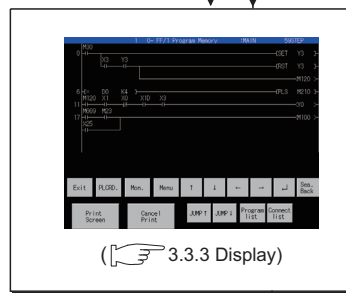
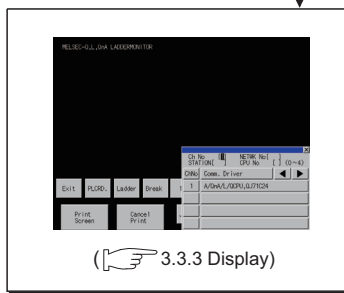

Menu Display format change/search/Menu window screen display

Connect list List/switch of targets

File list List/switch of ladder data

(☞ 3.5 Switching the Display Format, 3.6 Search Operation)

Exit
Touch

Enter
Touch

Exit
Touch

Ladder
Touch

PLCRD.
Touch

Menu
Connect list
File list
Touch

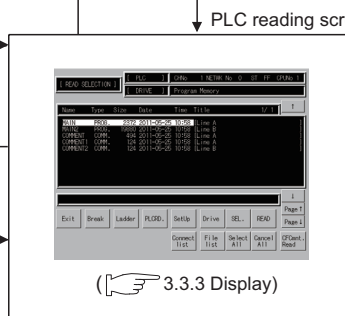
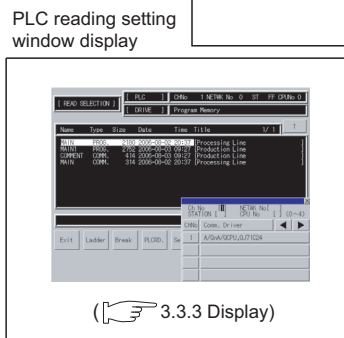

Exit
Touch

Exit
Touch

Exit
Touch

When the ladder monitor has been started from the utility

When the ladder monitor has been started by the special function switch

Switches to the Main Menu screen.

Switches to the user-created screen.

3.3.1 Setting and deleting media for saving ladder data

■ Setting the ladder data storage destination

(1) Setting for the MELSEC-Q/L/QnA ladder monitor

Up to 512 files of data used for the ladder monitor function (sequence programs, device comments) can be stored in a selected drive.

The ladder data storable capacity differs according to the ladder data storage destination.

Storage destination	Capacity
A: Standard CF Card	Up to the installed CF card available space.
B: Extended Memory Card	
C: Built-in Flash Memory	4MB

Storing ladder data eliminates the need to read ladder data from the PLC CPU every time powering on the GOT, reducing the time before executing the ladder monitor.

If the CF card is designated as a destination for storing data, ladder data of multiple destinations can be stored simultaneously.

For the ladder data storage destination setting, refer to the following.

When setting with the utility

 User's Manual for the GOT used

When setting with GT Designer3

 GT Designer3 Version1 Screen Design Manual (Fundamentals)

POINT

Precautions when the ladder data storage destination is set to [None]

- Only one sequence file and comment file of ladder data can be read in the GOT.
- When searching program files using the one-touch ladder jump function, specify a file to be searched.

(2) Setting for the A/FX ladder monitor

Ladder data cannot be stored.

For the A/FX ladder monitor, data for ladder monitoring are deleted every time the GOT is powered on again.

■ Deleting ladder data

Ladder data can be deleted with the ladder monitor screen or the utility.

When deleting the ladder data with the utility, the GOT clears all the stored ladder data.

To delete only the specific data, delete them on the ladder monitor screen.

For deletion of ladder data, refer to the following.

When deleting with the ladder monitor screen

 3.3.2 Display

When deleting with the utility

 User's Manual for the GOT used

3.3.2 Display

This subsection describes the procedure for reading the PLC to read the sequence program from the target controller when the ladder monitor is executed, and until the ladder monitor screen is displayed. The operation of reading the PLC depends on the controller type.

■ When the MELSEC-A/FX ladder monitor is executed

The MELSEC-A ladder monitor is taken as an example to describe the operation procedure.

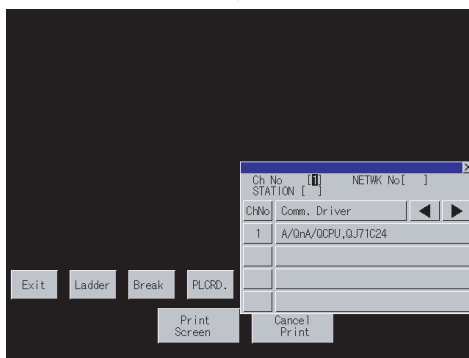
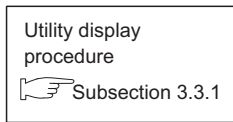

1. The communication setting window is displayed.
 - The name of the Communication driver installed in the GOT is displayed.
 - Touch "ChNo." on the communication setting window and set the channel number of the controller targeted to the ladder monitor.
 Touch the key, and move the cursor to "NETWK No []."

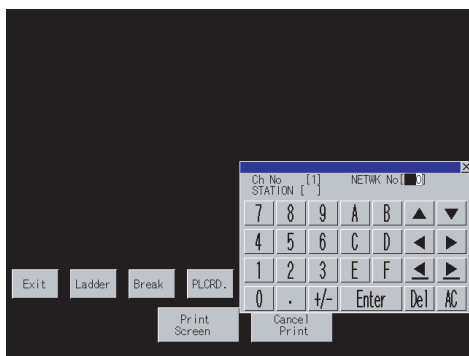

2. Set the network number of the target controller and the CPU station number according to the table shown below.

Setting	Connection form					
	Bus connection	Direct CPU connection	Computer link connection	Ethernet connection	CC-Link (intelligent device station)	MELSEC NET/10 connection
NETWK No		0		1 to 239	0	0: Host loop 1 to 255: Specified loop
STATION ^{*1}		FF		1 to 64	0: Master station 1 to 64: Local station	0: Control station 1 to 64: Normal station

*1 When the station No. is set to the host station (FF), set the network No. to 0.
For the operation of the key window, see the following:
 2.4.3 Key window setting columns and operation procedure
Entry is completed by touching the key, and the key window closes.



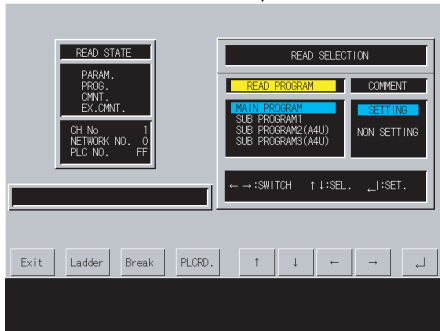

(Continued to next page)

(From previous page)

PLC reading screen



(Continued to next page)

3. Touch the , , , and  keys to specify the following items listed under "READ SECTION."

- Sequence program
(In the case of the MELSEC-A ladder monitor)
Main program
Subprogram 1
Subprogram 2 (A4U)
Subprogram 3 (A4U)

(In the case of the MELSEC-FX ladder monitor)
Main program (fixed)

- SETTING/NON SETTING for comment reading
In the case of the FXCPU

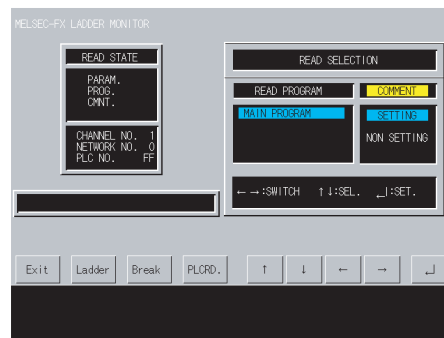

4. After the items under "READ SECTION" are specified, touch the  key.

POINT

Displaying the ladder monitor screen

The MELSEC-FX ladder monitor screen displays the sequence program that was executed when the PLC was read. If any of the set values of the sequence program is changed, re-read the PLC.

Changes to set values are displayed on the screen when the MELSEC-A ladder monitor is executed. It is not necessary to re-read the PLC.

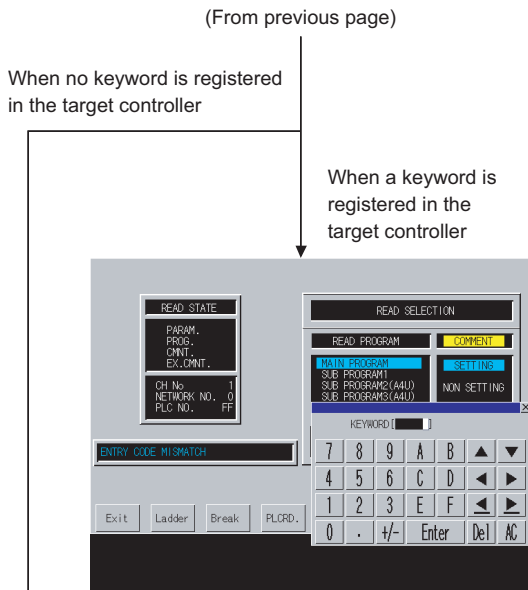

5. Enter the keyword registered in the target controller.
 (In the case of the MELSEC-A ladder monitor)
 The data entered can be corrected with the following keys:
- Del** key :Used to delete a character of the entered information.
 - AC** key :Used to delete all characters entered.

(In the case of the MELSEC-FX ladder monitor)
 Touch the **Keyword** key to enter the keyword registered in the target PLC CPU.

For the FX CPU keyword, refer to the following.

User's Manual for the GOT used

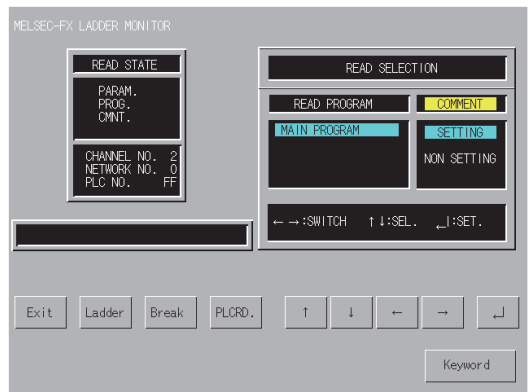

(Continued to next page)

(From previous page)

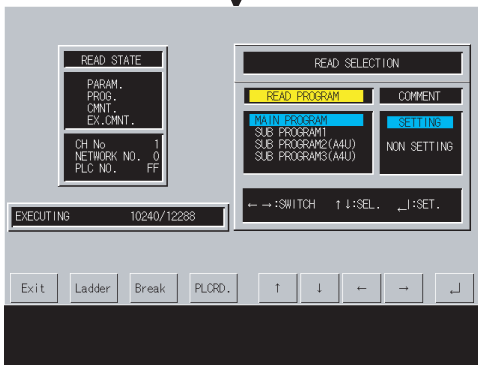

6. The sequence program is read.
 - The message "EXECUTING" is displayed.
 - The entire size of the program and the portion already read are displayed.

Portion already read/entire program size

- The reading of the PLC stops by touching the **Break** key.

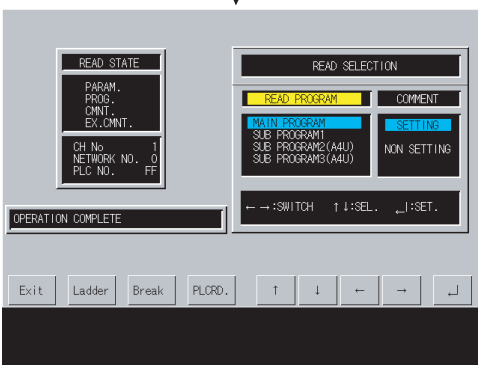

7. The reading of the sequence program is completed. The message "OPERATION COMPLETE" is displayed.

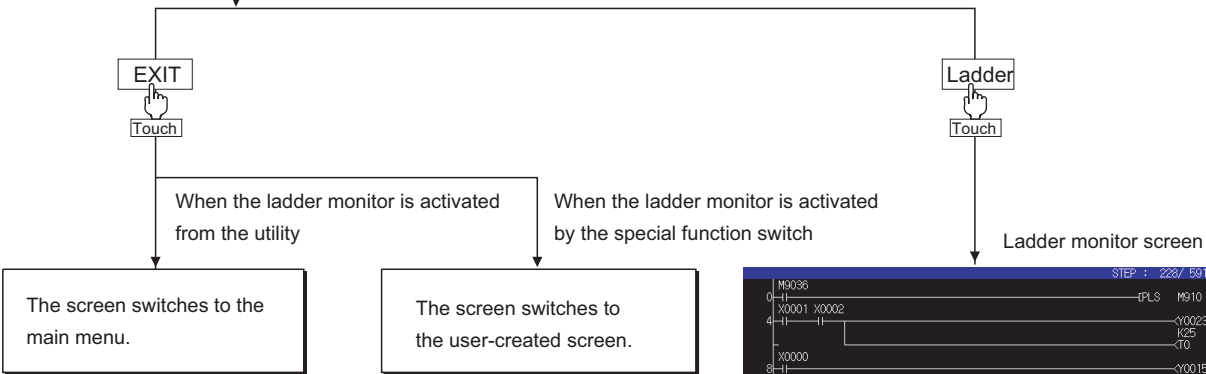

POINT

Reading the PLC in the following operations

Once the PLC is read, you do not have to read it in the following operations.

However, it must be re-read after you read it and then downloaded project data and when the power to the GOT is turned on again.

■ When the MELSEC-Q/L/QnA ladder monitor is executed

The MELSEC-Q ladder monitor is taken as an example to describe the operation procedure.

With regard to the MELSEC-QnA ladder monitor, if any keyword is entered in the target controller, it must be entered after procedure 5.

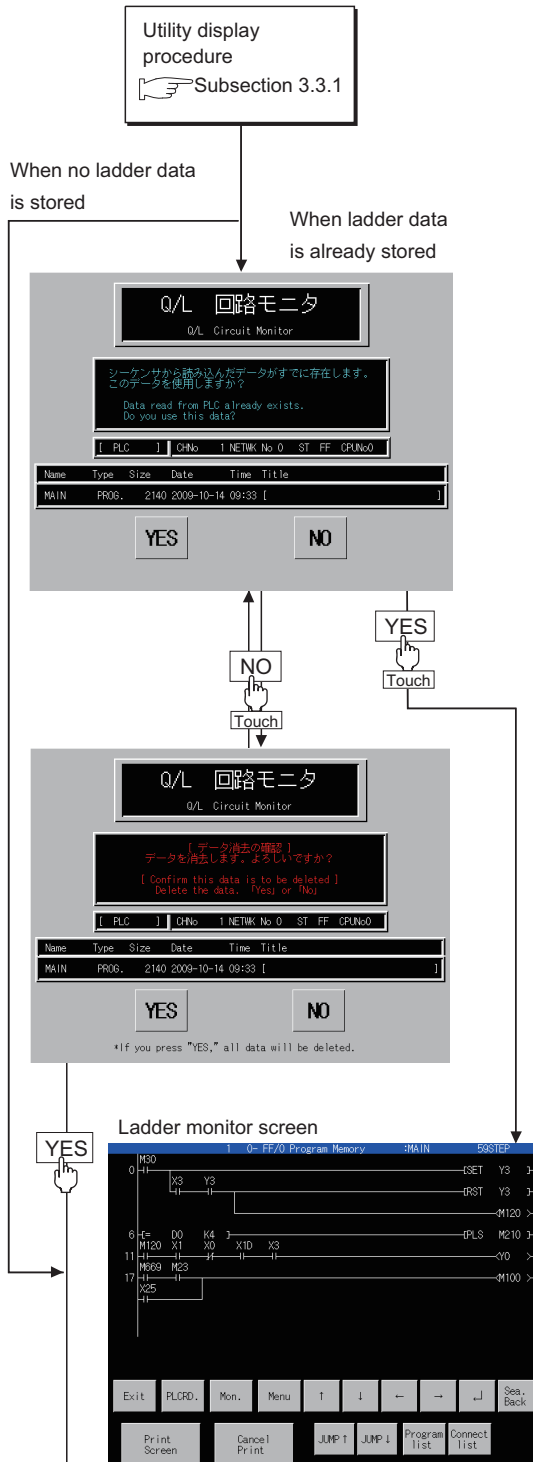

1. Select and touch **YES** or **NO** as described below.
 - To use stored ladder data, touch **YES**.
 - To delete stored ladder data and read new ladder data, touch **NO**.

2. Select and touch **YES** or **NO** as described below.
 - To delete stored ladder data, touch **YES**.
 - To keep stored ladder data, touch **NO**.

(Continued to next page)

(From previous page)

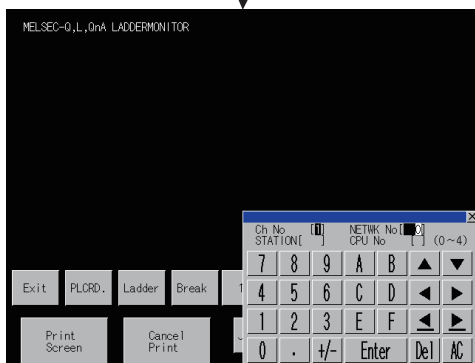
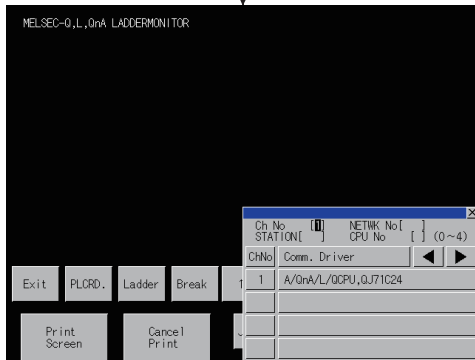

(Continued to next page)

- The communication setting window is displayed.
 - The name of the Communication driver installed in the GOT is displayed.
 - Set the channel number of the controller targeted to the ladder monitor.
 Touch the key, and move the cursor to "NETWK No []."

- Set the network number of the target controller, the CPU station number, and the CPU number according to the table shown below.

Setting	Setting range					
	Connection form					
	Bus connection, Direct CPU connection, Computer link connection	Ethernet connection	MELSECNET/H connection, MELSECNET/10 connection	CC-Link IE controller connection	CC-Link IE field network connection	CC-Link (intelligent device station)
NETWK No	0	1 to 239	0: Host loop 1 to 255: Specified loop	1 to 239	1 to 239	0
STATION*1	FF	1 to 64	0: Control station 1 to 64: Normal station	1 to 120	0: Master station 1 to 120: Local station	0: Master station 1 to 64: Local station
CPU No	0 to 4 (Set this item only for the MELSEC-Q ladder monitor.)					

*1 When the station No. is set to the host station (FF), set the network No. to 0.

For the operation of the key window, see the following:
 2.4.3 Key window setting columns and operation procedure

- Entry is completed by touching the key, and the key window closes.

POINT

In the case of Ethernet connection

Set a monitor target using GT Designer2 in advance.
 For further information about the setting of monitor target, see the following:

GOT1000 Series Connection Manual

(From previous page)

PLC reading screen



- The PLC reading screen is displayed. Touch the **SetUp** key. The setting window appears.

POINT

Displaying the ladder monitor screen

When the drive for storing ladder data is set to [C: Flash Memory], the ladder monitor screen displays the sequence program at the time of reading data from the PLC. If any of the set values of the sequence program is changed, re-read the PLC.

When the drive for storing ladder data is set to [A: Built-in CF card] or [B:Memory card], changes of the set values are reflected in the screen display. Rereading data from the PLC is not required.

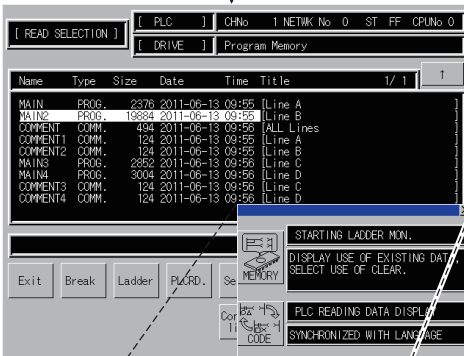

- The setting window appears. Make settings for the initial activation of the ladder monitor.* The settings shown below switch each time you touch the



key.

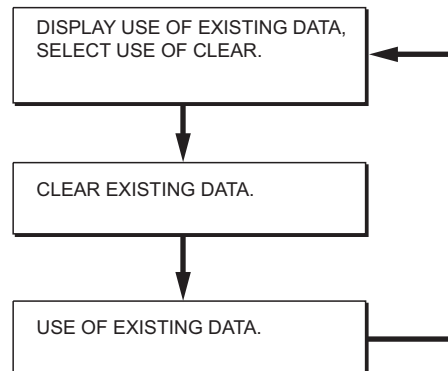

* This setting is invalid when the automatic PLC read setting is made or a searched file is specified, when performing coil search or defect search from the key code switch or the special function switch set for the advanced alarm display.

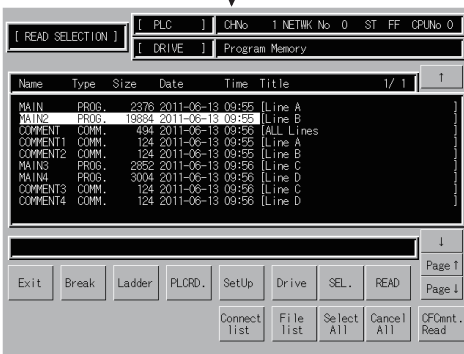
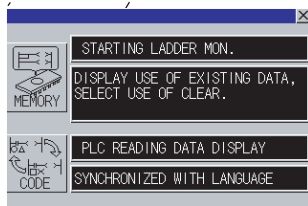

- After the setting is completed, touch the **Close** button to close the Setting window. Using the **Drive** key, select the target drive (applicable memory) in which the ladder data to be monitored is saved.

(Continued to next page)

(From previous page)

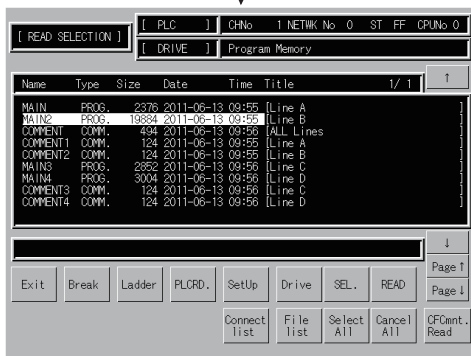

(Continued to next page)

9. The drive selection window is displayed. Enter the target drive (applicable memory).

Drive number setting range: 0 to 4

[Del] key :Used to delete a character of the entered information.

[AC] key :Used to delete all characters under the cursor.

[Enter] key :Registers the entered information.

When any keyword is set for the selected drive, enter the keyword.

If canceling the entry, reading of the drive is canceled.

10. A list of the files stored in the selected drive is displayed.

Using the keys shown below, select the file data you want to read.

[↑] key :Moves the cursor upward.

[↓] key :Moves the cursor downward.

[Page ↑] key :Displays the preceding page.

[Page ↓] key :Displays the following page.

[SEL.] key :Select/Cancel is switched by moving the cursor and touching this key.

[Select All] key :Selects all the files in the drive.

[Cancel All] key :Cancels all the file selections.

[READ] key :Starts the reading of the file data selected.

[CF Cmnt. Read] key :Starts reading a comment file from a CF card.

Set the drive to be used for reading the comment file in [Q/L/ QnA ladder monitor] of the utility or [GOT Setup] of GT Designer3.

☞ User's Manual for the GOT used

For reading comment files from CF cards, refer to the following.

☞ 3.3.4 Reading comment files from CF cards

POINT

Multiple ladder data storable

Multiple sequence and comment programs can be read.

For the PLC read setting, refer to the following.

☞ User's Manual for the GOT used

GT Designer3 Version1 Screen Design Manual (Fundamentals)

(From previous page)

When no password is entered
in the target controller

When a password is entered
in the target controller



11. Enter the password entered in the target controller.
In the case of the QCPU, a password is entered in the sequence and comment files.

POINT

When entering passwords for multiple files

When reading multiple files with passwords set, enter passwords for respective programs.
Canceling an entry cancels the reading of the file.

A-Z key : Uppercase alphabetic characters

a-z key : Lowercase alphabetic characters

The data entered can be corrected with the following keys:

Del key : Used to delete a character of the entered information.

AC key : Used to delete all characters entered.

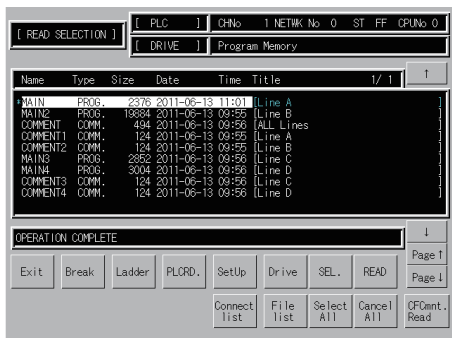

12. The sequence program is read.
 - The message "READING PROGRAM" is displayed.
 - The entire size of the program and the portion already read are displayed.
Portion already read/entire program size
 - The reading of the PLC stops by touching the **Break** key.

13. After sequence programs are read,
the message "OPERATION COMPLETE" is displayed.

(Continued to next page)

(From previous page)

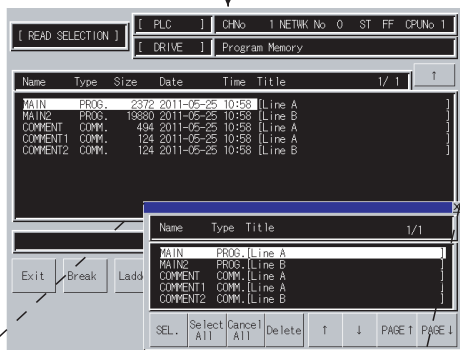

Connect list

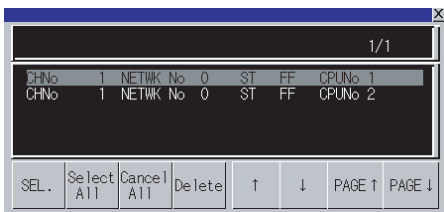

File list

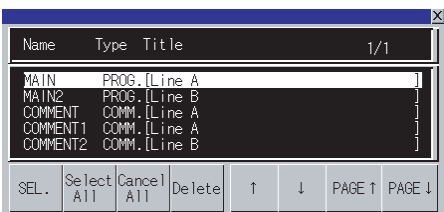

14. To delete the read ladder data, touch the **Connect list** key and **File list** key.

Select the **Connect list** key to delete all the files in one destination.

When it is touched, the sources from which program files and comment files are read are displayed in a list.

If the Q/L/QnA ladder monitor is set as the following, this key is not displayed.

- [Setting to save ladders] is set as [Save a ladder program].
- [Data save location] is set as [C: Flash Memory] or [Not store].

Select the **File list** key to delete one specific file.

When it is touched, the program files and comment files stored in the GOT or in the CF card are displayed in a list.

Operations can be performed by touching a key or the display part directly.

SEL. key :Select/cancel is switched by moving the cursor and touching this key.

Select All key :Selects all files.

Cancel All key :Cancels all selections.

Delete key :Deletes the file selected.

↑ key :Moves the cursor upward.

↓ key :Moves the cursor downward.

Page ↑ key :Displays the preceding page.

Page ↓ key :Displays the following page.

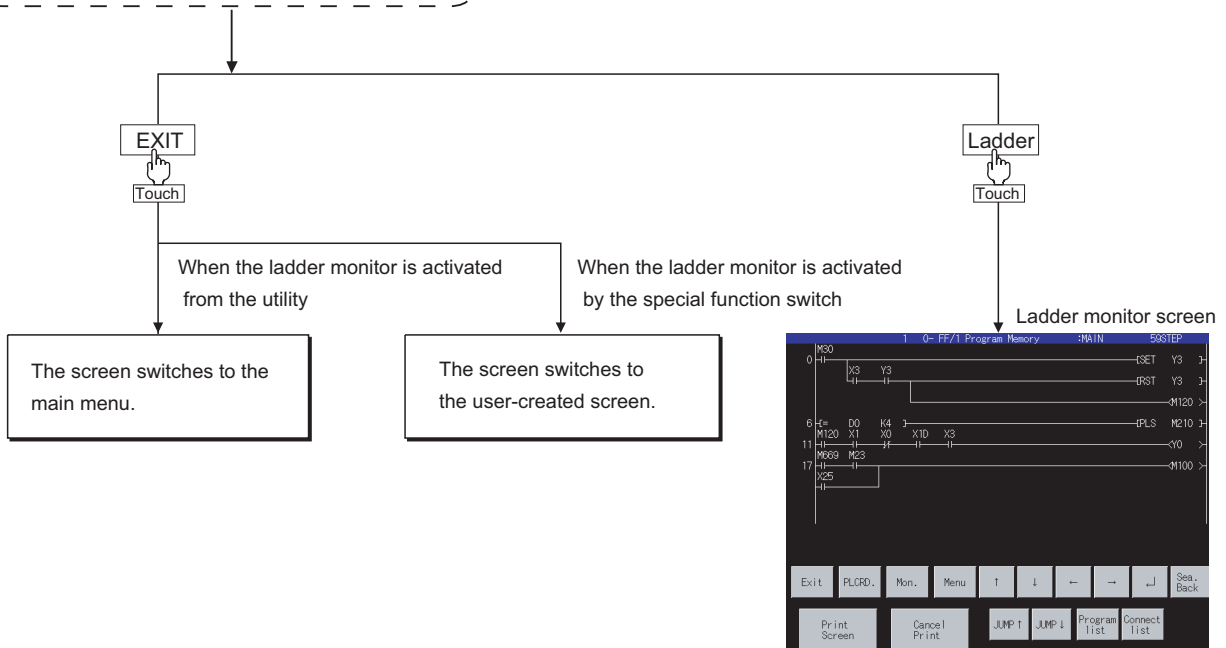

POINT

Reading the PLC in the following operations

Once the PLC is read with the power to the GOT turned on, you do not have to read it in the following operations.

3.3.3 Searching from the monitor screen

When starting a ladder monitor with object, coil-search/defect search can be automatically performed to the read sequence program and the result can be displayed on the monitor.

■ Usable objects and functions list

The following table shows the types of objects can be searched from a monitor screen and functions usable in each object.

For object setting to display searching result on ladder monitor, refer to the following manual.

 GT Designer3 Version1 Screen Design Manual (Fundamentals)

(1) MELSEC-Q/L/QnA ladder monitor

(○: Applicable ×: Inapplicable)

Object	Function			
	Automatic PLC read	Specify Search File	Coil	Factor
Special Function Switch	○ ^{*1}	○	○	○
Advanced Alarm Display	○ ^{*1}	○	○	○
Alarm List	×	×	○	×
History	×	×	○	×

*1 For reading comment files from CF cards, refer to the following.

 3.3.4 Reading comment files from CF cards

(2) MELSEC-A/FX ladder monitor

(○: Applicable ×: Inapplicable)

Object	Function			
	Automatic PLC read	Specify Search File	Coil	Factor
Special Function Switch	×	×	○	×
Advanced Alarm Display	×	×	○	×
Alarm List	×	×	○	×
History	×	×	○	×

■ Searching operation

(1) When displaying searching result with the Advanced Alarm Display or Special Function Switch

The following explains the procedure from touching the Key Code Switch for advanced alarm display or Special Function Switch and performing coil-search or defect search to display of a ladder block.*

The following flowchart explains the operation when the destination to save the ladder block data is specified.

* When performing MELSEC-A/FX ladder monitor, the operation is the same when displaying the searching result with Alarm List or History explained (2) .

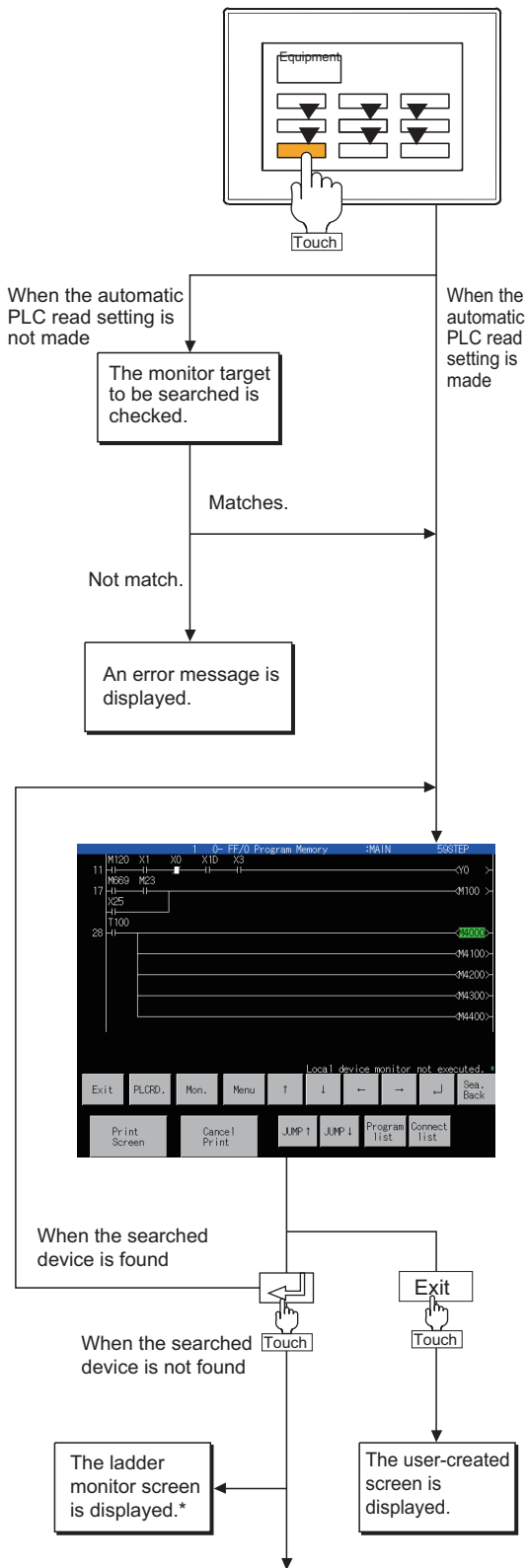

The following explains the operation taking MELSEC-Q ladder monitor as an example.



(Continued to next page)

* After coil-search, monitoring of the displayed ladder starts automatically. (During MELSEC-A/FX ladder monitor, touching the monitor key starts the same operation.)

1. Touch a key in monitor screen.
The operation differs depending on object setting.
 - (1) **When the Automatic PLC read setting is made**
 - (a) When [Specify Search File] is selected
Reads the specified sequence program.
 - (b) When [Specify Search File] is not selected
Reads all sequence programs in the program memory of the target controller.
For the setting method of Automatic PLC read, refer to the following.
 GT Designer3 Version1 Screen Design Manual (Fundamentals)
 - (2) **When the Automatic PLC read setting is not made**
Searching starts only when the monitor target of the sequence program that has been read and the monitor target that is set for searching on the object match. When they are mismatch, an error message appears. Read again to match the monitor target for searching on the PLC reading screen.
2. When a keyword is registered to the read target drive, enter the keyword.
To read a file to which a password is registered, enter the password.
If canceling the entry, reading of the drive or file is canceled.

After the read program is searched, the result is displayed.
3. Touching the  button searches consecutively. Touching the  button completes searching halfway.
4. If the searched device is not found in the read program, the message "DEVICE NOT FOUND" appears and searching is completed.
After searching, the program that has been read first is displayed on the ladder monitor screen.

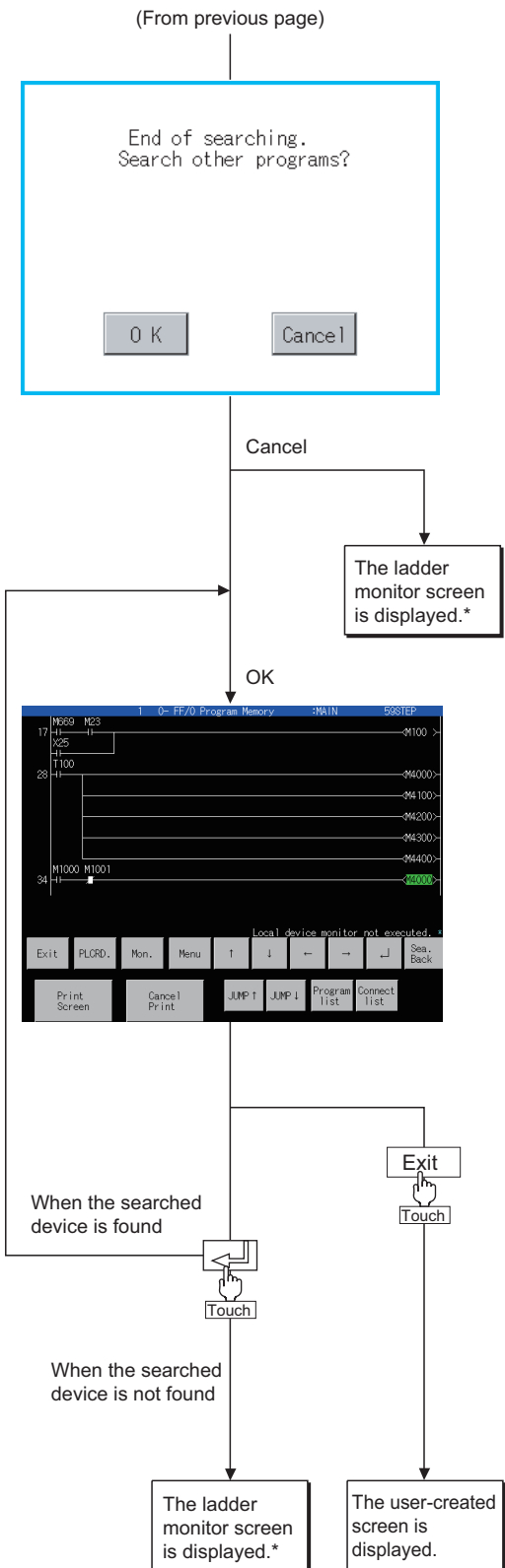

* After coil-search, monitoring of the ladder displayed is started automatically.

- When multiple read programs exist, the dialog box which asks about searching for other programs appears.

Touching the **OK** button starts searching to all other read programs.

- According to the order of the programs that have been read first, searching is started to the next file and the result is displayed.

- Touching the **←** searches consecutively. Touching the **Exit** button completes searching halfway.

POINT

Ladder display during consecutive search

When displaying the ladder block in the next sequence file, the previous search results are cleared. (☞ Section 3.6.3 Coil search)

- If the searched device is not found in all read programs, the message "DEVICE NOT FOUND" appears and searching is completed.

After searching, the program that has been read first is displayed on the ladder monitor screen.

(2) When displaying searching result with Alarm List/History

The following explains the procedure from touching the Key Code Switch for user alarm display and performing coil-search of sequence program to display of a ladder block.

POINT

Program to be searched

In Alarm List/History, coil-search is performed to the sequence program that has been displayed on the ladder monitor last among the read sequence programs.

However, when no ladder programs have not been displayed, coil-search is performed to the sequence program that has been read first.

Therefore, the file to be searched has to be read from the PLC reading screen beforehand.

For setting from the PLC reading screen, refer to the following section.

 3.3.3 Display

1

OVERVIEW

2

SYSTEM MONITOR

3

LADDER MONITOR
FUNCTION

4

MELSEC-A LIST
EDITOR

5

MELSEC-FX LIST
EDITOR

6

INTELLIGENT
MODULE MONITOR

7

NETWORK
MONITOR

8

Q MOTION
MONITOR

The following explains the operation taking MELSEC-Q ladder monitor as an example.

1. Touch a key in monitor screen.

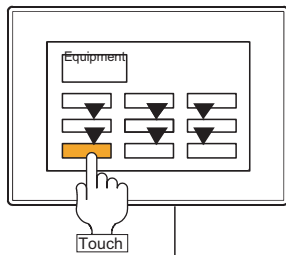

The monitor target to be searched is checked.

Not match.

Matches.

2. Searching starts only when the monitor target of the sequence program that has been read and the monitor target that is set on the object match.

When they are mismatch, an error message appears. Read again to match the monitor target for searching on the PLC reading screen.

In MELSEC-A/FX ladder monitor, an error message does not appear even they are mismatch, and searching continues.

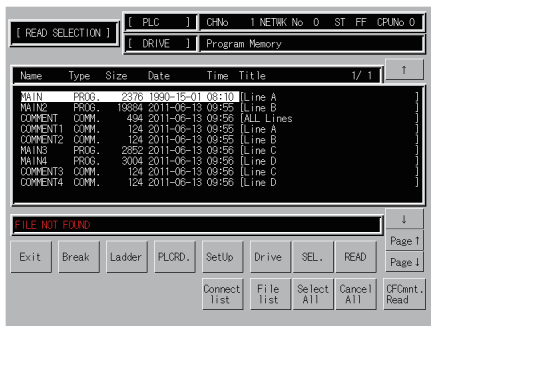

3. Searching result is displayed.

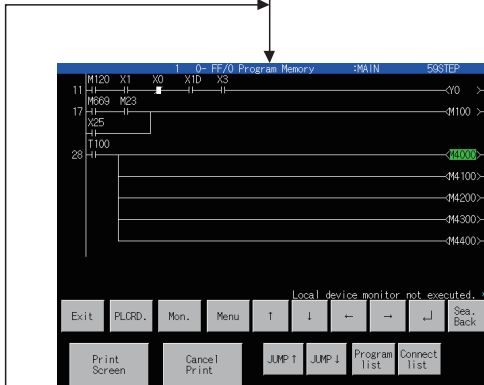

When the searched device is found

When the searched device is not found

The ladder monitor screen is displayed.*

The user-created screen is displayed.

4. Touching the button searches consecutively. Touching the button completes searching halfway.

5. If the searched device is not found, the message "DEVICE NOT FOUND" appears and searching is completed. After searching, the normal ladder monitor screen is displayed.

* After coil-search, monitoring of the ladder displayed is started automatically. (For the A/FX ladder monitor, touching the Mon. key provides the same operation.)

3.3.4 Reading comment files from CF cards

A comment file to be used for the ladder monitor can be read from a CF card installed on the GOT. Using a comment file stored in a CF card has the following advantages.

- The processing time is shorter than the one for reading a comment file from a PLC CPU.
- Writing comment file data into a PLC CPU is not required, so less memory of the PLC CPU is used.

■ Procedure for using comment files stored in CF cards

The following shows the procedure for using a comment file stored in a CF card.

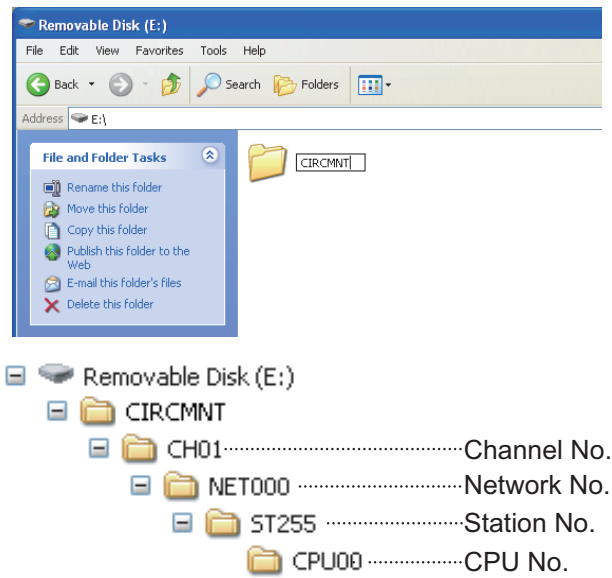

1. Create a folder with the folder name of CIRCMT in a CF card. When the CIRCMT folder already exists, creating a new CIRCMT folder is not required.

2. In the CIRCMT folder, create folders for CH No., network No., station No., and CPU No. of the monitored controller with a hierarchy as shown left.

Item	Folder name
CH No.	CH**
Network No.	NET***
Station No.	ST***
CPU No.	CPU**

Assign numbers to "*" marks.
(When the CH No. is 1, the folder name is CH01. When the monitor target is the host station, the folder name is ST255.)

3. To read a comment from the project data of GX Works2, save the project data again in the GX Developer format. A comment cannot be read from the project data of GX Works2. For how to save the project data of GX Works2 in the GX Developer format, refer to the following.

GX Works2 Version1 Operating Manual (Common)

4. A comment file (.wcd) is created when the project data is saved in the GX Developer format.

For project data that cannot be saved in the GX Developer format, export the data using [Write IC memory card] in GX Works2 and change the extension of the comment file from [.qcd] to [.wcd].

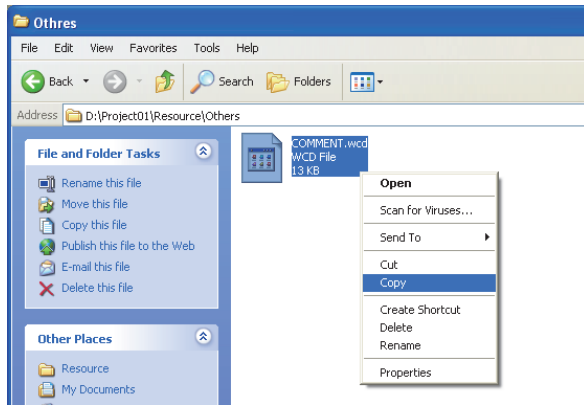

5. Copy the comment file (.wcd).

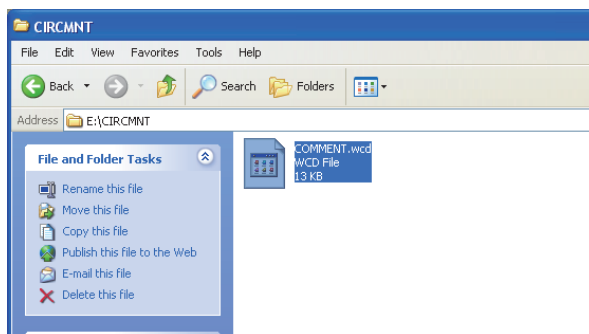

6. Copy a comment file (.wcd) from the project data of GX Developer.

7. Save the copied comment file in the CIRCMT folder created in the CF card. Install the CF card with the comment file on the GOT. Read the comment file with the ladder monitor.

POINT

When using comment files stored in CF cards

When comment files exist both in a CF card and a PLC, the comment file to be used may not be read. For using a comment file stored in a CF card, do not write comment file data into a PLC.

HINT

Displaying/hiding comments

The display/hide selection of comments can be set in the utility screen or in GT Designer3.

The status is reflected to the ladder monitor screen by setting the display/hide selection of comments in advance.



User's Manual for the GOT used
GT Designer 3 Version1 Screen Design Manual (Fundamentals)

3.4 Operation Procedure Common

This section describes the information and key functions displayed on the ladder monitor screen.

The display screen of the ladder monitor varies slightly with the GOT used. This chapter mainly uses the screen of the GT1575-V for explanation.

3.4.1 Information and key functions displayed on the screen

The ladder monitor screen depends on the controller type.

POINT

After executing PLC reading, if the controller comment or comment capacity is changed, the comment may not be correctly displayed on the ladder monitor screen.

When changing the comment or comment capacity, re-start the GOT.

(1) When the MELSEC-A/FX ladder monitor is executed

(a) Display monitor

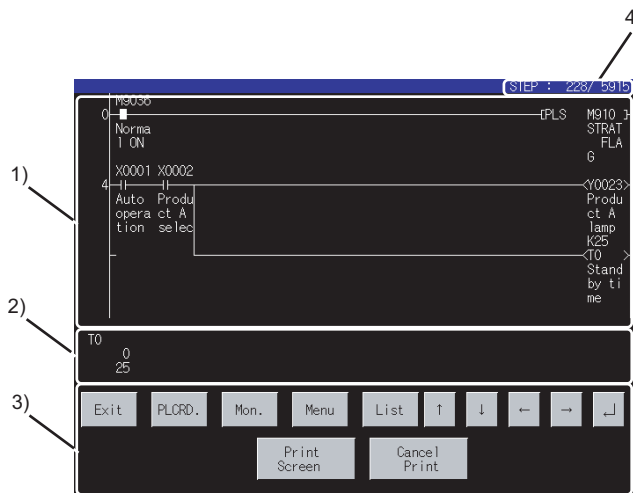

When comment is not displayed : maximum 8 lines
When comment is displayed : maximum 3 lines

ON/OFF status display for ladder monitor

· ON status :















· OFF status :

* The MCR command is normally displayed as

The information shown in the table below is displayed.

No.	Description
1)	Sequence program is displayed. A maximum of 11 contact points is displayed in one line of a ladder; for 12 contact points or more, move to the next line. When a comment display is specified, a comment is also displayed; expanded comments are given priority. For the method of displaying comments, see the following: 3.5.3 Switching comment/no-comment display
2)	A maximum of eight devices is displayed for the word device current value, timer and counter current value (upper row), and set value (lower row). When the set value is an indirect specification, the value of the indirectly specified device is displayed. To switch between decimal and hexadecimal for the displayed value, see the following: 3.5.2 Display switching of decimal numbers/hexadecimal numbers
3)	Display the keys used with the operation on the ladder monitor screen shown in (b) (Touch input).
4)	The display step number (left) and the remaining step number (right) are displayed.

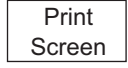
(b) Key functions (when the MELSEC-A/FX ladder monitor is executed)

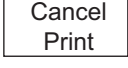
Key	Function
	Returns the screen to the one displayed when the ladder monitor was activated.
	Switches the screen to the PLC reading screen to read from the controller the sequence program to be monitored. For further information about PLC reading, see the following:  3.3.2 Display
	Starts monitoring the displayed sequence program.
	Displays the Menu window for ladder monitor ( (3) Menu window for the ladder monitor).
	Starts the list editor for A/FX. For details on the A/FX list editor, refer to the following.  · 4. MELSEC-A LIST EDITOR · 5. MELSEC-FX LIST EDITOR
	Scrolls the information upward by a ladder block.
	Scrolls the information downward by a ladder block.
	When the number of devices whose present and set values are within the display range shown in 2) on the preceding page is nine or more, the devices to be displayed are switched.
	Scrolls the information downward by a screen. In search operation, a search is continuously performed under the same conditions.
	Stores the displayed screen to the memory card in BMP/JPEG file format or prints it with a printer. For further information about hard copies, see the following:  3.4.2 Hard copy output
	The operation of this key is invalid.

(2) When the MELSEC-Q/L/QnA ladder monitor is executed

(a) Display screen

The screen display varies depending on the resolution of the GOT.

(GOT with VGA resolution)

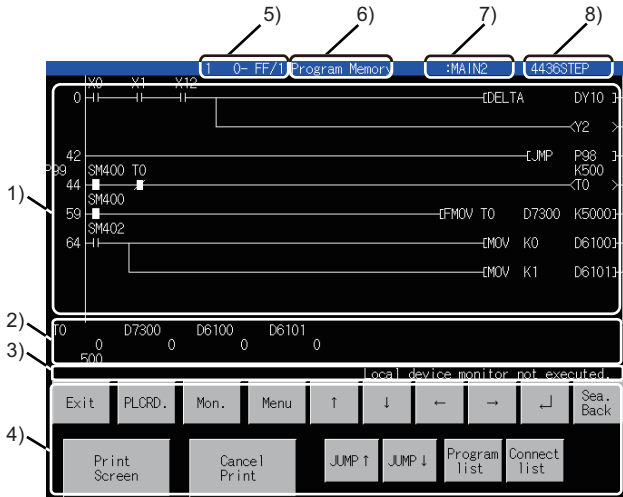

(GOT with SVGA or higher resolution)

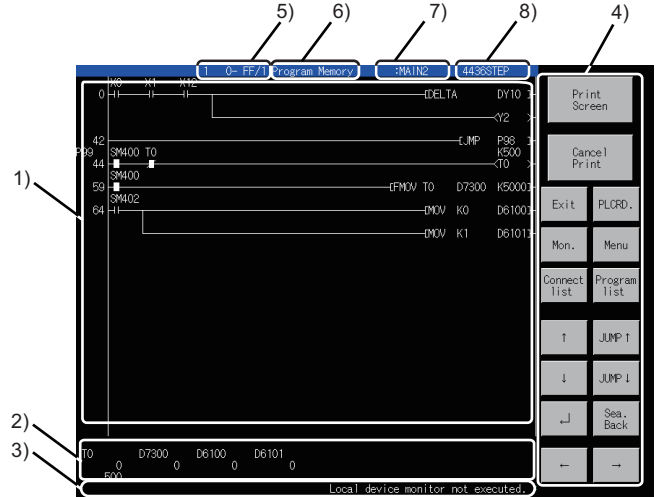

ON/OFF status display for ladder monitor

- ON status :
- OFF status :

* The MCR command is normally displayed as



















For the number of characters of comments and comment display, see the following:

- ➔ 3.5.3 Switching comment/no-comment display
- 3.5.4 Displaying 32 characters of comments

The information shown in the table below is displayed.

No.	Function
1)	Sequence program is displayed. A maximum of 11 contact points is displayed in one line of a ladder; for 12 contact points or more, move to the next line. When [Comment Display] is specified, comments are also displayed. For the method of displaying comments, see the following: ➔ 3.5.3 Switching comment/no-comment display.
2)	A maximum of eight devices is displayed for the word device current value, timer and counter current value (upper row), and set value (lower row). When the set value is an indirect specification, the value of the indirectly specified device is displayed. To switch between decimal and hexadecimal for the displayed value, see the following: ➔ 3.5.2 Display switching of decimal numbers/hexadecimal numbers.
3)	The current status of monitoring local devices is displayed. *** blinks just to the right of the local device monitor status display during communicating with a PLC CPU. Nothing is displayed without monitoring. • Auto setting(program names). : A local device is monitored. (The active program name is displayed.) • Local device monitor not executed. : A local device is not monitored. • Local device monitor is not supported. : The PLC CPU being used is inapplicable to the local device. For switching the local device monitor between execution and non-execution states, refer to the following. ➔ (3) Menu window for the ladder monitor
4)	Display the keys used with the operation on the ladder monitor screen shown in (b) (Touch input).
5)	The Ch No., the network No., the station No. and CPU No. are displayed. (Only when the MELSEC-Q ladder monitor function is executed.)
6)	The drive is displayed.
7)	The file name of the PLC program is displayed.
8)	The total number of steps in the current monitor PLC program is displayed.



(b) Key functions (when the MELSEC-Q/L/QnA ladder monitor is executed)

No.	Function
	Returns the screen to the one displayed when the ladder monitor was activated.
	Switches the screen to the PLC reading screen to read from the controller the sequence program to be monitored. For further information about PLC reading, see the following:  3.3.2 Display
	Starts monitoring the displayed sequence program.
	Displays the Menu window for ladder monitor ( (3) Menu window for the ladder monitor).
	When the number of devices whose present and set values are within the display range shown in 2) on the preceding page is nine or more, the devices to be displayed are switched.
	Scroll the information upward and downward by a ladder block.
	Scrolls the information downward by a screen. In search operation, a search is continuously performed under the same conditions.
	Displays back past device/contact point/coil searches or touch searches by one.
	Stores the displayed screen to the memory card in BMP/JPEG file format or prints it with a printer. For further information about hard copies, see the following:  3.4.2 Hard copy output
	The operation of this key is invalid.
 	Jump the information upward and downward by ten ladder blocks.
	Displays the program list window ( (4) Program list window)
	Displays the connect list window ( (5) Connect list window)

POINT

About the  key (Only when the MELSEC-Q/L/QnA ladder monitor is executed.)

(1) Continuous device search by  key





Immediately after the  key has been pressed to go back in the history, a continuous device search using the  key cannot be executed.

(2) Number of histories that can be gone back

Using the  key, you can go back into the history up to 100 ladders.

(3) Clearing search history

When any of the following operations is performed, the search history is cleared to return to the normal ladder display.

- When the   key is touched.
(When a single ladder block takes up more than one screen, scrolling can be made within the block.)
- When the   key is touched.
- When a step search, END search or defect search is executed.
- When a comment display is changed.
- When a new file is read by touching .

(4) Returning search results during searching in multiple sequence programs

(a) Displaying search results

For searching in multiple sequence programs, the GOT can display search results of the previously

searched program by touching the  key.

The GOT cannot display search results of multiple programs on one screen.

When programs are switched, the currently displayed search results of the program disappear from the screen.

(b) When searching program is deleted

For returning to the search results of the previously searched program by touching the  key during searching in multiple sequence programs, the touch operation is canceled when the previously searched program is deleted.

(3) Menu window for the ladder monitor

(a) Display screen

Dev.Sea.	Xref.	Cmnt.
Cont.Sea.	16/32Bit	Cmnt.32
Coil.Sea.	Dec.Hex.	Note
Step.Sea.	Test	Statement
End.Sea.	Local Dev.	

(b) Key functions

Key		Function
Search operation	Dev.Sea.	Displays the ladder block containing the specified device. ☞ 3.6.1 Device search
	Cont.Sea	Displays the ladder block containing the specified device. ☞ 3.6.2 Contact point search
	Coil.Sea.	Displays the ladder block containing the specified coil. ☞ 3.6.3 Coil search
	Step.Sea	Displays the ladder block containing the specified step number. ☞ 3.6.4 Step search
	End.Sea.	Displays the last ladder block of the sequence program. ☞ 3.6.5 Ladder end search
	Xref.	Searches the ladder blocks for the status of continuity/non-continuity of the contact point that turned on or off the coil on the sequence program. ☞ 3.6.6 Defect search
Display format switching	16/32Bit	Switches the word device and timer/counter values displayed on the ladder monitor screen to the 16-bit (one-word) or 32-bit (two-word) module. ☞ 3.5.1 Display switching of 16-bit (one-word)/32-bit (two-word) modules
	Dec.Hex.	Switches the word device and timer/counter values displayed on the ladder monitor screen to decimal or hexadecimal numbers. ☞ 3.5.2 Display switching of decimal numbers/hexadecimal numbers
	Cmnt.	Switches whether to display the comments added to the word and bit devices displayed on the ladder monitor screen. ☞ 3.5.3 Switching comment/no-comment display
	Cmnt.32	Displays the 32 characters of the comments to the word and bit devices displayed on the ladder monitor screen. For further information, see ☞ 3.5.4 Displaying 32 characters of comments This key is not displayed when the MELSEC-A and MELSEC-FX ladder monitor.
	Note	Switches whether to display integrated notes on the sequence program. Peripheral notes are represented by *. ☞ 3.5.5 Displaying notes This key is not displayed when the MELSEC-A and MELSEC-FX ladder monitor.
	Statement	Switches whether to display integrated statements on the sequence program. Peripheral statements are represented by *. ☞ 3.5.6 Displaying statements This key is not displayed when the MELSEC-A and MELSEC-FX ladder monitor.
Test operation	TEST	Changes device values on the screen when the ladder monitor is executed. For further information, see the following: ☞ 3.7 Test Operation
Local device monitor	Local Dev.	Switches the local device monitor between execution and non-execution states. ☞ 3.8 Local Device Monitor The key is not displayed with the MELSEC-QnA ladder monitor.

(4) Program list window



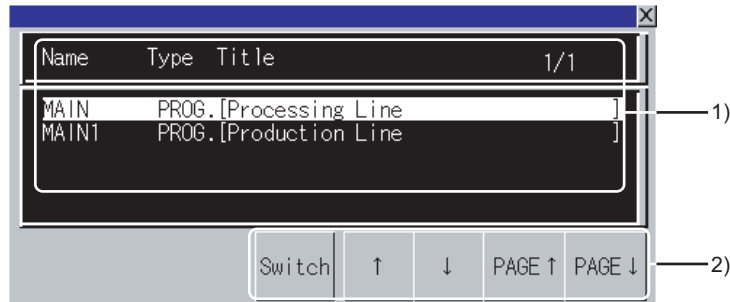

(a) Display screen



The following table shows the display details.

No.	Function
1)	Displays saved sequence program name.
2)	Displays the keys used in the program list window's operation. (Touch input) Besides key touch, a program name can be selected by touching the program name directly.

(b) Key functions

Key	Function
Switch	Switch the monitoring target in the ladder monitor screen to the selected sequence program.
 	Scrolls the display upward or downward by a file.
 	Scrolls the display upward or downward by a page.

(5) Connect list window



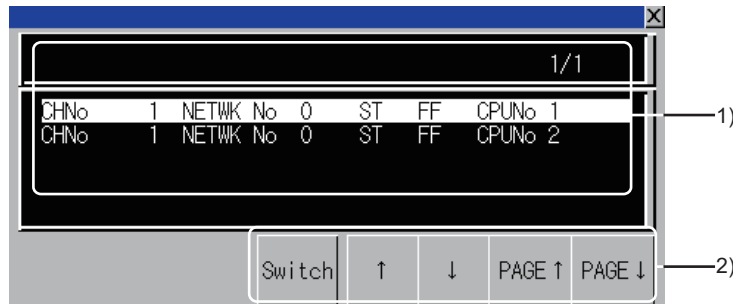

(a) Display screen



The following table shows the display details.

No.	Function
1)	The source from which the sequence program is read (destination) is displayed.
2)	Displays the keys used in the Connect list window's operation. (Touch input) Besides key touch, a destination can be selected by touching the destination directly.

(b) Key functions

Key	Function
Switch	Switch the monitoring target in the ladder monitor screen to the sequence program of the selected destination.
 	Scrolls the display upward or downward by a file.
 	Scrolls the display upward or downward by a page.

3.4.2 Hard copy output

This section describes how to store a ladder monitor screen to the memory card in BMP/JPEG file format or print it with a printer.

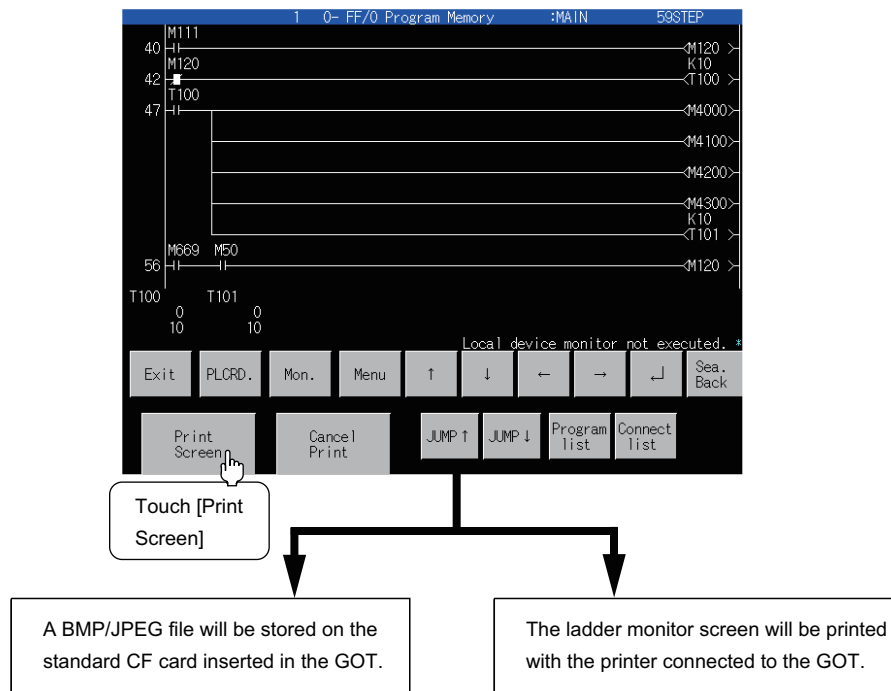

POINT

- Install the extended function OS (Printer) to the GOT when printing a ladder monitor screen.
- The output target (memory card/printer) of hard copy can be set in Hard Copy of GT Designer2. For details of hard copy setting, refer to the following.

☞ User's Manual for the GOT used

- When outputting a hard copy, the display can be inverted between white and black. For invert colors setting, refer to the following.

☞ GT Designer3 Version1 Screen Design Manual (Functions) 40. HARD COPY FUNCTION

3.5 Switching the Display Format

You can switch the display format (16-bit (one-word) module/32-bit (two word) module or decimal number/hexadecimal number) of word device and timer/counter values displayed on the ladder monitor screen, and whether to display the comments to the target devices.

3.5.1 Display switching of 16-bit (one-word)/32-bit (two-word) modules

During monitoring, the present values of word devices (except timers and counters) are displayed in the 16-bit or 32-bit module. These modules switch alternately each time you press the **16/32Bit** key.

POINT

Displaying timers and counters

You cannot switch the 16-bit (one-word) or 32-bit (two-word) module with regard to the present and set values of timers and counters. The GOT automatically selects to display them in the 16-bit (one-word) or 32-bit (two-word) module.

(Operation example: Switch 16-bit (one-word) module display to 32-bit (two-word) module display.)

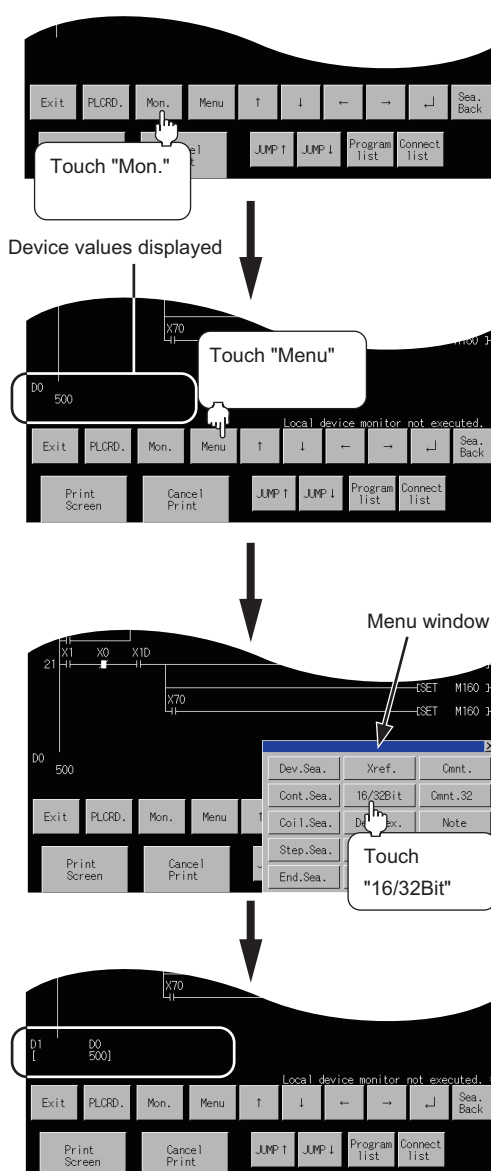

1. Touch **Mon.**

2. Touch **Menu**

3. Touch **16/32Bit**

4. The word devices are displayed in the 32-bit (two-word) module.

3.5.2 Display switching of decimal numbers/hexadecimal numbers

During monitoring, the present values of word devices and the present values (upper values) and set values (lower values) of timers/counters are displayed in decimal or hexadecimal numbers. The display formats switch alternately each time you press the **Dec.Hex.** key.

(Example of operation: Switching the decimal display to the hexadecimal display.)

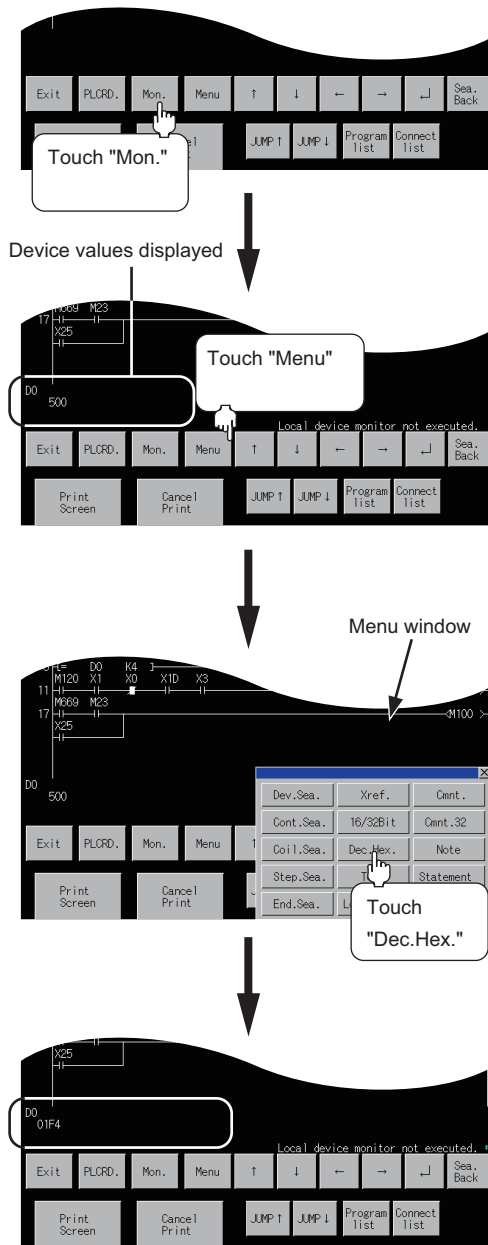

1. Touch **Mon.**

2. Touch **Menu**

3. Touch **Dec.Hex.**

4. The values are displayed in hexadecimal numbers.

3.5.3 Switching comment/no-comment display

Comments written in the target controller are displayed. Comment display and no-comment display switch alternately each time you press the **Cmnt.** key.

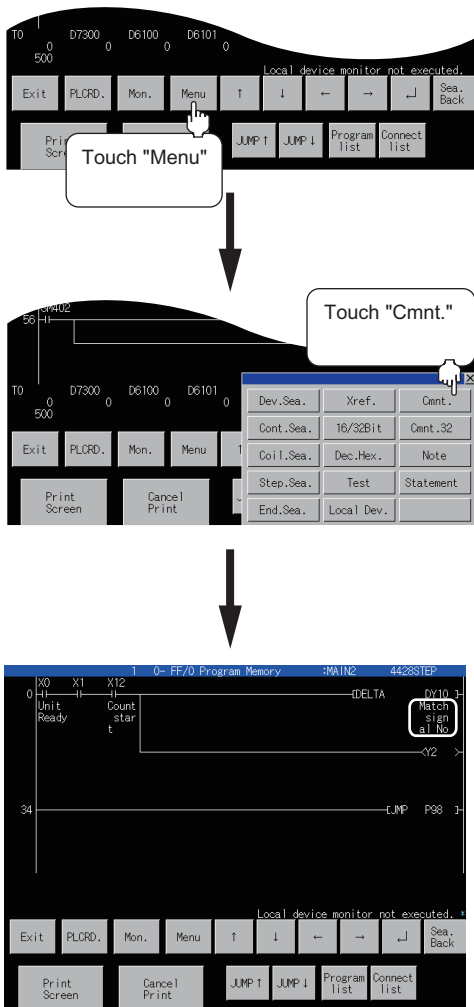

1. Touch **Menu** .

2. Touch **Cmnt.** .

3. Comments are displayed.
Each comment is displayed in five characters on three lines.

POINT

Priority of comment display

- (1) For the MELSEC-Q/L/QnA ladder monitor**
Either of Common Comment or Comment by program can be selected.
For the setting of comment display priority, refer to the following.

User's Manual for the GOT used

- (2) For the MELSEC-A ladder monitor**
The comment display priority is as follows.
Extension comment > Comment in Kanji or kana

3.5.4 Displaying 32 characters of comments

Comments can be displayed in 32 characters when the MELSEC-Q/L/QnA ladder monitor is executed. They are not displayed when the MELSEC-A/FX ladder monitor is executed.

(1) Procedure for displaying 32 characters of comments

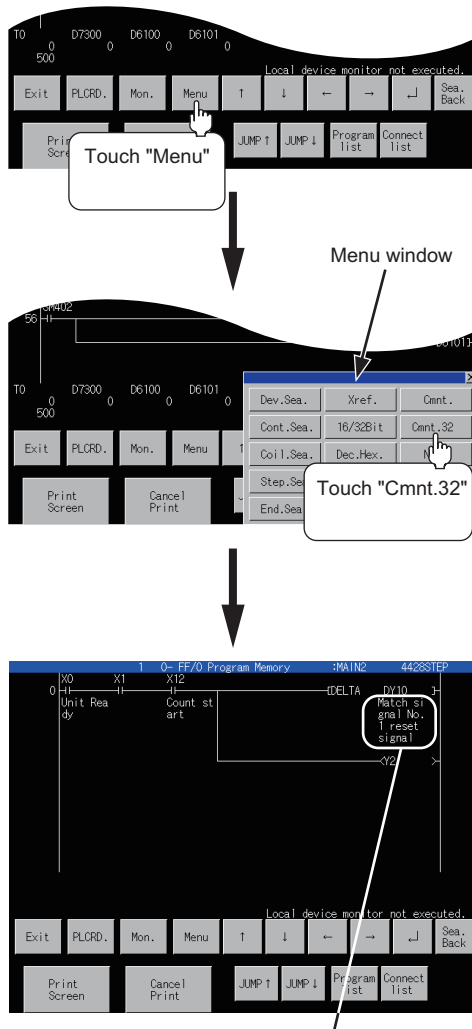

1. Touch `Menu`.

2. Touch `Cmnt.32`.

3. Comments are displayed in 32 characters. A comment is displayed in eight characters on four lines.

Display example of 32 characters of comment
A comment is displayed in eight characters on four lines.

(2) Comment display when the MELSEC-Q/L/QnA ladder monitor is executed

Comments are displayed as shown below when you touch each of the **Cmnt.** and **Cmnt.32** keys.

Present comment display status	Key operation	Comment display after key operation
No comments displayed	Touch the Cmnt. key.	Comments displayed
	Touch the Cmnt.32 key.	32 characters of comments displayed
Comments displayed	Touch the Cmnt. key.	No comments displayed
	Touch the Cmnt.32 key.	32 characters of comments displayed
32 characters of comments displayed	Touch the Cmnt. key.	Comments displayed
	Cmnt.32 key.	No 32 characters of comments displayed

(3) Numbers of lines and contact points that can be displayed when the MELSEC-Q/L/QnA ladder monitor is executed

The table below shows the numbers of lines and contact points that can be displayed in the statuses of no comments displayed, comments displayed, and 32 characters of comments displayed.

GOT	No comments displayed		Comments displayed		32 characters of comments displayed	
	Number of lines that can be displayed	Maximum number of contact points displayed	Number of lines displayed	Maximum number of contact points displayed	Number of lines displayed	Maximum number of contact points displayed
GT1695M-X GT1595-X	21	11	8	11	7	6
GT1685M-S GT1675M-S GT1665M-S GT1585V-S GT1585-S GT1575V-S GT1575-S	15	11	6	11	5	6
GT1675M-V GT1675-VN GT1672-VN GT1665M-V GT1662-VN GT1655-V GT1575-V GT1575-VN GT1572-VN GT1565-V GT1562-VN GT1555-V	8	11	3	11	2	6

1 OVERVIEW
2 SYSTEM MONITOR
3 LADDER MONITOR FUNCTION
4 MELSEC-A LIST EDITOR
5 MELSEC-FX LIST EDITOR
6 INTELLIGENT MODULE MONITOR
7 NETWORK MONITOR
8 Q MOTION MONITOR

3.5.5 Displaying notes

Notes in the sequence program can be displayed when the MELSEC-Q/L/QnA ladder monitor is executed. This subsection describes the operation procedure for displaying notes.

Notes cannot be displayed when the MELSEC-A/FX ladder monitor is executed.

Peripheral notes are represented by "**".

1. Touch **Menu**.

2. Touch **Note**.

3. Peripheral/Integrated notes are displayed.

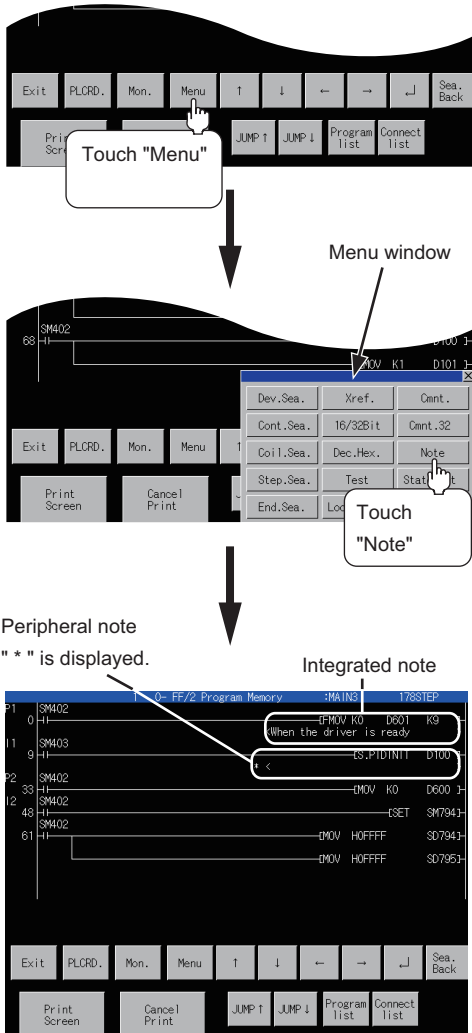

3.5.6 Displaying statements

Statements in the sequence program can be displayed when the MELSEC-Q/L/QnA ladder monitor is executed. This subsection describes the operation procedure for displaying statements. Statements cannot be displayed when the MELSEC-A/FX ladder monitor is executed. The following statements cannot be displayed and are represented by "*".

- Peripheral statements
- I statements (peripheral) and P statements (peripheral)

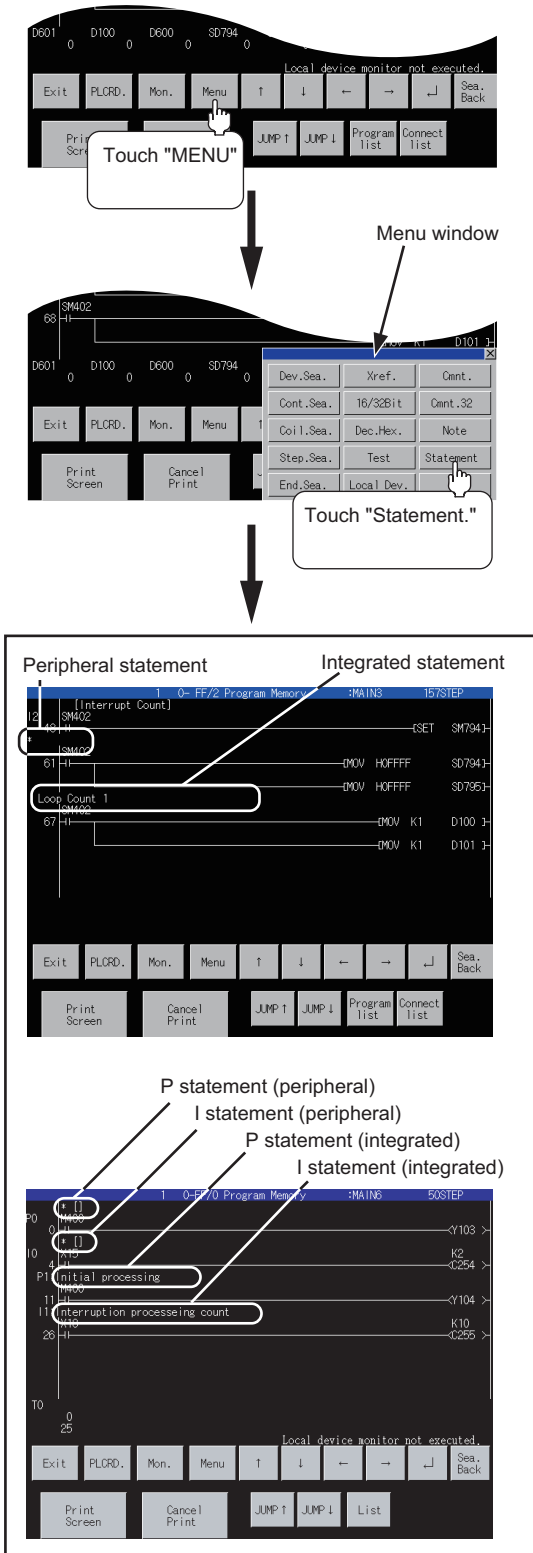

1. Touch **Menu**.

2. Touch **Statement**.

3. Peripheral/Integrated statements are displayed. Peripheral statements are represented by "*".

4. I/P statements are displayed. I statements (peripheral) and P statements (peripheral) are represented by "*".

3.5.7 Language switching of the sequence program (MELSEC-Q/L/QnA ladder monitor)

In the MELSEC-Q/L/QnA ladder monitor, language switching (Japanese/Korean/Simplified Chinese) is available for displaying the following items of a sequence program.

(To switch the language, register the following items with the language (Japanese/Korean/Simplified Chinese) used for the PLC READING DATA DISPLAY. To display Korean, for example, register the following items with Korean on GX Developer.)

- File name
- Title
- Comment
- Note
- Statement

Items other than the above (such as menu) are displayed with the system language.

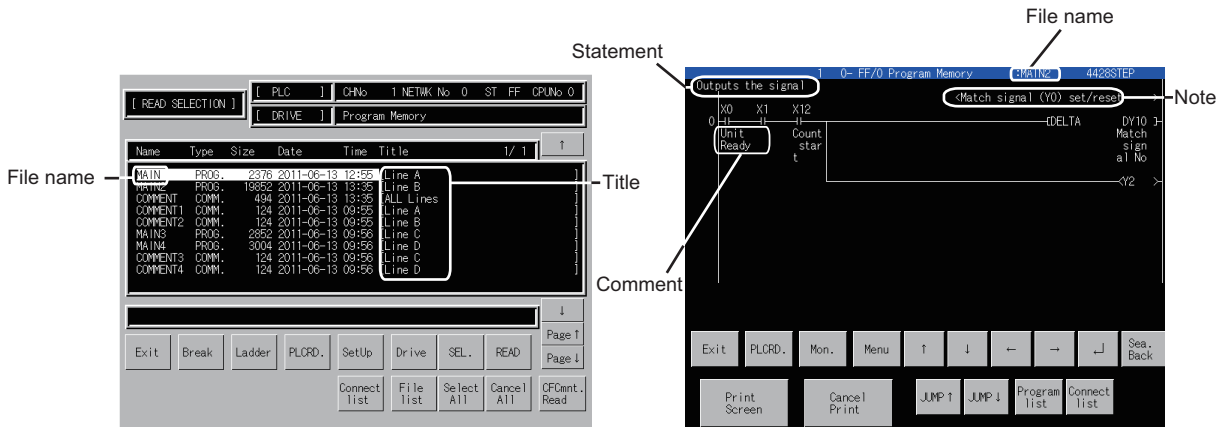

Example) PLC reading screen

Example) Ladder monitor screen

Display procedure for the PLC reading screen
 Subsection 3.3.3 2

PLC reading screen

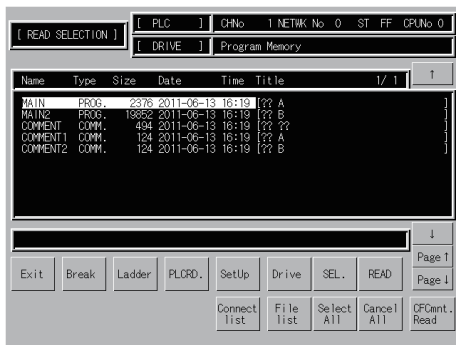

(Continued to next page)

1. Touch the **Setup** key. The setting window appears.

(From previous page)

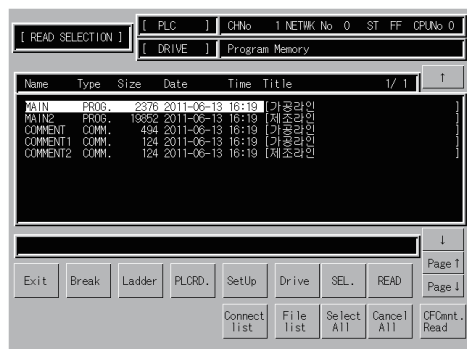
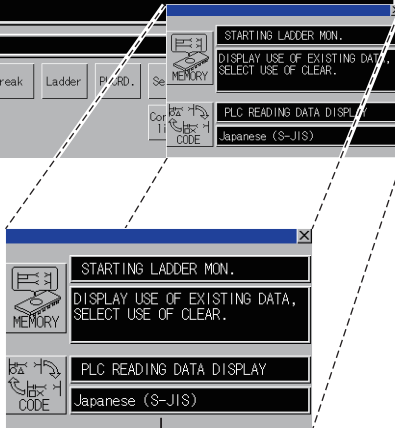

2. The setting window appears. Perform the PLC READING DATA DISPLAY.

The settings shown below switch with every

touching of the  key.

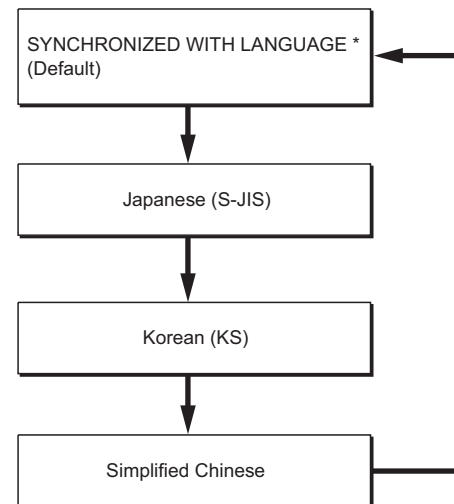

* The language set at [GOT setup] is displayed.

3. After completing the setting, touch the  button to close the setting window. The display is switched.

3.6 Search Operation

This section describes device search, contact point search, coil search, step search, ladder end search, defect search, and touch search.

POINT

(1) Searching among multiple programs

Search can be performed to multiple sequence programs read from PLC CPU.

For searchable items among multiple programs, refer to the following section.

 3.2 Specifications

(2) Searching in the specified program (only for the MELSEC-Q/L/QnA ladder monitor)

Search can be automatically performed to a program by specifying the file to be searched with a object such as the Special Function Switch.

 3.3.3 Searching from the monitor screen

3.6.1 Device search

Device search displays the ladder block that contains a specified device.

<Operation procedure>

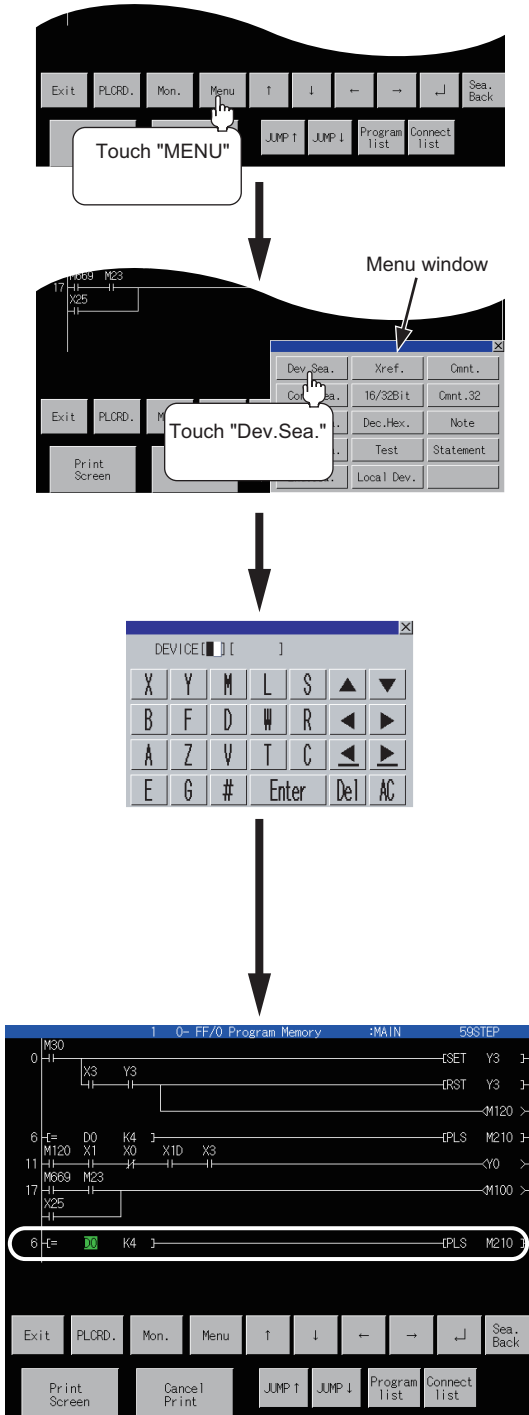

1. Touch **Menu** .
2. Touch **Dev.Sea.** .
3. Using the **◀** and **▶** keys, switch the input area, and enter a device name and its number. *1
 Example: Specify D0.
 After the device name and its number are entered, touch the **Enter** key. Input is completed, and the keyboard closes.
 - *1 The data entered can be corrected with the following keys:
 - Del** key: Used to delete a character of the entered information.
 - AC** key : Used to delete all characters entered.
4. The ladder block containing the specified device is displayed.
 The device is highlighted as shown in the display example below.
 (Display example)
D0

POINT

(1) Continuous read based on the same device

After a search, a continuous search can be performed based on the same device by touching  on the screen.

If you touch  another key, the continuous read function will be canceled.

(2) Ladder monitor display after a search

The ladder block containing the searched device is displayed.

Example) 1) When the entered device you want to search is "D0"

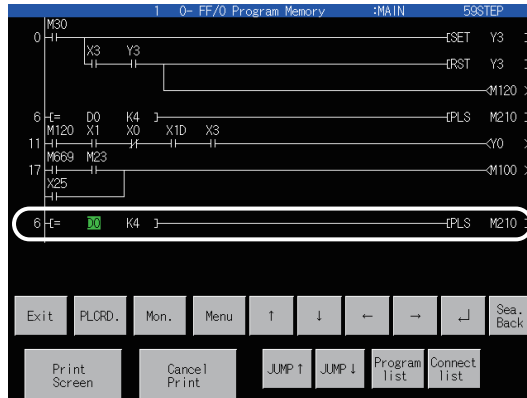

2) When the same search is continued

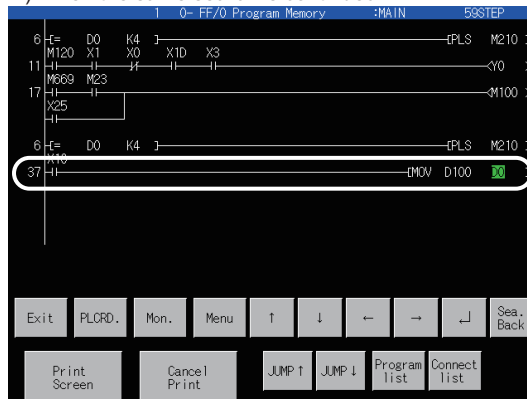

When searching multiple files with the MELSEC-Q/L/QnA ladder monitor, displaying the ladder block of the subsequent sequence file clears the previous display.



(3) Indirect specification device read

Indirect specification devices (index register (Z)) cannot be specified and read when the MELSEC-Q/L/QnA ladder monitor is executed.

3.6.2 Contact point search

Contact search displays the ladder block that contains a specified contact point.

<Operation procedure>

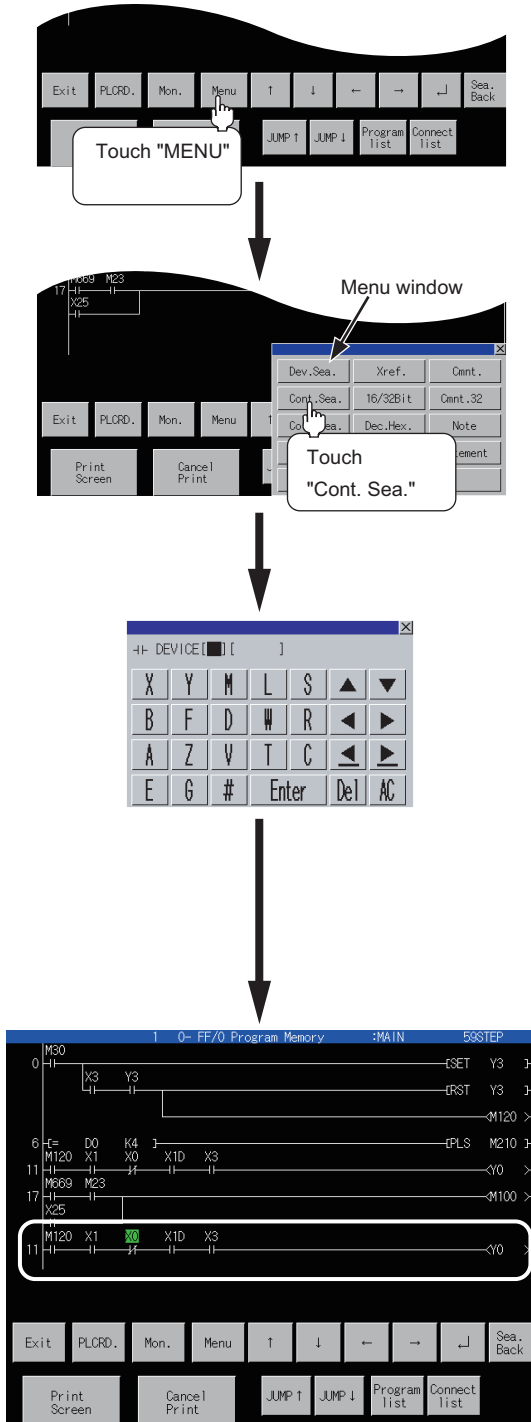

1. Touch **Menu**.

2. Touch **Cont.Sea.**

3. Using the **◀** and **▶** keys, switch the input area, and enter a device name and its number.*¹
 Example: Specify X1.
 After the device name and its number are entered, touch the **Enter** key. Input is completed, and the keyboard closes.

*1 The data entered can be corrected with the following keys:

Del key: Used to delete a character of the entered information.

AC key: Used to delete all characters entered.

4. The ladder block containing the specified contact point is displayed.
 The contact point is highlighted as shown in the display example below.
 (Display example)
X1

POINT

(1) Continuous read based on the same contact point

After a search, a continuous search can be performed based on the same contact point by touching  on the screen.

If you touch another  key, the continuous read function will be canceled.

(2) Ladder monitor display after a search

The ladder block containing the searched contact point is displayed.

Example) 1) When the entered contact point you want to search is "X1"

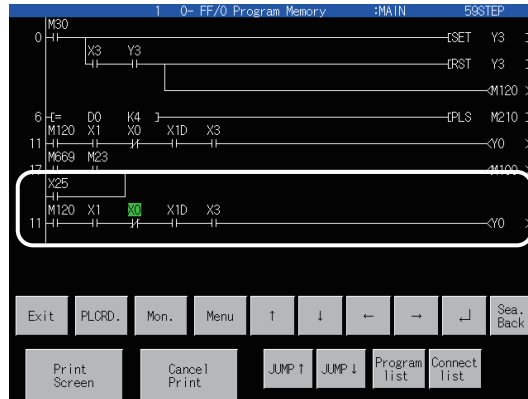

2) When the same search is continued

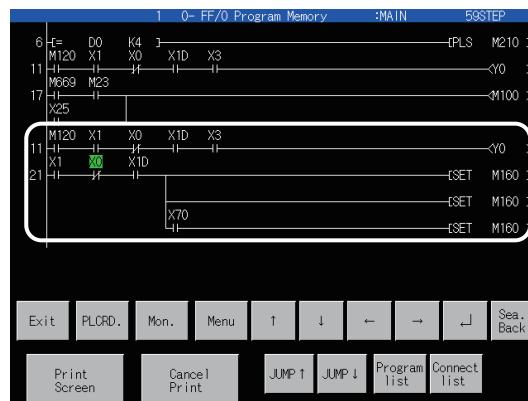

The ladder is displayed on the following line.

When searching multiple files with the MELSEC-Q/L/QnA ladder monitor, displaying the ladder block of the subsequent sequence file clears the previous display.

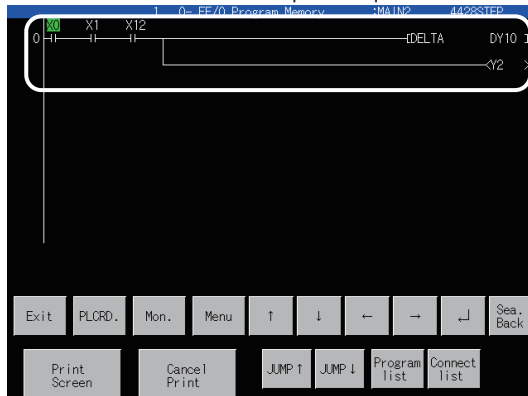

Only the ladder block(s) found in the subsequent sequence file is displayed.

3.6.3 Coil search

Coil search displays the ladder block that contains a specified coil.

<Operation procedure>

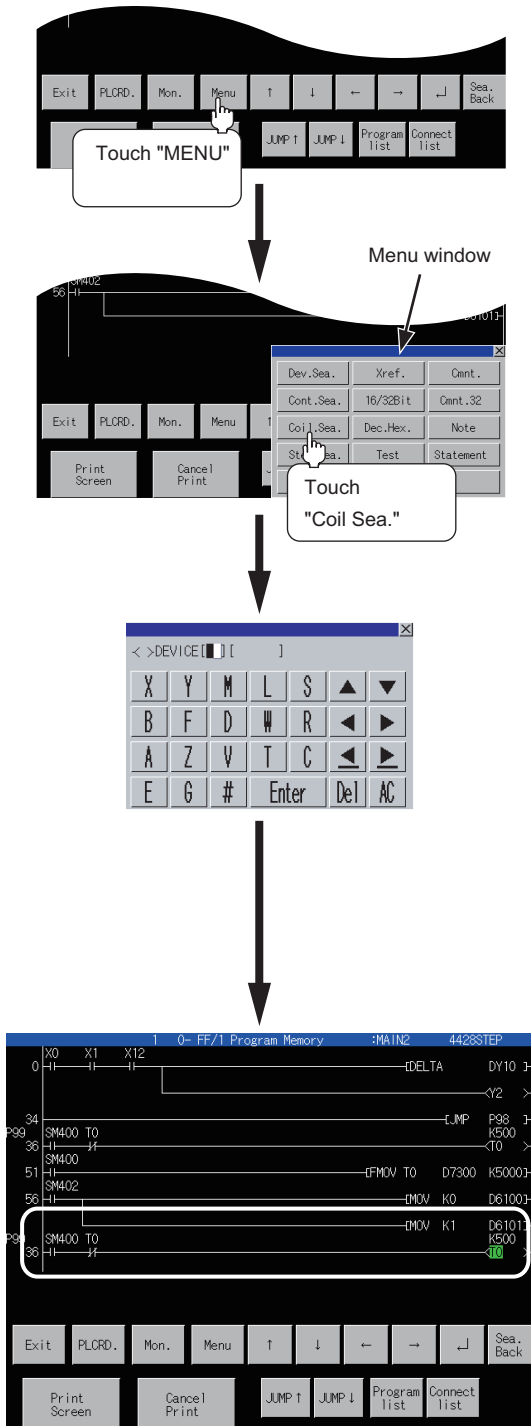

1. Touch **Menu**.

2. Touch **Coil.Sea.**

3. Using the **◀** and **▶** keys, switch the input area, and Enter a device name and its number.*1
 Example: Specify T0.
 After the device name and its number are entered, touch the **Enter** key. Input is completed, and the keyboard closes.

*1 The data entered can be corrected with the following keys:

Del key: Used to delete a character of the entered information.

AC key : Used to delete all characters entered.

4. The ladder block containing the specified coil is displayed.
 The coil name is highlighted as shown in the display example below.
 (Display example)

T0

POINT

(1) Continuous read based on the same coil

After a search, a continuous search can be performed based on the same coil by touching  on the screen.

 If you touch another key, the continuous read function will be canceled.

(2) Ladder monitor display after a search

The ladder block containing the searched coil is displayed.

Example) 1) When the entered coil you want to search is "M120"

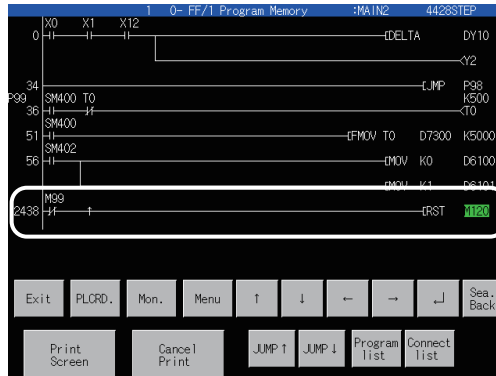

2) When the same search is continued

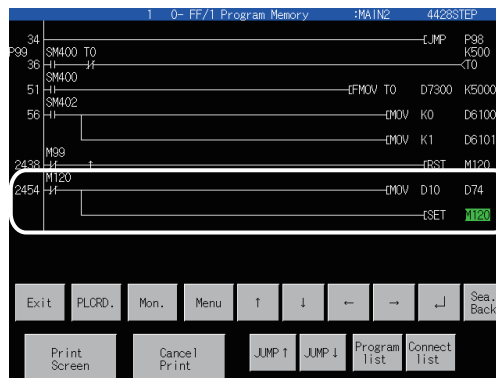

The ladder is displayed on the following line.

When searching multiple files with the MELSEC-Q/L/QnA ladder monitor, displaying the ladder block of the subsequent sequence file clears the previous display.

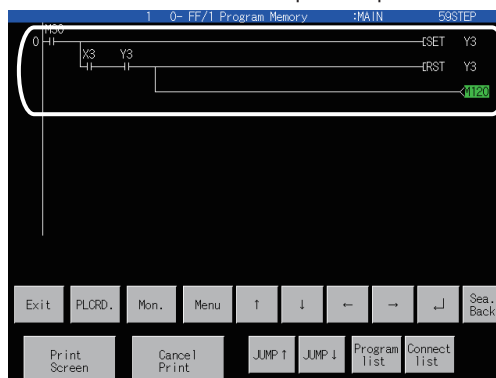

Only the ladder block(s) found in the subsequent sequence file is displayed.

3.6.4 Step search

Step search displays the ladder block that contains a specified step number.

<Operation procedure>

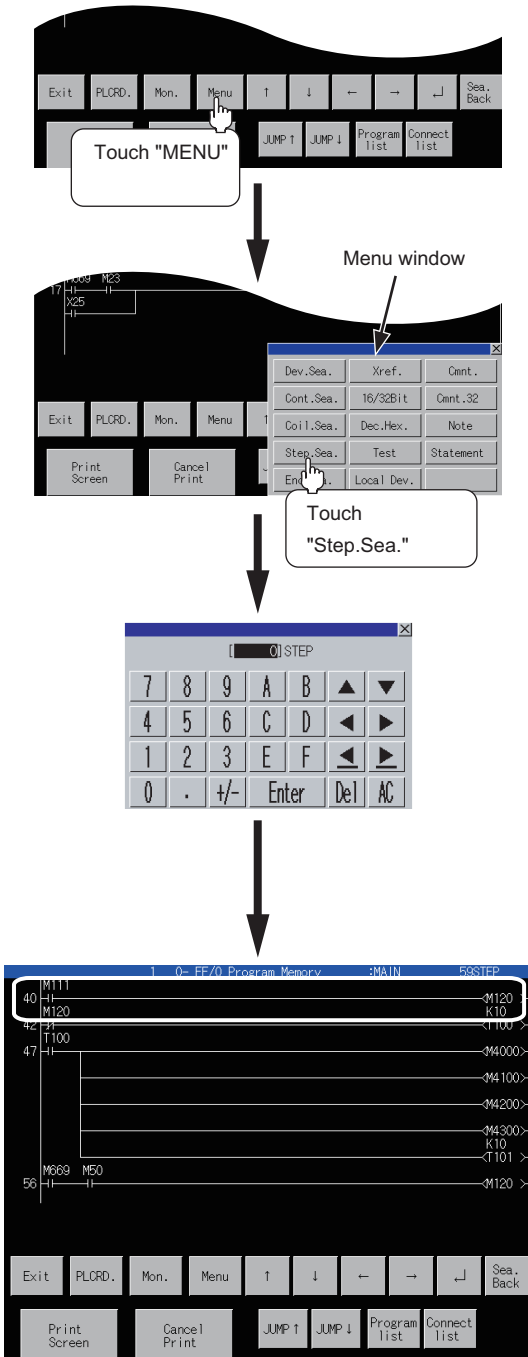

1. Touch **Menu** .

2. Touch **Step.Sea.** .

3. Enter a step number.*1
 Example: Specify step No. 40.
 After the step number is entered, touch the **Enter** key. Input is completed, and the keyboard closes.

*1 The data entered can be corrected with the following keys:
Del key: Used to delete a character of the entered information.
AC key : Used to delete all characters entered.

4. The ladder block is displayed with the specified step number at the top.
 (Display example)
 The ladder block of step No. 40 is displayed.

3.6.5 Ladder end search

Ladder end search displays the last ladder block of the sequence program.

<Operation procedure>

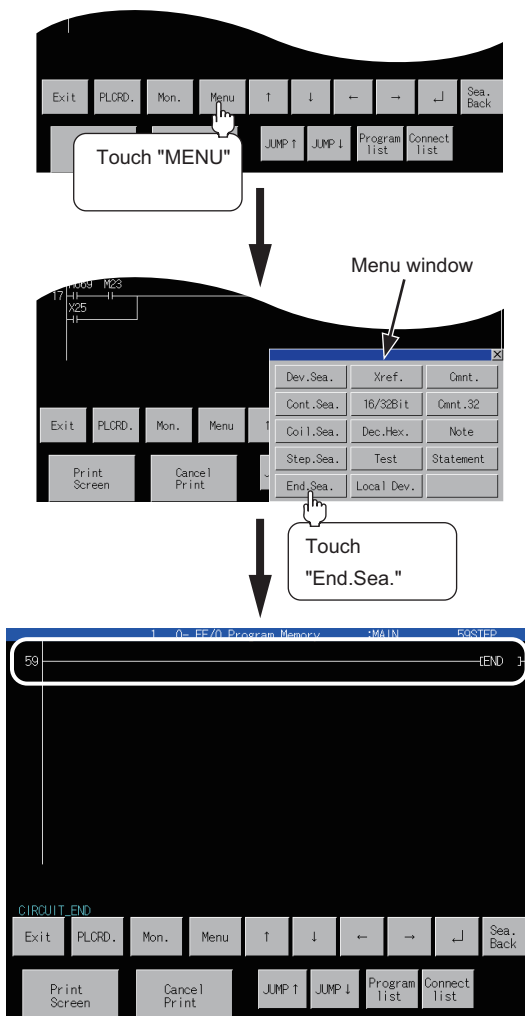

1. Touch **Menu**.

2. Touch **End.Sea.**

3. The last ladder block of the sequence program is displayed.
- MELSEC-Q/L/QnA ladder monitor
The ladder block of the end command is displayed.
 - MELSEC-A/FX ladder monitor
The last ladder block is displayed (the end command is not displayed).
The message "CIRCUIT_END" will be displayed.

3.6.6 Defect search

Defect search searches the ladder program for the status of conductive/non-conductive of the contact point that turned on or off the coil on the sequence program.

<Operation procedure>

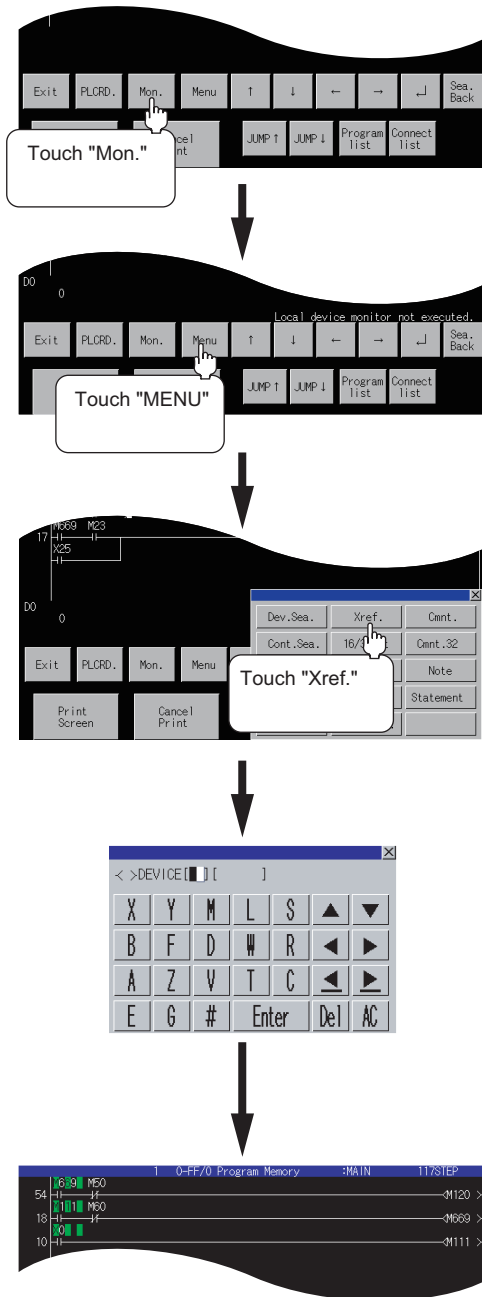

1. Touch **Mon.**

2. Touch **Menu.**

3. Touch **Xref.**

4. Select a coil, if necessary. Using the **◀** and **▶** keys, switch the input area, and enter the device name and its number of the selected coil.^{*1} Example: Specify M120. After the device name and its number are entered, touch the **Enter** key. Input is completed, and the keyboard closes.

^{*1} The data entered can be corrected with the following keys:

Del key: Used to delete a character of the entered information.

AC key: Used to delete all characters entered.

5. A search for the device begins, and the research result is displayed. To cancel a defect search, touch **ESC**. During a defect search, all key operations except **ESC** and **Exit** are invalid.

POINT

Operation before a defect search

In the case of the MELSEC-A/FX ladder monitor, touch **Mon.** before starting a defect search.

If you touch **Xref.** without touching **Mon.**, the message "NO MONITORING" will be displayed.

(1) Search result

Search results reveal any occurrences of the search device. They are useful when you determine whether a defective device is conductive or nonconductive.

If any occurrence of the search device is not found as a result of the search, a message appears on-screen, telling that "PROGRAM NOT FOUND."

(a) When an occurrence of the search device is found:

If an occurrence of the search device is found as a result of the search, the search for another defective device will automatically be started.

Example: After searching for Device M120 that is in the OFF state, "M669" will be displayed as a device that caused a failure.



After searching for Coil M120 that is in the OFF state, "M669" is displayed as a device that is not conductive.

Example: **M669**

* After searching for a device that is in the ON state, a device that is conductive is displayed. The entire field of the device name and number is highlighted on-screen.

Example: **M669**

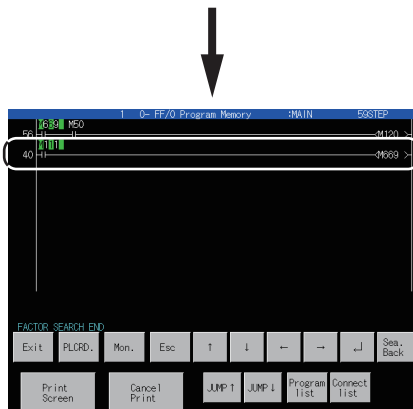

After searching for Coil M669 that is in the OFF state, "M111" is displayed as a device that is not conductive.

Example: **M111**

When there is no more defect, the "FACTOR SEARCH STOP" will be displayed, and the defect search will end.

The next defect is automatically searched.

- (b) When two occurrences of the search device are found.

If there are two or more devices that caused a failure, the "the defect search is interrupted" message appears and the defect search is terminated.

Example: After searching for Device M120 that is in the OFF state, "M669" and "M23" will be displayed as devices that caused a failure.

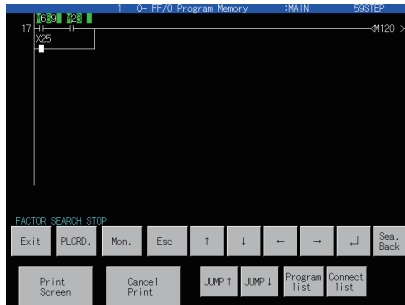

After searching for coil M120 that is in the OFF state, "M669" and "M23" are displayed as devices that are not conductive.

Example: **M669**, **M23**

* After searching for a device that is in the ON state, devices that are conductive are displayed. The entire field of the device name and number is highlighted on-screen.B

Example: **M669**, **M23**

When resuming the defect search, specify either of the found contacts M669 and X0025. After touching **ESC** to change it into **Menu**, execute the defect search.

POINT

Precautions for making defect search

(1) When the contact point searched is a b contact point

If a B-contact is found defective as a result of the defect search, a search for the cause of the ON/OFF state will be automatically switched.

(2) Screen display after a defect search

After the end of the defect search, the GOT stops monitor and displays the search result. Hence, the monitor screen of the GOT shows the result retained during the defect search.

(3) Display of defect search results

While the search result is displayed after the end of the defect search, the searched ladder can be displayed backwards by pressing **↑** **↓** (single ladder block scroll) or **JUMP↑** **JUMP↓** (10 ladder block jump (available for only the MELSEC-Q/L/QnA ladder monitor)).

Up to 100 ladders can be displayed on-screen. The following messages will appear at the start or the end of the search results.

- When viewing the start of search results: "This is the start of search results."
- When viewing the end of the search results: "This is the end of search results."

(4) Display of contact point and coil ON/OFF

1) During automatic search execution

- MELSEC-A/FX ladder monitor: Displays ON/OFF in the entire ladder displayed on the screen.
- MELSEC-Q/L/QnA ladder monitor: Displays ON/OFF in the ladder displayed last.

2) During search result display

The ON/OFF of the ladder block searched last and the monitor results of word devices are displayed.

(5) Switching the **Menu** / **ESC** key switch

When the defect search starts, **Menu** change into **ESC**.

Touch **ESC** during the defect search to stop the defect search and display the search result.

Further, touch **ESC** to change **ESC** into **Menu** and display the normal ladder.

(6) Screen display during a defect search

1) If the display data exceeds one screen during the defect search

The screen is scrolled automatically.

2) If the ladder step searched during the defect search exceeds one screen

- MELSEC-A/FX ladder monitor: The screen is scrolled automatically to the last line of the ladder step.
- MELSEC-Q/L/QnA ladder monitor: The screen is not scrolled automatically to display the ladder step.

(7) Screen display when you touch the ESC key

Touching ESC can stop the defect search. Search results are continuously displayed on-screen until ESC is touched.

The ladder step searched last is displayed as described below.

- MELSEC-A/FX ladder monitor: ON/OFF display is not provided.
 - MELSEC-Q/L/QnA ladder monitor: ON/OFF display is provided.
-

3.6.7 Touch search

Touch search is a function to search the coil of the same device by touching a contact point displayed on the ladder monitor screen, or to search the contact point of the same device by touching a coil. You can search sequence program from the first to last steps. This function is valid whenever a ladder monitor is normally displayed.

POINT

- Touch search is not available when the MELSEC-A/FX ladder monitor is executed.
- Touch search is not available for commands or word devices except contact points and coils.
- Touch search is not available when defect search is used.
(To use touch search, touch **ESC** to deactivate defect search.)

(1) Contact point search → coil search

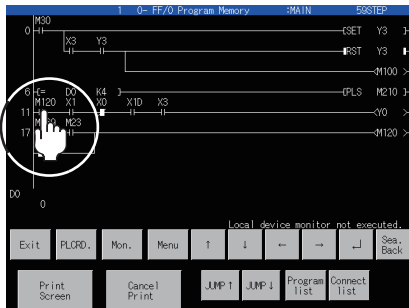

1. Touch a contact point on the screen.
Touch example: M120

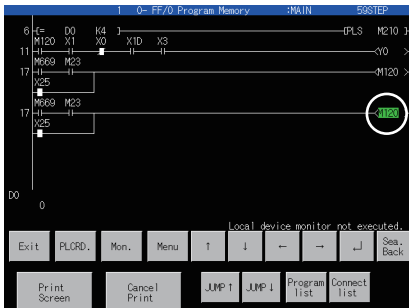

2. The coil of the same device in which the contact point exists is searched, and the ladder block containing the searched coil is added to the ladder blocks displayed. (The searched device is highlighted.)
Display example: **M120**

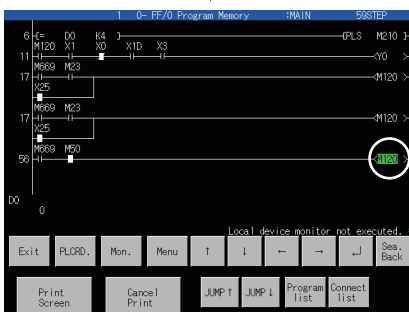

3. You can continuously search the ladder in the downward direction by touching .

The next coil is displayed.

4. When there is no more contact point of the same device in which the touched contact point exists, the message "DEVICE NOT FOUND" will be displayed.

(2) Operation procedure (coil touch → contact point search)

1. Touch a coil on the screen.

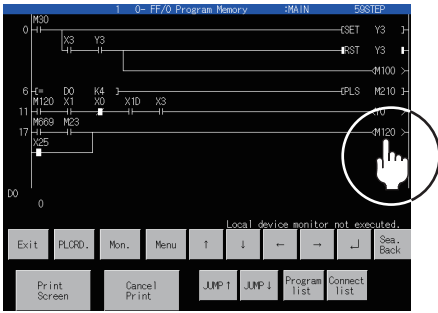

2. The contact point of the same device in which the coil exists is searched, and the ladder block containing the searched contact point is added to the ladder blocks displayed. (The searched device is highlighted.)

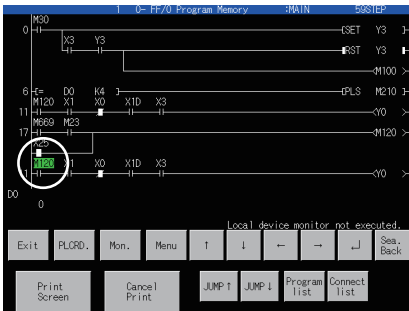

3. You can continuously search the ladder in the downward direction by touching .

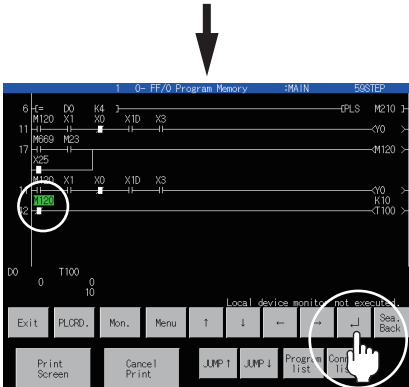

When searching multiple files with the MELSEC-Q /L/QnA ladder monitor, displaying the ladder block of the subsequent sequence file clears the previous display.

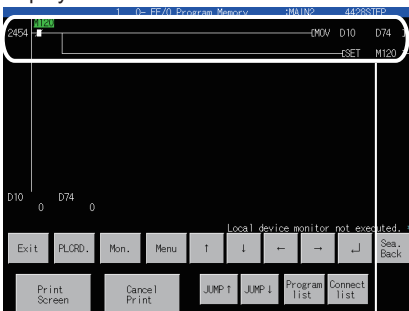

Only the ladder block(s) found in the subsequent sequence file is displayed.

next contact point is displayed.

4. When there is no more contact point of the same device in which the touched coil exists, the message "DEVICE NOT FOUND" will be displayed.

3.7 Test Operation

You can change device values and turn on and off bit devices on the screen when the ladder monitor is executed. This section describes how to display the test menu screen. For the procedure for changing device values and turning on and off bit devices, see the following.

 2.9 Test Operation

POINT

Before test operation

With the MELSEC-Q/L/QnA ladder monitor function, the GOT cannot write data to the devices in the QSCPU.

3.7.1 Displaying the test menu screen

(1) Displaying the test menu screen

The procedure for displaying the test menu screen during ladder monitoring is described below.

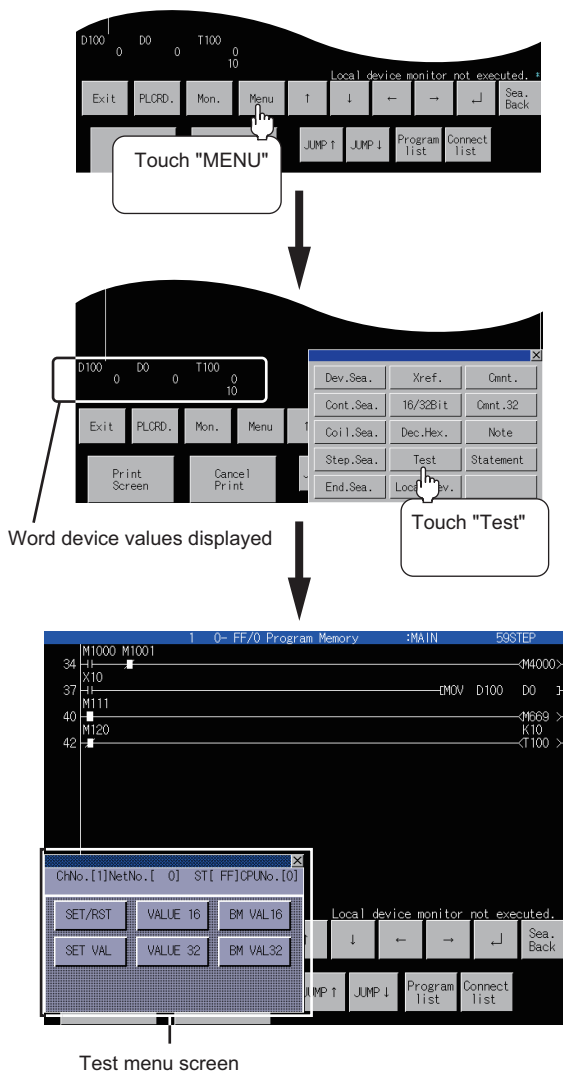



1. Touch **Menu**.

2. Touch **TEST**.

3. The test menu screen is displayed. Change device values by operating the window. For further information about the operation procedure, see the following:
 2.9 Test Operation

POINT

The present and set values of word devices are hidden behind the test menu screen. You can display hidden present and set values by scrolling them to the right or left using the  or  key.

3.8 Local Device Monitor

The GOT can monitor local devices with the MELSEC-Q ladder monitor. For local devices, refer to an applicable programmable controller manual.

POINT

Monitoring local devices

Local devices can be monitored only with the ladder monitor. Operations for monitoring local devices cannot be executed on the user-created screen.

3.8.1 Operation procedure for local device monitor

Every time the **Local Dev.** key is pressed, the local device monitor is switched between execution and non-execution states.

Starting local device monitor

The following shows how to start the local device monitor.

1. Touch **Mon.**

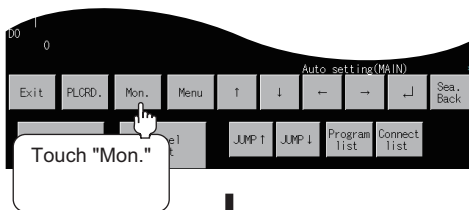

2. Touch **Menu**

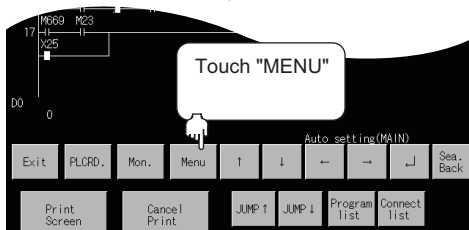

3. Touch **Local Dev.**

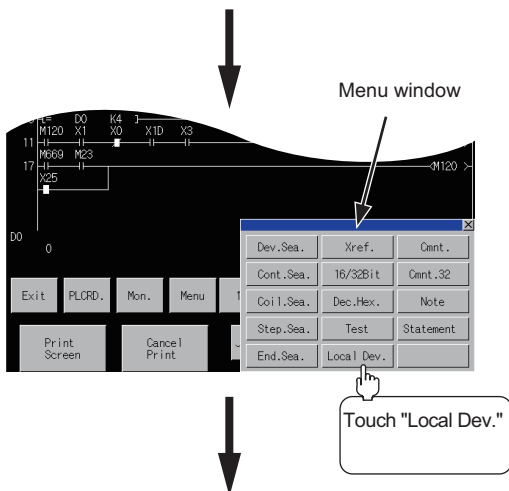

(Continued to next page)

(From previous page)

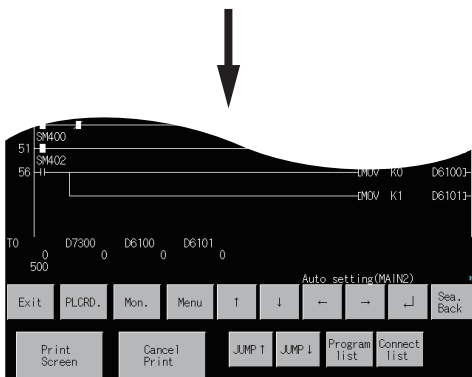
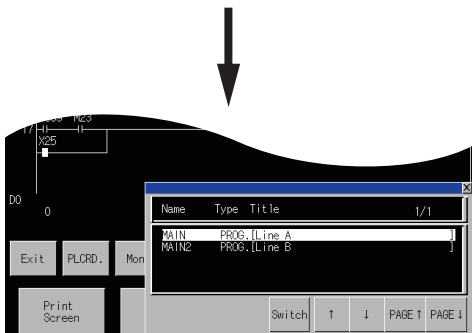
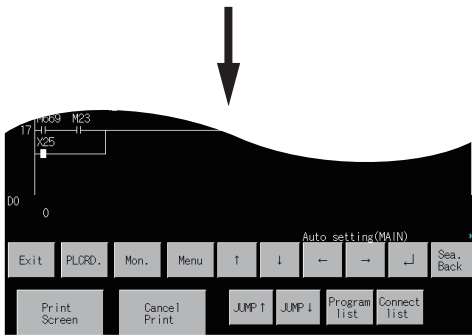

4. The local device monitor is started.

5. For changing a sequence program to be monitored, touch **File list**, and then change sequence programs on the program list window.

6. The local device monitor is started with the changed sequence program.

POINT

How to monitor local devices when ladder monitor starts

With setting the GOT setup, the GOT can start monitoring local devices when the ladder monitor starts. For settings for monitoring local devices when the ladder monitor starts, refer to the following.

 User's Manual for the GOT used

■ Ending local device monitor

The following shows how to end the local device monitor.

1. Touch **Menu**.

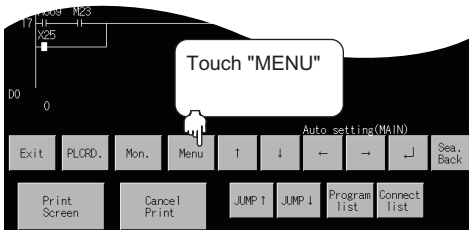

2. Touch **Local Dev.**

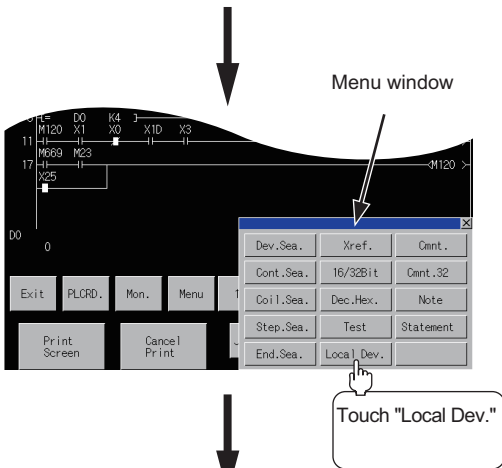

3. End the local device monitor.
The local device monitor is ended with the following operations.

- When touching **Exit** key
- When touching **PLCRD.** key

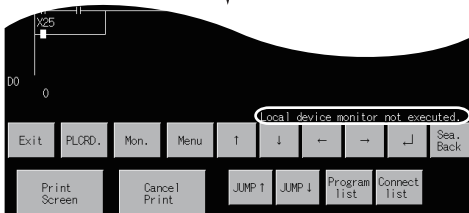

POINT

When ladder monitor screen is switched to other screens during executing local device monitor

When the ladder monitor screen is switched to other screens because of communication errors and others during monitoring local devices, the GOT keeps monitoring local devices.

For switching the local device monitor to non-execution state, restart the ladder monitor, and then switch the local device monitor to non-execution state.

3.9 Error Messages and Corrective Action

This section describes the error messages displayed when the ladder monitor function is executed, and corrective action.

Error message	Description	Corrective action
ENTRY CODE MISMATCH	The specified keyword is different from the keyword that is registered in the object PLC CPU.	Check the keyword that is registered in the object PLC CPU and specify again.
FILE NOT FOUND	(1) An attempt was made to switch to the ladder monitor screen when a sequence program had not been read. (2) When the file is selected and the "Read" key is pressed, the selected file does not exist in the PLC drive.	Read the sequence program that written in the object PLC CPU. (Ex.) A sub-sequence program can only be specified as A3 CPU/A4UCPU.
PLC COMMUNICATION ERROR	(1) Cannot communicate with PLC CPU of the specified network No. or station No. (2) The specified drive does not exist.	Check and correct the following: (1) Does the specified PLC CPU exist? (2) Is it online? (Data communication status?) (3) Has an error occurred? (4) Is CPU No. correct? (5) Power on the GOT again. and so on.
LOCK ON OTHER MACHINE. PLEASE CANCEL	File is locked with the peripheral equipment (GX Developer, GPPQ).	After reading and writing with the peripheral equipment (GX Developer, GPPQ), read the file again.
NOT EXISTING DRIVE, DRIVE ERROR	(1) The specified drive does not exist. (2) The specified drive is faulty.	(1) Check whether the specified drive exists or not. (2) Check whether the specified drive is faulty or not.
ENTRY CODE MISMATCH	The specified file password differs from the one registered as the file password of the corresponding PLC CPU.	Confirm the file password registered to the drive of the corresponding PLC CPU, and specify it again.
FILE NOT FOUND	(1) When reading file from PLC CPU • After selecting a file and pressing the "Read" key, the selected file does not exist in the PLC CPU drive. • When starting ladder monitor from the monitor screen, the selected file does not exist in the PLC CPU drive. (2) When reading file from CF card • No CF cards are inserted in the specified drive. • No comment files are stored in the CF card.	(1) When reading file from PLC CPU • Perform [Read from PLC] on the network No./station number input screen to update the file list. Change the specified drive (Target memory). • Check the sequence program in the PLC CPU. (2) When reading file from CF card • Check if a CF card is inserted in the specified drive. • Check if comment files are stored in the CF card.
USE BY OTHER MACHINE. PLEASE CANCEL	The sequence or comment is being used by the peripheral device (GX Developer).	Perform file read again after completion of read/write from/to the peripheral device (GX Developer).
2M bytes of comments were read since they exceeded 2M bytes.	Only 2M bytes of the comment file was read because its size is greater than 2M bytes.	Reduce the comments to bring the size of the comment file down below 2 Mbytes.
Outside CPU reset/device range/special module illegal access	The accessed special module is faulty or does not exist.	Check the system configuration.
FILE ACCESS ERROR. CONFIRM DRIVE.	The access error to file has occurred.	When the storage location of ladder data is set to [A: Standard CF Card] or [B: Extended Memory Card], check that the CF card is properly inserted. • Check if the CF card is properly inserted in the drive set for reading comment files.
INSUFFICIENT SAVING DRIVE CAPACITY.	Capacity of free disk of saving destination is insufficient.	Confirm the capacity of free disk of saving destination, increase the amount of free disk.
FILE ACCESS..<DO NOT PULL OUT THE PLUG>	File being accessed.	Do not turn off the power during message display. Wait until the message display goes out.

(Continued to next page)

Error message	Description	Corrective action
No END instruction.	The sequence program has no END instruction.	Check the sequence program with the peripheral device (GX Developer).
Instruction code abnormal.	The sequence program has an abnormal command code.	Check the sequence program with the peripheral device (GX Developer).
Ladder creation bad.	The sequence program has an abnormal circuit.	Check the sequence program with the peripheral device (GX Developer).
Please release the keyword.	Communication is not possible because a keyword is registered in the target PLC. (For FX3U(C) only)	Release the keyword for the target PLC.
The keyword is registered.	A keyword is set to the PLC that is targeted to the PLC reading on the PLC reading screen.	Release the keyword for the target PLC.
Cannot read multiple files.	Data Save Location is set to [None].	(1) When reading file from PLC CPU <ul style="list-style-type: none"> • Read only one program file or one comment file. (2) When reading file from CF card <ul style="list-style-type: none"> • No CF cards are inserted in the specified drive. • No comment files are stored in the CF card.
Number of files exceeds 512. Aborting . . .	The number of read file exceeds the maximum number of files can be treated in ladder monitor (512).	Delete superfluous files and perform reading again.
This is not a specified program.	When starting ladder monitor from a monitor, the monitor target of the specified device and that of the program already read to the GOT do not match.	Read the program again.
The specified file does not exist.	An invalid program is specified during monitoring local devices.	Check the sequence program in the PLC CPU, and then read the program again.
Local device monitor error.	An error occurs during monitoring local devices.	Check the settings in the PLC CPU, and read the program again.
Local device monitor is not supported.	The PLC CPU does not support the local device monitor function.	Check manuals for the PLC CPU.
PLC is protected.	The sequence program is protected by a block password at the PLC reading. (For FXCPU only)	Release the block password for the sequence program.

4. MELSEC-A LIST EDITOR



4.1 Features

The MELSEC-A list editor enables you to change the sequence program in the ACPU/QCPU (A mode). This function is intended to troubleshoot the PLC system and to streamline maintenance operations. By installing list editor for MELSEC-A, an Option OS, from GT Designer2 into the GOT, you can edit the ACPU/QCPU (A mode) PLC program. The features of the MELSEC-A list editor are described below.

■ Parameters and sequence programs are easy to maintain.

You can check or partly correct, change or add PLC CPU parameters and sequence programs simply by operating keys.

You can easily edit sequence programs without preparing any peripheral unit other than the GOT.

Example of changing sequence program commands

LD	X0		Changed	LD	X0	
OUT	Y20		→	MOV	D0	D1
LD	X1			LD	X1	
	}				}	

■ Combination with the ladder monitor

You can open the MELSEC-A List Editor window from the Ladder Monitor screen with a single touch, and can edit PLC program while checking the ladder.

You can also display a list from the step line displayed by the ladder monitor.

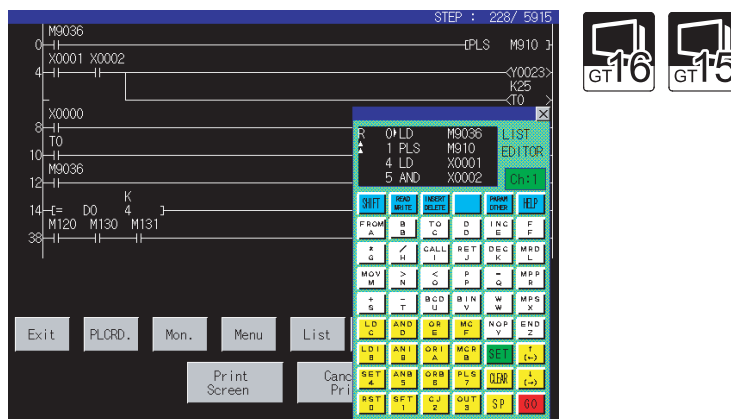

■ **Other stations are accessible.**

You can edit the sequence program for other stations in the data link system containing the GOT (or GOT-connected station), network system or CC-Link system.

■ **Help function**

A convenient help function is supported, which enables you to read, write, insert, and delete data as you select menus.

■ **Comment for each device can be displayed.**

Comment of the device at the cursor position can be displayed.

W	9	OUT	M50
▲	10	MOV	
	10▶	D1	
		Current value	

← Comment of D1 is displayed.

4.2 Specifications

4.2.1 System configuration

This subsection describes the PLC CPU series names and the connection forms between the GOT and the PLC for which the MELSEC-A list editor is available.

For further information about communication units and cables for each connection form, see the following:

 GOT1000 Series Connection Manual (Mitsubishi Products) for GT Works3

Targeted PLC

PLC
ACPU/QCPU (A mode) ^{*1*2}

- *1 Motion controller CPUs cannot be connected. The message "MOTION CONTROLLER NOT SUPPORTED" will be displayed when the MELSEC-A list editor function is activated.
- *2 When the PLC is A2USH-S1, it operates within the range of A3U; when the PLC is the A2SH-S1, A2SH, A1SH, or A1SJH, it operates within the range of A3N.

Connection forms

This function can be used in the following connection types.
When the GOT is connected to an ACPUCPU (A mode)

(○: Available, ×: Unavailable)

Function name	Connection form between GOT and PLC								
	Bus connection ^{*1*3}		Direct CPU connection	Ethernet connection ^{*4}		MELSEC NET/10 connection ^{*1*2}		CC-Link connection (intelligent device station) ^{*1*2}	
	GT16 GT15 GT11	GT14 GT12	GT16 GT15 GT14 GT12 GT11	GT16 GT15 GT14 GT12	GT11	GT16 GT15	GT14 GT12 GT11	GT16 GT15	GT14 GT12 GT11
MELSEC-A list editor	○	×	○	○	×	○	×	○	×

- *1 When the PLC is the A2SH-S1/A2SH/A1SH/A1SJH, use a CPU of version E or a later version. Programs cannot be written to CPUs of version D or an earlier version.
- *2 When the PLC is A3N, A2N-S1, A2N, or A1N, it can not be used.
- *3 When the PLC is QCPU (A mode), it cannot be used.
- *4 MELSEC-A list editor cannot be used when using CC-Link IE field network Ethernet adapter.

Required option OS and option function board

The option OS and option function board shown below are required.

 1.1.2 Hardware and OS' required for each function

(1) Option OS

Install the option OS in the above table to the GOT.
For the installation procedure, refer to the following.

 GT Designer3 Version 1 Screen Design Manual (Fundamentals) 8. COMMUNICATION WITH GOT

(2) OS memory space

The available memory space shown in the table above is required in the user area to install the option OS to the GOT.

For the procedure for checking the available memory space of the user area and information about the data using other user areas, refer to the following.

 GT Designer3 Version1 Screen Design Manual (Fundamentals) 8. COMMUNICATION WITH GOT

(3) Option function board

- (a) For GT16, GT14, and GT12
No option function board is required.
- (b) For GT15 and GT11
Mount one of the option function boards in the above table on the GOT.
For the GOTs with a built-in option function board, refer to the following.

 1.1.2 Hardware and OS' required for each function

For how to mount an option function board on the GOT, refer to the following.

 User's Manual for the GOT used

4.2.2 Access range

The access range is the same as the access range when the GOT is connected to a controller.
For details of the access range, refer to the following.

 GOT1000 Series Connection Manual (Mitsubishi Products) for GT Works3

4.2.3 Precautions

The points of precaution when using MELSEC-A list editor are described.

(1) Reading the MELSEC-A list editor by specifying a command

The MELSEC-A list editor cannot be ready by specifying a dedicated command.

(2) Using the MELSEC-A list editor together with the ladder monitor

Even if you execute the MELSEC-A list editor with the ladder monitor activated, edited information will not be reflected on the Ladder Monitor screen.

To reflect such edited information, perform the PLC reading of the ladder monitor again.

(3) Executing the MELSEC-A list editor

Execute the MELSEC-A list editor when the target PLC is not running.

It cannot be executed when the PLC is running.

(4) Changing sequence programs/parameters using another peripheral equipment

When using the MELSEC-A list editor, do not change programs or parameters in the PLC CPU from other peripheral equipment.

If you change programs or parameters, either reset the GOT main unit or set the PLC No. again.

If you carelessly change the program on one PLC from multiple units of peripheral equipment (including GOT), the contents of the program in the PLC CPU and the peripheral equipment may not be the same, resulting in an unintended operation of the PLC CPU.

(5) Writing sequence programs

Sequence programs cannot be written when the target CPU is operating EEPROM.

4.3 Operations for Display

This subsection describes an outline until the system monitor screen is displayed after List editor for MELSEC-A (Option OS) is installed in the GOT.

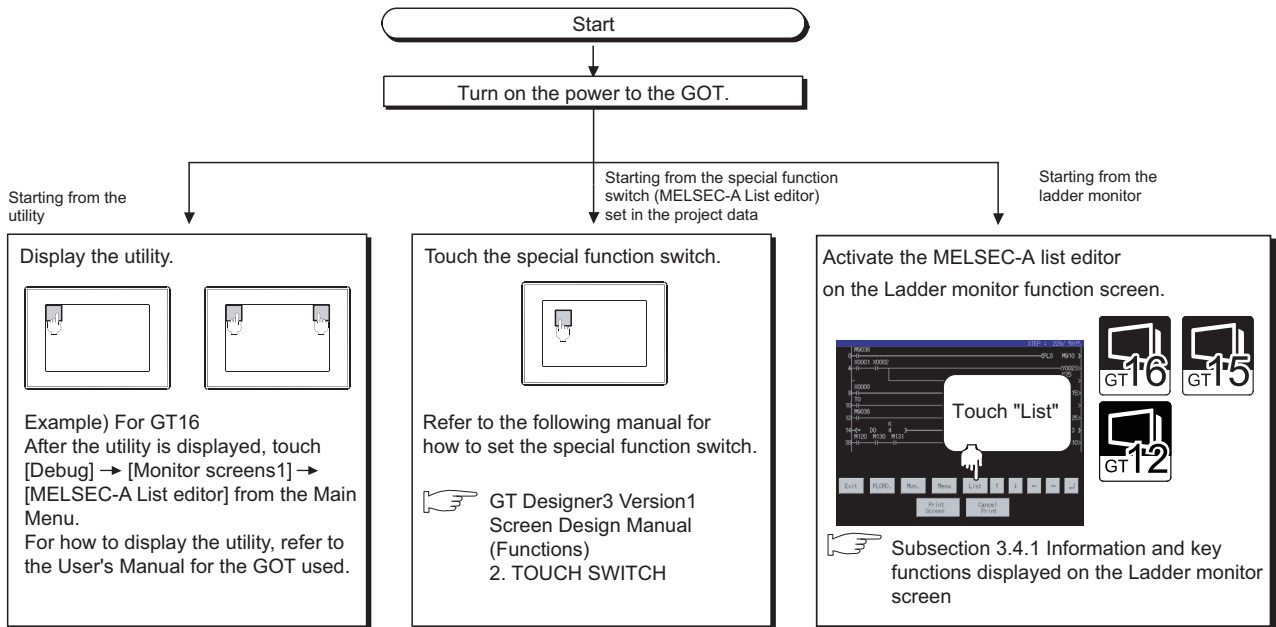

Set the Channel No.

ChNo	Comm. Driver
1	A/QnA/QCPU,QJ71C24
2	AJ71OC24, MELDAS C6+
3	Q BUS

Communication setting window *1

ChNo	STATION	NETWK No.	CPU No.
1	1	1	1
2	2	2	2
3	3	3	3

Read the PLC and display the sequence program.

(GT16, GT15, and GT12)

ChNo	STATION	NETWK No.	CPU No.
1	1	1	1
2	2	2	2
3	3	3	3

(GT14 and GT11)

(Continued to next page)

- 1 OVERVIEW
- 2 SYSTEM MONITOR
- 3 LADDER MONITOR FUNCTION
- 4 MELSEC-A LIST EDITOR
- 5 MELSEC-FX LIST EDITOR
- 6 INTELLIGENT MODULE MONITOR
- 7 NETWORK MONITOR
- 8 Q MOTION MONITOR

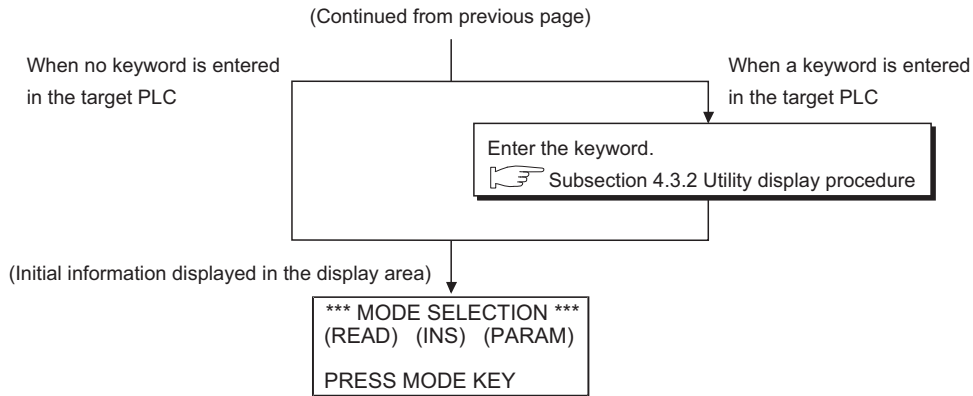

*1 The communication setting window is not displayed when starting from the ladder monitor.

POINT

(1) How to display the utility

For how to display the utility, refer to the following.

User's Manual for the GOT used

(2) Displaying communication setting window

After turning on the GOT, the communication setting window is displayed at the first startup of the MELSEC-A list editor only.

For displaying the communication setting window at the second or later startup, touch the button on the MELSEC-A list editor screen.

(3) If the project data has not been downloaded

The A list editor can be started from the utility even if the project data has not been downloaded to the GOT.

4.3.1 Operation of keyword input

If a keyword is registered in the ACPU when the connected ACPU or the ACPU PLC No. No. corresponding to the operation is changed, the GOT requests for input of the registered keyword. Input the keyword registered in the ACPU and press the **GO** key.
 If a keyword is not registered in the ACPU, this operation is not required.

Procedure for inputting the keyword for the MELSEC-A list editor

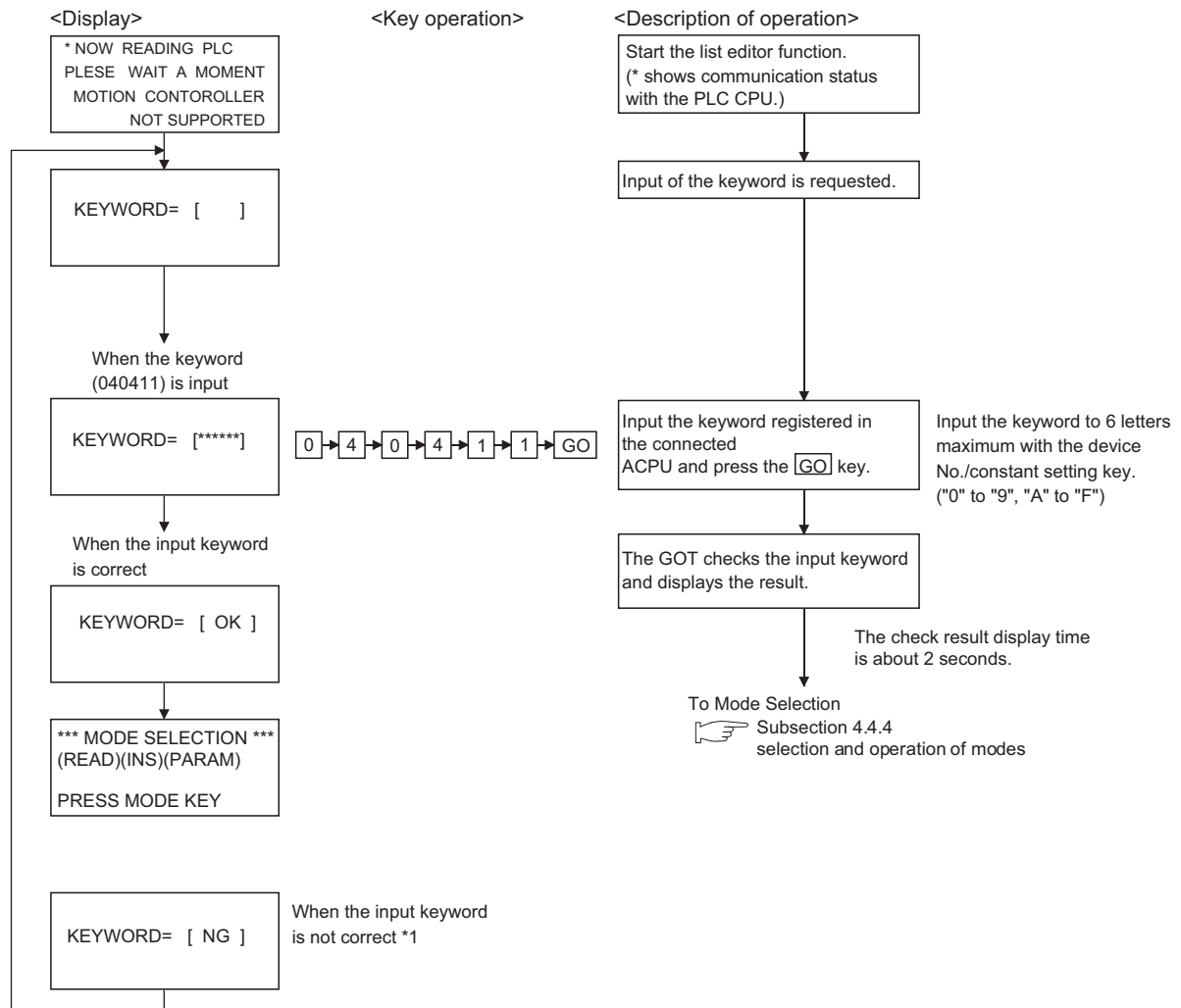

*1 When the input keyword does not match with the registered keyword, only the following operations in subsection 4.6.7 can be allowed.

- Other modes
- Error step reading
 - Buffer memory overall monitor
 - Time monitor
 - PLC No. setting
 - Main/sub switching

POINT

When you forgot the keyword entered in the ACPU

- Even if you are unsure of the keyword entered in the ACPU, you cannot delete it independently. If deleting user data, including sequence programs, does not cause any inconvenience to you, clear (delete) the entered keyword by <PLC memory all clear.>

Note that <PLC memory all clear> clears user data, including sequence programs, as well.

For further information about PLC memory all clear, see the following:

 4.5.6 PLC memory all clear

- When you know the keyword and want to change it or add a new keyword, see the following:

 4.6.1 Common operation

4.4 Operation Methods

4.4.1 Key arrangement and a list of key functions

- (1) The arrangement and functions of the keys displayed on the MELSEC-A List Editor window are described below.
- (a) Key arrangement and functions for GT16, GT15, and GT12

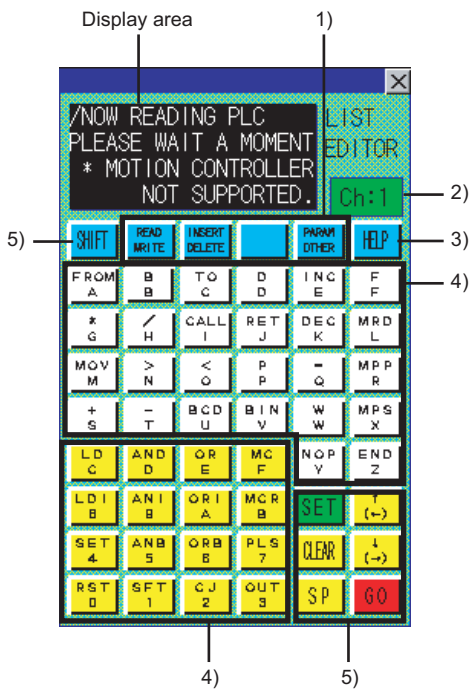

Key name	Summary of function	Reference section
1) Mode key	READ WRITE	The key that specifies read or write mode. Switch the valid key with [SHIFT] . 4.4.4 4.6.2 4.6.3
	INSERT DELETE	The key that specifies insert or delete mode. Switch the valid key with [SHIFT] . 4.4.4 4.6.4 4.6.5
	PARAM OTHER	The key that specifies parameter or other mode. Switch the upper and lower lines with [SHIFT] . 4.4.4 4.6.6 4.6.7
2) Ch no.	Ch:	Displays a Communication Ch No. -
3) Help key	HELP	The key that can operate the help function. 4.5.5
4) Command/ Device key	FROM A ? END Z	Key that inputs K/H at the input of command, device name and constant input. Only when the valid key of upper/lower character needs to be switched, switching is allowed with input of the [SHIFT] and [SET] keys. -
	RST 0 ? MC F	Key that inputs the command, device number and constant. Only when the valid key of upper/lower character needs to be switched, switching is allowed with input of the [SHIFT] and [SET] keys. -
5) Control key	SET	Key that declares start of step number input or automatic scroll. Switch key that makes the lower character valid on each key with dual functions. Whether upper or lower character is valid can be checked on the display. 4.4.4
	SHIFT	Switch key that makes the upper character valid on each key with dual functions. Whether upper or lower character is valid can be checked on the display. 4.4.4
	CLEAR	When the Help function is used, the screen returns to the display at the input of the [HELP] key. -
		In the Parameter mode, the process is cancelled. After restarting, continue the operation. -
		If the Clear key is pressed when the system is not in the Parameter mode, Other mode or Help function, the screen returns to the initial status of the mode selection. (The input commands or device numbers except for the mode are cleared.) This is used for repeating the procedure if incorrect keys are pressed. 4.4.7
	SP	Key that provides blank space at the command and at between device names. -
	↑ (←) (→) ↓	Key that moves the cursor on the display (▶ , ■) or determines scroll directions. 4.4.3
GO	Press this key at the last of a series of key operations to execute the operation. Check the details of key operations on the display before pressing this key. 4.4.5	

(b) Key arrangement and functions for GT14 and GT11

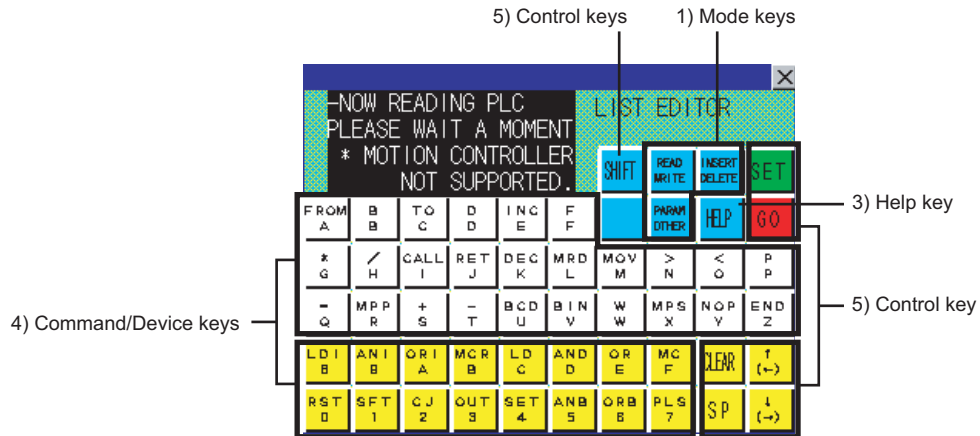

The functions of these keys are the same as those of the keys for the GT15. For a summary of the functions, see the preceding page.

(2) How to express keys and key operation descriptions

The keys for the MELSEC-A list editor and operation procedures are described in text in a simplified manner as shown below.

- (a) Some keys, such as $\boxed{\text{RST}_0}$ and $\boxed{\text{MOV}_M}$, are available for two different purposes. Operate such keys with either the upper or lower function indicated on them valid according to the operation. In descriptions, only the necessary functions are indicated on keys. (Example of description)

When entering the character "M," the $\boxed{\text{MOV}_M}$ key is indicated as \boxed{M} in the description.

Make upper or lower functions valid by using the $\boxed{\text{SHIFT}}$ key or the $\boxed{\text{SET}}$ key. For further information about the procedure for making upper or lower functions valid, see the following:

4.4.3 Switching valid keys (upper/lower functions)

- (b) The expression $\boxed{\text{Key 1}} \rightarrow \boxed{\text{Key 2}} \rightarrow \dots \rightarrow \boxed{\text{Key n}}$ means touching keys from $\boxed{\text{Key 1}}$ to $\boxed{\text{Key n}}$ in order. (Example of description)

The example of description shown below indicates that $\boxed{\text{SET}}$ must be touched first, \boxed{F} second, $\boxed{0}$ third, and $\boxed{\text{GO}}$ finally.



4.4.2 Display format of the display area

The following describes the position and content of each data field in the MELSEC-A list editor display area

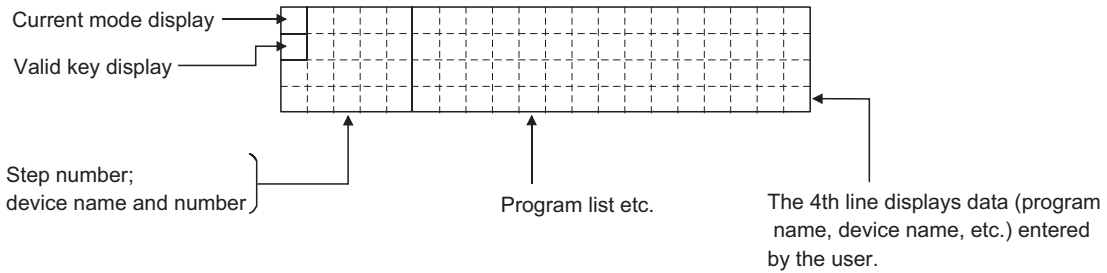

(1) Mode and valid key display

The following describes the mode and valid key display.

The mode display shows the MELSEC-A list editor mode selected by the user.

The valid key display shows which of the two functions assigned to each key is currently available: the function indicated at the upper part of the key or the function indicated at the lower part of the key.

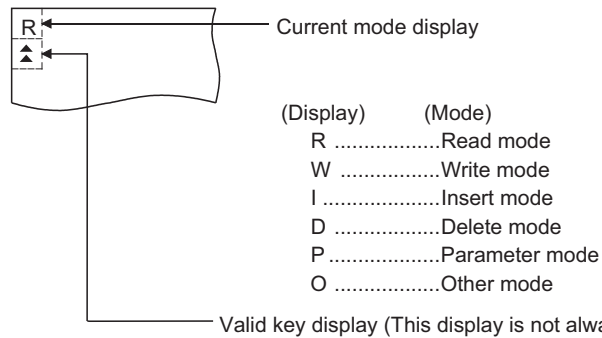

With regard to keys framed in dotted lines in the figure shown at the left, the valid key display indicates which of the two functions assigned to each key is valid:

- ▲ : Function indicated at the upper part of each key is available.
- ▼ : Function indicated at the lower part of each key is available.

Example: FROM A key

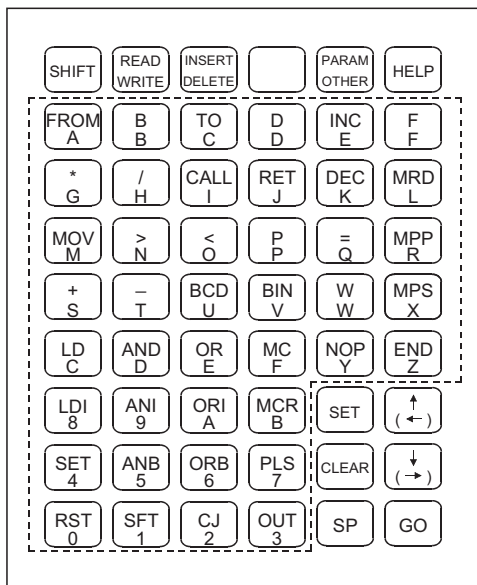
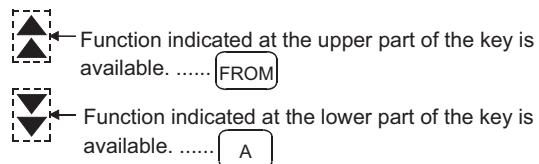

POINT

To switch between two functions of keys (functions indicated at upper and lower parts of the keys), press the **SHIFT** and **SET** keys.

☞ 4.4.3 Switching valid keys (upper/lower functions)

(2) The cursor appears

The cursor appears ■ and is highlighted during data input.

(3) Indication of the selected line

When a program list is displayed, the line currently selected for editing is indicated by "▶" appearing immediately after the step number.

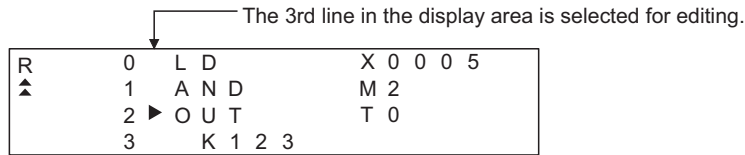

You can use the ↑ and ↓ keys to move "▶" up and down.

(4) Step number display

A step number is displayed as a decimal number.

On the 1st and 2nd lines in the display area, significant digits in the lower four digits of a step number are displayed.

On the 3rd and 4th lines in the display area, up to five significant digits in a step number are displayed.

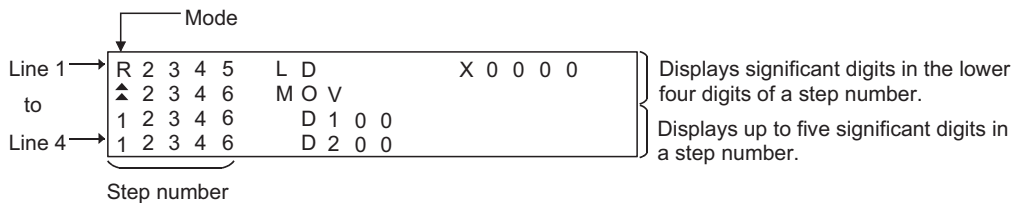

(5) Device display

Two or more device specifications attached to a basic or application instruction are displayed using the same step number.

For information on the step numbers, see Paragraph (4) above.

(6) Display of data input from the keys

Data input from the keys will appear at the cursor position. As more characters are input, the cursor moves to the right.

The cursor appears as " ■ ".

Example: The user enters SET → 1 → 0

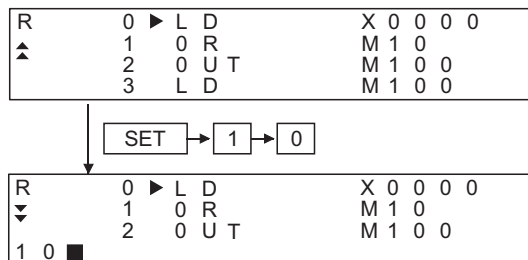

(7) Shifting of data to the left during the input of a program

When the user inputs a program, the codes entered before a touch on the **GO** key will appear on the 4th (bottom) line of the display area.

If the codes cannot appear on a single line, the display on the 4th line only will shift by a single character position to the left each time the user touches a key. (Each character that goes out of the display area by the left-shift operation is retained in the memory.)

```
W 1 1 5      M 5      X 0 0 0 5
▲ 1 2 0      L D      M 3
  1 2 1 ▶    N 0 P
P  K 2 1 4 7 4 8 3 6 4 7      D 1 0 0 0 ■
```

↑ The user has entered "DMOVP K2147483647 D1000".

You can move " ■ " in the specified direction (right or left) with the **(←)** or **(→)** key.

(8) Display of an error message

An error message will appear on the 4th line of the display area.

An error message on the display is cleared when you press any key. Then the display resumes the state before the appearance of the error message.

When an error message is displayed, take action according to the procedure described in the following section:

 4.7 Error Messages and Corrective Actions

4.4.3 Switching valid keys (upper/lower functions)

Make valid the upper or lower function of keys available for two different purposes to operate the MELSEC-A list editor.

(1) Switching the upper and lower functions of mode keys

In general, the upper functions of mode keys are valid.

To make the lower function of a mode key valid, touch the key and then the mode key.

During switching of the upper and lower functions of mode keys, the mark on the valid keys remains .

(2) Switching the upper and lower functions of command/device keys

Switch the upper and lower functions of command/device keys using the keys shown below, if necessary.

: Makes the upper function valid.

: Makes the lower function valid.

* The keys shown below can be operated even if the lower function of a key is valid.

(You do not need to operate the key.)

- Comparison symbol keys at the input of comparison operation commands: , , .
- Minus key in command source data: .

For further information about the display of valid keys, see the following:

 4.4.2 Display format of the display area

(3) Valid command/device keys after setting each mode

Valid command/device keys after setting each mode are shown below.

(a) Valid keys after setting read, write, and insert modes.

The upper functions of the command/device keys are valid.

If necessary, switch the upper and lower functions of necessary keys for operation.

(b) Valid keys after setting parameter, other, and help modes.

The lower functions of the command/device keys are valid.

If necessary, switch the upper and lower functions of necessary keys for operation.

4.4.4 Selection and operation of modes

Select appropriate modes of the MELSEC-A list editor for the operations described in Sections 4.5 and 4.6.

You can change modes as you desire during any of the operations described in Sections 4.5 and 4.6, so that you can continue operations while changing modes.

<input type="text" value="READ"/>	Read mode
<input type="text" value="WRITE"/>	Write mode
<input type="text" value="INSERT"/>	Insert mode
<input type="text" value="DELETE"/>	Delete mode
<input type="text" value="PARAM"/>	Parameter mode
<input type="text" value="OTHER"/>	Other mode



Mode key input is always valid.

Input of the mode key clears the input data except for the step numbers. The display returns to the initial status of the mode selection.

4.4.5 Command input procedures

Command input procedures can be classified as follows:

- 1) Input the command key to use the command on the key.
- 2) Input the alphanumeric keys corresponding to each character of command sequentially.
- 3) Select and input the command to be used from the Help function.

Command input procedures for 1) and 2) above are as follows.

For command input procedure 3) from the Help function, refer to 4.4.5 Command input procedures

POINT

When the command is input, the input details are displayed at the 4th line (the bottom line) on the display.

In the following description, the input of **[SP]** key may be omitted when a blank space between the input command and the cursor position is automatically inserted. Refer to the example in each description.

(1) For command code only

- (a) When the command available on the keyboard is input

[Command] → GO

(Ex) When END is input

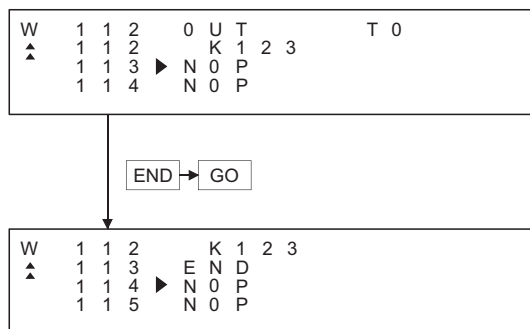

- (b) When the command not available on the keyboard is input

(Ex) When FOR K5 is input

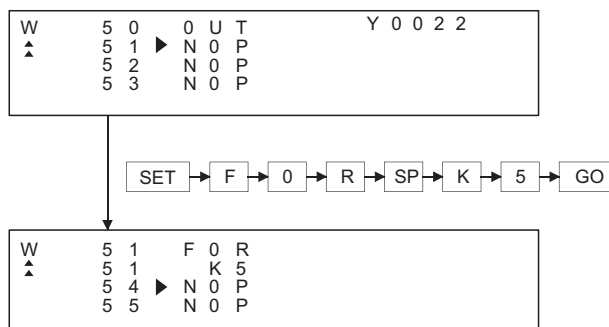

(2) For command code and device (1)

[Command] → [SP] → [DEVICE] → [DEVICE No.] → [GO]

(Ex) When LD X0 is input

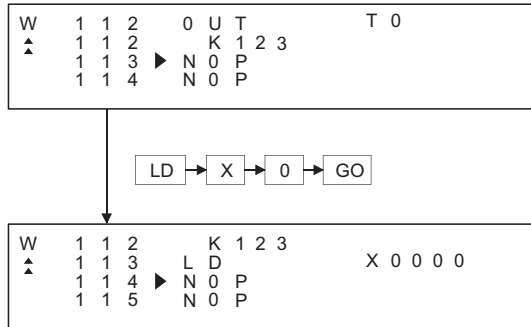

(3) For commands other than above

Input the [SP] key between the command and the device, the source data, and the destination data.

(Ex 1) When FMOV K2 D0 K5 is input

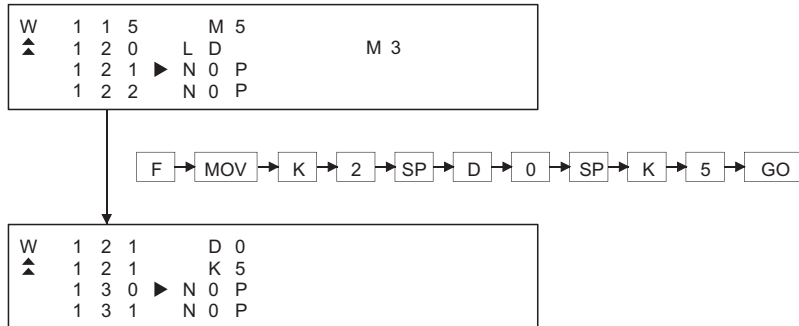

(Ex 2) When OUT T1 K10 is input

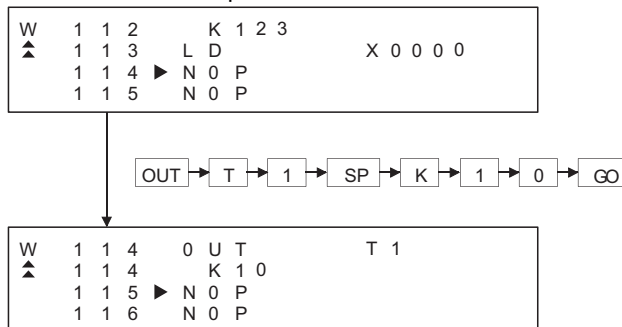

(Ex 3) When MC N3 M5 is input

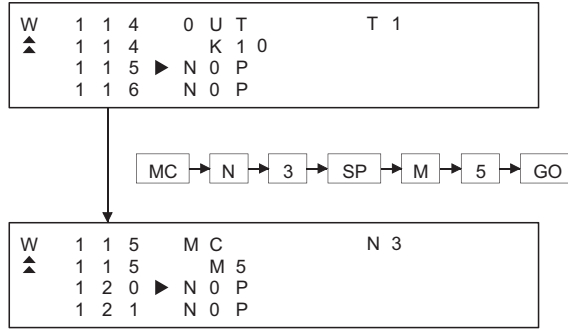

(Ex 4) When LD = K10 D10 is input

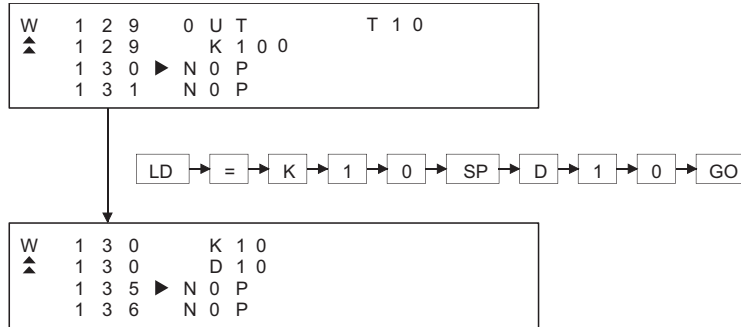

(Ex 5) When ANDD<=H7FFF D20 is input

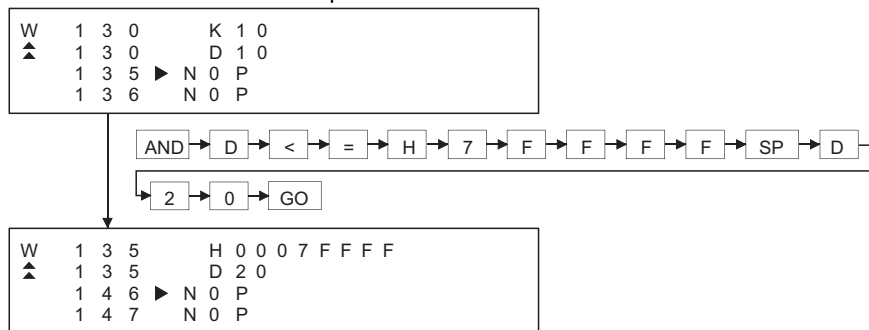

(4) Handling of devices M, L and S

Devices M, L and S in the Test, Monitor, Write and Insert modes change the display depending on the set parameters.

If LD L0 is input for the parameter setting of M0 to 999 and L1000 to L2047, the result is LD M0.

(5) For extension timer/extension counter of AnA and AnUCPU

When the extension timer (T256 to T2047) and the extension counter (C256 to C1023) are input as the first device of the command, input the first device and the device number.

(Ex) When OUT T256 D500 is input

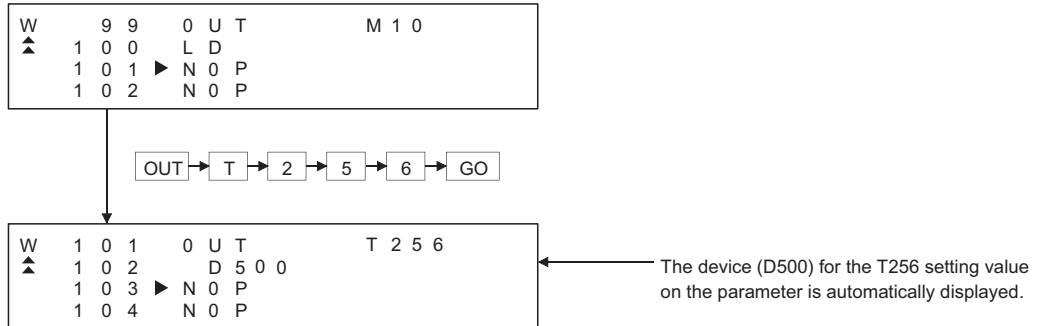

POINT

When the extension timer and the extension counter are used, be sure to set the 257 points or more and the setting value device (D, W, R) on the parameter for both the timer and the counter.

4.4.6 Hard copy output

Screens of the MELSEC-A list editor can be stored to a memory card in BMP/JPEG file format or printed with a printer. Refer to the following for the hard copy.(GT16/GT15 only)

- Starting the MELSEC-A list editor from the ladder monitor (☞ 3.4.2 Hard copy output)
- Setting the hard copy with GT Designer3.
☞ GT Designer3 Version1 Screen Design Manual (Functions) 40. HARD COPY FUNCTION

4.4.7 Action if an incorrect key is input

If an incorrect key is input, cancel the input contents.

■ Operation

(1) Before touching the [GO] key (before reading/writing the input contents)

Before touching the [GO] key, touch the [CLEAR] key.

(2) After touching the [GO] key (after reading/writing the input contents)

Write the command again. (☞ 5.4.5 Writing commands)

Commands finalized by writing and inserting operations are revised (overwritten) with the program writing.

HINT

When the [CLEAR] key is input in the parameter mode, the GOT stops the process. To continue the operation, carry on the key input.

4.4.8 List of functions

The table below shows the functions available for each mode.

Mode (mode display)	Function
Write (W)	Writes, adds, or modifies a program.
	Changes a device used at the selected step in the program.
	Displays a list of instructions that start with the specified character and allows the user to choose from them.
	Reads a program after allowing the user to specify a step number.
	Declares the specified part of the program NOP.
	Displays a comment for the specified device.
Read (R)	Reads a program after allowing the user to specify a step number.
	Reads a program after allowing the user to specify an instruction used.
	Reads a program after allowing the user to specify a device used.
	Automatically scrolls the display of a program that has been read up to a specified step.
	Corresponds to program read and automatic scroll functions described above.
	Displays a comment for the specified device.
Insert (I)	Inserts a new program into the displayed program.
	Displays a list of instructions that start with the specified character and allows the user to choose from them.
	Reads a program after allowing the user to specify a step number.
	Moves the selected part of the program to a specified part of the program.
	Copies the selected part of the program to a specified part of the program.
	Displays a comment for the specified device.
Delete (D)	Deletes a program at the specified step.
	Deletes the specified block in the program.
	Deletes all NOP instructions found in program codes described before the END instruction. (NOPLF instructions will not be deleted.)
	Displays a comment for the specified device.
Parameter (P))	Clears all parameters in the ACPU only.
	Sets or changes various parameters like those for the memory capacity, timer/counter, and latching range.
	Sets or changes a keyword.
Others (O)	Changes values set to timer/counter devices.
	Displays details of an error in the ACPU and the associated step number.
	Checks duplex coils, instruction codes, and other elements in the program.
	With regard to a special function unit of the specified I/O number, monitors the contents of the buffer memory at the specified address.
	Monitors the ACPU clock (D9025 through D9027).
	Clears all contents of the ACPU memory and resets it to the initial state.
	Clears the program (Main/Sub) currently selected.
	Clears all device memories except for special-D, special-M, and R.
	Switches the target ACPU in GOT operations in each mode.
	Switches the target program (Main/Sub) in GOT operations in each mode.
	Forcibly changes the ACPU running status between RUN and STOP.
	Performs a read or write operation to the ACPU memory in the machine language.

1

OVERVIEW

2

SYSTEM MONITOR

3

LADDER MONITOR
FUNCTION

4

MELSEC-A LIST
EDITOR

5

MELSEC-FX LIST
EDITOR

6

INTELLIGENT
MODULE MONITOR

7

NETWORK
MONITOR

8

Q MOTION
MONITOR

4.5 Basic Operation

This section takes an easy operation example to describe the basic operation of the MELSEC-A list editor.

4.5.1 Reading sequence programs

[Operation exaple]

<Key operation>

1. Select the "Read" mode.

2. Read the 0th step.

→ →

3.

<Display>

```
R 7 D20
^ 14 END
15▶NOP
16 NOP
```

```
R 0▶LD X0000
^ 1 OR Y0010
2 ANI X0001
3 OUT Y0010
```

```
R 3 OUT Y0010
^ 4▶OUT T0
4 K10
5 LD T0
```



Scroll the screen with the key.

4.5.2 Changing (Overwriting) commands

The example shown below is used to describe how to change sequence program commands.

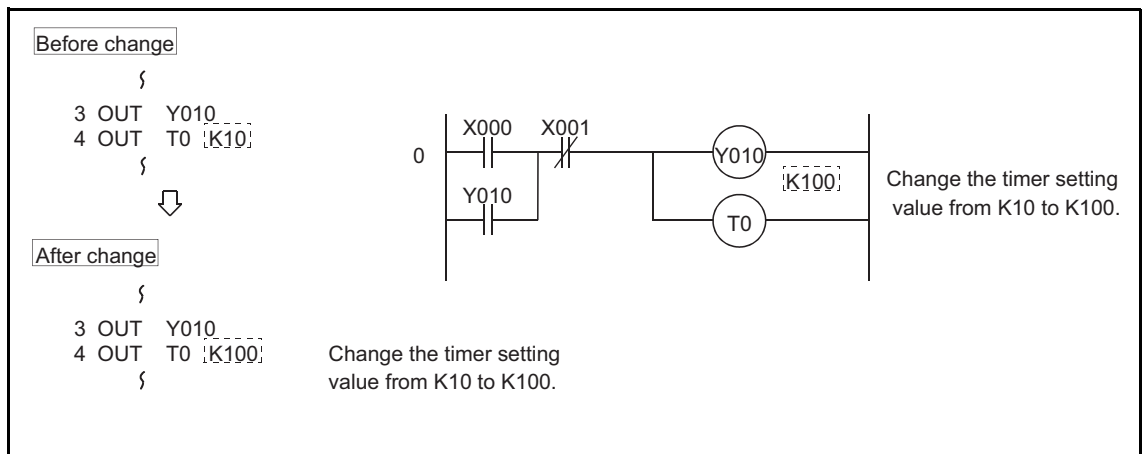

[Operation example]

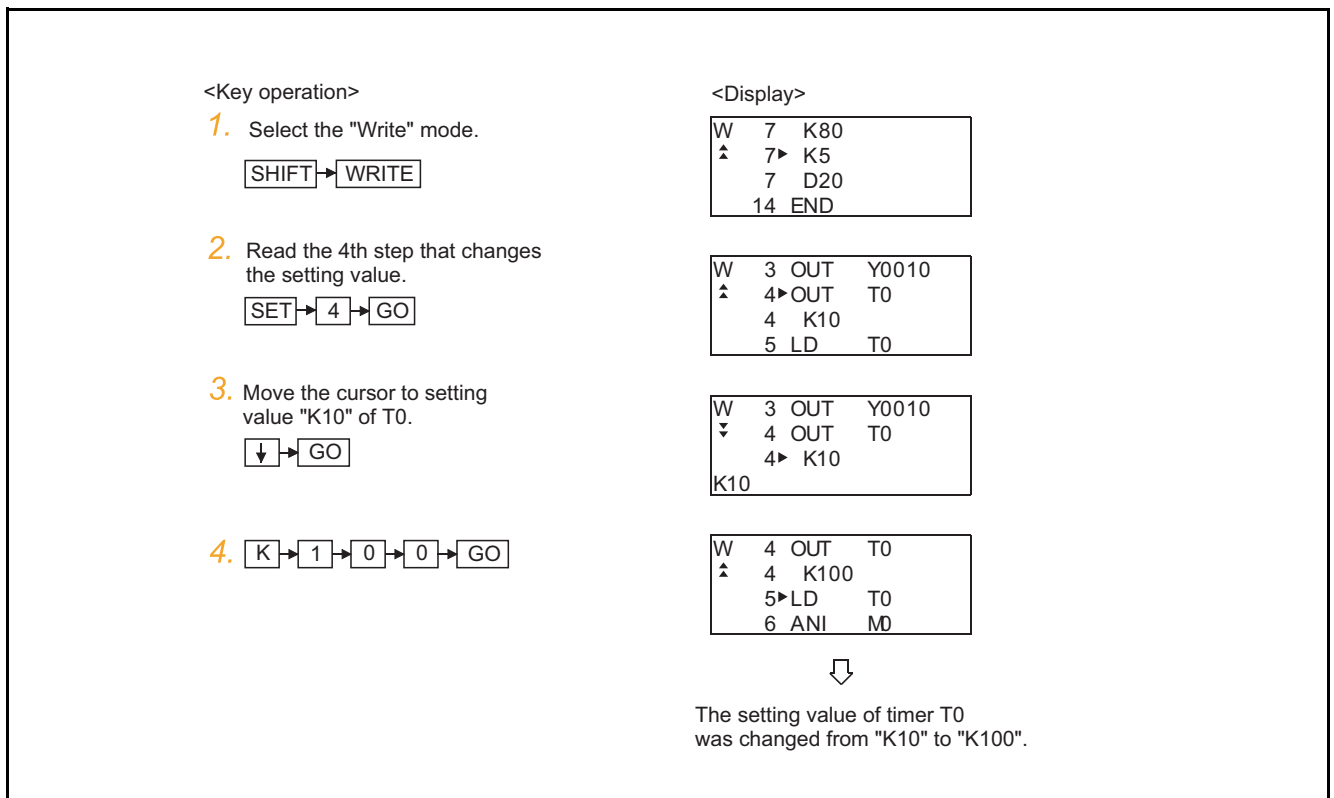

4.5.3 Adding (Inserting) commands

The example shown below is used to describe how to add sequence program commands.

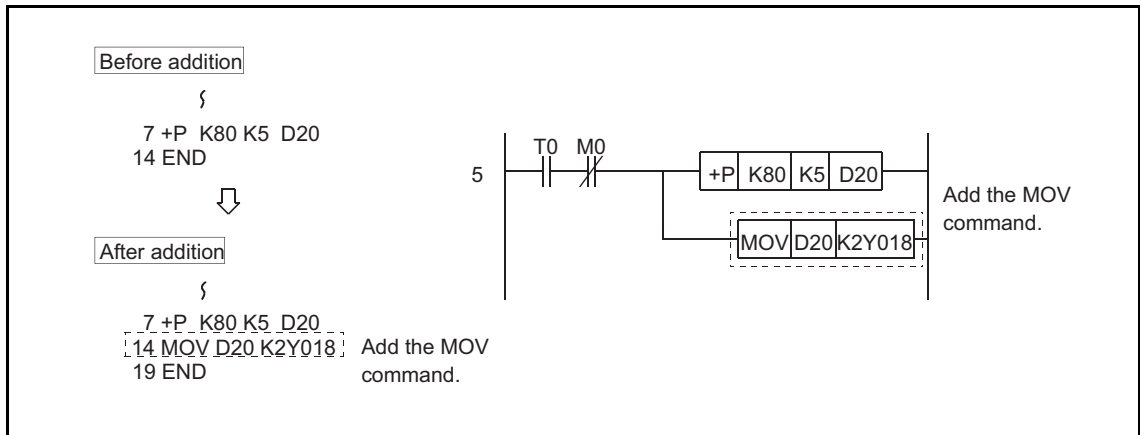

[Operation example]

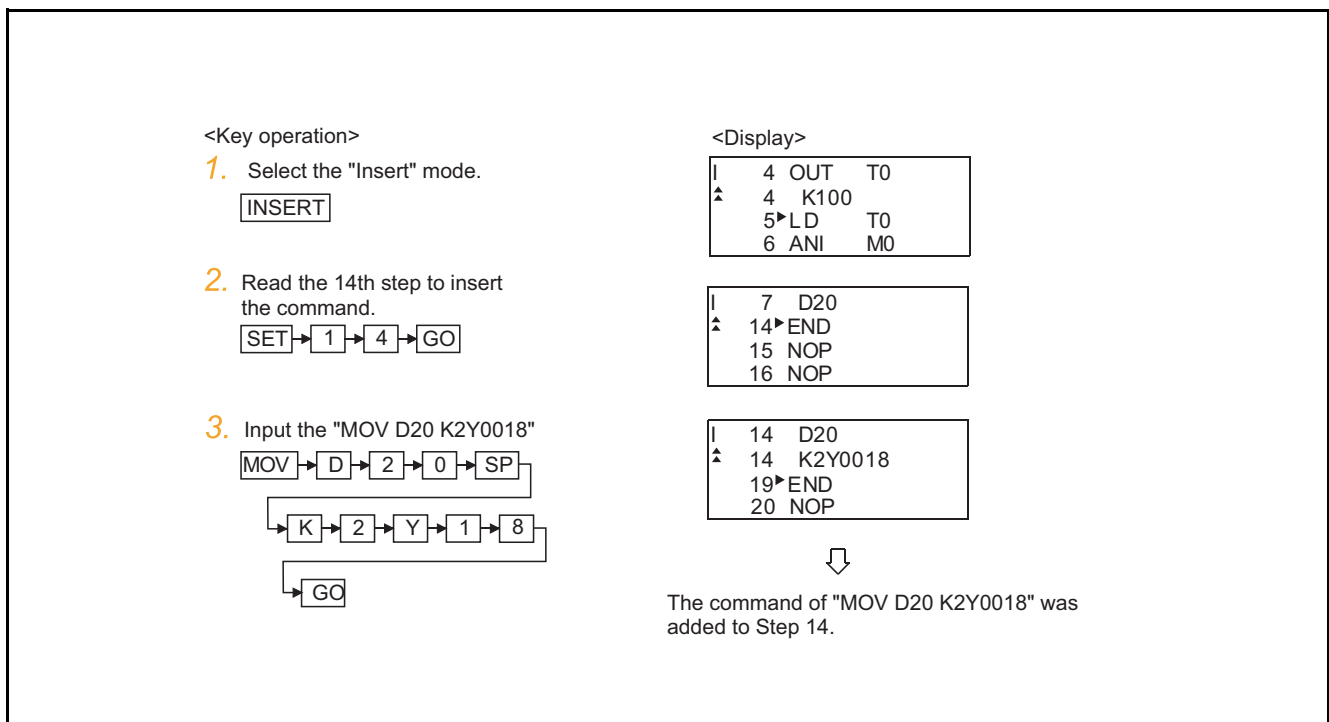

4.5.4 Deleting commands

The example shown below is used to describe how to delete sequence program commands.

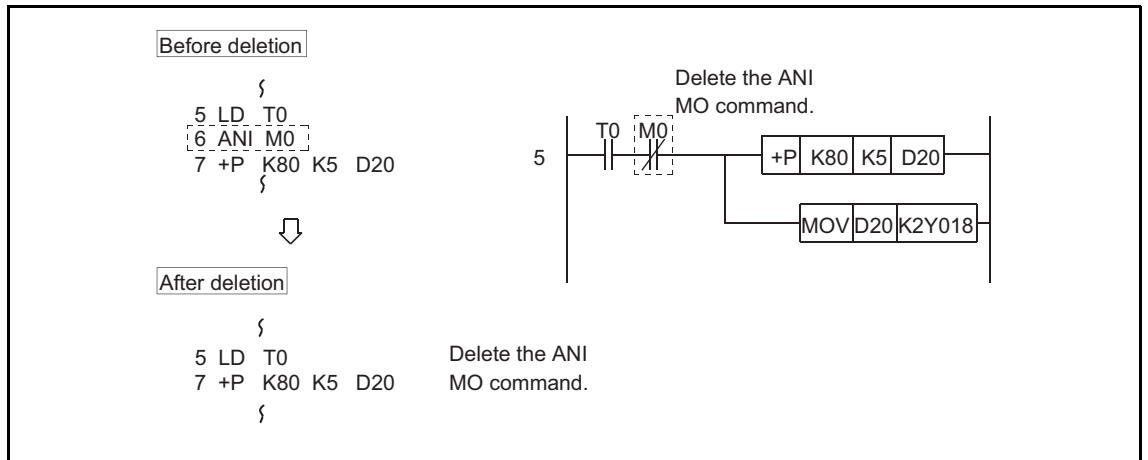

[Operation example]

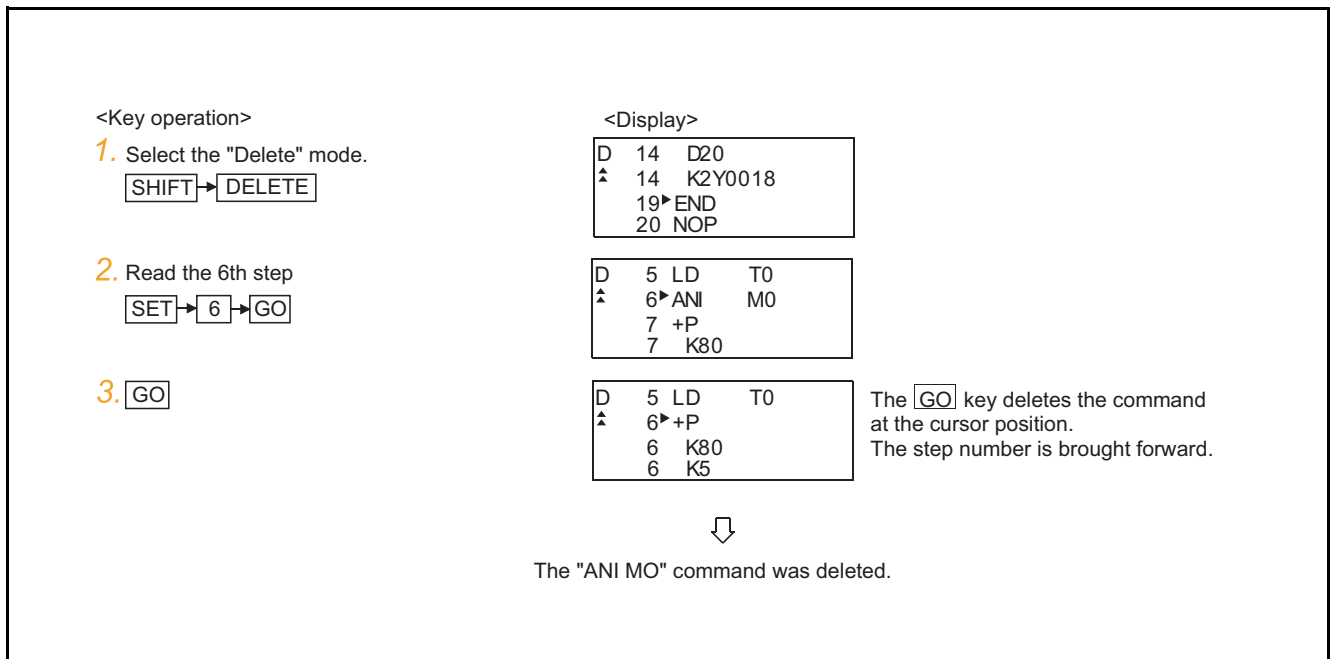

4.5.5 Using the help function

[HELP] is input to use the Help function.

Input of [HELP] displays the Help function menus in each mode. Select the corresponding item for execution.

(1) Reading the command in the sequence program

Example of reading the area using the "MOV" command in the sequence program.

[Operation example]

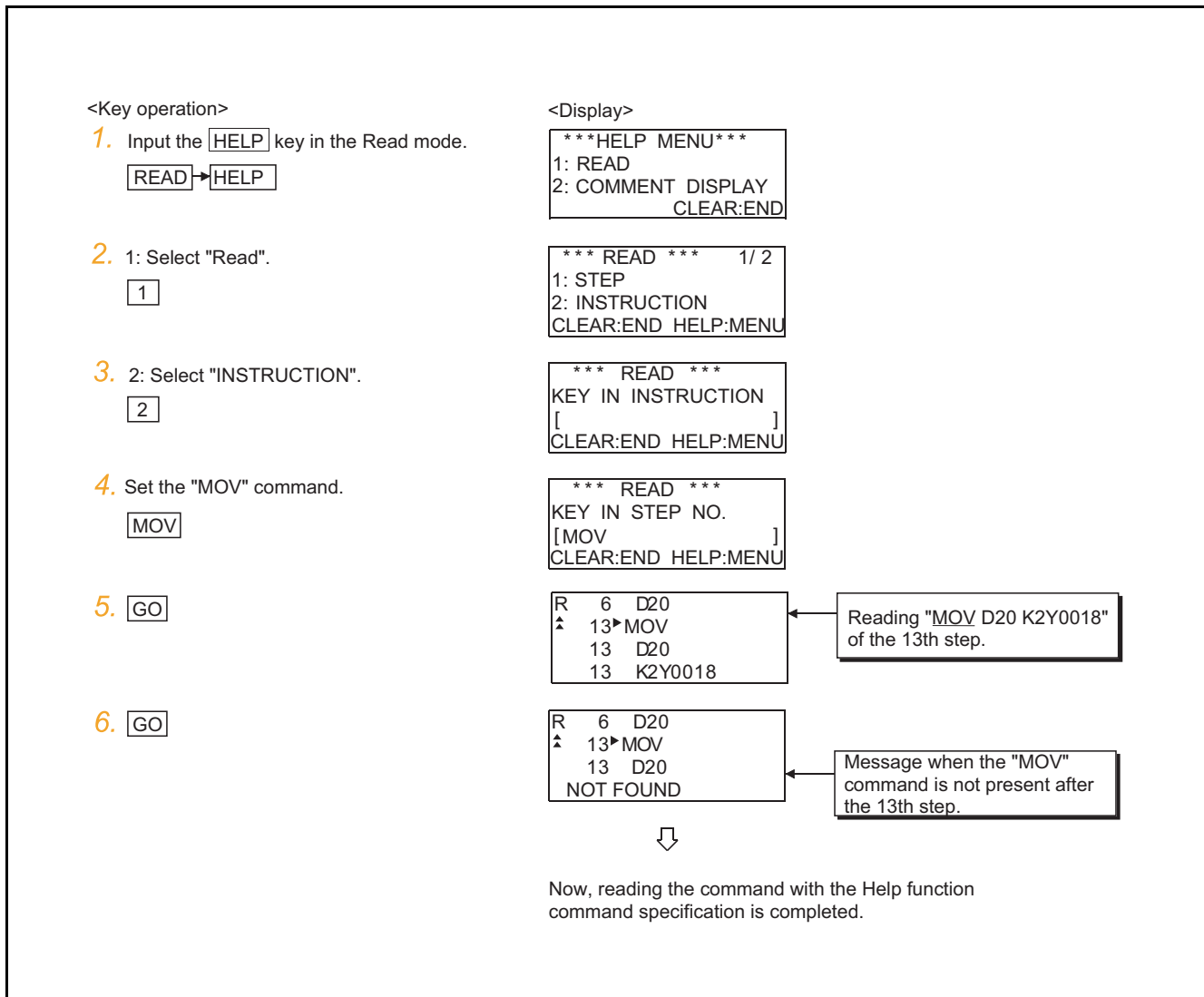

(2) Displaying comment

The following example shows the procedure of displaying the comment in the Read mode.

[Operation example]

<Key operation>	<Display>
1. Input the <input type="text" value="HELP"/> key in the Read mode. <input type="text" value="HELP"/>	<pre>***HELP MENU*** 1: READ 2: COMMENT DISPLAY CLEAR:END</pre>
2. Select "2: COMMENT DISPLAY". <input type="text" value="2"/>	<pre>***COMMENT DISP.*** 1: YES 2: NO CLEAR:END HELP:MENU</pre>
3. Select "1: YES". <input type="text" value="1"/>	<pre>R 0▶LD X0000 ^ 1 OUT Y0020 2 LD X0000 Motor start limit</pre> <p>Display the comment of the device at the cursor position.</p>
4. Move the cursor to the following step. <input type="text" value="↓"/>	<pre>R 0 LD X0000 ^ 1▶OUT Y0020 2 LD X0000 Motor start check</pre>

4.6 List of Operation Procedures

4.6.1 Common operation

Details	Purpose	Procedures (key input sequence)
Basic operation	Input of keyword at start-up	Keyword → GO
	Mode selection Switching of valid key	Mode key (READ , INSERT , PARAM) SHIFT → Mode key (WRITE , DELETE , OTHERS)
	Switching of valid key	Switch the valid key (function indicated at the upper/lower part of the key) by a user. SHIFT or SET
	Action for incorrect input	CLEAR , Mode key or SHIFT → Mode key
	Operation of command help function	Perform program display → HELP → 1 → 1 → 1 → Input the capital letter of the command.
	Display of Comment	Display the comment stored in the ACPU. Perform program display operation → HELP → 2 → 1 → 2
Command input operation	Command code only	Command → GO
	Command code and 1 device	Command → SP → Device → Device No. → GO
	Other than above (command key input)	Input the SP between the device, the source data and the destination.
	Other than above (device key input)	Input the SP between the command, the device, the source data and the destination.

1	OVERVIEW
2	SYSTEM MONITOR
3	LADDER MONITOR FUNCTION
4	MELSEC-A LIST EDITOR
5	MELSEC-FX LIST EDITOR
6	INTELLIGENT MODULE MONITOR
7	NETWORK MONITOR
8	Q MOTION MONITOR





4.6.2 Operation in write mode (W)

Details	Purpose	Procedures (key input sequence)
Continuous write in NOP	Set the specified range in the program to NOP.	Program display → HELP → 1 → 2 in the Write mode → 1 → Start step specification → GO → Final step specification → GO → 2 → Start step specification → GO
Write/modify (change) of program	Write the new program/modify (change)	SHIFT → WRITE → SET → Step number → GO → Com → GO ↑ ↓

4.6.3 Operation in read mode (R)

Details	Purpose	Procedures (key input sequence)
Command reading with the specified step number	Read the command of the specified step number in the program.	READ → SET → Step number → GO → GO
Read the command with the specified command.	Read the specified command in the program.	READ → Command → Device → Device number → GO ↓ GO
Read the command with the specified device.	Read the command with the specified device used in the program.	READ → SET → Device → Device number → GO ↓ GO
Automatic scroll	Display the program with automatic scroll.	Read operation above → SET → ↑ ↓ SET → Step number SET → SP → ↑ ↓

4.6.6 Operation in parameter mode (P)

Details	Purpose	Procedures (key input sequence)
Clearing all parameters	Return the parameters to the initial setting status.	PARAM → 1 → ↑ → GO → END → ↑ → GO
Parameter setting (for A0J2HCPU)	Set the parameters for the A0J2HCPU.	PARAM → 2 → 1)
Setting of latch range	Select the latch range from "No latch", "1/2 latch" and "All latch".	1) → 1 →  → GO → 2)
Setting of step relay	Set the availability (S1536 to 2047) of the step relay.	1) → 2 →  → GO → 2)
Completion of setting	When the parameter setting is complete, write the PLC CPU.	2) → CLEAR → END → ↑ → GO (End of writing is displayed.)
Parameter setting (other than A0J2HCPU)	Set the parameters other than A0J2HCPU.	PARAM → 2 → 1)
Setting of memory capacity	Set the main sequence program capacity and the file register capacity.	1) → 1 → Capacity → GO → END → 2) (For main, input unit: 1K step) 1) → 1 → ↓ → Capacity → GO → END → 2) (For sub, input unit: 1K step) 1) → 1 → ↓ → points → GO → END → 2) (For file register, input unit: 1K point)
M, L, S setting (other than AnA, AnUCPU)	Set the top device number used in the latch relay/step relay.	1) → 2 → Top number of L → GO → Top number of S → GO → 2)
M, L, S setting (AnA, AnUCPU only)	Set the top device number used in the latch relay/step relay/ internal relay.	1) → 2 → Top number of L → GO → Top number of S → GO → Top number of M → GO → 2)
Timer setting (other than AnACPU)	Set the top device used in the low speed/high speed/retentive timers.	1) → 3 → Top number of timer → GO → 2)
Timer setting (AnACPU)	Set the number of timers used, the top device number that stores the setting value after T256, and the top device used in the low speed/highspeed/retentive timers.	1) → 3 → No. of timers → GO → Top device for storage of setting values → GO → Top number of timer → GO → 2)
Counter setting (AnACPU only)	Set the number of counters used, and the top device number that stores the setting value after C255.	1) → 4 → No. of counters → GO → Top device for storage of setting values → GO → 2)
Setting of latch range WDT setting	Set the range of the device for latch setting.	1) → 5 →  → Top number of latch → GO →  → End number of latch → GO → END → 2)
WDT setting (other than AnA, AnU)	Set the value of the watchdog timer in the unit of 10 ms.	1) → 6 → WDT value → GO → 2) (input unit: 10 ms)
Setting of I/O control system (only for A3HCPU and A3MCP)	Set the I/O control system.	1) → 7 →  → GO → 2)
Completion of setting (write)	When parameter setting is complete, write the PLC CPU.	2) → CLEAR → END → ↑ → GO (End of writing is displayed.)

4.6.7 Operation in other mode (O)

Details	Purpose	Procedures (key input sequence)
Error check	Operation that checks the error step number/error code for the current error in the ACPU. (other than AnA and AnUCPU)	<p>(Except AnA, AnUCPU) (AnA, AnUCPU)</p>
Program check	Check the program(double coil, command code, END command).	<p>Step number</p>
Buffer memory batch monitoring	Monitor the buffer memory details of the special function unit.	<p>Top I/O number of unit</p> <p>Buffer memory address</p>
Clock monitor	Monitor the clock data of the ACPU.	
Clearing of all PC memories	Clear all memories in the ACPU.	
Clearing of all programs	Clear all sequence program, microcomputer program and T/ C setting value areas.	
Clearing of all device memories	Clear all details of the bit device and the word device in the ACPU.	
PLC No. setting	Set the PLC No. of other stations for access on the MELSECNET II (/B) or MELSECNET/10.	<p>1 2 -> PC No. -> GO 3 -> Network No. -> GO -> Station No. -> GO</p>
Main/sub-program switching	Select the main/sub- program displayed on the list edit screen.	
Remote run/stop	Operate the run/stop status of the ACPU from the GOT.	
Read/write of machine language	Specify the memory address (absolute address) of the ACPU. Read the memory details and write the machine language to the memory.	<p>Address (hexadecimal)</p> <p>Machine language code</p>

1 OVERVIEW
2 SYSTEM MONITOR
3 LADDER MONITOR FUNCTION
4 MELSEC-A LIST EDITOR
5 MELSEC-FX LIST EDITOR
6 INTELLIGENT MODULE MONITOR
7 NETWORK MONITOR
8 Q MOTION MONITOR

4.7 Error Messages and Corrective Actions

4.7.1 Error messages and corrective actions in direct CPU connection

If an error is detected with the MELSEC-A list editor during operation of each mode, an error message appears at the 4th line of the display.

Error messages, display conditions and corrective actions are displayed below. If an error message appears, take the following actions to resume operation.

1. Check the error message.
 2. Remove the cause of the error.
 3. Input the corresponding key.
- (The error message disappears. The screen returns to the status before error.)

(Example)

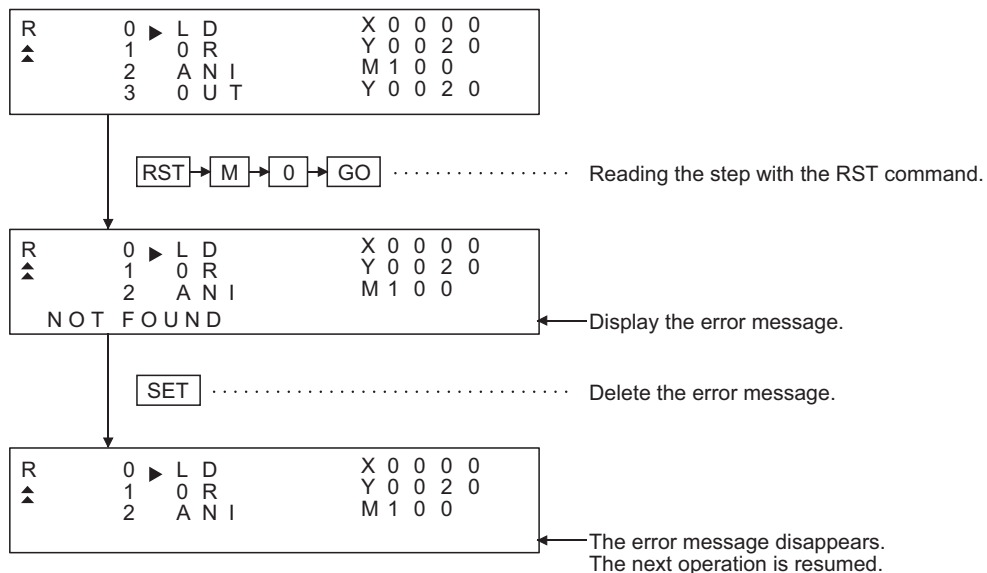

Error message	Description	Corrective action
Address error	In machine language writing, the address which was tried to be written was at the write-protect area.	Set the correct address.
No corresponding program	The specified command was not found.	Check the program.
Memory cassette check	In communication with the CPU for clearing the keyword or writing the parameter, the memory cassette is insufficient or not mounted.	(1) Mount the memory cassette properly. (2) Replace the memory cassette with a new one.
Step over error	The set step number is larger than the maximum step number.	Set the correct step number.
Setting error	Setting value is not correct.	Set the correct value.
Not selectable	The function which cannot be executed was selected.	Select other function.
Operation error	The set device symbol is incorrect.	Perform the correct key operation.
Device error	The specified command was not found. The device number exceeds the range.	(1) Set the correct device symbol. (2) Set the number within the range of CPU device.
Identical coil	The identical coil is found in the sequence program.	Proceed to the next operation if it does not affect the control. Correct the program if it affects the control.
Command error	When the program is read, it cannot be converted to the proper command.	When the CPU has detected the error, stop running of the operation. After resetting the CPU, check the command around the error. Write the correct command. (For check of the error step, refer to 4.6.7.)

(Continued to next page)

Error message	Description	Corrective action
Command setting error	The command set at the time of read, write or insert is not correct.	Set the correct command.
Memory protect	When writing in the Write or the Insert/Delete mode, the memory protect switch in the memory cassette is ON.	Turn OFF the memory protect switch in the memory cassette.
Capacity over	Memory assignment set in the parameter exceeded the capacity of the memory cassette.	Set the parameter within the capacity of the memory cassette.
No END command	There is no END command.	Write the END command at the last step of the program.
PLC communication error	When the list editor function is started, proper communication with the PLC is not made.	Restart the list editor function. If communication is not made properly, check the following: (1) GOT main unit (2) Connection of the cable (3) CPU main unit (if any error has occurred)
PLC COMM ERROR PLEASE CLOSE	When the editor for MELSEC-A is started, proper communication with the CPU is not made.	Close and restart the editor for MELSEC-A. If communication is not made properly, check the following: (1) GOT main unit (2) Connection of the cable (3) CPU main unit
PC write error	Correct writing was not made in the Write or Insert mode.	(1) Check the setting of RAM/ROM. (2) Check the RAM mounting. (3) Check the setting of the memory protect switch in the CPU.
PLC is running	Writing, insertion or deletion was attempted during running of the CPU.	Stop the CPU.
PC No. error	The PLC number is set to other station.	Change the PLC number and set the station for access to the host.
**KS over	The value exceeding the range of the program capacity by **K steps was attempted to be set.	Reduce the program capacity by **K steps for setting.
**KP over	The value exceeding the range of the file register capacity by **K points was attempted to be set.	The value exceeding the range of the file register capacity by **K points was attempted to be set.
Not available for QnACPU. Set the PLC No.	The CPU at the list edit destination is QnACPU.	Set the PLC number and change the station for access.
The keyword is not input. Set the PLC No.	The "GO" key was pressed without input of the keyword on the keyword input screen.	Set the PLC number and change the station for list edit. Or select the same station and input the keyword.
The PLC parameter was changed. Read the ladder monitor again.	The PLC parameter exceeding the file (R) register capacity was set.	Restart the GOT system if required.
The PLC parameter was changed. Restart the GOT system.	The capacity of the file (R) register was set.	Read the ladder monitor on the PLC again if required.
The PLC program was edited. Read the ladder monitor again.	Edit the PLC program.	Read the ladder monitor on the PLC again if required.

1

OVERVIEW

2

SYSTEM MONITOR

3

LADDER MONITOR
FUNCTION

4

MELSEC-A LIST
EDITOR

5

MELSEC-FX LIST
EDITOR

6

INTELLIGENT
MODULE MONITOR

7

NETWORK
MONITOR

8

Q MOTION
MONITOR

4.7.2 PLC CPU error messages and troubleshooting

When the error step read in other mode is performed, the error message and the error step of the current error in the ACPU are displayed.

Error messages, error details and corrective actions are displayed below. If an error message appears, take the following actions to resume operation.

1. Check the error message.
2. If the error code is not displayed, check the error code of special register D9008 with the system monitor function (Refer to Chapter 2.).
3. Remove the cause of the error.

(Display)

(1) Example of display for an error in the CPU other than AnA and AnU

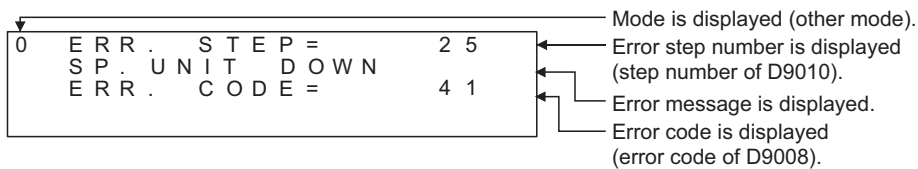

(2) Example of display for an error in the AnA or AnUCPU

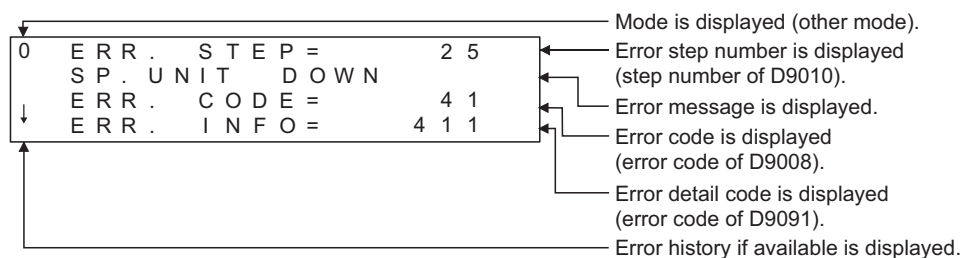

(3) Example of next display for the display of "↓" above (error history is available)

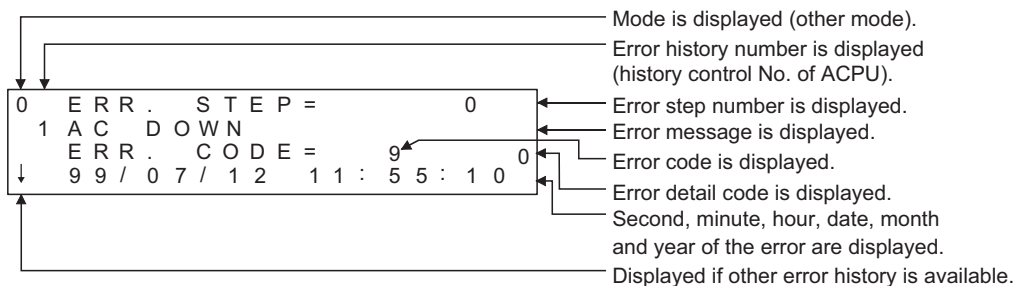

POINT

When an error message of the PLC CPU appears, refer to the ACPU programming manual (Common Command) and the user's manual for each CPU for corrective actions.

4.7.3 Error using list editor function on the link system

When the MELSEC-A list editor is used on the link system, the "PLC communication error (**)" may appear. In this case, check the error details and the corrective actions.

Error No.	Error message	Corrective action
2	Time-out error: No response to the request	Check the cable wiring.
4	Process cancel: New process request was given to the list editor function while the CPU is processing.	Perform correct key operations on the GOT.
5	Sum check error: A sum check error from the link communication has occurred.	There may be noise interference. Check the system again.
16	PLC No. error: There is no station corresponding to the PLC number.	Check the PLC number setting. Set the correct number.
19	This error may occur when the ACPU is reset during monitoring.	Perform the monitor setting again.
24	Remote error: Although remote stop/pause is performed from the computer link unit, remote run/stop is additionally performed.	Perform the remote run/stop/pause from either unit.
25	Refer to the next page for error messages and actions. After confirming the device value explained at the next page with the system monitor function, take action.	
32	Link error: While the slave station is monitoring the master station, the master station is reset.	Perform the monitor setting again.
34	EEPROM failure: The EEPROM, cannot be written due to EEPROM failure.	Replace the EEPROM with a new one.

[Detailed description of error No. "25"]

If error number "25" appears, the following causes are possible. Check the details and the corrective actions.

(1) When connected to the master station

Device number	Description	Details	
M9210	Link card error (for master station)	OFF : Normal ON : Error	The control depends on whether there is an error at the hardware of the link card. The link card in the CPU link unit is judged at the CPU. Replace the link unit.
M9224	Link status	OFF : Online ON : Offline, station-to-station test, or self-loopback test	The control depends on whether the master station itself is online or offline, or in the station-to-station mode or the self-loopback mode. Check the mode switch.
M9227	Loop test status	OFF : Not executed ON : Forward loop test and reverse loop test are being executed.	The control depends on whether the master station itself is executing the forward loop test or the reverse loop test.

(2) When connected to the local station

Device number	Description	Details	
M9211	Link card error (for local station)	OFF : Normal ON : Error	The control depends on whether there is an error at the hardware of the link card. The link card in the CPU link unit is judged at the CPU. Replace the link unit.
M9240	Link status	OFF : Online ON : Offline, station-to-station test, or self-loopback test	The control depends on whether the local station itself is online or offline, or in the station-to-station mode or the self-loopback mode. Check the mode switch.
M9257	Loop test status	OFF : Not executed ON : Forward loop test and reverse loop test are being executed.	The control depends on whether the local station itself is executing the forward loop test or the reverse loop test.

(3) When connected to the CPU in MELSECNET/10

An error in the MELSECNET/10 is reported using a four digit (hexadecimal) error number.

For details of the errors and corrective actions, see the MELSECNET/10 Network System Reference Manual.

If an error code not listed in the previous page is displayed, contact the nearest of our system service centers, agents, and branch offices.

5. MELSEC-FX LIST EDITOR



5.1 Features

The MELSEC-FX list editor enables you to change the sequence program in the FX PLC. This function is intended to troubleshoot the PLC system and to streamline maintenance operations. By installing list editor for MELSEC-A, an Option OS, from GT Designer3 into the GOT, you can edit the FX PLC program. The features of the MELSEC-FX list editor are described below.

■ Parameters and sequence programs are easy to maintain.

You can check or partly correct, change or add FX PLC CPU parameters and sequence programs simply by operating keys.

You can easily edit sequence programs without preparing any peripheral unit other than the GOT.

(Example of changing sequence program commands)

Changed

LD X000	→	LD X000
OUT Y020		OUT Y030
LD X001		LD X001

■ Combination with the ladder monitor

You can open the MELSEC-FX List Editor window from the Ladder Monitor screen with a single touch.

You can edit PLC program while checking the ladder.

You can also display a list from the step line displayed by the ladder monitor.

(GT16/GT15 only)

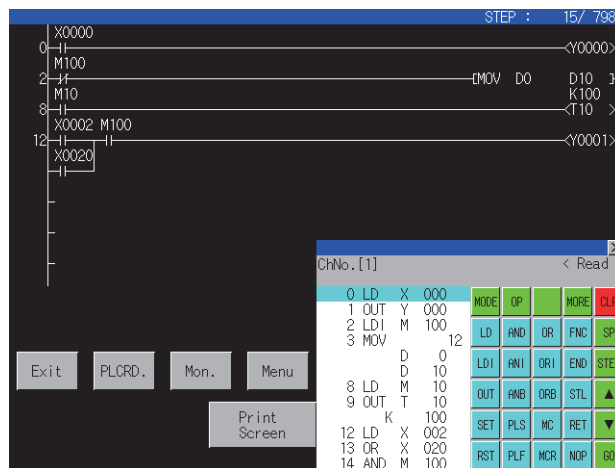

■ **Errors that occur during list editing can be checked easily.**

Error messages, error codes, and number of steps for errors that occur in the FX PLC can be checked. Details can be checked immediately even for errors that occur during list editing.

Error message	Detail	Step
I/O configuration error	1010	
PC/HPP communication error	6201	

■ **Commands and devices can be searched and displayed.**

Commands and devices used in sequence programs can be searched. The correction position can be searched for cases such as when you want to correct a specific device.

Searched device
M800

ChNo. [1]		< Read >	
Search device		MODE	OP
M 800		MORE	CLR
	D 0	.	V Z
	D 10		SP
8	LD M 10	8	9
9	OUT T 10		STEP
	K 100		
12	LD X 002	4	5 6 7
13	OR X 020		
14	AND M 100	0	1 2 3
			GO

→ Displays the searched device.

LD	M 800
OUT	T 10
	K 100
LD	X 002

5.2 Specifications

5.2.1 System configuration

This section describes the system configuration of the MELSEC-FX list editor. For connection type settings and precautions regarding the communication unit/cable and connection type, refer to the following.

 GOT1000 Series Connection Manual (Mitsubishi Products) for GT Works3

■ Controllers that can be edited with the MELSEC-FX list editor

Target controller
FXCPU*1

*1 Available only when using FX3U or FX3UC.

■ Connection forms

This function can be used in the following connection types.

(○: Available, x: Unavailable)

Function name		Connection form between GOT and PLC		
Name	Description	Direct CPU connection	Ethernet connection*2	
		GT16 GT15 GT14 GT12 GT11 GT10	GT16 GT15 GT14 GT12	GT11 GT10
MELSEC-FX list editor	Sequence program writing, parameter setting, PLC diagnostics and keyword registration, etc.	○	○*1	x

*1 Available only when using FX3U or FX3UC.

*2 MELSEC-FX list editor cannot be used when using CC-Link IE field network Ethernet adapter.

■ Required option OS and option function board

The option OS and option function board shown below are required.

 1.1.2 Hardware and OS' required for each function

(1) Option OS

- (a) For GT16, GT15, GT14, GT12, and GT11
Install the option OS in the above table to the GOT.
For the installation procedure, refer to the following.

 GT Designer3 Version1 Screen Design Manual (Fundamentals) 8. COMMUNICATION WITH GOT

- (b) For GT10
Installing the option OS is not required.

(2) OS memory space

The available memory space shown in the table above is required in the user area to install the option OS to the GOT.

For the procedure for checking the available memory space of the user area and information about the data using other user areas, refer to the following.

 GT Designer3 Version1 Screen Design Manual (Fundamentals) 8. COMMUNICATION WITH GOT

(3) Option function board

- (a) For GT16, GT14, GT12, and GT10
No option function board is required.
- (b) For GT15 and GT11
Mount one of the option function boards in the above table on the GOT.
For the GOTs with a built-in option function board, refer to the following.

 1.1.2 Hardware and OS' required for each function

For how to mount an option function board on the GOT, refer to the following.

 User's Manual for the GOT used

■ Functions list and monitor conditions

The following shows the memory that can be monitored by the MELSEC-FX list editor and the FX PLC status conditions.

(○ : Can be monitored △ : Can be monitored under certain conditions × : Cannot be monitored)

Function		Memory that can be monitored *2				FX PLC status	Reference
		Built-in memory	RAM memory cassette	EEPROM memory cassette, flash memory cassette	EPROM memory cassette		
Reading sequence programs	Displaying sequence programs	○	○	○	○	RUN/STOP	Section 5.4.3
	Searching commands/devices						Section 5.4.4
Writing sequence programs	Writing commands	○	○	△*1	×	For Stop only	Section 5.4.5
	Changing operands/set values						Section 5.4.6
Inserting commands		○	○	△*1	×	For Stop only	Section 5.4.5
Deleting commands							Section 5.4.7
Sequence program all clear							Section 5.4.8
PLC diagnostics		○	○	○	○	RUN/STOP	Section 5.4.9
Parameter setting	Display	○	○	△*1	×	For Stop only	Section 5.4.10
	Set						
Keyword		○	○	○	○	RUN/STOP	Section 5.4.11

*1 The operation is available only when the protect switch is OFF.

*2 The available memory differs depending on the FX PLC being used.
For further information, see the following.

 The hardware manual of the FX PLC being used

5.2.2 Access range

For the FXCPU in Ethernet connection, the GOT can monitor only the host station.
The access range other than the above is the same as the access range when the GOT is connected to a controller.
For details of the access range, refer to the following.

 GOT1000 Series Connection Manual (Mitsubishi Products) for GT Works3

5.2.3 Precautions

(1) Inapplicable GOT

The MELSEC-FX list editor cannot be used with the GOTs shown below.

GOT	Inapplicable GOT
GT10	GT1030, GT1020

(2) Using other peripheral equipment for sequence program/parameter change

When using the MELSEC-FX list editor, do not change programs or parameters in the PLC CPU from other peripheral equipment.

If you make a change, temporarily exit the MELSEC-FX list editor after the change is made, then start the MELSEC-FX list editor again.

If you carelessly change the program on one PLC from multiple units of peripheral equipment (including GOT), the contents of the program in the PLC CPU and the peripheral equipment may not be the same, resulting in an unintended operation of the PLC CPU.

(3) Sequence program change

Stop the FX PLC before changing (writing, inserting, deleting) a sequence program or changing parameters. Operation is not possible with the FX PLC running.

(4) If you press the key but the system does not proceed to the next operation (for example, a search)

Check the input contents (applied instruction number, device value, etc.).

(5) When used together with the ladder monitor

Even if you execute the MELSEC-FX list editor with the ladder monitor activated, edited information will not be reflected on the Ladder Monitor screen.

To reflect such edited information, perform the PLC reading of the ladder monitor again.

(6) When using list monitor

Only devices to be used for basic instructions can be monitored.

The status of devices (word, bit) to be used for application instructions cannot be monitored.

5.3 Operations for Display

This subsection describes an outline until the system monitor screen is displayed after List editor for MELSEC-FX (Option OS) is installed in the GOT.

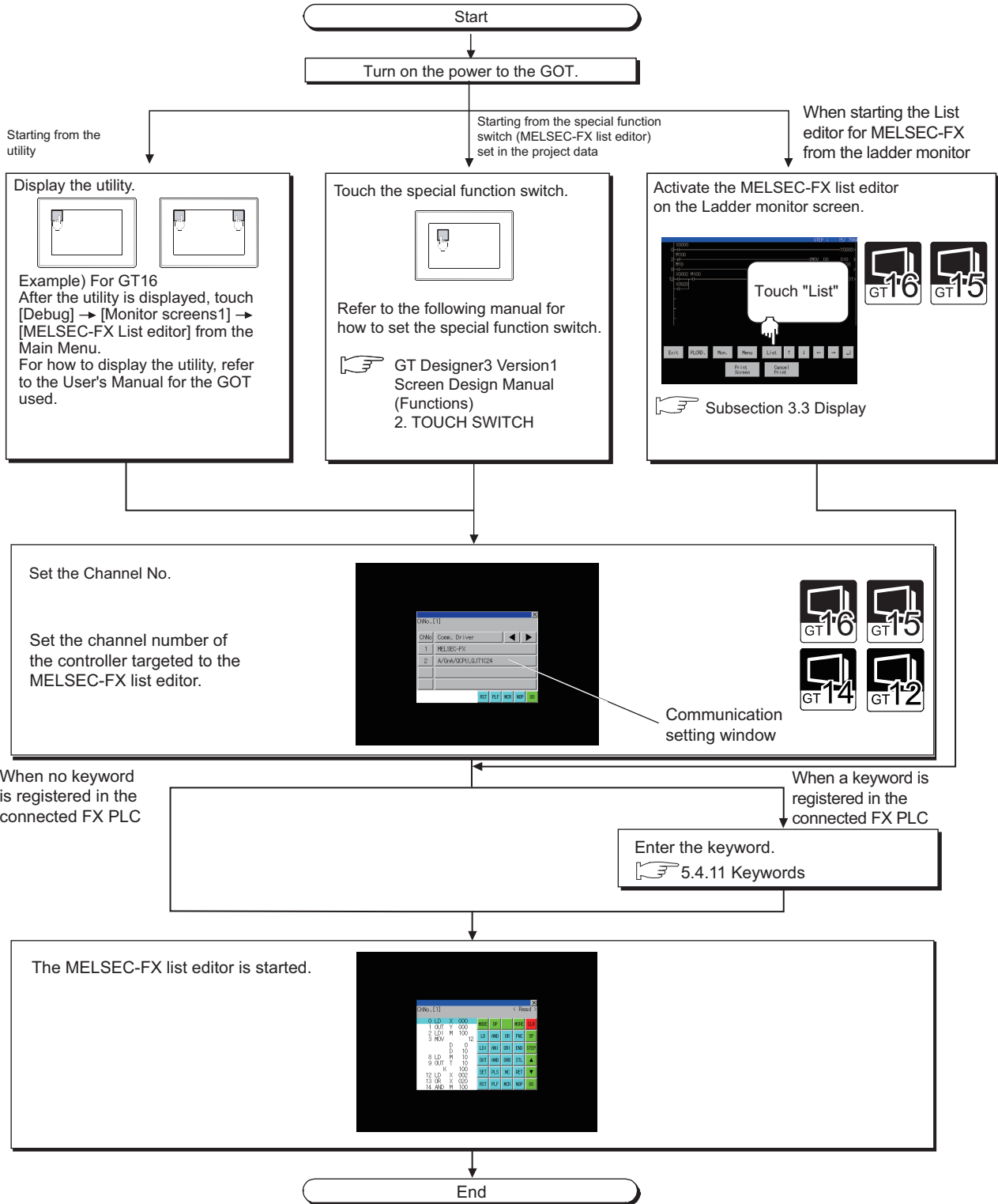

POINT

(1) How to display the utility

For how to display the utility, refer to the following.

 User's Manual for the GOT used

(2) Displaying communication setting window

After turning on the GOT, the communication setting window is displayed at the first startup of the MELSEC-FX list editor only.

For displaying the communication setting window at the second or later startup, touch [ChNo.] on the MELSEC-FX list editor screen. ( 5.4 Operation Method)

(3) If the project data has not been downloaded

The MELSEC-FX list editor can be started from the utility even if the project data has not been downloaded to the GOT.

Change screens

This section describes how to change the screen.

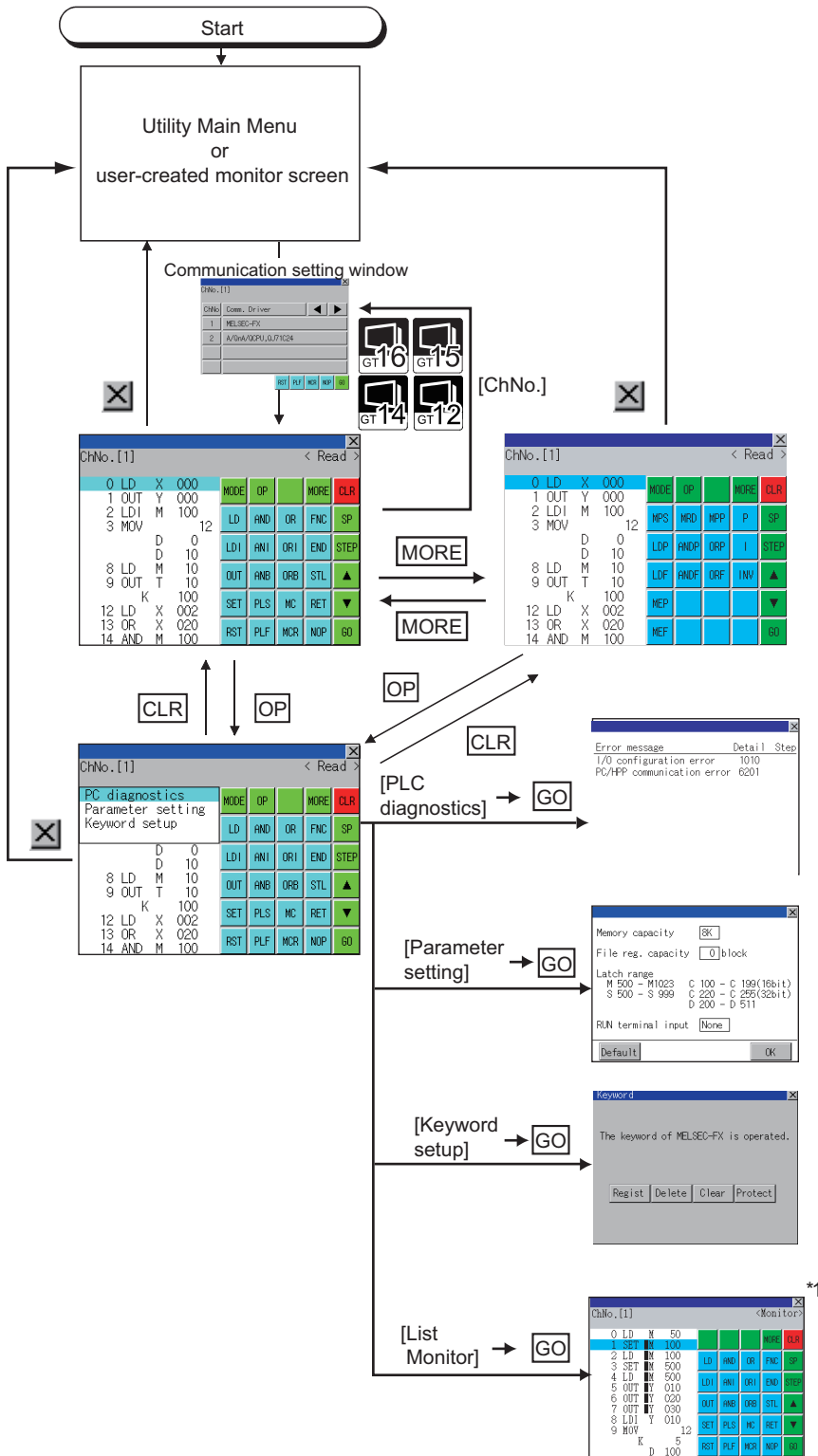

*1 With setting special function switches (FX list monitor), the list monitor can be started on the monitor screen. When the list monitor is started on the monitor screen, the list editor cannot be used. For how to set special function switches, refer to the following.

GT Designer3 Version1 Screen Design Manual (Functions)

5.4 Operation Procedures

This section describes the contents of the MELSEC-FX list editor and the key functions displayed on the screen. The display screen of the MELSEC-FX list editor varies slightly with the GOT used. This chapter mainly uses the screen of the GT1575-V for explanation.

5.4.1 Key arrangement and a list of key functions

The arrangement and functions of the keys displayed on the MELSEC-FX List Editor window are described below.



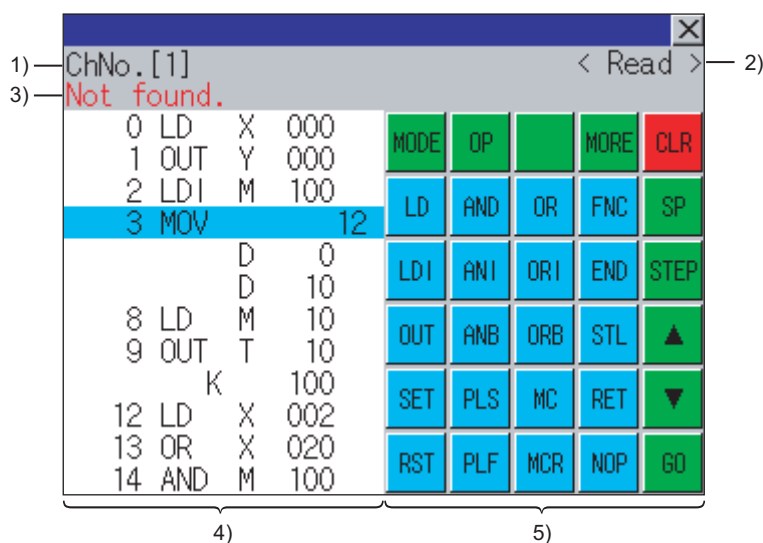











■ Displayed contents



No.	Item	Description
1)	Channel No. (Compatible with GT16/ GT15/GT14/GT12 only)	Displays the currently selected channel number. Touching "ChNo." displays the communication setting window. The communication setting window is not displayed if the MELSEC-FX list editor is started from the ladder monitor.
2)	Mode	Displays a mode for MELSEC-FX list editor. (☞ 5.4.2 Selection and operation of modes) [Monitor] is displayed when the list monitor is executed. (☞ 5.4.12 List monitor)
3)	Error message	Displays the contents of errors that occur with the MELSEC-FX list editor. (5.5 Error Messages and Corrective Action)
4)	List display area	Displays the sequence program in list format (12 digits). The position (line) that can be edited is displayed with a bar.
5)	Key area	Displays the keys that can be used with the MELSEC-FX list editor.

Key functions

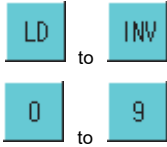
The table below shows the functions of the keys that are used for the operation on the MELSEC-FX list editor screen.

Key	Function
 (Compatible with GT16/GT15/GT14/GT12 only)	Displays the communication setting window. The communication setting window is not displayed if the MELSEC-FX list editor is started from the ladder monitor.
	Selects a mode for MELSEC-FX list editor. ( 5.4.2 Selection and operation of modes)
	Displays the PLC diagnostics, parameter setting, and keyword selection menu.
	Switches between command keyboard 1 and command keyboard 2. ( ■Keyboard switching)
	When inputting commands: Cancels the key input when only part of the command has been input. ( 5.4.14 Action for an incorrect key input) When option menu is displayed: Closes the option menu. Commands cannot be deleted with this key. ( 5.4.7 Deleting commands)
	Space key. This key is used when setting timers and counters, writing applied commands, etc.
	Displays the list from a specified step No. when the step No. is input.
	Moves the list display area bar up and down and switches the line being edited.
	Determines the key operation.
	Inputs commands, device names, etc. The key contents depend on the input contents. The commands that can be used differ depending on the target FX PLC. Refer to the manual for the FX PLC to be used.
	Exits the MELSEC-FX list editor.

Keyboard switching

Touching the **MORE** button switches the command keyboard 1 and command keyboard 2.

When you touch the button for a keyboard function, the optimum keyboard for input for that function is displayed automatically.

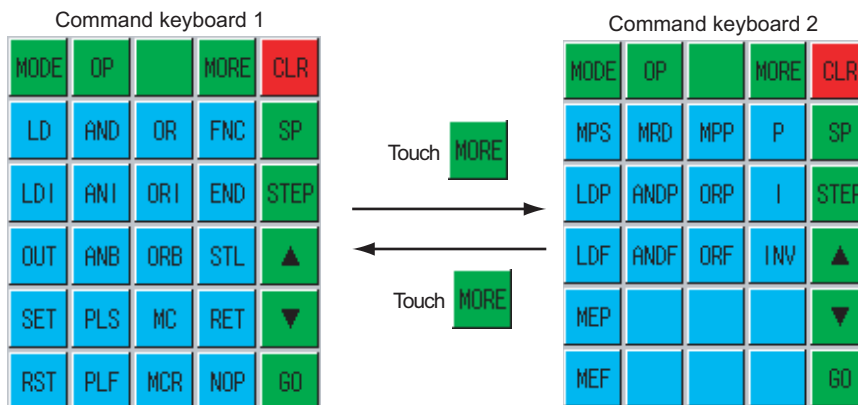

5.4.2 Selection and operation of modes

The MELSEC-FX list editor has four modes: READ, WRITE, INSERT, and DELETE.

Select an appropriate mode for the intended operation.

For more information on the mode to select, refer to the function operations from subsection 5.4.3 onward.

■ How to change modes

Touch the **MODE** button.

Each time you touch this button, the mode changes.

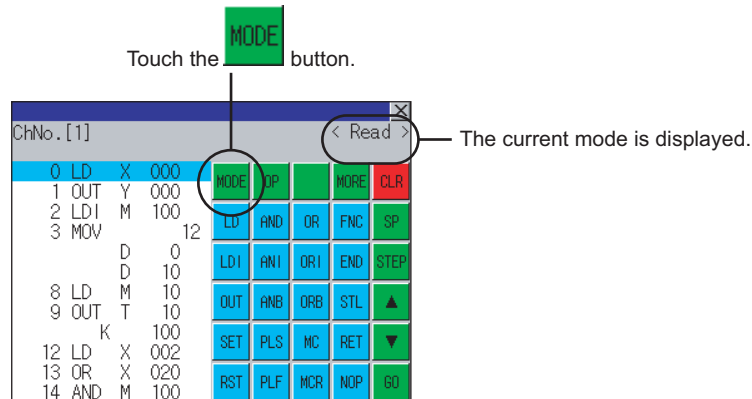

■ In the case the mode cannot be changed

In the following cases, only READ mode is allowed.

If you try to change to other than READ mode, an error message is displayed.

To change to other than READ mode, take the action below.

Error Message	Description	Corrective action
PLC is running	The FX PLC is in the RUN status.	Stop the FX PLC.
Can not write.	The protect switch of the EEPROM memory cassette is on.	Switch off the protect switch of the EEPROM memory cassette.
	The EPROM memory cassette is enabled.	Set a memory other than EPROM as the memory to write to.

5.4.3 Sequence program display

Sequence programs are read from the FX PLC to the GOT and displayed. There are two displaying methods: specifying the step number, and scrolling one screen at a time.

■ Display using cursor keys

(1) Operation

Scroll with  or .

(2) Example

Scroll one line upward or downward.

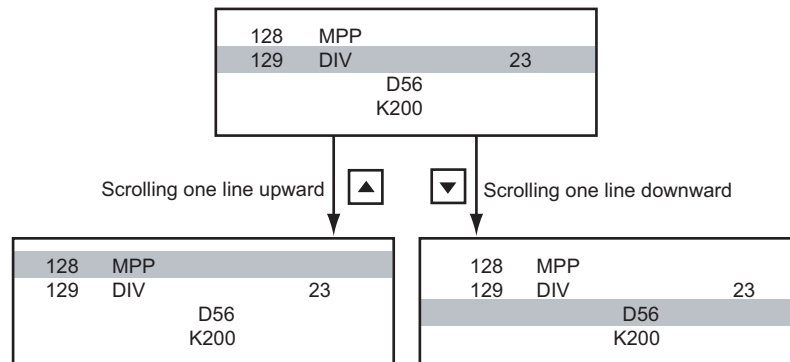

■ Display specifying the step number

(1) Operation

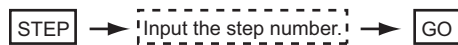

(2) Example

Displaying step number 123.

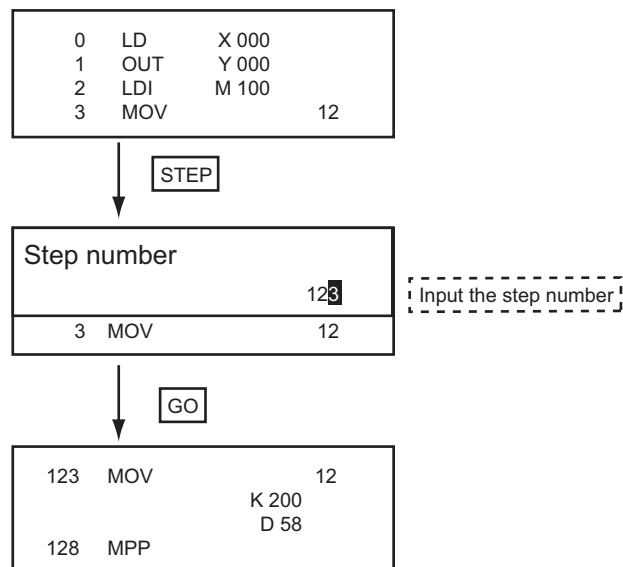

When the specified step number is the operand of an applied instruction

If the specified step number is a timer (T) or counter (C) set value or the operand of an applied instruction, that command section is displayed at the head.

■ Display scrolling one screen at a time

(1) Operation

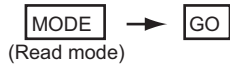

(2) Example

Displaying with scrolling one screen at a time.

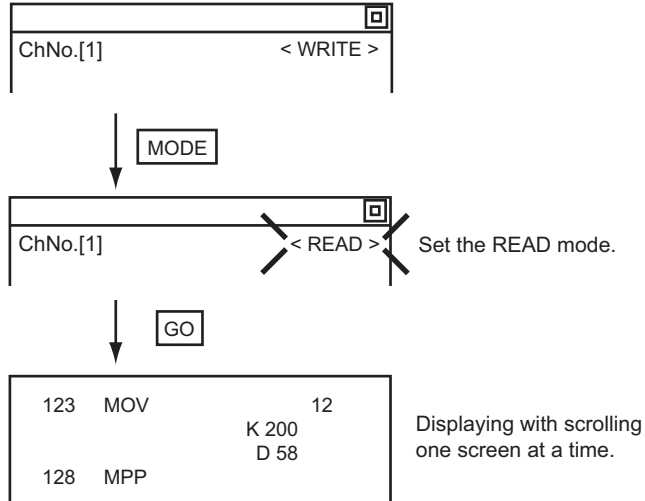

5.4.4 Searching commands and devices

Displays a command or device by searching it in sequence program from Step 0.

Command search

(1) Operation



- *1 If the command you want to search for is not on the keyboard, touch the **MODE** key to switch to the other keyboard. When searching for an applied instruction, touch the **FNC** key and input the applied instruction number. When searching for a label, touch **P** or **I** and input the pointer number.
(☞ 5.4.5 ■ Writing applied instructions)
- *2 Input only when searching for commands requiring a device name and device number.
- *3 After the search results are displayed, you can continue searching with the same conditions by touching the **GO** key. Touching any key other than the **GO** key ends the search.

(2) Example

Searching for LD M8000

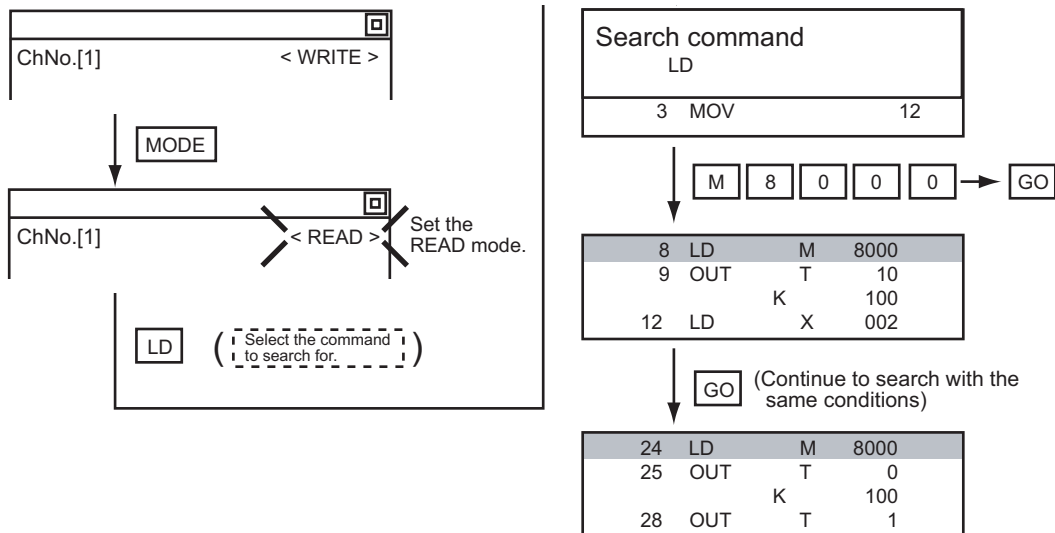

POINT

Pointer (P, I) searches

For pointer searches, only labels are searched.

Pointers specified as operands in applied instructions are not searched.

■ Device search

(1) Operation

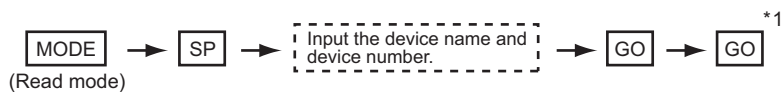

*1 After the search results are displayed, you can continue searching with the same conditions by touching the **GO** key. Touching any key other than the **GO** key ends the search.

(2) Example

Searching for LD M8000

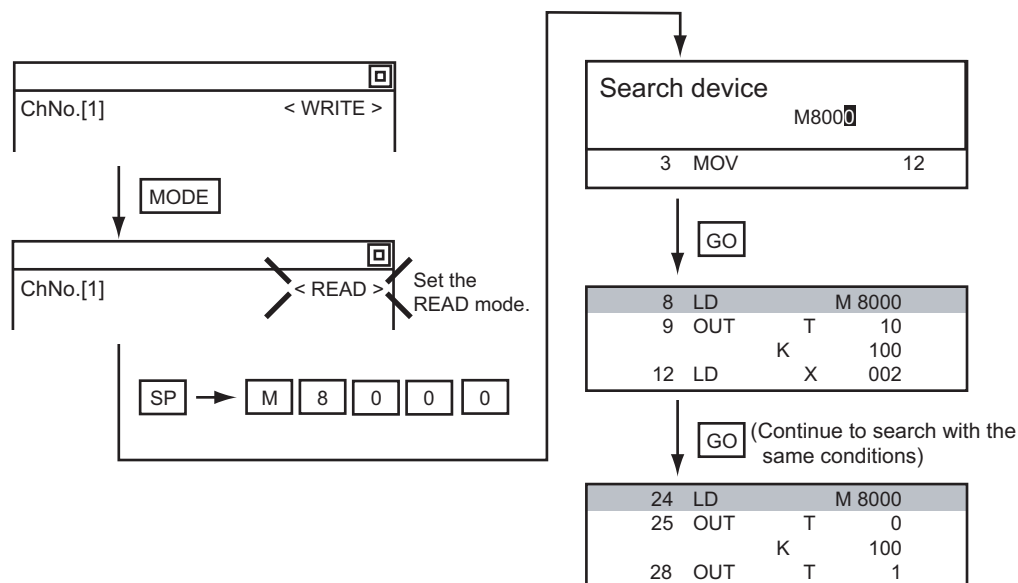

POINT

Devices that cannot be searched

The following devices cannot be searched.

- Pointers, interrupt pointers
- Constant K, constant H, constant E
- Bit devices with specifying numbers only
- Special function unit/block buffer memory
- Devices specified with the operand of an applied instruction

Pointers and interrupt pointers can be searched for with command searches.

(☞ ■Command search)

5.4.5 Writing commands

Writes a sequence program to the FX PLC. (Overwrite/Insert)

■ Writing basic commands

(1) Operations

(a) Inputting command only (Ex.: ANB, ORB command etc.)



For overwriting: (WRITE mode)
For insertion: (INSERT mode)

(b) Inputting command and device (LD, AND commands etc.)



For overwriting: (WRITE mode)
For insertion: (INSERT mode)

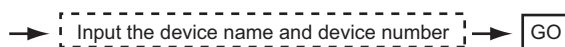

(c) Inputting command, No. 1 device, No. 2 device (MC, OUT (T, C) commands, etc.)

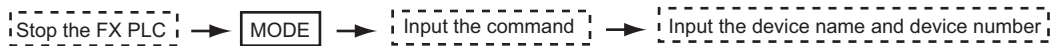

For overwriting: (WRITE mode)
For insertion: (INSERT mode)

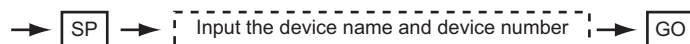

POINT

Moving the cursor to the position to write the command

When starting to write a command, place the cursor on the command line (the line on which the step number is displayed).

You cannot write a command with the cursor on an operand or set value line.

2	LDI	M	100	} Command line (Place the cursor on this line.)
3	MOV		12	
		D	0	} Operand, set value line (Cannot operate on this line.)
		D	10	

(2) Example

(a) Writing ORB command

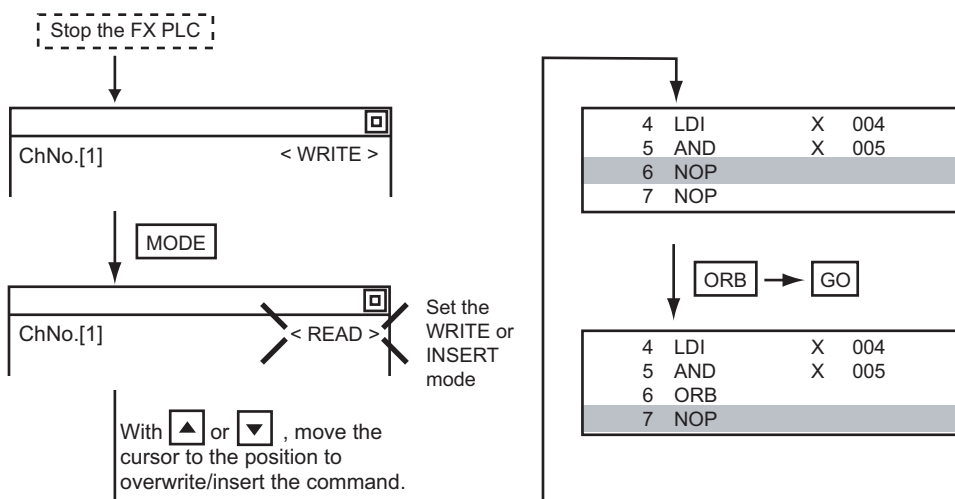

(b) Inputting LD X000

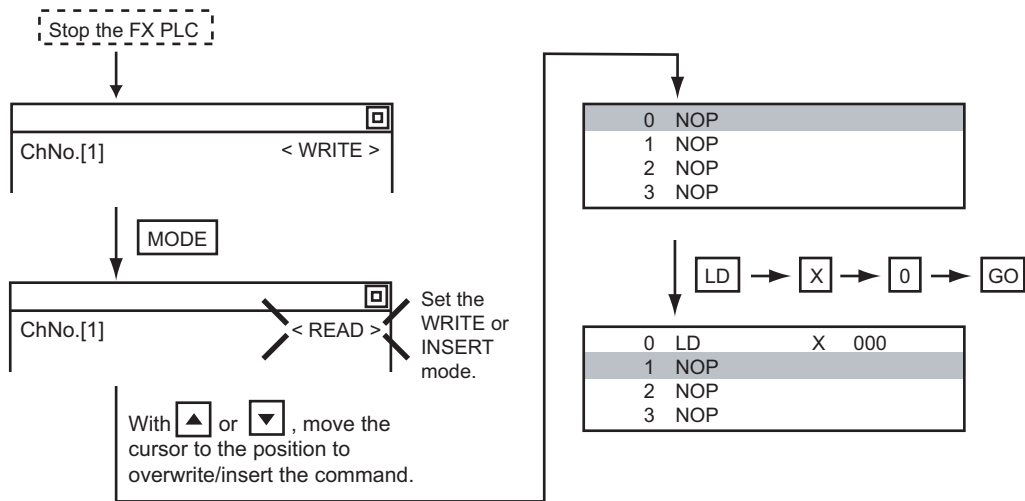

(c) Inputting OUT T100 K19

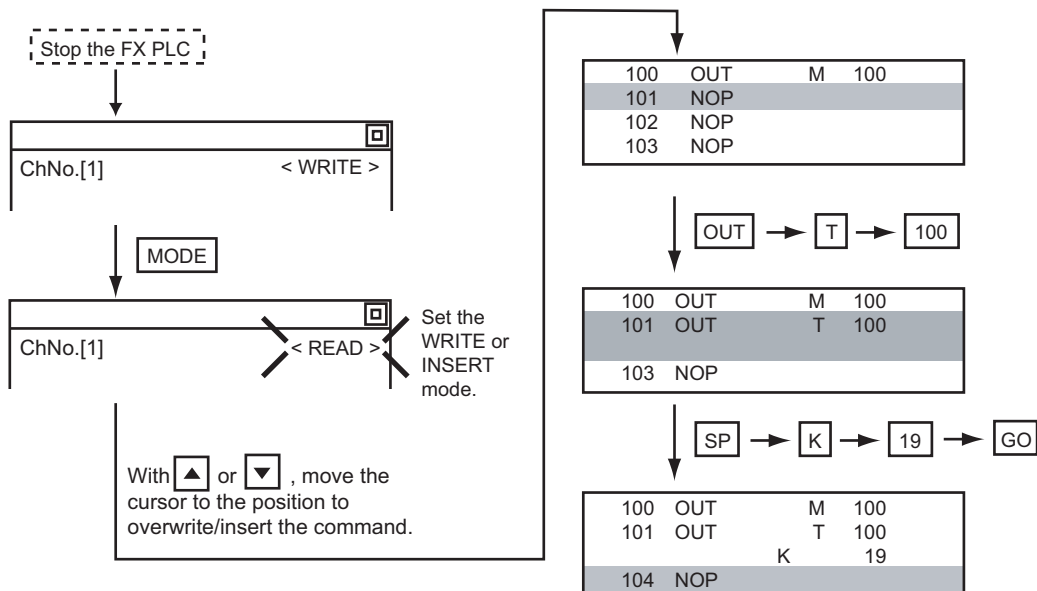

■ Writing applied instructions

(1) Operations

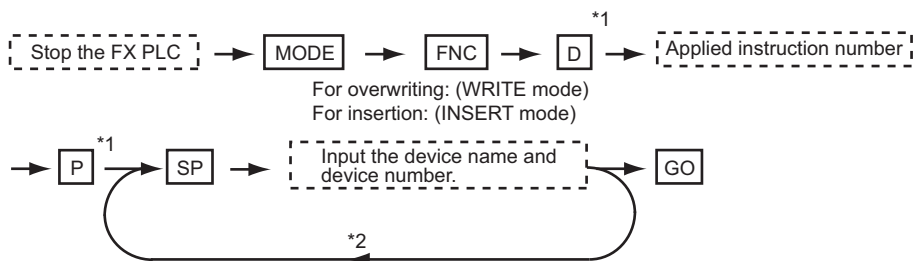

*1 [D] (double word command) and [P] (pulse execution format command) can also be input after the applied instruction number is input.

Inputting in the order [P] → [D] is also possible.

*2 When a command specifies multiple devices for operations, input the [SP] key followed by the device name and device number.

POINT

(1) Moving the cursor to the position to write the command

When starting to write a command, place the cursor on the command line (the line on which the step number is displayed).

You cannot write a command with the cursor on any other line.

2	LDI	M	100	} Command line (Place the cursor on this line.)
3	MOV		12	
		D	0	} Operand, set value line (Cannot operate on this line.)
		D	10	

(2) Commands using a text string constant for a command operand (such as ASC command)

With the MELSEC-FX list editor, text string constants cannot be written as operands. (such as ASC commands)

Use GX Developer for writing such commands.

(2) Example

Input "DMOVP D0 D2".

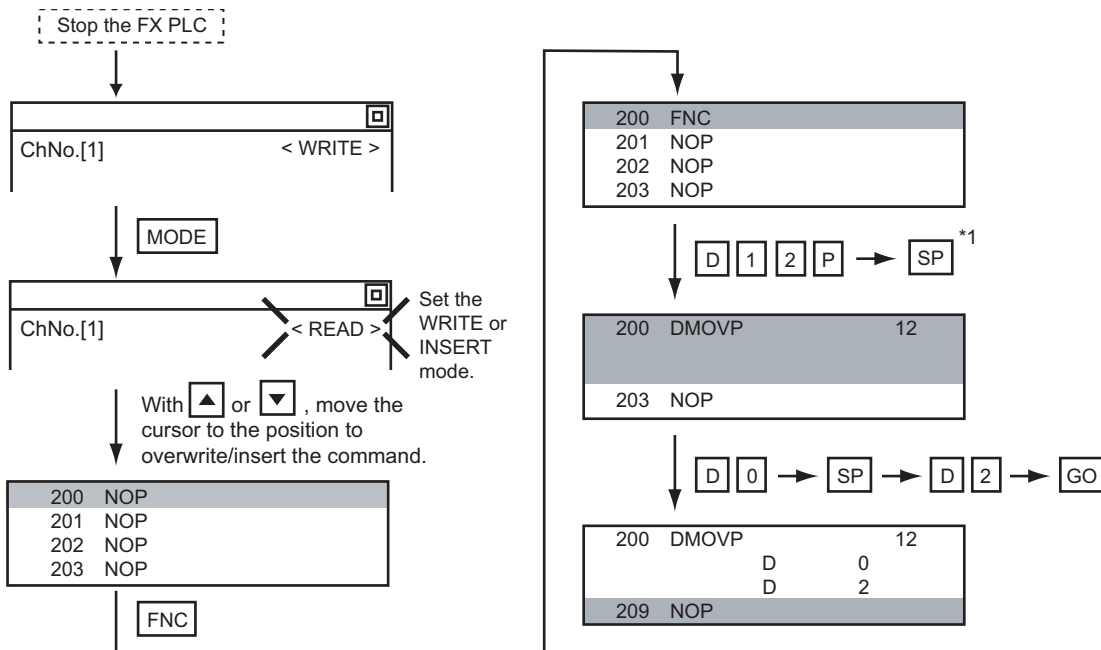

*1 The MOV command is FNC12.

5.4.6 Changing operands, set values

Changes the operand section of an applied instruction and OUT (T, C) command set value.

■ Operation

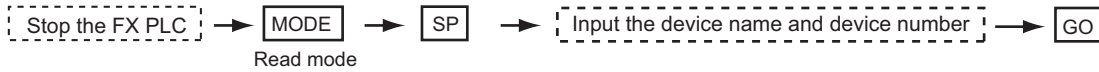

- *1 For decimal numbers, input K, then the number.
- For hexadecimal numbers, input H, then the number.

POINT

Moving the cursor to the line on which the operand or set value is to be changed

When starting to change an operand or a set value, place the cursor on the line of the operand or set value to be changed (the line on which the step number is not displayed).

If you place the cursor on the command line, the input operation is not possible.

2	LDI	M	100	} Command line (Cannot operate on this line.)
3	MOV		12	
		D	0	} Operand, set value line (Place the cursor on this line.)
		D	10	

■ Example

Changing "MOV D0 D10" to "MOV D0 D123"

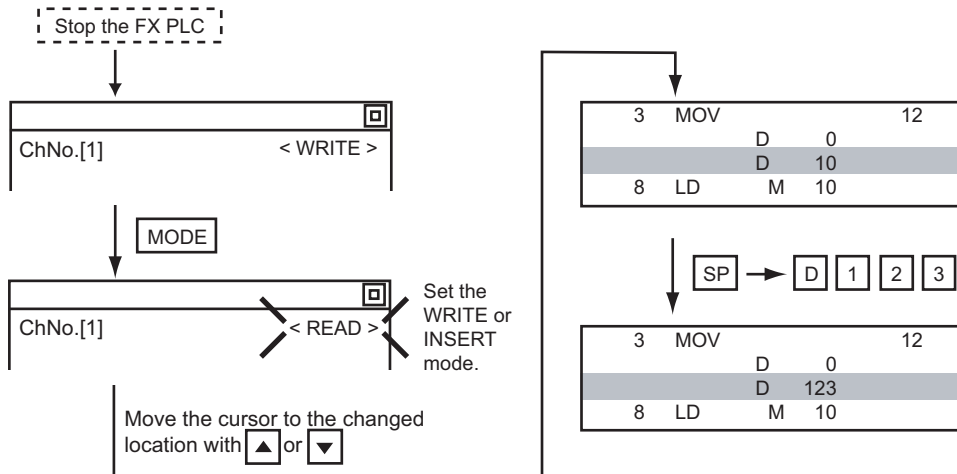

5.4.7 Deleting commands

Deletes one command at a time from a sequence program.

■ Operation

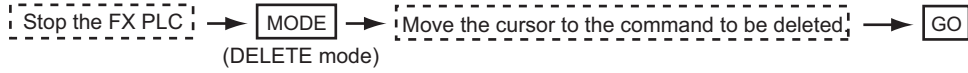

POINT

When moving the cursor to the position where the command is to be deleted.

Place the cursor on the command line (the line on which the step number is displayed).

You cannot delete the command if the cursor is placed on the line of an operand or set value.

2	LDI	M	100	} Command line (Place the cursor on this line.)
3	MOV		12	
		D	0	} Operand, set value line (Cannot operate on this line.)
		D	10	

■ Example

Deleting "OUT T10 K100"

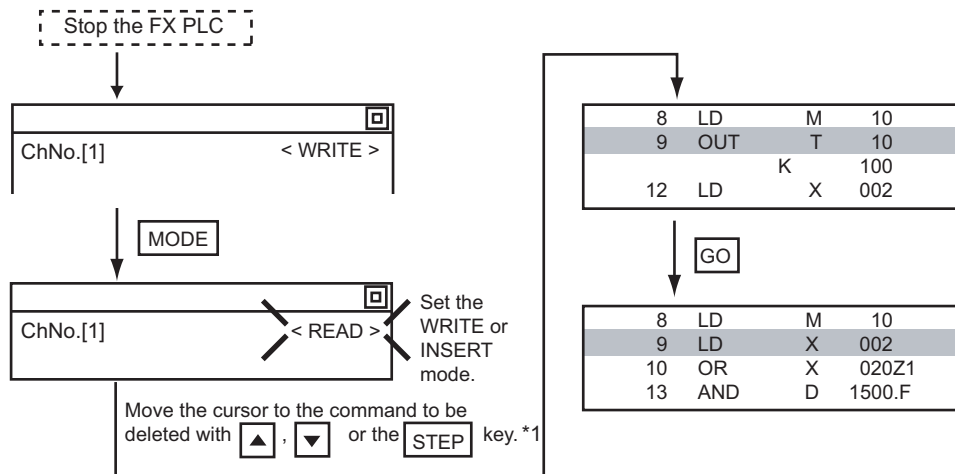

5.4.8 Sequence program all clear

Clears all the sequence programs.

■ Operation



■ Example

Clears all the sequence programs.

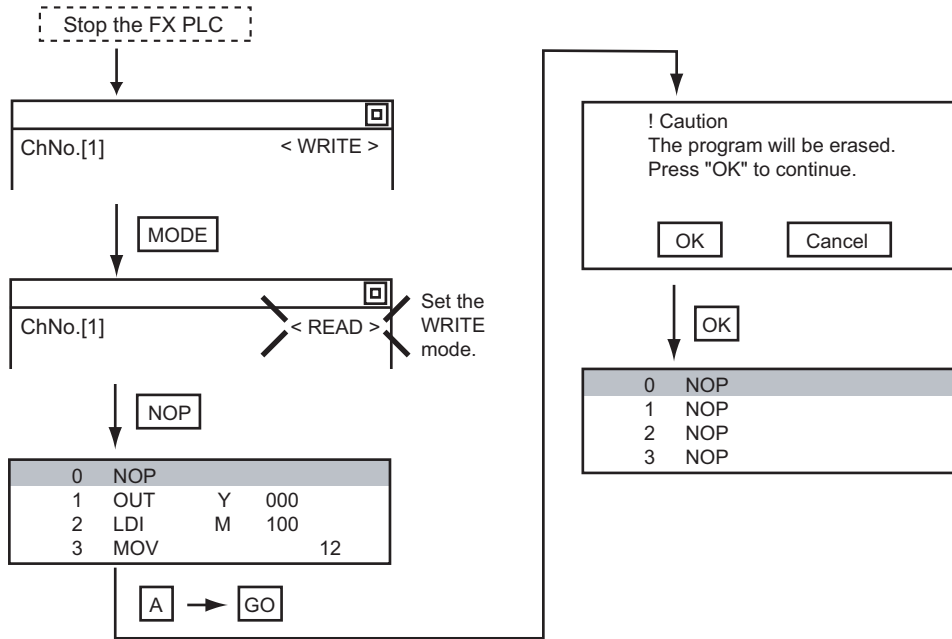

POINT

Items cleared when All Clear for a sequence program is performed

When All Clear is executed, the parameters before program execution are initialized and Latch Clear is executed. The memory space becomes the default value, the comment area a 0 block, the file register space a 0 block, and keywords unregistered.

After All Clear, set the above parameters etc. again.

5.4.9 PLC diagnostics

Displays the FX PLC error message, error code, and step at which the error occurred.

■ Operation

OP → [PLC diagnostics] → **GO**

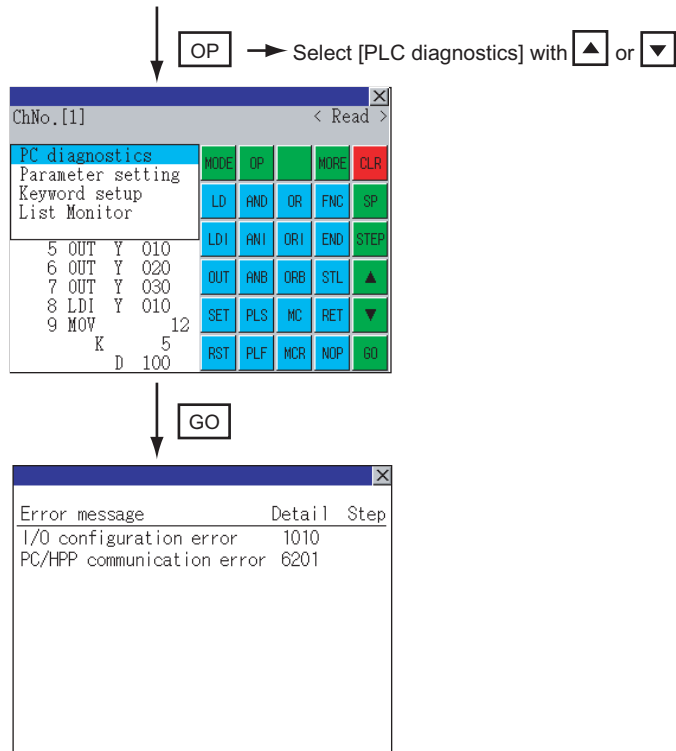

■ PLC diagnostics screen

The following describes the contents displayed on the PLC diagnostics screen and the function of on-screen key.

(1) Displayed contents

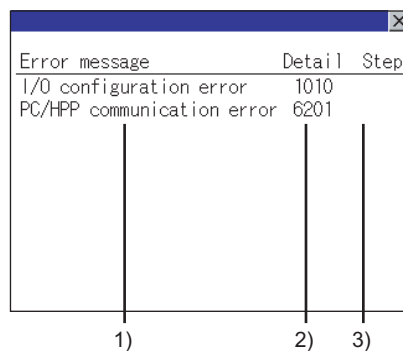

No.	Item	Display contents
1)	Error message	Displays the error message. (I/O configuration error/PLC hardware error/PC/HPP communication error/Serial communication error/Parameter error/Syntax error/Circuit error/Operation error)
2)	Detail	Displays the error code.
3)	Step	Displays the step number in the sequence program at which the error occurred. (This is displayed only for a syntax error, circuit error, or operation error.)

HINT

Error details

For details on an FX PLC error, refer to the following.

 Programming manual for the FX CPU used

(2) Key functions

The table below shows the functions of the keys that are used for the operation on the PLC diagnostics screen.

Key	Function
	Exits the PLC diagnostics.

5.4.10 Parameter setting

Sets FX PLC parameters.

Parameters that can be changed and change targets

(1) Parameters that can be changed

The parameters that can be changed with the MELSEC-FX list editor and the target FX PLCs are as follows.

(○ : Can be set/changed ✕ : Cannot be set/changed)

Item	Target CPU								
	FX0(S) /FX0N	FX1	FX2(C)	FX1S	FX1N(C)	FX2N(C)	FX3S	FX3G(C)	FX3U(C)
Memory space setting	✕	○	○	✕	✕	○	○	○	○
File register space setting	○ ^{*1}	✕	○	○	○	○	○	○	○
Latch range setting	✕ ^{*2}	○	○	✕ ^{*2}	✕ ^{*2}	○	✕	✕	○
RUN terminal setting	✕	✕	✕	○	○	○	○	○	○
Initialization of parameters	○	○	○	○	○	○	○	○	○

*1 When connecting an FX0(S), set "0".

Setting other than "0" causes a parameter error.

*2 When the parameters are initialized, the display on the MELSEC-FX list editor is different from the FX PLC default values, but do not change the latch range. Changing the latch range causes an error.

(2) Change targets

When a memory cassette is mounted, the parameters in the memory cassette are targeted for changes.

Operation

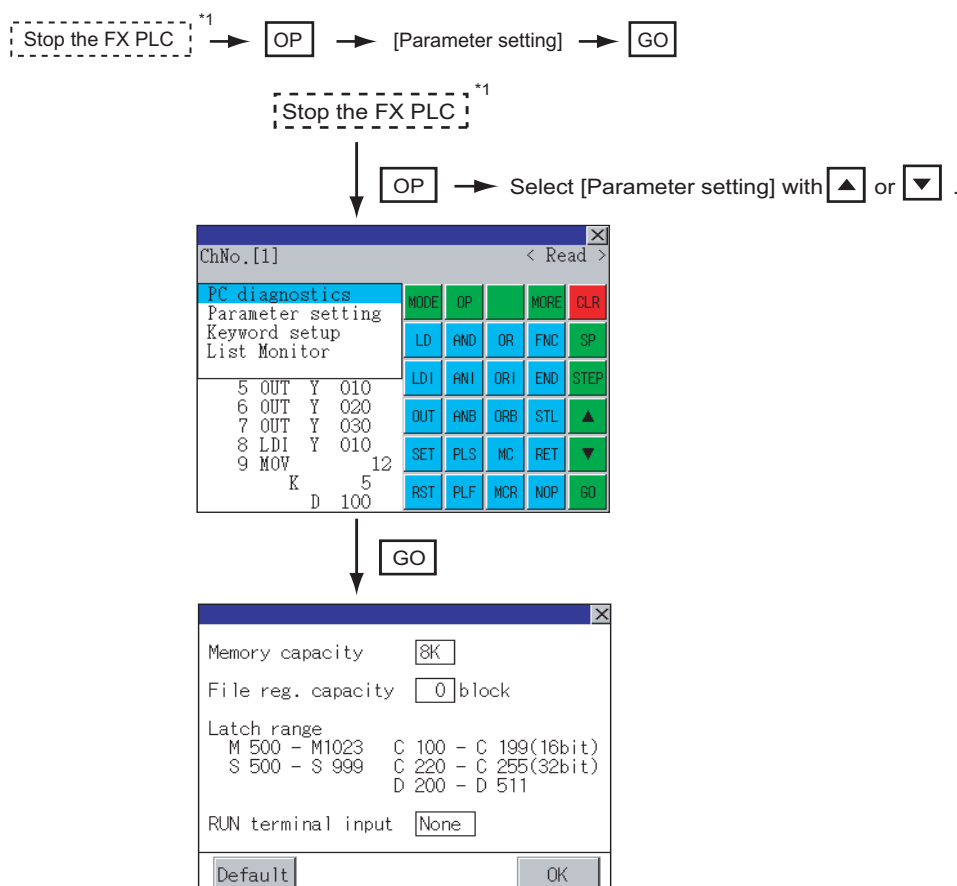

*1 When checking parameters (not changing), it is not necessary to stop the PLC.

Parameter setting screen

The following describes the contents displayed on the PLC diagnostics screen and the function of on-screen keys.

(1) Displayed contents

1) Memory capacity

2) File reg. capacity block

3) Latch range
M 500 - M1023 C 100 - C 199(16bit)
S 500 - S 999 C 220 - C 255(32bit)
D 200 - D 511

4) RUN terminal input

5)

No.	Item	Display contents
1)	Memory capacity	Sets the memory space (number of steps). If you touch the <input type="text" value="*K"/> section, you can change the memory space.
2)	File reg. capacity	Sets the memory space (number of blocks) allocated to the file register. Touch the <input type="text"/> section and input the number of blocks.
3)	Latch range	Sets the latch range (power failure hold area). Touch the number display section and input the value.
4)	RUN terminal input	Sets whether or not to use one of the FX PLC input terminals for RUN input. Touch the <input type="text"/> section and set the device to be set for the RUN terminal.
5)	Default	Initializes the parameters

POINT

Memory space for kana comments after changing memory space, file register space

If the memory space is set smaller than the total of the file register space and kana comment space, the kana comment space is automatically reduced.

(With the MELSEC-FX list editor, the kana comment space is not displayed.)

Note that if any setting as described below is made, the kana comment space is reduced.

(Settings that reduce kana comment space and the kana comment space after setting change)

Settings resulting in $N_m < N_f \times 500 + N_k \times 500 + 500$

$$\text{Kana comment space (steps) after setting change} = \frac{N_m - N_f \times 500 - 500}{500}$$

N_m : Memory space after change (steps)

N_f : File register space after change (blocks)

N_k : Comment space before change (blocks)

HINT

Settable range and default value



The settable range and the default value depend on the FX PLC type.

For details of the settable range and the default value, refer to the following.

Programming manual for the FX PLC used

(2) Key functions

The table below shows the functions of the keys that are used for the operation on the parameter setting screen.

Key	Function
	Initializes the parameters
	Completes the changed setting contents.
	Ends parameter setting.

5.4.11 Keywords

Registers, deletes, releases protection for, and sets protection for the FX PLC keywords.

■ Function usability of the MELSEC-FX list editor for keyword protection levels

The functions that can be used with the MELSEC-FX list editor depend on the keyword protection level.

(○ : Available, × : Unavailable)

Function		Keyword protection level				Reference
		All operation protect (All on-line operation protect) *2	Read/Incorrect write protection (Read/ write protect) *2	Incorrect write protect (Write protect) *2	Keyword not registered/keyword protection canceled	
Reading sequence programs	Displaying sequence programs	×	×	○	○	5.4.3
	Searching commands/ devices	×	×	○	○	5.4.4
Writing sequence programs	Writing commands	×	×	×	○	5.4.5
	Changing operands/set values	×	×	×	○	5.4.6
Inserting commands		×	×	×	○	5.4.5
Deleting commands		×	×	×	○	5.4.7
Sequence program all clear		×	×	×	○	5.4.8
PLC diagnostics		○*1	○	○	○	5.4.9
Parameter setting		×	×	×	○	5.4.10

*1 When the 2nd keyword is set to an FX PLC that supports 2nd keyword, it becomes "×" (cannot be used).

*2 The names within the parentheses () are for when a keyword + 2nd keyword is set.

■ Operation

→ [Keyword setup] →

↓
 → Select [Keyword setup] with or .

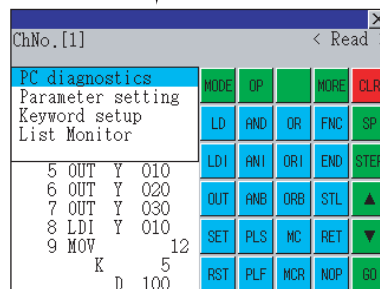

↓

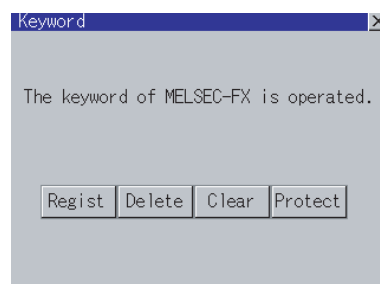

■ Keyword screen and protection level

When [Keyword setup] is selected with the MELSEC-FX list editor, the keyword screen is displayed.
For the keyword operation, refer to the following.

 User's Manual for the GOT used



Keywords

For details of the keyword, refer to the following.

 Programming manual for the FX PLC used

5.4.12 List monitor

The status of contacts and coils in a sequence program is displayed.

■ Operation

[OP] → [List Monitor] → [GO]

↓ [OP] → Select [List Monitor] with  

ChNo. [1] < Read >

PC diagnostics	MODE	OP	MORE	CLR
Parameter setting	LD	AND	OR	FNC
Keyword setup	LDI	ANI	ORI	END
List Monitor	OUT	ANB	ORB	STL
5 OUT Y 010	SET	PLS	MC	RET
6 OUT Y 020	RST	PLF	MCR	NOP
7 OUT Y 030				
8 LDI Y 010				
9 MOV K 5				
D 100				

↓ [GO]

ChNo. [1] < Monitor >

0 LD M 50				
1 SET M 100				
2 LD M 100	LD	AND	OR	FNC
3 SET M 500	LDI	ANI	ORI	END
4 LD M 500	OUT	ANB	ORB	STL
5 OUT Y 010	SET	PLS	MC	RET
6 OUT Y 020	RST	PLF	MCR	NOP
7 OUT Y 030				
8 LDI Y 010				
9 MOV K 5				
D 100				

When the list monitor is started on the FX list editor screen, the step numbers displayed on the FX list editor screen is displayed on the list monitor screen.

POINT

Starting list monitor with special function switches (FX list monitor)

With setting special function switches (FX list monitor), the list monitor can be started on the monitor screen.

When the list monitor is started on the monitor screen, the list editor cannot be used.



For how to set special function switches, refer to the following.

 GT Designer3 Version1 Screen Design Manual (Functions)

■ Displays and key functions

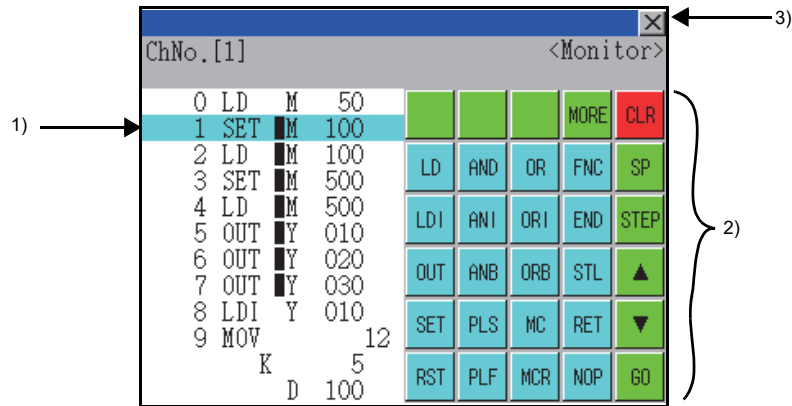
The following describes the displays for the list monitor.



No	Item	Display contents
1)	List display area* ¹	The status of contacts and coils is displayed on the left of device displays.
2)	Keys	The same operations as in the READ mode of the FX list editor can be executed.  5.4.3 Sequence program display
3)		Ends the list monitor. When the list monitor is executed on the FX list editor screen, the screen is switched to the FX list editor screen.

*1 The status of contacts and coils is displayed as below.

Type of instructio	Description	Status	
		■ Displayed	■ Not displayed
LD, AND, ORC(ontact instruction (Normal open))	Contact	ON	OFF
LDI, ANI, ORI(Contact instruction (Normal close))	Contact	OFF	ON
OUT, SET	TC: Coil	ON	OFF
	Except TC: Contact	ON	OFF
RST	TC: Reset	ON	OFF
	Word device	Value: 0	Value: Except 0
	Except TC and word device: Contac	OFF	ON
MC, STL	Contact	ON	OFF
LDP, ANDP, ORP, LDF, ANDF, ORF (Rise or fall contact instruction)	Not monitored	Always ■ not displayed	

5.4.13 Hard copy output

Screens of the MELSEC-FX list editor can be stored to a memory card in BMP/JPEG file format or printed with a printer. Refer to the following for the hard copy. (Saving to a memory card is available with GT16/GT15/GT14/GT12. Printing with a printer is only available with GT16/GT15.)

- Starting the MELSEC-FX list editor from the ladder monitor
 - ☞ 3.4.2 Hard copy output
- Setting the hard copy with GT Designer3
 - ☞ GT Designer3 Version1 Screen Design Manual (Functions) 40. HARD COPY FUNCTION

5.4.14 Action for an incorrect key input

If an incorrect key is input, cancel the input contents.

■ Operation

(1) Before touching the key (before reading/writing the input contents)

Before touching the key, touch the key.



(2) After touching the key (after reading/writing the input contents)

Write the command again. (☞ 5.4.5 Writing commands)

Commands finalized by writing and inserting operations are revised (overwritten) with the program writing.

5.5 Error Messages and Corrective Actions

This section describes the error messages displayed when the MELSEC-FX list editor is executed, and corrective action.

Error Message	Description	Corrective action
Can not display while protected.	The all-operation protect, anti-plagiarism, or incorrect write protect keyword is set.	<ul style="list-style-type: none"> • Check the protected operation. • Clear the keyword protection or delete the keyword.  5.4.11 Keywords
Can not operate while protected.		
PLC parameter error.	An FX PLC parameter is defective.	Set correct parameters in the FX PLC.
PLC communications error.	The communication with the FX PLC is defective.	<ul style="list-style-type: none"> • Check the FX PLC, cable, and GOT for abnormality. • Check whether the communication settings are correct or not.
PLC is running.	A writing operation etc. has been made while the FX PLC is running.	Stop the FX PLC.
Can not write.	<ul style="list-style-type: none"> • The memory to write to is EPROM. • The protect switch of the EEPROM is on. 	<ul style="list-style-type: none"> • Set other than EPROM for the memory to write to. • Switch off the protect switch of the EEPROM.
Step number is out of a range.	The specified step number exceeded the maximum number.	Specify a step number below the maximum value.
Not found.	The specified command cannot be found.	Proceed to the next operation.
Not found.	The specified device cannot be found.	Proceed to the next operation.
Step overflow.	The program may exceed the available space. (Writing is not executed.)	Check the program memory space and delete commands to keep it within the space.  5.4.7 Deleting commands
Command error.	An invalid command (non-existent command) was specified.	Input the correct command.
Protected by a block password.	The sequence program is protected by a block password at the PLC reading.	Release the block password for the sequence program.

POINT

How to erase an error message

An error message is not erased even if the cause of the error is eliminated.

To erase an error message, touch a key on the MELSEC-FX list editor screen.

6. INTELLIGENT MODULE MONITOR



6.1 Features

With the intelligent module monitor, you can use dedicated screens to monitor the buffer memory of the intelligent function module and make changes to the data. In addition, you can monitor the signal statuses of the I/O modules. The features of the intelligent module monitor are described below.

■ Realized monitoring with dedicated screens

You can monitor the intelligent function module(s) and I/O module(s) and make changes to the data using dedicated screens.

There is no need to create screens for monitoring or data changes, thereby reducing the drawing workload.

(1) For intelligent function module

As a menu of monitor items is displayed, select an item from the menu, and the corresponding monitor screen is then displayed.

Details of the buffer memory and the I/O signal statuses between the buffer memory and the PLC CPU are displayed in text, numerical values, and graphs on the monitor screens.

Select a monitor from the menu

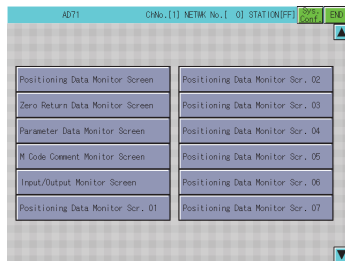

Select a menu

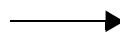

Monitor screen

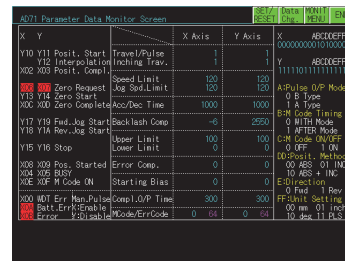

(2) For I/O module

The status of I/O signals to and from an external module is monitored.

Monitor screen

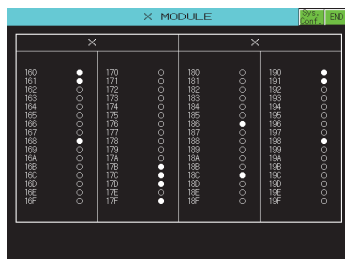

Enabled data change by write operations

The values are written into the buffer memory of the intelligent function module by writing values from the monitor screen.

(Writing example)

Monitor screen

X	Y	X Axis	Y Axis	X	ABCD0EFF
Y10	Y11	Posit. Start	Travel/Pulse	1	000000001010000
Y12	Y13	Interpolation	Inching Trav.	1	Y
Y14	Y15	Posit. Comp		1	ABCD0EFF
Y16	Y17	Zero Request	Speed Limit	120	111110111111111
Y18	Y19	Zero Start	Log Spd.Limit	120	
Y20	Y21	Zero Complete	Acc/Dec Time	1000	
Y22	Y23	Feed-Log Start	Backlash Comp	-6	2550
Y24	Y25	Rev-Log Start	Upper Limit	100	100
Y26	Y27	Stop	Lower Limit	0	0
Y28	Y29	Pop. Started	Error Comp.	0	0
Y30	Y31	BUSY	Startling Bias	0	0
Y32	Y33	PI Code ON		0	0
Y34	Y35	Err. Hous. Pulse	Comp.LOP Time	300	300
Y36	Y37	Batt. Err. Enable		00 mm	01 inch
Y38	Y39	Error	Y-01 sab	Code/ErrCode	0 04 0 04

Select writing

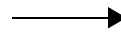

When changing a change-permitted channel

X	Y	X Axis	Y Axis	X	ABCD0EFF
Y10	Y11	Posit. Start	Travel/Pulse	1	000000001010000
Y12	Y13	Interpolation	Inching Trav.	1	Y
Y14	Y15	Posit. Comp		1	ABCD0EFF
Y16	Y17	Zero Request	Speed Limit	120	111110111111111
Y18	Y19	Zero Start	Log Spd.Limit	120	
Y20	Y21	Zero Complete	Acc/Dec Time	1000	
Y22	Y23	Feed-Log Start	Backlash Comp	-6	2550
Y24	Y25	Rev-Log Start	Upper Limit	100	100
Y26	Y27	Stop	Lower Limit	0	0
Y28	Y29	Pop. Started	Error Comp.	0	0
Y30	Y31	BUSY	Startling Bias	0	0
Y32	Y33	PI Code ON		0	0
Y34	Y35	Err. Hous. Pulse	Comp.LOP Time	300	300
Y36	Y37	Batt. Err. Enable		00 mm	01 inch
Y38	Y39	Error	Y-01 sab	Code/ErrCode	0 04 0 04

Enabled project data reusing for the intelligent module monitor

Intelligent module monitor data is saved in the following directory in a personal computer with GT Designer3 installed. (Saved as a G1 file)

Because the following data can be edited with GT Designer3, you can use part of the data for project data. (It is recommended that you copy the data to prevent accidental deletion of the data.)

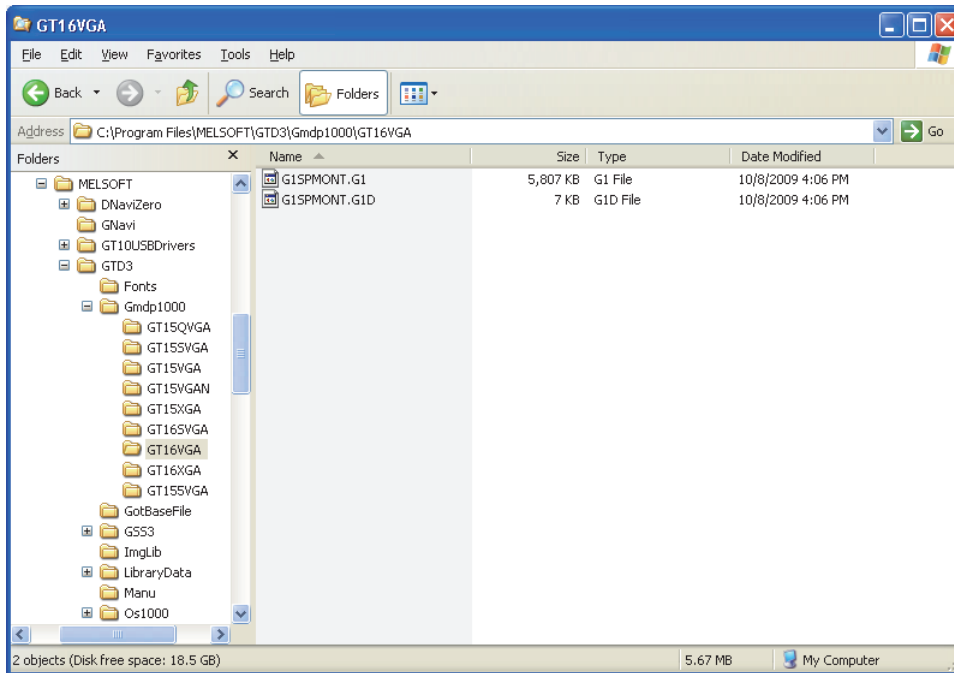

6.2 Specifications

6.2.1 System configuration

This section describes the system configuration of the intelligent module monitor.
For connection type settings and precautions regarding the communication unit/cable and connection type, refer to the following.

 GOT1000 Series Connection Manual (Mitsubishi Products) for GT Works3

■ Targeted equipments for the intelligent module monitor

(1) PLC CPU

PLC
QCPU (Q mode), motion controller (Q series)*1
QSCPU
LCPU
QnACPU*2
ACPU/QCPU (A mode)

*1 For the motion controller CPU (Q series), only the PLC CPU area (CPU No.1) in the Q170MCP and Q170MSCPU can be monitored.

*2 You cannot use Q4ARCPU.

(2) Intelligent function module

PLC CPU	Intelligent function module
QCPU (Q mode)	Q64AD, Q68ADV, Q68ADI, QD62, Q64DA, Q62DA, QD62D, QD62E, QD65PD2, QD73A1, QD75D □ (N), QD75P □ (N), QD75MH, QD75M, QD77MS, Input module, Output module
LCPU	L60AD4, L60DA4, LD62, LD62D, LD75D, LD75P, LD77MH, LD77MS, Input module (LX40C6, LX41C4, LX42C4), Output module (LY10R2, LY41NT1P, LY42NT1P)
QCPU (A mode), QnACPU, ACP	A62DA-S1, A68AD, A68ADN, A68RD, A84AD, A616AD, A616TD, A616DAV, A616DAI, A61LS, A62LS, AD61, AD70, AD70D, AD71, AD72, A1SD71, A1SD61, A1S64AD, A1S62DA, A1SD70, A1S62RD, A1SJ71PT32-S3, A1S63ADA, AJ71PT32-S3, AD75P*1, A1SD75P*2, AJ71ID1-R4, AJ71ID2-R4, A1SJ71ID1-R4, A1SJ71ID2-R4, A1S68DAV, A1S68DAI, A1S68AD, A1S64TCTT(BW)-S1, A1S64TCRT(BW)-S1, Input module, Output module

*1 AD75M1 (M2/M3) can be monitored in the range of AD75P1 (P2/P3).

*2 A1SD75M1 (M2/M3) can be monitored in the range of A1SD75P1 (P2/P3).

You can use the system monitor [BM MONITOR] to monitor intelligent function modules other than those listed above.

■ Connection type

This function can be used in the following connection types.

(○: Available, △: Partly restricted, ×: Unavailable)

Function		Connection type between GOT and PLC CPU							
Name	Description	Bus connection *6*7	Direct CPU connection *6*8	Computer link connection *6	Ethernet connection*9	MELSECNET/H connection*7, MELSECNET/10 connection*7	CC-Link IE controller connection*2*7, CC-Link IE field connection*3	CC-Link connection	
								ID*4*6	G4*5*6
Intelligent module monitor	Monitors buffer memory of intelligent function module and signal statuses of I/O modules	○	○	○	○	△*1	○	○	○

*1 For the MELSECNET/10 connection, use a QCPU and network module (QJ71LP21, QJ71LP21-25, QJ71LP21S-25, and QJ71BR11) with the function version B or later.

*2 Indicates the CC-Link IE controller network connection.

*3 Indicates CC-Link IE field network connection.

*4 Indicates CC-Link connection (Intelligent device station).

*5 Indicates CC-Link connection (via G4).

*6 The QSCPU does not support the connection type.

*7 The LCPUCPU does not support the connection type.

*8 When the GOT is connected to LCPUCPU, use L6ADP-R2.

*9 Intelligent module monitor cannot be used when using CC-Link IE field network Ethernet adapter.

■ Required option OS and option function board

The option OS and option function board shown below are required.

 1.1.2 Hardware and OS' required for each function

(1) Option OS

Install the option OS in the above table to the GOT.

For the installation procedure, refer to the following.

 GT Designer3 Version1 Screen Design Manual (Fundamentals) 8. COMMUNICATION WITH GOT

(2) OS memory space

The available memory space shown in the table above is required in the user area to install the option OS to the GOT.

For the procedure for checking the available memory space of the user area and information about the data using other user areas, refer to the following.

 GT Designer3 Version1 Screen Design Manual (Fundamentals) 8. COMMUNICATION WITH GOT

(3) Option function board

(a) For GT16

No option function board is required.

(b) For GT15

Mount one of the option function boards in the above table on the GOT.

For the GOTs with a built-in option function board, refer to the following.

 1.1.2 Hardware and OS' required for each function

For how to mount an option function board on the GOT, refer to the following.

 User's Manual for the GOT used

■ Required memory space for use of the intelligent module monitor

The memory space of the intelligent module monitor data is indicated below.

The memory space required for storing data into the internal memory of the GOT is the same as the memory space required for storing data into the hard disk of a personal computer.

(1) For QCPU (Q mode)

Stored screen data	Memory space (KB)
Intelligent module monitor data common information	40.4
400 to 402 (Q68ADV/Q68ADI/Q64AD)	19.7
403 to 405 (Q62DA/Q64DA)	14.1
406 to 407 (QD62D/QD62E/QD62)	17.7
408 to 430 (QD75P/QD75D)	572.8
431 to 467 (QD75M)	454
1001 to 1031 (QD75MH)	427.3
1033 to 1051 (QD65PD2)	239
1052 to 1055 (QD73A1)	76.1
1056 to 1105 (QD77MS4/QD77MS2)	695.5
1110 to 1260 (QD77MS16)	2058.2
1300 to 1390 (QD77GF16)	1435.5
Input module	0.0
Output module	0.0

(2) For LCPU

Stored screen data	Memory space (KB)
Intelligent module monitor data common information	40.4
1500 to 1504 (L60AD4)	69.9
1505 to 1509 (L60DA4)	66.0
1510 to 1511 (L62D/LD62)	17.4
1512 to 1534 (L75P/LD75D)	362.7
1535 to 1566 (LD77MH4)	460.7
1567 to 1681 (LD77MH16)	1736
1690 to 1739 (LD77MS4)	695.7
1750 to 1900 (LD77MS16)	2058.3
Input module	0.0
Output module	0.0

1

OVERVIEW

2

SYSTEM MONITOR

3

LADDER MONITOR
FUNCTION

4

MELSEC-A LIST
EDITOR

5

MELSEC-FX LIST
EDITOR

6

INTELLIGENT
MODULE MONITOR

7

NETWORK
MONITOR

8

Q MOTION
MONITOR

(3) For QCPU (A mode), QnACPU, and ACPU

Stored screen data	Memory space (KB)
Intelligent module monitor data common information	40.4
1 to 2 (A62DA-S1)	7.2
3 to 5 (A68AD)	11.0
6 to 8 (A68ADN)	17.4
9 to 11 (A68RD)	19.0
12 to 15 (A84AD)	21.8
16 to 34 (A616AD)	136.6
35 to 62 (A616TD)	254.1
63 to 65 (A616DAV)	18.1 ^{*3}
66 to 68 (A616DAI)	17.6 ^{*3}
69 to 70 (A61LS)	15.6
71 to 75 (A62LS)	79.0
76 (AD61)	8.4
77 to 79 (AD70)	22.2
80 to 83 (AD70D)	31.9
84 to 108 (AD71)	662.5
109 to 133 (AD72(A1SD71))	665.5
134 to 139 (AJ71PT32-S3)	47.2
146 to 150 (A1SD61)	40.8
151 to 153 (A1S64AD)	13.8
154 (A1S62DA)	5.6
155 to 157 (A1SD70)	22.9
158 to 160 (A1S62RD)	13.3
161 to 166 (A1SJ71PT32-S3)	46.9
167 to 169 (A1S63ADA)	18.1
170 to 206 (AD75P ^{*1})	621.7
207 to 210 (AJ71ID ^{*2})	43.8
211 to 213 (A1S68DAV)	13.3 ^{*3}
214 to 216 (A1S68DAI)	13.2 ^{*3}
217 to 219 (A1S68AD)	10.6
220 to 225 (A1S64TCTT/RT-S1)	52.7
Input module	0.0
Output module	0.0

*1 Use the screen for AD75P to monitor A1SD75P.

*2 Use the screen for AJ71ID to monitor A1SJ71ID.

*3 Downloading any of these enables monitoring both intelligent function modules.

6.2.2 Access range

■ When using bus connection/direct CPU connection/computer link connection

- The intelligent module monitor can monitor intelligent function modules on the bases of the connected station and other stations.
- The intelligent module monitor can only monitor systems of the following combinations when computer link connection is applied.

PLC CPU used	Computer link/serial communication module used*1
QCPU (Q mode)	QJ71C24
LCPU	LJ71C24, LJ71C24-R2
QCPU (A mode)	A1SJ71UC24
QnACPU	AJ71QC24, A1SJ71QC24
ACPU	AJ71UC24, A1SJ71UC24 AJ71C24-S8, A1SJ71C24, A1SCPUC24-R2, A2CCPUC24

*1 For details of module names, refer to the GOT1000 Series Connection Manual (Mitsubishi Products) for GT Works3.

- The following restrictions apply when monitoring other stations of MELSECNET/II data link systems. Only the host and master stations can be monitored when the connected station is a local station. Regardless of the type of connected station, no stations other than ACPUs can be monitored.
- When connected to a remote I/O station on the MELSECNET/H network system, the remote I/O station on the MELSECNET/H network system is displayed as QCPU in the system configuration display of the intelligent module monitor.
- A diagnosis of the remote I/O station on the MELSECNET/H network system is not performed.
- Intelligent function modules on the base of remote I/O stations other than those on the MELSECNET/H network system are not monitored.

■ When using MELSECNET/H, MELSECNET/10, or CC-Link IE controller network connection

- The intelligent module monitor can monitor intelligent function modules on the bases of the control station and normal stations.
- To monitor another network, routing parameters have to be set to the GOT side and PLC side. (Only with the MELSECNET/H communication unit or CC-Link IE controller network communication unit)
For the routing parameter setting, refer to the following.
Routing parameter setting for the GOT

 GOT1000 Series Connection Manual (Mitsubishi Products) for GT Works3

Routing parameter setting for PLC CPU
For MELSECNET/H communication unit

 Q Corresponding MELSECNET/H Network System Reference Manual (PLC to PLC network)

For CC-Link IE controller network communication unit

 CC-Link IE Controller Network Reference Manual

■ When using CC-Link IE field network connection

The intelligent module monitor can monitor intelligent function modules on the bases of the master station and local stations.

To monitor another network, routing parameters have to be set to the GOT side and PLC side.

For the routing parameter setting, refer to the following.

Routing parameter setting for the GOT

 GOT1000 Series Connection Manual (Mitsubishi Products) for GT Works3

Routing parameter setting for PLC CPU

 The User's Manual of the CC-Link IE field network system master/local module to be used

■ When using CC-Link connection (Intelligent device station/via G4)

- The intelligent module monitor can monitor intelligent function modules on the bases of the master station and local stations.

■ When using Ethernet connection

- The intelligent module monitor can monitor the intelligent function module on the base of the PLC CPU assigned the IP address.

(The station assigned in the Ethernet setting of GT Designer2 can be monitored.)

- To monitor another network, routing parameters have to be set to the GOT side and PLC side.
For the routing parameter setting, refer to the following.

Routing parameter setting for the GOT

 GOT1000 Series Connection Manual (Mitsubishi Products) for GT Works3

Routing parameter setting for PLC CPU

 Q Corresponding MELSECNET/H Network System Reference Manual (PLC to PLC network)

■ When the intelligent module monitor monitors the master station of the MELSECNET/II network on which any remote I/O station exists

- Be sure to assign I/O when the master station is AnN or AnACPU.
If I/O is not assigned, the system configuration of the intelligent module monitor will not be displayed correctly.
- Intelligent function modules on the base of remote I/O stations are not monitored.

■ With Universal model QCPU

With Universal model QCPU, the GOT can monitor up to 64 stations.

6.2.3 Precautions

■ Inapplicable GOT

The intelligent module monitor cannot be used with the GOTs shown below.

GOT	Inapplicable GOT
GT15	GT1555-Q, GT1550-Q

■ Special function modules that cannot be monitored

Modules displayed as "SP" on the System Configuration screen cannot be monitored using the intelligent module monitor.

To monitor these modules, use the system monitor function [BM MONITOR].

■ Display when connecting the small building-block type CPU

This precaution pertains to a situation where an extension base unit for a large building block type is connected to a small building-block type CPU (such as the A1SCPU) in the station connected to the GOT.

In this case, the intelligent function module on the large extension base unit is displayed on the System Configuration screen with the model name of the same type of the small building-block type intelligent function module.

If there is no small building-block type intelligent function module, "SP" is displayed and the object module cannot be monitored.

(Example)

Installed module	Model name displayed
AD72	→ A1SD71
AJ71ID	→ A1SJ71ID
AJ71PT32-S3	→ A1SJ71PT32-S3
AD75P	→ A1SD75P
A68ADN [CH1 to CH8]	→ A1S64AD [CH1 to CH4]
A68RD [CH1 to CH8]	→ A1S62RD [CH1 to CH2]

■ Monitoring intelligent function modules with restrictions

(1) When monitoring AD71 (S1, S2, S7)

When the previous slot of the AD71 module is an empty slot, monitoring is performed in the following way.

- The AD71 is treated as the AD72, and "AD72" is displayed on the System Configuration screen. In this case, select "AD72" that corresponds to the actual installed position.
- The monitor screen that displays as shown (a) above is a screen for the AD72. The number obtained by subtracting 10_H from the I/O signal number on the display is the number for when installing the AD71 in slot 0.

* To prevent the AD71 from being treated as the AD72, execute "Shift the installation position of AD71 forward" or "In the I/O assignments, assign 16 points to the previous empty slot of the AD71".

1

OVERVIEW

2

SYSTEM MONITOR

3

LADDER MONITOR
FUNCTION

4

MELSEC-A LIST
EDITOR

5

MELSEC-FX LIST
EDITOR

6

INTELLIGENT
MODULE MONITOR

7

NETWORK
MONITOR

8

Q MOTION
MONITOR

- (2) When monitoring the A68AD, A68ADN, or A68RD used with a small building-block type PLC CPU**
 The GOT recognizes the intelligent function module installed in a large building-block type extension base unit connected to a small building-block type PLC CPU (e.g. A1SCPU) as a small building-block type intelligent function module to monitor it.

Hence, there are the following precautions for the A68AD, A68ADN, and A68RD.

Intelligent function module	Precautions
A68AD	The A68AD cannot be displayed correctly because the buffer memory configuration differs between the A68AD and A1S68AD.
A68ADN	Among CH1 to CH8 of the A68ADN, CH5 to CH8 cannot be displayed because the A1S64AD has only CH1 to CH4.
A68RD	Among CH1 to CH8 of the A68RD, CH3 to CH8 cannot be displayed because the A1S62RD has only CH1 to CH2.

The above intelligent function modules can be monitored properly if they are installed in a base unit connected to a large building block type PLC CPU (e.g. AnUCPU).

- (3) When monitoring the A1SD75M, AD75M**

Displayed as A1SD75P or AD75P when the A1SD75M or AD75M is installed.

The A1SD75M or AD75M can be monitored within the monitoring range of the A1SD75P or AD75P.

- (4) When monitoring the A81CPU**

The A81CPU is monitored in the following way.

Item	64 points in first half	64 points in last half
Treatment of A81CPU	Treated as a module that cannot be monitored.	Treated as an input module.
System Configuration screen	Displays "Special X, Y []"	Displays "Input 64 X []"
Monitoring	Disabled	Enabled as inputs

- (5) When monitoring an I/O module**

- (a) Only the output signal can be monitored for an I/O module for which "Output []" is displayed on the System Configuration screen.

For input signals, monitor X of the PLC CPU device with the system monitor function.

■ Editing and reusing intelligent module monitor data

The project data for the intelligent module monitor cannot be edited by modifying or adding an object.

However, the data can be used on a user-created monitor screen.

■ Precautions for I/O allocation setting

- (1) Even when I/O numbers are set at random as shown below, in the case the GOT is connected to the QnACPU, the start XY numbers are displayed in order on the System Configuration screen. When performing intelligent module monitoring, always perform the I/O allocation in order from slot 0.

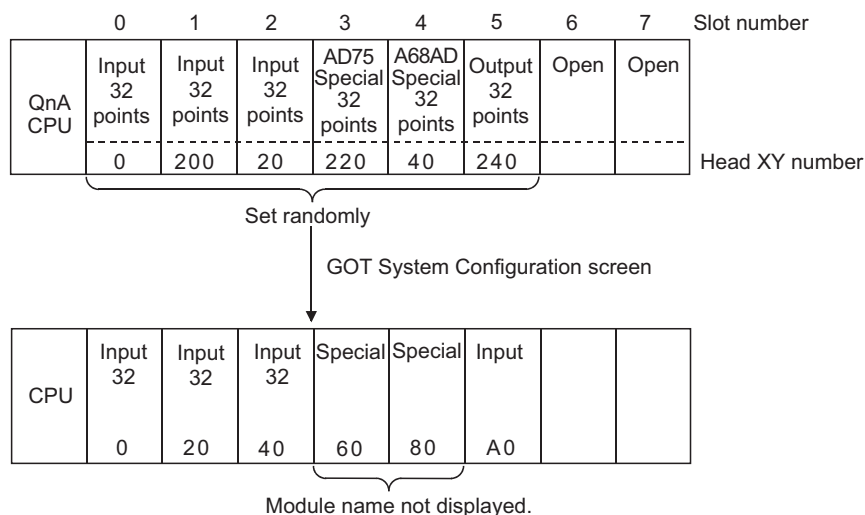

- (2) If the slot assigned with outputs in I/O assignment is not fitted with a module, the GOT displays it as input. (Common to ACPU and QnACPU)

■ Display provided when the QA1S6 □ extension base unit is used with the QCPU (Q mode)

This precaution pertains to a situation where the QA1S6 □ extension base unit is connected to the QCPU (Q mode) in a station connected to the GOT.

In this case, the abbreviated format is displayed for the following intelligent function modules on the System Configuration screen.

You can use the unit detail information to check the full format of the module displayed with the abbreviated format. Unsupported intelligent function modules are displayed as "SP", and the corresponding modules cannot be monitored.

Installed module	Model name displayed
A1S63ADA	63ADA
A1SJ71PT32-S3	J71PT32-
A1SJ71ID1-R4	J71ID
A1SJ71ID2-R4-S1	
A1S64TCTT(BW)-S1	64TCTT/R
A1S64TCRT(BW)-S1	

6.3 Operations for Display

This subsection describes the flow until the operation screen for the intelligent module monitor is displayed after the intelligent module monitor (Option OS) is installed in the GOT.

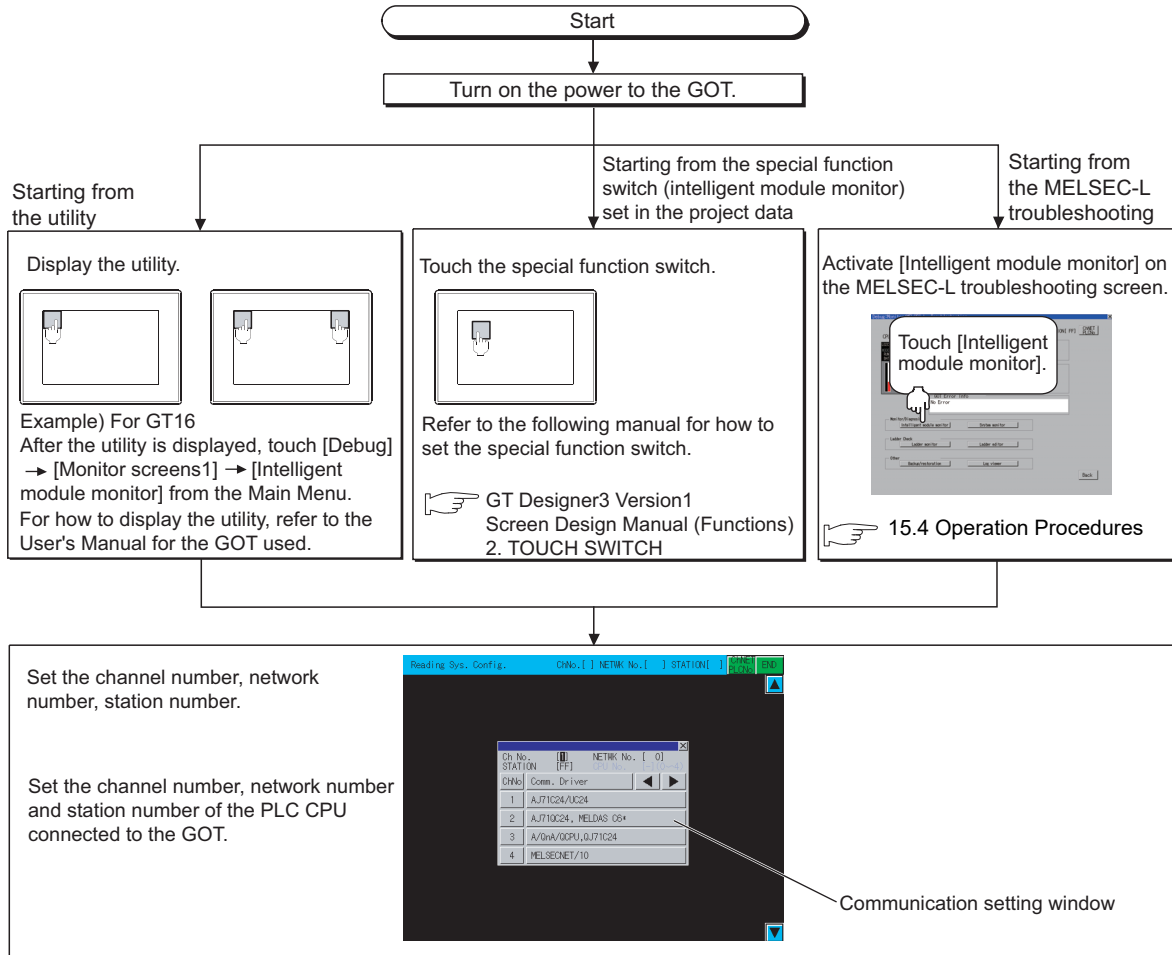

(Continued to next page)

(Continued from previous page)

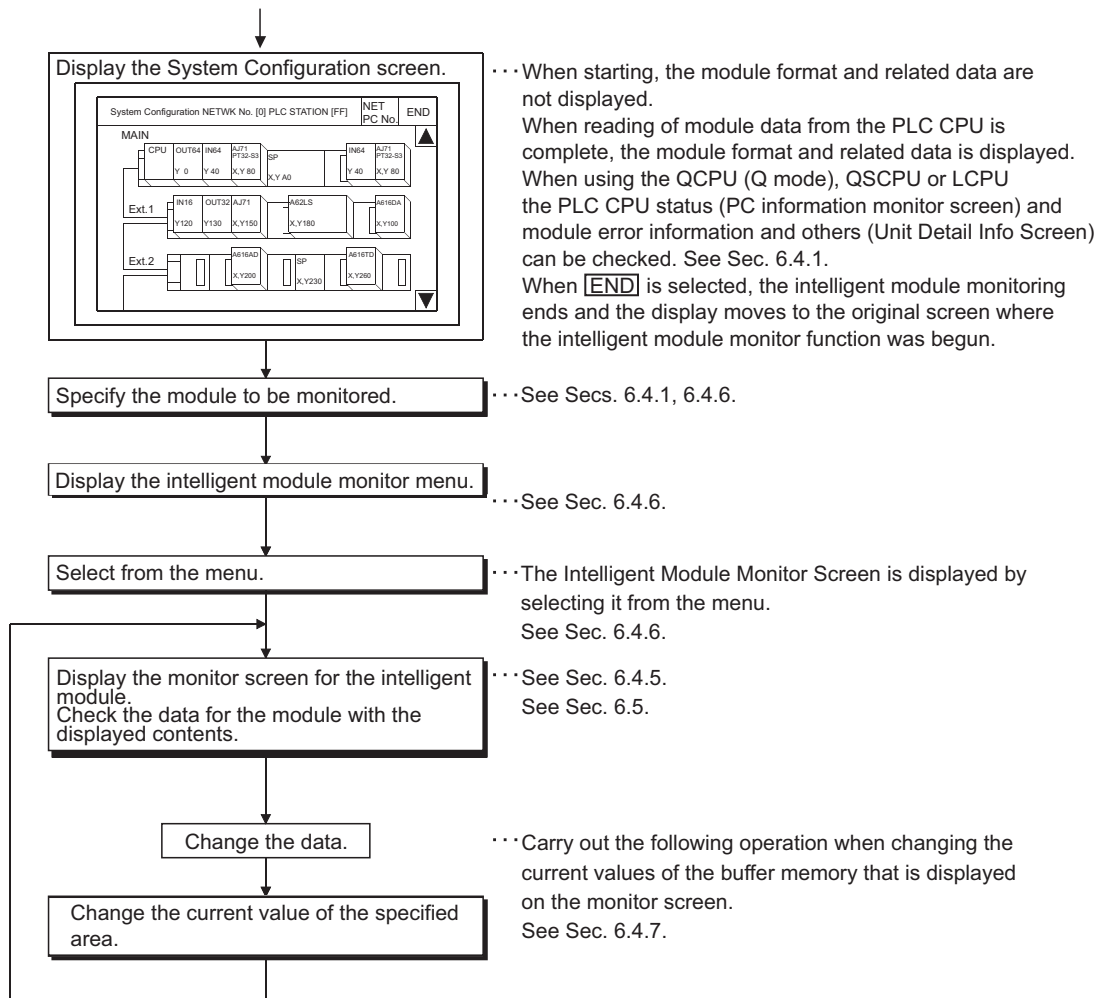

POINT

(1) How to display the utility

For how to display the utility, refer to the following.

User's Manual for the GOT used

(2) Displaying communication setting window

After turning on the GOT, the communication setting window is displayed at the first startup of the intelligent module monitor only.

For displaying the communication setting window at the second or later startup, touch the button on the intelligent module monitor screen.

6.4 Operation of Each Intelligent Module Monitor Screen

(3) If the project data has not been downloaded

The intelligent module monitor can be started from the utility even if the project data has not been downloaded to the GOT.

Changing screens

The following describes how to change the screen.

(1) When using QCPU (Q mode), Q series motion controller CPU, QSCPU, or LCPU

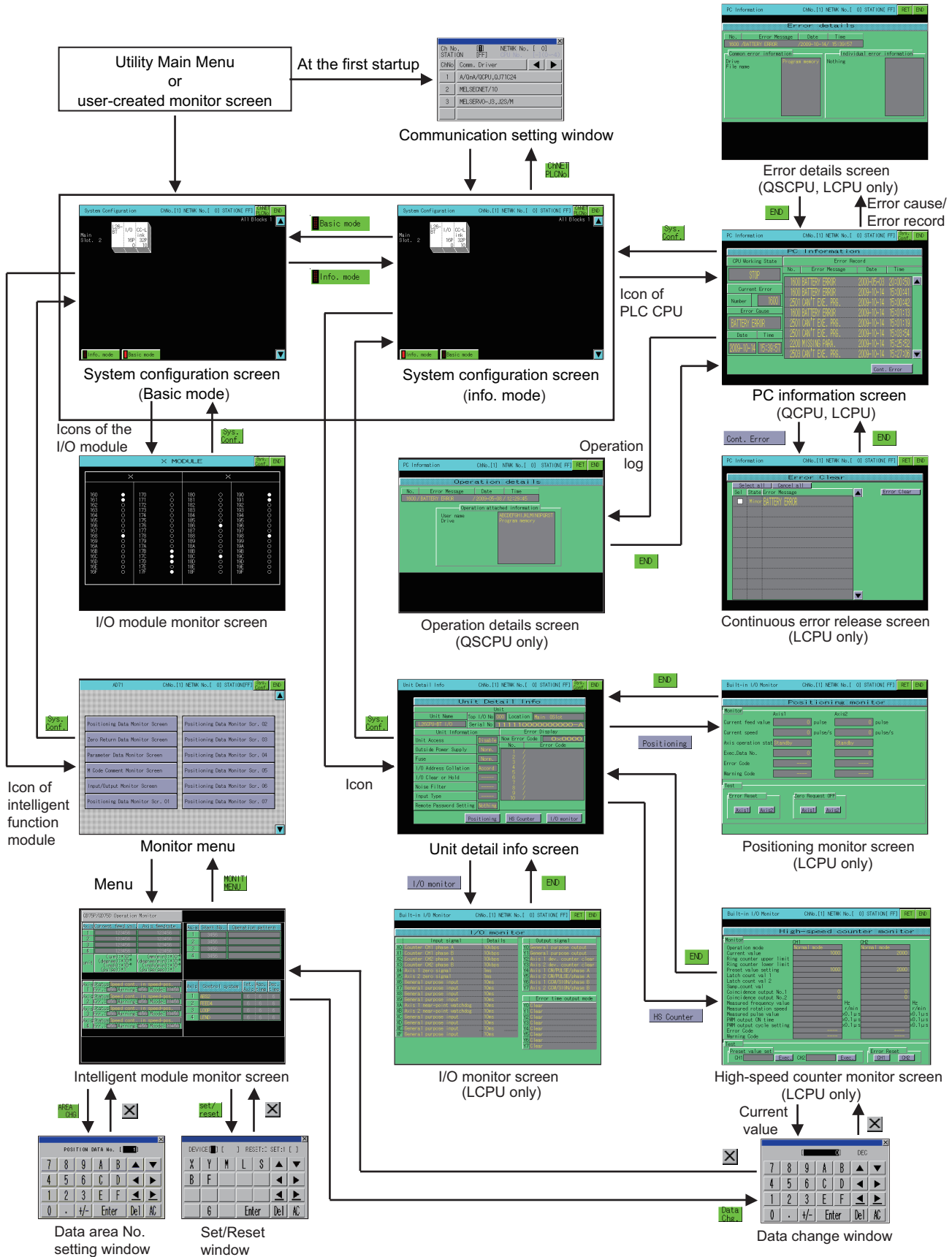

(2) When using QCPU (A mode), QnACPU or ACPUCPU

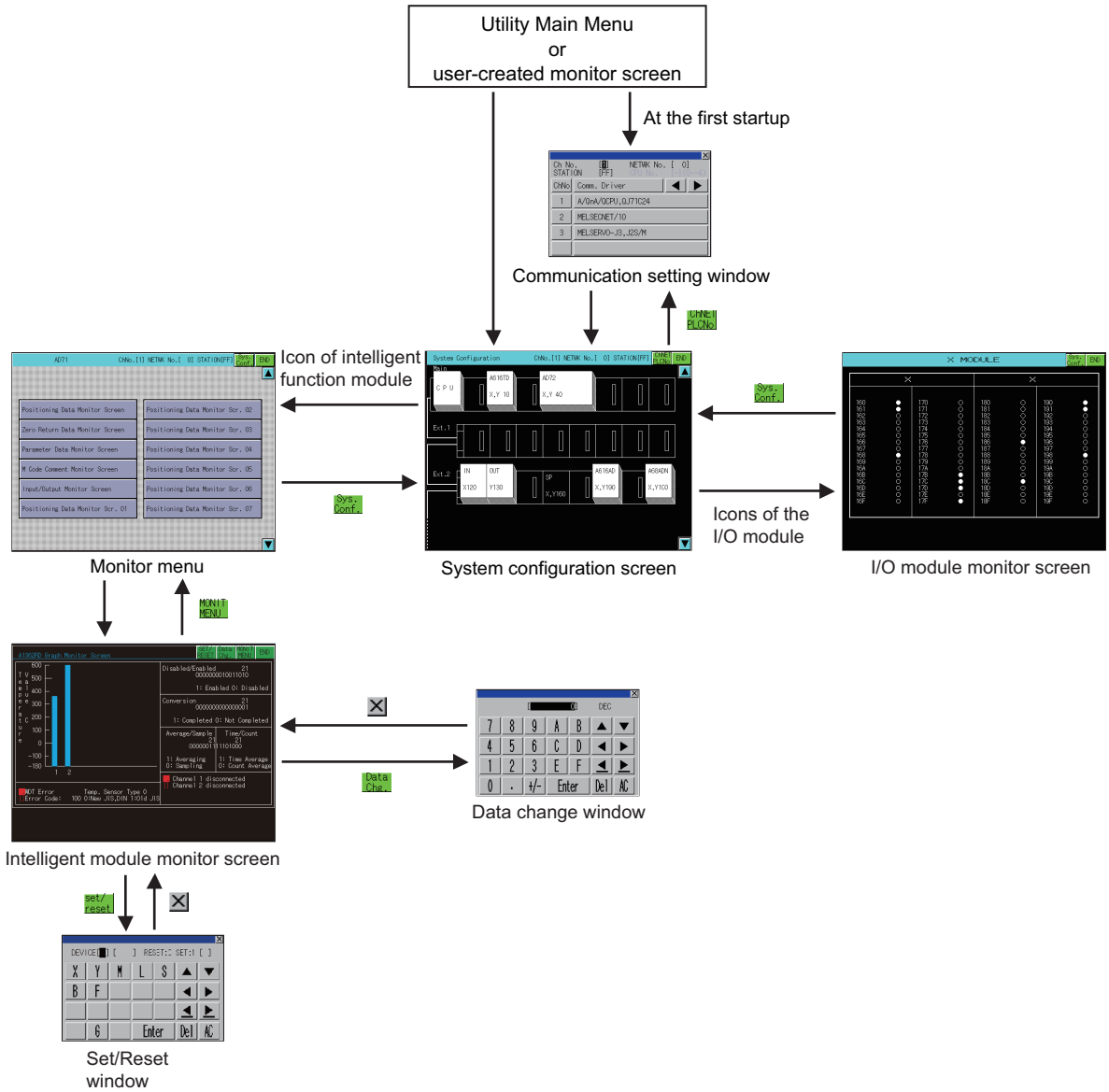

1	OVERVIEW
2	SYSTEM MONITOR
3	LADDER MONITOR FUNCTION
4	MELSEC-A LIST EDITOR
5	MELSEC-FX LIST EDITOR
6	INTELLIGENT MODULE MONITOR
7	NETWORK MONITOR
8	Q MOTION MONITOR

6.4 Operation of Each Intelligent Module Monitor Screen

This section describes the operations of the screens when using the intelligent module monitor.

6.4.1 Composition of the system configuration screen and key functions

This section describes the configuration of the System Configuration screen that is displayed after startup of the intelligent module monitor and the functions of the keys displayed on the screen.

■ When using the QCPU (Q mode), QSCPU or LCPU

(1) Displayed contents

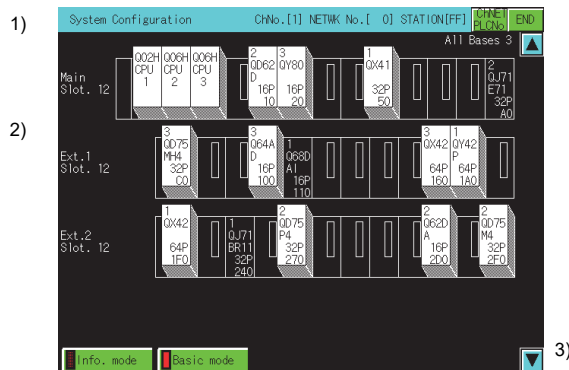

Item	Description
1)	Displays the channel number, network number and station number of the monitored station.
2)	<p>Displays the model name, I/O points, and start I/O number for the modules installed in the monitored station. The model name of the module and related data are displayed at the end of the module data readout from the PLC CPU.</p> <p>For an intelligent function module that cannot be monitored, the model name is displayed as "SP".</p> <p>The module icon becomes the key to switch to the screen where the monitoring of that module is performed. The communication setting window is displayed for the MELSECNET/H connection or MELSECNET/10 connection.</p> <p> 6.4.2 Setting method for other station monitoring</p> <p>Displays the CPU Nos. for the CPUs and the control CPU number for the installed modules when there are multiple CPU systems.</p>
3)	Display keys used for the operations on the System Configuration screen shown in (2). (Touch input)

(2) Key functions

The table below shows the functions of the keys that are used with the operation on the DEVICE MONITOR screen.

Key	Function
	Displays the communication setting window.
	Closes the monitoring and returns the screen to the one for starting the intelligent module monitor.
Icon of PLC CPU	The screen switches to the PC Information monitor screen. 6.4.3 Composition of PC Information monitor screen and key functions
Icon of intelligent function module	In intelligent module monitor mode: Switches to the screen where the intelligent module monitoring for that module is performed. In unit detail info mode: Switches to the screen displaying detailed information of the selected module.
	Switches the System Configuration screen to Info. mode. 6.4.4 Composition of the unit detail info screen and key functions
	Switches the System Configuration screen to Basic mode.
	Scrolls the display one stage up or down to display the system configuration of the currently undisplayed stage immediately before/after the currently displayed stage. Operations can be performed when the system configuration has three or more extension bases. : Scrolls one stage up. : Scrolls one stage down.

■ When using the QCPU (A mode), QnACPU, and ACPUCPU

(1) Displayed contents

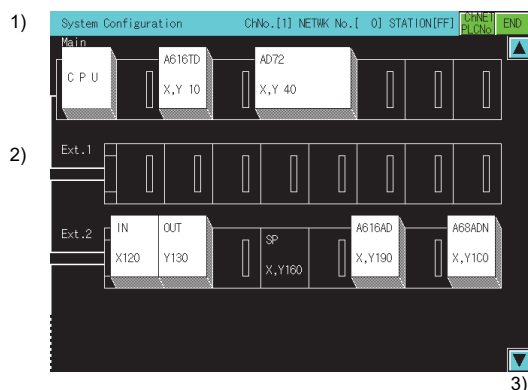

Item	Description
1)	Displays the channel number, network number and station number of the monitored station.
2)	<p>For modules installed in the monitored station, the model name and start No. of I/O signals are displayed for the intelligent function module, "IN"/"OUT" and the I/O points for the I/O module. The model name of the module and related data are displayed at the end of the module data readout from the PLC CPU.</p> <p>For an intelligent function module that cannot be monitored, "SP" and the start No. of the I/O signal are displayed.</p> <p>The display position of the module becomes the key to switch to the screen where the monitoring of that module is performed.</p> <p>The communication setting window is displayed for the MELSECNET/10 connection.</p> <p> 6.4.2 Setting method for other station monitoring</p>
3)	Display keys used for the operation on the System Configuration screen shown in (2).

(2) Key functions

The table below shows the functions of the keys that are used for the operation on the System Configuration screen.

Key	Function
	Displays the communication setting window.
	Closes the monitoring and returns the screen to the one for starting the intelligent module monitor.
Icon of intelligent function module	Switches to the screen where the intelligent module monitoring for that module is performed.
	<p>Scrolls the display one stage up or down to display the system configuration of the currently undisplayed stage immediately before/after the currently displayed stage.</p> <p>Operations can be performed when the system configuration has three or more extension bases.</p> <p> : Scrolls one stage up.</p> <p> : Scrolls one stage down.</p>

6.4.2 Setting method for other station monitoring

The following shows the setting methods for monitoring other stations with intelligent module monitor.

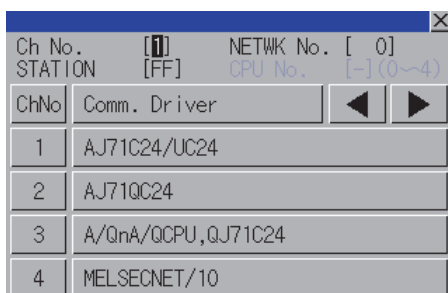
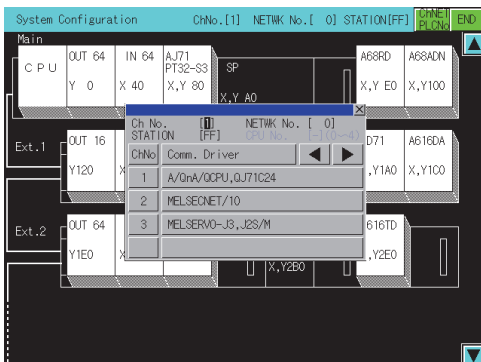

1. When the intelligent module monitor is started for the first time, the communication setting window is automatically opened by displaying the system configuration screen. Otherwise, touch the **ChNET/PLCNo.** button in the System Configuration screen to display the communication setting window.

2. In the communication setting window, select one from channels No.1 to 4. For the operation on the communication setting screen, refer to the following.
 - ☞ (1) Communication setting window

3. When the channel No. is selected, the screen on the left is displayed. Set the network number of the target controller and the CPU station number.

4. After selecting the station number, touch the enter key. The communication setting window closes and the system configuration of the set monitor destination is displayed. For further operations, refer to the following.
 - ☞ 6.4.6 Specifying a module to monitor and selecting monitor menu

(1) Communication setting window

(a) Displayed screen

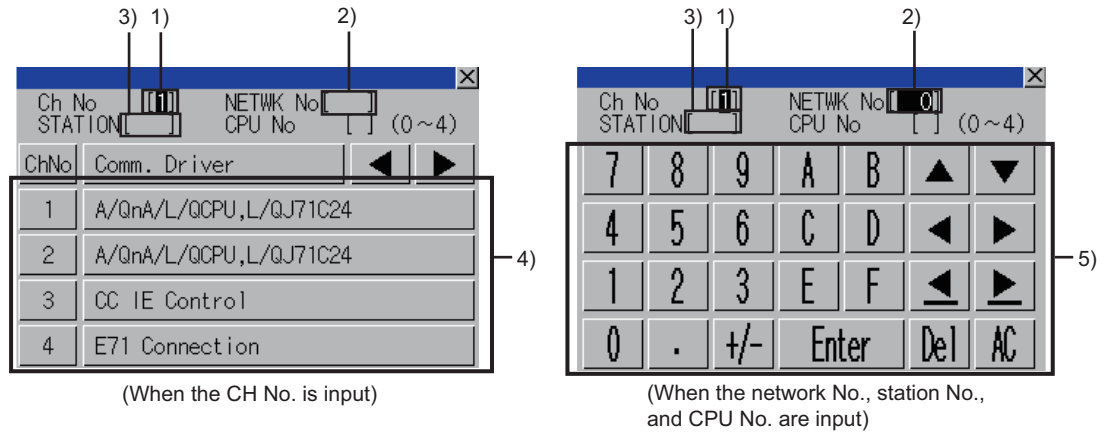

The following table shows the displayed contents.

No.	Item	Description	Setting range
1)	CH No. input area	Set the CH No. for the target controller.	1 to 4
2)	Network No. input area	Set the network No. for the target controller.	Differs depending on the connection type. <ul style="list-style-type: none"> • Bus connection, direct CPU connection, computer link connection: 0 • Ethernet connection, CC-Link IE controller network connection, CC-Link IE field network connection: 1 to 239 • MELSECNET/H, MELSECNET/10: 0 (host loop) / 1 to 255 (specified loop) • CC-Link (ID/G4) connection: 0
3)	Station No. input area	Set the station No. of the target controller. When the station No. is set to the host station (FF), set the network No. to 0.	Differs depending on the connection type. <ul style="list-style-type: none"> • Bus connection, direct CPU connection, computer link connection: FF (host station) • Ethernet connection: 1 to 64 • MELSECNET/H, MELSECNET/10: 0 (control station) / 1 to 64 (normal station) • CC-Link IE controller network connection: 1 to 120 • CC-Link IE field network connection: 0 (master station) / 1 to 120 (local station) • CC-Link (ID/G4) connection: 0 (master station) / 1 to 64 (local station)
4)	CH No. selection key	Set the CPU No.	-
5)	Keys	Keys for operations in the communication setting window shown in (b). (Touch input)	-

(b) Key functions

Key	Function
	Closes the communication setting window. When any of the CH No., network No., station No., and CPU No. is not input and the monitor target is not set, the communication setting window does not close.
	Moves the cursor among the input areas.
	Deletes all the input values and characters.
	Deletes an input value or character.
	Moves the cursor when the cursor is in the CH No. input area, network No. input area, or station No. input area. When the cursor is in the CPU No. input area and settings for the CH No., network No., and station No. are completed, the communication setting window closes and the PLC read screen appears.

6.4.3 Composition of PC Information monitor screen and key functions

This section describes the structure of the PC Information monitor screen that is displayed by specifying the QCPU (Q mode), QSCPU or LCPU on the System Configuration screen, and the key functions displayed on the screen. The GOT displays the PC Information monitor screen only when using the following controllers.

- QCPU (Q mode)
- QSCPU
- LCPU

■ When using the QCPU (Q mode) or LCPU

(1) The PC information monitor screen.

(a) Displayed contents



Item	Description
1)	Displays the channel number, network number and station number of the monitored station.
2)	Displays the keys that are used for the operation on the PC information monitor screen.
3)	Displays the operating status of the PLC CPU.
4)	Displays the currently occurring errors. When using the LCPU, touch the error cause to display the error detail screen. (2) Error details screen
5)	Displays the error record. Up to 100 error records can be displayed. When using the LCPU, touch the error record to display the error detail screen. (2) Error details screen

(b) Key functions

The table below shows the functions of the keys that are used for the operation on the PC information monitor screen.

Key	Function
	Switches the screen to the System Configuration screen. 6.4.1 Composition of the system configuration screen and key functions
	Closes the monitoring and returns the screen to the one for starting the intelligent module monitor.
	Scrolls the display one page up or down. ▲ : Scrolls one page up. ▼ : Scrolls one page down.
	Displayed only when LCPU is used. Shifts to the Continuation error clear screen. (3) Continuation error clear screen

(2) Error details screen

(a) Displayed contents

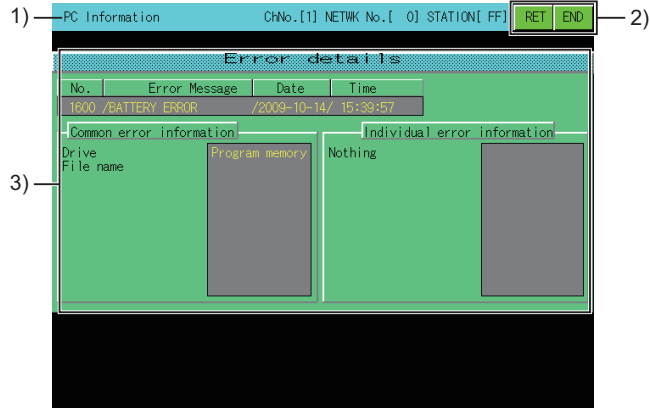

Item	Description
1)	Displays the channel number, network number and station number of the monitored station.
2)	Displays the keys that are used for the operation on the error details screen.
3)	Displays the common error information and individual error information based on the information stored in SD4 and SD5 of the LCPU. For the common error information and the individual error information, refer to the following. MELSEC-L CPU Module User's Manual (Function Explanation, Program Fundamentals)

(b) Key functions

The table below shows the functions of the keys that are used for the operation on the error details screen.

Key	Function
	Returns the screen to the PC Information monitor screen. 6.4.3 Composition of PC Information monitor screen and key functions
	Closes the monitoring and returns the screen to the one for starting the intelligent module monitor.

(3) Continuation error clear screen

(a) Displayed contents

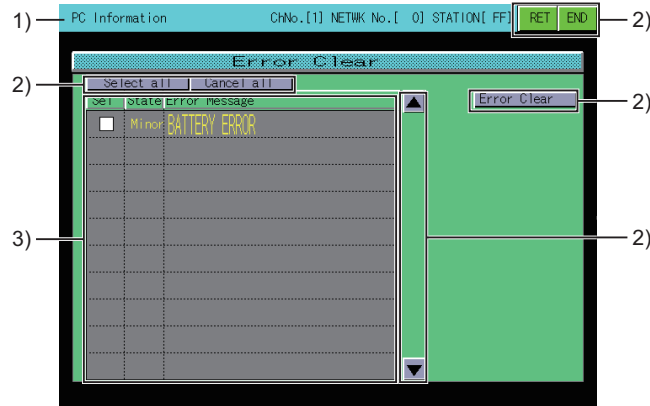

Item	Description
1)	Displays the channel number, network number and station number of the monitored station.
2)	Displays the keys that are used for the operation on the Continuation error clear screen.
3)	Displays the continuous error status that can be released, and the error messages. The following shows the continuous error status. <ul style="list-style-type: none"> • Specification: User specification error • Minor: Minor error Touch the check box of each continuous error to switch between releasing or not the error.

(b) Key functions

The table below shows the functions of the keys that are used for the operation on the Continuation error clear screen.

Key	Function
	Returns the screen to the PC Information monitor screen. 6.4.3 Composition of PC Information monitor screen and key functions
	Closes the monitoring and returns the screen to the one for starting the intelligent module monitor.
	Targets all continuous errors for the continuous error releasing.
	Unselects all continuous errors for the continuous error releasing.
	Scrolls the display one stage up or down.
	Releases the checked continuous errors.

POINT

Precautions for releasing continuous errors

- (1) If the error messages are the same, the errors are released regardless of the error code. Therefore, some error codes may be released even without the user intend to.
- (2) The annunciator memorizes the number of annunciators detected in the CPU modules. When canceling multiple annunciators, perform the error releasing multiple times.
- (3) Even after executing the error releasing, the detected error record is not deleted.

■ When using the QSCPU

(1) PC Information monitor screen



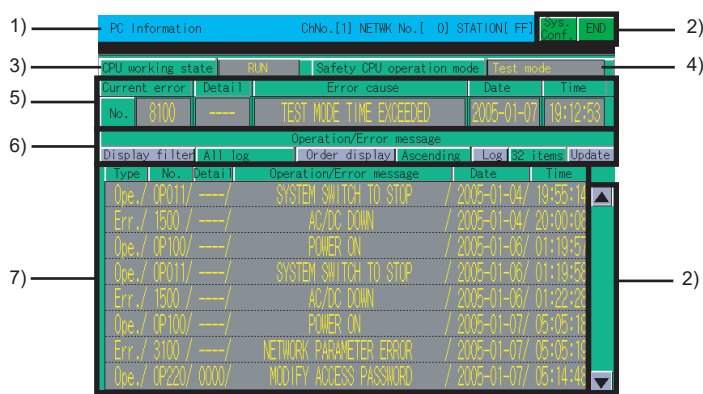







(a) Displayed contents



Item	Description
1)	Displays the channel number, network number, and station number of the monitored station.
2)	Displays the keys that are used for the operation on the System Configuration screen shown in (b).
3)	Displays the QSCPU operation status. (RUN/STOP)
4)	Displays the safety CPU operation mode. (Safety mode/Test mode)
5)	<p>Displays the error being occurred. Touching the error displays the Error details screen.</p> <p> ■When using the QSCPU (3) Error details screen</p> <p>No. : Displays the error code.</p> <p>Detail : Displays the detail code of the error log. ([----]) is displayed when no detail code exists.)</p> <p>Error cause : Displays the error details. Touching the item displays the Error details screen.</p> <p>Date, Time : Displays the date and the time that the error occurs.</p>
6)	<p>Set the items to be displayed in the log list.</p> <p> ■When using the QSCPU (1) (b) Key functions</p>
7)	<p>Displays the operation status, error information, and others of the monitored PLC CPU. (Log list)</p> <p>Type : Displays the log types. (Ope: Operation log, Err: Error log)</p> <p>No. : Displays the operation codes or error codes.</p> <p>Detail : Displays the 4-digit detail codes of the operation logs or the error logs for the errors occurred in the CC-Link Safety system remote I/O module. ([----]) is displayed when no detail code exists.)</p> <p>Operation/Error message : Displays the operation details or error messages. Displays "BROKEN OPERATION/ERROR LOG" when the log data is damaged.</p> <p>Date, Time : Displays the dates and the time of operations or the dates and time that errors occur.</p> <p>Touching an operation log displays the Operation details screen.</p> <p> ■When using the QSCPU (2) Operation details screen)</p> <p>Touching an error log displays the Error details screen.</p> <p> ■When using the QSCPU (3) Error details screen)</p>

(b) Key functions

The table below shows the functions of the keys that are used for the operation on the System Configuration screen.

Key	Function
	Switches the screen to the System Configuration screen.  6.4.1 Composition of the system configuration screen and key functions
	Closes the monitoring and returns the screen to the one for starting the intelligent module monitor.
	Switches the log types to be displayed in the log list. All log : Displays all the logs (error logs, operation logs). Error log : Displays the error logs only. Operation log : Displays the operation logs only.
	Sorts the log list in ascending or descending order.
	Switches the numbers of logs displayed in the log list. 32 items : Displays the latest 32 logs. 100 items : Displays the latest 100 logs. (When the number of displayed logs is switched from 100 to 32, 100 logs are displayed before touching the Update key.)
	Obtains the latest log information from the PLC CPU and updates the log list. (The displayed log data before touching the Update key is deleted.)
	Scrolls the display one page up or down.  : Scrolls one page up.  : Scrolls one page down.

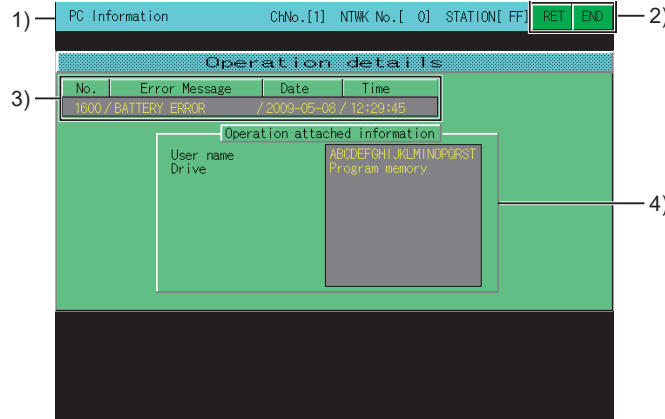

(2) Operation details screen

(a) Displayed contents



Item	Description
1)	Displays the channel number, network number, and station number of the monitored station.
2)	Displays the keys that are used for the operation on the System Configuration screen shown in (b).
3)	Displays the information of the error touched in the PC information monitor screen.
4)	Displays the detailed operating information according to the operation log information stored in the QSCPU.

(b) Key functions

Key	Function
	Returns the screen to the PC Information monitor screen.  6.4.3 Composition of PC Information monitor screen and key functions
	Closes the monitoring and returns the screen to the one for starting the intelligent module monitor.

(3) Error details screen

(a) Displayed contents

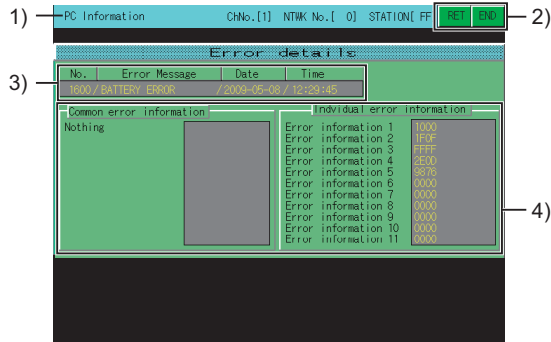

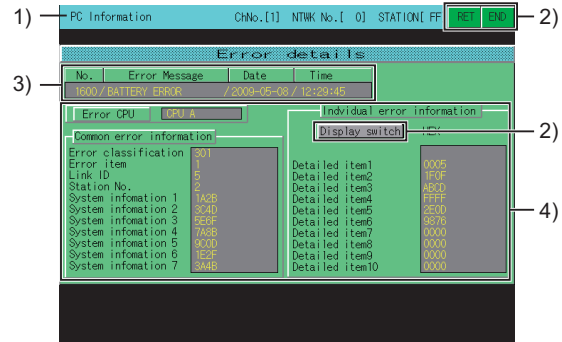

(Example) Error details screen for safety CPU error



(Example) Displaying individual error information for safety remote I/O station

Item	Description
1)	Displays the channel number, network number, and station number of the monitored station.
2)	Displays the keys that are used for the operation on the System Configuration screen shown in (b).
3)	Displays the information of the error touched in the PC information monitor screen.
4)	Displays the common error information and the individual error information according to the information stored in SD4 and subsequent devices of the QSCPU. For the common error information and the individual error information, refer to the following.  QSCPU User's Manual (Function Explanation, Program Fundamentals) When the individual error information for the safety remote I/O station is displayed, the numerical notation of the displayed data can be switched between decimal and hexadecimal numbers. (When the CC-Link Safety system master module cannot receive the error information from the safety remote I/O station, [****] is displayed for unreceived items.)

(b) Key functions

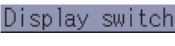
Key	Function
	Returns the screen to the PC Information monitor screen.  6.4.3 Composition of PC Information monitor screen and key functions
	Closes the monitoring and returns the screen to the one for starting the intelligent module monitor.
	Switches the numerical notation of the displayed data between decimal and hexadecimal numbers. (Only when the individual error information for the safety remote I/O station is displayed)

6.4.4 Composition of the unit detail info screen and key functions

This section describes the structure of the Unit Detail Info screen that is displayed by specifying a module on the System Configuration screen at Info. mode, and the key functions displayed on the screen. The GOT displays the Unit Detail Info screen only when using the following controllers.

- QCPU (Q mode)
- QSCPU
- LCPU

■ Displayed contents



Item	Description
1)	Displays the channel number, network number and station number of the monitored station.
2)	Displays keys used for the operations on the System Configuration screen.
3)	Displays the operating status, error information and other information of the targeted PLC CPU. Up to 10 error information events can be displayed.

■ Key functions

The following table shows the functions of the keys used for the operation on the Unit Detail Info screen.

Key	Function
	Switches the screen to the System Configuration screen. 6.4.1 Composition of the system configuration screen and key functions
	Closes the monitoring and returns the screen to the one for starting the intelligent module monitor.
	Displayed only when displaying information of the LCPU built-in I/O module. This button is available when [Positioning axis 1] or [Positioning axis 2] is set to [Use] in the parameter. Shifts to the positioning monitor screen. (1) Positioning monitor screen
	Displayed only when displaying information of the LCPU built-in I/O module. This button is available when [High-speed counter 1] or [High-speed counter 2] is set to [Use] in parameter. Shifts to the high-speed counter monitor screen. (2) High-speed counter monitor screen
	Displayed only when displaying information of the LCPU built-in I/O module. Shifts to the I/O monitor screen. (4) I/O monitor screen.

(1) Positioning monitor screen

(a) Displayed contents



Item	Description
1)	Displays the channel number, network number and station number of the monitored station.
2)	Displays the keys used for the operations in the positioning monitor screen.
3)	Displays the operation status of the positioning function. The operation status is displayed or hidden according to the parameter settings of built-in functions.

(b) Key functions

The following table shows the functions of the keys used for the operation on the positioning monitor screen.

Key	Function
	Return to the unit detail info screen. 6.4.4 Composition of the unit detail info screen and key functions
	Closes the monitoring and returns the screen to the one for starting the intelligent module monitor.
	Resets the error of the axis 1 or axis 2.
	Turns off the home position return request for axis 1 or axis 2.

POINT

Precautions for using the positioning monitor screen.

When the parameter settings of a built-in function is changed by programming software or others of the connecting device during the positioning monitor screen display, return to the unit detail info screen and display the position monitor screen again.

(2) High-speed counter monitor screen



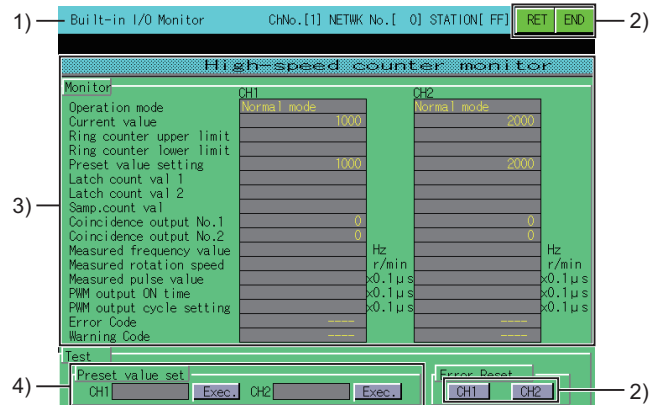

(a) Displayed contents



Item	Description
1)	Displays the channel number, network number and station number of the monitored station.
2)	Displays the keys used for the operation in the high-speed counter monitor screen.
3)	Displays the operation status of the high-speed counter function. The operation status is displayed or hidden according to the parameter settings of built-in functions.
4)	Displays the current value of the CH1 and CH2. Touch the current value and the data change window is displayed.  (3) Data change window

(b) Key functions

The following table shows the functions of the keys used for the operation on the high-speed counter monitor screen.

Key	Function
	Return to the unit detail info screen.  6.4.4 Composition of the unit detail info screen and key functions
	Closes the monitoring and returns the screen to the one for starting the intelligent module monitor.
	Reflects the preset value entered in the data change window to the PLC CPU.
	Reset the error of CH1 or CH2.

POINT

Precautions for using the high-speed counter monitor screen.

- When the parameter settings of a built-in function is changed by programming software or others of the connecting device during the high-speed counter monitor screen display, return to the unit detail info screen and display the high-speed counter monitor screen again.
- The preset value preset from the high-speed counter monitor screen is valid for the subsequent presets, unless it is set again in the sequence program.
- If the preset from the high-speed counter monitor screen and the preset by the sequence program are executed simultaneously, the setting value by the sequence program may be preset.

(3) Data change window

(a) Displayed contents



Item	Description
1)	Displays the entered value.
2)	Displays the keys used in the operation of the data change window.

(b) Key functions

The following table shows the functions of the keys used for the operation on the data change window.

Key	Function
	Closes the data change window.
	Changes the data change target.
	Sets the entered value to the preset value.
	Deletes one character of the entered value.
	Deletes all entered values.

(4) I/O monitor screen.

(a) Displayed contents

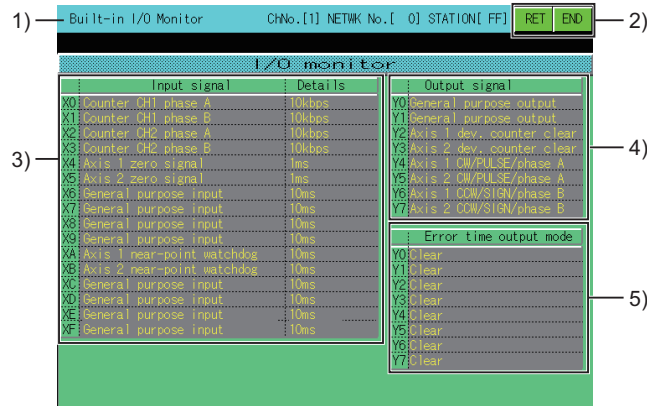

Item	Description
1)	Displays the channel number, network number and station number of the monitored station.
2)	Displays the keys used for the operations in the I/O monitor screen.
3)	Displays the status and values of functions assigned to the input signal.
4)	Displays the status of functions assigned to the output signal.
5)	Displays the setting status of the output mode during error, for the output signal.

(b) Key functions

The following table shows the functions of the keys used for the operation on the I/O monitor screen.

Key	Function
	Return to the unit detail info screen. 6.4.4 Composition of the unit detail info screen and key functions
	Closes the monitoring and returns the screen to the one for starting the intelligent module monitor.

6.4.5 Composition of the intelligent module monitor screen and key functions

This section describes the structure of the monitor screen that is displayed by specifying a module on the System Configuration screen (in Basic mode when the QCPU (Q mode), QSCPU or LCPU is used), and the key functions displayed on the screen.

■ Displayed contents (for A68RD)

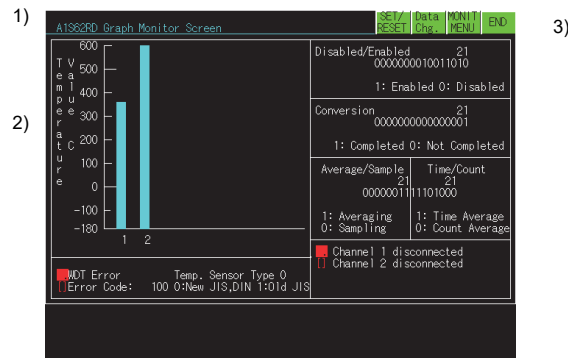

Item	Description
1)	Displays the model name of the module being monitored.
2)	Displays the buffer memory data of the module in its current form or in a graph. The status of I/O signals to and from PLC CPU is monitored. All data are displayed when the readout from the intelligent function module is completed. When testing, execute testing after moving the cursor to the display position of the target data.
3)	Displays keys used for the operations on the monitor screen.

■ Key functions

The table below shows the functions of keys that are used for the operations on the monitor screen.

Key	Function
SET/RESET	Starts testing (SET/RST) of the I/O signal between the PLC CPU and the intelligent function module.
Data Chg.	Starts changing (writing) the current values of the buffer memory of the intelligent function module displayed on the screen.
MONIT MENU	Closes the current monitor and returns to the screen displaying monitor menu. This operation can only be used when the intelligent function module has a monitor menu.
END	Closes the monitoring and returns the screen to the one for starting the intelligent module monitor.

6.4.6 Specifying a module to monitor and selecting monitor menu

This section uses the positioning module (AD71) as an example to describe the operations when starting the intelligent module monitor to monitor a desired module.

Operation procedure

Display System Configuration screen.

See Sec.6.4.1

Specify module to be monitored (Touch display position of module.)

- (1) From among the modules installed in the corresponding base unit, specify the intelligent function module whose format is displayed.
* : For modules where the format is not displayed, monitor with the system monitor function (See Sec.2).
Specify input/output modules according to Sec. 6.6.

Display screen that shows monitor menu.

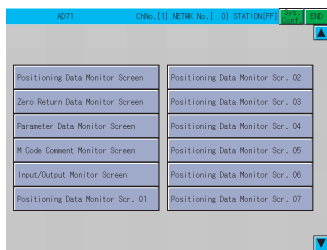

- (2) Specify the menu corresponding to the type of data to be monitored.
- (3) With modules for which the monitor menu cannot all be displayed in one screen, touch the ▲ ▼ keys at the right of the screen to scroll the display menu.

Specify menu to be monitored (Touch display position of menu.)

Display monitor screen of specified menu.

X	Y	X Axis	Y Axis	X	Y
				AB0000FF	000000000000
F10	V11	Posit. Start	Travel/Pluse	1	1
F12	V12	Repositioning	Initial Trav.	1	1
X02	X03	Posit. Comp	Speed Limit	120	120
F09	F09	Zero Request	Jog Spd. Limit	120	120
X13	X14	Zero Start	Zero Complete	1000	1000
X00	X00	Zero Complete	Acc/Dec Time	1000	1000
F17	F19	Feed Jog Start	Backlash Comp	-5	2550
F18	F14	Rev. Jog Start	Lower Limit	100	100
F15	F16	Stop	Upper Limit	0	0
X08	X09	Pos. Started	Error Comp.	0	0
X04	X05	BUSY	Starting Bias	0	0
X0E	X0F	M Code ON	Comp. Q/P Time	300	300
X00	X01	Err. Rep. Pulse	Comp. Q/P Time	300	300
F05	F06	Batt. Err. Enable	Mode/ErrCode	0	0
F08	F08	Error	Y-Disable	0	0

- (4) Check the contents of the display. Carry out the subsequent operation according to Sec. 6.5.
- (5) Carry out tests for the displayed data according to Sec.6.4.7.
 - Change current value of buffer memory
 - Turn output signal from PLC CPU on and off

Proceed to Sec. 6.4.7 and Sec. 6.5

6.4.7 Testing of the intelligent function module

! WARNING

- When testing the operation (changing a current buffer memory value) of the intelligent module monitor, read this manual carefully to fully understand the operation.
For devices that perform significant operations for the system, never perform test operation to change data.
Doing so can cause accidents due to false outputs or malfunctions.

Testing can be performed for all buffer memory data displayed on the current monitor screen. This section describes the operations for changing the current value of the buffer memory and turning on and off the output signal from the PLC CPU to the intelligent function module.

POINT

- Perform testing for the buffer memory that can be written from the PLC CPU and output signals that are output from the PLC CPU.**
- It is recommended that testing be performed with the PLC CPU in STOP status.**
If the PLC CPU is tested during RUN status, the test monitor display returns to display values output from the sequence program and output statuses.

Operation procedure

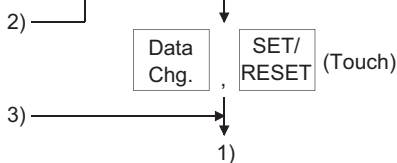
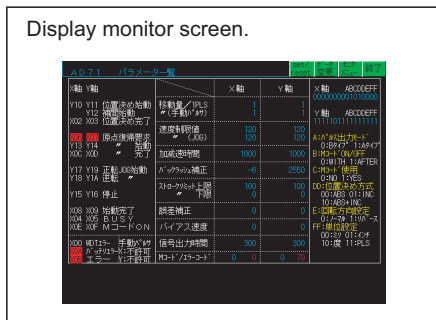

1)

Display key window on monitor screen.

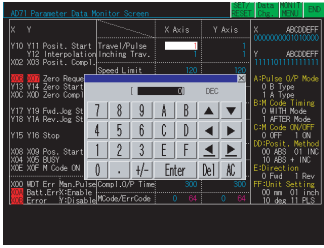

 (Touch: input confirmation)

3) (Test continues)

(Test ends)

 (Touch)

2)

*1 Do not perform the following tests.

If these tests are performed, the module may not operate correctly or the buffer memory/input signal may return to the output value/output status from the intelligent function module.

- 1) Testing of read-only buffer memory from the PLC CPU.
- 2) Testing of input signals from the intelligent function module to the PLC CPU.

*2 When testing buffer memory data, specify the change value in the following way.

- 1) For data where 16/32 bits are displayed with one number, specify a new value in decimal format.
- 2) For data where one number of 16/32 bits is displayed as a percent, such as with an A/D conversion module, specify a new value corresponding to the percentage in decimal format.

Example:

When the set value of the offset or gain is 0 to 2000 and you intend to change it to "50%", input "1000".

- 3) For data where 16 bits are displayed with "0" or "1" for each bit, specify a new value with changing the data to a decimal.

When  is touched (changes current value of buffer memory)

- All of the following operations can be carried out by touching the keys in the displayed key window.
- When you touch  at the upper left of the key window, the key window closes and the display returns to the monitor screen.

(1) Move the cursor to the position where the data to be tested is displayed. (*1) ( : Up/down  : Left/right)

(2) Use the numeric keys to specify the value to be changed. (*2)

The  key can be used to clear individual characters among those input.

When  is touched (tests the I/O signal)

- All of the following operations can be carried out by touching the keys in the displayed key window.
- When you touch  at the upper left of the key window, the key window closes and the display returns to the monitor screen.

(1) Use the alphabetic character keys to specify the name of the device to be tested, and then touch . (*1)

(2) Use the numeric keys to specify the device number, and then touch .

(3) Use the numeric keys to specify "Set" or "Reset".

: OFF : ON

6.5 Intelligent Module Monitor Screens

6.5.1 A62DA-S1 module monitoring

Screen example	No.	Buffer memory address	
		DEC	HEX
	1)	0, 1	0000, 0001
	2)	2 to 5	0002 to 0005
	3)	-	-
	1)	0, 1	0000, 0001
	2)	2, 4	0002, 0004
	3)	3, 5	0003, 0005
	4)	-	-

6.5.2 A68AD module monitoring

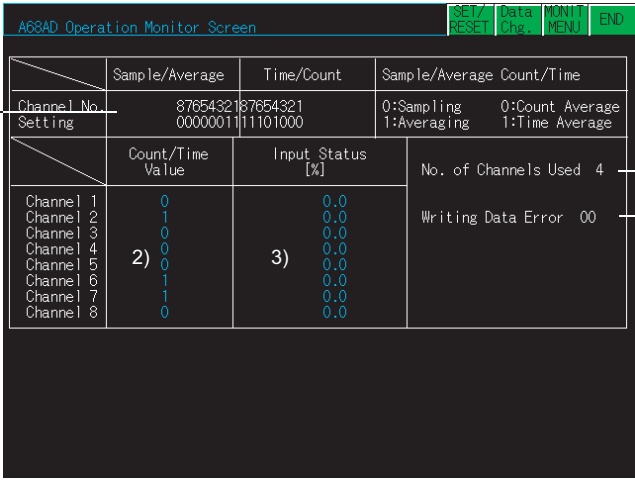
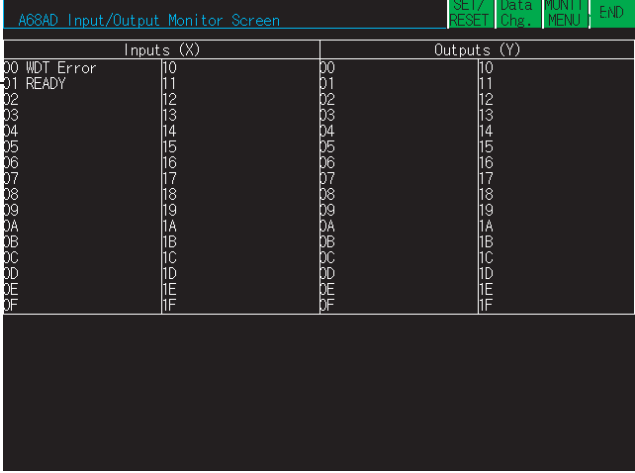
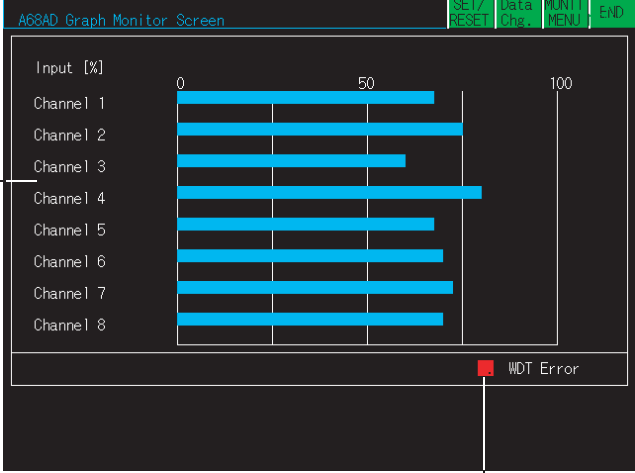
Screen example	No.	Buffer memory address	
		DEC	HEX
 <p>The screenshot shows the 'A68AD Operation Monitor Screen'. It features a top navigation bar with 'SET/RESET', 'Data Chg', 'MONIT/MENU', and 'END' buttons. The main display is divided into several sections: 'Channel No. Setting' (1), 'Sample/Average' and 'Time/Count' data, 'Sample/Average Count/Time' (0:Sampling, 1:Averaging), 'Count/Time Value' (2), 'Input Status [%]' (3), and 'No. of Channels Used' (4) which is 4. A 'Writing Data Error' (5) is also shown as 00.</p>	1)	1	0001
	2)	2 to 9	0002 to 0009
	3)	10 to 17	000A to 0011
	4)	0	0000
	5)	34	0022
	-	-	-
 <p>The screenshot shows the 'A68AD Input/Output Monitor Screen'. It displays two columns: 'Inputs (X)' and 'Outputs (Y)'. Each column lists hexadecimal addresses from 00 to 0F. The 'Inputs (X)' column shows '00 WDT Error' and '01 READY'. The 'Outputs (Y)' column shows '00' through '0F'.</p>	1)	-	-
		-	-
 <p>The screenshot shows the 'A68AD Graph Monitor Screen'. It displays a horizontal bar chart titled 'Input [%]' for 'Channel 1' through 'Channel 8'. The x-axis ranges from 0 to 100. Channel 1 has a value of 50. Channel 2 is approximately 75, Channel 3 is approximately 60, Channel 4 is approximately 85, Channel 5 is approximately 70, Channel 6 is approximately 75, Channel 7 is approximately 75, and Channel 8 is approximately 75. A red square icon labeled 'WDT Error' is shown at the bottom right.</p>	1)	10 to 17	000A to 0011
	2)	-	-
	-	-	-

6.5.3 A68ADN module monitoring

Screen example	No.	Buffer memory address																																														
		DEC	HEX																																													
<p>A68ADN Operation Monitor Screen</p> <p>Channel Setting: 87654321, 0000011010100100 0:Disabled 1:Enabled</p> <p>Sample/Average: 87654321, 000010011000100 0:Sampling 1:Averaging 0:Count Average 1:Time Average</p> <table border="1"> <thead> <tr> <th>Channel</th> <th>Count/Time Value</th> <th>Input Status [%] Resolution 1</th> <th>Input Status [%] Resolution 2</th> <th>Input Status [%] Resolution 3</th> </tr> </thead> <tbody> <tr><td>Channel 1</td><td>0</td><td>0.0</td><td>0.0</td><td>0.0</td></tr> <tr><td>Channel 2</td><td>0</td><td>0.0</td><td>0.0</td><td>0.0</td></tr> <tr><td>Channel 3</td><td>0</td><td>0.0</td><td>0.0</td><td>0.0</td></tr> <tr><td>Channel 4</td><td>0</td><td>0.0</td><td>0.0</td><td>0.0</td></tr> <tr><td>Channel 5</td><td>3</td><td>0.0</td><td>4</td><td>0.0</td></tr> <tr><td>Channel 6</td><td>0</td><td>0.0</td><td>0.0</td><td>0.0</td></tr> <tr><td>Channel 7</td><td>0</td><td>0.0</td><td>0.0</td><td>0.0</td></tr> <tr><td>Channel 8</td><td>0</td><td>0.0</td><td>0.0</td><td>0.0</td></tr> </tbody> </table> <p>Error Code: 0 Resolution Selection 0 [1:1/4000,2:1/8000,3:1/12000]</p>	Channel	Count/Time Value	Input Status [%] Resolution 1	Input Status [%] Resolution 2	Input Status [%] Resolution 3	Channel 1	0	0.0	0.0	0.0	Channel 2	0	0.0	0.0	0.0	Channel 3	0	0.0	0.0	0.0	Channel 4	0	0.0	0.0	0.0	Channel 5	3	0.0	4	0.0	Channel 6	0	0.0	0.0	0.0	Channel 7	0	0.0	0.0	0.0	Channel 8	0	0.0	0.0	0.0	1)	0	0000
	Channel	Count/Time Value	Input Status [%] Resolution 1	Input Status [%] Resolution 2	Input Status [%] Resolution 3																																											
	Channel 1	0	0.0	0.0	0.0																																											
	Channel 2	0	0.0	0.0	0.0																																											
	Channel 3	0	0.0	0.0	0.0																																											
	Channel 4	0	0.0	0.0	0.0																																											
Channel 5	3	0.0	4	0.0																																												
Channel 6	0	0.0	0.0	0.0																																												
Channel 7	0	0.0	0.0	0.0																																												
Channel 8	0	0.0	0.0	0.0																																												
2)	1	0001																																														
3)	2 to 9	0002 to 0009																																														
4)	10 to 17	000A to 0011																																														
5)	18	0012																																														
6)	20	0014																																														
	-	-	-																																													
<p>A68ADN Input/Output Monitor Screen</p> <table border="1"> <thead> <tr> <th>Inputs (X)</th> <th>Outputs (Y)</th> </tr> </thead> <tbody> <tr><td>00 WDT Error</td><td>00</td></tr> <tr><td>01 READY</td><td>01</td></tr> <tr><td>02 Error</td><td>02 Error Reset</td></tr> <tr><td>03</td><td>03</td></tr> <tr><td>04</td><td>04</td></tr> <tr><td>05</td><td>05</td></tr> <tr><td>06</td><td>06</td></tr> <tr><td>07</td><td>07</td></tr> <tr><td>08</td><td>08</td></tr> <tr><td>09</td><td>09</td></tr> <tr><td>0A</td><td>0A</td></tr> <tr><td>0B</td><td>0B</td></tr> <tr><td>0C</td><td>0C</td></tr> <tr><td>0D</td><td>0D</td></tr> <tr><td>0E</td><td>0E</td></tr> <tr><td>0F</td><td>0F</td></tr> </tbody> </table>	Inputs (X)	Outputs (Y)	00 WDT Error	00	01 READY	01	02 Error	02 Error Reset	03	03	04	04	05	05	06	06	07	07	08	08	09	09	0A	0A	0B	0B	0C	0C	0D	0D	0E	0E	0F	0F	1)	-	-											
	Inputs (X)	Outputs (Y)																																														
	00 WDT Error	00																																														
	01 READY	01																																														
	02 Error	02 Error Reset																																														
03	03																																															
04	04																																															
05	05																																															
06	06																																															
07	07																																															
08	08																																															
09	09																																															
0A	0A																																															
0B	0B																																															
0C	0C																																															
0D	0D																																															
0E	0E																																															
0F	0F																																															
	-	-	-																																													
<p>A68ADN Graph Monitor Screen</p> <table border="1"> <thead> <tr> <th>Resolution Selection</th> <th>1</th> <th>2</th> <th>3</th> </tr> </thead> <tbody> <tr> <td>Channel 1</td> <td>~80%</td> <td>~80%</td> <td>~80%</td> </tr> <tr> <td>Channel 2</td> <td>~50%</td> <td>~50%</td> <td>~50%</td> </tr> <tr> <td>Channel 3</td> <td>~50%</td> <td>~50%</td> <td>~50%</td> </tr> <tr> <td>Channel 4</td> <td>~50%</td> <td>~50%</td> <td>~50%</td> </tr> <tr> <td>Channel 5</td> <td>~50%</td> <td>~50%</td> <td>~50%</td> </tr> <tr> <td>Channel 6</td> <td>~50%</td> <td>~50%</td> <td>~50%</td> </tr> <tr> <td>Channel 7</td> <td>~50%</td> <td>~50%</td> <td>~50%</td> </tr> <tr> <td>Channel 8</td> <td>~50%</td> <td>~50%</td> <td>~50%</td> </tr> </tbody> </table> <p>Resolution Selection 0 Error WDT Error</p>	Resolution Selection	1	2	3	Channel 1	~80%	~80%	~80%	Channel 2	~50%	~50%	~50%	Channel 3	~50%	~50%	~50%	Channel 4	~50%	~50%	~50%	Channel 5	~50%	~50%	~50%	Channel 6	~50%	~50%	~50%	Channel 7	~50%	~50%	~50%	Channel 8	~50%	~50%	~50%	1)	10 to 17	000A to 0011									
	Resolution Selection	1	2	3																																												
	Channel 1	~80%	~80%	~80%																																												
	Channel 2	~50%	~50%	~50%																																												
Channel 3	~50%	~50%	~50%																																													
Channel 4	~50%	~50%	~50%																																													
Channel 5	~50%	~50%	~50%																																													
Channel 6	~50%	~50%	~50%																																													
Channel 7	~50%	~50%	~50%																																													
Channel 8	~50%	~50%	~50%																																													
2)	20	0014																																														
3)	-	-																																														
4)	-	-																																														
	-	-	-																																													

1 OVERVIEW
2 SYSTEM MONITOR
3 LADDER MONITOR FUNCTION
4 MELSEC-A LIST EDITOR
5 MELSEC-FX LIST EDITOR
6 INTELLIGENT MODULE MONITOR
7 NETWORK MONITOR
8 Q MOTION MONITOR

6.5.4 A68RD module monitoring

Screen example	No.	Buffer memory address																																			
		DEC	HEX																																		
<p>A68RD Operation Monitor Screen</p> <table border="1"> <thead> <tr> <th>Temp. Value (16 bits)</th> <th>Temp. Value (32 bits)</th> <th>Time/Count</th> <th>Disabled/Enabled</th> </tr> </thead> <tbody> <tr> <td>1) 0.0</td> <td>2) 0.000</td> <td>3) 0</td> <td>87654321 0000000000000001</td> </tr> <tr> <td>0.0</td> <td>0.000</td> <td>1</td> <td>1: Enabled 0: Disabled</td> </tr> <tr> <td>0.0</td> <td>0.000</td> <td>0</td> <td>Conversion 87654321 0000000000000001</td> </tr> <tr> <td>0.0</td> <td>0.000</td> <td>0</td> <td>1: Completed 0: Not Completed</td> </tr> <tr> <td>0.0</td> <td>0.000</td> <td>0</td> <td>Average/Sample Time/Count 8765432187654321 0000000000000000</td> </tr> <tr> <td>0.0</td> <td>0.000</td> <td>1</td> <td>1: Averaging 1: Time Average 0: Sampling 0: Count Average</td> </tr> <tr> <td>0.0</td> <td>0.000</td> <td>0</td> <td>CH1 disconn. CH5 disconn. CH2 disconn. CH6 disconn. CH3 disconn. CH7 disconn. CH4 disconn. CH8 disconn.</td> </tr> </tbody> </table> <p>WDT Error: Error Code: 100 Temp. Sensor Type 0 0:New JIS,DIN 1:01d JIS</p>	Temp. Value (16 bits)	Temp. Value (32 bits)	Time/Count	Disabled/Enabled	1) 0.0	2) 0.000	3) 0	87654321 0000000000000001	0.0	0.000	1	1: Enabled 0: Disabled	0.0	0.000	0	Conversion 87654321 0000000000000001	0.0	0.000	0	1: Completed 0: Not Completed	0.0	0.000	0	Average/Sample Time/Count 8765432187654321 0000000000000000	0.0	0.000	1	1: Averaging 1: Time Average 0: Sampling 0: Count Average	0.0	0.000	0	CH1 disconn. CH5 disconn. CH2 disconn. CH6 disconn. CH3 disconn. CH7 disconn. CH4 disconn. CH8 disconn.	1)	10 to 17	000A to 0011		
	Temp. Value (16 bits)	Temp. Value (32 bits)	Time/Count	Disabled/Enabled																																	
	1) 0.0	2) 0.000	3) 0	87654321 0000000000000001																																	
	0.0	0.000	1	1: Enabled 0: Disabled																																	
	0.0	0.000	0	Conversion 87654321 0000000000000001																																	
	0.0	0.000	0	1: Completed 0: Not Completed																																	
	0.0	0.000	0	Average/Sample Time/Count 8765432187654321 0000000000000000																																	
	0.0	0.000	1	1: Averaging 1: Time Average 0: Sampling 0: Count Average																																	
	0.0	0.000	0	CH1 disconn. CH5 disconn. CH2 disconn. CH6 disconn. CH3 disconn. CH7 disconn. CH4 disconn. CH8 disconn.																																	
	2)	18 to 33	0012 to 0021																																		
3)	2 to 9	0002 to 0009																																			
4)	0	0000																																			
5)	35	0023																																			
6)	1	0001																																			
7)	-	-																																			
8)	34	0022																																			
9)	36	0024																																			
10)	-	-																																			
-	-	-	-																																		
<p>A68RD Input/Output Monitor Screen</p> <table border="1"> <thead> <tr> <th>Inputs (X)</th> <th>Outputs (Y)</th> </tr> </thead> <tbody> <tr> <td>00 WDT Error</td> <td>10</td> </tr> <tr> <td>01 READY</td> <td>11</td> </tr> <tr> <td>02 Write Data Error</td> <td>12 Error Reset</td> </tr> <tr> <td>03 CH1 Disconnected</td> <td>13</td> </tr> <tr> <td>04 CH2 Disconnected</td> <td>14</td> </tr> <tr> <td>05 CH3 Disconnected</td> <td>15</td> </tr> <tr> <td>06 CH4 Disconnected</td> <td>16</td> </tr> <tr> <td>07 CH5 Disconnected</td> <td>17</td> </tr> <tr> <td>08 CH6 Disconnected</td> <td>18</td> </tr> <tr> <td>09 CH7 Disconnected</td> <td>19</td> </tr> <tr> <td>0A CH8 Disconnected</td> <td>1A</td> </tr> <tr> <td>0B</td> <td>1B</td> </tr> <tr> <td>0C</td> <td>1C</td> </tr> <tr> <td>0D</td> <td>1D</td> </tr> <tr> <td>0E</td> <td>1E</td> </tr> <tr> <td>0F</td> <td>1F</td> </tr> </tbody> </table>	Inputs (X)	Outputs (Y)	00 WDT Error	10	01 READY	11	02 Write Data Error	12 Error Reset	03 CH1 Disconnected	13	04 CH2 Disconnected	14	05 CH3 Disconnected	15	06 CH4 Disconnected	16	07 CH5 Disconnected	17	08 CH6 Disconnected	18	09 CH7 Disconnected	19	0A CH8 Disconnected	1A	0B	1B	0C	1C	0D	1D	0E	1E	0F	1F	1)	-	-
	Inputs (X)	Outputs (Y)																																			
00 WDT Error	10																																				
01 READY	11																																				
02 Write Data Error	12 Error Reset																																				
03 CH1 Disconnected	13																																				
04 CH2 Disconnected	14																																				
05 CH3 Disconnected	15																																				
06 CH4 Disconnected	16																																				
07 CH5 Disconnected	17																																				
08 CH6 Disconnected	18																																				
09 CH7 Disconnected	19																																				
0A CH8 Disconnected	1A																																				
0B	1B																																				
0C	1C																																				
0D	1D																																				
0E	1E																																				
0F	1F																																				
-	-	-	-																																		
<p>A68RD Graph Monitor Screen</p> <table border="1"> <thead> <tr> <th>Sample/Average</th> <th>Count/Time</th> </tr> </thead> <tbody> <tr> <td>8765432187654321</td> <td>87654321</td> </tr> <tr> <td>0000000000000000</td> <td>0000000000000000</td> </tr> </tbody> </table> <p>1: Averaging 1: Time Average 0: Sampling 0: Count Average</p> <p>CH1 disconn. CH5 disconn. CH2 disconn. CH6 disconn. CH3 disconn. CH7 disconn. CH4 disconn. CH8 disconn.</p> <p>WDT Error: Error Code: 100 Temp. Sensor Type 0 0:New JIS,DIN 1:01d JIS</p>	Sample/Average	Count/Time	8765432187654321	87654321	0000000000000000	0000000000000000	1)	10 to 17	000A to 0011																												
	Sample/Average	Count/Time																																			
	8765432187654321	87654321																																			
	0000000000000000	0000000000000000																																			
	2)	0	0000																																		
	3)	35	0023																																		
	4)	1	0001																																		
5)	-	-																																			
6)	34	0022																																			
7)	36	0024																																			
-	-	-	-																																		

6.5.5 A84AD module monitoring

Screen example	No.	Buffer memory address																																																																																																																																									
		DEC	HEX																																																																																																																																								
<p>A84AD Operation Monitor Screen</p> <table border="1"> <thead> <tr> <th></th> <th>Input/Output Status [%]</th> <th>Temp. Value [C]</th> <th>Module Code</th> <th>O/P Over</th> <th>O/P Under</th> </tr> </thead> <tbody> <tr> <td>Channel 1</td> <td>0.0</td> <td>50.0</td> <td>0</td> <td>0</td> <td>0</td> </tr> <tr> <td>Channel 2</td> <td>0.0</td> <td>50.0</td> <td>0</td> <td>0</td> <td>0</td> </tr> <tr> <td>Channel 3</td> <td>0.0</td> <td>50.0</td> <td>0</td> <td>0</td> <td>0</td> </tr> <tr> <td>Channel 4</td> <td>0.0</td> <td>50.0</td> <td>0</td> <td>0</td> <td>0</td> </tr> <tr> <td>Loaded Module Code</td> <td>02,04,05,10,12,13,14,15,18,1A,1C,1E,1F</td> <td>06,07,16,17</td> <td>18,1A,1C,1E,1F</td> <td>Writing Data Error CH:0</td> <td>Error Code:0</td> </tr> <tr> <td>Channel</td> <td colspan="4">4321</td> <td> <input type="checkbox"/> WDT Error <input type="checkbox"/> Module 1 Fault <input type="checkbox"/> Module 2 Fault <input type="checkbox"/> Module 3 Fault <input type="checkbox"/> Module 4 Fault </td> </tr> <tr> <td>O/P Enable Valid</td> <td colspan="4">○○○○○○○○○○○○○○○○○○○○</td> <td></td> </tr> <tr> <td>O/P Enabled</td> <td colspan="4">0 0 0 0</td> <td></td> </tr> </tbody> </table>		Input/Output Status [%]	Temp. Value [C]	Module Code	O/P Over	O/P Under	Channel 1	0.0	50.0	0	0	0	Channel 2	0.0	50.0	0	0	0	Channel 3	0.0	50.0	0	0	0	Channel 4	0.0	50.0	0	0	0	Loaded Module Code	02,04,05,10,12,13,14,15,18,1A,1C,1E,1F	06,07,16,17	18,1A,1C,1E,1F	Writing Data Error CH:0	Error Code:0	Channel	4321				<input type="checkbox"/> WDT Error <input type="checkbox"/> Module 1 Fault <input type="checkbox"/> Module 2 Fault <input type="checkbox"/> Module 3 Fault <input type="checkbox"/> Module 4 Fault	O/P Enable Valid	○○○○○○○○○○○○○○○○○○○○					O/P Enabled	0 0 0 0					1)	10 to 13	000A to 000D																																																																																		
		Input/Output Status [%]	Temp. Value [C]	Module Code	O/P Over	O/P Under																																																																																																																																					
	Channel 1	0.0	50.0	0	0	0																																																																																																																																					
	Channel 2	0.0	50.0	0	0	0																																																																																																																																					
	Channel 3	0.0	50.0	0	0	0																																																																																																																																					
	Channel 4	0.0	50.0	0	0	0																																																																																																																																					
	Loaded Module Code	02,04,05,10,12,13,14,15,18,1A,1C,1E,1F	06,07,16,17	18,1A,1C,1E,1F	Writing Data Error CH:0	Error Code:0																																																																																																																																					
	Channel	4321				<input type="checkbox"/> WDT Error <input type="checkbox"/> Module 1 Fault <input type="checkbox"/> Module 2 Fault <input type="checkbox"/> Module 3 Fault <input type="checkbox"/> Module 4 Fault																																																																																																																																					
	O/P Enable Valid	○○○○○○○○○○○○○○○○○○○○																																																																																																																																									
O/P Enabled	0 0 0 0																																																																																																																																										
	2)	18 to 21	0012 to 0015																																																																																																																																								
	3)	28 to 31	001C to 001F																																																																																																																																								
	4)	22 to 25	0016 to 0019																																																																																																																																								
	5)	22 to 25	0016 to 0019																																																																																																																																								
	6)	26	001A																																																																																																																																								
	7)	27	001B																																																																																																																																								
	8)	-	-																																																																																																																																								
	9)	-	-																																																																																																																																								
	-	-	-																																																																																																																																								
<p>A84AD Setting Monitor Screen</p> <table border="1"> <thead> <tr> <th colspan="2">Processing Mode</th> <th rowspan="2">Count/Time</th> <th rowspan="2">Offset [%]</th> <th rowspan="2">Gain [%]</th> </tr> <tr> <th>Sample/Average</th> <th>Count/Time</th> </tr> </thead> <tbody> <tr> <td>CH</td> <td>4321</td> <td>4321</td> <td>0</td> <td>0</td> </tr> <tr> <td>0: Sampling</td> <td>0: Count Average</td> <td>0</td> <td>0</td> <td>0</td> </tr> <tr> <td>1: Averaging</td> <td>1: Time Average</td> <td>0</td> <td>0</td> <td>0</td> </tr> </tbody> </table>	Processing Mode		Count/Time	Offset [%]	Gain [%]	Sample/Average	Count/Time	CH	4321	4321	0	0	0: Sampling	0: Count Average	0	0	0	1: Averaging	1: Time Average	0	0	0	1)	1	0001																																																																																																																		
	Processing Mode					Count/Time	Offset [%]	Gain [%]																																																																																																																																			
	Sample/Average	Count/Time																																																																																																																																									
	CH	4321	4321	0	0																																																																																																																																						
0: Sampling	0: Count Average	0	0	0																																																																																																																																							
1: Averaging	1: Time Average	0	0	0																																																																																																																																							
	2)	2 to 5	0002 to 0005																																																																																																																																								
	3)	32, 34, 36, 38	0020, 0022, 0024, 0026																																																																																																																																								
	4)	33, 35, 37, 39	0021, 0023, 0025, 0027																																																																																																																																								
	-	-	-																																																																																																																																								
<p>A84AD Input/Output Monitor Screen</p> <table border="1"> <thead> <tr> <th colspan="4">Inputs (X)</th> <th colspan="4">Outputs (Y)</th> </tr> </thead> <tbody> <tr> <td>00</td><td>10</td><td>WDT Error</td><td>20</td> <td>00</td><td>10</td><td>20</td><td>CH1 Enabled</td> </tr> <tr> <td>01</td><td>11</td><td>READY</td><td>21</td> <td>01</td><td>11</td><td>21</td><td>CH2 Enabled</td> </tr> <tr> <td>02</td><td>12</td><td>CH1 Mod. Fault</td><td>22</td> <td>02</td><td>12</td><td>22</td><td>CH3 Enabled</td> </tr> <tr> <td>03</td><td>13</td><td>CH2 Mod. Fault</td><td>23</td> <td>03</td><td>13</td><td>23</td><td>CH4 Enabled</td> </tr> <tr> <td>04</td><td>14</td><td>CH3 Mod. Fault</td><td>24</td> <td>04</td><td>14</td><td>24</td><td></td> </tr> <tr> <td>05</td><td>15</td><td>CH4 Mod. Fault</td><td>25</td> <td>05</td><td>15</td><td>25</td><td></td> </tr> <tr> <td>06</td><td>16</td><td></td><td>26</td> <td>06</td><td>16</td><td>26</td><td></td> </tr> <tr> <td>07</td><td>17</td><td></td><td>27</td> <td>07</td><td>17</td><td>27</td><td></td> </tr> <tr> <td>08</td><td>18</td><td></td><td>28</td> <td>08</td><td>18</td><td>28</td><td></td> </tr> <tr> <td>09</td><td>19</td><td></td><td>29</td> <td>09</td><td>19</td><td>29</td><td></td> </tr> <tr> <td>0A</td><td>1A</td><td></td><td>2A</td> <td>0A</td><td>1A</td><td>2A</td><td></td> </tr> <tr> <td>0B</td><td>1B</td><td></td><td>2B</td> <td>0B</td><td>1B</td><td>2B</td><td></td> </tr> <tr> <td>0C</td><td>1C</td><td></td><td>2C</td> <td>0C</td><td>1C</td><td>2C</td><td></td> </tr> <tr> <td>0D</td><td>1D</td><td></td><td>2D</td> <td>0D</td><td>1D</td><td>2D</td><td></td> </tr> <tr> <td>0E</td><td>1E</td><td></td><td>2E</td> <td>0E</td><td>1E</td><td>2E</td><td></td> </tr> <tr> <td>0F</td><td>1F</td><td></td><td>2F</td> <td>0F</td><td>1F</td><td>2F</td><td></td> </tr> </tbody> </table>	Inputs (X)				Outputs (Y)				00	10	WDT Error	20	00	10	20	CH1 Enabled	01	11	READY	21	01	11	21	CH2 Enabled	02	12	CH1 Mod. Fault	22	02	12	22	CH3 Enabled	03	13	CH2 Mod. Fault	23	03	13	23	CH4 Enabled	04	14	CH3 Mod. Fault	24	04	14	24		05	15	CH4 Mod. Fault	25	05	15	25		06	16		26	06	16	26		07	17		27	07	17	27		08	18		28	08	18	28		09	19		29	09	19	29		0A	1A		2A	0A	1A	2A		0B	1B		2B	0B	1B	2B		0C	1C		2C	0C	1C	2C		0D	1D		2D	0D	1D	2D		0E	1E		2E	0E	1E	2E		0F	1F		2F	0F	1F	2F		1)	-	-
	Inputs (X)				Outputs (Y)																																																																																																																																						
00	10	WDT Error	20	00	10	20	CH1 Enabled																																																																																																																																				
01	11	READY	21	01	11	21	CH2 Enabled																																																																																																																																				
02	12	CH1 Mod. Fault	22	02	12	22	CH3 Enabled																																																																																																																																				
03	13	CH2 Mod. Fault	23	03	13	23	CH4 Enabled																																																																																																																																				
04	14	CH3 Mod. Fault	24	04	14	24																																																																																																																																					
05	15	CH4 Mod. Fault	25	05	15	25																																																																																																																																					
06	16		26	06	16	26																																																																																																																																					
07	17		27	07	17	27																																																																																																																																					
08	18		28	08	18	28																																																																																																																																					
09	19		29	09	19	29																																																																																																																																					
0A	1A		2A	0A	1A	2A																																																																																																																																					
0B	1B		2B	0B	1B	2B																																																																																																																																					
0C	1C		2C	0C	1C	2C																																																																																																																																					
0D	1D		2D	0D	1D	2D																																																																																																																																					
0E	1E		2E	0E	1E	2E																																																																																																																																					
0F	1F		2F	0F	1F	2F																																																																																																																																					
	-	-	-																																																																																																																																								

1 OVERVIEW
2 SYSTEM MONITOR
3 LADDER MONITOR FUNCTION
4 MELSEC-A LIST EDITOR
5 MELSEC-FX LIST EDITOR
6 INTELLIGENT MODULE MONITOR
7 NETWORK MONITOR
8 Q MOTION MONITOR

Screen example		No.	Buffer memory address	
			DEC	HEX
<p>1) - Points to the bar chart area.</p> <p>2) - Points to the Temp. Value [C] column in the table.</p> <p>3) - Points to the Module Code column in the table.</p> <p>4) - Points to the O/P Enable Valid and Enabled status indicators.</p> <p>5) - Points to the legend for WDT Error and Module Faults.</p>	1)	10 to 13	000A to 000D	
	2)	18 to 21	0012 to 0015	
	3)	28 to 31	001C to 001F	
	4)	27	001B	
	5)	-	-	
	-	-	-	

6.5.6 A616AD module monitoring

Screen example	No.	Buffer memory address																																																																	
		DEC	HEX																																																																
<p>1) Enable FEDCBA9876543210 0000000000000000 0: Disabled 1: Enabled</p> <p>2) Data Format FEDCBA9876543210 Setting 0000000000000000</p> <p>Error Code 0</p> <p>Error FEDCBA9876543210 CNT No. 0000000000000000</p> <p>Sampling time 0 ms</p> <p>Input Status [%] For Data Format 0: Refer to left hand side values. Format 1: Refer to right hand side values.</p> <table border="1"> <tr><td>CH 0</td><td>0.0</td><td>0.0</td><td>CH 8</td><td>0.0</td><td>0.0</td></tr> <tr><td>CH 1</td><td>0.0</td><td>0.0</td><td>CH 9</td><td>0.0</td><td>0.0</td></tr> <tr><td>CH 2</td><td>0.0</td><td>0.0</td><td>CH A</td><td>0.0</td><td>0.0</td></tr> <tr><td>CH 3</td><td>0.0</td><td>0.0</td><td>CH B</td><td>0.0</td><td>0.0</td></tr> <tr><td>CH 4</td><td>0.0</td><td>0.0</td><td>CH C</td><td>0.0</td><td>0.0</td></tr> <tr><td>CH 5</td><td>0.0</td><td>0.0</td><td>CH D</td><td>0.0</td><td>0.0</td></tr> <tr><td>CH 6</td><td>0.0</td><td>0.0</td><td>CH E</td><td>0.0</td><td>0.0</td></tr> <tr><td>CH 7</td><td>0.0</td><td>0.0</td><td>CH F</td><td>0.0</td><td>0.0</td></tr> </table> <p>Direct Access INPUT CH:4 MX CH:4 I/P: 0.0 50.0</p> <p>7) 8)</p>	CH 0	0.0	0.0	CH 8	0.0	0.0	CH 1	0.0	0.0	CH 9	0.0	0.0	CH 2	0.0	0.0	CH A	0.0	0.0	CH 3	0.0	0.0	CH B	0.0	0.0	CH 4	0.0	0.0	CH C	0.0	0.0	CH 5	0.0	0.0	CH D	0.0	0.0	CH 6	0.0	0.0	CH E	0.0	0.0	CH 7	0.0	0.0	CH F	0.0	0.0	1)	15	000F																
	CH 0	0.0	0.0	CH 8	0.0	0.0																																																													
	CH 1	0.0	0.0	CH 9	0.0	0.0																																																													
	CH 2	0.0	0.0	CH A	0.0	0.0																																																													
	CH 3	0.0	0.0	CH B	0.0	0.0																																																													
	CH 4	0.0	0.0	CH C	0.0	0.0																																																													
	CH 5	0.0	0.0	CH D	0.0	0.0																																																													
	CH 6	0.0	0.0	CH E	0.0	0.0																																																													
CH 7	0.0	0.0	CH F	0.0	0.0																																																														
2)	4	0004																																																																	
3)	48 to 63	0030 to 003F																																																																	
4)	5	0005																																																																	
5)	6	0006																																																																	
6)	3	0003																																																																	
7)	0,1	0000, 0001																																																																	
8)	2	0002																																																																	
<p>1) Enable FEDCBA9876543210 0000000000000000 0: Disabled 1: Enabled</p> <p>2) Data Format # Setting 0000000000000000</p> <p>Error Code 0</p> <p>Error FEDCBA9876543210 CNT No. 0000000000000000</p> <p>Sampling time 0 ms</p> <p>Input Status [%] For Data Format 0: Refer to left hand side values. Format 1: Refer to right hand side values.</p> <table border="1"> <tr><td>CH 0</td><td>0.0</td><td>0.0</td><td>CH 8</td><td>0.0</td><td>0.0</td></tr> <tr><td>CH 1</td><td>0.0</td><td>0.0</td><td>CH 9</td><td>0.0</td><td>0.0</td></tr> <tr><td>CH 2</td><td>0.0</td><td>0.0</td><td>CH A</td><td>0.0</td><td>0.0</td></tr> <tr><td>CH 3</td><td>0.0</td><td>0.0</td><td>CH B</td><td>0.0</td><td>0.0</td></tr> <tr><td>CH 4</td><td>0.0</td><td>0.0</td><td>CH C</td><td>0.0</td><td>0.0</td></tr> <tr><td>CH 5</td><td>0.0</td><td>0.0</td><td>CH D</td><td>0.0</td><td>0.0</td></tr> <tr><td>CH 6</td><td>0.0</td><td>0.0</td><td>CH E</td><td>0.0</td><td>0.0</td></tr> <tr><td>CH 7</td><td>0.0</td><td>0.0</td><td>CH F</td><td>0.0</td><td>0.0</td></tr> </table> <p>Direct Access INPUT CH:0 MX CH:0 I/P: 0.0 0.0</p> <p>7) 8) 9)</p>	CH 0	0.0	0.0	CH 8	0.0	0.0	CH 1	0.0	0.0	CH 9	0.0	0.0	CH 2	0.0	0.0	CH A	0.0	0.0	CH 3	0.0	0.0	CH B	0.0	0.0	CH 4	0.0	0.0	CH C	0.0	0.0	CH 5	0.0	0.0	CH D	0.0	0.0	CH 6	0.0	0.0	CH E	0.0	0.0	CH 7	0.0	0.0	CH F	0.0	0.0	1)	16 to 23	0010 to 0017																
	CH 0	0.0	0.0	CH 8	0.0	0.0																																																													
	CH 1	0.0	0.0	CH 9	0.0	0.0																																																													
	CH 2	0.0	0.0	CH A	0.0	0.0																																																													
	CH 3	0.0	0.0	CH B	0.0	0.0																																																													
	CH 4	0.0	0.0	CH C	0.0	0.0																																																													
	CH 5	0.0	0.0	CH D	0.0	0.0																																																													
	CH 6	0.0	0.0	CH E	0.0	0.0																																																													
	CH 7	0.0	0.0	CH F	0.0	0.0																																																													
2)	4	0004																																																																	
3)	256 to 383	0100 to 017F																																																																	
4)	5	0005																																																																	
5)	6	0006																																																																	
6)	3	0003																																																																	
7)	0	0000																																																																	
8)	1	0001																																																																	
9)	2	0002																																																																	
<p>1) Inputs (X) Outputs (Y)</p> <table border="1"> <tr><td>00 WDT Error</td><td>10</td><td>00</td><td>10</td></tr> <tr><td>01 READY</td><td>11</td><td>01</td><td>11</td></tr> <tr><td>02 Error</td><td>12</td><td>02</td><td>12</td></tr> <tr><td>03</td><td>13</td><td>03</td><td>13</td></tr> <tr><td>04</td><td>14</td><td>04</td><td>14</td></tr> <tr><td>05</td><td>15</td><td>05</td><td>15</td></tr> <tr><td>06</td><td>16</td><td>06</td><td>16</td></tr> <tr><td>07</td><td>17</td><td>07</td><td>17</td></tr> <tr><td>08</td><td>18</td><td>08</td><td>18 Direct Access</td></tr> <tr><td>09</td><td>19</td><td>09</td><td>19</td></tr> <tr><td>0A</td><td>1A</td><td>0A</td><td>1A</td></tr> <tr><td>0B</td><td>1B</td><td>0B</td><td>1B</td></tr> <tr><td>0C</td><td>1C</td><td>0C</td><td>1C</td></tr> <tr><td>0D</td><td>1D</td><td>0D</td><td>1D</td></tr> <tr><td>0E</td><td>1E</td><td>0E</td><td>1E</td></tr> <tr><td>0F</td><td>1F</td><td>0F</td><td>1F</td></tr> </table>	00 WDT Error	10	00	10	01 READY	11	01	11	02 Error	12	02	12	03	13	03	13	04	14	04	14	05	15	05	15	06	16	06	16	07	17	07	17	08	18	08	18 Direct Access	09	19	09	19	0A	1A	0A	1A	0B	1B	0B	1B	0C	1C	0C	1C	0D	1D	0D	1D	0E	1E	0E	1E	0F	1F	0F	1F	1)	-	-
00 WDT Error	10	00	10																																																																
01 READY	11	01	11																																																																
02 Error	12	02	12																																																																
03	13	03	13																																																																
04	14	04	14																																																																
05	15	05	15																																																																
06	16	06	16																																																																
07	17	07	17																																																																
08	18	08	18 Direct Access																																																																
09	19	09	19																																																																
0A	1A	0A	1A																																																																
0B	1B	0B	1B																																																																
0C	1C	0C	1C																																																																
0D	1D	0D	1D																																																																
0E	1E	0E	1E																																																																
0F	1F	0F	1F																																																																

1 OVERVIEW
2 SYSTEM MONITOR
3 LADDER MONITOR FUNCTION
4 MELSEC-A LIST EDITOR
5 MELSEC-FX LIST EDITOR
6 INTELLIGENT MODULE MONITOR
7 NETWORK MONITOR
8 Q MOTION MONITOR

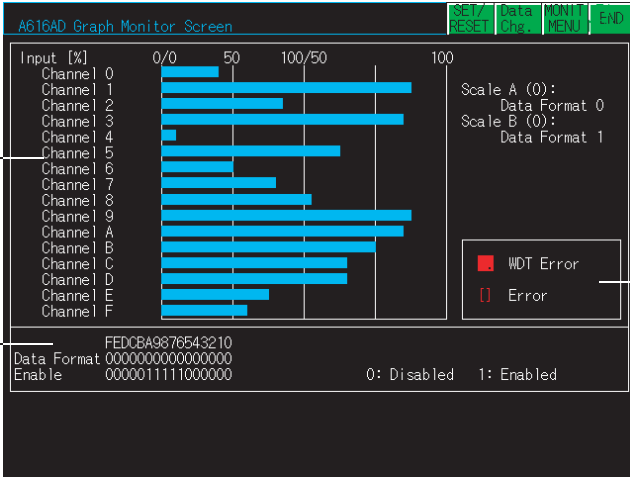
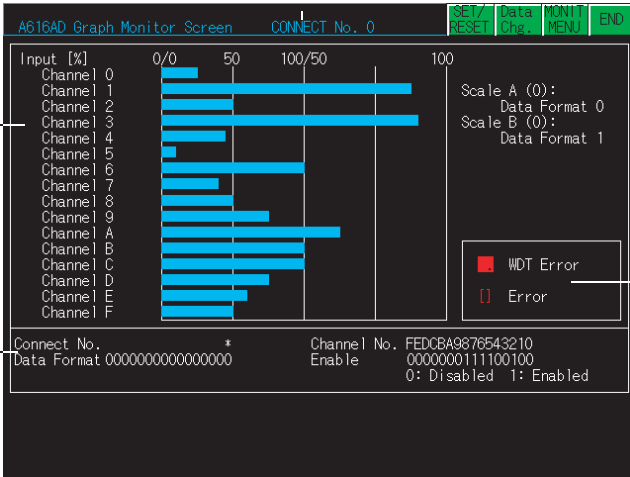
Screen example		No.	Buffer memory address	
			DEC	HEX
	1)	48 to 63	0030 to 003F	
	2)	-	-	
	3)	4 15	0004 000F	
-	-	-	-	
	1)	256 to 383	0100 to 017F	
	2)	-	-	
	3)	4 16 to 23	0004 0010 to 0017	
-	-	-	-	

6.5.7 A616TD module monitoring

Screen example	No.	Buffer memory address																																																																	
		DEC	HEX																																																																
<p>1) Channel No. FEDCBA9876543210 Conversion 0000011111000000 Enable 0: Disabled 1: Enabled</p> <p>2) Channel No. FEDCBA9876543210 Data Format 0000000000000000</p> <p>3) Error Code 18 4) Error FEDCBA9876543210 5) CNT No. 1111100000110000</p> <p>6) Input Status [%] For Data Format 0: Refer to left hand side values Format 1: Refer to right hand side values</p> <table border="1"> <tr><td>CH 0</td><td>0.0</td><td>50.0</td><td>CH 8</td><td>0.0</td><td>50.0</td></tr> <tr><td>CH 1</td><td>0.0</td><td>50.0</td><td>CH 9</td><td>0.0</td><td>50.0</td></tr> <tr><td>CH 2</td><td>0.0</td><td>50.0</td><td>CH A</td><td>0.0</td><td>50.0</td></tr> <tr><td>CH 3</td><td>0.0</td><td>50.0</td><td>CH B</td><td>0.0</td><td>50.0</td></tr> <tr><td>CH 4</td><td>0.0</td><td>50.0</td><td>CH C</td><td>0.0</td><td>50.0</td></tr> <tr><td>CH 5</td><td>0.0</td><td>50.0</td><td>CH D</td><td>0.0</td><td>50.0</td></tr> <tr><td>CH 6</td><td>0.0</td><td>50.0</td><td>CH E</td><td>0.0</td><td>50.0</td></tr> <tr><td>CH 7</td><td>0.0</td><td>50.0</td><td>CH F</td><td>0.0</td><td>50.0</td></tr> </table> <p>7) Digital Value Error 8) Temp. Values Error 9) Discontinuity Error</p>	CH 0	0.0	50.0	CH 8	0.0	50.0	CH 1	0.0	50.0	CH 9	0.0	50.0	CH 2	0.0	50.0	CH A	0.0	50.0	CH 3	0.0	50.0	CH B	0.0	50.0	CH 4	0.0	50.0	CH C	0.0	50.0	CH 5	0.0	50.0	CH D	0.0	50.0	CH 6	0.0	50.0	CH E	0.0	50.0	CH 7	0.0	50.0	CH F	0.0	50.0	1)	15	000F																
	CH 0	0.0	50.0	CH 8	0.0	50.0																																																													
	CH 1	0.0	50.0	CH 9	0.0	50.0																																																													
	CH 2	0.0	50.0	CH A	0.0	50.0																																																													
	CH 3	0.0	50.0	CH B	0.0	50.0																																																													
	CH 4	0.0	50.0	CH C	0.0	50.0																																																													
	CH 5	0.0	50.0	CH D	0.0	50.0																																																													
	CH 6	0.0	50.0	CH E	0.0	50.0																																																													
	CH 7	0.0	50.0	CH F	0.0	50.0																																																													
	2)	0	0000																																																																
	3)	1	0001																																																																
	4)	2	0002																																																																
	5)	4	0004																																																																
	6)	112 to 127	0070 to 007F																																																																
	7)	-	-																																																																
	8)	-	-																																																																
	9)	-	-																																																																
	-	-	-																																																																
<p>1) Channel No. FEDCBA9876543210 Conversion 0000000111110100 Enable 0: Disabled 1: Enabled</p> <p>2) Digital Value Err FEDCBA9876543210 Temp. Value Err 0000000000000000 Discontinuity Err 0000000000000000 3) Disc. Error Enable 0000000000000000 0:Normal/Disabled 1:Break/Enabled</p> <p>4) Input Status [%] Format 0 Format 1 Temp. Value [C] Input Status [%] Format 0 Format 1 Temp. Value [C]</p> <table border="1"> <tr><td>CH 0</td><td>0.0</td><td>50.0</td><td>0.0</td><td>CH 8</td><td>0.0</td><td>50.0</td><td>0.0</td></tr> <tr><td>CH 1</td><td>0.0</td><td>50.0</td><td>0.0</td><td>CH 9</td><td>0.0</td><td>50.0</td><td>0.0</td></tr> <tr><td>CH 2</td><td>0.0</td><td>50.0</td><td>0.0</td><td>CH A</td><td>0.0</td><td>50.0</td><td>0.0</td></tr> <tr><td>CH 3</td><td>0.0</td><td>50.0</td><td>0.0</td><td>CH B</td><td>0.0</td><td>50.0</td><td>0.0</td></tr> <tr><td>CH 4</td><td>0.0</td><td>50.0</td><td>0.0</td><td>CH C</td><td>0.0</td><td>50.0</td><td>0.0</td></tr> <tr><td>CH 5</td><td>0.0</td><td>50.0</td><td>0.0</td><td>CH D</td><td>0.0</td><td>50.0</td><td>0.0</td></tr> <tr><td>CH 6</td><td>0.0</td><td>50.0</td><td>0.0</td><td>CH E</td><td>0.0</td><td>50.0</td><td>0.0</td></tr> <tr><td>CH 7</td><td>0.0</td><td>50.0</td><td>0.0</td><td>CH F</td><td>0.0</td><td>50.0</td><td>0.0</td></tr> </table> <p>5) Digital Output/Temp. Value D=0: 0.0 C D=4000: 0.0 C 6) Error</p> <p>7) 8) 9) 10) 11)</p>	CH 0	0.0	50.0	0.0	CH 8	0.0	50.0	0.0	CH 1	0.0	50.0	0.0	CH 9	0.0	50.0	0.0	CH 2	0.0	50.0	0.0	CH A	0.0	50.0	0.0	CH 3	0.0	50.0	0.0	CH B	0.0	50.0	0.0	CH 4	0.0	50.0	0.0	CH C	0.0	50.0	0.0	CH 5	0.0	50.0	0.0	CH D	0.0	50.0	0.0	CH 6	0.0	50.0	0.0	CH E	0.0	50.0	0.0	CH 7	0.0	50.0	0.0	CH F	0.0	50.0	0.0	1)	-	-
	CH 0	0.0	50.0	0.0	CH 8	0.0	50.0	0.0																																																											
	CH 1	0.0	50.0	0.0	CH 9	0.0	50.0	0.0																																																											
	CH 2	0.0	50.0	0.0	CH A	0.0	50.0	0.0																																																											
	CH 3	0.0	50.0	0.0	CH B	0.0	50.0	0.0																																																											
	CH 4	0.0	50.0	0.0	CH C	0.0	50.0	0.0																																																											
	CH 5	0.0	50.0	0.0	CH D	0.0	50.0	0.0																																																											
	CH 6	0.0	50.0	0.0	CH E	0.0	50.0	0.0																																																											
	CH 7	0.0	50.0	0.0	CH F	0.0	50.0	0.0																																																											
		2)	16 to 23	0010 to 0017																																																															
		3)	0	0000																																																															
	4)	384 to 511	0180 to 01FF																																																																
	5)	80 to 87	0050 to 0057																																																																
	6)	96 to 103	0060 to 0067																																																																
	7)	64 to 71	0040 to 0047																																																																
	8)	32 to 39	0020 to 0027																																																																
	9)	512 to 639	0200 to 027F																																																																
	10)	48 to 63	0030 to 003F																																																																
	11)	-	-																																																																
	-	-	-																																																																
<p>1) Inputs (X) Outputs (Y)</p> <table border="1"> <tr><td>00 WDT Error</td><td>10</td><td>00</td><td>10 LED Display</td></tr> <tr><td>01 READY</td><td>11</td><td>01</td><td>11</td></tr> <tr><td>02 Error</td><td>12</td><td>02</td><td>12</td></tr> <tr><td>03 Discon. Error</td><td>13</td><td>03</td><td>13</td></tr> <tr><td>04 Digital Error</td><td>14</td><td>04</td><td>14</td></tr> <tr><td>05 Temp. Error</td><td>15</td><td>05</td><td>15</td></tr> <tr><td>06</td><td>16</td><td>06</td><td>16</td></tr> <tr><td>07</td><td>17</td><td>07</td><td>17</td></tr> <tr><td>08</td><td>18</td><td>08</td><td>18</td></tr> <tr><td>09</td><td>19</td><td>09</td><td>19</td></tr> <tr><td>0A</td><td>1A</td><td>0A</td><td>1A</td></tr> <tr><td>0B</td><td>1B</td><td>0B</td><td>1B</td></tr> <tr><td>0C</td><td>1C</td><td>0C</td><td>1C</td></tr> <tr><td>0D</td><td>1D</td><td>0D</td><td>1D</td></tr> <tr><td>0E</td><td>1E</td><td>0E</td><td>1E</td></tr> <tr><td>0F</td><td>1F</td><td>0F</td><td>1F</td></tr> </table>	00 WDT Error	10	00	10 LED Display	01 READY	11	01	11	02 Error	12	02	12	03 Discon. Error	13	03	13	04 Digital Error	14	04	14	05 Temp. Error	15	05	15	06	16	06	16	07	17	07	17	08	18	08	18	09	19	09	19	0A	1A	0A	1A	0B	1B	0B	1B	0C	1C	0C	1C	0D	1D	0D	1D	0E	1E	0E	1E	0F	1F	0F	1F	1)	-	-
00 WDT Error	10	00	10 LED Display																																																																
01 READY	11	01	11																																																																
02 Error	12	02	12																																																																
03 Discon. Error	13	03	13																																																																
04 Digital Error	14	04	14																																																																
05 Temp. Error	15	05	15																																																																
06	16	06	16																																																																
07	17	07	17																																																																
08	18	08	18																																																																
09	19	09	19																																																																
0A	1A	0A	1A																																																																
0B	1B	0B	1B																																																																
0C	1C	0C	1C																																																																
0D	1D	0D	1D																																																																
0E	1E	0E	1E																																																																
0F	1F	0F	1F																																																																
	-	-	-																																																																

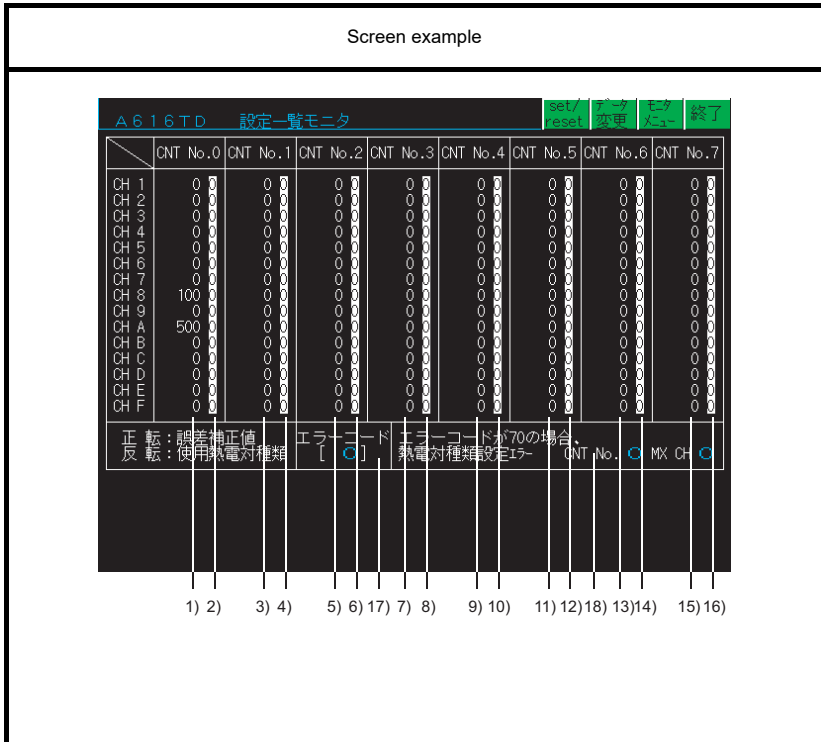

No.	Buffer memory address	
	DEC	HEX
1)	129 to 143	0081 to 008F
2)	257 to 271	0101 to 010F
3)	145 to 159	0091 to 009F
4)	273 to 287	0111 to 011F
5)	161 to 175	00A1 to 00AF
6)	289 to 303	0121 to 012F
7)	177 to 191	00B1 to 00BF
8)	305 to 319	0131 to 013F
9)	193 to 207	00C1 to 00CF
10)	321 to 335	0141 to 014F
11)	209 to 223	00D1 to 00DF
12)	337 to 351	0151 to 015F
13)	225 to 239	00E1 to 00EF
14)	353 to 367	0161 to 016F
15)	241 to 255	00F1 to 00FF
16)	369 to 383	0171 to 017F
17)	1	0001
18)	3	0003
-	-	-

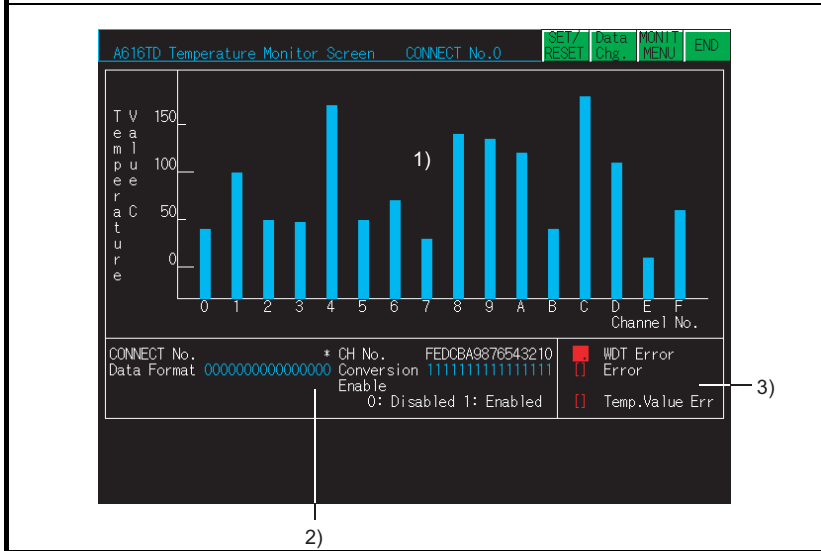

1)	512 to 639	0200 to 027F
2)	0	0000
3)	16 to 23	0010 to 0017
-	-	-

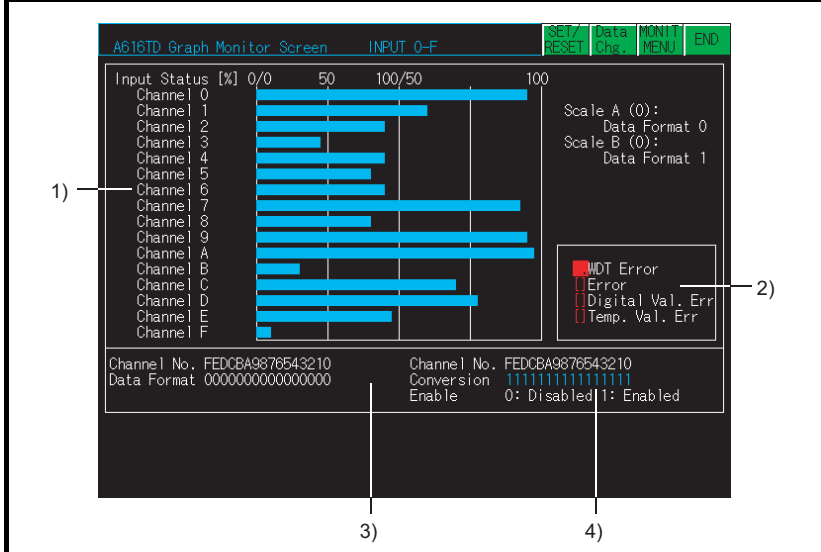

1)	112 to 127	0070 to 007F
2)	-	-
3)	0	0000
4)	15	000F
-	-	-

Screen example	No.	Buffer memory address	
		DEC	HEX
	1)	384 to 511	0180 to 01FF
	2)	512 to 639	0200 to 027F
	3)	-	-
	4)	0 16 to 23	0000 0010 to 0017
	-	-	-

- 1
OVERVIEW
- 2
SYSTEM MONITOR
- 3
LADDER MONITOR
FUNCTION
- 4
MELSEC-A LIST
EDITOR
- 5
MELSEC-FX LIST
EDITOR
- 6
INTELLIGENT
MODULE MONITOR
- 7
NETWORK
MONITOR
- 8
Q MOTION
MONITOR

6.5.8 A616DAV, A616DAI module monitoring

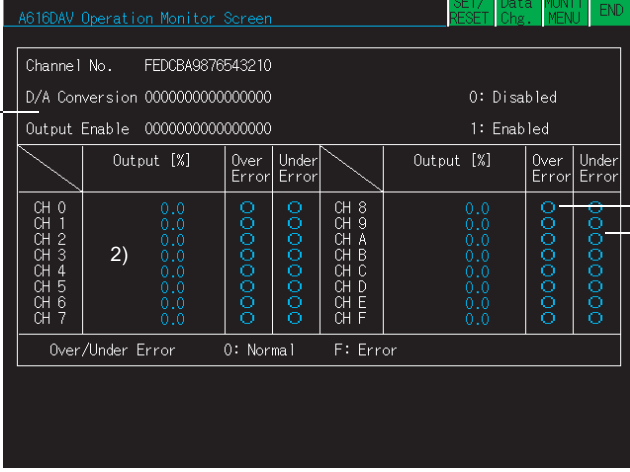
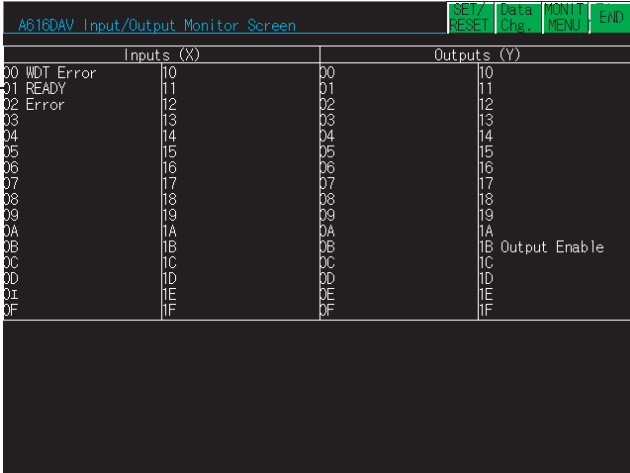
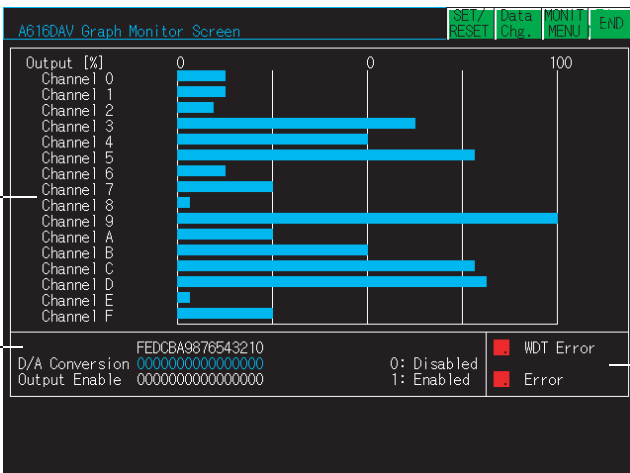
Screen example	No.	Buffer memory address																																																																									
		DEC	HEX																																																																								
 <p>1) Channel No. FEDCBA9876543210 D/A Conversion 0000000000000000 0: Disabled Output Enable 0000000000000000 1: Enabled</p> <table border="1"> <thead> <tr> <th></th> <th>Output [%]</th> <th>Over Error</th> <th>Under Error</th> <th></th> <th>Output [%]</th> <th>Over Error</th> <th>Under Error</th> </tr> </thead> <tbody> <tr><td>CH 0</td><td>0.0</td><td>○</td><td>○</td><td>CH 8</td><td>0.0</td><td>○</td><td>○</td></tr> <tr><td>CH 1</td><td>0.0</td><td>○</td><td>○</td><td>CH 9</td><td>0.0</td><td>○</td><td>○</td></tr> <tr><td>CH 2</td><td>0.0</td><td>○</td><td>○</td><td>CH A</td><td>0.0</td><td>○</td><td>○</td></tr> <tr><td>CH 3</td><td>0.0</td><td>○</td><td>○</td><td>CH B</td><td>0.0</td><td>○</td><td>○</td></tr> <tr><td>CH 4</td><td>0.0</td><td>○</td><td>○</td><td>CH C</td><td>0.0</td><td>○</td><td>○</td></tr> <tr><td>CH 5</td><td>0.0</td><td>○</td><td>○</td><td>CH D</td><td>0.0</td><td>○</td><td>○</td></tr> <tr><td>CH 6</td><td>0.0</td><td>○</td><td>○</td><td>CH E</td><td>0.0</td><td>○</td><td>○</td></tr> <tr><td>CH 7</td><td>0.0</td><td>○</td><td>○</td><td>CH F</td><td>0.0</td><td>○</td><td>○</td></tr> </tbody> </table> <p>Over/Under Error 0: Normal F: Error</p> <p>2) 3) 4)</p>		Output [%]	Over Error	Under Error		Output [%]	Over Error	Under Error	CH 0	0.0	○	○	CH 8	0.0	○	○	CH 1	0.0	○	○	CH 9	0.0	○	○	CH 2	0.0	○	○	CH A	0.0	○	○	CH 3	0.0	○	○	CH B	0.0	○	○	CH 4	0.0	○	○	CH C	0.0	○	○	CH 5	0.0	○	○	CH D	0.0	○	○	CH 6	0.0	○	○	CH E	0.0	○	○	CH 7	0.0	○	○	CH F	0.0	○	○	1)	0 1	0000 0001
		Output [%]	Over Error	Under Error		Output [%]	Over Error	Under Error																																																																			
	CH 0	0.0	○	○	CH 8	0.0	○	○																																																																			
	CH 1	0.0	○	○	CH 9	0.0	○	○																																																																			
	CH 2	0.0	○	○	CH A	0.0	○	○																																																																			
CH 3	0.0	○	○	CH B	0.0	○	○																																																																				
CH 4	0.0	○	○	CH C	0.0	○	○																																																																				
CH 5	0.0	○	○	CH D	0.0	○	○																																																																				
CH 6	0.0	○	○	CH E	0.0	○	○																																																																				
CH 7	0.0	○	○	CH F	0.0	○	○																																																																				
	2)	16 to 31	0010 to 001F																																																																								
	3)	48 to 63	0030 to 003F																																																																								
	4)	48 to 63	0030 to 003F																																																																								
	-	-	-																																																																								
 <p>1) Inputs (X) Outputs (Y)</p> <table border="1"> <thead> <tr> <th>Inputs (X)</th> <th>Outputs (Y)</th> </tr> </thead> <tbody> <tr><td>00 WDT Error</td><td>00</td></tr> <tr><td>01 READY</td><td>01</td></tr> <tr><td>02 Error</td><td>02</td></tr> <tr><td>03</td><td>03</td></tr> <tr><td>04</td><td>04</td></tr> <tr><td>05</td><td>05</td></tr> <tr><td>06</td><td>06</td></tr> <tr><td>07</td><td>07</td></tr> <tr><td>08</td><td>08</td></tr> <tr><td>09</td><td>09</td></tr> <tr><td>0A</td><td>0A</td></tr> <tr><td>0B</td><td>0B Output Enable</td></tr> <tr><td>0C</td><td>0C</td></tr> <tr><td>0D</td><td>0D</td></tr> <tr><td>0E</td><td>0E</td></tr> <tr><td>0F</td><td>0F</td></tr> </tbody> </table>	Inputs (X)	Outputs (Y)	00 WDT Error	00	01 READY	01	02 Error	02	03	03	04	04	05	05	06	06	07	07	08	08	09	09	0A	0A	0B	0B Output Enable	0C	0C	0D	0D	0E	0E	0F	0F	1)	-	-																																						
	Inputs (X)	Outputs (Y)																																																																									
00 WDT Error	00																																																																										
01 READY	01																																																																										
02 Error	02																																																																										
03	03																																																																										
04	04																																																																										
05	05																																																																										
06	06																																																																										
07	07																																																																										
08	08																																																																										
09	09																																																																										
0A	0A																																																																										
0B	0B Output Enable																																																																										
0C	0C																																																																										
0D	0D																																																																										
0E	0E																																																																										
0F	0F																																																																										
	-	-	-																																																																								
 <p>1) Output [%] Channel 0 to Channel F</p> <p>2) Channel No. FEDCBA9876543210 D/A Conversion 0000000000000000 0: Disabled Output Enable 0000000000000000 1: Enabled</p> <p>3) WDT Error Error</p>	1)	16 to 31	10 to 1F																																																																								
		2)	0 1	0 1																																																																							
		3)	-	-																																																																							
		-	-	-																																																																							

6.5.9 A61LS module monitoring

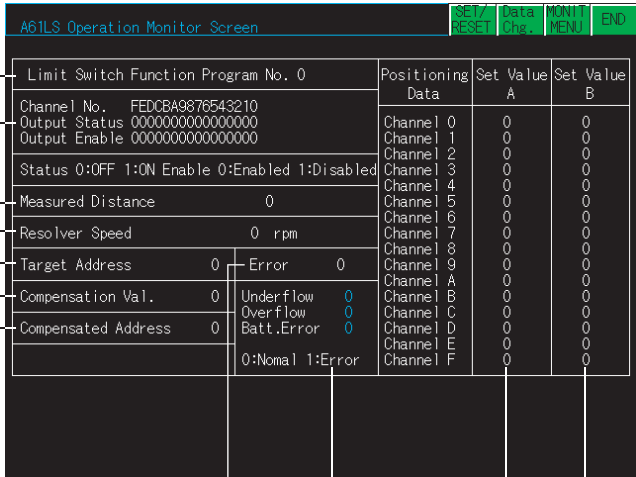
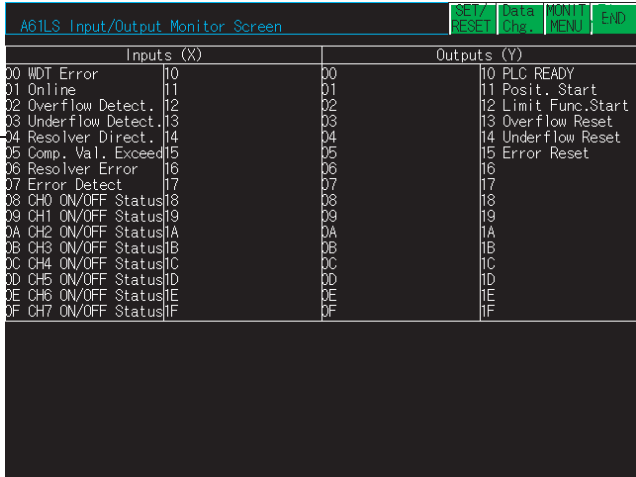
Screen example	No.	Buffer memory address	
		DEC	HEX
 <p>1) Limit Switch Function Program No. 0</p> <p>2) Channel No. FEDCBA9876543210 Output Status 0000000000000000 Output Enable 0000000000000000</p> <p>3) Measured Distance 0</p> <p>4) Resolver Speed 0 rpm</p> <p>5) Target Address 0 Error 0</p> <p>6) Compensation Val. 0 Underflow 0 Overflow 0</p> <p>7) Compensated Address 0 Batt.Error 0 0:Nomal 1:Error</p> <p>8) 9) 10) 10)</p>	1)	11	000B
	2)	4,10	0004, 000A
	3)	5, 6	0005, 0006
	4)	3	0003
	5)	12	000C
	6)	7	0007
	7)	0	0000
	8)	8	0008
	9)	2,1,9	0002,0001,0009
	10)	13 to 44	000D to 002C
	-	-	-
 <p>1)</p>	1)	-	-
		-	-

1 OVERVIEW

2 SYSTEM MONITOR

3 LADDER MONITOR FUNCTION

4 MELSEC-A LIST EDITOR

5 MELSEC-FX LIST EDITOR

6 INTELLIGENT MODULE MONITOR

7 NETWORK MONITOR

8 Q MOTION MONITOR

6.5.10 A62LS module monitoring

Screen example		No.	Buffer memory address		
			DEC	HEX	
		1)	-	-	
		2)	7	0007	
		3)	4	0004	
		4)	8	0008	
		5)	2	0002	
		6)	0	0000	
		7)	10	000A	
		8)	9	0009	
		9)	5	0005	
		10)	6	0006	
		10)	12 to 667	000C to 029B	
		-	-	-	
		1)	-	-	
				-	-
				-	-
				-	-
				-	-
				-	-
				-	-
				-	-
				-	-
				-	-

6.5.11 AD61 module monitoring

Screen example	No.	Buffer memory address																																																																																				
		DEC	HEX																																																																																			
<p>AD61 Operation Monitor Screen</p> <table border="1"> <thead> <tr> <th></th> <th>Present Value</th> <th>Set Value</th> <th>Mode</th> <th>Mode</th> </tr> </thead> <tbody> <tr> <td>Channel 1</td> <td>1) 0</td> <td>2) 0</td> <td>3) 1</td> <td>8: 1-Phase</td> </tr> <tr> <td>Channel 2</td> <td>0</td> <td>0</td> <td></td> <td>18: 2-Phase</td> </tr> </tbody> </table> <table border="1"> <thead> <tr> <th colspan="2">Inputs (X)</th> <th colspan="2">Outputs (Y)</th> </tr> </thead> <tbody> <tr><td>00</td><td>CH1 Count Greater</td><td>10</td><td>CH1 Equal Reset</td></tr> <tr><td>01</td><td>CH1 Count Equal</td><td>11</td><td>CH1 Preset Cmd.</td></tr> <tr><td>02</td><td>CH1 Count Less</td><td>12</td><td>CH1 Equal O/P</td></tr> <tr><td>03</td><td>CH1 Ext. Preset</td><td>13</td><td>CH1 Down Count</td></tr> <tr><td>04</td><td>CH2 Count Greater</td><td>14</td><td>CH1 Count Enable</td></tr> <tr><td>05</td><td>CH2 Count Equal</td><td>15</td><td>CH1 Value Read</td></tr> <tr><td>06</td><td>CH2 Count Less</td><td>16</td><td>CH1 Ext. Preset</td></tr> <tr><td>07</td><td>CH2 Ext. Preset</td><td>17</td><td>CH2 Equal Reset</td></tr> <tr><td>08</td><td></td><td>18</td><td>CH2 Preset Cmd.</td></tr> <tr><td>09</td><td></td><td>19</td><td>CH2 Equal O/P</td></tr> <tr><td>0A</td><td></td><td>1A</td><td>CH2 Down Count</td></tr> <tr><td>0B</td><td></td><td>1B</td><td>CH2 Count Enable</td></tr> <tr><td>0C</td><td></td><td>1C</td><td>CH2 Value Read</td></tr> <tr><td>0D</td><td></td><td>1D</td><td>CH2 Ext. Preset</td></tr> <tr><td>0E</td><td></td><td>1E</td><td></td></tr> <tr><td>0F</td><td></td><td>1F</td><td></td></tr> </tbody> </table>		Present Value	Set Value	Mode	Mode	Channel 1	1) 0	2) 0	3) 1	8: 1-Phase	Channel 2	0	0		18: 2-Phase	Inputs (X)		Outputs (Y)		00	CH1 Count Greater	10	CH1 Equal Reset	01	CH1 Count Equal	11	CH1 Preset Cmd.	02	CH1 Count Less	12	CH1 Equal O/P	03	CH1 Ext. Preset	13	CH1 Down Count	04	CH2 Count Greater	14	CH1 Count Enable	05	CH2 Count Equal	15	CH1 Value Read	06	CH2 Count Less	16	CH1 Ext. Preset	07	CH2 Ext. Preset	17	CH2 Equal Reset	08		18	CH2 Preset Cmd.	09		19	CH2 Equal O/P	0A		1A	CH2 Down Count	0B		1B	CH2 Count Enable	0C		1C	CH2 Value Read	0D		1D	CH2 Ext. Preset	0E		1E		0F		1F		1)	4, 5, 36, 37	0004, 0005, 0024, 0025
		Present Value	Set Value	Mode	Mode																																																																																	
	Channel 1	1) 0	2) 0	3) 1	8: 1-Phase																																																																																	
	Channel 2	0	0		18: 2-Phase																																																																																	
	Inputs (X)		Outputs (Y)																																																																																			
00	CH1 Count Greater	10	CH1 Equal Reset																																																																																			
01	CH1 Count Equal	11	CH1 Preset Cmd.																																																																																			
02	CH1 Count Less	12	CH1 Equal O/P																																																																																			
03	CH1 Ext. Preset	13	CH1 Down Count																																																																																			
04	CH2 Count Greater	14	CH1 Count Enable																																																																																			
05	CH2 Count Equal	15	CH1 Value Read																																																																																			
06	CH2 Count Less	16	CH1 Ext. Preset																																																																																			
07	CH2 Ext. Preset	17	CH2 Equal Reset																																																																																			
08		18	CH2 Preset Cmd.																																																																																			
09		19	CH2 Equal O/P																																																																																			
0A		1A	CH2 Down Count																																																																																			
0B		1B	CH2 Count Enable																																																																																			
0C		1C	CH2 Value Read																																																																																			
0D		1D	CH2 Ext. Preset																																																																																			
0E		1E																																																																																				
0F		1F																																																																																				
2)	6, 7, 38, 39	0006, 0007, 0026, 0027																																																																																				
3)	3, 35	0003, 0023																																																																																				
4)	-	-																																																																																				
-	-	-	-																																																																																			

1 OVERVIEW

2 SYSTEM MONITOR

3 LADDER MONITOR
FUNCTION

4 MELSEC-A LIST
EDITOR

5 MELSEC-FX LIST
EDITOR

6 INTELLIGENT
MODULE MONITOR

7 NETWORK
MONITOR

8 Q MOTION
MONITOR

6.5.12 AD70/A1SD70 module monitoring

Screen example		No.	Buffer memory address	
			DEC	HEX
		1)	-	-
		2)	100, 101	0064, 0065
		3)	102, 103	0066, 0067
		4)	106, 107	006A, 006B
		5)	61, 62	003D, 003E
		6)	65, 66	0041, 0042
		7)	63, 64	003F, 0040
		8)	67, 68	0043, 0044
		9)	60	003C
		10)	111	006F
		11)	104	0068
		12)	105	0069
		13)	80, 81	0050, 0051
		14)	88, 89	0058, 0059
		15)	82, 83	0052, 0053
		16)	84, 85	0054, 0055
		17)	0, 1	0000, 0001
		18)	2, 3	0002, 0003
		19)	4, 5	0004, 0005
		20)	20, 21	0014, 0015
		21)	22	0016
		22)	23	0017
		23)	24	0018
		24)	25	0019
		1)	-	-
		2)	100, 101	0064, 0065
		3)	102, 103	0066, 0067
		4)	106, 107	006A, 006B
		5)	61, 62	003D, 003E
		6)	65, 66	0041, 0042
		7)	63, 64	003F, 0040
		8)	67, 68	0043, 0044
		9)	60	003C
		10)	111	006F
		11)	104	0068
		12)	105	0069
		13)	80, 81	0050, 0051
		14)	88, 89	0058, 0059
		15)	82, 83	0052, 0053
		16)	84, 85	0054, 0055
		17)	108, 109	006C, 006D
		18)	46, 47	002E, 002F
		19)	40, 41	0028, 0029
		20)	42, 43	002A, 002B
		21)	44, 45	002C, 002D

Screen example	No.	Buffer memory address	
		DEC	HEX
	1)	-	-

1	OVERVIEW
2	SYSTEM MONITOR
3	LADDER MONITOR FUNCTION
4	MELSEC-A LIST EDITOR
5	MELSEC-FX LIST EDITOR
6	INTELLIGENT MODULE MONITOR
7	NETWORK MONITOR
8	Q MOTION MONITOR

6.5.13 AD70D module monitoring

Screen example		No.	Buffer memory address	
			DEC	HEX
		1)	-	-
		2)	100, 101	0064, 0065
		3)	102, 103	0066, 0067
		4)	104, 105	0068, 0069
		5)	61, 62	003D, 003E
		6)	65, 66	0041, 0042
		7)	63, 64	003F, 0040
		8)	67, 68	0043, 0044
		9)	60	003C
		10)	119	0077
		11)	120	0078
		12)	121	0079
		13)	122	007A
		14)	123	007B
		15)	80, 81	0050, 0051
		16)	86, 87	0056, 0057
		17)	82, 83	0052, 0053
		18)	84, 85	0054, 0055
		19)	89	0059
		20)	110	006E
		21)	111	006F
		22)	112	0070
		23)	113	0071
		24)	125	007D
		25)	126	007E
		1)	-	-
		2)	100, 101	0064, 0065
		3)	102, 103	0066, 0067
		4)	104, 105	0068, 0069
		5)	30, 31	001E, 001F
		6)	32, 33	0020, 0021
		7)	34, 35	0022, 0023
		8)	108, 109	006C, 006D
		9)	106, 107	006A, 006B
		10)	36, 37	0024, 0025
		11)	119	0077
		12)	120	0078
		13)	121	0079
		14)	122	007A
		15)	123	007B
		16)	80, 81	0050, 0051
		17)	86, 87	0056, 0057
		18)	82, 83	0052, 0053
		19)	84, 85	0054, 0055
		20)	89	0059
		21)	110	006E
		22)	111	006F
		23)	112	0070
		24)	113	0071
		25)	125	007D
		26)	126	007E

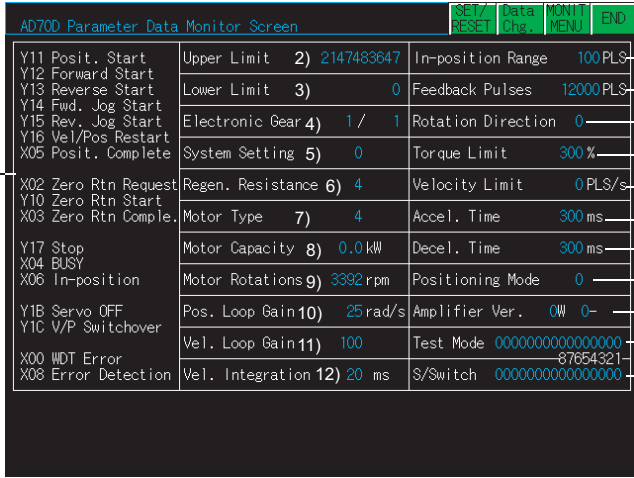
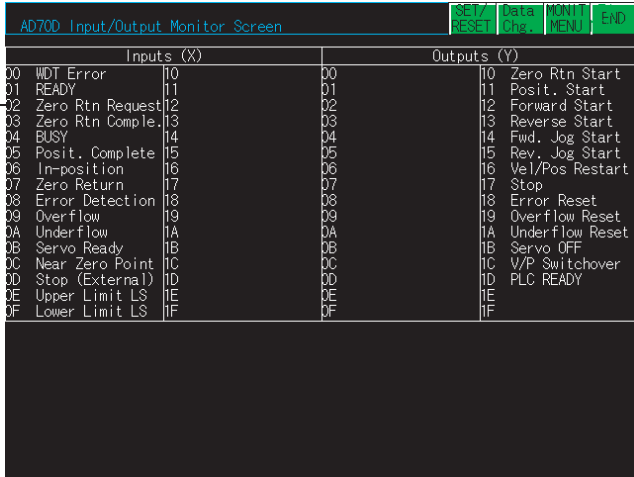
Screen example		No.	Buffer memory address	
			DEC	HEX
		1)	-	-
2)		0, 1	0000, 0001	
3)		2, 3	0002, 0003	
4)		4, 5	0004, 0005	
5)		10	000A	
6)		11	000B	
7)		12	000C	
8)		13	000D	
9)		14	000E	
10)		15	000F	
11)		16	0010	
12)		17	0011	
13)		18	0012	
14)		19	0013	
15)		20	0014	
16)		21	0015	
17)		40, 41	0028, 0029	
18)		42	002A	
19)		43	002B	
20)		44	002C	
21)		114 to 117	0072 to 0075	
22)		125	007D	
23)		126	007E	
		1)	-	-

- 1
OVERVIEW
- 2
SYSTEM MONITOR
- 3
LADDER MONITOR
FUNCTION
- 4
MELSEC-A LIST
EDITOR
- 5
MELSEC-FX LIST
EDITOR
- 6
INTELLIGENT
MODULE MONITOR
- 7
NETWORK
MONITOR
- 8
Q MOTION
MONITOR

6.5.14 AD71 module monitoring

Screen example	No.	Buffer memory address			
		X axis		Y axis	
		DEC	HEX	DEC	HEX
<p>AD71 Positioning Data Monitor Screen</p> <p>1) X Y Y10 Y11 Posit. Start Y12 Interpolation X02 X03 Posit. Compl. X06 X07 Zero Request Y13 Y14 Zero Start X0C X0D Zero Complete Y17 Y19 Fwd.Jog Start Y18 Rev.Jog Start Y15 Y16 Stop X08 X09 Pos. Started X04 X05 BUSY X0E X0F M Code ON X00 WDT Err. Man.Pulse X0A Batt.ErrX: X0B Error Y:</p> <p>3) X Axis 4) Y Axis</p> <p>2) 13) 14) 15)</p>	1)	-	-	-	-
	2)	47	002F	347	015B
	3)	48	0030	348	015C
	4)	39	0027	339	0153
	5)	602	025A	604	025C
	6)	603	025B	605	025D
	7)	41	0029	341	0155
	8)	42	002A	342	0156
	9)	7912	1EE8	7922	1EF2
	10)	7913	1EE9	7923	1EF3
	11)	600	0258	601	0259
	12)	7874	1EC2	7894	1ED6
	13)	40	0028	340	0154
	14)	44	002C	344	0158
	15)	7875	1EC3	7895	1ED7
<p>AD71 Zero Return Data Monitor Screen</p> <p>1) X Y Y10 Y11 Posit. Start Y12 Interpolation X02 X03 Posit. Compl. X06 X07 Zero Request Y13 Y14 Zero Start X0C X0D Zero Complete Y17 Y19 Fwd.Jog Start Y18 Rev.Jog Start Y15 Y16 Stop X08 X09 Pos. Started X04 X05 BUSY X0E X0F M Code ON X00 WDT Err. Man.Pulse X0A Batt.ErrX:Disable X0B Error Y:Disable</p> <p>3) X Axis 4) Y Axis</p> <p>2) 13) 14) 15) 16) 17)</p>	1)	-	-	-	-
	2)	47	002F	347	015B
	3)	48	0030	348	015C
	4)	39	0027	339	0153
	5)	602	025A	604	025C
	6)	603	025B	605	025D
	7)	41	0029	341	0155
	8)	42	002A	342	0156
	9)	7912	1EE8	7922	1EF2
	10)	7913	1EE9	7923	1EF3
	11)	600	0258	601	0259
	12)	7874	1EC2	7894	1ED6
	13)	40	0028	340	0154
	14)	45	002D	345	0159
	15)	7918	1EEE	7928	1EF8
	16)	7917	1EED	7927	1EF7
	17)	7916	1EEC	7926	1EF6

Screen example		No.	Buffer memory address			
			X axis		Y axis	
			DEC	HEX	DEC	HEX
		1)	-	-	-	-
		2)	0	0	347	015B
		3)	7873	1EC1	7893	1ED5
		4)	7884	1ECC	7904	1EE0
		5)	7885	1ECD	7905	1EE1
		6)	7874	1EC2	7894	1ED6
		7)	7875	1EC3	7895	1ED7
		8)	7876	1EC4	7896	1ED8
		9)	7877	1EC5	7897	1ED9
		10)	7878	1EC6	7898	1EDA
		11)	7879	1EC7	7899	1EDB
		12)	7880	1EC8	7900	1EDC
		13)	7881	1EC9	7901	1EDD
		14)	7882	1ECA	7902	1EDE
		15)	7883	1ECB	7903	1EDF
		16)	7886	1ECE	7906	1EE2
		17)	7887	1ECF	7907	1EE3
		18)	46	002E	346	015A
		19)	45	002D	345	0159
		20)	7872	1EC0	7892	1ED4
		1)	-	-	-	-
		2)	47	002F	347	015B
		3)	46	002E	346	015A
		4)	49	0031	349	015D
		5)	200	00C8	500	01F4
		6)	48	0030	348	015C
		7)	39	0027	339	0153
		8)	45	002D	345	0159
		9)	43	002B	343	0157
		10)	-	-	-	-

- 1 OVERVIEW
- 2 SYSTEM MONITOR
- 3 LADDER MONITOR FUNCTION
- 4 MELSEC-A LIST EDITOR
- 5 MELSEC-FX LIST EDITOR
- 6 INTELLIGENT MODULE MONITOR
- 7 NETWORK MONITOR
- 8 Q MOTION MONITOR

Screen example	No.	Buffer memory address			
		X axis		Y axis	
		DEC	HEX	DEC	HEX
	1)	-	-	-	-
	1)	5072 to 5871	13D0 to 16EF	7072 to 7871	1BA0 to 1EBF
	2)	4272 to 4671	10B0 to 123F	6272 to 6671	1880 to 1A0F
	3)	4672 to 5071	1240 to 13CF	6672 to 7071	1A10 to 1B9F
	4)	3872 to 4271	0F20 to 10AF	5872 to 6271	16F0 to 187F
	5)	3872 to 4271	0F20 to 10AF	5872 to 6271	16F0 to 187F
	-	-	-	-	-

6.5.15 AD72/A1SD71 module monitoring

Screen example	No.	Buffer memory address			
		X axis		Y axis	
		DEC	HEX	DEC	HEX
	1)	-	-	-	-
	2)	47	002F	347	015B
	3)	48	0030	348	015C
	4)	39	0027	339	0153
	5)	602	025A	604	025C
		603	025B	605	025D
	6)	41	0029	341	0155
		42	002A	342	0156
	7)	7912	1EE8	7922	1EF2
		7913	1EE9	7923	1EF3
	8)	600	0258	601	0259
	9)	7874	1EC2	7894	1ED6
	10)	40	0028	340	0154
	11)	44	002C	344	0158
	12)	7875	1EC3	7895	1ED7
13)	46	002E	346	015A	
14)	45	002D	345	0159	
15)	0	0000	300	012C	
	to	to	to	to	
	37	0025	337	0151	
	1)	-	-	-	-
	2)	47	002F	347	015B
	3)	48	0030	348	015C
	4)	39	0027	339	0153
	5)	602	025A	604	025C
		603	025B	605	025D
	6)	41	0029	341	0155
		42	002A	342	0156
	7)	7912	1EE8	7922	1EF2
		7913	1EE9	7923	1EF3
	8)	600	0258	601	0259
	9)	7874	1EC2	7894	1ED6
	10)	40	0028	340	0154
	11)	7914	1EEA	7924	1EF4
	12)	7915	1EEB	7925	1EF5
	13)	46	002E	346	015A
	14)	45	002D	345	0159
15)	7918	1EEE	7928	1EF8	
16)	7917	1EED	7927	1EF7	
17)	7916	1EEC	7926	1EF6	

1

OVERVIEW

2

SYSTEM MONITOR

3

LADDER MONITOR
FUNCTION

4

MELSEC-A LIST
EDITOR

5

MELSEC-FX LIST
EDITOR

6

INTELLIGENT
MODULE MONITOR

7

NETWORK
MONITOR

8

Q MOTION
MONITOR

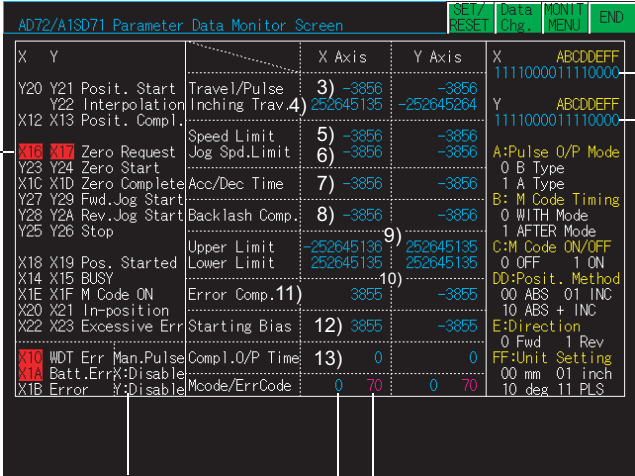
Screen example		Buffer memory address				
		No.	X axis		Y axis	
			DEC	HEX	DEC	HEX
		1)	-	-	-	-
		2)	47	002F	347	015B
		3)	7873	1EC1	7893	1ED5
		4)	7884	1ECC	7904	1EE0
		5)	7885	1ECD	7905	1EE1
		6)	7874	1EC2	7894	1ED6
		7)	7875	1EC3	7895	1ED7
		8)	7876	1EC4	7896	1ED8
		9)	7877	1EC5	7897	1ED9
		10)	7878	1EC6	7898	1EDA
		11)	7879	1EC7	7899	1EDB
		12)	7880	1EC8	7900	1EDC
		13)	7881	1EC9	7901	1EDD
		14)	7882	1ECA	7902	1EDE
		15)	7883	1ECB	7903	1EDF
		16)	7886	1ECE	7906	1EE2
		1)	46	002E	346	015A
		2)	45	002D	345	0159
		3)	7872	1EC0	7892	1ED4
		4)	49	0031	349	015D
		5)	200	00C8	500	01F4
		6)	48	0030	348	015C
		7)	39	0027	339	0153
		8)	45	002D	345	0159
			43	002B	343	0157
			-	-	-	-

Screen example	No.	Buffer memory address			
		X axis		Y axis	
		DEC	HEX	DEC	HEX
	1)	-	-	-	-
	1)	5072 to 5871	13D0 to 16EF	7072 to 7871	1BA0 to 1EBF
	2)	4272 to 4671	10B0 to 123F	6272 to 6671	1880 to 1A0F
	3)	4672 to 5071	1240 to 13CF	6672 to 7071	1A10 to 1B9F
	4)	3872 to 4271	0F20 to 10AF	5872 to 6271	16F0 to 187F
	5)	3872 to 4271	0F20 to 10AF	5872 to 6271	16F0 to 187F
	-	-	-	-	-

1

OVERVIEW

2

SYSTEM MONITOR

3

LADDER MONITOR
FUNCTION

4

MELSEC-A LIST
EDITOR

5

MELSEC-FX LIST
EDITOR

6

INTELLIGENT
MODULE MONITOR

7

NETWORK
MONITOR

8

Q MOTION
MONITOR

6.5.16 AJ71PT32-S3/A1SJ71PT32-S3 module monitoring

Screen example	No.	Buffer memory address																																																																																																	
		DEC	HEX																																																																																																
<p>AJ71PT32-S3 I/O Monitor Scr. (I/O Dedicated Mode)</p> <table border="1"> <thead> <tr> <th colspan="2">Inputs (X)</th> <th colspan="2">Outputs (Y)</th> </tr> </thead> <tbody> <tr><td>00 Hardware Fault</td><td>10</td><td>00</td><td>10</td></tr> <tr><td>01 Link Working</td><td>11</td><td>01</td><td>11</td></tr> <tr><td>02</td><td>12</td><td>02</td><td>12</td></tr> <tr><td>03</td><td>13</td><td>03</td><td>13</td></tr> <tr><td>04</td><td>14</td><td>04</td><td>14</td></tr> <tr><td>05 Test Mode</td><td>15</td><td>05</td><td>15</td></tr> <tr><td>06 Link Error Detect</td><td>16</td><td>06</td><td>16</td></tr> <tr><td>07 Link Comms. Error</td><td>17</td><td>07</td><td>17</td></tr> <tr><td>08</td><td>18</td><td>08</td><td>18 Link Comms.Start</td></tr> <tr><td>09</td><td>19</td><td>09</td><td>19</td></tr> <tr><td>0A</td><td>1A</td><td>0A</td><td>1A FROM/TO Response</td></tr> <tr><td>0B</td><td>1B</td><td>0B</td><td>1B Faulty Sta.Clear</td></tr> <tr><td>0C</td><td>1C</td><td>0C</td><td>1C</td></tr> <tr><td>0D</td><td>1D</td><td>0D</td><td>1D Error Reset</td></tr> <tr><td>0E</td><td>1E</td><td>0E</td><td>1E</td></tr> <tr><td>0F</td><td>1F</td><td>0F</td><td>1F</td></tr> </tbody> </table>	Inputs (X)		Outputs (Y)		00 Hardware Fault	10	00	10	01 Link Working	11	01	11	02	12	02	12	03	13	03	13	04	14	04	14	05 Test Mode	15	05	15	06 Link Error Detect	16	06	16	07 Link Comms. Error	17	07	17	08	18	08	18 Link Comms.Start	09	19	09	19	0A	1A	0A	1A FROM/TO Response	0B	1B	0B	1B Faulty Sta.Clear	0C	1C	0C	1C	0D	1D	0D	1D Error Reset	0E	1E	0E	1E	0F	1F	0F	1F	1)	-	-																												
Inputs (X)		Outputs (Y)																																																																																																	
00 Hardware Fault	10	00	10																																																																																																
01 Link Working	11	01	11																																																																																																
02	12	02	12																																																																																																
03	13	03	13																																																																																																
04	14	04	14																																																																																																
05 Test Mode	15	05	15																																																																																																
06 Link Error Detect	16	06	16																																																																																																
07 Link Comms. Error	17	07	17																																																																																																
08	18	08	18 Link Comms.Start																																																																																																
09	19	09	19																																																																																																
0A	1A	0A	1A FROM/TO Response																																																																																																
0B	1B	0B	1B Faulty Sta.Clear																																																																																																
0C	1C	0C	1C																																																																																																
0D	1D	0D	1D Error Reset																																																																																																
0E	1E	0E	1E																																																																																																
0F	1F	0F	1F																																																																																																
<p>AJ71PT32-S3 Link Data Monitor Screen</p> <table border="1"> <tr> <td>No. of Remote Stations</td> <td>0</td> <td>Communication Error Code</td> <td>0</td> </tr> <tr> <td>Accumulative Faulty Station Detection</td> <td>0: Normal 1: Error</td> <td></td> <td></td> </tr> <tr> <td>Remote I/O Units Card Data</td> <td></td> <td></td> <td></td> </tr> <tr> <td>ST: 8 7 6 5 4 3 2 1</td> <td></td> <td>FEDCB49876543210</td> <td></td> </tr> <tr> <td>8 - 1000000000000000</td> <td></td> <td>16 - 1000000000000000</td> <td></td> </tr> <tr> <td>16 - 9000000000000000</td> <td></td> <td>32 - 1700000000000000</td> <td></td> </tr> <tr> <td>24 - 1700000000000000</td> <td></td> <td>48 - 3300000000000000</td> <td></td> </tr> <tr> <td>32 - 2500000000000000</td> <td></td> <td>64 - 4900000000000000</td> <td></td> </tr> <tr> <td>40 - 3300000000000000</td> <td></td> <td></td> <td></td> </tr> <tr> <td>48 - 4100000000000000</td> <td></td> <td>Faulty Station Detection</td> <td></td> </tr> <tr> <td>56 - 4900000000000000</td> <td></td> <td>FEDCB49876543210</td> <td></td> </tr> <tr> <td>64 - 5700000000000000</td> <td></td> <td>16 - 1000000000000000</td> <td></td> </tr> <tr> <td>Card Data: 00 No remote unit or no initial communication</td> <td></td> <td>32 - 1700000000000000</td> <td></td> </tr> <tr> <td>01 Input, partial refresh or remote terminal</td> <td></td> <td>48 - 3300000000000000</td> <td></td> </tr> <tr> <td>10 Output remote unit</td> <td></td> <td>64 - 4900000000000000</td> <td></td> </tr> <tr> <td>Accumulative Input Error Detection for Partial Refresh</td> <td></td> <td></td> <td></td> </tr> <tr> <td>FEDCB49876543210</td> <td></td> <td></td> <td></td> </tr> <tr> <td>0000000000000000</td> <td></td> <td></td> <td></td> </tr> <tr> <td>Input Faulty Error Detection for Partial Refresh</td> <td></td> <td></td> <td></td> </tr> <tr> <td>FEDCB49876543210</td> <td></td> <td></td> <td></td> </tr> <tr> <td>0000000000000000</td> <td></td> <td></td> <td></td> </tr> <tr> <td>Remote Terminal Unit Faulty Station</td> <td></td> <td></td> <td></td> </tr> <tr> <td>No. FEDCB49876543210</td> <td></td> <td></td> <td></td> </tr> <tr> <td>0000000000000000</td> <td></td> <td></td> <td></td> </tr> </table>	No. of Remote Stations	0	Communication Error Code	0	Accumulative Faulty Station Detection	0: Normal 1: Error			Remote I/O Units Card Data				ST: 8 7 6 5 4 3 2 1		FEDCB49876543210		8 - 1000000000000000		16 - 1000000000000000		16 - 9000000000000000		32 - 1700000000000000		24 - 1700000000000000		48 - 3300000000000000		32 - 2500000000000000		64 - 4900000000000000		40 - 3300000000000000				48 - 4100000000000000		Faulty Station Detection		56 - 4900000000000000		FEDCB49876543210		64 - 5700000000000000		16 - 1000000000000000		Card Data: 00 No remote unit or no initial communication		32 - 1700000000000000		01 Input, partial refresh or remote terminal		48 - 3300000000000000		10 Output remote unit		64 - 4900000000000000		Accumulative Input Error Detection for Partial Refresh				FEDCB49876543210				0000000000000000				Input Faulty Error Detection for Partial Refresh				FEDCB49876543210				0000000000000000				Remote Terminal Unit Faulty Station				No. FEDCB49876543210				0000000000000000				1) 2) 3) 4) 5) 6) 7) 8)	0 70 to 77 195 107 90 to 93 100 to 103 598 599	0000 0046 to 004D 00C3 006B 005A to 005D 0064 to 0067 0256 0257
No. of Remote Stations	0	Communication Error Code	0																																																																																																
Accumulative Faulty Station Detection	0: Normal 1: Error																																																																																																		
Remote I/O Units Card Data																																																																																																			
ST: 8 7 6 5 4 3 2 1		FEDCB49876543210																																																																																																	
8 - 1000000000000000		16 - 1000000000000000																																																																																																	
16 - 9000000000000000		32 - 1700000000000000																																																																																																	
24 - 1700000000000000		48 - 3300000000000000																																																																																																	
32 - 2500000000000000		64 - 4900000000000000																																																																																																	
40 - 3300000000000000																																																																																																			
48 - 4100000000000000		Faulty Station Detection																																																																																																	
56 - 4900000000000000		FEDCB49876543210																																																																																																	
64 - 5700000000000000		16 - 1000000000000000																																																																																																	
Card Data: 00 No remote unit or no initial communication		32 - 1700000000000000																																																																																																	
01 Input, partial refresh or remote terminal		48 - 3300000000000000																																																																																																	
10 Output remote unit		64 - 4900000000000000																																																																																																	
Accumulative Input Error Detection for Partial Refresh																																																																																																			
FEDCB49876543210																																																																																																			
0000000000000000																																																																																																			
Input Faulty Error Detection for Partial Refresh																																																																																																			
FEDCB49876543210																																																																																																			
0000000000000000																																																																																																			
Remote Terminal Unit Faulty Station																																																																																																			
No. FEDCB49876543210																																																																																																			
0000000000000000																																																																																																			
<p>AJ71PT32-S3 Batch Refresh Data Monitor Screen</p> <table border="1"> <thead> <tr> <th>Station Number</th> <th>Transmission Data</th> <th>Receive Data</th> </tr> </thead> <tbody> <tr> <td>4 - 1</td> <td>76543210765432107654321076543210</td> <td>76543210765432107654321076543210</td> </tr> <tr> <td>8 - 5</td> <td>00000000000000000000000000000000</td> <td>00000000000000000000000000000000</td> </tr> <tr> <td>12 - 9</td> <td>00000000000000000000000000000000</td> <td>00000000000000000000000000000000</td> </tr> <tr> <td>16 - 13</td> <td>00000000000000000000000000000000</td> <td>00000000000000000000000000000000</td> </tr> <tr> <td>20 - 17</td> <td>00000000000000000000000000000000</td> <td>00000000000000000000000000000000</td> </tr> <tr> <td>24 - 21</td> <td>00000000000000000000000000000000</td> <td>00000000000000000000000000000000</td> </tr> <tr> <td>28 - 25</td> <td>00000000000000000000000000000000</td> <td>00000000000000000000000000000000</td> </tr> <tr> <td>32 - 29</td> <td>00000000000000000000000000000000</td> <td>00000000000000000000000000000000</td> </tr> <tr> <td>36 - 33</td> <td>00000000000000000000000000000000</td> <td>00000000000000000000000000000000</td> </tr> <tr> <td>40 - 37</td> <td>00000000000000000000000000000000</td> <td>00000000000000000000000000000000</td> </tr> <tr> <td>44 - 41</td> <td>00000000000000000000000000000000</td> <td>00000000000000000000000000000000</td> </tr> <tr> <td>48 - 45</td> <td>00000000000000000000000000000000</td> <td>00000000000000000000000000000000</td> </tr> <tr> <td>52 - 49</td> <td>00000000000000000000000000000000</td> <td>00000000000000000000000000000000</td> </tr> <tr> <td>56 - 53</td> <td>00000000000000000000000000000000</td> <td>00000000000000000000000000000000</td> </tr> <tr> <td>60 - 57</td> <td>00000000000000000000000000000000</td> <td>00000000000000000000000000000000</td> </tr> <tr> <td>64 - 61</td> <td>00000000000000000000000000000000</td> <td>00000000000000000000000000000000</td> </tr> </tbody> </table>	Station Number	Transmission Data	Receive Data	4 - 1	76543210765432107654321076543210	76543210765432107654321076543210	8 - 5	00000000000000000000000000000000	00000000000000000000000000000000	12 - 9	00000000000000000000000000000000	00000000000000000000000000000000	16 - 13	00000000000000000000000000000000	00000000000000000000000000000000	20 - 17	00000000000000000000000000000000	00000000000000000000000000000000	24 - 21	00000000000000000000000000000000	00000000000000000000000000000000	28 - 25	00000000000000000000000000000000	00000000000000000000000000000000	32 - 29	00000000000000000000000000000000	00000000000000000000000000000000	36 - 33	00000000000000000000000000000000	00000000000000000000000000000000	40 - 37	00000000000000000000000000000000	00000000000000000000000000000000	44 - 41	00000000000000000000000000000000	00000000000000000000000000000000	48 - 45	00000000000000000000000000000000	00000000000000000000000000000000	52 - 49	00000000000000000000000000000000	00000000000000000000000000000000	56 - 53	00000000000000000000000000000000	00000000000000000000000000000000	60 - 57	00000000000000000000000000000000	00000000000000000000000000000000	64 - 61	00000000000000000000000000000000	00000000000000000000000000000000	1) 2)	10 to 41 110 to 141	000A to 0029 006E to 008D																																													
Station Number	Transmission Data	Receive Data																																																																																																	
4 - 1	76543210765432107654321076543210	76543210765432107654321076543210																																																																																																	
8 - 5	00000000000000000000000000000000	00000000000000000000000000000000																																																																																																	
12 - 9	00000000000000000000000000000000	00000000000000000000000000000000																																																																																																	
16 - 13	00000000000000000000000000000000	00000000000000000000000000000000																																																																																																	
20 - 17	00000000000000000000000000000000	00000000000000000000000000000000																																																																																																	
24 - 21	00000000000000000000000000000000	00000000000000000000000000000000																																																																																																	
28 - 25	00000000000000000000000000000000	00000000000000000000000000000000																																																																																																	
32 - 29	00000000000000000000000000000000	00000000000000000000000000000000																																																																																																	
36 - 33	00000000000000000000000000000000	00000000000000000000000000000000																																																																																																	
40 - 37	00000000000000000000000000000000	00000000000000000000000000000000																																																																																																	
44 - 41	00000000000000000000000000000000	00000000000000000000000000000000																																																																																																	
48 - 45	00000000000000000000000000000000	00000000000000000000000000000000																																																																																																	
52 - 49	00000000000000000000000000000000	00000000000000000000000000000000																																																																																																	
56 - 53	00000000000000000000000000000000	00000000000000000000000000000000																																																																																																	
60 - 57	00000000000000000000000000000000	00000000000000000000000000000000																																																																																																	
64 - 61	00000000000000000000000000000000	00000000000000000000000000000000																																																																																																	

Screen example	No.	Buffer memory address	
		DEC	HEX
<p>Station 0 Invalid Data Either Transmission or Receive Data Valid</p>	1)	300 to 363	012C to 016B
	2)	600 to 663	0258 to 0297
	1)	-	-
	-	-	-

1	OVERVIEW
2	SYSTEM MONITOR
3	LADDER MONITOR FUNCTION
4	MELSEC-A LIST EDITOR
5	MELSEC-FX LIST EDITOR
6	INTELLIGENT MODULE MONITOR
7	NETWORK MONITOR
8	Q MOTION MONITOR

6.5.17 A1SD61 module monitoring

Screen example	No.	Buffer memory address																																																																					
		DEC	HEX																																																																				
<p>A1SD61 Operation Monitor Screen (CH1,2)</p> <p>Y10 Count Enable Y11 Decremental Count Y12 Preset Command Y13 Ring Counter X0D Sampling/Periodic</p> <p>Y15 Limit Switch Output Y14 Counter Function Start</p> <p>Counter Setting: 0</p> <p>0: No setting 1: Latch counter 2: Sampling counter 3: Periodic pulse counter 4: Count disable</p> <p>Channel No. LS, O/P Status: 8 7 6 5 4 3 2 1 0 0 0 0 0 0 0 0</p> <p>No. of Dogs: ON CH.1 OFF No. of Dogs: ON CH.2 OFF</p> <p>D 0 0 0 0 0 0 0 0 1 0 0 0 1 0 6 2 0 0 2 3 0 3 0 0 0 0 0 0</p> <p>65536</p> <p>Present Value: -1 Counter Function Count Value: 65536 Preset Value: 0 Ring Counter Value: 0 Pulse I/P Mode: 0</p> <p>0: A-Phase I/P and decremental count 1: A-Phase and B-Phase I/P 2: 2-Phase I/P X 1 3: 2-Phase I/P X 2 4: 2-Phase I/P X 4</p>	1)	-	-																																																																				
	2)	-	-																																																																				
	3)	11	000B																																																																				
	4)	12 to 147	000C to 0093																																																																				
	5)	5	0005																																																																				
	6)	-	-																																																																				
	7)	0, 1	0000, 0001																																																																				
	8)	2, 3	0002, 0003																																																																				
	9)	6, 7	0006, 0007																																																																				
	10)	8, 9	0008, 0009																																																																				
	11)	4	0004																																																																				
	-	-	-																																																																				
<p>A1SD61 Input/Output Monitor Screen</p> <table border="1"> <thead> <tr> <th colspan="2">Inputs (X)</th> <th colspan="2">Outputs (Y)</th> </tr> </thead> <tbody> <tr><td>00</td><td>WDT Error</td><td>00</td><td>Count Enable</td></tr> <tr><td>01</td><td>CH1 LS Output</td><td>01</td><td>Decrement Count</td></tr> <tr><td>02</td><td>CH2 LS Output</td><td>02</td><td>Preset Command</td></tr> <tr><td>03</td><td>CH3 LS Output</td><td>03</td><td>Ring Counter</td></tr> <tr><td>04</td><td>CH4 LS Output</td><td>04</td><td>Counter Function</td></tr> <tr><td>05</td><td>CH5 LS Output</td><td>05</td><td>LS Output</td></tr> <tr><td>06</td><td>CH6 LS Output</td><td>06</td><td>Reset Preset</td></tr> <tr><td>07</td><td>CH7 LS Output</td><td>07</td><td>Error Reset</td></tr> <tr><td>08</td><td>CH8 LS Output</td><td>08</td><td></td></tr> <tr><td>09</td><td>LS O/P Enable</td><td>09</td><td></td></tr> <tr><td>0A</td><td>Ext. Preset</td><td>0A</td><td></td></tr> <tr><td>0B</td><td>Error Flag</td><td>0B</td><td></td></tr> <tr><td>0C</td><td>Fuse/Power OFF</td><td>0C</td><td></td></tr> <tr><td>0D</td><td>Sampling/Period</td><td>0D</td><td></td></tr> <tr><td>0E</td><td></td><td>0E</td><td></td></tr> <tr><td>0F</td><td></td><td>0F</td><td></td></tr> </tbody> </table>	Inputs (X)		Outputs (Y)		00	WDT Error	00	Count Enable	01	CH1 LS Output	01	Decrement Count	02	CH2 LS Output	02	Preset Command	03	CH3 LS Output	03	Ring Counter	04	CH4 LS Output	04	Counter Function	05	CH5 LS Output	05	LS Output	06	CH6 LS Output	06	Reset Preset	07	CH7 LS Output	07	Error Reset	08	CH8 LS Output	08		09	LS O/P Enable	09		0A	Ext. Preset	0A		0B	Error Flag	0B		0C	Fuse/Power OFF	0C		0D	Sampling/Period	0D		0E		0E		0F		0F		1)	-	-
	Inputs (X)		Outputs (Y)																																																																				
00	WDT Error	00	Count Enable																																																																				
01	CH1 LS Output	01	Decrement Count																																																																				
02	CH2 LS Output	02	Preset Command																																																																				
03	CH3 LS Output	03	Ring Counter																																																																				
04	CH4 LS Output	04	Counter Function																																																																				
05	CH5 LS Output	05	LS Output																																																																				
06	CH6 LS Output	06	Reset Preset																																																																				
07	CH7 LS Output	07	Error Reset																																																																				
08	CH8 LS Output	08																																																																					
09	LS O/P Enable	09																																																																					
0A	Ext. Preset	0A																																																																					
0B	Error Flag	0B																																																																					
0C	Fuse/Power OFF	0C																																																																					
0D	Sampling/Period	0D																																																																					
0E		0E																																																																					
0F		0F																																																																					
	-	-	-																																																																				

6.5.18 A1S64AD module monitoring

Screen example		No.	Buffer memory address	
			DEC	HEX
		1)	0	0000
		2)	1	0001
		3)	2 to 5	0002 to 0005
		4)	10 to 13	000A to 000D
		5)	18	0012
		6)	20	0014
		-	-	-
		1)	-	-
		-	-	-
		1)	10 to 13	000A to 000D
		2)	20	0014
		3)	-	-
		4)	-	-
		-	-	-

1 OVERVIEW
2 SYSTEM MONITOR
3 LADDER MONITOR FUNCTION
4 MELSEC-A LIST EDITOR
5 MELSEC-FX LIST EDITOR
6 INTELLIGENT MODULE MONITOR
7 NETWORK MONITOR
8 Q MOTION MONITOR

6.5.19 A1S62DA module monitoring

Screen example	No.	Buffer memory address	
		DEC	HEX
	1)	0	0000
	2)	1	0001
	3)	2	0002
	4)	-	-
	5)	1, 2	0001, 0002
	6)		
	7)		
	8)		
	9)		
	10)		
	11)	10	000A
	12)	11	000B
	13)	9	0009
-	-	-	

6.5.20 A1S62RD module monitoring

Screen example	No.	Buffer memory address	
		DEC	HEX
<p>1) 360.0 2) 360.487 3) 0</p> <p>4) Disabled/Enabled 21 0000000010011010 1: Enabled 0: Disabled</p> <p>5) Conversion 21 0000000000000001 1: Completed 0: Not Completed</p> <p>6) Average/Sample 21 Time/Count 21 00000011 11101000 1: Averaging 6) 1: Time Average 0: Sampling 0: Count Average</p> <p>7) WDT Error 100 Temp. Sensor Type 0 Error Code: 100 0:New JIS,DIN 1:01d JIS</p> <p>8) 9)</p>	1)	10, 11	000A, 000B
	2)	18 to 21	0012 to 0015
	3)	2, 3	0002, 0003
	4)	0	0000
	5)	35	0023
	6)	1	0001
	7)	-	-
	8)	34	0022
	9)	36	0024
-	-	-	-
<p>1) 00 WDT Error 10 00 00</p> <p>01 READY 11 01 01</p> <p>02 Error Detection 12 02 12 Error Reset</p> <p>03 CH1 Disconnected 13 03 03</p> <p>04 CH2 Disconnected 14 04 04</p> <p>05 15 05 05</p> <p>06 16 06 06</p> <p>07 17 07 07</p> <p>08 18 08 08</p> <p>09 19 09 09</p> <p>0A 1A 0A 1A</p> <p>0B 1B 0B 1B</p> <p>0C 1C 0C 1C</p> <p>0D 1D 0D 1D</p> <p>0E 1E 0E 1E</p> <p>0F 1F 0F 1F</p>	1)	-	-
	-	-	-
<p>1) 360.0 2) 360.487</p> <p>2) Disabled/Enabled 21 0000000010011010 1: Enabled 0: Disabled</p> <p>3) Conversion 21 0000000000000001 1: Completed 0: Not Completed</p> <p>4) Average/Sample 21 Time/Count 21 00000011 11101000 1: Averaging 4) 1: Time Average 0: Sampling 0: Count Average</p> <p>5) WDT Error 100 Temp. Sensor Type 0 Error Code: 100 0:New JIS,DIN 1:01d JIS</p> <p>6) 7)</p>	1)	10, 11	000A, 000B
	2)	0	0000
	3)	35	0023
	4)	1	0001
	5)	-	-
	6)	34	0022
	7)	36	0024
-	-	-	-

1 OVERVIEW
2 SYSTEM MONITOR
3 LADDER MONITOR FUNCTION
4 MELSEC-A LIST EDITOR
5 MELSEC-FX LIST EDITOR
6 INTELLIGENT MODULE MONITOR
7 NETWORK MONITOR
8 Q MOTION MONITOR

6.5.21 A1S63ADA module monitoring

Screen example		No.	Buffer memory address	
			DEC	HEX
		1)	0	0000
		2)	15	000F
		3)	1	0001
		4)	2, 3	0002, 0003
		5)	11, 12	000B, 000C
		6)	4	0004
		7)	5	0005
		8)	10	000A
		9)	13	000D
		10)	16	0010
		11)	14	000E
		-	-	-
		1)	-	-
		2)	6	0006
		3)	7, 8, 9	0007, 0008, 0009
		4)	18 to 37	0012 to 0025
		5)	17	0011
		6)	16	0010
		7)	14	000E
		8)	14	000E
		-	-	-
		1)	-	-
		-	-	-

Screen example		No.	Buffer memory address																																																											
			Axis 1		Axis 2		Axis 3																																																							
			DEC	HEX	DEC	HEX	DEC	HEX																																																						
<table border="1"> <thead> <tr> <th colspan="2">AD75P Basic Parameter 2</th> <th>SET/RESET</th> <th>Data Chg.</th> <th>MONI/MENU</th> <th>END</th> </tr> <tr> <th>Parameter</th> <th>Valid Range</th> <th>1Axis</th> <th>2Axis</th> <th>3Axis</th> <th></th> </tr> </thead> <tbody> <tr> <td>1) Speed Limit</td> <td>1 to 600000000 [$\times 10^{-2}$ mm/min] 1 to 600000000 [$\times 10^{-3}$ inch/min] 1 to 600000000 [$\times 10^{-3}$ deg/min] 1 to 1000000 [PLS/sec]</td> <td>12345678</td> <td>123458678</td> <td>12345678</td> <td></td> </tr> <tr> <td>2) Accel.Time #0</td> <td>1 to 65535 /8388608 [msec]</td> <td>123456</td> <td>123456</td> <td>123456</td> <td></td> </tr> <tr> <td>3) Decel.Time #0</td> <td>1 to 65535 /8388608 [msec]</td> <td>123456</td> <td>123456</td> <td>123456</td> <td></td> </tr> <tr> <td>-</td> <td></td> <td>-</td> <td>-</td> <td>-</td> <td>-</td> </tr> </tbody> </table>		AD75P Basic Parameter 2		SET/RESET	Data Chg.	MONI/MENU	END	Parameter	Valid Range	1Axis	2Axis	3Axis		1) Speed Limit	1 to 600000000 [$\times 10^{-2}$ mm/min] 1 to 600000000 [$\times 10^{-3}$ inch/min] 1 to 600000000 [$\times 10^{-3}$ deg/min] 1 to 1000000 [PLS/sec]	12345678	123458678	12345678		2) Accel.Time #0	1 to 65535 /8388608 [msec]	123456	123456	123456		3) Decel.Time #0	1 to 65535 /8388608 [msec]	123456	123456	123456		-		-	-	-	-	1)	6	0006	156	009C	306	0132																		
		AD75P Basic Parameter 2		SET/RESET	Data Chg.	MONI/MENU	END																																																							
		Parameter	Valid Range	1Axis	2Axis	3Axis																																																								
		1) Speed Limit	1 to 600000000 [$\times 10^{-2}$ mm/min] 1 to 600000000 [$\times 10^{-3}$ inch/min] 1 to 600000000 [$\times 10^{-3}$ deg/min] 1 to 1000000 [PLS/sec]	12345678	123458678	12345678																																																								
		2) Accel.Time #0	1 to 65535 /8388608 [msec]	123456	123456	123456																																																								
		3) Decel.Time #0	1 to 65535 /8388608 [msec]	123456	123456	123456																																																								
		-		-	-	-	-																																																							
			7	0007	157	009D	307	0133																																																						
		2)	8	0008	158	009E	308	0134																																																						
			9	0009	159	009F	309	0135																																																						
		3)	10	000A	160	00A0	310	0136																																																						
	11	000B	161	00A1	311	0137																																																								
-	-	-	-	-	-	-																																																								
<table border="1"> <thead> <tr> <th colspan="2">AD75P Extended Parameter 1</th> <th>SET/RESET</th> <th>Data Chg.</th> <th>MONI/MENU</th> <th>END</th> </tr> <tr> <th>Parameter</th> <th>Valid Range</th> <th>Axis1</th> <th>Axis2</th> <th>Axis3</th> <th></th> </tr> </thead> <tbody> <tr> <td>1) Back Lash Compensation</td> <td>0 to 65535 [$\times 10^{-1}$ μm] [$\times 10^{-5}$ inch] [$\times 10^{-5}$ degree] [PLS]</td> <td>123456</td> <td>123456</td> <td>123456</td> <td></td> </tr> <tr> <td>2) Upper S/W Stroke Limit</td> <td>-2147483648 to 2147483647 [$\times 10^{-1}$ μm] [$\times 10^{-5}$ inch] [PLS]</td> <td>1234567890</td> <td>1234567890</td> <td>1234567890</td> <td></td> </tr> <tr> <td>3) Lower S/W Stroke Limit</td> <td>0 to 35999999 [$\times 10^{-5}$ degree] [PLS]</td> <td>1234567890</td> <td>1234567890</td> <td>1234567890</td> <td></td> </tr> <tr> <td>4) S/WStrokeLimMode</td> <td>0:ValCommon 1:ValMechan</td> <td>0</td> <td>0</td> <td>0</td> <td></td> </tr> <tr> <td>5) S/WStrokeLimit For JOG & MPG</td> <td>0:Disabled 1:Enabled</td> <td>0</td> <td>0</td> <td>0</td> <td></td> </tr> <tr> <td>6) Torque Limit</td> <td>1 to 500 [%]</td> <td>123456</td> <td>123456</td> <td>123456</td> <td></td> </tr> <tr> <td>-</td> <td></td> <td>-</td> <td>-</td> <td>-</td> <td>-</td> </tr> </tbody> </table>		AD75P Extended Parameter 1		SET/RESET	Data Chg.	MONI/MENU	END	Parameter	Valid Range	Axis1	Axis2	Axis3		1) Back Lash Compensation	0 to 65535 [$\times 10^{-1}$ μ m] [$\times 10^{-5}$ inch] [$\times 10^{-5}$ degree] [PLS]	123456	123456	123456		2) Upper S/W Stroke Limit	-2147483648 to 2147483647 [$\times 10^{-1}$ μ m] [$\times 10^{-5}$ inch] [PLS]	1234567890	1234567890	1234567890		3) Lower S/W Stroke Limit	0 to 35999999 [$\times 10^{-5}$ degree] [PLS]	1234567890	1234567890	1234567890		4) S/WStrokeLimMode	0:ValCommon 1:ValMechan	0	0	0		5) S/WStrokeLimit For JOG & MPG	0:Disabled 1:Enabled	0	0	0		6) Torque Limit	1 to 500 [%]	123456	123456	123456		-		-	-	-	-	1)	15	000F	165	00A5	315	013B
		AD75P Extended Parameter 1		SET/RESET	Data Chg.	MONI/MENU	END																																																							
		Parameter	Valid Range	Axis1	Axis2	Axis3																																																								
		1) Back Lash Compensation	0 to 65535 [$\times 10^{-1}$ μ m] [$\times 10^{-5}$ inch] [$\times 10^{-5}$ degree] [PLS]	123456	123456	123456																																																								
		2) Upper S/W Stroke Limit	-2147483648 to 2147483647 [$\times 10^{-1}$ μ m] [$\times 10^{-5}$ inch] [PLS]	1234567890	1234567890	1234567890																																																								
		3) Lower S/W Stroke Limit	0 to 35999999 [$\times 10^{-5}$ degree] [PLS]	1234567890	1234567890	1234567890																																																								
		4) S/WStrokeLimMode	0:ValCommon 1:ValMechan	0	0	0																																																								
		5) S/WStrokeLimit For JOG & MPG	0:Disabled 1:Enabled	0	0	0																																																								
		6) Torque Limit	1 to 500 [%]	123456	123456	123456																																																								
		-		-	-	-	-																																																							
			16	0010	166	00A6	316	013C																																																						
2)	17	0011	167	00A7	317	013D																																																								
	18	0012	168	00A8	318	013E																																																								
3)	19	0013	169	00A9	319	013F																																																								
	20	0014	170	00AA	320	0140																																																								
4)	21	0015	171	00AB	321	0141																																																								
	22	0016	172	00AC	322	0142																																																								
5)	23	0017	173	00AD	323	0143																																																								
	24	0018	174	00AE	324	0144																																																								
-	-	-	-	-	-	-																																																								
<table border="1"> <thead> <tr> <th colspan="2">AD75P Extended Parameter 2</th> <th>SET/RESET</th> <th>Data Chg.</th> <th>MONI/MENU</th> <th>END</th> </tr> <tr> <th>Parameter</th> <th>Valid Range</th> <th>Axis1</th> <th>Axis2</th> <th>Axis3</th> <th></th> </tr> </thead> <tbody> <tr> <td>1) Accel.Time#1</td> <td>1 to 65535 /8388608 [msec]</td> <td>123456</td> <td>123456</td> <td>123456</td> <td></td> </tr> <tr> <td>Accel.Time#2</td> <td>1 to 65535 /8388608 [msec]</td> <td>123456</td> <td>123456</td> <td>123456</td> <td></td> </tr> <tr> <td>Accel.Time#3</td> <td>1 to 65535 /8388608 [msec]</td> <td>123456</td> <td>123456</td> <td>123456</td> <td></td> </tr> <tr> <td>2) Decel.Time#1</td> <td>1 to 65535 /8388608 [msec]</td> <td>123456</td> <td>123456</td> <td>123456</td> <td></td> </tr> <tr> <td>Decel.Time#2</td> <td>1 to 65535 /8388608 [msec]</td> <td>123456</td> <td>123456</td> <td>123456</td> <td></td> </tr> <tr> <td>Decel.Time#3</td> <td>1 to 65535 /8388608 [msec]</td> <td>123456</td> <td>123456</td> <td>123456</td> <td></td> </tr> <tr> <td>-</td> <td></td> <td>-</td> <td>-</td> <td>-</td> <td>-</td> </tr> </tbody> </table>		AD75P Extended Parameter 2		SET/RESET	Data Chg.	MONI/MENU	END	Parameter	Valid Range	Axis1	Axis2	Axis3		1) Accel.Time#1	1 to 65535 /8388608 [msec]	123456	123456	123456		Accel.Time#2	1 to 65535 /8388608 [msec]	123456	123456	123456		Accel.Time#3	1 to 65535 /8388608 [msec]	123456	123456	123456		2) Decel.Time#1	1 to 65535 /8388608 [msec]	123456	123456	123456		Decel.Time#2	1 to 65535 /8388608 [msec]	123456	123456	123456		Decel.Time#3	1 to 65535 /8388608 [msec]	123456	123456	123456		-		-	-	-	-	1)	36 to 41	0024 to 0029	186 to 191	00BA to 00BF	336 to 341	0150 to 0155
		AD75P Extended Parameter 2		SET/RESET	Data Chg.	MONI/MENU	END																																																							
		Parameter	Valid Range	Axis1	Axis2	Axis3																																																								
		1) Accel.Time#1	1 to 65535 /8388608 [msec]	123456	123456	123456																																																								
		Accel.Time#2	1 to 65535 /8388608 [msec]	123456	123456	123456																																																								
		Accel.Time#3	1 to 65535 /8388608 [msec]	123456	123456	123456																																																								
		2) Decel.Time#1	1 to 65535 /8388608 [msec]	123456	123456	123456																																																								
		Decel.Time#2	1 to 65535 /8388608 [msec]	123456	123456	123456																																																								
		Decel.Time#3	1 to 65535 /8388608 [msec]	123456	123456	123456																																																								
		-		-	-	-	-																																																							
		2)	42 to 47	002A to 002F	192 to 197	00C0 to 00C5	342 to 347	0156 to 015B																																																						
-	-	-	-	-	-	-																																																								

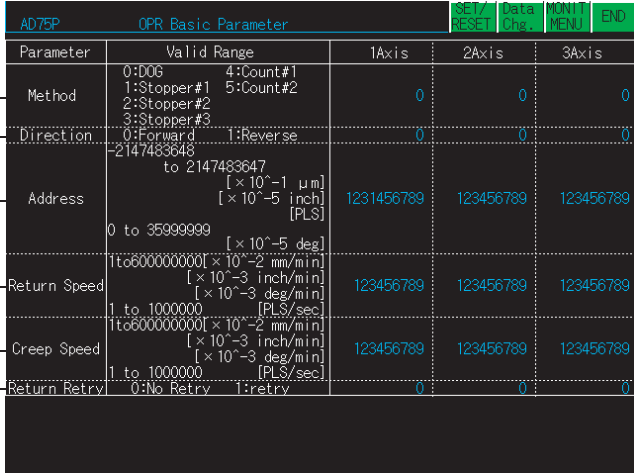
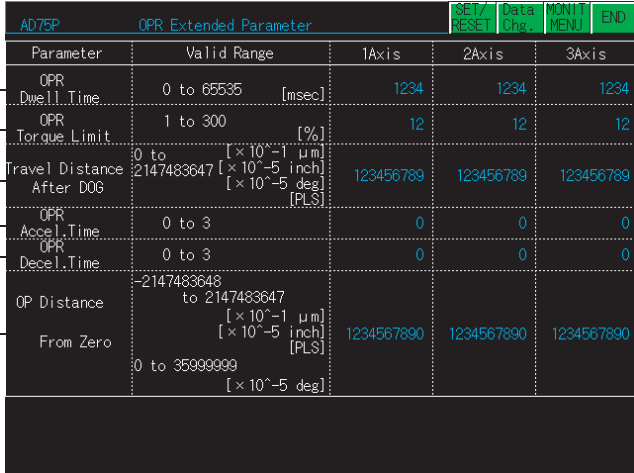
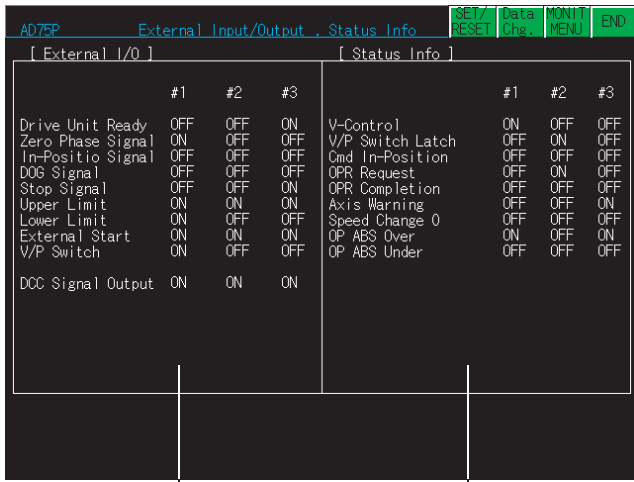
Screen example		No.	Buffer memory address					
			Axis 1		Axis 2		Axis 3	
			DEC	HEX	DEC	HEX	DEC	HEX
		1)	70	0046	220	00DC	370	0172
		2)	71	0047	221	00DD	371	0173
		3)	72	0048	222	00DE	372	0174
			73	0049	223	00DF	373	0175
		4)	74	004A	224	00E0	374	0176
			75	004B	225	00E1	375	0177
		5)	76	004C	226	00E2	376	0178
			77	004D	227	00E3	377	0179
		6)	78	004E	228	00E4	378	017A
		-	-	-	-	-	-	-
		1)	79	004F	229	00E5	379	017B
		2)	86	0056	236	00EC	386	0182
		3)	80	0050	230	00E6	380	017C
			81	0051	231	00E7	381	017D
		4)	82	0052	232	00E8	382	017E
		5)	83	0053	233	00E9	383	017F
		6)	84	0054	234	00EA	384	0180
			85	0055	235	00EB	385	0181
		-	-	-	-	-	-	-
		1)	816	0330	916	0394	1016	03F8
		2)	817	0331	917	0395	1017	03F9
		-	-	-	-	-	-	-

- 1 OVERVIEW
- 2 SYSTEM MONITOR
- 3 LADDER MONITOR FUNCTION
- 4 MELSEC-A LIST EDITOR
- 5 MELSEC-FX LIST EDITOR
- 6 INTELLIGENT MODULE MONITOR
- 7 NETWORK MONITOR
- 8 Q MOTION MONITOR

Screen example		Buffer memory address						
		No.	Axis 1		Axis 2		Axis 3	
			DEC	HEX	DEC	HEX	DEC	HEX
	1)	818	0332	918	0396	1018	03FA	
		819	0333	919	0397	1019	03FB	
	2)	802	0322	902	0386	1002	03EA	
		803	0323	903	0387	1003	03EB	
	-	-	-	-	-	-	-	
	1)	820	0334	920	0398	1020	03FC	
		821	0335	921	0399	1021	03FD	
	2)	810	032A	910	038E	1010	03F2	
		811	032B	911	038F	1011	03F3	
	3)	812	032C	912	0390	1012	03F4	
		813	032D	913	0391	1013	03F5	
	-	-	-	-	-	-	-	
	1)	1154	0482	1204	04B4	1254	04E6	
		1155	0483	1205	04B5	1255	04E7	
	2)	1156	0484	1206	04B6	1256	04E8	
		1157	0485	1207	04B7	1257	04E9	
	3)	1159	0487	1209	04B9	1259	04EB	
	4)	1172	0494	1222	04C6	1272	04F8	
	5)	1173	0495	1223	04C7	1273	04F9	
	6)	1175	0497	1225	04C9	1275	04FB	
	7)	1171	0493	1221	04C5	1271	04F7	
	-	-	-	-	-	-	-	

Screen example		No.	Buffer memory address					
			Axis 1		Axis 2		Axis 3	
			DEC	HEX	DEC	HEX	DEC	HEX
		1)	822	0336	922	039A	1022	03FE
			823	0337	923	039B	1023	03FF
		2)	824	0338	924	039C	1024	0400
			825	0339	925	039D	1025	0401
		3)	826	033A	926	039E	1026	0402
		4)						
		5)	816	0330	916	0394	1016	03F8
		6)						
		7)						
			-	-	-	-	-	-
		1)	832	0340	932	03A4	1032	0408
			827	033B	927	039F	1027	0403
			828	033C	928	03A0	1028	0404
			829	033D	929	03A1	1029	0405
		2)	1160	0488	1210	04BA	1260	04EC
			1161	0489	1211	04BB	1261	04ED
		3)	1168	0490	1218	04C2	1268	04F4
			1169	0491	1219	04C3	1269	04F5
		4)	1167	048F	1217	04C1	1267	04F3
			-	-	-	-	-	-
		1)	814	032E	914	0392	1014	03F6
			815	032F	915	0393	1015	03F7
		2)	1164	048C	1214	04BE	1264	04F0
			1165	048D	1215	04BF	1265	04F1
		3)	817	0331	917	0395	1017	03F9
		4)	1163	048B	1213	04BD	1263	04EF
		5)	817	0331	917	0395	1017	03F9
			-	-	-	-	-	-

- 1 OVERVIEW
- 2 SYSTEM MONITOR
- 3 LADDER MONITOR FUNCTION
- 4 MELSEC-A LIST EDITOR
- 5 MELSEC-FX LIST EDITOR
- 6 INTELLIGENT MODULE MONITOR
- 7 NETWORK MONITOR
- 8 Q MOTION MONITOR

Screen example	No.	Buffer memory address					
		Axis 1		Axis 2		Axis 3	
		DEC	HEX	DEC	HEX	DEC	HEX
	1)	624 to 687	0270 to 02AF	624 to 687	0270 to 02AF	624 to 687	0270 to 02AF
	2)	689 to 752	02B1 to 02F0	689 to 752	02B1 to 02F0	689 to 752	02B1 to 02F0
	-	-	-	-	-	-	-
	1)	543 to 622	021F to 026E	543 to 622	021F to 026E	543 to 622	021F to 026E
	2)	462 to 541	01CE to 021D	462 to 541	01CE to 021D	462 to 541	01CE to 021D
	-	-	-	-	-	-	-
	1)	1300 to 2299	0514 to 08FB	2300 to 3299	08FC to 0CE3	3300 to 4299	0CE4 to 10CB
	2)	-	-	-	-	-	-
	3)	-	-	-	-	-	-

6.5.23 AJ71ID1(ID2)-R4/A1SJ71ID1(ID2)-R4 module monitoring

Screen example	No.	Buffer memory address			
		X axis		Y axis	
		DEC	HEX	DEC	HEX
	1)	-	-	-	-
	1)	0	0000	4000	0FA0
	2)	1	0001	4001	0FA1
	3)	2	0002	4002	0FA2
	4)	8	0008	4008	0FA8
	5)	22	0016	4022	0FB6
	6)	23	0017	4023	0FB7
	7)	4	0004	4004	0FA4
	8)	5	0005	4005	0FA5
		-	-	4010	0FAA
		12	000C	4012	0FAC
		14	000E	4014	0FAE
		to	to	to	to
		18	0012	4018	0FB2
		-	-	-	-
	1)	100	0064	4100	1004
		to	to	to	to
		163	00A3	4163	1043
		-	-	-	-

1	OVERVIEW
2	SYSTEM MONITOR
3	LADDER MONITOR FUNCTION
4	MELSEC-A LIST EDITOR
5	MELSEC-FX LIST EDITOR
6	INTELLIGENT MODULE MONITOR
7	NETWORK MONITOR
8	Q MOTION MONITOR

6.5.24 A1S68DAV/A1S68DAI module monitoring

Screen example	No.	Buffer memory address	
		DEC	HEX
<p>1) -</p>	1)	0	0000
	2)	1 to 8	0001 to 0008
	3)	10 to 17	000A to 0011
	4)	10 to 17	000A to 0011
<p>1) -</p>	1)	-	-
	-	-	-
<p>1) -</p> <p>2) -</p> <p>3) -</p>	1)	1 to 8	0001 to 0008
	2)	0	0000
	3)	-	-
-	-	-	-

6.5.25 A1S68AD module monitoring

Screen example	No.	Buffer memory address	
		DEC	HEX
<p>1) A/D Conversion</p> <p>2) A/D Method</p> <p>3) Averaging</p> <p>4) A/D Conversion</p> <p>5) Averaging Time/Number</p> <p>6) Input Status [%]</p> <p>7) Error Code</p>	1)	0	0000
	2)	2	0002
	3)	2	0002
	4)	28	001C
	5)	10 to 17	000A to 0011
	6)	20 to 27	0014 to 001B
	7)	1	0001
<p>1) WDT Error</p>	1)	-	-
	-	-	-
<p>1) Input [%]</p> <p>2) WDT Error</p>	1)	20 to 27	0014 to 001B
	2)	-	-

1

OVERVIEW

2

SYSTEM MONITOR

3

LADDER MONITOR
FUNCTION

4

MELSEC-A LIST
EDITOR

5

MELSEC-FX LIST
EDITOR

6

INTELLIGENT
MODULE MONITOR

7

NETWORK
MONITOR

8

Q MOTION
MONITOR

6.5.26 A1S64TCTT(BW)/A1S64TCRT(BW)-S1 monitoring

Screen example		No.	Buffer memory address							
			CH1		CH2		CH3		CH4	
			DEC	HEX	DEC	HEX	DEC	HEX	DEC	HEX
		1)	32	0020	64	0040	96	0060	128	0080
		2)	32	0020	64	0040	96	0060	128	0080
		3)	1	0001	2	0002	3	0003	4	0004
		4)	9	0009	10	000A	11	000B	12	000C
		5)	34	0022	66	0042	98	0062	130	0082
		6)	13	000D	14	000E	15	000F	16	0010
		7)	-	-	-	-	-	-	-	-
		8)	-	-	-	-	-	-	-	-
		1)	5	0005	6	0006	7	0007	8	0008
			-	-	-	-	-	-	-	-

Screen example	No.	Buffer memory address							
		CH1		CH2		CH3		CH4	
		DEC	HEX	DEC	HEX	DEC	HEX	DEC	HEX
<p>1) Input range Measurement unit Dec. point position 0 3)</p> <p>Pro.Val.Dec.P.P.=0 400 Set Val.Dec.P.P.=0 100 Man.Val.0 100 6)</p> <p>(PV) Dec.P.P.=1 40.0 (SV) Dec.P.P.=1 10.0 (MV) [%]</p> <p>7) Proportional s.(P) 0.0% Integral time(I) 0 sec Derivative time(D) 0sec 9)</p> <p>10) Write error Error address 2 Cause Write is allow only in the set mod 12)</p> <p>11) Alert alarm No. 1 2 3 4</p> <p>13) Set.Val.Dec.P.P.=0 0 0 0 0 18)</p> <p>(SV) Dec.P.P.=1 0.0 0.0 0.0 0.0</p> <p>14) Mode setting 0 0 0 0 19)</p> <p>15) CT selection 0 400.0 A 0.0 A Output Upper 0.0 %</p> <p>1 40.00 A 0.00 A Limiter Lower 0.0 %</p> <p>20) Expanded graph Normal Graph</p> <p>PV SV -100 0 400 PV SV -2000 0 8000</p> <p>16) 17)</p>	1)	32	0020	64	0040	96	0060	128	0080
	2)	32	0020	64	0040	96	0060	128	0080
	3)	1	0001	2	0002	3	0003	4	0004
	4)	9	0009	10	000A	11	000B	12	000C
	5)	34	0022	66	0042	98	0062	130	0082
	6)	13	000D	14	000E	15	000F	16	0010
	7)	35	0023	67	0043	99	0063	131	0083
	8)	36	0024	68	0044	100	0064	132	0084
	9)	37	0025	69	0045	101	0065	133	0085
	10)	-	-	-	-	-	-	-	-
	11)	0	0000	0	0000	0	0000	0	0000
	12)	0	0000	0	0000	0	0000	0	0000
	13)	38	0026	70	0046	102	0066	134	0086
	14)	to	to	to	to	to	to	to	to
	15)	160	00A0	160	00A0	160	00A0	160	00A0
	16)	to	to	to	to	to	to	to	to
	17)	163	00A3	163	00A3	163	00A3	163	00A3
	18)	57	0039	89	0059	121	0079	153	0099
	19)	25	0019	26	001A	27	001B	28	001C
	20)	171	00AB	172	00AC	173	00AD	174	00AE
	42	002A	74	004A	106	006A	138	008A	
	43	002B	75	004B	107	006B	139	008B	
	-	-	-	-	-	-	-	-	
	9	0009	10	000A	11	000B	12	0000	

- 1 OVERVIEW
- 2 SYSTEM MONITOR
- 3 LADDER MONITOR FUNCTION
- 4 MELSEC-A LIST EDITOR
- 5 MELSEC-FX LIST EDITOR
- 6 INTELLIGENT MODULE MONITOR
- 7 NETWORK MONITOR
- 8 Q MOTION MONITOR

6.5.27 Q68ADV/Q68ADI/Q64AD module monitoring

Screen example		No.	Buffer memory address																																			
			DEC	HEX																																		
<p>Q68ADV/Q68ADI/Q64AD Operation Monitor</p> <p>Channel: 8 7 6 5 4 3 2 1</p> <p>1) A/D conv. 10100100 0 Used 1:OFF</p> <p>2) A/D conv. complete 00000000 0 Incomplete 1:Completed</p> <p>3) Average process setting 00000001 0 Sampling 1:averaging</p> <p>4) 00101100 0 Number 1:1</p> <p>Setting range: HEX 00000000</p> <p>0.4 to 20(mA)/1.0 to 20(mA)/2.1 to 5(V) 0.4 to 5(V) /4:-10 to +10(V) 0.4 to +10(V)/F>User range setting</p> <table border="1"> <thead> <tr> <th>Average Time/Count</th> <th>Digital value</th> </tr> <tr> <th>Output</th> <th>Minimum</th> <th>Maximum</th> </tr> </thead> <tbody> <tr> <td>CH1: 2500</td> <td>0</td> <td>0</td> </tr> <tr> <td>CH2: 0</td> <td>0</td> <td>1</td> </tr> <tr> <td>CH3: 0</td> <td>0</td> <td>120</td> </tr> <tr> <td>CH4: 0</td> <td>0</td> <td>123</td> </tr> <tr> <td>CH5: 0</td> <td>0</td> <td>0</td> </tr> <tr> <td>CH6: 0</td> <td>0</td> <td>0</td> </tr> <tr> <td>CH7: 0</td> <td>0</td> <td>0</td> </tr> <tr> <td>CH8: 0</td> <td>0</td> <td>0</td> </tr> </tbody> </table> <p>5) 7) 8) 9) 10)</p>		Average Time/Count	Digital value	Output	Minimum	Maximum	CH1: 2500	0	0	CH2: 0	0	1	CH3: 0	0	120	CH4: 0	0	123	CH5: 0	0	0	CH6: 0	0	0	CH7: 0	0	0	CH8: 0	0	0	6)	1)	0	0000				
		Average Time/Count	Digital value																																			
		Output	Minimum	Maximum																																		
		CH1: 2500	0	0																																		
		CH2: 0	0	1																																		
		CH3: 0	0	120																																		
		CH4: 0	0	123																																		
		CH5: 0	0	0																																		
		CH6: 0	0	0																																		
		CH7: 0	0	0																																		
CH8: 0	0	0																																				
	2)	10	000A																																			
	3)	9	0009																																			
	4)	9	0009																																			
	5)	20, 21	0014, 0015																																			
	6)	19	0013																																			
	7)	1 to 8	0001 to 0008																																			
	8)	11 to 18	000B to 0012																																			
	9)	30, 32, 34, 36, 38, 40, 42, 44	001E, 0020, 0022, 0024, 0026, 0028, 002A, 002C																																			
	10)	31, 33, 35, 37, 39, 41, 43, 45	001F, 0021, 0023, 0025, 0027, 0029, 002B, 002D																																			
	-	-	-																																			
<p>Q68ADV/Q68ADI/Q64AD Input/Output Monitor</p> <table border="1"> <thead> <tr> <th>X</th> <th>Y</th> </tr> </thead> <tbody> <tr> <td>00 Module READY</td> <td>08 High resolution</td> </tr> <tr> <td>01 Temp. drift comp.</td> <td>09 Operation set</td> </tr> <tr> <td>02</td> <td>0A Offset/gain mode</td> </tr> <tr> <td>03</td> <td>0B Ch. change done</td> </tr> <tr> <td>04</td> <td>0C Ch. change req.</td> </tr> <tr> <td>05</td> <td>0D Max/min val. RST</td> </tr> <tr> <td>06</td> <td>0E A/D conv. done</td> </tr> <tr> <td>07</td> <td>0F Error flag</td> </tr> <tr> <td></td> <td>08 Op. cond. set req.</td> </tr> <tr> <td></td> <td>09 User range write</td> </tr> <tr> <td></td> <td>0A Ch. change req.</td> </tr> <tr> <td></td> <td>0B</td> </tr> <tr> <td></td> <td>0C</td> </tr> <tr> <td></td> <td>0D</td> </tr> <tr> <td></td> <td>0E</td> </tr> <tr> <td></td> <td>0F</td> </tr> </tbody> </table> <p>1)</p>		X	Y	00 Module READY	08 High resolution	01 Temp. drift comp.	09 Operation set	02	0A Offset/gain mode	03	0B Ch. change done	04	0C Ch. change req.	05	0D Max/min val. RST	06	0E A/D conv. done	07	0F Error flag		08 Op. cond. set req.		09 User range write		0A Ch. change req.		0B		0C		0D		0E		0F	1)	-	-
		X	Y																																			
00 Module READY	08 High resolution																																					
01 Temp. drift comp.	09 Operation set																																					
02	0A Offset/gain mode																																					
03	0B Ch. change done																																					
04	0C Ch. change req.																																					
05	0D Max/min val. RST																																					
06	0E A/D conv. done																																					
07	0F Error flag																																					
	08 Op. cond. set req.																																					
	09 User range write																																					
	0A Ch. change req.																																					
	0B																																					
	0C																																					
	0D																																					
	0E																																					
	0F																																					
	-	-	-																																			
<p>Q68ADV/Q68ADI/Q64AD Graph Monitor</p> <p>1)</p> <p>2)</p>		1)	11 to 18	000B to 0012																																		
		2)	-	-																																		
	-	-	-																																			

6.5.28 Q62DA/Q64DA module monitoring

Screen example	No.	Buffer memory address																																														
		DEC	HEX																																													
<p>Q62DA/Q64DA Operation Monitor</p> <p>1) D/A conv: 0100</p> <p>2) Setting range: 0000</p> <p>3) Digital value table:</p> <table border="1"> <tr> <th>CH</th> <th>Digital value</th> <th>Set value</th> <th>Over</th> <th>Under</th> </tr> <tr> <td>CH1</td> <td>2500</td> <td></td> <td></td> <td></td> </tr> <tr> <td>CH2</td> <td></td> <td></td> <td></td> <td></td> </tr> <tr> <td>CH3</td> <td></td> <td></td> <td></td> <td></td> </tr> <tr> <td>CH4</td> <td></td> <td></td> <td></td> <td></td> </tr> </table> <p>4) Set value table:</p> <table border="1"> <tr> <th>CH</th> <th>Set value</th> <th>Over</th> <th>Under</th> </tr> <tr> <td>CH1</td> <td></td> <td></td> <td></td> </tr> <tr> <td>CH2</td> <td></td> <td></td> <td></td> </tr> <tr> <td>CH3</td> <td></td> <td></td> <td></td> </tr> <tr> <td>CH4</td> <td></td> <td></td> <td></td> </tr> </table> <p>5) Error code: 0100</p>	CH	Digital value	Set value	Over	Under	CH1	2500				CH2					CH3					CH4					CH	Set value	Over	Under	CH1				CH2				CH3				CH4				1)	0	0000
	CH	Digital value	Set value	Over	Under																																											
	CH1	2500																																														
	CH2																																															
	CH3																																															
CH4																																																
CH	Set value	Over	Under																																													
CH1																																																
CH2																																																
CH3																																																
CH4																																																
	2)	20	0014																																													
	3)	1 to 4	0001 to 0004																																													
	4)	11 to 14	000B to 000E																																													
	5)	19	0013																																													
<p>Q62DA/Q64DA Input/Output Monitor</p> <p>1) Status messages:</p> <ul style="list-style-type: none"> 00 Module READY 01 Op. cond. set done 02 Offset/gain mode 03 Ch. change done 04 Set val. change 05 Sync. output mode 06 Error flag 07 Error clear req. 	1)	-	-																																													
		-	-	-																																												
<p>Q62DA/Q64DA Graph Monitor</p> <p>3) Graph input</p> <p>4) Error messages</p> <p>1) Minimum error table:</p> <table border="1"> <tr> <th>CH</th> <th>Minimum error</th> <th>Maximum error</th> </tr> <tr> <td>CH1</td> <td></td> <td></td> </tr> <tr> <td>CH2</td> <td></td> <td></td> </tr> <tr> <td>CH3</td> <td></td> <td></td> </tr> <tr> <td>CH4</td> <td></td> <td></td> </tr> </table> <p>2) Maximum error table:</p> <table border="1"> <tr> <th>CH</th> <th>Minimum error</th> <th>Maximum error</th> </tr> <tr> <td>CH1</td> <td></td> <td></td> </tr> <tr> <td>CH2</td> <td></td> <td></td> </tr> <tr> <td>CH3</td> <td></td> <td></td> </tr> <tr> <td>CH4</td> <td></td> <td></td> </tr> </table>	CH	Minimum error	Maximum error	CH1			CH2			CH3			CH4			CH	Minimum error	Maximum error	CH1			CH2			CH3			CH4			1)	11 to 14	000B to 000E															
	CH	Minimum error	Maximum error																																													
	CH1																																															
	CH2																																															
CH3																																																
CH4																																																
CH	Minimum error	Maximum error																																														
CH1																																																
CH2																																																
CH3																																																
CH4																																																
	2)	11 to 14	000B to 000E																																													
	3)	1 to 4	0001 to 0004																																													
	4)	-	-																																													
	-	-	-																																													

1 OVERVIEW

2 SYSTEM MONITOR

3 LADDER MONITOR FUNCTION

4 MELSEC-A LIST EDITOR

5 MELSEC-FX LIST EDITOR

6 INTELLIGENT MODULE MONITOR

7 NETWORK MONITOR

8 Q MOTION MONITOR

6.5.29 QD62D/QD62E/QD62 module monitoring

Screen example		No.	Buffer memory address	
			DEC	HEX
	1)	00 to 01	0000 to 0001	
		32 to 33	0020 to 0021	
	2)	02 to 03	0002 to 0003	
		34 to 35	0022 to 0023	
	3)	04 to 05	0004 to 0005	
		36 to 37	0024 to 0025	
	4)	06 to 07	0006 to 0007	
		38 to 39	0026 to 0027	
	5)	10, 42	000A, 002A	
		12 to 13	000C to 000D	
	6)	44 to 45	002C to 002D	
		14 to 15	000E to 000F	
	7)	46 to 47	002E to 002F	
	8)	16 to 17	0010 to 0011	
	48 to 49	0030 to 0031		
9)	18 to 19	0012 to 0013		
	50 to 51	0032 to 0033		
10)	20 to 21	0014 to 0015		
	52 to 53	0034 to 0035		
11)	22 to 23	0016 to 0017		
	54 to 55	0036 to 0037		
	12)	08, 40	0008, 0028	
	13)	11, 43	000B, 002B	
	14)	09, 41	0009, 0029	
	1)	-	-	
	-	-	-	

6.5.30 QD65PD2 module monitoring

Screen example		No.	Buffer memory address	
			DEC	HEX
<p>QD65PD2 Operation Monitor</p> <p>1) Operation mode: CH1 Normal Mode, CH2 Normal Mode</p> <p>2) External input status: bit 5-10, bit 4-10, bit 10-15</p> <p>3) Terminal status: EQU 1000000, OUT 1000000</p> <p>9) Error status: 0:Normal 1:Error</p> <p>10) Latest error: Code, Time</p> <p>11) Error reset command: 0:No reset 1:Reset</p>	1)	1451	05AB	
	1951	079F		
	2)	1450	05AA	
	1950	079E		
	3)	951	03B7	
	4)	952	03B8	
	5)	953	03B9	
	6)	1460	05B4	
	1960	07A8		
	7)	1461 to 1464	05B5 to 05B8	
	1960 to 1964	07A8 to 07AC		
8)	954	03BA		
9)	1470	05BE		
1970	07B2			
10)	1471 to 1474	5BF to 5C2		
1971 to 1974	07B3 to 07B6			
11)	1480	05C8		
1980	07BC			
<p>QD65PD2 Operation Monitor (Normal1)</p> <p>1) Phase Z (preset) trigger setting: CH1, CH2</p> <p>2) External preset request detection: CH1, CH2</p> <p>3) Periodic interrupt setting: CH1, CH2</p> <p>4) Ring counter lower, Ring counter upper, Preset value</p> <p>5) Present value</p> <p>6) Selected counter function</p> <p>7) Count disable function</p>	1)	1000	03E8	
	1500	05DC		
	2)	1000	03E8	
	1500	05DC		
	3)	1001	03E9	
	1501	05DD		
	4)	1010 to 1011	03F2 to 03F3	
	1510 to 1511	05E6 to 05E7		
	5)	1012 to 1013	03F4 to 03F5	
	1512 to 1513	05E8 to 05E9		
	6)	1014 to 1015	03F6 to 03F7	
1514 to 1515	05EA to 05EB			
7)	1017	03F9		
1517	05ED			
8)	1016	03F8		
1516	05EC			
9)	1020	03FC		
1520	05F0			
10)	1050 to 1051	041A to 041B		
1550 to 1551	060E to 060F			
11)	1070	042E		
1570	0622			

1 OVERVIEW

2 SYSTEM MONITOR

3 LADDER MONITOR FUNCTION

4 MELSEC-A LIST EDITOR

5 MELSEC-FX LIST EDITOR

6 INTELLIGENT MODULE MONITOR

7 NETWORK MONITOR

8 Q MOTION MONITOR

Screen example		No.	Buffer memory address	
			DEC	HEX
<p>QD65PD2 Operation Monitor (Normal2)</p> <p>1) Present value CH1: 123456 CH2: 123456</p> <p>2) Latch count value CH1: 123456 CH2: 123456</p> <p>3) Latch count value (input terminal) CH1: 123456 CH2: 123456</p> <p>4) Sampling count value CH1: 123456 CH2: 123456</p> <p>5) Periodic pulse count diff.val.: 123456 pre.val.: 123456</p> <p>6) Overflow/underflow Smp./Per. counter ope.flag: Not measured</p> <p>7) CH1 Overflow: Not measured CH2 Underflow: Not measured</p> <p>8) Selected counter function CH1 Count disable function CH2 Count disable function</p> <p>9)</p>	1)	1050 to 1051 1550 to 1551	041A to 41B 060E to 060F	
	2)	1052 to 1053 1552 to 1553	041C to 041D 0610 to 0611	
	3)	1054 to 1055 1554 to 1555	041E to 041F 0612 to 0613	
	4)	1056 to 1057 1556 to 1557	0420 to 0421 0614 to 0615	
	5)	1058 to 1059 1558 to 1559	0422 to 0423 0616 to 0617	
	6)	1060 to 1061 1560 to 1561	0424 to 0425 0618 to 0619	
	7)	1072 1572	0430 0624	
	8)	1071 1571	042F 0623	
	9)	1070 1570	042E 0622	
	10)	1074 1574	0432 0626	
	11)	1075 1575	0433 0627	
	12)	1076 1576	0434 0628	
	13)	1077 1577	0435 0629	
	14)	1022 1522	03FE 05F2	
	15)	1023 1523	03FF 05F3	
	16)	1024 1524	0400 05F4	
	17)	1025 1525	0401 05F5	
<p>QD65PD2 Operation Monitor (Frequency)</p> <p>1) Time unit setting (frequency measurement) CH1: 6 CH2: 6</p> <p>2) Moving average count (frequency measurement) CH1: 456 CH2: 456</p> <p>3) CH1 Count enable CH2 Count enable</p> <p>4) Measured frequency value update flag reset command CH1: 6 CH2: 6</p>	1)	1100 1600	044C 0640	
	2)	1101 1601	044D 0641	
	3)	-	-	
	4)	1120 1620	0460 0654	
	5)	1130 1630	046A 065E	
	6)	1131 1631	046B 065F	
	7)	1132 to 1133 1632 to 1633	046C to 046D 0660 to 0661	
	-	-	-	

Screen example		No.	Buffer memory address	
			DEC	HEX
		1)	1150	047E
			1650	0672
		2)	1151	047F
			1651	0673
		3)	1152 to 1153	0480 to 0481
			1652 to 1653	0674 to 0675
		4)	-	-
		5)	1170	0492
			1670	0686
		6)	1180	049C
			1680	0690
		7)	1181	049D
			1681	0691
		8)	1182 to 1183	049E to 049F
			1682 to 1683	0692 to 0693
		-	-	-
		1)	-	-
		2)	1200	04B0
			1700	06A4
		3)	1201	04B1
			1701	06A5
		4)	1210	04BA
			1710	06AE
		5)	1212	04BC
			1712	06B0
		6)	1211	04BB
	1711	06AF		
7)	1213	04BD		
	1713	06B1		
8)	1220	04C4		
	1720	06B8		
9)	1240	04D8		
	1740	06CC		
10)	1221	04C5		
	1721	06B9		
11)	1241	04D9		
	1741	06CD		
12)	1222 to 1223	04C6 to 04C7		
	1722 to 1723	06BA to 06BB		
13)	1242 to 1243	04DA to 04DB		
	1742 to 1743	06CE to 06CF		

1

OVERVIEW

2

SYSTEM MONITOR

3

LADDER MONITOR FUNCTION

4

MELSEC-A LIST EDITOR

5

MELSEC-FX LIST EDITOR

6

INTELLIGENT MODULE MONITOR

7

NETWORK MONITOR

8

Q MOTION MONITOR

Screen example		No.	Buffer memory address	
			DEC	HEX
	1)	950	03B6	
	2)	1300	0514	
		1800	0708	
	3)	1302 to 1303	0516 to 0517	
		1802 to 1803	070A to 070B	
	4)	1304 to 1305	0518 to 0519	
1804 to 1805		070C to 070D		
5)	-	-		
6)	-	-		
	1)	-	-	
	-	-	-	
	-	-	-	
	-	-	-	
	-	-	-	
	-	-	-	
	1)	950	03B6	
	2)	1050 to 1051	041A to 041B	
		1550 to 1551	060E to 060F	
	3)	0	0000	
	4)	1	0001	
5)	2	0002		
-	-	-	-	

Screen example		No.	Buffer memory address																																											
			DEC	HEX																																										
<p>QD65PD2 Coincidence output function2</p> <p>Channel assignment status Coincidence 8 7 6 5 4 3 2 1 output 6 6 6 6 6 6 6 6</p> <p>0:Not assigned 1:CH1 2:CH2</p> <p>Coincidence output condition setting Coincidence 8 7 6 5 4 3 2 1 output 6 6 6 6 6 6 6 6</p> <p>0:Coincidence 1:Within-range 2:Out-of-range</p> <table border="1"> <tr><th>Item</th><th>CH1</th><th>CH2</th></tr> <tr><td>Present value</td><td>123456</td><td>123456</td></tr> </table> <p>Counter value greater/smaller Coincidence 8 7 6 5 4 3 2 1 output 00 00 00 00 00 00 00 00</p> <p>01:Point setting (00 n) > Present value 00:Point setting (00 n) = Present value 10:Point setting (00 n) < Present value</p> <p>Setting change request Coincidence 8 7 6 5 4 3 2 1 output 6 6 6 6 6 6 6 6</p> <p>0:Not requested 1:Requested</p>		Item	CH1	CH2	Present value	123456	123456	1)	950	03B6																																				
		Item	CH1	CH2																																										
		Present value	123456	123456																																										
		2)	0	0																																										
		3)	1050 to 1051	041A to 041B																																										
			1550 to 1551	060E to 060F																																										
		4)	190	00BE																																										
		5)	100 to 101	0064 to 0065																																										
			102 to 103	0066 to 0067																																										
			104 to 105	0068 to 0069																																										
			106 to 107	006A to 006B																																										
			108 to 109	006C to 006D																																										
			110 to 111	006E to 006F																																										
			112 to 113	0070 to 0071																																										
			114 to 115	0072 to 0073																																										
		6)	120 to 121	0078 to 0079																																										
124 to 125	007C to 007D																																													
128 to 129	0080 to 0081																																													
132 to 133	0084 to 0085																																													
136 to 137	0088 to 0089																																													
140 to 141	008C to 008D																																													
144 to 145	0090 to 0091																																													
148 to 149	0094 to 0095																																													
7)	122 to 123	007A to 007B																																												
	126 to 127	007E to 007D																																												
	130 to 131	0082 to 0083																																												
	134 to 135	0086 to 0087																																												
	138 to 139	008A to 008B																																												
	142 to 143	008E to 008F																																												
	146 to 147	0092 to 0093																																												
	150 to 151	0096 to 0097																																												
8)	180 to 187	00B4 to 00BB																																												
<p>QD65PD2 Cam switch function(CO 1)</p> <p>Channel assignment status Coincidence 8 7 6 5 4 3 2 1 output 6 6 6 6 6 6 6 6</p> <p>0:Not assigned 1:CH1 2:CH2</p> <table border="1"> <tr><th>Item</th><th>CH1</th><th>CH2</th></tr> <tr><td>Present value</td><td>123456</td><td>123456</td></tr> </table> <p>Step type 0:Start from output status OFF 1:Start from output status ON</p> <p>Number of steps 56 Setting range 0 to 16</p> <table border="1"> <tr><th colspan="4">Step setting</th></tr> <tr><td>No.1</td><td>123456</td><td>No.9</td><td>123456</td></tr> <tr><td>No.2</td><td>123456</td><td>No.10</td><td>123456</td></tr> <tr><td>No.3</td><td>123456</td><td>No.11</td><td>123456</td></tr> <tr><td>No.4</td><td>123456</td><td>No.12</td><td>123456</td></tr> <tr><td>No.5</td><td>123456</td><td>No.13</td><td>123456</td></tr> <tr><td>No.6</td><td>123456</td><td>No.14</td><td>123456</td></tr> <tr><td>No.7</td><td>123456</td><td>No.15</td><td>123456</td></tr> <tr><td>No.8</td><td>123456</td><td>No.16</td><td>123456</td></tr> </table>		Item	CH1	CH2	Present value	123456	123456	Step setting				No.1	123456	No.9	123456	No.2	123456	No.10	123456	No.3	123456	No.11	123456	No.4	123456	No.12	123456	No.5	123456	No.13	123456	No.6	123456	No.14	123456	No.7	123456	No.15	123456	No.8	123456	No.16	123456	1)	950	03B6
		Item	CH1	CH2																																										
		Present value	123456	123456																																										
		Step setting																																												
		No.1	123456	No.9	123456																																									
		No.2	123456	No.10	123456																																									
		No.3	123456	No.11	123456																																									
		No.4	123456	No.12	123456																																									
		No.5	123456	No.13	123456																																									
		No.6	123456	No.14	123456																																									
		No.7	123456	No.15	123456																																									
		No.8	123456	No.16	123456																																									
		2)	1050 to 1051	041A to 041B																																										
		3)	1550 to 1551	060E to 060F																																										
			200	00C8																																										
		4)	201	00C9																																										
5)	202 to 203	00CA to 00CB																																												
	204 to 205	00CC to 00CD																																												
	:	:																																												
	232 to 233	00E8 to 00E9																																												
-	-	-																																												

*1 In the QD65PD2 Cam switch function(CO 2) screen and the following screens, the value that +40 (decimal) is added to the one in the previous screen is the buffer memory address.

- 1 OVERVIEW
- 2 SYSTEM MONITOR
- 3 LADDER MONITOR FUNCTION
- 4 MELSEC-A LIST EDITOR
- 5 MELSEC-FX LIST EDITOR
- 6 INTELLIGENT MODULE MONITOR
- 7 NETWORK MONITOR
- 8 Q MOTION MONITOR

Screen example	No.	Buffer memory address																																																																									
		DEC	HEX																																																																								
<p>QD65PD2 Error log</p> <p>[SET/ Data MONIT RESET/ Chg. MENU END]</p> <table border="1"> <thead> <tr> <th colspan="3">Error log</th> </tr> <tr> <th>No.</th> <th>Code</th> <th>Time</th> </tr> </thead> <tbody> <tr><td>56</td><td>3456</td><td>3456/56/56 (SUN) 56:56:56</td></tr> <tr><td>56</td><td>3456</td><td>3456/56/56 (SUN) 56:56:56</td></tr> <tr><td>56</td><td>3456</td><td>3456/56/56 (SUN) 56:56:56</td></tr> <tr><td>56</td><td>3456</td><td>3456/56/56 (SUN) 56:56:56</td></tr> <tr><td>56</td><td>3456</td><td>3456/56/56 (SUN) 56:56:56</td></tr> <tr><td>56</td><td>3456</td><td>3456/56/56 (SUN) 56:56:56</td></tr> <tr><td>56</td><td>3456</td><td>3456/56/56 (SUN) 56:56:56</td></tr> <tr><td>56</td><td>3456</td><td>3456/56/56 (SUN) 56:56:56</td></tr> <tr><td>56</td><td>3456</td><td>3456/56/56 (SUN) 56:56:56</td></tr> <tr><td>56</td><td>3456</td><td>3456/56/56 (SUN) 56:56:56</td></tr> </tbody> </table> <table border="1"> <thead> <tr> <th colspan="3">Error log</th> </tr> <tr> <th>No.</th> <th>Code</th> <th>Time</th> </tr> </thead> <tbody> <tr><td>56</td><td>3456</td><td>3456/56/56 (SUN) 56:56:56</td></tr> <tr><td>56</td><td>3456</td><td>3456/56/56 (SUN) 56:56:56</td></tr> <tr><td>56</td><td>3456</td><td>3456/56/56 (SUN) 56:56:56</td></tr> <tr><td>56</td><td>3456</td><td>3456/56/56 (SUN) 56:56:56</td></tr> <tr><td>56</td><td>3456</td><td>3456/56/56 (SUN) 56:56:56</td></tr> <tr><td>56</td><td>3456</td><td>3456/56/56 (SUN) 56:56:56</td></tr> <tr><td>56</td><td>3456</td><td>3456/56/56 (SUN) 56:56:56</td></tr> <tr><td>56</td><td>3456</td><td>3456/56/56 (SUN) 56:56:56</td></tr> <tr><td>56</td><td>3456</td><td>3456/56/56 (SUN) 56:56:56</td></tr> <tr><td>56</td><td>3456</td><td>3456/56/56 (SUN) 56:56:56</td></tr> </tbody> </table> <p>1) ————</p> <p>2) ————</p>	Error log			No.	Code	Time	56	3456	3456/56/56 (SUN) 56:56:56	56	3456	3456/56/56 (SUN) 56:56:56	56	3456	3456/56/56 (SUN) 56:56:56	56	3456	3456/56/56 (SUN) 56:56:56	56	3456	3456/56/56 (SUN) 56:56:56	56	3456	3456/56/56 (SUN) 56:56:56	56	3456	3456/56/56 (SUN) 56:56:56	56	3456	3456/56/56 (SUN) 56:56:56	56	3456	3456/56/56 (SUN) 56:56:56	56	3456	3456/56/56 (SUN) 56:56:56	Error log			No.	Code	Time	56	3456	3456/56/56 (SUN) 56:56:56	56	3456	3456/56/56 (SUN) 56:56:56	56	3456	3456/56/56 (SUN) 56:56:56	56	3456	3456/56/56 (SUN) 56:56:56	56	3456	3456/56/56 (SUN) 56:56:56	56	3456	3456/56/56 (SUN) 56:56:56	56	3456	3456/56/56 (SUN) 56:56:56	56	3456	3456/56/56 (SUN) 56:56:56	56	3456	3456/56/56 (SUN) 56:56:56	56	3456	3456/56/56 (SUN) 56:56:56	1)	6000	1770
	Error log																																																																										
No.	Code	Time																																																																									
56	3456	3456/56/56 (SUN) 56:56:56																																																																									
56	3456	3456/56/56 (SUN) 56:56:56																																																																									
56	3456	3456/56/56 (SUN) 56:56:56																																																																									
56	3456	3456/56/56 (SUN) 56:56:56																																																																									
56	3456	3456/56/56 (SUN) 56:56:56																																																																									
56	3456	3456/56/56 (SUN) 56:56:56																																																																									
56	3456	3456/56/56 (SUN) 56:56:56																																																																									
56	3456	3456/56/56 (SUN) 56:56:56																																																																									
56	3456	3456/56/56 (SUN) 56:56:56																																																																									
56	3456	3456/56/56 (SUN) 56:56:56																																																																									
Error log																																																																											
No.	Code	Time																																																																									
56	3456	3456/56/56 (SUN) 56:56:56																																																																									
56	3456	3456/56/56 (SUN) 56:56:56																																																																									
56	3456	3456/56/56 (SUN) 56:56:56																																																																									
56	3456	3456/56/56 (SUN) 56:56:56																																																																									
56	3456	3456/56/56 (SUN) 56:56:56																																																																									
56	3456	3456/56/56 (SUN) 56:56:56																																																																									
56	3456	3456/56/56 (SUN) 56:56:56																																																																									
56	3456	3456/56/56 (SUN) 56:56:56																																																																									
56	3456	3456/56/56 (SUN) 56:56:56																																																																									
56	3456	3456/56/56 (SUN) 56:56:56																																																																									
	2)	6010 to 6164	177A to 1814																																																																								
	-	-	-																																																																								

6.5.31 QD73A1 module monitoring

Screen example		No.	Buffer memory address	
			DEC	HEX
		1)	-	-
		2)	100, 101	0064, 0065
		3)	102, 103	0066, 0067
		4)	114, 115	0072, 0073
		5)	106, 107	006A, 006B
		6)	61, 62	003D, 003E
		7)	65, 66	0041, 0042
		8)	63, 64	003F, 0040
		9)	67, 68	0043, 0044
		10)	60	003C
		11)	111	006F
		12)	104	0068
		13)	105	0069
		14)	80, 81	0050, 0051
		15)	90	005A
		16)	88, 89	0058, 0059
		17)	82, 83	0052, 0053
		18)	91	005B
		19)	84, 85	0054, 0055
		20)	0, 1	0000, 0001
		21)	2, 3	0002, 0003
		22)	4, 5	0004, 0005
		23)	20, 21	0014, 0015
		24)	22	0016
		25)	23	0017
		26)	24	0018
		27)	25	0019
		1)	-	-
		2)	100, 101	0064, 0065
		3)	102, 103	0066, 0067
		4)	106, 107	006A, 006B
		5)	61, 62	003D, 003E
		6)	65, 66	0041, 0042
		7)	63, 64	003F, 0040
		8)	67, 68	0043, 0044
		9)	67, 68	0043, 0044
		10)	60	003C
		11)	111	006F
		12)	104	0068
		13)	105	0069
		14)	80, 81	0050, 0051
		15)	90	005A
		16)	88, 89	0058, 0059
		17)	82, 83	0052, 0053
		18)	91	005B
		19)	84, 85	0054, 0055
		20)	108, 109	006C, 006D
		21)	46, 47	002E, 002F
		22)	40, 41	0028, 0029
		23)	42, 43	002A, 002B
		24)	44, 45	002C, 002D

1

OVERVIEW

2

SYSTEM MONITOR

3

LADDER MONITOR
FUNCTION

4

MELSEC-A LIST
EDITOR

5

MELSEC-FX LIST
EDITOR

6

INTELLIGENT
MODULE MONITOR

7

NETWORK
MONITOR

8

Q MOTION
MONITOR

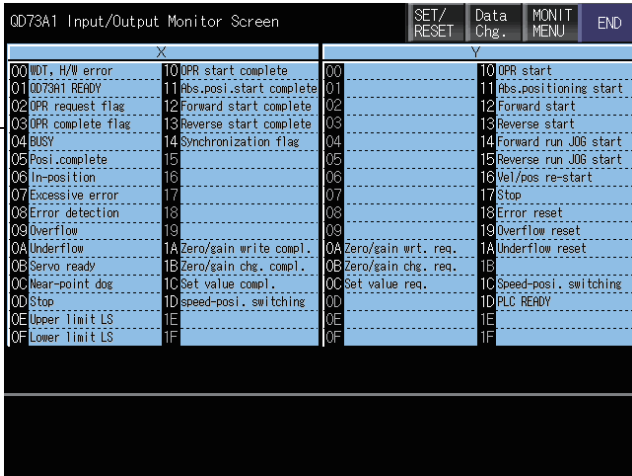
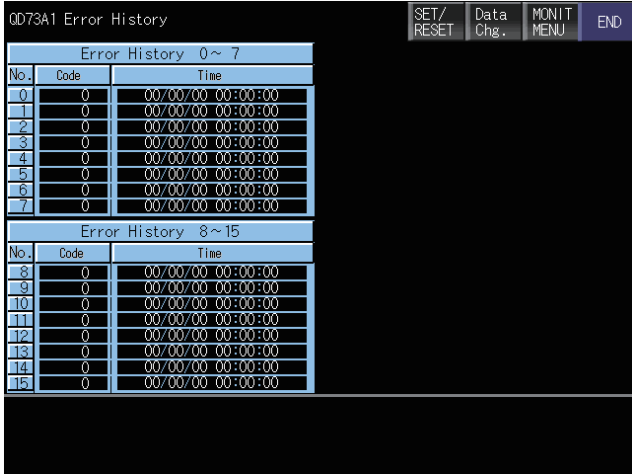
Screen example	No.	Buffer memory address																																																																					
		DEC	HEX																																																																				
 <p>QD73A1 Input/Output Monitor Screen</p> <p>SET/RESET Data Chg. MONIT MENU END</p> <table border="1"> <thead> <tr> <th colspan="2">X</th> <th colspan="2">Y</th> </tr> </thead> <tbody> <tr><td>00</td><td>Wdt. H/W error</td><td>10</td><td>OPR start complete</td></tr> <tr><td>01</td><td>QD73A1 READY</td><td>11</td><td>Abs.posi.start complete</td></tr> <tr><td>02</td><td>OPR request flag</td><td>12</td><td>Forward start complete</td></tr> <tr><td>03</td><td>OPR complete flag</td><td>13</td><td>Reverse start complete</td></tr> <tr><td>04</td><td>BUSY</td><td>14</td><td>Synchronization flag</td></tr> <tr><td>05</td><td>Posi.complete</td><td>15</td><td>Reverse run JOG start</td></tr> <tr><td>06</td><td>In-position</td><td>16</td><td>Vel/pos re-start</td></tr> <tr><td>07</td><td>Excessive error</td><td>17</td><td>Stop</td></tr> <tr><td>08</td><td>Error detection</td><td>18</td><td>Error reset</td></tr> <tr><td>09</td><td>Overflow</td><td>19</td><td>Overflow reset</td></tr> <tr><td>0A</td><td>Underflow</td><td>1A</td><td>Zero/gain wrt. req.</td></tr> <tr><td>0B</td><td>Servo ready</td><td>1B</td><td>Zero/gain chg. req.</td></tr> <tr><td>0C</td><td>Near-point dog</td><td>1C</td><td>Set value req.</td></tr> <tr><td>0D</td><td>Stop</td><td>1D</td><td>speed-posi. switching</td></tr> <tr><td>0E</td><td>Upper limit LS</td><td>1E</td><td>PLC READY</td></tr> <tr><td>0F</td><td>Lower limit LS</td><td>1F</td><td></td></tr> </tbody> </table>	X		Y		00	Wdt. H/W error	10	OPR start complete	01	QD73A1 READY	11	Abs.posi.start complete	02	OPR request flag	12	Forward start complete	03	OPR complete flag	13	Reverse start complete	04	BUSY	14	Synchronization flag	05	Posi.complete	15	Reverse run JOG start	06	In-position	16	Vel/pos re-start	07	Excessive error	17	Stop	08	Error detection	18	Error reset	09	Overflow	19	Overflow reset	0A	Underflow	1A	Zero/gain wrt. req.	0B	Servo ready	1B	Zero/gain chg. req.	0C	Near-point dog	1C	Set value req.	0D	Stop	1D	speed-posi. switching	0E	Upper limit LS	1E	PLC READY	0F	Lower limit LS	1F		1)	-	-
X		Y																																																																					
00	Wdt. H/W error	10	OPR start complete																																																																				
01	QD73A1 READY	11	Abs.posi.start complete																																																																				
02	OPR request flag	12	Forward start complete																																																																				
03	OPR complete flag	13	Reverse start complete																																																																				
04	BUSY	14	Synchronization flag																																																																				
05	Posi.complete	15	Reverse run JOG start																																																																				
06	In-position	16	Vel/pos re-start																																																																				
07	Excessive error	17	Stop																																																																				
08	Error detection	18	Error reset																																																																				
09	Overflow	19	Overflow reset																																																																				
0A	Underflow	1A	Zero/gain wrt. req.																																																																				
0B	Servo ready	1B	Zero/gain chg. req.																																																																				
0C	Near-point dog	1C	Set value req.																																																																				
0D	Stop	1D	speed-posi. switching																																																																				
0E	Upper limit LS	1E	PLC READY																																																																				
0F	Lower limit LS	1F																																																																					
 <p>QD73A1 Error History</p> <p>SET/RESET Data Chg. MONIT MENU END</p> <table border="1"> <thead> <tr> <th colspan="3">Error History 0~7</th> </tr> <tr> <th>No.</th> <th>Code</th> <th>Time</th> </tr> </thead> <tbody> <tr><td>0</td><td>0</td><td>00/00/00 00:00:00</td></tr> <tr><td>1</td><td>0</td><td>00/00/00 00:00:00</td></tr> <tr><td>2</td><td>0</td><td>00/00/00 00:00:00</td></tr> <tr><td>3</td><td>0</td><td>00/00/00 00:00:00</td></tr> <tr><td>4</td><td>0</td><td>00/00/00 00:00:00</td></tr> <tr><td>5</td><td>0</td><td>00/00/00 00:00:00</td></tr> <tr><td>6</td><td>0</td><td>00/00/00 00:00:00</td></tr> <tr><td>7</td><td>0</td><td>00/00/00 00:00:00</td></tr> </tbody> </table> <table border="1"> <thead> <tr> <th colspan="3">Error History 8~15</th> </tr> <tr> <th>No.</th> <th>Code</th> <th>Time</th> </tr> </thead> <tbody> <tr><td>8</td><td>0</td><td>00/00/00 00:00:00</td></tr> <tr><td>9</td><td>0</td><td>00/00/00 00:00:00</td></tr> <tr><td>10</td><td>0</td><td>00/00/00 00:00:00</td></tr> <tr><td>11</td><td>0</td><td>00/00/00 00:00:00</td></tr> <tr><td>12</td><td>0</td><td>00/00/00 00:00:00</td></tr> <tr><td>13</td><td>0</td><td>00/00/00 00:00:00</td></tr> <tr><td>14</td><td>0</td><td>00/00/00 00:00:00</td></tr> <tr><td>15</td><td>0</td><td>00/00/00 00:00:00</td></tr> </tbody> </table>	Error History 0~7			No.	Code	Time	0	0	00/00/00 00:00:00	1	0	00/00/00 00:00:00	2	0	00/00/00 00:00:00	3	0	00/00/00 00:00:00	4	0	00/00/00 00:00:00	5	0	00/00/00 00:00:00	6	0	00/00/00 00:00:00	7	0	00/00/00 00:00:00	Error History 8~15			No.	Code	Time	8	0	00/00/00 00:00:00	9	0	00/00/00 00:00:00	10	0	00/00/00 00:00:00	11	0	00/00/00 00:00:00	12	0	00/00/00 00:00:00	13	0	00/00/00 00:00:00	14	0	00/00/00 00:00:00	15	0	00/00/00 00:00:00	1)	120 to 183	0078 to 00B7								
Error History 0~7																																																																							
No.	Code	Time																																																																					
0	0	00/00/00 00:00:00																																																																					
1	0	00/00/00 00:00:00																																																																					
2	0	00/00/00 00:00:00																																																																					
3	0	00/00/00 00:00:00																																																																					
4	0	00/00/00 00:00:00																																																																					
5	0	00/00/00 00:00:00																																																																					
6	0	00/00/00 00:00:00																																																																					
7	0	00/00/00 00:00:00																																																																					
Error History 8~15																																																																							
No.	Code	Time																																																																					
8	0	00/00/00 00:00:00																																																																					
9	0	00/00/00 00:00:00																																																																					
10	0	00/00/00 00:00:00																																																																					
11	0	00/00/00 00:00:00																																																																					
12	0	00/00/00 00:00:00																																																																					
13	0	00/00/00 00:00:00																																																																					
14	0	00/00/00 00:00:00																																																																					
15	0	00/00/00 00:00:00																																																																					

6.5.32 QD75P [] (N)/QD75D [] (N) module monitoring

Screen example		No.	Buffer memory address	
			DEC	HEX
<p>1) Current feed val. Axis feedrate</p> <p>2) Axis Start No. Operation pattern</p> <p>3) Unit: (mm)$\times 10^3$, (degrees)$\times 10^{-3}$, (inch)$\times 10^{-3}$, (pulse)$\times 1$; (mm/min)$\times 10^3$, (degrees/min)$\times 10^3$, (inch/min)$\times 10^3$, (pulse/sec)$\times 1$</p> <p>4) Axis Status: Standby, Err.: 0, Warning: 0, Mode: 0</p> <p>5) Axis Control system</p> <p>6) Int. Axis, Acc. Time, Dec. Time</p> <p>7) 8) 9) 10) 11) 12)</p>	1)	800 to 801	0320 to 0321	
	900 to 901	0384 to 0385		
	1000 to 1001	03E8 to 03E9		
	1100 to 1101	044C to 044D		
	2)	812 to 813	032C to 032D	
	912 to 913	0390 to 0391		
	1012 to 1013	03F4 to 03F5		
	1112 to 1113	0458 to 0459		
	3)	809, 909,	0329, 038D,	
	1009, 1109	03F1, 0455		
	4)	806, 906,	0326, 038A,	
	1006, 1106	03EE, 0452		
5)	807, 907,	0327, 038B,		
1007, 1107	03EF, 0453			
6)	808, 908,	0328, 038C,		
1008, 1108	03F0, 0454			
7)	829, 929,	033D, 03A1,		
1029, 1129	0405, 0469			
8) to 12)	838, 938,	0346, 03AA,		
1038, 1138	040E, 0472			
<p>1)</p>	1)	-	-	
<p>1) Unit setting: 0mm 1inch 2degree 3pulse</p> <p>2) Pulse output mode: 0PLS/SIGN, 1CW/CCW, 2A p./B p., 3A p./B p.</p> <p>3) Movement amount per pulse (AP): 1 to 65535 (pulse)</p> <p>4) Movement amount per rotation (AR): 1 to 65535, +10⁻³(mm), +10⁻³(inch), +10⁻³(deg), +10⁻³(pulse)</p> <p>5) Unit magnification: 1/10/100/1000/fold</p> <p>6) Rotation direction setting: 0Forward run pulse output, 1Reverse run pulse output</p> <p>7) Setting range: 0 to 2000000000 (mm/min)$\times 10^{-3}$, (inch/min)$\times 10^{-3}$, (degree/min)$\times 10^{-3}$, (pulse/sec)$\times 1$</p>	1)	0, 150, 300, 450	0000, 0096, 012C, 01C2	
	2)	4, 154, 304, 454	0004, 009A, 0130, 01C6	
	3)	1, 151, 301, 451	0001, 0097, 012D, 01C3	
	4)	2, 152, 302, 452	0002, 0098, 012E, 01C4	
	5)	3, 153, 303, 453	0003, 0099, 012F, 01C5	
	6)	5, 155, 305, 455	0005, 009B, 0131, 01C7	
	7)	6, 156, 306, 456	0006, 009C, 0132, 01C8	
-	-	-		

1 OVERVIEW

2 SYSTEM MONITOR

3 LADDER MONITOR FUNCTION

4 MELSEC-A LIST EDITOR

5 MELSEC-FX LIST EDITOR

6 INTELLIGENT MODULE MONITOR

7 NETWORK MONITOR

8 Q MOTION MONITOR

Screen example		No.	Buffer memory address	
			DEC	HEX
		1)	10 to 11	000A to 000B
			160 to 161	00A0 to 00A1
			310 to 311	0136 to 0137
			460 to 461	01CC to 01CD
		2)	12 to 13	000C to 000D
			162 to 163	00A2 to 00A3
			312 to 313	0138 to 0139
		3)	462 to 463	01CE to 01CF
			14 to 15	000E to 000F
			164 to 165	00A4 to 00A5
-	314 to 315	013A to 013B		
	464 to 465	01D0 to 01D1		
		1)	17, 167, 317, 467	0011, 00A7, 013D, 01D3
			2)	18 to 19
		168 to 169		00A8 to 00A9
		318 to 319		013E to 013F
		468 to 469		01D4 to 01D5
		20 to 21		0014 to 0015
		3)	170 to 171	00AA to 00AB
			320 to 321	0140 to 0141
		4)	470 to 471	01D6 to 01D7
			33	0021
5)	22, 172, 322, 472	0016, 00AC, 0142, 01D8		
	23, 173, 323, 473	0017, 00AD, 0143, 01D9		
6)	26, 176, 326, 476	001A, 00B0, 0146, 01DC		
			1)	27, 177, 327, 477
2)			28, 178, 328, 478	001C, 00B2, 0148, 01DE
			3)	29, 179, 329, 479
4)				24 to 25
			174 to 175	00AE to 00AF
			324 to 325	0144 to 0145
5)			474 to 475	01DA to 01DB
			30, 180, 330, 480	001E, 00B4, 014A, 01E0
6)			32, 182, 332, 482	0020, 00B6, 014C, 01E2
			7)	31, 181, 331, 481

Screen example		No.	Buffer memory address	
			DEC	HEX
<p>QD75P/QD75D Detailed parameters 2-1</p> <p>1) JOG speed limit value</p> <p>2) Decel. time</p> <p>3) Setting range</p> <p>4) Item</p> <p>5) Set range</p>	1)	36 to 41	0024 to 0029	
	1)	186 to 191	00BA to 00BF	
		336 to 341	0150 to 0155	
		486 to 491	01E6 to 01EB	
	2)	42 to 47	002A to 002F	
		192 to 197	00C0 to 00C5	
		342 to 347	0156 to 015B	
	3)	492 to 497	01EC to 01F0	
		48 to 49	0030 to 0031	
		198 to 199	00C6 to 00C7	
	4)	348 to 349	015C to 015D	
		498 to 499	01F2 to 01F3	
	5)	50, 200, 350, 500	0032, 00C8, 015E, 01F4	
		51, 201, 351, 501	0033, 00C9, 015F, 01F5	
	<p>QD75P/QD75D Detailed parameters 2-2</p> <p>1) Acc/Dec. Type selection</p> <p>2) S-pattern %</p> <p>3) Sudden stop dead time</p> <p>4) Sudden stop deceleration time</p> <p>5) Position complete signal output time</p> <p>6) Sudden stop deceleration time</p> <p>7) Position complete signal output time</p> <p>8) Allowed circular trib. error width</p> <p>9) External command function selection</p>	1)	52, 202, 352, 502	0034, 00CA, 0160, 01F6
2)		53, 203, 353, 503	0035, 00CB, 0161, 01F7	
		56, 206, 356, 506	0038, 00CE, 0164, 01FA	
		57, 207, 357, 507	0039, 00CF, 0165, 01FB	
5)		58, 208, 358, 508	003A, 00D0, 0166, 01FC	
		54, 204, 354, 504	0036, 00CC, 0162, 01F8	
7)		59, 209, 359, 509	003B, 00D1, 0167, 01FD	
		60 to 61	003C to 003D	
8)		210 to 211	00D2 to 00D3	
		360 to 361	0168 to 0169	
9)		510 to 511	01FE to 01FF	
		62, 212, 362, 512	003E, 00D4, 016A, 0200	

1 OVERVIEW

2 SYSTEM MONITOR

3 LADDER MONITOR FUNCTION

4 MELSEC-A LIST EDITOR

5 MELSEC-FX LIST EDITOR

6 INTELLIGENT MODULE MONITOR

7 NETWORK MONITOR

8 Q MOTION MONITOR

Screen example		No.	Buffer memory address	
			DEC	HEX
		1)	79, 229, 379, 529	004F, 00E5, 017B, 0211
		2)	82, 232, 382, 532	0052, 00E8, 017E, 0214
		3)	83, 233, 383, 533	0053, 00E9, 017F, 0215
		4)	86, 236, 386, 536	0056, 00EC, 0182, 0218
		5)	80 to 81	0050 to 0051
			230 to 231	00E6 to 00E7
			380 to 381	017C to 017D
		6)	530 to 531	0212 to 0213
			84 to 85	0054 to 0055
234 to 235	00EA to 00EB			
7)	87, 237, 387, 537	0057, 00ED, 0183, 0219		
8)	88, 238, 388, 538	0058, 00EE, 0184, 021A		
9)	89, 239, 389, 539	0059, 00EF, 0185, 021B		
		1)	70, 220, 370, 520	0046, 00DC, 0172, 0208
		2)	71, 221, 371, 521	0047, 00DD, 0173, 0209
		3)	78, 228, 378, 528	004E, 00E4, 017A, 0210
		4)	72 to 73	0048 to 0049
			222 to 223	00DE to 00DF
			372 to 373	0174 to 0175
		5)	522 to 523	020A to 020B
			74 to 75	004A to 004B
			224 to 225	00E0 to 00E1
		6)	374 to 375	0176 to 0177
			524 to 525	020C to 020D
			76 to 77	004C to 004D
226 to 227	00E2 to 00E3			
376 to 377	0178 to 0179			
526 to 527	020E to 020F			

Screen example	No.	Buffer memory address	
		DEC	HEX
	1)	816, 916, 1016, 1116	0330, 0394, 03F8, 045C
	2)	817, 917, 1017, 1117	0331, 0395, 03F9, 045D
	1)	818 to 819	0332 to 0333
	2)	918 to 919	0396 to 0397
	3)	1018 to 1019	03FA to 03FB
	4)	1118 to 1119	045E to 045F
	6)	802 to 803	0322 to 0323
	7)	902 to 903	0386 to 0387
	2)	1002 to 1003	03EA to 03EB
	3)	1102 to 1103	044E to 044F
	3)	820 to 821	0334 to 0335
	4)	920 to 921	0398 to 0399
	4)	1020 to 1021	03FC to 03FD
	5)	1120 to 1121	0460 to 0461
	5)	810 to 811	032A to 032B
	6)	910 to 911	038E to 038F
	6)	1010 to 1011	03F2 to 03F3
	7)	1110 to 1111	0456 to 0457
	5)	812 to 813	032C to 032D
	6)	912 to 913	0390 to 0391
	6)	1012 to 1013	03F4 to 03F5
	7)	1112 to 1113	0458 to 0459
	6)	830, 930, 1030, 1130	033E, 03A2, 0406, 046A
	7)	831, 931, 1031, 1131	033F, 03A3, 0407, 046B

- 1
OVERVIEW
- 2
SYSTEM MONITOR
- 3
LADDER MONITOR FUNCTION
- 4
MELSEC-A LIST EDITOR
- 5
MELSEC-FX LIST EDITOR
- 6
INTELLIGENT MODULE MONITOR
- 7
NETWORK MONITOR
- 8
Q MOTION MONITOR

Screen example	No.	Buffer memory address																																																														
		DEC	HEX																																																													
<p>Axis monitor data-2</p> <p>Special start data</p> <table border="1"> <tr><th>Axis</th><th>Instr. code</th><th>Instr. para.</th><th>Data No.</th></tr> <tr><td>1</td><td>0</td><td>0</td><td>0</td></tr> <tr><td>2</td><td>0</td><td>0</td><td>0</td></tr> <tr><td>3</td><td>0</td><td>0</td><td>0</td></tr> <tr><td>4</td><td>0</td><td>0</td><td>0</td></tr> </table> <p>Special start repetition counter</p> <table border="1"> <tr><th>Axis1</th><th>Axis2</th><th>Axis3</th><th>Axis4</th></tr> <tr><td>0</td><td>0</td><td>0</td><td>0</td></tr> </table> <p>Control system repetition counter</p> <table border="1"> <tr><th>Axis1</th><th>Axis2</th><th>Axis3</th><th>Axis4</th></tr> <tr><td>0</td><td>0</td><td>0</td><td>0</td></tr> </table> <p>Data being executed</p> <table border="1"> <tr><th>Axis</th><th>Tkt. data pointer</th><th>Pos. data number</th><th>Block No.</th><th>Previous position</th></tr> <tr><td>1</td><td>0</td><td>0</td><td>0</td><td>0</td></tr> <tr><td>2</td><td>0</td><td>0</td><td>0</td><td>0</td></tr> <tr><td>3</td><td>0</td><td>0</td><td>0</td><td>0</td></tr> <tr><td>4</td><td>0</td><td>0</td><td>0</td><td>0</td></tr> </table> <p>1) 4) 5) 2) 6) 7) 3)</p>	Axis	Instr. code	Instr. para.	Data No.	1	0	0	0	2	0	0	0	3	0	0	0	4	0	0	0	Axis1	Axis2	Axis3	Axis4	0	0	0	0	Axis1	Axis2	Axis3	Axis4	0	0	0	0	Axis	Tkt. data pointer	Pos. data number	Block No.	Previous position	1	0	0	0	0	2	0	0	0	0	3	0	0	0	0	4	0	0	0	0	1)	827, 927, 1027, 1127	033B, 039F, 0403, 0467
	Axis	Instr. code	Instr. para.	Data No.																																																												
	1	0	0	0																																																												
	2	0	0	0																																																												
	3	0	0	0																																																												
	4	0	0	0																																																												
	Axis1	Axis2	Axis3	Axis4																																																												
	0	0	0	0																																																												
	Axis1	Axis2	Axis3	Axis4																																																												
	0	0	0	0																																																												
Axis	Tkt. data pointer	Pos. data number	Block No.	Previous position																																																												
1	0	0	0	0																																																												
2	0	0	0	0																																																												
3	0	0	0	0																																																												
4	0	0	0	0																																																												
2)	828, 928, 1028, 1128	033C, 03A0, 0404, 0468																																																														
3)	829, 929, 1029, 1129	033D, 03A1, 0405, 0469																																																														
4)	834, 934, 1034, 1134	0342, 03A6, 040A, 046E																																																														
5)	835, 936, 1036, 1135	0343, 03A8, 040C, 046F																																																														
6)	836, 936, 1036, 1136	0344, 03A8, 040C, 0470																																																														
7)	837, 937, 1037, 1137	0345, 03A9, 040D, 0471																																																														
8)	832, 932, 1032, 1132	0340, 03A4, 0408, 046C																																																														
9)	833, 933, 1033, 1133	0341, 03A5, 0409, 046D																																																														
-	-	-																																																														
<p>OPR</p> <p>Travel after NFD ON</p> <table border="1"> <tr><td>1</td><td>0</td></tr> <tr><td>2</td><td>0</td></tr> <tr><td>3</td><td>0</td></tr> <tr><td>4</td><td>0</td></tr> </table> <p>($\mu\text{m} \times 10^3$) (inch $\times 10^3$) (degree $\times 10^3$) (pulse $\times 1$)</p> <table border="1"> <tr><th>Axis</th><th>Torque limit stored value</th><th>Zero point</th><th>Near point</th><th>Upper limit</th><th>Lower limit</th></tr> <tr><td>1</td><td>125 (%)</td><td>●</td><td>●</td><td>●</td><td>●</td></tr> <tr><td>2</td><td>0 (%)</td><td>●</td><td>●</td><td>●</td><td>●</td></tr> <tr><td>3</td><td>383 (%)</td><td>●</td><td>●</td><td>●</td><td>●</td></tr> <tr><td>4</td><td>0 (%)</td><td>●</td><td>●</td><td>●</td><td>●</td></tr> </table> <p>2) 3) 4) 5) 6)</p>	1	0	2	0	3	0	4	0	Axis	Torque limit stored value	Zero point	Near point	Upper limit	Lower limit	1	125 (%)	●	●	●	●	2	0 (%)	●	●	●	●	3	383 (%)	●	●	●	●	4	0 (%)	●	●	●	●	1)	824 to 825 924 to 925 1024 to 1025 1124 to 1125	0338 to 0339 039C to 039D 0400 to 0401 0464 to 0465																							
	1	0																																																														
	2	0																																																														
	3	0																																																														
	4	0																																																														
	Axis	Torque limit stored value	Zero point	Near point	Upper limit	Lower limit																																																										
1	125 (%)	●	●	●	●																																																											
2	0 (%)	●	●	●	●																																																											
3	383 (%)	●	●	●	●																																																											
4	0 (%)	●	●	●	●																																																											
2)	826, 926, 1026, 1126	033A, 039E, 0402, 0466																																																														
3)	816, 916, 1016, 1116	0330, 0394, 03F8, 045C																																																														
4)																																																																
5)																																																																
6)																																																																
<p>Speed-position control</p> <p>SPSO partitioning amount</p> <table border="1"> <tr><th>Axis</th><th>Amount</th></tr> <tr><td>Axis1</td><td>0</td></tr> <tr><td>Axis2</td><td>0</td></tr> <tr><td>Axis3</td><td>1500</td></tr> <tr><td>Axis4</td><td>0</td></tr> </table> <p>($\mu\text{m} \times 10^3$) (degree $\times 10^3$) (inch $\times 10^3$) (pulse $\times 1$)</p> <p>SPSO movement amount change register</p> <table border="1"> <tr><th>Axis</th><th>Setting range</th></tr> <tr><td>Axis1</td><td>0 to 2147483647</td></tr> <tr><td>Axis2</td><td>0 to 2147483647</td></tr> <tr><td>Axis3</td><td>0 to 2147483647</td></tr> <tr><td>Axis4</td><td>0 to 2147483647</td></tr> </table> <p>($\mu\text{m} \times 10^3$) (inch $\times 10^3$) (degree $\times 10^3$) (pulse $\times 1$)</p> <p>Item</p> <table border="1"> <tr><th>Item</th><th>Axis1</th><th>Axis2</th><th>Axis3</th><th>Axis4</th></tr> <tr><td>Speed-position switching latch</td><td>●</td><td>●</td><td>●</td><td>●</td></tr> <tr><td>In speed control</td><td>●</td><td>●</td><td>●</td><td>●</td></tr> <tr><td>Speed-position switching enable</td><td>0:Disable</td><td>0:Disable</td><td>0:Disable</td><td>1:Enable</td></tr> </table> <p>3) 4) 5)</p>	Axis	Amount	Axis1	0	Axis2	0	Axis3	1500	Axis4	0	Axis	Setting range	Axis1	0 to 2147483647	Axis2	0 to 2147483647	Axis3	0 to 2147483647	Axis4	0 to 2147483647	Item	Axis1	Axis2	Axis3	Axis4	Speed-position switching latch	●	●	●	●	In speed control	●	●	●	●	Speed-position switching enable	0:Disable	0:Disable	0:Disable	1:Enable	1)	814 to 815 914 to 915 1014 to 1015 1114 to 1115	032E to 032F 0392 to 0393 03F6 to 03F7 045A to 045B																					
	Axis	Amount																																																														
	Axis1	0																																																														
	Axis2	0																																																														
	Axis3	1500																																																														
	Axis4	0																																																														
	Axis	Setting range																																																														
	Axis1	0 to 2147483647																																																														
	Axis2	0 to 2147483647																																																														
	Axis3	0 to 2147483647																																																														
Axis4	0 to 2147483647																																																															
Item	Axis1	Axis2	Axis3	Axis4																																																												
Speed-position switching latch	●	●	●	●																																																												
In speed control	●	●	●	●																																																												
Speed-position switching enable	0:Disable	0:Disable	0:Disable	1:Enable																																																												
2)	1526 to 1527 1626 to 1627 1726 to 1727 1826 to 1827	05F6 to 05F7 065A to 065B 06BE to 06BF 0722 to 0723																																																														
3)	817, 917, 1017, 1117	0331, 0395, 03F9, 045D																																																														
4)	817, 917, 1017, 1117	0331, 0395, 03F9, 045D																																																														
5)	1528, 1628, 1728, 1828	05F8, 065C, 06C0, 0724																																																														
-	-	-																																																														

Screen example		No.	Buffer memory address	
			DEC	HEX
<p>QD75P/QD75D Position-speed control</p> <p>1) PSVC speed change register</p> <p>Axis1: 0 Axis2: 0 Axis3: 0 Axis4: 0</p> <p>Setting range: 0 to 2000000000 (mm/min):*10⁻⁶ 0 to 2147483647 (inch/min):*10⁻⁶ 0 to 1000000 (pulse/sec):*1</p> <p>2) Position-speed switching latch</p> <p>3) In speed control</p> <p>4) Position-speed switching enable 0:Disable 1:Enable</p>	<p>SET/RESET Data Chg. MONIT MENU END</p>	1)	1530 to 1531	05FA to 05FB
		1532 to 1533	065E to 065F	
		1730 to 1731	06C2 to 06C3	
		1830 to 1831	0726 to 0727	
<p>QD75P/QD75D Axis control data-1</p> <p>1) New current value</p> <p>Axis1: 0 Axis2: 0 Axis3: 0 Axis4: 0</p> <p>Setting range: -2147483648 to 2147483647 (μm):*10⁻¹ 0 to 35999999 (inch):*10⁻⁶ 0 to 35999999 (degree):*10⁻⁶</p> <p>2) New speed value</p> <p>Axis1: 0 Axis2: 0 Axis3: 0 Axis4: 0</p> <p>Setting range: 0 to 2000000000 (mm/min):*10⁻⁶ 0 to 2147483647 (inch/min):*10⁻⁶ 0 to 1000000 (pulse/sec):*1</p>	<p>SET/RESET Data Chg. MONIT MENU END</p>	1)	1506 to 1507	05E2 to 05E3
		1606 to 1607	0646 to 0647	
		1706 to 1707	06AA to 06AB	
		1806 to 1807	070E to 070F	
		2)	1514 to 1515	05EA to 05EB
		1614 to 1615	064E to 064F	
		1714 to 1715	06B2 to 06B3	
		1814 to 1815	0716 to 0717	
3)	1513, 1613, 1713, 1813	05E9, 064D, 06B1, 0715		
4)	1544, 1644, 1744, 1844	0608, 066C, 06D0, 0734		
5)	1545, 1645, 1745, 1845	0609, 066D, 06D1, 0735		
6)	1546, 1646, 1746, 1846	060A, 066E, 06D2, 0736		
7)	1547, 1647, 1747, 1847	060B, 066F, 06D3, 0737		
8)	1505, 1605, 1705, 1805	05E1, 0645, 06A9, 070D		

- 1 OVERVIEW
- 2 SYSTEM MONITOR
- 3 LADDER MONITOR FUNCTION
- 4 MELSEC-A LIST EDITOR
- 5 MELSEC-FX LIST EDITOR
- 6 INTELLIGENT MODULE MONITOR
- 7 NETWORK MONITOR
- 8 Q MOTION MONITOR

Screen example		No.	Buffer memory address	
			DEC	HEX
		1)	1500, 1600, 1700, 1800	05DC, 0640, 06A4, 0708
		2)	1501, 1601, 1701, 1801	05DD, 0641, 06A5, 0709
		3)	1502, 1602, 1702, 1802	05DE, 0642, 06A6, 070A
		4)	1503, 1603, 1703, 1803	05DF, 0643, 06A7, 070B
		5)	1504, 1604, 1704, 1804	05E0, 0644, 06A8, 070C
		6)	1512, 1612, 1712, 1812	05E8, 064C, 06B0, 0714
		7)	1516, 1616, 1716, 1816	05EC, 0650, 06B4, 0718
		8)	1508 to 1509 1608 to 1609 1708 to 1709 1808 to 1809	05E4 to 05E5 0648 to 0649 06AC to 06AD 0710 to 0711
		9)	1510 to 1511 1610 to 1611 1710 to 1711 1810 to 1811	05E6 to 05E7 064A to 064B 06AE to 06AF 0712 to 0713
		10)	1520, 1620, 1720, 1820	05F0, 0654, 06B8, 071C
		11)	1521, 1621, 1721, 1821	05F1, 0655, 06B9, 071D
		12)	1522 to 1523 1622 to 1623 1722 to 1723 1822 to 1823	05F2 to 05F3 0656 to 0657 06BA to 06BB 071E to 071F
		13)	1524, 1624, 1724, 1824	05F4, 0658, 06BC, 0720
				1)
2)	1548, 1648, 1748, 1848			060C, 0670, 06D4, 0738
3)	1549, 1649, 1749, 1849			060D, 0671, 06D5, 0739
4)	1550, 1650, 1750, 1850			060E, 0672, 06D6, 073A
5)	1540, 1640, 1740, 1840, 1541, 1641, 1741, 1841, 1542, 1642, 1742, 1842, 1543, 1643, 1743, 1843	0604, 0668, 06CC, 0730, 0605, 0669, 06CD, 0731, 0606, 066A, 06CE, 0732, 0607, 066B, 06CF, 0733		
-	-	-		

Screen example		No.	Buffer memory address	
			DEC	HEX
	1)	1517, 1617, 1717, 1817	05ED, 0651, 06B5, 0719	
	2)	1518 to 1519	05EE to 05EF	
		1618 to 1619	0652 to 0653	
		1718 to 1719	06B6 to 06B7	
	3)	1818 to 1819	071A to 071B	
		1534 to 1535	05FE to 05FF	
		1634 to 1635	0662 to 0663	
	4)	1734 to 1735	06C6 to 06C7	
		1834 to 1835	072A to 072B	
		1536 to 1537	0600 to 0601	
1636 to 1637		0664 to 0665		
-	-	-	-	
	-	-	-	
	1)	1212 to 1291	04BC to 050B	
	-	-	-	
	1)	1293 to 1356	050D to 054C	
	2)	1358 to 1421	054E to 058D	
	-	-	-	

- 1 OVERVIEW
- 2 SYSTEM MONITOR
- 3 LADDER MONITOR FUNCTION
- 4 MELSEC-A LIST EDITOR
- 5 MELSEC-FX LIST EDITOR
- 6 INTELLIGENT MODULE MONITOR
- 7 NETWORK MONITOR
- 8 Q MOTION MONITOR

Screen example		No.	Buffer memory address	
			DEC	HEX
	1)	2000 to 2002, 2004 to 2012, 2014 to 2022, 2024 to 2029	07D0 to 07D2, 07D4 to 07DC, 07DE to 07E6, 07E8 to 07ED,	
	2)	8000 to 8002, 8004 to 8012, 8014 to 8022, 8024 to 8029	1F40 to 1F42, 1F44 to 1F4C, 1F4E to 1F56, 1F58 to 1F5D	
	3)	14000 to 14002, 14004 to 14012, 14014 to 14022, 14024 to 14029	36B0 to 36B2, 36B4 to 36BC, 36BE to 36C6, 36C8 to 36CD	
	4)	20000 to 20002, 20004 to 20012, 20014 to 20022, 20024 to 20029	4E20 to 4E22, 4E24 to 4E2C, 4E2E to 4E36, 4E38 to 4E3D	
	-	-	-	

6.5.33 QD75M module monitoring

Screen example	No.	Buffer memory address		
		DEC	HEX	
<p>1) Current feed, Axis feedrate</p> <p>2) Start No., Operation pattern</p> <p>3) Status, Control system</p> <p>4) Unit</p> <p>5) Warning</p> <p>6) Mode</p> <p>7) Unit</p> <p>8) Operation pattern</p> <p>9) Control system</p> <p>10) Init. Axis</p> <p>11) Acc. time</p> <p>12) Dec. time</p>	1)	800 to 801 900 to 901 1000 to 1001 1100 to 1101	0320 to 0321 0384 to 0385 03E8 to 03E9 044C to 044D	
	2)	812 to 813 912 to 913 1012 to 1013 1112 to 1113	032C to 032D 0390 to 0391 03F4 to 03F5 0458 to 0459	
	3)	809, 909, 1009, 1109	0329, 038D, 03F1, 0455	
	4)	806, 906, 1006, 1106	0326, 038A, 03EE, 0452	
	5)	807, 907, 1007, 1107	0327, 038B, 03EF, 0453	
	6)	808, 908, 1008, 1108	0328, 038C, 03F0, 0454	
	7)	829, 929, 1029, 1129	033D, 03A1, 0405, 0469	
	8) to 12)	838, 938, 1038, 1138	0346, 03AA, 040E, 0472	
	<p>1) Input/Output Monitor</p>	1)	-	-
		-	-	-
	<p>1) Unit setting</p> <p>2) Movement amount per pulse</p> <p>3) Unit magnification (Am)</p> <p>4) Movement amount per rotation (AR)</p>	1)	0, 150, 300, 450	0000, 0096, 012C, 01C2
		2)	2 to 3, 152 to 153, 302 to 303, 452 to 453	0002 to 0003, 0098 to 0099, 012E to 012F 01C4 to 01C7
3)		1, 151, 301, 451	0001, 0097, 012D, 01C3	
4)		4 to 5, 154 to 155, 304 to 305, 454 to 455	0004 to 0005, 009A to 009B, 0130 to 0131, 01C6 to 01C7	
-	-	-	-	

1 OVERVIEW
2 SYSTEM MONITOR
3 LADDER MONITOR FUNCTION
4 MELSEC-A LIST EDITOR
5 MELSEC-FX LIST EDITOR
6 INTELLIGENT MODULE MONITOR
7 NETWORK MONITOR
8 Q MOTION MONITOR

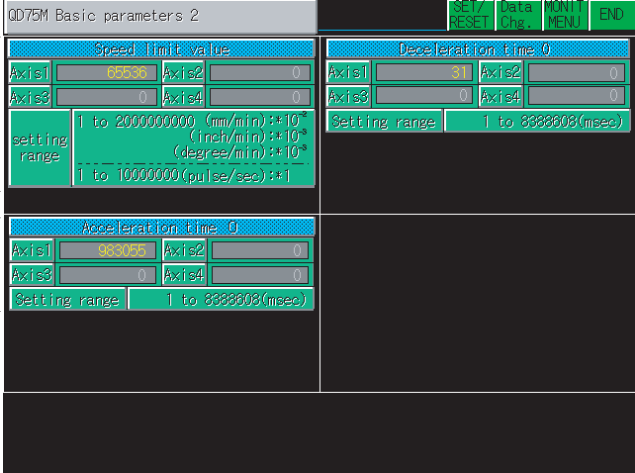
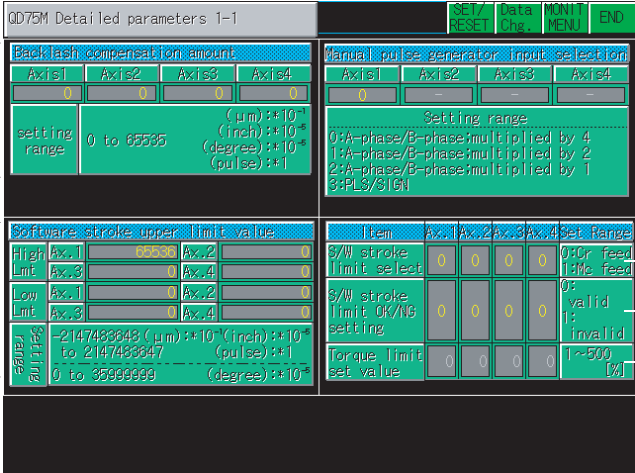
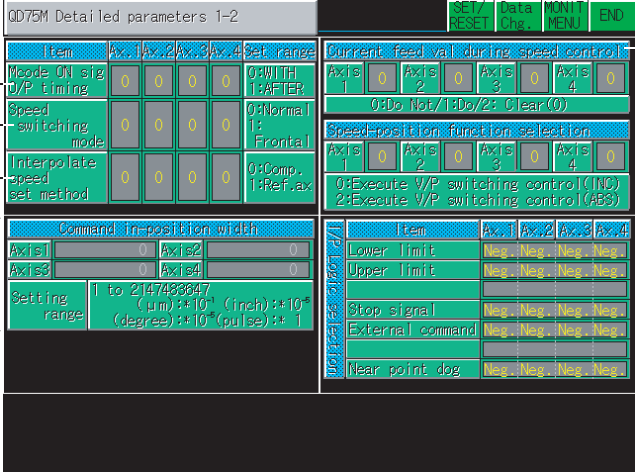
Screen example		No.	Buffer memory address	
			DEC	HEX
		1)	10 to 11	000A to 000B
		1)	160 to 161	00A0 to 00A1
			310 to 311	0136 to 0137
			460 to 461	01CC to 01CD
			12 to 13	000C to 000D
		2)	162 to 163	00A2 to 00A3
			312 to 313	0138 to 0139
			462 to 463	01CE to 01CF
		3)	14 to 15	000E to 000F
			164 to 165	00A4 to 00A5
314 to 315	013A to 013B			
-	464 to 465	01D0 to 01D1		
		1)	17, 167, 317, 467	0011, 00A7, 013D, 01D3
		2)	18 to 19	0012 to 0013
			168 to 169	00A8 to 00A9
			318 to 319	013E to 013F
			468 to 469	01D4 to 01D5
			20 to 21	0014 to 0015
			170 to 171	00AA to 00AB
		320 to 321	0140 to 0141	
		470 to 471	01D6 to 01D7	
		3)	33	0021
4)	22, 172, 322, 472	0016, 00AC, 0142, 01D8		
5)	23, 173, 323, 473	0017, 00AD, 0143, 01D9		
6)	26, 176, 326, 476	001A, 00B0, 0146, 01DC		
		1)	27, 177, 327, 477	001B, 00B1, 0147, 01DD
		2)	28, 178, 328, 478	001C, 00B2, 0148, 01DE
			29, 179, 329, 479	001D, 00B3, 0149, 01DF
		3)	24 to 25	0018 to 0019
			174 to 175	00AE to 00AF
			324 to 325	0144 to 0145
		4)	474 to 475	01DA to 01DB
			30, 180, 330, 480	001E, 00B4, 014A, 01E0
		5)	34, 184, 334, 484	0022, 00B8, 014E, 01E4
			31, 181, 331, 481	001F, 00B5, 014B, 01E1
6)	-	-		
7)	-	-		

Screen example		No.	Buffer memory address																											
			DEC	HEX																										
	<table border="1"> <thead> <tr> <th colspan="2">JOG speed limit value</th> </tr> <tr> <th>Axis1</th> <th>Axis2</th> </tr> </thead> <tbody> <tr> <td>0</td> <td>0</td> </tr> <tr> <td>0</td> <td>0</td> </tr> </tbody> </table> <table border="1"> <thead> <tr> <th>Item</th> <th>Axis1</th> <th>Axis2</th> <th>Axis3</th> <th>Axis4</th> <th>Set range</th> </tr> </thead> <tbody> <tr> <td>JOG accel. time select</td> <td>0</td> <td>0</td> <td>0</td> <td>0</td> <td>0 to 3</td> </tr> <tr> <td>JOG decel. time select</td> <td>0</td> <td>0</td> <td>0</td> <td>0</td> <td>0 to 3</td> </tr> </tbody> </table>	JOG speed limit value		Axis1	Axis2	0	0	0	0	Item	Axis1	Axis2	Axis3	Axis4	Set range	JOG accel. time select	0	0	0	0	0 to 3	JOG decel. time select	0	0	0	0	0 to 3	1)	36 to 41	0024 to 0029
		JOG speed limit value																												
		Axis1	Axis2																											
		0	0																											
		0	0																											
		Item	Axis1	Axis2	Axis3	Axis4	Set range																							
		JOG accel. time select	0	0	0	0	0 to 3																							
		JOG decel. time select	0	0	0	0	0 to 3																							
		2)	186 to 191	00BA to 00BF																										
			336 to 341	0150 to 0155																										
		3)	42 to 47	002A to 002F																										
			192 to 197	00C0 to 00C5																										
			342 to 347	0156 to 015B																										
		4)	48 to 49	0030 to 0031																										
			198 to 199	00C6 to 00C7																										
348 to 349	015C to 015D																													
5)	50, 200, 350, 500	0032, 00C8, 015E, 01F4																												
	51, 501, 351, 501	0033, 01F5, 015F, 01F5																												
	<table border="1"> <thead> <tr> <th colspan="2">Allowed circular int. error width</th> </tr> <tr> <th>Axis1</th> <th>Axis2</th> </tr> </thead> <tbody> <tr> <td>0</td> <td>0</td> </tr> <tr> <td>0</td> <td>0</td> </tr> </tbody> </table> <table border="1"> <thead> <tr> <th>Item</th> <th>Axis1</th> <th>Axis2</th> <th>Axis3</th> <th>Axis4</th> <th>Set range</th> </tr> </thead> <tbody> <tr> <td>Sudden stop deceleration time</td> <td>0</td> <td>0</td> <td>0</td> <td>0</td> <td>1 to 65536 (ms)</td> </tr> <tr> <td>Position complete signal output time</td> <td>0</td> <td>0</td> <td>0</td> <td>0</td> <td>0 to 65536 (ms)</td> </tr> </tbody> </table>	Allowed circular int. error width		Axis1	Axis2	0	0	0	0	Item	Axis1	Axis2	Axis3	Axis4	Set range	Sudden stop deceleration time	0	0	0	0	1 to 65536 (ms)	Position complete signal output time	0	0	0	0	0 to 65536 (ms)	1)	52, 202, 352, 502	0034, 00CA, 0160, 01F6
		Allowed circular int. error width																												
		Axis1	Axis2																											
		0	0																											
		0	0																											
		Item	Axis1	Axis2	Axis3	Axis4	Set range																							
		Sudden stop deceleration time	0	0	0	0	1 to 65536 (ms)																							
		Position complete signal output time	0	0	0	0	0 to 65536 (ms)																							
		2)	53, 203, 353, 503	0035, 00CB, 0161, 01F7																										
			56, 206, 356, 506	0038, 00CE, 0164, 01FA																										
3)	57, 207, 357, 507	0039, 00CF, 0165, 01FB																												
	58, 208, 358, 508	003A, 00D0, 0166, 01FC																												
4)	54 to 55, 204 to 205, 354 to 355, 504 to 505	0036 to 0037, 00CC to 00CD, 0162 to 0163, 01F8 to 01F9																												
	59, 209, 359, 509	003B, 00D1, 0167, 01FD																												
5)	60 to 61	003C to 003D																												
	210 to 211	00D2 to 00D3																												
	360 to 361	0168 to 0169																												
6)	510 to 511	01FE to 01FF																												
	62, 212, 362, 512	003E, 00D4, 016A, 0200																												
7)	64 to 65, 214 to 215, 364 to 365, 514 to 515	0040 to 0041, 00D6 to 00D7, 016C to 016D, 0202 to 0203																												
	64 to 65	0040 to 0041																												
	214 to 215, 364 to 365, 514 to 515	00D6 to 00D7, 016C to 016D, 0202 to 0203																												

- 1 OVERVIEW
- 2 SYSTEM MONITOR
- 3 LADDER MONITOR FUNCTION
- 4 MELSEC-A LIST EDITOR
- 5 MELSEC-FX LIST EDITOR
- 6 INTELLIGENT MODULE MONITOR
- 7 NETWORK MONITOR
- 8 Q MOTION MONITOR

Screen example		No.	Buffer memory address	
			DEC	HEX
		1)	79, 229, 379, 529	004F, 00E5, 017B, 0211
		2)	82, 232, 382, 532	0052, 00E8, 017E, 0214
		3)	83, 233, 383, 533	0053, 00E9, 017F, 0215
		4)	86, 236, 386, 536	0056, 00EC, 0182, 0218
		5)	80 to 81	0050 to 0051
			230 to 231	00E6 to 00E7
			380 to 381	017C to 017D
		6)	530 to 531	0212 to 0213
84 to 85	0054 to 0055			
234 to 235	00EA to 00EB			
7)	384 to 385	0180 to 0181		
	534 to 535	0216 to 0217		
8)	88, 238, 388, 538	0058, 00EE, 0184, 021A		
	89, 239, 389, 539	0059, 00EF, 0185, 021B		
		1)	70, 220, 370, 520	0046, 00DC, 0172, 0208
		2)	71, 221, 371, 521	0047, 00DD, 0173, 0209
		3)	78, 228, 378, 528	004E, 00E4, 017A, 0210
		4)	72 to 73	0048 to 0049
			222 to 223	00DE to 00DF
		5)	372 to 373	0174 to 0175
			522 to 523	020A to 020B
		6)	74 to 75	004A to 004B
			224 to 225	00E0 to 00E1
			374 to 375	0176 to 0177
		6)	524 to 525	020C to 020D
			76 to 77	004C to 004D
226 to 227	00E2 to 00E3			
6)	376 to 377	0178 to 0179		
	526 to 527	020E to 020F		

Screen example		No.	Buffer memory address	
			DEC	HEX
	1)	816, 916, 1016, 1116	0330, 0394, 03F8, 045C	
	2)	817, 917, 1017, 1117	0331, 0395, 03F9, 045D	
	1)	818 to 819	0332 to 0333	
	2)	918 to 919	0396 to 0397	
	3)	1018 to 1019	03FA to 03FB	
	4)	1118 to 1119	045E to 045F	
	5)	802 to 803	0322 to 0323	
	6)	902 to 903	0386 to 0387	
	7)	1002 to 1003	03EA to 03EB	
	8)	1102 to 1103	044E to 044F	
	9)	820 to 821	0334 to 0335	
	10)	920 to 921	0398 to 0399	
	11)	1020 to 1021	03FC to 03FD	
	12)	1120 to 1121	0460 to 0461	
	13)	810 to 811	032A to 032B	
	14)	910 to 911	038E to 038F	
	15)	1010 to 1011	03F2 to 03F3	
	16)	1110 to 1111	0456 to 0457	
	17)	812 to 813	032C to 032D	
	18)	912 to 913	0390 to 0391	
	19)	1012 to 1013	03F4 to 03F5	
20)	1112 to 1113	0458 to 0459		
21)	830, 930, 1030, 1130	033E, 03A2, 0406, 046A		
22)	831, 931, 1031, 1131	033F, 03A3, 0407, 046B		

- 1 OVERVIEW
- 2 SYSTEM MONITOR
- 3 LADDER MONITOR FUNCTION
- 4 MELSEC-A LIST EDITOR
- 5 MELSEC-FX LIST EDITOR
- 6 INTELLIGENT MODULE MONITOR
- 7 NETWORK MONITOR
- 8 Q MOTION MONITOR

Screen example	No.	Buffer memory address																																																																																																																																																		
		DEC	HEX																																																																																																																																																	
<p>QD75M Axis monitor data-2</p> <p>Special start data</p> <table border="1"> <tr><th>Axis</th><th>Instr. code</th><th>Instr. para.</th><th>Data No.</th></tr> <tr><td>1</td><td>0</td><td>0</td><td>0</td></tr> <tr><td>2</td><td>0</td><td>0</td><td>0</td></tr> <tr><td>3</td><td>0</td><td>0</td><td>0</td></tr> <tr><td>4</td><td>0</td><td>0</td><td>0</td></tr> </table> <p>Special start repetition counter</p> <table border="1"> <tr><th>Axis1</th><th>Axis2</th><th>Axis3</th><th>Axis4</th></tr> <tr><td>0</td><td>0</td><td>0</td><td>0</td></tr> </table> <p>Control system repetition counter</p> <table border="1"> <tr><th>Axis1</th><th>Axis2</th><th>Axis3</th><th>Axis4</th></tr> <tr><td>0</td><td>0</td><td>0</td><td>0</td></tr> </table> <p>Data being executed</p> <table border="1"> <tr><th>Axis</th><th>Instr. data counter</th><th>Pos. data number</th><th>Block No.</th><th>Previous position</th></tr> <tr><td>1</td><td>0</td><td>0</td><td>0</td><td>0</td></tr> <tr><td>2</td><td>0</td><td>0</td><td>0</td><td>0</td></tr> <tr><td>3</td><td>0</td><td>0</td><td>0</td><td>0</td></tr> <tr><td>4</td><td>0</td><td>0</td><td>0</td><td>0</td></tr> </table> <p>1) 4) 5) 2) 6) 7) 3)</p>	Axis	Instr. code	Instr. para.	Data No.	1	0	0	0	2	0	0	0	3	0	0	0	4	0	0	0	Axis1	Axis2	Axis3	Axis4	0	0	0	0	Axis1	Axis2	Axis3	Axis4	0	0	0	0	Axis	Instr. data counter	Pos. data number	Block No.	Previous position	1	0	0	0	0	2	0	0	0	0	3	0	0	0	0	4	0	0	0	0	1)	827, 927, 1027, 1127	033B, 039F, 0403, 0467																																																																																				
	Axis	Instr. code	Instr. para.	Data No.																																																																																																																																																
	1	0	0	0																																																																																																																																																
	2	0	0	0																																																																																																																																																
	3	0	0	0																																																																																																																																																
	4	0	0	0																																																																																																																																																
	Axis1	Axis2	Axis3	Axis4																																																																																																																																																
	0	0	0	0																																																																																																																																																
	Axis1	Axis2	Axis3	Axis4																																																																																																																																																
0	0	0	0																																																																																																																																																	
Axis	Instr. data counter	Pos. data number	Block No.	Previous position																																																																																																																																																
1	0	0	0	0																																																																																																																																																
2	0	0	0	0																																																																																																																																																
3	0	0	0	0																																																																																																																																																
4	0	0	0	0																																																																																																																																																
2)	828, 928, 1028, 1128	033C, 03A0, 0404, 0468																																																																																																																																																		
3)	829, 929, 1029, 1129	033D, 03A1, 0405, 0469																																																																																																																																																		
4)	834, 934, 1034, 1134	0342, 03A6, 040A, 046E																																																																																																																																																		
5)	835, 935, 1035, 1135	0343, 03A8, 040B, 046F																																																																																																																																																		
6)	836, 936, 1036, 1136	0344, 03A8, 040C, 0470																																																																																																																																																		
7)	837, 937, 1037, 1137	0345, 03A9, 040D, 0471																																																																																																																																																		
8)	832, 932, 1032, 1132	0340, 03A4, 0408, 046C																																																																																																																																																		
9)	833, 933, 1033, 1133	0341, 03A5, 0409, 046D																																																																																																																																																		
	-	-	-																																																																																																																																																	
<p>QD75M Axis monitor data-3</p> <p>Servo parameter</p> <table border="1"> <tr><th>Axis</th><th>(1)</th><th>(2)</th><th>(3)</th><th>(4)</th><th>(5)</th><th>(6)</th><th>(7)</th></tr> <tr><td>1</td><td>0</td><td>0</td><td>0</td><td>0</td><td>0</td><td>0</td><td>0</td></tr> <tr><td>2</td><td>0</td><td>0</td><td>0</td><td>0</td><td>0</td><td>0</td><td>0</td></tr> <tr><td>3</td><td>0</td><td>0</td><td>0</td><td>0</td><td>0</td><td>0</td><td>0</td></tr> <tr><td>4</td><td>0</td><td>0</td><td>12</td><td>0</td><td>0</td><td>0</td><td>0</td></tr> </table> <p>(1)Auto tuning (5)Position loop gain[rad/sec] (2)Load inertia ratio*10⁻¹ (6)Speed loop gain[rad/sec] (3)Position loop gain[rad/sec] (7)Velocity integral cooperation[sec] (4)Speed loop gain[rad/sec]</p> <p>Servo amplifier S/W number</p> <table border="1"> <tr><th>Axis</th><th>1</th><th>2</th><th>3</th><th>4</th><th>5</th><th>6</th><th>7</th><th>8</th><th>9</th><th>10</th><th>11</th><th>12</th><th>13</th><th>14</th><th>15</th><th>16</th><th>17</th><th>18</th><th>19</th><th>20</th></tr> <tr><td>1</td><td>00</td><td>00</td><td>00</td><td>00</td><td>00</td><td>00</td><td>00</td><td>00</td><td>00</td><td>00</td><td>00</td><td>00</td><td>00</td><td>00</td><td>00</td><td>00</td><td>00</td><td>00</td><td>00</td><td>00</td></tr> <tr><td>2</td><td>00</td><td>00</td><td>00</td><td>00</td><td>00</td><td>00</td><td>00</td><td>00</td><td>00</td><td>00</td><td>00</td><td>00</td><td>00</td><td>00</td><td>00</td><td>00</td><td>00</td><td>00</td><td>00</td><td>00</td></tr> <tr><td>3</td><td>00</td><td>00</td><td>00</td><td>00</td><td>00</td><td>00</td><td>00</td><td>00</td><td>00</td><td>00</td><td>00</td><td>00</td><td>00</td><td>00</td><td>00</td><td>00</td><td>00</td><td>00</td><td>00</td><td>00</td></tr> <tr><td>4</td><td>00</td><td>00</td><td>00</td><td>00</td><td>00</td><td>00</td><td>00</td><td>00</td><td>00</td><td>00</td><td>00</td><td>00</td><td>00</td><td>00</td><td>00</td><td>00</td><td>00</td><td>00</td><td>00</td><td>00</td></tr> </table> <p>Value is character code. (JIS Code)</p> <p>1) 4) 2) 5) 3)</p>	Axis	(1)	(2)	(3)	(4)	(5)	(6)	(7)	1	0	0	0	0	0	0	0	2	0	0	0	0	0	0	0	3	0	0	0	0	0	0	0	4	0	0	12	0	0	0	0	Axis	1	2	3	4	5	6	7	8	9	10	11	12	13	14	15	16	17	18	19	20	1	00	00	00	00	00	00	00	00	00	00	00	00	00	00	00	00	00	00	00	00	2	00	00	00	00	00	00	00	00	00	00	00	00	00	00	00	00	00	00	00	00	3	00	00	00	00	00	00	00	00	00	00	00	00	00	00	00	00	00	00	00	00	4	00	00	00	00	00	00	00	00	00	00	00	00	00	00	00	00	00	00	00	00	1)	848 to 849, 948 to 949, 1048 to 1049, 1148 to 1149	0350 to 0351, 03B4 to 03B5, 0418 to 0419, 047C to 047D
	Axis	(1)	(2)	(3)	(4)	(5)	(6)	(7)																																																																																																																																												
	1	0	0	0	0	0	0	0																																																																																																																																												
	2	0	0	0	0	0	0	0																																																																																																																																												
	3	0	0	0	0	0	0	0																																																																																																																																												
	4	0	0	12	0	0	0	0																																																																																																																																												
	Axis	1	2	3	4	5	6	7	8	9	10	11	12	13	14	15	16	17	18	19	20																																																																																																																															
	1	00	00	00	00	00	00	00	00	00	00	00	00	00	00	00	00	00	00	00	00																																																																																																																															
	2	00	00	00	00	00	00	00	00	00	00	00	00	00	00	00	00	00	00	00	00																																																																																																																															
	3	00	00	00	00	00	00	00	00	00	00	00	00	00	00	00	00	00	00	00	00																																																																																																																															
	4	00	00	00	00	00	00	00	00	00	00	00	00	00	00	00	00	00	00	00	00																																																																																																																															
	2)	850 to 851, 950 to 951, 1050 to 1051, 1150 to 1151	0352 to 0353, 03B6 to 03B7, 041A to 041B, 047E to 047F																																																																																																																																																	
	3)	852 to 853, 952 to 953, 1052 to 1053, 1152 to 1153	0354 to 0355, 03B8 to 03B9, 041C to 041D, 0480 to 0481																																																																																																																																																	
4)	854 to 855, 954 to 955, 1054 to 1055, 1154 to 1155	0356 to 0357, 03BA to 03BB, 041E to 041F, 0482 to 0483																																																																																																																																																		
5)	856, 956, 1056, 1156	0358, 03BC, 0420, 0484																																																																																																																																																		
6)	857, 957, 1057, 1157	0359, 03BD, 0421, 0485																																																																																																																																																		
	858, 958, 1058, 1158	035A, 03BE, 0422, 0486																																																																																																																																																		
	859, 959, 1059, 1159	035B, 03BF, 0423, 0487																																																																																																																																																		
	860, 960, 1060, 1160	035C, 03C0, 0424, 0488																																																																																																																																																		
	861, 961, 1061, 1161	035D, 03C1, 0425, 0489																																																																																																																																																		
	862, 962, 1062, 1162	035E, 03C2, 0426, 048A																																																																																																																																																		
7)	863, 963, 1063, 1163	035F, 03C2, 0427, 048B																																																																																																																																																		
	864 to 869, 964 to 969, 1064 to 1069, 1164 to 1169	0360 to 0365, 03C4 to 03C9, 0428 to 042D, 048C to 0491																																																																																																																																																		

Screen example		No.	Buffer memory address	
			DEC	HEX
<p>1) Parameter error No. (BIT 0:OK, 1:ERROR)</p> <p>2) Servo status</p> <p>3) Regenerative load ratio</p> <p>4) Actual load ratio</p> <p>5) Peak load ratio</p>	<p>1)</p> <p>2)</p> <p>3)</p> <p>4)</p> <p>5)</p>	870, 970, 1070, 1170	0366, 03CA, 042E, 0492	
		871, 971, 1071, 1171	0367, 03CB, 042F, 0493	
		872, 972, 1072, 1172	0368, 03CC, 0430, 0494	
		873, 973, 1073, 1173	0369, 03CD, 0431, 0495	
		874, 974, 1074, 1174	036A, 03CE, 0432, 0496	
<p>1) Axis travel after NPO ON</p> <p>2) Torque stored value</p> <p>3) Near point limit</p> <p>4) Upper limit</p> <p>5) Lower limit</p>	<p>1)</p> <p>2)</p> <p>3)</p> <p>4)</p> <p>5)</p>	877, 977, 1077, 1177	036D, 03D1, 0435, 0499	
		878, 978, 1078, 1178	036E, 03D2, 0436, 049A	
		879, 979, 1079, 1179	036F, 03D3, 0437, 049B	
		880, 980, 1080, 1180	0370, 03D4, 0438, 049C	
		824 to 825	0338 to 0339	
924 to 925	039C to 039D			
1024 to 1025	0400 to 0401			
1124 to 1125	0464 to 0465			
826, 926, 1026, 1126	033A, 039E, 0402, 0466			
816, 916, 1016, 1116	0330, 0394, 03F8, 045C			
<p>1) SPSG position amount</p> <p>2) SPSG movement amount change register</p> <p>3) Speed-position switching latch</p> <p>4) In speed control</p> <p>5) Speed-position switching enable</p>	<p>1)</p> <p>2)</p> <p>3)</p> <p>4)</p> <p>5)</p>	814 to 815	032E to 032F	
		914 to 915	0392 to 0393	
		1014 to 1015	03F6 to 03F7	
		1114 to 1115	045A to 045B	
		1526 to 1527	05F6 to 05F7	
		1626 to 1627	065A to 065B	
		1726 to 1727	06BE to 06BF	
		1826 to 1827	0722 to 0723	
		817, 917, 1017, 1117	0331, 0395, 03F9, 045D	
		817, 917, 1017, 1117	0331, 0395, 03F9, 045D	
1528, 1628, 1728, 1828	05F8, 065C, 06C0, 0724			
-	-			

- 1 OVERVIEW
- 2 SYSTEM MONITOR
- 3 LADDER MONITOR FUNCTION
- 4 MELSEC-A LIST EDITOR
- 5 MELSEC-FX LIST EDITOR
- 6 INTELLIGENT MODULE MONITOR
- 7 NETWORK MONITOR
- 8 Q MOTION MONITOR

Screen example	No.	Buffer memory address		
		DEC	HEX	
	1)	1530 to 1531	05FA to 05FB	
		1630 to 1631	065E to 065F	
		1730 to 1731	06C2 to 06C3	
		1830 to 1831	0726 to 0727	
	2)	817, 917, 1017, 1117	0331, 0395, 03F9, 045D	
	3)	817, 917, 1017, 1117	0331, 0395, 03F9, 045D	
	4)	1532, 1632, 1732, 1832	05FC, 0660, 06C4, 0728	
	-	-	-	
		1)	1506 to 1507	05E2 to 05E3
			1606 to 1607	0646 to 0647
		1706 to 1707	06AA to 06AB	
		1806 to 1807	070E to 070F	
2)		1514 to 1515	05EA to 05EB	
		1614 to 1615	064E to 064F	
		1714 to 1715	06B2 to 06B3	
		1814 to 1815	0716 to 0717	
3)		1513, 1613, 1713, 1813	05E9, 064D, 06B1, 0715	
4)		1544, 1644, 1744, 1844	0608, 066C, 06D0, 0734	
5)		1545, 1645, 1745, 1845	0609, 066D, 06D1, 0735	
6)		1546, 1646, 1746, 1846	060A, 066E, 06D2, 0736	
7)		1547, 1647, 1747, 1847	060B, 066F, 06D3, 0737	
8)		1505, 1605, 1705, 1805	05E1, 0645, 06A9, 070D	

Screen example		No.	Buffer memory address	
			DEC	HEX
		1)	1500, 1600, 1700, 1800	05DC, 0640, 06A4, 0708
		2)	1501, 1601, 1701, 1801	05DD, 0641, 06A5, 0709
		3)	1502, 1602, 1702, 1802	05DE, 0642, 06A6, 070A
		4)	1503, 1603, 1703, 1803	05DF, 0643, 06A7, 070B
		5)	1504, 1604, 1704, 1804	05E0, 0644, 06A8, 070C
		6)	1512, 1612, 1712, 1812	05E8, 064C, 06B0, 0714
		7)	1516, 1616, 1716, 1816	05EC, 0650, 06B4, 0718
		8)	1508 to 1509 1608 to 1609 1708 to 1709 1808 to 1809	05E4 to 05E5 0648 to 0649 06AC to 06AD 0710 to 0711
		9)	1510 to 1511 1610 to 1611 1710 to 1711 1810 to 1811	05E6 to 05E7 064A to 064B 06AE to 06AF 0712 to 0713
		10)	1520, 1620, 1720, 1820	05F0, 0654, 06B8, 071C
		11)	1521, 1621, 1721, 1821	05F1, 0655, 06B9, 071D
		12)	1522 to 1523 1622 to 1623 1722 to 1723 1822 to 1823	05F2 to 05F3 0656 to 0657 06BA to 06BB 071E to 071F
		13)	1524, 1624, 1724, 1824	05F4, 0658, 06BC, 0720
		14)	1525, 1625, 1725, 1825	05F5, 0659, 06BD, 0721
		1)	1538, 1638, 1738, 1838	0602, 0666, 06CA, 072E
		2)	1548, 1648, 1748, 1848	060C, 0670, 06D4, 0738
		3)	1549, 1649, 1749, 1849	060D, 0671, 06D5, 0739
		4)	1550, 1650, 1750, 1850	060E, 0672, 06D6, 073A
		5)	1540, 1640, 1740, 1840, 1541, 1641, 1741, 1841, 1542, 1642, 1742, 1842, 1543, 1643, 1743, 1843	0604, 0668, 06CC, 0730, 0605, 0669, 06CD, 0731, 0606, 066A, 06CE, 0732, 0607, 066B, 06CF, 0733
		-	-	-

1 OVERVIEW

2 SYSTEM MONITOR

3 LADDER MONITOR FUNCTION

4 MELSEC-A LIST EDITOR

5 MELSEC-FX LIST EDITOR

6 INTELLIGENT MODULE MONITOR

7 NETWORK MONITOR

8 Q MOTION MONITOR

Screen example	No.	Buffer memory address	
		DEC	HEX
<p>1) Incrching movement amount</p> <p>2) JOG speed</p> <p>3) Target position change value (Address)</p> <p>4) Target position change value (Speed)</p>	1)	1517, 1617, 1717, 1817	05ED, 0651, 06B5, 0719
	2)	1518 to 1519	05EE to 05EF
		1618 to 1619	0652 to 0653
		1718 to 1719	06B6 to 06B7
	3)	1818 to 1819	071A to 071B
		1534 to 1535	05FE to 05FF
		1634 to 1635	0662 to 0663
	4)	1734 to 1735	06C6 to 06C7
		1834 to 1835	072A to 072B
		1536 to 1537	0600 to 0601
1636 to 1637		0664 to 0665	
1736 to 1737		06C8 to 06C9	
-	-	-	
<p>1) Start History (0 to 7)</p> <p>Start History (8 to 15)</p>	1)	1212 to 1291	04BC to 050B
	-	-	-
<p>1) Error History (0 to 7)</p> <p>Warning History (0 to 7)</p> <p>2) Error History (8 to 15)</p> <p>Warning History (8 to 15)</p>	1)	1293 to 1356	050D to 054C
	2)	1358 to 1421	054E to 058D
	-	-	-
		-	-

Screen example		No.	Buffer memory address	
			DEC	HEX
		1)	2000 to 2002, 2004 to 2012, 2014 to 2022, 2024 to 2029	07D0 to 07D2, 07D4 to 07DC, 07DE to 07E6, 07E8 to 07ED
		2)	8000 to 8002, 8004 to 8012, 8014 to 8022, 8024 to 8029	1F40 to 1F42, 1F44 to 1F4C, 1F4E to 1F56, 1F58 to 1F5D
		3)	14000 to 14002, 14004 to 14012, 14014 to 14022, 14024 to 14029	36B0 to 36B2, 36B4 to 36BC, 36BE to 36C6, 36C8 to 36CD
		4)	20000 to 20002, 20004 to 20012, 20014 to 20022, 20024 to 20029	4E20 to 4E22, 4E24 to 4E2C, 4E2E to 4E36, 4E38 to 4E3D
		-	-	-
		1)	30100, 30200, 30300, 30400	07594, 075F8 0765C, 076C0
		2)	30101, 30201, 30301, 30401	07595, 075F9 0765D, 076C1
		3)	30102, 30202,	07596, 075FA
		4)	30302, 30402	0765E, 076C2
		5)	30103, 30203, 30303, 30403	07597, 075FB 0765F, 076C3
		6)	30104, 30204, 30304, 30404	07598, 075FC 07660, 076C4
		7)	30105, 30205, 30305, 30405	07599, 075FD 07661, 076C5
		8)	30106, 30206, 30306, 30406	0759A, 075FE 07662, 076C6
		9)	30107, 30207, 30307, 30407	0759B, 075FF 07663, 076C7
		10)	30108, 30208, 30308, 30408	0759C, 07600 07664, 076C8
		11)	30109, 30209, 30309, 30409	0759D, 07601 07665, 076C9

- 1 OVERVIEW
- 2 SYSTEM MONITOR
- 3 LADDER MONITOR FUNCTION
- 4 MELSEC-A LIST EDITOR
- 5 MELSEC-FX LIST EDITOR
- 6 INTELLIGENT MODULE MONITOR
- 7 NETWORK MONITOR
- 8 Q MOTION MONITOR

Screen example		No.	Buffer memory address	
			DEC	HEX
		1)	30113, 30213, 30313, 30413	075A1, 07605 07669, 076CD
		2)	30114, 30214, 30314, 30414	075A2, 07606 0766A, 076CE
		3)	30115, 30215, 30315, 30415	075A3, 07607 0766B, 076CF
		4)	30116, 30216, 30316, 30416	075A4, 07608 0766C, 076D0
		5)	30112, 30212, 30312, 30412	075A0, 07604 07668, 076CC
		6)	30117, 30217, 30317, 30417	075A5, 07609 0766D, 076D1
		7)	30119, 30219, 30319, 30419	075A7, 0760B 0766F, 076D3
		8)	30120, 30220, 30320, 30420	075A8, 0760C 07670, 076D4
		9)	30121, 30221, 30321, 30421	075A9, 0760D 07671, 076D5
		10)	30118, 30218, 30318, 30418	075A6, 0760A 0766E, 076D2
		11)	30122, 30222, 30322, 30422	075AA, 0760E 07672, 076D6
		1)	30123, 30223, 30323, 30423	075AB, 0760F 07673, 076D7
		2)		
		3)		
		4)	30124, 30224, 30324, 30424	075AC, 07610 07674, 076D8
		5)		
		6)		
		7)	30125, 30225, 30325, 30425	075AD, 07611 07675, 076D9
		8)		
		9)		
		1)	30127, 30227, 30327, 30427	075AF, 07613 07677, 076DB
		2)	30128, 30228, 30328, 30428	075B0, 07614 07678, 076DC
		3)	30129, 30229, 30329, 30429	075B1, 07615 07679, 076DD
		4)		
		5)	30130, 30230, 30330, 30430	075B2, 07616 0767A, 076DE
		6)	30131, 30231, 30331, 30431	075B3, 07617 0767B, 076DF
		7)	30132, 30232, 30332, 30432	075B4, 07618 0767C, 076E0
		8)		

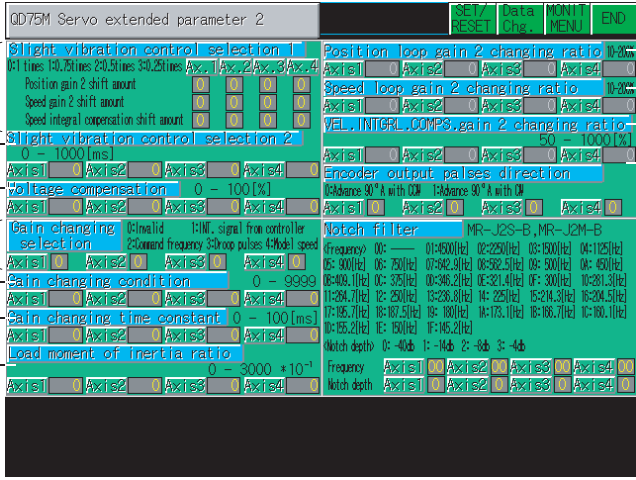
Screen example		No.	Buffer memory address	
			DEC	HEX
	1) to 4)	30133, 30233, 30333, 30433	075B5, 07619, 0767D, 076E1	
	5)	30134, 30234, 30334, 30434	075B6, 0761A, 0767E, 076E2	
	6)	30136, 30236, 30336, 30436	075B8, 0761C, 07680, 076E4	
	7)	30138, 30238, 30338, 30438	075BA, 0761E, 07682, 076E6	
	-	-	-	
	1)	30143, 30243, 30343, 30443	075BF, 07623, 07687, 076EB	
	2)	30144, 30244, 30344, 30444	075C0, 07624, 07688, 076EC	
	3)	30145, 30245, 30345, 30445	075C1, 07605, 07689, 076ED	
	4)	30149, 30249, 30349, 30449	075C5, 07629, 0768D, 076F1	
	5)	30150, 30250, 30350, 30450	075C6, 0762A, 0768E, 076F2	
	6)	30151, 30251, 30351, 30451	075C7, 0762B, 0768F, 076F3	
	7)	30152, 30252, 30352, 30452	075C8, 0762C, 07690, 076F4	
	8)	30153, 30253, 30353, 30453	075C9, 0762D, 07691, 076F5	
	9)	30154, 30254, 30354, 30454	075CA, 0762E, 07692, 076F5	
	10)	30155, 30255, 30355, 30455	075CB, 0762F, 07693, 076F6	
	11)	30160, 30260, 30360, 30460	075D0, 07634, 07698, 076FC	
	12)	30161, 30261, 30361, 30461	075D1, 07635, 07699, 076FD	

- 1 OVERVIEW
- 2 SYSTEM MONITOR
- 3 LADDER MONITOR FUNCTION
- 4 MELSEC-A LIST EDITOR
- 5 MELSEC-FX LIST EDITOR
- 6 INTELLIGENT MODULE MONITOR
- 7 NETWORK MONITOR
- 8 Q MOTION MONITOR

6.5.34 QD75MH module monitoring

Screen example	No.	Buffer memory address	
		DEC	HEX
<p>QD75MH Operation Monitor</p> <p>1) Axis Current feed val. 2) Axis feedrate 3) 4) unit (Cumulative) (degree) (inch) (pulse) (mm/min) (degree/min) (inch/min) (pulse/sec)</p> <p>5) Axis Status Standby 6) 7) 8) 9) Emergency stop input</p> <p>10) 11) 12) 13) Operation pattern</p> <p>14) 15) 16) 17) Axis Control system</p>	1)	800, 812	320, 32C
	2)	900, 912	384, 390
	3)	1000, 1012	3E8, 3F4
	4)	1100, 1112	44C, 458
	5)	806 to 809	326 to 329
	6)	906 to 909	38A to 38D
	7)	1006 to 1009	3EE to 3F1
	8)	1106 to 1109	452 to 455
	9)	1431	597
	10)	829, 838	33D, 346
	11)	929, 938	3A1, 3AA
	12)	1029, 1038	405, 40E
	13)	1129, 1138	469, 472
	14)	838	346
	15)	938	3AA
	16)	1038	40E
	17)	1138	472
-	-	-	-
<p>QD75MH Input/Output Monitor</p> <p>1) 10) 11) 12) 13) 14) 15) 16) 17) Axis status and job completion indicators</p>	1)	-	-
<p>QD75MH Basic parameters 1</p> <p>1) Unit setting: 2: mm, 0: inch, 0: degree, 0: pulse</p> <p>2) Movement amount per pulse (Pulse/rotation) for axes 1-4</p> <p>3) Unit magnification (Am) for axes 1-4</p>	1)	0, 150, 300, 450	0, 96, 12C, 1C2
	2)	2 to 3, 152 to 153, 302 to 303, 452 to 453	2 to 3, 98 to 99, 12E to 12F, 1C4 to 1C5
	3)	1, 151, 301, 451	1, 97, 12D, 1C3
	4)	4 to 5, 154 to 155, 304 to 305, 454 to 455	4 to 5, 9A to 9B, 130 to 131, 1C6 to 1C7
-	-	-	-

Screen example		No.	Buffer memory address	
			DEC	HEX
		1)	10 to 11, 160 to 161, 310 to 311, 460 to 461	A to B, A0 to A1, 136 to 137, 1CC to 1CD
		2)	12 to 13, 162 to 163, 312 to 313, 462 to 463	C to D, A2 to A3, 138 to 139, 1CE to 1CF
		3)	14 to 15, 164 to 165, 314 to 315, 464 to 465	E to F, A4 to A5, 13A to 13B, 1D0 to 1D1
		1)	17, 167, 317, 467	11, A7, 13D, 1D3
		2)	18 to 19, 168 to 169, 318 to 319, 468 to 469	12 to 13, A8 to A9, 13E to 13F, 1D4 to 1D5
		3)	20 to 21, 170 to 171, 320 to 321, 470 to 471	14 to 15, AA to AB, 140 to 141, 1D6 to 1D7
		4)	33	21
		5)	22, 172, 322, 472	16, AC, 142, 1D8
		6)	23, 173, 323, 473	17, AD, 143, 1D9
		7)	26, 176, 326, 476	1A, B0, 146, 1DC
		1)	27, 177, 327, 477	1B, B1, 147, 1DD
		2)	28, 178, 328, 478	1C, B2, 148, 1DE
		3)	29, 179, 329, 479	1D, B3, 149, 1DF
		4)	24 to 25, 174 to 175, 324 to 325, 474 to 475	18 to 19, AE to AF, 144 to 145, 1DA to 1DB
		5)	30, 180, 330, 480	1F, B4, 14A, 1E0
		6)	31, 181, 331, 481	20, B5, 14B, 1E1
		7)	34, 184, 334, 484	22, B8, 14E, 1E4
		8)	32, 182, 332, 482	21, B6, 14C, 1E2
		9)	35	23

- 1 OVERVIEW
- 2 SYSTEM MONITOR
- 3 LADDER MONITOR FUNCTION
- 4 MELSEC-A LIST EDITOR
- 5 MELSEC-FX LIST EDITOR
- 6 INTELLIGENT MODULE MONITOR
- 7 NETWORK MONITOR
- 8 Q MOTION MONITOR

Screen example		No.	Buffer memory address	
			DEC	HEX
		1)	36 to 37, 186 to 187, 336 to 337, 486 to 487	24 to 25, BA to BB, 150 to 151, 1E6 to 1E7
		2)	38 to 39, 188 to 189, 338 to 339, 488 to 489	26 to 27, BC to BD, 152 to 153, 1E8 to 1E9
		3)	40 to 41, 190 to 191, 340 to 341, 490 to 491	28 to 29, BE to BF, 154 to 155, 1EA to 1EB
		4)	42 to 43, 192 to 193, 342 to 343, 492 to 493	2A to 2B, C0 to C1, 156 to 157, 1EC to 1ED
		5)	44 to 45, 194 to 195, 344 to 345, 494 to 495	2C to 2D, C2 to C3, 158 to 159, 1EE to 1EF
		6)	46 to 47, 196 to 197, 346 to 347, 496 to 497	2E to 2F, C4 to C5, 15A to 15B, 1F0 to 1F1
		7)	48 to 49, 198 to 199, 348 to 349, 498 to 499	30 to 31, C6 to C7, 15C to 15D, 1F2 to 1F3
		8)	50, 200, 350, 500	32, C8, 15E, 1F4
		9)	51, 201, 351, 501	33, C9, 15F, 1F5
		1)	52, 202, 352, 502	34, CA, 160, 1F6
		2)	53, 203, 353, 503	35, CB, 161, 1F7
		3)	56, 206, 356, 506	38, CE, 164, 1FA
		4)	57, 207, 357, 507	39, CF, 165, 1FB
		5)	58, 208, 358, 508	3A, D0, 166, 1FC
		6)	54 to 55, 204 to 205, 354 to 355, 504 to 505	36 to 37, CC to CD, 162 to 163, 1F8 to 1F9
		7)	59, 209, 359, 509	3B, D1, 167, 1FD
		8)	60 to 61, 210 to 211, 360 to 361, 510 to 511	3C to 3D, D2 to D3, 168 to 169, 1FE to 1FF
		9)	62, 212, 362, 512	3E, D4, 16A, 200
		10)	63, 213, 363, 513	3F, D5, 16B, 201
		11)	64, 214, 364, 514	40, D6, 16C, 202
		1)	82, 232, 382, 532	52, E8, 17E, 214
		2)	83, 233, 383, 533	53, E9, 17F, 215
		3)	86, 236, 386, 536	56, EC, 182, 218
		4)	87, 237, 387, 537	57, ED, 183, 219
		5)	80 to 81, 230 to 231, 380 to 381, 530 to 531	50 to 51, E6 to E7, 17C to 17D, 212 to 213
		6)	84 to 85, 234 to 235, 384 to 385, 534 to 535	54 to 55, EA to EB, 180 to 181, 216 to 217
		7)	88, 238, 388, 538	58, EE, 184, 21A
		8)	89, 239, 389, 539	59, EF, 185, 21B

Screen example		No.	Buffer memory address	
			DEC	HEX
		1)	70, 220, 370, 520	46, DC, 172, 208
		2)	71, 221, 371, 521	47, DD, 173, 209
		3)	78, 228, 378, 528	4E, E4, 17A, 210
		4)	72 to 73, 222 to 223, 372 to 373, 522 to 523	48 to 49, DE to DF, 174 to 175, 20A to 20B
		5)	74 to 75, 224 to 225, 374 to 375, 524 to 525	4A to 4B, E0 to E1, 176 to 177, 20C to 20D
		6)	76 to 77, 226 to 227, 376 to 377, 526 to 527	4C to 4D, E2 to E3, 178 to 179, 20E to 20F
		1)	816	330
		2)	916	394
		3)	1016	3F8
		4)	1116	45C
		5)	817	331
		6)	917	395
		7)	1017	3F9
		8)	1117	45D
		1)	818 to 819, 802 to 803	332 to 333, 322 to 323
		2)	918 to 919, 902 to 903	396 to 397, 386 to 387
		3)	1018 to 1019, 1002 to 1003	3FA to 3FB, 3EA to 3EB
		4)	1118 to 1119, 1102 to 1103	45E to 45F, 44E to 44F
		5)	820 to 821, 810 to 811, 812 to 813	334 to 335, 32A to 32B, 32C to 32D
		6)	920 to 921, 910 to 911, 912 to 913	398 to 399, 38E to 38F, 390 to 391
		7)	1020 to 1021, 1010 to 1011, 1012 to 1013	3FC to 3FD, 3F2 to 3F3, 3F4 to 3F5
		8)	1120 to 1121, 1110 to 1111, 1112 to 1113	460 to 461, 456 to 457, 458 to 459
		9)	830, 930, 1030, 1130	33E, 3A2, 406, 46A
		10)	831, 931, 1031, 1131	33F, 3A3, 407, 46B
-	-	-	-	

1 OVERVIEW

2 SYSTEM MONITOR

3 LADDER MONITOR FUNCTION

4 MELSEC-A LIST EDITOR

5 MELSEC-FX LIST EDITOR

6 INTELLIGENT MODULE MONITOR

7 NETWORK MONITOR

8 Q MOTION MONITOR

Screen example		No.	Buffer memory address																																																																																
			DEC	HEX																																																																															
<p>QD75MH Axis monitor data-2</p> <p>Special start data</p> <table border="1"> <thead> <tr> <th>Axis</th> <th>Instr. code</th> <th>Instr. para</th> <th>Data No.</th> </tr> </thead> <tbody> <tr><td>1</td><td>0</td><td>0</td><td>0</td></tr> <tr><td>2</td><td>0</td><td>0</td><td>0</td></tr> <tr><td>3</td><td>0</td><td>0</td><td>0</td></tr> <tr><td>4</td><td>0</td><td>0</td><td>0</td></tr> </tbody> </table> <p>Special start repetition counter</p> <table border="1"> <thead> <tr> <th>Axis1</th> <th>Axis2</th> <th>Axis3</th> <th>Axis4</th> </tr> </thead> <tbody> <tr><td>0</td><td>0</td><td>0</td><td>0</td></tr> </tbody> </table> <p>Control system repetition counter</p> <table border="1"> <thead> <tr> <th>Axis1</th> <th>Axis2</th> <th>Axis3</th> <th>Axis4</th> </tr> </thead> <tbody> <tr><td>0</td><td>0</td><td>0</td><td>0</td></tr> </tbody> </table> <p>Data being executed</p> <table border="1"> <thead> <tr> <th>Axis</th> <th>Test data pointer</th> <th>Pos. data number</th> <th>Block No.</th> <th>Previous position</th> </tr> </thead> <tbody> <tr><td>1</td><td>0</td><td>0</td><td>0</td><td>0</td></tr> <tr><td>2</td><td>0</td><td>0</td><td>0</td><td>0</td></tr> <tr><td>3</td><td>0</td><td>0</td><td>0</td><td>0</td></tr> <tr><td>4</td><td>0</td><td>0</td><td>0</td><td>0</td></tr> </tbody> </table>		Axis	Instr. code	Instr. para	Data No.	1	0	0	0	2	0	0	0	3	0	0	0	4	0	0	0	Axis1	Axis2	Axis3	Axis4	0	0	0	0	Axis1	Axis2	Axis3	Axis4	0	0	0	0	Axis	Test data pointer	Pos. data number	Block No.	Previous position	1	0	0	0	0	2	0	0	0	0	3	0	0	0	0	4	0	0	0	0	1) 827 to 829	33B to 33D																			
		Axis	Instr. code	Instr. para	Data No.																																																																														
		1	0	0	0																																																																														
		2	0	0	0																																																																														
		3	0	0	0																																																																														
		4	0	0	0																																																																														
		Axis1	Axis2	Axis3	Axis4																																																																														
		0	0	0	0																																																																														
		Axis1	Axis2	Axis3	Axis4																																																																														
		0	0	0	0																																																																														
Axis	Test data pointer	Pos. data number	Block No.	Previous position																																																																															
1	0	0	0	0																																																																															
2	0	0	0	0																																																																															
3	0	0	0	0																																																																															
4	0	0	0	0																																																																															
2) 927 to 929	39F to 3A1																																																																																		
3) 1027 to 1029	403 to 405																																																																																		
4) 1127 to 1129	467 to 469																																																																																		
5) 834 to 837	34x2 to 345																																																																																		
6) 934 to 937	3A6 to 3A9																																																																																		
7) 1034 to 1037	40A to 40D																																																																																		
8) 1134 to 1137	46E to 471																																																																																		
9) 832, 932, 1032, 1132	340, 3A4, 408, 46C																																																																																		
10) 833, 933, 1033, 1133	341, 3A5, 409, 46D																																																																																		
-		-	-																																																																																
<p>QD75MH Axis monitor data-3</p> <table border="1"> <thead> <tr> <th>Axis</th> <th>OPR. increment</th> <th>Actual present val.</th> <th>Error counter val.</th> </tr> </thead> <tbody> <tr><td>1</td><td>0</td><td>0</td><td>0</td></tr> <tr><td>2</td><td>0</td><td>0</td><td>0</td></tr> <tr><td>3</td><td>0</td><td>0</td><td>0</td></tr> <tr><td>4</td><td>0</td><td>0</td><td>0</td></tr> </tbody> </table> <p>(μm):$\times 10^{-1}$ (degree):$\times 10^{-2}$ (inch):$\times 10^{-5}$ (pulse):$\times 1$</p> <table border="1"> <thead> <tr> <th>Axis</th> <th>Number of motor rotation</th> <th>Motor current</th> <th>Axis</th> <th>Servo amplifier S/W number</th> </tr> </thead> <tbody> <tr><td>1</td><td>0</td><td>0</td><td>1</td><td>000000000000000000000000</td></tr> <tr><td>2</td><td>0</td><td>0</td><td>2</td><td>000000000000000000000000</td></tr> <tr><td>3</td><td>0</td><td>0</td><td>3</td><td>000000000000000000000000</td></tr> <tr><td>4</td><td>0</td><td>0</td><td>4</td><td>000000000000000000000000</td></tr> </tbody> </table> <p>(rpm):$\times 10^{-1}$ (%) :$\times 10^{-1}$ Value is character code.(JIS8 Code)</p>		Axis	OPR. increment	Actual present val.	Error counter val.	1	0	0	0	2	0	0	0	3	0	0	0	4	0	0	0	Axis	Number of motor rotation	Motor current	Axis	Servo amplifier S/W number	1	0	0	1	000000000000000000000000	2	0	0	2	000000000000000000000000	3	0	0	3	000000000000000000000000	4	0	0	4	000000000000000000000000	1) 848 to 849, 850 to 851, 852 to 853	350 to 351, 352 to 353, 354 to 355																																			
		Axis	OPR. increment	Actual present val.	Error counter val.																																																																														
		1	0	0	0																																																																														
		2	0	0	0																																																																														
		3	0	0	0																																																																														
		4	0	0	0																																																																														
		Axis	Number of motor rotation	Motor current	Axis	Servo amplifier S/W number																																																																													
		1	0	0	1	000000000000000000000000																																																																													
		2	0	0	2	000000000000000000000000																																																																													
		3	0	0	3	000000000000000000000000																																																																													
		4	0	0	4	000000000000000000000000																																																																													
		2) 948 to 949, 950 to 951, 952 to 953	3B4 to 3B5, 3B6 to 3B7, 3B8 to 3B9																																																																																
3) 1048 to 1049, 1050 to 1051, 1052 to 1053	418 to 419, 41A to 41B, 41C to 41D																																																																																		
4) 1148 to 1149, 1150 to 1151, 1152 to 1153	47C to 47D, 47E to 47F, 480 to 481																																																																																		
5) 854 to 855, 856 to 857	356 to 357, 358 to 359																																																																																		
6) 954 to 955, 956 to 957	3BA to 3BB, 3BC to 3BD																																																																																		
7) 1054 to 1055, 1056 to 1057	41E to 41F, 420 to 421																																																																																		
8) 1154 to 1155, 1156 to 1157	480 to 481, 482 to 483																																																																																		
9) 864 to 869	360 to 365																																																																																		
10) 964 to 969	3C4 to 3C9																																																																																		
11) 1064 to 1069	428 to 42D																																																																																		
12) 1164 to 1169	48C to 491																																																																																		
-		-	-																																																																																
<p>QD75MH Axis monitor data-4</p> <table border="1"> <thead> <tr> <th>Parameter error No.</th> <th>Axis1</th> <th>Axis2</th> <th>Axis3</th> <th>Axis4</th> </tr> </thead> <tbody> <tr><td>0</td><td>0</td><td>0</td><td>0</td><td>0</td></tr> </tbody> </table> <p>1 to 13 : PA01 to PA13 19 to 63 : PB01 to PB45 64 to 95 : PC01 to PC32 96 to 127 : PD01 to PD32 128 to 167 : PE01 to PE40 128 to 199 : PS01 to PS32</p> <table border="1"> <thead> <tr> <th>Item</th> <th>Axis1</th> <th>Axis2</th> <th>Axis3</th> <th>Axis4</th> </tr> </thead> <tbody> <tr><td>Zero point passed</td><td>0</td><td>0</td><td>0</td><td>0</td></tr> <tr><td>Zero speed</td><td>0</td><td>0</td><td>0</td><td>0</td></tr> <tr><td>Ready ON</td><td>0</td><td>0</td><td>0</td><td>0</td></tr> <tr><td>Servo ON</td><td>0</td><td>0</td><td>0</td><td>0</td></tr> <tr><td>Servo alarm</td><td>0</td><td>0</td><td>0</td><td>0</td></tr> <tr><td>In-position</td><td>0</td><td>0</td><td>0</td><td>0</td></tr> <tr><td>Torque limit</td><td>0</td><td>0</td><td>0</td><td>0</td></tr> <tr><td>Abs. value cleared</td><td>0</td><td>0</td><td>0</td><td>0</td></tr> <tr><td>Warning</td><td>0</td><td>0</td><td>0</td><td>0</td></tr> </tbody> </table> <table border="1"> <thead> <tr> <th>Item</th> <th>Axis1</th> <th>Axis2</th> <th>Axis3</th> <th>Axis4</th> </tr> </thead> <tbody> <tr><td>Regenerative load ratio</td><td>0</td><td>0</td><td>0</td><td>0</td></tr> <tr><td>Actual load ratio</td><td>0</td><td>0</td><td>0</td><td>0</td></tr> <tr><td>Peak load ratio</td><td>0</td><td>0</td><td>0</td><td>0</td></tr> </tbody> </table>		Parameter error No.	Axis1	Axis2	Axis3	Axis4	0	0	0	0	0	Item	Axis1	Axis2	Axis3	Axis4	Zero point passed	0	0	0	0	Zero speed	0	0	0	0	Ready ON	0	0	0	0	Servo ON	0	0	0	0	Servo alarm	0	0	0	0	In-position	0	0	0	0	Torque limit	0	0	0	0	Abs. value cleared	0	0	0	0	Warning	0	0	0	0	Item	Axis1	Axis2	Axis3	Axis4	Regenerative load ratio	0	0	0	0	Actual load ratio	0	0	0	0	Peak load ratio	0	0	0	0	1) 870, 970, 1070, 1170	366, 3CA, 42E, 492
		Parameter error No.	Axis1	Axis2	Axis3	Axis4																																																																													
		0	0	0	0	0																																																																													
		Item	Axis1	Axis2	Axis3	Axis4																																																																													
		Zero point passed	0	0	0	0																																																																													
		Zero speed	0	0	0	0																																																																													
Ready ON	0	0	0	0																																																																															
Servo ON	0	0	0	0																																																																															
Servo alarm	0	0	0	0																																																																															
In-position	0	0	0	0																																																																															
Torque limit	0	0	0	0																																																																															
Abs. value cleared	0	0	0	0																																																																															
Warning	0	0	0	0																																																																															
Item	Axis1	Axis2	Axis3	Axis4																																																																															
Regenerative load ratio	0	0	0	0																																																																															
Actual load ratio	0	0	0	0																																																																															
Peak load ratio	0	0	0	0																																																																															
2) 876, 976, 1076, 1176	36C, 3D0, 434, 498																																																																																		
3) 877, 977, 1077, 1177	36D, 3D1, 435, 499																																																																																		
4) 878, 978, 1078, 1178	36E, 3D2, 436, 49A																																																																																		
5) 879, 979, 1079, 1179	36F, 3D3, 437, 49B																																																																																		
6) 880, 980, 1080, 1180	370, 3D4, 438, 49C																																																																																		
-		-	-																																																																																

Screen example	No.	Buffer memory address	
		DEC	HEX
<p>QD75MH OPR</p> <p>Axis Travel after NPO On</p> <p>1) 1 0</p> <p>2) 2 0</p> <p>3) 3 0</p> <p>4) 4 0</p> <p>(μm):$\times 10^3$ (inch):$\times 10^3$ (degree):$\times 10^3$ (pulse):$\times 1$</p> <p>Axes Torque limit stored value Near point Upper limit Lower limit</p> <p>5) 1 123 (%) <input checked="" type="checkbox"/> <input checked="" type="checkbox"/> <input checked="" type="checkbox"/></p> <p>6) 2 <input type="checkbox"/> (%) <input checked="" type="checkbox"/> <input checked="" type="checkbox"/> <input checked="" type="checkbox"/></p> <p>7) 3 383 (%) <input checked="" type="checkbox"/> <input checked="" type="checkbox"/> <input checked="" type="checkbox"/></p> <p>8) 4 <input type="checkbox"/> (%) <input checked="" type="checkbox"/> <input checked="" type="checkbox"/> <input checked="" type="checkbox"/></p>	1)	824 to 825	338 to 339
	2)	924 to 925	39C to 39D
	3)	1024 to 1025	400 to 401
	4)	1124 to 1125	464 to 465
	5)	826, 816	33A, 330
	6)	926, 916	39E, 394
	7)	1026, 1016	402, 3F8
	8)	1126, 1116	466, 45C
<p>QD75MH Speed-position control</p> <p>SPSC positioning amount</p> <p>1) Axis1 <input type="checkbox"/></p> <p>2) Axis2 <input type="checkbox"/></p> <p>3) Axis3 1500</p> <p>4) Axis4 <input type="checkbox"/></p> <p>(μm):$\times 10^3$ (degree):$\times 10^3$ (inch):$\times 10^3$ (pulse):$\times 1$</p> <p>SPSC movement amount change register</p> <p>5) Axis1 0 Axis2 0</p> <p>6) Axis3 0 Axis4 0</p> <p>Setting range 0 to 2147483647 (μm):$\times 10^3$ (inch):$\times 10^3$ (degree):$\times 10^3$ (pulse):$\times 1$</p> <p>Item: Speed-position switching latch <input checked="" type="checkbox"/> <input checked="" type="checkbox"/> <input checked="" type="checkbox"/> <input checked="" type="checkbox"/></p> <p>In speed control <input checked="" type="checkbox"/> <input checked="" type="checkbox"/> <input checked="" type="checkbox"/> <input checked="" type="checkbox"/></p> <p>Speed-position switching enable 0:Disable 1:Enable</p>	1)	814 to 815	32E to 32F
	2)	914 to 915	392 to 393
	3)	1014 to 1015	3F6 to 3F7
	4)	1114 to 1115	45A to 45B
	5)	1526 to 1527, 1626 to 1627	5F6 to 5F7, 65A to 65B
	6)	1726 to 1727, 1826 to 1927	6BE to 6BF, 722 to 723
	7)	817, 917, 1017, 1117	330, 395, 3F9, 45D
	8)	1528, 1628, 1728, 1828	5F8, 65C, 6C0, 724
<p>QD75MH Position-speed control</p> <p>PSCC speed change register</p> <p>1) Axis1 <input type="checkbox"/> Axis2 <input type="checkbox"/></p> <p>2) Axis3 <input type="checkbox"/> Axis4 <input type="checkbox"/></p> <p>Setting range 0 to 2000000000 (mm/min):$\times 10^3$ (inch/min):$\times 10^3$ (degree/min):$\times 10^3$ 0 to 500000000 (pulse/sec):$\times 1$</p> <p>Item: Position-speed switching latch <input checked="" type="checkbox"/> <input checked="" type="checkbox"/> <input checked="" type="checkbox"/> <input checked="" type="checkbox"/></p> <p>In speed control <input checked="" type="checkbox"/> <input checked="" type="checkbox"/> <input checked="" type="checkbox"/> <input checked="" type="checkbox"/></p> <p>Position-speed switching enable 0:Disable 1:Enable</p>	1)	1530 to 1531, 1630 to 1631	5FA to 5FB, 65E to 65F
	2)	1730 to 1731, 1830 to 1931	6C2 to 6C3, 726 to 727
	3)	817, 917, 1017, 1117	331, 395, 3F9, 45D
	4)	1532, 1632, 1732, 1832	5FC, 660, 6C4, 728

- 1 OVERVIEW
- 2 SYSTEM MONITOR
- 3 LADDER MONITOR FUNCTION
- 4 MELSEC-A LIST EDITOR
- 5 MELSEC-FX LIST EDITOR
- 6 INTELLIGENT MODULE MONITOR
- 7 NETWORK MONITOR
- 8 Q MOTION MONITOR

Screen example		No.	Buffer memory address	
			DEC	HEX
		1)	1506 to 1507, 1606 to 1607	5E2 to 5E3, 646 to 647
		2)	1706 to 1707, 1806 to 1807	6AA to 6AB, 70E to 70F
		3)	1514 to 1515, 1614 to 1615	5EA to 5EB, 64E to 64F
		4)	1714 to 1715, 1814 to 1815	6B2 to 6B3, 716 to 717
		5)	1513, 1613, 1713, 1813	5E9, 64D, 6B1, 715
		6)	1544, 1644, 1744, 1844	608, 66C, 6D0, 734,
		7)	1545, 1645, 1745, 1845	609, 66D, 6B1, 735
		8)	1546, 1646, 1746, 1846	60A, 66E, 6B2, 736
		9)	1547, 1647, 1747, 1847	60B, 66F, 6B3, 737
		10)	1505, 1605, 1705, 1805	5E1, 645, 6A9, 70D
		-	-	-
		1)	1500, 1600, 1700, 1800	5DC, 640, 6A4, 708
		2)	1501, 1601, 1701, 1801	5DD, 641, 6A5, 709
		3)	1502, 1602, 1702, 1802	5DE, 642, 6A6, 70A
		4)	1503, 1603, 1703, 1803	5DF, 643, 6A7, 70B
		5)	1504, 1604, 1704, 1804	5E0, 644, 6A8, 70C
		6)	1512, 1612, 1712, 1812	5E8, 64C, 6B0, 714
		7)	1516, 1616, 1716, 1816	5EC, 650, 6B4, 718
		8)	1508 to 1509, 1608 to 1609, 1708 to 1709, 1808 to 1809	5E4 to 5E5, 648 to 649, 6AC to 6AD, 710 to 711
		9)	1510 to 1511, 1610 to 1611, 1710 to 1711, 1810 to 1811	5E6 to 5E7, 64A to 64B, 6AE to 6AF, 712 to 713
		10)	1520, 1620, 1720, 1820	5F0, 654, 6B8, 71C
		11)	1521, 1621, 1721, 1821	5F1, 655, 6B9, 71D
		12)	1522 to 1523, 1622 to 1623, 1722 to 1723, 1822 to 1823	5F2 to 5F3, 656 to 657, 6BA to 6BB, 71E to 71F
		13)	1524, 1624, 1724, 1824	5F4, 658, 6BC, 720
14)	1525, 1625, 1725, 1825	5F5, 659, 6BD, 721		
-	-	-		

Screen example		No.	Buffer memory address	
			DEC	HEX
		1)	1538, 1638, 1738, 1838	602, 670, 6CA, 72E
1)	Pos. change	2)	1548, 1648, 1748, 1848	60C, 670, 6D4, 738
2)	Teaching data selection	3)	1549, 1649, 1749, 1849	60D, 671, 6D5, 739
3)	positioning data No.	4)	1550, 1650, 1750, 1850	60E, 672, 606, 73A
4)	ABS	5)	1540, 1640, 1740, 1840	604, 668, 6CB, 730
	direction in degrees	6)	1541, 1641, 1741, 1841	605, 669, 6CD, 731
		7)	1542, 1642, 1742, 1842	606, 66A, 6CE, 732
		8)	1543, 1643, 1743, 1843	607, 66B, 6D0, 733
		9)	1551, 1651, 1751, 1851	60F, 673, 6D7, 73B
		10)	1552 to 1553, 1652 to 1653, 1752 to 1753, 1852 to 1853	610 to 611, 674 to 675, 6D8 to 6D9, 73C to 73D
		11)	1559, 1659, 1759, 1859	617, 67B, 6DF, 743
		-	-	-
		1)	1517, 1617	5ED, 651
1)	Inching movement amount	2)	1717, 1817	6B5, 719
2)	Setting range	3)	1518 to 1519, 1618 to 1619	5EE to 5EF, 652 to 653
		4)	1718 to 1719, 1818 to 1819	6B6 to 6B7, 71A to 71B
		5)	1534 to 1535, 1634 to 1635	5FE to 5FF, 662 to 663
3)	JOG speed	6)	1734 to 1735, 1834 to 1835	6C6 to 6C7, 72A to 72B
4)	Setting range	7)	1536 to 1537, 1636 to 1637	600 to 601, 664 to 665
		8)	1736 to 1737, 1836 to 1837	6C8 to 6C9, 72C to 72D
		-	-	-

1

OVERVIEW

2

SYSTEM MONITOR

3

LADDER MONITOR FUNCTION

4

MELSEC-A LIST EDITOR

5

MELSEC-FX LIST EDITOR

6

INTELLIGENT MODULE MONITOR

7

NETWORK MONITOR

8

Q MOTION MONITOR

Screen example		No.	Buffer memory address	
			DEC	HEX
		1)	1212 to 1216	4BC to 4C0
		2)	1217 to 1221	4C1 to 4C5
		3)	1222 to 1226	4C6 to 4CA
		4)	1227 to 1231	4CB to 4CF
		5)	1232 to 1236	4D0 to 4D4
		6)	1237 to 1241	4D5 to 4D9
		7)	1242 to 1246	4DA to 4DE
		8)	1247 to 1251	4DF to 4E3
		9)	1252 to 1256	4E4 to 4E8
		10)	1257 to 1261	4E9 to 4ED
		11)	1262 to 1266	4EE to 4F2
		12)	1267 to 1271	4F3 to 4F7
		13)	1272 to 1276	4F8 to 4FC
		14)	1277 to 1281	4FD to 501
		15)	1282 to 1286	502 to 506
		16)	1287 to 1291	507 to 50B
		-	-	-
		1)	1293 to 1296	50D to 510
		2)	1297 to 1300	511 to 514
		3)	1301 to 1304	515 to 518
		4)	1305 to 1308	519 to 51C
		5)	1309 to 1312	51D to 520
		6)	1313 to 1316	521 to 524
		7)	1317 to 1320	525 to 528
		8)	1321 to 1324	529 to 52C
		9)	1325 to 1328	52D to 530
		10)	1329 to 1332	531 to 534
		11)	1333 to 1336	535 to 538
		12)	1337 to 1340	539 to 53C
		13)	1341 to 1344	53D to 540
		14)	1345 to 1348	541 to 544
		15)	1349 to 1352	545 to 548
16)	1353 to 1356	549 to 54C		
17)	1358 to 1361	54E to 551		
18)	1362 to 1365	552 to 555		
19)	1366 to 1369	556 to 559		
20)	1370 to 1373	55A to 55D		
21)	1374 to 1377	55E to 561		
22)	1378 to 1381	562 to 565		
23)	1382 to 1385	566 to 569		
24)	1386 to 1389	56A to 56D		
25)	1390 to 1393	56E to 571		
26)	1394 to 1397	572 to 575		
27)	1398 to 1401	576 to 579		
28)	1402 to 1405	57A to 57D		
29)	1406 to 1409	57E to 581		
30)	1410 to 1413	582 to 585		
31)	1414 to 1417	586 to 589		
32)	1418 to 1421	58A to 58D		
-	-	-		

Screen example		No.	Buffer memory address																																																																																																			
			DEC	HEX																																																																																																		
<p>QD75MH Positioning data</p> <table border="1"> <thead> <tr> <th colspan="2"></th> <th>AREA</th> <th>SET/</th> <th>Data</th> <th>MONIT</th> <th>END</th> </tr> <tr> <th colspan="2"></th> <th>CHG</th> <th>RESET</th> <th>Chg.</th> <th>MENU</th> <th></th> </tr> </thead> <tbody> <tr> <td colspan="2"></td> <td colspan="2">AXIS1</td> <td colspan="2">AXIS3</td> <td></td> </tr> <tr> <td>No.</td> <td>Pat. Int. Cont. Acc. Dec. Dwell. Mode</td> <td>No.</td> <td>Pat. Int. Cont. Acc. Dec. Dwell. Mode</td> <td colspan="2"></td> <td></td> </tr> <tr> <td></td> <td>Address Arc. address Instr. speed</td> <td></td> <td>Address Arc. address Instr. speed</td> <td colspan="2"></td> <td></td> </tr> <tr> <td>1)</td> <td>00 00 0 00 00 0 0</td> <td>7)</td> <td>00 00 0 00 00 0 0</td> <td colspan="2"></td> <td>6537</td> </tr> <tr> <td>2)</td> <td>00 00 0 00 00 0 0</td> <td>8)</td> <td>00 00 0 00 00 0 0</td> <td colspan="2"></td> <td>7</td> </tr> <tr> <td>3)</td> <td>00 00 0 00 00 0 0</td> <td>9)</td> <td>00 00 0 00 00 0 0</td> <td colspan="2"></td> <td></td> </tr> <tr> <td colspan="2"></td> <td colspan="2">AXIS2</td> <td colspan="2">AXIS4</td> <td></td> </tr> <tr> <td>No.</td> <td>Pat. Int. Cont. Acc. Dec. Dwell. Mode</td> <td>No.</td> <td>Pat. Int. Cont. Acc. Dec. Dwell. Mode</td> <td colspan="2"></td> <td></td> </tr> <tr> <td></td> <td>Address Arc. address Instr. speed</td> <td></td> <td>Address Arc. address Instr. speed</td> <td colspan="2"></td> <td></td> </tr> <tr> <td>4)</td> <td>00 00 0 00 00 0 0</td> <td>10)</td> <td>00 00 0 00 00 0 0</td> <td colspan="2"></td> <td></td> </tr> <tr> <td>5)</td> <td>00 00 0 00 00 0 0</td> <td>11)</td> <td>00 00 0 00 00 0 0</td> <td colspan="2"></td> <td></td> </tr> <tr> <td>6)</td> <td>00 00 0 00 00 0 0</td> <td>12)</td> <td>00 00 0 00 00 0 0</td> <td colspan="2"></td> <td></td> </tr> </tbody> </table>				AREA	SET/	Data	MONIT	END			CHG	RESET	Chg.	MENU				AXIS1		AXIS3			No.	Pat. Int. Cont. Acc. Dec. Dwell. Mode	No.	Pat. Int. Cont. Acc. Dec. Dwell. Mode					Address Arc. address Instr. speed		Address Arc. address Instr. speed				1)	00 00 0 00 00 0 0	7)	00 00 0 00 00 0 0			6537	2)	00 00 0 00 00 0 0	8)	00 00 0 00 00 0 0			7	3)	00 00 0 00 00 0 0	9)	00 00 0 00 00 0 0						AXIS2		AXIS4			No.	Pat. Int. Cont. Acc. Dec. Dwell. Mode	No.	Pat. Int. Cont. Acc. Dec. Dwell. Mode					Address Arc. address Instr. speed		Address Arc. address Instr. speed				4)	00 00 0 00 00 0 0	10)	00 00 0 00 00 0 0				5)	00 00 0 00 00 0 0	11)	00 00 0 00 00 0 0				6)	00 00 0 00 00 0 0	12)	00 00 0 00 00 0 0				1)	2000 to 2002, 2004 to 2009	7D0 to 7D2, 7D4 to 7D9
		AREA	SET/	Data	MONIT	END																																																																																																
		CHG	RESET	Chg.	MENU																																																																																																	
		AXIS1		AXIS3																																																																																																		
No.	Pat. Int. Cont. Acc. Dec. Dwell. Mode	No.	Pat. Int. Cont. Acc. Dec. Dwell. Mode																																																																																																			
	Address Arc. address Instr. speed		Address Arc. address Instr. speed																																																																																																			
1)	00 00 0 00 00 0 0	7)	00 00 0 00 00 0 0			6537																																																																																																
2)	00 00 0 00 00 0 0	8)	00 00 0 00 00 0 0			7																																																																																																
3)	00 00 0 00 00 0 0	9)	00 00 0 00 00 0 0																																																																																																			
		AXIS2		AXIS4																																																																																																		
No.	Pat. Int. Cont. Acc. Dec. Dwell. Mode	No.	Pat. Int. Cont. Acc. Dec. Dwell. Mode																																																																																																			
	Address Arc. address Instr. speed		Address Arc. address Instr. speed																																																																																																			
4)	00 00 0 00 00 0 0	10)	00 00 0 00 00 0 0																																																																																																			
5)	00 00 0 00 00 0 0	11)	00 00 0 00 00 0 0																																																																																																			
6)	00 00 0 00 00 0 0	12)	00 00 0 00 00 0 0																																																																																																			
		2)	2010 to 2012, 2014 to 2019	7DA to 7DC, 7DE to 7E3																																																																																																		
		3)	2020 to 2022, 2024 to 2029	7E4 to 7E6, 7E8 to 7ED																																																																																																		
		4)	8000 to 8002, 8004 to 8009	1F40 to 1F41, 1F44 to 1F49																																																																																																		
		5)	8010 to 8012, 8014 to 8019	1F4A to 1F4C, 1F4E to 1F53																																																																																																		
		6)	8020 to 8022, 8024 to 8029	1F54 to 1F56, 1F58 to 1F5D																																																																																																		
		7)	14000 to 14002, 14004 to 14009	36B0 to 36B2, 36B4 to 36B9																																																																																																		
		8)	14010 to 14012, 14014 to 14019	36BA to 36BB, 36BE to 36C3																																																																																																		
		9)	14020 to 14022, 14024 to 14029	36C4 to 36C6, 36C8 to 36CD																																																																																																		
		10)	20000 to 20002, 20004 to 20009	4E20 to 4E22, 4E24 to 4E29																																																																																																		
		11)	20010 to 20012, 20014 to 20019	4E2A to 4E2C, 4E2E to 4E33																																																																																																		
		12)	20020 to 20022, 20024 to 20029	4E34 to 4E36, 4E38 to 4E3D																																																																																																		
		-	-	-																																																																																																		
<p>QD75MH Servo parameter Basic setting</p> <table border="1"> <thead> <tr> <th colspan="2"></th> <th>AREA</th> <th>SET/</th> <th>Data</th> <th>MONIT</th> <th>END</th> </tr> <tr> <th colspan="2"></th> <th>CHG</th> <th>RESET</th> <th>Chg.</th> <th>MENU</th> <th></th> </tr> </thead> <tbody> <tr> <td></td> <td>Item</td> <td>AXIS1</td> <td>AXIS2</td> <td>AXIS3</td> <td>AXIS4</td> <td>Setting range</td> </tr> <tr> <td>1)</td> <td>Selection of regenerative brake option</td> <td>5</td> <td>0</td> <td>0</td> <td>0</td> <td>0:Invalid 1:MF-JS-B</td> </tr> <tr> <td>2)</td> <td>Emergency stop input</td> <td>0</td> <td>0</td> <td>0</td> <td>0</td> <td>00:Not used 02:MF-R002 03:MF-R012 04:MF-R032 05:MF-R030 06:MF-R050 08:MF-R001 09:MF-R051</td> </tr> <tr> <td>3)</td> <td>Emergency stop input</td> <td>0</td> <td>0</td> <td>0</td> <td>0</td> <td>0:Invalid 1:Valid</td> </tr> <tr> <td>4)</td> <td>Emergency stop input</td> <td>0</td> <td>0</td> <td>0</td> <td>0</td> <td>0:Invalid 1:Valid</td> </tr> <tr> <td>5)</td> <td>Gain adjustment mode</td> <td>0</td> <td>0</td> <td>0</td> <td>0</td> <td>0:Interpolation 1:Auto tuning1 3:Manual 2:Auto tuning2</td> </tr> <tr> <td>6)</td> <td>Response</td> <td>0</td> <td>0</td> <td>0</td> <td>0</td> <td>1 16 32 Low Middle High 10Hz 100Hz 1000Hz</td> </tr> <tr> <td>7)</td> <td>Interpolation range</td> <td>0</td> <td>0</td> <td>0</td> <td>0</td> <td>0 to 50000[pulse]</td> </tr> <tr> <td>8)</td> <td>Interpolation range</td> <td>0</td> <td>0</td> <td>0</td> <td>0</td> <td>0:00W 1:0W</td> </tr> <tr> <td>9)</td> <td>Interpolation range</td> <td>0</td> <td>0</td> <td>0</td> <td>0</td> <td>1 to 65535[pulse]</td> </tr> </tbody> </table>				AREA	SET/	Data	MONIT	END			CHG	RESET	Chg.	MENU			Item	AXIS1	AXIS2	AXIS3	AXIS4	Setting range	1)	Selection of regenerative brake option	5	0	0	0	0:Invalid 1:MF-JS-B	2)	Emergency stop input	0	0	0	0	00:Not used 02:MF-R002 03:MF-R012 04:MF-R032 05:MF-R030 06:MF-R050 08:MF-R001 09:MF-R051	3)	Emergency stop input	0	0	0	0	0:Invalid 1:Valid	4)	Emergency stop input	0	0	0	0	0:Invalid 1:Valid	5)	Gain adjustment mode	0	0	0	0	0:Interpolation 1:Auto tuning1 3:Manual 2:Auto tuning2	6)	Response	0	0	0	0	1 16 32 Low Middle High 10Hz 100Hz 1000Hz	7)	Interpolation range	0	0	0	0	0 to 50000[pulse]	8)	Interpolation range	0	0	0	0	0:00W 1:0W	9)	Interpolation range	0	0	0	0	1 to 65535[pulse]	1)	30100, 30300, 30500, 30700	7594, 765C, 7724, 77EC														
		AREA	SET/	Data	MONIT	END																																																																																																
		CHG	RESET	Chg.	MENU																																																																																																	
	Item	AXIS1	AXIS2	AXIS3	AXIS4	Setting range																																																																																																
1)	Selection of regenerative brake option	5	0	0	0	0:Invalid 1:MF-JS-B																																																																																																
2)	Emergency stop input	0	0	0	0	00:Not used 02:MF-R002 03:MF-R012 04:MF-R032 05:MF-R030 06:MF-R050 08:MF-R001 09:MF-R051																																																																																																
3)	Emergency stop input	0	0	0	0	0:Invalid 1:Valid																																																																																																
4)	Emergency stop input	0	0	0	0	0:Invalid 1:Valid																																																																																																
5)	Gain adjustment mode	0	0	0	0	0:Interpolation 1:Auto tuning1 3:Manual 2:Auto tuning2																																																																																																
6)	Response	0	0	0	0	1 16 32 Low Middle High 10Hz 100Hz 1000Hz																																																																																																
7)	Interpolation range	0	0	0	0	0 to 50000[pulse]																																																																																																
8)	Interpolation range	0	0	0	0	0:00W 1:0W																																																																																																
9)	Interpolation range	0	0	0	0	1 to 65535[pulse]																																																																																																
		2)	30102, 30302, 30502 30702	7596, 765E, 7726, 77EE																																																																																																		
		3)	30103, 30303, 30503, 30703	7797, 765F, 7727, 77EF																																																																																																		
		4)	30104, 30304, 30504, 30704	7798, 7660, 7728, 77F0																																																																																																		
		5)	30108, 30308, 30508, 30708	759C, 7664, 772C, 77F4																																																																																																		
		6)	30109, 30309, 30509, 30709	759D, 7665, 772D, 77F5																																																																																																		
		7)	30110, 30310, 30510, 30710	7591, 7666, 772E, 77F6																																																																																																		
		8)	30114, 30314, 30514, 30714	75A2, 766A, 7732, 77FA																																																																																																		
		9)	30115, 30315, 30515, 30715	75A3, 766B, 7733, 77FB																																																																																																		
		-	-	-																																																																																																		

- 1 OVERVIEW
- 2 SYSTEM MONITOR
- 3 LADDER MONITOR FUNCTION
- 4 MELSEC-A LIST EDITOR
- 5 MELSEC-FX LIST EDITOR
- 6 INTELLIGENT MODULE MONITOR
- 7 NETWORK MONITOR
- 8 Q MOTION MONITOR

Screen example		No.	Buffer memory address							
			DEC	HEX						
		1)	30119, 30319, 30519, 30719	75A7, 766F, 7737, 77FF						
1)	Filter tuning mode	0	0	0	0	0	0:Filter OFF 1:Filter tuning 2:Manual	2)	30120, 30320, 30520 30720	75A8, 7670, 7738, 7800
2)	Vibration suppression control tuning mode	0	0	0	0	0	0:Vibration control OFF 1:Vibration ctrl tuning 2:Manual	3)	30122, 30322, 30522, 30722	75AA, 7672, 773A, 7802
3)	Resonance suppress gain	0	0	0	0	0	0 to 100[%]	4)	30124, 30324, 30524, 30724	75AC, 7674, 773C, 7804
4)	Resonance suppress filter 1	0	0	0	0	0	0 to 3000($\times 10^{-3}$) [times]	5)	30125, 30325, 30525, 30725	75AD, 7675, 773D, 7805
5)	Resonance suppress gain	0	0	0	0	0	1 to 2000[rad/s]	6)	30126, 30326, 30526, 30726	75AE, 7676, 773E, 7806
6)	Resonance suppress gain	0	0	0	0	0	1 to 1000[rad/s]	7)	30127, 30327, 30527, 30727	75AF, 7677, 773F, 7807
7)	Resonance suppress gain	0	0	0	0	0	20 to 50000[rad/s]	8)	30128, 30328, 30528, 30728	75B0, 7678, 7740, 7808
8)	Resonance suppress gain	5	0	0	0	0	1 to 10000($\times 10^{-3}$) [ms]	9)	30129, 30329, 30529, 30729	75B1, 7679, 7741, 7809
9)	Resonance suppress gain	0	0	0	0	0	0 to 1000($\times 10^{-3}$) [%]	10)	30131, 30331, 30531, 30731	75B3, 767B, 7743, 780B
10)	Resonance suppress gain	0	0	0	0	0	100 to 4500[Hz]	11)	30133, 30333, 30533, 30733	75B5, 767D, 7745, 780D
11)	Resonance suppress gain	0	0	0	0	0	100 to 4500[Hz]	12)	30136, 30336, 30536, 30736	75B8, 7680, 7748, 7810
12)	Resonance suppress gain	0	0	0	0	0	100 to 18000[rad/s]	13)	30141, 30341, 30541, 30741	75BD, 7685, 774D, 7815
13)	Low pass filter selection	0	0	0	0	0	0:Automatic setting 1:Manual setting	-	-	-
		1)	30132, 30332, 30532, 30732	75B4, 767C, 7744, 780C						
1)	Notch depth selection	0	0	0	0	0	0 1 2 3 Deep ← → Shallow -40dB ← -14dB -3dB -4dB	2)	30134, 30334, 30534, 30734	75B6, 767E, 7746, 780E
2)	Notch width selection	0	0	0	0	0	0 1 2 3 Standard ← → Wide $\alpha=2$ $\alpha=3$ $\alpha=4$ $\alpha=5$	3)	30137, 30337, 30537, 30737	75B9, 7681, 7749, 7811
3)	Resonance suppression filter 2	0	0	0	0	0	0:Invalid 1:Valid	4)	30138, 30338, 30538, 30738	75BA, 7682, 774A, 7812
4)	Notch depth selection	0	0	0	0	0	0 1 2 3 Deep ← → Shallow -40dB ← -14dB -3dB -4dB	5)	30142, 30342, 30542, 30742	75BE, 7686, 774E, 7816
5)	Notch width selection	0	0	0	0	0	0 1 2 3 Standard ← → Wide $\alpha=2$ $\alpha=3$ $\alpha=4$ $\alpha=5$	-	-	-
6)	Resonance suppress gain	0	0	0	0	0	1 to 1000($\times 10^{-3}$) [Hz]			
7)	Resonance suppress gain	0	0	0	0	0	1 to 1000($\times 10^{-3}$) [Hz]			
8)	Resonance suppress gain	0	0	0	0	0	0:Invalid 1:Valid			
9)	PID control selection	0	0	0	0	0	0:PID control is valid. 3:PID control is always valid.			

Screen example						No.	Buffer memory address																																																							
							DEC	HEX																																																						
QD75MH Servo parameter Gain/Filter-3 <table border="1"> <thead> <tr> <th>Item</th> <th>Axis1</th> <th>Axis2</th> <th>Axis3</th> <th>Axis4</th> <th>Setting range</th> </tr> </thead> <tbody> <tr><td>1) Gain</td><td>0</td><td>0</td><td>0</td><td>0</td><td>0 to 9999</td></tr> <tr><td>2) Load inertia ratio to gain switch servo</td><td>0</td><td>0</td><td>0</td><td>0</td><td>0 to 100[ms]</td></tr> <tr><td>3) Load inertia ratio to gain switch servo</td><td>0</td><td>0</td><td>0</td><td>0</td><td>0 to 3000($\times 10^{-3}$)</td></tr> <tr><td>4) Vibration freq setup</td><td>0</td><td>0</td><td>0</td><td>0</td><td>1 to 2000[rad/s]</td></tr> <tr><td>5) Acceleration freq setup</td><td>0</td><td>0</td><td>0</td><td>0</td><td>20 to 50000[rad/s]</td></tr> <tr><td>6) Vibration freq setup</td><td>0</td><td>0</td><td>0</td><td>0</td><td>1 to 50000($\times 10^{-3}$) [ms]</td></tr> <tr><td>7) Acceleration freq setup</td><td>0</td><td>0</td><td>0</td><td>0</td><td>1 to 1000($\times 10^{-3}$) [Hz]</td></tr> <tr><td>8) Acceleration freq setup</td><td>0</td><td>0</td><td>0</td><td>0</td><td>1 to 1000($\times 10^{-3}$) [Hz]</td></tr> </tbody> </table>						Item	Axis1	Axis2	Axis3	Axis4	Setting range	1) Gain	0	0	0	0	0 to 9999	2) Load inertia ratio to gain switch servo	0	0	0	0	0 to 100[ms]	3) Load inertia ratio to gain switch servo	0	0	0	0	0 to 3000($\times 10^{-3}$)	4) Vibration freq setup	0	0	0	0	1 to 2000[rad/s]	5) Acceleration freq setup	0	0	0	0	20 to 50000[rad/s]	6) Vibration freq setup	0	0	0	0	1 to 50000($\times 10^{-3}$) [ms]	7) Acceleration freq setup	0	0	0	0	1 to 1000($\times 10^{-3}$) [Hz]	8) Acceleration freq setup	0	0	0	0	1 to 1000($\times 10^{-3}$) [Hz]	1)	30145, 30345, 30545, 30745	75C1, 7689, 7751, 7819
Item	Axis1	Axis2	Axis3	Axis4	Setting range																																																									
1) Gain	0	0	0	0	0 to 9999																																																									
2) Load inertia ratio to gain switch servo	0	0	0	0	0 to 100[ms]																																																									
3) Load inertia ratio to gain switch servo	0	0	0	0	0 to 3000($\times 10^{-3}$)																																																									
4) Vibration freq setup	0	0	0	0	1 to 2000[rad/s]																																																									
5) Acceleration freq setup	0	0	0	0	20 to 50000[rad/s]																																																									
6) Vibration freq setup	0	0	0	0	1 to 50000($\times 10^{-3}$) [ms]																																																									
7) Acceleration freq setup	0	0	0	0	1 to 1000($\times 10^{-3}$) [Hz]																																																									
8) Acceleration freq setup	0	0	0	0	1 to 1000($\times 10^{-3}$) [Hz]																																																									
						2)	30146, 30346, 30546, 30746	75C2, 768A, 7752, 781A																																																						
						3)	30147, 30347, 30547, 30747	75C3, 768B, 7753, 781B																																																						
						4)	30148, 30348, 30548, 30748	75C4, 768C, 7754, 781C																																																						
						5)	30149, 30349, 30549, 30749	75C5, 768D, 7755, 781D																																																						
						6)	30150, 30350, 30550, 30750	75C6, 768E, 7756, 781E																																																						
Gain changing selection <table border="1"> <thead> <tr> <th>Item</th> <th>Axis1</th> <th>Axis2</th> <th>Axis3</th> <th>Axis4</th> </tr> </thead> <tbody> <tr><td>00:Invalid</td><td>0</td><td>0</td><td>0</td><td>0</td></tr> <tr><td>01:Control command by the controller is effective.</td><td></td><td></td><td></td><td></td></tr> <tr><td>02:Command frequency is more than PB27.</td><td></td><td></td><td></td><td></td></tr> <tr><td>03:(Motor encoder unit)Droop pulse is more than PB27.</td><td></td><td></td><td></td><td></td></tr> <tr><td>04:Model speed is more than PB27.</td><td></td><td></td><td></td><td></td></tr> <tr><td>12:Command frequency is less than PB27.</td><td></td><td></td><td></td><td></td></tr> <tr><td>13:(Motor encoder unit)Droop pulse is less than PB27.</td><td></td><td></td><td></td><td></td></tr> <tr><td>14:Model speed is less than PB27.</td><td></td><td></td><td></td><td></td></tr> </tbody> </table>						Item	Axis1	Axis2	Axis3	Axis4	00:Invalid	0	0	0	0	01:Control command by the controller is effective.					02:Command frequency is more than PB27.					03:(Motor encoder unit)Droop pulse is more than PB27.					04:Model speed is more than PB27.					12:Command frequency is less than PB27.					13:(Motor encoder unit)Droop pulse is less than PB27.					14:Model speed is less than PB27.					7)	30151, 30351, 30551, 30751	75C7, 768F, 7757, 781F									
Item	Axis1	Axis2	Axis3	Axis4																																																										
00:Invalid	0	0	0	0																																																										
01:Control command by the controller is effective.																																																														
02:Command frequency is more than PB27.																																																														
03:(Motor encoder unit)Droop pulse is more than PB27.																																																														
04:Model speed is more than PB27.																																																														
12:Command frequency is less than PB27.																																																														
13:(Motor encoder unit)Droop pulse is less than PB27.																																																														
14:Model speed is less than PB27.																																																														
						8)	30152, 30352, 30552, 30752	75C8, 7690, 7758, 7820																																																						
						9)	30144, 30344, 30544, 30744	75C0, 7688, 7750, 7818																																																						
						-	-	-																																																						
QD75MH Servo parameter Ex. setting-1 <table border="1"> <thead> <tr> <th>Item</th> <th>Axis1</th> <th>Axis2</th> <th>Axis3</th> <th>Axis4</th> <th>Setting range</th> </tr> </thead> <tbody> <tr><td>1) Motorless operation level</td><td>0</td><td>0</td><td>0</td><td>0</td><td>1 to 200[rev]</td></tr> <tr><td>2) Motorless operation level</td><td>0</td><td>0</td><td>0</td><td>0</td><td>0 to 1000[ms]</td></tr> <tr><td>3) Encoder pulse output return selection</td><td>0</td><td>0</td><td>0</td><td>0</td><td>0:0CW 1:0CW (progress to A phases 90°)</td></tr> <tr><td>4) Encoder pulse output setting selection</td><td>0</td><td>0</td><td>0</td><td>0</td><td>0:Output pulse dgn. 1:Division ratio setting</td></tr> <tr><td>5) Function selection C1 Serial encoder cable</td><td>0</td><td>0</td><td>0</td><td>0</td><td>0:2-wire 1:4-wire</td></tr> <tr><td>6) Function selection C2 Motor-less operation</td><td>0</td><td>0</td><td>0</td><td>0</td><td>0:Invalid 1:Valid</td></tr> <tr><td>7) Motor-less operation</td><td>0</td><td>0</td><td>0</td><td>0</td><td>0 to 10000[r/min]</td></tr> </tbody> </table>						Item	Axis1	Axis2	Axis3	Axis4	Setting range	1) Motorless operation level	0	0	0	0	1 to 200[rev]	2) Motorless operation level	0	0	0	0	0 to 1000[ms]	3) Encoder pulse output return selection	0	0	0	0	0:0CW 1:0CW (progress to A phases 90°)	4) Encoder pulse output setting selection	0	0	0	0	0:Output pulse dgn. 1:Division ratio setting	5) Function selection C1 Serial encoder cable	0	0	0	0	0:2-wire 1:4-wire	6) Function selection C2 Motor-less operation	0	0	0	0	0:Invalid 1:Valid	7) Motor-less operation	0	0	0	0	0 to 10000[r/min]	1)	30164, 30364, 30564, 30764	75D4, 769C, 7764, 782C						
Item	Axis1	Axis2	Axis3	Axis4	Setting range																																																									
1) Motorless operation level	0	0	0	0	1 to 200[rev]																																																									
2) Motorless operation level	0	0	0	0	0 to 1000[ms]																																																									
3) Encoder pulse output return selection	0	0	0	0	0:0CW 1:0CW (progress to A phases 90°)																																																									
4) Encoder pulse output setting selection	0	0	0	0	0:Output pulse dgn. 1:Division ratio setting																																																									
5) Function selection C1 Serial encoder cable	0	0	0	0	0:2-wire 1:4-wire																																																									
6) Function selection C2 Motor-less operation	0	0	0	0	0:Invalid 1:Valid																																																									
7) Motor-less operation	0	0	0	0	0 to 10000[r/min]																																																									
						2)	30165, 30365, 30565, 30765	75D5, 769D, 7765, 782D																																																						
						3)	30166, 30366, 30566, 30766	75D6, 769E, 7766, 782E																																																						
						4)	30167, 30367, 30567, 30767	75D7, 769F, 7767, 782F																																																						
						5)	30168, 30368, 30568, 30768	75D8, 76A0, 7768, 7830																																																						
						6)	30170, 30370, 30570, 30770	75DA, 76A2, 776A, 7832																																																						
						7)																																																								
						-	-	-																																																						

1

OVERVIEW

2

SYSTEM MONITOR

3

LADDER MONITOR FUNCTION

4

MELSEC-A LIST EDITOR

5

MELSEC-FX LIST EDITOR

6

INTELLIGENT MODULE MONITOR

7

NETWORK MONITOR

8

Q MOTION MONITOR

Screen example	No.	Buffer memory address	
		DEC	HEX
	1)	30174, 30374, 30574, 30774	75DE, 76A6, 776E, 7836
	2)	30175, 30375, 30575, 30775	75DF, 76A7, 776F, 7837
	3)	30172, 30372, 30572, 30772	75DC, 76A4, 776C, 7834
	4)	30173, 30373, 30573, 30773	75DD, 76A5, 776D, 7835
	-	-	-
	1)	30202, 30402, 30602, 30802	75FA, 76C2, 778A, 7852
	2)	30203, 30403, 30603, 30803	75FB, 76C3, 778B, 7853
	3)	30204, 30404, 30604, 30804	75FC, 76C4, 778C, 7854
		-	-

6.5.35 QD77MS4, QD77MS2 module monitoring

Screen example		No.	Buffer memory address	
			DEC	HEX
<p>QD77MS4 Operation Monitor</p> <p>1) Axis Current feed val. Axis feedrate</p> <p>2) 1 0 0</p> <p>3) 2 0 0</p> <p>4) 3 0 0</p> <p>4) 4 0 0</p> <p>5) (um):*10⁻¹ (mm/min):*10⁻² (degree):*10⁻² (degree/min):*10⁻² (inch):*10⁻² (inch/min):*10⁻² (pulse):*1 (pulse/sec):*1</p> <p>6) Axis Status Unconnection/Ampl. power OFF</p> <p>7) 1 Err. 0 Warning 0 Mode 0</p> <p>8) 2 Err. 0 Warning 0 Mode 0</p> <p>9) 3 Err. 0 Warning 0 Mode 0</p> <p>10) 4 Err. 0 Warning 0 Mode 0</p> <p>11) Emergency stop input</p> <p>12) Axis Start No. Operation pattern</p> <p>13) 1 0</p> <p>14) 2 0</p> <p>15) 3 0</p> <p>16) 4 0</p> <p>17) Axis Control system Int. Acc. Dec. time time</p> <p>14) 1 ABS2 0 0 0</p> <p>15) 2 FEED4 0 0 0</p> <p>16) 3 LOOP 0 0 0</p> <p>17) 4 LEND 0 0 0</p>		1)	800, 812	320, 32C
		2)	900, 912	384, 390
		3)	1000, 1012	3E8, 3F4
		4)	1100, 1112	44C, 458
		5)	806 to 809	326 to 329
		6)	906 to 909	326 to 329
		7)	1006 to 1009	3EE to 3F1
		8)	1106 to 1109	452 to 455
		9)	1431	597
		10)	829, 838	33D, 346
		11)	929, 938	3A1, 3AA
		12)	1029, 1038	405, 40E
		13)	1129, 1138	469, 472
		14)	838	346
		15)	938	3AA
		16)	1038	40E
		17)	1138	472
		-	-	-
<p>QD77MS4 Input/Output Monitor</p> <p>1) X Y</p> <p>1) QD77_READY 0 Axis1 Error 0 PLC READY 0 Axis1 FWD JOG</p> <p>2) Synchronization 0 Axis2 Error 0 All Axis Servo ON 0 Axis1 RVS JOG</p> <p>3) 0 Axis3 Error 0 0 Axis2 FWD JOG</p> <p>4) 0 Axis4 Error 0 0 Axis2 RVS JOG</p> <p>5) 0 Axis1 M code ON 0 Axis1 BUSY 0 Axis3 FWD JOG</p> <p>6) 0 Axis2 M code ON 0 Axis2 BUSY 0 Axis3 RVS JOG</p> <p>7) 0 Axis3 M code ON 0 Axis3 BUSY 0 Axis4 FWD JOG</p> <p>8) 0 Axis4 M code ON 0 Axis4 BUSY 0 Axis4 RVS JOG</p> <p>9) 0 Axis1 Started 0 Axis1 Pos. start 0</p> <p>10) 0 Axis2 Started 0 Axis2 Pos. start 0</p> <p>11) 0 Axis3 Started 0 Axis3 Pos. start 0</p> <p>12) 0 Axis4 Started 0 Axis4 Pos. start 0</p> <p>13) 0 Axis1 Pos. done 0 Ax1 Exe prohibit 0</p> <p>14) 0 Axis2 Pos. done 0 Ax2 Exe prohibit 0</p> <p>15) 0 Axis3 Pos. done 0 Ax3 Exe prohibit 0</p> <p>16) 0 Axis4 Pos. done 0 Ax4 Exe prohibit 0</p>		1)	-	-
<p>QD77MS4 Basic parameters 1</p> <p>1) Item Axis1 Axis2 Axis3 Axis4 Bias speed at start</p> <p>Unit 0 0 0 0 Axis1 0 Axis2 0</p> <p>setting 0:mm 1:inch 2:degree 3:pulse Axis3 0 Axis4 0</p> <p>Setting range 0 to 2000000000 (mm/min):*10⁻² (inch/min):*10⁻³ (degree/min):*10⁻³ 0 to 1000000000 (pulse/sec):*1</p> <p>2) Movement amount per pulse Movement amount per pulse</p> <p>Pulse/rotation(Ap) Axis1 0 Axis2 0 Axis1 0 Axis2 0</p> <p>Axis3 0 Axis4 0 Axis3 0 Axis4 0</p> <p>1 to 2000000000[pulse] *10⁻¹:[μm]</p> <p>Unit magnification (Am) *10⁻¹:[inch] [degree]</p> <p>3) Axis1 0 Axis2 0 *1 [pulse]</p> <p>Axis3 0 Axis4 0</p> <p>1/10/100/1000/Fold</p>		1)	0, 150, 300, 450	0, 96, 12C, 1C2
		2)	2 to 3, 152 to 153, 302 to 303, 452 to 453	2 to 3, 98 to 99, 12E to 12F, 1C4 to 1C5
		3)	1, 151, 301, 451	1, 97, 12D, 1C3
		4)	6 to 7, 156 to 157, 306 to 307, 456 to 457	6 to 7, 9C to 9D, 132 to 133, 1C8 to 1C9
		-5)	4 to 5, 154 to 155, 304 to 305, 454 to 455	4 to 5, 9A to 9B, 130 to 131, 1C6 to 1C7
		-	-	-

Screen example	No.	Buffer memory address	
		DEC	HEX
<p>1) { Speed limit value } 2) { Acceleration time 0 } 3) { Deceleration time 0 }</p>	1)	10 to 11, 160 to 161, 310 to 311, 460 to 461	A to B, A0 to A1, 136 to 137, 1CC to 1CD
	2)	12 to 13, 162 to 163, 312 to 313, 462 to 463	C to D, A2 to A3, 138 to 139, 1CE to 1CF
	3)	14 to 15, 164 to 165, 314 to 315, 464 to 465	E to F, A4 to A5, 13A to 13B, 1D0 to 1D1
<p>1) { Backlash compensation amount } 2) { Software stroke upper limit value } 3) { Man-pls input selection } 4) { Torque limit set value }</p>	1)	17, 167, 317, 467	11, A7, 13D, 1D3
	2)	18 to 19, 168 to 169, 318 to 319, 468 to 469	12 to 13, A8 to A9, 13E to 13F, 1D4 to 1D5
	3)	20 to 21, 170 to 171, 320 to 321, 470 to 471	14 to 15, AA to AB, 140 to 141, 1D6 to 1D7
	4)	33	21
	5)	22, 172, 322, 472	16, AC, 142, 1D8
	6)	23, 173, 323, 473	17, AD, 143, 1D9
	7)	26, 176, 326, 476	1A, B0, 146, 1DC
<p>1) { Mode ON sig } 2) { Speed switching mode } 3) { Interpolate speed set method } 4) { Command in-position width } 5) { Current feed val during speed control } 6) { Speed-position function selection }</p>	1)	27, 177, 327, 477	1B, B1, 147, 1DD
	2)	28, 178, 328, 478	1C, B2, 148, 1DE
	3)	29, 179, 329, 479	1D, B3, 149, 1DF
	4)	24 to 25, 174 to 175, 324 to 325, 474 to 475	18 to 19, AE to AF, 144 to 145, 1DA to 1DB
	5)	30, 180, 330, 480	1F, B4, 14A, 1E0
	6)	31, 181, 331, 481	20, B5, 14B, 1E1
	7)	34, 184, 334, 484	22, B8, 14E, 1E4
	8)	32, 182, 332, 482	21, B6, 14C, 1E2
	9)	35	23

Screen example		No.	Buffer memory address	
			DEC	HEX
		1)	36 to 37, 186 to 187, 336 to 337, 486 to 487	24 to 25, BA to BB, 150 to 151, 1E8 to 1E7
		2)	38 to 39, 188 to 189, 338 to 339, 488 to 489	26 to 27, BC to BD, 152 to 153, 1E8 to 1E9
		3)	40 to 41, 190 to 191, 340 to 341, 490 to 491	28 to 29, BE to BF, 154 to 155, 1EA to 1EB
		4)	42 to 43, 192 to 193, 342 to 343, 492 to 493	2A to 2B, C0 to C1, 156 to 157, 1EC to 1ED
		5)	44 to 45, 194 to 195, 344 to 345, 494 to 495	2C to 2D, C2 to C3, 158 to 159, 1EE to 1EF
		6)	46 to 47, 196 to 197, 346 to 347, 496 to 497	2E to 2F, C4 to C5, 15A to 15B, 1F0 to 1F1
		7)	48 to 49, 198 to 199, 348 to 349, 498 to 499	30 to 31, C6 to C7, 15C to 15D, 1F2 to 1F3
		8)	50, 200, 350, 500	32, C8, 15E, 1F4
		9)	51, 201, 351, 501	33, C9, 15F, 1F5
		1)	52, 202, 352, 502	34, CA, 160, 1F6
		2)	53, 203, 353, 503	35, CB, 161, 1F7
		3)	56, 206, 356, 506	38, CE, 164, 1FA
		4)	57, 207, 357, 507	39, CF, 165, 1FB
		5)	58, 208, 358, 508	3A, D0, 166, 1FC
		6)	54, 204, 354, 504	36, CC, 162, 1F8
		7)	59, 209, 359, 509	3B, D1, 167, 1FD
		8)	67, 217, 367, 517	43, D9, 16F, 205
		9)	60 to 61, 210 to 211, 360 to 361, 510 to 511	3C to 3D, D2 to D3, 168 to 169, 1FE to 1FF
		10)	62, 212, 362, 512	3E, D4, 16A, 200
		11)	63, 213, 363, 513	3F, D5, 16B, 201
		12)	64 to 65, 214 to 215, 364 to 365, 514 to 515	40 to 41, D6 to D7, 16C to 16D, 202 to 203
		1)	82, 232, 382, 532	52, E8, 17E, 214
		2)	83, 233, 383, 533	53, E9, 17F, 215
		3)	86, 236, 386, 536	56, EC, 182, 218
		4)	87, 237, 387, 537	57, ED, 183, 219
		5)	80 to 81, 230 to 231, 380 to 381, 530 to 531	50 to 51, E6 to E7, 17C to 17D, 212 to 213
		6)	84 to 85, 234 to 235, 384 to 385, 534 to 535	54 to 55, EA to EB, 180 to 181, 216 to 217
		7)	88, 238, 388, 538	58, EE, 184, 21A
		8)	89, 239, 389, 539	59, EF, 185, 21B

- 1 OVERVIEW
- 2 SYSTEM MONITOR
- 3 LADDER MONITOR FUNCTION
- 4 MELSEC-A LIST EDITOR
- 5 MELSEC-FX LIST EDITOR
- 6 INTELLIGENT MODULE MONITOR
- 7 NETWORK MONITOR
- 8 Q MOTION MONITOR

Screen example		No.	Buffer memory address	
			DEC	HEX
		1)	70, 220, 370, 520	46, DC, 172, 208
		2)	71, 221, 371, 521	47, DD, 173, 209
		3)	78, 228, 378, 528	4E, E4, 17A, 210
		4)	72 to 73, 222 to 223, 372 to 373, 522 to 523	48 to 49, DE to DF, 174 to 175, 20A to 20B
		5)	74 to 75, 224 to 225, 374 to 375, 524 to 525	4A to 4B, E0 to E1, 176 to 177, 20C to 20D
		6)	76 to 77, 226 to 227, 376 to 377, 526 to 527	4C to 4D, E2 to E3, 178 to 179, 20E to 20F
		-	-	-
		1)	816	330
		2)	916	394
		3)	1016	3F8
		4)	1116	45C
		5)	817	331
		6)	917	395
		7)	1017	3F9
		8)	1117	45D
		-	-	-
		1)	818 to 819, 802 to 803	332 to 333, 322 to 323
		2)	918 to 919, 902 to 903	396 to 397, 386 to 387
		3)	1018 to 1019, 1002 to 1003	3FA to 3FB, 3EA to 3EB
		4)	1118 to 1119, 1102 to 1103	45E to 45F, 44E to 44F
		5)	820 to 821, 810 to 811, 812 to 813	334 to 335, 32A to 32B, 32C to 32D
		6)	920 to 921, 910 to 911, 912 to 913	398 to 399, 38E to 38F, 390 to 391
		7)	1020 to 1021, 1010 to 1011, 1012 to 1013	3FC to 3FD, 3F2 to 3F3, 3F4 to 3F5
		8)	1120 to 1121, 1110 to 1111, 1112 to 1113	460 to 461, 456 to 457, 458 to 459
		9)	830, 930, 1030, 1130	33E, 3A2, 406, 46A
		10)	831, 931, 1031, 1131	33F, 3A3, 407, 46B
		-	-	-

Screen example		Buffer memory address																																																																																																																																										
		DEC	HEX																																																																																																																																									
<p>QD77MS4 Axis monitor data-2</p> <table border="1"> <thead> <tr> <th colspan="4">Special start data</th> <th colspan="4">Special start repetition counter</th> </tr> <tr> <th>Axis</th> <th>Instr. code</th> <th>Instr. para</th> <th>Data No.</th> <th>Axis1</th> <th>Axis2</th> <th>Axis3</th> <th>Axis4</th> </tr> </thead> <tbody> <tr> <td>1)</td> <td>1</td> <td>00</td> <td>0</td> <td>0</td> <td>0</td> <td>0</td> <td>0</td> </tr> <tr> <td>2)</td> <td>2</td> <td>00</td> <td>0</td> <td>0</td> <td>0</td> <td>0</td> <td>0</td> </tr> <tr> <td>3)</td> <td>3</td> <td>00</td> <td>0</td> <td>0</td> <td>0</td> <td>0</td> <td>0</td> </tr> <tr> <td>4)</td> <td>4</td> <td>00</td> <td>0</td> <td>0</td> <td>0</td> <td>0</td> <td>0</td> </tr> </tbody> </table> <table border="1"> <thead> <tr> <th colspan="4">Control system repetition counter</th> </tr> <tr> <th>Axis1</th> <th>Axis2</th> <th>Axis3</th> <th>Axis4</th> </tr> </thead> <tbody> <tr> <td>0</td> <td>0</td> <td>0</td> <td>0</td> </tr> </tbody> </table> <table border="1"> <thead> <tr> <th colspan="4">Data being executed</th> <th>Previous position</th> </tr> <tr> <th>Axis</th> <th>1st data pointer</th> <th>Pos. data number</th> <th>Block No.</th> <th></th> </tr> </thead> <tbody> <tr> <td>5)</td> <td>1</td> <td>0</td> <td>0</td> <td>0</td> </tr> <tr> <td>6)</td> <td>2</td> <td>0</td> <td>0</td> <td>0</td> </tr> <tr> <td>7)</td> <td>3</td> <td>0</td> <td>0</td> <td>0</td> </tr> <tr> <td>8)</td> <td>4</td> <td>0</td> <td>0</td> <td>0</td> </tr> </tbody> </table> <p>[Instruction code] 00:Block start(Normal start) 01:Condition start 02:Wait start 03:Simultaneous start 04:FOR loop 05:FOR condition 06:NEXT</p>	Special start data				Special start repetition counter				Axis	Instr. code	Instr. para	Data No.	Axis1	Axis2	Axis3	Axis4	1)	1	00	0	0	0	0	0	2)	2	00	0	0	0	0	0	3)	3	00	0	0	0	0	0	4)	4	00	0	0	0	0	0	Control system repetition counter				Axis1	Axis2	Axis3	Axis4	0	0	0	0	Data being executed				Previous position	Axis	1st data pointer	Pos. data number	Block No.		5)	1	0	0	0	6)	2	0	0	0	7)	3	0	0	0	8)	4	0	0	0	1)	827 to 829	33B to 33D																																															
	Special start data				Special start repetition counter																																																																																																																																							
	Axis	Instr. code	Instr. para	Data No.	Axis1	Axis2	Axis3	Axis4																																																																																																																																				
	1)	1	00	0	0	0	0	0																																																																																																																																				
	2)	2	00	0	0	0	0	0																																																																																																																																				
	3)	3	00	0	0	0	0	0																																																																																																																																				
	4)	4	00	0	0	0	0	0																																																																																																																																				
	Control system repetition counter																																																																																																																																											
	Axis1	Axis2	Axis3	Axis4																																																																																																																																								
	0	0	0	0																																																																																																																																								
Data being executed				Previous position																																																																																																																																								
Axis	1st data pointer	Pos. data number	Block No.																																																																																																																																									
5)	1	0	0	0																																																																																																																																								
6)	2	0	0	0																																																																																																																																								
7)	3	0	0	0																																																																																																																																								
8)	4	0	0	0																																																																																																																																								
	2)	927 to 929	39F to 3A1																																																																																																																																									
	3)	1027 to 1029	403 to 405																																																																																																																																									
	4)	1127 to 1129	467 to 469																																																																																																																																									
	5)	834 to 837	342 to 345																																																																																																																																									
	6)	934 to 937	3A6 to 3A9																																																																																																																																									
	7)	1034 to 1037	40A to 40D																																																																																																																																									
	8)	1134 to 1137	46E to 471																																																																																																																																									
	9)	832, 932, 1032, 1132	340, 3A4, 408, 46C																																																																																																																																									
	10)	833, 933, 1033, 1133	341, 3A5, 409, 46D																																																																																																																																									
	-	-	-																																																																																																																																									
<p>QD77MS4 Axis monitor data-3</p> <table border="1"> <thead> <tr> <th>Axis</th> <th>OPR Increment</th> <th>Actual present val</th> <th>Error counter val</th> </tr> </thead> <tbody> <tr> <td>1)</td> <td>1</td> <td>0</td> <td>0</td> </tr> <tr> <td>2)</td> <td>2</td> <td>0</td> <td>0</td> </tr> <tr> <td>3)</td> <td>3</td> <td>0</td> <td>0</td> </tr> <tr> <td>4)</td> <td>4</td> <td>0</td> <td>0</td> </tr> </tbody> </table> <p>(μm):$\times 10^{-3}$ (degree):$\times 10^{-4}$ (inch):$\times 10^{-4}$ (pulse):$\times 1$</p> <table border="1"> <thead> <tr> <th>Axis</th> <th>Number of motor rotation</th> <th>Motor current</th> <th>Axis</th> <th>Servo amplifier S/W number</th> </tr> </thead> <tbody> <tr> <td>5)</td> <td>1</td> <td>0</td> <td>1</td> <td>00 00 00 00 00 00 00 00 00 00</td> </tr> <tr> <td>6)</td> <td>2</td> <td>0</td> <td>2</td> <td>00 00 00 00 00 00 00 00 00 00</td> </tr> <tr> <td>7)</td> <td>3</td> <td>0</td> <td>3</td> <td>00 00 00 00 00 00 00 00 00 00</td> </tr> <tr> <td>8)</td> <td>4</td> <td>0</td> <td>4</td> <td>00 00 00 00 00 00 00 00 00 00</td> </tr> </tbody> </table> <p>(rpm):$\times 10^{-1}$ (%) :$\times 10^{-1}$ Value is character code. (J188 Code)</p>	Axis	OPR Increment	Actual present val	Error counter val	1)	1	0	0	2)	2	0	0	3)	3	0	0	4)	4	0	0	Axis	Number of motor rotation	Motor current	Axis	Servo amplifier S/W number	5)	1	0	1	00 00 00 00 00 00 00 00 00 00	6)	2	0	2	00 00 00 00 00 00 00 00 00 00	7)	3	0	3	00 00 00 00 00 00 00 00 00 00	8)	4	0	4	00 00 00 00 00 00 00 00 00 00	1)	848 to 849, 850 to 851, 852 to 853	350 to 351, 352 to 353, 354 to 355																																																																																												
	Axis	OPR Increment	Actual present val	Error counter val																																																																																																																																								
	1)	1	0	0																																																																																																																																								
	2)	2	0	0																																																																																																																																								
	3)	3	0	0																																																																																																																																								
	4)	4	0	0																																																																																																																																								
	Axis	Number of motor rotation	Motor current	Axis	Servo amplifier S/W number																																																																																																																																							
	5)	1	0	1	00 00 00 00 00 00 00 00 00 00																																																																																																																																							
	6)	2	0	2	00 00 00 00 00 00 00 00 00 00																																																																																																																																							
	7)	3	0	3	00 00 00 00 00 00 00 00 00 00																																																																																																																																							
	8)	4	0	4	00 00 00 00 00 00 00 00 00 00																																																																																																																																							
		2)	948 to 949, 950 to 951, 952 to 953	3B4 to 3B5, 3B6 to 3B7, 3B8 to 3B9																																																																																																																																								
	3)	1048 to 1049, 1050 to 1051, 1052 to 1053	418 to 419, 41A to 41B, 41C to 41D																																																																																																																																									
	4)	1148 to 1149, 1150 to 1151, 1152 to 1153	47C to 47D, 47E to 47F, 480 to 481																																																																																																																																									
	5)	854 to 855, 856 to 857	356 to 357, 358 to 359																																																																																																																																									
	6)	954 to 955, 956 to 957	3BA to 3BB, 3BC to 3BD																																																																																																																																									
	7)	1054 to 1055, 1056 to 1057	41E to 41F, 420 to 421																																																																																																																																									
	8)	1154 to 1155, 1156 to 1157	480 to 481, 482 to 483																																																																																																																																									
	9)	864 to 869	360 to 365																																																																																																																																									
	10)	964 to 969	3C4 to 3C9																																																																																																																																									
	11)	1064 to 1069	428 to 42D																																																																																																																																									
	12)	1164 to 1169	48C to 491																																																																																																																																									
	-	-	-																																																																																																																																									
<p>QD77MS4 Axis monitor data-4</p> <table border="1"> <thead> <tr> <th colspan="4">Parameter error No.</th> <th colspan="4">[Servo status]</th> </tr> <tr> <th>Axis1</th> <th>Axis2</th> <th>Axis3</th> <th>Axis4</th> <th>Item</th> <th>Ax.1</th> <th>Ax.2</th> <th>Ax.3</th> <th>Ax.4</th> </tr> </thead> <tbody> <tr> <td>1)</td> <td>0</td> <td>0</td> <td>0</td> <td>0</td> <td>Zero point passed</td> <td>●</td> <td>●</td> <td>●</td> <td>●</td> </tr> <tr> <td></td> <td></td> <td></td> <td></td> <td></td> <td>Zero speed</td> <td>●</td> <td>●</td> <td>●</td> <td>●</td> </tr> <tr> <td></td> <td></td> <td></td> <td></td> <td></td> <td>Ready ON</td> <td>●</td> <td>●</td> <td>●</td> <td>●</td> </tr> <tr> <td></td> <td></td> <td></td> <td></td> <td></td> <td>Servo ON</td> <td>●</td> <td>●</td> <td>●</td> <td>●</td> </tr> <tr> <td></td> <td></td> <td></td> <td></td> <td></td> <td>Servo alarm</td> <td>●</td> <td>●</td> <td>●</td> <td>●</td> </tr> <tr> <td></td> <td></td> <td></td> <td></td> <td></td> <td>In-position</td> <td>●</td> <td>●</td> <td>●</td> <td>●</td> </tr> <tr> <td></td> <td></td> <td></td> <td></td> <td></td> <td>Torque limit</td> <td>●</td> <td>●</td> <td>●</td> <td>●</td> </tr> <tr> <td></td> <td></td> <td></td> <td></td> <td></td> <td>Abs. value cleared</td> <td>●</td> <td>●</td> <td>●</td> <td>●</td> </tr> <tr> <td></td> <td></td> <td></td> <td></td> <td></td> <td>Warning</td> <td>●</td> <td>●</td> <td>●</td> <td>●</td> </tr> <tr> <td></td> <td></td> <td></td> <td></td> <td></td> <td>Regenerative load ratio</td> <td>0</td> <td>0</td> <td>0</td> <td>0</td> </tr> <tr> <td></td> <td></td> <td></td> <td></td> <td></td> <td>Actual load ratio</td> <td>0</td> <td>0</td> <td>0</td> <td>0</td> </tr> <tr> <td></td> <td></td> <td></td> <td></td> <td></td> <td>Peak load ratio</td> <td>0</td> <td>0</td> <td>0</td> <td>0</td> </tr> </tbody> </table> <p><SSONET [] / H> 1 to 64 : PA01 to PA64 65 to 128 : PB01 to PB64 129 to 192 : PC01 to PC64 193 to 256 : PD01 to PD64 257 to 320 : PE01 to PE64 321 to 384 : PF01 to PF64 385 to 448 : Po01 to Po64 449 to 512 : PSo1 to PSo64 513 to 576 : PL01 to PL64 577 to 640 : PT01 to PT64</p> <p><SSONET [] > 1 to 18 : PA01 to PA18 19 to 63 : PB01 to PB45 64 to 95 : PC01 to PC32 96 to 127 : PD01 to PD32 128 to 167 : PE01 to PE40 168 to 183 : PF01 to PF16 184 to 199 : Po01 to Po16 200 to 231 : PSo1 to PSo32 232 : PA19</p>	Parameter error No.				[Servo status]				Axis1	Axis2	Axis3	Axis4	Item	Ax.1	Ax.2	Ax.3	Ax.4	1)	0	0	0	0	Zero point passed	●	●	●	●						Zero speed	●	●	●	●						Ready ON	●	●	●	●						Servo ON	●	●	●	●						Servo alarm	●	●	●	●						In-position	●	●	●	●						Torque limit	●	●	●	●						Abs. value cleared	●	●	●	●						Warning	●	●	●	●						Regenerative load ratio	0	0	0	0						Actual load ratio	0	0	0	0						Peak load ratio	0	0	0	0	1)	870, 970, 1070, 1170	366, 3CA, 42E, 492
	Parameter error No.				[Servo status]																																																																																																																																							
	Axis1	Axis2	Axis3	Axis4	Item	Ax.1	Ax.2	Ax.3	Ax.4																																																																																																																																			
	1)	0	0	0	0	Zero point passed	●	●	●	●																																																																																																																																		
						Zero speed	●	●	●	●																																																																																																																																		
						Ready ON	●	●	●	●																																																																																																																																		
					Servo ON	●	●	●	●																																																																																																																																			
					Servo alarm	●	●	●	●																																																																																																																																			
					In-position	●	●	●	●																																																																																																																																			
					Torque limit	●	●	●	●																																																																																																																																			
					Abs. value cleared	●	●	●	●																																																																																																																																			
					Warning	●	●	●	●																																																																																																																																			
					Regenerative load ratio	0	0	0	0																																																																																																																																			
					Actual load ratio	0	0	0	0																																																																																																																																			
					Peak load ratio	0	0	0	0																																																																																																																																			
	2)	876, 976, 1076, 1176	36C, 3D0, 434, 498																																																																																																																																									
	3)	877, 977, 1077, 1177	36D, 3D1, 435, 499																																																																																																																																									
	4)	878, 978, 1078, 1178	36E, 3D2, 436, 49A																																																																																																																																									
	5)	879, 979, 1079, 1179	36F, 3D3, 437, 49B																																																																																																																																									
	6)	880, 980, 1080, 1180	370, 3D4, 438, 49C																																																																																																																																									
	-	-	-																																																																																																																																									

- 1 OVERVIEW
- 2 SYSTEM MONITOR
- 3 LADDER MONITOR FUNCTION
- 4 MELSEC-A LIST EDITOR
- 5 MELSEC-FX LIST EDITOR
- 6 INTELLIGENT MODULE MONITOR
- 7 NETWORK MONITOR
- 8 Q MOTION MONITOR

Screen example		No.	Buffer memory address	
			DEC	HEX
		1)	824 to 825	338 to 339
		2)	924 to 925	39C to 39D
		3)	1024 to 1025	400 to 401
		4)	1124 to 1125	464 to 465
		5)	826, 816	33A, 330
		6)	926, 916	39E, 394
		7)	1026, 1016	402, 3F8
		8)	1126, 1116	466, 45C
		1)	814 to 815	32E to 32F
		2)	914 to 915	392 to 393
		3)	1014 to 1015	3F6 to 3F7
		4)	1114 to 1115	45A to 45B
		5)	1526 to 1527, 1626 to 1627	5F6 to 5F7, 65A to 65B
		6)	1726 to 1727, 1826 to 1927	6BE to 6BF, 722 to 723
		7)	817, 917, 1017, 1117	330, 395, 3F9, 45D
		8)	1528, 1628, 1728, 1828	5F8, 65C, 6C0, 724
		1)	1530 to 1531, 1630 to 1631	5FA to 5FB, 65E to 65F
		2)	1730 to 1731, 1830 to 1931	6C2 to 6C3, 726 to 727
		3)	817, 917, 1017, 1117	331, 395, 3F9, 45D
		4)	1532, 1632, 1732, 1832	5FC, 660, 6C4, 728
		-	-	-
		-	-	-
		-	-	-
		-	-	-

Screen example		No.	Buffer memory address	
			DEC	HEX
		1)	1506 to 1507, 1606 to 1607	5E2 to 5E3, 646 to 647
		2)	1706 to 1707, 1806 to 1807	6AA to 6AB, 70E to 70F
		3)	1514 to 1515, 1614 to 1615	5EA to 5EB, 64E to 64F
		4)	1714 to 1715, 1814 to 1815	6B2 to 6B3, 716 to 717
		5)	1513, 1613, 1713, 1813	5E9, 64D, 6B1, 715
		6)	1544, 1644, 1744, 1844	608, 66C, 6D0, 734
		7)	1545, 1645, 1745, 1845	609, 66D, 6B1, 735
		8)	1546, 1646, 1746, 1846	60A, 66E, 6B2, 736
		9)	1547, 1647, 1747, 1847	60B, 66F, 6B3, 737
		10)	1505, 1605, 1705, 1805	5E1, 645, 6A9, 70D
		1)	1500, 1600, 1700, 1800	5DC, 640, 6A4, 708
		2)	1501, 1601, 1701, 1801	5DD, 641, 6A5, 709
		3)	1502, 1602, 1702, 1802	5DE, 642, 6A6, 70A
		4)	1503, 1603, 1703, 1803	5DF, 643, 6A7, 70B
		5)	1504, 1604, 1704, 1804	5E0, 644, 6A8, 70C
		6)	1512, 1612, 1712, 1812	5E8, 64C, 6B0, 714
		7)	1516, 1616, 1716, 1816	5EC, 650, 6B4, 718
		8)	1508 to 1509, 1608 to 1609, 1708 to 1709, 1808 to 1809	5E4 to 5E5, 648 to 649, 6AC to 6AD, 710 to 711
		9)	1510 to 1511, 1610 to 1611, 1710 to 1711, 1810 to 1811	5E6 to 5E7, 64A to 64B, 6AE to 6AF, 712 to 713
		10)	1520, 1620, 1720, 1820	5F0, 654, 6B8, 71C
		11)	1521, 1621, 1721, 1821	5F1, 655, 6B9, 71D
		12)	1522 to 1523, 1622 to 1623, 1722 to 1723, 1822 to 1823	5F2 to 5F3, 656 to 657, 6BA to 6BB, 71E to 71F
		13)	1524, 1624, 1724, 1824	5F4, 658, 6BC, 720
		14)	1525, 1625, 1725, 1825	5F5, 659, 6BD, 721
-	-	-	-	

- 1 OVERVIEW
- 2 SYSTEM MONITOR
- 3 LADDER MONITOR FUNCTION
- 4 MELSEC-A LIST EDITOR
- 5 MELSEC-FX LIST EDITOR
- 6 INTELLIGENT MODULE MONITOR
- 7 NETWORK MONITOR
- 8 Q MOTION MONITOR

Screen example		No.	Buffer memory address	
			DEC	HEX
		1)	1538, 1638, 1738, 1838	602, 670, 6CA, 72E
1)	Pos.change	2)	1548, 1648, 1748, 1848	60C, 670, 6D4, 738
2)	Teaching data selection	3)	1549, 1649, 1749, 1849	60D, 671, 6D5, 739
3)	Teaching positioning data No.	4)	1550, 1650, 1750, 1850	60E, 672, 606, 73A
4)	ABS direction in degrees	5)	1540, 1640, 1740, 1840	604, 668, 6CB, 730
		6)	1541, 1641, 1741, 1841	605, 669, 6CD, 731
		7)	1542, 1642, 1742, 1842	606, 66A, 6CE, 732
		8)	1543, 1643, 1743, 1843	607, 66B, 6D0, 733
		9)	1551, 1651, 1751, 1851	60F, 673, 6D7, 73B
		10)	1552, 1652, 1752, 1852	610, 674, 6D8, 73C
		11)	1559, 1659, 1759, 1859	617, 67B, 6DF, 743
		12)	1565, 1665, 1765, 1865	61D, 681, 6E5, 749
		-	-	-
		1)	1517, 1617	5ED, 651
1)	Inching movement amount	2)	1717, 1817	6B5, 719
2)	Setting range	3)	1518 to 1519, 1618 to 1619	5EE to 5EF, 652 to 653
		4)	1718 to 1719, 1818 to 1819	6B6 to 6B7, 71A to 71B
		5)	1534 to 1535, 1634 to 1635	5FE to 5FF, 662 to 663
3)	JOG speed	6)	1734 to 1735, 1834 to 1835	6C6 to 6C7, 72A to 72B
4)	Setting range	7)	1536 to 1537, 1636 to 1637	600 to 601, 664 to 665
		8)	1736 to 1737, 1836 to 1837	6C8 to 6C9, 72C to 72D
		-	-	-

Screen example		No.	Buffer memory address			
			DEC	HEX		
		1)	1212 to 1216	4BC to 4C0		
		2)	1217 to 1221	4C1 to 4C5		
		3)	1222 to 1226	4C6 to 4CA		
		4)	1227 to 1231	4CB to 4CF		
		5)	1232 to 1236	4D0 to 4D4		
		6)	1237 to 1241	4D5 to 4D9		
		7)	1242 to 1246	4DA to 4DE		
		8)	1247 to 1251	4DF to 4E3		
				9)	1252 to 1256	4E4 to 4E8
				10)	1257 to 1261	4E9 to 4ED
				11)	1262 to 1266	4EE to 4F2
				12)	1267 to 1271	4F3 to 4F7
				13)	1272 to 1276	4F8 to 4FC
				14)	1277 to 1281	4FD to 501
				15)	1282 to 1286	502 to 506
				16)	1287 to 1291	507 to 50B
-	-			-		
1)	1293 to 1296			50D to 510		
2)	1297 to 1300			511 to 514		
3)	1301 to 1304			515 to 518		
4)	1305 to 1308			519 to 51C		
5)	1309 to 1312			51D to 520		
6)	1313 to 1316			521 to 524		
7)	1317 to 1320			525 to 528		
8)	1321 to 1324	529 to 52C				
9)	1325 to 1328	52D to 530				
10)	1329 to 1332	531 to 534				
11)	1333 to 1336	535 to 538				
12)	1337 to 1340	539 to 53C				
13)	1341 to 1344	53D to 540				
14)	1345 to 1348	541 to 544				
15)	1349 to 1352	545 to 548				
16)	1353 to 1356	549 to 54C				
17)	1358 to 1361	54E to 551				
18)	1362 to 1365	552 to 555				
19)	1366 to 1369	556 to 559				
20)	1370 to 1373	55A to 55D				
21)	1374 to 1377	55E to 561				
22)	1378 to 1381	562 to 565				
23)	1382 to 1385	566 to 569				
24)	1386 to 1389	56A to 56D				
25)	1390 to 1393	56E to 571				
26)	1394 to 1397	572 to 575				
27)	1398 to 1401	576 to 579				
28)	1402 to 1405	57A to 57D				
29)	1406 to 1409	57E to 581				
30)	1410 to 1413	582 to 585				
31)	1414 to 1417	586 to 589				
32)	1418 to 1421	58A to 58D				
33)	31300 to 31315	7A44 to 7A53				
34)	31316 to 31331	7A54 to 7A63				
-	-	-				

1 OVERVIEW
2 SYSTEM MONITOR
3 LADDER MONITOR FUNCTION
4 MELSEC-A LIST EDITOR
5 MELSEC-FX LIST EDITOR
6 INTELLIGENT MODULE MONITOR
7 NETWORK MONITOR
8 Q MOTION MONITOR

Screen example		No.	Buffer memory address																																																																
			DEC	HEX																																																															
<p>QD77MS4 Positioning data</p> <table border="1"> <thead> <tr> <th colspan="2">Axis1</th> <th colspan="2">Axis3</th> </tr> <tr> <th>No</th> <th>Pat., Int., Cont, Acc., Dec., Dwell, Moode</th> <th>No</th> <th>Pat., Int., Cont, Acc., Dec., Dwell, Moode</th> </tr> <tr> <th></th> <th>Address Arc address Instr. speed</th> <th></th> <th>Address Arc address Instr. speed</th> </tr> </thead> <tbody> <tr> <td>1)</td> <td>00 00 56 00 00 23456 23456 123456 123456 123456</td> <td>7)</td> <td>00 00 56 00 00 23456 23456 123456 123456 123456</td> </tr> <tr> <td>2)</td> <td>00 00 56 00 00 23456 23456 123456 123456 123456</td> <td>8)</td> <td>00 00 56 00 00 23456 23456 123456 123456 123456</td> </tr> <tr> <td>3)</td> <td>00 00 56 00 00 23456 23456 123456 123456 123456</td> <td>9)</td> <td>00 00 56 00 00 23456 23456 123456 123456 123456</td> </tr> </tbody> </table> <table border="1"> <thead> <tr> <th colspan="2">Axis2</th> <th colspan="2">Axis4</th> </tr> <tr> <th>No</th> <th>Pat., Int., Cont, Acc., Dec., Dwell, Moode</th> <th>No</th> <th>Pat., Int., Cont, Acc., Dec., Dwell, Moode</th> </tr> <tr> <th></th> <th>Address Arc address Instr. speed</th> <th></th> <th>Address Arc address Instr. speed</th> </tr> </thead> <tbody> <tr> <td>4)</td> <td>00 00 56 00 00 23456 23456 123456 123456 123456</td> <td>10)</td> <td>00 00 56 00 00 23456 23456 123456 123456 123456</td> </tr> <tr> <td>5)</td> <td>00 00 56 00 00 23456 23456 123456 123456 123456</td> <td>11)</td> <td>00 00 56 00 00 23456 23456 123456 123456 123456</td> </tr> <tr> <td>6)</td> <td>00 00 56 00 00 23456 23456 123456 123456 123456</td> <td>12)</td> <td>00 00 56 00 00 23456 23456 123456 123456 123456</td> </tr> </tbody> </table> <p>[Pattern] 00: Positioning complete 01: Continuous positioning control 11: Continuous path control [Control] 01H:RBS1 02H:INC1 03H:FEED1 04H:VF1 05H:VR1 06H:VPF 07H:VPR 08H:PVF 09H:PVF 06H:RBS2 08H:INC2 09H:FEED2 0D:H:RBS 0EH:INC 0FH:RBS_CW 10H:RBS_CW 11H:INC_CW 12H:INC_CW 13H:VF2 14H:VR2 15H:RBS3 16H:INC3 17H:FEED3 18H:VF3 19H:VR3 1AH:RBS4 1BH:INC4 1CH:FEED4 1DH:VF4 1EH:VR4 60H:VOP 61H:POS 62H:JUMP 63H:LOOP 64H:END</p>					Axis1		Axis3		No	Pat., Int., Cont, Acc., Dec., Dwell, Moode	No	Pat., Int., Cont, Acc., Dec., Dwell, Moode		Address Arc address Instr. speed		Address Arc address Instr. speed	1)	00 00 56 00 00 23456 23456 123456 123456 123456	7)	00 00 56 00 00 23456 23456 123456 123456 123456	2)	00 00 56 00 00 23456 23456 123456 123456 123456	8)	00 00 56 00 00 23456 23456 123456 123456 123456	3)	00 00 56 00 00 23456 23456 123456 123456 123456	9)	00 00 56 00 00 23456 23456 123456 123456 123456	Axis2		Axis4		No	Pat., Int., Cont, Acc., Dec., Dwell, Moode	No	Pat., Int., Cont, Acc., Dec., Dwell, Moode		Address Arc address Instr. speed		Address Arc address Instr. speed	4)	00 00 56 00 00 23456 23456 123456 123456 123456	10)	00 00 56 00 00 23456 23456 123456 123456 123456	5)	00 00 56 00 00 23456 23456 123456 123456 123456	11)	00 00 56 00 00 23456 23456 123456 123456 123456	6)	00 00 56 00 00 23456 23456 123456 123456 123456	12)	00 00 56 00 00 23456 23456 123456 123456 123456	1)	2000 to 2002, 2004 to 2009	7D0 to 7D2, 7D4 to 7D9												
Axis1		Axis3																																																																	
No	Pat., Int., Cont, Acc., Dec., Dwell, Moode	No	Pat., Int., Cont, Acc., Dec., Dwell, Moode																																																																
	Address Arc address Instr. speed		Address Arc address Instr. speed																																																																
1)	00 00 56 00 00 23456 23456 123456 123456 123456	7)	00 00 56 00 00 23456 23456 123456 123456 123456																																																																
2)	00 00 56 00 00 23456 23456 123456 123456 123456	8)	00 00 56 00 00 23456 23456 123456 123456 123456																																																																
3)	00 00 56 00 00 23456 23456 123456 123456 123456	9)	00 00 56 00 00 23456 23456 123456 123456 123456																																																																
Axis2		Axis4																																																																	
No	Pat., Int., Cont, Acc., Dec., Dwell, Moode	No	Pat., Int., Cont, Acc., Dec., Dwell, Moode																																																																
	Address Arc address Instr. speed		Address Arc address Instr. speed																																																																
4)	00 00 56 00 00 23456 23456 123456 123456 123456	10)	00 00 56 00 00 23456 23456 123456 123456 123456																																																																
5)	00 00 56 00 00 23456 23456 123456 123456 123456	11)	00 00 56 00 00 23456 23456 123456 123456 123456																																																																
6)	00 00 56 00 00 23456 23456 123456 123456 123456	12)	00 00 56 00 00 23456 23456 123456 123456 123456																																																																
		2)	2010 to 2012, 2014 to 2019	7DA to 7DC, 7DE to 7E3																																																															
		3)	2020 to 2022, 2024 to 2029	7E4 to 7E6, 7E8 to 7ED																																																															
		4)	8000 to 8002, 8004 to 8009	1F40 to 1F41, 1F44 to 1F49																																																															
		5)	8010 to 8012, 8014 to 8019	1F4A to 1F4C, 1F4E to 1F53																																																															
		6)	8020 to 8022, 8024 to 8029	1F54 to 1F56, 1F58 to 1F5D																																																															
		7)	14000 to 14002, 14004 to 14009	36B0 to 36B2, 36B4 to 36B9																																																															
		8)	14010 to 14012, 14014 to 14019	36BA to 36BB, 36BE to 36C3																																																															
		9)	14020 to 14022, 14024 to 14029	36C4 to 36C6, 36C8 to 36CD																																																															
		10)	20000 to 20002, 20004 to 20009	4E20 to 4E22, 4E24 to 4E29																																																															
		11)	20010 to 20012, 20014 to 20019	4E2A to 4E2C, 4E2E to 4E33																																																															
		12)	20020 to 20022, 20024 to 20029	4E34 to 4E36, 4E38 to 4E3D																																																															
		-	-	-																																																															
<p>QD77MS4 Servo parameter Basic setting1</p> <table border="1"> <thead> <tr> <th>Item</th> <th>Axis1</th> <th>Axis2</th> <th>Axis3</th> <th>Axis4</th> <th>Setting range</th> </tr> </thead> <tbody> <tr> <td>1) Servo series</td> <td>0</td> <td>0</td> <td>0</td> <td>0</td> <td>0:Invalid 1,3,4,6:MR-J3(W)-B 7:MR-MT1200 32:MR-J4-B 96:VC II 4097,4128:Virt.</td> </tr> <tr> <td>2) Selection of regenerative brake option</td> <td>00</td> <td>00</td> <td>00</td> <td>00</td> <td>00:Not used 02:MR-RB032 03:MR-RB12 04:MR-RB32 05:MR-RB30 06:MR-RB50 08:MR-RB31 09:MR-RB51</td> </tr> <tr> <td>3) Reg. detection sys.</td> <td>0</td> <td>0</td> <td>0</td> <td>0</td> <td>0:Invalid 1:Valid</td> </tr> <tr> <td>4) Func. selection A-1 Emergency stop input</td> <td>0</td> <td>0</td> <td>0</td> <td>0</td> <td>0:Valid 1:Invalid</td> </tr> <tr> <td>5) Auto tuning Rain adjustment mode</td> <td>0</td> <td>0</td> <td>0</td> <td>0</td> <td>0:Interpolation 1:Auto tuning1 3:Manual 2:Auto tuning2</td> </tr> <tr> <td>6) Auto tuning Response</td> <td>16</td> <td>16</td> <td>16</td> <td>16</td> <td>1:Low 16:Middle 32:High 10Hz 160Hz 400Hz</td> </tr> <tr> <td>7) Positioning range</td> <td>23456</td> <td>0</td> <td>0</td> <td>0</td> <td>0 to 50000[pulse]</td> </tr> <tr> <td>8) Rotation direction</td> <td>0</td> <td>0</td> <td>0</td> <td>0</td> <td>0:CCW 1:CW</td> </tr> <tr> <td>9) Encoder output pulses</td> <td>1</td> <td>1</td> <td>1</td> <td>1</td> <td>1 to 65535[pulse]</td> </tr> </tbody> </table>					Item	Axis1	Axis2	Axis3	Axis4	Setting range	1) Servo series	0	0	0	0	0:Invalid 1,3,4,6:MR-J3(W)-B 7:MR-MT1200 32:MR-J4-B 96:VC II 4097,4128:Virt.	2) Selection of regenerative brake option	00	00	00	00	00:Not used 02:MR-RB032 03:MR-RB12 04:MR-RB32 05:MR-RB30 06:MR-RB50 08:MR-RB31 09:MR-RB51	3) Reg. detection sys.	0	0	0	0	0:Invalid 1:Valid	4) Func. selection A-1 Emergency stop input	0	0	0	0	0:Valid 1:Invalid	5) Auto tuning Rain adjustment mode	0	0	0	0	0:Interpolation 1:Auto tuning1 3:Manual 2:Auto tuning2	6) Auto tuning Response	16	16	16	16	1:Low 16:Middle 32:High 10Hz 160Hz 400Hz	7) Positioning range	23456	0	0	0	0 to 50000[pulse]	8) Rotation direction	0	0	0	0	0:CCW 1:CW	9) Encoder output pulses	1	1	1	1	1 to 65535[pulse]	1)	30100, 30300, 30500, 30700	7594, 765C, 7724, 77EC
Item	Axis1	Axis2	Axis3	Axis4	Setting range																																																														
1) Servo series	0	0	0	0	0:Invalid 1,3,4,6:MR-J3(W)-B 7:MR-MT1200 32:MR-J4-B 96:VC II 4097,4128:Virt.																																																														
2) Selection of regenerative brake option	00	00	00	00	00:Not used 02:MR-RB032 03:MR-RB12 04:MR-RB32 05:MR-RB30 06:MR-RB50 08:MR-RB31 09:MR-RB51																																																														
3) Reg. detection sys.	0	0	0	0	0:Invalid 1:Valid																																																														
4) Func. selection A-1 Emergency stop input	0	0	0	0	0:Valid 1:Invalid																																																														
5) Auto tuning Rain adjustment mode	0	0	0	0	0:Interpolation 1:Auto tuning1 3:Manual 2:Auto tuning2																																																														
6) Auto tuning Response	16	16	16	16	1:Low 16:Middle 32:High 10Hz 160Hz 400Hz																																																														
7) Positioning range	23456	0	0	0	0 to 50000[pulse]																																																														
8) Rotation direction	0	0	0	0	0:CCW 1:CW																																																														
9) Encoder output pulses	1	1	1	1	1 to 65535[pulse]																																																														
		2)	30102, 30302 30502 30702	7596, 765E, 7726, 77EE																																																															
		3)	30103, 30303 30503, 30703	7797, 765F, 7727, 77EF																																																															
		4)	30104, 30304, 30504, 30704	7798, 7660, 7728, 77F0																																																															
		5)	30108, 30308, 30508, 30708	759C, 7664, 772C, 77F4																																																															
		6)	30109, 30309, 30509, 30709	759D, 7665, 772D, 77F5																																																															
		7)	30110, 30310, 30510, 30710	7591, 7666, 772E, 77F6																																																															
		8)	30114, 30314, 30514, 30714	75A2, 766A, 7732, 77FA																																																															
		9)	30115, 30315, 30515, 30715	75A3, 766B, 7733, 77FB																																																															
		-	-	-																																																															
<p>QD77MS4 Servo parameter Basic setting2</p> <table border="1"> <thead> <tr> <th>Item</th> <th>Axis1</th> <th>Axis2</th> <th>Axis3</th> <th>Axis4</th> <th>Setting range</th> </tr> </thead> <tbody> <tr> <td>1) Func. selection A-1 forced stop decel.</td> <td>0</td> <td>0</td> <td>0</td> <td>0</td> <td>0:Disabled 2:Enabled</td> </tr> <tr> <td>2) Encoder output p. Z</td> <td>1</td> <td>1</td> <td>1</td> <td>1</td> <td>1 to 65535[pulse]</td> </tr> <tr> <td>3) Servo motor series</td> <td>1</td> <td>1</td> <td>1</td> <td>1</td> <td></td> </tr> <tr> <td>4) Servo motor type</td> <td>1</td> <td>1</td> <td>1</td> <td>1</td> <td></td> </tr> </tbody> </table>					Item	Axis1	Axis2	Axis3	Axis4	Setting range	1) Func. selection A-1 forced stop decel.	0	0	0	0	0:Disabled 2:Enabled	2) Encoder output p. Z	1	1	1	1	1 to 65535[pulse]	3) Servo motor series	1	1	1	1		4) Servo motor type	1	1	1	1		1)	30104, 30304, 30504, 30704	7598, 7660 7728, 77F0																														
Item	Axis1	Axis2	Axis3	Axis4	Setting range																																																														
1) Func. selection A-1 forced stop decel.	0	0	0	0	0:Disabled 2:Enabled																																																														
2) Encoder output p. Z	1	1	1	1	1 to 65535[pulse]																																																														
3) Servo motor series	1	1	1	1																																																															
4) Servo motor type	1	1	1	1																																																															
		2)	30116, 30316, 30516, 30716	75A4, 766C, 7734, 77FC																																																															
		3)	30117, 30317, 30517, 30717	75A5, 766D, 7735, 77FD																																																															
		4)	30118, 30318, 30518, 30718	75A4, 766E, 7736, 77FE																																																															
		-	-	-																																																															

Screen example						No.	Buffer memory address	
							DEC	HEX
						1)	31632, 31882, 32132, 32382	7B90, 7C8A, 7D84, 7E7E
						2)	31633, 31883, 32133, 32383	7B91, 7C8B, 7D85, 7E7F
						3)	31636, 31886, 32136, 32386	7B94, 7C8E, 7D88, 7E82
						4)	31635, 31885, 32135, 32385	7B93, 7C8D, 7D87, 7E81
-						-	-	-
						1)	30119, 30319, 30519, 30719	75A7, 766F, 7737, 77FF
						2)	30120, 30320, 30520, 30720	75A8, 7670, 7738, 7800
						3)	30122, 30322, 30522, 30722	75AA, 7672, 773A, 7802
						4)	30124, 30324, 30524, 30724	75AC, 7674, 773C, 7804
						5)	30125, 30325, 30525, 30725	75AD, 7675, 773D, 7805
						6)	30126, 30326, 30526, 30726	75AE, 7676, 773E, 7806
						7)	30127, 30327, 30527, 30727	75AF, 7677, 773F, 7807
						8)	30128, 30328, 30528, 30728	75B0, 7678, 7740, 7808
						9)	30129, 30329, 30529, 30729	75B1, 7679, 7741, 7809
						10)	30131, 30331, 30531, 30731	75B3, 767B, 7743, 780B
						11)	30133, 30333, 30533, 30733	75B5, 767D, 7745, 780D
						12)	30136, 30336, 30536, 30736	75B8, 7680, 7748, 7810
						13)	30141, 30341, 30541, 30741	75BD, 7685, 774D, 7815
-						-	-	-
						1)	30132, 30332, 30532, 30732	75B4, 767C, 7744, 780C
						3)	30134, 30334, 30534, 30734	75B6, 767E, 7746, 780E
						4)	30137, 30337, 30537, 30737	75B9, 7681, 7749, 7811
						6)	30138, 30338, 30538, 30738	75BA, 7682, 774A, 7812
						7)	30142, 30342, 30542, 30742	75BE, 7686, 774E, 7816
-						-	-	-

- 1 OVERVIEW
- 2 SYSTEM MONITOR
- 3 LADDER MONITOR FUNCTION
- 4 MELSEC-A LIST EDITOR
- 5 MELSEC-FX LIST EDITOR
- 6 INTELLIGENT MODULE MONITOR
- 7 NETWORK MONITOR
- 8 Q MOTION MONITOR

Screen example		No.	Buffer memory address																																																																																																																																						
			DEC	HEX																																																																																																																																					
<div style="display: flex; justify-content: space-between; align-items: center;"> <div style="width: 45%;"> <table border="1" style="width: 100%; border-collapse: collapse;"> <thead> <tr> <th colspan="6">QD77MS4 Servo parameter Gain/Filter-3</th> <th>SET/RESET</th> <th>Data Chg.</th> <th>MONIT MENU</th> <th>END</th> </tr> <tr> <th>Item</th> <th>Axis1</th> <th>Axis2</th> <th>Axis3</th> <th>Axis4</th> <th>Setting range</th> <th colspan="4"></th> </tr> </thead> <tbody> <tr> <td>1) Gain switch condition</td> <td>0</td> <td>0</td> <td>0</td> <td>0</td> <td>0 to 9999</td> <td colspan="4"></td> </tr> <tr> <td>2) Const. at gain switch</td> <td>0</td> <td>0</td> <td>0</td> <td>0</td> <td>0 to 100[ms]</td> <td colspan="4"></td> </tr> <tr> <td>3) Load inertia ratio to gain switch servo</td> <td>0</td> <td>0</td> <td>0</td> <td>0</td> <td>0 to 3000(*10⁻¹)</td> <td colspan="4"></td> </tr> <tr> <td>4) Position loop gain</td> <td>1</td> <td>1</td> <td>1</td> <td>1</td> <td>1 to 2000[rad/s]</td> <td colspan="4"></td> </tr> <tr> <td>5) Speed loop gain</td> <td>100</td> <td>100</td> <td>100</td> <td>100</td> <td>20 to 50000[rad/s]</td> <td colspan="4"></td> </tr> <tr> <td>6) Speed integral comp.</td> <td>1</td> <td>1</td> <td>1</td> <td>1</td> <td>1 to 50000(*10⁻¹)[ms]</td> <td colspan="4"></td> </tr> <tr> <td>7) Vibration freq setup</td> <td>1</td> <td>1</td> <td>1</td> <td>1</td> <td>1 to 1000(*10⁻¹)[Hz]</td> <td colspan="4"></td> </tr> <tr> <td>8) Resonance freq setup</td> <td>1</td> <td>1</td> <td>1</td> <td>1</td> <td>1 to 1000(*10⁻¹)[Hz]</td> <td colspan="4"></td> </tr> <tr> <td colspan="6">Gain changing selection</td> <td>Axis1</td> <td>Axis2</td> <td>Axis3</td> <td>Axis4</td> </tr> <tr> <td colspan="6"></td> <td>1</td> <td>1</td> <td>1</td> <td>1</td> </tr> <tr> <td colspan="6"> 00:Invalid 01:Control command by the controller is effective. 02:Command frequency is more than PB27. 03:(Motor encoder unit)Droop pulse is more than PB27. 04:Model speed is more than PB27. 12:Command frequency is less than PB27. 13:(Motor encoder unit)Droop pulse is less than PB27. 14:Model speed is less than PB27. </td> <td colspan="4"></td> </tr> </tbody> </table> </div> <div style="width: 5%; text-align: center;">9)</div> </div>					QD77MS4 Servo parameter Gain/Filter-3						SET/RESET	Data Chg.	MONIT MENU	END	Item	Axis1	Axis2	Axis3	Axis4	Setting range					1) Gain switch condition	0	0	0	0	0 to 9999					2) Const. at gain switch	0	0	0	0	0 to 100[ms]					3) Load inertia ratio to gain switch servo	0	0	0	0	0 to 3000(*10 ⁻¹)					4) Position loop gain	1	1	1	1	1 to 2000[rad/s]					5) Speed loop gain	100	100	100	100	20 to 50000[rad/s]					6) Speed integral comp.	1	1	1	1	1 to 50000(*10 ⁻¹)[ms]					7) Vibration freq setup	1	1	1	1	1 to 1000(*10 ⁻¹)[Hz]					8) Resonance freq setup	1	1	1	1	1 to 1000(*10 ⁻¹)[Hz]					Gain changing selection						Axis1	Axis2	Axis3	Axis4							1	1	1	1	00:Invalid 01:Control command by the controller is effective. 02:Command frequency is more than PB27. 03:(Motor encoder unit)Droop pulse is more than PB27. 04:Model speed is more than PB27. 12:Command frequency is less than PB27. 13:(Motor encoder unit)Droop pulse is less than PB27. 14:Model speed is less than PB27.										1)	30145, 30345, 30545, 30745	75C1, 7689, 7751, 7819
QD77MS4 Servo parameter Gain/Filter-3						SET/RESET	Data Chg.	MONIT MENU	END																																																																																																																																
Item	Axis1	Axis2	Axis3	Axis4	Setting range																																																																																																																																				
1) Gain switch condition	0	0	0	0	0 to 9999																																																																																																																																				
2) Const. at gain switch	0	0	0	0	0 to 100[ms]																																																																																																																																				
3) Load inertia ratio to gain switch servo	0	0	0	0	0 to 3000(*10 ⁻¹)																																																																																																																																				
4) Position loop gain	1	1	1	1	1 to 2000[rad/s]																																																																																																																																				
5) Speed loop gain	100	100	100	100	20 to 50000[rad/s]																																																																																																																																				
6) Speed integral comp.	1	1	1	1	1 to 50000(*10 ⁻¹)[ms]																																																																																																																																				
7) Vibration freq setup	1	1	1	1	1 to 1000(*10 ⁻¹)[Hz]																																																																																																																																				
8) Resonance freq setup	1	1	1	1	1 to 1000(*10 ⁻¹)[Hz]																																																																																																																																				
Gain changing selection						Axis1	Axis2	Axis3	Axis4																																																																																																																																
						1	1	1	1																																																																																																																																
00:Invalid 01:Control command by the controller is effective. 02:Command frequency is more than PB27. 03:(Motor encoder unit)Droop pulse is more than PB27. 04:Model speed is more than PB27. 12:Command frequency is less than PB27. 13:(Motor encoder unit)Droop pulse is less than PB27. 14:Model speed is less than PB27.																																																																																																																																									
					2)	30146, 30346, 30546, 30746	75C2, 768A, 7752, 781A																																																																																																																																		
					3)	30147, 30347, 30547, 30747	75C3, 768B, 7753, 781B																																																																																																																																		
					4)	30148, 30348, 30548, 30748	75C4, 768C, 7754, 781C																																																																																																																																		
					5)	30149, 30349, 30549, 30749	75C5, 768D, 7755, 781D																																																																																																																																		
					6)	30150, 30350, 30550, 30750	75C6, 768E, 7756, 781E																																																																																																																																		
					7)	30151, 30351, 30551, 30751	75C7, 768F, 7757, 781F																																																																																																																																		
					8)	30152, 30352, 30552, 30752	75C8, 7690, 7758, 7820																																																																																																																																		
					9)	30144, 30344, 30544, 30744	75C0, 7688, 7750, 7818																																																																																																																																		
					-	-	-																																																																																																																																		
<div style="display: flex; justify-content: space-between; align-items: center;"> <div style="width: 45%;"> <table border="1" style="width: 100%; border-collapse: collapse;"> <thead> <tr> <th colspan="6">QD77MS4 Servo parameter Gain/Filter-4</th> <th>SET/RESET</th> <th>Data Chg.</th> <th>MONIT MENU</th> <th>END</th> </tr> <tr> <th>Item</th> <th>Axis1</th> <th>Axis2</th> <th>Axis3</th> <th>Axis4</th> <th>Setting range</th> <th colspan="4"></th> </tr> </thead> <tbody> <tr> <td>1) Vibration suppression control 2 tuning mode</td> <td>0</td> <td>0</td> <td>1</td> <td>2</td> <td>0: Disabled 1: Automatic setting 2: Manual setting</td> <td colspan="4"></td> </tr> <tr> <td>2) Torque fb loop gain</td> <td>0</td> <td>0</td> <td>0</td> <td>0</td> <td>0 to 18000[rad/s]</td> <td colspan="4"></td> </tr> <tr> <td>3) Overchoat amount comp</td> <td>0</td> <td>0</td> <td>100</td> <td>0</td> <td>0 to 100[%]</td> <td colspan="4"></td> </tr> <tr> <td rowspan="2">4) Shaft resonance suppression filter setting frequency</td> <td colspan="4">00</td> <td>00:Disabled 01:Disabled</td> <td colspan="4"></td> </tr> <tr> <td colspan="4">01</td> <td>02: 0F 0F 1F High Middle Low 400Hz 800Hz 200Hz</td> <td colspan="4"></td> </tr> <tr> <td>5) Notch depth selection</td> <td>0</td> <td>0</td> <td>0</td> <td>0</td> <td>0 1 2 3 Deep ← → Shallow =40dB =14dB =3dB =4dB</td> <td colspan="4"></td> </tr> <tr> <td>6) VRF1 Vibration freq. damping</td> <td>0</td> <td>0</td> <td>0</td> <td>0</td> <td>0 to 30(*10⁻²)</td> <td colspan="4"></td> </tr> <tr> <td>7) VRF1 Resonance freq. damping</td> <td>0</td> <td>0</td> <td>0</td> <td>0</td> <td>0 to 30(*10⁻²)</td> <td colspan="4"></td> </tr> </tbody> </table> </div> </div>					QD77MS4 Servo parameter Gain/Filter-4						SET/RESET	Data Chg.	MONIT MENU	END	Item	Axis1	Axis2	Axis3	Axis4	Setting range					1) Vibration suppression control 2 tuning mode	0	0	1	2	0: Disabled 1: Automatic setting 2: Manual setting					2) Torque fb loop gain	0	0	0	0	0 to 18000[rad/s]					3) Overchoat amount comp	0	0	100	0	0 to 100[%]					4) Shaft resonance suppression filter setting frequency	00				00:Disabled 01:Disabled					01				02: 0F 0F 1F High Middle Low 400Hz 800Hz 200Hz					5) Notch depth selection	0	0	0	0	0 1 2 3 Deep ← → Shallow =40dB =14dB =3dB =4dB					6) VRF1 Vibration freq. damping	0	0	0	0	0 to 30(*10 ⁻²)					7) VRF1 Resonance freq. damping	0	0	0	0	0 to 30(*10 ⁻²)					1)	30120, 30320, 30520, 30720	75A8, 7670, 7738, 7800																															
QD77MS4 Servo parameter Gain/Filter-4						SET/RESET	Data Chg.	MONIT MENU	END																																																																																																																																
Item	Axis1	Axis2	Axis3	Axis4	Setting range																																																																																																																																				
1) Vibration suppression control 2 tuning mode	0	0	1	2	0: Disabled 1: Automatic setting 2: Manual setting																																																																																																																																				
2) Torque fb loop gain	0	0	0	0	0 to 18000[rad/s]																																																																																																																																				
3) Overchoat amount comp	0	0	100	0	0 to 100[%]																																																																																																																																				
4) Shaft resonance suppression filter setting frequency	00				00:Disabled 01:Disabled																																																																																																																																				
	01				02: 0F 0F 1F High Middle Low 400Hz 800Hz 200Hz																																																																																																																																				
5) Notch depth selection	0	0	0	0	0 1 2 3 Deep ← → Shallow =40dB =14dB =3dB =4dB																																																																																																																																				
6) VRF1 Vibration freq. damping	0	0	0	0	0 to 30(*10 ⁻²)																																																																																																																																				
7) VRF1 Resonance freq. damping	0	0	0	0	0 to 30(*10 ⁻²)																																																																																																																																				
					2)	30121, 30321, 30521, 30721	75A9, 7671, 7739, 7801																																																																																																																																		
					3)	30130, 30330, 30530, 30730	75B2, 767A, 7742, 780A																																																																																																																																		
					4)	30135, 30335, 30535, 30735	75B7, 767F, 7747, 780F																																																																																																																																		
					5)	30139, 30339, 30539, 30739	75BB, 7683, 774B, 7813																																																																																																																																		
					6)	30139, 30339, 30539, 30739	75BB, 7683, 774B, 7813																																																																																																																																		
					7)	30140, 30340, 30540, 30740	75BC, 7684, 774C, 7814																																																																																																																																		
					-	-	-																																																																																																																																		
<div style="display: flex; justify-content: space-between; align-items: center;"> <div style="width: 45%;"> <table border="1" style="width: 100%; border-collapse: collapse;"> <thead> <tr> <th colspan="6">QD77MS4 Servo parameter Gain/Filter-5</th> <th>SET/RESET</th> <th>Data Chg.</th> <th>MONIT MENU</th> <th>END</th> </tr> <tr> <th>Item</th> <th>Axis1</th> <th>Axis2</th> <th>Axis3</th> <th>Axis4</th> <th>Setting range</th> <th colspan="4"></th> </tr> </thead> <tbody> <tr> <td>1) VRF1 Vibration freq. after gain switching</td> <td>0</td> <td>0</td> <td>0</td> <td>0</td> <td>0 to 30(*10⁻²)</td> <td colspan="4"></td> </tr> <tr> <td>2) VRF1 Resonance freq. after gain switching</td> <td>0</td> <td>0</td> <td>0</td> <td>0</td> <td>0 to 30(*10⁻²)</td> <td colspan="4"></td> </tr> <tr> <td rowspan="2">3) Command notch filter setting frequency selection</td> <td colspan="4">0</td> <td>00:Disabled</td> <td colspan="4"></td> </tr> <tr> <td colspan="4">01</td> <td>01: 2F 5F High Middle Low 200Hz 30Hz 4.5Hz</td> <td colspan="4"></td> </tr> <tr> <td>4) Notch depth selection</td> <td>0</td> <td>0</td> <td>0</td> <td>0</td> <td>0 7 F Deep ← Middle → Shallow =40dB =7.2dB =0.5dB</td> <td colspan="4"></td> </tr> </tbody> </table> </div> </div>					QD77MS4 Servo parameter Gain/Filter-5						SET/RESET	Data Chg.	MONIT MENU	END	Item	Axis1	Axis2	Axis3	Axis4	Setting range					1) VRF1 Vibration freq. after gain switching	0	0	0	0	0 to 30(*10 ⁻²)					2) VRF1 Resonance freq. after gain switching	0	0	0	0	0 to 30(*10 ⁻²)					3) Command notch filter setting frequency selection	0				00:Disabled					01				01: 2F 5F High Middle Low 200Hz 30Hz 4.5Hz					4) Notch depth selection	0	0	0	0	0 7 F Deep ← Middle → Shallow =40dB =7.2dB =0.5dB					1)	30153, 30353, 30553, 30753	75C9, 7691, 7759, 7821																																																													
QD77MS4 Servo parameter Gain/Filter-5						SET/RESET	Data Chg.	MONIT MENU	END																																																																																																																																
Item	Axis1	Axis2	Axis3	Axis4	Setting range																																																																																																																																				
1) VRF1 Vibration freq. after gain switching	0	0	0	0	0 to 30(*10 ⁻²)																																																																																																																																				
2) VRF1 Resonance freq. after gain switching	0	0	0	0	0 to 30(*10 ⁻²)																																																																																																																																				
3) Command notch filter setting frequency selection	0				00:Disabled																																																																																																																																				
	01				01: 2F 5F High Middle Low 200Hz 30Hz 4.5Hz																																																																																																																																				
4) Notch depth selection	0	0	0	0	0 7 F Deep ← Middle → Shallow =40dB =7.2dB =0.5dB																																																																																																																																				
					2)	30154, 30354, 30554, 30754	75CA, 5692, 775A, 7822																																																																																																																																		
					3)	30163, 30363, 30563, 30763	75D3, 769B, 7763, 782B																																																																																																																																		
					4)	30163, 30363, 30563, 30763	75D3, 769B, 7763, 782B																																																																																																																																		
					-	-	-																																																																																																																																		

Screen example		No.	Buffer memory address	
			DEC	HEX
		1)	31645, 31895, 32145, 32395	7B9D, 7C97, 7D91, 7E8B
		2)	31646, 31896, 32146, 32396	7B9E, 7C98, 7D92, 7E8C
		3)		
		4)	31647, 31897, 32147, 32397	7B9F, 7C99, 7D93, 7E8D
		5)	31648, 31898, 32148, 32398	7BA0, 7C9A, 7D94, 7E8E
		6)		
		7)		
		8)		
		9)		
		1)	31649, 31899, 32149, 32399	7BA1, 7C9B, 7D95, 7E8F
		2)	31650, 31900, 32150, 32400	7BA2, 7C9C, 7D96, 7E90
		3)		
		4)	31651, 31901, 32151, 32401	7BA3, 7C9D, 7D97, 7E91
		5)	31652, 31902, 32152, 32402	7BA4, 7C9E, 7D98, 7E92
		6)	31653, 31903, 32153, 32403	7BA5, 7C9F, 7D99, 7E93
		7)	31654, 31904, 32154, 32404	7BA6, 7CA0, 7D9A, 7E94
		8)		
		9)		
		1)	31455, 31705, 31955, 32205	7ADF, 7BD9, 7CD3, 7DCD
		2)	31456, 31706, 31956, 32206	7AE0, 7BDA, 7CD4, 7DCE
		3)	31457, 31707, 31957, 32207	7AE1, 7BDB, 7CD5, 7DCF
		4)	31458, 31708, 31958, 32208	7AE2, 7BDC, 7CD6, 7DD0
		5)	31459, 31709, 31959, 32209	7AE3, 7BDD, 7CD7, 7DD1
		6)		
		7)		
		8)		

1 OVERVIEW
2 SYSTEM MONITOR
3 LADDER MONITOR FUNCTION
4 MELSEC-A LIST EDITOR
5 MELSEC-FX LIST EDITOR
6 INTELLIGENT MODULE MONITOR
7 NETWORK MONITOR
8 Q MOTION MONITOR

Screen example		No.	Buffer memory address																																																							
			DEC	HEX																																																						
<p>QD77MS4 Servo parameter Ex. setting1-1</p> <table border="1"> <thead> <tr> <th>Item</th> <th>Axis1</th> <th>Axis2</th> <th>Axis3</th> <th>Axis4</th> <th>Setting range</th> </tr> </thead> <tbody> <tr> <td>1) Limit sensitive level</td> <td>1</td> <td>1</td> <td>1</td> <td>1</td> <td>1 to 2000[rev]</td> </tr> <tr> <td>2) EM brake sequence</td> <td>0</td> <td>0</td> <td>0</td> <td>0</td> <td>0 to 1000[ms]</td> </tr> <tr> <td>3) Encoder pulse output direction selection</td> <td>1</td> <td>0</td> <td>0</td> <td>0</td> <td>0:0CW 1:0CW (progress to A phases 90°)</td> </tr> <tr> <td>4) Encoder pulse output setting selection</td> <td>0</td> <td>0</td> <td>0</td> <td>0</td> <td>0:Output pulse dsgr. 1:Division ratio setting</td> </tr> <tr> <td>5) Function selection C1 Serial encoder cable</td> <td>0</td> <td>0</td> <td>0</td> <td>0</td> <td>0:2-wire 1:4-wire</td> </tr> <tr> <td>6) Function selection C2 Motor-less operation</td> <td>0</td> <td>0</td> <td>0</td> <td>0</td> <td>0:Invalid 1:Valid</td> </tr> <tr> <td>7) Zero speed</td> <td>0</td> <td>0</td> <td>0</td> <td>0</td> <td>0 to 10000[r/min]</td> </tr> </tbody> </table>		Item	Axis1	Axis2	Axis3	Axis4	Setting range	1) Limit sensitive level	1	1	1	1	1 to 2000[rev]	2) EM brake sequence	0	0	0	0	0 to 1000[ms]	3) Encoder pulse output direction selection	1	0	0	0	0:0CW 1:0CW (progress to A phases 90°)	4) Encoder pulse output setting selection	0	0	0	0	0:Output pulse dsgr. 1:Division ratio setting	5) Function selection C1 Serial encoder cable	0	0	0	0	0:2-wire 1:4-wire	6) Function selection C2 Motor-less operation	0	0	0	0	0:Invalid 1:Valid	7) Zero speed	0	0	0	0	0 to 10000[r/min]	1)	30164, 30364, 30564, 30764	75D4, 769C, 7764, 782C						
Item	Axis1	Axis2	Axis3	Axis4	Setting range																																																					
1) Limit sensitive level	1	1	1	1	1 to 2000[rev]																																																					
2) EM brake sequence	0	0	0	0	0 to 1000[ms]																																																					
3) Encoder pulse output direction selection	1	0	0	0	0:0CW 1:0CW (progress to A phases 90°)																																																					
4) Encoder pulse output setting selection	0	0	0	0	0:Output pulse dsgr. 1:Division ratio setting																																																					
5) Function selection C1 Serial encoder cable	0	0	0	0	0:2-wire 1:4-wire																																																					
6) Function selection C2 Motor-less operation	0	0	0	0	0:Invalid 1:Valid																																																					
7) Zero speed	0	0	0	0	0 to 10000[r/min]																																																					
		2)	30165, 30365, 30565, 30765	75D5, 769D, 7765, 782D																																																						
		3)	30166, 30366, 30566, 30766	75D6, 769E, 7766, 782E																																																						
		4)	30167, 30367, 30567, 30767	75D7, 769F, 7767, 782F																																																						
		5)	30168, 30368, 30568, 30768	75D8, 76A0, 7768, 7830																																																						
		6)	30168, 30368, 30568, 30768	75D8, 76A0, 7768, 7830																																																						
		7)	30170, 30370, 30570, 30770	75DA, 76A2, 776A, 7832																																																						
		-	-	-																																																						
<p>QD77MS4 Servo parameter Ex. setting1-2</p> <table border="1"> <thead> <tr> <th>Item</th> <th>Axis1</th> <th>Axis2</th> <th>Axis3</th> <th>Axis4</th> <th>Setting range</th> </tr> </thead> <tbody> <tr> <td>Analog monitor 1 offset</td> <td>999</td> <td>777</td> <td>777</td> <td>777</td> <td>000 to 999[ms]</td> </tr> <tr> <td>Analog monitor 2 offset</td> <td>100</td> <td>444</td> <td>777</td> <td>777</td> <td>000 to 999[ms]</td> </tr> <tr> <td>Analog monitor output selection(ch1)</td> <td>00</td> <td>00</td> <td>00</td> <td>00</td> <td></td> </tr> <tr> <td>Analog monitor output selection(ch2)</td> <td>00</td> <td>00</td> <td>00</td> <td>00</td> <td></td> </tr> </tbody> </table> <p>Setting range</p> <p>0:Servo motor speed(±8V/max. speed) 1:Torque(±8V/max. torque) 2:Servo motor speed(+8V/max. speed) 3:Torque(+8V/max. torque) 4:Current command(±8V/max. currc) 5:Command speed(±8V/max. command speed) 6:Droop puls(±10V/100puls[Encoder unit]) 7:Droop puls(±10V/1000puls[Encoder unit]) 8:Droop puls(±10V/10000puls[Encoder unit]) 9:Droop puls(±10V/100000puls[Encoder unit]) A:Feedback position(±10V/1,000,000puls[Encoder unit]) B:Feedback position(±10V/10,000,000puls[Encoder unit]) C:Feedback position(±10V/100,000,000puls[Encoder unit]) D:Bus voltage(+8V/400V, Amplifier of 200V) Bus voltage(+8V/800V, Amplifier of 400V) E·F·15~1F:Un-output(Zero output)</p>		Item	Axis1	Axis2	Axis3	Axis4	Setting range	Analog monitor 1 offset	999	777	777	777	000 to 999[ms]	Analog monitor 2 offset	100	444	777	777	000 to 999[ms]	Analog monitor output selection(ch1)	00	00	00	00		Analog monitor output selection(ch2)	00	00	00	00		1)	30174, 30374, 30574, 30774	75DE, 76A6, 776E, 7836																								
Item	Axis1	Axis2	Axis3	Axis4	Setting range																																																					
Analog monitor 1 offset	999	777	777	777	000 to 999[ms]																																																					
Analog monitor 2 offset	100	444	777	777	000 to 999[ms]																																																					
Analog monitor output selection(ch1)	00	00	00	00																																																						
Analog monitor output selection(ch2)	00	00	00	00																																																						
		2)	30175, 30375, 30575, 30775	75DF, 76A7, 776F, 7837																																																						
		3)	30172, 30372, 30572, 30772	75DC, 76A4, 776C, 7834																																																						
		4)	30173, 30373, 30573, 30773	75DD, 76A5, 776D, 7835																																																						
		-	-	-																																																						
<p>QD77MS4 Servo parameter Ex. setting1-3</p> <table border="1"> <thead> <tr> <th>Item</th> <th>Axis1</th> <th>Axis2</th> <th>Axis3</th> <th>Axis4</th> <th>Setting range</th> </tr> </thead> <tbody> <tr> <td>Selection of the encoders for encoder output pulse</td> <td>0</td> <td>0</td> <td>0</td> <td>0</td> <td>0:Servo motor encoder 1:Load-side encoder</td> </tr> <tr> <td>Func. selection C-3 EE alarm level unit</td> <td>0</td> <td>0</td> <td>0</td> <td>0</td> <td>0 to 3</td> </tr> <tr> <td>OS alarm detect. level</td> <td>0</td> <td>0</td> <td>0</td> <td>0</td> <td>0 to 20000[r/min]</td> </tr> <tr> <td>Func. selection C-4 home position setting condition</td> <td>0</td> <td>0</td> <td>0</td> <td>0</td> <td>0:2-phase after power on 1:Need to pass 2:Not need to pass</td> </tr> <tr> <td>Func. selection C-5 [AL. E9 Main circuit off warning]</td> <td>0</td> <td>0</td> <td>0</td> <td>0</td> <td>0:ready on and servo on 1:servo-on</td> </tr> <tr> <td>Func. selection C-7 Undervoltage alarm</td> <td>0</td> <td>0</td> <td>0</td> <td>0</td> <td>0:Method 1 1:Method 2</td> </tr> <tr> <td>Alarm history clear</td> <td>0</td> <td>0</td> <td>0</td> <td>0</td> <td>0:Disabled 1:Enabled</td> </tr> <tr> <td>FS dec. time constant</td> <td>0</td> <td>0</td> <td>0</td> <td>0</td> <td>0 to 20000[ms]</td> </tr> </tbody> </table>		Item	Axis1	Axis2	Axis3	Axis4	Setting range	Selection of the encoders for encoder output pulse	0	0	0	0	0:Servo motor encoder 1:Load-side encoder	Func. selection C-3 EE alarm level unit	0	0	0	0	0 to 3	OS alarm detect. level	0	0	0	0	0 to 20000[r/min]	Func. selection C-4 home position setting condition	0	0	0	0	0:2-phase after power on 1:Need to pass 2:Not need to pass	Func. selection C-5 [AL. E9 Main circuit off warning]	0	0	0	0	0:ready on and servo on 1:servo-on	Func. selection C-7 Undervoltage alarm	0	0	0	0	0:Method 1 1:Method 2	Alarm history clear	0	0	0	0	0:Disabled 1:Enabled	FS dec. time constant	0	0	0	0	0 to 20000[ms]	1)	30166, 30366, 30566, 30766	75D6, 769E, 7766, 782E
Item	Axis1	Axis2	Axis3	Axis4	Setting range																																																					
Selection of the encoders for encoder output pulse	0	0	0	0	0:Servo motor encoder 1:Load-side encoder																																																					
Func. selection C-3 EE alarm level unit	0	0	0	0	0 to 3																																																					
OS alarm detect. level	0	0	0	0	0 to 20000[r/min]																																																					
Func. selection C-4 home position setting condition	0	0	0	0	0:2-phase after power on 1:Need to pass 2:Not need to pass																																																					
Func. selection C-5 [AL. E9 Main circuit off warning]	0	0	0	0	0:ready on and servo on 1:servo-on																																																					
Func. selection C-7 Undervoltage alarm	0	0	0	0	0:Method 1 1:Method 2																																																					
Alarm history clear	0	0	0	0	0:Disabled 1:Enabled																																																					
FS dec. time constant	0	0	0	0	0 to 20000[ms]																																																					
		2)	30169, 30369, 30569, 30769	75D9, 76A1, 7769, 7831																																																						
		3)	30171, 30371, 30571, 30771	75DB, 76A3, 776B, 7833																																																						
		4)	30180, 30380, 30580, 30780	75E4, 76AC, 7774, 783C																																																						
		5)	30181, 30381, 30581, 30781	75E5, 76AD, 7775, 783D																																																						
		6)	30183, 30383, 30583, 30783	75E7, 76AF, 7777, 783F																																																						
		7)	30184, 30384, 30584, 30784	75E8, 76B0, 7778, 7840																																																						
		8)	30187, 30387, 30587, 30787	75EB, 76B3, 777B, 7843																																																						
		-	-	-																																																						

Screen example						No.	Buffer memory address	
							DEC	HEX
						1)	30190, 30390, 30590, 30790	75EE, 76B6, 777E, 7846
						2)	30192, 30392, 30592, 30792	75F0, 76B8, 7780, 7848
						3)	30194, 30394,	75F2, 76BA,
						4)	30594, 30794	7782, 784A
						-	-	-
						1)	30202, 30402, 30602, 30802	75FA, 76C2, 778A, 7852
						2)	30203, 30403, 30603, 30803	75FB, 76C3, 778B, 7853
						3)	30204, 30404, 30604, 30804	75FC, 76C4, 778C, 7854
						4)	30207, 30407, 30607, 30807	75FF, 76C7, 778F, 7857
						5)	30209, 30409, 30609, 30809	7601, 76C9, 7791, 7859
						-	-	-
						1)	30228, 30428, 30628, 30828	7614, 76DC, 77A4, 786C
						2)	30230, 30430, 30630, 30830	7616, 76DE, 77A6, 786E
						3)		
						4)		
						5)	30231, 30431, 30631, 30831	7617, 76DF, 77A7, 786F
						6)	30232, 30432, 30632, 30832	7618, 76E0, 77A8, 7870
						7)	30233, 30433, 30633, 30833	7619, 76E1, 77A9, 7871
						8)	30234, 30434, 30634, 30834	761A, 76E2, 77AA, 7872
						-	-	-

- 1 OVERVIEW
- 2 SYSTEM MONITOR
- 3 LADDER MONITOR FUNCTION
- 4 MELSEC-A LIST EDITOR
- 5 MELSEC-FX LIST EDITOR
- 6 INTELLIGENT MODULE MONITOR
- 7 NETWORK MONITOR
- 8 Q MOTION MONITOR

Screen example						No.	Buffer memory address		
							DEC	HEX	
						1)	30235, 30435, 30635, 30835	761B, 76E3, 77AB, 7873	
1)	Fully closed loop dual feedback filter	0	0	0	0	0 to 4500[rad/s]	2)	30237, 30437, 30637, 30837	761D, 76E5, 77AD, 7875
2)	Posit. deviation error detection level	0	0	0	0	0:1kpulse unit 1:1pulse unit	3)		
3)	Droop pulse mon. selection for controller disp.	0	0	0	0	0:Servo motor encoder 1:Load-side encoder 2:Deviation between S&L	4)		
4)	FB pulses mon. selection for controller disp.	0	0	0	0	0:Servo motor encoder 1:Load-side encoder	5)	30261, 30461, 30661, 30861	7635, 76FD, 77C5, 788D
5)	Feedback pulse E032 Numerator	1000	1000	1000	1000	1 to 65535	6)	30262, 30462, 30662, 30862	7636, 76FE, 77C6, 788E
6)	Feedback pulse E032 Denominator	1000	1000	1000	23456	1 to 65535	-	-	-
						1)	31712, 31962, 32212, 32462	78E0, 7CDA, 7DD4, 7ECE	
	Function selection E3 Robust filter select.	0	0	0	0	0:Disabled 1:Enabled	-	-	-
						1)	30905, 30955, 31005, 31055	78B9, 78EB, 791D, 794F	
	Func. selection F-5 Electronic dynamic brake	0	0	0	0	0:Automatic 2:Disabled	2)	30911, 30961, 31011, 31061	78BF, 78F1, 7923, 7955
	Electronic dynamic brake operating time	0	0	0	0	0 ~ 10000[ms]	-	-	-

Screen example						No.	Buffer memory address																																																																							
							DEC	HEX																																																																						
QD77MS4 Servo parameter Ex. setting3-2 <table border="1"> <thead> <tr> <th>Item</th> <th>Axis1</th> <th>Axis2</th> <th>Axis3</th> <th>Axis4</th> <th>Setting range</th> </tr> </thead> <tbody> <tr> <td>Drive recorder switching time set.</td> <td>0</td> <td>0</td> <td>0</td> <td>0</td> <td>-1 to 32767[ms]</td> </tr> <tr> <td>Vibration tough drive OSC detection level</td> <td>0</td> <td>0</td> <td>0</td> <td>0</td> <td>0 to 100[%]</td> </tr> <tr> <td>Vibration tough drive Oscillation detection alarm selection</td> <td>0</td> <td>0</td> <td>0</td> <td>0</td> <td>0:[AL.54 OSC detection] 1:[AL.F3.1 OSC detect.] 2: function disabled</td> </tr> <tr> <td>power failure tough drive - Detect. time</td> <td>30</td> <td>100</td> <td>100</td> <td>100</td> <td>30 to 200[ms]</td> </tr> <tr> <td>Machine diagnosis function - Friction judgement speed</td> <td>0</td> <td>0</td> <td>0</td> <td>0</td> <td>0 to Permissible speed [r/min]</td> </tr> </tbody> </table>						Item	Axis1	Axis2	Axis3	Axis4	Setting range	Drive recorder switching time set.	0	0	0	0	-1 to 32767[ms]	Vibration tough drive OSC detection level	0	0	0	0	0 to 100[%]	Vibration tough drive Oscillation detection alarm selection	0	0	0	0	0:[AL.54 OSC detection] 1:[AL.F3.1 OSC detect.] 2: function disabled	power failure tough drive - Detect. time	30	100	100	100	30 to 200[ms]	Machine diagnosis function - Friction judgement speed	0	0	0	0	0 to Permissible speed [r/min]	1)	31740, 31990, 32240, 32490	7BFC, 7CF6, 7DF0, 7EEA																																		
Item	Axis1	Axis2	Axis3	Axis4	Setting range																																																																									
Drive recorder switching time set.	0	0	0	0	-1 to 32767[ms]																																																																									
Vibration tough drive OSC detection level	0	0	0	0	0 to 100[%]																																																																									
Vibration tough drive Oscillation detection alarm selection	0	0	0	0	0:[AL.54 OSC detection] 1:[AL.F3.1 OSC detect.] 2: function disabled																																																																									
power failure tough drive - Detect. time	30	100	100	100	30 to 200[ms]																																																																									
Machine diagnosis function - Friction judgement speed	0	0	0	0	0 to Permissible speed [r/min]																																																																									
						2)	31742, 31992, 32242, 32492	7BFE, 7CF8, 7DF2, 7EEC																																																																						
						3)	31743, 31993, 32243, 32493	7BFF, 7CF9, 7DF3, 7EED																																																																						
						4)	31744, 31994, 32244, 32494	7C00, 7CFA, 7DF4, 7EEE																																																																						
						5)	31750, 32000, 32250, 32500	7C06, 7D00, 7DFA, 7EF4																																																																						
						-	-	-																																																																						
QD77MS4 Servo parameter Motor setting1 <table border="1"> <thead> <tr> <th>Item</th> <th>Axis1</th> <th>Axis2</th> <th>Axis3</th> <th>Axis4</th> <th>Setting range</th> </tr> </thead> <tbody> <tr> <td>motor magnetic pole detection selection</td> <td>0</td> <td>0</td> <td>0</td> <td>0</td> <td>0: detection disabled 1: at first servo-on 5: at every servo-on</td> </tr> <tr> <td>Stop interval selection at the home position return</td> <td>0</td> <td>0</td> <td>0</td> <td>0</td> <td>0: 8192 pulses 1: 131072 pulses 2: 262144 pulses 3: 1048576 pulses 4: 4194304 pulses 5: 16777216 pulses 6: 67108864 pulses</td> </tr> <tr> <td>Linear encoder resolution - Numerator</td> <td>1</td> <td>1</td> <td>1</td> <td>1</td> <td>1 to 65535[um]</td> </tr> <tr> <td>Linear encoder resolution - Denominator</td> <td>1</td> <td>1</td> <td>1</td> <td>1</td> <td>1 to 65535[um]</td> </tr> </tbody> </table>						Item	Axis1	Axis2	Axis3	Axis4	Setting range	motor magnetic pole detection selection	0	0	0	0	0: detection disabled 1: at first servo-on 5: at every servo-on	Stop interval selection at the home position return	0	0	0	0	0: 8192 pulses 1: 131072 pulses 2: 262144 pulses 3: 1048576 pulses 4: 4194304 pulses 5: 16777216 pulses 6: 67108864 pulses	Linear encoder resolution - Numerator	1	1	1	1	1 to 65535[um]	Linear encoder resolution - Denominator	1	1	1	1	1 to 65535[um]	1)	31784, 32034, 32284, 32534	7C28, 7D22, 7E1C, 7F16																																								
Item	Axis1	Axis2	Axis3	Axis4	Setting range																																																																									
motor magnetic pole detection selection	0	0	0	0	0: detection disabled 1: at first servo-on 5: at every servo-on																																																																									
Stop interval selection at the home position return	0	0	0	0	0: 8192 pulses 1: 131072 pulses 2: 262144 pulses 3: 1048576 pulses 4: 4194304 pulses 5: 16777216 pulses 6: 67108864 pulses																																																																									
Linear encoder resolution - Numerator	1	1	1	1	1 to 65535[um]																																																																									
Linear encoder resolution - Denominator	1	1	1	1	1 to 65535[um]																																																																									
						2)	31784, 32034, 32284, 32534	7C28, 7D22, 7E1C, 7F16																																																																						
						3)	31785, 32035, 32285, 32535	7C29, 7D23, 7E1D, 7F17																																																																						
						4)	31786, 32036, 32286, 32536	7C2A, 7D24, 7E1E, 7F18																																																																						
						-	-	-																																																																						
QD77MS4 Servo parameter Motor setting2 <table border="1"> <thead> <tr> <th>Item</th> <th>Axis1</th> <th>Axis2</th> <th>Axis3</th> <th>Axis4</th> <th>Setting range</th> </tr> </thead> <tbody> <tr> <td>Linear servo motor/DD motor function select.2 [AL.42] detection function selection</td> <td>0</td> <td>0</td> <td>0</td> <td>6</td> <td></td> </tr> <tr> <td rowspan="7">Setting range</td> <td>value</td> <td>TRQ/thrust deviation</td> <td>Speed deviation error</td> <td>Posit. deviation error</td> <td></td> </tr> <tr> <td>0</td> <td>Disabled</td> <td>Disabled</td> <td>Disabled</td> <td></td> </tr> <tr> <td>1</td> <td>Disabled</td> <td>Enabled</td> <td>Enabled</td> <td></td> </tr> <tr> <td>2</td> <td>Disabled</td> <td>Enabled</td> <td>Disabled</td> <td></td> </tr> <tr> <td>3</td> <td>Disabled</td> <td>Enabled</td> <td>Enabled</td> <td></td> </tr> <tr> <td>4</td> <td>Enabled</td> <td>Disabled</td> <td>Disabled</td> <td></td> </tr> <tr> <td>5</td> <td>Enabled</td> <td>Enabled</td> <td>Enabled</td> <td></td> </tr> <tr> <td>6</td> <td>Enabled</td> <td>Enabled</td> <td>Disabled</td> <td></td> </tr> <tr> <td>7</td> <td>Enabled</td> <td>Enabled</td> <td>Enabled</td> <td></td> </tr> <tr> <td>Linear servo motor/DD motor function select.2 [AL.42] detection function controller reset</td> <td>0</td> <td>0</td> <td>0</td> <td>0</td> <td></td> </tr> <tr> <td>Setting range</td> <td colspan="2">0: Reset disabled</td> <td colspan="2">1: Reset enabled</td> <td></td> </tr> </tbody> </table>						Item	Axis1	Axis2	Axis3	Axis4	Setting range	Linear servo motor/DD motor function select.2 [AL.42] detection function selection	0	0	0	6		Setting range	value	TRQ/thrust deviation	Speed deviation error	Posit. deviation error		0	Disabled	Disabled	Disabled		1	Disabled	Enabled	Enabled		2	Disabled	Enabled	Disabled		3	Disabled	Enabled	Enabled		4	Enabled	Disabled	Disabled		5	Enabled	Enabled	Enabled		6	Enabled	Enabled	Disabled		7	Enabled	Enabled	Enabled		Linear servo motor/DD motor function select.2 [AL.42] detection function controller reset	0	0	0	0		Setting range	0: Reset disabled		1: Reset enabled			1)	31787, 32037, 32287, 32537	7C2B, 7D25, 7E1F, 7F19
Item	Axis1	Axis2	Axis3	Axis4	Setting range																																																																									
Linear servo motor/DD motor function select.2 [AL.42] detection function selection	0	0	0	6																																																																										
Setting range	value	TRQ/thrust deviation	Speed deviation error	Posit. deviation error																																																																										
	0	Disabled	Disabled	Disabled																																																																										
	1	Disabled	Enabled	Enabled																																																																										
	2	Disabled	Enabled	Disabled																																																																										
	3	Disabled	Enabled	Enabled																																																																										
	4	Enabled	Disabled	Disabled																																																																										
	5	Enabled	Enabled	Enabled																																																																										
6	Enabled	Enabled	Disabled																																																																											
7	Enabled	Enabled	Enabled																																																																											
Linear servo motor/DD motor function select.2 [AL.42] detection function controller reset	0	0	0	0																																																																										
Setting range	0: Reset disabled		1: Reset enabled																																																																											
						2)	-	-																																																																						

- 1 OVERVIEW
- 2 SYSTEM MONITOR
- 3 LADDER MONITOR FUNCTION
- 4 MELSEC-A LIST EDITOR
- 5 MELSEC-FX LIST EDITOR
- 6 INTELLIGENT MODULE MONITOR
- 7 NETWORK MONITOR
- 8 Q MOTION MONITOR

Screen example	No.	Buffer memory address																																																													
		DEC	HEX																																																												
<p>QD77MS4 Servo parameter Motor setting3</p> <table border="1"> <thead> <tr> <th>Item</th> <th>Axis1</th> <th>Axis2</th> <th>Axis3</th> <th>Axis4</th> <th>Setting range</th> </tr> </thead> <tbody> <tr> <td>Position deviation error detection level</td> <td>0</td> <td>0</td> <td>0</td> <td>0</td> <td>0 to 1000[mm]/[0.01rev]</td> </tr> <tr> <td>Speed deviation error detection level</td> <td>0</td> <td>0</td> <td>0</td> <td>0</td> <td>0 to 5000[mm/s]/[r/min]</td> </tr> <tr> <td>TRQ/thrust deviation error detection level</td> <td>0</td> <td>0</td> <td>0</td> <td>0</td> <td>0 to 1000[%]</td> </tr> <tr> <td>Magnetic pole detection volt. level</td> <td>0</td> <td>0</td> <td>0</td> <td>0</td> <td>0 to 100[%]</td> </tr> </tbody> </table> <table border="1"> <thead> <tr> <th>Item</th> <th>Axis1</th> <th>Axis2</th> <th>Axis3</th> <th>Axis4</th> </tr> </thead> <tbody> <tr> <td>Linear servo motor/DD motor func. selection3</td> <td>0</td> <td>0</td> <td>0</td> <td>0</td> </tr> <tr> <td>Magnetic pole detection method selection</td> <td colspan="4">0:Position detection 4:Minute position detection</td> </tr> </tbody> </table> <table border="1"> <thead> <tr> <th>Item</th> <th>Axis1</th> <th>Axis2</th> <th>Axis3</th> <th>Axis4</th> </tr> </thead> <tbody> <tr> <td>Linear servo motor/DD motor func. selection3</td> <td>0</td> <td>0</td> <td>0</td> <td>0</td> </tr> <tr> <td>Stroke limit enabled/disabled selection</td> <td colspan="4">0:Enabled 1:Disabled</td> </tr> </tbody> </table>	Item	Axis1	Axis2	Axis3	Axis4	Setting range	Position deviation error detection level	0	0	0	0	0 to 1000[mm]/[0.01rev]	Speed deviation error detection level	0	0	0	0	0 to 5000[mm/s]/[r/min]	TRQ/thrust deviation error detection level	0	0	0	0	0 to 1000[%]	Magnetic pole detection volt. level	0	0	0	0	0 to 100[%]	Item	Axis1	Axis2	Axis3	Axis4	Linear servo motor/DD motor func. selection3	0	0	0	0	Magnetic pole detection method selection	0:Position detection 4:Minute position detection				Item	Axis1	Axis2	Axis3	Axis4	Linear servo motor/DD motor func. selection3	0	0	0	0	Stroke limit enabled/disabled selection	0:Enabled 1:Disabled				1)	31788, 32038, 32288, 32538	7C2C, 7D26, 7E20, 7F1A
	Item	Axis1	Axis2	Axis3	Axis4	Setting range																																																									
	Position deviation error detection level	0	0	0	0	0 to 1000[mm]/[0.01rev]																																																									
	Speed deviation error detection level	0	0	0	0	0 to 5000[mm/s]/[r/min]																																																									
	TRQ/thrust deviation error detection level	0	0	0	0	0 to 1000[%]																																																									
	Magnetic pole detection volt. level	0	0	0	0	0 to 100[%]																																																									
Item	Axis1	Axis2	Axis3	Axis4																																																											
Linear servo motor/DD motor func. selection3	0	0	0	0																																																											
Magnetic pole detection method selection	0:Position detection 4:Minute position detection																																																														
Item	Axis1	Axis2	Axis3	Axis4																																																											
Linear servo motor/DD motor func. selection3	0	0	0	0																																																											
Stroke limit enabled/disabled selection	0:Enabled 1:Disabled																																																														
	2)	31789, 32039, 32289, 32539	7C2D, 7D27, 7E21, 7F1B																																																												
	3)	31790, 32040, 32290, 32540	7C2E, 7D28, 7E22, 7F1C																																																												
	4)	31792, 32042, 32292, 32542	7C30, 7D2A, 7E24, 7F1E																																																												
	5)	31791, 32041, 32291, 32541	7C2F, 7D29, 7E23, 7F1D																																																												
	6)	-	-																																																												
<p>QD77MS4 Servo parameter Motor setting4</p> <table border="1"> <thead> <tr> <th>Item</th> <th>Axis1</th> <th>Axis2</th> <th>Axis3</th> <th>Axis4</th> <th>Setting range</th> </tr> </thead> <tbody> <tr> <td>Minute position detection method selection</td> <td>0</td> <td>0</td> <td>0</td> <td>0</td> <td>0:Low F:High Low F:Middle F:High</td> </tr> <tr> <td>Load to motor mass ratio/load to motor inertia ratio selection</td> <td>0</td> <td>0</td> <td>0</td> <td>0</td> <td>0:10times or less 1toF:10times to140times F:150times or more</td> </tr> <tr> <td>Minute position detection method identification signal amplitude</td> <td>0</td> <td>0</td> <td>0</td> <td>0</td> <td>0 to 100[%]</td> </tr> </tbody> </table>	Item	Axis1	Axis2	Axis3	Axis4	Setting range	Minute position detection method selection	0	0	0	0	0:Low F:High Low F:Middle F:High	Load to motor mass ratio/load to motor inertia ratio selection	0	0	0	0	0:10times or less 1toF:10times to140times F:150times or more	Minute position detection method identification signal amplitude	0	0	0	0	0 to 100[%]	1)	31800, 32050, 32300, 32550	7C38, 7D32, 7E2C, 7F26																																				
	Item	Axis1	Axis2	Axis3	Axis4	Setting range																																																									
	Minute position detection method selection	0	0	0	0	0:Low F:High Low F:Middle F:High																																																									
Load to motor mass ratio/load to motor inertia ratio selection	0	0	0	0	0:10times or less 1toF:10times to140times F:150times or more																																																										
Minute position detection method identification signal amplitude	0	0	0	0	0 to 100[%]																																																										
	2)	31801, 32051, 32301, 32551	7C39, 7D33, 7E2D, 7F27																																																												
	3)	-	-																																																												

6.5.36 QD77MS16 module monitoring

Screen example

No.	Axis	Buffer memory address		No.	Axis	Buffer memory address		
		DEC	HEX			DEC	HEX	
1)	1 to 4	2400, 2500, 2600, 2700	960, 9C4, A28, A8C	4)	-	4231	1087	
	5 to 8	2800, 2900, 3000, 3100	AF0, B54, BB8, C1C		5)	1 to 4	2429, 2529, 2629, 2729	97D, 9E1, A45, AA9
	9 to 12	3200, 3300, 3400, 3500	C80, CE4, D48, DAC			5 to 8	2829, 2929, 3029, 3129	B0D, B71, BD5, C39
	13 to 16	3600, 3700, 3800, 3900	E10, E74, ED8, F3C			9 to 12	3229, 3329, 3429, 3529	C9D, D01, D65, DC9
2)	1 to 4	2412, 2512, 2612, 2712	96C, 9D0, A34, A98	6)	13 to 16	3629, 3729, 3829, 3929	E2D, E91, EF5, F59	
	5 to 8	2812, 2912, 3012, 3112	AFC, B60, BC4, C28		1 to 4	2438, 2538, 2638, 2738	986, 9EA, A4E, AB2	
	9 to 12	3212, 3312, 3412, 3512	C8C, CF0, D54, DB8		5 to 8	2838, 2938, 3038, 3138	B16, B7A, BDE, C42	
	13 to 16	3612, 3712, 3812, 3912	E1C, E80, EE4, F48		9 to 12	3238, 3338, 3438, 3538	CA6, D0A, D6E, DD2	
3)	1 to 4	2406 to 2409, 2506 to 2509, 2606 to 2609, 2706 to 2709	966 to 969, 9CA to 9CD, A2E to A31, A92 to A95	7)	13 to 16	3638, 3738, 3838, 3938	E36, E9A, EFE, F62	
		5 to 8	2806 to 2809, 2906 to 2909, 3006 to 3009, 3106 to 3109		AF6 to AF9, B5A to B5D, BBE to BC1, C22 to C25	1 to 4	2441, 2541, 2641, 2741	989, 9ED, A51, AB5
	9 to 12	3206 to 3209, 3306 to 3309, 3406 to 3409, 3506 to 3509	C86 to C89, CEA to CED, D4E to D51, DB2 to DB5		5 to 8	2841, 2941, 3041, 3141	B19, B7D, BE1, C45	
		13 to 16	3606 to 3609, 3706 to 3709, 3806 to 3809, 3906 to 3909		E16 to E19, E7A to E7D, EDE to EE1, F42 to F45	9 to 12	3241, 3341, 3441, 3541	CA9, D0D, D71, DD5
-	-	-	-	1 to 4	2438, 2538, 2638, 2738	986, 9EA, A4E, AB2		
-	-	-	-	5 to 8	2838, 2938, 3038, 3138	B16, B7A, BDE, C42		
-	-	-	-	9 to 12	3238, 3338, 3438, 3538	CA6, D0A, D6E, DD2		
-	-	-	-	13 to 16	3638, 3738, 3838, 3938	E36, E9A, EFE, F62		

Screen example

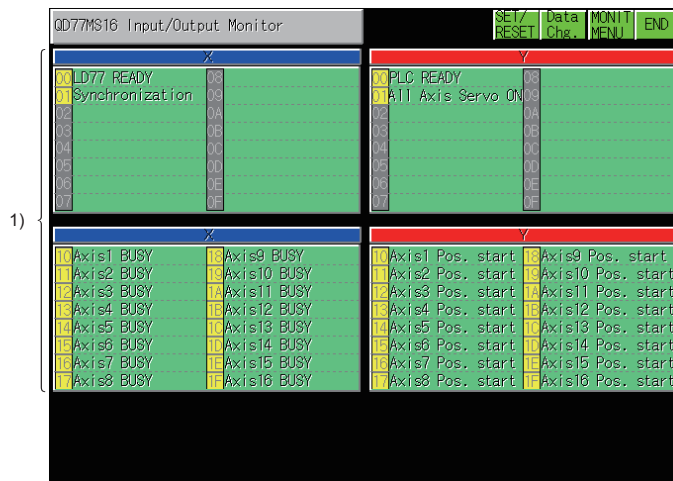

No.	Axis	Buffer memory address		No.	Axis	Buffer memory address	
		DEC	HEX			DEC	HEX
1)	-	-	-	-	-	-	-

Screen example

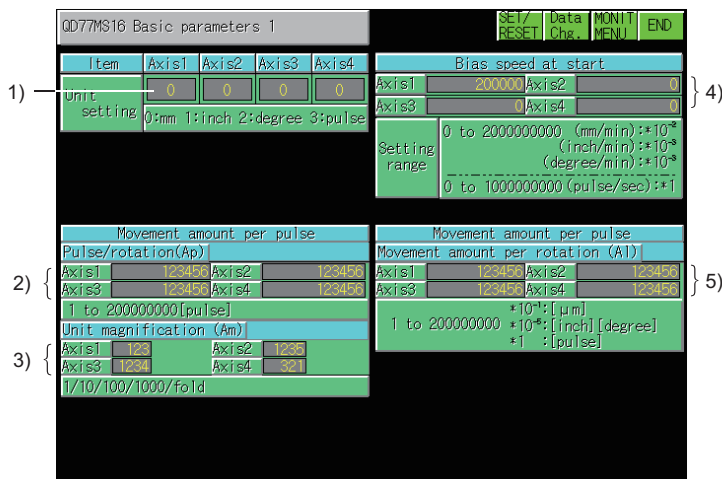

No.	Axis	Buffer memory address		No.	Axis	Buffer memory address	
		DEC	HEX			DEC	HEX
1)	1 to 4	0, 150, 300, 450	0, 96, 12C, 1C2	4)	1 to 4	6 to 7, 156 to 157, 306 to 307, 456 to 457	6 to 7, 9C to 9D, 132 to 133, 1C8 to 1C9
	5 to 8	600, 750, 900, 1050,	258, 2EE, 3E8, 47E		5 to 8	606 to 607, 756 to 757, 906 to 907, 1056 to 1057	25E to 25F, 2F4 to 2F5, 38A to 38B, 420 to 421
	9 to 12	1200, 1350, 1500, 1650	514, 5AA, 640, 6D6		9 to 12	1206 to 1207, 1356 to 1357, 1506 to 1507, 1656 to 1657	4B6 to 4B7, 54C to 54D, 5E2 to 5E3, 678 to 679
	13 to 16	1800, 1950, 2100, 2250	708, 79E, 834, 8CA		13 to 16	1806 to 1807, 1956 to 1957, 2106 to 2107, 2256 to 2257	70E to 70F, 7A4 to 7A5, 83A to 83B, 8D0 to 8D1
2)	1 to 4	2 to 3, 152 to 153, 302 to 303, 452 to 453	2 to 3, 98 to 99, 12E to 12F, 1C4 to 1C5	5)	1 to 4	4 to 5, 154 to 155, 304 to 305, 454 to 455	4 to 5, 9A to 9B, 130 to 131 1C6 to 1C7
	5 to 8	602 to 603, 752 to 753, 902 to 903, 1052 to 1053	25A to 25B, 2F0 to 2F1, 386 to 387, 41C to 41D		5 to 8	604 to 605, 754 to 755, 904 to 905, 1054 to 1055	25C to 25D, 2F2 to 2F3, 388 to 389, 41E to 41F
	9 to 12	1202 to 1203, 1352 to 1353, 1502 to 1503, 1652 to 1653	4B2 to 4B3, 548 to 549, 5DE to 5DF, 674 to 675		9 to 12	1204 to 1205, 1354 to 1355, 1504 to 1505, 1654 to 1655	4B4 to 4B5, 54A to 54B, 5E0 to 5E1, 676 to 677
	13 to 16	1802 to 1803, 1952 to 1953, 2102 to 2103, 2252 to 2253	70A to 70B, 7A0 to 7A1, 836 to 837, 8CC to 8CD		13 to 16	1804 to 1805, 1954 to 1955, 2104 to 2105, 2254 to 2255	70C to 70D, 7A2 to 7A3, 838 to 839, 8CE to 8CF
3)	1 to 4	1, 151, 301, 451	1, 97, 12D, 1C3	-	-	-	-
	5 to 8	601, 751, 901, 1051	259, 2EF, 385, 41B	-	-	-	-
	9 to 12	1201, 1351, 1501, 1651	4B1, 547, 5DD, 673	-	-	-	-
	13 to 16	1801, 1951, 2101, 2251	709, 79F, 835, 8CB	-	-	-	-

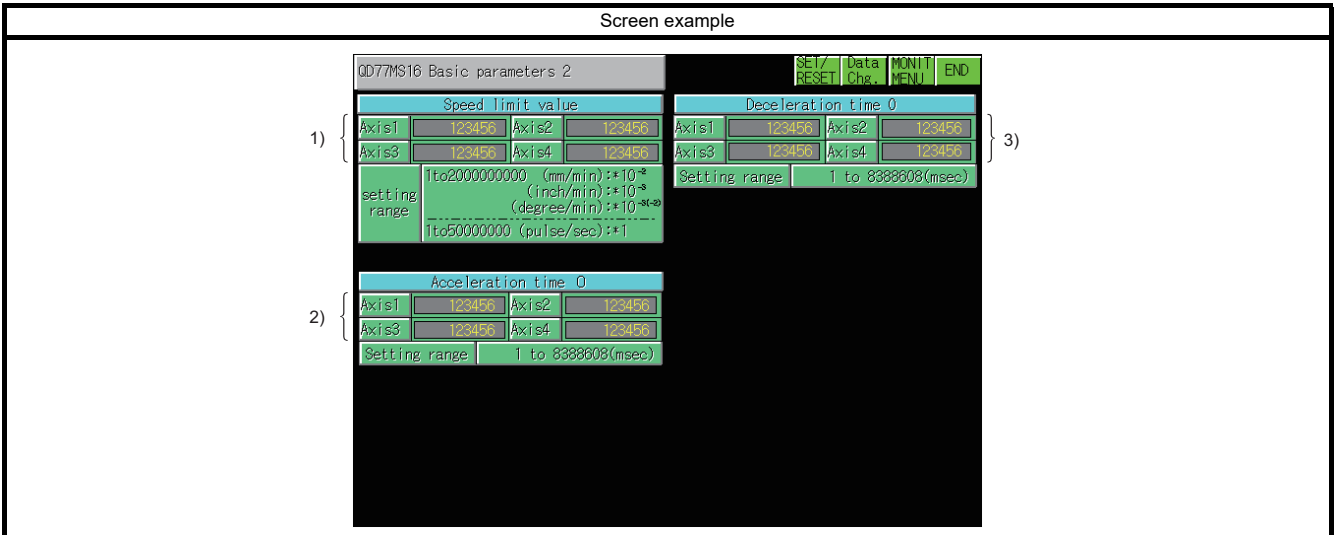

No.	Axis	Buffer memory address		No.	Axis	Buffer memory address	
		DEC	HEX			DEC	HEX
1)	1 to 4	10 to 11, 160 to 161, 310 to 311, 460 to 461	A to B, A0 to A1, 136 to 137, 1CC to 1CD	2)	9 to 12	1212 to 1213, 1362 to 1363, 1512 to 1513, 1662 to 1663	4BC to 4BD, 552 to 553, 5E8 to 5E9, 67E to 67F
	5 to 8	610 to 611, 760 to 761, 910 to 911, 1060 to 1061	262 to 263, 2F8 to 2F9, 2F8 to 2F9, 424 to 425		13 to 16	1812 to 1813, 1962 to 1963, 2112 to 2113, 2262 to 2263	714 to 715, 7AA to 7AB, 840 to 841, 8D6 to 8D7
	9 to 12	1210 to 1211, 1360 to 1361, 1510 to 1511, 1660 to 1661	4BA to 4BB, 550 to 551, 5E6 to 5E7, 67C to 67D	3)	1 to 4	14 to 15, 164 to 165, 314 to 315, 464 to 465	E to F, A4 to A5, 13A to 13B, 1D0 to 1D1
	13 to 16	1810 to 1811, 1960 to 1961, 2110 to 2111, 2260 to 2261	712 to 713, 7A8 to 7A9, 83E to 83F, 8D4 to 8D5		5 to 8	614 to 615, 764 to 765, 914 to 915, 1064 to 1065	266 to 267, 2FC to 2FD, 392 to 393, 428 to 429
2)	1 to 4	12 to 13, 162 to 163, 312 to 313, 462 to 463	C to D, A2 to A3, 138 to 139, 1CE to 1CF	9 to 12	1214 to 1215, 1364 to 1365, 1514 to 1515, 1664 to 1665	4BE to 4BF, 554 to 555, 5EA to 5EB, 680 to 681	
	5 to 8	612 to 613, 762 to 763, 912 to 913, 1062 to 1063	264 to 265, 2FA to 2FB, 390 to 391, 426 to 427	13 to 16	1814 to 1815, 1964 to 1965, 2114 to 2115, 2264 to 2265	716 to 717, 7AC to 7AD, 842 to 843, 8D8 to 8D9	

- 1 OVERVIEW
- 2 SYSTEM MONITOR
- 3 LADDER MONITOR FUNCTION
- 4 MELSEC-A LIST EDITOR
- 5 MELSEC-FX LIST EDITOR
- 6 INTELLIGENT MODULE MONITOR
- 7 NETWORK MONITOR
- 8 Q MOTION MONITOR

Screen example

4)

QD77MS16 Detailed parameters 1-1

Backlash compensation amount				Man-pl: input selection			
Axis1	Axis2	Axis3	Axis4	Axis1	Axis2	Axis3	Axis4
3456	123456	65535	0	0	-	-	-
setting range: 0 to 65535				Setting range:			
(μm):*10 ⁻¹ (inch):*10 ⁻⁵ (degree):*10 ⁻⁵ (pulse):*1				0:A-phase/B-phase/multiplied by 4 1:A-phase/B-phase/multiplied by 2 2:A-phase/B-phase/multiplied by 1 3:PLS/SIGN			

Software stroke upper limit value		Item		Ax.1	Ax.2	Ax.3	Ax.4	Set Range
High limit	Ax.1: 123456 Ax.3: 123456	Ax.2: 123456 Ax.4: 123456	S/W stroke limit select	0	0	0	0	0:0r feed 1:1r feed
Low limit	Ax.1: 0 Ax.3: 0	Ax.2: 0 Ax.4: 0	S/W stroke limit OK/NG setting	0	0	0	0	0:valid 1:invalid

Torque limit set value			
Axis1	Axis2	Axis3	Axis4
100	1000	50	1
1 ~ 1000(%)			

1) points to the Backlash compensation amount table.

2) points to the Software stroke upper limit value table.

3) points to the Software stroke upper limit value table.

5) points to the S/W stroke limit select table.

6) points to the S/W stroke limit OK/NG setting table.

7) points to the Torque limit set value table.

No.	Axis	Buffer memory address		No.	Axis	Buffer memory address		
		DEC	HEX			DEC	HEX	
1)	1 to 4	17, 167, 317, 467	11, A7, 13D, 1D3	3)	13 to 16	1820 to 1821, 1970 to 1971, 2120 to 2121, 2270 to 2271	71C to 71D, 7B2 to 7B3, 848 to 849, 8DE to 8DF	
	5 to 8	617, 767, 917, 1067	617, 767, 917, 1067		4)	-	33	21
	9 to 12	1217, 1367, 1517, 1667	1217, 1367, 1517, 1667		5)	1 to 4	22, 172, 322, 472	16, AC, 142, 1D8
	13 to 16	1817, 1967, 2117, 2267	1817, 1967, 2117, 2267			5 to 8	622, 772, 922, 1072	622, 772, 922, 1072
2)	1 to 4	18 to 19, 168 to 169, 318 to 319, 468 to 469	12 to 13, A8 to A9, 13E to 13F, 1D4 to 1D5	9 to 12	1222, 1372, 1522, 1672	1222, 1372, 1522, 1672		
	5 to 8	618 to 619, 768 to 769, 918 to 919, 1068 to 1069	26A to 26B, 300 to 301, 396 to 397, 42C to 42D	13 to 16	1822, 1972, 2122, 2272	1822, 1972, 2122, 2272		
	9 to 12	1218 to 1219, 1368 to 1369, 1518 to 1519, 1668 to 1669	4C2 to 4C3, 558 to 559, 5EE to 5EF, 684 to 685	6)	1 to 4	23, 173, 323, 473	17, AD, 143, 1D9	
	13 to 16	1818 to 1819, 1968 to 1969, 2118 to 2119, 2268 to 2269	71A to 71B, 7B0 to 7B1, 846 to 847, 8DC to 8DD		5 to 8	623, 773, 923, 1073	26F, 305, 39B, 431	
3)	1 to 4	20 to 21, 170 to 171, 320 to 321, 470 to 471	14 to 15, AA to AB, 140 to 141, 1D6 to 1D7	9 to 12	1223, 1373, 1523, 1673	4C7, 55D, 5F3, 689		
	5 to 8	620 to 621, 770 to 771, 920 to 921, 1070 to 1071	26C to 26D, 302 to 303, 398 to 399, 42E to 42F	13 to 16	1823, 1973, 2123, 2273	71F, 7B5, 84B, 8E1		
	9 to 12	1220 to 1221, 1370 to 1371, 1520 to 1521, 1670 to 1671	4C4 to 4C5, 55A to 55B, 5F0 to 5F1, 686 to 687	7)	1 to 4	26, 176, 326, 476	1A, B0, 146, 1DC	
					5 to 8	626, 776, 926, 1076	272, 308, 39E, 434	
-	-	-	-	-	-	-		

Screen example

No.	Axis	Buffer memory address		No.	Axis	Buffer memory address	
		DEC	HEX			DEC	HEX
1)	1 to 4	27, 177, 327, 477	1B, B1, 147, 1DD	5)	1 to 4	30, 180, 330, 480	1E, B4, 14A, 1E0
	5 to 8	627, 777, 927, 1077	273, 309, 39F, 435		5 to 8	630, 780, 930, 1080	276, 30C, 3A2, 438
	9 to 12	1227, 1377, 1527, 1677	4CB, 561, 5F7, 68D		9 to 12	1230, 1380, 1530, 1680	4CE, 564, 5FA, 690
	13 to 16	1827, 1977, 2127, 2277	723, 7B9, 84F, 8E5		13 to 16	1830, 1980, 2130, 2280	726, 7BC, 852, 8E8
2)	1 to 4	28, 178, 328, 478	1C, B2, 148, 1DE	6)	1 to 4	31, 181, 331, 481	1F, B5, 14B, 1E1
	5 to 8	628, 778, 928, 1078	274, 30A, 3A0, 436		5 to 8	631, 781, 931, 1081	277, 30D, 3A3, 439
	9 to 12	1228, 1378, 1528, 1678	4CC, 562, 5F8, 68E		9 to 12	1231, 1381, 1531, 1681	4CF, 565, 5FB, 691
	13 to 16	1828, 1978, 2128, 2278	724, 7BA, 850, 8E6		13 to 16	1831, 1981, 2131, 2281	727, 7BD, 853, 8E9
3)	1 to 4	29, 179, 329, 479	1D, B3, 149, 1DF	7)	1 to 4	34, 184, 334, 484	22, B8, 14E, 1E4
	5 to 8	629, 779, 929, 1079	275, 30B, 3A1, 437		5 to 8	634, 784, 934, 1084	27A, 310, 3A6, 43C
	9 to 12	1229, 1379, 1529, 1679	4CD, 563, 5F9, 68F		9 to 12	1234, 1384, 1534, 1684	4D2, 568, 5FE, 694
	13 to 16	1829, 1979, 2129, 2279	725, 7BB, 851, 8E7		13 to 16	1834, 1984, 2134, 2284	72A, 7C0, 856, 8EC
4)	1 to 4	24 to 25, 174 to 175, 324 to 325, 474 to 475	18 to 19, AE to AF, 144 to 145, 1DA to 1DB	8)	1 to 4	32, 182, 332, 482	20, B6, 14C, 1E2
	5 to 8	624 to 625, 774 to 775, 924 to 925, 1074 to 1075	270 to 271, 306 to 307, 39C to 39D, 432 to 433		5 to 8	632, 782, 932, 1082	278, 30E, 3A4, 43A
	9 to 12	1224 to 1225, 1374 to 1375, 1524 to 1525, 1674 to 1675	4C8 to 4C9, 55E to 55F, 5F4 to 5F5, 68A to 68B		9 to 12	1232, 1382, 1532, 1682	4D0, 566, 5FC, 692
	13 to 16	1824 to 1825, 1974 to 1975, 2124 to 2125, 2274 to 2275	720 to 721, 7B6 to 7B7, 84C to 84D, 8E2 to 8E3		13 to 16	1832, 1982, 2132, 2282	728, 7BE, 854, 8EA
				9)	-	35	23

- 1 OVERVIEW
- 2 SYSTEM MONITOR
- 3 LADDER MONITOR FUNCTION
- 4 MELSEC-A LIST EDITOR
- 5 MELSEC-FX LIST EDITOR
- 6 INTELLIGENT MODULE MONITOR
- 7 NETWORK MONITOR
- 8 Q MOTION MONITOR

Screen example

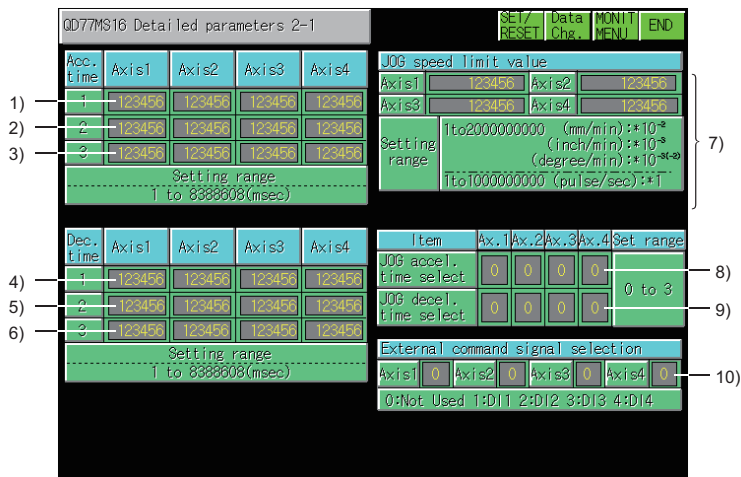

No.	Axis	Buffer memory address		No.	Axis	Buffer memory address		
		DEC	HEX			DEC	HEX	
1)	1 to 4	36 to 37, 186 to 187, 336 to 337, 486 to 487	24 to 25, BA to BB, 150 to 151, 1E6 to 1E7	5)	5 to 8	644 to 645, 794 to 794, 944 to 944, 1094 to 1094	284 to 284, 31A to 31A, 3B0 to 3B0, 446 to 446	
	5 to 8	636 to 637, 786 to 787, 936 to 937, 1086 to 1087	27C to 27D, 312 to 313, 3A8 to 3A9, 43E to 43F		9 to 12	1244 to 1244, 1394 to 1394, 1544 to 1544, 1694 to 1694	4DC to 4DC, 572 to 572, 608 to 608, 69E to 69E	
	9 to 12	1236 to 1237, 1386 to 1387, 1536 to 1537, 1686 to 1687	4D4 to 4D5, 56A to 56B, 600 to 601, 696 to 697		13 to 16	1844 to 1844, 1994 to 1994, 2144 to 2144, 2294 to 2294	734 to 734, 7CA to 7CA, 860 to 860, 8F6 to 8F6	
	13 to 16	1836 to 1837, 1986 to 1987, 2136 to 2137, 2286 to 2287	72C to 72D, 7C2 to 7C3, 858 to 859, 8EE to 8EF	6)	1 to 4	46 to 47, 196 to 197, 346 to 347, 496 to 497	2E to 2F, C4 to C5, 15A to 15B, 1F0 to 1F1	
2)	1 to 4	38 to 39, 188 to 189, 338 to 339, 488 to 489	26 to 27, BC to BD, 152 to 153, 1E8 to 1E9		5 to 8	646 to 646, 796 to 796, 946 to 946, 1096 to 1096	286 to 286, 31C to 31C, 3B2 to 3B2, 448 to 448	
	5 to 8	638 to 639, 788 to 789, 938 to 939, 1088 to 1089	27E to 27F, 314 to 315, 3AA to 3AB, 440 to 441		9 to 12	1246 to 1246, 1396 to 1396, 1546 to 1546, 1696 to 1696	4DE to 4DE, 574 to 574, 60A to 60A, 6A0 to 6A0	
	9 to 12	1238 to 1239, 1388 to 1389, 1538 to 1539, 1688 to 1689	4D6 to 4D7, 56C to 56D, 602 to 603, 698 to 699		13 to 16	1846 to 1846, 1996 to 1996, 2146 to 2146, 2296 to 2296	736 to 736, 7CC to 7CC, 862 to 862, 8F8 to 8F8	
13 to 16	1838 to 1839, 1988 to 1989, 2138 to 2139, 2288 to 2289	72E to 72F, 7C4 to 7C5, 85A to 85B, 8F0 to 8F1	7)	1 to 4	48 to 49, 198 to 199, 348 to 349, 498 to 499	30 to 31, C6 to C7, 15C to 15D, 1F2 to 1F3		
3)	1 to 4	40 to 41, 190 to 191, 340 to 341, 490 to 491		28 to 29, BE to BF, 154 to 155, 1EA to 1EB	5 to 8	648 to 649, 798 to 799, 948 to 949, 1098 to 1099	288 to 289, 31E to 31F, 3B4 to 3B5, 44A to 44B	
	5 to 8	640 to 641, 790 to 791, 940 to 941, 1090 to 1091		280 to 281, 316 to 317, 3AC to 3AD, 442 to 443	9 to 12	1248 to 1249, 1398 to 1399, 1548 to 1549, 1698 to 1699	4E0 to 4E1, 576 to 577, 60C to 60D, 6A2 to 6A3	
	9 to 12	1240 to 1241, 1390 to 1391, 1540 to 1541, 1690 to 1691		4D8 to 4D9, 56E to 56F, 604 to 605, 69A to 69B	13 to 16	1848 to 1849, 1998 to 1999, 2148 to 2149, 2298 to 2299	738 to 739, 7CE to 7CF, 864 to 865, 8FA to 8FB	
13 to 16	1840 to 1841, 1990 to 1991, 2140 to 2141, 2290 to 2291	730 to 731, 7C6 to 7C7, 85C to 85D, 8F2 to 8F3	8)	1 to 4	50, 200, 350, 500	32, C8, 15E, 1F4		
4)	1 to 4	42 to 43, 192 to 193, 342 to 343, 492 to 493		2A to 2B, C0 to C1, 156 to 157, 1EC to 1ED	5 to 8	650, 800, 950, 1100	28A, 320, 3B6, 44C	
	5 to 8	642 to 643, 792 to 793, 942 to 943, 1092 to 1093		282 to 283, 318 to 319, 3AE to 3AF, 444 to 445	9 to 12	1250, 1400, 1550, 1700	4E2, 578, 60E, 6A4	
	9 to 12	1242 to 1243, 1392 to 1393, 1542 to 1543, 1692 to 1693		4DA to 4DB, 570 to 571, 606 to 607, 69C to 69D	13 to 16	1850, 2000, 2150, 2300	73A, 7D0, 866, 8FC	
	13 to 16	1842 to 1843, 1992 to 1993, 2142 to 2143, 2292 to 2293	732 to 733, 7C8 to 7C9, 85E to 85F, 8F4 to 8F5	9)	1 to 4	51, 201, 351, 501	33, C9, 15F, 1F5	
5)	1 to 4	44 to 45, 194 to 195, 344 to 345, 494 to 495	2C to 2D, C2 to C3, 158 to 159, 1EE to 1EF		5 to 8	651, 801, 951, 1101	28B, 321, 3B7, 44D	
	10)	1 to 4	44 to 45, 194 to 195, 344 to 345, 494 to 495		2C to 2D, C2 to C3, 158 to 159, 1EE to 1EF	9 to 12	1251, 1401, 1551, 1701	4E3, 579, 60F, 6A5
						13 to 16	1851, 2001, 2151, 2301	73B, 7D1, 867, 8FD
10)	1 to 4	44 to 45, 194 to 195, 344 to 345, 494 to 495	2C to 2D, C2 to C3, 158 to 159, 1EE to 1EF	44 to 45, 194 to 195, 344 to 345, 494 to 495	2C to 2D, C2 to C3, 158 to 159, 1EE to 1EF	5 to 8	669, 819, 969, 1119	29D, 333, 3C9, 45F
						9 to 12	1269, 1419, 1569, 1719	4F5, 58B, 621, 6B7
						13 to 16	1869, 2019, 2169, 2319	74D, 7E3, 879, 90F

Screen example

No.	Axis	Buffer memory address		No.	Axis	Buffer memory address		
		DEC	HEX			DEC	HEX	
1)	1 to 4	52, 202, 352, 502	34, CA, 160, 1F6	7)	1 to 4	59, 209, 359, 509	3B, D1, 167, 1FD	
	5 to 8	652, 802, 952, 1102	28C, 322, 3B8, 44E		5 to 8	659, 809, 959, 1109	293, 329, 3BF, 455	
	9 to 12	1252, 1402, 1552, 1702	4E4, 57A, 610, 6A6		9 to 12	1259, 1409, 1559, 1709	4EB, 581, 617, 6AD	
	13 to 16	1852, 2002, 2152, 2302	73C, 7D2, 868, 8FE		13 to 16	1859, 2009, 2159, 2309	743, 7D9, 86F, 905	
2)	1 to 4	53, 203, 353, 503	35, CB, 161, 1F7	8)	1	67	43	
	5 to 8	653, 803, 953, 1103	28D, 323, 3B9, 44F		9)	1 to 4	60 to 61, 210 to 211, 360 to 361, 510 to 511	3C to 3D, D2 to D3, 168 to 169, 1FE to 1FF
	9 to 12	1253, 1403, 1553, 1703	4E5, 57B, 611, 6A7			5 to 8	660 to 661, 810 to 811, 960 to 961, 1110 to 1111	294 to 295, 32A to 32B, 3C0 to 3C1, 456 to 457
	13 to 16	1853, 2003, 2153, 2303	73D, 7D3, 869, 8FF			9 to 12	1260 to 1261, 1410 to 1411, 1560 to 1561, 1710 to 1711	4EC to 4ED, 582 to 583, 618 to 619, 6AE to 6AF
3)	1 to 4	56, 206, 356, 506	38, CE, 164, 1FA	10)	13 to 16	1860 to 1861, 2010 to 2011, 2160 to 2160, 2310 to 2311	744 to 745, 7DA to 7DB, 870 to 871, 906 to 907	
	5 to 8	656, 806, 956, 1106	290, 326, 3BC, 452		1 to 4	62, 212, 362, 512	3E, D4, 16A, 200	
	9 to 12	1256, 1406, 1556, 1706	4E8, 57E, 614, 6AA		5 to 8	662, 812, 962, 1112	296, 32C, 3C2, 458	
	13 to 16	1856, 2006, 2156, 2306	740, 7D6, 86C, 902		9 to 12	1262, 1412, 1562, 1712	4EE, 584, 61A, 6B0	
4)	1 to 4	57, 207, 357, 507	39, CF, 165, 1FB	11)	13 to 16	1862, 2012, 2162, 2312	746, 7DC, 872, 908	
	5 to 8	657, 807, 957, 1107	291, 327, 3BD, 453		1 to 4	63, 213, 363, 513	3F, D5, 16B, 201	
	9 to 12	1257, 1407, 1557, 1707	4E9, 57F, 615, 6AB		5 to 8	663 to 664, 813 to 814, 963 to 964, 1113 to 1114	297 to 298, 32D to 32E, 3C3 to 3C4, 459 to 45A	
	13 to 16	1857, 2007, 2157, 2307	741, 7D7, 86D, 903		9 to 12	1263 to 1264, 1413 to 1414, 1563 to 1564, 1713 to 1714	4EF to 4F0, 585 to 586, 61B to 61C, 6B1 to 6B2	
5)	1 to 4	58, 208, 358, 508	3A, D0, 166, 1FC	12)	13 to 16	1863 to 1864, 2013 to 2014, 2163 to 2164, 2313 to 2314	747 to 748, 7DD to 7DE, 873 to 874, 909 to 90A	
	5 to 8	658, 808, 958, 1108	292, 328, 3BE, 454		1 to 4	64 to 65, 214 to 215, 364 to 365, 514 to 515	40 to 41, D6 to D7, 16C to 16D, 202 to 203	
	9 to 12	1258, 1408, 1558, 1708	4EA, 580, 616, 6AC		5 to 8	664 to 665, 814 to 815, 964 to 965, 1114 to 1115	298 to 299, 32E to 32F, 3C4 to 3C5, 45A to 45B	
	13 to 16	1858, 2008, 2158, 2308	742, 7D8, 86E, 904		9 to 12	1264 to 1265, 1414 to 1415, 1564 to 1565, 1714 to 1715	4F0 to 4F1, 586 to 587, 61C to 61D, 6B2 to 6B3	
6)	1 to 4	54 to 55, 204 to 205, 354 to 355, 504 to 505	36 to 37, CC to CD, 162 to 163, 1F8 to 1F9	12)	13 to 16	1864 to 1865, 2014 to 2015, 2164 to 2165, 2314 to 2315	748 to 749, 7DE to 7DF, 874 to 875, 90A to 90B	
	5 to 8	654 to 655, 804 to 805, 954 to 955, 1104 to 1105	28E to 28F, 324 to 325, 3BA to 3BB, 450 to 451		1 to 4	64 to 65, 214 to 215, 364 to 365, 514 to 515	40 to 41, D6 to D7, 16C to 16D, 202 to 203	
	9 to 12	1254 to 1255, 1404 to 1405, 1554 to 1555, 1704 to 1705	4E6 to 4E7, 57C to 57D, 612 to 613, 6A8 to 6A9		5 to 8	664 to 665, 814 to 815, 964 to 965, 1114 to 1115	298 to 299, 32E to 32F, 3C4 to 3C5, 45A to 45B	
	13 to 16	1854 to 1855, 2004 to 2005, 2154 to 2155, 2304 to 2305	73E to 73F, 7D4 to 7D5, 86A to 86B, 900 to 901		9 to 12	1264 to 1265, 1414 to 1415, 1564 to 1565, 1714 to 1715	4F0 to 4F1, 586 to 587, 61C to 61D, 6B2 to 6B3	

1 OVERVIEW
2 SYSTEM MONITOR
3 LADDER MONITOR FUNCTION
4 MELSEC-A LIST EDITOR
5 MELSEC-FX LIST EDITOR
6 INTELLIGENT MODULE MONITOR
7 NETWORK MONITOR
8 Q MOTION MONITOR

Screen example

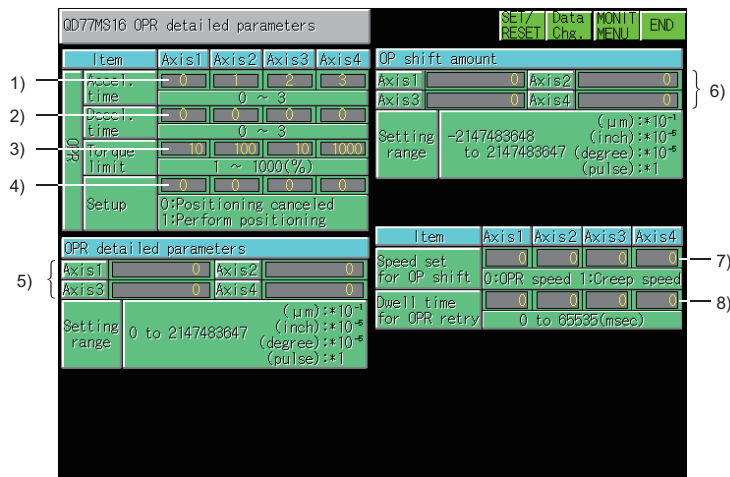

No.	Axis	Buffer memory address		No.	Axis	Buffer memory address	
		DEC	HEX			DEC	HEX
1)	1 to 4	82, 232, 382, 532	52, E8, 17E, 214	5)	1 to 4	80 to 81, 230 to 231, 380 to 381, 530 to 531	50 to 51, E6 to E7, 17C to 17D, 212 to 213
	5 to 8	682, 832, 982, 1132	2AA, 340, 3D6, 46C		5 to 8	680 to 681, 830 to 831, 980 to 981, 1130 to 1131	2A8 to 2A9, 33E to 33F, 3D4 to 3D5, 46A to 46B
	9 to 12	1282, 1432, 1582, 1732	502, 598, 62E, 6C4		9 to 12	1280 to 1281, 1430 to 1431, 1580 to 1581, 1730 to 1731	500 to 501, 596 to 597, 62C to 62D, 6C2 to 6C3
	13 to 16	1882, 2032, 2182, 2332	75A, 7F0, 886, 91C		13 to 16	1880 to 1881, 2030 to 2031, 2180 to 2181, 2330 to 2331	758 to 759, 7EE to 7EF, 884 to 885, 91A to 91B
2)	1 to 4	83, 233, 383, 533	53, E9, 17F, 215	6)	1 to 4	84 to 85, 234 to 235, 384 to 385, 534 to 535	54 to 55, EA to EB, 180 to 181, 216 to 217
	5 to 8	683, 833, 983, 1133	2AB, 341, 3D7, 46D		5 to 8	684 to 685, 834 to 835, 984 to 985, 1134 to 1135	2AC to 2AD, 342 to 343, 3D8 to 3D9, 46E to 46F
	9 to 12	1283, 1433, 1583, 1733	503, 599, 62F, 6C5		9 to 12	1284 to 1285, 1434 to 1435, 1584 to 1585, 1734 to 1735	504 to 505, 59A to 59B, 630 to 631, 6C6 to 6C7
	13 to 16	1883, 2033, 2183, 2333	75B, 7F1, 887, 91D		13 to 16	1884 to 1885, 2034 to 2035, 2184 to 2185, 2334 to 2335	75C to 75D, 7F2 to 7F3, 888 to 889, 91E to 91F
3)	1 to 4	86, 236, 386, 536	56, EC, 182, 218	7)	1 to 4	88, 238, 388, 538	58, EE, 184, 21A
	5 to 8	686, 836, 986, 1136	2AE, 344, 3DA, 470		5 to 8	688, 838, 988, 1138	2B0, 346, 3DC, 472
	9 to 12	1286, 1436, 1586, 1736	506, 59C, 632, 6C8		9 to 12	1288, 1438, 1588, 1738	508, 59E, 634, 6CA
	13 to 16	1886, 2036, 2186, 2336	75E, 7F4, 88A, 920		13 to 16	1888, 2038, 2188, 2338	760, 7F6, 88C, 922
4)	1 to 4	87, 237, 387, 537	57, ED, 183, 219	8)	1 to 4	89, 239, 389, 539	59, EF, 185, 21B
	5 to 8	687, 837, 987, 1137	2AF, 345, 3DB, 471		5 to 8	689, 839, 989, 1139	2B1, 347, 3DD, 473
	9 to 12	1287, 1437, 1587, 1737	507, 59D, 633, 6C9		9 to 12	1289, 1439, 1589, 1739	509, 59F, 635, 6CB
	13 to 16	1887, 2037, 2187, 2337	75F, 7F5, 88B, 921		13 to 16	1889, 2039, 2189, 2339	761, 7F7, 88D, 923

Screen example

No.	Axis	Buffer memory address		No.	Axis	Buffer memory address		
		DEC	HEX			DEC	HEX	
1)	1 to 4	70, 220, 370, 520	46, DC, 172, 208	4)	13 to 16	1872 to 1873, 2022 to 2023, 2172 to 2173, 2322 to 2323	750 to 751, 7E6 to 7E7, 87C to 87D, 912 to 913	
	5 to 8	670, 820, 970, 1120	29E, 334, 3CA, 460		5)	1 to 4	74 to 75, 224 to 225, 374 to 375, 524 to 525	4A to 4B, E0 to E1, 176 to 177, 20C to 20D
	9 to 12	1270, 1420, 1570, 1720	4F6, 58C, 622, 6B8			5 to 8	674 to 675, 824 to 825, 974 to 975, 1124 to 1125	2A2 to 2A3, 338 to 339, 3CE to 3CF, 464 to 465
	13 to 16	1870, 2020, 2170, 2320	74E, 7E4, 87A, 910			9 to 12	1274 to 1275, 1424 to 1425, 1574 to 1575, 1724 to 1725	4FA to 4FB, 590 to 591, 626 to 627, 6BC to 6BD
2)	1 to 4	71, 221, 371, 521	47, DD, 173, 209	13 to 16	1874 to 1875, 2024 to 2025, 2174 to 2175, 2324 to 2325	752 to 753, 7E8 to 7E9, 87E to 87F, 914 to 915		
	5 to 8	671, 821, 971, 1121	29F, 335, 3CB, 461		6)	1 to 4	76 to 77, 226 to 227, 376 to 377, 526 to 527	4C to 4D, E2 to E3, 178 to 179, 20E to 20F
	9 to 12	1271, 1421, 1571, 1721	4F7, 58D, 623, 6B9			5 to 8	676 to 677, 826 to 827, 976 to 977, 1126 to 1127	2A4 to 2A5, 33A to 33B, 3D0 to 3D1, 466 to 467
3)	13 to 16	1871, 2021, 2171, 2321	74F, 7E5, 87B, 911	9 to 12	1276 to 1277, 1426 to 1427, 1576 to 1577, 1726 to 1727	4FC to 4FD, 592 to 593, 628 to 629, 6BE to 6BF		
	1 to 4	78, 228, 378, 528	4E, E4, 17A, 210		13 to 16	1876 to 1877, 2026 to 2027, 2176 to 2177, 2326 to 2327	754 to 755, 7EA to 7EB, 880 to 881, 916 to 917	
	5 to 8	678, 828, 978, 1128	2A6, 33C, 3D2, 468					
9 to 12	1278, 1428, 1578, 1728	4FE, 594, 62A, 6C0						
4)	13 to 16	1878, 2028, 2178, 2328	756, 7EC, 882, 918					
	1 to 4	72 to 73, 222 to 223, 372 to 373, 522 to 523	48 to 49, DE to DF, 174 to 175, 20A to 20B					
	5 to 8	672 to 673, 822 to 823, 972 to 973, 1122 to 1123	2A0 to 2A1, 336 to 337, 3CC to 3CD, 462 to 463					
9 to 12	1272 to 1273, 1422 to 1423, 1572 to 1573, 1722 to 1723	4F8 to 4F9, 58E to 58F, 624 to 625, 6BA to 6BB						

Screen example

No.	Axis	Buffer memory address		No.	Axis	Buffer memory address	
		DEC	HEX			DEC	HEX
1)	1 to 4	2416, 2516, 2616, 2716	970, 9D4, A38, A9C	2)	1 to 4	2417, 2517, 2617, 2717	971, 9D5, A39, A9D
	5 to 8	2816, 2916, 3016, 3116	B00, B64, BC8, C2C		5 to 8	2817, 2917, 3017, 3117	B01, B65, BC9, C2D
	9 to 12	3216, 3316, 3416, 3516	C90, CF4, D58, DBC		9 to 12	3217, 3317, 3417, 3517	C91, CF5, D59, DBD
	13 to 16	3616, 3716, 3816, 3916	E20, E84, EE8, F4C		13 to 16	3617, 3717, 3817, 3917	E21, E85, EE9, F4D

Screen example

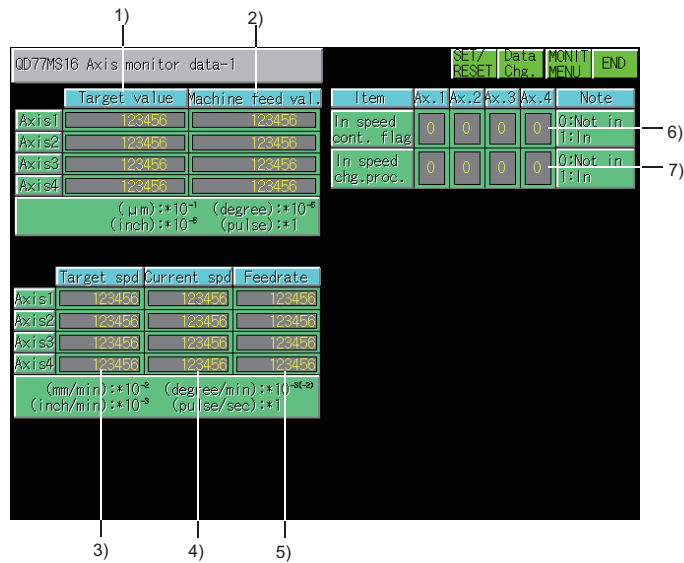

No.	Axis	Buffer memory address		No.	Axis	Buffer memory address	
		DEC	HEX			DEC	HEX
1)	1 to 4	2418 to 2419, 2518 to 2519, 2618 to 2619, 2718 to 2719	972 to 973, 9D6 to 9D7, A3A to A3B, A9E to A9F	4)	1 to 4	2410 to 2411, 2510 to 2511, 2610 to 2611, 2710 to 2711	96A to 96B, 9CE to 9CF, A32 to A33, A96 to A97
	5 to 8	2818 to 2819, 2918 to 2919, 3018 to 3019, 3118 to 3119	B02 to B03, B66 to B67, BCA to BCB, C2E to C2F		5 to 8	2810 to 2811, 2910 to 2911, 3010 to 3011, 3110 to 3111	AFA to AFB, B5E to B5F, BC2 to BC3, C26 to C27
	9 to 12	3218 to 3219, 3318 to 3319, 3418 to 3419, 3518 to 3519	C92 to C93, CF6 to CF7, D5A to D5B, DBE to DBF		9 to 12	3210 to 3211, 3310 to 3311, 3410 to 3411, 3510 to 3511	C8A to C8B, CEE to CEF, D52 to D53, DB6 to DB7
	13 to 16	3618 to 3619, 3718 to 3719, 3818 to 3819, 3918 to 3919	E22 to E23, E86 to E87, EEA to EEB, F4E to F4F		13 to 16	3610 to 3611, 3710 to 3711, 3810 to 3811, 3910 to 3911	E1A to E1B, E7E to E7F, EE2 to EE3, F46 to F47
2)	1 to 4	2402 to 2403, 2502 to 2503, 2602 to 2603, 2702 to 2703	962 to 963, 9C6 to 9C7, A2A to A2B, A8E to A8F	5)	1 to 4	2412 to 2413, 2512 to 2513, 2612 to 2613, 2712 to 2713	96C to 96D, 9D0 to 9D1, A34 to A35, A98 to A99
	5 to 8	2802 to 2803, 2902 to 2903, 3002 to 3003, 3102 to 3103	AF2 to AF3, B56 to B57, BBA to BBB, C1E to C1F		5 to 8	2812 to 2813, 2912 to 2913, 3012 to 3013, 3112 to 3113	AFC to AFD, B60 to B61, BC4 to BC5, C28 to C29
	9 to 12	3202 to 3203, 3302 to 3303, 3402 to 3403, 3502 to 3503	C82 to C83, CE6 to CE7, D4A to D4B, DAE to DAF		9 to 12	3212 to 3213, 3312 to 3313, 3412 to 3413, 3512 to 3513	C8C to C8D, CF0 to CF1, D54 to D55, DB8 to DB9
	13 to 16	3602 to 3603, 3702 to 3703, 3802 to 3803, 3902 to 3903	E12 to E13, E76 to E77, EDA to EDB, F3E to F3F		13 to 16	3612 to 3613, 3712 to 3713, 3812 to 3813, 3912 to 3913	E1C to E1D, E80 to E81, EE4 to EE5, F48 to F49
3)	1 to 4	2420 to 2421, 2520 to 2521, 2620 to 2621, 2720 to 2721	974 to 975, 9D8 to 9D9, A3C to A3D, AA0 to AA1	6)	1 to 4	2430, 2530, 2630, 2730	97E, 9E2, A46, AAA
	5 to 8	2820 to 2821, 2920 to 2921, 3020 to 3021, 3120 to 3121	B04 to B05, B68 to B69, BCC to BCD, C30 to C31		5 to 8	2830, 2930, 3030, 3130	B0E, B72, BD6, C3A
	9 to 12	3220 to 3221, 3320 to 3321, 3420 to 3421, 3520 to 3521	C94 to C95, CF8 to CF9, D5C to D5D, DC0 to DC1		9 to 12	3230, 3330, 3430, 3530	C9E, D02, D66, DCA
	13 to 16	3620 to 3621, 3720 to 3721, 3820 to 3821, 3920 to 3921	E24 to E25, E88 to E89, EEC to EED, F50 to F51		13 to 16	3630, 3730, 3830, 3930	E2E, E92, EF6, F5A
7)	1 to 4	2431, 2531, 2631, 2731	97F, 9E3, A47, AAB	7)	1 to 4	2431, 2531, 2631, 2731	97F, 9E3, A47, AAB
	5 to 8	2831, 2931, 3031, 3131	B0F, B73, BD7, C3B		5 to 8	2831, 2931, 3031, 3131	B0F, B73, BD7, C3B
	9 to 12	3231, 3331, 3431, 3531	C9F, D03, D67, DCB		9 to 12	3231, 3331, 3431, 3531	C9F, D03, D67, DCB
	13 to 16	3631, 3731, 3831, 3931	E2F, E93, EF7, F5B		13 to 16	3631, 3731, 3831, 3931	E2F, E93, EF7, F5B

Screen example

1) 2) 3)

Special start data					Special start repetition counter			
Axis	Instr. code	Instr. para	Data	No.	Axis1	Axis2	Axis3	Axis4
1	00	0	0	1	100	0	1	100
2	00	0	0	1				
3	00	0	0	3				
4	00	0	0	2				

8) 9)

Data being executed				
Axis	1st data pointer	Pos. data number	Block No.	Previous position
1	1	1234	1	1
2	2	123	20	1
3	1	12	40	1
4	100	1	60	1

4) 5) 6) 7)

[Instruction code]
 00:Block start(Normal start) 01:Condition start 02:Wait start
 03:Simultaneous start 04:FOR loop 05:FOR condition 06:NEXT

No.	Axis	Buffer memory address		No.	Axis	Buffer memory address	
		DEC	HEX			DEC	HEX
1)	1 to 4	2427, 2527, 2627, 2727	97B, 9DF, A43, AA7	6)	1 to 4	2436, 2536, 2636, 2736	984, 9E8, A4C, AB0
	5 to 8	2827, 2927, 3027, 3127	B0B, B6F, BD3, C37		5 to 8	2836, 2936, 3036, 3136	B14, B78, BDC, C40
	9 to 12	3227, 3327, 3427, 3527	C9B, CFF, D63, DC7		9 to 12	3236, 3336, 3436, 3536	CA4, D08, D6C, DD0
	13 to 16	3627, 3727, 3827, 3927	E2B, E8F, EF3, F57		13 to 16	3636, 3736, 3836, 3936	E34, E98, EFC, F60
2)	1 to 4	2428, 2528, 2628, 2728	97C, 9E0, A44, AA8	7)	1 to 4	2437, 2537, 2637, 2737	985, 9E9, A4D, AB1
	5 to 8	2828, 2928, 3028, 3128	B0C, B70, BD4, C38		5 to 8	2837, 2937, 3037, 3137	B15, B79, BDD, C41
	9 to 12	3228, 3328, 3428, 3528	C9C, D00, D64, DC8		9 to 12	3237, 3337, 3437, 3537	CA5, D09, D6D, DD1
	13 to 16	3628, 3728, 3828, 3928	E2C, E90, EF4, F58		13 to 16	3637, 3737, 3837, 3937	E35, E99, EFD, F61
3)	1 to 4	2429, 2529, 2629, 2729	97D, 9E1, A45, AA9	8)	1 to 4	2432, 2532, 2632, 2732	980, 9E4, A48, AAC
	5 to 8	2829, 2929, 3029, 3129	B0D, B71, BD5, C39		5 to 8	2832, 2932, 3032, 3132	B10, B74, BD8, C3C
	9 to 12	3229, 3329, 3429, 3529	C9D, D01, D65, DC9		9 to 12	3232, 3332, 3432, 3532	CA0, D04, D68, DCC
	13 to 16	3629, 3729, 3829, 3929	E2D, E91, EF5, F59		13 to 16	3632, 3732, 3832, 3932	E30, E94, EF8, F5C
4)	1 to 4	2434, 2534, 2634, 2734	982, 9E6, A4A, AAE	9)	1 to 4	2433, 2533, 2633, 2733	981, 9E5, A49, AAD
	5 to 8	2834, 2934, 3034, 3134	B12, B76, BDA, C3E		5 to 8	2833, 2933, 3033, 3133	B11, B75, BD9, C3D
	9 to 12	3234, 3334, 3434, 3534	CA2, D06, D6A, DCE		9 to 12	3233, 3333, 3433, 3533	CA1, D05, D69, DCD
	13 to 16	3634, 3734, 3834, 3934	E32, E96, EFA, F5E		13 to 16	3633, 3733, 3833, 3933	E31, E95, EF9, F5D
5)	1 to 4	2435, 2535, 2635, 2735	983, 9E7, A4B, AAF	-	-	-	-
	5 to 8	2835, 2935, 3035, 3135	B13, B77, BDB, C3F				
	9 to 12	3235, 3335, 3435, 3535	CA3, D07, D6B, DCF				
	13 to 16	3635, 3735, 3835, 3935	E33, E97, EFB, F5F				

- 1 OVERVIEW
- 2 SYSTEM MONITOR
- 3 LADDER MONITOR FUNCTION
- 4 MELSEC-A LIST EDITOR
- 5 MELSEC-FX LIST EDITOR
- 6 INTELLIGENT MODULE MONITOR
- 7 NETWORK MONITOR
- 8 Q MOTION MONITOR

Screen example

QD77MS16 Axis monitor data-3				SET/	Data	MONIT	END
Axis	OPR Increment	Actual present val	Error counter val		RESET	Chg.	MENU
1	123456	123456	123456				
2	123456	123456	123456				
3	123456	123456	123456				
4	123456	123456	123456				
		(μm):*10 ⁻¹ (inch):*10 ⁻⁴	(degree):*10 ⁻⁴ (pulse):*				
Axis	Number of motor rotation	Motor current	Axis	Servo amplifier S/W number			
1	123456	1000	1	00 00 00 00 00 00 00 00 00 00			
2	123456	1000	2	00 00 00 00 00 00 00 00 00 00			
3	123456	1000	3	00 00 00 00 00 00 56 00 00 00			
4	123456	1000	4	00 00 00 00 00 00 00 00 00 00			
		(rpm):*10 ⁻¹	(%) :*10 ⁻¹	Value is character code.(JIS8 Code)			

No.	Axis	Buffer memory address		No.	Axis	Buffer memory address	
		DEC	HEX			DEC	HEX
1)	1 to 4	2448 to 2449, 2548 to 2549, 2648 to 2649, 2748 to 2749	990 to 991, 9F4 to 9F5, A58 to A59, ABC to ABD	4)	1 to 4	2454 to 2455, 2554 to 2555, 2654 to 2655, 2754 to 2755	996 to 997, 9FA to 9FB, A5E to A5F, AC2 to AC3
	5 to 8	2848 to 2849, 2948 to 2949, 3048 to 3049, 3148 to 3149	B20 to B21, B84 to B85, BE8 to BE9, C4C to C4D		5 to 8	2854 to 2855, 2954 to 2955, 3054 to 3055, 3154 to 3155	B26 to B27, B8A to B8B, BEE to BEF, C52 to C53
	9 to 12	3248 to 3249, 3348 to 3349, 3448 to 3449, 3548 to 3549	CB0 to CB1, D14 to D15, D78 to D79, DDC to DDD		9 to 12	3254 to 3255, 3354 to 3355, 3454 to 3455, 3554 to 3555	CB6 to CB7, D1A to D1B, D7E to D7F, DE2 to DE3
	13 to 16	3648 to 3649, 3748 to 3749, 3848 to 3849, 3948 to 3949	E40 to E41, EA4 to EA5, F08 to F09, F6C to F6D		13 to 16	3654 to 3655, 3754 to 3755, 3854 to 3855, 3954 to 3955	E46 to E47, EAA to EAB, F0E to F0F, F72 to F73
2)	1 to 4	2450 to 2451, 2550 to 2551, 2650 to 2651, 2750 to 2751	992 to 993, 9F6 to 9F7, A5A to A5B, ABE to ABF	5)	1 to 4	2456, 2556, 2656, 2756	998, 9FC, A60, AC4
	5 to 8	2850 to 2851, 2950 to 2951, 3050 to 3051, 3150 to 3151	B22 to B23, B86 to B87, BEA to BEB, C4E to C4F		5 to 8	2856, 2956, 3056, 3156	B28, B8C, BF0, C54
	9 to 12	3250 to 3251, 3350 to 3351, 3450 to 3451, 3550 to 3551	CB2 to CB3, D16 to D17, D7A to D7B, DDE to DDF		9 to 12	3256, 3356, 3456, 3556	CB8, D1C, D80, DE4
	13 to 16	3650 to 3651, 3750 to 3751, 3850 to 3851, 3950 to 3951	E42 to E43, EA6 to EA7, FOA to F0B, F6E to F6F		13 to 16	3656, 3756, 3856, 3956	E48, EAC, F10, F74
3)	1 to 4	2452 to 2453, 2552 to 2553, 2652 to 2653, 2752 to 2753	994 to 995, 9F8 to 9F9, A5C to A5D, AC0 to AC1	6)	1 to 4	2464 to 2469, 2564 to 2569, 2664 to 2669, 2764 to 2769	9A0 to 9A5, A04 to A09, A68 to A6D, ACC to AD1
	5 to 8	2852 to 2853, 2952 to 2953, 3052 to 3053, 3152 to 3153	B24 to B25, B88 to B89, BEC to BED, C50 to C51		5 to 8	2864 to 2869, 2964 to 2969, 3064 to 3069, 3164 to 3169	B30 to B35, B94 to B99, BF8 to BFD, C5C to C61
	9 to 12	3252 to 3253, 3352 to 3353, 3452 to 3453, 3552 to 3553	CB4 to CB5, D18 to D19, D7C to D7D, DE0 to DE1		9 to 12	3264 to 3269, 3364 to 3369, 3464 to 3469, 3564 to 3569	CC0 to CC5, D24 to D29, D88 to D8D, DEC to DF1
	13 to 16	3652 to 3653, 3752 to 3753, 3852 to 3853, 3952 to 3953	E44 to E45, EA8 to EA9, F0C to F0D, F70 to F71		13 to 16	3664 to 3669, 3764 to 3769, 3864 to 3869, 3964 to 3969	E50 to E55, EB4 to EB9, F18 to F1D, F7C to F81

Screen example

1) Parameter error No.

2) [Servo status]

3) [SSONET I/O]

4) Regenerative load ratio

5) Actual load ratio

6) Peak load ratio

No.	Axis	Buffer memory address		No.	Axis	Buffer memory address	
		DEC	HEX			DEC	HEX
1)	1 to 4	2470, 2570, 2670, 2770	9A6, A0A, A6E, AD2	4)	1 to 4	2478, 2578, 2678, 2778	9AE, A12, A76, ADA
	5 to 8	2870, 2970, 3070, 3170	B36, B9A, BFE, C62		5 to 8	2878, 2978, 3078, 3178	B3E, BA2, C06, C6A
	9 to 12	3270, 3370, 3470, 3570	CC6, D2A, D8E, DF2		9 to 12	3278, 3378, 3478, 3578	CCE, D32, D96, DFA
	13 to 16	3670, 3770, 3870, 3970	E56, EBA, F1E, F82		13 to 16	3678, 3778, 3878, 3978	E5E, EC2, F26, F8A
2)	1 to 4	2476, 2576, 2676, 2776	9AC, A10, A74, AD8	5)	1 to 4	2479, 2579, 2679, 2779	9AF, A13, A77, ADB
	5 to 8	2876, 2976, 3076, 3176	B3C, BA0, C04, C68		5 to 8	2879, 2979, 3079, 3179	B3F, BA3, C07, C6B
	9 to 12	3276, 3376, 3476, 3576	CCC, D30, D94, DF8		9 to 12	3279, 3379, 3479, 3579	CCF, D33, D97, DFB
	13 to 16	3676, 3776, 3876, 3976	E5C, EC0, F24, F88		13 to 16	3679, 3779, 3879, 3979	E5F, EC3, F27, F8B
3)	1 to 4	2477, 2577, 2677, 2777	9AD, A11, A75, AD9	6)	1 to 4	2480, 2580, 2680, 2780	9B0, A14, A78, ADC
	5 to 8	2877, 2977, 3077, 3177	B3D, BA1, C05, C69		5 to 8	2880, 2980, 3080, 3180	B40, BA4, C08, C6C
	9 to 12	3277, 3377, 3477, 3577	CCD, D31, D95, DF9		9 to 12	3280, 3380, 3480, 3580	CD0, D34, D98, DFC
	13 to 16	3677, 3777, 3877, 3977	E5D, EC1, F25, F89		13 to 16	3680, 3780, 3880, 3980	E60, EC4, F28, F8C

Screen example

1) QD77MS16 OPR

2) Torque limit stored value

3) Near point limit

No.	Axis	Buffer memory address		No.	Axis	Buffer memory address	
		DEC	HEX			DEC	HEX
1)	1 to 4	2424 to 2425, 2524 to 2525, 2624 to 2625, 2724 to 2725	978 to 979, 9DC to 9DD, A40 to A41, AA4 to AA5	2)	1 to 4	2426, 2526, 2626, 2726	97A, 9DE, A42, AA6
	5 to 8	2824 to 2825, 2924 to 2925, 3024 to 3025, 3124 to 3125	B08 to B09, B6C to B6D, BD0 to BD1, C34 to C35		5 to 8	2826, 2926, 3026, 3126	B0A, B6E, BD2, C36
	9 to 12	3224 to 3225, 3324 to 3325, 3424 to 3425, 3524 to 3525	C98 to C99, CFC to CFD, D60 to D61, DC4 to DC5		9 to 12	3226, 3326, 3426, 3526	C9A, CFE, D62, DC6
	13 to 16	3624 to 3625, 3724 to 3725, 3824 to 3825, 3924 to 3925	E28 to E29, E8C to E8D, EF0 to EF1, F54 to F55		13 to 16	3626, 3726, 3826, 3926	E2A, E8E, EF2, F56
3)	1 to 4			3)	1 to 4	2416, 2516, 2616, 2716	970, 9D4, A38, A9C
	5 to 8				5 to 8	2816, 2916, 3016, 3116	B00, B64, BC8, C2C
	9 to 12				9 to 12	3216, 3316, 3416, 3516	C90, CF4, D58, DBC
	13 to 16				13 to 16	3616, 3716, 3816, 3916	E20, E84, EE8, F4C

Screen example

1) 0077MS16 Speed-position control

Item	Ax.1	Ax.2	Ax.3	Ax.4
Speed-position switching latch	●	●	●	●
In speed control	●	●	●	●
Speed-position switching enable	0	0	0	0

2) SPSC movement amount change register

Axis	Setting range
Axis1	123456
Axis2	123456
Axis3	123456
Axis4	123456

3) 4) (pointing to the right side of the interface)

No.	Axis	Buffer memory address		No.	Axis	Buffer memory address	
		DEC	HEX			DEC	HEX
1)	1 to 4	2414 to 2415, 2514 to 2515, 2614 to 2615, 2714 to 2715	96E to 96F, 9D2 to 9D3, A36 to A37, A9A to A9B	2)	9 to 12	5126 to 5127, 5226 to 5227, 5326 to 5327, 5426 to 5427	1406 to 1407, 146A to 146B, 14CE to 14CF, 1532 to 1533
	5 to 8	2814 to 2815, 2914 to 2915, 3014 to 3015, 3114 to 3115	AFE to AFF, B62 to B63, BC6 to BC7, C2A to C2B		13 to 16	5526 to 5527, 5626 to 5627, 5726 to 5727, 5826 to 5827	1596 to 1597, 15FA to 15FB, 165E to 165F, 16C2 to 16C3
	9 to 12	3214 to 3215, 3314 to 3315, 3414 to 3415, 3514 to 3515	C8E to C8F, CF2 to CF3, D56 to D57, DBA to DBB	3)	1 to 4	2417, 2517, 2617, 2717	971, 9D5, A39, A9D
	13 to 16	3614 to 3615, 3714 to 3715, 3814 to 3815, 3914 to 3915	E1E to E1F, E82 to E83, EE6 to EE7, F4A to F4B		13 to 16	3617, 3717, 3817, 3917	E21, E85, EE9, F4D
2)	1 to 4	4326 to 4327, 4426 to 4427, 4526 to 4527, 4626 to 4627	10E6 to 10E7, 114A to 114B, 11AE to 11AF, 1212 to 1213	4)	1 to 4	4328, 4428, 4528, 4628	10E8, 114C, 11B0, 1214
	5 to 8	4726 to 4727, 4826 to 4827, 4926 to 4927, 5026 to 5027	1276 to 1277, 12DA to 12DB, 133E to 133F, 13A2 to 13A3		5 to 8	4728, 4828, 4928, 5028	1278, 12DC, 1340, 13A4
					9 to 12	5128, 5228, 5328, 5428	1408, 146C, 14D0, 1534
					13 to 16	5528, 5628, 5728, 5828	1598, 15FC, 1660, 16C4

Screen example

QD77MS16 Position-speed control

SET/ Data MONIT
RESET Chg. MENU END

1) {

PSSC speed change register			
Axis1	123456	Axis2	123456
Axis3	123456	Axis4	123456
Setting	0to2000000000 (mm/min):*10 ⁻²		
range	0to500000000 (inch/min):*10 ⁻³		
	0to500000000 (degree/min):*10 ⁻³⁽⁴⁾		
	0to500000000 (pulse/sec):*1		

Item	Ax.1	Ax.2	Ax.3	Ax.4
Position-speed switching latch	<input type="checkbox"/>	<input type="checkbox"/>	<input type="checkbox"/>	<input type="checkbox"/>
In speed control	<input type="checkbox"/>	<input type="checkbox"/>	<input type="checkbox"/>	<input type="checkbox"/>
Position-speed switching enable	0:Disable 1:Enable			

2) }
3) }

No.	Axis	Buffer memory address		No.	Axis	Buffer memory address	
		DEC	HEX			DEC	HEX
1)	1 to 4	4330 to 4331, 4430 to 4431, 4530 to 4531, 4630 to 4631	10EA to 10EB, 114E to 114F, 11B2 to 11B3, 1216 to 1217	2)	1 to 4	2417, 2517, 2617, 2717	971, 9D5, A39, A9D
	5 to 8	4730 to 4731, 4830 to 4831, 4930 to 4931, 5030 to 5031	127A to 127B, 12DE to 12DF, 1342 to 1343, 13A6 to 13A7		5 to 8	2817, 2917, 3017, 3117	B01, B65, BC9, C2D
	9 to 12	5130 to 5131, 5230 to 5231, 5330 to 5331, 5430 to 5431	140A to 140B, 146E to 146F, 14D2 to 14D3, 1536 to 1537		9 to 12	3217, 3317, 3417, 3517	C91, CF5, D59, DBD
	13 to 16	5530 to 5531, 5630 to 5631, 5730 to 5731, 5830 to 5831	159A to 159B, 15FE to 15FF, 1662 to 1663, 16C6 to 16C7	3)	1 to 4	4332, 4432, 4532, 4632	10EC, 1150, 11B4, 1218
		5 to 8	4732, 4832, 4932, 5032		127C, 12E0, 1344, 13A8		
		9 to 12	5132, 5232, 5332, 5432		140C, 1470, 14D4, 1538		
			13 to 16	5532, 5632, 5732, 5832	159C, 1600, 1664, 16C8		

- 1 OVERVIEW
- 2 SYSTEM MONITOR
- 3 LADDER MONITOR FUNCTION
- 4 MELSEC-A LIST EDITOR
- 5 MELSEC-FX LIST EDITOR
- 6 INTELLIGENT MODULE MONITOR
- 7 NETWORK MONITOR
- 8 Q MOTION MONITOR

Screen example

QD77MS16 Axis control data-1

SET Data MONIT END
RESET Chg. MENU

1) New current value

Item	Ax.1	Ax.2	Ax.3	Ax.4	Set value
Torq. boost	500	1	20	100	1 to 30000
Step mode	0	0	0	0	0:Dec. unit 1:data No.
Step valid flag	0	0	0	0	0:Invalid 1:Valid
Step start information	0	0	0	0	0:Completed 1:Continue 2:Restarts

2) New speed value

Item	Ax.1	Ax.2	Ax.3	Ax.4	Set value
Skip command	0	0	0	0	0:Completed 1:Skip
Use ext. command	0	0	0	0	0:Invalid 1:Valid

No.	Axis	Buffer memory address		No.	Axis	Buffer memory address	
		DEC	HEX			DEC	HEX
1)	1 to 4	4306 to 4307, 4406 to 4407, 4506 to 4507, 4606 to 4607	10D2 to 10D3, 1136 to 1137, 119A to 119B, 11FE to 11FF	3)	1 to 4	4313, 4413, 4513, 4613	10D9, 113D, 11A1, 1205
	5 to 8	4706 to 4707, 4806 to 4807, 4906 to 4907, 5006 to 5007	1262 to 1263, 12C6 to 12C7, 132A to 132B, 138E to 138F		5 to 8	4713, 4813, 4913, 5013	1269, 12CD, 1331, 1395
	9 to 12	5106 to 5107, 5206 to 5207, 5306 to 5307, 5406 to 5407	13F2 to 13F3, 1456 to 1457, 14BA to 14BB, 151E to 151F		9 to 12	5113, 5213, 5313, 5413	13F9, 145D, 14C1, 1525
	13 to 16	5506 to 5507, 5606 to 5607, 5706 to 5707, 5806 to 5807	1582 to 1583, 15E6 to 15E7, 164A to 164B, 16AE to 16AF		13 to 16	5513, 5613, 5713, 5813	1589, 15ED, 1651, 16B5
2)	1 to 4	4314 to 4315, 4414 to 4415, 4514 to 4515, 4614 to 4615	10DA to 10DB, 113E to 113F, 11A2 to 11A3, 1206 to 1207	6)	1 to 4	4346, 4446, 4546, 4646	10FA, 115E, 11C2, 1226
					5 to 8	4746, 4846, 4946, 5046	128A, 12EE, 1352, 13B6
					9 to 12	5146, 5246, 5346, 5446	141A, 147E, 14E2, 1546
					13 to 16	5546, 5646, 5746, 5846	15AA, 160E, 1672, 16D6
	5 to 8	4714 to 4715, 4814 to 4815, 4914 to 4915, 5014 to 5015	126A to 126B, 12CE to 12CF, 1332 to 1333, 1396 to 1397	7)	1 to 4	4347, 4447, 4547, 4647	10FB, 115F, 11C3, 1227
					5 to 8	4747, 4847, 4947, 5047	128B, 12EF, 1353, 13B7
					9 to 12	5147, 5247, 5347, 5447	141B, 147F, 14E3, 1547
					13 to 16	5547, 5647, 5747, 5847	15AB, 160F, 1673, 16D7
	9 to 12	5114 to 5115, 5214 to 5215, 5314 to 5315, 5414 to 5415	13FA to 13FB, 145E to 145F, 14C2 to 14C3, 1526 to 1527	8)	1 to 4	4305, 4405, 4505, 4605	10D1, 1135, 1199, 11FD
					5 to 8	4705, 4805, 4905, 5005	1261, 12C5, 1329, 138D
					9 to 12	5105, 5205, 5305, 5405	13F1, 1455, 14B9, 151D
					13 to 16	5505, 5605, 5705, 5805	1581, 15E5, 1649, 16AD

Screen example

QD77MS16 Axis control data-2					SET / Data MONIT RESET Chg. MENU END				
Item	Axis1	Axis2	Axis3	Axis4	Item	Axis1	Axis2	Axis3	Axis4
1) Start No.	1	7000	9001	9004	New acc. Time	123456	123456	123456	123456
2) Start point No.	1	1	50	25	New dec. Time	0 to 8388008(msec)			
3) Axis error reset	0	0	0	0	TRQ Tr locus OP	0	0	0	0
4) Restart command	0	0	0	0	OPR req Flag OFF	0	0	0	0
5) M mode OFF request	0	0	0	0	MPG I/P mag.	1000	1000	1000	1000
6) I/O time chg Tr SPD chg,ON/OFF	0	0	0	0	MPG enable	0	0	0	0
7) Speed change request	1	1	0	0	New Torq value	0	0	0	0

No.	Axis	Buffer memory address		No.	Axis	Buffer memory address	
		DEC	HEX			DEC	HEX
1)	1 to 4	4300, 4400, 4500, 4600	10CC, 1130, 1194, 11F8	9)	1 to 4	4310 to 4311, 4410 to 4411, 4510 to 4511, 4610 to 4611	10D6 to 10D7, 113A to 113B, 119E to 119F, 1202 to 1203
	5 to 8	4700, 4800, 4900, 5000	125C, 12C0, 1324, 1388		5 to 8	4710 to 4711, 4810 to 4811, 4910 to 4911, 5010 to 5011	1266 to 1267, 12CA to 12CB, 132E to 132F, 1392 to 1393
	9 to 12	5100, 5200, 5300, 5400	13EC, 1450, 14B4, 1518		9 to 12	5110 to 5111, 5210 to 5211, 5310 to 5311, 5410 to 5411	13F6 to 13F7, 145A to 145B, 14BE to 14BF, 1522 to 1523
	13 to 16	5500, 5600, 5700, 5800	157C, 15E0, 1644, 16A8		13 to 16	5510 to 5511, 5610 to 5611, 5710 to 5711, 5810 to 5811	1586 to 1587, 15EA to 15EB, 164E to 164F, 16B2 to 16B3
2)	1 to 4	4301, 4401, 4501, 4601	10CD, 1131, 1195, 11F9	10)	1 to 4	4320, 4420, 4520, 4620	10E0, 1144, 11A8, 120C
	5 to 8	4701, 4801, 4901, 5001	125D, 12C1, 1325, 1389		5 to 8	4720, 4820, 4920, 5020	1270, 12D4, 1338, 139C
	9 to 12	5101, 5201, 5301, 5401	13ED, 1451, 14B5, 1519		9 to 12	5120, 5220, 5320, 5420	1400, 1464, 14C8, 152C
	13 to 16	5501, 5601, 5701, 5801	157D, 15E1, 1645, 16A9		13 to 16	5520, 5620, 5720, 5820	1590, 15F4, 1658, 16BC
3)	1 to 4	4302, 4402, 4502, 4602	10CE, 1132, 1196, 11FA	11)	1 to 4	4321, 4421, 4521, 4621	10E1, 1145, 11A9, 120D
	5 to 8	4702, 4802, 4902, 5002	125E, 12C2, 1326, 138A		5 to 8	4721, 4821, 4921, 5021	1271, 12D5, 1339, 139D
	9 to 12	5102, 5202, 5302, 5402	13EE, 1452, 14B6, 151A		9 to 12	5121, 5221, 5321, 5421	1401, 1465, 14C9, 152D
	13 to 16	5502, 5602, 5702, 5802	157E, 15E2, 1646, 16AA		13 to 16	5521, 5621, 5721, 5821	1591, 15F5, 1659, 16BD
4)	1 to 4	4303, 4403, 4503, 4603	10CF, 1133, 1197, 11FB	12)	1 to 4	4322 to 4323, 4422 to 4423, 4522 to 4523, 4622 to 4623	10E2 to 10E3, 1146 to 1147, 11AA to 11AB, 120E to 120F
	5 to 8	4703, 4803, 4903, 5003	125F, 12C3, 1327, 138B		5 to 8	4722 to 4723, 4822 to 4823, 4922 to 4923, 5022 to 5023	1272 to 1273, 12D6 to 12D7, 133A to 133B, 139E to 139F
	9 to 12	5103, 5203, 5303, 5403	13EF, 1453, 14B7, 151B		9 to 12	5122 to 5123, 5222 to 5223, 5322 to 5323, 5422 to 5423	1402 to 1403, 1466 to 1467, 14CA to 14CB, 152E to 152F
	13 to 16	5503, 5603, 5703, 5803	157F, 15E3, 1647, 16AB		13 to 16	5522 to 5523, 5622 to 5623, 5722 to 5723, 5822 to 5823	1592 to 1593, 15F6 to 15F7, 165A to 165B, 16BE to 16BF
5)	1 to 4	4304, 4404, 4504, 4604	10D0, 1134, 1198, 11FC	13)	1 to 4	4324, 4424, 4524, 4624	10E4, 1148, 11AC, 1210
	5 to 8	4704, 4804, 4904, 5004	1260, 12C4, 1328, 138C		5 to 8	4724, 4824, 4924, 5024	1274, 12D8, 133C, 13A0
	9 to 12	5104, 5204, 5304, 5404	13F0, 1454, 14B8, 151C		9 to 12	5124, 5224, 5324, 5424	1404, 1468, 14CC, 1530
	13 to 16	5504, 5604, 5704, 5804	1580, 15E4, 1648, 16AC		13 to 16	5524, 5624, 5724, 5824	1594, 15F8, 165C, 16C0
6)	1 to 4	4312, 4412, 4512, 4612	10D8, 113C, 11A0, 1204	14)	1 to 4	4325, 4425, 4525, 4625	10E5, 1149, 11AD, 1211
	5 to 8	4712, 4812, 4912, 5012	1268, 12CC, 1330, 1394		5 to 8	4725, 4825, 4925, 5025	1275, 12D9, 133D, 13A1
	9 to 12	5112, 5212, 5312, 5412	13F8, 145C, 14C0, 1524		9 to 12	5125, 5225, 5325, 5425	1405, 1469, 14CD, 1531
	13 to 16	5512, 5612, 5712, 5812	1588, 15EC, 1650, 16B4		13 to 16	5525, 5625, 5725, 5825	1595, 15F9, 165D, 16C1
7)	1 to 4	4316, 4416, 4516, 4616	10DC, 1140, 11A4, 1208	8)	1 to 4	4308 to 4309, 4408 to 4409, 4508 to 4509, 4608 to 4609	10D4 to 10D5, 1138 to 1139, 119C to 119D, 1200 to 1201
	5 to 8	4716, 4816, 4916, 5016	126C, 12D0, 1334, 1398		5 to 8	4708 to 4709, 4808 to 4809, 4908 to 4909, 5008 to 5009	1264 to 1265, 12C8 to 12C9, 132C to 132D, 1390 to 1391
	9 to 12	5116, 5216, 5316, 5416	13FC, 1460, 14C4, 1528		9 to 12	5108 to 5109, 5208 to 5209, 5308 to 5309, 5408 to 5409	13F4 to 13F5, 1458 to 1459, 14BC to 14BD, 1520 to 1521
	13 to 16	5516, 5616, 5716, 5816	158C, 15F0, 1654, 16B8		13 to 16	5508 to 5509, 5608 to 5609, 5708 to 5709, 5808 to 5809	1584 to 1585, 15E8 to 15E9, 164C to 164D, 16B0 to 16B1

- 1 OVERVIEW
- 2 SYSTEM MONITOR
- 3 LADDER MONITOR FUNCTION
- 4 MELSEC-A LIST EDITOR
- 5 MELSEC-FX LIST EDITOR
- 6 INTELLIGENT MODULE MONITOR
- 7 NETWORK MONITOR
- 8 Q MOTION MONITOR

Screen example

QD77MS16 Axis control data-3					SET/ Data MONIT	RESET Chg. MENU	END
1)	Item	Axis1	Axis2	Axis3	Axis4	Simultaneous starting axis start data	
	Pos. change	0	0	0	0	Data No.	Axis1 Axis2 Axis3 Axis4
		0:Completed 1:Request				Own axis	1 1 1 1
2)	Teaching data selection	0	0	0	0	Axis No.1	1 1 1 1
		0:Address 1:Arc data				Axis No.2	600 600 600 600
3)	Teaching positioning data No.	1	600	1	600	Axis No.3	600 600 600 600
		1 to 600				0:Nontarget / 1 to 600:Start data No.	
4)	Item	Axis1	Axis2	Axis3	Axis4	Item	Axis1 Axis2 Axis3 Axis4
	ABS direction in degrees	0	0	0	0	SV OFF command	0:Servo ON 1:Servo OFF
		0:Shortcut 1:Right 2:Left				Torque output	100 1000 100 0
						0 to 1000(%)	
	Simultaneous starting axis					Gain switch	0 0 0 0
	Item	Axis1	Axis2	Axis3	Axis4	Switch command	0:OFF 1:ON
	Num of Ax	4	4	4	4	PID-PID	1 0 0 1
	Axis No.1	10	10	10	10	chg.req.	0:Completed 1:Request
	Axis No.2	10	10	10	10		
	Axis No.3	10	10	10	10		

No.	Axis	Buffer memory address		No.	Axis	Buffer memory address	
		DEC	HEX			DEC	HEX
1)	1 to 4	4338, 4438, 4538, 4638	10F2, 1156, 11BA, 121E	8)	1 to 4	4341, 4441, 4541, 4641	10F5, 1159, 11BD, 1221
	5 to 8	4738, 4838, 4938, 5038	1282, 12E6, 134A, 13AE		5 to 8	4741, 4841, 4941, 5041	1285, 12E9, 134D, 13B1
	9 to 12	5138, 5238, 5338, 5438	1412, 1476, 14DA, 153E		9 to 12	5141, 5241, 5341, 5441	1415, 1479, 14DD, 1541
	13 to 16	5538, 5638, 5738, 5838	15A2, 1606, 166A, 16CE		13 to 16	5541, 5641, 5741, 5841	15A5, 1609, 166D, 16D1
2)	1 to 4	4348, 4448, 4548, 4648	10FC, 1160, 11C4, 1228	9)	1 to 4	4343, 4443, 4543, 4643	10F7, 115B, 11BF, 1223
	5 to 8	4748, 4848, 4948, 5048	128C, 12F0, 1354, 13B8		5 to 8	4743, 4843, 4943, 5043	1287, 12EB, 134F, 13B3
	9 to 12	5148, 5248, 5348, 5448	141C, 1480, 14E4, 1548		9 to 12	5143, 5243, 5343, 5443	1417, 147B, 14DF, 1543
	13 to 16	5548, 5648, 5748, 5848	15AC, 1610, 1674, 16D8		13 to 16	5543, 5643, 5743, 5843	15A7, 160B, 166F, 16D3
3)	1 to 4	4349, 4449, 4549, 4649	10FD, 1161, 11C5, 1229	10)	1 to 4	4351, 4451, 4551, 4651	10FF, 1163, 11C7, 122B
	5 to 8	4749, 4849, 4949, 5049	128D, 12F1, 1355, 13B9		5 to 8	4751, 4851, 4951, 5051	128F, 12F3, 1357, 13BB
	9 to 12	5149, 5249, 5349, 5449	141D, 1481, 14E5, 1549		9 to 12	5151, 5251, 5351, 5451	141F, 1483, 14E7, 154B
	13 to 16	5549, 5649, 5749, 5849	15AD, 1611, 1675, 16D9		13 to 16	5551, 5651, 5751, 5851	15AF, 1613, 1677, 16DB
4)	1 to 4	4350, 4450, 4550, 4650	10FE, 1162, 11C6, 122A	11)	1 to 4	4352, 4452, 4552, 4652	1100, 1164, 11C8, 122C
	5 to 8	4750, 4850, 4950, 5050	128E, 12F2, 1356, 13BA		5 to 8	4752, 4852, 4952, 5052	1290, 12F4, 1358, 13BC
	9 to 12	5150, 5250, 5350, 5450	141E, 1482, 14E6, 154A		9 to 12	5152, 5252, 5352, 5452	1420, 1484, 14E8, 154C
	13 to 16	5550, 5650, 5750, 5850	15AE, 1612, 1676, 16DA		13 to 16	5552, 5652, 5752, 5852	15B0, 1614, 1678, 16DC
5)	1 to 4	4339, 4439, 4539, 4639	10F3, 1157, 11BB, 121F	12)	1 to 4	4359, 4459, 4559, 4659	1107, 116B, 11CF, 1233
	5 to 8	4739, 4839, 4939, 5039	1283, 12E7, 134B, 13AF		5 to 8	4759, 4859, 4959, 5059	1297, 12FB, 135F, 13C3
	9 to 12	5139, 5239, 5339, 5439	1413, 1477, 14DB, 153F		9 to 12	5159, 5259, 5359, 5459	1427, 148B, 14EF, 1553
	13 to 16	5539, 5639, 5739, 5839	15A3, 1607, 166B, 16CF		13 to 16	5559, 5659, 5759, 5859	15B7, 161B, 167F, 16E3
6)	1 to 4	4340, 4440, 4540, 4640	10F4, 1158, 11BC, 1220	13)	1 to 4	4365, 4465, 4565, 4665	110D, 1171, 11D5, 1239
	5 to 8	4740, 4840, 4940, 5040	1284, 12E8, 134C, 13B0		5 to 8	4765, 4865, 4965, 5065	129D, 1301, 1365, 13C9
	9 to 12	5140, 5240, 5340, 5440	1414, 1478, 14DC, 1540		9 to 12	5165, 5265, 5365, 5465	142D, 1491, 14F5, 1559
	13 to 16	5540, 5640, 5740, 5840	15A4, 1608, 166C, 16D0		13 to 16	5565, 5665, 5765, 5865	15BD, 1621, 1685, 16E9
7)	1 to 4	4341, 4441, 4541, 4641	10F5, 1159, 11BD, 1221	-	-	-	-
	5 to 8	4741, 4841, 4941, 5041	1285, 12E9, 134D, 13B1				
	9 to 12	5141, 5241, 5341, 5441	1415, 1479, 14DD, 1541				
	13 to 16	5541, 5641, 5741, 5841	15A5, 1609, 166D, 16D1				

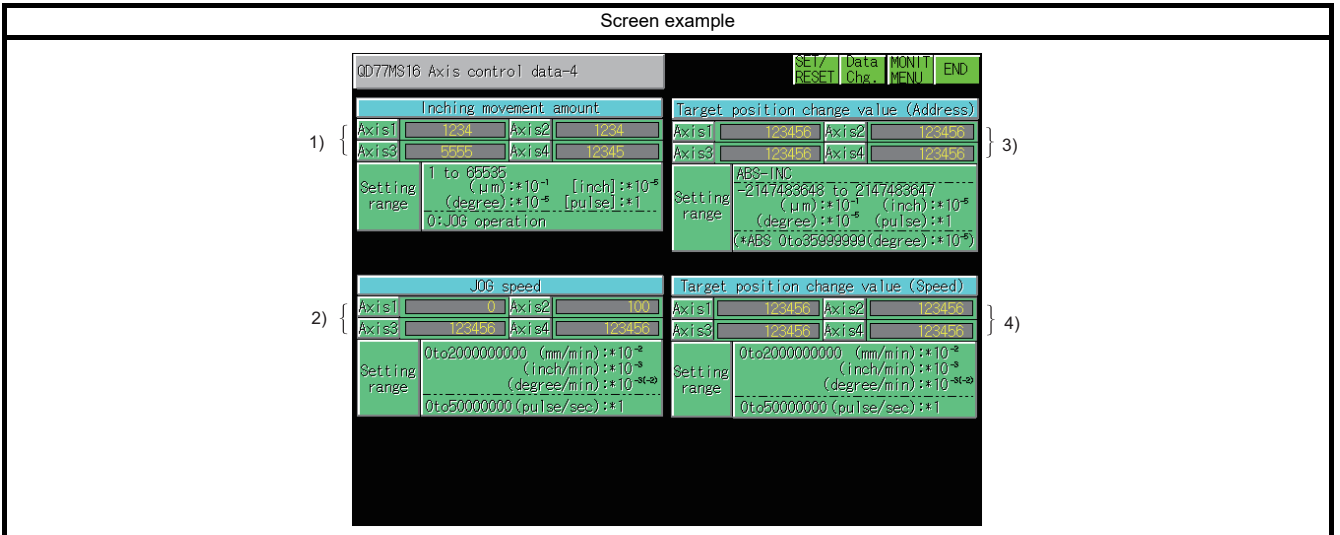

No.	Axis	Buffer memory address		No.	Axis	Buffer memory address	
		DEC	HEX			DEC	HEX
1)	1 to 4	4317, 4417, 4517, 4617	10DD, 1141, 11A5, 1209	3)	1 to 4	4334 to 4335, 4434 to 4435, 4534 to 4535, 4634 to 4635	10EE to 10EF, 1152 to 1153, 11B6 to 11B7, 121A to 121B
	5 to 8	4717, 4817, 4917, 5017	126D, 12D1, 1335, 1399		5 to 8	4734 to 4735, 4834 to 4835, 4934 to 4935, 5034 to 5035	127E to 127F, 12E2 to 12E3, 1346 to 1347, 13AA to 13AB
	9 to 12	5117, 5217, 5317, 5417	13FD, 1461, 14C5, 1529		9 to 12	5134 to 5135, 5234 to 5235, 5334 to 5335, 5434 to 5435	140E to 140F, 1472 to 1473, 14D6 to 14D7, 153A to 153B
	13 to 16	5517, 5617, 5717, 5817	158D, 15F1, 1655, 16B9		13 to 16	5534 to 5535, 5634 to 5635, 5734 to 5735, 5834 to 5835	159E to 159F, 1602 to 1603, 1666 to 1667, 16CA to 16CB
2)	1 to 4	4318 to 4319, 4418 to 4419, 4518 to 4519, 4618 to 4619	10DE to 10DF, 1142 to 1143, 11A6 to 11A7, 120A to 120B	4)	1 to 4	4336 to 4337, 4436 to 4437, 4536 to 4537, 4636 to 4637	10F0 to 10F1, 1154 to 1155, 11B8 to 11B9, 121C to 121D
	5 to 8	4718 to 4719, 4818 to 4819, 4918 to 4919, 5018 to 5019	126E to 126F, 12D2 to 12D3, 1336 to 1337, 139A to 139B		5 to 8	4736 to 4737, 4836 to 4837, 4936 to 4937, 5036 to 5037	1280 to 1281, 12E4 to 12E5, 1348 to 1349, 13AC to 13AD
	9 to 12	5118 to 5119, 5218 to 5219, 5318 to 5319, 5418 to 5419	13FE to 13FF, 1462 to 1463, 14C6 to 14C7, 152A to 152B		9 to 12	5136 to 5137, 5236 to 5237, 5336 to 5337, 5436 to 5437	1410 to 1411, 1474 to 1475, 14D8 to 14D9, 153C to 153D
	13 to 16	5518 to 5519, 5618 to 5619, 5718 to 5719, 5818 to 5819	158E to 158F, 15F2 to 15F3, 1656 to 1657, 16BA to 16BB		13 to 16	5536 to 5537, 5636 to 5637, 5736 to 5737, 5836 to 5837	15A0 to 15A1, 1604 to 1605, 1668 to 1669, 16CC to 16CD

- 1
OVERVIEW
- 2
SYSTEM MONITOR
- 3
LADDER MONITOR FUNCTION
- 4
MELSEC-A LIST EDITOR
- 5
MELSEC-FX LIST EDITOR
- 6
INTELLIGENT MODULE MONITOR
- 7
NETWORK MONITOR
- 8
Q MOTION MONITOR

Screen example

No.	Axis	Buffer memory address		No.	Axis	Buffer memory address	
		DEC	HEX			DEC	HEX
1)	-	4012 to 4016	FAC to FB0	9)	-	4052 to 4056	FD4 to FD8
2)	-	4017 to 4021	FB1 to FB5	10)	-	4057 to 4061	FD9 to FDD
3)	-	4022 to 4026	FB6 to FBA	11)	-	4062 to 4066	FDE to FE2
4)	-	4027 to 4031	FBB to FBF	12)	-	4067 to 4071	FE3 to FE7
5)	-	4032 to 4036	FC0 to FC4	13)	-	4072 to 4076	FE8 to FEC
6)	-	4037 to 4041	FC5 to FC9	14)	-	4077 to 4081	FED to FF1
7)	-	4042 to 4046	FCA to FCE	15)	-	4082 to 4086	FF2 to FF6
8)	-	4047 to 4051	FCF to FD3	16)	-	4087 to 4091	FF7 to FFB

Screen example

No.	Axis	Buffer memory address		No.	Axis	Buffer memory address		No.	Axis	Buffer memory address	
		DEC	HEX			DEC	HEX			DEC	HEX
1)	-	4093 to 4096	FFD to 1000	13)	-	4141 to 4144	102D to 1030	25)	-	4190 to 4193	105E to 1061
2)	-	4097 to 4100	1001 to 1004	14)	-	4145 to 4148	1031 to 1034	26)	-	4194 to 4197	1062 to 1065
3)	-	4101 to 4104	1005 to 1008	15)	-	4149 to 4152	1035 to 1038	27)	-	4198 to 4201	1066 to 1069
4)	-	4105 to 4108	1009 to 100C	16)	-	4153 to 4156	1039 to 103C	28)	-	4202 to 4205	106A to 106D
5)	-	4109 to 4112	100D to 1010	17)	-	4158 to 4161	103E to 1041	29)	-	4206 to 4209	106E to 1071
6)	-	4113 to 4116	1011 to 1014	18)	-	4162 to 4165	1042 to 1045	30)	-	4210 to 4213	1072 to 1075
7)	-	4117 to 4120	1015 to 1018	19)	-	4166 to 4169	1046 to 1049	31)	-	4214 to 4217	1076 to 1079
8)	-	4121 to 4124	1019 to 101C	20)	-	4170 to 4173	104A to 104D	32)	-	4218 to 4221	107A to 107D
9)	-	4125 to 4128	101D to 1020	21)	-	4174 to 4177	104E to 1051	33)	-	31300 to 31315	7A44 to 7A53
10)	-	4129 to 4132	1021 to 1024	22)	-	4178 to 4181	1052 to 1055				
11)	-	4133 to 4136	1025 to 1028	23)	-	4182 to 4185	1056 to 1059	34)	-	31316 to 31331	7A54 to 7A63
12)	-	4137 to 4140	1029 to 102C	24)	-	4186 to 4189	105A to 105D				

Screen example

0077MS16 Positioning data										AREA	SET/	Data	MONIT	END	
Axis1					Axis3										
No	Patt.	Int.	Cont.	Acc.	Dec.	Dwell	Moode	No	Patt.	Int.	Cont.	Acc.	Dec.	Dwell	Moode
	Address		Arc address		Instr. speed				Address		Arc address		Instr. speed		
1)	00	000	0	00	00	0	0		00	000	0	00	00	0	0
			0			0	0				0			0	0
2)	00	000	0	00	00	0	0		00	000	0	00	00	0	0
			0			0	0				0			0	0
3)	00	000	0	00	00	0	0		00	000	0	00	00	0	0
			0			0	0				0			0	0
Axis2					Axis4										
No	Patt.	Int.	Cont.	Acc.	Dec.	Dwell	Moode	No	Patt.	Int.	Cont.	Acc.	Dec.	Dwell	Moode
	Address		Arc address		Instr. speed				Address		Arc address		Instr. speed		
4)	00	000	0	00	00	0	0		00	000	0	00	00	0	0
			0			0	0				0			0	0
5)	00	000	0	00	00	0	0		00	000	0	00	00	0	0
			0			0	0				0			0	0
6)	00	000	0	00	00	0	0		00	000	0	00	00	0	0
			0			0	0				0			0	0

[Pattern] 00: Positioning complete 01: Continuous positioning control 11: Continuous path control
 [Control] 01H:RES1 02H:INC1 03H:FEED1 04H:VF1 05H:VR1 06H:VPF 07H:VPR 08H:PVF 09H:PIV 09H:PIR
 0AH:RES2 0BH:INC2 0CH:FEED2 0DH:RES 0EH:INC 0FH:RES_CW 10H:RES_CCW 11H:INC_CW 12H:INC_CCW
 13H:VF2 14H:VR2 15H:RES3 16H:INC3 17H:FEED3 18H:VF3 19H:VR3 1AH:RES4 1BH:INC4
 1CH:FEED4 1DH:VF4 1EH:VR4 60H:NOP 61H:POS 62H:JUMP 63H:LOOP 64H:LEND

No.	Axis	Buffer memory address		No.	Axis	Buffer memory address		No.	Axis	Buffer memory address	
		DEC	HEX			DEC	HEX			DEC	HEX
1)	1	6000 to 6002, 6004 to 6009	1770 to 1772, 1774 to 1779	5)	2	7010 to 7012, 7014 to 7019	1B62 to 1B64, 1B66 to 1B6B	9)	3	8020 to 8022, 8024 to 8029	1F54 to 1F56, 1F58 to 1F5D
	5	10000 to 10002, 10004 to 10009	2710 to 2712, 2714 to 2719		6	11010 to 11012, 11014 to 11019	2B02 to 2B04, 2B06 to 2B0B		7	12020 to 12022, 12024 to 12029	2EF4 to 2EF6, 2EF8 to 2EFD
	9	14000 to 14002, 14004 to 14009	36B0 to 36B2, 36B4 to 36B9		10	15010 to 15012, 15014 to 15019	3AA2 to 3AA4, 3AA6 to 3AAB		11	16020 to 16022, 16024 to 16029	3E94 to 3E96, 3E98 to 3E9D
	13	18000 to 18002, 18004 to 18009	4650 to 4652, 4654 to 4659		14	19010 to 19012, 19014 to 19019	4A42 to 4A44, 4A46 to 4A4B		15	20020 to 20022, 20024 to 20029	4E34 to 4E36, 4E38 to 4E3D
2)	1	6010 to 6012, 6014 to 6019	177A to 177C, 177E to 1783	6)	2	7020 to 7022, 7024 to 7029	1B6C to 1B6E, 1B70 to 1B75	10)	4	9000 to 9002, 9004 to 9009	2328 to 232A, 232C to 2331
	5	10010 to 10012, 10014 to 10019	271A to 271C, 271E to 2723		6	11020 to 11022, 11024 to 11029	2B0C to 2B0E, 2B10 to 2B15		8	13000 to 13002, 13004 to 13009	32C8 to 32CA, 32CC to 32D1
	9	14010 to 14012, 14014 to 14019	36BA to 36BC, 36BE to 36C3		10	15020 to 15022, 15024 to 15029	3AAC to 3AAE, 3AB0 to 3AB5		12	17000 to 17002, 17004 to 17009	4268 to 426A, 426C to 4271
	13	18010 to 18012, 18014 to 18019	465A to 465C, 465E to 4663		14	19020 to 19022, 19024 to 19029	4A4C to 4A4E, 4A50 to 4A55		16	21000 to 21002, 21004 to 21009	5208 to 520A, 520C to 5211
3)	1	6020 to 6022, 6024 to 6029	1784 to 1786, 1788 to 178D	7)	3	8000 to 8002, 8004 to 8009	1F40 to 1F42, 1F44 to 1F49	11)	4	9010 to 9012, 9014 to 9019	2332 to 2334, 2336 to 233B
	5	10020 to 10022, 10024 to 10029	2724 to 2726, 2728 to 272D		7	12000 to 12002, 12004 to 12009	2EE0 to 2EE2, 2EE4 to 2EE9		8	13010 to 13012, 13014 to 13019	32D2 to 32D4, 32D6 to 32DB
	9	14020 to 14022, 14024 to 14029	36C4 to 36C6, 36C8 to 36CD		11	16000 to 16002, 16004 to 16009	3E80 to 3E82, 3E84 to 3E89		12	17010 to 17012, 17014 to 17019	4272 to 4274, 4276 to 427B
	13	18020 to 18022, 18024 to 18029	4664 to 4666, 4668 to 466D		15	20000 to 20002, 20004 to 20009	4E20 to 4E22, 4E24 to 4E29		16	21010 to 21012, 21014 to 21019	5212 to 5214, 5216 to 521B
4)	2	7000 to 7002, 7004 to 7009	1B58 to 1B5A, 1B5C to 1B61	8)	3	8010 to 8012, 8014 to 8019	1F4A to 1F4C, 1F4E to 1F53	12)	4	9020 to 9022, 9024 to 9029	233C to 233E, 2340 to 2345
	6	11000 to 11002, 11004 to 11009	2AF8 to 2AFA, 2AFC to 2B01		7	12010 to 12012, 12014 to 12019	2EEA to 2EEC, 2EEE to 2EF3		8	13020 to 13022, 13024 to 13029	32DC to 32DE, 32E0 to 32E5
	10	15000 to 15002, 15004 to 15009	3A98 to 3A9A, 3A9C to 3AA1		11	16010 to 16012, 16014 to 16019	3E8A to 3E8C, 3E8E to 3E93		12	17020 to 17022, 17024 to 17029	427C to 427E, 4280 to 4285
	14	19000 to 19002, 19004 to 19009	4A38 to 4A3A, 4A3C to 4A41		15	20010 to 20012, 20014 to 20019	4E2A to 4E2C, 4E2E to 4E33		16	21020 to 21022, 21024 to 21029	521C to 521E, 5220 to 5225

- 1 OVERVIEW
- 2 SYSTEM MONITOR
- 3 LADDER MONITOR FUNCTION
- 4 MELSEC-A LIST EDITOR
- 5 MELSEC-FX LIST EDITOR
- 6 INTELLIGENT MODULE MONITOR
- 7 NETWORK MONITOR
- 8 Q MOTION MONITOR

Screen example

QD77MS16 Sv. parameter Basic setting-1					SET/RESET	Data Chg.	MONIT MENU	END
Item	Axis1	Axis2	Axis3	Axis4	Setting range			
1) Servo series	0	0	3456	0	0:Invalid 1,3,4,6:MR-J3(W)-B 7:MR-MT1200 32:MR-J4-B 98:VC II 4097,4128:Virt.			
2) Selection of regenerative brake option	00	00	00	00	00:Not used 02:MR-RB032 03:MR-RB12 04:MR-RB32 05:MR-RB30 06:MR-RB50 08:MR-RB31 09:MR-RB51			
3) Acc. decel. detection sys.	0	0	0	0	0:Invalid 1:Valid			
4) Func. selection A-1 Emergency stop input	0	0	0	0	0:Valid 1:Invalid			
5) Gain adjustment mode	0	0	0	0	0:Interpolation 1:Auto tuning1 3:Manual 2:Auto tuning2			
6) Response	1	1	1	1	1 16 32 Low Middle High 10Hz 100Hz 400Hz			
7) In position range	000	3000	4000	5000	0 to 50000[pulse]			
8) Rotation direction	0	0	0	0	0:CCW 1:CW			
9) Encoder output pulses	1	1	65535	65535	1 to 65535[pulse]			

No.	Axis	Buffer memory address		No.	Axis	Buffer memory address		No.	Axis	Buffer memory address	
		DEC	HEX			DEC	HEX			DEC	HEX
1)	1 to 4	28400, 28500, 28600, 28700	6EF0, 6F54, 6FB8, 701C	4)	1 to 4	28404, 28504, 28604, 28704	6EF4, 6F58, 6FBC, 7020	7)	1 to 4	28410, 28510, 28610, 28710	6EFA, 6F5E, 6FC2, 7026
	5 to 8	28800, 28900, 29000, 29100	7080, 70E4, 7148, 71AC		5 to 8	28804, 28904, 29004, 29104	7084, 70E8, 714C, 71B0		5 to 8	28810, 28910, 29010, 29110	708A, 70EE, 7152, 71B6
	9 to 12	29200, 29300, 29400, 29500	7210, 7274, 72D8, 733C		9 to 12	29204, 29304, 29404, 29504	7214, 7278, 72DC, 7340		9 to 12	29210, 29310, 29410, 29510	721A, 727E, 72E2, 7346
	13 to 16	29600, 29700, 29800, 29900	73A0, 7404, 7468, 74CC		13 to 16	29604, 29704, 29804, 29904	73A4, 7408, 746C, 74D0		13 to 16	29610, 29710, 29810, 29910	73AA, 740E, 7472, 74D6
2)	1 to 4	28402, 28502, 28602, 28702	6EF2, 6F56, 6FBA, 701E	5)	1 to 4	28408, 28508, 28608, 28708	6EF8, 6F5C, 6FC0, 7024	8)	1 to 4	28414, 28514, 28614, 28714	6EFE, 6F62, 6FC6, 702A
	5 to 8	28802, 28902, 29002, 29102	7082, 70E6, 714A, 71AE		5 to 8	28808, 28908, 29008, 29108	7088, 70EC, 7150, 71B4		5 to 8	28814, 28914, 29014, 29114	708E, 70F2, 7156, 71BA
	9 to 12	29202, 29302, 29402, 29502	7212, 7276, 72DA, 733E		9 to 12	29208, 29308, 29408, 29508	7218, 727C, 72E0, 7344		9 to 12	29214, 29314, 29414, 29514	721E, 7282, 72E6, 734A
	13 to 16	29602, 29702, 29802, 29902	73A2, 7406, 746A, 74CE		13 to 16	29608, 29708, 29808, 29908	73A8, 740C, 7470, 74D4		13 to 16	29614, 29714, 29814, 29914	73AE, 7412, 7476, 74DA
3)	1 to 4	28403, 28503, 28603, 28703	6EF3, 6F57, 6FBB, 701F	6)	1 to 4	28409, 28509, 28609, 28709	6EF9, 6F5D, 6FC1, 7025	9)	1 to 4	28415, 28515, 28615, 28715	6EFF, 6F63, 6FC7, 702B
	5 to 8	28803, 28903, 29003, 29103	7083, 70E7, 714B, 71AF		5 to 8	28809, 28909, 29009, 29109	7089, 70ED, 7151, 71B5		5 to 8	28815, 28915, 29015, 29115	708F, 70F3, 7157, 71BB
	9 to 12	29203, 29303, 29403, 29503	7213, 7277, 72DB, 733F		9 to 12	29209, 29309, 29409, 29509	7219, 727D, 72E1, 7345		9 to 12	29215, 29315, 29415, 29515	721F, 7283, 72E7, 734B
	13 to 16	29603, 29703, 29803, 29903	73A3, 7407, 746B, 74CF		13 to 16	29609, 29709, 29809, 29909	73A9, 740D, 7471, 74D5		13 to 16	29615, 29715, 29815, 29915	73AF, 7413, 7477, 74DB

Screen example

QD77MS16 Sv. parameter Basic setting-2						SET/	Data	MONIT/	END
						RESET	Chg.	MENU	
Item	Axis1	Axis2	Axis3	Axis4	Setting range				
1) Func. selection A-1 Forced stop decel.	0	0	0	0	0:Disabled 2:Enabled				
2) Encoder output p. 2	1	1	1	1	1 to 65535[pulse]				
3) Servo motor series	0	0	1000	1000					
4) Servo motor type	1000	1000	0	0					

No.	Axis	Buffer memory address		No.	Axis	Buffer memory address	
		DEC	HEX			DEC	HEX
1)	1 to 4	28404, 28504, 28604, 28704	6EF4, 6F58, 6FBC, 7020	3)	1 to 4	28417, 28517, 28617, 28717	6F01, 6F65, 6FC9, 702D
	5 to 8	28804, 28904, 29004, 29104	7084, 70E8, 714C, 71B0		5 to 8	28817, 28917, 29017, 29117	7091, 70F5, 7159, 71BD
	9 to 12	29204, 29304, 29404, 29504	7214, 7278, 72DC, 7340		9 to 12	29217, 29317, 29417, 29517	7221, 7285, 72E9, 734D
	13 to 16	29604, 29704, 29804, 29904	73A4, 7408, 746C, 74D0		13 to 16	29617, 29717, 29817, 29917	73B1, 7415, 7479, 74DD
2)	1 to 4	28416, 28516, 28616, 28716	6F00, 6F64, 6FC8, 702C	4)	1 to 4	28418, 28518, 28618, 28718	6F02, 6F66, 6FCA, 702E
	5 to 8	28816, 28916, 29016, 29116	7090, 70F4, 7158, 71BC		5 to 8	28818, 28918, 29018, 29118	7092, 70F6, 715A, 71BE
	9 to 12	29206, 29306, 29406, 29506	7216, 727A, 72DE, 7342		9 to 12	29218, 29318, 29418, 29518	7222, 7286, 72EA, 734E
	13 to 16	29606, 29706, 29806, 29906	73A6, 740A, 746E, 74D2		13 to 16	29618, 29718, 29818, 29918	73B2, 7416, 747A, 74DE

Screen example

QD77MS16 Sv. parameter Basic setting-3						SET/	Data	MONIT/	END
						RESET	Chg.	MENU	
Item	Axis1	Axis2	Axis3	Axis4	Setting range				
1) Tough drive setting Vibration selection	0	0	0	0	0:Disabled 1:Enabled				
2) Tough drive setting power failure	1	1	1	1	0:Disabled 1:Enabled				
3) Func. selection A-3 One-touch tuning	0	0	0	0	0:Disabled 1:Enabled				
4) Func. selection A-4 Vibration suppression	1	1	1	1	0: Standard mode 1: 3 inertia mode 2: Low response mode				
5) Drive reorder	Alarm detail No.	00	00	00	00				
6) Arbitrary alarm trig.	Alarm No.	00	00	00	00				

No.	Axis	Buffer memory address		No.	Axis	Buffer memory address	
		DEC	HEX			DEC	HEX
1)	1 to 4	31632, 31702, 31772, 31842	7B90, 7BD6, 7C1C, 7C62	4)	1 to 4	31636, 31706, 31776, 31846	7B94, 7BDA, 7C20, 7C66
	5 to 8	31912, 31982, 32052, 32122	7CA8, 7CEE, 7D34, 7D7A		5 to 8	31916, 31986, 32056, 32126	7CAC, 7CF2, 7D38, 7D7E
	9 to 12	32192, 32262, 32332, 32402	7DC0, 7E06, 7E4C, 7E92		9 to 12	32196, 32266, 32336, 32406	7DC4, 7E0A, 7E50, 7E96
	13 to 16	32472, 32542, 32612, 32682	7ED8, 7F1E, 7F64, 7FAA		13 to 16	32476, 32546, 32616, 32686	7EDC, 7F22, 7F68, 7FAE
2)	1 to 4	31633, 31703, 31773, 31843	7B91, 7BD7, 7C1D, 7C63	5)	1 to 4	31635, 31705, 31775, 31845	7B93, 7BD9, 7C1F, 7C65
	5 to 8	31913, 31983, 32053, 32123	7CA9, 7CEF, 7D35, 7D7B		5 to 8	31915, 31985, 32055, 32125	7CAB, 7CF1, 7D37, 7D7D
	9 to 12	32193, 32263, 32333, 32403	7DC1, 7E07, 7E4D, 7E93		9 to 12	32195, 32265, 32335, 32405	7DC3, 7E09, 7E4F, 7E95
	13 to 16	32473, 32543, 32613, 32683	7ED9, 7F1F, 7F65, 7FAB		13 to 16	32475, 32545, 32615, 32685	7EDB, 7F21, 7F67, 7FAD

Screen example

QD77MS16 Servo parameter Gain/Filter-1					SET/RESET	Data Chg.	MONIT. MENU	END
Item	Axis1	Axis2	Axis3	Axis4	Setting range			
1) Filter tuning mode	0	0	0	0	0:Filter OFF 1:Filter tuning 2:Manual			
2) Vibration suppression control tuning mode	0	0	0	0	0:Vibration control OFF 1:Vibration ctrl tuning 2:Manual			
3) Feed forward gain	0	0	0	0	0 to 100[%]			
4) Load inertia moment	0	0	0	0	0 to 3000(*10 ⁻³) [times]			
5) Motor loop gain	1	1	1	1	1 to 2000[rad/s]			
6) Position loop gain	1	1	1	1	1 to 1000[rad/s]			
7) Speed loop gain	20	20	20	20	20 to 50000[rad/s]			
8) Speed integral comp.	1	1	1	1	1 to 10000(*10 ⁻³) [ms]			
9) Speed differ. comp.	0	0	0	0	0 to 1000(*10 ⁻³) [%]			
10) Resonance suppl. 1	100	100	100	100	100 to 4500[Hz]			
11) Resonance suppl. 2	100	1000	1000	1000	100 to 4500[Hz]			
12) Low pass filter	1000	2000	3000	4111	100 to 18000[rad/s]			
13) Low pass filter selection	0	0	0	0	0:Automatic setting 1:Manual setting			

No.	Axis	Buffer memory address		No.	Axis	Buffer memory address		No.	Axis	Buffer memory address	
		DEC	HEX			DEC	HEX			DEC	HEX
1)	1 to 4	28419, 28519, 28619, 28719	6F03, 6F67, 6FCB, 702F	6)	1 to 4	28426, 28526, 28626, 28726	6F0A, 6F6E, 6FD2, 7036	11)	1 to 4	28433, 28533, 28633, 28733	6F11, 6F75, 6FD9, 703D
	5 to 8	28819, 28919, 29019, 29119	7093, 70F7, 715B, 71BF		5 to 8	28826, 28926, 29026, 29126	709A, 70FE, 7162, 71C6		5 to 8	28833, 28933, 29033, 29133	70A1, 7105, 7169, 71CD
	9 to 12	29219, 29319, 29419, 29519	7223, 7287, 72EB, 734F		9 to 12	29226, 29326, 29426, 29526	722A, 728E, 72F2, 7356		9 to 12	29233, 29333, 29433, 29533	7231, 7295, 72F9, 735D
	13 to 16	29619, 29719, 29819, 29919	73B3, 7417, 747B, 74DF		13 to 16	29626, 29726, 29826, 29926	73BA, 741E, 7482, 74E6		13 to 16	29633, 29733, 29833, 29933	73C1, 7425, 7489, 74ED
2)	1 to 4	28420, 28520, 28620, 28720	6F04, 6F68, 6FCC, 7030	7)	1 to 4	28427, 28527, 28627, 28727	6F0B, 6F6F, 6FD3, 7037	12)	1 to 4	28436, 28536, 28636, 28736	6F14, 6F78, 6FDC, 7040
	5 to 8	28820, 28920, 29020, 29120	7094, 70F8, 715C, 71C0		5 to 8	28827, 28927, 29027, 29127	709B, 70FF, 7163, 71C7		5 to 8	28836, 28936, 29036, 29136	70A4, 7108, 716C, 71D0
	9 to 12	29220, 29320, 29420, 29520	7224, 7288, 72EC, 7350		9 to 12	29227, 29327, 29427, 29527	722B, 728F, 72F3, 7357		9 to 12	29236, 29336, 29436, 29536	7234, 7298, 72FC, 7360
	13 to 16	29620, 29720, 29820, 29920	73B4, 7418, 747C, 74E0		13 to 16	29627, 29727, 29827, 29927	73BB, 741F, 7483, 74E7		13 to 16	29636, 29736, 29836, 29936	73C4, 7428, 748C, 74F0
3)	1 to 4	28422, 28522, 28622, 28722	6F06, 6F6A, 6FCE, 7032	8)	1 to 4	28428, 28528, 28628, 28728	6F0C, 6F70, 6FD4, 7038	13)	1 to 4	28441, 28541, 28641, 28741	6F19, 6F7D, 6FE1, 7045
	5 to 8	28822, 28922, 29022, 29122	7096, 70FA, 715E, 71C2		5 to 8	28828, 28928, 29028, 29128	709C, 7100, 7164, 71C8		5 to 8	28841, 28941, 29041, 29141	70A9, 710D, 7171, 71D5
	9 to 12	29222, 29322, 29422, 29522	7226, 728A, 72EE, 7352		9 to 12	29228, 29328, 29428, 29528	722C, 7290, 72F4, 7358		9 to 12	29241, 29341, 29441, 29541	7239, 729D, 7301, 7365
	13 to 16	29622, 29722, 29822, 29922	73B6, 741A, 747E, 74E2		13 to 16	29628, 29728, 29828, 29928	73BC, 7420, 7484, 74E8		13 to 16	29641, 29741, 29841, 29941	73C9, 742D, 7491, 74F5
4)	1 to 4	28424, 28524, 28624, 28724	6F08, 6F6C, 6FD0, 7034	9)	1 to 4	28429, 28529, 28629, 28729	6F0D, 6F71, 6FD5, 7039	-	-	-	-
	5 to 8	28824, 28924, 29024, 29124	7098, 70FC, 7160, 71C4		5 to 8	28829, 28929, 29029, 29129	709D, 7101, 7165, 71C9				
	9 to 12	29224, 29324, 29424, 29524	7228, 728C, 72F0, 7354		9 to 12	29229, 29329, 29429, 29529	722D, 7291, 72F5, 7359				
	13 to 16	29624, 29724, 29824, 29924	73B8, 741C, 7480, 74E4		13 to 16	29629, 29729, 29829, 29929	73BD, 7421, 7485, 74E9				
5)	1 to 4	28425, 28525, 28625, 28725	6F09, 6F6D, 6FD1, 7035	10)	1 to 4	28431, 28531, 28631, 28731	6F0F, 6F73, 6FD7, 703B	-	-	-	-
	5 to 8	28825, 28925, 29025, 29125	7099, 70FD, 7161, 71C5		5 to 8	28831, 28931, 29031, 29131	709F, 7103, 7167, 71CB				
	9 to 12	29225, 29325, 29425, 29525	7229, 728D, 72F1, 7355		9 to 12	29231, 29331, 29431, 29531	722F, 7293, 72F7, 735B				
	13 to 16	29625, 29725, 29825, 29925	73B9, 741D, 7481, 74E5		13 to 16	29631, 29731, 29831, 29931	73BF, 7423, 7487, 74EB				

Screen example

QD77MS16 Servo parameter Gain/Filter-2						SET/RESET	Data Chg.	MONIT MENU	END	
	Item	Axis1	Axis2	Axis3	Axis4	Setting range				
1)	Notch shape selection 1	Notch depth selection	1	1	1	1	0	1	2	3
							Deep ← → Shallw			
2)	Notch width selection 1	Notch width selection	0	0	0	0	Standard	←	→	Wide
							α=2	α=3	α=4	α=5
3)	Resonance suppression filter 2	0	0	0	0	0:Invalid 1:Valid				
4)	Notch shape selection 1	Notch depth selection	0	0	0	0	0	1	2	3
							Deep ← → Shallw			
5)	Notch width selection 1	Notch width selection	0	0	0	0	Standard	←	→	Wide
							α=2	α=3	α=4	α=5
6)	Vibration freq.	100	1000	1000	1000	1 to 1000(*10 ⁻³) [Hz]				
7)	Resonance freq.	1000	1000	1000	1000	1 to 1000(*10 ⁻³) [Hz]				
8)	High VIB Supp	0	0	0	0	0:Invalid 1:Valid				
9)	PI-PID switch over selection		0	0	0	0:PI control is valid.				
							3:PID control is always valid.			

No.	Axis	Buffer memory address		No.	Axis	Buffer memory address		No.	Axis	Buffer memory address	
		DEC	HEX			DEC	HEX			DEC	HEX
1)	1 to 4	28400, 28500, 28600, 28700	6EF0, 6F54, 6FB8, 701C	4)	1 to 4	28404, 28504, 28604, 28704	6EF4, 6F58, 6FBC, 7020	7)	1 to 4	28410, 28510, 28610, 28710	6EFA, 6F5E, 6FC2, 7026
	5 to 8	28800, 28900, 29000, 29100	7080, 70E4, 7148, 71AC		5 to 8	28804, 28904, 29004, 29104	7084, 70E8, 714C, 71B0		5 to 8	28810, 28910, 29010, 29110	708A, 70EE, 7152, 71B6
	9 to 12	29200, 29300, 29400, 29500	7210, 7274, 72D8, 733C		9 to 12	29204, 29304, 29404, 29504	7214, 7278, 72DC, 7340		9 to 12	29210, 29310, 29410, 29510	721A, 727E, 72E2, 7346
	13 to 16	29600, 29700, 29800, 29900	73A0, 7404, 7468, 74CC		13 to 16	29604, 29704, 29804, 29904	73A4, 7408, 746C, 74D0		13 to 16	29610, 29710, 29810, 29910	73AA, 740E, 7472, 74D6
2)	1 to 4	28402, 28502, 28602, 28702	6EF2, 6F56, 6FBA, 701E	5)	1 to 4	28408, 28508, 28608, 28708	6EF8, 6F5C, 6FC0, 7024	8)	1 to 4	28414, 28514, 28614, 28714	6EFE, 6F62, 6FC6, 702A
	5 to 8	28802, 28902, 29002, 29102	7082, 70E6, 714A, 71AE		5 to 8	28808, 28908, 29008, 29108	7088, 70EC, 7150, 71B4		5 to 8	28814, 28914, 29014, 29114	708E, 70F2, 7156, 71BA
	9 to 12	29202, 29302, 29402, 29502	7212, 7276, 72DA, 733E		9 to 12	29208, 29308, 29408, 29508	7218, 727C, 72E0, 7344		9 to 12	29214, 29314, 29414, 29514	721E, 7282, 72E6, 734A
	13 to 16	29602, 29702, 29802, 29902	73A2, 7406, 746A, 74CE		13 to 16	29608, 29708, 29808, 29908	73A8, 740C, 7470, 74D4		13 to 16	29614, 29714, 29814, 29914	73AE, 7412, 7476, 74DA
3)	1 to 4	28403, 28503, 28603, 28703	6EF3, 6F57, 6FBB, 701F	6)	1 to 4	28409, 28509, 28609, 28709	6EF9, 6F5D, 6FC1, 7025	9)	1 to 4	28415, 28515, 28615, 28715	6EFF, 6F63, 6FC7, 702B
	5 to 8	28803, 28903, 29003, 29103	7083, 70E7, 714B, 71AF		5 to 8	28809, 28909, 29009, 29109	7089, 70ED, 7151, 71B5		5 to 8	28815, 28915, 29015, 29115	708F, 70F3, 7157, 71BB
	9 to 12	29203, 29303, 29403, 29503	7213, 7277, 72DB, 733F		9 to 12	29209, 29309, 29409, 29509	7219, 727D, 72E1, 7345		9 to 12	29215, 29315, 29415, 29515	721F, 7283, 72E7, 734B
	13 to 16	29603, 29703, 29803, 29903	73A3, 7407, 746B, 74CF		13 to 16	29609, 29709, 29809, 29909	73A9, 740D, 7471, 74D5		13 to 16	29615, 29715, 29815, 29915	73AF, 7413, 7477, 74DB

- 1 OVERVIEW
- 2 SYSTEM MONITOR
- 3 LADDER MONITOR FUNCTION
- 4 MELSEC-A LIST EDITOR
- 5 MELSEC-FX LIST EDITOR
- 6 INTELLIGENT MODULE MONITOR
- 7 NETWORK MONITOR
- 8 Q MOTION MONITOR

Screen example

QD77MS16 Servo parameter Gain/Filter-3					SET/	Data	MONIT	END
					RESET	Chg.	MENU	
Item	Axis1	Axis2	Axis3	Axis4	Setting range			
1) Gain switch condition	0	0	0	0	0 to 9999			
2) Const. at gain switch	100	100	100	100	0 to 100[ms]			
3) Load inertia ratio to gain switch servo	0	0	0	0	0 to 3000(*10 ⁻¹)			
4) Position loop gain	1	1	1	1	1 to 2000[rad/s]			
5) Speed loop gain	20	100	100	100	20 to 50000[rd/s]			
6) Speed integral comp.	1	1	1	100	1 to 50000(*10 ⁻¹)[ms]			
7) Vibration freq setup	100	1000	1000	1000	1 to 1000(*10 ⁻¹)[Hz]			
8) Resonance freq setup	1	1	1	1	1 to 1000(*10 ⁻¹)[Hz]			
Item	Axis1	Axis2	Axis3	Axis4				
Gain changing selection	00	00	00	00	9)			
00:Invalid 01:Control command by the controller is effective. 02:Command frequency is more than PB27. 03:(Motor encoder unit)Droop pulse is more than PB27. 04:Model speed is more than PB27. 12:Command frequency is less than PB27. 13:(Motor encoder unit)Droop pulse is less than PB27. 14:Model speed is less than PB27.								

No.	Axis	Buffer memory address		No.	Axis	Buffer memory address	
		DEC	HEX			DEC	HEX
1)	1 to 4	28445, 28545, 28645, 28745	6F1D, 6F81, 6FE5, 7049	6)	1 to 4	28450, 28550, 28650, 28750	6F22, 6F86, 6FEA, 704E
	5 to 8	28845, 28945, 29045, 29145	70AD, 7111, 7175, 71D9		5 to 8	28850, 28950, 29050, 29150	70B2, 7116, 717A, 71DE
	9 to 12	29245, 29345, 29445, 29545	723D, 72A1, 7305, 7369		9 to 12	29250, 29350, 29450, 29550	7242, 72A6, 730A, 736E
	13 to 16	29645, 29745, 29845, 29945	73CD, 7431, 7495, 74F9		13 to 16	29650, 29750, 29850, 29950	73D2, 7436, 749A, 74FE
2)	1 to 4	28446, 28546, 28646, 28746	6F1E, 6F82, 6FE6, 704A	7)	1 to 4	28451, 28551, 28651, 28751	6F23, 6F87, 6FEB, 704F
	5 to 8	28846, 28946, 29046, 29146	70AE, 7112, 7176, 71DA		5 to 8	28851, 28951, 29051, 29151	70B3, 7117, 717B, 71DF
	9 to 12	29246, 29346, 29446, 29546	723E, 72A2, 7306, 736A		9 to 12	29251, 29351, 29451, 29551	7243, 72A7, 730B, 736F
	13 to 16	29646, 29746, 29846, 29946	73CE, 7432, 7496, 74FA		13 to 16	29651, 29751, 29851, 29951	73D3, 7437, 749B, 74FF
3)	1 to 4	28447, 28547, 28647, 28747	6F1F, 6F83, 6FE7, 704B	8)	1 to 4	28452, 28552, 28652, 28752	6F24, 6F88, 6FEC, 7050
	5 to 8	28847, 28947, 29047, 29147	70AF, 7113, 7177, 71DB		5 to 8	28852, 28952, 29052, 29152	70B4, 7118, 717C, 71E0
	9 to 12	29247, 29347, 29447, 29547	723F, 72A3, 7307, 736B		9 to 12	29252, 29352, 29452, 29552	7244, 72A8, 730C, 7370
	13 to 16	29647, 29747, 29847, 29947	73CF, 7433, 7497, 74FB		13 to 16	29652, 29752, 29852, 29952	73D4, 7438, 749C, 7500
4)	1 to 4	28448, 28548, 28648, 28748	6F20, 6F84, 6FE8, 704C	9)	1 to 4	28444, 28544, 28644, 28744	6F1C, 6F80, 6FE4, 7048
	5 to 8	28848, 28948, 29048, 29148	70B0, 7114, 7178, 71DC		5 to 8	28844, 28944, 29044, 29144	70AC, 7110, 7174, 71D8
	9 to 12	29248, 29348, 29448, 29548	7240, 72A4, 7308, 736C		9 to 12	29244, 29344, 29444, 29544	723C, 72A0, 7304, 7368
	13 to 16	29648, 29748, 29848, 29948	73D0, 7434, 7498, 74FC		13 to 16	29644, 29744, 29844, 29944	73CC, 7430, 7494, 74F8
5)	1 to 4	28449, 28549, 28649, 28749	6F21, 6F85, 6FE9, 704D	-	-	-	-
	5 to 8	28849, 28949, 29049, 29149	70B1, 7115, 7179, 71DD	-	-	-	-
	9 to 12	29249, 29349, 29449, 29549	7241, 72A5, 7309, 736D	-	-	-	-
	13 to 16	29649, 29749, 29849, 29949	73D1, 7435, 7499, 74FD	-	-	-	-

Screen example

QD77MS16 Servo parameter Gain/Filter-4						SET/ Data RESET Chg. MONIT MENU END
Item	Axis1	Axis2	Axis3	Axis4	Setting range	
1) Vibration suppression control 2 tuning mode	0	0	0	0	0: Disabled 1: Automatic setting 2: Manual setting	
2) Torque feedback gain	0	0	0	0	0 to 18000[rad/s]	
3) Overshoot amount comp.	0	0	0	0	0 to 100[%]	
4) Shaft resonance suppression filter setting frequency	00	00	00	00	00:Disabled 01:Disabled 02: 0F 0F 0F 0F High Middle Low 4500Hz 600Hz 290Hz	
5) Notch depth selection	0	0	0	0	0 1 2 3 Deep ← → Shallow =4.0dB =14.0dB =3.0dB =4.0dB	
6) VRF1 Vibration freq. damping	0	0	0	0	0 to 30(*10 ⁻²)	
7) VRF1 Resonance freq. damping	0	0	0	0	0 to 30(*10 ⁻²)	

No.	Axis	Buffer memory address		No.	Axis	Buffer memory address	
		DEC	HEX			DEC	HEX
1)	1 to 4	28420, 28520, 28620, 28720	6F04, 6F68, 6FCC, 7030	4)	1 to 4	28435, 28535, 28635, 28735	6F13, 6F77, 6FDB, 703F
	5 to 8	28820, 28920, 29020, 29120	7094, 70F8, 715C, 71C0		5 to 8	28835, 28935, 29035, 29135	70A3, 7107, 716B, 71CF
	9 to 12	29220, 29320, 29420, 29520	7224, 7288, 72EC, 7350		9 to 12	29235, 29335, 29435, 29535	7233, 7297, 72FB, 735F
	13 to 16	29620, 29720, 29820, 29920	73B4, 7418, 747C, 74E0		13 to 16	29635, 29735, 29835, 29935	73C3, 7427, 748B, 74EF
2)	1 to 4	28421, 28521, 28621, 28721	6F05, 6F69, 6FCD, 7031	6)	1 to 4	28439, 28539, 28639, 28739	6F17, 6F7B, 6FDF, 7043
	5 to 8	28821, 28921, 29021, 29121	7095, 70F9, 715D, 71C1		5 to 8	28839, 28939, 29039, 29139	70A7, 710B, 716F, 71D3
	9 to 12	29221, 29321, 29421, 29521	7225, 7289, 72ED, 7351		9 to 12	29239, 29339, 29439, 29539	7237, 729B, 72FF, 7363
	13 to 16	29621, 29721, 29821, 29921	73B5, 7419, 747D, 74E1		13 to 16	29639, 29739, 29839, 29939	73C7, 742B, 748F, 74F3
3)	1 to 4	28430, 28530, 28630, 28730	6F0E, 6F72, 6FD6, 703A	7)	1 to 4	28440, 28540, 28640, 28740	6F18, 6F7C, 6FE0, 7044
	5 to 8	28830, 28930, 29030, 29130	709E, 7102, 7166, 71CA		5 to 8	28840, 28940, 29040, 29140	70A8, 710C, 7170, 71D4
	9 to 12	29230, 29330, 29430, 29530	722E, 7292, 72F6, 735A		9 to 12	29240, 29340, 29440, 29540	7238, 729C, 7300, 7364
	13 to 16	29630, 29730, 29830, 29930	73BE, 7422, 7486, 74EA		13 to 16	29640, 29740, 29840, 29940	73C8, 742C, 7490, 74F4

Screen example

QD77MS16 Servo parameter Gain/Filter-5						SET/ Data RESET Chg. MONIT MENU END
Item	Axis1	Axis2	Axis3	Axis4	Setting range	
1) VRF1 Vibration freq. after gain switching	0	0	0	0	0 to 30(*10 ⁻²)	
2) VRF1 Resonance freq. after gain switching	0	0	0	0	0 to 30(*10 ⁻²)	
3) Command notch filter setting frequency selection	0	0	0	0	00:Disabled 01: 2F 0F 5F High Middle Low 2250Hz 30Hz 4.5Hz	
4) Notch depth selection	0	0	0	0	0 7 F Deep Middle Shallow =40.0dB =7.2dB =0.6dB	

No.	Axis	Buffer memory address		No.	Axis	Buffer memory address	
		DEC	HEX			DEC	HEX
1)	1 to 4	28453, 28553, 28653, 28753	6F25, 6F89, 6FED, 7051	3)	1 to 4	28463, 28563, 28663, 28763	6F2F, 6F93, 6FF7, 705B
	5 to 8	28853, 28953, 29053, 29153	70B5, 7119, 717D, 71E1		5 to 8	28863, 28963, 29063, 29163	70BF, 7123, 7187, 71EB
	9 to 12	29253, 29353, 29453, 29553	7245, 72A9, 730D, 7371		9 to 12	29263, 29363, 29463, 29563	724F, 72B3, 7317, 737B
	13 to 16	29653, 29753, 29853, 29953	73D5, 7439, 749D, 7501		13 to 16	29663, 29763, 29863, 29963	73DF, 7443, 74A7, 750B
2)	1 to 4	28454, 28554, 28654, 28754	6F26, 6F8A, 6FEE, 7052				
	5 to 8	28854, 28954, 29054, 29154	70B6, 711A, 717E, 71E2				
	9 to 12	29254, 29354, 29454, 29554	7246, 72AA, 730E, 7372				
	13 to 16	29654, 29754, 29854, 29954	73D6, 743A, 749E, 7502				

Screen example

QD77MS16 Servo parameter Gain/Filter-6						SET/RESET	Data Chg.	MONIT MENU	END
Item	Axis1	Axis2	Axis3	Axis4	Setting range				
1) Resonance suppr. 3	10	3000	1000	1000	10 to 4500[Hz]				
2) Resonance suppression filter 3	0	0	0	0	0:Disabled 1:Enabled				
3) Notch filter selection	0	1	2	3	Deep ← → Shallow				
	-40dB	-14dB	-8dB	-4dB					
4) Notch width selection	0	1	2	3	Standard ← → Wide				
	$\alpha=2$	$\alpha=3$	$\alpha=4$	$\alpha=5$					
5) Resonance suppr. 4	1000	1000	10	10	10 to 4500[Hz]				
6) Resonance suppression filter 4	0	0	0	0	0:Disabled 1:Enabled				
7) Notch filter selection 4	0	1	2	3	Deep ← → Shallow				
	-40dB	-14dB	-8dB	-4dB					
8) Notch width selection 4	0	1	2	3	Standard ← → Wide				
	$\alpha=2$	$\alpha=3$	$\alpha=4$	$\alpha=5$					

No.	Axis	Buffer memory address		No.	Axis	Buffer memory address	
		DEC	HEX			DEC	HEX
1)	1 to 4	31645, 31715, 31785, 31855	7B9D, 7BE3, 7C29, 7C6F	5)	1 to 4	31647, 31717, 31787, 31857	7B9F, 7BE5, 7C2B, 7C71
	5 to 8	31925, 31995, 32065, 32135	7CB5, 7CFB, 7D41, 7D87		5 to 8	31927, 31997, 32067, 32137	7CB7, 7CFD, 7D43, 7D89
	9 to 12	32205, 32275, 32345, 32415	7DCD, 7E13, 7E59, 7E9F		9 to 12	32207, 32277, 32347, 32417	7DCF, 7E15, 7E5B, 7EA1
	13 to 16	32485, 32555, 32625, 32695	7EE5, 7F2B, 7F71, 7FB7		13 to 16	32487, 32557, 32627, 32697	7EE7, 7F2D, 7F73, 7FB9
2)	1 to 4	31646, 31716, 31786, 31856	7B9E, 7BE4, 7C2A, 7C70	6)	1 to 4	31648, 31718, 31788, 31858	7BA0, 7BE6, 7C2C, 7C72
	5 to 8	31926, 31996, 32066, 32136	7CB6, 7CFC, 7D42, 7D88		5 to 8	31928, 31998, 32068, 32138	7CB8, 7CFE, 7D44, 7D8A
3)	9 to 12	32206, 32276, 32346, 32416	7DCE, 7E14, 7E5A, 7EA0	7)	9 to 12	32208, 32278, 32348, 32418	7DD0, 7E16, 7E5C, 7EA2
	13 to 16	32486, 32556, 32626, 32696	7EE6, 7F2C, 7F72, 7FB8		8)	13 to 16	32488, 32558, 32628, 32698

Screen example

QD77MS16 Servo parameter Gain/Filter-7						SET/RESET	Data Chg.	MONIT MENU	END
Item	Axis1	Axis2	Axis3	Axis4	Setting range				
1) Resonance suppr. 5	10	4500	3000	1000	10 to 4500[Hz]				
2) Resonance suppression filter 5	0	0	0	0	0:Disabled 1:Enabled				
3) Notch filter selection	0	1	2	3	Deep ← → Shallow				
	-40dB	-14dB	-8dB	-4dB					
4) Notch width selection	0	1	2	3	Standard ← → Wide				
	$\alpha=2$	$\alpha=3$	$\alpha=4$	$\alpha=5$					
5) VRF2 Vibration freq.	1	1	1	1	1 to 3000(*10 ⁻⁴)[Hz]				
6) VRF2 Resonance freq.	200	1400	1000	2000	1 to 3000(*10 ⁻⁴)[Hz]				
7) VRF2 Vibration freq. damping	0	0	0	0	0 to 30(*10 ⁻²)				
8) VRF2 Resonance freq. damping	0	0	0	0	0 to 30(*10 ⁻²)				

No.	Axis	Buffer memory address		No.	Axis	Buffer memory address	
		DEC	HEX			DEC	HEX
1)	1 to 4	31649, 31719, 31789, 31859	7BA1, 7BE7, 7C2D, 7C73	6)	1 to 4	31652, 31722, 31792, 31862	7BA4, 7BEA, 7C30, 7C76
	5 to 8	31929, 31999, 32069, 32139	7CB9, 7CFF, 7D45, 7D8B		5 to 8	31932, 32002, 32072, 32142	7CBC, 7D02, 7D48, 7D8E
	9 to 12	32209, 32279, 32349, 32419	7DD1, 7E17, 7E5D, 7EA3		9 to 12	32212, 32282, 32352, 32422	7DD4, 7E1A, 7E60, 7EA6
	13 to 16	32489, 32559, 32629, 32699	7EE9, 7F2F, 7F75, 7FBB		13 to 16	32492, 32562, 32632, 32702	7EEC, 7F32, 7F78, 7FBE
2)	1 to 4	31650, 31720, 31790, 31860	7BA2, 7BE8, 7C2E, 7C74	7)	1 to 4	31653, 31723, 31793, 31863	7BA5, 7BEB, 7C31, 7C77
	5 to 8	31930, 32000, 32070, 32140	7CBA, 7D00, 7D46, 7D8C		5 to 8	31933, 32003, 32073, 32143	7CBD, 7D03, 7D49, 7D8F
3)	9 to 12	32210, 32280, 32350, 32420	7DD2, 7E18, 7E5E, 7EA4	7)	9 to 12	32213, 32283, 32353, 32423	7DD5, 7E1B, 7E61, 7EA7
	13 to 16	32490, 32560, 32630, 32700	7EEA, 7F30, 7F76, 7FBC		8)	13 to 16	32493, 32563, 32633, 32703
5)	1 to 4	31651, 31721, 31791, 31861	7BA3, 7BE9, 7C2F, 7C75	8)		1 to 4	31654, 31724, 31794, 31864
	5 to 8	31931, 32001, 32071, 32141	7CBB, 7D01, 7D47, 7D8D		5 to 8	31934, 32004, 32074, 32144	7CBE, 7D04, 7D4A, 7D90
	9 to 12	32211, 32281, 32351, 32421	7DD3, 7E19, 7E5F, 7EA5		9 to 12	32214, 32284, 32354, 32424	7DD6, 7E1C, 7E62, 7EA8
	13 to 16	32491, 32561, 32631, 32701	7EEB, 7F31, 7F77, 7FBD		13 to 16	32494, 32564, 32634, 32704	7EEE, 7F34, 7F7A, 7FC0

Screen example

OD77MS16 Servo parameter Gain/Filter-8					SET/	Data	MONIT	END
					RESET	Chg.	MENU	
Item	Axis1	Axis2	Axis3	Axis4	Setting range			
1) VRF2 Vibration freq. after gain switching	1000	1000	1000	1000	1 to 3000(*10 ⁻¹) [Hz]			
2) VRF2 Resonance freq. after gain switching	2000	2000	2000	2000	1 to 3000(*10 ⁻¹) [Hz]			
3) VRF2 V. freq. damping after gain switching	0	0	0	0	0 to 30(*10 ⁻²)			
4) VRF2 R. freq. damping after gain switching	0	0	0	0	0 to 30(*10 ⁻²)			
5) Model loop gain after gain switching	1000	1000	1000	1000	1 to 2000[rad/s]			

No.	Axis	Buffer memory address		No.	Axis	Buffer memory address	
		DEC	HEX			DEC	HEX
1)	1 to 4	31455, 31525, 31595, 31665	7ADF, 7B25, 7B6B, 7BB1	4)	1 to 4	31458, 31528, 31598, 31668	7AE2, 7B28, 7B6E, 7BB4
	5 to 8	31735, 31805, 31875, 31945	7BF7, 7C3D, 7C83, 7CC9		5 to 8	31738, 31808, 31878, 31948	7BFA, 7C40, 7C86, 7CCC
	9 to 12	32015, 32085, 32155, 32225	7D0F, 7D55, 7D9B, 7DE1		9 to 12	32018, 32088, 32158, 32228	7D12, 7D58, 7D9E, 7DE4
	13 to 16	32295, 32365, 32435, 32505	7E27, 7E6D, 7EB3, 7EF9		13 to 16	32298, 32368, 32438, 32508	7E2A, 7E70, 7EB6, 7EFC
2)	1 to 4	31456, 31526, 31596, 31666	7AE0, 7B26, 7B6C, 7BB2	5)	1 to 4	31459, 31529, 31599, 31669	7AE3, 7B29, 7B6F, 7BB5
	5 to 8	31736, 31806, 31876, 31946	7BF8, 7C3E, 7C84, 7CCA		5 to 8	31739, 31809, 31879, 31949	7BFB, 7C41, 7C87, 7CCD
	9 to 12	32016, 32086, 32156, 32226	7D10, 7D56, 7D9C, 7DE2		9 to 12	32019, 32089, 32159, 32229	7D13, 7D59, 7D9F, 7DE5
	13 to 16	32296, 32366, 32436, 32506	7E28, 7E6E, 7EB4, 7EFA		13 to 16	32299, 32369, 32439, 32509	7E2B, 7E71, 7EB7, 7EFD
3)	1 to 4	31457, 31527, 31597, 31667	7AE1, 7B27, 7B6D, 7BB3	-	-	-	-
	5 to 8	31737, 31807, 31877, 31947	7BF9, 7C3F, 7C85, 7CCB				
	9 to 12	32017, 32087, 32157, 32227	7D11, 7D57, 7D9D, 7DE3				
	13 to 16	32297, 32367, 32437, 32507	7E29, 7E6F, 7EB5, 7EFB				

- 1 OVERVIEW
- 2 SYSTEM MONITOR
- 3 LADDER MONITOR FUNCTION
- 4 MELSEC-A LIST EDITOR
- 5 MELSEC-FX LIST EDITOR
- 6 INTELLIGENT MODULE MONITOR
- 7 NETWORK MONITOR
- 8 Q MOTION MONITOR

Screen example

QD77MS16 Sv. parameter Ex. setting1-1						SET/	Data	MONIT	END
						RESET	Chg.	MENU	
Item	Axis1	Axis2	Axis3	Axis4	Setting range				
1) Encoder excessive level	1	1	1	1	1 to 200[rev]				
2) EM brake response	0	0	0	1	0 to 1000[ms]				
3) Encoder pulse output direction selection	0	0	0	0	0:00W 1:0W (progress to A phases 90°)				
4) Encoder pulse output setting selection	0	0	0	0	0:Output pulse dsgn. 1:Division ratio setting				
5) Function selection C1 Serial encoder cable	0	0	0	0	0:2-wire 1:4-wire				
6) Function selection C2 Motor-less operation	0	0	0	0	0:Invalid 1:Valid				
7) Zero speed	10000	10000	10000	10000	0 to 10000[r/min]				

No.	Axis	Buffer memory address		No.	Axis	Buffer memory address	
		DEC	HEX			DEC	HEX
1)	1 to 4	28464, 28564, 28664, 28764	6F30, 6F94, 6FF8, 705C	5)	1 to 4	28467, 28567, 28667, 28767	6F33, 6F97, 6FFB, 705F
	5 to 8	28864, 28964, 29064, 29164	70C0, 7124, 7188, 71EC		5 to 8	28867, 28967, 29067, 29167	70C3, 7127, 718B, 71EF
	9 to 12	29264, 29364, 29464, 29564	7250, 72B4, 7318, 737C		9 to 12	29267, 29367, 29467, 29567	7253, 72B7, 731B, 737F
	13 to 16	29664, 29764, 29864, 29964	73E0, 7444, 74A8, 750C		13 to 16	29667, 29767, 29867, 29967	73E3, 7447, 74AB, 750F
2)	1 to 4	28465, 28565, 28665, 28765	6F31, 6F95, 6FF9, 705D	6)	1 to 4	28468, 28568, 28668, 28768	6F34, 6F98, 6FFC, 7060
	5 to 8	28865, 28965, 29065, 29165	70C1, 7125, 7189, 71ED		5 to 8	28868, 28968, 29068, 29168	70C4, 7128, 718C, 71F0
	9 to 12	29265, 29365, 29465, 29565	7251, 72B5, 7319, 737D		9 to 12	29268, 29368, 29468, 29568	7254, 72B8, 731C, 7380
	13 to 16	29665, 29765, 29865, 29965	73E1, 7445, 74A9, 750D		13 to 16	29668, 29768, 29868, 29968	73E4, 7448, 74AC, 7510
3)	1 to 4	28466, 28566, 28666, 28766	6F32, 6F96, 6FFA, 705E	7)	1 to 4	28470, 28570, 28670, 28770	6F36, 6F9A, 6FFE, 7062
	5 to 8	28866, 28966, 29066, 29166	70C2, 7126, 718A, 71EE		5 to 8	28870, 28970, 29070, 29170	70C6, 712A, 718E, 71F2
4)	9 to 12	29266, 29366, 29466, 29566	7252, 72B6, 731A, 737E		9 to 12	29270, 29370, 29470, 29570	7256, 72BA, 731E, 7382
	13 to 16	29666, 29766, 29866, 29966	73E2, 7446, 74AA, 750E		13 to 16	29670, 29770, 29870, 29970	73E6, 744A, 74AE, 7512

Screen example

QD77MS16 Sv. parameter Ex. setting1-2						SET/	Data	MONIT	END
						RESET	Chg.	MENU	
Item	Axis1	Axis2	Axis3	Axis4	Setting range				
Analog monitor 1 offset	0	0	0	0	000 to 999[r/min]	1)			
Analog monitor 2 offset	0	0	0	0	000 to 999[r/min]	2)			
Item	Axis1	Axis2	Axis3	Axis4					
Analog monitor output selection(ch1)	0	0	0	0	3)				
Analog monitor output selection(ch2)	0	0	0	0	4)				
Setting range									
0: Servo motor speed(±8V/max. speed)									
1: Torque(±8V/max. torque)									
2: Servo motor speed(+8V/max. speed)									
3: Torque(+8V/max. torque)									
4: Current command(±8V/max. curre)									
5: Command speed(±8V/max. command speed)									
6: Droop puls(±10V/1000puls[Encoder unit])									
7: Droop puls(±10V/10000puls[Encoder unit])									
8: Droop puls(±10V/100000puls[Encoder unit])									
9: Droop puls(±10V/1000000puls[Encoder unit])									
A: Feedback position(±10V/1,000,000puls[Encoder unit])									
B: Feedback position(±10V/10,000,000puls[Encoder unit])									
C: Feedback position(±10V/100,000,000puls[Encoder unit])									
D: Bus voltage(+8V/400V, Amplifier of 200V)									
E: Bus voltage(+8V/800V, Amplifier of 400V)									
F: F·15~1F:Un-output(Zero output)									

No.	Axis	Buffer memory address		No.	Axis	Buffer memory address	
		DEC	HEX			DEC	HEX
1)	1 to 4	28474, 28574, 28674, 28774	6F3A, 6F9E, 7002, 7066	3)	1 to 4	28472, 28572, 28672, 28772	6F38, 6F9C, 7000, 7064
	5 to 8	28874, 28974, 29074, 29174	70CA, 712E, 7192, 71F6		5 to 8	28872, 28972, 29072, 29172	70C8, 712C, 7190, 71F4
	9 to 12	29274, 29374, 29474, 29574	725A, 72BE, 7322, 7386		9 to 12	29272, 29372, 29472, 29572	7258, 72BC, 7320, 7384
	13 to 16	29674, 29774, 29874, 29974	73EA, 744E, 74B2, 7516		13 to 16	29672, 29772, 29872, 29972	73E8, 744C, 74B0, 7514
2)	1 to 4	28475, 28575, 28675, 28775	6F3B, 6F9F, 7003, 7067	4)	1 to 4	28473, 28573, 28673, 28773	6F39, 6F9D, 7001, 7065
	5 to 8	28875, 28975, 29075, 29175	70CB, 712F, 7193, 71F7		5 to 8	28873, 28973, 29073, 29173	70C9, 712D, 7191, 71F5
	9 to 12	29275, 29375, 29475, 29575	725B, 72BF, 7323, 7387		9 to 12	29273, 29373, 29473, 29573	7259, 72BD, 7321, 7385
	13 to 16	29675, 29775, 29875, 29975	73EB, 744F, 74B3, 7517		13 to 16	29673, 29773, 29873, 29973	73E9, 744D, 74B1, 7515

Screen example

QD77MS16 Sv. parameter Ex. setting1-3						SET/RESET	Data Chg.	MONIT MENU	END
Item	Axis1	Axis2	Axis3	Axis4	Setting range				
Selection of the encoders for encoder output pulse	0	0	0	0	0:Servo motor encoder 1:Load-side encoder	1)			
Func. selection C-3 EE alarm level unit	0	0	0	0	0 to 3	2)			
OS alarm detect.level	0	0	0	0	0 to 20000[1/r/min]	3)			
Func. selection C-4 home position setting condition	0	0	0	0	Z-phase after power on 0:Need to pass 1:Not need to pass	4)			
Func. selection C-5 [AL, E9 Main circuit off warning]	0	0	0	0	Detection with 0:ready-on and servo-on 1:servo-on	5)			
Func. selection C-7 Undervoltage alarm	0	0	0	0	0:Method 1 1:Method 2	6)			
Alarm history clear	0	0	0	0	0:Disabled 1:Enabled	7)			
FS dec. time constant	0	0	0	0	0 to 20000[ms]	8)			

No.	Axis	Buffer memory address		No.	Axis	Buffer memory address	
		DEC	HEX			DEC	HEX
1)	1 to 4	28466, 28566, 28666, 28766	6F32, 6F96, 6FFA, 705E	5)	1 to 4	28481, 28581, 28681, 28781	6F41, 6FA5, 7009, 706D
	5 to 8	28866, 28966, 29066, 29166	70C2, 7126, 718A, 71EE		5 to 8	28881, 28981, 29081, 29181	70D1, 7135, 7199, 71FD
	9 to 12	29266, 29366, 29466, 29566	7252, 72B6, 731A, 737E		9 to 12	29281, 29381, 29481, 29581	7261, 72C5, 7329, 738D
	13 to 16	29666, 29766, 29866, 29966	73E2, 7446, 74AA, 750E		13 to 16	29681, 29781, 29881, 29981	73F1, 7455, 74B9, 751D
2)	1 to 4	28469, 28569, 28669, 28769	6F35, 6F99, 6FFD, 7061	6)	1 to 4	28483, 28583, 28683, 28783	6F43, 6FA7, 700B, 706F
	5 to 8	28869, 28969, 29069, 29169	70C5, 7129, 718D, 71F1		5 to 8	28883, 28983, 29083, 29183	70D3, 7137, 719B, 71FF
	9 to 12	29269, 29369, 29469, 29569	7255, 72B9, 731D, 7381		9 to 12	29283, 29383, 29483, 29583	7263, 72C7, 732B, 738F
	13 to 16	29669, 29769, 29869, 29969	73E5, 7449, 74AD, 7511		13 to 16	29683, 29783, 29883, 29983	73F3, 7457, 74BB, 751F
3)	1 to 4	28471, 28571, 28671, 28771	6F37, 6F9B, 6FFF, 7063	7)	1 to 4	28484, 28584, 28684, 28784	6F44, 6FA8, 700C, 7070
	5 to 8	28871, 28971, 29071, 29171	70C7, 712B, 718F, 71F3		5 to 8	28884, 28984, 29084, 29184	70D4, 7138, 719C, 7200
	9 to 12	29271, 29371, 29471, 29571	7257, 72BB, 731F, 7383		9 to 12	29284, 29384, 29484, 29584	7264, 72C8, 732C, 7390
	13 to 16	29671, 29771, 29871, 29971	73E7, 744B, 74AF, 7513		13 to 16	29684, 29784, 29884, 29984	73F4, 7458, 74BC, 7520
4)	1 to 4	28480, 28580, 28680, 28780	6F40, 6FA4, 7008, 706C	8)	1 to 4	28487, 28587, 28687, 28787	6F47, 6FAB, 700F, 7073
	5 to 8	28880, 28980, 29080, 29180	70D0, 7134, 7198, 71FC		5 to 8	28887, 28987, 29087, 29187	70D7, 713B, 719F, 7203
	9 to 12	29280, 29380, 29480, 29580	7260, 72C4, 7328, 738C		9 to 12	29287, 29387, 29487, 29587	7267, 72CB, 732F, 7393
	13 to 16	29680, 29780, 29880, 29980	73F0, 7454, 74B8, 751C		13 to 16	29687, 29787, 29887, 29987	73F7, 745B, 74BF, 7523

Screen example

QD77MS16 Sv. parameter Ex. setting1-4						SET/RESET	Data Chg.	MONIT MENU	END
Item	Axis1	Axis2	Axis3	Axis4	Setting range				
Func. selection C-9 encoder pulse count polarity	0	0	0	0	0CW/positive direction 0:Encoder pulse inc. 1:Encoder pulse dec.	1)			
Func. selection C-B POL reflection	0	0	0	0	0:Disabled 1:Enabled	2)			
V-Ax freefall prevention compensation	0	0	0	0	-25000 to 25000 (*10 ⁻⁴) [rev]	3)			

No.	Axis	Buffer memory address		No.	Axis	Buffer memory address		No.	Axis	Buffer memory address	
		DEC	HEX			DEC	HEX			DEC	HEX
1)	1 to 4	28490, 28590, 28690, 28790	6F4A, 6FAE, 7012, 7076	2)	1 to 4	28492, 28592, 28692, 28792	6F4C, 6FB0, 7014, 7078	3)	1 to 4	28494, 28594, 28694, 28794	6F4E, 6FB2, 7016, 707A
	5 to 8	28890, 28990, 29090, 29190	70DA, 713E, 71A2, 7206		5 to 8	28892, 28992, 29092, 29192	70DC, 7140, 71A4, 7208		5 to 8	28894, 28994, 29094, 29194	70DE, 7142, 71A6, 720A
	9 to 12	29290, 29390, 29490, 29590	726A, 72CE, 7332, 7396		9 to 12	29292, 29392, 29492, 29592	726C, 72D0, 7334, 7398		9 to 12	29294, 29394, 29494, 29594	726E, 72D2, 7336, 739A
	13 to 16	29690, 29790, 29890, 29990	73FA, 745E, 74C2, 7526		13 to 16	29692, 29792, 29892, 29992	73FC, 7460, 74C4, 7528		13 to 16	29694, 29794, 29894, 29994	73FE, 7462, 74C6, 752A

6.5.37 QD77GF16 module monitoring

Screen example

The screenshot displays the 'QD77GF16 Operation Monitor' interface. It features several data tables and status indicators. Callouts 1) through 8) point to specific elements:

- 1)** Points to the 'Current feed val.' and 'axis feedrate' columns.
- 2)** Points to the 'unit' column, which lists units like (μm), (degree), (inch), and (pulse) with their respective scales.
- 3)** Points to the 'Status' and 'Err.' columns for axes 1-4, showing messages like 'Unconnection/Amp. power OFF' and 'Warning'.
- 4)** Points to the 'Emergency stop input' status, which is currently 'ON'.
- 5)** Points to the 'Start No.' column.
- 6)** Points to the 'Operation pattern' column.
- 7)** Points to the 'Control system' column.
- 8)** Points to the 'Int. Axis', 'Acc. time', and 'Dec. time' columns.

No.	Axis	Buffer memory address		No.	Axis	Buffer memory address		
		DEC	HEX			DEC	HEX	
1)	1 to 4	2400, 2500, 2600, 2700	960, 9C4, A28, A8C	4)	-	4231	1087	
	5 to 8	2800, 2900, 3000, 3100	AF0, B54, BB8, C1C		5)	1 to 4	2429, 2529, 2629, 2729	97D, 9E1, A45, AA9
	9 to 12	3200, 3300, 3400, 3500	C80, CE4, D48, DAC			5 to 8	2829, 2929, 3029, 3129	B0D, B71, BD5, C39
	13 to 16	3600, 3700, 3800, 3900	E10, E74, ED8, F3C				9 to 12	3229, 3329, 3429, 3529
2)	1 to 4	2412, 2512, 2612, 2712	96C, 9D0, A34, A98	6)		13 to 16		3629, 3729, 3829, 3929
	5 to 8	2812, 2912, 3012, 3112	AFC, B60, BC4, C28		7)	1 to 4	2438, 2538, 2638, 2738	986, 9EA, A4E, AB2
	9 to 12	3212, 3312, 3412, 3512	C8C, CF0, D54, DB8			5 to 8	2838, 2938, 3038, 3138	B16, B7A, BDE, C42
	13 to 16	3612, 3712, 3812, 3912	E1C, E80, EE4, F48				9 to 12	3238, 3338, 3438, 3538
3)	1 to 4	2406 to 2409, 2506 to 2509, 2606 to 2609, 2706 to 2709	966 to 969, 9CA to 9CD, A2E to A31, A92 to A95	8)		13 to 16		3638, 3738, 3838, 3938
					5 to 8	2806 to 2809, 2906 to 2909, 3006 to 3009, 3106 to 3109	AF6 to AF9, B5A to B5D, BBE to BC1, C22 to C25	1 to 4
	9 to 12	3206 to 3209, 3306 to 3309, 3406 to 3409, 3506 to 3509	C86 to C89, CEA to CED, D4E to D51, DB2 to DB5					
					13 to 16	3606 to 3609, 3706 to 3709, 3806 to 3809, 3906 to 3909	E16 to E19, E7A to E7D, EDE to EE1, F42 to F45	9 to 12
	1 to 4	2438, 2538, 2638, 2738	986, 9EA, A4E, AB2					
					5 to 8	2838, 2938, 3038, 3138	B16, B7A, BDE, C42	9 to 12
	9 to 12	3238, 3338, 3438, 3538	CA6, D0A, D6E, DD2					
					-	-	-	-

Screen example

No.	Axis	Buffer memory address		No.	Axis	Buffer memory address	
		DEC	HEX			DEC	HEX
1)	-	-	-	-	-	-	-

Screen example

No.	Axis	Buffer memory address		No.	Axis	Buffer memory address	
		DEC	HEX			DEC	HEX
1)	1 to 4	0, 150, 300, 450	0, 96, 12C, 1C2	4)	1 to 4	6 to 7, 156 to 157, 306 to 307, 456 to 457	6 to 7, 9C to 9D, 132 to 133 1C8 to 1C9
	5 to 8	600, 750, 900, 1050,	258, 2EE, 3E8, 47E		5 to 8	606 to 607, 756 to 757, 906 to 907, 1056 to 1057	25E to 25F, 2F4 to 2F5, 38A to 38B, 420 to 421
	9 to 12	1200, 1350, 1500, 1650	514, 5AA, 640, 6D6		9 to 12	1206 to 1207, 1356 to 1357, 1506 to 1507, 1656 to 1657	4B6 to 4B7, 54C to 54D, 5E2 to 5E3, 678 to 679
	13 to 16	1800, 1950, 2100, 2250	708, 79E, 834, 8CA		13 to 16	1806 to 1807, 1956 to 1957, 2106 to 2107, 2256 to 2257	70E to 70F, 7A4 to 7A5, 83A to 83B, 8D0 to 8D1
2)	1 to 4	2 to 3, 152 to 153, 302 to 303, 452 to 453	2 to 3, 98 to 99, 12E to 12F, 1C4 to 1C5	5)	1 to 4	4 to 5, 154 to 155, 304 to 305, 454 to 455	4 to 5, 9A to 9B, 130 to 131 1C6 to 1C7
	5 to 8	602 to 603, 752 to 753, 902 to 903, 1052 to 1053	25A to 25B, 2F0 to 2F1, 386 to 387, 41C to 41D		5 to 8	604 to 605, 754 to 755, 904 to 905, 1054 to 1055	25C to 25D, 2F2 to 2F3, 388 to 389, 41E to 41F
	9 to 12	1202 to 1203, 1352 to 1353, 1502 to 1503, 1652 to 1653	4B2 to 4B3, 548 to 549, 5DE to 5DF, 674 to 675		9 to 12	1204 to 1205, 1354 to 1355, 1504 to 1505, 1654 to 1655	4B4 to 4B5, 54A to 54B, 5E0 to 5E1, 676 to 677
	13 to 16	1802 to 1803, 1952 to 1953, 2102 to 2103, 2252 to 2253	70A to 70B, 7A0 to 7A1, 836 to 837, 8CC to 8CD		13 to 16	1804 to 1805, 1954 to 1955, 2104 to 2105, 2254 to 2255	70C to 70D, 7A2 to 7A3, 838 to 839, 8CE to 8CF
3)	1 to 4	1, 151, 301, 451	1, 97, 12D, 1C3	-	-	-	-
	5 to 8	601, 751, 901, 1051	259, 2EF, 385, 41B	-	-	-	-
	9 to 12	1201, 1351, 1501, 1651	4B1, 547, 5DD, 673	-	-	-	-
	13 to 16	1801, 1951, 2101, 2251	709, 79F, 835, 8CB	-	-	-	-

Screen example

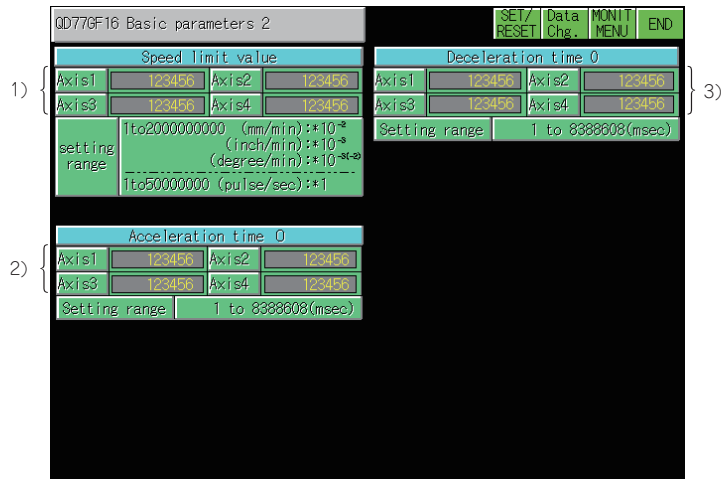

No.	Axis	Buffer memory address		No.	Axis	Buffer memory address	
		DEC	HEX			DEC	HEX
1)	1 to 4	10 to 11, 160 to 161, 310 to 311, 460 to 461	A to B, A0 to A1, 136 to 137, 1CC to 1CD	2)	9 to 12	1212 to 1213, 1362 to 1363, 1512 to 1513, 1662 to 1663	4BC to 4BD, 552 to 553, 5E8 to 5E9, 67E to 67F
	5 to 8	610 to 611, 760 to 761, 910 to 911, 1060 to 1061	262 to 263, 2F8 to 2F9, 2F8 to 2F9, 424 to 425		13 to 16	1812 to 1813, 1962 to 1963, 2112 to 2113, 2262 to 2263	714 to 715, 7AA to 7AB, 840 to 841, 8D6 to 8D7
	9 to 12	1210 to 1211, 1360 to 1361, 1510 to 1511, 1660 to 1661	4BA to 4BB, 550 to 551, 5E6 to 5E7, 67C to 67D	3)	1 to 4	14 to 15, 164 to 165, 314 to 315, 464 to 465	E to F, A4 to A5, 13A to 13B, 1D0 to 1D1
	13 to 16	1810 to 1811, 1960 to 1961, 2110 to 2111, 2260 to 2261	712 to 713, 7A8 to 7A9, 83E to 83F, 8D4 to 8D5		5 to 8	614 to 615, 764 to 765, 914 to 915, 1064 to 1065	266 to 267, 2FC to 2FD, 392 to 393, 428 to 429
2)	1 to 4	12 to 13, 162 to 163, 312 to 313, 462 to 463	C to D, A2 to A3, 138 to 139, 1CE to 1CF	9 to 12	1214 to 1215, 1364 to 1365, 1514 to 1515, 1664 to 1665	4BE to 4BF, 554 to 555, 5EA to 5EB, 680 to 681	
	5 to 8	612 to 613, 762 to 763, 912 to 913, 1062 to 1063	264 to 265, 2FA to 2FB, 390 to 391, 426 to 427	13 to 16	1814 to 1815, 1964 to 1965, 2114 to 2115, 2264 to 2265	716 to 717, 7AC to 7AD, 842 to 843, 8D8 to 8D9	

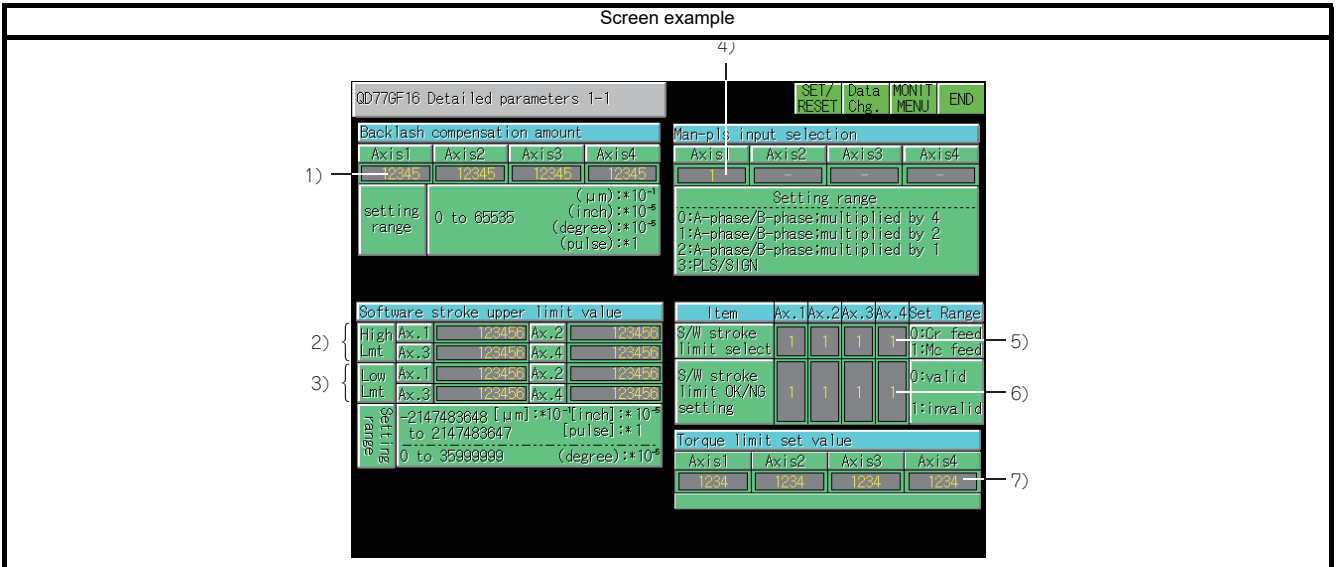

No.	Axis	Buffer memory address		No.	Axis	Buffer memory address		
		DEC	HEX			DEC	HEX	
1)	1 to 4	17, 167, 317, 467	11, A7, 13D, 1D3	3)	13 to 16	1820 to 1821, 1970 to 1971, 2120 to 2121, 2270 to 2271	71C to 71D, 7B2 to 7B3, 848 to 849, 8DE to 8DF	
	5 to 8	617, 767, 917, 1067	617, 767, 917, 1067		4)	-	33	21
	9 to 12	1217, 1367, 1517, 1667	1217, 1367, 1517, 1667		5)	1 to 4	22, 172, 322, 472	16, AC, 142, 1D8
	13 to 16	1817, 1967, 2117, 2267	1817, 1967, 2117, 2267			5 to 8	622, 772, 922, 1072	622, 772, 922, 1072
2)	1 to 4	18 to 19, 168 to 169, 318 to 319, 468 to 469	12 to 13, A8 to A9, 13E to 13F, 1D4 to 1D5	9 to 12	1222, 1372, 1522, 1672	1222, 1372, 1522, 1672		
	5 to 8	618 to 619, 768 to 769, 918 to 919, 1068 to 1069	26A to 26B, 300 to 301, 396 to 397, 42C to 42D	13 to 16	1822, 1972, 2122, 2272	1822, 1972, 2122, 2272		
	9 to 12	1218 to 1219, 1368 to 1369, 1518 to 1519, 1668 to 1669	4C2 to 4C3, 558 to 559, 5EE to 5EF, 684 to 685	6)	1 to 4	23, 173, 323, 473	17, AD, 143, 1D9	
	13 to 16	1818 to 1819, 1968 to 1969, 2118 to 2119, 2268 to 2269	71A to 71B, 7B0 to 7B1, 846 to 847, 8DC to 8DD		5 to 8	623, 773, 923, 1073	26F, 305, 39B, 431	
3)	1 to 4	20 to 21, 170 to 171, 320 to 321, 470 to 471	14 to 15, AA to AB, 140 to 141, 1D6 to 1D7	9 to 12	1223, 1373, 1523, 1673	4C7, 55D, 5F3, 689		
	5 to 8	620 to 621, 770 to 771, 920 to 921, 1070 to 1071	26C to 26D, 302 to 303, 398 to 399, 42E to 42F	13 to 16	1823, 1973, 2123, 2273	71F, 7B5, 84B, 8E1		
	7)	1 to 4	20 to 21, 170 to 171, 320 to 321, 470 to 471	14 to 15, AA to AB, 140 to 141, 1D6 to 1D7	1 to 4	26, 176, 326, 476	1A, B0, 146, 1DC	
		5 to 8	620 to 621, 770 to 771, 920 to 921, 1070 to 1071	26C to 26D, 302 to 303, 398 to 399, 42E to 42F	5 to 8	626, 776, 926, 1076	272, 308, 39E, 434	
-	-	-	-	-	-	-	-	
-	-	-	-	-	-	-	-	

- 1 OVERVIEW
- 2 SYSTEM MONITOR
- 3 LADDER MONITOR FUNCTION
- 4 MELSEC-A LIST EDITOR
- 5 MELSEC-FX LIST EDITOR
- 6 INTELLIGENT MODULE MONITOR
- 7 NETWORK MONITOR
- 8 Q MOTION MONITOR

Screen example

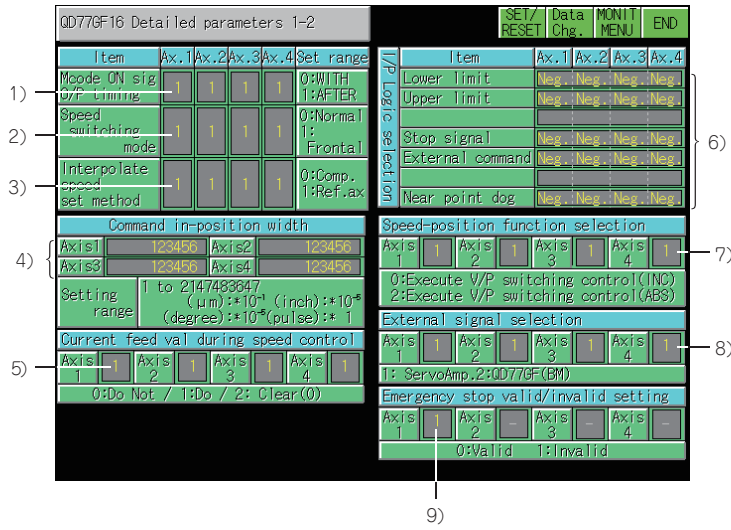

No.	Axis	Buffer memory address		No.	Axis	Buffer memory address	
		DEC	HEX			DEC	HEX
1)	1 to 4	27, 177, 327, 477	1B, B1, 147, 1DD	5)	1 to 4	30, 180, 330, 480	1E, B4, 14A, 1E0
	5 to 8	627, 777, 927, 1077	273, 309, 39F, 435		5 to 8	630, 780, 930, 1080	276, 30C, 3A2, 438
	9 to 12	1227, 1377, 1527, 1677	4CB, 561, 5F7, 68D		9 to 12	1230, 1380, 1530, 1680	4CE, 564, 5FA, 690
	13 to 16	1827, 1977, 2127, 2277	723, 7B9, 84F, 8E5		13 to 16	1830, 1980, 2130, 2280	726, 7BC, 852, 8E8
2)	1 to 4	28, 178, 328, 478	1C, B2, 148, 1DE	6)	1 to 4	31, 181, 331, 481	1F, B5, 14B, 1E1
	5 to 8	628, 778, 928, 1078	274, 30A, 3A0, 436		5 to 8	631, 781, 931, 1081	277, 30D, 3A3, 439
	9 to 12	1228, 1378, 1528, 1678	4CC, 562, 5F8, 68E		9 to 12	1231, 1381, 1531, 1681	4CF, 565, 5FB, 691
	13 to 16	1828, 1978, 2128, 2278	724, 7BA, 850, 8E6		13 to 16	1831, 1981, 2131, 2281	727, 7BD, 853, 8E9
3)	1 to 4	29, 179, 329, 479	1D, B3, 149, 1DF	7)	1 to 4	34, 184, 334, 484	22, B8, 14E, 1E4
	5 to 8	629, 779, 929, 1079	275, 30B, 3A1, 437		5 to 8	634, 784, 934, 1084	27A, 310, 3A6, 43C
	9 to 12	1229, 1379, 1529, 1679	4CD, 563, 5F9, 68F		9 to 12	1234, 1384, 1534, 1684	4D2, 568, 5FE, 694
	13 to 16	1829, 1979, 2129, 2279	725, 7BB, 851, 8E7		13 to 16	1834, 1984, 2134, 2284	72A, 7C0, 856, 8EC
4)	1 to 4	24 to 25, 174 to 175, 324 to 325, 474 to 475	18 to 19, AE to AF, 144 to 145, 1DA to 1DB	8)	1 to 4	32, 182, 332, 482	20, B6, 14C, 1E2
	5 to 8	624 to 625, 774 to 775, 924 to 925, 1074 to 1075	270 to 271, 306 to 307, 39C to 39D, 432 to 433		5 to 8	632, 782, 932, 1082	278, 30E, 3A4, 43A
	9 to 12	1224 to 1225, 1374 to 1375, 1524 to 1525, 1674 to 1675	4C8 to 4C9, 55E to 55F, 5F4 to 5F5, 68A to 68B		9 to 12	1232, 1382, 1532, 1682	4D0, 566, 5FC, 692
	13 to 16	1824 to 1825, 1974 to 1975, 2124 to 2125, 2274 to 2275	720 to 721, 7B6 to 7B7, 84C to 84D, 8E2 to 8E3		13 to 16	1832, 1982, 2132, 2282	728, 7BE, 854, 8EA
				9)	-	35	23

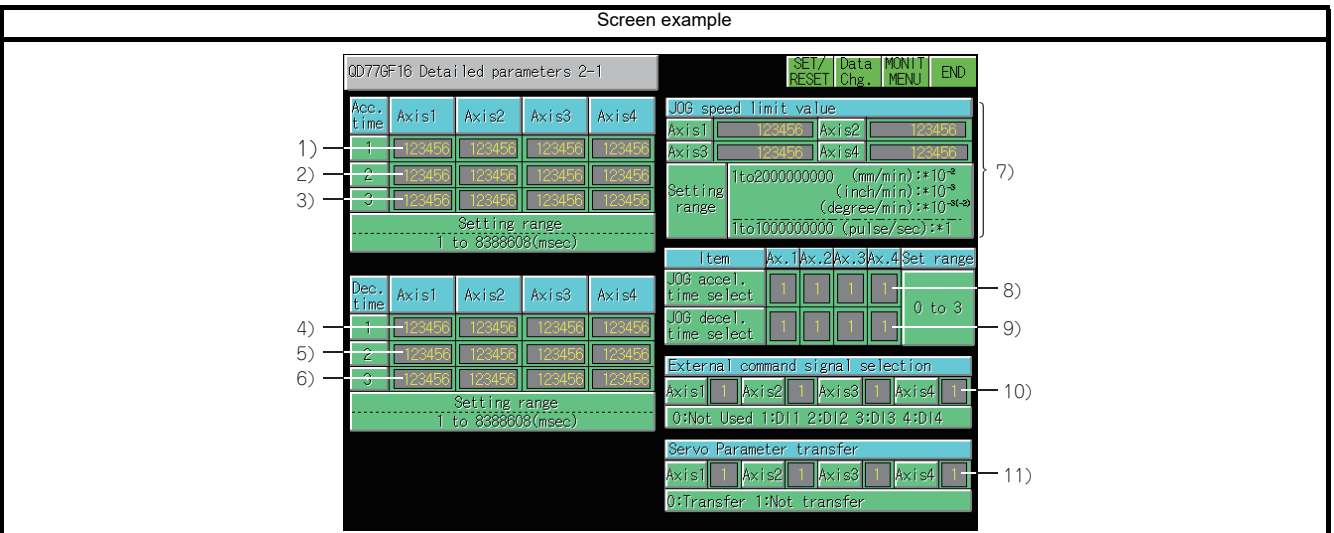

No.	Axis	Buffer memory address		No.	Axis	Buffer memory address	
		DEC	HEX			DEC	HEX
1)	1 to 4	36 to 37, 186 to 187, 336 to 337, 486 to 487	24 to 25, BA to BB, 150 to 151, 1E6 to 1E7	6)	1 to 4	46 to 47, 196 to 197, 346 to 347, 496 to 497	2E to 2F, C4 to C5, 15A to 15B, 1F0 to 1F1
	5 to 8	636 to 637, 786 to 787, 936 to 937, 1086 to 1087	27C to 27D, 312 to 313, 3A8 to 3A9, 43E to 43F		5 to 8	646 to 646, 796 to 796, 946 to 946, 1096 to 1096	286 to 286, 31C to 31C, 3B2 to 3B2, 448 to 448
	9 to 12	1236 to 1237, 1386 to 1387, 1536 to 1537, 1686 to 1687	4D4 to 4D5, 56A to 56B, 600 to 601, 696 to 697		9 to 12	1246 to 1246, 1396 to 1396, 1546 to 1546, 1696 to 1696	4DE to 4DE, 574 to 574, 60A to 60A, 6A0 to 6A0
	13 to 16	1836 to 1837, 1986 to 1987, 2136 to 2137, 2286 to 2287	72C to 72D, 7C2 to 7C3, 858 to 859, 8EE to 8EF		13 to 16	1846 to 1846, 1996 to 1996, 2146 to 2146, 2296 to 2296	736 to 736, 7CC to 7CC, 862 to 862, 8F8 to 8F8
2)	1 to 4	38 to 39, 188 to 189, 338 to 339, 488 to 489	26 to 27, BC to BD, 152 to 153, 1E8 to 1E9	7)	1 to 4	48 to 49, 198 to 199, 348 to 349, 498 to 499	30 to 31, C6 to C7, 15C to 15D, 1F2 to 1F3
	5 to 8	638 to 639, 788 to 789, 938 to 939, 1088 to 1089	27E to 27F, 314 to 315, 3AA to 3AB, 440 to 441		5 to 8	648 to 649, 798 to 799, 948 to 949, 1098 to 1099	288 to 289, 31E to 31F, 3B4 to 3B5, 44A to 44B
	9 to 12	1238 to 1239, 1388 to 1389, 1538 to 1539, 1688 to 1689	4D6 to 4D7, 56C to 56D, 602 to 603, 698 to 699		9 to 12	1248 to 1249, 1398 to 1399, 1548 to 1549, 1698 to 1699	4E0 to 4E1, 576 to 577, 60C to 60D, 6A2 to 6A3
	13 to 16	1838 to 1839, 1988 to 1989, 2138 to 2139, 2288 to 2289	72E to 72F, 7C4 to 7C5, 85A to 85B, 8F0 to 8F1		13 to 16	1848 to 1849, 1998 to 1999, 2148 to 2149, 2298 to 2299	738 to 739, 7CE to 7CF, 864 to 865, 8FA to 8FB
3)	1 to 4	40 to 41, 190 to 191, 340 to 341, 490 to 491	28 to 29, BE to BF, 154 to 155, 1EA to 1EB	8)	1 to 4	50, 200, 350, 500	32, C8, 15E, 1F4
	5 to 8	640 to 641, 790 to 791, 940 to 941, 1090 to 1091	280 to 281, 316 to 317, 3AC to 3AD, 442 to 443		5 to 8	650, 800, 950, 1100	28A, 320, 3B6, 44C
	9 to 12	1240 to 1241, 1390 to 1391, 1540 to 1541, 1690 to 1691	4D8 to 4D9, 56E to 56F, 604 to 605, 69A to 69B		9 to 12	1250, 1400, 1550, 1700	4E2, 578, 60E, 6A4
	13 to 16	1840 to 1841, 1990 to 1991, 2140 to 2141, 2290 to 2291	730 to 731, 7C6 to 7C7, 85C to 85D, 8F2 to 8F3		13 to 16	1850, 2000, 2150, 2300	73A, 7D0, 866, 8FC
4)	1 to 4	42 to 43, 192 to 193, 342 to 343, 492 to 493	2A to 2B, C0 to C1, 156 to 157, 1EC to 1ED	9)	1 to 4	51, 201, 351, 501	33, C9, 15F, 1F5
	5 to 8	642 to 643, 792 to 793, 942 to 943, 1092 to 1093	282 to 283, 318 to 319, 3AE to 3AF, 444 to 445		5 to 8	651, 801, 951, 1101	28B, 321, 3B7, 44D
	9 to 12	1242 to 1243, 1392 to 1393, 1542 to 1543, 1692 to 1693	4DA to 4DB, 570 to 571, 606 to 607, 69C to 69D		9 to 12	1251, 1401, 1551, 1701	4E3, 579, 60F, 6A5
	13 to 16	1842 to 1843, 1992 to 1993, 2142 to 2143, 2292 to 2293	732 to 733, 7C8 to 7C9, 85E to 85F, 8F4 to 8F5		13 to 16	1851, 2001, 2151, 2301	73B, 7D1, 867, 8FD
5)	1 to 4	44 to 45, 194 to 195, 344 to 345, 494 to 495	2C to 2D, C2 to C3, 158 to 159, 1EE to 1EF	10)	1 to 4	69, 219, 369, 519	45, DB, 171, 207
	5 to 8	644 to 645, 794 to 794, 944 to 944, 1094 to 1094	284 to 284, 31A to 31A, 3B0 to 3B0, 446 to 446		5 to 8	669, 819, 969, 1119	29D, 333, 3C9, 45F
	9 to 12	1244 to 1244, 1394 to 1394, 1544 to 1544, 1694 to 1694	4DC to 4DC, 572 to 572, 608 to 608, 69E to 69E		9 to 12	1269, 1419, 1569, 1719	4F5, 58B, 621, 6B7
	13 to 16	1844 to 1844, 1994 to 1994, 2144 to 2144, 2294 to 2294	734 to 734, 7CA to 7CA, 860 to 860, 8F6 to 8F6		13 to 16	1869, 2019, 2169, 2319	74D, 7E3, 879, 90F
-	1 to 4	44 to 45, 194 to 195, 344 to 345, 494 to 495	2C to 2D, C2 to C3, 158 to 159, 1EE to 1EF	11)	1 to 4	113, 263, 413, 563	71, 107, 19D, 233
	5 to 8	644 to 645, 794 to 794, 944 to 944, 1094 to 1094	284 to 284, 31A to 31A, 3B0 to 3B0, 446 to 446		5 to 8	713, 863, 1013, 1163	2C9, 35F, 3F5, 48B
	9 to 12	1244 to 1244, 1394 to 1394, 1544 to 1544, 1694 to 1694	4DC to 4DC, 572 to 572, 608 to 608, 69E to 69E		9 to 12	1313, 1463, 1613, 1763	521, 5B7, 64D, 6E3
	13 to 16	1844 to 1844, 1994 to 1994, 2144 to 2144, 2294 to 2294	734 to 734, 7CA to 7CA, 860 to 860, 8F6 to 8F6		13 to 16	1913, 2063, 2213, 2363	779, 80F, 8A5, 93B

- 1 OVERVIEW
- 2 SYSTEM MONITOR
- 3 LADDER MONITOR FUNCTION
- 4 MELSEC-A LIST EDITOR
- 5 MELSEC-FX LIST EDITOR
- 6 INTELLIGENT MODULE MONITOR
- 7 NETWORK MONITOR
- 8 Q MOTION MONITOR

Screen example

No.	Axis	Buffer memory address		No.	Axis	Buffer memory address		
		DEC	HEX			DEC	HEX	
1)	1 to 4	52, 202, 352, 502	34, CA, 160, 1F6	7)	1 to 4	59, 209, 359, 509	3B, D1, 167, 1FD	
	5 to 8	652, 802, 952, 1102	28C, 322, 3B8, 44E		5 to 8	659, 809, 959, 1109	293, 329, 3BF, 455	
	9 to 12	1252, 1402, 1552, 1702	4E4, 57A, 610, 6A6		9 to 12	1259, 1409, 1559, 1709	4EB, 581, 617, 6AD	
	13 to 16	1852, 2002, 2152, 2302	73C, 7D2, 868, 8FE		13 to 16	1859, 2009, 2159, 2309	743, 7D9, 86F, 905	
2)	1 to 4	53, 203, 353, 503	35, CB, 161, 1F7	8)	1	67	43	
	5 to 8	653, 803, 953, 1103	28D, 323, 3B9, 44F		9)	1 to 4	60 to 61, 210 to 211, 360 to 361, 510 to 511	3C to 3D, D2 to D3, 168 to 169, 1FE to 1FF
	9 to 12	1253, 1403, 1553, 1703	4E5, 57B, 611, 6A7			5 to 8	660 to 661, 810 to 811, 960 to 961, 1110 to 1111	294 to 295, 32A to 32B, 3C0 to 3C1, 456 to 457
	13 to 16	1853, 2003, 2153, 2303	73D, 7D3, 869, 8FF			9 to 12	1260 to 1261, 1410 to 1411, 1560 to 1561, 1710 to 1711	4EC to 4ED, 582 to 583, 618 to 619, 6AE to 6AF
3)	1 to 4	56, 206, 356, 506	38, CE, 164, 1FA	10)		13 to 16	1860 to 1861, 2010 to 2011, 2160 to 2160, 2310 to 2311	744 to 745, 7DA to 7DB, 870 to 871, 906 to 907
	5 to 8	656, 806, 956, 1106	290, 326, 3BC, 452		1 to 4	62, 212, 362, 512	3E, D4, 16A, 200	
	9 to 12	1256, 1406, 1556, 1706	4E8, 57E, 614, 6AA		5 to 8	662, 812, 962, 1112	296, 32C, 3C2, 458	
	13 to 16	1856, 2006, 2156, 2306	740, 7D6, 86C, 902		9 to 12	1262, 1412, 1562, 1712	4EE, 584, 61A, 6B0	
4)	1 to 4	57, 207, 357, 507	39, CF, 165, 1FB	11)	13 to 16	1862, 2012, 2162, 2312	746, 7DC, 872, 908	
	5 to 8	657, 807, 957, 1107	291, 327, 3BD, 453		1 to 4	63, 213, 363, 513	3F, D5, 16B, 201	
	9 to 12	1257, 1407, 1557, 1707	4E9, 57F, 615, 6AB		5 to 8	663 to 664, 813 to 814, 963 to 964, 1113 to 1114	297 to 298, 32D to 32E, 3C3 to 3C4, 459 to 45A	
	13 to 16	1857, 2007, 2157, 2307	741, 7D7, 86D, 903		9 to 12	1263 to 1264, 1413 to 1414, 1563 to 1564, 1713 to 1714	4EF to 4F0, 585 to 586, 61B to 61C, 6B1 to 6B2	
5)	1 to 4	58, 208, 358, 508	3A, D0, 166, 1FC	12)	13 to 16	1863 to 1864, 2013 to 2014, 2163 to 2164, 2313 to 2314	747 to 748, 7DD to 7DE, 873 to 874, 909 to 90A	
	5 to 8	658, 808, 958, 1108	292, 328, 3BE, 454		1 to 4	64 to 65, 214 to 215, 364 to 365, 514 to 515	40 to 41, D6 to D7, 16C to 16D, 202 to 203	
	9 to 12	1258, 1408, 1558, 1708	4EA, 580, 616, 6AC,		5 to 8	664 to 665, 814 to 815, 964 to 965, 1114 to 1115	298 to 299, 32E to 32F, 3C4 to 3C5, 45A to 45B	
	13 to 16	1858, 2008, 2158, 2308	742, 7D8, 86E, 904		9 to 12	1264 to 1265, 1414 to 1415, 1564 to 1565, 1714 to 1715	4F0 to 4F1, 586 to 587, 61C to 61D, 6B2 to 6B3	
6)	1 to 4	54 to 55, 204 to 205, 354 to 355, 504 to 505	36 to 37, CC to CD, 162 to 163, 1F8 to 1F9	12)	13 to 16	1864 to 1865, 2014 to 2015, 2164 to 2165, 2314 to 2315	748 to 749, 7DE to 7DF, 874 to 875, 90A to 90B	
	5 to 8	654 to 655, 804 to 805, 954 to 955, 1104 to 1105	28E to 28F, 324 to 325, 3BA to 3BB, 450 to 451		1 to 4	64 to 65, 214 to 215, 364 to 365, 514 to 515	40 to 41, D6 to D7, 16C to 16D, 202 to 203	
	9 to 12	1254 to 1255, 1404 to 1405, 1554 to 1555, 1704 to 1705	4E6 to 4E7, 57C to 57D, 612 to 613, 6A8 to 6A9		5 to 8	664 to 665, 814 to 815, 964 to 965, 1114 to 1115	298 to 299, 32E to 32F, 3C4 to 3C5, 45A to 45B	
	13 to 16	1854 to 1855, 2004 to 2005, 2154 to 2155, 2304 to 2305	73E to 73F, 7D4 to 7D5, 86A to 86B, 900 to 901		9 to 12	1264 to 1265, 1414 to 1415, 1564 to 1565, 1714 to 1715	4F0 to 4F1, 586 to 587, 61C to 61D, 6B2 to 6B3	

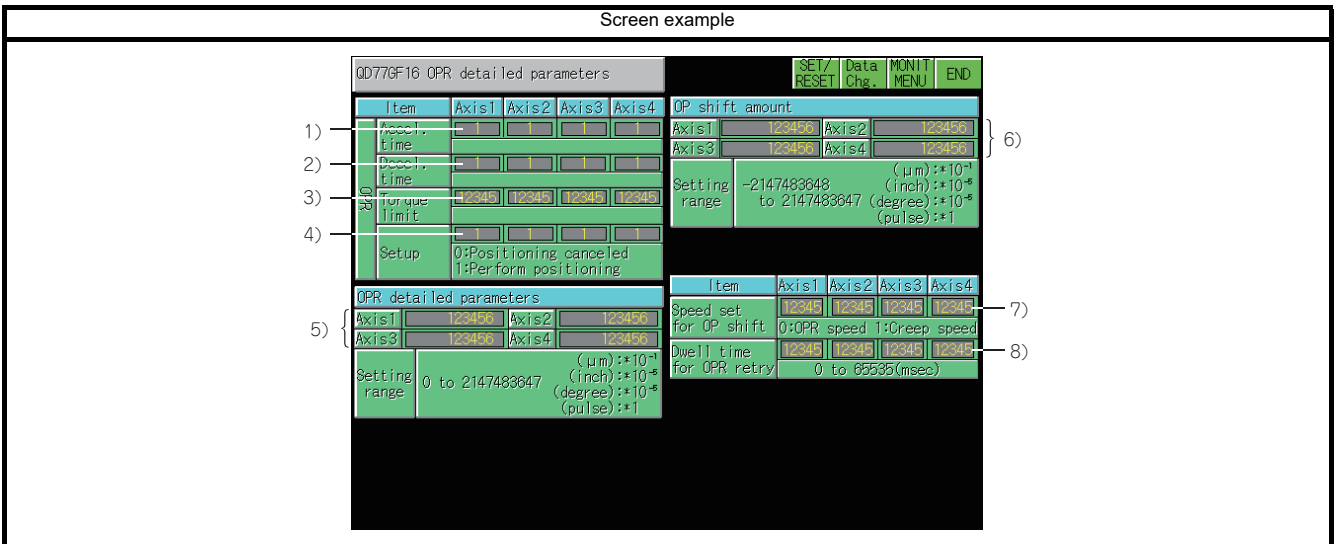

No.	Axis	Buffer memory address		No.	Axis	Buffer memory address	
		DEC	HEX			DEC	HEX
1)	1 to 4	82, 232, 382, 532	52, E8, 17E, 214	5)	1 to 4	80 to 81, 230 to 231, 380 to 381, 530 to 531	50 to 51, E6 to E7, 17C to 17D, 212 to 213
	5 to 8	682, 832, 982, 1132	2AA, 340, 3D6, 46C		5 to 8	680 to 681, 830 to 831, 980 to 981, 1130 to 1131	2A8 to 2A9, 33E to 33F, 3D4 to 3D5, 46A to 46B
	9 to 12	1282, 1432, 1582, 1732	502, 598, 62E, 6C4		9 to 12	1280 to 1281, 1430 to 1431, 1580 to 1581, 1730 to 1731	500 to 501, 596 to 597, 62C to 62D, 6C2 to 6C3
	13 to 16	1882, 2032, 2182, 2332	75A, 7F0, 886, 91C		13 to 16	1880 to 1881, 2030 to 2031, 2180 to 2181, 2330 to 2331	758 to 759, 7EE to 7EF, 884 to 885, 91A to 91B
2)	1 to 4	83, 233, 383, 533	53, E9, 17F, 215	6)	1 to 4	84 to 85, 234 to 235, 384 to 385, 534 to 535	54 to 55, EA to EB, 180 to 181, 216 to 217
	5 to 8	683, 833, 983, 1133	2AB, 341, 3D7, 46D		5 to 8	684 to 685, 834 to 835, 984 to 985, 1134 to 1135	2AC to 2AD, 342 to 343, 3D8 to 3D9, 46E to 46F
	9 to 12	1283, 1433, 1583, 1733	503, 599, 62F, 6C5		9 to 12	1284 to 1285, 1434 to 1435, 1584 to 1585, 1734 to 1735	504 to 505, 59A to 59B, 630 to 631, 6C6 to 6C7
	13 to 16	1883, 2033, 2183, 2333	75B, 7F1, 887, 91D		13 to 16	1884 to 1885, 2034 to 2035, 2184 to 2185, 2334 to 2335	75C to 75D, 7F2 to 7F3, 888 to 889, 91E to 91F
3)	1 to 4	86, 236, 386, 536	56, EC, 182, 218	7)	1 to 4	88, 238, 388, 538	58, EE, 184, 21A
	5 to 8	686, 836, 986, 1136	2AE, 344, 3DA, 470		5 to 8	688, 838, 988, 1138	2B0, 346, 3DC, 472
	9 to 12	1286, 1436, 1586, 1736	506, 59C, 632, 6C8		9 to 12	1288, 1438, 1588, 1738	508, 59E, 634, 6CA
	13 to 16	1886, 2036, 2186, 2336	75E, 7F4, 88A, 920		13 to 16	1888, 2038, 2188, 2338	760, 7F6, 88C, 922
4)	1 to 4	87, 237, 387, 537	57, ED, 183, 219	8)	1 to 4	89, 239, 389, 539	59, EF, 185, 21B
	5 to 8	687, 837, 987, 1137	2AF, 345, 3DB, 471		5 to 8	689, 839, 989, 1139	2B1, 347, 3DD, 473
	9 to 12	1287, 1437, 1587, 1737	507, 59D, 633, 6C9		9 to 12	1289, 1439, 1589, 1739	509, 59F, 635, 6CB
	13 to 16	1887, 2037, 2187, 2337	75F, 7F5, 88B, 921		13 to 16	1889, 2039, 2189, 2339	761, 7F7, 88D, 923

- 1
- OVERVIEW
- 2
- SYSTEM MONITOR
- 3
- LADDER MONITOR FUNCTION
- 4
- MELSEC-A LIST EDITOR
- 5
- MELSEC-FX LIST EDITOR
- 6
- INTELLIGENT MODULE MONITOR
- 7
- NETWORK MONITOR
- 8
- Q MOTION MONITOR

Screen example

No.	Axis	Buffer memory address		No.	Axis	Buffer memory address		
		DEC	HEX			DEC	HEX	
1)	1 to 4	70, 220, 370, 520	46, DC, 172, 208	4)	13 to 16	1872 to 1873, 2022 to 2023, 2172 to 2173, 2322 to 2323	750 to 751, 7E6 to 7E7, 87C to 87D, 912 to 913	
	5 to 8	670, 820, 970, 1120	29E, 334, 3CA, 460		5)	1 to 4	74 to 75, 224 to 225, 374 to 375, 524 to 525	4A to 4B, E0 to E1, 176 to 177, 20C to 20D
	9 to 12	1270, 1420, 1570, 1720	4F6, 58C, 622, 6B8			5 to 8	674 to 675, 824 to 825, 974 to 975, 1124 to 1125	2A2 to 2A3, 338 to 339, 3CE to 3CF, 464 to 465
	13 to 16	1870, 2020, 2170, 2320	74E, 7E4, 87A, 910			9 to 12	1274 to 1275, 1424 to 1425, 1574 to 1575, 1724 to 1725	4FA to 4FB, 590 to 591, 626 to 627, 6BC to 6BD
2)	1 to 4	71, 221, 371, 521	47, DD, 173, 209	6)	1 to 4	76 to 77, 226 to 227, 376 to 377, 526 to 527	4C to 4D, E2 to E3, 178 to 179, 20E to 20F	
	5 to 8	671, 821, 971, 1121	29F, 335, 3CB, 461		5 to 8	676 to 677, 826 to 827, 976 to 977, 1126 to 1127	2A4 to 2A5, 33A to 33B, 3D0 to 3D1, 466 to 467	
	9 to 12	1271, 1421, 1571, 1721	4F7, 58D, 623, 6B9		9 to 12	1276 to 1277, 1426 to 1427, 1576 to 1577, 1726 to 1727	4FC to 4FD, 592 to 593, 628 to 629, 6BE to 6BF	
	13 to 16	1871, 2021, 2171, 2321	74F, 7E5, 87B, 911		13 to 16	1876 to 1877, 2026 to 2027, 2176 to 2177, 2326 to 2327	754 to 755, 7EA to 7EB, 880 to 881, 916 to 917	
3)	1 to 4	78, 228, 378, 528	4E, E4, 17A, 210					
	5 to 8	678, 828, 978, 1128	2A6, 33C, 3D2, 468					
	9 to 12	1278, 1428, 1578, 1728	4FE, 594, 62A, 6C0					
	13 to 16	1878, 2028, 2178, 2328	756, 7EC, 882, 918					
4)	1 to 4	72 to 73, 222 to 223, 372 to 373, 522 to 523	48 to 49, DE to DF, 174 to 175, 20A to 20B					
	5 to 8	672 to 673, 822 to 823, 972 to 973, 1122 to 1123	2A0 to 2A1, 336 to 337, 3CC to 3CD, 462 to 463					
	9 to 12	1272 to 1273, 1422 to 1423, 1572 to 1573, 1722 to 1723	4F8 to 4F9, 58E to 58F, 624 to 625, 6BA to 6BB					

Screen example

No.	Axis	Buffer memory address		No.	Axis	Buffer memory address	
		DEC	HEX			DEC	HEX
1)	1 to 4	2416, 2516, 2616, 2716	970, 9D4, A38, A9C	2)	1 to 4	2417, 2517, 2617, 2717	971, 9D5, A39, A9D
	5 to 8	2816, 2916, 3016, 3116	B00, B64, BC8, C2C		5 to 8	2817, 2917, 3017, 3117	B01, B65, BC9, C2D
	9 to 12	3216, 3316, 3416, 3516	C90, CF4, D58, DBC		9 to 12	3217, 3317, 3417, 3517	C91, CF5, D59, DBD
	13 to 16	3616, 3716, 3816, 3916	E20, E84, EE8, F4C		13 to 16	3617, 3717, 3817, 3917	E21, E85, EE9, F4D

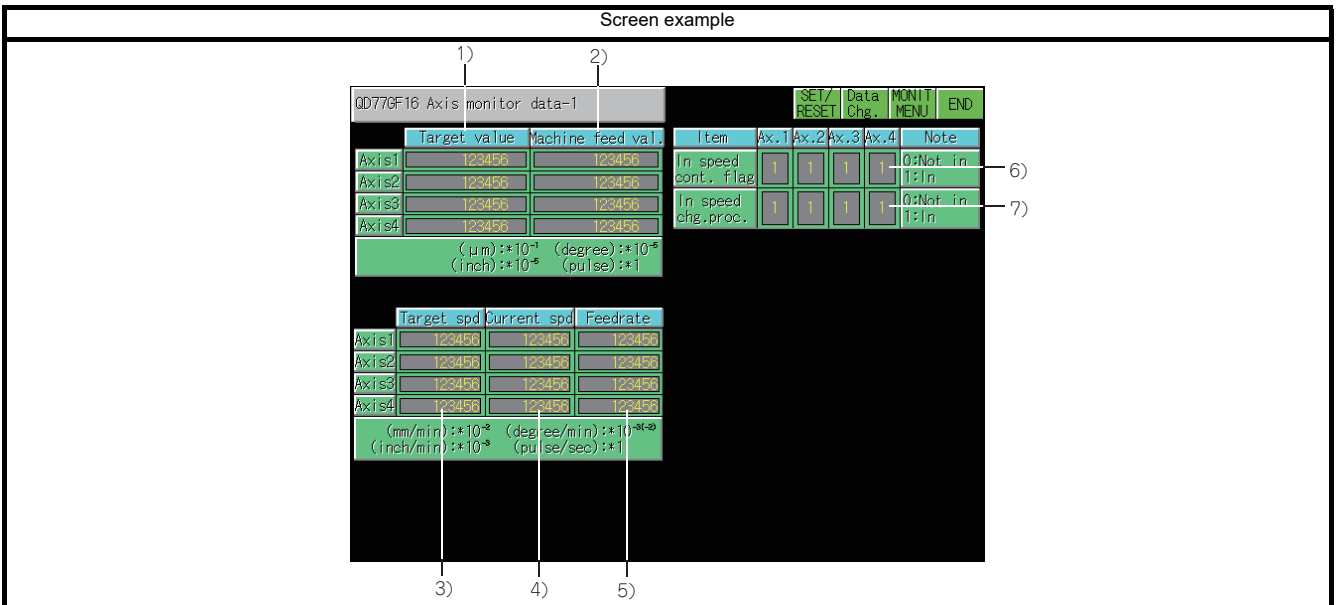

No.	Axis	Buffer memory address		No.	Axis	Buffer memory address	
		DEC	HEX			DEC	HEX
1)	1 to 4	2418 to 2419, 2518 to 2519, 2618 to 2619, 2718 to 2719	972 to 973, 9D6 to 9D7, A3A to A3B, A9E to A9F	4)	1 to 4	2410 to 2411, 2510 to 2511, 2610 to 2611, 2710 to 2711	96A to 96B, 9CE to 9CF, A32 to A33, A96 to A97
	5 to 8	2818 to 2819, 2918 to 2919, 3018 to 3019, 3118 to 3119	B02 to B03, B66 to B67, BCA to BCB, C2E to C2F		5 to 8	2810 to 2811, 2910 to 2911, 3010 to 3011, 3110 to 3111	AFA to AFB, B5E to B5F, BC2 to BC3, C26 to C27
	9 to 12	3218 to 3219, 3318 to 3319, 3418 to 3419, 3518 to 3519	C92 to C93, CF6 to CF7, D5A to D5B, DBE to DBF		9 to 12	3210 to 3211, 3310 to 3311, 3410 to 3411, 3510 to 3511	C8A to C8B, CEE to CEF, D52 to D53, DB6 to DB7
	13 to 16	3618 to 3619, 3718 to 3719, 3818 to 3819, 3918 to 3919	E22 to E23, E86 to E87, EEA to EEB, F4E to F4F		13 to 16	3610 to 3611, 3710 to 3711, 3810 to 3811, 3910 to 3911	E1A to E1B, E7E to E7F, EE2 to EE3, F46 to F47
2)	1 to 4	2402 to 2403, 2502 to 2503, 2602 to 2603, 2702 to 2703	962 to 963, 9C6 to 9C7, A2A to A2B, A8E to A8F	5)	1 to 4	2412 to 2413, 2512 to 2513, 2612 to 2613, 2712 to 2713	96C to 96D, 9D0 to 9D1, A34 to A35, A98 to A99
	5 to 8	2802 to 2803, 2902 to 2903, 3002 to 3003, 3102 to 3103	AF2 to AF3, B56 to B57, BBA to BBB, C1E to C1F		5 to 8	2812 to 2813, 2912 to 2913, 3012 to 3013, 3112 to 3113	AFC to AFD, B60 to B61, BC4 to BC5, C28 to C29
	9 to 12	3202 to 3203, 3302 to 3303, 3402 to 3403, 3502 to 3503	C82 to C83, CE6 to CE7, D4A to D4B, DAE to DAF		9 to 12	3212 to 3213, 3312 to 3313, 3412 to 3413, 3512 to 3513	C8C to C8D, CF0 to CF1, D54 to D55, DB8 to DB9
	13 to 16	3602 to 3603, 3702 to 3703, 3802 to 3803, 3902 to 3903	E12 to E13, E76 to E77, EDA to EDB, F3E to F3F		13 to 16	3612 to 3613, 3712 to 3713, 3812 to 3813, 3912 to 3913	E1C to E1D, E80 to E81, EE4 to EE5, F48 to F49
3)	1 to 4	2420 to 2421, 2520 to 2521, 2620 to 2621, 2720 to 2721	974 to 975, 9D8 to 9D9, A3C to A3D, AA0 to AA1	6)	1 to 4	2430, 2530, 2630, 2730	97E, 9E2, A46, AAA
	5 to 8	2820 to 2821, 2920 to 2921, 3020 to 3021, 3120 to 3121	B04 to B05, B68 to B69, BCC to BCD, C30 to C31		5 to 8	2830, 2930, 3030, 3130	B0E, B72, BD6, C3A
	9 to 12	3220 to 3221, 3320 to 3321, 3420 to 3421, 3520 to 3521	C94 to C95, CF8 to CF9, D5C to D5D, DC0 to DC1		9 to 12	3230, 3330, 3430, 3530	C9E, D02, D66, DCA
	13 to 16	3620 to 3621, 3720 to 3721, 3820 to 3821, 3920 to 3921	E24 to E25, E88 to E89, EEC to EED, F50 to F51		13 to 16	3630, 3730, 3830, 3930	E2E, E92, EF6, F5A
				7)	1 to 4	2431, 2531, 2631, 2731	97F, 9E3, A47, AAB
					5 to 8	2831, 2931, 3031, 3131	B0F, B73, BD7, C3B
					9 to 12	3231, 3331, 3431, 3531	C9F, D03, D67, DCB
					13 to 16	3631, 3731, 3831, 3931	E2F, E93, EF7, F5B

- 1 OVERVIEW
- 2 SYSTEM MONITOR
- 3 LADDER MONITOR FUNCTION
- 4 MELSEC-A LIST EDITOR
- 5 MELSEC-FX LIST EDITOR
- 6 INTELLIGENT MODULE MONITOR
- 7 NETWORK MONITOR
- 8 Q MOTION MONITOR

Screen example

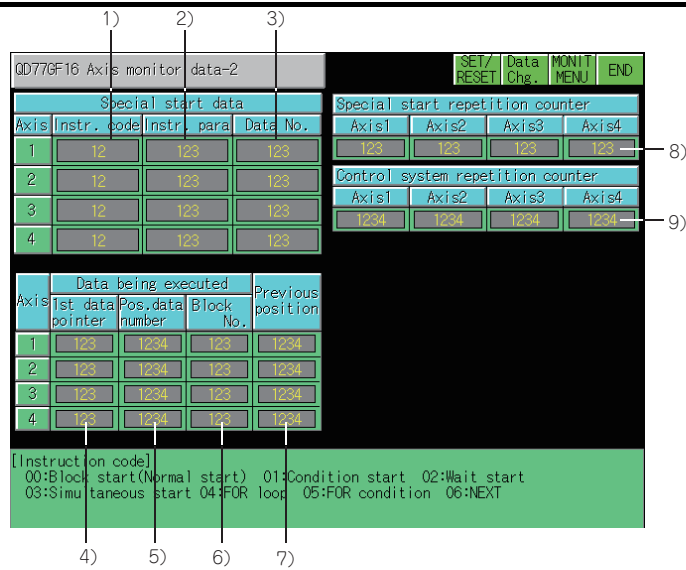

No.	Axis	Buffer memory address		No.	Axis	Buffer memory address	
		DEC	HEX			DEC	HEX
1)	1 to 4	2427, 2527, 2627, 2727	97B, 9DF, A43, AA7	6)	1 to 4	2436, 2536, 2636, 2736	984, 9E8, A4C, AB0
	5 to 8	2827, 2927, 3027, 3127	B0B, B6F, BD3, C37		5 to 8	2836, 2936, 3036, 3136	B14, B78, BDC, C40
	9 to 12	3227, 3327, 3427, 3527	C9B, CFF, D63, DC7		9 to 12	3236, 3336, 3436, 3536	CA4, D08, D6C, DD0
	13 to 16	3627, 3727, 3827, 3927	E2B, E8F, EF3, F57		13 to 16	3636, 3736, 3836, 3936	E34, E98, EFC, F60
2)	1 to 4	2428, 2528, 2628, 2728	97C, 9E0, A44, AA8	7)	1 to 4	2437, 2537, 2637, 2737	985, 9E9, A4D, AB1
	5 to 8	2828, 2928, 3028, 3128	B0C, B70, BD4, C38		5 to 8	2837, 2937, 3037, 3137	B15, B79, BDD, C41
	9 to 12	3228, 3328, 3428, 3528	C9C, D00, D64, DC8		9 to 12	3237, 3337, 3437, 3537	CA5, D09, D6D, DD1
	13 to 16	3628, 3728, 3828, 3928	E2C, E90, EF4, F58		13 to 16	3637, 3737, 3837, 3937	E35, E99, EFD, F61
3)	1 to 4	2429, 2529, 2629, 2729	97D, 9E1, A45, AA9	8)	1 to 4	2432, 2532, 2632, 2732	980, 9E4, A48, AAC
	5 to 8	2829, 2929, 3029, 3129	B0D, B71, BD5, C39		5 to 8	2832, 2932, 3032, 3132	B10, B74, BD8, C3C
	9 to 12	3229, 3329, 3429, 3529	C9D, D01, D65, DC9		9 to 12	3232, 3332, 3432, 3532	CA0, D04, D68, DCC
	13 to 16	3629, 3729, 3829, 3929	E2D, E91, EF5, F59		13 to 16	3632, 3732, 3832, 3932	E30, E94, EF8, F5C
4)	1 to 4	2434, 2534, 2634, 2734	982, 9E6, A4A, AAE	9)	1 to 4	2433, 2533, 2633, 2733	981, 9E5, A49, AAD
	5 to 8	2834, 2934, 3034, 3134	B12, B76, BDA, C3E		5 to 8	2833, 2933, 3033, 3133	B11, B75, BD9, C3D
	9 to 12	3234, 3334, 3434, 3534	CA2, D06, D6A, DCE		9 to 12	3233, 3333, 3433, 3533	CA1, D05, D69, DCD
	13 to 16	3634, 3734, 3834, 3934	E32, E96, EFA, F5E		13 to 16	3633, 3733, 3833, 3933	E31, E95, EF9, F5D
5)	1 to 4	2435, 2535, 2635, 2735	983, 9E7, A4B, AAF	-	-	-	-
	5 to 8	2835, 2935, 3035, 3135	B13, B77, BDB, C3F				
	9 to 12	3235, 3335, 3435, 3535	CA3, D07, D6B, DCF				
	13 to 16	3635, 3735, 3835, 3935	E33, E97, EFB, F5F				

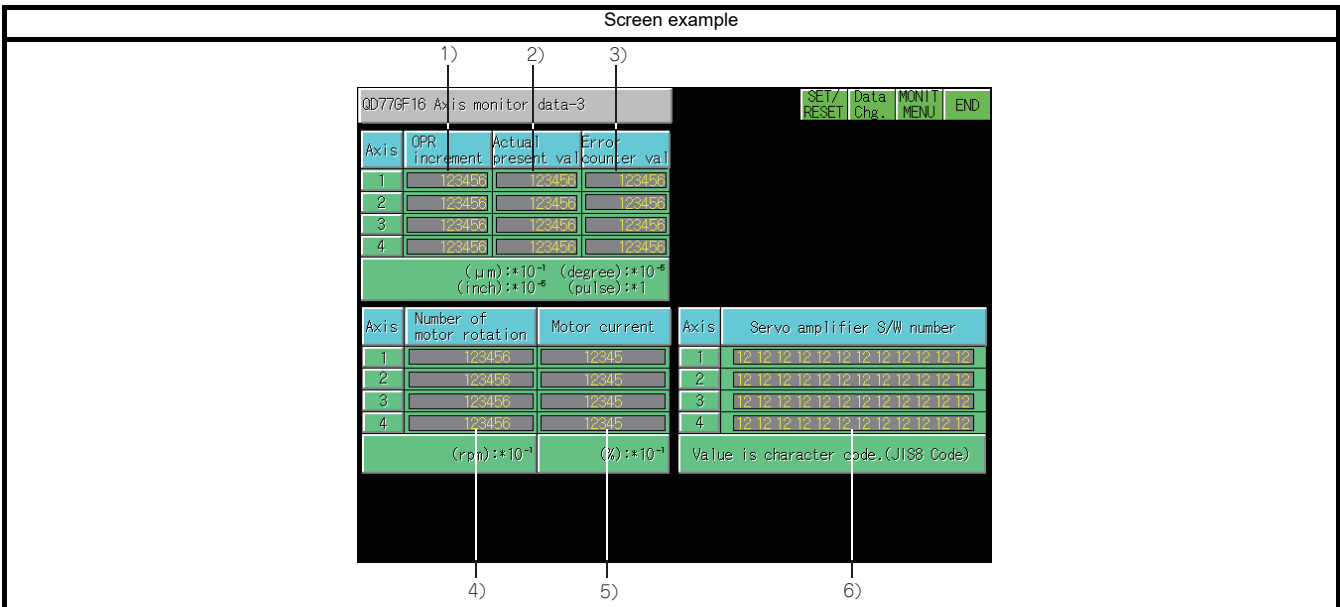

No.	Axis	Buffer memory address		No.	Axis	Buffer memory address	
		DEC	HEX			DEC	HEX
1)	1 to 4	2448 to 2449, 2548 to 2549, 2648 to 2649, 2748 to 2749	990 to 991, 9F4 to 9F5, A58 to A59, ABC to ABD	4)	1 to 4	2454 to 2455, 2554 to 2555, 2654 to 2655, 2754 to 2755	996 to 997, 9FA to 9FB, A5E to A5F, AC2 to AC3
	5 to 8	2848 to 2849, 2948 to 2949, 3048 to 3049, 3148 to 3149	B20 to B21, B84 to B85, BE8 to BE9, C4C to C4D		5 to 8	2854 to 2855, 2954 to 2955, 3054 to 3055, 3154 to 3155	B26 to B27, B8A to B8B, BEE to BEF, C52 to C53
	9 to 12	3248 to 3249, 3348 to 3349, 3448 to 3449, 3548 to 3549	CB0 to CB1, D14 to D15, D78 to D79, DDC to DDD		9 to 12	3254 to 3255, 3354 to 3355, 3454 to 3455, 3554 to 3555	CB6 to CB7, D1A to D1B, D7E to D7F, DE2 to DE3
	13 to 16	3648 to 3649, 3748 to 3749, 3848 to 3849, 3948 to 3949	E40 to E41, EA4 to EA5, F08 to F09, F6C to F6D		13 to 16	3654 to 3655, 3754 to 3755, 3854 to 3855, 3954 to 3955	E46 to E47, EAA to EAB, F0E to F0F, F72 to F73
2)	1 to 4	2450 to 2451, 2550 to 2551, 2650 to 2651, 2750 to 2751	992 to 993, 9F6 to 9F7, A5A to A5B, ABE to ABF	5)	1 to 4	2456, 2556, 2656, 2756	998, 9FC, A60, AC4
	5 to 8	2850 to 2851, 2950 to 2951, 3050 to 3051, 3150 to 3151	B22 to B23, B86 to B87, BEA to BEB, C4E to C4F		5 to 8	2856, 2956, 3056, 3156	B28, B8C, BF0, C54
	9 to 12	3250 to 3251, 3350 to 3351, 3450 to 3451, 3550 to 3551	CB2 to CB3, D16 to D17, D7A to D7B, DDE to DDF		9 to 12	3256, 3356, 3456, 3556	CB8, D1C, D80, DE4
	13 to 16	3650 to 3651, 3750 to 3751, 3850 to 3851, 3950 to 3951	E42 to E43, EA6 to EA7, F0A to F0B, F6E to F6F		13 to 16	3656, 3756, 3856, 3956	E48, EAC, F10, F74
3)	1 to 4	2452 to 2453, 2552 to 2553, 2652 to 2653, 2752 to 2753	994 to 995, 9F8 to 9F9, A5C to A5D, AC0 to AC1	6)	1 to 4	2464 to 2469, 2564 to 2569, 2664 to 2669, 2764 to 2769	9A0 to 9A5, A04 to A09, A68 to A6D, ACC to AD1
	5 to 8	2852 to 2853, 2952 to 2953, 3052 to 3053, 3152 to 3153	B24 to B25, B88 to B89, BEC to BED, C50 to C51		5 to 8	2864 to 2869, 2964 to 2969, 3064 to 3069, 3164 to 3169	B30 to B35, B94 to B99, BF8 to BFD, C5C to C61
	9 to 12	3252 to 3253, 3352 to 3353, 3452 to 3453, 3552 to 3553	CB4 to CB5, D18 to D19, D7C to D7D, DE0 to DE1		9 to 12	3264 to 3269, 3364 to 3369, 3464 to 3469, 3564 to 3569	CC0 to CC5, D24 to D29, D88 to D8D, DEC to DF1
	13 to 16	3652 to 3653, 3752 to 3753, 3852 to 3853, 3952 to 3953	E44 to E45, EA8 to EA9, F0C to F0D, F70 to F71		13 to 16	3664 to 3669, 3764 to 3769, 3864 to 3869, 3964 to 3969	E50 to E55, EB4 to EB9, F18 to F1D, F7C to F81

- 1 OVERVIEW
- 2 SYSTEM MONITOR
- 3 LADDER MONITOR FUNCTION
- 4 MELSEC-A LIST EDITOR
- 5 MELSEC-FX LIST EDITOR
- 6 INTELLIGENT MODULE MONITOR
- 7 NETWORK MONITOR
- 8 Q MOTION MONITOR

Screen example

No.	Axis	Buffer memory address		No.	Axis	Buffer memory address	
		DEC	HEX			DEC	HEX
1)	1 to 4	2470, 2570, 2670, 2770	9A6, A0A, A6E, AD2	4)	9 to 12	3282, 3382, 3482, 3582	CD2, D36, D9A, DFE
	5 to 8	2870, 2970, 3070, 3170	B36, B9A, BFE, C62		13 to 16	3682, 3782, 3882, 3982	E62, EC6, F2A, F8E
	9 to 12	3270, 3370, 3470, 3570	CC6, D2A, D8E, DF2		5)	1 to 4	2478, 2578, 2678, 2778
	13 to 16	3670, 3770, 3870, 3970	E56, EBA, F1E, F82	5 to 8		2878, 2978, 3078, 3178	B3E, BA2, C06, C6A
2)	1 to 4	2476, 2576, 2676, 2776	9AC, A10, A74, AD8	9 to 12	3278, 3378, 3478, 3578	CCE, D32, D96, DFA	
	5 to 8	2876, 2976, 3076, 3176	B3C, BA0, C04, C68	13 to 16	3678, 3778, 3878, 3978	E5E, EC2, F26, F8A	
	9 to 12	3276, 3376, 3476, 3576	CCC, D30, D94, DF8	6)	1 to 4	2479, 2579, 2679, 2779	9AF, A13, A77, ADB
13 to 16	3676, 3776, 3876, 3976	E5C, EC0, F24, F88	5 to 8		2879, 2979, 3079, 3179	B3F, BA3, C07, C6B	
3)	1 to 4	2477, 2577, 2677, 2777	9AD, A11, A75, AD9		9 to 12	3279, 3379, 3479, 3579	CCF, D33, D97, DFB
	5 to 8	2877, 2977, 3077, 3177	B3D, BA1, C05, C69	13 to 16	3679, 3779, 3879, 3979	E5F, EC3, F27, F8B	
	9 to 12	3277, 3377, 3477, 3577	CCD, D31, D95, DF9	7)	1 to 4	2480, 2580, 2680, 2780	9B0, A14, A78, ADC
13 to 16	3677, 3777, 3877, 3977	E5D, EC1, F25, F89	5 to 8		2880, 2980, 3080, 3180	B40, BA4, C08, C6C	
4)	1 to 4	2482, 2582, 2682, 2782	9B2, A16, A7A, ADE		9 to 12	3280, 3380, 3480, 3580	CD0, D34, D98, DFC
	5 to 8	2882, 2982, 3082, 3182	B42, BA6, C0A, C6E	13 to 16	3680, 3780, 3880, 3980	E60, EC4, F28, F8C	

Screen example

No.	Axis	Buffer memory address		No.	Axis	Buffer memory address	
		DEC	HEX			DEC	HEX
1)	1 to 4	2424 to 2425, 2524 to 2525, 2624 to 2625, 2724 to 2725	978 to 979, 9DC to 9DD, A40 to A41, AA4 to AA5	2)	1 to 4	2426, 2526, 2626, 2726	97A, 9DE, A42, AA6
		5 to 8	B08 to B09, B6C to B6D, BD0 to BD1, C34 to C35		5 to 8	2826, 2926, 3026, 3126	B0A, B6E, BD2, C36
	9 to 12	C98 to C99, CFC to CFD, D60 to D61, DC4 to DC5	13 to 16		3226, 3326, 3426, 3526	C9A, CFE, D62, DC6	
	13 to 16	3624 to 3625, 3724 to 3725, 3824 to 3825, 3924 to 3925	E28 to E29, E8C to E8D, EF0 to EF1, F54 to F55	3)	1 to 4	2416, 2516, 2616, 2716	970, 9D4, A38, A9C
9 to 12	3424 to 3425, 3524 to 3525	E28 to E29, E8C to E8D, EF0 to EF1, F54 to F55	5 to 8		2816, 2916, 3016, 3116	B00, B64, BC8, C2C	
	13 to 16		3616, 3716, 3816, 3916		E20, E84, EE8, F4C		

Screen example

No.	Axis	Buffer memory address		No.	Axis	Buffer memory address	
		DEC	HEX			DEC	HEX
1)	1 to 4	2414 to 2415, 2514 to 2515, 2614 to 2615, 2714 to 2715	96E to 96F, 9D2 to 9D3, A36 to A37, A9A to A9B	2)	9 to 12	5126 to 5127, 5226 to 5227, 5326 to 5327, 5426 to 5427	1406 to 1407, 146A to 146B, 14CE to 14CF, 1532 to 1533
	5 to 8	2814 to 2815, 2914 to 2915, 3014 to 3015, 3114 to 3115	AFE to AFF, B62 to B63, BC6 to BC7, C2A to C2B		13 to 16	5526 to 5527, 5626 to 5627, 5726 to 5727, 5826 to 5827	1596 to 1597, 15FA to 15FB, 165E to 165F, 16C2 to 16C3
	9 to 12	3214 to 3215, 3314 to 3315, 3414 to 3415, 3514 to 3515	C8E to C8F, CF2 to CF3, D56 to D57, DBA to DBB	3)	1 to 4	2417, 2517, 2617, 2717	971, 9D5, A39, A9D
	13 to 16	3614 to 3615, 3714 to 3715, 3814 to 3815, 3914 to 3915	E1E to E1F, E82 to E83, EE6 to EE7, F4A to F4B		5 to 8	2817, 2917, 3017, 3117	B01, B65, BC9, C2D
2)	1 to 4	4326 to 4327, 4426 to 4427, 4526 to 4527, 4626 to 4627	10E6 to 10E7, 114A to 114B, 11AE to 11AF, 1212 to 1213	4)	1 to 4	4328, 4428, 4528, 4628	10E8, 114C, 11B0, 1214
		5 to 8	4726 to 4727, 4826 to 4827, 4926 to 4927, 5026 to 5027		1276 to 1277, 12DA to 12DB, 133E to 133F, 13A2 to 13A3	5 to 8	4728, 4828, 4928, 5028
	9 to 12	5126 to 5127, 5226 to 5227, 5326 to 5327, 5426 to 5427	96E to 96F, 9D2 to 9D3, A36 to A37, A9A to A9B	9 to 12	5128, 5228, 5328, 5428	1408, 146C, 14D0, 1534	
		13 to 16	5526 to 5527, 5626 to 5627, 5726 to 5727, 5826 to 5827	E1E to E1F, E82 to E83, EE6 to EE7, F4A to F4B	13 to 16	5528, 5628, 5728, 5828	1598, 15FC, 1660, 16C4

Screen example

QD776F16 Position-speed control

SET/RESET Data Chg. MONIT MENU END

PSSC speed change register

1) Axis1 123456 Axis2 123456
 Axis3 123456 Axis4 123456

Setting range
 0 to 2000000000 (mm/min): *10⁻²
 (inch/min): *10⁻³
 (degree/min): *10⁻³
 0 to 500000000 (pulse/sec): *1

Item	Ax.1	Ax.2	Ax.3	Ax.4
Position-speed switching latch	<input type="checkbox"/>	<input type="checkbox"/>	<input type="checkbox"/>	<input type="checkbox"/>
In speed control	<input type="checkbox"/>	<input type="checkbox"/>	<input type="checkbox"/>	<input type="checkbox"/>
Position-speed switching enable	0:Disable 1:Enable			

2)
3)

No.	Axis	Buffer memory address		No.	Axis	Buffer memory address	
		DEC	HEX			DEC	HEX
1)	1 to 4	4330 to 4331, 4430 to 4431, 4530 to 4531, 4630 to 4631	10EA to 10EB, 114E to 114F, 11B2 to 11B3, 1216 to 1217	2)	1 to 4	2417, 2517, 2617, 2717	971, 9D5, A39, A9D
	5 to 8	4730 to 4731, 4830 to 4831, 4930 to 4931, 5030 to 5031	127A to 127B, 12DE to 12DF, 1342 to 1343, 13A6 to 13A7		5 to 8	2817, 2917, 3017, 3117	B01, B65, BC9, C2D
	9 to 12	5130 to 5131, 5230 to 5231, 5330 to 5331, 5430 to 5431	140A to 140B, 146E to 146F, 14D2 to 14D3, 1536 to 1537		9 to 12	3217, 3317, 3417, 3517	C91, CF5, D59, DBD
	13 to 16	5530 to 5531, 5630 to 5631, 5730 to 5731, 5830 to 5831	159A to 159B, 15FE to 15FF, 1662 to 1663, 16C6 to 16C7		13 to 16	3617, 3717, 3817, 3917	E21, E85, EE9, F4D
3)	1 to 4			1 to 4	4332, 4432, 4532, 4632	10EC, 1150, 11B4, 1218	
	5 to 8			5 to 8	4732, 4832, 4932, 5032	127C, 12E0, 1344, 13A8	
	9 to 12			9 to 12	5132, 5232, 5332, 5432	140C, 1470, 14D4, 1538	
	13 to 16			13 to 16	5532, 5632, 5732, 5832	159C, 1600, 1664, 16C8	

Screen example

QD776F16 Axis control data-1					SET/RESET	Data Chg.	MONIT MENU	END		
New current value					Item	Ax.1	Ax.2	Ax.3	Ax.4	Set value
1) {	Axis1	123456	Axis2	123456	Torg.boost	123	123	123	123	1 to 200(%)
	Axis3	123456	Axis4	123456	Step mode	1	1	1	1	0:Dec.unit 1:data No.
	Setting range				Step valid flag	1	1	1	1	0:Invalid 1:Valid
-2147483648 (um):*10 ⁻¹ to 2147483647 (inch):*10 ⁻⁵ 0 to 35999999 (pulse):*1 (degree):*10 ⁻⁵				Step start information	1	1	1	1	0:Completed 1:Invalid 2:RESTARTS	
New speed value					Item	Ax.1	Ax.2	Ax.3	Ax.4	Set value
2) {	Axis1	123456	Axis2	123456	Skip command	1	1	1	1	0:Completed 1:Skip
	Axis3	123456	Axis4	123456	Use ext. command	1	1	1	1	0:Invalid 1:Valid
	Setting range									
0 to 2000000000 (mm/min):*10 ⁻² (inch/min):*10 ⁻⁵ (degree/min):*10 ⁻⁵ 0 to 500000000 (pulse/sec):*1										

No.	Axis	Buffer memory address		No.	Axis	Buffer memory address	
		DEC	HEX			DEC	HEX
1)	1 to 4	4306 to 4307, 4406 to 4407, 4506 to 4507, 4606 to 4607	10D2 to 10D3, 1136 to 1137, 119A to 119B, 11FE to 11FF	3)	1 to 4	4313, 4413, 4513, 4613	10D9, 113D, 11A1, 1205
	5 to 8	4706 to 4707, 4806 to 4807, 4906 to 4907, 5006 to 5007	1262 to 1263, 12C6 to 12C7, 132A to 132B, 138E to 138F		5 to 8	4713, 4813, 4913, 5013	1269, 12CD, 1331, 1395
	9 to 12	5106 to 5107, 5206 to 5207, 5306 to 5307, 5406 to 5407	13F2 to 13F3, 1456 to 1457, 14BA to 14BB, 151E to 151F		9 to 12	5113, 5213, 5313, 5413	13F9, 145D, 14C1, 1525
	13 to 16	5506 to 5507, 5606 to 5607, 5706 to 5707, 5806 to 5807	1582 to 1583, 15E6 to 15E7, 164A to 164B, 16AE to 16AF		13 to 16	5513, 5613, 5713, 5813	1589, 15ED, 1651, 16B5
2)	1 to 4	4314 to 4315, 4414 to 4415, 4514 to 4515, 4614 to 4615	10DA to 10DB, 113E to 113F, 11A2 to 11A3, 1206 to 1207	6)	1 to 4	4346, 4446, 4546, 4646	10FA, 115E, 11C2, 1226
					5 to 8	4746, 4846, 4946, 5046	128A, 12EE, 1352, 13B6
					9 to 12	5146, 5246, 5346, 5446	141A, 147E, 14E2, 1546
					13 to 16	5546, 5646, 5746, 5846	15AA, 160E, 1672, 16D6
	5 to 8	4714 to 4715, 4814 to 4815, 4914 to 4915, 5014 to 5015	126A to 126B, 12CE to 12CF, 1332 to 1333, 1396 to 1397	7)	1 to 4	4347, 4447, 4547, 4647	10FB, 115F, 11C3, 1227
					5 to 8	4747, 4847, 4947, 5047	128B, 12EF, 1353, 13B7
					9 to 12	5147, 5247, 5347, 5447	141B, 147F, 14E3, 1547
					13 to 16	5547, 5647, 5747, 5847	15AB, 160F, 1673, 16D7
	9 to 12	5114 to 5115, 5214 to 5215, 5314 to 5315, 5414 to 5415	13FA to 13FB, 145E to 145F, 14C2 to 14C3, 1526 to 1527	8)	1 to 4	4305, 4405, 4505, 4605	10D1, 1135, 1199, 11FD
					5 to 8	4705, 4805, 4905, 5005	1261, 12C5, 1329, 138D
					9 to 12	5105, 5205, 5305, 5405	13F1, 1455, 14B9, 151D
					13 to 16	5505, 5605, 5705, 5805	1581, 15E5, 1649, 16AD

1

OVERVIEW

2

SYSTEM MONITOR

3

LADDER MONITOR FUNCTION

4

MELSEC-A LIST EDITOR

5

MELSEC-FX LIST EDITOR

6

INTELLIGENT MODULE MONITOR

7

NETWORK MONITOR

8

Q MOTION MONITOR

Screen example

QD776F16 Axis control data-2					SET/	Data	MONIT	END		
					RESET	Chg.	MENU			
1)	Item	Axis1	Axis2	Axis3	Axis4	Item	Axis1	Axis2	Axis3	Axis4
	1) New acc time	1234	1234	1234	1234	New acc time	12345	12345	12345	12345
2)	2) Start time point No.	1~800	7000~7004	9001~9004		New dec time	0 to 8888008(msec)			
3)	3) Axis emg reset	0:Completed	1:Request			IRQ in locus OP	0:Completed	1:Request		
4)	4) Restart command	0:Completed	1:Request			OPR req flag OFF	0:Completed	1:Request		
5)	5) M code OFF request	0:Completed	1:Request			MPG I/P mag.	1 to 10000			
6)	6) M/Frms chg in SPD chg,ON/OFF	0:Disable	1:Enable			MPG enable	0:Disable	1:Enable		
7)	7) Speed change request	0:Completed	1:Request			New Torq value	0:Do not / 1 to limit:Do			

No.	Axis	Buffer memory address		No.	Axis	Buffer memory address		
		DEC	HEX			DEC	HEX	
1)	1 to 4	4300, 4400, 4500, 4600	10CC, 1130, 1194, 11F8	8)	13 to 16	5508 to 5509, 5608 to 5609, 5708 to 5709, 5808 to 5809	1584 to 1585, 15E8 to 15E9, 164C to 164D, 16B0 to 16B1	
	5 to 8	4700, 4800, 4900, 5000	125C, 12C0, 1324, 1388		9)	1 to 4	4310 to 4311, 4410 to 4411, 4510 to 4511, 4610 to 4611	10D6 to 10D7, 113A to 113B, 119E to 119F, 1202 to 1203
	9 to 12	5100, 5200, 5300, 5400	13EC, 1450, 14B4, 1518			5 to 8	4710 to 4711, 4810 to 4811, 4910 to 4911, 5010 to 5011	1266 to 1267, 12CA to 12CB, 132E to 132F, 1392 to 1393
	13 to 16	5500, 5600, 5700, 5800	157C, 15E0, 1644, 16A8			9 to 12	5110 to 5111, 5210 to 5211, 5310 to 5311, 5410 to 5411	13F6 to 13F7, 145A to 145B, 14BE to 14BF, 1522 to 1523
2)	1 to 4	4301, 4401, 4501, 4601	10CD, 1131, 1195, 11F9	10)		13 to 16	5510 to 5511, 5610 to 5611, 5710 to 5711, 5810 to 5811	1586 to 1587, 15EA to 15EB, 164E to 164F, 16B2 to 16B3
	5 to 8	4701, 4801, 4901, 5001	125D, 12C1, 1325, 1389		1 to 4	4320, 4420, 4520, 4620	10E0, 1144, 11A8, 120C	
	9 to 12	5101, 5201, 5301, 5401	13ED, 1451, 14B5, 1519		5 to 8	4720, 4820, 4920, 5020	1270, 12D4, 1338, 139C	
	13 to 16	5501, 5601, 5701, 5801	157D, 15E1, 1645, 16A9		9 to 12	5120, 5220, 5320, 5420	1400, 1464, 14C8, 152C	
3)	1 to 4	4302, 4402, 4502, 4602	10CE, 1132, 1196, 11FA	11)	13 to 16	5520, 5620, 5720, 5820	1590, 15F4, 1658, 16BC	
	5 to 8	4702, 4802, 4902, 5002	125E, 12C2, 1326, 138A		1 to 4	4321, 4421, 4521, 4621	10E1, 1145, 11A9, 120D	
	9 to 12	5102, 5202, 5302, 5402	13EE, 1452, 14B6, 151A		5 to 8	4721, 4821, 4921, 5021	1271, 12D5, 1339, 139D	
	13 to 16	5502, 5602, 5702, 5802	157E, 15E2, 1646, 16AA		9 to 12	5121, 5221, 5321, 5421	1401, 1465, 14C9, 152D	
4)	1 to 4	4303, 4403, 4503, 4603	10CF, 1133, 1197, 11FB	12)	13 to 16	5521, 5621, 5721, 5821	1591, 15F5, 1659, 16BD	
	5 to 8	4703, 4803, 4903, 5003	125F, 12C3, 1327, 138B		1 to 4	4322 to 4323, 4422 to 4423, 4522 to 4523, 4622 to 4623	10E2 to 10E3, 1146 to 1147, 11AA to 11AB, 120E to 120F	
	9 to 12	5103, 5203, 5303, 5403	13EF, 1453, 14B7, 151B		5 to 8	4722 to 4723, 4822 to 4823, 4922 to 4923, 5022 to 5023	1272 to 1273, 12D6 to 12D7, 133A to 133B, 139E to 139F	
	13 to 16	5503, 5603, 5703, 5803	157F, 15E3, 1647, 16AB		9 to 12	5122 to 5123, 5222 to 5223, 5322 to 5323, 5422 to 5423	1402 to 1403, 1466 to 1467, 14CA to 14CB, 152E to 152F	
5)	1 to 4	4304, 4404, 4504, 4604	10DD, 1134, 1198, 11FC	13)	13 to 16	5522 to 5523, 5622 to 5623, 5722 to 5723, 5822 to 5823	1592 to 1593, 15F6 to 15F7, 165A to 165B, 16BE to 16BF	
	5 to 8	4704, 4804, 4904, 5004	1260, 12C4, 1328, 138C		1 to 4	4324, 4424, 4524, 4624	10E4, 1148, 11AC, 1210	
	9 to 12	5104, 5204, 5304, 5404	13F0, 1454, 14B8, 151C		5 to 8	4724, 4824, 4924, 5024	1274, 12D8, 133C, 13A0	
	13 to 16	5504, 5604, 5704, 5804	1580, 15E4, 1648, 16AC		9 to 12	5124, 5224, 5324, 5424	1404, 1468, 14CC, 1530	
6)	1 to 4	4312, 4412, 4512, 4612	10D8, 113C, 11A0, 1204	14)	13 to 16	5524, 5624, 5724, 5824	1594, 15F8, 165C, 16C0	
	5 to 8	4712, 4812, 4912, 5012	1268, 12CC, 1330, 1394		1 to 4	4325, 4425, 4525, 4625	10E5, 1149, 11AD, 1211	
	9 to 12	5112, 5212, 5312, 5412	13F8, 145C, 14C0, 1524		5 to 8	4725, 4825, 4925, 5025	1275, 12D9, 133D, 13A1	
	13 to 16	5512, 5612, 5712, 5812	1588, 15EC, 1650, 16B4		9 to 12	5125, 5225, 5325, 5425	1405, 1469, 14CD, 1531	
7)	1 to 4	4316, 4416, 4516, 4616	10DC, 1140, 11A4, 1208	14)	13 to 16	5525, 5625, 5725, 5825	1595, 15F9, 165D, 16C1	
	5 to 8	4716, 4816, 4916, 5016	126C, 12D0, 1334, 1398		1 to 4			
	9 to 12	5116, 5216, 5316, 5416	13FC, 1460, 14C4, 1528		5 to 8			
	13 to 16	5516, 5616, 5716, 5816	158C, 15F0, 1654, 16B8		9 to 12			
8)	1 to 4	4308 to 4309, 4408 to 4409, 4508 to 4509, 4608 to 4609	10D4 to 10D5, 1138 to 1139, 119C to 119D, 1200 to 1201					
	5 to 8	4708 to 4709, 4808 to 4809, 4908 to 4909, 5008 to 5009	1264 to 1265, 12C8 to 12C9, 132C to 132D, 1390 to 1391					
	9 to 12	5108 to 5109, 5208 to 5209, 5308 to 5309, 5408 to 5409	13F4 to 13F5, 1458 to 1459, 14BC to 14BD, 1520 to 1521					

Screen example

No.	Axis	Buffer memory address		No.	Axis	Buffer memory address	
		DEC	HEX			DEC	HEX
1)	1 to 4	4338, 4438, 4538, 4638	10F2, 1156, 11BA, 121E	8)	1 to 4	4341, 4441, 4541, 4641	10F5, 1159, 11BD, 1221
	5 to 8	4738, 4838, 4938, 5038	1282, 12E6, 134A, 13AE		5 to 8	4741, 4841, 4941, 5041	1285, 12E9, 134D, 13B1
	9 to 12	5138, 5238, 5338, 5438	1412, 1476, 14DA, 153E		9 to 12	5141, 5241, 5341, 5441	1415, 1479, 14DD, 1541
	13 to 16	5538, 5638, 5738, 5838	15A2, 1606, 166A, 16CE		13 to 16	5541, 5641, 5741, 5841	15A5, 1609, 166D, 16D1
2)	1 to 4	4348, 4448, 4548, 4648	10FC, 1160, 11C4, 1228	9)	1 to 4	4343, 4443, 4543, 4643	10F7, 115B, 11BF, 1223
	5 to 8	4748, 4848, 4948, 5048	128C, 12F0, 1354, 13B8		5 to 8	4743, 4843, 4943, 5043	1287, 12EB, 134F, 13B3
	9 to 12	5148, 5248, 5348, 5448	141C, 1480, 14E4, 1548		9 to 12	5143, 5243, 5343, 5443	1417, 147B, 14DF, 1543
	13 to 16	5548, 5648, 5748, 5848	15AC, 1610, 1674, 16D8		13 to 16	5543, 5643, 5743, 5843	15A7, 160B, 166F, 16D3
3)	1 to 4	4349, 4449, 4549, 4649	10FD, 1161, 11C5, 1229	10)	1 to 4	4351, 4451, 4551, 4651	10FF, 1163, 11C7, 122B
	5 to 8	4749, 4849, 4949, 5049	128D, 12F1, 1355, 13B9		5 to 8	4751, 4851, 4951, 5051	128F, 12F3, 1357, 13BB
	9 to 12	5149, 5249, 5349, 5449	141D, 1481, 14E5, 1549		9 to 12	5151, 5251, 5351, 5451	141F, 1483, 14E7, 154B
	13 to 16	5549, 5649, 5749, 5849	15AD, 1611, 1675, 16D9		13 to 16	5551, 5651, 5751, 5851	15AF, 1613, 1677, 16DB
4)	1 to 4	4350, 4450, 4550, 4650	10FE, 1162, 11C6, 122A	11)	1 to 4	4352, 4452, 4552, 4652	1100, 1164, 11C8, 122C
	5 to 8	4750, 4850, 4950, 5050	128E, 12F2, 1356, 13BA		5 to 8	4752, 4852, 4952, 5052	1290, 12F4, 1358, 13BC
	9 to 12	5150, 5250, 5350, 5450	141E, 1482, 14E6, 154A		9 to 12	5152, 5252, 5352, 5452	1420, 1484, 14E8, 154C
	13 to 16	5550, 5650, 5750, 5850	15AE, 1612, 1676, 16DA		13 to 16	5552, 5652, 5752, 5852	15B0, 1614, 1678, 16DC
5)	1 to 4	4339, 4439, 4539, 4639	10F3, 1157, 11BB, 121F	12)	1 to 4	4359, 4459, 4559, 4659	1107, 116B, 11CF, 1233
	5 to 8	4739, 4839, 4939, 5039	1283, 12E7, 134B, 13AF		5 to 8	4759, 4859, 4959, 5059	1297, 12FB, 135F, 13C3
	9 to 12	5139, 5239, 5339, 5439	1413, 1477, 14DB, 153F		9 to 12	5159, 5259, 5359, 5459	1427, 148B, 14EF, 1553
	13 to 16	5539, 5639, 5739, 5839	15A3, 1607, 166B, 16CF		13 to 16	5559, 5659, 5759, 5859	15B7, 161B, 167F, 16E3
6)	1 to 4	4340, 4440, 4540, 4640	10F4, 1158, 11BC, 1220	13)	1 to 4	4365, 4465, 4565, 4665	110D, 1171, 11D5, 1239
	5 to 8	4740, 4840, 4940, 5040	1284, 12E8, 134C, 13B0		5 to 8	4765, 4865, 4965, 5065	129D, 1301, 1365, 13C9
	9 to 12	5140, 5240, 5340, 5440	1414, 1478, 14DC, 1540		9 to 12	5165, 5265, 5365, 5465	142D, 1491, 14F5, 1559
	13 to 16	5540, 5640, 5740, 5840	15A4, 1608, 166C, 16D0		13 to 16	5565, 5665, 5765, 5865	15BD, 1621, 1685, 16E9
7)	1 to 4	4341, 4441, 4541, 4641	10F5, 1159, 11BD, 1221	-	-	-	-
	5 to 8	4741, 4841, 4941, 5041	1285, 12E9, 134D, 13B1				
	9 to 12	5141, 5241, 5341, 5441	1415, 1479, 14DD, 1541				
	13 to 16	5541, 5641, 5741, 5841	15A5, 1609, 166D, 16D1				

1 OVERVIEW
 2 SYSTEM MONITOR
 3 LADDER MONITOR FUNCTION
 4 MELSEC-A LIST EDITOR
 5 MELSEC-FX LIST EDITOR
 6 INTELLIGENT MODULE MONITOR
 7 NETWORK MONITOR
 8 Q MOTION MONITOR

Screen example

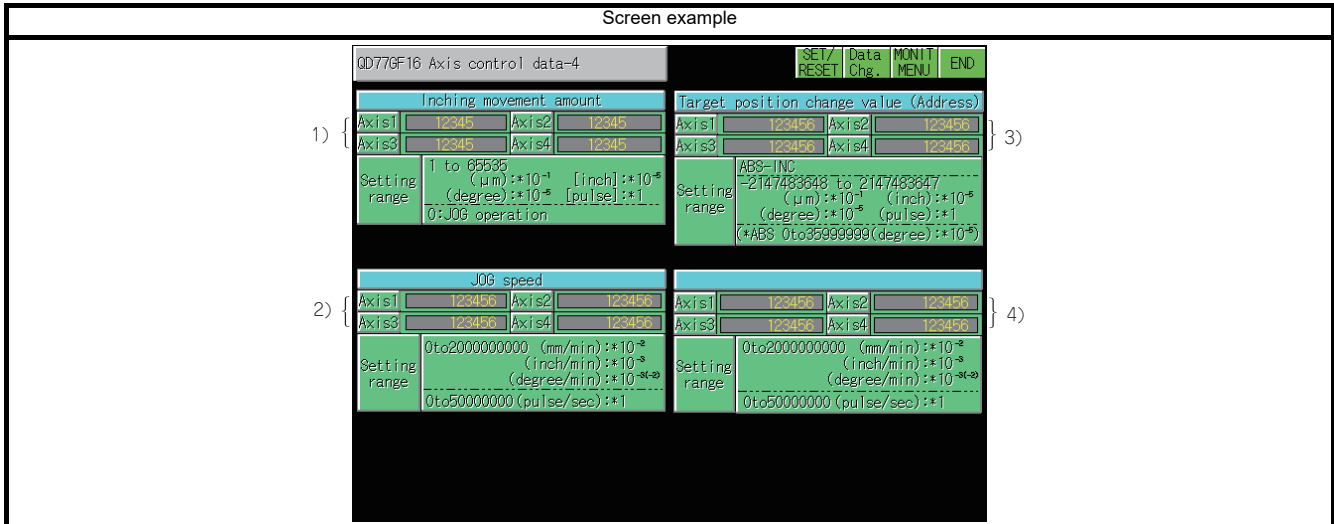

No.	Axis	Buffer memory address		No.	Axis	Buffer memory address	
		DEC	HEX			DEC	HEX
1)	1 to 4	4317, 4417, 4517, 4617	10DD, 1141, 11A5, 1209	3)	1 to 4	4334 to 4335, 4434 to 4435, 4534 to 4535, 4634 to 4635	10EE to 10EF, 1152 to 1153, 11B6 to 11B7, 121A to 121B
	5 to 8	4717, 4817, 4917, 5017	126D, 12D1, 1335, 1399		5 to 8	4734 to 4735, 4834 to 4835, 4934 to 4935, 5034 to 5035	127E to 127F, 12E2 to 12E3, 1346 to 1347, 13AA to 13AB
	9 to 12	5117, 5217, 5317, 5417	13FD, 1461, 14C5, 1529		9 to 12	5134 to 5135, 5234 to 5235, 5334 to 5335, 5434 to 5435	140E to 140F, 1472 to 1473, 14D6 to 14D7, 153A to 153B
	13 to 16	5517, 5617, 5717, 5817	158D, 15F1, 1655, 16B9		13 to 16	5534 to 5535, 5634 to 5635, 5734 to 5735, 5834 to 5835	159E to 159F, 1602 to 1603, 1666 to 1667, 16CA to 16CB
2)	1 to 4	4318 to 4319, 4418 to 4419, 4518 to 4519, 4618 to 4619	10DE to 10DF, 1142 to 1143, 11A6 to 11A7, 120A to 120B	4)	1 to 4	4336 to 4337, 4436 to 4437, 4536 to 4537, 4636 to 4637	10F0 to 10F1, 1154 to 1155, 11B8 to 11B9, 121C to 121D
	5 to 8	4718 to 4719, 4818 to 4819, 4918 to 4919, 5018 to 5019	126E to 126F, 12D2 to 12D3, 1336 to 1337, 139A to 139B		5 to 8	4736 to 4737, 4836 to 4837, 4936 to 4937, 5036 to 5037	1280 to 1281, 12E4 to 12E5, 1348 to 1349, 13AC to 13AD
	9 to 12	5118 to 5119, 5218 to 5219, 5318 to 5319, 5418 to 5419	13FE to 13FF, 1462 to 1463, 14C6 to 14C7, 152A to 152B		9 to 12	5136 to 5137, 5236 to 5237, 5336 to 5337, 5436 to 5437	1410 to 1411, 1474 to 1475, 14D8 to 14D9, 153C to 153D
	13 to 16	5518 to 5519, 5618 to 5619, 5718 to 5719, 5818 to 5819	158E to 158F, 15F2 to 15F3, 1656 to 1657, 16BA to 16BB		13 to 16	5536 to 5537, 5636 to 5637, 5736 to 5737, 5836 to 5837	15A0 to 15A1, 1604 to 1605, 1668 to 1669, 16CC to 16CD

Screen example

No.	Axis	Buffer memory address		No.	Axis	Buffer memory address	
		DEC	HEX			DEC	HEX
1)	-	4012 to 4016	FAC to FB0	9)	-	4052 to 4056	FD4 to FD8
2)	-	4017 to 4021	FB1 to FB5	10)	-	4057 to 4061	FD9 to FDD
3)	-	4022 to 4026	FB6 to FBA	11)	-	4062 to 4066	FDE to FE2
4)	-	4027 to 4031	FBB to FBF	12)	-	4067 to 4071	FE3 to FE7
5)	-	4032 to 4036	FC0 to FC4	13)	-	4072 to 4076	FE8 to FEC
6)	-	4037 to 4041	FC5 to FC9	14)	-	4077 to 4081	FED to FF1
7)	-	4042 to 4046	FCA to FCE	15)	-	4082 to 4086	FF2 to FF6
8)	-	4047 to 4051	FCF to FD3	16)	-	4087 to 4091	FF7 to FFB

Screen example

No.	Axis	Buffer memory address		No.	Axis	Buffer memory address		No.	Axis	Buffer memory address	
		DEC	HEX			DEC	HEX			DEC	HEX
1)	-	4093 to 4096	FFD to 1000	13)	-	4141 to 4144	102D to 1030	25)	-	4190 to 4193	105E to 1061
2)	-	4097 to 4100	1001 to 1004	14)	-	4145 to 4148	1031 to 1034	26)	-	4194 to 4197	1062 to 1065
3)	-	4101 to 4104	1005 to 1008	15)	-	4149 to 4152	1035 to 1038	27)	-	4198 to 4201	1066 to 1069
4)	-	4105 to 4108	1009 to 100C	16)	-	4153 to 4156	1039 to 103C	28)	-	4202 to 4205	106A to 106D
5)	-	4109 to 4112	100D to 1010	17)	-	4158 to 4161	103E to 1041	29)	-	4206 to 4209	106E to 1071
6)	-	4113 to 4116	1011 to 1014	18)	-	4162 to 4165	1042 to 1045	30)	-	4210 to 4213	1072 to 1075
7)	-	4117 to 4120	1015 to 1018	19)	-	4166 to 4169	1046 to 1049	31)	-	4214 to 4217	1076 to 1079
8)	-	4121 to 4124	1019 to 101C	20)	-	4170 to 4173	104A to 104D	32)	-	4218 to 4221	107A to 107D
9)	-	4125 to 4128	101D to 1020	21)	-	4174 to 4177	104E to 1051	33)	-	31300 to 31315	7A44 to 7A53
10)	-	4129 to 4132	1021 to 1024	22)	-	4178 to 4181	1052 to 1055	34)	-	31316 to 31331	7A54 to 7A63
11)	-	4133 to 4136	1025 to 1028	23)	-	4182 to 4185	1056 to 1059	-	-	-	-
12)	-	4137 to 4140	1029 to 102C	24)	-	4186 to 4189	105A to 105D	-	-	-	-

Screen example

QD77GF16 Positioning data										AREA	SET/	Data	MONIT	END	
										CHG	RESET	Chg.	MENU		
Axis1					Axis3										
No	Patt.	Int.	Cont.	Acc.	Dec.	Dwell	Moode	No	Patt.	Int.	Cont.	Acc.	Dec.	Dwell	Moode
	Address			Arc address		Instr.	speed		Address			Arc address		Instr.	speed
1)	00	123	12	00	00	12345	12345	00	123	12	00	00	12345	12345	7)
		123456		123456		123456			123456		123456		123456		123456
2)	00	123	12	00	00	12345	12345	00	123	12	00	00	12345	12345	8)
		123456		123456		123456			123456		123456		123456		123456
3)	00	123	12	00	00	12345	12345	00	123	12	00	00	12345	12345	9)
		123456		123456		123456			123456		123456		123456		123456
Axis2					Axis4										
No	Patt.	Int.	Cont.	Acc.	Dec.	Dwell	Moode	No	Patt.	Int.	Cont.	Acc.	Dec.	Dwell	Moode
	Address			Arc address		Instr.	speed		Address			Arc address		Instr.	speed
4)	00	123	12	00	00	12345	12345	00	123	12	00	00	12345	12345	10)
		123456		123456		123456			123456		123456		123456		123456
5)	00	123	12	00	00	12345	12345	00	123	12	00	00	12345	12345	11)
		123456		123456		123456			123456		123456		123456		123456
6)	00	123	12	00	00	12345	12345	00	123	12	00	00	12345	12345	12)
		123456		123456		123456			123456		123456		123456		123456

[Pattern] 00: Positioning complete 01: Continuous positioning control 11: Continuous path control
 Control)
 01H:RBS1 02H:INC1 03H:FEED1 04H:VF1 05H:VR1 06H:VFF 07H:VPR 08H:PVF 09H:PVW 09H:PVW
 01H:RBS2 02H:INC2 03H:FEED2 04H:RBS 05H:INC 06H:ABS, CW 07H:ABS, CCW 08H:INC, CW 09H:INC, CCW
 10H:RBS3 11H:VR2 12H:RBS3 13H:INC3 14H:FEED3 15H:VF3 16H:VR3 17H:VPR 18H:PVF 19H:PVW 20H:PVW
 21H:RBS4 22H:VF4 23H:VR4 24H:NOP 25H:POS 26H:JUMP 27H:LOOP 28H:LEND

No.	Axis	Buffer memory address		No.	Axis	Buffer memory address		No.	Axis	Buffer memory address	
		DEC	HEX			DEC	HEX			DEC	HEX
1)	1	6000 to 6002, 6004 to 6009	1770 to 1772, 1774 to 1779	5)	2	7010 to 7012, 7014 to 7019	1B62 to 1B64, 1B66 to 1B6B	9)	3	8020 to 8022, 8024 to 8029	1F54 to 1F56, 1F58 to 1F5D
	5	10000 to 10002, 10004 to 10009	2710 to 2712, 2714 to 2719		6	11010 to 11012, 11014 to 11019	2B02 to 2B04, 2B06 to 2B0B		7	12020 to 12022, 12024 to 12029	2EF4 to 2EF6, 2EF8 to 2EFD
	9	14000 to 14002, 14004 to 14009	36B0 to 36B2, 36B4 to 36B9		10	15010 to 15012, 15014 to 15019	3AA2 to 3AA4, 3AA6 to 3AAB		11	16020 to 16022, 16024 to 16029	3E94 to 3E96, 3E98 to 3E9D
	13	18000 to 18002, 18004 to 18009	4650 to 4652, 4654 to 4659		14	19010 to 19012, 19014 to 19019	4A42 to 4A44, 4A46 to 4A4B		15	20020 to 20022, 20024 to 20029	4E34 to 4E36, 4E38 to 4E3D
2)	1	6010 to 6012, 6014 to 6019	177A to 177C, 177E to 1783	6)	2	7020 to 7022, 7024 to 7029	1B6C to 1B6E, 1B70 to 1B75	10)	4	9000 to 9002, 9004 to 9009	2328 to 232A, 232C to 2331
	5	10010 to 10012, 10014 to 10019	271A to 271C, 271E to 2723		6	11020 to 11022, 11024 to 11029	2B0C to 2B0E, 2B10 to 2B15		8	13000 to 13002, 13004 to 13009	32C8 to 32CA, 32CC to 32D1
	9	14010 to 14012, 14014 to 14019	36BA to 36BC, 36BE to 36C3		10	15020 to 15022, 15024 to 15029	3AAC to 3AAE, 3AB0 to 3AB5		12	17000 to 17002, 17004 to 17009	4268 to 426A, 426C to 4271
	13	18010 to 18012, 18014 to 18019	465A to 465C, 465E to 4663		14	19020 to 19022, 19024 to 19029	4A4C to 4A4E, 4A50 to 4A55		16	21000 to 21002, 21004 to 21009	5208 to 520A, 520C to 5211
3)	1	6020 to 6022, 6024 to 6029	1784 to 1786, 1788 to 178D	7)	3	8000 to 8002, 8004 to 8009	1F40 to 1F42, 1F44 to 1F49	11)	4	9010 to 9012, 9014 to 9019	2332 to 2334, 2336 to 233B
	5	10020 to 10022, 10024 to 10029	2724 to 2726, 2728 to 272D		7	12000 to 12002, 12004 to 12009	2EE0 to 2EE2, 2EE4 to 2EE9		8	13010 to 13012, 13014 to 13019	32D2 to 32D4, 32D6 to 32DB
	9	14020 to 14022, 14024 to 14029	36C4 to 36C6, 36C8 to 36CD		11	16000 to 16002, 16004 to 16009	3E80 to 3E82, 3E84 to 3E89		12	17010 to 17012, 17014 to 17019	4272 to 4274, 4276 to 427B
	13	18020 to 18022, 18024 to 18029	4664 to 4666, 4668 to 466D		15	20000 to 20002, 20004 to 20009	4E20 to 4E22, 4E24 to 4E29		16	21010 to 21012, 21014 to 21019	5212 to 5214, 5216 to 521B
4)	2	7000 to 7002, 7004 to 7009	1B58 to 1B5A, 1B5C to 1B61	8)	3	8010 to 8012, 8014 to 8019	1F4A to 1F4C, 1F4E to 1F53	12)	4	9020 to 9022, 9024 to 9029	233C to 233E, 2340 to 2345
	6	11000 to 11002, 11004 to 11009	2AF8 to 2AFA, 2AFC to 2B01		7	12010 to 12012, 12014 to 12019	2EEA to 2EEC, 2EEE to 2EF3		8	13020 to 13022, 13024 to 13029	32DC to 32DE, 32E0 to 32E5
	10	15000 to 15002, 15004 to 15009	3A98 to 3A9A, 3A9C to 3AA1		11	16010 to 16012, 16014 to 16019	3E8A to 3E8C, 3E8E to 3E93		12	17020 to 17022, 17024 to 17029	427C to 427E, 4280 to 4285
	14	19000 to 19002, 19004 to 19009	4A38 to 4A3A, 4A3C to 4A41		15	20010 to 20012, 20014 to 20019	4E2A to 4E2C, 4E2E to 4E33		16	21020 to 21022, 21024 to 21029	521C to 521E, 5220 to 5225

6.5.38 L60AD4 module monitoring

Screen example	No.	Buffer memory address	
		DEC	HEX
<p>L60AD4 Operation Monitor 1</p> <p>Channel: 4 3 2 1 ERROR: 4 1 1</p> <p>1) A/D conv. 0:On 1:OFF</p> <p>2) A/D conv. complete 0:incomplet 1:completed</p> <p>3) Average process (064AD) 0:sampling 1:averaging</p> <p>4) Average process (Normal) 0:number 1:Time</p> <p>5) Average process (Normal) 0:sampling 1:averaging 2:number 3:move</p> <p>Setting range HEX 3456</p> <p>0:4~20(mA) 1:0~20(mA) 2:1~5(V) 3:0~5(V) 4:-10~+10(V) 5:0~+10(V) F>User range setting</p> <p>6) 8) 9) 10) 11)</p>	1)	0	0000
	2)	10	000A
	3)	9	0009
	4)	9	0009
	5)	24	0018
	6)	20	0014
	7)	19	0013
	8)	1 to 4	0001 to 0004
	9)	11 to 14	000B to 000E
	10)	30, 32, 34, 36	001E, 0020, 0022, 0024
	11)	31, 33, 35, 37	001F, 0021, 0023, 0025
<p>L60AD4 Operation Monitor 2</p> <p>1) Input sig. err. 0:enable 1:disable</p> <p>2) Input sig. err. 0:enable 1:disable</p> <p>3) Input sig. err. 0:enable 1:disable</p> <p>4) Input sig. err. Flag 0:Normal 1:Error</p> <p>5) Warning Output Flag Upper</p> <p>6) Warning Output Flag Lower</p> <p>7) 8) 9)</p> <p>10) 11) 12) 13)</p>	1)	47	002F
	2)	48	0030
	3)	53	0035
	4)	49	0031
	5)	50	0032
	6)	50	0032
	7)	54 to 57	0036 to 0039
	8)	63, 65, 67, 69	003F, 0041, 0043, 0045
	9)	62, 64, 66, 68	003E, 0040, 0042, 0044
	10)	89, 93, 97, 101	0059, 005D, 0061, 0065
	11)	88, 92, 96, 100	0058, 005C, 0060, 0064
	12)	87, 91, 95, 99	0057, 005B, 005F, 0063
	13)	86, 90, 94, 98	0056, 005A, 005E, 0062
	14)	142 to 145	008E to 0091
<p>L60AD4 Error History</p> <p>1)</p>	1)	1800, 1810 to 1964	0708, 0712 to 07AC
	-	-	-

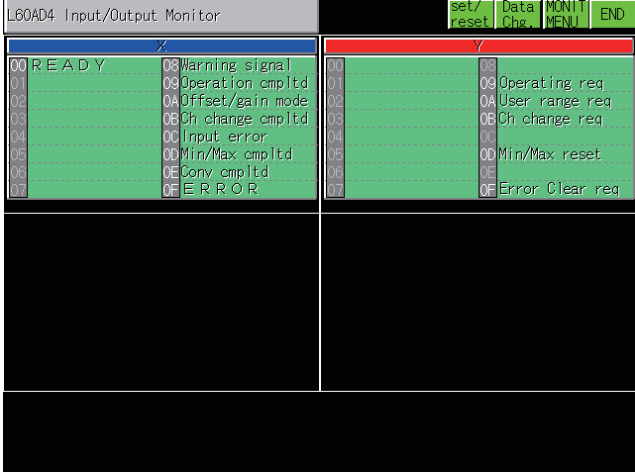
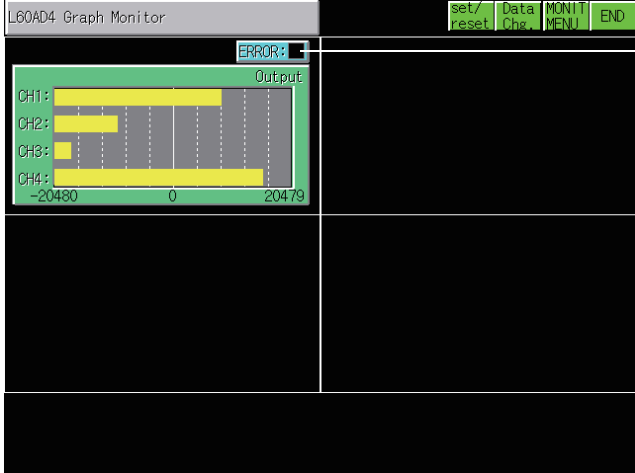
Screen example	No.	Buffer memory address																																	
		DEC	HEX																																
 <p>L60AD4 Input/Output Monitor</p> <table border="1"> <tr> <td>00 R E A D Y</td> <td>08 Warning signal</td> <td>01</td> <td>08 Operating req</td> </tr> <tr> <td>01</td> <td>09 Operation cpltd</td> <td>02</td> <td>09 User range req</td> </tr> <tr> <td>02</td> <td>0A Offset/gain mode</td> <td>03</td> <td>0A Ch change req</td> </tr> <tr> <td>03</td> <td>0B Ch change cpltd</td> <td>04</td> <td>0B Min/Max reset</td> </tr> <tr> <td>04</td> <td>0C Input error</td> <td>05</td> <td>0C Min/Max reset</td> </tr> <tr> <td>05</td> <td>0D Min/Max cpltd</td> <td>06</td> <td>0E Error Clear req</td> </tr> <tr> <td>06</td> <td>0E Conv cpltd</td> <td>07</td> <td></td> </tr> <tr> <td>07</td> <td>0F E R R O R</td> <td></td> <td></td> </tr> </table>	00 R E A D Y	08 Warning signal	01	08 Operating req	01	09 Operation cpltd	02	09 User range req	02	0A Offset/gain mode	03	0A Ch change req	03	0B Ch change cpltd	04	0B Min/Max reset	04	0C Input error	05	0C Min/Max reset	05	0D Min/Max cpltd	06	0E Error Clear req	06	0E Conv cpltd	07		07	0F E R R O R			1)	-	-
00 R E A D Y	08 Warning signal	01	08 Operating req																																
01	09 Operation cpltd	02	09 User range req																																
02	0A Offset/gain mode	03	0A Ch change req																																
03	0B Ch change cpltd	04	0B Min/Max reset																																
04	0C Input error	05	0C Min/Max reset																																
05	0D Min/Max cpltd	06	0E Error Clear req																																
06	0E Conv cpltd	07																																	
07	0F E R R O R																																		
 <p>L60AD4 Graph Monitor</p> <p>ERROR: -</p> <p>Output</p> <p>CH1: [Bar]</p> <p>CH2: [Bar]</p> <p>CH3: [Bar]</p> <p>CH4: [Bar]</p> <p>-20480 0 20479</p>	1) 2)	11 to 14 -	000B to 000E -																																

6.5.39 L60DA4 module monitoring

Screen example	No.	Buffer memory address	
		DEC	HEX
<p>1) I/A conv</p> <p>2) Setting range</p> <p>3) Digital value</p> <p>4) Set value</p> <p>5) Over</p> <p>6) L60DA4 Operation Monitor1</p> <p>7) Remarks</p>	1)	0	0000
	2)	20	0014
	3)	1 to 4	0001 to 0004
	4)	11 to 14	000B to 000E
	5)	11 to 14	000B to 000E
	6)	19	0013
	7)	26	001A
<p>1) Warning sig</p> <p>2) Scaling</p> <p>3) Warning Output Flag</p> <p>4) Warning Output</p> <p>5) Scaling</p> <p>6) Setting range</p> <p>7) Upper</p> <p>8) Lower</p>	1)	47	002F
	2)	53	0035
	3)	48	0030
	4)	48	0030
	5)	55, 57, 59, 61	0037, 0039, 003B, 003D
	6)	54, 56, 58, 60	0036, 0038, 003A, 003C
	7)	86, 88, 90, 92	0056, 0058, 005A, 005C
	8)	87, 89, 91, 93	0057, 0059, 005B, 005D
<p>1) Error History</p>	1)	1800, 1810 to 1964	0708, 0712 to 07AC
	-	-	-

1 OVERVIEW

2 SYSTEM MONITOR

3 LADDER MONITOR FUNCTION

4 MELSEC-A LIST EDITOR

5 MELSEC-FX LIST EDITOR

6 INTELLIGENT MODULE MONITOR

7 NETWORK MONITOR

8 Q MOTION MONITOR

Screen example	No.	Buffer memory address																
		DEC	HEX															
<p>L60DA4 Input/Output Monitor</p> <p>00 R.E.A.D.Y. 08 Operation cmplt'd 01 CH1Output enable 09 Operating req 01 09 Offset/gain mode 02 CH2Output enable 0A User range req 02 0A Ch change cmplt'd 03 CH3Output enable 0B Ch change req 03 0B Value changed 04 CH4Output enable 0C Value change req 04 0C 05 0D 05 0D Warning signal 0E Warning clear 06 0E Ext. power ready 0F E.R.R.O.R. 0F Error clear req</p>	1)	-	-															
<p>L60DA4 Graph Monitor</p> <p>CH1: CH2: CH3: CH4: Input</p> <p>-20480 0 20479</p> <table border="1"> <thead> <tr> <th></th> <th>Lower error</th> <th>Upper error</th> </tr> </thead> <tbody> <tr> <td>CH1</td> <td></td> <td></td> </tr> <tr> <td>CH2</td> <td></td> <td></td> </tr> <tr> <td>CH3</td> <td></td> <td></td> </tr> <tr> <td>CH4</td> <td></td> <td></td> </tr> </tbody> </table>		Lower error	Upper error	CH1			CH2			CH3			CH4			1) 2) 3) 4)	1 to 4 - 11 to 14 11 to 14	0001 to 0004 - 000B to 000E 000B to 000E
	Lower error	Upper error																
CH1																		
CH2																		
CH3																		
CH4																		
	-	-	-															

6.5.40 LD62D/LD62 module monitoring

Screen example		No.	Buffer memory address	
			DEC	HEX
		1)	00 to 01	0000 to 0001
			32 to 33	0020 to 0021
		2)	02 to 03	0002 to 0003
			34 to 35	0022 to 0023
		3)	04 to 05	0004 to 0005
			36 to 37	0024 to 0025
		4)	06 to 07	0006 to 0007
			38 to 39	0026 to 0027
		5)	10, 42	000A, 002A
		6)	12 to 13	000C to 000D
			44 to 45	002C to 002D
		7)	14 to 15	000E to 000F
			46 to 47	002E to 002F
		8)	16 to 17	0010 to 0011
	48 to 49	0030 to 0031		
9)	18 to 19	0012 to 0013		
	50 to 51	0032 to 0033		
10)	20 to 21	0014 to 0015		
	52 to 53	0034 to 0035		
11)	22 to 23	0016 to 0017		
	54 to 55	0036 to 0037		
12)	08, 40	0008, 0028		
13)	11, 43	000B, 002B		
14)	09, 41	0009, 0029		
		1)	-	-
	-	-		

1 OVERVIEW
2 SYSTEM MONITOR
3 LADDER MONITOR FUNCTION
4 MELSEC-A LIST EDITOR
5 MELSEC-FX LIST EDITOR
6 INTELLIGENT MODULE MONITOR
7 NETWORK MONITOR
8 Q MOTION MONITOR

6.5.41 LD75P/LD75D module monitoring

Screen example		No.	Buffer memory address	
			DEC	HEX
	1)	800 to 801	0320 to 0321	
	900 to 901	0384 to 0385		
	1000 to 1001	03E8 to 03E9		
	1100 to 1101	044C to 044D		
	2)	812 to 813	032C to 032D	
	912 to 913	0390 to 0391		
	1012 to 1013	03F4 to 03F5		
	1112 to 1113	0458 to 0459		
	3)	809, 909,	0329, 038D,	
	1009, 1109	03F1, 0455		
	4)	806, 906,	0326, 038A,	
	1006, 1106	03EE, 0452		
5)	807, 907,	0327, 038B,		
1007, 1107	03EF, 0453			
6)	808, 908,	0328, 038C,		
1008, 1108	03F0, 0454			
7)	829, 929,	033D, 03A1,		
1029, 1129	0405, 0469			
8) to 12)	838, 938,	0346, 03AA,		
1038, 1138	040E, 0472			
1)	-	-		
	-	-		
1)	0, 150, 300, 450	0000, 0096, 012C, 01C2		
2)	4, 154, 304, 454	0004, 009A, 0130, 01C6		
3)	1, 151, 301, 451	0001, 0097, 012D, 01C3		
4)	2, 152, 302, 452	0002, 0098, 012E, 01C4		
5)	3, 153, 303, 453	0003, 0099, 012F, 01C5		
6)	5, 155, 305, 455	0005, 009B, 0131, 01C7		
7)	6, 156, 306, 456	0006, 009C, 0132, 01C8		
-	-	-		

Screen example		No.	Buffer memory address																																																																	
			DEC	HEX																																																																
<p>LD75P/LD75D Detailed parameters 2-1</p> <p>1) Acc. time</p> <table border="1"> <tr><th>Axis1</th><th>Axis2</th><th>Axis3</th><th>Axis4</th></tr> <tr><td>1000</td><td>1000</td><td>1000</td><td>1000</td></tr> <tr><td>1000</td><td>1000</td><td>1000</td><td>1000</td></tr> <tr><td>1000</td><td>1000</td><td>1000</td><td>1000</td></tr> </table> <p>Setting range 1 to 8388608(msec)</p> <p>2) Dec. time</p> <table border="1"> <tr><th>Axis1</th><th>Axis2</th><th>Axis3</th><th>Axis4</th></tr> <tr><td>1000</td><td>1000</td><td>1000</td><td>1000</td></tr> <tr><td>1000</td><td>1000</td><td>1000</td><td>1000</td></tr> <tr><td>1000</td><td>1000</td><td>1000</td><td>1000</td></tr> </table> <p>Setting range 1 to 8388608(msec)</p> <p>3) JOG speed limit value</p> <table border="1"> <tr><th>Axis1</th><th>Axis2</th><th>Axis3</th><th>Axis4</th></tr> <tr><td>20000</td><td>20000</td><td>20000</td><td>20000</td></tr> <tr><td>20000</td><td>20000</td><td>20000</td><td>20000</td></tr> </table> <p>Setting range 1 to 2000000000 (mm/min):*10⁻³ (inch/min):*10⁻³ (degree/min):*10⁻³ 1 to 40000000 (pulse/sec):*1</p> <p>4) JOG accel. time select</p> <table border="1"> <tr><th>Item</th><th>Axis1</th><th>Axis2</th><th>Axis3</th><th>Axis4</th><th>Set range</th></tr> <tr><td>JOG accel. time select</td><td>0</td><td>0</td><td>0</td><td>0</td><td>0 to 3</td></tr> <tr><td>JOG decel. time select</td><td>0</td><td>0</td><td>0</td><td>0</td><td></td></tr> </table>	Axis1	Axis2	Axis3	Axis4	1000	1000	1000	1000	1000	1000	1000	1000	1000	1000	1000	1000	Axis1	Axis2	Axis3	Axis4	1000	1000	1000	1000	1000	1000	1000	1000	1000	1000	1000	1000	Axis1	Axis2	Axis3	Axis4	20000	20000	20000	20000	20000	20000	20000	20000	Item	Axis1	Axis2	Axis3	Axis4	Set range	JOG accel. time select	0	0	0	0	0 to 3	JOG decel. time select	0	0	0	0		1)	36 to 41	0024 to 0029			
	Axis1	Axis2	Axis3	Axis4																																																																
	1000	1000	1000	1000																																																																
	1000	1000	1000	1000																																																																
	1000	1000	1000	1000																																																																
	Axis1	Axis2	Axis3	Axis4																																																																
	1000	1000	1000	1000																																																																
	1000	1000	1000	1000																																																																
	1000	1000	1000	1000																																																																
	Axis1	Axis2	Axis3	Axis4																																																																
	20000	20000	20000	20000																																																																
	20000	20000	20000	20000																																																																
	Item	Axis1	Axis2	Axis3	Axis4	Set range																																																														
	JOG accel. time select	0	0	0	0	0 to 3																																																														
	JOG decel. time select	0	0	0	0																																																															
		186 to 191	00BA to 00BF																																																																	
		336 to 341	0150 to 0155																																																																	
		486 to 491	01E6 to 01EB																																																																	
	2)	42 to 47	002A to 002F																																																																	
		192 to 197	00C0 to 00C5																																																																	
		342 to 347	0156 to 015B																																																																	
		492 to 497	01EC to 01F0																																																																	
	3)	48 to 49	0030 to 0031																																																																	
		198 to 199	00C6 to 00C7																																																																	
		348 to 349	015C to 015D																																																																	
		498 to 499	01F2 to 01F3																																																																	
	4)	50, 200, 350, 500	0032, 00C8, 015E, 01F4																																																																	
	5)	51, 201, 351, 501	0033, 00C9, 015F, 01F5																																																																	
<p>LD75P/LD75D Detailed parameters 2-2</p> <p>1) Acc/Dec Type selection</p> <table border="1"> <tr><th>Item</th><th>Axis1</th><th>Axis2</th><th>Axis3</th><th>Axis4</th><th>Set range</th></tr> <tr><td>0:Ramp</td><td>0</td><td>0</td><td>0</td><td>0</td><td>0:Ramp</td></tr> <tr><td>1:Curve</td><td>0</td><td>0</td><td>0</td><td>0</td><td>1:Curve</td></tr> </table> <p>2) S-pattern %</p> <table border="1"> <tr><td>100</td><td>100</td><td>100</td><td>100</td><td>1-100(%)</td></tr> </table> <p>3) Sudden stop</p> <table border="1"> <tr><td>1</td><td>0</td><td>0</td><td>0</td><td>0:Normal</td></tr> </table> <p>4) decel. time</p> <table border="1"> <tr><td>2</td><td>0</td><td>0</td><td>0</td><td>1:Sudden stop</td></tr> </table> <p>5) Sudden stop deceleration time</p> <table border="1"> <tr><th>Axis1</th><th>Axis2</th><th>Axis3</th><th>Axis4</th></tr> <tr><td>1000</td><td>1000</td><td>1000</td><td>1000</td></tr> </table> <p>Setting range 1 to 8388608 (ms)</p> <p>6) Position complete signal output time</p> <table border="1"> <tr><th>Axis1</th><th>Axis2</th><th>Axis3</th><th>Axis4</th></tr> <tr><td>300</td><td>300</td><td>300</td><td>300</td></tr> </table> <p>Setting range 0 to 85535 (ms)</p> <p>7) External command function selection</p> <table border="1"> <tr><th>Axis1</th><th>Axis2</th><th>Axis3</th><th>Axis4</th></tr> <tr><td>0</td><td>0</td><td>0</td><td>0</td></tr> </table> <p>Setting range 0:External positioning start 1:External speed change request 2:Speed-position, position-speed switching request 3:Skip request</p> <p>8) Allowed circular int. error width</p> <table border="1"> <tr><th>Axis1</th><th>Axis2</th><th>Axis3</th><th>Axis4</th></tr> <tr><td>100</td><td>100</td><td>100</td><td>100</td></tr> </table> <p>Setting range 0 to 100000 (μm):*10⁻¹ (inch):*10⁻³ (degree):*10⁻³ (pulse):*1</p>	Item	Axis1	Axis2	Axis3	Axis4	Set range	0:Ramp	0	0	0	0	0:Ramp	1:Curve	0	0	0	0	1:Curve	100	100	100	100	1-100(%)	1	0	0	0	0:Normal	2	0	0	0	1:Sudden stop	Axis1	Axis2	Axis3	Axis4	1000	1000	1000	1000	Axis1	Axis2	Axis3	Axis4	300	300	300	300	Axis1	Axis2	Axis3	Axis4	0	0	0	0	Axis1	Axis2	Axis3	Axis4	100	100	100	100	1)	52, 202, 352, 502	0034, 00CA, 0160, 01F6
	Item	Axis1	Axis2	Axis3	Axis4	Set range																																																														
	0:Ramp	0	0	0	0	0:Ramp																																																														
	1:Curve	0	0	0	0	1:Curve																																																														
	100	100	100	100	1-100(%)																																																															
	1	0	0	0	0:Normal																																																															
	2	0	0	0	1:Sudden stop																																																															
	Axis1	Axis2	Axis3	Axis4																																																																
	1000	1000	1000	1000																																																																
	Axis1	Axis2	Axis3	Axis4																																																																
	300	300	300	300																																																																
	Axis1	Axis2	Axis3	Axis4																																																																
	0	0	0	0																																																																
	Axis1	Axis2	Axis3	Axis4																																																																
	100	100	100	100																																																																
	2)	53, 203, 353, 503	0035, 00CB, 0161, 01F7																																																																	
	3)	56, 206, 356, 506	0038, 00CE, 0164, 01FA																																																																	
	4)	57, 207, 357, 507	0039, 00CF, 0165, 01FB																																																																	
	5)	58, 208, 358, 508	003A, 00D0, 0166, 01FC																																																																	
	6)	54, 204, 354, 504	0036, 00CC, 0162, 01F8																																																																	
	7)	59, 209, 359, 509	003B, 00D1, 0167, 01FD																																																																	
	8)	60 to 61	003C to 003D																																																																	
		210 to 211	00D2 to 00D3																																																																	
		360 to 361	0168 to 0169																																																																	
		510 to 511	01FE to 01FF																																																																	
	9)	62, 212, 362, 512	003E, 00D4, 016A, 0200																																																																	

Screen example		No.	Buffer memory address	
			DEC	HEX
		1)	79, 229, 379, 529	004F, 00E5, 017B, 0211
		2)	82, 232, 382, 532	0052, 00E8, 017E, 0214
		3)	83, 233, 383, 533	0053, 00E9, 017F, 0215
		4)	86, 236, 386, 536	0056, 00EC, 0182, 0218
		5)	80 to 81 230 to 231 380 to 381	0050 to 0051 00E6 to 00E7 017C to 017D
		6)	530 to 531 84 to 85 234 to 235 384 to 385	0212 to 0213 0054 to 0055 00EA to 00EB 0180 to 0181
		7)	534 to 535	0216 to 0217
		8)	87, 237, 387, 537	0057, 00ED, 0183, 0219
		9)	88, 238, 388, 538	0058, 00EE, 0184, 021A
		1)	89, 239, 389, 539	0059, 00EF, 0185, 021B
		1)	70, 220, 370, 520	0046, 00DC, 0172, 0208
		2)	71, 221, 371, 521	0047, 00DD, 0173, 0209
		3)	78, 228, 378, 528	004E, 00E4, 017A, 0210
		4)	72 to 73 222 to 223 372 to 373	0048 to 0049 00DE to 00DF 0174 to 0175
		5)	522 to 523 74 to 75 224 to 225 374 to 375	020A to 020B 004A to 004B 00E0 to 00E1 0176 to 0177
		6)	524 to 525 76 to 77 226 to 227 376 to 377	020C to 020D 004C to 004D 00E2 to 00E3 0178 to 0179
		5)	526 to 527	020E to 020F

- 1 OVERVIEW
- 2 SYSTEM MONITOR
- 3 LADDER MONITOR FUNCTION
- 4 MELSEC-A LIST EDITOR
- 5 MELSEC-FX LIST EDITOR
- 6 INTELLIGENT MODULE MONITOR
- 7 NETWORK MONITOR
- 8 Q MOTION MONITOR

Screen example		No.	Buffer memory address	
			DEC	HEX
		1)	816, 916, 1016, 1116	0330, 0394, 03F8, 045C
		2)	817, 917, 1017, 1117	0331, 0395, 03F9, 045D
-		-	-	-
		1)	818 to 819	0332 to 0333
		918 to 919	0396 to 0397	
		1018 to 1019	03FA to 03FB	
		1118 to 1119	045E to 045F	
		2)	802 to 803	0322 to 0323
		902 to 903	0386 to 0387	
		1002 to 1003	03EA to 03EB	
1102 to 1103	044E to 044F			
3)	820 to 821	0334 to 0335		
920 to 921	0398 to 0399			
1020 to 1021	03FC to 03FD			
1120 to 1121	0460 to 0461			
4)	810 to 811	032A to 032B		
910 to 911	038E to 038F			
1010 to 1011	03F2 to 03F3			
1110 to 1111	0456 to 0457			
5)	812 to 813	032C to 032D		
912 to 913	0390 to 0391			
1012 to 1013	03F4 to 03F5			
1112 to 1113	0458 to 0459			
6)	830, 930, 1030, 1130	033E, 03A2, 0406, 046A		
7)	831, 931, 1031, 1131	033F, 03A3, 0407, 046B		

Screen example		No.	Buffer memory address	
			DEC	HEX
		1)	827, 927, 1027, 1127	033B, 039F, 0403, 0467
		2)	828, 928, 1028, 1128	033C, 03A0, 0404, 0468
		3)	829, 929, 1029, 1129	033D, 03A1, 0405, 0469
		4)	834, 934, 1034, 1134	0342, 03A6, 040A, 046E
		5)	835, 935, 1035, 1135	0343, 03A7, 040B, 046F
		6)	836, 936, 1036, 1136	0344, 03A8, 040C, 0470
		7)	837, 937, 1037, 1137	0345, 03A9, 040D, 0471
		8)	832, 932, 1032, 1132	0340, 03A4, 0408, 046C
		9)	833, 933, 1033, 1133	0341, 03A5, 0409, 046D
		-	-	-
		1)	824 to 825 924 to 925 1024 to 1025 1124 to 1125	0338 to 0339 039C to 039D 0400 to 0401 0464 to 0465
		2)	826, 926, 1026, 1126	033A, 039E, 0402, 0466
		3)	816, 916, 1016, 1116	0330, 0394, 03F8, 045C
		4)		
		5)		
		6)		
		7)		
		-	-	-
		1)	814 to 815 914 to 915 1014 to 1015 1114 to 1115	032E to 032F 0392 to 0393 03F6 to 03F7 045A to 045B
		2)	1526 to 1527 1626 to 1627 1726 to 1727 1826 to 1827	05F6 to 05F7 065A to 065B 06BE to 06BF 0722 to 0723
		3)	817, 917, 1017, 1117	0331, 0395, 03F9, 045D
		4)	817, 917, 1017, 1117	0331, 0395, 03F9, 045D
		5)	1528, 1628, 1728, 1828	05F8, 065C, 06C0, 0724
		-	-	-

- 1 OVERVIEW
- 2 SYSTEM MONITOR
- 3 LADDER MONITOR FUNCTION
- 4 MELSEC-A LIST EDITOR
- 5 MELSEC-FX LIST EDITOR
- 6 INTELLIGENT MODULE MONITOR
- 7 NETWORK MONITOR
- 8 Q MOTION MONITOR

Screen example		No.	Buffer memory address	
			DEC	HEX
<p>LD75P/LD75D Position-speed control</p> <p>SET/RESET Data Chg. MONIT MENU END</p> <p>PSSC speed change register</p> <p>Axis1 0 Axis2 0 Axis3 0 Axis4 0</p> <p>1) Setting range 0 to 2000000000 (mm/min):*10⁻³ (inch/min):*10⁻³ (degree/min):*10⁻³ 0 to 40000000 (pulse/sec):*1</p> <p>Item Ax.1 Ax.2 Ax.3 Ax.4</p> <p>2) Position-speed switching latch <input type="checkbox"/> <input type="checkbox"/> <input type="checkbox"/> <input type="checkbox"/></p> <p>3) In speed control <input type="checkbox"/> <input type="checkbox"/> <input type="checkbox"/> <input type="checkbox"/></p> <p>4) Position-speed switching enable 0:Disable 1:Enable</p>	1)	1530 to 1531	05FA to 05FB	
		1630 to 1631	065E to 065F	
		1730 to 1731	06C2 to 06C3	
		1830 to 1831	0726 to 0727	
<p>LD75P/LD75D Axis control data-1</p> <p>SET/RESET Data Chg. MONIT MENU END</p> <p>New current value</p> <p>Axis1 0 Axis2 0 Axis3 0 Axis4 0</p> <p>1) Setting range -2147493648 to 2147493647 (um):*10⁻¹ (inch):*10⁻³ (pulse):*1 0 to 35999999 (degree):*10⁻³</p> <p>Item Ax.1 Ax.2 Ax.3 Ax.4 Set value</p> <p>Torg.boost 100 100 100 100 1 to 300(%) 3)</p> <p>Step mode 0 0 0 0 0:Dec.unit 1:data No. 4)</p> <p>Step valid flag 0 0 0 0 0:Invalid 1:Valid 5)</p> <p>Step start information 0 0 0 0 0:Completed 1:Continue 2:Restart 6)</p> <p>New speed value</p> <p>Axis1 0 Axis2 0 Axis3 0 Axis4 0</p> <p>2) Setting range 0 to 2000000000 (mm/min):*10⁻³ (inch/min):*10⁻³ (degree/min):*10⁻³ 0 to 40000000 (pulse/sec):*1</p> <p>Item Ax.1 Ax.2 Ax.3 Ax.4 Set value</p> <p>Skip command 0 0 0 0 0:Completed 1:Skip 7)</p> <p>Use ext. command 0 0 0 0 0:Invalid 1:Valid 8)</p>	2)	1506 to 1507	05E2 to 05E3	
		1606 to 1607	0646 to 0647	
		1706 to 1707	06AA to 06AB	
		1806 to 1807	070E to 070F	
<p>LD75P/LD75D Axis control data-1</p> <p>SET/RESET Data Chg. MONIT MENU END</p> <p>New current value</p> <p>Axis1 0 Axis2 0 Axis3 0 Axis4 0</p> <p>1) Setting range -2147493648 to 2147493647 (um):*10⁻¹ (inch):*10⁻³ (pulse):*1 0 to 35999999 (degree):*10⁻³</p> <p>Item Ax.1 Ax.2 Ax.3 Ax.4 Set value</p> <p>Torg.boost 100 100 100 100 1 to 300(%) 3)</p> <p>Step mode 0 0 0 0 0:Dec.unit 1:data No. 4)</p> <p>Step valid flag 0 0 0 0 0:Invalid 1:Valid 5)</p> <p>Step start information 0 0 0 0 0:Completed 1:Continue 2:Restart 6)</p> <p>New speed value</p> <p>Axis1 0 Axis2 0 Axis3 0 Axis4 0</p> <p>2) Setting range 0 to 2000000000 (mm/min):*10⁻³ (inch/min):*10⁻³ (degree/min):*10⁻³ 0 to 40000000 (pulse/sec):*1</p> <p>Item Ax.1 Ax.2 Ax.3 Ax.4 Set value</p> <p>Skip command 0 0 0 0 0:Completed 1:Skip 7)</p> <p>Use ext. command 0 0 0 0 0:Invalid 1:Valid 8)</p>	1)	1514 to 1515	05EA to 05EB	
		1614 to 1615	064E to 064F	
		1714 to 1715	06B2 to 06B3	
		1814 to 1815	0716 to 0717	
		1513, 1613, 1713, 1813	05E9, 064D, 06B1, 0715	
		1544, 1644, 1744, 1844	0608, 066C, 06D0, 0734	
		1545, 1645, 1745, 1845	0609, 066D, 06D1, 0735	
		1546, 1646, 1746, 1846	060A, 066E, 06D2, 0736	
1547, 1647, 1747, 1847	060B, 066F, 06D3, 0737			
1505, 1605, 1705, 1805	05E1, 0645, 06A9, 070D			

Screen example										No.	Buffer memory address																																																																																																
											DEC	HEX																																																																																															
<div style="display: flex; justify-content: space-between;"> <div style="width: 45%;"> <p>LD75P/LD75D Axis control data-2</p> <table border="1"> <thead> <tr> <th>Item</th> <th>Axis1</th> <th>Axis2</th> <th>Axis3</th> <th>Axis4</th> </tr> </thead> <tbody> <tr> <td>Start</td> <td>0</td> <td>0</td> <td>0</td> <td>0</td> </tr> <tr> <td>Starting point No.</td> <td colspan="4">1~600, 7000~7004, 9001~9004</td> </tr> <tr> <td>Starting point No.</td> <td>0</td> <td>0</td> <td>0</td> <td>0</td> </tr> <tr> <td>Axis error reset</td> <td>0</td> <td>0</td> <td>0</td> <td>0</td> </tr> <tr> <td>Restart command</td> <td colspan="4">0:Completed 1:Request</td> </tr> <tr> <th>Item</th> <th>Axis1</th> <th>Axis2</th> <th>Axis3</th> <th>Axis4</th> </tr> <tr> <td>M code OFF request</td> <td colspan="4">0:Completed 1:Request</td> </tr> <tr> <td>A/D time chg. in SPD chg./ON/OFF</td> <td colspan="4">0:Disable 1:Enable</td> </tr> <tr> <td>Speed change request</td> <td colspan="4">0:Completed 1:Request</td> </tr> </tbody> </table> </div> <div style="width: 45%;"> <p>SET/RESET Data Chg. MONIT MENU END</p> <table border="1"> <thead> <tr> <th>Item</th> <th>Axis1</th> <th>Axis2</th> <th>Axis3</th> <th>Axis4</th> </tr> </thead> <tbody> <tr> <td>New acc. time</td> <td colspan="4">0 to 888808(msec)</td> </tr> <tr> <td>New dec. time</td> <td colspan="4">0 to 888808(msec)</td> </tr> <tr> <td>IRQ in locus OP</td> <td colspan="4">0:Completed 1:Request</td> </tr> <tr> <td>OPR req. flag OFF</td> <td colspan="4">0:Completed 1:Request</td> </tr> <tr> <th>Item</th> <th>Axis1</th> <th>Axis2</th> <th>Axis3</th> <th>Axis4</th> </tr> <tr> <td>MPG I/P mag.</td> <td>1</td> <td>1</td> <td>1</td> <td>1</td> </tr> <tr> <td>MPG enable</td> <td colspan="4">1 to 1000</td> </tr> <tr> <td>New Torq. value</td> <td colspan="4">0:Do not / 1 to limit:Do</td> </tr> </tbody> </table> </div> </div>										Item	Axis1	Axis2	Axis3	Axis4	Start	0	0	0	0	Starting point No.	1~600, 7000~7004, 9001~9004				Starting point No.	0	0	0	0	Axis error reset	0	0	0	0	Restart command	0:Completed 1:Request				Item	Axis1	Axis2	Axis3	Axis4	M code OFF request	0:Completed 1:Request				A/D time chg. in SPD chg./ON/OFF	0:Disable 1:Enable				Speed change request	0:Completed 1:Request				Item	Axis1	Axis2	Axis3	Axis4	New acc. time	0 to 888808(msec)				New dec. time	0 to 888808(msec)				IRQ in locus OP	0:Completed 1:Request				OPR req. flag OFF	0:Completed 1:Request				Item	Axis1	Axis2	Axis3	Axis4	MPG I/P mag.	1	1	1	1	MPG enable	1 to 1000				New Torq. value	0:Do not / 1 to limit:Do				1)	1500, 1600, 1700, 1800	05DC, 0640, 06A4, 0708
Item	Axis1	Axis2	Axis3	Axis4																																																																																																							
Start	0	0	0	0																																																																																																							
Starting point No.	1~600, 7000~7004, 9001~9004																																																																																																										
Starting point No.	0	0	0	0																																																																																																							
Axis error reset	0	0	0	0																																																																																																							
Restart command	0:Completed 1:Request																																																																																																										
Item	Axis1	Axis2	Axis3	Axis4																																																																																																							
M code OFF request	0:Completed 1:Request																																																																																																										
A/D time chg. in SPD chg./ON/OFF	0:Disable 1:Enable																																																																																																										
Speed change request	0:Completed 1:Request																																																																																																										
Item	Axis1	Axis2	Axis3	Axis4																																																																																																							
New acc. time	0 to 888808(msec)																																																																																																										
New dec. time	0 to 888808(msec)																																																																																																										
IRQ in locus OP	0:Completed 1:Request																																																																																																										
OPR req. flag OFF	0:Completed 1:Request																																																																																																										
Item	Axis1	Axis2	Axis3	Axis4																																																																																																							
MPG I/P mag.	1	1	1	1																																																																																																							
MPG enable	1 to 1000																																																																																																										
New Torq. value	0:Do not / 1 to limit:Do																																																																																																										
										2)	1501, 1601, 1701, 1801	05DD, 0641, 06A5, 0709																																																																																															
										3)	1502, 1602, 1702, 1802	05DE, 0642, 06A6, 070A																																																																																															
										4)	1503, 1603, 1703, 1803	05DF, 0643, 06A7, 070B																																																																																															
										5)	1504, 1604, 1704, 1804	05E0, 0644, 06A8, 070C																																																																																															
										6)	1512, 1612, 1712, 1812	05E8, 064C, 06B0, 0714																																																																																															
										7)	1516, 1616, 1716, 1816	05EC, 0650, 06B4, 0718																																																																																															
										8)	1508 to 1509	05E4 to 05E5																																																																																															
											1608 to 1609	0648 to 0649																																																																																															
											1708 to 1709	06AC to 06AD																																																																																															
										9)	1808 to 1809	0710 to 0711																																																																																															
											1510 to 1511	05E6 to 05E7																																																																																															
											1610 to 1611	064A to 064B																																																																																															
											1710 to 1711	06AE to 06AF																																																																																															
										10)	1810 to 1811	0712 to 0713																																																																																															
											1520, 1620, 1720, 1820	05F0, 0654, 06B8, 071C																																																																																															
											1521, 1621, 1721, 1821	05F1, 0655, 06B9, 071D																																																																																															
										12)	1522 to 1523	05F2 to 05F3																																																																																															
											1622 to 1623	0656 to 0657																																																																																															
											1722 to 1723	06BA to 06BB																																																																																															
											1822 to 1823	071E to 071F																																																																																															
										13)	1524, 1624, 1724, 1824	05F4, 0658, 06BC, 0720																																																																																															
										14)	1525, 1625, 1725, 1825	05F5, 0659, 06BD, 0721																																																																																															
<div style="display: flex; justify-content: space-between;"> <div style="width: 45%;"> <p>LD75P/LD75D Axis control data-3</p> <table border="1"> <thead> <tr> <th>Item</th> <th>Axis1</th> <th>Axis2</th> <th>Axis3</th> <th>Axis4</th> </tr> </thead> <tbody> <tr> <td>Pos. change</td> <td colspan="4">0:Completed 1:Request</td> </tr> <tr> <td>Teaching data selection</td> <td colspan="4">0:Address 1:Arc data</td> </tr> <tr> <td>Teaching positioning data No.</td> <td colspan="4">1 to 600</td> </tr> <tr> <th>Item</th> <th>Axis1</th> <th>Axis2</th> <th>Axis3</th> <th>Axis4</th> </tr> <tr> <td>ABS direction in degrees</td> <td colspan="4">0:Shortcut 1:Right 2:Left</td> </tr> </tbody> </table> </div> <div style="width: 45%;"> <p>SET/RESET Data Chg. MONIT MENU END</p> <table border="1"> <thead> <tr> <th>Item</th> <th>Axis1</th> <th>Axis2</th> <th>Axis3</th> <th>Axis4</th> </tr> </thead> <tbody> <tr> <td>Simultaneous starting axis start data</td> <td colspan="4">Data No. Axis1 Axis2 Axis3 Axis4</td> </tr> <tr> <td></td> <td>Axis1</td> <td>Axis2</td> <td>Axis3</td> <td>Axis4</td> </tr> <tr> <td></td> <td>Axis2</td> <td>Axis3</td> <td>Axis4</td> <td></td> </tr> <tr> <td></td> <td>Axis3</td> <td>Axis4</td> <td></td> <td></td> </tr> <tr> <td></td> <td>Axis4</td> <td></td> <td></td> <td></td> </tr> <tr> <td></td> <td colspan="4">0:Nontarget / 1 to 600:Start data No.</td> </tr> </tbody> </table> </div> </div>										Item	Axis1	Axis2	Axis3	Axis4	Pos. change	0:Completed 1:Request				Teaching data selection	0:Address 1:Arc data				Teaching positioning data No.	1 to 600				Item	Axis1	Axis2	Axis3	Axis4	ABS direction in degrees	0:Shortcut 1:Right 2:Left				Item	Axis1	Axis2	Axis3	Axis4	Simultaneous starting axis start data	Data No. Axis1 Axis2 Axis3 Axis4					Axis1	Axis2	Axis3	Axis4		Axis2	Axis3	Axis4			Axis3	Axis4				Axis4					0:Nontarget / 1 to 600:Start data No.				1)	1538, 1638, 1738, 1838	0602, 0666, 06CA, 072E																														
Item	Axis1	Axis2	Axis3	Axis4																																																																																																							
Pos. change	0:Completed 1:Request																																																																																																										
Teaching data selection	0:Address 1:Arc data																																																																																																										
Teaching positioning data No.	1 to 600																																																																																																										
Item	Axis1	Axis2	Axis3	Axis4																																																																																																							
ABS direction in degrees	0:Shortcut 1:Right 2:Left																																																																																																										
Item	Axis1	Axis2	Axis3	Axis4																																																																																																							
Simultaneous starting axis start data	Data No. Axis1 Axis2 Axis3 Axis4																																																																																																										
	Axis1	Axis2	Axis3	Axis4																																																																																																							
	Axis2	Axis3	Axis4																																																																																																								
	Axis3	Axis4																																																																																																									
	Axis4																																																																																																										
	0:Nontarget / 1 to 600:Start data No.																																																																																																										
										2)	1548, 1648, 1748, 1848	060C, 0670, 06D4, 0738																																																																																															
										3)	1549, 1649, 1749, 1849	060D, 0671, 06D5, 0739																																																																																															
										4)	1550, 1650, 1750, 1850	060E, 0672, 06D6, 073A																																																																																															
										5)	1540, 1640, 1740, 1840, 1541, 1641, 1741, 1841, 1542, 1642, 1742, 1842, 1543, 1643, 1743, 1843	0604, 0668, 06CC, 0730, 0605, 0669, 06CD, 0731, 0606, 066A, 06CE, 0732, 0607, 066B, 06CF, 0733																																																																																															
										-	-	-																																																																																															

- 1 OVERVIEW
- 2 SYSTEM MONITOR
- 3 LADDER MONITOR FUNCTION
- 4 MELSEC-A LIST EDITOR
- 5 MELSEC-FX LIST EDITOR
- 6 INTELLIGENT MODULE MONITOR
- 7 NETWORK MONITOR
- 8 Q MOTION MONITOR

Screen example		No.	Buffer memory address	
			DEC	HEX
	1)	1517, 1617, 1717, 1817	05ED, 0651, 06B5, 0719	
	2)	1518 to 1519	05EE to 05EF	
		1618 to 1619	0652 to 0653	
		1718 to 1719	06B6 to 06B7	
	3)	1818 to 1819	071A to 071B	
		1534 to 1535	05FE to 05FF	
		1634 to 1635	0662 to 0663	
	4)	1734 to 1735	06C6 to 06C7	
		1834 to 1835	072A to 072B	
		1536 to 1537	0600 to 0601	
1636 to 1637		0664 to 0665		
-	1736 to 1737	06C8 to 06C9		
	1836 to 1837	072C to 072D		
-	-	-		
	1)	1212 to 1291	04BC to 050B	
-	-	-		
	1)	1293 to 1356	050D to 054C	
-	2)	1358 to 1421	054E to 058D	
	1)	-	-	
-	-	-		
	2)	-	-	

Screen example		No.	Buffer memory address	
			DEC	HEX
		1)	2000 to 2002, 2004 to 2012, 2014 to 2022, 2024 to 2029	07D0 to 07D2, 07D4 to 07DC, 07DE to 07E6, 07E8 to 07ED,
		2)	8000 to 8002, 8004 to 8012, 8014 to 8022, 8024 to 8029	1F40 to 1F42, 1F44 to 1F4C, 1F4E to 1F56, 1F58 to 1F5D
		3)	14000 to 14002, 14004 to 14012, 14014 to 14022, 14024 to 14029	36B0 to 36B2, 36B4 to 36BC, 36BE to 36C6, 36C8 to 36CD
		4)	20000 to 20002, 20004 to 20012, 20014 to 20022, 20024 to 20029	4E20 to 4E22, 4E24 to 4E2C, 4E2E to 4E36, 4E38 to 4E3D
		-	-	-

1

OVERVIEW

2

SYSTEM MONITOR

3

LADDER MONITOR
FUNCTION

4

MELSEC-A LIST
EDITOR

5

MELSEC-FX LIST
EDITOR

6

INTELLIGENT
MODULE MONITOR

7

NETWORK
MONITOR

8

Q MOTION
MONITOR

6.5.42 LD77MH4 module monitoring

Screen example		No.	Buffer memory address	
			DEC	HEX
<p>LD77MH4 Operation Monitor</p> <p>1) Axis Current feed val. Axis feedrate</p> <p>2) 123456 123456</p> <p>3) 123456 123456</p> <p>4) 123456 123456</p> <p>5) Axis Status: Inconnection/Amp. power OFF</p> <p>6) Axis Status: speed cont. in speed-pos</p> <p>7) Axis Status: Absolute position restore</p> <p>8) Axis Status: speed cont. in speed-pos</p> <p>9) Emergency stop input</p> <p>10) Positioning comp.</p> <p>11) Positioning comp.</p> <p>12) Positioning comp.</p> <p>13) Positioning comp.</p> <p>14) ABS2</p> <p>15) FEED4</p> <p>16) L00P</p> <p>17) LEND</p>		1)	800, 812	320, 32C
		2)	900, 912	384, 390
		3)	1000, 1012	3E8, 3F4
		4)	1100, 1112	44C, 458
		5)	806 to 809	326 to 329
		6)	906 to 909	38A to 38D
		7)	1006 to 1009	3EE to 3F1
		8)	1106 to 1109	452 to 455
		9)	1431	597
		10)	829, 838	33D, 346
		11)	929, 938	3A1, 3AA
		12)	1029, 1038	405, 40E
		13)	1129, 1138	469, 472
		14)	838	346
		15)	938	3AA
		16)	1038	40E
		17)	1138	472
<p>LD77MH4 Input/Output Monitor</p> <p>1) LD77 READY</p> <p>Synchronization</p> <p>Axis1 Error</p> <p>Axis2 Error</p> <p>Axis3 Error</p> <p>Axis4 Error</p> <p>Axis1 M code ON</p> <p>Axis2 M code ON</p> <p>Axis3 M code ON</p> <p>Axis4 M code ON</p> <p>Axis1 BUSY</p> <p>Axis2 BUSY</p> <p>Axis3 BUSY</p> <p>Axis4 BUSY</p> <p>Axis1 stop</p> <p>Axis2 stop</p> <p>Axis3 stop</p> <p>Axis4 stop</p> <p>Axis1 Pos. start</p> <p>Axis2 Pos. start</p> <p>Axis3 Pos. start</p> <p>Axis4 Pos. start</p> <p>Axis1 Exe prohibit</p> <p>Axis2 Exe prohibit</p> <p>Axis3 Exe prohibit</p> <p>Axis4 Exe prohibit</p>		-	-	-
<p>LD77MH4 Basic parameters 1</p> <p>1) Unit setting</p> <p>2) Movement amount per pulse</p> <p>3) Unit magnification (Am)</p>		1)	0, 150, 300, 450	0, 96, 12C, 1C2
		2)	2 to 3, 152 to 153, 302 to 303, 452 to 453	2 to 3, 98 to 99, 12E to 12F, 1C4 to 1C5
		3)	1, 151, 301, 451	1, 97, 12D, 1C3
		4)	4 to 5, 154 to 155, 304 to 305, 454 to 455	4 to 5, 9A to 9B, 130 to 131, 1C6 to 1C7
		-	-	-

Screen example		No.	Buffer memory address	
			DEC	HEX
	1) } 2) } 3) }	1)	10 to 11, 160 to 161, 310 to 311, 460 to 461	A to B, A0 to A1, 136 to 137, 1CC to 1CD
		2)	12 to 13, 162 to 163, 312 to 313, 462 to 463	C to D, A2 to A3, 138 to 139, 1CE to 1CF
		3)	14 to 15, 164 to 165, 314 to 315, 464 to 465	E to F, A4 to A5, 13A to 13B, 1D0 to 1D1
	1) } 2) } 3) } 4) } 5) } 6) } 7) }	1)	17, 167, 317, 467	11, A7, 13D, 1D3
		2)	18 to 19, 168 to 169, 318 to 319, 468 to 469	12 to 13, A8 to A9, 13E to 13F, 1D4 to 1D5
		3)	20 to 21, 170 to 171, 320 to 321, 470 to 471	14 to 15, AA to AB, 140 to 141, 1D6 to 1D7
		4)	33	21
		5)	22, 172, 322, 472	16, AC, 142, 1D8
		6)	23, 173, 323, 473	17, AD, 143, 1D9
		7)	26, 176, 326, 476	1A, B0, 146, 1DC
	1) } 2) } 3) } 4) } 5) } 6) } 7) } 8) } 9) }	1)	27, 177, 327, 477	1B, B1, 147, 1DD
		2)	28, 178, 328, 478	1C, B2, 148, 1DE
		3)	29, 179, 329, 479	1D, B3, 149, 1DF
		4)	24 to 25, 174 to 175, 324 to 325, 474 to 475	18 to 19, AE to AF, 144 to 145, 1DA to 1DB
		5)	30, 180, 330, 480	1F, B4, 14A, 1E0
		6)	31, 181, 331, 481	20, B5, 14B, 1E1
		7)	34, 184, 334, 484	22, B8, 14E, 1E4
		8)	32, 182, 332, 482	21, B6, 14C, 1E2
		9)	35	23

- 1 OVERVIEW
- 2 SYSTEM MONITOR
- 3 LADDER MONITOR FUNCTION
- 4 MELSEC-A LIST EDITOR
- 5 MELSEC-FX LIST EDITOR
- 6 INTELLIGENT MODULE MONITOR
- 7 NETWORK MONITOR
- 8 Q MOTION MONITOR

Screen example		No.	Buffer memory address	
			DEC	HEX
		1)	36 to 37, 186 to 187, 336 to 337, 486 to 487	24 to 25, BA to BB, 150 to 151, 1E6 to 1E7
		2)	38 to 39, 188 to 189, 338 to 339, 488 to 489	26 to 27, BC to BD, 152 to 153, 1E8 to 1E9
		3)	40 to 41, 190 to 191, 340 to 341, 490 to 491	28 to 29, BE to BF, 154 to 155, 1EA to 1EB
		4)	42 to 43, 192 to 193, 342 to 343, 492 to 493	2A to 2B, C0 to C1, 156 to 157, 1EC to 1ED
		5)	44 to 45, 194 to 195, 344 to 345, 494 to 495	2C to 2D, C2 to C3, 158 to 159, 1EE to 1EF
		6)	46 to 47, 196 to 197, 346 to 347, 496 to 497	2E to 2F, C4 to C5, 15A to 15B, 1F0 to 1F1
		7)	48 to 49, 198 to 199, 348 to 349, 498 to 499	30 to 31, C6 to C7, 15C to 15D, 1F2 to 1F3
		8)	50, 200, 350, 500	32, C8, 15E, 1F4
		9)	51, 201, 351, 501	33, C9, 15F, 1F5
		-	-	-
		1)	52, 202, 352, 502	34, CA, 160, 1F6
		2)	53, 203, 353, 503	35, CB, 161, 1F7
		3)	56, 206, 356, 506	38, CE, 164, 1FA
		4)	57, 207, 357, 507	39, CF, 165, 1FB
		5)	58, 208, 358, 508	3A, D0, 166, 1FC
		6)	54, 204, 354, 504	36, CC, 162, 1F8
		7)	59, 209, 359, 509	3B, D1, 167, 1FD
		8)	67, 217, 367, 517	43, D9, 16F, 205
		9)	60 to 61, 210 to 211, 360 to 361, 510 to 511	3C to 3D, D2 to D3, 168 to 169, 1FE to 1FF
		10)	62, 212, 362, 512	3E, D4, 16A, 200
		11)	63, 213, 363, 513	3F, D5, 16B, 201
		12)	64 to 65, 214 to 215, 364 to 365, 514 to 515	40 to 41, D6 to D7, 16C to 16D, 202 to 203
		-	-	-
		1)	82, 232, 382, 532	52, E8, 17E, 214
		2)	83, 233, 383, 533	53, E9, 17F, 215
		3)	86, 236, 386, 536	56, EC, 182, 218
		4)	87, 237, 387, 537	57, ED, 183, 219
		5)	80 to 81, 230 to 231, 380 to 381, 530 to 531	50 to 51, E6 to E7, 17C to 17D, 212 to 213
		6)	84 to 85, 234 to 235, 384 to 385, 534 to 535	54 to 55, EA to EB, 180 to 181, 216 to 217
		7)	88, 238, 388, 538	58, EE, 184, 21A
		8)	89, 239, 389, 539	59, EF, 185, 21B
		-	-	-

Screen example		No.	Buffer memory address	
			DEC	HEX
		1)	70, 220, 370, 520	46, DC, 172, 208
		2)	71, 221, 371, 521	47, DD, 173, 209
		3)	78, 228, 378, 528	4E, E4, 17A, 210
		4)	72 to 73, 222 to 223, 372 to 373, 522 to 523	48 to 49, DE to DF, 174 to 175, 20A to 20B
		5)	74 to 75, 224 to 225, 374 to 375, 524 to 525	4A to 4B, E0 to E1, 176 to 177, 20C to 20D
		6)	76 to 77, 226 to 227, 376 to 377, 526 to 527	4C to 4D, E2 to E3, 178 to 179, 20E to 20F
		1)	816	330
		2)	916	394
		3)	1016	3F8
		4)	1116	45C
		5)	817	331
		6)	917	395
		7)	1017	3F9
		8)	1117	45D
		1)	818 to 819, 802 to 803	332 to 333, 322 to 323
		2)	918 to 919, 902 to 903	396 to 397, 386 to 387
		3)	1018 to 1019, 1002 to 1003	3FA to 3FB, 3EA to 3EB
		4)	1118 to 1119, 1102 to 1103	45E to 45F, 44E to 44F
		5)	820 to 821, 810 to 811, 812 to 813	334 to 335, 32A to 32B, 32C to 32D
		6)	920 to 921, 910 to 911, 912 to 913	398 to 399, 38E to 38F, 390 to 391
		7)	1020 to 1021, 1010 to 1011, 1012 to 1013	3FC to 3FD, 3F2 to 3F3, 3F4 to 3F5
		8)	1120 to 1121, 1110 to 1111, 1112 to 1113	460 to 461, 456 to 457, 458 to 459
		9)	830, 930, 1030, 1130	33E, 3A2, 406, 46A
		10)	831, 931, 1031, 1131	33F, 3A3, 407, 46B

- 1 OVERVIEW
- 2 SYSTEM MONITOR
- 3 LADDER MONITOR FUNCTION
- 4 MELSEC-A LIST EDITOR
- 5 MELSEC-FX LIST EDITOR
- 6 INTELLIGENT MODULE MONITOR
- 7 NETWORK MONITOR
- 8 Q MOTION MONITOR

Screen example		No.	Buffer memory address																																																																																									
			DEC	HEX																																																																																								
<p>LD77MH4 Axis monitor data-2</p> <p>Special start data</p> <table border="1"> <thead> <tr> <th>Axis</th> <th>Instr. code</th> <th>Instr. para</th> <th>Data No.</th> </tr> </thead> <tbody> <tr><td>1</td><td>56</td><td>456</td><td>456</td></tr> <tr><td>2</td><td>56</td><td>456</td><td>456</td></tr> <tr><td>3</td><td>56</td><td>456</td><td>456</td></tr> <tr><td>4</td><td>56</td><td>456</td><td>456</td></tr> </tbody> </table> <p>Special start repetition counter</p> <table border="1"> <thead> <tr> <th>Axis1</th> <th>Axis2</th> <th>Axis3</th> <th>Axis4</th> </tr> </thead> <tbody> <tr> <td>456</td> <td>456</td> <td>456</td> <td>456</td> </tr> </tbody> </table> <p>Control system repetition counter</p> <table border="1"> <thead> <tr> <th>Axis1</th> <th>Axis2</th> <th>Axis3</th> <th>Axis4</th> </tr> </thead> <tbody> <tr> <td>3456</td> <td>3456</td> <td>3456</td> <td>3456</td> </tr> </tbody> </table> <p>Data being executed</p> <table border="1"> <thead> <tr> <th>Axis</th> <th>Inst. data pointer</th> <th>Pos. data number</th> <th>Block No.</th> <th>Previous position</th> </tr> </thead> <tbody> <tr><td>1</td><td>56</td><td>3456</td><td>456</td><td>3456</td></tr> <tr><td>2</td><td>56</td><td>3456</td><td>456</td><td>3456</td></tr> <tr><td>3</td><td>56</td><td>3456</td><td>456</td><td>3456</td></tr> <tr><td>4</td><td>56</td><td>3456</td><td>456</td><td>3456</td></tr> </tbody> </table> <p>[Instruction code] 00:Block start(Normal start) 01:Condition start 02:Wait start 03:Simultaneous start 04:FOR loop 05:FOR condition 06:NEXT</p>		Axis	Instr. code	Instr. para	Data No.	1	56	456	456	2	56	456	456	3	56	456	456	4	56	456	456	Axis1	Axis2	Axis3	Axis4	456	456	456	456	Axis1	Axis2	Axis3	Axis4	3456	3456	3456	3456	Axis	Inst. data pointer	Pos. data number	Block No.	Previous position	1	56	3456	456	3456	2	56	3456	456	3456	3	56	3456	456	3456	4	56	3456	456	3456	1)	827 to 829	33B to 33D																											
		Axis	Instr. code	Instr. para	Data No.																																																																																							
		1	56	456	456																																																																																							
		2	56	456	456																																																																																							
		3	56	456	456																																																																																							
		4	56	456	456																																																																																							
		Axis1	Axis2	Axis3	Axis4																																																																																							
		456	456	456	456																																																																																							
		Axis1	Axis2	Axis3	Axis4																																																																																							
		3456	3456	3456	3456																																																																																							
Axis	Inst. data pointer	Pos. data number	Block No.	Previous position																																																																																								
1	56	3456	456	3456																																																																																								
2	56	3456	456	3456																																																																																								
3	56	3456	456	3456																																																																																								
4	56	3456	456	3456																																																																																								
	2)	927 to 929	39F to 3A1																																																																																									
	3)	1027 to 1029	403 to 405																																																																																									
	4)	1127 to 1129	467 to 469																																																																																									
	5)	834 to 837	342 to 345																																																																																									
	6)	934 to 937	3A6 to 3A9																																																																																									
	7)	1034 to 1037	40A to 40D																																																																																									
	8)	1134 to 1137	46E to 471																																																																																									
	9)	832, 932, 1032, 1132	340, 3A4, 408, 46C																																																																																									
	10)	833, 933, 1033, 1133	341, 3A5, 409, 46D																																																																																									
	-	-	-																																																																																									
<p>LD77MH4 Axis monitor data-3</p> <p>Actual present value</p> <table border="1"> <thead> <tr> <th>Axis</th> <th>OPR. Increment</th> <th>Actual present val.</th> <th>Error counter val.</th> </tr> </thead> <tbody> <tr><td>1</td><td>123456</td><td>123456</td><td>123456</td></tr> <tr><td>2</td><td>123456</td><td>123456</td><td>123456</td></tr> <tr><td>3</td><td>123456</td><td>123456</td><td>123456</td></tr> <tr><td>4</td><td>123456</td><td>123456</td><td>123456</td></tr> </tbody> </table> <p>Number of rotation</p> <table border="1"> <thead> <tr> <th>Axis</th> <th>Number of rotation</th> <th>Motor current</th> </tr> </thead> <tbody> <tr><td>1</td><td>123456</td><td>23456</td></tr> <tr><td>2</td><td>123456</td><td>23456</td></tr> <tr><td>3</td><td>123456</td><td>23456</td></tr> <tr><td>4</td><td>123456</td><td>23456</td></tr> </tbody> </table> <p>Servo amplifier S/W number</p> <table border="1"> <thead> <tr> <th>Axis</th> <th>Servo amplifier S/W number</th> </tr> </thead> <tbody> <tr><td>1</td><td>56565656565656565656565656565656</td></tr> <tr><td>2</td><td>56565656565656565656565656565656</td></tr> <tr><td>3</td><td>56565656565656565656565656565656</td></tr> <tr><td>4</td><td>56565656565656565656565656565656</td></tr> </tbody> </table>		Axis	OPR. Increment	Actual present val.	Error counter val.	1	123456	123456	123456	2	123456	123456	123456	3	123456	123456	123456	4	123456	123456	123456	Axis	Number of rotation	Motor current	1	123456	23456	2	123456	23456	3	123456	23456	4	123456	23456	Axis	Servo amplifier S/W number	1	56565656565656565656565656565656	2	56565656565656565656565656565656	3	56565656565656565656565656565656	4	56565656565656565656565656565656	1)	848 to 849, 850 to 851, 852 to 853	350 to 351, 352 to 353, 354 to 355																																											
		Axis	OPR. Increment	Actual present val.	Error counter val.																																																																																							
		1	123456	123456	123456																																																																																							
		2	123456	123456	123456																																																																																							
		3	123456	123456	123456																																																																																							
		4	123456	123456	123456																																																																																							
		Axis	Number of rotation	Motor current																																																																																								
		1	123456	23456																																																																																								
		2	123456	23456																																																																																								
		3	123456	23456																																																																																								
		4	123456	23456																																																																																								
		Axis	Servo amplifier S/W number																																																																																									
1	56565656565656565656565656565656																																																																																											
2	56565656565656565656565656565656																																																																																											
3	56565656565656565656565656565656																																																																																											
4	56565656565656565656565656565656																																																																																											
	2)	948 to 949, 950 to 951, 952 to 953	3B4 to 3B5, 3B6 to 3B7, 3B8 to 3B9																																																																																									
	3)	1048 to 1049, 1050 to 1051, 1052 to 1053	418 to 419, 41A to 41B, 41C to 41D																																																																																									
	4)	1148 to 1149, 1150 to 1151, 1152 to 1153	47C to 47D, 47E to 47F, 480 to 481																																																																																									
	5)	854 to 855, 856 to 857	356 to 357, 358 to 359																																																																																									
	6)	954 to 955, 956 to 957	3BA to 3BB, 3BC to 3BD																																																																																									
	7)	1054 to 1055, 1056 to 1057	41E to 41F, 420 to 421																																																																																									
	8)	1154 to 1155, 1156 to 1157	480 to 481, 482 to 483																																																																																									
	9)	864 to 869	360 to 365																																																																																									
	10)	964 to 969	3C4 to 3C9																																																																																									
	11)	1064 to 1069	428 to 42D																																																																																									
	12)	1164 to 1169	48C to 491																																																																																									
	-	-	-																																																																																									
<p>LD77MH4 Axis monitor data-4</p> <p>Parameter error No.</p> <table border="1"> <thead> <tr> <th>Axis1</th> <th>Axis2</th> <th>Axis3</th> <th>Axis4</th> </tr> </thead> <tbody> <tr> <td>40</td> <td>456</td> <td>456</td> <td>456</td> </tr> </tbody> </table> <p>Servo status</p> <table border="1"> <thead> <tr> <th>Item</th> <th>Axis1</th> <th>Axis2</th> <th>Axis3</th> <th>Axis4</th> </tr> </thead> <tbody> <tr><td>Zero point passed</td><td>●</td><td>●</td><td>●</td><td>●</td></tr> <tr><td>Zero speed</td><td>●</td><td>●</td><td>●</td><td>●</td></tr> <tr><td>Ready ON</td><td>●</td><td>●</td><td>●</td><td>●</td></tr> <tr><td>Servo ON</td><td>●</td><td>●</td><td>●</td><td>●</td></tr> <tr><td>Servo alarm</td><td>●</td><td>●</td><td>●</td><td>●</td></tr> <tr><td>Position</td><td>●</td><td>●</td><td>●</td><td>●</td></tr> <tr><td>Force limit</td><td>●</td><td>●</td><td>●</td><td>●</td></tr> <tr><td>Abs. value cleared</td><td>●</td><td>●</td><td>●</td><td>●</td></tr> <tr><td>Warning</td><td>●</td><td>●</td><td>●</td><td>●</td></tr> </tbody> </table> <p>Regenerative load ratio</p> <table border="1"> <thead> <tr> <th>Item</th> <th>Axis1</th> <th>Axis2</th> <th>Axis3</th> <th>Axis4</th> </tr> </thead> <tbody> <tr> <td>Regenerative load ratio</td> <td>456</td> <td>456</td> <td>456</td> <td>456</td> </tr> </tbody> </table> <p>Actual load ratio</p> <table border="1"> <thead> <tr> <th>Item</th> <th>Axis1</th> <th>Axis2</th> <th>Axis3</th> <th>Axis4</th> </tr> </thead> <tbody> <tr> <td>Actual load ratio</td> <td>456</td> <td>456</td> <td>456</td> <td>456</td> </tr> </tbody> </table> <p>Peak load ratio</p> <table border="1"> <thead> <tr> <th>Item</th> <th>Axis1</th> <th>Axis2</th> <th>Axis3</th> <th>Axis4</th> </tr> </thead> <tbody> <tr> <td>Peak load ratio</td> <td>456</td> <td>456</td> <td>456</td> <td>456</td> </tr> </tbody> </table>		Axis1	Axis2	Axis3	Axis4	40	456	456	456	Item	Axis1	Axis2	Axis3	Axis4	Zero point passed	●	●	●	●	Zero speed	●	●	●	●	Ready ON	●	●	●	●	Servo ON	●	●	●	●	Servo alarm	●	●	●	●	Position	●	●	●	●	Force limit	●	●	●	●	Abs. value cleared	●	●	●	●	Warning	●	●	●	●	Item	Axis1	Axis2	Axis3	Axis4	Regenerative load ratio	456	456	456	456	Item	Axis1	Axis2	Axis3	Axis4	Actual load ratio	456	456	456	456	Item	Axis1	Axis2	Axis3	Axis4	Peak load ratio	456	456	456	456	1)	870, 970, 1070, 1170	366, 3CA, 42E, 492
		Axis1	Axis2	Axis3	Axis4																																																																																							
		40	456	456	456																																																																																							
		Item	Axis1	Axis2	Axis3	Axis4																																																																																						
		Zero point passed	●	●	●	●																																																																																						
		Zero speed	●	●	●	●																																																																																						
Ready ON	●	●	●	●																																																																																								
Servo ON	●	●	●	●																																																																																								
Servo alarm	●	●	●	●																																																																																								
Position	●	●	●	●																																																																																								
Force limit	●	●	●	●																																																																																								
Abs. value cleared	●	●	●	●																																																																																								
Warning	●	●	●	●																																																																																								
Item	Axis1	Axis2	Axis3	Axis4																																																																																								
Regenerative load ratio	456	456	456	456																																																																																								
Item	Axis1	Axis2	Axis3	Axis4																																																																																								
Actual load ratio	456	456	456	456																																																																																								
Item	Axis1	Axis2	Axis3	Axis4																																																																																								
Peak load ratio	456	456	456	456																																																																																								
	2)	876, 976, 1076, 1176	36C, 3D0, 434, 498																																																																																									
	3)	877, 977, 1077, 1177	36D, 3D1, 435, 499																																																																																									
	4)	878, 978, 1078, 1178	36E, 3D2, 436, 49A																																																																																									
	5)	879, 979, 1079, 1179	36F, 3D3, 437, 49B																																																																																									
	6)	880, 980, 1080, 1180	370, 3D4, 438, 49C																																																																																									
	-	-	-																																																																																									

Screen example	No.	Buffer memory address	
		DEC	HEX
	1)	824 to 825	338 to 339
	2)	924 to 925	39C to 39D
	3)	1024 to 1025	400 to 401
	4)	1124 to 1125	464 to 465
	5)	826, 816	33A, 330
	6)	926, 916	39E, 394
	7)	1026, 1016	402, 3F8
	8)	1126, 1116	466, 45C
	1)	814 to 815	32E to 32F
	2)	914 to 915	392 to 393
	3)	1014 to 1015	3F6 to 3F7
	4)	1114 to 1115	45A to 45B
	5)	1526 to 1527, 1626 to 1627	5F6 to 5F7, 65A to 65B
	6)	1726 to 1727, 1826 to 1927	6BE to 6BF, 722 to 723
	7)	817, 917, 1017, 1117	330, 395, 3F9, 45D
	8)	1528, 1628, 1728, 1828	5F8, 65C, 6C0, 724
	1)	1530 to 1531, 1630 to 1631	5FA to 5FB, 65E to 65F
	2)	1730 to 1731, 1830 to 1931	6C2 to 6C3, 726 to 727
	3)	817, 917, 1017, 1117	331, 395, 3F9, 45D
	4)	1532, 1632, 1732, 1832	5FC, 660, 6C4, 728

- 1
OVERVIEW
- 2
SYSTEM MONITOR
- 3
LADDER MONITOR
FUNCTION
- 4
MELSEC-A LIST
EDITOR
- 5
MELSEC-FX LIST
EDITOR
- 6
INTELLIGENT
MODULE MONITOR
- 7
NETWORK
MONITOR
- 8
Q MOTION
MONITOR

Screen example		No.	Buffer memory address	
			DEC	HEX
		1)	1506 to 1507, 1606 to 1607	5E2 to 5E3, 646 to 647
		2)	1706 to 1707, 1806 to 1807	6AA to 6AB, 70E to 70F
		3)	1514 to 1515, 1614 to 1615	5EA to 5EB, 64E to 64F
		4)	1714 to 1715, 1814 to 1815	6B2 to 6B3, 716 to 717
		5)	1513, 1613, 1713, 1813	5E9, 64D, 6B1, 715
		6)	1544, 1644, 1744, 1844	608, 66C, 6D0, 734,
		7)	1545, 1645, 1745, 1845	609, 66D, 6B1, 735
		8)	1546, 1646, 1746, 1846	60A, 66E, 6B2, 736
		9)	1547, 1647, 1747, 1847	60B, 66F, 6B3, 737
		10)	1505, 1605, 1705, 1805	5E1, 645, 6A9, 70D
		-	-	-
		1)	1500, 1600, 1700, 1800	5DC, 640, 6A4, 708
		2)	1501, 1601, 1701, 1801	5DD, 641, 6A5, 709
		3)	1502, 1602, 1702, 1802	5DE, 642, 6A6, 70A
		4)	1503, 1603, 1703, 1803	5DF, 643, 6A7, 70B
		5)	1504, 1604, 1704, 1804	5E0, 644, 6A8, 70C
		6)	1512, 1612, 1712, 1812	5E8, 64C, 6B0, 714
		7)	1516, 1616, 1716, 1816	5EC, 650, 6B4, 718
		8)	1508 to 1509, 1608 to 1609, 1708 to 1709, 1808 to 1809	5E4 to 5E5, 648 to 649, 6AC to 6AD, 710 to 711
		9)	1510 to 1511, 1610 to 1611, 1710 to 1711, 1810 to 1811	5E6 to 5E7, 64A to 64B, 6AE to 6AF, 712 to 713
		10)	1520, 1620, 1720, 1820	5F0, 654, 6B8, 71C
		11)	1521, 1621, 1721, 1821	5F1, 655, 6B9, 71D
		12)	1522 to 1523, 1622 to 1623, 1722 to 1723, 1822 to 1823	5F2 to 5F3, 656 to 657, 6BA to 6BB, 71E to 71F
		13)	1524, 1624, 1724, 1824	5F4, 658, 6BC, 720
		14)	1525, 1625, 1725, 1825	5F5, 659, 6BD, 721
		-	-	-

Screen example		No.	Buffer memory address																																																																																																																																																																																		
			DEC	HEX																																																																																																																																																																																	
<p>LD77MH4 Axis control data-3</p> <table border="1"> <tr> <td>Item</td> <td>Axis1</td> <td>Axis2</td> <td>Axis3</td> <td>Axis4</td> <td>Item</td> <td>Axis1</td> <td>Axis2</td> <td>Axis3</td> <td>Axis4</td> </tr> <tr> <td>1) Pos. change</td> <td>0</td> <td>0</td> <td>0</td> <td>0</td> <td>Simultaneous starting axis start data</td> <td>Axis1</td> <td>456</td> <td>456</td> <td>456</td> <td>456</td> </tr> <tr> <td>2) Teaching data selection</td> <td>0</td> <td>0</td> <td>0</td> <td>0</td> <td>Data No.</td> <td>Axis1</td> <td>456</td> <td>456</td> <td>456</td> <td>456</td> </tr> <tr> <td>3) Teaching positioning data No.</td> <td>456</td> <td>456</td> <td>456</td> <td>456</td> <td>Axis2</td> <td>456</td> <td>456</td> <td>456</td> <td>456</td> <td>456</td> </tr> <tr> <td></td> <td></td> <td></td> <td></td> <td></td> <td>Axis3</td> <td>456</td> <td>456</td> <td>456</td> <td>456</td> <td>456</td> </tr> <tr> <td></td> <td></td> <td></td> <td></td> <td></td> <td>Axis4</td> <td>456</td> <td>456</td> <td>456</td> <td>456</td> <td>456</td> </tr> <tr> <td></td> <td></td> <td></td> <td></td> <td></td> <td>0:Nontarget / 1 to 600:Start data No.</td> <td></td> <td></td> <td></td> <td></td> <td></td> </tr> <tr> <td></td> <td></td> <td></td> <td></td> <td></td> <td>0:Completed 1:Request</td> <td></td> <td></td> <td></td> <td></td> <td></td> </tr> </table> <table border="1"> <tr> <td>Item</td> <td>Axis1</td> <td>Axis2</td> <td>Axis3</td> <td>Axis4</td> <td>Item</td> <td>Axis1</td> <td>Axis2</td> <td>Axis3</td> <td>Axis4</td> </tr> <tr> <td>4) ABC direction in degrees</td> <td>0</td> <td>0</td> <td>0</td> <td>0</td> <td>SV OFF command</td> <td>0</td> <td>0</td> <td>0</td> <td>0</td> </tr> <tr> <td></td> <td></td> <td></td> <td></td> <td></td> <td>0:Servo ON 1:Servo OFF</td> <td></td> <td></td> <td></td> <td></td> </tr> <tr> <td></td> <td></td> <td></td> <td></td> <td></td> <td>Torque output</td> <td>0</td> <td>0</td> <td>0</td> <td>0</td> </tr> <tr> <td></td> <td></td> <td></td> <td></td> <td></td> <td>0 to 1000(%)</td> <td></td> <td></td> <td></td> <td></td> </tr> <tr> <td></td> <td></td> <td></td> <td></td> <td></td> <td>Gain switch</td> <td>0</td> <td>0</td> <td>0</td> <td>0</td> </tr> <tr> <td></td> <td></td> <td></td> <td></td> <td></td> <td>Switch command</td> <td>0:OFF 1:ON</td> <td></td> <td></td> <td></td> </tr> <tr> <td></td> <td></td> <td></td> <td></td> <td></td> <td>PI-PID chg. req.</td> <td>0</td> <td>0</td> <td>0</td> <td>0</td> </tr> <tr> <td></td> <td></td> <td></td> <td></td> <td></td> <td>0:Completed 1:Request</td> <td></td> <td></td> <td></td> <td></td> </tr> </table>		Item	Axis1	Axis2	Axis3	Axis4	Item	Axis1	Axis2	Axis3	Axis4	1) Pos. change	0	0	0	0	Simultaneous starting axis start data	Axis1	456	456	456	456	2) Teaching data selection	0	0	0	0	Data No.	Axis1	456	456	456	456	3) Teaching positioning data No.	456	456	456	456	Axis2	456	456	456	456	456						Axis3	456	456	456	456	456						Axis4	456	456	456	456	456						0:Nontarget / 1 to 600:Start data No.											0:Completed 1:Request						Item	Axis1	Axis2	Axis3	Axis4	Item	Axis1	Axis2	Axis3	Axis4	4) ABC direction in degrees	0	0	0	0	SV OFF command	0	0	0	0						0:Servo ON 1:Servo OFF										Torque output	0	0	0	0						0 to 1000(%)										Gain switch	0	0	0	0						Switch command	0:OFF 1:ON									PI-PID chg. req.	0	0	0	0						0:Completed 1:Request					1)	1538, 1638, 1738, 1838	602, 670, 6CA, 72E
Item	Axis1	Axis2	Axis3	Axis4	Item	Axis1	Axis2	Axis3	Axis4																																																																																																																																																																												
1) Pos. change	0	0	0	0	Simultaneous starting axis start data	Axis1	456	456	456	456																																																																																																																																																																											
2) Teaching data selection	0	0	0	0	Data No.	Axis1	456	456	456	456																																																																																																																																																																											
3) Teaching positioning data No.	456	456	456	456	Axis2	456	456	456	456	456																																																																																																																																																																											
					Axis3	456	456	456	456	456																																																																																																																																																																											
					Axis4	456	456	456	456	456																																																																																																																																																																											
					0:Nontarget / 1 to 600:Start data No.																																																																																																																																																																																
					0:Completed 1:Request																																																																																																																																																																																
Item	Axis1	Axis2	Axis3	Axis4	Item	Axis1	Axis2	Axis3	Axis4																																																																																																																																																																												
4) ABC direction in degrees	0	0	0	0	SV OFF command	0	0	0	0																																																																																																																																																																												
					0:Servo ON 1:Servo OFF																																																																																																																																																																																
					Torque output	0	0	0	0																																																																																																																																																																												
					0 to 1000(%)																																																																																																																																																																																
					Gain switch	0	0	0	0																																																																																																																																																																												
					Switch command	0:OFF 1:ON																																																																																																																																																																															
					PI-PID chg. req.	0	0	0	0																																																																																																																																																																												
					0:Completed 1:Request																																																																																																																																																																																
		2)	1548, 1648, 1748, 1848	60C, 670, 6D4, 738																																																																																																																																																																																	
		3)	1549, 1649, 1749, 1849	60D, 671, 6D5, 739																																																																																																																																																																																	
		4)	1550, 1650, 1750, 1850	60E, 672, 606, 73A																																																																																																																																																																																	
		5)	1540, 1640, 1740, 1840	604, 668, 6CB, 730																																																																																																																																																																																	
		6)	1541, 1641, 1741, 1841	605, 669, 6CD, 731																																																																																																																																																																																	
		7)	1542, 1642, 1742, 1842	606, 66A, 6CE, 732																																																																																																																																																																																	
		8)	1543, 1643, 1743, 1843	607, 66B, 6D0, 733																																																																																																																																																																																	
		9)	1551, 1651, 1751, 1851	60F, 673, 6D7, 73B																																																																																																																																																																																	
		10)	1552, 1652, 1752, 1852	610, 674, 6D8, 73C																																																																																																																																																																																	
		11)	1559, 1659, 1759, 1859	617, 67B, 6DF, 743																																																																																																																																																																																	
		12)	1565, 1665, 1765, 1865	61D, 681, 6E5, 749																																																																																																																																																																																	
		-	-	-																																																																																																																																																																																	
<p>LD77MH4 Axis control data-4</p> <table border="1"> <tr> <td>Axis1</td> <td>23456</td> <td>Axis2</td> <td>23456</td> <td>Axis3</td> <td>123456</td> <td>Axis4</td> <td>123456</td> </tr> <tr> <td>Axis2</td> <td>23456</td> <td>Axis4</td> <td>23456</td> <td>Axis3</td> <td>123456</td> <td>Axis1</td> <td>123456</td> </tr> <tr> <td>Setting range</td> <td>1 to 65535 (um)**10⁻¹ (inch)**10⁻⁸ (degree)**10⁻⁸ (pulse)**1</td> <td>0:JOG operation</td> <td></td> <td>Setting range</td> <td>ABS-INC -2147483648 to 2147483647 (um)**10⁻¹ (inch)**10⁻⁸ (degree)**10⁻⁸ (pulse)**1 (*ABS: 0to85999999(degree)**10⁻⁸)</td> <td></td> <td></td> </tr> </table> <table border="1"> <tr> <td>Axis1</td> <td>123456</td> <td>Axis2</td> <td>123456</td> <td>Axis3</td> <td>123456</td> <td>Axis4</td> <td>123456</td> </tr> <tr> <td>Axis2</td> <td>123456</td> <td>Axis4</td> <td>123456</td> <td>Axis3</td> <td>123456</td> <td>Axis1</td> <td>123456</td> </tr> <tr> <td>Setting range</td> <td>0to2000000000 (mm/min)**10⁻² (inch/min)**10⁻⁸ (degree/min)**10⁻⁸</td> <td>0to500000000 (pulse/sec)**1</td> <td></td> <td>Setting range</td> <td>0to2000000000 (mm/min)**10⁻² (inch/min)**10⁻⁸ (degree/min)**10⁻⁸</td> <td>0to500000000 (pulse/sec)**1</td> <td></td> </tr> </table>		Axis1	23456	Axis2	23456	Axis3	123456	Axis4	123456	Axis2	23456	Axis4	23456	Axis3	123456	Axis1	123456	Setting range	1 to 65535 (um)**10 ⁻¹ (inch)**10 ⁻⁸ (degree)**10 ⁻⁸ (pulse)**1	0:JOG operation		Setting range	ABS-INC -2147483648 to 2147483647 (um)**10 ⁻¹ (inch)**10 ⁻⁸ (degree)**10 ⁻⁸ (pulse)**1 (*ABS: 0to85999999(degree)**10 ⁻⁸)			Axis1	123456	Axis2	123456	Axis3	123456	Axis4	123456	Axis2	123456	Axis4	123456	Axis3	123456	Axis1	123456	Setting range	0to2000000000 (mm/min)**10 ⁻² (inch/min)**10 ⁻⁸ (degree/min)**10 ⁻⁸	0to500000000 (pulse/sec)**1		Setting range	0to2000000000 (mm/min)**10 ⁻² (inch/min)**10 ⁻⁸ (degree/min)**10 ⁻⁸	0to500000000 (pulse/sec)**1		1)	1517, 1617	5ED, 651																																																																																																																																	
Axis1	23456	Axis2	23456	Axis3	123456	Axis4	123456																																																																																																																																																																														
Axis2	23456	Axis4	23456	Axis3	123456	Axis1	123456																																																																																																																																																																														
Setting range	1 to 65535 (um)**10 ⁻¹ (inch)**10 ⁻⁸ (degree)**10 ⁻⁸ (pulse)**1	0:JOG operation		Setting range	ABS-INC -2147483648 to 2147483647 (um)**10 ⁻¹ (inch)**10 ⁻⁸ (degree)**10 ⁻⁸ (pulse)**1 (*ABS: 0to85999999(degree)**10 ⁻⁸)																																																																																																																																																																																
Axis1	123456	Axis2	123456	Axis3	123456	Axis4	123456																																																																																																																																																																														
Axis2	123456	Axis4	123456	Axis3	123456	Axis1	123456																																																																																																																																																																														
Setting range	0to2000000000 (mm/min)**10 ⁻² (inch/min)**10 ⁻⁸ (degree/min)**10 ⁻⁸	0to500000000 (pulse/sec)**1		Setting range	0to2000000000 (mm/min)**10 ⁻² (inch/min)**10 ⁻⁸ (degree/min)**10 ⁻⁸	0to500000000 (pulse/sec)**1																																																																																																																																																																															
		2)	1717, 1817	6B5, 719																																																																																																																																																																																	
		3)	1518 to 1519, 1618 to 1619	5EE to 5EF, 652 to 653																																																																																																																																																																																	
		4)	1718 to 1719, 1818 to 1819	6B6 to 6B7, 71A to 71B																																																																																																																																																																																	
		5)	1534 to 1535, 1634 to 1635	5FE to 5FF, 662 to 663																																																																																																																																																																																	
		6)	1734 to 1735, 1834 to 1835	6C6 to 6C7, 72A to 72B																																																																																																																																																																																	
		7)	1536 to 1537, 1636 to 1637	600 to 601, 664 to 665																																																																																																																																																																																	
		8)	1736 to 1737, 1836 to 1837	6C8 to 6C9, 72C to 72D																																																																																																																																																																																	
		-	-	-																																																																																																																																																																																	

- 1 OVERVIEW
- 2 SYSTEM MONITOR
- 3 LADDER MONITOR FUNCTION
- 4 MELSEC-A LIST EDITOR
- 5 MELSEC-FX LIST EDITOR
- 6 INTELLIGENT MODULE MONITOR
- 7 NETWORK MONITOR
- 8 Q MOTION MONITOR

Screen example		No.	Buffer memory address	
			DEC	HEX
		1)	1212 to 1216	4BC to 4C0
		2)	1217 to 1221	4C1 to 4C5
		3)	1222 to 1226	4C6 to 4CA
		4)	1227 to 1231	4CB to 4CF
		5)	1232 to 1236	4D0 to 4D4
		6)	1237 to 1241	4D5 to 4D9
		7)	1242 to 1246	4DA to 4DE
		8)	1247 to 1251	4DF to 4E3
		9)	1252 to 1256	4E4 to 4E8
		10)	1257 to 1261	4E9 to 4ED
		11)	1262 to 1266	4EE to 4F2
		12)	1267 to 1271	4F3 to 4F7
		13)	1272 to 1276	4F8 to 4FC
		14)	1277 to 1281	4FD to 501
		15)	1282 to 1286	502 to 506
		16)	1287 to 1291	507 to 50B
		-	-	-
		1)	1293 to 1296	50D to 510
		2)	1297 to 1300	511 to 514
		3)	1301 to 1304	515 to 518
		4)	1305 to 1308	519 to 51C
		5)	1309 to 1312	51D to 520
		6)	1313 to 1316	521 to 524
		7)	1317 to 1320	525 to 528
		8)	1321 to 1324	529 to 52C
		9)	1325 to 1328	52D to 530
		10)	1329 to 1332	531 to 534
		11)	1333 to 1336	535 to 538
		12)	1337 to 1340	539 to 53C
		13)	1341 to 1344	53D to 540
		14)	1345 to 1348	541 to 544
		15)	1349 to 1352	545 to 548
		16)	1353 to 1356	549 to 54C
		17)	1358 to 1361	54E to 551
		18)	1362 to 1365	552 to 555
		19)	1366 to 1369	556 to 559
		20)	1370 to 1373	55A to 55D
		21)	1374 to 1377	55E to 561
		22)	1378 to 1381	562 to 565
		23)	1382 to 1385	566 to 569
		24)	1386 to 1389	56A to 56D
		25)	1390 to 1393	56E to 571
		26)	1394 to 1397	572 to 575
		27)	1398 to 1401	576 to 579
		28)	1402 to 1405	57A to 57D
		29)	1406 to 1409	57E to 581
		30)	1410 to 1413	582 to 585
		31)	1414 to 1417	586 to 589
32)	1418 to 1421	58A to 58D		
-	-	-		

Screen example		No.	Buffer memory address																																																																												
			DEC	HEX																																																																											
<p>LD77MH4 Positioning data</p> <table border="1"> <thead> <tr> <th colspan="2">Axis1</th> <th colspan="2">Axis3</th> </tr> <tr> <th>No</th> <th>Pat. Int. Cont. Acc. Dec. Dwell Mode</th> <th>No</th> <th>Pat. Int. Cont. Acc. Dec. Dwell Mode</th> </tr> <tr> <th>Address</th> <th>Arc address</th> <th>Instr. speed</th> <th>Address</th> <th>Arc address</th> <th>Instr. speed</th> </tr> </thead> <tbody> <tr> <td>1) {</td> <td>00 00 56 00 00 23456 23456</td> <td>123456</td> <td>123456</td> <td>00 00 56 00 00 23456 23456</td> <td>123456</td> <td>123456</td> <td>7) {</td> </tr> <tr> <td>2) {</td> <td>00 00 56 00 00 23456 23456</td> <td>123456</td> <td>123456</td> <td>00 00 56 00 00 23456 23456</td> <td>123456</td> <td>123456</td> <td>8) {</td> </tr> <tr> <td>3) {</td> <td>00 00 56 00 00 23456 23456</td> <td>123456</td> <td>123456</td> <td>00 00 56 00 00 23456 23456</td> <td>123456</td> <td>123456</td> <td>9) {</td> </tr> <tr> <td colspan="2">Axis2</td> <td colspan="2">Axis4</td> </tr> <tr> <th>No</th> <th>Pat. Int. Cont. Acc. Dec. Dwell Mode</th> <th>No</th> <th>Pat. Int. Cont. Acc. Dec. Dwell Mode</th> </tr> <tr> <th>Address</th> <th>Arc address</th> <th>Instr. speed</th> <th>Address</th> <th>Arc address</th> <th>Instr. speed</th> </tr> <tr> <td>4) {</td> <td>00 00 56 00 00 23456 23456</td> <td>123456</td> <td>123456</td> <td>00 00 56 00 00 23456 23456</td> <td>123456</td> <td>123456</td> <td>10) {</td> </tr> <tr> <td>5) {</td> <td>00 00 56 00 00 23456 23456</td> <td>123456</td> <td>123456</td> <td>00 00 56 00 00 23456 23456</td> <td>123456</td> <td>123456</td> <td>11) {</td> </tr> <tr> <td>6) {</td> <td>00 00 56 00 00 23456 23456</td> <td>123456</td> <td>123456</td> <td>00 00 56 00 00 23456 23456</td> <td>123456</td> <td>123456</td> <td>12) {</td> </tr> </tbody> </table> <p>[Pattern] 00: Positioning complete 01: Continuous positioning control 11: Continuous path control [Control] 02H:INC1 03H:FEED1 04H:VF1 05H:VR1 06H:VRF 07H:VPR 08H:PVF 09H:PVF 0AH:RBS2 0BH:INC2 0CH:FEED2 0DH:ABS 0EH:INC~ 0FH:ABS_CW 10H:ABS_CW 11H:INC_CW 12H:INC_CW 13H:VF2 14H:VR2 15H:RBS3 16H:INC3 17H:FEED3 18H:VF3 19H:VR3 1AH:RBS4 1BH:INC4 1CH:FEED4 1DH:VF4 1EH:VR4 1FH:RBS 1GH:VRF 1IH:VPR 1JH:RBS 1KH:VRF</p>		Axis1		Axis3		No	Pat. Int. Cont. Acc. Dec. Dwell Mode	No	Pat. Int. Cont. Acc. Dec. Dwell Mode	Address	Arc address	Instr. speed	Address	Arc address	Instr. speed	1) {	00 00 56 00 00 23456 23456	123456	123456	00 00 56 00 00 23456 23456	123456	123456	7) {	2) {	00 00 56 00 00 23456 23456	123456	123456	00 00 56 00 00 23456 23456	123456	123456	8) {	3) {	00 00 56 00 00 23456 23456	123456	123456	00 00 56 00 00 23456 23456	123456	123456	9) {	Axis2		Axis4		No	Pat. Int. Cont. Acc. Dec. Dwell Mode	No	Pat. Int. Cont. Acc. Dec. Dwell Mode	Address	Arc address	Instr. speed	Address	Arc address	Instr. speed	4) {	00 00 56 00 00 23456 23456	123456	123456	00 00 56 00 00 23456 23456	123456	123456	10) {	5) {	00 00 56 00 00 23456 23456	123456	123456	00 00 56 00 00 23456 23456	123456	123456	11) {	6) {	00 00 56 00 00 23456 23456	123456	123456	00 00 56 00 00 23456 23456	123456	123456	12) {	1) 2000 to 2002, 2004 to 2009	7D0 to 7D2, 7D4 to 7D9
Axis1		Axis3																																																																													
No	Pat. Int. Cont. Acc. Dec. Dwell Mode	No	Pat. Int. Cont. Acc. Dec. Dwell Mode																																																																												
Address	Arc address	Instr. speed	Address	Arc address	Instr. speed																																																																										
1) {	00 00 56 00 00 23456 23456	123456	123456	00 00 56 00 00 23456 23456	123456	123456	7) {																																																																								
2) {	00 00 56 00 00 23456 23456	123456	123456	00 00 56 00 00 23456 23456	123456	123456	8) {																																																																								
3) {	00 00 56 00 00 23456 23456	123456	123456	00 00 56 00 00 23456 23456	123456	123456	9) {																																																																								
Axis2		Axis4																																																																													
No	Pat. Int. Cont. Acc. Dec. Dwell Mode	No	Pat. Int. Cont. Acc. Dec. Dwell Mode																																																																												
Address	Arc address	Instr. speed	Address	Arc address	Instr. speed																																																																										
4) {	00 00 56 00 00 23456 23456	123456	123456	00 00 56 00 00 23456 23456	123456	123456	10) {																																																																								
5) {	00 00 56 00 00 23456 23456	123456	123456	00 00 56 00 00 23456 23456	123456	123456	11) {																																																																								
6) {	00 00 56 00 00 23456 23456	123456	123456	00 00 56 00 00 23456 23456	123456	123456	12) {																																																																								
		2) 2010 to 2012, 2014 to 2019	7DA to 7DC, 7DE to 7E3																																																																												
		3) 2020 to 2022, 2024 to 2029	7E4 to 7E6, 7E8 to 7ED																																																																												
		4) 8000 to 8002, 8004 to 8009	1F40 to 1F41, 1F44 to 1F49																																																																												
		5) 8010 to 8012, 8014 to 8019	1F4A to 1F4C, 1F4E to 1F53																																																																												
		6) 8020 to 8022, 8024 to 8029	1F54 to 1F56, 1F58 to 1F5D																																																																												
		7) 14000 to 14002, 14004 to 14009	36B0 to 36B2, 36B4 to 36B9																																																																												
		8) 14010 to 14012, 14014 to 14019	36BA to 36BB, 36BE to 36C3																																																																												
		9) 14020 to 14022, 14024 to 14029	36C4 to 36C6, 36C8 to 36CD																																																																												
		10) 20000 to 20002, 20004 to 20009	4E20 to 4E22, 4E24 to 4E29																																																																												
		11) 20010 to 20012, 20014 to 20019	4E2A to 4E2C, 4E2E to 4E33																																																																												
		12) 20020 to 20022, 20024 to 20029	4E34 to 4E36, 4E38 to 4E3D																																																																												
		-	-																																																																												
<p>LD77MH4 Servo parameter Basic setting</p> <table border="1"> <thead> <tr> <th>Item</th> <th>Axis1</th> <th>Axis2</th> <th>Axis3</th> <th>Axis4</th> <th>Setting range</th> </tr> </thead> <tbody> <tr> <td>1) Servo series</td> <td>6</td> <td>6</td> <td>6</td> <td>6</td> <td>0:Invalid 1:MR-J3-B 3:MR-J3-B(Fully closed) 4:MR-J3-B(Linear) 8:MR-J3(Direct Drive)</td> </tr> <tr> <td>2) Selection of regenerative brake option</td> <td>56</td> <td>56</td> <td>56</td> <td>56</td> <td>00:Not used 02:MR-R8082 03:MR-R812 04:MR-R862 05:MR-R860 06:MR-R850 08:MR-R851 09:MR-R851</td> </tr> <tr> <td>3) 0 pos. detection sys.</td> <td>6</td> <td>6</td> <td>6</td> <td>6</td> <td>0:Invalid 1:Valid</td> </tr> <tr> <td>4) Func. selection A-1 Emergency stop input</td> <td>6</td> <td>6</td> <td>6</td> <td>6</td> <td>0:Valid 1:Invalid</td> </tr> <tr> <td>5) Auto tuning mode</td> <td>6</td> <td>6</td> <td>6</td> <td>6</td> <td>0:Interpolation 1:Auto tuning1 3:Manual 2:Auto tuning2</td> </tr> <tr> <td>6) Response</td> <td>56</td> <td>56</td> <td>56</td> <td>56</td> <td>1 16 32 Low 1/10Hz 1/20Hz 1/40Hz</td> </tr> <tr> <td>7) In position range</td> <td>23456</td> <td>23456</td> <td>23456</td> <td>23456</td> <td>0 to 50000[pulse]</td> </tr> <tr> <td>8) Rotation direction</td> <td>6</td> <td>6</td> <td>6</td> <td>6</td> <td>0:CCW 1:CW</td> </tr> <tr> <td>9) Encoder output pulses</td> <td>23456</td> <td>23456</td> <td>23456</td> <td>23456</td> <td>1 to 85569[pulse]</td> </tr> </tbody> </table>		Item	Axis1	Axis2	Axis3	Axis4	Setting range	1) Servo series	6	6	6	6	0:Invalid 1:MR-J3-B 3:MR-J3-B(Fully closed) 4:MR-J3-B(Linear) 8:MR-J3(Direct Drive)	2) Selection of regenerative brake option	56	56	56	56	00:Not used 02:MR-R8082 03:MR-R812 04:MR-R862 05:MR-R860 06:MR-R850 08:MR-R851 09:MR-R851	3) 0 pos. detection sys.	6	6	6	6	0:Invalid 1:Valid	4) Func. selection A-1 Emergency stop input	6	6	6	6	0:Valid 1:Invalid	5) Auto tuning mode	6	6	6	6	0:Interpolation 1:Auto tuning1 3:Manual 2:Auto tuning2	6) Response	56	56	56	56	1 16 32 Low 1/10Hz 1/20Hz 1/40Hz	7) In position range	23456	23456	23456	23456	0 to 50000[pulse]	8) Rotation direction	6	6	6	6	0:CCW 1:CW	9) Encoder output pulses	23456	23456	23456	23456	1 to 85569[pulse]	1) 30100, 30300, 30500, 30700	7594, 765C, 7724, 77EC																
Item	Axis1	Axis2	Axis3	Axis4	Setting range																																																																										
1) Servo series	6	6	6	6	0:Invalid 1:MR-J3-B 3:MR-J3-B(Fully closed) 4:MR-J3-B(Linear) 8:MR-J3(Direct Drive)																																																																										
2) Selection of regenerative brake option	56	56	56	56	00:Not used 02:MR-R8082 03:MR-R812 04:MR-R862 05:MR-R860 06:MR-R850 08:MR-R851 09:MR-R851																																																																										
3) 0 pos. detection sys.	6	6	6	6	0:Invalid 1:Valid																																																																										
4) Func. selection A-1 Emergency stop input	6	6	6	6	0:Valid 1:Invalid																																																																										
5) Auto tuning mode	6	6	6	6	0:Interpolation 1:Auto tuning1 3:Manual 2:Auto tuning2																																																																										
6) Response	56	56	56	56	1 16 32 Low 1/10Hz 1/20Hz 1/40Hz																																																																										
7) In position range	23456	23456	23456	23456	0 to 50000[pulse]																																																																										
8) Rotation direction	6	6	6	6	0:CCW 1:CW																																																																										
9) Encoder output pulses	23456	23456	23456	23456	1 to 85569[pulse]																																																																										
		2) 30102, 30302, 30502, 30702	7596, 765E, 7726, 77EE																																																																												
		3) 30103, 30303, 30503, 30703	7797, 765F, 7727, 77EF																																																																												
		4) 30104, 30304, 30504, 30704	7798, 7660, 7728, 77F0																																																																												
		5) 30108, 30308, 30508, 30708	759C, 7664, 772C, 77F4																																																																												
		6) 30109, 30309, 30509, 30709	759D, 7665, 772D, 77F5																																																																												
		7) 30110, 30310, 30510, 30710	7591, 7666, 772E, 77F6																																																																												
		8) 30114, 30314, 30514, 30714	75A2, 766A, 7732, 77FA																																																																												
		9) 30115, 30315, 30515, 30715	75A3, 766B, 7733, 77FB																																																																												
		-	-																																																																												

- 1 OVERVIEW
- 2 SYSTEM MONITOR
- 3 LADDER MONITOR FUNCTION
- 4 MELSEC-A LIST EDITOR
- 5 MELSEC-FX LIST EDITOR
- 6 INTELLIGENT MODULE MONITOR
- 7 NETWORK MONITOR
- 8 Q MOTION MONITOR

Screen example		No.	Buffer memory address	
			DEC	HEX
		1)	30119, 30319, 30519, 30719	75A7, 766F, 7737, 77FF
		2)	30120, 30320, 30520 30720	75A8, 7670, 7738, 7800
		3)	30122, 30322, 30522, 30722	75AA, 7672, 773A, 7802
		4)	30124, 30324, 30524, 30724	75AC, 7674, 773C, 7804
		5)	30125, 30325, 30525, 30725	75AD, 7675, 773D, 7805
		6)	30126, 30326, 30526, 30726	75AE, 7676, 773E, 7806
		7)	30127, 30327, 30527, 30727	75AF, 7677, 773F, 7807
		8)	30128, 30328, 30528, 30728	75B0, 7678, 7740, 7808
		9)	30129, 30329, 30529, 30729	75B1, 7679, 7741, 7809
		10)	30131, 30331, 30531, 30731	75B3, 767B, 7743, 780B
		11)	30133, 30333, 30533, 30733	75B5, 767D, 7745, 780D
		12)	30136, 30336, 30536, 30736	75B8, 7680, 7748, 7810
		13)	30141, 30341, 30541, 30741	75BD, 7685, 774D, 7815
		-	-	-
		1)	30132, 30332, 30532, 30732	75B4, 767C, 7744, 780C
		2)		
		3)	30134, 30334, 30534, 30734	75B6, 767E, 7746, 780E
		4)		
		5)		
		6)	30137, 30337, 30537, 30737	75B9, 7681, 7749, 7811
		7)	30138, 30338, 30538, 30738	75BA, 7682, 774A, 7812
		8)	30142, 30342, 30542, 30742	75BE, 7686, 774E, 7816
		9)		
		-	-	-

Screen example						No.	Buffer memory address																																																													
							DEC	HEX																																																												
<div style="border: 1px solid black; padding: 5px;"> <p>LD77MH4 Servo parameter Gain/Filter-3</p> <table border="1" style="width: 100%; border-collapse: collapse;"> <thead> <tr> <th>Item</th> <th>Axis1</th> <th>Axis2</th> <th>Axis3</th> <th>Axis4</th> <th>Setting range</th> </tr> </thead> <tbody> <tr> <td>Gain switch</td> <td>3450</td> <td>3450</td> <td>3450</td> <td>3450</td> <td>0 to 9999</td> </tr> <tr> <td>Const. at gain switch</td> <td>450</td> <td>450</td> <td>450</td> <td>450</td> <td>0 to 100[ms]</td> </tr> <tr> <td>Load inertia ratio to gain switch servo</td> <td>3450</td> <td>3450</td> <td>3450</td> <td>3450</td> <td>0 to 3000($\times 10^{-1}$)</td> </tr> <tr> <td>Position loop gain</td> <td>3450</td> <td>3450</td> <td>3450</td> <td>3450</td> <td>1 to 2000[rad/s]</td> </tr> <tr> <td>Speed loop gain</td> <td>23450</td> <td>23450</td> <td>23450</td> <td>23450</td> <td>20 to 50000[rds/s]</td> </tr> <tr> <td>Speed integral comp.</td> <td>23450</td> <td>23450</td> <td>23450</td> <td>23450</td> <td>1 to 50000($\times 10^{-1}$) [ms]</td> </tr> <tr> <td>Vibration freq setup</td> <td>3450</td> <td>3450</td> <td>3450</td> <td>3450</td> <td>1 to 1000($\times 10^{-1}$) [Hz]</td> </tr> <tr> <td>Resonance freq setup</td> <td>3450</td> <td>3450</td> <td>3450</td> <td>3450</td> <td>1 to 1000($\times 10^{-1}$) [Hz]</td> </tr> <tr> <td colspan="5">Gain changing selection</td> <td>50</td> </tr> </tbody> </table> <p>9)</p> <div style="border: 1px solid black; padding: 5px; margin-top: 5px;"> <p>00:Invalid 01:Control command by the controller is effective. 02:Command frequency is more than PB27. 03:(Motor encoder unit)Droop pulse is more than PB27. 04:Model speed is more than PB27. 12:Command frequency is less than PB27. 13:(Motor encoder unit)Droop pulse is less than PB27. 14:Model speed is less than PB27.</p> </div> </div>						Item	Axis1	Axis2	Axis3	Axis4	Setting range	Gain switch	3450	3450	3450	3450	0 to 9999	Const. at gain switch	450	450	450	450	0 to 100[ms]	Load inertia ratio to gain switch servo	3450	3450	3450	3450	0 to 3000($\times 10^{-1}$)	Position loop gain	3450	3450	3450	3450	1 to 2000[rad/s]	Speed loop gain	23450	23450	23450	23450	20 to 50000[rds/s]	Speed integral comp.	23450	23450	23450	23450	1 to 50000($\times 10^{-1}$) [ms]	Vibration freq setup	3450	3450	3450	3450	1 to 1000($\times 10^{-1}$) [Hz]	Resonance freq setup	3450	3450	3450	3450	1 to 1000($\times 10^{-1}$) [Hz]	Gain changing selection					50	1)	30145, 30345, 30545, 30745	75C1, 7689, 7751, 7819
Item	Axis1	Axis2	Axis3	Axis4	Setting range																																																															
Gain switch	3450	3450	3450	3450	0 to 9999																																																															
Const. at gain switch	450	450	450	450	0 to 100[ms]																																																															
Load inertia ratio to gain switch servo	3450	3450	3450	3450	0 to 3000($\times 10^{-1}$)																																																															
Position loop gain	3450	3450	3450	3450	1 to 2000[rad/s]																																																															
Speed loop gain	23450	23450	23450	23450	20 to 50000[rds/s]																																																															
Speed integral comp.	23450	23450	23450	23450	1 to 50000($\times 10^{-1}$) [ms]																																																															
Vibration freq setup	3450	3450	3450	3450	1 to 1000($\times 10^{-1}$) [Hz]																																																															
Resonance freq setup	3450	3450	3450	3450	1 to 1000($\times 10^{-1}$) [Hz]																																																															
Gain changing selection					50																																																															
						2)	30146, 30346, 30546, 30746	75C2, 768A, 7752, 781A																																																												
						3)	30147, 30347, 30547, 30747	75C3, 768B, 7753, 781B																																																												
						4)	30148, 30348, 30548, 30748	75C4, 768C, 7754, 781C																																																												
						5)	30149, 30349, 30549, 30749	75C5, 768D, 7755, 781D																																																												
						6)	30150, 30350, 30550, 30750	75C6, 768E, 7756, 781E																																																												
						7)	30151, 30351, 30551, 30751	75C7, 768F, 7757, 781F																																																												
						8)	30152, 30352, 30552, 30752	75C8, 7690, 7758, 7820																																																												
						9)	30144, 30344, 30544, 30744	75C0, 7688, 7750, 7818																																																												
						-	-	-																																																												
<div style="border: 1px solid black; padding: 5px;"> <p>LD77MH4 Servo parameter Ex. setting-1</p> <table border="1" style="width: 100%; border-collapse: collapse;"> <thead> <tr> <th>Item</th> <th>Axis1</th> <th>Axis2</th> <th>Axis3</th> <th>Axis4</th> <th>Setting range</th> </tr> </thead> <tbody> <tr> <td>Error excessive level</td> <td>450</td> <td>450</td> <td>450</td> <td>450</td> <td>1 to 200[rev]</td> </tr> <tr> <td>EM brake release</td> <td>3450</td> <td>3450</td> <td>3450</td> <td>3450</td> <td>0 to 1000[ms]</td> </tr> <tr> <td>Encoder pulse output direction selection</td> <td>6</td> <td>6</td> <td>6</td> <td>6</td> <td>0:0CW 1:0CW (progress to A phases 90°)</td> </tr> <tr> <td>Encoder pulse output setting selection</td> <td>6</td> <td>6</td> <td>6</td> <td>6</td> <td>0:Output pulse dsbn. 1:Division ratio setting</td> </tr> <tr> <td>Function selection C1 Serial encoder cable</td> <td>6</td> <td>6</td> <td>6</td> <td>6</td> <td>0:2-wire 1:4-wire</td> </tr> <tr> <td>Function selection C2 Motor-less operation</td> <td>6</td> <td>6</td> <td>6</td> <td>6</td> <td>0:Invalid 1:Valid</td> </tr> <tr> <td>Zero speed</td> <td>23450</td> <td>23450</td> <td>23450</td> <td>23450</td> <td>0 to 10000[r/min]</td> </tr> </tbody> </table> </div>						Item	Axis1	Axis2	Axis3	Axis4	Setting range	Error excessive level	450	450	450	450	1 to 200[rev]	EM brake release	3450	3450	3450	3450	0 to 1000[ms]	Encoder pulse output direction selection	6	6	6	6	0:0CW 1:0CW (progress to A phases 90°)	Encoder pulse output setting selection	6	6	6	6	0:Output pulse dsbn. 1:Division ratio setting	Function selection C1 Serial encoder cable	6	6	6	6	0:2-wire 1:4-wire	Function selection C2 Motor-less operation	6	6	6	6	0:Invalid 1:Valid	Zero speed	23450	23450	23450	23450	0 to 10000[r/min]	1)	30164, 30364, 30564, 30764	75D4, 769C, 7764, 782C												
Item	Axis1	Axis2	Axis3	Axis4	Setting range																																																															
Error excessive level	450	450	450	450	1 to 200[rev]																																																															
EM brake release	3450	3450	3450	3450	0 to 1000[ms]																																																															
Encoder pulse output direction selection	6	6	6	6	0:0CW 1:0CW (progress to A phases 90°)																																																															
Encoder pulse output setting selection	6	6	6	6	0:Output pulse dsbn. 1:Division ratio setting																																																															
Function selection C1 Serial encoder cable	6	6	6	6	0:2-wire 1:4-wire																																																															
Function selection C2 Motor-less operation	6	6	6	6	0:Invalid 1:Valid																																																															
Zero speed	23450	23450	23450	23450	0 to 10000[r/min]																																																															
						2)	30165, 30365, 30565, 30765	75D5, 769D, 7765, 782D																																																												
						3)	30166, 30366, 30566, 30766	75D6, 769E, 7766, 782E																																																												
						4)	30167, 30367, 30567, 30767	75D7, 769F, 7767, 782F																																																												
						5)	30168, 30368, 30568, 30768	75D8, 76A0, 7768, 7830																																																												
						6)	30170, 30370, 30570, 30770	75DA, 76A2, 776A, 7832																																																												
						-	-	-																																																												

- 1 OVERVIEW
- 2 SYSTEM MONITOR
- 3 LADDER MONITOR FUNCTION
- 4 MELSEC-A LIST EDITOR
- 5 MELSEC-FX LIST EDITOR
- 6 INTELLIGENT MODULE MONITOR
- 7 NETWORK MONITOR
- 8 Q MOTION MONITOR

Screen example	No.	Buffer memory address																																	
		DEC	HEX																																
<div style="border: 1px solid black; padding: 5px;"> <p>LD77MH4 Servo parameter Ex. setting-2</p> <table border="1" style="width: 100%; border-collapse: collapse;"> <thead> <tr> <th>Item</th> <th>Axis1</th> <th>Axis2</th> <th>Axis3</th> <th>Axis4</th> <th>Setting range</th> </tr> </thead> <tbody> <tr> <td>Analog monitor 1 offset</td> <td>3456</td> <td>3456</td> <td>3456</td> <td>3456</td> <td>000 to 999999</td> </tr> <tr> <td>Analog monitor 2 offset</td> <td>3456</td> <td>3456</td> <td>3456</td> <td>3456</td> <td>000 to 999999</td> </tr> </tbody> </table> <table border="1" style="width: 100%; border-collapse: collapse;"> <thead> <tr> <th>Item</th> <th>Axis1</th> <th>Axis2</th> <th>Axis3</th> <th>Axis4</th> </tr> </thead> <tbody> <tr> <td>Analog monitor output selection(ch1)</td> <td>56</td> <td>56</td> <td>56</td> <td>56</td> </tr> <tr> <td>Analog monitor output selection(ch2)</td> <td>56</td> <td>56</td> <td>56</td> <td>56</td> </tr> </tbody> </table> <p>Setting range</p> <p>0: Servo motor speed(±8V/max. speed) 1: Torque(±8V/max. torque) 2: Servo motor speed(+8V/max. speed) 3: Torque(+8V/max. torque) 4: Current command(±8V/max. curre) 5: Command speed(±8V/max. command speed) 6: Droop puls(±10V/100puls[Encoder unit]) 7: Droop puls(±10V/1000puls[Encoder unit]) 8: Droop puls(±10V/10000puls[Encoder unit]) 9: Droop puls(±10V/100000puls[Encoder unit]) A: Feedback position(±10V/1,000,000puls[Encoder unit]) B: Feedback position(±10V/10,000,000puls[Encoder unit]) C: Feedback position(±10V/100,000,000puls[Encoder unit]) D: Bus voltage(+8V/400V Amplifier of 200V) Bus voltage(+8V/300V Amplifier of 400V) E · F · 15 ~ 1F: Un-output (Zero output)</p> </div>	Item	Axis1	Axis2	Axis3	Axis4	Setting range	Analog monitor 1 offset	3456	3456	3456	3456	000 to 999999	Analog monitor 2 offset	3456	3456	3456	3456	000 to 999999	Item	Axis1	Axis2	Axis3	Axis4	Analog monitor output selection(ch1)	56	56	56	56	Analog monitor output selection(ch2)	56	56	56	56	<p>1) 30174, 30374, 30574, 30774</p> <p>2) 30175, 30375, 30575, 30775</p> <p>3) 30172, 30372, 30572, 30772</p> <p>4) 30173, 30373, 30573, 30773</p>	<p>75DE, 76A6, 776E, 7836</p> <p>75DF, 76A7, 776F, 7837</p> <p>75DC, 76A4, 776C, 7834</p> <p>75DD, 76A5, 776D, 7835</p>
Item	Axis1	Axis2	Axis3	Axis4	Setting range																														
Analog monitor 1 offset	3456	3456	3456	3456	000 to 999999																														
Analog monitor 2 offset	3456	3456	3456	3456	000 to 999999																														
Item	Axis1	Axis2	Axis3	Axis4																															
Analog monitor output selection(ch1)	56	56	56	56																															
Analog monitor output selection(ch2)	56	56	56	56																															
<div style="border: 1px solid black; padding: 5px;"> <p>LD77MH4 Servo parameter I/O setting</p> <table border="1" style="width: 100%; border-collapse: collapse;"> <thead> <tr> <th>Item</th> <th>Axis1</th> <th>Axis2</th> <th>Axis3</th> <th>Axis4</th> </tr> </thead> <tbody> <tr> <td>Output signal device selection 1</td> <td>56</td> <td>56</td> <td>56</td> <td>56</td> </tr> <tr> <td>Output signal device selection 2</td> <td>56</td> <td>56</td> <td>56</td> <td>56</td> </tr> <tr> <td>Output signal device selection 3</td> <td>56</td> <td>56</td> <td>56</td> <td>56</td> </tr> </tbody> </table> <p>Setting range</p> <p>0: Always OFF 1: RDY (Ready is ON) 2: RD (Servo is ON) 3: ALM (Trouble) 4: TRP (In-position) 5: HEB (Electromagnetic brake interlock) 6: DB (External dynamic brake) 7: TLD (Limiting torque) 8: WNG (Warning) 9: BWN (Battery warning) A: SA (Speed reached) C: ZSP (Zero speed) F: ODP (Variable gain selection) 11: ABSV (Absolute position erasing)</p> </div>	Item	Axis1	Axis2	Axis3	Axis4	Output signal device selection 1	56	56	56	56	Output signal device selection 2	56	56	56	56	Output signal device selection 3	56	56	56	56	<p>1) 30202, 30402, 30602, 30802</p> <p>2) 30203, 30403, 30603, 30803</p> <p>3) 30204, 30404, 30604, 30804</p>	<p>75FA, 76C2, 778A, 7852</p> <p>75FB, 76C3, 778B, 7853</p> <p>75FC, 76C4, 778C, 7854</p>													
Item	Axis1	Axis2	Axis3	Axis4																															
Output signal device selection 1	56	56	56	56																															
Output signal device selection 2	56	56	56	56																															
Output signal device selection 3	56	56	56	56																															

6.5.43 LD77MH16 module monitoring

Screen example

No.	Axis	Buffer memory address		No.	Axis	Buffer memory address		
		DEC	HEX			DEC	HEX	
1)	1 to 4	2400, 2500, 2600, 2700	960, 9C4, A28, A8C	4)	-	4231	1087	
	5 to 8	2800, 2900, 3000, 3100	AF0, B54, BB8, C1C		5)	1 to 4	2429, 2529, 2629, 2729	97D, 9E1, A45, AA9
	9 to 12	3200, 3300, 3400, 3500	C80, CE4, D48, DAC			5 to 8	2829, 2929, 3029, 3129	B0D, B71, BD5, C39
	13 to 16	3600, 3700, 3800, 3900	E10, E74, ED8, F3C				9 to 12	3229, 3329, 3429, 3529
2)	1 to 4	2412, 2512, 2612, 2712	96C, 9D0, A34, A98	6)		1 to 4		2438, 2538, 2638, 2738
	5 to 8	2812, 2912, 3012, 3112	AFC, B60, BC4, C28		5 to 8	2838, 2938, 3038, 3138	B16, B7A, BDE, C42	
	9 to 12	3212, 3312, 3412, 3512	C8C, CF0, D54, DB8			9 to 12	3238, 3338, 3438, 3538	CA6, D0A, D6E, DD2
	13 to 16	3612, 3712, 3812, 3912	E1C, E80, EE4, F48		7)		1 to 4	2441, 2541, 2641, 2741
3)	1 to 4	2406 to 2409, 2506 to 2509, 2606 to 2609, 2706 to 2709	966 to 969, 9CA to 9CD, A2E to A31, A92 to A95	5 to 8		2841, 2941, 3041, 3141	B19, B7D, BE1, C45	
	5 to 8	2806 to 2809, 2906 to 2909, 3006 to 3009, 3106 to 3109	AF6 to AF9, B5A to B5D, BBE to BC1, C22 to C25			9 to 12	3241, 3341, 3441, 3541	CA9, D0D, D71, DD5
	9 to 12	3206 to 3209, 3306 to 3309, 3406 to 3409, 3506 to 3509	C86 to C89, CEA to CED, D4E to D51, DB2 to DB5	1 to 4			2438, 2538, 2638, 2738	986, 9EA, A4E, AB2
	13 to 16	3606 to 3609, 3706 to 3709, 3806 to 3809, 3906 to 3909	E16 to E19, E7A to E7D, EDE to EE1, F42 to F45		5 to 8	2838, 2938, 3038, 3138	B16, B7A, BDE, C42	
-	-	-	-	9 to 12		3238, 3338, 3438, 3538	CA6, D0A, D6E, DD2	
-	-	-	-	13 to 16	3638, 3738, 3838, 3938	E36, E9A, EFE, F62		

Screen example

No.	Axis	Buffer memory address		No.	Axis	Buffer memory address	
		DEC	HEX			DEC	HEX
1)	-	-	-	-	-	-	-

Screen example

No.	Axis	Buffer memory address		No.	Axis	Buffer memory address	
		DEC	HEX			DEC	HEX
1)	1 to 4	0, 150, 300, 450	0, 96, 12C, 1C2	3)	1 to 4	1, 151, 301, 451	1, 97, 12D, 1C3
	5 to 8	600, 750, 900, 1050,	258, 2EE, 3E8, 47E		5 to 8	601, 751, 901, 1051	259, 2EF, 385, 41B
	9 to 12	1200, 1350, 1500, 1650	514, 5AA, 640, 6D6		9 to 12	1201, 1351, 1501, 1651	4B1, 547, 5DD, 673
	13 to 16	1800, 1950, 2100, 2250	708, 79E, 834, 8CA		13 to 16	1801, 1951, 2101, 2251	709, 79F, 835, 8CB
2)	1 to 4	2 to 3, 152 to 153, 302 to 303, 452 to 453	2 to 3, 98 to 99, 12E to 12F, 1C4 to 1C5	4)	1 to 4	4 to 5, 154 to 155, 304 to 305, 454 to 455	4 to 5, 9A to 9B, 130 to 131 1C6 to 1C7
	5 to 8	602 to 603, 752 to 753, 902 to 903, 1052 to 1053	25A to 25B, 2F0 to 2F1, 386 to 387, 41C to 41D		5 to 8	604 to 605, 754 to 755, 904 to 905, 1054 to 1055	25C to 25D, 2F2 to 2F3, 388 to 389, 41E to 41F
	9 to 12	1202 to 1203, 1352 to 1353, 1502 to 1503, 1652 to 1653	4B2 to 4B3, 548 to 549, 5DE to 5DF, 674 to 675		9 to 12	1204 to 1205, 1354 to 1355, 1504 to 1505, 1654 to 1655	4B4 to 4B5, 54A to 54B, 5E0 to 5E1, 676 to 677
	13 to 16	1802 to 1803, 1952 to 1953, 2102 to 2103, 2252 to 2253	70A to 70B, 7A0 to 7A1, 836 to 837, 8CC to 8CD		13 to 16	1804 to 1805, 1954 to 1955, 2104 to 2105, 2254 to 2255	70C to 70D, 7A2 to 7A3, 838 to 839, 8CE to 8CF

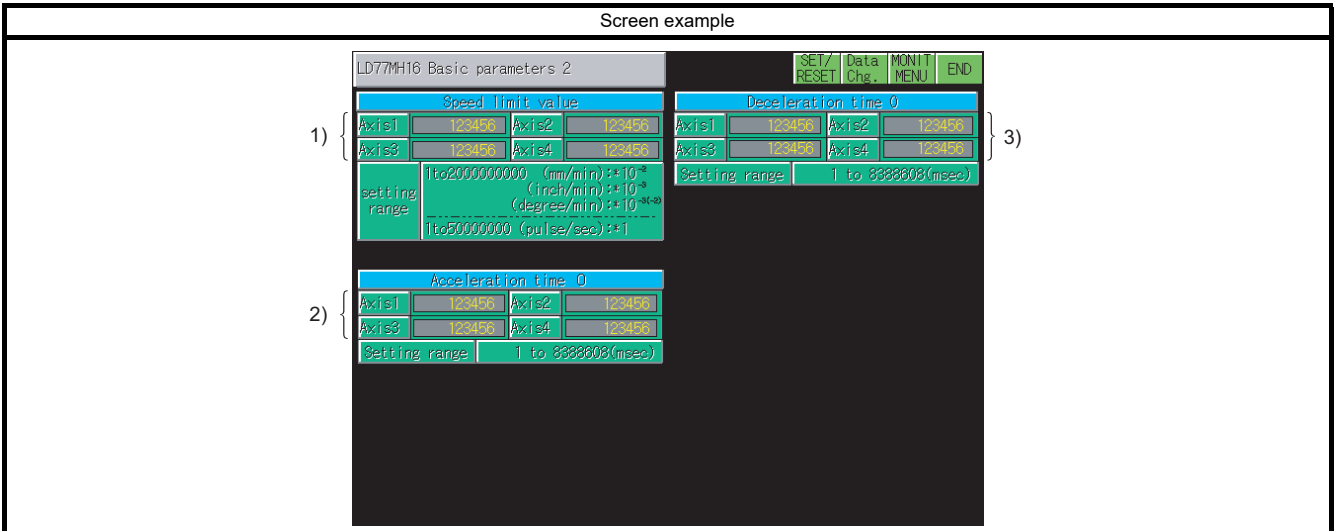

No.	Axis	Buffer memory address		No.	Axis	Buffer memory address	
		DEC	HEX			DEC	HEX
1)	1 to 4	10 to 11, 160 to 161, 310 to 311, 460 to 461	A to B, A0 to A1, 136 to 137, 1CC to 1CD	2)	9 to 12	1212 to 1213, 1362 to 1363, 1512 to 1513, 1662 to 1663	4BC to 4BD, 552 to 553, 5E8 to 5E9, 67E to 67F
	5 to 8	610 to 611, 760 to 761, 910 to 911, 1060 to 1061	262 to 263, 2F8 to 2F9, 2F8 to 2F9, 424 to 425		13 to 16	1812 to 1813, 1962 to 1963, 2112 to 2113, 2262 to 2263	714 to 715, 7AA to 7AB, 840 to 841, 8D6 to 8D7
	9 to 12	1210 to 1211, 1360 to 1361, 1510 to 1511, 1660 to 1661	4BA to 4BB, 550 to 551, 5E6 to 5E7, 67C to 67D	3)	1 to 4	14 to 15, 164 to 165, 314 to 315, 464 to 465	E to F, A4 to A5, 13A to 13B, 1D0 to 1D1
	13 to 16	1810 to 1811, 1960 to 1961, 2110 to 2111, 2260 to 2261	712 to 713, 7A8 to 7A9, 83E to 83F, 8D4 to 8D5		5 to 8	614 to 615, 764 to 765, 914 to 915, 1064 to 1065	266 to 267, 2FC to 2FD, 392 to 393, 428 to 429
2)	1 to 4	12 to 13, 162 to 163, 312 to 313, 462 to 463	C to D, A2 to A3, 138 to 139, 1CE to 1CF	9 to 12	1214 to 1215, 1364 to 1365, 1514 to 1515, 1664 to 1665	4BE to 4BF, 554 to 555, 5EA to 5EB, 680 to 681	
	5 to 8	612 to 613, 762 to 763, 912 to 913, 1062 to 1063	264 to 265, 2FA to 2FB, 390 to 391, 426 to 427	13 to 16	1814 to 1815, 1964 to 1965, 2114 to 2115, 2264 to 2265	716 to 717, 7AC to 7AD, 842 to 843, 8D8 to 8D9	

- 1
- OVERVIEW
- 2
- SYSTEM MONITOR
- 3
- LADDER MONITOR
FUNCTION
- 4
- MELSEC-A LIST
EDITOR
- 5
- MELSEC-FX LIST
EDITOR
- 6
- INTELLIGENT
MODULE MONITOR
- 7
- NETWORK
MONITOR
- 8
- Q MOTION
MONITOR

Screen example

4)

The screenshot shows the 'LD77MH16 Detailed parameters 1-1' screen. It is divided into several sections:

- Backlash compensation amount:** A table with columns for Axis1, Axis2, Axis3, and Axis4. Values are 150, 23456, 23456, and 23456. A 'setting range' is shown as 0 to 62535. Units are listed as (um)*10⁴, (inch)*10⁴, (degree)*10⁴, and (pulse)*1.
- Man-op's input selection:** A table with columns for Axis1, Axis2, Axis3, and Axis4. Values are 6, 6, 6, and 6. A 'Setting range' is shown as 0: A-phase/B-phase multiplied by 4, 2: A-phase/B-phase multiplied by 1, 3: PLS/SIGN.
- Software stroke upper limit value:** A table with columns for High/Low Limit and Axis1-4. Values are 123456. A 'setting range' is shown as 0: valid, 1: invalid.
- Torque limit set value:** A table with columns for Axis1, Axis2, Axis3, and Axis4. Values are 450, 300, 300, and 450. A 'setting range' is shown as 1 ~ 1000%.

Annotations 1) through 7) point to specific elements in the screenshot.

No.	Axis	Buffer memory address		No.	Axis	Buffer memory address			
		DEC	HEX			DEC	HEX		
1)	1 to 4	17, 167, 317, 467	11, A7, 13D, 1D3	3)	13 to 16	1820 to 1821, 1970 to 1971, 2120 to 2121, 2270 to 2271	71C to 71D, 7B2 to 7B3, 848 to 849, 8DE to 8DF		
	5 to 8	617, 767, 917, 1067	617, 767, 917, 1067		4)	-	33	21	
	9 to 12	1217, 1367, 1517, 1667	1217, 1367, 1517, 1667			5)	1 to 4	22, 172, 322, 472	16, AC, 142, 1D8
	13 to 16	1817, 1967, 2117, 2267	1817, 1967, 2117, 2267				5 to 8	622, 772, 922, 1072	622, 772, 922, 1072
2)	1 to 4	18 to 19, 168 to 169, 318 to 319, 468 to 469	12 to 13, A8 to A9, 13E to 13F, 1D4 to 1D5	9 to 12	1222, 1372, 1522, 1672		1222, 1372, 1522, 1672		
	5 to 8	618 to 619, 768 to 769, 918 to 919, 1068 to 1069	26A to 26B, 300 to 301, 396 to 397, 42C to 42D	13 to 16	1822, 1972, 2122, 2272		1822, 1972, 2122, 2272		
	9 to 12	1218 to 1219, 1368 to 1369, 1518 to 1519, 1668 to 1669	4C2 to 4C3, 558 to 559, 5EE to 5EF, 684 to 685	6)	1 to 4	23, 173, 323, 473	17, AD, 143, 1D9		
	13 to 16	1818 to 1819, 1968 to 1969, 2118 to 2119, 2268 to 2269	71A to 71B, 7B0 to 7B1, 846 to 847, 8DC to 8DD		5 to 8	623, 773, 923, 1073	26F, 305, 39B, 431		
3)	1 to 4	20 to 21, 170 to 171, 320 to 321, 470 to 471	14 to 15, AA to AB, 140 to 141, 1D6 to 1D7		9 to 12	1223, 1373, 1523, 1673	4C7, 55D, 5F3, 689		
	5 to 8	620 to 621, 770 to 771, 920 to 921, 1070 to 1071	26C to 26D, 302 to 303, 398 to 399, 42E to 42F		13 to 16	1823, 1973, 2123, 2273	71F, 7B5, 84B, 8E1		
	7)	1 to 4	20 to 21, 170 to 171, 320 to 321, 470 to 471	14 to 15, AA to AB, 140 to 141, 1D6 to 1D7	1 to 4	26, 176, 326, 476	1A, B0, 146, 1DC		
		5 to 8	620 to 621, 770 to 771, 920 to 921, 1070 to 1071	26C to 26D, 302 to 303, 398 to 399, 42E to 42F	5 to 8	626, 776, 926, 1076	272, 308, 39E, 434		
9 to 12		1220 to 1221, 1370 to 1371, 1520 to 1521, 1670 to 1671	4C4 to 4C5, 55A to 55B, 5F0 to 5F1, 686 to 687	9 to 12	1226, 1376, 1526, 1676	4CA, 560, 5F6, 68C			
-	-	-	-	-	-	-			

Screen example

No.	Axis	Buffer memory address		No.	Axis	Buffer memory address	
		DEC	HEX			DEC	HEX
1)	1 to 4	27, 177, 327, 477	1B, B1, 147, 1DD	5)	1 to 4	30, 180, 330, 480	1E, B4, 14A, 1E0
	5 to 8	627, 777, 927, 1077	273, 309, 39F, 435		5 to 8	630, 780, 930, 1080	276, 30C, 3A2, 438
	9 to 12	1227, 1377, 1527, 1677	4CB, 561, 5F7, 68D		9 to 12	1230, 1380, 1530, 1680	4CE, 564, 5FA, 690
	13 to 16	1827, 1977, 2127, 2277	723, 7B9, 84F, 8E5		13 to 16	1830, 1980, 2130, 2280	726, 7BC, 852, 8E8
2)	1 to 4	28, 178, 328, 478	1C, B2, 148, 1DE	6)	1 to 4	31, 181, 331, 481	1F, B5, 14B, 1E1
	5 to 8	628, 778, 928, 1078	274, 30A, 3A0, 436		5 to 8	631, 781, 931, 1081	277, 30D, 3A3, 439
	9 to 12	1228, 1378, 1528, 1678	4CC, 562, 5F8, 68E		9 to 12	1231, 1381, 1531, 1681	4CF, 565, 5FB, 691
	13 to 16	1828, 1978, 2128, 2278	724, 7BA, 850, 8E6		13 to 16	1831, 1981, 2131, 2281	727, 7BD, 853, 8E9
3)	1 to 4	29, 179, 329, 479	1D, B3, 149, 1DF	7)	1 to 4	34, 184, 334, 484	22, B8, 14E, 1E4
	5 to 8	629, 779, 929, 1079	275, 30B, 3A1, 437		5 to 8	634, 784, 934, 1084	27A, 310, 3A6, 43C
	9 to 12	1229, 1379, 1529, 1679	4CD, 563, 5F9, 68F		9 to 12	1234, 1384, 1534, 1684	4D2, 568, 5FE, 694
	13 to 16	1829, 1979, 2129, 2279	725, 7BB, 851, 8E7		13 to 16	1834, 1984, 2134, 2284	72A, 7C0, 856, 8EC
4)	1 to 4	24 to 25, 174 to 175, 324 to 325, 474 to 475	18 to 19, AE to AF, 144 to 145, 1DA to 1DB	8)	1 to 4	32, 182, 332, 482	20, B6, 14C, 1E2
	5 to 8	624 to 625, 774 to 775, 924 to 925, 1074 to 1075	270 to 271, 306 to 307, 39C to 39D, 432 to 433		5 to 8	632, 782, 932, 1082	278, 30E, 3A4, 43A
	9 to 12	1224 to 1225, 1374 to 1375, 1524 to 1525, 1674 to 1675	4C8 to 4C9, 55E to 55F, 5F4 to 5F5, 68A to 68B		9 to 12	1232, 1382, 1532, 1682	4D0, 566, 5FC, 692
	13 to 16	1824 to 1825, 1974 to 1975, 2124 to 2125, 2274 to 2275	720 to 721, 7B6 to 7B7, 84C to 84D, 8E2 to 8E3		13 to 16	1832, 1982, 2132, 2282	728, 7BE, 854, 8EA
				9)	-	35	23

- 1
- OVERVIEW
- 2
- SYSTEM MONITOR
- 3
- LADDER MONITOR FUNCTION
- 4
- MELSEC-A LIST EDITOR
- 5
- MELSEC-FX LIST EDITOR
- 6
- INTELLIGENT MODULE MONITOR
- 7
- NETWORK MONITOR
- 8
- Q MOTION MONITOR

Screen example

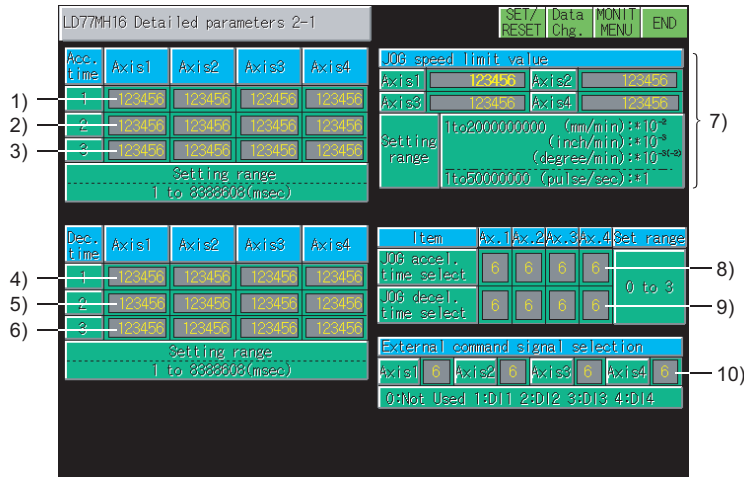

No.	Axis	Buffer memory address		No.	Axis	Buffer memory address		
		DEC	HEX			DEC	HEX	
1)	1 to 4	36 to 37, 186 to 187, 336 to 337, 486 to 487	24 to 25, BA to BB, 150 to 151, 1E6 to 1E7	5)	5 to 8	644 to 645, 794 to 794, 944 to 944, 1094 to 1094	284 to 284, 31A to 31A, 3B0 to 3B0, 446 to 446	
	5 to 8	636 to 637, 786 to 787, 936 to 937, 1086 to 1087	27C to 27D, 312 to 313, 3A8 to 3A9, 43E to 43F		9 to 12	1244 to 1244, 1394 to 1394, 1544 to 1544, 1694 to 1694	4DC to 4DC, 572 to 572, 608 to 608, 69E to 69E	
	9 to 12	1236 to 1237, 1386 to 1387, 1536 to 1537, 1686 to 1687	4D4 to 4D5, 56A to 56B, 600 to 601, 696 to 697		13 to 16	1844 to 1844, 1994 to 1994, 2144 to 2144, 2294 to 2294	734 to 734, 7CA to 7CA, 860 to 860, 8F6 to 8F6	
	13 to 16	1836 to 1837, 1986 to 1987, 2136 to 2137, 2286 to 2287	72C to 72D, 7C2 to 7C3, 858 to 859, 8EE to 8EF		1 to 4	46 to 47, 196 to 197, 346 to 347, 496 to 497	2E to 2F, C4 to C5, 15A to 15B, 1F0 to 1F1	
2)	1 to 4	38 to 39, 188 to 189, 338 to 339, 488 to 489	26 to 27, BC to BD, 152 to 153, 1E8 to 1E9	6)	5 to 8	646 to 646, 796 to 796, 946 to 946, 1096 to 1096	286 to 286, 31C to 31C, 3B2 to 3B2, 448 to 448	
	5 to 8	638 to 639, 788 to 789, 938 to 939, 1088 to 1089	27E to 27F, 314 to 315, 3AA to 3AB, 440 to 441		9 to 12	1246 to 1246, 1396 to 1396, 1546 to 1546, 1696 to 1696	4DE to 4DE, 574 to 574, 60A to 60A, 6A0 to 6A0	
	9 to 12	1238 to 1239, 1388 to 1389, 1538 to 1539, 1688 to 1689	4D6 to 4D7, 56C to 56D, 602 to 603, 698 to 699		13 to 16	1846 to 1846, 1996 to 1996, 2146 to 2146, 2296 to 2296	736 to 736, 7CC to 7CC, 862 to 862, 8F8 to 8F8	
	13 to 16	1838 to 1839, 1988 to 1989, 2138 to 2139, 2288 to 2289	72E to 72F, 7C4 to 7C5, 85A to 85B, 8F0 to 8F1		1 to 4	48 to 49, 198 to 199, 348 to 349, 498 to 499	30 to 31, C6 to C7, 15C to 15D, 1F2 to 1F3	
3)	1 to 4	40 to 41, 190 to 191, 340 to 341, 490 to 491	28 to 29, BE to BF, 154 to 155, 1EA to 1EB	7)	5 to 8	648 to 649, 798 to 799, 948 to 949, 1098 to 1099	288 to 289, 31E to 31F, 3B4 to 3B5, 44A to 44B	
	5 to 8	640 to 641, 790 to 791, 940 to 941, 1090 to 1091	280 to 281, 316 to 317, 3AC to 3AD, 442 to 443		9 to 12	1248 to 1249, 1398 to 1399, 1548 to 1549, 1698 to 1699	4E0 to 4E1, 576 to 577, 60C to 60D, 6A2 to 6A3	
	9 to 12	1240 to 1241, 1390 to 1391, 1540 to 1541, 1690 to 1691	4D8 to 4D9, 56E to 56F, 604 to 605, 69A to 69B		13 to 16	1848 to 1849, 1998 to 1999, 2148 to 2149, 2298 to 2299	738 to 739, 7CE to 7CF, 864 to 865, 8FA to 8FB	
	13 to 16	1840 to 1841, 1990 to 1991, 2140 to 2141, 2290 to 2291	730 to 731, 7C6 to 7C7, 85C to 85D, 8F2 to 8F3		1 to 4	50, 200, 350, 500	32, C8, 15E, 1F4	
4)	1 to 4	42 to 43, 192 to 193, 342 to 343, 492 to 493	2A to 2B, C0 to C1, 156 to 157, 1EC to 1ED	8)	5 to 8	650, 800, 950, 1100	28A, 320, 3B6, 44C	
	5 to 8	642 to 643, 792 to 793, 942 to 943, 1092 to 1093	282 to 283, 318 to 319, 3AE to 3AF, 444 to 445		9 to 12	1250, 1400, 1550, 1700	4E2, 578, 60E, 6A4	
	9 to 12	1242 to 1243, 1392 to 1393, 1542 to 1543, 1692 to 1693	4DA to 4DB, 570 to 571, 606 to 607, 69C to 69D		13 to 16	1850, 2000, 2150, 2300	73A, 7D0, 866, 8FC	
	13 to 16	1842 to 1843, 1992 to 1993, 2142 to 2143, 2292 to 2293	732 to 733, 7C8 to 7C9, 85E to 85F, 8F4 to 8F5	9)	1 to 4	51, 201, 351, 501	33, C9, 15F, 1F5	
		5 to 8	651, 801, 951, 1101		28B, 321, 3B7, 44D			
5)	1 to 4	44 to 45, 194 to 195, 344 to 345, 494 to 495	2C to 2D, C2 to C3, 158 to 159, 1EE to 1EF	10)	9 to 12	1251, 1401, 1551, 1701	4E3, 579, 60F, 6A5	
		9 to 12	1242 to 1243, 1392 to 1393, 1542 to 1543, 1692 to 1693		606 to 607, 69C to 69D	13 to 16	1851, 2001, 2151, 2301	73B, 7D1, 867, 8FD
		1 to 4	69, 219, 369, 519		45, DB, 171, 207			
					5 to 8	669, 819, 969, 1119	29D, 333, 3C9, 45F	
					9 to 12	1269, 1419, 1569, 1719	4F5, 58B, 621, 6B7	
					13 to 16	1869, 2019, 2169, 2319	74D, 7E3, 879, 90F	

Screen example

No.	Axis	Buffer memory address		No.	Axis	Buffer memory address		
		DEC	HEX			DEC	HEX	
1)	1 to 4	52, 202, 352, 502	34, CA, 160, 1F6	7)	1 to 4	59, 209, 359, 509	3B, D1, 167, 1FD	
	5 to 8	652, 802, 952, 1102	28C, 322, 3B8, 44E		5 to 8	659, 809, 959, 1109	293, 329, 3BF, 455	
	9 to 12	1252, 1402, 1552, 1702	4E4, 57A, 610, 6A6		9 to 12	1259, 1409, 1559, 1709	4EB, 581, 617, 6AD	
	13 to 16	1852, 2002, 2152, 2302	73C, 7D2, 868, 8FE		13 to 16	1859, 2009, 2159, 2309	743, 7D9, 86F, 905	
2)	1 to 4	53, 203, 353, 503	35, CB, 161, 1F7	8)	1	67	43	
	5 to 8	653, 803, 953, 1103	28D, 323, 3B9, 44F		9)	1 to 4	60 to 61, 210 to 211, 360 to 361, 510 to 511	3C to 3D, D2 to D3, 168 to 169, 1FE to 1FF
	9 to 12	1253, 1403, 1553, 1703	4E5, 57B, 611, 6A7			5 to 8	660 to 661, 810 to 811, 960 to 961, 1110 to 1111	294 to 295, 32A to 32B, 3C0 to 3C1, 456 to 457
	13 to 16	1853, 2003, 2153, 2303	73D, 7D3, 869, 8FF			9 to 12	1260 to 1261, 1410 to 1411, 1560 to 1561, 1710 to 1711	4EC to 4ED, 582 to 583, 618 to 619, 6AE to 6AF
3)	1 to 4	56, 206, 356, 506	38, CE, 164, 1FA	10)	13 to 16	1860 to 1861, 2010 to 2011, 2160 to 2160, 2310 to 2311	744 to 745, 7DA to 7DB, 870 to 871, 906 to 907	
	5 to 8	656, 806, 956, 1106	290, 326, 3BC, 452		1 to 4	62, 212, 362, 512	3E, D4, 16A, 200	
	9 to 12	1256, 1406, 1556, 1706	4E8, 57E, 614, 6AA		5 to 8	662, 812, 962, 1112	296, 32C, 3C2, 458	
	13 to 16	1856, 2006, 2156, 2306	740, 7D6, 86C, 902		9 to 12	1262, 1412, 1562, 1712	4EE, 584, 61A, 6B0	
4)	1 to 4	57, 207, 357, 507	39, CF, 165, 1FB	11)	13 to 16	1862, 2012, 2162, 2312	746, 7DC, 872, 908	
	5 to 8	657, 807, 957, 1107	291, 327, 3BD, 453		1 to 4	63, 213, 363, 513	3F, D5, 16B, 201	
	9 to 12	1257, 1407, 1557, 1707	4E9, 57F, 615, 6AB		5 to 8	663 to 664, 813 to 814, 963 to 964, 1113 to 1114	297 to 298, 32D to 32E, 3C3 to 3C4, 459 to 45A	
	13 to 16	1857, 2007, 2157, 2307	741, 7D7, 86D, 903		9 to 12	1263 to 1264, 1413 to 1414, 1563 to 1564, 1713 to 1714	4EF to 4F0, 585 to 586, 61B to 61C, 6B1 to 6B2	
5)	1 to 4	58, 208, 358, 508	3A, D0, 166, 1FC	12)	13 to 16	1863 to 1864, 2013 to 2014, 2163 to 2164, 2313 to 2314	747 to 748, 7DD to 7DE, 873 to 874, 909 to 90A	
	5 to 8	658, 808, 958, 1108	292, 328, 3BE, 454		1 to 4	64 to 65, 214 to 215, 364 to 365, 514 to 515	40 to 41, D6 to D7, 16C to 16D, 202 to 203	
	9 to 12	1258, 1408, 1558, 1708	4EA, 580, 616, 6AC,		5 to 8	664 to 665, 814 to 815, 964 to 965, 1114 to 1115	298 to 299, 32E to 32F, 3C4 to 3C5, 45A to 45B	
	13 to 16	1858, 2008, 2158, 2308	742, 7D8, 86E, 904		9 to 12	1264 to 1265, 1414 to 1415, 1564 to 1565, 1714 to 1715	4F0 to 4F1, 586 to 587, 61C to 61D, 6B2 to 6B3	
6)	1 to 4	54 to 55, 204 to 205, 354 to 355, 504 to 505	36 to 37, CC to CD, 162 to 163, 1F8 to 1F9	12)	13 to 16	1864 to 1865, 2014 to 2015, 2164 to 2165, 2314 to 2315	748 to 749, 7DE to 7DF, 874 to 875, 90A to 90B	
	5 to 8	654 to 655, 804 to 805, 954 to 955, 1104 to 1105	28E to 28F, 324 to 325, 3BA to 3BB, 450 to 451		1 to 4	64 to 65, 214 to 215, 364 to 365, 514 to 515	40 to 41, D6 to D7, 16C to 16D, 202 to 203	
	9 to 12	1254 to 1255, 1404 to 1405, 1554 to 1555, 1704 to 1705	4E6 to 4E7, 57C to 57D, 612 to 613, 6A8 to 6A9		5 to 8	664 to 665, 814 to 815, 964 to 965, 1114 to 1115	298 to 299, 32E to 32F, 3C4 to 3C5, 45A to 45B	
	13 to 16	1854 to 1855, 2004 to 2005, 2154 to 2155, 2304 to 2305	73E to 73F, 7D4 to 7D5, 86A to 86B, 900 to 901		9 to 12	1264 to 1265, 1414 to 1415, 1564 to 1565, 1714 to 1715	4F0 to 4F1, 586 to 587, 61C to 61D, 6B2 to 6B3	

1 OVERVIEW
 2 SYSTEM MONITOR
 3 LADDER MONITOR FUNCTION
 4 MELSEC-A LIST EDITOR
 5 MELSEC-FX LIST EDITOR
 6 INTELLIGENT MODULE MONITOR
 7 NETWORK MONITOR
 8 Q MOTION MONITOR

Screen example

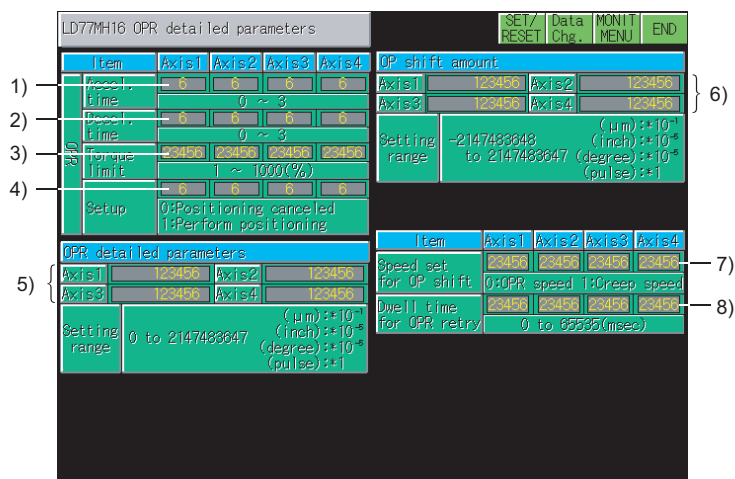

No.	Axis	Buffer memory address		No.	Axis	Buffer memory address	
		DEC	HEX			DEC	HEX
1)	1 to 4	82, 232, 382, 532	52, E8, 17E, 214	5)	1 to 4	80 to 81, 230 to 231, 380 to 381, 530 to 531	50 to 51, E6 to E7, 17C to 17D, 212 to 213
	5 to 8	682, 832, 982, 1132	2AA, 340, 3D6, 46C		5 to 8	680 to 681, 830 to 831, 980 to 981, 1130 to 1131	2A8 to 2A9, 33E to 33F, 3D4 to 3D5, 46A to 46B
	9 to 12	1282, 1432, 1582, 1732	502, 598, 62E, 6C4		9 to 12	1280 to 1281, 1430 to 1431, 1580 to 1581, 1730 to 1731	500 to 501, 596 to 597, 62C to 62D, 6C2 to 6C3
	13 to 16	1882, 2032, 2182, 2332	75A, 7F0, 886, 91C		13 to 16	1880 to 1881, 2030 to 2031, 2180 to 2181, 2330 to 2331	758 to 759, 7EE to 7EF, 884 to 885, 91A to 91B
2)	1 to 4	83, 233, 383, 533	53, E9, 17F, 215	6)	1 to 4	84 to 85, 234 to 235, 384 to 385, 534 to 535	54 to 55, EA to EB, 180 to 181, 216 to 217
	5 to 8	683, 833, 983, 1133	2AB, 341, 3D7, 46D		5 to 8	684 to 685, 834 to 835, 984 to 985, 1134 to 1135	2AC to 2AD, 342 to 343, 3D8 to 3D9, 46E to 46F
	9 to 12	1283, 1433, 1583, 1733	503, 599, 62F, 6C5		9 to 12	1284 to 1285, 1434 to 1435, 1584 to 1585, 1734 to 1735	504 to 505, 59A to 59B, 630 to 631, 6C6 to 6C7
	13 to 16	1883, 2033, 2183, 2333	75B, 7F1, 887, 91D		13 to 16	1884 to 1885, 2034 to 2035, 2184 to 2185, 2334 to 2335	75C to 75D, 7F2 to 7F3, 888 to 889, 91E to 91F
3)	1 to 4	86, 236, 386, 536	56, EC, 182, 218	7)	1 to 4	88, 238, 388, 538	58, EE, 184, 21A
	5 to 8	686, 836, 986, 1136	2AE, 344, 3DA, 470		5 to 8	688, 838, 988, 1138	2B0, 346, 3DC, 472
	9 to 12	1286, 1436, 1586, 1736	506, 59C, 632, 6C8		9 to 12	1288, 1438, 1588, 1738	508, 59E, 634, 6CA
	13 to 16	1886, 2036, 2186, 2336	75E, 7F4, 88A, 920		13 to 16	1888, 2038, 2188, 2338	760, 7F6, 88C, 922
4)	1 to 4	87, 237, 387, 537	57, ED, 183, 219	8)	1 to 4	89, 239, 389, 539	59, EF, 185, 21B
	5 to 8	687, 837, 987, 1137	2AF, 345, 3DB, 471		5 to 8	689, 839, 989, 1139	2B1, 347, 3DD, 473
	9 to 12	1287, 1437, 1587, 1737	507, 59D, 633, 6C9		9 to 12	1289, 1439, 1589, 1739	509, 59F, 635, 6CB
	13 to 16	1887, 2037, 2187, 2337	75F, 7F5, 88B, 921		13 to 16	1889, 2039, 2189, 2339	761, 7F7, 88D, 923

Screen example

No.	Axis	Buffer memory address		No.	Axis	Buffer memory address		
		DEC	HEX			DEC	HEX	
1)	1 to 4	70, 220, 370, 520	46, DC, 172, 208	4)	13 to 16	1872 to 1873, 2022 to 2023, 2172 to 2173, 2322 to 2323	750 to 751, 7E6 to 7E7, 87C to 87D, 912 to 913	
	5 to 8	670, 820, 970, 1120	29E, 334, 3CA, 460		5)	1 to 4	74 to 75, 224 to 225, 374 to 375, 524 to 525	4A to 4B, E0 to E1, 176 to 177, 20C to 20D
	9 to 12	1270, 1420, 1570, 1720	4F6, 58C, 622, 6B8			5 to 8	674 to 675, 824 to 825, 974 to 975, 1124 to 1125	2A2 to 2A3, 338 to 339, 3CE to 3CF, 464 to 465
	13 to 16	1870, 2020, 2170, 2320	74E, 7E4, 87A, 910			9 to 12	1274 to 1275, 1424 to 1425, 1574 to 1575, 1724 to 1725	4FA to 4FB, 590 to 591, 626 to 627, 6BC to 6BD
2)	1 to 4	71, 221, 371, 521	47, DD, 173, 209	6)	13 to 16	1874 to 1875, 2024 to 2025, 2174 to 2175, 2324 to 2325	752 to 753, 7E8 to 7E9, 87E to 87F, 914 to 915	
	5 to 8	671, 821, 971, 1121	29F, 335, 3CB, 461		1 to 4	76 to 77, 226 to 227, 376 to 377, 526 to 527	4C to 4D, E2 to E3, 178 to 179, 20E to 20F	
	9 to 12	1271, 1421, 1571, 1721	4F7, 58D, 623, 6B9		5 to 8	676 to 677, 826 to 827, 976 to 977, 1126 to 1127	2A4 to 2A5, 33A to 33B, 3D0 to 3D1, 466 to 467	
	13 to 16	1871, 2021, 2171, 2321	74F, 7E5, 87B, 911	9 to 12	1276 to 1277, 1426 to 1427, 1576 to 1577, 1726 to 1727	4FC to 4FD, 592 to 593, 628 to 629, 6BE to 6BF		
3)	1 to 4	78, 228, 378, 528	4E, E4, 17A, 210	6)	13 to 16	1876 to 1877, 2026 to 2027, 2176 to 2177, 2326 to 2327	754 to 755, 7EA to 7EB, 880 to 881, 916 to 917	
	5 to 8	678, 828, 978, 1128	2A6, 33C, 3D2, 468		1)	1 to 4	2416, 2516, 2616, 2716	970, 9D4, A38, A9C
	9 to 12	1278, 1428, 1578, 1728	4FE, 594, 62A, 6C0			5 to 8	2816, 2916, 3016, 3116	B00, B64, BC8, C2C
	13 to 16	1878, 2028, 2178, 2328	756, 7EC, 882, 918			9 to 12	3216, 3316, 3416, 3516	C90, CF4, D58, DBC
4)	1 to 4	72 to 73, 222 to 223, 372 to 373, 522 to 523	48 to 49, DE to DF, 174 to 175, 20A to 20B	2)	13 to 16	3616, 3716, 3816, 3916	E20, E84, EE8, F4C	
	5 to 8	672 to 673, 822 to 823, 972 to 973, 1122 to 1123	2A0 to 2A1, 336 to 337, 3CC to 3CD, 462 to 463		1 to 4	2417, 2517, 2617, 2717	971, 9D5, A39, A9D	
	9 to 12	1272 to 1273, 1422 to 1423, 1572 to 1573, 1722 to 1723	4F8 to 4F9, 58E to 58F, 624 to 625, 6BA to 6BB		5 to 8	2817, 2917, 3017, 3117	B01, B65, BC9, C2D	
	13 to 16	1872 to 1873, 2022 to 2023, 2172 to 2173, 2322 to 2323	74E to 74F, 7E4 to 7E5, 87A to 87B, 910 to 911		9 to 12	3217, 3317, 3417, 3517	C91, CF5, D59, DBD	

Screen example

No.	Axis	Buffer memory address		No.	Axis	Buffer memory address	
		DEC	HEX			DEC	HEX
1)	1 to 4	2416, 2516, 2616, 2716	970, 9D4, A38, A9C	2)	1 to 4	2417, 2517, 2617, 2717	971, 9D5, A39, A9D
	5 to 8	2816, 2916, 3016, 3116	B00, B64, BC8, C2C		5 to 8	2817, 2917, 3017, 3117	B01, B65, BC9, C2D
	9 to 12	3216, 3316, 3416, 3516	C90, CF4, D58, DBC		9 to 12	3217, 3317, 3417, 3517	C91, CF5, D59, DBD
	13 to 16	3616, 3716, 3816, 3916	E20, E84, EE8, F4C		13 to 16	3617, 3717, 3817, 3917	E21, E85, EE9, F4D

Screen example

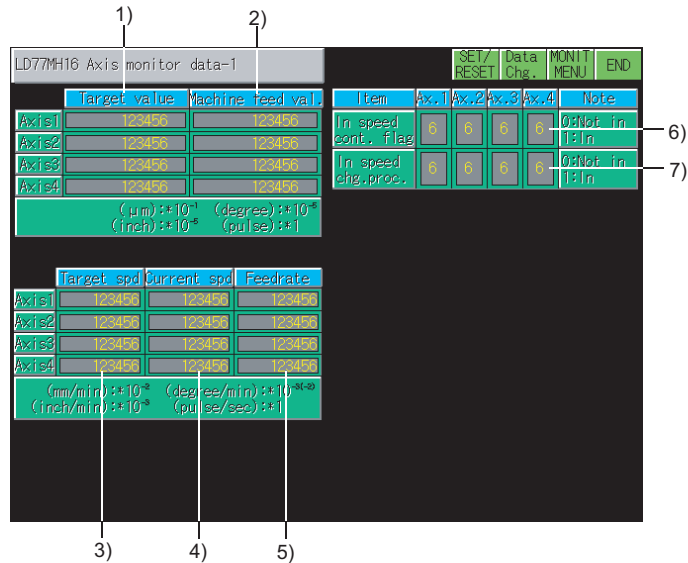

No.	Axis	Buffer memory address		No.	Axis	Buffer memory address	
		DEC	HEX			DEC	HEX
1)	1 to 4	2418 to 2419, 2518 to 2519, 2618 to 2619, 2718 to 2719	972 to 973, 9D6 to 9D7, A3A to A3B, A9E to A9F	4)	1 to 4	2410 to 2411, 2510 to 2511, 2610 to 2611, 2710 to 2711	96A to 96B, 9CE to 9CF, A32 to A33, A96 to A97
	5 to 8	2818 to 2819, 2918 to 2919, 3018 to 3019, 3118 to 3119	B02 to B03, B66 to B67, BCA to BCB, C2E to C2F		5 to 8	2810 to 2811, 2910 to 2911, 3010 to 3011, 3110 to 3111	AFA to AFB, B5E to B5F, BC2 to BC3, C26 to C27
	9 to 12	3218 to 3219, 3318 to 3319, 3418 to 3419, 3518 to 3519	C92 to C93, CF6 to CF7, D5A to D5B, DBE to DBF		9 to 12	3210 to 3211, 3310 to 3311, 3410 to 3411, 3510 to 3511	C8A to C8B, CEE to CEF, D52 to D53, DB6 to DB7
	13 to 16	3618 to 3619, 3718 to 3719, 3818 to 3819, 3918 to 3919	E22 to E23, E86 to E87, EEA to EEB, F4E to F4F		13 to 16	3610 to 3611, 3710 to 3711, 3810 to 3811, 3910 to 3911	E1A to E1B, E7E to E7F, EE2 to EE3, F46 to F47
2)	1 to 4	2402 to 2403, 2502 to 2503, 2602 to 2603, 2702 to 2703	962 to 963, 9C6 to 9C7, A2A to A2B, A8E to A8F	5)	1 to 4	2412 to 2413, 2512 to 2513, 2612 to 2613, 2712 to 2713	96C to 96D, 9D0 to 9D1, A34 to A35, A98 to A99
	5 to 8	2802 to 2803, 2902 to 2903, 3002 to 3003, 3102 to 3103	AF2 to AF3, B56 to B57, BBA to BBB, C1E to C1F		5 to 8	2812 to 2813, 2912 to 2913, 3012 to 3013, 3112 to 3113	AFC to AFD, B60 to B61, BC4 to BC5, C28 to C29
	9 to 12	3202 to 3203, 3302 to 3303, 3402 to 3403, 3502 to 3503	C82 to C83, CE6 to CE7, D4A to D4B, DAE to DAF		9 to 12	3212 to 3213, 3312 to 3313, 3412 to 3413, 3512 to 3513	C8C to C8D, CF0 to CF1, D54 to D55, DB8 to DB9
	13 to 16	3602 to 3603, 3702 to 3703, 3802 to 3803, 3902 to 3903	E12 to E13, E76 to E77, EDA to EDB, F3E to F3F		13 to 16	3612 to 3613, 3712 to 3713, 3812 to 3813, 3912 to 3913	E1C to E1D, E80 to E81, EE4 to EE5, F48 to F49
3)	1 to 4	2420 to 2421, 2520 to 2521, 2620 to 2621, 2720 to 2721	974 to 975, 9D8 to 9D9, A3C to A3D, AA0 to AA1	6)	1 to 4	2430, 2530, 2630, 2730	97E, 9E2, A46, AAA
	5 to 8	2820 to 2821, 2920 to 2921, 3020 to 3021, 3120 to 3121	B04 to B05, B68 to B69, BCC to BCD, C30 to C31		5 to 8	2830, 2930, 3030, 3130	B0E, B72, BD6, C3A
	9 to 12	3220 to 3221, 3320 to 3321, 3420 to 3421, 3520 to 3521	C94 to C95, CF8 to CF9, D5C to D5D, DC0 to DC1		9 to 12	3230, 3330, 3430, 3530	C9E, D02, D66, DCA
	13 to 16	3620 to 3621, 3720 to 3721, 3820 to 3821, 3920 to 3921	E24 to E25, E88 to E89, EEC to EED, F50 to F51	13 to 16	3630, 3730, 3830, 3930	E2E, E92, EF6, F5A	
7)	1 to 4	2420 to 2421, 2520 to 2521, 2620 to 2621, 2720 to 2721	974 to 975, 9D8 to 9D9, A3C to A3D, AA0 to AA1	7)	1 to 4	2431, 2531, 2631, 2731	97F, 9E3, A47, AAB
	5 to 8	2820 to 2821, 2920 to 2921, 3020 to 3021, 3120 to 3121	B04 to B05, B68 to B69, BCC to BCD, C30 to C31		5 to 8	2831, 2931, 3031, 3131	B0F, B73, BD7, C3B
	9 to 12	3220 to 3221, 3320 to 3321, 3420 to 3421, 3520 to 3521	C94 to C95, CF8 to CF9, D5C to D5D, DC0 to DC1		9 to 12	3231, 3331, 3431, 3531	C9F, D03, D67, DCB
	13 to 16	3620 to 3621, 3720 to 3721, 3820 to 3821, 3920 to 3921	E24 to E25, E88 to E89, EEC to EED, F50 to F51		13 to 16	3631, 3731, 3831, 3931	E2F, E93, EF7, F5B

Screen example

The screenshot shows the following components:

- 1)** Title bar: LD77MH16 Axis monitor data-2
- 2)** Navigation buttons: SET/RESET, Data Chg., MONIT MENU, END
- 3)** Special start data table:

Axis	Instr.	code	Instr. para	Data No.
1	56		456	456
2	56		456	456
3	56		456	456
4	56		456	456
- 8)** Special start repetition counter table:

Axis1	Axis2	Axis3	Axis4
456	456	456	456
- 9)** Control system repetition counter table:

Axis1	Axis2	Axis3	Axis4
3456	3456	3456	3456
- 4)** Data being executed table:

Axis	1st data pointer	Pos. data number	Block No.	Previous position
1	456	3456	456	3456
2	456	3456	456	3456
3	456	3456	456	3456
4	456	3456	456	3456
- 5)** Legend:

Instruction code:
 00:Block start(Normal start) 01:Condition start 02:Wait start
 03:Simultaneous start 04:FOR loop 05:FOR condition 06:NEXT

No.	Axis	Buffer memory address		No.	Axis	Buffer memory address	
		DEC	HEX			DEC	HEX
1)	1 to 4	2427, 2527, 2627, 2727	97B, 9DF, A43, AA7	6)	1 to 4	2436, 2536, 2636, 2736	984, 9E8, A4C, AB0
	5 to 8	2827, 2927, 3027, 3127	B0B, B6F, BD3, C37		5 to 8	2836, 2936, 3036, 3136	B14, B78, BDC, C40
	9 to 12	3227, 3327, 3427, 3527	C9B, CFF, D63, DC7		9 to 12	3236, 3336, 3436, 3536	CA4, D08, D6C, DD0
	13 to 16	3627, 3727, 3827, 3927	E2B, E8F, EF3, F57		13 to 16	3636, 3736, 3836, 3936	E34, E98, EFC, F60
2)	1 to 4	2428, 2528, 2628, 2728	97C, 9E0, A44, AA8	7)	1 to 4	2437, 2537, 2637, 2737	985, 9E9, A4D, AB1
	5 to 8	2828, 2928, 3028, 3128	B0C, B70, BD4, C38		5 to 8	2837, 2937, 3037, 3137	B15, B79, BDD, C41
	9 to 12	3228, 3328, 3428, 3528	C9C, D00, D64, DC8		9 to 12	3237, 3337, 3437, 3537	CA5, D09, D6D, DD1
	13 to 16	3628, 3728, 3828, 3928	E2C, E90, EF4, F58		13 to 16	3637, 3737, 3837, 3937	E35, E99, EFD, F61
3)	1 to 4	2429, 2529, 2629, 2729	97D, 9E1, A45, AA9	8)	1 to 4	2432, 2532, 2632, 2732	980, 9E4, A48, AAC
	5 to 8	2829, 2929, 3029, 3129	B0D, B71, BD5, C39		5 to 8	2832, 2932, 3032, 3132	B10, B74, BD8, C3C
	9 to 12	3229, 3329, 3429, 3529	C9D, D01, D65, DC9		9 to 12	3232, 3332, 3432, 3532	CA0, D04, D68, DCC
	13 to 16	3629, 3729, 3829, 3929	E2D, E91, EF5, F59		13 to 16	3632, 3732, 3832, 3932	E30, E94, EF8, F5C
4)	1 to 4	2434, 2534, 2634, 2734	982, 9E6, A4A, AAE	9)	1 to 4	2433, 2533, 2633, 2733	981, 9E5, A49, AAD
	5 to 8	2834, 2934, 3034, 3134	B12, B76, BDA, C3E		5 to 8	2833, 2933, 3033, 3133	B11, B75, BD9, C3D
	9 to 12	3234, 3334, 3434, 3534	CA2, D06, D6A, DCE		9 to 12	3233, 3333, 3433, 3533	CA1, D05, D69, DCD
	13 to 16	3634, 3734, 3834, 3934	E32, E96, EFA, F5E		13 to 16	3633, 3733, 3833, 3933	E31, E95, EF9, F5D
5)	1 to 4	2435, 2535, 2635, 2735	983, 9E7, A4B, AAF	-	-	-	-
	5 to 8	2835, 2935, 3035, 3135	B13, B77, BDB, C3F				
	9 to 12	3235, 3335, 3435, 3535	CA3, D07, D6B, DCF				
	13 to 16	3635, 3735, 3835, 3935	E33, E97, EFB, F5F				

- 1 OVERVIEW
- 2 SYSTEM MONITOR
- 3 LADDER MONITOR FUNCTION
- 4 MELSEC-A LIST EDITOR
- 5 MELSEC-FX LIST EDITOR
- 6 INTELLIGENT MODULE MONITOR
- 7 NETWORK MONITOR
- 8 Q MOTION MONITOR

Screen example

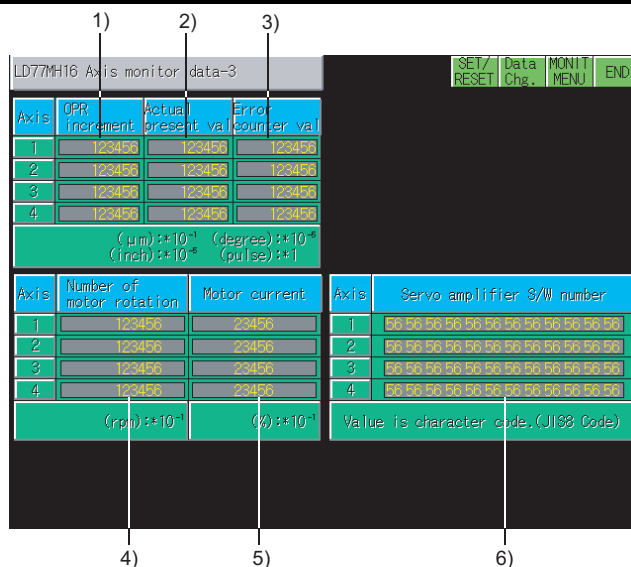

No.	Axis	Buffer memory address		No.	Axis	Buffer memory address	
		DEC	HEX			DEC	HEX
1)	1 to 4	2448 to 2449, 2548 to 2549, 2648 to 2649, 2748 to 2749	990 to 991, 9F4 to 9F5, A58 to A59, ABC to ABD	4)	1 to 4	2454 to 2455, 2554 to 2555, 2654 to 2655, 2754 to 2755	996 to 997, 9FA to 9FB, A5E to A5F, AC2 to AC3
	5 to 8	2848 to 2849, 2948 to 2949, 3048 to 3049, 3148 to 3149	B20 to B21, B84 to B85, BE8 to BE9, C4C to C4D		5 to 8	2854 to 2855, 2954 to 2955, 3054 to 3055, 3154 to 3155	B26 to B27, B8A to B8B, BEE to BEF, C52 to C53
	9 to 12	3248 to 3249, 3348 to 3349, 3448 to 3449, 3548 to 3549	CB0 to CB1, D14 to D15, D78 to D79, DDC to DDD		9 to 12	3254 to 3255, 3354 to 3355, 3454 to 3455, 3554 to 3555	CB6 to CB7, D1A to D1B, D7E to D7F, DE2 to DE3
	13 to 16	3648 to 3649, 3748 to 3749, 3848 to 3849, 3948 to 3949	E40 to E41, EA4 to EA5, F08 to F09, F6C to F6D		13 to 16	3654 to 3655, 3754 to 3755, 3854 to 3855, 3954 to 3955	E46 to E47, EAA to EAB, F0E to F0F, F72 to F73
2)	1 to 4	2450 to 2451, 2550 to 2551, 2650 to 2651, 2750 to 2751	992 to 993, 9F6 to 9F7, A5A to A5B, ABE to ABF	5)	1 to 4	2456, 2556, 2656, 2756	998, 9FC, A60, AC4
	5 to 8	2850 to 2851, 2950 to 2951, 3050 to 3051, 3150 to 3151	B22 to B23, B86 to B87, BEA to BEB, C4E to C4F		5 to 8	2856, 2956, 3056, 3156	B28, B8C, BF0, C54
	9 to 12	3250 to 3251, 3350 to 3351, 3450 to 3451, 3550 to 3551	CB2 to CB3, D16 to D17, D7A to D7B, DDE to DDF		9 to 12	3256, 3356, 3456, 3556	CB8, D1C, D80, DE4
	13 to 16	3650 to 3651, 3750 to 3751, 3850 to 3851, 3950 to 3951	E42 to E43, EA6 to EA7, FOA to F0B, F6E to F6F		13 to 16	3656, 3756, 3856, 3956	E48, EAC, F10, F74
3)	1 to 4	2452 to 2453, 2552 to 2553, 2652 to 2653, 2752 to 2753	994 to 995, 9F8 to 9F9, A5C to A5D, AC0 to AC1	6)	1 to 4	2464 to 2469, 2564 to 2569, 2664 to 2669, 2764 to 2769	9A0 to 9A5, A04 to A09, A68 to A6D, ACC to AD1
	5 to 8	2852 to 2853, 2952 to 2953, 3052 to 3053, 3152 to 3153	B24 to B25, B88 to B89, BEC to BED, C50 to C51		5 to 8	2864 to 2869, 2964 to 2969, 3064 to 3069, 3164 to 3169	B30 to B35, B94 to B99, BF8 to BFD, C5C to C61
	9 to 12	3252 to 3253, 3352 to 3353, 3452 to 3453, 3552 to 3553	CB4 to CB5, D18 to D19, D7C to D7D, DE0 to DE1		9 to 12	3264 to 3269, 3364 to 3369, 3464 to 3469, 3564 to 3569	CC0 to CC5, D24 to D29, D88 to D8D, DEC to DF1
	13 to 16	3652 to 3653, 3752 to 3753, 3852 to 3853, 3952 to 3953	E44 to E45, EA8 to EA9, F0C to F0D, F70 to F71		13 to 16	3664 to 3669, 3764 to 3769, 3864 to 3869, 3964 to 3969	E50 to E55, EB4 to EB9, F18 to F1D, F7C to F81

Screen example

The screenshot shows a menu with options: [SET/RESET], [Data Chg.], [MONIT MENU], and [END].

Parameter error No.

Axis1	Axis2	Axis3	Axis4
456	456	456	456

1) - Points to the parameter error numbers.

[Servo status]

Item	Ax.1	Ax.2	Ax.3	Ax.4
Zero point passed	●	●	●	●
Zero speed	●	●	●	●
Ready ON	●	●	●	●
Servo ON	●	●	●	●
Servo alarm	●	●	●	●
Imposition	●	●	●	●
Torque limit	●	●	●	●
Abs. value cleared	●	●	●	●
Warning	●	●	●	●

2) - Points to the servo status indicators.

3) - Points to the servo status indicators.

Parameter Error Details:

Item	Axis1	Axis2	Axis3	Axis4
Regenerative load ratio	456	456	456	456
Actual load ratio	456	456	456	456
Peak load ratio	456	456	456	456

4) - Points to Regenerative load ratio.
5) - Points to Actual load ratio.
6) - Points to Peak load ratio.

No.	Axis	Buffer memory address		No.	Axis	Buffer memory address	
		DEC	HEX			DEC	HEX
1)	1 to 4	2470, 2570, 2670, 2770	9A6, A0A, A6E, AD2	4)	1 to 4	2478, 2578, 2678, 2778	9AE, A12, A76, ADA
	5 to 8	2870, 2970, 3070, 3170	B36, B9A, BFE, C62		5 to 8	2878, 2978, 3078, 3178	B3E, BA2, C06, C6A
	9 to 12	3270, 3370, 3470, 3570	CC6, D2A, D8E, DF2		9 to 12	3278, 3378, 3478, 3578	CCE, D32, D96, DFA
	13 to 16	3670, 3770, 3870, 3970	E56, EBA, F1E, F82		13 to 16	3678, 3778, 3878, 3978	E5E, EC2, F26, F8A
2)	1 to 4	2476, 2576, 2676, 2776	9AC, A10, A74, AD8	5)	1 to 4	2479, 2579, 2679, 2779	9AF, A13, A77, ADB
	5 to 8	2876, 2976, 3076, 3176	B3C, BA0, C04, C68		5 to 8	2879, 2979, 3079, 3179	B3F, BA3, C07, C6B
	9 to 12	3276, 3376, 3476, 3576	CCC, D30, D94, DF8		9 to 12	3279, 3379, 3479, 3579	CCF, D33, D97, DFB
	13 to 16	3676, 3776, 3876, 3976	E5C, EC0, F24, F88		13 to 16	3679, 3779, 3879, 3979	E5F, EC3, F27, F8B
3)	1 to 4	2477, 2577, 2677, 2777	9AD, A11, A75, AD9	6)	1 to 4	2480, 2580, 2680, 2780	9B0, A14, A78, ADC
	5 to 8	2877, 2977, 3077, 3177	B3D, BA1, C05, C69		5 to 8	2880, 2980, 3080, 3180	B40, BA4, C08, C6C
	9 to 12	3277, 3377, 3477, 3577	CCD, D31, D95, DF9		9 to 12	3280, 3380, 3480, 3580	CD0, D34, D98, DFC
	13 to 16	3677, 3777, 3877, 3977	E5D, EC1, F25, F89		13 to 16	3680, 3780, 3880, 3980	E60, EC4, F28, F8C

Screen example

The screenshot shows a menu with options: [SET/RESET], [Data Chg.], [MONIT MENU], and [END].

Axis Travel after NPD ON

Axis	Travel after NPD ON
1	123456
2	123456
3	123456
4	123456

1) - Points to the travel after NPD ON values.

2) - Points to the torque limit settings.

Torque Limit Settings:

Axis	Torque limit stored value	Near point	Upper limit	Lower limit
1	3456 (%)	●	●	●
2	3456 (%)	●	●	●
3	3456 (%)	●	●	●
4	3456 (%)	●	●	●

3) - Points to the torque limit settings.

Unit conversion: (μm)::10⁻¹, (inch)::10⁻⁴, (degree)::10⁻¹, (pulse)::1

No.	Axis	Buffer memory address		No.	Axis	Buffer memory address	
		DEC	HEX			DEC	HEX
1)	1 to 4	2424 to 2425, 2524 to 2525, 2624 to 2625, 2724 to 2725	978 to 979, 9DC to 9DD, A40 to A41, AA4 to AA5	2)	1 to 4	2426, 2526, 2626, 2726	97A, 9DE, A42, AA6
	5 to 8	2824 to 2825, 2924 to 2925, 3024 to 3025, 3124 to 3125	B08 to B09, B6C to B6D, BD0 to BD1, C34 to C35		5 to 8	2826, 2926, 3026, 3126	B0A, B6E, BD2, C36
	9 to 12	3224 to 3225, 3324 to 3325, 3424 to 3425, 3524 to 3525	C98 to C99, CFC to CFD, D60 to D61, DC4 to DC5		9 to 12	3226, 3326, 3426, 3526	C9A, CFE, D62, DC6
	13 to 16	3624 to 3625, 3724 to 3725, 3824 to 3825, 3924 to 3925	E28 to E29, E8C to E8D, EF0 to EF1, F54 to F55		13 to 16	3626, 3726, 3826, 3926	E2A, E8E, EF2, F56
3)	1 to 4	2416, 2516, 2616, 2716	970, 9D4, A38, A9C	3)	1 to 4	2416, 2516, 2616, 2716	970, 9D4, A38, A9C
	5 to 8	2816, 2916, 3016, 3116	B00, B64, BC8, C2C		5 to 8	2816, 2916, 3016, 3116	B00, B64, BC8, C2C
	9 to 12	3216, 3316, 3416, 3516	C90, CF4, D58, DBC		9 to 12	3216, 3316, 3416, 3516	C90, CF4, D58, DBC
	13 to 16	3616, 3716, 3816, 3916	E20, E84, EE8, F4C		13 to 16	3616, 3716, 3816, 3916	E20, E84, EE8, F4C

Screen example

No.	Axis	Buffer memory address		No.	Axis	Buffer memory address	
		DEC	HEX			DEC	HEX
1)	1 to 4	2414 to 2415, 2514 to 2515, 2614 to 2615, 2714 to 2715	96E to 96F, 9D2 to 9D3, A36 to A37, A9A to A9B	2)	9 to 12	5126 to 5127, 5226 to 5227, 5326 to 5327, 5426 to 5427	1406 to 1407, 146A to 146B, 14CE to 14CF, 1532 to 1533
	5 to 8	2814 to 2815, 2914 to 2915, 3014 to 3015, 3114 to 3115	AFE to AFF, B62 to B63, BC6 to BC7, C2A to C2B		13 to 16	5526 to 5527, 5626 to 5627, 5726 to 5727, 5826 to 5827	1596 to 1597, 15FA to 15FB, 165E to 165F, 16C2 to 16C3
	9 to 12	3214 to 3215, 3314 to 3315, 3414 to 3415, 3514 to 3515	C8E to C8F, CF2 to CF3, D56 to D57, DBA to DBB	3)	1 to 4	2417, 2517, 2617, 2717	971, 9D5, A39, A9D
	13 to 16	3614 to 3615, 3714 to 3715, 3814 to 3815, 3914 to 3915	E1E to E1F, E82 to E83, EE6 to EE7, F4A to F4B		5 to 8	2817, 2917, 3017, 3117	B01, B65, BC9, C2D
2)	1 to 4	4326 to 4327, 4426 to 4427, 4526 to 4527, 4626 to 4627	10E6 to 10E7, 114A to 114B, 11AE to 11AF, 1212 to 1213	4)	1 to 4	4328, 4428, 4528, 4628	10E8, 114C, 11B0, 1214
	5 to 8	4726 to 4727, 4826 to 4827, 4926 to 4927, 5026 to 5027	1276 to 1277, 12DA to 12DB, 133E to 133F, 13A2 to 13A3		5 to 8	4728, 4828, 4928, 5028	1278, 12DC, 1340, 13A4
				9 to 12	5128, 5228, 5328, 5428	1408, 146C, 14D0, 1534	
				13 to 16	5528, 5628, 5728, 5828	1598, 15FC, 1660, 16C4	

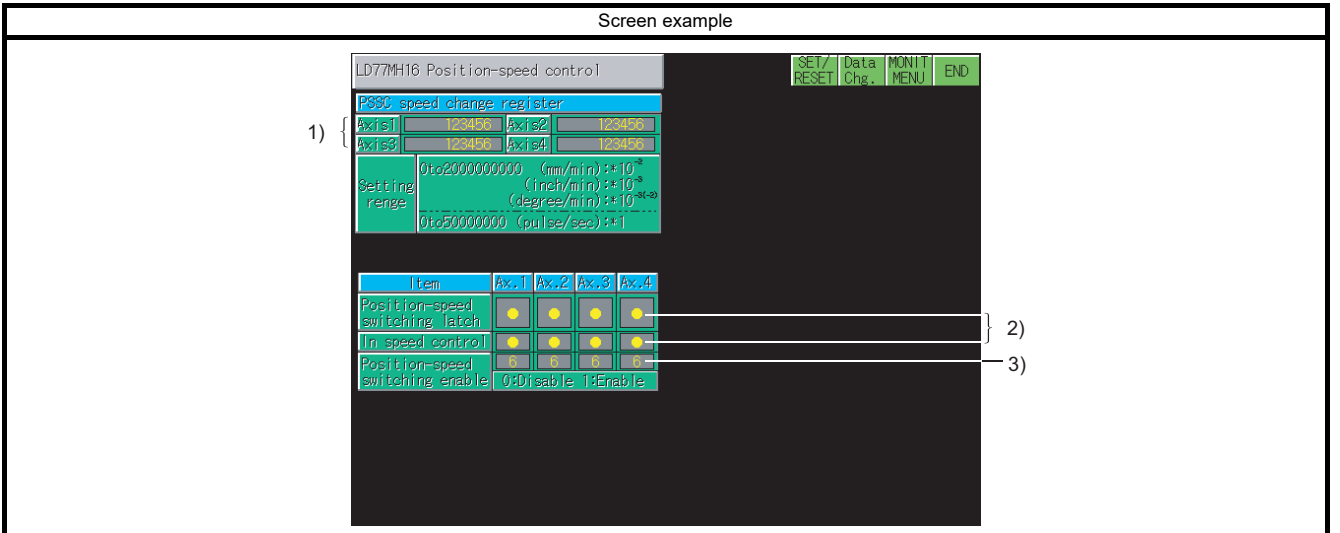

No.	Axis	Buffer memory address		No.	Axis	Buffer memory address	
		DEC	HEX			DEC	HEX
1)	1 to 4	4330 to 4331, 4430 to 4431, 4530 to 4531, 4630 to 4631	10EA to 10EB, 114E to 114F, 11B2 to 11B3, 1216 to 1217	2)	1 to 4	2417, 2517, 2617, 2717	971, 9D5, A39, A9D
	5 to 8	4730 to 4731, 4830 to 4831, 4930 to 4931, 5030 to 5031	127A to 127B, 12DE to 12DF, 1342 to 1343, 13A6 to 13A7		5 to 8	2817, 2917, 3017, 3117	B01, B65, BC9, C2D
	9 to 12	5130 to 5131, 5230 to 5231, 5330 to 5331, 5430 to 5431	140A to 140B, 146E to 146F, 14D2 to 14D3, 1536 to 1537		9 to 12	3217, 3317, 3417, 3517	C91, CF5, D59, DBD
	13 to 16	5530 to 5531, 5630 to 5631, 5730 to 5731, 5830 to 5831	159A to 159B, 15FE to 15FF, 1662 to 1663, 16C6 to 16C7	3)	13 to 16	3617, 3717, 3817, 3917	E21, E85, EE9, F4D
			1 to 4		4332, 4432, 4532, 4632	10EC, 1150, 11B4, 1218	
			5 to 8		4732, 4832, 4932, 5032	127C, 12E0, 1344, 13A8	
				9 to 12	5132, 5232, 5332, 5432	140C, 1470, 14D4, 1538	
				13 to 16	5532, 5632, 5732, 5832	159C, 1600, 1664, 16C8	

- 1
OVERVIEW
- 2
SYSTEM MONITOR
- 3
LADDER MONITOR FUNCTION
- 4
MELSEC-A LIST EDITOR
- 5
MELSEC-FX LIST EDITOR
- 6
INTELLIGENT MODULE MONITOR
- 7
NETWORK MONITOR
- 8
Q MOTION MONITOR

Screen example

The screenshot displays two main sections: 'New current value' and 'New speed value'. Each section has a table for setting values across four axes (Ax.1 to Ax.4) and a corresponding table for item settings.

1) New current value

Item	Ax.1	Ax.2	Ax.3	Ax.4	Set value
Torq. boost	6	6	6	6	1 to 30000
Step mode	6	6	6	6	0:Dec. unit 1:Data No.
Step valid flag	6	6	6	6	0:Invalid 1:Valid
Step start information	6	6	6	6	0:Completed 1:Continuing 2:Restarts

Setting range

Axis 1	123456	Axis 2	123456
Axis 3	123456	Axis 4	123456
-2147483648 (um):+10 ⁻¹			
to 2147483647 (inch):+10 ⁻⁵			
0 to 36888889 (pulse):+1			

2) New speed value

Item	Ax.1	Ax.2	Ax.3	Ax.4	Set value
Skip command	6	6	6	6	0:Completed 1:Skip
Use exit. command	6	6	6	6	0:Invalid 1:Valid

Setting range

Axis 1	123456	Axis 2	123456
Axis 3	123456	Axis 4	123456
0 to 200000000 (mm/min):+10 ⁰			
to 200000000 (inch/min):+10 ⁻⁵			
0 to 500000000 (pulse/sec):+1			

No.	Axis	Buffer memory address		No.	Axis	Buffer memory address	
		DEC	HEX			DEC	HEX
1)	1 to 4	4306 to 4307, 4406 to 4407, 4506 to 4507, 4606 to 4607	10D2 to 10D3, 1136 to 1137, 119A to 119B, 11FE to 11FF	3)	1 to 4	4313, 4413, 4513, 4613	10D9, 113D, 11A1, 1205
	5 to 8	4706 to 4707, 4806 to 4807, 4906 to 4907, 5006 to 5007	1262 to 1263, 12C6 to 12C7, 132A to 132B, 138E to 138F		5 to 8	4713, 4813, 4913, 5013	1269, 12CD, 1331, 1395
	9 to 12	5106 to 5107, 5206 to 5207, 5306 to 5307, 5406 to 5407	13F2 to 13F3, 1456 to 1457, 14BA to 14BB, 151E to 151F		9 to 12	5113, 5213, 5313, 5413	13F9, 145D, 14C1, 1525
	13 to 16	5506 to 5507, 5606 to 5607, 5706 to 5707, 5806 to 5807	1582 to 1583, 15E6 to 15E7, 164A to 164B, 16AE to 16AF		13 to 16	5513, 5613, 5713, 5813	1589, 15ED, 1651, 16B5
2)	1 to 4	4314 to 4315, 4414 to 4415, 4514 to 4515, 4614 to 4615	10DA to 10DB, 113E to 113F, 11A2 to 11A3, 1206 to 1207	6)	1 to 4	4346, 4446, 4546, 4646	10FA, 115E, 11C2, 1226
					5 to 8	4746, 4846, 4946, 5046	128A, 12EE, 1352, 13B6
					9 to 12	5146, 5246, 5346, 5446	141A, 147E, 14E2, 1546
					13 to 16	5546, 5646, 5746, 5846	15AA, 160E, 1672, 16D6
	5 to 8	4714 to 4715, 4814 to 4815, 4914 to 4915, 5014 to 5015	126A to 126B, 12CE to 12CF, 1332 to 1333, 1396 to 1397	7)	1 to 4	4347, 4447, 4547, 4647	10FB, 115F, 11C3, 1227
					5 to 8	4747, 4847, 4947, 5047	128B, 12EF, 1353, 13B7
					9 to 12	5147, 5247, 5347, 5447	141B, 147F, 14E3, 1547
					13 to 16	5547, 5647, 5747, 5847	15AB, 160F, 1673, 16D7
	9 to 12	5114 to 5115, 5214 to 5215, 5314 to 5315, 5414 to 5415	13FA to 13FB, 145E to 145F, 14C2 to 14C3, 1526 to 1527	8)	1 to 4	4305, 4405, 4505, 4605	10D1, 1135, 1199, 11FD
					5 to 8	4705, 4805, 4905, 5005	1261, 12C5, 1329, 138D
					9 to 12	5105, 5205, 5305, 5405	13F1, 1455, 14B9, 151D
					13 to 16	5505, 5605, 5705, 5805	1581, 15E5, 1649, 16AD

Screen example

LD77MH16 Axis control data-2					SET/ Data MONIT RESET Chg. MENU END				
Item	Axis1	Axis2	Axis3	Axis4	Item	Axis1	Axis2	Axis3	Axis4
1) Max. start No.	3456	3456	3456	3456	New acc. time	123456	123456	123456	123456
2) Start time point No.	56	56	56	56	New dec. time	123456	123456	123456	123456
3) Axis error reset	0	0	0	0	TRQ In	0	0	0	0
4) Restart command	0	0	0	0	Locus OP	0	0	0	0
5) M reset OFF request	0	0	0	0	OPR req. flag OFF	0	0	0	0
6) M/P time chg. in SPD chg. ON/OFF based	0	0	0	0	MFG I/P mag.	23456	23456	23456	23456
7) M/P time change request	0	0	0	0	MFG enable	0	0	0	0
					New Torq. value	3456	3456	3456	3456

No.	Axis	Buffer memory address		No.	Axis	Buffer memory address	
		DEC	HEX			DEC	HEX
1)	1 to 4	4300, 4400, 4500, 4600	10CC, 1130, 1194, 11F8	9)	1 to 4	4310 to 4311, 4410 to 4411, 4510 to 4511, 4610 to 4611	10D6 to 10D7, 113A to 113B, 119E to 119F, 1202 to 1203
	5 to 8	4700, 4800, 4900, 5000	125C, 12C0, 1324, 1388		5 to 8	4710 to 4711, 4810 to 4811, 4910 to 4911, 5010 to 5011	1266 to 1267, 12CA to 12CB, 132E to 132F, 1392 to 1393
	9 to 12	5100, 5200, 5300, 5400	13EC, 1450, 14B4, 1518		9 to 12	5110 to 5111, 5210 to 5211, 5310 to 5311, 5410 to 5411	13F6 to 13F7, 145A to 145B, 14BE to 14BF, 1522 to 1523
	13 to 16	5500, 5600, 5700, 5800	157C, 15E0, 1644, 16A8		13 to 16	5510 to 5511, 5610 to 5611, 5710 to 5711, 5810 to 5811	1586 to 1587, 15EA to 15EB, 164E to 164F, 16B2 to 16B3
2)	1 to 4	4301, 4401, 4501, 4601	10CD, 1131, 1195, 11F9	10)	1 to 4	4320, 4420, 4520, 4620	10E0, 1144, 11A8, 120C
	5 to 8	4701, 4801, 4901, 5001	125D, 12C1, 1325, 1389		5 to 8	4720, 4820, 4920, 5020	1270, 12D4, 1338, 139C
	9 to 12	5101, 5201, 5301, 5401	13ED, 1451, 14B5, 1519		9 to 12	5120, 5220, 5320, 5420	1400, 1464, 14C8, 152C
	13 to 16	5501, 5601, 5701, 5801	157D, 15E1, 1645, 16A9		13 to 16	5520, 5620, 5720, 5820	1590, 15F4, 1658, 16BC
3)	1 to 4	4302, 4402, 4502, 4602	10CE, 1132, 1196, 11FA	11)	1 to 4	4321, 4421, 4521, 4621	10E1, 1145, 11A9, 120D
	5 to 8	4702, 4802, 4902, 5002	125E, 12C2, 1326, 138A		5 to 8	4721, 4821, 4921, 5021	1271, 12D5, 1339, 139D
	9 to 12	5102, 5202, 5302, 5402	13EE, 1452, 14B6, 151A		9 to 12	5121, 5221, 5321, 5421	1401, 1465, 14C9, 152D
	13 to 16	5502, 5602, 5702, 5802	157E, 15E2, 1646, 16AA		13 to 16	5521, 5621, 5721, 5821	1591, 15F5, 1659, 16BD
4)	1 to 4	4303, 4403, 4503, 4603	10CF, 1133, 1197, 11FB	12)	1 to 4	4322 to 4323, 4422 to 4423, 4522 to 4523, 4622 to 4623	10E2 to 10E3, 1146 to 1147, 11AA to 11AB, 120E to 120F
	5 to 8	4703, 4803, 4903, 5003	125F, 12C3, 1327, 138B		5 to 8	4722 to 4723, 4822 to 4823, 4922 to 4923, 5022 to 5023	1272 to 1273, 12D6 to 12D7, 133A to 133B, 139E to 139F
	9 to 12	5103, 5203, 5303, 5403	13EF, 1453, 14B7, 151B		9 to 12	5122 to 5123, 5222 to 5223, 5322 to 5323, 5422 to 5423	1402 to 1403, 1466 to 1467, 14CA to 14CB, 152E to 152F
	13 to 16	5503, 5603, 5703, 5803	157F, 15E3, 1647, 16AB		13 to 16	5522 to 5523, 5622 to 5623, 5722 to 5723, 5822 to 5823	1592 to 1593, 15F6 to 15F7, 165A to 165B, 16BE to 16BF
5)	1 to 4	4304, 4404, 4504, 4604	10D0, 1134, 1198, 11FC	13)	1 to 4	4324, 4424, 4524, 4624	10E4, 1148, 11AC, 1210
	5 to 8	4704, 4804, 4904, 5004	1260, 12C4, 1328, 138C		5 to 8	4724, 4824, 4924, 5024	1274, 12D8, 133C, 13A0
	9 to 12	5104, 5204, 5304, 5404	13F0, 1454, 14B8, 151C		9 to 12	5124, 5224, 5324, 5424	1404, 1468, 14CC, 1530
	13 to 16	5504, 5604, 5704, 5804	1580, 15E4, 1648, 16AC		13 to 16	5524, 5624, 5724, 5824	1594, 15F8, 165C, 16C0
6)	1 to 4	4312, 4412, 4512, 4612	10D8, 113C, 11A0, 1204	14)	1 to 4	4325, 4425, 4525, 4625	10E5, 1149, 11AD, 1211
	5 to 8	4712, 4812, 4912, 5012	1268, 12CC, 1330, 1394		5 to 8	4725, 4825, 4925, 5025	1275, 12D9, 133D, 13A1
	9 to 12	5112, 5212, 5312, 5412	13F8, 145C, 14C0, 1524		9 to 12	5125, 5225, 5325, 5425	1405, 1469, 14CD, 1531
	13 to 16	5512, 5612, 5712, 5812	1588, 15EC, 1650, 16B4		13 to 16	5525, 5625, 5725, 5825	1595, 15F9, 165D, 16C1
7)	1 to 4	4316, 4416, 4516, 4616	10DC, 1140, 11A4, 1208				
	5 to 8	4716, 4816, 4916, 5016	126C, 12D0, 1334, 1398				
	9 to 12	5116, 5216, 5316, 5416	13FC, 1460, 14C4, 1528				
	13 to 16	5516, 5616, 5716, 5816	158C, 15F0, 1654, 16B8				
8)	1 to 4	4308 to 4309, 4408 to 4409, 4508 to 4509, 4608 to 4609	10D4 to 10D5, 1138 to 1139, 119C to 119D, 1200 to 1201				
	5 to 8	4708 to 4709, 4808 to 4809, 4908 to 4909, 5008 to 5009	1264 to 1265, 12C8 to 12C9, 132C to 132D, 1390 to 1391				
	9 to 12	5108 to 5109, 5208 to 5209, 5308 to 5309, 5408 to 5409	13F4 to 13F5, 1458 to 1459, 14BC to 14BD, 1520 to 1521				
	13 to 16	5508 to 5509, 5608 to 5609, 5708 to 5709, 5808 to 5809	1584 to 1585, 15E8 to 15E9, 164C to 164D, 16B0 to 16B1				

- 1 OVERVIEW
- 2 SYSTEM MONITOR
- 3 LADDER MONITOR FUNCTION
- 4 MELSEC-A LIST EDITOR
- 5 MELSEC-FX LIST EDITOR
- 6 INTELLIGENT MODULE MONITOR
- 7 NETWORK MONITOR
- 8 Q MOTION MONITOR

Screen example

The screenshot displays the 'LD77MH16 Axis control data-3' screen. It features a top navigation bar with buttons for 'SET/ Data', 'RESET Chg.', 'MONIT MENU', and 'END'. The main area is divided into several sections:

- 1) Simultaneous starting axis start data:** A table with columns for 'Item', 'Axis1', 'Axis2', 'Axis3', 'Axis4', and 'Data No.'. Values include '0' for 'Pos. change' and '456' for 'Axis No.1-3'.
- 2) Teaching data selection:** A table with columns for 'Item', 'Axis1', 'Axis2', 'Axis3', 'Axis4', and 'Data No.'. Values include '0' for 'Teaching' and '456' for 'Axis No.1-3'.
- 3) Teaching positioning data No.:** A table with columns for 'Item', 'Axis1', 'Axis2', 'Axis3', 'Axis4', and 'Data No.'. Values include '1 to 600' for 'Teaching' and '0' for 'Axis No.1-3'.
- 4) Direction in degrees:** A table with columns for 'Item', 'Axis1', 'Axis2', 'Axis3', 'Axis4', and 'Data No.'. Values include '0' for 'Dir.' and '0' for 'Axis No.1-3'.
- 5) Simultaneous starting axis:** A table with columns for 'Item', 'Axis1', 'Axis2', 'Axis3', 'Axis4', and 'Data No.'. Values include '0' for 'Dir.' and '56' for 'Axis No.1-3'.
- 6) SW OFF command:** A table with columns for 'Item', 'Axis1', 'Axis2', 'Axis3', 'Axis4', and 'Data No.'. Values include '0' for 'SW OFF' and '3456' for 'Torque output'.
- 7) Gain switch:** A table with columns for 'Item', 'Axis1', 'Axis2', 'Axis3', 'Axis4', and 'Data No.'. Values include '0' for 'Gain switch' and '0' for 'Axis No.1-3'.
- 8) P/I-PID chg.req.:** A table with columns for 'Item', 'Axis1', 'Axis2', 'Axis3', 'Axis4', and 'Data No.'. Values include '0' for 'P/I-PID chg.req.' and '0' for 'Axis No.1-3'.

No.	Axis	Buffer memory address		No.	Axis	Buffer memory address	
		DEC	HEX			DEC	HEX
1)	1 to 4	4338, 4438, 4538, 4638	10F2, 1156, 11BA, 121E	8)	1 to 4	4341, 4441, 4541, 4641	10F5, 1159, 11BD, 1221
	5 to 8	4738, 4838, 4938, 5038	1282, 12E6, 134A, 13AE		5 to 8	4741, 4841, 4941, 5041	1285, 12E9, 134D, 13B1
	9 to 12	5138, 5238, 5338, 5438	1412, 1476, 14DA, 153E		9 to 12	5141, 5241, 5341, 5441	1415, 1479, 14DD, 1541
	13 to 16	5538, 5638, 5738, 5838	15A2, 1606, 166A, 16CE		13 to 16	5541, 5641, 5741, 5841	15A5, 1609, 166D, 16D1
2)	1 to 4	4348, 4448, 4548, 4648	10FC, 1160, 11C4, 1228	9)	1 to 4	4343, 4443, 4543, 4643	10F7, 115B, 11BF, 1223
	5 to 8	4748, 4848, 4948, 5048	128C, 12F0, 1354, 13B8		5 to 8	4743, 4843, 4943, 5043	1287, 12EB, 134F, 13B3
	9 to 12	5148, 5248, 5348, 5448	141C, 1480, 14E4, 1548		9 to 12	5143, 5243, 5343, 5443	1417, 147B, 14DF, 1543
	13 to 16	5548, 5648, 5748, 5848	15AC, 1610, 1674, 16D8		13 to 16	5543, 5643, 5743, 5843	15A7, 160B, 166F, 16D3
3)	1 to 4	4349, 4449, 4549, 4649	10FD, 1161, 11C5, 1229	10)	1 to 4	4351, 4451, 4551, 4651	10FF, 1163, 11C7, 122B
	5 to 8	4749, 4849, 4949, 5049	128D, 12F1, 1355, 13B9		5 to 8	4751, 4851, 4951, 5051	128F, 12F3, 1357, 13BB
	9 to 12	5149, 5249, 5349, 5449	141D, 1481, 14E5, 1549		9 to 12	5151, 5251, 5351, 5451	141F, 1483, 14E7, 154B
	13 to 16	5549, 5649, 5749, 5849	15AD, 1611, 1675, 16D9		13 to 16	5551, 5651, 5751, 5851	15AF, 1613, 1677, 16DB
4)	1 to 4	4350, 4450, 4550, 4650	10FE, 1162, 11C6, 122A	11)	1 to 4	4352, 4452, 4552, 4652	1100, 1164, 11C8, 122C
	5 to 8	4750, 4850, 4950, 5050	128E, 12F2, 1356, 13BA		5 to 8	4752, 4852, 4952, 5052	1290, 12F4, 1358, 13BC
	9 to 12	5150, 5250, 5350, 5450	141E, 1482, 14E6, 154A		9 to 12	5152, 5252, 5352, 5452	1420, 1484, 14E8, 154C
	13 to 16	5550, 5650, 5750, 5850	15AE, 1612, 1676, 16DA		13 to 16	5552, 5652, 5752, 5852	15B0, 1614, 1678, 16DC
5)	1 to 4	4339, 4439, 4539, 4639	10F3, 1157, 11BB, 121F	12)	1 to 4	4359, 4459, 4559, 4659	1107, 116B, 11CF, 1233
	5 to 8	4739, 4839, 4939, 5039	1283, 12E7, 134B, 13AF		5 to 8	4759, 4859, 4959, 5059	1297, 12FB, 135F, 13C3
	9 to 12	5139, 5239, 5339, 5439	1413, 1477, 14DB, 153F		9 to 12	5159, 5259, 5359, 5459	1427, 148B, 14EF, 1553
	13 to 16	5539, 5639, 5739, 5839	15A3, 1607, 166B, 16CF		13 to 16	5559, 5659, 5759, 5859	15B7, 161B, 167F, 16E3
6)	1 to 4	4340, 4440, 4540, 4640	10F4, 1158, 11BC, 1220	13)	1 to 4	4365, 4465, 4565, 4665	110D, 1171, 11D5, 1239
	5 to 8	4740, 4840, 4940, 5040	1284, 12E8, 134C, 13B0		5 to 8	4765, 4865, 4965, 5065	129D, 1301, 1365, 13C9
	9 to 12	5140, 5240, 5340, 5440	1414, 1478, 14DC, 1540		9 to 12	5165, 5265, 5365, 5465	142D, 1491, 14F5, 1559
	13 to 16	5540, 5640, 5740, 5840	15A4, 1608, 166C, 16D0		13 to 16	5565, 5665, 5765, 5865	15BD, 1621, 1685, 16E9
7)	1 to 4	4341, 4441, 4541, 4641	10F5, 1159, 11BD, 1221	-	-	-	-
	5 to 8	4741, 4841, 4941, 5041	1285, 12E9, 134D, 13B1				
	9 to 12	5141, 5241, 5341, 5441	1415, 1479, 14DD, 1541				
	13 to 16	5541, 5641, 5741, 5841	15A5, 1609, 166D, 16D1				

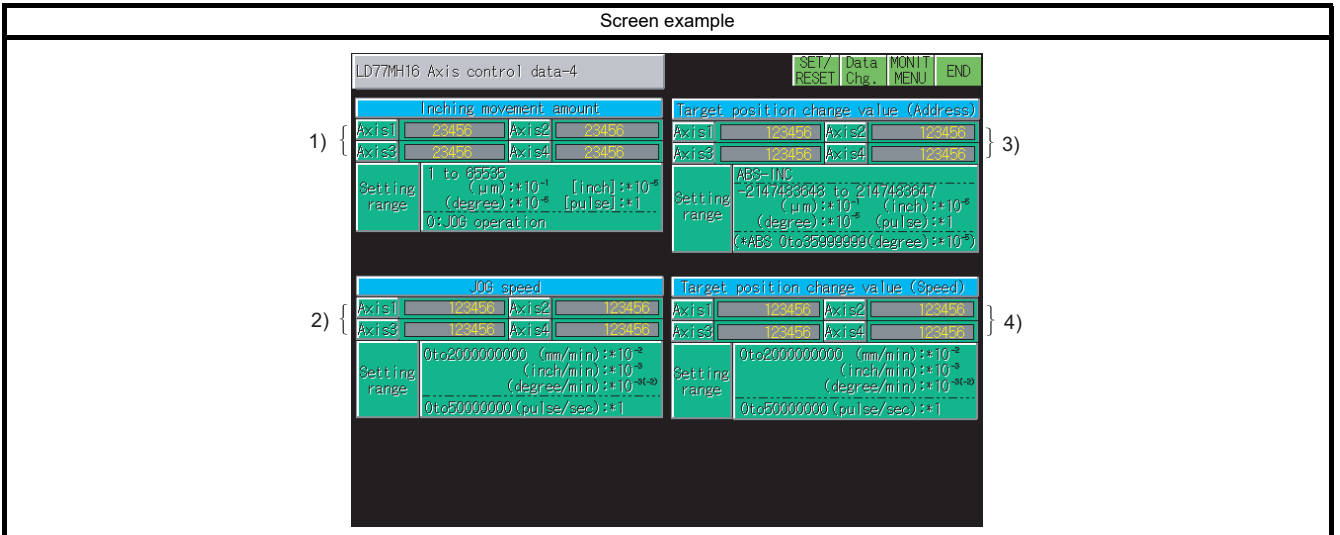

No.	Axis	Buffer memory address		No.	Axis	Buffer memory address	
		DEC	HEX			DEC	HEX
1)	1 to 4	4317, 4417, 4517, 4617	10DD, 1141, 11A5, 1209	3)	1 to 4	4334 to 4335, 4434 to 4435, 4534 to 4535, 4634 to 4635	10EE to 10EF, 1152 to 1153, 11B6 to 11B7, 121A to 121B
	5 to 8	4717, 4817, 4917, 5017	126D, 12D1, 1335, 1399		5 to 8	4734 to 4735, 4834 to 4835, 4934 to 4935, 5034 to 5035	127E to 127F, 12E2 to 12E3, 1346 to 1347, 13AA to 13AB
	9 to 12	5117, 5217, 5317, 5417	13FD, 1461, 14C5, 1529		9 to 12	5134 to 5135, 5234 to 5235, 5334 to 5335, 5434 to 5435	140E to 140F, 1472 to 1473, 14D6 to 14D7, 153A to 153B
	13 to 16	5517, 5617, 5717, 5817	158D, 15F1, 1655, 16B9		13 to 16	5534 to 5535, 5634 to 5635, 5734 to 5735, 5834 to 5835	159E to 159F, 1602 to 1603, 1666 to 1667, 16CA to 16CB
2)	1 to 4	4318 to 4319, 4418 to 4419, 4518 to 4519, 4618 to 4619	10DE to 10DF, 1142 to 1143, 11A6 to 11A7, 120A to 120B	4)	1 to 4	4336 to 4337, 4436 to 4437, 4536 to 4537, 4636 to 4637	10F0 to 10F1, 1154 to 1155, 11B8 to 11B9, 121C to 121D
	5 to 8	4718 to 4719, 4818 to 4819, 4918 to 4919, 5018 to 5019	126E to 126F, 12D2 to 12D3, 1336 to 1337, 139A to 139B		5 to 8	4736 to 4737, 4836 to 4837, 4936 to 4937, 5036 to 5037	1280 to 1281, 12E4 to 12E5, 1348 to 1349, 13AC to 13AD
	9 to 12	5118 to 5119, 5218 to 5219, 5318 to 5319, 5418 to 5419	13FE to 13FF, 1462 to 1463, 14C6 to 14C7, 152A to 152B		9 to 12	5136 to 5137, 5236 to 5237, 5336 to 5337, 5436 to 5437	1410 to 1411, 1474 to 1475, 14D8 to 14D9, 153C to 153D
	13 to 16	5518 to 5519, 5618 to 5619, 5718 to 5719, 5818 to 5819	158E to 158F, 15F2 to 15F3, 1656 to 1657, 16BA to 16BB		13 to 16	5536 to 5537, 5636 to 5637, 5736 to 5737, 5836 to 5837	15A0 to 15A1, 1604 to 1605, 1668 to 1669, 16CC to 16CD

- 1 OVERVIEW
- 2 SYSTEM MONITOR
- 3 LADDER MONITOR FUNCTION
- 4 MELSEC-A LIST EDITOR
- 5 MELSEC-FX LIST EDITOR
- 6 INTELLIGENT MODULE MONITOR
- 7 NETWORK MONITOR
- 8 Q MOTION MONITOR

Screen example

LD77MH16 Start History

SET/ Data MONIT
RESET Chg. MENU END

Start History (0 to 7)						
No.	Axis	Start	Kind	Time	Judge	
1)	1)	00	Re	0456	06 06 06 06 06 06	456
2)	2)	00	Re	0456	06 06 06 06 06 06	456
3)	3)	00	Re	0456	06 06 06 06 06 06	456
4)	4)	00	Re	0456	06 06 06 06 06 06	456
5)	5)	00	Re	0456	06 06 06 06 06 06	456
6)	6)	00	Re	0456	06 06 06 06 06 06	456
7)	7)	00	Re	0456	06 06 06 06 06 06	456
8)	8)	00	Re	0456	06 06 06 06 06 06	456

Start History (8 to 15)						
No.	Axis	Start	Kind	Time	Judge	
9)	9)	00	Re	0456	06 06 06 06 06 06	456
10)	10)	00	Re	0456	06 06 06 06 06 06	456
11)	11)	00	Re	0456	06 06 06 06 06 06	456
12)	12)	00	Re	0456	06 06 06 06 06 06	456
13)	13)	00	Re	0456	06 06 06 06 06 06	456
14)	14)	00	Re	0456	06 06 06 06 06 06	456
15)	15)	00	Re	0456	06 06 06 06 06 06	456
16)	16)	00	Re	0456	06 06 06 06 06 06	456

No.	Axis	Buffer memory address		No.	Axis	Buffer memory address	
		DEC	HEX			DEC	HEX
1)	-	4012 to 4016	FAC to FB0	9)	-	4052 to 4056	FD4 to FD8
2)	-	4017 to 4021	FB1 to FB5	10)	-	4057 to 4061	FD9 to FDD
3)	-	4022 to 4026	FB6 to FBA	11)	-	4062 to 4066	FDE to FE2
4)	-	4027 to 4031	FBB to FBF	12)	-	4067 to 4071	FE3 to FE7
5)	-	4032 to 4036	FC0 to FC4	13)	-	4072 to 4076	FE8 to FEC
6)	-	4037 to 4041	FC5 to FC9	14)	-	4077 to 4081	FED to FF1
7)	-	4042 to 4046	FCA to FCE	15)	-	4082 to 4086	FF2 to FF6
8)	-	4047 to 4051	FCF to FD3	16)	-	4087 to 4091	FF7 to FFB

Screen example

LD77MH16 Error & Warning History

SET/ Data MONIT
RESET Chg. MENU END

Error History (0 to 7)				Warning History (0 to 7)				
No.	Axis	Code	Time	No.	Axis	Code	Time	
1)	0)	56	456	06 06 06 06 06 06	0)	56	456	06 06 06 06 06 06
2)	1)	56	456	06 06 06 06 06 06	1)	56	456	06 06 06 06 06 06
3)	2)	56	456	06 06 06 06 06 06	2)	56	456	06 06 06 06 06 06
4)	3)	56	456	06 06 06 06 06 06	3)	56	456	06 06 06 06 06 06
5)	4)	56	456	06 06 06 06 06 06	4)	56	456	06 06 06 06 06 06
6)	5)	56	456	06 06 06 06 06 06	5)	56	456	06 06 06 06 06 06
7)	6)	56	456	06 06 06 06 06 06	6)	56	456	06 06 06 06 06 06
8)	7)	56	456	06 06 06 06 06 06	7)	56	456	06 06 06 06 06 06

Error History (8 to 15)				Warning History (8 to 15)				
No.	Axis	Code	Time	No.	Axis	Code	Time	
9)	8)	56	456	06 06 06 06 06 06	8)	56	456	06 06 06 06 06 06
10)	9)	56	456	06 06 06 06 06 06	9)	56	456	06 06 06 06 06 06
11)	10)	56	456	06 06 06 06 06 06	10)	56	456	06 06 06 06 06 06
12)	11)	56	456	06 06 06 06 06 06	11)	56	456	06 06 06 06 06 06
13)	12)	56	456	06 06 06 06 06 06	12)	56	456	06 06 06 06 06 06
14)	13)	56	456	06 06 06 06 06 06	13)	56	456	06 06 06 06 06 06
15)	14)	56	456	06 06 06 06 06 06	14)	56	456	06 06 06 06 06 06
16)	15)	56	456	06 06 06 06 06 06	15)	56	456	06 06 06 06 06 06

No.	Axis	Buffer memory address		No.	Axis	Buffer memory address		No.	Axis	Buffer memory address	
		DEC	HEX			DEC	HEX			DEC	HEX
1)	-	4093 to 4096	FFD to 1000	12)	-	4137 to 4140	1029 to 102C	23)	-	4182 to 4185	1056 to 1059
2)	-	4097 to 4100	1001 to 1004	13)	-	4141 to 4144	102D to 1030	24)	-	4186 to 4189	105A to 105D
3)	-	4101 to 4104	1005 to 1008	14)	-	4145 to 4148	1031 to 1034	25)	-	4190 to 4193	105E to 1061
4)	-	4105 to 4108	1009 to 100C	15)	-	4149 to 4152	1035 to 1038	26)	-	4194 to 4197	1062 to 1065
5)	-	4109 to 4112	100D to 1010	16)	-	4153 to 4156	1039 to 103C	27)	-	4198 to 4201	1066 to 1069
6)	-	4113 to 4116	1011 to 1014	17)	-	4158 to 4161	103E to 1041	28)	-	4202 to 4205	106A to 106D
7)	-	4117 to 4120	1015 to 1018	18)	-	4162 to 4165	1042 to 1045	29)	-	4206 to 4209	106E to 1071
8)	-	4121 to 4124	1019 to 101C	19)	-	4166 to 4169	1046 to 1049	30)	-	4210 to 4213	1072 to 1075
9)	-	4125 to 4128	101D to 1020	20)	-	4170 to 4173	104A to 104D	31)	-	4214 to 4217	1076 to 1079
10)	-	4129 to 4132	1021 to 1024	21)	-	4174 to 4177	104E to 1051	32)	-	4218 to 4221	107A to 107D
11)	-	4133 to 4136	1025 to 1028	22)	-	4178 to 4181	1052 to 1055	-	-	-	-

Screen example

LD77MH16 Positioning data										AREA	SET/	Data	MONIT	END	
										CHG	RESET	Chg.	MENU		
Axis1					Axis3										
No	Pat.	Int.	Cont.	Acc.	Dec.	Dwell	Mode	No	Pat.	Int.	Cont.	Acc.	Dec.	Dwell	Mode
	Address		Arc address		Instr. speed				Address		Arc address		Instr. speed		
1)	00	00	56	00	00	23456	23456	00	00	56	00	00	23456	23456	7)
	123456		123456		123456				123456		123456		123456		
2)	00	00	56	00	00	23456	23456	00	00	56	00	00	23456	23456	8)
	123456		123456		123456				123456		123456		123456		
3)	00	00	56	00	00	23456	23456	00	00	56	00	00	23456	23456	9)
	123456		123456		123456				123456		123456		123456		
Axis2					Axis4										
No	Pat.	Int.	Cont.	Acc.	Dec.	Dwell	Mode	No	Pat.	Int.	Cont.	Acc.	Dec.	Dwell	Mode
	Address		Arc address		Instr. speed				Address		Arc address		Instr. speed		
4)	00	00	56	00	00	23456	23456	00	00	56	00	00	23456	23456	10)
	123456		123456		123456				123456		123456		123456		
5)	00	00	56	00	00	23456	23456	00	00	56	00	00	23456	23456	11)
	123456		123456		123456				123456		123456		123456		
6)	00	00	56	00	00	23456	23456	00	00	56	00	00	23456	23456	12)
	123456		123456		123456				123456		123456		123456		
[Pattern] 00: Positioning complete 01: Continuous positioning control 11: Continuous path control [Control] 01H:RBS1 02H:INC1 03H:FEED1 04H:VF1 05H:VR1 06H:VRF 07H:VFR 08H:PVF 09H:PAR 09H:RBS2 08H:INC2 09H:FEED2 04H:RBS 0EH:INC 0FH:RBS_CW 10H:RBS_CW 11H:INC_CW 12H:INC_CW 13H:VF2 14H:VR2 15H:RBS3 16H:INC3 17H:FEED3 18H:VF3 19H:VR3 19H:RBS4 18H:INC4 1GH:FEED4 10H:VRF4 1EH:VR4 80H:NOP 81H:POS 82H:JUMP 83H:LOOP 84H:END															

No.	Axis	Buffer memory address		No.	Axis	Buffer memory address		No.	Axis	Buffer memory address	
		DEC	HEX			DEC	HEX			DEC	HEX
1)	1	6000 to 6002, 6004 to 6009	1770 to 1772, 1774 to 1779	5)	2	7010 to 7012, 7014 to 7019	1B62 to 1B64, 1B66 to 1B6B	9)	3	8020 to 8022, 8024 to 8029	1F54 to 1F56, 1F58 to 1F5D
	5	10000 to 10002, 10004 to 10009	2710 to 2712, 2714 to 2719		6	11010 to 11012, 11014 to 11019	2B02 to 2B04, 2B06 to 2B0B		7	12020 to 12022, 12024 to 12029	2EF4 to 2EF6, 2EF8 to 2EFD
	9	14000 to 14002, 14004 to 14009	36B0 to 36B2, 36B4 to 36B9		10	15010 to 15012, 15014 to 15019	3AA2 to 3AA4, 3AA6 to 3AAB		11	16020 to 16022, 16024 to 16029	3E94 to 3E96, 3E98 to 3E9D
	13	18000 to 18002, 18004 to 18009	4650 to 4652, 4654 to 4659		14	19010 to 19012, 19014 to 19019	4A42 to 4A44, 4A46 to 4A4B		15	20020 to 20022, 20024 to 20029	4E34 to 4E36, 4E38 to 4E3D
2)	1	6010 to 6012, 6014 to 6019	177A to 177C, 177E to 1783	6)	2	7020 to 7022, 7024 to 7029	1B6C to 1B6E, 1B70 to 1B75	10)	4	9000 to 9002, 9004 to 9009	2328 to 232A, 232C to 2331
	5	10010 to 10012, 10014 to 10019	271A to 271C, 271E to 2723		6	11020 to 11022, 11024 to 11029	2B0C to 2B0E, 2B10 to 2B15		8	13000 to 13002, 13004 to 13009	32C8 to 32CA, 32CC to 32D1
	9	14010 to 14012, 14014 to 14019	36BA to 36BC, 36BE to 36C3		10	15020 to 15022, 15024 to 15029	3AAC to 3AAE, 3AB0 to 3AB5		12	17000 to 17002, 17004 to 17009	4268 to 426A, 426C to 4271
	13	18010 to 18012, 18014 to 18019	465A to 465C, 465E to 4663		14	19020 to 19022, 19024 to 19029	4A4C to 4A4E, 4A50 to 4A55		16	21000 to 21002, 21004 to 21009	5208 to 520A, 520C to 5211
3)	1	6020 to 6022, 6024 to 6029	1784 to 1786, 1788 to 178D	7)	3	8000 to 8002, 8004 to 8009	1F40 to 1F42, 1F44 to 1F49	11)	4	9010 to 9012, 9014 to 9019	2332 to 2334, 2336 to 233B
	5	10020 to 10022, 10024 to 10029	2724 to 2726, 2728 to 272D		7	12000 to 12002, 12004 to 12009	2EE0 to 2EE2, 2EE4 to 2EE9		8	13010 to 13012, 13014 to 13019	32D2 to 32D4, 32D6 to 32DB
	9	14020 to 14022, 14024 to 14029	36C4 to 36C6, 36C8 to 36CD		11	16000 to 16002, 16004 to 16009	3E80 to 3E82, 3E84 to 3E89		12	17010 to 17012, 17014 to 17019	4272 to 4274, 4276 to 427B
	13	18020 to 18022, 18024 to 18029	4664 to 4666, 4668 to 466D		15	20000 to 20002, 20004 to 20009	4E20 to 4E22, 4E24 to 4E29		16	21010 to 21012, 21014 to 21019	5212 to 5214, 5216 to 521B
4)	2	7000 to 7002, 7004 to 7009	1B58 to 1B5A, 1B5C to 1B61	8)	3	8010 to 8012, 8014 to 8019	1F4A to 1F4C, 1F4E to 1F53	12)	4	9020 to 9022, 9024 to 9029	233C to 233E, 2340 to 2345
	6	11000 to 11002, 11004 to 11009	2AF8 to 2AFA, 2AFC to 2B01		7	12010 to 12012, 12014 to 12019	2EEA to 2EEC, 2EEE to 2EF3		8	13020 to 13022, 13024 to 13029	32DC to 32DE, 32E0 to 32E5
	10	15000 to 15002, 15004 to 15009	3A98 to 3A9A, 3A9C to 3AA1		11	16010 to 16012, 16014 to 16019	3E8A to 3E8C, 3E8E to 3E93		12	17020 to 17022, 17024 to 17029	427C to 427E, 4280 to 4285
	14	19000 to 19002, 19004 to 19009	4A38 to 4A3A, 4A3C to 4A41		15	20010 to 20012, 20014 to 20019	4E2A to 4E2C, 4E2E to 4E33		16	21020 to 21022, 21024 to 21029	521C to 521E, 5220 to 5225

1 OVERVIEW
2 SYSTEM MONITOR
3 LADDER MONITOR FUNCTION
4 MELSEC-A LIST EDITOR
5 MELSEC-FX LIST EDITOR
6 INTELLIGENT MODULE MONITOR
7 NETWORK MONITOR
8 Q MOTION MONITOR

Screen example

LD77MH16 Servo parameter Basic setting					SET/ Data MONIT	RESET Chg. MENU END
Item	Axis1	Axis2	Axis3	Axis4	Setting range	
1) Servo series	6	6	6	6	0:Invalid 1:MR-J3-B 3:MR-J3-B(Fully closed) 4:MR-J3-B(Linear) 6:MR-J3(Direct Drive)	
2) Selection of regenerative brake option	56	56	56	56	00:Not used 02:MR-R6032 03:MR-R612 04:MR-R632 05:MR-R650 06:MR-R650 03:MR-R631 04:MR-R651	
3) Load detection sys.	6	6	6	6	0:Invalid 1:Valid	
4) Func. selection A-I emergency stop input	6	6	6	6	0:Valid 1:Invalid	
5) Auto tuning Gain adjustment mode	6	6	6	6	0:Interpolation 1:Auto tuning1 3:Manual 2:Auto tuning2	
	56	56	56	56	1 2 16 32 Low Middle High 10Hz 60Hz 600Hz	
7) Lin. position range	23406	23456	23456	23456	0 to 65535[pulse]	
8) Rotation direction	6	6	6	6	0:CCW 1:CW	
9) Encoder output pulses	23406	23456	23456	23456	1 to 65535[pulse]	

No.	Axis	Buffer memory address		No.	Axis	Buffer memory address		No.	Axis	Buffer memory address	
		DEC	HEX			DEC	HEX			DEC	HEX
1)	1 to 4	28400, 28500, 28600, 28700	6EF0, 6F54, 6FB8, 701C	4)	1 to 4	28404, 28504, 28604, 28704	6EF4, 6F58, 6FBC, 7020	7)	1 to 4	28410, 28510, 28610, 28710	6EFA, 6F5E, 6FC2, 7026
	5 to 8	28800, 28900, 29000, 29100	7080, 70E4, 7148, 71AC		5 to 8	28804, 28904, 29004, 29104	7084, 70E8, 714C, 71B0		5 to 8	28810, 28910, 29010, 29110	708A, 70EE, 7152, 71B6
	9 to 12	29200, 29300, 29400, 29500	7210, 7274, 72D8, 733C		9 to 12	29204, 29304, 29404, 29504	7214, 7278, 72DC, 7340		9 to 12	29210, 29310, 29410, 29510	721A, 727E, 72E2, 7346
	13 to 16	29600, 29700, 29800, 29900	73A0, 7404, 7468, 74CC		13 to 16	29604, 29704, 29804, 29904	73A4, 7408, 746C, 74D0		13 to 16	29610, 29710, 29810, 29910	73AA, 740E, 7472, 74D6
2)	1 to 4	28402, 28502, 28602, 28702	6EF2, 6F56, 6FBA, 701E	5)	1 to 4	28408, 28508, 28608, 28708	6EF8, 6F5C, 6FC0, 7024	8)	1 to 4	28414, 28514, 28614, 28714	6EFE, 6F62, 6FC6, 702A
	5 to 8	28802, 28902, 29002, 29102	7082, 70E6, 714A, 71AE		5 to 8	28808, 28908, 29008, 29108	7088, 70EC, 7150, 71B4		5 to 8	28814, 28914, 29014, 29114	708E, 70F2, 7156, 71BA
	9 to 12	29202, 29302, 29402, 29502	7212, 7276, 72DA, 733E		9 to 12	29208, 29308, 29408, 29508	7218, 727C, 72E0, 7344		9 to 12	29214, 29314, 29414, 29514	721E, 7282, 72E6, 734A
	13 to 16	29602, 29702, 29802, 29902	73A2, 7406, 746A, 74CE		13 to 16	29608, 29708, 29808, 29908	73A8, 740C, 7470, 74D4		13 to 16	29614, 29714, 29814, 29914	73AE, 7412, 7476, 74DA
3)	1 to 4	28403, 28503, 28603, 28703	6EF3, 6F57, 6FBB, 701F	6)	1 to 4	28409, 28509, 28609, 28709	6EF9, 6F5D, 6FC1, 7025	9)	1 to 4	28415, 28515, 28615, 28715	6EFF, 6F63, 6FC7, 702B
	5 to 8	28803, 28903, 29003, 29103	7083, 70E7, 714B, 71AF		5 to 8	28809, 28909, 29009, 29109	7089, 70ED, 7151, 71B5		5 to 8	28815, 28915, 29015, 29115	708F, 70F3, 7157, 71BB
	9 to 12	29203, 29303, 29403, 29503	7213, 7277, 72DB, 733F		9 to 12	29209, 29309, 29409, 29509	7219, 727D, 72E1, 7345		9 to 12	29215, 29315, 29415, 29515	721F, 7283, 72E7, 734B
	13 to 16	29603, 29703, 29803, 29903	73A3, 7407, 746B, 74CF		13 to 16	29609, 29709, 29809, 29909	73A9, 740D, 7471, 74D5		13 to 16	29615, 29715, 29815, 29915	73AF, 7413, 7477, 74DB

Screen example

LD77MH16 Servo parameter Gain/Filter-1					SET/	Data	MONIT	END
					RESET	Chg.	MENU	
Item	Ax1s1	Ax1s2	Ax1s3	Ax1s4	Setting range			
1) Filter tuning mode	6	6	6	6	0:Filter OFF 1:Filter tuning 2:Manual			
2) Vibration suppression control tuning mode	6	6	6	6	0:Vibration control OFF 1:Vibration ctrl tuning 2:Manual			
3) Feed forward gain	456	456	456	456	0 to 100[%]			
4) Load inertia moment	3456	3456	3456	3456	0 to 3000(*10 ⁻⁴) [t·m ²]			
5) Motor loop gain	3456	3456	3456	3456	1 to 2000 [rad/s]			
6) Position loop gain	3456	3456	3456	3456	1 to 1000 [rad/s]			
7) Speed loop gain	23456	23456	23456	23456	20 to 50000 [rad/s]			
8) Speed integral comp	23456	23456	23456	23456	1 to 10000(*10 ⁻⁴) [ms]			
9) Speed differ. comp	3456	3456	3456	3456	0 to 1000(*10 ⁻⁴) [%]			
10) Resonance suppl. 1	3456	3456	3456	3456	100 to 4500 [Hz]			
11) Resonance suppl. 2	3456	3456	3456	3456	100 to 4500 [Hz]			
12) Low pass filter	23456	23456	23456	23456	100 to 18000 [rad/s]			
13) Low pass filter selection	6	6	6	6	0:Automatic setting 1:Manual setting			

No.	Axis	Buffer memory address		No.	Axis	Buffer memory address		No.	Axis	Buffer memory address					
		DEC	HEX			DEC	HEX			DEC	HEX				
1)	1 to 4	28419, 28519, 28619, 28719	6F03, 6F67, 6FCB, 702F	6)	1 to 4	28426, 28526, 28626, 28726	6F0A, 6F6E, 6FD2, 7036	11)	1 to 4	28433, 28533, 28633, 28733	6F11, 6F75, 6FD9, 703D				
	5 to 8	28819, 28919, 29019, 29119	7093, 70F7, 715B, 71BF		5 to 8	28826, 28926, 29026, 29126	709A, 70FE, 7162, 71C6		5 to 8	28833, 28933, 29033, 29133	70A1, 7105, 7169, 71CD				
	9 to 12	29219, 29319, 29419, 29519	7223, 7287, 72EB, 734F		9 to 12	29226, 29326, 29426, 29526	722A, 728E, 72F2, 7356		9 to 12	29233, 29333, 29433, 29533	7231, 7295, 72F9, 735D				
	13 to 16	29619, 29719, 29819, 29919	73B3, 7417, 747B, 74DF		13 to 16	29626, 29726, 29826, 29926	73BA, 741E, 7482, 74E6		13 to 16	29633, 29733, 29833, 29933	73C1, 7425, 7489, 74ED				
2)	1 to 4	28420, 28520, 28620, 28720	6F04, 6F68, 6FCC, 7030	7)	1 to 4	28427, 28527, 28627, 28727	6F0B, 6F6F, 6FD3, 7037	12)	1 to 4	28436, 28536, 28636, 28736	6F14, 6F78, 6FDC, 7040				
	5 to 8	28820, 28920, 29020, 29120	7094, 70F8, 715C, 71C0		5 to 8	28827, 28927, 29027, 29127	709B, 70FF, 7163, 71C7		5 to 8	28836, 28936, 29036, 29136	70A4, 7108, 716C, 71D0				
	9 to 12	29220, 29320, 29420, 29520	7224, 7288, 72EC, 7350		9 to 12	29227, 29327, 29427, 29527	722B, 728F, 72F3, 7357		9 to 12	29236, 29336, 29436, 29536	7234, 7298, 72FC, 7360				
	13 to 16	29620, 29720, 29820, 29920	73B4, 7418, 747C, 74E0		13 to 16	29627, 29727, 29827, 29927	73BB, 741F, 7483, 74E7		13 to 16	29636, 29736, 29836, 29936	73C4, 7428, 748C, 74F0				
3)	1 to 4	28422, 28522, 28622, 28722	6F06, 6F6A, 6FCE, 7032	8)	1 to 4	28428, 28528, 28628, 28728	6F0C, 6F70, 6FD4, 7038	13)	1 to 4	28441, 28541, 28641, 28741	6F19, 6F7D, 6FE1, 7045				
	5 to 8	28822, 28922, 29022, 29122	7096, 70FA, 715E, 71C2		5 to 8	28828, 28928, 29028, 29128	709C, 7100, 7164, 71C8		5 to 8	28841, 28941, 29041, 29141	70A9, 710D, 7171, 71D5				
	9 to 12	29222, 29322, 29422, 29522	7226, 728A, 72EE, 7352		9 to 12	29228, 29328, 29428, 29528	722C, 7290, 72F4, 7358		9 to 12	29241, 29341, 29441, 29541	7239, 729D, 7301, 7365				
	13 to 16	29622, 29722, 29822, 29922	73B6, 741A, 747E, 74E2		13 to 16	29628, 29728, 29828, 29928	73BC, 7420, 7484, 74E8		13 to 16	29641, 29741, 29841, 29941	73C9, 742D, 7491, 74F5				
4)	1 to 4	28424, 28524, 28624, 28724	6F08, 6F6C, 6FD0, 7034	9)	1 to 4	28429, 28529, 28629, 28729	6F0D, 6F71, 6FD5, 7039								
	5 to 8	28824, 28924, 29024, 29124	7098, 70FC, 7160, 71C4		5 to 8	28829, 28929, 29029, 29129	709D, 7101, 7165, 71C9								
	9 to 12	29224, 29324, 29424, 29524	7228, 728C, 72F0, 7354		9 to 12	29229, 29329, 29429, 29529	722D, 7291, 72F5, 7359								
	13 to 16	29624, 29724, 29824, 29924	73B8, 741C, 7480, 74E4		13 to 16	29629, 29729, 29829, 29929	73BD, 7421, 7485, 74E9								
5)	1 to 4	28425, 28525, 28625, 28725	6F09, 6F6D, 6FD1, 7035	10)	1 to 4	28431, 28531, 28631, 28731	6F0F, 6F73, 6FD7, 703B								
	5 to 8	28825, 28925, 29025, 29125	7099, 70FD, 7161, 71C5		5 to 8	28831, 28931, 29031, 29131	709F, 7103, 7167, 71CB								
	9 to 12	29225, 29325, 29425, 29525	7229, 728D, 72F1, 7355		9 to 12	29231, 29331, 29431, 29531	722F, 7293, 72F7, 735B								
	13 to 16	29625, 29725, 29825, 29925	73B9, 741D, 7481, 74E5		13 to 16	29631, 29731, 29831, 29931	73BF, 7423, 7487, 74EB								

1 OVERVIEW
2 SYSTEM MONITOR
3 LADDER MONITOR FUNCTION
4 MELSEC-A LIST EDITOR
5 MELSEC-FX LIST EDITOR
6 INTELLIGENT MODULE MONITOR
7 NETWORK MONITOR
8 Q MOTION MONITOR

Screen example

LD77MH16 Servo parameter Gain/Filter-2					SET/RESET	Data Chg.	MONI MENU	END
Item	Axis1	Axis2	Axis3	Axis4	Setting range			
1) Notch depth selection	6	6	6	6	0	1	2	3
					Deep	←	→	Wide
2) Notch width selection	6	6	6	6	0	1	2	3
					Standard	←	→	Wide
3) Resonance suppression filter 2	6	6	6	6	0	1	2	3
					Deep	←	→	Wide
4) Notch depth selection	6	6	6	6	0	1	2	3
					Deep	←	→	Wide
5) Notch width selection	6	6	6	6	0	1	2	3
					Standard	←	→	Wide
6) Vibration freq.	3450	3450	3450	3450	1 to 1000(×10 ⁻³) [Hz]			
7) Resonance freq.	3450	3450	3450	3450	1 to 1000(×10 ⁻³) [Hz]			
8) PI-PID switch-over selection	6	6	6	6	0	1	2	3
9) PI-PID switch-over selection	6	6	6	6	0:PI control is valid. 3:PID control is always valid.			

No.	Axis	Buffer memory address		No.	Axis	Buffer memory address		No.	Axis	Buffer memory address	
		DEC	HEX			DEC	HEX			DEC	HEX
1)	1 to 4	28400, 28500, 28600, 28700	6EF0, 6F54, 6FB8, 701C	4)	1 to 4	28404, 28504, 28604, 28704	6EF4, 6F58, 6FBC, 7020	7)	1 to 4	28410, 28510, 28610, 28710	6EFA, 6F5E, 6FC2, 7026
	5 to 8	28800, 28900, 29000, 29100	7080, 70E4, 7148, 71AC		5 to 8	28804, 28904, 29004, 29104	7084, 70E8, 714C, 71B0		5 to 8	28810, 28910, 29010, 29110	708A, 70EE, 7152, 71B6
	9 to 12	29200, 29300, 29400, 29500	7210, 7274, 72D8, 733C		9 to 12	29204, 29304, 29404, 29504	7214, 7278, 72DC, 7340		9 to 12	29210, 29310, 29410, 29510	721A, 727E, 72E2, 7346
	13 to 16	29600, 29700, 29800, 29900	73A0, 7404, 7468, 74CC		13 to 16	29604, 29704, 29804, 29904	73A4, 7408, 746C, 74D0		13 to 16	29610, 29710, 29810, 29910	73AA, 740E, 7472, 74D6
2)	1 to 4	28402, 28502, 28602, 28702	6EF2, 6F56, 6FBA, 701E	5)	1 to 4	28408, 28508, 28608, 28708	6EF8, 6F5C, 6FC0, 7024	8)	1 to 4	28414, 28514, 28614, 28714	6EFE, 6F62, 6FC6, 702A
	5 to 8	28802, 28902, 29002, 29102	7082, 70E6, 714A, 71AE		5 to 8	28808, 28908, 29008, 29108	7088, 70EC, 7150, 71B4		5 to 8	28814, 28914, 29014, 29114	708E, 70F2, 7156, 71BA
	9 to 12	29202, 29302, 29402, 29502	7212, 7276, 72DA, 733E		9 to 12	29208, 29308, 29408, 29508	7218, 727C, 72E0, 7344		9 to 12	29214, 29314, 29414, 29514	721E, 7282, 72E6, 734A
	13 to 16	29602, 29702, 29802, 29902	73A2, 7406, 746A, 74CE		13 to 16	29608, 29708, 29808, 29908	73A8, 740C, 7470, 74D4		13 to 16	29614, 29714, 29814, 29914	73AE, 7412, 7476, 74DA
3)	1 to 4	28403, 28503, 28603, 28703	6EF3, 6F57, 6FBB, 701F	6)	1 to 4	28409, 28509, 28609, 28709	6EF9, 6F5D, 6FC1, 7025	9)	1 to 4	28415, 28515, 28615, 28715	6EFF, 6F63, 6FC7, 702B
	5 to 8	28803, 28903, 29003, 29103	7083, 70E7, 714B, 71AF		5 to 8	28809, 28909, 29009, 29109	7089, 70ED, 7151, 71B5		5 to 8	28815, 28915, 29015, 29115	708F, 70F3, 7157, 71BB
	9 to 12	29203, 29303, 29403, 29503	7213, 7277, 72DB, 733F		9 to 12	29209, 29309, 29409, 29509	7219, 727D, 72E1, 7345		9 to 12	29215, 29315, 29415, 29515	721F, 7283, 72E7, 734B
	13 to 16	29603, 29703, 29803, 29903	73A3, 7407, 746B, 74CF		13 to 16	29609, 29709, 29809, 29909	73A9, 740D, 7471, 74D5		13 to 16	29615, 29715, 29815, 29915	73AF, 7413, 7477, 74DB

Screen example

LD77MH16 Servo parameter Gain/Filter-3					SET/	Data	MONIT	END
					RESET	Chg.	MENU	
Item	Axis1	Axis2	Axis3	Axis4	Setting range			
1) Gain switch condition	3456	3456	3456	3456	0 to 9999			
2) Over at gain switch	456	456	456	456	0 to 100[ms]			
3) Load inertia ratio to gain switch servo	3456	3456	3456	3456	0 to 3000(*10 ⁻¹)			
4) Position loop gain	3456	3456	3456	3456	1 to 2000[rad/s]			
5) Speed loop gain	23456	23456	23456	23456	20 to 50000[rad/s]			
6) Speed integral comp.	23456	23456	23456	23456	1 to 50000(*10 ⁻¹) [ms]			
7) Vibration freq setup	3456	3456	3456	3456	1 to 1000(*10 ⁻¹) [Hz]			
8) Resonance freq setup	3456	3456	3456	3456	1 to 1000(*10 ⁻¹) [Hz]			
Item	Axis1	Axis2	Axis3	Axis4				
Gain changing selection	56	56	56	56	9)			
ERROR MESSAGES 00: Invalid 01: Control command by the controller is effective. 02: Command frequency is more than P627. 03: (Motor encoder unit) Droop pulse is more than P627. 04: Model speed is more than P627. 12: Command frequency is less than P627. 13: (Motor encoder unit) Droop pulse is less than P627. 14: Model speed is less than P627.								

No.	Axis	Buffer memory address		No.	Axis	Buffer memory address	
		DEC	HEX			DEC	HEX
1)	1 to 4	28445, 28545, 28645, 28745	6F1D, 6F81, 6FE5, 7049	6)	1 to 4	28450, 28550, 28650, 28750	6F22, 6F86, 6FEA, 704E
	5 to 8	28845, 28945, 29045, 29145	70AD, 7111, 7175, 71D9		5 to 8	28850, 28950, 29050, 29150	70B2, 7116, 717A, 71DE
	9 to 12	29245, 29345, 29445, 29545	723D, 72A1, 7305, 7369		9 to 12	29250, 29350, 29450, 29550	7242, 72A6, 730A, 736E
	13 to 16	29645, 29745, 29845, 29945	73CD, 7431, 7495, 74F9		13 to 16	29650, 29750, 29850, 29950	73D2, 7436, 749A, 74FE
2)	1 to 4	28446, 28546, 28646, 28746	6F1E, 6F82, 6FE6, 704A	7)	1 to 4	28451, 28551, 28651, 28751	6F23, 6F87, 6FEB, 704F
	5 to 8	28846, 28946, 29046, 29146	70AE, 7112, 7176, 71DA		5 to 8	28851, 28951, 29051, 29151	70B3, 7117, 717B, 71DF
	9 to 12	29246, 29346, 29446, 29546	723E, 72A2, 7306, 736A		9 to 12	29251, 29351, 29451, 29551	7243, 72A7, 730B, 736F
	13 to 16	29646, 29746, 29846, 29946	73CE, 7432, 7496, 74FA		13 to 16	29651, 29751, 29851, 29951	73D3, 7437, 749B, 74FF
3)	1 to 4	28447, 28547, 28647, 28747	6F1F, 6F83, 6FE7, 704B	8)	1 to 4	28452, 28552, 28652, 28752	6F24, 6F88, 6FEC, 7050
	5 to 8	28847, 28947, 29047, 29147	70AF, 7113, 7177, 71DB		5 to 8	28852, 28952, 29052, 29152	70B4, 7118, 717C, 71E0
	9 to 12	29247, 29347, 29447, 29547	723F, 72A3, 7307, 736B		9 to 12	29252, 29352, 29452, 29552	7244, 72A8, 730C, 7370
	13 to 16	29647, 29747, 29847, 29947	73CF, 7433, 7497, 74FB		13 to 16	29652, 29752, 29852, 29952	73D4, 7438, 749C, 7500
4)	1 to 4	28448, 28548, 28648, 28748	6F20, 6F84, 6FE8, 704C	9)	1 to 4	28444, 28544, 28644, 28744	6F1C, 6F80, 6FE4, 7048
	5 to 8	28848, 28948, 29048, 29148	70B0, 7114, 7178, 71DC		5 to 8	28844, 28944, 29044, 29144	70AC, 7110, 7174, 71D8
	9 to 12	29248, 29348, 29448, 29548	7240, 72A4, 7308, 736C		9 to 12	29244, 29344, 29444, 29544	723C, 72A0, 7304, 7368
	13 to 16	29648, 29748, 29848, 29948	73D0, 7434, 7498, 74FC		13 to 16	29644, 29744, 29844, 29944	73CC, 7430, 7494, 74F8
5)	1 to 4	28449, 28549, 28649, 28749	6F21, 6F85, 6FE9, 704D	-	-	-	-
	5 to 8	28849, 28949, 29049, 29149	70B1, 7115, 7179, 71DD	-	-	-	-
	9 to 12	29249, 29349, 29449, 29549	7241, 72A5, 7309, 736D	-	-	-	-
	13 to 16	29649, 29749, 29849, 29949	73D1, 7435, 7499, 74FD	-	-	-	-

- 1 OVERVIEW
- 2 SYSTEM MONITOR
- 3 LADDER MONITOR FUNCTION
- 4 MELSEC-A LIST EDITOR
- 5 MELSEC-FX LIST EDITOR
- 6 INTELLIGENT MODULE MONITOR
- 7 NETWORK MONITOR
- 8 Q MOTION MONITOR

Screen example

LD77MH16 Servo parameter Ex. setting-1					SET/	Data	MONIT	END
					RESET	Chg.	MENU	
Item	Axis1	Axis2	Axis3	Axis4	Setting range			
1) Limit excessive level	450	450	450	450	1 to 200[rev]			
2) Error pulse timeout	456	3456	3456	3456	0 to 1000[ms]			
3) Encoder pulse output direction selection	6	6	6	6	0:CCW 1:CW (progress to A phases 90°)			
4) Encoder pulse output setting selection	6	6	6	6	0:Output pulse 4sgn. 1:Division ratio setting			
5) Function selection C1 Serial encoder cable	6	6	6	6	0:2-wire 1:4-wire			
6) Function selection C2 Motor-less operation	6	6	6	6	0:Invalid 1:Valid			
7) Zero speed	456	23456	23456	23456	0 to 10000[r/min]			

No.	Axis	Buffer memory address		No.	Axis	Buffer memory address	
		DEC	HEX			DEC	HEX
1)	1 to 4	28464, 28564, 28664, 28764	6F30, 6F94, 6FF8, 705C	5)	1 to 4	28467, 28567, 28667, 28767	6F33, 6F97, 6FFB, 705F
	5 to 8	28864, 28964, 29064, 29164	70C0, 7124, 7188, 71EC		5 to 8	28867, 28967, 29067, 29167	70C3, 7127, 718B, 71EF
	9 to 12	29264, 29364, 29464, 29564	7250, 72B4, 7318, 737C		9 to 12	29267, 29367, 29467, 29567	7253, 72B7, 731B, 737F
	13 to 16	29664, 29764, 29864, 29964	73E0, 7444, 74A8, 750C		13 to 16	29667, 29767, 29867, 29967	73E3, 7447, 74AB, 750F
2)	1 to 4	28465, 28565, 28665, 28765	6F31, 6F95, 6FF9, 705D	6)	1 to 4	28468, 28568, 28668, 28768	6F34, 6F98, 6FFC, 7060
	5 to 8	28865, 28965, 29065, 29165	70C1, 7125, 7189, 71ED		5 to 8	28868, 28968, 29068, 29168	70C4, 7128, 718C, 71F0
	9 to 12	29265, 29365, 29465, 29565	7251, 72B5, 7319, 737D		9 to 12	29268, 29368, 29468, 29568	7254, 72B8, 731C, 7380
	13 to 16	29665, 29765, 29865, 29965	73E1, 7445, 74A9, 750D		13 to 16	29668, 29768, 29868, 29968	73E4, 7448, 74AC, 7510
3)	1 to 4	28466, 28566, 28666, 28766	6F32, 6F96, 6FFA, 705E	7)	1 to 4	28470, 28570, 28670, 28770	6F36, 6F9A, 6FFE, 7062
	5 to 8	28866, 28966, 29066, 29166	70C2, 7126, 718A, 71EE		5 to 8	28870, 28970, 29070, 29170	70C6, 712A, 718E, 71F2
4)	9 to 12	29266, 29366, 29466, 29566	7252, 72B6, 731A, 737E		9 to 12	29270, 29370, 29470, 29570	7256, 72BA, 731E, 7382
	13 to 16	29666, 29766, 29866, 29966	73E2, 7446, 74AA, 750E		13 to 16	29670, 29770, 29870, 29970	73E6, 744A, 74AE, 7512

Screen example

LD77MH16 Servo parameter Ex. setting-2					SET/	Data	MONIT	END
					RESET	Chg.	MENU	
Item	Axis1	Axis2	Axis3	Axis4	Setting range			
Analog monitor 1 offset	3456	3456	3456	3456	000 to 999[mm]			
Analog monitor 2 offset	3456	3456	3456	3456	000 to 999[mm]			
Item	Axis1	Axis2	Axis3	Axis4				
Analog monitor output selection(ch1)	56	56	56	56				
Analog monitor output selection(ch2)	56	56	56	56				
Setting range								
0: Servo motor speed(±3V/max. speed)								
1: Torque(±3V/max. torque)								
2: Servo motor speed(±3V/max. speed)								
3: Torque(±3V/max. torque)								
4: Current command(±3V/max. current)								
5: Command speed(±3V/max. command speed)								
6: Droop pulse(±10V/100puls[Encoder unit])								
7: Droop pulse(±10V/1000puls[Encoder unit])								
8: Droop pulse(±10V/10000puls[Encoder unit])								
9: Droop pulse(±10V/100000puls[Encoder unit])								
A: Feedback position(±10V/1,000,000puls[Encoder unit])								
B: Feedback position(±10V/10,000,000puls[Encoder unit])								
C: Feedback position(±10V/100,000,000puls[Encoder unit])								
D: Bus voltage(±3V/400V, Amplifier of 200V)								
E: Bus voltage(±3V/300V, Amplifier of 400V)								
F: F-15~F3Un-output (Zero output)								

No.	Axis	Buffer memory address		No.	Axis	Buffer memory address	
		DEC	HEX			DEC	HEX
1)	1 to 4	28474, 28574, 28674, 28774	6F3A, 6F9E, 7002, 7066	3)	1 to 4	28472, 28572, 28672, 28772	6F38, 6F9C, 7000, 7064
	5 to 8	28874, 28974, 29074, 29174	70CA, 712E, 7192, 71F6		5 to 8	28872, 28972, 29072, 29172	70C8, 712C, 7190, 71F4
	9 to 12	29274, 29374, 29474, 29574	725A, 72BE, 7322, 7386		9 to 12	29272, 29372, 29472, 29572	7258, 72BC, 7320, 7384
	13 to 16	29674, 29774, 29874, 29974	73EA, 744E, 74B2, 7516		13 to 16	29672, 29772, 29872, 29972	73E8, 744C, 74B0, 7514
2)	1 to 4	28475, 28575, 28675, 28775	6F3B, 6F9F, 7003, 7067	4)	1 to 4	28473, 28573, 28673, 28773	6F39, 6F9D, 7001, 7065
	5 to 8	28875, 28975, 29075, 29175	70CB, 712F, 7193, 71F7		5 to 8	28873, 28973, 29073, 29173	70C9, 712D, 7191, 71F5
	9 to 12	29275, 29375, 29475, 29575	725B, 72BF, 7323, 7387		9 to 12	29273, 29373, 29473, 29573	7259, 72BD, 7321, 7385
	13 to 16	29675, 29775, 29875, 29975	73EB, 744F, 74B3, 7517		13 to 16	29673, 29773, 29873, 29973	73E9, 744D, 74B1, 7515

6.5.44 LD77MS4 module monitoring

Screen example		No.	Buffer memory address			
			DEC	HEX		
<p>LD77MS4 Operation Monitor</p> <p>Axis Current feed val. Axis feedrate</p> <p>Axis Start No. Operation pattern</p> <p>unit (μm):*10⁻¹ (mm/min):*10⁻² (degree):*10⁻³ (inch):*10⁻³ (pulse):*1</p> <p>Axis Status Unconnection/Amp. power OFF</p> <p>Axis Status Speed cont. in speed-pos.</p> <p>Axis Status Absolute position restore</p> <p>Emergency stop input</p>		1)	800, 812	320, 32C		
		2)	900, 912	384, 390		
		3)	1000, 1012	3E8, 3F4		
		4)	1100, 1112	44C, 458		
		5)	806 to 809	326 to 329		
		6)	906 to 909	38A to 38D		
		7)	1006 to 1009	3EE to 3F1		
		8)	1106 to 1109	452 to 455		
		9)	1431	597		
		10)	829, 838	33D, 346		
		11)	929, 938	3A1, 3AA		
		12)	1029, 1038	405, 40E		
		13)	1129, 1138	469, 472		
		14)	838	346		
		15)	938	3AA		
		16)	1038	40E		
		17)	1138	472		
<p>LD77MS4 Input/Output Monitor</p> <p>LD77 READY</p> <p>Synchronization</p> <p>Axis1 M code ON</p> <p>Axis2 M code ON</p> <p>Axis3 M code ON</p> <p>Axis4 M code ON</p> <p>Axis1 Error</p> <p>Axis2 Error</p> <p>Axis3 Error</p> <p>Axis4 Error</p> <p>Axis1 BUSY</p> <p>Axis2 BUSY</p> <p>Axis3 BUSY</p> <p>Axis4 BUSY</p> <p>PLC READY</p> <p>All Axis Servo ON</p> <p>Axis1 stop</p> <p>Axis2 stop</p> <p>Axis3 stop</p> <p>Axis4 stop</p> <p>Axis1 Pos. start</p> <p>Axis2 Pos. start</p> <p>Axis3 Pos. start</p> <p>Axis4 Pos. start</p> <p>Axis1 Pos. done</p> <p>Axis2 Pos. done</p> <p>Axis3 Pos. done</p> <p>Axis4 Pos. done</p> <p>Axis1 FWD JOG</p> <p>Axis1 RVS JOG</p> <p>Axis2 FWD JOG</p> <p>Axis2 RVS JOG</p> <p>Axis3 FWD JOG</p> <p>Axis3 RVS JOG</p> <p>Axis4 FWD JOG</p> <p>Axis4 RVS JOG</p>		1)	-	-		
		-	-	-		
		<p>LD77MS4 Basic parameters 1</p> <p>Item Axis1 Axis2 Axis3 Axis4</p> <p>Unit setting 0:mm 1:inch 2:degree 3:pulse</p> <p>Bias speed at start</p> <p>Movement amount per pulse</p> <p>Movement amount per rotation (A1)</p> <p>Unit magnification (Am)</p>		1)	0, 150, 300, 450	0, 96, 12C, 1C2
				2)	2 to 3, 152 to 153, 302 to 303, 452 to 453	2 to 3, 98 to 99, 12E to 12F, 1C4 to 1C5
				3)	1, 151, 301, 451	1, 97, 12D, 1C3
				4)	6 to 7, 156 to 157, 306 to 307, 456 to 457	6 to 7, 9C to 9D, 132 to 133, 1C8 to 1C9
				5)	4 to 5, 154 to 155, 304 to 305, 454 to 455	4 to 5, 9A to 9B, 130 to 131, 1C6 to 1C7
				-	-	-

1 OVERVIEW

2 SYSTEM MONITOR

3 LADDER MONITOR FUNCTION

4 MELSEC-A LIST EDITOR

5 MELSEC-FX LIST EDITOR

6 INTELLIGENT MODULE MONITOR

7 NETWORK MONITOR

8 Q MOTION MONITOR

Screen example		No.	Buffer memory address	
			DEC	HEX
		1)	10 to 11, 160 to 161, 310 to 311, 460 to 461	A to B, A0 to A1, 136 to 137, 1CC to 1CD
		2)	12 to 13, 162 to 163, 312 to 313, 462 to 463	C to D, A2 to A3, 138 to 139, 1CE to 1CF
		3)	14 to 15, 164 to 165, 314 to 315, 464 to 465	E to F, A4 to A5, 13A to 13B, 1D0 to 1D1
		1)	17, 167, 317, 467	11, A7, 13D, 1D3
		2)	18 to 19, 168 to 169, 318 to 319, 468 to 469	12 to 13, A8 to A9, 13E to 13F, 1D4 to 1D5
		3)	20 to 21, 170 to 171, 320 to 321, 470 to 471	14 to 15, AA to AB, 140 to 141, 1D6 to 1D7
		4)	33	21
		5)	22, 172, 322, 472	16, AC, 142, 1D8
		6)	23, 173, 323, 473	17, AD, 143, 1D9
		7)	26, 176, 326, 476	1A, B0, 146, 1DC
		1)	27, 177, 327, 477	1B, B1, 147, 1DD
		2)	28, 178, 328, 478	1C, B2, 148, 1DE
		3)	29, 179, 329, 479	1D, B3, 149, 1DF
		4)	24 to 25, 174 to 175, 324 to 325, 474 to 475	18 to 19, AE to AF, 144 to 145, 1DA to 1DB
		5)	30, 180, 330, 480	1F, B4, 14A, 1E0
		6)	31, 181, 331, 481	20, B5, 14B, 1E1
		7)	34, 184, 334, 484	22, B8, 14E, 1E4
		8)	32, 182, 332, 482	21, B6, 14C, 1E2
		9)	35	23

Screen example		No.	Buffer memory address	
			DEC	HEX
<p>LD77MS4 Detailed parameters 2-1</p> <p>1) JOG speed limit value</p> <p>2) JOG speed limit value</p> <p>3) JOG speed limit value</p> <p>4) JOG accel. time select</p> <p>5) JOG accel. time select</p> <p>6) JOG accel. time select</p>		1)	36 to 37, 186 to 187, 336 to 337, 486 to 487	24 to 25, BA to BB, 150 to 151, 1E6 to 1E7
		2)	38 to 39, 188 to 189, 338 to 339, 488 to 489	26 to 27, BC to BD, 152 to 153, 1E8 to 1E9
		3)	40 to 41, 190 to 191, 340 to 341, 490 to 491	28 to 29, BE to BF, 154 to 155, 1EA to 1EB
		4)	42 to 43, 192 to 193, 342 to 343, 492 to 493	2A to 2B, C0 to C1, 156 to 157, 1EC to 1ED
		5)	44 to 45, 194 to 195, 344 to 345, 494 to 495	2C to 2D, C2 to C3, 158 to 159, 1EE to 1EF
		6)	46 to 47, 196 to 197, 346 to 347, 496 to 497	2E to 2F, C4 to C5, 15A to 15B, 1F0 to 1F1
		7)	48 to 49, 198 to 199, 348 to 349, 498 to 499	30 to 31, C6 to C7, 15C to 15D, 1F2 to 1F3
		8)	50, 200, 350, 500	32, C8, 15E, 1F4
		9)	51, 201, 351, 501	33, C9, 15F, 1F5
<p>LD77MS4 Detailed parameters 2-2</p> <p>1) Allowed circular int. error width</p> <p>2) Allowed circular int. error width</p> <p>3) Allowed circular int. error width</p> <p>4) Allowed circular int. error width</p> <p>5) Allowed circular int. error width</p> <p>6) Allowed circular int. error width</p> <p>7) Allowed circular int. error width</p> <p>8) Allowed circular int. error width</p> <p>9) Allowed circular int. error width</p> <p>10) External command function selection</p> <p>11) External command function selection</p> <p>12) External command function selection</p>		1)	52, 202, 352, 502	34, CA, 160, 1F6
		2)	53, 203, 353, 503	35, CB, 161, 1F7
		3)	56, 206, 356, 506	38, CE, 164, 1FA
		4)	57, 207, 357, 507	39, CF, 165, 1FB
		5)	58, 208, 358, 508	3A, D0, 166, 1FC
		6)	54, 204, 354, 504	36, CC, 162, 1F8
		7)	59, 209, 359, 509	3B, D1, 167, 1FD
		8)	67, 217, 367, 517	43, D9, 16F, 205
		9)	60 to 61, 210 to 211, 360 to 361, 510 to 511	3C to 3D, D2 to D3, 168 to 169, 1FE to 1FF
		10)	62, 212, 362, 512	3E, D4, 16A, 200
		11)	63, 213, 363, 513	3F, D5, 16B, 201
		12)	64 to 65, 214 to 215, 364 to 365, 514 to 515	40 to 41, D6 to D7, 16C to 16D, 202 to 203
<p>LD77MS4 OPR detailed parameters</p> <p>1) OP shift amount</p> <p>2) OP shift amount</p> <p>3) OP shift amount</p> <p>4) OP shift amount</p> <p>5) OPR detailed parameters</p> <p>6) OPR detailed parameters</p> <p>7) OPR detailed parameters</p> <p>8) OPR detailed parameters</p>		1)	82, 232, 382, 532	52, E8, 17E, 214
		2)	83, 233, 383, 533	53, E9, 17F, 215
		3)	86, 236, 386, 536	56, EC, 182, 218
		4)	87, 237, 387, 537	57, ED, 183, 219
		5)	80 to 81, 230 to 231, 380 to 381, 530 to 531	50 to 51, E6 to E7, 17C to 17D, 212 to 213
		6)	84 to 85, 234 to 235, 384 to 385, 534 to 535	54 to 55, EA to EB, 180 to 181, 216 to 217
		7)	88, 238, 388, 538	58, EE, 184, 21A
		8)	89, 239, 389, 539	59, EF, 185, 21B

- 1 OVERVIEW
- 2 SYSTEM MONITOR
- 3 LADDER MONITOR FUNCTION
- 4 MELSEC-A LIST EDITOR
- 5 MELSEC-FX LIST EDITOR
- 6 INTELLIGENT MODULE MONITOR
- 7 NETWORK MONITOR
- 8 Q MOTION MONITOR

Screen example		No.	Buffer memory address	
			DEC	HEX
		1)	70, 220, 370, 520	46, DC, 172, 208
		2)	71, 221, 371, 521	47, DD, 173, 209
		3)	78, 228, 378, 528	4E, E4, 17A, 210
		4)	72 to 73, 222 to 223, 372 to 373, 522 to 523	48 to 49, DE to DF, 174 to 175, 20A to 20B
		5)	74 to 75, 224 to 225, 374 to 375, 524 to 525	4A to 4B, E0 to E1, 176 to 177, 20C to 20D
		6)	76 to 77, 226 to 227, 376 to 377, 526 to 527	4C to 4D, E2 to E3, 178 to 179, 20E to 20F
		-	-	-
		1)	816	330
		2)	916	394
		3)	1016	3F8
		4)	1116	45C
		5)	817	331
		6)	917	395
		7)	1017	3F9
		8)	1117	45D
		-	-	-
		1)	818 to 819, 802 to 803	332 to 333, 322 to 323
		2)	918 to 919, 902 to 903	396 to 397, 386 to 387
		3)	1018 to 1019, 1002 to 1003	3FA to 3FB, 3EA to 3EB
		4)	1118 to 1119, 1102 to 1103	45E to 45F, 44E to 44F
		5)	820 to 821, 810 to 811, 812 to 813	334 to 335, 32A to 32B, 32C to 32D
		6)	920 to 921, 910 to 911, 912 to 913	398 to 399, 38E to 38F, 390 to 391
		7)	1020 to 1021, 1010 to 1011, 1012 to 1013	3FC to 3FD, 3F2 to 3F3, 3F4 to 3F5
		8)	1120 to 1121, 1110 to 1111, 1112 to 1113	460 to 461, 456 to 457, 458 to 459
		9)	830, 930, 1030, 1130	33E, 3A2, 406, 46A
		10)	831, 931, 1031, 1131	33F, 3A3, 407, 46B
		-	-	-

Screen example					No.	Buffer memory address																																																																																																																							
						DEC	HEX																																																																																																																						
<p>LD77MS4 Axis monitor data-2</p> <table border="1"> <tr> <td colspan="4">Special start data</td> <td colspan="4">Special start repetition counter</td> </tr> <tr> <th>Axis</th> <th>Instr. code</th> <th>Instr. para</th> <th>Data No.</th> <th>Axis1</th> <th>Axis2</th> <th>Axis3</th> <th>Axis4</th> </tr> <tr> <td>1)</td> <td>12</td> <td>123</td> <td>123</td> <td>123</td> <td>123</td> <td>123</td> <td>123</td> </tr> <tr> <td>2)</td> <td>12</td> <td>123</td> <td>123</td> <td colspan="4">Control system repetition counter</td> </tr> <tr> <td>3)</td> <td>12</td> <td>123</td> <td>123</td> <td>Axis1</td> <td>Axis2</td> <td>Axis3</td> <td>Axis4</td> </tr> <tr> <td>4)</td> <td>12</td> <td>123</td> <td>123</td> <td>1234</td> <td>1234</td> <td>1234</td> <td>1234</td> </tr> </table> <table border="1"> <tr> <td colspan="4">Data being executed</td> <td>Previous position</td> </tr> <tr> <th>Axis</th> <th>1st data pointer</th> <th>Pos. data number</th> <th>Block No.</th> <th></th> </tr> <tr> <td>5)</td> <td>123</td> <td>1234</td> <td>123</td> <td>1234</td> </tr> <tr> <td>6)</td> <td>123</td> <td>1234</td> <td>123</td> <td>1234</td> </tr> <tr> <td>7)</td> <td>123</td> <td>1234</td> <td>123</td> <td>1234</td> </tr> <tr> <td>8)</td> <td>123</td> <td>1234</td> <td>123</td> <td>1234</td> </tr> </table> <p>[Instruction code] 00:Block start(Normal start) 01:Condition start 02:Wait start 03:Simultaneous start 04:FOR loop 05:FOR condition 06:NEXT</p>					Special start data				Special start repetition counter				Axis	Instr. code	Instr. para	Data No.	Axis1	Axis2	Axis3	Axis4	1)	12	123	123	123	123	123	123	2)	12	123	123	Control system repetition counter				3)	12	123	123	Axis1	Axis2	Axis3	Axis4	4)	12	123	123	1234	1234	1234	1234	Data being executed				Previous position	Axis	1st data pointer	Pos. data number	Block No.		5)	123	1234	123	1234	6)	123	1234	123	1234	7)	123	1234	123	1234	8)	123	1234	123	1234	1)	827 to 829	33B to 33D																																								
Special start data				Special start repetition counter																																																																																																																									
Axis	Instr. code	Instr. para	Data No.	Axis1	Axis2	Axis3	Axis4																																																																																																																						
1)	12	123	123	123	123	123	123																																																																																																																						
2)	12	123	123	Control system repetition counter																																																																																																																									
3)	12	123	123	Axis1	Axis2	Axis3	Axis4																																																																																																																						
4)	12	123	123	1234	1234	1234	1234																																																																																																																						
Data being executed				Previous position																																																																																																																									
Axis	1st data pointer	Pos. data number	Block No.																																																																																																																										
5)	123	1234	123	1234																																																																																																																									
6)	123	1234	123	1234																																																																																																																									
7)	123	1234	123	1234																																																																																																																									
8)	123	1234	123	1234																																																																																																																									
					2)	927 to 929	39F to 3A1																																																																																																																						
					3)	1027 to 1029	403 to 405																																																																																																																						
					4)	1127 to 1129	467 to 469																																																																																																																						
					5)	834 to 837	342 to 345																																																																																																																						
					6)	934 to 937	3A6 to 3A9																																																																																																																						
					7)	1034 to 1037	40A to 40D																																																																																																																						
					8)	1134 to 1137	46E to 471																																																																																																																						
					9)	832, 932, 1032, 1132	340, 3A4, 408, 46C																																																																																																																						
					10)	833, 933, 1033, 1133	341, 3A5, 409, 46D																																																																																																																						
					-	-	-																																																																																																																						
<p>LD77MS4 Axis monitor data-3</p> <table border="1"> <tr> <th>Axis</th> <th>OPR increment</th> <th>Actual present val</th> <th>Error counter val</th> </tr> <tr> <td>1)</td> <td>123456</td> <td>123456</td> <td>123456</td> </tr> <tr> <td>2)</td> <td>123456</td> <td>123456</td> <td>123456</td> </tr> <tr> <td>3)</td> <td>123456</td> <td>123456</td> <td>123456</td> </tr> <tr> <td>4)</td> <td>123456</td> <td>123456</td> <td>123456</td> </tr> </table> <p>(μm):$\times 10^{-1}$ (degree):$\times 10^{-5}$ (inch):$\times 10^{-5}$ (pulse):$\times 1$</p> <table border="1"> <tr> <th>Axis</th> <th>Number of motor rotation</th> <th>Motor current</th> <th>Axis</th> <th>Servo amplifier S/W number</th> </tr> <tr> <td>5)</td> <td>123456</td> <td>12345</td> <td>1</td> <td>12 12 12 12 12 12 12 12 12 12</td> </tr> <tr> <td>6)</td> <td>123456</td> <td>12345</td> <td>2</td> <td>12 12 12 12 12 12 12 12 12 12</td> </tr> <tr> <td>7)</td> <td>123456</td> <td>12345</td> <td>3</td> <td>12 12 12 12 12 12 12 12 12 12</td> </tr> <tr> <td>8)</td> <td>123456</td> <td>12345</td> <td>4</td> <td>12 12 12 12 12 12 12 12 12 12</td> </tr> </table> <p>(rpm):$\times 10^{-1}$ (%) :$\times 10^{-1}$ Value is character code. (J188 Code)</p>					Axis	OPR increment	Actual present val	Error counter val	1)	123456	123456	123456	2)	123456	123456	123456	3)	123456	123456	123456	4)	123456	123456	123456	Axis	Number of motor rotation	Motor current	Axis	Servo amplifier S/W number	5)	123456	12345	1	12 12 12 12 12 12 12 12 12 12	6)	123456	12345	2	12 12 12 12 12 12 12 12 12 12	7)	123456	12345	3	12 12 12 12 12 12 12 12 12 12	8)	123456	12345	4	12 12 12 12 12 12 12 12 12 12	1)	848 to 849, 850 to 851, 852 to 853	350 to 351, 352 to 353, 354 to 355																																																																									
Axis	OPR increment	Actual present val	Error counter val																																																																																																																										
1)	123456	123456	123456																																																																																																																										
2)	123456	123456	123456																																																																																																																										
3)	123456	123456	123456																																																																																																																										
4)	123456	123456	123456																																																																																																																										
Axis	Number of motor rotation	Motor current	Axis	Servo amplifier S/W number																																																																																																																									
5)	123456	12345	1	12 12 12 12 12 12 12 12 12 12																																																																																																																									
6)	123456	12345	2	12 12 12 12 12 12 12 12 12 12																																																																																																																									
7)	123456	12345	3	12 12 12 12 12 12 12 12 12 12																																																																																																																									
8)	123456	12345	4	12 12 12 12 12 12 12 12 12 12																																																																																																																									
					2)	948 to 949, 950 to 951, 952 to 953	3B4 to 3B5, 3B6 to 3B7, 3B8 to 3B9																																																																																																																						
					3)	1048 to 1049, 1050 to 1051, 1052 to 1053	418 to 419, 41A to 41B, 41C to 41D																																																																																																																						
					4)	1148 to 1149, 1150 to 1151, 1152 to 1153	47C to 47D, 47E to 47F, 480 to 481																																																																																																																						
					5)	854 to 855, 856 to 857	356 to 357, 358 to 359																																																																																																																						
					6)	954 to 955, 956 to 957	3BA to 3BB, 3BC to 3BD																																																																																																																						
					7)	1054 to 1055, 1056 to 1057	41E to 41F, 420 to 421																																																																																																																						
					8)	1154 to 1155, 1156 to 1157	480 to 481, 482 to 483																																																																																																																						
					9)	864 to 869	360 to 365																																																																																																																						
					10)	964 to 969	3C4 to 3C9																																																																																																																						
					11)	1064 to 1069	428 to 42D																																																																																																																						
					12)	1164 to 1169	48C to 491																																																																																																																						
					-	-	-																																																																																																																						
<p>LD77MS4 Axis monitor data-4</p> <table border="1"> <tr> <th colspan="4">Parameter error No.</th> <th colspan="4">[Servo status]</th> </tr> <tr> <th>Axis1</th> <th>Axis2</th> <th>Axis3</th> <th>Axis4</th> <th>Item</th> <th>Ax.1</th> <th>Ax.2</th> <th>Ax.3</th> <th>Ax.4</th> </tr> <tr> <td>1)</td> <td>123</td> <td>123</td> <td>123</td> <td>Zero point passed</td> <td>●</td> <td>●</td> <td>●</td> <td>●</td> </tr> <tr> <td></td> <td></td> <td></td> <td></td> <td>Zero speed</td> <td>●</td> <td>●</td> <td>●</td> <td>●</td> </tr> <tr> <td></td> <td></td> <td></td> <td></td> <td>Ready ON</td> <td>●</td> <td>●</td> <td>●</td> <td>●</td> </tr> <tr> <td></td> <td></td> <td></td> <td></td> <td>Servo ON</td> <td>●</td> <td>●</td> <td>●</td> <td>●</td> </tr> <tr> <td></td> <td></td> <td></td> <td></td> <td>Servo alarm</td> <td>●</td> <td>●</td> <td>●</td> <td>●</td> </tr> <tr> <td></td> <td></td> <td></td> <td></td> <td>Imposition</td> <td>●</td> <td>●</td> <td>●</td> <td>●</td> </tr> <tr> <td></td> <td></td> <td></td> <td></td> <td>Torque limit</td> <td>●</td> <td>●</td> <td>●</td> <td>●</td> </tr> <tr> <td></td> <td></td> <td></td> <td></td> <td>Abs. value cleared</td> <td>●</td> <td>●</td> <td>●</td> <td>●</td> </tr> <tr> <td></td> <td></td> <td></td> <td></td> <td>Warning</td> <td>●</td> <td>●</td> <td>●</td> <td>●</td> </tr> </table> <table border="1"> <tr> <th>Item</th> <th>Axis1</th> <th>Axis2</th> <th>Axis3</th> <th>Axis4</th> </tr> <tr> <td>Regenerative load ratio</td> <td>123</td> <td>123</td> <td>123</td> <td>123</td> </tr> <tr> <td>Actual load ratio</td> <td>123</td> <td>123</td> <td>123</td> <td>123</td> </tr> <tr> <td>Peak load ratio</td> <td>123</td> <td>123</td> <td>123</td> <td>123</td> </tr> </table> <p><SSONET []> 1 to 64 : PA01 to PA64 65 to 128 : PB01 to PB64 129 to 192 : PC01 to PC64 193 to 256 : PD01 to PD64 257 to 320 : PE01 to PE64 321 to 384 : PF01 to PF64 385 to 448 : PG01 to PG64 449 to 512 : PH01 to PH64 513 to 576 : PI01 to PI64 577 to 640 : PJ01 to PJ64</p> <p><SSONET []> 1 to 18 : PA01 to PA18 19 to 63 : PB01 to PB45 64 to 95 : PC01 to PC32 96 to 127 : PD01 to PD32 128 to 167 : PE01 to PE40 168 to 183 : PF01 to PF16 184 to 199 : PG01 to PG16 200 to 231 : PH01 to PH32 232 : PA19</p>					Parameter error No.				[Servo status]				Axis1	Axis2	Axis3	Axis4	Item	Ax.1	Ax.2	Ax.3	Ax.4	1)	123	123	123	Zero point passed	●	●	●	●					Zero speed	●	●	●	●					Ready ON	●	●	●	●					Servo ON	●	●	●	●					Servo alarm	●	●	●	●					Imposition	●	●	●	●					Torque limit	●	●	●	●					Abs. value cleared	●	●	●	●					Warning	●	●	●	●	Item	Axis1	Axis2	Axis3	Axis4	Regenerative load ratio	123	123	123	123	Actual load ratio	123	123	123	123	Peak load ratio	123	123	123	123	1)	870, 970, 1070, 1170	366, 3CA, 42E, 492
Parameter error No.				[Servo status]																																																																																																																									
Axis1	Axis2	Axis3	Axis4	Item	Ax.1	Ax.2	Ax.3	Ax.4																																																																																																																					
1)	123	123	123	Zero point passed	●	●	●	●																																																																																																																					
				Zero speed	●	●	●	●																																																																																																																					
				Ready ON	●	●	●	●																																																																																																																					
				Servo ON	●	●	●	●																																																																																																																					
				Servo alarm	●	●	●	●																																																																																																																					
				Imposition	●	●	●	●																																																																																																																					
				Torque limit	●	●	●	●																																																																																																																					
				Abs. value cleared	●	●	●	●																																																																																																																					
				Warning	●	●	●	●																																																																																																																					
Item	Axis1	Axis2	Axis3	Axis4																																																																																																																									
Regenerative load ratio	123	123	123	123																																																																																																																									
Actual load ratio	123	123	123	123																																																																																																																									
Peak load ratio	123	123	123	123																																																																																																																									
					2)	876, 976, 1076, 1176	36C, 3D0, 434, 498																																																																																																																						
					3)	877, 977, 1077, 1177	36D, 3D1, 435, 499																																																																																																																						
					4)	878, 978, 1078, 1178	36E, 3D2, 436, 49A																																																																																																																						
					5)	879, 979, 1079, 1179	36F, 3D3, 437, 49B																																																																																																																						
					6)	880, 980, 1080, 1180	370, 3D4, 438, 49C																																																																																																																						
					-	-	-																																																																																																																						

- 1 OVERVIEW
- 2 SYSTEM MONITOR
- 3 LADDER MONITOR FUNCTION
- 4 MELSEC-A LIST EDITOR
- 5 MELSEC-FX LIST EDITOR
- 6 INTELLIGENT MODULE MONITOR
- 7 NETWORK MONITOR
- 8 Q MOTION MONITOR

Screen example		No.	Buffer memory address	
			DEC	HEX
<p>LD77MS4 OPR</p> <p>Axis Travel after NPD ON</p> <p>1) Axis 1 123456</p> <p>2) Axis 2 123456</p> <p>3) Axis 3 123456</p> <p>4) Axis 4 123456</p> <p>(μm):*10^{-1} (inch):*10^{-5} (degree):*10^{-5} (pulse):*1</p> <p>5) Torque limit stored value Near point Upper limit Lower limit</p> <p>6) Axis 1 1234 (%)</p> <p>7) Axis 2 1234 (%)</p> <p>8) Axis 3 1234 (%)</p> <p>Axis 4 1234 (%)</p>	1)	824 to 825	338 to 339	
	2)	924 to 925	39C to 39D	
	3)	1024 to 1025	400 to 401	
	4)	1124 to 1125	464 to 465	
	5)	826, 816	33A, 330	
	6)	926, 916	39E, 394	
	7)	1026, 1016	402, 3F8	
	8)	1126, 1116	466, 45C	
<p>LD77MS4 Speed-position control</p> <p>SPSC positioning amount</p> <p>1) Axis 1 123456</p> <p>2) Axis 2 123456</p> <p>3) Axis 3 123456</p> <p>4) Axis 4 123456</p> <p>(μm):*10^{-1} (degree):*10^{-4} (inch):*10^{-5} (pulse):*1</p> <p>5) SPSC movement amount change register</p> <p>6) Axis 1 123456 Axis 2 123456</p> <p>Axis 3 123456 Axis 4 123456</p> <p>Setting range 0 to 2147483647 (μm):*10^{-1} (inch):*10^{-5} (degree):*10^{-5} (pulse):*1</p> <p>Item Ax.1 Ax.2 Ax.3 Ax.4</p> <p>Speed-position switching latch</p> <p>In speed control</p> <p>Speed-position switching enable 0:Disable 1:Enable</p>	1)	814 to 815	32E to 32F	
	2)	914 to 915	392 to 393	
	3)	1014 to 1015	3F6 to 3F7	
	4)	1114 to 1115	45A to 45B	
	5)	1526 to 1527, 1626 to 1627	5F6 to 5F7, 65A to 65B	
	6)	1726 to 1727, 1826 to 1927	6BE to 6BF, 722 to 723	
	7)	817, 917, 1017, 1117	330, 395, 3F9, 45D	
	8)	1528, 1628, 1728, 1828	5F8, 65C, 6C0, 724	
<p>LD77MS4 Position-speed control</p> <p>PSSC speed change register</p> <p>1) Axis 1 123456 Axis 2 123456</p> <p>2) Axis 3 123456 Axis 4 123456</p> <p>Setting range 0 to 2000000000 (mm/min):*10^{-2} (inch/min):*10^{-3} (degree/min):*10^{-3} 0 to 500000000 (pulse/sec):*1</p> <p>Item Ax.1 Ax.2 Ax.3 Ax.4</p> <p>Position-speed switching latch</p> <p>In speed control</p> <p>Position-speed switching enable 0:Disable 1:Enable</p>	1)	1530 to 1531, 1630 to 1631	5FA to 5FB, 65E to 65F	
	2)	1730 to 1731, 1830 to 1931	6C2 to 6C3, 726 to 727	
	3)	817, 917, 1017, 1117	331, 395, 3F9, 45D	
	4)	1532, 1632, 1732, 1832	5FC, 660, 6C4, 728	

Screen example		No.	Buffer memory address	
			DEC	HEX
		1)	1506 to 1507, 1606 to 1607	5E2 to 5E3, 646 to 647
		2)	1706 to 1707, 1806 to 1807	6AA to 6AB, 70E to 70F
		3)	1514 to 1515, 1614 to 1615	5EA to 5EB, 64E to 64F
		4)	1714 to 1715, 1814 to 1815	6B2 to 6B3, 716 to 717
		5)	1513, 1613, 1713, 1813	5E9, 64D, 6B1, 715
		6)	1544, 1644, 1744, 1844	608, 66C, 6D0, 734
		7)	1545, 1645, 1745, 1845	609, 66D, 6B1, 735
		8)	1546, 1646, 1746, 1846	60A, 66E, 6B2, 736
		9)	1547, 1647, 1747, 1847	60B, 66F, 6B3, 737
		10)	1505, 1605, 1705, 1805	5E1, 645, 6A9, 70D
		-	-	-
		1)	1500, 1600, 1700, 1800	5DC, 640, 6A4, 708
		2)	1501, 1601, 1701, 1801	5DD, 641, 6A5, 709
		3)	1502, 1602, 1702, 1802	5DE, 642, 6A6, 70A
		4)	1503, 1603, 1703, 1803	5DF, 643, 6A7, 70B
		5)	1504, 1604, 1704, 1804	5E0, 644, 6A8, 70C
		6)	1512, 1612, 1712, 1812	5E8, 64C, 6B0, 714
		7)	1516, 1616, 1716, 1816	5EC, 650, 6B4, 718
		8)	1508 to 1509, 1608 to 1609, 1708 to 1709, 1808 to 1809	5E4 to 5E5, 648 to 649, 6AC to 6AD, 710 to 711
		9)	1510 to 1511, 1610 to 1611, 1710 to 1711, 1810 to 1811	5E6 to 5E7, 64A to 64B, 6AE to 6AF, 712 to 713
		10)	1520, 1620, 1720, 1820	5F0, 654, 6B8, 71C
		11)	1521, 1621, 1721, 1821	5F1, 655, 6B9, 71D
		12)	1522 to 1523, 1622 to 1623, 1722 to 1723, 1822 to 1823	5F2 to 5F3, 656 to 657, 6BA to 6BB, 71E to 71F
		13)	1524, 1624, 1724, 1824	5F4, 658, 6BC, 720
		14)	1525, 1625, 1725, 1825	5F5, 659, 68D, 721
		-	-	-

- 1 OVERVIEW
- 2 SYSTEM MONITOR
- 3 LADDER MONITOR FUNCTION
- 4 MELSEC-A LIST EDITOR
- 5 MELSEC-FX LIST EDITOR
- 6 INTELLIGENT MODULE MONITOR
- 7 NETWORK MONITOR
- 8 Q MOTION MONITOR

Screen example		No.	Buffer memory address	
			DEC	HEX
		1)	1538, 1638, 1738, 1838	602, 670, 6CA, 72E
		2)	1548, 1648, 1748, 1848	60C, 670, 6D4, 738
		3)	1549, 1649, 1749, 1849	60D, 671, 6D5, 739
		4)	1550, 1650, 1750, 1850	60E, 672, 606, 73A
		5)	1540, 1640, 1740, 1840	604, 668, 6CB, 730
		6)	1541, 1641, 1741, 1841	605, 669, 6CD, 731
		7)	1542, 1642, 1742, 1842	606, 66A, 6CE, 732
		8)	1543, 1643, 1743, 1843	607, 66B, 6D0, 733
		9)	1551, 1651, 1751, 1851	60F, 673, 6D7, 73B
		10)	1552, 1652, 1752, 1852	610, 674, 6D8, 73C
		11)	1559, 1659, 1759, 1859	617, 67B, 6DF, 743
		12)	1565, 1665, 1765, 1865	61D, 681, 6E5, 749
		-	-	-
		1)	1517, 1617	5ED, 651
		2)	1717, 1817	6B5, 719
		3)	1518 to 1519, 1618 to 1619	5EE to 5EF, 652 to 653
		4)	1718 to 1719, 1818 to 1819	6B6 to 6B7, 71A to 71B
		5)	1534 to 1535, 1634 to 1635	5FE to 5FF, 662 to 663
		6)	1734 to 1735, 1834 to 1835	6C6 to 6C7, 72A to 72B
		7)	1536 to 1537, 1636 to 1637	600 to 601, 664 to 665
		8)	1736 to 1737, 1836 to 1837	6C8 to 6C9, 72C to 72D
		-	-	-

Screen example		No.	Buffer memory address	
			DEC	HEX
		1)	1212 to 1216	4BC to 4C0
		2)	1217 to 1221	4C1 to 4C5
		3)	1222 to 1226	4C6 to 4CA
		4)	1227 to 1231	4CB to 4CF
		5)	1232 to 1236	4D0 to 4D4
		6)	1237 to 1241	4D5 to 4D9
		7)	1242 to 1246	4DA to 4DE
		8)	1247 to 1251	4DF to 4E3
		9)	1252 to 1256	4E4 to 4E8
		10)	1257 to 1261	4E9 to 4ED
		11)	1262 to 1266	4EE to 4F2
		12)	1267 to 1271	4F3 to 4F7
		13)	1272 to 1276	4F8 to 4FC
		14)	1277 to 1281	4FD to 501
		15)	1282 to 1286	502 to 506
		16)	1287 to 1291	507 to 50B
		-	-	-
		1)	1293 to 1296	50D to 510
		2)	1297 to 1300	511 to 514
		3)	1301 to 1304	515 to 518
		4)	1305 to 1308	519 to 51C
		5)	1309 to 1312	51D to 520
		6)	1313 to 1316	521 to 524
		7)	1317 to 1320	525 to 528
		8)	1321 to 1324	529 to 52C
		9)	1325 to 1328	52D to 530
		10)	1329 to 1332	531 to 534
		11)	1333 to 1336	535 to 538
		12)	1337 to 1340	539 to 53C
		13)	1341 to 1344	53D to 540
		14)	1345 to 1348	541 to 544
		15)	1349 to 1352	545 to 548
		16)	1353 to 1356	549 to 54C
		17)	1358 to 1361	54E to 551
18)	1362 to 1365	552 to 555		
19)	1366 to 1369	556 to 559		
20)	1370 to 1373	55A to 55D		
21)	1374 to 1377	55E to 561		
22)	1378 to 1381	562 to 565		
23)	1382 to 1385	566 to 569		
24)	1386 to 1389	56A to 56D		
25)	1390 to 1393	56E to 571		
26)	1394 to 1397	572 to 575		
27)	1398 to 1401	576 to 579		
28)	1402 to 1405	57A to 57D		
29)	1406 to 1409	57E to 581		
30)	1410 to 1413	582 to 585		
31)	1414 to 1417	586 to 589		
32)	1418 to 1421	58A to 58D		
33)	31300 to 31315	7A44 to 7A53		
34)	31316 to 31331	7A54 to 7A63		
-	-	-		

- 1
OVERVIEW
- 2
SYSTEM MONITOR
- 3
LADDER MONITOR FUNCTION
- 4
MELSEC-A LIST EDITOR
- 5
MELSEC-FX LIST EDITOR
- 6
INTELLIGENT MODULE MONITOR
- 7
NETWORK MONITOR
- 8
Q MOTION MONITOR

Screen example		No.	Buffer memory address																																																																																																																																																																																																																																																																																													
			DEC	HEX																																																																																																																																																																																																																																																																																												
<div style="border: 1px solid black; padding: 5px;"> <div style="display: flex; justify-content: space-between; border-bottom: 1px solid black;"> LD77MS4 Positioning data SET/ Data MONIT RESET Chg. MENU END </div> <table border="1" style="width: 100%; border-collapse: collapse; text-align: center;"> <thead> <tr> <th colspan="7">Axis1</th> <th colspan="7">Axis3</th> </tr> <tr> <th>No</th><th>Patt.</th><th>Int.</th><th>Cont.</th><th>Acc.</th><th>Dec.</th><th>Dwell</th><th>Mcode</th> <th>No</th><th>Patt.</th><th>Int.</th><th>Cont.</th><th>Acc.</th><th>Dec.</th><th>Dwell</th><th>Mcode</th> </tr> <tr> <th></th><th>Address</th><th></th><th></th><th>Arc address</th><th></th><th>Instr.</th><th>speed</th> <th></th><th>Address</th><th></th><th></th><th>Arc address</th><th></th><th>Instr.</th><th>speed</th> </tr> </thead> <tbody> <tr> <td>1)</td><td>00</td><td>00</td><td>12</td><td>00</td><td>00</td><td>12345</td><td>12345</td> <td>7)</td><td>00</td><td>00</td><td>12</td><td>00</td><td>00</td><td>12345</td><td>12345</td> </tr> <tr> <td></td><td></td><td></td><td></td><td>123456</td><td></td><td></td><td>123456</td> <td></td><td></td><td></td><td></td><td>123456</td><td></td><td></td><td>123456</td> </tr> <tr> <td>2)</td><td>00</td><td>00</td><td>12</td><td>00</td><td>00</td><td>12345</td><td>12345</td> <td>8)</td><td>00</td><td>00</td><td>12</td><td>00</td><td>00</td><td>12345</td><td>12345</td> </tr> <tr> <td></td><td></td><td></td><td></td><td>123456</td><td></td><td></td><td>123456</td> <td></td><td></td><td></td><td></td><td>123456</td><td></td><td></td><td>123456</td> </tr> <tr> <td>3)</td><td>00</td><td>00</td><td>12</td><td>00</td><td>00</td><td>12345</td><td>12345</td> <td>9)</td><td>00</td><td>00</td><td>12</td><td>00</td><td>00</td><td>12345</td><td>12345</td> </tr> <tr> <td></td><td></td><td></td><td></td><td>123456</td><td></td><td></td><td>123456</td> <td></td><td></td><td></td><td></td><td>123456</td><td></td><td></td><td>123456</td> </tr> </tbody> </table> <table border="1" style="width: 100%; border-collapse: collapse; text-align: center;"> <thead> <tr> <th colspan="7">Axis2</th> <th colspan="7">Axis4</th> </tr> <tr> <th>No</th><th>Patt.</th><th>Int.</th><th>Cont.</th><th>Acc.</th><th>Dec.</th><th>Dwell</th><th>Mcode</th> <th>No</th><th>Patt.</th><th>Int.</th><th>Cont.</th><th>Acc.</th><th>Dec.</th><th>Dwell</th><th>Mcode</th> </tr> <tr> <th></th><th>Address</th><th></th><th></th><th>Arc address</th><th></th><th>Instr.</th><th>speed</th> <th></th><th>Address</th><th></th><th></th><th>Arc address</th><th></th><th>Instr.</th><th>speed</th> </tr> </thead> <tbody> <tr> <td>4)</td><td>00</td><td>00</td><td>12</td><td>00</td><td>00</td><td>12345</td><td>12345</td> <td>10)</td><td>00</td><td>00</td><td>12</td><td>00</td><td>00</td><td>12345</td><td>12345</td> </tr> <tr> <td></td><td></td><td></td><td></td><td>123456</td><td></td><td></td><td>123456</td> <td></td><td></td><td></td><td></td><td>123456</td><td></td><td></td><td>123456</td> </tr> <tr> <td>5)</td><td>00</td><td>00</td><td>12</td><td>00</td><td>00</td><td>12345</td><td>12345</td> <td>11)</td><td>00</td><td>00</td><td>12</td><td>00</td><td>00</td><td>12345</td><td>12345</td> </tr> <tr> <td></td><td></td><td></td><td></td><td>123456</td><td></td><td></td><td>123456</td> <td></td><td></td><td></td><td></td><td>123456</td><td></td><td></td><td>123456</td> </tr> <tr> <td>6)</td><td>00</td><td>00</td><td>12</td><td>00</td><td>00</td><td>12345</td><td>12345</td> <td>12)</td><td>00</td><td>00</td><td>12</td><td>00</td><td>00</td><td>12345</td><td>12345</td> </tr> <tr> <td></td><td></td><td></td><td></td><td>123456</td><td></td><td></td><td>123456</td> <td></td><td></td><td></td><td></td><td>123456</td><td></td><td></td><td>123456</td> </tr> </tbody> </table> <p style="font-size: small; margin-top: 5px;"> [Pattern] 00: Positioning complete 01: Continuous positioning control 11: Continuous path control [Control] 01H:ABS1 02H:INC1 03H:FEED1 04H:VF1 05H:VR1 06H:VPF 07H:VPR 08H:PVF 09H:VPR 04H:ABS2 08H:INC2 09H:FEED2 04H:ABS 06H:INC 07H:ABS_CW 10H:ABS_CCW 11H:INC_CW 12H:INC_CCW 13H:VF2 14H:VR2 15H:ABS3 16H:INC3 17H:FEED3 18H:VF3 19H:VR3 19H:ABS4 18H:INC4 10H:FEED4 10H:VF4 10H:VR4 80H:NOP 81H:POS 82H:JUMP 83H:LOOP 84H:LEND </p> </div>		Axis1							Axis3							No	Patt.	Int.	Cont.	Acc.	Dec.	Dwell	Mcode	No	Patt.	Int.	Cont.	Acc.	Dec.	Dwell	Mcode		Address			Arc address		Instr.	speed		Address			Arc address		Instr.	speed	1)	00	00	12	00	00	12345	12345	7)	00	00	12	00	00	12345	12345					123456			123456					123456			123456	2)	00	00	12	00	00	12345	12345	8)	00	00	12	00	00	12345	12345					123456			123456					123456			123456	3)	00	00	12	00	00	12345	12345	9)	00	00	12	00	00	12345	12345					123456			123456					123456			123456	Axis2							Axis4							No	Patt.	Int.	Cont.	Acc.	Dec.	Dwell	Mcode	No	Patt.	Int.	Cont.	Acc.	Dec.	Dwell	Mcode		Address			Arc address		Instr.	speed		Address			Arc address		Instr.	speed	4)	00	00	12	00	00	12345	12345	10)	00	00	12	00	00	12345	12345					123456			123456					123456			123456	5)	00	00	12	00	00	12345	12345	11)	00	00	12	00	00	12345	12345					123456			123456					123456			123456	6)	00	00	12	00	00	12345	12345	12)	00	00	12	00	00	12345	12345					123456			123456					123456			123456	1)	2000 to 2002, 2004 to 2009	7D0 to 7D2, 7D4 to 7D9
Axis1							Axis3																																																																																																																																																																																																																																																																																									
No	Patt.	Int.	Cont.	Acc.	Dec.	Dwell	Mcode	No	Patt.	Int.	Cont.	Acc.	Dec.	Dwell	Mcode																																																																																																																																																																																																																																																																																	
	Address			Arc address		Instr.	speed		Address			Arc address		Instr.	speed																																																																																																																																																																																																																																																																																	
1)	00	00	12	00	00	12345	12345	7)	00	00	12	00	00	12345	12345																																																																																																																																																																																																																																																																																	
				123456			123456					123456			123456																																																																																																																																																																																																																																																																																	
2)	00	00	12	00	00	12345	12345	8)	00	00	12	00	00	12345	12345																																																																																																																																																																																																																																																																																	
				123456			123456					123456			123456																																																																																																																																																																																																																																																																																	
3)	00	00	12	00	00	12345	12345	9)	00	00	12	00	00	12345	12345																																																																																																																																																																																																																																																																																	
				123456			123456					123456			123456																																																																																																																																																																																																																																																																																	
Axis2							Axis4																																																																																																																																																																																																																																																																																									
No	Patt.	Int.	Cont.	Acc.	Dec.	Dwell	Mcode	No	Patt.	Int.	Cont.	Acc.	Dec.	Dwell	Mcode																																																																																																																																																																																																																																																																																	
	Address			Arc address		Instr.	speed		Address			Arc address		Instr.	speed																																																																																																																																																																																																																																																																																	
4)	00	00	12	00	00	12345	12345	10)	00	00	12	00	00	12345	12345																																																																																																																																																																																																																																																																																	
				123456			123456					123456			123456																																																																																																																																																																																																																																																																																	
5)	00	00	12	00	00	12345	12345	11)	00	00	12	00	00	12345	12345																																																																																																																																																																																																																																																																																	
				123456			123456					123456			123456																																																																																																																																																																																																																																																																																	
6)	00	00	12	00	00	12345	12345	12)	00	00	12	00	00	12345	12345																																																																																																																																																																																																																																																																																	
				123456			123456					123456			123456																																																																																																																																																																																																																																																																																	
	2)	2010 to 2012, 2014 to 2019	7DA to 7DC, 7DE to 7E3																																																																																																																																																																																																																																																																																													
	3)	2020 to 2022, 2024 to 2029	7E4 to 7E6, 7E8 to 7ED																																																																																																																																																																																																																																																																																													
	4)	8000 to 8002, 8004 to 8009	1F40 to 1F41, 1F44 to 1F49																																																																																																																																																																																																																																																																																													
	5)	8010 to 8012, 8014 to 8019	1F4A to 1F4C, 1F4E to 1F53																																																																																																																																																																																																																																																																																													
	6)	8020 to 8022, 8024 to 8029	1F54 to 1F56, 1F58 to 1F5D																																																																																																																																																																																																																																																																																													
	7)	14000 to 14002, 14004 to 14009	36B0 to 36B2, 36B4 to 36B9																																																																																																																																																																																																																																																																																													
	8)	14010 to 14012, 14014 to 14019	36BA to 36BB, 36BE to 36C3																																																																																																																																																																																																																																																																																													
	9)	14020 to 14022, 14024 to 14029	36C4 to 36C6, 36C8 to 36CD																																																																																																																																																																																																																																																																																													
	10)	20000 to 20002, 20004 to 20009	4E20 to 4E22, 4E24 to 4E29																																																																																																																																																																																																																																																																																													
	11)	20010 to 20012, 20014 to 20019	4E2A to 4E2C, 4E2E to 4E33																																																																																																																																																																																																																																																																																													
	12)	20020 to 20022, 20024 to 20029	4E34 to 4E36, 4E38 to 4E3D																																																																																																																																																																																																																																																																																													
	-	-	-																																																																																																																																																																																																																																																																																													
<div style="border: 1px solid black; padding: 5px;"> <div style="display: flex; justify-content: space-between; border-bottom: 1px solid black;"> LD77MS4 Servo parameter Basic setting1 SET/ Data MONIT RESET Chg. MENU END </div> <table border="1" style="width: 100%; border-collapse: collapse; text-align: center;"> <thead> <tr> <th>Item</th> <th>Axis1</th> <th>Axis2</th> <th>Axis3</th> <th>Axis4</th> <th>Setting range</th> </tr> </thead> <tbody> <tr> <td>1) Servo series</td> <td>1234</td> <td>1234</td> <td>1234</td> <td>1234</td> <td>0:Invalid 1,3,4,6:MR-J3(W)-B 7:MR-MT1200 82:MR-J4-B 96:VC II 4097,4128:Virt.</td> </tr> <tr> <td>2) Selection of regenerative brake option</td> <td>12</td> <td>12</td> <td>12</td> <td>12</td> <td>00:Not used 02:MR-RB032 03:MR-RB12 04:MR-RB32 05:MR-RB30 06:MR-RB50 08:MR-RB31 09:MR-RB51</td> </tr> <tr> <td>3) V pos. detection sys.</td> <td>1</td> <td>1</td> <td>1</td> <td>1</td> <td>0:Invalid 1:Valid</td> </tr> <tr> <td>4) Func. selection A-1 Emergency stop input</td> <td>1</td> <td>1</td> <td>1</td> <td>1</td> <td>0:Valid 1:Invalid</td> </tr> <tr> <td>5) Auto tuning Gain adjustment mode</td> <td>1</td> <td>1</td> <td>1</td> <td>1</td> <td>0:Interpolation 1:Auto tuning1 3:Manual 2:Auto tuning2</td> </tr> <tr> <td>6) Auto tuning Response</td> <td>12</td> <td>12</td> <td>12</td> <td>12</td> <td>1 Hz 16 Hz 32 Hz Low Middle High 10Hz 60Hz 400Hz</td> </tr> <tr> <td>7) Home position range</td> <td>12345</td> <td>12345</td> <td>12345</td> <td>12345</td> <td>0 to 50000[pulse]</td> </tr> <tr> <td>8) Rotation direction</td> <td>1</td> <td>1</td> <td>1</td> <td>1</td> <td>0:CCW 1:CW</td> </tr> <tr> <td>9) Encoder output pulses</td> <td>12345</td> <td>12345</td> <td>12345</td> <td>12345</td> <td>1 to 65535[pulse]</td> </tr> </tbody> </table> </div>		Item	Axis1	Axis2	Axis3	Axis4	Setting range	1) Servo series	1234	1234	1234	1234	0:Invalid 1,3,4,6:MR-J3(W)-B 7:MR-MT1200 82:MR-J4-B 96:VC II 4097,4128:Virt.	2) Selection of regenerative brake option	12	12	12	12	00:Not used 02:MR-RB032 03:MR-RB12 04:MR-RB32 05:MR-RB30 06:MR-RB50 08:MR-RB31 09:MR-RB51	3) V pos. detection sys.	1	1	1	1	0:Invalid 1:Valid	4) Func. selection A-1 Emergency stop input	1	1	1	1	0:Valid 1:Invalid	5) Auto tuning Gain adjustment mode	1	1	1	1	0:Interpolation 1:Auto tuning1 3:Manual 2:Auto tuning2	6) Auto tuning Response	12	12	12	12	1 Hz 16 Hz 32 Hz Low Middle High 10Hz 60Hz 400Hz	7) Home position range	12345	12345	12345	12345	0 to 50000[pulse]	8) Rotation direction	1	1	1	1	0:CCW 1:CW	9) Encoder output pulses	12345	12345	12345	12345	1 to 65535[pulse]	1)	30100, 30300, 30500, 30700	7594, 765C, 7724, 77EC																																																																																																																																																																																																																																
Item	Axis1	Axis2	Axis3	Axis4	Setting range																																																																																																																																																																																																																																																																																											
1) Servo series	1234	1234	1234	1234	0:Invalid 1,3,4,6:MR-J3(W)-B 7:MR-MT1200 82:MR-J4-B 96:VC II 4097,4128:Virt.																																																																																																																																																																																																																																																																																											
2) Selection of regenerative brake option	12	12	12	12	00:Not used 02:MR-RB032 03:MR-RB12 04:MR-RB32 05:MR-RB30 06:MR-RB50 08:MR-RB31 09:MR-RB51																																																																																																																																																																																																																																																																																											
3) V pos. detection sys.	1	1	1	1	0:Invalid 1:Valid																																																																																																																																																																																																																																																																																											
4) Func. selection A-1 Emergency stop input	1	1	1	1	0:Valid 1:Invalid																																																																																																																																																																																																																																																																																											
5) Auto tuning Gain adjustment mode	1	1	1	1	0:Interpolation 1:Auto tuning1 3:Manual 2:Auto tuning2																																																																																																																																																																																																																																																																																											
6) Auto tuning Response	12	12	12	12	1 Hz 16 Hz 32 Hz Low Middle High 10Hz 60Hz 400Hz																																																																																																																																																																																																																																																																																											
7) Home position range	12345	12345	12345	12345	0 to 50000[pulse]																																																																																																																																																																																																																																																																																											
8) Rotation direction	1	1	1	1	0:CCW 1:CW																																																																																																																																																																																																																																																																																											
9) Encoder output pulses	12345	12345	12345	12345	1 to 65535[pulse]																																																																																																																																																																																																																																																																																											
	2)	30102, 30302, 30502 30702	7596, 765E, 7726, 77EE																																																																																																																																																																																																																																																																																													
	3)	30103, 30303, 30503, 30703	7797, 765F, 7727, 77EF																																																																																																																																																																																																																																																																																													
	4)	30104, 30304, 30504, 30704	7798, 7660, 7728, 77F0																																																																																																																																																																																																																																																																																													
	5)	30108, 30308, 30508, 30708	759C, 7664, 772C, 77F4																																																																																																																																																																																																																																																																																													
	6)	30109, 30309, 30509, 30709	759D, 7665, 772D, 77F5																																																																																																																																																																																																																																																																																													
	7)	30110, 30310, 30510, 30710	7591, 7666, 772E, 77F6																																																																																																																																																																																																																																																																																													
	8)	30114, 30314, 30514, 30714	75A2, 766A, 7732, 77FA																																																																																																																																																																																																																																																																																													
	9)	30115, 30315, 30515, 30715	75A3, 766B, 7733, 77FB																																																																																																																																																																																																																																																																																													
	-	-	-																																																																																																																																																																																																																																																																																													
<div style="border: 1px solid black; padding: 5px;"> <div style="display: flex; justify-content: space-between; border-bottom: 1px solid black;"> LD77MS4 Servo parameter Basic setting2 SET/ Data MONIT RESET Chg. MENU END </div> <table border="1" style="width: 100%; border-collapse: collapse; text-align: center;"> <thead> <tr> <th>Item</th> <th>Axis1</th> <th>Axis2</th> <th>Axis3</th> <th>Axis4</th> <th>Setting range</th> </tr> </thead> <tbody> <tr> <td>1) Func. selection A-1 Forced stop decel.</td> <td>1</td> <td>1</td> <td>1</td> <td>1</td> <td>0:Disabled 2:Enabled</td> </tr> <tr> <td>2) Encoder output p. 2</td> <td>12345</td> <td>12345</td> <td>12345</td> <td>12345</td> <td>1 to 65535[pulse]</td> </tr> <tr> <td>3) Servo motor series</td> <td>1234</td> <td>1234</td> <td>1234</td> <td>1234</td> <td></td> </tr> <tr> <td>4) Servo motor type</td> <td>1234</td> <td>1234</td> <td>1234</td> <td>1234</td> <td></td> </tr> </tbody> </table> </div>		Item	Axis1	Axis2	Axis3	Axis4	Setting range	1) Func. selection A-1 Forced stop decel.	1	1	1	1	0:Disabled 2:Enabled	2) Encoder output p. 2	12345	12345	12345	12345	1 to 65535[pulse]	3) Servo motor series	1234	1234	1234	1234		4) Servo motor type	1234	1234	1234	1234		1)	30104, 30304, 30504, 30704	7598, 7660, 7728, 77F0																																																																																																																																																																																																																																																														
Item	Axis1	Axis2	Axis3	Axis4	Setting range																																																																																																																																																																																																																																																																																											
1) Func. selection A-1 Forced stop decel.	1	1	1	1	0:Disabled 2:Enabled																																																																																																																																																																																																																																																																																											
2) Encoder output p. 2	12345	12345	12345	12345	1 to 65535[pulse]																																																																																																																																																																																																																																																																																											
3) Servo motor series	1234	1234	1234	1234																																																																																																																																																																																																																																																																																												
4) Servo motor type	1234	1234	1234	1234																																																																																																																																																																																																																																																																																												
	2)	30116, 30316, 30516, 30716	75A4, 766C, 7734, 77FC																																																																																																																																																																																																																																																																																													
	3)	30117, 30317, 30517, 30717	75A5, 766D, 7735, 77FD																																																																																																																																																																																																																																																																																													
	4)	30118, 30318, 30518, 30718	75A4, 766E, 7736, 77FE																																																																																																																																																																																																																																																																																													
	-	-	-																																																																																																																																																																																																																																																																																													

Screen example						No.	Buffer memory address																																																																																					
							DEC	HEX																																																																																				
<p>LD77MS4 Servo parameter Basic setting3</p> <table border="1"> <thead> <tr> <th>Item</th> <th>Axis1</th> <th>Axis2</th> <th>Axis3</th> <th>Axis4</th> <th>Setting range</th> </tr> </thead> <tbody> <tr> <td>Tough drive setting</td> <td>1</td> <td>1</td> <td>1</td> <td>1</td> <td>0:Disabled 1:Enabled</td> </tr> <tr> <td>Vibration selection</td> <td>1</td> <td>1</td> <td>1</td> <td>1</td> <td>0:Disabled 1:Enabled</td> </tr> <tr> <td>Tough drive setting power failure</td> <td>1</td> <td>1</td> <td>1</td> <td>1</td> <td>0:Disabled 1:Enabled</td> </tr> <tr> <td>Func. selection A-3 One-touch tuning</td> <td>1</td> <td>1</td> <td>1</td> <td>1</td> <td>0:Disabled 1:Enabled</td> </tr> <tr> <td>Func. selection A-4 Vibration suppression</td> <td>1</td> <td>1</td> <td>1</td> <td>1</td> <td>0: Standard mode 1: 3 Inertia mode 2: Low response mode</td> </tr> <tr> <td>Item</td> <td>Axis1</td> <td>Axis2</td> <td>Axis3</td> <td>Axis4</td> <td></td> </tr> <tr> <td>Drive recorder</td> <td>Alarm detail No.</td> <td>12</td> <td>12</td> <td>12</td> <td>12</td> </tr> <tr> <td>arbitrary alarm trig.</td> <td>Alarm No.</td> <td>12</td> <td>12</td> <td>12</td> <td>12</td> </tr> </tbody> </table>						Item	Axis1	Axis2	Axis3	Axis4	Setting range	Tough drive setting	1	1	1	1	0:Disabled 1:Enabled	Vibration selection	1	1	1	1	0:Disabled 1:Enabled	Tough drive setting power failure	1	1	1	1	0:Disabled 1:Enabled	Func. selection A-3 One-touch tuning	1	1	1	1	0:Disabled 1:Enabled	Func. selection A-4 Vibration suppression	1	1	1	1	0: Standard mode 1: 3 Inertia mode 2: Low response mode	Item	Axis1	Axis2	Axis3	Axis4		Drive recorder	Alarm detail No.	12	12	12	12	arbitrary alarm trig.	Alarm No.	12	12	12	12	1)	31632, 31882, 32132, 32382	7B90, 7C8A, 7D84, 7E7E																														
Item	Axis1	Axis2	Axis3	Axis4	Setting range																																																																																							
Tough drive setting	1	1	1	1	0:Disabled 1:Enabled																																																																																							
Vibration selection	1	1	1	1	0:Disabled 1:Enabled																																																																																							
Tough drive setting power failure	1	1	1	1	0:Disabled 1:Enabled																																																																																							
Func. selection A-3 One-touch tuning	1	1	1	1	0:Disabled 1:Enabled																																																																																							
Func. selection A-4 Vibration suppression	1	1	1	1	0: Standard mode 1: 3 Inertia mode 2: Low response mode																																																																																							
Item	Axis1	Axis2	Axis3	Axis4																																																																																								
Drive recorder	Alarm detail No.	12	12	12	12																																																																																							
arbitrary alarm trig.	Alarm No.	12	12	12	12																																																																																							
						2)	31633, 31883, 32133, 32383	7B91, 7C8B, 7D85, 7E7F																																																																																				
						3)	31636, 31886, 32136, 32386	7B94, 7C8E, 7D88, 7E82																																																																																				
						4)	31635, 31885, 32135, 32385	7B93, 7C8D, 7D87, 7E81																																																																																				
						-	-	-																																																																																				
<p>LD77MS4 Servo parameter Gain/Filter-1</p> <table border="1"> <thead> <tr> <th>Item</th> <th>Axis1</th> <th>Axis2</th> <th>Axis3</th> <th>Axis4</th> <th>Setting range</th> </tr> </thead> <tbody> <tr> <td>Filter tuning mode</td> <td>1</td> <td>1</td> <td>1</td> <td>1</td> <td>0:Filter OFF 1:Filter tuning 2:Manual</td> </tr> <tr> <td>Vibration suppression control tuning mode</td> <td>1</td> <td>1</td> <td>1</td> <td>1</td> <td>0:Vibration control OFF 1:Vibration ctrl tuning 2:Manual</td> </tr> <tr> <td>Feed forward gain</td> <td>123</td> <td>123</td> <td>123</td> <td>123</td> <td>0 to 100[%]</td> </tr> <tr> <td>Load inertia moment</td> <td>1234</td> <td>1234</td> <td>1234</td> <td>1234</td> <td>0 to 3000(*10⁻⁴) [times]</td> </tr> <tr> <td>Model loop gain</td> <td>1234</td> <td>1234</td> <td>1234</td> <td>1234</td> <td>1 to 2000 [rad/s]</td> </tr> <tr> <td>Position loop gain</td> <td>1234</td> <td>1234</td> <td>1234</td> <td>1234</td> <td>1 to 1000 [rad/s]</td> </tr> <tr> <td>Speed loop gain</td> <td>12345</td> <td>12345</td> <td>12345</td> <td>12345</td> <td>20 to 50000 [rad/s]</td> </tr> <tr> <td>Speed integral comp</td> <td>12345</td> <td>12345</td> <td>12345</td> <td>12345</td> <td>1 to 10000(*10⁻⁴) [ms]</td> </tr> <tr> <td>Speed filter comp</td> <td>1234</td> <td>1234</td> <td>1234</td> <td>1234</td> <td>0 to 1000(*10⁻⁴) [%]</td> </tr> <tr> <td>Resonance suppr. 1</td> <td>1234</td> <td>1234</td> <td>1234</td> <td>1234</td> <td>100 to 4500 [Hz]</td> </tr> <tr> <td>Resonance suppr. 2</td> <td>1234</td> <td>1234</td> <td>1234</td> <td>1234</td> <td>100 to 4500 [Hz]</td> </tr> <tr> <td>Low pass filter</td> <td>12345</td> <td>12345</td> <td>12345</td> <td>12345</td> <td>100 to 18000 [rad/s]</td> </tr> <tr> <td>Low pass filter selection</td> <td>1</td> <td>1</td> <td>1</td> <td>1</td> <td>0:Automatic setting 1:Manual setting</td> </tr> </tbody> </table>						Item	Axis1	Axis2	Axis3	Axis4	Setting range	Filter tuning mode	1	1	1	1	0:Filter OFF 1:Filter tuning 2:Manual	Vibration suppression control tuning mode	1	1	1	1	0:Vibration control OFF 1:Vibration ctrl tuning 2:Manual	Feed forward gain	123	123	123	123	0 to 100[%]	Load inertia moment	1234	1234	1234	1234	0 to 3000(*10 ⁻⁴) [times]	Model loop gain	1234	1234	1234	1234	1 to 2000 [rad/s]	Position loop gain	1234	1234	1234	1234	1 to 1000 [rad/s]	Speed loop gain	12345	12345	12345	12345	20 to 50000 [rad/s]	Speed integral comp	12345	12345	12345	12345	1 to 10000(*10 ⁻⁴) [ms]	Speed filter comp	1234	1234	1234	1234	0 to 1000(*10 ⁻⁴) [%]	Resonance suppr. 1	1234	1234	1234	1234	100 to 4500 [Hz]	Resonance suppr. 2	1234	1234	1234	1234	100 to 4500 [Hz]	Low pass filter	12345	12345	12345	12345	100 to 18000 [rad/s]	Low pass filter selection	1	1	1	1	0:Automatic setting 1:Manual setting	1)	30119, 30319, 30519, 30719	75A7, 766F, 7737, 77FF
Item	Axis1	Axis2	Axis3	Axis4	Setting range																																																																																							
Filter tuning mode	1	1	1	1	0:Filter OFF 1:Filter tuning 2:Manual																																																																																							
Vibration suppression control tuning mode	1	1	1	1	0:Vibration control OFF 1:Vibration ctrl tuning 2:Manual																																																																																							
Feed forward gain	123	123	123	123	0 to 100[%]																																																																																							
Load inertia moment	1234	1234	1234	1234	0 to 3000(*10 ⁻⁴) [times]																																																																																							
Model loop gain	1234	1234	1234	1234	1 to 2000 [rad/s]																																																																																							
Position loop gain	1234	1234	1234	1234	1 to 1000 [rad/s]																																																																																							
Speed loop gain	12345	12345	12345	12345	20 to 50000 [rad/s]																																																																																							
Speed integral comp	12345	12345	12345	12345	1 to 10000(*10 ⁻⁴) [ms]																																																																																							
Speed filter comp	1234	1234	1234	1234	0 to 1000(*10 ⁻⁴) [%]																																																																																							
Resonance suppr. 1	1234	1234	1234	1234	100 to 4500 [Hz]																																																																																							
Resonance suppr. 2	1234	1234	1234	1234	100 to 4500 [Hz]																																																																																							
Low pass filter	12345	12345	12345	12345	100 to 18000 [rad/s]																																																																																							
Low pass filter selection	1	1	1	1	0:Automatic setting 1:Manual setting																																																																																							
						2)	30120, 30320, 30520, 30720	75A8, 7670, 7738, 7800																																																																																				
						3)	30122, 30322, 30522, 30722	75AA, 7672, 773A, 7802																																																																																				
						4)	30124, 30324, 30524, 30724	75AC, 7674, 773C, 7804																																																																																				
						5)	30125, 30325, 30525, 30725	75AD, 7675, 773D, 7805																																																																																				
						6)	30126, 30326, 30526, 30726	75AE, 7676, 773E, 7806																																																																																				
						7)	30127, 30327, 30527, 30727	75AF, 7677, 773F, 7807																																																																																				
						8)	30128, 30328, 30528, 30728	75B0, 7678, 7740, 7808																																																																																				
						9)	30129, 30329, 30529, 30729	75B1, 7679, 7741, 7809																																																																																				
						10)	30131, 30331, 30531, 30731	75B3, 767B, 7743, 780B																																																																																				
						11)	30133, 30333, 30533, 30733	75B5, 767D, 7745, 780D																																																																																				
						12)	30136, 30336, 30536, 30736	75B8, 7680, 7748, 7810																																																																																				
						13)	30141, 30341, 30541, 30741	75BD, 7685, 774D, 7815																																																																																				
						-	-	-																																																																																				
<p>LD77MS4 Servo parameter Gain/Filter-2</p> <table border="1"> <thead> <tr> <th>Item</th> <th>Axis1</th> <th>Axis2</th> <th>Axis3</th> <th>Axis4</th> <th>Setting range</th> </tr> </thead> <tbody> <tr> <td>Notch shape selection 1</td> <td>1</td> <td>1</td> <td>1</td> <td>1</td> <td>0 1 2 3 Deep ← → Shallow -40dB ← -14dB → -8dB → -4dB</td> </tr> <tr> <td>Notch width selection</td> <td>1</td> <td>1</td> <td>1</td> <td>1</td> <td>Standard ← → Wide α=2 α=3 α=4 α=5</td> </tr> <tr> <td>Resonance suppression filter 2</td> <td>1</td> <td>1</td> <td>1</td> <td>1</td> <td>0:Invalid 1:Valid</td> </tr> <tr> <td>Notch shape selection 1</td> <td>1</td> <td>1</td> <td>1</td> <td>1</td> <td>0 1 2 3 Deep ← → Shallow -40dB ← -14dB → -8dB → -4dB</td> </tr> <tr> <td>Notch width selection</td> <td>1</td> <td>1</td> <td>1</td> <td>1</td> <td>Standard ← → Wide α=2 α=3 α=4 α=5</td> </tr> <tr> <td>Vibration freq.</td> <td>1234</td> <td>1234</td> <td>1234</td> <td>1234</td> <td>1 to 1000(*10⁻⁴) [Hz]</td> </tr> <tr> <td>Resonance freq.</td> <td>1234</td> <td>1234</td> <td>1234</td> <td>1234</td> <td>1 to 1000(*10⁻⁴) [Hz]</td> </tr> <tr> <td>Smart vib suppr</td> <td>1</td> <td>1</td> <td>1</td> <td>1</td> <td>0:Invalid 1:Valid</td> </tr> <tr> <td>PI-PID switch-over selection</td> <td>1</td> <td>1</td> <td>1</td> <td>1</td> <td>0:PI control is valid. 3:PID control is always valid.</td> </tr> </tbody> </table>						Item	Axis1	Axis2	Axis3	Axis4	Setting range	Notch shape selection 1	1	1	1	1	0 1 2 3 Deep ← → Shallow -40dB ← -14dB → -8dB → -4dB	Notch width selection	1	1	1	1	Standard ← → Wide α=2 α=3 α=4 α=5	Resonance suppression filter 2	1	1	1	1	0:Invalid 1:Valid	Notch shape selection 1	1	1	1	1	0 1 2 3 Deep ← → Shallow -40dB ← -14dB → -8dB → -4dB	Notch width selection	1	1	1	1	Standard ← → Wide α=2 α=3 α=4 α=5	Vibration freq.	1234	1234	1234	1234	1 to 1000(*10 ⁻⁴) [Hz]	Resonance freq.	1234	1234	1234	1234	1 to 1000(*10 ⁻⁴) [Hz]	Smart vib suppr	1	1	1	1	0:Invalid 1:Valid	PI-PID switch-over selection	1	1	1	1	0:PI control is valid. 3:PID control is always valid.	1)	30132, 30332, 30532, 30732	75B4, 767C, 7744, 780C																								
Item	Axis1	Axis2	Axis3	Axis4	Setting range																																																																																							
Notch shape selection 1	1	1	1	1	0 1 2 3 Deep ← → Shallow -40dB ← -14dB → -8dB → -4dB																																																																																							
Notch width selection	1	1	1	1	Standard ← → Wide α=2 α=3 α=4 α=5																																																																																							
Resonance suppression filter 2	1	1	1	1	0:Invalid 1:Valid																																																																																							
Notch shape selection 1	1	1	1	1	0 1 2 3 Deep ← → Shallow -40dB ← -14dB → -8dB → -4dB																																																																																							
Notch width selection	1	1	1	1	Standard ← → Wide α=2 α=3 α=4 α=5																																																																																							
Vibration freq.	1234	1234	1234	1234	1 to 1000(*10 ⁻⁴) [Hz]																																																																																							
Resonance freq.	1234	1234	1234	1234	1 to 1000(*10 ⁻⁴) [Hz]																																																																																							
Smart vib suppr	1	1	1	1	0:Invalid 1:Valid																																																																																							
PI-PID switch-over selection	1	1	1	1	0:PI control is valid. 3:PID control is always valid.																																																																																							
						2)	30134, 30334, 30534, 30734	75B6, 767E, 7746, 780E																																																																																				
						3)	30137, 30337, 30537, 30737	75B9, 7681, 7749, 7811																																																																																				
						4)	30138, 30338, 30538, 30738	75BA, 7682, 774A, 7812																																																																																				
						5)	30142, 30342, 30542, 30742	75BE, 7686, 774E, 7816																																																																																				
						-	-	-																																																																																				

- 1 OVERVIEW
- 2 SYSTEM MONITOR
- 3 LADDER MONITOR FUNCTION
- 4 MELSEC-A LIST EDITOR
- 5 MELSEC-FX LIST EDITOR
- 6 INTELLIGENT MODULE MONITOR
- 7 NETWORK MONITOR
- 8 Q MOTION MONITOR

Screen example		No.	Buffer memory address																																																																																																																
			DEC	HEX																																																																																																															
<table border="1"> <thead> <tr> <th colspan="5">LD77MS4 Servo parameter Gain/Filter-3</th> <th>SET/RESET</th> <th>Data Chg.</th> <th>MONIT MENU</th> <th>END</th> </tr> <tr> <th>Item</th> <th>Axis1</th> <th>Axis2</th> <th>Axis3</th> <th>Axis4</th> <th colspan="4">Setting range</th> </tr> </thead> <tbody> <tr> <td>1) Gain switch condition</td> <td>1234</td> <td>1234</td> <td>1234</td> <td>1234</td> <td colspan="4">0 to 9999</td> </tr> <tr> <td>2) Const. at gain switch</td> <td>123</td> <td>123</td> <td>123</td> <td>123</td> <td colspan="4">0 to 100[ms]</td> </tr> <tr> <td>3) Load inertia ratio to gain switch servo</td> <td>1234</td> <td>1234</td> <td>1234</td> <td>1234</td> <td colspan="4">0 to 3000(*10⁻¹)</td> </tr> <tr> <td>4) Position loop gain</td> <td>1234</td> <td>1234</td> <td>1234</td> <td>1234</td> <td colspan="4">1 to 2000[rad/s]</td> </tr> <tr> <td>5) Speed loop gain</td> <td>12345</td> <td>12345</td> <td>12345</td> <td>12345</td> <td colspan="4">20 to 50000[rad/s]</td> </tr> <tr> <td>6) Speed integral comp.</td> <td>12345</td> <td>12345</td> <td>12345</td> <td>12345</td> <td colspan="4">1 to 50000(*10⁻¹)[ms]</td> </tr> <tr> <td>7) Vibration freq setup</td> <td>1234</td> <td>1234</td> <td>1234</td> <td>1234</td> <td colspan="4">1 to 1000(*10⁻¹)[Hz]</td> </tr> <tr> <td>8) Resonance freq setup</td> <td>1234</td> <td>1234</td> <td>1234</td> <td>1234</td> <td colspan="4">1 to 1000(*10⁻¹)[Hz]</td> </tr> <tr> <td colspan="5">Gain changing selection</td> <td>12</td> <td>12</td> <td>12</td> <td>12</td> </tr> <tr> <td colspan="5">Setting range</td> <td colspan="4"> 00:Invalid 01:Control command by the controller is effective. 02:Command frequency is more than PB27. 03:(Motor encoder unit)Droop pulse is more than PB27. 04:Model speed is more than PB27. 12:Command frequency is less than PB27. 13:(Motor encoder unit)Droop pulse is less than PB27. 14:Model speed is less than PB27. </td> </tr> </tbody> </table>					LD77MS4 Servo parameter Gain/Filter-3					SET/RESET	Data Chg.	MONIT MENU	END	Item	Axis1	Axis2	Axis3	Axis4	Setting range				1) Gain switch condition	1234	1234	1234	1234	0 to 9999				2) Const. at gain switch	123	123	123	123	0 to 100[ms]				3) Load inertia ratio to gain switch servo	1234	1234	1234	1234	0 to 3000(*10 ⁻¹)				4) Position loop gain	1234	1234	1234	1234	1 to 2000[rad/s]				5) Speed loop gain	12345	12345	12345	12345	20 to 50000[rad/s]				6) Speed integral comp.	12345	12345	12345	12345	1 to 50000(*10 ⁻¹)[ms]				7) Vibration freq setup	1234	1234	1234	1234	1 to 1000(*10 ⁻¹)[Hz]				8) Resonance freq setup	1234	1234	1234	1234	1 to 1000(*10 ⁻¹)[Hz]				Gain changing selection					12	12	12	12	Setting range					00:Invalid 01:Control command by the controller is effective. 02:Command frequency is more than PB27. 03:(Motor encoder unit)Droop pulse is more than PB27. 04:Model speed is more than PB27. 12:Command frequency is less than PB27. 13:(Motor encoder unit)Droop pulse is less than PB27. 14:Model speed is less than PB27.				1)	30145, 30345, 30545, 30745	75C1, 7689, 7751, 7819
LD77MS4 Servo parameter Gain/Filter-3					SET/RESET	Data Chg.	MONIT MENU	END																																																																																																											
Item	Axis1	Axis2	Axis3	Axis4	Setting range																																																																																																														
1) Gain switch condition	1234	1234	1234	1234	0 to 9999																																																																																																														
2) Const. at gain switch	123	123	123	123	0 to 100[ms]																																																																																																														
3) Load inertia ratio to gain switch servo	1234	1234	1234	1234	0 to 3000(*10 ⁻¹)																																																																																																														
4) Position loop gain	1234	1234	1234	1234	1 to 2000[rad/s]																																																																																																														
5) Speed loop gain	12345	12345	12345	12345	20 to 50000[rad/s]																																																																																																														
6) Speed integral comp.	12345	12345	12345	12345	1 to 50000(*10 ⁻¹)[ms]																																																																																																														
7) Vibration freq setup	1234	1234	1234	1234	1 to 1000(*10 ⁻¹)[Hz]																																																																																																														
8) Resonance freq setup	1234	1234	1234	1234	1 to 1000(*10 ⁻¹)[Hz]																																																																																																														
Gain changing selection					12	12	12	12																																																																																																											
Setting range					00:Invalid 01:Control command by the controller is effective. 02:Command frequency is more than PB27. 03:(Motor encoder unit)Droop pulse is more than PB27. 04:Model speed is more than PB27. 12:Command frequency is less than PB27. 13:(Motor encoder unit)Droop pulse is less than PB27. 14:Model speed is less than PB27.																																																																																																														
					2)	30146, 30346, 30546, 30746	75C2, 768A, 7752, 781A																																																																																																												
					3)	30147, 30347, 30547, 30747	75C3, 768B, 7753, 781B																																																																																																												
					4)	30148, 30348, 30548, 30748	75C4, 768C, 7754, 781C																																																																																																												
					5)	30149, 30349, 30549, 30749	75C5, 768D, 7755, 781D																																																																																																												
					6)	30150, 30350, 30550, 30750	75C6, 768E, 7756, 781E																																																																																																												
					7)	30151, 30351, 30551, 30751	75C7, 768F, 7757, 781F																																																																																																												
					8)	30152, 30352, 30552, 30752	75C8, 7690, 7758, 7820																																																																																																												
					9)	30144, 30344, 30544, 30744	75C0, 7688, 7750, 7818																																																																																																												
					-	-	-																																																																																																												
<table border="1"> <thead> <tr> <th colspan="5">LD77MS4 Servo parameter Gain/Filter-4</th> <th>SET/RESET</th> <th>Data Chg.</th> <th>MONIT MENU</th> <th>END</th> </tr> <tr> <th>Item</th> <th>Axis1</th> <th>Axis2</th> <th>Axis3</th> <th>Axis4</th> <th colspan="4">Setting range</th> </tr> </thead> <tbody> <tr> <td>1) Vibration suppression control Z tuning mode</td> <td>1</td> <td>1</td> <td>1</td> <td>1</td> <td colspan="4">0: Disabled 1: Automatic setting 2: Manual setting</td> </tr> <tr> <td>2) Torque fb loop gain</td> <td>12345</td> <td>12345</td> <td>12345</td> <td>12345</td> <td colspan="4">0 to 18000[rad/s]</td> </tr> <tr> <td>3) Overboost amount comp</td> <td>123</td> <td>123</td> <td>123</td> <td>123</td> <td colspan="4">0 to 100[%]</td> </tr> <tr> <td>4) Shaft resonance suppression filter setting frequency</td> <td>12</td> <td>12</td> <td>12</td> <td>12</td> <td colspan="4"> 00:Disabled 01:Disabled 02: 0F 0F 1F High Middle Low 400Hz 800Hz 200Hz </td> </tr> <tr> <td>5) Notch depth selection</td> <td>1</td> <td>1</td> <td>1</td> <td>1</td> <td colspan="4"> 0 1 2 3 Deep Middle Shallow =40dB =14dB =3dB =4dB </td> </tr> <tr> <td>6) VRF1 Vibration freq. damping</td> <td>12</td> <td>12</td> <td>12</td> <td>12</td> <td colspan="4">0 to 30(*10⁻²)</td> </tr> <tr> <td>7) VRF1 Resonance freq. damping</td> <td>12</td> <td>12</td> <td>12</td> <td>12</td> <td colspan="4">0 to 30(*10⁻²)</td> </tr> </tbody> </table>					LD77MS4 Servo parameter Gain/Filter-4					SET/RESET	Data Chg.	MONIT MENU	END	Item	Axis1	Axis2	Axis3	Axis4	Setting range				1) Vibration suppression control Z tuning mode	1	1	1	1	0: Disabled 1: Automatic setting 2: Manual setting				2) Torque fb loop gain	12345	12345	12345	12345	0 to 18000[rad/s]				3) Overboost amount comp	123	123	123	123	0 to 100[%]				4) Shaft resonance suppression filter setting frequency	12	12	12	12	00:Disabled 01:Disabled 02: 0F 0F 1F High Middle Low 400Hz 800Hz 200Hz				5) Notch depth selection	1	1	1	1	0 1 2 3 Deep Middle Shallow =40dB =14dB =3dB =4dB				6) VRF1 Vibration freq. damping	12	12	12	12	0 to 30(*10 ⁻²)				7) VRF1 Resonance freq. damping	12	12	12	12	0 to 30(*10 ⁻²)				1)	30120, 30320, 30520, 30720	75A8, 7670, 7738, 7800																											
LD77MS4 Servo parameter Gain/Filter-4					SET/RESET	Data Chg.	MONIT MENU	END																																																																																																											
Item	Axis1	Axis2	Axis3	Axis4	Setting range																																																																																																														
1) Vibration suppression control Z tuning mode	1	1	1	1	0: Disabled 1: Automatic setting 2: Manual setting																																																																																																														
2) Torque fb loop gain	12345	12345	12345	12345	0 to 18000[rad/s]																																																																																																														
3) Overboost amount comp	123	123	123	123	0 to 100[%]																																																																																																														
4) Shaft resonance suppression filter setting frequency	12	12	12	12	00:Disabled 01:Disabled 02: 0F 0F 1F High Middle Low 400Hz 800Hz 200Hz																																																																																																														
5) Notch depth selection	1	1	1	1	0 1 2 3 Deep Middle Shallow =40dB =14dB =3dB =4dB																																																																																																														
6) VRF1 Vibration freq. damping	12	12	12	12	0 to 30(*10 ⁻²)																																																																																																														
7) VRF1 Resonance freq. damping	12	12	12	12	0 to 30(*10 ⁻²)																																																																																																														
					2)	30121, 30321, 30521, 30721	75A9, 7671, 7739, 7801																																																																																																												
					3)	30130, 30330, 30530, 30730	75B2, 767A, 7742, 780A																																																																																																												
					4)	30135, 30335, 30535, 30735	75B7, 767F, 7747, 780F																																																																																																												
					5)	30139, 30339, 30539, 30739	75BB, 7683, 774B, 7813																																																																																																												
					6)	30140, 30340, 30540, 30740	75BC, 7684, 774C, 7814																																																																																																												
					-	-	-																																																																																																												
<table border="1"> <thead> <tr> <th colspan="5">LD77MS4 Servo parameter Gain/Filter-5</th> <th>SET/RESET</th> <th>Data Chg.</th> <th>MONIT MENU</th> <th>END</th> </tr> <tr> <th>Item</th> <th>Axis1</th> <th>Axis2</th> <th>Axis3</th> <th>Axis4</th> <th colspan="4">Setting range</th> </tr> </thead> <tbody> <tr> <td>1) VRF1 Vibration freq. after gain switching</td> <td>12</td> <td>12</td> <td>12</td> <td>12</td> <td colspan="4">0 to 30(*10⁻²)</td> </tr> <tr> <td>2) VRF1 Resonance freq. after gain switching</td> <td>12</td> <td>12</td> <td>12</td> <td>12</td> <td colspan="4">0 to 30(*10⁻²)</td> </tr> <tr> <td>3) Command notch filter setting frequency selection</td> <td>12</td> <td>12</td> <td>12</td> <td>12</td> <td colspan="4"> 00:Disabled 01 2F 5F High Middle Low 200Hz 30Hz 4.5Hz </td> </tr> <tr> <td>4) Notch depth selection</td> <td>1</td> <td>1</td> <td>1</td> <td>1</td> <td colspan="4"> 0 7 F Deep Middle Shallow =40dB =7.2dB =0.5dB </td> </tr> </tbody> </table>					LD77MS4 Servo parameter Gain/Filter-5					SET/RESET	Data Chg.	MONIT MENU	END	Item	Axis1	Axis2	Axis3	Axis4	Setting range				1) VRF1 Vibration freq. after gain switching	12	12	12	12	0 to 30(*10 ⁻²)				2) VRF1 Resonance freq. after gain switching	12	12	12	12	0 to 30(*10 ⁻²)				3) Command notch filter setting frequency selection	12	12	12	12	00:Disabled 01 2F 5F High Middle Low 200Hz 30Hz 4.5Hz				4) Notch depth selection	1	1	1	1	0 7 F Deep Middle Shallow =40dB =7.2dB =0.5dB				1)	30153, 30353, 30553, 30753	75C9, 7691, 7759, 7821																																																						
LD77MS4 Servo parameter Gain/Filter-5					SET/RESET	Data Chg.	MONIT MENU	END																																																																																																											
Item	Axis1	Axis2	Axis3	Axis4	Setting range																																																																																																														
1) VRF1 Vibration freq. after gain switching	12	12	12	12	0 to 30(*10 ⁻²)																																																																																																														
2) VRF1 Resonance freq. after gain switching	12	12	12	12	0 to 30(*10 ⁻²)																																																																																																														
3) Command notch filter setting frequency selection	12	12	12	12	00:Disabled 01 2F 5F High Middle Low 200Hz 30Hz 4.5Hz																																																																																																														
4) Notch depth selection	1	1	1	1	0 7 F Deep Middle Shallow =40dB =7.2dB =0.5dB																																																																																																														
					2)	30154, 30354, 30554, 30754	75CA, 5692, 775A, 7822																																																																																																												
					3)	30163, 30363, 30563, 30763	75D3, 769B, 7763, 782B																																																																																																												
					4)																																																																																																														
					-	-	-																																																																																																												

Screen example						No.	Buffer memory address	
							DEC	HEX
						1)	31645, 31895, 32145, 32395	7B9D, 7C97, 7D91, 7E8B
1)	Resonance suppression filter 3	1234	1234	1234	1234	2)	31646, 31896, 32146, 32396	7B9E, 7C98, 7D92, 7E8C
2)	Notch shape selection 3	1	1	1	1	3)		
3)	Notch depth selection	1	1	1	1	4)	31647, 31897, 32147, 32397	7B9F, 7C99, 7D93, 7E8D
4)	Notch width selection	1	1	1	1	5)		
5)	Resonance suppression filter 4	1234	1234	1234	1234	6)	31648, 31898, 32148, 32398	7BA0, 7C9A, 7D94, 7E8E
6)	Notch shape selection 4	1	1	1	1	7)		
7)	Notch depth selection	1	1	1	1	8)		
8)	Notch width selection	1	1	1	1			
						1)	31649, 31899, 32149, 32399	7BA1, 7C9B, 7D95, 7E8F
1)	Resonance suppression filter 5	1234	1234	1234	1234	2)	31650, 31900, 32150, 32400	7BA2, 7C9C, 7D96, 7E90
2)	Notch shape selection 5	1	1	1	1	3)		
3)	Notch depth selection	1	1	1	1	4)	31651, 31901, 32151, 32401	7BA3, 7C9D, 7D97, 7E91
4)	Notch width selection	1	1	1	1	5)		
5)	VRF2 Vibration freq.	1234	1234	1234	1234	6)	31652, 31902, 32152, 32402	7BA4, 7C9E, 7D98, 7E92
6)	VRF2 Resonance freq.	1234	1234	1234	1234	7)	31653, 31903, 32153, 32403	7BA5, 7C9F, 7D99, 7E93
7)	VRF2 Vibration freq. damping	12	12	12	12	8)	31654, 31904, 32154, 32404	7BA6, 7CA0, 7D9A, 7E94
8)	VRF2 Resonance freq. damping	12	12	12	12			
						1)	31455, 31705, 31955, 32205	7ADF, 7BD9, 7CD3, 7DCD
1)	VRF2 Vibration freq. after gain switching	1234	1234	1234	1234	2)	31456, 31706, 31956, 32206	7AE0, 7BDA, 7CD4, 7DCE
2)	VRF2 Resonance freq. after gain switching	1234	1234	1234	1234	3)	31457, 31707, 31957, 32207	7AE1, 7BDB, 7CD5, 7DCF
3)	VRF2 V. freq. damping after gain switching	12	12	12	12	4)		
4)	VRF2 R. freq. damping after gain switching	12	12	12	12	5)	31458, 31708, 31958, 32208	7AE2, 7BDC, 7CD6, 7DD0
5)	Model loop gain after gain switching	1234	1234	1234	1234	6)	31459, 31709, 31959, 32209	7AE3, 7BDD, 7CD7, 7DD1

- 1 OVERVIEW
- 2 SYSTEM MONITOR
- 3 LADDER MONITOR FUNCTION
- 4 MELSEC-A LIST EDITOR
- 5 MELSEC-FX LIST EDITOR
- 6 INTELLIGENT MODULE MONITOR
- 7 NETWORK MONITOR
- 8 Q MOTION MONITOR

Screen example		No.	Buffer memory address																																																																																																								
			DEC	HEX																																																																																																							
<table border="1"> <thead> <tr> <th colspan="6">LD77M34 Servo parameter Ex. setting1-1</th> <th>SET/RESET</th> <th>Data Chg.</th> <th>MONIT MENU</th> <th>END</th> </tr> <tr> <th>Item</th> <th>Axis1</th> <th>Axis2</th> <th>Axis3</th> <th>Axis4</th> <th>Setting range</th> <th></th> <th></th> <th></th> <th></th> </tr> </thead> <tbody> <tr> <td>1) Error excessive level</td> <td>123</td> <td>123</td> <td>123</td> <td>123</td> <td>1 to 200[rev]</td> <td></td> <td></td> <td></td> <td></td> </tr> <tr> <td>2) EM brake sequence</td> <td>1234</td> <td>1234</td> <td>1234</td> <td>1234</td> <td>0 to 1000[ms]</td> <td></td> <td></td> <td></td> <td></td> </tr> <tr> <td>3) Encoder pulse output direction selection</td> <td>1</td> <td>1</td> <td>1</td> <td>1</td> <td>0:0CW 1:0W (progress to A phases 90°)</td> <td></td> <td></td> <td></td> <td></td> </tr> <tr> <td>4) Encoder pulse output setting selection</td> <td>1</td> <td>1</td> <td>1</td> <td>1</td> <td>0:Output pulse dsgr. 1:Division ratio setting</td> <td></td> <td></td> <td></td> <td></td> </tr> <tr> <td>5) Function selection C1 Serial encoder cable</td> <td>1</td> <td>1</td> <td>1</td> <td>1</td> <td>0:2-wire 1:4-wire</td> <td></td> <td></td> <td></td> <td></td> </tr> <tr> <td>6) Function selection C2 Motor-less operation</td> <td>1</td> <td>1</td> <td>1</td> <td>1</td> <td>0:Invalid 1:Valid</td> <td></td> <td></td> <td></td> <td></td> </tr> <tr> <td>7) Zero speed</td> <td>12345</td> <td>12345</td> <td>12345</td> <td>12345</td> <td>0 to 10000[r/min]</td> <td></td> <td></td> <td></td> <td></td> </tr> </tbody> </table>					LD77M34 Servo parameter Ex. setting1-1						SET/RESET	Data Chg.	MONIT MENU	END	Item	Axis1	Axis2	Axis3	Axis4	Setting range					1) Error excessive level	123	123	123	123	1 to 200[rev]					2) EM brake sequence	1234	1234	1234	1234	0 to 1000[ms]					3) Encoder pulse output direction selection	1	1	1	1	0:0CW 1:0W (progress to A phases 90°)					4) Encoder pulse output setting selection	1	1	1	1	0:Output pulse dsgr. 1:Division ratio setting					5) Function selection C1 Serial encoder cable	1	1	1	1	0:2-wire 1:4-wire					6) Function selection C2 Motor-less operation	1	1	1	1	0:Invalid 1:Valid					7) Zero speed	12345	12345	12345	12345	0 to 10000[r/min]					1)	30164, 30364, 30564, 30764	75D4, 769C, 7764, 782C										
LD77M34 Servo parameter Ex. setting1-1						SET/RESET	Data Chg.	MONIT MENU	END																																																																																																		
Item	Axis1	Axis2	Axis3	Axis4	Setting range																																																																																																						
1) Error excessive level	123	123	123	123	1 to 200[rev]																																																																																																						
2) EM brake sequence	1234	1234	1234	1234	0 to 1000[ms]																																																																																																						
3) Encoder pulse output direction selection	1	1	1	1	0:0CW 1:0W (progress to A phases 90°)																																																																																																						
4) Encoder pulse output setting selection	1	1	1	1	0:Output pulse dsgr. 1:Division ratio setting																																																																																																						
5) Function selection C1 Serial encoder cable	1	1	1	1	0:2-wire 1:4-wire																																																																																																						
6) Function selection C2 Motor-less operation	1	1	1	1	0:Invalid 1:Valid																																																																																																						
7) Zero speed	12345	12345	12345	12345	0 to 10000[r/min]																																																																																																						
					2)	30165, 30365, 30565, 30765	75D5, 769D, 7765, 782D																																																																																																				
					3)	30166, 30366, 30566, 30766	75D6, 769E, 7766, 782E																																																																																																				
					4)	30167, 30367, 30567, 30767	75D7, 769F, 7767, 782F																																																																																																				
					5)	30168, 30368, 30568, 30768	75D8, 76A0, 7768, 7830																																																																																																				
					6)	30169, 30369, 30569, 30769	75D9, 76A1, 7769, 7831																																																																																																				
					7)	30170, 30370, 30570, 30770	75DA, 76A2, 776A, 7832																																																																																																				
					-	-	-																																																																																																				
<table border="1"> <thead> <tr> <th colspan="6">LD77M34 Servo parameter Ex. setting1-2</th> <th>SET/RESET</th> <th>Data Chg.</th> <th>MONIT MENU</th> <th>END</th> </tr> <tr> <th>Item</th> <th>Axis1</th> <th>Axis2</th> <th>Axis3</th> <th>Axis4</th> <th>Setting range</th> <th></th> <th></th> <th></th> <th></th> </tr> </thead> <tbody> <tr> <td>Analog monitor 1 offset</td> <td>1234</td> <td>1234</td> <td>1234</td> <td>1234</td> <td>000 to 000[Hz]</td> <td></td> <td></td> <td></td> <td></td> </tr> <tr> <td>Analog monitor 2 offset</td> <td>1234</td> <td>1234</td> <td>1234</td> <td>1234</td> <td>000 to 000[Hz]</td> <td></td> <td></td> <td></td> <td></td> </tr> <tr> <th>Item</th> <th>Axis1</th> <th>Axis2</th> <th>Axis3</th> <th>Axis4</th> <th>Setting range</th> <th></th> <th></th> <th></th> <th></th> </tr> <tr> <td>Analog monitor output selection(ch1)</td> <td>12</td> <td>12</td> <td>12</td> <td>12</td> <td></td> <td></td> <td></td> <td></td> <td></td> </tr> <tr> <td>Analog monitor output selection(ch2)</td> <td>12</td> <td>12</td> <td>12</td> <td>12</td> <td></td> <td></td> <td></td> <td></td> <td></td> </tr> <tr> <td colspan="10"> 0:Servo motor speed(±8V/max. speed) 1:Torque(±8V/max. torque) 2:Servo motor speed(+8V/max. speed) 3:Torque(+8V/max. torque) 4:Current command(±8V/max. curre) 5:Command speed(±8V/max. command speed) 6:Droop puls(±10V/100puls[Encoder unit]) 7:Droop puls(±10V/1000puls[Encoder unit]) 8:Droop puls(±10V/10000puls[Encoder unit]) 9:Droop puls(±10V/100000puls[Encoder unit]) A:Feedback position(±10V/1,000,000puls[Encoder unit]) B:Feedback position(±10V/10,000,000puls[Encoder unit]) C:Feedback position(±10V/100,000,000puls[Encoder unit]) D:Bus voltage(+8V/400V, Amplifier of 200V) Bus voltage(+8V/800V, Amplifier of 400V) E·F·15~1F:Un-output(Zero output) </td> </tr> </tbody> </table>					LD77M34 Servo parameter Ex. setting1-2						SET/RESET	Data Chg.	MONIT MENU	END	Item	Axis1	Axis2	Axis3	Axis4	Setting range					Analog monitor 1 offset	1234	1234	1234	1234	000 to 000[Hz]					Analog monitor 2 offset	1234	1234	1234	1234	000 to 000[Hz]					Item	Axis1	Axis2	Axis3	Axis4	Setting range					Analog monitor output selection(ch1)	12	12	12	12						Analog monitor output selection(ch2)	12	12	12	12						0:Servo motor speed(±8V/max. speed) 1:Torque(±8V/max. torque) 2:Servo motor speed(+8V/max. speed) 3:Torque(+8V/max. torque) 4:Current command(±8V/max. curre) 5:Command speed(±8V/max. command speed) 6:Droop puls(±10V/100puls[Encoder unit]) 7:Droop puls(±10V/1000puls[Encoder unit]) 8:Droop puls(±10V/10000puls[Encoder unit]) 9:Droop puls(±10V/100000puls[Encoder unit]) A:Feedback position(±10V/1,000,000puls[Encoder unit]) B:Feedback position(±10V/10,000,000puls[Encoder unit]) C:Feedback position(±10V/100,000,000puls[Encoder unit]) D:Bus voltage(+8V/400V, Amplifier of 200V) Bus voltage(+8V/800V, Amplifier of 400V) E·F·15~1F:Un-output(Zero output)										1)	30174, 30374, 30574, 30774	75DE, 76A6, 776E, 7836																				
LD77M34 Servo parameter Ex. setting1-2						SET/RESET	Data Chg.	MONIT MENU	END																																																																																																		
Item	Axis1	Axis2	Axis3	Axis4	Setting range																																																																																																						
Analog monitor 1 offset	1234	1234	1234	1234	000 to 000[Hz]																																																																																																						
Analog monitor 2 offset	1234	1234	1234	1234	000 to 000[Hz]																																																																																																						
Item	Axis1	Axis2	Axis3	Axis4	Setting range																																																																																																						
Analog monitor output selection(ch1)	12	12	12	12																																																																																																							
Analog monitor output selection(ch2)	12	12	12	12																																																																																																							
0:Servo motor speed(±8V/max. speed) 1:Torque(±8V/max. torque) 2:Servo motor speed(+8V/max. speed) 3:Torque(+8V/max. torque) 4:Current command(±8V/max. curre) 5:Command speed(±8V/max. command speed) 6:Droop puls(±10V/100puls[Encoder unit]) 7:Droop puls(±10V/1000puls[Encoder unit]) 8:Droop puls(±10V/10000puls[Encoder unit]) 9:Droop puls(±10V/100000puls[Encoder unit]) A:Feedback position(±10V/1,000,000puls[Encoder unit]) B:Feedback position(±10V/10,000,000puls[Encoder unit]) C:Feedback position(±10V/100,000,000puls[Encoder unit]) D:Bus voltage(+8V/400V, Amplifier of 200V) Bus voltage(+8V/800V, Amplifier of 400V) E·F·15~1F:Un-output(Zero output)																																																																																																											
					2)	30175, 30375, 30575, 30775	75DF, 76A7, 776F, 7837																																																																																																				
					3)	30172, 30372, 30572, 30772	75DC, 76A4, 776C, 7834																																																																																																				
					4)	30173, 30373, 30573, 30773	75DD, 76A5, 776D, 7835																																																																																																				
					-	-	-																																																																																																				
<table border="1"> <thead> <tr> <th colspan="6">LD77M34 Servo parameter Ex. setting1-3</th> <th>SET/RESET</th> <th>Data Chg.</th> <th>MONIT MENU</th> <th>END</th> </tr> <tr> <th>Item</th> <th>Axis1</th> <th>Axis2</th> <th>Axis3</th> <th>Axis4</th> <th>Setting range</th> <th></th> <th></th> <th></th> <th></th> </tr> </thead> <tbody> <tr> <td>Selection of the encoders for encoder output pulse</td> <td>1</td> <td>1</td> <td>1</td> <td>1</td> <td>0:Servo motor encoder 1:Load-side encoder</td> <td></td> <td></td> <td></td> <td></td> </tr> <tr> <td>Func. selection C-3 EE alarm level unit</td> <td>1</td> <td>1</td> <td>1</td> <td>1</td> <td>0 to 3</td> <td></td> <td></td> <td></td> <td></td> </tr> <tr> <td>OS alarm detect.level</td> <td>12345</td> <td>12345</td> <td>12345</td> <td>12345</td> <td>0 to 20000[r/min]</td> <td></td> <td></td> <td></td> <td></td> </tr> <tr> <td>Func. selection C-4 home position setting condition</td> <td>1</td> <td>1</td> <td>1</td> <td>1</td> <td>0:Z-phase after power on 1:Need to pass 2:Not need to pass</td> <td></td> <td></td> <td></td> <td></td> </tr> <tr> <td>Func. selection C-5 [AL, E9 Main circuit off warning]</td> <td>1</td> <td>1</td> <td>1</td> <td>1</td> <td>0:ready on and servo on 1:serve-on</td> <td></td> <td></td> <td></td> <td></td> </tr> <tr> <td>Func. selection C-7 Undervoltage alarm</td> <td>1</td> <td>1</td> <td>1</td> <td>1</td> <td>0:Method 1 1:Method 2</td> <td></td> <td></td> <td></td> <td></td> </tr> <tr> <td>Alarm history clear</td> <td>1</td> <td>1</td> <td>1</td> <td>1</td> <td>0:Disabled 1:Enabled</td> <td></td> <td></td> <td></td> <td></td> </tr> <tr> <td>FS dec. time constant</td> <td>12345</td> <td>12345</td> <td>12345</td> <td>12345</td> <td>0 to 20000[ms]</td> <td></td> <td></td> <td></td> <td></td> </tr> </tbody> </table>					LD77M34 Servo parameter Ex. setting1-3						SET/RESET	Data Chg.	MONIT MENU	END	Item	Axis1	Axis2	Axis3	Axis4	Setting range					Selection of the encoders for encoder output pulse	1	1	1	1	0:Servo motor encoder 1:Load-side encoder					Func. selection C-3 EE alarm level unit	1	1	1	1	0 to 3					OS alarm detect.level	12345	12345	12345	12345	0 to 20000[r/min]					Func. selection C-4 home position setting condition	1	1	1	1	0:Z-phase after power on 1:Need to pass 2:Not need to pass					Func. selection C-5 [AL, E9 Main circuit off warning]	1	1	1	1	0:ready on and servo on 1:serve-on					Func. selection C-7 Undervoltage alarm	1	1	1	1	0:Method 1 1:Method 2					Alarm history clear	1	1	1	1	0:Disabled 1:Enabled					FS dec. time constant	12345	12345	12345	12345	0 to 20000[ms]					1)	30166, 30366, 30566, 30766	75D6, 769E, 7766, 782E
LD77M34 Servo parameter Ex. setting1-3						SET/RESET	Data Chg.	MONIT MENU	END																																																																																																		
Item	Axis1	Axis2	Axis3	Axis4	Setting range																																																																																																						
Selection of the encoders for encoder output pulse	1	1	1	1	0:Servo motor encoder 1:Load-side encoder																																																																																																						
Func. selection C-3 EE alarm level unit	1	1	1	1	0 to 3																																																																																																						
OS alarm detect.level	12345	12345	12345	12345	0 to 20000[r/min]																																																																																																						
Func. selection C-4 home position setting condition	1	1	1	1	0:Z-phase after power on 1:Need to pass 2:Not need to pass																																																																																																						
Func. selection C-5 [AL, E9 Main circuit off warning]	1	1	1	1	0:ready on and servo on 1:serve-on																																																																																																						
Func. selection C-7 Undervoltage alarm	1	1	1	1	0:Method 1 1:Method 2																																																																																																						
Alarm history clear	1	1	1	1	0:Disabled 1:Enabled																																																																																																						
FS dec. time constant	12345	12345	12345	12345	0 to 20000[ms]																																																																																																						
					2)	30169, 30369, 30569, 30769	75D9, 76A1, 7769, 7831																																																																																																				
					3)	30171, 30371, 30571, 30771	75DB, 76A3, 776B, 7833																																																																																																				
					4)	30180, 30380, 30580, 30780	75E4, 76AC, 7774, 783C																																																																																																				
					5)	30181, 30381, 30581, 30781	75E5, 76AD, 7775, 783D																																																																																																				
					6)	30183, 30383, 30583, 30783	75E7, 76AF, 7777, 783F																																																																																																				
					7)	30184, 30384, 30584, 30784	75E8, 76B0, 7778, 7840																																																																																																				
					8)	30187, 30387, 30587, 30787	75EB, 76B3, 777B, 7843																																																																																																				
					-	-	-																																																																																																				

Screen example						No.	Buffer memory address																																																			
							DEC	HEX																																																		
<div style="display: flex; justify-content: space-between; align-items: center;"> <div style="font-size: small;">LD77MS4 Servo parameter Ex. setting1-4</div> <div style="text-align: right; font-size: x-small;"> SET/RESET Data Chg. MONIT MENU END </div> </div> <table border="1" style="width: 100%; border-collapse: collapse; text-align: center;"> <thead> <tr> <th style="width: 15%;">Item</th> <th style="width: 10%;">Axis1</th> <th style="width: 10%;">Axis2</th> <th style="width: 10%;">Axis3</th> <th style="width: 10%;">Axis4</th> <th style="width: 45%;">Setting range</th> </tr> </thead> <tbody> <tr> <td>1) Func. selection C-9 encoder pulse count polarity</td> <td>1</td> <td>1</td> <td>1</td> <td>1</td> <td>0:CW/positive direction 1:Encoder pulse inc. 1:Encoder pulse dec.</td> </tr> <tr> <td>2) Func. selection C-B PUL reflection</td> <td>1</td> <td>1</td> <td>1</td> <td>1</td> <td>0:Disabled 1:Enabled</td> </tr> <tr> <td>3) W-Ax freefall prevention compensation</td> <td>123456</td> <td>123456</td> <td>123456</td> <td>123456</td> <td>-25000 to 25000 (*10⁻⁴) [rev]</td> </tr> </tbody> </table>						Item	Axis1	Axis2	Axis3	Axis4	Setting range	1) Func. selection C-9 encoder pulse count polarity	1	1	1	1	0:CW/positive direction 1:Encoder pulse inc. 1:Encoder pulse dec.	2) Func. selection C-B PUL reflection	1	1	1	1	0:Disabled 1:Enabled	3) W-Ax freefall prevention compensation	123456	123456	123456	123456	-25000 to 25000 (*10 ⁻⁴) [rev]	1)	30190, 30390, 30590, 30790	75EE, 76B6, 777E, 7846																										
Item	Axis1	Axis2	Axis3	Axis4	Setting range																																																					
1) Func. selection C-9 encoder pulse count polarity	1	1	1	1	0:CW/positive direction 1:Encoder pulse inc. 1:Encoder pulse dec.																																																					
2) Func. selection C-B PUL reflection	1	1	1	1	0:Disabled 1:Enabled																																																					
3) W-Ax freefall prevention compensation	123456	123456	123456	123456	-25000 to 25000 (*10 ⁻⁴) [rev]																																																					
						2)	30192, 30392, 30592, 30792	75F0, 76B8, 7780, 7848																																																		
						3)	30194, 30394, 30594, 30794	75F2, 76BA, 7782, 784A																																																		
						-	-	-																																																		
<div style="display: flex; justify-content: space-between; align-items: center;"> <div style="font-size: small;">LD77MS4 Servo parameter I/O setting</div> <div style="text-align: right; font-size: x-small;"> SET/RESET Data Chg. MONIT MENU END </div> </div> <table border="1" style="width: 100%; border-collapse: collapse; text-align: center;"> <thead> <tr> <th style="width: 15%;">Item</th> <th style="width: 10%;">Axis1</th> <th style="width: 10%;">Axis2</th> <th style="width: 10%;">Axis3</th> <th style="width: 10%;">Axis4</th> <th style="width: 45%;">Setting range</th> </tr> </thead> <tbody> <tr> <td>Output signal device selection 1</td> <td>12</td> <td>12</td> <td>12</td> <td>12</td> <td></td> </tr> <tr> <td>Output signal device selection 2</td> <td>12</td> <td>12</td> <td>12</td> <td>12</td> <td></td> </tr> <tr> <td>Output signal device selection 3</td> <td>12</td> <td>12</td> <td>12</td> <td>12</td> <td></td> </tr> <tr> <td colspan="6">Setting range</td> </tr> <tr> <td colspan="6"> 0:Always OFF 1:RDY(Ready is ON) 2:RD(Servo is ON) 3:ALM(Trouble) 4:INP(In-position) 5:MBR(Electromagnetic brake interlock) 6:DB(External dynamic brake) 7:TLC(Limiting torque) 8:WNG(Warning) 9:BNIG(Battery warning) A:SA(Speed reached) C:ZSP(Zero speed) F:ODPS(Variable gain selection) 11:ABS(Absolute position erasing) </td> </tr> <tr> <td>Func. selection D-1 SV motor thermistor</td> <td>1</td> <td>1</td> <td>1</td> <td>1</td> <td>0:Enabled 1:Disabled</td> </tr> <tr> <td>Func. selection D-3 output dev. at warn.</td> <td>1</td> <td>1</td> <td>1</td> <td>1</td> <td>0:0ff 1:0n</td> </tr> </tbody> </table>						Item	Axis1	Axis2	Axis3	Axis4	Setting range	Output signal device selection 1	12	12	12	12		Output signal device selection 2	12	12	12	12		Output signal device selection 3	12	12	12	12		Setting range						0:Always OFF 1:RDY(Ready is ON) 2:RD(Servo is ON) 3:ALM(Trouble) 4:INP(In-position) 5:MBR(Electromagnetic brake interlock) 6:DB(External dynamic brake) 7:TLC(Limiting torque) 8:WNG(Warning) 9:BNIG(Battery warning) A:SA(Speed reached) C:ZSP(Zero speed) F:ODPS(Variable gain selection) 11:ABS(Absolute position erasing)						Func. selection D-1 SV motor thermistor	1	1	1	1	0:Enabled 1:Disabled	Func. selection D-3 output dev. at warn.	1	1	1	1	0:0ff 1:0n	1)	30202, 30402, 30602, 30802	75FA, 76C2, 778A, 7852		
Item	Axis1	Axis2	Axis3	Axis4	Setting range																																																					
Output signal device selection 1	12	12	12	12																																																						
Output signal device selection 2	12	12	12	12																																																						
Output signal device selection 3	12	12	12	12																																																						
Setting range																																																										
0:Always OFF 1:RDY(Ready is ON) 2:RD(Servo is ON) 3:ALM(Trouble) 4:INP(In-position) 5:MBR(Electromagnetic brake interlock) 6:DB(External dynamic brake) 7:TLC(Limiting torque) 8:WNG(Warning) 9:BNIG(Battery warning) A:SA(Speed reached) C:ZSP(Zero speed) F:ODPS(Variable gain selection) 11:ABS(Absolute position erasing)																																																										
Func. selection D-1 SV motor thermistor	1	1	1	1	0:Enabled 1:Disabled																																																					
Func. selection D-3 output dev. at warn.	1	1	1	1	0:0ff 1:0n																																																					
						2)	30203, 30403, 30603, 30803	75FB, 76C3, 778B, 7853																																																		
						3)	30204, 30404, 30604, 30804	75FC, 76C4, 778C, 7854																																																		
						4)	30207, 30407, 30607, 30807	75FF, 76C7, 778F, 7857																																																		
						5)	30209, 30409, 30609, 30809	7601, 76C9, 7791, 7859																																																		
						-	-	-																																																		
<div style="display: flex; justify-content: space-between; align-items: center;"> <div style="font-size: small;">LD77MS4 Servo parameter Ex. setting2-1</div> <div style="text-align: right; font-size: x-small;"> SET/RESET Data Chg. MONIT MENU END </div> </div> <table border="1" style="width: 100%; border-collapse: collapse; text-align: center;"> <thead> <tr> <th style="width: 15%;">Item</th> <th style="width: 10%;">Axis1</th> <th style="width: 10%;">Axis2</th> <th style="width: 10%;">Axis3</th> <th style="width: 10%;">Axis4</th> <th style="width: 45%;">Setting range</th> </tr> </thead> <tbody> <tr> <td>Fully closed loop function selection</td> <td>1</td> <td>1</td> <td>1</td> <td>1</td> <td>0:Always enabled 1:switching semi./full.</td> </tr> <tr> <td rowspan="3">Fully closed loop 1 error detection function selection</td> <td>1</td> <td>1</td> <td>1</td> <td>1</td> <td>0:Disabled 1:Speed deviation error 2:Pos. deviation error 3:S/P deviation error</td> </tr> <tr> <td>1</td> <td>1</td> <td>1</td> <td>1</td> <td>0:Continuous detection 1:detection at stop</td> </tr> <tr> <td>1</td> <td>1</td> <td>1</td> <td>1</td> <td>0:Reset disabled 1:Reset enabled</td> </tr> <tr> <td rowspan="2">Fully closed loop 2 feedback pulse EC61 Numerator</td> <td>12345</td> <td>12345</td> <td>12345</td> <td>12345</td> <td>1 to 99995</td> </tr> <tr> <td>12345</td> <td>12345</td> <td>12345</td> <td>12345</td> <td>1 to 99995</td> </tr> <tr> <td rowspan="2">Fully closed loop 3 error detection level(Spd. dev.)</td> <td>12345</td> <td>12345</td> <td>12345</td> <td>12345</td> <td>1 to 50000[1/min]</td> </tr> <tr> <td>12345</td> <td>12345</td> <td>12345</td> <td>12345</td> <td>1 to 20000[1/pulse]</td> </tr> </tbody> </table>						Item	Axis1	Axis2	Axis3	Axis4	Setting range	Fully closed loop function selection	1	1	1	1	0:Always enabled 1:switching semi./full.	Fully closed loop 1 error detection function selection	1	1	1	1	0:Disabled 1:Speed deviation error 2:Pos. deviation error 3:S/P deviation error	1	1	1	1	0:Continuous detection 1:detection at stop	1	1	1	1	0:Reset disabled 1:Reset enabled	Fully closed loop 2 feedback pulse EC61 Numerator	12345	12345	12345	12345	1 to 99995	12345	12345	12345	12345	1 to 99995	Fully closed loop 3 error detection level(Spd. dev.)	12345	12345	12345	12345	1 to 50000[1/min]	12345	12345	12345	12345	1 to 20000[1/pulse]	1)	30228, 30428, 30628, 30828	7614, 76DC, 77A4, 786C
Item	Axis1	Axis2	Axis3	Axis4	Setting range																																																					
Fully closed loop function selection	1	1	1	1	0:Always enabled 1:switching semi./full.																																																					
Fully closed loop 1 error detection function selection	1	1	1	1	0:Disabled 1:Speed deviation error 2:Pos. deviation error 3:S/P deviation error																																																					
	1	1	1	1	0:Continuous detection 1:detection at stop																																																					
	1	1	1	1	0:Reset disabled 1:Reset enabled																																																					
Fully closed loop 2 feedback pulse EC61 Numerator	12345	12345	12345	12345	1 to 99995																																																					
	12345	12345	12345	12345	1 to 99995																																																					
Fully closed loop 3 error detection level(Spd. dev.)	12345	12345	12345	12345	1 to 50000[1/min]																																																					
	12345	12345	12345	12345	1 to 20000[1/pulse]																																																					
						2)	30230, 30430, 30630, 30830	7616, 76DE, 77A6, 786E																																																		
						3)																																																				
						4)																																																				
						5)	30231, 30431, 30631, 30831	7617, 76DF, 77A7, 786F																																																		
						6)	30232, 30432, 30632, 30832	7618, 76E0, 77A8, 7870																																																		
						7)	30233, 30433, 30633, 30833	7619, 76E1, 77A9, 7871																																																		
						8)	30234, 30434, 30634, 30834	761A, 76E2, 77AA, 7872																																																		
						-	-	-																																																		

- 1 OVERVIEW
- 2 SYSTEM MONITOR
- 3 LADDER MONITOR FUNCTION
- 4 MELSEC-A LIST EDITOR
- 5 MELSEC-FX LIST EDITOR
- 6 INTELLIGENT MODULE MONITOR
- 7 NETWORK MONITOR
- 8 Q MOTION MONITOR

Screen example						No.	Buffer memory address																																											
							DEC	HEX																																										
<div style="display: flex; justify-content: space-between; align-items: center;"> LD77MS4 Servo parameter Ex. setting2-2 <div style="border: 1px solid black; padding: 2px;"> SET/ Data MONIT END RESET Chg. MENU </div> </div> <table border="1" style="width: 100%; border-collapse: collapse; text-align: center;"> <thead> <tr> <th style="width: 20%;">Item</th> <th style="width: 10%;">Axis1</th> <th style="width: 10%;">Axis2</th> <th style="width: 10%;">Axis3</th> <th style="width: 10%;">Axis4</th> <th style="width: 50%;">Setting range</th> </tr> </thead> <tbody> <tr> <td>1) Fully closed loop Posit. feedback filter</td> <td>1234</td> <td>1234</td> <td>1234</td> <td>1234</td> <td>0 to 4500[rad/s]</td> </tr> <tr> <td>2) Posit. deviation error detection level</td> <td>1</td> <td>1</td> <td>1</td> <td>1</td> <td>0:1pulse unit 1:1pulse unit</td> </tr> <tr> <td>3) Droop pulse mon. selection for controller disp.</td> <td>1</td> <td>1</td> <td>1</td> <td>1</td> <td>0:Servo motor encoder 1:Load-side encoder 2:Deviation between S&L</td> </tr> <tr> <td>4) FB pulses mon. selection for controller disp.</td> <td>1</td> <td>1</td> <td>1</td> <td>1</td> <td>0:Servo motor encoder 1:Load-side encoder</td> </tr> <tr> <td>5) Feedback pulse EOB2 Numerator</td> <td>12345</td> <td>12345</td> <td>12345</td> <td>12345</td> <td>1 to 65535</td> </tr> <tr> <td>6) Feedback pulse EOB2 Denominator</td> <td>12345</td> <td>12345</td> <td>12345</td> <td>12345</td> <td>1 to 65535</td> </tr> </tbody> </table>						Item	Axis1	Axis2	Axis3	Axis4	Setting range	1) Fully closed loop Posit. feedback filter	1234	1234	1234	1234	0 to 4500[rad/s]	2) Posit. deviation error detection level	1	1	1	1	0:1pulse unit 1:1pulse unit	3) Droop pulse mon. selection for controller disp.	1	1	1	1	0:Servo motor encoder 1:Load-side encoder 2:Deviation between S&L	4) FB pulses mon. selection for controller disp.	1	1	1	1	0:Servo motor encoder 1:Load-side encoder	5) Feedback pulse EOB2 Numerator	12345	12345	12345	12345	1 to 65535	6) Feedback pulse EOB2 Denominator	12345	12345	12345	12345	1 to 65535	1)	30235, 30435, 30635, 30835	761B, 76E3, 77AB, 7873
Item	Axis1	Axis2	Axis3	Axis4	Setting range																																													
1) Fully closed loop Posit. feedback filter	1234	1234	1234	1234	0 to 4500[rad/s]																																													
2) Posit. deviation error detection level	1	1	1	1	0:1pulse unit 1:1pulse unit																																													
3) Droop pulse mon. selection for controller disp.	1	1	1	1	0:Servo motor encoder 1:Load-side encoder 2:Deviation between S&L																																													
4) FB pulses mon. selection for controller disp.	1	1	1	1	0:Servo motor encoder 1:Load-side encoder																																													
5) Feedback pulse EOB2 Numerator	12345	12345	12345	12345	1 to 65535																																													
6) Feedback pulse EOB2 Denominator	12345	12345	12345	12345	1 to 65535																																													
						2)	30237, 30437, 30637, 30837	761D, 76E5, 77AD, 7875																																										
						3)																																												
						4)																																												
						5)	30261, 30461, 30661, 30861	7635, 76FD, 77C5, 788D																																										
						6)	30262, 30462, 30662, 30862	7636, 76FE, 77C6, 788E																																										
						-	-	-																																										
<div style="display: flex; justify-content: space-between; align-items: center;"> LD77MS4 Servo parameter Ex. setting2-3 <div style="border: 1px solid black; padding: 2px;"> SET/ Data MONIT END RESET Chg. MENU </div> </div> <table border="1" style="width: 100%; border-collapse: collapse; text-align: center;"> <thead> <tr> <th style="width: 20%;">Item</th> <th style="width: 10%;">Axis1</th> <th style="width: 10%;">Axis2</th> <th style="width: 10%;">Axis3</th> <th style="width: 10%;">Axis4</th> <th style="width: 50%;">Setting range</th> </tr> </thead> <tbody> <tr> <td>Function selectionE3</td> <td>1</td> <td>1</td> <td>1</td> <td>1</td> <td>0:Disabled</td> </tr> <tr> <td>Robust filter select.</td> <td></td> <td></td> <td></td> <td></td> <td>1:Enabled</td> </tr> </tbody> </table>						Item	Axis1	Axis2	Axis3	Axis4	Setting range	Function selectionE3	1	1	1	1	0:Disabled	Robust filter select.					1:Enabled	1)	31712, 31962, 32212, 32462	7BE0, 7CDA, 7DD4, 7ECE																								
Item	Axis1	Axis2	Axis3	Axis4	Setting range																																													
Function selectionE3	1	1	1	1	0:Disabled																																													
Robust filter select.					1:Enabled																																													
						-	-	-																																										
<div style="display: flex; justify-content: space-between; align-items: center;"> LD77MS4 Servo parameter Ex. setting3-1 <div style="border: 1px solid black; padding: 2px;"> SET/ Data MONIT END RESET Chg. MENU </div> </div> <table border="1" style="width: 100%; border-collapse: collapse; text-align: center;"> <thead> <tr> <th style="width: 20%;">Item</th> <th style="width: 10%;">Axis1</th> <th style="width: 10%;">Axis2</th> <th style="width: 10%;">Axis3</th> <th style="width: 10%;">Axis4</th> <th style="width: 50%;">Setting range</th> </tr> </thead> <tbody> <tr> <td>Func. selection F-5 Electronic dynamic brake</td> <td>1</td> <td>1</td> <td>1</td> <td>1</td> <td>0:Automatic 2:Disabled</td> </tr> <tr> <td>Electronic dynamic brake operating time</td> <td>12345</td> <td>12345</td> <td>12345</td> <td>12345</td> <td>0 ~ 10000[ms]</td> </tr> </tbody> </table>						Item	Axis1	Axis2	Axis3	Axis4	Setting range	Func. selection F-5 Electronic dynamic brake	1	1	1	1	0:Automatic 2:Disabled	Electronic dynamic brake operating time	12345	12345	12345	12345	0 ~ 10000[ms]	1)	30905, 30955, 31005, 31055	78B9, 78EB, 791D, 794F																								
Item	Axis1	Axis2	Axis3	Axis4	Setting range																																													
Func. selection F-5 Electronic dynamic brake	1	1	1	1	0:Automatic 2:Disabled																																													
Electronic dynamic brake operating time	12345	12345	12345	12345	0 ~ 10000[ms]																																													
						2)	30911, 30961, 31011, 31061	78BF, 78F1, 7923, 7955																																										
						-	-	-																																										

Screen example						No.	Buffer memory address																																																																							
							DEC	HEX																																																																						
LD77MS4 Servo parameter Ex. setting3-2 <table border="1"> <thead> <tr> <th>Item</th> <th>Axis1</th> <th>Axis2</th> <th>Axis3</th> <th>Axis4</th> <th>Setting range</th> </tr> </thead> <tbody> <tr> <td>Drive recorder switching time set.</td> <td>12345</td> <td>12345</td> <td>12345</td> <td>12345</td> <td>-1 to 32767[ms]</td> </tr> <tr> <td>Vibration tough drive OSC detection level</td> <td>123</td> <td>123</td> <td>123</td> <td>123</td> <td>0 to 100[%]</td> </tr> <tr> <td>Vibration tough drive Oscillation detection alarm selection</td> <td>1</td> <td>1</td> <td>1</td> <td>1</td> <td>0:[AL_54 OSC detection] 1:[AL_F3.1 OSC detect.] 2: function disabled</td> </tr> <tr> <td>power failure tough drive - Detect. time</td> <td>123</td> <td>123</td> <td>123</td> <td>123</td> <td>30 to 200[ms]</td> </tr> <tr> <td>Machine diagnosis function - Friction judgement speed</td> <td>12345</td> <td>12345</td> <td>12345</td> <td>12345</td> <td>0 to Permissible speed [r/min]</td> </tr> </tbody> </table>						Item	Axis1	Axis2	Axis3	Axis4	Setting range	Drive recorder switching time set.	12345	12345	12345	12345	-1 to 32767[ms]	Vibration tough drive OSC detection level	123	123	123	123	0 to 100[%]	Vibration tough drive Oscillation detection alarm selection	1	1	1	1	0:[AL_54 OSC detection] 1:[AL_F3.1 OSC detect.] 2: function disabled	power failure tough drive - Detect. time	123	123	123	123	30 to 200[ms]	Machine diagnosis function - Friction judgement speed	12345	12345	12345	12345	0 to Permissible speed [r/min]	1)	31740, 31990, 32240, 32490	7BFC, 7CF6, 7DF0, 7EEA																																		
Item	Axis1	Axis2	Axis3	Axis4	Setting range																																																																									
Drive recorder switching time set.	12345	12345	12345	12345	-1 to 32767[ms]																																																																									
Vibration tough drive OSC detection level	123	123	123	123	0 to 100[%]																																																																									
Vibration tough drive Oscillation detection alarm selection	1	1	1	1	0:[AL_54 OSC detection] 1:[AL_F3.1 OSC detect.] 2: function disabled																																																																									
power failure tough drive - Detect. time	123	123	123	123	30 to 200[ms]																																																																									
Machine diagnosis function - Friction judgement speed	12345	12345	12345	12345	0 to Permissible speed [r/min]																																																																									
						2)	31742, 31992, 32242, 32492	7BFE, 7CF8, 7DF2, 7EEC																																																																						
						3)	31743, 31993, 32243, 32493	7BFF, 7CF9, 7DF3, 7EED																																																																						
						4)	31744, 31994, 32244, 32494	7C00, 7CFA, 7DF4, 7EEE																																																																						
						5)	31750, 32000, 32250, 32500	7C06, 7D00, 7DFA, 7EF4																																																																						
						-	-	-																																																																						
LD77MS4 Servo parameter Motor setting1 <table border="1"> <thead> <tr> <th>Item</th> <th>Axis1</th> <th>Axis2</th> <th>Axis3</th> <th>Axis4</th> <th>Setting range</th> </tr> </thead> <tbody> <tr> <td>DD motor magnetic pole detection selection</td> <td>1</td> <td>1</td> <td>1</td> <td>1</td> <td>0: detection disabled 1: at first servo-on 5: at every servo-on</td> </tr> <tr> <td>Stop interval selection at the home position return</td> <td>1</td> <td>1</td> <td>1</td> <td>1</td> <td>0: 8192 pulses 1: 131072 pulses 2: 262144 pulses 3: 1048576 pulses 4: 4194304 pulses 5: 16777216 pulses 6: 67108864 pulses</td> </tr> <tr> <td>Linear encoder resolution - Numerator</td> <td>12345</td> <td>12345</td> <td>12345</td> <td>12345</td> <td>1 to 65535[um]</td> </tr> <tr> <td>Linear encoder resolution - Denominator</td> <td>12345</td> <td>12345</td> <td>12345</td> <td>12345</td> <td>1 to 65535[um]</td> </tr> </tbody> </table>						Item	Axis1	Axis2	Axis3	Axis4	Setting range	DD motor magnetic pole detection selection	1	1	1	1	0: detection disabled 1: at first servo-on 5: at every servo-on	Stop interval selection at the home position return	1	1	1	1	0: 8192 pulses 1: 131072 pulses 2: 262144 pulses 3: 1048576 pulses 4: 4194304 pulses 5: 16777216 pulses 6: 67108864 pulses	Linear encoder resolution - Numerator	12345	12345	12345	12345	1 to 65535[um]	Linear encoder resolution - Denominator	12345	12345	12345	12345	1 to 65535[um]	1)	31784, 32034, 32284, 32534	7C28, 7D22, 7E1C, 7F16																																								
Item	Axis1	Axis2	Axis3	Axis4	Setting range																																																																									
DD motor magnetic pole detection selection	1	1	1	1	0: detection disabled 1: at first servo-on 5: at every servo-on																																																																									
Stop interval selection at the home position return	1	1	1	1	0: 8192 pulses 1: 131072 pulses 2: 262144 pulses 3: 1048576 pulses 4: 4194304 pulses 5: 16777216 pulses 6: 67108864 pulses																																																																									
Linear encoder resolution - Numerator	12345	12345	12345	12345	1 to 65535[um]																																																																									
Linear encoder resolution - Denominator	12345	12345	12345	12345	1 to 65535[um]																																																																									
						2)	31784, 32034, 32284, 32534	7C28, 7D22, 7E1C, 7F16																																																																						
						3)	31785, 32035, 32285, 32535	7C29, 7D23, 7E1D, 7F17																																																																						
						4)	31786, 32036, 32286, 32536	7C2A, 7D24, 7E1E, 7F18																																																																						
						-	-	-																																																																						
LD77MS4 Servo parameter Motor setting2 <table border="1"> <thead> <tr> <th>Item</th> <th>Axis1</th> <th>Axis2</th> <th>Axis3</th> <th>Axis4</th> <th>Setting range</th> </tr> </thead> <tbody> <tr> <td>Linear servo motor/DD motor function select.2 [AL_42] detection function selection</td> <td>1</td> <td>1</td> <td>1</td> <td>1</td> <td></td> </tr> <tr> <td rowspan="7">Setting range</td> <td>value</td> <td>TRQ/thrust deviation</td> <td>Speed deviation error</td> <td>Posit. deviation error</td> <td></td> </tr> <tr> <td>0</td> <td></td> <td>Disabled</td> <td>Disabled</td> <td>Disabled</td> </tr> <tr> <td>1</td> <td>Disabled</td> <td></td> <td>Enabled</td> <td>Enabled</td> </tr> <tr> <td>2</td> <td></td> <td>Enabled</td> <td></td> <td>Disabled</td> </tr> <tr> <td>3</td> <td></td> <td></td> <td>Enabled</td> <td>Enabled</td> </tr> <tr> <td>4</td> <td>Enabled</td> <td></td> <td>Disabled</td> <td>Disabled</td> </tr> <tr> <td>5</td> <td></td> <td></td> <td>Enabled</td> <td>Enabled</td> </tr> <tr> <td>6</td> <td></td> <td>Enabled</td> <td></td> <td>Disabled</td> </tr> <tr> <td>7</td> <td></td> <td></td> <td>Enabled</td> <td>Enabled</td> </tr> <tr> <td>Linear servo motor/DD motor function select.2 [AL.42] detection function controller reset</td> <td>1</td> <td>1</td> <td>1</td> <td>1</td> <td></td> </tr> <tr> <td>Setting range</td> <td colspan="2">0:Reset disabled</td> <td colspan="2">1:Reset enabled</td> <td></td> </tr> </tbody> </table>						Item	Axis1	Axis2	Axis3	Axis4	Setting range	Linear servo motor/DD motor function select.2 [AL_42] detection function selection	1	1	1	1		Setting range	value	TRQ/thrust deviation	Speed deviation error	Posit. deviation error		0		Disabled	Disabled	Disabled	1	Disabled		Enabled	Enabled	2		Enabled		Disabled	3			Enabled	Enabled	4	Enabled		Disabled	Disabled	5			Enabled	Enabled	6		Enabled		Disabled	7			Enabled	Enabled	Linear servo motor/DD motor function select.2 [AL.42] detection function controller reset	1	1	1	1		Setting range	0:Reset disabled		1:Reset enabled			1)	31787, 32037, 32287, 32537	7C2B, 7D25, 7E1F, 7F19
Item	Axis1	Axis2	Axis3	Axis4	Setting range																																																																									
Linear servo motor/DD motor function select.2 [AL_42] detection function selection	1	1	1	1																																																																										
Setting range	value	TRQ/thrust deviation	Speed deviation error	Posit. deviation error																																																																										
	0		Disabled	Disabled	Disabled																																																																									
	1	Disabled		Enabled	Enabled																																																																									
	2		Enabled		Disabled																																																																									
	3			Enabled	Enabled																																																																									
	4	Enabled		Disabled	Disabled																																																																									
	5			Enabled	Enabled																																																																									
6		Enabled		Disabled																																																																										
7			Enabled	Enabled																																																																										
Linear servo motor/DD motor function select.2 [AL.42] detection function controller reset	1	1	1	1																																																																										
Setting range	0:Reset disabled		1:Reset enabled																																																																											
						2)	31787, 32037, 32287, 32537	7C2B, 7D25, 7E1F, 7F19																																																																						
						-	-	-																																																																						

- 1 OVERVIEW
- 2 SYSTEM MONITOR
- 3 LADDER MONITOR FUNCTION
- 4 MELSEC-A LIST EDITOR
- 5 MELSEC-FX LIST EDITOR
- 6 INTELLIGENT MODULE MONITOR
- 7 NETWORK MONITOR
- 8 Q MOTION MONITOR

Screen example	No.	Buffer memory address																																																																		
		DEC	HEX																																																																	
<p>LD77MS4 Servo parameter Motor setting3</p> <table border="1"> <thead> <tr> <th>Item</th> <th>Axis1</th> <th>Axis2</th> <th>Axis3</th> <th>Axis4</th> <th>Setting range</th> </tr> </thead> <tbody> <tr> <td>Position deviation error detection level</td> <td>1234</td> <td>1234</td> <td>1234</td> <td>1234</td> <td>0 to 1000[mm]/[0.01rev]</td> </tr> <tr> <td>Speed deviation error detection level</td> <td>1234</td> <td>1234</td> <td>1234</td> <td>1234</td> <td>0 to 5000[mm/s]/[r/min]</td> </tr> <tr> <td>TRQ/thrust deviation error detection level</td> <td>1234</td> <td>1234</td> <td>1234</td> <td>1234</td> <td>0 to 1000[%]</td> </tr> <tr> <td>Magnetic pole detection volt. level</td> <td>123</td> <td>123</td> <td>123</td> <td>123</td> <td>0 to 100[%]</td> </tr> </tbody> </table> <table border="1"> <thead> <tr> <th>Item</th> <th>Axis1</th> <th>Axis2</th> <th>Axis3</th> <th>Axis4</th> </tr> </thead> <tbody> <tr> <td>Linear servo motor/DD motor func. selection3</td> <td>1</td> <td>1</td> <td>1</td> <td>1</td> </tr> <tr> <td>Magnetic pole detection method selection</td> <td colspan="4">0:Position detection 4:Minute position detection</td> </tr> <tr> <td>Setting range</td> <td colspan="4">0:Enabled 1:Disabled</td> </tr> </tbody> </table> <table border="1"> <thead> <tr> <th>Item</th> <th>Axis1</th> <th>Axis2</th> <th>Axis3</th> <th>Axis4</th> </tr> </thead> <tbody> <tr> <td>Linear servo motor/DD motor func. selection3</td> <td>1</td> <td>1</td> <td>1</td> <td>1</td> </tr> <tr> <td>Stroke limit enabled/disabled selection</td> <td colspan="4">0:Enabled 1:Disabled</td> </tr> </tbody> </table>	Item	Axis1	Axis2	Axis3	Axis4	Setting range	Position deviation error detection level	1234	1234	1234	1234	0 to 1000[mm]/[0.01rev]	Speed deviation error detection level	1234	1234	1234	1234	0 to 5000[mm/s]/[r/min]	TRQ/thrust deviation error detection level	1234	1234	1234	1234	0 to 1000[%]	Magnetic pole detection volt. level	123	123	123	123	0 to 100[%]	Item	Axis1	Axis2	Axis3	Axis4	Linear servo motor/DD motor func. selection3	1	1	1	1	Magnetic pole detection method selection	0:Position detection 4:Minute position detection				Setting range	0:Enabled 1:Disabled				Item	Axis1	Axis2	Axis3	Axis4	Linear servo motor/DD motor func. selection3	1	1	1	1	Stroke limit enabled/disabled selection	0:Enabled 1:Disabled				1)	31788, 32038, 32288, 32538	7C2C, 7D26, 7E20, 7F1A
	Item	Axis1	Axis2	Axis3	Axis4	Setting range																																																														
	Position deviation error detection level	1234	1234	1234	1234	0 to 1000[mm]/[0.01rev]																																																														
	Speed deviation error detection level	1234	1234	1234	1234	0 to 5000[mm/s]/[r/min]																																																														
	TRQ/thrust deviation error detection level	1234	1234	1234	1234	0 to 1000[%]																																																														
	Magnetic pole detection volt. level	123	123	123	123	0 to 100[%]																																																														
Item	Axis1	Axis2	Axis3	Axis4																																																																
Linear servo motor/DD motor func. selection3	1	1	1	1																																																																
Magnetic pole detection method selection	0:Position detection 4:Minute position detection																																																																			
Setting range	0:Enabled 1:Disabled																																																																			
Item	Axis1	Axis2	Axis3	Axis4																																																																
Linear servo motor/DD motor func. selection3	1	1	1	1																																																																
Stroke limit enabled/disabled selection	0:Enabled 1:Disabled																																																																			
	2)	31789, 32039, 32289, 32539	7C2D, 7D27, 7E21, 7F1B																																																																	
	3)	31790, 32040, 32290, 32540	7C2E, 7D28, 7E22, 7F1C																																																																	
	4)	31792, 32042, 32292, 32542	7C30, 7D2A, 7E24, 7F1E																																																																	
	5)	31791, 32041, 32291, 32541	7C2F, 7D29, 7E23, 7F1D																																																																	
	-	-	-																																																																	
<p>LD77MS4 Servo parameter Motor setting4</p> <table border="1"> <thead> <tr> <th>Item</th> <th>Axis1</th> <th>Axis2</th> <th>Axis3</th> <th>Axis4</th> <th>Setting range</th> </tr> </thead> <tbody> <tr> <td>Minute position detection function selection</td> <td>1</td> <td>1</td> <td>1</td> <td>1</td> <td>0:Low F:High</td> </tr> <tr> <td>Load to motor mass ratio/load to motor inertia ratio selection</td> <td>1</td> <td>1</td> <td>1</td> <td>1</td> <td>0:10times or less 1toE:10times to140times F:150times or more</td> </tr> <tr> <td>Minute position detection method identification signal amplitude</td> <td>123</td> <td>123</td> <td>123</td> <td>123</td> <td>0 to 100[%]</td> </tr> </tbody> </table>	Item	Axis1	Axis2	Axis3	Axis4	Setting range	Minute position detection function selection	1	1	1	1	0:Low F:High	Load to motor mass ratio/load to motor inertia ratio selection	1	1	1	1	0:10times or less 1toE:10times to140times F:150times or more	Minute position detection method identification signal amplitude	123	123	123	123	0 to 100[%]	1)	31800, 32050, 32300, 32550	7C38, 7D32, 7E2C, 7F26																																									
	Item	Axis1	Axis2	Axis3	Axis4	Setting range																																																														
	Minute position detection function selection	1	1	1	1	0:Low F:High																																																														
Load to motor mass ratio/load to motor inertia ratio selection	1	1	1	1	0:10times or less 1toE:10times to140times F:150times or more																																																															
Minute position detection method identification signal amplitude	123	123	123	123	0 to 100[%]																																																															
	2)	31801, 32051, 32301, 32551	7C39, 7D33, 7E2D, 7F27																																																																	
	3)																																																																			
	-	-	-																																																																	

6.5.45 LD77MS16 module monitoring

Screen example

No.	Axis	Buffer memory address		No.	Axis	Buffer memory address				
		DEC	HEX			DEC	HEX			
1)	1 to 4	2400, 2500, 2600, 2700	960, 9C4, A28, A8C	4)	-	4231	1087			
	5 to 8	2800, 2900, 3000, 3100	AF0, B54, BB8, C1C	5)	1 to 4	2429, 2529, 2629, 2729	97D, 9E1, A45, AA9			
	9 to 12	3200, 3300, 3400, 3500	C80, CE4, D48, DAC		5 to 8	2829, 2929, 3029, 3129	B0D, B71, BD5, C39			
	13 to 16	3600, 3700, 3800, 3900	E10, E74, ED8, F3C		9 to 12	3229, 3329, 3429, 3529	C9D, D01, D65, DC9			
2)	1 to 4	2412, 2512, 2612, 2712	96C, 9D0, A34, A98	13 to 16	3629, 3729, 3829, 3929	E2D, E91, EF5, F59	6)	1 to 4	2438, 2538, 2638, 2738	986, 9EA, A4E, AB2
	5 to 8	2812, 2912, 3012, 3112	AFC, B60, BC4, C28	5 to 8	2838, 2938, 3038, 3138	B16, B7A, BDE, C42		5 to 8	2838, 2938, 3038, 3138	B16, B7A, BDE, C42
	9 to 12	3212, 3312, 3412, 3512	C8C, CF0, D54, DB8	9 to 12	3238, 3338, 3438, 3538	CA6, D0A, D6E, DD2		9 to 12	3238, 3338, 3438, 3538	CA6, D0A, D6E, DD2
	13 to 16	3612, 3712, 3812, 3912	E1C, E80, EE4, F48	13 to 16	3638, 3738, 3838, 3938	E36, E9A, EFE, F62		13 to 16	3638, 3738, 3838, 3938	E36, E9A, EFE, F62
3)	1 to 4	2406 to 2409, 2506 to 2509, 2606 to 2609, 2706 to 2709	966 to 969, 9CA to 9CD, A2E to A31, A92 to A95	7)	1 to 4	2441, 2541, 2641, 2741	989, 9ED, A51, AB5			
	5 to 8	2806 to 2809, 2906 to 2909, 3006 to 3009, 3106 to 3109	AF6 to AF9, B5A to B5D, BBE to BC1, C22 to C25		5 to 8	2841, 2941, 3041, 3141	B19, B7D, BE1, C45	5 to 8	2841, 2941, 3041, 3141	B19, B7D, BE1, C45
	9 to 12	3206 to 3209, 3306 to 3309, 3406 to 3409, 3506 to 3509	C86 to C89, CEA to CED, D4E to D51, DB2 to DB5		9 to 12	3241, 3341, 3441, 3541	CA9, D0D, D71, DD5	9 to 12	3241, 3341, 3441, 3541	CA9, D0D, D71, DD5
	13 to 16	3606 to 3609, 3706 to 3709, 3806 to 3809, 3906 to 3909	E16 to E19, E7A to E7D, EDE to EE1, F42 to F45	8)	1 to 4	2438, 2538, 2638, 2738	986, 9EA, A4E, AB2	1 to 4	2438, 2538, 2638, 2738	986, 9EA, A4E, AB2
			5 to 8		2838, 2938, 3038, 3138	B16, B7A, BDE, C42	5 to 8	2838, 2938, 3038, 3138	B16, B7A, BDE, C42	
			9 to 12		3238, 3338, 3438, 3538	CA6, D0A, D6E, DD2	9 to 12	3238, 3338, 3438, 3538	CA6, D0A, D6E, DD2	
				13 to 16	3638, 3738, 3838, 3938	E36, E9A, EFE, F62	13 to 16	3638, 3738, 3838, 3938	E36, E9A, EFE, F62	
				-	-	-	-			

Screen example



No.	Axis	Buffer memory address		No.	Axis	Buffer memory address	
		DEC	HEX			DEC	HEX
1)	-	-	-	-	-	-	-

Screen example

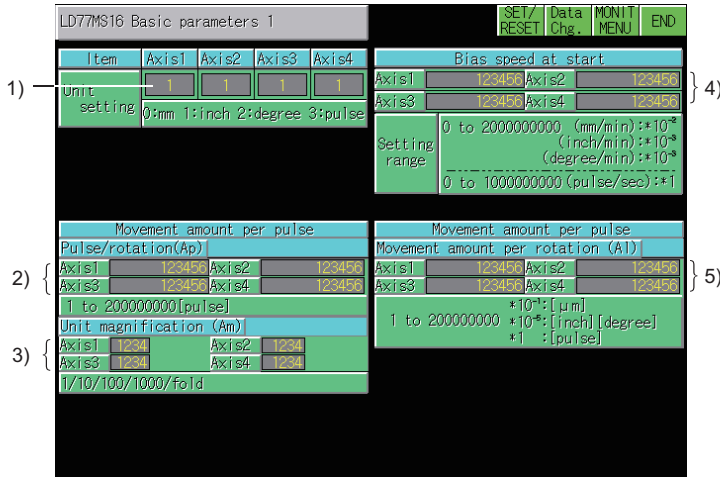

No.	Axis	Buffer memory address		No.	Axis	Buffer memory address	
		DEC	HEX			DEC	HEX
1)	1 to 4	0, 150, 300, 450	0, 96, 12C, 1C2	4)	1 to 4	6 to 7, 156 to 157, 306 to 307, 456 to 457	6 to 7, 9C to 9D, 132 to 133, 1C8 to 1C9
	5 to 8	600, 750, 900, 1050	258, 2EE, 3E8, 47E		5 to 8	606 to 607, 756 to 757, 906 to 907, 1056 to 1057	25E to 25F, 2F4 to 2F5, 38A to 38B, 420 to 421
	9 to 12	1200, 1350, 1500, 1650	514, 5AA, 640, 6D6		9 to 12	1206 to 1207, 1356 to 1357, 1506 to 1507, 1656 to 1657	4B6 to 4B7, 54C to 54D, 5E2 to 5E3, 678 to 679
	13 to 16	1800, 1950, 2100, 2250	708, 79E, 834, 8CA		13 to 16	1806 to 1807, 1956 to 1957, 2106 to 2107, 2256 to 2257	70E to 70F, 7A4 to 7A5, 83A to 83B, 8D0 to 8D1
2)	1 to 4	2 to 3, 152 to 153, 302 to 303, 452 to 453	2 to 3, 98 to 99, 12E to 12F, 1C4 to 1C5	5)	1 to 4	4 to 5, 154 to 155, 304 to 305, 454 to 455	4 to 5, 9A to 9B, 130 to 131, 1C6 to 1C7
	5 to 8	602 to 603, 752 to 753, 902 to 903, 1052 to 1053	25A to 25B, 2F0 to 2F1, 386 to 387, 41C to 41D		5 to 8	604 to 605, 754 to 755, 904 to 905, 1054 to 1055	25C to 25D, 2F2 to 2F3, 388 to 389, 41E to 41F
	9 to 12	1202 to 1203, 1352 to 1353, 1502 to 1503, 1652 to 1653	4B2 to 4B3, 548 to 549, 5DE to 5DF, 674 to 675		9 to 12	1204 to 1205, 1354 to 1355, 1504 to 1505, 1654 to 1655	4B4 to 4B5, 54A to 54B, 5E0 to 5E1, 676 to 677
	13 to 16	1802 to 1803, 1952 to 1953, 2102 to 2103, 2252 to 2253	70A to 70B, 7A0 to 7A1, 836 to 837, 8CC to 8CD		13 to 16	1804 to 1805, 1954 to 1955, 2104 to 2105, 2254 to 2255	70C to 70D, 7A2 to 7A3, 838 to 839, 8CE to 8CF
3)	1 to 4	1, 151, 301, 451	1, 97, 12D, 1C3	-	-	-	-
	5 to 8	601, 751, 901, 1051	259, 2EF, 385, 41B	-	-	-	-
	9 to 12	1201, 1351, 1501, 1651	4B1, 547, 5DD, 673	-	-	-	-
	13 to 16	1801, 1951, 2101, 2251	709, 79F, 835, 8CB	-	-	-	-

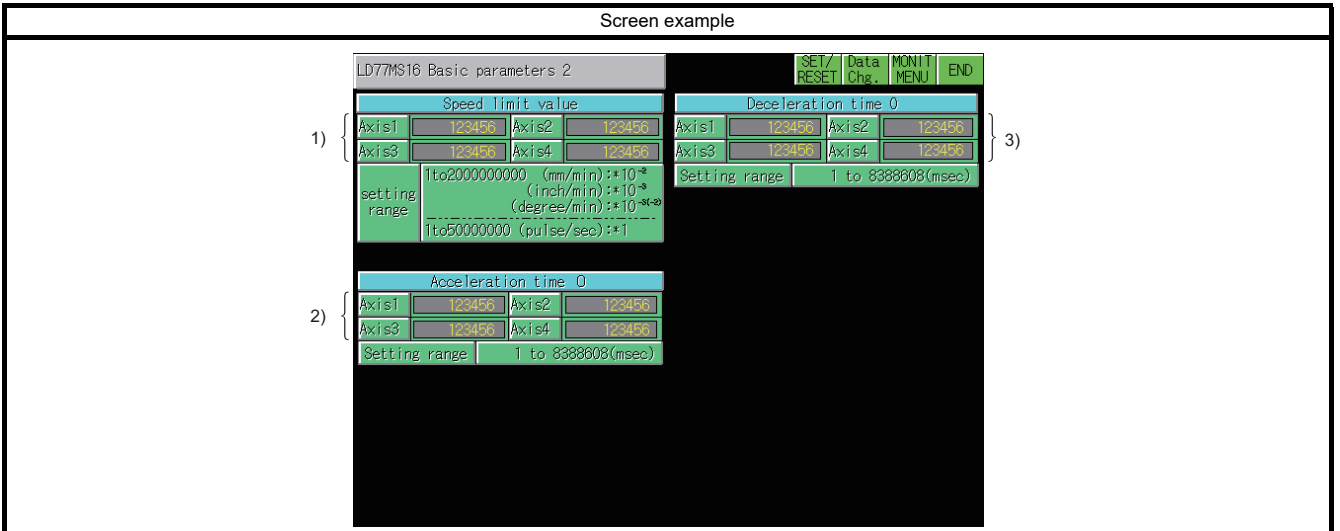

No.	Axis	Buffer memory address		No.	Axis	Buffer memory address	
		DEC	HEX			DEC	HEX
1)	1 to 4	10 to 11, 160 to 161, 310 to 311, 460 to 461	A to B, A0 to A1, 136 to 137, 1CC to 1CD	2)	9 to 12	1212 to 1213, 1362 to 1363, 1512 to 1513, 1662 to 1663	4BC to 4BD, 552 to 553, 5E8 to 5E9, 67E to 67F
	5 to 8	610 to 611, 760 to 761, 910 to 911, 1060 to 1061	262 to 263, 2F8 to 2F9, 2F8 to 2F9, 424 to 425		13 to 16	1812 to 1813, 1962 to 1963, 2112 to 2113, 2262 to 2263	714 to 715, 7AA to 7AB, 840 to 841, 8D6 to 8D7
	9 to 12	1210 to 1211, 1360 to 1361, 1510 to 1511, 1660 to 1661	4BA to 4BB, 550 to 551, 5E6 to 5E7, 67C to 67D	3)	1 to 4	14 to 15, 164 to 165, 314 to 315, 464 to 465	E to F, A4 to A5, 13A to 13B, 1D0 to 1D1
	13 to 16	1810 to 1811, 1960 to 1961, 2110 to 2111, 2260 to 2261	712 to 713, 7A8 to 7A9, 83E to 83F, 8D4 to 8D5		5 to 8	614 to 615, 764 to 765, 914 to 915, 1064 to 1065	266 to 267, 2FC to 2FD, 392 to 393, 428 to 429
2)	1 to 4	12 to 13, 162 to 163, 312 to 313, 462 to 463	C to D, A2 to A3, 138 to 139, 1CE to 1CF	9 to 12	1214 to 1215, 1364 to 1365, 1514 to 1515, 1664 to 1665	4BE to 4BF, 554 to 555, 5EA to 5EB, 680 to 681	
	5 to 8	612 to 613, 762 to 763, 912 to 913, 1062 to 1063	264 to 265, 2FA to 2FB, 390 to 391, 426 to 427	13 to 16	1814 to 1815, 1964 to 1965, 2114 to 2115, 2264 to 2265	716 to 717, 7AC to 7AD, 842 to 843, 8D8 to 8D9	

- 1
- OVERVIEW
- 2
- SYSTEM MONITOR
- 3
- LADDER MONITOR
FUNCTION
- 4
- MELSEC-A LIST
EDITOR
- 5
- MELSEC-FX LIST
EDITOR
- 6
- INTELLIGENT
MODULE MONITOR
- 7
- NETWORK
MONITOR
- 8
- Q MOTION
MONITOR

Screen example

No.	Axis	Buffer memory address		No.	Axis	Buffer memory address		
		DEC	HEX			DEC	HEX	
1)	1 to 4	17, 167, 317, 467	11, A7, 13D, 1D3	3)	13 to 16	1820 to 1821, 1970 to 1971, 2120 to 2121, 2270 to 2271	71C to 71D, 7B2 to 7B3, 848 to 849, 8DE to 8DF	
	5 to 8	617, 767, 917, 1067	617, 767, 917, 1067		4)	-	33	21
	9 to 12	1217, 1367, 1517, 1667	1217, 1367, 1517, 1667		5)	1 to 4	22, 172, 322, 472	16, AC, 142, 1D8
	13 to 16	1817, 1967, 2117, 2267	1817, 1967, 2117, 2267			5 to 8	622, 772, 922, 1072	622, 772, 922, 1072
2)	1 to 4	18 to 19, 168 to 169, 318 to 319, 468 to 469	12 to 13, A8 to A9, 13E to 13F, 1D4 to 1D5	9 to 12		1222, 1372, 1522, 1672	1222, 1372, 1522, 1672	
	5 to 8	618 to 619, 768 to 769, 918 to 919, 1068 to 1069	26A to 26B, 300 to 301, 396 to 397, 42C to 42D	13 to 16	1822, 1972, 2122, 2272	1822, 1972, 2122, 2272		
	9 to 12	1218 to 1219, 1368 to 1369, 1518 to 1519, 1668 to 1669	4C2 to 4C3, 558 to 559, 5EE to 5EF, 684 to 685	6)	1 to 4	23, 173, 323, 473	17, AD, 143, 1D9	
	3)	1 to 4	20 to 21, 170 to 171, 320 to 321, 470 to 471		14 to 15, AA to AB, 140 to 141, 1D6 to 1D7	5 to 8	623, 773, 923, 1073	26F, 305, 39B, 431
5 to 8		620 to 621, 770 to 771, 920 to 921, 1070 to 1071	26C to 26D, 302 to 303, 398 to 399, 42E to 42F		9 to 12	1223, 1373, 1523, 1673	4C7, 55D, 5F3, 689	
9 to 12		1220 to 1221, 1370 to 1371, 1520 to 1521, 1670 to 1671	4C4 to 4C5, 55A to 55B, 5F0 to 5F1, 686 to 687	13 to 16	1823, 1973, 2123, 2273	71F, 7B5, 84B, 8E1		
7)	1 to 4	20 to 21, 170 to 171, 320 to 321, 470 to 471	14 to 15, AA to AB, 140 to 141, 1D6 to 1D7	1 to 4	26, 176, 326, 476	1A, B0, 146, 1DC		
	5 to 8	620 to 621, 770 to 771, 920 to 921, 1070 to 1071	26C to 26D, 302 to 303, 398 to 399, 42E to 42F	5 to 8	626, 776, 926, 1076	272, 308, 39E, 434		
	9 to 12	1220 to 1221, 1370 to 1371, 1520 to 1521, 1670 to 1671	4C4 to 4C5, 55A to 55B, 5F0 to 5F1, 686 to 687	9 to 12	1226, 1376, 1526, 1676	4CA, 560, 5F6, 68C		
-	-	-	-	-	-	-	-	

Screen example

LD77MS16 Detailed parameters 1-2

Item	Ax.1	Ax.2	Ax.3	Ax.4	Set range
Mode ON sig	1	1	1	1	0:WITH 1:AFTER
Speed switching mode	1	1	1	1	0:Normal 1:Frontal
Interpolate set method	1	1	1	1	0:Comp. 1:Ref.ax
Command in-position width					
Axis1	123456	Axis2	123456		
Axis3	123456	Axis4	123456		
Setting range	1 to 2147483647 (μm):* 10^4 (Inch):* 10^6 (degree):* 10^4 (pulse):* 1				
Current feed val during speed control					
Axis1	1	Axis2	1	Axis3	1
Axis4	1				
0:Do Not / 1:Do / 2: Clear (0)					

Item	Ax.1	Ax.2	Ax.3	Ax.4
Lower limit	Neg.	Neg.	Neg.	Neg.
Upper limit	Neg.	Neg.	Neg.	Neg.
Stop signal	Neg.	Neg.	Neg.	Neg.
External command	Neg.	Neg.	Neg.	Neg.
Near point dog	Neg.	Neg.	Neg.	Neg.

Axis	1	2	3	4	
Axis1	1	Axis2	1	Axis3	1
Axis4	1				

0:Execute W/P switching control (INC)
2:Execute V/P switching control (ABS)

Axis	1	2	3	4	
Axis1	1	Axis2	1	Axis3	1
Axis4	1				

1: ServoAmp, 2:LD77MS(BM)

Axis	1	2	3	4	
Axis1	1	Axis2	1	Axis3	1
Axis4	1				

0:Valid 1:Invalid

No.	Axis	Buffer memory address		No.	Axis	Buffer memory address	
		DEC	HEX			DEC	HEX
1)	1 to 4	27, 177, 327, 477	1B, B1, 147, 1DD	5)	1 to 4	30, 180, 330, 480	1E, B4, 14A, 1E0
	5 to 8	627, 777, 927, 1077	273, 309, 39F, 435		5 to 8	630, 780, 930, 1080	276, 30C, 3A2, 438
	9 to 12	1227, 1377, 1527, 1677	4CB, 561, 5F7, 68D		9 to 12	1230, 1380, 1530, 1680	4CE, 564, 5FA, 690
	13 to 16	1827, 1977, 2127, 2277	723, 7B9, 84F, 8E5		13 to 16	1830, 1980, 2130, 2280	726, 7BC, 852, 8E8
2)	1 to 4	28, 178, 328, 478	1C, B2, 148, 1DE	6)	1 to 4	31, 181, 331, 481	1F, B5, 14B, 1E1
	5 to 8	628, 778, 928, 1078	274, 30A, 3A0, 436		5 to 8	631, 781, 931, 1081	277, 30D, 3A3, 439
	9 to 12	1228, 1378, 1528, 1678	4CC, 562, 5F8, 68E		9 to 12	1231, 1381, 1531, 1681	4CF, 565, 5FB, 691
	13 to 16	1828, 1978, 2128, 2278	724, 7BA, 850, 8E6		13 to 16	1831, 1981, 2131, 2281	727, 7BD, 853, 8E9
3)	1 to 4	29, 179, 329, 479	1D, B3, 149, 1DF	7)	1 to 4	34, 184, 334, 484	22, B8, 14E, 1E4
	5 to 8	629, 779, 929, 1079	275, 30B, 3A1, 437		5 to 8	634, 784, 934, 1084	27A, 310, 3A6, 43C
	9 to 12	1229, 1379, 1529, 1679	4CD, 563, 5F9, 68F		9 to 12	1234, 1384, 1534, 1684	4D2, 568, 5FE, 694
	13 to 16	1829, 1979, 2129, 2279	725, 7BB, 851, 8E7		13 to 16	1834, 1984, 2134, 2284	72A, 7C0, 856, 8EC
4)	1 to 4	24 to 25, 174 to 175, 324 to 325, 474 to 475	18 to 19, AE to AF, 144 to 145, 1DA to 1DB	8)	1 to 4	32, 182, 332, 482	20, B6, 14C, 1E2
	5 to 8	624 to 625, 774 to 775, 924 to 925, 1074 to 1075	270 to 271, 306 to 307, 39C to 39D, 432 to 433		5 to 8	632, 782, 932, 1082	278, 30E, 3A4, 43A
	9 to 12	1224 to 1225, 1374 to 1375, 1524 to 1525, 1674 to 1675	4C8 to 4C9, 55E to 55F, 5F4 to 5F5, 68A to 68B		9 to 12	1232, 1382, 1532, 1682	4D0, 566, 5FC, 692
	13 to 16	1824 to 1825, 1974 to 1975, 2124 to 2125, 2274 to 2275	720 to 721, 7B6 to 7B7, 84C to 84D, 8E2 to 8E3		13 to 16	1832, 1982, 2132, 2282	728, 7BE, 854, 8EA
				9)	-	35	23

- 1 OVERVIEW
- 2 SYSTEM MONITOR
- 3 LADDER MONITOR FUNCTION
- 4 MELSEC-A LIST EDITOR
- 5 MELSEC-FX LIST EDITOR
- 6 INTELLIGENT MODULE MONITOR
- 7 NETWORK MONITOR
- 8 Q MOTION MONITOR

Screen example

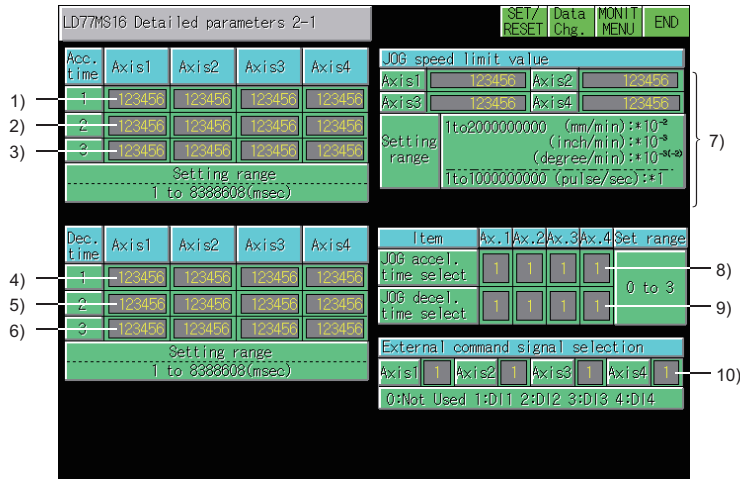

No.	Axis	Buffer memory address		No.	Axis	Buffer memory address		
		DEC	HEX			DEC	HEX	
1)	1 to 4	36 to 37, 186 to 187, 336 to 337, 486 to 487	24 to 25, BA to BB, 150 to 151, 1E6 to 1E7	5)	5 to 8	644 to 645, 794 to 794, 944 to 944, 1094 to 1094	284 to 284, 31A to 31A, 3B0 to 3B0, 446 to 446	
	5 to 8	636 to 637, 786 to 787, 936 to 937, 1086 to 1087	27C to 27D, 312 to 313, 3A8 to 3A9, 43E to 43F		9 to 12	1244 to 1244, 1394 to 1394, 1544 to 1544, 1694 to 1694	4DC to 4DC, 572 to 572, 608 to 608, 69E to 69E	
	9 to 12	1236 to 1237, 1386 to 1387, 1536 to 1537, 1686 to 1687	4D4 to 4D5, 56A to 56B, 600 to 601, 696 to 697		13 to 16	1844 to 1844, 1994 to 1994, 2144 to 2144, 2294 to 2294	734 to 734, 7CA to 7CA, 860 to 860, 8F6 to 8F6	
	13 to 16	1836 to 1837, 1986 to 1987, 2136 to 2137, 2286 to 2287	72C to 72D, 7C2 to 7C3, 858 to 859, 8EE to 8EF		6)	1 to 4	46 to 47, 196 to 197, 346 to 347, 496 to 497	2E to 2F, C4 to C5, 15A to 15B, 1F0 to 1F1
2)	1 to 4	38 to 39, 188 to 189, 338 to 339, 488 to 489	26 to 27, BC to BD, 152 to 153, 1E8 to 1E9	5 to 8		646 to 646, 796 to 796, 946 to 946, 1096 to 1096	286 to 286, 31C to 31C, 3B2 to 3B2, 448 to 448	
	5 to 8	638 to 639, 788 to 789, 938 to 939, 1088 to 1089	27E to 27F, 314 to 315, 3AA to 3AB, 440 to 441	9 to 12		1246 to 1246, 1396 to 1396, 1546 to 1546, 1696 to 1696	4DE to 4DE, 574 to 574, 60A to 60A, 6A0 to 6A0	
	9 to 12	1238 to 1239, 1388 to 1389, 1538 to 1539, 1688 to 1689	4D6 to 4D7, 56C to 56D, 602 to 603, 698 to 699	13 to 16		1846 to 1846, 1996 to 1996, 2146 to 2146, 2296 to 2296	736 to 736, 7CC to 7CC, 862 to 862, 8F8 to 8F8	
3)	13 to 16	1838 to 1839, 1988 to 1989, 2138 to 2139, 2288 to 2289	72E to 72F, 7C4 to 7C5, 85A to 85B, 8F0 to 8F1	7)	1 to 4	48 to 49, 198 to 199, 348 to 349, 498 to 499	30 to 31, C6 to C7, 15C to 15D, 1F2 to 1F3	
		1 to 4	40 to 41, 190 to 191, 340 to 341, 490 to 491		28 to 29, BE to BF, 154 to 155, 1EA to 1EB	5 to 8	648 to 649, 798 to 799, 948 to 949, 1098 to 1099	288 to 289, 31E to 31F, 3B4 to 3B5, 44A to 44B
		5 to 8	640 to 641, 790 to 791, 940 to 941, 1090 to 1091		280 to 281, 316 to 317, 3AC to 3AD, 442 to 443	9 to 12	1248 to 1249, 1398 to 1399, 1548 to 1549, 1698 to 1699	4E0 to 4E1, 576 to 577, 60C to 60D, 6A2 to 6A3
		9 to 12	1240 to 1241, 1390 to 1391, 1540 to 1541, 1690 to 1691		4D8 to 4D9, 56E to 56F, 604 to 605, 69A to 69B	13 to 16	1848 to 1849, 1998 to 1999, 2148 to 2149, 2298 to 2299	738 to 739, 7CE to 7CF, 864 to 865, 8FA to 8FB
4)	1 to 4	42 to 43, 192 to 193, 342 to 343, 492 to 493	2A to 2B, C0 to C1, 156 to 157, 1EC to 1ED	8)	1 to 4	50, 200, 350, 500	32, C8, 15E, 1F4	
	5 to 8	642 to 643, 792 to 793, 942 to 943, 1092 to 1093	282 to 283, 318 to 319, 3AE to 3AF, 444 to 445		5 to 8	650, 800, 950, 1100	28A, 320, 3B6, 44C	
	9 to 12	1242 to 1243, 1392 to 1393, 1542 to 1543, 1692 to 1693	4DA to 4DB, 570 to 571, 606 to 607, 69C to 69D		9 to 12	1250, 1400, 1550, 1700	4E2, 578, 60E, 6A4	
	13 to 16	1842 to 1843, 1992 to 1993, 2142 to 2143, 2292 to 2293	732 to 733, 7C8 to 7C9, 85E to 85F, 8F4 to 8F5		13 to 16	1850, 2000, 2150, 2300	73A, 7D0, 866, 8FC	
5)	1 to 4	44 to 45, 194 to 195, 344 to 345, 494 to 495	2C to 2D, C2 to C3, 158 to 159, 1EE to 1EF	9)	1 to 4	51, 201, 351, 501	33, C9, 15F, 1F5	
		10)	5 to 8		651, 801, 951, 1101	28B, 321, 3B7, 44D		
			9 to 12		1251, 1401, 1551, 1701	4E3, 579, 60F, 6A5		
			13 to 16		1851, 2001, 2151, 2301	73B, 7D1, 867, 8FD		

Screen example

LD77MS16 Detailed parameters 2-2					SET/	Data	MONIT	END		
					RESET	Chg.	MENU			
1)	Item	Ax.1	Ax.2	Ax.3	Ax.4	Set range	Allowed circular int. error width			
	Acc/Dec type selection	1	1	1	1	0:Ramp 1:Curve	Axis1	Axis2	Axis3	Axis4
2)	Curve #	123	123	123	123	T=100(%)	123456	123456	123456	123456
3)	Sudden stop	1	1	1	1	0:Normal	Setting range			
4)	Speed time	2	2	2	2	1:Sudden stop	0 to 100000			
5)	Sudden stop deceleration time	3	3	3	3		External command function selection			
6)	Position complete signal output time	Axis1	Axis2	Axis3	Axis4		Ax.1	Ax.2	Ax.3	Ax.4
7)	Man-pls input type selection	1	1	1	1	0:External positioning start 1:External speed change request 2:Speed-position, position-speed switching request 3:Skip request 4:High speed input request	0	0	0	0
8)	Restart allowable range(servo OFF->ON)	Axis1	Axis2	Axis3	Axis4		Ax.1	Ax.2	Ax.3	Ax.4
	0:Differential-output type 1:Voltage-output/Open-collector type	0	0	0	0		0:Valid	1:Invalid		

No.	Axis	Buffer memory address		No.	Axis	Buffer memory address	
		DEC	HEX			DEC	HEX
1)	1 to 4	52, 202, 352, 502	34, CA, 160, 1F6	7)	1 to 4	59, 209, 359, 509	3B, D1, 167, 1FD
	5 to 8	652, 802, 952, 1102	28C, 322, 3B8, 44E		5 to 8	659, 809, 959, 1109	293, 329, 3BF, 455
	9 to 12	1252, 1402, 1552, 1702	4E4, 57A, 610, 6A6		9 to 12	1259, 1409, 1559, 1709	4EB, 581, 617, 6AD
	13 to 16	1852, 2002, 2152, 2302	73C, 7D2, 868, 8FE		13 to 16	1859, 2009, 2159, 2309	743, 7D9, 86F, 905
2)	1 to 4	53, 203, 353, 503	35, CB, 161, 1F7	8)	1	67	43
	5 to 8	653, 803, 953, 1103	28D, 323, 3B9, 44F	9)	1 to 4	60 to 61, 210 to 211, 360 to 361, 510 to 511	3C to 3D, D2 to D3, 168 to 169, 1FE to 1FF
	9 to 12	1253, 1403, 1553, 1703	4E5, 57B, 611, 6A7		5 to 8	660 to 661, 810 to 811, 960 to 961, 1110 to 1111	294 to 295, 32A to 32B, 3C0 to 3C1, 456 to 457
13 to 16	1853, 2003, 2153, 2303	73D, 7D3, 869, 8FF	9 to 12		1260 to 1261, 1410 to 1411, 1560 to 1561, 1710 to 1711	4EC to 4ED, 582 to 583, 618 to 619, 6AE to 6AF	
3)	1 to 4	56, 206, 356, 506	38, CE, 164, 1FA	10)	13 to 16	1860 to 1861, 2010 to 2011, 2160 to 2160, 2310 to 2311	744 to 745, 7DA to 7DB, 870 to 871, 906 to 907
	5 to 8	656, 806, 956, 1106	290, 326, 3BC, 452		1 to 4	62, 212, 362, 512	3E, D4, 16A, 200
	9 to 12	1256, 1406, 1556, 1706	4E8, 57E, 614, 6AA		5 to 8	662, 812, 962, 1112	296, 32C, 3C2, 458
4)	1 to 4	57, 207, 357, 507	39, CF, 165, 1FB	11)	9 to 12	1262, 1412, 1562, 1712	4EE, 584, 61A, 6B0
	5 to 8	657, 807, 957, 1107	291, 327, 3BD, 453		13 to 16	1862, 2012, 2162, 2312	746, 7DC, 872, 908
	9 to 12	1257, 1407, 1557, 1707	4E9, 57F, 615, 6AB		1 to 4	63, 213, 363, 513	3F, D5, 16B, 201
	13 to 16	1857, 2007, 2157, 2307	741, 7D7, 86D, 903		5 to 8	663 to 664, 813 to 814, 963 to 964, 1113 to 1114	297 to 298, 32D to 32E, 3C3 to 3C4, 459 to 45A
5)	1 to 4	58, 208, 358, 508	3A, DO, 166, 1FC	12)	9 to 12	1263 to 1264, 1413 to 1414, 1563 to 1564, 1713 to 1714	4EF to 4F0, 585 to 586, 61B to 61C, 6B1 to 6B2
	5 to 8	658, 808, 958, 1108	292, 328, 3BE, 454		13 to 16	1863 to 1864, 2013 to 2014, 2163 to 2164, 2313 to 2314	747 to 748, 7DD to 7DE, 873 to 874, 909 to 90A
	9 to 12	1258, 1408, 1558, 1708	4EA, 580, 616, 6AC		1 to 4	64 to 65, 214 to 215, 364 to 365, 514 to 515	40 to 41, D6 to D7, 16C to 16D, 202 to 203
	13 to 16	1858, 2008, 2158, 2308	742, 7D8, 86E, 904		5 to 8	664 to 665, 814 to 815, 964 to 965, 1114 to 1115	298 to 299, 32E to 32F, 3C4 to 3C5, 45A to 45B
6)	1 to 4	54 to 55, 204 to 205, 354 to 355, 504 to 505	36 to 37, CC to CD, 162 to 163, 1F8 to 1F9	12)	9 to 12	1264 to 1265, 1414 to 1415, 1564 to 1565, 1714 to 1715	4F0 to 4F1, 586 to 587, 61C to 61D, 6B2 to 6B3
	5 to 8	654 to 655, 804 to 805, 954 to 955, 1104 to 1105	28E to 28F, 324 to 325, 3BA to 3BB, 450 to 451		13 to 16	1864 to 1865, 2014 to 2015, 2164 to 2165, 2314 to 2315	748 to 749, 7DE to 7DF, 874 to 875, 90A to 90B
	9 to 12	1254 to 1255, 1404 to 1405, 1554 to 1555, 1704 to 1705	4E6 to 4E7, 57C to 57D, 612 to 613, 6A8 to 6A9				
	13 to 16	1854 to 1855, 2004 to 2005, 2154 to 2155, 2304 to 2305	73E to 73F, 7D4 to 7D5, 86A to 86B, 900 to 901				

- 1 OVERVIEW
- 2 SYSTEM MONITOR
- 3 LADDER MONITOR FUNCTION
- 4 MELSEC-A LIST EDITOR
- 5 MELSEC-FX LIST EDITOR
- 6 INTELLIGENT MODULE MONITOR
- 7 NETWORK MONITOR
- 8 Q MOTION MONITOR

Screen example

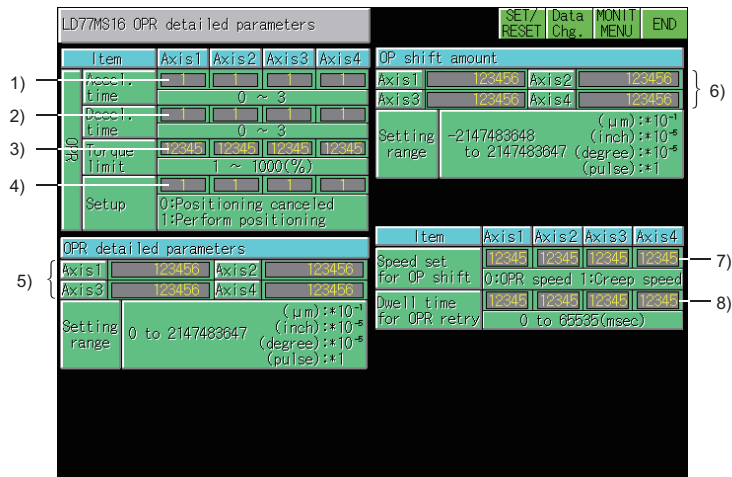

No.	Axis	Buffer memory address		No.	Axis	Buffer memory address	
		DEC	HEX			DEC	HEX
1)	1 to 4	82, 232, 382, 532	52, E8, 17E, 214	5)	1 to 4	80 to 81, 230 to 231, 380 to 381, 530 to 531	50 to 51, E6 to E7, 17C to 17D, 212 to 213
	5 to 8	682, 832, 982, 1132	2AA, 340, 3D6, 46C		5 to 8	680 to 681, 830 to 831, 980 to 981, 1130 to 1131	2A8 to 2A9, 33E to 33F, 3D4 to 3D5, 46A to 46B
	9 to 12	1282, 1432, 1582, 1732	502, 598, 62E, 6C4		9 to 12	1280 to 1281, 1430 to 1431, 1580 to 1581, 1730 to 1731	500 to 501, 596 to 597, 62C to 62D, 6C2 to 6C3
	13 to 16	1882, 2032, 2182, 2332	75A, 7F0, 886, 91C		13 to 16	1880 to 1881, 2030 to 2031, 2180 to 2181, 2330 to 2331	758 to 759, 7EE to 7EF, 884 to 885, 91A to 91B
2)	1 to 4	83, 233, 383, 533	53, E9, 17F, 215	6)	1 to 4	84 to 85, 234 to 235, 384 to 385, 534 to 535	54 to 55, EA to EB, 180 to 181, 216 to 217
	5 to 8	683, 833, 983, 1133	2AB, 341, 3D7, 46D		5 to 8	684 to 685, 834 to 835, 984 to 985, 1134 to 1135	2AC to 2AD, 342 to 343, 3D8 to 3D9, 46E to 46F
	9 to 12	1283, 1433, 1583, 1733	503, 599, 62F, 6C5		9 to 12	1284 to 1285, 1434 to 1435, 1584 to 1585, 1734 to 1735	504 to 505, 59A to 59B, 630 to 631, 6C6 to 6C7
	13 to 16	1883, 2033, 2183, 2333	75B, 7F1, 887, 91D		13 to 16	1884 to 1885, 2034 to 2035, 2184 to 2185, 2334 to 2335	75C to 75D, 7F2 to 7F3, 888 to 889, 91E to 91F
3)	1 to 4	86, 236, 386, 536	56, EC, 182, 218	7)	1 to 4	88, 238, 388, 538	58, EE, 184, 21A
	5 to 8	686, 836, 986, 1136	2AE, 344, 3DA, 470		5 to 8	688, 838, 988, 1138	2B0, 346, 3DC, 472
	9 to 12	1286, 1436, 1586, 1736	506, 59C, 632, 6C8		9 to 12	1288, 1438, 1588, 1738	508, 59E, 634, 6CA
	13 to 16	1886, 2036, 2186, 2336	75E, 7F4, 88A, 920		13 to 16	1888, 2038, 2188, 2338	760, 7F6, 88C, 922
4)	1 to 4	87, 237, 387, 537	57, ED, 183, 219	8)	1 to 4	89, 239, 389, 539	59, EF, 185, 21B
	5 to 8	687, 837, 987, 1137	2AF, 345, 3DB, 471		5 to 8	689, 839, 989, 1139	2B1, 347, 3DD, 473
	9 to 12	1287, 1437, 1587, 1737	507, 59D, 633, 6C9		9 to 12	1289, 1439, 1589, 1739	509, 59F, 635, 6CB
	13 to 16	1887, 2037, 2187, 2337	75F, 7F5, 88B, 921		13 to 16	1889, 2039, 2189, 2339	761, 7F7, 88D, 923

Screen example

No.	Axis	Buffer memory address		No.	Axis	Buffer memory address		
		DEC	HEX			DEC	HEX	
1)	1 to 4	70, 220, 370, 520	46, DC, 172, 208	4)	13 to 16	1872 to 1873, 2022 to 2023, 2172 to 2173, 2322 to 2323	750 to 751, 7E6 to 7E7, 87C to 87D, 912 to 913	
	5 to 8	670, 820, 970, 1120	29E, 334, 3CA, 460		5)	1 to 4	74 to 75, 224 to 225, 374 to 375, 524 to 525	4A to 4B, E0 to E1, 176 to 177, 20C to 20D
	9 to 12	1270, 1420, 1570, 1720	4F6, 58C, 622, 6B8			5 to 8	674 to 675, 824 to 825, 974 to 975, 1124 to 1125	2A2 to 2A3, 338 to 339, 3CE to 3CF, 464 to 465
	13 to 16	1870, 2020, 2170, 2320	74E, 7E4, 87A, 910			9 to 12	1274 to 1275, 1424 to 1425, 1574 to 1575, 1724 to 1725	4FA to 4FB, 590 to 591, 626 to 627, 6BC to 6BD
2)	1 to 4	71, 221, 371, 521	47, DD, 173, 209	6)		13 to 16	1874 to 1875, 2024 to 2025, 2174 to 2175, 2324 to 2325	752 to 753, 7E8 to 7E9, 87E to 87F, 914 to 915
	5 to 8	671, 821, 971, 1121	29F, 335, 3CB, 461		1 to 4	76 to 77, 226 to 227, 376 to 377, 526 to 527	4C to 4D, E2 to E3, 178 to 179, 20E to 20F	
	9 to 12	1271, 1421, 1571, 1721	4F7, 58D, 623, 6B9		5 to 8	676 to 677, 826 to 827, 976 to 977, 1126 to 1127	2A4 to 2A5, 33A to 33B, 3D0 to 3D1, 466 to 467	
	13 to 16	1871, 2021, 2171, 2321	74F, 7E5, 87B, 911		9 to 12	1276 to 1277, 1426 to 1427, 1576 to 1577, 1726 to 1727	4FC to 4FD, 592 to 593, 628 to 629, 6BE to 6BF	
3)	1 to 4	78, 228, 378, 528	4E, E4, 17A, 210	6)	13 to 16	1876 to 1877, 2026 to 2027, 2176 to 2177, 2326 to 2327	754 to 755, 7EA to 7EB, 880 to 881, 916 to 917	
	5 to 8	678, 828, 978, 1128	2A6, 33C, 3D2, 468		1)	1 to 4	2416, 2516, 2616, 2716	970, 9D4, A38, A9C
	9 to 12	1278, 1428, 1578, 1728	4FE, 594, 62A, 6C0			5 to 8	2816, 2916, 3016, 3116	B00, B64, BC8, C2C
	13 to 16	1878, 2028, 2178, 2328	756, 7EC, 882, 918			9 to 12	3216, 3316, 3416, 3516	C90, CF4, D58, DBC
4)	1 to 4	72 to 73, 222 to 223, 372 to 373, 522 to 523	48 to 49, DE to DF, 174 to 175, 20A to 20B	13 to 16		3616, 3716, 3816, 3916	E20, E84, EE8, F4C	
	5 to 8	672 to 673, 822 to 823, 972 to 973, 1122 to 1123	2A0 to 2A1, 336 to 337, 3CC to 3CD, 462 to 463	2)	1 to 4	2417, 2517, 2617, 2717	971, 9D5, A39, A9D	
	9 to 12	1272 to 1273, 1422 to 1423, 1572 to 1573, 1722 to 1723	4F8 to 4F9, 58E to 58F, 624 to 625, 6BA to 6BB		5 to 8	2817, 2917, 3017, 3117	B01, B65, BC9, C2D	
	5)	1 to 4	74, 224, 374, 524		49, EE, 174, 211	9 to 12	3217, 3317, 3417, 3517	C91, CF5, D59, DBD
5 to 8		674 to 675, 824 to 825, 974 to 975, 1124 to 1125	2A2 to 2A3, 338 to 339, 3CE to 3CF, 464 to 465		13 to 16	3617, 3717, 3817, 3917	E21, E85, EE9, F4D	
9 to 12		1274 to 1275, 1424 to 1425, 1574 to 1575, 1724 to 1725	4FA to 4FB, 590 to 591, 626 to 627, 6BC to 6BD	1)	1 to 4	2416, 2516, 2616, 2716	970, 9D4, A38, A9C	
13 to 16		1874 to 1875, 2024 to 2025, 2174 to 2175, 2324 to 2325	752 to 753, 7E8 to 7E9, 87E to 87F, 914 to 915		5 to 8	2816, 2916, 3016, 3116	B00, B64, BC8, C2C	
2)	1 to 4	71, 221, 371, 521	47, DD, 173, 209		9 to 12	3216, 3316, 3416, 3516	C90, CF4, D58, DBC	
	5 to 8	671, 821, 971, 1121	29F, 335, 3CB, 461		13 to 16	3616, 3716, 3816, 3916	E20, E84, EE8, F4C	
	9 to 12	1271, 1421, 1571, 1721	4F7, 58D, 623, 6B9	2)	1 to 4	2417, 2517, 2617, 2717	971, 9D5, A39, A9D	
	13 to 16	1871, 2021, 2171, 2321	74F, 7E5, 87B, 911		5 to 8	2817, 2917, 3017, 3117	B01, B65, BC9, C2D	
3)	1 to 4	78, 228, 378, 528	4E, E4, 17A, 210		9 to 12	3217, 3317, 3417, 3517	C91, CF5, D59, DBD	
	5 to 8	678, 828, 978, 1128	2A6, 33C, 3D2, 468		13 to 16	3617, 3717, 3817, 3917	E21, E85, EE9, F4D	
	9 to 12	1278, 1428, 1578, 1728	4FE, 594, 62A, 6C0	1)	1 to 4	2416, 2516, 2616, 2716	970, 9D4, A38, A9C	
	13 to 16	1878, 2028, 2178, 2328	756, 7EC, 882, 918		5 to 8	2816, 2916, 3016, 3116	B00, B64, BC8, C2C	
4)	1 to 4	72 to 73, 222 to 223, 372 to 373, 522 to 523	48 to 49, DE to DF, 174 to 175, 20A to 20B		9 to 12	3216, 3316, 3416, 3516	C90, CF4, D58, DBC	
	5 to 8	672 to 673, 822 to 823, 972 to 973, 1122 to 1123	2A0 to 2A1, 336 to 337, 3CC to 3CD, 462 to 463		13 to 16	3616, 3716, 3816, 3916	E20, E84, EE8, F4C	
	9 to 12	1272 to 1273, 1422 to 1423, 1572 to 1573, 1722 to 1723	4F8 to 4F9, 58E to 58F, 624 to 625, 6BA to 6BB	2)	1 to 4	2417, 2517, 2617, 2717	971, 9D5, A39, A9D	
	5)	1 to 4	74, 224, 374, 524		49, EE, 174, 211	5 to 8	2817, 2917, 3017, 3117	B01, B65, BC9, C2D
5 to 8		674 to 675, 824 to 825, 974 to 975, 1124 to 1125	2A2 to 2A3, 338 to 339, 3CE to 3CF, 464 to 465		9 to 12	3217, 3317, 3417, 3517	C91, CF5, D59, DBD	
9 to 12		1274 to 1275, 1424 to 1425, 1574 to 1575, 1724 to 1725	4FA to 4FB, 590 to 591, 626 to 627, 6BC to 6BD		13 to 16	3617, 3717, 3817, 3917	E21, E85, EE9, F4D	

Screen example

No.	Axis	Buffer memory address		No.	Axis	Buffer memory address	
		DEC	HEX			DEC	HEX
1)	1 to 4	2416, 2516, 2616, 2716	970, 9D4, A38, A9C	2)	1 to 4	2417, 2517, 2617, 2717	971, 9D5, A39, A9D
	5 to 8	2816, 2916, 3016, 3116	B00, B64, BC8, C2C		5 to 8	2817, 2917, 3017, 3117	B01, B65, BC9, C2D
	9 to 12	3216, 3316, 3416, 3516	C90, CF4, D58, DBC		9 to 12	3217, 3317, 3417, 3517	C91, CF5, D59, DBD
	13 to 16	3616, 3716, 3816, 3916	E20, E84, EE8, F4C		13 to 16	3617, 3717, 3817, 3917	E21, E85, EE9, F4D

Screen example

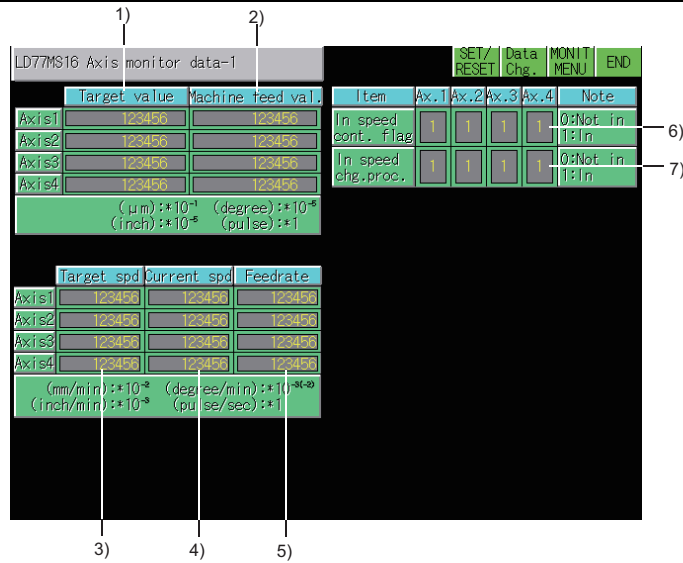

No.	Axis	Buffer memory address		No.	Axis	Buffer memory address	
		DEC	HEX			DEC	HEX
1)	1 to 4	2418 to 2419, 2518 to 2519, 2618 to 2619, 2718 to 2719	972 to 973, 9D6 to 9D7, A3A to A3B, A9E to A9F	4)	1 to 4	2410 to 2411, 2510 to 2511, 2610 to 2611, 2710 to 2711	96A to 96B, 9CE to 9CF, A32 to A33, A96 to A97
	5 to 8	2818 to 2819, 2918 to 2919, 3018 to 3019, 3118 to 3119	B02 to B03, B66 to B67, BCA to BCB, C2E to C2F		5 to 8	2810 to 2811, 2910 to 2911, 3010 to 3011, 3110 to 3111	AFA to AFB, B5E to B5F, BC2 to BC3, C26 to C27
	9 to 12	3218 to 3219, 3318 to 3319, 3418 to 3419, 3518 to 3519	C92 to C93, CF6 to CF7, D5A to D5B, DBE to DBF		9 to 12	3210 to 3211, 3310 to 3311, 3410 to 3411, 3510 to 3511	C8A to C8B, CEE to CEF, D52 to D53, DB6 to DB7
	13 to 16	3618 to 3619, 3718 to 3719, 3818 to 3819, 3918 to 3919	E22 to E23, E86 to E87, EEA to EEB, F4E to F4F		13 to 16	3610 to 3611, 3710 to 3711, 3810 to 3811, 3910 to 3911	E1A to E1B, E7E to E7F, EE2 to EE3, F46 to F47
2)	1 to 4	2402 to 2403, 2502 to 2503, 2602 to 2603, 2702 to 2703	962 to 963, 9C6 to 9C7, A2A to A2B, A8E to A8F	5)	1 to 4	2412 to 2413, 2512 to 2513, 2612 to 2613, 2712 to 2713	96C to 96D, 9D0 to 9D1, A34 to A35, A98 to A99
	5 to 8	2802 to 2803, 2902 to 2903, 3002 to 3003, 3102 to 3103	AF2 to AF3, B56 to B57, BBA to BBB, C1E to C1F		5 to 8	2812 to 2813, 2912 to 2913, 3012 to 3013, 3112 to 3113	AFC to AFD, B60 to B61, BC4 to BC5, C28 to C29
	9 to 12	3202 to 3203, 3302 to 3303, 3402 to 3403, 3502 to 3503	C82 to C83, CE6 to CE7, D4A to D4B, DAE to DAF		9 to 12	3212 to 3213, 3312 to 3313, 3412 to 3413, 3512 to 3513	C8C to C8D, CF0 to CF1, D54 to D55, DB8 to DB9
	13 to 16	3602 to 3603, 3702 to 3703, 3802 to 3803, 3902 to 3903	E12 to E13, E76 to E77, EDA to EDB, F3E to F3F		13 to 16	3612 to 3613, 3712 to 3713, 3812 to 3813, 3912 to 3913	E1C to E1D, E80 to E81, EE4 to EE5, F48 to F49
3)	1 to 4	2420 to 2421, 2520 to 2521, 2620 to 2621, 2720 to 2721	974 to 975, 9D8 to 9D9, A3C to A3D, AA0 to AA1	6)	1 to 4	2430, 2530, 2630, 2730	97E, 9E2, A46, AAA
	5 to 8	2820 to 2821, 2920 to 2921, 3020 to 3021, 3120 to 3121	B04 to B05, B68 to B69, BCC to BCD, C30 to C31		5 to 8	2830, 2930, 3030, 3130	B0E, B72, BD6, C3A
	9 to 12	3220 to 3221, 3320 to 3321, 3420 to 3421, 3520 to 3521	C94 to C95, CF8 to CF9, D5C to D5D, DC0 to DC1		9 to 12	3230, 3330, 3430, 3530	C9E, D02, D66, DCA
	13 to 16	3620 to 3621, 3720 to 3721, 3820 to 3821, 3920 to 3921	E24 to E25, E88 to E89, EEC to EED, F50 to F51		13 to 16	3630, 3730, 3830, 3930	E2E, E92, EF6, F5A
				7)	1 to 4	2431, 2531, 2631, 2731	97F, 9E3, A47, AAB
					5 to 8	2831, 2931, 3031, 3131	B0F, B73, BD7, C3B
					9 to 12	3231, 3331, 3431, 3531	C9F, D03, D67, DCB
					13 to 16	3631, 3731, 3831, 3931	E2F, E93, EF7, F5B

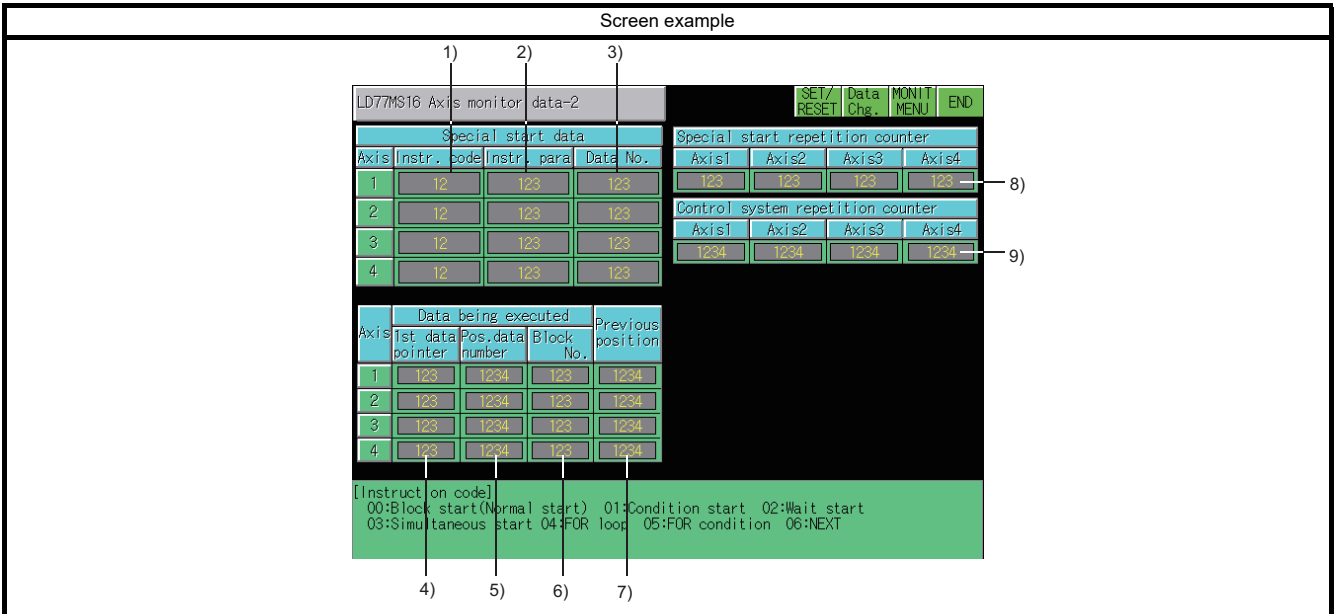

No.	Axis	Buffer memory address		No.	Axis	Buffer memory address	
		DEC	HEX			DEC	HEX
1)	1 to 4	2427, 2527, 2627, 2727	97B, 9DF, A43, AA7	6)	1 to 4	2436, 2536, 2636, 2736	984, 9E8, A4C, AB0
	5 to 8	2827, 2927, 3027, 3127	B0B, B6F, BD3, C37		5 to 8	2836, 2936, 3036, 3136	B14, B78, BDC, C40
	9 to 12	3227, 3327, 3427, 3527	C9B, CFF, D63, DC7		9 to 12	3236, 3336, 3436, 3536	CA4, D08, D6C, DD0
	13 to 16	3627, 3727, 3827, 3927	E2B, E8F, EF3, F57		13 to 16	3636, 3736, 3836, 3936	E34, E98, EFC, F60
2)	1 to 4	2428, 2528, 2628, 2728	97C, 9E0, A44, AA8	7)	1 to 4	2437, 2537, 2637, 2737	985, 9E9, A4D, AB1
	5 to 8	2828, 2928, 3028, 3128	B0C, B70, BD4, C38		5 to 8	2837, 2937, 3037, 3137	B15, B79, BDD, C41
	9 to 12	3228, 3328, 3428, 3528	C9C, D00, D64, DC8		9 to 12	3237, 3337, 3437, 3537	CA5, D09, D6D, DD1
	13 to 16	3628, 3728, 3828, 3928	E2C, E90, EF4, F58		13 to 16	3637, 3737, 3837, 3937	E35, E99, EFD, F61
3)	1 to 4	2429, 2529, 2629, 2729	97D, 9E1, A45, AA9	8)	1 to 4	2432, 2532, 2632, 2732	980, 9E4, A48, AAC
	5 to 8	2829, 2929, 3029, 3129	B0D, B71, BD5, C39		5 to 8	2832, 2932, 3032, 3132	B10, B74, BD8, C3C
	9 to 12	3229, 3329, 3429, 3529	C9D, D01, D65, DC9		9 to 12	3232, 3332, 3432, 3532	CA0, D04, D68, DCC
	13 to 16	3629, 3729, 3829, 3929	E2D, E91, EF5, F59		13 to 16	3632, 3732, 3832, 3932	E30, E94, EF8, F5C
4)	1 to 4	2434, 2534, 2634, 2734	982, 9E6, A4A, AAE	9)	1 to 4	2433, 2533, 2633, 2733	981, 9E5, A49, AAD
	5 to 8	2834, 2934, 3034, 3134	B12, B76, BDA, C3E		5 to 8	2833, 2933, 3033, 3133	B11, B75, BD9, C3D
	9 to 12	3234, 3334, 3434, 3534	CA2, D06, D6A, DCE		9 to 12	3233, 3333, 3433, 3533	CA1, D05, D69, DCD
	13 to 16	3634, 3734, 3834, 3934	E32, E96, EFA, F5E		13 to 16	3633, 3733, 3833, 3933	E31, E95, EF9, F5D
5)	1 to 4	2435, 2535, 2635, 2735	983, 9E7, A4B, AAF	-	-	-	-
	5 to 8	2835, 2935, 3035, 3135	B13, B77, BDB, C3F				
	9 to 12	3235, 3335, 3435, 3535	CA3, D07, D6B, DCF				
	13 to 16	3635, 3735, 3835, 3935	E33, E97, EFB, F5F				

1 OVERVIEW
2 SYSTEM MONITOR
3 LADDER MONITOR FUNCTION
4 MELSEC-A LIST EDITOR
5 MELSEC-FX LIST EDITOR
6 INTELLIGENT MODULE MONITOR
7 NETWORK MONITOR
8 Q MOTION MONITOR

Screen example

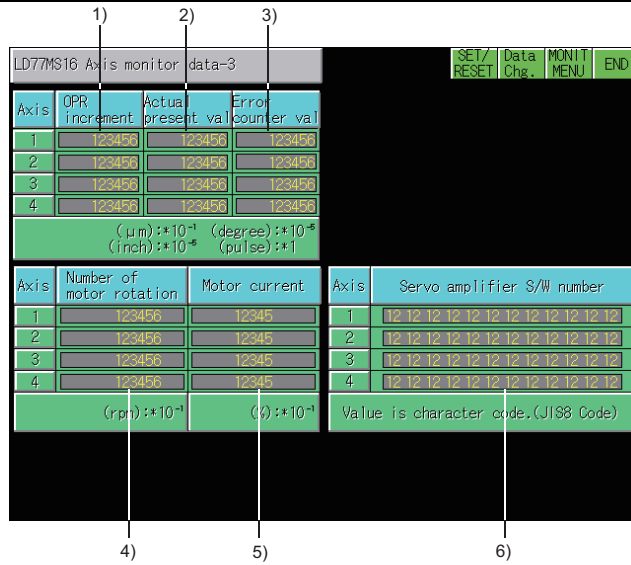

No.	Axis	Buffer memory address		No.	Axis	Buffer memory address	
		DEC	HEX			DEC	HEX
1)	1 to 4	2448 to 2449, 2548 to 2549, 2648 to 2649, 2748 to 2749	990 to 991, 9F4 to 9F5, A58 to A59, ABC to ABD	4)	1 to 4	2454 to 2455, 2554 to 2555, 2654 to 2655, 2754 to 2755	996 to 997, 9FA to 9FB, A5E to A5F, AC2 to AC3
	5 to 8	2848 to 2849, 2948 to 2949, 3048 to 3049, 3148 to 3149	B20 to B21, B84 to B85, BE8 to BE9, C4C to C4D		5 to 8	2854 to 2855, 2954 to 2955, 3054 to 3055, 3154 to 3155	B26 to B27, B8A to B8B, BEE to BEF, C52 to C53
	9 to 12	3248 to 3249, 3348 to 3349, 3448 to 3449, 3548 to 3549	CB0 to CB1, D14 to D15, D78 to D79, DDC to DDD		9 to 12	3254 to 3255, 3354 to 3355, 3454 to 3455, 3554 to 3555	CB6 to CB7, D1A to D1B, D7E to D7F, DE2 to DE3
	13 to 16	3648 to 3649, 3748 to 3749, 3848 to 3849, 3948 to 3949	E40 to E41, EA4 to EA5, F08 to F09, F6C to F6D		13 to 16	3654 to 3655, 3754 to 3755, 3854 to 3855, 3954 to 3955	E46 to E47, EAA to EAB, F0E to F0F, F72 to F73
2)	1 to 4	2450 to 2451, 2550 to 2551, 2650 to 2651, 2750 to 2751	992 to 993, 9F6 to 9F7, A5A to A5B, ABE to ABF	5)	1 to 4	2456, 2556, 2656, 2756	998, 9FC, A60, AC4
	5 to 8	2850 to 2851, 2950 to 2951, 3050 to 3051, 3150 to 3151	B22 to B23, B86 to B87, BEA to BEB, C4E to C4F		5 to 8	2856, 2956, 3056, 3156	B28, B8C, BF0, C54
	9 to 12	3250 to 3251, 3350 to 3351, 3450 to 3451, 3550 to 3551	CB2 to CB3, D16 to D17, D7A to D7B, DDE to DDF		9 to 12	3256, 3356, 3456, 3556	CB8, D1C, D80, DE4
	13 to 16	3650 to 3651, 3750 to 3751, 3850 to 3851, 3950 to 3951	E42 to E43, EA6 to EA7, F0A to F0B, F6E to F6F		13 to 16	3656, 3756, 3856, 3956	E48, EAC, F10, F74
3)	1 to 4	2452 to 2453, 2552 to 2553, 2652 to 2653, 2752 to 2753	994 to 995, 9F8 to 9F9, A5C to A5D, AC0 to AC1	6)	1 to 4	2464 to 2469, 2564 to 2569, 2664 to 2669, 2764 to 2769	9A0 to 9A5, A04 to A09, A68 to A6D, ACC to AD1
	5 to 8	2852 to 2853, 2952 to 2953, 3052 to 3053, 3152 to 3153	B24 to B25, B88 to B89, BEC to BED, C50 to C51		5 to 8	2864 to 2869, 2964 to 2969, 3064 to 3069, 3164 to 3169	B30 to B35, B94 to B99, BF8 to BFD, C5C to C61
	9 to 12	3252 to 3253, 3352 to 3353, 3452 to 3453, 3552 to 3553	CB4 to CB5, D18 to D19, D7C to D7D, DE0 to DE1		9 to 12	3264 to 3269, 3364 to 3369, 3464 to 3469, 3564 to 3569	CC0 to CC5, D24 to D29, D88 to D8D, DEC to DF1
	13 to 16	3652 to 3653, 3752 to 3753, 3852 to 3853, 3952 to 3953	E44 to E45, EA8 to EA9, F0C to F0D, F70 to F71		13 to 16	3664 to 3669, 3764 to 3769, 3864 to 3869, 3964 to 3969	E50 to E55, EB4 to EB9, F18 to F1D, F7C to F81

Screen example

No.	Axis	Buffer memory address		No.	Axis	Buffer memory address	
		DEC	HEX			DEC	HEX
1)	1 to 4	2470, 2570, 2670, 2770	9A6, A0A, A6E, AD2	4)	1 to 4	2478, 2578, 2678, 2778	9AE, A12, A76, ADA
	5 to 8	2870, 2970, 3070, 3170	B36, B9A, BFE, C62		5 to 8	2878, 2978, 3078, 3178	B3E, BA2, C06, C6A
	9 to 12	3270, 3370, 3470, 3570	CC6, D2A, D8E, DF2		9 to 12	3278, 3378, 3478, 3578	CCE, D32, D96, DFA
	13 to 16	3670, 3770, 3870, 3970	E56, EBA, F1E, F82		13 to 16	3678, 3778, 3878, 3978	E5E, EC2, F26, F8A
2)	1 to 4	2476, 2576, 2676, 2776	9AC, A10, A74, AD8	5)	1 to 4	2479, 2579, 2679, 2779	9AF, A13, A77, ADB
	5 to 8	2876, 2976, 3076, 3176	B3C, BA0, C04, C68		5 to 8	2879, 2979, 3079, 3179	B3F, BA3, C07, C6B
	9 to 12	3276, 3376, 3476, 3576	CCC, D30, D94, DF8		9 to 12	3279, 3379, 3479, 3579	CCF, D33, D97, DFB
	13 to 16	3676, 3776, 3876, 3976	E5C, EC0, F24, F88		13 to 16	3679, 3779, 3879, 3979	E5F, EC3, F27, F8B
3)	1 to 4	2477, 2577, 2677, 2777	9AD, A11, A75, AD9	6)	1 to 4	2480, 2580, 2680, 2780	9B0, A14, A78, ADC
	5 to 8	2877, 2977, 3077, 3177	B3D, BA1, C05, C69		5 to 8	2880, 2980, 3080, 3180	B40, BA4, C08, C6C
	9 to 12	3277, 3377, 3477, 3577	CCD, D31, D95, DF9		9 to 12	3280, 3380, 3480, 3580	CD0, D34, D98, DFC
	13 to 16	3677, 3777, 3877, 3977	E5D, EC1, F25, F89		13 to 16	3680, 3780, 3880, 3980	E60, EC4, F28, F8C

Screen example

No.	Axis	Buffer memory address		No.	Axis	Buffer memory address	
		DEC	HEX			DEC	HEX
1)	1 to 4	2424 to 2425, 2524 to 2525, 2624 to 2625, 2724 to 2725	978 to 979, 9DC to 9DD, A40 to A41, AA4 to AA5	2)	1 to 4	2426, 2526, 2626, 2726	97A, 9DE, A42, AA6
	5 to 8	2824 to 2825, 2924 to 2925, 3024 to 3025, 3124 to 3125	B08 to B09, B6C to B6D, BD0 to BD1, C34 to C35		5 to 8	2826, 2926, 3026, 3126	B0A, B6E, BD2, C36
	9 to 12	3224 to 3225, 3324 to 3325, 3424 to 3425, 3524 to 3525	C98 to C99, CFC to CFD, D60 to D61, DC4 to DC5		9 to 12	3226, 3326, 3426, 3526	C9A, CFE, D62, DC6
	13 to 16	3624 to 3625, 3724 to 3725, 3824 to 3825, 3924 to 3925	E28 to E29, E8C to E8D, EF0 to EF1, F54 to F55		13 to 16	3626, 3726, 3826, 3926	E2A, E8E, EF2, F56
3)	1 to 4			1 to 4	2416, 2516, 2616, 2716	970, 9D4, A38, A9C	
	5 to 8			5 to 8	2816, 2916, 3016, 3116	B00, B64, BC8, C2C	
	9 to 12			9 to 12	3216, 3316, 3416, 3516	C90, CF4, D58, DBC	
	13 to 16			13 to 16	3616, 3716, 3816, 3916	E20, E84, EE8, F4C	

Screen example

No.	Axis	Buffer memory address		No.	Axis	Buffer memory address	
		DEC	HEX			DEC	HEX
1)	1 to 4	2414 to 2415, 2514 to 2515, 2614 to 2615, 2714 to 2715	96E to 96F, 9D2 to 9D3, A36 to A37, A9A to A9B	2)	9 to 12	5126 to 5127, 5226 to 5227, 5326 to 5327, 5426 to 5427	1406 to 1407, 146A to 146B, 14CE to 14CF, 1532 to 1533
	5 to 8	2814 to 2815, 2914 to 2915, 3014 to 3015, 3114 to 3115	AFE to AFF, B62 to B63, BC6 to BC7, C2A to C2B		13 to 16	5526 to 5527, 5626 to 5627, 5726 to 5727, 5826 to 5827	1596 to 1597, 15FA to 15FB, 165E to 165F, 16C2 to 16C3
	9 to 12	3214 to 3215, 3314 to 3315, 3414 to 3415, 3514 to 3515	C8E to C8F, CF2 to CF3, D56 to D57, DBA to DBB	3)	1 to 4	2417, 2517, 2617, 2717	971, 9D5, A39, A9D
	13 to 16	3614 to 3615, 3714 to 3715, 3814 to 3815, 3914 to 3915	E1E to E1F, E82 to E83, EE6 to EE7, F4A to F4B		5 to 8	2817, 2917, 3017, 3117	B01, B65, BC9, C2D
2)	1 to 4	4326 to 4327, 4426 to 4427, 4526 to 4527, 4626 to 4627	10E6 to 10E7, 114A to 114B, 11AE to 11AF, 1212 to 1213	4)	1 to 4	4328, 4428, 4528, 4628	10E8, 114C, 11B0, 1214
	5 to 8	4726 to 4727, 4826 to 4827, 4926 to 4927, 5026 to 5027	1276 to 1277, 12DA to 12DB, 133E to 133F, 13A2 to 13A3		5 to 8	4728, 4828, 4928, 5028	1278, 12DC, 1340, 13A4
					9 to 12	5128, 5228, 5328, 5428	1408, 146C, 14D0, 1534
					13 to 16	5528, 5628, 5728, 5828	1598, 15FC, 1660, 16C4

Screen example

LD77MS16 Position-speed control

PSSC speed change register

1) {

Axis1	123456	Axis2	123456
Axis3	123456	Axis4	123456

Setting range

0to2000000000 (mm/min):*10⁻³

(inch/min):*10⁻³

(degree/min):*10⁻³

0to500000000 (pulse/sec):*1

SET/ Data MONIT
RESET Chg. MENU END

Item	Ax.1	Ax.2	Ax.3	Ax.4
Position-speed switching latch	●	●	●	●
In speed control	●	●	●	●
Position-speed switching enable	0:Disable 1:Enable			

2) }
3) }

No.	Axis	Buffer memory address		No.	Axis	Buffer memory address	
		DEC	HEX			DEC	HEX
1)	1 to 4	4330 to 4331, 4430 to 4431, 4530 to 4531, 4630 to 4631	10EA to 10EB, 114E to 114F, 11B2 to 11B3, 1216 to 1217	2)	1 to 4	2417, 2517, 2617, 2717	971, 9D5, A39, A9D
	5 to 8	4730 to 4731, 4830 to 4831, 4930 to 4931, 5030 to 5031	127A to 127B, 12DE to 12DF, 1342 to 1343, 13A6 to 13A7		5 to 8	2817, 2917, 3017, 3117	B01, B65, BC9, C2D
	9 to 12	5130 to 5131, 5230 to 5231, 5330 to 5331, 5430 to 5431	140A to 140B, 146E to 146F, 14D2 to 14D3, 1536 to 1537		9 to 12	3217, 3317, 3417, 3517	C91, CF5, D59, DBD
	13 to 16	5530 to 5531, 5630 to 5631, 5730 to 5731, 5830 to 5831	159A to 159B, 15FE to 15FF, 1662 to 1663, 16C6 to 16C7	3)	1 to 4	4332, 4432, 4532, 4632	10EC, 1150, 11B4, 1218
			5 to 8		4732, 4832, 4932, 5032	127C, 12E0, 1344, 13A8	
			9 to 12		5132, 5232, 5332, 5432	140C, 1470, 14D4, 1538	
			13 to 16	5532, 5632, 5732, 5832	159C, 1600, 1664, 16C8		

- 1 OVERVIEW
- 2 SYSTEM MONITOR
- 3 LADDER MONITOR FUNCTION
- 4 MELSEC-A LIST EDITOR
- 5 MELSEC-FX LIST EDITOR
- 6 INTELLIGENT MODULE MONITOR
- 7 NETWORK MONITOR
- 8 Q MOTION MONITOR

Screen example

The screenshot shows the 'LD77MS16 Axis control data-1' screen. It is divided into two main sections, labeled 1) and 2).
 Section 1) 'New current value' shows four axes (Axis1 to Axis4) with a value of 123456. Below this is a 'Setting range' field with a value of -2147483648 to 2147483647. To the right is a control panel with buttons for 'SET/RESET', 'Data Chg.', 'MONIT MENU', and 'END'. Below these buttons is a table with columns for 'Item', 'Ax.1', 'Ax.2', 'Ax.3', 'Ax.4', and 'Set value'. The items include Torq.boost, Step mode, Step valid flag, and Step start information.
 Section 2) 'New speed value' shows four axes (Axis1 to Axis4) with a value of 123456. Below this is a 'Setting range' field with a value of 0 to 500000000. To the right is a control panel with buttons for 'SET/RESET', 'Data Chg.', 'MONIT MENU', and 'END'. Below these buttons is a table with columns for 'Item', 'Ax.1', 'Ax.2', 'Ax.3', 'Ax.4', and 'Set value'. The items include Skip command and Use ext. command.

No.	Axis	Buffer memory address		No.	Axis	Buffer memory address	
		DEC	HEX			DEC	HEX
1)	1 to 4	4306 to 4307, 4406 to 4407, 4506 to 4507, 4606 to 4607	10D2 to 10D3, 1136 to 1137, 119A to 119B, 11FE to 11FF	3)	1 to 4	4313, 4413, 4513, 4613	10D9, 113D, 11A1, 1205
	5 to 8	4706 to 4707, 4806 to 4807, 4906 to 4907, 5006 to 5007	1262 to 1263, 12C6 to 12C7, 132A to 132B, 138E to 138F		5 to 8	4713, 4813, 4913, 5013	1269, 12CD, 1331, 1395
	9 to 12	5106 to 5107, 5206 to 5207, 5306 to 5307, 5406 to 5407	13F2 to 13F3, 1456 to 1457, 14BA to 14BB, 151E to 151F		9 to 12	5113, 5213, 5313, 5413	13F9, 145D, 14C1, 1525
	13 to 16	5506 to 5507, 5606 to 5607, 5706 to 5707, 5806 to 5807	1582 to 1583, 15E6 to 15E7, 164A to 164B, 16AE to 16AF		13 to 16	5513, 5613, 5713, 5813	1589, 15ED, 1651, 16B5
2)	1 to 4	4314 to 4315, 4414 to 4415, 4514 to 4515, 4614 to 4615	10DA to 10DB, 113E to 113F, 11A2 to 11A3, 1206 to 1207	6)	1 to 4	4346, 4446, 4546, 4646	10FA, 115E, 11C2, 1226
					5 to 8	4746, 4846, 4946, 5046	128A, 12EE, 1352, 13B6
					9 to 12	5146, 5246, 5346, 5446	141A, 147E, 14E2, 1546
					13 to 16	5546, 5646, 5746, 5846	15AA, 160E, 1672, 16D6
	5 to 8	4714 to 4715, 4814 to 4815, 4914 to 4915, 5014 to 5015	126A to 126B, 12CE to 12CF, 1332 to 1333, 1396 to 1397	7)	1 to 4	4347, 4447, 4547, 4647	10FB, 115F, 11C3, 1227
					5 to 8	4747, 4847, 4947, 5047	128B, 12EF, 1353, 13B7
					9 to 12	5147, 5247, 5347, 5447	141B, 147F, 14E3, 1547
					13 to 16	5547, 5647, 5747, 5847	15AB, 160F, 1673, 16D7
	9 to 12	5114 to 5115, 5214 to 5215, 5314 to 5315, 5414 to 5415	13FA to 13FB, 145E to 145F, 14C2 to 14C3, 1526 to 1527	8)	1 to 4	4305, 4405, 4505, 4605	10D1, 1135, 1199, 11FD
					5 to 8	4705, 4805, 4905, 5005	1261, 12C5, 1329, 138D
					9 to 12	5105, 5205, 5305, 5405	13F1, 1455, 14B9, 151D
					13 to 16	5505, 5605, 5705, 5805	1581, 15E5, 1649, 16AD



No.	Axis	Buffer memory address		No.	Axis	Buffer memory address	
		DEC	HEX			DEC	HEX
1)	1 to 4	4300, 4400, 4500, 4600	10CC, 1130, 1194, 11F8	1 to 4	4310 to 4311, 4410 to 4411, 4510 to 4511, 4610 to 4611	10D6 to 10D7, 113A to 113B, 119E to 119F, 1202 to 1203	
	5 to 8	4700, 4800, 4900, 5000	125C, 12C0, 1324, 1388		5 to 8	4710 to 4711, 4810 to 4811, 4910 to 4911, 5010 to 5011	1266 to 1267, 12CA to 12CB, 132E to 132F, 1392 to 1393
	9 to 12	5100, 5200, 5300, 5400	13EC, 1450, 14B4, 1518		9 to 12	5110 to 5111, 5210 to 5211, 5310 to 5311, 5410 to 5411	13F6 to 13F7, 145A to 145B, 14BE to 14BF, 1522 to 1523
	13 to 16	5500, 5600, 5700, 5800	157C, 15E0, 1644, 16A8		13 to 16	5510 to 5511, 5610 to 5611, 5710 to 5711, 5810 to 5811	1586 to 1587, 15EA to 15EB, 164E to 164F, 16B2 to 16B3
2)	1 to 4	4301, 4401, 4501, 4601	10CD, 1131, 1195, 11F9	9)	1 to 4	4320, 4420, 4520, 4620	10E0, 1144, 11A8, 120C
	5 to 8	4701, 4801, 4901, 5001	125D, 12C1, 1325, 1389		5 to 8	4720, 4820, 4920, 5020	1270, 12D4, 1338, 139C
	9 to 12	5101, 5201, 5301, 5401	13ED, 1451, 14B5, 1519		9 to 12	5120, 5220, 5320, 5420	1400, 1464, 14C8, 152C
	13 to 16	5501, 5601, 5701, 5801	157D, 15E1, 1645, 16A9		13 to 16	5520, 5620, 5720, 5820	1590, 15F4, 1658, 16BC
3)	1 to 4	4302, 4402, 4502, 4602	10CE, 1132, 1196, 11FA	10)	1 to 4	4321, 4421, 4521, 4621	10E1, 1145, 11A9, 120D
	5 to 8	4702, 4802, 4902, 5002	125E, 12C2, 1326, 138A		5 to 8	4721, 4821, 4921, 5021	1271, 12D5, 1339, 139D
	9 to 12	5102, 5202, 5302, 5402	13EE, 1452, 14B6, 151A		9 to 12	5121, 5221, 5321, 5421	1401, 1465, 14C9, 152D
	13 to 16	5502, 5602, 5702, 5802	157E, 15E2, 1646, 16AA		13 to 16	5521, 5621, 5721, 5821	1591, 15F5, 1659, 16BD
4)	1 to 4	4303, 4403, 4503, 4603	10CF, 1133, 1197, 11FB	11)	1 to 4	4322 to 4323, 4422 to 4423, 4522 to 4523, 4622 to 4623	10E2 to 10E3, 1146 to 1147, 11AA to 11AB, 120E to 120F
	5 to 8	4703, 4803, 4903, 5003	125F, 12C3, 1327, 138B		5 to 8	4722 to 4723, 4822 to 4823, 4922 to 4923, 5022 to 5023	1272 to 1273, 12D6 to 12D7, 133A to 133B, 139E to 139F
	9 to 12	5103, 5203, 5303, 5403	13EF, 1453, 14B7, 151B		9 to 12	5122 to 5123, 5222 to 5223, 5322 to 5323, 5422 to 5423	1402 to 1403, 1466 to 1467, 14CA to 14CB, 152E to 152F
	13 to 16	5503, 5603, 5703, 5803	157F, 15E3, 1647, 16AB		13 to 16	5522 to 5523, 5622 to 5623, 5722 to 5723, 5822 to 5823	1592 to 1593, 15F6 to 15F7, 165A to 165B, 16BE to 16BF
5)	1 to 4	4304, 4404, 4504, 4604	10D0, 1134, 1198, 11FC	12)	1 to 4	4324, 4424, 4524, 4624	10E4, 1148, 11AC, 1210
	5 to 8	4704, 4804, 4904, 5004	1260, 12C4, 1328, 138C		5 to 8	4724, 4824, 4924, 5024	1274, 12D8, 133C, 13A0
	9 to 12	5104, 5204, 5304, 5404	13F0, 1454, 14B8, 151C		9 to 12	5124, 5224, 5324, 5424	1404, 1468, 14CC, 1530
	13 to 16	5504, 5604, 5704, 5804	1580, 15E4, 1648, 16AC		13 to 16	5524, 5624, 5724, 5824	1594, 15F8, 165C, 16C0
6)	1 to 4	4312, 4412, 4512, 4612	10D8, 113C, 11A0, 1204	13)	1 to 4	4325, 4425, 4525, 4625	10E5, 1149, 11AD, 1211
	5 to 8	4712, 4812, 4912, 5012	1268, 12CC, 1330, 1394		5 to 8	4725, 4825, 4925, 5025	1275, 12D9, 133D, 13A1
	9 to 12	5112, 5212, 5312, 5412	13F8, 145C, 14C0, 1524		9 to 12	5125, 5225, 5325, 5425	1405, 1469, 14CD, 1531
	13 to 16	5512, 5612, 5712, 5812	1588, 15EC, 1650, 16B4		13 to 16	5525, 5625, 5725, 5825	1595, 15F9, 165D, 16C1
7)	1 to 4	4316, 4416, 4516, 4616	10DC, 1140, 11A4, 1208	14)	1 to 4	4325, 4425, 4525, 4625	10E5, 1149, 11AD, 1211
	5 to 8	4716, 4816, 4916, 5016	126C, 12D0, 1334, 1398		5 to 8	4725, 4825, 4925, 5025	1275, 12D9, 133D, 13A1
	9 to 12	5116, 5216, 5316, 5416	13FC, 1460, 14C4, 1528		9 to 12	5125, 5225, 5325, 5425	1405, 1469, 14CD, 1531
	13 to 16	5516, 5616, 5716, 5816	158C, 15F0, 1654, 16B8		13 to 16	5525, 5625, 5725, 5825	1595, 15F9, 165D, 16C1
8)	1 to 4	4308 to 4309, 4408 to 4409, 4508 to 4509, 4608 to 4609	10D4 to 10D5, 1138 to 1139, 119C to 119D, 1200 to 1201	13)	1 to 4	4324, 4424, 4524, 4624	10E4, 1148, 11AC, 1210
	5 to 8	4708 to 4709, 4808 to 4809, 4908 to 4909, 5008 to 5009	1264 to 1265, 12C8 to 12C9, 132C to 132D, 1390 to 1391		5 to 8	4724, 4824, 4924, 5024	1274, 12D8, 133C, 13A0
	9 to 12	5108 to 5109, 5208 to 5209, 5308 to 5309, 5408 to 5409	13F4 to 13F5, 1458 to 1459, 14BC to 14BD, 1520 to 1521		9 to 12	5124, 5224, 5324, 5424	1404, 1468, 14CC, 1530
	13 to 16	5508 to 5509, 5608 to 5609, 5708 to 5709, 5808 to 5809	1584 to 1585, 15E8 to 15E9, 164C to 164D, 16B0 to 16B1		13 to 16	5524, 5624, 5724, 5824	1594, 15F8, 165C, 16C0

- 1 OVERVIEW
- 2 SYSTEM MONITOR
- 3 LADDER MONITOR FUNCTION
- 4 MELSEC-A LIST EDITOR
- 5 MELSEC-FX LIST EDITOR
- 6 INTELLIGENT MODULE MONITOR
- 7 NETWORK MONITOR
- 8 Q MOTION MONITOR

Screen example

LD77MS16 Axis control data-3					SET/ Data MONIT	RESET Chg. MENU	END	
1)	Item	Axis1	Axis2	Axis3	Axis4	Simultaneous starting axis start data		
	Pos.change	1	1	1	1	Data No.	Axis1 Axis2 Axis3 Axis4	
		0:Completed 1:Request				Own axis	123 123 123 123	
2)	Teachin _z data selection	1	1	1	1	Axis No.1	123 123 123 123	
		0:Address 1: Arc data				Axis No.2	123 123 123 123	
3)	Teachin _z positioning data No.	123	123	123	123	Axis No.3	123 123 123 123	
		1 to 600				0:Nontarget / 1 to 600:Start data No.		
4)	Item	Axis1	Axis2	Axis3	Axis4	Item	Axis1 Axis2 Axis3 Axis4	
	ABS direction in degrees	1	1	1	1	SV OFF command	1 1 1 1	
		0:Shortcut 1:Right 2:Left				0:Servo ON 1:Servo OFF		
						torque output	1234 1234 1234 1234	
						0 to 1000(%)		
						gain switch	1 1 1 1	
						Switch command 0:OFF 1:ON		
						PI-PID chg.req.	1 1 1 1	
						0:Completed 1:Request		
	Simultaneous starting axis							
	Item	Axis1	Axis2	Axis3	Axis4			
	Num of Ax	1	1	1	1			
	Axis No.1	12	12	12	12			
	Axis No.2	12	12	12	12			
	Axis No.3	12	12	12	12			

No.	Axis	Buffer memory address		No.	Axis	Buffer memory address	
		DEC	HEX			DEC	HEX
1)	1 to 4	4338, 4438, 4538, 4638	10F2, 1156, 11BA, 121E	8)	1 to 4	4341, 4441, 4541, 4641	10F5, 1159, 11BD, 1221
	5 to 8	4738, 4838, 4938, 5038	1282, 12E6, 134A, 13AE		5 to 8	4741, 4841, 4941, 5041	1285, 12E9, 134D, 13B1
	9 to 12	5138, 5238, 5338, 5438	1412, 1476, 14DA, 153E		9 to 12	5141, 5241, 5341, 5441	1415, 1479, 14DD, 1541
	13 to 16	5538, 5638, 5738, 5838	15A2, 1606, 166A, 16CE		13 to 16	5541, 5641, 5741, 5841	15A5, 1609, 166D, 16D1
2)	1 to 4	4348, 4448, 4548, 4648	10FC, 1160, 11C4, 1228	9)	1 to 4	4343, 4443, 4543, 4643	10F7, 115B, 11BF, 1223
	5 to 8	4748, 4848, 4948, 5048	128C, 12F0, 1354, 13B8		5 to 8	4743, 4843, 4943, 5043	1287, 12EB, 134F, 13B3
	9 to 12	5148, 5248, 5348, 5448	141C, 1480, 14E4, 1548		9 to 12	5143, 5243, 5343, 5443	1417, 147B, 14DF, 1543
	13 to 16	5548, 5648, 5748, 5848	15AC, 1610, 1674, 16D8		13 to 16	5543, 5643, 5743, 5843	15A7, 160B, 166F, 16D3
3)	1 to 4	4349, 4449, 4549, 4649	10FD, 1161, 11C5, 1229	10)	1 to 4	4351, 4451, 4551, 4651	10FF, 1163, 11C7, 122B
	5 to 8	4749, 4849, 4949, 5049	128D, 12F1, 1355, 13B9		5 to 8	4751, 4851, 4951, 5051	128F, 12F3, 1357, 13BB
	9 to 12	5149, 5249, 5349, 5449	141D, 1481, 14E5, 1549		9 to 12	5151, 5251, 5351, 5451	141F, 1483, 14E7, 154B
	13 to 16	5549, 5649, 5749, 5849	15AD, 1611, 1675, 16D9		13 to 16	5551, 5651, 5751, 5851	15AF, 1613, 1677, 16DB
4)	1 to 4	4350, 4450, 4550, 4650	10FE, 1162, 11C6, 122A	11)	1 to 4	4352, 4452, 4552, 4652	1100, 1164, 11C8, 122C
	5 to 8	4750, 4850, 4950, 5050	128E, 12F2, 1356, 13BA		5 to 8	4752, 4852, 4952, 5052	1290, 12F4, 1358, 13BC
	9 to 12	5150, 5250, 5350, 5450	141E, 1482, 14E6, 154A		9 to 12	5152, 5252, 5352, 5452	1420, 1484, 14E8, 154C
	13 to 16	5550, 5650, 5750, 5850	15AE, 1612, 1676, 16DA		13 to 16	5552, 5652, 5752, 5852	15B0, 1614, 1678, 16DC
5)	1 to 4	4339, 4439, 4539, 4639	10F3, 1157, 11BB, 121F	12)	1 to 4	4359, 4459, 4559, 4659	1107, 116B, 11CF, 1233
	5 to 8	4739, 4839, 4939, 5039	1283, 12E7, 134B, 13AF		5 to 8	4759, 4859, 4959, 5059	1297, 12FB, 135F, 13C3
	9 to 12	5139, 5239, 5339, 5439	1413, 1477, 14DB, 153F		9 to 12	5159, 5259, 5359, 5459	1427, 148B, 14EF, 1553
	13 to 16	5539, 5639, 5739, 5839	15A3, 1607, 166B, 16CF		13 to 16	5559, 5659, 5759, 5859	15B7, 161B, 167F, 16E3
6)	1 to 4	4340, 4440, 4540, 4640	10F4, 1158, 11BC, 1220	13)	1 to 4	4365, 4465, 4565, 4665	110D, 1171, 11D5, 1239
	5 to 8	4740, 4840, 4940, 5040	1284, 12E8, 134C, 13B0		5 to 8	4765, 4865, 4965, 5065	129D, 1301, 1365, 13C9
	9 to 12	5140, 5240, 5340, 5440	1414, 1478, 14DC, 1540		9 to 12	5165, 5265, 5365, 5465	142D, 1491, 14F5, 1559
	13 to 16	5540, 5640, 5740, 5840	15A4, 1608, 166C, 16D0		13 to 16	5565, 5665, 5765, 5865	15BD, 1621, 1685, 16E9
7)	1 to 4	4341, 4441, 4541, 4641	10F5, 1159, 11BD, 1221	-	-	-	-
	5 to 8	4741, 4841, 4941, 5041	1285, 12E9, 134D, 13B1				
	9 to 12	5141, 5241, 5341, 5441	1415, 1479, 14DD, 1541				
	13 to 16	5541, 5641, 5741, 5841	15A5, 1609, 166D, 16D1				

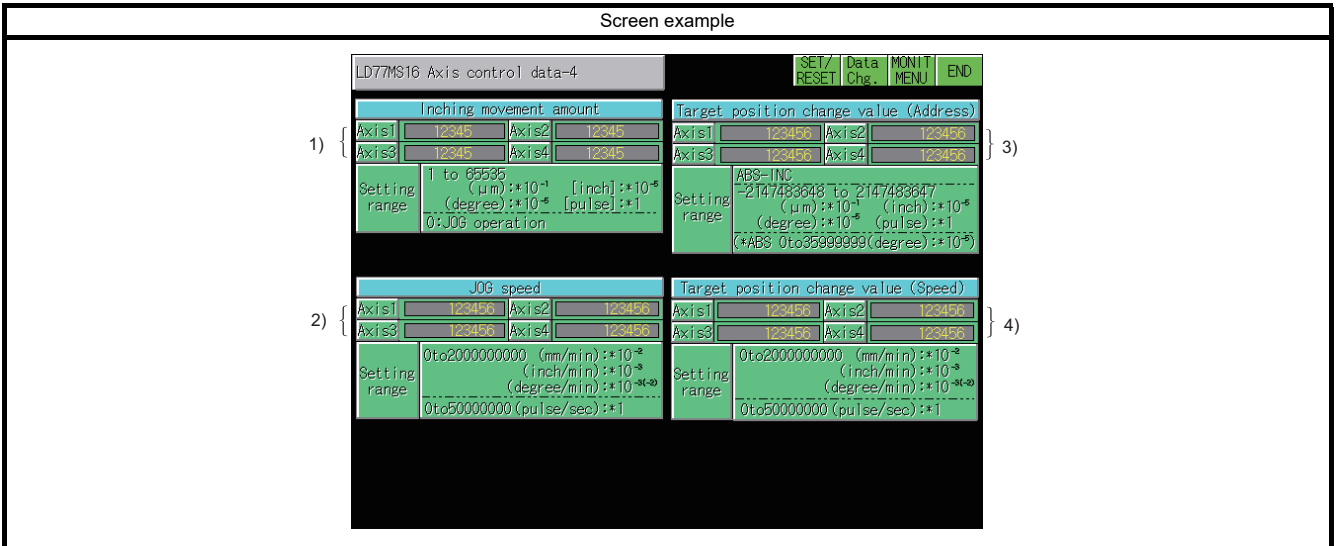

No.	Axis	Buffer memory address		No.	Axis	Buffer memory address	
		DEC	HEX			DEC	HEX
1)	1 to 4	4317, 4417, 4517, 4617	10DD, 1141, 11A5, 1209	3)	1 to 4	4334 to 4335, 4434 to 4435, 4534 to 4535, 4634 to 4635	10EE to 10EF, 1152 to 1153, 11B6 to 11B7, 121A to 121B
	5 to 8	4717, 4817, 4917, 5017	126D, 12D1, 1335, 1399		5 to 8	4734 to 4735, 4834 to 4835, 4934 to 4935, 5034 to 5035	127E to 127F, 12E2 to 12E3, 1346 to 1347, 13AA to 13AB
	9 to 12	5117, 5217, 5317, 5417	13FD, 1461, 14C5, 1529		9 to 12	5134 to 5135, 5234 to 5235, 5334 to 5335, 5434 to 5435	140E to 140F, 1472 to 1473, 14D6 to 14D7, 153A to 153B
	13 to 16	5517, 5617, 5717, 5817	158D, 15F1, 1655, 16B9		13 to 16	5534 to 5535, 5634 to 5635, 5734 to 5735, 5834 to 5835	159E to 159F, 1602 to 1603, 1666 to 1667, 16CA to 16CB
2)	1 to 4	4318 to 4319, 4418 to 4419, 4518 to 4519, 4618 to 4619	10DE to 10DF, 1142 to 1143, 11A6 to 11A7, 120A to 120B	4)	1 to 4	4336 to 4337, 4436 to 4437, 4536 to 4537, 4636 to 4637	10F0 to 10F1, 1154 to 1155, 11B8 to 11B9, 121C to 121D
	5 to 8	4718 to 4719, 4818 to 4819, 4918 to 4919, 5018 to 5019	126E to 126F, 12D2 to 12D3, 1336 to 1337, 139A to 139B		5 to 8	4736 to 4737, 4836 to 4837, 4936 to 4937, 5036 to 5037	1280 to 1281, 12E4 to 12E5, 1348 to 1349, 13AC to 13AD
	9 to 12	5118 to 5119, 5218 to 5219, 5318 to 5319, 5418 to 5419	13FE to 13FF, 1462 to 1463, 14C6 to 14C7, 152A to 152B		9 to 12	5136 to 5137, 5236 to 5237, 5336 to 5337, 5436 to 5437	1410 to 1411, 1474 to 1475, 14D8 to 14D9, 153C to 153D
	13 to 16	5518 to 5519, 5618 to 5619, 5718 to 5719, 5818 to 5819	158E to 158F, 15F2 to 15F3, 1656 to 1657, 16BA to 16BB		13 to 16	5536 to 5537, 5636 to 5637, 5736 to 5737, 5836 to 5837	15A0 to 15A1, 1604 to 1605, 1668 to 1669, 16CC to 16CD

- 1 OVERVIEW
- 2 SYSTEM MONITOR
- 3 LADDER MONITOR FUNCTION
- 4 MELSEC-A LIST EDITOR
- 5 MELSEC-FX LIST EDITOR
- 6 INTELLIGENT MODULE MONITOR
- 7 NETWORK MONITOR
- 8 Q MOTION MONITOR

Screen example

LD77MS16 Positioning data										SET/RESET	Data Chg.	MONIT MENU	END		
Axis1					Axis3										
No	Pat.	Int.	Cont.	Acc.	Dec.	Dwell	Moode	No	Pat.	Int.	Cont.	Acc.	Dec.	Dwell	Moode
Address		Arc address		Instr. speed				Address		Arc address		Instr. speed			
1)	00	123	12	00	00	12345	12345	00	123	12	00	00	12345	12345	7)
2)	00	123	12	00	00	12345	12345	00	123	12	00	00	12345	12345	8)
3)	00	123	12	00	00	12345	12345	00	123	12	00	00	12345	12345	9)
Axis2					Axis4										
No	Pat.	Int.	Cont.	Acc.	Dec.	Dwell	Moode	No	Pat.	Int.	Cont.	Acc.	Dec.	Dwell	Moode
Address		Arc address		Instr. speed				Address		Arc address		Instr. speed			
4)	00	123	12	00	00	12345	12345	00	123	12	00	00	12345	12345	10)
5)	00	123	12	00	00	12345	12345	00	123	12	00	00	12345	12345	11)
6)	00	123	12	00	00	12345	12345	00	123	12	00	00	12345	12345	12)

[Pattern] 00: Positioning complete 01: Continuous positioning control 11: Continuous path control
 [Control] 02H:INC1 03H:FEED1 04H:VF1 05H:VR1 06H:VVF 07H:VFR 08H:PVF 09H:PIR 09H:RES1
 01H:RES1 02H:INC2 03H:FEED2 04H:ABS 05H:INC~ 06H:ABS_CW 07H:ABS_CW 08H:INC_CW 09H:INC_CW
 10H:RES2 01H:INC2 02H:FEED2 03H:ABS 04H:INC~ 05H:ABS_CW 06H:ABS_CW 07H:INC_CW 08H:INC_CW
 09H:RES2 10H:RES2 11H:RES2 12H:RES2 13H:RES2 14H:RES2 15H:RES2 16H:RES2 17H:RES2 18H:RES2 19H:RES2
 20H:RES2 21H:RES2 22H:RES2 23H:RES2 24H:RES2 25H:RES2 26H:RES2 27H:RES2 28H:RES2 29H:RES2
 30H:RES2 31H:RES2 32H:RES2 33H:RES2 34H:RES2 35H:RES2 36H:RES2 37H:RES2 38H:RES2 39H:RES2
 40H:RES2 41H:RES2 42H:RES2 43H:RES2 44H:RES2 45H:RES2 46H:RES2 47H:RES2 48H:RES2 49H:RES2
 50H:RES2 51H:RES2 52H:RES2 53H:RES2 54H:RES2 55H:RES2 56H:RES2 57H:RES2 58H:RES2 59H:RES2
 60H:RES2 61H:RES2 62H:RES2 63H:RES2 64H:RES2 65H:RES2 66H:RES2 67H:RES2 68H:RES2 69H:RES2
 70H:RES2 71H:RES2 72H:RES2 73H:RES2 74H:RES2 75H:RES2 76H:RES2 77H:RES2 78H:RES2 79H:RES2
 80H:RES2 81H:RES2 82H:RES2 83H:RES2 84H:RES2 85H:RES2 86H:RES2 87H:RES2 88H:RES2 89H:RES2
 90H:RES2 91H:RES2 92H:RES2 93H:RES2 94H:RES2 95H:RES2 96H:RES2 97H:RES2 98H:RES2 99H:RES2
 100H:RES2 101H:RES2 102H:RES2 103H:RES2 104H:RES2 105H:RES2 106H:RES2 107H:RES2 108H:RES2 109H:RES2
 110H:RES2 111H:RES2 112H:RES2 113H:RES2 114H:RES2 115H:RES2 116H:RES2 117H:RES2 118H:RES2 119H:RES2
 120H:RES2 121H:RES2 122H:RES2 123H:RES2 124H:RES2 125H:RES2 126H:RES2 127H:RES2 128H:RES2 129H:RES2
 130H:RES2 131H:RES2 132H:RES2 133H:RES2 134H:RES2 135H:RES2 136H:RES2 137H:RES2 138H:RES2 139H:RES2
 140H:RES2 141H:RES2 142H:RES2 143H:RES2 144H:RES2 145H:RES2 146H:RES2 147H:RES2 148H:RES2 149H:RES2
 150H:RES2 151H:RES2 152H:RES2 153H:RES2 154H:RES2 155H:RES2 156H:RES2 157H:RES2 158H:RES2 159H:RES2
 160H:RES2 161H:RES2 162H:RES2 163H:RES2 164H:RES2 165H:RES2 166H:RES2 167H:RES2 168H:RES2 169H:RES2
 170H:RES2 171H:RES2 172H:RES2 173H:RES2 174H:RES2 175H:RES2 176H:RES2 177H:RES2 178H:RES2 179H:RES2
 180H:RES2 181H:RES2 182H:RES2 183H:RES2 184H:RES2 185H:RES2 186H:RES2 187H:RES2 188H:RES2 189H:RES2
 190H:RES2 191H:RES2 192H:RES2 193H:RES2 194H:RES2 195H:RES2 196H:RES2 197H:RES2 198H:RES2 199H:RES2
 200H:RES2 201H:RES2 202H:RES2 203H:RES2 204H:RES2 205H:RES2 206H:RES2 207H:RES2 208H:RES2 209H:RES2
 210H:RES2 211H:RES2 212H:RES2 213H:RES2 214H:RES2 215H:RES2 216H:RES2 217H:RES2 218H:RES2 219H:RES2
 220H:RES2 221H:RES2 222H:RES2 223H:RES2 224H:RES2 225H:RES2 226H:RES2 227H:RES2 228H:RES2 229H:RES2
 230H:RES2 231H:RES2 232H:RES2 233H:RES2 234H:RES2 235H:RES2 236H:RES2 237H:RES2 238H:RES2 239H:RES2
 240H:RES2 241H:RES2 242H:RES2 243H:RES2 244H:RES2 245H:RES2 246H:RES2 247H:RES2 248H:RES2 249H:RES2
 250H:RES2 251H:RES2 252H:RES2 253H:RES2 254H:RES2 255H:RES2 256H:RES2 257H:RES2 258H:RES2 259H:RES2
 260H:RES2 261H:RES2 262H:RES2 263H:RES2 264H:RES2 265H:RES2 266H:RES2 267H:RES2 268H:RES2 269H:RES2
 270H:RES2 271H:RES2 272H:RES2 273H:RES2 274H:RES2 275H:RES2 276H:RES2 277H:RES2 278H:RES2 279H:RES2
 280H:RES2 281H:RES2 282H:RES2 283H:RES2 284H:RES2 285H:RES2 286H:RES2 287H:RES2 288H:RES2 289H:RES2
 290H:RES2 291H:RES2 292H:RES2 293H:RES2 294H:RES2 295H:RES2 296H:RES2 297H:RES2 298H:RES2 299H:RES2
 300H:RES2 301H:RES2 302H:RES2 303H:RES2 304H:RES2 305H:RES2 306H:RES2 307H:RES2 308H:RES2 309H:RES2
 310H:RES2 311H:RES2 312H:RES2 313H:RES2 314H:RES2 315H:RES2 316H:RES2 317H:RES2 318H:RES2 319H:RES2
 320H:RES2 321H:RES2 322H:RES2 323H:RES2 324H:RES2 325H:RES2 326H:RES2 327H:RES2 328H:RES2 329H:RES2
 330H:RES2 331H:RES2 332H:RES2 333H:RES2 334H:RES2 335H:RES2 336H:RES2 337H:RES2 338H:RES2 339H:RES2
 340H:RES2 341H:RES2 342H:RES2 343H:RES2 344H:RES2 345H:RES2 346H:RES2 347H:RES2 348H:RES2 349H:RES2
 350H:RES2 351H:RES2 352H:RES2 353H:RES2 354H:RES2 355H:RES2 356H:RES2 357H:RES2 358H:RES2 359H:RES2
 360H:RES2 361H:RES2 362H:RES2 363H:RES2 364H:RES2 365H:RES2 366H:RES2 367H:RES2 368H:RES2 369H:RES2
 370H:RES2 371H:RES2 372H:RES2 373H:RES2 374H:RES2 375H:RES2 376H:RES2 377H:RES2 378H:RES2 379H:RES2
 380H:RES2 381H:RES2 382H:RES2 383H:RES2 384H:RES2 385H:RES2 386H:RES2 387H:RES2 388H:RES2 389H:RES2
 390H:RES2 391H:RES2 392H:RES2 393H:RES2 394H:RES2 395H:RES2 396H:RES2 397H:RES2 398H:RES2 399H:RES2
 400H:RES2 401H:RES2 402H:RES2 403H:RES2 404H:RES2 405H:RES2 406H:RES2 407H:RES2 408H:RES2 409H:RES2
 410H:RES2 411H:RES2 412H:RES2 413H:RES2 414H:RES2 415H:RES2 416H:RES2 417H:RES2 418H:RES2 419H:RES2
 420H:RES2 421H:RES2 422H:RES2 423H:RES2 424H:RES2 425H:RES2 426H:RES2 427H:RES2 428H:RES2 429H:RES2
 430H:RES2 431H:RES2 432H:RES2 433H:RES2 434H:RES2 435H:RES2 436H:RES2 437H:RES2 438H:RES2 439H:RES2
 440H:RES2 441H:RES2 442H:RES2 443H:RES2 444H:RES2 445H:RES2 446H:RES2 447H:RES2 448H:RES2 449H:RES2
 450H:RES2 451H:RES2 452H:RES2 453H:RES2 454H:RES2 455H:RES2 456H:RES2 457H:RES2 458H:RES2 459H:RES2
 460H:RES2 461H:RES2 462H:RES2 463H:RES2 464H:RES2 465H:RES2 466H:RES2 467H:RES2 468H:RES2 469H:RES2
 470H:RES2 471H:RES2 472H:RES2 473H:RES2 474H:RES2 475H:RES2 476H:RES2 477H:RES2 478H:RES2 479H:RES2
 480H:RES2 481H:RES2 482H:RES2 483H:RES2 484H:RES2 485H:RES2 486H:RES2 487H:RES2 488H:RES2 489H:RES2
 490H:RES2 491H:RES2 492H:RES2 493H:RES2 494H:RES2 495H:RES2 496H:RES2 497H:RES2 498H:RES2 499H:RES2
 500H:RES2 501H:RES2 502H:RES2 503H:RES2 504H:RES2 505H:RES2 506H:RES2 507H:RES2 508H:RES2 509H:RES2
 510H:RES2 511H:RES2 512H:RES2 513H:RES2 514H:RES2 515H:RES2 516H:RES2 517H:RES2 518H:RES2 519H:RES2
 520H:RES2 521H:RES2 522H:RES2 523H:RES2 524H:RES2 525H:RES2 526H:RES2 527H:RES2 528H:RES2 529H:RES2
 530H:RES2 531H:RES2 532H:RES2 533H:RES2 534H:RES2 535H:RES2 536H:RES2 537H:RES2 538H:RES2 539H:RES2
 540H:RES2 541H:RES2 542H:RES2 543H:RES2 544H:RES2 545H:RES2 546H:RES2 547H:RES2 548H:RES2 549H:RES2
 550H:RES2 551H:RES2 552H:RES2 553H:RES2 554H:RES2 555H:RES2 556H:RES2 557H:RES2 558H:RES2 559H:RES2
 560H:RES2 561H:RES2 562H:RES2 563H:RES2 564H:RES2 565H:RES2 566H:RES2 567H:RES2 568H:RES2 569H:RES2
 570H:RES2 571H:RES2 572H:RES2 573H:RES2 574H:RES2 575H:RES2 576H:RES2 577H:RES2 578H:RES2 579H:RES2
 580H:RES2 581H:RES2 582H:RES2 583H:RES2 584H:RES2 585H:RES2 586H:RES2 587H:RES2 588H:RES2 589H:RES2
 590H:RES2 591H:RES2 592H:RES2 593H:RES2 594H:RES2 595H:RES2 596H:RES2 597H:RES2 598H:RES2 599H:RES2
 600H:RES2 601H:RES2 602H:RES2 603H:RES2 604H:RES2 605H:RES2 606H:RES2 607H:RES2 608H:RES2 609H:RES2
 610H:RES2 611H:RES2 612H:RES2 613H:RES2 614H:RES2 615H:RES2 616H:RES2 617H:RES2 618H:RES2 619H:RES2
 620H:RES2 621H:RES2 622H:RES2 623H:RES2 624H:RES2 625H:RES2 626H:RES2 627H:RES2 628H:RES2 629H:RES2
 630H:RES2 631H:RES2 632H:RES2 633H:RES2 634H:RES2 635H:RES2 636H:RES2 637H:RES2 638H:RES2 639H:RES2
 640H:RES2 641H:RES2 642H:RES2 643H:RES2 644H:RES2 645H:RES2 646H:RES2 647H:RES2 648H:RES2 649H:RES2
 650H:RES2 651H:RES2 652H:RES2 653H:RES2 654H:RES2 655H:RES2 656H:RES2 657H:RES2 658H:RES2 659H:RES2
 660H:RES2 661H:RES2 662H:RES2 663H:RES2 664H:RES2 665H:RES2 666H:RES2 667H:RES2 668H:RES2 669H:RES2
 670H:RES2 671H:RES2 672H:RES2 673H:RES2 674H:RES2 675H:RES2 676H:RES2 677H:RES2 678H:RES2 679H:RES2
 680H:RES2 681H:RES2 682H:RES2 683H:RES2 684H:RES2 685H:RES2 686H:RES2 687H:RES2 688H:RES2 689H:RES2
 690H:RES2 691H:RES2 692H:RES2 693H:RES2 694H:RES2 695H:RES2 696H:RES2 697H:RES2 698H:RES2 699H:RES2
 700H:RES2 701H:RES2 702H:RES2 703H:RES2 704H:RES2 705H:RES2 706H:RES2 707H:RES2 708H:RES2 709H:RES2
 710H:RES2 711H:RES2 712H:RES2 713H:RES2 714H:RES2 715H:RES2 716H:RES2 717H:RES2 718H:RES2 719H:RES2
 720H:RES2 721H:RES2 722H:RES2 723H:RES2 724H:RES2 725H:RES2 726H:RES2 727H:RES2 728H:RES2 729H:RES2
 730H:RES2 731H:RES2 732H:RES2 733H:RES2 734H:RES2 735H:RES2 736H:RES2 737H:RES2 738H:RES2 739H:RES2
 740H:RES2 741H:RES2 742H:RES2 743H:RES2 744H:RES2 745H:RES2 746H:RES2 747H:RES2 748H:RES2 749H:RES2
 750H:RES2 751H:RES2 752H:RES2 753H:RES2 754H:RES2 755H:RES2 756H:RES2 757H:RES2 758H:RES2 759H:RES2
 760H:RES2 761H:RES2 762H:RES2 763H:RES2 764H:RES2 765H:RES2 766H:RES2 767H:RES2 768H:RES2 769H:RES2
 770H:RES2 771H:RES2 772H:RES2 773H:RES2 774H:RES2 775H:RES2 776H:RES2 777H:RES2 778H:RES2 779H:RES2
 780H:RES2 781H:RES2 782H:RES2 783H:RES2 784H:RES2 785H:RES2 786H:RES2 787H:RES2 788H:RES2 789H:RES2
 790H:RES2 791H:RES2 792H:RES2 793H:RES2 794H:RES2 795H:RES2 796H:RES2 797H:RES2 798H:RES2 799H:RES2
 800H:RES2 801H:RES2 802H:RES2 803H:RES2 804H:RES2 805H:RES2 806H:RES2 807H:RES2 808H:RES2 809H:RES2
 810H:RES2 811H:RES2 812H:RES2 813H:RES2 814H:RES2 815H:RES2 816H:RES2 817H:RES2 818H:RES2 819H:RES2
 820H:RES2 821H:RES2 822H:RES2 823H:RES2 824H:RES2 825H:RES2 826H:RES2 827H:RES2 828H:RES2 829H:RES2
 830H:RES2 831H:RES2 832H:RES2 833H:RES2 834H:RES2 835H:RES2 836H:RES2 837H:RES2 838H:RES2 839H:RES2
 840H:RES2 841H:RES2 842H:RES2 843H:RES2 844H:RES2 845H:RES2 846H:RES2 847H:RES2 848H:RES2 849H:RES2
 850H:RES2 851H:RES2 852H:RES2 853H:RES2 854H:RES2 855H:RES2 856H:RES2 857H:RES2 858H:RES2 859H:RES2
 860H:RES2 861H:RES2 862H:RES2 863H:RES2 864H:RES2 865H:RES2 866H:RES2 867H:RES2 868H:RES2 869H:RES2
 870H:RES2 871H:RES2 872H:RES2 873H:RES2 874H:RES2 875H:RES2 876H:RES2 877H:RES2 878H:RES2 879H:RES2
 880H:RES2 881H:RES2 882H:RES2 883H:RES2 884H:RES2 885H:RES2 886H:RES2 887H:RES2 888H:RES2 889H:RES2
 890H:RES2 891H:RES2 892H:RES2 893H:RES2 894H:RES2 895H:RES2 896H:RES2 897H:RES2 898H:RES2 899H:RES2
 900H:RES2 901H:RES2 902H:RES2 903H:RES2 904H:RES2 905H:RES2 906H:RES2 907H:RES2 908H:RES2 909H:RES2
 910H:RES2 911H:RES2 912H:RES2 913H:RES2 914H:RES2 915H:RES2 916H:RES2 917H:RES2 918H:RES2 919H:RES2
 920H:RES2 921H:RES2 922H:RES2 923H:RES2 924H:RES2 925H:RES2 926H:RES2 927H:RES2 928H:RES2 929H:RES2
 930H:RES2 931H:RES2 932H:RES2 933H:RES2 934H:RES2 935H:RES2 936H:RES2 937H:RES2 938H:RES2 939H:RES2
 940H:RES2 941H:RES2 942H:RES2 943H:RES2 944H:RES2 945H:RES2 946H:RES2 947H:RES2 948H:RES2 949H:RES2
 950H:RES2 951H:RES2 952H:RES2 953H:RES2 954H:RES2 955H:RES2 956H:RES2 957H:RES2 958H:RES2 959H:RES2
 960H:RES2 961H:RES2 962H:RES2 963H:RES2 964H:RES2 965H:RES2 966H:RES2 967H:RES2 968H:RES2 969H:RES2
 970H:RES2 971H:RES2 972H:RES2 973H:RES2 974H:RES2 975H:RES2 976H:RES2 977H:RES2 978H:RES2 979H:RES2
 980H:RES2 981H:RES2 982H:RES2 983H:RES2 984H:RES2 985H:RES2 986H:RES2 987H:RES2 988H:RES2 989H:RES2
 990H:RES2 991H:RES2 992H:RES2 993H:RES2 994H:RES2 995H:RES2 996H:RES2 997H:RES2 998H:RES2 999H:RES2
 1000H:RES2

No.	Axis	Buffer memory address		No.	Axis	Buffer memory address		No.	Axis	Buffer memory address	
		DEC	HEX			DEC	HEX			DEC	HEX
1)	1	6000 to 6002, 6004 to 6009	1770 to 1772, 1774 to 1779	5)	2	7010 to 7012, 7014 to 7019	1B62 to 1B64, 1B66 to 1B6B	9)	3	8020 to 8022, 8024 to 8029	1F54 to 1F56, 1F58 to 1F5D
	5	10000 to 10002, 10004 to 10009	2710 to 2712, 2714 to 2719		6	11010 to 11012, 11014 to 11019	2B02 to 2B04, 2B06 to 2B0B		7	12020 to 12022, 12024 to 12029	2EF4 to 2EF6, 2EF8 to 2EFD
	9	14000 to 14002, 14004 to 14009	36B0 to 36B2, 36B4 to 36B9		10	15010 to 15012, 15014 to 15019	3AA2 to 3AA4, 3AA6 to 3AAB		11	16020 to 16022, 16024 to 16029	3E94 to 3E96, 3E98 to 3E9D
	13	18000 to 18002, 18004 to 18009	4650 to 4652, 4654 to 4659		14	19010 to 19012, 19014 to 19019	4A42 to 4A44, 4A46 to 4A4B		15	20020 to 20022, 20024 to 20029	4E34 to 4E36, 4E38 to 4E3D
2)	1	6010 to 6012, 6014 to 6019	177A to 177C, 177E to 1783	6)	2	7020 to 7022, 7024 to 7029	1B6C to 1B6E, 1B70 to 1B75	10)	4	9000 to 9002, 9004 to 9009	2328 to 232A, 232C to 2331
	5	10010 to 10012, 10014 to 10019	271A to 271C, 271E to 2723		6	11020 to 11022, 11024 to 11029	2B0C to 2B0E, 2B10 to 2B15		8	13000 to 13002, 13004 to 13009	32C8 to 32CA, 32CC to 32D1
	9	14010 to 14012, 14014 to 14019	36BA to 36BC, 36BE to 36C3		10	15020 to 15022, 15024 to 15029	3AAC to 3AAE, 3AB0 to 3AB5		12	17000 to 17002, 17004 to 17009	4268 to 426A, 426C to 4271
	13	18010 to 18012, 18014 to 18019	465A to 465C, 465E to 4663		14	19020 to 19022, 19024 to 19029	4A4				

Screen example

LD77MS16 Sv. parameter Basic setting-1					SET/	Data	MONIT	END
					RESET	Chg.	MENJ	
Item	Axis1	Axis2	Axis3	Axis4	Setting range			
1) Servo series	1234	1234	1234	1234	0:Invalid 1:3,4,6:MR-J3(W)-B 7:MR-MT1200 32:MR-J4-B 93:VC II 4097,4128:Virt.			
2) Selection of regenerative brake option	12	12	12	12	0:Not used 02:MR-RB032 03:MR-RB12 04:MR-RB32 05:MR-RB30 06:MR-RB50 08:MR-RB31 09:MR-RB51			
3) 0 pos. detection sys.	1	1	1	1	0:Invalid 1:Valid			
4) Func. selection A-1 emergency stop input	1	1	1	1	0:Valid 1:Invalid			
5) Auto tuning Gain adjustment mode	1	1	1	1	0:Interpolation 1:Auto tuning1 3:Manual 2:Auto tuning2			
6) Auto tuning Response	12	12	12	12	1 ~ 16 32 Low ~ Middle ~ High 10Hz ~ 60Hz ~ 400Hz			
7) Min position range	12345	12345	12345	12345	0 to 50000[pulse]			
8) Rotation direction	1	1	1	1	0:00W 1:0W			
9) Encoder output pulses	12345	12345	12345	12345	1 to 65535[pulse]			

No.	Axis	Buffer memory address		No.	Axis	Buffer memory address		No.	Axis	Buffer memory address	
		DEC	HEX			DEC	HEX			DEC	HEX
1)	1 to 4	28400, 28500, 28600, 28700	6EF0, 6F54, 6FB8, 701C	4)	1 to 4	28404, 28504, 28604, 28704	6EF4, 6F58, 6FBC, 7020	7)	1 to 4	28410, 28510, 28610, 28710	6EFA, 6F5E, 6FC2, 7026
	5 to 8	28800, 28900, 29000, 29100	7080, 70E4, 7148, 71AC		5 to 8	28804, 28904, 29004, 29104	7084, 70E8, 714C, 71B0		5 to 8	28810, 28910, 29010, 29110	708A, 70EE, 7152, 71B6
	9 to 12	29200, 29300, 29400, 29500	7210, 7274, 72D8, 733C		9 to 12	29204, 29304, 29404, 29504	7214, 7278, 72DC, 7340		9 to 12	29210, 29310, 29410, 29510	721A, 727E, 72E2, 7346
	13 to 16	29600, 29700, 29800, 29900	73A0, 7404, 7468, 74CC		13 to 16	29604, 29704, 29804, 29904	73A4, 7408, 746C, 74D0		13 to 16	29610, 29710, 29810, 29910	73AA, 740E, 7472, 74D6
2)	1 to 4	28402, 28502, 28602, 28702	6EF2, 6F56, 6FBA, 701E	5)	1 to 4	28408, 28508, 28608, 28708	6EF8, 6F5C, 6FC0, 7024	8)	1 to 4	28414, 28514, 28614, 28714	6EFE, 6F62, 6FC6, 702A
	5 to 8	28802, 28902, 29002, 29102	7082, 70E6, 714A, 71AE		5 to 8	28808, 28908, 29008, 29108	7088, 70EC, 7150, 71B4		5 to 8	28814, 28914, 29014, 29114	708E, 70F2, 7156, 71BA
	9 to 12	29202, 29302, 29402, 29502	7212, 7276, 72DA, 733E		9 to 12	29208, 29308, 29408, 29508	7218, 727C, 72E0, 7344		9 to 12	29214, 29314, 29414, 29514	721E, 7282, 72E6, 734A
	13 to 16	29602, 29702, 29802, 29902	73A2, 7406, 746A, 74CE		13 to 16	29608, 29708, 29808, 29908	73A8, 740C, 7470, 74D4		13 to 16	29614, 29714, 29814, 29914	73AE, 7412, 7476, 74DA
3)	1 to 4	28403, 28503, 28603, 28703	6EF3, 6F57, 6FBB, 701F	6)	1 to 4	28409, 28509, 28609, 28709	6EF9, 6F5D, 6FC1, 7025	9)	1 to 4	28415, 28515, 28615, 28715	6EFF, 6F63, 6FC7, 702B
	5 to 8	28803, 28903, 29003, 29103	7083, 70E7, 714B, 71AF		5 to 8	28809, 28909, 29009, 29109	7089, 70ED, 7151, 71B5		5 to 8	28815, 28915, 29015, 29115	708F, 70F3, 7157, 71BB
	9 to 12	29203, 29303, 29403, 29503	7213, 7277, 72DB, 733F		9 to 12	29209, 29309, 29409, 29509	7219, 727D, 72E1, 7345		9 to 12	29215, 29315, 29415, 29515	721F, 7283, 72E7, 734B
	13 to 16	29603, 29703, 29803, 29903	73A3, 7407, 746B, 74CF		13 to 16	29609, 29709, 29809, 29909	73A9, 740D, 7471, 74D5		13 to 16	29615, 29715, 29815, 29915	73AF, 7413, 7477, 74DB

Screen example

LD77MS16 Sv. parameter Basic setting-2						SET/RESET	Data Chg.	MONIT MENU	END
Item	Axis1	Axis2	Axis3	Axis4	Setting range				
1) Func. selection A-1 Forced stop decel.	1	1	1	1	0:Disabled 2:Enabled				
2) Encoder output p. 2	12345	12345	12345	12345	1 to 65535[pulse]				
3) Servo motor series	1234	1234	1234	1234					
4) Servo motor type	1234	1234	1234	1234					

No.	Axis	Buffer memory address		No.	Axis	Buffer memory address	
		DEC	HEX			DEC	HEX
1)	1 to 4	28404, 28504, 28604, 28704	6EF4, 6F58, 6FBC, 7020	3)	1 to 4	28417, 28517, 28617, 28717	6F01, 6F65, 6FC9, 702D
	5 to 8	28804, 28904, 29004, 29104	7084, 70E8, 714C, 71B0		5 to 8	28817, 28917, 29017, 29117	7091, 70F5, 7159, 71BD
	9 to 12	29204, 29304, 29404, 29504	7214, 7278, 72DC, 7340		9 to 12	29217, 29317, 29417, 29517	7221, 7285, 72E9, 734D
	13 to 16	29604, 29704, 29804, 29904	73A4, 7408, 746C, 74D0		13 to 16	29617, 29717, 29817, 29917	73B1, 7415, 7479, 74DD
2)	1 to 4	28416, 28516, 28616, 28716	6F00, 6F64, 6FC8, 702C	4)	1 to 4	28418, 28518, 28618, 28718	6F02, 6F66, 6FCA, 702E
	5 to 8	28816, 28916, 29016, 29116	7090, 70F4, 7158, 71BC		5 to 8	28818, 28918, 29018, 29118	7092, 70F6, 715A, 71BE
	9 to 12	29206, 29306, 29406, 29506	7216, 727A, 72DE, 7342		9 to 12	29218, 29318, 29418, 29518	7222, 7286, 72EA, 734E
	13 to 16	29606, 29706, 29806, 29906	73A6, 740A, 746E, 74D2		13 to 16	29618, 29718, 29818, 29918	73B2, 7416, 747A, 74DE

Screen example

LD77MS16 Sv. parameter Basic setting-3						SET/RESET	Data Chg.	MONIT MENU	END
Item	Axis1	Axis2	Axis3	Axis4	Setting range				
1) Tough drive setting Vibration selection	1	1	1	1	0:Disabled 1:Enabled				
2) Tough drive setting power failure	1	1	1	1	0:Disabled 1:Enabled				
3) Func. selection A-3 One-touch tuning	1	1	1	1	0:Disabled 1:Enabled				
4) Func. selection A-4 Vibration suppression	1	1	1	1	0: Standard mode 1: 3 inertia mode 2: Low response mode				
5) Drive recorder arbitrary alarm trig.	Alarm detail No.	12	12	12	12				
6) arbitrary alarm trig.	Alarm No.	12	12	12	12				

No.	Axis	Buffer memory address		No.	Axis	Buffer memory address	
		DEC	HEX			DEC	HEX
1)	1 to 4	31632, 31702, 31772, 31842	7B90, 7BD6, 7C1C, 7C62	4)	1 to 4	31636, 31706, 31776, 31846	7B94, 7BDA, 7C20, 7C66
	5 to 8	31912, 31982, 32052, 32122	7CA8, 7CEE, 7D34, 7D7A		5 to 8	31916, 31986, 32056, 32126	7CAC, 7CF2, 7D38, 7D7E
	9 to 12	32192, 32262, 32332, 32402	7DC0, 7E06, 7E4C, 7E92		9 to 12	32196, 32266, 32336, 32406	7DC4, 7E0A, 7E50, 7E96
	13 to 16	32472, 32542, 32612, 32682	7ED8, 7F1E, 7F64, 7FAA		13 to 16	32476, 32546, 32616, 32686	7EDC, 7F22, 7F68, 7FAE
2)	1 to 4	31633, 31703, 31773, 31843	7B91, 7BD7, 7C1D, 7C63	5)	1 to 4	31635, 31705, 31775, 31845	7B93, 7BD9, 7C1F, 7C65
	5 to 8	31913, 31983, 32053, 32123	7CA9, 7CEF, 7D35, 7D7B		5 to 8	31915, 31985, 32055, 32125	7CAB, 7CF1, 7D37, 7D7D
	9 to 12	32193, 32263, 32333, 32403	7DC1, 7E07, 7E4D, 7E93		9 to 12	32195, 32265, 32335, 32405	7DC3, 7E09, 7E4F, 7E95
	13 to 16	32473, 32543, 32613, 32683	7ED9, 7F1F, 7F65, 7FAB		13 to 16	32475, 32545, 32615, 32685	7EDB, 7F21, 7F67, 7FAD



Screen example

LD77MS16 Servo parameter Gain/Filter-1					SET/	Data	MONIT	END
					RESET	Chg.	MENU	
Item	Axis1	Axis2	Axis3	Axis4	Setting range			
1) Filter tuning mode	1	1	1	1	0:Filter OFF 1:Filter tuning 2:Manual			
2) Vibration suppression control tuning mode	1	1	1	1	0:Vibration control OFF 1:Vibration ctrl tuning 2:Manual			
3) Feed forward gain	123	123	123	123	0 to 100[%]			
4) Load inertia moment	1234	1234	1234	1234	0 to 3000(*10 ⁻⁴) [times]			
5) Model loop gain	1234	1234	1234	1234	1 to 2000 [rad/s]			
6) Position loop gain	1234	1234	1234	1234	1 to 1000 [rad/s]			
7) Speed loop gain	12345	12345	12345	12345	20 to 50000 [rad/s]			
8) Speed integral comp	12345	12345	12345	12345	1 to 10000(*10 ⁻⁴) [ms]			
9) Speed differ. comp	1234	1234	1234	1234	0 to 1000(*10 ⁻⁴) [%]			
10) Resonance suppr. 1	1234	1234	1234	1234	100 to 4500 [Hz]			
11) Resonance suppr. 2	1234	1234	1234	1234	100 to 4500 [Hz]			
12) Low pass filter	12345	12345	12345	12345	100 to 18000 [rad/s]			
13) Low pass filter selection	1	1	1	1	0:Automatic setting 1:Manual setting			

No.	Axis	Buffer memory address		No.	Axis	Buffer memory address		No.	Axis	Buffer memory address	
		DEC	HEX			DEC	HEX			DEC	HEX
1)	1 to 4	28419, 28519, 28619, 28719	6F03, 6F67, 6FCB, 702F	6)	1 to 4	28426, 28526, 28626, 28726	6F0A, 6F6E, 6FD2, 7036	11)	1 to 4	28433, 28533, 28633, 28733	6F11, 6F75, 6FD9, 703D
	5 to 8	28819, 28919, 29019, 29119	7093, 70F7, 715B, 71BF		5 to 8	28826, 28926, 29026, 29126	709A, 70FE, 7162, 71C6		5 to 8	28833, 28933, 29033, 29133	70A1, 7105, 7169, 71CD
	9 to 12	29219, 29319, 29419, 29519	7223, 7287, 72EB, 734F		9 to 12	29226, 29326, 29426, 29526	722A, 728E, 72F2, 7356		9 to 12	29233, 29333, 29433, 29533	7231, 7295, 72F9, 735D
	13 to 16	29619, 29719, 29819, 29919	73B3, 7417, 747B, 74DF		13 to 16	29626, 29726, 29826, 29926	73BA, 741E, 7482, 74E6		13 to 16	29633, 29733, 29833, 29933	73C1, 7425, 7489, 74ED
2)	1 to 4	28420, 28520, 28620, 28720	6F04, 6F68, 6FCC, 7030	7)	1 to 4	28427, 28527, 28627, 28727	6F0B, 6F6F, 6FD3, 7037	12)	1 to 4	28436, 28536, 28636, 28736	6F14, 6F78, 6FDC, 7040
	5 to 8	28820, 28920, 29020, 29120	7094, 70F8, 715C, 71C0		5 to 8	28827, 28927, 29027, 29127	709B, 70FF, 7163, 71C7		5 to 8	28836, 28936, 29036, 29136	70A4, 7108, 716C, 71D0
	9 to 12	29220, 29320, 29420, 29520	7224, 7288, 72EC, 7350		9 to 12	29227, 29327, 29427, 29527	722B, 728F, 72F3, 7357		9 to 12	29236, 29336, 29436, 29536	7234, 7298, 72FC, 7360
	13 to 16	29620, 29720, 29820, 29920	73B4, 7418, 747C, 74E0		13 to 16	29627, 29727, 29827, 29927	73BB, 741F, 7483, 74E7		13 to 16	29636, 29736, 29836, 29936	73C4, 7428, 748C, 74F0
3)	1 to 4	28422, 28522, 28622, 28722	6F06, 6F6A, 6FCE, 7032	8)	1 to 4	28428, 28528, 28628, 28728	6F0C, 6F70, 6FD4, 7038	13)	1 to 4	28441, 28541, 28641, 28741	6F19, 6F7D, 6FE1, 7045
	5 to 8	28822, 28922, 29022, 29122	7096, 70FA, 715E, 71C2		5 to 8	28828, 28928, 29028, 29128	709C, 7100, 7164, 71C8		5 to 8	28841, 28941, 29041, 29141	70A9, 710D, 7171, 71D5
	9 to 12	29222, 29322, 29422, 29522	7226, 728A, 72EE, 7352		9 to 12	29228, 29328, 29428, 29528	722C, 7290, 72F4, 7358		9 to 12	29241, 29341, 29441, 29541	7239, 729D, 7301, 7365
	13 to 16	29622, 29722, 29822, 29922	73B6, 741A, 747E, 74E2		13 to 16	29628, 29728, 29828, 29928	73BC, 7420, 7484, 74E8		13 to 16	29641, 29741, 29841, 29941	73C9, 742D, 7491, 74F5
4)	1 to 4	28424, 28524, 28624, 28724	6F08, 6F6C, 6FD0, 7034	9)	1 to 4	28429, 28529, 28629, 28729	6F0D, 6F71, 6FD5, 7039				
	5 to 8	28824, 28924, 29024, 29124	7098, 70FC, 7160, 71C4		5 to 8	28829, 28929, 29029, 29129	709D, 7101, 7165, 71C9				
	9 to 12	29224, 29324, 29424, 29524	7228, 728C, 72F0, 7354		9 to 12	29229, 29329, 29429, 29529	722D, 7291, 72F5, 7359				
	13 to 16	29624, 29724, 29824, 29924	73B8, 741C, 7480, 74E4		13 to 16	29629, 29729, 29829, 29929	73BD, 7421, 7485, 74E9				
5)	1 to 4	28425, 28525, 28625, 28725	6F09, 6F6D, 6FD1, 7035	10)	1 to 4	28431, 28531, 28631, 28731	6F0F, 6F73, 6FD7, 703B				
	5 to 8	28825, 28925, 29025, 29125	7099, 70FD, 7161, 71C5		5 to 8	28831, 28931, 29031, 29131	709F, 7103, 7167, 71CB				
	9 to 12	29225, 29325, 29425, 29525	7229, 728D, 72F1, 7355		9 to 12	29231, 29331, 29431, 29531	722F, 7293, 72F7, 735B				
	13 to 16	29625, 29725, 29825, 29925	73B9, 741D, 7481, 74E5		13 to 16	29631, 29731, 29831, 29931	73BF, 7423, 7487, 74EB				

Screen example

LD77MS16 Servo parameter Gain/Filter-2						SET/RESET	Data Chg.	MONIT MENU	END
Item	Axis1	Axis2	Axis3	Axis4	Setting range				
1) Notch shape selection 1	1	1	1	1	0	1	2	3	
					Deep =40dB	←	→	Shallow =4dB	
2) Notch width selection	1	1	1	1	0	1	2	3	
					Standard α=2	←	→	Wide α=5	
3) Resonance suppression filter 2	1	1	1	1	0:Invalid 1:Valid				
4) Notch shape selection 1	1	1	1	1	0	1	2	3	
					Deep =40dB	←	→	Shallow =4dB	
5) Notch width selection	1	1	1	1	0	1	2	3	
					Standard α=2	←	→	Wide α=5	
6) Vibration freq.	1234	1234	1234	1234	1 to 1000(*10 ⁻³) [Hz]				
7) Resonance freq.	1234	1234	1234	1234	1 to 1000(*10 ⁻³) [Hz]				
8) High Vib Suppr	1	1	1	1	0:Invalid 1:Valid				
9) PI-PID switch over selection	1	1	1	1	0:PI control is valid. 3:PID control is always valid.				

No.	Axis	Buffer memory address		No.	Axis	Buffer memory address		No.	Axis	Buffer memory address	
		DEC	HEX			DEC	HEX			DEC	HEX
1)	1 to 4	28400, 28500, 28600, 28700	6EF0, 6F54, 6FB8, 701C	4)	1 to 4	28404, 28504, 28604, 28704	6EF4, 6F58, 6FBC, 7020	7)	1 to 4	28410, 28510, 28610, 28710	6EFA, 6F5E, 6FC2, 7026
	5 to 8	28800, 28900, 29000, 29100	7080, 70E4, 7148, 71AC		5 to 8	28804, 28904, 29004, 29104	7084, 70E8, 714C, 71B0		5 to 8	28810, 28910, 29010, 29110	708A, 70EE, 7152, 71B6
	9 to 12	29200, 29300, 29400, 29500	7210, 7274, 72DB, 733C		9 to 12	29204, 29304, 29404, 29504	7214, 7278, 72DC, 7340		9 to 12	29210, 29310, 29410, 29510	721A, 727E, 72E2, 7346
	13 to 16	29600, 29700, 29800, 29900	73A0, 7404, 7468, 74CC		13 to 16	29604, 29704, 29804, 29904	73A4, 7408, 746C, 74D0		13 to 16	29610, 29710, 29810, 29910	73AA, 740E, 7472, 74D6
2)	1 to 4	28402, 28502, 28602, 28702	6EF2, 6F56, 6FBA, 701E	5)	1 to 4	28408, 28508, 28608, 28708	6EF8, 6F5C, 6FC0, 7024	8)	1 to 4	28414, 28514, 28614, 28714	6EFE, 6F62, 6FC6, 702A
	5 to 8	28802, 28902, 29002, 29102	7082, 70E6, 714A, 71AE		5 to 8	28808, 28908, 29008, 29108	7088, 70EC, 7150, 71B4		5 to 8	28814, 28914, 29014, 29114	708E, 70F2, 7156, 71BA
	9 to 12	29202, 29302, 29402, 29502	7212, 7276, 72DA, 733E		9 to 12	29208, 29308, 29408, 29508	7218, 727C, 72E0, 7344		9 to 12	29214, 29314, 29414, 29514	721E, 7282, 72E6, 734A
	13 to 16	29602, 29702, 29802, 29902	73A2, 7406, 746A, 74CE		13 to 16	29608, 29708, 29808, 29908	73A8, 740C, 7470, 74D4		13 to 16	29614, 29714, 29814, 29914	73AE, 7412, 7476, 74DA
3)	1 to 4	28403, 28503, 28603, 28703	6EF3, 6F57, 6FB9, 701F	6)	1 to 4	28409, 28509, 28609, 28709	6EF9, 6F5D, 6FC1, 7025	9)	1 to 4	28415, 28515, 28615, 28715	6EFF, 6F63, 6FC7, 702B
	5 to 8	28803, 28903, 29003, 29103	7083, 70E7, 714B, 71AF		5 to 8	28809, 28909, 29009, 29109	7089, 70ED, 7151, 71B5		5 to 8	28815, 28915, 29015, 29115	708F, 70F3, 7157, 71BB
	9 to 12	29203, 29303, 29403, 29503	7213, 7277, 72DB, 733F		9 to 12	29209, 29309, 29409, 29509	7219, 727D, 72E1, 7345		9 to 12	29215, 29315, 29415, 29515	721F, 7283, 72E7, 734B
	13 to 16	29603, 29703, 29803, 29903	73A3, 7407, 746B, 74CF		13 to 16	29609, 29709, 29809, 29909	73A9, 740D, 7471, 74D5		13 to 16	29615, 29715, 29815, 29915	73AF, 7413, 7477, 74DB

- 1 OVERVIEW
- 2 SYSTEM MONITOR
- 3 LADDER MONITOR FUNCTION
- 4 MELSEC-A LIST EDITOR
- 5 MELSEC-FX LIST EDITOR
- 6 INTELLIGENT MODULE MONITOR
- 7 NETWORK MONITOR
- 8 Q MOTION MONITOR

Screen example

LD77MS16 Servo parameter Gain/Filter-3					SET/RESET	Data Chg.	MONI MENU	END
Item	Axis1	Axis2	Axis3	Axis4	Setting range			
1) Gain switch condition	1234	1234	1234	1234	0 to 9999			
2) Const. at gain switch	123	123	123	123	0 to 100[ms]			
3) Load inertia ratio to gain switch servo	1234	1234	1234	1234	0 to 3000(*10 ⁻¹)			
4) Position loop gain	1234	1234	1234	1234	1 to 2000[rad/s]			
5) Speed loop gain	12345	12345	12345	12345	20 to 50000[rd/s]			
6) Speed integral comp.	12345	12345	12345	12345	1 to 50000(*10 ⁻¹)[ms]			
7) Vibration freq setup	1234	1234	1234	1234	1 to 1000(*10 ⁻¹)[Hz]			
8) Resonance freq setup	1234	1234	1234	1234	1 to 1000(*10 ⁻¹)[Hz]			
Item	Axis1	Axis2	Axis3	Axis4				
Gain changing selection	12	12	12	12	9)			
00:Invalid 01:Control command by the controller is effective. 02:Command frequency is more than PB27. 03:(Motor encoder unit)Droop pulse is more than PB27. 04:Model speed is more than PB27. 12:Command frequency is less than PB27. 13:(Motor encoder unit)Droop pulse is less than PB27. 14:Model speed is less than PB27.								

No.	Axis	Buffer memory address		No.	Axis	Buffer memory address	
		DEC	HEX			DEC	HEX
1)	1 to 4	28445, 28545, 28645, 28745	6F1D, 6F81, 6FE5, 7049	6)	1 to 4	28450, 28550, 28650, 28750	6F22, 6F86, 6FEA, 704E
	5 to 8	28845, 28945, 29045, 29145	70AD, 7111, 7175, 71D9		5 to 8	28850, 28950, 29050, 29150	70B2, 7116, 717A, 71DE
	9 to 12	29245, 29345, 29445, 29545	723D, 72A1, 7305, 7369		9 to 12	29250, 29350, 29450, 29550	7242, 72A6, 730A, 736E
	13 to 16	29645, 29745, 29845, 29945	73CD, 7431, 7495, 74F9		13 to 16	29650, 29750, 29850, 29950	73D2, 7436, 749A, 74FE
2)	1 to 4	28446, 28546, 28646, 28746	6F1E, 6F82, 6FE6, 704A	7)	1 to 4	28451, 28551, 28651, 28751	6F23, 6F87, 6FEB, 704F
	5 to 8	28846, 28946, 29046, 29146	70AE, 7112, 7176, 71DA		5 to 8	28851, 28951, 29051, 29151	70B3, 7117, 717B, 71DF
	9 to 12	29246, 29346, 29446, 29546	723E, 72A2, 7306, 736A		9 to 12	29251, 29351, 29451, 29551	7243, 72A7, 730B, 736F
	13 to 16	29646, 29746, 29846, 29946	73CE, 7432, 7496, 74FA		13 to 16	29651, 29751, 29851, 29951	73D3, 7437, 749B, 74FF
3)	1 to 4	28447, 28547, 28647, 28747	6F1F, 6F83, 6FE7, 704B	8)	1 to 4	28452, 28552, 28652, 28752	6F24, 6F88, 6FEC, 7050
	5 to 8	28847, 28947, 29047, 29147	70AF, 7113, 7177, 71DB		5 to 8	28852, 28952, 29052, 29152	70B4, 7118, 717C, 71E0
	9 to 12	29247, 29347, 29447, 29547	723F, 72A3, 7307, 736B		9 to 12	29252, 29352, 29452, 29552	7244, 72A8, 730C, 7370
	13 to 16	29647, 29747, 29847, 29947	73CF, 7433, 7497, 74FB		13 to 16	29652, 29752, 29852, 29952	73D4, 7438, 749C, 7500
4)	1 to 4	28448, 28548, 28648, 28748	6F20, 6F84, 6FE8, 704C	9)	1 to 4	28444, 28544, 28644, 28744	6F1C, 6F80, 6FE4, 7048
	5 to 8	28848, 28948, 29048, 29148	70B0, 7114, 7178, 71DC		5 to 8	28844, 28944, 29044, 29144	70AC, 7110, 7174, 71D8
	9 to 12	29248, 29348, 29448, 29548	7240, 72A4, 7308, 736C		9 to 12	29244, 29344, 29444, 29544	723C, 72A0, 7304, 7368
	13 to 16	29648, 29748, 29848, 29948	73D0, 7434, 7498, 74FC		13 to 16	29644, 29744, 29844, 29944	73CC, 7430, 7494, 74F8
5)	1 to 4	28449, 28549, 28649, 28749	6F21, 6F85, 6FE9, 704D	-	-	-	-
	5 to 8	28849, 28949, 29049, 29149	70B1, 7115, 7179, 71DD		-	-	-
	9 to 12	29249, 29349, 29449, 29549	7241, 72A5, 7309, 736D		-	-	-
	13 to 16	29649, 29749, 29849, 29949	73D1, 7435, 7499, 74FD		-	-	-

Screen example

LD77MS16 Servo parameter Gain/Filter-4						SET/RESET	Data Chg.	MONIT MENU	END
Item	Axis1	Axis2	Axis3	Axis4	Setting range				
1) Vibration suppression control 2 tuning mode	1	1	1	1	0: Disabled 1: Automatic setting 2: Manual setting				
2) Torque fb loop gain	12345	12345	12345	12345	0 to 18000[rad/s]				
3) Overshoot amount comp	123	123	123	123	0 to 100[%]				
4) Shaft resonance suppression filter setting frequency	12	12	12	12	00:Disabled 01:Disabled 02:HF 0F:LF				
					High Middle Low 4500Hz 600Hz 200Hz				
5) Notch depth selection	1	1	1	1	0 1 2 3 Deep ← → Yellow				
					=40dB =14dB =8dB =4dB				
6) VRF1 Vibration freq. damping	12	12	12	12	0 to 30(*10 ⁻²)				
7) VRF1 Resonance freq. damping	12	12	12	12	0 to 30(*10 ⁻²)				

No.	Axis	Buffer memory address		No.	Axis	Buffer memory address	
		DEC	HEX			DEC	HEX
1)	1 to 4	28420, 28520, 28620, 28720	6F04, 6F68, 6FCC, 7030	4)	1 to 4	28435, 28535, 28635, 28735	6F13, 6F77, 6FDB, 703F
	5 to 8	28820, 28920, 29020, 29120	7094, 70F8, 715C, 71C0		5 to 8	28835, 28935, 29035, 29135	70A3, 7107, 716B, 71CF
	9 to 12	29220, 29320, 29420, 29520	7224, 7288, 72EC, 7350		9 to 12	29235, 29335, 29435, 29535	7233, 7297, 72FB, 735F
	13 to 16	29620, 29720, 29820, 29920	73B4, 7418, 747C, 74E0		13 to 16	29635, 29735, 29835, 29935	73C3, 7427, 748B, 74EF
2)	1 to 4	28421, 28521, 28621, 28721	6F05, 6F69, 6FCD, 7031	6)	1 to 4	28439, 28539, 28639, 28739	6F17, 6F7B, 6FDF, 7043
	5 to 8	28821, 28921, 29021, 29121	7095, 70F9, 715D, 71C1		5 to 8	28839, 28939, 29039, 29139	70A7, 710B, 716F, 71D3
	9 to 12	29221, 29321, 29421, 29521	7225, 7289, 72ED, 7351		9 to 12	29239, 29339, 29439, 29539	7237, 729B, 72FF, 7363
	13 to 16	29621, 29721, 29821, 29921	73B5, 7419, 747D, 74E1		13 to 16	29639, 29739, 29839, 29939	73C7, 742B, 748F, 74F3
3)	1 to 4	28430, 28530, 28630, 28730	6F0E, 6F72, 6FD6, 703A	7)	1 to 4	28440, 28540, 28640, 28740	6F18, 6F7C, 6FE0, 7044
	5 to 8	28830, 28930, 29030, 29130	709E, 7102, 7166, 71CA		5 to 8	28840, 28940, 29040, 29140	70A8, 710C, 7170, 71D4
	9 to 12	29230, 29330, 29430, 29530	722E, 7292, 72FE, 735A		9 to 12	29240, 29340, 29440, 29540	7238, 729C, 7300, 7364
	13 to 16	29630, 29730, 29830, 29930	73BE, 7422, 7486, 74EA		13 to 16	29640, 29740, 29840, 29940	73C8, 742C, 7490, 74F4

Screen example

LD77MS16 Servo parameter Gain/Filter-5						SET/RESET	Data Chg.	MONIT MENU	END
Item	Axis1	Axis2	Axis3	Axis4	Setting range				
1) VRF1 Vibration freq. after gain switching	12	12	12	12	0 to 30(*10 ⁻²)				
2) VRF1 Resonance freq. after gain switching	12	12	12	12	0 to 30(*10 ⁻²)				
3) Command notch filter frequency selection	12	12	12	12	00:Disabled 01:HF 2F:LF High Middle Low 2200Hz 30Hz 4.5Hz				
					Notch depth selection	1	1	1	1

No.	Axis	Buffer memory address		No.	Axis	Buffer memory address		
		DEC	HEX			DEC	HEX	
1)	1 to 4	28453, 28553, 28653, 28753	6F25, 6F89, 6FED, 7051	3)	1 to 4	28463, 28563, 28663, 28763	6F2F, 6F93, 6FF7, 705B	
	5 to 8	28853, 28953, 29053, 29153	70B5, 7119, 717D, 71E1		5 to 8	28863, 28963, 29063, 29163	70BF, 7123, 7187, 71EB	
	9 to 12	29253, 29353, 29453, 29553	7245, 72A9, 730D, 7371		4)	9 to 12	29263, 29363, 29463, 29563	724F, 72B3, 7317, 737B
	13 to 16	29653, 29753, 29853, 29953	73D5, 7439, 749D, 7501			13 to 16	29663, 29763, 29863, 29963	73DF, 7443, 74A7, 750B
2)	1 to 4	28454, 28554, 28654, 28754	6F26, 6F8A, 6FEE, 7052	-	-	-	-	
	5 to 8	28854, 28954, 29054, 29154	70B6, 711A, 717E, 71E2	-	-	-	-	
	9 to 12	29254, 29354, 29454, 29554	7246, 72AA, 730E, 7372	-	-	-	-	
	13 to 16	29654, 29754, 29854, 29954	73D6, 743A, 749E, 7502	-	-	-	-	

Screen example

LD77MS16 Servo parameter Gain/Filter-6						SET/RESET	Data Chg.	MONIT MENU	END
Item	Axis1	Axis2	Axis3	Axis4	Setting range				
1) Resonance suppr. 3	1234	1234	1234	1234	10 to 4500[Hz]				
2) Resonance suppr- ession filter 3	1	1	1	1	0:Disabled 1:Enabled				
3) Notch stirape selection	1	1	1	1	0 1 2 3	Deep	←	→	Shallow
					-40dB	-14dB	-8dB	-4dB	
4) Notch stirape selection	1	1	1	1	0 1 2 3	Standard	←	→	Wide
					$\alpha=2$	$\alpha=3$	$\alpha=4$	$\alpha=5$	
5) Resonance suppr. 4	1234	1234	1234	1234	10 to 4500[Hz]				
6) Resonance suppr- ession filter 4	1	1	1	1	0:Disabled 1:Enabled				
7) Notch stirape selection	1	1	1	1	0 1 2 3	Deep	←	→	Shallow
					-40dB	-14dB	-8dB	-4dB	
8) Notch stirape selection	1	1	1	1	0 1 2 3	Standard	←	→	Wide
					$\alpha=2$	$\alpha=3$	$\alpha=4$	$\alpha=5$	

No.	Axis	Buffer memory address		No.	Axis	Buffer memory address	
		DEC	HEX			DEC	HEX
1)	1 to 4	31645, 31715, 31785, 31855	7B9D, 7BE3, 7C29, 7C6F	5)	1 to 4	31647, 31717, 31787, 31857	7B9F, 7BE5, 7C2B, 7C71
	5 to 8	31925, 31995, 32065, 32135	7CB5, 7CFB, 7D41, 7D87		5 to 8	31927, 31997, 32067, 32137	7CB7, 7CFD, 7D43, 7D89
	9 to 12	32205, 32275, 32345, 32415	7DCD, 7E13, 7E59, 7E9F		9 to 12	32207, 32277, 32347, 32417	7DCF, 7E15, 7E5B, 7EA1
	13 to 16	32485, 32555, 32625, 32695	7EE5, 7F2B, 7F71, 7FB7		13 to 16	32487, 32557, 32627, 32697	7EE7, 7F2D, 7F73, 7FB9
2)	1 to 4	31646, 31716, 31786, 31856	7B9E, 7BE4, 7C2A, 7C70	6)	1 to 4	31648, 31718, 31788, 31858	7BA0, 7BE6, 7C2C, 7C72
	5 to 8	31926, 31996, 32066, 32136	7CB6, 7CFC, 7D42, 7D88		5 to 8	31928, 31998, 32068, 32138	7CB8, 7CFE, 7D44, 7D8A
3)	9 to 12	32206, 32276, 32346, 32416	7DCE, 7E14, 7E5A, 7EA0	7)	9 to 12	32208, 32278, 32348, 32418	7DD0, 7E16, 7E5C, 7EA2
	13 to 16	32486, 32556, 32626, 32696	7EE6, 7F2C, 7F72, 7FB8		8)	13 to 16	32488, 32558, 32628, 32698

Screen example

LD77MS16 Servo parameter Gain/Filter-7						SET/RESET	Data Chg.	MONIT MENU	END
Item	Axis1	Axis2	Axis3	Axis4	Setting range				
1) Resonance suppr. 5	1234	1234	1234	1234	10 to 4500[Hz]				
2) Resonance suppr- ession filter 5	1	1	1	1	0:Disabled 1:Enabled				
3) Notch stirape selection	1	1	1	1	0 1 2 3	Deep	←	→	Shallow
					-40dB	-14dB	-8dB	-4dB	
4) Notch stirape selection	1	1	1	1	0 1 2 3	Standard	←	→	Wide
					$\alpha=2$	$\alpha=3$	$\alpha=4$	$\alpha=5$	
5) VRF2 Vibration freq.	1234	1234	1234	1234	1 to 3000(*10 ⁻⁴)[Hz]				
6) VRF2 Resonance freq.	1234	1234	1234	1234	1 to 3000(*10 ⁻⁴)[Hz]				
7) VRF2 Vibration freq. damping	12	12	12	12	0 to 30(*10 ⁻²)				
8) VRF2 Resonance freq. damping	12	12	12	12	0 to 30(*10 ⁻²)				

No.	Axis	Buffer memory address		No.	Axis	Buffer memory address	
		DEC	HEX			DEC	HEX
1)	1 to 4	31649, 31719, 31789, 31859	7BA1, 7BE7, 7C2D, 7C73	6)	1 to 4	31652, 31722, 31792, 31862	7BA4, 7BEA, 7C30, 7C76
	5 to 8	31929, 31999, 32069, 32139	7CB9, 7CFF, 7D45, 7D8B		5 to 8	31932, 32002, 32072, 32142	7CBC, 7D02, 7D48, 7D8E
	9 to 12	32209, 32279, 32349, 32419	7DD1, 7E17, 7E5D, 7EA3		9 to 12	32212, 32282, 32352, 32422	7DD4, 7E1A, 7E60, 7EA6
	13 to 16	32489, 32559, 32629, 32699	7EE9, 7F2F, 7F75, 7FB3		13 to 16	32492, 32562, 32632, 32702	7EEC, 7F32, 7F78, 7FB4
2)	1 to 4	31650, 31720, 31790, 31860	7BA2, 7BE8, 7C2E, 7C74	7)	1 to 4	31653, 31723, 31793, 31863	7BA5, 7BEB, 7C31, 7C77
	5 to 8	31930, 32000, 32070, 32140	7CBA, 7D00, 7D46, 7D8C		5 to 8	31933, 32003, 32073, 32143	7CBD, 7D03, 7D49, 7D8F
3)	9 to 12	32210, 32280, 32350, 32420	7DD2, 7E18, 7E5E, 7EA4	7)	9 to 12	32213, 32283, 32353, 32423	7DD5, 7E1B, 7E61, 7EA7
	13 to 16	32490, 32560, 32630, 32700	7EEA, 7F30, 7F76, 7FBC		8)	13 to 16	32493, 32563, 32633, 32703
5)	1 to 4	31651, 31721, 31791, 31861	7BA3, 7BE9, 7C2F, 7C75	8)		1 to 4	31654, 31724, 31794, 31864
	5 to 8	31931, 32001, 32071, 32141	7CBB, 7D01, 7D47, 7D8D		5 to 8	31934, 32004, 32074, 32144	7CBE, 7D04, 7D4A, 7D90
	9 to 12	32211, 32281, 32351, 32421	7DD3, 7E19, 7E5F, 7EA5		9 to 12	32214, 32284, 32354, 32424	7DD6, 7E1C, 7E62, 7EA8
	13 to 16	32491, 32561, 32631, 32701	7EEB, 7F31, 7F77, 7FBD		13 to 16	32494, 32564, 32634, 32704	7EEE, 7F34, 7F7A, 7FC0

Screen example

LD77MS16 Servo parameter Gain/Filter-8					SET/ RESET	Data Chg.	MONIT MENU	END
Item	Axis1	Axis2	Axis3	Axis4	Setting range			
1) VRF2 Vibration freq. after gain switching	1234	1234	1234	1234	1 to 3000(*10 ⁻¹) [Hz]			
2) VRF2 Resonance freq. after gain switching	1234	1234	1234	1234	1 to 3000(*10 ⁻¹) [Hz]			
3) VRF2 V. freq. damping after gain switching	12	12	12	12	0 to 30(*10 ⁻²)			
4) VRF2 R. freq. damping after gain switching	12	12	12	12	0 to 30(*10 ⁻²)			
5) Model loop gain after gain switching	1234	1234	1234	1234	1 to 2000[rad/s]			

No.	Axis	Buffer memory address		No.	Axis	Buffer memory address	
		DEC	HEX			DEC	HEX
1)	1 to 4	31455, 31525, 31595, 31665	7ADF, 7B25, 7B6B, 7BB1	4)	1 to 4	31458, 31528, 31598, 31668	7AE2, 7B28, 7B6E, 7BB4
	5 to 8	31735, 31805, 31875, 31945	7BF7, 7C3D, 7C83, 7CC9		5 to 8	31738, 31808, 31878, 31948	7BFA, 7C40, 7C86, 7CCC
	9 to 12	32015, 32085, 32155, 32225	7D0F, 7D55, 7D9B, 7DE1		9 to 12	32018, 32088, 32158, 32228	7D12, 7D58, 7D9E, 7DE4
	13 to 16	32295, 32365, 32435, 32505	7E27, 7E6D, 7EB3, 7EF9		13 to 16	32298, 32368, 32438, 32508	7E2A, 7E70, 7EB6, 7EFC
2)	1 to 4	31456, 31526, 31596, 31666	7AE0, 7B26, 7B6C, 7BB2	5)	1 to 4	31459, 31529, 31599, 31669	7AE3, 7B29, 7B6F, 7BB5
	5 to 8	31736, 31806, 31876, 31946	7BF8, 7C3E, 7C84, 7CCA		5 to 8	31739, 31809, 31879, 31949	7BFB, 7C41, 7C87, 7CCD
	9 to 12	32016, 32086, 32156, 32226	7D10, 7D56, 7D9C, 7DE2		9 to 12	32019, 32089, 32159, 32229	7D13, 7D59, 7D9F, 7DE5
	13 to 16	32296, 32366, 32436, 32506	7E28, 7E6E, 7EB4, 7EFA		13 to 16	32299, 32369, 32439, 32509	7E2B, 7E71, 7EB7, 7EFD
3)	1 to 4	31457, 31527, 31597, 31667	7AE1, 7B27, 7B6D, 7BB3	-	-	-	-
	5 to 8	31737, 31807, 31877, 31947	7BF9, 7C3F, 7C85, 7CCB				
	9 to 12	32017, 32087, 32157, 32227	7D11, 7D57, 7D9D, 7DE3				
	13 to 16	32297, 32367, 32437, 32507	7E29, 7E6F, 7EB5, 7EFB				

- 1
OVERVIEW
- 2
SYSTEM MONITOR
- 3
LADDER MONITOR
FUNCTION
- 4
MELSEC-A LIST
EDITOR
- 5
MELSEC-FX LIST
EDITOR
- 6
INTELLIGENT
MODULE MONITOR
- 7
NETWORK
MONITOR
- 8
Q MOTION
MONITOR

Screen example

LD77MS16 Sv. parameter Ex. setting1-1					SET/ Data MONIT	RESET Chg. MENU	END
Item	Axis1	Axis2	Axis3	Axis4	Setting range		
1) Error excessive level	123	123	123	123	1 to 200[rev]		
2) EM brake sequence	1234	1234	1234	1234	0 to 1000[ms]		
3) Encoder pulse output direction selection	1	1	1	1	0:0CW 1:0CW (progress to A phases 90°)		
4) Encoder pulse output setting selection	1	1	1	1	0:Output pulse dsgr. 1:Division ratio setting		
5) Function selection C1 Serial encoder cable	1	1	1	1	0:2-wire 1:4-wire		
6) Function selection C2 Motor-less operation	1	1	1	1	0:Invalid 1:Valid		
7) Zero speed	12345	12345	12345	12345	0 to 10000[r/min]		

No.	Axis	Buffer memory address		No.	Axis	Buffer memory address	
		DEC	HEX			DEC	HEX
1)	1 to 4	28464, 28564, 28664, 28764	6F30, 6F94, 6FF8, 705C	5)	1 to 4	28467, 28567, 28667, 28767	6F33, 6F97, 6FFB, 705F
	5 to 8	28864, 28964, 29064, 29164	70C0, 7124, 7188, 71EC		5 to 8	28867, 28967, 29067, 29167	70C3, 7127, 718B, 71EF
	9 to 12	29264, 29364, 29464, 29564	7250, 72B4, 7318, 737C		9 to 12	29267, 29367, 29467, 29567	7253, 72B7, 731B, 737F
	13 to 16	29664, 29764, 29864, 29964	73E0, 7444, 74A8, 750C		13 to 16	29667, 29767, 29867, 29967	73E3, 7447, 74AB, 750F
2)	1 to 4	28465, 28565, 28665, 28765	6F31, 6F95, 6FF9, 705D	6)	1 to 4	28468, 28568, 28668, 28768	6F34, 6F98, 6FFC, 7060
	5 to 8	28865, 28965, 29065, 29165	70C1, 7125, 7189, 71ED		5 to 8	28868, 28968, 29068, 29168	70C4, 7128, 718C, 71F0
	9 to 12	29265, 29365, 29465, 29565	7251, 72B5, 7319, 737D		9 to 12	29268, 29368, 29468, 29568	7254, 72B8, 731C, 7380
	13 to 16	29665, 29765, 29865, 29965	73E1, 7445, 74A9, 750D		13 to 16	29668, 29768, 29868, 29968	73E4, 7448, 74AC, 7510
3)	1 to 4	28466, 28566, 28666, 28766	6F32, 6F96, 6FFA, 705E	7)	1 to 4	28470, 28570, 28670, 28770	6F36, 6F9A, 6FFE, 7062
	5 to 8	28866, 28966, 29066, 29166	70C2, 7126, 718A, 71EE		5 to 8	28870, 28970, 29070, 29170	70C6, 712A, 718E, 71F2
4)	9 to 12	29266, 29366, 29466, 29566	7252, 72B6, 731A, 737E		9 to 12	29270, 29370, 29470, 29570	7256, 72BA, 731E, 7382
	13 to 16	29666, 29766, 29866, 29966	73E2, 7446, 74AA, 750E		13 to 16	29670, 29770, 29870, 29970	73E6, 744A, 74AE, 7512

Screen example

LD77MS16 Sv. parameter Ex. setting1-2					SET/ Data MONIT	RESET Chg. MENU	END
Item	Axis1	Axis2	Axis3	Axis4	Setting range		
Analog monitor 1 offset	1234	1234	1234	1234	000 to 999[μV]		
Analog monitor 2 offset	1234	1234	1234	1234	000 to 999[μV]		
Analog monitor output selection(ch1)	12	12	12	12	0:Servo motor speed(±8V/max. speed) 1:Torque(±8V/max. torque) 2:Servo motor speed(+8V/max. speed) 3:Torque(+8V/max. torque) 4:Current command(±8V/max. curre) 5:Command speed(±8V/max. command speed) 6:Drrop puls(±10V/100puls[Encoder unit]) 7:Drrop puls(±10V/1000puls[Encoder unit]) 8:Drrop puls(±10V/10000puls[Encoder unit]) 9:Drrop puls(±10V/100000puls[Encoder unit]) A:Feedback position(±10V/1,000,000puls[Encoder unit]) B:Feedback position(±10V/10,000,000puls[Encoder unit]) C:Feedback position(±10V/100,000,000puls[Encoder unit]) D:Bus voltage(+8V/400V, Amplifier of 200V) E:Bus voltage(+8V/800V, Amplifier of 400V) F:IF~IF:Un-output(Zero output)		
Analog monitor output selection(ch2)	12	12	12	12			

No.	Axis	Buffer memory address		No.	Axis	Buffer memory address	
		DEC	HEX			DEC	HEX
1)	1 to 4	28474, 28574, 28674, 28774	6F3A, 6F9E, 7002, 7066	3)	1 to 4	28472, 28572, 28672, 28772	6F38, 6F9C, 7000, 7064
	5 to 8	28874, 28974, 29074, 29174	70CA, 712E, 7192, 71F6		5 to 8	28872, 28972, 29072, 29172	70C8, 712C, 7190, 71F4
	9 to 12	29274, 29374, 29474, 29574	725A, 72BE, 7322, 7386		9 to 12	29272, 29372, 29472, 29572	7258, 72BC, 7320, 7384
	13 to 16	29674, 29774, 29874, 29974	73EA, 744E, 74B2, 7516		13 to 16	29672, 29772, 29872, 29972	73E8, 744C, 74B0, 7514
2)	1 to 4	28475, 28575, 28675, 28775	6F3B, 6F9F, 7003, 7067	4)	1 to 4	28473, 28573, 28673, 28773	6F39, 6F9D, 7001, 7065
	5 to 8	28875, 28975, 29075, 29175	70CB, 712F, 7193, 71F7		5 to 8	28873, 28973, 29073, 29173	70C9, 712D, 7191, 71F5
	9 to 12	29275, 29375, 29475, 29575	725B, 72BF, 7323, 7387		9 to 12	29273, 29373, 29473, 29573	7259, 72BD, 7321, 7385
	13 to 16	29675, 29775, 29875, 29975	73EB, 744F, 74B3, 7517		13 to 16	29673, 29773, 29873, 29973	73E9, 744D, 74B1, 7515

Screen example

LD77MS16 Sv. parameter Ex. setting1-3					SET/RESET	Data Chg.	MONIT MENU	END
Item	Axis1	Axis2	Axis3	Axis4	Setting range			
Selection of the encoders for encoder output pulse	1	1	1	1	0:Servo motor encoder 1:Load-side encoder			
Func. selection C-3 EE alarm level unit	1	1	1	1	0 to 3			
OS alarm detect. level	12345	12345	12345	12345	0 to 20000(r/min)			
Func. selection C-4 home position setting condition	1	1	1	1	Z-phase after power on 0:Need to pass 1:Not need to pass			
Func. selection C-5 [AL, E9 Main circuit off warning]	1	1	1	1	Detection with 0:ready-on and servo-on 1:servo-on			
Func. selection C-7 Undervoltage alarm	1	1	1	1	0:Method 1 1:Method 2			
Alarm history clear	1	1	1	1	0:Disabled 1:Enabled			
FS dec. time constant	12345	12345	12345	12345	0 to 20000(ms)			

No.	Axis	Buffer memory address		No.	Axis	Buffer memory address	
		DEC	HEX			DEC	HEX
1)	1 to 4	28466, 28566, 28666, 28766	6F32, 6F96, 6FFA, 705E	5)	1 to 4	28481, 28581, 28681, 28781	6F41, 6FA5, 7009, 706D
	5 to 8	28866, 28966, 29066, 29166	70C2, 7126, 718A, 71EE		5 to 8	28881, 28981, 29081, 29181	70D1, 7135, 7199, 71FD
	9 to 12	29266, 29366, 29466, 29566	7252, 72B6, 731A, 737E		9 to 12	29281, 29381, 29481, 29581	7261, 72C5, 7329, 738D
	13 to 16	29666, 29766, 29866, 29966	73E2, 7446, 74AA, 750E		13 to 16	29681, 29781, 29881, 29981	73F1, 7455, 74B9, 751D
2)	1 to 4	28469, 28569, 28669, 28769	6F35, 6F99, 6FFD, 7061	6)	1 to 4	28483, 28583, 28683, 28783	6F43, 6FA7, 700B, 706F
	5 to 8	28869, 28969, 29069, 29169	70C5, 7129, 718D, 71F1		5 to 8	28883, 28983, 29083, 29183	70D3, 7137, 719B, 71FF
	9 to 12	29269, 29369, 29469, 29569	7255, 72B9, 731D, 7381		9 to 12	29283, 29383, 29483, 29583	7263, 72C7, 732B, 738F
	13 to 16	29669, 29769, 29869, 29969	73E5, 7449, 74AD, 7511		13 to 16	29683, 29783, 29883, 29983	73F3, 7457, 74BB, 751F
3)	1 to 4	28471, 28571, 28671, 28771	6F37, 6F9B, 6FFF, 7063	7)	1 to 4	28484, 28584, 28684, 28784	6F44, 6FA8, 700C, 7070
	5 to 8	28871, 28971, 29071, 29171	70C7, 712B, 718F, 71F3		5 to 8	28884, 28984, 29084, 29184	70D4, 7138, 719C, 7200
	9 to 12	29271, 29371, 29471, 29571	7257, 72BB, 731F, 7383		9 to 12	29284, 29384, 29484, 29584	7264, 72C8, 732C, 7390
	13 to 16	29671, 29771, 29871, 29971	73E7, 744B, 74AF, 7513		13 to 16	29684, 29784, 29884, 29984	73F4, 7458, 74BC, 7520
4)	1 to 4	28480, 28580, 28680, 28780	6F40, 6FA4, 7008, 706C	8)	1 to 4	28487, 28587, 28687, 28787	6F47, 6FAB, 700F, 7073
	5 to 8	28880, 28980, 29080, 29180	70D0, 7134, 7198, 71FC		5 to 8	28887, 28987, 29087, 29187	70D7, 713B, 719F, 7203
	9 to 12	29280, 29380, 29480, 29580	7260, 72C4, 7328, 738C		9 to 12	29287, 29387, 29487, 29587	7267, 72CB, 732F, 7393
	13 to 16	29680, 29780, 29880, 29980	73F0, 7454, 74B8, 751C		13 to 16	29687, 29787, 29887, 29987	73F7, 745B, 74BF, 7523

Screen example

LD77MS16 Sv. parameter Ex. setting1-4					SET/RESET	Data Chg.	MONIT MENU	END
Item	Axis1	Axis2	Axis3	Axis4	Setting range			
Func. selection C-9 encoder pulse count polarity	1	1	1	1	0CW/positive direction 1:Encoder pulse inc. 1:Encoder pulse dec.			
Func. selection C-B POL reflection	1	1	1	1	0:Disabled 1:Enabled			
V-Ax freefall prevention compensation	123456	123456	123456	123456	-25000 to 25000 (*10 ⁻⁴) [rev]			

No.	Axis	Buffer memory address		No.	Axis	Buffer memory address		No.	Axis	Buffer memory address	
		DEC	HEX			DEC	HEX			DEC	HEX
1)	1 to 4	28490, 28590, 28690, 28790	6F4A, 6FAE, 7012, 7076	2)	1 to 4	28492, 28592, 28692, 28792	6F4C, 6FB0, 7014, 7078	3)	1 to 4	28494, 28594, 28694, 28794	6F4E, 6FB2, 7016, 707A
	5 to 8	28890, 28990, 29090, 29190	70DA, 713E, 71A2, 7206		5 to 8	28892, 28992, 29092, 29192	70DC, 7140, 71A4, 7208		5 to 8	28894, 28994, 29094, 29194	70DE, 7142, 71A6, 720A
	9 to 12	29290, 29390, 29490, 29590	726A, 72CE, 7332, 7396		9 to 12	29292, 29392, 29492, 29592	726C, 72D0, 7334, 7398		9 to 12	29294, 29394, 29494, 29594	726E, 72D2, 7336, 739A
	13 to 16	29690, 29790, 29890, 29990	73FA, 745E, 74C2, 7526		13 to 16	29692, 29792, 29892, 29992	73FC, 7460, 74C4, 7528		13 to 16	29694, 29794, 29894, 29994	73FE, 7462, 74C6, 752A

6.6 Operating I/O Module Monitor Screen

This section describes the operation of the various screens in the intelligent module monitor function, when monitoring input or output modules.

6.6.1 Specifying the module to be monitored

This section describes how to start monitoring for an input or output module with the intelligent module monitor function.

Operation procedure

Display the System Configuration screen.

..... See Sec. 6.4.1

Specify the module to be monitored

(Touch the position at which the module is displayed.)

- (1) From among the modules installed in the corresponding base unit, specify the module whose "Input" or "Output" is displayed.
Refer to Section 6.4.1 for the way to specify the intelligent function module.
- (2) For information on confirming the displayed contents and subsequent operation, please see Sec. 6.6.2.
* Tests cannot be conducted on input or output modules.

Display the monitor screen for the specified module.

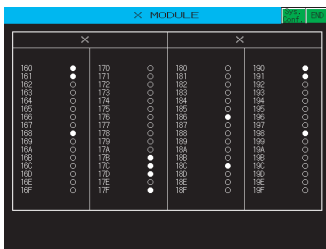

To Sec. 13.2

6.6.2 Monitor screen configuration and key functions

This section describes the configuration of monitor screens displayed by specifying the input module on the system configuration screen, and explains the functions of keys displayed on the screen.

■ Displayed contents (for an input module)



Item	Description
1)	Displays the type of object module (input or output module).
2)	Displays keys used for the operations on the monitor screen.
3)	Displays the name of the signal being monitored (X or Y).
4)	Displays the number and status of the I/O signal. The statuses of input and output signals are displayed after they are read out from the corresponding module. Displays up to 64 points.(●: ON, ○: OFF)

■ Key functions

The table below shows the functions of keys that are used for the operations on the monitor screen.

Key	Function
	Closes the current monitor and returns to the System Configuration screen.
	Closes the monitoring and returns the screen to the one for starting the intelligent module monitor.

6.7 Error Messages and Corrective Action

This section describes the error messages displayed when the intelligent module monitor is executed, and corrective action.

Error message	Description	Corrective action
Communication channel setup error	There is no channel for communication.	Check that the channel number is correctly set in the Communication Settings.
Communications error	Communication could not be established with the PLC CPU.	Check the connection status between the PLC CPU and the GOT (disconnected or cut cables). Has an error occurred in the PLC CPU?
Monitor Data Can Not Find	The special data (intelligent module monitor data) has not been downloaded to the GOT.	Download the special data (intelligent module monitor data) to the GOT.
This PLC type is not supported	The intelligent module monitor selected an unsupported PLC CPU.	Use the PLC CPU supported by the intelligent module monitor.  6.2.1 System configuration

7. NETWORK MONITOR



7.1 Features

The network monitor function enables the GOT to monitor and display the statuses of the MELSECNET/H, MELSECNET/10, MELSECNET(II), CC-Link IE controller networks, and CC-Link IE field networks. The features of the network monitor are described below.

■ **Selectable from detailed monitoring or other station monitoring for a desired network by the line monitor**

The line monitor enables you to monitor the statuses of all network lines connected to the host. In addition, you can also perform detailed monitoring of a desired network and monitoring of other stations by touch input on the line monitor.

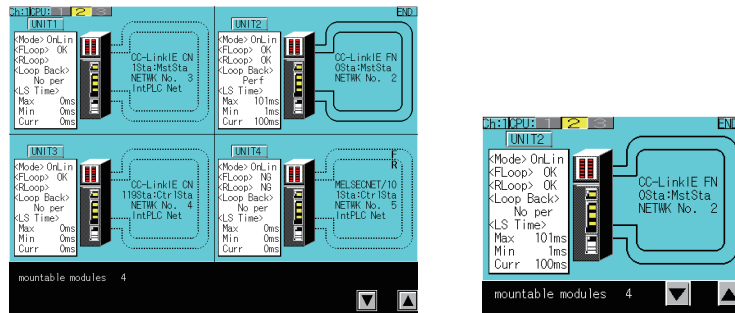

(GOT with VGA or higher resolution)

(GOT with QVGA resolution)

■ **Monitoring available for the detailed network information with the detailed monitor**

Dedicated monitor screens are displayed according to the network type of the connected host.

Network type: MELSECNET(II), master station

MELSECNET(II), local station

MELSECNET/10 and MELSECNET/H, control station and normal station

MELSECNET/10 and MELSECNET/H, remote master station

CC-Link IE controller network, control station and normal station

CC-Link IE field network, master station and local station

■ Monitoring available for other stations statuses with the other station monitor

You can monitor the following statuses of other stations connected to the network.

- Communication status of each station
- Data link status of each station
- Parameter status of each station
- CPU action status of each station
- CPU RUN status of each station
- Loop status of each station

Other station monitor menu



Other station communication status monitor

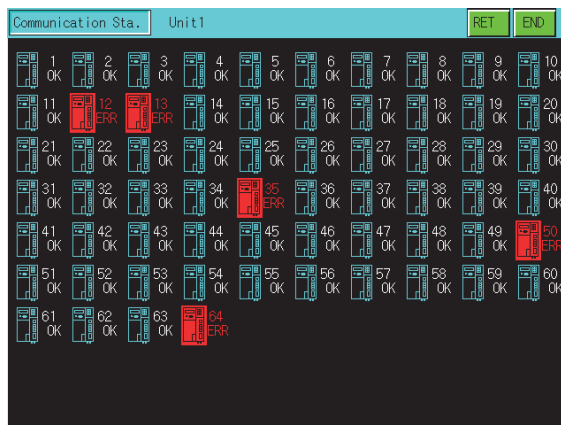

7.2 Specifications

7.2.1 System configuration

This section describes the system configuration of the network monitor.
For connection type settings and precautions regarding the communication unit/cable and connection type, refer to the following.

 GOT1000 Series Connection Manual (Mitsubishi Products) for GT Works3

Target controller

Controller
QCPU (Q mode), motion controller (Q series) ^{*1}
LCPU
QnACPU
ACPU/QCPU (A mode)
Motion controller (A series)

*1 For the motion controller CPU (Q series), only the PLC CPU area (CPU No.1) in the Q170MCPUCPU and Q170MSCPU can be monitored.

Connection type

This function can be used in the following connection types.

- (1) **When the GOT is connected to a QCPU (Q mode), motion controller (Q series), QnACPU, or motion controller (A series)**

(○: Available, △: Partly restricted, X: Unavailable)

Function		Connection type between GOT and controller							
Name	Description	Bus connection	Direct CPU connection	Computer link connection	Ethernet connection ^{*6}	MELSEC NET/H connection, MELSEC NET/10 connection ^{*5}	CC-Link IE controller connection ^{*1} , CC-Link IE field connection ^{*2}	CC-Link connection	
								ID ^{*3}	G4 ^{*4}
Network monitor	Monitors the statuses of the following networks. • MELSECNET/H network • MELSECNET/10 network • MELSECNET(II) network • CC-Link IE controller network • CC-Link IE field network	○	○	○	○	△ ^{*5}	○	○	○

*1 Indicates the CC-Link IE controller network connection.

*2 Indicates CC-Link IE field network connection.

*3 Indicates CC-Link connection (Intelligent device station).

*4 Indicates CC-Link connection (via G4).

*5 When the GOT is connected to the MELSECNET/H or MELSECNET/10, use a QCPU and a network module (QJ71LP21, QJ71LP21-25, QJ71LP21S-25, QJ71LP21G, or QJ71BR11) of function version B or a later version.

*6 Network monitor cannot be used when using CC-Link IE field network Ethernet adapter.

(2) When the GOT is connected to an ACPU/QCPU (A mode)

(○: Available, △: Partly restricted, ✕: Unavailable)

Function		Connection type between GOT and controller						
Name	Description	Bus connection	Direct CPU connection	Computer link connection	Ethernet connection	MELSECNET/10 connection	CC-Link connection	
							ID ^{*1}	G4 ^{*2}
Network monitor	Monitoring the network status of MELSECNET/H, MELSECNET/10 and MELSECNET(II)	○	○	△ ^{*3}	○	○	○	○

*1 Indicates CC-Link connection (Intelligent device station).

*2 Indicates CC-Link connection (via G4).

*3 Monitoring is not possible when the target CPU is AnUCPU and a MELSECNET/10 network module is used.

■ Required option OS and option function board

The option OS and option function board shown below are required.

 1.1.2 Hardware and OS' required for each function

(1) Option OS

Install the option OS in the above table to the GOT.

For the installation procedure, refer to the following.

 GT Designer3 Version1 Screen Design Manual (Fundamentals) 8. COMMUNICATION WITH GOT

(2) OS memory space

The available memory space shown in the table above is required in the user area to install the option OS to the GOT.

For the procedure for checking the available memory space of the user area and information about the data using other user areas, refer to the following.

 GT Designer3 Version1 Screen Design Manual (Fundamentals) 8. COMMUNICATION WITH GOT

(3) Option function board

(a) For GT16

No option function board is required.

(b) For GT15

Mount one of the option function boards in the above table on the GOT.

For the GOTs with a built-in option function board, refer to the following.

 1.1.2 Hardware and OS' required for each function

For how to mount an option function board on the GOT, refer to the following.

 User's Manual for the GOT used

7.2.2 Network information that can be monitored

The network information that can be monitored with the network monitor and the link types are as follows.

(○ : Can be monitored, × : Cannot be monitored)

Function	Network Information	MELSEC NET(II) master station	MELSEC NET(II) local station	MELSEC NET/10, MELSEC NET/H control station	MELSEC NET/10, MELSEC NET/H normal station	MELSEC NET/10, MELSEC NET/H remote master station	CC-Link IE controller network control station	CC-Link IE controller network normal station	CC-Link IE field network master station	CC-Link IE field network local station
Line monitor	Network category display	○	○	○	○	○	○	○	○	○
	Network number display	×	×	○	○	○	○	○	○	○
	Station number display	○	○	○	○	○	○	○	○	○
	Host operation mode	○	○	○	○	○	○	○	○	○
	Host loop line status	○	○	○	○	○	○	○	○	×
	Loopback execution status	○	○	○	○	○	○	○	○	×
	Link scan time display	○	×	○	○	○	○	○	○	○
	Data link system loop status	○	×	○	○	○	○	○	○	×
	Host communication status	×	○ ^{*1}	×	×	×	×	×	×	×
Detailed monitor	Host information	Host number	○	○	○	○	○	○	○	○
		Host	○	○	×	×	×	×	×	×
		Network number	×	×	○	○	○	○	○	○
		Group number	×	×	○	○	×	○	○	×
	Control station information	Specified control station	×	×	○	○	×	○	○	×
		Current control station	×	×	○	○	×	○	○	×
		Communication information	×	×	○	○	×	○	○	×
		Sub-control-station link	×	×	○	○	×	○	○	×
		Remote-I/O-master-station station number	×	×	○	○	×	○	○	×
	Data link information	Total of linked stations	○	○	○	○	○	○	○	○
		Largest connected stations	×	×	○	○	○	○	○	○
		Largest data-linked station	×	×	○	○	○	○	○	○
		Communication status	×	○	○	○	○	○	○	○
		Causes of interrupted communication	×	×	○	○	○	○	○	○
		Causes of data link stoppage	×	×	○	○	○	○	○	○
	Constant link scan	Constant link scan	×	×	○	○	○	○	○	○
	BWY receive	BWY from the master station	×	○	×	×	×	×	×	×
	BW receive	BW from the master station in the higher loop	×	○	×	×	×	×	×	×

(Continued to next page)

Function	Network Information	MELSEC NET (II) master station	MELSEC NET (II) local station	MELSEC NET/10, MELSEC NET/H control station	MELSEC NET/10, MELSEC NET/H normal Station	MELSEC NET/10, MELSEC NET/H remote master station	CC-Link IE controller network control station	CC-Link IE controller network normal station	CC-Link IE field network master station	CC-Link IE field network local station	
Detailed monitor	Loopback	Forward loop status	○	○	○ ^{*2}	○ ^{*2}	○ ^{*2}	○ ^{*3}	○ ^{*3}	×	×
		Reverse loop status	○	○	○ ^{*2}	○ ^{*2}	○ ^{*2}	○ ^{*3}	○ ^{*3}	×	×
		Loopback station (forward loop)	○	×	○ ^{*2}	○ ^{*2}	○ ^{*2}	○ ^{*3}	○ ^{*3}	×	×
		Loopback station (reverse loop)	○	×	○ ^{*2}	○ ^{*2}	○ ^{*2}	○ ^{*3}	○ ^{*3}	×	×
		Loop switching frequency	○	×	○ ^{*2}	○ ^{*2}	○ ^{*2}	○	○	×	×
		PORT1 Loop	×	×	×	×	×	×	×	○ ^{*4}	×
		PORT2 Loop	×	×	×	×	×	×	×	○ ^{*4}	×
		Loop Back Sta.1	×	×	×	×	×	×	×	○ ^{*4}	×
		Loop Back Sta.2	×	×	×	×	×	×	×	○ ^{*4}	×
		#of Loop Switching	×	×	×	×	×	×	×	×	×
Host status	Parameter settings	×	×	○	○	×	○	○	×	×	
	Designation of reserved station	×	×	○	○	○	○	○	○	○	
	Communications mode	×	×	○	○	○	○	○	○	○	
	Designation of transmission	×	×	○ ^{*2}	○ ^{*2}	○ ^{*2}	○	○	×	×	
	Transmission status	×	×	○ ^{*2}	○ ^{*2}	○ ^{*2}	○	○	×	×	
Other station monitor	Communication status of each station	○	×	○	○	○	○	○	○	○	
	Communications status of each station	×	×	○	○	○	○	○	○	○	
	Parameter status of each station	○	×	○	○	○	○	○	○	○	
	CPU action status of each station	○	○	○	○	×	○	○	○	○	
	CPU RUN status of each station	○	○	○	○	×	○	○	○	○	
	Loop status of each station	○	×	○ ^{*2}	○ ^{*2}	○ ^{*2}	×	×	×	×	

- *1 Monitoring is only possible when connected to a MELSECNET(II) local station.
- *2 Monitoring is possible only when using a MELSECNET/H or MELSECNET/10 loop system.
- *3 The loop names vary depending on the network system to be monitored as shown below.

MELSECNET/H, MELSECNET/10, MELSECNET(II) network systems	CC-Link IE controller network
Forward loop	OUT-side loop
Reverse loop	IN-side loop

- *4 Monitoring is possible only when using a loopback function.

7.2.3 Access range

In bus connection, direct CPU connection, computer link connection, or Ethernet connection, only the host station can be monitored.

In MELSECNET/H connection or MELSECNET/10 connection, only the control station can be monitored.

In CC-Link connection (Intelligent device station), only the master station can be monitored.

In CC-Link connection (via G4), only the host and master stations can be monitored.

When the GOT is connected to the remote I/O station in MELSECNET/H network system, no stations can be monitored. The GOT cannot monitor stations on the MELSECNET/G network system.

The access range other than above is the same as the access range when the GOT is connected to a controller.

For details of the access range, refer to the following.

 GOT1000 Series Connection Manual (Mitsubishi Products) for GT Works3

7.2.4 Precautions

(1) Station monitored as the host

The station monitored as the host differs depending on the connection type.

Connection type	Station monitored as the host
Bus connection, direct CPU connection, computer link connection	Connected station (target)
Ethernet connection	Station set as the host with the Ethernet setting of GT Designer3
MELSECNET/H connection, MELSECNET/10 connection CC-Link IE controller network connection	Control station
CC-Link connection (Intelligent device station), CC-Link connection (Via G4), CC-Link IE field network connection	Master station

(2) When the network monitor cannot be displayed correctly

The network monitor cannot be displayed correctly in the following cases.

- (a) When the network module is performing offline testing
The network monitor cannot be displayed correctly during offline testing.
Set the network module mode to online.
- (b) When the network parameter has been changed
The network monitor cannot be displayed correctly when the network parameter is changed.
Restart the network monitor.
- (c) When there is a network parameter error
The network monitor cannot be displayed correctly when there is a network parameter error.
Review the network parameter.
- (d) When the network parameter has not been set to the QCPU
The network monitor cannot be displayed correctly when the network parameter is not set to the QCPU.
Be sure to set the network parameter when monitoring the network with the GOT.
- (e) When changing the head addresses on CPU side to which refresh parameter is set
The network monitor cannot be displayed correctly if the SB and SW head addresses on CPU side are changed while refresh parameter is set in the network parameter for the QCPU.
To monitor the network with the GOT, set the SB and SW head addresses on CPU side to default.
However, for CC-Link IE field network connection, set the SB and SW head addresses on CPU side according to the position where the network module is installed.

Installation position of the network module			
1st	2nd	3rd	4th
0000	0200	0400	0600

(3) When monitoring MELSECNET/H, CC-Link IE controller network, or CC-Link IE field network

Even if a network module on the MELSECNET/H, CC-Link IE controller network, or CC-Link IE field network is being monitored, a MELSECNET/10 display is provided in either of the following cases:

- The normal station has been started due to a communication error (cable disconnection, etc.)
- The monitor target is the remote master station.

(4) When monitoring MELSECNET(II)

When connected to a QnACPU and the master station of the MELSECNET(II), monitoring cannot be done with the keyword being defined.

(5) When the CPU type of the connection target of the GOT is AnNCPU or AnACPU

Even when using the network module of the MELSECNET/10, the network information that can be monitored is the content of the MELSECNET(II).

(6) Display of loop status for CC-Link IE field network

In ring topology with CC-Link IE field network, if an error occurs in a local module which is not directly connected to a master module and the network comes into loopback status, information cannot be acquired from the master station.

Therefore, in the above case, the loop status cannot be displayed on the line monitor normally.

- When an error occurs in a local station which is directly connected to a master station

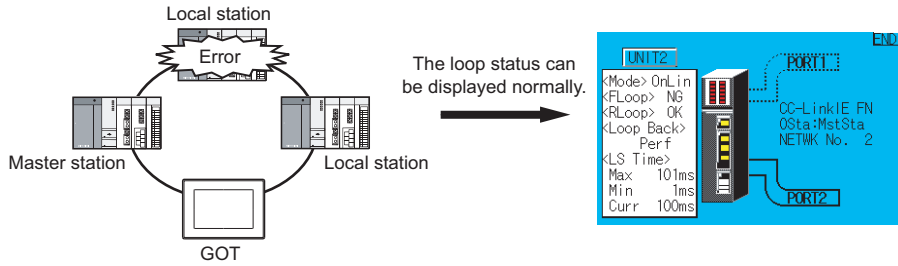

- When an error occurs in a local station which is not directly connected to a master station

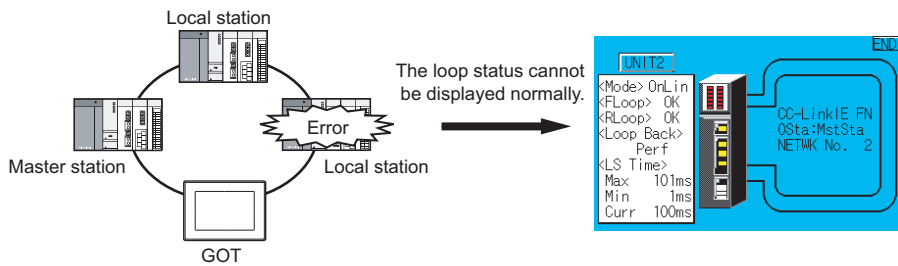

7.3 Operations for display

This section describes the flow until the operation screen for the network monitor is displayed after the network monitor (Option OS) is installed in the GOT.

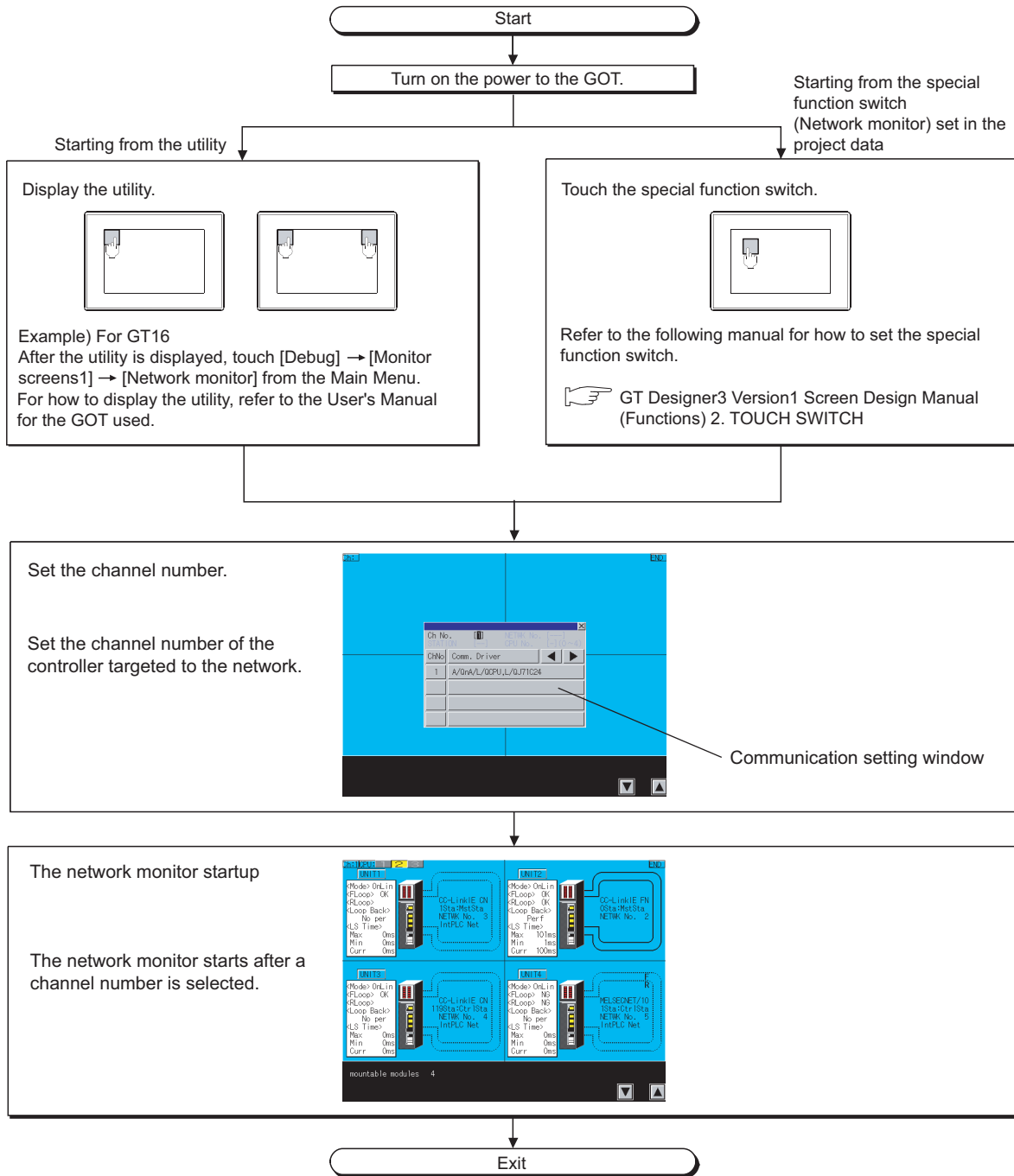

POINT

(1) How to display the utility

For how to display the utility, refer to the following.

 User's Manual for the GOT used

(2) Displaying communication setting window

After turning on the GOT, the communication setting window is displayed at the first startup of the network monitor only.

For displaying the communication setting window at the second or later startup, touch the Ch : button on the network monitor screen. ( 7.4 Operation Procedures)

(3) If the project data has not been downloaded

The network monitor can be started from the utility even if the project data has not been downloaded to the GOT.

■ Changing screens

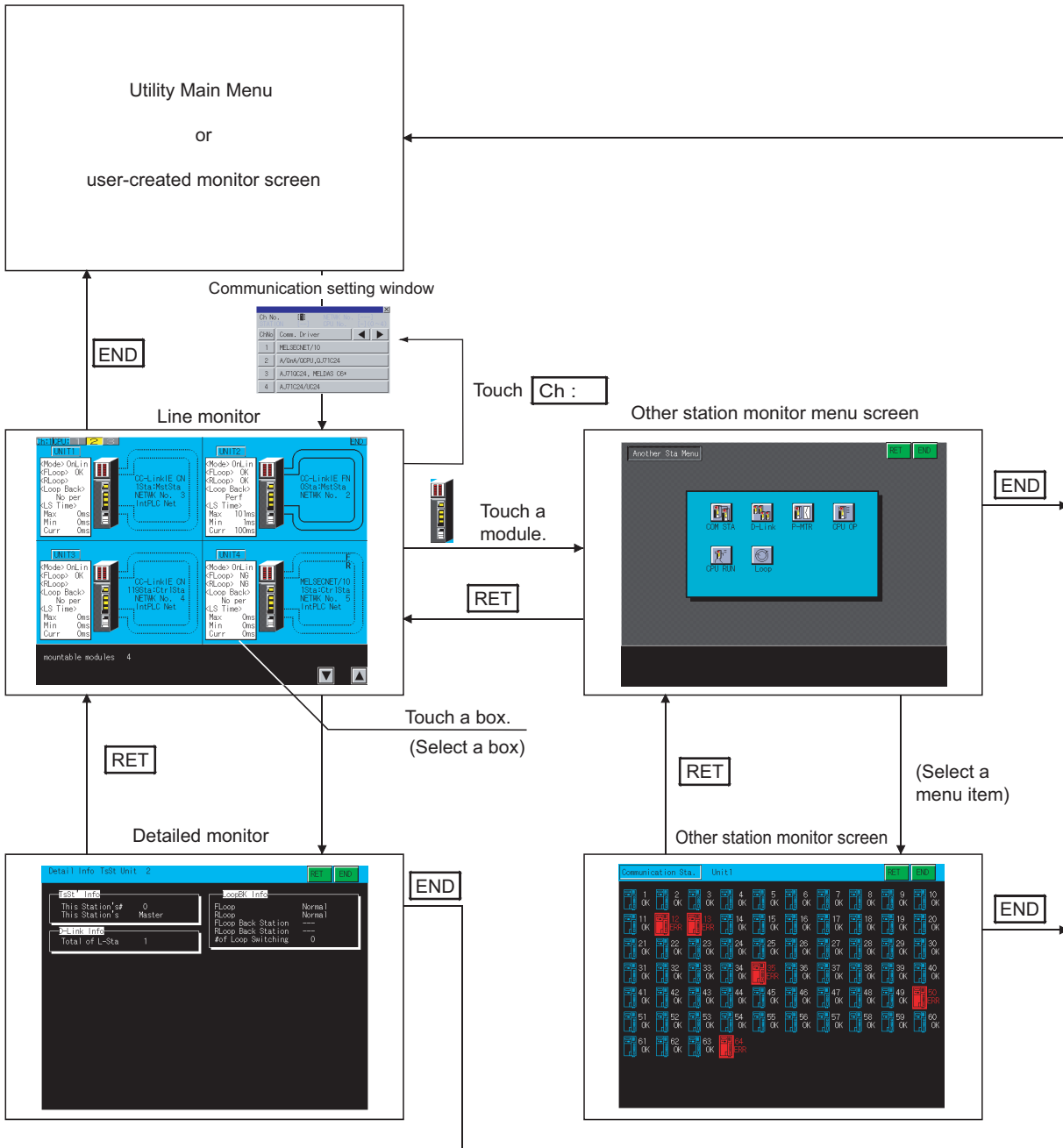

7.4 Operation Procedures

This section describes the information and key functions displayed on the network monitor screen.

The display on the network monitor screen varies slightly depending on the GOT used, and a screen for the GT1575-V is used for the descriptions in this section.

7.4.1 Line monitor

This section describes the structure of the monitor screen and the common operations used when executing the line monitor.

■ Display contents and keys functions

This section describes the line monitor screen configuration and the function of keys displayed on the screen after starting the network monitor.

(1) Displayed contents

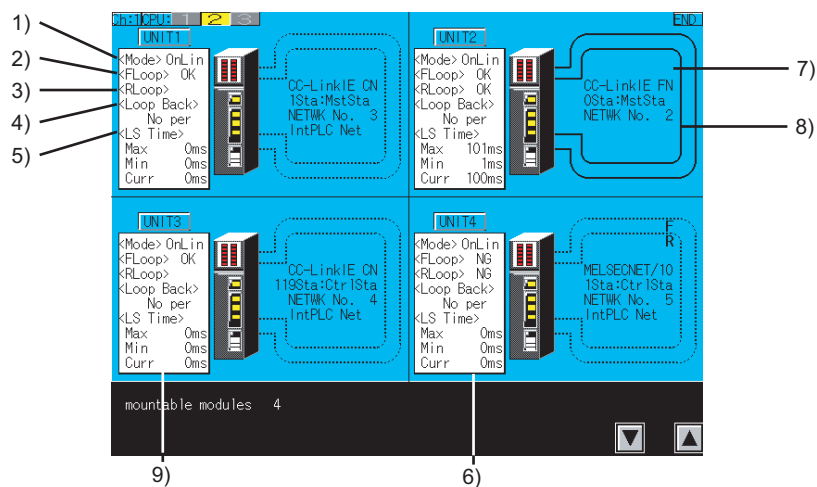

No.	Display contents
1)	This shows the operation mode of the host. (On-line, Off-line, Test ^{*1})
2)	This shows the status of the F-loop (Forward loop). (OK, NG) ^{*2}
3)	This shows the status of the R-loop (Reverse loop). (OK, NG) ^{*2}
4)	This shows whether the loopback was executed or not. (Executed, Not executed)
5)	This shows the link scan time required for the control station and the normal station, for the remote master station and the remote I/O station, and for the master station and all the sub-stations. Maximum (the maximum value of link scan time) Minimum (the minimum value of link scan time) Current (the current value of link scan time)
6)	This shows the communication status of the host. (Only for MELSECNET(II) local station) P-MTR WAIT :Ready to receive parameters from the master station. Cyclic com :Normal communication Com. suspension :Communication is suspended because the host is disconnected.
7)	This shows the network category, network number, and station number.

(Continued to next page)

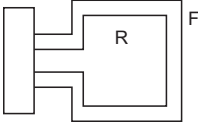
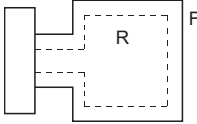
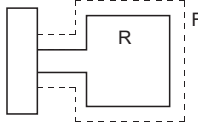
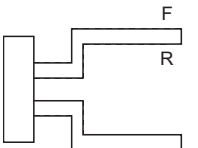
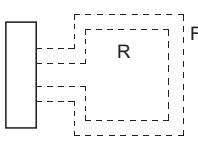
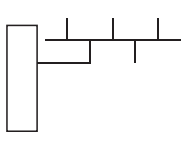
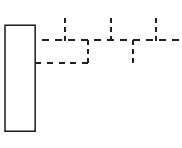
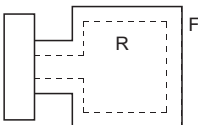
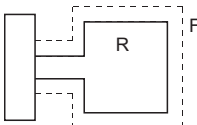
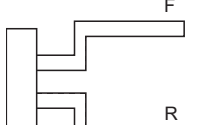
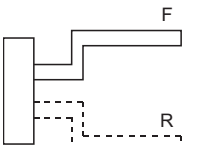
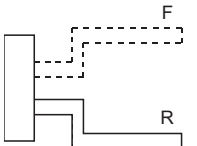
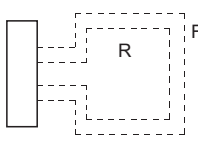
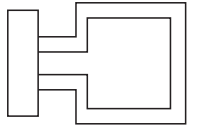
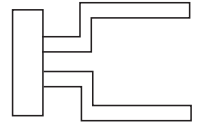
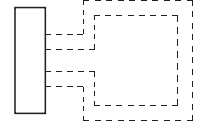
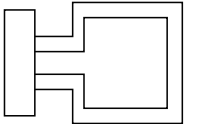
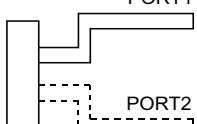
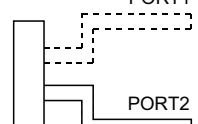
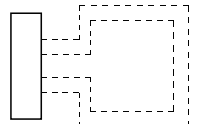
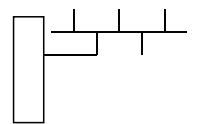
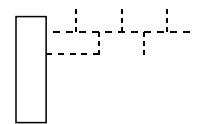
No.	Display contents
	<p>For the MELSECNET/H and MELSECNET/10 network systems, the loop status is displayed as shown below. (Forward loop: F, Reverse loop: R)</p> <p>(a) Forward loop: OK Reverse loop: OK</p>  <p>(b) Forward loop: OK Reverse loop: NG</p>  <p>(c) Forward loop: NG Reverse loop: OK</p>  <p>(d) Loopback in execution</p>  <p>(e) Forward loop: NG Reverse loop: NG</p>  <p>(f) MELSECNET/10 coaxial bus (OK)</p>  <p>(g) MELSECNET/10 coaxial bus (NG)</p> 
8)	<p>For the MELSECNET(II) network system, the loop status is displayed as shown below. (Forward loop: F, Reverse loop: R)</p> <p>(a) Data link in execution in forward loop</p>  <p>(b) Data link in execution in reverse loop.</p>  <p>(c) Loopback is performed in the forward/reverse loop direction.</p>  <p>(d) Loopback is performed in the forward loop direction only.</p>  <p>(e) Loopback is performed in the reverse loop direction only.</p>  <p>(f) Data link is not available.</p> 
	<p>For the CC-Link IE controller network, the loop status is displayed as shown below.</p> <p>(a) Normal status</p>  <p>(b) Loopback in execution</p>  <p>(c) All stations with errors</p> 
	<p>For the CC-Link IE field network, the loop status is displayed as shown below.</p> <p>(a) Normal status (ring topology)</p>  <p>(b) Loopback in execution on PORT1 side (ring topology)</p>  <p>(c) Loopback in execution on PORT2 side (ring topology)</p>  <p>(d) Error status (ring topology)</p>  <p>(e) Normal status (star topology/line topology)</p>  <p>(f) Error status (star topology/line topology)</p> 
9)	<p>This shows the number of installed network modules.</p>

- *1 [Test] is only displayed when using MELSECNET(II).
When using a system other than MELSECNET(II), [Off-line] is displayed even during testing of the forward or reverse loop.
- *2 The loop names vary depending on the network system to be monitored as shown below.

MELSECNET/H, MELSECNET/10, MELSECNET(II) network systems	CC-Link IE controller network	CC-Link IE field network
Forward loop	OUT-side loop	PORT1-side loop
Reverse loop	IN-side loop	PORT2-side loop

POINT

When the GOT target is AnACPU or AnNCPU







"MELSECNET(II)" is displayed even if a MELSECNET/10 network module is installed.

In addition, if there is a master station and local station, module 1 of the line monitor is displayed as "Master station".

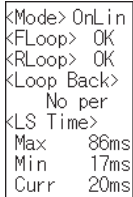
Network module		Display on the GOT	
1st module	2nd module	Module 1	Module 2
Local station	Master station	Master station	Local station

(2) Key functions

This section describes the function of keys to be used for the line monitor operations.

Key	Function
	Exits the line monitor and returns to the screen where the network monitor function was started.
	Switches to the detailed monitor screen that corresponds to the module displayed on the current monitor screen. This key is effective for each screen.
	Switches to the other station monitor menu that corresponds to the network displayed on the current monitor screen. This key is effective for each screen.
	Displays the communication setting window.
	Changes the monitoring destination CPU using the controller number. (For multi-CPU system connection only) The controller number is displayed according to the number of CPUs loaded.
	Touch  to switch the displayed module to the next one. Touch  to switch the displayed module to the previous one.

7.4.2 Detailed monitor

This section describes the detailed monitor and the common operations used when executing the line monitor.

■ Display contents and keys functions: acting as a MELSECNET/H or MELSECNET/10 Control station/normal station

This section describes the contents of the detailed monitor and the function of on-screen keys. All these are displayed and used when the host acts as the control station/normal station on the MELSECNET/H, MELSECNET/10.

(1) Displayed contents

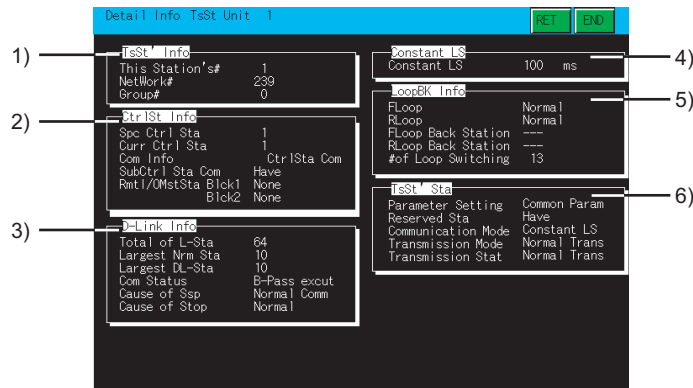

No.	Item	Display contents
1)	TsSt Info	<ul style="list-style-type: none"> • This Station's # : Indicates the station number of the host. • Network # : Indicates the network number. • Group # : Indicates the group number.
2)	Ctrl St Info	<ul style="list-style-type: none"> • Spc Ctrlr Sta : Indicates the station number of the station that is specified as a control station. • Curr Ctrl Sta : Indicates the station number of a station that is currently acting as the control station. • Com Info : Indicates whether the host is communicating with the control station or the sub-control station. • SubCtrl Sta Com : Indicates whether there is a sub-control station link. • Rmt I/OMstSt*1 : Displays the station number of the remote I/O master station for X/Y communication block1 and block 2. Displays "None" when there is no setting.
3)	D-Link Info	<ul style="list-style-type: none"> • Total of L-Sta : Indicates the maximum number of the stations to be linked. The maximum number is defined by common parameters. • Largest Nrm Sta : Indicates the maximum station number of the station performing a communication in a normal condition. • Largest DL-Sta : Indicates the maximum station number of the station that is data-linked. • Com Status : Shows the current communications status of the host. (D-Link in prog/D-Link Stop (A)/D-Link Stop (H)/B-Pass excut/Disconnection/Loop test/Set Conf. test/Sta Odr. Conf./Com. test/Offline test/Reset. in prgr.) • Causes of Ssp : Indicates the causes why the communications were interrupted. This indicates "Normal" if communications are normal. (Normal/Offline/Offline Test/Line error/Disconnection/Initialize/Others (error codes)) • Causes of Stop : Indicates the causes why the data link was stopped. This indicates "Normal" if communications are normal. (Stop disignat/No common para/Host Para error/Host CPU error/Com. suspension/Others)

(Continued to next page)



No.	Item	Display contents
4)	Constant LS	Indicates the predetermined time of constant link scans.
5)	LoopBK Info*2	<ul style="list-style-type: none"> • FLoop : Shows the status of the forward loop lines of the host. (Normal/LoopBK Trans/D-Link Impo) • RLoop : Shows the status of the reverse loop lines of the host. (Normal/LoopBK Trans/D-Link Impo) • FLoop Back Station : Indicates the station number of a station that executes the loopback along the forward loop. Displays "---" when the loopback is operating normally. • RLoop Back Station : Indicates the station number of a station that executes the loopback along the reverse loop. Displays "---" when the loopback is operating normally. • # of Loop Switching : Indicates the cumulative number of times for which loops have been switched.
6)	TsSt' Sta	<ul style="list-style-type: none"> • Parameter Setting : Common Param, Common + Spec if, Default Param, Default + Specif • Reserved Sta : Indicates the availability of a reserved station. (Have/None) • Communication Mode : Indicates either "Normal mode" or "Constant LS." • Transmission Mode : Indicates either "Normal Trans" or "Multiple Trans."*2 • Transmission Stat : Indicates either "Normal Trans" or "Multiple Trans."*2

*1 This is not displayed when the CPU type of the GOT connection target is AnNCPu or AnACPU

*2 "---" is displayed when coaxial bus connections are established.

(2) Key functions

The table below shows the function of keys that are used on the detailed monitor.

Key	Function
	Returns to the line monitor.
	Exits the detailed monitor and returns to the screen where the network monitor function was executed.

■ Display contents and keys functions: acting as a MELSECNET/H, MELSECNET/10 remote master station

This section describes the screen configuration of the detailed monitor and the function of on-screen keys when the host acts as the remote master station on the MELSECNET/H, MELSECNET/10.

(1) Displayed contents

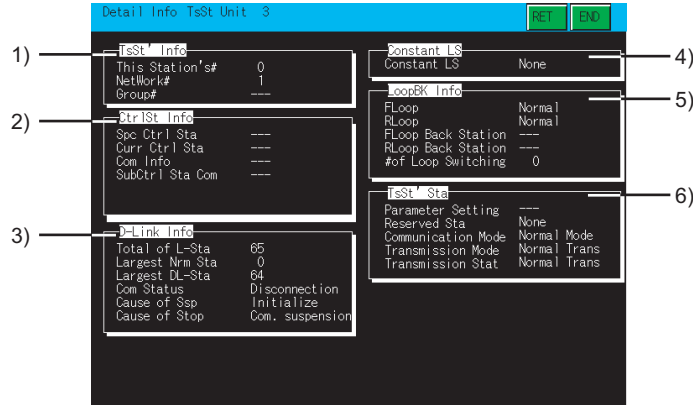

No.	Item	Display contents
1)	TsSt Info	<ul style="list-style-type: none"> • This Stations # : Indicates the station number of the host. • Network # : Indicates the network number. • Group # : Not displayed. ("---" is displayed.)
2)	Ctrl St Info	<ul style="list-style-type: none"> • SpC Ctrl Sta : Not displayed. ("---" is displayed.) • Curr Ctrl Sta : Not displayed. ("---" is displayed.) • Com Info : Not displayed. ("---" is displayed.) • SubCtrl-Sta Com : Not displayed. ("---" is displayed.)
3)	D-Link Info	<ul style="list-style-type: none"> • Total of L-Sta : Indicates the maximum number of the stations to be linked, which is set by common parameters. • Largest Nrm Sta : Indicates the maximum station number of the station that is connected in a normal condition. • Largest DL-Sta : Indicates the maximum station number of the station that is performing data link. • Com Status : Shows the current communications status of the host. (D-Link in prog/D-Link Stop (A)/D-Link Stop (H)/B-Pass excut/Disconnection/Loop test/Set Conf. test/Sta Odr. Conf./Com. test/Offline test/Reset. in prgr.) • Causes of Ssp : Indicates the causes why the communications were interrupted. This indicates "Normal" if communications are normal. (Normal/Offline/Offline Test/Line error/Disconnection/Initialize/Others (error codes)) • Causes of Stop : Indicates the causes why the data link was stopped. This indicates "Normal" if communications are normal. (Stop designat/No common para/Host Para error/Host CPU error/Com. suspension/Others (error codes))
4)	Constant LS	Indicates the predetermined time of constant link scans.

(Continued to next page)

No.	Item	Display contents
5)	LoopBK Info* ¹	<ul style="list-style-type: none"> • FLoop : Shows the status of the forward loop lines of the host. (Normal/LoopBK Trans/D-Link Impo) • RLoop : Shows the status of the reverse loop lines of the host. (Normal/LoopBK Trans/D-Link Impo) • FLoop Back Station : Indicates the station number of a station that executes the loopback along the forward loop. Displays "---" when the loopback is operating normally. • RLoop Back Station : Indicates the station number of a station that executes the loopback along the reverse loop. Displays "---" when the loopback is operating normally. • # of Loop Switching : Indicates the cumulative number of times for which loops have been switched.
6)	TsSt' Sta	<ul style="list-style-type: none"> • Parameter Setting : Not displayed. ("---" is displayed.) • Reserved Sta : Indicates the availability of a reserved station. (Have/None) • Communication Mode : Indicates either "Normal mode" or "Constant LS." • Transmission Mode : Indicates either "Normal Trans" or "Multiple Trans."*¹ • Transmission Stat : Indicates either "Normal Trans" or "Multiple Trans."*¹

*1 "---" is displayed when coaxial bus connections are established.

(2) Key functions

The table below shows the function of keys that are used on the detailed monitor.

Key	Function
RET	Returns to the line monitor.
END	Exits the detailed monitor and returns to the screen where the network monitor function was started.

■ Display contents and keys functions: acting as a MELSECNET(II) master station

This section describes the screen configuration of the detailed monitor and the function of on-screen keys when the host acts as the master station on the MELSECNET(II).

(1) Displayed contents

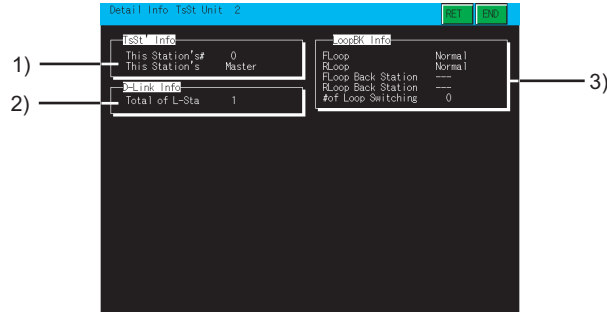

No.	Item	Display contents
1)	TsSt Info	This Station's # : This shows the station number of the host. This Station's : Indicates the category of the host.
2)	D-Link Info	Indicates the maximum number of the stations to be linked, which is defined by common parameters.
3)	LoopBK Info	<ul style="list-style-type: none"> • FLoop : Shows the status of the forward loop lines of the host. (Normal/NG) • RLoop : Shows the status of the reverse loop lines of the host. (Normal/NG) • FLoop Back Station : Indicates the station number of a station that executes the loopback along the forward loop. When loopback is normal, "---" is displayed. When there is no loopback station, "F" is displayed. • RLoop Back Station : Indicates the station number of a station that executes the loopback along the reverse loop. When loopback is normal, "---" is displayed. When there is no loopback station, "R" is displayed. • # of Loop Switching : Indicates the cumulative number of times for which loops have been switched.

(2) Key functions

The table below shows the function of keys that are used on the detailed monitor.

Key	Function
RET	Returns to the line monitor.
END	Exits the detailed monitor and returns to the screen where the network monitor function was started.

■ Display contents and keys functions: acting as a MELSECNET(II) local station

This section describes the screen configuration of the detailed monitor and the function of on-screen keys when the host acts as the local station on the MELSECNET(II).

(1) Displayed contents

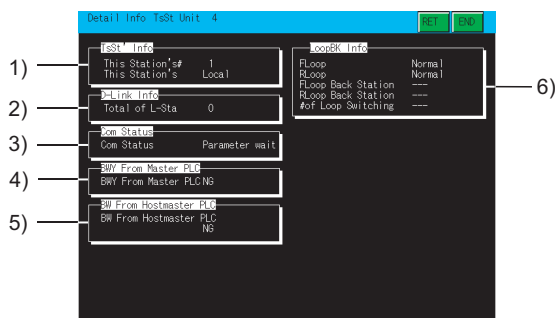

No.	Item	Display contents
1)	TsStf Info	<ul style="list-style-type: none"> This Station's # : Indicates the station number of the host. This Station's : Indicates the category of the host.
2)	D-Link Info	<ul style="list-style-type: none"> Total of L-Sta : Indicates the maximum number of the stations to be linked, which is defined by common parameters.
3)	Com status	This shows the communication status of the host. (Parameter wait/Cyclic comm/Com. suspension)
4)	BWY From Master	This shows the status of receiving Device BWY from the master station. OK: Data is being received by cyclic communication. NG: Unable to receive because the host is disconnected, etc.
5)	BW From Hostmaster	This shows the status of receiving Device BW from the master station of a dual-layer system. OK: Data is being received by cyclic communication. NG: Unable to receive because the host is disconnected, etc.
6)	LoopBK Info	<ul style="list-style-type: none"> FLoop : Shows the status of the forward loop lines of the host. (Normal/NG) RLoop : Shows the status of the reverse loop lines of the host. (Normal/NG) FLoop Back Station : Not displayed. ("---" is displayed.) RLoop Back Station : Not displayed. ("---" is displayed.) # of Loop Switching : Not displayed. ("---" is displayed.)

(2) Key functions

The table below shows the function of keys that are used on the detailed monitor.

Key	Function
	Returns to the line monitor.
	Exits the detailed monitor and returns to the screen where the network monitor function was started.

■ Display contents and keys functions when monitoring CC-Link IE controller network

This section describes the screen configuration of the detailed monitor and the functions of on-screen keys when the GOT monitors a control station or normal station on the CC-Link IE controller network set as the host station.

(1) Displayed contents

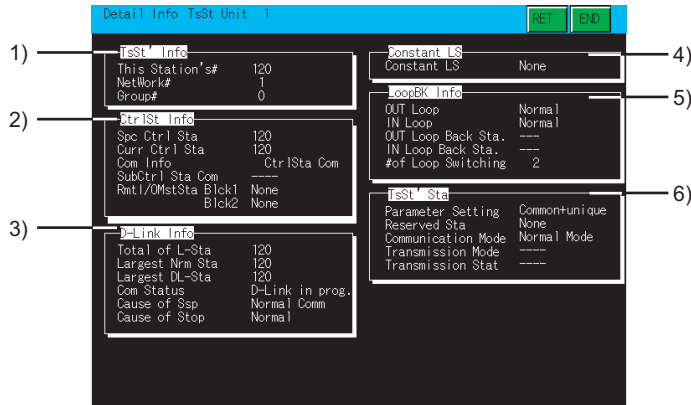

No.	Item	Display contents
1)	TsSt' Info	<ul style="list-style-type: none"> • This Station's# : Displays the host station number. • NetWork# : Displays the network number of the host station. • Group# : Displays the group number.
2)	CtrlSt Info	<ul style="list-style-type: none"> • Spc Ctrl Sta : Displays the station number set as the control station. • Curr Ctrl Sta : Displays the station number of the station currently operating as the control station. • Com Info : Displays whether the GOT communicates with the control station or sub-control station. • SubCtrl Sta Com : Not displayed ([---] is displayed.) • RmtI/OMstSta : Displays the station numbers of the I/O master stations for block 1 and block 2. [None] is displayed with no setting.
3)	D-Link Info	<ul style="list-style-type: none"> • Total of L-Sta : Displays the total number of stations on the monitored network set for common parameters. • Largest Nrm Sta : Displays the maximum station number of the station communicating normally. • Largest DL-Sta : Displays the maximum station number of the station performing a data link. • Com Status : Displays the current communication status of the host station. (D-Link in prog., D-Link stopped, B-Pass excut, B-Pass stopped, Offline test, Offline) • Cause of Ssp^{*1} : Displays the reason for the interrupted communication. [Normal Comm] is displayed with normal communications. (Cable disconnct, Wrong cable, Checking cables, Disconnect/retrn, Offline mode, Offline test, Self-check mode) • Cause of Stop^{*2} : Displays the reason for the interrupted data link. [Normal] is displayed with normal data links. (Stop disignat, D-Link time up, Testing line, Param not rcvcd, Invlid Host No., Set Rsvd Sta., Dup Host No., Dup CtrlSta No., Sta No. not set, Invlid NTWK No., Host Para error, Params in comm., CPU stop error, CPU pwr stp err)



(Continued to next page)

No.	Item	Display contents
4)	Constant LS	Displays the set contact link scan time.
5)	LoopBK Info	<ul style="list-style-type: none"> • OUT Loop : Displays the OUT-side loop line status of the host station. (Normal, LoopBK Trans, All Sta. NG) • IN Loop : Displays the IN-side loop line status of the host station. (Normal, LoopBK Trans, All Sta. NG) • OUT Loop Back Sta. : Displays the station number of the OUT-side loopback station. [---] is displayed with normal loopbacks. • IN Loop Back Sta. : Displays the station number of the IN-side loopback station. [---] is displayed with normal loopbacks. • #of Loop Switching : Displays the accumulated number of switching loops.
6)	TsSt' Sta	<ul style="list-style-type: none"> • Parameter Setting : Displays [No parameters], [Common Param], [Unique param], or [Common+unique]. • Reserved Sta : Displays whether a reserved station exists or not. • Communication Mode : Displays [Normal Mode] or [Constant LS]. • Transmission Mode : Not displayed ([---] is displayed.) • Transmission Stat : Not displayed ([---] is displayed.)

*1 When the station is in the hardware test mode, self-loopback test mode, circuit test mode, or station-to-station test mode, [Offline test] is displayed.
*2 For duplication of the control station or station number, [Dup CtrlSta No.] is displayed.

(2) Key functions

The table below shows the function of keys that are used on the detailed monitor.

Key	Function
	Returns to the line monitor.
	Exits the detailed monitor and returns to the screen where the network monitor function was started.

■ Display contents and keys functions when monitoring a master/local station on the CC-Link IE field network

This section describes the screen configuration of the detailed monitor and the functions of on-screen keys when the GOT monitors a master station or local station on the CC-Link IE field network set as the host station.

(1) Displayed contents

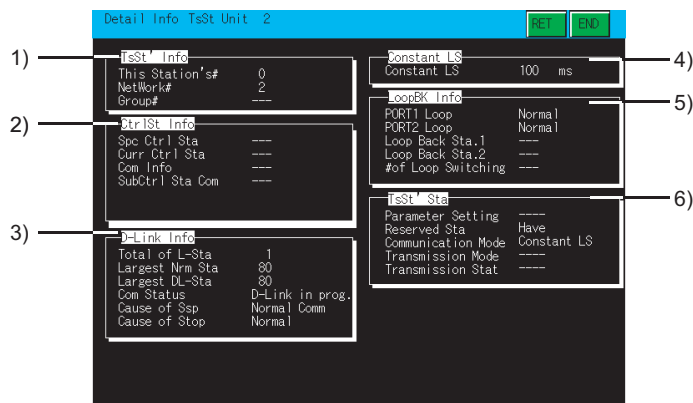

No.	Item	Display contents
1)	TsSt' Info	<ul style="list-style-type: none"> • This Station's# : Displays the host station number. • NetWork# : Displays the network number of the host station. • Group# : Not displayed ([---] is displayed.)
2)	CtrlSt Info	<ul style="list-style-type: none"> • Spc Ctrl Sta : Not displayed ([---] is displayed.) • Curr Ctrl Sta : Not displayed ([---] is displayed.) • Com Info : Not displayed ([---] is displayed.) • SubCtrl Sta Com : Not displayed ([---] is displayed.)

(Continued to next page)

No.	Item	Display contents
3)	D-Link Info	<ul style="list-style-type: none"> • Total of L-Sta : Displays the total number of stations on the monitored network set for common parameters. • Largest Nrm Sta : Displays the maximum station number of the station communicating normally. • Largest DL-Sta : Displays the maximum station number of the station performing a data link. • Com Status : Displays the current communication status of the host station. (D-Link in prog., B-Pass excut, B-Pass stopped, Offline test, Offline) • Cause of Ssp^{*1} : Displays the reason for the interrupted communication. [Normal Comm] is displayed with normal communications. (Cable disconnct, Disconnct/retrn, Offline mode, Offline test) • Cause of Stop : Displays the reason for the interrupted data link. [Normal] is displayed with normal data links. (Stop designat, D-Link time up, No Slave Sta., Param not rcvd, Invlid Host No., Set Rsvd Sta., Dup Host No., Dup Master Sta., Sta No. not set, Host Para error, Params in comm., Station Type, CPU stop error, Ring connection)
4)	Constant LS	Displays the set contact link scan time.
5)	LoopBK Info	<ul style="list-style-type: none"> • PORT1 Loop : Shows the status of the PORT1-side loop. (Normal/LoopBK Trans/D-Link Impo) • PORT2 Loop : Shows the status of the PORT2-side loop. (Normal/LoopBK Trans/D-Link Impo) • Loop Back Sta.1 : Indicates the station number of a station that executes the loopback. [---] is displayed with normal loopbacks. • Loop Back Sta.2 : Indicates the station number of a station that executes the loopback. [---] is displayed with normal loopbacks. • #of Loop Switching : Displays the accumulated number of switching loops.
6)	TsSt' Sta	<ul style="list-style-type: none"> • Parameter Setting : Not displayed ([---] is displayed.) • Reserved Sta : Displays whether a reserved station exists or not. • Communication Mode : Displays [Normal Mode] or [Constant LS]. • Transmission Mode : Not displayed ([---] is displayed.) • Transmission Stat : Not displayed ([---] is displayed.)

*1 When the station is in the hardware test mode, offline test mode, or self-loopback test mode, [Offline test] is displayed.

(2) Key functions

The table below shows the function of keys that are used on the detailed monitor.

Key	Function
RET	Returns to the line monitor.
END	Exits the detailed monitor and returns to the screen where the network monitor function was started.

7.4.3 Other station monitor

This section describes the structure of the monitor screen and the common operations used when executing the other station monitor.

■ Display contents and keys functions: other station monitor menu

This section describes the other station monitor menu screen and the function of on-screen keys. The menu screen for the other station monitor is displayed by touching a module number displayed on the host monitor screen. By this other station monitor menu, each of the other station monitor can be specified.

(1) Displayed contents

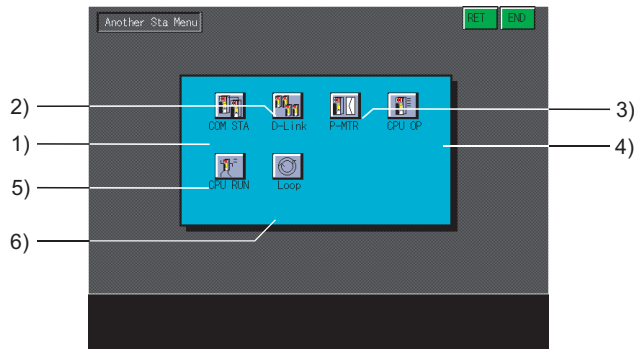

No.	Item	Display contents
1)	COM STA	Switches to the communication status monitor for other stations. ^{*1} (☞ 7.4.4 Other station communication status monitor)
2)	D-Link	Switches to the data link status monitor for other stations. ^{*2} (☞ 7.4.5 Other station data link status monitor)
3)	P-MTR	Switches to the parameter status monitor for other stations. ^{*1} (☞ 7.4.6 Other station parameter status monitor)
4)	CPU OP	Switches to the CPU operation status monitor for other stations. ^{*3} (☞ 7.4.7 Other station CPU operation status monitor)
5)	CPU RUN	Switches to the CPU RUN status monitor for other stations. ^{*3} (☞ 7.4.8 Other station CPU RUN status monitor)
6)	Loop	Switches to the loop status monitor for other stations. ^{*4} (☞ 7.4.9 Other station loop status monitor)

*1 This cannot be selected when a MELSECNET(II) local station is selected using the line monitor.

*2 This cannot be selected when a MELSECNET(II) master station or local station is selected using the line monitor.

*3 This cannot be selected when a remote I/O station is selected using the line monitor.

*4 The other station loop status monitor is not available in the following conditions.

- When a local station on the MELSECNET(II) network system is selected using the line monitor
- When a MELSECNET network system with coaxial cables is used
- When a station on the CC-Link IE controller network or CC-Link IE field network is selected using the line monitor

(2) Key functions

The table below shows the function of keys to be used for the other station monitor operations.

Key	Function
	Switches to each monitor for other stations.
	Returns to the line monitor.
	Exits the other station monitor screen and returns to the screen where the network monitor function was started.

7.4.4 Other station communication status monitor

This section describes the screen configuration of the other station communication status monitor and the function of keys displayed on it.

This screen cannot be displayed for a MELSECNET(II) local station.

(1) Displayed contents

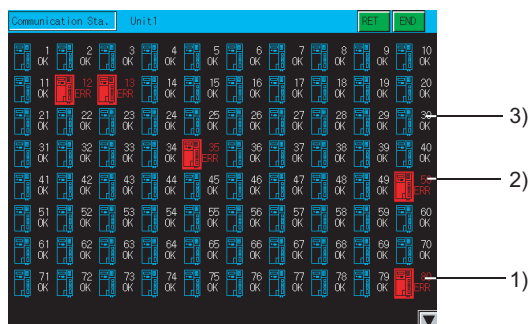

No.	Display contents
1)	Displays the communication status by station number. (OK/ERR) The station numbers displayed do not indicate the number of station numbers in the network, rather the maximum number of communication stations. For CC-Link IE field network, station number 1 to 120 are displayed regardless of the number of station numbers in the network.
2)	Any station in an abnormal condition is highlighted.
3)	Reserved stations are displayed as normal stations.

(2) Key functions

The table below shows the functions of the keys that are used for the other station communications status monitor operations.

Key	Function
RET	Returns to the other station monitor.
END	Exits the other station communication statuses monitor screen and returns to the screen where the network monitor was started.
▼ ▲	Switches the screen display of stations. (1 to 80 stations/81 to 120 stations)

7.4.5 Other station data link status monitor

This section describes the screen configuration of the other station data link status monitor and the function of on-screen keys.

This screen cannot be displayed for a MELSECNET(II) master station or local station.

(1) Displayed contents

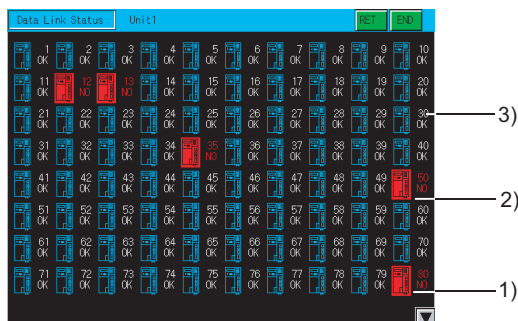

No.	Display contents
1)	Displays the data link status by station number. (OK/NO) The station numbers displayed do not indicate the number of station numbers in the network, rather the maximum number of communication stations. For CC-Link IE field network, station number 1 to 120 are displayed regardless of the number of station numbers in the network.
2)	Any station to which data link is not performed is highlighted.
3)	Reserved stations are displayed as having a data link established.

(2) Key functions

The table below shows the function of keys that are used for the operations of other station data link status monitor.

Key	Function
RET	Returns to the other station monitor.
END	Exits the other station data link status monitor screen and returns to the screen where the network monitor was started.
▼ ▲	Switches the screen display of stations. (1 to 80 stations/81 to 120 stations)

7.4.6 Other station parameter status monitor

This section describes the screen configuration of the other station parameter status monitor and the function of on-screen keys.

This screen cannot be displayed for a MELSECNET(II) local station.

(1) Displayed contents

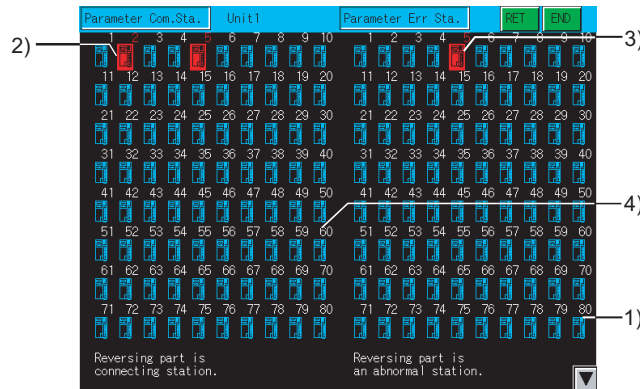

No.	Display contents
1)	Displays the parameter status by station number. The station numbers displayed do not indicate the number of station numbers in the network, rather the maximum number of communication stations. For CC-Link IE field network, station number 1 to 120 are displayed regardless of the number of station numbers in the network.
2)	Any station whose parameters are monitored is highlighted.*1
3)	Any station in an abnormal condition is highlighted.
4)	Reserved stations are displayed as normal stations.

*1 Only [Parameter Err Sta.] is displayed when connecting to a MELSECNET(II) master station.

(2) Key functions

The table below shows the function of keys that are used for the operations of the other station parameter status monitor.

Key	Function
	Returns to the other station monitor.
	Exits the other station parameter status monitor screen and returns to the screen where the network monitor was started.
	Switches the screen display of stations. (1 to 80 stations/81 to 120 stations)

7.4.7 Other station CPU operation status monitor

This section describes the screen configuration of the other station CPU operation status monitor and the function of on-screen keys.

This screen cannot be displayed for a remote I/O network system.

(1) Displayed contents

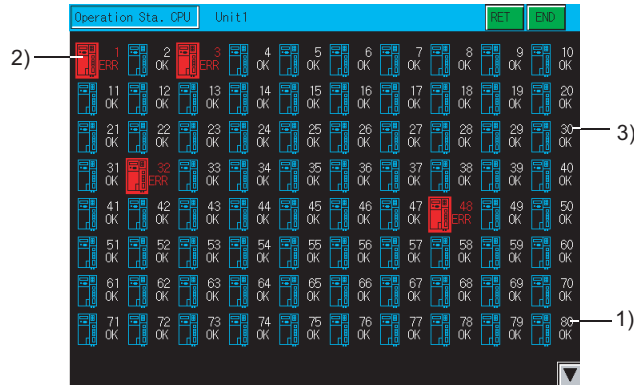

No.	Display contents
1)	Displays the CPU operation status by station number. (OK/ERR) The station number displayed does not indicate the station number in the network, rather the maximum number of communication stations. For CC-Link IE field network, station number 1 to 120 are displayed regardless of the number of station numbers in the network.
2)	Any station that stays in an abnormal condition or out of operation is highlighted.
3)	Reserved stations and unconnected stations are displayed as normal stations.

(2) Key functions

The table below shows the function of keys that are used for the operations of the other station CPU operation status monitor.

Key	Function
	Returns to the other station monitor.
	Exits the other station CPU operation status monitor screen and returns to the screen where the network monitor was started.
	Switches the screen display of stations. (1 to 80 stations/81 to 120 stations)

7.4.8 Other station CPU RUN status monitor

This section describes the other station CPU RUN status monitor and the function of on-screen keys. This screen cannot be displayed for a remote I/O network system.

(1) Displayed contents

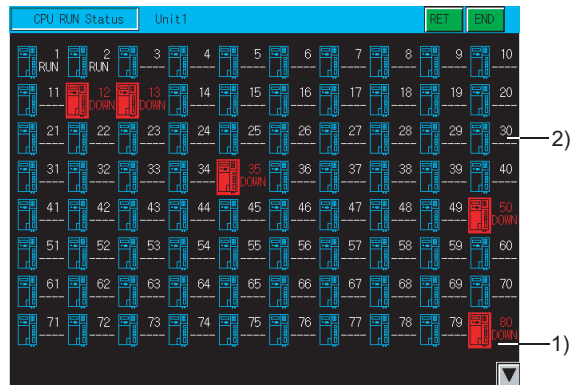

No.	Display contents
1)	Displays the CPU operation status by station number. (RUN/STOP) "DOWN" is displayed for stations with communication errors. Up to 64 stations are displayed regardless of the number of stations in a network. For CC-Link IE controller network or CC-Link IE field network, station number 1 to 120 are displayed regardless of the number of station numbers in the network.
2)	"---" is displayed for a reserved station and the statuses of stations beyond the maximum communication stations, or when a MELSECNET(II) local station has been selected in the line monitor.

(2) Key functions

The table below shows the function of keys that are used for the operations of the other station CPU RUN status monitor.

Key	Function
	Returns to the other station monitor.
	Exits the other station CPU RUN status monitor screen and returns to the screen where the network monitor was started.
	Switches the screen display of stations. (1 to 80 stations/81 to 120 stations)

7.4.9 Other station loop status monitor

This section describes the screen configuration of the other station loop status monitor and the function of on-screen keys.

The other station loop status monitor is not available in the following conditions.

- When a local station on the MELSECNET(II) network system is selected using the line monitor
- When a MELSECNET network system with coaxial cables is used
- When a station on the CC-Link IE controller network or CC-Link IE field network is selected using the line monitor.

(1) Displayed contents

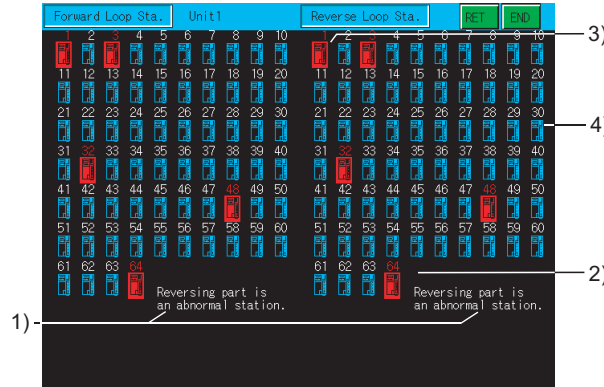

No.	Display contents
1)	The F-loop (forward loop) status and the R-loop (reverse loop) status are displayed.
2)	The station numbers displayed do not indicate the number of station numbers in the network, rather the maximum number of communication stations.
3)	Any station that stays in an abnormal condition is highlighted.
4)	Reserved stations are displayed as normal stations.

(2) Key functions

The table below shows the function of keys that are used for the operations of the other station loop status monitor.

Key	Function
RET	Returns to the other station monitor.
END	Exits the other station loop status monitor screen and returns to the screen where the network monitor was started.

7.5 Error Message and Corrective Action

The following shows the error messages that are displayed during the network monitor operation and how to handle them.

Error message	Contents of error	Action to take
Communication channel setup error	There is no channel for communication.	Set the channel number in the Communication Settings of the utility.
Can not Communication	Communication could not be established with the PLC CPU.	<ul style="list-style-type: none">• Check the connections between the controller and the GOT for disconnected connectors and cables.• Check if an error has occurred in the controller.
Key Word error	A keyword has been set in the parameter when monitoring the MELSECNET(II) master station of the QnACPU.	Release the set keyword.

8. Q MOTION MONITOR



8.1 Features

The Q motion monitor enables the servo monitoring and parameter setting of the motion controller CPU. The following are the features of the Q motion monitor.

■ Various servo monitor data can be displayed on multiple monitor screens

The Q motion monitor function has multiple monitor screens, on which you can monitor servo data in a variety of patterns.
(Display examples)

Present Value Monitor

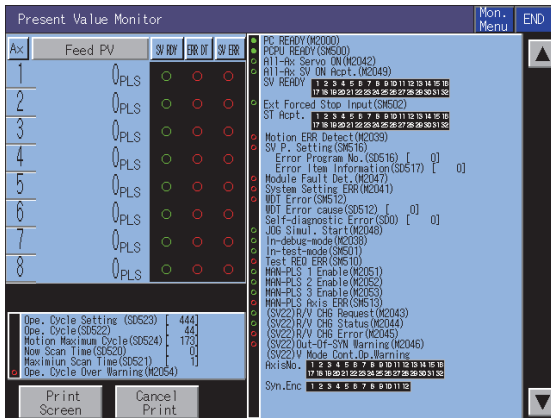

- Monitors and displays the feed current values and actual current values of all running axes.

(☞ 8.4.4 Present Value Monitor screen)

Error List



- Displays the history of errors that occurred on and after the leading edge of PLC ready (M2000).

(☞ 8.4.6 Error List screen)

Positioning Monitor

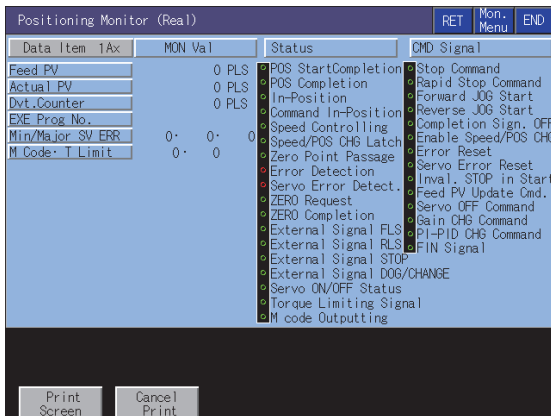

- Monitors the details of the positioning data set to any axis.

(☞ 8.4.8 Positioning Monitor screen)

Error List Designated-Axis

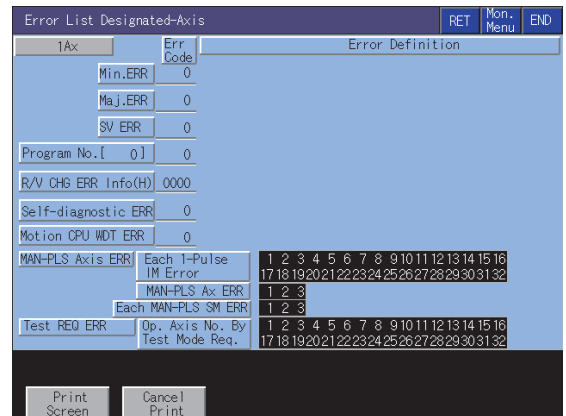

- Displays the latest errors that occurred on the specified axis.

(☞ 8.4.7 Error List Designated-Axis screen)

■ Servo parameters can be changed by writing

(Write example: Changing the setting of the auto tuning function)

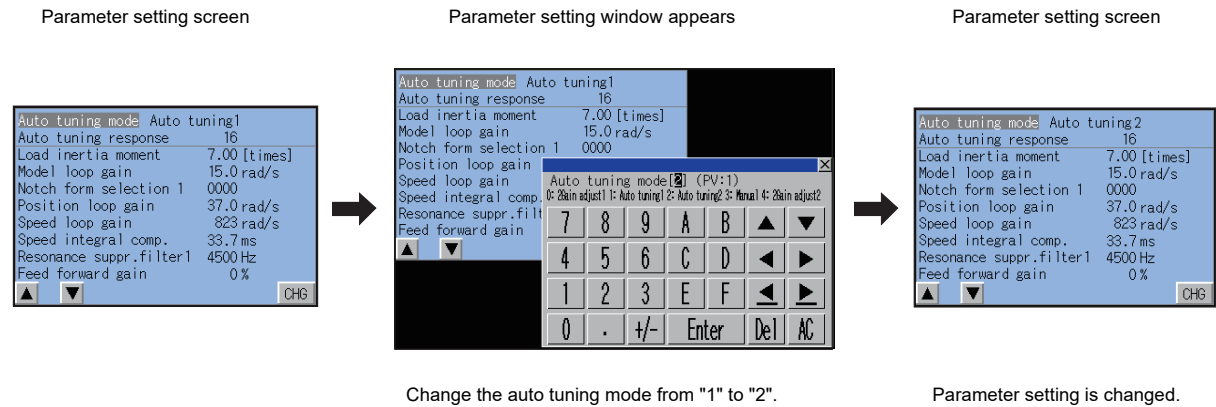

1. By performing writing from the parameter setting screen, write the servo parameter setting (basic parameters/adjustment parameters) to the motion controller CPU.
2. To change a servo parameter setting, enter the necessary numerical value or option number from the automatically displayed key window, and write it to the motion controller CPU.

8.2 Specifications

8.2.1 System configuration

This chapter describes the system configuration of the Q motion monitor.
For connection type settings and precautions regarding the communication unit/cable and connection type, refer to the following.

 GOT1000 Series Connection Manual (Mitsubishi Products) for GT Works3

■ Target motion controller CPU of the Q motion monitor

Motion controller CPU
Motion controller CPU (Q series) ^{*1*2}

- *1 Use the following production number motion controller CPU when using the Q172CPU or Q173CPU.
 - For bus connection and direct CPU connection
Q172CPU: Production number K***** or later
Q173CPU: Production number J***** or later
 - For a connection other than bus connection and direct CPU connection
Q172CPU: Production number N***** or later
Q173CPU: Production number M***** or later
- *2 When using the OS (SV13 or SV22) with the Q172CPU, Q173CPU, Q172CPUN, or Q173CPUN, install the following version.
SW6RN-SV13Q □: 00H or later (00E or later when using the Q172CPU or Q173CPU with a bus connection or direct CPU connection)
SW6RN-SV22Q □: 00H or later (00E or later when using the Q172CPU or Q173CPU with a bus connection or direct CPU connection)

■ Connection type

This function can be used in the following connection types.

(1) When the GOT is connected to a QCPU (Q mode), QnACPU, or motion controller CPU

(○: Available, △: Partly restricted, X: Unavailable)

Function		Connection type between GOT and controller							
Name	Description	Bus connection	Direct CPU connection	Computer link connection	Ethernet connection ^{*4}	MELSEC NET/H connection, MELSEC NET/10 connection	CC-Link IE controller connection ^{*1}	CC-Link connection	
								ID ^{*2}	G4 ^{*3}
Servo monitor	Monitors the present value, positioning error and other servo-related items on a variety of monitor screens.		○		○	○	○	○	○
Parameter settings	Changes the setting of the servo parameter.								

- *1 Indicates the CC-Link IE controller network connection.
- *2 Indicates CC-Link connection (Intelligent device station).
- *3 Indicates CC-Link connection (via G4).
- *4 Q motion monitor cannot be used when using CC-Link IE field network Ethernet adapter.

■ Required option OS and option function board

The option function OS and option function board shown below are required.

 1.1.2 Hardware and OS' required for each function

(1) Option OS

Install the option OS in the above table to the GOT.

For the installation procedure, refer to the following.

 GT Designer3 Version1 Screen Design Manual (Fundamentals) 8. COMMUNICATION WITH GOT

(2) OS memory space

The available memory space shown in the table above is required in the user area to install the option OS to the GOT.

For the procedure for checking the available memory space of the user area and information about the data using other user areas, refer to the following.

 GT Designer3 Version1 Screen Design Manual (Fundamentals) 8. COMMUNICATION WITH GOT

(3) Option function board

(a) For GT16

No option function board is required.

(b) For GT15

Mount one of the option function boards in the above table on the GOT.

For the GOTs with a built-in option function board, refer to the following.

 1.1.2 Hardware and OS' required for each function

For how to mount an option function board on the GOT, refer to the following.

 The Use's Manual of GOT used

■ Required special data

Write the Q motion monitor data to the GOT.

The available memory space of the user area for writing varies depending on the Q motion monitor data to be used.

Refer to the capacity of the Q motion monitor data in the following table and calculate the required space for writing.

For the procedure for writing to the GOT and for checking the available memory space of the user area and information about the data using other user areas, refer to the following.

 GT Designer3 Version1 Screen Design Manual (Fundamentals) 8. COMMUNICATION WITH GOT

(1) GT1695, GT1685, GT1675M-S, GT1665M-S, GT1595, GT1585, GT1575V-S, GT1575-S

Q motion monitor data	Q motion monitor data capacity (KB)									
	Q172 CPU	Q173 CPU	Q172H CPU	Q173H CPU	Q172D CPU	Q173D CPU	Q172DS CPU	Q173DS CPU	Q170M CPU	Q170MS CPU
Common information	40.4	40.4	40.4	40.4	40.4	40.4	40.4	40.4	40.4	40.4
500 [PV Mon. [172] Feed]	15.5	-	15.5	-	-	-	-	-	-	-
501 [PV Mon. [172] Act.]	15.5	-	15.5	-	-	-	-	-	-	-
503 [PV Mon. [173] Feed]	-	23.2	-	23.2	-	-	-	-	-	-
504 [PV Mon. [173] Act.]	-	23.2	-	23.2	-	-	-	-	-	-
506 [SFC Error History]	9.5	9.5	9.5	9.5	-	-	-	-	-	-
507 [Error List Mon.]	12.4	12.4	12.4	12.4	-	-	-	-	-	-
508 [Err. List-Ax[172R]]	7.3	-	7.3	-	-	-	-	-	-	-
509 [Err. List-Ax[173R]]	-	11.8	-	11.8	-	-	-	-	-	-
510 [Err. List-Ax Virt.]	5.8	5.8	5.8	5.8	-	-	-	-	-	-
511 [Position.Mon. Real:Q17x]	7.6	7.6	-	-	-	-	-	-	-	-

(Continued to next page)

Q motion monitor data	Q motion monitor data capacity (KB)									
	Q172 CPU	Q173 CPU	Q172H CPU	Q173H CPU	Q172D CPU	Q173D CPU	Q172DS CPU	Q173DS CPU	Q170M CPU	Q170MS CPU
512 [Position.Mon. Virt.:Q17x]	6.7	6.7	-	-	-	-	-	-	-	-
513 [PV History Mon.]	10.7	10.7	10.7	10.7	10.7	10.7	10.7	10.7	10.7	10.7
514 [Servo Monitor]	2.6	2.6	2.6	2.6	-	-	-	-	-	-
515 [Parameter Setting:Q17x]	4.3	4.3	-	-	-	-	-	-	-	-
516 [Parameter Setting:Q17xH/Q17xD]	-	-	3.7	3.7	3.7 ^{*1}	3.7 ^{*1}	-	-	-	-
517 [Parameter Setting:Q17xD(E)/Q170M]	-	-	-	-	3.8 ^{*1}	3.8 ^{*1}	-	-	3.8	3.8
520 [Position.Mon. Real:Q17xH]	-	-	7.8	7.8	-	-	-	-	-	-
521 [Position.Mon. Virt.:Q17xH]	-	-	6.9	6.9	-	-	-	-	-	-
530 [PV Mon. [172] Feed:Q17xD]	-	-	-	-	16.1	-	-	-	-	-
531 [PV Mon. [172] Act.:Q17xD]	-	-	-	-	16.1	-	-	-	-	-
533 [PV Mon. [173] Feed:Q17xD]	-	-	-	-	-	23.8	-	-	-	-
534 [PV Mon. [173] Act.:Q17xD]	-	-	-	-	-	23.8	-	-	-	-
536 [SFC Error History:Q17xD/Q170M]	-	-	-	-	9.7	9.7	-	-	9.7	9.7
537 [Error List Mon.:Q17xD/Q170M]	-	-	-	-	12.9	12.9	-	-	12.9	12.9
538 [Err. List-Ax[172R]:Q17xD]	-	-	-	-	7.3	-	-	-	-	-
539 [Err. List-Ax[173R]:Q17xD]	-	-	-	-	-	11.8	-	-	-	-
540 [Err. List-Ax Virt.:Q17xD/Q170M]	-	-	-	-	5.8	5.8	-	-	5.8	5.8
541 [Position.Mon. Real:Q17xD/Q170M]	-	-	-	-	7.8	7.8	-	-	7.8	7.8
542 [Position.Mon. Virt.:Q17xD/Q170M]	-	-	-	-	6.9	6.9	-	-	6.9	6.9
544 [Servo Monitor:Q17xD/Q170M]	-	-	-	-	2.6	2.6	-	-	2.6	2.6
560 [PV Mon. Feed:Q170M]	-	-	-	-	-	-	-	-	18.8	18.8
561 [PV Mon. Act.:Q170M]	-	-	-	-	-	-	-	-	18.8	18.8
566 [SFC Error History(E):Q17xD/Q170M]	-	-	-	-	10.2	10.2	-	-	10.2	10.2
567 [Error List Mon(E):Q17xD/Q170M]	-	-	-	-	13.4	13.4	-	-	13.4	13.4
568 [Err. List-Ax:Q170M]	-	-	-	-	-	-	-	-	8.7	8.7
570 [PV Mon. [172] Feed:Q17xDS]	-	-	-	-	-	-	19.8	19.8	-	-
571 [PV Mon. [172] Act.:Q17xDS]	-	-	-	-	-	-	19.8	19.8	-	-
573 [PV Mon. [173] Feed:Q17xDS]	-	-	-	-	-	-	24.5	24.5	-	-
574 [PV Mon. [173] Act.:Q17xDS]	-	-	-	-	-	-	24.5	24.5	-	-
576 [SFC Error History:Q17xDS]	-	-	-	-	-	-	10.2	10.2	-	-
577 [Error List Mon.:Q17xDS]	-	-	-	-	-	-	13.4	13.4	-	-
578 [Err. List-Ax[172R]:Q17xDS]	-	-	-	-	-	-	8.7	-	-	-
579 [Err. List-Ax[173R]:Q17xDS]	-	-	-	-	-	-	-	11.8	-	-
580 [Err. List-Ax Virt.:Q17xDS]	-	-	-	-	-	-	5.8	5.8	-	-
581 [Position.Mon. Real:Q17xDS]	-	-	-	-	-	-	7.9	7.9	-	-
582 [Position.Mon. Virt.:Q17xDS]	-	-	-	-	-	-	7.0	7.0	-	-
584 [Servo Monitor:Q17xDS]	-	-	-	-	-	-	2.6	2.6	-	-
585 [Parameter Setting:Q17xDS]	-	-	-	-	-	-	3.8	3.8	-	-

*1 Either 516 or 517 can be selected.

1 OVERVIEW
2 SYSTEM MONITOR
3 LADDER MONITOR FUNCTION
4 MELSEC-A LIST EDITOR
5 MELSEC-FX LIST EDITOR
6 INTELLIGENT MODULE MONITOR
7 NETWORK MONITOR
8 Q MOTION MONITOR

(2) GT1675M-V, GT1675-VN, GT1672-VN, GT1665M-V, GT1655-V, GT1575-V, GT1565-V, GT1555-V

Q motion monitor data	Q motion monitor data capacity (KB)									
	Q172 CPU	Q173 CPU	Q172H CPU	Q173H CPU	Q172D CPU	Q173D CPU	Q172DS CPU	Q173DS CPU	Q170M CPU	Q170MS CPU
Common information	40.4	40.4	40.4	40.4	40.4	40.4	40.4	40.4	40.4	40.4
500 [PV Mon. [172] Feed]	15.4	-	15.4	-	-	-	-	-	-	-
501 [PV Mon. [172] Act.]	15.4	-	15.4	-	-	-	-	-	-	-
503 [PV Mon. [173] Feed]	-	23.1	-	23.1	-	-	-	-	-	-
504 [PV Mon. [173] Act.]	-	23.1	-	23.1	-	-	-	-	-	-
506 [SFC Error History]	9.4	9.4	9.4	9.4	-	-	-	-	-	-
507 [Error List Mon.]	12.4	12.4	12.4	12.4	-	-	-	-	-	-
508 [Err. List-Ax[172R]]	7.3	-	7.3	-	-	-	-	-	-	-
509 [Err. List-Ax[173R]]	-	11.8	-	11.8	-	-	-	-	-	-
510 [Err. List-Ax Virt.]	5.7	5.7	5.7	5.7	-	-	-	-	-	-
511 [Position.Mon. Real:Q17x]	7.6	7.6	-	-	-	-	-	-	-	-
512 [Position.Mon. Virt.:Q17x]	6.7	6.7	-	-	-	-	-	-	-	-
513 [PV History Mon.]	10.6	10.6	10.6	10.6	10.6	10.6	10.6	10.6	10.6	10.6
514 [Servo Monitor]	2.6	2.6	2.6	2.6	-	-	-	-	-	-
515 [Parameter Setting:Q17x]	4.3	4.3	-	-	-	-	-	-	-	-
516 [Parameter Setting:Q17xH/Q17xD]	-	-	3.7	3.7	3.7 ^{*1}	3.7 ^{*1}	-	-	-	-
517 [Parameter Setting:Q17xD(E)/Q170M]	-	-	-	-	3.8 ^{*1}	3.8 ^{*1}	-	-	3.8	3.8
520 [Position.Mon. Real:Q17xH]	-	-	7.7	7.7	-	-	-	-	-	-
521 [Position.Mon. Virt.:Q17xH]	-	-	6.8	6.8	-	-	-	-	-	-
530 [PV Mon. [172] Feed:Q17xD]	-	-	-	-	16.1	-	-	-	-	-
531 [PV Mon. [172] Act.:Q17xD]	-	-	-	-	16.1	-	-	-	-	-
533 [PV Mon. [173] Feed:Q17xD]	-	-	-	-	-	23.8	-	-	-	-
534 [PV Mon. [173] Act.:Q17xD]	-	-	-	-	-	23.8	-	-	-	-
536 [SFC Error History:Q17xD/Q170M]	-	-	-	-	9.7	9.7	-	-	9.7	9.7
537 [Error List Mon.:Q17xD/Q170M]	-	-	-	-	12.9	12.9	-	-	12.9	12.9
538 [Err. List-Ax[172R]:Q17xD]	-	-	-	-	7.3	-	-	-	-	-
539 [Err. List-Ax[173R]:Q17xD]	-	-	-	-	-	11.8	-	-	-	-
540 [Err. List-Ax Virt.:Q17xD/Q170M]	-	-	-	-	5.8	5.8	-	-	5.8	5.8
541 [Position.Mon. Real:Q17xD/Q170M]	-	-	-	-	7.7	7.7	-	-	7.7	7.7
542 [Position.Mon. Virt.:Q17xD/Q170M]	-	-	-	-	6.8	6.8	-	-	6.8	6.8
544 [Servo Monitor:Q17xD/Q170M]	-	-	-	-	2.6	2.6	-	-	2.6	2.6
560 [PV Mon. Feed:Q170M]	-	-	-	-	-	-	-	-	18.7	18.7
561 [PV Mon. Act.:Q170M]	-	-	-	-	-	-	-	-	18.8	18.8
566 [SFC Error History(E):Q17xD/Q170M]	-	-	-	-	10.2	10.2	-	-	10.2	10.2
567 [Error List Mon(E):Q17xD/Q170M]	-	-	-	-	13.4	13.4	-	-	13.4	13.4
568 [Err. List-Ax:Q170M]	-	-	-	-	-	-	-	-	8.7	8.7
570 [PV Mon. [172] Feed:Q17xDS]	-	-	-	-	-	-	19.8	19.8	-	-
571 [PV Mon. [172] Act.:Q17xDS]	-	-	-	-	-	-	19.8	19.8	-	-
573 [PV Mon. [173] Feed:Q17xDS]	-	-	-	-	-	-	24.4	24.4	-	-
574 [PV Mon. [173] Act.:Q17xDS]	-	-	-	-	-	-	24.4	24.4	-	-
576 [SFC Error History:Q17xDS]	-	-	-	-	-	-	10.2	10.2	-	-
577 [Error List Mon.:Q17xDS]	-	-	-	-	-	-	13.4	13.4	-	-

(Continued to next page)

Q motion monitor data	Q motion monitor data capacity (KB)									
	Q172 CPU	Q173 CPU	Q172H CPU	Q173H CPU	Q172D CPU	Q173D CPU	Q172DS CPU	Q173DS CPU	Q170M CPU	Q170MS CPU
578 [Err. List-Ax[172R]:Q17xDS]	-	-	-	-	-	-	8.7	-	-	-
579 [Err. List-Ax[173R]:Q17xDS]	-	-	-	-	-	-	-	11.8	-	-
580 [Err. List-Ax Virt.:Q17xDS]	-	-	-	-	-	-	5.7	5.7	-	-
581 [Position.Mon. Real:Q17xDS]	-	-	-	-	-	-	7.8	7.8	-	-
582 [Position.Mon. Virt.:Q17xDS]	-	-	-	-	-	-	6.9	6.9	-	-
584 [Servo Monitor:Q17xDS]	-	-	-	-	-	-	2.6	2.6	-	-
585 [Parameter Setting:Q17xDS]	-	-	-	-	-	-	3.8	3.8	-	-

*1 Either 516 or 517 can be selected.

(3) GT1675-VN, GT1672-VN, GT1662-VN, GT1575-VN, GT1572-VN, GT1562-VN

Q motion monitor data	Q motion monitor data capacity (KB)									
	Q172 CPU	Q173 CPU	Q172H CPU	Q173H CPU	Q172D CPU	Q173D CPU	Q172DS CPU	Q173DS CPU	Q170M CPU	Q170MS CPU
Common information	40.4	40.4	40.4	40.4	40.4	40.4	40.4	40.4	40.4	40.4
500 [PV Mon. [172] Feed]	14.4	-	14.4	-	-	-	-	-	-	-
501 [PV Mon. [172] Act.]	14.4	-	14.4	-	-	-	-	-	-	-
503 [PV Mon. [173] Feed]	-	21.9	-	21.9	-	-	-	-	-	-
504 [PV Mon. [173] Act.]	-	21.9	-	21.9	-	-	-	-	-	-
506 [SFC Error History]	8.7	8.7	8.7	8.7	-	-	-	-	-	-
507 [Error List Mon.]	11.6	11.6	11.6	11.6	-	-	-	-	-	-
508 [Err. List-Ax[172R]]	5.8	-	5.8	-	-	-	-	-	-	-
509 [Err. List-Ax[173R]]	-	10.3	-	10.3	-	-	-	-	-	-
510 [Err. List-Ax Virt.]	4.2	4.2	4.2	4.2	-	-	-	-	-	-
511 [Position.Mon. Real:Q17x]	6.9	6.9	-	-	-	-	-	-	-	-
512 [Position.Mon. Virt.:Q17x]	6.1	6.1	-	-	-	-	-	-	-	-
513 [PV History Mon.]	9.6	9.6	9.6	9.6	9.6	9.6	9.6	9.6	9.6	9.6
514 [Servo Monitor]	2.1	2.1	2.1	2.1	-	-	-	-	-	-
515 [Parameter Setting:Q17x]	3.9	3.9	-	-	-	-	-	-	-	-
516 [Parameter Setting:Q17xH/Q17xD]	-	-	3.3	3.3	3.3 ^{*1}	3.3 ^{*1}	-	-	-	-
517 [Parameter Setting:Q17xD(E)/Q170M]	-	-	-	-	4.2 ^{*1}	4.2 ^{*1}	-	-	4.2	4.2
520 [Position.Mon. Real:Q17xH]	-	-	7.0	7.0	-	-	-	-	-	-
521 [Position.Mon. Virt.:Q17xH]	-	-	6.2	6.2	-	-	-	-	-	-
530 [PV Mon. [172] Feed:Q17xD]	-	-	-	-	16.2	-	-	-	-	-
531 [PV Mon. [172] Act.:Q17xD]	-	-	-	-	16.2	-	-	-	-	-
533 [PV Mon. [173] Feed:Q17xD]	-	-	-	-	-	23.9	-	-	-	-
534 [PV Mon. [173] Act.:Q17xD]	-	-	-	-	-	23.9	-	-	-	-
536 [SFC Error History:Q17xD/Q170M]	-	-	-	-	10.0	10.0	-	-	10.0	10.0
537 [Error List Mon.:Q17xD/Q170M]	-	-	-	-	13.2	13.2	-	-	13.2	13.2
538 [Err. List-Ax[172R]:Q17xD]	-	-	-	-	7.6	-	-	-	-	-
539 [Err. List-Ax[173R]:Q17xD]	-	-	-	-	-	12.0	-	-	-	-
540 [Err. List-Ax Virt.:Q17xD/Q170M]	-	-	-	-	6.1	6.1	-	-	6.1	6.1
541 [Position.Mon. Real:Q17xD/Q170M]	-	-	-	-	8.0	8.0	-	-	8.0	8.0
542 [Position.Mon. Virt.:Q17xD/Q170M]	-	-	-	-	7.1	7.1	-	-	7.1	7.1

(Continued to next page)

Q motion monitor data	Q motion monitor data capacity (KB)									
	Q172 CPU	Q173 CPU	Q172H CPU	Q173H CPU	Q172D CPU	Q173D CPU	Q172DS CPU	Q173DS CPU	Q170M CPU	Q170MS CPU
544 [Servo Monitor:Q17xD/Q170M]	-	-	-	-	2.8	2.8	-	-	2.8	2.8
560 [PV Mon. Feed:Q170M]	-	-	-	-	-	-	-	-	18.9	18.9
561 [PV Mon. Act.:Q170M]	-	-	-	-	-	-	-	-	18.9	18.9
566 [SFC Error History(E):Q17xD/Q170M]	-	-	-	-	10.5	10.5	-	-	10.5	10.5
567 [Error List Mon(E):Q17xD/Q170M]	-	-	-	-	13.9	13.9	-	-	13.9	13.9
568 [Err. List-Ax:Q170M]	-	-	-	-	-	-	-	-	9.0	9.0
570 [PV Mon. [172] Feed:Q17xDS]	-	-	-	-	-	-	19.9	19.9	-	-
571 [PV Mon. [172] Act.:Q17xDS]	-	-	-	-	-	-	19.9	19.9	-	-
573 [PV Mon. [173] Feed:Q17xDS]	-	-	-	-	-	-	24.6	24.6	-	-
574 [PV Mon. [173] Act.:Q17xDS]	-	-	-	-	-	-	24.6	24.6	-	-
576 [SFC Error History:Q17xDS]	-	-	-	-	-	-	10.5	10.5	-	-
577 [Error List Mon.:Q17xDS]	-	-	-	-	-	-	13.9	13.9	-	-
578 [Err. List-Ax[172R]:Q17xDS]	-	-	-	-	-	-	9.0	-	-	-
579 [Err. List-Ax[173R]:Q17xDS]	-	-	-	-	-	-	-	12.0	-	-
580 [Err. List-Ax Virt.:Q17xDS]	-	-	-	-	-	-	6.1	6.1	-	-
581 [Position.Mon. Real:Q17xDS]	-	-	-	-	-	-	8.1	8.1	-	-
582 [Position.Mon. Virt.:Q17xDS]	-	-	-	-	-	-	7.2	7.2	-	-
584 [Servo Monitor:Q17xDS]	-	-	-	-	-	-	2.8	2.8	-	-
585 [Parameter Setting:Q17xDS]	-	-	-	-	-	-	4.2	4.2	-	-

*1 Either 516 or 517 can be selected.

(4) GT1555-Q, GT1550-Q

Q motion monitor data	Q motion monitor data capacity (KB)									
	Q172 CPU	Q173 CPU	Q172H CPU	Q173H CPU	Q172D CPU	Q173D CPU	Q172DS CPU	Q173DS CPU	Q170M CPU	Q170MS CPU
Common information	20	20	20	20	20	20	20	20	20	20
500 [PV Mon. [172] Feed]	8.2	-	8.2	-	-	-	-	-	-	-
501 [PV Mon. [172] Act.]	8.2	-	8.2	-	-	-	-	-	-	-
503 [PV Mon. [173] Feed]	-	8.8	-	8.8	-	-	-	-	-	-
504 [PV Mon. [173] Act.]	-	8.7	-	8.7	-	-	-	-	-	-
506 [SFC Error History]	5.5	5.5	5.5	5.5	-	-	-	-	-	-
507 [Error List Mon.]	11.8	11.8	11.8	11.8	-	-	-	-	-	-
508 [Err. List-Ax. Real]	3.4	-	3.4	-	-	-	-	-	-	-
509 [Err. List-Ax. Virt]	4.9	4.9	4.9	4.9	-	-	-	-	-	-
511 [Position.Mon. Real]	3.4	3.4	3.4	3.4	-	-	-	-	-	-
512 [Position.Mon. Virt.]	4.0	4.0	4.0	4.0	-	-	-	-	-	-
514 [Servo Monitor]	2.1	2.1	2.1	2.1	-	-	-	-	-	-
515 [Parameter Setting:Q17x]	3.7	3.7	-	-	-	-	-	-	-	-
516 [Parameter Setting:Q17xH/Q17xD]	-	-	3.1	3.1	3.1 ^{*1}	3.1 ^{*1}	-	-	-	-
517 [Parameter Setting:Q17xD(E)/Q170M]	-	-	-	-	3.3 ^{*1}	3.3 ^{*1}	-	-	3.3	3.3
530 [PV Mon. [172] Feed:Q17xD]	-	-	-	-	8.3	-	-	-	-	-
531 [PV Mon. [172] Act.:Q17xD]	-	-	-	-	8.3	-	-	-	-	-
533 [PV Mon. [173] Feed:Q17xD]	-	-	-	-	-	8.8	-	-	-	-

(Continued to next page)

Q motion monitor data	Q motion monitor data capacity (KB)									
	Q172 CPU	Q173 CPU	Q172H CPU	Q173H CPU	Q172D CPU	Q173D CPU	Q172DS CPU	Q173DS CPU	Q170M CPU	Q170MS CPU
534 [PV Mon. [173] Act.:Q17xD]	-	-	-	-	-	8.8	-	-	-	-
536 [SFC Error History:Q17xD/Q170M]	-	-	-	-	5.7	5.7	-	-	5.7	5.7
537 [Error List Mon.:Q17xD/Q170M]	-	-	-	-	11.8	11.8	-	-	11.8	11.8
538 [Err. List-Ax. Real:Q17xD/Q170M]	-	-	-	-	3.4	3.4	-	-	3.4	3.4
539 [Err. List-Ax Virt.:Q17xD/Q170M]	-	-	-	-	4.9	4.9	-	-	4.9	4.9
541 [Position.Mon. Real:Q17xD/Q170M]	-	-	-	-	3.4	3.4	-	-	8.0	8.0
542 [Position.Mon. Virt.:Q17xD/Q170M]	-	-	-	-	4.0	4.0	-	-	4.0	4.0
544 [Servo Monitor:Q17xD/Q170M]	-	-	-	-	2.1	2.1	-	-	2.1	2.1
560 [PV Mon. Feed:Q170M]	-	-	-	-	-	-	-	-	8.8	8.8
561 [PV Mon. Act.:Q170M]	-	-	-	-	-	-	-	-	8.8	8.8
566 [SFC Error History(E):Q17xD/Q170M]	-	-	-	-	5.7	5.7	-	-	5.7	5.7
567 [Error List Mon(E):Q17xD/Q170M]	-	-	-	-	12.3	12.3	-	-	12.3	12.3
570 [PV Mon. [172] Feed:Q17xDS]	-	-	-	-	-	-	8.8	-	-	-
571 [PV Mon. [172] Act.:Q17xDS]	-	-	-	-	-	-	8.8	-	-	-
573 [PV Mon. [173] Feed:Q17xDS]	-	-	-	-	-	-	-	8.8	-	-
574 [PV Mon. [173] Act.:Q17xDS]	-	-	-	-	-	-	-	8.8	-	-
576 [SFC Error History:Q17xDS]	-	-	-	-	-	-	5.7	5.7	-	-
577 [Error List Mon.:Q17xDS]	-	-	-	-	-	-	12.3	12.3	-	-
578 [Err. List-Ax. Real:Q17xDS]	-	-	-	-	-	-	3.4	-	-	-
579 [Err. List-Ax[173R]:Q17xDS]	-	-	-	-	-	-	-	4.9	-	-
581 [Position.Mon. Real:Q17xDS]	-	-	-	-	-	-	3.4	3.4	-	-
582 [Position.Mon. Virt.:Q17xDS]	-	-	-	-	-	-	4.0	4.0	-	-
584 [Servo Monitor:Q17xDS]	-	-	-	-	-	-	2.1	2.1	-	-
585 [Parameter Setting:Q17xDS]	-	-	-	-	-	-	3.3	3.3	-	-

*1 Either 516 or 517 can be selected.

■ Servo amplifiers whose parameter can be set

The Q motion monitor allows you to set the parameter of servo amplifiers shown below.

Motion controller CPU	Servo amplifier
Q172CPU, Q173CPU	MR-H-B, MR-J-B, MR-J2-B, MR-J2S-B, MR-J2M, MR-J2-03B5
Q172HCPU, Q173HCPU	MR-J3-B, MR-J3-BS, MR-J3W-B, MR-J3-B-RJ006, MR-J3-B-RJ004
Q172DCPU, Q173DCPU, Q170MCP	MR-J3-B, MR-J3-BS, MR-J3W-B, MR-J3-B-RJ006, MR-J3-B-RJ004, MR-J3-B-RJ080W
Q172DSCPU, Q173DSCPU, Q170MSCPU	MR-J3-B, MR-J3-BS, MR-J3W-B, MR-J3-B-RJ006, MR-J3-B-RJ004, MR-J3-B-RJ080W, MR-J4-B, MR-J4W-B

1 OVERVIEW
2 SYSTEM MONITOR
3 LADDER MONITOR FUNCTION
4 MELSEC-A LIST EDITOR
5 MELSEC-FX LIST EDITOR
6 INTELLIGENT MODULE MONITOR
7 NETWORK MONITOR
8 Q MOTION MONITOR

8.2.2 Access range

For the MELSECNET/H, MELSECNET/10, and CC-Link IE controller network connections, the GOT can monitor the motion controller CPU on the control station only.

In CC-Link connection (Intelligent device station), only the motion controller CPU in master station can be monitored.

In Ethernet connection, only the motion controller CPU in host station can be monitored.

The access range other than that mentioned above is the same as the access range when the GOT is connected to a controller.

For details of the access range, refer to the following.

 GOT1000 Series Connection Manual (Mitsubishi Products) for GT Works3

8.2.3 Precautions

(1) Main OS software package for motion controller

The only Main OS software package that can be used is SV13 or SV22.

(2) When using GT1555-Q and GT1550-Q

The present value history monitor is not supported.

(3) When setting parameters for Q172HCPU or Q173HCPU

When setting parameters for Q172HCPU or Q173HCPU, after parameter entry, set the switch on the CPU to STOP and RUN again, or reset the CPU.

8.3 Operations for Display

This section describes the flow until the Q motion monitor operation screen is displayed after the Q motion monitor (Option OS) is installed in the GOT.

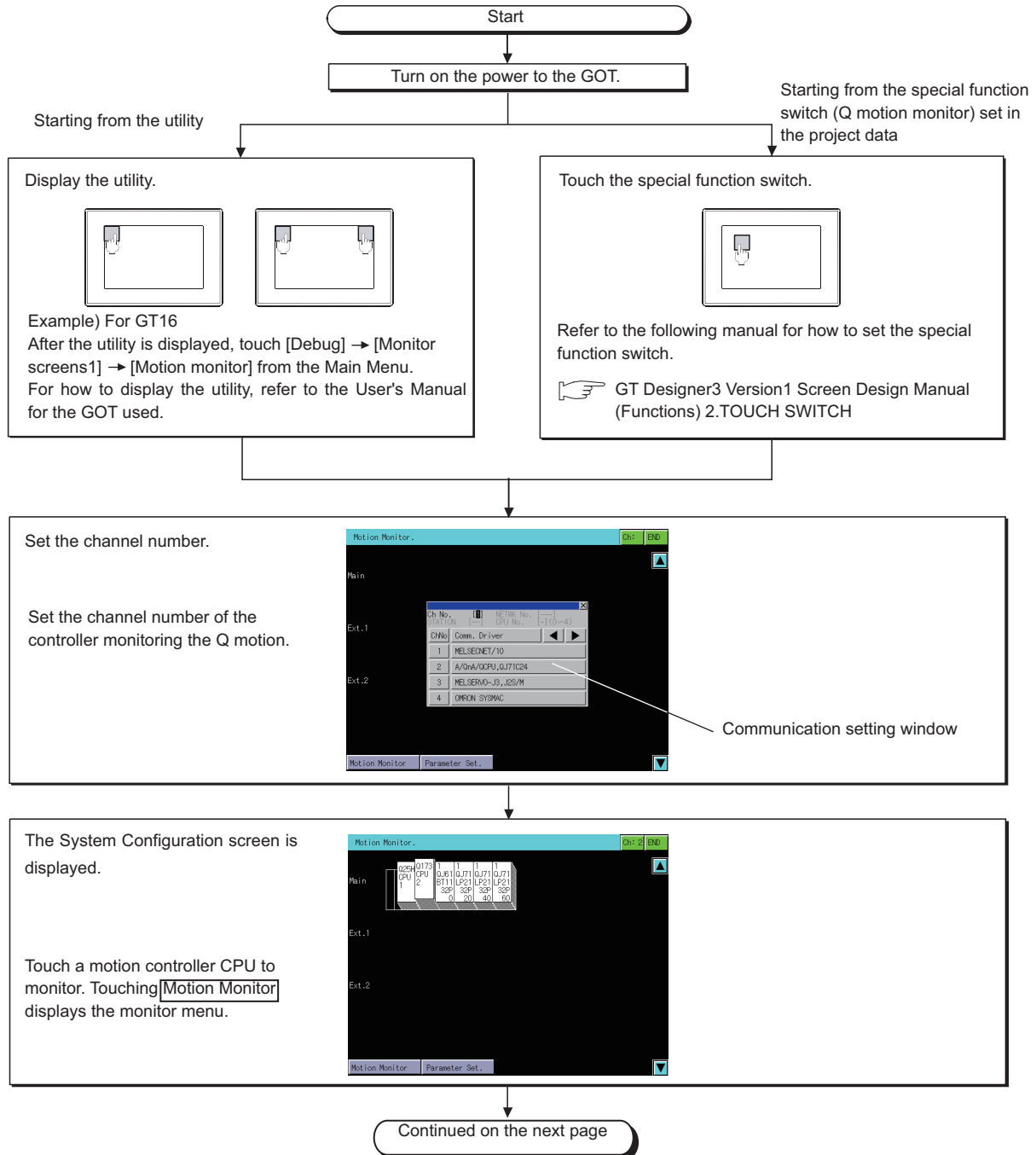

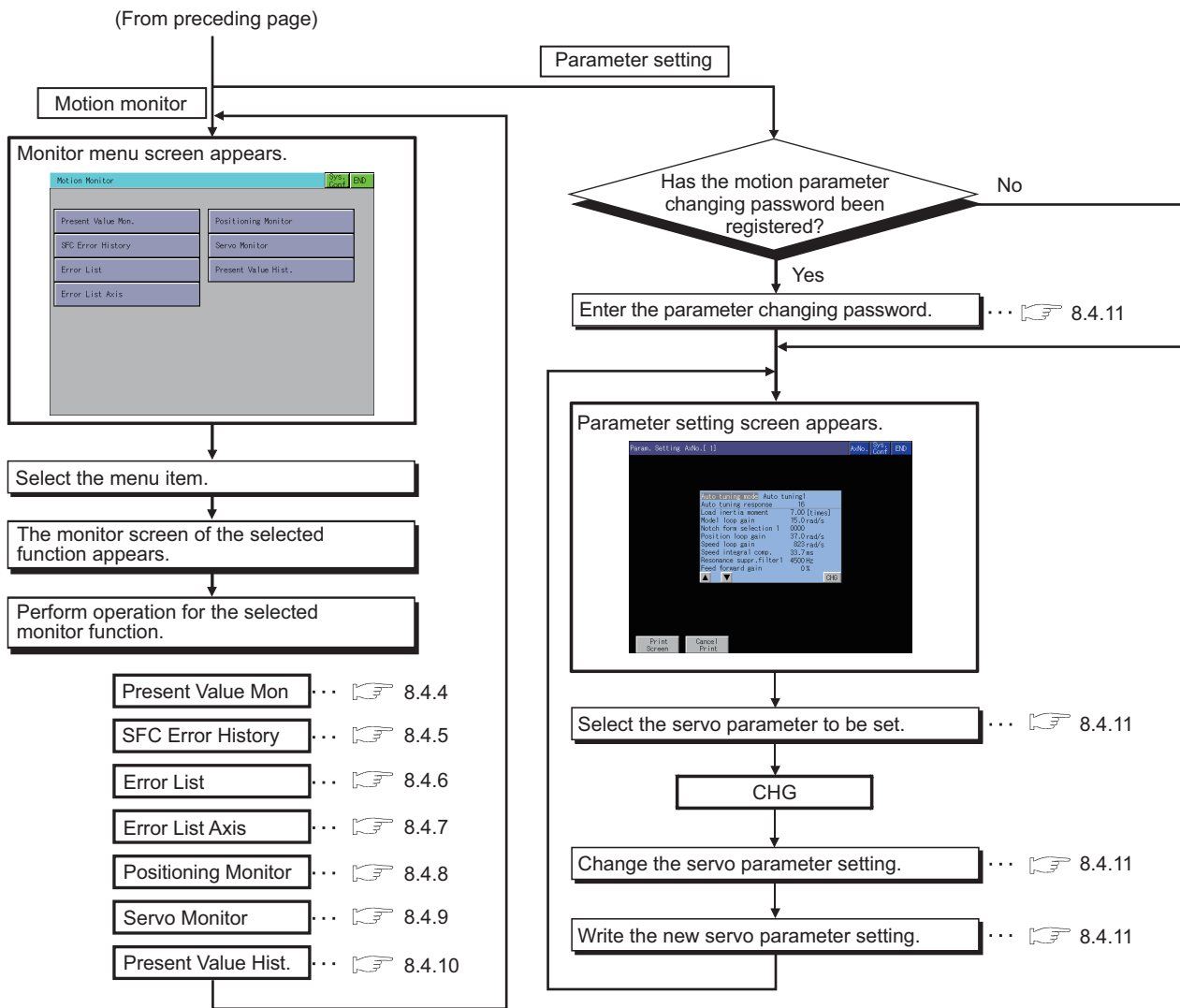

POINT

(1) How to display the utility

For how to display the utility, refer to the following.

User's Manual for the GOT used

(2) Displaying communication setting window

After turning on the GOT, the communication setting window is displayed at the first startup of the Q motion monitor only.

For displaying the communication setting window at the second or later startup, touch the Ch: button on the Q motion monitor screen. (8.4 Operation Procedures)

(3) If the project data has not been downloaded

The Q motion monitor can be started from the utility even if the project data has not been downloaded to the GOT.

■ Changing screens

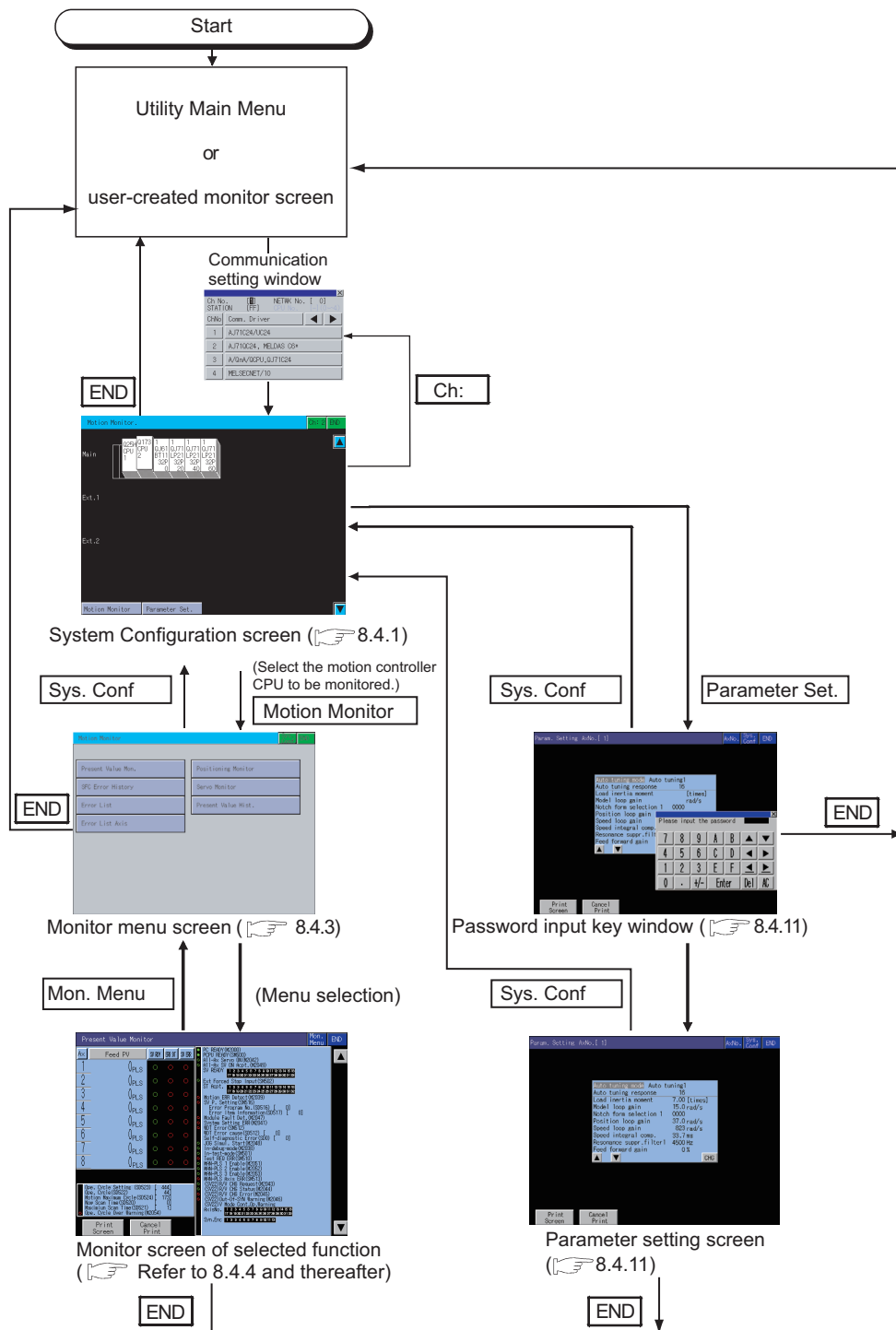

HINT

Screen displayed at next startup

At next startup, the last exited screen is displayed.

However, the last exited screen will not be displayed when the GOT is restarted due to an installation of the OS, turning the GOT power from off to on, or a reset.

8.4 Operation Procedures

This section explains screen operations to be performed when using the Q motion monitor.
 The display screen of the Q motion monitor varies slightly with the GOT used.
 This section mainly uses the screen of the GT1575-V for explanation.

8.4.1 System configuration screen layout

This section describes the configuration of the System Configuration screen that is displayed after startup of the Q motion monitor and the functions of the keys displayed on the screen.









■ Displayed contents

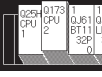

No.	Description
1)	The CPU numbers are displayed for CPUs and the control CPU number for the installed module. To choose the motion controller CPU for servo monitor/servo parameter setting, touch the respective display position.
2)	Displays the keys used with the operation on the System Configuration screen.(Touch input)

■ Key functions

The table below shows the functions of the keys that are used for the operation on the System Configuration screen.

Key	Function
	Displays the communication setting window.
	Exits the monitor and returns to the screen where the Q motion monitor was started.
	Selects the motion controller CPU where servo monitor/servo parameter setting is performed.
	Changes the System Configuration screen to the monitor menu screen. (☞ 8.4.3 Monitor Menu screen)
	Changes the System Configuration screen to parameter setting screen. (☞ 8.4.11 Parameter setting screen)
	Scrolls the display one stage up or down to display the system configuration of the currently undisplayed stage immediately before/after the currently displayed stage.  : Scrolls down one stage.  : Scrolls up one stage.

8.4.2 Setting method for other station monitoring

The following shows the setting methods for monitoring other stations with Q motion monitor.

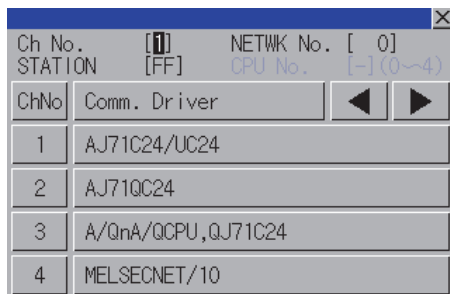

1. In the communication setting window, select one from channels No.1 to 4.
For the operation on the communication setting screen, refer to the following.
 (1) Communication setting window
2. When the channel No. is selected, the screen on the left is displayed.
Set the network number of the target controller and the CPU station number.
3. After selecting the station number, touch the enter key. The communication setting window closes and the system configuration of the set monitor destination is displayed.

(1) Communication setting window

(a) Displayed screen

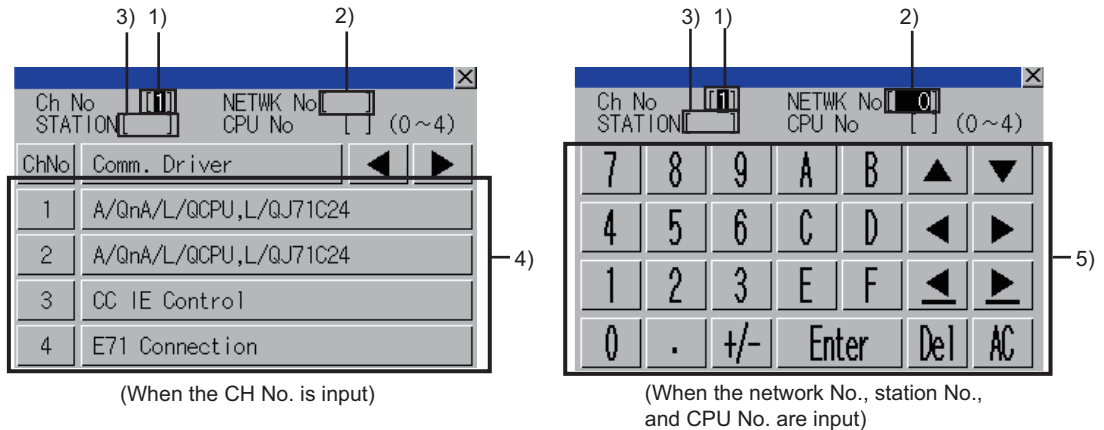

The following table shows the displayed contents.

No.	Item	Description	Setting range
1)	CH No. input area	Set the CH No. for the target controller.	1 to 4
2)	Network No. input area	Set the network No. for the target controller.	Differs depending on the connection type. <ul style="list-style-type: none"> • Bus connection, direct CPU connection, computer link connection: 0 • Ethernet connection, CC-Link IE controller network connection: 1 to 239 • MELSECNET/H, MELSECNET/10: 0 (host loop) / 1 to 255 (specified loop) • CC-Link (ID/G4) connection: 0
3)	Station No. input area	Set the station No. of the target controller. When the station No. is set to the host station (FF), set the network No. to 0.	Differs depending on the connection type. <ul style="list-style-type: none"> • Bus connection, direct CPU connection, computer link connection: FF (host station) • Ethernet connection: 1 to 64 • MELSECNET/H, MELSECNET/10: 0 (master station) / 1 to 64 (local station) • CC-Link IE controller network connection: 1 to 120 • CC-Link (ID/G4) connection: 0 (master station) / 1 to 64 (local station)
4)	CH No. selection key	Select a CH No.	-
5)	Keys	Keys for operations in the communication setting window shown in (b). (Touch input)	-

(b) Key functions

Key	Function
	Closes the communication setting window. When any of the CH No., network No., station No., and CPU No. is not input and the monitor target is not set, the communication setting window does not close.
	Moves the cursor among the input areas.
	Deletes all the input values and characters.
	Deletes an input value or character.
	Moves the cursor when the cursor is in the CH No. input area, network No. input area, or station No. input area. When the cursor is in the CPU No. input area and settings for the CH No., network No., and station No. are completed, the communication setting window closes and the PLC read screen appears.

8.4.3 Monitor Menu screen

The Q motion monitor allows you to monitor various servo monitor data on multiple monitor screens. To display any of the monitor screens, make a selection on the monitor menu screen.

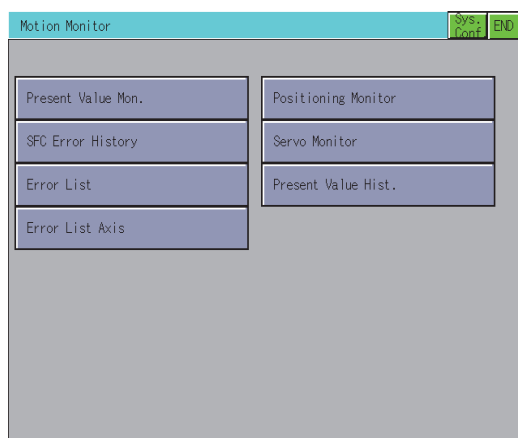

Item	Description
Present Value Mon.	Monitors and displays the feed current values and actual current values of all running axes. (☞ 8.4.4 Present Value Monitor screen)
SFC Error History	Displays the history of errors that occurred in SFC programs from when the motion CPU was powered on or reset. (☞ 8.4.5 SFC Error History screen)
Error List	Displays the history of errors that occurred on and after the leading edge of PLC ready (M2000). (☞ 8.4.6 Error List screen)
Error List Axis	Displays the latest errors that occurred on the specified axis. (☞ 8.4.7 Error List Designated-Axis screen)
Positioning Monitor	Monitors the details of the positioning data set to any axis. (☞ 8.4.8 Positioning Monitor screen)
Servo Monitor	Monitors the servo monitor/servo amplifier. (☞ 8.4.9 Servo Monitor screen)
Present Value Hist.	Displays the history of encoder present values, servo command values and monitor present values of the ABS axis at servo amplifier power-on/off or at home position return. (☞ 8.4.10 Present Value History Monitor screen) Not displayed when using the GT1550-Q or GT1555-Q.

8.4.4 Present Value Monitor screen

This section describes the display data of the Present Value Monitor screen and the key functions displayed on the screen.

■ Displayed contents

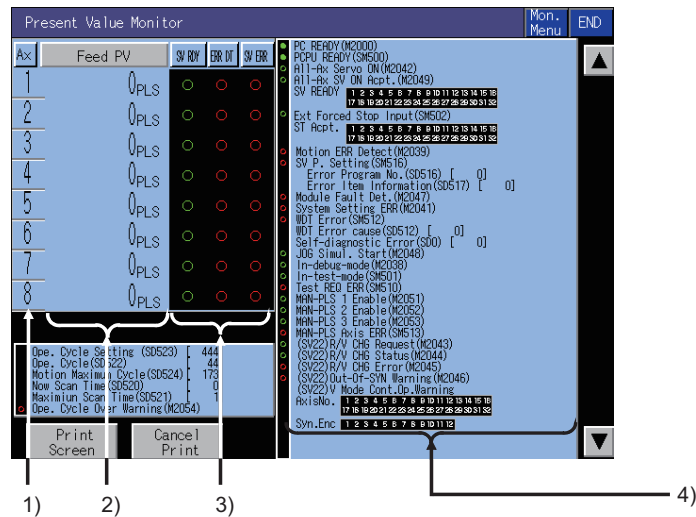

No.	Item	Function
1)	Ax	The axis numbers of the running axes being monitored are displayed.
2)	Feed PV/Actual PV	The feed present values or actual present values of the running axes are displayed. Touching the display part of the monitored value switches to the positioning monitor screen of the touched axis number. (☞ 8.4.8 Positioning Monitor screen)
3)	SV RDY, ERR DT, SV ERR	Whether the servo ready signals, major/minor errors and servo error detection signals are ON (lit) or OFF (not lit) are displayed. Touching the error indication part "●" switches to the Error List Designated-Axis screen of the touched axis number. (☞ 8.4.7 Error List Designated-Axis screen)
4)	Bit device screen	The common bit devices are always monitored and displayed. <ul style="list-style-type: none"> • Error detection type bit devices Displayed in red • General status type bit devices Displayed in green

■ Key functions

The table below shows the functions of the keys used for operation of the Present Value Monitor screen.

Key	Function
<div style="border: 1px solid gray; padding: 2px; display: inline-block;">Feed PV</div> / <div style="border: 1px solid gray; padding: 2px; display: inline-block;">Actual PV</div>	Touching the key alternates the monitor item between the "feed present value" and "actual present value". (Only in the real mode)
<div style="border: 1px solid blue; padding: 2px; display: inline-block;">Mon. Menu</div>	Returns to the monitor menu screen.
<div style="border: 1px solid blue; padding: 2px; display: inline-block;">END</div>	Exits the present value monitor and returns to the screen where the Q motion monitor was started.
▲ ▼	Switches the displayed axis number. (Displayed only for Q173CPU, Q173HCPU, Q173DCPU, Q170MCPU, Q172DCPU, and Q173DCPU monitoring.)
<div style="border: 1px solid gray; padding: 2px; display: inline-block;">Print Screen</div>	Stores the displayed screen to the memory card in BMP/JPEG file format or prints it with a printer. For further information about hard copies, refer to the following: (☞ 8.4.12 Hard copy output)
<div style="border: 1px solid gray; padding: 2px; display: inline-block;">Cancel Print</div>	The operation of this key is invalid.

8.4.5 SFC Error History screen

This section describes the display data of the SFC Error History screen and the key functions displayed on the screen.

■ Displayed contents

SFC Error History screen displays the history of error which occurs in the motion SFC programs.

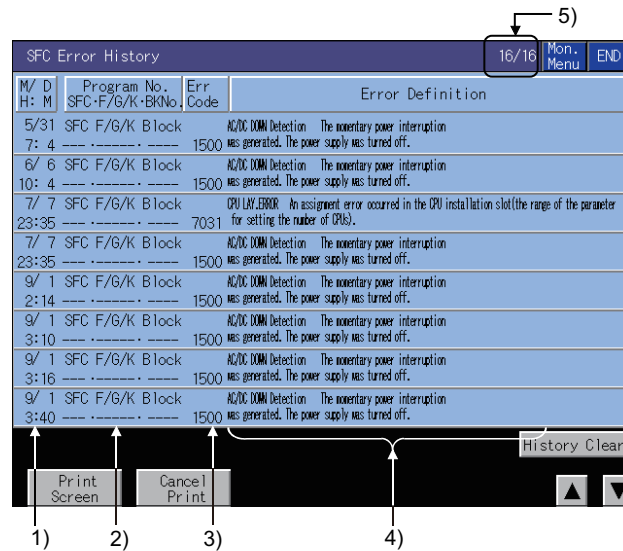

No.	Item	Description
1)	M/D H:M	Displays the dates and time when SFC errors occurred. The eight latest errors are displayed for the history of errors. The 128 errors are displayed for Q172DCPU, Q173DCPU, Q170MCP, Q172DSCPU, and Q173DSCPU.
2)	Program No.	Displays the SFC program numbers where SFC errors occurred.
3)	Err Code	Displays the error codes of the errors that occurred.
4)	Error Definition	Displays the definitions of the SFC errors that occurred.
5)	Page	Displays the page number and the total number of pages of the SFC error history. (Only with Q172DCPU, Q173DCPU, Q170MCP, Q172DSCPU, and Q173DSCPU)

■ Key functions

The table below shows the functions of the keys used for operation of the SFC Error History screen.

Key	Function
	Returns to the monitor menu screen.
	Exits the SFC Error History screen and returns to the screen where the Q motion monitor was started.
	Stores the displayed screen to the memory card in BMP/JPEG file format or prints it with a printer. For further information about hard copies, refer to the following: (8.4.12 Hard copy output)
	The operation of this key is invalid.
	Clears the error history. (Only with Q172DCPU, Q173DCPU, Q170MCP, Q172DSCPU, and Q173DSCPU)
	Scrolls the history display up and down by eight histories when the SFC error history is displayed. (by four histories for QVGA) (Only with Q172DCPU, Q173DCPU, Q170MCP, Q172DSCPU, and Q173DSCPU)

8.4.6 Error List screen

This section describes the display data of the Error List screen and the key functions displayed on the screen.

■ Displayed contents



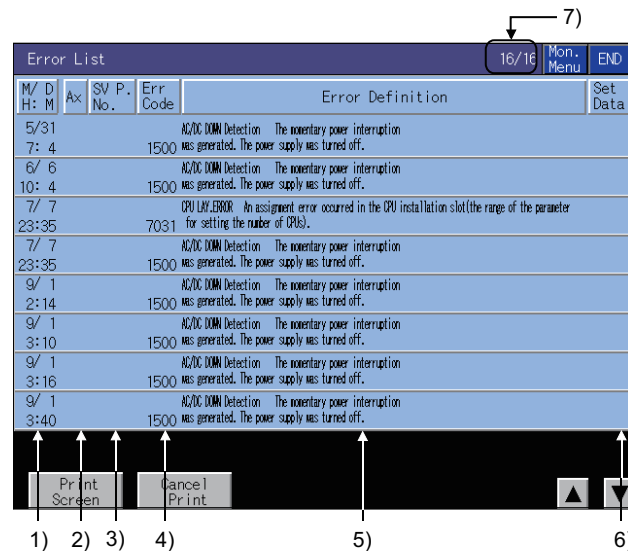



The error list screen displays the error which occurs in the motion controller CPU.
(Errors occurred in motion SFC programs are also displayed.)



No.	Item	Description
1)	M/D H:M	The dates and time when errors occurred are displayed. The eight latest errors are displayed. The 128 errors are displayed for Q172DCPU, Q173DCPU, Q170MCP, Q172DSCPU, and Q173DSCPU.
2)	Ax	The axis numbers and axis types of the axes where errors occurred are displayed. Virtual axis : Virtual Synchronous encoder axis : Sync
3)	SV P. No.	The servo program numbers that were being executed when the error occurred are displayed. The execution destination of the servo program in error is not displayed.Using the servo program number, refer to the execution destination.
4)	Err Code	Displays the types and error codes of the errors that occurred. The error types are displayed as indicated below. <ul style="list-style-type: none"> • Minor error Minor • Major error Major • Servo error Servo • Servo program setting error Servo P • Real/virtual switching Switch • Test mode request error Test • Manual pulse generator setting error Manual • PCPU ERROR P-WDT • SSCNET ERROR Communication error
5)	Error Definition	The definitions of the errors that occurred are displayed.
6)	Set Data	The program number in error is displayed if the set data has any errors.
7)	Page	Displays the page number and the total number of pages of the error list. (Only with Q172DCPU, Q173DCPU, Q170MCP, Q172DSCPU, and Q173DSCPU)

■ Key functions

The table below shows the functions of the keys that are used for the operation on the Error List screen.

Key	Function
	Returns to the monitor menu screen.
	Exits the Error List screen and returns to the screen where the Q motion monitor was started.
	Stores the displayed screen to the memory card in BMP/JPEG file format or prints it with a printer. For further information about hard copies, refer to the following:  8.4.12 Hard copy output
	The touch operation of this key is invalid.
	Scrolls the history display up and down by eight histories when the error list is displayed. (Only with Q172DCPU, Q173DCPU, Q170MCP, Q172DSCPU, and Q173DSCPU)

8.4.7 Error List Designated-Axis screen

This section describes the display data of the Error List Designated-Axis screen and the key functions displayed on the screen.



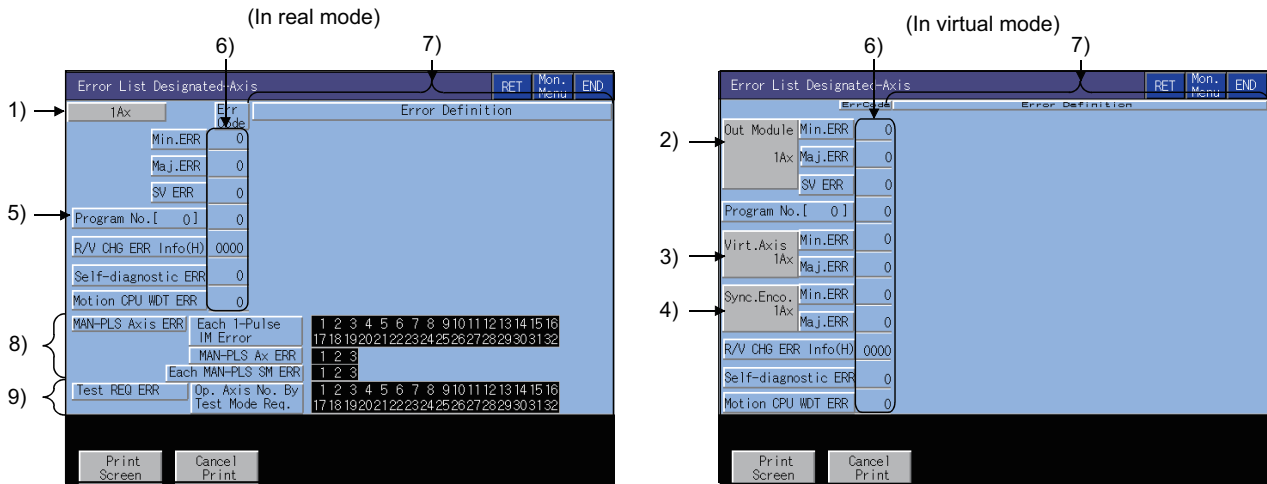







■ Displayed contents



No.	Item	Description	
1)	Axis No.	Displays the axis number currently being monitored.	
2)	Out Module	Displays the output module axis number currently being monitored.	
3)	Virt. Axis	Displays the virtual axis number currently being monitored.	
4)	Sync. Enco.	Displays the synchronous encoder axis number currently being monitored.	
5)	Program No.	Displays the servo program numbers that were being executed when the error occurred.	
6)	Err Code	Displays the error codes of the minor/major/servo error, servo program setting error, real/virtual switching error information (error code: hexadecimal), personal computer link communication error code and motion CPU WDT error that are currently occurring.	
7)	Error Definition	Displays the definitions of the errors that occurred.	
8)	MAN-PLS Axis ERR	Each 1-Pulse 1M Error	Displays the axes where a 1-pulse input magnification setting error occurred.
		MAN-PLS Ax ERR	Displays the errors of the axis numbers set to the manual pulse generators P1 to P3.
		Each MAN-PLS SM ERR	Displays the errors of the smoothing magnifications set to the manual pulse generators P1 to P3.
9)	Test REQ ERR	Displays the axis numbers that are being started at a test mode request.	

■ Key functions

The table below shows the functions of the keys that are used for the operation of the Error List Designated-Axis screen.

Key	Function
 (Only in the real mode)  /  /  (Only in the virtual mode) (Display example: When axis 1 is monitored)	Switches the axes to be monitored.
	Returns to the previous screen.
	Returns to the monitor menu screen.
	Exits the Error List Designated-Axis monitor screen and returns to the screen where the Q motion monitor was started.
	Stores the displayed screen to the memory card in BMP/JPEG file format or prints it with a printer. For further information about hard copies, refer to the following:  8.4.12 Hard copy output
	The touch operation of this key is invalid.

8.4.8 Positioning Monitor screen

This section describes the display data of the Positioning Monitor screen and the key functions displayed on the screen.



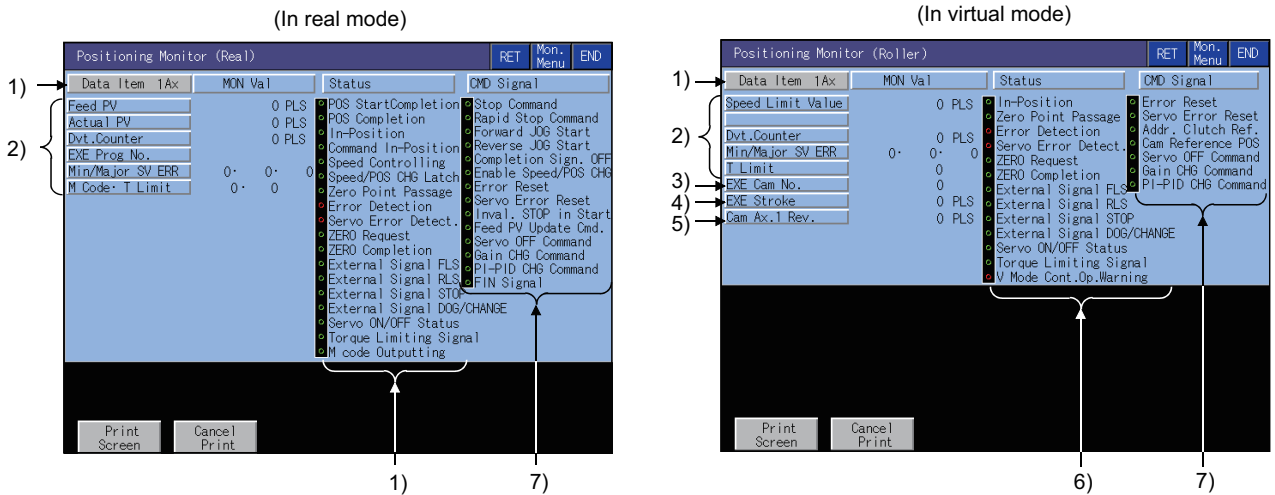



■ Displayed contents



No.	Item	Description
1)	Data Item	Displays the axis numbers of the running axes being monitored. For the virtual axis, the axis type is displayed. <ul style="list-style-type: none"> • Roller • Ballscrew • Rotary table • Cam
2)	Feed PV	Displays the data during positioning control of the PCPU. <ul style="list-style-type: none"> • Feed PV : Target address output to the servo amplifier (value of the roller surface speed for the roller axis) • Actual PV : Actually traveled present value (no value is displayed for the roller axis) • Dvt. Counter : Difference between feed present value and actual present value • EXE Prog No. : Servo program number in execution • Min/Major SV ERR : rror code of the latest minor/major/servo error • M Code • T Limit : The M code and torque limit of the servo program in execution
3)	EXE Cam No.	Displays the cam number currently controlled.
4)	EXE Stroke	Displays the stroke amount currently controlled.
5)	Cam Ax. 1 Rev.	Displays the present value within one cam axis revolution pulse.
6)	Status	Displays ON and OFF of the symbols that represent the axis-by-axis control statuses. <ul style="list-style-type: none"> • In the ON status, the symbol is lit green. • At error or servo error detection, the symbol is lit red.
7)	CMD Signal	Displays ON and OFF of the positioning command signals. In the ON status, the signal is lit green.

■ Key functions

The table below shows the functions of the keys used for operation of the positioning monitor screen.

Key	Function
 (Display example: When axis 1 is monitored)	Changes the axes to be monitored.
	Returns to the previous screen.
	Returns to the monitor menu screen.
	Exits the positioning monitor and returns to the screen where the Q motion monitor was started.
	Stores the displayed screen to the memory card in BMP/JPEG file format or prints it with a printer. For further information about hard copies, refer to the following:  8.4.12 Hard copy output
	The operation of this key is invalid.

8.4.9 Servo Monitor screen

This section describes the display data of the Servo Monitor screen and the key functions displayed on the screen.



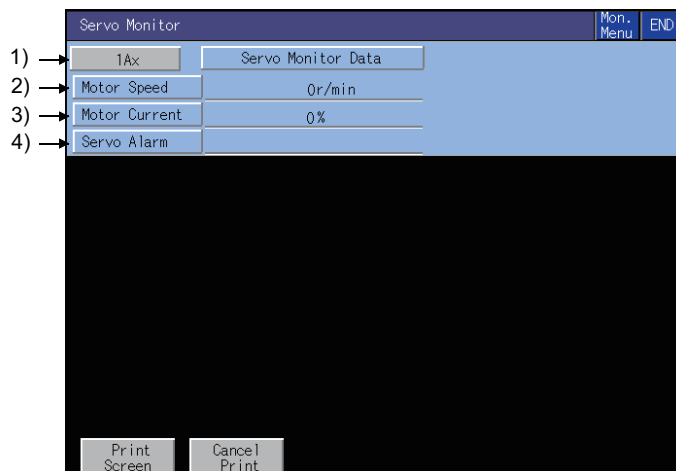



■ Displayed contents



No.	Item	Description
1)	Ax	Displays the axis number currently being monitored.
2)	Motor Speed	Displays the actual speed of the servo motor.
3)	Motor Current	Displays the motor current value at the rated current of 100%.
4)	Servo Alarm	Displays the alarm detected by the servo amplifier.

■ Key functions

The table below shows the functions of the keys that are used for operation of the servo monitor screen.

Key	Function
 (Display example: When axis 1 is monitored)	Changes the axes to be monitored.
	Returns to the monitor menu screen.
	Exits the servo monitoring and returns to the screen where the Q motion monitor was started.
	Stores the displayed screen to the memory card in BMP/JPEG file format or prints it with a printer. For further information about hard copies, refer to the following:  8.4.12 Hard copy output
	The operation of this key is invalid.

8.4.10 Present Value History Monitor screen

This section describes the display data of the Present Value History Monitor screen and the key functions displayed on the screen.







■ Displayed contents

Item	M/ D H: M	Encoder PV Multi Rev/1Rev	SV CMD Val	Monitor PV	ALM
HP Data	0/ 0 0: 0	OH· OH	OH	0	----
MON Val	2/24 13:32	OH· OH	OH	0.0000	----
Nw PWR ON1	2/24 12:47	OH· OH	OH	0.0000	0
PWR OFF1	2/24 12:47	OH· OH	OH	0.0000	----
PWR ON2	2/24 12:46	OH· OH	OH	0.0000	0
PWR OFF2	2/24 12: 1	OH· OH	OH	0.0000	----
PWR ON3	2/24 11:57	OH· OH	OH	0.0000	0
PWR OFF3	2/24 11:57	OH· OH	OH	0.0000	----
Od PWR ON4	2/24 11:54	OH· OH	OH	0.0000	0

No.	Item	Description
1)	Ax	Displays the axis number of the axis currently being monitored.
2)	HP Data	Displays the following values monitored at home position return. <ul style="list-style-type: none"> • Home position return completion time • Encoder present value <ul style="list-style-type: none"> Multi-revolution data of absolute position reference point data Within-one-revolution position of absolute position reference point data • Servo command value • Monitor present value
3)	MON Val	Displays the following present monitor values. <ul style="list-style-type: none"> • Present time • Encoder present value <ul style="list-style-type: none"> Present multi-revolution data of encoder present value Present within-one-revolution position of encoder present value • Present servo command value • Present monitor present value
4)	PWR ON/PWR OFF	Displays the four past present values of the ABS axis at servo amplifier power-on/off. <p>[At power-on]</p> <ul style="list-style-type: none"> • Power-on time • Encoder present value <ul style="list-style-type: none"> Multi-revolution data of initial encoder Single-revolution data of initial encoder • Servo command value after recovery • Monitor present value after recovery • Alarm occurrence information at present value recovery (error code of minor/major error) <p>[At power-off]</p> <ul style="list-style-type: none"> • Servo amplifier power-off time • Encoder present value <ul style="list-style-type: none"> Multi-revolution data of encoder present value before servo amplifier power-off Single-revolution data of encoder present value before servo amplifier power-off • Servo command at servo amplifier power-off • Monitor present value at servo amplifier power-off

■ Key functions

The table below shows the functions of the keys used for operation of the Present Value History Monitor screen.

Key	Function
 (Display example: When axis 1 is monitored)	Changes the axes to be monitored.
	Returns to the monitor menu screen.
	Exits the Present Value History Monitor screen and returns to the screen where the Q motion monitor was started.
	Stores the displayed screen to the memory card in BMP/JPEG file format or prints it with a printer. For further information about hard copies, refer to the following:  8.4.12 Hard copy output
	The touch operation of this key is invalid.

8.4.11 Parameter setting screen

You can set the servo parameters (basic parameters/adjustment parameters) of the connected motion controller CPU. This section describes the display data of the parameter setting screen and the key functions displayed on the screen.

■ Displayed screen

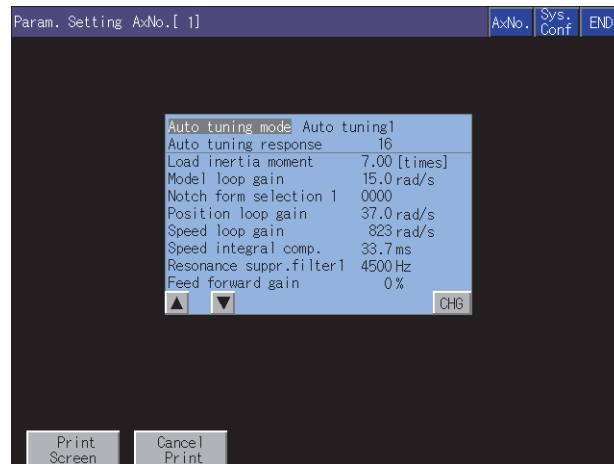

■ Key functions

The table below shows the functions of the keys that are used with the operation on the parameter setting screen.

Key	Function
	Changes the servo parameter setting of the selected item.
	Selects the servo parameter setting item.
	Changes the axis whose parameter setting will be made.
	Returns to the System Configuration screen.
	Exits the parameter setting and returns to the screen where the Q motion monitor was started.
	Stores the displayed screen to the memory card in BMP/JPEG file format or prints it with a printer. For further information about hard copies, refer to the following: 8.4.12 Hard copy output
	The touch operation of this key is invalid.

■ Inputting the password

The password input key window appears for accessing the parameter setting screen when the password setting data for changing motion parameters is written to the GOT with GT Designer3.

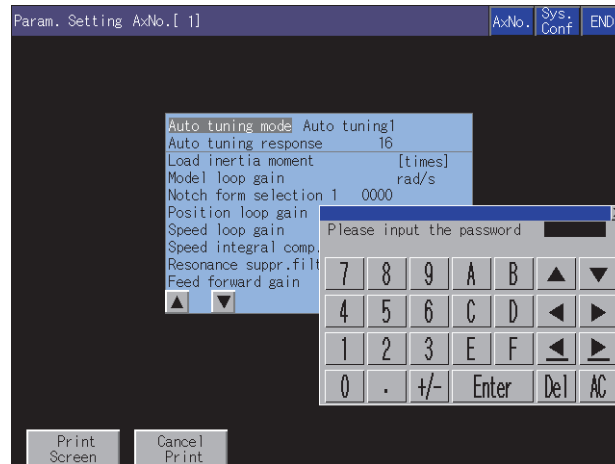

(1) Function

- If the password matches, the parameter setting screen is displayed.
- If the password does not match, an error message is displayed. Touching **Sys. Conf** returns to the System Configuration screen.
- Only numbers and letters A to F can be used for the password setting. (Up to 8 characters)
- The password for changing the motion parameters is set with GT Designer3.
For details of the setting password, refer to the following.

👉 GT Designer3 Version1 Screen Design Manual (Fundamentals) 4.7 Security Setting

(2) Operations

- (a) Inputting the password
Touch the key window and enter a password.
After entering the password, touch **Enter** to set the password.
To edit the input characters, touch **Del** to delete the characters, and then input the new characters.
- (b) Canceling password input
Touch **✕** to return to the monitor screen.

Parameter setting operation

The following describes the procedure of changing the setting of the [Auto Tuning] item as an example of the parameter setting operation.

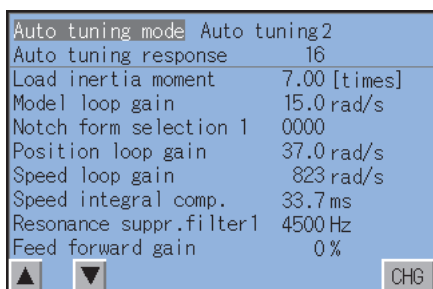
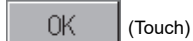
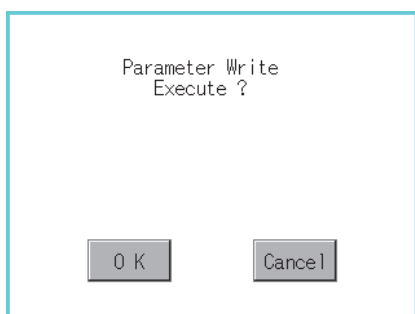
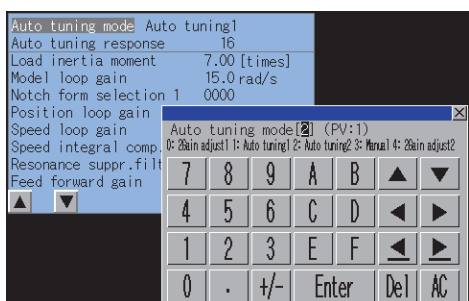
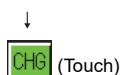
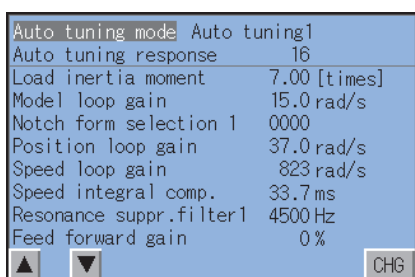

1. Select the item whose parameter is to be set with the **▲**, **▼** keys, and touch the **CHG** key.

2. As the parameter setting window appears, enter the parameter setting with **Alphanumeric**, and touch **Enter** to confirm the setting.

To cancel the parameter setting operation, touch **✕** at the top right of the screen to close the parameter setting window.

3. As the confirmation window appears, touch **OK** to write the parameter setting to the motion controller CPU. To cancel writing of the parameter setting, touch **Cancel**.

4. After writing is completed, the parameter setting screen whose display has been updated to the new parameter setting is displayed.

8.4.12 Hard copy output

This section describes how to store a screen to the memory card in BMP/JPEG file format or print it with a printer when executing the Q motion monitor.

Hard copy methods differ depending on the GOT to be used.

(1) GOT with VGA or higher resolution

Hard copy output operations are performed by touching the "Print Screen" or "Cancel Print" key displayed on the screen.

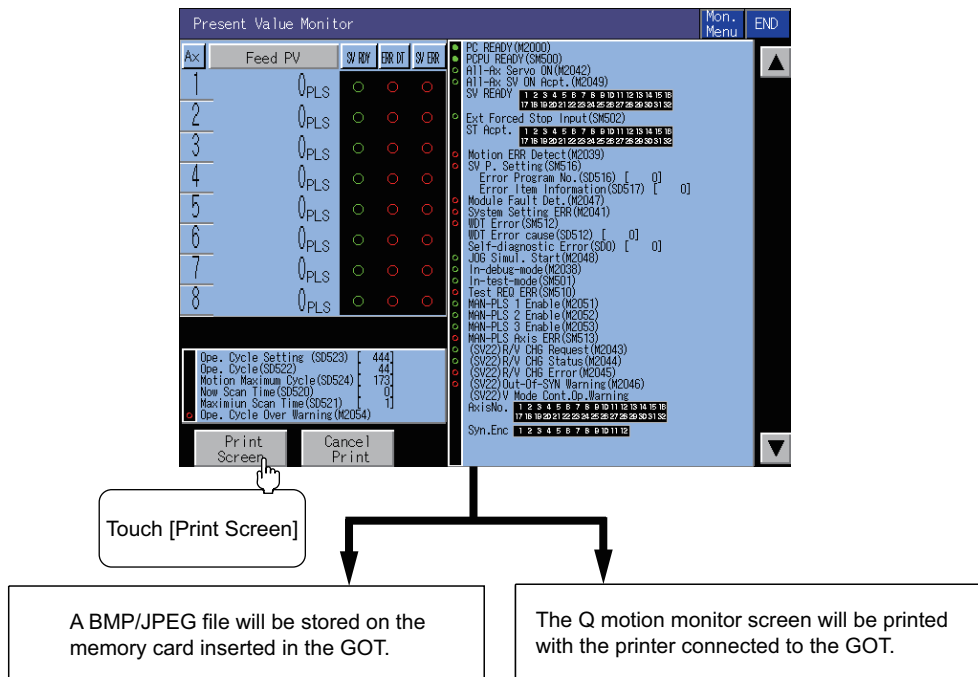

(2) GOT with QVGA resolution

Hard copy output operations are performed by turning ON/OFF the start or abort trigger device that has been set in the GT Designer3.

POINT

- Install the extended function OS (Printer) to the GOT when printing a Q motion monitor screen.
- The output target (CF card/printer) of hard copy can be set in [Hard Copy] of GT Designer3. For details of hard copy setting, refer to the following.

User's Manual for the GOT used

GT Designer3 Version1 Screen Design Manual (Functions) 40. HARD COPY FUNCTION

8.5 Error Messages and Corrective Action

This section describes the error messages that may be displayed during Q motion monitor operation and their corrective action.

Error message	Error definition	Corrective action
No. PLC Communications	Communication cannot be established with the PLC CPU of the monitor target.	<ul style="list-style-type: none"> • Check the status of the connection between the controller and the GOT (disconnected or cut cables). • Check if an error has occurred in the controller.
This PLC type is not supported	A motion controller CPU that cannot be monitored was selected on the System Configuration screen.	Select a motion controller CPU that can be monitored on the System Configuration screen. (☞ 8.2.1 ■ Target motion controller CPU of the Q motion monitor)
Controller's OS type is different	The motion controller OS installed in the motion controller CPU (Q172CPU, Q173CPU) of the monitor target is other than SV13 or SV22.	Install SV13 or SV22 in the motion controller CPU (Q172CPU, Q173CPU) of the monitor target as the motion controller OS.
It is not a version for GOT	The version of the motion controller OS installed in the motion controller CPU of the monitor target is not compatible with the Q motion monitor.	Install a motion controller OS that is compatible with the Q motion monitor in the motion controller. (☞ GOT1000 Series Connection Manual (Mitsubishi Products) for GT Works3)
Monitor data not found	The monitor data was not installed or was deleted.	Download the monitor data of the motion monitor.
Unused axis selected	The axis number selected has not been set.	<ul style="list-style-type: none"> • Select the axis number that has been set. • Set the axis using the peripheral software.
It is not possible to select	During servo parameter setting, an item that cannot be set has been selected.	Select an item that can be set.
Incorrect setting range	A value that is outside the setting range has been set.	Set the value within the setting range.
Unmatched password	The password that was input as the motion parameter changing password is incorrect.	Input the correct password.
Communication channel setup error	A communication driver that is compatible with the Q motion monitor is not installed.	Install a compatible communication driver.
Unsupport amp. selected	The axis number set with a servo amplifier whose parameter cannot be set has been selected.	Set the axis number with a servo amplifier whose parameter can be set.

POINT

How to clear a displayed error message

For errors that occur with the connection to a controller (communication error, etc.), the error message does not disappear even after the cause of the error has been removed.

To delete the error message, restart the GOT.

9. SERVO AMPLIFIER MONITOR



9.1 Features

Various monitor functions, changes to the parameter settings and test operations can be performed on the servo amplifier connected to the GOT.

The features of the servo amplifier monitor are described below.

Real-time display of the servo amplifier status

☞ 9.4.3 Monitor functions, 9.4.4 Alarm function

A list of the status of the servo amplifier connected to the GOT and the alarm details can be displayed in real-time. (Display examples)

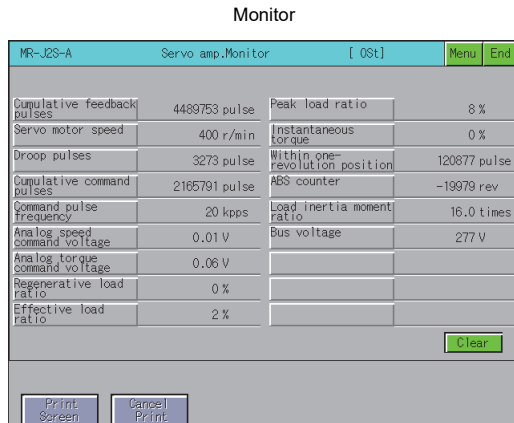

- Displays monitor data of the servo amplifier in a list.

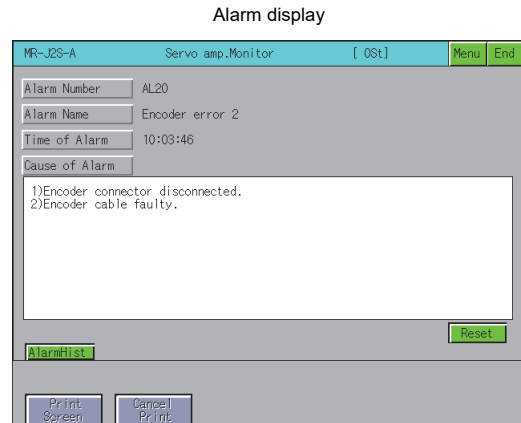

- Displays the details (number, name, occurrence time and cause of alarm) of the alarm currently occurring in the servo amplifier. The alarm can also be reset.

Various diagnostics of the servo amplifier can be performed

☞ 9.4.5 Diagnostics function

There are multiple diagnostics functions to enable various diagnostics of the servo amplifier to be performed. (Display examples)

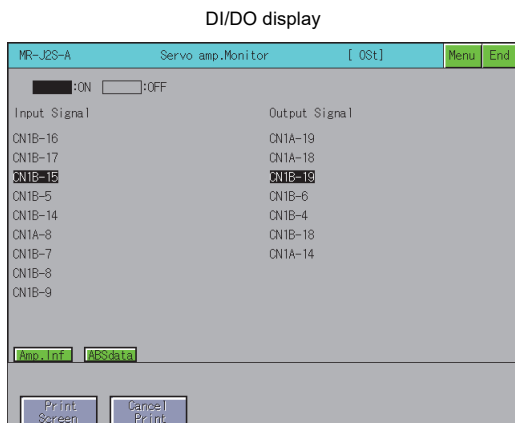

- Displays a list of the ON/OFF status of the external I/O signals of the servo amplifier.

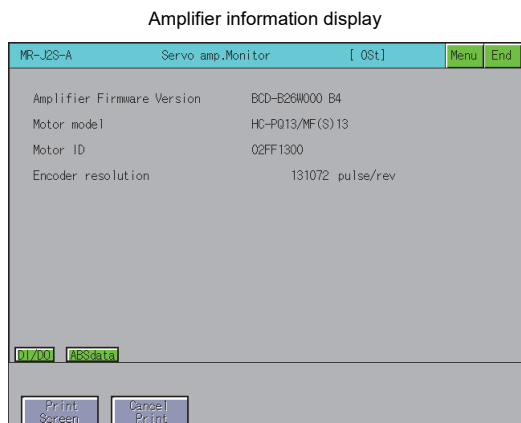

- Displays the servo amplifier software number and servo motor information (model name, ID and encoder resolution).

■ Writing of the servo parameters is enabled

☞ 9.4.6 Parameter setting

The servo amplifier parameters can be read, changed and written to the servo amplifier.

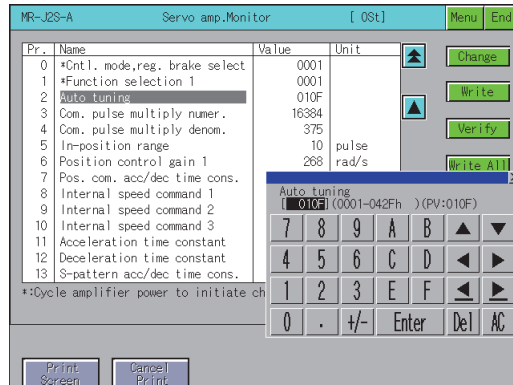

■ Various test operations can be performed

☞ 9.4.7 Test operations

Various test operations can be performed on the connected servo amplifier.

(Display examples)

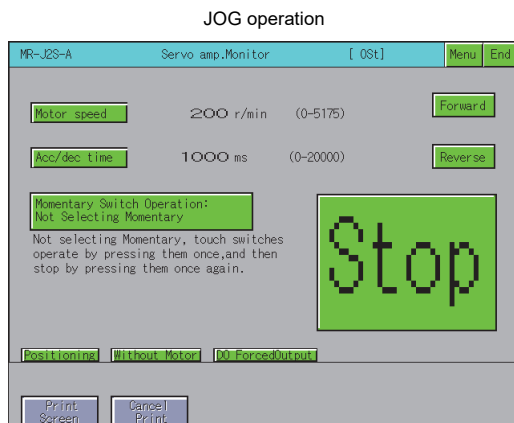

- The servo amplifier rotates while the Forward or Reverse key is touched.

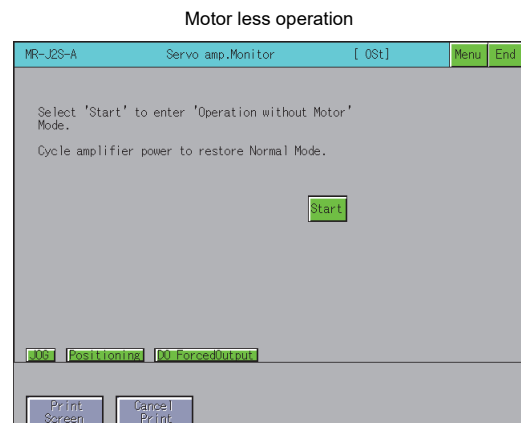

- Simulates motion of the servo motor within the servo amplifier even when the servo motor is not connected.

9.2 Specifications

9.2.1 System configuration

This section describes the system configuration of the servo amplifier monitor. For connection type settings and precautions regarding the communication unit/cable and connection type, refer to the following.

 GOT1000 Series Connection Manual (Mitsubishi Products) for GT Works3

■ Servo amplifiers targeted for the servo amplifier monitor

Servo amplifier
MELSERVO-J2-Super series
MELSERVO-J2M series
MELSERVO-J3 series*1
MELSERVO-J4 series*2

*1 Only MR-J3-□A is supported.

*2 Only MR-J4-□A is supported.

■ Connection type

This function can be used in the following connection types.

(○: Available, ✕: Unavailable)

Function		Connection type between GOT and servo amplifier
Name	Description	Direct connection
Servo amplifier monitor	Servo amplifier monitor, changing the servo parameter settings and test operations	○

■ Required option OS and option function board

The option OS and option function board shown below are required.

 1.1.2 Hardware and OS' required for each function

(1) Option OS

Install the option OS in the above table to the GOT.

For the installation procedure, refer to the following.

 GT Designer3 Version1 Screen Design Manual (Fundamentals) 8. COMMUNICATION WITH GOT

(2) OS memory space

The available memory space shown in the table above is required in the user area to install the option OS to the GOT.

For the procedure for checking the available memory space of the user area and information about the data using other user areas, refer to the following.

 GT Designer3 Version1 Screen Design Manual (Fundamentals) 8. COMMUNICATION WITH GOT

(3) Option function board

(a) For GT16

No option function board is required.

(b) For GT15

Mount one of the option function boards in the above table on the GOT.

For the GOTs with a built-in option function board, refer to the following.

 1.1.2 Hardware and OS' required for each function

For how to mount an option function board on the GOT, refer to the following.

 User's Manual for the GOT used

■ List of servo amplifier types that can be monitored and functions

The list of servo amplifier types that can be monitored and their functions is shown below.

(1) MELSERVO-J2-Super series and MELSERVO-J2M series

(○ : Monitoring is possible with the servo amplifier monitor X : Monitoring is not possible with the servo amplifier monitor - : Function unavailable)

Function	Servo Amplifier	MELSERVO-J2-Super series		MELSERVO-J2M series	
		MR-J2S-□A	MR-J2S-□CP	MR-J2M-P8A	MR-J2M-□DU
Setup	Model selection	○	○	○	○
	Baud rate*1	○	○	○	○
	Station No. Selection*1	○	○	-	-
	Station selection	○	○	○	○
	Axis selection	-	-	○	○
	Automatic demo	X	-	-	X
Monitor	Display all	○	○	○	○
	High speed monitor	X	X	X	X
	Multi-axis listing	-	-	X	X
	Trend graph	X	X	-	X
	I/O Input/Output display	-	-	-	-
Alarm	Display	○	○	○	○
	History	○	○	○	○
	Amplifier data	X	X	X	X
Diagnostic	I/O display	○	○	○	-
	Function device display	-	○	○	○
	No motor rotation	X	X	-	X
	Total power-on time	X	X	X	X
	Software number display	○	○	○	○
	Motor data display	○	○	-	○
	Tuning data	X	X	-	X
	Amplifier information	○	○	○	○
	Absolute encoder data	○	○	-	○
	Automatic voltage control	X	-	-	-
Parameters	Axis name setting	X	X	-	X
	Unit composition listing	-	-	○	○
	Parameter list	○	○	-	-
	Tuning	X	X	-	X
	Change list	X	X	X	X
	IFU parameter	-	-	○	○
	DRU parameter	-	-	○	○
	Parameter copy	-	-	-	-
	Device setting	-	X	X	X
Basic setting	-	-	-	-	
Test	Gain/Filter	-	-	-	-
	Extension setting	-	-	-	-
	I/O setting	-	-	-	-
	Jog	○	○	-	○
	Positioning	○	○	-	○
	Operation w/o motor	○	○	-	○
MELSEC-L TROUBLE SHOOTING	Forced output	○	○	○	-
	Program test	X	-	-	X
	Single-step feed	-	X	-	-

(Continued to next page)

(○ : Monitoring is possible with the servo amplifier monitor X : Monitoring is not possible with the servo amplifier monitor - : Function unavailable)

Function \ Servo Amplifier		MR-J2-Super series		MR-J2M series	
		MR-J2S-□A	MR-J2S-□CP	MR-J2M-P8A	MR-J2M-□DU
Point-data	Point table	-	X	-	-
Advanced-function	Machine analyzer	X	-	-	X
	Gain search	X	-	-	X
	Machine simulation	X	-	-	X
	Robust disturbance compensation	-	-	-	-

*1 Set the baud rate and station number setting with Communication Settings.
For how to set the connecting device settings, refer to the following.

 GT Designer3 Version1 Screen Design Manual (Fundamentals)

(2) MELSERVO-J3 series and MELSERVO-J4 series

(○ : Monitoring is possible with the servo amplifier monitor X : Monitoring is not possible with the servo amplifier monitor - : Function unavailable)

Function \ Servo Amplifier		MELSERVO-J3 series	MELSERVO-J4 series
		MR-J3-□A	MR-J4-□A
Setup	Model selection	○	○
	Station selection	○	○
	Connection Setting	X	X
Monitor	Display all	○	○
	I/O Monitor*1	○	○
	Trend graph	X	X
Diagnostic	Display	○	○
	History	○	○
	Alarm Onset Data	X	X
	Drive Recorder	-	X
	No motor rotation	X	X
	System Configuration*2	○	○
	Life Diagnosis	X	X
	Machine Diagnosis	-	X
	Amplifier information*2	○	○
	Absolute encoder data	○	○
I/O Display*1	○	○	
Parameters	Parameter Setting	○	○
	Axis Name Setting	X	X
Test	Jog	○	○
	Positioning	○	○
	Operation w/o motor	○	○
	Forced output	○	○
	Program test	X	X
	Test Mode Information	X	X
Adjustment	One-touch Tuning	-	X
	Tuning	X	X
	Machine Analyzer	X	X
	Advanced Gain Search	X	X

*1 It is displayed with "DI/DO display screen" in "Diagnostic".

*2 It is displayed with "Amplifier information display screen" in "Diagnostic".

Required special data

The following special data is required.

- (a) When using GT1695M-X, GT1685M-S, GT1675M-S, GT1675M-V, GT1665M-S, GT1665M-V, GT1595-X, GT1585V-S, GT1585-S, GT1575V-S, GT1575-S

(- : Unavailable)

Function details		Stored screen data	Memory space (KB)					
			For MR-J2S-□A monitoring	For MR-J2S-□CP monitoring	For MR-J2M-P8A monitoring	For MR-J2M-□DU monitoring	For MR-J3-□A monitoring	For MR-J4-□A monitoring
Servo amplifier monitor data common information			40.4					
Monitor		600 "S-*/M-A/J3-A"	4.4					
		601 "Monitor: J4-A"	-	-	-	-	-	5.0
Alarm	Alarm display	602 "Alarm: ALL"	2.6					
	Alarm history	604 "Alarm Hist.: ALL"	3.3					
Diagnostics function	DI/DO display	610 "I/O Display: S-A"	2.7	-	-	-	-	-
		611 "I/O Display: S-CP"	-	3.0	-	-	-	-
		612 "I/O Display: M-A IFU"	-	-	4.8	-	-	-
		613 "I/O Display: M-A D01"	-	-	-	3.9	-	-
		614 "I/O Display: J3-A/J4-A"	-	-	-	-	2.8	
	Function device display	620 "Function Dev.: S-CP"	-	3.3	-	-	-	-
		621 "Function Dev.: M-A IFU"	-	-	5.1	-	-	-
		622 "Function Dev.: M-A DRU"	-	-	-	5.1	-	-
	Amplifier information display	630 "Amp inf.: S-A"	2.4	-	-	-	-	-
		631 "Amp inf.: S-CP"	-	2.5	-	-	-	-
		632 "Amp inf.: M-A IFU"	-	-	2.4	-	-	-
		633 "Amp inf.: M-A DRU"	-	-	-	2.6	-	-
		634 "Amp inf.: J3-A/J4-A"	-	-	-	-	2.7	
	ABS data display	640 "ABS data: S-A/J3-A/J4-A"	2.9	-	-	-	2.9	
		642 "ABS data: S-CP"	-	3.4	-	-	-	-
		644 "ABS data: M-A DRU"	-	-	-	3.4	-	-
	Unit composition list display	647 "Unit Comp.: M-A IFU"	-	-	3.8	-	-	-
		648 "Unit Comp.: M-A DRU"	-	-	-	3.8	-	-
Parameter setting		650 "Parameters: S-**"	4.4		-	-	-	
		651 "Parameters: M-A IFU"	-	-	4.6		-	
		652 "Parameters: M-A DRU"	-	-	5.0		-	
		653 "Parameter Basic setting: J3-A"	-	-	-	-	5.1	
		654 "Parameters Gain/Filter: J3-A"	-	-	-	-	5.2	
		655 "Parameters Ext. setting: J3-A"	-	-	-	-	5.2	
		656 "Parameters I/O setting: J3-A"	-	-	-	-	5.2	
Test	JOG operation	660 "JOG operation: S-*/J3-A/J4-A"	3.8		-	-	3.8	
		661 "JOG operation: M-A DRU"	-	-	-	3.5	-	
	Positioning operation	663 "Positioning: S-**"	3.8		-	-	-	
		664 "Positioning: M-A DRU"	-	-	-	3.6	-	
		665 "Positioning: J3-A"	-	-	-	-	4.3	
	Motor-less operation	666 "Motor-less op: S-*/J3-A"	2.7		-	-	2.7	
		667 "Motor-less op: M-A DRU"	-	-	-	2.5	-	
		668 "Motor-less op: J4-A"	-	-	-	-	2.6	
	DO forced output	669 "DO Forced Out: S-A"	4.1	-	-	-	-	
		670 "DO Forced Out: S-CP"	-	3.8	-	-	-	
671 "DO Forced Out: M-A IFU"		-	-	8.2	-	-		
672 "DO Forced Out: M-A D01"		-	-	3.8	-	-		
673 "DO Forced Out: J3-A/J4-A"		-	-	-	-	4.0		
Parameter setting		680 "Parameters Basic setting: J4-A"	-	-	-	-	5.7	
		681 "Parameters Gain/Filter: J4-A"	-	-	-	-	5.7	
		682 "Parameters Ext.setting: J4-A"	-	-	-	-	5.7	
		683 "Parameters I/O setting: J4-A"	-	-	-	-	5.7	
		684 "Parameters Ext.setting-2: J4-A"	-	-	-	-	5.7	
		685 "Parameters Ext.setting-3: J4-A"	-	-	-	-	5.7	

(b) When using GT1675-VN, GT1672-VN, GT1662-VN, GT1575-V, GT1575-VN, GT1572-VN, GT1565-V, GT1562-VN, GT1555-V

(- : Unavailable)

Function details		Stored screen data	Memory space (KB)					
			For MR-J2S-□A monitoring	For MR-J2S-□CP monitoring	For MR-J2M-P8A monitoring	For MR-J2M-□DU monitoring	For MR-J3-□A monitoring	For MR-J4-□A monitoring
Servo amplifier monitor data common information			40.4					
Monitor		600 "S-*/M-A/J3-A"	4.4					
		601 "Monitor: J4-A"	-	-	-	-	-	5.0
Alarm	Alarm display	602 "Alarms: ALL"	2.6					
	Alarm history	604 "Alarms Hist.: ALL"	3.3					
Diagnostics function	DI/DO display	610 "I/O Display: S-A"	2.7	-	-	-	-	-
		611 "I/O Display: S-CP"	-	3.0	-	-	-	-
		612 "I/O Display: M-A IFU"	-	-	4.8	-	-	-
		613 "I/O Display: M-A D01"	-	-	3.9	-	-	-
		614 "I/O Display: J3-A/J4-A"	-	-	-	-	2.7	
	Function device display	620 "Function Dev.: S-CP"	-	3.3	-	-	-	-
		621 "Function Dev.: M-A IFU"	-	-	5.3	-	-	-
		622 "Function Dev.: M-A DRU"	-	-	-	5.3	-	-
	Amplifier information display	630 "Amp inf.: S-A"	2.4	-	-	-	-	-
		631 "Amp inf.: S-CP"	-	2.5	-	-	-	-
		632 "Amp inf.: M-A IFU"	-	-	2.4	-	-	-
		633 "Amp inf.: M-A DRU"	-	-	-	2.6	-	-
		634 "I/O Display: J3-A/J4-A"	-	-	-	-	2.7	
	ABS data display	640 "ABS data: S-A/J3-A/J4-A"	2.4	-	-	-	2.9	
		642 "ABS data: S-CP"	-	3.4	-	-	-	-
		644 "ABS data: M-A DRU"	-	-	-	3.4	-	-
Unit composition list display	647 "Unit Comp.: M-A IFU"	-	-	3.8	-	-	-	
	648 "Unit Comp.: M-A DRU"	-	-	-	3.8	-	-	
Parameter setting		650 "Parameters: S-**"	4.4		-	-	-	
		651 "Parameters: M-A IFU"	-	-	4.6		-	
		652 "Parameters: M-A DRU"	-	-	-	5.0	-	
		653 "Parameters Basic setting: J3-A"	-	-	-	-	5.2	
		654 "Parameters Gain/Filter: J3-A"	-	-	-	-	5.2	
		655 "Parameters Ext. setting: J3-A"	-	-	-	-	5.2	
		656 "Parameters I/O setting: J3-A"	-	-	-	-	5.2	
Test	JOG operation	660 "JOG operation: S-*/J3-A/J4-A"	3.8		-	-	3.8	
		661 "JOG operation: M-A DRU"	-	-	-	3.5	-	
	Positioning operation	663 "Positioning: S-**"	3.8		-	-	-	
		664 "Positioning: M-A DRU"	-	-	-	3.6	-	
		665 "Positioning: J3-A/J4-A"	-	-	-	-	4.3	
	Motor-less operation	666 "Motor-less op: S-*/J3-A"	2.7		-	-	2.7	
		667 "Motor-less op: M-A DRU"	-	-	-	2.5	-	
		668 "Motor-less op: J4-A"	-	-	-	-	2.6	
	DO forced output	669 "DO Forced Out: S-A"	4.1	-	-	-	-	
		670 "DO Forced Out: S-CP"	-	3.8	-	-	-	
671 "DO Forced Out: M-A"		-	-	8.2	-	-		
672 "DO Forced Out: M-A D01"		-	-	3.9	-	-		
673 "DO Forced Out: J3-A/J4-A"		-	-	-	-	4.0		
Parameter setting		680 "Parameters Basic setting: J4-A"	-	-	-	-	5.7	
		681 "Parameters Gain/Filter: J4-A"	-	-	-	-	5.7	
		682 "Parameters Ext.setting: J4-A"	-	-	-	-	5.7	
		683 "Parameters I/O setting: J4-A"	-	-	-	-	5.7	
		684 "Parameters Ext.setting-2: J4-A"	-	-	-	-	5.7	
		685 "Parameters Ext.setting-3: J4-A"	-	-	-	-	5.7	

(c) When using GT1555-Q, GT1550-Q

(- : Unavailable)

Function details		Stored screen data	Memory space (KB)					
			For MR-J2S-□A monitoring	For MR-J2S-□CP monitoring	For MR-J2M-P8A monitoring	For MR-J2M-□DU monitoring	For MR-J3-□A monitoring	For MR-J4-□A monitoring
Servo amplifier monitor data common information			20.0					
Monitor		600 "S-*/M-A/J3-A"	2.5					
Alarm	Alarm display	602 "Alarms: ALL"	1.8					
	Alarm history	604 "Alarms Hist.: ALL"	2.3					
Diagnostics function	DI/DO display	610 "I/O Display: S-A"	2.2	-	-	-	-	-
		611 "I/O Display: S-CP"	-	2.4	-	-	-	-
		612 "I/O Display: M-A IFU"	-	-	3.7	-	-	-
		613 "I/O Display: M-A D01"	-	-	-	3.1	-	-
		614 "I/O Display: J3-A/J4-A"	-	-	-	-	2.0	
	Function device display	620 "Func. Dev.: S-CP"	-	2.4	-	-	-	-
		621 "Func. Dev. In1: M-A IFU"	-	-	3.1	-	-	-
		622 "Func. Dev. In2: M-A IFU"	-	-	3.1	-	-	-
		623 "Func. Dev. Out1: M-A IFU"	-	-	3.2	-	-	-
		624 "Func. Dev. Out2: M-A IFU"	-	-	2.7	-	-	-
		625 "Func. Dev. In1: M-A DRU"	-	-	-	3.1	-	-
		626 "Func. Dev. In2: M-A DRU"	-	-	-	3.0	-	-
		627 "Func. Dev. Out1: M-A DRU"	-	-	-	3.1	-	-
	Amplifier information display	630 "Amp inf.: S-A"	1.6	-	-	-	-	-
		631 "Amp inf.: S-CP"	-	1.7	-	-	-	-
		632 "Amp inf.: M-A IFU"	-	-	1.6	-	-	-
		633 "Amp inf.: M-A DRU"	-	-	-	1.8	-	-
		634 "Amp. inf.1: J3-A/J4-A"	-	-	-	-	2.1	
	ABS data display	640 "ABS data Cur.: S-A/J3-A/J4-A"	1.9	-	-	-	-	1.9
		641 "ABS data Orig: S-A/J3-A/J4-A"	2.0	-	-	-	-	2.0
		642 "ABS data Cur.: S-CP"	-	2.2	-	-	-	-
		643 "ABS data Orig: S-CP"	-	2.2	-	-	-	-
		644 "ABS data Cur.: M-A DRU"	-	-	-	2.2	-	-
	Unit composition list display	647 "Unit Comp.: M-A IFU"	-	-	2.8	-	-	-
		648 "Unit Comp.: M-A DRU"	-	-	-	2.8	-	-
	Parameter setting	650 "Parameters: S-**"		3.5		-	-	-
		651 "Parameters: M-A IFU"	-	-	3.7	-	-	-
		652 "Parameters: M-A DRU"	-	-	-	4.0	-	-
653 "Parameters Basic setting: J3-A"		-	-	-	-	4.2	-	
654 "Parameters Gain/Filter: J3-A"		-	-	-	-	4.2	-	
655 "Parameters Ext. setting: J3-A"		-	-	-	-	4.2	-	
656 "Parameters I/O setting: J3-A"		-	-	-	-	4.2	-	
Test	JOG operation	660 "Jog operation: S-*/J3-A/J4-A"	2.8		-	-	2.8	
		661 "Jog operation: M-A DRU"	-	-	-	2.5	-	
	Positioning operation	663 "Positioning: S-**"	2.9		-	-	-	
		664 "Positioning: M-A DRU"	-	-	-	2.6	-	
		665 "Positioning: J3-A/J4-A"	-	-	-	-	3.3	
	Motor-less operation	666 "Motor-less op: S-*/J3-A"	1.9		-	-	1.9	
667 "Motor-less op: M-A DRU"		-	-	-	1.7	-		
668 "Motor-less op: J4-A"		-	-	-	-	1.8		

(Continued to next page)

9
SERVO AMPLIFIER MONITOR
10
CNC MONITOR FUNCTIONS
11
BACKUP/RESTORE
12
CNC DATA I/O
13
SFC MONITOR
14
LADDER EDITOR
15
MELSEC-L TROUBLE SHOOTING
16
LOG VIEWER

(- : Unavailable)

Function details		Stored screen data	Memory space (KB)					
			For MR-J2S-□A monitoring	For MR-J2S-□CP monitoring	For MR-J2M-P8A monitoring	For MR-J2M-□DU monitoring	For MR-J3-□A monitoring	For MR-J4-□A monitoring
Test	DO forced output	669 "DO Forced Out: S-A"	3.3	-	-	-	-	-
		670 "DO Forced Out: S-CP"	-	3.1	-	-	-	-
		671 "DO Forced Out: M-A IFU"	-	-	6.7	-	-	-
		672 "DO Forced Out: M-A D01"	-	-	-	3.0	-	-
		673 "DO Forced Out: J3-A/J4-A"	-	-	-	-	3.3	
Parameter setting		680 "Parameters Basic setting: J4-A"	-	-	-	-	-	4.7
		681 "Parameters Gain/Filter: J4-A"	-	-	-	-	-	4.7
		682 "Parameters Ext.setting: J4-A"	-	-	-	-	-	4.7
		683 "Parameters I/O setting: J4-A"	-	-	-	-	-	4.7
		684 "Parameters Ext.setting-2: J4-A"	-	-	-	-	-	4.7
		685 "Parameters Ext.setting-3: J4-A"	-	-	-	-	-	4.7

(1) Special data

Download the special data indicated in the table above to the GOT.
For how to download, refer to the following.

 GT Designer3 Version1 Screen Design Manual (Fundamentals) 8. COMMUNICATION WITH GOT

(2) Memory space for special data

The available memory space shown in the table above is required in the user area to download the special data to the GOT.

For the procedure for checking the available memory space of the user area and information about the data using other user areas, refer to the following.

 GT Designer3 Version1 Screen Design Manual (Fundamentals) 8. COMMUNICATION WITH GOT

9.2.2 Access range

The access range is the same as the access range when the GOT is connected to a controller.
For details of the access range, refer to the following.

 GOT1000 Series Connection Manual (Mitsubishi Products) for GT Works3

9.2.3 Precautions

(1) Before using the servo amplifier monitor

Read the manual of the connected servo amplifier carefully and make sure you understand the contents before performing servo amplifier monitoring.

(2) Test operation

Be sure to read the precautions listed below before performing a test operation.

 9.4.7 Test operations

(3) Time displayed on the servo amplifier monitor

If the time data of the GOT is incorrect, the time on the servo amplifier monitor will not be displayed correctly. Refer to the following for the GOT clock data.

 GT Designer3 Version1 Screen Design Manual (Fundamentals)

(4) Setting details

Use the same settings for the servo amplifier monitor on the GOT (Setup screen ( 9.4.2)) and the servo amplifier.

If the settings are different, proper communications may not be performed.

(5) Servo amplifier monitored

One servo amplifier can be selected to be monitored among 32 servo amplifiers.

If multiple servo amplifiers are connected, select one servo amplifier to monitor.

(6) Background processing during parameter being input or output

Do not monitor the device of the servo amplifier parameter by the function which is operated background (such as device data transfer, logging, recipe, advanced recipe) while parameters are being input or output. Data may not be written or read normally or a communication error may occur.

9.3 Operations of Display

This section describes the flow until the servo amplifier monitor operation screen is displayed after the servo amplifier monitor (Option OS) is installed in the GOT.

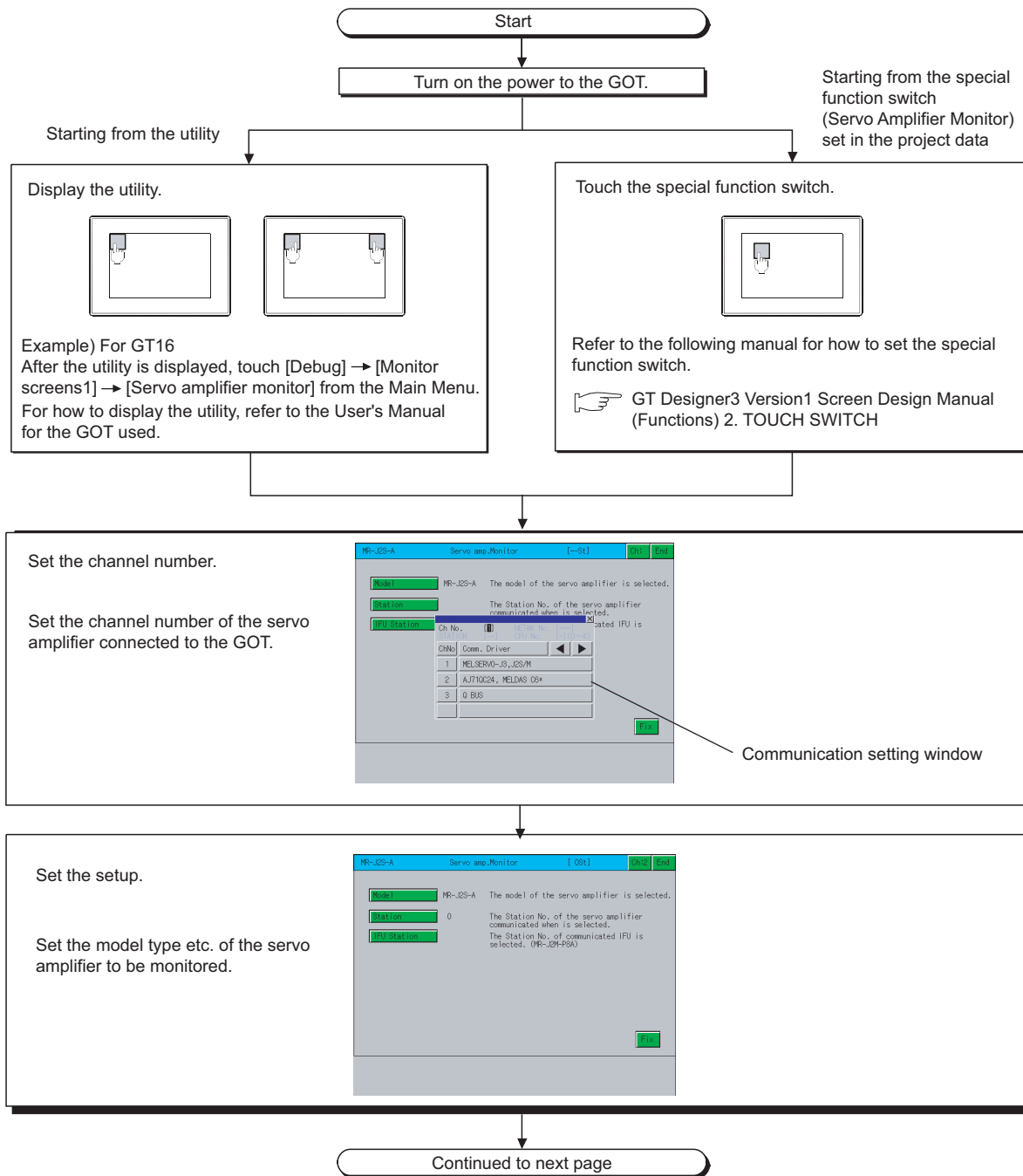

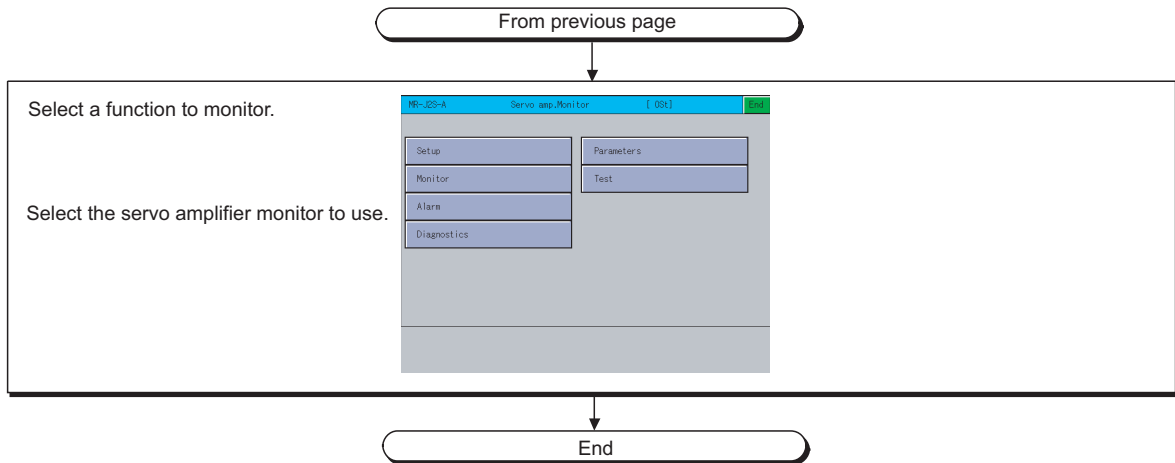

POINT

(1) How to display the utility

For how to display the utility, refer to the following.

User's Manual for the GOT used

(2) Displaying communication setting window

After turning on the GOT, the communication setting window is displayed at the first startup of the servo amplifier monitor only.

For displaying the communication setting window at the second or later startup, touch the button on the servo amplifier monitor screen.

9.4 Operations of Servo Amplifier Monitor Screens

(3) If the project data has not been downloaded

The servo amplifier monitor can be started from the utility even if the project data has not been downloaded to the GOT.

■ Changing screens

The following describes how to change the screen.

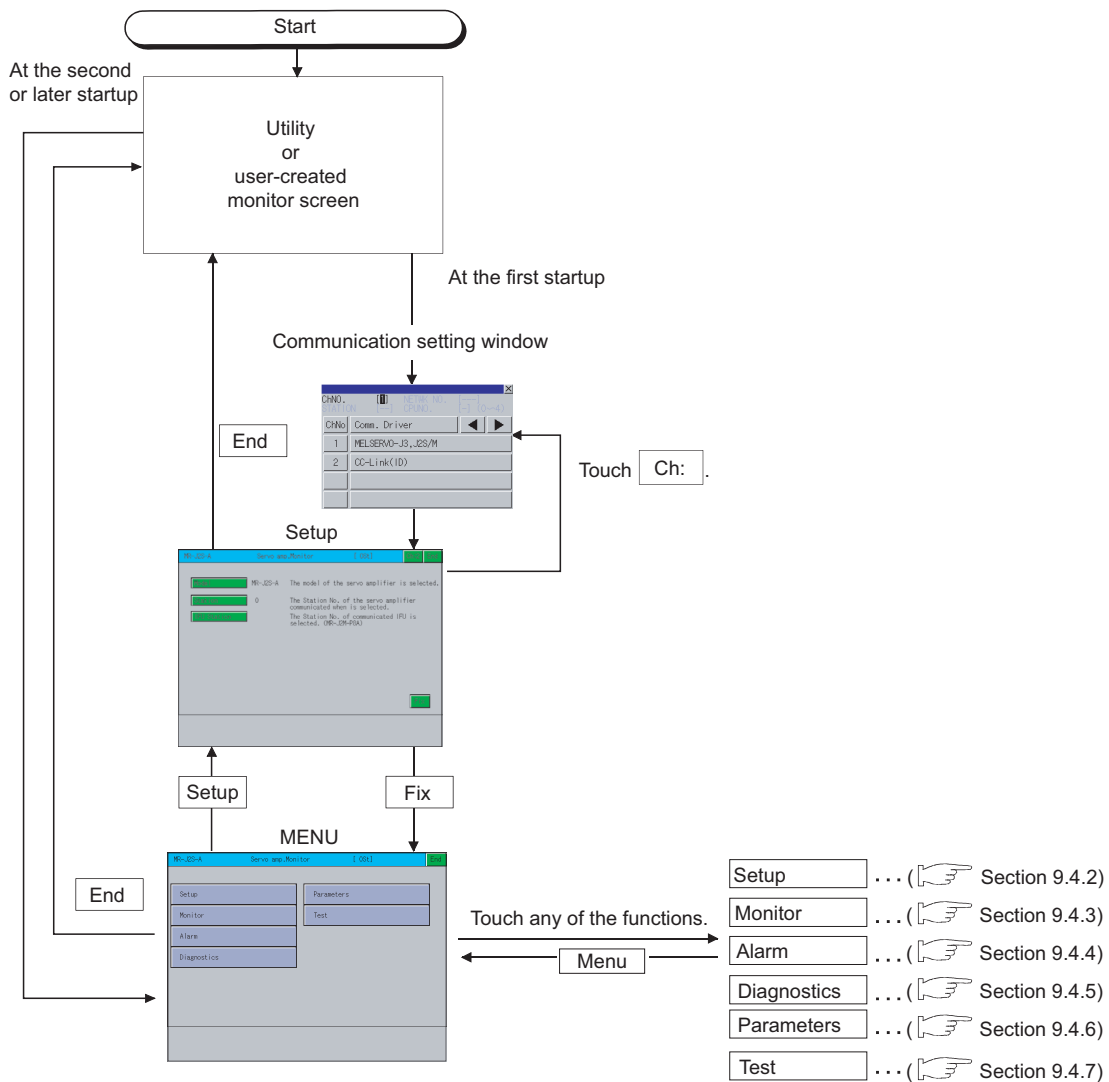

To exit by touching **End**

At next startup of the servo amplifier monitor, the last exited screen is displayed.

If using the same screen frequently, exiting with the **End** button is convenient.

However, the last exited screen is not displayed if the servo amplifier monitor screen data was deleted due to an installation of the OS, turning the GOT power from off to on, or a reset.

9.4 Operations of Servo Amplifier Monitor Screens

This section describes the operations of the screens when using the servo amplifier monitor. The display screen of the servo amplifier monitor varies slightly with the GOT used. This section mainly uses the screen of the GT1575-V for explanation.

9.4.1 Servo amplifier monitor

With the servo amplifier monitor, various monitor functions, parameter setting changes and test operations can be performed on the servo amplifier connected to the GOT.

To display a function, make a selection on the function selection menu screen.

(Function selection menu screen)

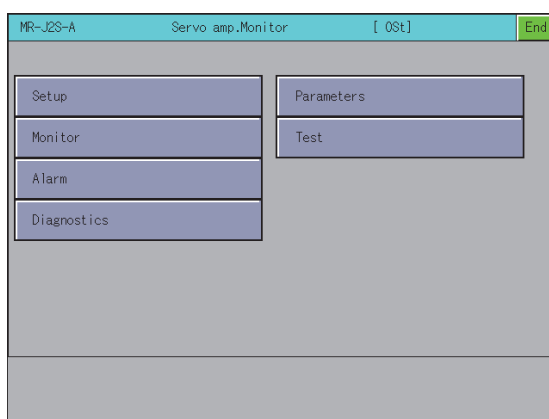

- 1) Setup Selects the servo amplifier type to monitor, the station number setting (station number selection), and the IFU station number.
☞ 9.4.2
- 2) Monitor Displays all monitor data of the servo amplifier in real-time.
☞ 9.4.3
- 3) Alarm Displays the alarm that is currently occurring and the history. Also resets the alarm and clears the history.
☞ 9.4.4
- 4) Diagnostics Performs the following various diagnostics on the connected servo amplifier.
☞ 9.4.5
 - DI/DO display : Displays the ON/OFF status of the external I/O signals.
 - Function device display : Displays the ON/OFF status of the I/O function devices.
 - Amplifier information display : Displays the model name, ID and encoder resolution of the servo motor connected to the servo amplifier.
 - ABS data display : Displays the absolute position data of the absolute position detection system.
 - Unit composition list display : Displays a list of servo amplifier unit composition.
- 5) Parameters Displays the parameter data and changes the parameter settings.
☞ 9.4.6
- 6) Test Performs various test operations (JOG operation, positioning operation, motor-less operation and DO forced output).
☞ 9.4.7

9.4.2 Setup

This is used to set the communication with the servo amplifier.

POINT

- (1) **Before making the settings on the setup screen, also make the same settings on the servo amplifier side.**
If the settings on this screen and the settings on the servo amplifier do not match, proper communications may not be performed.
- (2) **The settings on the setup screen return to the initial state when the GOT is turned off or reset.**
After turning on the power to the GOT, perform the settings on the setup screen again.

■ Setup screen

This section describes the display data of the setup screen and the key functions displayed on the screen.

(1) Displayed contents

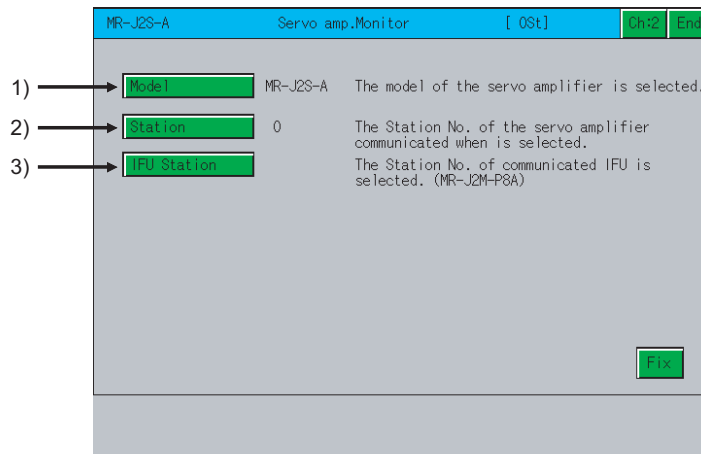

* [Axis number] and [Capacity setting] cannot be set.

No.	Item	Description
1)	Model	Displays the model of the servo amplifier to be connected.
2)	Station	Displays the station number (00 to 31) of the servo amplifier to communicate with.
3)	IFU Station	Displays the serial communication station number of the IFU (interface unit).

(2) Key functions

The table below shows the functions of the keys that are used for the operations of the setup screen.

Key	Function
Model	Sets the model of the servo amplifier to be connected.
Station	Sets the station number (00 to 31) of the servo amplifier to communicate with.
IFU Station ^{*1}	Sets the serial communication station number of the IFU (interface unit).
Fix	Sets the setup details and returns to the function selection menu screen.
End	Exits the servo amplifier monitor.
Ch:2	Displays the communication setting window.

*1 This is valid only when MR-J2M-P8A is connected.

9.4.3 Monitor functions

Displays all monitor data of the servo amplifier in real-time.

■ Monitor screen

The following describes the display data of the monitor screen and the key functions displayed on the screen.

(1) Displayed contents

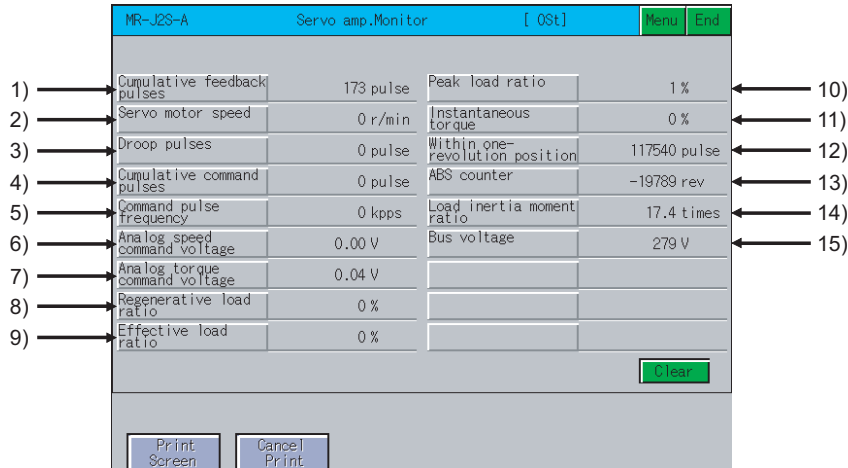

No.	Item	Description
1)	Cumulative feedback pulses	Counts the feedback pulses from the servo motor encoder and displays the result. <ul style="list-style-type: none"> When the set value exceeds "9999999", counting begins from "0". During reverse rotation, the – sign is added.
2)	Servo motor speed	Displays the speed of the servo motor. <ul style="list-style-type: none"> The value is displayed with the 0.1r/min unit rounded off. During reverse rotation, the – sign is added.
3)	Droop pulses	Displays the droop pulses of the deviation counter. <ul style="list-style-type: none"> During reverse rotation, the – sign is added.
4)	Cumulative command pulses	Counts the position command input pulses and displays the result. <ul style="list-style-type: none"> Since the value before multiplication of the electrical gear (CMX/CDV) is displayed, it may not match the cumulative feedback pulse display. During reverse rotation command, the – sign is added.
5)	Command pulse frequency	Displays the frequency of the position command input pulse. <ul style="list-style-type: none"> The value before multiplication of the electrical gear (CMX/CDV) is displayed. During reverse rotation command, the – sign is added.
6)	Analog speed command voltage (during speed control mode)*1	Displays the input voltage of the analog speed command (VC).
	Analog speed limit voltage (during torque control mode)*1	Displays the input voltage of the analog speed limit (VLA).
7)	Analog torque command voltage (during position/speed control mode)*1	Displays the voltage of the analog torque limit (TLA).
	Analog torque limit voltage (during torque control mode)*1	Displays the voltage of the analog torque limit (TC).







(Continued to next page)

No.	Item	Description
8)	Regenerative load ratio	Displays the ratio of the regenerative power to the permissible regenerative power in %. <ul style="list-style-type: none"> The permissible regenerative power differs depending on the presence/absence of the regenerative brake option. Set parameter No. 0 correctly according to the regenerative brake option. (Set to 80% or lower as a guide.)
9)	Effective load ratio	Displays the continuous effective load torque. <ul style="list-style-type: none"> The effective value is displayed on the assumption that the rated torque is 100%.
10)	Peak load ratio	Displays the maximum torque generated. <ul style="list-style-type: none"> The maximum value for the past 15 seconds is displayed on the assumption that the rated torque is 100%.
11)	Instantaneous torque	Displays the instantaneous torque. <ul style="list-style-type: none"> The value of the generated torque is displayed in real time on the assumption that the rated torque is 100%.
12)	Within one-revolution position	Displays the within one-revolution position in the servo motor in pulse units of the encoder. <ul style="list-style-type: none"> When the value exceeds the maximum pulse count, it returns to 0.
13)	ABS counter	Displays the distance from the home position (0) in the absolute position detection system as the multi-revolution counter value of the absolute position encoder.
14)	Load inertia moment ratio	Displays the estimated ratio of the servo motor shaft-equivalent load inertia moment to the servo motor's inertia moment.
15)	Bus voltage	Displays the voltage (between P and N) of the main circuit converter.

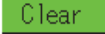
*1: This is displayed only when the MR-J2S-□ A is connected.

(2) Key functions

The table below shows the functions of the keys that are used for the operations on the monitor screen.

Key	Function
	Clears the values of [Cumulative feedback pulses] and [Cumulative command pulses] to 0.
	Returns to the function selection menu screen.
	Exits the servo amplifier monitor.
	Stores the displayed screen to the memory card in BMP/JPEG file format or prints it with a printer. For further information about hard copies, refer to the following:  8.4.12 Hard copy output
	The touch operation of this key is invalid.

9.4.4 Alarm function

The following alarms are displayed.

- Alarm display : Displays the alarm that is currently occurring. (☞ ■Alarm display screen)
- Alarm history : Displays the history of alarms that occurred. (☞ ■Alarm history screen)

The screen changes as follows after **Alarm** is selected on the function selection menu screen.

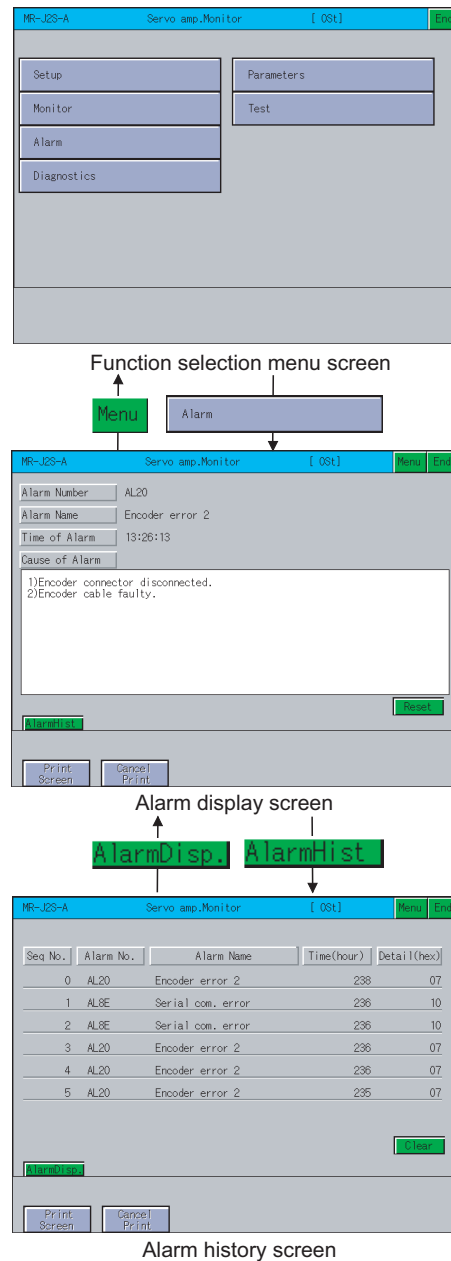

POINT

If the alarm display screen data has not been downloaded to the GOT, the message "Monitor data not found" is displayed and the subsequent screens are not displayed.

■ Alarm display screen

The following describes the display data of the alarm display screen and the key functions displayed on the screen.

(1) Displayed contents

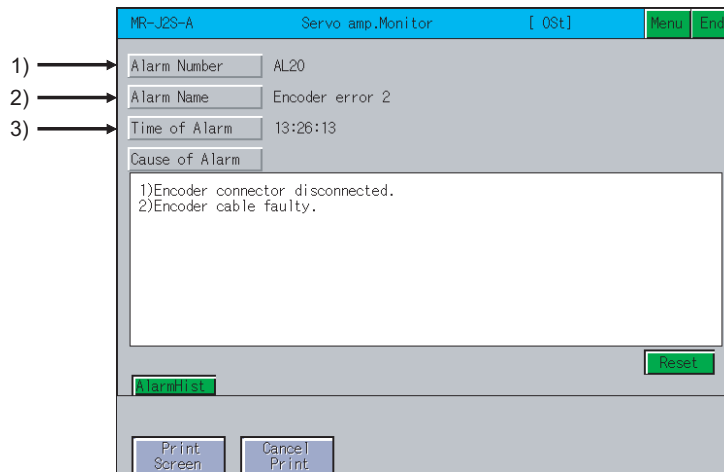

No.	Item	Description
1)	Alarm Number	Displays the number of the alarm that occurred.
2)	Alarm Name	Displays the name of the alarm that occurred.
3)	Time of Alarm	Displays the date and time when the alarm occurred. <ul style="list-style-type: none"> The alarm occurrence time is displayed on the basis of the clock data of the GOT. If there is an error in the servo amplifier before it is connected to the GOT, an alarm is displayed when the servo amplifier is connected to the GOT. In this case, the time when the servo amplifier is connected to the GOT is displayed as the alarm occurrence time.

(2) Key functions

The table below shows the functions of the keys that are used for operations of the alarm display screen.

Key	Function
	Resets the alarm. <ul style="list-style-type: none"> The reset alarm is stored as the latest alarm.
	Changes to the alarm history screen (■Alarm history screen).
	Returns to the function selection menu screen.
	Exits the servo amplifier monitor.
	Stores the displayed screen to the memory card in BMP/JPEG file format or prints it with a printer. For further information about hard copies, refer to the following: 9.4.8 Hard copy output
	The touch operation of this key is invalid.

Alarm history screen

The following describes the display data of the alarm history screen and the key functions displayed on the screen.

(1) Displayed contents

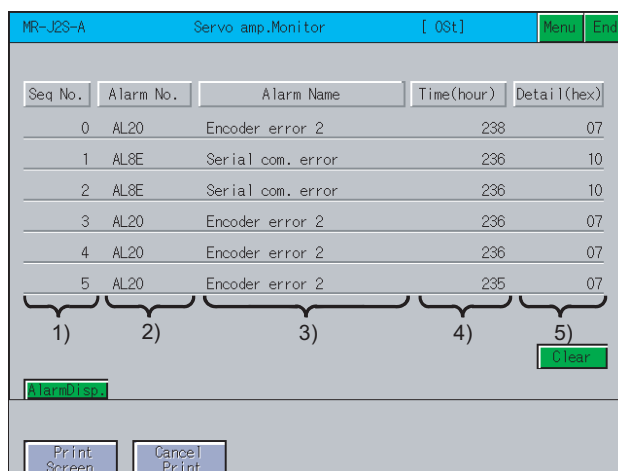

No.	Item	Description
1)	Seq No.	Displays the alarm history, starting from the latest alarm, in order. • Later alarms have smaller Seq Nos. (0 indicates the latest alarm) • Up to six alarms can be displayed in the alarm history.
2)	Alarm No.	Displays the number of the alarm that occurred.
3)	Alarm Name	Displays the name of the alarm that occurred.
4)	Time (hour)	Displays the energization time of the servo amplifier until alarm occurrence on the assumption that the time at factory shipment is "0".
5)	Detail (hex)	Displays the code for detailed alarm information.





(2) Key functions

The table below shows the functions of the keys that are used for operations of the alarm history screen.

Key	Function
	Clears the alarm history stored in the servo amplifier.
	Changes to the Alarm Display screen (■Alarm display screen).
	Returns to the function selection menu screen.
	Exits the servo amplifier monitor.
	Stores the displayed screen to the memory card in BMP/JPEG file format or prints it with a printer. For further information about hard copies, refer to the following: 9.4.8 Hard copy output
	The touch operation of this key is invalid.

9.4.5 Diagnostics function

This function performs the following various diagnostics on the connected servo amplifier.

- DI/DO display : Displays the ON/OFF status of the external I/O signals.
( ■DI/DO display screen)
- Function device display : Displays the ON/OFF status of the I/O function devices.
( ■Function device display screen)
- Amplifier information display : Displays the model name, ID and encoder resolution of the servo motor connected to the servo amplifier.
( ■Amplifier information display screen)
- ABS data display : Displays the absolute position data of the absolute position detection system.
( ■ABS data display screen)
- Unit composition list display : Displays a list of servo amplifier unit compositions.
( ■Unit composition list display screen)

(1) Changing screens

The screen changes as follows after **Diagnostics** is selected on the function selection menu screen. Depending on the model of the connected servo amplifier, some screens may not be displayed. Refer to the following for the screens that cannot be displayed.

9.2.1 ■List of servo amplifier types that can be monitored and functions

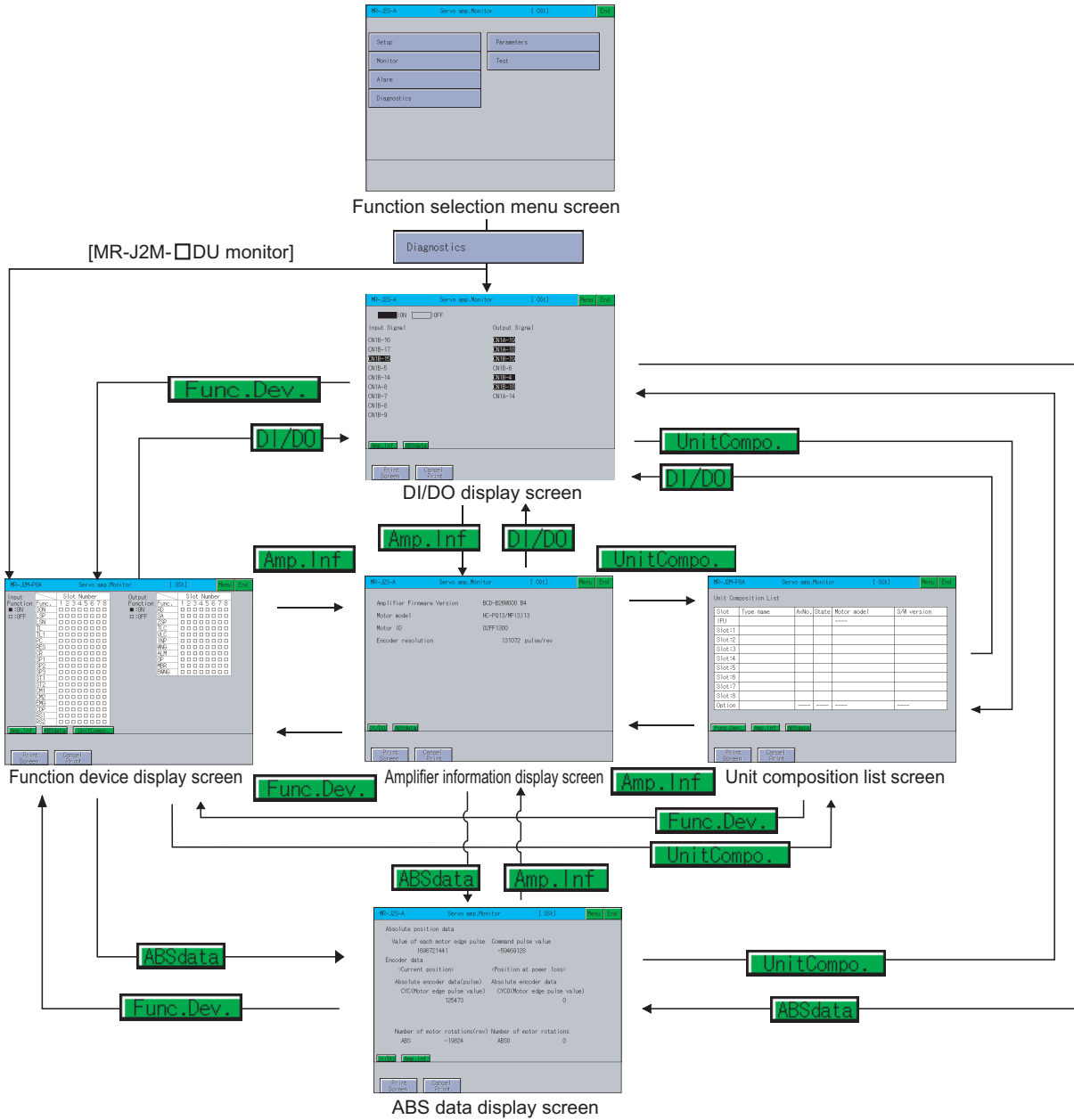

POINT

If the DI/DO display screen data or function device display screen data (only when monitoring the MR-J2M-□DU) has not been downloaded to the GOT, "Monitor data not found" is displayed and the subsequent screens are not displayed.

DI/DO display screen

The following describes the display data of the DI/DO display screen and the key functions displayed on the screen.

(1) Displayed contents

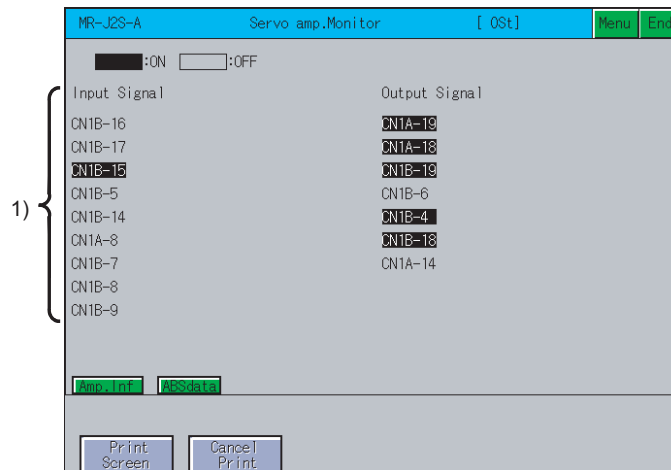

No.	Item	Description
1)	Input/Output Signal	Displays whether the DI/DO signal is ON (lit) or OFF (not lit).

(2) Key functions

The table below shows the functions of the keys that are used for the operations of the DI/DO display screen.

Key	Function
*1	Displays the DI/DO signal of the extension IO unit.
	Changes to the function device screen (☞ ■Function device display screen).
	Changes to the amplifier information screen (☞ ■Amplifier information display screen).
	Changes to the unit composition list screen (☞ ■Unit composition list display screen).
	Changes to the ABS data screen (☞ ■ABS data display screen).
	Returns to the function selection menu screen.
	Exits the servo amplifier monitor.
	Stores the displayed screen to the memory card in BMP/JPEG file format or prints it with a printer. For further information about hard copies, refer to the following: ☞ 9.4.8 Hard copy output
	The touch operation of this key is invalid.

*1 This is valid only when MR-J2M-P8A is connected.

Function device display screen

The following describes the display data of the function device display screen and the key functions displayed on the screen.

(1) Displayed contents

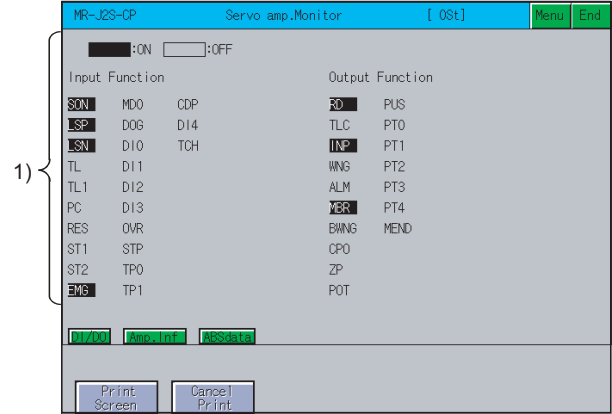
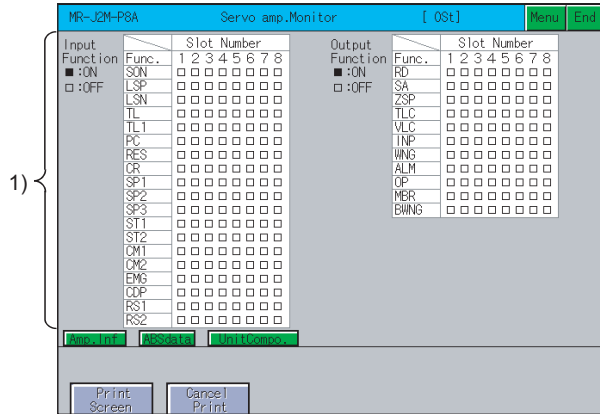

[When MR-J2S-□CP is monitored]

No.	Item	Description
1)	Input/Output Function	Displays the ON (■) or OFF (□) status for each I/O signal.

(2) Key functions

The table below shows the functions of the keys that are used for the operations of the function device display screen.

Key	Function
	Changes to the DI/DO display screen (☞ ■DI/DO display screen).
	Changes to the ABS data screen (☞ ■ABS data display screen).
	Changes to the amplifier information screen (☞ ■Amplifier information display screen).
	Changes to the unit composition list screen (☞ ■Unit composition list display screen).
	Returns to the function selection menu screen.
	Exits the servo amplifier monitor.
	Stores the displayed screen to the memory card in BMP/JPEG file format or prints it with a printer. For further information about hard copies, refer to the following: ☞ 9.4.8 Hard copy output
	The touch operation of this key is invalid.

■ Amplifier information display screen

The following describes the display data of the amplifier information display screen and the key functions displayed on the screen.

(1) Displayed contents

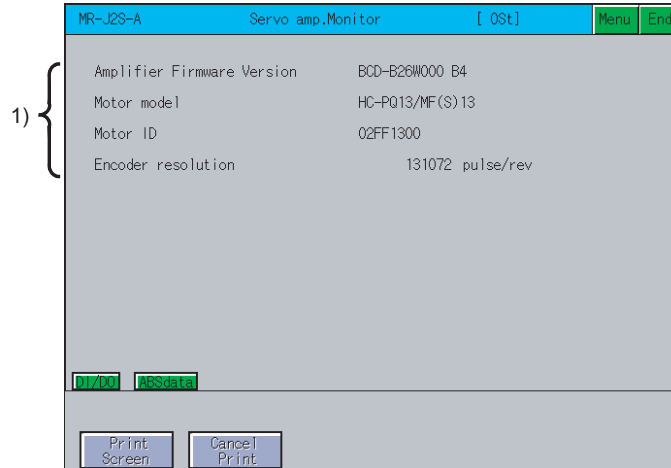

No.	Item	Description
1)	Servo amplifier model.*1	Displays the model name of the servo amplifier.
	Amplifier Firmware Version	Displays the software number of the servo amplifier connected to the GOT.
	Accumulated power-on time*1	Displays the cumulative time of the control power-on after the product was shipped from the factory.
	Num. of inrush cur. sw. time*1	Displays the number of times the rush relay has been turned on/off after the product was shipped from the factory.
	Optional card model*1	Displays the model name of the option card installed in the servo amplifier. If no option card is installed, then "No connection" is displayed.
	Motor model*2	Displays the model name of the servo motor connected to the servo amplifier.
	Motor ID*2	Displays the ID of the servo motor connected to the servo amplifier.
	Encoder resolution*2	Displays the encoder resolution of the servo motor connected to the servo amplifier.

*1 This is displayed only for MR-J3-□A or MR-J4-□A.

*2 This is not displayed when monitoring the MR-J2M-P8A.

(2) Key functions

The table below shows the functions of the keys that are used for the operations of the amplifier information display screen.

Key	Function
	Changes to the DI/DO display screen (☞ ■DI/DO display screen).
	Changes to the function device screen (☞ ■Function device display screen).
	Changes to the ABS data screen (☞ ■ABS data display screen).
	Changes to the unit composition list screen (☞ ■Unit composition list display screen).
	Returns to the function selection menu screen.
	Exits the servo amplifier monitor.
	Stores the displayed screen to the memory card in BMP/JPEG file format or prints it with a printer. For further information about hard copies, refer to the following: ☞ 9.4.8 Hard copy output
	The touch operation of this key is invalid.

■ ABS data display screen

The following describes the display data of the ABS data display screen and the key functions displayed on the screen.

(1) Displayed contents

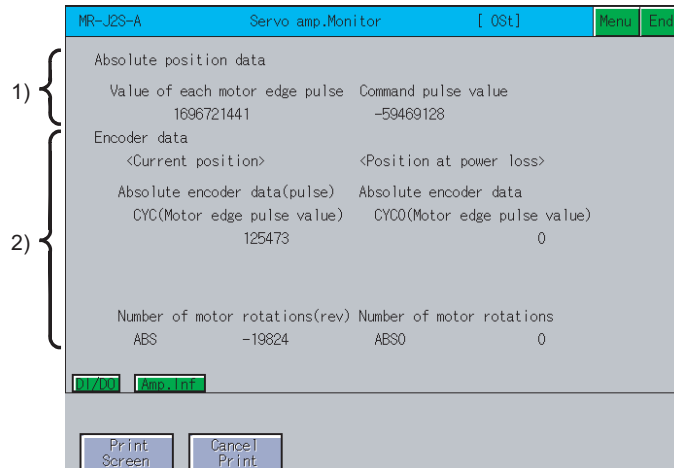

No.	Item	Description
1)	Absolute position data	Displays the absolute position data in the absolute position detection system with the following items. <ul style="list-style-type: none"> • Motor edge pulse value • Command pulse value
2)	Encoder data	Displays the encoder data with the following items. <p>Current position</p> <ul style="list-style-type: none"> • Absolute encoder data • CYC (Motor edge pulse value) • CYC (Command pulse value) • Number of motor rotations ABS <p>Position at power loss</p> <ul style="list-style-type: none"> • Absolute encoder data • CYC0 (Motor edge pulse value) • CYC0 (Command pulse value) • Number of motor rotations ABS0

(2) Key functions

The table below shows the functions of the keys that are used for the operations of the ABS data display screen.

Key	Function
	Changes to the DI/DO display screen (☞ ■DI/DO display screen).
	Changes to the function device screen (☞ ■Function device display screen).
	Changes to the unit composition list screen (☞ ■Unit composition list display screen).
	Changes to the amplifier information screen (☞ ■Amplifier information display screen).
	Returns to the function selection menu screen.
	Exits the servo amplifier monitor.
	Stores the displayed screen to the memory card in BMP/JPEG file format or prints it with a printer. For further information about hard copies, refer to the following: ☞ 9.4.8 Hard copy output
	The touch operation of this key is invalid.

■ Unit composition list display screen

The following describes the display data of the unit composition list screen and the key functions displayed on the screen.

(1) Displayed contents

Slot	Type name	AxNo.	State	Motor model	S/W version
IFU				----	
Slot:1					
Slot:2					
Slot:3					
Slot:4					
Slot:5					
Slot:6					
Slot:7					
Slot:8					
Option					

No.	Item	Description
1)	Type name	Displays the model name of the drive unit (DRU), interface unit (IFU) and option unit installed in each slot.
2)	AxNo.	Displays the axis number of the drive unit (DRU) and interface unit (IFU).
3)	State	Displays status of the drive unit (DRU) and interface unit (IFU) and the alarm/warning number.
4)	Motor model	Displays the model name of the motor connected to the drive unit (DRU).
5)	S/W version	Displays the software number of the drive unit (DRU) and interface unit (IFU).

(2) Key functions

The table below shows the functions of the keys that are used for the operations of the unit composition list screen.

Key	Function
	Changes to the DI/DO display screen (☞ ■DI/DO display screen).
	Changes to the ABS data screen (☞ ■ABS data display screen).
	Changes to the amplifier information screen (☞ ■Amplifier information display screen).
	Changes to the function device screen (☞ ■Function device display screen).
	Returns to the function selection menu screen.
	Exits the servo amplifier monitor.
	Stores the displayed screen to the memory card in BMP/JPEG file format or prints it with a printer. For further information about hard copies, refer to the following: ☞ 9.4.8 Hard copy output
	The touch operation of this key is invalid.

9.4.6 Parameter setting

You can use the parameter setting function to set the servo parameters (basic parameters/expansion parameter 1, 2) of the connected servo amplifier.

The password input key window appears for accessing the parameter setting screen of the servo amplifier monitor when the password is set with GT Designer3.

The screen changes as follows after **Parameters** is selected on the function selection menu screen.

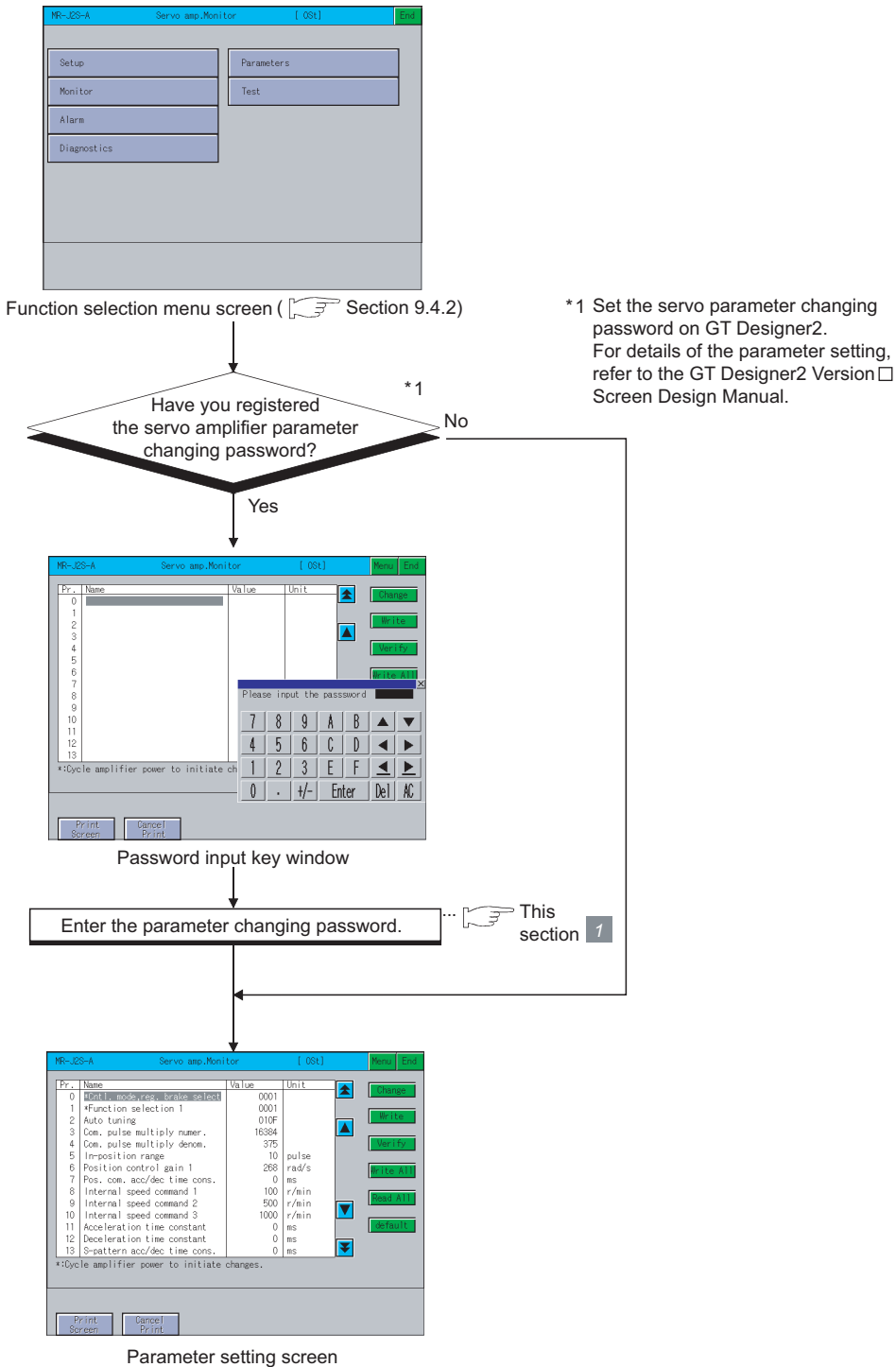

■ Password input operation procedure

The following describes the procedure for inputting the password for changing the servo parameters.

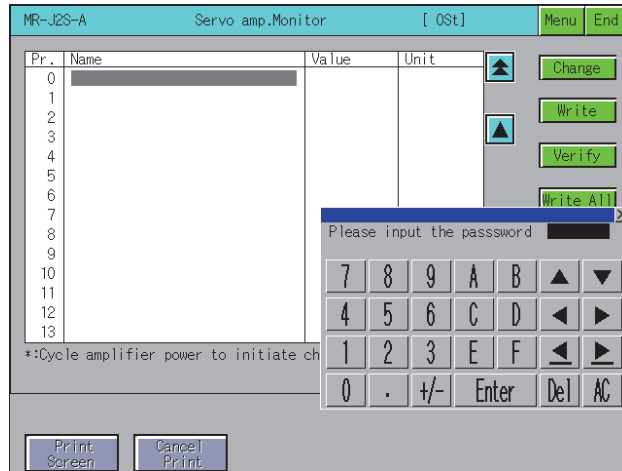

(1) Functions

- If the input password matches, the parameter setting screen is displayed.
- If the input password does not match, an error message is displayed.
Touching returns to the function selection menu screen.
- Numerical numbers and letters A to F can be used for a password.

(2) Operations

(a) Inputting the password

Touch to and to to input the password.

After inputting the password, touch to set the password.

To edit the input characters, touch to delete the characters, and then input the new characters.

(b) Canceling password input

Touch to return to the monitor screen.

Parameter setting screen

The following describes the display data of the parameter setting screen and the key functions displayed on the screen.

POINT

Parameters with an asterisk (*) preceding the name become valid after the parameters are set and the power of the servo amplifier is turned off and then on again.

(1) Display screen

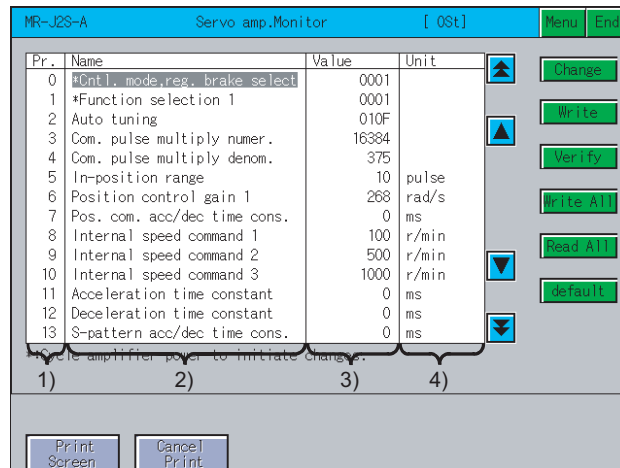















No.	Item	Description
1)	Pr.	Displays the parameter number.
2)	Name	Displays the parameter name.
3)	Value	Displays the present set value of the parameter.
4)	Unit	Displays the setting unit for each parameter.

(2) Key functions

The table below shows the functions of the keys that are used with the operations on the parameter setting screen.

Key	Function
	Selects the servo parameter setting item.
	Displays the parameter items with scrolling a page up/down.
	Changes the servo parameter settings read to the GOT internal memory.
	Writes the servo parameter settings of the selected items to the servo amplifier.
	Matches all parameter values presently displayed on the GOT with the servo amplifier parameter values.
	Writes all parameter values presently displayed on the GOT to the parameters of the servo amplifier.
	Reads all parameter values from the servo amplifier to the GOT and displays those values.
	Returns all parameter values to their initial values.

(Continued to next page)

Key	Function
  *1	Switches between the parameter display for the drive unit (DRU) and interface unit (IFU) each time this is touched.
 *1	Selects the slot number of the drive unit (DRU).
 *2	Changes the gain filter parameter.
  *2	Changes the extension setting parameter.
 *3	Changes the extension setting 2 parameter.
 *3	Changes the extension setting 3 parameter.
 *2	Changes the I/O setting parameter.
	Returns to the function selection menu screen.
	Exits the servo amplifier monitor.
	Stores the displayed screen to the memory card in BMP/JPEG file format or prints it with a printer. For further information about hard copies, refer to the following:  9.4.8 Hard copy output
	The touch operation of this key is invalid.

*1: This is displayed only when MR-J2M-P8A is connected.

*2: This is displayed only when MR-J3-□A or MR-J4-□A is connected.

*3: This is displayed only when MR-J4-□A is connected.

POINT

Operations of when is executed for the MR-J3-□A parameters

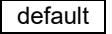
The operation when  is executed differs depending on the displayed parameter screen, as shown in (1) and (2) below.

(1) Basic setting, gain/filter or extension setting parameter screen

The 000BH processing (reference/writing is possible only for basic setting, gain/filter and extension setting parameter) is performed.

(2) I/O setting parameter screen

The 000CH processing (reference/writing is possible for all parameters) is performed.

Parameter setting operation

The following describes the procedure of changing the setting of the "Auto tuning" item as an example of the parameter setting operation.

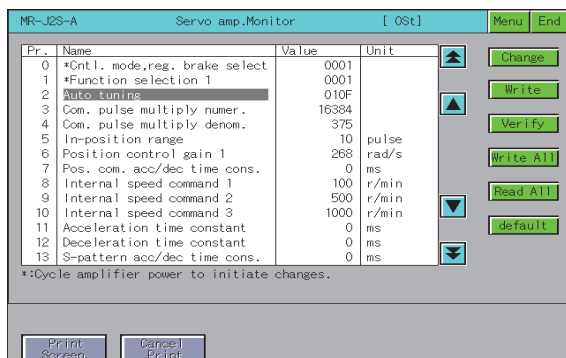
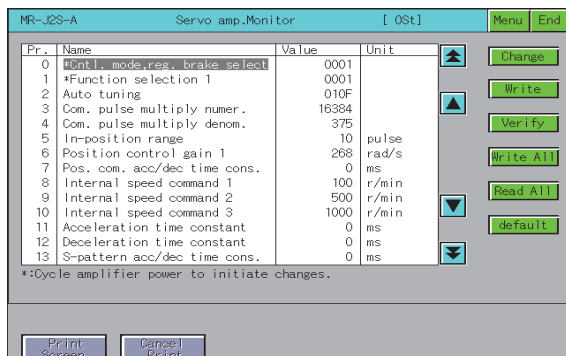
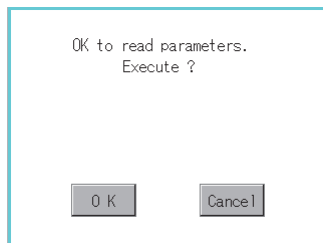
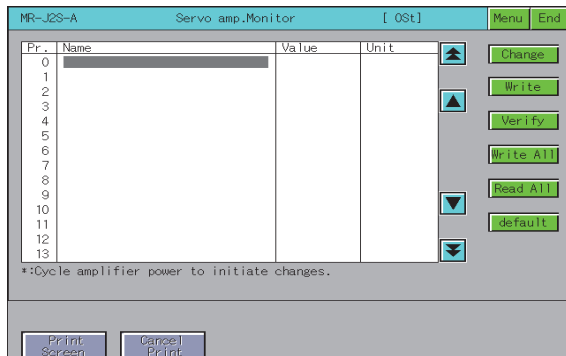

(To next page)

1. Touch the **Read All** key.
The parameter values within the servo amplifier are displayed on the screen.

2. The parameter read confirmation window is displayed.
Touch the **OK** key to read the parameter values within the servo amplifier to the GOT.

3. The read parameter values within the servo amplifier are displayed on the screen.
Parameters that cannot be written or read are not displayed on the parameter setting screen.

4. Select the item whose parameter is to be set with the **▲** or **▼** key, and touch the **Change** key.

(From previous page)

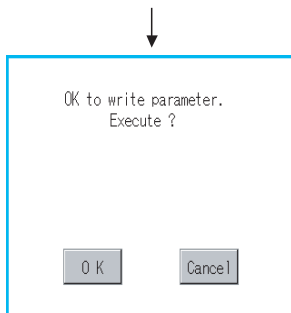
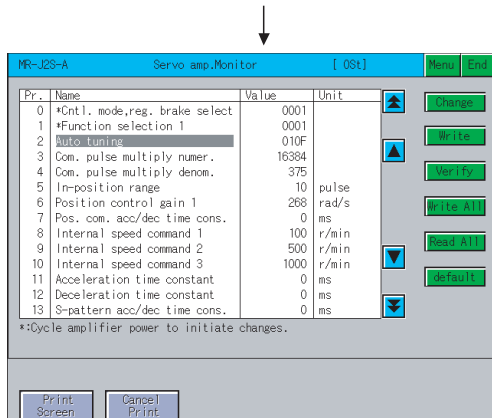
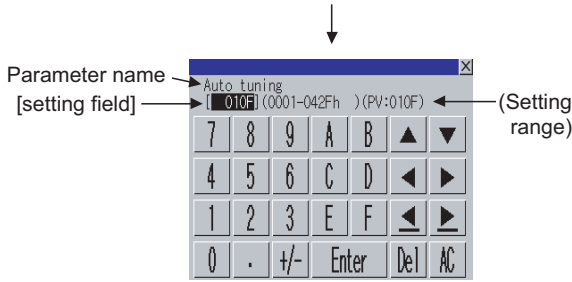

5. As the parameter setting window appears, enter the parameter setting with alphanumeric keys, and touch **Enter** to confirm the setting.
To cancel the parameter setting operation, touch **X** to close the parameter setting window.
6. The parameter setting is changed on the parameter setting screen. Select the changed parameter item, and touch the **Write** key.
If there are multiple parameter items with changed settings, touch the **Write All** key to write all parameter items with changed settings.
7. A confirmation window appears.
Touch the **OK** key to write the parameter setting(s) to the servo amplifier.
To cancel writing of the parameter setting(s), touch **Cancel** key.
This completes the writing operation of the parameter setting.

POINT

- (1) **The changes to the parameter setting are written to the E2PROM of the servo amplifier.**
Consequently, the written parameter setting is retained even if the power of the amplifier is off.
- (2) **If the following parameter settings are changed on the servo amplifier, be sure to also change the settings on the GOT setup screen (9.4.2) in the same way.**
If the settings on the setup screen and the servo amplifier do not match, normal communications with the servo amplifier may not be performed.
 - Station number setting
 - IFU station number setting

9.4.7 Test operations

This function performs the following test operations on the connected servo amplifier.

- JOG operation : The servo motor rotates while the Forward or Reverse key is touched.
(☞ ■ JOG operation screen)
- Positioning operation : This operation starts when the Forward or Reverse key is touched, and the servo motor rotates by the preset distance.
(☞ ■ Positioning operation screen)
- Motor-less operation : Simulates the motion of the servo motor within the servo amplifier even when the servo motor is not connected.
(☞ ■ Motor-less operation screen)
- DO forced output : Forcibly turns the output signals ON/OFF regardless of the output conditions of the servo amplifier output signals.
(☞ ■)

(1) Changing screens

The screen changes as follows after **Test** is selected on the function selection menu screen. Depending on the model of the connected servo amplifier, some screens may not be displayed. Refer to the following for the screens that cannot be displayed.

☞ 9.2.1 ■ List of servo amplifier types that can be monitored and functions

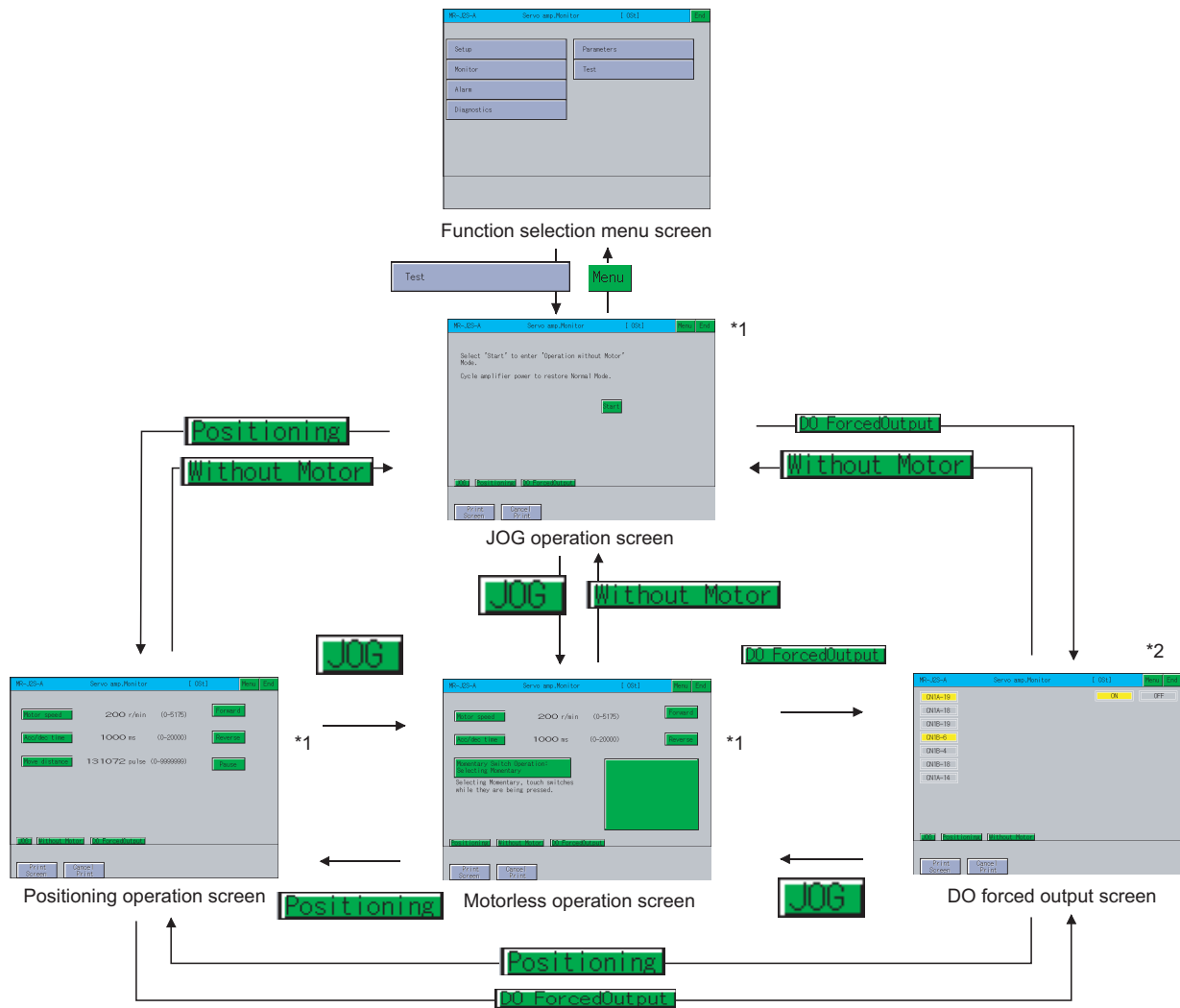

*1 Not displayed for MR-J2M-P8A monitor
*2 Not displayed for MR-J2M-□DU monitor

POINT

If the JOG operation screen data has not been downloaded to the GOT, "Monitor data not found" is displayed and the subsequent screens are not displayed.

■ Precautions for test operations

The following describes the precautions when performing a test operation of the servo amplifier monitor.

WARNING

- Do not operate the servo amplifier switches with wet hands. Doing so can cause an electric shock.
- Do not perform operations with the front cover of the servo amplifier removed. Doing so can cause an electric shock since the high-voltage terminals and live parts are exposed.
- Do not open the front cover of the servo amplifier when the power is on or during operation. Doing so can cause an electric shock.

CAUTION

- Be sure to read the precautions for test operation in the manuals of the servo amplifier before performing a test operation.
- Check parameters of the servo amplifier before starting operation. Unexpected operations may occur depending on the machine.
- The heat sink, regenerative brake resistor, servo motor and other parts of the servo amplifier may be hot while the power is on or for a period after the power is turned off; therefore, do not touch or bring parts (cables etc.) close to them. Doing so can cause fire or damage to the parts.

(1) Servo on

For test operation of JOG operation/positioning operation, the SON digital input signal of the servo amplifier is turned on automatically in the servo amplifier to start operation, regardless of the ON/OFF status of the SON signal of the digital I/O signal of the servo amplifier.

In addition, the servo amplifier does not accept any external command pulses and input signals (excluding emergency stop) until the test operation screen is exited.

The SON automatically turns on when touching the **Forward** or **Reverse** key on the JOG operation screen or positioning operation screen of the servo amplifier monitor.

(2) Stop

POINT

To perform an emergency stop, turn off the emergency stop signal of the servo amplifier or turn off the input power.

- (a) Use the following procedure to stop test operation from the servo amplifier monitor.
 - JOG operation: Release the **Forward** or **Reverse** key.
 - Positioning operation: Touch the **Pause** key.
- (b) The servo motor stops if any of the following states occurs during test operation.
 - The communication cable is disconnected.
 - The screen is switched to another servo amplifier monitor screen or the servo amplifier monitor is exited. However, during motor-less operation, the test mode is not canceled until the servo amplifier is powered off.

■ Preparations for test operations

When performing test operations, it is necessary to make the test operation settings on the connected servo amplifier.

Refer to the manual of the connected servo amplifier for details of making settings on the servo amplifier to perform test operations.

■ JOG operation screen

This section describes the display data of the JOG operation screen and the key functions displayed on the screen.

(1) Displayed contents

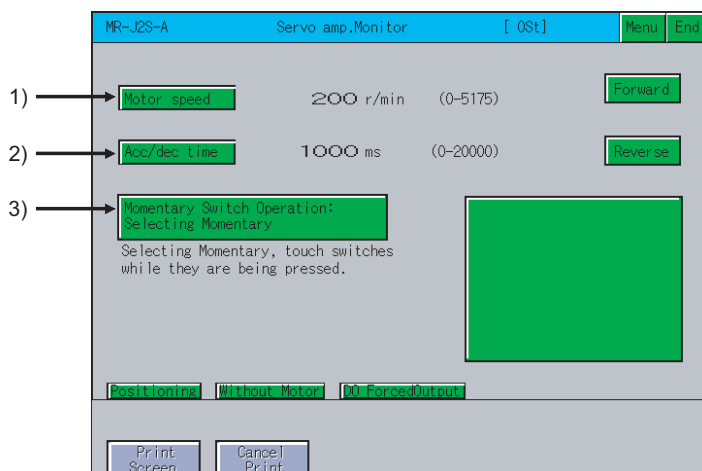















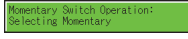



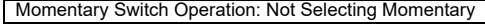



No.	Item	Description
1)	Motor speed	Displays the set speed of the servo motor.
2)	Acc/dec time	Displays the set acceleration/deceleration time constant.
3)	Momentary Switch Operation	Displays how to operate the JOG operation.

(2) Operation

- (a) When selecting **Momentary Switch Operation: Selecting Momentary**
- Start operation
Touch the **Forward** or **Reverse** key.
 - Stop operation
Release the **Forward** or **Reverse** key.
- (b) When selecting **Momentary Switch Operation: Not Selecting Momentary**
- Start operation
Touch the **Forward** or **Reverse** key.
 - Stop operation
Touch the **Pause** key.

(3) Key functions

The table below shows the functions of the keys that are used for the operations of the JOG operation screen.

Key	Function
	Runs the servo motor in the forward rotation (CCW) direction.
	Runs the servo motor in the reverse rotation (CW) direction.
	Changes the speed of the servo motor.
	Changes the acceleration/deceleration time constant.
 	Touching this changes the operation mode (momentary operation/no momentary operation).  The servo motor rotates while the  or  key is touched. (Releasing your finger from these keys stops the operation.)  The servo motor rotates while the  or  key is touched, stops when the  key is touched.
	Changes to the positioning operation screen ( ■ Positioning operation screen).
	Changes to the motor-less operation screen ( ■ Motor-less operation screen).
	Changes to the DO forced output screen ( ■).
	Returns to the function selection menu screen.
	Exits the servo amplifier monitor.
	Stores the displayed screen to the memory card in BMP/JPEG file format or prints it with a printer. For further information about hard copies, refer to the following:  9.4.8 Hard copy output
	The touch operation of this key is invalid.

■ Positioning operation screen

The following describes the display data of the positioning operation screen and the key functions displayed on the screen.

(1) Displayed contents

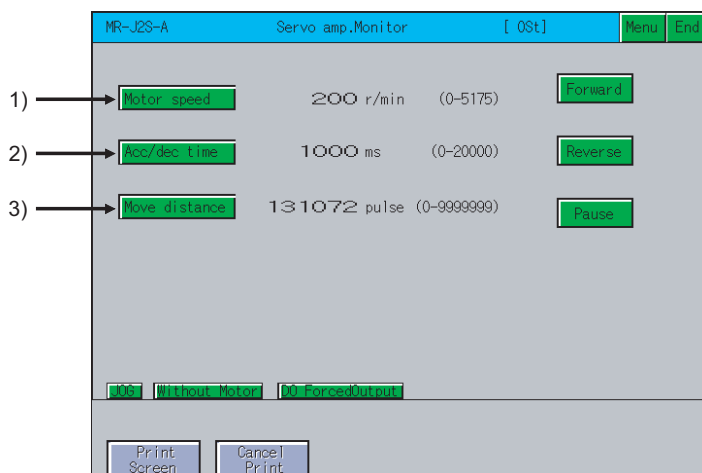

No.	Item	Description
1)	Motor speed	Displays the set speed of the servo motor.
2)	Acc/dec time	Displays the set acceleration/deceleration time constant.
3)	Move distance	Displays the set distance.

(2) Operation

(a) MELSERVO-J2-Super series and MELSERVO-J2 series

- Start operation

Touch the **Forward** or **Reverse** key.

To resume operation that has been paused, touch the **Forward** key to resume forward rotation or the **Reverse** key to resume reverse rotation.

- Stop operation

When the set distance has been reached, operation stops.

Touching the **Pause** key pauses the operation.

If touch the **Pause** key again after the operation is paused, the remaining distance is erased.

(b) MR-J3-□A and MR-J4-□A

- Start operation

Touch the **Forward** or **Reverse** key.

To resume the operation that has been paused, touch the **Restart** key to resume the rotation.













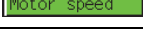
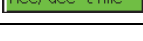
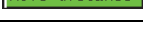

- Stop operation

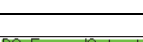
When the set distance has been reached, operation stops.

Touching the **Pause** key pauses the operation. If touch the **Clear** key again after the operation is paused, the remaining distance is erased.

(3) Key functions

The table below shows the functions of the keys that are used for the operations of the positioning operation screen.

Key	Function
	Runs the servo motor in the forward rotation (CCW) direction.
	Runs the servo motor in the reverse rotation (CW) direction.
 *1	Stops the rotation of the servo motor temporarily.
 *2	Resumes the rotation of the paused servo motor.
 *2	Deletes the remaining distance of the paused servo motor.
	Changes the rotation speed of the servo motor.
	Changes the acceleration/deceleration time constant.
	Changes the distance.
	Changes to the JOG operation screen ( ■JOG operation screen).
	Changes to the motor-less operation screen ( ■Motor-less operation screen).
	Changes to the DO forced output screen ( ■).
	Returns to the function selection menu screen.
	Exits the servo amplifier monitor.
	Stores the displayed screen to the memory card in BMP/JPEG file format or prints it with a printer. For further information about hard copies, refer to the following:  9.4.8 Hard copy output
	The touch operation of this key is invalid.

*1: This is displayed only when MELSERVO-J2-Super series or MELSERVO-J2M series is connected.

*2: This is displayed only when MR-J3-□A series or MR-J4-□A is connected.

Motor-less operation screen

The following describes the display data of the motor-less operation screen and the key functions displayed on the screen.

POINT

Start and end of the motor-less operation with MR-J4-□A.

Changing the parameter PC60 (*COPD) starts and ends the motor-less operation.

PC60 (*COPD) can be changed by [Ext. setting] in the parameter setting screen.

 ■Parameter setting screen

- Start: After setting PC60 (*COPD) to 1, turn on the servo amplifier again.
- End: After setting PC60 (*COPD) to 0, turn on the servo amplifier again.

(1) Displayed contents

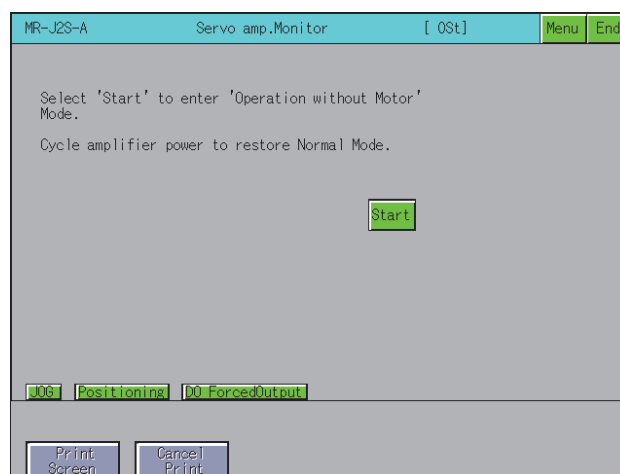











(2) Operation

- Start operation
 - Touch the **Start** key.
- Stop operation
 - To cancel the motor-less operation, turn the power of the servo amplifier off.

(3) Key functions

The table below shows the functions of the keys that are used for the operations of the motor-less operation screen.

Key	Function
	Starts motor-less operation.
	Changes to the JOG operation screen ( ■JOG operation screen).
	Changes to the positioning operation screen ( ■Positioning operation screen).
	Changes to the DO forced output screen ( ■DO forced output screen).
	Returns to the function selection menu screen.
	Exits the servo amplifier monitor.
	Stores the displayed screen to the memory card in BMP/JPEG file format or prints it with a printer. For further information about hard copies, refer to the following:  9.4.8 Hard copy output

(Continued to next page)

Key	Function
	The touch operation of this key is invalid.

DO forced output screen

The following describes the display data of the DO forced output screen and the key functions displayed on the screen.

(1) Displayed contents

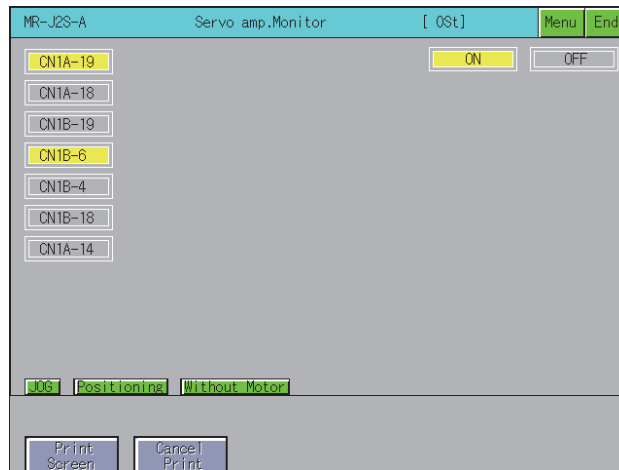







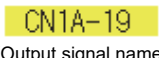

No.	Item	Description
1)	ON/OFF status of output signals	Displays the ON/OFF status of the servo amplifier output signals. • After this screen has been switched to another screen, all external I/O signals are turned off.

(2) Operation

When the name of an output signal is touched, the ON/OFF status of that signal is inverted and written to the servo amplifier.

(3) Key functions

The table below shows the functions of the keys used for the operations of the DO forced output screen.

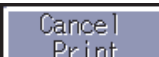
Key	Function
 (Output signal name)	Touching the signal name of an output signal sets or resets the status for that signal. • If the present output signal is ON, then the signal is turned off (RESET). • If it is OFF, then it is turned on (SET).
 *1	Displays the external output signals of the extension I/O unit.
	Changes to the JOG operation screen (☞ ■JOG operation screen).
	Changes to the positioning operation screen (☞ ■Positioning operation screen).
	Changes to the motor-less operation screen (☞ ■Motor-less operation screen).
	Returns to the function selection menu screen.
	Exits the servo amplifier monitor.
	Stores the displayed screen to the m5memory card in BMP/JPEG file format or prints it with a printer. For further information about hard copies, refer to the following: ☞ 9.4.8 Hard copy output
	The touch operation of this key is invalid.

*1: This is displayed only when the MR-J2M-P8A is connected.

9.4.8 Hard copy output

This section describes how to store a screen to the memory card in BMP/JPEG file format or print it with a printer when executing the amplifier monitor. Hard copy methods differ depending on the GOT to be used.

(1) GOT with VGA or higher resolution

Hard copy output operations are performed by touching the "Print Screen" or "Cancel Print" key displayed on the screen.

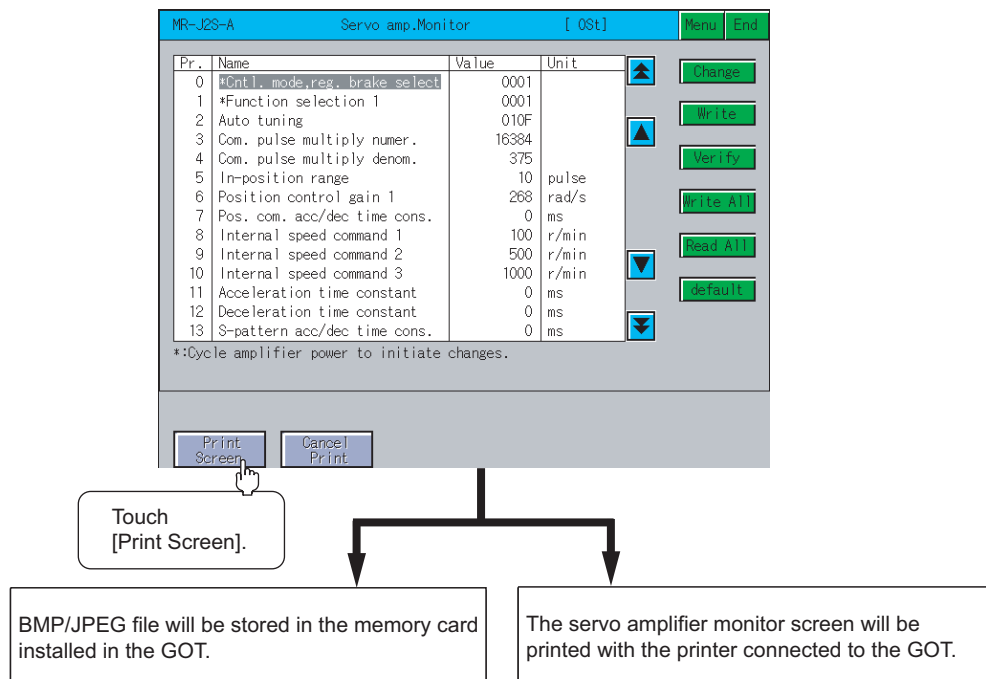

(2) GOT with QVGA resolution

Hard copy output operations are performed by turning ON/OFF the start or abort trigger device that has been set in the GT Designer3.

POINT

- Install the extended function OS (Printer) to the GOT when printing a servo amplifier monitor screen.
- The output target (CF card/printer) of hard copy can be set in [Hard Copy] of GT Designer3. For details of hard copy setting, refer to the following.



User's Manual for the GOT used

GT Designer3 Version1 Screen Design Manual (Functions) 40.HARD COPY FUNCTION

9.5 Error Messages and Corrective Action

This section describes the error messages that may be displayed during servo amplifier monitor operation and their corrective action.

Error message	Error definition	Corrective action
Monitor data not found	The monitor data have not installed or have been deleted.	Download the monitor data of the servo amplifier monitor.
It is not possible to set.	An item that cannot be set was selected.	Select an item that can be set.
No AMP Communications	Communication can not be established with the servo amplifier set as the monitor destination.	<ul style="list-style-type: none"> • Check the connection state between the servo amplifier and the GOT (connector disconnection, cable wire break). • Check if an error has occurred in the servo amplifier. • Set the same values to the setup screen on the servo amplifier monitor and the parameter setting on the servo amplifier.
This test mode cannot be selected. Operation without Motor rotation.	Another test operation function has started.	Exit the other test operation function.
SON Make sure that operation is at a stop.	The servo amplifier SON signal is ON.	Turn off the servo amplifier SON signal.
Incorrect setting range	A value outside the setting range was set when setting the servo parameter of the servo amplifier.	Set the servo parameter of the servo amplifier within the setting range.
Servo alarm has occurred. Alarm:**	An alarm occurred on the connected servo amplifier.	Reset the alarm on the servo amplifier.
Unit not found	The drive unit is not installed in the selected slot.	Select the slot where the drive unit is installed.
Unmatched password	The password that was input as the password for changing the servo amplifier parameter is incorrect.	Input the correct password.
Can't write to servo amp. Normally.	Failed to write the parameter.	Check the write data. Check the setup information.
Please confirm forward or reversal stroke end (LSP or LSN)	The servo amplifier LSP/LSN signal is OFF.	Turn on the servo amplifier LSP/LSN signal.
Communication channel setup error	The channel No. setting or communication driver setting is incorrect.	Check the communication settings.
It is not possible to select.	<ul style="list-style-type: none"> • MR-J2M-P8A, MR-J3-□A, or MR-J4-□A was selected with the station No. selection setting set to [No]. • A channel with no station number was selected for the MR-J2M-P8A. 	<ul style="list-style-type: none"> • Set the station No. selection setting to [Yes]. • Select a channel with a station number.

10. CNC MONITOR FUNCTIONS



10.1 Features

Functions, such as Position Display Monitor, Alarm Diagnosis Monitor, Tool Offset/Param, Program Monitor and APLC Release Screen, equivalent to the MELDAS dedicated display are available for the MELDAS connected to the GOT.

Position Display Monitor

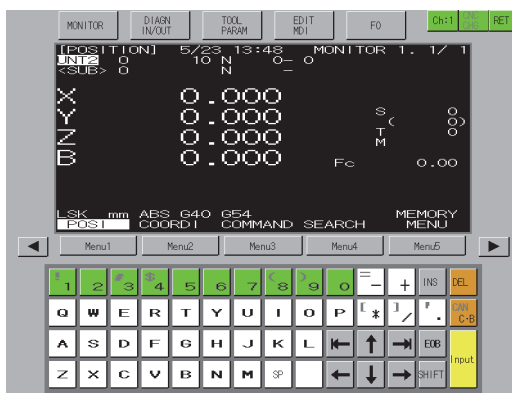

Alarm Diagnosis Monitor



Tool Offset Monitor

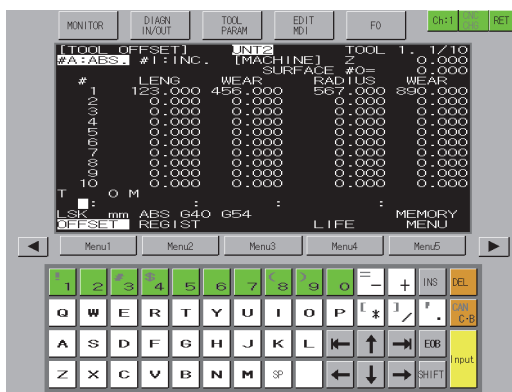

Program Monitor

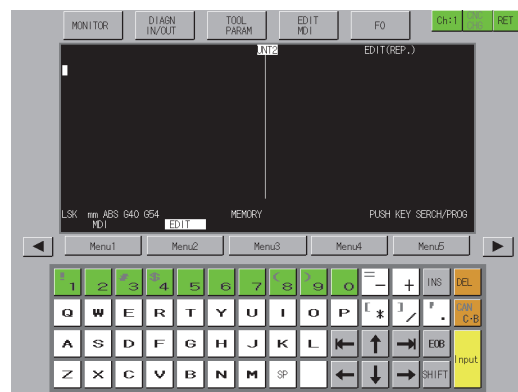

APLC function



9 SERVO AMPLIFIER MONITOR
10 CNC MONITOR FUNCTIONS
11 BACKUP/RESTORE
12 CNC DATA I/O
13 SFC MONITOR
14 LADDER EDITOR
15 MELSEC-L TROUBLE SHOOTING
16 LOG VIEWER

10.2 Specifications

10.2.1 System configuration

This section describes CNC type which the CNC data I/O function can be used and connection types between the GOT and the CNC.

For connection type settings and precautions regarding the communication unit/cable and connection type, refer to the following.

 GOT1000 Series Connection Manual (Mitsubishi Products) for GT Works3

■ Target CNC of the CNC monitor

CNC
C70, C6/C64

■ Connection type

This function can be used in the following connection types.

(○: Available, ✕: Unavailable)

Function		Connection type between GOT and controller		
Name	Details	Bus connection	Ethernet connection ^{*3}	MELSECNET/10 connection
CNC monitor	Monitors the CNC (C70, C6/C64) and changes the parameters	○ ^{*1}	○	○ ^{*2}

*1 Applicable to the CNC C70 only

*2 Applicable to the CNC C6/C64 only

*3 CNC monitor cannot be used when using CC-Link IE field network Ethernet adapter.

■ Required option OS and option function board

The option function OS and option function board shown below are required.

 1.1.2 Hardware and OS' required for each function

(1) Option OS

Install the option OS in the above table to the GOT.

For the installation procedure, refer to the following.

 GT Designer3 Version1 Screen Design Manual (Fundamentals) 8. COMMUNICATION WITH GOT

(2) OS memory space

The available memory space shown in the table above is required in the user area to install the option OS to the GOT.

For the procedure for checking the available memory space of the user area and information about the data using other user areas, refer to the following.

 GT Designer3 Version1 Screen Design Manual (Fundamentals) 8. COMMUNICATION WITH GOT

(3) Option function board

(a) For GT16

No option function board is required.

(b) For GT15

Mount one of the option function boards in the above table on the GOT.

For the GOTs with a built-in option function board, refer to the following.

 1.1.2 Hardware and OS' required for each function

For how to mount an option function board on the GOT, refer to the following.

 User's Manual for the GOT used

■ CNC functions that can be monitored

The CNC monitor function allows the following functions to be monitored.

For details of each function, refer to the manual for each CNC.

Item	Description	CNC C70	MELDAS C6/C64
Position Display Monitor	Position	○	○
	Coordinate	○	○
	Command	○	○
	Program search	○	○
	PLC switch	×	○
	Common variable	○	○
	Local variable	○	○
Alarm Diagnosis Monitor	Alarm message	○	○
	Servo monitor	○	○
	Spindle monitor	○	○
	PLC interface diagnosis	○	○
	Absolute position monitor	○	○
	Adjustment	×	○
	NC data sampling	○	×
	Operation history	○	○
	Configuration	○	○
	Data input	×	○
	Data output	×	○
	Program erase	○	○
	Program file	○	○
	Program copy	○	○
	Flash ATA card I/F	×	○
Auxiliary axis parameter	×	○	
Auxiliary axis monitor	×	○	
Tool Offset/Param	Wear data (L system)	○	○
	Tool length data (L system)	○	○
	Tool nose data (L system)	○	○
	Tool life management (L system)	○	○
	Tool offset (L/M system)	○	○
	Tool registration (L system)	○	○
	Workpiece coordinate	○	○
	Machining parameter	○	○
	I/O parameter	×	○
Other parameters	○	○	
Program Monitor	MDI editing	○	○
APLC Release Screen	APLC Release Screen	○	○

9

SERVO AMPLIFIER
MONITOR

10

CNC MONITOR
FUNCTIONS

11

BACKUP/RESTORE

12

CNC DATA I/O

13

SFC MONITOR

14

LADDER EDITOR

15

MELSEC-L
TROUBLE
SHOOTING

16

LOG VIEWER

10.2.2 Access range

- (1) **Bus connection**
One GOT can monitor up to two CNCs by switching the CNCs.
Up to five GOTs can simultaneously monitor one CNC.
- (2) **Ethernet connection**
One GOT can monitor up to 64 CNCs by switching the CNCs.
Up to eight GOTs can simultaneously monitor one CNC.
- (3) **MELSECNET/10 connection**
GOT monitors the control station only.

10.2.3 Precautions

- (1) **Before using the CNC monitor**
Read the manual of the connected CNC carefully and make sure you understand the contents before using the CNC monitor function.

- (2) **Inapplicable GOT**

The CNC monitor cannot be used with the GOTs shown below.

GOT	Inapplicable GOT
GT16	GT1675M-V, GT1675-VN, GT1672-VN, GT1665M-V, GT1662-VN, GT1655-V
GT15	GT1575-V, GT1575-VN, GT1572-VN, GT156□, GT155□

- (3) **Usable CNC**

The CNC monitor is applicable to the CNC C70 and MELDAS C6/C64.

- (a) CNC C70
Use the CNC C70 with the system software version of BND-1006W000-A0 or later.
- (b) MELDAS C6/64
Use the MELDAS C6/C64 with the system software version of BND-377W010-D0 or later.

10.3 Operations for Display

Start operation for the CNC Monitor

This section describes the flow until the operation screen of the CNC monitor is displayed after the CNC monitor (Option OS) is installed in the GOT.
 For the start operation of the CNC monitor using the special function switch, refer to the following.

Start operation using the special function switch

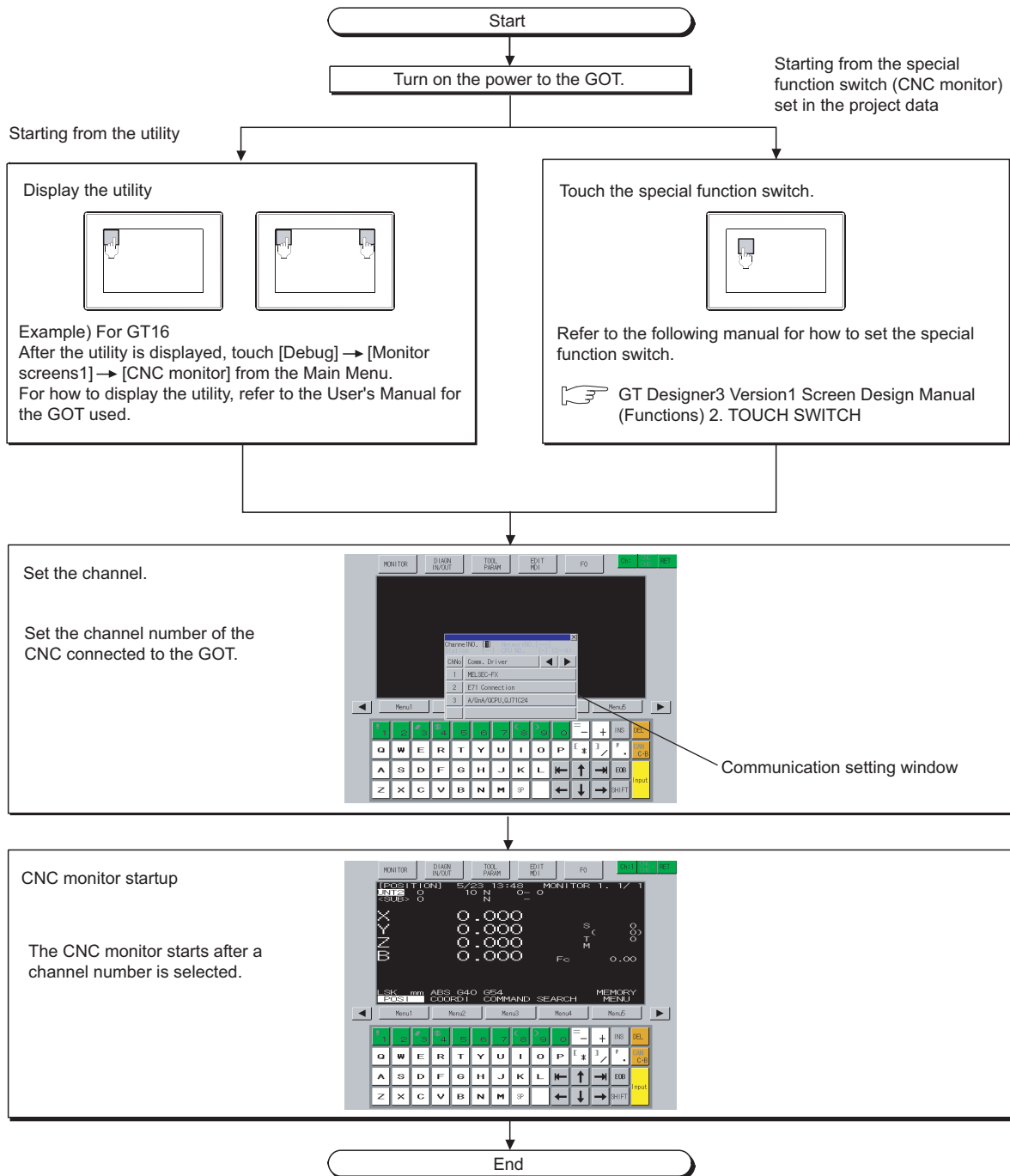

POINT

(1) How to display the utility

For how to display the utility, refer to the following.

 User's Manual for the GOT used

(2) Communication setting window display

The communication setting window is displayed only at initial startup of the CNC monitor after turning on the GOT power.

To display the communication setting window at startup from the second time or after, touch the Ch: button on the CNC monitor screen.

 10.4 Operation Procedures)

(3) If the project data has not been downloaded

The CNC monitor can be started from the utility even if the project data has not been downloaded to the GOT.

Start operation using the special function switch

CNC monitor can be started by using the special function switch.

The CNC monitor screen of controllers which have been set can be displayed by touching the special function switches to which the following settings are configured.

- Select [CNC monitor] in [Switch Action], and select the [Specify the destination to connect the screen of CNC Monitor] check box.

For Q-bus connection, [CPU No.] of [Network] should be 2 or more.

Operation at start differs depending on the setting contents of the special function switch.

For the setting items for the special function switch, refer to the following.

 GT Designer3 Version1 Screen Design Manual (Functions) 2. TOUCH SWITCH

Changing screens

This section describes how to change the screen.

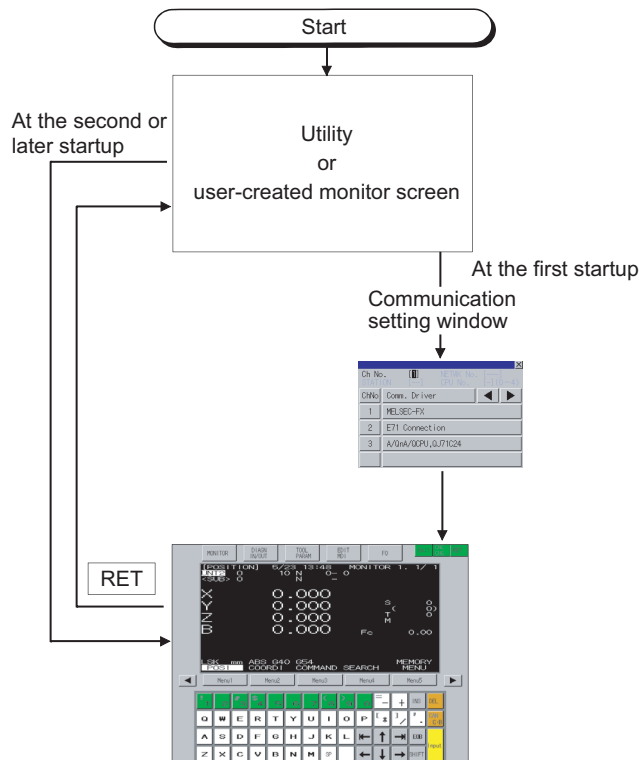

When exiting the CNC monitor function by touching RET, the last exited screen will be displayed when the CNC monitor function is started next time.

10.4 Operation Procedures



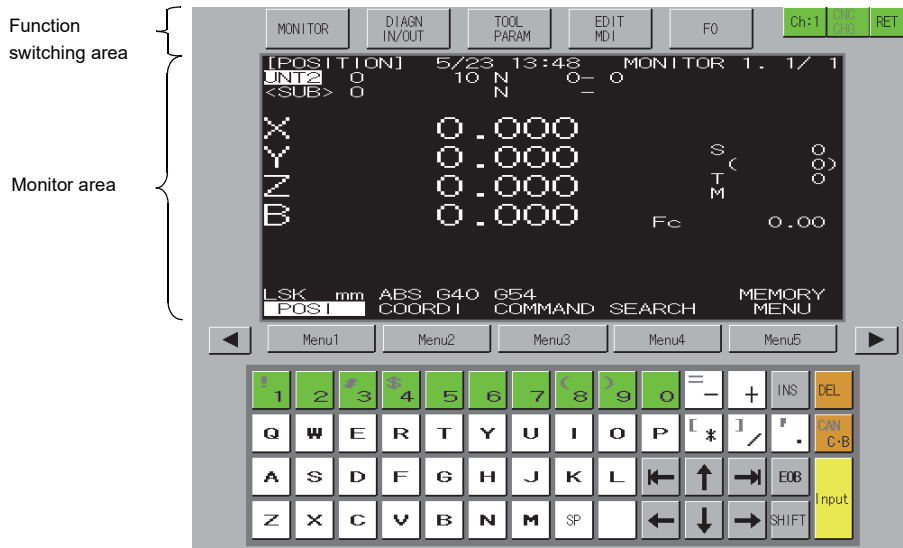













This section describes the display data of the CNC monitor screen and the key functions displayed on the screen.



Item	Display data						
Function switching area	Selects the function to be displayed and CNC monitor termination.						
	Switches the monitor area to position display monitor.						
	Switches the monitor area to alarm diagnosis monitor.						
	Switches the monitor area to tool compensation parameter.						
	Switches the monitor area to program monitor.						
	Switches the monitor area to the APLC screen. If the monitored CNC unit does not include the APLC release function, the screen turns blank (nothing is displayed). (In this case, use a function switching key to switch the monitor to another function.)						
	Displays the communication setting window.						
	<ul style="list-style-type: none"> For bus connection The button does not function. (Specify the monitoring target in the communication setting window.) For Ethernet connection Switches the monitor among the CNC units when connected to multiple CNC units. The MELDAS C6/C64 units are switched in the order set in the Ethernet setting of GT Designer2. For MELSECNET/10 connection Cannot be operated because only control station can be monitored (switching not required). 						
	Terminates the CNC monitor function and returns to a monitor screen or the utility of the GOT.						
Monitor area	Functions, such as Position Display Monitor, Alarm Diagnosis Monitor, Tool Offset/Param and Program Monitor, equivalent to the MELDAS dedicated display are available. The graphic and ladder editor functions are not available.						
to	Switches to the monitor that corresponds to the items in the menu area. In the case of the above screen, the menu items are as follows. <table style="margin-left: 40px; border: none;"> <tr> <td> : Relative value</td> <td> : PLC switch</td> <td> : Common editing</td> </tr> <tr> <td> : Local variable</td> <td> : Menu switching</td> <td></td> </tr> </table> When the MELDAS dedicated display is valid, the "Other display operating" message and "Key operation right" menu are displayed. Select the "Key operation right" menu when operating keys on the GOT.	: Relative value	: PLC switch	: Common editing	: Local variable	: Menu switching	
: Relative value	: PLC switch	: Common editing					
: Local variable	: Menu switching						

(Continued to next page)

9 SERVO AMPLIFIER MONITOR
 10 CNC MONITOR FUNCTIONS
 11 BACKUP/RESTORE
 12 CNC DATA I/O
 13 SFC MONITOR
 14 LADDER EDITOR
 15 MELSEC-L TROUBLE SHOOTING
 16 LOG VIEWER

Item	Display data
	Switches to the previous page when there are multiple pages displayed on the screen.
	Switches to the next page when there are multiple pages displayed on the screen.
Keyboard	Sets data to the monitor area.
Alphanumeric/symbol key	Enters alphabets (upper case only), numerals, spaces or symbols. The grayed symbol can be entered after the  key is touched.
   	Moves the cursor up, down, left or right. (Repeat function is available)
 	Moves the cursor to the previous or subsequent block. (Repeat function is available)
	Deletes one character at the cursor position.
	Switches the Insert mode.
	Deletes one block while editing machining program. After touching the  key, touch the  key to delete all blocks being displayed on the screen.
	Enters EOB(;) into the machining program.
	Determines the entry.
	Switches the key function.

10.5 Error Messages and Corrective Action

This section describes the error messages that may be displayed during CNC monitor operation and their corrective action.

If two or more of the following errors have occurred, the error with the higher priority is displayed.

Priority	Error message	Error definition	Corrective action
Higher  Lower	Support communication driver is not installed. (CNC MONITOR)	The compatible communication driver is not installed in the GOT.	Install the compatible communication driver in the GOT. Bus connection: Bus(Q) Ethernet connection: QJ71E71/AJ71(Q)E71,Q17nNC MELSECNET/10 connection: MELSECNET/10
	The IP address of CNC to monitor is not set up. (CNC MONITOR)	The IP address of the CNC has not been set.	After setting the IP address of the CNC to be monitored in the Ethernet setting of GT Designer3, download the project data to the GOT.
	Communication channel setup error	There is no channel for communication.	Check that the channel No. is correctly set in the communication settings.

- 9
- SERVO AMPLIFIER MONITOR
- 10
- CNC MONITOR FUNCTIONS
- 11
- BACKUP/RESTORE
- 12
- CNC DATA I/O
- 13
- SFC MONITOR
- 14
- LADDER EDITOR
- 15
- MELSEC-L TROUBLE SHOOTING
- 16
- LOG VIEWER

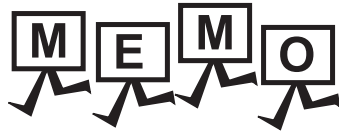

11. BACKUP/RESTORE



11.1 Features

Setting data, including a sequence program, parameters, and setting values, for a controller connected to the GOT can be saved (backed up) in a memory card or USB memory in the GOT. The following shows features of the backup/restore function.



GOT backup

The backup/restore function is applicable to controllers connected to the GOT. For backing up the GOT setting data, use the GOT data package acquisition function. For the GOT data package acquisition function, refer to the following.

 User's Manual for the GOT used

■ Backing up or restoring system without personal computer for reducing downtime

Setting data for a controller connected to the GOT can be backed up, and the data can be restored to the controller. With backing up setting data for a controller, the data can be restored to the controller with the GOT connected to the controller even though the controller has to be replaced because of problems, including failures. As a result, the system can be easily restored.

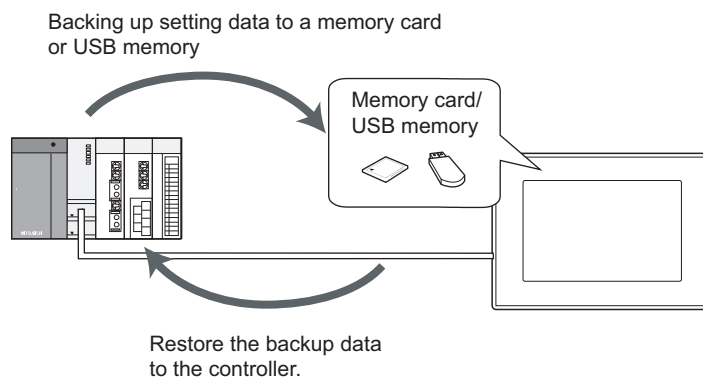

■ Enabling creating the same system without personal computer

With restoring the backed up setting data to controllers in other systems, the same system can be created without a personal computer.

Improving security

When the backup/restore function is used, browsing and changing setting data is limited with a password and the security is improved.

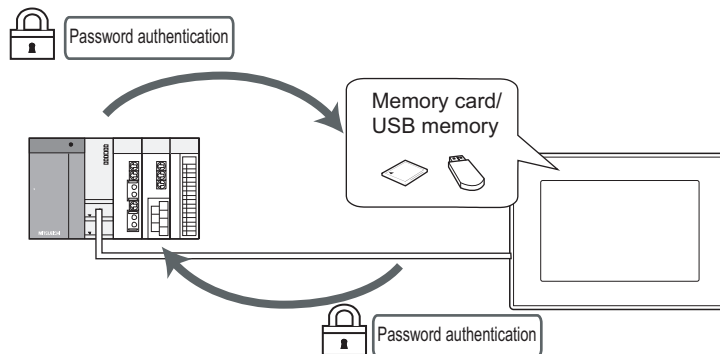

Automatically backing up data with trigger

By setting the trigger device or the days and time, the GOT can automatically back up setting data for controllers. By controlling the backup with the set trigger device, the GOT can automatically back up setting data for controllers after the data are changed.

By setting the days and time, the GOT can back up setting data for controllers periodically.

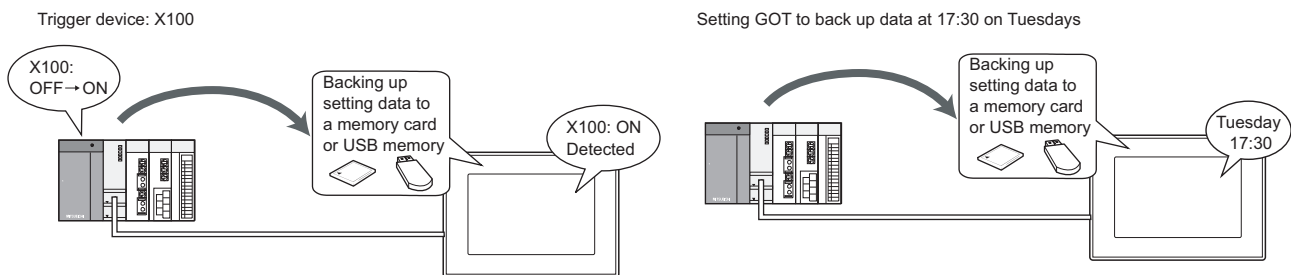

Batch backup/restoration can be performed to multiple controllers on the network

Batch backup/restoration can be performed to multiple controllers on the network per channel. Target controllers for the backup/restoration can be specified per station.

👉 11.3.4 Network batch backup/restore

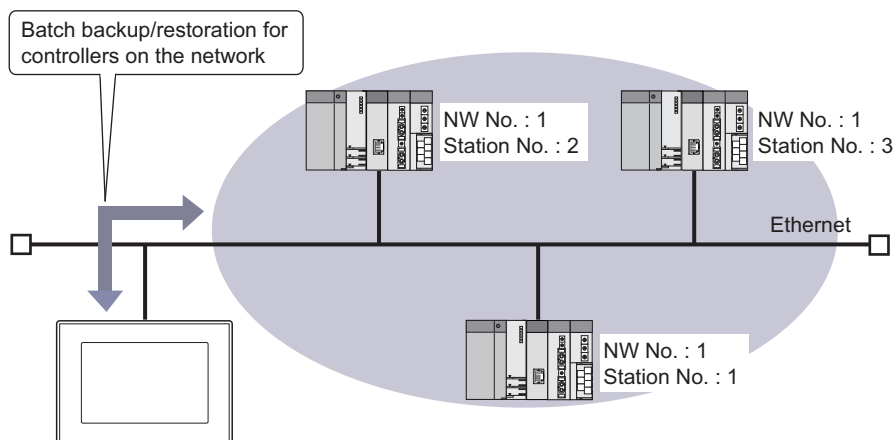

11.2 Specifications

11.2.1 System configuration

This section describes the system configuration for the backup/restore function. For connection type settings and precautions regarding the communication unit/cable and connection type, refer to the following.

 GOT1000 Series Connection Manual (Mitsubishi Products) for GT Works3

Target controller

Controller*1
QCPU(Q mode)*2*3*4
LCPU
Motion controller CPU(Q Series)*5*6
CNC C70
Robot controller*7
FXCPU*8

*1 When executing the network batch backup/restoration, use controllers compatible with the Ethernet connection. For the controllers compatible with Ethernet connection, refer to the following.

 GOT1000 Series Connection Manual (Mitsubishi Products) for GT Works3

- *2 Excluding the Q12PRHCPU, Q25PRHCPU.
- *3 Use a PLC CPU with the function version of B or later.
- *4 The backup/restore function cannot be used with the redundant CPU.
- *5 Use the following production number motion controller CPU when using the Q172CPU or Q173CPU.
 - For bus connection and direct CPU connection
Q172CPU: Production number K***** or later
Q173CPU: Production number J***** or later
 - For connections other than bus connection and direct CPU connection
Q172CPU: Production number N***** or later
Q173CPU: Production number M***** or later
- *6 The operation system software of SV13 and SV22 are available only. Use a motion controller CPU with the following OS installed when using the Q172CPU, Q173CPU, Q172CPUN, or Q173CPUN.
 - SW6RN-SV13Q□:00H or later
(00E or later for using the Q172CPU or Q173CPU with the bus connection or direct CPU connection)
 - SW6RN-SV22Q□:00H or later
(00E or later for using the Q172CPU or Q173CPU with the bus connection or direct CPU connection)
- *7 For using CRnQ-700 or CRnD-700, use robot controllers with the following versions or later.

Robot controller	Version
CRnQ-700	N8 or later
CRnD-700	P8 or later

- *8 To restore the backup data containing a special parameter, use the following version of CPU.
 - FX3U(C) version: 3.10 or later
 - FX3G(C) version: 2.00 or later

Connection type

This function can be used in the following connection types.

(○: Applicable, △: Partly restricted, ✕: Inapplicable)

Function		Connection type between GOT and controller			
Name	Description	Bus connection *1*2	Direct CPU connection *1	Computer link connection *1	Ethernet connection
Backup/restore	Backs up setting data for a controller connected to the GOT and restores the data to the controller.	△*5	○*3	△*6	△*4*6

- *1 This connection is not supported for CRnD-700.
- *2 The LCPU does not support the connection type.
- *3 When the GOT is connected to LCPU, use L6ADP-R2.
- *4 Backup/Restore cannot be used when using CC-Link IE field network Ethernet adapter.

- *5 When the multiple CPU system is used, the restoration cannot be performed to a QCPU with the factory-settings or whose memory is formatted.
- *6 The restoration cannot be performed to a QCPU with the factory-settings or whose memory is formatted.

■ Required extended function OS

The following extended function OS is required.

 1.1.2 Hardware and OS' required for each function

(1) Extended function OS

Install the extended function OS shown in the above table on the GOT.

For the installation procedure, refer to the following.

 GT Designer3 Version1 Screen Design Manual (Fundamentals) 8. COMMUNICATION WITH GOT

(2) OS memory space

For installing the extended function OS, the available space shown in the above table is required in the user area.

For the procedure for checking the available memory space of the user area and information about the data using other user areas, refer to the following.

 GT Designer3 Version1 Screen Design Manual (Fundamentals) 8. COMMUNICATION WITH GOT

■ Required hardware

The following hardware is required.

GOT	Hardware
GT16	CF card/USB memory
GT14	SD card/USB memory
GT12	CF card
GT15	CF card

■ Data to be backed up and restored

The following shows data to be backed up and restored.

Data other than the the following data cannot be backed up and restored.

(1) Basic model QCPU

Item	Description	File name
Parameter	Parameter for operating a programmable controller	PARAM.QPA
Intelligent function module parameter	Parameter for intelligent function modules	IPARAM.QPA
Sequence program	Program that the CPU operates	MAIN.QPG
SFC program	Sequence program with the SFC programming format	MAIN-SFC.QPG
File register	Data stored in file registers	MAIN.QDR
Device comment	Device comment to be stored in a programmable controller	MAIN.QCD
Device initial value	Setting the device initial value	MAIN.QDI

- *1 The file register in the Flash card installed in the CPU is always restored without confirming saving. Select whether restoring or not the file register stored in the SRAM card or standard RAM in the dialog box displayed when restoration is executed. When the file register is not restored, the existing file register is deleted. Therefore, programs of the controller may not work normally. If a problem occurs in the operation of the controller after restoration, perform the restoration again, including to the file register.

(2) High Performance model QCPU

Item	Description	File name
Parameter	Parameter for operating a programmable controller	PARAM.QPA
Intelligent function module parameter	Parameter for intelligent function modules	IPARAM.QPA
Program	Program that the CPU operates (Including SFC program)	***.QPG
Device comment	Device comment to be stored in a programmable controller	***.QCD
Boot operation specification file	Batch file for starting programs stored in ROM and others	AUTOEXEC.QBT
Device initial value	Setting the device initial value	***.QDI
File register ^{*1}	Data stored in file registers	***.QDR
Sampling trace file ^{*2}	Sampling trace data that the specified device data is continuously collected with the specified timing	***.QTD
Failure history data ^{*2}	Failure history data that are recorded self-diagnostic results	***.QFD
Programmable controller user data	Any user-created data stored in a memory card	***.*** (Optional)

- *1 The file register in the Flash card installed in the CPU is always restored without confirming saving. Select whether restoring or not the file register stored in the SRAM card or standard RAM in the dialog box displayed when restoration is executed. When the file register is not restored, the existing file register is deleted. Therefore, programs of the controller may not work normally. If a problem occurs in the operation of the controller after restoration, perform the restoration again, including to the file register.
- *2 The item can be backed up only.

(3) Universal model QCPU

Item	Description	File name
Parameter	Parameter for operating a programmable controller	PARAM.QPA
Intelligent function module parameter	Parameter for intelligent function modules	IPARAM.QPA
Program	Program that the CPU operates (Including SFC program)	***.QPG
Device comment	Device comment to be stored in a programmable controller	***.QCD
Boot operation specification file	Batch file for starting programs stored in ROM and others	AUTOEXEC.QBT
Device initial value	Setting the device initial value	***.QDI
File register ^{*1}	Data stored in file registers	***.QDR
Sampling trace file ^{*2}	Sampling trace data that the specified device data is continuously collected with the specified timing	***.QTD
Programmable controller user data	Any user-created data stored in a memory card	***.*** (Optional)
File for storing device data	Device data used for the SP.DEVST and S.DEVLD instructions	DEVSTORE.QST
Drive heading	The heading of the drive	QN.DAT
Remote password	Remote password settings	00000000.QTM
Monitor sequence extension	Data to increase the speed of monitors from other stations.	MONITOR.Q0*
Latch data backup file	Stores the backup data for the latch data backup function to the standard ROM.	LCHDAT00.QBK

- *1 The file register in the Flash card installed in the CPU is always restored without confirming saving. Select whether restoring or not the file register stored in the SRAM card or standard RAM in the dialog box displayed when restoration is executed. When the file register is not restored, the existing file register is deleted. Therefore, programs of the controller may not work normally. If a problem occurs in the operation of the controller after restoration, perform the restoration again, including to the file register.
- *2 The item can be backed up only.

(4) LCPU

Item	Description	File name
Parameter	Parameter for operating a programmable controller	PARAM.QPA
Intelligent function module parameter	Parameter for intelligent function modules	IPARAM.QPA
Program	Program that the CPU operates (Including SFC program)	***.QPG
Device comment	Device comment to be stored in a programmable controller	***.QCD
Boot operation specification file	Batch file for starting programs stored in ROM and others	AUTOEXEC.QBT
Device initial value	Setting the device initial value	***.QDI
File register* ¹	Data stored in file registers	***.QDR
Sampling trace file* ²	Sampling trace data that the specified device data is continuously collected with the specified timing	***.QTD
Programmable controller user data	Any user-created data stored in a memory card	***.*** (Optional)
File for storing device data	Device data used for the SP.DEVST and S.DEVLD instructions	DEVSTORE.QST
Drive heading	The heading of the drive	QN.DAT
Remote password	Remote password settings	00000000.QTM
Monitor sequence extension	Data to increase the speed of monitors from other stations.	MONITOR.Q0*
Latch data backup file	Stores the backup data for the latch data backup function to the standard ROM.	LCHDAT00.QBK
Data logging setting file	Setting the data logging	LOGCOM.QLG LOG01.QLG to LOG10.QLG
Menu definition file	Menu defining files	MENUDEF.QDF

- *1 The file register in the Flash card installed in the CPU is always restored without confirming saving.
Select whether restoring or not the file register stored in the SRAM card or standard RAM in the dialog box displayed when restoration is executed.
When the file register is not restored, the existing file register is deleted.
Therefore, programs of the controller may not work normally.
If a problem occurs in the operation of the controller after restoration, perform the restoration again, including to the file register.
- *2 The item can be backed up only.

(5) Q series motion controller CPU

Item	Description	File name
Motion SFC program conversion file (control code)	File where SFC code, G-code and F/FS code files are combined and converted into CPU's Motion SFC program code memory storage format	sfcprog.cod
Motion SFC program conversion file (text)	File where G list and F/FS list files are combined and converted into CPU's Motion SFC program text memory storage format	sfcprog.bin
Motion SFC parameter file	Motion SFC control parameter setting information files	sfcprmD.bin ^{*1}
		sfcprm.bin ^{*2}
K code file	Internal code files of servo program	svprog.bin
System setting data file	System setting data information files	svsystemD.bin ^{*1}
		svsystemH.bin ^{*3}
		svsystem.bin ^{*4}
High speed read setting file	High speed read setting information files	svlatchD.bin ^{*1}
		svlatch.bin ^{*2}
Optional data monitor setting file	Optional data monitor information files	svsysmonD.bin ^{*1}
		svsysmon.bin ^{*2}
Servo data file	Axis data parameter block information files	svdataD.bin ^{*1}
		svdataH.bin ^{*3}
	Servo parameter information files	svparaH.bin ^{*3}
	Servo parameter information files	svdata.bin ^{*4}
		svdata2.bin ^{*4}
Limit switch setting data information files	svls.bin	
Mechanical system program conversion file	File after conversion of mechanical system program edit information file into internal codes	svmchprm.bin ^{*5}
Cam data conversion file	Cam data files of cam No.1 to 64	svcamprm.bin ^{*5}
	Cam data files of cam No.101 to 164	svcampr2.bin ^{*5}
	Cam data files of cam No.201 to 264	svcampr3.bin ^{*5}
	Cam data files of cam No.301 to 364	svcampr4.bin ^{*5}
Cam Edit data	Cam Edit data files	svcameditD.bin
Vision sensor parameter	Vision sensor parameter setting information files	visionD.bin
User safety sequence program	Safety sequence program files	safetyD.bin
Mark detection setting data	Mark detection setting data	svmarkD.bin
Q series PLC common parameter file	Data files of Multiple CPU setting, I/O assignment, and others	param.wpa
Multiple CPU high speed refresh setting	Multiple CPU high speed refresh setting information files	svrefresh.bin ^{*1}

*1 The data can be backed up or restored only with the Q172DCPU, Q173DCPU, Q170MCP, or Q170MSCPU.

*2 The data can be backed up or restored only with the Q172HCP, Q173HCP, Q172CP, Q173CP, Q172CPUN, or Q173CPUN.

*3 The data can be backed up or restored only with the Q172HCP or Q173HCP.

*4 The data can be backed up or restored only with the Q172CP, Q173CP, Q172CPUN, or Q173CPUN.

*5 The data can be backed up or restored with the SV22 operating system software only.

*6 The data can be backed up or restored only with the Q172HCP, Q173HCP, Q172DCP, Q173DCP, Q170MCP, or Q170MSCPU.

(6) CNC C70

Item	Description	File name
Machining program	All programs for operating a machine tool with a CNC	ALL.PRG
Parameter	Parameter for operating a CNC	ALL.PRM
Tool offset data	Offset data of the tool length compensation and tool radius compensation	TOOL.OFS
Workpiece offset data	Offset data between the machine coordinate system and workpiece coordinate system	WORK.OFS
Common variable	Macro variables applicable to different machining programs	COMMON.VAR
CNC ladder	User-created PLC program (ladder)	USERPLC.LAD

(7) Robot controller

Item	Description	File name
Error log	Error log (all levels)	AError.LOG
	Error log (low level)	LError.LOG
	Error log (caution level)	CError.LOG
	Error log (high level)	HError.LOG
Error count	Total errors	TTLERROR.DAT
Common parameter	Common parameters	COMMON.PRM
Mechanical parameter	Parameter for robots	(Machine name) # (Machine No. 1 to 3).PRM
Backup information	Setting information on backup	BKUP.SYS
Mechanical information	Information on the robot	MECHA.SYS
System program	System based program files	sysalgn.MB5/MB4
		sysimac.MB5/MB4
		Sysorg.MB5/MB4
		Syssafe.MB5/MB4
		Systembase.MB5/MB4
User program	User-created robot programs	***.MB5/MB4
Robot serial	Serial No. for robots	RobotSerial.ser
Maintenance forecast information	Information on maintenance forecast	MFInfo.mfb

(8) FX CPU

Item	Description	File name
Parameter	Parameter for operating a programmable controller	INFO.FPG
Device comment	Device comment to be stored in a programmable controller	
Sequence program	Program that the CPU operates	
Special program ^{*1}	Positioning setting/Initial value parameter	
File register	Data stored in file registers	
Extension file register ^{*2}	Data stored in extension file registers	
Built-in CC-Link/LT setting ^{*3}	CC-Link/LT parameter	
Special parameter ^{*1}	Special adapter/special block parameter saved in the main unit	

*1 The data can be backed up or restored with the FX3U(C) series and FX3G(C) series only.

*2 The data can be backed up or restored with the FX3U(C) series only.

*3 The data are stored in the FX3U-32MT-LT-2 only.

(9) Data for software

Item		Description	File name
Label program		Data for GX Developer	PROJINFO.CAB
Symbolic data		Symbolic data for PX Developer	#FBDQINF.BIN
Source information	Simple project (with label)	GX Works2 data	SRCINFOM.CAB SRCINFOM.C32
	Structured project	GX Works2 data	SRCINFOI.CAB SRCINFOI.C32
New source information	Simple project (with label)	GX Works2 data	SRCINF1M.CAB SRCINF2M.CAB SRCINF1M.C32 SRCINF2M.C32
	Structured project	GX Works2 data	SRCINF1I.CAB SRCINF2I.CAB SRCINF1I.C32 SRCINF2I.C32

Backup setting

Backup settings are created when executing the backup, and are stored in a CF card or USB memory with the following folder structure.

CF card/USB memory CF card or USB memory in the drive set as the storage location for the backup setting

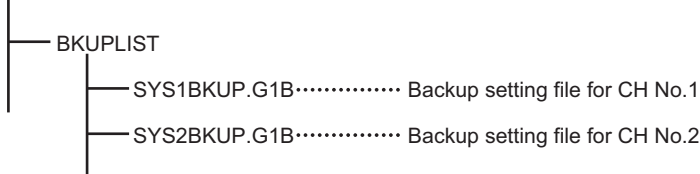

For how to set the storage location for the backup setting, refer to the following.

11.3.1 Setting storage location for backup data

GT Designer3 Version1 Screen Design Manual (Fundamentals) 4.9. GOT Display and Operation Setting

Backup data

(1) Storing backup data

When backups for the same channel are executed several times, the backup data are stored in a CF card or USB memory. (Backup data stored in the CF card or USB memory are not overwritten.)

(2) Storage location for backup

Backup data are stored in a CF card or USB memory with the following folder structure.

CF card/USB memory CF card or USB memory in the drive set as the storage location for backup data

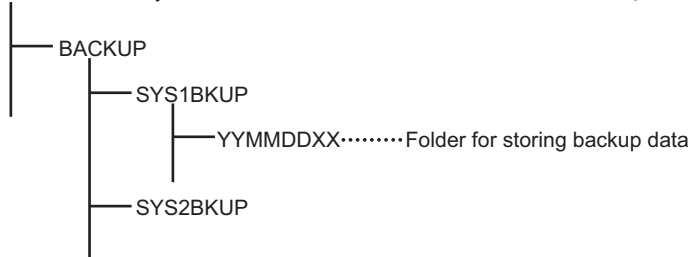

For how to set the storage location for backup data, refer to the following.

11.3.1 Setting storage location for backup data

GT Designer3 Version1 Screen Design Manual (Fundamentals) 4.9. GOT Display and Operation Setting

9 SERVO AMPLIFIER MONITOR
 10 CNC MONITOR FUNCTIONS
 11 BACKUP/RESTORE
 12 CNC DATA I/O
 13 SFC MONITOR
 14 LADDER EDITOR
 15 MELSEC-L TROUBLE SHOOTING
 16 LOG VIEWER

(3) Folders for backup data

Backup data are stored by the folder, and a folder name (YYMMDDXX) is set as follows.

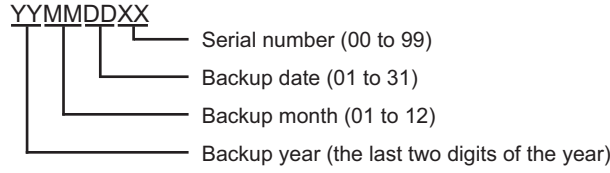

Example) Folder name for the 10th backup data for Ch.1 on November 22nd, 2006

Folder name: 06112209

When names of folders for backup data include XX of 99, the backup data cannot be stored.

Up to 100 backups can be executed per channel in a day.

■ Log files for backing up or restoring

When backing up or restoring, the controllers and files to be backed up or restored are recorded in log files (When backing up or restoring, they are overwritten.)

Log files are created in the folder where each backup data is stored.

■ Backup data

(a) File format

Item	Setting
File name, extension	result.txt
File format	SJIS text format

(b) Format

```
[BACKUP]
BACKUP_NAME=SYS1BKUP
TIME=09/09/16 20:25:46
1 / 2, NG=1
CH=01, NET=001, ST=002
CPU=01, PLC, Q02HCPU
COPYFILES0000=D0\PARAM.QPA OK
COPYFILES0001=D0\MAIN.QPG OK
COPYFILES0002=D0\PRG1.QPG OK
COPYFILES0003=D0\MAIN.QCD OK
2 / 2, NG=1
```

Item	Setting
Header	Displays the executed operation type. ([BACKUP]: Backup, [RESTORE]: Restore)
Backup setting	Displays the backup setting name.
Start time	Displays the start time for backing up or restoring.
Target devices	Displays the CH No., network No., station No., CPU No., unit type, and model of the target device when backing up or restoring. The following shows the display contents for unit types. <ul style="list-style-type: none"> • PLC: PLC CPU • NC : NC • MC : Motion controller • SV : Servo Amplifier • INV : Inverter • RC : Robot controller
Files	Displays the backed up or restored files.
Backup/restore status	Recorded only when network batch backing up or restoring. Displays the number of controllers which the backup/restore is completed, the number of all target controllers, the number of controllers which backup/restore is completed, and the number of errors, by station.

11.2.2 Access range

(1) Access range with connection types

The following shows a target controller of the backup/restore execution with each connection type.

Connection type	Target controller
Bus connection, Direct CPU connection, computer link connection, Ethernet connection	Host station
Ethernet connection	Host station, Other station

(2) With multi-channel function

With the multi-channel function, the backup and restoration is executed per channel.

(3) Backing up/restoring data for multiple CPU system

For the backup, the batch backup for all CPUs or specified backup of CPU No. 1 to 4 can be selected with the utility setting.

The restoration is executed with specifying CPU No. 1 to 4.

When the backup or restoration is executed with specifying CPU No. 1 to 4, multiple CPUs (CPU No. 1 to 4) can be specified.

11.2.3 Precautions

■ Precautions for backup

(1) Data that cannot be backed up

The GOT cannot back up device current values and data stored in device memories.

For collecting device current values, use the advanced recipe function.

For how to use the advanced recipe function, refer to the following manual.

 GT Designer3 Version1 Screen Design Manual (Functions) 25.3 Advanced Recipe Function

For collecting data stored in device memories, use GX Developer.

(2) Names of files to be backed up

When characters other than the characters defined in the shift JIS code and ASCII code are used for file names, the file names may not be correctly displayed with the data backed up on the GOT.

For using the backup/restore function, use characters in the JIS code and ASCII code for file names.

(3) Backing up data stored in file registers

Because backing up data stored in file registers takes a long time, some file register data may have different time stamps in one backup data. Therefore, synchronism of the data is not assured.

Backing up intelligent function module parameters

(4) Backing up intelligent function module parameters

For backing up an intelligent function module parameter (IPARAM.QPA), only the parameters that can be stored in the PLC CPU are the target parameters.

To store other intelligent function module parameters than those, GX Configurator applied to GX Works2 and the intelligent function module is required.

For the intelligent function module parameters that can be stored in the PLC CPU, refer to the following.

 GX Works2 Version 1 Operating Manual (Intelligent Function Module)

■ Precautions for restore

(1) Communication status between GOT and target controllers

For restoring data, enable the target controllers of the restoration to communicate with the GOT.

When the target controllers of the restoration cannot communicate with the GOT, the restoration cannot be executed.

(2) STOP status during restoration

CPUs for the programmable controller and motion controller are in the STOP status with the remote STOP before the restoration.

For the CNC C70, the CNC ladder is in the STOP status.

The CPUs and CNC ladder remain in the STOP status after the restoration is completed.

Restart the controllers.

(3) When restoration is canceled

When the restoration is canceled, all the data are not restored to the controllers and the controllers may not correctly operate.

When the restoration is canceled, be sure to execute the restoration again.

The CPUs and CNC ladder remain in the STOP status after the restoration is canceled.

Restart the controllers.

(4) System configuration with controllers for restoration

Set the same system configuration with the controllers for the restoration as those for the backup.

Failure to do so disables the GOT to restore data to the controllers.

When the system configuration with the controllers for the restoration is the same as those for the backup, the GOT can restore data to the controllers even if the connection type and CH No. for the restoration differ from those for the backup.

(5) Controller operations

Controllers may malfunction by changing set values, device values, and others during the restoration.

Check that data to be restored is the appropriate data, and then execute the restoration with paying attention to the controller operations.

■ Common precautions for backup and restore

(1) Password for backup/restore

When a password for a controller is changed after setting the password for the backup/restore, set a new password for the backup/restore.

For setting the password for the backup/restore, refer to the following.

 11.3.2 Security and password

(2) Precautions for GT Designer3

Do not execute the following operations with GT Designer3 during the backup/restore.

Operation with GT Designer2			
OS installation,	BootOS installation,	CoreOS installation,	Project download,
Special data download			

When the above operations are executed, the backup/restore is stopped.

(3) Precautions for GX Developer

(a) Do not access the target controller of the backup/restore with GX Developer during the backup/restore. Doing so stops the backup/restore.

(b) Do not execute the backup/restore on the GOT while the target controller of the backup/restore is accessed by GX Developer. Doing so causes a communication error on GX Developer. (The backup/restore is executed.)

(4) Precautions for multiple GOTs

Do not access the backup/restoration-target controller from multiple GOTs simultaneously.

If the target controller is accessed from multiple GOTs simultaneously, the backup or restoration is cancelled.

(5) CPU with a security key

The backup/restore cannot be executed on the CPU on which the security key is set.

To execute the backup/restore, check the setting of the CPU.

When the target controllers of the backup/restore include both the CPU with the security key and the CPU without the security key, the backup/restore is executed only for the CPU without the security key.

(6) Precautions for the Flash card

All the data stored in the Flash card is backed up or restored as one file (FlashCard.dat).

■ Precautions for QCPU

The restoration to QCPU with the factory-settings or whose memory is formatted is available only in the following cases.

- For a single CPU system: When the connection type is the bus connection or direct CPU connection
- For a multiple CPU system: When the connection type is the direct CPU connection

However, in a multiple CPU system which includes a QCPU with the factory-settings or whose memory is formatted, batch restoration to multiple controllers cannot be performed.

Restore each controller with the following procedure.

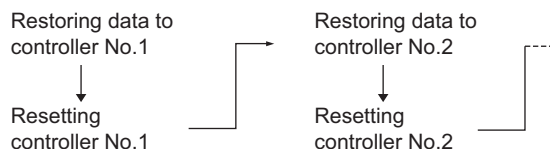

■ Precautions for motion controller CPUs

(1) OS for motion controller CPU

The OS for the motion controller CPU cannot be backed up or restored.

For backing up or restoring setting data for the motion controller CPU, install an appropriate OS on the motion controller CPU in advance.

(2) Backup/restore target

The GOT backs up or restores data stored in the SRAM built in the motion controller CPU, regardless of the operation mode.

For writing data to the FLASH ROM built in the motion controller CPU, restore the data to the SRAM, and then write the data in the SRAM to the FLASH ROM with MT Developer.

(3) Backup

For backing up data for controllers including the motion controller CPU, do not set the motion controller CPU to the installation mode.

When the motion controller CPU is set to the installation mode, the GOT does not back up data for the motion controller CPU. (The GOT backs up data for the other controllers on the same base unit.)

(4) Restoration

For restoring data to controllers including the motion controller CPU, do not set the motion controller CPU to the installation mode or test mode.

Doing so stops the restoration operation of the GOT.

When the restoration is stopped, be sure to execute the restoration again.

Failure to do so causes the GOT not to write all the data into the controllers, resulting in incorrect operations of the controllers.

■ Precautions for CNC

The backed up CNC data includes machining programs, parameters, and others. Those data are related one another.

Therefore, when any of the data is changed with a text editor and others, the GOT cannot restore the backed up CNC data to the CNC.

For editing CNC data, use the CNC data I/O function.

 12. CNC DATA I/O

■ Precautions for robot controller

(1) Restoration during program execution

The restoration cannot be performed during program execution.

(2) Confirmation before restoring

- Confirm the error cause in advance, since the error record is deleted by restoring.
- Confirm that the error C7500 "No battery voltage" does not occur when restoring.

(3) Restoration when replacing a robot

If models of robots are different, the restoration cannot be performed.

If a robot, motor, reducer, or belt is replaced, configure the origin setting.

If a robot controller is compatible with the maintenance forecast, reset the maintenance forecast when replacing the robot or belt.

(4) Operations during backing up or restoration on the GOT

Do not execute [Program read], [Program save], [Backup/Restore] or others for robot controllers to be backed up or restored from RT ToolBox2 or R56TB, while backing up or restoring on the GOT.

Doing so causes lack of consistency of data in a robot controller or acquired from RT ToolBox2.

(5) Version of the robot controller

The backed up data of the robot controller version R1d/S1d or later cannot be restored in the robot controller version R1c/S1c or earlier.

(6) Edit and restoration of backup data

The data backed up on the GOT can be edited and restored with RT ToolBox2.

To edit and restore data with RT ToolBox2, copy the data backed up on the GOT to the Backup folder in the project folder in RT ToolBox2.

However, the following data cannot be restored on the GOT.

- Data edited with RT ToolBox2 after the backup on the GOT.
- Data backed up with RT ToolBox2 or R56TB.

■ Precautions for FXCPU

(1) Attaching a memory cassette

When a memory cassette is attached to a FXCPU, data in the memory cassette is backed up.

When a memory cassette is not attached to the FXCPU, data in the built-in memory is backed up.

(2) Keyword setting

The following table shows whether the backup/restore function is executed or not by each keyword setting.

(Executed: ○ Not executed: ×)

Function	Protection that cannot be disabled by keyword			With keyword						Without keyword
	Write protection	Read/Write protection	All operation protection	Write protection		Read/Write protection		All operation protection		
	Enabled	Enabled	Enabled	Enabled	Disabled	Enabled	Disabled	Enabled	Disabled	
(Trigger) Backup	○	×	×	○	○	×	○	×	○	○
Restore	×	×	×	×	○	×	○	×	○	○

(3) Keyword for restoring data

When data are restored to a target FXCPU, a keyword in the FXCPU is held.

For setting or disabling a keyword for the FXCPU, refer to the following manual.

 User's Manual for the GOT used

Programming manual for the FXCPU used

(4) Backup data which contains source information

When the target FXCPU of the restoration does not support source information, the backup data which contains source information cannot be restored.

11.3 Operations for Display

The following describes the outline for displaying the operation screen for the backup/restore after installing Backup/Restore (extended function OS) on the GOT.

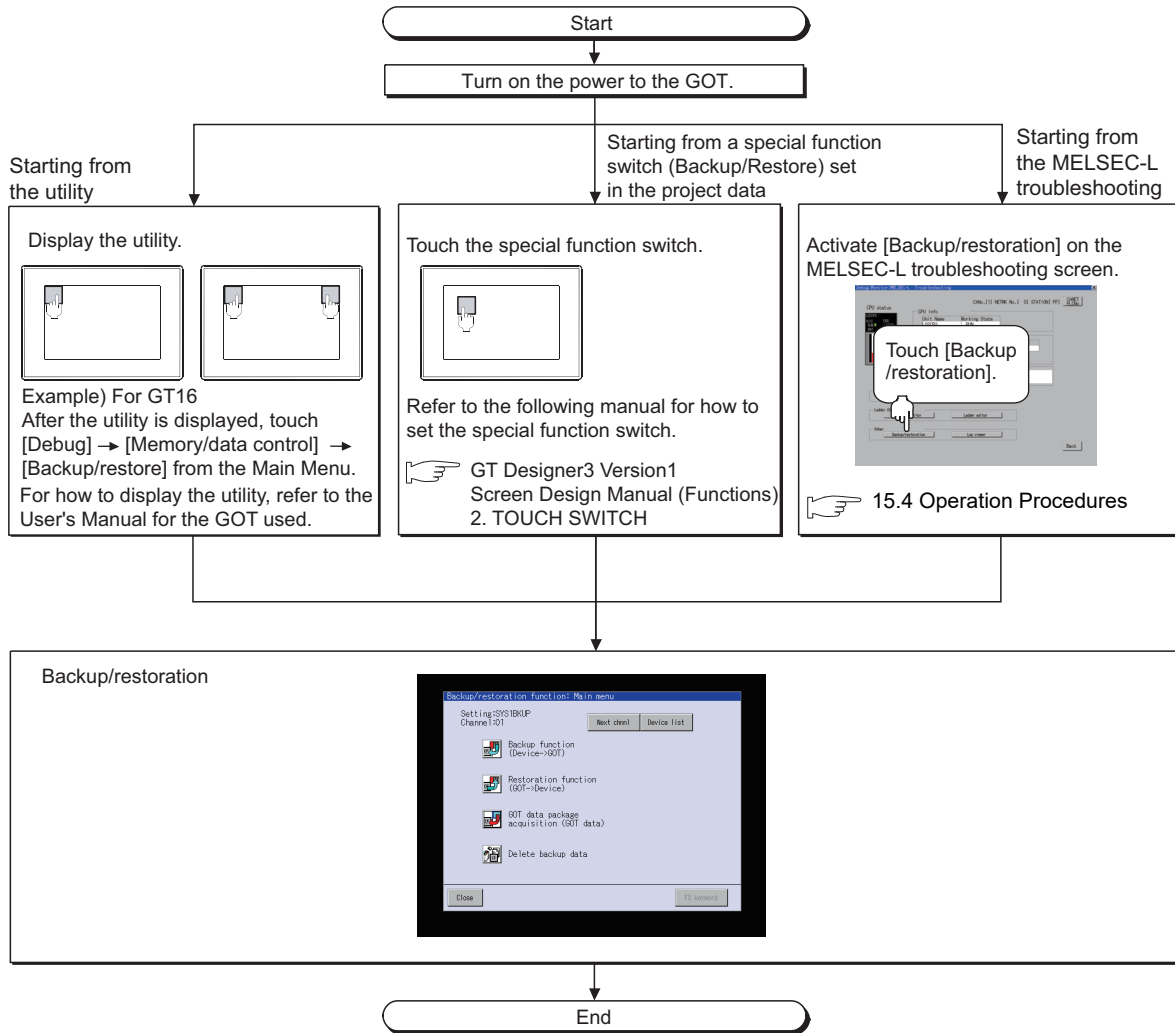

POINT

- (1) **How to display the utility**
For how to display the utility, refer to the following.
 User's Manual for the GOT used
- (2) **When GOT has no project data**
The backup/restore can be started with the utility even though the GOT has no project data.

Changing screens

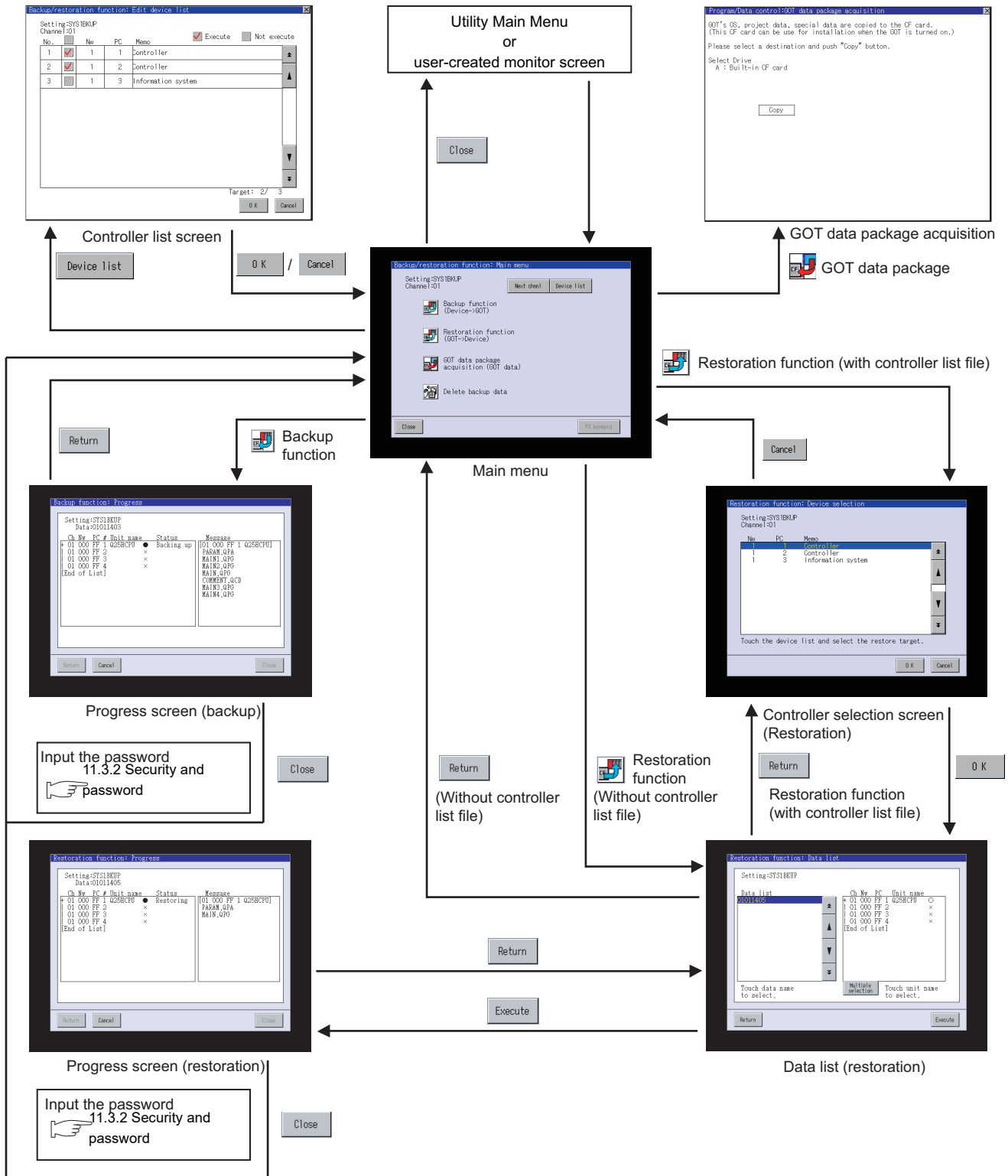

■ Background processing stop

By the background processing stop signal (GS522.b0), background processing by other functions (alarm, logging, device monitoring) can be stopped during the backup/restoration.

When background processing is performed, the backup/restoration and other functions are alternately performed. Therefore, backup/restoration takes much time, but the monitoring of the controller continues.

When background processing is not performed, processing of other functions stop until the backup/restoration is completed.

Therefore, the monitoring of the controller stops, but the backup/restoration takes less time.

* When background processing is performed

Backup/restoration and other functions alternately perform communication.

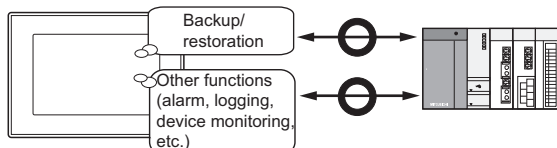

* When background processing is stopped

Other functions stop communication until backup/restoration is completed.

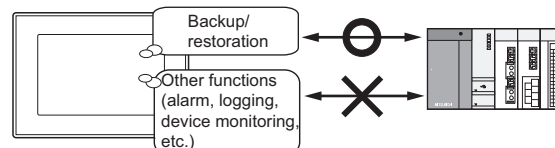

GOT special register	Description	
Background processing stop signal (GS522.b0)	OFF	In the backup/restoration, background processing is performed.
	ON	In the backup/restoration, background processing is not performed.

POINT

(1) Log file save setting

Before background processing is stopped, set the file saving for the functions that collect log data such as the alarm and logging.

Without setting the file saving, all log data such as alarm data and logging data are lost after backup/restoration is completed.

(2) Functions disabled during background processing stop

When background processing is stopped, in the backup/restoration, all functions stop except for the backup/restoration.

Therefore, the following functions that collect log data cannot acquire the data in the backup/restoration.

- Advanced alarm function/alarm function
- Operation log function
- Logging function
- Advanced recipe function/recipe function

(3) Background processing stop for trigger backup

During the trigger backup, turning on the background processing stop signal (GS522.b0) does not stop background processing.

Background processing is always performed.

11.3.1 Setting storage location for backup data

Set the storage location that backup data are stored.

Set the storage location for backup data in the backup/restoration setting of the utility.

■ Display procedure

(1) For GT16 and GT12

Select [Debug] → [Debug setting] → [Backup/restoration setting] from the utility.

(2) For GT15 and GT14

Select [GOT setup] → [Backup/restoration setting] from the utility.

■ Settings

Drive for backup setting	A:Built-in CF card
Drive for backup data	A:Built-in CF card
Trig bkup setting	Setting...
Max. of bkup data (1-50, 0: No limit)	0
Enable CPU No. setting	NO

Item	Description
Drive for backup setting	Specify the drive for storing backup settings, including parameters and passwords for controllers.
Drive for backup data	Specify the drive for storing backup data.
Trigger backup setting	The GOT automatically backs up data when triggers (Rise, Time) specified for each backup setting are met.
Max. of backup data	Set the maximum number of backup data to be stored. (When 0 is specified, the GOT does not check the number of backup data to be stored.)
Enable CPU No. setting	Set whether to enable the CPU No. setting or not. (When [Enabled] is selected, the GOT starts to communicate with only the specified PLC. Therefore the network batch backup/restoration on the multiple PLCs cannot be executed.)

POINT

Setting on GT Designer3

The backup/restoration setting can also be set in the GOT setup on GT Designer3.

For the GOT setup of GT Designer3, refer to the following.

 GT Designer3 Version1 Screen Design Manual (Fundamentals) 4.9 GOT Display and Operation Setting

11.3.2 Security and password

By setting the passwords, the password authentication is available when the backup/restore is executed. The password authentication uses the password for the backup/restore and passwords for controllers.

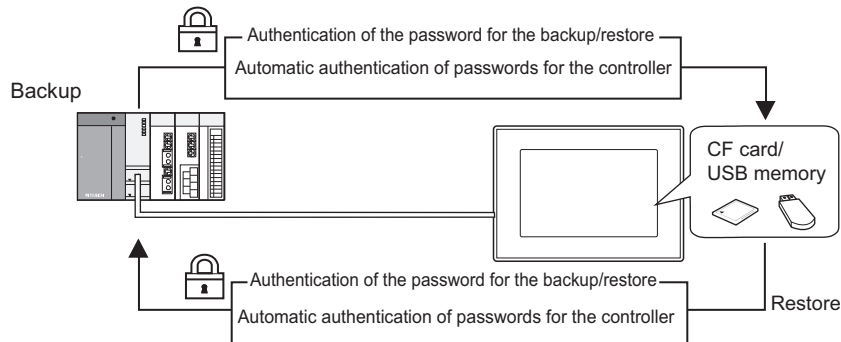

The following shows the passwords used for the backup/restore.

Password	Description
Password for backup/restore	Password for the backup/restore function Set the password on the GOT at the first backup. Before setting the password, set passwords for controllers in advance.
Passwords for controllers	Passwords set for the files for the target controllers of the backup/restore Set the passwords with software for the controllers when writing the files to the controllers.

After the first backup (after setting the password for the backup/restore), the user has no need to input the passwords for the controllers. (The passwords for the controllers are automatically verified.)
The following shows the security advantages.

User	Advantage
Administrator	No need to disclose the passwords for the controllers to the operator (Preventing anyone other than the administrator to browse or edit setting data for the controllers.)
Operator	The backup/restore is executed by using the password for the backup/restore only. (No need to input passwords for the controllers)

POINT

Before setting password for backup/restore

When the user forgets the password for the backup/restore, the backup/restore cannot be executed. In that case, execute the backup again by using a formatted or new CF card or USB memory.

For how to set the password for the backup/restore, refer to the following.

■ Setting password for backup/restore

How to use the password for the backup/restore, refer to the following.

■ How to use password for backup/restore

■ Setting password for backup/restore

The password for the backup/restore can be set only when the following condition is satisfied at the first backup.

- When passwords are set for the files for the backup target controller

At the first backup, the password authentication for the controller is required.

The following shows the operating procedure at the first backup.

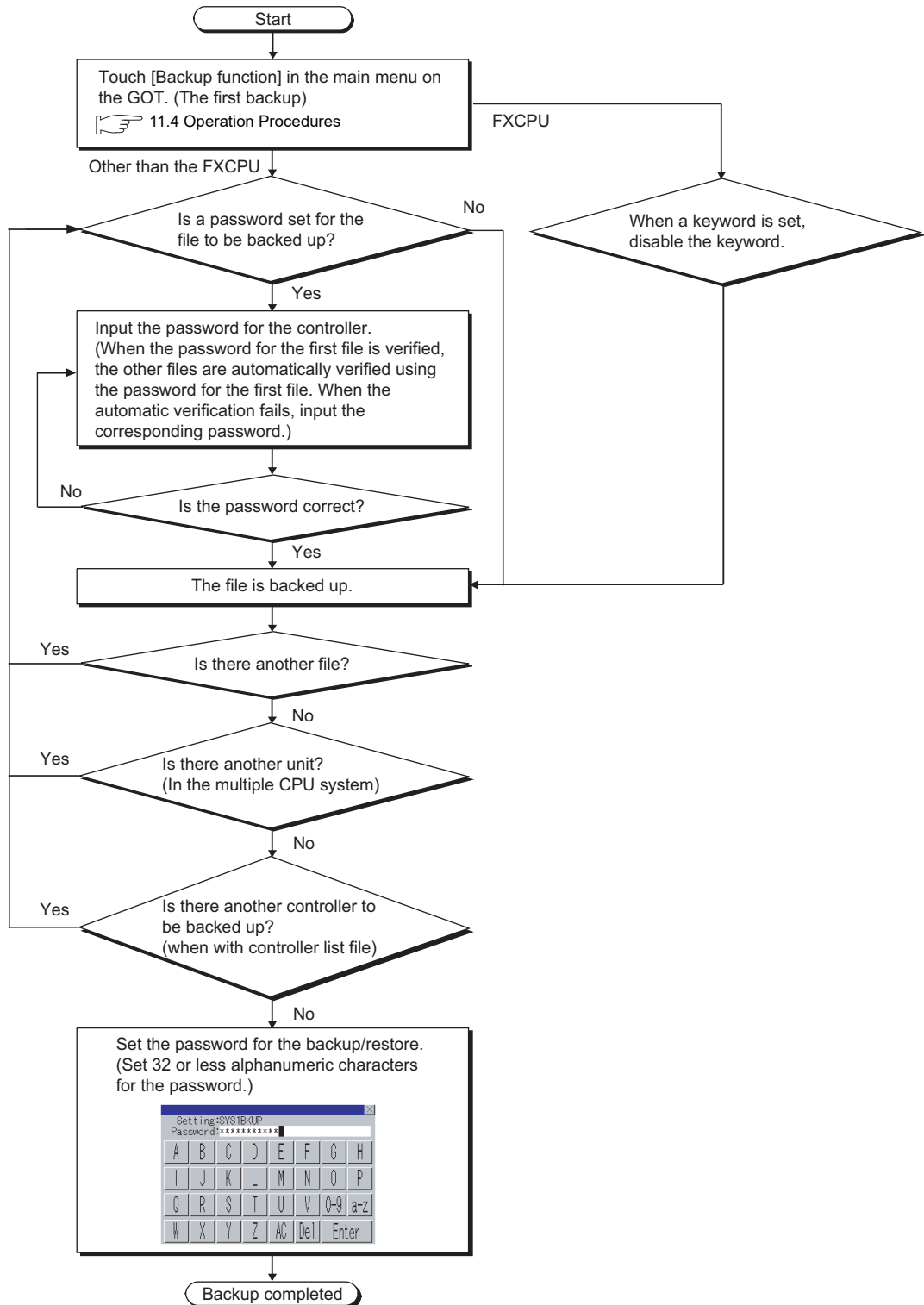

POINT

(1) Setting password

For ensuring the security, setting a password of 8 or more characters that cannot be easily guessed is recommended.

When the password is leaked, the same system can be created. Pay enough attention to managing the password.

(2) Passwords for motion controller CPU

(a) File name

When a password for a motion controller CPU data is input, the GOT does not display the file name. The GOT displays the data type only.

(b) Setting passwords for data without any contents

When contents of the following motion controller CPU data do not exist, do not set any passwords for the data.

- SFC program
- Mechanical system program
- Cam data

When passwords are set for the data without any contents, the automatic password authentication is unavailable when the GOT executes the backup.

As a result, the user must input the passwords each time.

(3) FXCPU keyword

To back up or restore data in the FXCPU, disable a keyword in advance.

 11.4 ■Key functions

■ How to use password for backup/restore

(1) Backup

The following shows the operating procedure for the backup after setting the password for the backup/restore.

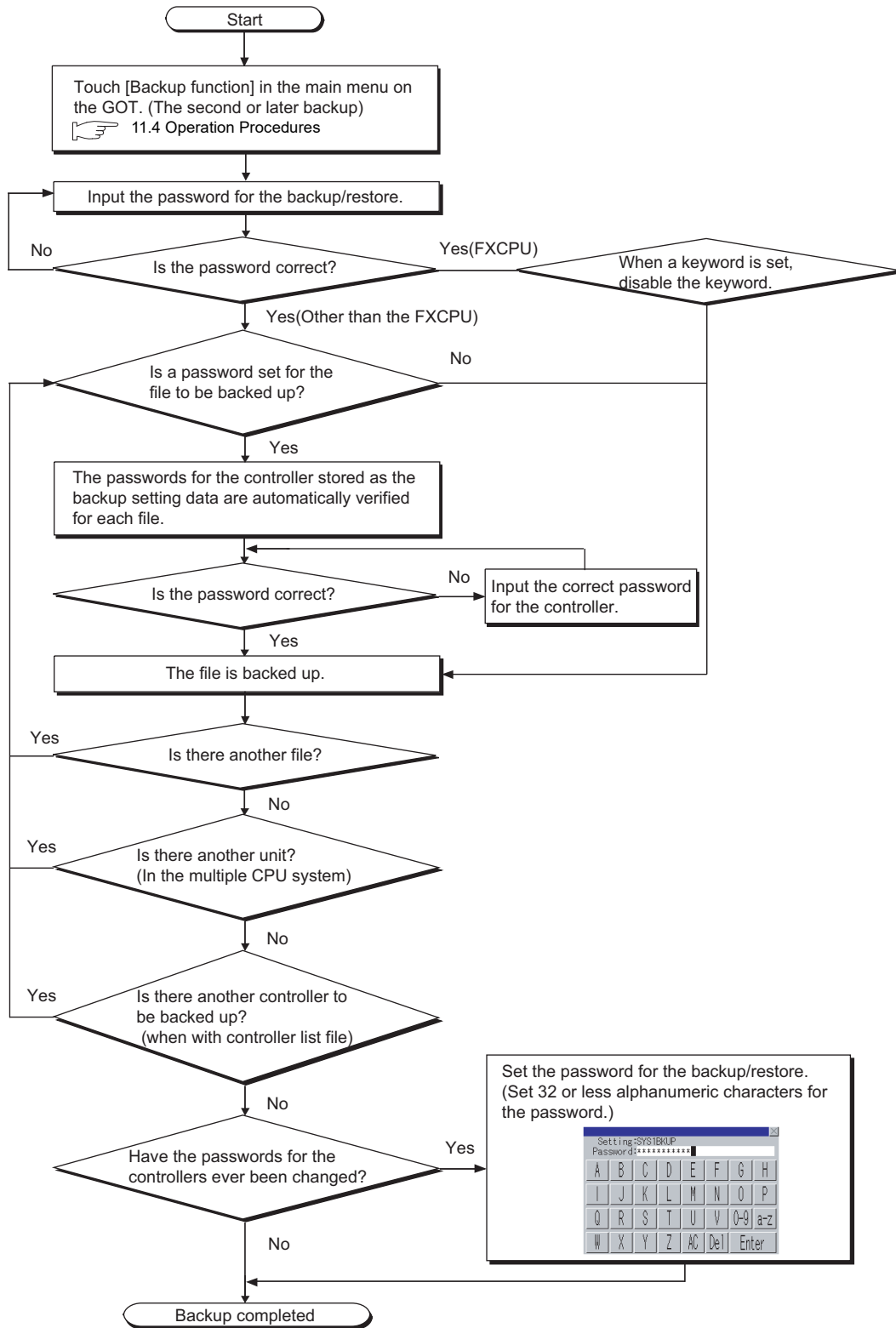

POINT

When passwords for controllers are changed

When the password input is cancelled and the backup is stopped, the backed up files until the backup is stopped are all deleted.

(2) Restoration

The following shows the operating procedure for the restoration after setting the password for the backup/restore.

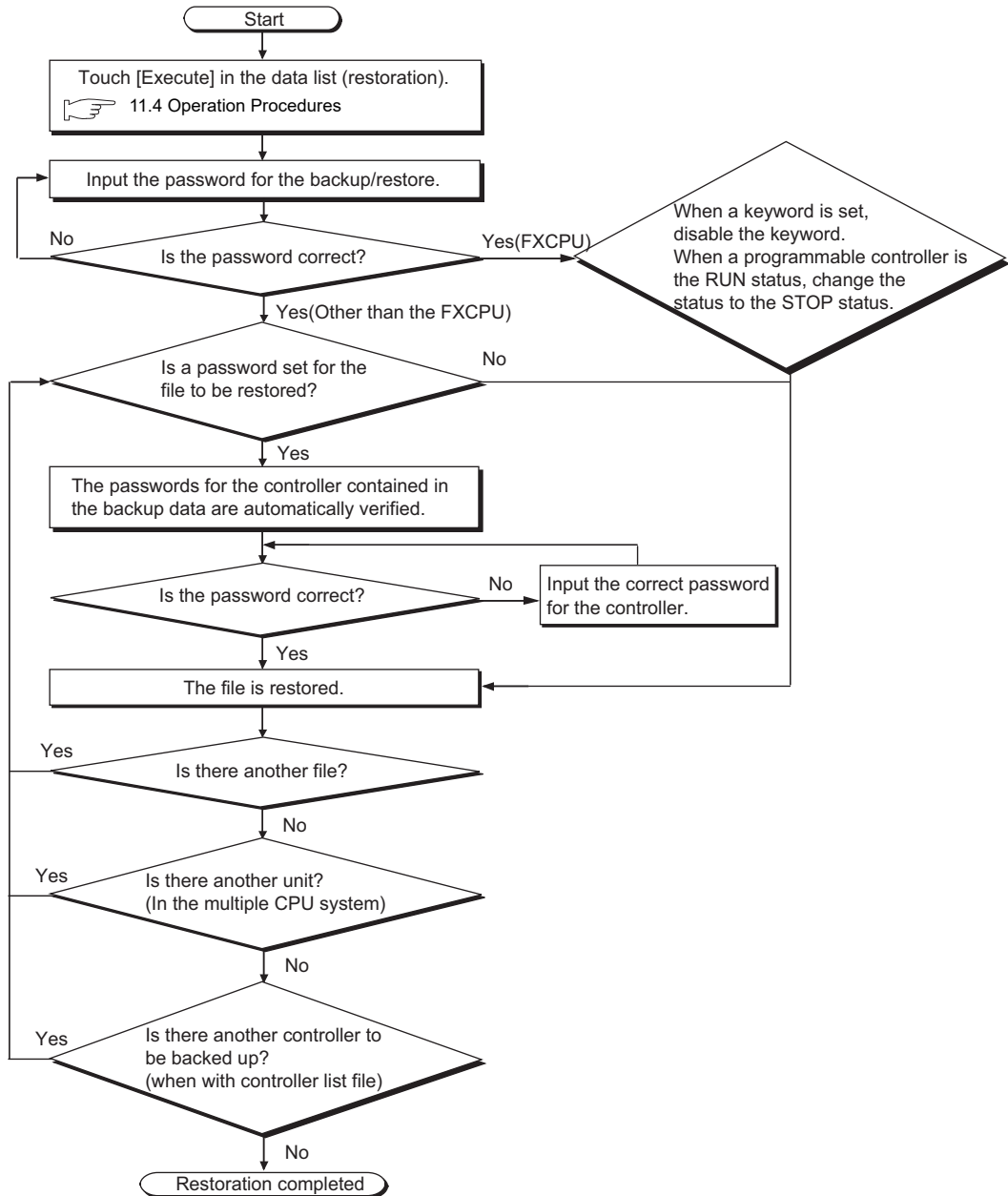

POINT

When passwords for controllers are changed

When the password input is cancelled and the restoration is stopped, the restored files until the restoration is stopped remain in the controller.

When only any of the files are restored, the data can be inconsistent in the entire system.

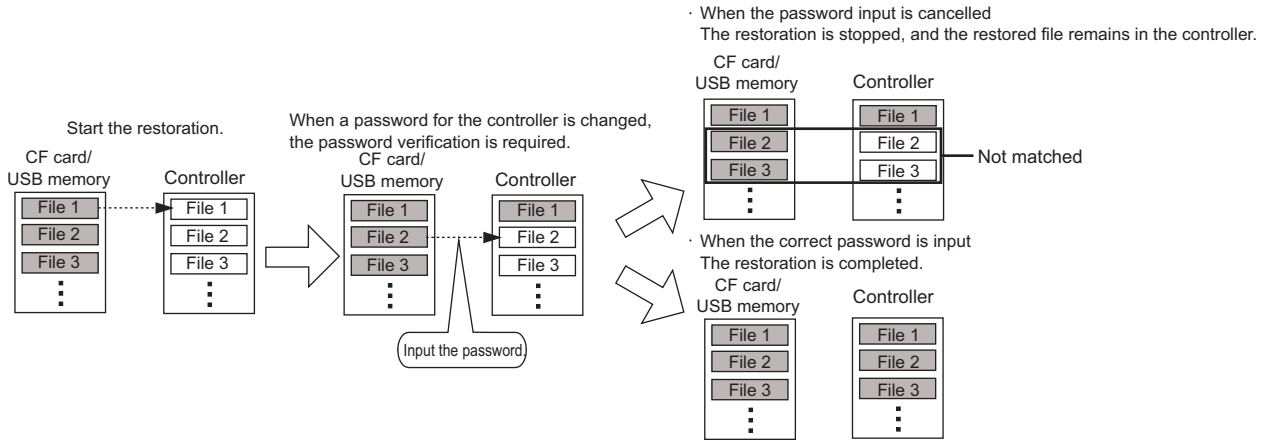

11.3.3 Trigger backup

The GOT can automatically back up setting data for controllers with the trigger device or the days and time set. Setting the trigger type selects whether to execute the backup with the trigger device or with the days and time.

(1) When trigger type is set to [Rise]

The GOT executes the backup when the set trigger device turns on.

Use the backup with the trigger device for automatically backing up setting data for controllers after the setting data are changed.

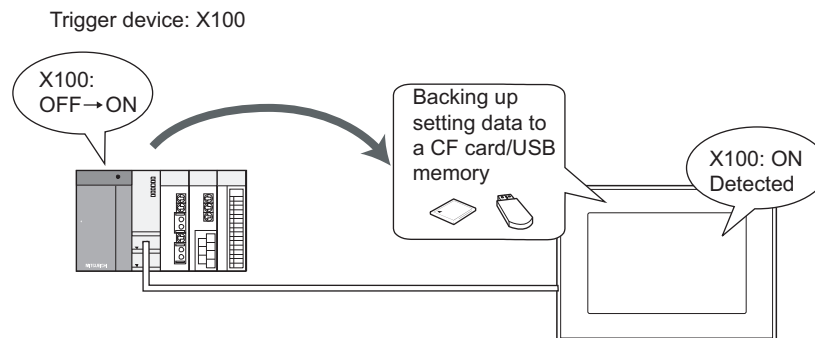

(2) When trigger type is set to [Time]

The GOT executes the backup at the specified time on the specified days.

Use the backup with the time for backing up setting data periodically.

Setting GOT to back up data at 17:30 on Tuesdays

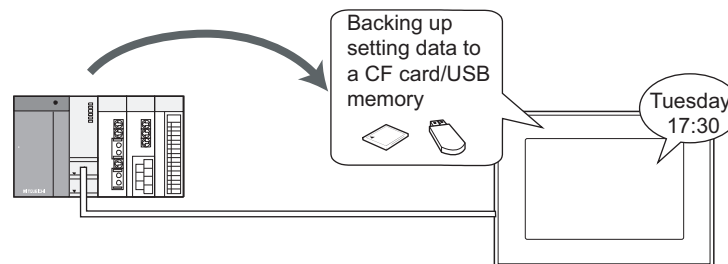

(3) Maximum number of backup data

With the trigger backup, the maximum number of backup data to be stored can be specified.

When the number of backup data exceeds the maximum number of backup data, the GOT automatically deletes the oldest backup data.

Therefore, the GOT does not fail to store the latest backup data.

(4) Checking backup data changes

When performing backup, the GOT compares the previous backup data with the setting data, for each controller. When the current setting data for any of the controllers differ from the previous backup data, the GOT backs up setting data for all the controllers on the same base unit.

When the current setting data for all the controllers are the same as the previous backup data, the GOT does not execute the backup.

Therefore, the GOT does not store the same backup data.

■ How to set trigger backup

(1) Flow of settings

The following shows the flow of settings for using the trigger backup.

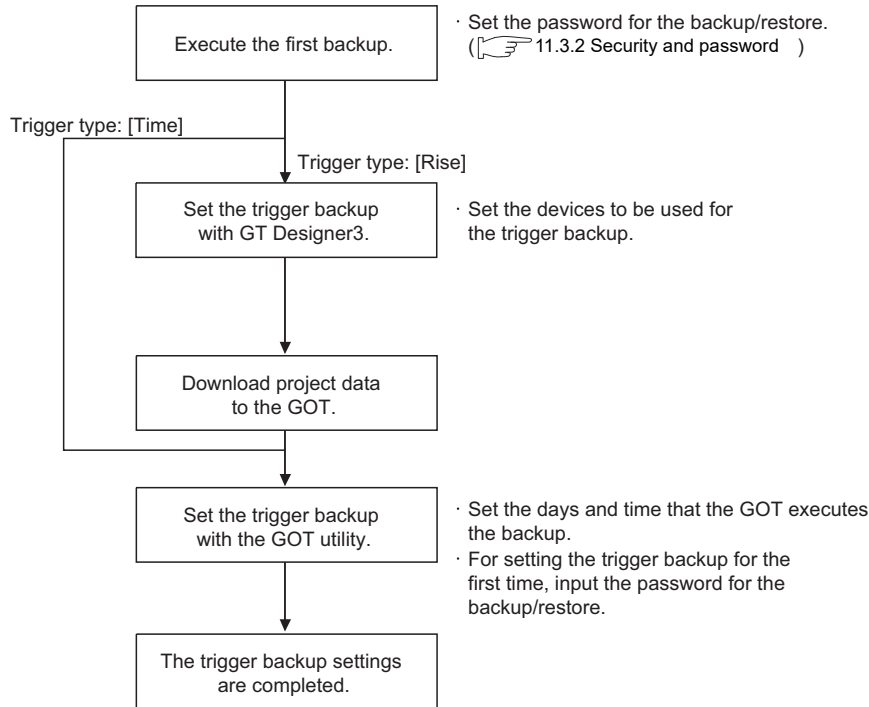

POINT

Inputting password for backup/restore

The GOT automatically executes the backup when the trigger condition is met.

The password authentication with the password for the backup/restore is not executed.

By executing the password authentication with the password for the backup/restore when setting the trigger backup with the GOT utility, unauthorized users cannot execute the backup.

Without inputting the password for the backup/restore when setting the trigger backup, an error occurs and the GOT does not execute the backup even if the trigger condition is met.

Input the password for the backup/restore in the trigger backup setting of the GOT utility.

For setting the trigger backup with the GOT utility, refer to the following.

☞ User's Manual for the GOT used

(2) Setting items for trigger backup

Set the trigger backup with GT Designer2 and the GOT utility.

For the setting items for GT Designer2, refer to the following.

☞ GT Designer3 Version1 Screen Design Manual (Fundamentals)

For the setting items for the GOT utility, refer to the following.

☞ The User's Manual of GOT used

■ Controlling backup with devices

The GOT controls the trigger backup with devices.

The following shows the devices to be used for the trigger backup.

- Trigger device
- Process notification device
- Backup error notification device
- Trigger backup processing setting No. notification (GS657)
- Trigger backup data send delay (GS521)

For the devices and how to set the devices, refer to the following.

 GT Designer3 Version1 Screen Design Manual (Fundamentals)

(1) When normal backup is executed

(a) When trigger type is set to [Rise]

Turn on the trigger device, and then the GOT starts the backup.

When the backup is started, the process notification device turns on.

Turn off the trigger device right after the process notification device turns on. (The trigger device does not automatically turn off.)

When the backup is completed, the process notification device turns off.

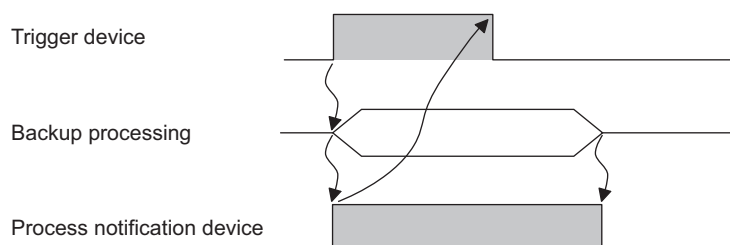

(b) When trigger type is set to [Time]

The GOT starts the backup at the time specified for the trigger backup.

When the backup is started, the process notification device turns on, and the time trigger automatically turns off.

When the backup is completed, the process notification device turns off.

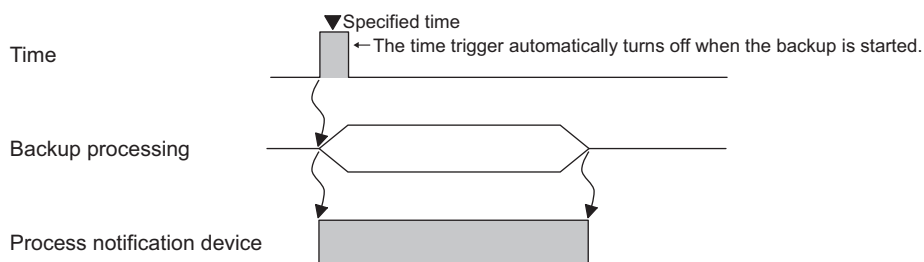

(2) Error handling

When an error occurs during the trigger backup, the backup error notification device stores the trigger ID corresponding to the trigger setting set for the backup with the error, and a system alarm occurs.

Check the system alarm, and then remove error causes.

For system alarms and corrective actions, refer to the following manual.

 User's Manual for the GOT used

The backup error notification device stores 0 when the next trigger backup is executed.

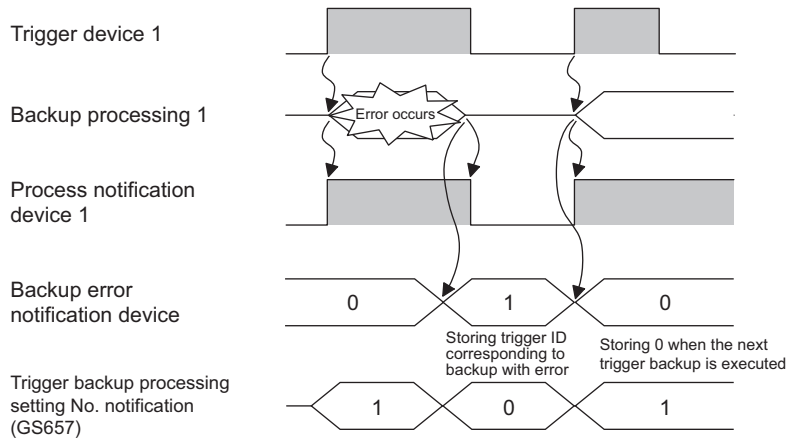

(3) Setting send delay time

The backup/restore function can set the delay time for backup communication intervals.

Setting of the delay time can reduce the load of other processes (such as monitoring objects) with the backup process.

The actually time set by the set value is listed as follows.

Set value	Delay time
0	None
1 to 100	Set value × 5(ms)
101 or more	500(ms)

POINT

Setting of trigger backup data send delay

Backup communication times are longer than a default when the trigger backup data send delay is set.

Set the suitable delay time to match the processing condition of backup function and others (such as monitoring objects).

■ Precautions for trigger backup

The following shows precautions for the trigger backup.

(1) GOT operations during trigger backup

The GOT may take a long time to monitor devices and to operate during the trigger backup.

Execute the trigger backup when the operator does not operate the GOT.

Updating data with the functions that collect device values, including the logging function, may also take a long time.

(2) Displaying device name on GOT

When the trigger device is set to [Rise], the GOT displays the device name of [??] without the extended function OS of the device name converter installed.

For displaying the device name correctly, install the extended function OS of the device name converter on the GOT.

(3) First backup

The trigger backup is unavailable for the first backup.

Manually execute the first backup, and then set the password for the backup/restore and passwords for controllers. After the settings, set the trigger backup.

(4) Passwords for controllers

When passwords for controllers stored in the backup setting differ from current passwords for the controllers, the backup operation is canceled.

For executing the trigger backup, check that passwords for controllers have no changes.

When the backup operation is canceled, manually execute the backup again, and then input correct passwords.

(5) File register backup

To check if the file register has been changed, the date of the last file update and the date of writing data to the controller are compared.

If the device values in the file register is changed, backup is not executed.

Set the backup data not to be checked for changes so that all data in the file register is backed up.

For the details, refer to the following.

 User's Manual for the GOT used

(6) Checking file register changes

When the trigger backup is frequently executed, set [Check the file register changes] to [Not execute] with the GOT utility because data stored in file registers frequently changes.

When [Check the file register changes] is set to [Execute], the GOT backs up data stored in the file registers every time the trigger condition is met even if the other setting data for the controller are not changed.

As a result, the number of backup data increases in the CF card. When the number of backup data exceeds the maximum number of backup data, old backup data are deleted.

For obtaining data stored in file registers only, use the advanced recipe function.

For how to use the advanced recipe function, refer to the following.

 GT Designer3 Version1 Screen Design Manual (Functions) 25.3 Advanced Recipe Function

(7) Backup on a motion controller CPU, CNC, robot controller, or FXCPU

If the following are to be backed up, the GOT does not compare the previous backup data with the controller setting data.

- A motion controller CPU, CNC, and robot controller are mounted on the same base unit.
- FXCPU

As a result, the GOT executes the backup even if the setting data for the controllers have no changes.

For backing up setting data only when the data are changed, set the trigger type to [Rise].

Create a sequence program so that the trigger device turns on only when the setting data are changed.

Therefore, the number of backup data can be minimized.

(8) Backup on a robot controller

The robot controller is not compatible with checking changes. Therefore, if the backup is executed in the following way, the communication speed and program execution speed may slow.

- The trigger backup is frequently executed.
- Multiple robot controllers are connected.
- Backup data is large, due to the large number of programs.

(9) Screens that trigger backup can be executed

The trigger backup can be executed only when the GOT displays a monitor screen.

- (a) When the trigger condition is met while the GOT displays a screen other than monitor screens, including the utility screen and ladder monitor screen, the GOT does not execute the backup.
When a screen other than monitor screens is switched to a monitor screen, the GOT executes the backup.
- (b) When a monitor screen is switched to a screen other than monitor screens during the trigger backup, the GOT stops the backup and the GOT deletes the data in process.
When the screen is switched to a monitor screen, the GOT executes the backup again.
- (c) When the following are operated, the GOT does not execute the backup even if a screen other than monitor screens is switched to a monitor screen.
 - Restarting the GOT
 - Changing the trigger backup setting with the GOT utility

(10) When another trigger condition is met during backup

The GOT cannot detect that another trigger condition is met.

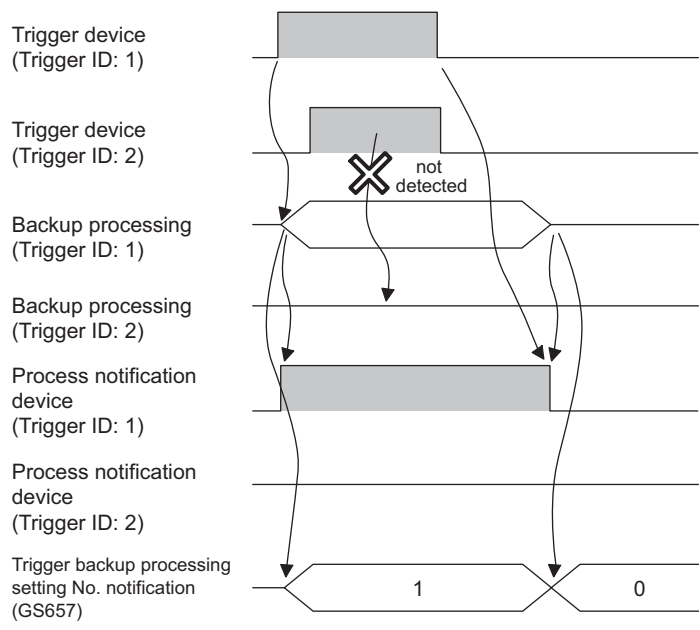

For ensuring the trigger backup, establish a handshake with the trigger device and the process notification device.

An example of a handshake is shown on the next page.

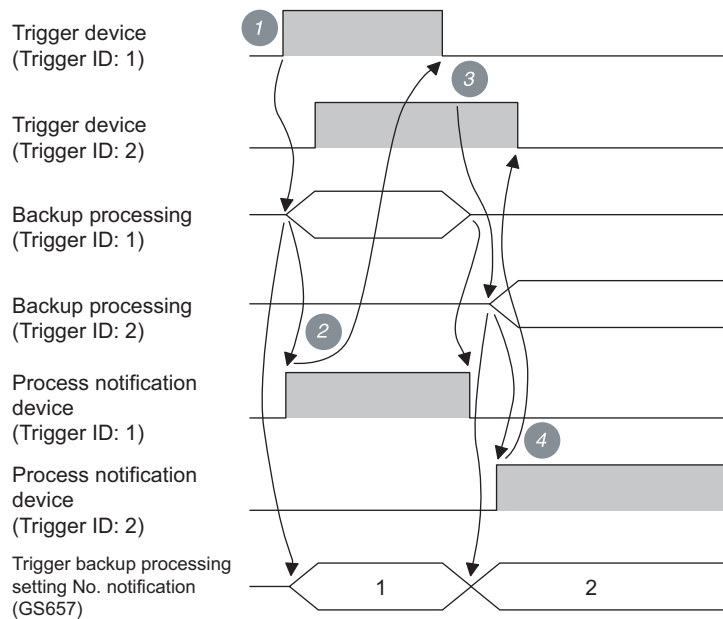

1. The trigger device (Trigger ID: 1) turns on, and then the GOT starts the backup (Trigger ID: 1).
2. When the backup is started, the process notification device (Trigger ID: 1) turns on, and the trigger backup processing setting No. notification (GS657) stores the trigger ID. When the process notification device turns on, the trigger device (Trigger ID: 1) turns off.
3. When the backup (Trigger ID: 1) is completed, the GOT recognizes that the trigger device (Trigger ID: 2) is on and the GOT starts the backup (Trigger ID: 2).
4. When the backup is started, the process notification device (Trigger ID: 2) turns on, and the trigger backup processing setting No. notification (GS657) stores the trigger ID. When the process notification device turns on, the trigger device (Trigger ID: 2) turns off.

(11) When multiple trigger conditions are simultaneously met

The GOT executes the backup with the smallest trigger ID first.

(12) When trigger device is on at GOT startup

The GOT recognizes that the trigger condition is met, and then the GOT executes the backup.

Create a sequence program so that the trigger device turns off after the GOT checks that the process notification device turns on.

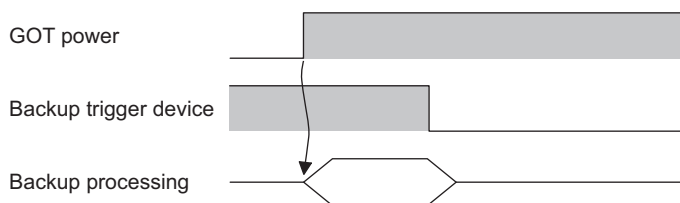

11.3.4 Network batch backup/restore

The backup or restoration can be executed to multiple controllers on the network system.

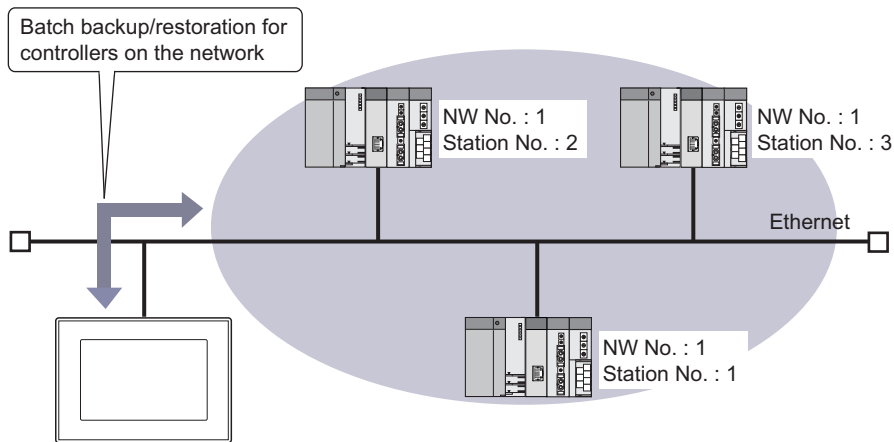

To backup or restore multiple controllers on the network, create a controller list file.

POINT

Before performing network batch backup/restoration

When backing up or restoring to controllers on the network, set the parameters to the controllers for communicating with the GOT.

If the controller cannot communicate with the GOT, the backup or restoration cannot be performed.

For how to connect controllers with the GOT, refer to the following.

☞ GOT1000 Series Connection Manual (Mitsubishi Products) for GT Works3

Flow to perform the network batch backup/restoration

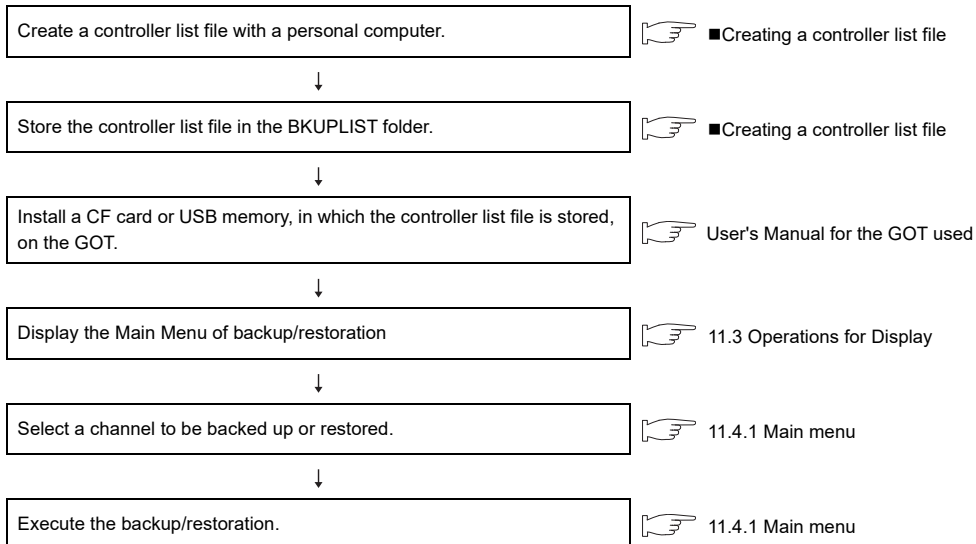

For the operation after executing the network batch backup/restore, refer to the following.

☞ ■Operation after executing the network batch backup or restoration

■ Creating a controller list file

For the controller list file, set the network No. and the station number of the controller to be backed up or restored. The controller list file can be set to each backup setting file.

(1) Controller list file specification

(a) Specification

Item	Setting
File name, extension	SYSnNET.INI (Assign the CH No. to be backed up or restored to "n" in the file name.)
File format	Unicode text format
Encode format	Little endian with UTF-16 BOM

(b) Format

Up to 64 controllers to be backed up or restored can be set. (The 65th or later are invalid.)

When performing the backup or restoration, the controller list file settings are executed from the top.

	A	B	C	D
1	#BKUPRSTR NET TARGET LIST			
2	#DATA VERSION	1		
3	#ACT	NET	ST	NOTE
4		1	1	1 Controller
5		1	1	2 Controller
6		0	1	3 Information system
7				

4) 5) 6) 7)

No.	Item	Setting
1)	Header	Indicates that it is the controller list file.
2)	Data version	Displays the data version of the controller list file. Set the version to 1.
3)	Controller list	Indicates the title of the controller list.
4)	Execution/non-execution	Set whether to execute or not the backup or restoration. (0: Non-execution, 1: Execution)
5)	Network No.	Set the network No. of controllers to be backed up or restored. (0 to 239)
6)	Station No.	Set the station No. of controllers to be backed up or restored. (0 to 120) If the network No. is 0, 255 (host) can also be set.
7)	Memo	Both 2-byte and 1-byte characters can be set. Up to 30 characters are displayed in the controller list screen.

POINT

Precautions for creating a controller list file

(1) When " is entered

- Even if " is entered in the memo, it is not treated as a quotation mark for the character string, the text to the line feed is considered a character string.
- If numerical values are put in "s, a format error occurs.

(2) When creating with a text editor

When the controller list file is created with a text editor, delimit data with tabs.
If unnecessary tabs are entered, a format error occurs.

(2) Controller list file creation

The controller list file must be created by the user. The following shows how to create it with Microsoft Excel®

1. Start Microsoft Excel® and set the controllers to be backed up or restored, according to the format.

	A	B	C	D
1	#BKUPRSTR_NET_TARGET_LIST			
2	#DATA_VERSION	1		
3	#ACT	NET	ST	NOTE
4		1	1	1 Controller
5		1	1	2 Controller
6		0	1	3 Information system
7				

For the format of the file, refer to the following.

 (1) Controller list file specification

2. Select [File] → [Save As...] to display the [Save As...] dialog box.
3. Select [Unicode Text (*.txt)] in [Save as type].
4. Enter the file name according to the CH No. to be used and press the [Save] button with the extension INI.
For the specification of the file name, refer to the following.

 (1) Controller list file specification

(3) Controller list file storage

Store the created controller list file in the same folder as the backup setting.

For the storage location for the backup setting, refer to the following.

 11.2.1 System configuration

1. Check whether a storage folder for the backup (BKUPLIST) exists in the CF card or not.
(If the backup is executed, the folder is automatically created)
If no storage folder exists, create it.

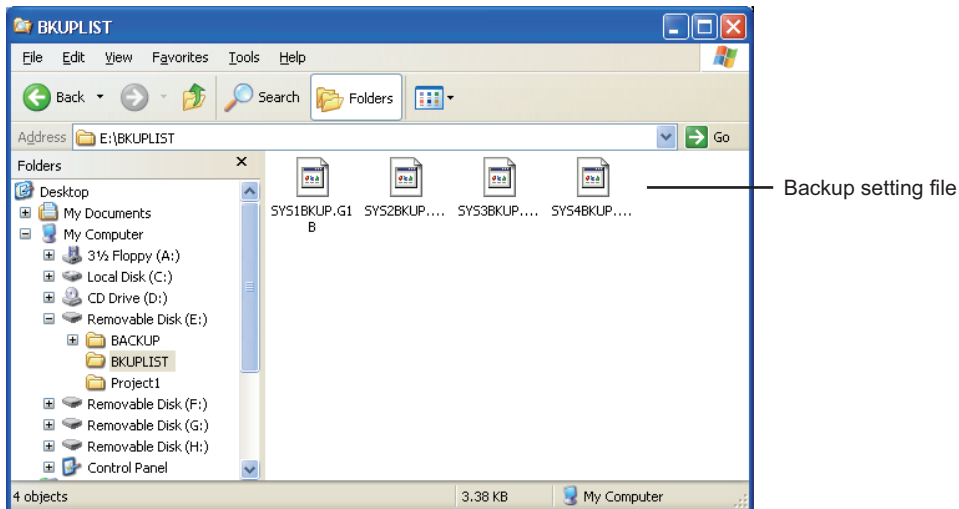

2. Store the created controller list file in the storage folder for the backup.

■ Operation after executing the network batch backup or restoration

When the network batch backup/restoration is executed, the following operations are performed.

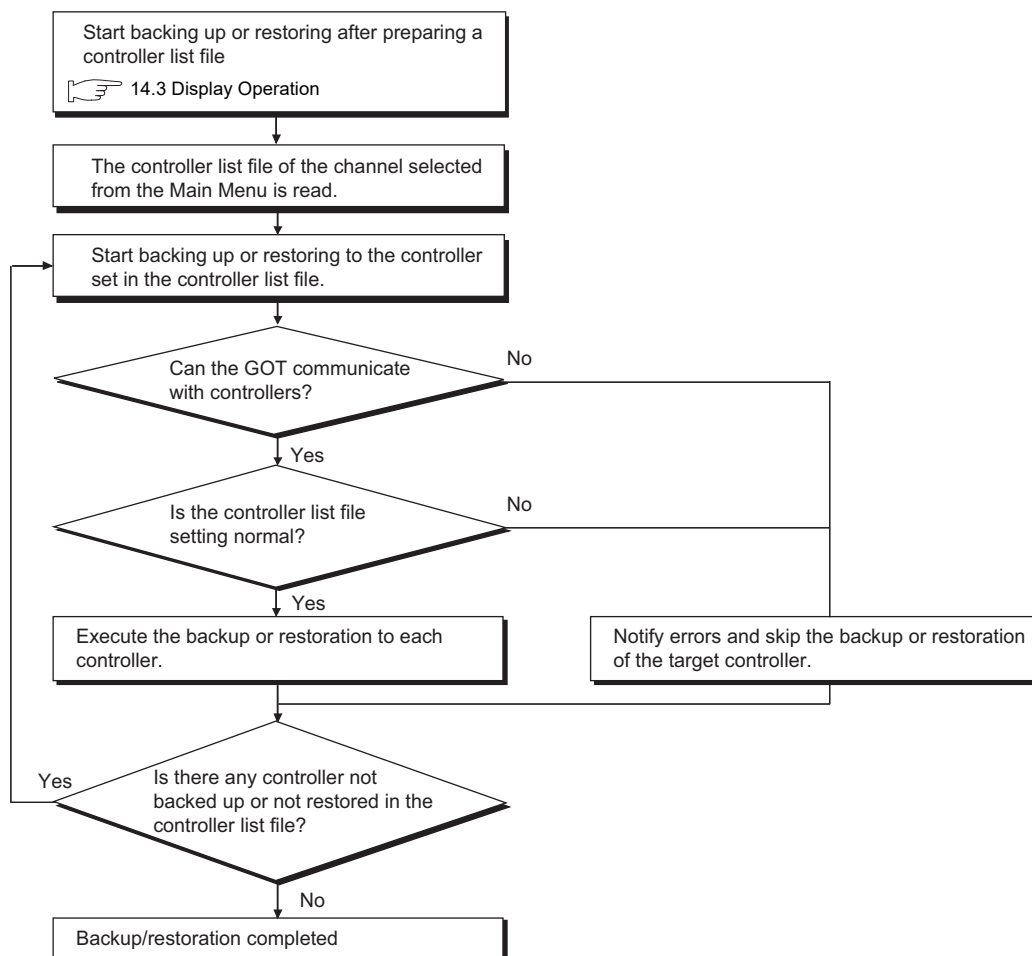

(1) Operations if an error occurs during backup

If an error occurs, the backup being executed is canceled and the error dialog box is displayed. (The error is displayed by the controller set in the controller list file.)

After the error dialog box is closed, the backup to the next controller set in the controller list file is continued. However, the backup data cannot be written because a CF card is not installed or does not have sufficient capacity, the backup to all controllers is canceled.

(2) Handling of the backup data when the backup is canceled

Backup data of controllers canceled for an error occurrence or a cancellation of password input on the controller is deleted by the controller set in the controller list file.

Backup data backed up normally remains by the controller set in the controller list file.

(3) Operations if a password on the controller is set to the backup target

If the password input on the controller is canceled, the backup being executed is canceled and the backup to the next controller set in the controller list file is continued.

If a password for backup or restoration is set on the GOT, a password on the controller can be input to the controller, for which the password input was canceled, at the next time.

By inputting the correct password, password input is not required at the next execution.

For the password for backup or restoration, refer to the following.

11.3.2 Security and password

(4) Operation for trigger backup

- The backup does not executed if the GOT cannot communicate with controllers because of a communication error or others.
- If no previous backup data to be compared exists, the backup is executed.
- Even if the backup being executed is canceled for an error occurrence, the backup to the next controller set in the controller list file is continued.

11.4 Operation Procedures

This section describes the backup/restore display details and the functions of the keys displayed on the screen. The display screen for the backup/restore differs depending on the GOT to be used. This section explains the display screen with the GT1575-V screen.

11.4.1 Main menu

The following describes the display and the key functions on the Backup/restoration function : Main menu screen.

■ Display details

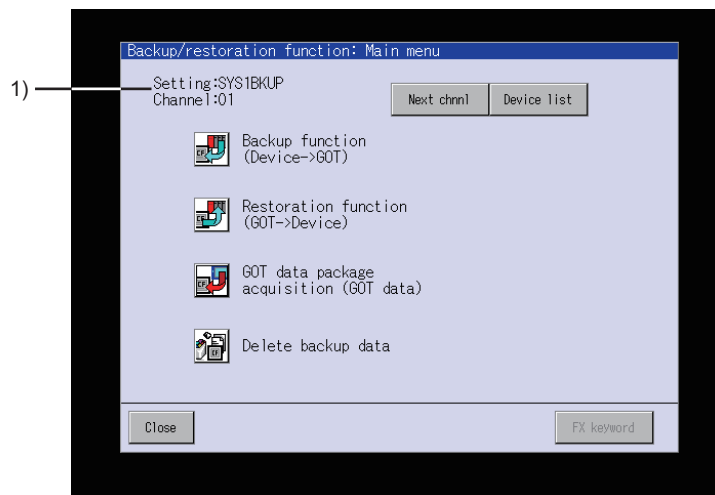

No.	Display details
1)	Displays the target channel No. of the backup and the setting name for the backup/restore (Fixed).

■ Key functions

Key	Function
	Switches the target channels of the backup/restore.
	Available when the controller list file is stored in the same folder as the backup setting. 11.3.4 Network batch backup/restore Shifts to the controller list screen. If a CF card which stores the controller list file is installed on the GOT after displaying the Main Menu or switching a channel, the [Device List] button is not valid. To validate the [Device List] button, switch a channel and select the same channel again.
Backup function	Starts the backup.
Restoration function	Switches the screen to the Restoration function: Data list screen.
GOT data package	Switches the screen to the setting screen of the GOT data package acquisition. User's Manual for the GOT used The key is not displayed on the GT1555-Q and GT1550-Q.
Delete backup data	Deletes the oldest data among backup data already stored in a CF card or USB memory in the GOT.
	Ends the backup/restore, and then the screen is switched to the backup/restore startup screen.
	Displays the FX keyword screen. (This key is displayed only when the FXCPU is connected.) For the operation of a keyword including disabling a keyword, refer to the following manual. User's Manual for the GOT used

11.4.2 Progress screen (backup)

This following describes the display details and the key functions on the Backup function: Progress screen.

■ Display details

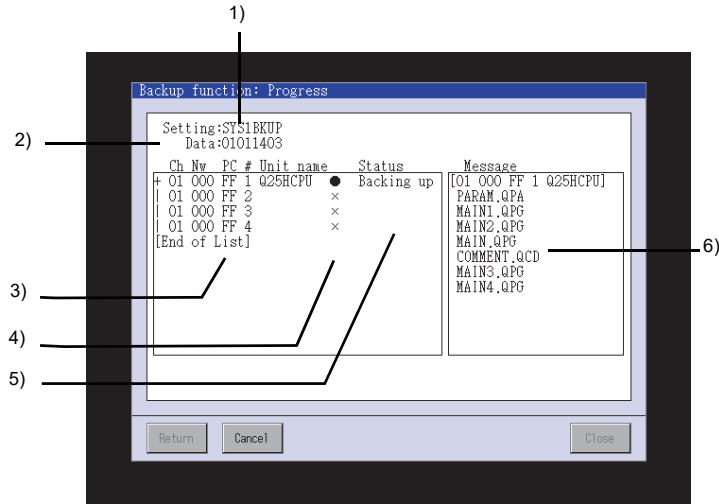

No.	Display details
1)	Displays the setting name for the backup/restore (Fixed).
2)	Displays the backup data name.
3)	Displays the channel No., network No., station No., CPU No., and module name for the target controller in a list. When the CPU No. setting is enabled, select the controller to be backed up by touching it. Displays also the progress situation of each station when the network batch backup is executed. ((Progression: (Number of completed controllers)/(Number of set controllers) NG = (Number of error controllers))
4)	Displays the target controller status of the backup. ● : Backup target ○ : Not backup target × : Access disabled
5)	Displays the backup progress status. Backing up : The backup is in processing. Aborting : The backup cancellation is in processing. Completed : The backup is completed.
6)	Displays the file name in processing.

■ Key functions

Key	Function
	Switches the screen to the Backup/restoration function: Main menu screen.
	Cancels the backup.
	Ends the backup/restore, and then the screen is switched to the backup/restore startup screen.

11.4.3 Data list (restoration)

The following describes the display details and the key functions on the Restoration function: Data list screen.

■ Display detail

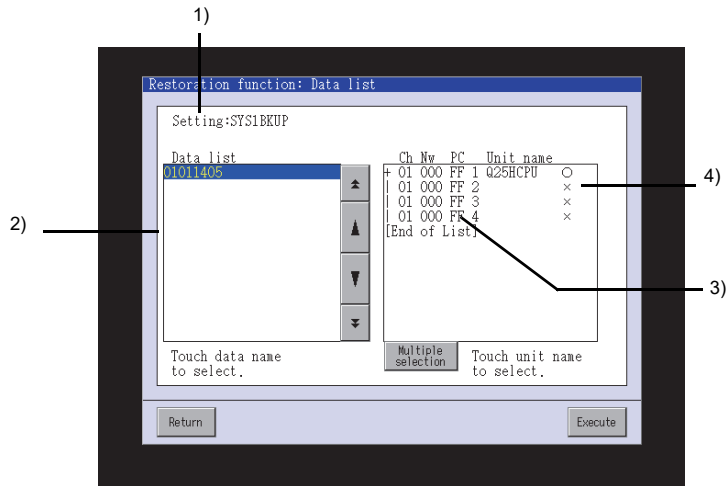

No.	Display details
1)	Displays the setting name for the backup/restore (Fixed).
2)	Displays backup data stored in a CF card or USB memory. Select a backup data to be restored with touching the data.
3)	Displays the channel No., network No., station No., module No., and unit name for the target controller of the restoration.
4)	Displays the target controller status of the restoration. Select a target controller of the restoration with touching the controller. <ul style="list-style-type: none"> ● : Restoration target ○ : Not restoration target × : Access disabled

■ Key functions

Key	Function
	Scrolls the data list up and down by one line.
	Scrolls the data list up and down by one page.
	Switches the number of target controllers of the restoration. <ul style="list-style-type: none"> • Single selection: Select [Single selection] when selecting only one target controller of the restoration. • Multiple selection: Select [Multiple selection] when selecting multiple target controllers of the restoration.
	Return to the previous screen, before shifting to the Data list screen.
	Starts the restoration.

11.4.4 Progress screen (restoration)

This following describes the display details and the key functions on the Restoration function: Progress screen.

■ Display details

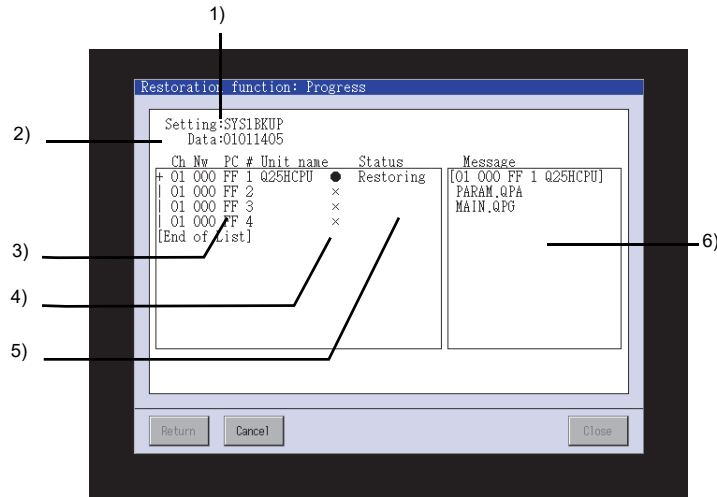

No.	Display details
1)	Displays the setting name for the backup/restore (Fixed).
2)	Displays the backup data name.
3)	Displays the channel No., network No., station No., module No., and unit name for the target controller of the restoration.
4)	Displays the target controller status of the restoration. ● : Restoration target ○ : Not restoration target × : Access disabled ? : Restoration failed
5)	Displays the restoration progress status. Restoring : The restoration is in processing. Aborting : The restoration cancellation is in processing. Completed : The restoration is completed. Abort : The restoration cancellation is completed. Comm.error : The restoration is failed with the communication failed. Data error : The restoration is failed with backup data errors.
6)	Displays the file name in processing.

■ Key functions

Key	Function
	Switches the screen to the Backup/restoration function: Main menu screen.
	Cancels the restoration.
	Ends the backup/restore, and then the screen is switched to the backup/restore startup screen.

11.4.5 Controller list screen

The following describes the display details and the key functions on the Controller list screen.

■ Display details

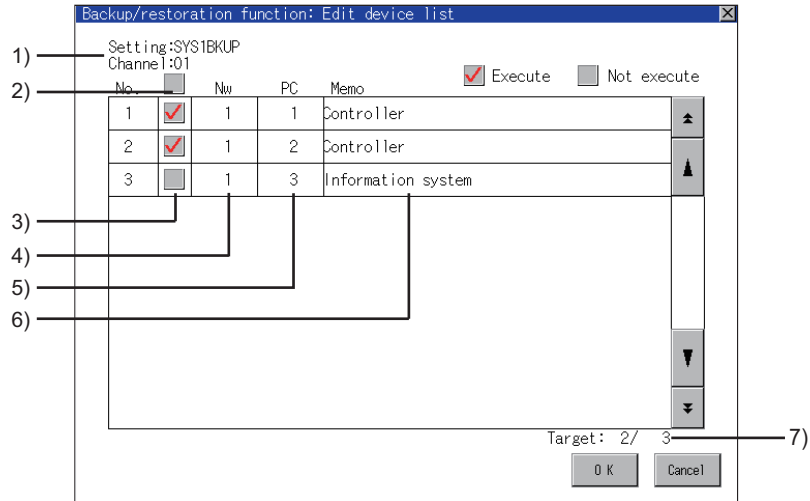

No.	Display details
1)	Displays the target channel No. of the backup/restore and the setting name for the backup/restore (Fixed).
2)	Switches execution/non-execution of all settings.
3)	Switches execution/non-execution of each setting.
4)	Displays the network number.
5)	Displays the station number.
6)	Displays the memo.
7)	Displays the target number of the backup/restore. (Executed/all settings)

■ Key functions

Key	Function
	Scrolls the data list up and down by one line.
	Scrolls the data list up and down by one page.
	Saves the edited information in the controller list file and switches the screen to the Backup/restoration function: Main menu screen.
	The edited information is deleted and switches the screen to the Backup/restoration function: Main menu screen.

11.4.6 Controller selection screen (Restoration)

The following describes the display and the key functions on the Restoration function: Controller selection screen.

■ Display details

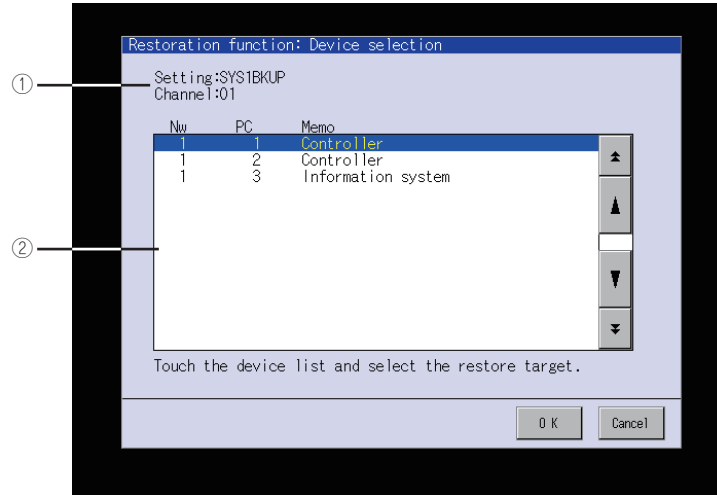

No.	Display details
1)	Displays the target channel No. of the backup/restore and the setting name for the backup/restore (Fixed).
2)	Displays all settings in the controller list file. By touching a line, whether restore or not each controller can be switched. The controller in the highlighted line to be restored.

■ Key functions

Key	Function
	Scrolls the data list up and down by one line.
	Scrolls the data list up and down by one page.
	Switches the screen to the Restoration function: Data list screen.
	Switches the screen to the Backup/restoration function: Main menu screen.

11.5 Backup Data Conversion Tool

Backup data are created by the backup/restore function, and the backup data are stored in a CF card. Backup Data Conversion Tool enables the backup data to convert into data editable with GX Developer. The tool also enables backup data edited by GX Developer to convert into data for the restoration on the GOT.

POINT

Data to be converted

Only backup data created by the backup/restore function can be converted with Backup Data Conversion Tool. The following data cannot be converted with Backup Data Conversion Tool.

- Newly-created data by GX Developer
- Backup data with new files added by GX Developer
- Backup data for the Q00JCPU, Q00CPU, Q01CPU, and FXCPU

11.5.1 Operating environment

Use Backup Data Conversion Tool in the following operating environment.

Item	Description
Personal computer	Personal computer that Windows runs on.
OS (English)	<ul style="list-style-type: none"> • Microsoft® Windows® 10 Enterprise (32 bit, 64 bit)^{*1*2*3} • Microsoft® Windows® 10 Pro (32 bit, 64 bit)^{*1*2*3} • Microsoft® Windows® 10 Home (32 bit, 64 bit)^{*1*2} • Microsoft® Windows® 8.1 Enterprise (32 bit, 64 bit)^{*1*2*3*4} • Microsoft® Windows® 8.1 Pro (32 bit, 64 bit)^{*1*2*3*4} • Microsoft® Windows® 8.1 (32 bit, 64 bit)^{*1*2*4} • Microsoft® Windows® 8 Enterprise (32 bit, 64 bit)^{*1*2*3*4} • Microsoft® Windows® 8 Pro (32 bit, 64 bit)^{*1*2*3*4} • Microsoft® Windows® 8 (32 bit, 64 bit)^{*1*2*4} • Microsoft® Windows® 7 Ultimate (32 bit, 64 bit)^{*1*2*5} • Microsoft® Windows® 7 Enterprise (32 bit, 64 bit)^{*1*2*5} • Microsoft® Windows® 7 Professional (32 bit, 64 bit)^{*1*2*5} • Microsoft® Windows® 7 Home Premium (32 bit, 64 bit)^{*1*2} • Microsoft® Windows® 7 Starter (32 bit)^{*1} • Microsoft® Windows Vista® Ultimate (32 bit) Service Pack1 or later^{*1} • Microsoft® Windows Vista® Enterprise (32 bit) Service Pack1 or later^{*1} • Microsoft® Windows Vista® Business (32 bit) Service Pack1 or later^{*1} • Microsoft® Windows Vista® Home Premium (32 bit) Service Pack1 or later^{*1} • Microsoft® Windows Vista® Home Basic (32 bit) Service Pack1 or later^{*1} • Microsoft® Windows® XP Professional (32 bit) Service Pack2 or later^{*1} • Microsoft® Windows® XP Home Edition (32 bit) Service Pack2 or later^{*1} • Microsoft® Windows® 2000 Professional Service Pack4 or later
CPU	Use the CPU which the above OSs run on.
Memory	Use the memory which the above OSs run on.
Display	Resolution 640 × 480 dots or more
Hard disk space	500KB or more
Display color	High Color (16 bits) or more
Others	The mouse, keyboard, memory card, or card reader

- *1 The following functions are not supported.
- Application start in Windows compatibility mode
 - Fast user switching
 - Change your desktop themes (fonts)
 - Remote desktop
 - DPI setting other than the normal size (For Windows Vista and Windows XP)
- *2 The touch feature is not supported.
- *3 Hyper-V is not supported.
- *4 Modern UI Style is not supported.
- *5 Windows XP Mode is not supported.

11.5.2 How to install and start Backup Data Conversion Tool

Installing Backup Data Conversion Tool is not required.
Start Backup Data Conversion Tool with the following procedures.

1. Copy BkupRstrDataConv.exe to the hard disk and others on the personal computer.
Get the above file from one of the followings.
 - GT Works3 DVD (Disk5 folder)
 - GTD3 folder on the personal computer
 - Contact your local distributor.
2. Double-click the copied BkupRstrDataConv.exe, and then the tool starts. Refer to the following, and set the tool.

11.5.3 How to use Backup Data Conversion Tool

■ Setting items

The following shows the setting items of Backup Data Conversion Tool.

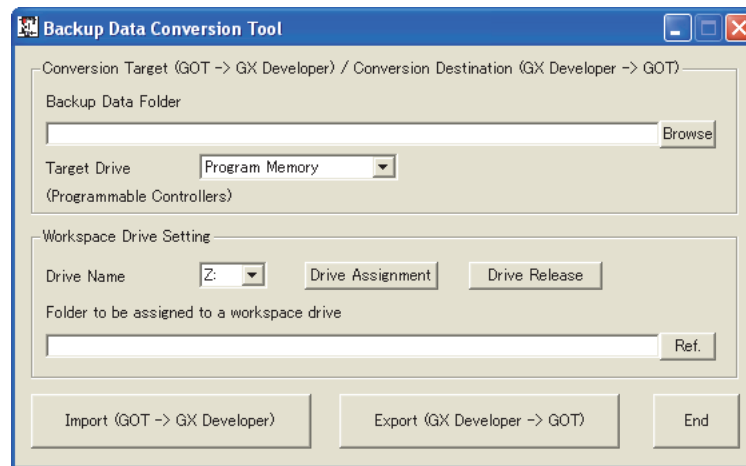

Item	Description
Conversion Target	Specify data to be converted.
Backup Data Folder* ¹	Specify the storage location of the backup data (setting data: UNITINFO.G1B) created with the backup/restore function by clicking the Browse button.
Target Drive	Select the PLC drive that has setting data to be converted.
Workspace Drive Setting	Set the settings for editing backup data with GX Developer.
Drive Name	Specify [IC Card drive] to be specified for [Read IC memory card] and [Write IC memory card] on GX Developer.
Folder to be assigned to a workspace drive* ¹	Specify the target folder of [Drive Name] by clicking the Ref. button.
Drive Assignment	Click the item, and then [Folder to be assigned to a workspace drive] is assigned to [Drive Name]. ([Folder to be assigned to a workspace drive] is automatically assigned to [Drive Name] normally. Use the button when the drive assignment setting is canceled by clicking the Drive Release button and a drive is assigned again.)
Drive Release	Click the item, and then the drive assignment setting is canceled.

Item	Description
Import (GOT → GX Developer)	Converts the backup data to data editable with GX Developer
Export (GX Developer → GOT)	Converts data edited by GX Developer to data applicable to the backup/restore.
End	Ends Backup Data Conversion Tool.

For details of *1, refer to the following.

*1 Folder name and file name

(a) Number of characters set for folder and file names

The GOT recognizes the file location with a path as shown below.

Set the folder and file names so that the total number of characters in the path is within 78 characters.

The user can set the folder name and file name only.

(Other than the folder and file names are automatically set.)

Example) Path of QPG file to be stored in memory card

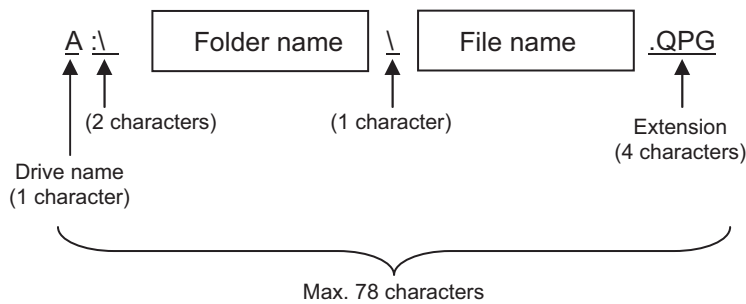

■ Operation flow

The following shows the operation flow for Backup Data Conversion Tool.

(1) Editing backup data with GX Developer

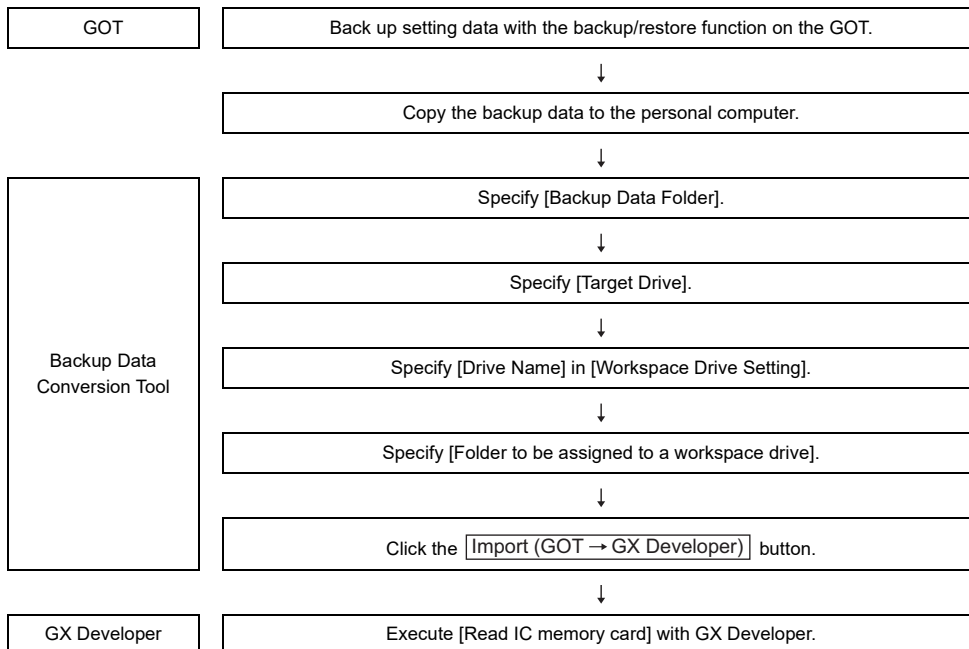

(2) Restoring data edited by GX Developer

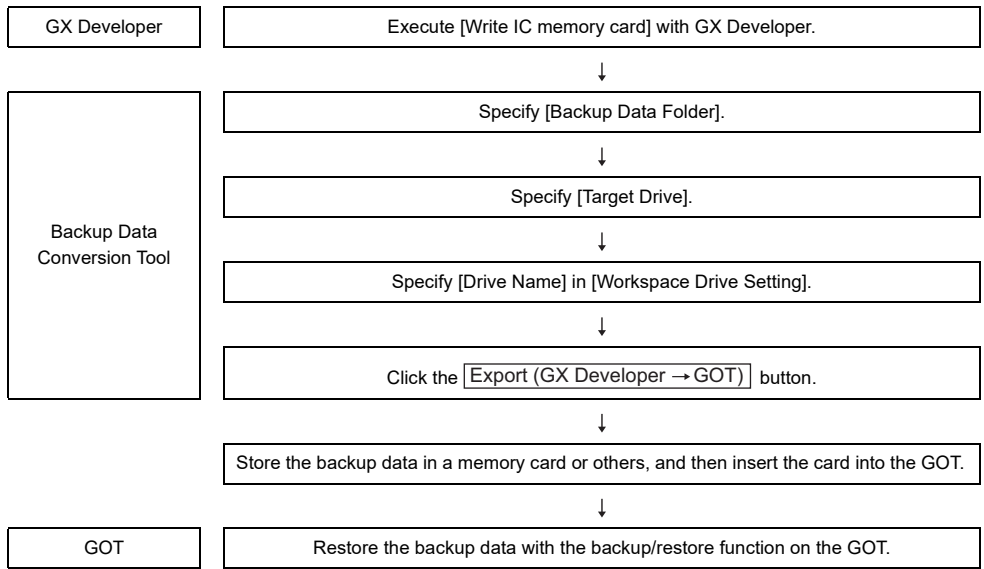



11.5.4 Precautions

■ Precautions for the backup data conversion

- (1) Backup data of a PLC CPU not compatible with the integrated circuit memory card**
 The Q00JCPU, Q00CPU, Q01CPU, and FXCPU do not support the read/write IC memory card function of GX Developer. Therefore, backup data converted with Backup Data Conversion Tool cannot be edited.
- (2) Backup data of a sequence program created in GX Works2**
 Once backup data created with GX Works2 is converted by using Backup Data Conversion Tool, the data can be edited with GX Works2. To edit the data with GX Works2, use GX Works2 Ver.1.73B or later.

11.6 Errors and Corrective Actions

■ Common to backup and restoration

Error	Cause	Corrective action
The backup/restore function cannot be used.	The extended function OS of the backup/restore is not installed on the GOT.	Install the extended function OS on the GOT.
The backup setting is not found.	The backup setting is not stored in the CF card or USB memory in the GOT. No CF card or USB memory is installed to the drive specified for storing the backup setting.	<ul style="list-style-type: none"> • Install a CF card or USB memory with the backup setting stored. • Check the storage location for the backup setting with the utility.
The backup data are not found.	The backup data are not stored in the CF card or USB memory in the GOT. No CF card or USB memory is installed to the drive specified for storing the backup data.	<ul style="list-style-type: none"> • Install a CF card or USB memory with the backup data stored. • Check the storage location for the backup data with the utility.
The backup/restore cannot be executed because the user does not know the password for the backup/restore.	The user does not remember the password. The password is incorrect.	<ul style="list-style-type: none"> • Check with the administrator of the system regarding the password for the backup/restore. • Execute the backup again by using a formatted or new CF card or USB memory.
The backup/restore cannot be completed because a communication error occurs between the GOT and a controller during the backup/restore.	The communication settings and communication driver for the GOT are incorrectly set.	Check if the communication settings and communication driver for the GOT are correctly set.
	Because parameters for the controller are incorrectly set, the controller does not recognize the GOT.	Check if the parameters for the controller is correctly set with tools, including GX Developer, for the controller.
	The controller is turned off.	Turn on the controller.
The controller list file is abnormal.	The cable is not correctly connected.	Check the cable.
	The description in the header part of the controller list file is abnormal.	Check the format of the controller list file and describe following the format.  11.3.4 Network batch backup/restore
The controller list file is invalid.	<ul style="list-style-type: none"> • The description in the controller list file is invalid. • The network number and station number are outside the range. • The network number and station number are overlapped. 	<ul style="list-style-type: none"> • Check the format of the controller list file and describe following format. • Describe the network number and the station number so that they are not overlapped in the available setting range.  11.3.4 Network batch backup/restore

■ Backup

Error	Cause	Corrective action
The backup data cannot be written into a CF card or USB memory.	No CF card or USB memory is installed to the GOT.	Install a CF card or USB memory to the drive specified for storing the backup setting or backup data.
	The CF card or USB memory does not have free space.	Install a CF card or USB memory with enough free space. Delete unnecessary files in the CF card or USB memory.
	The CF card or USB memory is set to write-protect.	Set the CF card or USB memory to writable. The attributes of backup data files stored in the CF card or USB memory cannot be changed with the GOT. Set the files to writable with a personal computer.
	The drive does not exist.	Check if the drive specified for storing the backup setting or backup data exists. (Check if the CF card unit is installed on the GOT.)

(Continued to next page)

Error	Cause	Corrective action
Setting data (files and data) cannot be obtained from the controller.	The GOT cannot communicate with the controller.	Check the following. GOT <ul style="list-style-type: none"> • Check if the cable is correctly connected to the GOT. • Check if the correct communication driver is installed on the GOT. • Check if the communication settings are correctly set. Controller <ul style="list-style-type: none"> • Check if the parameters are set. • Check if the cable is correctly connected to the controller. • Check if the controller is turned on.
The backup cannot be executed because passwords for files of the controller are set.	<ul style="list-style-type: none"> • The user does not remember the password. • The password is incorrect. (The first backup) • Passwords for files of the controller are changed. 	Check with the administrator of the system regarding the passwords for files of the controller.

■ Restoration

Error	Cause	Corrective action
Setting data (files and data) cannot be written into the controller.	The GOT cannot communicate with the controller.	Check the following. GOT <ul style="list-style-type: none"> • Check if the cable is correctly connected to the GOT. • Check if the correct communication driver is installed on the GOT. • Check if the communication settings are correctly set. Controller <ul style="list-style-type: none"> • Check if the parameters are set. • Check if the cable is correctly connected to the controller. • Check if the controller is turned on.
	The target controller of the restoration is a different kind of controller from the target controller of the backup.	<ul style="list-style-type: none"> • Check if the system configuration for the restoration is the same as that for the backup. • Check if the target controller of the restoration is the same as that of the backup or the same kind of controller.
The restoration cannot be executed because passwords for files of the controller are set.	<ul style="list-style-type: none"> • The passwords for files written in the controller are changed. 	Check with the administrator of the system regarding the passwords for files of the controller.
The restoration to the robot controller cannot be executed because the Initialization of the robot program is failed.	A program name that does not exist in the robot controller may be set to the slot.	Check the parameter [SLTn] or [Online] → [Parameter] → [Slot list] in the workspace of RT ToolBox2 and to check if a program name that does not exist in the robot controller is set or not to the slot. If it is set, set a blank space for the program name and restore again after restarting.



12. CNC DATA I/O



12.1 Features

With the CNC data I/O function, the GOT can copy, compare, and delete machining programs, parameters, and others in the CNC connected to the GOT.

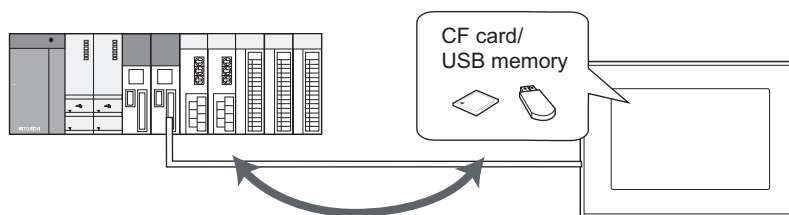

Copy, compare or delete the CNC data.

12.2 Specifications

12.2.1 System configuration

This section describes the target CNC of the CNC data I/O and the connection types for connecting the GOT to the CNC. For connection type settings and precautions regarding the communication unit/cable and connection type, refer to the following.

GOT1000 Series Connection Manual (Mitsubishi Products) for GT Works3

■ Target CNC of CNC data I/O

CNC
CNC C70

■ Connection type

This function can be used in the following connection types.

(○: Available, ✕: Unavailable)

Function		Connection type between GOT and CNC	
Name	Description	Bus connection	Ethernet connection ^{*2}
CNC data I/O	Data I/O between the CNC and GOT	○	○ ^{*1}

*1 Applicable only with the Display I/F connection.

*2 CNC Data I/O cannot be used when using CC-Link IE field network Ethernet adapter.

Required extended function OS

The following extended function OS is required.

 1.1.2 Hardware and OS* required for each function

(1) Extended function OS

Install the extended function OS shown in the above table on the GOT.

For the installation procedure, refer to the following.

 GT Designer3 Version1 Screen Design Manual (Fundamentals) 8. COMMUNICATION WITH GOT

(2) OS memory space

For installing the extended function OS, the available space shown in the above table is required in the user area.

For the procedure for checking the available memory space of the user area and information about the data using other user areas, refer to the following.

 GT Designer3 Version1 Screen Design Manual (Fundamentals) 8. COMMUNICATION WITH GOT

Required hardware

The following hardware is required.

GOT	Hardware
GT16	CF card/USB memory
GT15	CF card

CNC data that can be handled

The following data can be input, output and compared with the CNC data I/O function.

For details of the data, refer to the manual for the CNC to be used.

Target data	Description	File name	File unit		
			Input	Output	Compare
Machining program	Machining parameters	ALL.PRG, O_.PRG	○	○	○ ^{*2}
Parameter	Parameter	ALL.PRM	○	○	○ ^{*3}
Tool offset data	Tool offset data	TOOL.OFS	○	○	○
Workpiece offset data	Workpiece offset data	WORK.OFS	○	○	○
Common variable	Common variable	COMMON.VAR	○	○	○
Maintenance data	CNC ladder	USERPLC.LAD	○	○	×
	R resister data	RREG.REG	×	○	×
	C resister data	CREG.REG	×	○	×
	T resister data	TREG.REG	×	○	×
	Operation history data	TRACE.TRC	×	○	×
	CNC sampling data	NCSAMP.CSV	×	○	×
	SRAM data files	SRAM.BIN	×	○	×
Cycle monitor data	Sampling related package file	ALL.SMP	○	○	×
	Sampling setting file	SAMPLING.PRM	○	○	×
	PLC data collection setting file	FLCSAMP.CTF	○	○	×
	PLC draw setting file	PLCSAMP.MMG	○	○	×
	PLC collection data file	PLCSAMPH.CSV	○ ^{*1}	○	×
	CNC collection data file	NCSAMPH.CSV	○ ^{*1}	○	×

*1 PLC collection data file (PLCSAMPH.CSV) and CNC collection data file (NCSAMPH.CSV) can be input when selecting Sampling related package file (ALL.SMP).

*2 When the software version of CNC is earlier than D2, machining programs cannot be compared.

*3 When the software version of CNC is earlier than D2, the parameter files in type II cannot be compared.

12.2.2 Access range

(1) Bus connection

One GOT can execute the CNC data I/O on up to two CNCs by switching the CNCs.

(2) Ethernet connection

One GOT can execute the CNC data I/O on up to 64 CNCs by switching the CNCs.

12.2.3 Precautions

(1) Before using CNC data I/O

Read the manual of the connected CNC carefully and make sure you understand the contents before using the CNC data I/O.

(2) Inapplicable GOT

The CNC data I/O cannot be used with the GOTs shown below.

GOT	Inapplicable GOT
GT16	GT1675M-V, GT1675-VN, GT1672-VN, GT1665M-V, GT1662-VN, GT1655-V
GT15	GT1575-V, GT1575-VN, GT1572-VN, GT156□, GT155□

(3) Folder name and file name

(a) Number of characters set for folder and file names

The GOT recognizes the file location with a path as shown below.

Set the folder and file names so that the total number of characters in the path is within 78 characters.

The user can set the folder name and file name only.

(Other than the folder and file names are automatically set.)

Example) Path of file to be stored in CF card

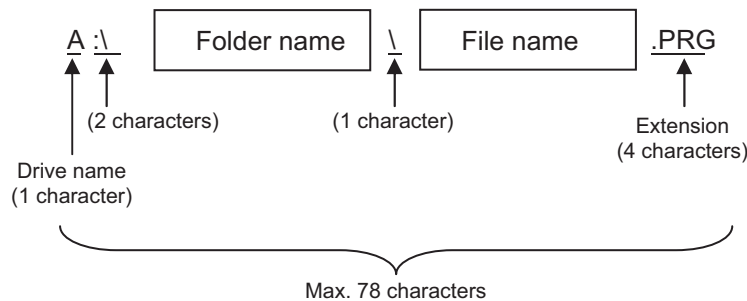

HINT

When setting hierarchy to folder

For setting [Folder Name], enter \ between folder names.

(\ is counted as one character.)

The maximum number of hierarchy levels for creating folders is 20.

(Setting example)

[Folder Name] : PPROJECT1\ABC

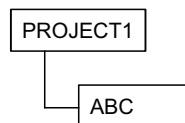

(b) For characters and symbols that are used in folder names and file names, refer to the following.

- Capital of one-byte alphanumeric characters
- Symbols including # \$ % & ' () + - . = @ [] ^ _ { } ?
A one-byte space is not applicable.

(c) Character strings that cannot be set

The following character strings cannot be used in a folder name and a file name.
(The character strings cannot be used irrespective of capital or small letters.)

- COM1 to COM9
- LPT1 to LPT9
- AUX
- CON
- NUL
- PRN
- CLOCK\$

The following folder names and file names also cannot be used.

- Folder names starting with G1
- Folder and file names starting with a period or \
- Folder and file names ending with a period or \
- Folder and file names with a period or two periods only

The folder names and the file names that contain the following character strings are not displayed correctly.

- Multi-byte code
- Kanji, hiragana, katakana, and one-byte katakana

(4) Protect for data I/O

When the data protection key 1, 2, or 3 and edit lock B or C is valid, the data I/O is restricted.

Comparison can also be performed when the data protection key 1, 2, or 3 and edit lock B or C is valid.

However, the software version of CNC is earlier than D2, cancel the data protection key 1, 2, 3 and edit lock B, C before performing comparison.

For the data protection key 1, 2, 3 and edit lock B, C, refer to the following.

 C70 Series INSTRUCTION MANUAL

(5) Changing CNC file names

When outputting a file in the CNC and changing the file name, do not change the extension of a maintenance data file. If the extension is changed, the maintenance data file is not recognized.

 12.4 ■Display details in list

(6) Highlight display in the Comparison error details window

The comparison of parameter files is performed not only for the parameter values but also for the values of the format. Therefore, the part which is not a parameter value may be highlighted when the values are different between the CF card side and CNC side.

 12.4 ■Compare

12.3 Operations for Display

Start operation for the CNC Data I/O

The following describes the outline for displaying the operation screen for the CNC data I/O after installing CNC Data I/O and GOT Platform Library (extended function OS) on the GOT.
 For the start operation of the CNC Data I/O using the special function switch, refer to the following.

☞ Start operation using the special function switch

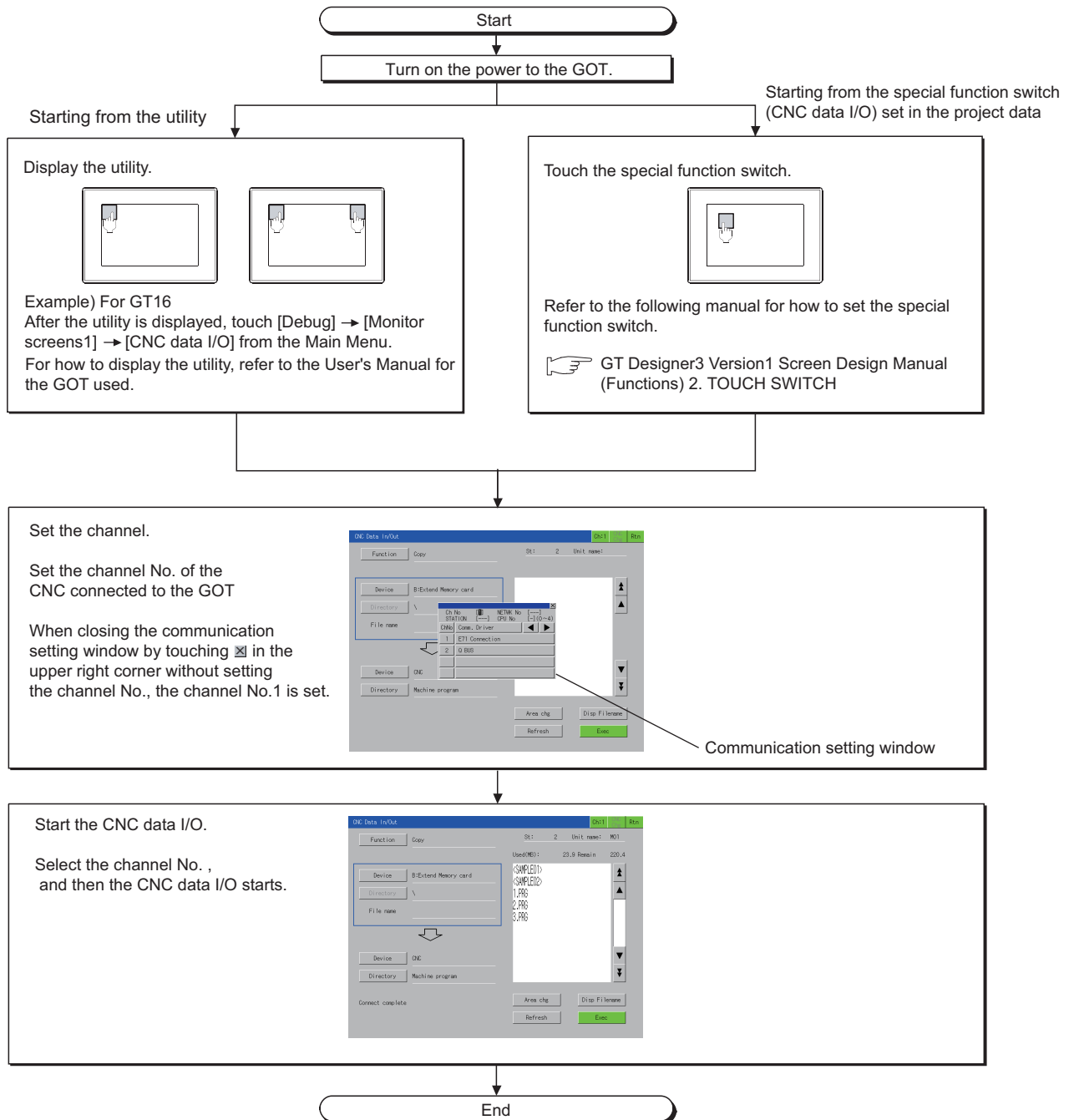

9
SERVO AMPLIFIER MONITOR
10
CNC MONITOR FUNCTIONS
11
BACKUP/RESTORE
12
CNC DATA I/O
13
SEC MONITOR
14
LADDER EDITOR
15
MELSEC-L TROUBLE SHOOTING
16
LOG VIEWER

POINT

(1) How to display the utility

For how to display the utility, refer to the following.

 User's Manual for the GOT used

(2) Displaying communication setting window

After turning on the GOT, the communication setting window is displayed at the first startup of the CNC data I/O only.

For displaying the communication setting window at the second or later startup, touch the Ch: button on the CNC data I/O screen.

 12.4 Operation Procedures

(3) If the project data has not been downloaded

The CNC data I/O can be started from the utility even if the project data has not been downloaded to the GOT.

Start operation using the special function switch

CNC Data I/O can be started by using the special function switch.

The CNC Data I/O of controllers which have been set can be displayed by touching the special function switches to which the following settings are configured.

- Select [CNC Data I/O] in [Switch Action], and select the [Specify the destination to connect the screen of CNC Data Input/Output] check box.

For Q-bus connection, [CPU No.] of [Network] should be 2 or more.

Operation at start differs depending on the setting contents of the special function switch.

For the setting items for the special function switch, refer to the following.

 GT Designer3 Version1 Screen Design Manual (Functions) 2. TOUCH SWITCH

Changing screens

The following describes how to change the screen.

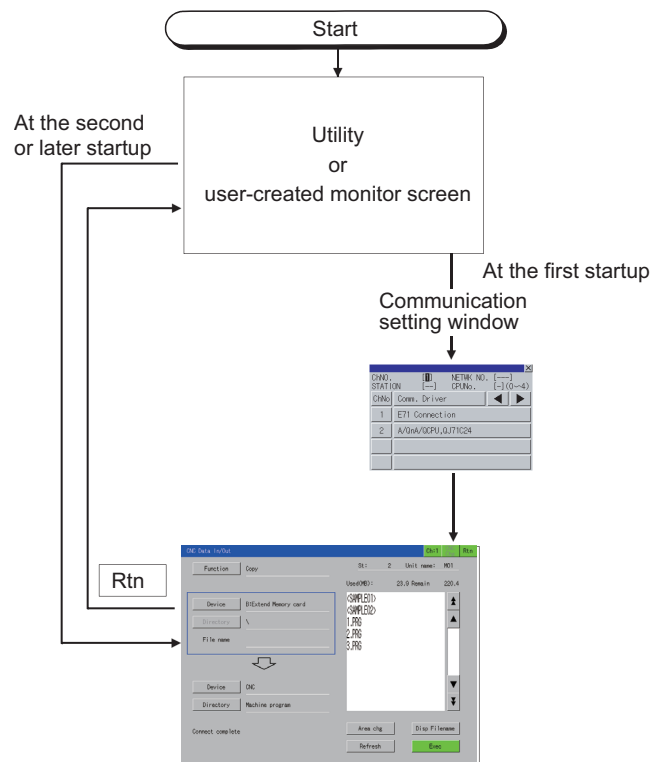

For exiting the CNC data I/O by touching Rtn, the last exited screen is displayed when the CNC data I/O starts next time.

12.4 Operation Procedures

■ Displayed contents

This section describes the display details for the CNC data I/O and the functions of the keys displayed on the screen.

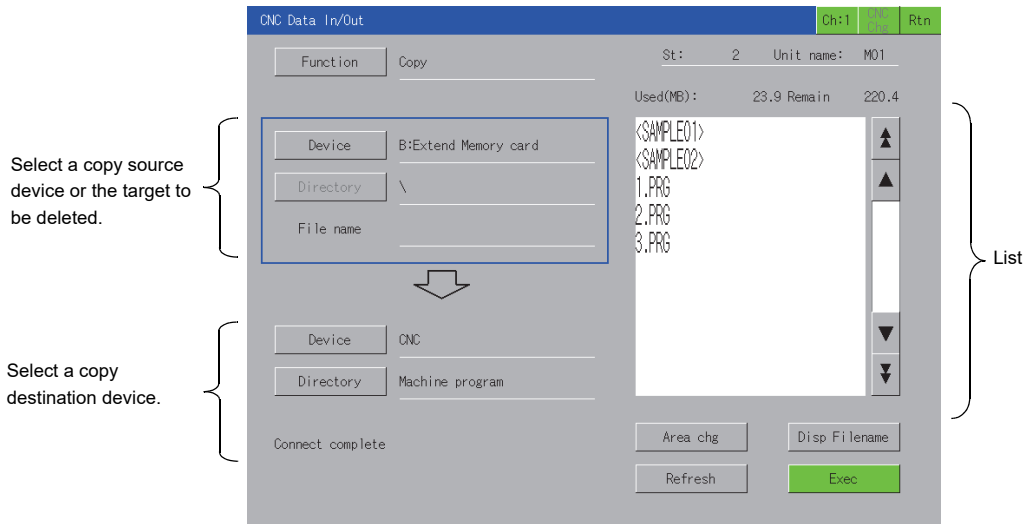

Item	Description
Ch:1	Displays the communication setting window.
CNC Data	<ul style="list-style-type: none"> For bus connection Switches CNCs to be monitored when multiple CNCs are connected. The monitoring target is switched in order of the module number. For Ethernet connection Switches CNCs to be monitored when multiple CNCs are connected. The monitoring target is switched in order of the setting for the Ethernet on GT Designer3.
Rtn	Ends the CNC data I/O, and then the screen is returned to the monitor screen or the screen for the utility of the GOT.
Function	<p>Displays the function selection window.</p> <p>Select a function to be executed ([Copy]/[Compare]/[Delete]/[Create a directory]/[USB Drive Stop]*1).</p> <ul style="list-style-type: none"> For [Copy] After selecting a function, the selected function is displayed. (☞ ■Copy) For [Compare] After selecting a function, the selected function is displayed. (☞ ■Compare) For [Delete] After selecting a function, the selected function is displayed. (☞ ■Delete) For [Create a directory] The key window to create any directory is displayed. (☞ ■Creating a directory) For [USB Drive Stop]*1 The window for confirming to stop the USB drive is displayed.
Device	<p>Displays the device selection window.</p> <p>Select the target of [Function] ([CNC]/[E:USB Drive]*1/[B:Extend Memory card]/[A:Built in CF card]). After selecting the target, the selected target is displayed.</p>

(Continued to next page)

Item	Description
<div style="border: 1px solid gray; padding: 2px; width: fit-content; margin: 5px auto;">Directory</div>	<p>The settings and display details differ depending on the setting for [Device].</p> <ul style="list-style-type: none"> For [CNC] <ul style="list-style-type: none"> Displays the CNC data selection window. Select a CNC data that [Function] is executed. After selecting a CNC data, the selected CNC data is displayed. For [E:USB Drive]*1, [B:Extend Memory card], or [A:Built in CF card] <ul style="list-style-type: none"> Displays the directory selected in the list. (The Directory button cannot be touched.) Up to 28 characters are displayed as the directory.
<p>File name</p>	<p>Displays the file name selected in the list.</p> <p>When outputting a file, the file name can be changed by using a key window.</p> <p>( ■ Changing the file name when outputting the file)</p>
<p>Above the list</p>	<p>The display details differ depending on the setting for [Device].</p> <ul style="list-style-type: none"> For [CNC] <ul style="list-style-type: none"> [Entry], [Remain]: <ul style="list-style-type: none"> Displays the number of programs registered and the number of registerable programs left as user-created machining programs. [Character], [Remain]: <ul style="list-style-type: none"> Displays the number of characters registered and the number of registerable characters left as user-created machining programs. The number of registerable characters left is displayed by 250 characters. For [E:USB Drive]*1, [B:Extend Memory card], or [A:Built in CF card] <ul style="list-style-type: none"> [Used(KB)], [Remain]: <ul style="list-style-type: none"> Displays the used space and available space of the memory card.
<p>List</p>	<p>Displays the data in the target selected for [Device].</p> <p>When [E:USB Drive]*1, [B:Extend Memory card], or [A:Built in CF card] is selected, the directory is displayed as < >. Touching < > displays the data in the directory. (Touching <.> displays the upper directory.)</p> <p>The copy source device is set to [E:USB Drive]*1, [B:Extend Memory card], or [A:Built in CF card], the directory for the file is displayed in the directory field of the copy destination device (CNC).</p>
<div style="display: flex; justify-content: center; gap: 10px;"> <div style="border: 1px solid gray; padding: 2px;">▲</div> <div style="border: 1px solid gray; padding: 2px;">▼</div> </div>	<p>Scrolls the list up/down by 10 items.</p>
<div style="display: flex; justify-content: center; gap: 10px;"> <div style="border: 1px solid gray; padding: 2px;">▲▲</div> <div style="border: 1px solid gray; padding: 2px;">▼▼</div> </div>	<p>Scrolls the list up/down by 50 items.</p>
<div style="border: 1px solid gray; padding: 2px; width: fit-content; margin: 5px auto;">Area chg</div>	<p>Switches the setting targets (blue frame in the left side of the screen) up and down.</p> <p>When [Function] is selected for [Delete], the setting targets cannot be switched.</p>
<div style="border: 1px solid gray; padding: 2px; width: fit-content; margin: 5px auto;">Disp Filename</div>	<p>The display details differ depending on the setting for [Device].</p> <p>File names are switched every time the button on the left is touched.</p> <ul style="list-style-type: none"> For [CNC] <ul style="list-style-type: none"> Switches only when [Machine program] is selected for [Directory]. The display contents in the list are switched as shown below every time the button is touched. <div style="margin: 10px 0;"> <div style="display: flex; justify-content: space-around; align-items: center;"> <div style="border: 1px solid black; padding: 2px;">File name and comment</div> <div style="font-size: 24px;">→</div> <div style="border: 1px solid black; padding: 2px;">File name and number of characters</div> </div> <div style="display: flex; justify-content: center; margin-top: 5px;"> <div style="border: 1px solid black; padding: 2px; margin-right: 5px;">↑</div> <div style="border: 1px solid black; padding: 2px; margin-right: 5px;">↓</div> </div> </div> <p>Display contents other than CNC machine program cannot be touched.</p> For [E:USB Drive]*1, [B:Extend Memory card], or [A:Built in CF card] <ul style="list-style-type: none"> The display contents in the list are switched as shown below every time the button is touched. <div style="margin: 10px 0;"> <div style="display: flex; justify-content: space-around; align-items: center;"> <div style="border: 1px solid black; padding: 2px;">File name</div> <div style="font-size: 24px;">→</div> <div style="border: 1px solid black; padding: 2px;">File name and file size</div> <div style="font-size: 24px;">→</div> <div style="border: 1px solid black; padding: 2px;">File name and date and hour</div> </div> <div style="display: flex; justify-content: center; margin-top: 5px;"> <div style="border: 1px solid black; padding: 2px; margin-right: 5px;">↑</div> <div style="border: 1px solid black; padding: 2px; margin-right: 5px;">↓</div> </div> </div> <p>The file size is displayed in KB.</p>
<div style="border: 1px solid gray; padding: 2px; width: fit-content; margin: 5px auto;">Refresh</div>	<p>Updates the list.</p>
<div style="border: 1px solid gray; padding: 2px; width: fit-content; margin: 5px auto; background-color: #90EE90;">Exec</div>	<p>Executes the settings.</p>

*1 The USB drive is applicable to GT16 only.

Copy

Files can be copied between [CNC] of the monitoring target and [E:USB Drive]/[B:Extend Memory card]/[A:Built in CF card].

The following explains an example of copying the [CNC] machining program file [1.PRG] into [A:Built in CF card].

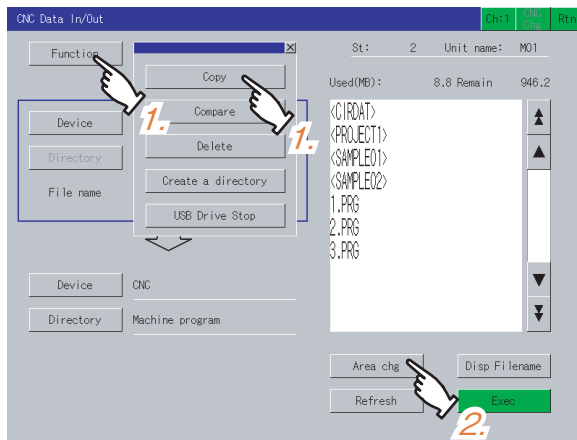

1. Touch the [Function] button and then touch the [Copy] button.
2. Touch the [Area chg] button to switch the setting target to the copy source device.

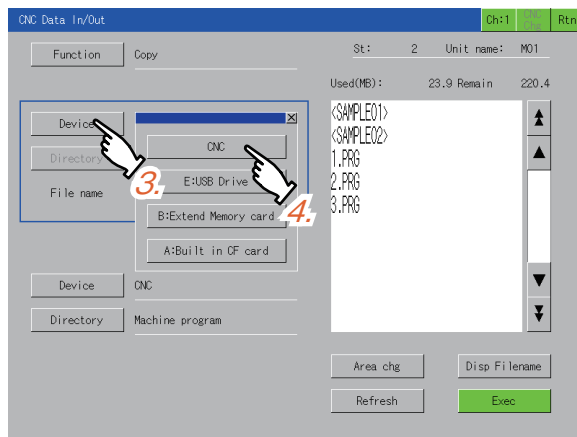

3. Touch the [Device] button of the setting target in the copy source device.
4. Select [CNC].

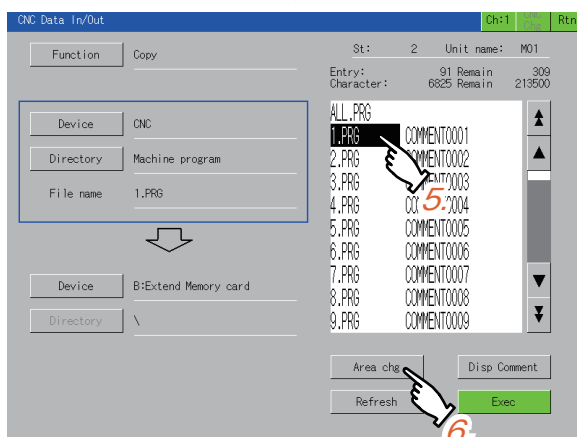

5. Select the setting target file [1.PRG] in the list of the copy source device.
6. Touch the [Area chg] button to switch the setting target to the copy destination device.

Continued to next page

From previous page

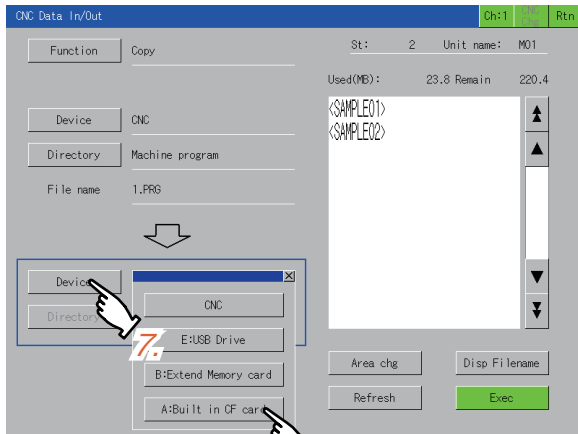

7. Touch the [Device] button.
8. Select the setting target device [A:Built in CF card] in the copy destination devices.

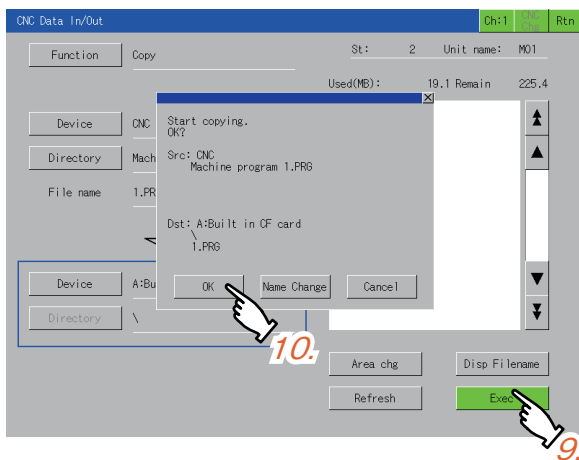

9. Touch the [Exec] button. A dialog box as shown in the left appears.
10. Touching the [OK] button copies [1.PR] to [A:Built in CF card].

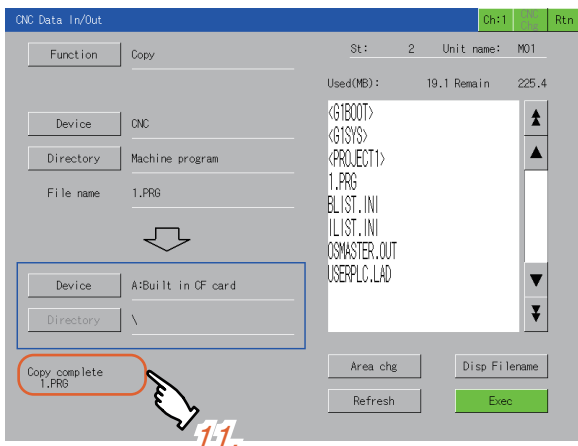

11. The message [Copy complete] is displayed in the message area.



Selection of a device in the copy source device/copy destination device

When [CNC] is selected for [Device] in the copy source device/copy destination device, [E:USB Drive]/[B:Extend Memory card]/[A:Built in CF card] will be selected for another [Device].
When [E:USB Drive]/[B:Extend Memory card]/[A:Built in CF card] is selected for [Device] in the copy source device/copy destination device, [CNC] will be selected for another [Device].
Example) When [CNC] is selected for [Device] in the copy source device and [A:Built in CF card] is selected for [Device] in the copy destination device, selecting [CNC] for [Device] in the copy destination device switches [Device] in the copy source device to [A:Built in CF card].

Compare

Files in [E: USB Drive]/[B: Extended Memory card]/[A: Built in CF card] can be compared with files in CNC of the monitoring target.

The following explains an example of comparing the file [ALL.PRG] in the CF card (A drive) with the files in CNC.

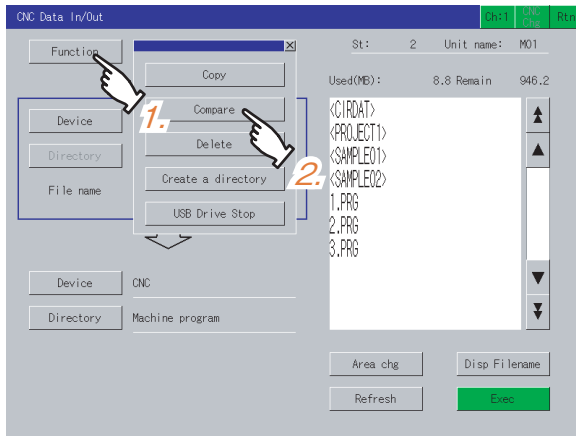

1. Touch the [Function] button.

2. Touch the [Compare] button in the displayed window.

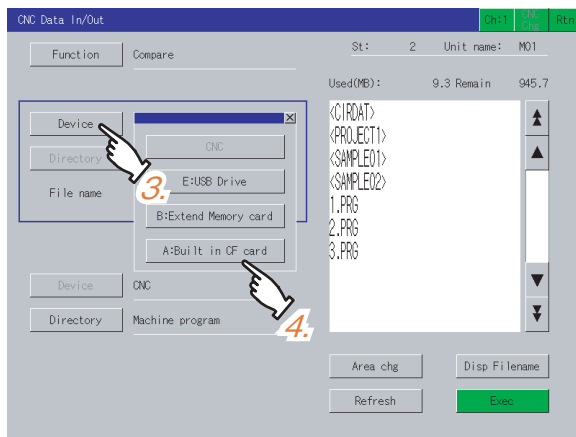

3. Touch the [Device] button.

4. Touch the [A: Built in CF card] button in the displayed window.

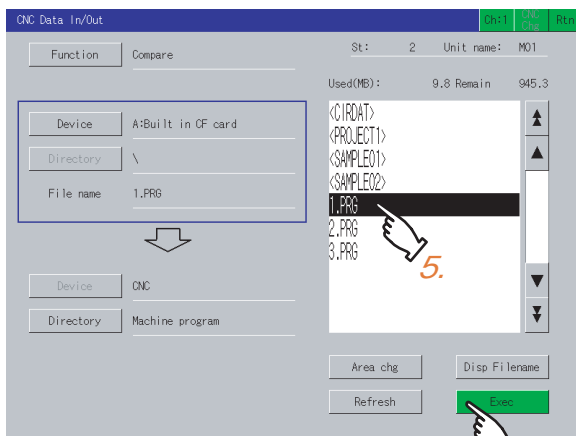

5. Select the file to be compared in the list.

6. Touch the [Exec] button. Touching this starts comparison.

7. When the file in the CF card matches a file in CNC, a comparison completion message appears.
 ■ Comparison error details window
 However, the software version of CNC is earlier than D2, the Comparison error details window does not appear.

(1) Comparison error details window

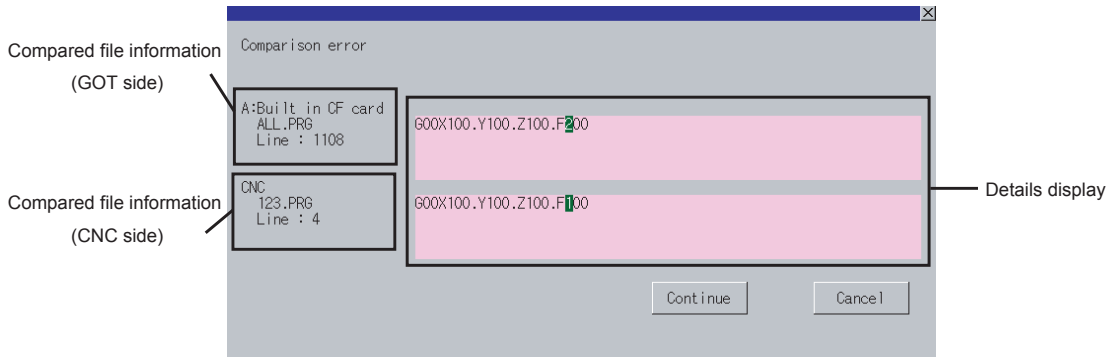

Item	Description
Compared file information (GOT side)	Displays the device name on the GOT side, compared file name, and mismatch line number of the data.
Compared file information (CNC side)	Displays the device name on CNC side, compared file name and line number of the inconsistent data. The line number is displayed only when the machining programs are compared.
Details display	Displays the contents of the line which is found to be inconsistent in comparison. The first inconsistent character is highlighted. Up to 250 characters can be displayed in a single line. However, characters are not highlighted in the following cases: <ul style="list-style-type: none"> • When the first inconsistent character is on 251st or later. • When the corresponding line does not exist in the comparison source file or the comparison target file.
Continue	Touching this button closes the window and continues the comparison.
Cancel	Touching this button closes the window and cancels the comparison.



Displayed line number

There is a difference between GOT side and CNC side in how to display the line number.

- GOT side:
A head line (O number) is displayed as the first line.
- CNC side:
A head line (O number) is displayed as the zeroth line since the head line (O number) is treated as a file name.

Delete

Files stored in [CNC] of the monitoring target or [E:USB Drive]/[B:Extend Memory card]/[A:Built in CF card]) can be deleted.

The following explains an example of deleting [CNC] machining program files [1.PRG], [2.PRG] and [3.PRG].

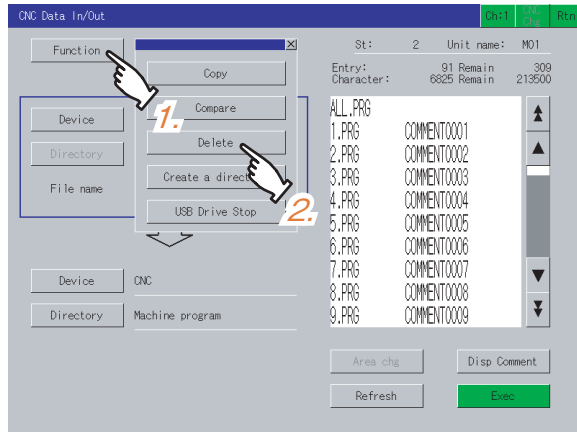

1. Touch the [Function] button.
2. Touch the [Delete] button.

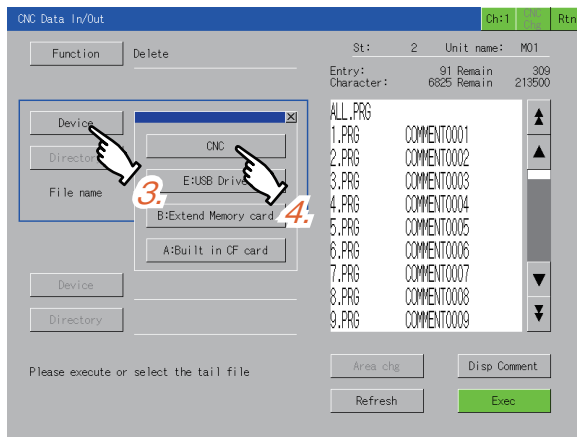

3. Touch the [Device] button.
4. Select [CNC] button.

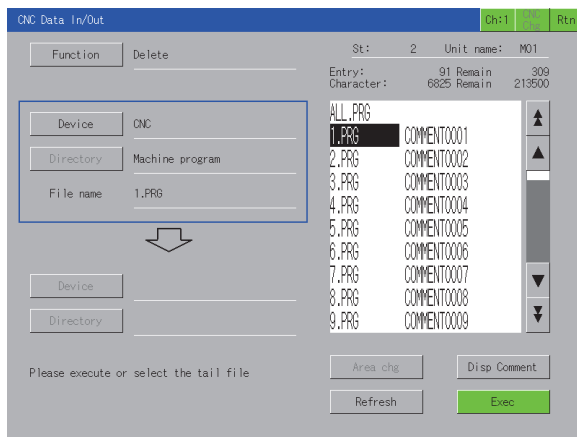

5. Select the file [1.PRG] at the head of the list to delete.
Selecting the file [1.PRG] again cancels the selection.
Start the procedure from the step 7 to delete one file only.

Continued to next page

From previous page

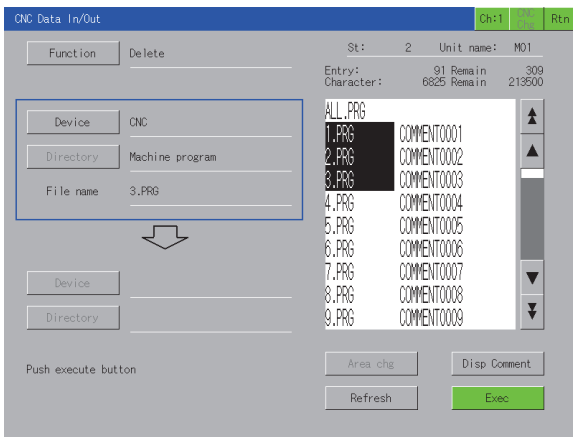

6. Select the file [3.PRG] at the end of the list to delete.
The files [1.PRG], [2.PRG] and [3.PRG] are all selected.
In addition, when selecting [ALL.PRG], [ALL.PRG] only is selected.

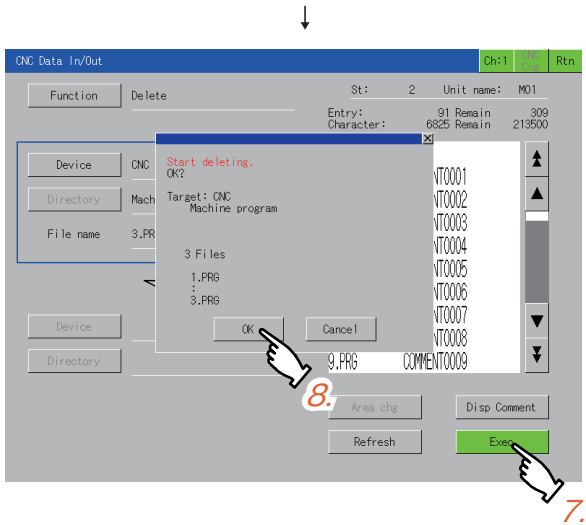

7. Touch the [Exec] button. The delete confirmation dialog box appears.
8. Touching the [OK] button deletes the selected file. Touching the [Cancel] button cancels the deletion.

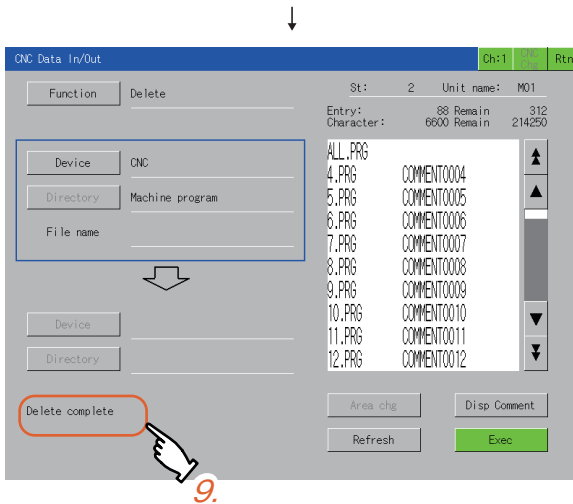

9. The message [Delete complete] is displayed in the message area.

POINT

Precautions for deleting files

When [ALL.PRG] shown in the list is deleted, the deleted files vary according to the selected [Device].

- For [CNC]
When selecting and deleting [ALL.PRG], all the files displayed in the list are deleted.
- For [E:USB Drive], [B:Extend Memory card], or [A:Built in CF card]
When selecting and deleting [ALL.PRG], [ALL.PRG] only is deleted.

■ Changing the file name when outputting the file

When copying a file to a [CF card]/[USB memory], the file name in the copy destination device can be changed. The following explains an example of outputting a [CNC] machining program file to [A:Built in CF card] with changing the file name from [ALL.PRG] to [SAMPLE.PRG].

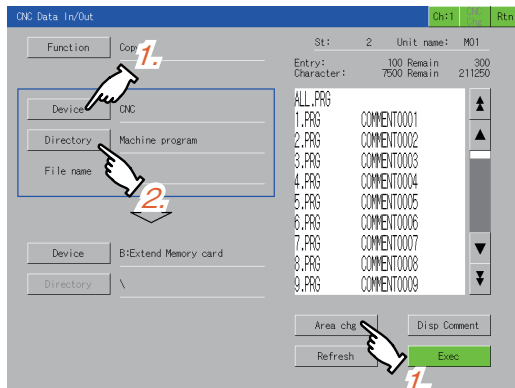

1. Touch the [Area chg] button to switch the setting target to the copy destination device. Set the copy destination device to [A:Built in CF card].

2. Touch the [Device] button. The device selection window appears. Set the copy source device to [CNC] and the directory to [Machine program].

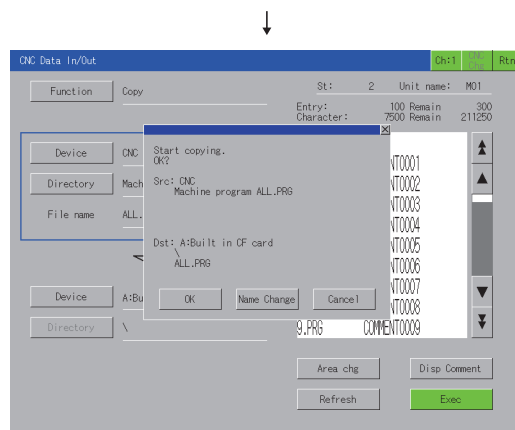

3. Touch [ALL.PRG] in the list. Touch the [Exec] button. The copy confirmation window as shown in the left appears.

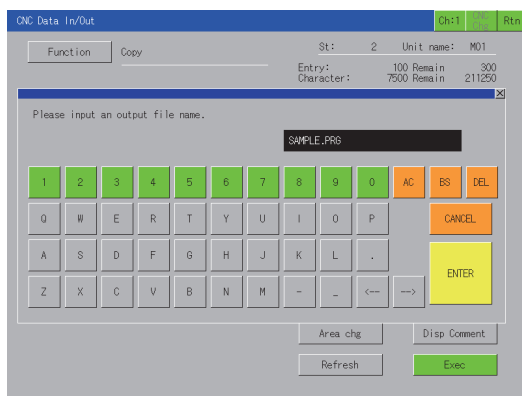

4. Touch the [Name Change] button. (Touching the [OK] button copies the file with the old file name.) A key window appears. Touch the [AC] key to delete the old file name from the input value display area. Key operation using a USB keyboard is also available.

☞ (2) Input using a USB keyboard

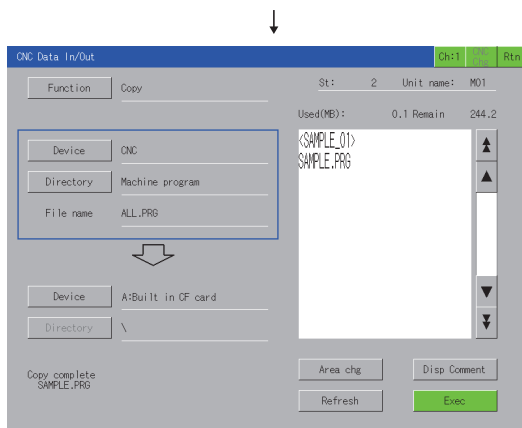

5. Input "SAMPLE.PRG". Touch the [ENTER] key. The key window closes and the copy confirmation window appears. Touching the [OK] button starts copying the file with the new file name "SAMPLE.PRG". The file name is changed to "SAMPLE.PRG" in the copy destination device. The message [Copy complete] is displayed in the message area.

(2) Input using a USB keyboard

When a key window is displayed, a USB keyboard can be used for key input.
For the corresponding keys, refer to the following.

Key	Description
Characters, numbers, symbols	Press the key on the USB keyboard corresponding to the key displayed in the key window, to input it into the input value display area.
Shift + Delete	Deletes all characters in the input value display area.
Backspace	Deletes one character to the left of the cursor in the input value display area.
Delete	Deletes one character to the right of the cursor in the input value display area.
Esc	Closes the key window without reflecting the values in the input value display area.
Enter	Closes the key window after reflecting the values in the input value display area.

When using the USB keyboard, install the extended function OS (USB mouse/keyboard) to the GOT.
For the extended OS (USB mouse/keyboard) installation methods, refer to the following.

 GT Designer3 Version1 Screen Design Manual (Fundamentals)

For the setting method of USB keyboards, refer to the following.

 User's Manual for the GOT used

■ Creating a directory

Any directory can be created in a [CF card]/[USB memory].

The following explains an example of creating the "SAMPLE01" directory in [A:Built in CF card].

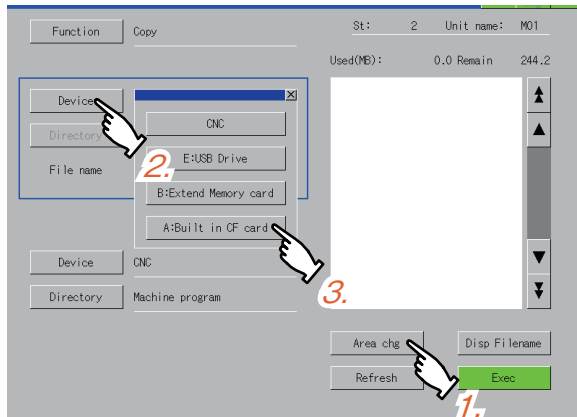

1. Touch the [Area chg] button to switch the setting target to the copy source device/deletion target.
2. Touch the [Device] button.
3. Touch the [A:Built in CF card] button.

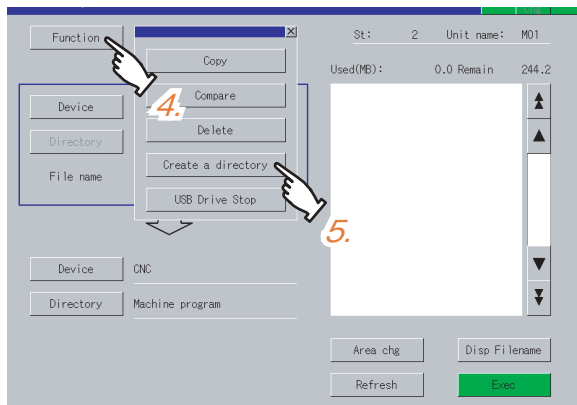

4. Touch the [Function] button.
5. Touch the [Create a directory] button.

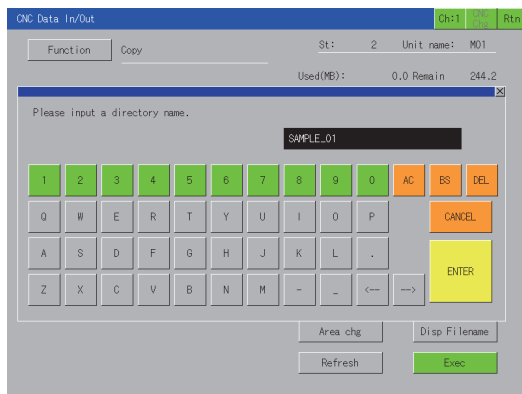

6. The window shown in the left appears. Input "SAMPLE01".
7. Touch the [ENTER] key. The window shown in the left closes. Key operation using a USB keyboard is also available. (2) Input using a USB keyboard

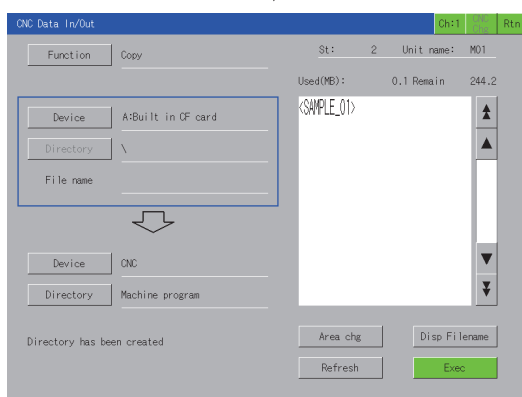

8. The list is updated, and the "SAMPLE01" directory is created. The message [Directory has been created] is displayed in the message area.

■ Display details in list

The following shows file names to be displayed in the list on the CNC data I/O screen.

Target data	Description	File name to be displayed in list
Machining program ^{*1*2}	Machining program	ALL.PRG, O_.PRG
Parameter ^{*3}	Parameter	ALL.PRM
Tool offset data	Tool offset data	TOOL.OFS
Workpiece offset data	Workpiece offset data	WORK.OFS
Common variable	Common variable	COMMON.VAR
Maintenance data	CNC ladder	USERPLC.LAD
	R resister data	RREG.REG
	C resister data	CREG.REG
	T resister data	TREG.REG
	Operation history data	TRACE.TRC
	CNC sampling data	NCSAMP.CSV
	SRAM data files	SRAM.BIN
Cycle monitor data	Sampling related package file	ALL.SMP
	Sampling setting file	SAMPLING.PRM
	PLC data collection setting file	FLCSAMP.CTF
	PLC draw setting file	PLCSAMP.MMG
	PLC collection data file	PLCSAMPH.CSV
	CNC collection data file	NCSAMPH.CSV

- *1 When the base specifications parameter of #1166 fixpro is set to 1, the fixed cycle program is the target data. When the CNC has machining programs, ALL.PRG is displayed at the top of the list.
- *2 When the software version of CNC is earlier than D1, machining programs cannot be compared.
- *3 When the software version of CNC is earlier than D1, the parameter files in type II cannot be compared.

12.5 Error Messages and Corrective Actions

The following shows the error messages for the CNC data I/O and the corrective actions.

Error message	Error	Corrective action
Communication error	<ul style="list-style-type: none"> The CNC is powered OFF, the cable is disconnected, the connection target is other than CNC. The communication failed when communication driver is selected in the communication setting window, or when [CNC Chg] button is touched. 	<ul style="list-style-type: none"> Set the correct connection and settings. Turn the CNC power supply ON again.
Unable to exec : PLC built in CNC running	The PLC CPU built in the CNC is in operation.	Stop the operation of the PLC CPU built in the CNC, and then execute the CNC data I/O again.
CNC is busy	CNC is busy because it is executing the other I/Os.	Please wait a moment and execute it again.
Failed to stop USB drive	The GOT fails to stop the USB drive.	Check the USB memory.
Unable to exec : Program running	The GOT cannot execute the CNC data I/O because the CNC is in operation.	Stop the CNC operation, and then execute the CNC data I/O again.
Out of memory	The capacity of the data to be written exceeds the CNC memory capacity.	Make enough space in the CNC memory by operations, including deleting machining programs, and then execute the CNC data I/O again.
The same name exists	The directory name cannot be created because the same name already exists.	Enter another name.
In sampling	The CNC data I/O cannot be executed because sampling is in execution.	Stop sampling and then execute the CNC data I/O again.
File not found	The file to be copied does not exist.	Set the correct settings, and then execute the CNC data I/O again.
The file cannot be compared	<p>The file cannot be used for comparison because of any of the following reasons:</p> <ul style="list-style-type: none"> The file is not the target of the comparison function. The software of CNC does not support the comparison function. 	<ul style="list-style-type: none"> Check the file type and select a file again.  12.2.1 ■CNC data that can be handled Update the software version of CNC.
Timeout	The GOT fails to communicate with the CNC.	Check the connection.
Communication Channel Setup Error.	The specified channel does not exist.	Set the correct communication settings.
Can't create a directory	The directory cannot be created.	<ul style="list-style-type: none"> Directories cannot be created when the device is set to the CNC. A memory card is not ready to write. The number 99 exists in the serial number when outputting a sampling related package file (ALL.SMP) (Example: A directory named SMP09012399 exists on January 23rd, 2009.)
Directory illegal	The directory cannot be displayed because it is invalid.	Set the correct directory settings, and then execute the CNC data I/O again.
Data protect	The data is protected.	Check that the data protection key and the edit lock are set to be invalid, and then execute the CNC data I/O again.
No. of registration over	The number of registerable programs is exceeded.	Delete unnecessary machining programs, and then execute the CNC data I/O again.
Path is too long	The directory name cannot be created because the path is too long.	Reconsider the directory/file name.
Too many files	Files cannot be displayed because the number of files and directories in the memory card is too large.	Reduce the number of files/directories to 1024 or less.

(Continued to next page)

Error message	Error	Corrective action
File is not specified	The Exec button is pressed even though a file is not specified.	Specify a file, and then execute the CNC data I/O again.
Some error found in file system	Errors occur in file systems.	File system errors Format the NC memory.
Can not write file	The file cannot be written in the copy destination device.	<ul style="list-style-type: none"> • Check if the copy destination device is ready for data writing. • TRACE.TRC and NCSAMP.CSV cannot be copied to the CNC.
Can not write file Format Error	The format cannot be written because it is invalid.	Check the format of the parameter.
Can not write file Range Over	The value cannot be written because it is invalid.	Check the set value of the parameter.
Can not write file In sampling	The GOT cannot write the file to the CNC because sampling is in progress.	Write the file to the CNC after sampling is completed.
Can not write file Can't set superposition waveform	The superposition waveform cannot be set because the parameters of the wave type 1 and the wave type 2 are not matched when inputting the wave type 2. For example, [Superposition] is set to [OFF] in the parameters of the cycle monitor.	Configure the correct parameter settings or input the correct data.
Can not read out file	The file to be copied cannot be read.	Check if the copy source device is ready for data reading.
Filename illegal	The file name is invalid.	Check the file name, and then execute the CNC data I/O again.
Memory Card not exist	No USB memory, extended memory card, or CF card is inserted into the GOT.	Check that a USB memory, extended memory card, or CF card is inserted into the GOT.
Program No. duplicate	The GOT tries to copy ALL.ORG to the CNC, but the machining program with the same number already exists in the CNC, so the GOT cannot execute the CNC data I/O.	Delete the machining program in the CNC, and then execute the CNC data I/O again.
The Ethernet settings of the monitoring target CNC are not correct.	The connection cannot be completed because the combination of N/W No. and PC station No. which is specified in the project data created with GT Designer3 does not exist in the Ethernet settings.	Set the correct special function switch and Ethernet settings.
Error	Other errors	Turn off the GOT and CNC. Check data in the CF card and the connection status. Then, execute the CNC data I/O again.

13. SFC MONITOR



13.1 Features

With the SFC monitor function, the GOT can monitor SFC programs of controllers, and changing device values of the programs is available.

The function improves the efficiency in troubleshooting and maintenance of PLC systems with SFC programs. The following shows features of the SFC monitor function.

■ Displaying SFC programs in SFC diagram format

The GOT can monitor SFC programs of the PLC CPU and display the programs in the SFC diagram format (MELSAP3 or MELSAP-L format).

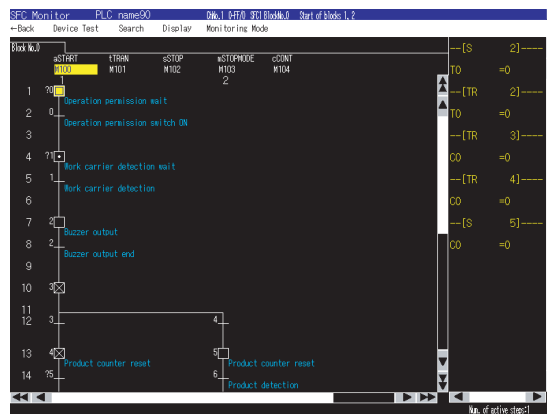

SFC diagram monitor screen

The following screens are displayed with the SFC monitor function.

- PLC read screen
(☞ 13.5 How to Operate PLC Read Screen)
- Block list screen
(☞ 13.6 How to Operate Block List Screen)
- SFC diagram monitor screen
(☞ 13.7 How to Operate SFC Diagram Monitor Screen)

Touching a step or transition condition on the SFC diagram monitor screen displays an enlarged operation output/ transition condition sequence program.

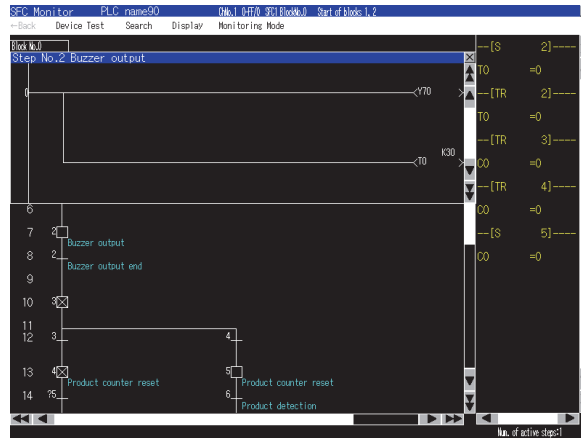

■ Switching display formats, device comment display, and languages

The following are available.

- Switching the display formats of device values
- Switching whether to display or hide device comments
- Switching languages for file names of SFC programs, comments, and others

(1) Switching display formats

On the SFC diagram monitor screen, the display formats for the current values of word devices can be switched between decimal and hexadecimal numbers.

(2) Switching device comment display

Whether to display or hide device comments used in SFC programs can be switched.

(3) Switching languages

Block titles, file titles and comments can be displayed in the language set for the language switching in the GOT utility with comment files created with the SJIS code, KS code, GB code, and/or ASCII code.

With a CF card storing comment files created with the SJIS code, KS code, GB code, and/or ASCII code, comments can be displayed in the language corresponding to any character code in the CF card, regardless of the language set in the GOT utility.

Interaction with ladder monitor function

By only selecting a device on the SFC diagram monitor screen and starting the ladder monitor, the GOT can search and display the device in a ladder program.

(☞ 13.7.3 ■ Display menu)

The function is useful for searching for a device used within both a SFC program and a ladder program in the ladder program.

Example) When turning on Y22 device with ladder program including interlock circuit

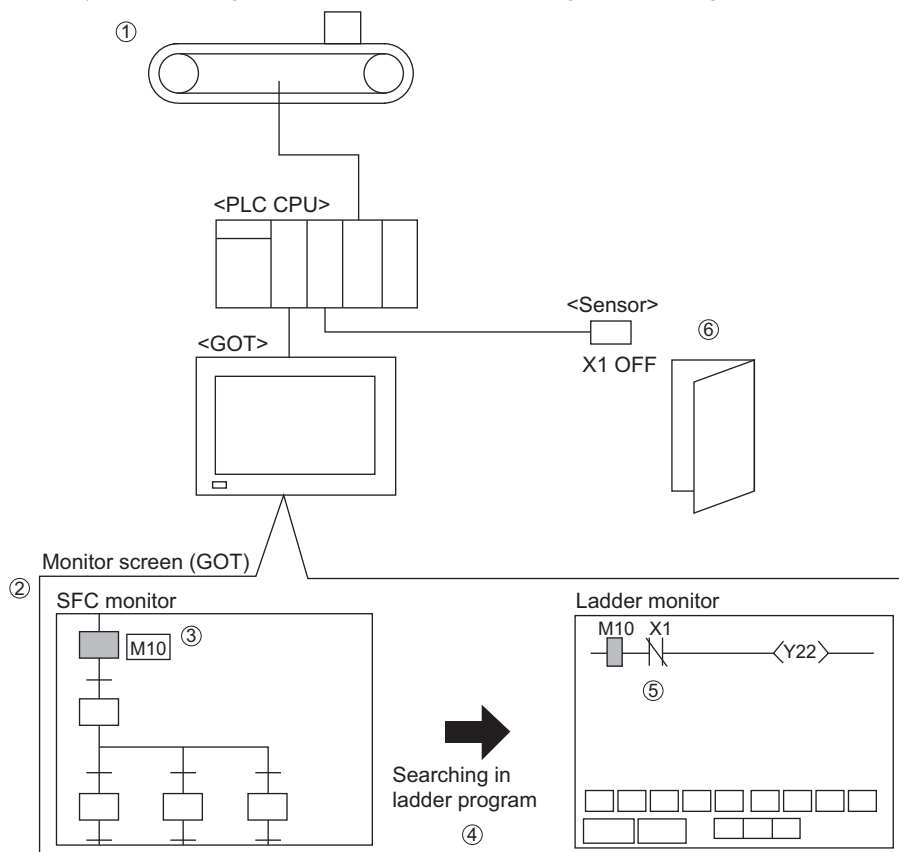

1. Finding that the machine stops
2. Checking an active step with the SFC monitor
3. Checking that the machine operation command (M10) is on
4. Touching M10 and starting the ladder monitor
5. Finding out that Y22 (machine operation) is off because X1 is off
6. Finding out that the machine stops because the door is open (X1 is off)

13.2 Specifications

13.2.1 System configuration

This section describes the system configuration for the SFC monitor function.

For connection type settings and precautions regarding the communication unit/cable and connection type, refer to the following.

 GOT1000 Series Connection Manual (Mitsubishi Products) for GT Works3

■ Target controller

Controller
QCPU (Q mode) ^{*1}
LCPU

^{*1} For creating a multiple CPU system with the Q00CPU, Q01CPU, Q02CPU, Q02HCPU, Q06HCPU, Q12HCPU, and/or Q25HCPU, use CPUs with the function version B or later.

■ Connection type

This function can be used in the following connection types.

(○: Available, ×: Unavailable)

Function		Connection form between GOT and controller							
Name	Description	Bus connection ^{*8}	Direct CPU connection ^{*9}	Computer link connection	Ethernet connection ^{*7}	MELSECNET/H connection ^{*8} , MELSECNET/10 connection ^{*1*8}	CC-Link IE controller connection ^{*2*8} , CC-Link IE field connection ^{*3}	CC-Link connection	
								ID ^{*4}	G4 ^{*4*5}
SFC monitor	Monitors SFC programs.	○ ^{*6*7}	○	○	○	○	○	○	○

^{*1} For the MELSECNET/10 connection, use a QCPU and network module (QJ71LP21, QJ71LP21-25, QJ71LP21S-25, and QJ71BR11) with the function version B or later.

^{*2} Indicates the CC-Link IE controller network connection.

^{*3} Indicates CC-Link IE field network connection.

^{*4} Indicates CC-Link connection (Intelligent device station).

^{*5} Indicates CC-Link connection (via G4).

^{*6} The Q12PRHCPU and Q25PRHCPU are not available.

^{*7} SFC monitor cannot be used when using CC-Link IE field network Ethernet adapter.

^{*8} The LCPU does not support the connection type.

^{*9} When the GOT is connected to LCPU, use L6ADP-R2.

Required extended function OS, option OS, and option function board

The following extended function OS, option OS, and option function board are required.

 1.1.2 Hardware and OS' required for each function

POINT

For using the SFC monitor function, a capacity of 6201KB or more is required in the user area of the specified drive for installing the extended function OS and option OS. (For using the GOT with the built-in flash memory of 5MB, set the OS boot drive to [A: Standard CF Card].)

For operating GOT Function Expansion Library (option OS), a capacity of 8192KB is required in the user area of the GOT memory. (A total memory capacity of 14393KB is required for using the SFC monitor function.)

Therefore, the following settings are required depending on the GOT to be used.

GOT	Required setting
GT1575-VN, GT1572-VN, GT1562-VN	<ul style="list-style-type: none"> Setting the OS boot drive to [A: Standard CF Card] Memory expansion (Installing an option function board with add-on memory)
GT15 other than the above	<ul style="list-style-type: none"> Memory expansion (Installing an option function board with add-on memory)

For setting the OS boot drive, refer to the following.

 GT Designer3 Version1 Screen Design Manual (Fundamentals) 8. COMMUNICATION WITH GOT

(1) Extended function OS and option OS

Install the above extended OS and option OS on the GOT.

For the installation procedure, refer to the following.

 GT Designer3 Version1 Screen Design Manual (Fundamentals) 8. COMMUNICATION WITH GOT

(2) OS memory space

For installing the extended function OS and option OS, the available space shown in the above table is required in the user area.

For the procedure for checking the available memory space of the user area and information about the data using other user areas, refer to the following.

 GT Designer3 Version1 Screen Design Manual (Fundamentals) 8. COMMUNICATION WITH GOT

(3) Option function board

(a) For GT16

No option function board is required.

(b) For GT15

Mount one of the option function boards in the above table on the GOT.

For the GOTs with a built-in option function board, refer to the following.

 1.1.2 Hardware and OS' required for each function

For how to mount an option function board on the GOT, refer to the following.

 User's Manual for the GOT used

Required hardware

The following hardware is required.

Hardware
CF card

13.2.2 Devices and range that can be monitored

The device range varies depending on the CPU to be used.

(○: Possible, ×: Impossible)

Device	Device range	Program display	Device monitor display	Search operation
Input	X0 to 1FFF, DX0 to FFF	○	○	○
Output	Y0 to 1FFF, DY0 to FFF	○	○	○
Internal relay	M0 to 61439	○	○	○
Latch relay	L0 to 32767	○	○	○
Link relay	B0 to FFFF	○	○	○
Timer	T0 to 32767	○	○	○
Retentive timer	ST0 to 32767	○	○	○
Counter	C0 to 32767	○	○	○
Data register	D0 to 12287	○	○	○
Link register	W0 to 1FFF	○	○	○
Annunciator	F0 to 32767	○	○	○
Edge relay	V0 to 2047	○	×	○
File register	R0 to 32767	○	○	○
	ZR0 to 4849663	○	○	○
Extended data register	D0 to 4910079	○	○	○
Extended link register	W0 to 4AEBFF	○	○	○
Link special relay	SB0 to 7FF	○	○	○
Link special register	SW0 to 7FF	○	○	○
Step relay	S0 to 8191, BL □ ¥S □	○	×	○
Index register	Z0 to 19	○ ^{*1}	○	○
Special relay	SM0 to 2047	○	○	○
Special register	SD0 to 2047	○	○	○
Function input	FX0 to F	○	×	○
Function output	FY0 to F	○	×	○
Function register	FD0 to 4	○	×	○
Link direct device	J □ □ ¥ □ □	○	×	×
Module access device	U □ □ ¥ □ □	○	×	×
	U3En □ □ ¥ □ □			
Nesting	N0 to 14	×	×	×
Pointer	P0 to 4095	×	×	×
Interrupt pointer	I0 to 255	×	×	×
SFC block device	BL0 to 319	○	×	○
SFC transition device	TR0 to 511, BL □ ¥TR □	○	×	○
Network No. specification device	J0 to 255	○	×	×
I/O No. specification device	U0 to 1FF 3E0 to 3E3	○	×	×
Macro instruction argument device	VD0 to	×	×	×

*1 When a ZZ device is used, "ZZ" can be displayed.

13.2.3 Access range

The access range is the same as the access range when the GOT is connected to a controller.
For details of the access range, refer to the following.

 GOT1000 Series Connection Manual (Mitsubishi Products) for GT Works3

13.2.4 Precautions

(1) Inapplicable GOT

The SFC monitor cannot be used with the GOTs shown below.

GOT	Inapplicable GOT
GT15	GT1555-Q, GT1550-Q

(2) Precautions for operations during SFC monitor startup

Do not operate the following with the GOT during the SFC monitor startup.
Doing so may delete stored data and cause the SFC monitor to operate incorrectly.

- Turning on or off the CF card access switch
- Inserting or removing a CF card

(3) Precautions for devices

- (a) The GOT cannot search for indexing devices.
- (b) The GOT cannot monitor local devices.

(4) Precautions for setting [Locus] for line graphs

The SFC monitor function is not available when [Locus] is set for line graphs.
For using the SFC monitor function, do not set [Locus] for line graphs.

(5) Precautions for file names (program names) of comment files to be read

Only files with the file names (program names) with one-byte alphanumeric characters are applicable to the GOT.

When project data are created on GX Developer, use only one-byte alphanumeric characters for file names (program names).

13.3 Operations for Display

The following describes the outline for displaying the SFC monitor operation screens after installing GOT Platform Library (extended function OS), SFC Monitor (option OS), and GOT Function Expansion Library (option OS) on the GOT.

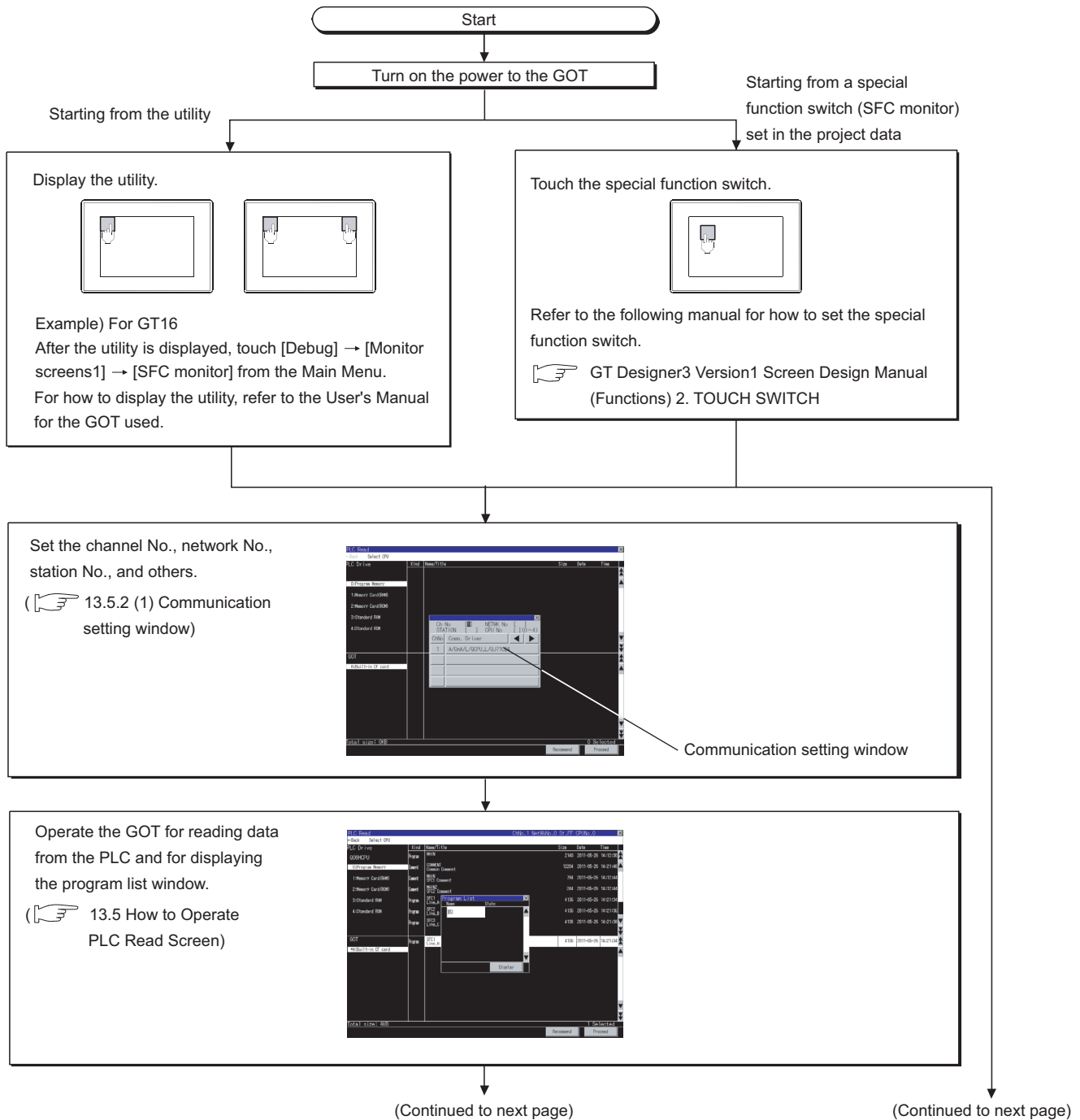

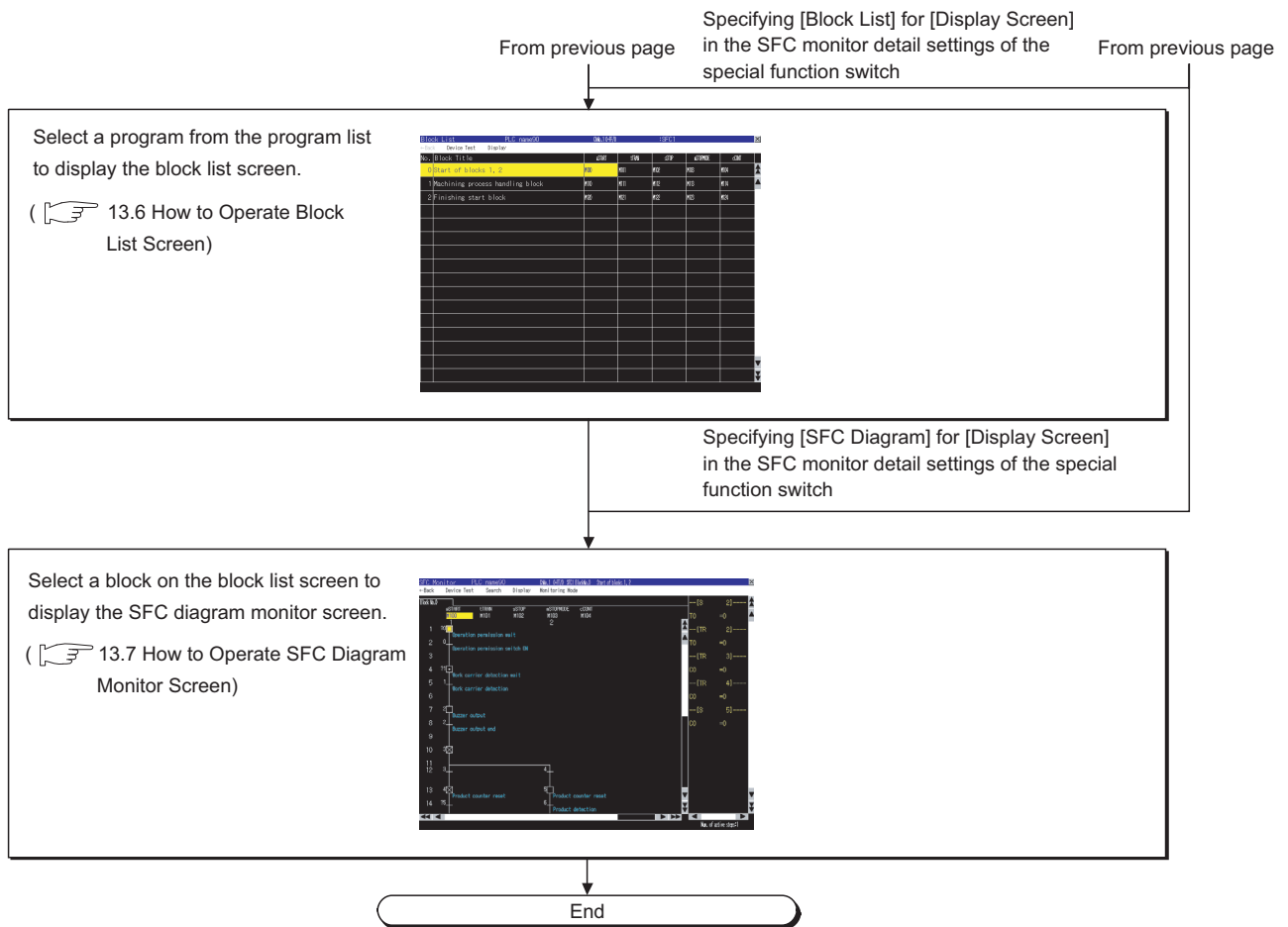

POINT

(1) How to display the utility

For how to display the utility, refer to the following.

☞ User's Manual for the GOT used

(2) Reading data from PLC when reclosing GOT

Reading data from the PLC is not required when reclosing the GOT power, because SFC programs and comment files are stored in a CF card for the SFC monitor function.

☞ 13.3.1 Setting SFC data storage location

(3) When GOT has no project data

The SFC monitor can be started with the utility even though the GOT has no project data.

Changing screens

The following describes how to change the screen.

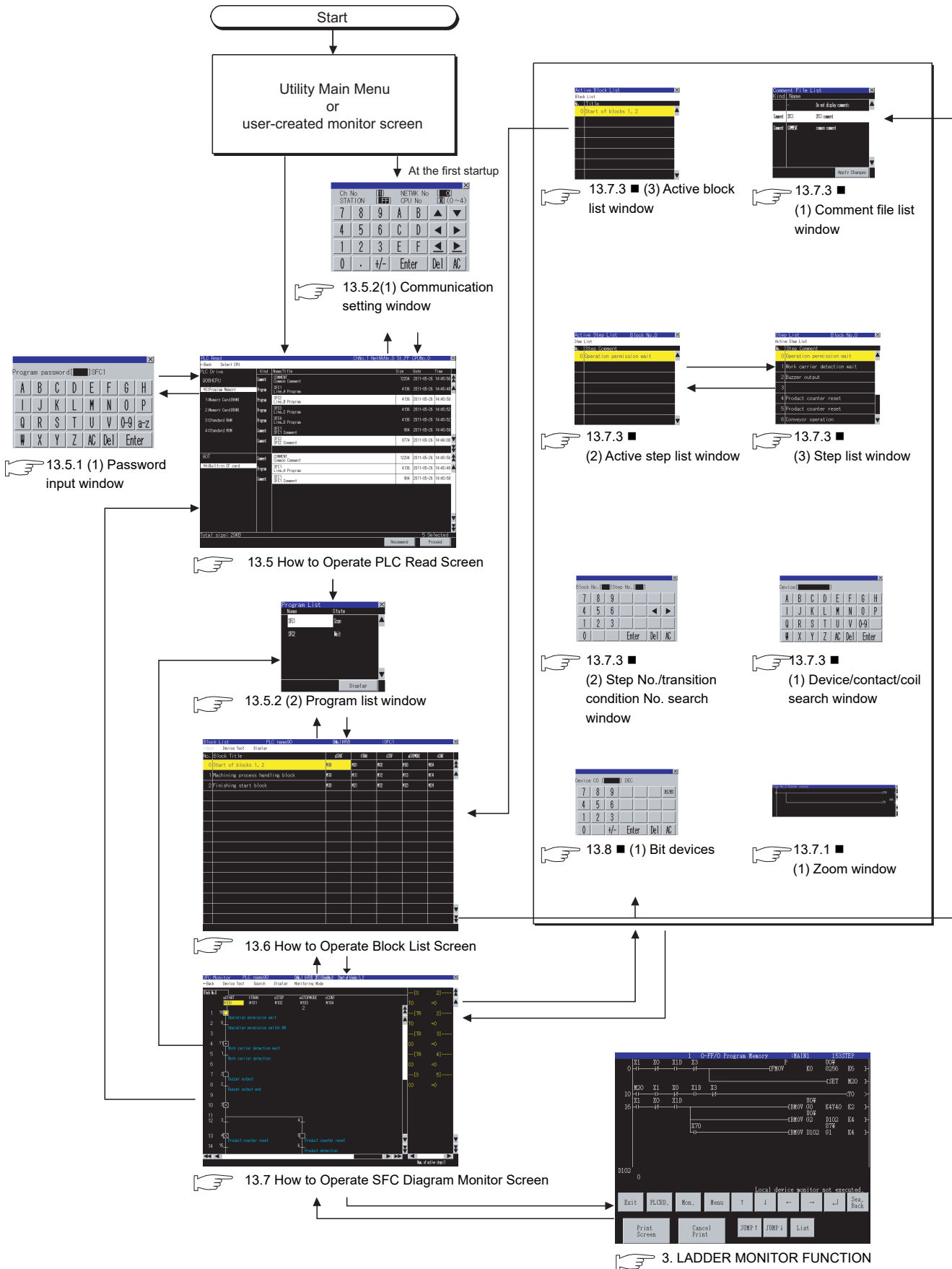

13.3.1 Setting SFC data storage location

■ Setting SFC data storage location

The selected drive of the GOT (CF card) can store up to 512 files of SFC data (SFC programs, device comments) used for the SFC monitor function.

SFC data are stored in the storage location that stores ladder data for the ladder monitor function. Only the A drive (standard CF card) or B drive (extended memory card) is available for storing SFC data. For the ladder data storage destination setting, refer to the following.

When setting with GOT utility

 User's Manual for the GOT used

When setting with GT Designer3

 GT Designer3 Version1 Screen Design Manual (Fundamentals) 4.9 GOT Display and Operation Setting

13.3.2 Reading comment files from CF card

The SFC monitor function uses comment files stored in a CF card installed in the GOT.

■ Procedure for using comment files stored in CF cards

The following shows the procedure for using a comment file stored in a CF card.

(1) When displaying comments in language set for language switching of GOT utility

Store comment files in a CF card on the PLC read screen.

For how to store comment files in a CF card on the PLC read screen, refer to the following.

 13.5 How to Operate PLC Read Screen

(2) When displaying comments in any language regardless of language set for language switching of GOT utility

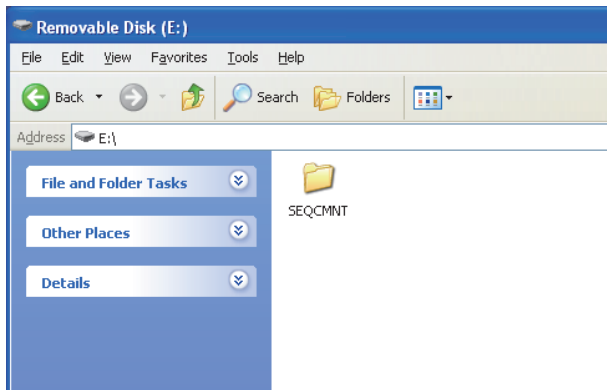

1. Create a SEQCMNT folder in a CF card. When the SEQCMNT folder already exists, creating a new SEQCMNT folder is not required.

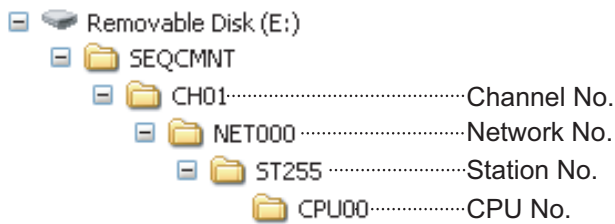





2. In the SEQCMNT folder, create folders for CH No., network No., station No., and CPU No. of the monitored controller with a hierarchy as shown left.

Item	Folder name
CH No.	CH**
Network No.	NET***
Station No.	ST***
CPU No.	CPU**

Assign numbers to "*" marks.

(When the CH No. is 1, the folder name is CH01. When the monitor target is the host station, the folder name is ST255.)

(Continued to next page)

- 
CPU00.....CPU No.
- 
ASCIIFor storing comments with ASCII code
- 
GBFor storing comments with GB code
- 
KSFor storing comments with KS code
- 
SJISFor storing comments with SJIS code

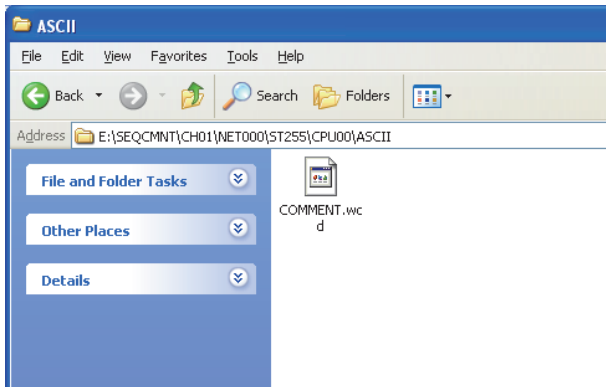
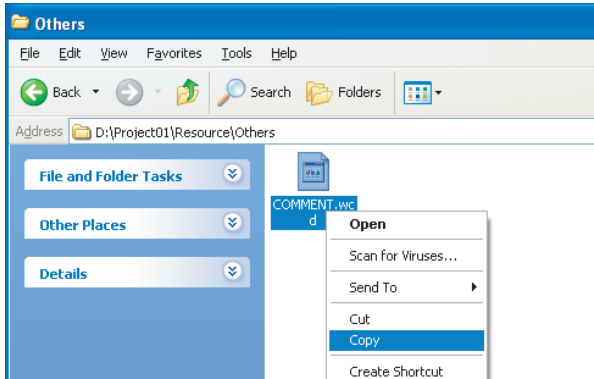

(Example: Storing comment files with ASCII code in the ASCII folder.)

3. In the CPU No. folder, create folders for storing comment files by character code.

Item	Folder name
Folder for SJIS code	SJIS
Folder for KS code	KS
Folder for GB code	GB
Folder for ASCII code	ASCII

4. Copy a comment file (.wcd) from the project data of GX Developer.

5. Store the copied comment files in the folders for each character code in the CF card.

Comment character code	Storage folder name
SJIS code	SJIS
KS code	KS
GB code	GB
ASCII code	ASCII

6. Install the CF card with the comment file on the GOT.
Switch comment files on the SFC diagram monitor screen for displaying the comments in an appropriate language.

13.4 Setting Display Format

The display format of word device values displayed on the SFC diagram monitor screen, language, the display mode of SFC programs, and others can be set.

13.4.1 Switching languages of SFC programs

Languages (Japanese/Korean/Simplified Chinese) of comments to be displayed on the SFC monitor screens can be switched during monitoring.

For switching languages, comment files in the language to be displayed must be created in advance.

 13.3.2 Reading comment files from CF card

The following shows the relations between the language selected in the GOT utility and comment files with each character code.

Language	Comment file
Japanese	Comment files with SJIS code
Korean	Comment files with KS code
Simplified Chinese	Comment files with GB code
Other than the above	Comment files with ASCII code

13.4.2 Setting display mode of SFC programs

The display mode of SFC programs on the SFC diagram monitor screen can be set.

 13.7.3 ■Display menu

The MELSAP-L program display mode is available regardless of the read SFC program format (MELSAP3, MELSAP-L). In the MELSAP-L program display mode, operation output/transition condition sequence programs are displayed as [?????] when the GOT displays a SFC program with the MELSAP3 format.

The following shows how the GOT displays sequence programs with and without the MELSAP-L program display mode.

Item	With MELSAP-L program display mode	Without MELSAP-L program display mode
Displayed operation output/transition condition sequence program	The GOT displays a sequence program on the SFC diagram monitor screen.	The GOT displays a sequence program in the zoom window by touching a step or transition condition on the SFC diagram monitor screen.

13.4.3 Setting zoom comment display mode

Whether to display or hide comments and notes in the zoom window can be set.

 13.7.3 ■Monitoring Mode menu

13.4.4 Switching display formats between decimal and hexadecimal numbers

The display formats of word device values on the SFC diagram monitor screen can be switched between decimal and hexadecimal numbers.

 13.7.3 ■Display menu

13.4.5 Setting automatic scroll mode

The automatic scroll can be switched between enabled or disabled states.

In the automatic scroll mode, the GOT displays active steps on the SFC diagram monitor screen by automatically scrolling the screen when all the following conditions are satisfied.

- No active step is displayed on the SFC diagram monitor screen.
- The displayed block has an active step.

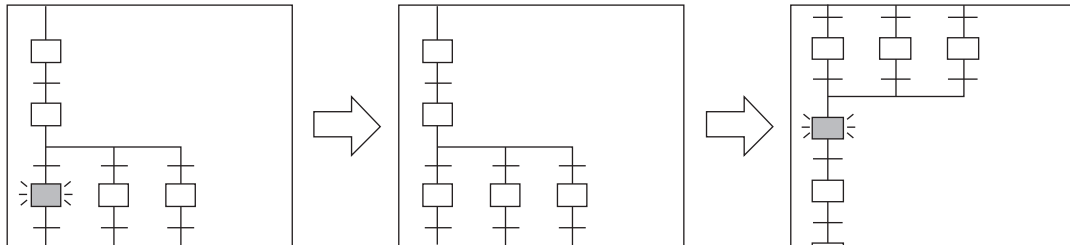

The step status becomes inactive.

An active step in the block is displayed by automatically scrolling the screen.

For setting the automatic scroll mode, refer to the following.

 13.7.3 ■ Display menu

For the SFC diagram monitor screen, refer to the following.

 13.7 How to Operate SFC Diagram Monitor Screen

13.5 How to Operate PLC Read Screen

On the PLC read screen, the GOT reads SFC programs and comment files used for the SFC monitor function from the PLC.

The following describes how to operate the PLC read screen.

13.5.1 Displayed contents

The following describes the configuration of the PLC read screen displayed after the SFC monitor starts and key functions on the screen.

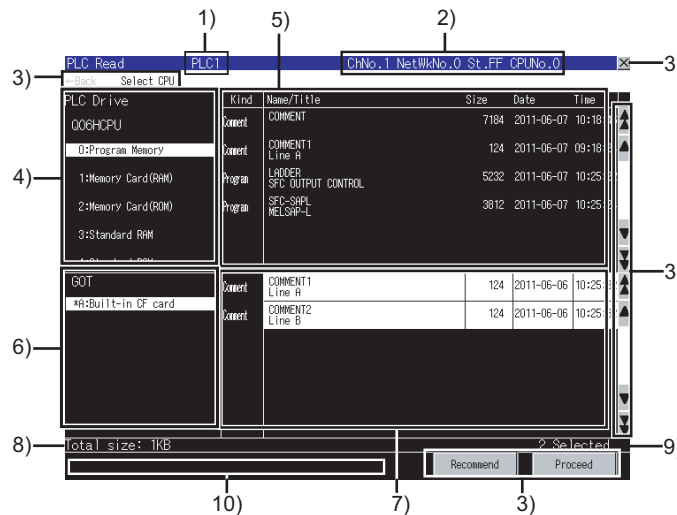

No.	Item	Description
1)	PLC name	Displays the label set in the PLC name setting for the target PLC CPU.
2)	Target controller	Displays CH No., network No., station No., and CPU No. of the target PLC CPU.
3)	Keys	Keys for operations on the PLC read screen shown in section 13.5.2. (Touch input)
4)	Target drive list (target controller)	Displays the target PLC CPU model and the drives in a list. Selecting a drive displays files within the drive in the file list (target controller). For the drive that stores files selected in the file list (target controller), [*] is displayed to the left of the drive name.
5)	File list (target controller)	Displays the program types, file names/titles, sizes, dates, and times of all the files within the drive selected in the target drive list (target controller). (The date and time show those of updated files.) A file to be read can be selected from the file list. (The selected file is highlighted.) For program files, only SFC program files in the program memory can be selected. For selecting the file name selected in the file list (GOT), the file selection in the file list (GOT) is canceled. When a password is set for the selected file, the password input window appears. (☞ (1) Password input window)

(Continued to next page)

No.	Item	Description
6)	Target drive list (GOT)	Displays the drive set for [Data save location] in the MELSEC-Q/QnA ladder monitor settings. (For the SFC monitor function, only the A drive (standard CF card) or B drive (extended memory card) is available.) For the drive that stores files displayed in the file list (GOT), [*] is displayed to the left of the drive name.
7)	File list (GOT)	Displays the program types, file names/titles, sizes, dates, and times of all the files within the drive selected in the target drive list (GOT). (The date and time show those of updated files.) A file to be read can be selected from the file list. (The selected file is highlighted.) For selecting the file name selected in the file list (target controller), the file selection in the file list (target controller) is canceled.
8)	Total file size	Displays the total data size of files selected in the file list (target controller) and file list (GOT).
9)	Number of selected files	Displays the total number of files selected in the file list (target controller) and file list (GOT).
10)	Message display area	Displays error messages and others.

9	SERVO AMPLIFIER MONITOR
10	CNC MONITOR FUNCTIONS
11	BACKUP/RESTORE
12	CNC DATA I/O
13	SFC MONITOR
14	LADDER EDITOR
15	MELSEC-L TROUBLE SHOOTING
16	LOG VIEWER

(1) Password input window

After the password authentication has succeeded, the password is authenticated automatically for the following files with the same password.

(The password input window is not displayed.)

(a) Displayed screen

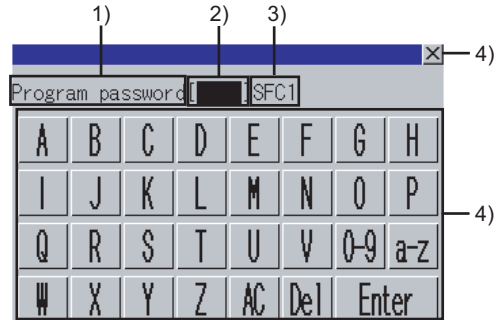

The following table shows the displayed contents.









No.	Item	Description
1)	Password type	Displays the type of the password to be input. (Program password/Comment password)
2)	Password input area	Set the password.
3)	File name	Displays the file name.
4)	Keys	Keys for operations in the password input window shown in (b) (Touch input)

(b) Key functions

Key	Function
⊗	Closes the password input window and cancels the password input operation.
0-9	Switches the key type to the value.
A-Z	Switches the key type to the alphabet (uppercase).
a-z	Switches the key type to the alphabet (lowercase).
AC	Deletes all the input values and characters.
Del	Deletes an input value or character.
Enter	Authenticates the password set in the password input area.

13.5.2 Key functions

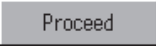
The following shows the functions of the keys used for operating the PLC read screen.

Key	Function
	Returns the screen to the last screen that is displayed right before the PLC read screen appears. The key is disabled when the last screen is the GOT utility screen or user-created monitor screen.
Select CPU	Displays the communication setting window.  13.5.2 (1) Communication setting window)
	Exits the SFC monitor and returns the screen to the SFC monitor startup screen.
	Scrolls the display area up and down by one line.
	Scrolls the display area up and down by one page.
	Available only when [0:Program Memory] is selected from the target drive list (target controller). Touching the key selects all the SFC program files, common comment files, and comment files for the selected SFC program files in the file list (target controller). When files with the same name are displayed in the file list (target controller) and file list (GOT), touching the key selects a file as shown below. <ul style="list-style-type: none"> For SFC program files <ul style="list-style-type: none"> When the updated dates and times differ between the files, touching the key selects the file in the file list (target controller). When the updated dates and times are the same between the files, touching the key selects the file in the file list (GOT). For comment files <ul style="list-style-type: none"> When the updated dates and times differ between the files, touching the key selects the latest file. When the updated dates and times are the same between the files, touching the key selects the file in the file list (GOT).
	Writes the file selected in the file list (target controller) into the CF card displayed in the target drive list (GOT). The file written into the CF card on the PLC read screen is stored in the SEQDAT folder. After writing, among files other than comment files in the CF card, files that are not selected in the file list (GOT) are deleted. Then, the program list window appears.  (2) Program list window

(1) Communication setting window

(a) Displayed screen

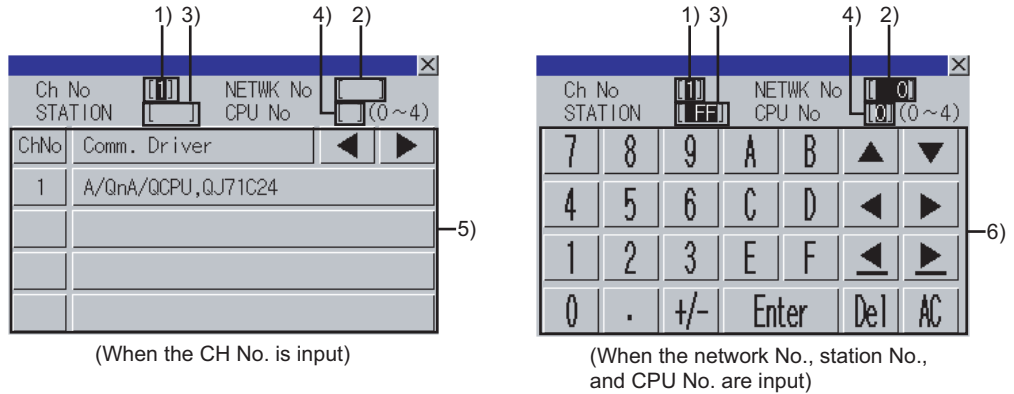

The following table shows the displayed contents.

No.	Item	Description
1)	CH No. input area	Set the CH No. for the target controller.
2)	Network No. input area	Set the network No. for the target controller.
3)	Station No. input area	Set the station No. of the target controller. When the station No. is set to the host station (FF), set the network No. to 0.
4)	CPU No. input area	Set the CPU No.
5)	CH No. selection key	Select a CH No.
6)	Keys	Keys for operations in the communication setting window shown in (b). (Touch input)

(b) Key functions

Key	Function
	Closes the communication setting window. When any of the CH No., network No., station No., and CPU No. is not input and the monitor target is not set, the communication setting window does not close.
	Moves the cursor among the input areas.
	Deletes all the input values and characters.
	Deletes an input value or character.
	Moves the cursor when the cursor is in the CH No. input area, network No. input area, or station No. input area. When the cursor is in the CPU No. input area and settings for the CH No., network No., and station No. are completed, the communication setting window closes and the PLC read screen appears.

(2) Program list window

The GOT displays the read SFC programs in a list.

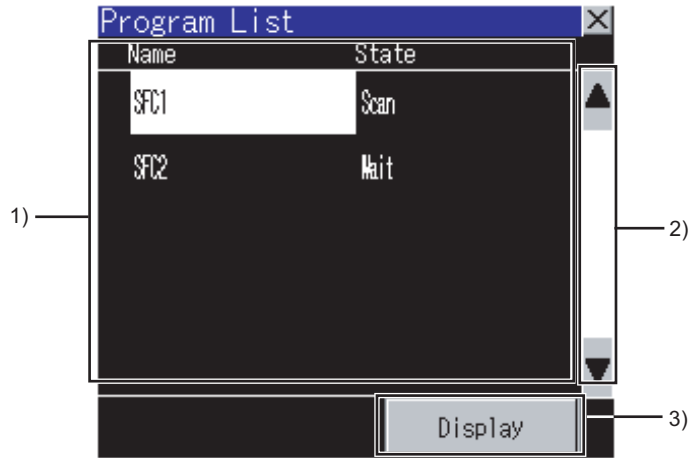

(a) Displayed screen



The following table shows the displayed contents.

No.	Item	Description
1)	SFC program file list	Displays the file names and execution statuses of the read SFC programs. The execution statuses show execution types set for the programs. A touched SFC program file is highlighted.
2)	Keys	Keys for operations in the program list window shown in (b). (Touch input)

(b) Key functions

Key	Function
	Scrolls the display area up and down by one line.
	Displays the blocks of the SFC program file selected in the SFC program file list on the block list screen.  13.6 How to Operate Block List Screen)

13.6 How to Operate Block List Screen

On the block list screen, the GOT displays blocks within the read SFC program in a list.
The following describes how to operate the block list screen.

13.6.1 Displayed contents

The following describes the configuration of the block list screen, menus and key functions on the screen.

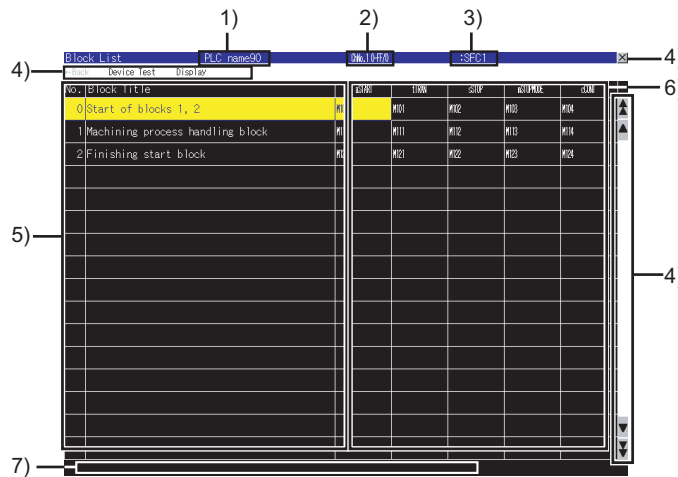

No.	Item	Description
1)	PLC name	Displays the label set in the PLC name setting for the target PLC CPU.
2)	Target controller	Displays the CH No., network No., station No., and CPU No of the target PLC CPU as shown below. • CH No. network No.-station No./CPU No.
3)	Program name	Displays the file name (without the extension) of the displayed program.
4)	Keys	Keys for operations on the block list screen shown in section 13.6.2. (Touch input)
5)	Block list	Displays the block numbers and block titles in the displayed program. The block numbers are not displayed with no block. Active blocks are highlighted. Selecting a block title displays the block data on the SFC diagram monitor screen. ( 13.7 How to Operate SFC Diagram Monitor Screen)
6)	Block information list	Displays block information for each block. When devices are set for the block information, the set devices are displayed in the corresponding cells.
7)	Message display area	Displays error messages and others.

13.6.2 Key functions

The following shows the functions of the keys used for operating the block list screen.

Key	Function
←Back	Returns the screen to the last screen that is displayed right before the block list screen appears. The key is disabled when the last screen is the GOT utility screen or user-created monitor screen.
Device Test	Sets the device test mode. Touching the key in the device test mode cancels the device test mode. (☞ 13.8 Test Operation)
Display	Displays menus used for operations on the block list screen. (☞ 13.6.3 ■Display menu)
⊗	Exits the SFC monitor and returns the screen to the SFC monitor startup screen.
▲ ▼	Scrolls the display area up and down by one line.
▲ ▼	Scrolls the display area up and down by one page.

13.6.3 Menus

The following shows operations for the menus displayed on the block list screen.

■ Display menu

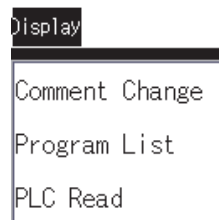

Key	Function	Reference section
Comment change	Displays the comment file list window.	13.7.3 ■ Display menu (1)
Program List	Displays the program list window.	13.5.2 (2)
PLC Read	Displays the PLC read screen.	13.5

13.7 How to Operate SFC Diagram Monitor Screen

On the SFC diagram monitor screen, the GOT monitors and displays data of the block selected on the block list screen in the SFC diagram.

The following describes how to operate the SFC diagram monitor screen.

13.7.1 Displayed contents





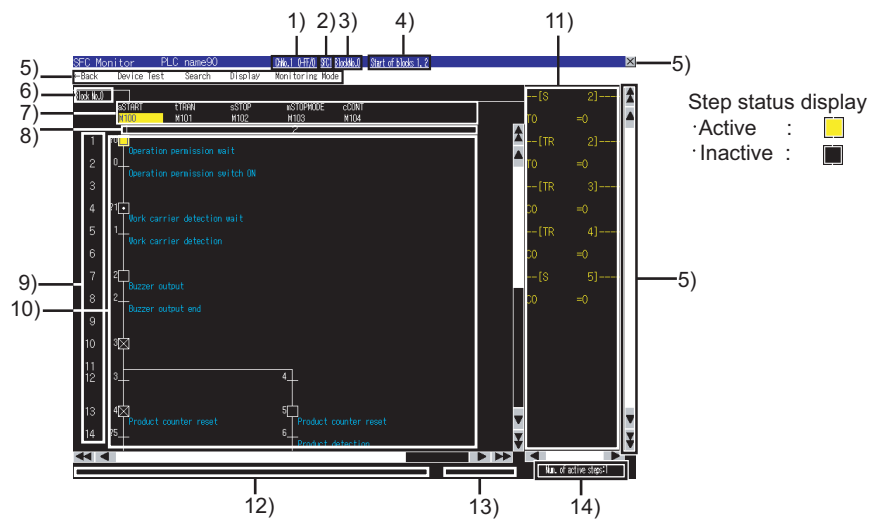

■ SFC diagram monitor screen

The following describes the configuration of the SFC diagram monitor screen, menus and key functions on the screen.

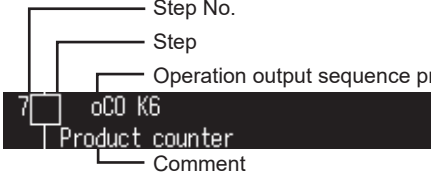
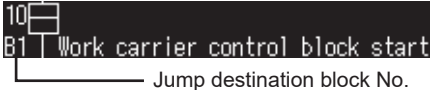

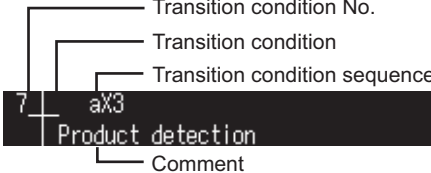
No.	Item	Description
1)	Target controller	Displays the CH No., network No., station No., and CPU No. of the target PLC CPU as shown below. • CH No. network No.-station No./CPU No.
2)	Program name	Displays the file name of the displayed program.
3)	Block No.	Displays the block No. of the displayed block.
4)	Block title	Displays the block title of the displayed block.
5)	Keys	Keys for operations on the SFC diagram monitor screen shown in section 13.7.2. (Touch input)
6)	Block switching tab	Displays the block No. of the block displayed in the SFC diagram display area. Touching a tab displays the corresponding block data in the SFC diagram display area. (Tabs displayed to the right of the touched tab are removed.)
7)	Block information display area	Displays the block information of the displayed block. When the displayed block is in any status of the block information, the corresponding device is highlighted. When the block information is set, the set devices are displayed.
8)	Column No.	Displays the column numbers.
9)	Row No.	Displays the row numbers.

(Continued to next page)

No.	Item	Description
10)	SFC diagram display area	<p>Displays a SFC program in the SFC diagram format.</p> <ul style="list-style-type: none"> Step display   <p>Touching a step displays the zoom window.  (1) Zoom window</p> <p>Touching a step with a jump destination block No. displays a block switching tab, and then the jump destination block data is displayed in the SFC diagram display area.</p> <ul style="list-style-type: none"> Transition condition display  <p>Touching a transition condition displays the zoom window.  (1) Zoom window</p>
11)	Device current value display area	Displays the current values of word devices displayed in the SFC diagram display area.
12)	Message display area	Displays error messages and others.
13)	Automatic scroll status display area	Displays [Scrolling automatically] with the automatic scroll mode. Nothing is displayed without the automatic scroll mode.  13.4.5 Setting automatic scroll mode)
14)	Number of active steps	Displays the number of active steps in the displayed block. Touching the item displays the active step list window.  13.7.3 ■ (2) Active step list window)

*1 Operation output/transition condition sequence programs are displayed in the MELSAP-L program display mode only.
 13.7.3 ■ Display menu)

POINT

Displayed contents of SFC diagram monitor screen

(1) Display mode at first display of SFC diagram monitor screen

The display mode state at the first display of the SFC diagram monitor screen differs depending on the SFC program format.

SFC program format	State at the first display
MELSAP3 format	Without MELSAP-L program display mode
MELSAP-L format	With MELSAP-L program display mode

For the display mode of SFC programs, refer to the following.

 13.4.2 Setting display mode of SFC programs

(2) Comment display at first display of SFC diagram monitor screen

The following shows the order of comment files to be used at the first display of the SFC diagram monitor screen after reading data from the PLC. (When the CF card has no comment file, no comment is displayed.)

Priority order	Comment files used for SFC diagram monitor screen
1	Comment files by program within the SEQCMNT folder in the CF card
2	Common comment files within the SEQCMNT folder in the CF card
3	Comment files by program within the SEQDAT folder in the CF card
4	Common comment files within the SEQDAT folder in the CF card

(1) Zoom window

The GOT can display operation output/transition condition sequence programs in the ladder format.

(a) Displayed screen

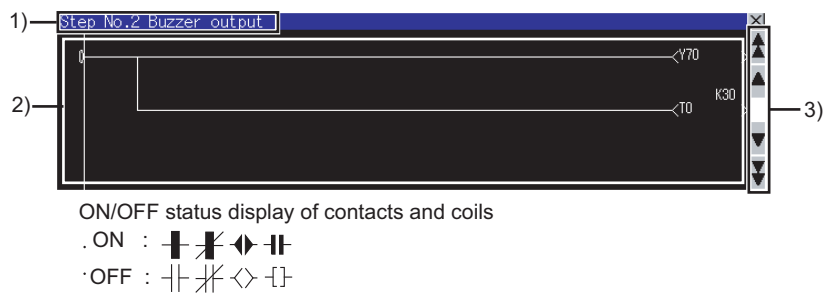

The following table shows the displayed contents.









No.	Item	Description
1)	Type	<ul style="list-style-type: none"> For displaying operation output sequence program The step number and step comment are displayed. For displaying transition condition sequence program The transition condition number and transition condition comment are displayed.
2)	Ladder program display area	Displays an operation output/transition condition sequence program. Comments and notes are displayed in the zoom comment display mode. (13.7.3 ■Display menu)
3)	Keys	Keys for operations in the zoom window shown in (b). (Touch input)

(b) Key functions

Key	Function
	Scrolls the display area up and down by one line.
	Scrolls the display area up and down by one page.

13.7.2 Key functions

The following shows the functions of keys used for operating the SFC diagram monitor screen.

Key	Function
←Back	Returns the screen to the last screen that is displayed right before the SFC diagram monitor screen appears. The key is disabled when the last screen is the GOT utility screen or user-created monitor screen.
Device Test	Sets the device test mode. Touching the key in the device test mode cancels the device test mode. ( 13.8 Test Operation)
Search	Displays menus used for operations on the SFC diagram monitor screen. ( 13.7.3 ■Search menu)
Display	Displays menus used for operations on the SFC diagram monitor screen. ( 13.7.3 ■Display menu)
Monitoring Mode	Displays menus used for operations on the SFC diagram monitor screen. ( 13.7.3 ■Monitoring Mode menu)
	Exits the SFC monitor and returns the screen to the SFC monitor startup screen.
	Scrolls the display area up and down by one line.
	Scrolls the display area up and down by one page.
	Scrolls the display area right and left by one column.
	Scrolls the display area right and left by one page.

13.7.3 Menus

The following shows operations for the menus displayed on the SFC diagram monitor screen.

■ Search menu

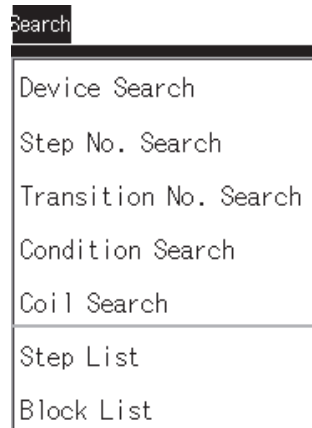

Key	Function	Reference section
Device Search	Displays the device/contact/coil search window.	(1)
Step No. Search	Displays the step No./transition condition No. search window.	(2)
Transition No. Search	Displays the step No./transition condition No. search window.	(2)
Condition Search	Displays the device/contact/coil search window.	(1)
Coil Search	Displays the device/contact/coil search window.	(1)
Step List	Displays the step list window.	(3)
Block List	Displays the block list screen.	13.6

(1) Device/contact/coil search window

The GOT can search for devices in a SFC program.

(a) Displayed screen

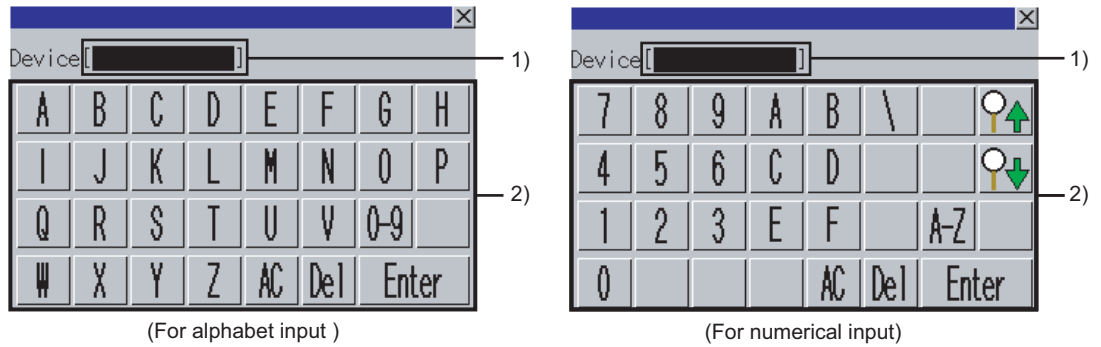

The following table shows the displayed contents.

No.	Item	Description
1)	Device input area	Set a device to be searched.
2)	Keys	Keys for operations in the device/contact/coil search window shown in (b) (Touch input)

(b) Key functions

Key	Function
	Deletes all the input values and characters.
	Deletes an input value or character.
	Switches the key type to the value.
	Switches the key type to the alphabet.
	Searches for the input device in the upward direction. When multiple blocks are set, the GOT searches for the device in descending order of the block No. When the device is found without the MELSAP-L program display mode, the GOT displays an operation output/transition condition sequence program corresponding to the step or transition condition with the device in the zoom window.
	Search for the input device in the downward direction. When multiple blocks are set, the GOT searches for the device in ascending order of the block No. When the device is found without the MELSAP-L program display mode, the GOT displays an operation output/transition condition sequence program corresponding to the step or transition condition with the device in the zoom window.



Precautions for device/contact/coil search window

Searching for any bits in word devices is not available.
Specify word devices for searching for any bits.

(2) Step No./transition condition No. search window

The GOT can search for steps and transition conditions in a block.

(a) Displayed screen

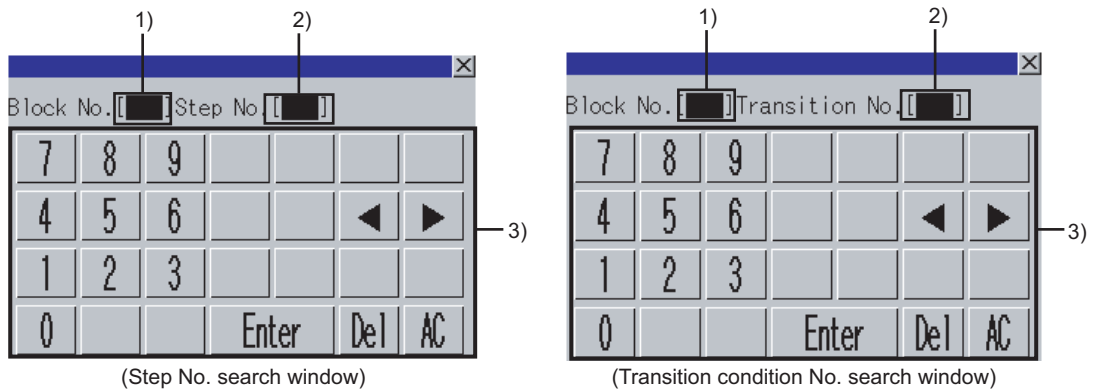

The following table shows the displayed contents.

No.	Item	Description
1)	Block No. input area	Set the block No. of the block to be searched. The GOT searches for a step or transition condition in the set block.
2)	Step No./transition condition No. input area	Set the step No. or transition condition No. of the step or transition condition to be searched.
3)	Keys	Keys for operations in the step No./transition condition No. search window shown in (b) (Touch input)

(b) Key functions

Key	Function
◀ ▶	Moves the cursor among the input areas.
Enter	<ul style="list-style-type: none"> When the cursor is in the block No. input area Moves the cursor to the step No./transition condition No. input area. When the cursor is in the step No./transition condition No. input area Searches for a step or transition condition in the set block. When the searched step or transition condition is found, the step No./transition condition No. search window closes and the GOT displays data of the step or transition condition on the SFC diagram monitor screen. (The step or transition condition is highlighted.)
Del	Deletes an input value or character.
AC	Deletes all the input values and characters.

(3) Step list window

The GOT displays steps in a block.

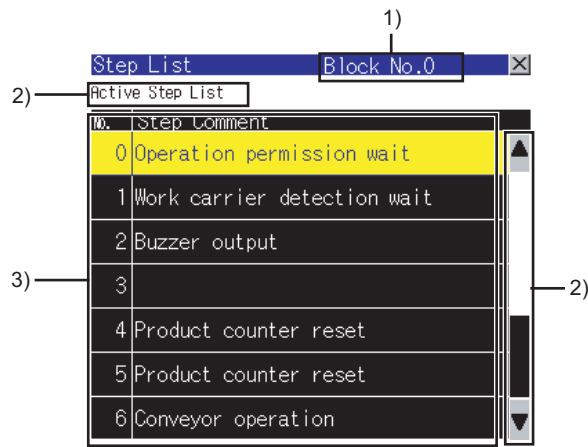

(a) Displayed screen



The following table shows the displayed contents.

No.	Item	Description
1)	Block No.	Displays the block No. of the displayed block.
2)	Keys	Keys for operations in the step list window shown in (b) (Touch input)
3)	Step list	Displays the step numbers and step comments of the steps in the displayed block. Selecting a step searches for the step, and the GOT displays the step data on the SFC diagram monitor screen. (Active steps are highlighted.)

(b) Key functions

Key	Function
Active Step List	Displays the active step list window. ( (2) Active step list window)
	Scrolls the display area up and down by one line.

■ Display menu

Display
MELSAP-L Program Display
Comment Display in Zoom Window
Comment Change
Automatic Scroll
Active Step List
Active Block List
Program List
PLC Read
Ladder Monitor

Key	Function	Reference section
MELSAP-L Program Display	Sets the MELSAP-L program display mode. Touching the key in the MELSAP-L program display mode cancels the MELSAP-L program display mode.	13.4.2
Comment Display in Zoom Window	Sets the zoom comment display mode. Touching the key in the zoom comment display mode cancels the zoom comment display mode.	13.4.3
Comment change	Displays the comment file list window.	(1)
Automatic Scroll	Sets the automatic scroll mode. Touching the key in the automatic scroll mode cancels the automatic scroll mode.	13.4.5
Active Step List	Displays the active step list window.	(2)
Active Block List	Displays the active block list window.	(3)
Program List	Displays the program list window.	13.5.2 (2)
PLC Read	Displays the PLC read screen.	13.5
Ladder Monitor	Starts the ladder monitor. Touching the key with a device selected can automatically search for the device with the ladder monitor.*1	3.

*1 For the automatic search with the ladder monitor, settings for automatically reading sequence programs are required.
For settings for automatically reading sequence programs, refer to the following.

When setting with GOT utility

 User's Manual for the GOT used

When setting with GT Designer3

 GT Designer3 Version1 Screen Design Manual (Fundamentals) 4.9 GOT Display and Operation Setting

(1) Comment file list window

The GOT displays the comment file list.

(a) Displayed screen

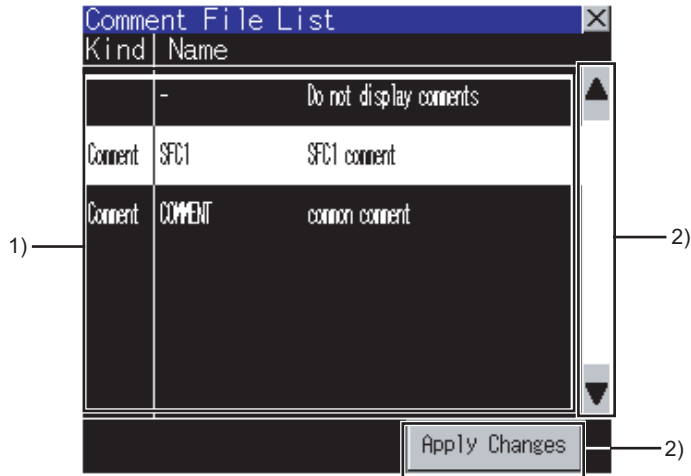

The following table shows the displayed contents.

No.	Item	Description
1)	Comment file list	Among comment files stored in the CF card, the file names and titles of the comment files and common comment files used for the displayed SFC program are displayed. For switching comments, select a comment file to be used. For hiding comments, select [Do not display comments]. A selected comment file is highlighted.
2)	Keys	Keys for operations in the comment file list window shown in (b) (Touch input)

(b) Key functions

Key	Function
	Scrolls the display area up and down by one line.
	Closes the comment file list window and displays the SFC diagram monitor screen with the comments of the file selected from the comment file list.

(2) Active step list window

The GOT displays active steps in the displayed block.

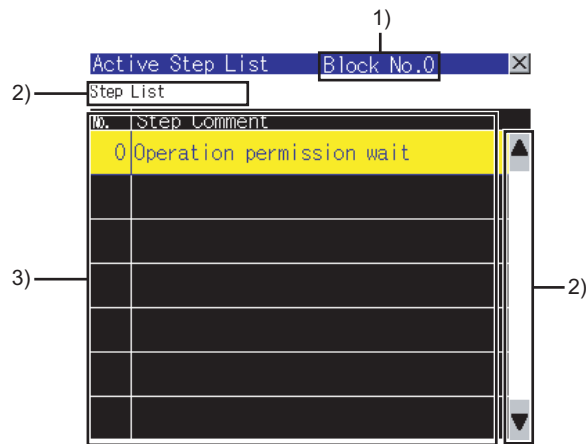

(a) Displayed screen



The following table shows the displayed contents.

No.	Item	Description
1)	Block No.	Displays the block No. of the displayed block.
2)	Keys	Keys for operations in the active step list window shown in (b) (Touch input)
3)	Active step list	Displays the step numbers and step comments of the active steps in the displayed block. Selecting a step searches for the step, and the GOT displays the step data on the SFC diagram monitor screen.

(b) Key functions

Key	Function
Step List	Displays the step list window.  13.7.3 ■Search menu (3) Step list window
 	Scrolls the display area up and down by one line.

POINT

Precautions for active step list window

When the statuses of steps change, the displayed contents of the active step list in the active step list window change. Therefore, selecting a step may be difficult depending on the frequency of the step status change.

When selecting a step is difficult, select a step from the step list in the step list window.

 13.7.3 ■Search menu (3) Step list window

(3) Active block list window

The GOT displays active blocks in the read SFC program.

(a) Displayed screen

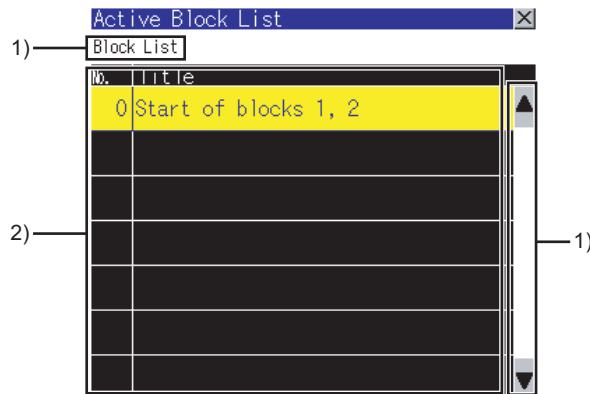

The following table shows the displayed contents.

No.	Item	Description
1)	Keys	Keys for operations in the active block list window shown in (b) (Touch input)
2)	Active block list	Displays the block numbers and block titles of active blocks in the read SFC program. Selecting a block displays the block data on the SFC diagram monitor screen.

(b) Key functions

Key	Function
Block List	Displays the block list screen. (13.6 How to Operate Block List Screen)
	Scrolls the display area up and down by one line.

POINT

Precautions for active block list window

When the statuses of blocks change, the displayed contents of the active block list in the active block list window change. Therefore, selecting a block may be difficult depending on the frequency of the block status change. When selecting a block is difficult, select a block from the block list on the block list screen.

13.6 How to Operate Block List Screen

■ Monitoring Mode menu

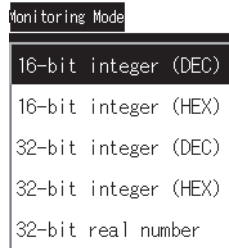

Key	Function	Reference section
16-bit integer (DEC)	Displays the device values in the device current value display area as 16-bit decimal numbers.	13.4.4
16-bit integer (HEX)	Displays the device values in the device current value display area as 16-bit hexadecimal numbers.	13.4.4
32-bit integer (DEC)	Displays the device values in the device current value display area as 32-bit decimal numbers.	13.4.4
32-bit integer (HEX)	Displays the device values in the device current value display area as 32-bit hexadecimal numbers.	13.4.4
32-bit real number	Displays the device values in the device current value display area as 32-bit floating-point numbers with the exponential representation.	13.4.4

13.8 Test Operation

In the device test mode of the SFC monitor, device values can be changed on the screen. For setting the device test mode, refer to the following.

 13.6.2 Key functions

13.7.2 Key functions

The test operation of devices is available by touching devices on the following screens in the device test mode.

Screen applicable to device test mode	Reference section
Block information list on the block list screen	13.6.1
SFC diagram display area on the SFC diagram monitor screen	13.7.1 ■SFC diagram monitor screen
Device current value display area on the SFC diagram monitor screen	
Ladder program display area in the zoom window	13.7.1 ■SFC diagram monitor screen (1)

Touching a device displays the device test window.

(1) When touching bit devices

A bit device is switched between ON and OFF states in the device test window.

(2) When touching word devices

The GOT writes the value input in the device test window into the selected word device.

■ How to operate device test window

(1) Bit devices

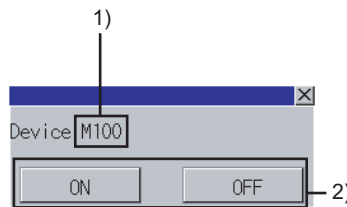

(a) Displayed screen



The following table shows the displayed contents.

No.	Item	Description
1)	Device	Displays the selected device.
2)	Keys	Keys for operations in the device test window shown in (b).

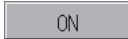
(b) Key functions

Key	Function
	Turns on the bit device and writes the device state to the PLC CPU.
	Turns off the bit device and writes the device state to the PLC CPU.

(2) Word devices

(a) Displayed screen

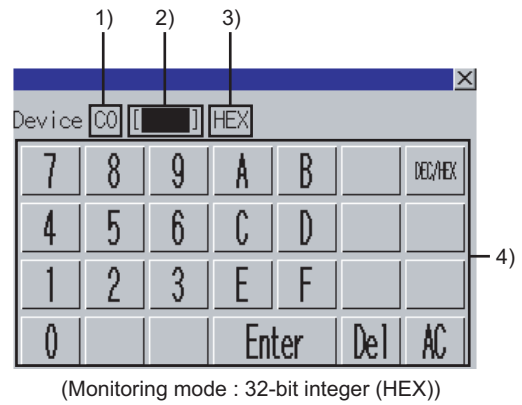
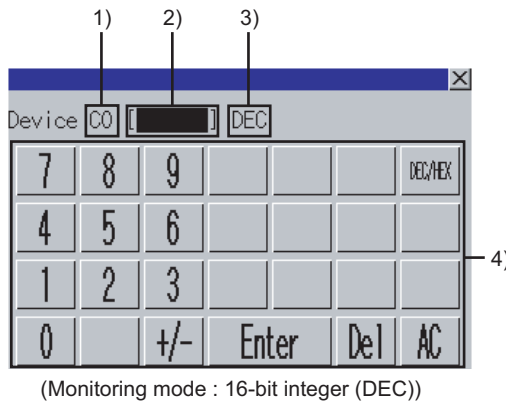

The following table shows the displayed contents.

No.	Item	Description
1)	Device	Displays the selected device.
2)	Device value input area	Set the value to be written into the selected device.
3)	Input mode	Displays the current input mode. (DEC: decimal number. HEX: hexadecimal number)
4)	Keys	Keys for operations in the device test window shown in (b).

(b) Key functions

Key	Function
	Closes the device test window.
	Switches the input modes. (DEC, HEX)
	Writes the value input in the device value input area into the PLC CPU.
	Deletes an input value or character.
	Deletes all the input values and characters.

13.9 Error Messages and Corrective Action

The following shows the error messages for the SFC monitor and the corrective actions.

Error message	Description	Corrective action
Failed to write the value to the device.	In the device test mode, the GOT fails to write the value into the device of the PLC CPU.	(1) Check the communications between the GOT and PLC CPU, and make sure that the GOT communicates with the PLC CPU. (2) Check if the target device is writable with parameters of the target PLC CPU.
Failed to communicate with CPU.	The GOT cannot communicate with the target PLC CPU.	Check the communications between the GOT and PLC CPU, and make sure that the GOT communicates with the PLC CPU.
File access error. Confirm the CF card.	A file access error occurs.	(1) When no CF card is installed, install a CF card. (2) When the CF card access switch is off, turn on the switch. (3) Check if the CF card is formatted with FAT16. When the CF card is not formatted with FAT16, format the CF card with FAT16 and install the card in the GOT.
Failed to get the information.	<ul style="list-style-type: none"> The GOT cannot communicate with the PLC CPU. A file with faulty file name is selected. 	<ul style="list-style-type: none"> Check the communications between the GOT and PLC CPU, and make sure that the GOT communicates with the PLC CPU. Select the file after changing the message display language to one which can display the file name in the utility. Change the file name with GX Developer.
Failed to save files because of an insufficient capacity of CF card.	The CF card has insufficient space for storing files.	(1) Delete files in the CF card. (2) Install a large capacity CF card.
The file(file name) is broken. The file is unselected.	The file read from the CF card is broken.	(1) Do not select broken files. (2) Overwrite the broken file with the unbroken file.
Failed to write (file name) to CF card.	The GOT fails to write the file into the CF card.	(1) When no CF card is installed, install a CF card. (2) When the CF card access switch is off, turn on the switch. (3) Check if folders and files within the SEQDAT folder in the CF card are writable. When the folders and files are not writable, make sure that the folders and files are writable. (4) Check if the CF card is formatted with FAT16. When the CF card is not formatted with FAT16, format the CF card with FAT16 and install the card in the GOT.
Change the Data save location of Q/QnA ladder monitor to A: or B:	The SFC monitor is started with [Data save location] is set to a drive other than [A: Built-in CF card] and [B:Memory card] in the MELSEC-Q/L/QnA ladder monitor setting.	Set [Data save location] to [A: Built-in CF card] or [B:Memory card] in the MELSEC-Q/L/QnA ladder monitor setting of the GOT utility.
The ladder block is too big to display.	The GOT cannot display a sequence program in the zoom window because the program has a ladder block with 25 or more lines.	Split the ladder block.
The specified block does not exist. Confirm the program.	The GOT cannot display the specified block data in the SFC diagram because the specified block does not exist.	Correct the program with GX Developer and operate the GOT for reading the file from the PLC.
The file(file name) is broken. Perform PLC Read and read the file again.	The GOT cannot display the program file data on the block list screen or SFC diagram monitor screen because the program file is broken.	Operate the GOT for reading the file from the PLC.
The device range has been changed. Please read the file again.	The GOT cannot read the target device values of the SFC monitor because the device range is changed in the PLC parameter setting during the SFC monitor.	Operate the GOT for reading the file from the PLC.
Cannot read programs other than SFC program.	The program file specified by a key on the block list screen or the SFC diagram monitor screen is not a SFC program.	Specify a SFC program by a key on the block list screen or the SFC diagram monitor screen.



A series of 20 horizontal lines spaced evenly down the page, providing a template for writing text.

14. LADDER EDITOR



14.1 Features

With the ladder editor function, the GOT can monitor and edit a sequence program in the ladder diagram format of a controller, and changing current device values of the program is available. The features of the ladder editor are shown below.

■ Editing sequence programs by using the GOT

Editing sequence programs in the ladder diagram format is available.

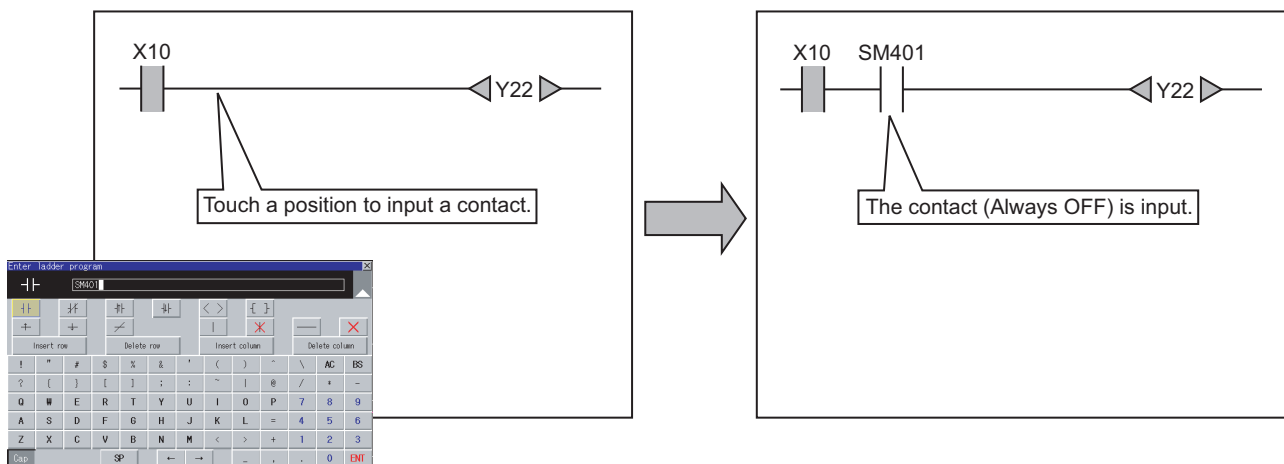

The following screens are displayed with the ladder editor function.

- PLC read screen (👉 14.5 How to Operate PLC Read Screen)
- Ladder monitor screen (👉 14.6 How to Operate Ladder Monitor Screen)
- Ladder editor screen (👉 14.7 How to Operate Ladder Editor Screen)

■ Switching display formats, device comment display, and languages

The following are available.

- Switching the display formats of device values
- Switching whether to display or hide device comments
- Switching languages for file names of sequence programs, comments, and others

(1) Switching display formats

On the Ladder monitor screen, the display formats for the current values of word devices can be switched between decimal and hexadecimal numbers.

(2) Switching device comment display

Whether to display or hide device comments used in sequence programs can be switched.

(3) Switching languages

File titles and comments can be displayed in the language set for the language switching in the GOT utility with comment files created with the SJIS code, KS code, GB code, and/or ASCII code.

With a CF card storing comment files created with the SJIS code, KS code, GB code, and/or ASCII code, comments can be displayed in the language corresponding to any character code in the CF card, regardless of the language set in the GOT utility.

■ Displaying registered ladder blocks is available

On the Ladder registration monitor window, displaying registered ladder blocks is available.

☞ 14.6.3 Menus

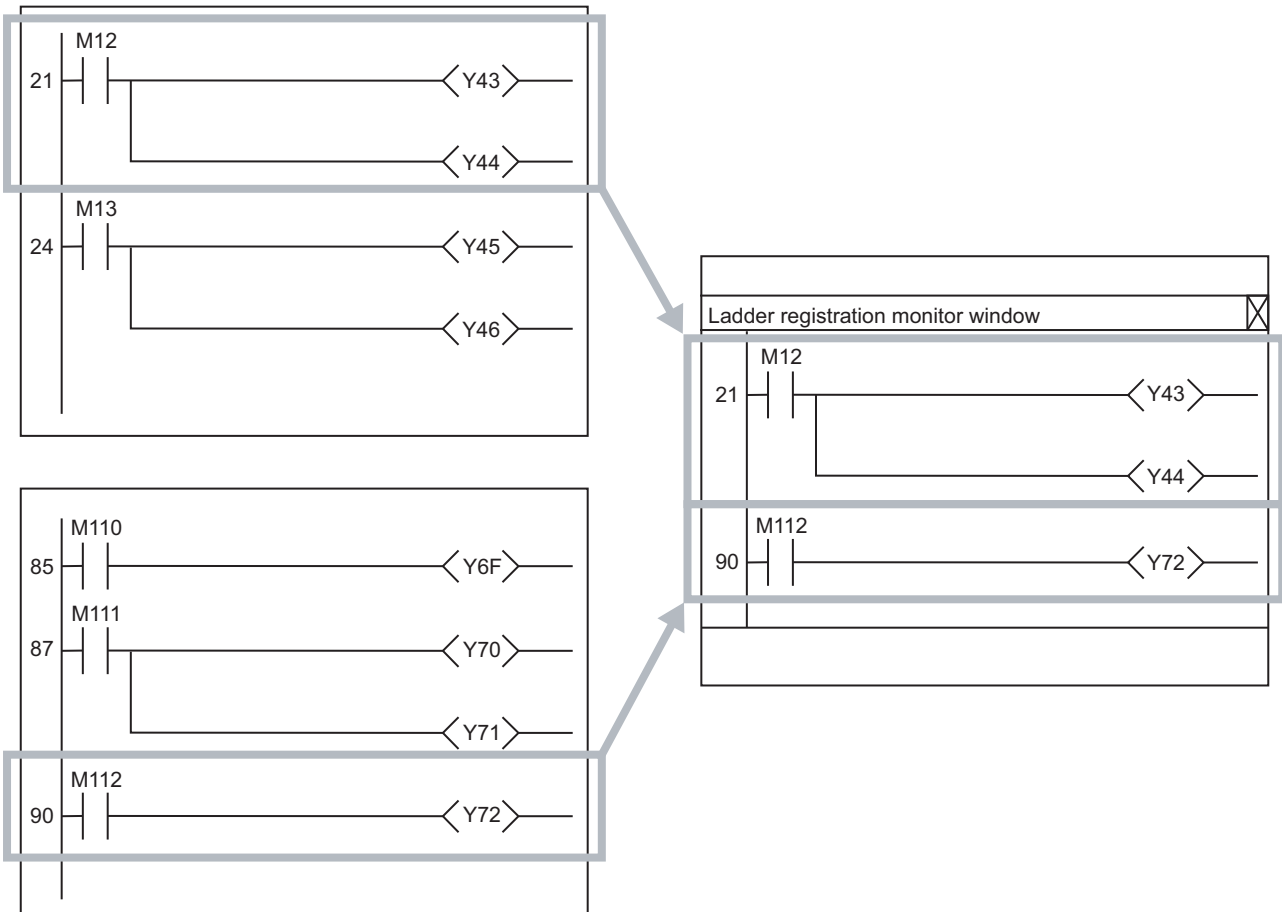

Enhanced interaction with objects (one-touch ladder jump function)

(1) Interaction with the special function switch

Set a program file or device to be searched to the special function switch.

This enables that the automatic PLC read can be executed and a device can be searched automatically by touching the special function switch placed on the user-created screen.

Even a person who is not the operator familiar with the equipment inside can trace the source of the equipment error without fail by simple operations, reducing time to stop the error.

Example) Coil searching by touching a special function switch

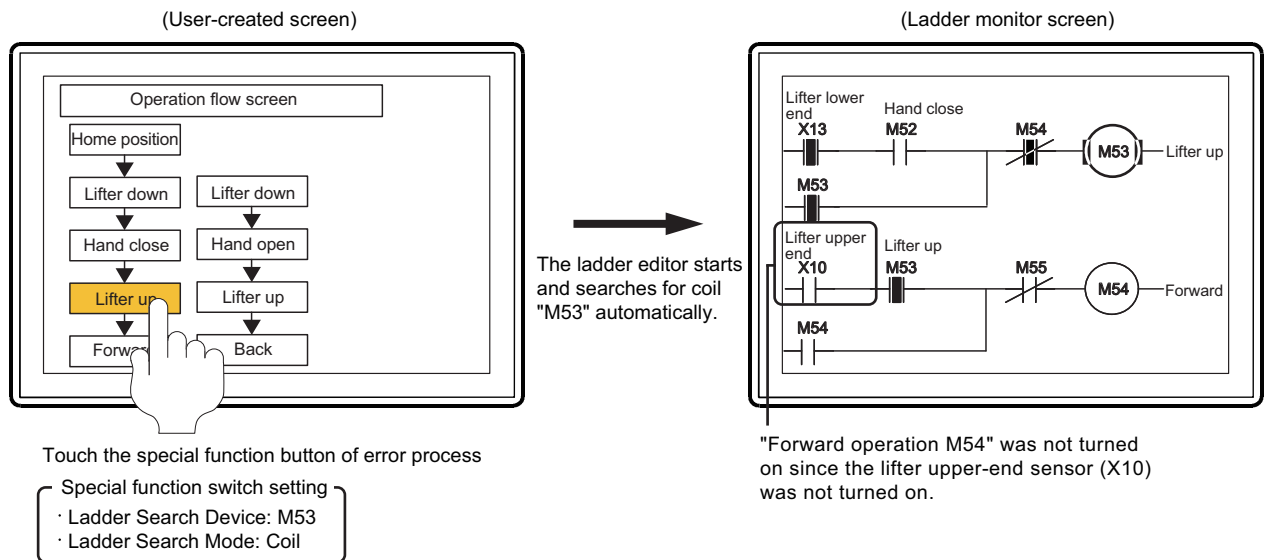

(2) Interaction with the advanced user alarm display, alarm history display, and user alarm display

Select an alarm in various alarm displays and touching the key code switch (setting the key code of Display Ladder (Ladder Editor)). This enables to start the Ladder Editor and a device of alarm can be searched.

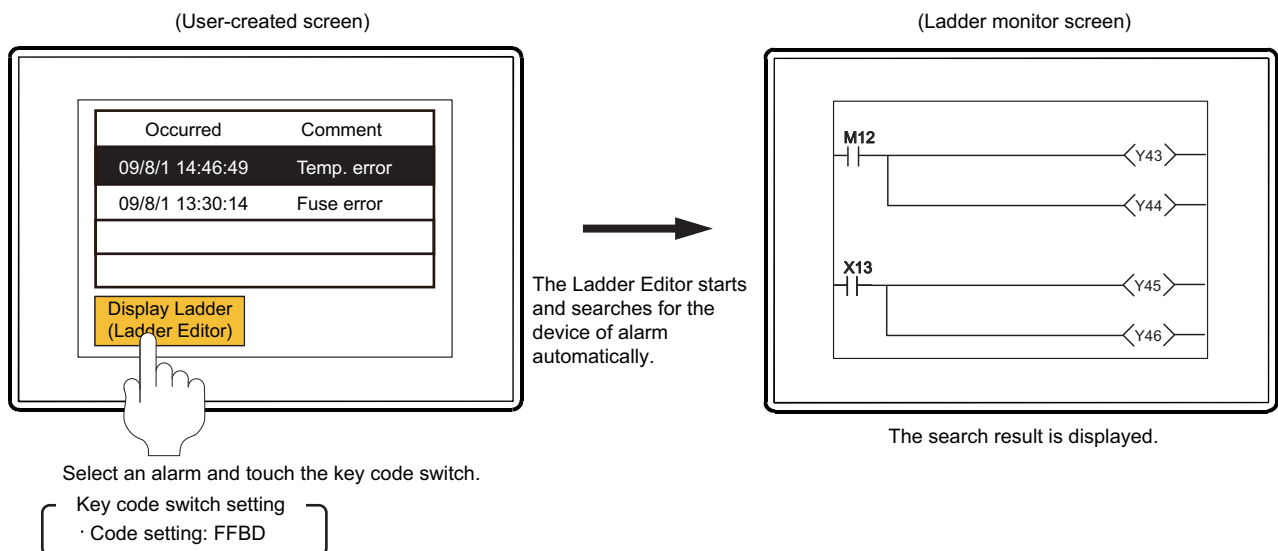

14.2 Specifications

14.2.1 System configuration

This section describes the system configuration for the ladder editor function. For connection type settings and precautions regarding the communication unit/cable and connection type, refer to the following.

GOT1000 Series Connection Manual (Mitsubishi Products) for GT Works3

Target controller

Controller
QCPU ^{*1} , motion controller (Q series) ^{*2}
LCPU
CNC (C70)

- *1 Excluding the Q02PHCPU, Q06PHCPU, Q12PHCPU, Q25PHCPU, Q12PRHCPU, Q25PHCPU, QnUDPVCPU. For creating a multiple CPU system with the Q00CPU, Q01CPU, Q02CPU, Q02HCPU, Q06HCPU, Q12HCPU, and/or Q25HCPU, use CPUs with the function version B or later.
- *2 For the motion controller CPU (Q series), only the PLC CPU area (CPU No.1) in the Q170MCPUCPU can be monitored.

Connection type

This function can be used in the following connection types.

(○: Available, x: Unavailable)

Function		Connection form between GOT and controller							
Name	Description	Bus connection ^{*1}	Direct CPU connection ^{*2}	Computer link connection	Ethernet connection ^{*9}	MELSECNET/H connection ^{*1} , MELSECNET/10 connection ^{*1*3}	CC-Link IE controller connection ^{*1*4} , CC-Link IE field connection ^{*5*6}	CC-Link connection	
								ID ^{*7}	G4 ^{*8}
Ladder editor	Monitors and edits a sequence program in the ladder diagram format in a controller, or changes current device values of the program.	○	○	○	○	○	○	○	○

- *1 The LCPU does not support the connection type.
- *2 When the GOT is connected to LCPU, use L6ADP-R2.
- *3 For the MELSECNET/10 connection, use a QCPU and network module (QJ71LP21, QJ71LP21-25, QJ71LP21S-25, QJ71LP21G, and QJ71BR11) with the function version B or later.
- *4 Indicates the CC-Link IE controller network connection.
- *5 Indicates CC-Link IE field network connection.
- *6 Q00JCPU, Q00CPU, Q01CPU, Q02CPU, Q02HCPU, Q06HCPU, Q12HCPU and Q25HCPU are not available.
- *7 Indicates CC-Link connection (Intelligent device station).
- *8 Indicates CC-Link connection (via G4).
- *9 Ladder editor cannot be used when using CC-Link IE field network Ethernet adapter.

Required extended function OS, option OS, and option function board

The following extended function OS, option OS, and option function board are required.

1.1.2 Hardware and OS' required for each function

(1) Extended function OS and option OS

Install the above extended OS and option OS on the GOT. For the installation procedure, refer to the following.

GT Designer3 Version1 Screen Design Manual (Fundamentals) 8. COMMUNICATION WITH GOT

(2) OS memory space

For installing the extended function OS and option OS, the available space shown in the above table is required in the user area.

For the procedure for checking the available memory space of the user area and information about the data using other user areas, refer to the following.

 GT Designer3 Version1 Screen Design Manual (Fundamentals) 8. COMMUNICATION WITH GOT

(3) Option function board

(a) For GT16

No option function board is required.

(b) For GT15

Mount one of the option function boards in the above table on the GOT.

For the GOTs with a built-in option function board, refer to the following.

 1.1.2 Hardware and OS' required for each function

For how to mount an option function board on the GOT, refer to the following.

 User's Manual for the GOT used

POINT

For using the ladder editor function, a capacity of 9949KB or more is required in the user area of the specified drive for installing the extended function OS and option OS.

A total memory capacity of 21212KB is required for using the ladder editor function.

For using the ladder editor function, set the OS boot drive to [A: Standard CF Card] and mount an option function board with 16MB or more memory on the GOT.

For setting the OS boot drive, refer to the following.

 GT Designer3 Version1 Screen Design Manual (Fundamentals) 8. COMMUNICATION WITH GOT

Required hardware

The following hardware is required.

Hardware
CF card

14.2.2 Devices and range that can be monitored

The device range varies depending on the CPU to be used.

(○: Possible, x: Impossible)

Device*1	Device range	Program display	Device monitor display	Search operation
Input	X0 to 1FFF, DX0 to FFF	○	○	○
Output	Y0 to 1FFF, DY0 to FFF	○	○	○
Internal relay*1	M0 to 8191 to 61439	○	○	○
Latch relay	L0 to 32767	○	○	○
Link relay*2	B0 to 1FFF to EFFF	○	○	○
Timer	T0 to 32767	○	○	○
Retentive timer	ST0 to 32767	○	○	○
Counter	C0 to 32767	○	○	○
Data register	D0 to 12287	○	○	○
Link register	W0 to 1FFF	○	○	○
Annunciator	F0 to 32767	○	○	○
Edge relay	V0 to 2047	○	x	○
File register	R0 to 32767	○	○	○
	ZR0 to 4849663	○	○	○
Extended data register*2	D0 to 4910079	○	○	○
Extended link register*2	W0 to 4AEBFF	○	○	○
Link special relay	SB0 to 7FFF	○	○	○
Link special register	SW0 to 7FFF	○	○	○
Index register	Z0 to 19	○	○	○
Special relay	SM0 to 2047	○	○	○
Special register	SD0 to 2047	○	○	○
Function input	FX0 to F	○	x	○
Function output	FY0 to F	○	x	○
Function register	FD0 to 4	○	x	○
Link direct device	J□□□□	○	x	x
Module access device	J□□□□ U3En□□□□	○	x	x
Nesting	N0 to 14	○	x	x
Pointer	P0 to 8191	○	x	○*3
Interrupt pointer	I0 to 255	○	x	○*3
SFC block device	BL0 to 319	○	x	○
SFC transition device	TR0 to 511, BL□\TR□	○	x	○
Network No. specification device	J0 to 255	○	x	x
I/O No. specification device	U0 to 1FF 3E0 to 3	○	x	x
Macro instruction argument device	VD0 to	○	x	x

*1 The GOT can monitor local devices. For applicable devices and device ranges, refer to manual of the PLC CPU.

*2 The extended data register and extended link register are applicable to Universal model QCPU only.

*3 Device cannot be replaced.

14.2.3 Access range

The access range is the same as the access range when the GOT is connected to a controller. For details of the access range, refer to the following.

 GOT1000 Series Connection Manual (Mitsubishi Products) for GT Works3

14.2.4 Precautions

(1) Inapplicable GOT

The ladder editor cannot be used with the GOTs shown below.

GOT	Inapplicable GOT
GT16	GT1655-V
GT15	GT1555-V, GT1555-Q, and GT1550-Q

(2) Precautions for operations during SFC monitor startup

Do not operate the following with the GOT during the ladder editor startup.

Doing so may delete stored data and cause the ladder editor function to operate incorrectly.

- Turning on or off the CF card access switch
- Inserting or removing a CF card

(3) Backup

Before editing the program with the ladder editor function, backup the program with the backup/restore function to restore an original sequence program.

 11. BACKUP/RESTORE

(4) Precautions for setting [Locus] for line graphs (For GT15)

For GT15, the ladder editor function is not available when [Locus] is set for line graphs.

For using the ladder editor function with GT15, do not set [Locus] for line graphs.

(5) Precautions for the online program change

Precautions for the online program change with the ladder editor function are the same as the online program change with GX Works2/GX Developer, except the followings.

For details of precautions on the online program change, refer to the followings.

 GX Works2 Version1 Operating Manual (Common)
GX Developer Version8 Operating Manual
QnUCPU User's Manual (Function Explanation, Program Fundamentals)

The following items are the difference between GX Works2/GX Developer online program change when using the ladder editor function.

- Online program change is not available for programs other than program memories.
- Online program change cannot be executed with the pointer at the top. Do not execute the online program change simultaneously from multiple points.
- Online program change is not available by file unit.
- No option setting is available for preventing from executing the fall instruction.
- Online program change is not available when the reserved area is exceeded by the change. Execute Write to PLC when the reserved area is exceeded.
- The setting whether to transfer or not to the program memory cannot be changed after the writing is completed. When the online program change to the universal model QCPU is executed, all the program cache memory information is transferred at once, after the online program change.
- If the setting of GOT days and time is February 29th when using the Q00JCPU, Q01CPU or Q00CPU, the online program change cannot be executed. Change days and time of the GOT to something other than February 29th and execute the online program change again.

(6) Precautions for creating the program

The ladder editor is not available for the program which uses labels. When using the ladder editor, create the program in the simple project which does not use labels.

(7) Instructions that cannot be displayed or edited by using the ladder editor function

For the ladder editor function, ladder blocks that use the following instructions cannot be displayed or edited. When the following instructions are input during editing, an error message is displayed and the instructions cannot be input.

The program with the following instructions cannot be written into the PLC CPU.

Sequence instruction	Shift instruction	n-bit shift of n-bit data	SFTBR(P), SFTBL(P)
		n-words shift of n-words data	SFTWR(P), SFTWL(P)
	Contact instruction	Contact	LDPI, LDFI, ANDPI, ANDFI, ORPI, ORFI
Basic instruction	Comparison operation instruction	BIN 32-bit block data comparisons	DBKCMPE(P), DBKCMPE<>(P), DBKCMPE>(P), DBKCMPE>=(P), DBKCMPE<(P), DBKCMPE<=(P)
	Arithmetic operation instruction	BIN 32-bit data block addition and subtraction operations	DBK+(P), DBK-(P)
	Data transfer instruction	Identical 32-bit data block transfers	DFMOV(P)
Application instruction	Data processing instruction	Calculation of averages	MEAN(P), DMEAN(P)
	Special function instruction	Exponentiation operation	POW(P), POWD(P)
		Common logarithm operation	LOG10(P), LOG10D(P)
	Data control instruction	Scaling (point-by-point coordinate data)	SCL(P), DSCL(P)
		Scaling (X or Y coordinate data)	SCL2(P), DSCL2(P)
	Clock instruction	Date comparison	LDDT=, ANDDT=, ORDT=, LDDT<>, ANDDT<>, ORDT<>, LDDT>, ANDDT>, ORDT>, LDDT>=, ANDDT>=, ORDT>=, LDDT<, ANDDT<, ORDT<,
Clock comparison		LDTM<=, ANDTM<=, ORTM<=, LDTM=, ANDTM=, ORTM=, LDTM<>, ANDTM<>, ORTM<>, LDTM>, ANDTM>, ORTM>, LDTM<=, ANDTM<=, ORTM<=, LDTM>, ANDTM>, ORTM>, LDTM>=, ANDTM>=, ORTM>=,	
QCPU instruction	Select refresh instruction	CCOM(P)	

14.3 Display Operation

Start operation for the Ladder Editor

The following describes the outline for displaying the ladder editor operation screens after installing GOT Platform Library (extended function OS), Ladder editor (option OS), and GOT Function Expansion Library (option OS) on the GOT.

For the start operation of the Ladder Editor using the One-touch Ladder Jump function, refer to the following.

■ Start operation when using the One-touch Ladder Jump function

For the changing screens for the security setting, refer to the following.

14.3.4 Setting the security

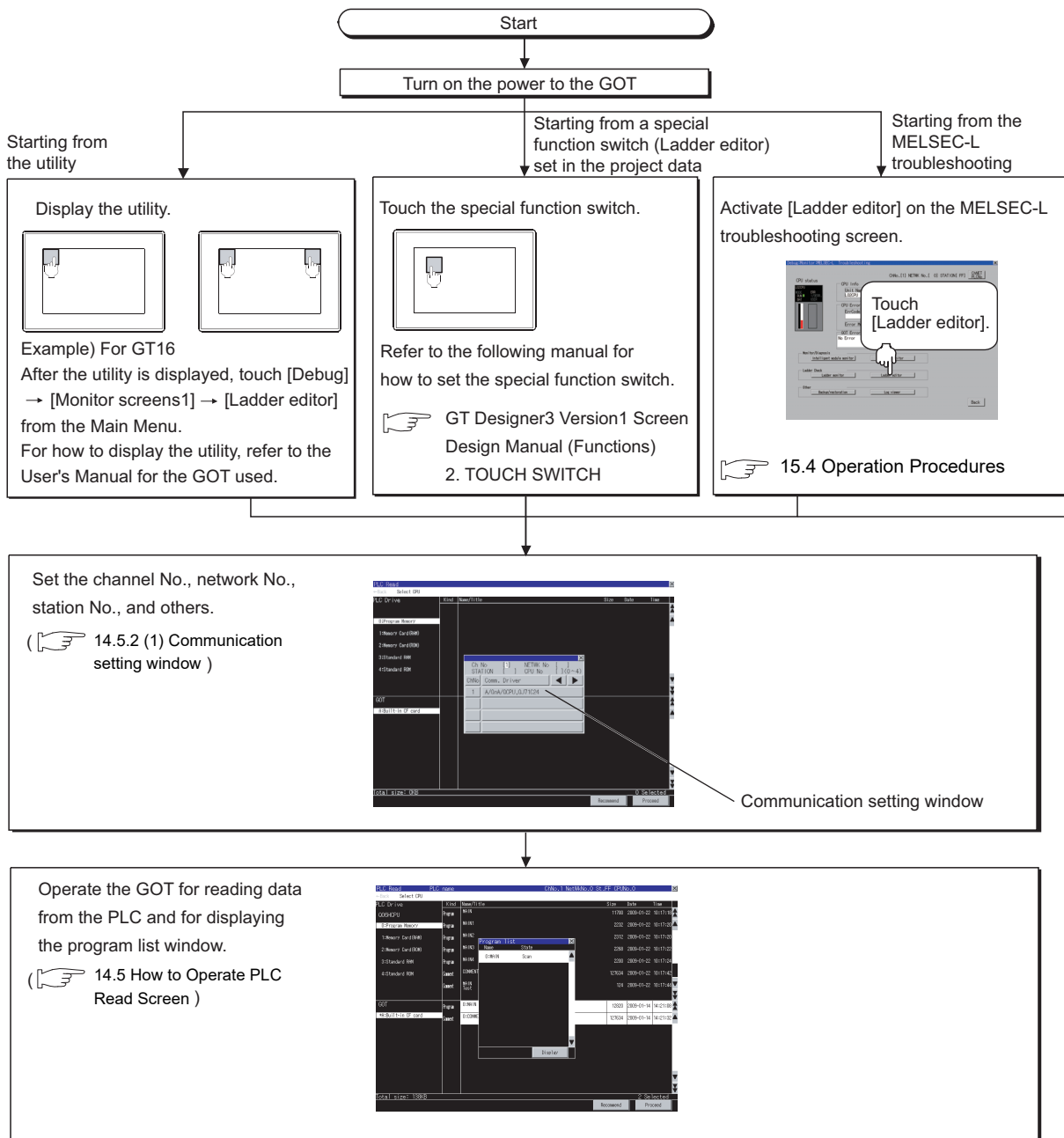

(Continued to next page)

(Continued to next page)

From previous page

Select a program from the program list to display the Ladder monitor screen.

( 14.6 How to Operate Ladder Monitor Screen)

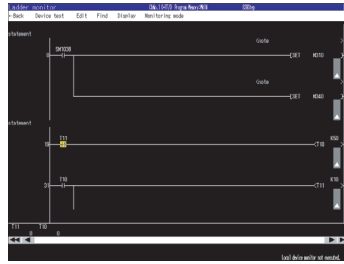

Display the Ladder editor screen from the Edit menu in the Ladder monitor screen.

( 14.7 How to Operate Ladder Editor Screen)

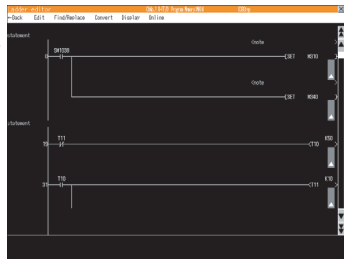

End

POINT

(1) How to display the utility

For how to display the utility, refer to the following.

 User's Manual for the GOT used

(2) Reading data from PLC when reclosing GOT

Reading data from the PLC is not required when reclosing the GOT power, because sequence programs and comment files are stored in a CF card for the ladder editor function.

 14.3.1 Setting ladder data storage location

■ Start operation when using the One-touch Ladder Jump function

By using the special function switch, advanced user alarm display, or others, start the Ladder Editor, and sequence program files can be read automatically and devices can be searched automatically. The following shows objects which can use the One-touch Ladder Jump function.

Object
Special function switch, advanced user alarm display, alarm history display, user alarm display

POINT

Before executing the automatic PLC read

(1) Setting the automatic PLC read

When reading a sequence program file or a comment file from controllers, the automatic PLC read have to be set on GT Designer3 or in the utility.

For the setting of automatic PLC read, refer to the following.

 GT Designer3 Version1 Screen Design Manual (Fundamentals) 4.9 GOT Display and Operation Setting

User's Manual for the GOT used

(2) Specifying an automatic PLC read file

With the special function switch or advanced user alarm display, the target sequence program of automatic PLC read can be specified in each object setting.

However, the operation differs depending on the automatic PLC read setting on GT Designer3 or in the utility.

Automatic PLC read setting of GT Designer3/utility	File name specification in objects	Operation
Done	Done	The specified sequence program file is read automatically.
	None	All sequence program files are read automatically.
None	Done	No sequence program file is read. To search automatically, if a sequence program file of the specified file name among the sequence program files read in the GOT exists, it is executed.
	None	No sequence program file is read. To search automatically, if a sequence program file read in the GOT exists, it is executed to all files.

(1) Starting from the special function switch





Select [Ladder Editor] in [Switch Action] and the [Use One-touch Ladder Jump] check box of the special function switch. By touching this switch, Ladder Editor can be started.

Operation at start differs depending on the setting contents of the special function switch.

For the setting items for the special function switch, refer to the following.

 GT Designer3 Version1 Screen Design Manual (Functions) 2. TOUCH SWITCH

(○: Set, x : Not set)

Setting		Operation for touching the special function switch
Search Method	Specify Search File	
Specify Search Device*1	○	 (a)
	x	 (b)
Specify Connected Station*2	○	 (c)
	x	 (d)

*1 When [Specify Search Device] is selected, set [Ladder Search Device] and [Ladder Search Mode].
The setting of PLC station number is included in the [Ladder Search Device] setting.

*2 When [Specify Connected Station] is selected, set [CH No.] and [Network].
If [Other] in [Network] is selected, also set [N/W No.], [PC Station No.] and [CPU Machine].

(a) Operations for searching a device with specifying the file name

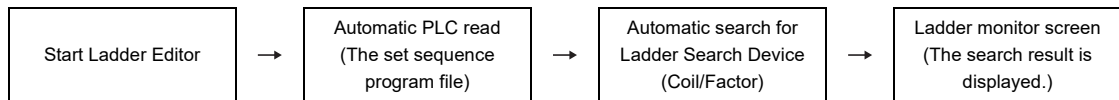

(b) Operations for searching a device without specifying the file name

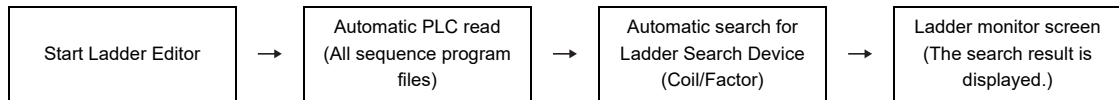

(c) Operations for searching a connected station with specifying the file name

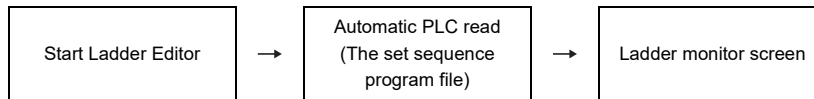

(d) Operations for setting a connected station without specifying the file name

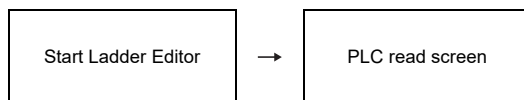

Operations for the special function switch when not using the One-touch Ladder Jump function

When the [Use One-touch Ladder Jump] is not selected, the operation for touching the special function switch is the same as when starting from the utility.

 ■Start operation for the Ladder Editor

(2) Starting from the advanced user alarm display

By selecting an alarm in the advanced user alarm display and touching the key code switch (setting the key code of the [Display Ladder (Ladder Editor)]), the Ladder Editor can be started and the device of alarm can be searched.

Operation at start differs depending on the setting contents of the advanced user alarm observation.

For the setting items for advanced user alarm observation, refer to the following.

GT Designer3 Version1 Screen Design Manual (Functions) 11.3 Advanced User Alarm Display

(O: Set, x: Not set)

Ladder search setting*1		Operation for touching the key code switch
Ladder Search Mode	Specify Search File	
O	O	(a)
O	x	(b)

*1 The setting of PLC station number is included in the target device.

(a) Operations for setting the Ladder Search Mode and file name

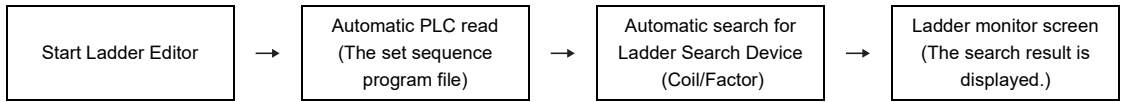

(b) Operations for setting the Ladder Search Mode

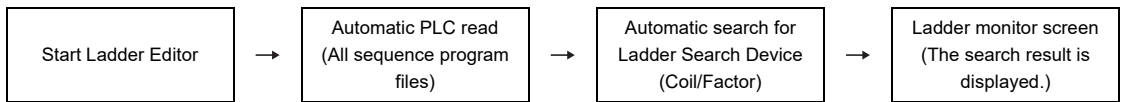

(3) Starting from the alarm history display or user alarm display

By selecting an alarm in the alarm history display or user alarm display and touching the key code switch (setting the key code of the [Display ladder (Ladder Editor)]), the Ladder Editor can be started and the device of alarm can be coil-searched.

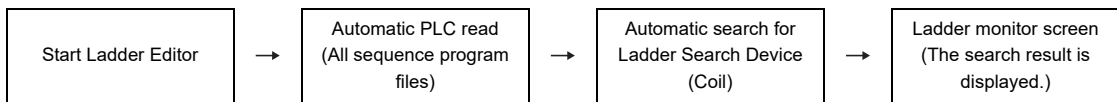

For the alarm history display, refer to the following.

GT Designer3 Version1 Screen Design Manual (Functions) 11.5 Alarm History Display

For the user alarm display, refer to the following.

GT Designer3 Version1 Screen Design Manual (Functions) 11.6 User Alarm Display

Changing screens

The following describes how to change the screen.

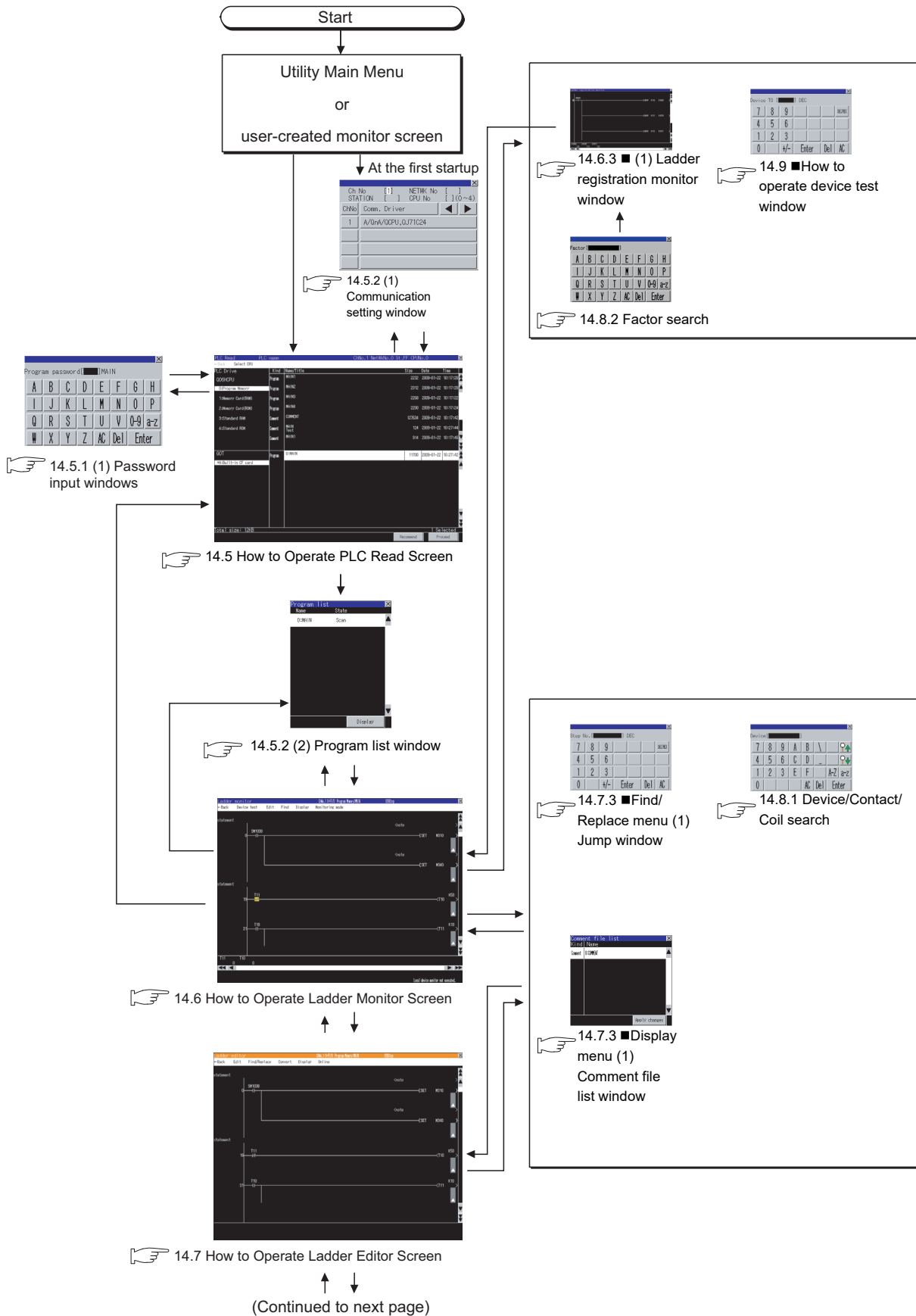

(Continued to next page)

From previous page



14.8.3 Replace device

14.8.4 Change open/close contact

14.7.3 ■ (1) Verify result window

14.7.3 ■ (3) Remote operation window

14.7.3 ■ (4) Copy program memory data into ROM window

14.7.1 ■ (1) Enter ladder program window

POINT

(1) Changing screens when using the One-touch Ladder Jump function

For changing screens when using the One-touch Ladder Jump function, refer to the following.

14.3 ■ Start operation when using the One-touch Ladder Jump function

(2) Changing screens when setting the security

For changing screens when setting the security, refer to the following.

14.3.4 Setting the security

14.3.1 Setting ladder data storage location

■ Setting ladder data storage location

Ladder data (sequence programs and device comments) for the ladder editor function are stored in the storage location that stores ladder data for the Q/QnA ladder monitor. Only the A drive (standard CF card) or B drive (extended memory card) is available for storing ladder data.

For the ladder data storage destination setting, refer to the following.

When setting with GOT utility

 User's Manual for the GOT used

When setting with GT Designer3

 GT Designer3 Version1 Screen Design Manual (Fundamentals) 4.9 GOT Display and Operation Setting

14.3.2 Reading comment files from CF card

The ladder editor function uses comment files stored in a CF card installed in the GOT.

■ Procedure for using comment files stored in CF cards

The following shows the procedure for using a comment file stored in a CF card.

(1) When displaying comments in language set for language switching of GOT utility

Store comment files in a CF card on the PLC read screen.

For how to store comment files in a CF card on the PLC read screen, refer to the following.

 14.5 How to Operate PLC Read Screen

(2) When displaying comments in any language regardless of language set for language switching of GOT utility

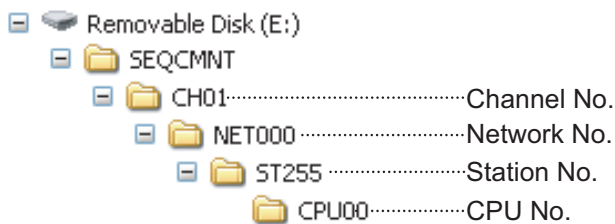

1. Create a SEQCMNT folder in a CF card. When the SEQCMNT folder already exists, creating a new SEQCMNT folder is not required.

2. In the SEQCMNT folder, create folders for CH No., network No., station No., and CPU No. of the monitored controller with a hierarchy as shown left.

Item	Folder name
CH No.	CH**
Network No.	NET***
Station No.	ST***
CPU No.	CPU**

Assign numbers to "*" marks.
 (When the CH No. is 1, the folder name is CH01. When the monitor target is the host station, the folder name is ST255.)

(Continued to next page)

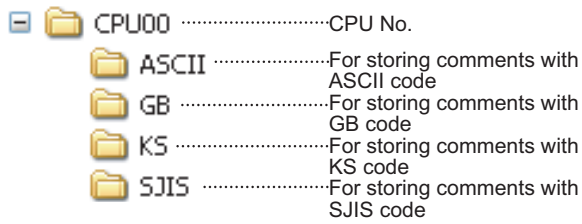

3. In the CPU No. folder, create folders for storing comment files by character code.

Item	Folder name
Folder for SJIS code	SJIS
Folder for KS code	KS
Folder for GB code	GB
Folder for ASCII code	ASCII

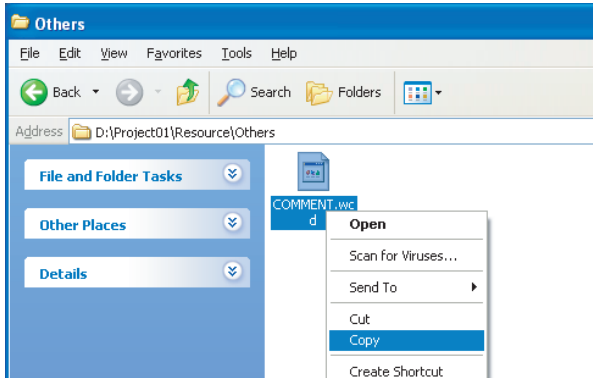

4. Copy a comment file (.wcd) from the project data of GX Developer.

For the procedure for creating a comment file, refer to the following.

☞ 3.3.4 Reading comment files from CF cards Procedure 2 to 4

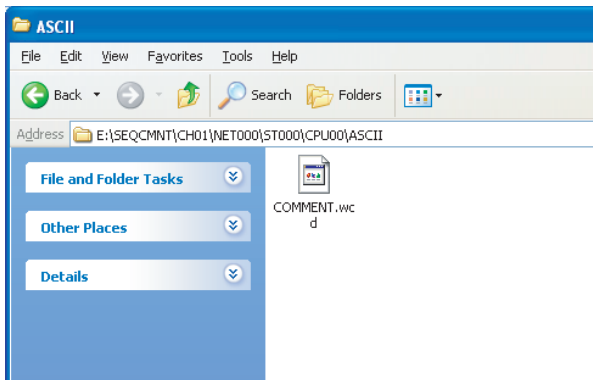

(Example: Storing comment files with ASCII code in the ASCII folder.)

5. Store the copied comment files in the folders for each character code in the CF card.

Comment character code	Storage folder name
SJIS code	SJIS
KS code	KS
GB code	GB
ASCII code	ASCII

6. Install the CF card with the comment file on the GOT.

Switch comment files on the Ladder monitor screen for displaying the comments in appropriate language.

POINT

Restrictions on using comment files

The following restrictions apply when displaying comments assigned to each bit of word devices.

- Ladder edit OS version 05.16.00 or later is required.
- If switching to comment files stored in the CF card, they cannot be displayed.

14.3.3 Program update check

The GOT checks if there is any difference between sequence program files read in the GOT and sequence programs stored in controllers, while the Ladder monitor screen or Ladder Editor screen is displayed.

■ Specification of the program update check

(1) Check criterion

The updated dates and times of sequence program files are compared.

(2) Check timing

The program update is checked when the Ladder monitor screen or Ladder editor screen are displayed.

After that, it is checked in a five minutes cycle while the Ladder monitor screen is displayed and in a two minutes cycle while the Ladder Editor screen is displayed.

■ Operations for the program update check

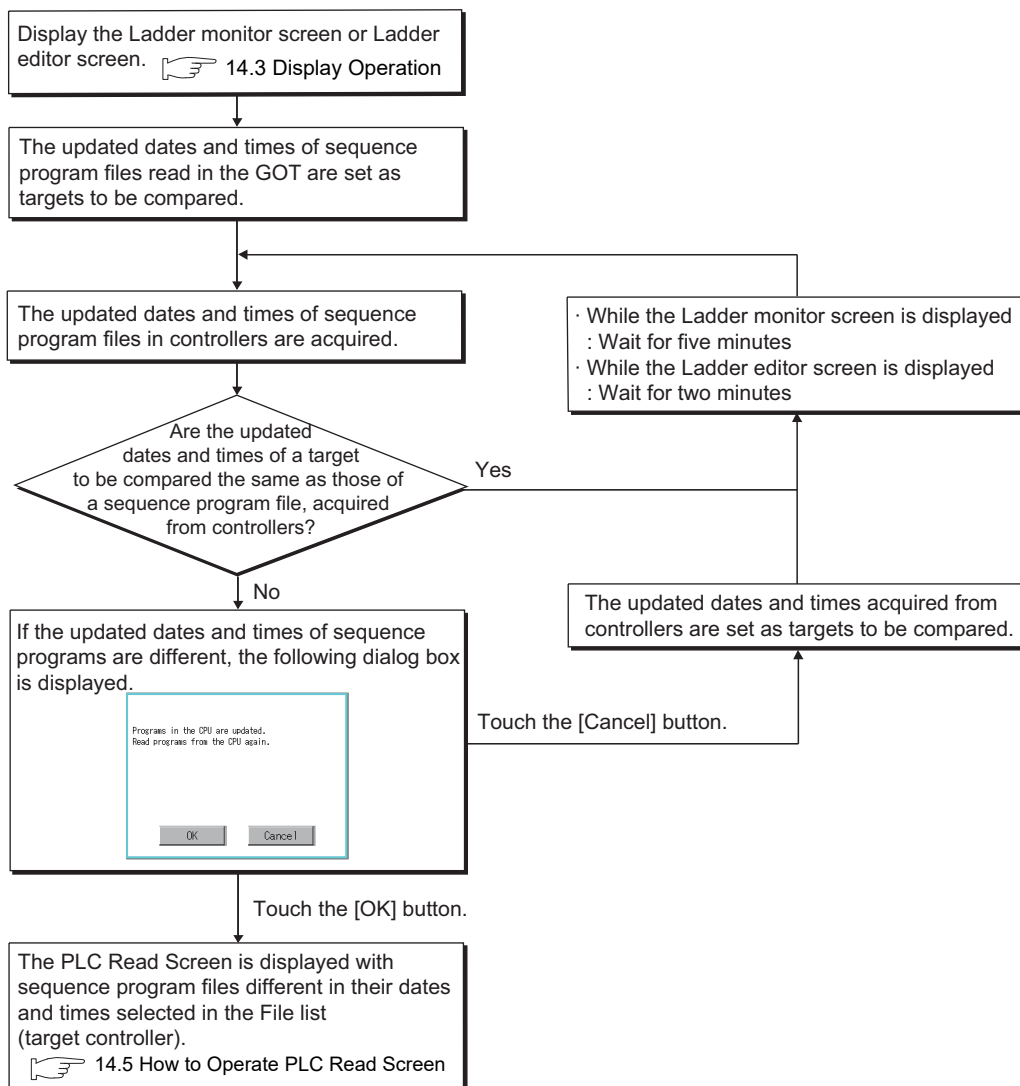

14.3.4 Setting the security

The device test window and Ladder editor screen displays can be limited by passwords.

■ Specification of the security setting

(1) Security types

Type	Description
Restriction by bit devices	The changing screens is restricted by the Authorization Device. The changing screens is authorized when the Authorization Device is ON.
Restriction by a password	The changing screens is restricted by a Password. When changing screens, the security password input dialog box is displayed.

The restriction types above can be used together.

(2) Setting method for security

Set the security setting in the [System Security] tab in the [Environmental Setting] dialog box (Security) on GT Designer3.

The following shows the setting method for each security type.

Type	Setting method
Restriction by bit devices	Select the [Authorization Device] check box of [Device Test Operation] or [Ladder Editor Screen Display] and set bit devices.
Restriction by a password	Set [Password] of [Device Test Operation] or [Ladder Editor Screen Display].

For the setting of the [Environmental Setting] dialog box, refer to the following.

 GT Designer3 Version1 Screen Design Manual (Fundamentals) 4.7 Security Setting

■ Changing screens when setting the security

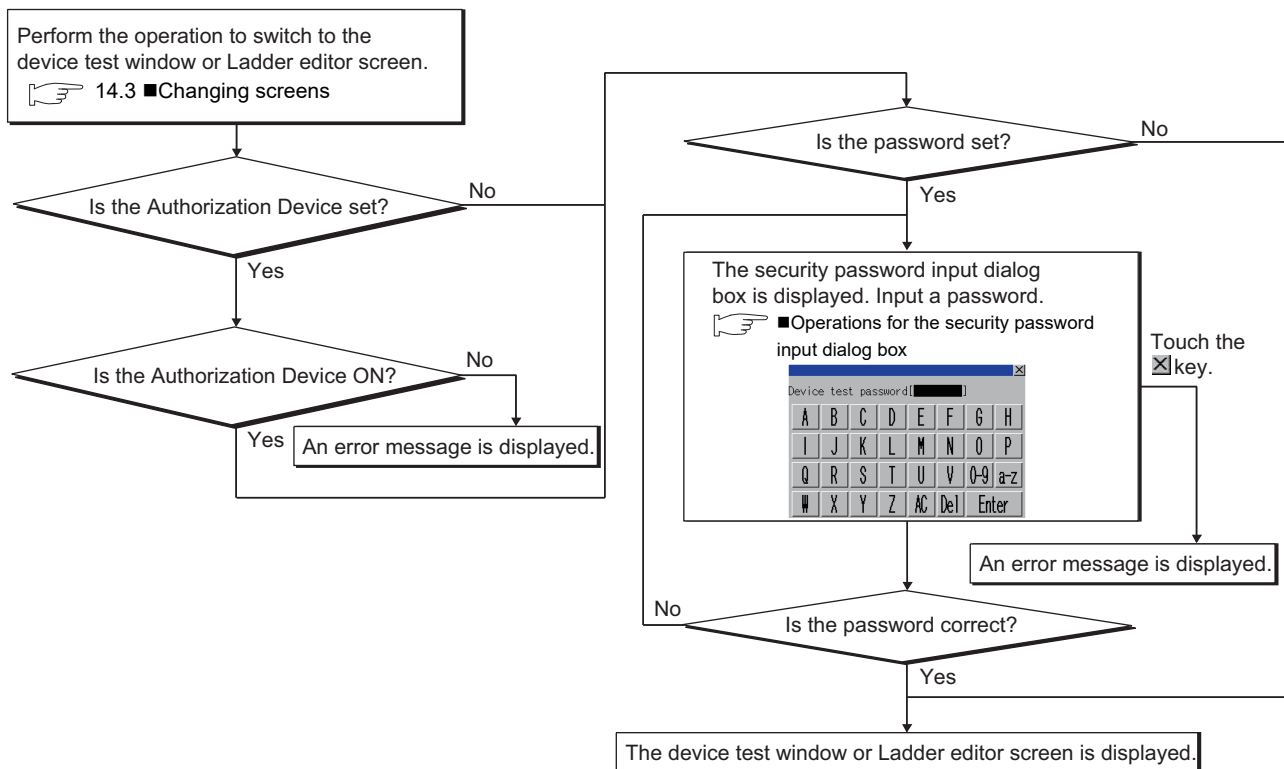

■ Operations for the security password input dialog box

(1) Displayed screen

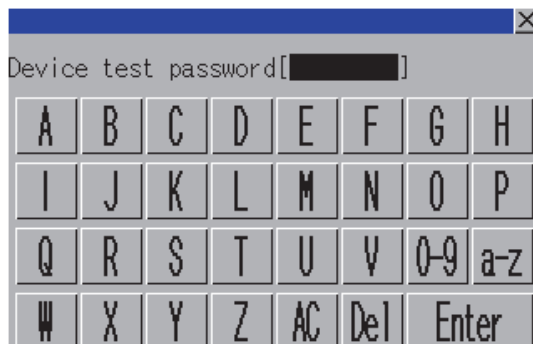

The following table shows the displayed contents.

No.	Item	Description
1)	Password type	Displays the type of the password to be input. (Device test password/Ladder editor password)
2)	Password input area	Set the password.
3)	Keys	Keys for operations in the security password input window.

(2) Key functions

Key	Function
✕	Closes the security password input window and cancels the password input operation.
0-9	Switches the key type to the value.
A-Z	Switches the key type to the alphabet (uppercase).
a-z	Switches the key type to the alphabet (lowercase).
AC	Deletes all the input values and characters.
Del	Deletes an input value or character.
Enter	Verifies the password set in the password input area.

14.4 Setting Display Format

The display format of word device values displayed on screens for the ladder editor function, language, the display mode of sequence programs, and others can be set.

14.4.1 Switching languages of sequence programs

Languages (Japanese, Korean, or Simplified Chinese) of comments to be displayed on screens for the ladder editor function can be switched when monitoring.

For switching languages, comment files in the language to be displayed must be created in advance.

 14.3.2 Reading comment files from CF card

The following shows the relations between the language selected in the GOT utility and comment files with each character code.

Language	Comment file
Japanese	Comment files with SJIS code
Korean	Comment files with KS code
Simplified Chinese	Comment files with GB code
Other than the above	Comment files with ASCII code

14.4.2 Switching comment display mode

Set whether to display or hide comments, statements and notes on the Ladder monitor screen or Ladder editor screen.

 14.6.3 ■Display menu

14.7.3 ■Display menu

14.4.3 Switching display formats between decimal and hexadecimal numbers

The display formats of word device values on the Ladder monitor screen can be switched between decimal and hexadecimal numbers.

 14.6.3 ■Monitoring Mode menu

14.5 How to Operate PLC Read Screen

On the PLC read screen, the GOT reads sequence programs and comment files used for the ladder editor function from the PLC.
The following describes how to operate the PLC read screen.

14.5.1 Displayed contents

The following describes the configuration of the PLC read screen displayed after the ladder editor starts and key functions on the screen.

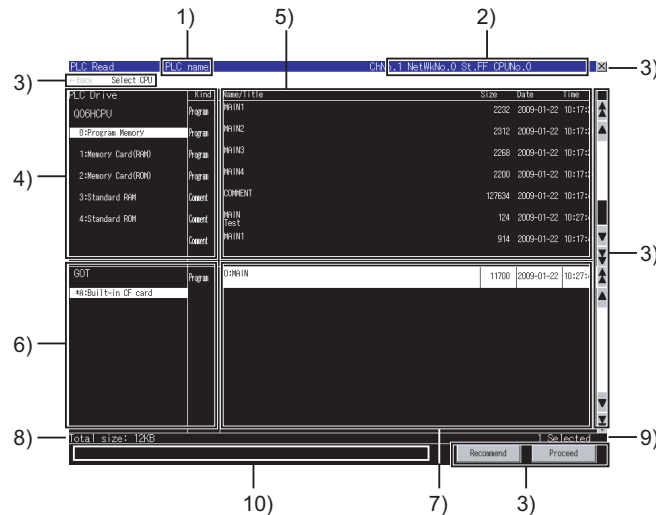

No.	Item	Description
1)	PLC name	Displays the label set in the PLC name setting for the target PLC CPU.
2)	Target controller	Displays CH No., network No., station No., and CPU No. of the target PLC CPU.
3)	Keys	Keys for operations on the PLC read screen shown in section 14.5.2. (Touch input)
4)	Target drive list (target controller)	Displays the target PLC CPU model and the drives in a list. Selecting a drive displays files within the drive in the file list (target controller). For the drive that stores files selected in the file list (target controller), [*] is displayed to the left of the drive name.
5)	File list (target controller)	Displays the program types, file names, titles, sizes, dates, and times of all the files within the drive selected in the target drive list (target controller). (The date and time show those of updated files.) A file to be read can be selected from the file list. (The selected file is highlighted.) For program files, only sequence program files in the program memory can be selected. For selecting the file name selected in the file list (GOT), the file selection in the file list (GOT) is canceled. When a password is set for the selected file, the password input window appears. ((1) Password input window)
6)	Target drive list (GOT)	Displays the drive set for [Data save location] in the MELSEC-Q/L/QnA ladder monitor settings. (For the ladder editor function, only the A drive (standard CF card) or B drive (extended memory card) is available.) For the drive that stores files displayed in the file list (GOT), [*] is displayed to the left of the drive name.
7)	File list (GOT)	Displays the program types, file names, titles, sizes, dates, and times of all the files within the drive selected in the target drive list (GOT). (The date and time show those of updated files.) A file to be read can be selected from the file list. (The selected file is highlighted.) For selecting the file name selected in the file list (target controller), the file selection in the file list (target controller) is canceled.

(Continued to next page)

No.	Item	Description
8)	Total file size	Displays the total data size of files selected in the file list (target controller) and file list (GOT).
9)	Number of selected files	Displays the total number of files selected in the file list (target controller) and file list (GOT).
10)	Message display area	Displays error messages and others.

(1) Password input window

(a) Displayed screen

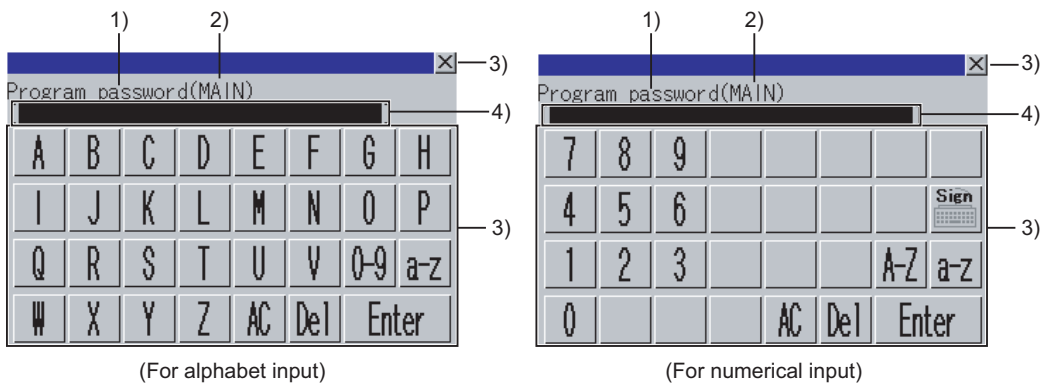

The following table shows the displayed contents.







No.	Item	Description
1)	Password type	Displays the type of the password to be input. (Program password/Comment password/Parameter password)
2)	Password input area	Set the password.
3)	File name	Displays the file name.
4)	Keys	Keys for operations in the password input window shown in (b)

(b) Key functions

No.	Description
	Closes the password input window and cancels the password input operation.
	Switches the key type to the value.
	Switches the key type to the symbol.
	Switches the key type to the alphabet (uppercase).
	Switches the key type to the alphabet (lowercase).
	Deletes all the input values and characters.
	Deletes an input value or character.
	Verifies the password set in the password input area. When the password verification for the first file is successful, the password verification for the other files is automatically executed with the same password.

14.5.2 Key functions

The following shows the functions of the keys used for operating the PLC read screen.

Key	Function
←Back	Returns the screen to the last screen that is displayed right before the PLC read screen appears. The key is disabled when the last screen is the GOT utility screen or user-created monitor screen.
Select CPU	Displays the communication setting window.  (1) Communication setting window
	Exits the ladder editor and returns the screen to the ladder editor startup screen.
	Scrolls the display area up and down by one line.
	Scrolls the display area up and down by one page.
	Available when program files are displayed in the target drive list (target controller). Touching the key selects all the sequence program files, common comment files, and comment files for the selected sequence program files in the file list (target controller). When files with the same name are displayed in the file list (target controller) and file list (GOT), touching the key selects a file as shown below. <ul style="list-style-type: none"> • For sequence program files <ul style="list-style-type: none"> When the updated dates and times differ between the files, touching the key selects the file in the file list (target controller). When the updated dates and times are the same between the files, touching the key selects the file in the file list (GOT). • For comment files <ul style="list-style-type: none"> When the updated dates and times differ between the files, touching the key selects the latest file. When the updated dates and times are the same between the files, touching the key selects the file in the file list (GOT).
	Writes the file selected in the file list (target controller) into the CF card displayed in the target drive list (GOT). The file written into the CF card on the PLC read screen is stored in the SEQDAT folder. After writing, among files other than comment files in the CF card, files that are not selected in the file list (GOT) are deleted. Then, the program list window appears.  (2) Program list window

(1) Communication setting window

(a) Displayed screen

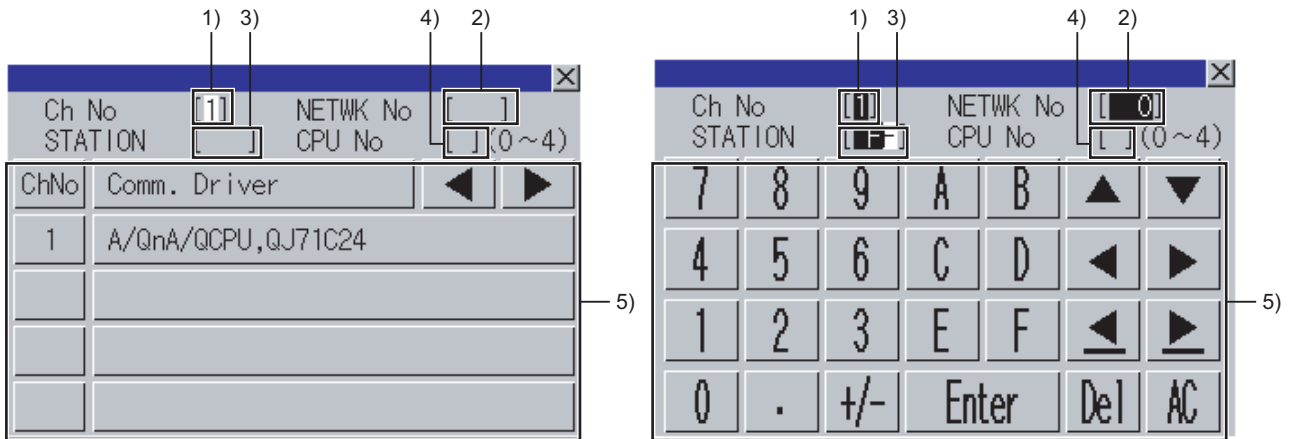

The following table shows the displayed contents.

No.	Item	Description
1)	CH No. input area	Set the CH No. for the target controller.
2)	Network No. input area	Set the network No. for the target controller.
3)	Station No. input area	Set the station No. of the target controller. When the station No. is set to the host station (FF), set the network No. to 0.
4)	CPU No. input area	Set the CPU No.
5)	CH No. selection key	Select a CH No.
6)	Keys	Keys for operations in the communication setting window shown in (b). (Touch input)

(b) Key functions

Key	Function
	Closes the communication setting window. When any of the CH No., network No., station No., and CPU No. is not input and the monitor target is not set, the communication setting window does not close.
	Moves the cursor among the input areas.
	Deletes all the input values and characters.
	Deletes an input value or character.
	Moves the cursor when the cursor is in the CH No. input area, network No. input area, or station No. input area. When the cursor is in the CPU No. input area and settings for the CH No., network No., and station No. are completed, the communication setting window closes and the PLC read screen appears.

(2) Program list window

Displaying the read sequence programs in a list is available.

(a) Displayed screen

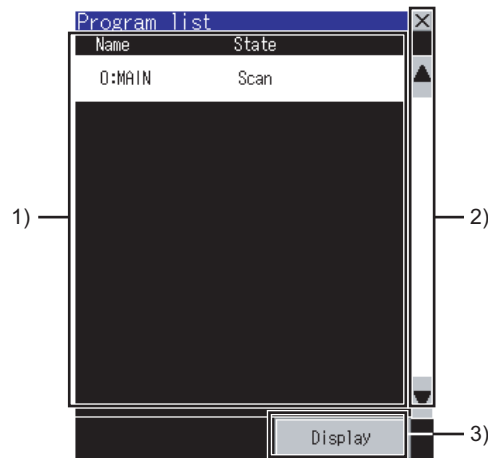

The following table shows the displayed contents.

No.	Item	Description
1)	Sequence program file list	Displays the file names and execution statuses of the read sequence programs. The execution statuses show execution types set for the programs. A touched sequence program file is highlighted.
2)	Keys	Keys for operations in the program list window shown in (b). (Touch input)

(b) Key functions

Key	Function
	Closes the Program List window.
	Scrolls the display area up and down by one line.
	Displays the sequence program file selected in the sequence program file list on the Ladder monitor screen. (14.6 How to Operate Ladder Monitor Screen)

14.6 How to Operate Ladder Monitor Screen

On the Ladder monitor screen, the GOT displays the read sequence program.
The following describes how to operate the Ladder monitor screen.

14.6.1 Displayed contents

The following describes the configuration of the Ladder monitor screen, menus and key functions on the screen.

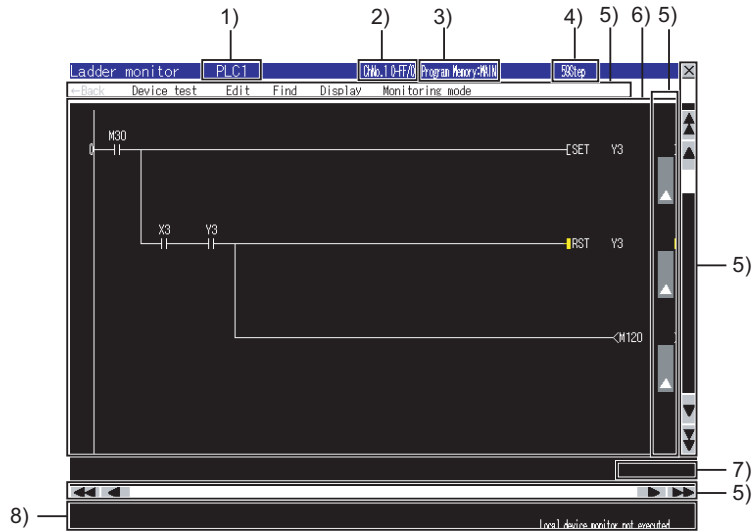



No.	Item	Description								
1)	PLC name	Displays the label set in the PLC name setting for the target PLC CPU.								
2)	Target controller	Displays the CH No., network No., station No., and CPU No of the target PLC CPU as shown below. • CH No. network No.-station No./CPU No.								
3)	Program name	Displays the file name of the displayed sequence program.								
4)	Number of steps	Displays the number of steps for the displayed sequence program.								
5)	Keys	Keys operations for the Ladder monitor screen shown in 14.6.2. (Touch input)								
6)	Ladder display area	<p>Displays the read sequence program. By touching a device, it is selected and surrounded with a green frame.</p> <ul style="list-style-type: none"> The following shows the conductive status <table style="width: 100%; border: none;"> <tr> <td style="text-align: center;">Non-conductive status</td> <td style="text-align: center;">Conductive status</td> </tr> <tr> <td style="text-align: center;">Contact </td> <td style="text-align: center;">Contact </td> </tr> <tr> <td style="text-align: center;">Coil </td> <td style="text-align: center;">Coil </td> </tr> <tr> <td style="text-align: center;">Instruction *1 </td> <td style="text-align: center;">Instruction *1 </td> </tr> </table> <ul style="list-style-type: none"> When contacts, coils, and outputs are the selection status, touching the area displays the device search window. (☞ 14.8.1 Device/Contact/Coil search) Displaying the first step number When the Ladder registration monitor window is opened, the first step number of registerable ladder blocks is highlighted. Touching the area registers the specified ladder block in the window. (For the Factor mode, it is not registered even if it is touched.) (☞ 14.6.3 ■Display menu (1) Ladder registration monitor window) 	Non-conductive status	Conductive status	Contact	Contact	Coil	Coil	Instruction *1	Instruction *1
Non-conductive status	Conductive status									
Contact	Contact									
Coil	Coil									
Instruction *1	Instruction *1									
7)	Current device value display area	Displays the current value of the displayed word device.								
8)	Message display area	Displays error messages and others.								

*1 The conductive status of the following instructions is displayed only on the screen.
SET, RST, PLS, PLF, SFT, SFTP, FF, DELTA, DELTAP, MC

14.6.2 Key functions

The following shows the functions of the keys used for operating the Ladder monitor screen.

Key	Function
←Back	Returns the screen to the last screen that is displayed right before the Ladder monitor screen appears. The key is disabled when the last screen is the GOT utility screen or user-created monitor screen.
Edit	Displays the Edit menu. Touching [Start editing] displays the Ladder editor screen. (☞ 14.7 How to Operate Ladder Editor Screen)
Device test	Sets the device test mode. Touching the key in the device test mode cancels the device test mode. (☞ 14.9 Test Operation)
Find	Displays the Find menu. (☞ 14.6.3 ■Find menu)
Display	Displays the Display menu. (☞ 14.6.3 ■Display menu)
	The comment and note of the touched line can be displayed/hidden. If the touched line is the first line in the ladder block, the statement of the touched ladder block can be displayed/hidden.
	Scrolls the display area up and down by one line.
	Scrolls the display area up and down by one page.

14.6.3 Menus

The following shows operations for the menus displayed on the Ladder monitor screen.

■ Edit menu



Key	Function	Reference section
	Switches to the Ladder editor screen.	14.7

Find menu

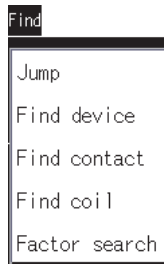

Key	Function	Reference section
Jump	Displays the jump window.	14.7.3 ■Find/Replace menu (1)
Find device	Displays the device search window.	14.8.1
Find contact	Displays the device search window	14.8.1
Find coil	Displays the device search window	14.8.1
Factor search	Displays the Factor window.	14.8.2

Display menu

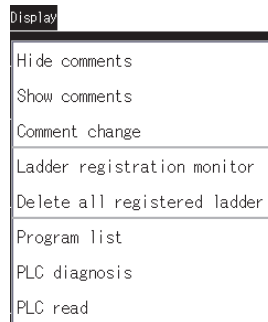

Key	Function	Reference section
Hide comments	Hides the comments, statements or notes in the ladder display area.	14.4.2
Show comments	Displays the comments, statements or notes in the ladder display area.	
Comment change	Displays the comment file list window.	14.7.3 ■Display menu (1)
Ladder registration monitor	Displays the Ladder registration monitor window.	(1)
Delete all registered ladder	Deletes all registered ladder blocks in the Ladder registration monitor window.	(1)
Program list	Displays the program list window	14.5.2 (2)
PLC diagnosis	Displays the PLC diagnosis screen.	14.7.3 ■Online menu (2)
PLC read	Displays the PLC read screen.	14.5

(1) Ladder registration monitor window

Displaying or deleting the registered ladder blocks is available.

(a) Displayed screen

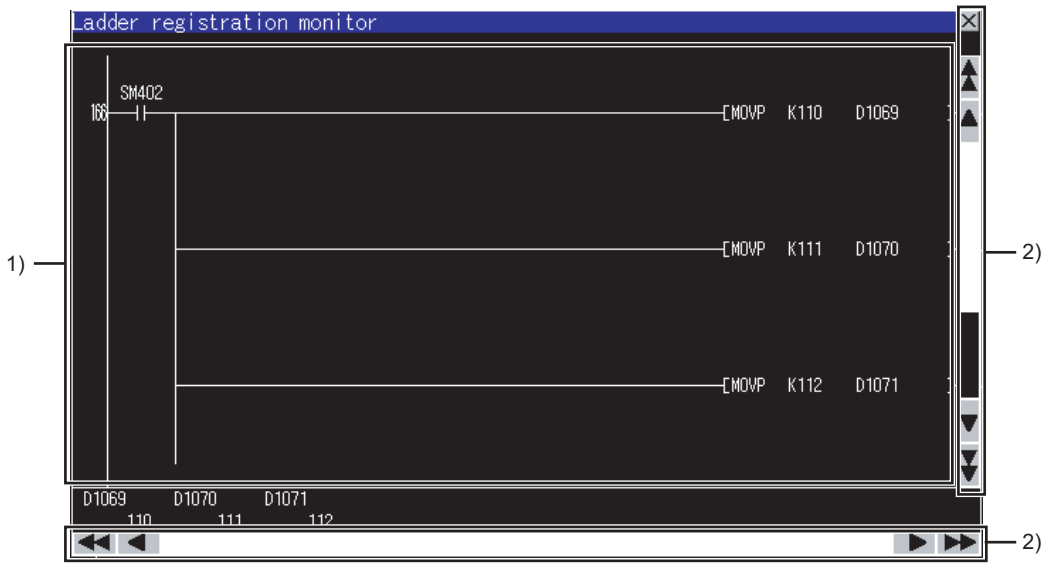

The following table shows the displayed contents.

No.	Item	Description
1)	Ladder display area	A ladder block selected on the Ladder monitor screen is added as the last registered ladder block on the Ladder registration monitor window. Touching the first step number displays the dialog box to delete the ladder block. (For the Factor mode, it is not deleted even if it is touched.)
2)	Keys	Keys for operations in the Ladder registration monitor window shown in (b).

(b) Key functions

Item	Description
	Closes the Ladder registration monitor window.
	Scrolls the display area up and down by one line.
	Scrolls the display area up and down by one page.
	Scrolls the display area right and left by one column.
	Scrolls the display area right and left by one page.

(2) Ladder registration monitor window

Numbers of lines and contacts displayable on the ladder monitor screen

The following shows the numbers of lines and contacts that are displayable under the following conditions: no comments are displayed and comments are displayed.

GOT	No comments displayed		Comments displayed	
	Number of lines that can be displayed	Maximum number of contact points displayed	Number of lines displayed	Maximum number of contact points displayed
GT1695M-X GT1595-X	13	11	6	11
GT1685M-S GT1675M-S GT1665M-S GT1585V-S GT1585-S GT1575V-S GT1575-S	9	11	4	11
GT1675M-V GT1675-VN GT1672-VN GT1665M-V GT1662-VN GT1655-V GT1575-V GT1575-VN GT1572-VN GT1565-V GT1562-VN GT1555-V	7	11	3	11

■ Monitoring Mode menu

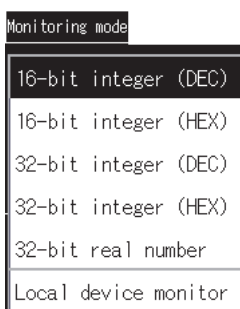

Key	Function	Reference section
16-bit integer (DEC)	Displays the device values in the device current value display area as 16-bit decimal numbers.	-
16-bit integer (HEX)	Displays the device values in the device current value display area as 16-bit hexadecimal numbers.	-
32-bit integer (DEC)	Displays the device values in the device current value display area as 32-bit decimal numbers.	-
32-bit integer (HEX)	Displays the device values in the device current value display area as 32-bit hexadecimal numbers.	-
32-bit real number	Displays the device values in the device current value display area as 32-bit floating-point numbers with the exponential representation.	-
Local device monitor	Displays local devices monitored by the GOT.	(1)

(1) Monitoring local devices

- When the GOT monitors local devices, the scan time increases.
- When local devices are displayed on the screen, touching the [local devices monitor] key cancels the display of local devices.
- When the Ladder monitor screen is switched to other screen, or the displayed program is switched to other program, the GOT cancels the display of local devices.

14.7 How to Operate Ladder Editor Screen

On the Ladder editor screen, editing sequence programs, finding devices, and displaying comments are available. The following describes how to operate the Ladder editor screen.

14.7.1 Displayed contents

■ Ladder editor screen

The following describes the configuration of the Ladder editor screen, menus and key functions on the screen.

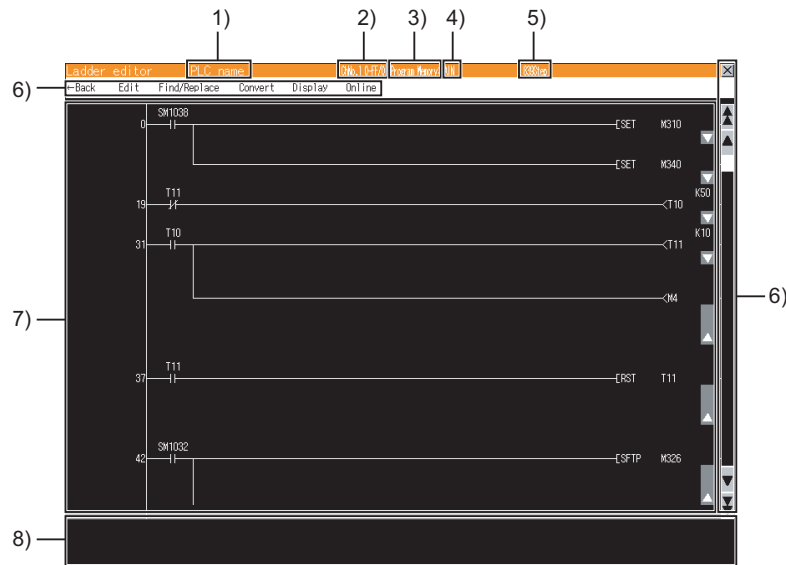

No.	Item	Description
1)	PLC name	Displays the label set in the PLC name setting for the target PLC CPU.
2)	Target controller	Displays the CH No., network No., station No., and CPU No. of the target PLC CPU as shown below. • CH No. network No.-station No./CPU No.
3)	Drive name	Displays the drive of the controller for the displayed sequence program.
4)	Program name	Displays the file name of the displayed program.
5)	Number of steps	Displays the number of steps for the displayed sequence program.
6)	Keys	Keys for operations for the Ladder editor screen shown in 14.7.2. (Touch input)
7)	Ladder display area	Displays the read sequence program. By touching a contact, coil, statement, or note, the item is highlighted and the Ladder input window is displayed. ((1) Enter ladder program window) Touch [Show comments] from the [Display] menu to display the comments, statements or notes. Touch [Hide comments] from the [Display] menu to hide the comments, statements or notes. Displays the first step number of ladder blocks. Touching the first step number of ladder blocks highlights the touched position, and displays the Enter ladder program window. ((1) Enter ladder program window)
8)	Message display area	Displays error messages and others.

POINT

(1) Restrictions on ladder blocks that can be edited with the ladder editor function

In the ladder editor function, ladder blocks exceeding 25 lines cannot be edited.

Even ladder blocks displayed within 24 lines with GX Works2/GX Developer may be displayed exceeding 25 lines on the GOT.

(2) Displaying the Ladder editor screen when setting the security

By setting the security on GT Designer3, the display of the Ladder editor screen can be limited.

For the security setting, refer to the following.

 14.3.4 Setting the security

(1) Enter ladder program window

Editing sequence programs is available.

(a) Displayed screen

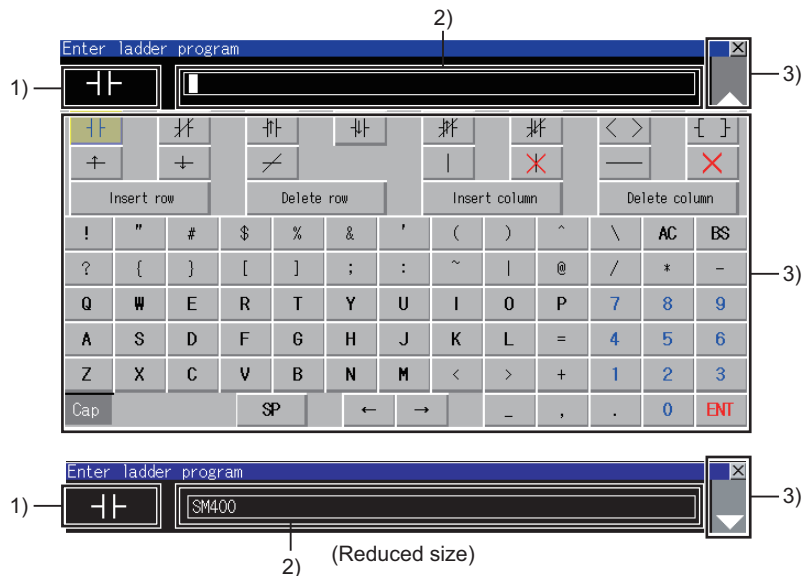

The following table shows the displayed contents.

No.	Item	Description
1)	Ladder symbol display area	Displays the ladder symbol selected in the ladder display area.
2)	Text display area	Displays devices, sequence programs, statements, and notes selected in the Ladder symbol display area. The cursor is displayed at the position to be input. If devices, sequence programs, statements, and notes are not fully displayed in the display area, move the cursor to the border of the side where the display was cut, and touch the cursor to scroll the displayed contents. Only one-byte alphanumeric characters can be input for statements and notes. If characters other than one-byte alphanumeric characters input on GX Developer are deleted on the GOT, they cannot be input again.
3)	Keys	Keys for operations in the Enter ladder program window shown in (b).

POINT



Types of statements and notes that can be entered

Statements and notes that can be entered are integrated statements and notes.

Peripheral statements and notes cannot be entered.

(If the * is entered at the start of statements and notes, an error occurs.)

(b) Key functions

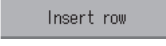

Key	Function
	Closes the Enter ladder program window. The displayed contents are not reflected.
	Touch the key to input a normally open contact.
	Touch the key to input a normally closed contact.
	Touch the key to input a leading edge pulse.
	Touch the key to input a trailing edge pulse.
	Touch the key to input a leading edge pulse rejection.
	Touch the key to input a trailing edge rejection.
	Touch the key to input a conversion of operation result to leading edge pulse.
	Touch the key to input a conversion of operation result to trailing edge pulse.
	Touch the key to input a coil.
	Touch the key to input an application instruction.
	Touch the key to input a vertical line.
	Touch the key to delete a vertical line.
	Touch the key to input a horizontal line.
	Touch the key to delete a ladder.
	Inserts one row in the specified position.
	Deletes the specified row.
	Inserts one column in the specified position.
	Deletes the specified column.
	Reflects the displayed contents, and closes the Enter ladder program window.
	Reduces the size of the Enter ladder program window.
	Changes the Enter ladder program window from the reduced size to the default size.
	Switches the alphabetic characters between the uppercase and the lowercase.

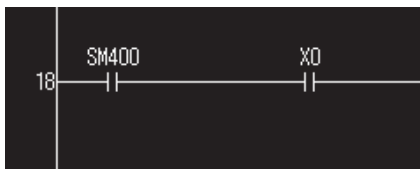
- (c) Inputting or deleting ladders
- Inputting contacts or instructions
- (Operation example: Inputting a contact (X0))



1. Touch a position to input a contact (X0).

2. The Enter ladder program window appears.

3. Touch the  key.
The ladder symbol corresponding to the touched key is displayed on the ladder symbol display area.
Input X0 in the text display area, and touch the  key.

4. The contact (X0) is input.

- Deleting contacts or instructions
(Operation example: Deleting a contact (X0))

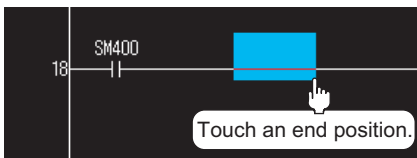

1. Touch a contact (X0) to be deleted.
2. The Enter ladder program window appears.
3. Touch the  key.
Touch the end position of the contact (X0).
4. The contact (X0) is deleted.

- Inputting vertical lines or horizontal lines
(Operation example: Inputting a vertical line)

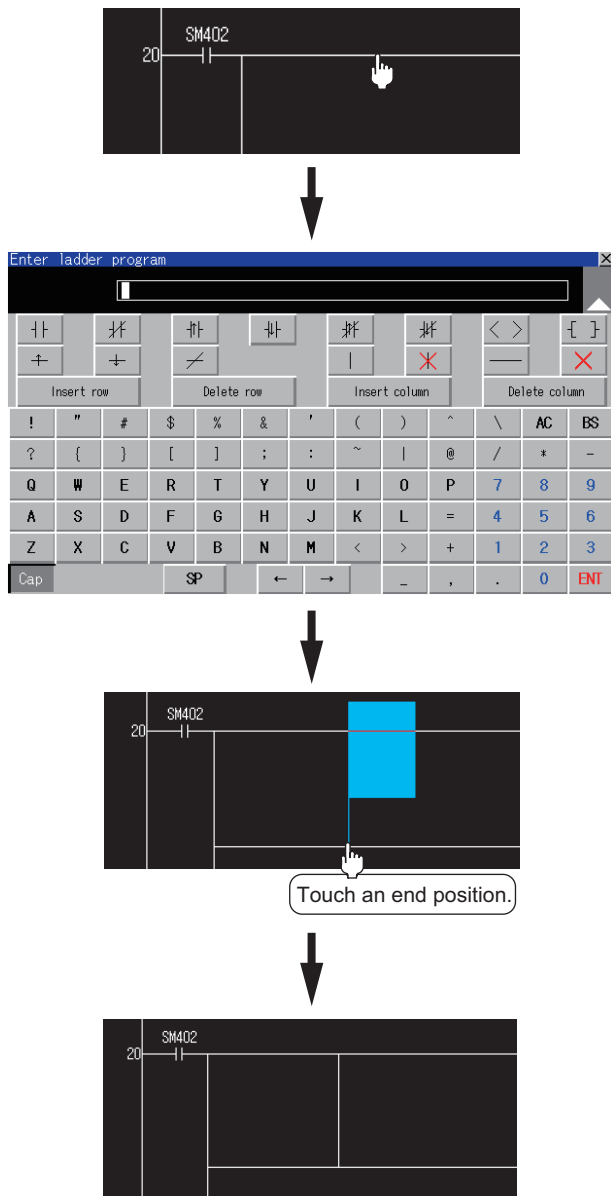

1. Touch a position to input a vertical line.
2. The Enter ladder program window appears.
3. Touch the  key.
Touch the end position to input the vertical line.
4. The vertical line is input.

- Deleting vertical lines or horizontal lines
(Operation example: Deleting a vertical line)

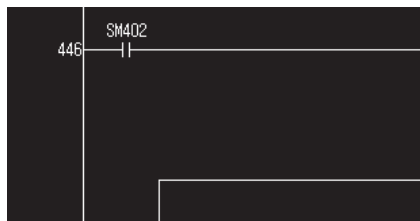
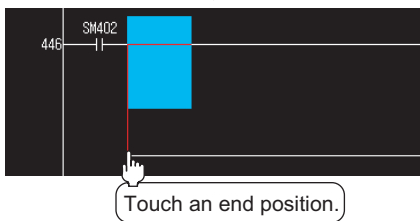
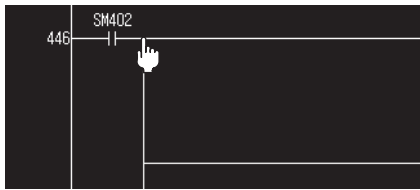

1. Touch a position to delete a vertical line.

2. The Enter ladder program window appears.

3. Touch  key.
Touch the end position to delete the vertical line.

4. The vertical line is deleted.

- Inputting rows and columns
(Operation example: Inputting a row)

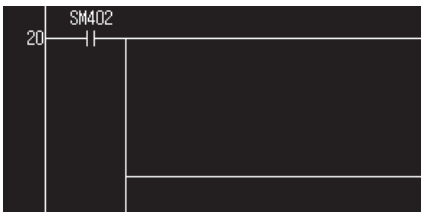
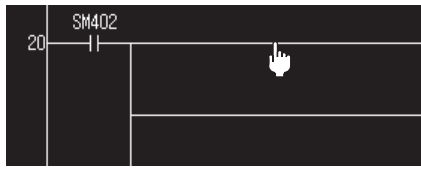

- Deleting rows and columns
(Operation example: Deleting a row)











1. Touch a position to insert a row.
2. The Enter ladder program window appears.
3. Touch the **Insert row** key.
The Enter ladder program window is closed, and the row is inserted.

1. Touch a position to delete a row.
2. The Enter ladder program window appears.
3. Touch the **Delete row** key.
The Enter ladder program window is closed, and the row is deleted.

14.7.2 Key functions

The following shows the functions of keys used for operating the Ladder editor screen.

Key	Function
←Back	Returns the screen to the last screen that is displayed right before the Ladder editor screen appears. The key is disabled when the last screen is the GOT utility screen or user-created monitor screen.
Edit	Displays the Edit menu.  14.7.3 ■Edit menu)
Find/Replace	Displays the Find/Replace menu. When the Find/Replace menu is displayed, touching the key closes the menu.  14.7.3 ■Find/Replace menu)
Convert	Displays the Convert menu.  14.7.3 ■Convert menu)
Display	Displays the Display menu.  14.7.3 ■Display menu)
Online	Displays the Online menu.  14.7.3 ■Online menu)
	Exits the Ladder editor screen and returns the screen to the ladder editor startup screen.
	The comment and note of the touched line can be displayed/hidden. If the touched line is the first line in the ladder block, the statement of the touched ladder block can be displayed/hidden.
	Scrolls the display area up and down by one line.
	Scrolls the display area up and down by one page.

14.7.3 Menus

The following shows operations for the menu displayed on the Ladder editor screen.

■ Edit menu

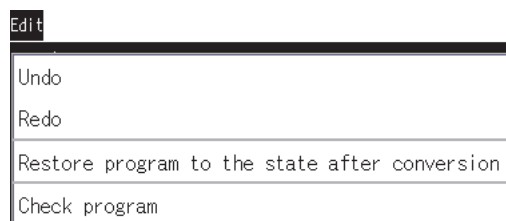

Key	Function	Reference section
Undo	Undoes the last edit operation. The GOT can be returned to the state right after the last but one conversion, write during RUN, Replace Device or Change open/close contact.	-
Redo	Redoes the operation which was undone using the [Undo] key.	-
Restore program to the state after conversion	Restores the edited ladder to the state just after conversion.	-
Check program	Executes the program check to check if programs have consistency or double coils do not exist.	-

POINT

Deleting ladders which are not converted

When deleting ladders which are not converted, a dialog box is displayed.

When touching the [OK] button in the dialog box, the ladders which are not converted are deleted, as well as the operation history. Therefore, the [Undo] and [Redo] keys do not operate.

Also, touch the [Cancel] button to return to the previous screen.

Find/Replace menu



Key	Function	Reference section
Jump	Displays the jump window.	(1)
Find device	Displays the device search window.	14.8.1
Find contact	Displays the device search window.	14.8.1
Find coil	Displays the device search window.	14.8.1
Replace device	Displays the replace device window.	14.8.3
Change open/close contact	Displays the change open/close contact window.	14.8.4

(1) Jump window

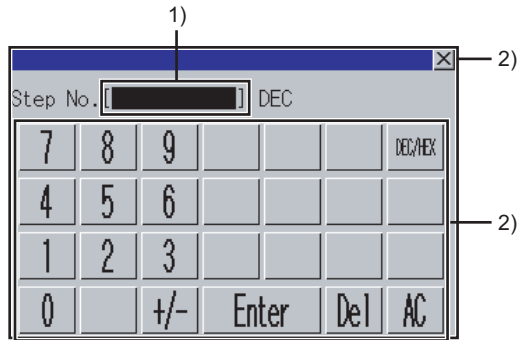

(a) Displayed contents

No.	Item	Description
1)	Jump destination step number input area	Displays the input step number.
2)	Keys	Keys for operations in the jump window shown in (b). (Touch input)

(b) Key functions

Key	Function
	Closes the jump window.
	Displays a row that includes the input step number on the center of the ladder display area.
	Deletes an input value or character.
	Deletes all the input values and characters.

■ Convert menu

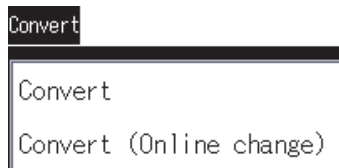

Key	Function	Reference section
Convert	Convert the editing program to the execution program.	-
Convert (Online change)	Convert the editing program to the execution program and execute the online change to controllers.	-

POINT

Precautions for the online change

For the precautions for the online change, refer to the following.

14.2.4 Precautions

Instruction Manual of the controller to use

■ Display menu

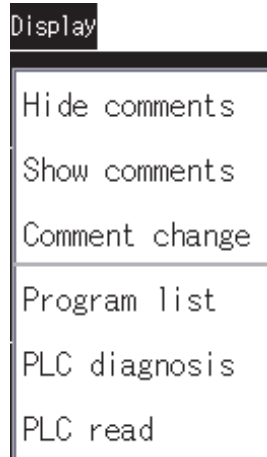

Key	Function	Reference section
Hide comments	Hides the comments, statements or notes in the ladder display area.	14.4.2
Show comments	Displays the comments, statements or notes in the ladder display area.	
Comment change	Displays the comment file list window.	(1)
Program list	Displays the program list window	14.5.2 (2)
PLC diagnosis	Displays the PLC diagnosis screen.	14.7.3 ■Online menu (2)
PLC read	Displays the PLC read screen.	14.5

(1) Comment file list window

The GOT displays the comment file list.

(a) Displayed screen

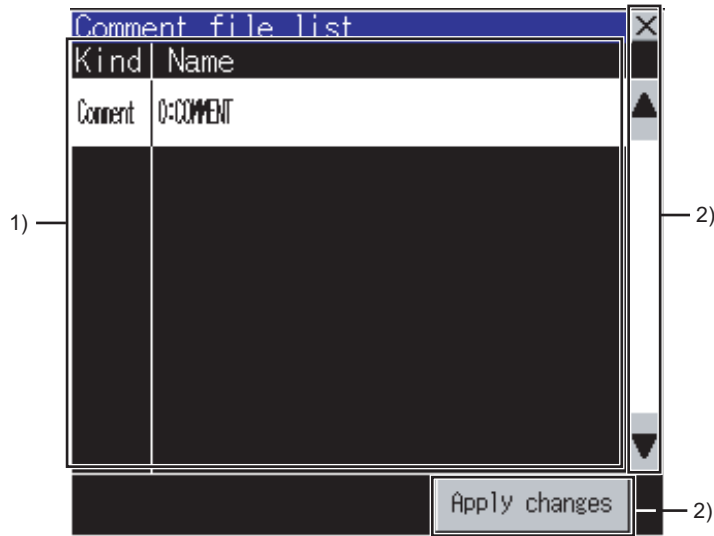

The following table shows the displayed contents.

No.	Item	Description
1)	Comment file list	Among comment files stored in the CF card, the file names and titles of the comment files, and common comment files used for the displayed sequence program are displayed. For switching comments, select a comment file to be used. A selected comment file is highlighted.
2)	Keys	Keys for operations in the comment file list window shown in (b) (Touch input)

(b) Key functions

Key	Function
	Closes the Comment file list window.
	Scrolls the display area up and down by one line.
	Closes the Comment file list window and displays the ladder display area with the comments of the file selected from the comment file list.

(2) Numbers of lines and contacts displayable on the ladder editor screen

The following shows the numbers of lines and contacts that are displayable under the following conditions: no comments are displayed and comments are displayed.

GOT	No comments displayed		Comments displayed	
	Number of lines that can be displayed	Maximum number of contact points displayed	Number of lines displayed	Maximum number of contact points displayed
GT1695M-X GT1595-X	13	11	6	11
GT1685M-S GT1675M-S GT1665M-S GT1585V-S GT1585-S GT1575V-S GT1575-S	9	11	4	11
GT1675M-V GT1675-VN GT1672-VN GT1665M-V GT1662-VN GT1655-V GT1575-V GT1575-VN GT1572-VN GT1565-V GT1562-VN GT1555-V	7	11	3	11

9 SERVO AMPLIFIER MONITOR

10 CNC MONITOR FUNCTIONS

11 BACKUP/RESTORE

12 CNC DATA I/O

13 SFC MONITOR





14 LADDER EDITOR

15 MELSEC-L TROUBLE SHOOTING

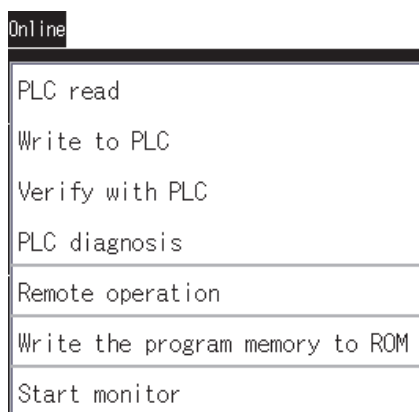
16 LOG VIEWER

■ Online menu



Key	Function	Reference section
PLC read	Displays the PLC read screen.	14.5
Write to PLC	Checks the edited sequence program, and writes the program into the PLC CPU. Set the PLC CPU to the STOP status, and write the program into the PLC CPU. To execute the online change, execute it using the [Convert (Online change)] in the [Convert] menu.  ■Convert menu)	-
Verify with PLC	Verifies the sequence program displayed on the ladder display area and the program in the PLC CPU. If the programs do not match, the Verify result window is displayed.  (1) Verify result window)	(1)
PLC diagnosis	Displays the PLC diagnosis screen.	(2)
Remote operation	Displays the Remote operation window.  (3) Remote operation window)	(3)
Write the program memory to ROM	Displays the Copy program memory data into ROM window.  (4) Copy program memory data into ROM window)	(4)
Start monitor	Displays the Ladder monitor screen.  14.6 How to Operate Ladder Monitor Screen)	14.6

(1) Verify result window

Displaying the result of the program verification with the PLC is available.

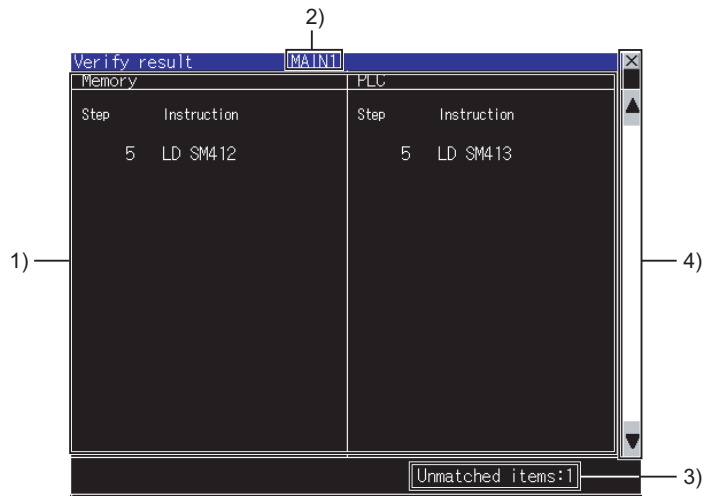

(a) Displayed screen



The following table shows the displayed contents.

No.	Item	Description
1)	Verification result display area	Displays the unmatched items. Up to 100 items are displayed. The program verification is stopped when unmatched items are more than 100.
2)	Program name display area	Displays the file name of the verified program.
3)	Unmatched item count display area	Displays the number of unmatched items displayed on the Verify result window.
4)	Keys	Keys for operations in the Verify result window shown in (b). (Touch input)

(b) Key functions

Key	Function
	Closes the Verify result window.
	Scrolls the display area up and down by one line.

(2) PLC diagnosis window

Displays the PLC diagnosis screen.

(a) Displayed screen



The following table shows the displayed contents.

No.	Item	Description
1)	Error No.	Displays the error number of the destination PLC found by PLC diagnosis. Displays [No errors exist.] when no error occurs.
2)	Error contents	Displays the message corresponding to the error number of the destination PLC.
3)	Occurrence date and time	Displays the error occurrence date and time when an error occurs in the destination PLC.
4)	Program name	Displays the program name when the error in the destination PLC is a program error. If the error is not a program error, [----] is displayed.
5)	Step No.	Displays the sequence step number highlighted in yellow when the error in the destination PLC is a program error. By touching the sequence step number where an error occurs, the PLC diagnosis dialog box will be closed and the screen will be switched to the ladder display. The screen jumps to sequence step number where the error occurs and the area of error is highlighted in a red rectangle. If the error is not a program error, [----] is displayed.

(b) Key functions

Key	Function
	Closes the PLC diagnosis window.

(3) Remote operation window

Changing the operation status of the PLC CPU by using the remote operation is available.

(a) Displayed screen

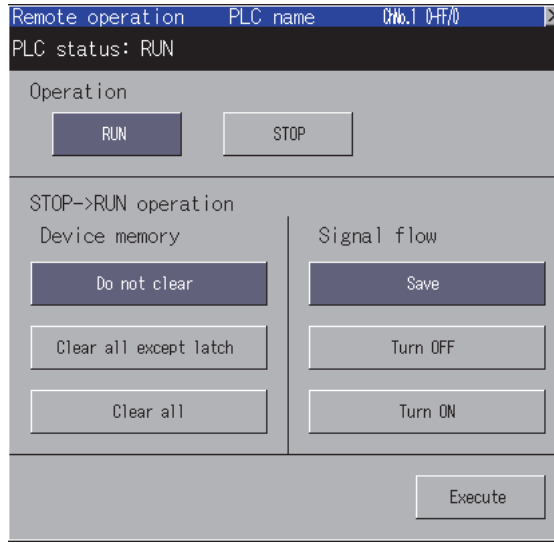

The following table shows the displayed contents.

No.	Item	Description
1)	Operation	Select an operation (RUN or STOP key), and touch the Execute key. RUN : The PLC CPU becomes the remote RUN status. STOP : The PLC CPU becomes the remote STOP status.
2)	STOP → RUN operation	Set the status of devices and signals when executing the remote RUN. Device memory Do not clear : The PLC CPU operates device values prior to the remote STOP. Clear all except latch : Clears all device values to zero except the latched devices. Clear all : Clears all device values to zero. Signal flow Save : Keeps signals prior to the remote STOP, and outputs the signals. Turn OFF : Turns off the signal. Turn ON : Turns on the signal.
3)	Execute	Executes the remote RUN or STOP.

(4) Copy program memory data into ROM window

Writing data in the program memory into a ROM is available.

(a) Displayed screen

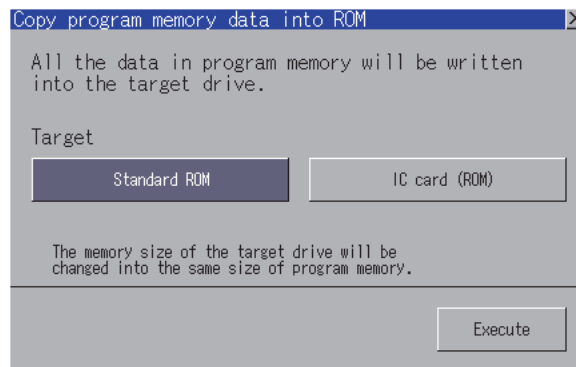



The following table shows the displayed contents.

No.	Item	Description
1)	Target	Touch the target ROM. Standard ROM : Set the standard ROM in the PLC CPU as the target. IC card (ROM) : Set the IC memory card (Flash card) inserted in the PLC CPU as the target.
2)	Execute	Touching the key writes data in the program memory into the target ROM.

14.8 Find/Replace Operation

14.8.1 Device/Contact/Coil search

Ladder blocks including the set devices are searched.
They can be searched continuously in multiple sequence program files.

1. Execute any of the following operations to display the device search window.
 - Touch the [Find] → [Find device]/[Find contact]/[Find coil] menu on the Ladder monitor screen.
 - Touch the [Find/Replace] → [Find device]/[Find contact]/[Find coil] menu on the Ladder editor screen.
2. Set a device to be searched and touch the  /[Enter] key
 - Displayed screen









(For alphabet input)



(For numerical input)

No.	Item	Description
1)	Device input area	Set a device to be searched. Bit device words cannot be specified. The device can be input also by selecting a device on the ladder monitor screen, ladder editor screen, Ladder registration monitor window.
2)	Keys	Keys for operations in the device search window shown in (b).

• Key functions

Key	Function
	Closes the device search window.
	Deletes all the input values and characters.
	Deletes an input value or character.
	Switches the key type to the value.
	Switches the key type to the alphabet.
	Searches the input device in descending order of the step number.
	Searches the input device in ascending order of the step number. If the device is selected on the Ladder monitor screen or Ladder editor screen, the search starts from the selected device.

(Continued to next page)

Key	Function
	<p>Searches the input device in ascending order of the step number.</p> <p>If the device is selected on the Ladder monitor screen or Ladder editor screen, the search starts from the selected device.</p> <p>However, the search starts always from the start of the program in the following conditions.</p> <ul style="list-style-type: none"> • When searching for the first time after the device search window is displayed. • When starting to search consecutively after searching

3. The ladder block which has the searched device is displayed and the device is surrounded with a green frame.

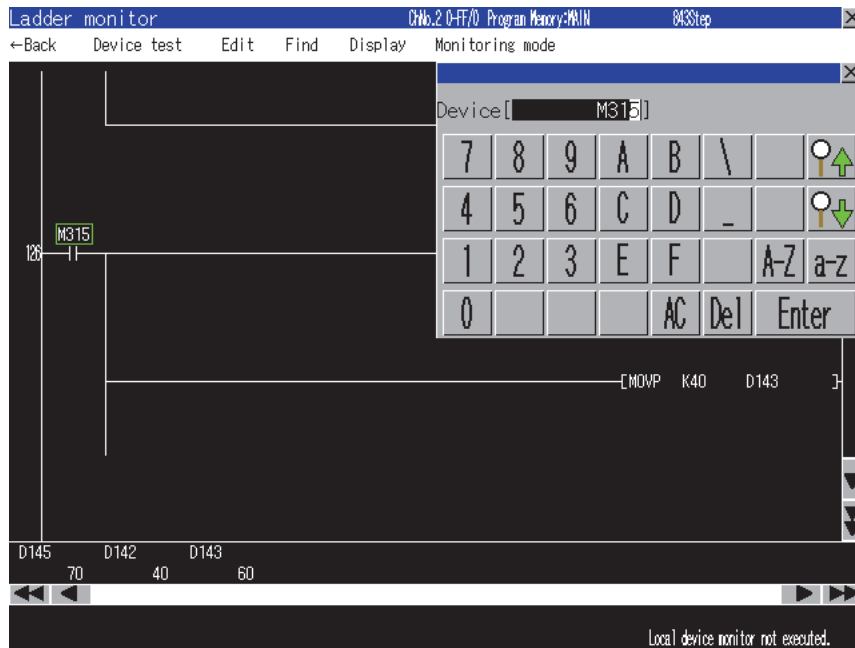

14.8.2 Factor search

The contact point that affected the set device status (ON/OFF) is searched backwards in ladder blocks.

1. Touch the [Find] → [Factor] menu from the Ladder monitor screen to display the factor search window.
2. Set a device to be searched, and touch the [Enter] key
 - Displayed screen



(For alphabet input)



(For numerical input)

No.	Item	Description
1)	Device input area	Set a device to be searched. Bit device words cannot be specified. Also, by selecting a device on the Ladder monitor screen, the device can be input.
2)	Keys	Keys for operations in Factor search window.

• Key functions

Key	Function
	Closes the Factor search window.
	Deletes all the input values and characters.
	Deletes an input value or character.
	Switches the key type to the value.
	Switches the key type to the alphabet.
	By touching the key, the Factor search window is closed and the Ladder registration monitor window is displayed. The search starts from the last step. If the device is selected on the Ladder monitor screen, the search starts from the selected device. When the search is executed, ladder blocks registered in the Ladder registration monitor window are deleted.

The following shows the target instructions and coils for Factor search.

Instruction, coil	Target of the search operation
Instruction	LD, LDI, AND, ANI, OR, ORI
Coil	OUT, OUTH

3. The Factor search window is closed and the Ladder registration monitor window is displayed. The sequence programs displayed on the ladder monitor screen are searched. Then, the factor ladder blocks for the set device are registered in order. The ladder blocks newly registered are always displayed in the Ladder monitor window during the factor search. The factor devices are highlighted.

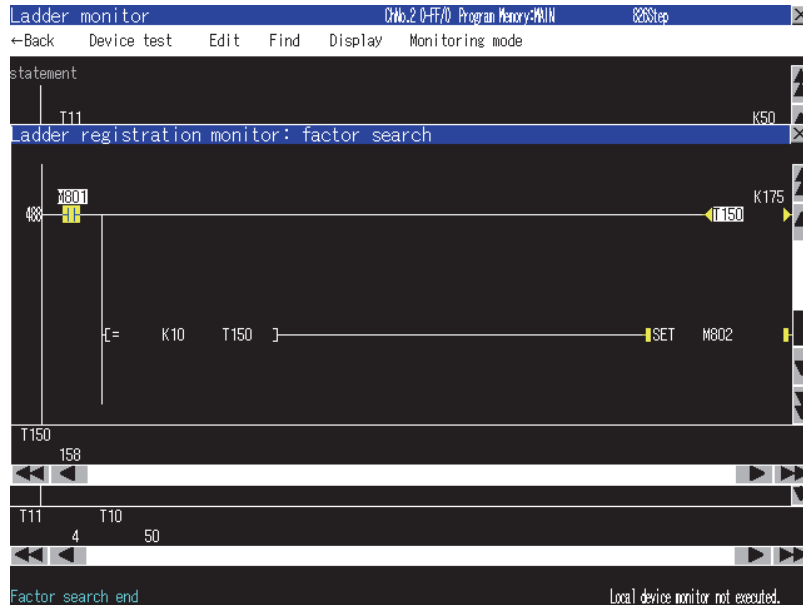

For the Ladder registration monitor window, refer to the following.

 14.6.3 ■Display menu (1) Ladder registration monitor window

4. The message [Factor search is completed.] is displayed in the message area when the search is completed. When closing the Ladder registration monitor window, the factor search mode is released.

POINT

Cancellation of the factor search

(1) When there are multiple factor contacts

The message [Factor search was aborted because there were multiple factor contact points.] is displayed in the message area on the ladder monitor screen.

When continuing the factor search based on the interrupted result, execute the factor search based on one of the found contacts.

(2) When the ladder blocks registered in the Ladder registration monitor window exceed 100

The message [Factor search was aborted because the number of ladder blocks exceeded 100.] is displayed in the message area on the ladder monitor screen.

When restarting the factor search, proceed the factor search based on the contact of the 100th ladder block.

14.8.3 Replace device

1. Touch the [Find/Replace] → [Replace device] menu on the Ladder editor screen to display the Replace device window.
2. Set the current device and new device, and touch the [Enter] key.
 - Displayed screen



(For alphabet input)



(For numerical input)

No.	Item	Description
1)	Current device display area	Set a current device. The device can be input also by selecting a device on the Ladder editor screen.
2)	New device display area	Set a new device. The device can be input also by selecting a device on the Ladder editor screen.
3)	Keys	Displays the keys used in the operation in the Replace device window.

- Key functions

Key	Function
	Closes the Replace device window.
	Touching the key after inputting a current device moves the cursor to the new device display area.
	Switches the key type to the value.
	Switches the key type to the alphabet (uppercase).
	Switches the key type to the alphabet (lowercase).
	Deletes all the input values and characters.
	Deletes an input value or character.
	Replaces the current device to the new device.

3. All the old devices in the sequence programs displayed on the Ladder editor screen are replaced with new devices.

14.8.4 Change open/close contact

1. Touch the [Find/Replace] → [Change open/close contact] menu on the Ladder editor screen to display the Change open/close contact window.
2. Set the device to change the contact and touch the [Enter] key.
 - Displayed screen



(For alphabet input)



(For numerical input)

No.	Item	Description
1)	Device input area	Set a device for changing a normally open contact or a normally closed contact. The item can be set also by selecting in the ladder editor screen.
2)	Keys	Displays the keys used in the operation in the Change open/close contact window.

- Key functions

Key	Function
	Closes the Change open/close contact window.
	Switches the key type to the value.
	Switches the key type to the alphabet (uppercase).
	Switches the key type to the alphabet (lowercase).
	Deletes all the input values and characters.
	Deletes an input value or character.
	Changes a normally open contact or a normally closed contact.

3. The contacts of devices in the sequence program displayed in the Ladder editor screen are changed from A to B or B to A.

14.9 Test Operation

In the device test mode, device values can be changed on the screen. For setting the device test mode, refer to the following.

 14.6.2 Key functions

The test operation of devices is available by touching devices on the following screens in the device test mode.

Screen applicable to device test mode	Reference section
Ladder monitor screen	14.6.2

POINT

Displaying the device test window when setting the security

By setting the security on GT Designer3, the display of the device test window can be limited. For the security setting, refer to the following.

 14.3.4 Setting the security

Touching a device displays the device test window.

(1) When touching bit devices

A bit device is switched between ON and OFF states in the device test window.

(2) When touching word devices

The GOT writes the value input in the device test window into the selected word device.

How to operate device test window

(1) Bit devices

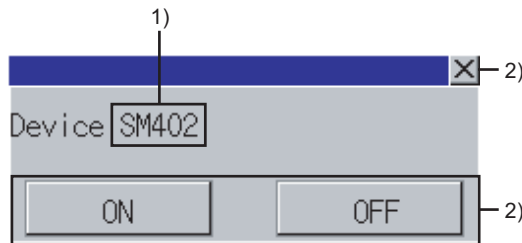

(a) Displayed screen



The following table shows the displayed contents.

No.	Item	Description
1)	Device	Displays the selected device.
2)	Keys	Keys for operations in the device test window shown in (b).

(b) Key functions

Key	Function
	Closes the device test window.
	Turns on the bit device and writes the device state to the PLC CPU.
	Turns off the bit device and writes the device state to the PLC CPU.

(2) Word devices

(a) Displayed screen

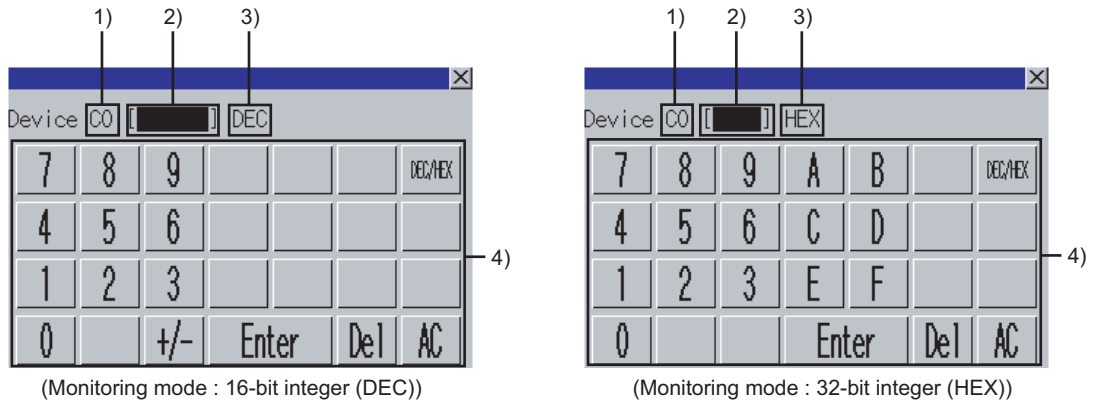

The following table shows the displayed contents.

No.	Item	Description
1)	Device	Displays the selected device.
2)	Device value input area	Set the value to be written into the selected device.
3)	Input mode	Displays the current input mode. (DEC: decimal number. HEX: hexadecimal number)
4)	Keys	Keys for operations in the device test window shown in (b).

(b) Key functions

Key	Function
	Closes the device test window.
	Switches the input modes. (DEC, HEX)
	Writes the value input in the device value input area into the PLC CPU.
	Deletes an input value or character.
	Deletes all the input values and characters.

14.10 Error Messages and Corrective Action

The following shows the error messages for the ladder editor and the corrective actions.

■ Error messages for CF card access

Error message	Description	Corrective action
File access error. Confirm the CF card.	<ul style="list-style-type: none"> No CF card is inserted in the GOT. The CF card access switch is off. A CF card with a format error is inserted in the GOT. The CF card has insufficient free space for writing a file. The folder for the ladder editor function in the CF card is write-protected. 	<ol style="list-style-type: none"> Insert a CF card without a format error in the GOT. If the CF card access switch is off, turn on the switch. Delete files in the CF card. Insert a CF card with a large capacity. Cancel the write-protect setting for the folder that is used for the ladder editor function in the CF card.
Failed to write (file name) to CF card. Confirm the CF card.	<ul style="list-style-type: none"> No CF card is inserted in the GOT. The CF card access switch is off. A CF card with a format error is inserted in the GOT. The CF card has insufficient free space for writing a file. The folder for the ladder editor function in the CF card is write-protected. 	<ol style="list-style-type: none"> Insert a CF card without a format error in the GOT. If the CF card access switch is off, turn on the switch. Delete files in the CF card. Insert a CF card with a large capacity. Cancel the write-protect setting for the folder that is used for the ladder editor function in the CF card.
Failed to save files because of an insufficient capacity of CF card.	The CF card has insufficient free space for writing a file.	<ol style="list-style-type: none"> Delete files in the CF card. Insert a CF card with a large capacity.
The file (file name) is broken. The file is unselected.	The read file in the CF card is corrupted.	Read the file from the PLC CPU again.
The file (file name) is broken. Perform PLC Read and read the file again.	<ul style="list-style-type: none"> The temporary file used on the Ladder editor screen or the Ladder monitor screen in the CF card is corrupted. The writing of files into CF card is failed due to an insufficient capacity of CF card. 	<ul style="list-style-type: none"> Read the file from the PLC CPU again. Delete unnecessary files in the CF card. Or insert a CF card with a larger free space.
The file (file name) is broken. Please read the file in the program list again.	The temporary file used on the Ladder editor screen or the Ladder monitor screen in the CF card is corrupted.	Select the program displayed in the Program list window again.
The file (file name) is broken.	When searching for devices in an undisplayed program, a file in the CF card is corrupted.	Read the file from the PLC CPU again.
Failed to check program. Confirm the CF card.	The GOT cannot access the temporary file in the CF card during a program check.	<ol style="list-style-type: none"> Insert a CF card without a format error in the GOT. If the CF card access switch is off, turn on the switch. Delete files in the CF card. Insert a CF card with a large capacity. Cancel the write-protect setting for the folder that is used for the ladder editor function in the CF card.
Failed to verify with PLC. Please check the CF card.	The GOT cannot access the temporary file in the CF card during the PLC program verification.	<ol style="list-style-type: none"> Insert a CF card without a format error in the GOT. If the CF card access switch is off, turn on the switch. Delete files in the CF card. Insert a CF card with a large capacity. Cancel the write-protect setting for the folder that is used for the ladder editor function in the CF card.
Parameter file is corrupted. Please restart the ladder editor.	The parameter file in the CF card is corrupted.	Exit the ladder editor function, and then start the function again.

■ Error messages for communication

Error message	Description	Corrective action
Failed to communicate with CPU.	The GOT cannot communicate with the PLC CPU.	(1) Check the line status between the GOT and the PLC CPU, and make the GOT communicate with the PLC CPU. (2) Check if the PLC CPU supports the ladder editor function.
Failed to communicate with CPU.	The GOT cannot communicate with the PLC CPU.	Check the line status between the GOT and the PLC CPU, and make the GOT communicate with the PLC CPU.
Failed to get the information of CPU because of bad connection.	The GOT cannot communicate with the PLC CPU.	Check the line status between the GOT and the PLC CPU, and make the GOT communicate with the PLC CPU.
Failed to get the information.	<ul style="list-style-type: none"> The GOT cannot communicate with the PLC CPU. A file with faulty file name is selected. 	<ul style="list-style-type: none"> Check the communications between the GOT and PLC CPU, and make sure that the GOT communicates with the PLC CPU. Select the file after changing the message display language to one which can display the file name in the utility. Change the file name with GX Developer.
The CPU protect switch is ON. Turn OFF the protect switch.	<ul style="list-style-type: none"> The system protect switch of the PLC CPU is on. The PLC CPU is in the boot process. 	(1) Turn off the system protect switch of the PLC CPU. (2) Wait until the boot process of the PLC CPU is completed.
The CPU is not in STOP mode. Please change the CPU to STOP mode.	Any operation that the PLC CPU cannot execute during running is performed.	Set the PLC CPU to the STOP status.
CPU drive error. Please confirm the drive status.	The target drive does not function.	Format the target drive by using GX Developer.
The specified file does not exist in the CPU. Please confirm the file in the drive.	The specified file does not exist in the PLC CPU.	Check files in the specified drive of the PLC CPU.
The specified file in the CPU is invalid. Please confirm the file in the drive.	The specified file in the PLC CPU is corrupted.	Delete the specified file by using GX Developer, and then create the file again.
The file cannot be accessed while it is being accessed by other connected equipment or it is being transferred.	<ul style="list-style-type: none"> Other GOTs or GX Developer access the connected PLC CPU. The QCPU transfers program files from the program cache memory to the program memory. 	<ul style="list-style-type: none"> Access the file when other devices do not access the connected PLC CPU. Access the file after QCPU completes the transference from the program cache memory to the program memory.
The data cannot be written to the specified CPU because the total data size may exceed the drive capacity.	The specified drive of the PLC CPU runs out of space.	Reduce the capacity of the file to be written.
The specified file is invalid.	The specified file in the PLC CPU is corrupted.	Format the target drive by using GX Developer, and then write the specified file.
There is no consecutive free space in the drive of the specified CPU. Please clean up the drive.	The specified drive of the PLC CPU does not have consecutive free space.	Execute [Arrange PLC memory] with GX Developer.
Failed to write data to the specified CPU. Please check if the target flash ROM has an error or not.	An error occurs when writing/deleting data to/from the specified drive of the PLC CPU.	Check the specified drive by using GX Developer.
The specified file does not exist.	The specified drive or file does not exist in the PLC CPU.	Read data from the PLC, and check if the specified drive exists.
The file (file name) does not exist. Please check if the file exists using PLC Read.	When reading data from the PLC, the program file corresponding to the specified program on the ladder display area does not exist in the PLC CPU.	Read data from the PLC, and check if the specified file exists.
The specified CPU drive has an error. Please check the drive.	The specified drive of the PLC CPU is faulty.	(1) Execute [Format PLC memory] with GX Developer. (2) If the specified drive is the flash ROM, write data to the PLC (flash ROM) again.
The specified file is under processing.	The specified drive of the PLC CPU is in use.	Execute the same operation later.
Invalid password.	The password to access the specified file is incorrect.	Input the correct password.

(Continued to next page)

Error message	Description	Corrective action
The specified CPU drive is write-protected.	Data is written to the write-protect drive of the PLC CPU.	Cancel the write-protect setting for the specified drive of the PLC CPU.
Too many files are being accessed at the same time.	Other devices are accessing too many files in the PLC CPU at the same time.	Reduce the number of files being accessed by other devices.
The specified CPU drive cannot be accessed.	The specified drive does not exist in the PLC CPU.	Read data from the PLC, and specify a drive that exists in the PLC CPU.
Failed to access the specified CPU drive. Please check the drive status.	<ul style="list-style-type: none"> No memory card is inserted in the specified drive of the PLC CPU. The memory card is faulty. 	<ol style="list-style-type: none"> Insert a memory card in the specified drive of the PLC CPU. Format the memory card in the specified drive by using GX Developer.
The specified CPU drive has an error. Please check the drive status.	The specified drive in the PLC CPU does not function.	Format the specified drive by using GX Developer.
The specified CPU drive is not formatted.	The specified drive of the PLC CPU is not formatted.	Format the specified drive by using GX Developer.
CPU memory card is not inserted.	No memory card is inserted in the specified drive of the PLC CPU.	Insert a memory card in the specified drive.
The type of the CPU memory card is wrong. Please check the memory card.	<ul style="list-style-type: none"> An unsupported memory card is inserted in the specified drive of the PLC CPU. No memory card is inserted in the specified drive of the PLC CPU. 	Insert a supported memory card in the specified drive.
The CPU is write protected. Please remove the protection.	The PLC CPU is write-protected.	Cancel the write-protect setting for the PLC CPU.
The specified CPU drive cannot be used. Please check the drive.	The specified drive of the PLC CPU does not exist.	Read data from the PLC, and check if the specified drive exists.
PLC types of the program (file name) and the connected PLC are not the same. Perform PLC Read and read the data again.	The PLC CPU type of the program file stored in the CF card differs from the connected PLC CPU type.	Read a program file that exists in the PLC CPU.
The program before modification on the GOT and the program being registered on the CPU do not match. Please perform PLC Read and read the program again.	When a program is written into the PLC, the target file does not exist in the PLC CPU, or the type of the program differs from that of the target file.	Read a program file that exists in the PLC CPU
Failed to write the value to the device.	The GOT cannot write device values to the PLC CPU with the device test.	Read the program being displayed from the PLC again.
Parameter file is corrupted. The ladder editor cannot be used.	The GOT cannot read parameters from the PLC CPU.	Write the parameters to the PLC CPU by using GX Developer.
The file has invalid date or timestamp. Please check the GOT clock data.	<ul style="list-style-type: none"> The date of the GOT is wrong. PC writing or online change is executed to Q00JCPU, Q00CPU, or Q01CPU when the date of the GOT is Feb. 29th. 	<ul style="list-style-type: none"> Set the date of the GOT properly. When executing PC writing or online change to the Q00JCPU, Q00CPU, or Q01CPU, set the date of the GOT other than Feb. 29th.
Communication of the online debug function failed.	Communication of the online debug function failed.	<ul style="list-style-type: none"> Execute after registering the online debug function (online change, trace, monitor with conditions, etc.) in GX Developer. Execute after confirming the communication path such as communication cables.
Specified contents of the online debug function are invalid.	Specified contents of the online debug function are invalid.	<ul style="list-style-type: none"> Execute after registering the online debug function (online change, trace, monitor with conditions, etc.) in GX Developer. Execute after confirming the communication path such as communication cables.
An error occurred when verifying the specified program and the program in the CPU. Please read the file again.	The sequence program after modification of the online change operation differs from the program before modification.	Execute the online change after executing PLC read to equalize the sequence program of the GOT and PLC CPU by PLC read.

(Continued to next page)

Error message	Description	Corrective action
END instruction cannot be written to a CPU module while the module is running.	The END instruction is inserted or deleted by the online change.	<ul style="list-style-type: none"> • Check the contents of the specified sequence program file. • Write the program after setting the PLC CPU to the stop status.
Reserved area for online change is insufficient. Online change cannot be performed.	The file capacity is exceeded by the online change.	<ul style="list-style-type: none"> • Check the capacity of the specified sequence program file. • Write the program after setting the PLC CPU to the stop status.
There are instructions that cannot be handled in the CPU.	An instruction, which is not compatible with the CPU type set in the project, exists in the sequence program executing the online change.	<ul style="list-style-type: none"> • Check if the PLC CPU type is correct. • Check the sequence program and delete the invalid instruction.
The step to be written is invalid.	<ul style="list-style-type: none"> • The step to be written is invalid. • The start position of the online change was not specified with a correct program step No. 	<ul style="list-style-type: none"> • Write the program after setting the PLC CPU to the stop status. • Check if the GX Developer is compatible with the CPU type and CPU version set in the project.
The instruction that was written during online change is invalid.	The instruction of the online change is wrong.	<ul style="list-style-type: none"> • Execute the online change again. • Write the program after setting the PLC CPU to the stop status.
The number of blocks to be written by online change is invalid.	Block size error (The number of the online change is invalid.)	Check the number of the block for the online change.
The specified file is too large to read.	A program file exceeding 260k steps was read.	Split the program to sections within 260k steps.

■ Error messages for editing

Error message	Description	Corrective action
The instruction is incorrect.	The input instruction is incorrect.	Input the correct instruction.
The specified device is not available.	The input device name is incorrect.	Input the correct device name.
The device number is out of range.	The device number outside the range is input.	Input the correct device number.
Too many rows are being edited. Data cannot be entered.	On the edited ladder, 49 or more rows are input.	Delete rows to be 48 or less per edited ladder.
The ladder block is too large. Data cannot be entered.	On a ladder block, 25 or more rows are input.	Delete rows to be 24 or less per ladder block.
The edit position is incorrect.	<ul style="list-style-type: none"> • A specified position is incorrect to input a ladder. • A space of a specified position is too narrow to input a ladder. • A start position and end position are not specified in the same column to input a vertical line. • An end position is specified in an upper row of the start position to input a vertical line. • A start position and end position are not specified in the same row to input a horizontal line. • A start position and end position are not specified in the same row to delete a ladder. 	<ol style="list-style-type: none"> (1) Input a ladder in a correct position. (2) Insert columns, and then input a ladder. (3) Specify a correct end position for a vertical line or horizontal line, and then input the line. (4) Specify a correct end position, and then delete a ladder.
Line statements exist in the ladder program and the data cannot be edited. Please delete the line statements from the ladder program.	A vertical line that overlaps an interlinear statement is input.	Delete the interlinear statement, and then input a vertical line.
PI devices exist in the ladder program and the data cannot be edited. Please delete the PI devices from the ladder program.	A vertical line that overlaps a pointer or interrupt pointer is input.	Delete the pointer or interrupt pointer, and then input a vertical line.

(Continued to next page)

Error message	Description	Corrective action
There is a ladder block which cannot be displayed in the ladder program. Data cannot be edited.	<ul style="list-style-type: none"> On a ladder block, 25 or more rows are edited. An incomplete ladder block is edited. 	(1) Edit the ladder block in 24 rows or less by using GX Developer, and then write the program into the PLC CPU. (2) Write the program into the PLC CPU by using GX Developer again because the program may be corrupted.
Statements should be 64 characters or less.	A statement with 65 characters or more was entered.	Enter statements with 64 characters or less.
Notes should be 32 characters or less.	A note with 33 characters or more was entered.	Enter notes with 32 characters or less.
Conversion (online change) failed due to communication error.	The GOT fails to communicate with the PLC during conversion (online change).	<ul style="list-style-type: none"> Check the communication setting. Check cables. Verify with PLC. Operate the GOT for reading the program from the PLC.
Peripheral statements cannot be entered.	A peripheral statement was entered.	Delete the peripheral statement.
Peripheral notes cannot be entered.	A peripheral note was entered.	Delete the peripheral note.

■ Error messages for conversion

Error message	Description	Corrective action
The data being edited is too large. Please reduce the data being edited.	Too many ladders are not converted. The data cannot be converted.	Reduce the ladders which are not converted before conversion.
There is a ladder which cannot be converted. Correct the ladder at the cursor position.	When a ladder block is converted, the ladder block is not completed.	Complete the ladder block, and then convert the ladder block.
The ladder block is too large to convert. Please reduce the size of the ladder block.	Too large ladder blocks are not converted. The data cannot be converted.	Delete or split the ladder block before conversion.

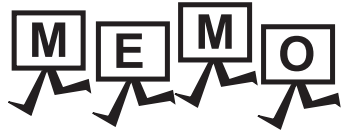

15. MELSEC-L TROUBLESHOOTING



15.1 Features

MELSEC-L troubleshooting enables you to display the status and errors of the LCPU connected to the GOT and the errors of the GOT.

In addition, you can start the ladder monitor or others from the MELSEC-L troubleshooting screen.

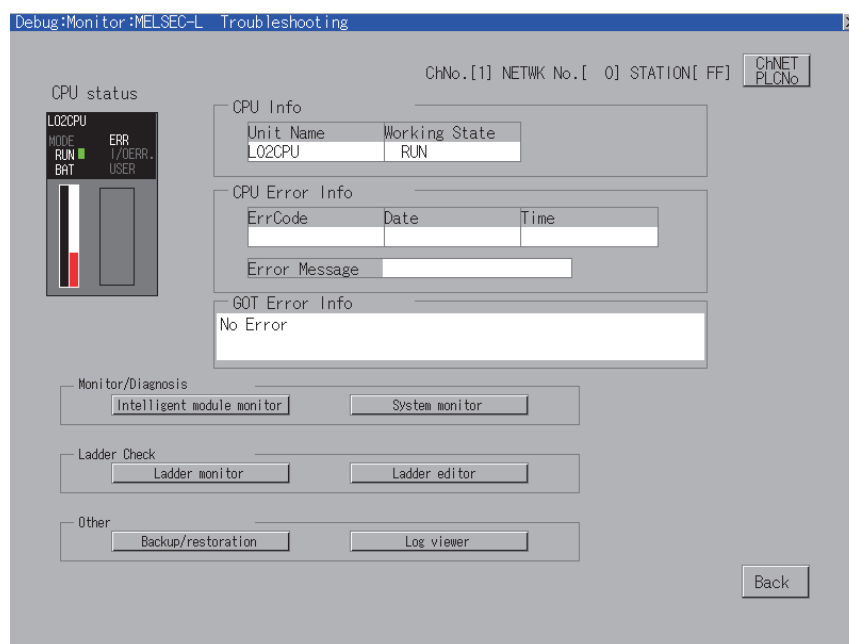

15.2 Specifications

15.2.1 System configuration

This section describes the system configuration of the MELSEC-L troubleshooting.

For connection type settings and precautions regarding the communication unit/cable and connection type, refer to the following.

 GOT1000 Series Connection Manual (Mitsubishi Products) for GT Works3

■ Target controller

Controller
LCPU

■ Connection type

This function can be used in the following connection types.

(○: Available, ×: Unavailable)

Function		Connection type between GOT and LCPU				
Name	Description	Direct CPU connection	Computer link connection	Ethernet connection ^{*4}	CC-Link connection	
					ID ^{*1}	G4 ^{*2}
MELSEC-L troubleshooting	Displays the status and errors of the LCPU and starts various monitor functions.	○ ^{*3}	○	○	○	○

*1 Indicates CC-Link connection (Intelligent device station).

*2 Indicates CC-Link connection (via G4).

*3 When the GOT is connected to LCPU, use L6ADP-R2.

*4 MELSEC-L troubleshooting cannot be used when using CC-Link IE field network Ethernet adapter.

■ Required Extended function OS

The following extended function OS is required.

 1.1.2 Hardware and OS' required for each function

(1) Extended function OS

Install the extended function OS of MELSEC-L troubleshooting on the GOT.

For the installation procedure, refer to the following.

 GT Designer3 Version1 Screen Design Manual (Fundamentals) 8. COMMUNICATION WITH GOT

(2) Option OS

For installing the extended function OS, the available space shown in the above table is required in the user area.

For the procedure for checking the available memory space of the user area and information about the data using other user areas, refer to the following.

 GT Designer3 Version1 Screen Design Manual (Fundamentals) 8. COMMUNICATION WITH GOT

15.2.2 Access range

■ When using direct CPU connection/computer link connection

The LCPU of the host station can be monitored.

■ When using Ethernet connection

The LCPU of the host and other stations can be monitored.

■ When using CC-Link connection (Intelligent device station/via G4)

The LCPU of the master and local stations can be monitored.

15.3 Operation for Display

This section describes the flow until the MELSEC-L troubleshooting operation screen is displayed, after the MELSEC-L troubleshooting (Option OS) is installed in the GOT.

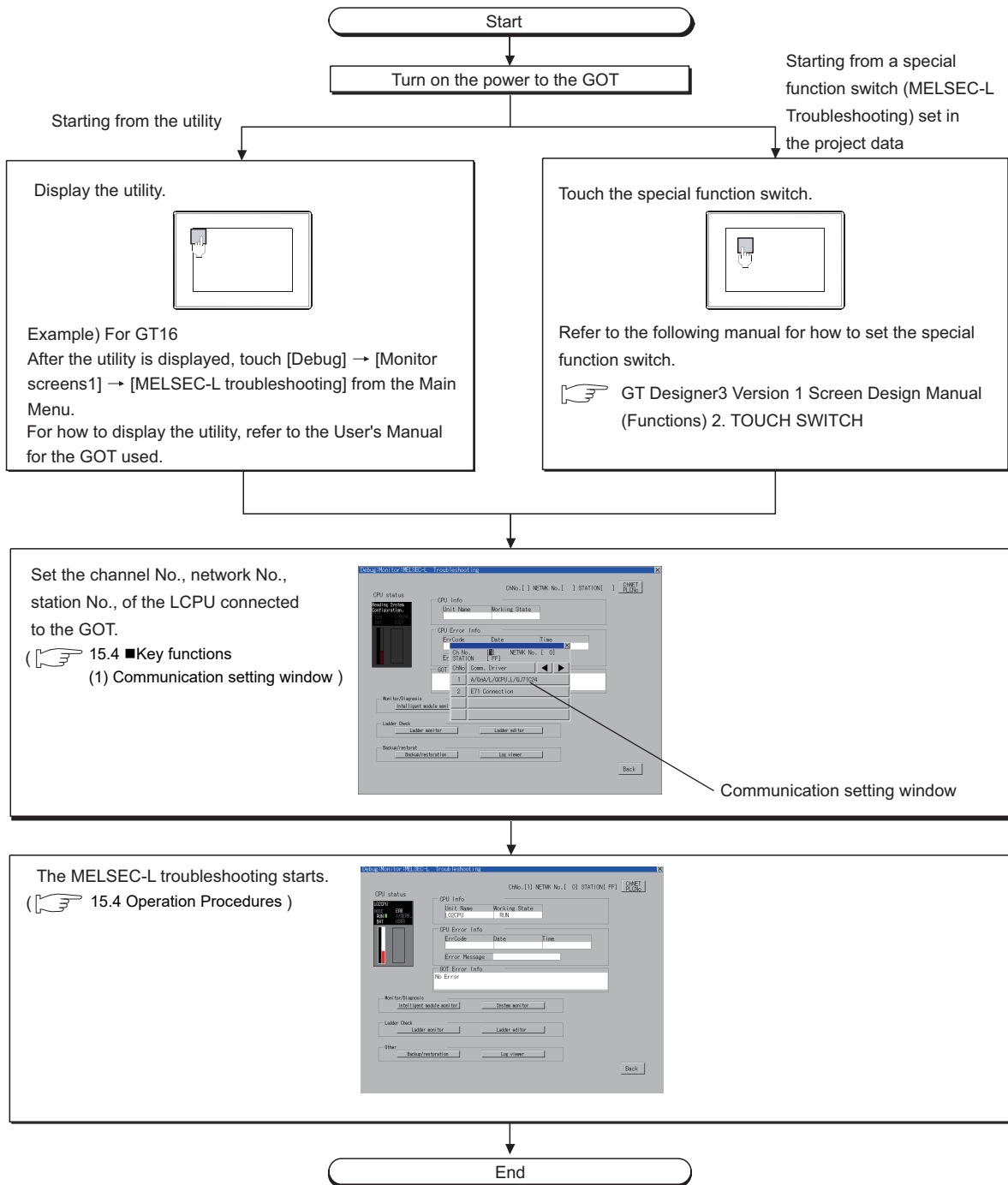

POINT

(1) How to display the utility

For how to display the utility, refer to the following.

 User's Manual for the GOT used

(2) Displaying communication setting window

After turning on the GOT, the communication setting window is displayed at the first startup of the MELSEC-L troubleshooting only.

For displaying the communication setting window at the second or later startup, touch the  button on the MELSEC-L troubleshooting screen.

 15.4 Operation Procedures

(3) If the project data has not been downloaded

The MELSEC-L troubleshooting can be started from the utility even if the project data has not been downloaded to the GOT.

Changing screens

This section describes how to change the screen.

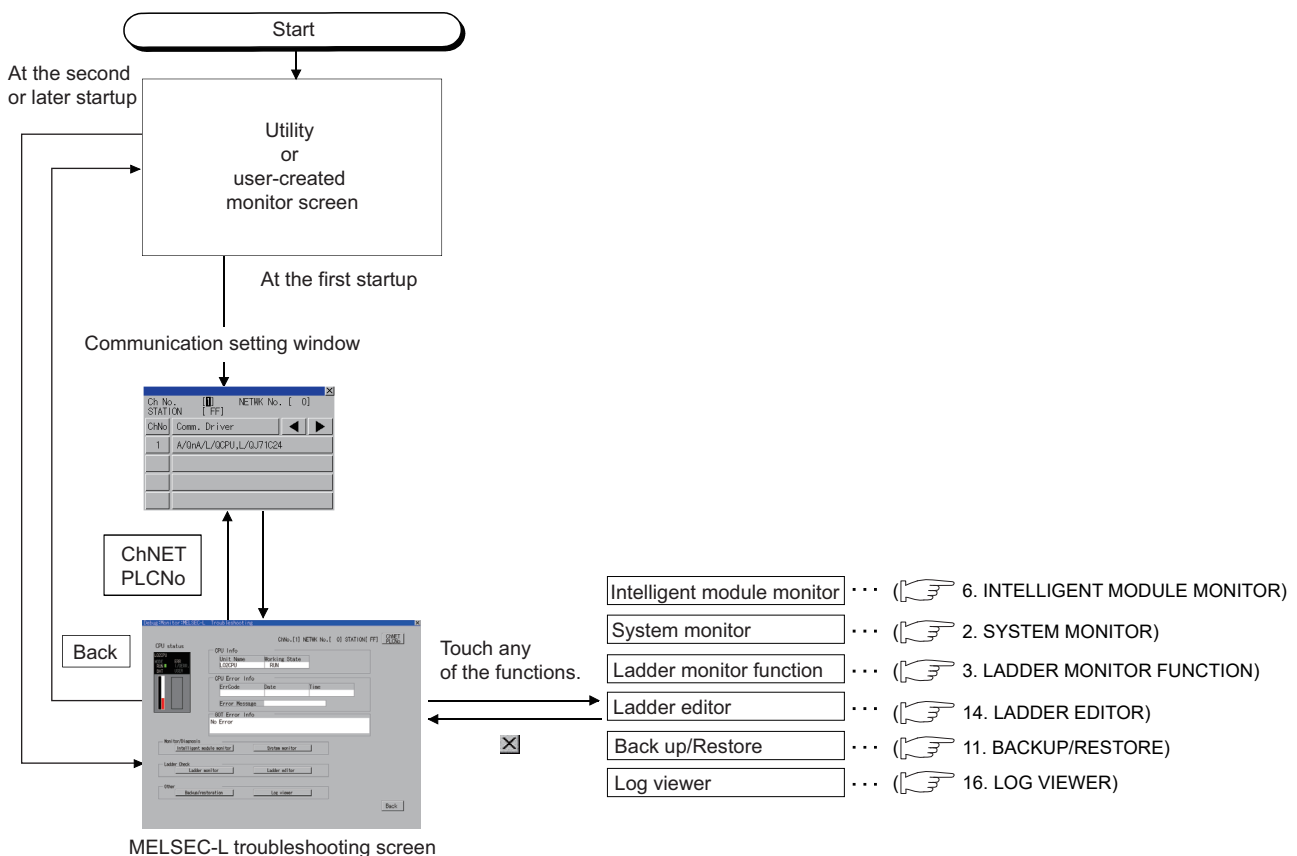

15.4 Operation Procedures

This section describes the display details for the MELSEC-L troubleshooting and the functions of the keys displayed on the screen.

■ Displayed contents

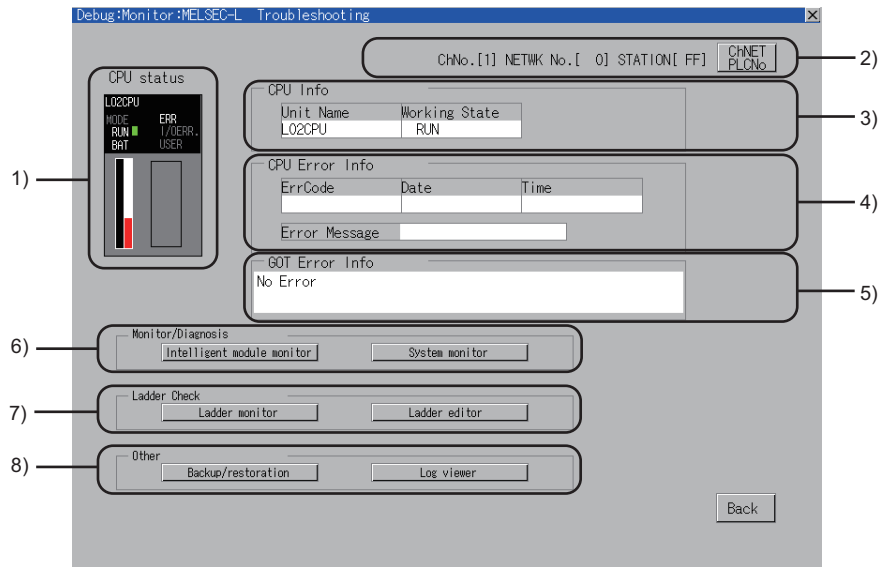

No.	Item	Display contents
1)	CPU status	Displays the LCPU status. (Only LED of BAT, RUN, and ERR is lit.) The LED on the screen and the LED display on the PLC body may not match depending on the error status.
2)	Channel information	Displays the set channel number, network number, and station number.
3)	CPU Info	Displays the model and the operation status of the LCPU.
4)	CPU Error Info	Displays error information of the LCPU.
5)	GOT Error Info	Displays error information of the GOT. The alarm can be canceled with the [Reset] button on the System alarm display screen. 👉 User's Manual for the GOT used
6)	Monitor/Diagnosis	Displays buttons to start the intelligent module monitor and system monitor.
7)	Ladder Check	Displays buttons to start the ladder monitor and ladder editor.
8)	Backup/restoration	Displays buttons to start the backup/restore and log viewer.

■ Key functions

Key	Function
	Displays the communication setting window. 👉 (1) Communication setting window
	Starts the intelligent module monitor. 👉 6. INTELLIGENT MODULE MONITOR
	Starts the system monitor. 👉 2. SYSTEM MONITOR
	Starts the ladder monitor. 👉 3. LADDER MONITOR FUNCTION
	Starts the ladder editor. 👉 14. LADDER EDITOR
	Starts the backup/restore. 👉 11. BACKUP/RESTORE
	Starts the log viewer. 👉 16. LOG VIEWER
	Closes the MELSEC-L troubleshooting and returns the screen to the one for starting the MELSEC-L troubleshooting.

(1) Communication setting window

(a) Display monitor

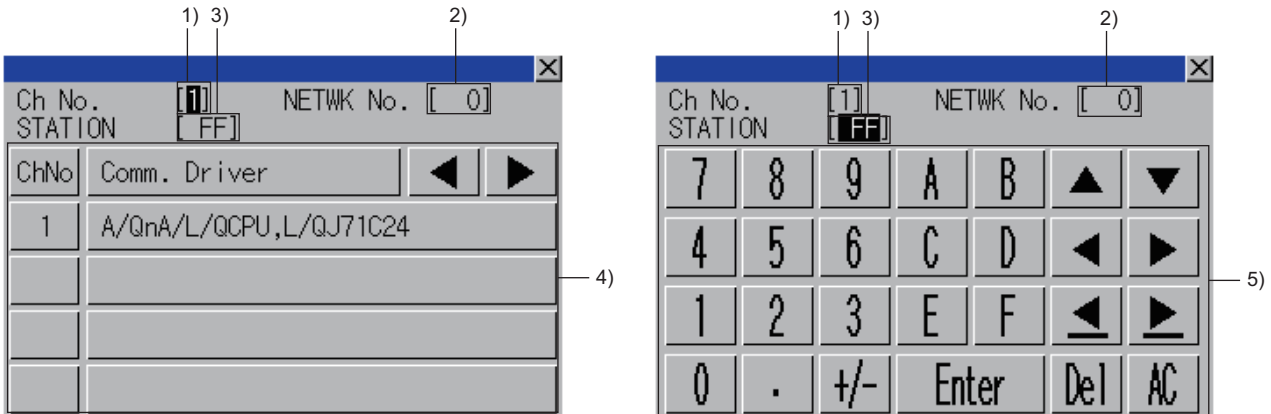

The information shown in the table below is displayed.

No.	Item	Display contents
1)	CH No. input area	Set the CH No. for the target controller.
2)	Network No. input area	Set the network No. for the target controller.
3)	Station No. input area	Set the station No. of the target controller. When the station No. is set to the host station (FF), set the network No. to 0.
4)	CH No. selection key	Select a CH No.
5)	Keys	Displays the keys used in the operation in the communication setting window.

(b) Key functions

Key	Function
	Closes the communication setting window. When any of the CH No., network No., and station No. is not input and the monitor target is not set, the communication setting window does not close.
	Moves the cursor among the input areas.
	Deletes all the input values and characters.
	Deletes an input value or character.
	Moves the cursor when the cursor is in the CH No. input area, network No. input area, or station No. input area.

15.5 Error Messages and Corrective Action

The following shows the error messages for the MELSEC-L troubleshooting and the corrective actions.

Error message	Description	Corrective action
Communications error	Communication could not be established with the PLC CPU.	Connections between the PLC CPU and the GOT (disconnected or cut cables). Has an error occurred in the PLC CPU?

16. LOG VIEWER



16.1 Features

With the log viewer function, the GOT displays the logging data acquired from the high speed data logger module, the PLC CPU, and the BOX data logger, and controls the files. The features of the log viewer are shown below.

■ Displaying logging data without a personal computer

- Using the log viewer function, the logging data stored in the CF card attached to the high speed data logger module or the BOX data logger, or the SD card attached to the PLC CPU is viewed on the GOT.
- The logging data can be stored in a CF card or USB memory attached to the GOT, and displayed on the GOT.

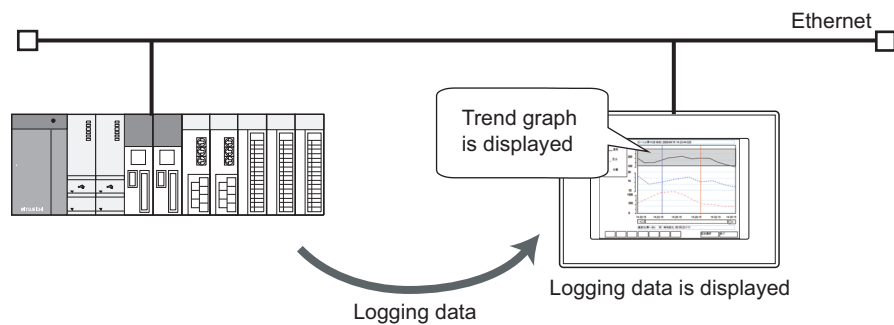

■ Logging data can be retrieved from GOT

The logging data acquired from the high speed data logger module, the PLC CPU, and the BOX data logger can be retrieved from the GOT to the personal computer.

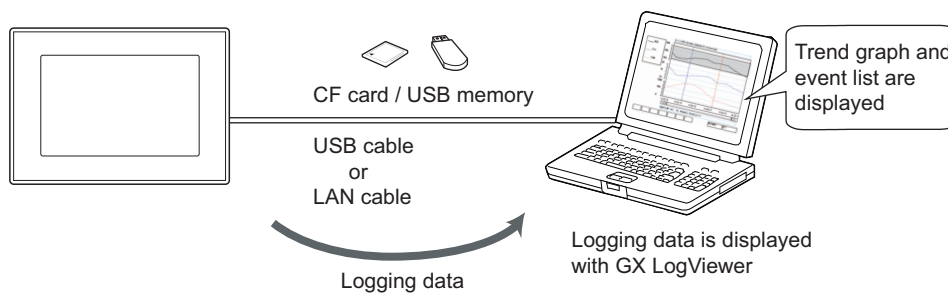

16.2 Specifications

16.2.1 System configuration

This section describes the system configuration of the log viewer.

■ Target controller

(1) High Speed Data Logger Module

Model
QD81DL96

(2) PLC CPU

PLC
LCPU* ¹ , QnUDVCPU

*1 L02SCPU and L02SCPU-CM are not available.

(3) BOX Data Logger

Model
NZ2DL

■ Connection type

This function can be used in the following connection types.

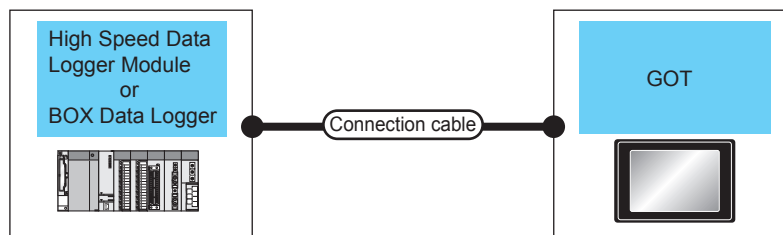

PLC		Connection cable* ¹	Max. distance* ³	GOT		Number of connectable equipment
Model	Connection type			Option device	Model	
QD81DL96* ⁴	Ethernet connection	Shielded twisted pair cable (STP), Unshielded twisted pair cable (UTP) Category 3, 4 and 5	100m	- (Built into GOT)	GT16* ²	16 GOTs
LCPU* ⁵						
QnUDVCPU* ⁵						
NZ2DL* ⁶						

*1 The destination connected with the twisted pair cable varies with the configuration of the applicable Ethernet network system. Connect to the Ethernet module, hub, transceiver or other system equipment corresponding to the applicable Ethernet network system.

Use cables, connectors, and hubs that meet the IEEE802.3 10BASE-T/100BASE-TX standard.

*2 When connecting GT16 of the function version A to an equipment that meets the 10BASE (-T/2/5) standard, use the switching hub and operate in a 10Mbps/100Mbps mixed environment. For how to check the function version, refer to the following.

☞ User's Manual for the GOT used

*3 A length between a hub and a node.

*4 For the system configuration of high speed data logger module, refer to the following manual.

☞ High Speed Data Logger Module User's Manual

*5 For the system configuration of the PLC CPU with the built-in Ethernet interface, refer to the following manual.

☞ MELSEC-L CPU Module User's Manual (Built-In Ethernet Function)

QnUCPU User's Manual (Communication via Built-in Ethernet Port)

*6 For the system configuration of the BOX data logger, refer to the following manual.

☞ BOX data logger User's Manual

■ Required hardware

A CF card or a USB memory is necessary in the following cases.

- Displaying or managing logging data stored in a memory card/USB memory
- Reading out and displaying logging data of 4MB or more from the controller

16.2.2 GOT Side Settings

■ Setting communication interface

To use the log viewer function, [GOT IP Address] must be set in any of the following procedures.

Setting method	Reference section
Set [Destination I/F] of [Ethernet Download] in the [PC (Data Transfer)] dialog box.	GT Designer3 Version1 Screen Design Manual (Fundamentals) 8. COMMUNICATION WITH GOT
Set the Ethernet driver in [Driver] in the [Controller Setting] dialog box.	GOT1000 Series Connection Manual (Mitsubishi Products) for GT Works3 1.1.1 Setting connected equipment (Channel setting)
Select [Communication Setting] of [Gateway] in the [Controller Setting] dialog box and select the [Use the function of Gateway] check box.	GT Designer3 Version1 Screen Design Manual (Fundamentals) 8. COMMUNICATION WITH GOT

After completing the setting on GT Designer3, install the required OS to the GOT.

■ Required Extended function OS

The following extended function OS is required.

 1.1.2 Hardware and OS' required for each function

(1) Extended function OS

Install the extended function OS of log viewer to the GOT.

For the installation procedure, refer to the following.

 GT Designer3 Version1 Screen Design Manual (Fundamentals) 8. COMMUNICATION WITH GOT

(2) OS memory space

For installing the extended function OS, the available space shown in the above table is required in the user area.

For the procedure for checking the available memory space of the user area and information about the data using other user areas, refer to the following.

 GT Designer3 Version1 Screen Design Manual (Fundamentals) 8. COMMUNICATION WITH GOT

16.2.3 Access range

The high speed data logger module, the PLC CPU module, or the BOX data logger which is connected to the GOT via the HUB using the Ethernet cable, can be monitored.

Monitoring via the Internet cannot be performed.

For details of the high speed data logger module, refer to the following.

 High Speed Data Logger Module User's Manual

For details of the PLC CPU module, refer to the following.

 MELSEC-L CPU Module User's Manual (Built-In Ethernet Function)

QnUCPU User's Manual (Communication via Built-in Ethernet Port)

16.2.4 Precautions

(1) Display screen

When displaying log viewer on GT1675-VN, GT1672-VN, or GT1662-VN, the visibility of the screen may be affected by the color combination.

(2) Handling CF card/USB memory during the access

Do not remove the CF card/USB memory and do not turn off the CF card access switch during the access. Doing so may damage files in the GOT or in the CF card/USB memory.

(3) Connection to the PLC CPU

To use the log viewer function using the PLC CPU, [FTP Setting] is required on the PLC CPU.

The FTP setting method for GX Works2 is described below.

For details of GX Works2, refer to the following.

 GX Works2 Version1 Operating Manual (Common)

MELSEC-L CPU Module User's Manual (Built-In Ethernet Function)

QnUCPU User's Manual (Communication via Built-in Ethernet Port)

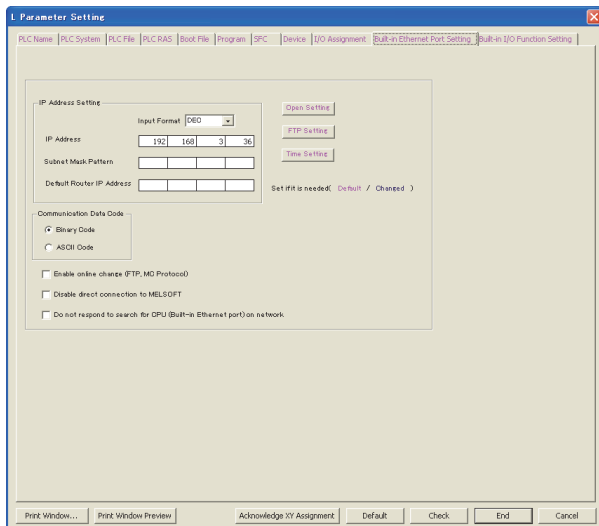

1. Click the [Built-in Ethernet Port setting] tab in the [L Parameter setting] window.

2. Click the [FTP Setting] button.

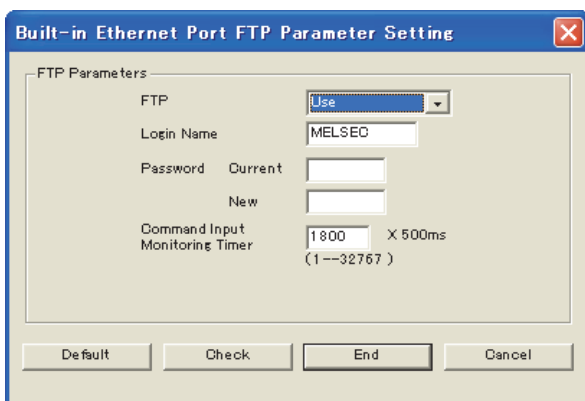

3. Switch the item of [FTP] to [Use].

(4) Logging data supported

Only data log can be displayed with the log viewer.

Event logs cannot be displayed.

(5) Access to storing files

[Storing file] is for use in temporarily storing the data currently collected by the high speed data logger module, the PLC CPU, or the BOX data logger.

Precautions for accessing to [Storing file] are different according to the controller.

(a) High speed data logger module and BOX data logger

- During the file switching from [Storing file] to [saved file], [Storing file] and [saved file] may not exist temporarily.
- When [Storing file] is selected and an error message saying that the file cannot be found appears, select [Storing file] again.
- Since data is stored in [Storing file] as needed, the copied file size may be larger than the size of when [Storing file] is selected.
- The data is also stored as needed even when [Storing file] is being copied, so the copying file size may appear larger than the file size of when selected.

 High Speed Data Logger Module User's Manual

(b) PLC CPU

Reference and copying are not available since [Storing file] cannot be selected.

When [Storing file] is full, the data cannot be browsed until the file is switched to [saved file].

 MELSEC-L CPU Module User's Manual (Data Logging Function)

The following shows the storage location of [Storing file] and [saved file].

```
/LOGGING ..... Folder for log viewer function (the folder name is fixed)
/LOG01 ..... Folder for setting No.1 (the folder name is specified by the user)
  LOG01.CSV *1 ..... [Storing file] (saved just below the user specified folder)
  /00000001 ..... [saved file] storage folder (automatically created in serial number)
                    [saved file] (moved to the [saved file] storage folder when [Storing file] becomes full)
    00000001.CSV }
    00000002.CSV } Referring and copying are enabled.
    00000003.CSV }
  /00000101
  :
/LOG02 ..... Folder for setting No.2
  LOG02.CSV *1 ..... [Storing file]
/LOG03 ..... Folder for setting No.3
  LOG03.CSV *1 ..... [Storing file]
  :
```

*1 Operations such as referring or copying are not enabled. (Only confirmation of the file name is enabled.)

16.3 Operations for Display

This section describes the flow until the log viewer operation screen is displayed, after the log viewer (Option OS) is installed in the GOT.

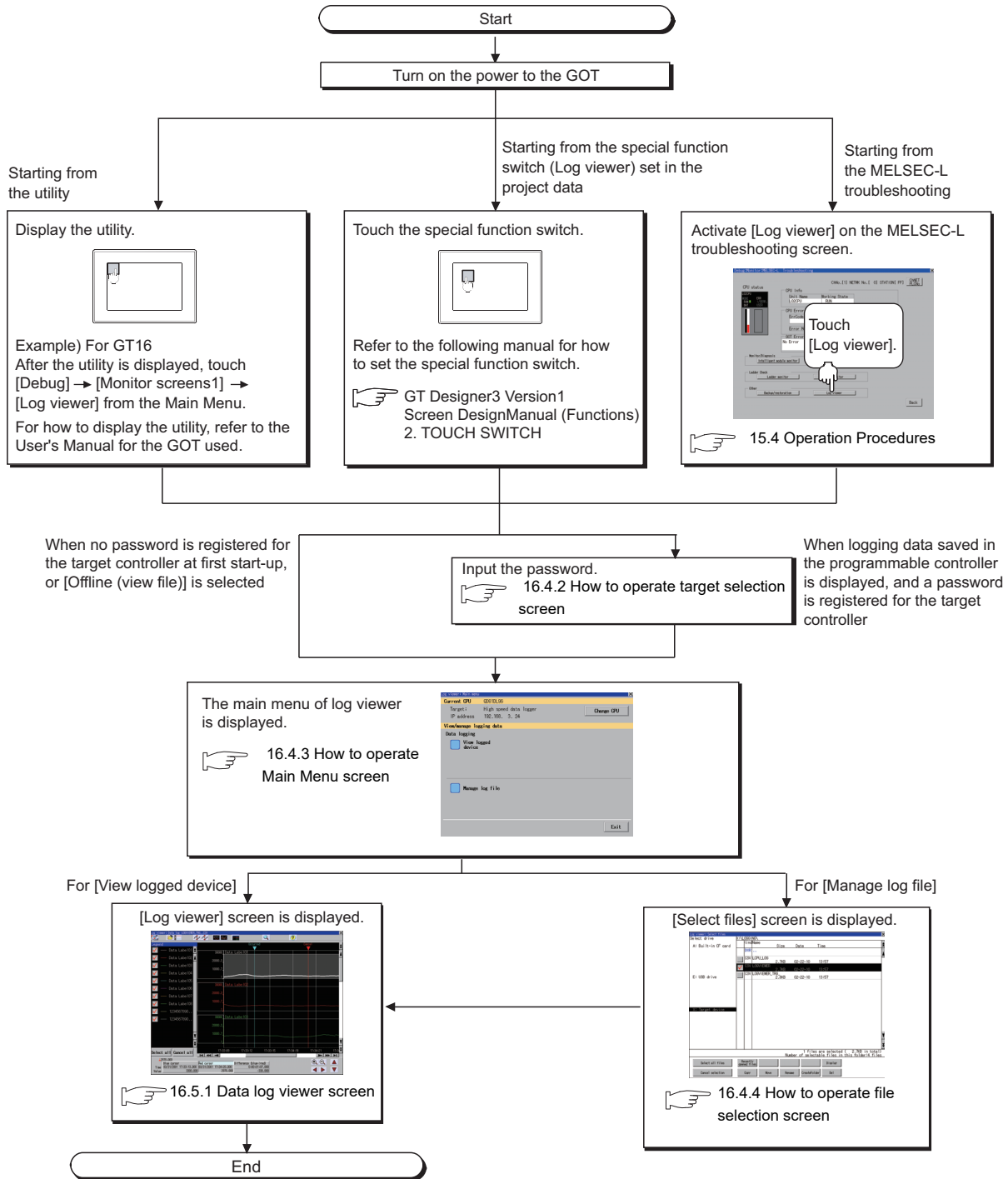

POINT

(1) How to display the utility

For how to display the utility, refer to the following.

User's Manual for the GOT used

(2) Displaying target setting window

For displaying the target setting window, touch the [Change CPU] button on the Main Menu screen of log viewer.

To display the connection selection screen, touch the [High speed data logger module / BOX data logger]/ [QnUDVCPU / LCPU] button.

Touch the [Offline (view file)] button to display the file selection screen.

(3) If the project data has not been downloaded

The log viewer can be started with the utility even though the GOT has no project data.

16.3.1 Changing screens when view logged device is selected

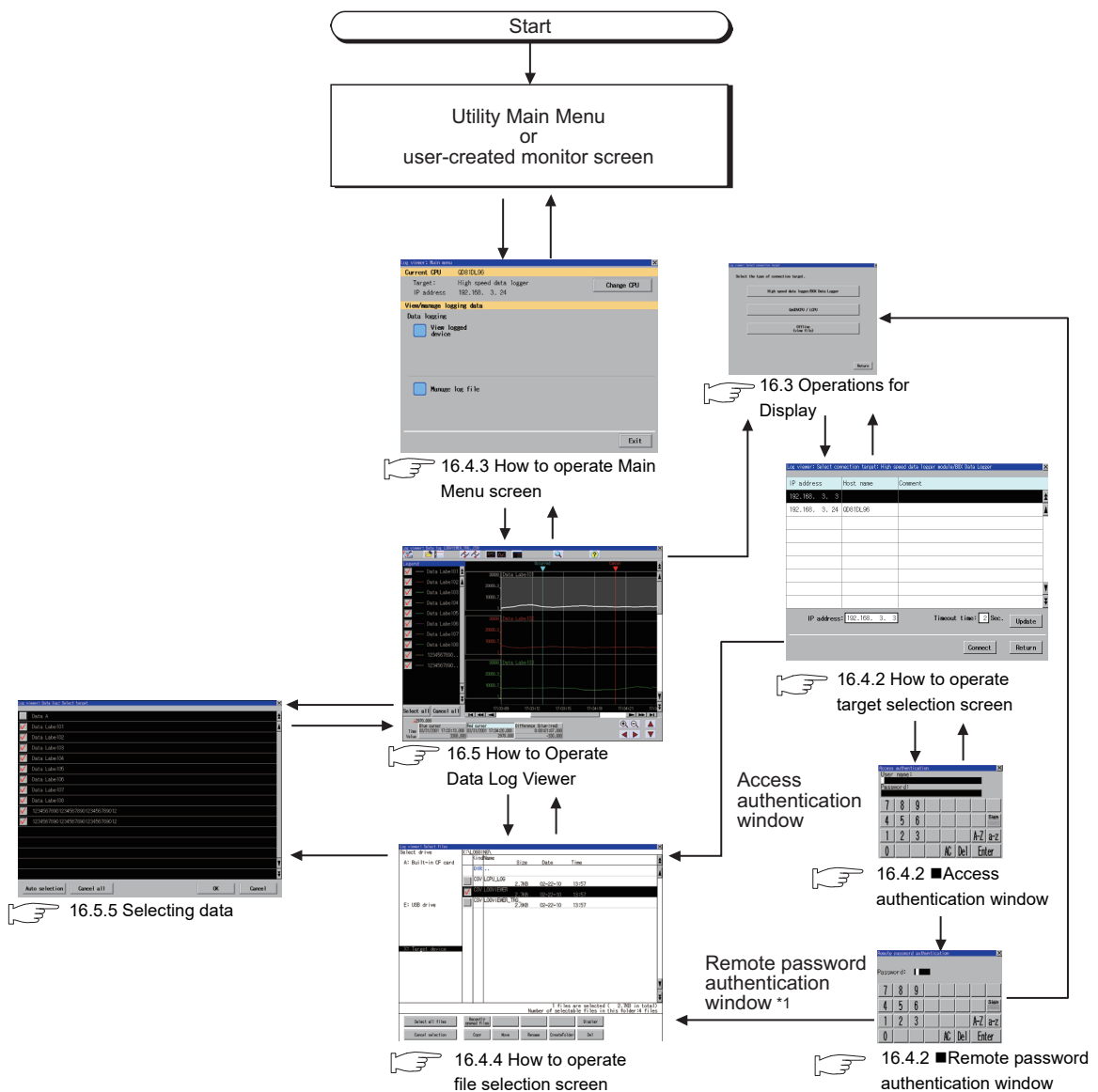

*1 Displayed only when LCPU is selected and the remote password is set.

16.3.2 Changing screens when manage log file is selected

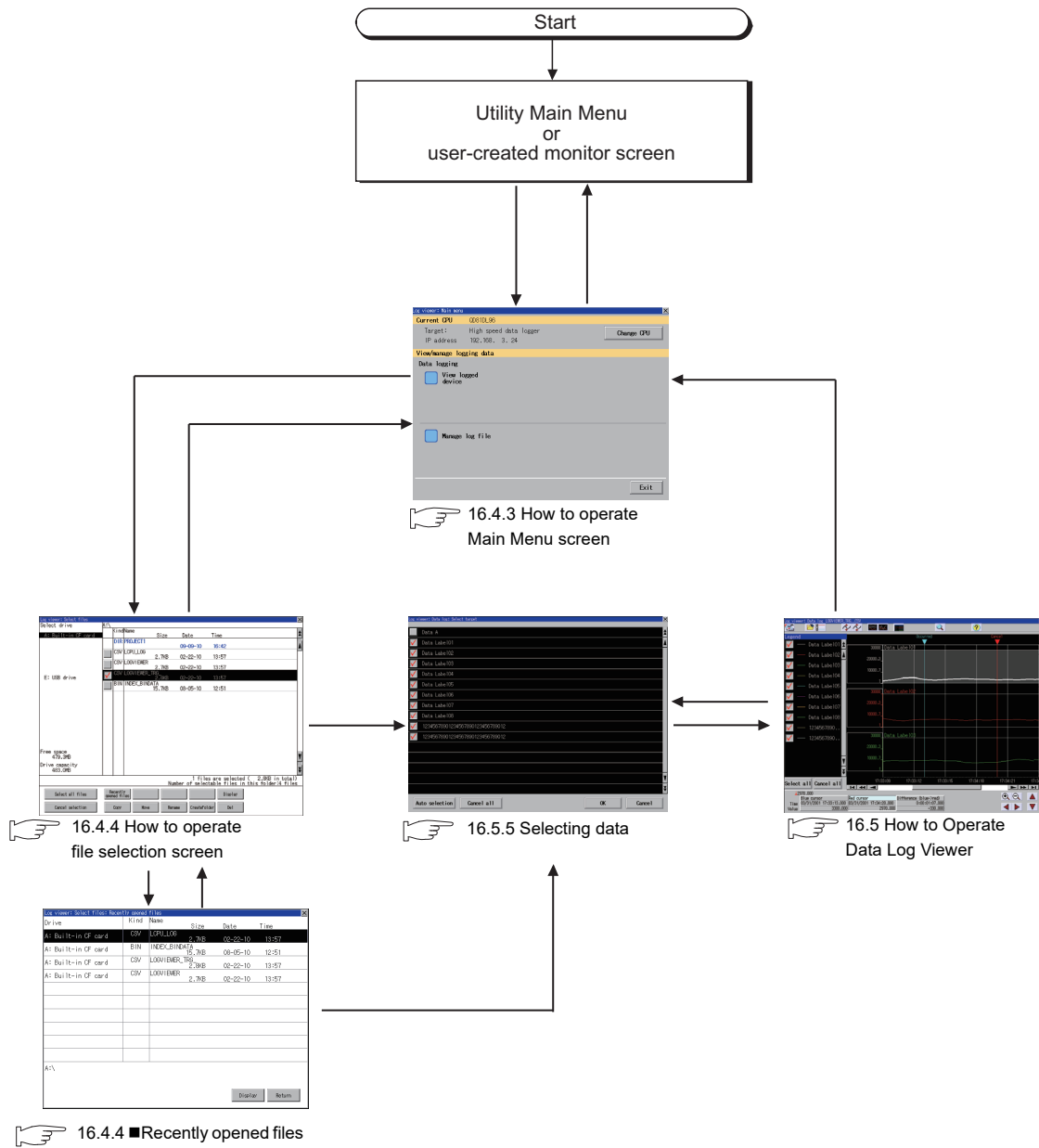

16.4 How to Operate Various Selection Screens

This section describes each screen contents displayed in log viewer and the functions of the keys displayed on the screen.

16.4.1 How to operate target setting window

Touch the [Change CPU] button in [Main Menu] to display the following screen.

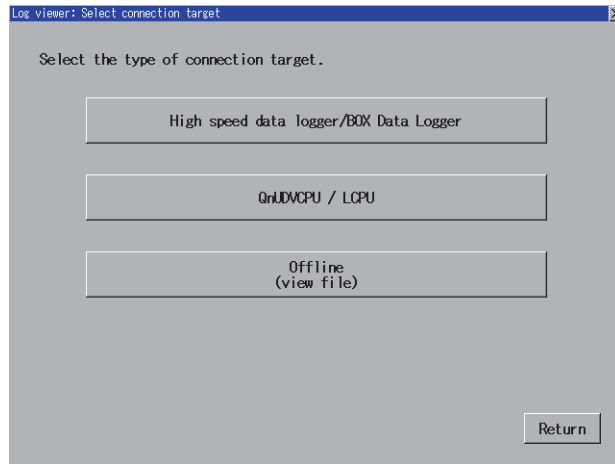

Key	Function
/ Return	Closes the target setting window and returns to the Main Menu screen.
/	Displays the target selection screen.
	16.4.2 How to operate target selection screen
	Displays the Main Menu screen. 16.4.3 How to operate Main Menu screen

16.4.2 How to operate target selection screen

When [High speed data logger module / BOX data logger] or [QnUDVCPU / LCPU] is selected in the target setting window, the following screen appears.

■ Target selection screen





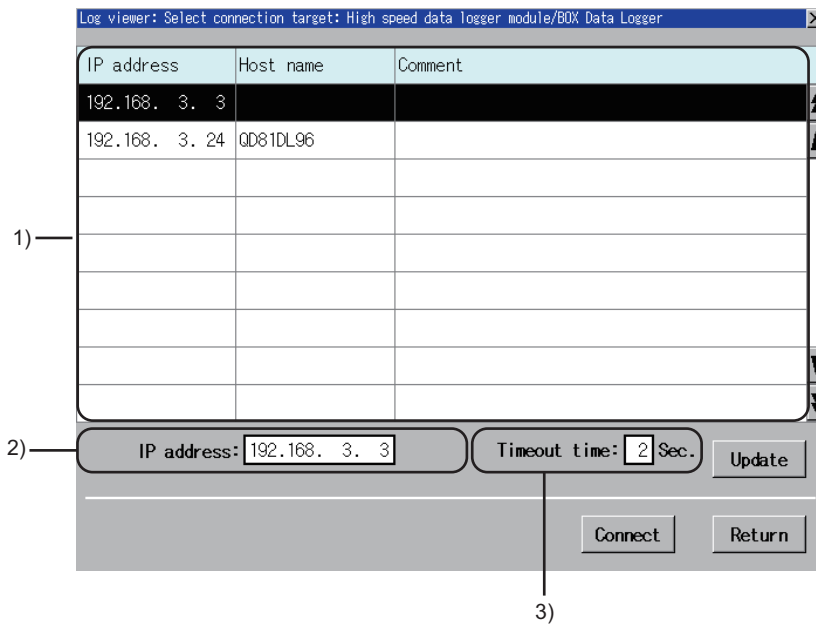

The following screen appears when [High speed data logger module / BOX data logger] is selected. A similar screen also appears when [QnUDVCPU / LCPU] is selected.

(1) Displayed contents

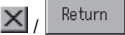

No.	Item	Display contents
1)	Connection target list display area	Displays the list of the high speed data logger modules or the PLC CPUs which can be accessed from the GOT. To select a high speed data logger module or a PLC CPU, touch it in the list.
2)	IP address display area	Displays the selected IP address. ☞ ■IP Address input window
3)	Timeout time display area	Displays the Timeout time. ☞ ■Timeout time input window

(2) Key functions

Key	Function
	Closes the target selection screen and returns to the target setting screen.
	Scrolls the display area up and down by one line.
	Scrolls the display area up and down by one page.
	Updates the displayed content of the connection target list.
	<p>Connects to the high speed data logger module or the PLC CPU selected from the connection target list or the IP address.</p> <p>When the password is set on the connected high speed data logger module or the PLC CPU, the access authentication window appears.</p> <p> 16.4.2 ■Access authentication window</p> <p>When no password is set on the connected high speed data logger module or the PLC CPU, the Main Menu screen appears.</p> <p> 16.4.3 ■How to operate Main Menu screen</p>

■ IP Address input window



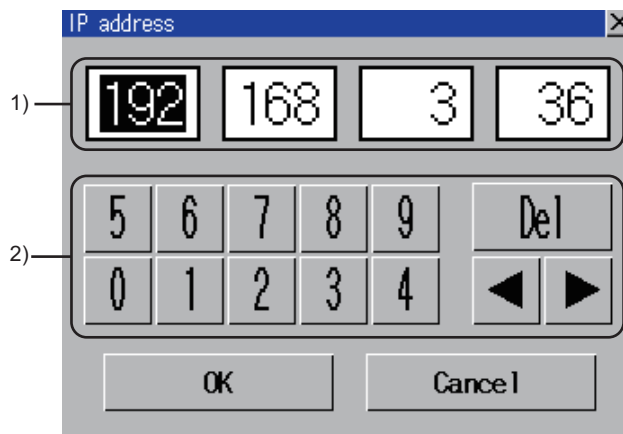

Touch the IP address input display area to display the following window.

(1) Displayed contents



No.	Item	Display contents
1)	IP address input area	Set the IP address.
2)	Input keys	Keys for operations in the IP address input window.

(2) Key functions

Key	Function
	Closes the IP address input window and cancels the IP address input operation.
	The IP address of the input numerical value is reflected.
	Deletes one character of the entered numerical value.
	Moves the cursor among the input areas.

■ Timeout time input window

Touch the Timeout time display area to display the following window.

(1) Displayed contents

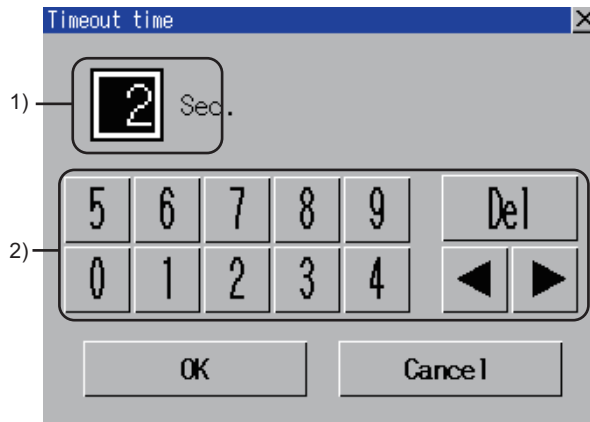

No.	Item	Display contents
1)	Timeout time input area	Set the Timeout time.
2)	Input keys	Keys for operations in the Timeout time input window.

(2) Key functions

Key	Function
	Closes the Timeout time window and cancels the Timeout time input operation.
	The Timeout time of the input numerical value is reflected.
	Deletes one character of the entered numerical value.
	Moves the cursor among the input areas.

■ Access authentication window

When the password is set to the connection target, touch the [Connect] button on the target selection screen to display the following window.

(1) Displayed contents

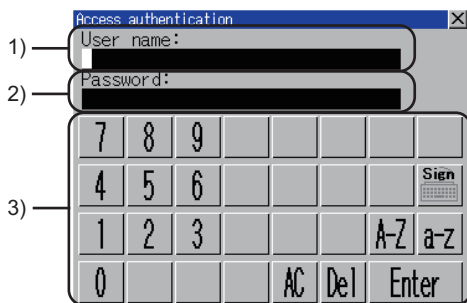



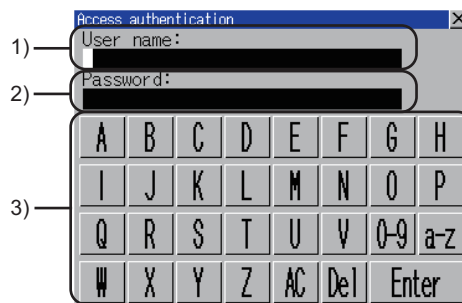







For numerical input



For alphabet input (upper case characters)

No.	Item	Display contents
1)	User name input area	Set the user name to input.
2)	Password input area	Set the password to input.
3)	Keys	Keys for operations in the user name input area and password input area shown in (2).

(2) Key functions

Key	Function
	Closes the Access authentication window and cancels the user name and password input operation.
	Switches the key type to the symbol.
	Switches the key type to the value.
	Switches the key type to the alphabet (uppercase).
	Switches the key type to the alphabet (lowercase).
	A space is input at the cursor position.
	Deletes all the input values and characters.
	Deletes an input value or character.
	Verifies the user name and password set in the user name input area and password input area. When the remote password is set on the connected PLC CPU, the remote password authentication window appears.  16.4.2 ■Remote password authentication window When no remote password is set on the connected PLC CPU, the Main Menu screen appears.  16.4.3 ■How to operate Main Menu screen

■ Remote password authentication window

When the remote password is set, the following window appears after access authentication is completed.

(1) Displayed contents



No.	Item	Display contents
1)	Password input area	Set the password to input.
2)	Keys	Keys for operations in the password input area shown in (2).

(2) Key functions

The key functions are the same as those of [Access authentication].

For details of key functions, refer to the following.

 ■Access authentication window (2) Key functions



16.4.3 How to operate Main Menu screen

After the target is selected, the following screen appears.



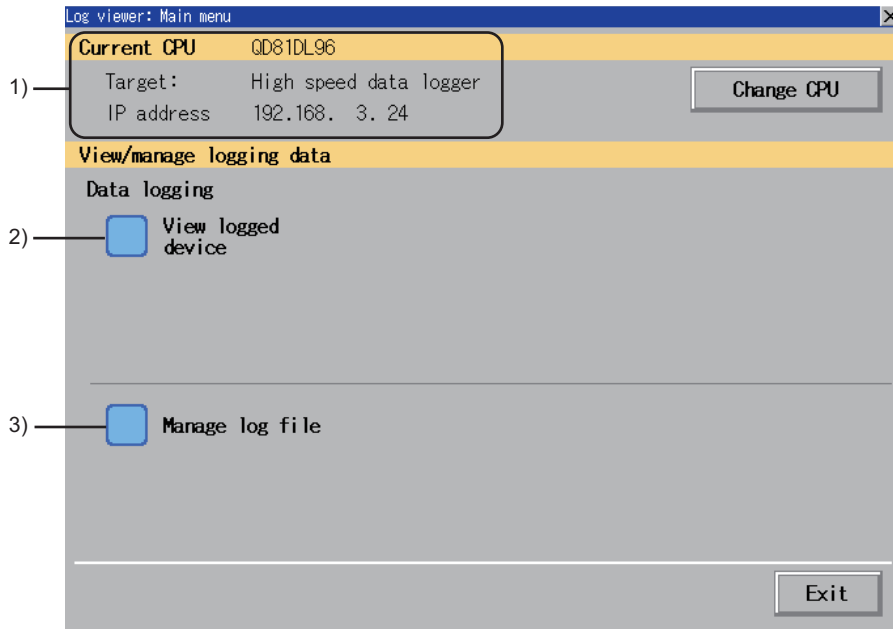

■ Displayed contents

The following screen appears when [High speed data logger module / BOX data logger] is selected. A similar screen also appears when [QnUDVCPU / LCPU] is selected.



No.	Item	Display contents
1)	Target controller display area	Displays the target device name and IP address.
2)	View logged device	Displays the logging data stored in the target device as a graph.  16.5 How to Operate Data Log Viewer
3)	Manage log file	Controls the logging data stored in the target device.  16.4.4 How to operate file selection screen

■ Key functions

Key	Function
 / 	Closes the Main Menu and returns to the target setting screen.  16.4.2 How to operate target selection screen
	Displays the target setting window.  16.3 Operations for Display

16.4.4 How to operate file selection screen

Select in the following procedure to display the file selection screen.

- Touch [View logged device] in the Main Menu screen
- Touch the folder icon on the data log viewer screen.

■ File selection screen

(1) Displayed contents

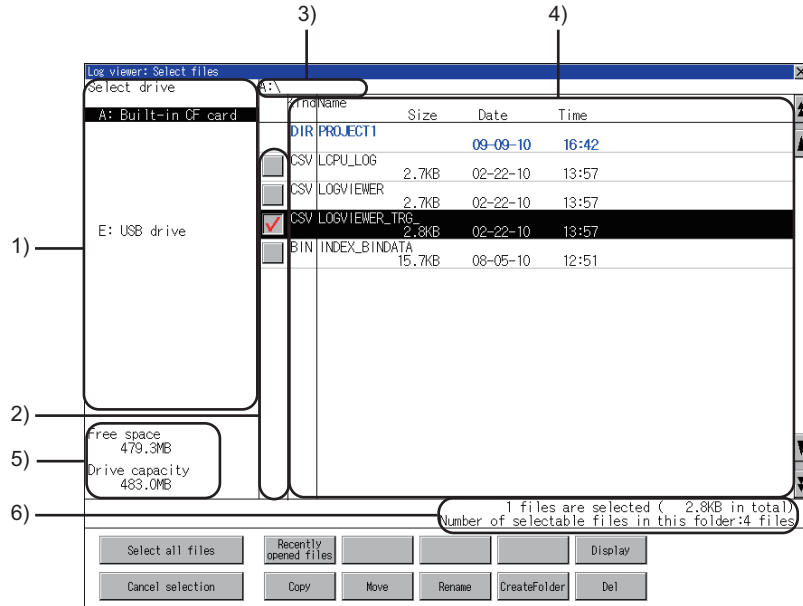

No.	Item	Display contents
1)	Target drive list	The corresponding drive can be selected.
2)	Check box	If the check box is selected, up to 512 files can be selected.
3)	Path name	Displays the path name of drive/folder which is currently displayed.
4)	File list	Displays the files stored in the selected drive in a list. Only the CSV format ^{*1} , BIN format ^{*2} , and XLS format ^{*3} are displayed.
5)	The size of drive	Displays the size in use and the entire size of the drive which is selected by drive selection. Not displayed when [X:Target device] is selected.
6)	Number of folders and files	Displays the total number of displayed folders and files.

*1 Only logging data acquired from the high speed data logger, the PLC CPU, or the BOX data logger can be displayed as a graph in the data log viewer.

*2 Only logging data acquired from the high speed data logger or the BOX data logger can be displayed as a graph in the data log viewer.

*3 Cannot be displayed as a graph in data log viewer.

POINT

Restrictions when [X:Target device] is selected in select drive.















The logging data stored in the high speed data logger module, the PLC CPU, or the BOX data logger is displayed in a list.

Regarding graph display, logging data of up to 4MB can be displayed as a graph. However, logging data exceeding 4MB cannot be displayed as a graph.

To display logging data exceeding 4MB as a graph, copy it to the USB memory/CF card of the GOT and select the logging data in the copy destination.

The logging data stored in the CF card or the USB memory attached to the GOT cannot be copied to the high speed data logger module, the PLC CPU, or the BOX data logger.

(2) Key functions

Key	Function
	Closes the file selection screen and returns to the target setting window.
	Scrolls the display area up and down by one line.
	Scrolls the display area up and down by one page.
 / 	Multiple files can be selected or canceled at once. Touch the [Select all files] button to select all files. If the number of the displayed files is exceeds 513, the first 512 files are selected.
	Displays a list of recently opened files.  16.4.4 ■ Recently opened files screen
	Displays the selected file in log viewer.  16.5 How to Operate Data Log Viewer
	Copies the selected file. ^{*1}
	Moves the selected file. ^{*1*2}
	Renames the selected file. ^{*1*2}
	Creates a folder. ^{*1*2}
	Deletes the selected file. ^{*1*2}

*1 For how to operate, refer to the following.

 User's Manual for the GOT used

*2 If [X:Target device] is selected in select drive, the key functions are disabled.

Recently opened files screen

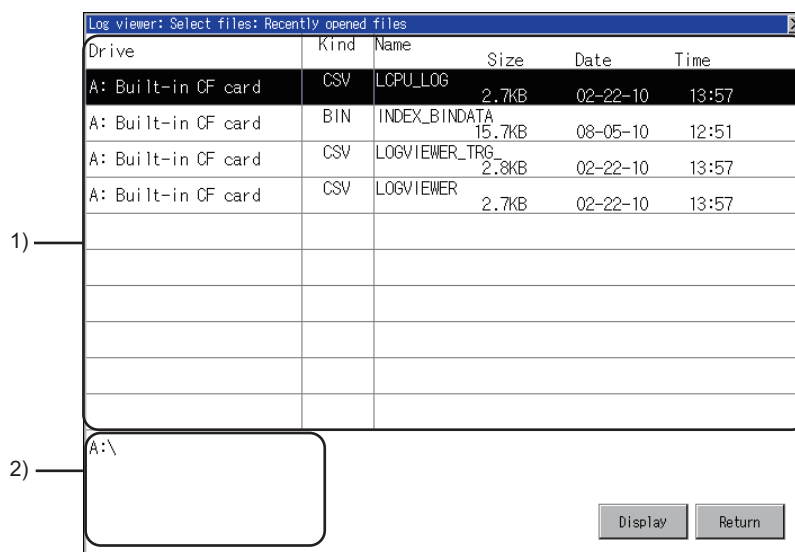

Touch the [Recently opened files] button in the file selection screen to display the following screen.

(1) Displayed contents



No.	Item	Display contents
1)	File list	Displays a list of recently opened files. From the recently opened files, the latest one is displayed in the first line, and the oldest one is displayed in the last line. (Up to 10 files)
2)	Target drive display area	Displays the path of the selected drive. Files in [X:Target device] have also the information of connected controllers displayed.

(2) Key functions

Key	Function
 / Return	Closes the recently opened files screen and returns to the file selection screen.
	Displays the selected file in log viewer.  16.5 How to Operate Data Log Viewer

POINT

Recently opened files screen history specifications

- Up to 10 files are saved, and when the 11th file is saved, the oldest file is deleted.
- Even if opening the same file multiple times, it is counted as one file.
- If files with the same path and file name are stored in multiple controllers, the history of opening each file is counted as one file.
- The history is deleted when restarting GOT or when turning the GOT power supply OFF.
- The size at the last time the file was opened is displayed in the file list.
- If the selected drive is [X:Target device], connection operation is performed to controllers which are not connected to other devices. Also, if the controller is connected to another device, the connection operation is performed to the newly selected controller.

16.5 How to Operate Data Log Viewer

On the data log viewer screen, the logging data stored in the high speed data logger module/PLC CPU/BOX data logger or CF card/USB memory is displayed as a graph.
The following describes how to operate the data log viewer screen.

16.5.1 Data log viewer screen

■ Displayed contents

This section describes the screen configuration displayed on the data log viewer screen and the functions of the keys displayed on the screen.

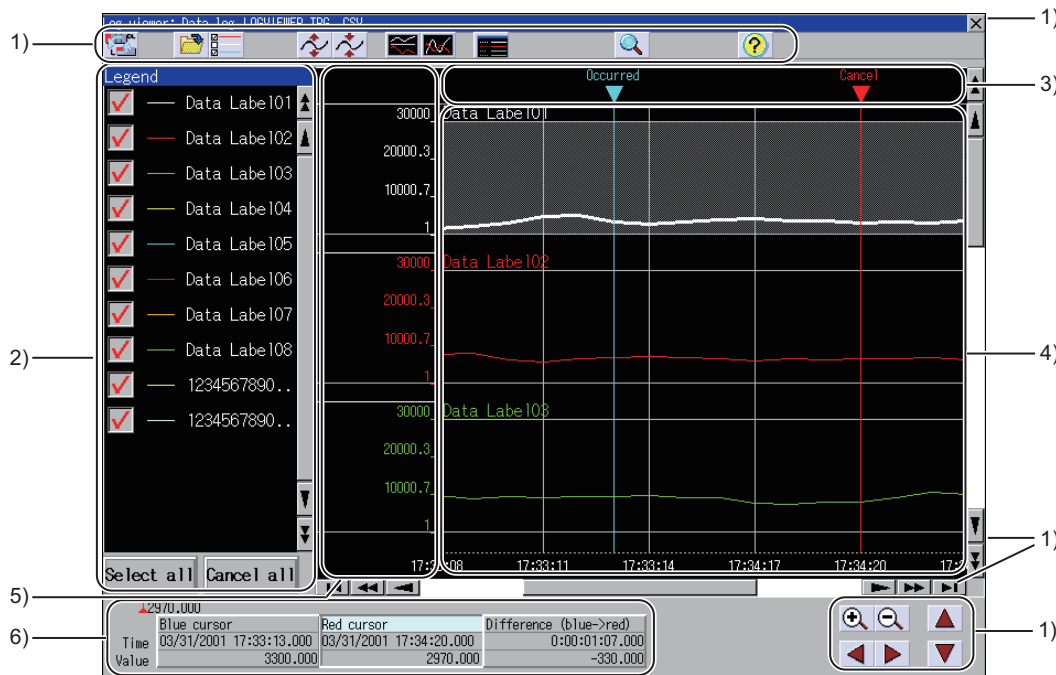

No.	Item	Display contents
1)	Keys	Keys for operations in the data log viewer screen.
2)	Legend display area	Data to be displayed in the graph display area can be selected. The line type and logging data name displayed in the graph display area are displayed. ☞ 16.5.2 Legend display
3)	Trigger mark display area	The trigger mark appears when the target data is the logging data to which the trigger is set. When the trigger conditions are satisfied, it is displayed as [Occurred] in blue. When the trigger is restored, it is displayed as [Cancel] in red. The trigger mark appears only when the target data is trigger logging.
4)	Graph display area	Displays the data name, graph, and cursor of the target data. The background of the selected graph is displayed in gray. The maximum number of sampling points that are displayable on the graph differs according to the GOT resolution.*1
5)	Scale display area	Displays the scale of the target data. Touch the scale display area to display the upper and lower limit values change window. Then the upper and lower limit values can be changed. ☞ 16.5.3 Upper and lower limit values setting
6)	Cursor position information display area	Touch the [Blue cursor]/[Red cursor] button in the cursor position information display area to move [Blue cursor]/[Red cursor] displayed in the graph display area to any position. The time and value at the selected position of the graph are displayed. The changed amount of the time and difference from [Blue cursor] to [Red cursor] is also displayed. ☞ 16.5.4 Cursor position information

For details of *1, refer to the following.

Name	Resolution (dots)	With legend display	Without legend display
GT16**-X	1024 × 768	705	897
GT16**-S	800 × 600	482	674
GT16**-V	640 × 480	321	513

POINT

Graph display area

(1) Graph display when missing some logging data

When some logging data is missing, the corresponding part in the graph line is displayed with an interruption. A long and short dash-alternate vertical line is displayed before and after the missing part.





















The cursor position information will not be displayed when the missing part is between [Blue cursor]/[Red cursor] or at the cursor.

(2) Graph horizontal axis display

When the logging data includes time information, the horizontal axis is displayed in time (hour: minute: second).

When the logging data does not include time information, the horizontal axis is displayed in index number (integer).

Key functions

Key	Function
	Closes the data log viewer screen, and returns to the previous screen.
	Displays the target setting screen.  16.4.2 How to operate target selection screen
	Opens the file selection screen and displays the list of the files stored in the high speed data logger module/PLC CPU or CF card/USB memory.  16.4.4 How to operate file selection screen
	Select the data to view.  16.5.5 Selecting data
	Enlarges vertically the graph selected in the graph display area.
	Reduces vertically the graph selected in the graph display area.
	Arranges the graph selected in the graph display area horizontally.
	Cascades the graph selected in the graph display area.
	Displays or hides the legend display area.  16.5.2 Legend display
	Searches the time/index data specified by the graph which is selected in the graph display area.  16.5.6 Searching data
	Displays the help screen for icon.  16.5.7 Help
	Scrolls the display area up and down by one line.
	Scrolls the display area up and down by one page.
	Scrolls the display area right and left by one sampling.

(Continued to next page)

Key	Function
	Scrolls the display area right and left by one sampling.
	Scrolls the display area right and left by one page.
	Scrolls the display area to the beginning or end of the selected graph.
	Enlarges/reduces the display area horizontally.
	Moves the selected cursor right and left.
	Switches the selected graph up or down.

16.5.2 Legend display

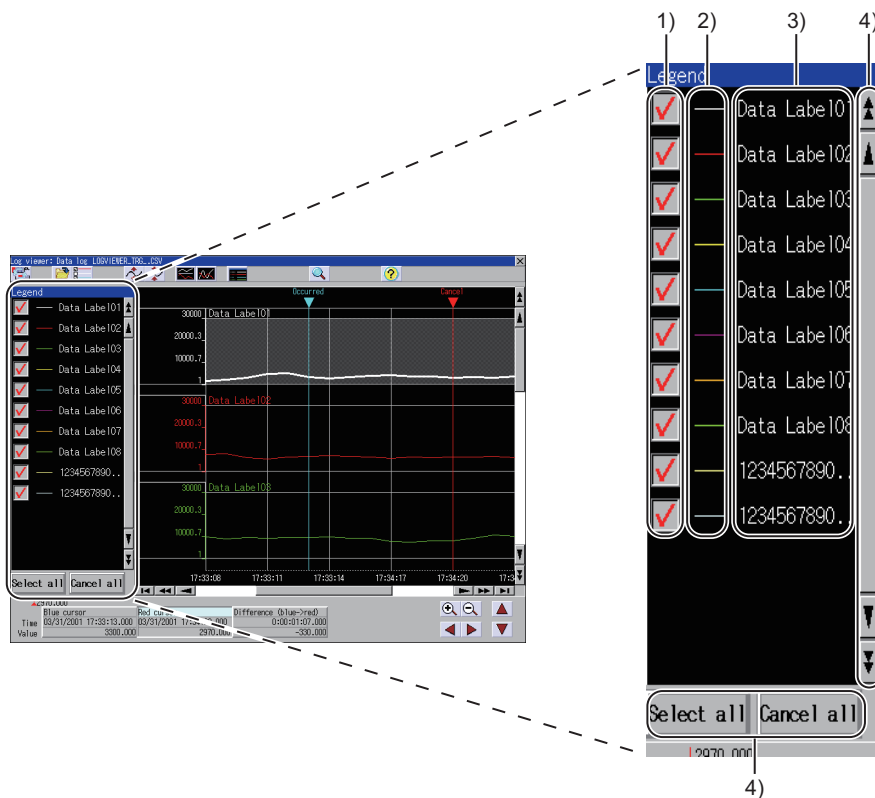

The following explains the legend display.

■ Displayed contents



No.	Item	Display contents
1)	Check box	Select the checkbox to display the corresponding graph.
2)	Line type display area	Displays the line type of the target graph.
3)	Data name display area	Displays the data name of the target graph. When the data name exceeds 12 characters, the first 10 characters are displayed. The rest of the characters are displayed with [...].
4)	Keys	Keys for operations in the legend display window.

■ Key functions

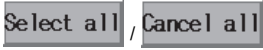
Key	Function
	Scrolls the display area up and down by one line.
	Scrolls the display area up and down by one page.
	Displays or hides all graphs.

16.5.3 Upper and lower limit values setting



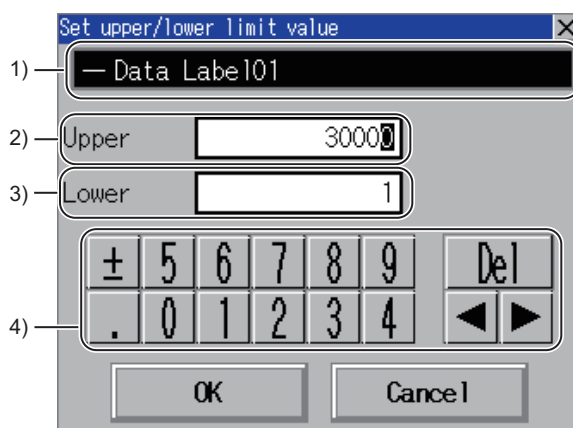

The following explains the upper and lower limit values setting.
Touch the scale display area to display the following window.
The scale can be changed by changing the upper and lower limit values.

■ Displayed contents



No.	Item	Display contents
1)	Target data display area	Displays the data name and line type of the target data.
2)	Upper limit value display area	Set the value and exponent of the target data upper limit value.
3)	Lower limit value display area	Set the value and exponent of the target data lower limit value.
4)	Keys	Keys for operations in the upper and lower limit values setting window.

■ Key functions

Key	Function
	Closes the upper and lower limit values setting window and cancels the upper and lower limit values input operation.
	The values which are input as upper and lower limits are displayed on the scales.
	Deletes an input value or character.
	Moves the cursor among the input areas.

16.5.4 Cursor position information

The display screen shows the status that the red cursor is selected.
Time and value of the blue cursor/red cursor whose graph is selected are displayed in the graph area.

■ Displayed contents

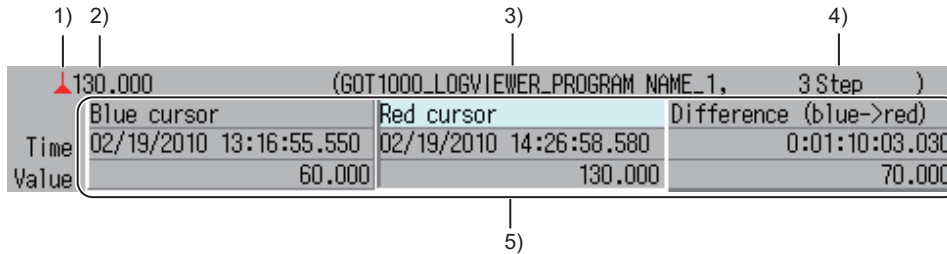

No.	Item	Display contents
1)	Selecting cursor color	Displays the color of the selected cursor. The above chart shows the status that [Red cursor] button is touched.
2)	Cursor read value	Displays the value of the intersection of graph and cursor selected in the graph display area. The above chart shows the value that [Red cursor] button is touched.
3)	Program name	Displays the program name executed in the PLC CPU. The program name is displayed only when the PLC CPU is selected.
4)	Step number	Displays the step number of the program executed in the PLC CPU. The step number is displayed only when the PLC CPU is selected.
5)	Cursor display area	Select a graph in the graph display area, to display the time at the cursor position and the value of the intersection of the selected graph. Touch the [Blue cursor]/[Red cursor] button to select the target cursor for operating. The target cursor can be moved by touching the graph display area or the cursor moving buttons. For [Difference(blue → red)], the changed amount of [Red cursor] is displayed from [Blue cursor].  16.5.1 Data log viewer screen

16.5.5 Selecting data

Data selection screen displays the data list of the files stored in the selected high speed data logger module/PLC CPU/BOX data logger or CF card/USB memory.

Up to 16 pieces of data can be selected in the data selection screen.





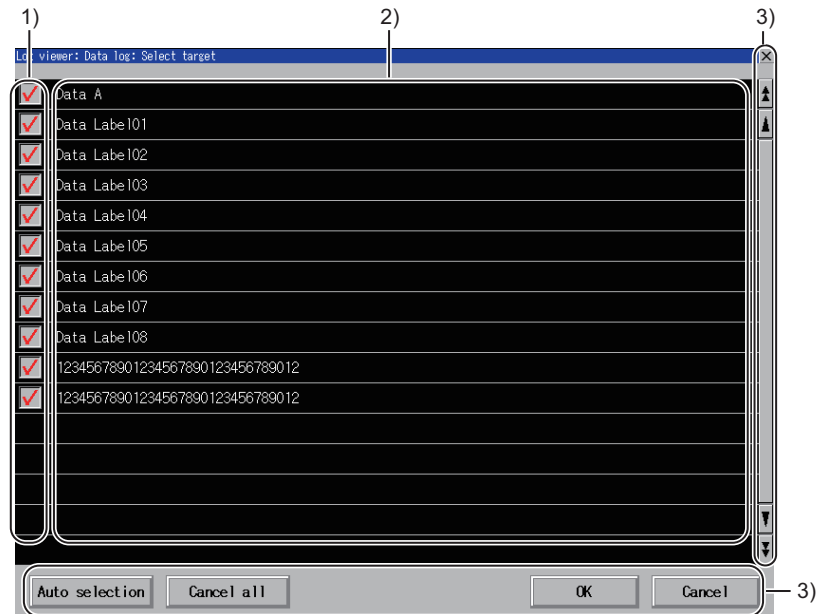



The following explains the data selection screen.

■ Displayed contents

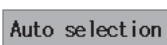

No.	Item	Display contents
1)	Check box	Graph is displayed in the data log viewer by selecting the check box.
2)	Data name list display area	Displays the data names.
3)	Keys	Keys for operations in the data selection screen.

■ Key functions

Key	Function
 / 	Closes the data selection screen, and returns to the log viewer screen.
	The logging data selected in the data selection screen is displayed on the data log viewer.
 	Scrolls the display area up and down by one line.
 	Scrolls the display area up and down by one page.
	Selects up to 16 logging data displayed in the data name list display area, from the top.
	Cancels all the selected data.

16.5.6 Searching data

On the data search screen, input the time/index to search the data in the graph which is displayed in the data log viewer screen and shows the data of the files stored in the high speed data logger module/PLC CPU/BOX data logger or CF card/USB memory.

The following explains the data search screen.

■ Displayed contents

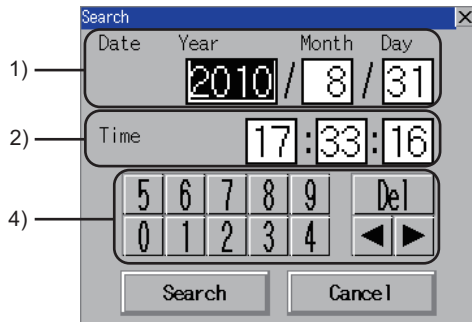

When the logging data includes time information

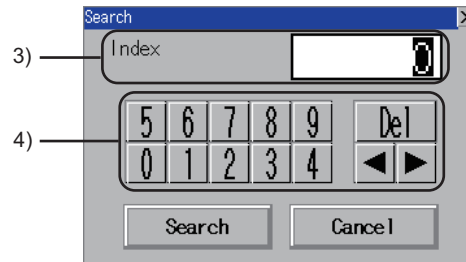

When the logging data does not include time information,

No.	Item	Display contents
1)	Date input area	Input the date to be searched. When this screen is displayed, the date on the right of the graph at screen opening is displayed.
2)	Time input area	Input the time to be searched. When this screen is displayed, the time on the right of the graph at screen opening is displayed.
3)	Index number input area	Input the index number to be searched. When this screen is displayed, the index on the right of the graph at screen opening is displayed.
4)	Keys	Displays the key to be used at the operation in the data search screen.

■ Key functions

Key	Function
	Closes the data search screen.
	Searches the graph displayed in the data log viewer screen with the values input in the data search screen.

16.5.7 Help

The following explains the help window.
Help window displays the contents of icons.

■ Displayed contents

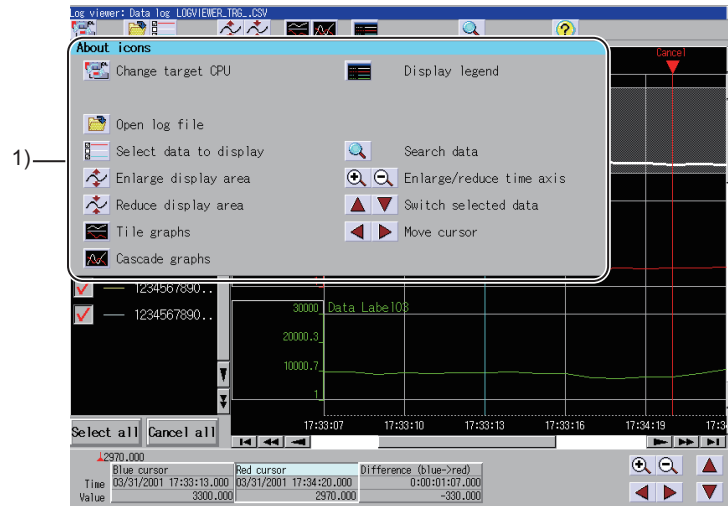

No.	Item	Display contents
1)	Help window display area	Displays functions of the icons in the window. Help window closes by touching any place in the help window display area. While the help window is displayed, touching other than the help window display area is invalid.

16.6 Error Messages and Corrective Actions

This section describes the error messages for the log viewer and the corresponding corrective actions.

Error message	Error	Corrective action
Failed to communicate with the specified destination (IP address). Confirm the IP address and communication line.	The GOT cannot communicate with the high speed data logger module or the PLC CPU.	(1) Check the communications between the GOT and the high speed data logger module or the PLC CPU, and make sure that the GOT communicates with the high speed data logger module or the PLC CPU. (2) Check that the GOT and the high speed data logger module or the PLC CPU are connected in a connection type that can be communicated.
Authentication failed. Please enter operator name and password again.	The GOT cannot authenticate because the operator name and password are incorrect in access authentication.	Enter the correct operator name and password.
Authentication failed. Please enter password again.	The GOT cannot authenticate because the password is incorrect in remote password.	Enter the correct password.
Failed to obtain the data.	The GOT cannot access the file in which the logging data is stored.	Select the file in which the logging data is stored on the log viewer screen.
The selected data is not the data of data logging. Please check the file.	The GOT cannot display the selected data because it does not comply with data log viewer.	Select a file which complies with log viewer.
The size of the log file is too large to view with this function.	The log file cannot be viewed because the file size of the view target log file is larger than the file maximum size that can be viewed with log viewer.	Select a logging data with a file size compatible with log viewer.
The selected file was not found. The file structure may have been changed since the file was previously viewed. Select a file from the file selection screen.	The file selected in the recently opened files list screen does not exist.	Select a file from the file selection screen.
Data has not been selected. Select data.	No data is selected.	Select the data to display in log viewer.
The maximum number of data has already been selected and additional data cannot be selected. Cancel unnecessary data and select data again.	Data cannot be selected additionally because the number of selected data reaches the upper limit (16) on the data selection screen.	Cancel unnecessary data and select data again.
The entered value is invalid. Review the value of year, month, date, hour, minute, and second.	The GOT cannot search because the entered date and time value is invalid.	Enter the correct value.
Error The entered value is invalid. The result should be as follows. Upper limit > lower limit	The GOT cannot display the value because it is invalid during the upper and lower limit values setting.	Enter numerical values that comply with the following. Upper limit > lower limit

17. MOTION SFC MONITOR



17.1 Features

With Motion SFC Monitor, the GOT can monitor motion SFC programs in the motion controller CPU (Q series) connected to GOT and device values.

The following describes the features of the motion SFC monitor.

■ SFC diagram display

SFC diagrams of motion SFC programs can be displayed.

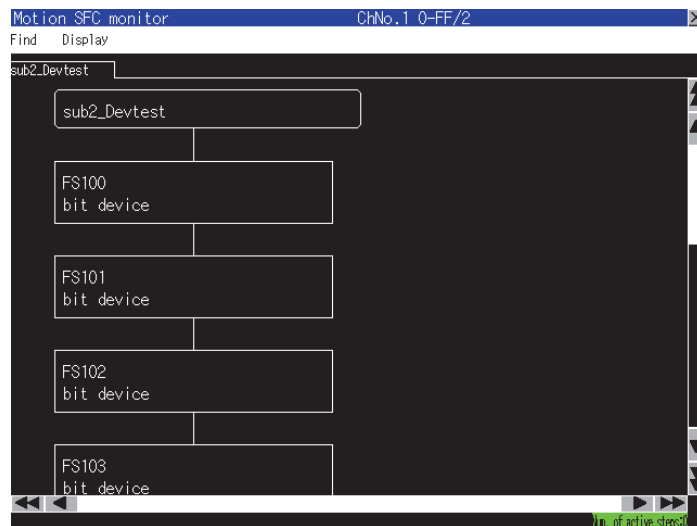

■ Starting from the special function switch

The motion SFC program automatic PLC reading at motion SFC monitor startup and the SFC diagram display of the set motion SFC program can be executed by touching the special function switch placed on the user-created screen. For the required settings for the special function switches, refer to the following.

17.3 ■ Start operation using the special function switch

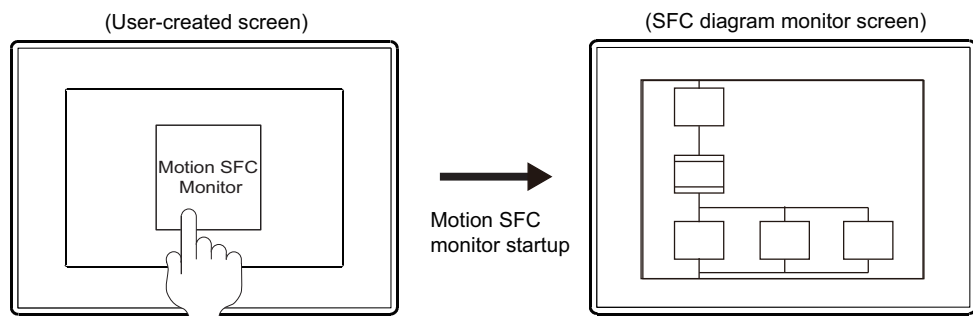

Touch the special function switch with the following settings.

- Special function switch setting
- Display Screen: SFC Diagram
- File Name: MainProgram

Motion SFC programs are read automatically from the motion controller CPU, and the motion SFC programs with the set file name are displayed.

17.2 Specifications

17.2.1 System configuration

This section describes the system configuration of the motion SFC monitor.

For connection type settings and precautions regarding the communication unit/cable and connection type, refer to the following.

 GOT1000 Series Connection Manual (Mitsubishi Products) for GT Works3

Target controller

Controller
Motion controller CPU(Q Series) ^{*1*2}

- *1 Use the following production number motion controller CPU when using the Q172CPU or Q173CPU.
 - For bus connection and direct CPU connection
Q172CPU: Production number K***** or later
Q173CPU: Production number J***** or later
 - For connections other than bus connection and direct CPU connection
Q172CPU: Production number N***** or later
Q173CPU: Production number M***** or later
- *2 The operation system software of SV13 and SV22 are available only.
Use a motion controller CPU with the following OS installed when using the Q172CPU, Q173CPU, Q172CPUN, or Q173CPUN.
 - SW6RN-SV13Q□:00H or later
(00E or later for using the Q172CPU or Q173CPU with the bus connection or direct CPU connection)
 - SW6RN-SV22Q□:00H or later
(00E or later for using the Q172CPU or Q173CPU with the bus connection or direct CPU connection)

Connection type

This function can be used in the following connection types.

(○: Applicable, ✕: Inapplicable)

Function		Connection type between GOT and controller							
Name	Description	Bus connection	Direct connection	Computer link connection	Ethernet connection ^{*4}	MELSECNET/H connection, MELSECNET/10 connection	CC-Link IE controller ^{*1}	CC-Link connection	
								ID ^{*2}	G4 ^{*3}
Motion SFC monitor	Motion SFC program monitoring	○	○	○	○	○	○	○	○

- *1 Indicates the CC-Link IE controller network connection.
- *2 Indicates CC-Link connection (Intelligent device station).
- *3 Indicates CC-Link connection (via G4).
- *4 Motion SFC monitor cannot be used when using CC-Link IE field network Ethernet adapter.

Required extended function OS, option OS, and option function board

The following extended function OS, option OS, and option function board are required.

 1.1.2 Hardware and OS' required for each function

(1) Extended function OS and option OS

Install the option OS and the extended function OS of the motion SFC monitor to the GOT.

For the installation procedure, refer to the following.

 GT Designer3 Version1 Screen Design Manual (Fundamentals) 8. COMMUNICATION WITH GOT

(2) OS memory space

For installing the extended function OS, the available space shown in the above table is required in the user area.

For the procedure for checking the available memory space of the user area and information about the data using other user areas, refer to the following.

 GT Designer3 Version1 Screen Design Manual (Fundamentals) 8. COMMUNICATION WITH GOT

(3) Option function board

- (a) For GT16
No option function board is required.
- (b) For GT15
For the GOTs with a built-in option function board, refer to the following.

 1.1.2 Hardware and OS' required for each function

For how to mount an option function board on the GOT, refer to the following.

 User's Manual for the GOT used

■ Required hardware

The following hardware is required.

Hardware
CF card

17.2.2 Devices and range that can be monitored

(○: Possible, ×: Impossible)

Device	Device range	Program display	Current value monitor
Input relay (X/PX)	X0 to 1FFF	○	○
Output relay (Y/PY)	Y0 to 1FFF	○	○
Internal relay (M)	M0 to 12287	○	○
Special relay (M)	M9000 to 9255	○	○
Latch relay (L)	L0 to 8191	○	○
Link relay (B)	B0 to 1FFF	○	○
Annunciator (F)	F0 to 2047	○	○
Special relay (SM)	SM0 to 2255	○	○
Data register (D)	D0 to 8191	○	○
Special register (D)	D9000 to 9255	○	○
Link register (W)	W0 to 1FFF	○	○
Special register (SD)	SD0 to 2255	○	○
Motion register (#) ^{*1}	#0 to 8191	○	○
Coasting timer (FT)	FT	○	×
Multiple CPU area device (U3E □ \G)	U3E □ \G10000 to 24335	○	○

*1 To monitor the motion register, the following should be set in the [Controller Setting] dialog box of GT Designer3.
 • Select a type compatible to the motion controller to be used in the [Controller Type] of the CH to connect the motion controller.
 For the setting methods of the [Controller Setting] dialog box and the types compatible to motion controller CPUs, refer to the following.

 GOT1000 Series Connection Manual (Mitsubishi Products) for GT Works3

17.2.3 Access range

The access range is the same as the access range when the GOT is connected to a controller.
 For details of the access range, refer to the following.

 GOT1000 Series Connection Manual (Mitsubishi Products) for GT Works3

17.2.4 Readable motion SFC programs

Motion SFC monitor can read the following programs.

- Control codes (SFC diagram, F/FS and G)
- Text (F/FS and G)

17.2.5 Displayable character codes

The displayable character code of comments and program names on the motion SFC monitor differs according to the language selected in the utility.

Displayable character code	Language of utility
SJIS	Japanese
ASCII	English, Chinese (Traditional), German
GB	Chinese (Simplified)
KS	Korean

For switching the language of the utility, refer to the following.

 User's Manual for the GOT used

17.2.6 Precautions

(1) Inapplicable GOT

The motion SFC monitor cannot be used with the GOTs shown below.

GOT	Inapplicable GOT
GT15	GT1555-Q, GT1550-Q

(2) Operations when using motion SFC monitoring

Do not execute the following operations to GOT while using motion SFC monitor.

Doing so may delete stored data and cause the motion SFC monitor to operate incorrectly.

- Turning on or off the CF card access switch
- Inserting or removing a CF card

(3) Settings that make the motion SFC monitor unavailable

The motion SFC monitor function is not available when [Locus] is set for line graphs.

(4) Motion SFC programs with soft security key

The software security key is set to the motion controller CPU, the motion SFC program cannot be read with the GOT.

For the software security key, refer to the programming manual (common) of Q172DSCPU or Q173DSCPU.

17.3 Operations for Display

Start operation for the Motion SFC Monitor

The following describes the outline for displaying the motion SFC monitor operation screens after installing GOT Platform Library (extended function OS), and Motion SFC Monitor (option OS) on the GOT.

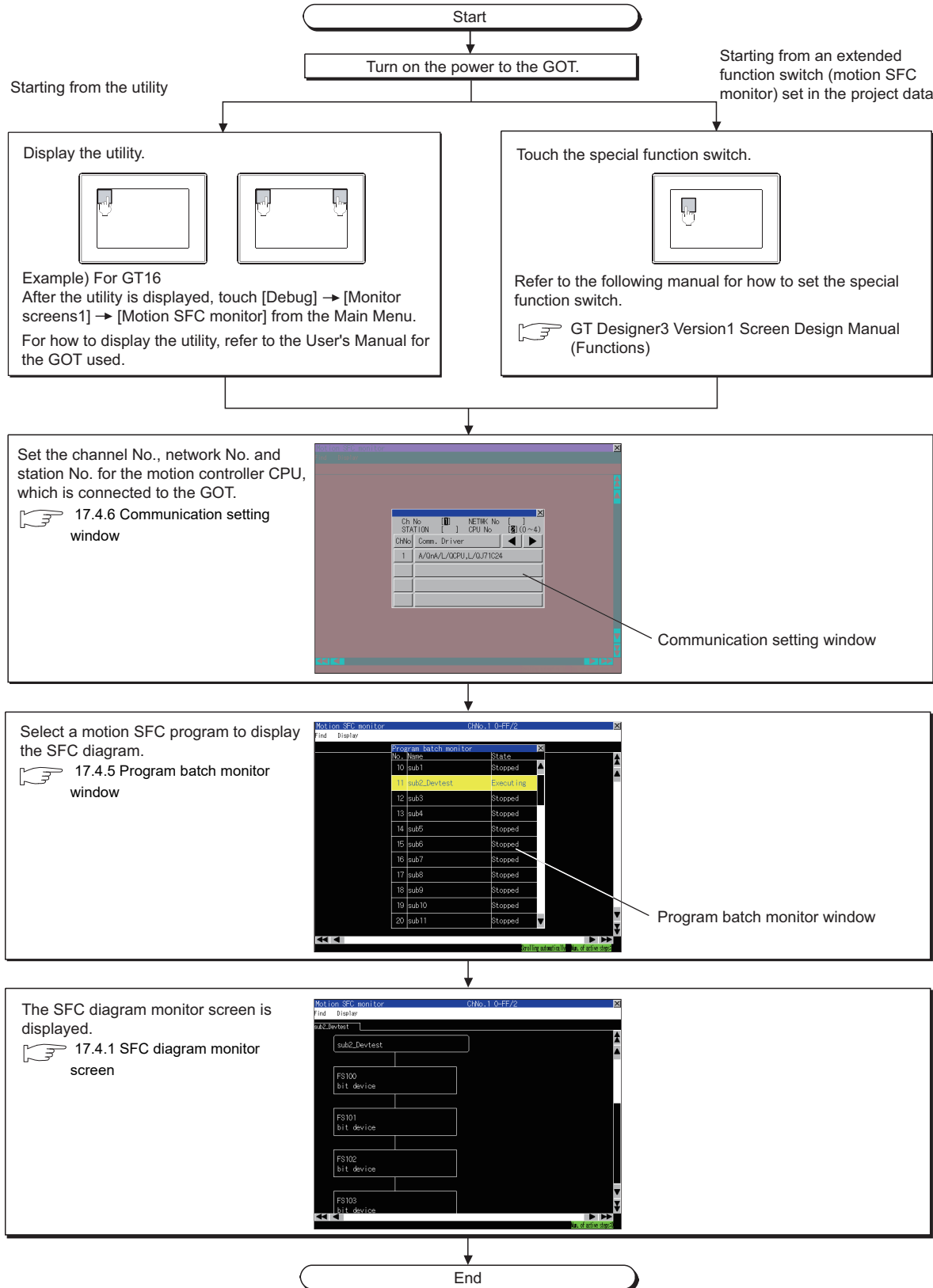

POINT

(1) How to display the utility

For how to display the utility, refer to the following.

 User's Manual for the GOT used

(2) Reading data from PLC when reclosing GOT

Save the motion SFC program in the CF card for the motion SFC monitor.

Reading the motion SFC program is not required when restoring the power supply of the GOT.

 17.3.1 Setting motion SFC program storage location

(3) When GOT has not project data

The motion SFC monitor can be started with the utility even though the GOT has no project data.

Start operation using the special function switch

After using the special function switch to start the motion SFC monitor, the automatic read of the motion SFC program and the SFC diagram display of the set SFC program can be executed.

(1) Starting from the special function switch

The motion SFC monitor can be started by touching the special function switches to which the following settings are configured.



- Select [Motion SFC Monitor] in [Switch Action], and select the [Use Program Batch Monitor Window/SFC Diagram display function] check box.

Operation at start differs depending on the setting contents of the special function switch.

For the setting items for the special function switch, refer to the following.

 GT Designer3 Version1 Screen Design Manual (Functions) 2. TOUCH SWITCH

(O: Set, x: Not set)

Setting	Operation for touching the special function switch
Select [Program Batch Monitor Window] in [Display Screen]. (Set [CH No.] and [Network] as well.)	 (a)
Select [SFC Diagram] in [Display Screen]. (Set [CH No.], [Network] and [File Name] as well.)	 (b)

(a) Operations for selecting [Program Batch Monitor Window]

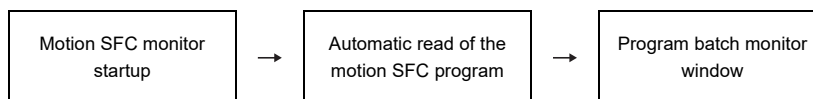

(b) Operations for selecting [SFC Diagram]

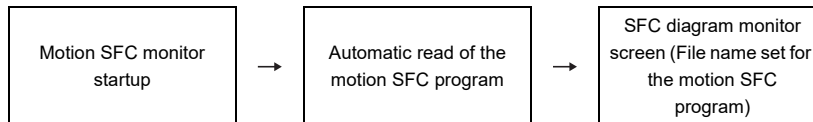

Changing screens

The following describes how to change the screen.

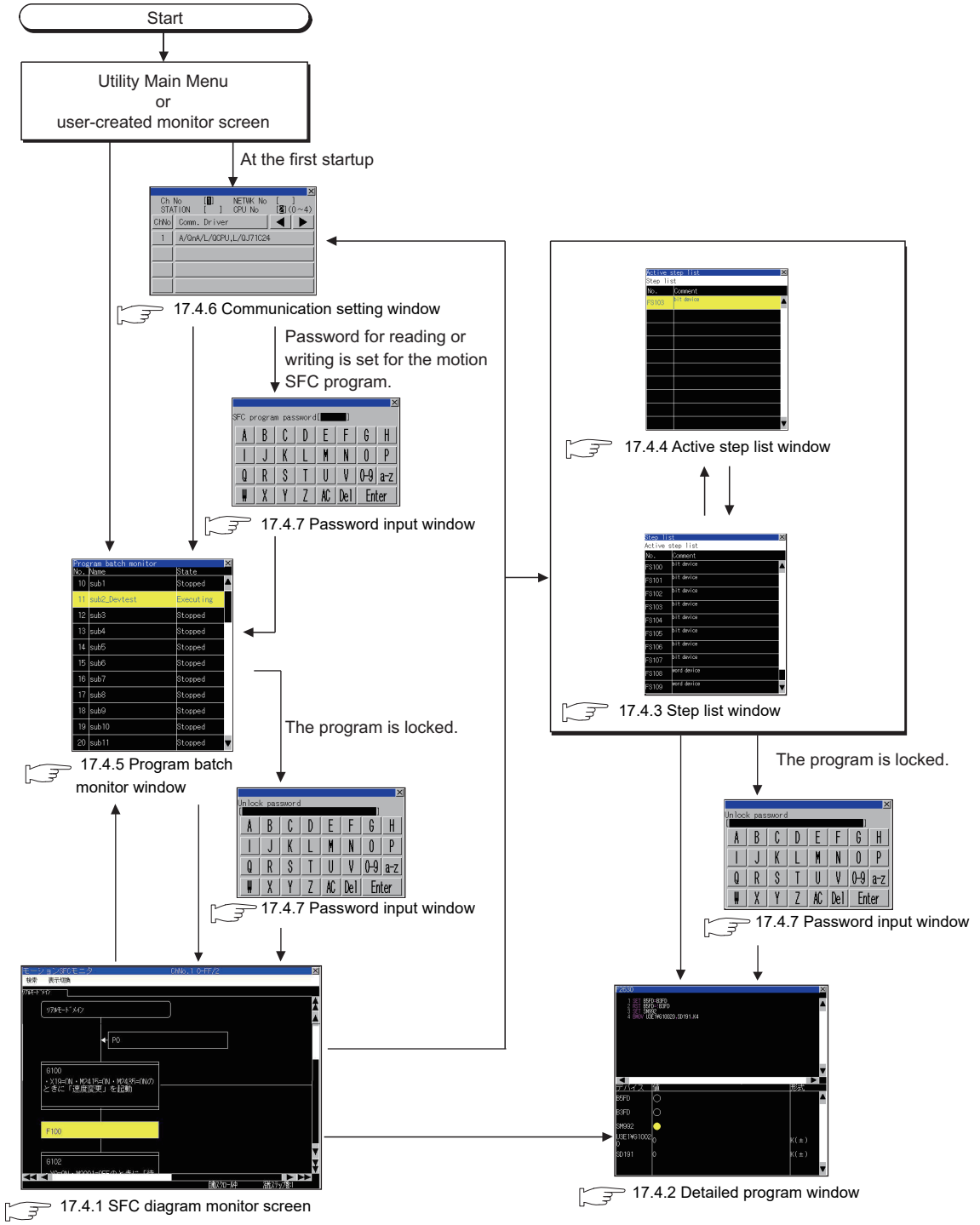

POINT

Screen transition when using the special function switch

For the screen transition when using the special function switch for the automatic read of the motion SFC program and the display of the SFC diagram monitor screen, refer to the following.

➡ 17.3 ■ Start operation using the special function switch

17.3.1 Setting motion SFC program storage location

The motion SFC program read from the motion controller CPU is stored in the storage location that stores ladder data for the ladder monitor function.

Only the [A:Built-in CF card] or [B:Memory card] is available for storing motion SFC programs.

For the ladder data storage destination setting, refer to the following.

- When setting with GOT utility

 User's Manual for the GOT used

- When setting with GT Designer3

 GT Designer3 Version1 Screen Design Manual (Fundamentals) 4.9 GOT Display and Operation Setting

17.4 Operation Procedures

17.4.1 SFC diagram monitor screen

■ Displayed contents

The following describes the contents of the SFC diagram monitor screen and key functions on the screen.

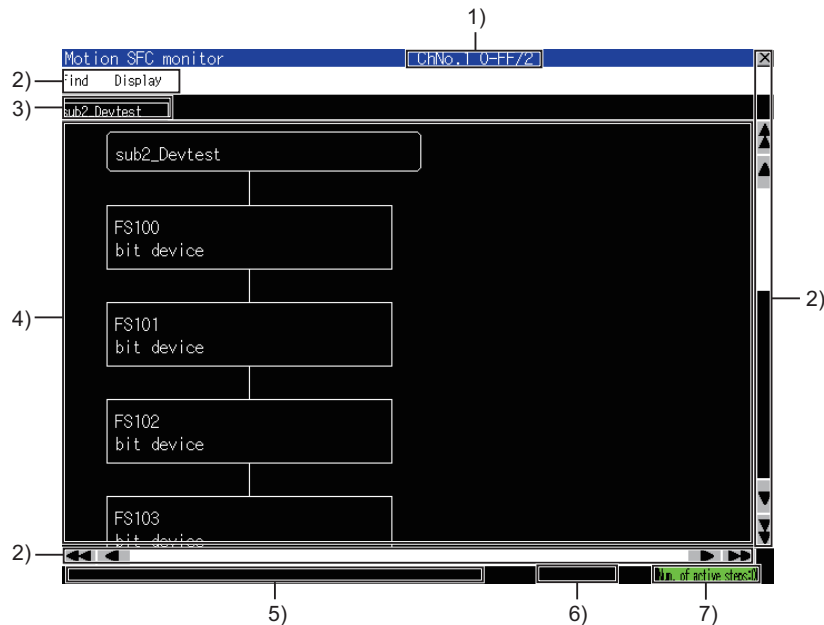

No.	Item	Display contents
1)	Target controller display area	Displays CH No., network No., station No., and CPU No. of the motion controller CPU set as the target. • CH No. network No.-station No./CPU No.
2)	Keys	Keys for operations on the SFC diagram monitor screen.
3)	Program switching tab	Displays the program name of the program displayed in the SFC diagram display area. Touching a tab displays the corresponding program in the SFC diagram display area. Tabs displayed to the right of the touched tab are removed. If the detailed program window is open, the tabs will be closed.
4)	SFC diagram display area	Displays the SFC diagram of the motion SFC program. Active steps are displayed in yellow, and waiting steps are displayed in red. The locked step or transition is shown as below. • Inactive : Gray • Active : Pongee • Waiting : Dark red For displayed motion SFC diagram symbols, refer to the following. ☞ (1) Motion SFC diagram symbol The followings can be selected in the SFC diagram display area. • Valid/invalid of comment display • Valid/invalid of automatic scroll ☞ ■Menus (2) Display menu
5)	Message display area	Displays error messages and others.
6)	Automatic scroll status display area	Displays [Scrolling automatically] when the automatic scroll mode is valid. Nothing is displayed when the automatic scroll mode is invalid. When the automatic scroll is valid, the automatic scroll turns invalid by touching the automatic scroll status display area.
7)	Number of active steps display area	Displays the number of active steps. Active step list window is displayed by touching this area. ☞ 17.4.4 Active step list window

(1) Motion SFC diagram symbol

The following describes the motion SFC diagram symbols displayed in the SFC diagram display area.

Classification	Name	Symbol	Function
Program start/end	START		Indicates the program entrance by the program name.
	END		Indicates the program end (exit).
Step ^{*1}	Motion control step		-
	Once execution type operation control step		Detailed program window is displayed by touching this area.
	Scan execution type operation control step		17.4.2 Detailed program window
	Subroutine call/start step		Touch this to add a tab with the name of the program which is set for the subroutine call/start step, to the right of the program switching tab.
	Clear step		The program corresponding to the added program switching tab is displayed in the SFC display area. If the detailed program window is open, the tab will be closed.
Transition ^{*1}	Shift		Touch this to display the detailed program window. 17.4.2 Detailed program window The device name of the set bit device is displayed on WAITON and WAITOFF. Even if the label is set to the bit device, the device name is displayed.
	Shift Y/N		
	WAIT		
	WAIT Y/N		
	WAITON		
	WAITOFF		
Jump	Normal		Touch this to search the jump/pointer of the same number.
	Coupling		
Pointer	Normal		Found jump/pointers are displayed in the SFC diagram display area.
	Coupling		

*1 Touching the locked step or transition displays the password input window.

17.4.7 Password input window

POINT

Precautions for changing the motion controller CPU to the debug mode

When MT Developer/MT Works2 changes the motion controller CPU to the debug mode, Shift Y/N and WAIT Y/N in active status may not be highlighted in yellow.

Check the active status of Shift Y/N and WAIT Y/N with MT Developer/MT Works2.

Key functions

The following describes key functions for operations on the SFC diagram monitor screen.

Key	Function
Find	Displays the Find menu. ■Menus (1) Search menu
Display	Displays the Display menu. ■Menus (2) Display menu
	Closes the motion SFC monitor and returns to the screen for starting the motion SFC monitor.
	Scrolls the display area up and down by one line.
	Scrolls the display area up and down by one page.
	Scrolls the display area right and left by one column.
	Scrolls the display area right and left by one page.

Menus

The following shows the operations for menus displayed on the SFC diagram monitor screen.

(1) Search menu





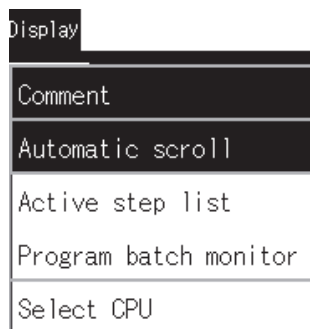

Key	Function
Step list	Displays the step list window. 17.4.3 Step list window

(2) Display menu

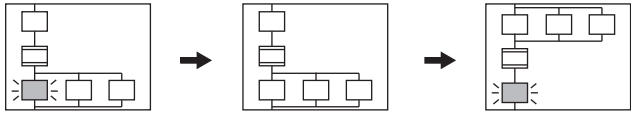

Key	Function
Comment	Sets valid/invalid of the comment display. <div style="display: flex; justify-content: space-around;"> <div style="text-align: center;"> Comment display valid </div> <div style="text-align: center;"> Comment display invalid </div> </div>

(Continued to next page)

Key	Function
<p>Automatic scroll</p>	<p>Switches the automatic scroll to valid/invalid.</p> <p>When the automatic scroll is valid and all the following conditions are satisfied, the active steps are displayed on the SFC diagram monitor screen by automatically scrolling the screen.</p> <ul style="list-style-type: none"> • No active step is displayed on the SFC diagram monitor screen. • The displayed motion SFC program has an active step. <div style="display: flex; align-items: center; justify-content: center;">  </div> <p>The step status becomes inactive.</p> <p>An active step in the block is displayed by automatically scrolling the screen.</p> <p>Displays [Scrolling automatically] in the automatic scroll status display area of the SFC diagram monitor screen when the automatic scroll is valid.</p> <p> 17.4.1 SFC diagram monitor screen</p>
<p>Active step list</p>	<p>Displays the active step list window</p> <p> 17.4.4 Active step list window</p>
<p>Program batch monitor</p>	<p>Displays the program batch monitor window.</p> <p> 17.4.5 Program batch monitor window</p>
<p>Select CPU</p>	<p>Displays the communication setting window.</p> <p> 17.4.6 Communication setting window</p>

17.4.2 Detailed program window

■ Displayed contents

The following describes the contents of the detailed program window and the key functions displayed on the screen.

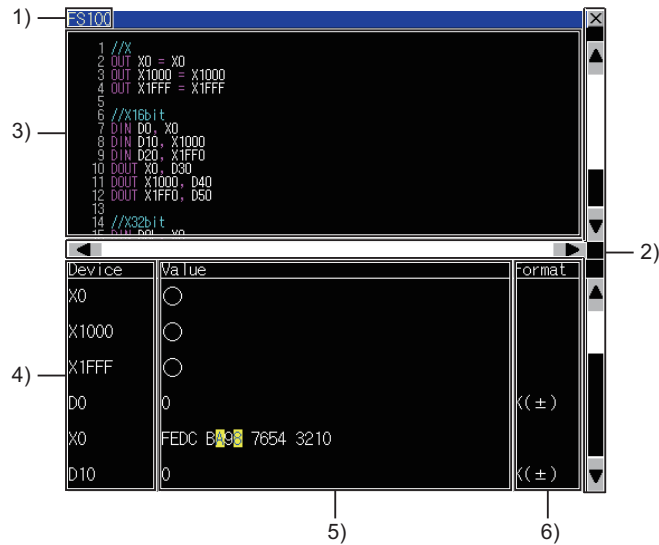

No.	Item	Display contents
1)	Number display area	Displays the step/transition number.
2)	Keys	Displays the keys for operations on the detailed program window.
3)	Program display area	<p>Displays the arithmetic control program/transition program. When the automatic scroll is valid and the active step is changed, the arithmetic control program/transition program of the active step is displayed. When the locked step becomes active, the displayed contents do not change in the detailed program window.</p> <p>☞ 17.4.1 ■ Display menu The arithmetic control program/transition program of the touched step/transition is displayed by touching the step/transition on the step list window or active step list window.</p> <p>☞ 17.4.3 Step list window 17.4.4 Active step list window</p>
4)	Device display area	<p>Displays the devices (device name/device No./data type) which is used in the arithmetic control program/transition program displayed in the program display area. Data type is only displayed when the device is the word device (32-bit integer type/64-bit floating point number type).</p> <div style="text-align: center;"> <p>D2012L ├── Data type (L: 32 bits, F: 64 bits) ├── Device number └── Device name</p> </div> <p>The number of displayable devices differs according to the device type. Up to 288 points can be displayed when the devices are counted in the following way.</p> <ul style="list-style-type: none"> • Bit device (1 bit): 1 point • Bit device (16 bits): 2 points • Bit device (32 bits): 4 points • Word device (16-bit integer type): 2 points • Word device (32-bit integer type): 4 points • Word device (64-bit floating point number type): 8 points <p>When the label is set to the motion SFC program, the displayed name varies depending on the connected motion controller CPU.</p> <ul style="list-style-type: none"> • Q172DSCPU and Q173DSCPU: The label name is displayed. However, the current value is not displayed. • Other than the above: The device name is displayed.

(Continued to next page)

No.	Item	Display contents
5)	Current value display area	<p>Displays the current value of the device which is used in the arithmetic control program/transition program displayed in the program display area.</p> <p>If the current value cannot be acquired from the motion controller CPU, the value will not be displayed. The following shows the displayed contents of each device.</p> <ul style="list-style-type: none"> • Bit device (1 bit) : Yellow ○ is displayed at ON, and ● is displayed at OFF. • Bit device (16 bits/32 bits): the lowest digits of 16-bit/32-bit portion of the initial device are displayed side-by-side. <p>The contents are displayed only when the device No. of the specified initial device is a multiple of 16. When the device is ON, the background of the device No. is displayed in yellow.</p> <p>Example) The current value display of Bit device X18 (16 bits)</p> <div style="text-align: center;"> </div> <ul style="list-style-type: none"> • Word device: Displays in the display format set in the display format display area.
6)	Display format display area	<p>Displays the display format of the word device which is used in the arithmetic control program/transition program displayed in the program display area. (Not displayed when using bit device.)</p> <p>The following shows the display format types.</p> <ul style="list-style-type: none"> • K (±) : Signed decimal • K (+) : Unsigned decimal • H : Hexadecimal (H is displayed on the head of the value in the current value display area.) • BIN : Binary • FLOAT: Floating-point number (The current value is displayed in the exponential representation.) <p>Display format can be changed by touching the display format display area. By touching the area, display format changes in the following order.</p> <ul style="list-style-type: none"> • 16/32Bit : K(±) → K(+) → H → BIN • 64Bit : FLOAT → H

■ Key functions

Key	Function
	Close the detailed program window.
	Scrolls the display area up and down by one line.
	Scrolls the display area right and left by one column.

17.4.3 Step list window

Step list window displays the steps and transitions.

■ Displayed contents

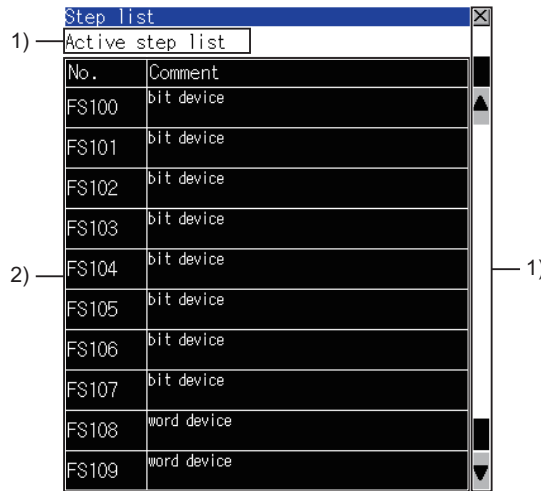

No.	Item	Display contents
1)	Keys	Keys for operations on the step list window.
2)	Step display area	<p>Displays the step/transition numbers and comments set in the step/transition. Active steps are displayed in yellow, and waiting steps are displayed in red. The locked step or transition is shown as below.</p> <ul style="list-style-type: none"> • Inactive : Gray • Active : Pongee • Waiting : Dark red <p>Touching the step or transition displays the step or transition on the SFC diagram monitor screen. In addition, the program is displayed on the detailed program window. (When the step or transition is locked, the authentication is needed on the password input window.)</p> <p>The following shows the types of steps and transitions.</p> <ul style="list-style-type: none"> • Kn : Motion control step • Fn : Once execution type operation control step • FSn : Scan execution type operation control step • GSUB : Subroutine call/start step • Gn : Shift, Shift Y/N, WAIT and WAIT Y/N • WAITON : WAITON • WAITOFF : WAITOFF <p>Depending on the step/transition, the displayed contents of comments may be as follows.</p> <ul style="list-style-type: none"> • GSUB (Subroutine call/start step) : Call destination/startup destination program name • WAITOFF and WAITOFF : Bit device name

POINT

Precautions for changing the motion controller CPU to the debug mode

When MT Developer/MT Works2 changes the motion controller CPU to the debug mode, Shift Y/N and WAIT Y/N in active status may not be highlighted in yellow.

Check the active status of Shift Y/N and WAIT Y/N with MT Developer/MT Works2.

■ Key functions

Key	Function
Active step list	Closes the step list window and displays the active step list window. 17.4.4 Active step list window
	Closes the step list window
	Scrolls the display area up and down by one line.

17.4.4 Active step list window

Displays the active steps.

■ Displayed contents

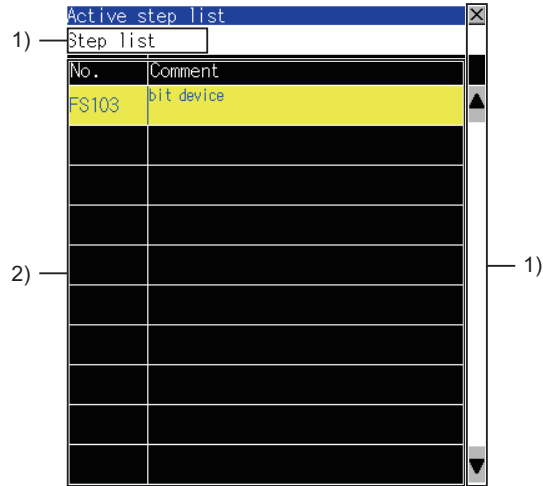

No.	Item	Display contents
1)	Keys	Keys for operations on the active step list window.
2)	Active step display area	<p>Displays the active step numbers and comments set in the active step. The step or transition is displayed as below.</p> <ul style="list-style-type: none"> • Not locked : Yellow • Locked : Pongee <p>Touching the step or transition displays the step or transition on the SFC diagram monitor screen. In addition, the program is displayed on the detailed program window. (When the step or transition is locked, the authentication is needed on the password input window.)</p> <p>The following shows the types of steps and transitions.</p> <ul style="list-style-type: none"> • Kn : Motion control step • Fn : Once execution type operation control step • FSn : Scan execution type operation control step • GSUB : Subroutine call/start step • Gn : Shift, Shift Y/N, WAIT and WAIT Y/N • WAITON : WAITON • WAITOFF : WAITOFF <p>Depending on the step/transition, the displayed contents of comments may be as follows.</p> <ul style="list-style-type: none"> • GSUB (Subroutine call/start step) : Call destination/startup destination program name • WAITOFF and WAITOFF : Bit device name



POINT

Precautions for changing the motion controller CPU to the debug mode

When MT Developer/MT Works2 changes the motion controller CPU to the debug mode, Shift Y/N and WAIT Y/N in active status may not be displayed in the active step display area.

Check the active status of Shift Y/N and WAIT Y/N with MT Developer/MT Works2.

■ Key functions

Key	Function
Step list	Closes the step list window and displays the active step list window.  17.4.3 Step list window
	Closes the active step list window.
	Scrolls the display area up and down by one line.

17.4.5 Program batch monitor window

The following shows the operation for selecting the motion SFC program to display on the SFC diagram monitor screen.

■ Displayed contents

No.	Name	State
10	sub1	Stopped
11	sub2_Devtest	Executing
12	sub3	Stopped
13	sub4	Stopped
14	sub5	Stopped
15	sub6	Stopped
16	sub7	Stopped
17	sub8	Stopped
18	sub9	Stopped
19	sub10	Stopped
20	sub11	Stopped

No.	Item	Display contents
1)	Program status display area	<p>Displays the program No., program name and program status of the motion SFC program read from the motion controller CPU.</p> <p>The program is displayed as below.</p> <ul style="list-style-type: none"> • Unlocked and running program : Yellow • Locked program : Gray • Locked and running program : Pongee <p>Touching a program name closes the program batch monitor window and displays the corresponding program on the SFC diagram monitor screen. If the detailed program window is open, the tabs will be closed.)</p> <p> 17.4.1 SFC diagram monitor screen</p> <p>Touching the locked program displays the password input window.</p> <p> 17.4.7 Password input window</p>
2)	Keys	Keys for operations on the program batch monitor window.

■ Key functions

Key	Function
	Closes the program batch monitor window.
	Scrolls the display area up and down by one line.

17.4.6 Communication setting window

Sets the motion controller CPU for monitoring.

■ Displayed contents

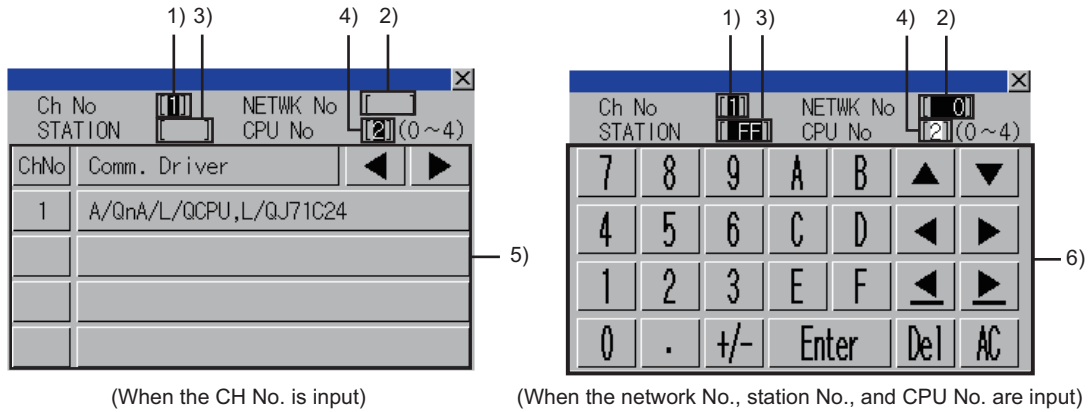

The following table shows the displayed contents.

No.	Item	Display contents
1)	CH No. input area	Set the CH No. for the target controller.
2)	Network No. input area	Set the network No. for the target controller.
3)	Station No. input area	Set the station No. of the target controller. When the station No. is set to the host station (FF), set the network No. to 0.
4)	CPU No. input area	Set the CPU No.
5)	CH No. selection key	Select a CH No.
6)	Keys	Keys for operations in the communication setting window shown in (b). (Touch input)

■ Key functions

Key	Function
	Closes the communication setting window. When any of the CH No., network No., station No., and CPU No. is not input and the monitor target is not set, the communication setting window does not close.
	Moves the cursor among the input areas.
	The operation differs depending on the status at touch. <ul style="list-style-type: none"> When the cursor is in the CH No. input area, network No. input area, or station No. input area: Moves the cursor. When the cursor is in the CPU No. input area and settings for the CH No., network No., and station No. are completed: The communication setting window closes and the PLC read screen appears. Displays the password input window when the read motion SFC program requires a password. <ul style="list-style-type: none"> 17.4.7 Password input window When the program does not require any password, the program batch monitor window appears. <ul style="list-style-type: none"> 17.4.5 Program batch monitor window
	Deletes an input value or character.
	Deletes all the input values and characters.

17.4.7 Password input window

Executes the password authentication of the motion SFC program.

After the password authentication has succeeded, the password is authenticated automatically with the same password for the following time. (The password input window is not displayed.)

■ Displayed contents

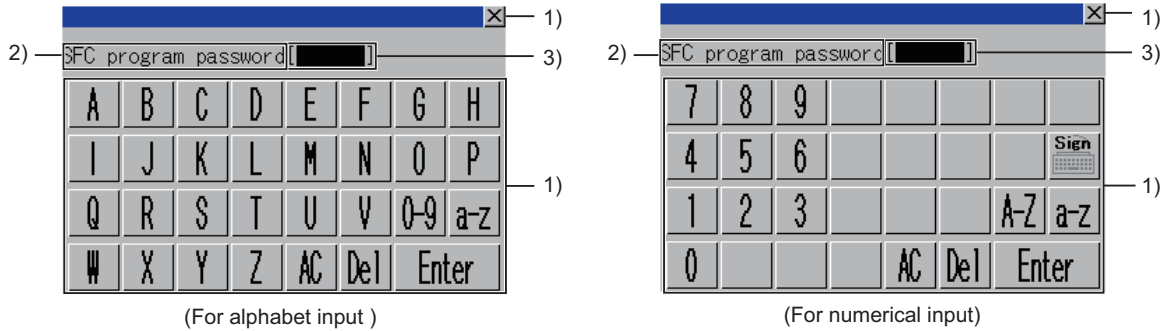

No.	Item	Display contents
1)	Keys	Keys for operations in the password input window.
2)	Password type	Displays the type of the password to be input. <ul style="list-style-type: none"> • SFC program password : The password for writing or reading • Unlock password : The password for unlocking the program
3)	Password input area	Set the password.

■ Key functions

Key	Function
	Closes the password input window and cancels the password input operation.
	Switches the key type to the value.
	Switches the key type to the symbol.
	Switches the key type to the alphabet (uppercase).
	Switches the key type to the alphabet (lowercase).
	Deletes all the input values and characters.
	Deletes an input value or character.
	Authenticates the password set in the password input area.

18. CNC MACHINING PROGRAM EDIT



18.1 Features

With CNC machining program edit function, the GOT can edit machining programs and MDI programs of the CNC connected to the GOT.

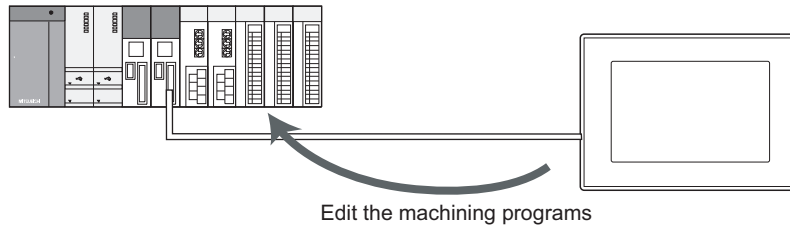

18.2 Specifications

18.2.1 System configuration

This section describes the target CNC for which CNC machining program edit can be used and the connection type between the GOT and the CNC.
For connection type settings and precautions regarding the communication unit/cable and connection type, refer to the following.

GOT1000 Series Connection Manual (Mitsubishi Products) for GT Works3

■ Target CNC of CNC data I/O

CNC
CNC C70

■ Connection type

This function can be used in the following connection types.

(○: Available, ✕: Unavailable)

Function		Connection type between GOT and CNC	
Name	Description	Bus connection	Ethernet connection*2
CNC machining program edit	Editing of CNC machining program edit	○	○*1

*1 Applicable only with the Display I/F connection.

*2 CNC Data I/O cannot be used when using CC-Link IE field network Ethernet adapter.

■ Required extended function OS

The following extended function OS is required.

 1.1.2 Hardware and OS' required for each function

(1) Extended function OS

Install the extended function OS for CNC machining program edit on the GOT.
For the installation procedure, refer to the following.

 GT Designer3 Version1 Screen Design Manual (Fundamentals)

(2) OS memory space

For installing the extended function OS, the available space shown in the above table is required in the user area.

For the procedure for checking the available memory space of the user area and information about the data using other user areas, refer to the following.

 GT Designer3 Version1 Screen Design Manual (Fundamentals)

18.2.2 Access range

(1) Bus connection

One GOT can execute the CNC data I/O on up to two CNCs by switching the CNCs.

(2) Ethernet connection

One GOT can execute the CNC data I/O on up to 64 CNCs by switching the CNCs.

18.2.3 Recautions

(1) Before executing CNC machining program edit

Read carefully the manual of the connected CNC and make sure you understand the descriptions before executing CNC machining program edit.

(2) Inapplicable GOT

The CNC data I/O cannot be used with the GOTs shown below.

GOT	Inapplicable GOT
GT16	GT1675M-V, GT1675-VN, GT1672-VN, GT1665M-V, GT1662-VN, GT1655-V
GT15	GT1575-V, GT1575-VN, GT1572-VN, GT156□, GT155□

(3) Protection for the editing of the machining programs

When even one of the data protection key 3, the edit lock B, and the edit lock C is valid, CNC machining program edit is restricted.

Even when one of the data protection key 3, the edit lock B, and the edit lock C is valid, the machining programs can be opened.

For the data protection key 3, the edit lock B, and the edit lock C, refer to the following.

 C70 Series INSTRUCTION MANUAL

(4) CNC software version

CNC software version	Function	
	Machining program list display	Machining program edit
BND-1006W000-D6 or less	○	×
BND-1006W000-D6 or more	○	○

18.3 Operations for Display

Start operation for CNC machining program edit

The following describes the outline for displaying the operation screen for CNC machining program edit after installing CNC Machining Program Edit and GOT Platform Library (extended function OS) on the GOT. Configure the setting for the special function switch to set the channel No. of the CNC which is connected to the GOT and the network before CNC machining program edit is started. For the start operation of CNC machining program edit using the special function switch, refer to the following.

Start operation using the special function switch

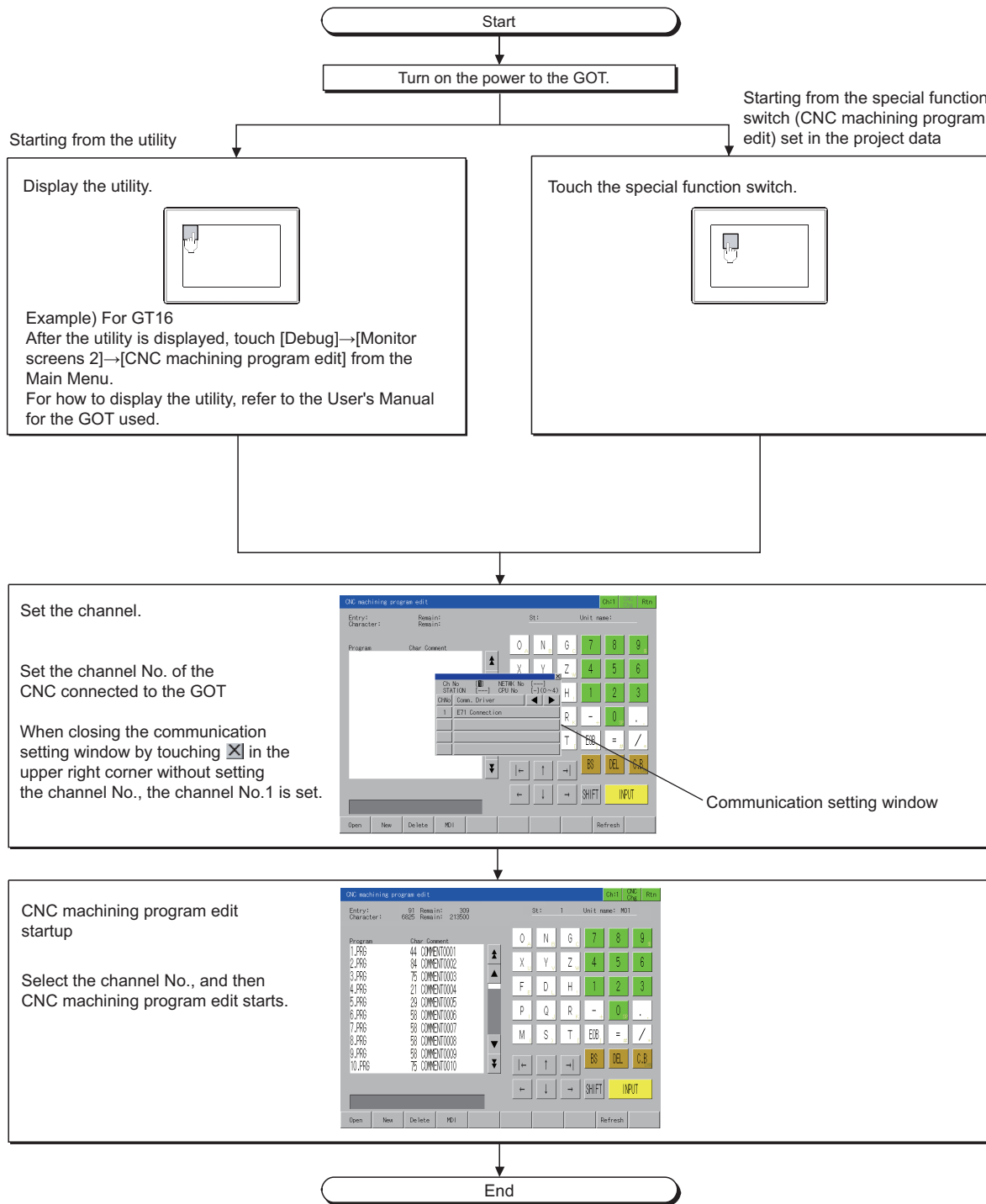

POINT

(1) How to display the utility

For how to display the utility, refer to the following.

 User's Manual for the GOT used

(2) Displaying communication setting window

The communication setting window is displayed only at the first startup of CNC machining program edit after the GOT is turned on.

To display the communication setting window at the second or later startup, touch the **Ch:** button on CNC machining program edit screen.

 18.4 Operation Procedures

(3) If the project data has not been downloaded

CNC machining program edit can be started from the utility if the project data has not been downloaded to the GOT.

■ Start operation using the special function switch

CNC machining program edit is started by the special function switch.

CNC machining program edit screen of the specified controller is displayed by touching the special function switch on which the following setting has been configured.

- Select [CNC Machining Program Edit] in [Switch Action], and select the [Specify the destination to connect the screen of CNC Machining Program Edit] check box.

For Q-bus connection, [CPU No.] of [Network] should be 2 or more.

Operation at start differs depending on the setting contents of the special function switch.

For the setting items for the special function switch, refer to the following.

 GT Designer3 Version1 Screen Design Manual (Functions)

■ Changing screens

The following describes how to change the screen.

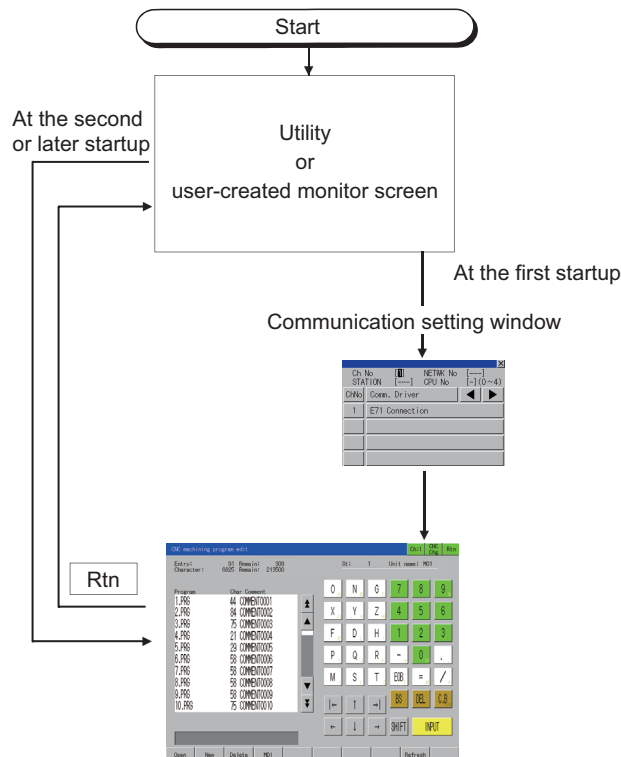

When exiting CNC machining program edit by touching **Rtn**, the last exited screen will be displayed at the next startup of CNC machining program edit.

18.4 Operation Procedures





This section describes the screens and the software keyboard used for CNC machining program edit. For the editing procedure of machining programs and MDI programs, refer to the following.

 C70 Series INSTRUCTION MANUAL

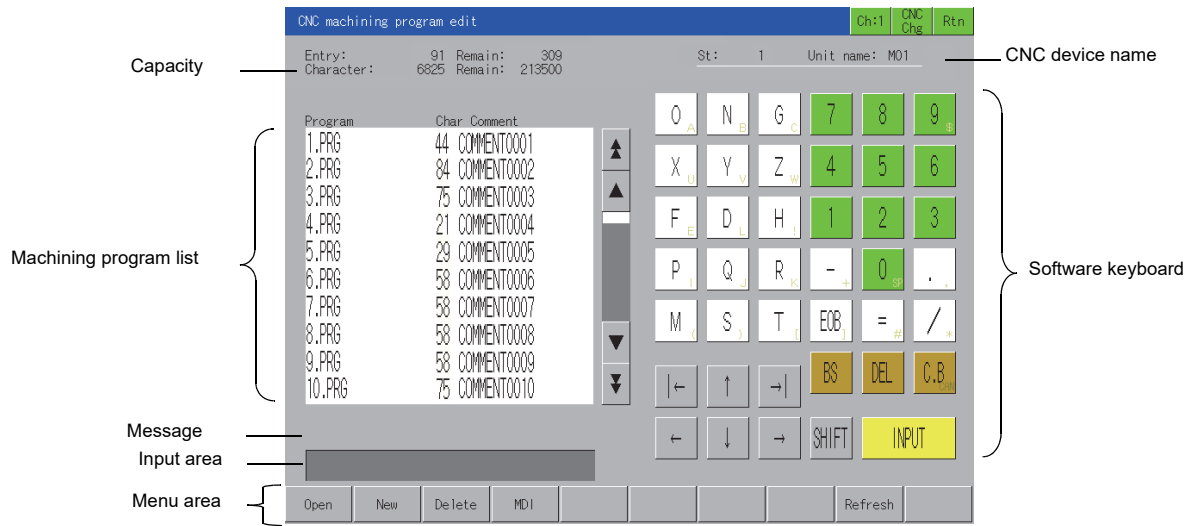





■ List screen

This subsection describes the details of the screen displaying the CNC machining program list and the functions of the keys on the screen.

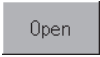

Item	Description
	Displays the communication setting window.
	<ul style="list-style-type: none"> For the bus connection Switches CNCs to be monitored when multiple CNCs are connected. Switches CNCs to be monitored in the order of the module number. For the Ethernet connection Switches CNCs to be monitored when multiple CNCs are connected. Switches CNCs to be monitored in the order specified in the Ethernet setting on GT Designer3.
	Ends CNC machining program edit, and then the screen is returned to the monitor screen or the utility screen of the GOT.
CNC device name	For the bus connection, CPU No. and the module name are displayed. For the Ethernet connection, the station No. and the module name are displayed.
Capacity	<ul style="list-style-type: none"> Entry and remain Displays the number of the machining programs registered by the user and the remaining number of registrable programs. Character and remain Displays the number of the characters in the machining programs registered by the user and the remaining number of registrable characters.
Machining program list	Displays the CNC machining program list. Displays the programs in the ascending order of the program number. When the program comments include the multi-byte code (such as shift JIS code), the list is not displayed properly.
	Scrolls the list up/down by 10 items.
	Scrolls the list up/down by 50 items.

(Continued to next page)

Item	Description
<p>Message</p>	<p>Displays guidance messages and error messages. For details of the error messages, refer to the following.  18.5 Error Messages and Corrective Actions</p>
<p>Input area</p>	<p>Used to input the machining program name.</p>
<p>Software keyboard</p>	<p>Used to input the machining program name. ".PRG" is not required to be input. For details of the software keyboard, refer to the following.  ■Software keyboard</p>
<p></p>	<p>Opens the existing machining program. To open the machining program, select the program from the list or input the program name in the input area, and then touch the INPUT key. When opening the machining program, the user can directly jump to the block No. of the sequence No. selected by the user. Input the Machining program name/Sequence No./Block No. in the input area, and then touch the INPUT key. Example) To jump to the block No. 0 of the sequence No. 110 of 123.PRG, input 123/110/0 or 123/110 in the input area, and then touch the INPUT key.</p>
<p></p>	<p>Creates a new machining program. To open a new machining program, input a new machining program name in the input area and then touch the INPUT key.</p>
<p></p>	<p>Delete the existing machining program. The user selects the machining program from the list or inputs the program name in the input area, and touches the INPUT key, and then the confirmation dialog box appears. To delete the machining program, touch the [OK] button.</p>
<p></p>	<p>Opens the MDI program. Switches to the MDI program editor screen.</p>
<p></p>	<p>Updates the list.</p>





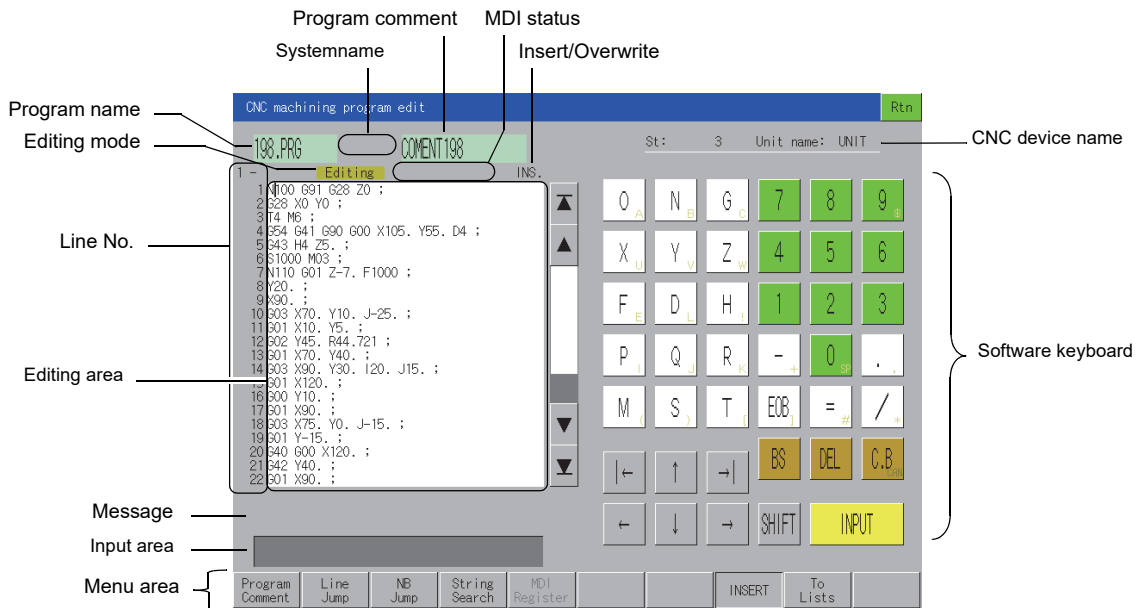







■ Editor screen

This subsection describes the details of the editor screen for CNC machining program edit and the functions of the keys on the screen.



Item	Description
	Ends CNC machining program edit, and then the screen is returned to the monitor screen or the utility screen of the GOT.
CNC device name	For the bus connection, CPU No. and the module name are displayed. For the Ethernet connection, station No. and the module name are displayed.
Program name	Displays the name of the program currently displayed on the screen. MDI.PRG is displayed while the MDI program is edited.
Program comment	Displays the comment of the program currently displayed on the screen. Not displayed for the MDI program. The program comments that include the following character strings are not displayed properly. <ul style="list-style-type: none"> Character strings including multi-byte code Character strings including kanji, hiragana, katakana, and one-byte katakana
Editing mode	Indicates that the user is editing the program. Not displayed when the user is not editing the program.
MDI status	Displays the status of the MDI program. No MDI setting: Indicates the status that the MDI program cannot be run. To change the MDI status to MDI set comp., move the cursor to the user-selected position within the program and touch the INPUT key. MDI set comp.: Indicates the status that the MDI program can be run. The background color of the selected line number is changed to light blue. The status of MDI set comp. is canceled when the user starts to edit. MDI running: Indicates the status that the MDI program is being run.
Insert/Overwrite	Insert/Overwrite display is switched depending on the insert/overwrite mode.
Line No.	Displays the line number. Initial line No.: Displays the number of the line displayed in the top of the editing area. Line No.: Displays the lower four digits of the line number.
Editing area	Displays the programs. 22 lines × 40 characters can be displayed in the editing area. The following operations are executed by touching the editing area. <ul style="list-style-type: none"> The cursor is moved to the position the user touches. When the user touches any space in which no characters is displayed, the cursor is moved to the nearest position therefrom and that the characters can be input. Each item in the menu area is switched from ON to OFF. Note that the cursor is moved to the beginning of the highlighted strings during the character string search.

(Continued to next page)

Item	Description
	Scrolls to the previous page/next page.
	Jumps to the first line/last line.
Message	Displays guidance messages and error messages. For details of the error messages, refer to the following.  18.5 Error Messages and Corrective Actions
Input area	Whether the characters can be input into the input area depends on each item in the menu area.
Software keyboard	Used to edit the machining program. For details of the software keyboard, refer to the following.  ■Software keyboard
System name	Displays the name of the systems in which the MDI program is displayed and the MDI setting is configured.
	Used to input a comment for the machining program. To reflect the input value, input the comment in the input area and touch the INPUT key. Up to 18 characters are input in the program comment. The comment cannot be input in the MDI program.
	Used to move to the user-selected line The user inputs the line number in the input area and touches the INPUT key, and then the selected line is displayed in the top of the editing area. When the line number that does not exist in the program, E, and EOR are input in the input area, the last line is displayed.
	Used to move to the block No. of the sequence No. selected by the user. The user inputs the Sequence No./Block No. in the input area and touches the INPUT key, and then the selected position is displayed in the top of the editing area. When no block No. is input, it is considered as 0. Example) To jump to the block No. 0 of the sequence No. 110, input 110/0 or 110 in the input area and touch the INPUT key.
	Searches the character strings and moves to the found string. The user inputs the character string in the input area and touches the INPUT key, and then the search starts from the position on which the cursor is located. The found string is highlighted. When the target string is not found before the search is finished at the last line of the program, the search starts from the first line. Up to 11 characters are searched.
	Switches between the systems to configure the MDI setting.
	Registers the MDI program as the CNC machining program. The user inputs the machining program number in the input area and touches the INPUT key, and then the MDI program is registered. Registration can be executed only when the MDI program is opened.
	ON: Indicates the insert mode. OFF: Indicates the overwrite mode. Switches ON/OFF by touching the key. Initial status is set to ON (insert mode).
	Moves to the list screen.

■ Software keyboard

This subsection describes the details of the software keyboard, and the functions of the keys displayed on the screen.

Key operation using a USB keyboard is also available.







 ■ Inputting using a USB keyboard



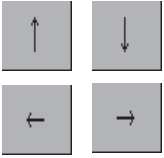

SHIFT OFF



SHIFT ON













Item	Description
Alphanumeric/symbol	Used to input alphabets, numerals, spaces, or symbols. The grayed symbol can be input after the SHIFT key is touched
	Inputs EOB(:) into the machining program.
	When the SHIFT key is ON, the grayed symbol can be input. Once the grayed symbol is entered, the SHIFT key is switched to OFF.
	Moves the cursor up, down, left, or right.
	<ul style="list-style-type: none"> • Editing area Moves the cursor to the beginning of the word. When the cursor is located on the beginning of the word, it is moved to the beginning of the previous word. • Input area Moves the cursor to the first character in the string.
	<ul style="list-style-type: none"> • Editing area Moves the cursor to the beginning of the next word. • Input area Moves the cursor to the last character in the string.
	Deletes the previous character of the position on which the cursor is located.
	Deletes the character on which the cursor is located.

(Continued to next page)

Item	Description
	<ul style="list-style-type: none"> • Editing area Deletes all the characters in the block in which the cursor is located. • Input area Deletes all the characters in the input area.
	<ul style="list-style-type: none"> • Editing area Deletes all the characters in the displayed page. • Input area Deletes all the characters in the input area.
	<ul style="list-style-type: none"> • Editing area Stores the machining program that the user is editing. Stores the MDI program that the user is editing, and changes the MDI status to MDI set comp.. • Input area Set the input contents to execute.

■ Inputting using a USB keyboard

Key operation may be different between the USB keyboard and the keys of the screen.
Refer to the following table.

Item	Description
	Shift+Tab
	Tab
	Shift+Delete, Home
	Shift+Home
	Enter
 	Shift+Page Up
 	Shift+Page Down
 	Page Up / Page Down
Menu area	<ul style="list-style-type: none"> • List screen F1: Open, F2: New, F3: Delete, F4: MDI, F9: Refresh • Editor screen F1: Program Comment, F2: Line Jump, F3: NB Jump, F4: String Search, F5: MDI Register, F7: System Change, F8: INSERT, F9: To Lists
	No key corresponding to the SHIFT key.

When using the USB keyboard, install the extended function OS (USB mouse/keyboard) to the GOT.
For the installation procedure for the extended function OS (USB mouse/keyboard), refer to the following.

 GT Designer3 Version1 Screen Design Manual (Fundamentals)

For the setting method of USB keyboards, refer to the following.

 User's Manual for the GOT used

18.5 Error Messages and Corrective Actions

The following shows the error messages for CNC machining program edit and the corrective actions.

Error message	Error	Corrective action
CNC version not compatible	The CNC version is not compatible for CNC machining program edit.	Use the latest version of CNC.
Cannot execute except in MDI mode	Since the parameter of the MDI setting lock (#1144 mdlkof) is 0 (MDI setting disabled), the MDI setting cannot be configured except in the MDI mode.	Change to the MDI mode, or set the proper parameter.
Unable to execute: Program running	CNC machining program edit cannot be executed for the machining program which is running.	Stop running the machining program, and then execute CNC machining program edit again.
NB not found	The block number that does not exist is specified in the NB jump function.	Input the correct block number.
Program not designated	The INPUT key is touched before the machining program is designated.	Designate the machining program, and then touch the INPUT key.
Program does not exist	The machining program that does not exist is specified.	Input the correct machining program number.
Program No. duplicate	The specified machining program number cannot be registered since the same number already exists	Input any other number which is not used.
Program No. illegal	The specified machining program number is invalid.	Input the proper machining program number.
Memory over	The maximum capacity of the memory is exceeded.	Make enough space in the memory by deleting the machining programs.
Data protected	Since even one of the data protection key 1, 2, and 3, and the edit lock B and C is valid, CNC machining program edit cannot be executed.	Check that the data protection key 1, 2, and 3, and the edit lock B and C are set to be invalid, and then execute CNC machining program edit again.
No. of registrations over	The maximum number of registrable programs is exceeded.	Delete the unnecessary machining programs, and then execute CNC machining program edit again.
Input error	The data is input in the incorrect format.	Input the data in the correct format.
An error found in file system	An error found in file system	Format the CNC memory.
Cannot write file	A machining program cannot be written.	Format the CNC memory.
Cannot read file	A machining program cannot be read.	Format the CNC memory.
Program display locked	The machining program cannot be displayed due to the program display lock C (#1122pglk_c).	Check the parameter values.
No. of block characters over	The maximum number of characters allowed per block is exceeded.	Output the machining program using the CNC data I/O function, and delete characters to be 587 or less per block.
Unable to execute: Editing	While the machining program is edited, the change of the program comment, NB jump, string search, MDI registration, and the scrolling outside the editing area cannot be executed	Cancel the editing mode, and then execute those operations again.

(Continued to next page)

Error message	Error	Corrective action
Unable to execute: Another device is connecting	The editing screen is displayed on the CNC monitor of the target CNC.	Switch the editing screen displayed on the CNC monitor of the target CNC to other screen.
	The same program is displayed on the other GOT.	Close the overlapped program on the other GOT.
	While the machining program is edited by the other device, the GOT is turned on and immediately the same program is attempted to be opened.	After 60 seconds have passed since the GOT was turned on, open the program again.
	The number of machining programs opened by the target CNC has reached the maximum number allowed (10 programs).	Close the program on the other GOT.
	The other GOT is executing the file access including I/O and comparison of the target file.	After the process is completed on the other GOT, execute CNC machining program edit again.
No. of characters over	The maximum number of characters allowed for the input area is exceeded.	Reduce the number of the input characters.
Time-out	The GOT fails to communicate with the CNC.	Check the connection.
Communication error	The GOT fails to establish the initial communication with the CNC.	<ul style="list-style-type: none"> • Check that the CNC is powered on, the cable is connected, and the connection target is the CNC. • Configure the proper connection and settings.
Error	Other errors	<p>Turn off the GOT and the CNC, and check the connection.</p> <p>Check the format of the CNC memory, and then execute CNC machining program edit again.</p>

19. MOTION PROGRAM (SV43) EDITOR



This function is available for a motion controller OS (SV43) special model.
For details of this function, please contact us.

19.1 Features

19.2 Specifications

19.3 Operations for Display

19.4 Operation Procedures

19.5 Error Messages and Corrective Actions

17

MOTION SFC
MONITOR

18

CNC MACHINING
PROGRAM EDIT

19

MOTION PROGRAM
(SV43) EDITOR

20

MOTION PROGRAM
(SV43) I/O



20. MOTION PROGRAM (SV43) I/O



This function is available for a motion controller OS (SV43) special model.
For details of this function, please contact us.

20.1 Features

20.2 Specifications

20.3 Operations for Display

20.4 Operation Procedures

20.5 Error Messages and Corrective Actions

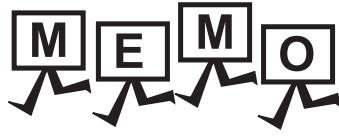

INDEX

[B]

BACKUP/RESTORE

Access range	11-11
Background processing stop.....	11-17
Changing screens	11-16
Data list (restoration).....	11-38
Data to be backed up and restored.....	11-4
Display operation	11-15
Main menu	11-36
Operation procedures	11-36
Precautions	11-11
Progress screen (backup).....	11-37
Progress screen (restoration)	11-39
Security and password.....	11-19
Setting storage location for backup data.....	11-18
Specifications.....	11-3
System configuration	11-3
Trigger backup	11-25

[C]

CNC DATA I/O

Access range	12-3
Changing screens	12-6
Connection type	12-1
Display	12-5
Error Messages and Corrective Actions	12-19
Operation Procedures	12-7
Precautions	12-3
Required extended function OS.....	12-2
Specifications.....	12-1
System configuration	12-1
Target CNC of CNC data I/O	12-1

CNC MONITOR FUNCTIONS

Access range	10-4
Display	10-5
Error Messages and Corrective Action	10-9
Operation Procedures	10-7
Precautions	10-4
Specifications.....	10-2
System configuration	10-2

[E]

Enter ladder program window.....	14-35
----------------------------------	-------

[F]

Find menu.....	14-30
----------------	-------

[I]

INTELLIGENT MODULE MONITOR

Access range	6-7
Composition of PC Information monitor screen and key functions (only when using QCPU (Q mode)).....	6-20

Composition of the intelligent module

monitor screen and key	6-31
Composition of the system configuration screen and key functions	6-16
Composition of the unit detail info screen and key functions (only when using QCPU (Q mode)).....	6-26
Display	6-12
Error Messages and Corrective Action	6-300
Intelligent Module Monitor Screens.....	6-35
Monitor screen configuration and key functions	6-299
Operating I/O Module Monitor Screen	6-298
Operation of Each Intelligent Module Monitor Screen.....	6-16
Precautions	6-9
QD73A1 module monitoring.....	6-87
QD77GF16 module monitoring	6-174
QD77MS16 module monitoring.....	6-143
QD77MS4, QD77MS2 module monitoring	6-125
Setting method for other station monitoring	6-18
Specifications	6-3
Specifying a module to monitor and selecting monitor menu	6-32
Specifying the module to be monitored.....	6-298
System configuration.....	6-3
Testing of the intelligent function module	6-33

[L]

LADDER EDITOR

Access range	14-7
Comment file list window.....	14-46,14-47
Communication setting window.....	14-26
Copy program memory data into ROM window	14-52
Devices and range that can be monitored	14-6
Display menu	14-30
Display Operation.....	14-9
Edit menu	14-42
Enter ladder program window	14-35
Error Messages and Corrective Action	14-61
Find menu	14-30
Find/Replace menu	14-43
How to Operate Ladder Editor Screen	14-34
How to Operate Ladder Monitor Screen	14-28
How to Operate PLC Read Screen	14-23
Inputting or deleting ladders.....	14-37
Jump window	14-44
Ladder registration monitor window	14-31,14-32
Monitoring Mode menu	14-33
Online menu.....	14-48
Password input window.....	14-24
Precautions	14-7
Program list window	14-27

Reading comment files from CF card.....	14-17	Specifications	16-2
Remote operation window.....	14-51	System configuration.....	16-2
Setting Display Format.....	14-22	Target controller	16-2
Setting ladder data storage location.....	14-16		
Specifications	14-4	[M]	
Switching display formats between decimal and hexadecimal numbers	14-22	MELSEC-A LIST EDITOR	
Switching languages of sequence programs .	14-22	Access range	4-4
System configuration.....	14-4	Action if an incorrect key is input.....	4-18
Test Operation	14-59	Adding (Inserting) commands	4-22
Verify result window	14-49	Basic Operation.....	4-20
LADDER MONITOR FUNCTION		Changing (Overwriting) commands.....	4-21
Access range	3-11	Command input procedures	4-15
Coil search	3-59	Common operation.....	4-27
Contact point search	3-57	Deleting commands	4-23
Defect search	3-63	Display	4-5
Device search	3-55	Display format of the display area	4-11
Devices and range that can be monitored	3-9	Error Messages and Corrective Actions.....	4-32
Display	3-14	Error messages and corrective actions in direct CPU connection	4-32
Display switching of 16-bit (one-word)/32-bit (two-word) modules.....	3-45	Error using list editor function on the link system	4-35
Display switching of decimal numbers/hexadecimal numbers	3-46	Hard copy output.....	4-18
Displaying 32 characters of comments	3-48	Key arrangement and a list of key functions	4-9
Displaying notes.....	3-50	List of functions	4-19
Displaying statements.....	3-51	List of Operation Procedures	4-27
Displaying the test menu screen.....	3-69	Operation Methods.....	4-9
Error Messages and Corrective Action	3-73	Operation of keyword input	4-7
Hard copy output.....	3-44	PLC CPU error messages and troubleshooting	4-34
Information and key functions displayed on the screen	3-37	PLC memory all clear.....	4-26
Ladder end search	3-62	Precautions	4-4
Operation Procedure Common	3-37	Reading sequence programs	4-20
Precautions	3-11	Selection and operation of modes.....	4-14
Search Operation.....	3-54	Specifications	4-3
Searching from the monitor screen.....	3-30	Switching valid keys (upper/lower functions)....	4-14
Setting and deleting media for saving ladder data	3-19	System configuration.....	4-3
Specifications.....	3-4	Using the help function.....	4-24
Starts reading a comment file from a CF card .	3-27	MELSEC-FX LIST EDITOR	
Step search.....	3-61	Action for an incorrect key input.....	5-31
Switching comment/no-comment display.....	3-47	Changing operands, set values.....	5-19
Switching the Display Format.....	3-45	Deleting commands	5-20
System configuration.....	3-4	Display	5-6
Test Operation	3-69	Error Messages and Corrective Actions.....	5-32
Touch search	3-67	Hard copy output.....	5-31
LOG VIEWER		Key arrangement and a list of key functions	5-9
Access range	16-3	Keywords	5-27
Changing screens when manage log file is selected	16-8	List monitor.....	5-29
Changing screens when view logged device is selected.....	16-7	Operation Procedures	5-9
Connection type	16-2	Parameter setting	5-24
Display	16-6	PLC diagnostics	5-22
Error Messages and Corrective Actions.....	16-26	Searching commands and devices	5-14
Help.....	16-25	Selection and operation of modes.....	5-11
How to operate Main Menu screen	16-14	Sequence program all clear	5-21
Precautions	16-4	Sequence program display	5-12
Required extended function OS	16-3	Specifications	5-3
Setting communication interface	16-3	System configuration.....	5-3
		Writing commands	5-16
		MOTION SFC MONITOR	
		Access range	17-3

Active step list window	17-16	[S]	
Changing screens	17-7	SERVO AMPLIFIER MONITOR	
Communication setting window	17-18	Access range	9-10
Connection type	17-2	Alarm function	9-19
Detailed program window	17-13	Diagnostics function	9-22
Devices and range that can be monitored	17-3	Display	9-12
Display	17-5	Error Messages and Corrective Action	9-44
Displayable character codes	17-4	Hard copy output	9-43
Password input window	17-19	Monitor functions	9-17
Precautions	17-4	Operations of Servo Amplifier Monitor Screens	9-15
Program batch monitor window	17-17	Parameter setting	9-29
Required extended function OS, option OS, and option function board	17-2	Precautions	9-11
Required hardware	17-3	Servo amplifier monitor	9-15
SFC diagram monitor screen	17-9	Setup	9-16
Specifications	17-2	Specifications	9-3
System configuration	17-2	System configuration	9-3
Target controller	17-2	Test operations	9-35
[N]		SFC MONITOR	
NETWORK MONITOR		Access range	13-7
Access range	7-7	Active block list window	13-35
Detailed monitor	7-16	Active step list window	13-34
Display	7-10	Changing screens	13-10
Error Message and Corrective Action	7-32	Comment file list window	13-33
Line monitor	7-13	Communication setting window	8-16, 13-20
Network information that can be monitored	7-6	Device/contact/coil search window	13-29
Operation Procedures	7-13	Devices and range that can be monitored	13-6
Other station communication status monitor	7-26	Display Operation	13-8
Other station CPU operation status monitor	7-29	Error Messages and Corrective Action	13-39
Other station CPU RUN status monitor	7-30	How to Operate Block List Screen	13-22
Other station data link status monitor	7-27	Display menu	13-23
Other station loop status monitor	7-31	How to Operate device test window	13-37
Other station monitor	7-25	How to Operate PLC Read Screen	13-16
Other station parameter status monitor	7-28	How to Operate SFC Diagram Monitor Screen	13-24
Precautions	7-8	Display menu	13-32
Specifications	7-3	Search menu	13-28
System configuration	7-3	Monitoring Mode menu	13-36
[Q]		Password input window	13-18
Q MOTION MONITOR		Precautions	13-7
Access range	8-10	Program list window	13-21
Display	8-11	Reading comment files from CF card	13-12
Error List Designated-Axis screen	8-22	Setting automatic scroll mode	13-15
Error List screen	8-20	Setting Display Format	13-14
Error Messages and Corrective Action	8-33	Setting display mode of SFC programs	13-14
Hard copy output	8-32	Setting SFC data storage location	13-11
Monitor Menu screen	8-17	Setting zoom comment display mode	13-14
Operation Procedures	8-14	Specifications	13-4
Parameter setting screen	8-29	Step list window	13-31
Positioning Monitor screen	8-24	Step No./transition condition No. search window	13-30
Precautions	8-10	Switching display formats between decimal and hexadecimal numbers	13-14
Present Value History Monitor screen	8-27	Switching languages of SFC programs	13-14
Present Value Monitor screen	8-18	System configuration	13-4
Servo Monitor screen	8-26	Test Operation	13-37
SFC Error History screen	8-19	Zoom window	13-26
Specifications	8-3	SYSTEM MONITOR	
System configuration	8-3	Access range	2-13
System configuration screen layout	8-14		

Batch Monitor	2-34
BM Monitor (Monitoring Buffer Memory)	2-42
Changing screens	2-28
Deleting entry devices	2-33
Devices that can be monitored	2-13
Display	2-15
Entering monitor devices (specifying monitor stations and devices)	2-18
Entry Monitor	2-29
Error Messages and Corrective Action	2-52
Information and set items displayed on each setting key window	2-47
Information displayed on the Batch Monitor screen and key functions	2-34
Information displayed on the BM Monitor screen and key functions	2-42
Information displayed on the Entry Monitor screen and key functions	2-29
Information displayed on the TC Monitor screen and key functions	2-38
Information displayed on the test menu screen and key functions	2-46
Key window setting columns and operation procedure	2-21
Precautions	2-14
Procedure for batch monitor basic operation ...	2-37
Procedure for BM monitor basic operation	2-44
Procedure for canceling TC monitor keywords	2-41
Procedure for displaying the test menu screen and the setting key window screen	2-45
Procedure for entry monitor basic operation ...	2-32
Procedure for TC monitor basic operation	2-40
Quick test operation of monitor devices	2-24
Specifications	2-5
Switching the display format (DEC/HEX) and comment/no-comment	2-22
System configuration	2-5
TC Monitor (Monitoring Timers and Counters)	2-38
Test Operation	2-45
Test operation basic procedure	2-51
Test operation procedure	2-49

REVISIONS

* The manual number is given on the bottom left of the back cover.

Print Date	* Manual Number	Revision
Oct. 2009	SH(NA)-080863ENG-A	First printing : GT Designer3 Version1.01B
Jan. 2010	SH(NA)-080863ENG-B	<p>Compatible with GT Works3 Version1.10L</p> <ul style="list-style-type: none"> • The monitor and change of the T/C set value when the FXCPU is connected are supported for the system monitor. • The BM monitor when the FXCPU is connected is supported for the system monitor. • The network batch backup/restore is supported for the backup/restore. • The robot controller is added to compatible models for the backup/restore. • The one-touch ladder jump function, program update check, and security setting are supported for the ladder editor. • The conversion (online change) in the ladder editor is supported • The LCPU is added to compatible models for the system monitor. • The LCPU is added to compatible models for the ladder monitor. • The LCPU is added to compatible models for the intelligent module monitor. • The LCPU is added to compatible models for the backup/restore. • The MELSEC-L troubleshooting is supported.
May 2010	SH(NA)-080863ENG-C	<p>Compatible with GT Designer3 Version1.14Q</p> <ul style="list-style-type: none"> • The following models are added to compatible models for the system monitor and the backup/restore. QCPU (Q50UDEH, Q100UDEH), motion controller CPU (Q172D-S1, Q173D-S1) • The following models are added to compatible models for the ladder monitor. QCPU (Q50UDEH, Q100UDEH) • The following models are added to compatible models for the intelligent module monitor. QCPU (Q50UDEH, Q100UDEH), motion controller CPU (Q172D-S1, Q173D-S1), intelligent function module (LD62, LD62D, LD75D, LD75P, LD77MH), input module (LX41C4), output module (LY41NT1P)) • The following models are added to compatible models for the network monitor and the Q motion monitor. Motion controller CPU (Q172D-S1, Q173D-S1)
Jun. 2010	SH(NA)-080863ENG-D	<p>Compatible with GT Designer3 Version1.17T.</p> <ul style="list-style-type: none"> • GT1675-VN, GT1672-VN and GT1662-VN are supported. • SoftGOT-GOT link function is supported. • Printer (Serial) is supported. • The following functions are added to the CNC data I/O. • File item display button and scroll button are added to the main menu screen. • LCPU and motion controller CPU (Q series) are added to compatible models for the ladder edit. • The following functions are added to the ladder edit. Check timing of the program update check is changed and [PLC Read] is added to the online menu. • The following functions are added to the MELSEC-L troubleshooting. Ladder edit and log viewer display buttons are added. • Log viewer is supported. • Motion SFC monitor is supported.
Oct. 2010	SH(NA)-080863ENG-E	<p>Compatible with GT Designer3 Version1.19V.</p> <ul style="list-style-type: none"> • Partial correction

(Continued to next page)

* The manual number is given on the bottom left of the back cover.

Print Date	* Manual Number	Revision
Jan. 2011	SH(NA)-080863ENG-F	<p>Compatible with GT Designer3 Version1.23Z</p> <ul style="list-style-type: none"> The following models are added to compatible models for the SFC monitor. QCPU (Q00UJ, Q00U, Q01U, Q10UD(E)H, Q20UD(E)H, Q50UDEH, Q100UDEH) The following models are added to compatible models for the ladder edit. QCPU (Q50UDEH, Q100UDEH) The following functions are added to the ladder monitor, CNC monitor and CNC Data I/O. Screen display by specifying the destination with special function switch. The following functions are added to the log viewer. Display/hide legend, recently opened files list screen, search screen, enlarge/reduce graph display area
Apr. 2011	SH(NA)-080863ENG-G	<p>Compatible with GT Designer3 Version1.28E.</p> <ul style="list-style-type: none"> GT1655-V is supported. The servo amplifier whose parameter can be set with the Q motion monitor is added.
Jul. 2011	SH(NA)-080863ENG-H	<p>Compatible with GT Designer3 Version1.31H</p> <ul style="list-style-type: none"> The following functions are supported in the CC-Link IE field network connection: System monitor, ladder monitor, intelligent module monitor, network monitor, CNC monitor, SFC monitor, ladder editor Ladder monitor supports the following functions: XGA display, Store/switch the ladder data of multiple destinations The following models are added to compatible models for the intelligent module monitor: QD65PD2 module, LD77MH16 module CNC data I/O supports the file comparison. SFC monitor supports the following functions: Comment display in Chinese (Simplified), Search operation of device ZR, D or W The following model is added to compatible models for the ladder editor: LCPUR Ladder editor supports the following functions: Search operation of pointer (P) or interrupt pointer (I) Fold/unfold of comments Motion program (SV43) editor is supported.
Oct. 2011	SH(NA)-080863ENG-I	<p>Compatible with GT Designer3 Version1.37P</p> <ul style="list-style-type: none"> The information of GT12 is added. <p>The following functions are supported with GT14:</p> <ul style="list-style-type: none"> System monitor, MELSEC-A list editor, MELSEC-FX list editor, backup/restoration The backup/restore function supports the background processing stop. The motion program (SV43) I/O is supported.
Jan. 2012	SH(NA)-080863ENG-J	<p>Compatible with GT Designer3 Version1.40S</p> <ul style="list-style-type: none"> Compatible with VNC® server function Error messages are added in the following functions: Ladder monitor, MELSEC-FX list editor The following models are added to compatible models for the intelligent module monitor: QD75P □ N, QD75D □ N
Apr. 2012	SH(NA)-080863ENG-K	<p>Compatible with GT Designer3 Version1.45X</p> <ul style="list-style-type: none"> The backup/restore function supports the backup CPU No. setting.

(Continued to next page)

* The manual number is given on the bottom left of the back cover.

Print Date	* Manual Number	Revision
Jun. 2012	SH(NA)-080863ENG-L	<p>Compatible with GT Designer3 Version1.54G</p> <ul style="list-style-type: none"> • QD73A1, QD77MS2/4/16, LD75P1/2, and LD75D1/2 are added to compatible models for the intelligent module monitor. • Q172DSCPU and Q173DSCPU are added to compatible models for the Q motion monitor. • The design of the monitor screen is changed in the Q motion monitor. • The MELSERVO-J4 series is added to compatible models for the servo amplifier monitor. • Q172DSCPU and Q173DSCPU are added to compatible models for the backup/restore. • Q172DSCPU and Q173DSCPU are added to compatible models for the motion SFC monitor. • The motion SFC monitor supports unlocking the program.
Sep. 2012	SH(NA)-080863ENG-M	<p>Compatible with GT Designer3 Version1.58L</p> <ul style="list-style-type: none"> • The GT14 supports the operator authentication. • The FX3U(C) and FX3G(C) support the backup/restoration of special parameters. • The description regarding the maximum number of sampling points displayable in the graph display area of the data log viewer is added.
Nov. 2012	SH(NA)-080863ENG-N	<ul style="list-style-type: none"> • SAFETY PRECAUTIONS changed • Editing the data converted by Backup Data Conversion Tool with GX Works2 is supported.
Feb. 2013	SH(NA)-080863ENG-O	<p>Compatible with GT Designer3 Version1.67V</p> <ul style="list-style-type: none"> • The CNC manufacturing program editor is supported. • The GT14 supports the VNC server function. • The GT14 supports the kana-kanji conversion (enhanced version). • Q03UDVCP, Q04UDVCP, Q06UDVCP, Q13UDVCP, and Q26UDVCP are added to compatible models for the log viewer. • Q03UDVCP, Q04UDVCP, Q06UDVCP, Q13UDVCP, Q26UDVCP, L02SCPU, and L26CPU are added to compatible models for the backup/restore.
May 2013	SH(NA)-080863ENG-P	<p>Compatible with GT Works3 Version1.70Y</p> <ul style="list-style-type: none"> • The motion controllers (Q170MSCPU, L06CPU) are added to compatible models for the system monitor. • The motion controllers (Q170MSCPU, L06CPU) are added to compatible models for the ladder monitor. • The motion controllers (Q170MSCPU, L06CPU) are added to compatible models for the intelligent module monitor. • The motion controllers (Q170MSCPU, L06CPU) are added to compatible models for the network monitor. • The motion controller (Q170MSCPU) is added to compatible models for the Q motion monitor. • The motion controllers (Q170MSCPU, L06CPU) are added to compatible models for the backup/restore function. • The motion controller (L06CPU) is added to compatible models for the log viewer.

(Continued to next page)

* The manual number is given on the bottom left of the back cover.

Print Date	* Manual Number	Revision
Jun. 2013	SH(NA)-080863ENG-Q	Compatible with GT Designer3 Version1.74C. <ul style="list-style-type: none"> • The Backup Data Conversion Tool supports Windows® 8. • L02SCPU-P, L06CPU-P, L26CPU-P are added to the compatible models for the ladder monitor. • The FX3S is added to the compatible models for the FX list editor. • LD77MS4 and LD77MS16 are added to the compatible models for the intelligent module monitor. • L02SCPU-P, L06CPU-P, and L26CPU-P are added to the compatible models for the network monitor. • Q24DHCCPU-LS is added to the compatible models for the Q motion monitor. • L02SCPU-P, L06CPU-P, and L26CPU-P are added to the compatible models for the MELSEC-L troubleshooting.
Sep. 2013	SH(NA)-080863ENG-R	Compatible with GT Designer3 Version1.100E <ul style="list-style-type: none"> • Annotated
Nov. 2013	SH(NA)-080863ENG-S	Compatible with GT Designer3 Version1.104J <ul style="list-style-type: none"> • NZ2DL is added to the compatible models for the BOX data logger. • CR750-Q, CR751-Q, CR750-D, and CR751-D are added to compatible models for the backup/restore.
Jan. 2014	SH(NA)-080863ENG-T	Compatible with GT Designer3 Version1.108N <ul style="list-style-type: none"> • The extended function OS and option OS for the SFC monitor and ladder editor are added.
Jun. 2014	SH(NA)-080863ENG-U	Compatible with GT Works3 Version1.117X <ul style="list-style-type: none"> • R04CPU, R08CPU, R16CPU, R32CPU, R120CPU, R16MTCPU, R32MTCPU are added to the compatible models for the system monitor. • R04CPU, R08CPU, R16CPU, R32CPU, R120CPU, R16MTCPU, R32MTCPU are added to the compatible models for the network monitor.
Oct. 2014	SH(NA)-080863ENG-V	<ul style="list-style-type: none"> • GT1450-QMBDE and GT1450-QMBD have been supported. • Precautions are added to the backup/restore.
May 2015	SH(NA)-080863ENG-W	<ul style="list-style-type: none"> • Partial corrections
May 2016	SH(NA)-080863ENG-X	<ul style="list-style-type: none"> • Backup Data Conversion Tool is compatible with Windows® 8.1 and Windows® 10.
Oct. 2017	SH(NA)-080863ENG-Y	<ul style="list-style-type: none"> • Partial corrections
Oct. 2019	SH(NA)-080863ENG-Z	<ul style="list-style-type: none"> • Partial corrections
Jun. 2020	SH(NA)-080863ENG-AA	<ul style="list-style-type: none"> • Partial corrections
Oct. 2020	SH(NA)-080863ENG-AB	<ul style="list-style-type: none"> • Partial corrections
Oct. 2022	SH(NA)-080863ENG-AC	<ul style="list-style-type: none"> • Some corrections
Apr. 2023	SH(NA)-080863ENG-AD	<ul style="list-style-type: none"> • Some corrections

This manual confers no industrial property rights or any rights of any other kind, nor does it confer any patent licenses. Mitsubishi Electric Corporation cannot be held responsible for any problems involving industrial property rights which may occur as a result of using the contents noted in this manual.

WARRANTY

Please confirm the following product warranty details before using this product.

1. Gratis Warranty Term and Gratis Warranty Range

If any faults or defects (hereinafter "Failure") found to be the responsibility of Mitsubishi occurs during use of the product within the gratis warranty term, the product shall be repaired at no cost via the sales representative or Mitsubishi Service Company. However, if repairs are required onsite at domestic or overseas location, expenses to send an engineer will be solely at the customer's discretion. Mitsubishi shall not be held responsible for any re-commissioning, maintenance, or testing on-site that involves replacement of the failed module.

[Gratis Warranty Term]

The gratis warranty term of the product shall be for thirty-six (36) months after the date of purchase or delivery to a designated place.

Note that after manufacture and shipment from Mitsubishi, the maximum distribution period shall be six (6) months, and the longest gratis warranty term after manufacturing shall be forty-two (42) months. The gratis warranty term of repair parts shall not exceed the gratis warranty term before repairs.

[Gratis Warranty Range]

- (1) The customer shall be responsible for the primary failure diagnosis unless otherwise specified.
If requested by the customer, Mitsubishi Electric Corporation or its representative firm may carry out the primary failure diagnosis at the customer's expense.
The primary failure diagnosis will, however, be free of charge should the cause of failure be attributable to Mitsubishi Electric Corporation.
- (2) The range shall be limited to normal use within the usage state, usage methods and usage environment, etc., which follow the conditions and precautions, etc., given in the instruction manual, user's manual and caution labels on the product.
- (3) Even within the gratis warranty term, repairs shall be charged for in the following cases.
 1. Failure occurring from inappropriate storage or handling, carelessness or negligence by the user. Failure caused by the user's hardware or software design.
 2. Failure caused by unapproved modifications, etc., to the product by the user.
 3. When the Mitsubishi product is assembled into a user's device, Failure that could have been avoided if functions or structures, judged as necessary in the legal safety measures the user's device is subject to or as necessary by industry standards, had been provided.
 4. Failure that could have been avoided if consumable parts designated in the instruction manual had been correctly serviced or replaced.
 5. Replacing consumable parts such as the battery, backlight and fuses.
 6. Failure caused by external irresistible forces such as fires or abnormal voltages, and Failure caused by force majeure such as earthquakes, lightning, wind and water damage.
 7. Failure caused by reasons unpredictable by scientific technology standards at time of shipment from Mitsubishi.
 8. Any other failure found not to be the responsibility of Mitsubishi or that admitted not to be so by the user.

2. Onerous repair term after discontinuation of production

- (1) Mitsubishi shall accept onerous product repairs for seven (7) years after production of the product is discontinued.
Discontinuation of production shall be notified with Mitsubishi Technical Bulletins, etc.
- (2) Product supply (including repair parts) is not available after production is discontinued.

3. Overseas service

Overseas, repairs shall be accepted by Mitsubishi's local overseas FA Center. Note that the repair conditions at each FA Center may differ.

4. Exclusion of loss in opportunity and secondary loss from warranty liability

Regardless of the gratis warranty term, Mitsubishi shall not be liable for compensation to damages caused by any cause found not to be the responsibility of Mitsubishi, loss in opportunity, lost profits incurred to the user by Failures of Mitsubishi products, special damages and secondary damages whether foreseeable or not, compensation for accidents, and compensation for damages to products other than Mitsubishi products, replacement by the user, maintenance of on-site equipment, start-up test run and other tasks.

5. Changes in product specifications

The specifications given in the catalogs, manuals or technical documents are subject to change without prior notice.

6. Product application

- (1) In using the Mitsubishi graphic operation terminal, the usage conditions shall be that the application will not lead to a major accident even if any problem or fault should occur in the graphic operation terminal device, and that backup and fail-safe functions are systematically provided outside of the device for any problem or fault.
- (2) The Mitsubishi graphic operation terminal has been designed and manufactured for applications in general industries, etc. Thus, applications in which the public could be affected such as in nuclear power plants and other power plants operated by respective power companies, and applications in which a special quality assurance system is required, such as for Railway companies or Public service purposes shall be excluded from the graphic operation terminal applications.
In addition, applications in which human life or property that could be greatly affected, such as in aircraft, medical applications, incineration and fuel devices, manned transportation equipment for recreation and amusement, and safety devices, shall also be excluded from the graphic operation terminal range of applications.
However, in certain cases, some applications may be possible, providing the user consults the local Mitsubishi representative outlining the special requirements of the project, and providing that all parties concerned agree to the special circumstances, solely at our discretion.
In some of three cases, however, Mitsubishi Electric Corporation may consider the possibility of an application, provided that the customer notifies Mitsubishi Electric Corporation of the intention, the application is clearly defined and any special quality is not required.

Intellectual Property Rights

■ Trademarks

GOT is a registered trademark of Mitsubishi Electric Corporation.

Microsoft, Windows, Windows NT, Windows Server, Windows Vista, and Windows 7 are registered trademarks or trademarks of Microsoft Corporation in the United States and other countries.

Adobe and Adobe Reader are registered trademarks of Adobe Systems Incorporated.

Intel, Intel Core, Pentium, and Celeron are trademarks or registered trademarks of Intel Corporation in the United States and other countries.

MODBUS is a trademark of Schneider Electric SA.

VNC is a registered trademark of RealVNC Ltd. in the United States and other countries.

Other company and product names herein are either trademarks or registered trademarks of their respective owners.

■ Copyrights

The screens (screenshots) are used in accordance with the Microsoft Corporation guideline.

GRAPHIC OPERATION TERMINAL

GOT1000 Series

User's Manual (Extended Functions, Option Functions) for GT Works3

MODEL	GT1000-U(EXT-OPT)-E
MODEL CODE	_____
SH(NA)-080863ENG-AD(2304)MEE	

MITSUBISHI ELECTRIC CORPORATION

HEAD OFFICE: TOKYO BLDG., 2-7-3, MARUNOUCHI, CHIYODA-KU, TOKYO 100-8310, JAPAN
NAGOYA WORKS: 1-14, YADA-MINAMI 5-CHOME, HIGASHI-KU, NAGOYA 461-8670, JAPAN

When exported from Japan, this manual does not require application to the Ministry of Economy, Trade and Industry for service transaction permission.

Specifications subject to change without notice.